

# RADIO-TV EXPERIMENTER

50 CENTS

In Canada. 60 cents



For sound satisfaction:  
**SUPER HI-FI FM  
RECORD PLAYER**  
page 15

- OVER 50 PROJECTS •
- TRF Tuner
- Pee-Wee Broadcasters
- FM Tuner
- Transistor Tester
- Rhombic TV Antenna
- Electric Eyes
- TV Interference Filters
- VHF Transceiver
- Midget Transistor Sets
- Portable Superhet
- Electronic Metronome



**Build Your Own  
WRIST RADIO**



**Combination Home  
INTERCOM-RADIO**

**Sun-Powered**

- Batteries
- Motor
- Relay
- Receivers

**GREATEST  
ADVANCE IN  
SHOP-METHOD  
HOME TRAINING**

**EARN MORE MONEY... GET INTO**

# TELEVISION

## ELECTRONICS - RADIO

**Learn ALL 8 PHASES in ONE MODERN HOME-STUDY COURSE**  
At Home - In Spare Time

### YOU GET ALL THIS NEWEST PRACTICAL EQUIPMENT

- Parts to build a modern TV set, including all tubes plus a large screen Picture Tube
- Parts to build a powerful Superhet Receiver, standard broadcast and short wave
- Parts to conduct many experiments and build Continuity Checker, RF Oscillator, TV Circuits, Audio Oscillator, TRF Receiver, Signal Generator
- A Valuable Professional Multitester



**19 BIG KITS  
YOURS TO KEEP**

### YOUR NATIONAL SCHOOLS TELERAMA COURSE COVERS ALL 8 PHASES

- |                                    |                                |
|------------------------------------|--------------------------------|
| 1. TELEVISION, INCLUDING COLOR TV  | 5. PREPARATION FOR FCC LICENSE |
| 2. RADIO, FM AND AM                | 6. AUTOMATION                  |
| 3. INDUSTRIAL ELECTRONICS          | 7. RADAR AND MICRO WAVES       |
| 4. SOUND RECORDING AND HI FIDELITY | 8. COMMUNICATIONS              |

### YOU ARE NEEDED IN THE TELEVISION-ELECTRONICS-RADIO INDUSTRY!

You can build a secure future for yourself if you get into Electronics NOW! Today's shortage of trained technicians creates tremendous opportunities. National Schools Shop-Method trained technicians are in constant and growing demand for high-pay jobs in Broadcasting and Communications, Electronic Research, Servicing and Repair, and many other branches.

Let National Schools, a Resident Technical School for over 50 years train you for today's unlimited opportunities in electronics! Our Shop Method trains you to be a MASTER TECHNICIAN. Completely up to date, developed by experienced instructors and engineers, your Telerama Course will teach you all phases of the industry quickly, clearly and correctly. You can master the most modern projects, such as Color TV, printed circuits - even prepare for FCC License without taking a special

course. You can handle sales, servicing, manufacturing, or make good money in your own business. SEND FOR FACTS TODAY!

**EARN AS YOU LEARN.** Many of our students earn their entire tuition and more in Spare Time jobs we show them how to do while learning.

**YOU GET EVERYTHING YOU NEED** - Clear, profusely illustrated lessons, shop-tested manuals, modern circuit diagrams, practical job projects - all the valuable equipment shown above

- many other materials and services - consultation privilege with our qualified staff, and Graduate Employment Service. EVERYTHING YOU NEED for outstanding success in Electronics.

### RESIDENT TRAINING AT LOS ANGELES

If you wish to take your training in our Resident School at Los Angeles, the world's TV capital, start NOW in our big, modern Shops, Labs and Radio-TV Studios. Here you work with latest Electronic equipment - professionally installed - finest, most complete facilities offered by any school. Expert, friendly instructors. Personal attention. Graduate Employment Service. Help in finding home near school - and part time job while you learn. Check box in coupon for full information.



**FREE!**

Fully illustrated "Career" Book in TV-Radio-Electronics. PLUS actual sample lesson - yours at no cost, no obligation, CLIP COUPDN NOW... MAIL IT TODAY!



## NATIONAL SCHOOLS

APPROVED FOR G. I. TRAINING  
4000 S. FIGUEROA ST., LOS ANGELES 37, CALIF.  
187 N. LA SALLE ST., CHICAGO 1, ILL.  
IN CANADA: 811 W. HASTINGS ST., VANCOUVER, B. C.

### NATIONAL SCHOOLS

TECHNICAL TRADE TRAINING SINCE 1905  
LOS ANGELES 37, CALIFORNIA

GET FAST SERVICE - MAIL NOW TO OFFICE NEAREST YOU!

NATIONAL SCHOOLS, DEPT. RKK-17  
4000 S. FIGUEROA ST. LOS ANGELES 37, CALIF. OR 187 N. LA SALLE ST. CHICAGO 1, ILL.  
Rush free TV-Radio "Opportunity" Book and sample lesson. No salesman will call.

NAME \_\_\_\_\_ AGE \_\_\_\_\_  
ADDRESS \_\_\_\_\_  
CITY \_\_\_\_\_ ZONE \_\_\_\_\_ STATE \_\_\_\_\_

Check if interested ONLY in Resident School training at Los Angeles. VETERANS. Give date of Discharge.

# RADIO-TV Experimenter

VOLUME FOUR

## CONTENTS

Super Hi-Fi FM Record Player.....	15	Two-Tube FM Receiver.....	106
Mighty Mite Audio Amplifier.....	21	Having Fun with "Talking Coils".....	109
Sun-Powered Radio.....	23	3-in-1 TV Control.....	113
Pee-Wee Receiver.....	27	Turntable for Your TV Receiver.....	114
Wrist Radio.....	29	TV Antenna Coupler.....	115
Tuned Radio Frequency Tuner.....	32	Transistorized Loop Crystal Receiver.....	117
VHF Amateur Radiotelephone Station..	35	Selsyn Motor Remote Control.....	120
Rhombics for Top TV Reception.....	43	Portable Di-Pole Antennas.....	122
Power Line Interference Filters.....	47	Transistor Amplifier.....	124
Micro-Switch Telegraph Sounder.....	50	Trapping TV Interference.....	126
Solar Battery and Motor.....	51	Transistor Tester.....	128
Transistorized Sun-Powered Receiver....	58	Utilitarian Test Leads.....	132
6-Volt Solar Battery.....	64	Careers in Radio-TV Servicing.....	133
Home Intercom-Radio Set.....	69	One Tube Electronic Metronome.....	138
Aluminum Folding Rule Antenna.....	72	Motion-Stopping Stroboscope.....	140
The Versatile Printed Circuit.....	73	Li'l Gem 4-Tube Receiver.....	144
Sun-Powered Relay.....	75	Frequency Modulation Tuner.....	147
Pee-Wee Home Broadcasters.....	79	Electronic Multi-Unit.....	151
Improving Loudspeaker Performance....	82	Bedside Lamp Crystal Set.....	155
Stabilizing Rolling TV Pictures.....	83	Portable Superhet.....	158
Two TV Sets on One Antenna.....	84	Multi-Meter.....	163
New Tubes to TV's Rescue.....	85	Sound-Powered Interphone.....	166
Noise Filter for Record Players.....	88	Small Fry Crystal Set.....	167
TV Speaker Control.....	89	Extension Speaker.....	168
AM Superhet Tuner.....	91	How to Solder It Right.....	169
Roll-Away Radiotelegraph Station.....	94	Experimenter's Power Supply.....	172
Small Fry Television Silencer.....	102	Code Practice Oscillator.....	174
Electric Eyes and Photo Timers.....	103	Tuning Conveniences.....	176

Cover by H. Charles McBarron, Jr.

**Curt Johnson**, Handbook Editor  
**Bill Wadkins**, Assistant Art Director, for Handbooks  
**Herb Siegel**, Handbook Editorial Assistant  
**Thomas A. Blanchard**, Radio-TV Editor

Published and Copyrighted 1957 by  
**SCIENCE AND MECHANICS PUBLISHING COMPANY**  
 450 East Ohio Street Chicago 11, Illinois

The Radio-TV Experimenter contains a selection of the most popular electronics projects and radio and TV maintenance articles that have appeared in Science and Mechanics Magazine, plus a number of projects and helpful articles on the same subject appearing for the first time. The editors have brought together in one handy volume a series of projects for those who want to build or repair radios or television sets, who want to do experimental work in these lines and those who want to try other interesting projects.

### Editorial Board

**V. D. ANGERMAN**  
 Editor and Publisher  
**DON DINWIDDIE**  
 Managing Editor  
**ART YOUNGQUIST**  
 Home Workshop Editor  
**KENNETH WYLIE**  
 Feature Editor  
**P. D. URBAIN**  
 Associate Editor  
**L. G. ANDERSEN**  
 Associate Editor  
**MILO ADLER**  
 Special Consultant  
**F. M. EISENZOPH**  
 Art Director  
**CHUCK BACHTELL**  
 Assistant Art Director

# Cast your ballot for a successful future!

# 256 I. C. S. COURSES



Whether you stand at a machine or sit at a desk . . . whether you're making \$75 a week or \$75 hundred a year . . . whether your interest is Power Plants or Paper Pulp, Advertising or Electronics . . . chances are I. C. S. has exactly the course you need to get ahead.

I. C. S. is not only the oldest and largest correspondence school. It also offers the most courses. 256 in all. Each one success-proved by graduates who rose to top technical and administrative positions. Chief engineers. Superintendents. Foremen. Managers. Executive assistants.

I. C. S. Courses cover bedrock facts and theory plus practical, on-the-job applications. No skimping. Texts

are prepared by leading business and industrial authorities working with I. C. S. editors and educators. They are constantly being reviewed and revised in line with current developments.

As an I. C. S. student, you study in your spare time, set your own pace. No time lost getting to class or waiting for slower students to catch up. If you wish, I. C. S. will make progress reports to your employer. You win recognition as a "comer," one who is ready to move ahead. Thousands of students report pay increases and promotions within a few months of enrollment. All graduates win the coveted, approved I. C. S. diploma.

**3 FREE BOOKS!** Check the subject that interests you in the coupon below. I. C. S. will rush you (1) a special book outlining your opportunities in this field, (2) the 32-page gold mine of career tips, "How to Succeed," (3) a sample I. C. S. lesson (Math.) demonstrating the famous "I. C. S. Method." "X" MARKS OPPORTUNITY.



For Real Job Security—Get an I. C. S. Diploma! I. C. S., Scranton 9, Penna. Member, National Home Study Council

## INTERNATIONAL CORRESPONDENCE SCHOOLS

## 65<sup>TH</sup> YEAR

BOX 23034M, SCRANTON 9, PENNA.

Without cost or obligation, send me "HOW TO SUCCEED" and the opportunity booklet about the field

(Partial list of 256 courses)

BEFORE which I have marked X (plus sample lesson)

### ARCHITECTURE and BUILDING CONSTRUCTION

- Air Conditioning—Refrig.
- Architecture
- Architectural Interiors
- Building Contractor
- Building Estimator
- Building Maintenance
- Carpentry and Mill Work
- Heating
- Painting Contractor
- Plumbing
- Reading Arch. Blueprints

### ART

- Cartooning
- Commercial Art
- Fashion Illustrating
- Magazine Illustrating
- Show Card and Sign Lettering
- Sketching and Painting

### AUTOMOTIVE

- Auto Body Rebuilding
- Auto Elec. Technician
- Auto-Engine Tune Up
- Automobile Mechanic

### AVIATION

- Aeronautical Engineering Jr.
- Aircraft & Engine Mechanic

### BUSINESS

- Advertising
- Bookkeeping and Accounting
- Business Administration
- Business Correspondence
- Public Accounting
- Credit Salesmanship
- Federal Tax
- Letter-writing Improvement
- Office Management
- Professional Secretary
- Retail Business Management
- Sales Management
- Stenographic-Secretarial
- Traffic Management

### CHEMISTRY

- Analytical Chemistry
- Chemical Engineering
- Chem. Lab. Technician
- General Chemistry
- Natural Gas Prod. & Trans.
- Petroleum Engineering
- Plastics
- Pulp and Paper Making

### CIVIL, STRUCTURAL ENGINEERING

- Civil Engineering
- Construction Engineering
- Highway Engineering
- Reading Struct. Blueprints
- Sanitary Engineering
- Structural Engineering
- Surveying and Mapping

### DRAFTING

- Aircraft Drafting
- Architectural Drafting
- Electrical Drafting
- Mechanical Drafting
- Mine Surveying and Mapping
- Plumbing Drawing and Estimating
- Structural Drafting

### ELECTRICAL

- Electrical Engineering
- Electrical Maintenance
- Electrician  Contracting
- Lineman
- High School
- Commercial  Good English
- High School Subjects
- Mathematics

### LEADERSHIP

- Foremanship
- Industrial Supervision
- Leadership and Organization
- Personnel-Labor Relations

### MECHANICAL AND SHOP

- Gas-Electric Welding
- Heat Treatment  Metallurgy
- Industrial Engineering
- Industrial Instrumentation
- Industrial Supervision
- Internal Combustion Engines
- Machine Design-Drafting
- Machine Shop Inspection
- Machine Shop Practice
- Mechanical Engineering
- Quality Control
- Reading Shop Blueprints
- Refrigeration
- Sheet Metal Worker
- Tool Design
- Toolmaking

### RADIO, TELEVISION

- Industrial Electronics
- Practical Radio TV Eng'ring
- Radio and TV Servicing
- Radio Operating

### TELEVISION Technician

- RAILROAD
- Air Brake Equipment
- Car Inspector
- Diesel Engineer & Fireman
- Section Foreman
- STEAM AND DIESEL POWER
- Combustion Engineering
- Diesel-Elec.  Diesel Eng's
- Electric Light and Power
- Stationary Fireman
- Stationary Steam Engineering

### TEXTILE

- Carding and Spinning
- Cotton, Rayon, Woolen Mfg.
- Finishing and Dyeing
- Loom Fix'g  Textile Des'ing
- Textile Eng'g  Throwing
- Warping and Weaving

### MISCELLANEOUS

- Domestic Refrigeration
- Marine Engineering
- Ocean Navigation
- Professional Engineering
- Short Story Writing
- Telephony

Name \_\_\_\_\_ Age \_\_\_\_\_ Home Address \_\_\_\_\_

City \_\_\_\_\_ Zone \_\_\_\_\_ State \_\_\_\_\_ Working Hours \_\_\_\_\_ A.M. to P.M.

Occupation \_\_\_\_\_ Canadian residents send coupon to International Correspondence Schools, Canadian, Ltd., Montreal, Canada. . . . Special tuition rates to members of the U. S. Armed Forces

# BUILD 16 RADIO CIRCUITS AT HOME

only \$19.95

with the New Improved PROGRESSIVE RADIO "EDU-KIT"

Reg. U.S. Pat. Off.



## A Practical Home Radio Course

Now Includes  
 TESTER, SOLDERING IRON, HIGH FIDELITY SIGNAL TRACER, CODE OSCILLATOR, PRINTED CIRCUIT SIGNAL INJECTOR

- No Knowledge of Radio Necessary
- No Additional Parts or Tools Needed
- Excellent Background for TV

## NOW! FREE TOOLS WITH "EDU-KIT" WHAT THE "EDU-KIT" OFFERS YOU

The "Edu-Kit" offers you an outstanding PRACTICAL HOME RADIO COURSE at a rock-bottom price. Our Kit is designed to train Radio & Electronics Technicians making use of the most modern methods of home training. You will learn radio theory, construction practice and servicing.

You will learn how to build radios, using regular schematics; how to wire and solder in a professional manner; how to service and troubleshoot radios. You will work with the standard type of punched metal chassis as well as the latest development of Printed Circuit chassis.

You will learn the basic principles of radio. You will construct, study and work with RF and AF amplifiers, tuned oscillators, detectors, rectifiers, test equipment. You will learn and practice code, using the Progressive Code Oscillator. You will learn and practice trouble-shooting, using the Progressive Signal Tracer, the Progressive Signal Injector, the Progressive Dynamic Radio & Electronics Tester, and the accompanying instructional material.

You will receive training for the Novice, Technician and General Classes of F.C.C. Radio Amateur Licenses. You will build 16 Receiver, Transmitter, Code Oscillator, Signal Tracer and Signal Injector circuits, and learn how to operate them. You will receive an excellent background for Television.

Absolutely no previous knowledge of radio or science is required. The "Edu-Kit" is the product of many years of teaching and engineering experience. The "Edu-Kit" will provide you with a basic education in Electronics and Radio, worth many times the complete price of \$19.95. The Signal Tracer alone is worth more than the price of the entire kit.

## THE KIT FOR EVERYONE

You do not need the slightest background in radio or science. Whether you are interested in Radio & Electronics because you want an interesting hobby, a well paying business or a job with a future, you will find the "Edu-Kit" a worthwhile investment.

Here is an excerpt from a letter that we received from Loren DePriest, 1486 4th St., Mansfield, Ohio: "I have spent many pleasant hours in constructing the radios from the schematics in your book, and have learned a great deal from them. Being as I am interested in Radio, I consider the money spent for your course as a wise investment. I have learned more from your course by actually doing than I did from an expensive course."

Many thousands of individuals of all ages and backgrounds have successfully used the "Edu-Kit" in more than 79 countries of the world. The "Edu-Kit" has been carefully designed, step by step, so that

you cannot make a mistake. The "Edu-Kit" allows you to teach yourself at your own rate. No instructor is necessary.

The "Edu-Kit" is also used for courses of study, extra-curricular activities, industrial personnel training and rehabilitation. The "Edu-Kit" is used by Jr. High Schools, High Schools, Technical Schools, Jr. Colleges, Colleges, Universities, Industrial Firms, Rehabilitation Hospitals, Boards of Education, U. S. Govt. agencies, United Nations Educational, Scientific and Cultural Organizations (UNESCO), Veterans Administration, and numerous adult radio and young peoples' groups and clubs. The "Edu-Kit" is also popular with servicemen throughout this country and abroad.

Designed for universal use, the "Edu-Kit" operates on any voltage from 105 to 125 volts AC and DC. For use in countries employing higher line voltages, a 210-250 Volt AC/DC model is available.

## PROGRESSIVE TEACHING METHOD

The Progressive Radio "Edu-Kit" is the foremost educational radio kit in the world, and is universally accepted as the standard in the field of electronics training. The "Edu-Kit" uses the modern educational principle of "Learn by Doing." Therefore you construct, learn schematics, study theory, practice trouble-shooting—all in a closely integrated program designed to provide an easily-learned, thorough and interesting background in radio.

You begin by examining the various radio parts of the "Edu-Kit." You then construct function, theory and wiring of these parts. Then you build a simple radio. With this first set you will enjoy listening to regular broadcast stations, learn theory, practice testing and trouble-shooting. Then you build a more advanced radio, learn more advanced theory and techniques. Gradually, in a progressive manner, and at your own rate, you will find yourself constructing more advanced multi-tube radio circuits, and doing work like a professional Radio Technician.

## THE "EDU-KIT" IS COMPLETE

You will receive all parts and instructions necessary to build 16 different radio and electronics circuits, each guaranteed to operate. Our Kits contain tubes, tube sockets, variable electrolytic and paper dielectric condensers, resistors, tie strips, coils, hardware, tubing, punched metal chassis, Instruction Manuals, etc.

In addition you receive Printed Circuit materials, including Printed Circuit chassis, special tube sockets, hardware and instructions. You also receive a useful set of

tools, a professional electric soldering iron, and a self-powered Dynamic Radio & Electronics Tester. The "Edu-Kit" also includes Code Instructions and the Progressive Code Oscillator. In addition, F.C.C. type Questions and Answers for Radio Amateur License training. You will also receive lessons for servicing with the Progressive Signal Tracer and the Progressive Signal Injector, a High Fidelity Guide and a Quiz Book. You receive all parts, tools, instructions, etc. Everything is yours to keep.

**FREE**  
 Hi-Fi, Radio & TV Servicing Manuals on request (see coupon below)

## SERVICING LESSONS

You will learn trouble-shooting and servicing in a progressive manner. You will practice repairs on the sets that you construct. You will learn symptoms and causes of troubles in home, portable and car radios. You will learn how to use the professional Signal Tracer, the unique Signal Injector and the dynamic Radio & Electronics Tester. While you are learning in this practical way you will be able to do many a repair job for your friends and neighbors, and charge fees which will far exceed the price of the "Edu-Kit." Our Consultation Service will help you with any technical problems you may have.

J. Stataitis, of 25 Poplar Pl., Waterbury, Conn., writes: "I have repaired several sets for my friends, and made money. The "Edu-Kit" paid for itself. I was ready to spend \$240 for a Course, but I found your ad and sent for your Kit."

## FROM OUR MAIL BAG

Ben Valerio, P. O. Box 21, Magna, Utah: "The Edu-Kits are wonderful. Here I am sending you the questions and also the answers for them. I have been in Radio for the last seven years, but like to work with Radio Kits, and like to build Radio Testing Equipment. I enjoyed every minute I worked with the different kits; the Signal Tracer works fine. Also like to let you know that I feel proud of becoming a member of your Radio-TV Club."

Robert A. Shuff, 1534 Monroie Ave., Huntington, W. Va.: "Thought I would drop you a few lines to say that I received my Edu-Kit, and was really amazed that such a bargain can be had at such a low price. I have already started repairing radios and phonographs. My friends were really surprised to see me get into the swing of it so quickly. The trouble-shooting Tester that comes with the Kit is really swell, and finds the trouble if there is any to be found."

## PRINTED CIRCUITRY

At no increase in price, the "Edu-Kit" now includes Printed Circuitry. You build a Printed Circuit Signal Injector, a unique servicing instrument that can detect many Radio and TV troubles. This revolutionary new technique of radio construction is now becoming popular in commercial radio and TV sets.

A Printed Circuit is a special insulated chassis on which has been deposited a conducting material, which takes the place of wiring. The various parts are merely plugged in and soldered to terminals.

## UNCONDITIONAL MONEY-BACK GUARANTEE

ORDER DIRECT FROM AD  
 RECEIVE FREE BONUS RESISTOR KIT WORTH \$5

## FREE EXTRAS

- SET OF TOOLS • RADIO & ELECTRONICS TESTER • ELECTRIC SOLDERING IRON • TESTER INSTRUCTION MANUAL • HIGH FIDELITY GUIDE • QUIZZES • TELEVISION BOOK • RADIO TROUBLE-SHOOTING BOOK • MEMBERSHIP IN RADIO-TV CLUB CONSULTATION SERVICE

- Send "Edu-Kit" Postpaid. I enclose full payment of \$19.95.
- Send "Edu-Kit" C.O.D. I will pay \$19.95 plus postage.
- Send me FREE additional information describing "Edu-Kit." Include FREE valuable Hi-Fi, Radio and TV Servicing Literature. (Outside U.S.A.—No C.O.D.'s. Send check on U.S. bank or Intern'l M.D. "Edu-Kit" for 105-125 V. AC/DC \$20.95; 210-250 V. AC/DC \$23.45.)

Name .....  
 Address .....

**PROGRESSIVE "EDU-KITS" INC.**  
 497 Union Ave., Room 501NN, Brooklyn 11, N. Y.

# HIGHLIGHTS of CONCORD'S 1957 CATALOG

**Alliance Triceptor All Channel Antenna**  
CHAN. 2-13

- A Real DX Antenna • All Aluminum Construction • Minimum Wind Resistance • Can Be Stacked Elements Snap Into Position In One Motion • Full Instruction Sheet.

Reg. Price \$16.95  
**CONCORD CLOSEOUT PRICE \$8.95**  
Stock No. TC-1-SM  
Shipping Wgt. 12 Lbs.

**TIMER AND ELECTRIC CLOCK DESK SET**



Reg. Price \$6.95  
Stock No. COMP-SM  
Shipping Wgt. 2 Lbs.

The "Desk Companion" offers a fine electric clock, plus a handy timer. Timer is calibrated for one hour period. Bell announces time elapsed. Entire unit made of durable plastic in gold hammetone. SIZE: 10" L x 8 1/2" H x 1 1/2" D. 105-120V. 60 cycle AC.

**\$2.95**

**Imported 9 Piece Drafting Set**



- Compass 4 1/2" with Pencil, Pen and Divider Parts • Divider 4 1/2" • Reversible Spring Bow Compass 3 1/2" for Pencil & Ink • Ruling Pen 4 1/2" • Capsule with Extra Leads

Stock No. D617-SM  
Regularly sells for \$8.50  
**Complete \$2.49**

**IMPORTED MICROSCOPES**



**\$4.95**

- Three Lenses Color Corrected • 100X - 200X - 300X Magnification • Turret Type for Easy Power Selection • Rack and Pinion Focusing • Heavy Base and Stand • Inclines Through 90° • Adjustable Sub Stage Mirror • Includes Fitted Wooden Cabinet

Shipping Wgt. 5 Lbs.  
Stock No. MIC-SM

Same Fine Microscope Listed Above Complete with Self Powered Light Source  
Shipping Wgt. 5 Lbs.  
Stock No. MIC-SM-L ..... **\$6.95**  
Reg. \$14.95

**Sewing Machine Replacement Motors**



**PRICE \$3.79** each

- 1/15 H.P. • Complete with 1 1/2" Pulley • Mounting Bracket with centers, 4 1/2" apart • Can be mounted vertically, horizontally, etc. • 1" long, 3/4" diameter shaft.

Stock No. SEW-MOT SM  
Shipping Wgt. 2 lbs.

**"PORTABLE" SPOT LIGHT**



**12 VOLTS**  
Reg. \$9.95

- Boats, Cars • 10 Feet of Cable • Throws Light for Hundreds of Feet • Built in Sighting Unit • Sealed Beam Lens • Made To Government Specs. Stock No. SP LITE **\$2.99** ea. SM Wgt. 4 lbs.

**HI-FI COAX SPEAKERS**



These superb instruments are built especially for Concord by one of the leading audio manufacturers in the country. Acoustically designed for finest reproduction. One piece molded cones in both woofer and tweeter. Has cross-over network. Response uniform 50-13,000 cps. Heavy Alnico magnets (15" model has 2 lb. magnet).

15" — \$19.95 12" — \$10.65 8" — \$8.45

**CUSTOM REAR DECK AUTO SPEAKER SET**



**THE FINEST IN PM ALNICO-5 SPEAKERS!**

A complete kit for custom installation of a car rear deck speaker. Contains wide range speaker, handsome grille, speaker switch, wire and hardware.

Stock No. RDSK-69-SM 6x9  
Sprk. Kit ..... **\$4.99**

Stock No. RDSK-57-SM 5x7  
Sprk. Kit ..... **\$4.35**

Ship. Wgt. 5 Lbs.

**TS-9 PUSH-TO-TALK HANDSETS**



Handy units for use in mobile, CD units, ham use, etc. complete with 6 foot 3 wire rubber covered cable.

**\$5.25** Reg. Price \$9.50  
EA. Stock No. PM-2-SM  
Wgt. 3 Lbs.

**DOUBLE IMPORTED HEADPHONES**



2000 Ohms & 4000 Ohms Imp. Superlative value! Ruggedly built, lightweight. Double, high flux magnet. Hardened steel headband, adjustable. 5-ft. tinsel braided cord.

No. 22635M4000 Ohms Imp. per pair **\$2.75**  
No. 22645M2000 Ohms Imp. per pair **\$2.50**

**FAMOUS MAKE FINE CRYSTAL MIKES!**



**1. MODEL 101-SM—THE LEADER**

Floor stand, table stand, or hand held. 6 foot shielded cable, stand adaptor. Response better than 60-7000 CPS. Output level 49 db. Finest crystal units.

Reg. Price \$9.95  
**\$3.95**

**2. MODEL 102-SM—THE CHAMPION**

Response 60-8500 CPS. Output level 45 db. .... **\$2.99**

**2-WAY SOUND-POWER PHONES**



Many Uses  
**No Batteries Needed**

These sound-powered phones are ideal for roof installation of TV antennas. Gets the work done faster, without hand signals. Unit is comfortable, easy to wear. Manufactured by the world's largest makers of electronics equipment. Push-to-talk buttons on mike. With heavy cable and plug.

Stock No. SM-SPM&N  
—Used. Wt. 7 lbs. **\$4.95**  
Net, per unit, Mike & Phones .....  
Set of 2 units, listed above Net **\$9.75**

**MAGNETIC EARPHONE**



1000 Ohm. Miniature type, plugs directly into ear. 5-ft. plastic covered cord and headband.

No. 743MC ..... each **\$1.95**

**CRYSTAL EARPHONE**

NOW AVAILABLE  
1000 Ohm. Molded plastic shell, miniature type, fits into ear. 5-ft. plastic covered cord. High impedance, crystal element.

No. 748 SM ..... each **\$1.59**

**GEIGER COUNTER**



**A** Pocket size Geiger Counter. Our lowest priced. Measures tiny increases in radiation. Take it anywhere. Includes low cost pen light battery with earphone head set, battery, radio-active material for testing purposes and AEC booklet "Prospecting for Uranium." Aluminum case, 1 1/2 x 2-5/16 x 4 inches. A terrific buy. Shipping weight 2 pounds. Order now.

Stock No. 6154-SM ..... **\$12.95**  
Reg. Price \$19.95.

**B** "El Dorado" Geiger Counter. FREE! \$2.50 Book "Uranium, Where It Is and How to Find It." Portable instrument with ultra-sensitive features. Loud clicks on earphones, bright flashes on neon bulb make ore discovery easy. Beta-window. Halogen-type Geiger tube. Aluminum case 1 3/4 x 4 1/2 in. Shoulder strap. Includes flashlight batteries. Weighs 2 1/2 lbs. Shpg. wt. 4 lbs.

Stock No. 6156-SM ..... **\$29.95**  
Reg. Price \$49.95.

**ELECTRIC SPRAY GUN JIFFY SPRAY**



**\$6.95**  
Reg. \$10.95

Sprays paints, lacquers, enamels, varnishes, chemicals, insecticides, oils, deodorants, etc. No Compressor required. Complete with 16 1/2 oz. jar, 8 ft. line cord, Two Nozzle tips. 110-120 V 60 cyc. AC. Shpg. wt. 5 lbs.

Stock No. JIF-1 SM

**\$135.00 DELCO SELECT-O-MATIC**

• 9 TUBES • 6 VOLT AUTO RADIO  
**CONCORD SPECIAL**

General Motors **\$34.95**  
Finest Radio Complete



- Ideal for Cars, Boats, Trucks, Tractors, Farms, Summer Camps • Push-Pull 6V8 Output • Extended Range 6 x 9" PM Speaker • Full B'cast Range • Signal Seeker Tuning and • Manual Tuning TOO!

Stock No. DEL-AR-SM

**CONCORD RADIO CORP.** 45 WARREN ST., N. Y. 7  
RUSH THE FOLLOWING ITEMS:

1—  
2—  
3—  
4—FREE CATALOG

I AM ENCLOSING \$  
 SEND C.O.D. I ENCLOSE 20% DEPOSIT

NAME  
ADDRESS

**'Quick-Hot' 200-watt Solder Gun**

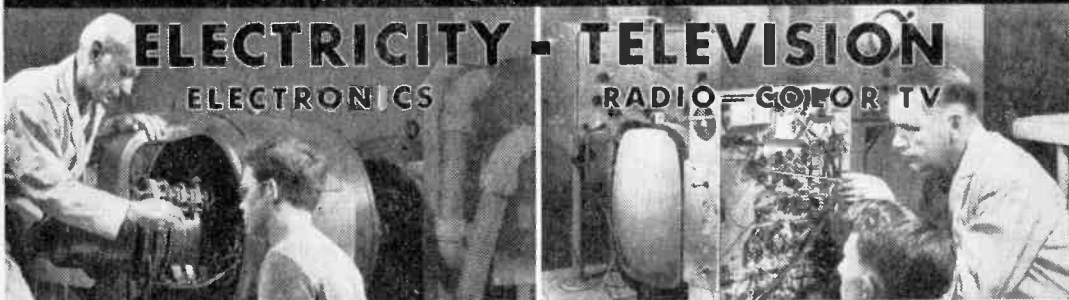


No. 288  
Reg. \$9.95  
**COMBINATION SALE**

**1 LB. OF FINEST SOLDER FREE** with each gun  
Built-in spotlight. Special long-nose tip melts solder in 4 seconds. For 105-125 Volts, 60 cycles AC. Shpg. wt. 3 lbs.

Stock No. SG-1-SM **\$7.35**

**Train in Great Shops of COYNE for better jobs in**



**TWO TOP OPPORTUNITY FIELDS**

Whether 17 or up to 45 years of age, train the Coyne way for a better job and a real future in **ELECTRICITY-ELECTRONICS** or **TELEVISION-RADIO**, fields that offer a world of opportunities. Train on real, full-size equipment at COYNE where thousands of successful men have trained for nearly 60 years—largest, oldest, best equipped school of its kind—established 1899. No advanced education or previous experience needed. Employment service to graduates. **START NOW—PAY LATER**—Liberal Finance Plans and Easy Payment Plans. Also part-time employment help for students. Training in Refrigeration and Electric Appliances can be included.

B. W. COOKE Jr., President



FOUNDED 1899

A Technical Trade Institute Operated Not For Profit  
500 S. Paulina Street, Chicago, Dept. 26-83H

ELECTRICITY • RADIO • TELEVISION • REFRIGERATION • ELECTRONICS

**MAIL COUPON FOR FREE BOOK**

Send coupon for 48-page illustrated book "Guide to Careers in Electricity-Electronics and Television-Radio." No cost; no obligation; no salesman will call. Vets and Non-Vets get vital facts now!



B. W. COOKE Jr., President  
COYNE ELECTRICAL SCHOOL  
500 S. Paulina St., Chicago 12, Ill., Dept. 26-83H

Send BIG FREE book and details of your training offer. This does not obligate me and no salesman will call. I am interested in:

( ) Electricity-Electronics ( ) Television-Radio

Name \_\_\_\_\_

Address \_\_\_\_\_

City \_\_\_\_\_ State \_\_\_\_\_

**COYNE QUALITY**

**TELEVISION  
RADIO - COLOR TV**

Home Training  
at Unbelievably Low Cost



The future is YOURS in TELEVISION!

A fabulous field—good pay—fascinating work—a prosperous future in a good job, or independence in your own business!

Coyne brings you MODERN-QUALITY Television Home Training; training designed to meet Coyne standards at truly lowest cost—you pay for training only—no costly "put together kits." Not an old Radio Course with Television "tacked on." Here is MODERN TELEVISION TRAINING including Radio, UHF and Color TV. No Radio background or previous experience needed. Personal guidance by Coyne Staff. **Practical Job Guides** to show you how to do actual servicing jobs—**make money early in course**. Free Life-time Employment Service to Graduates.

B. W. COOKE, Jr.,  
President



Coyne—the Institution behind this training... the largest, oldest, best equipped residential school of its kind. Founded 1899.



A TECHNICAL TRADE INSTITUTE OPERATED NOT FOR PROFIT

500 S. Paulina Street, Chicago 12, Dept. 26-HT9

**Send Coupon for Free Book**

and full details, including easy Payment Plan. No obligation, no salesman will call.



COYNE Television  
Home Training Division  
500 S. Paulina St., Chicago 12, Ill.  
Dept. 26-HT9

Send Free Book and details on how I can get Coyne Quality Television Home Training at low cost and easy terms.

Name \_\_\_\_\_

Address \_\_\_\_\_

City \_\_\_\_\_ State \_\_\_\_\_

# GET THE WORLD'S LEADING RADIO-TV-HI-FI CATALOG



**FREE**

**VALUE-PACKED  
356  
PAGE 1957  
ALLIED  
ELECTRONIC  
SUPPLY GUIDE**

**Builders, Experimenters, Hi-Fi Hobbyists:  
SAVE ON EVERYTHING IN ELECTRONICS!**

You'll find everything you'll need to build any project in the 1957 ALLIED Catalog. Select from the world's largest stocks of parts, tubes, tools, books, diagrams—see our famous Knight-Kits, Hi-Fi systems and components, recorders, Amateur equipment, test instruments, TV components—everything at lowest, money-saving prices. Write for your FREE ALLIED Catalog today!

**ALLIED'S own famous knight-kits**

### Transistor Radio Kit

Experiment with the marvel of transistors! Printed circuit mounting board simplifies assembly—only a few solder connections required. Delivers excellent AM broadcast reception. Compact, fits in palm of your hand; works from single penlight cell that lasts for months. Complete with all parts, transistor and penlight cell. Shpg. wt., 2 lbs.

83 Y 765. Transistor Radio Kit, only . . . \$4.35  
83 Y 266. Headset & Antenna Kit, . . . \$3.15

### Famous 2-Band "Space-Spinner"

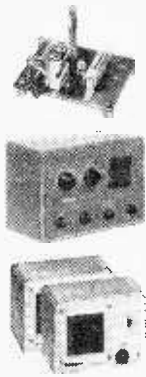
Remarkable new 2-band receiver. Band-switch selects thrilling short wave on 6 to 18 mc (amateur, aircraft, police, marine); and full AM standard broadcast. Very sensitive regenerative circuit; 4" PM speaker; beam-power output. Easy to build. Complete with all parts, tubes, calibrated panel (less cabinet). For AC-DC. 4½ lbs.

83 Y 243. "Space-Spinner" Kit only . . . \$15.95  
83 Y 247. Cabinet for above . . . \$2.90

### 2-Way Intercom Kit

Build your own complete two-station intercom. It's easy to do with simple step-by-step instructions supplied. Use in home or office. Makes ideal "baby sitter." Extra high gain—full output from only a whisper. Complete with 50 ft. cable (up to 200 ft. may be added), beautiful antique-white cases, tubes and all parts. For AC-DC. Shpg. wt., 7 lbs.

83 Y 295. 2-Way Intercom Kit only . . . \$14.75



**Dozens of Other Kits Available**

## ALLIED RADIO

**FREE catalog**

**ALLIED RADIO CORP., Dept. 64-57  
100 N. Western Ave., Chicago 80, Ill.**

Send FREE 356-Page Catalog

Send Kit No. 83 Y 765.

Send Kit No. 83 Y 243.

Send Kit No. 83 Y 295.

\$\_\_\_\_\_enclosed

**ALL PRICES NET**

**F.O.B. CHICAGO**

Name \_\_\_\_\_

Address \_\_\_\_\_

City \_\_\_\_\_ Zone \_\_\_\_\_ State \_\_\_\_\_

# FM-TUNER KITS . . . . \$23<sup>95</sup>

Excellent Sensitivity and Low Noise Characteristic  
**SEE PAGE 147 FOR FULL INFORMATION**

# AM-FM TUNER KITS . . . . \$31<sup>95</sup>

**ROSE ELECTRONICS, Inc.**  
76 Vesey St., New York 7, N. Y., COrtlandt 7-6195

## Develop 380,000 Volts

### With This Van de Graaff Generator

Every electrical experimenter will want to build an operating model of the full-size electrostatic generator that aided in the development of the atomic bomb. This model will perform a variety of fascinating experiments and develop up to 380,000 volts. Complete bill of materials and step-by-step construction details make it easy to build the generator. Two large, illustrated plans, size 22x34 inches. Order Craft Print No. 197—Price \$1.00. Also, "Souped-Up" Tesla Coil, Craft Print No. 191—Price 50¢. Both plans, \$1.30.

### SCIENCE AND MECHANICS

450 East Ohio St., Dept. R-572  
Chicago 11, Ill.



**NOW!**

# FIX TV FAST!

**No Experience Necessary—  
New Book Gives You Easy,  
Step-by-Step Instructions**

**All New! 2nd  
Revised Edition  
TRANSISTORS  
COLOR  
UHF and LATEST  
TV CIRCUITS**

Get this brand-new, complete handbook for sure-fire how-to-do-it knowledge of TV repair, installation, maintenance and troubleshooting. You'll be amazed how easy it is to fix your own TV set with the help of this manual. And you'll find it equally as easy to make spare-time money fixing TV sets for your neighbors and friends. Perhaps you will want to get a service shop job . . . even start your own full-time business.

**USE IT 10 DAYS FREE!** Coupon below brings you TELEVISION SERVICING on FREE trial for 10 days, without cost or obligation. Mail it NOW.

TV repair . . . how to test tubes . . . how to use the basic tools of . . . how to install sets and antennas, etc., etc. Contains complete, up-to-date information on color, UHF, transistors.

Mr. C. W. Morris of Charleston, W. Va., Says: "TELEVISION SERVICING is worth many times its cost. I have paid as much as \$200.00 for courses that haven't given me the clear understanding

Prentice-Hall, Inc., Dept. 5747-A-2

Englewood Cliffs, New Jersey

Send me TELEVISION SERVICING for 10 days FREE TRIAL. Within 10 days I will either return it and owe nothing—or keep it and send \$1.95 down (plus postage) and \$2 monthly for 2 months.

Name \_\_\_\_\_

Address \_\_\_\_\_

City \_\_\_\_\_ Zone \_\_\_\_\_ State \_\_\_\_\_

**SAVE! Send \$5.95 with this coupon and we'll pay postage & packing.**



# GET IN ON THE TV

# BOOM!



L. C. Lane, B.S., M.A.  
President, Radio-Television Training Association. Executive Director, Pierce School of Radio & Television.

## TRAIN FOR A TOP-PAY JOB AS A TELEVISION TECHNICIAN

**NO PREVIOUS EXPERIENCE NEEDED — study AT HOME in your SPARE TIME**

Next to the atom and hydrogen bombs, the biggest noise being made today is by the booming radio-television-electronics industry.

Now, while the boom is on in full force, is the time for you to think about how you can share in the high pay and good job security that this ever-expanding field offers to trained technicians.

Just figure it out for yourself. There are more than 400 television broadcasting stations operating right now

and hundreds more to be built; more than 34 million sets in the country and sales increasing daily. Soon moderately priced color television sets will be on the market and the color stampede will be on.

All these facts mean that good jobs will be looking for good men. You can be one of those men if you take advantage of my training now — the same training that has already prepared hundreds of men for successful careers in the radio-television-electronics field.



Super-Het Radio Receiver

AF-RF Signal Generator



C-W Telephone Transmitter



Public Address System Combination Voltmeter-Ammeter-Ohmmeter



### LEARN BY DOING

As part of your training I give you the equipment you need to set up your own home laboratory and prepare for a BETTER-PAY TV JOB. You build and keep an Electromagnetic TV RECEIVER designed and engineered to take any size picture tube up to 21-inch, (10-inch tube furnished. Slight extra cost for larger sizes.) . . . also a Super-Het Radio Receiver, AF-RF Signal Generator, Combination Voltmeter-Ammeter-Ohmmeter, C-W Telephone Transmitter, Public Address System, AC-DC Power supply. Everything supplied, including all tubes.



Sylvania Now Sponsoring RTTA's Color TV Technician Course  
One of the nation's largest electronics manufacturer's and marketer's Sylvania Electric Products Inc. in its continuing effort to cooperate with independent service dealers is now sponsoring the RTTA Color Television Technician Course.

**FCC COACHING COURSE** Qualifies you for Higher Pay! Given to all my students AT NO EXTRA COST. Helps you qualify for the TOP JOBS in Radio-TV that demand an FCC license! Full training and preparation at home for your FCC license.

No experience necessary! You learn by practicing with professional equipment I send you. Many of my graduates who now hold down good paying technician jobs started with only grammar school training.

If you have previous Armed Forces or civilian radio experience you can finish your training several months earlier by taking my FM-TV Technician Course. Train at home with kits of parts, plus equipment to build YOUR OWN TV RECEIVER. ALL FURNISHED AT NO EXTRA COST!

After you finish your home study training in the Radio-FM-TV Technician Course or the FM-TV Technician Course you get two weeks, 50 hours, of intensive Laboratory work on modern electronic equipment at our associate school in New York City, Pierce School of Radio & Television.

**COLOR TV TECHNICIAN COURSE**—All new! Learn the latest. Be prepared for those Color TV servicing profits ahead! Contains the most up-to-date servicing data, procedures and circuits.

**RADIO-FM-TV TECHNICIAN TRAINING**

**FM-TV TECHNICIAN TRAINING**

**EXTRA LABORATORY TRAINING IN NEW YORK CITY AT NO EXTRA COST!**

## VETERANS!

My School fully approved to train Veterans under new Korean G. I. Bill. Don't lose your school benefits by waiting too long. Write discharge date on coupon.

YOU GET THESE *free!*



### MAIL THIS COUPON TODAY!

Mr. Leonard C. Lane, President  
RADIO-TELEVISION TRAINING ASSOCIATION  
Dept. EX-10, 52 East 19th Street, New York 3, N. Y.  
Dear Mr. Lane: Send me your NEW FREE BOOK, FREE SAMPLE LESSON, and FREE aids that will show me how I can make TOP MONEY in TELEVISION. I understand I am under no obligation.

(PLEASE PRINT PLAINLY)

Name \_\_\_\_\_ Age \_\_\_\_\_  
Address \_\_\_\_\_  
City \_\_\_\_\_ Zone \_\_\_\_\_ State \_\_\_\_\_

- Color TV Course
- Radio-FM-TV Technician Course
- FM-TV Technician Course
- TV Studio Technician Course

**VETERANS!**  
Write discharge date

## Radio-Television Training Association

52 EAST 19th STREET • NEW YORK 3, N. Y.

Licensed by the State of New York • Approved for Veteran Training

The newest hobby under the sun!

# BUILD THIS SOLAR POWERED RADIO!

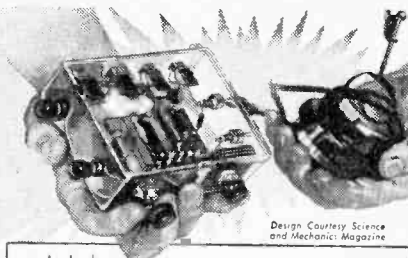
and many other sun-powered electronic,  
electrical and photometric devices featuring  
International Rectifier Corporation SUN BATTERIES!

Everyone—from the beginner with a basic understanding of electrical work to the experienced professional engineer—can build this pocket size portable radio—powered by the sun! No batteries—not even an On-Off switch. All you need is sunshine! The basis for this radio is the International B2M Sun Battery. This unit is a scientific, accurate, precision-made photovoltaic instrument that directly converts light into electrical energy. This radio is just one of many devices you can build powered by solar energy. You have read about this new field of science. Be among the first in this newest hobby. Put the sun to work for you!

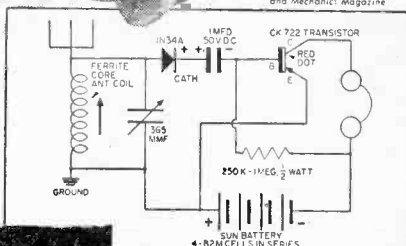
THIS NEW BOOK TELLS YOU ALL ABOUT SUN BATTERIES—PHOTOCELLS—AND HOW TO USE THEM. Packed with information and applications, this illustrated book shows wiring, diagrams and plans—every detail necessary to build many interesting devices.

\$1.50

THIS IS THE FAMOUS B2M SUN BATTERY YOU'VE READ ABOUT. Widely used in experiments, this unit in bright sunlight (10,000 ft. candles) will deliver 2 milliamperes at 250 millivolts under optimum conditions; will last indefinitely with proper care. A \$2.50 value for only.....\$1.50



Design Courtesy Science and Mechanics Magazine



**FREE** Complete plans for building this radio. At your electronic parts distributor.

GET THE B2M SUN BATTERY AND ALL OTHER COMPONENTS REQUIRED AT LEADING ELECTRONIC PARTS DISTRIBUTORS EVERYWHERE. If your favorite distributor doesn't feature the B2M Sun Battery send check or money order to

International Rectifier Corporation  
El Segundo, California

**SPECIAL OFFER, The book and the B2M Sun Battery for only \$2.85 at your distributor**

## Do you WISH you were EMPLOYED in ELECTRONICS?

We can train you and place you in an electronics technician job in the short time of only 12 weeks!

### F.C.C. License—the Key to Better Jobs

An FCC commercial (not amateur) license is your ticket to higher pay and more interesting employment. This license is Federal Government evidence of your qualifications in electronics. Employers are eager to hire licensed technicians.

### Grantham Training is Best

Grantham School of Electronics specializes in preparing students to pass FCC examinations. We train you quickly and well. All courses begin with basic fundamentals—NO previous training required. Beginners get 2nd class license in 8 weeks. 1st class in 4 additional weeks.

### Learn by Mail or in Residence

You can train either by correspondence or in residence at either division of Grantham School of Electronics—Hollywood, Calif., or Washington, D.C. Our free booklet, "Opportunities in Electronics," gives details of both types of courses. Send for your free copy today.

### MAIL NOW TO OFFICE NEAREST YOU

(mail in envelope or paste on postal card)

### Grantham School, Desk E

1505 N. Western Ave. OR 821—19th Street N. W.  
Hollywood 27, Calif. Washington 6, D. C.

Please send me your free booklet, telling how I can get my commercial FCC license quickly. I understand there is no obligation and no salesman will call.

NAME .....

ADDRESS .....

CITY ..... STATE .....



## Instead of a job... train for a Career

Industrial growth... automation... technical advances create career opportunities for engineers, accountants, management experts. Share rewards awaiting college-trained men. Important firms visit campus regularly to employ Tri-State College graduates. Start any quarter in this world-famed college. Approved for veterans.

### Bachelor of Science degree in 27 months

Complete Radio Engineering course... TV, UHF, FM, Electronics. Also degree courses in Mechanical, Civil, Electrical, Aeronautical and Chemical Engineering. In 56 Months a B.S. in Business Administration (General Business, Accounting, Motor Transport Management majors). Capable students may accelerate. 36-weeks course in Drafting Intensive program; technical fundamentals stressed; comprehensive courses with more professional class hours. Small classes; personalized instruction. For earnest, mature students whose time and budget require accelerated courses and modest costs. Preparatory courses. Beautiful campus in friendly college town. Well-equipped, new and modernized buildings and laboratories. Enter June, Sept., Jan., March. Write Jean McCarthy, Director of Admissions, for "Your Career in Engineering and Commerce."



## TRI-STATE COLLEGE

3756 College Avenue

Angola, Indiana

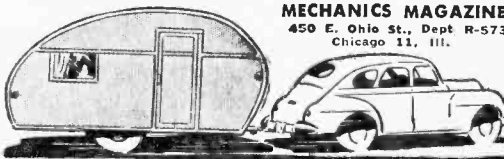
## Want a Trailer?

### BUILD IT YOURSELF

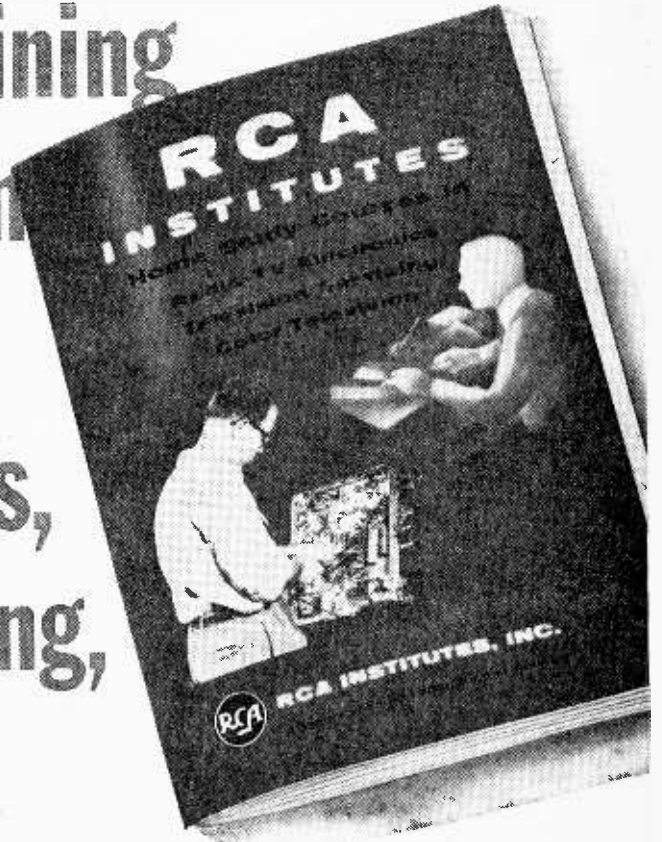
Ideal for week-ends, fishing or vacation trips. Compact, roomy, comfortable; sleeps two people. Designed for all modern conveniences—sink, water tank and pump, stove, kitchen table, cupboard, clothes closet, drawer chest, storage space, electric lights, ventilator, etc. Sturdy, simple construction. Overall body length, 12 ft. 6 in., weight 1,100 lbs. Our master plan gives bill of materials, explains every construction detail. Satisfaction guaranteed. Order Craft Print No. 50 now!

PLANS  
50¢

SCIENCE AND  
MECHANICS MAGAZINE  
450 E. Ohio St., Dept R-573  
Chicago 11, Ill.



**RCA offers you the finest training at home in Radio-TV electronics, TV servicing, Color TV**



**SEND FOR THIS FREE BOOK NOW!**

The instruction you receive and equipment you get (and keep) will start you on your way. Pay-as-you-learn. You pay for only one study group at a time. This 52 page book contains complete information on Home Study Courses for the beginner and the advanced student.



**RCA INSTITUTES, INC.**  
 A SERVICE OF RADIO CORPORATION of AMERICA  
 350 WEST FOURTH STREET, NEW YORK 14, N.Y.

RCA Institutes, Inc., Home Study RTE-126  
 350 West Fourth Street New York 14, N. Y.  
 Without obligation, send me FREE CATALOG  
 on Home Study Courses in Radio, Television  
 and Color TV. No salesman will call.

Name ..... Please Print .....  
 Address .....  
 City ..... Zone ..... State .....

**VETERANS  
 KOREAN G.I.  
 P. L. 550  
 CHECK HERE  
 ( )**

Abraham Marcus, co-author of famous best-seller  
"Elements of Radio" makes amazing offer!



## TRY MY TV and RADIO REPAIR COURSE FREE FOR 1 MONTH

"If you haven't earned at least \$100 in spare time during that period you pay not a cent."

Here it is! The most amazing guarantee ever offered on any radio-TV course anywhere! We'll send you Abraham Marcus' course to use FREE for one full month! If in that time you haven't actually made \$100 fixing radios and TV sets, just return the books to us and pay not a penny!

Why do we make this sensational offer? First, because these books are so easy to use. They are written in the same clear, easy-to-understand language that made the author's "Elements of Radio" a 1,000,000-copy best-seller. Second, because these books get right to the point—tell you what to do in 1-2-3 fashion. For example, once you master the first few chapters of the TV book you are ready for business—ready to do service jobs in the field—jobs that account for over 80% of all service calls.

DON'T WAIT! You risk nothing when you send the coupon below. You don't have to keep the books and pay for them unless you actually make extra money fixing radios and TV sets. Even when you decide to keep them, you pay on easy terms. Mail the coupon now.

### MAIL THIS COUPON

Prentice-Hall, Inc., Dept. 5747-A1  
Englewood Cliffs, New Jersey

Please send me Abraham Marcus' TV & RADIO REPAIR COURSE (3 volumes) for 10 days FREE examination. Within 10 days I will either return it and owe nothing, or send my first payment of \$5.60. Then, after I have used the course for a FULL MONTH, if I am not satisfied I may return it and you will refund my first payment. Or I will keep the course and send you two more payments of \$5.60 a month for two months.

Name .....

Address .....

City .....

Zone ..... State .....

### WHAT YOU GET IN THESE 3 GIANT VOLUMES

#### ELEMENTS OF TELEVISION SERVICING.

Analyzes and illustrates more TV defects than any other book, and provides complete, step-by-step procedure for correcting each. You can actually SEE what to do by looking at the pictures. Reveals for the first time all details, theory and servicing procedures for the RCA 28-tube color television receiver, the CBS-Columbia Model 205 color set, and the Motorola 19-inch color receiver.

**RADIO PROJECTS.** Build your own receivers! Gives you 10 easy-to-follow projects, including crystal detector receiver—diode detector receiver—regenerative receiver—audio-frequency amplifier—tuned-radio-frequency tuner—AC-DC superheterodyne receiver—etc.

**RADIO SERVICING Theory and Practice.** Here is everything you need to know about radio repair, replacement, and adjustment. Easy-to-understand, step-by-step self-training handbook shows you how to locate and remedy defects quickly. Covers TRF receivers; superheterodyne receivers, short-wave, portable, automobile receivers, etc. Explains how to use testing instruments, such as meter, vacuum-tube voltmeters, tube checkers, etc., etc.



(See Feature Story on Page 69)

## FARM TELEPHONE CABINETS



Slightly used crank style CABINETS (once used everywhere) for Home Hobby Shops. Complete with transmitter, receiver, bells, crank and shelf (Less Generator). **Has all of the outside parts.** Make beautiful, unique **Radio Cabinets, Liquor Chests, Spice Cabinets, Flower Planters, etc.** Immediate deliveries assured \$7.00. F.O.B. Chicago.

### TELEPHONES

#### Desk Stand Style

Slightly Used but in Excellent Condition



Inter-House Phones  
Loud Speakers  
House to Barn, etc.  
Microphones

**\$2.75**

Postpaid in U.S.A.

Educational Purposes, Toys, etc.

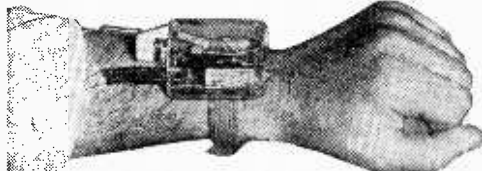
Come complete, ready to use with detailed wiring instructions included. \$2.75 each, two for \$5.00.

WRITE FOR ILLUSTRATED BULLETIN "BB"

**MICROPHONE, Dept. BB-1**

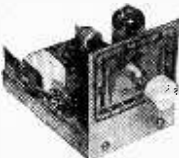
1760 W. Lunt Ave.  
Chicago 26, Ill.

## WRIST RADIO - \$3.95



No need to search around to find ALL the parts to build the Wrist Radio described in this issue of Radio-TV Experimenter. We'll supply \$4 grade metal transistor, micro-glass diode, plastic case, bakelite chassis plate, tuning coil & knob, both ceramic capacitors, battery clips, hardware and wire—everything for \$3.98 postpaid. Set uses only 15¢ 1½v. hearing aid battery, sold by hearing aid dealers in your town. Set works with regular magnetic earphones or we'll furnish a real miniature hearing aid phone for \$3.75. Do not confuse with cheap imported phones which rarely work.

## PEE-WEE RADIO - \$3.95



This set has pulled in stations 1500 miles away. It can be converted into a novel radio broadcaster, too, as described in this issue of Radio-TV Experimenter. All parts furnished so that radio can be changed from radio to broadcaster or vice versa. Because of rise in tube prices we can no longer supply radio alone at \$2.98. Better, you get components for both projects for just \$3.98. Set uses standard or miniature phone available at \$3.75. Hearing aid battery available from local hearing aid dealers at same price we would charge.

WE PAY POSTAGE ON ALL ORDERS. SEND CHECK OR MONEY-ORDER. DO NOT RISK CASH. SORRY, NO C.O.D. WITHOUT \$1 deposit. FOREIGN ORDERS SHIPPED 1st CLASS MAIL POSTPAID ANYWHERE AT SAME PRICE, but C.O.D.'s can not be filled outside U.S.A.

### ELECTRO-MITE

Reg. U. S. Pat. Off.

SPRINGDALE 636-X CONN.

**LOOK THEM OVER!**



A wide variety of opportunities awaits the **Trained Man** in the **Fast Growing Fields of**

# TELEVISION

## RADIO • ELECTRONICS

**CHECK THESE OUTSTANDING OPPORTUNITIES!**

- 1. YOUR OWN SERVICE SHOP—Selling, installing, servicing Television (including Color TV) and Radio receivers, sound systems, etc.
- 2. MILITARY ELECTRONICS—Automatic weapons control and communications technician, etc.
- 3. RADAR TECHNICIAN—Operation and maintenance of navigation devices, etc.
- 4. TV-RADIO BROADCASTING—Studio technician, control room operator, TV camera man. FCC licensed operator.
- 5. INDUSTRIAL TELEVISION—Installation, operation servicing of closed circuit TV systems.
- 6. AIRCRAFT RADIO—Flight tester, control tower operator, radio operator.
- 7. AUTOMATION ELECTRONICS—Specialist on electronic instruments and automatic controls.
- 8. TWO-WAY RADIO—Operation and maintenance of police, taxi, bus, truck communications systems.
- 9. REMOTE CONTROLS—Laboratory specialist on servo-mechanisms, guided missiles, radio-controlled devices.
- 10. COMPUTERS—Install and maintain Electronic "Brain" devices for office and industry.

... PLUS MANY OTHERS

Scores of jobs like those above in the technical end of Television-Radio-Electronics are open to men with proper training. Hundreds of DeVry graduates hold jobs like those. Many prepared at home and then we helped them get started. Hundreds had no previous technical training, no high school diploma, and while training never left home nor quit their jobs. Many were married men. Some paid for their training by repairing TV and Radio sets in their spare time.

DTI's program helps you do this because it is *different*. You get on-the-job type experience, clear explanations. You build and keep your own test equipment, as you perform over 300 practical projects. You use visual training HOME MOVIES and the remarkable Electro-Lab. You may even build a fine quality 21-inch Television set, if you wish.

### TRAIN IN OUR WELL-EQUIPPED LABORATORIES

If you prefer, you can get all of your training in our great Chicago Laboratories. Friendly, capable instructors work closely with you, as you learn about the commercial equipment you encounter later in the field. Students use this fine equipment, including the broadcast-type cameras, monitors, microphones, etc. in our TV-Radio studios ... the color TV sets ... the test instruments, etc. Send coupon for details.

### EMPLOYMENT SERVICE

Placement is the "payoff" in any training program. We have close contact with many employers in our field. We are proud of our graduates—for they have done us proud! That's why we believe we can help you get started. And if you are thinking of going into business for yourself, we help you there too.

**IMPORTANT FACTS ABOUT MILITARY SERVICE**  
We have valuable information showing how to make the most of your service in the Armed Forces. Mail the coupon.

### HOME MOVIES

We loan you a projector and many reels of instructive film. Run them off yourself. How clear the basic principles of Electronics can be with this helpful training aid—a DTI exclusive!



### EXCLUSIVE ELECTRO-LAB\*

Wiring diagrams show up through the transparent base. You follow each diagram, making scores of circuits. Parts are mounted quickly, easily with spring clip connectors. Over 300 projects include the building of a 5-inch Oscilloscope and a Vacuum Tube Voltmeter ... both valuable test instruments.

\*Trademark

### HERE'S ALL YOU DO

If you are 17 to 55 and want to prepare to get into a field with good pay and promising future, just fill in the coupon and send it to us. We will tell you how you may get ready for a wonderful future for yourself and your loved ones.

Accredited Member of National Home Study Council

### SEND COUPON! GET FREE BOOKLET!

DeVry Technical Institute  
4141 Belmont Ave., Chicago 41, Ill., Dept. RTV-M

I would like a copy of "Electronics and YOU" showing many opportunities in Television-Radio-Electronics, and how DTI may prepare me for a start in this billion dollar field.

Of the opportunities listed above, I am interested in No. \_\_\_\_\_

Name \_\_\_\_\_ Age \_\_\_\_\_

Street \_\_\_\_\_ Apt. \_\_\_\_\_

City \_\_\_\_\_ Zone \_\_\_\_\_ State \_\_\_\_\_

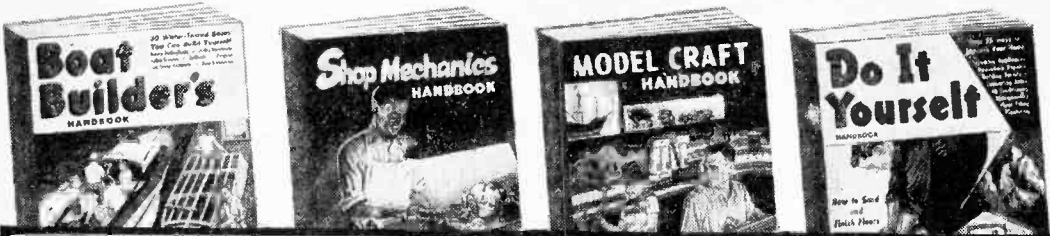
1038 DTI's training is also available in Canada



One of America's Foremost Electronics Training Centers  
**DeVRY TECHNICAL INSTITUTE**

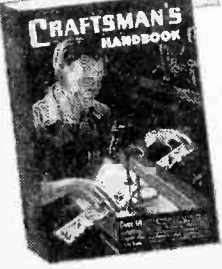
Formerly DeForest's Training, Inc.

4141 BELMONT AVENUE, CHICAGO 41, ILLINOIS



# Which of these How-to-Do-It Books Do You Want for Only 50¢?

**8 Big Illustrated Books • Every One a Gold Mine of Ideas for Making and Repairing Things**



Here's a whale of a bargain! 8 big books that show you exactly "how-to-do-it" and get professional results every time! Every one is jam-packed with pictures and simple step-by-step directions. Only 50¢ each. (Or even better, you can have all eight for only \$3.) Just pick the ones you want—rush coupon below while present supply lasts! Money back if not delighted.

**11 SPORTS CRAFT HANDBOOK**  
How to build, use, repair outdoor sports equipment. Covers outboard motors; guns, boats, fishing tackle, archery, golf, etc. How to restring tennis rackets, tie flies, make spinning rods, build swimming pool, overhaul canoe, build cruiser, sailboat, folding sled, reloading ammunition, and much more. 160 pages.

**12 PHOTO CRAFTSMAN . . .**  
Over 90 fascinating projects! Complete basic course in photo developing. How to make and use: flash-gun, enlarger, movie titler, speed-light, strobograph, electrical timer, boom light, copying stand, rotary print washer, projector, print flattener, camera bellows, coldlight enlarger, etc. Plus complete plans for apartment darkroom. 160 pages.

**14 DO-IT-YOURSELF HANDBOOK . . .**  
Big home-owner's treasury shows HOW TO: finish wood floors, install ventilating fans, plaster rooms, tile floors, install Thermopane windows, build furniture, make lamp shades, patch plywood, service appliances, plus 34 pages of home furnishing accessory ideas—all with step-by-step photos, plans and diagrams. 160 pages.

**4 CRAFTSMAN'S HANDBOOK.** Over 60 useful things to make—Tables, Cabinets, Captain's Chair, Early American Furniture, Simple Upholstery, Dressing Table-Desk, Toys, Sailing Dinghy, Wall Bracket, How to do Veneering, Wall Safe, Pantograph, Functional Furniture, and much, much more. 192 illustrated pages.

**5 BOAT BUILDER'S HANDBOOK . . .**  
30 Water-tested boats you can build. Everything from an 8-ft. racing hydroplane to a 28-ft. auxiliary cruiser. Includes speedy outboard runabouts, pram, utility boat, sailboat, canvas kayak, outboard cruiserette, dinghy, rowboat, catamaran, Class B racer, de Luxe sports runabout, fold-up boat, skiff, trailer boat, aqua planes, etc. In all, 30 boat plans. 192 pages.

**6 CRAFTWORK . . .**  
Fascinating projects using simple tools. Decorative Candle-making, Chip carving, picture framing, floral jewelry, hooked rugs, ceramic mold making, silversmithing, wire bending, pewter platters, wood carving, making molds, hand-made tie clips, sandals, and many other projects, plus a complete course in leathercrafting. 192 pages.

**7 MODEL CRAFT HANDBOOK . . .**  
A prize collection of 44 model projects—Model Railroad and Circus, Working Jet Engine, Famous Guns, Airplanes, Antique Autos, Gas and Steam Engines, Tallyho Coach, Model Racing Yacht, Remote Radio Controlled Cabin Cruiser, 1812 Cannon, 1860 Station Wagon, etc., etc. 192 big pages, many pictures.

**8 SHOP MECHANIC'S HANDBOOK . . .**  
Everything you want to know about building and using home workshop tools. Lathe, Bench Grinder, etc. Treasure of ideas. 192 pages.

**SPECIAL All 8 FOR ONLY \$3.00**

**SAVE MONEY!**  
If you order 2 or more books, you save 10¢ on each book! On 2 books, you deduct 20¢; on 3 books 30¢, etc. All 8 for only \$3.00.

**—RUSH THIS ORDER FORM—**  
Science & Mechanics Magazine, Dept. R-575  
450 East Ohio Street, Chicago 11, Illinois

Enclosed is \$\_\_\_\_\_ Please send the books whose numbers I have encircled below. (Numbers correspond with descriptions above.)

or  CHECK BOX TO GET ALL 8 BOOKS (\$4.00 VALUE) \$3.00

4 5 6 7 8 11 12 14

NAME \_\_\_\_\_

ADDRESS \_\_\_\_\_

CITY, ZONE & STATE \_\_\_\_\_

**Free!**  
WITH THIS OFFER

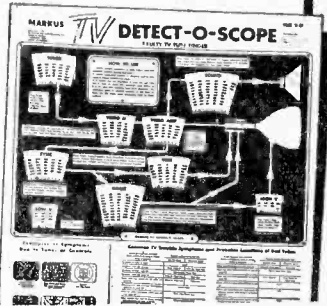
60% to 75% of all TV failures are caused by *faulty tubes*. This amazing new giant-sized "Detect-O-Scope" tells you, *at a glance*, exactly how to spot bad tubes in any TV set. Saves time, money — makes you an "expert" TV trouble-shooter! Gives

**YOURS FREE WITH THE FAMOUS MANUAL DESCRIBED BELOW**

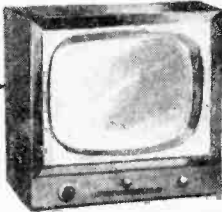
**Amazing New TV "DETECT-O-SCOPE"**

Enables You to  
**Spot Bad TV Tubes  
in a jiffy!**

identification numbers of tubes that may be causing trouble; shows you how to locate, check and replace them safely. 16x21 inches; copy-righted. Sells for \$1.00 but yours absolutely **FREE** on this offer!



**FIX TV AND RADIO SETS RIGHT AWAY**



—even if you never fixed a lamp or doorbell before!

McGraw-Hill's Amazing New  
Low-Cost Instruction Manual Skips  
Hard-to-Understand "Theories"  
and Formulas — Tells **HOW-TO-DO-IT** in **PLAIN ENGLISH**



**AT LAST**—a well-known **EXPERT** tells you in **PLAIN ENGLISH** how to fix TV or radio sets! Right from the very first chapters you can start doing simple repairs... and before you're **HALF** way through the manual, you can fix **HALF** the television and radio sets that you encounter. In just a few weeks you can start fixing your own and friends' sets... even start your own money-making business at home.

**NO** complicated formulas! **NOT** a study book! Deals only with parts that go wrong in sets—tells **HOW** to find the trouble — and the **EASY** way to **FIX IT!**

**Why It's So EASY**

John Markus, Associate Editor of Electronics Magazine, spent **FOUR** years making this one-volume manual practical and easy-to-follow — even



**Save Money on Your Own Set**

Save \$50 to \$100 a year installing and servicing your own set. Book tells what to do if picture is blurred—split—distorted—tilted—wiggles—too pale or black — jitters — "snow"—drifts—etc.

for the most "unhandy" beginner. A-B-C directions and 700 clear photos, diagrams, and drawings show exactly **WHAT** and **HOW** to fix, step-by-step. Includes everything you need to know: *where* and *how* to buy tubes and parts; where and how to get an official circuit diagram of any set; how to choose and use basic tools; how to test tubes **WITHOUT** a tube tester; how to use 58 common TV controls; simple "cures" for common TV and radio troubles; how to fix loudspeakers, phono pick-

ups, install and check antennas—and much more.

**SEND NO MONEY**

Mail coupon below—*without money!* When book arrives try it out on your own or neighbors' sets. See how simple and easy it makes nearly every repair job. Make it pay for itself in 10 days or don't keep it. Mail coupon **NOW** to: **McGraw-Hill Book Co., Dept. SM-57, 327 West 41st St., New York 36, N. Y.**

**Tells How To "Cash In" ON THE BIG DEMAND FOR RADIO-TV REPAIRMEN**

Over 25 million TV sets... over 100 million radios! Make nice extra money just fixing sets for friends and neighbors in your spare time... or start your own full-time repair business. Book tells exactly how to get started; which tubes to stock; how to make a service call. Actually start fixing sets and making money before you're half-way through book.



**PARTIAL CONTENTS**

How to Remove and Replace Tubes • Testing Tubes without a Tester • Using a Table Tester • Power Supply Troubles • How to Test and Replace Resistors, Controls, Switches, Condensers, Coils, Transformers • Speakers • Phono Pickups • Antennas and **MUCH MORE.**

**FREE 10-DAY TRIAL COUPON**

**McGraw-Hill Book Co., Dept. SM-57, 327 West 41st St., New York 36, N. Y.**

Please send me the big TV **DETECT-O-SCOPE** Chart **FREE**, with a copy of John Markus' **Television and Radio Repairing** for 10 days' **FREE EXAMINATION**. If not delighted, I may return book, pay nothing. Otherwise, I will send only \$1.95, plus few cents delivery charges; then 3 monthly installments of \$2.00 each. The **Detect-O-Scope** Chart is to be mine to keep **FREE**, in any case.

Name.....

Address.....SM-57

City.....Zone.....State.....

**SAVE MONEY.** Check here if enclosing \$7.95 **WITH** coupon. Then **WE** pay all delivery charges. Same 10-day return privilege. (Offer good in **U.S.A. only**.)

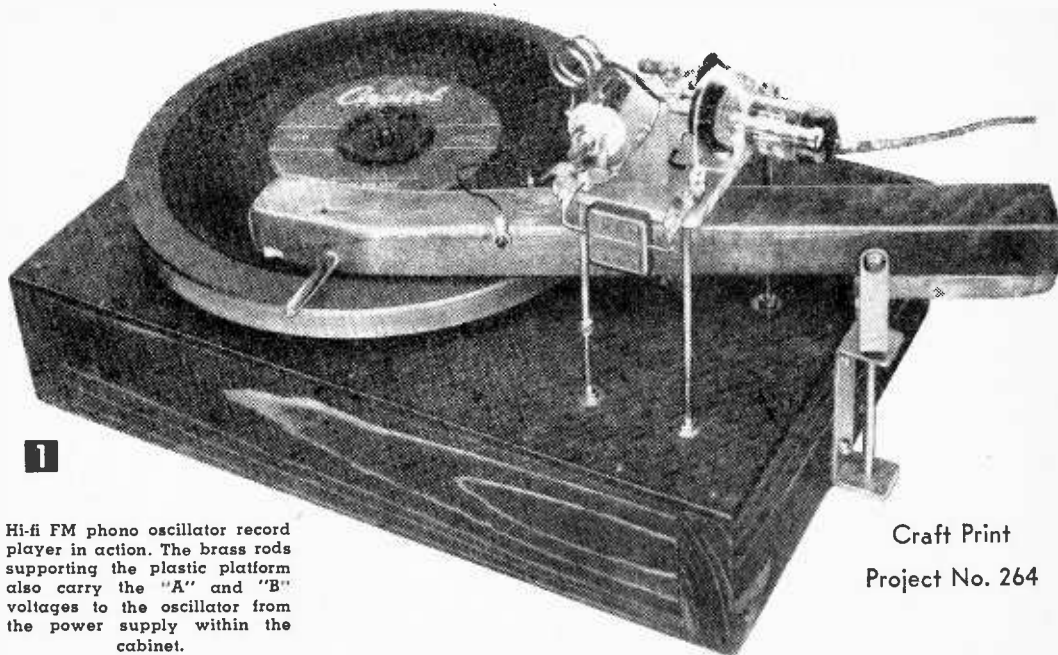
**SCIENCE and  
MECHANICS'  
DO-IT-YOURSELF  
LIBRARY**

50¢ each

Boat Builder's Handbook  
 Build It Yourself  
 Car Owner's Handbook  
 Craftsman's Handbook  
 Craftwork  
 Do-It-Yourself Handbook  
 Home Electrical Handbook  
 Home Owner's Handbook  
 Home Workshop Handbook  
 1001 How-to Kinks  
 How to Start a  
 Successful Small Business  
 Model Craft Handbook  
 Outdoor Living  
 Photo Craftsman  
 Shop Mechanic's Handbook  
 Sportsman's Handbook  
 Toys and Games  
 You Can Make

Copyright 1957 by  
**SCIENCE AND MECHANICS**  
 Publishing Company  
 450 East Ohio Street  
 Chicago 11, Illinois





1

Hi-fi FM phono oscillator record player in action. The brass rods supporting the plastic platform also carry the "A" and "B" voltages to the oscillator from the power supply within the cabinet.

Craft Print

Project No. 264

**A**MPLITUDE-MODULATED phono oscillators that play phonograph records through standard (AM) receivers do not give high-fidelity results because: 1) such players invariably use crystal phono pickups for modulating the oscillators, and most crystal pickups—judged by the high standards of today—have a comparatively narrow and non-linear frequency response and a comparatively high distortion content; 2) the selective I.F. stages in most AM superheterodyne receivers cannot pass a wide enough range of musical frequencies, (the "highs" are attenuated); and 3) the audio amplifiers and speakers in most AM receivers are simply not designed for high-fidelity sound reproduction. So here's a record player with a simple phono oscillator—directly frequency-modulated by a home-made capacitance type of phono pickup—which *will* put a wide-range, low-distortion signal through the air to your FM radio. The quality of reproduction is then limited only by the quality of the records played, and by the audio amplifier and speaker system in your FM receiver.

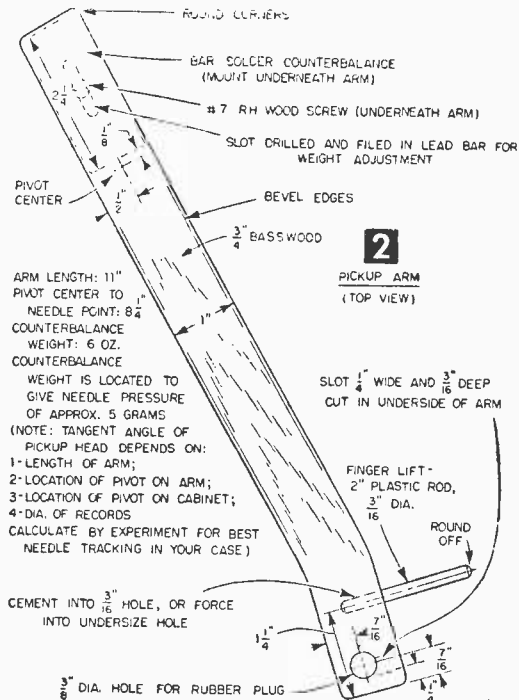
The player in Fig. 1 was built to handle 45-rpm records only, but you can easily alter it to handle the larger diameter 78's and LP's without in any way detracting from its performance. Note that the oscillator is built on a plastic platform supported by four brass rods. To handle 10-in. or 12-in. 78 rpm or LP records, set these rods slightly further back on the cabinet and space them slightly further apart to provide for wider swing of the pickup arm.

# Hi-Fi FM Record Player

By ARTHUR TRAUFFER

**The Capacitance Phono Pickup.** In theory, and in practice, a capacitance pickup—when used with a suitable oscillator and low-distortion demodulator—can be made to have the most linear response over the widest frequency range with the lowest distortion of any phono pickup ever conceived. Capacitance pickups have been developed that have practically zero distortion, a nearly linear frequency response from 20 to 20,000 cps., and a needle pressure so low that they can play back a wax "master" recording without damaging it. For \$2 or less, you can build a capacity pickup that compares favorably with such wonder devices. With patient experimentation and study, you may develop a capacity pickup and oscillator-demodulator system that will equal or surpass them.

Capacity phono pickups can be built in many different ways, but in every case the operating principle is the same. A phono needle with a precision jewel tip, or a small duraluminum or magnesium tube with a jewel point cemented into one end, is mounted so that it can move freely from side-to-side, thus forming the variable plate of the pickup's capacitor. The stationary plate is a small metal plate mounted to one side of the needle so that there is a small air space between it and the needle. The needle and the plate are connected across the coil of a low-power oscil-

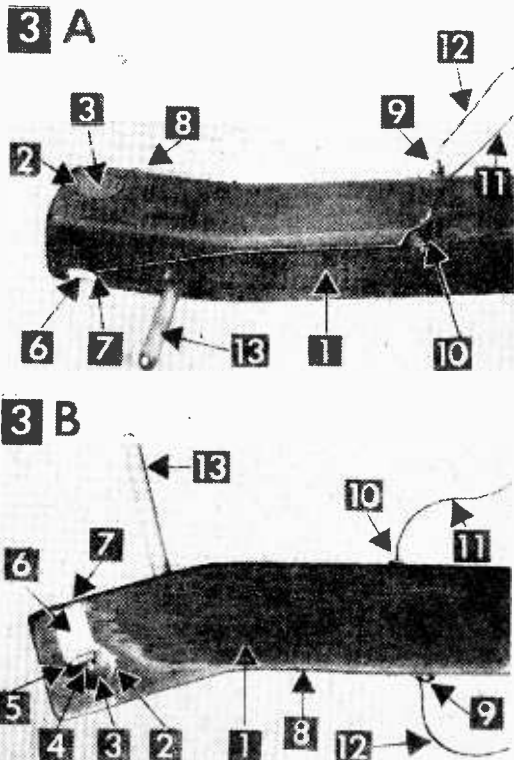


lator, and since any change in the spacing between needle and plate results in a change in the capacitance across the coil, the mean-frequency of the oscillator shifts in accordance with the movement of the needle. Thus, as the needle rides in the record grooves, the mean-frequency of the oscillator is shifted from side-to-side at the command of the wave-forms in the record grooves.

The oscillator radiates a frequency-modulated wave which can be picked up on a nearby FM receiver (or, less desirably, "slope detected" on a nearby AM receiver); or which can be detected by a closely-coupled demodulator and fed into a high-fidelity audio amplifier and speaker. Possible variations are almost endless; it's a real "happy hunting grounds" for experimenters and hi-fi enthusiasts!

**The Pickup Arm.** Figure 2 shows the construction details for our wooden pickup arm. The arm was jig-sawed from good quality basswood (used because it has less mechanical resonance than many other woods), sanded smooth, and stained with walnut stain. Metal should not be used for making the arm because of the capacitance effect it would have with the leads run along its sides.

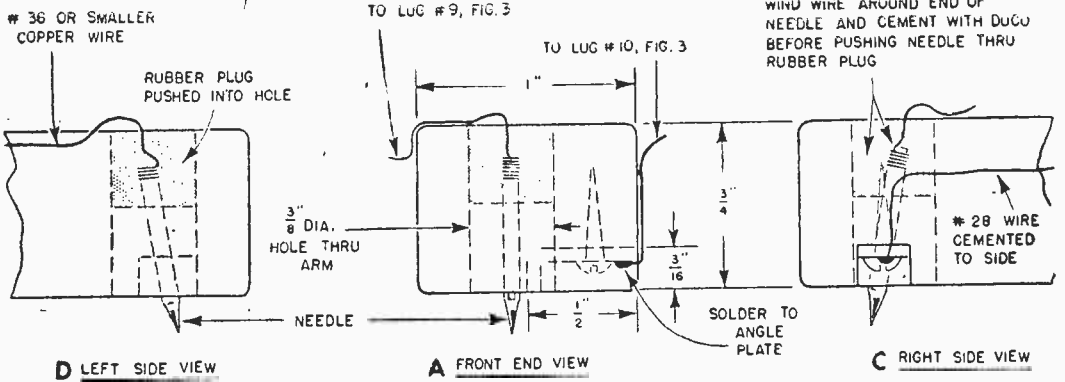
Figures 3 and 4 give construction details for the capacitance pickup itself. It consists essentially of a phono needle pushed into a soft rubber plug, and a small metal angle-plate mounted to one side. When drilling the 3/8 in. dia. hole, use a sharp bit to prevent chipping the wood. The 1/4 in. wide slot is cut with a single-edge razor blade and squared off with a narrow flat file. When bending the angle-plate, make the bend in a vise using a



Three-quarter top and side view (A) and bottom view (B) of capacitance pick-up arm. Details shown are: 1) tone arm; 2) 3/8" dia. hole; 3) rubber plug cut from Goodyear #200 eraser; 4) phono needle pushed through rubber plug (the Recoton #2812R "Allgroove" jewel needle shown here was later replaced with an Audiopoint #123 microgroove sapphire stylus); 5) brass or copper angle-plate screw-fastened in slot cut in bottom of arm; 6) slot filled with Plastic Wood to kill possible mechanical resonances of angle-plate; 7) #28-gauge copper wire soldered to angle-plate and cemented along side of arm to soldering lug #10; 8) #36-gauge copper wire cemented along side of arm connecting needle to soldering lug #9; 9 & 10) soldering lugs screw-fastened to arm; 11) flexible wire lead from lug to "ground" side of oscillator coil and variable-capacitor; 12) flexible wire lead from lug to grid side of oscillator coil and variable-capacitor; 13) finger-lift.

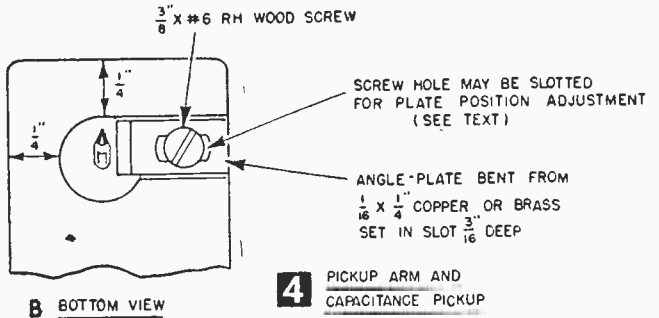
hammer so you get a square bend. The 3/16 x 1/4 in. face of the angle (the side that faces the needle) should be filed flat, and the burred edges smoothed off. The hole in the angle-plate (Fig. 4B) for the mounting screw can be elongated with a rat-tail file, so you can adjust the position of the angle-plate in relation to the phono needle.

You can cut a clean round plug from a Goodyear #200 soft rubber pencil eraser with a thin-wall metal tube (such as the cap of a dime store fountain pen with its end and clip removed) by pushing down on the eraser with a slight twisting motion. The plug should be about 1/16 in. larger in dia. than the hole in the wood, so that it fits the hole snugly but can be pushed up or down at will. Before cutting the plug out of the eraser, sharpen the cutting edge of the metal tube



by cutting around the inside of the edge with a small knife blade. The needle is the most critical part of the whole assembly. Its shank should be straight, with a uniform cross-section, and it should be made from metal that has the least amount of mechanical resonance in the audio range. It should also have a precisely ground and polished sapphire point. ("Precious metal" points don't wear any too long, and diamond points cost too much.)

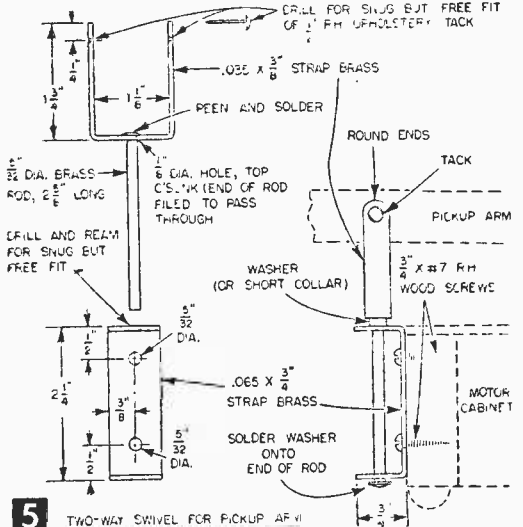
Use a needle with a point radius of .001 for LP and 45 rpm records, and another needle with



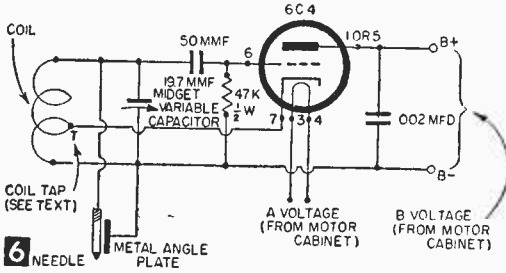
**4** PICKUP ARM AND CAPACITANCE PICKUP

a point radius of .003 for 78 rpm records. Don't use a .001 needle on 78's, or a .003 needle on LP's and 45's. A .001 point is too small for the grooves of 78's and a .003 point is too large to properly engage the high-frequency wave-forms in the grooves of LP's and 45's. The so-called "all-groove" needles, having a compromise point of .002 for playing records of all three speeds, are not recommended for this capacitance pickup—or any other pickup for that matter. An "all-groove" needle does not give top fidelity on any of the three speeds, and, when such a needle's point be-

MATERIALS LIST—HI-FI FM PHONO OSCILLATOR	
No.	Description
Pickup Arm and Capacitance Pickup	
1 pc	3/4 x 1 1/2 x 11" basswood
1	2 1/4" strip bar solder
1	3/16" dia. plastic rod, 2" long
3	#6 rh wood screws, 3/8" long
1	#7 rh wood screw, 1/2" long
1	eraser (Goodyear #200)
1	phonograph needle
2	soldering lugs
1 pc	.065 x 1/4 x 1 1/8" copper or brass stock
Swivel for Pickup Arm	
1 pc	.065 x 3/8 x 4 3/4" strap brass
1 pc	.065 x 3/4 x 3 3/4" strap brass
1	5/32" dia. brass rod, 2 5/8" long
2	#7 rh wood screws, 3/4" long
2	rh upholstery tacks, 1/2" long
1	5/32" dia. washer
Oscillator	
4	3/16" dia. brass rods 4" long
1	1/8 x 2 x 3 1/2" polystyrene panel
1 pc	.065 x 1/2 x 1 1/4" brass
1 pc	.035 x 1 x 1 1/2" copper (three-way lug)
1 pc	.035 x 7/8 x 1 1/2" aluminum
5	3/16" dia washers
17	10-32 hex nuts
1	10-32 fil.h machine screw, 3/8" long
1	6 1/2" length #12 or #14 gage bare copper wire
8	soldering lugs
1	6C4 miniature triode
1	Amphenol 7-pin miniature tube socket
1	19.7 mmf. miniature variable capacitor (Johnson type 20M11 or equiv.)
1	.002 mfd. capacitor (mica)
1	50 mmf. capacitor (ceramic or mica)
1	47K (47,000) ohm resistor, 1/2 w.
5	A batteries, 1 1/2 V. each
1	B battery, 67 1/2 V.
Miscellaneous wire, Duco cement, Plastic Wood	



**5** TWO-WAY SWIVEL FOR PICKUP ARM



comes worn in gritty shellac 78 rpm grooves, it will tear the grooves in vinylite LP's and 45's.

The best needle that the writer has been able to find for his capacitance pickup is the Audio-point #123 "Red Circle" Sapphire Microgroove needle. This stylus is a product of Audio Devices Inc. (444 Madison Ave., New York 22, N.Y.) and can be obtained through local distributors in the leading cities of the country. The price of the needle is \$2 list, or about \$1.20 net from electronic parts mail-order houses. Since it has a micro-groove point, it should not be used on 78 rpm records.

Scrape the shank of the needle you select bright and clean, then tightly wind 6 turns of bare #36-gage copper wire around the shank close to the end. Hold the turns fast with Duco cement. Push a darning needle through the plug, at a slight forward angle as in Fig. 4, to form a path for the phono needle, and then push the needle in place. Leave a little loop in the wire above the rubber plug to allow for future needle or plug adjustment, and cement the wire lead securely along the side of the arm with Duco cement. This wire lead terminates at a soldering lug screw-fastened to the

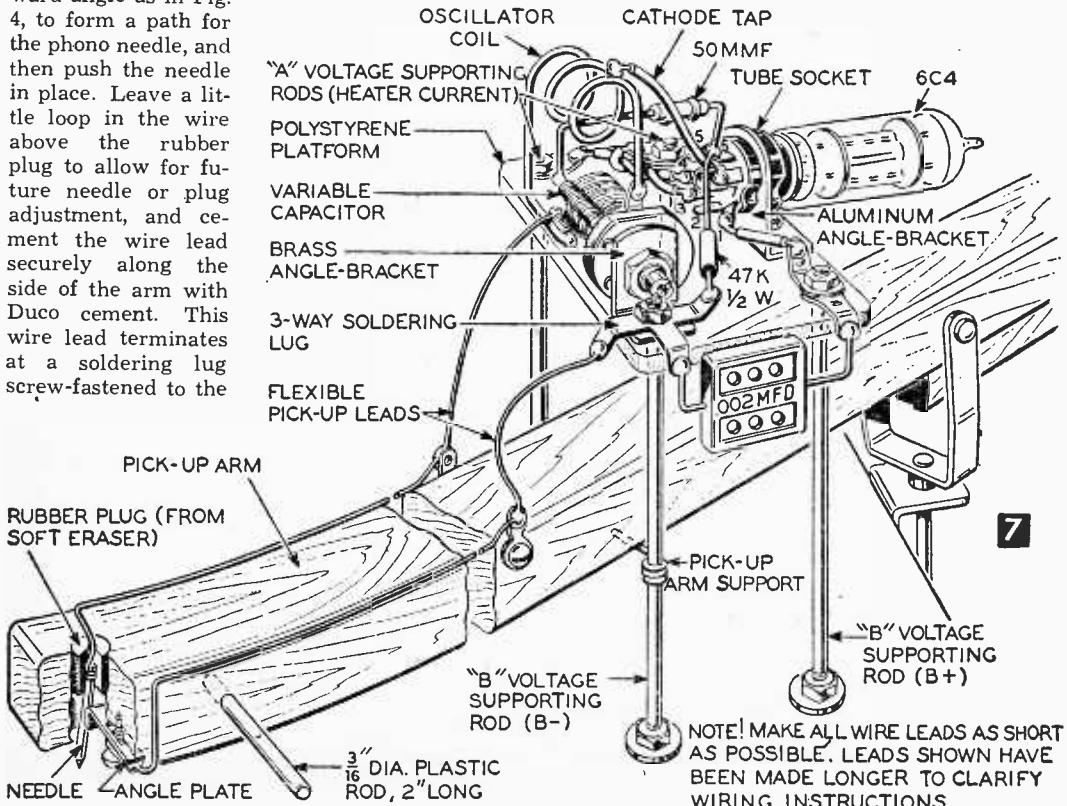
side of the arm (#9, Fig. 3).

Now solder a #28 wire lead to the outer end of the metal angle-plate, leave a small loop in the wire, and cement this lead securely along the side of the arm, terminating it at the soldering lug on the other side of the arm from the termination of the needle lead. Adjustment of the needle and angle-plate will be dealt with later in this article.

Figure 5 shows how the writer built a simple swivel from strap brass and brass rod. You may have to make some alterations to suit your own set-up, or—to save some time and work—you can use the swivel from an old crystal-pickup arm (obtainable for little or nothing at radio repair shops). In either case, be sure that the swivel moves freely in all directions.

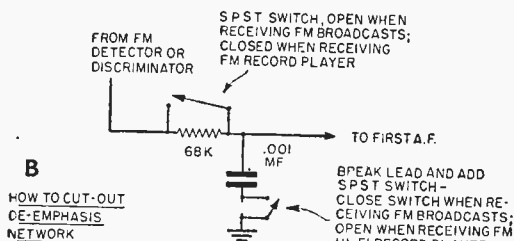
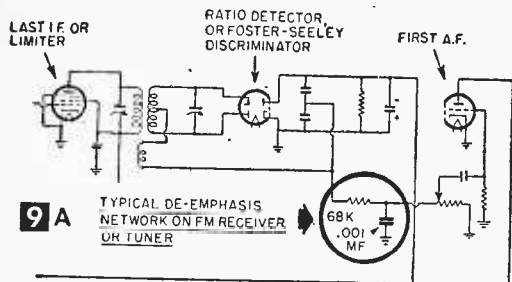
### The Oscillator

Figures 6 and 7 give wiring and construction details of the mainspring of the entire unit, a simple Hartley oscillator. The oscillator is mounted on a polystyrene platform which is supported by four brass rods. These rods also carry the "A" and "B" voltages to the oscillator from the power supply inside the motor cabinet. (If you wish, you can do away with the platform and rods, and mount the oscillator on top of the motor cabinet to the rear of the turntable, or you can



NOTE! MAKE ALL WIRE LEADS AS SHORT AS POSSIBLE. LEADS SHOWN HAVE BEEN MADE LONGER TO CLARIFY WIRING INSTRUCTIONS.





FM record-player transmits all the highs and lows that anybody can put on a phonograph record, it is now up to the FM receiver to reproduce all it receives.

FM broadcast stations purposely boost the high musical frequencies ahead of the transmitter modulator. This is called "pre-emphasis." Accordingly, most FM receivers incorporate a resistor-capacitor network between their detectors and audio sections to reduce the highs to their normal level. This is called "de-emphasis." De-emphasis helps to reduce high-frequency noise impulses picked up by FM receivers.

Since the de-emphasis network in an FM receiver or FM tuner is, in effect, a fixed "tone control" which attenuates the high musical frequencies, it is obvious that if this network is not cut out, you are not going to get all the highs put out by the FM record-player. But by installing two S.P.S.T. toggle switches on the rear of the FM receiver or FM tuner chassis, you can temporarily cut out the de-emphasis network while listening to the record-player. Figure 9 shows where to find the de-emphasis network on an FM receiver or tuner and where to connect the toggle switches.

If you want even more highs (and the best present-day records have 'em) you can disconnect the grid-to-chassis or plate-to-chassis bypass capacitors in the audio section of the FM receiver. Besides cutting out the de-emphasis network, this writer removed two plate by-pass capacitors in the audio section of his FM receiver and the reproduction when receiving his FM record-player is so realistic it's startling!

**A Few Pointers.** The farther you push the phono needle into the rubber plug on the pickup arm of the record player, the less compliance the needle will have; and vice versa. The smaller the air space between the needle and the angle-plate, the greater the frequency shift (with modulation) of the oscillator, and the louder the re-

ceived signal in the FM radio; and vice versa. Don't make the needle compliance too great, however, and don't make the air gap between the needle and plate too small, or you may have some trouble keeping the signal tuned-in correctly when playing badly warped records or records with off-center spindle holes—especially with FM receivers that tune sharply.

The Audiopoint #123 needle has an over-all length of about  $1\frac{3}{16}$  in., which makes it a little longer than most other needles. The writer clipped about  $\frac{1}{8}$  in. off the shank end of his with a pair of side-cutters and filed this end flat to shorten and reduce the mass of the needle. Since a capacity phono-pickup is a modulating device and not a voltage generating device, the needle has no work to do but to ride in the grooves of the record; consequently, the mass of the vibrating member (needle or stylus, etc.) can be reduced to a minimum to allow it to respond to every little wave-form in the record grooves, and with less flexing of the groove walls. Low mass and high compliance of the stylus also makes possible very low needle pressures, which increases the life of both needle and records. The writer adjusted his pickup for a needle pressure of 5 grams. The pickup arm should be designed and placed to give the best possible needle tracking from the outer grooves to the inner grooves on the records. All of the above can be best learned by experimenting.

The oscillator of the FM record-player radiates directly from the coil and puts out a good signal up to approximately 50 ft. Don't connect an antenna to the oscillator, and don't use over 90 v. of B-plus on the plate of the 6C4, or you may hear from the FCC. Of course, this caution applies to all phono oscillators. It's better to put the phono oscillator closer to the receiver than to increase its power.

With some phono motors, the metal-to-metal friction of the turntable spindle in its socket causes an annoying "scratch" in the signal which cannot be eliminated by an FM receiver. If you are bothered with this, you can kill the noise at its source by taking the spindle and turntable to a machine shop and having a lathe operator turn you out an exact duplicate of the spindle from a fiber or bakelite rod. The writer had this done for only \$1.50. Another method is to reduce the diameter of the spindle's shank just enough so you can slip a plastic sleeve over it. The outside dia. of the plastic sleeve (when it is on the spindle) should be equal to the original dia. of the spindle shank.

• Craft Print No. 264, in enlarged size for building the Hi-Fi FM Record Player is available at 50¢. SPECIAL QUANTITY DISCOUNT! If you order two or more craft prints (this or any other prints), you may deduct 10¢ from the regular price of each print. Hence, for two prints deduct 20¢; three prints, deduct 30¢, etc. Order by print number, enclosing remittance (no C.O.D.'s or stamps) from Craft Print Dept. R56, SCIENCE AND MECHANICS, 450 East Ohio Street, Chicago 11, Illinois. See coupon on last page of this handbook.

Top view of Mighty Mike (circle). Chassis measures only 1 1/4 x 3 3/8 x 4 1/4 in., yet circuit components are far from crowded.



# Mighty Mite Audio Amplifier

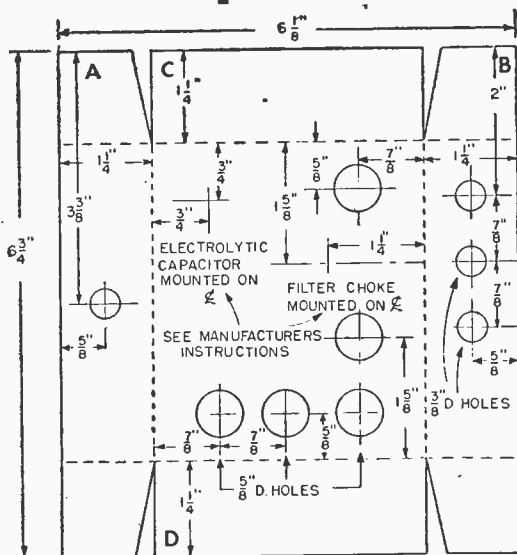
By THOMAS A. BLANCHARD

CONSTRUCTED on an aluminum chassis smaller than two king-size cigarette packs laid side by side, this compact little audio amplifier reproduces microphone or phonograph input with amazing power. And its output can be

## MATERIALS LIST—AUDIO AMPLIFIER

- 1 pc. #16 aluminum 6/8 x 6 3/4 (chassis)
- 4 7-pin miniature sockets (Amphenol)
- 1 3-pin cable plug (Amphenol)
- 1 3-pin socket (Amphenol)
- 1 line cord and plug
- 2 Miniature phono plugs and matching jacks (ICA)
- 1 ac-dc filter choke; 3.5 to 8.5 h., 50 ma. (Stancor)
- 1 output transformer with primary for 2500-ohm tube load; 3-4 ohm sec.\*\*
- Misc. hardware
- Resistors (1/2-watt except as otherwise indicated)
- 1 75 ohm, 10-watt wire-wound
- 1 150 ohm, 1-watt
- 1 3300 ohm, 2-watt
- 1 68,000 ohm (68K)
- 2 270,000 ohm (270K)
- 2 470,000 ohms (470K)
- 1 500,000 ohm (500K; Vol. Control & Pwr. Sw.)
- 2.2 meg.
- Capacitors (150 D.C. W.V. or higher)
- 1 triple-section electrolytic 100-30-30 mf., or 50-50-50 mf. (Sprague)
- 1 25 mf., 50 v. electrolytic
- 3 .01 mf. paper capacitors
- 1 .1 mf. paper capacitor
- 1 .05 mf. paper capacitor
- Tubes (.15 amp. miniatures)
- 1 12BA6 Mike Pre-Amp.
- 1 12AV6 Audio Amp.
- 1 50C5 Beam Power Amp.
- 1 35W4 Half-Wave Rectifier

\*\* Operates with any size PM speaker. The larger the speaker, the better the fidelity, assuming speaker is mounted in a suitable baffle.



1 CHASSIS 1 1/4 x 3 3/8 x 4 1/4" (BEND ALONG DOTTED LINES A AND B 90° DOWN, ENDS IN 90°, C AND D DOWN 90°)

fed into any size PM speaker from 6 in. to 12 in.

The chassis is laid out and drilled and punched as in Fig. 1. Top-chassis layout is shown in Fig. 2; Figs. 3 and 4 detail the circuit wiring.

If you mount the completed amplifier in a fully insulated cabinet, and cover the shielded phono-pickup cable with vinyl "spaghetti" tubing, all ground returns in the amplifier may be made directly to its chassis. If the pickup shield braid





possible. Likewise, the Phono Input and Volume Control leads to the grid of the 12AV6 should be as short and direct as possible. If ordinary radio hook-up wire is used, place the leads from the input jacks against the chassis and away from the tube heater circuits. If possible, use short lengths of shielded wire from the jacks, grounding the outer metal braid to the chassis.

The output of the amplifier terminates at a miniature Amphenol connector. This permits the

output transformer to be mounted on the frame of whatever size PM speaker is used, and interchanged with other sizes at will. The size of the paper capacitor across the primary of the output transformer is indicated as any value between .01 and .05 mf. The .01 mf. size is sufficient to kill record surface noise without cutting the higher recorded frequencies, but if you desire more emphasis on the bass, try other sizes up to .05 mf. until you find the size which suits you.

## How to Put the Sun to Work

Craft Print Project  
No. 248

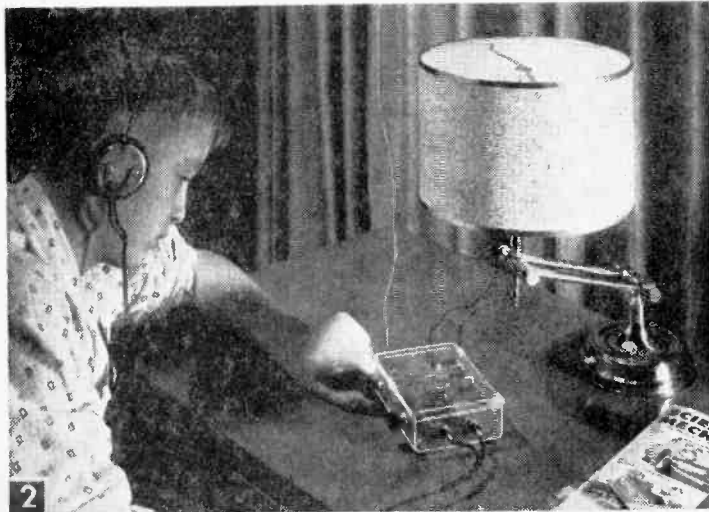
**I**F WE can make the air we breathe carry radio programs to us, why not let sunlight power the receiver which captures those radio waves? Research laboratories have originated and developed radio receivers which operate on sunlight. Now, at last, you can do the same, without being an engineering genius or spending a miniature fortune.

# Sun-Powered RADIO

By HAROLD P. STRAND



Testing the completed receiver, under (1) sunlight and (2) a 100 watt lamp. Although the set works equally well under both natural and artificial light, direct sunlight gives you much stronger reception.

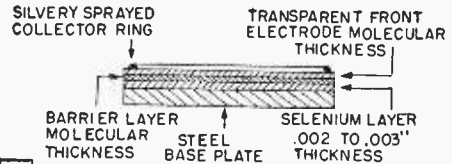


For example, you can build the radio set shown in Fig. 1 for about \$11-12 in materials—a small investment considering the fun you will get from it. It is a pocket-size portable, requires no conventional dry cells for power, and it doesn't even need an On-Off switch. Simply holding your hand over the selenium photocells which capture the sunpower, will shut off or tone way down

## How Selenium Photocells Convert Sun Power

IN DESIGNING sun-powered projects like the radio shown in Fig. 1, you can convert sunlight into electricity using selenium photocells. These are relatively low-cost and easy to obtain, but convert at best only about 1% of the light striking them into electrical power. Another method would be to use silicon cells, which are somewhat costly. Their advantage is that they are about 11% efficient. Bell Telephone Labs, for instance, uses 400 silicon cells mounted in a glass-covered case on a telephone pole, to power an experimental telephone line in Georgia.

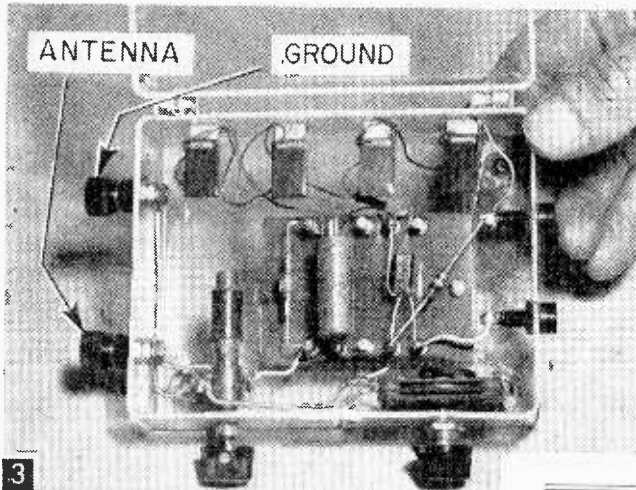
For this radio project, we used selenium cells, because they will do the job nicely and you can get them easily at a moderate price. Fig. A shows a simplified sectional view of one of these cells, correctly called selenium barrier-layer, self-generating photoelectric cells. The light which hits it penetrates the transparent front electrode and causes the selenium to release electrons. These released electrons travel across the barrier layer and are trapped on the front electrode to form a negative charge. (The unilateral conductivity of the barrier layer prevents the electrons from returning, except for some small leakage.) The



**A** SECTIONAL VIEW OF SELENIUM CELL

negative charge on the front electrode is in turn transmitted to the collector ring. This ring then becomes the negative, and the base plate the positive terminal of the cell.

When these two terminals are connected to the actuating device or amplifier, current of about 600 microamps per lumen will flow, through a resistance of 100 ohms. Therefore, in such a cell, we have a source of *d-c* current similar to a dry cell, which can be connected in groups with other similar cells in series, parallel, or series-parallel, to obtain the desired voltage and current output.



**3** Closeup of radio with lid of plastic case up.

Mount phone jacks and ground and antenna terminals, as well as the #MS215 miniature tuning condenser, and the ferrite-core tuned antenna coil, into their respective positions in the plastic case as shown in Figs. 3 through 8.

For the next step, attach the cell brackets to the back of the case with machine screws and nuts as shown in Figs. 6 through 8. The cells mount as shown in Fig. 4.

These B2M cells cost from \$1.47 to \$2.50 each (depending on where you buy them). They measure .040 x .443 x .724 in., have an active area of .26 in., and are rated at .5 volt open-circuit voltage, 2 milliamperes with

those objectionable commercials. On cloudy days or at night, you can operate the set by shining a 100 to 150 watt light bulb on the photocells—thanks to the low load requirements of the tiny transistor used in this set. However, do not allow temperature in excess of 185°F on the cells or they may be damaged. In other words keep light bulb back a foot or more for prolonged operation. An explanation of why we chose the B2M type photocells for this project, is given in the box copy at the top of this page.

**Constructing the Radio.** As Figs. 3-6 show, this pocket-size radio has a diode detector and transistor amplifier built into a standard plastic case. In place of the dry cell usually used for power, four B2M photocells which will not need replacing are mounted on the back side of the case. Drill all the mounting holes in the plastic case as shown in Fig. 7, and in turn, mount the diode, capacitor, resistor and transistor on the terminal board.

### MATERIALS LIST—SUN-POWERED RADIO

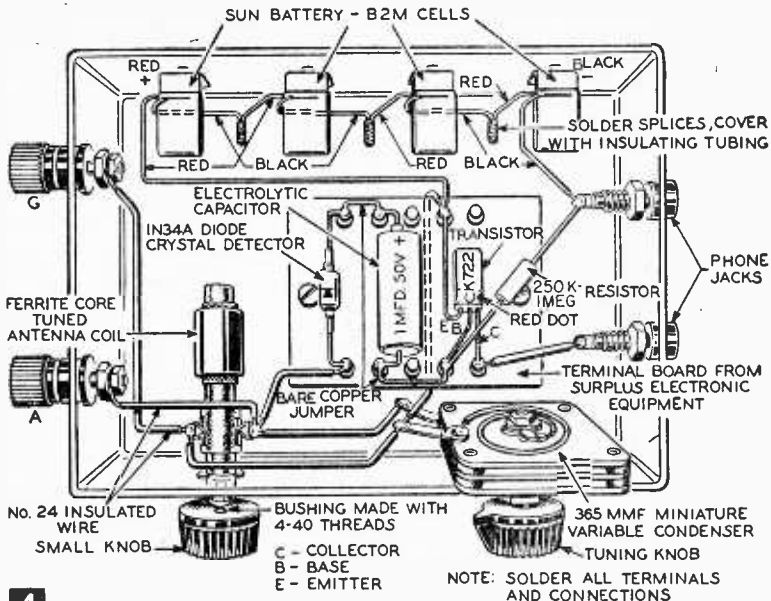
- 1 plastic case with hinged cover  $1\frac{1}{4} \times 3\frac{1}{16} \times 4\frac{1}{16}$ " inside measurements (Lafayette Radio, 110 Federal Street, Boston, Mass., or 100 Sixth Avenue, New York, N. Y. Cat. #MS 162, \$0.32).
  - 1 International Rectifier Corp. B2M photocell sun batteries (Lafayette Radio or Allied Radio, 100 N. Western Avenue, Chicago 80, Illinois. About \$1.47 each).
  - 1 antenna coil with adjustable high Q core for broadcast range 540-1700 kc. (Lafayette or Allied Radio).
  - 1 Sylvania crystal diode 1N34A (Lafayette or Allied Radio).
  - 1 1-mfd. electrolytic capacitor 50 volt, Cornell-Dubilier BBR-1-50 or equivalent. (Allied Radio.)
  - 1 250,000, 1 meg.  $\frac{1}{2}$  watt resistor (Lafayette or Allied Radio).
  - 1 Raytheon CK 722 transistor (Lafayette or Allied Radio).
  - 1 365 miniature tuning condenser (Lafayette Radio Cat. #MS 215, \$0.69).
  - 2 phone tip jacks (Allied Radio Cat. #41 H 115, \$0.12 each).
  - 2 insulated binding posts (Allied Radio Cat. #41 H 350 Eby Type 30, each \$0.21).
  - 4 rubber feet knobs  $\frac{1}{2}$ " diameter, no screws (any local radio supply store).
  - 1 terminal board with 5 terminals for solder (take from old electronic surplus equipment or make up).
  - 1 small Bakelite knob to fit condenser shaft.
  - 1 small Bakelite knob that can be pushed and threaded to fit coil shaft. (Lafayette Radio MS-185 \$0.07)
- #24 hook-up insulated wire, screws, nuts, etc.

a 10 ohm load, and a power output of .3 milliwatts with a 100 ohm load, when used in average sunlight. Under artificial light, or with lower intensity natural daylight, the ratings will of course be lower, though the set will still work well if other conditions are favorable.

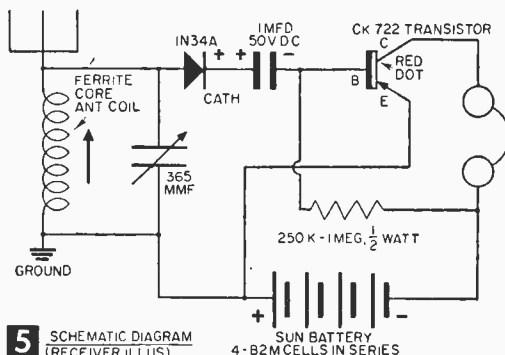
Complete the wiring of the mounted components as shown in Figs. 3 through 6, soldering all connections and keeping the leads as short as possible. Cementing four rubber knobs to the bottom of the case at the four corners will raise the case up enough to provide clearance for the nuts securing the terminal board.

**Testing the Receiver.** With the wiring completed, attach an antenna wire about 25 ft. long, and clip a ground wire to a grounded light fixture, heating pipe, radiator, plate screw on a wall outlet, or finger clip on a dial phone. In some rural areas far removed from radio stations, an outside antenna about 100 ft. long may be needed to bring the stations in well. For headphones, use the common magnetic type of 2,000 ohm or higher resistance.

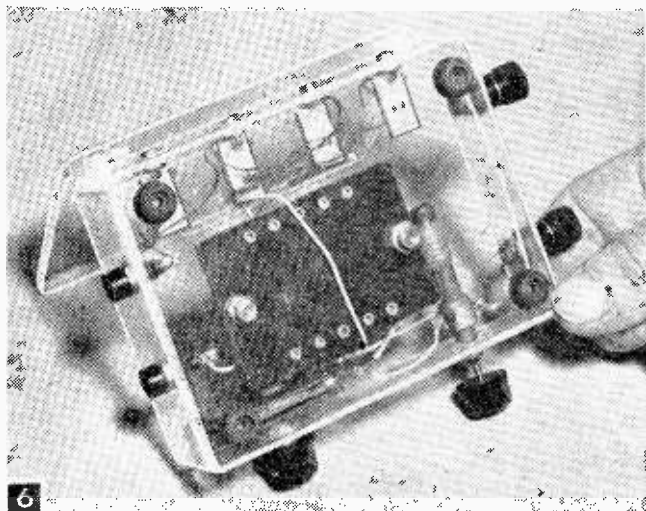
Plug in earphone jacks and hold radio so strong sunlight shines on photoelectric cells. Reception should start immediately and you can tune radio by turning both the tuning condenser knob and antenna coil knob to get the strongest



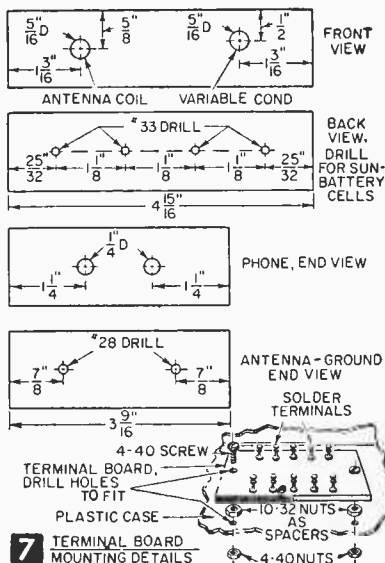
4 PICTORIAL DIAGRAM



5 SCHEMATIC DIAGRAM (RECEIVER ILLUS)



View from underside of terminal board. Note mounting of four cells with the brackets furnished against back of plastic case.



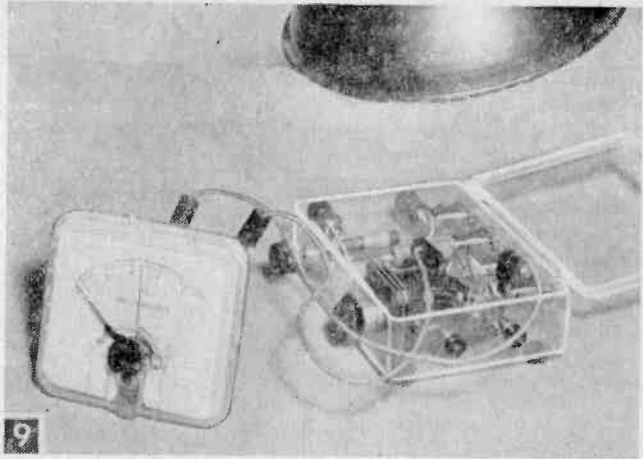
7 TERMINAL BOARD MOUNTING DETAILS

and clearest signals, and separate the stations.

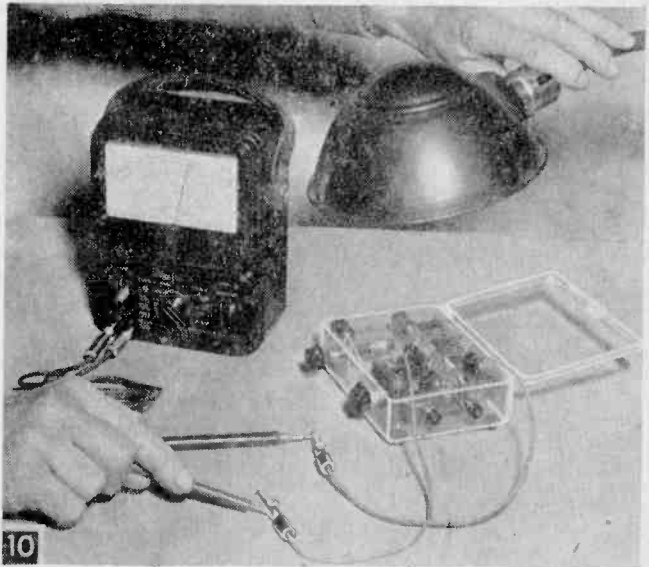
If you are located in a steel-framed building in a large city close to the broadcasting stations, don't expect top-notch performance from this set. Like the crystal set designs from which this is adapted, you won't get the maximum sensitivity and selectivity under such conditions. So take the set out to your Cousin Emma's house in the suburbs if you really want to see what it will do.

**Indoor Light Test.** As Fig. 9 shows, we conducted a test of current output with a 0-1 milliammeter under a 100-watt lamp. With the milliammeter in the circuit, it gives a reading of .5 milliamperes current, with the light source about 8-10 in. above the cells. Under sunlight, this reading would be around 2 milliamperes. (When using a lamp to activate the cells, remember not to let the hot bulb stay close to cells for long periods of time, since heating cells over 185°F will injure them.)

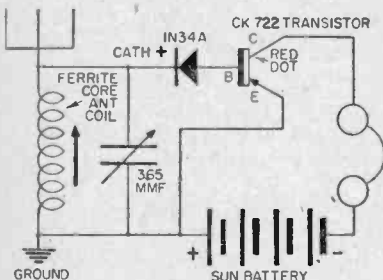
Figure 10 shows a test of the radio, using a high resistance voltmeter (20,000 ohms per volt), which places a very light load on the cells. With this setup, and still using a 100 watt



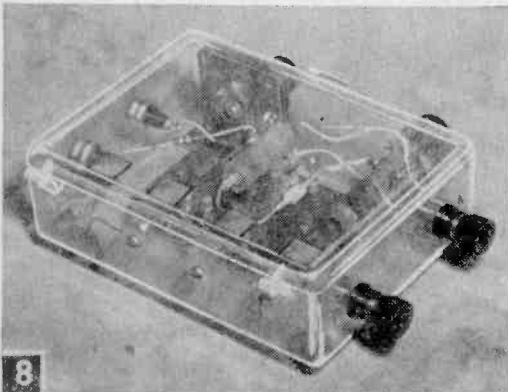
With a 100 watt lamp for illumination, a current of .5 milliamperes was generated by the photocells. In good sunlight, this would be around 2 ma. more or less, depending on the individual cells.



Voltage across the cells in a test with a high resistance voltmeter was 1.4 volts.



11 ALTERNATE CIRCUIT FOR EXPERIMENT

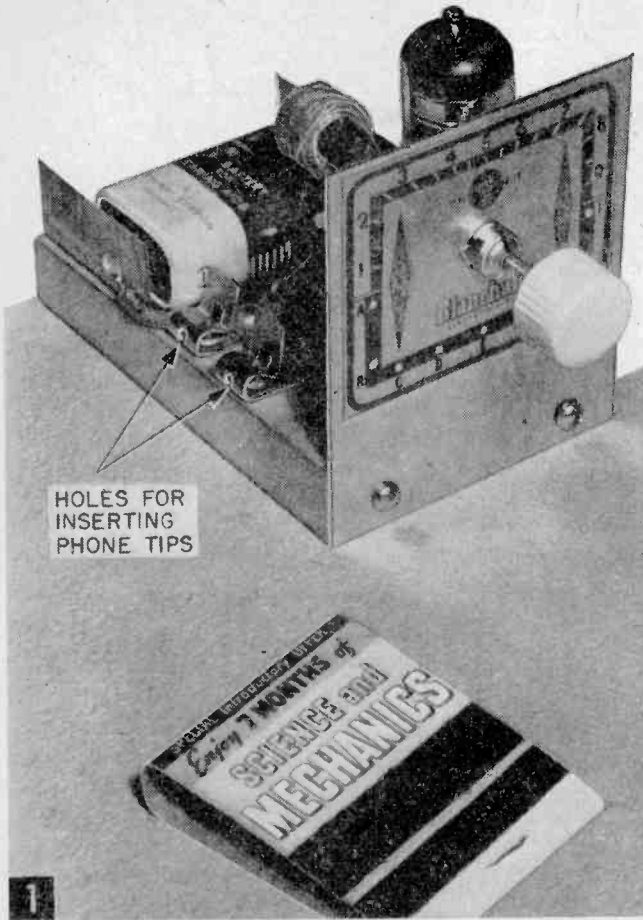


View from rear with plastic lid closed. Insulated terminal posts are used for the antenna and ground.

light bulb, we got a reading of about 1.4 volts across the battery.

The circuit shown is only one of many you could use—just so long as your circuit does not require more than 1½-3 volts normally from a dry cell. Figure 11 shows another type of circuit you might want to try out—if you are in an experimenting mood.

• Craft Print No. 248, in enlarged size for building the Sun-Powered Radio is available at 50¢. SPECIAL QUANTITY DISCOUNT! If you order two or more craft prints (this or any other prints), you may deduct 10¢ from the regular price of each print. Hence, for two prints deduct 20¢; three prints, deduct 30¢, etc. Order by print number, enclosing remittance (no C.O.D.'s or stamps) from Craft Print Dept., R56, SCIENCE AND MECHANICS, 450 East Ohio Street, Chicago 11, Illinois. See coupon on last page of this handbook.



HOLES FOR  
INSERTING  
PHONE TIPS



This midget super-regenerative set has pulled in stations 1500 miles away with good volume. For headphones, use a single or double type of not less than 2000 ohms.

Close-up of pee-wee set and book of matches. Tuner slug is screw-driven for micrometer tuning accuracy. Coil snaps into 5/16-in. chassis hole.

## Pee-Wee Radio Packs a Punch

**A**LTHOUGH this truly tiny radio uses a minimum of components, it will outperform conventional regenerative sets which are more complex and less efficient than the super-regenerative circuit this midget uses.

Moreover, a regenerative type set is often difficult to tune since either a variable capacitor or resistance circuit must be used in addition to tuning control to prevent excess feedback (whistles). The pee-wee set shown is single-dial tuned and provides excellent earphone reception. With 4000 ohm headphones, it has brought in stations 1500 miles away.

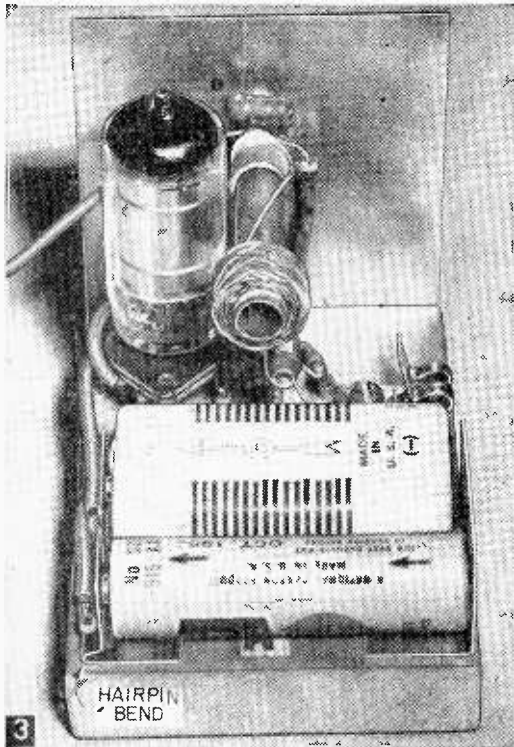
For local earphone reception, clip the antenna lead to a metal object, or for very loud volume to a finger stop on a dial phone. In remote areas, use a 50 ft. antenna and a ground connection to the metal battery clip which is at A-minus and B-minus potential (see Figs. 4 and 5). A ground is not needed otherwise.

Build the set on a  $\frac{1}{2}$  x  $2\frac{1}{2}$  x  $3\frac{3}{8}$  in. "bread-board" pine block. The panel is a  $2\frac{1}{4}$  x  $2\frac{5}{8}$  in.

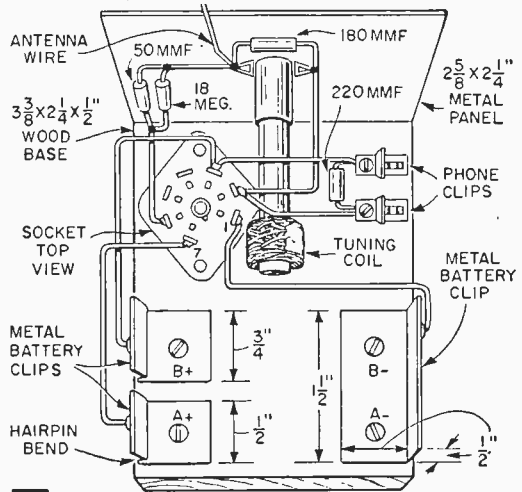
aluminum metal plate attached to the base with wood screws. Panel holes are drilled as in Fig. 3-A. The tuning coil is a ferrite slug-tuned antenna loop coil with a snap-mounting. The screw-driven slug permits the set to be tuned with micrometer sharpness. Once tuned, it will not jar out of adjustment as do variable capacitor-tuned sets.

The set is powered by a  $22\frac{1}{2}$  volt hearing aid B battery such as the Eveready #412 or #412E. The A battery is an ordinary penlite cell such as the Eveready #911. Both cells connect to the circuit by means of simple homemade clips (Figs. 1, 3 and 4). These were formed from 1-in. wide tin strips bent to an L-shape. Secure the clips to the wood base with  $\frac{3}{8}$  in. flathead screws. Note in Fig. 3 that a "hairpin" bend is made in the A and B clips with flatnose pliers so these clips have a spring action for holding batteries securely.

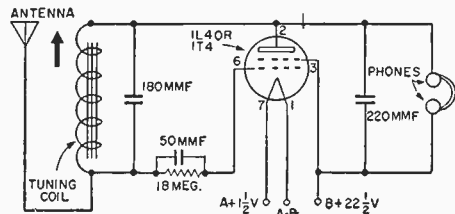
The socket for the miniature pentode tube (either a 1L4 or 1T4) is a wafer type. While spacers might have been made to support the



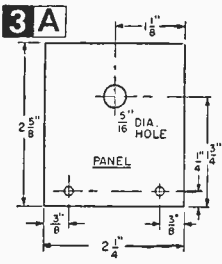
3 Rear view of radio. Parts arrangement corresponds with layout in Fig. 4. Penlite and hearing aid battery fit into homemade clips on wooden "breadboard" chassis.



4 PICTORIAL WIRING DIAGRAM



5 SCHEMATIC PLAN



socket with its regular mounting holes, we found a rigid socket support required just a single drive-screw (a spiral nail) in the center grounding ferrule of the socket. This arrangement, permits easy connection of leads to socket lugs without the obstructions

caused by the socket being mounted on spacers. Note that the type of Fahnestock clips used as earphone terminals have holes in the ends of the

clips so phone tips may be inserted "jack-fashion" (Fig. 1).

The 180 mmf ceramic capacitor shunted across the tuning coil allows the set to tune from about 1400 to 660 kc. However, to tune above 1400, this value should be about 100 mmf. To tune below 660 kc, use 250 mmf. The 180 mmf, however, is the best all-around value for tuning in the majority of U. S. radio broadcast frequencies. By disconnecting the coil capacitor, this set will tune in the 75 meter "ham" band as well as ship-to-shore and other special service transmissions.

To shut off the receiver, simply remove the A battery (penlite cell). When inserting batteries, no harm will come should the penlite cell accidentally contact the B-battery clips. However, should the B-battery make contact across the A-battery clips, the tube will blow instantly! So, when installing or replacing the B battery, make sure the tube is out of its socket. To prevent accidental tube blow-out, drive a 1-in. brad into base board between the two batteries; this brad will prevent the B-battery from fitting between the wrong clips.

The 22½ volt hearing aid battery will last quite a while. The penlite cell will require more frequent replacement. But, if you rotate two penlite cells, using each not more than ½ hour at a time, you'll get about 100% increase in life of the A batteries which you use.

MATERIALS LIST—PEE-WEE RADIO

- 1 2¼ x 2½ aluminum metal panel
- 1 ½ x 2¼ x 3⅜ in. pine wood base
- 1 7-pin miniature wafer socket
- 1 1L4 or 1T4 miniature pentode tube
- 1 Ferrite slug-tuned antenna coil
- 2 Fahnestock clips
- 1 Eveready Mini-Max (or equiv.) #412(E) 22½v. battery
- 1 Eveready Nine-Lives (or equiv.) #915 1½v. Penlite cell

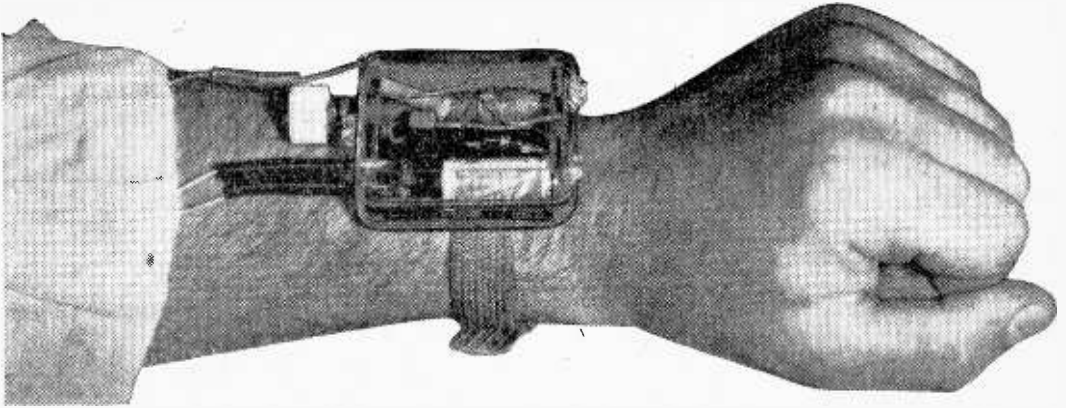
CAPACITORS

- 1 50 mmf ceramic fixed capacitor
- 1 180 mmf ceramic fixed capacitor
- 1 220 mmf ceramic fixed capacitor

RESISTOR

- 1 18 megohm, ½ or ¼ watt composition resistor

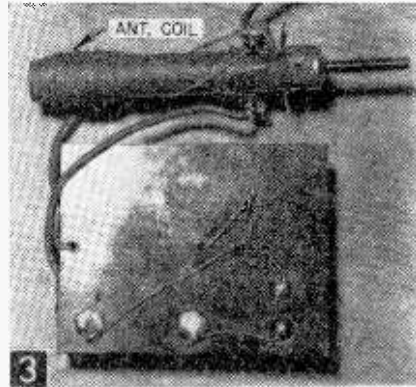
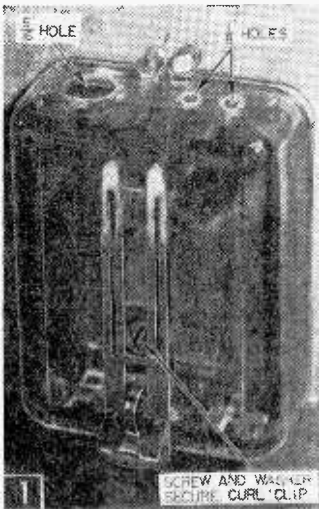
A complete kit of electronic parts and hardware for building the "Pee-Wee Radio," including tube and punched aluminum panel, knob and dial plate is available from Electro-Mite, Springdale 636, Conn. for \$2.98. Phone and batteries are extra.



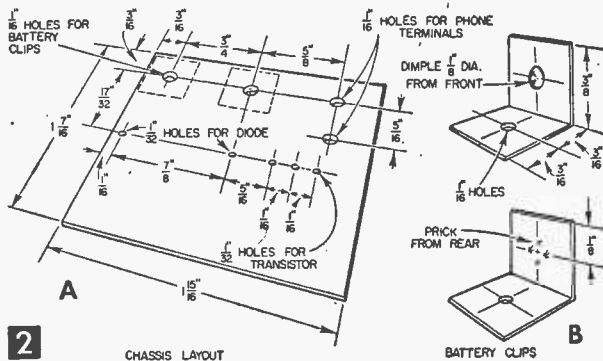
# WRIST RADIO

lighter, than a diminutive hearing aid whose manufacturer advertises his unit as tiny enough to be hidden in milady's hair. Only slightly larger than a book of paper matches, it still has up to twice the volume and selectivity of ordinary transistor or transistor-diode circuits.

In spite of its tiny dimensions, all parts for the set are readily available. The polystyrene plastic case you'll find on the "Cosmetics" counters of any dime store. There also you'll find the versatile clip which attaches to the case. The trade name is "Lady Ellen Curl Clips." Get the 1 $\frac{1}{8}$ -in. size.



Left, the versatile curl clip is fastened to the case with screw and washer. Holes in end of case are for phone clips and antenna coil. Above, underside of chassis. Virtually all wiring is done with pigtail leads of circuit components.



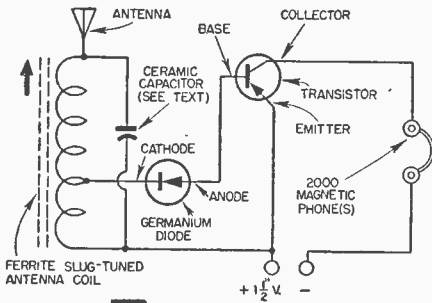
For the chassis, we used a 1 $\frac{1}{8}$  x 1 $\frac{15}{16}$  in. piece of linen impregnated Bakelite. Thin fiber or cardboard can also be used. Lay out and punch the  $\frac{1}{16}$  in. holes (Fig. 2A) with a paper punch and pierce the  $\frac{1}{32}$  in. holes for diode and transistor with a needle. If you use cardboard for the chassis, dip it in shellac, remove and allow to dry after making mounting holes. Repeat if necessary to give the cardboard the stiffness that fiber or Bakelite has.

Insert the germanium diode and transistor "pigtail" leads into their mounting holes and bend to right angles on the underside of the chassis (Fig. 3).

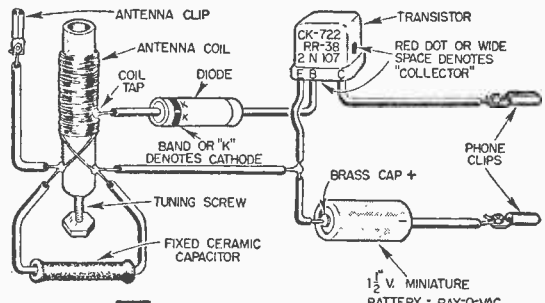
This gives rigidity to circuit components without resorting to ultra-miniature clips and sockets.

Make the battery clips from strips of brass, copper or tinfoil as in Fig. 2B. To hold the brass cap end of the battery securely, dent or dimple one of the clips with a  $\frac{1}{8}$ -in. flat punch, or

**T**HIS super-small set can—honestly—be called a *Wrist, Clip-On, or Pendant Radio*; its minute size lends itself to these applications without forcing the name upon it as is done so often with sets that should have been labeled *Pocket Radios Only*. It's one-third smaller, and 75%



4 SCHEMATIC



5 WIRING PICTORIAL

## MATERIALS LIST—WRIST RADIO

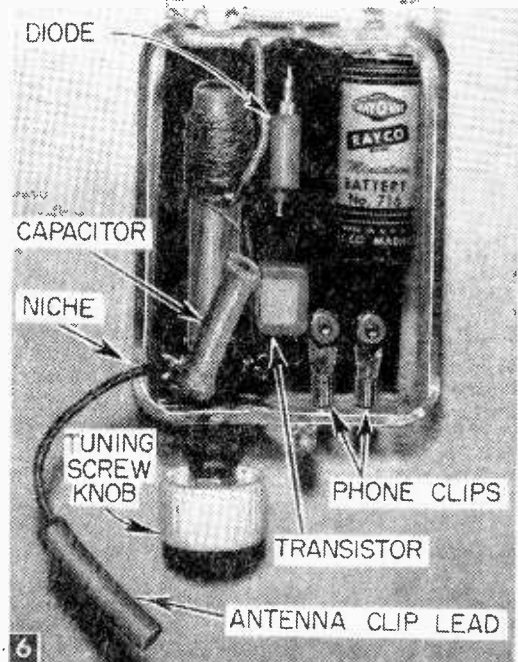
No.	Description
1	Plastic utility box, 2 $\frac{1}{8}$ x 1 $\frac{3}{4}$ x $\frac{7}{8}$ in.
1	General purpose diode (1N34, 1N66, 1N48, or 1N65)
1	Transistor (CK-722, RR-38 or 2N107)
1	Ferrite antenna coil (Miller, Stanwyck, Grayburne, etc.)
1	Ceramic fixed capacitor (120 mmf. to tune 1590-880 kc.; 220 mmf. to tune 880-550 kc.)
1	Pair standard magnetic headphones, or miniature earphone (D.C. resistance should be 2000 ohms minimum)
1	Miniature flashlight battery (Ray-O-Vac #716 or any other size "N" 1 $\frac{1}{2}$ v. cell. If mercury type cell should be used, note that cap is minus, not plus as with regular batteries)
3	Tube pin contacts salvaged from octal wafer socket
5	2-56 x $\frac{1}{8}$ in. brass machine screws and nuts
1	4-40 nut or 4-40 knob for tuner screw
1	Small alligator clip, or "frictional" paper clip)
1	3 ft. length light, flexible hook-up wire
1	"Lady Ellen" curl clip, 1 $\frac{1}{8}$ " size
A	Kit containing all parts for building this set except headphones and battery is available for \$3.98 postpaid from Electro-Mite, Springdale 636, Conn.

machine screw. To prevent the smooth, zinc shell end of the battery from sliding out of position, pierce the other clip with a prick punch or nail. Fasten the battery clips to the chassis with 2-56 machine screws and nuts not more than  $\frac{1}{8}$  in. long and the phone clips with 2-56 screws.

The set uses either standard-size or hearing-aid-size magnetic phones. Standard-size phones have cords fitted with tips, but with the miniature phone you'll have to add them. To do this, carefully remove about  $\frac{1}{4}$  in. of the insulation from the cord to expose its tinsel conductors. Then place a common pin parallel with the tinsel conductors, and bind pin and tinsel together with a single strand of ordinary stranded fixture wire, snip off the protruding end of the pin and solder.

Suppose you use standard-size phones—then what about the jacks we used? Well, these are nothing more than the pin clips used in cheap octal wafer tube sockets. A 5¢ socket yields 8 of them if you don't have an old socket from which you can salvage the 3 used in this project. If your standard-size phone tips don't fit, simply compress the clips with a pliers until they do.

Except for the coil connections, wire all components on the underside of the chassis with the transistor and diode pigtail leads (Fig. 3); separate hook-up wire is not required. When soldering to the screw terminal points, use a thumbnail-size wad of wet cleansing tissue pressed over the pigtail lead so that heat is not

6 Set with case open. It measures only 2 $\frac{1}{8}$ x1 $\frac{3}{4}$ x $\frac{7}{8}$  in.

transmitted up into the diode or transistor. Just as soon as the solder sets, move the wad over the hot connection so that it will cool rapidly. This protects transistor and diode from damage. Electrical connections are shown in Fig. 4; physical connections, in Fig. 5.

In order to provide the most efficient match between the high-impedance resonant circuit of coil and capacitor and the low-impedance diode detector—which, in turn, feeds into the low impedance transistor—the ferrite slug-tuned antenna coil is tapped 16 turns from the outside end of the winding. Using the coil shown in Fig. 3, which has a progressive type winding, you needn't count off turns; just unwind 21 inches of wire. This is equal to 16 turns. Carefully scrape off the cotton insulation and form a small loop, then rewind the coil wire as closely as possible into its original space and pie-layer arrangement and reconnect the end of the coil to the terminal lug. No great harm will result,



however, if you "scramble wind" the turns back on the coil form.

With two short lengths of light stranded, plastic-covered hook-up wire, connect one coil lug and the tap to chassis components. With a third length, connect the inside coil lug to another octal socket clip. This is the antenna connection. A 3 ft. length of wire fitted with a small alligator clip and brass weatherstrip nail or phone tip attaches to it. Removed from the set when not in use, this type of antenna eliminates dangling wires.

A fixed ceramic capacitor connected across the coil lugs completes the wiring. Its value will depend upon stations operating in your area. If stations tune in between 1590 and 880 kc., the value of the capacitor should be about 120 mmf. To tune from 880 kc. to the top of the dial, 550 kc., use 220 mmf. Solder a 4-40 brass nut to the end of the threaded coil slug, or a small bakelite knob with a 4-40 lock nut, to turn the coil's tuning slug in and out.

When testing the set before installing in its case, attach the alligator clip to the finger stop or metal box of your telephone. If wiring is correct, and the correct size capacitor for your area is across the coil, you may find that powerful local stations are so loud that the earphone is overloaded and reception distorted. If this happens, remove the alligator clip from the phone. The volume will still be loud, but the set will be free of distortion—and quite selective.

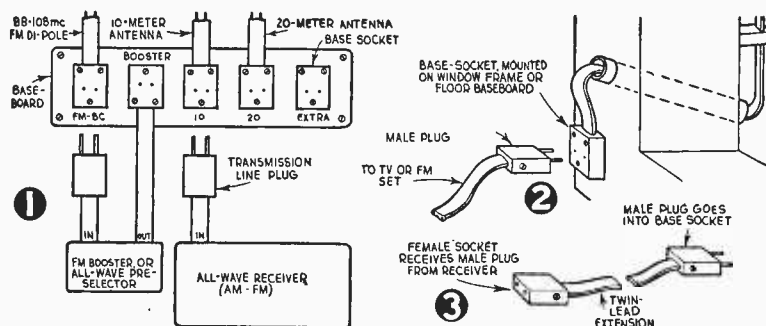
Try the antenna clip on metal lamp bases, screens, bedsprings, etc., but you will probably find you can let it hang free and still get good reception.

With the set tested, it's ready for mounting in the case. Drill two 1/8-in. holes for the phone clips and a 5/16-in. hole for mounting the tuning coil (Fig. 1). Drill a 1/16-in. hole in the back of the case for securing the curl clip and slip a 5/16-in. dia. washer over a 2-56 screw and clamp the clip between washer and case. The chassis with its wiring friction-fits in the case.

The antenna lead passes through a niche filed between case lid and cover. (Fig. 6.) When not in use, it's tucked inside. Since the case is transparent, a snapshot, colorful floral print or decal can be inserted under the lid when the set is used as a Pendant Radio. There is a 1/8-in. hole in the curl clip to which either a ribbon or chain may be attached. As a Wrist Radio, a plain leather strap is all that is required—the set clips to the strap—and as a Clip-On Radio, it clips to tie, shirt pocket, belt.

We've obtained fair results with an aluminum-foil-lined hat as a walking antenna, receiving 50 kw. stations located 20 airline miles away. For so tiny a receiver, mobility is asking a lot, but in many areas this stunt is possible. Note that no ground connection is required for normal reception. In remote areas, of course, a ground may be connected to the battery's minus terminal.—THOMAS A. BLANCHARD.

## Low-Loss Uniform-Impedance Antenna Switchboard

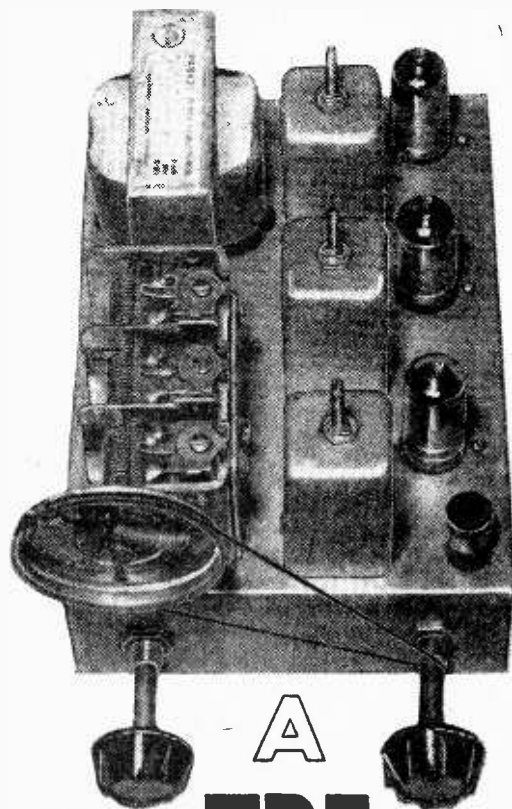


tors, AM-FM receivers and transmitters may be plugged in or out of various dipole antennas for highest efficiency. Mount sockets on a hardwood base board and label sockets as shown. Place the switchboard for shortest leads to apparatus. Use 300-ohm ribbon twin-lead for all connections shown.

### Low-Loss Uniform-Impedance Antenna Connectors for TV Sets

When connecting outdoor antennas to TV sets, insert a pair of Mosley 300-ohm transmission line connectors in the twin-lead between window and set. Mount a 311 socket on window frame or floor baseboard, and connect a 301 plug to lead going to receiver (Fig. 2). Thus, the set may be quickly disconnected when the housewife wants to move the receiver for cleaning, or a twin-lead extension may be added easily when you want to move the receiver to another place in the room. In the latter case, connect a female socket to one end of extension, and a male plug to other (Fig. 3).—A. T.

**D**X radio hobbyists, hams and experimenters can solve the problem of antenna switching and booster in-and-out switching by the use of Mosley polystyrene 300-ohm twin-lead male plugs, and female base-sockets (Fig. 1). This switchboard does away with the common hay-wire switching arrangements using knife-switches or toggle switches, which often result in UHF losses and impedance changes due to poor insulation and capacitances in the switches. By this method, many different combinations are possible whereby boosters, ham-band preselec-



# A TRF TUNER

This tuned-radio-frequency receiver gives AM stations many of the high fidelity qualities of FM

By THOMAS A. BLANCHARD

**W**HEN the saga of radio is finally, fully documented by historians, too much emphasis cannot be placed on the Tuned Radio Frequency circuit. From its very beginnings in the "catwhisker" crystal detector, followed by Lee De Forest's vacuum tube detector, radio was guided through its golden days by the T.R.F. circuit. (And they were golden days, in spite of Lee De Forest's half-joking reference to the industry which he made possible through his invention of the triode as "De Forest's prime evil.")

The first T.R.F. receivers appeared with as many as four tuning dials on the console panel. Tuning in a station was something like opening a safe: each stage had to be tuned individually. After a few years, someone struck

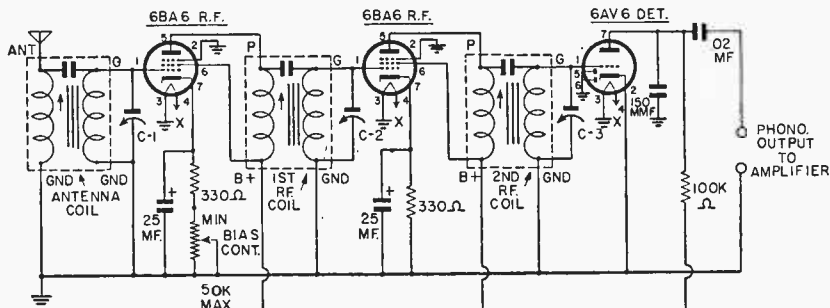
Top-front view of T.R.F. tuner. Knob on left is bias control. Use of a cord drive mechanism with knob on right is optional (see text).

upon the idea of connecting the various tuning capacitors to a common dial and individual tuning capacitors were spaced across the full width of the chassis and connected together with belts and pulleys. No one had thought of the ganged tuning capacitor as we know it today.

Before long, however, the development of the superheterodyne receiver began to steal some of the T.R.F.'s thunder. The superhet was both highly sensitive and selective; the T.R.F. was not. Moreover, the superhet could operate on an indoor loop antenna while the T.R.F. required a rooftop hookup. By the early 30's, practically all radio manufacturers had abandoned T.R.F. circuits in favor of the superheterodyne. And until the comparatively recent coming of Hi-Fi, few persons stopped to notice that modern sets do not have that sharp, clear quality that T.R.F. sets, back in the "good old days," had.

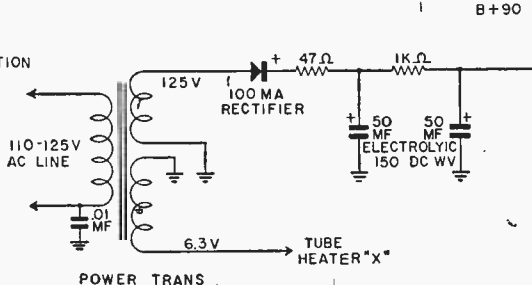
Since the T.R.F. amplifies the incoming signal through a series of R.F. stages without introducing "foreign signals" to obtain reception, the quality of its reception is naturally superior to that of the superhet where the incoming radio signal is mixed with a signal of another frequency generated by the set's local oscillator, then amplified through a series of I.F. stages. The background "purr and swish" present in the reception of a superhet cannot be fully realized until a comparison is made with a T.R.F. set, tuned to the same station. With a T.R.F. set, you can actually hear every little nuance in a record as clearly as if you were listening to your own record player. With a superhet, this is not possible. Thus, many Hi-Fi fans are turning to binaural tapes, recordings and radio reception. With a binaural system, records are provided with two sound tracks with separate amplifiers and speakers for each track. Binaural radio reception is obtained by receiving a simulcast station's FM signal with an FM tuner and its AM signal with a T.R.F. tuner, a T.R.F. tuner like that in Fig. 1. With speakers in opposite corners of the room, you are surrounded by sound, stereophonic-like sound.

Since T.R.F. sets breathed their last commercially popular breath, many great improvements have been made in radio components, particularly in tubes and in coil efficiency. The circuit employed in the tuner described here is basically the same as the circuits of 30 years ago, but in place of the old, pear-shaped O1-A, 26 and 27 triodes, there are modern, miniature multi-element tubes. Similarly, the old, large, low-efficiency, air-wound coils have been superseded by precision-wound, high-Q ferrite-tuned units of extremely small dimensions. (Then too, we cannot overlook the development of the dry electrolytic capacitor. Today, many a 100 mfd. unit is smaller than the early 1/4 mfd. paper capacitors.)

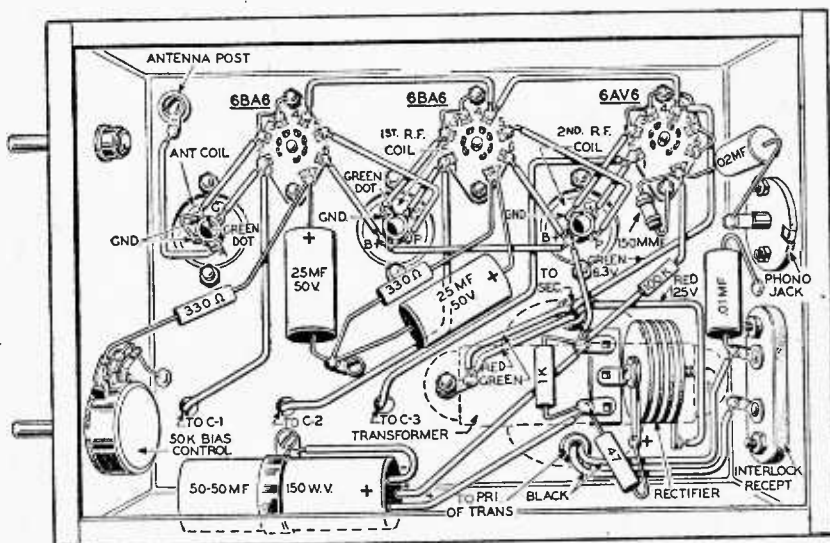


C-1, C-2, C-3  
3-GANG TUNER:  
365 MMF PER SECTION

2 TRF TUNER SCHEMATIC



POWER TRANS.



3 T.R.F. TUNER-PICTORIAL

Construct your T.R.F. tuner on a stock-size, 2 x 5 x 7 in. blank chassis. Figure 2A shows the general arrangement of parts and their positioning. All components should be assembled first from the Materials List and their individual mounting dimensions used as a final guide to the correct location for drilling and punching chassis holes.

Tube socket openings are made with a 3/4-in. chassis punch. The mounting holes for the 7-pin miniature wafer sockets are drilled to clear 3-48 x 3/8-in. rh machine screws. Sockets mount on 1-in. centers. The R.F. coils are mounted in aluminum shield cans to which are attached 6-32

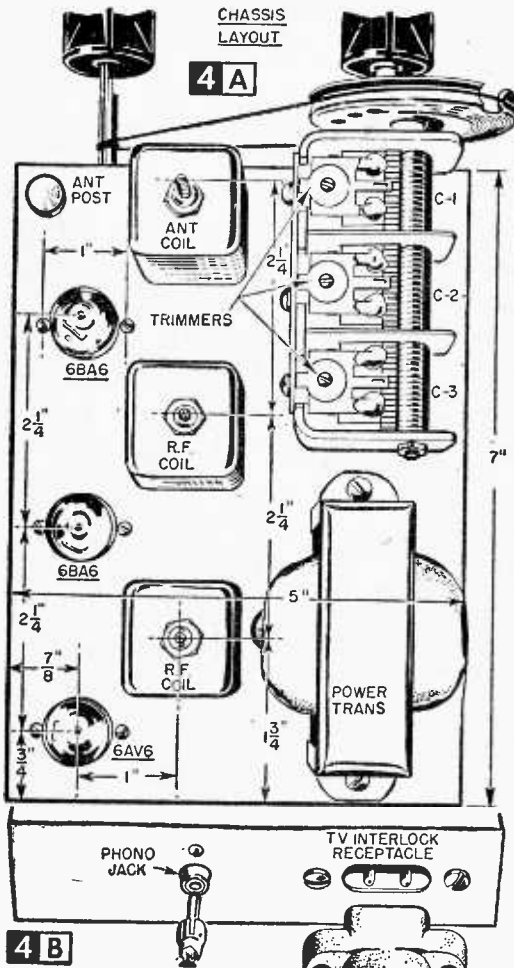
mounting screws on 1 1/8-in. centers. The mounting holes for shield cans are drilled first, then the 1-in. chassis holes which provide access to the R.F. coil lugs.

Drill a 3/8-in. hole in the front panel of the chassis for mounting the 50K potentiometer bias control. An additional 3/8-in. hole will be required for the panel shaft bearing-dial cord drive if this type of tuning mechanism is used. (Ordinarily, 3-gang tuners are furnished with a 1/4-in. shaft to which a tuning knob or dial may be attached directly. A Croname slide-rule dial also engages a tuner with a 1/4-in. shaft.)

The rear panel of the chassis has a 3/8-in. hole for mounting the phono jack flanked by two mounting holes on 1 1/8-in. centers to clear 3-48 x 3/8 in. rh machine screws. Drill two 3/8-in. holes 1/2 in. apart for the interlock receptacle and elongate with a flat file after snip-

ping out the metal separating the two holes. Drill one 3/8-in. hole on the top of the chassis for the antenna binding post and two for the power transformer leads and insert rubber grommets in the power transformer holes. Finally drill 1/4-in. holes under each section of the tuning capacitor for the leads which terminate on their stator lugs. The rotors of the tuner are automatically grounded when the 3-gang unit is bolted to the chassis.

Because tuners vary in design, mounting hole locations and screw sizes vary. Locate these chassis holes after obtaining the tuner. Note, too, that the capacitor in our model is mounted vertically.



Your capacitor may be designed for horizontal operation. There is ample room on the chassis for either mounting.

Before the stationary components are mounted to the chassis, install the coils in the aluminum shield cans. All coils are J. W. Miller, high-Q, unshielded. Each is provided with a 1/4-in. threaded bushing for universal mounting. When ordering coils, obtain the Miller S-32 shield cans also. A 1/4-in. hole is drilled in the top center of each can and the coils are mounted in them. (If you have three discarded I.F. transformer cans 1 1/8 x 2 1/8 in., you can mount the coils in them.) Place a fiber or bakelite washer on each side of the chassis when mounting the antenna binding post, and make certain that the mounting screw is in the center of the 3/8-in. clearance hole. If this binding post is accidentally grounded to chassis the tuner will not work. Wire the tuner as in Figs. 3 and 4.

The unit employs its own isolated power supply; to use, connect to power source and plug its phono output into the "phono" jacks of any radio or TV set or amplifier. A single conductor shielded cable connects the tuner output to the

### MATERIALS LIST—T.R.F. TUNER

- | No.                | Description                                                                                                |
|--------------------|------------------------------------------------------------------------------------------------------------|
| 1                  | 2 x 5 x 7" standard chassis base (Bud #CB-629, zinc plated #22 ga. steel)                                  |
| 3                  | 7-pin miniature wafer sockets (1-in. mounting holes)                                                       |
| 1                  | TV power cord and connector                                                                                |
| 1                  | phono jack                                                                                                 |
| 2                  | Phono plugs and length of single conductor cable with shield braid                                         |
| 1                  | antenna binding post                                                                                       |
| 3                  | J. W. Miller #S-32 shield cans (1 1/8 sq. x 2 1/8" high)                                                   |
| 8                  | 3-48 x 3/8" rh machine screws and nuts                                                                     |
| 8                  | 6-32 x 3/8" rh machine screws and nuts                                                                     |
| 2                  | 3/8" rubber grommets                                                                                       |
| 2                  | #6 soldering lugs                                                                                          |
| 1                  | 2-lug terminal strip                                                                                       |
| 2                  | 3/8" fiber or bakelite washers                                                                             |
| 1                  | 100 ma. selenium half-wave rectifier                                                                       |
| Capacitors         |                                                                                                            |
| 1                  | 3-gang tuner with trimmers (365 mmf. per section)                                                          |
| 2                  | 25 mf., 50 v. electrolytic (Cornell-Dubilier "Beaver")                                                     |
| 1                  | 50-50 mf., 150 v. electrolytic (Cornell-Dubilier type BBRD)                                                |
| 1                  | .01 mf. molded (Cornell-Dubilier #4S1 Cub)                                                                 |
| 1                  | .02 mf. molded (Cornell-Dubilier #4S2 Cub)                                                                 |
| 1                  | 150 mmf. ceramic (Cornell-Dubilier .00015)                                                                 |
| Resistors          |                                                                                                            |
| 2                  | 330 ohm, 1 w. (IRC)                                                                                        |
| 1                  | 100,000 ohm (100K), 1/2 w. (IRC)                                                                           |
| 1                  | 47 ohm, 1 w. (IRC)                                                                                         |
| 1                  | 1K (1,000 ohms), 1 w. (IRC)                                                                                |
| 1                  | 50K potentiometer (50,000 ohms; IRC control #13-123)                                                       |
| Coils-Transformers |                                                                                                            |
| 1                  | Stancor power transformer (PA-8421) Primary: 117 v., 60 CPS., secondary: 125 v., 50 ma. and 6.3 v., 2 amps |
| 1                  | High-"Q" broadcast coil (J. W. Miller #A-5495-A)                                                           |
| 2                  | High-"Q" broadcast R. F. coil (J. W. Miller #A-5495-RF)                                                    |

amplifier. The inner lead of this cable is soldered at each end to a "phono" plug, the outer metallic braid is soldered at each end to the plug shell. Use care when making this connection to see that no stray strand contacts the inner conductor.

With wiring completed, tubes in sockets, output connected to amplifier, and power on, the set is ready for alignment. (For an antenna, a length of wire 4 or 5 ft. long is usually ample.) With the bias control turned to maximum resistance, rotate the tuning capacitor until a local station is heard. Starting with the screw adjustment on the antenna coil, turn in or out for the strongest signal. Next, adjust the screw on the 1st R.F. coil for further improvement in the signal. Turn down the volume control on the amplifier as the signal, through coil adjustment on the T.R.F. tuner, becomes louder. Finally, adjust the ferrite slug screw on the 2nd R.F. coil, and, with a plastic handled screwdriver, make further sensitivity adjustments on the trimmers, starting with C-1.

Unlike its ancestors, this T.R.F. tuner will have almost the sensitivity and selectivity of a super-heterodyne. Moreover, it is unlikely that you will ever require more than 12 ft. of indoor antenna—even in a remote location. The variable bias control should not be confused with a volume control. Its function is to allow as much signal to reach the tuner as it can handle without overloading the input. On distant stations, the resistance in the cathode circuit will be at minimum (330 ohms). On more powerful and on local stations, rotating the 50K potentiometer will increase the cathode resistance to the point where the signal is free from distortion. Once you become familiar with this control's function, you can replace the round knob with a pointer and set the bias control at predetermined points.



# VHF Amateur Radiotelephone Station

The VHF amateur radiotelephone station in action. The operator is listening for an answer to a two-meter CQ.

By C. F. ROCKEY,  
W9SCH

**S**ELF-CONTAINED in a single chassis—except, of course, for antenna, microphone and headphones—this Very High Frequency transmitter-receiver operates in the 144 megacycle, two-meter amateur band. Probably as straightforward—and simple to construct—as a VHF station can be, its cost runs under \$60, less than one-fourth the cost of comparable, commercially made equipment. The receiver, tube for tube, develops maximum gain, has maximum sensitivity. It will easily receive signals from within and beyond the range of the transmitter; also, its efficiently engineered R.F. stage greatly reduces signal-radiation interference during reception. And, since all three stages of the transmitter are tuned to a different frequency, self-oscillation of a transmitter stage (with attendant off-frequency operation) is virtually impossible. No tricky “overtone” oscillator circuit, requiring hand-picked crystals, is used; no neutralization is necessary; there is no spurious signal output from the push-push final amplifier.

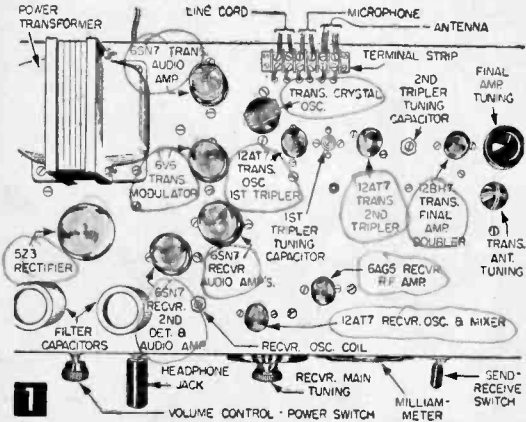
**Construction of Power Supply and Receiver.** On the 4 x 10 x 17-in. chassis, punch socket holes (Figs. 1 and 2) with  $1\frac{3}{16}$ -in. dia. and  $\frac{3}{4}$ -in. dia. socket punches (obtainable at electronics supply store) and mount the power trans-

former, rectifier tube socket, filter capacitors, filter choke coil, terminal strip, and volume control-power switch. (Mounting holes for the transformer are drilled from the data supplied by the manufacturer; tube sockets, filter choke and other station circuit components, except where otherwise indicated, are fastened to the chassis with 6-32 x  $\frac{3}{8}$ -in. machine screws and nuts.)

Wiring for the power supply is shown in Fig. 3. (Figure 6 gives a pictorial wiring diagram for both receiver and transmitter sections.) Solder all connections with rosin core solder, checking connections at each step. When the wiring has been double-checked, connect a line cord to the proper terminals on the terminal strip (Fig. 1), insert the 5Z3 rectifier tube in its socket, plug the line cord into a power outlet and turn on the power switch. Now connect a d-c voltmeter from B+ to chassis; it should read between 300 and 400 volts. If it doesn't, check for faulty wiring or a defective tube and remedy or replace.

With the power supply working, mount and wire the send-receive switch (mount according to manufacturer's instructions; see Fig. 4 for wiring), the receiver's 6AG5 and 12AT7 sockets (with rh 4-36 x  $\frac{1}{4}$ -in. screws) and the sockets for the receiver section's two 6SN7's. Then mount and wire the receiver's main tuning capacitor's

**CAUTION:** Although anyone may use the VHF receiver, the transmitter cannot be used without an amateur's license issued by the FCC. Failure to obtain a valid license from the FCC exposes the offender to a maximum penalty of \$10,000 and/or two years imprisonment.



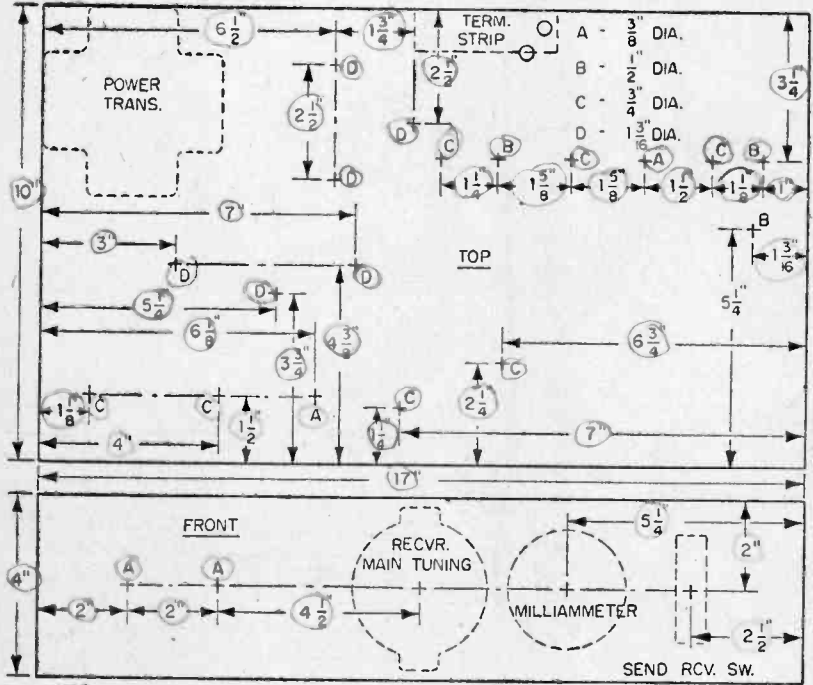
vernier tuning dial (according to manufacturer's instructions) and the headphone jack. Wire the audio amplifier sections of the 6SN7's (see Fig. 5) starting with the stage which feeds the headphone jack (all tubes get B+ via the B+ section of the send-receive switch). As the wiring of each audio amplifier stage is completed, test it by plugging a pair of magnetic headphones into the headphone jack and—with power on and send-receive switch in receive position—

touching a screwdriver to the grid of the section under test. Grasp the metal shaft of the screwdriver; touch nothing else. When the end of the screwdriver is brought into contact with a grid, a hum should be heard in the phones. If a stage does not operate, the difficulty is incorrect wiring, a solder-blob short, or a defective component.

Next, wind the second detector coil (Fig. 7), mount it, and wire the 6SN7 second-detector section into the receiver circuit.

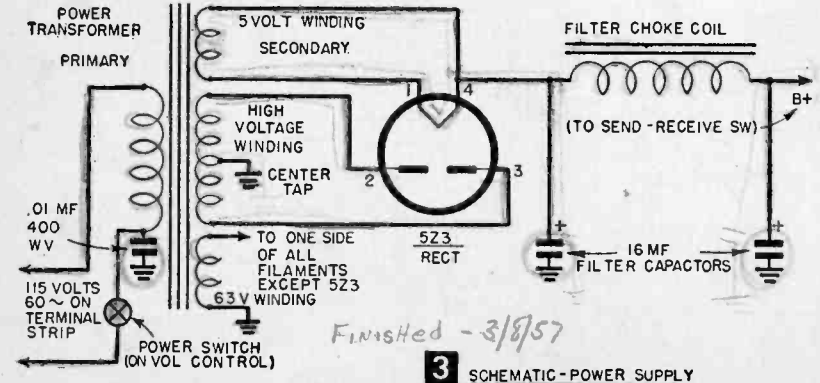
Test the second detector by applying power, plugging in the phones, and turning up the volume control. With the control turned about halfway up, a loud, clean hiss should be heard in the phones; backing the control down should cause the hiss to die away smoothly. If no hiss is present in the phones, recheck wiring and circuit components.

**High Frequency Section of the Receiver.** When wiring the VHF stages of the receiver (or transmit-



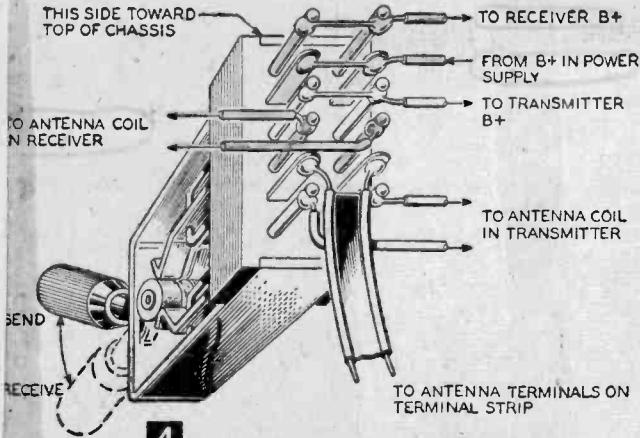
2 CHASSIS LAYOUT

*Finished - 3/6/57*



3 SCHEMATIC-POWER SUPPLY

*Finished - 3/8/57*



**4** SEND-RECEIVE SWITCH (END VIEW)

ter), keep all leads as short and direct as possible. A lead 1 in. long is considered short enough for ordinary broadcast and shortwave equipment, but at 144 megacycles it is far too long. Also, use a minimum amount of solder; use ceramic bypass and coupling capacitors; and establish one ground point for each stage, returning all chassis grounds for the stage to that point.

In Fig. 5, RFC1 designates an Ohmite Z-144 VHF R.F. choke, the plate load of the 6AG5 R.F. amplifier. The tuning coil in the 6AG5's

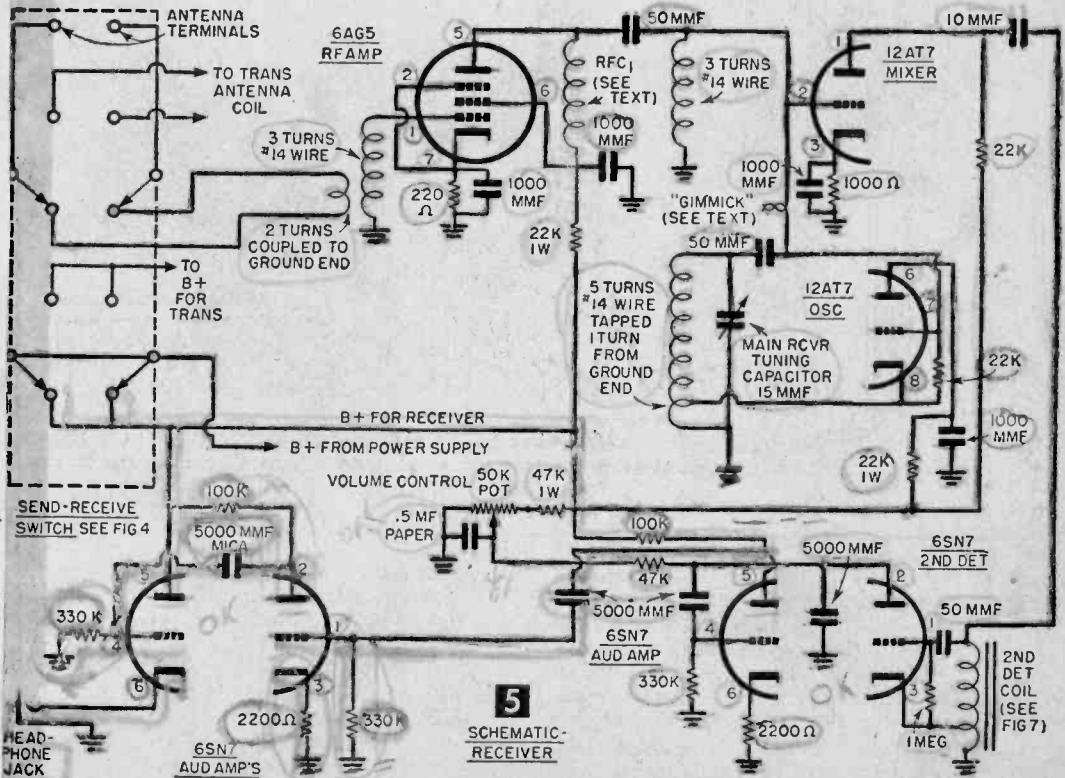
grid circuit consists of three turns of #14 tinned copper wire. Wind this coil on a 1/2-in. dia. form (we used a 1/2-in. drill shank) and then remove the form, leaving an "air-wound, air-spaced" coil. To properly adjust this coil, a grid-dip meter is needed. Usually, such a meter can be borrowed from another amateur.

With the 6AG5 and the meter in the circuit (instructions for the use of the grid-dip meter are supplied by the manufacturer), spread apart or squeeze together the three turns of the coil until the meter indicates that the circuit is resonant to about 146 megacycles. For our receiver, this condition occurred when the coil was about 1/2 in. long.

Wind and adjust the coil in the grid circuit of the 12AT7 mixer in the same manner, but with both the 6AG5 and the 12AT7 in their sockets and all other connections properly made.

The small, home-made capacitor, labelled "Gimmick" in Fig. 5, consists of two pieces of ordinary hook-up wire (insulation left on) twisted together three times. It couples the signal from the oscillator to the mixer.

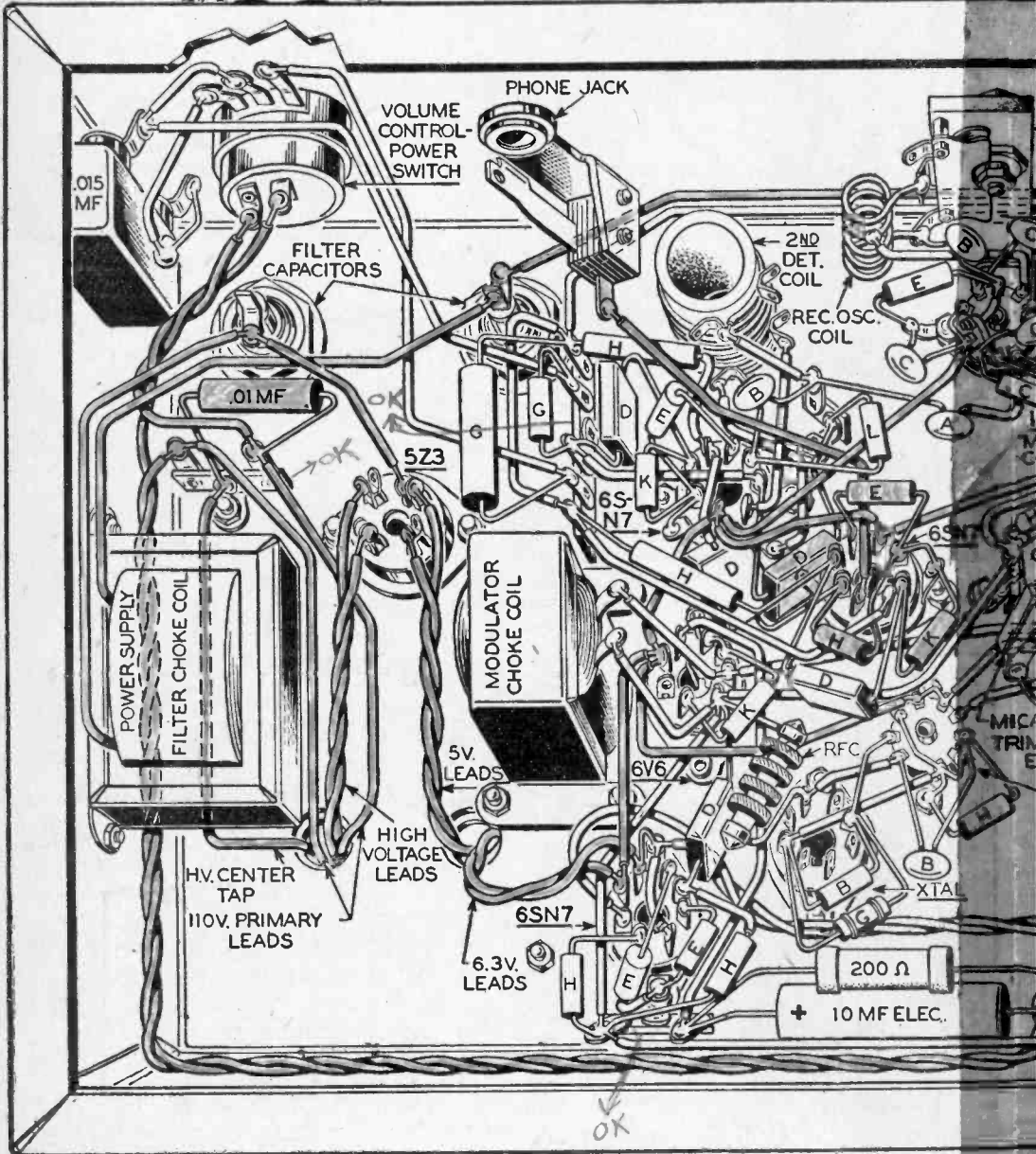
The oscillator coil consists of five turns of #14 wire wound as were the three-turn grid coils. The cathode lead from the oscillator sec-



**5** SCHEMATIC-RECEIVER

6

LEGEND			
A- 10MMF	D-5000MMF	G- 47K	K-330K
B- 50 MMF	E- 2.2K	H-100K	L-1 MEG.
C-1000MMF	F- 22K	J-220K	



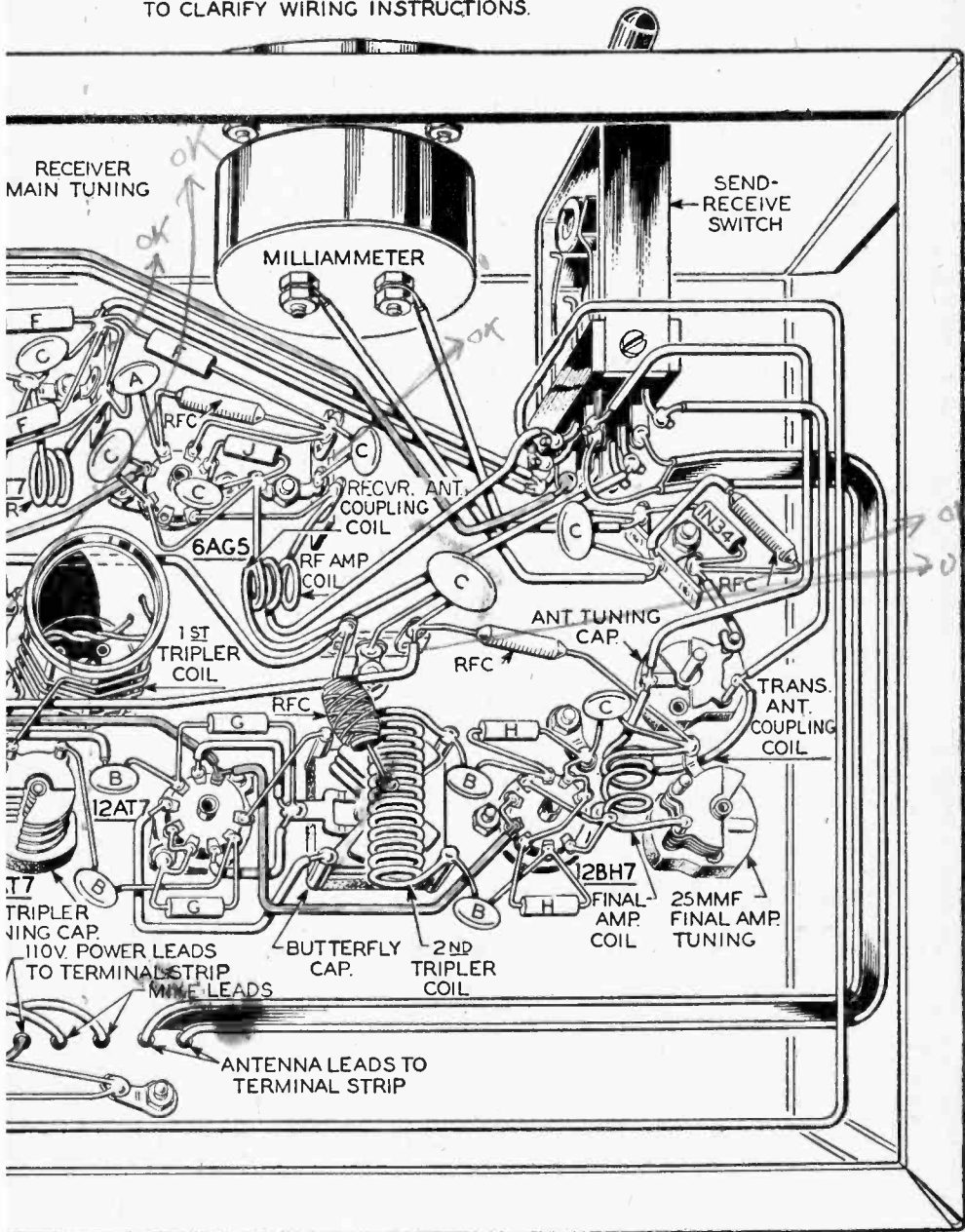
tion of the 12AT7 is soldered to the coil one turn from the ground end. When the R.F. amplifier, mixer and oscillator circuits are completed, apply power and throw the send-receive switch to the receive position. The tuning range for the oscillator, as indicated by a grid-dip meter, should be from within about 115 to about 132 megacycles. If the oscillator is not oscillating, look for shorts between tube pins or try a dif-

ferent 12AT7. If the oscillator's tuning range is incorrect, squeeze or spread the oscillator coil turns slightly until the correct range is obtained.

When the oscillator is working correctly, plug the headphones into their jack, adjust the volume control for a good, strong hiss, set the grid-dip meter for 145 megacycles and place it about 10 ft. from the set. Now tune the main tuning dial on



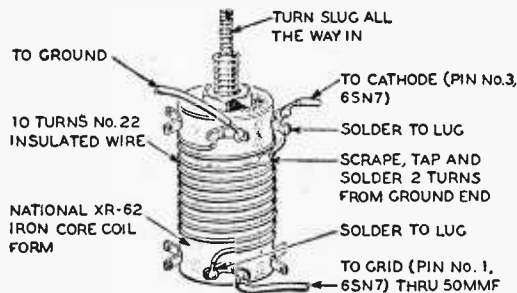
NOTE! MAKE ALL WIRE LEADS AS SHORT AS POSSIBLE.  
LEADS SHOWN HAVE BEEN MADE LONGER  
TO CLARIFY WIRING INSTRUCTIONS.



ceiver throughout its range. At some point  
e dial the hiss should disappear. Turning  
rid-dip meter off should cause it to re-  
r. If it does, the receiver is operative. If  
sn't, you'll need to recheck the wiring in  
ixer and R.F. amplifier circuits only; the  
stor has been checked.  
test purposes, couple a dipole antenna (see  
3) to the 6AG5 R.F. amplifier grid coil

by means of one turn of wire inserted between  
the two turns at the ground end of the grid  
coil. With the volume turned up, tune the main  
receiver tuning dial through its range. If there  
are radio-equipped taxicabs, mobile radio tele-  
phones, or other 144-megacycle amateurs operat-  
ing within range of you, you should hear them.

Note that when a signal is tuned in, the hiss  
from the receiver tends to disappear and the



**7** SECOND DETECTOR COIL  
(WHEN WOUND, COAT WITH POLYSTYRENE CEMENT)

voice signal takes its place. The stronger the signal, the more completely the hiss will disappear. Slight readjustment of the volume control and slight retuning will often do wonders to clear up a weak signal.

Finish work on the receiver section by connecting the antenna coil leads of the 6AG5 directly to the appropriate connections of the send-receive switch (Fig. 4). Then run a short length of 300 ohm "twin-lead" TV lead-in line from the proper switch connections to the antenna terminals on the Jones terminal strip and connect antenna lead-ins to these terminals.

**Construction of the Transmitter.** Fasten tube sockets for the 12AT7's, 12BH7 and crystal (use 6-32 screws for the crystal socket, 4-36 for tube sockets) and mount the 50 mmf first-tripler tuning capacitor, the "butterfly" second-tripler tuning capacitor, and the 25 mmf final amplifier tuning and antenna tuning capacitors. Be sure that the 50 mmf and the 25 mmf capacitors are mounted with shafts insulated from the chassis. (Drill the shaft hole large enough to give the shaft ample clearance.)

First wire the crystal oscillator (see Figs. 6 and 9), wiring to any two *alternate* pins desired on the crystal socket. In the oscillator's plate circuit, RFC2 (Fig. 9) designates a National R-100 2½ mh R.F. choke.

Choose your crystal frequency according to the class of amateur license you hold. If you hold a general class license, any crystal frequency between 8.000 and 8.210 megacycles will do. If you are a novice, choose a crystal frequency between 8.032 and 8.132 megacycles.

When the crystal oscillator circuit wiring is completed, plug the crystal into the socket pins that are connected to the oscillator circuit. Apply power and throw the send-receive switch into the *send* position. Now, *holding it by its glass envelope*, touch the base of a 2-watt neon bulb to the plate connection (pin #1) of the 12AT7 oscillator tube. A faint but definite bluish-red glow of the neon bulb indicates satisfactory operation of the oscillator circuit. If no glow is observed, recheck the wiring or substitute a different crystal.

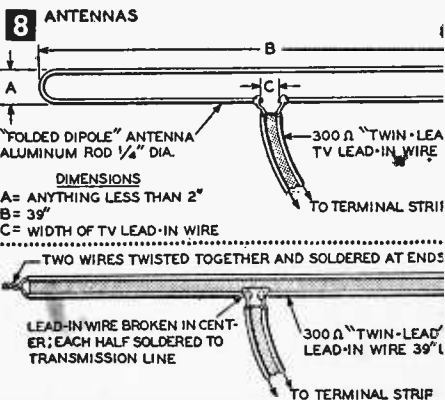
Next, wire the first tripler circuit. The first tripler coil is wound as shown in Fig. 10.

With the first tripler wired, apply power and

set grid-dip meter to about 24 megacycles; the grid-dip meter coil near the tripler coil; adjust the 50 mmf capacitor until maximum output from the tripler is observed on the meter. This adjustment must be made with an *insulated* screwdriver to avoid shocks and to insure accurate tuning.

When a good, strong indication is secured on the grid-dip meter, insert the loop of the mitter tuning lamp (see Fig. 11) into the middle of the tripler coil with the loop of the lamp parallel to the turns of the coil. When the lamp is in all the way into the coil, and the 50 mmf capacitor is readjusted for maximum tripler output, a noticeable glow of the lamp filament should be observed.

Now, wire the second-tripler 12AT7. The second-tripler coil consists of 12 turns of #14 copper wire wound on a ½-in. dia. form. Wind the turns carefully to make the entire coil 1¾-in. long, then remove the form. Conne



A is superior for outdoor installations.  
B is suitable for indoor or temporary use.

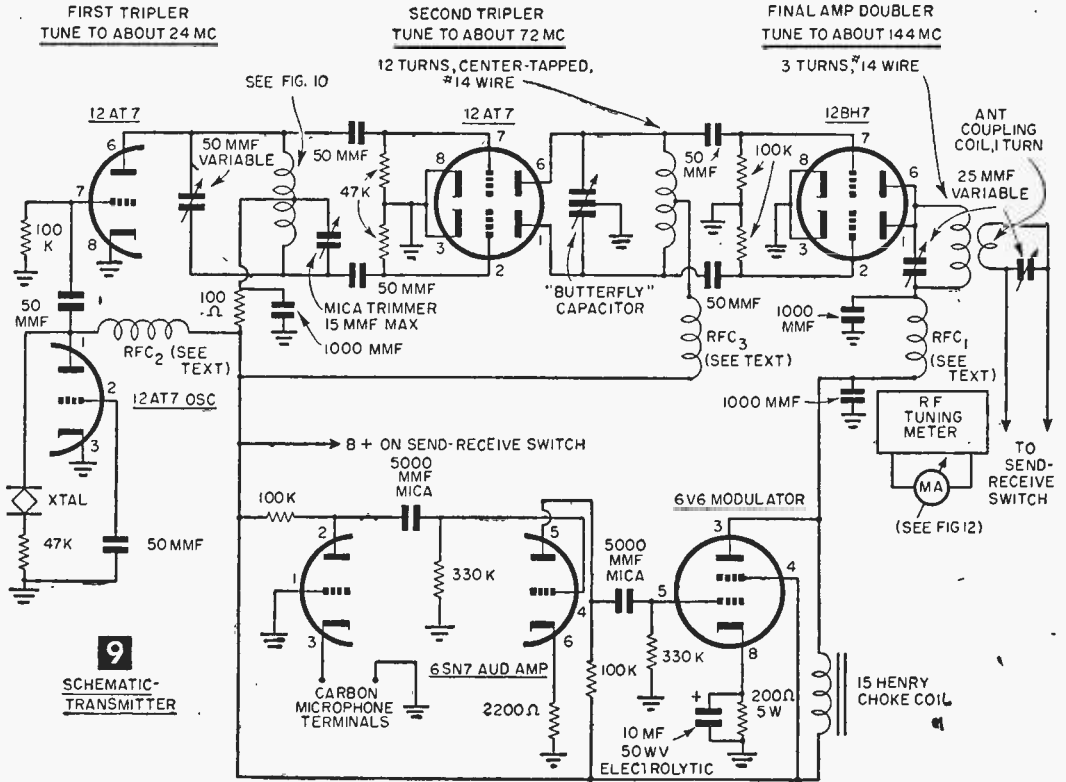
#### RULES FOR ERECTING ANTENNA

- (1) Keep it horizontal.
- (2) Keep it broadside to the directions you wish to work.
- (3) Erect it as high above ground as possible.

coil between the two stationary sets of plate leads of the "butterfly" capacitor. Keep leads as short as possible.

The R.F. choke (RFC3) connected to the tap of the second-tripler coil is made by screwing 100 turns of magnet wire equal in size to #22 around a 1 megohm, 1/2-watt carbon resistor. Solder the ends of the coil to the resistor leads, dope liberally with polystyrene cement, and solder RFC3 into the circuit.

Insert the 12AT7 in its socket and apply power. Tune the grid-dip meter to about 72 megacycles and adjust the "butterfly" capacitor for maximum second-tripler output. Then insert the loop of the tuning lamp between the middle of the second-tripler coil and readjust the "butterfly" capacitor for maximum second-tripler output. Then, using an insulated screwdriver,



just the *first*-tripler 50 mmf tuning capacitor until the tuning lamp (still in the second-tripler circuit) glows brightly. Now, adjust the first-tripler 15 mmf mica trimmer capacitor and the first-tripler 50 mmf tuning capacitor alternately, until the tuning lamp glows at nearly full brilliance.

The final stage of the transmitter's R.F. section to be wired is the push-push doubler final amplifier. It operates at the output frequency of 144 megacycles, so make every lead as short as possible. The final-amplifier tank coil consists of three turns of #14 tinned copper wire 1/2-in. in diameter. Space out the turns until the length of the entire coil is about one in., remove the form, and connect the coil across the final amplifier tuning capacitor. Keep leads to minimum length.

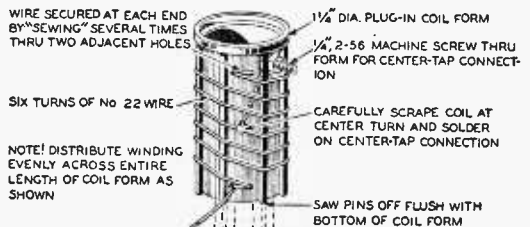
When the final amplifier is completed, tune the grid-dip meter to about 144 megacycles, insert the 12BH7 tube in its socket and, after the tube has heated, apply B+ by throwing the send-receive switch to *send*. Using the insulated screwdriver, adjust the 25 mmf final-tuning capacitor for maximum indication on the grid-dip meter and readjust the "butterfly" capacitor for maximum output at the final amplifier. Then insert the tuning lamp between the turns of the final amplifier coil. It should gleam brilliantly.

Finally, wire the audio amplifier and modulator. (RFC1 designates an Ohmite Z-144 VHF R.F. choke.) To test the audio amplifier-modu-

lator system, temporarily replace the 15 henry choke coil in the modulator plate circuit with the primary of any loudspeaker output transformer and loudspeaker. With the microphone connected and the send-receive switch in the *send* position, speaking into the microphone should produce a loud, clear signal from the loudspeaker.

Now insert a single-turn antenna coupling coil into the final-amplifier tuning coil at the end farthest from the 12BH7 socket. Push it well down into the final-amplifier coil to obtain tight coupling and run its leads directly to the 25 mmf antenna tuning capacitor. From there, run leads directly to the proper terminals of the send-receive switch (see Fig. 4).

Give the entire transmitter a final test by connecting a #48 dial lamp bulb directly across the antenna terminals on the terminal strip. With every component in the circuit and with the



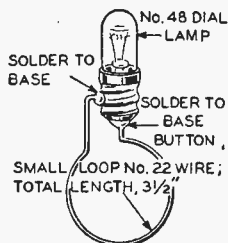
10 FIRST-TRIPLER COIL

send-receive switch in *send* position, the lamp should glow brightly. Touch-up the various tuning adjustments for maximum brilliance of the lamp and then speak clearly and directly into the microphone. The lamp should flicker noticeably, indicating that modulation is taking place.

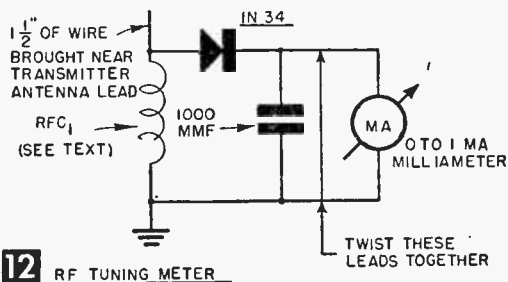
**MATERIALS LIST—AMATEUR RADIOTELEPHONE STATION**

- |        |                                                                                                             |
|--------|-------------------------------------------------------------------------------------------------------------|
| Req'd. | Receiver and Power Supply                                                                                   |
|        | 10 x 17 x 4" aluminum chassis                                                                               |
|        | knob, 1/4" shaft                                                                                            |
|        | terminal strip, 6 terminal (Jones barrier 6-140) → OK.                                                      |
|        | 8-prong sockets (Amphenol type MIP) → OK.                                                                   |
|        | 9-prong sockets (Amphenol, 59-410)                                                                          |
|        | 7-prong miniature socket (Amphenol, 147-505)                                                                |
|        | power transformer (Stancor type PC-8410 or equivalent)                                                      |
|        | filter choke coil (Stancor type C-1001 or equivalent)                                                       |
|        | can type electrolytic capacitors, 16 MFD 450 v.v. (Cornell-Dubilier, Type KR-516A or equivalent)            |
|        | single circuit phone jack                                                                                   |
|        | Vernier dial, 0-100-0 scale (National type BM)                                                              |
|        | 4BD1 anti-capacity switch (Federal #1424) → OK.                                                             |
|        | 50K linear taper potentiometer, with switch (50,000 ohms)                                                   |
|        | pair 2000 ohm headphones (Trim "Dependable" or equiv.)                                                      |
|        | phone plug                                                                                                  |
|        | power line cord with plug                                                                                   |
|        | .01 mf, 400 volt paper capacitor                                                                            |
|        | Ohmite Z-144 R.F. choke                                                                                     |
|        | 1000 mmf disk type ceramic capacitors                                                                       |
|        | 50 mmf disk type ceramic capacitors                                                                         |
|        | 10 mmf disk type ceramic capacitors                                                                         |
|        | 1000 ohm, 1/2 watt composition resistor                                                                     |
|        | 220 ohm, 1/2 watt composition resistor                                                                      |
|        | 100K ohm, 1/2 watt composition resistors (100,000 ohms)                                                     |
|        | 47K ohm, 1 watt composition resistor (47,000 ohms)                                                          |
|        | 47K, 1/2 watt composition resistors (47,000 ohms)                                                           |
|        | 27K, 1/2 watt composition resistors (22,000 ohms)                                                           |
|        | 22K, 1 watt composition resistors (22,000 ohms)                                                             |
|        | 330K, 1/2 watt composition resistors (330,000 ohms)                                                         |
|        | 2200 ohm, 1/2 watt carbon resistors                                                                         |
|        | 100 ohm, 1/2 watt carbon resistor                                                                           |
|        | 1 meg., 1 watt carbon resistor                                                                              |
|        | 0.5 mf paper capacitor                                                                                      |
|        | 5000 mmf mica capacitors, "postage stamp" type ceramic, iron core coil form (National type XR-62)           |
|        | 15 mmf midget variable capacitor (Hammarlund type HF15 or equivalent)                                       |
|        | 523 tube → OK                                                                                               |
|        | 6SN7GTB tubes                                                                                               |
|        | 12A7 tube                                                                                                   |
|        | 6AG5 tube                                                                                                   |
|        | #14 tinned copper wire → OK                                                                                 |
|        | hook-up wire, solder                                                                                        |
|        | tube polystyrene cement                                                                                     |
|        | tiepoints                                                                                                   |
|        | screws                                                                                                      |
|        | miscellaneous hardware                                                                                      |
|        | 300 ohm twin lead TV antenna lead-in wire                                                                   |
|        | #22 insulated magnet wire                                                                                   |
|        | antenna materials, as desired                                                                               |
|        | Transmitter                                                                                                 |
|        | knobs, 1/4" shaft                                                                                           |
|        | choke coil (Stancor type C-1002 or equivalent)                                                              |
|        | 0-1 milliammeter (Triplate)                                                                                 |
|        | 0.5 mf, 200 v. paper capacitor (Sprague or equivalent)                                                      |
|        | 10 mf, 50 v. electrolytic capacitor (Sprague or equivalent)                                                 |
|        | Ohmite type Z-144 VHF RF chokes                                                                             |
|        | 2 1/2 mh RF choke (National R-100)                                                                          |
|        | 1/4" ribbed plastic coil form (ICA)                                                                         |
|        | 25 mmf midget variable capacitor (Hammarlund type APC 25 or equivalent)                                     |
|        | 50 mmf midget variable capacitor (Hammarlund type APC 50 or equivalent)                                     |
|        | "Butterfly" type midget variable capacitor, 10 mmf per section (Johnson 11MB11)                             |
|        | 1 1/2-15 mmf mica trimmer capacitor                                                                         |
|        | 1N34 crystal diode                                                                                          |
|        | quartz transmitting crystal, about 8 megacycles, see text (Petersen radio "PR" type Z2 or Bliley type AX-2) |
|        | 6SN7GTB tube                                                                                                |
|        | 12A7 tubes                                                                                                  |
|        | 12BH7 tube                                                                                                  |
|        | 6V6GT tube → OK                                                                                             |
|        | #48; 2 v., 60 MA dial lamps → OK                                                                            |
|        | 2 watt neon bulb → OK                                                                                       |
|        | single-button, telephone-type microphone → OK                                                               |
|        | 2-lug tiepoint                                                                                              |

The R.F. output meter (Fig. 12) assures proper tuning of the transmitter under all conditions. Fasten the 1N34 crystal diode, the RFC1 choke (an Ohmite Z-144) and the 1000 mmf capacitor to a two-lug tiepoint strip mounted near the transmitter antenna tuning capacitor. The 1 1/2-in. pickup lead should be brought within about 1/2 in.



**11 TRANSMITTER TUNING LAMP**



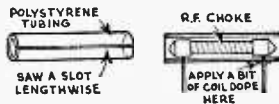
**12 RF TUNING METER**

of the transmitter 25 mmf antenna tuning capacitor and a twisted pair of wires run to the 0-to-1 milliammeter on the front of the chassis. Apply power, and throw send-receive switch to *send*. If the meter reads backwards, reverse the leads to it. Position the pickup lead so that when the transmitter is operating and the antenna is properly loaded the meter reads about mid-scale. The transmitter may now be easily adjusted by tuning for the greatest meter reading.

Connect the transmitter to one of the antennas shown in Fig. 8, put the antenna as high and in the clear as possible and you're ready to go on the air. With a dipole antenna 25 ft. high, your range of communication will be around 10 miles; with a dipole antenna 50 ft. high, it will be about 15 miles; 100 ft. high will get you out 20 miles. With a high-gain directional antenna system, you can get out in excess of 100 miles under special atmospheric conditions.

**Polystyrene Tubing Insulates Chokes**

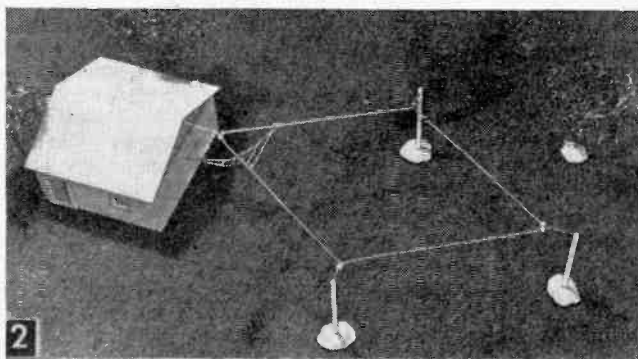
• To protect the metal ends of an RF choke from accidental contacts in a crowded radio chassis saw a lengthwise slot on one side of a length of polystyrene tubing, and slip it over the RF choke. For straight-wound chokes, 1/2 in. OD tubing is about right, but for pie-wound chokes use larger tubing. Coil-dope or speaker-cement applied to wire leads where they enter tubing keeps tubing from slipping off choke. Or, heat the ends of the tubing and pinch them shut.—ARTHUR TRAUFFER.





The author's rooftop version of the rhombic antenna. Here the terminating resistor is being attached to the end of the diamond-shaped antenna which points at the TV broadcasting station.

## Boost TV Reception with a RHOMBIC



Backyard version of the high-gain, ghost-chasing rhombic—for those who have the space.

For high gain operation on a wide spread of frequencies, use this diamond shape

By ELBERT ROBBERSON

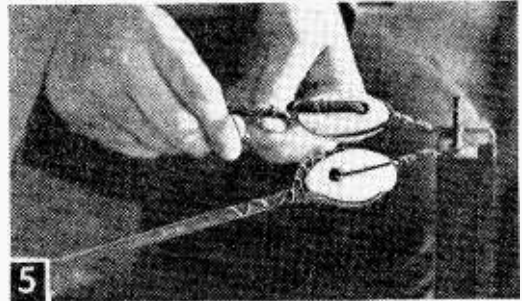
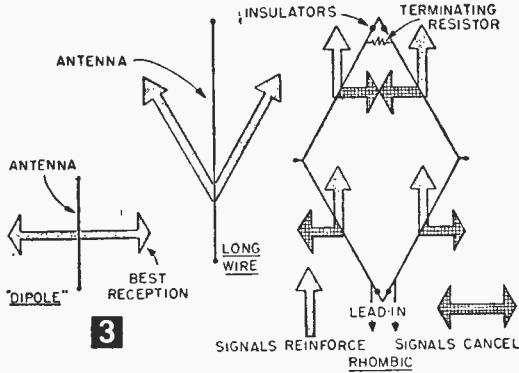
gain operation on a wide spread of frequencies, nothing is better. This is no mere theory. Drive past any of the huge "antenna farms" of global, commercial, or military communications stations, and you'll see acres of rhombics. These people don't fool around—their antennas mean dollars and cents, or life and death. If they want to receive Rio, they simply

point a rhombic in that direction.

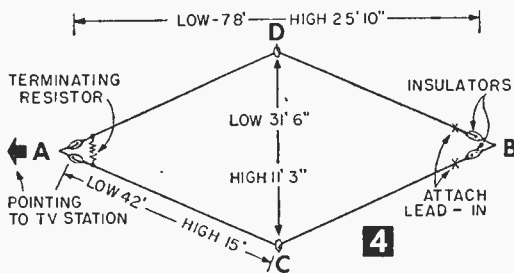
**H**OW would you like a TV antenna you can make yourself, using nothing more complicated than wire, wood, and insulators? And how would it be if this antenna licked ghosts, cut down on the living-room snowstorm, or brought in stations that were previously out of range? If this sounds interesting, the rhombic antenna is for you.

Don't let the name scare you off. Rhombic simply means "diamond shaped." And for high-

Figures 1 and 2 show you two ways in which a rhombic can be rigged up depending on the space you have available. But, before we start the actual job of rigging, let's see how a rhombic works. Since the "dipole" (Fig. 3) receives best at right angles to its length, you aim it broadside to a station. Stretch out the antenna so it is longer than a wavelength, and it receives best from a diagonal direction. Tie four long antennas to-



At each end of the rhombic, the wires are insulated from each other by two insulators. The end halliard ties to their center point.



- 200' WIRE - NO 12 COPPER
- 6-INSULATORS - BIRNBACH # 473 AIRPLANE TYPE, OR EQUIVALENT
- 1-RESISTOR - 820 OHM  $\pm$  10%,  $\frac{1}{2}$  WATT, CARBON, ALLEN BRADLEY AB OR EQUIVALENT LEAD-IN, SEE FIG 5

gether in the diamond shape shown, and the four "lobes" on the individual legs which point in the same direction add forces, while the remainder, pulling in opposite directions, cancel each other. Thus, signals coming from the lengthwise direction scamper on in, picking up more energy as they go down the lead in to the TV set. Reflections and interfering noises from all other directions just get lost.

To keep unwanted signals from bouncing around in the antenna, a "terminating resistor" short circuits the end opposite the TV-receiver connection. Wrong-way signals hit this resistor, turn into heat, and are seen no more.

Now for the construction. Fig. 4 is a plan view, looking down from above, showing dimensions for both the "low" channels from 2 to 6, and the "high" from 7 to 13. If you are interested only in the high band, use the smaller dimensions. For reception of low-band stations, or some of both high and low, use the large dimensions. And if, because of space limitations, you can't quite follow these specifications, don't completely abandon the idea of a rhombic. A compromise design for mounting the rhombic inside the attic or even under a room rug (we'll describe these later) may still give you better reception than you'd get with a pretty heavy stack of aluminum on the roof.

When a global communications outfit wants to erect antennas they buy a farm, stake out a batch of 90-foot poles, and string the wires between

them. But smaller operators, by using trees, houses, and other nearby objects from which to hang corners of the antenna, can quite often get by with one or two poles at the most. The antenna does not have to be right by your window, so locate it where you have the maximum of already-existing support. Hang the antenna as high as possible, 12-15 feet where the signal strength is not too low, up to 30-40 feet in extremely poor fringe reception areas. If you don't know what the signal field strength is at your location, hold a hand-held dipole "probe" at different levels. At any point where the dipole picks up signal, the rhombic antenna should work.

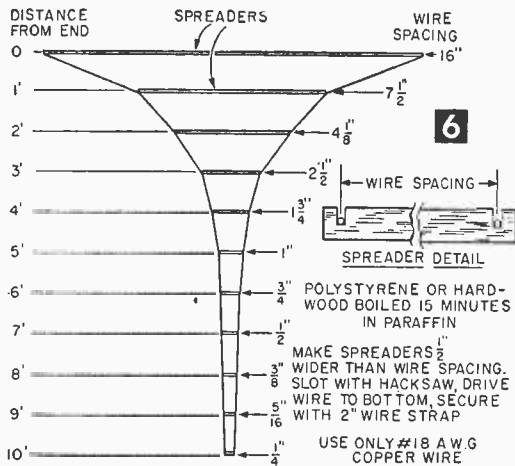
The prime requirement for laying out a rhombic antenna is that it be pointed accurately at the desired station. Unlike other antennas, this one is sharp, and a 10° error is enough to miss the signals completely. You might be able to "fudge" the ends one way or the other to improve response when the antenna is up, but it is actually easier to point it right in the first place.

To do this, you need a chart, protractor and a compass. The chart should be the navigational kind—either aeronautical or marine—not a road map. U.S. Coast and Geodetic Survey offices in major cities, and aero or marine supply companies can supply charts of your area.

Mark the locations of both yourself and the TV transmitting antenna accurately on the chart. Draw a line between the two points, and this is the line down which your antenna should point.

Then draw a vertical north-south line through your location, and take your protractor in hand. If the TV station is to your east, the angle measured clockwise between north and the station line is the true bearing of the station. With a station to your west, measure counterclockwise from north, then subtract this angle from 360°, and the resulting angle will be the true bearing of the station.

On the chart, or in an almanac, find the "variation", or "magnetic declination" for your locality. In the United States, this may be any figure from 21° west, for Eastport, Maine, to 23° east in Seattle. To change the true bearing from the chart to a compass bearing you can lay out on the ground, add westerly variation to the true figure, or subtract easterly. In case the true figure is not



large enough to make subtraction possible, first add  $360^\circ$  to it. On the other hand, if the sum of your addition is greater than  $360^\circ$ , subtract this amount from the result. The end result in any event will be a compass-bearing figure between  $0^\circ$  and  $359^\circ$ .

Now, on the ground below the point where the TV-set end of the rhombic will hang (A in Fig. 4), place the compass. Rotate the compass shell so the zero mark on the scale comes under the north end of the needle. Then have someone with a flag-marked stake march off several feet down the approximate bearing line. Sight over the compass center through the bearing figure, and have your flag man drive the stake exactly on this line. Lay out the dimensions of the desired rhombic along this line on the ground, and plant poles or string ropes from nearby objects for support. Points of support should be at the same height so the antenna will be level. Clothesline pulleys and rope can be used for halliards to jockey the rhombic into the air.

It's best to rig the antenna on the ground. Following the dimensions of Fig. 4, drive a small stake at each corner. Temporarily fasten two "egg" insulators to each end stake (Fig. 5), and one egg to each side stake. Run a length of stranded copper wire through each side insulator, pull taut and secure the ends into the end eggs. The result is two lengths of wire, insulated from each other, each forming one side of the diamond.

At the end of the antenna facing the TV station (A in Fig. 4), solder the terminating resistor, then cover it with a protective wrapping of plastic insulating tape. Form the leads so the resistor will ride above the side wires, to prevent its collecting water.

The lead-in line to the TV set attaches to the other end (B in Fig. 4). With a rhombic antenna, the lead-in requires an "impedance transformer" between the antenna and the conventional "twinlead" ribbon. Here is the reason. When light goes from a medium of one conductivity to another, reflection occurs. Likewise, TV waves will "reflect" from abrupt changes in lead-in line resist-

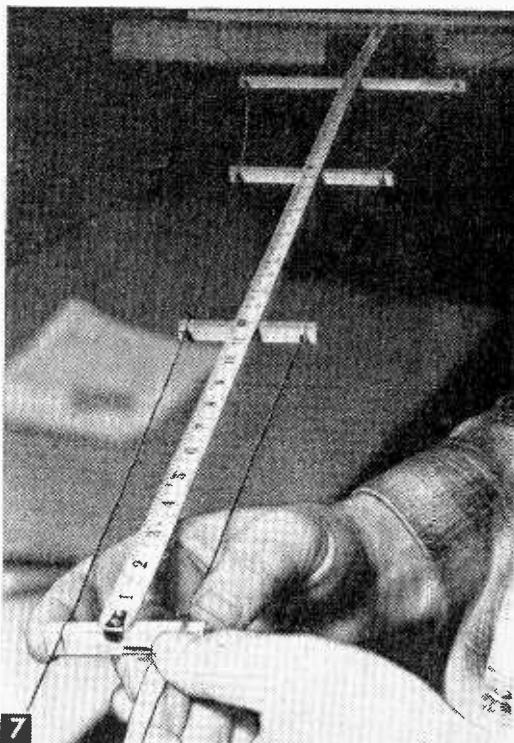
ance. This causes ghosts or spotty reception.

To carry the TV-signal currents through a transition from rhombic-antenna resistance (800 ohms) to the twinlead resistance (300 ohms) a line section with a gradually changing resistance is used. This is called an "exponential line," and it is easier to make (Fig. 6) than to pronounce. Attach two 11-ft. lengths of #18 copper wire to points 16 in. apart, and pull the other ends tautly together at one point. Give the wires a good jerk to pull out the bumps. Then just fit the spreaders to the line at one-foot intervals (Fig. 7), securing them with a wrap of #18 wire as you go. The result will be a line section with the required resistance taper.

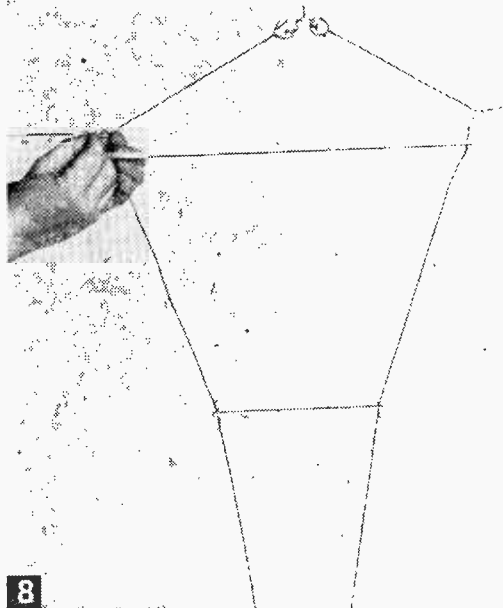
The large end of the exponential line (Fig. 8) is soldered to the antenna wires at the point where they are separated just 16 inches. Cut the tapered line to a 10-ft. length and solder regular twinlead ribbon to the small end. If the exponential line tends to twist at the small end, add spacers until the wires can't tangle.

Now attach the halliards to the corner insulators, disconnect the stakes, and hoist the rhombic into position. Trim the adjustment of the halliards very carefully so the diamond lies flat, and is aimed horizontally.

Since long-distance TV waves may not follow a straight line, it's wise to "touch up" the aiming of your rhombic after it is in place, by pulling the ends one way and the other, and also raising and



Set the spacers in the exponential line one foot apart, then wire in place.



**8** Solder the exponential line to the sides of the rhombic at the point where they are just 16 in. apart. Attach conventional twinlead 300-ohm ribbon to the small end of the line.

lowering them a few degrees while someone watches the TV picture. The aiming which gives the best picture is the one to use—and sometimes a correction in the pointing of only a few inches can make a difference.

**Rhombic for City Folks.** City dwellers, or folks with no yards, can often benefit by the use of a “jury-rigged” rhombic. Suppose you can’t hang a 70-ft. or even a 20-ft. wire diamond “out in the clear”. A smaller rhombic antenna can be strung between stub posts on the roof, or even between the rafters in the attic. And second-story dwellers (if the rooms aren’t metal lathed) may find that a rhombic under the rug will beat the usual inside antenna, or a conventional dipole huddled in the usual jungle of housetop hardware.

No strict rule can be laid down for the angles or dimensions of jury-rigged rhombics because of the varying effects of nearby objects. But in general, as a rhombic is made smaller, it should broaden out. With the antenna temporarily in place, the sides and corners can be pulled out and back using strings or dry pieces of wood to alter the aim, while somebody watches the TV picture for best response.

As in erecting full-size antennas, the first thing to determine is the direction of the transmitting station. In crowded areas, this can be judged from the alignment of nearby dipole antennas. The rhombic should point at right angles to the dipole arms.

Atop flat roofs, (Fig. 1) light halliards can be attached to the building parapet or short posts erected at the diamond’s corner points, so the antenna hangs a few inches off the roof surface.

The main requirement is that the wire be above the water and snow level, and that it not drape in contact with pipes or other wires.

If a peaked-roof house is oriented properly, and approximately square, the rhombic may be hung around the edges of the roof at the eaves or on stub posts nailed to the corners. Or—again if the house is properly oriented—you can hang two opposite corners of the diamond on the opposite peaks of the roof, supporting the other corners by center posts on the roof sides, rising up to the peak height.

The antenna may be hung indoors in an empty attic. Insulated No. 20 hookup wire can be used inside, with heavy string or cord for insulation and support. Find the line of the antenna with a compass, then drive nails in the rafters above and outside the corner points so the spans of wire will hang level and uniform.

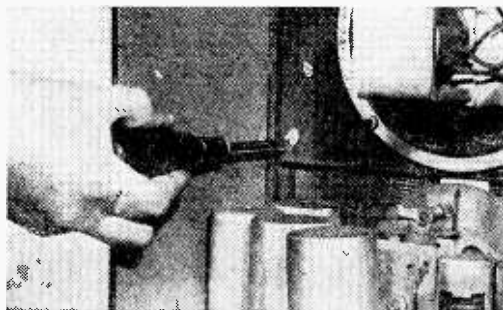
A rhombic can even be laid under the rug, if you live above ground floor and the building is not metal lathed or sheathed. Either roll up the rug and “Scotch-tape” No. 20 insulated wire to the floor, or slide the wire under the rug from the diamond corner points, pulling it taut for straight sides. Use all the space available, to make the antenna as large as possible, and use the same care in orienting it as you would outside. If desired, twinlead ribbon with the wires connected together at each end can be used instead of ordinary hookup wire.

With an under-the-rug rhombic, niceties like the exponential line transformer may be impossible to accommodate. In this event, simply attach the lead-in ribbon to the antenna wires. The terminating resistor can also be eliminated, if it is found that no increase in noise results.

Although the rough-and-ready rhombic which is jury-rigged anywhere is naturally not intended as a mainstay in fringe areas, it will often give better results over simple dipoles in any location, especially in the suppression of ghost images and ignition or other electrical interference.

### Eliminating Distortion

- Frequently sound distortion on a radio is caused by the vibration of the speaker mounting. To eliminate such distortion, tighten screws holding the speaker to the mounting board and those holding the mounting board to the radio cabinet.—H. LEEPER.

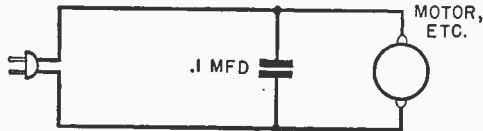
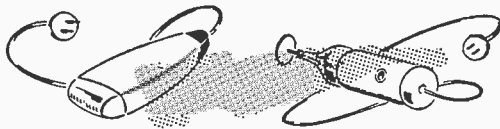




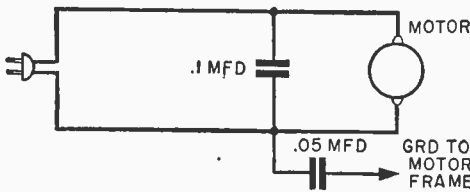
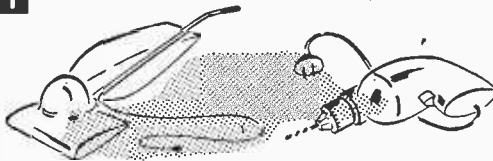
# Power Line INTERFERENCE FILTERS

## For TV and Radio

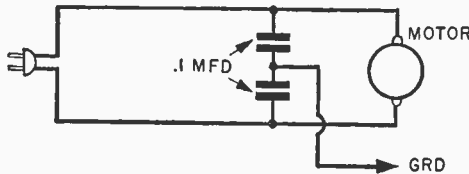
By THOMAS A. BLANCHARD



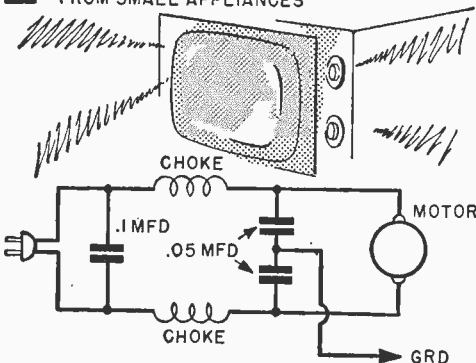
**1** FOR SHAVERS AND HAND GRINDERS



**2** FOR VACUUM CLEANERS, FOOD MIXERS, HAND DRILLS AND OTHER METAL-HOUSED ELECTRIC APPLIANCES.



**3** READY-MADE FILTERS FOR INTERFERENCE FROM SMALL APPLIANCES



**4** FOR TV SET INTERFERENCE FROM NON-TRACEABLE SOURCE, ALSO FOR APPLIANCES THAT PRODUCE SEVERE INTERFERENCE

IS YOUR TV picture frequently ruined by white and black dots or dashes running across the screen? Is your radio reception marred by hash noises and clicks? Don't blame these conditions on some local radio amateur, because chances are he has nothing to do with it. It may come as a shock, but that gentle little lady with the dressmaking establishment up the street, may be the guilty party.

Brush-type fractional motors, neon signs, arcing caused by power relays, spot welding equipment and power lines contacting tree branches are perhaps the most common causes of radio and TV interference. But the aggravating interference can be eliminated, especially if you can track the interference to its source.

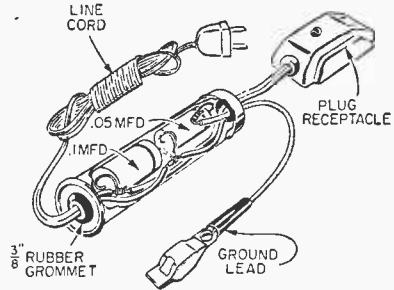
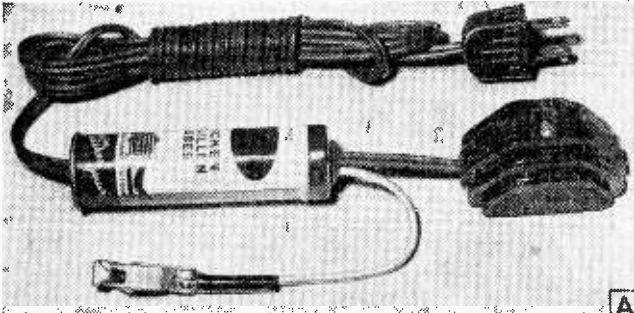
The most effective correction is to install a suitable filter between the convenience outlet and device causing the interference. For instance, the simple filter shown in Fig. 2 will eliminate most, if not all, of the interference created by the dressmaker and her sewing machine—not only on your set, but all your neighbors' as well.

Many manufacturers of such appliances as hand grinders, drills, food mixers, vacuum cleaners and sewing machines install capacitors in their products to tune out and return to ground any spurious signals generated by the motor brushes. If you own a sewing machine, electric razor or hand power tool that produces no harsh noise when plugged into the same outlet as your radio set, rest assured it will not create TV picture interference either.

The four low-cost filter circuits shown in this article are designed to solve a variety of specific interference problems. Figure 1 shows a simple filter for electric shavers and hand grinders. Often there is enough room within the case of the appliance to connect a .1 mfd 150 working volt paper capacitor across the terminals to which the fixture cord is connected.

If you find .1 mfd is not fully effective, try .5 or 1 mfd, if space permits installation within the case. Be sure to install the filter as close to the motor as possible. The fixture cord acts as an antenna, and filters connected across the plug may be only 25% as effective as those installed at the source of interference.

Figures 2 and 5 show a filter which has proved excellent for vacuum cleaners, food mixers, hand



**A** **B** FILTER FOR SMALL ELECTRIC HAND TOOLS (SEE SCHEMATIC NO.2)

**5** Where space is at a premium, filter network may be installed in line cord. Here a bouillon cube can houses .05 and .1 mfd radio type paper capacitors.

drills and other electrical appliances in metal housings. The hookup is the same as in Fig. 1, except that the metal motor case is grounded to one side of the power line through a .05 mfd capacitor.

Where space within the motor housing does not permit installation of capacitors, the arrangement in Fig. 5A and B may be employed. Drill 3/8-in. dia. holes in both ends of a bouillon cube can and fit them with rubber grommets. Then pass the appliance cord through one of the can grommets. Strip off the insulation as shown, and solder the two capacitors in place. Tape all exposed leads and slip the capacitors into the container where they remain protected from damage. You can attach the ground lead permanently to the motor housing.

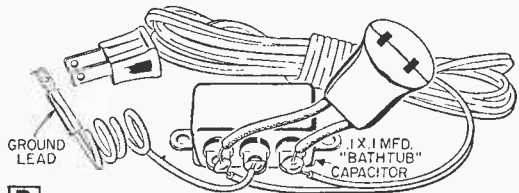
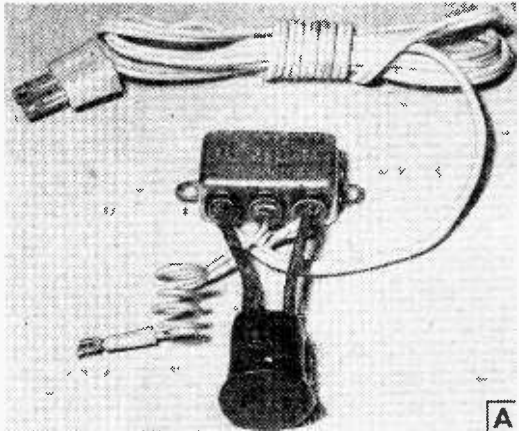
If you want to install this filter on an extension cord for temporary or experimental use, wind the appliance cord into a hank so its radiating effect is minimized.

Figures 3 and 6A show a filter you might call ready made, in that the capacitors are neatly encased in a small metal housing provided with mounting ears. Two or more of these bathtub capacitor condensers are enclosed in a small case with a common ground terminal. The unit shown is a Cornell-Dubilier .1x.1 mfd size, and the outer lugs are connected across the power line, while the center lug is grounded to the appliance (Fig. 6B).

Figures 4, 7 and 8 show a deluxe power line filter designed for use at the radio or TV set for filtering out interference that cannot be tracked to its source. The two R.F. chokes used, in addition to filter capacitors, also make it ideal for installation on appliances that produce severe interference.

For the compact original model, we used a 2 3/4 x 2 5/8 x 2 1/8-in. LMB radio chassis box, punching a 1 1/8-in. hole in the top for inserting Amphenol's No. 61-F female receptacle (physically identical to Amphenol retainer ring type tube sockets). But you can house the filter components in any friction lid cannister such as those in which paste hand soaps and candy are sometimes packaged.

On one side of the box cover, make a 3/8 x 1/8-in. hole for fixture cord and the mounting screw for



**B** READY MADE FILTER (SEE SCHEMATIC NO.3)

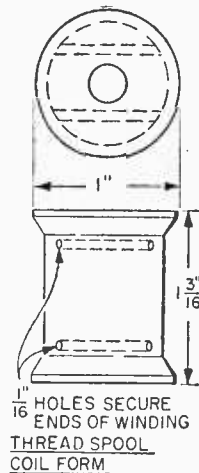
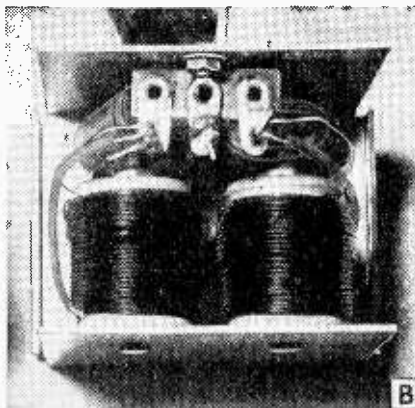
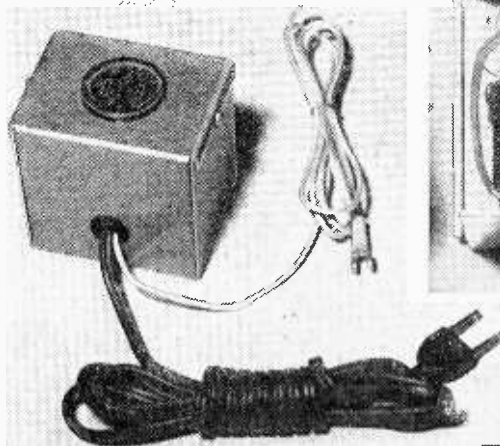
**6** Dual bathtub-type radio capacitors provide a ready-made filter. Line is connected to outer lugs, while center lug is grounded to housing of electrical device (see Fig. 6B).

a 3-lug solder tie-strip. Make two 1/8-in. holes on the opposite side of the box cover for mounting the choke coils.

For coil forms, use ordinary small thread spools. Drill two 1/16-in. holes in each spool as shown in Fig. 8 for anchoring the start and finish of the coil windings. Wind each coil with 18 ft. of No. 20 enameled magnet wire. Then insert the wire through one spool hole, allowing about 3 in. of wire to project. Bend this lead back to secure it on the spool, then wind on the magnet wire in fairly even layers. About 3 1/2 layers will result. Anchor the end of the coil in the remaining hole previously drilled in the side of the spool.

To keep the hole in the side of the spool from being covered up in the winding operation, we inserted a 1 1/2-in. finishing nail in it. When the

**7** A) This compact power line filter is installed between radio or TV set and convenience outlet. Ground lead is attached to water or radiator pipe (see Fig. 8).



**B)** Filter with cover removed. Choke coils are wound on ordinary cotton spools. Capacitors are paper tubular units terminated on 3-lug tie strip in foreground.

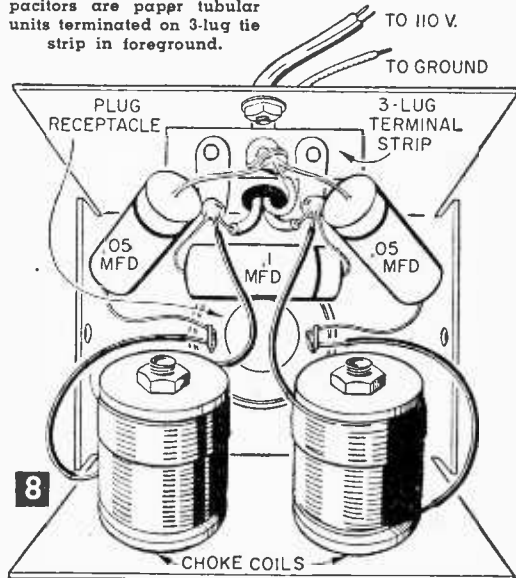
winding was complete, we withdrew and threaded the magnet wire in the opening to anchor the coil turns. You can mount the coils inside the box with 8-32 x 1½-in. brass or aluminum machine screws. Slip a ½ or ¾-in. washer on each screw before the nut, to compensate for the large hole in the thread spool.

Remove insulation from ends of magnet wire with a penknife or sandpaper before attempting soldering. The neat and rigid 3-lug tie strip provides terminal points for all loose components. Radio spaghetti insulation slipped over the bare capacitor pigtail leads will prevent shorts.

For use with a radio or TV set, the choke coils are more than adequate. However, they will heat up if circuit load exceeds 500 watts. So, if this type filter is installed on a heavy demand device such as a welder, the filter coils must then be wound with heavier, No. 12, 14, 16 or 18 gage magnet wire. Also, you'll need larger thread spools to hold 18 ft of the heavier gage wire. If space is no problem, you can use 1-in. dia. Bakelite tubing for the coils, and the 18 ft of wire can then be wound in a single layer.

All the filters we have described may show greater efficiency when the line cord is reversed in the outlet, and when the filter lead is grounded to a water pipe as well as the appliance housing. But remember, that a motor with defective brush holders or field winding may blow a fuse when an external water pipe ground is added. So, the motor short must be located and corrected.

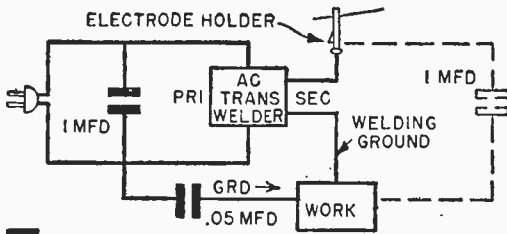
Two of the most insidious types of radio and TV interference stem from arc welders and neon signs. The filter circuit shown in Fig. 9 (a modification of that shown in Fig. 2) will often correct the trouble if you install it at the source. With an ac transformer-type home shop welder, attach a 1 mfd capacitor across the transformer



primary. Then connect the .05 mfd ground lead to the metal part being welded. A 1 mfd capacitor connected across the welding rod electrode holder and work (see dotted lines in Fig. 9) may further help to reduce interference.

Many neon sign transformers are made with built-in filters. As in Fig. 2, a capacitor of from .1 to 1 mfd is connected internally across the transformer's primary winding (Fig. 10). Another capacitor (.01 to .1 mfd) is connected from one side of the primary to an internal center-tap of the high voltage secondary and the metal transformer case. The case, in turn, is grounded to a water pipe.

If the transformer in question has developed an "open" capacitor, attach a mfd unit across the 115 volt primary line. Attach a .1 mfd from one side of power line to transformer case, scraping off the enamel to permit a soldered connection. Try grounding the case to a water pipe. You can also try reversing the primary line plug in



**9** FILTER FOR ARC WELDERS

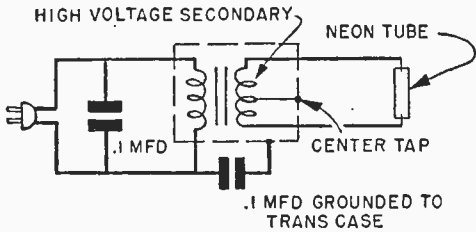
its outlet as previously suggested to reduce interference. This will often eliminate the last traces of trouble.

Because blinking neon signs usually denote a defective transformer, faulty tube electrodes or gas leakage, a filter may prove useless in such cases until a sign man is called to put the display in proper working order.

The capacitor values in the various filters outlined here have proved sufficient for average conditions. Where interference is extremely heavy, larger capacitor values may be substituted for further rectification.

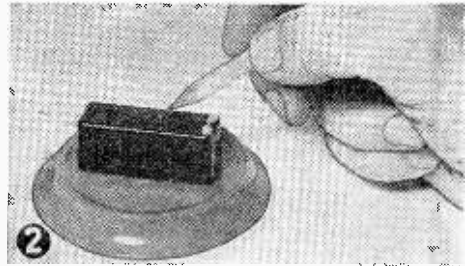
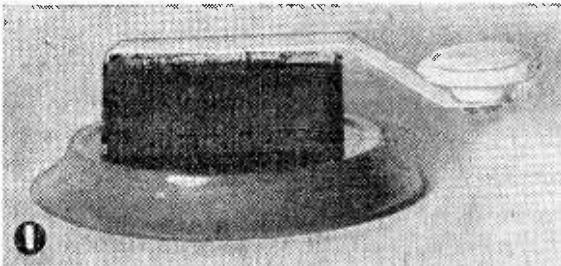
### Separate Loop Antennas

**W**HEN using a separate loop antenna with a portable receiver in a steel-frame building, place the loop near a corner of a window, not at the center. Try different loop positions with the set tuned to a weak station. The center of a steel-framed window is usually a signal dead spot.

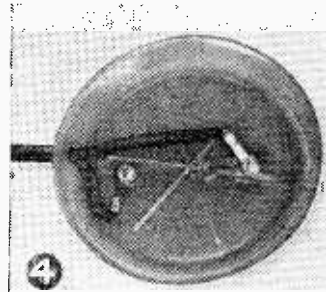
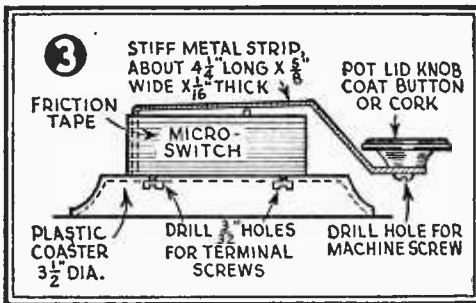


**10** FILTER FOR NEON TUBES

## Micro-Switch Telegraph Sounder



**I**F YOU send code by pressing the pin of a micro-switch (Fig. 2) as you would press the knob of a transmitting key, you'll note that it sounds like a Western Union telegraph sounder. Using this fact, you can make a simple combination sounder and key from a micro-switch, and a dime store plastic coaster, to use when practicing telegraph code.

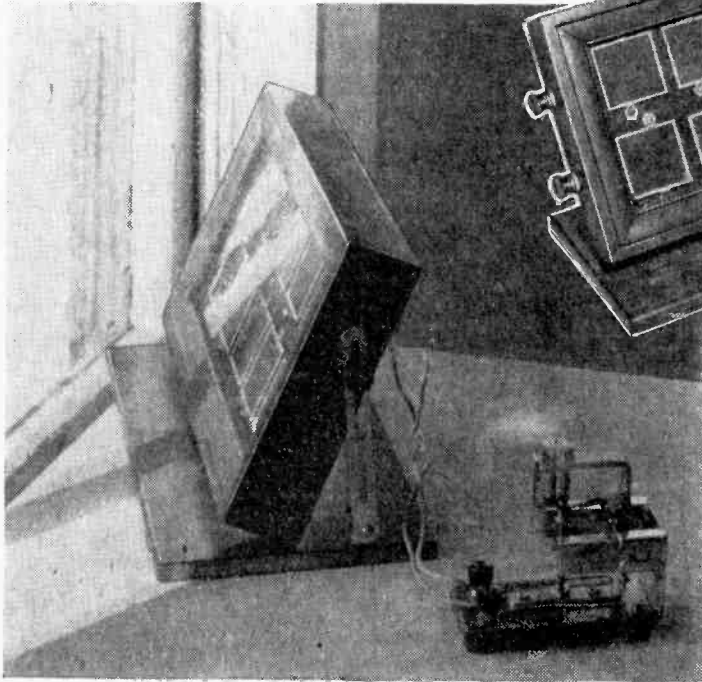


To make the instrument, mount micro-switch on bottom side of plastic coaster with 2 terminal screws on switch bottom. Coaster serves as a base for sounder and key and as an effective sounding-board to make clicks louder. To make a lever for switch, cut a strip of stiff metal about  $4\frac{1}{4}$  in. long x  $\frac{5}{8}$  in. wide, and bend as shown

(Figs. 1 and 3). Tape bent strip securely to rear of switch by winding 3 or 4 turns of electrical tape tightly all around switch. Knob for lever can be a pot lid knob, coat button, or a cork.

You can also use this device as a radio code practicing key by making wire connections to terminal screws on bottom of switch for a buzzer and a battery (Fig. 4). To do this, drill a  $\frac{1}{4}$  in. dia. hole through side of coaster as passage for wires.—ARTHUR TRAUFFER.

Solar battery at work operating small motor designed for small power output. Inset shows close-up of battery and its 10 self-generating selenium photoelectric cells.



Craft Print Project No. 251

electrically driven motor that can be run by the sun battery.

The battery itself consists of 10 International B-15 cells. Five of these cells are connected parallel in two groups, and the two parallel groups are then connected in series (Fig. 2). In bright sunlight (10,000 foot candles), this produces an open-circuit voltage of about .9-1 volt, using a high resistance Simpson Model 260 voltmeter. Measuring across the terminals to find current output we obtained 180-190 milliamperes, using the 0-500 milliamp position of the multimeter switch. This would be close to the short-circuit current, were it not for the low resistance of the meter. When a load is applied, there will, of

# Building a Working Sun Battery and Motor

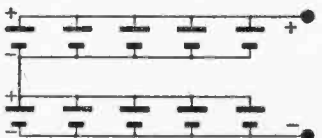
## The Solar Battery

ON pages 23, 24, 25 and 26, we showed you how to construct a small sun-powered radio project. Now let's try using larger size, self-generating photoelectric cells to produce a solar battery that will deliver greater electric power than our small radio required. How much electric power? Well, enough to run a small motor as shown in Fig. 1.

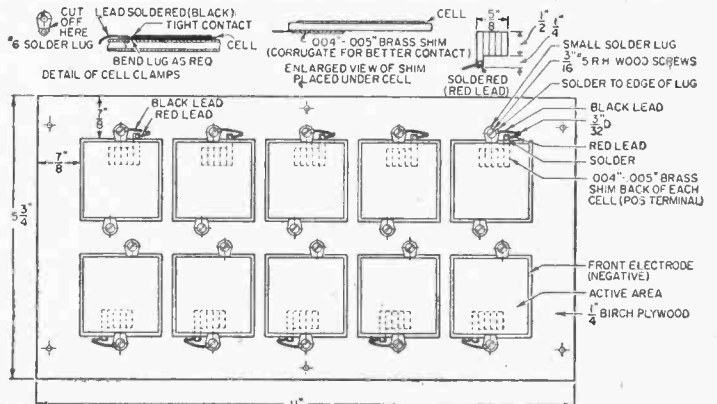
First, we'll show you how to build that sun-powered battery. Then we will explain the construction of the small,

course, be some voltage drop, just as there is in most electrical generators.

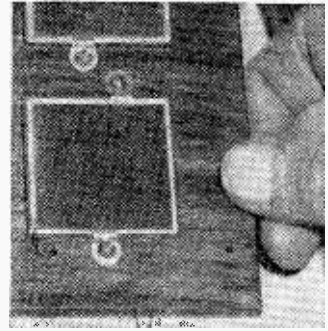
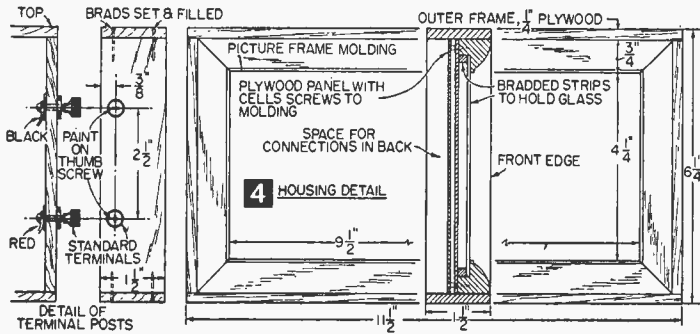
Since the B-15 photocells are supplied without leads, you will need to attach them to a mounting



2 SCHEMATIC OF SERIES-PARALLEL CELL CONNECTIONS. OPEN CIRCUIT VOLTAGE OF BATTERY, 9-1 VOLT. SHORT-CIRCUIT CURRENT, 180-190 MA.



3 10 CELL MOUNTING DETAILS, USING B-15 CELLS WITHOUT FIXED LEADS.



Closeup showing one cell attached to mounting panel.

#### MATERIALS LIST—SUN BATTERY

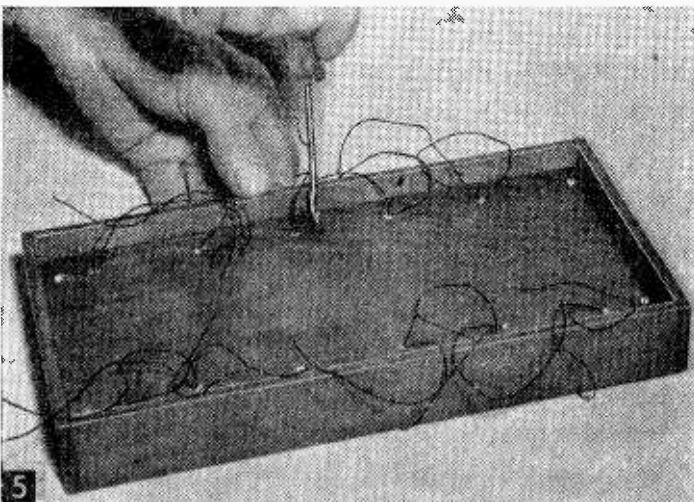
No.	Description	Use
1 pc	$\frac{1}{4}$ x $5\frac{3}{4}$ x 11" birch plywood	cell mounting board
1 pc	$\frac{3}{4}$ " wide, about 3' long unfinished picture frame molding	frame
2 pcs	$\frac{1}{4}$ x $1\frac{1}{2}$ x $11\frac{1}{2}$ " birch plywood	outer frame
2 pcs	$\frac{1}{4}$ x $1\frac{1}{2}$ x $5\frac{3}{4}$ " birch plywood	outer frame
1 pc	$\frac{3}{8}$ x $5\frac{5}{8}$ x 12" birch plywood	base
1 pc	$\frac{1}{8}$ x $6\frac{1}{4}$ x $11\frac{1}{2}$ " Masonite hardboard or plywood	back panel
10	International Rectifier Corp. self-generating photocells type B-15. Allied Radio, 100 N. Western Avenue, Chicago 80, Ill. Cat. 7E739, \$5.88 each. Do not come equipped with leads, use method shown in a drawing for mounting, or can be equipped with leads on special order at an additional cost.	cell
20	#6 solder lugs, Allied Radio Cat., 44N608, 30 for \$0.29.	cell clamps
10 ft	miniature vinyl covered #30, 7-strand tinned copper wire, half black and half red. Radio Shack Corp., 167 Washington Street, Boston, Mass. Alpha #2606 wire. Comes in 25 foot rolls. One red and one black roll, \$1.55 pp. in U. S.	cell leads
2	Jones Barrier terminal strips, type 10-140 (Allied Radio Cat., 41H805, \$0.56 each; Radio Shack Corp., Cat. 01-635, same price)	
2	terminal posts (Allied Radio Cat., 41H369, \$0.15 each)	
1	insulated thumb nut from an old B-battery	slide support
1	8-32 rh brass machine screw with nut and washer	slide support
1 pc	.065-.065 x $\frac{1}{2}$ x $4\frac{1}{2}$ " brass	slide support
1 pc	.065 x $\frac{1}{2}$ x $1\frac{1}{8}$ " brass	slide support bracket
1	$\frac{1}{8}$ " dia. rh soft iron rivet about $\frac{3}{16}$ " long	slide support
1	$\frac{3}{8}$ " #7 rh brass wood screw	slide support
2	1" brass butt hinges	
4	#5 fh wood screws $\frac{1}{4}$ " long	hinges to base
4	4.40 fh machine screws about $\frac{1}{4}$ " long with nuts	hinges to back panel
8	#2 or #3 brass rh wood screws $\frac{3}{8}$ " long	brass cover
	About 4 ft. #22 or #24 flexible insulated hookup wire	for inside connections
1 pc	glass to fit in frame rabbet	
20	#5 or #6 rh brass wood screws $\frac{3}{16}$ - $\frac{1}{4}$ " long	cell clamps
10 pcs	.004-.005 x $\frac{3}{4}$ x $\frac{5}{8}$ " brass shim stock (about)	cell contacts
	walnut oil stain, shellac, paste wax, brads, glue	

board with small clamps and contact strips (Fig. 3), so that flexible leads can be attached to the front and back surfaces for connections. While only 10 of these \$5.88 cells were used to make up our solar battery, the circuit output is somewhat marginal for use in such purposes as driving the small motor shown in Fig. 1.

If you can afford it, a total of 12 or 16 cells connected in the same series-parallel arrangement will give a good current increase and make the motor run with more speed and power. This motor, by the way, was designed so that friction at every point is reduced to a minimum, and it can therefore operate on the battery's low energy. Figure 1 shows the motor operating on a clear, sunny January day at an estimated armature speed of about 800-1000 rpm. Since the armature shaft must be supported in pivoted bearings to keep friction low, there is no shaft extension; instead, the power take-off is effected through a tiny gear train with a 2-1 ratio. This brings the fan speed in the test shown to around 400-500 rpm. Although the motor does not have much torque, it makes a striking visual demonstration of how sunlight can be converted to electricity.

#### Constructing the Battery.

After obtaining the cells and other components given in the materials list, secure the  $\frac{1}{4}$  x  $5\frac{3}{4}$  x 11 in. piece of smooth birch plywood on which you will mount the 10 cells. (If you plan to use 12 or 16 cells, in-



Fastening mounting panel into frame housing.

crease the mounting board size accordingly). Smooth the board up and then coat with walnut stain and two thin coats of shellac.

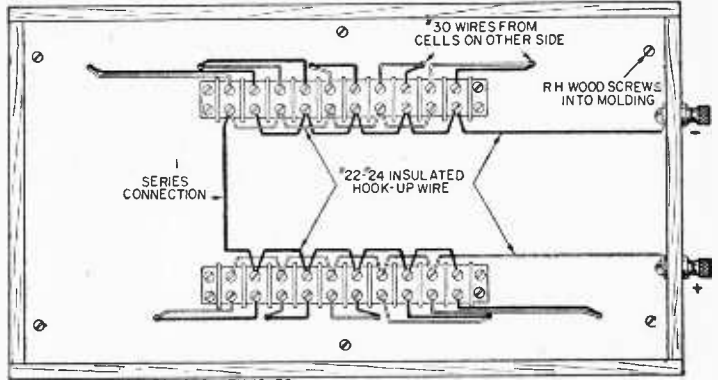
Each cell will need two clamps, made up as in Fig. 3 from #6 solder lugs, with their ends cut off and bent so they clamp down tightly on the aluminum frames of cells as shown. The front or sensitive side of the cell is the one with the brown finish; it has a narrow, brightly finished frame which is the front electrode. This front side of the cell is the negative and the back or underneath side of the cell is the positive polarity.

Plan out the spacing and mounting of the cells, and the attaching of the leads, as shown in Figs. 1, 3 and 4. Use vinyl-covered #30, 7-strand, tinned copper wire for the leads, with a red one for the positive side and a black color wire for the negative. Solder a black lead wire to one clamp of each cell contacting a front cell electrode. Make up pieces of shim brass to place under each cell as shown in Fig. 3, and solder a red lead to the projecting end of each piece of shim brass. After attaching leads and placing shim brass pieces under each cell as in Fig. 3, place cells over shim brass and screw down clamps to hold them in position. Take care to avoid having a negative terminal clamp shorting against the back brass piece or edge of cell, by placing the clamps so they bear only against the narrow aluminum-colored frame of the front cell surface.

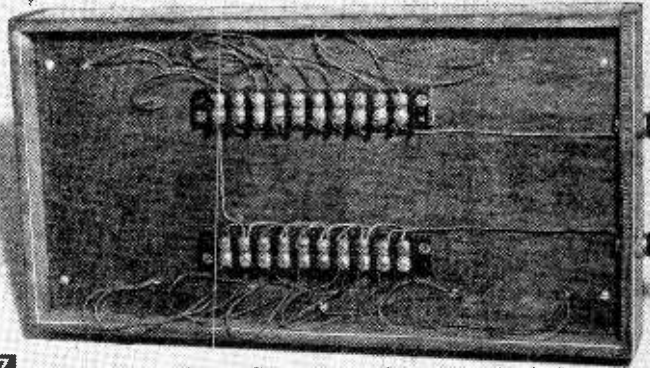
With cells mounted to board, you can feed leads through holes drilled in the board for them, carrying leads to back side of board for connections later on to terminal strips.

The next step is to make up the frame housing into which the mounting board for the cells will fit. As Fig. 4 shows, this housing is made up from picture frame molding and strips of birch plywood (which hold the glass) are attached to form a deeper area in which the wire connections can be made up. The Masonite hardboard backboard is attached, after you have completed the connections, to completely enclose the battery.

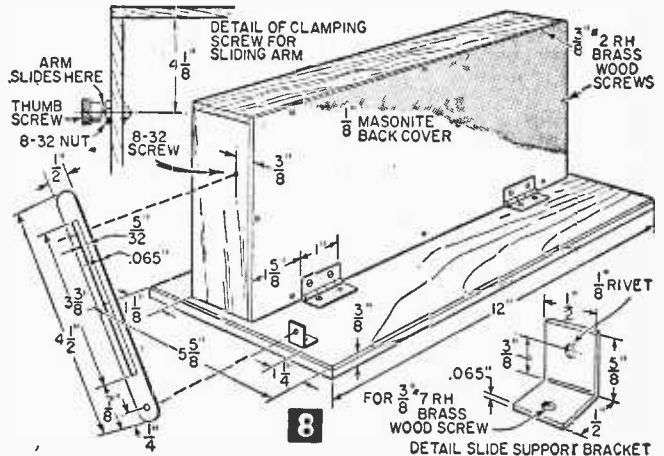
Screw the mounting board into the frame



**6** BACK PANEL WIRING CONNECTIONS

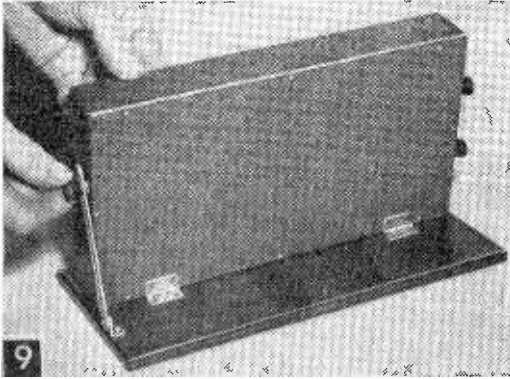


**7** Back connections made to terminal strips as detailed in Fig. 6.



**8**

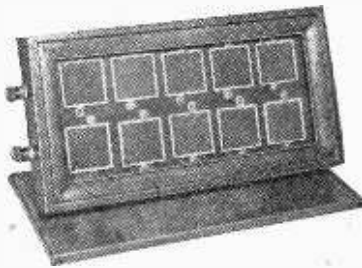
housing as shown in Fig. 5. For the connections on the back side of the mounting board, use two Jones Barrier strips of 10 terminal size or type 10-140, as shown in Figs. 6 and 7. Note that the leads from each group of 5 cells are connected to the screws of a strip. Wires are then used to connect all of black or negative leads together,



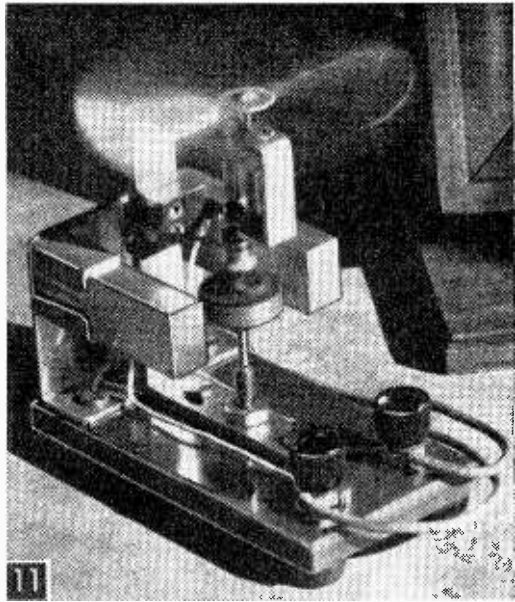
Back view of completed sun battery.

and another set of wires connect all red or positive leads to form a parallel bank of cells. The two groups of parallel-connected cells are then joined in series and two final lead wires go to two terminal posts at the end of the enclosure.

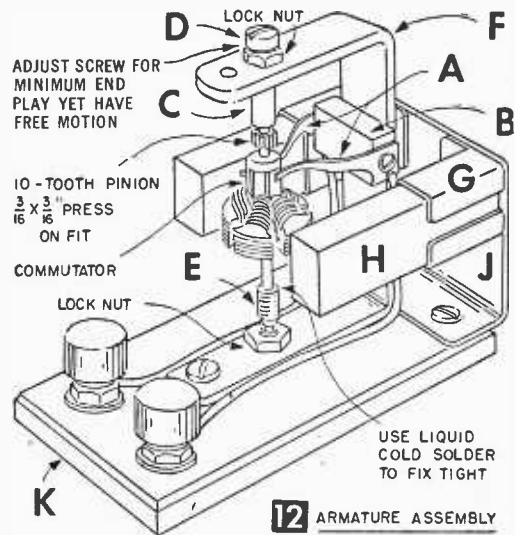
With your back panel connections complete, make up a base and hardboard backboard as in Fig. 8. Fit two small hinges to the base and backboard main unit and provide a slide fastener so that it can be tipped to meet the angle of the sun, as shown in Figs. 8 and 9. Finally, after careful sanding, coat all the woodwork with walnut oil staining, coat all the woodwork with wax. Then, after drying, apply two coats of shellac, lightly rubbing each after it is dry with fine steel wool, finish by waxing.



Front view of sun battery.



Solar motor in operation.



## The Solar Motor

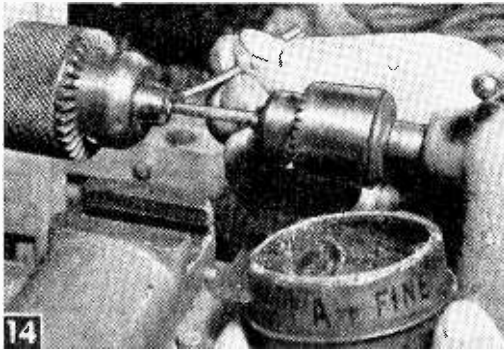
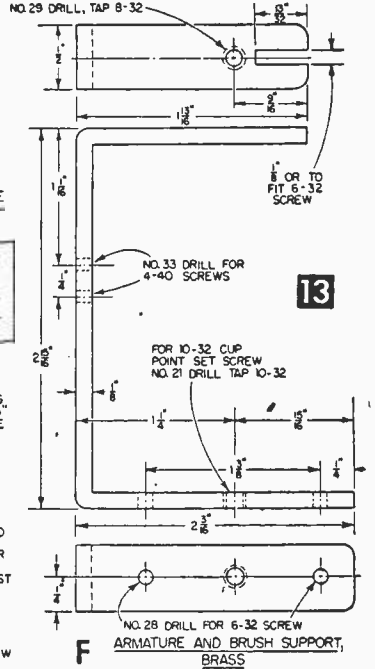
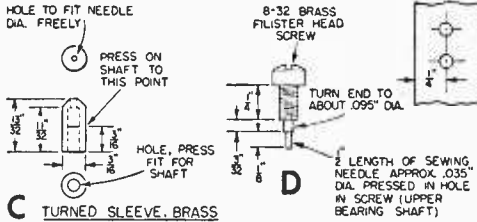
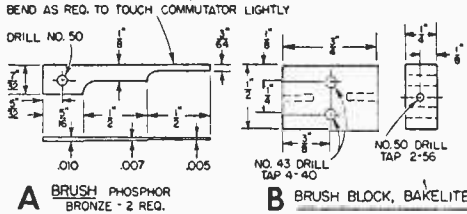
With the exception of the armature and bar magnets, the entire motor can be built in the home shop. The armature is taken from a kit sold by Lafayette Radio, New York 13, N. Y., listed as catalog #3113 for \$2.25. Although the kit contains all of the parts needed to make a miniature motor, only the armature, which has an excellent five-segment commutator, is used. The wound armature can be used as is, and in most cases will probably work all right. However, we found that by re-winding the armature with wire two sizes smaller (*Formvar* #33 magnet wire), the resistance was increased thus putting a lighter load on the battery. The armature, having but five coils which are easy to trace, makes it a simple matter to duplicate the method of winding with the smaller'

wire. Wind on the same number of turns as originally used and solder the start and finish ends of the coils to the commutator segments.

Make the armature and brush support (Fig. 13) next. Locate, drill and tap all the holes in the support and set aside while you make up the armature bearings. Since it is important the armature rotate with as little friction as possible, a single steel bearing ball of around .063 to .070 in. dia. is used as the lower armature bearing (Fig. 13). The steel ball can be taken from an old small or instrument type ball bearing by squeezing the outer race of the ball bearing in a vise until it cracks. For the ball retainers, lap and polish inside the cups of two cup-point,



hollow-head set-screws. Grip the setscrew in a lathe headstock chuck (Fig. 14) or a drill press and use a 1/8 in. dia. Bakelite or brass rod, shaped at one end to fit in the cup, to do the lapping and polishing. Set the 1/8 in. rod in a tail-stock chuck or, if you are using a drill press set the rod vertically in a drill press vise. Apply some fine

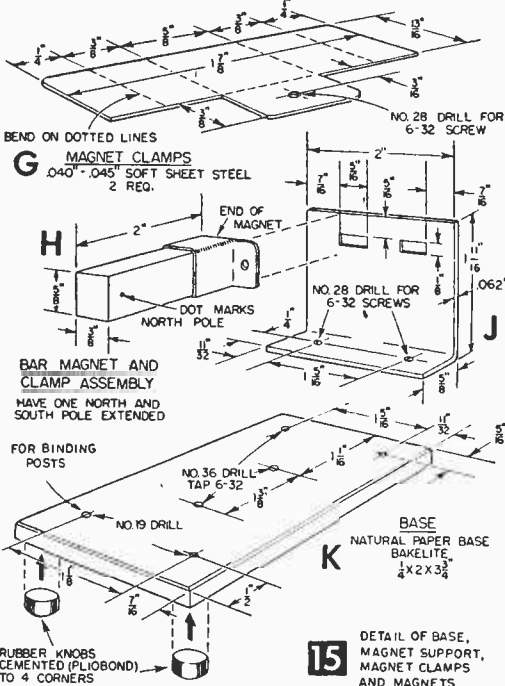


Applying fine valve-grinding compound to rounded end of Bakelite rod to polish cup of cup-point setscrew.

valve-grinding compound to the end of the rod and insert it in the cup of the revolving setscrew. Apply more grinding compound and repeat the operation until inside of cup has a smooth, highly polished surface.

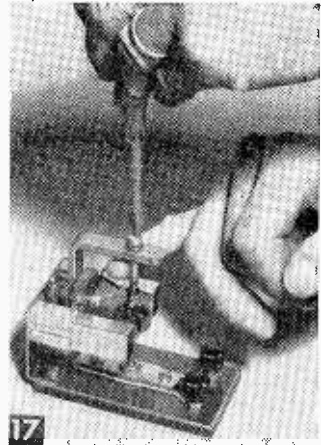
Fit one of the setscrews in the 10-32 tapped hole in the armature support with a nut so that it can be locked in place. Fasten the wrench-hole end of other setscrew to the lower end of the armature shaft with cold metallic solder that comes in a tube. Later, when the armature is assembled to the support, place the steel ball between the setscrews (Fig. 13E) to make the free-turning bearing. Before doing that, however, press a 10-tooth pinion gear, taken from an old clock, on the armature shaft to within 3/32 in. of the commutator. Then turn the brass sleeve (Fig. 13) and press-fit on the top end of the armature shaft. Also turn and drill a brass filister-head screw to take a 1/2 in. length of a large diameter (about .035) sewing needle (Fig. 13) and assemble the armature to the support.

Friction at the point of contact between brushes and commutator must also be kept at a minimum. To hold and insulate the brushes, make the brush block (Fig. 13) from Bakelite and fasten to the support with two 4-40 screws. Cut the brushes from a piece of phosphor bronze to the shape shown in Fig. 13, and carefully file or hammer them so that they taper to a thickness of about .005 in. at the ends. Use fine abrasive paper to make the surfaces of brushes that bear on the commutator smooth and frictionless as possible. Then bolt the brushes to the block with two 2-56x3/16 in. rh brass machine screws, and bend to shape as in Fig. 12 so that the ends of the brushes bear as lightly as possible on the



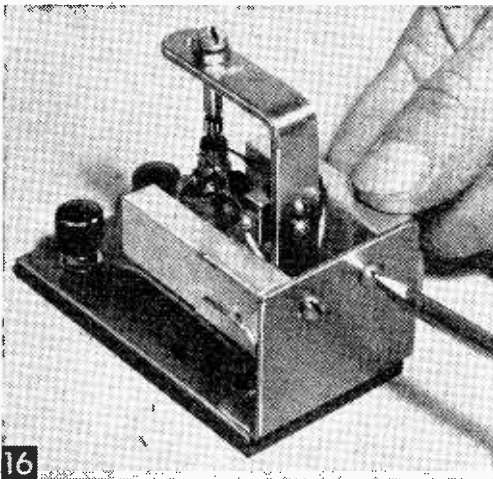
## MATERIALS LIST—SUN MOTOR

No.	Size and Description	Use
1 pc	$\frac{1}{4} \times 2 \times 3\frac{3}{4}$ " natural paper-base Bakelite	base
2 pcs	.062 x 2 x $2\frac{1}{16}$ " soft sheet steel	magnet support
2 pcs	.040-.045 x $1\frac{1}{16} \times 1\frac{7}{16}$ " soft sheet steel	magnet clamps
1 pc	$\frac{1}{8} \times \frac{1}{2} \times$ about 7" brass	armature support bracket
1 pc	$\frac{1}{16} \times \frac{3}{16} \times$ about 2" brass	fan unit frame
1 pc	$\frac{1}{16} \times \frac{3}{16} \times \frac{5}{16}$ " brass	fan unit frame
1 pc	$\frac{1}{4} \times \frac{1}{2} \times \frac{3}{4}$ " Bakelite	brush block
1 pc	$\frac{1}{8}$ O.D. x $1\frac{1}{16}$ " long brass tubing with I.D. to fit tightly on fan shaft. (May have to use solid rod stock and drill out center hole in lathe)	fan shaft spacer
1 pc	$\frac{3}{16}$ O.D. $1\frac{3}{32}$ " long brass rod	armature top sleeve
1	$\frac{3}{16}$ dia. about $\frac{3}{16}$ " long 10-tooth steel or brass pinion gear	
1	20-tooth pinion gear to mesh with above. Both gears may be taken from an old clock and bored out to fit	
1	$\frac{3}{8}$ " long x 8-32 brass filister head machine screw from a steel sewing needle .035" dia. and about $\frac{1}{4}$ " long	armature top bearing
1	8-32 brass hexagon nut	top bearing
1	$\frac{3}{16}$ " long 4-40 binder head or rh screw with washer	armature top bearing screw
1	.065-.070" dia. x $1\frac{1}{16}$ " long drill rod	fan unit
1 pc	about .030-.032" x $1\frac{1}{4} \times 3$ " sheet aluminum	fan shaft
2 pcs	.01 x $\frac{1}{32} \times 1\frac{1}{16}$ " phosphor bronze	fan
2 pcs	rubber bumper feet $\frac{1}{2}$ " dia. without screws	brushes
4	$\frac{3}{8}$ " long 8-32 fh brass machine screws	base
2	8-32 brass nuts and washers	binding posts
2	insulated thumb nuts from old B-Battery	binding posts
4	$\frac{3}{16}$ " long 6-32 binder head or rh brass machine screws	binding posts
2	$\frac{1}{4}$ " long 6-32 binder head or rh brass machine screws with nuts and lockwashers	support to base
2	$\frac{5}{16}$ " long 4-40 rh brass machine screws	magnet clamps
2	$\frac{3}{16}$ " long 2-56 rh brass machine screws with washers	brush block
1	armature from a miniature motor kit (sold by Lafayette Radio, 110 Federal Street, Boston, Mass., or 100 Sixth Avenue, New York, N. Y. Cat. #3113 \$2.25 for kit)	brushes
2	2 x $\frac{5}{8} \times \frac{3}{8}$ " permanent bar magnets (Lafayette Radio Cat. F 56 \$1.65 pr.)	
Misc.	#24 insulated hook-up wire, liquid cold solder (comes in tube) for fan, aluminum paint for magnets, Pliobond cement for rubber knobs. May need about 1 ounce of #33 Formvar magnet wire if armature has to be rewound (see text)	
1	steel ball about .063-.070" dia.	



Adjust bearings to the minimum amount of end play that will permit armature shaft to be spun freely when turned with your finger.

slotted holes in the support and assemble the entire magnet unit to the base. Then adjust the magnets as in Fig. 16 to provide an air gap of about  $\frac{1}{32}$  in. at each side of the armature core for the first test run. If the magnets you are using are stronger than the ones we used, the gap may



Adjusting bar magnets to give about a  $\frac{1}{32}$  in. gap on each side of armature.

commutator yet provide adequate electrical contact.

Now, make the base (Fig. 15), and bolt the support to it. Also make the magnet-clamps support and magnet clamps (Fig. 15). Set the magnets in the clamps so that one has the north pole extending and the other the south pole extending. Bolt the clamps to the clamps support with 6-32 screws, lockwashers and nuts through the

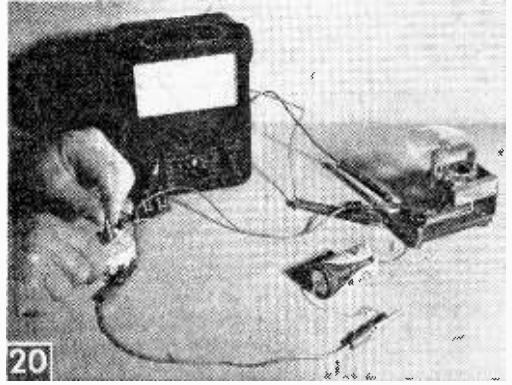
have to be increased for best starting and operating conditions. Too close a gap is undesirable for this type of motor because the magnetic attraction for the iron core may be too great for the motor to start with the current available from the sun battery. The wiring hook-up is simple, merely connect each brush to a binding post with #24 insulated hook-up wire. Adjust the bearings and brush pressure so that armature will continue rotating for several revolutions when given a quick spin with your fingers (Fig. 17). Apply a drop of clock oil to ball and top bearings.

Since it is not possible to have a shaft extension for power take-off with the pivot-type bearings used, a separate bracket to support a geared shaft and fan is bolted to the armature support (Fig. 18). Make the bracket pieces from a  $\frac{1}{16} \times \frac{3}{16}$  in. strip of brass, and bend to shape as in Fig. 19. Solder the two together and drill for the fan and gear shaft. Also drill and tap for the clamping screw. To assemble the shaft to the bracket, first drill out the bore on a 20-tooth gear for a tight fit on the brass tubing spacer. Place the spacer between the bracket in line with the holes drilled for the shaft and force the steel fan shaft through the tubing. If the press fit between shaft and tubing is not tight enough, tap the tubing with a centerpunch in one or two places. Cut the fan from sheet aluminum and drill for a press fit on the shaft. Use a drop of cold liquid solder to secure it to the shaft. Assemble the fan unit to the armature with a little play between the gears

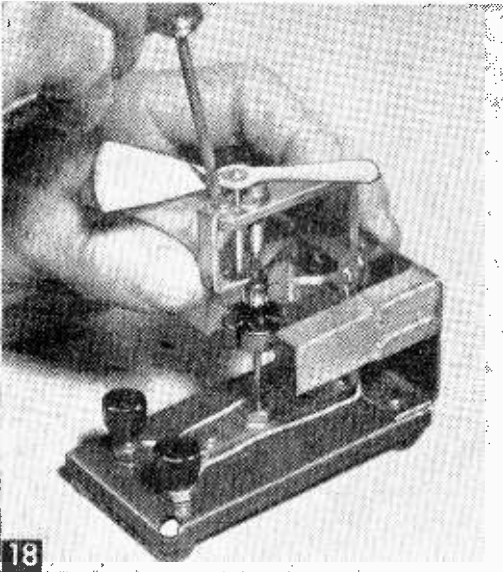
and fasten with the clamp screw as in Fig. 18, making sure the assembly turns very freely.

Now, give the motor a test and run-in on a single flashlight cell with a small rheostat connected in series to limit the input to about 1/2 a volt (.5 volt). Fig. 18 shows the rheostat being adjusted and a high resistance meter, like the Simpson Model 260, connected across the motor terminals to register the applied voltage. The meter selector switch is set for 2.5 volts scale.

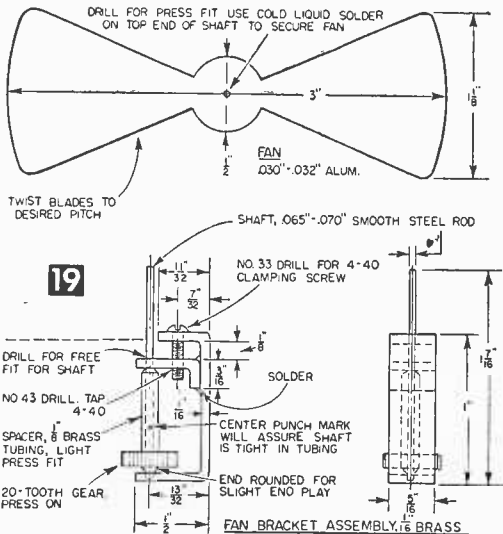
A test for current input should also be made. Place the switch on the meter to the 500 milli-ampere position and connect the leads in series with the rheostat and one line from the dry cell. In either the voltage or current test if the meter reads down scale, reverse the test leads. A read-



Using flashlight cell to test run completed motor with a rheostat connected in series to adjust voltage to 1/2 volt.



Clamping fan bracket to slotted end of armature support after gears have been properly meshed.

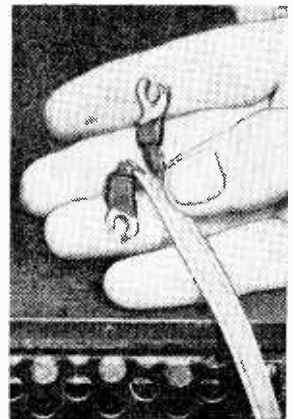


ing of around 90-100 milliamperes should be obtained if the motor is operating right and all parts turn easily. However, if the armature has not been rewound with smaller wire as suggested, the current will be somewhat higher. Allow the motor to run for an hour or more on the dry cell at .5 volts to run in the bearings and gears as well as better fit the brushes to the commutator. After this period if the motor seems to be working freely, try it on the sun battery in bright sunlight. While the battery may be operated under strong artificial light, such as a photo-flood lamp, it is not advised because the cells have a temperature limit of safety of 158° F. above which the cells can be permanently damaged. The use of a lamp may create an excessively high temperature and, except for very short periods, should not be used.—H. P. STRAND.

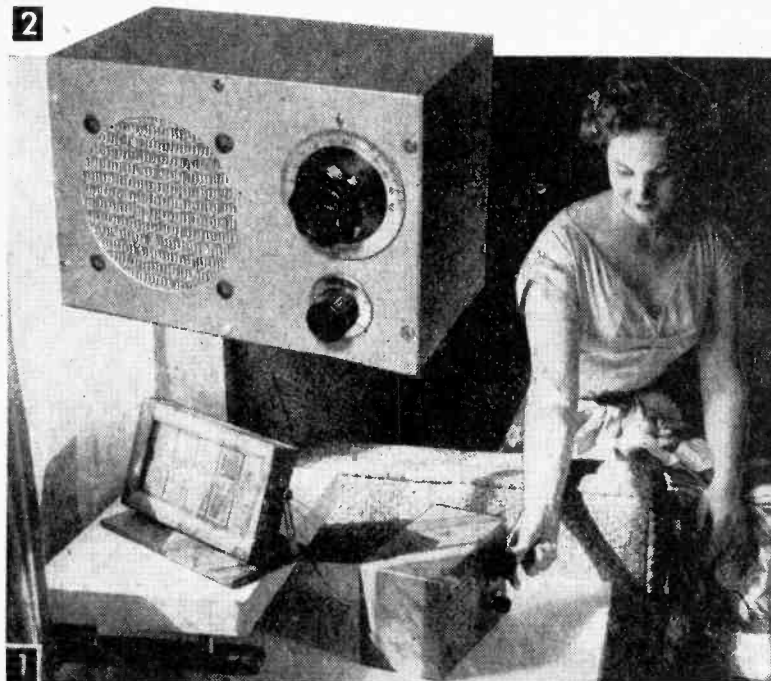
● Craft Print No. 251, in enlarged size for building the Solar Battery and Motor is available at \$1. SPECIAL QUANTITY DISCOUNT! If you order two or more craft prints (this or any other prints), you may deduct 10¢ from the regular price of each print. Hence, for two prints deduct 20¢; three prints, deduct 30¢, etc. Order by print number, enclosing remittance (no C.O.D.'s or stamps) from Craft Print Dept. R56, SCIENCE AND MECHANICS, 450 East Ohio Street, Chicago 11, Illinois. See coupon on last page of this handbook.

### Broken Leads Spoil TV

● If your TV picture is weak or flickers, with cross lines over the face of the tube, check the twin lead-in line connections on the back of the cabinet for breaks such as illustrated. In such cases the sound will often make crackling noises if there is intermittent contact at the break in the cable.—H. LEEPER.



2



Operating loudspeaker radio using sun battery (described on pp. 51-54) for power. Battery cells are reconnected in series to produce the more than 4 volts of power needed.

circuits, that we chose this easier-to-build version as a starter. Also, you will find that this circuit performs well in most locations. We found we could even get quite good performance in our location, simply by using a ground wire connected from a water pipe to the antenna terminal—though a better combination would be a good ground wire and about 20 ft. of insulated antenna wire.

#### Circuit Components.

For the transistors, Raytheon CK722 units were used because of low cost and availability. However, if you want to use a CK721 unit in the third or driver stage, you can get a volume increase. Actually, these CK721 units can be used in all three stages, but the added gain may be off-

set by increased noise level, and a tendency to distort at higher volume.

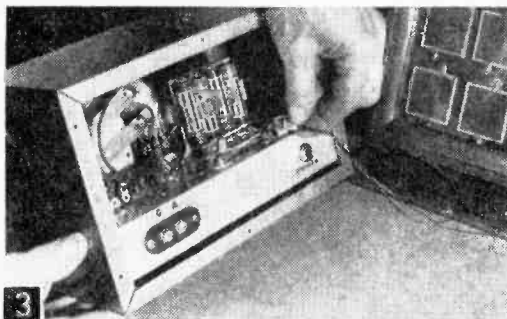
The 1N34-A diode acts as the detector and the signal is amplified by the transistors. The first transistor is capacity-coupled to the second transistor, using a 30 mfd capacitor for good low frequency response. The other stages are trans-

## Transistorized Sun Battery Radio

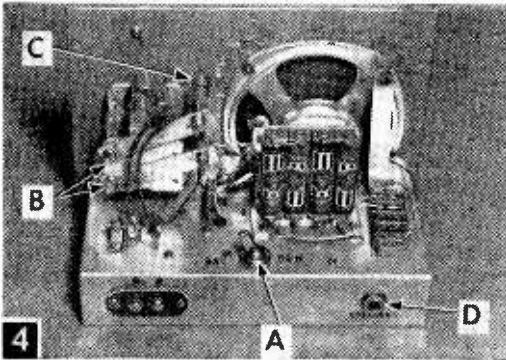
**T**HIS 5-transistor circuit makes an ideal companion for that sun battery constructed from plans on pages 51 through 54. If you built the sun battery, all you need do is reconnect its cells in series to get maximum voltage, then connect the battery to this radio set as in Fig. 3, and flip the switch on the chassis to SUN position. If you don't have the sun battery built or would prefer to power this set with dry cells (let's say it's an overcast day), then flip the switch to BAT position, as in Fig. 4.

Also note at D in Fig. 4 the jack built into the cabinet. This is marked SPEAKER. If you want to improve the tone quality of this set, you can plug an 8 or 10-in. external speaker—larger than the 5-incher built into this set—into this convenient jack. This automatically cuts out the set's 5-in. speaker and connects the larger speaker into the circuit.

Some of you may wonder why we used a tuned radio frequency circuit (Figs. 5 and 6), instead of the more sensitive and selective superhet circuit. The answer is that so many amateur builders have trouble building and lining up superhet



Radio can operate on either the four penlite cells shown, or with solar battery plugged into small jack (as is being done here).



Here receiver is shown complete except for installation of bracket and plug-in jack for sun battery connection. Note switch at A which permits changeover from penlite battery (BAT) to solar battery (SUN) operation. Also note jack plug (D) marked SPEAKER. External speakers larger than the 5-inch set speaker can be plugged in here, for improved tone reproduction. Details of B and C are shown below photo.

transistors, using 1000 ohm resistors and 60 mfd capacitors,

One word of caution—a transistor circuit like this which has a number of amplifying stages is a tricky job both to design and build, so follow specs carefully, particularly on the resistor values which are in some cases quite critical.

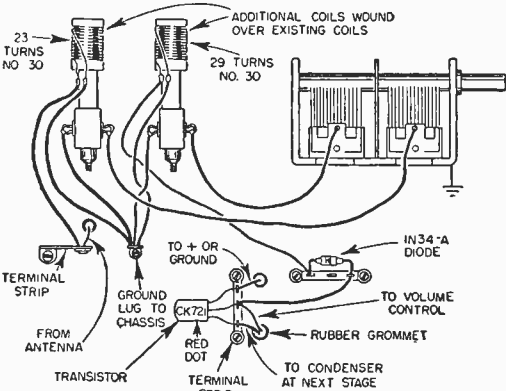
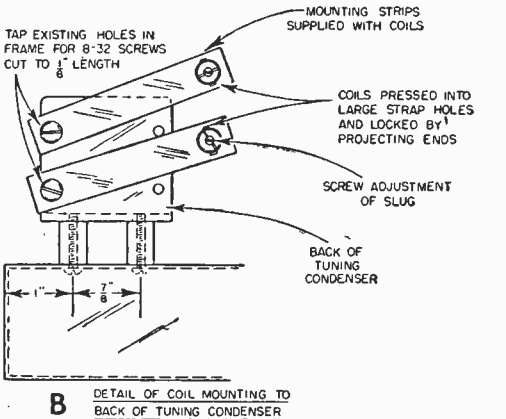
**Avoiding Transistor Troubles.** If you haven't tackled projects using transistors before, keep these points in mind. In comparison to a vacuum tube, the base of the transistor is similar to the grid, the collector is like the plate and the emitter is the cathode. In Fig. 6, the base is represented by a straight vertical line, the collector by a slanting line meeting the base, and the emitter looks the same except that it has an arrowhead. For identification of the three bare leads supplied with a transistor, you take the center lead for the base. The collector has a red dot opposite one of the outside leads and of course the other one is the emitter. This identification holds for the Raytheon CK721 and CK722 transistors used in this circuit.

Don't cut the transistor leads off any shorter than about 1 in., and use long-nosed pliers on each lead to be soldered so as to absorb the heat of soldering (hold the pliers on until the joint is cooled). Make any other connections to the same terminals with the usual hookup wire first, connecting the transistors last, with a quick application of heat and solder from an Ungar 23.5 watt soldering pencil.

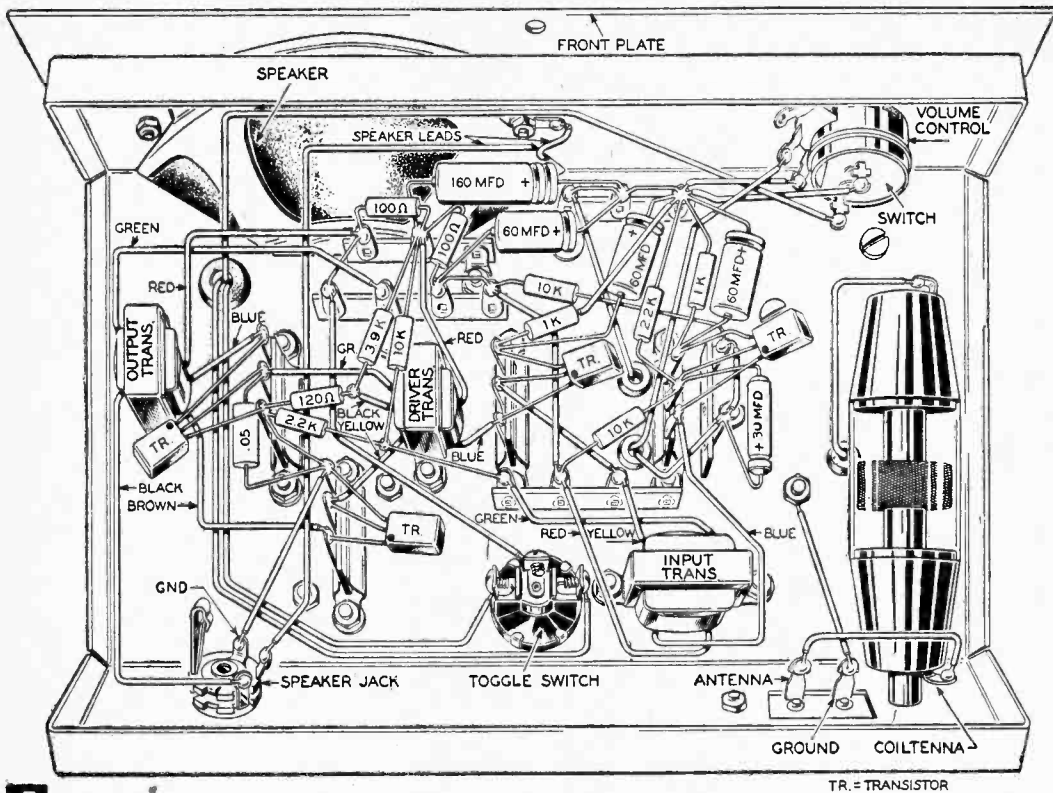
**Chassis Construction.** Figure 7 shows you the general chassis layout, location of holes, and mounting of some major components. For the cutaway in the front edge to allow the 5 inch speaker to set back as shown, use a hacksaw and dress edges smooth with a file. Locate and drill other chassis mounting holes as shown. Note the pipe spacers under the two-gang tuning condenser (Fig. 7D); these elevate the condenser so there will be room for the two dials on the front of the panel to operate.

The original front panel of the aluminum cabinet forms the radio panel. Cut out the large opening for the speaker (Fig. 7B) with a circle cutter and then drill holes for the condenser and volume control shafts. Note in Fig. 7D how the countersunk hole under the condenser shaft is used with a screw and pipe spacer to support the right side of the panel. Holes are also drilled for the speaker mounting screws at the approximate points shown, but measure the speaker you select for the exact locations.

Cement a piece of grille cloth over the back side of the speaker opening with Pliobond cement and then clamp speaker frame to the panel with



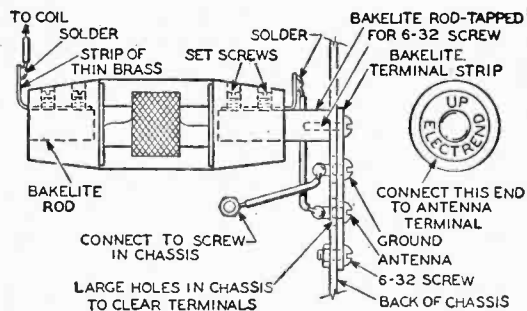
former-coupled for maximum gain. The position for the volume control (Figs. 5 and 6) serves to shunt the signal to ground through the variable resistance and thus vary the volume. The circuit uses a push-pull output stage and decoupling has been provided with two 100-ohm resistors and large capacitors so that there will be no feedback through the battery to cause distortion—which otherwise might have been a problem, since the battery impedance is common to all stages. The circuit is further stabilized by providing proper bias on the emitters of the second and third



## 5 PICTORIAL DIAGRAM

6-32 screws preferably of the low ornamental head type. Screws used at bottom of speaker should be long enough to pass through holes in chassis, so nuts can be attached to hold speaker in place. An aluminum strip brace supports the top end of the front panel as in Fig. 7C.

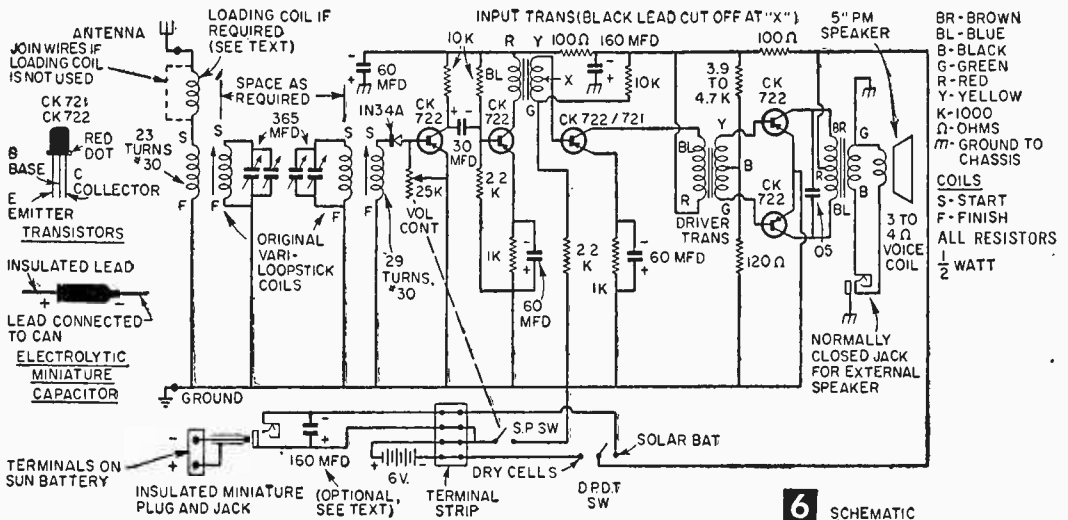
Of course, it's wise to make a trial layout with all your parts at hand before drilling holes for mounting. Most small parts can be mounted with 4-40 screws and nuts, or some 6-32 screws. Three-terminal strips are provided for the connections of each transistor and also the connecting wiring. Place additional terminal strips as shown to facilitate mounting of resistors and capacitors. Note in Fig. 5 that a loading coil is installed under the chassis and connected in the antenna line. This device, used with automobile whip antennas, seemed to help increase the pick-up and sensitivity of the radio, although it may not be needed in some locations. It is mounted by placing a piece of  $\frac{3}{16}$  in. diameter Bakelite rod in one end of the coil and clamping it to the coil end, with set screws provided, after pressing in a strip of thin sheet brass with the rod to use as a terminal. A 6-32 tapped hole is made in the free end of the rod and a screw used at the antenna-ground terminal strip turns in this hole to hold the coil secure to the chassis. At the other end of the coil, press in a short piece of the rod and also include another strip of brass.



**A** MOUNTING ELECTREND "COILTENNA" - A LOADING COIL TO IMPROVE SENSITIVITY. ANTENNA AND GROUND TERMINAL CONNECTIONS ALSO SHOWN.

Don't make any substitution for the coupling transformers specified, since these were a good match in the circuit. For all your wiring, use about #26 gage, flexible, plastic-insulated wire and make all connections that do not go to terminal screws tight with solder.

The two coils mounted to the back of the tuning condenser (Figs. 4C and 8A) are the r.f. transformers. Make these by taking two standard Grayburne ferri-loopsticks or antenna coils (sometimes called Vari-Loopsticks) and wind on additional turns of wire (Fig. 8A). On one unit, wind 23 turns of #30 enameled wire right over the cardboard tube that covers the existing wind-



The audio amplifier portion of this circuit was developed with the assistance of Raytheon Mfg. Co., engineering department.

**MATERIALS LIST—TRANSISTORIZED SUN BATTERY RADIO**

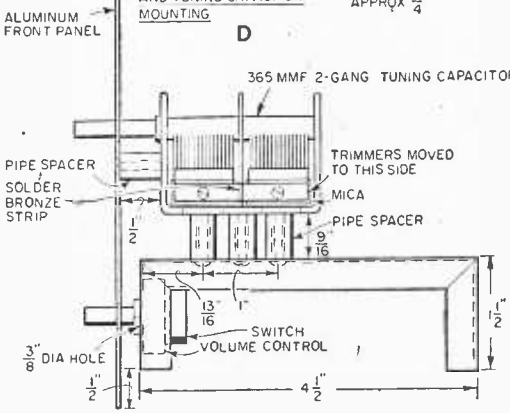
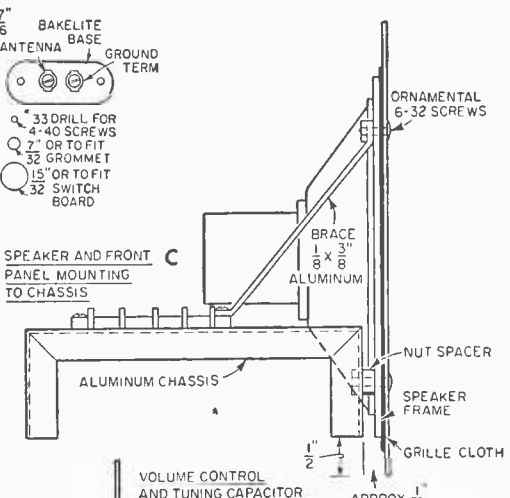
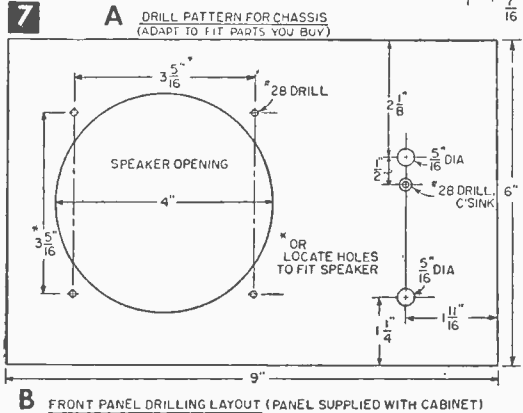
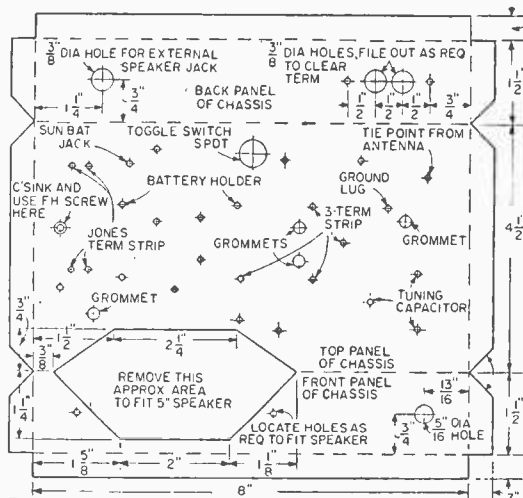
No.	Description
1	alum. hammertone gray cabinet 5 x 9 x 6", ICA 29801
1	alum. open end chassis 4 1/2 x 8 x 1 1/2"
1	5" PM speaker with 1.47 oz. magnet
1	tuning condenser, two gank 365 mmf. each section, miniature size Lafayette Radio MS-142
1	tuning dial 2 3/4" dia. 180° markings ICA type 2171
1	volume control knob (National HRS-4 or any similar type for 1/4" shaft)
1	battery holder for transistor circuits to take 4-Z cells or 9R cells Lafayette Radio MS-172
1	S.P.D.T. toggle switch 3-6 amperes
1	sub-miniature jack and plug for sun battery. Lafayette Radio MS-282 (jack) MS-281 (plug)
1	jack and plug for external speaker. Switchcraft Littell Jax Type 12-A (jack) Type 250 (plug)
2	Grayburne Vari-loopsticks with ferrite adjustable cores
1	barrier type terminal strip, 4-terminals, Cinch-Jones 4-140
1	2-terminal strip for antenna-ground connections
1	Sylvania 1N34-A diode or equivalent
1	Raytheon CK721 transistor
4	Raytheon CK722 transistors
6	chassis terminal strips or tie points, Cinch-Jones 2003, 3-terminal
1	volume control with attached S.P. switch 25,000 ohms, 1/4" shaft
1	chassis terminal strip, 1 lug Jones Type 51
1	chassis terminal strip, 2 lug Jones Type 52
4	chassis terminal strips, 3 lug Jones Type 53
1	AR 119 transistor output transformer (Lafayette Radio)
1	AR 109 transistor driver transformer (Lafayette Radio)
1	AR 129 transistor input transformer or can use AR 109 (Lafayette)
1	160 mfd. 6 volt electrolytic capacitor
3	60 mfd. 6 volt electrolytic capacitors
1	30 mfd. 6 volt electrolytic capacitor
1	.05 paper capacitor
<b>RESISTORS 1/2 watt (K-1000)</b>	
3	10K 1 120-ohms
2	2.2K 1 3.9K
2	1K 2 100-ohms
1	Electrend "Coiltenna" antenna loading coil (if desired for experimenting)
4	Burgess 9R cells or can use Z cells
<b>MISCELLANEOUS</b>	
4	rubber grommets for about 3/16" hole
1	pc. alum. about 1/16 x 3/8 x 3/4" (battery holder bracket)
1	pc. alum. about 1/16 x 1 1/2 x 7/16" (bracket for sub-miniature jack)
1	pc. alum. 1/16 x 3/8 x 3/4" (brace for front panel)
3	pipe spacers 7/16" long to pass 6-32 screws
1	pipe spacer 1/2" long to pass 6-32 screws
Misc. screws, nuts, hook-up wire, grille cloth, piece 3/16" dia. Bakelite rod for "Coiltenna" etc. Lafayette Radio, 110 Federal St., Boston, Mass., or 100 Sixth Ave., N. Y. 13, N. Y., can supply all the above electronic parts	

ing, making the turns flat and even. Solder an insulated flexible lead wire to the start and finish of the new coil, about 4 to 5 in. long. This will be the new antenna coil as indicated. Wind the coil counter-clockwise facing the open end of the coil form. For the other unit, likewise equipped with an additional coil, use 29 turns of the same size wire. Transparent Scotch tape will hold the turns of wire in place.

Mount the coils to the condenser with the flat mounting straps provided with the coils, as shown in Fig. 4B. Make the ground connections to a terminal solder lug attached to the chassis with a screw and nut. The other ends of the coils go to the points indicated in Figs. 4C and 6. In deciding whether to use the start or finish ends of the coils to terminal points, examine the original windings; the end which goes in under the coil in each instance is the start end of that winding and the end of the new winding which starts at the adjusting screw end will be the start of this winding. Fig. 8A shows where to connect start and finish ends.

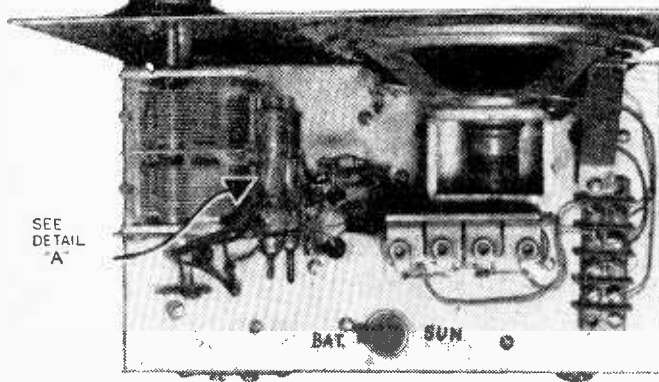
Their placement or position inductively couples these two coils together but you'll need to experiment with moving them either closer or further apart to find the best operating position. After the set is wired and battery cells are switched in the circuit, alignment can be carried out by adjusting the parallel condenser trimmers to the best positions on the high frequency end, and adjusting the slugs in the r.f. coils for the low frequency end.

With the particular tuning condenser used, the trimmers came at the left side of the main unit, which made them difficult to get at. With a pair of sharp diagonal pliers, I clipped off the projecting bits of steel holding the bronze flat spring of the trimmers in the slot, so the unit could then be carefully lifted out of place. At the opposite (right hand) side, a slot in the frame and tapped holes already provided in the insulating pieces accommodate the trimmers. The flat bronze strip

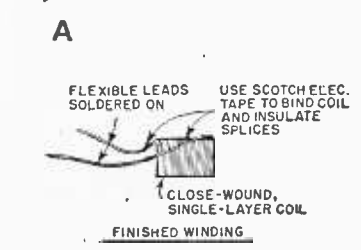
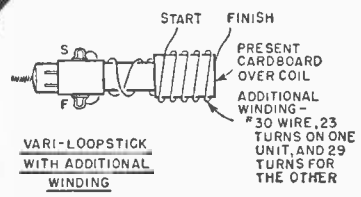


is then placed in the slot, the mica insulating separators placed between the spring and the flat base part of the fixed condenser plates and a drop of solder used at top and bottom edge of the spring to hold the assembly in place tightly (as is shown in Fig. 7D).

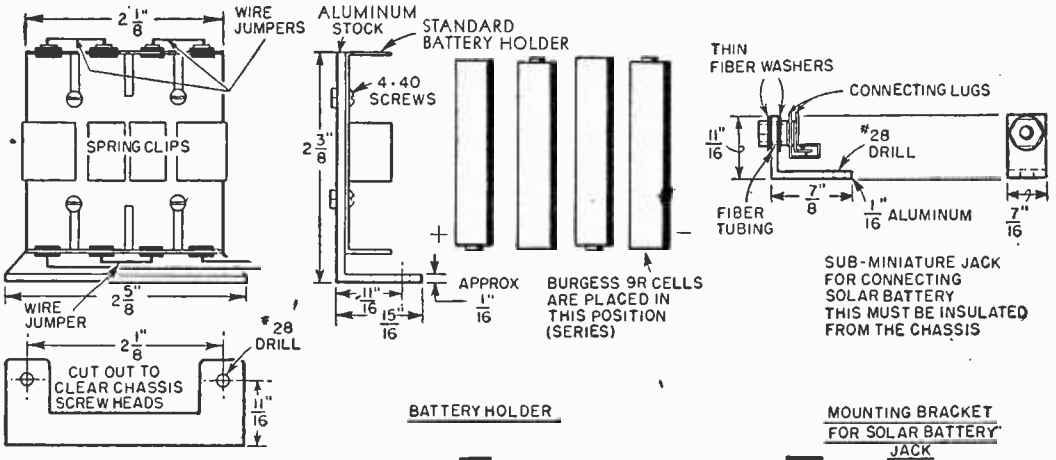
When all wiring is completed and checked carefully, attach the transistors to their terminal strips, and solder in the diode. Watch for the red dot marking on the transistors; this indicates the lead at that side is the collector. (A reversed connection can damage the transistors). The diode is marked on the side with a vertical



**8** Top view. Note that first transistor and diode have been placed next to coils and condenser. Construction and mounting of coils is detailed here at A and also in Fig. 4B and C.







straight line and an arrowhead meeting the line. The line indicates the cathode end. Connect this end to the coil as shown in Fig. 6.

Distortion develops easily in transistor circuits, especially where a number of them are involved. This can be due to a defective transistor and substitution or changing them around in the circuit may disclose where the trouble is located. Before installing any transistor, however, check it with a tester, one such as that described on pages 128 through 131 of this handbook. Frequently, a mismatch between stages also causes distortion but if you use the specified components and connect them properly, you shouldn't have this trouble. In developing this circuit, I used earphones at each successive stage as it was added, to check for distortion and thus be able to localize it.

Since the first transistor and the diode are in the space between the tuning condenser and the battery cells on top of the chassis, connections to the coils will be short and convenient. The battery holder for the dry cells is constructed as shown in Fig. 9 and installed as shown in the photos.

After building the set as shown in Figs. 4 and 8, I decided to add the miniature jack for connection of the sun battery as shown in Figs. 3 and 10. Make sure the jack is insulated from the chassis by the fiber tubing and washers shown; otherwise plugging in the solar battery would result in shorting out the S.P. switch. Connect the jack to the two screws indicated in Fig. 6. Use the terminals of the jack which connect to the neck or input sleeve and the larger of the two springs which is at the bottom. Connect the plug to two small insulated wires that go to the solar battery. Make sure you get the positive wire connecting that terminal of the sun battery to the positive terminal of the strip through the jack. Otherwise, a reversed connection could ruin the transistors.

**Performance Data.** If you run the radio off the four penlite dry cells connected in series, you'll get a total of 6 volts and the current drain

from the cells will average around 7-12 milliamperes so that these cells will last quite a while. You can, however, substitute a large 6-volt battery for longer life if you wish.

If you want to power the set with the sun battery, reconnect the sun battery cells in series. That is, connect the red lead from one cell to the black lead of the next one and continue this to the last cell. The red lead left over goes to the plus or positive terminal post and the black one goes to the minus or negative post. In bright sunlight, you will get about 4.4 volts from the solar battery, which powered this radio quite well.

If the radio tends to "motorboat" when on sun battery operation, add a 160 mfd electrolytic condenser across the sun battery jack, as shown in Fig. 6. Be sure to match up the plus and minus connections on the condenser with the plus and minus on the jack.

The article which begins on the next page details an even more compact sun battery with higher voltage, which you can mount right on top of the radio shown here.—HAROLD P. STRAND.

### Hood for Phono Needle

- To protect easily-damaged record player needles when moving the player for any reason, slip an empty film box over the head of the stylus.—H. LEEPER.

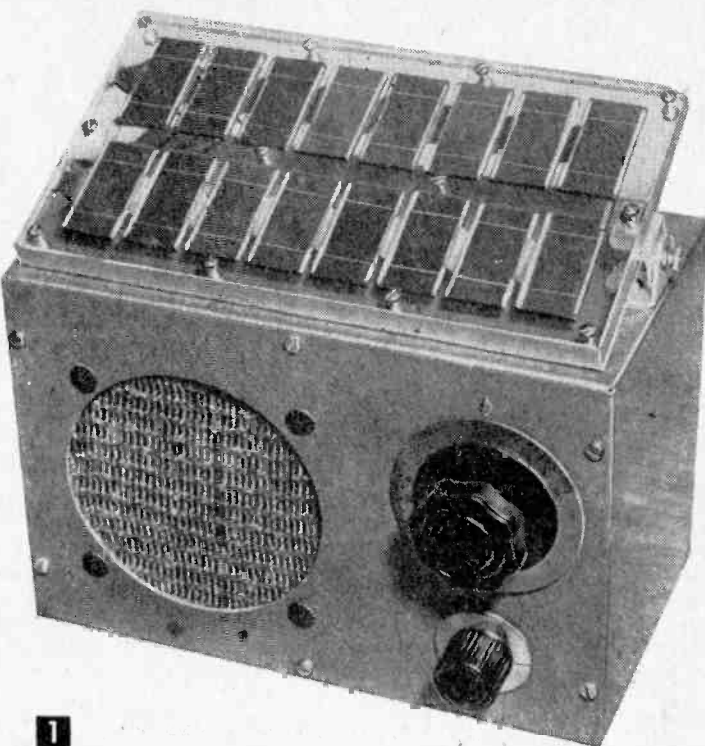


A solar battery of 16 selenium cells exposed to sunlight, powers this small transistor radio. On overcast days, a switch in back of the radio throws a bank of 4-penlite cells into the circuit to operate the radio.

**P**ERCHED on top of a small radio as shown in Fig. 1 this solar battery makes a real conversation piece. More important, however, is the fact that it operates the radio quite well, as you can proudly demonstrate to your friends. Simply passing your hand between the cell battery and the sunlight will immediately cut down appreciably the loudspeaker volume.

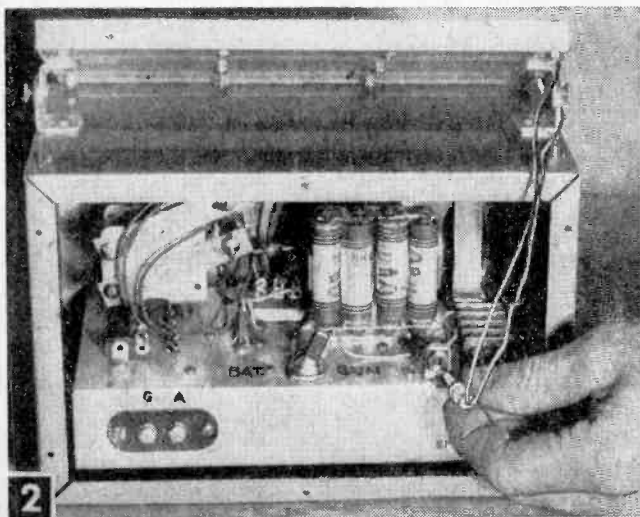
This neat 16-cell battery is the latest in a series of solar-power designs we have had specially developed for you radio experimenters. On pages 23 through 26, we showed you a simple 4-cell sun-powered head-phone radio, and a separate 10-cell solar battery that could be used to power either a toy-size motor (as shown on pages 54 through 57) or a loudspeaker radio (as shown on pages 58-63). That same portable transistor sun battery radio forms the basic unit for this new and more efficient 16-cell battery.

The battery itself uses 16 self-generating, selenium, type



**1**

## 6-Volt Solar Battery for Loudspeaker Radios



**2**

1B-10 photocells, which are series-connected and fitted into a neat plastic enclosure. Each cell measures  $\frac{7}{8} \times 1\frac{1}{16}$  in. and will deliver about 12-15 milliamperes in bright sunlight. When all 16 cells in series are exposed to bright sunlight, only the voltage is multiplied and you'll get a no-load voltage of about 7-7.5.

With the load of the radio this voltage drops as expected to 5-5.5 volts. (Since a class B amplifier is usually employed in these small sets, the volume setting will affect the current draw).

**Silicon Versus Selenium.** For those wealthier readers who have been clamoring for a solar battery which uses *silicon* instead of selenium type

Plugging in jack connecting solar battery into the radio circuit.

cells, we developed the experimental one described in the accompanying box copy. In brief, the \$82 worth of *silicon* cells will operate the small transistor radio shown but at a reduced volume due to the lower voltage. The 10 series-connected *silicon* cells used (Fig. A) produce about 3.4-3.8 volts at open circuit. This compares to a 4.4-5.0 volt output from the 10 series-connected *selenium*-cell battery (cost of cells—\$58) we showed you on pages 51-54, and the 7-7.5 volt output of the 16 selenium cell battery (cost of cells—\$39.20) shown in Fig. 1. Connecting cells

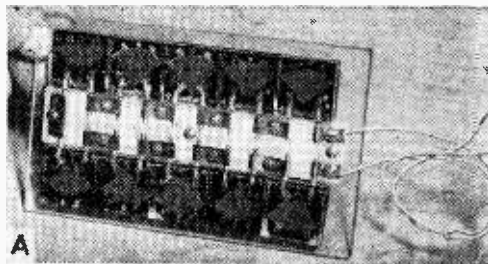
in series increases the voltage, but the current (ma) remains that of one cell. However, the increased efficiency of the silicon cells is due to the current (ma output) which with the voltage forms the *power output*. The P-100 Silicon cell with only .25 sq. in. area will show about .27 ma short circuit current in bright sunlight. The B-15 selenium cell with 2.25 sq. in. area will only deliver 20-22 ma of current under the same conditions. The 1B-10 Selenium cell (our latest battery) with 1.26 sq. in. area shows about 12-15 ma in a short circuit test.

## Why Not Use Silicon Cells?

Silicon photocells convert 11% of the solar energy they receive directly into electrical power. Selenium cells convert only 1-2%. But silicon cells at this time cost considerably more than the less efficient selenium type. If your wallet has that comfortably full feeling, however, you may still want to try building a solar battery with silicon type cells, along the lines shown in Figs. A and B adding as many cells as you need for voltage requirements.

Table A shows you the results you can expect to get with the silicon cells, compared to the results we obtained with one of the two selenium cell batteries we have built.

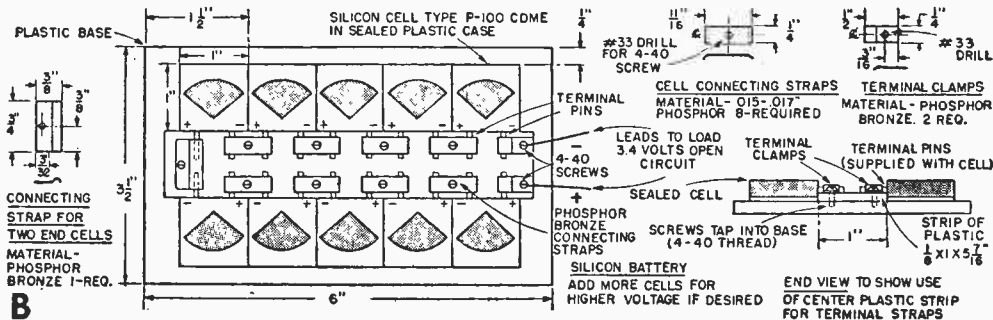
From Table A it can be seen that the silicon cells with only .25 sq. in. area have greater efficiency both at the short circuit output and the condition with the 100 ohm resistance test load. However, the open circuit voltage of the silicon type is somewhat less than for selenium. As the load conditions are reduced, there seems to be but little difference in values obtained. We also found that the short circuit current as measured across one selenium cell was about 20 milliamperes, whereas, in the series connected group of 10 cells this was reduced to about 12-14 milliamperes, indicating a somewhat high internal resistance in the cells. This compares with a reading of about 27 ma. for the short circuit current of the silicon cell and about the same when in the series connected group of 10 cells. In general, however, the lower cost of the selenium cells offsets some of these advantages and more cells can be used if required to meet specific applications.

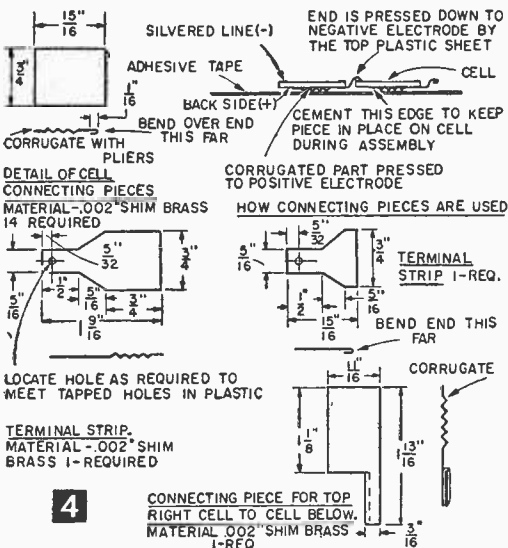
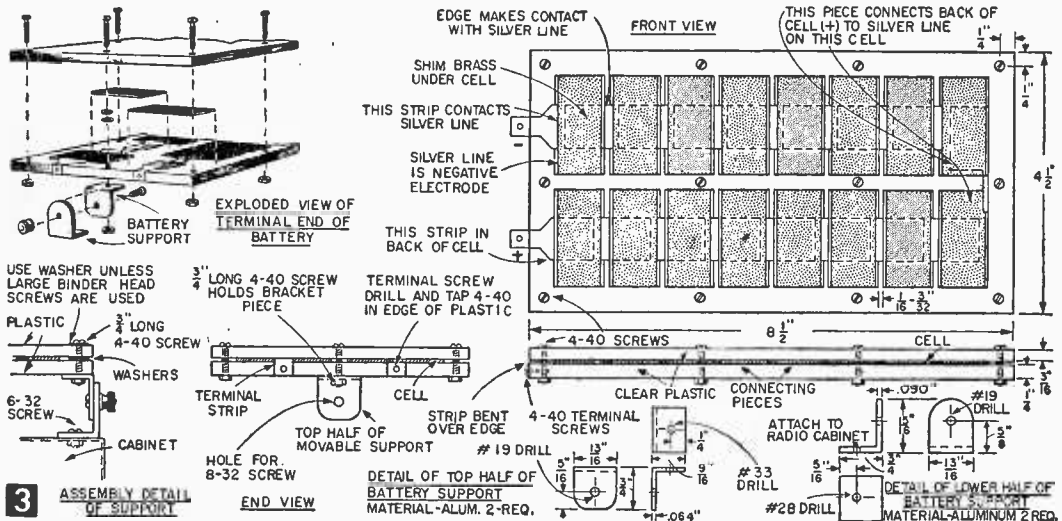


**A** Solar battery which uses 10 series-mounted P-100 silicon cells. These wedge-shaped cells are individually sealed in clear plastic and equipped with terminal pins marked plus and minus.

**TABLE A—COMPARISON OF TWO SOLAR BATTERIES IN OUTPUT**  
Photo Flood Lamp for Illumination  
**SILICON P-100 CELLS 10 IN SERIES**

Cost	Output Tests	Test on 5-transistor Radio
\$8.20 ea.	Open circuit volts 3.6	ma. Worked well but insufficient volume
<b>Total \$82.00</b>	Short cir. current 27	
	With 100-ohm load—volts 1.9	
	ma. 19	
	With 500-ohm load—volts 3	
	ma. 6	
	With 1000-ohm load—volts 3.3	
	ma. 3.3	
	Area of silicon cell—.25 square inches	
	<b>SELENIUM B-15 CELLS 10 IN SERIES</b>	
\$5.88 ea.	Open circuit volts 4.4	About the same as above
<b>Total \$58.80</b>	Short cir. current 12	
	With 100-ohm load—volts .9	
	ma. 9	
	With 500-ohm load—volts 3	
	ma. 6	
	With 1000-ohm load—volts 3.6	
	ma. 3.6	
	Area of selenium cell—2.25 square inches	





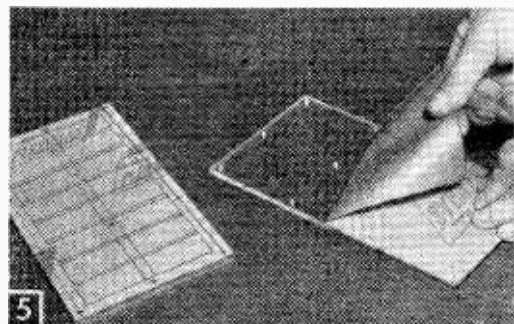
Reception on our loudspeaker radio, using the new 1-cell selenium battery, was very good with maximum volume just under that obtained with the four penlite cells on which this radio can also operate (Fig. 2). An adjustable mount allows you to tip the battery to meet the sun's angle. Two leads go from the plus and minus battery terminals to the sun connections of the radio, through a miniature plug-in jack (Fig. 2).

Place the pieces of  $\frac{3}{16}$  and  $\frac{1}{4}$  in. clear sheet plastic together and drill the required holes (Figs. 3 and 4). Drill through both pieces so that holes for bolts will line up properly. Don't peel off the paper protection that comes on the plastic until the holes have been drilled, to avoid scratching the surface (Fig. 5). From then on, handle the clean, polished plastic surface with care.

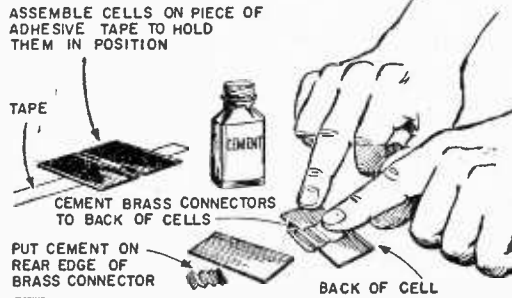
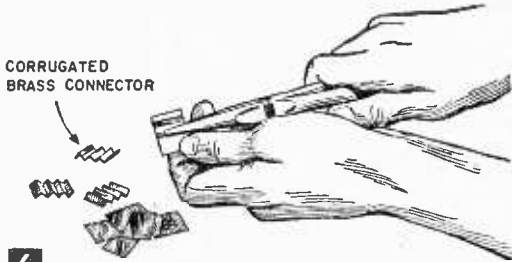
Make up the pieces of .002" brass shim stock as in Fig. 4. These will connect the cells together in series. Also make up the two pieces used for

#### MATERIALS LIST—6-VOLT SOLAR BATTERY

No.	Description
1 pc	clear Lucite or Plexiglas $\frac{1}{4} \times 8\frac{1}{2} \times 4\frac{1}{2}$ "
1 pc	clear Lucite or Plexiglas $\frac{3}{16} \times 8\frac{1}{2} \times 4\frac{1}{2}$ "
	The above pieces can be supplied by Forest Products, Inc., 131 Portland Street, Cambridge, Mass., for \$2 postpaid in U.S. and cut to size.
16	International Rectifier 1B10 selenium photocells; Lafayette Radio, 110 Federal Street, Boston, Mass., or Allied Radio, 100 N. Western Ave., Chicago 80, Ill., \$2.45 each. Brass shim stock .002" thick, enough to make the connecting pieces between cells and terminal strips as per drawings. Sold in auto supply stores for shimming bearings, etc. Comes in various-sized sheets.
10	4-40 binder head machine screws $\frac{5}{8}$ " long with nuts (clamping screws)
2	4-40 binder head machine screws $\frac{3}{4}$ " long with nuts (clamping screws) (Can also use round head screws with washers)
2 pcs	sheet aluminum $.090 \times 7\frac{1}{8} \times 1\frac{3}{4}$ " (radio case supporting pieces)
2 pcs	sheet aluminum $.064 \times 7\frac{1}{8} \times 1\frac{3}{4}$ " (top sections of battery case supports)
2	8-32 rh machine screws $\frac{3}{8}$ " long (adjustable support joint)
2	knurled thumb nuts from old dry cell (adjustable support joint)
2	6-32 rh machine screws $\frac{5}{16}$ " long with nuts (support to radio case)
2	4-40 rh machine screws $\frac{3}{16}$ " long (terminal screws)
1	plug to fit miniature jack on chassis
	About 12-14' of #26-28 flexible insulated wire. Glass-type Scotch adhesive tape #27 (radio supply stores)



Peeling paper backing off plastic after drilling of holes has been completed. Note on block at left how positions of photocells were penciled in, to make sure holes would be clear of cells.



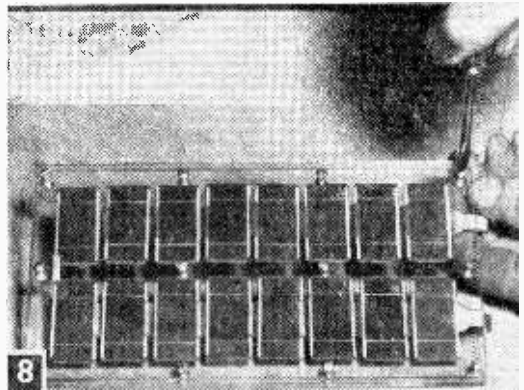
**7** ASSEMBLY OF CELLS

leads from the last two cells to the terminals. The back surface of each cell is the positive electrode and the narrow silvered line on the face side is the negative. For the series connections, you will connect the back side from one cell to the silvered line of the next and so on until all 16 cells are joined.

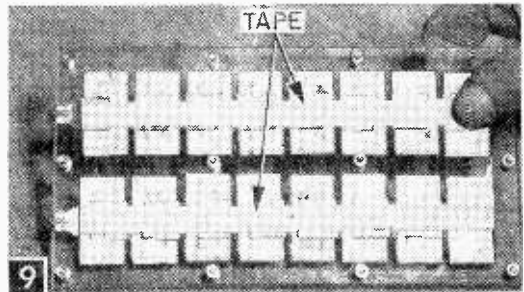
Since soldering might ruin the cells, the pieces of brass are first corrugated to make a good spring contact (Fig. 6) and then pressed hard against the cells by placing them between the two pieces of heavy plastic and tightening 12 clamping screws with nuts. Before assembling the cells, tack brass piece onto each cell with a little Pliobond cement at edges or corners only as in Fig. 7. Then assemble a row or group of 8 cells on a strip of glass adhesive tape; this holds them in position with the proper spacing between cells. Next assemble the second row of 8 cells on a strip of tape. Then place the two strips in position on the sheet of  $\frac{1}{4}$  in. plastic. Make sure the ends of the brass pieces are just bearing on the silvered lines and that all cells are clear from the holes for the bolts. Then put on the top plastic piece. Tighten the screws in the center first and gradually apply pressure with the others (Fig. 8) until the two plastic sheets are evenly compressed and plastic is not distorted from too much pressure at one point. There should be an even gap all around between the plastic of just under  $\frac{1}{16}$  in., which should result in clamping brass contact pieces to cell electrodes very tightly.

Incidentally, Scotch brand #27 glass adhesive tape used under the cells (Fig. 9) is a heat reactive tape that cures itself to surfaces from the action of heat, such as that from the sun.

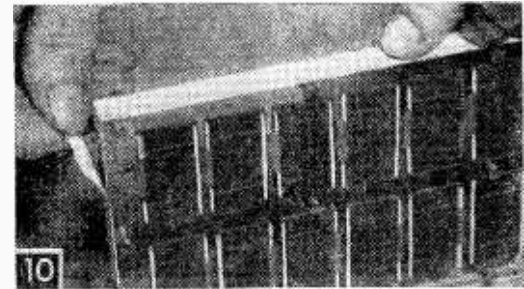
The brass terminal strips which come out between the plastic sheets (at the right in Fig. 8)



**8** Tightening two pieces of sheet plastic together, after cell strips have been placed between them.



**9** Bottom view of battery. Note tape strips on which each row of eight cells was mounted before placing between plastic.



**10** Apply woven glass adhesive tape to edge of plastic.

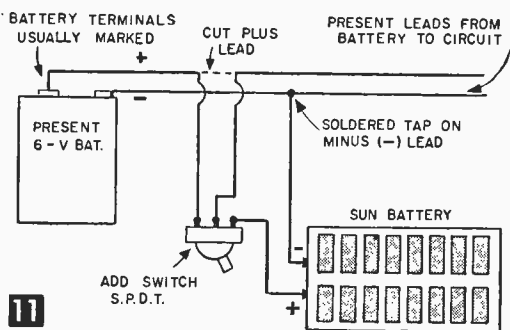
are cut off as required to meet the two holes drilled and tapped in the edge of the  $\frac{1}{4}$  in. plastic. Drill holes in the ends of the brass strips and use short 4-40 brass roundhead screws and washers as terminals. Mark the terminal having the strip coming from under the cell plus (+) and the other terminal minus (-).

To seal the battery parts against moisture, apply a band of the  $\frac{1}{2}$  in. Scotch #27 tape around the edge (Fig. 10). Coat this tape with aluminum paint for an attractive finish. Make the plus and minus markings at the terminals on this tape with black paint.

Figure 3 shows how angle bracket pieces are made from aluminum stock to provide an adjustable support holding the solar battery to the top

of our radio. One angle piece is fitted under the screw and nut at each end of the battery at the center. Corresponding angle pieces are attached to the cabinet top with screws and nuts, and 8-32 screws with thumb nuts from an old dry cell complete the assembly.

Figure 2 shows how two small flexible leads are carried from the battery terminals to make a plug and jack connection to the radio. This jack was detailed in the original project on building this radio (p. 63, this handbook). Note that the positive lead has a knot for quick identification as the positive lead. This polarity must be carefully observed in making the connections to the plug so that the positive side will go to the same side of the circuit as is supplied by the dry cells when the switch is on the BAT (battery) side. Once these connections at the plug have been

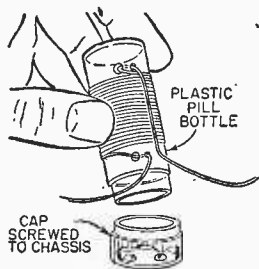


made and found correct, the polarity will always be right when the plug is inserted in the jack.

If you want to use this solar battery on a transistor radio of commercial make now powered by a 6-volt dry cell battery, make up a stand which will provide a separate unit of the battery. Most such commercial radios use quite small plastic cabinets so it might not be practical to mount the battery to them as we show it. If you try it, be careful to connect the sun battery to the radio with the correct polarity (Fig. 11). Otherwise, the transistors may become ruined by reversed polarity.—H.P.S.

### Pill-Bottle Coil Forms

• The plastic pill bottles used by the local drugstore to dispense prescriptions are useful to the electronic experimenter as coil forms. They are available in ¾ and 1-in. diameters and several different lengths for approximately 5¢ each.



Their non-hygroscopic qualities and inert characteristics make them ideal for electronic uses, and the semi-hard plastic provides some "tooth" to hold the wire when the winding is being

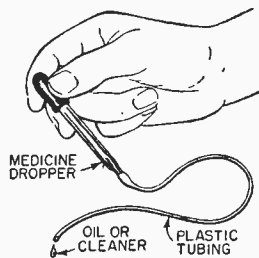
done. The containers can be easily cut with a coping or hack-saw or even a very fine-toothed carpenter's saw, and are easily drilled with a hand-drill. The pressure-fit caps can be installed for mounting purposes on the chassis with a small brass machine screw. Thus, when pruning coils to hit a certain frequency range, only the soldered wire ends have to be disconnected and the coil may be readily slipped off the cap.

When the winding is satisfactorily completed, a few swipes of coil dope (Quartz Q) will stabilize the characteristics of the inductance. Since the cement or dope may tend to soften the plastic material, use it sparingly so that the winding will bed itself into the form but not change the inductance too greatly.

While their use in variable frequency oscillators is not recommended, these coils have been tried with good results in a Clapp oscillator, so presumably the "Q" of the material must be fairly good.—R. L. PARMENTER.

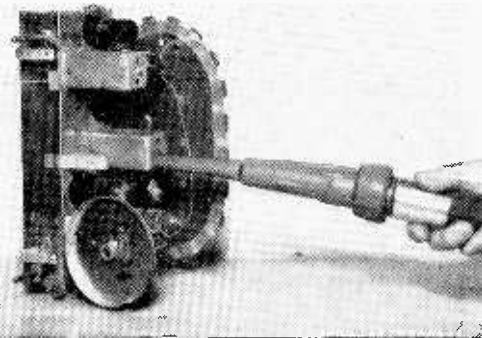
### Flexible Radio Tool

• Attach a short length of plastic tubing to the fine point of an eye dropper to construct a tool for reaching the remote controls of a radio or TV set. Use tool to apply liquid cleaners or lubricants, or to treat variable capacitors with a cleaner.—H. LEEPER.



### Nozzle Cleans Hard-to-Reach Places

• An inexpensive milking-machine inflation, when slipped over the end of the metal tube on a vacuum cleaner, makes a handy nozzle for cleaning a radio chassis, cabinet, or wherever the regular vacuum hose fixtures cannot reach. Made



of rubber, the inflation is flexible and will not scratch or cause shorts or shocks. Inflatons are available at many hardware stores, in all farm supply stores, and from Sears Roebuck, and Montgomery Ward.—ARTHUR TRAUFFER.

# Combination Intercom-Radio Set

For party line service *and* music, you need only two or more crank-type telephones, an ac-dc receiver and hookup wire

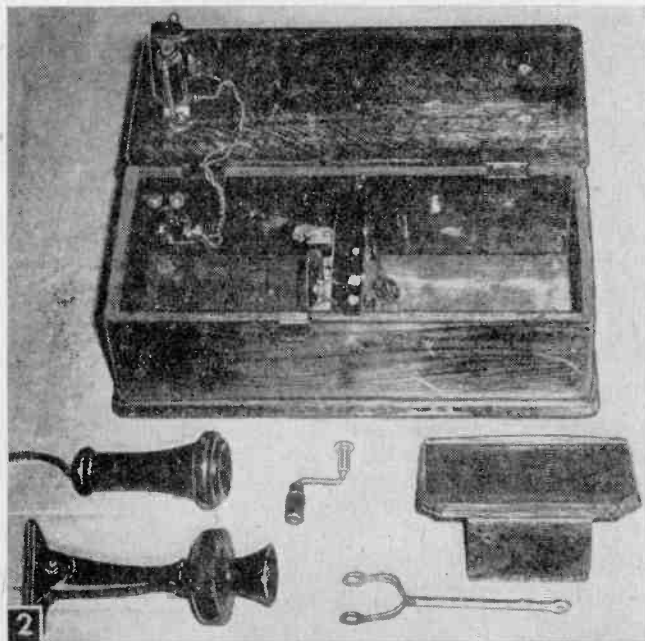
By THOMAS A. BLANCHARD

THE quaint rural crank-type telephone is rapidly vanishing from the American scene. Interior decorators have been buying up these bits of Americana and converting them into costly antique conversation pieces such as Spice Cabinets, Pin-Up Lamps, Liqueur Chests, etc. Here, we have used one of these antique telephones as a novel radio cabinet while preserving its original function as an intercommunicating device. Two or more of these wall phones may be rewired as in Fig. 5 and used to provide party line service (Fig. 1) between the several floors of the home; or home to garage or barn.

Since most every home has a small table-model radio set of the ac-dc type that has been set aside because of a broken cabinet, missing knob, or a minor circuit defect, we



Rural crank-type telephone houses radio. Youngster is listening to other member of family through intercom hook-up of old telephone.



will make use of such a set. If you do not have one of these radios you can pick up a traded-in set at your local appliance store for a couple of dollars. Readers who desire to put an old set into good working order will find complete data in Vol. 3 of Radio-TV Experimenter published by S&M and available for 50¢.

The wall telephone used was obtained from Telephone Repair & Supply Co., 1760 W. Lunt Ave., Chicago 26, Ill. The price of the phone is \$5 if picked up at the warehouse. If shipment is desired add \$2 for packing, plus postage on 20 pounds to your zone. Since many of these phones have seen 50 years service, both cabinet and exposed metal parts (Fig. 2) require refinishing in most instances.

To refinish the cabinet remove the exterior metal parts, hinge screws from the door and wood screws hold-

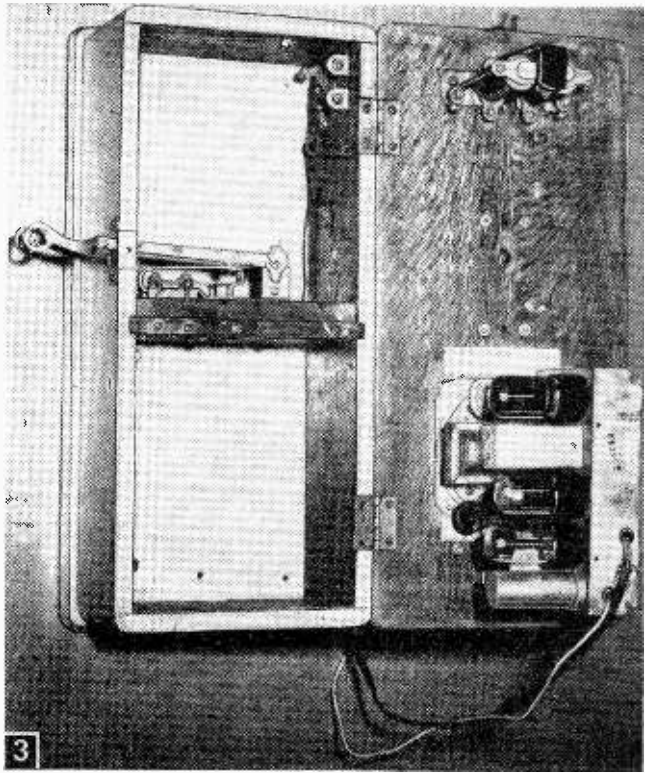
Wooden telephone cabinet and metal parts in "as purchased" condition.

ing the back of the cabinet. Strip off the old finish with paint and varnish remover of the 15% phenol type. Do not use a powder-type caustic paint remover mixed with water because it may warp the solid oak cabinet. Using an old brush, flow the remover on the wood and wait about a minute for the old finish to wrinkle. Then lift off the varnish or paint with a putty knife. Repeat the treatment again, this time wiping off any of the old finish remaining with steel wool. Then rub the wood with a rag soaked with turpentine to neutralize any phenol remaining in the wood grain.

**Radio Installation.** Because of the thousand and one shapes of radio chassis in existence we can not cover the installation of each. However, the following suggestions will take care of any and all sets. The total interior space available is  $4\frac{3}{8} \times 6\frac{1}{2} \times 16$  in. A removable shelf (Fig. 2) divides the cabinet into two compartments. With the set shown, it was not necessary to remove this shelf. However, if the radio chassis will not fit into the lower compartment, remove all of the shelf except the small strip required to support the phone hook switch. In fact, all of the shelf may be removed by mounting the switch on a small metal bracket. Small table sets have the speaker mounted to the chassis. To fit within the phone box it is usually possible to leave the speaker intact. However, if you are posed with a mounting problem, remove the speaker from the chassis and extend the wires connecting speaker to set. In this way, the speaker can be mounted in the front, top or side of cabinet where it fits most conveniently.

If, as in our case, the set is small enough to mount directly on the cabinet door (Fig. 3), the old radio cabinet may be used as a template for drilling the tuning and volume control shafts holes and location of the large speaker opening. Place a sheet of paper over the front of the old radio cabinet, and trace position of openings. Then transfer the hole locations to the door of the phone cabinet. In our conversion, the speaker opening was made with a "fly cutter" set for a  $3\frac{1}{4}$  in. dia. hole (Fig. 6). The round opening is optional since a square sawcut opening or series of  $\frac{1}{2}$  in. holes will serve just as well. The control shaft openings are drilled with a  $\frac{1}{2}$  in. wood bit. Because we have concealed the tuning and volume control knobs under the writing shelf (Fig. 4), it was also necessary to drill two  $\frac{1}{2}$  in. holes through the steel bracket supporting the shelf.

Now, check the chassis for fit. Do not be alarmed if you find that the control shafts are too short for attaching the original knobs. Any



Radio chassis is fastened to rear of telephone cabinet door.

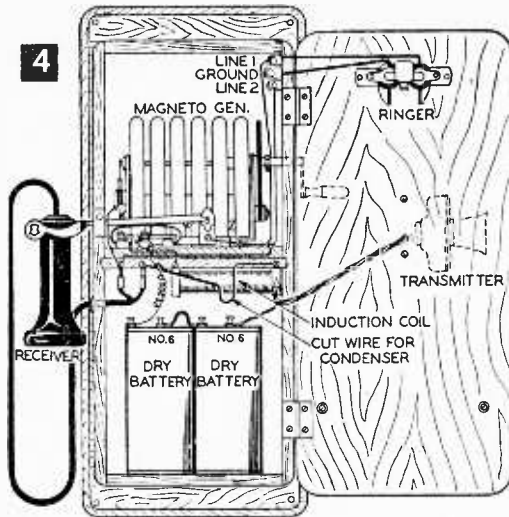
radio parts supplier can furnish "push on" knobs with an extended shank or ferrule. If the radio employed "push on" knobs merely replace with the extended type. On the other hand, if your set employed set-screw knobs a little extra work is required.

The round control shafts are  $\frac{1}{4}$  in. dia. whereas the "push on" knobs are designed to fit a splined and slotted  $\frac{7}{32}$  dia. shaft. Since the new knobs are made of soft polystyrene plastic, simply ream out the knob ferrule with a  $\frac{1}{4}$  inch drill. Insert the drill in a pin vise, or wrap a piece of cloth around the shank and twist by hand only. Heat generated by a power-driven drill will melt and distort the plastic. Because polystyrene has an elastic quality, these knobs will grip a smooth round shaft without the use of set-screws.

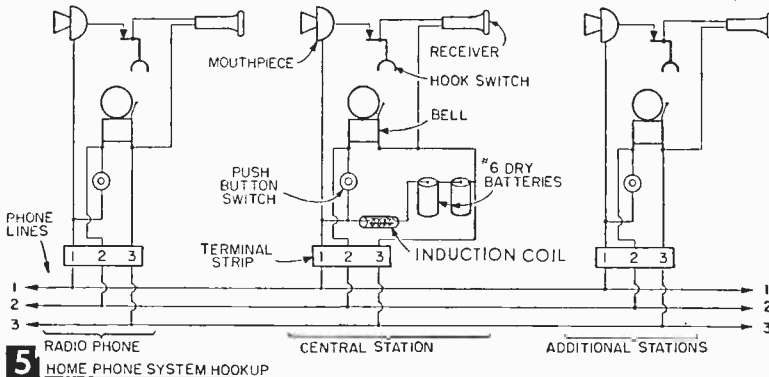
To allow for the displacement of heat generated by the radio tubes, a row of  $\frac{1}{4}$  inch holes may be drilled in the top and bottom of the phone cabinet. The last remaining detail is the installation of the loop antenna if the radio was so equipped. If this unit will not fit into the cabinet even though the excess cardboard backing is trimmed off, replace it with a non-directional ferrite rod-type loop. This tiny antenna is available from most radio supply houses for about \$1 complete with simple instructions for installing it.

We installed the radio chassis to the door of





Original factory diagram of wall type magneto telephone. This was model 697 made by American Electric Co., Chicago. Rewire as shown in Fig. 5.



the phone cabinet with two #6 x 1/2 in. round-head (rh) screws and washers. One screw in the unused speaker mounting hole, the other diagonally in the corner of the set chassis. Having checked alignment of radio chassis, remove it and set aside until cabinet is finished. There are several types of finishes that can be used, however each requires first filling the open-grained oak with paste wood filler. The cabinet may be given several coats of white shellac, and rubbed down with linseed oil and fine sandpaper. A limed-oak finish can be achieved by filling the oak with white paste-type wood filler. Follow with shellac as mentioned above. The cabinet may also be enameled in any desired color and decorated with decals.

While the cabinet finish is drying, clean the grease and rust from all metal parts with the phenol paint remover and steel wool. Follow by sanding or wire brush buffing before applying a new finish. Although the phenol solution will not remove the baked-on black enamel, it will remove all varnish and gum so that the parts can be painted with aluminum paint, black enamel,

or gold if you wish. Radio supply shops stock General Cement's Telephone Black and Chrome Paint.

If you do not wish to use the telephone as an intercommunicating device, the various unwired parts may be reassembled on the cabinet. Should you wish to use two or more phones as an intercommunicating system, the following applies:

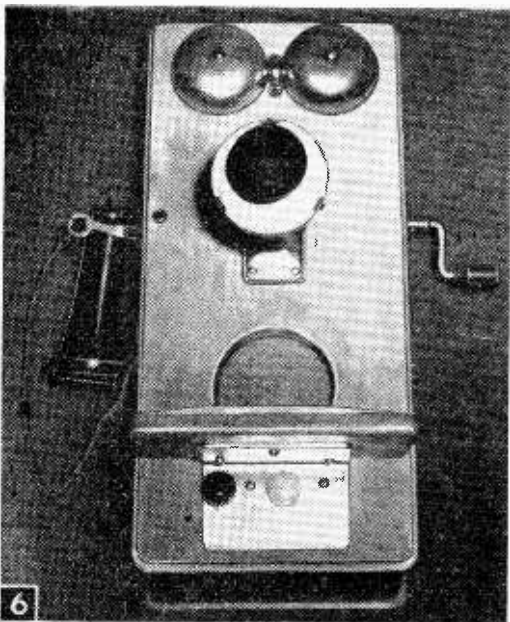
**Wiring a Home Telephone System.** The original rural telephone employed two electrical circuits (Fig. 5). For handling speech, two No. 6 dry cell batteries wired in series provided *talking current* to each phone. The 3 volts supplied by the batteries was not sufficient however, to ring the operator. Therefore, each phone was equipped with a hand-cranked magneto generator to provide the *ringing current*.

Many rural modernization jobs still required the magneto, and these units are removed from the old wall phones before they are offered to the public for sale. While the phone supplier includes the magneto crank for decorative use, he does not include a generator. For operating a phone system over short distances, the magneto is not necessary since the line resistance is low and the batteries can handle the ringing job quite well.

To put two or more telephones into operating condition, remove the old wiring and rewire with radio hookup wire, or plastic covered bell wire (Fig. 5). Each phone will require a 3-terminal, Jones-type barrier strip available from radio parts houses, and a door-bell push button. The push button may be installed over the hole formerly occupied by the generator hand crank.

Note in Fig. 5 that the central station unit includes an induction coil and dry cells. When three or more telephones are purchased, an induction coil will be furnished free if you ask for it. Other phones on your line require no coil or battery power. The central station can be located anywhere on the line . . . garage, basement, barn, etc. However, a central location on the line will prove most efficient. Phones may be inter-connected indoors by using two or three-conductor bell wire known as *thermostat wire*. While the phone system shown requires three lines, line 2 may be a ground return so that only two wires are used. In this instance, a water or steam pipe must be handy at each phone location. Scrape off any paint from the pipe and attach a radio ground strap with a wire long enough to connect to phone terminal 2.

The two wire hook-up greatly simplifies outdoor installations since two-wire twisted phone line is in plentiful supply in the surplus market.



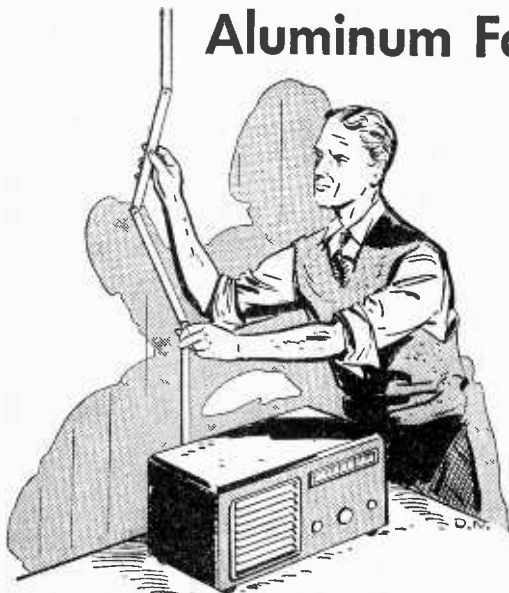
Refinished cabinet showing radio control knobs beneath writing shelf. Knobs of different colors were used to distinguish between volume and tuning. Speaker grille is 4 x 4 in. piece of aluminum fly screening taped to cabinet.

Moreover, for outdoor runs, TV lead-in wire is excellent and very inexpensive. When installing an outdoor line, it is important to provide lightning protection. Connect a TV arresistor across the line, and ground the center terminal to a water pipe. If a 3-wire line is used, connect the arresistor terminals to lines 1 and 3 and attach remaining ground terminal on arresistor to line 2. Then ground line 2 to earth via water pipe.

When several phones are installed on your home phone system, simple code ringing signals may be employed. Give each phone a number: 1, 2, 3, etc. To reach a certain phone, merely pulse the push switch the desired number of rings. Any phone on the line may be used to originate or receive a call.

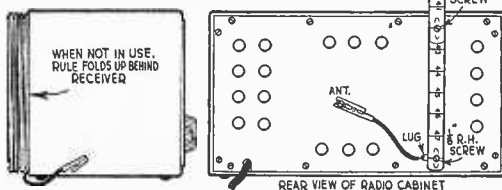
If the telephone line involves a long run of wire, additional battery power may be required. Add additional dry cells in series if ringing current isn't adequate with two cells. After the line is installed, check each phone receiver for correct polarity. With receiver off hook, unscrew cap. The metal diaphragm should be securely held by the magnet both when phone hook is up and pulled down. If disc slides off receiver with hook up, the battery polarity is reversed at the receiver. Disconnect the cable at receiver terminal screws and reverse the connections. When each diaphragm is "sucked in" by the receiver magnet, when hook is up, correct polarity has been established.

## Aluminum Folding Rule Antenna



home radios with or without built-in loops.

If rule is not rigid enough to be self-supporting when the full length of 72 in. is used, and you cannot devise some way to give it additional support either vertically or horizontally, cut it off at the 48 in. length by filing off or drilling out the rivet. Also remove the rivet at 42 in. Using the rivet holes, mount the 48 in. length of rule to rear panel of radio with two  $\frac{1}{8}$  in. dia. roundhead machine screws. The rule should overlap at 42 in. just as it did before the rivet was removed. A lug under the 48 in. hole allows a lead to be connected from rule to antenna terminal. Use an alligator clip or split-lug for connecting this lead to antenna terminal. If receiver has a built-in loop on rear panel, mount rule away from loop by means of spacer-sleeves made from metal, fiber, or plastic tubing, and long machine screws.—ARTHUR TRAUFFER.



WHEN mounted on the rear of a radio cabinet, an inexpensive aluminum folding rule makes a good vertical antenna which can be unfolded to different heights and then folded back out of sight again when not in use. This compact antenna can be used on portable all-wave receivers, and on table or floor model

# Printed Circuits

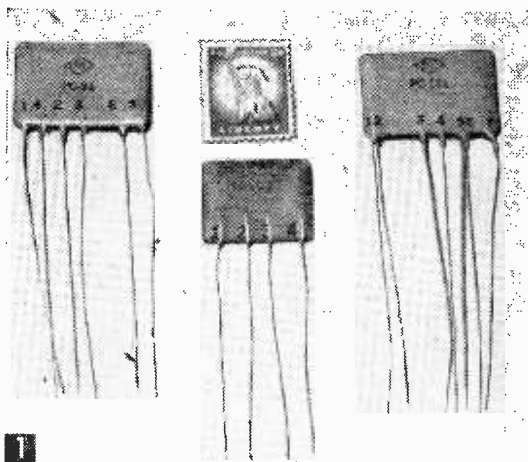
Circuitry becomes simpler, neater and cheaper with printed circuits. Stable, small in size and uniform in performance, they eliminate as many as nine individual circuit components in a single stage of amplification

**W**HAT is a printed circuit? Simply a ceramic plate on which a network of resistors and capacitors—even coils—are interconnected with a combination of silver and carbon "paths." These paths are printed on the ceramic plate either by a silk screen or an electroplating process and the plate is "fired" in an electric furnace to permanently fix the values to it. The plate, with its projecting "pig-tail" connecting leads, is then sealed in a protective phenolic covering and treated with a moisture-proofing wax.

Unless you possess the combined skills of an electrical, mechanical and chemical engineer, electroplater, silk screen technician and ceramic expert, don't waste time trying to make your own printed circuits. Particularly, since it is now possible to buy them for less than \$1 each, often for less than 50¢. While the standard printed circuits are produced by the millions, however, hearing aid amplifier plates are produced in small lots. Therefore, while the most elaborate "stock" plate is sold for less than \$1, a complete miniature amplifier plate costs over \$20.

Printed circuits are manufactured by several of the leading radio components manufacturers, including Centralab, Erie and Sprague. While there are more than two dozen different circuits manufactured, only four are of prime interest to the experimenter. These are the audio-interstage and audio-detector circuits for triode and for pentode, resistance-coupled amplifiers. These four also represent the most elaborate circuitry in the printed circuit series.

Standard printed circuits are only slightly larger than standard-sized postage stamps (Fig. 1). Some are available in a midget size only half the size of a stamp. (These midget units are designed for use in battery portable and ac-dc midget sets.) All printed circuits, regardless of manufacturer, employ a standard RETMA numbering system to designate the termination of each "pigtail" extending from the ceramic plate. A *triode interstage* plate has four external connections thus numbered; a *pentode interstage* plate, six; an *audio-triode detector*, seven; and



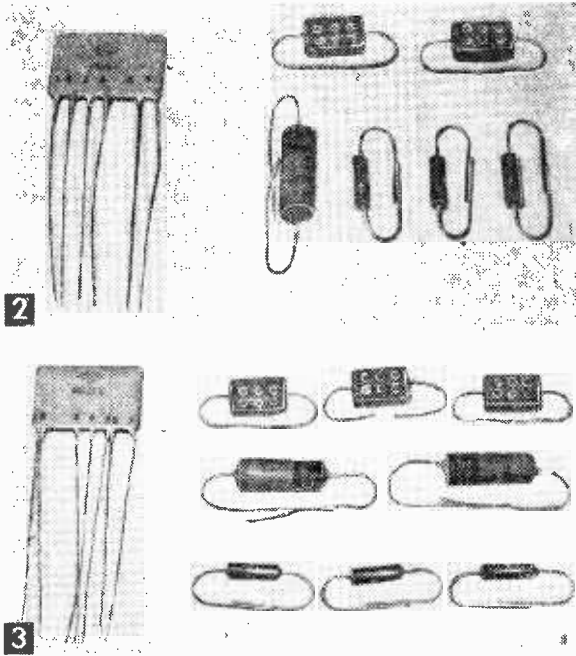
Printed circuits speed troubleshooting by eliminating the need to find exact component failure. Left, pentode amplifier plate; right, audio-detector stage. The triode coupler under the standard-size stamp is the standard size printed circuit. A midget triode plate is available that is about half the size of stamp.

an *audio-pentode detector* stage, nine.

Manufacturers sometimes have more than one printed plate available under each of the above categories. While both will be wired identically, the value of the coupling capacitor and the plate-screen grid resistor will be higher in one unit than in the other. Also, for a typical resistance-coupled amplifier, the experimenter can choose a printed interstage circuit with, say, a plate resistor of 250,000 ohms, a grid resistor of 500,000 ohms and coupling capacitor of .005 mf. and if the values in an available printed circuit do not exactly match the values indicated for a unit, this will still not materially affect the unit's operation.

Radio parts suppliers will furnish free pamphlets describing in detail the printed circuits available in the brand or brands he carries. This information may also be obtained by writing to the manufacturers listed in Table A. With such information it is a simple matter to check the audio components in a project against those available in printed circuits, thus enabling you to replace a number of individual circuit components with a single, small plate.

A four-wire, triode coupling plate, for instance, eliminates two resistors, a large paper capacitor and two mica capacitors. And instead of the 10 soldered connections required with the individual parts, the printed circuit requires only four to a stamp-size plate only 1/16-in. thick. Figure 2 shows a six-wire, pentode interstage coupler and the individual resistors and capacitors it replaces. Figure 5 shows how such a pentode coupler plate would be substituted for individual components in a representative amplifier. The components that could be replaced in a five-tube ac-dc radio when Centralab's Audet plate is used, and the Audet itself, are shown in



**TABLE A — WHO AND WHERE TO WRITE FOR LITERATURE ON PRINTED CIRCUITS**

- Centralab  
A Division of Globe-Union, Inc.  
900 E. Keefe  
Milwaukee 1, Wisc.
- Cornell-Dubilier Electric Corp.  
333 Hamilton Blvd.  
South Plainfield, N. J.
- Erie Resistor Corp.  
West 12th  
Erie, Penna.
- Sprague Products Co.  
Marshall St.  
North Adams, Mass.

The six-wire, pentode coupler (upper left) eliminates six separate parts, reduces the number of soldered connections by half and greatly reduces the space needed on a chassis.

The seven-wire CRL Audet (left center) eliminates eight conventional circuit components, cuts the number of necessary soldered connections from 16 to seven. The CRL nine-wire Pendet is the pentode counterpart of this triode audio-detector printed circuit amplifier stage.

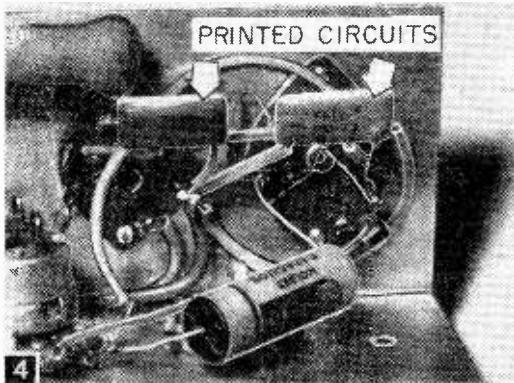


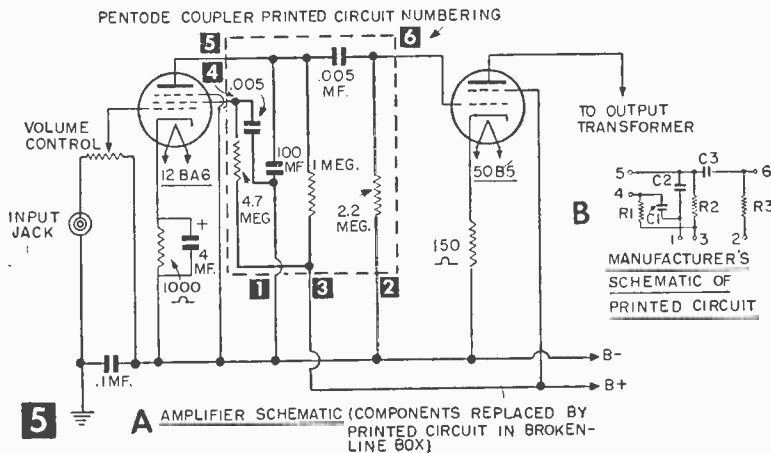
Fig. 3. Figure 4 shows a portion of the bottom of a chassis of a three-stage, resistance-coupled amplifier employing two midget triode printed circuits. The printed circuits are dwarfed by conventional components.

Both radio and television manufacturers use the same printed circuits that are available to the experimenter. Indeed, some TV set manufacturers employ coils and unit assemblies created by combined silk screen, vapor vacuum or bath electroplating methods. Elaborate bus circuits are also created by die-cutting aluminum or brass foil circuits which are affixed to plastic plates, with built-in sockets and other components riveted into the bus lines.

While simpler and less expensive than soldered and conventionally wired apparatus, such simplification has, on occasion, defeated its purpose.

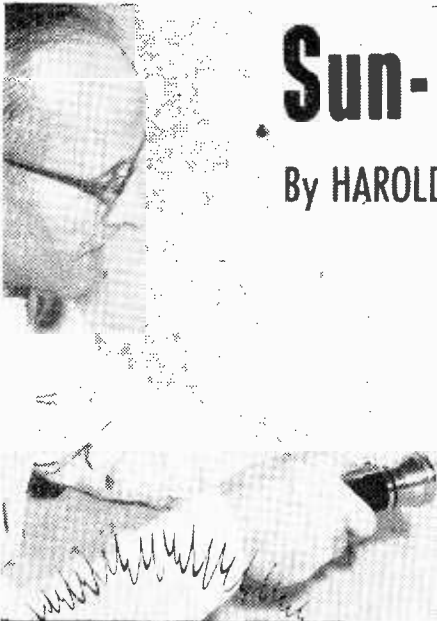
Imagine, for instance, having to replace a complete receiver—except for tubes and cabinet—because a pin clip in a tube socket has broken off. Thus, the happy medium of using printed ceramic plates in conjunction with other standard components has been found the most practical system by the electronic industry. As it has, by the experimenter who has discovered the amazing resourcefulness of printed circuits.—T. A. B.

Bottom view of portion of chassis of three-stage amplifier. Midget printed circuits are dwarfed by conventional circuit components.



# Sun-Powered RELAY

By HAROLD P. STRAND



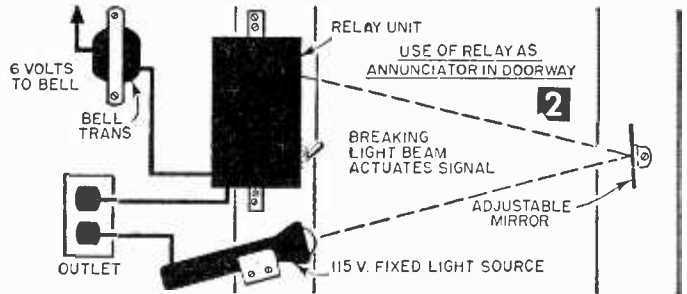
## How to Put the Sun to Work

For testing purposes, a flashlight can be used to operate the relay. With the lamp turned On and its line cord plugged into the sun relay's power take off, control is transferred to that unit.

### Craft Print Project No. 258

**T**HIS versatile relay turns lights, small motors, bells, buzzers, and a number of other types of electrical equipment on and off automatically—and it's activated solely by sunlight or by artificial light (Fig. 1). As a control device, it has a wide variety of applications. With the selector switch on the front panel set to supply current to the power take off if light to the cell is interrupted, the unit can be used as a burglar alarm, for instance, or as annunciator for stores and offices, Fig. 2. For use with low-voltage equipment such as a bell or buzzer, however, a step-down, bell-ringing transformer should be plugged into the power take-off. Or, with a set-up arranged so that objects pass in front of the light source, the relay can be used in a number of widely varied counting and sorting operations. In this case a special type of magnetic counter is connected to the power take off and the pulses developed by the passing objects are reflected on the counter dial.

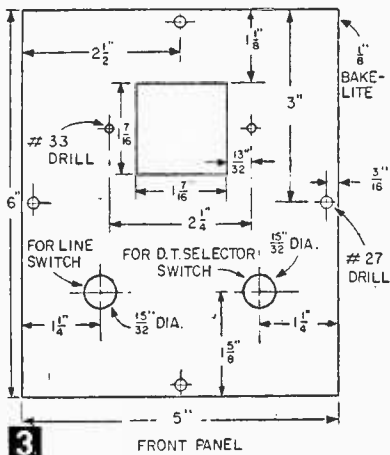
It is also possible, with a little experimenting to shield the cell from direct sunlight but still have it accessible to headlights, to employ the relay as the prime mover in an automatic garage-door opener. And on the farm, buildings such as the chicken house can be equipped to employ the



relay to turn the lights on automatically when it becomes dark and to turn them off automatically when the sun comes up.

The light-sensitive unit used in this relay is one of the international self-generating photo cells, type B-15. This is the same type of cell that was used in the sun battery described on pages 51-54. The circuit for this relay includes a transistor to amplify the low energy produced by the cell, a relatively large, power-control relay, and a smaller, more sensitive relay to actuate the power-control relay. The need for a battery to supply transistor bias is eliminated by using a small, full-wave rectifier with a step-down transformer to supply about 14 volts dc.

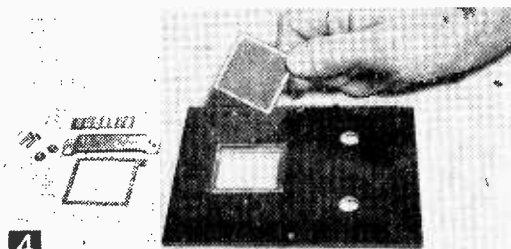
The 4 x 5 x 6 in. housing for the unit is an attractive, hammertone-gray aluminum cabinet with a front panel of 1/8 in. Bakelite. At the left side of the cabinet is a sensitivity control with which to make adjustments for different conditions of light. The line cord (Fig. 10) enters on the right side of the cabinet, just below a 10-amp fuse holder. The power take off to the controlled



equipment is located on the right side of the cabinet also, and two control switches are located on the front panel. One of these is the line switch and the other is the double-throw selector switch for reversing the action of the relay with respect to the particular operation wanted. On one position of the selector switch, light falling on the cell will turn on the 115 volts to the power take off. Normally, with the switch in this position, there is no power at the take off. On the other position, this action is reversed. That is, light reaching the cell turns off the power from the take off. Normally, with the switch in this position, there is 115 volts at the power take off.

The contacts of the power relay will handle loads of up to about 10 amps without excessive arcing. This current is also within the capacity of the #16 line cord. It is, of course, possible to design the power handling relay and the wiring for heavier loads if desired.

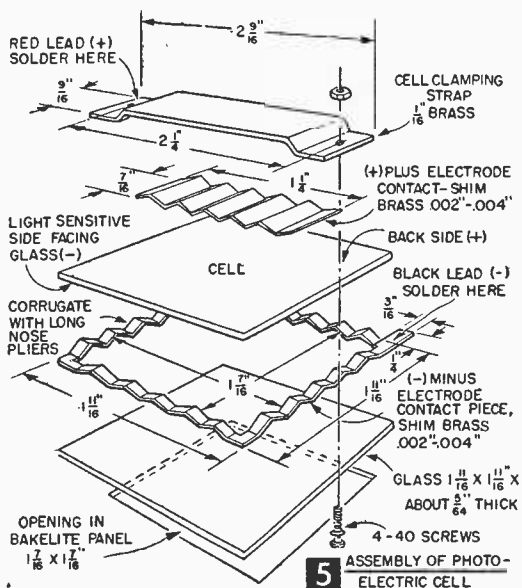
**Constructing the Relay.** On the front panel (Fig. 3), lay out the 1 7/16-in. square and drill 1/4 in dia. holes at the four corners. Use a jig or sabre saw to cut out this opening and square up the edges with a file. Drill holes for the control



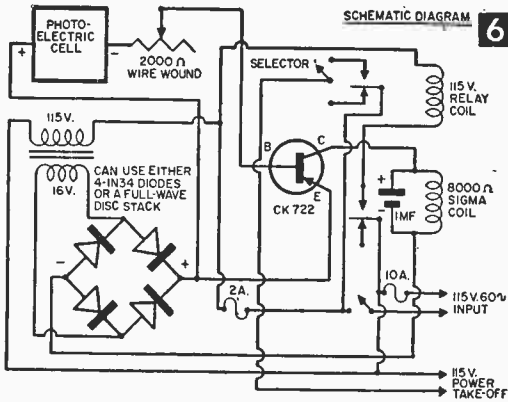
**4** The front panel ready for attachment of the International B-15 cell. The glass has been cemented to the panel. Other parts necessary for installation of the cell (held above the glass) are shown to the left of the panel.

MATERIALS LIST—SUN-POWERED RELAY

- 1 aluminum cabinet, hammertone gray finish 6x5x4" with removable front and back covers. Allied Radio, 100 N. Western Avenue, Chicago 80, Illinois. Cat. #86P306. ICA type 29812, \$1.44
- 1 International Rectifier B-15 unmounted photo cell. Allied Radio Cat. #7E739, \$5.88
- 1 Sigma relay, type 4F 8000 ohm coil. Lafayette Radio, 110 Federal St., Boston, Mass., or 100 6th Avenue, New York, \$4.95
- 1 power control relay, 115-v. a-c coil, D.P.D.T. Allied Radio Cat. #76P237, \$4.98. Advance type PG/2C/-115 VA
- 1 chime transformer, 115-v. 60 cycle primary, 16-v. secondary. Edwards #894. Electrical supply store
- 1 2000 ohm wire-wound control, 2 watts, Clarostat type 43-2000 or equivalent. Radio Shack Corp., 167 Washington St., Boston, Mass., \$0.73 or can use type 58, 4 watts, Allied Radio Cat. #31M020 \$0.73
- 1 knob with numbered dial, National HRS-3 0-10 Allied Radio Cat. #71H059, \$0.58
- 1 panel type fuse mounting, Littelfuse type 342001. Allied Radio Cat. #41B727, \$0.27
- 1 glass fuse, type 3AB, 250-v. 10 amp. Allied Radio Cat. #52B244, 5 fuses in package, \$0.44
- 1 fuse mount, Littelfuse type 3S7001. Allied Radio Cat. #52B292, \$0.10
- 1 glass fuse, type 3AG, 250-v., 2 amp. Allied Radio Cat. #52B236, 5 fuses in package, \$0.20
- 1 Jones barrier terminal strip, type 2-140. Allied Radio Cat. #41H800, \$0.14
- 1 Jones barrier terminal strip, type 3-140. Allied Radio Cat. #41H801, \$0.20
- 1 Raytheon transistor, type CK722. Allied Radio Cat. #5EC822, \$0.99
- 1 1 mfd. 50-v. electrolytic capacitor, type BBR (Cornell-Duhilier). Allied Radio Cat. #19L209, \$0.53
- 1 S.P.S.T. toggle switch, 15 amp. Allied Radio Cat. #34B534, \$0.54
- 1 S.P.D.T. toggle switch, 15 amp. Allied Radio Cat. #34B535, \$0.61
- 1 flush 115-v. receptacle with mounting flange (for power take off). Amprenol type 61-F1, Allied Radio Cat. #40H682, \$0.22
- 1 rubber line cord grommet for 3/8" hole. Allied Radio Cat. #44N620, pkg. of 12, \$0.29
- 1 small handle for top of cabinet. Hardware store, about \$0.15
- 4 rubber knob feet for machine screw mounting. Allied Radio Cat. #44N764, 5/8" size, pkg. of 6, \$0.29
- 1 full wave selenium rectifier, plates 1x1", 100-150 ma. capacity, 25-v. Federal type 101S-179132 or may be listed under other numbers for similar unit. Radio Shack Corp. has them in surplus, about \$0.49
- 1 pc Bakelite 1/8x5x6" (front panel)
- 1 pc Bakelite 1/4x3/4x1" (for block back of Sigma relay)
- 1 pc #16 flat parallel rubber line cord with attachment plug cap. 7-8 feet or longer as required. Electrical supply store
- 1 pc sheet brass about .055x7/16x23/4" (for cell clamp) scrap
- 1 pc brass shim stock about .003-.004" thick, 1 1/16x1 7/8" (cut to make contact frame for face electrode on cell) auto supply store
- 1 pc brass shim stock about .002-.004" thick, 1/2x1 1/2" (contact piece under cell clamp)
- Misc. screws, nuts, washers etc.
- Total cost runs around \$25



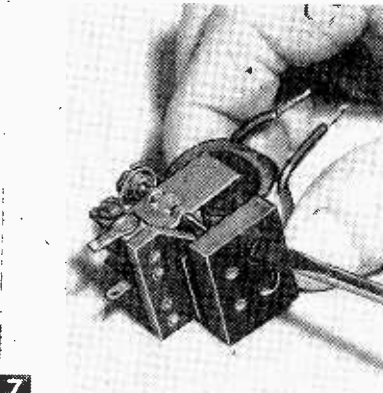
**5** ASSEMBLY OF PHOTO-ELECTRIC CELL



6

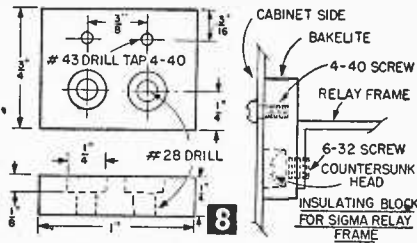
switches, four holes for the self-tapping screws that attach the panel to the box, and two holes on either side of the square opening for the screws and nuts that will hold the cell in place.

Next, cut a piece of window glass  $1\frac{1}{16} \times 1\frac{1}{16}$ -in. and cement it over the square opening, on the inner side, to protect the cell. Where the glass contacts the Bakelite, roughen the surface with sandpaper. Fasten the glass with Pliobond cement. The B-15 cell held in hand, Fig. 4, has the sensitive side identified by the narrow silver frame. This side is placed next to the glass, over a narrow frame cut from about .004-in. brass shim stock. After cutting the shim stock to size, corrugate it with pliers to insure good contact with the cell electrode. A strip of brass shim stock for



7

One of the two 6-32 countersunk screws being turned into the Sigma relay frame. The smaller holes on the Bakelite block are for the 4-40 screws used to fasten the assembly to the cabinet side.



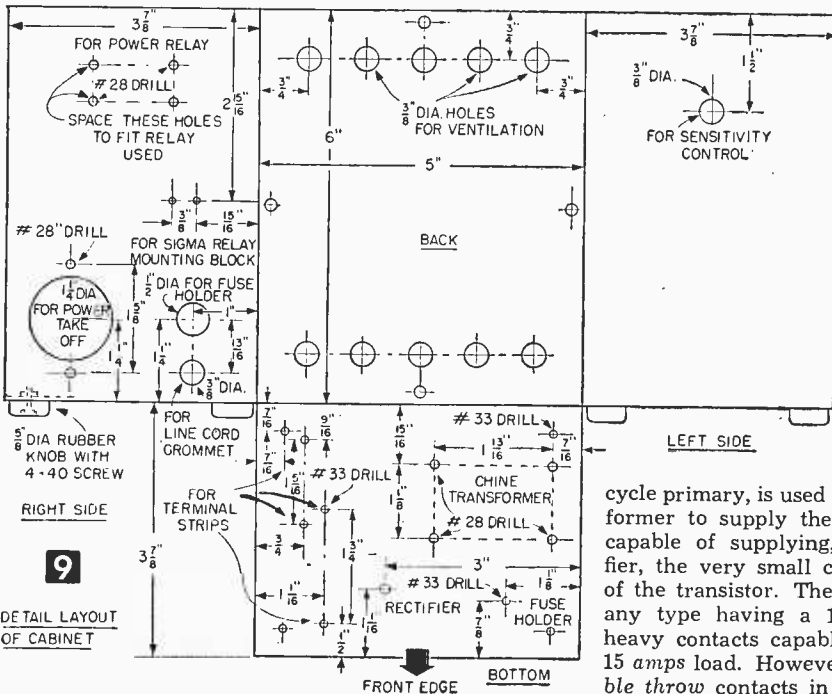
8

the top side contact and a heavy brass clamping strap completes the assembly of the photo-electric cell as in Fig. 5. Now set the front panel aside.

The components that make up the internal parts of the relay unit include a sensitive Sigma 4-F relay with an 8000 ohm coil, which is energized from the output of the transistor amplifier (Fig. 6). Since the arm of the relay is in the 115-volt line and is not insulated from the frame of the relay, insulation must be provided between the relay and the metal cabinet. A piece of Bakelite is used for this purpose (Figs. 7 and 8).

Figure 9 shows the layout of all holes in the cabinet. A 16-volt chime transformer with a 115-volt, 60

cycle primary, is used as a step-down transformer to supply the rectifier unit. It is capable of supplying, through the rectifier, the very small current requirements of the transistor. The power relay can be any type having a 115-volt ac coil and heavy contacts capable of handling a 10-15 amps load. However, it must have double throw contacts in order to work with



9

DETAIL LAYOUT OF CABINET

the selector switch on the panel. A single-pole variety can be used, but using a double-pole type and connecting them in parallel helps to minimize arcing.

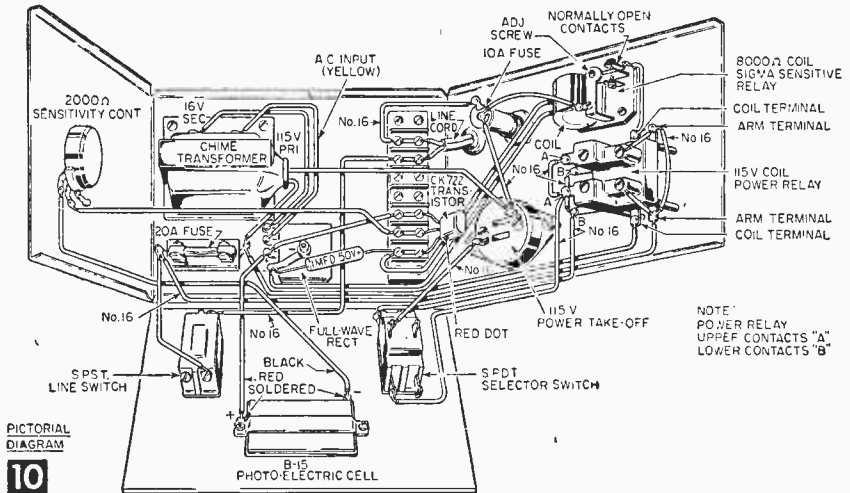
Rubber knobs or cabinet feet attach to the bottom of the cabinet with 4-40 screws and nuts. The knobs serve to elevate the bottom to provide clearance for the screw heads located there and also act as cushions for the unit.

All wiring in the 115-volt circuit between the line terminal strip and the switch, relay contacts, fuse and power take off should be made with #16 flexible insulated wire. The other wiring can be much lighter, #20 or smaller. Solder all connections not clamped with terminal screws. Note that the CK722 transistor has its leads clamped under three terminals of the terminal strip (Fig. 10). Be sure to connect all three leads from the transistor exactly as shown in the diagram. The rectifier is a full-wave 25-v. type, having four 1 x 1 in. plates. The yellow terminals are for the ac input from the transformer.

A 1 mfd. 50-volt electrolytic capacitor is used across the coil of the Sigma relay. This capacitor improves relay performance, eliminating the tendency to chatter with low intensity light on the cell. A 2 amp glass fuse in a mount attached to the bottom of the cabinet is used to protect the chime transformer and the coil of the 115-volt relay. A 10 amp line fuse is used in the holder to limit the load to a reasonable value.

When installation within the cabinet is complete, make connections to the front panel. Solder a length of #24 or #26 insulated stranded wire to the tab on the brass frame under the cell, color coded black for identification as the negative side, and solder a piece of red wire to the brass clamping strap for the positive lead. Connecting to the cell in this way eliminates the possibility of injury to it by direct soldering to its electrodes. The cell is wired in last for the same reason: to protect it. Connect and solder the black and red leads as in Fig. 10.

The Sigma sensitive relay comes adjusted for operation on about 2 ma. closure, but this adjustment should be changed with the unit completed by slightly moving the screw which controls the action of a hair spring until its sensitivity is increased to operate on about 1.2 to 1.4 ma. The best adjustment can be determined with the unit under test, but be careful of live terminals.



**Testing the Relay.** With a two-cell flashlight (as in Fig. 1), see if the relays will operate when the sensitivity control is set to its highest position (all the resistance cut out). A distance of about two to three feet between the cell and the light should enable proper operation. Moving the light back and forth across the cell surface should result in the unit's clicking in and out. If it doesn't, try adjusting the Sigma relay. A strong three-cell flashlight should operate the unit from distances up to about eight or ten feet. Connect a table lamp to the power take off of the relay and try the operation on both positions of the selector switch. On one position, light on the cell should light the lamp. On the other position, the lamp should go on without light on the cell, but when light is applied it should go out.

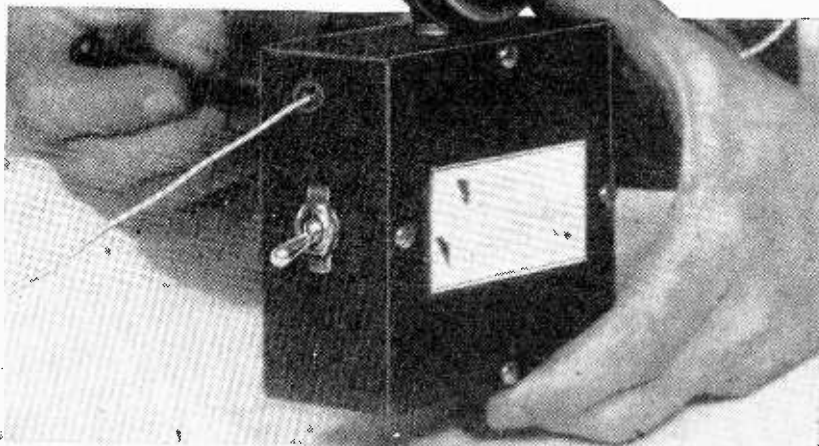
Now place the unit in a window where ordinary daylight, but not direct sunshine comes in. With the unit's line cord plugged into a wall outlet, the power switch On, and the selector switch in the proper position, the relay should immediately click in. Placing your hand in front of the cell should then result in the relay opening. Experiment with the sensitivity control and see how little sensitivity is required to get proper operation. There should be enough light for operation even on grey days.

● Craft Print No. 258, in enlarged size for building the Sun-Powered Relay is available at 50¢. SPECIAL QUANTITY DISCOUNT! If you order two or more craft prints (this or any other prints), you may deduct 10¢ from the regular price of each print. Hence, for two prints deduct 20¢, three prints deduct 30¢, etc. Order by print number, enclosing remittance (no C.O.D.'s or stamps) from Craft Print Dept. R56, SCIENCE & MECHANICS, 450 East Ohio Street, Chicago 11, Illinois. See coupon on last page of this handbook.

● A telephone 1,000 years old was discovered in the ruins of a Peruvian palace. It consisted of two gourd necks, one end of each covered with hide. A cord attached to the hide and pulled taut carries the sound of a human voice.



**1** Microphone of Pee-Wee Home Broadcaster #1 has been permanently attached to a box. Toggle switch and ground lead are seen at left. Tuner is adjusted to suitable wave length with an insulated screwdriver. Hole in box provides access to compression capacitor.



## Pee-Wee Home Broadcasters

To use the broadcaster for playing phonograph records through battery radio, simply replace the mechanical pickup with a crystal type. There is ample space inside the case of a portable spring-wound record player for both transmitter and batteries. Rural folks can convert standard Victor, Edison or Columbia phonographs simply by attaching a new pickup in the old machine.

**These small and novel sets broadcast voice or music through home radios with surprising volume and clarity!**

**O**UR first pee-wee broadcaster might well be called a "walkie-talkie." Operating on self-contained batteries, it will transmit both voice and music through any radio set in the home. It is designed for "carrier current" method of operation, that is, the signal travels to radio via water pipe or electrical wiring ground system.

This unit will operate with any electric radio, but may not always work with a battery portable unless set is provided with a ground connection. When properly used, broadcaster will not interfere with neighbor's sets. *Never attempt to transmit beyond the confines of your home, as that can result in serious trouble.*

The efficiency of this ultra-simple circuit is remarkable. The picture wiring plan is arranged so that it is unnecessary to follow our original design wherein the transmitter is housed in a 4 x 4 x 2 in. radio constructor's box. Lacking facilities to drill holes in metal, you can substitute a cardboard, wood or plastic box of any convenient size.

The broadcaster is reduced to a minimum of parts by use of a miniature 1S4 pentode tube which permits direct grid modulation of the old Hartley oscillator circuit.

Although a crystal microphone has good quality, it is weak and poor in sensitivity for this application. So we used a standard carbon telephone type transmitter. This mike, used in conjunction with a suitable mike transmitter and penlite cell, is extremely sensitive. A war surplus throat mike should prove equally good when used with the mike transformer.

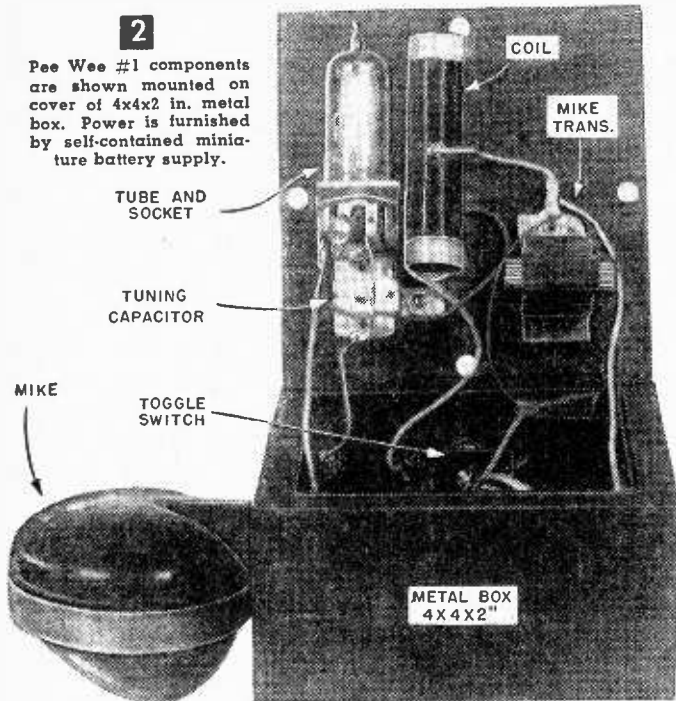
All components in the broadcaster-record player are standard with the exception of the home-made oscillator coil. The coil is wound on a 2½ in. length of cardboard, Bakelite, or fiber tubing, or on a solid length of ⅝ in. dia. wood rod. The coil winding consists of 180 turns of #30, 31, or 32 enameled copper magnet wire wound in an even, close layer. At the 90th turn, twist a loop in the wire for a center-tap and continue until you have a total of 180 turns. Secure the coil with shellac or Duco cement to prevent turns from working loose. In order to establish a firm connection, be sure to remove all enamel insulation from coil connections with fine sandpaper or emery board before attempting to solder into circuit. Likewise, all other circuit connections must be firmly soldered.

### MATERIALS LIST—PEE-WEE HOME BROADCASTER # 1

- 1 4 x 4 x 2 metal box (Bud, Par-Metal, etc., preferably with removable sides)
- 1 7-pin miniature socket
- 1 45-360 mmf. compression trimmer capacitor
- 1 100 mmf. mica coupling capacitor (optional)
- 1 470K, ½ watt resistor
- 1 small spool #30, 31, or 32 enameled magnet wire
- 1 coil form: ⅝ in. dia. by 2½ in. long (Bakelite, acetate, paper, fiber, cardboard or wood)
- 1 double pole, single throw toggle switch
- 1 24, 30 or 45 volt midget B battery
- 1 1½ volt standard flashlight battery
- 1 1½ volt penlite battery
- 1 midget 200 ohm-to-grid carbon mike transformer. Concord Radio (see below) can supply. (Stancor #A-4705 replacement part #32M8208 used for original)
- 1 miniature pentode tube, Type 1S4
- 1 200 ohm telephone type carbon mike. 200 ohm carbon throat mike from Concord Radio, Dept. A, 45 Warren St., N. Y. 7

**2**

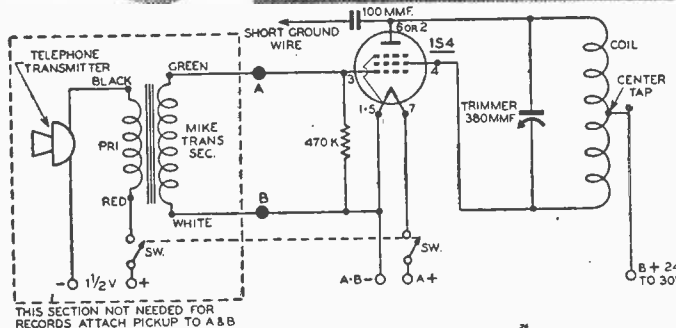
Pee Wee #1 components are shown mounted on cover of 4x4x2 in. metal box. Power is furnished by self-contained miniature battery supply.



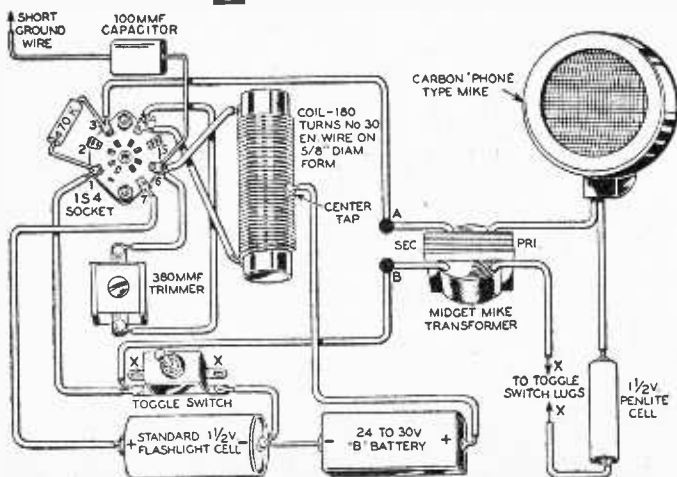
Batteries for broadcaster consist of a standard flashlight cell for operating filament of the 1S4. The B battery may be any size between 24 and 45 volts. However, if unit is to be enclosed in a very small box, a hearing aid type B battery, usually rated at 30 volts, should be used in order to fit into the limited space.

The ground connection is a short length of insulated wire connecting to plate of 1S4 pentode, through a small mica coupling capacitor. The lead is fitted with a clip so that it may be attached to a hot water or steam radiator water pipe. In many instances, the coupling capacitor may be omitted and wire attached directly to plate. Simply draping ground lead over radiator will give sufficient coupling, or an equally efficient coupling can be made by cutting the direct-connected ground lead, and tightly twisting the severed leads together a distance of about 4 in. Do not remove insulation from wire, as the twisted insulated wires become a coupling capacitor. The ground lead is actually connected to ground object when twisted wire coupling is used, since it functions like a mica coupling capacitor.

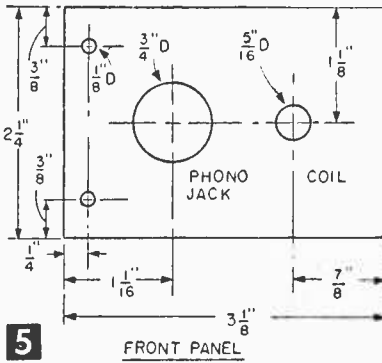
To pick up a "walkie-talkie" broadcast, tune your regular home set or sets to a point between 1500 and 1100 kc. where no commercial station is received. Now with an insulated screwdriver (or one made from a lollypop stick or plastic crochet needle) turn compression screw on 380 mmf. trimmer capacitor until a steady purr is heard in your radio. The purr indicates your set is tuned to transmitter's carrier wave. Make final precise adjustment by adjusting dial on radio set. The broadcaster is now ready for use. When using the carbon mike, you will have to talk from another room. Feedback, a sort of chain reaction between carbon mike and radio loudspeaker, will set up a tremendous howl unless microphone is shielded from radio by a wall. This condition will not prevail when using a phono pickup, nor should it happen if the volume of the radio is kept down, or in cases where a throat mike is employed.



**3** SCHEMATIC PLAN-PEE-WEE #1

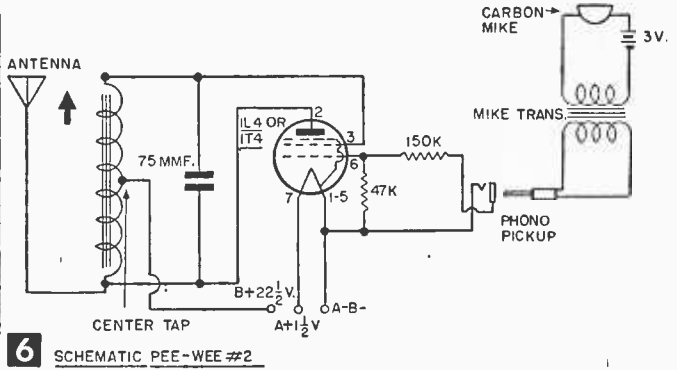


**4** PICTORIAL PLAN



5

FRONT PANEL



6

SCHEMATIC PEE-WEE #2

Similar in design to the Pee-Wee Home Broadcaster #1 (and third cousin to the Pee-Wee Radio, p. 27), our second pint-size broadcaster also employs the popular Hartley type oscillator, only in this case the circuit is tuned with a high-Q, ferrite core antenna coil instead of a trimmer capacitor. The grid modulated signal of Pee-Wee #2 is fed to a miniature 1L4 or 1T4 pentode tube with either a phono pickup or carbon mike. Practically any ordinary record player crystal develops sufficient pickup voltage to feed the grid, but a crystal mike does not. Therefore, a cheap carbon mike and mike transformer (powered by two Penlite cells) are used; they provide excellent voice response.

The chassis of Pee-Wee #2 is constructed of a 2 1/4 x 3 1/8 in. front panel of #20 aluminum screw-fastened to a 1/2 x 2 1/2 x 3 3/8 in. base of pine or other soft wood. Drill mounting holes for coil and phono jack as shown in Fig. 5. The tube socket is attached to the wood base by driving a 1-in. drive screw into the center ground ferrule of the socket. Wire according to Figs. 6 and 7.

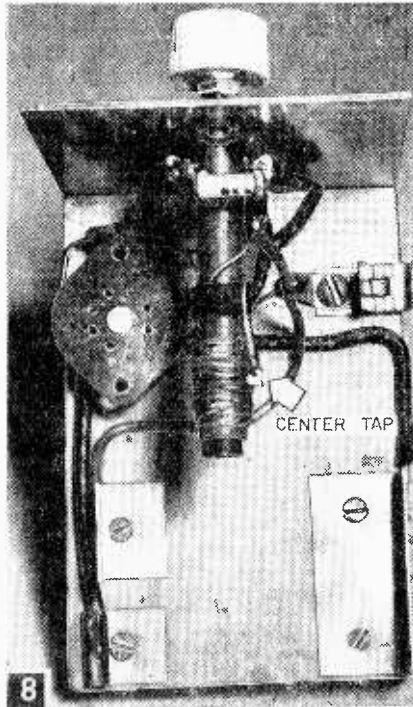
The ferrite slug-tuned antenna coil is not normally supplied with a tap for applying plate voltage. To provide such a tap, cut the outside coil wire from its lug terminal, unwind 32 in. of the Litz coil wire, scrape away the insulation at this point and twist the wire to form a small loop. Then rewind the coil form. (Scram-

ble-re-winding is perfectly satisfactory.)

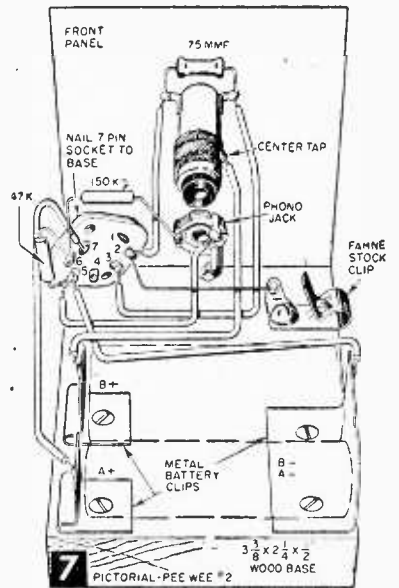
Having soldered the free end back on the coil lug, bind a length of hook-up wire to the coil form with a few turns of adhesive tape (Fig. 8) and solder one end to the loop on the coil, the other to the B-plus battery clip.

When Pee-Wee #2 is wired, insert batteries and attach a wire from unit's antenna clip to any handy metal object and turn on your radio. Set your radio's dial to between 1300 and 1600 kc., plug into phono jack of Pee-Wee with output from record player, and adjust the tuning screw of ferrite antenna coil until music is heard through your radio.

At close range, this little transmitter will deliver as strong a signal as your local stations. (Its total range is about 100 ft.) Trying the antenna on various metal objects will reveal the



8



7

PICTORIAL PEE-WEE #2

Center tap on ferrite slug-tuned antenna coil of Pee-Wee #2 is placed 32 in. from end, of coil which is then rewound. Set is shown here without tube or batteries.

## MATERIALS LIST—PEE-WEE HOME BROADCASTER #2

1	2 1/4 x 3 1/8" metal panel (#20 aluminum or equivalent)
1	1/2 x 2 1/4 x 3 3/8" wood base
1	7-pin miniature socket
1	miniature pentode tube, Type 1L4 or 1T4
1	ferrite antenna coil (Miller, Stanwyck, Grayburne, etc.)
1	Fahnestock spring contact clip
1	Eveready Mini-Max (or equivalent) #412 (E) 22 1/2 v. battery
1	Eveready Nine-Lives (or equivalent) #915 1 1/2 v. Penlite cell
1	Switchcraft phone jack, type 11
1	Switchcraft phone plug, type 250
1	75 mmf. ceramic fixed capacitor
1	47K, 1/2 or 1/4 watt resistor
1	150K, 1/2 or 1/4 watt resistor
1	Miscellaneous screws, scrap tin (for battery clips), hook-up wire

most effective pickup for you. We found a metal magazine rack effective all over the house, with just 3 ft. of wire ample for pick-up 10 feet from the radio. To sharp-tune, adjust either the Pee-Wee's antenna tuning screw or the radio dial.

As mentioned, a carbon mike is used for voice broadcasting. Most radio supply houses have these, as well as bargain shops which sell old telephone transmitters (see Materials List—Pee-Wee #1). In addition to the mike, a transformer and two Penlite cells will be needed. The mike transformer should be a 200 to 2500 ohm ratio or higher. Most radio houses have them, but a door-bell transformer (sold in dime stores) will work equally well. The mike is connected to the 6-8 v. secondary of the bell transformer through two Penlite cells wired in series to deliver 3 volts (see Fig. 6). The 115 v. primary leads of the bell transformer go to the phono jack.

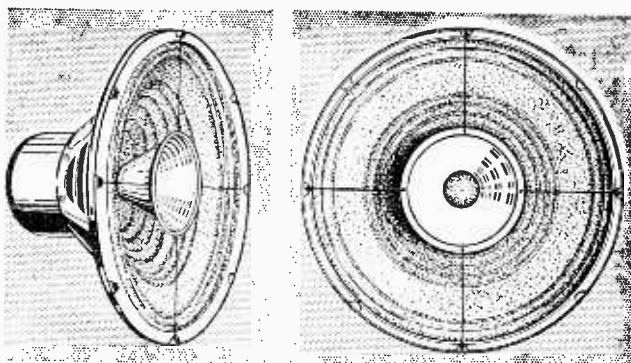
When a carbon mike is used, use a push-button switch to disconnect the batteries when not talking; otherwise, they will discharge at a rapid rate. When not in use, the unit itself is disconnected by removing the A battery from its clips. —T. A. BLANCHARD.

## Improving Loudspeaker Performance

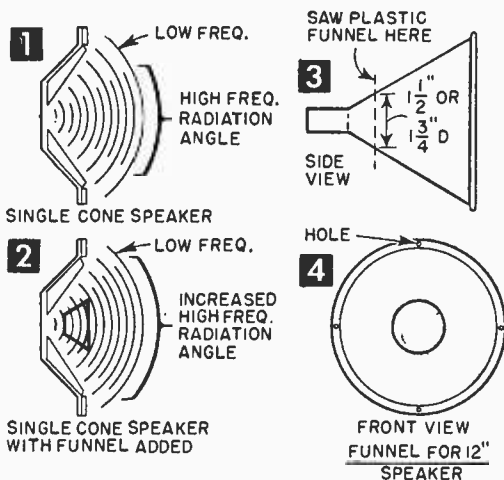
A LOUDSPEAKER cone radiates high frequency notes from the center of the cone in a narrow beam, while low frequencies are radiated from entire surface of cone at a very wide angle (Fig. 1). This is true even with better quality speakers of the single cone type, making it almost necessary to sit in front of the speaker to enjoy the highs in the best phono records or in an FM broadcast, particularly with amplifiers which have a good high frequency response.

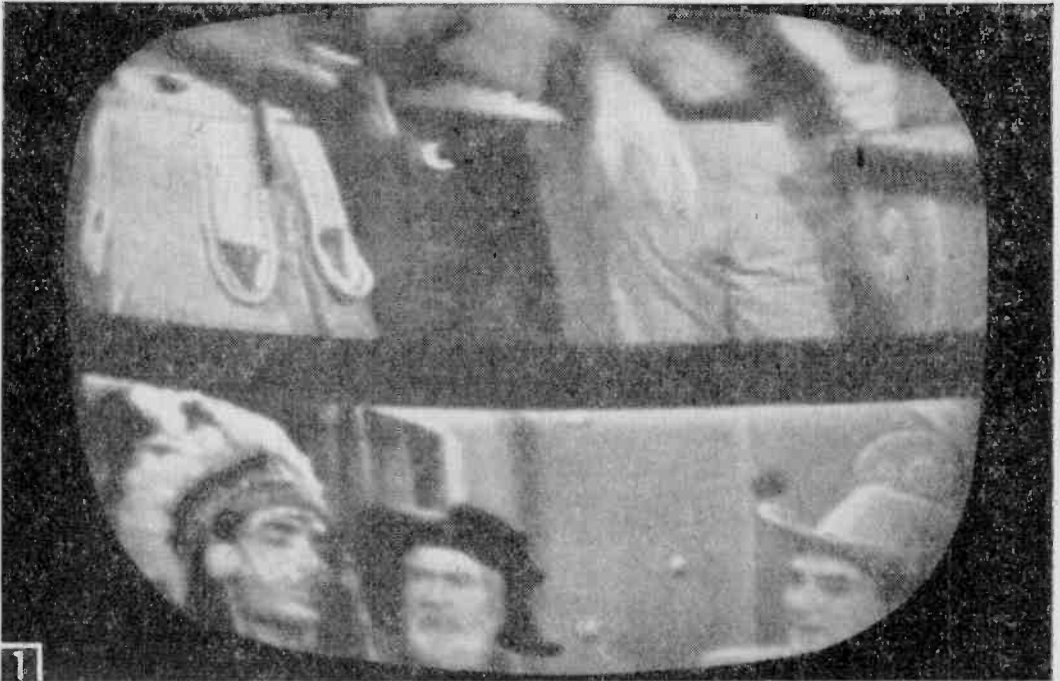
You can improve loudspeaker performance by mounting a 10-cent plastic funnel in center of speaker cone (see drawings) to spread the highs by allowing part to pass through center of funnel, while funnel sides force remainder out at an angle so they can be heard better all over the room (Fig. 2). The better quality single cone speakers, such as the Jensen P12-SX (pre-war model number PM12-CT), and the General Electric S-1201D, will especially benefit by this simple installation since they have an extended range up to 10,000 cps with some contribution to the 12,000 cps region, and perhaps higher.

Use a funnel 4 1/2 in. in dia. and 4 1/2 in. deep. Saw off spout (Fig. 3) so there is an opening in bottom of funnel about 1 1/2 or 1 3/4 in. in dia. Size of opening in bottom of funnel depends on size of high-frequency radiating area in center of cone, and on amount of highs you want to pass through funnel. Drill or burn with a hot needle 4 small holes through rim of funnel and suspend it in front center of speaker cone by means of strong fish line cord or small wire. Bottom of funnel should clear cone of large speaker by at least 1/2 to 5/8 in. to prevent damage to cone.



Dimensions given in this article work well with a 12 in. speaker; use a smaller funnel for an 8 in. speaker, and a larger one for a 15 in. speaker. —ARTHUR TRAUFFER.





1

Strong TV signals may cause rapid and slow rolling of picture by triggering the vertical synchro on your TV set.

# H-Pads Stabilize Rolling TV Pictures

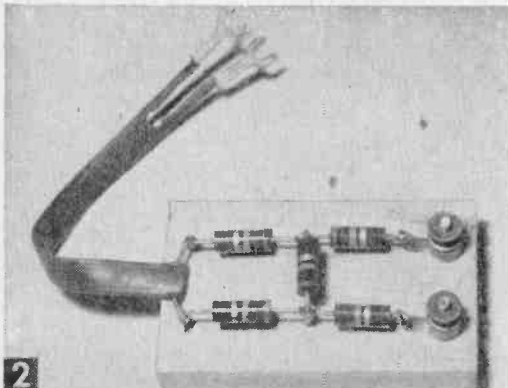
THE combination of the modern ultra-sensitive cascade tuner in TV sets made during the past few years, plus the greatly increased operating power of TV stations, may make the housetop antenna deliver too strong a signal.

The result is that the TV picture may roll (Fig. 1), blacken and pull to the right of the screen between "station breaks" or when the picture contrast control is advanced. These conditions can, of course, also be caused by defective components in the vertical synchro section of your receiver. But, where the trouble is due to

your antenna delivering too strong a signal, what happens is that the vertical circuitry loses its stability and cannot lock the picture in frame.

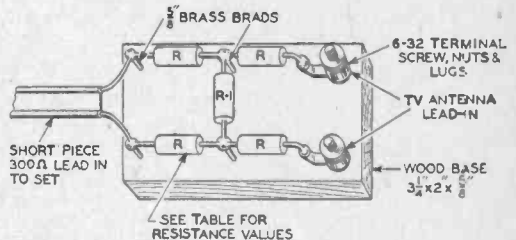
To eliminate this triggering action of strong TV signals, you can insert a simple resistance network between your set and the TV antenna. Because of the arrangement of the resistors (Figs. 2 and 3), this picture stabilizer is known as an "H-Pad."

In simple language the H-Pad is a picture volume control which reduces the R.F. signal delivered to the set's tuner input by the antenna.

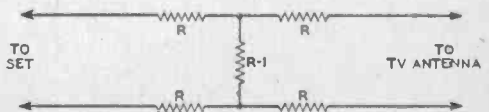


2

Simple H-Pads may be assembled on a small wood baseboard and connected in series with TV antenna.



3 PICTORIAL



4 SCHEMATIC

The strength of the signal reaching your TV receiver is expressed in decibels, which are convenient units for measuring intensity logarithmically (you hear, by the way, in proportion to the logarithm of the intensity rather than in direct linear response to it). The H-pad resistor combinations, which you will use to reduce the signal strength, are proportional to the degree of reduction (attenuation) of signal strength required. Thus, where the vertical circuit is only triggered infrequently by a slow roll, a 5-db (decibel) H-Pad may be all that you need. This unit has low series resistance and high shorting resistance. On the other hand, if your pictures are double or triple-triggered as evidenced by rapid rolling, up to 30-db attenuation may be required. Here the series resistors are high and the shunt or shorting resistor low. Table A indicates various resistor values needed to provide various degrees of attenuation.

For most vertical sync problems a 20-db stabilizer should prove about right. The unit shown in Fig. 2 was assembled on a  $\frac{5}{8} \times 2 \times 3\frac{1}{4}$ -in. block of wood. Holes were drilled and countersunk in one end for two  $1\frac{1}{2}$ -in. *fh* 6-32 machine screw binding posts.

Drive four  $\frac{5}{8}$ -in. long brass brads into the block, leaving  $\frac{3}{16}$  in. of the nail exposed. Then cut off excess portions of the resistor pigtail leads

TABLE A—H-PAD RESISTOR VALUES

Attenuation	Resistors R	Resistor R-1
30 db	150 ohms	22 ohms
25 db	150 ohms	33- 36 ohms*
20 db	120 ohms	56- 62 ohms*
15 db	120 ohms	120 ohms
10 db	82 ohms	220 ohms
5 db	47 ohms	470-510 ohms*

\*Use the larger value if available. Otherwise substitute smaller resistance value which all dealers stock.

and carefully solder resistors to the brad heads in a neat and rigid arrangement as shown in Fig. 2. A short length of 300-ohm TV lead-in wire allows the H-Pad to be attached to the set's antenna terminals, while the antenna itself is attached to the binding posts.

The resistors for any of the six H-Pads listed may be as small as  $\frac{1}{4}$ -watt size. If you prefer not to experiment with your own homemade H-Pads, you can purchase printed circuit H-Pads from the larger TV supply houses (see pages 73-74). Centralab Division, for instance, makes 10, 20, 30, and 40-db attenuators.

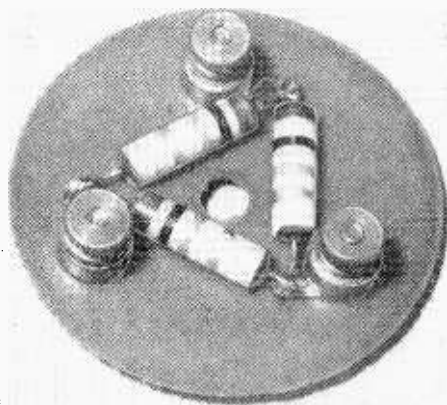
Centralab also has a tap switch unit containing all four printed circuits to allow change-over from 10 to 40 db by turning a switch knob. Usually one H-Pad is sufficient, but if it reduces the signal of more distant stations normally received, it should be switched out of the antenna lead-in when set is tuned to the distant stations that do not cause picture roll.—T. A. BLANCHARD.

## Two Sets-One Antenna with this TV COUPLER

lead-in to TV set #1, and a third lead to set #2 (see Figs. 2 and 3). Since the resistance network is balanced, any pair of terminals work equally well as antenna input or TV coupling.

Resistors may be rated as little as  $\frac{1}{4}$ -watt, and the choice of values is dependent upon availability. The 910 ohm size is ideal for flat, oval or round 300 ohm lead-in. If this size is not available, use the more popular 820 ohm units. The latter resistance also happens to provide a perfect match for the new 270 ohm foam rubber round lead-in now becoming popular.

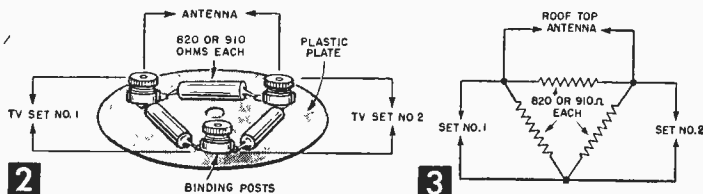
Some early TV sets were designed with an unbalanced 72 ohm input. Fair to good results may be obtained if one of the sets attached to coupler uses a 72 ohm co-ax lead-in from set to coupler, but line from antenna to coupler must be the modern 270 or 300 ohm impedance type.—T.A.B.

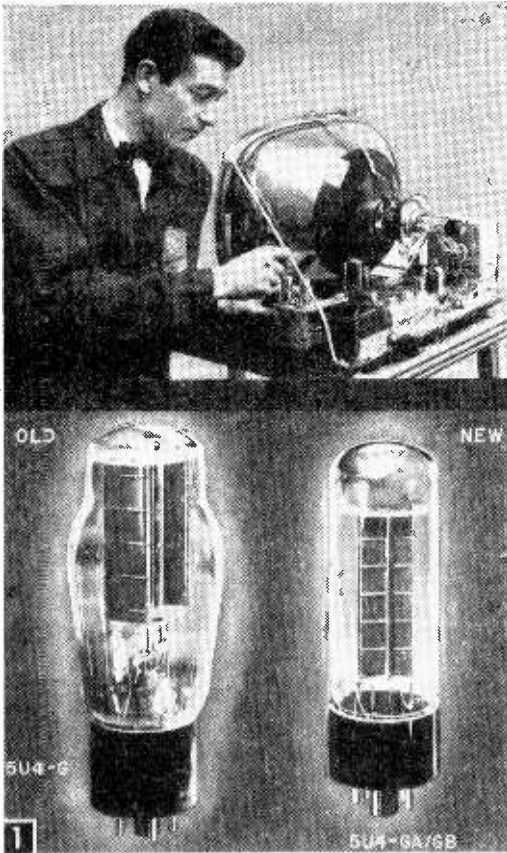


**T**WO TV receivers will operate efficiently off the same rooftop antenna by using this simple resistance bridge coupler. To assemble it, all you need are three 820 or 910 ohm composition resistors, three 6-32 x  $\frac{5}{8}$  in. machine screws and six matching nuts.

Arrange the resistors in a triangle on a small round or square piece of fiber or plastic (Fig. 1). For a neater appearance you can enclose them in a small plastic cosmetics box.

Connect the antenna lead-in to any adjacent pair of binding posts, running another piece of





Replacing old picture tube with new aluminized type will increase picture brilliance as much as 30%. But replacing conventional tubes with new "Service Designed" types may postpone the need for replacing picture tube. Old, pear-shaped 5U4-G rectifier (Fig. 1) has less current-carrying capacity than the new, streamlined, heavy-duty 5U4-GA/GB.

backs to replace short-lived, under-rated tubes.

Nor have breakdowns been confined to these relatively inexpensive tube replacements. Often a tube short goes on to ruin a set's internal circuitry components and a really whopping service bill results. Which is why, during the past year or so, tube manufacturers have gone all out to redesign tubes used in TV sets in an effort to minimize breakdowns in those types which have proved so troublesome in the past.

General Electric, for example, has recently released a total of 20 "Service Designed" tubes. Statistically, these 20 tubes represent 54% of the total tube replacements required by service technicians.

**Using the New Tubes.** The majority of TV failures can be remedied simply by replacing defective tubes. Table A lists the most typical TV troubles encountered. When you have trouble with your set, locate the particular symptom in the first column of Table A; then, in the second column, note those tubes which can cause the trouble. The tubes listed in the second column comprise most of the types in use today. (Those in *italics* are the most prone to failure.)

Table B lists the 20 new, redesigned tubes with both old and new type numbers and circuit function. All 20 of the new tubes are directly interchangeable with the old, even though their physical appearance may be completely unlike that of the old tube. A chassis diagram with tube locations by type number will be found on or inside your TV cabinet and all tubes listed in Tables A and B will be in plain sight on your set's chassis except for those inside the high-voltage cage.

Because of slight internal variations in tubes, the replacement of a 6J6 used in the tuner circuit may require readjustment of the individual oscillator slugs. To reach these slugs, pull off the channel selector knob. Beneath it is a screw for each channel. Using a plastic blade screwdriver, turn these screws to left or right (individually for each channel) until best sound and picture is obtained. When replacing tubes in the picture circuit, it may be necessary to readjust the various height-width and hold controls on the chassis so as to be compatible with the characteristics of the new tube or tubes used as replacements. These are the only readjustments you'll have to make when trouble-shooting your set with the new tubes.

Before replacing any tubes, however, be sure to *short the caps of high-voltage tubes to ground*. Do this by holding the blade of a *long screwdriver* from cap to chassis. And be sure the

## NEW TUBES to TV's Rescue

**R**EMEMBER the very early TV sets with their "giant" 7 and 8 in. cathode ray picture tubes? And how they were snapped up as fast as they arrived in the dealers' showrooms? And then how the tube industry went all out to develop CR tubes that would provide "still bigger" pictures? How screens jumped from 10 to 12 to 14 to 16 and up to 30 in. (and in the process changed from round to rectangular)?

Well, while all this was happening, and while circuits were constantly being improved and TV sets redesigned to require fewer and fewer conventional tubes, the fact remained that *except* for the CR tube, vital TV tubes were still largely types that had been designed for non-TV use. And because of the heavy current demands placed on tubes by TV, and the exacting internal characteristics required, millions of set owners (and servicemen, too) have been—and are being—plagued by the frequency of service call-

screwdriver handle is plastic or wood. Shorting the caps to ground discharges the filter capacitor in the high-voltage circuit. This capacitor can hold a charge for hours after the set has been turned off, and a severe shock could result if this precaution were to be ignored.

**Characteristics of the New Tubes.** While all of the new tubes have been redesigned internally, the physical shape of some tubes in the new series remains outwardly unchanged. Others have been redesigned both inside and out.

Figure 1, for instance, shows the original pear-shaped 5U4-G rectifier with elements supported by the mazda bulb type pressed stem. By employing a button stem similar to that used for miniature tubes, element supports were made much sturdier and shorter in the new, redesigned 5U4-GA/GB, permitting larger diode plates and greater current carrying capacity. In addition, the slim cylindrical glass envelope of the 5U4-GA/GB permits internal heat to be dissipated more rapidly to further prolong tube life.

The 6SN7-GTB and 12SN7-GTA twin triode

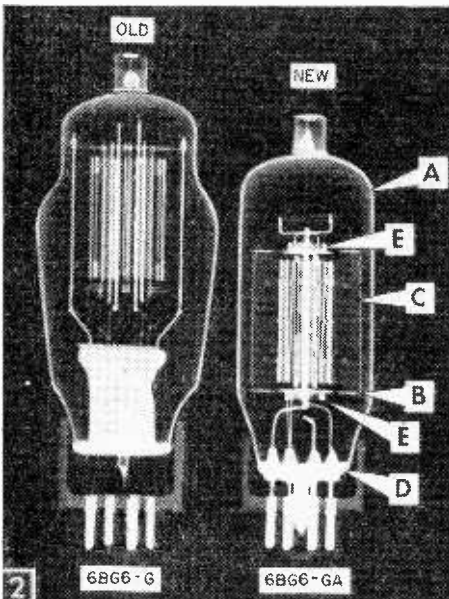
tubes, on the other hand, while retaining the same envelope diameter, have been made considerably shorter than previous models. The main feature of the 6SN7-GTB, however, is its new 600 ma. heater permitting a universal replacement type for both series and parallel wired sets, whether old or new.

X-Ray views of the old and new 6BG6-GA horizontal amplifiers (Fig. 2) clearly show how its new button-stem base and straight-side glass structure add shock resistance. The double mica

TABLE A  
TV TUBE TROUBLE-SHOOTING GUIDE

Trouble	Check These Tube(s)
No sound, no picture —screen dark	5U4, 5Y3, 6W6, 6Y6, 6AC7, 6AG7, 6CL6 (after checking set's fuse)
No sound, no picture —screen bright	6AC7, 6AG5, 6AH6, 6AL5, 6AM8, 6AN8, 6AU6, 6BA6, 6BC5, 6BG7, 6BK7, 6BQ7, 6BZ7, 6CB6, 6CF6, 6J6, 6U8, 12AT7, 12AU7, 12AV7, 12BH7, 12BY7
Sound, but no picture —screen dark	1B3, 1X2, 6AX4, 6BG6, 6BQ6, 6BX7, 6CU6, 6SN7, 6W4, 12AX4, 12SN7, 25BQ6 (fuse)
Sound, but picture squeezed top and bottom, or screen black with horizontal white line	6AS5, 6AH4, 6AQ5, 6BL7, 6C4, 6J5, 6K6, 6V6, 6W6, 6S4, 6SN7, 6U8, 12AU7, 12BH7, 12BY7, 12SN7, 25L6
Sound, but picture squeezed on sides, or screen black with vertical white line	5U4, 6AU5, 6AV5, 6AX4, 6BG6, 6BQ6, 6BX7, 6CD6, 6CU6, 6SN7, 6W4, 12AU7, 12BQ6, 12CD6, 25BQ6, 25CD6, 25W4
Picture frame rolls; won't lock on screen	6AH4, 6BX7, 6C4, 6J5, 6SN7, 12AU7, 12BH7, 12SN7

Some of the tubes listed may have the letters G or GT following their type numbers. The new types often have the added suffix A and B (see Table B). Tubes in italics cause 54% of all TV failures.



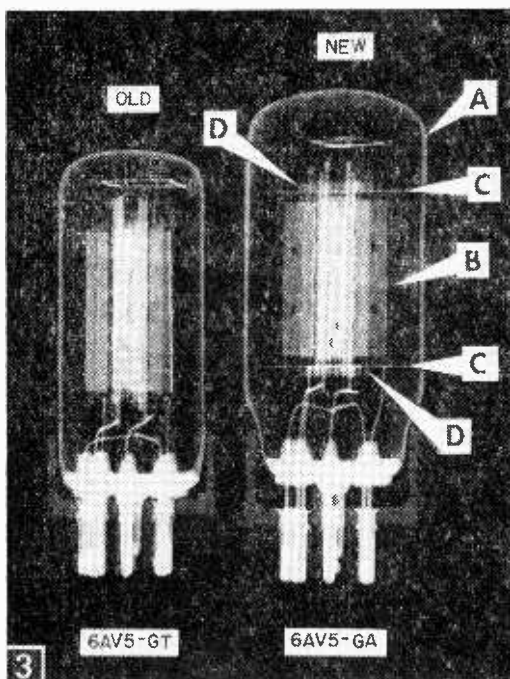
X-ray views of old 6BG6-G and new 6BG6-GA. Note A) new shape, B) bottom and top mica supports, C) shock resistant elements, D) button-stem base, and E) beam shield.

TABLE B

New Type*	Replaces	Circuit Function	Base
1B3-GT	old 1B3-GT	High-voltage, half-wave rectifier	Standard octal
1X2-A/B	1X2 and 1X2-A	High-voltage, half-wave rectifier	9-pin miniature
5U4-GA/GB	5U4-G and 5U4-GA	Low-voltage, full-wave rectifier	Octal
5Y3-GT	old 5Y3-GT	Low-voltage, full-wave rectifier	Octal
6AL5	old 6AL5	Detector/AGC twin diode	7-pin miniature
6AV5-GA	6AV5-GT	Horizontal-deflection amplifier	Octal
6AX4-GT	old 6AX4-GT	Horizontal deflection damping diode	Octal
6BG6-GA	6BG6-G	Horizontal deflection beam pentode amplifier	Octal
6BK7-A	6BK7	Twin triode cascade amplifier	9-pin miniature
6BQ6-GA/	6BQ6-GT/	Horizontal deflection beam	Octal
6CU6	6CU6	power amplifier	
6BQ7-A	6BQ7	Twin triode cascade amplifier	9-pin miniature
6BX7-GT	old 6BX7-GT	Twin triode vertical deflection vertical oscillator	Octal
6BZ7	old 6BZ7	Twin triode cascade R.F. amplifier	9-pin miniature
6CB6	old 6CB6	R.F. and I.F. wide-band amplifier	7-pin miniature
6CD6-GA	6CD6-G	Horizontal deflection beam power pentode	Octal
6J6	old 6J6	Twin triode R.F. amplifier oscillator or mixer	7-pin miniature
6SN7-GTB	6SN7-GT and 6SN7-GTA	General purpose amplifier and phase-inverter	Octal
12SN7-GTA	12SN7-GT	General purpose amplifier and phase-inverter	Octal
25CD6-GB	25CD6-GT	Horizontal deflection beam power pentode	Octal
25BQ6-GA/	25BQ6-GT/	Horizontal deflection beam	Octal
25CU6	25CU6	power amplifier	

\* New tubes that retain the old tube type number are identified by the tube carton.





Old 6AV5-GT was much smaller than new 6AV5-GA. New tube features A) larger bulb, B) larger plate area, C) new micas to reduce high-voltage arcing, and D) new beam shields.

element supports have also been redesigned to reduce inter-electrode leakage, thus reducing the chances of horizontal picture shrinkage. Beam shields located beneath the 6BG6-GA elements mask off stray electron bombardment and further increase operating stability.

The same changes made on the 6B6-GA have also been made on the 6CD6-GA and 25CD6-GB horizontal deflection amplifiers. Internally, earlier models of these tubes gave arc-over trouble causing horizontal picture streaking. In the new sweep tubes, newly designed micas correct this fault. In addition, the plate area of these tubes has been increased, raising the maximum plate positive-pulse voltage from 6600 to 7000 v. and plate dissipation from 15 to 20 w.

While a number of tubes have been reduced in size, others like the 6AV5-GT have been made larger in order to adequately handle the load imposed upon them. The X-ray view in Fig. 3 shows the old and new. The new version operates safely at high temperatures, withstands high pulse-plate voltages and is sturdy in construction. The larger glass envelope radiates more heat so the tube runs cooler and lasts longer. Redesigned and enlarged plate area reduce internal operating temperature with new micas minimizing high-voltage arcing. For stability, new beam shields mask off stray electron bombardment from micas and bulb.

Other tubes in the "Service Designed" series have improvements which are not quite as ob-

vious. For example, the outward appearance of the 1X2-A/B high voltage half-wave rectifier remains unchanged. Internally, however, a new filament shield post (nicknamed the "lightning rod") helps to neutralize electrostatic pull of the anode, reducing filament pull-outs to a minimum. The 1X2-A/B also employs a new filament coating that bonds securely to the wire. Because the coating will not flake off and expose the heating element, tube arc-overs are greatly reduced.

Improvements in the rest of the series are as noteworthy. The best approach when troubleshooting with these new tubes is to replace as many old tubes in the set as possible. Merely having an old tube check out "Good" on a tube tester proves nothing. In many instances, a tube does not become erratic until fully heated, that is, after it has been operating for anywhere from half an hour to several hours. Remember, tubes are usually tested cold and that "Good" tube is apt to be the dud that has been plaguing your TV reception.

When replacing tubes, don't overlook the fact that if your TV set is several years old and has seen plenty of use, it *may* be time to replace its CR tube. To take full advantage of tube developments, replace it with the new aluminized reflector type that increases picture brilliance as much as 30%. To date, no less than 50 types of picture tubes now feature this reflective coating.

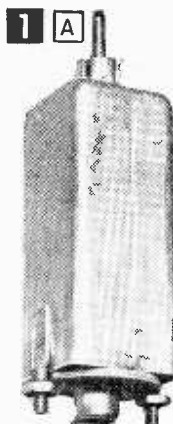
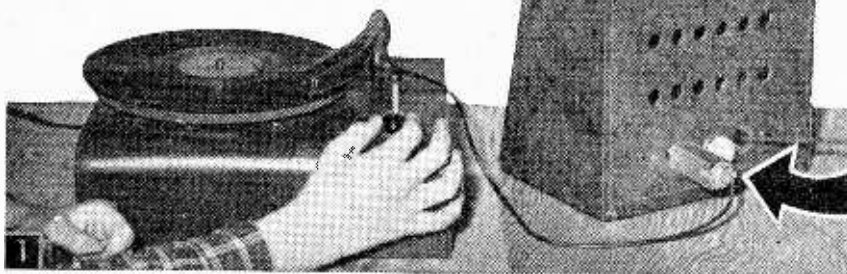
Space does not permit listing the 32 data tables covering TV picture tubes, but manuals containing this information can be purchased from parts suppliers. It is only necessary, however, to give the number of the old tube and ask for the aluminized version when ordering a new tube. The slight increase in price is well worth the extra outlay.—T.A.B.

### Pen Holder As Capacitor Trimmer

- When commercial trimmer tools are not available to fit certain slots or chassis openings, use a wood or fiber pen holder, substituting a narrow strip of thin metal for the pen point.



A midget IF transformer can (inset) housed the original phono surface noise and scratch filter, but other more common types of tin containers can be used. To use filter, merely plug unit into line between record player and amplifier or radio phono jack.



## Noise Filter for Record Playing

**R**ECORDS, both old and new, frequently suffer a common disease—surface noise. Here's a filter that should help to cut down that distracting scratching, so that you can enjoy even those old favorite records made before the advent of electronic recording.

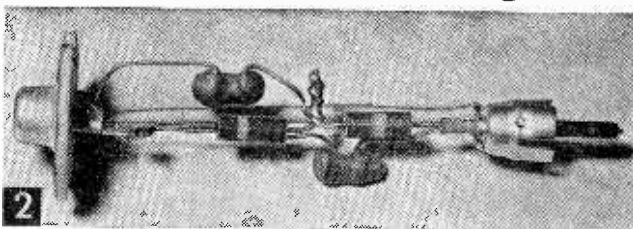
This record filter plugs into the input line of the phono amplifier (Fig. 1) so that in most instances no internal circuit changes are required, either at the record player or amplifier. The original unit was housed in a miniature IF transformer can (Fig. 1A), but any small metal container may be used.

Drill a  $\frac{7}{32}$ -in. hole in one end of the can; this hole will be just large enough for you to insert the neck of the ICA-type phono plug shell. Solder the shell to the can. If the housing is made of aluminum, first "tin" the areas around the  $\frac{7}{32}$ -in. hole with aluminum solder. You can then solder the shell to the aluminum with regular lead/tin alloy radio solder.

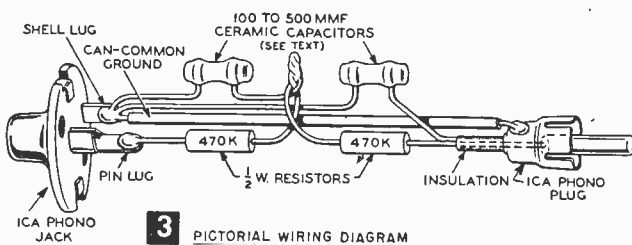
Drill a  $\frac{3}{8}$ -in. hole in the opposite end of the can, along with two  $\frac{1}{8}$ -in. holes for mounting an ICA-type phono jack. When screwed down with  $\frac{1}{4}$  x 4-40 machine screws, the jack shell is automatically grounded to the metal container.

The filter network (Figs. 2 and 3) consists of two 470k (470,000) ohm  $\frac{1}{2}$ -watt resistors and two ceramic capacitors with an identical capacity of 100 to 500 *mmf* each. Where surface noise is only slight, use capacitors of 100 *mmf* to 250 *mmf*. For old, scratched discs, use capacitors of about 500 *mmf*. The larger capacitors will somewhat increase the bass response of records, and suppress the highs, but at least you'll be able to hear both bass and treble far better with the annoying surface noise suppressed.

If you are very ambitious, substitute a pair of



The noise filter consists of six inexpensive radio components listed in Fig. 3.



**3** PICTORIAL WIRING DIAGRAM

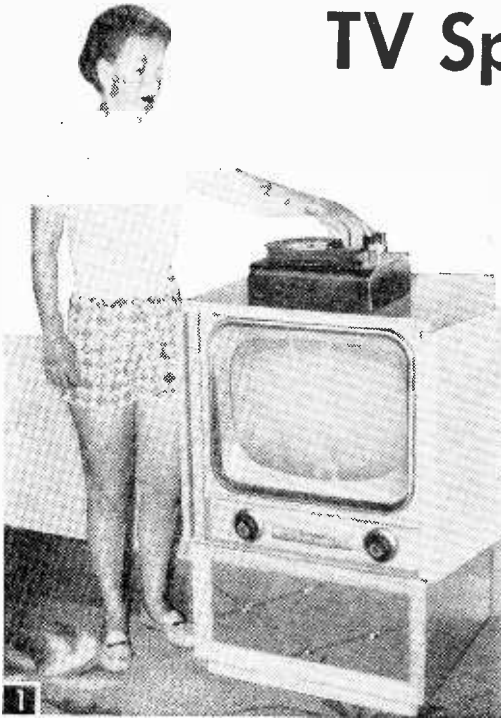
### MATERIALS LIST—RECORD NOISE FILTER

- 1 small friction lid can, or IF transformer shell
- 1 ICA type phono plug
- 1 ICA type phono jack
- 2 470k (470,000) ohm,  $\frac{1}{2}$ -watt composition resistors
- 2 fixed ceramic capacitors or adjustable trimmers (see text)
- 2  $\frac{1}{4}$  x 4-40 rh machine screws and nuts

adjustable mica trimmer capacitors with a range of about 100-500 *mmf* for the fixed ceramic types. Then with a screwdriver, you can adjust the capacitances to suit the condition of the record.

When wiring up the filter, be sure the resistor and capacitor lead to the phono-plug pin does not accidentally ground to the shell since this would render the phono inoperative. A short length of radio "spaghetti" or other insulation will prevent this.—T. A. BLANCHARD.

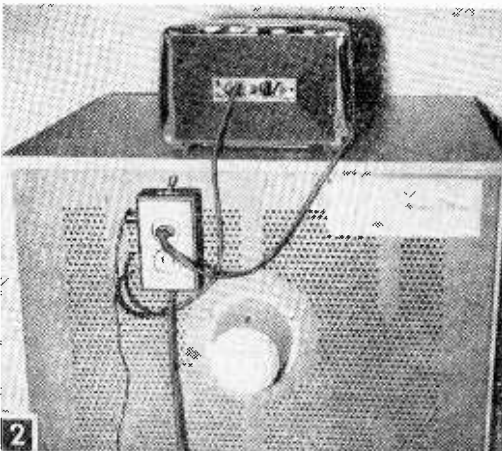
# TV Speaker Control



1 Portable record players and small radios achieve fine tone quality when played through speaker of TV console sets.

**P**URCHASING a TV set incorporating a radio and record changer becomes a needless expense with this simple speaker control. If you have a small radio or portable record player (Fig. 1) you can greatly improve the sound quality of either one by feeding the signal through the large 10 or 12 in. speaker of a console TV set.

Some TV sets provide a Phono Jack into which record players may be plugged. However, in



2 Speaker control box is concealed behind set. Small bracket holds it securely in place.

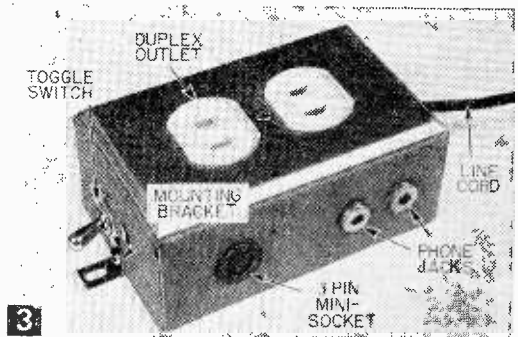
Any TV set becomes a combination radio or phonograph with this simple control. It also gives any small radio set full console, big-speaker tone quality at trifling cost!

By THOMAS A. BLANCHARD

nearly every instance, the entire TV set is drawing up to 300 watts when only 25 or 30 watts are needed for either records or conventional radio reception. This speaker control (Fig. 2) allows the TV speaker and its acoustic mounting to be employed while the TV set, itself, is turned off. Flipping the toggle switch on the control disconnects the TV speaker from the set, connects it to the table radio or phono, and turns "on" the power to the latter; all at the same time. Snapping the toggle switch "off," shuts off the radio and reconnects the TV chassis to the cabinet speaker.

The Speaker Control is fitted with a duplex outlet allowing plain record players with their separate amplifiers to function as one unit when switch is thrown.

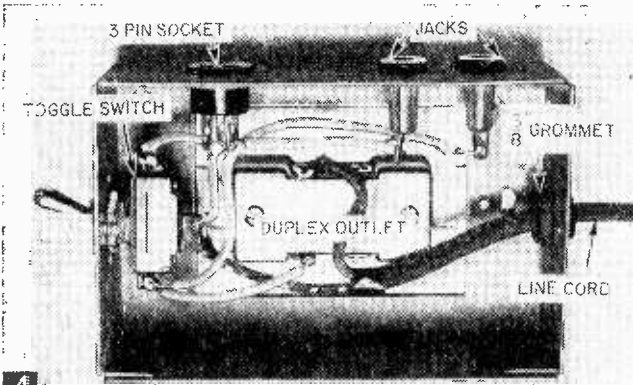
To make the speaker control (Figs. 3 and 4), drill a  $\frac{1}{2}$  in. hole through one end of a duplex



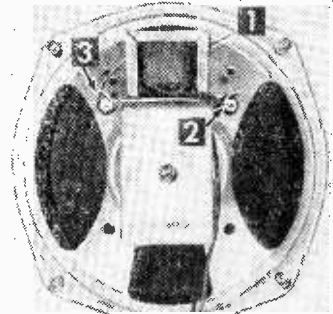
3 Speaker change-over switch provides two outlets for plugging in radio or phonograph.

outlet box, or other suitable metal utility box, for a double-pole, double-throw toggle switch. Drill a  $\frac{5}{8}$ -in. and two  $\frac{3}{8}$ -in. holes through one side for installing a 3-pin socket and two radio phono-tip jacks.

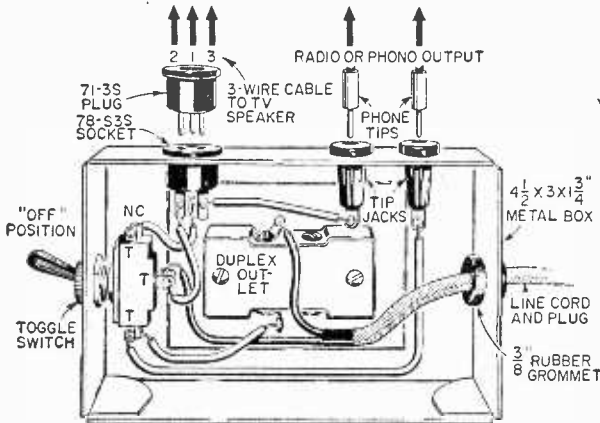
Mount the components and wire-up the circuit as in Fig 5. The 3-pin socket bears the numbers shown in drawing. However, toggle switch should be mounted with the lugs marked "T" in drawing being those nearest you or "topmost." The



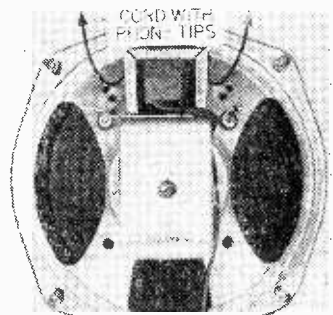
**4** Bottom view of speaker control. Metal box measures only 4½ x 3 x 1¼ in.



**6** TV SPEAKER  
Cable wire #3 is soldered to lefthand TV speaker lug. Wire on righthand speaker lug is removed and attached to cable wire #1. Wire #2 is then attached to righthand lug.



**5** PICTORIAL WIRING DIAGRAM



**7** Radio or phono player speaker is disconnected. Wires originally on speaker lugs are attached to 2-wire cable which plugs into "Phone Jacks".

**MATERIALS LIST—TV SPEAKER CONTROL**

No.	Description
1	4½ x 3 x 1¼" Wiremold outlet box, or similar wood or metal case
1	Duplex outlet and plate with "Off-On" plate
1	Double Pole-Double Throw Toggle Switch
1	Amphenol 3-pin socket (#78-S3S)
1	Amphenol 3-pin plug (#71-3S)
2	Phone Tip Jacks, plastic (Amphenol or Eby)
2	Phone Tips (Amphenol or ICA)
1	6 ft. fixture cord and plug
1	¾-in. plastic bushing or rubber grommet
	Sufficient hook-up wire for cables

lug marked "NC" in drawing denotes "no connection." Other than this precaution, the control box is free of wiring complexities. Fasten a small mounting bracket (Fig. 3) to the end of the control box for attaching box to back of TV console cabinet with one of the back cover screws.

**Installing Control.** Cut three lengths of hook-up wire long enough to reach from the 3-pin socket on control box to the two lugs on the TV speaker (Fig. 6). Solder the leads into the plug pins, then connect to speaker by attaching wire

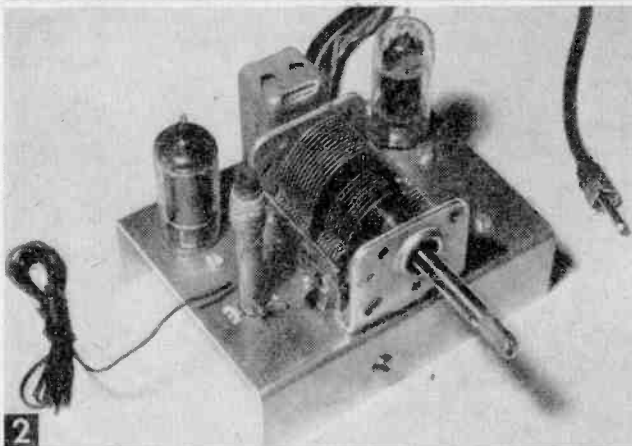
#3 to lefthand speaker wire being careful not to disconnect wire already soldered to this lug. Disconnect wire entirely on righthand speaker lug, and attach control lead #2 to the vacated righthand lug. Finally, connect the wire originally on the righthand lug to cable lead #1 and the TV set alterations are completed.

To feed the output of the record player or table radio into the control, use two suitable lengths of cord with phone tips attached to one end. Plug these into jacks on control. Connect the opposite ends of the jack cord to the two wires now attached to the radio or phono speaker lugs (Fig. 7). In other words the latter small speaker has been completely disconnected and its original connecting leads brought to the control box jacks.

Some TV sets as well as small radios may have their output transformer concealed within the chassis, or mounted on the speaker as shown. It is only necessary to remember that connections are made or altered only on the speaker soldering lugs. Do not disconnect or alter leads running from set to the transformer when it is located on the speaker.

## AM Superhet Tuner

Connected through a record player or instrument amplifier, this tiny superhet radio produces some really big results



This AM superhet tuner chassis is 5 in. wide by 3 in. deep, but you may alter shape of chassis if cabinet mounting space requires it. Set requires no loop or outside antenna.

**T**HIS tiny tuner may be used to convert a portable record player into a combination AM radio-phonograph. Or it may also be used with PA or musical instrument amplifiers. Although it is designed to fit inside the record player or amplifier case, you can make a small wooden cabinet to house it separately if you wish.

Both sensitivity and signal output are excellent, although this circuit employs only two tubes: a miniature 6BE6 (or 12BE6) as a mixer-oscillator, and a 6AT6 (or 12AT6) as detector-amplifier. In fact, the tuner, plus a small power supply, makes a fine set for earphone listening.

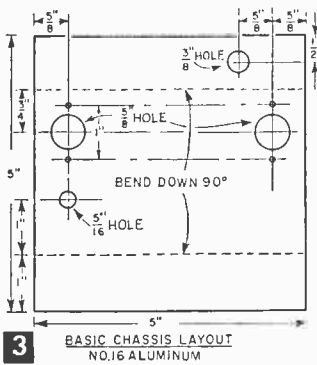
Figures 4 and 5 show you the few circuit com-

ponents required. You don't need a power supply because operating voltages are easily obtained from the record player-amplifier. The majority of portable record players employ a 3-tube *ac-dc* amplifier with a 12, 50 and 35-volt tube wired in series and connected to the power line through a large composition or wire-wound resistor having a value of between 125 and 150 ohms.

To obtain "heater" voltage for the tuner, you can simply eliminate the voltage dropping resistor, and wire the tuner's tube heaters in series with the tubes in the record player amplifier as in Fig. 6. In this case, 12-volt tubes are used in the tuner.

To obtain plate voltage (B plus), you merely connect this lead to *anode grid* ( $G^2$ ) of the phono amplifier's power output tube (the 50L6 to Pin #4, and the 50B5 or 50C5 to Pin #6). The B minus wire is connected to the amplifier chassis, unless an isolated ground system is employed in the amplifier. In that case, connect the B minus tuner lead to the amplifier lug on which the electrolytic capacitor negative lead is attached.

The radio signal from the superhet tuner is fed into the amplifier by plugging the shielded output cable into the mike jack, if the amplifier has one. If not, refer to Fig. 7, which shows how pickup is wired to grid and volume control of portable record players. The inner wire goes to

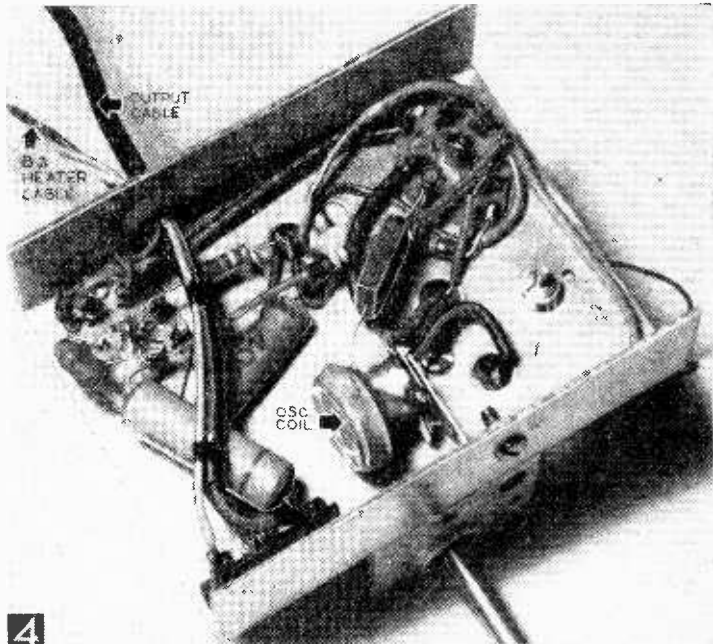


input tube's grid circuit, while the outer braid is grounded. To switch from pickup over to radio, a single pole-double throw wafer or toggle switch is mounted near the amplifier input tube, and the pickup cable and tuner output cable are wired to the switch as shown in Fig. 8.

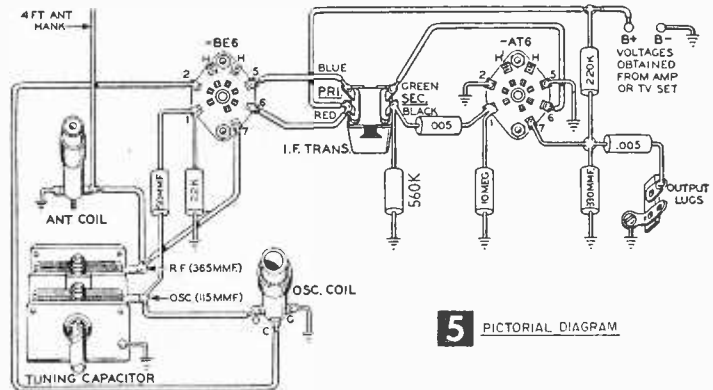
The present phono player volume and tone controls also serve for the radio. The tuner circuit is "hot" even when the amplifier is being used for records. When the tuner is used with record players employing 6-volt tubes, the tube heaters are wired in parallel and must be the 6-volt type as indicated in Fig. 6A. Phono amplifiers which use 6-volt tubes employ either an autowound power-filament transformer or one with isolated secondary. The latter type has ample current reserve to handle the additional tuner tubes.

A simple load test for transformers is to secure a small thermometer to the transformer with Scotch tape. After half an hour, note the reading. Now add the tuner tubes to the circuit. If the thermometer makes a sharp jump beyond the previous reading, the transformer is too small. In this case buy a small 6.3-volt filament transformer (1-amp rating is ample) and operate the tuner's heaters from this separate source. There is ample space to mount this transformer in the record player case.

The chassis layout in Fig. 3 is not complete due to variations in mounting the I.F. transformer and 2-gang superhet tuning capacitor. Drill the mounting holes for these components to fit the particular parts available from your supplier. The original chassis model was made from a 5x5-in. piece of No. 16 gage aluminum. The bent-up chassis measures 3 x 5 in., with a 3/4-in. overall height. You can, of course, alter the



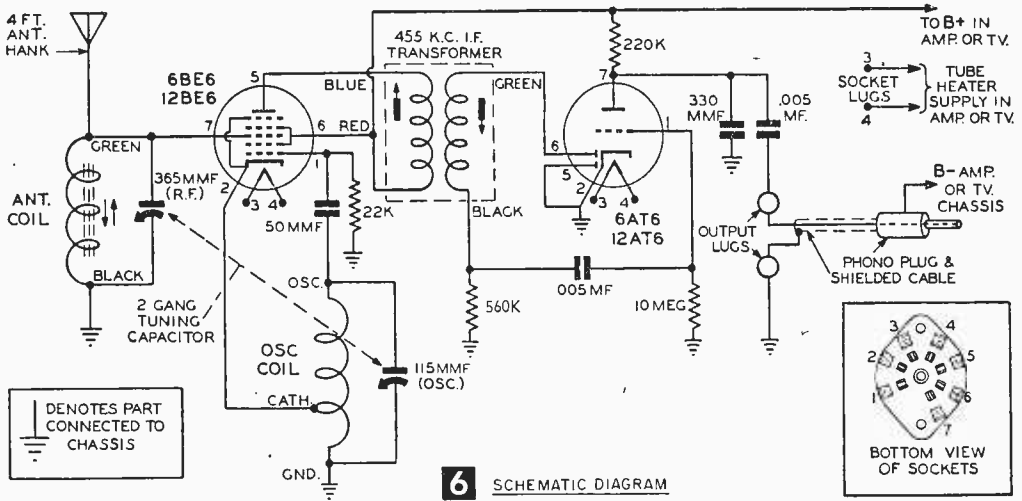
**4** Bottom view of tuner. Shielded cable feeds radio signal to amplifier in record player. Twisted leads connect to ac-dc supply of amplifier which also powers the AM tuner.



shape of the chassis if space within the record player case or cabinet poses a problem; it can be made long and narrow (very little wider, in fact, than the tuner condenser).

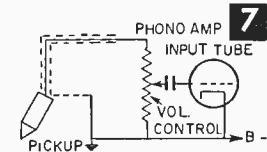
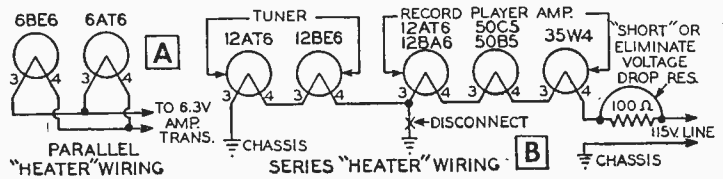
You should have no trouble wiring the components, but remember to locate the slug-tuned antenna coil on top of the chassis and the oscillator coil beneath the chassis. Wire all ground returns directly to the tuner chassis. When used with ac-dc record player amplifiers, the tuner chassis may be "hot." (Reversing cord in outlet will correct this, however.) Mounting the tuner inside a luggage or plastic carrying case renders it safe from shock. When used with transformer-powered amplifiers (except autowound types), no shock problem exists.

The circuit's sensitivity is due to the slug-tuned high Q antenna coil and I.F. transformer. The



antenna coil shown has a single winding. The slug is turned so that about  $\frac{3}{16}$  in. of core projects above the coil form. Exact adjustment is determined by tuning to a station near 1000 kc and setting screw to loudest signal. Do not tamper with the slug or trimmer adjustment screws on the I.F. transformer until the set is working. Usually the I.F. transformers are factory adjusted. Sometimes, a slight touching up will improve reception. Turn one screw left or right for loudest signal on a weak station. Thereafter, leave I.F. trimmer or slug screws a-l-o-n-e!

A compression trimmer



capacitor is provided on the 2-gang tuning capacitor for tracking the R.F. and oscillator sections. Tune set to a weak station near 1000 kc and adjust R.F. trimmer with plastic blade screwdriver for loudest signal. Then adjust oscillator trimmer to line up the station to its proper dial setting (if dial is used).

Although these simple alignment operations may be done after the tuner has been installed in the phono case, it is much more convenient if you leave heater and B voltage leads long and work with the tuner on your bench.

Earphones of 2000 ohms or more resistance attached to the output lugs permit finer adjustment than when the signal is fed through the amplifier speaker. Of course, if you do not own earphones, don't buy them especially for this purpose.

In the original model a ferrite core tunable type antenna coil was used. A 4-ft. length of light, insulated hook-up wire provides a unidirectional antenna far superior to the conventional, bulky loop antenna which requires the set to be positioned in the direction of the station for best signal pickup. If the 4-ft. length of wire proves annoying, cut a piece of *Reynolds, Wear-ever*, or *Alcoa* aluminum wrapping foil to fit within the lid of the record player. Stick it in place with pressure tape and attach the antenna pickup lead to the foil. This arrangement is neater than the 4-ft. lead and just about as efficient. In very remote areas, use a longer hank, or larger piece of aluminum to pull in stations with good volume.—T. A. BLANCHARD.

**MATERIALS LIST—SUPERHET TUNER CAPACITORS**

- 1 midget 2-section superhet tuning capacitor (365-115 mmf)
  - 1 50-mmf mica or ceramic fixed capacitor
  - 1 350-mmf mica or ceramic fixed capacitor
  - 2 .005-mf 400-v.v. paper capacitor
- RESISTORS**
- 1 10-megohm, 1/2-watt insulated carbon
  - 1 560K (560,000) 1/2-watt insulated carbon
  - 1 220K (220,000) 1/2-watt insulated carbon
  - 1 22K (22,000) 1/2-watt insulated carbon
- OTHER COMPONENTS**
- 1 aluminum chassis (formed from #16 gage, 5x5" panel)
  - 2 7-pin miniature wafer or molded sockets
  - 1 2-lug terminal strip
  - 1 single pole-double throw (1-pole, 2-position) rotary switch
  - 1 slug-tuned antenna coil; 535-1720 kc range, available from Electro-Mite, P.O. Box 636, Springdale, Conn. for \$1. If 4-lug coil (like Stanwyck #S-409) is substituted, connect lugs 2 & 3 to chassis. Connect #4 to antenna hank, and #1 RF section of tuning condenser and lug #7 of 6BE6 (or 12BE6) tube socket
  - 1 midget high gain 455 kc I.F. transformer (Stanwyck #1107, or Automatic, Miller, etc.)
  - 1 Hartley oscillator coil for 115 mmf tuner (or Stanwyck adjustable oscillator coil #212)
  - 1 550-1700 kc push-on tuning knob, or small bar knob and 550-1700 escutcheon plate.
- solder, small quantity hook-up wire, single shielded conductor, #6-32 and 4-32 machine screws and nuts are required (when not furnished with components)

# Roll-Away Amateur Radiotelegraph Station

By C. F. ROCKEY  
W9SCH

FOR small houses, trailers, or homes where the wife objects to a living room cluttered up with electronic gear, this wheel-away station is ideal. Under *no-use* conditions, it tucks away in a closet. Then, when you want to operate, you roll it out by your easy chair, connect the antenna, plug into any outlet, and start communicating with other "hams."

Suitable for either novice or general-class amateur operation, the transmitter in this radiotelegraph station supplies a conservative 20 watts of radio-frequency power (over one ampere was developed through a twenty ohm non-inductive resistor, by actual test). In the 3.5 to 3.8 megacycle band, this means a consistent night time transmission range of over 200 miles with a good antenna; the receiving range is limited only by propagation conditions. Despite its simplicity, the receiver is stable, sensitive, delivers a good "sock" in the phones, and stacks up well against super-heterodynes costing many times more. To get at the components in the unit for servicing or testing, all you have to do is remove six panel screws.

When you are ready to begin drilling the chassis mounting holes, check Figs. 2 through 6 for approximate hole locations. Since the power transformer is mounted first, outline its large "cutout" hole on the chassis, using the manufacturer's template supplied with transformer. Then, drill a line of closely-spaced 1/8-in. holes along the outlines of the cutout. Cold chisel out the metal between the holes. Next drill the mounting bolt holes according to the template, and mount the transformer on the chassis (Figs. 4 and 5).

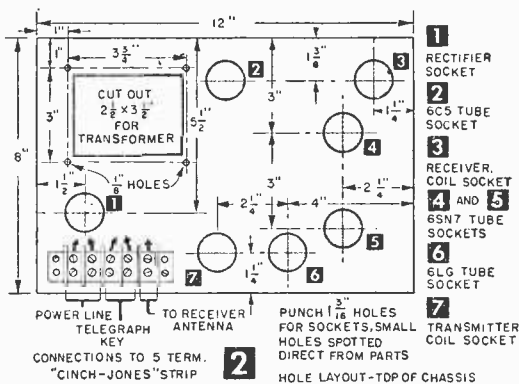
Next place tube sockets and other major parts loosely on the chassis and "play chess" with them to work out their exact location before drilling or punching any holes. Even though you'll build the transmitter later, locate and mount its tube sockets now, since the punching operation is



much easier now than when the chassis is half full of parts and wiring. Punch tube and coil socket holes with a 1 3/16 Greenlee socket-hole punch, and mount tube sockets and other parts to chassis with 1/4 in. long 6-32 screws and hex nuts.

Now, mount the "band-set," the 100 mmf variable capacitor, the regeneration-control potentiometer with its switch, and the 5 point Cinch-Jones terminal strip.

**Wiring the Power Supply.** Begin your wiring by connecting the 110-volt circuit and the primary circuit of the transformer as in Fig. 5. The power transformer primary, the switch on the back of the regeneration control potentiometer, and the "line" terminals on the 5-terminal strip on the





## MATERIALS LIST—ROLL-AWAY RADIOTELEGRAPH STATION

Should be bought when receiver and power supply are built:	3	angle brackets, 1/4 x 1/4" iron
1 plastic panel, 1/8 x 14 1/2 x 11 3/4" (obtainable from Northern	1	110-volt line cord 5' long, with plug
Plastics Corp., La Crosse, Wis.)	1/4 lb.	No. 22, cotton covered magnet wire
1 standard chassis base, 2 1/2 x 12 x 8" (Allied 86P915 zinc-	25 ft.	hookup wire
plated steel)		rosin core solder
1 National type BM-1 or BM-2 dial (Vernier)		Miscellaneous small screws, nuts and small hardware
1 Cinch-Jones 5-terminal Terminal Strip No. 5-151	Required for transmitter:	
1 1/2" dia. plug-in coil form, 4 prong, ICA No. 1051	1	Jumbo plug-in coil form, 4 prong, ICA No. 2670
1 power transformer with windings as follows:	1	flexible shaft coupling
700 volts center tap at 150 ma.	1	5" length 1/4" fiber rod
6.3 volts at 4.7 amperes	1	quartz transmitting crystal, Bliley Type AX <sub>2</sub> (see text for frequency)
5 volts at 2 amperes	1	crystal socket adapter
(Either Thordarson No. T24R06 or T22R06 will do.)	1	screw base pilot lamp socket
3 1 point-insulated tie lugs	1	2.5 mh rf chokes, National Type R-100 or Bud No. CH-9206
5 4 point-insulated tie lugs	2	S.P.S.T. toggle switch, H and H Type 20994A (optional, as "Send-receive" switch)
1 15 mmf midjet variable capacitor, Bud No. CE-2020	2	variable capacitors, 250 mmf. Cardwell No. XR-250-PS (available from Allen D. Cardwell Mfg. Corp., Plainville, Conn.) or National Type TMC-250 (also okay if mounting screws are modified)
1 100 mmf variable capacitor, Bud No. MC-1855	1	5 prong base mounting socket, ICA
4 Amphenol type MIP 8 prong sockets	2	50 mmf mica capacitors Standard, receiver-type pictail,
3 Amphenol type MIP 4 prong sockets	1	5000-ohm 20-watt wire- "postage stamp" micas, rated at
1 16 mfd 700-volt working, tubular electrolytic capacitor (Aerovox)		wound resistor about 300 w.v.—Aerovox
2 10 mfd 500 working volt tubular electrolytic capacitor (Sprague)	1	15K 10-watt wire wound resistor
7 4000 mmf mica capacitors } Standard, receiver-type pictail,	2	47-ohm 1-watt resistors
1 100 mmf mica capacitor } "postage stamp" micas, rated at	1	6C5 (metal if possible, otherwise GT) tube
1 1000 mmf mica capacitor } about 300 w.v.—Aerovox	1	6L6 (metal if possible, otherwise large glass) tube
1 0.25 mfd 200 working volt paper capacitor	2	2-watt GE neon lamps (one for spare)
1 0.01 mfd 400 working volt paper capacitor	1	6-8-watt, blue bead screw base pilot lamp bulb (for tuning lamp)
1 volume control potentiometer, 100K ohms, linear taper with switch (Centralab)	1	telegraph key, signal
1 22K 2-watt resistor	1/4 lb.	No. 18, cotton covered magnet wire
2 33K 1-watt resistors	Cabinet parts required:	
3 22K 1-watt resistors	1	small sash handle
3 2.2K 1-watt resistors	2	velocipede wheels 6 1/2" dia. including tire (obtain from toy or bicycle shop)
1 10 meg 1-watt resistor	16 1/2 in.	3/16" steel rod
3 100K 1-watt resistors	4	washers 7/16" hole dia.
2 220K 1-watt resistors	30 1/2	linear inches of white pine 9/2" wide by 3/4" thick
2 6SN7GT tubes	1 pc.	20 1/2 x 12 x 3/4" white pine
1 5Z3 tube	1 pc.	1 3/4 x 3 3/4 x 10" white pine
1 pr. Trim "Dependable" headphones		
4 knobs 1/4" hole set screw type		
6 binding posts		
1 pc. Reynolds wrap aluminum foil 4 x 11"		

rear of the chassis are all connected in series. Consult the manufacturer's literature (packed with the transformer) for the power transformer connections. Be sure to use rosin core solder only (no pastes or acids), and solder each joint carefully.

Check your wiring against Fig. 5 carefully as you go along, marking over each connection on Fig. 5 with colored pencil as it is made in the set. While wiring the primary circuit, remember to connect the .01 *mf* capacitor from one side of the line to chassis ground; otherwise the receiver will hum.

When the primary circuit has been wired, connect the high voltage winding and the 5 volt rectifier filament winding to the proper connection on the 5Z3 rectifier tube socket. Then connect the electrolytic filter capacitors and the 22K, 2 watt receiver B+ filter resistor. When connecting such small parts as these, use insulated tie-points to hold the ends of the parts firm (thus avoiding dangling parts which cause short-circuits). Fasten the supporting lug of these tie points under any convenient screw, such as those holding the tube-sockets.

The electrolytic capacitors must be "polarized" correctly, that is, they must be connected with the end marked plus to the positive side of the circuit. Otherwise the capacitor will destroy it-

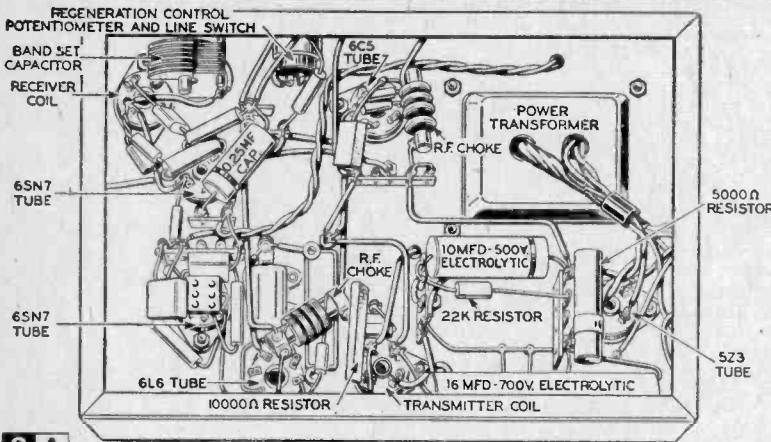
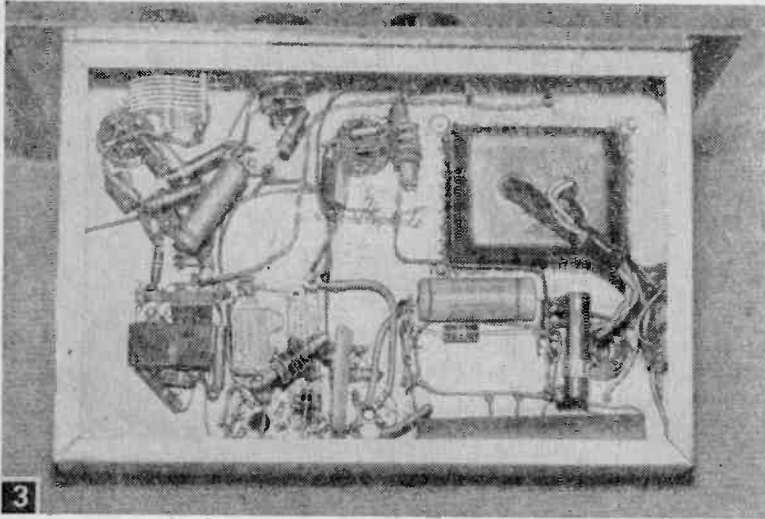
self, and may damage the rectifier tube. You don't have to observe this precaution with the paper and mica capacitors, however.

After checking the power supply section wiring, test it by (1) inserting the rectifier tube, (2) connecting the line cord to the line terminals (Fig. 3A) on the 5-terminal strip, (3) plugging into a power outlet and turning on the switch.

The rectifier tube filament should light. If not, recheck wiring. If it does, let power remain on for a few seconds and then *turn it off*. Now immediately take a short piece of insulated wire and touch one end to the chassis. Holding the wire by the insulation, touch the other end to pin No. 1 of the rectifier socket. The charge remaining in the electrolytic filter capacitors should pass through the wire and produce a snappy spark. If this does not happen, look for a wiring error or an old and defective part. Test for a charge in both electrolytic capacitors.

If you have a dc voltmeter, with at least a 400-volt maximum reading, measure the voltage from pin No. 1 of the rectifier tube socket to the chassis. This voltage, with the power on, should be between 350 and 450 volts.

**Wiring the Receiver.** First connect pin No. 8 of each of the 6SN7 (*V*<sub>1</sub> and *V*<sub>2</sub> on wiring diagram) sockets to the chassis. Then connect pin No. 7 of each of these sockets to-



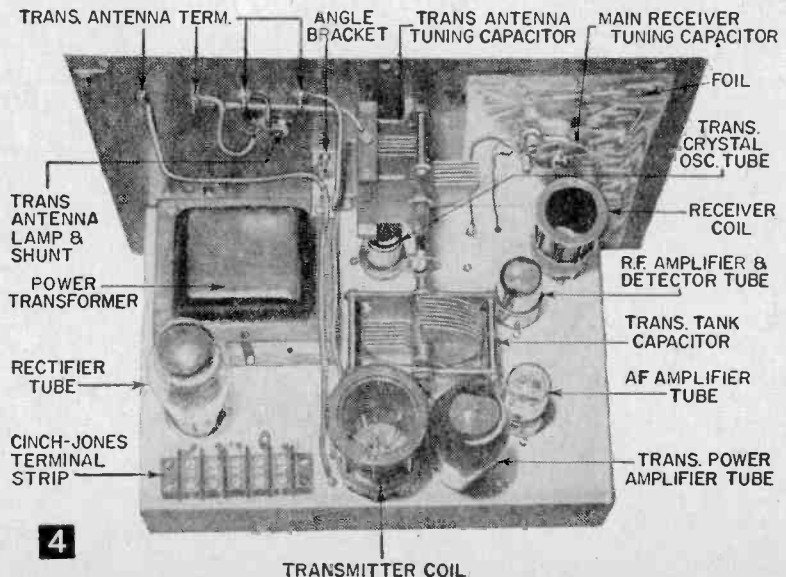
PICTORIAL DIAGRAM

gether and to one end of the 6.3 volt heater winding of the power transformer. Ground the other end of the heater winding. Next, insert the 6SN7 tubes in their sockets remove the rectifier tube, and apply power. Light from both tubes indicates the receiver heater circuit is okay. If both tubes do not light, recheck the wiring or have the tubes tested at your local radio-TV shop.

With the heater circuit functioning satisfactorily, begin with the antenna terminal on the 5-terminal strip and wire through each circuit: the

radio frequency (rf) amplifier, detector, and the two audio frequency (af) amplifier stages, in that order. Use insulated tie-point lugs as required to support the ends of the small parts. Arrange these small parts to run as directly as possible between their proper connections. Follow color-coding carefully to make sure the correct part is chosen each time. Always run grid and plate connections as directly as possible. Voltage-supply leads need not be so short but they should be pressed tightly down against the chassis to confine the surrounding fields and minimize hum and instability; running many of these in the chassis corners keeps them out of the way.

Note in Fig. 5 the special capacitor (called the "gimmick") connected between the plate of the rf amplifier and the grid end of the detector coil. Make this "gimmick" by twisting two short pieces of hookup wire tightly together, with insulation left on and closely-spaced twists, for just 10 tight



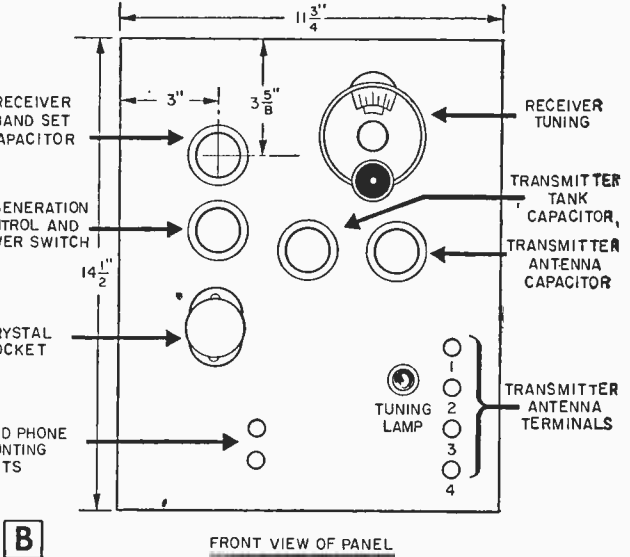
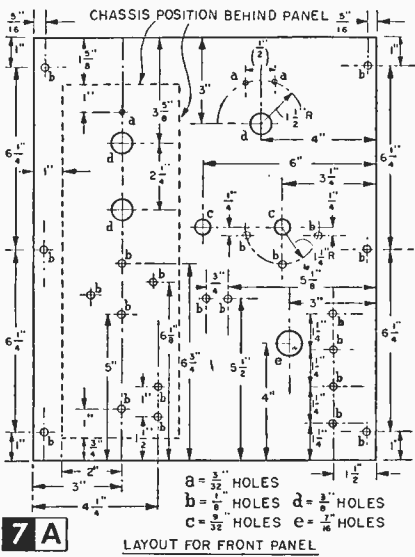
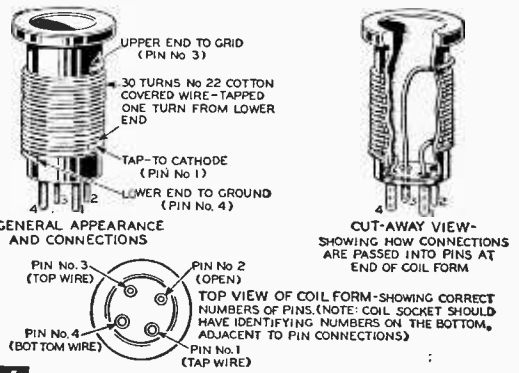
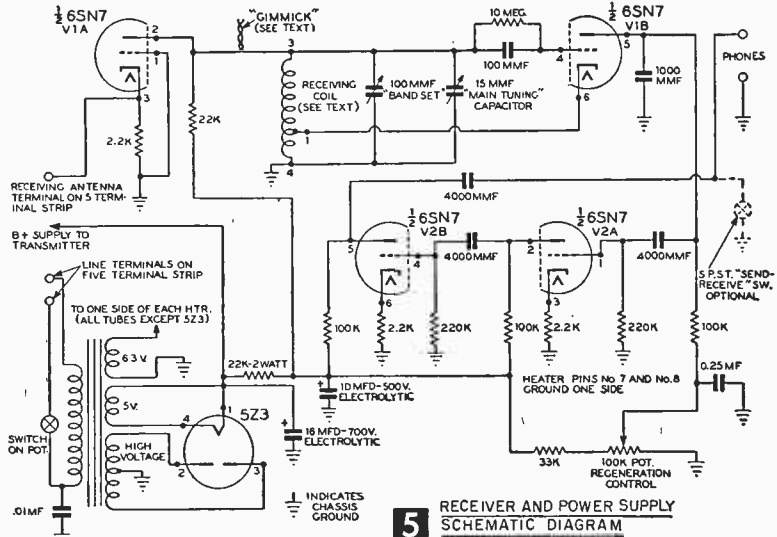
4

twists. This provides the correct capacity.

For the receiver coil (Fig. 6), close-wind 30 turns of No. 22 wire on the coil form, with the cathode tap one turn from the bottom (ground) end. Carefully connect and solder the coil ends and tap to the proper pins. Then plug the completed coil and all the tubes into their proper sockets.

Since the panel, which holds both the headphone terminals and the 15 mmf variable, main tuning capacitor, has not yet been drilled and installed (to keep the chassis as clear as possible for wiring work), you'll need to rig the receiver section so it can be tested without the panel. To do this, take two lengths of wire and connect one of these to the 4000 mmf series headphone capacitor; connect the other wire to chassis ground. "Skin" the unconnected ends of both wires and wind the skinned ends of the temporary headphone connections tightly around the tips on the ends of the headphone cords. (You can make sure these leads don't short-circuit against chassis by taping temporarily). Then apply power and turn on the switch.

With your headphones on, allow tubes a few seconds to warm up, then slowly advance the regeneration control potentiometer. When the control has been advanced from half to about two-thirds of its maximum value, the tube hiss should



## How to Get an Amateur Operator and Station License from the F.C.C.

1. Build a short wave receiver (such as the one described here). This helps you to learn technical radio practice.
  2. Memorize the international radiotelegraph code. Also read a simple book on elementary radio theory and code learning, such as "How to Become a Radio Amateur" and "The Radio Amateur's Handbook," both obtainable from the American Radio Relay League, 38 LaSalle Rd., West Hartford, Conn.
  3. Use the receiver you build to listen in the amateur radiotelegraph bands and try to write down what you hear. Listen to slow-sending stations first, before tackling the fast ones.
  4. When you can receive and write down "solid" all you hear from the slower stations, and much from the faster ones, connect a telegraph key, door buzzer, and a pair of dry-cells in series, and practice sending to yourself. Don't try to send, however, until you can receive well. If you know an amateur "ham" nearby, arrange to take your buzzer and key to his home and have him check your progress with the code periodically. Most amateurs are pleased to help a sincere beginner.
- You'll have to decide, however, whether you want to try for: the Novice-class Radio Operator License (which requires ability to handle 25 characters per minute on code, and little knowledge of theory, but restricts your usage privileges); or the Amateur General-class Radio Operator License (which requires 65 characters per minute and more theory, but imposes fewer restrictions on usage).
5. When your code speed, receiving and sending, approaches the legal requirements for the license you want, obtain from the American Radio Relay League (address above) a copy of "The Radio Amateur's License Manual." Study the Federal Communications Commission's radio regulations and radio theory upon which you will be examined by the government radio supervisor.
  6. When you feel competent in both code and theory, take your exam at the F.C.C. field office nearest your home. (Write to the Federal Communications Commission, Washington, D. C., for address of field office nearest you.) There is, at present, no license fee for any radio license issued by the U. S. Government.

noticeably increase and you should hear a soft click or thud. This thud is the "oscillation-point," or point of maximum reception sensitivity, and its presence indicates proper operation. If you don't hear it check over all wiring. When you are sure the wiring is correct, check the coil connections. When these are not correct, the feedback is in the wrong direction, and oscillation cannot possibly occur. With correct wiring, a properly-wound coil, and a good tube, the circuit cannot fail to operate.

When your detector circuit is oscillating smoothly and consistently, connect a short 5 or 10-ft. copper wire to the antenna terminal. Now, with regeneration control set just beyond the thud point, slowly rotate the band-set capacitor. Unless you live in an abnormally poor radio location, you should hear a large number of code signals, as well as steady whistles indicating the presence of radiophone stations. These indicate the receiver is operating properly and you may safely drill and install the panel. If you don't hear such signals, but the detector oscillates properly, check for a bad tube or wrong connection in the *rf* amplifier stage.

With the receiver operating properly, lay out the panel as shown in Fig. 7A. Carefully mark and drill the holes for passing the band-set capacitor and regeneration control potentiometer. Then, temporarily fasten panel to chassis, using the mounting nuts of the band-set capacitor and potentiometer. Then, with the panel in place, drill two  $\frac{1}{8}$ -in. holes (about one inch from each edge of the *chassis*) through both *chassis* and panel simultaneously; they will later pass 6-32 machine screws for fastening panel and chassis together.

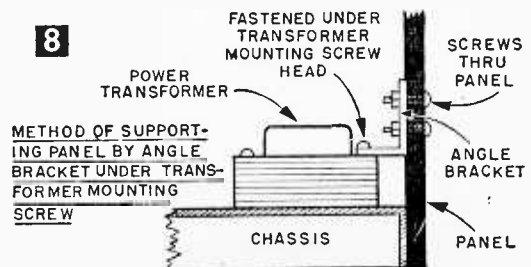
Remove the panel from the chassis and drill the  $\frac{3}{8}$ -in. hole at a point 3 in. from the left-hand

edge and about  $3\frac{5}{8}$  in. from the top, as you face the front of the panel; this hole is for mounting the 15 *mmf* main tuning capacitor (Fig. 7). Also lay out and drill the holes for mounting the vernier tuning dial at the same time, following the drilling template supplied by the manufacturer of the dial.

Now carefully remove the *left-front* mounting screw of the power transformer and clamp under it one leg of the  $1\frac{1}{4} \times 1\frac{1}{4}$ -in. angle bracket (Fig. 8). You'll need to drill another hole in the bracket to do this, but this bracket must be mounted so that the other leg of the bracket will serve as an adequate brace for the panel.

Place the panel in its correct position (note dotted lines in Fig. 7A) and mark the location for the  $\frac{1}{8}$ -in. screw holes for fastening the panel to this angle bracket. Complete the panel drilling for the receiver section by drilling two holes for the headphone binding posts (Fig. 7A).

Finish the panel by cutting a 4 x 11-in. piece of aluminum foil ("Reynolds-Wrap" or similar). Cement this to the *back* of the panel as shown in Fig. 4, with radio service, model airplane or "Duco" cement. This thin but effective shield eliminates all vestiges of hand-capacity from the receiver's operation.



When the cement has thoroughly dried, carefully mount the panel on the chassis, using the potentiometer and the bandset capacitor mounting nuts, and 6-32 screws through the 1/8-in. holes, as fastenings. Then insert and tighten 6-32 screws through the holes into the mounting bracket.

Now insert binding posts for the headphones, and run wires down to the 4000 mmf coupling capacitor, and to chassis ground (after first removing temporary connections). Mount the 15 mmf main tuning capacitor and its vernier tuning dial, setting the latter so that the dial reads zero with the plates fully enmeshed and the setscrew tightened. Run a lead from the stationary plates of the bandset capacitor to the stationary plates of the main tuning capacitor by the most direct route, drilling a 1/8-in. hole in the chassis to pass it. Then run another direct lead from the rotary plate connection to chassis ground, to relieve the aluminum foil of all but shielding currents.

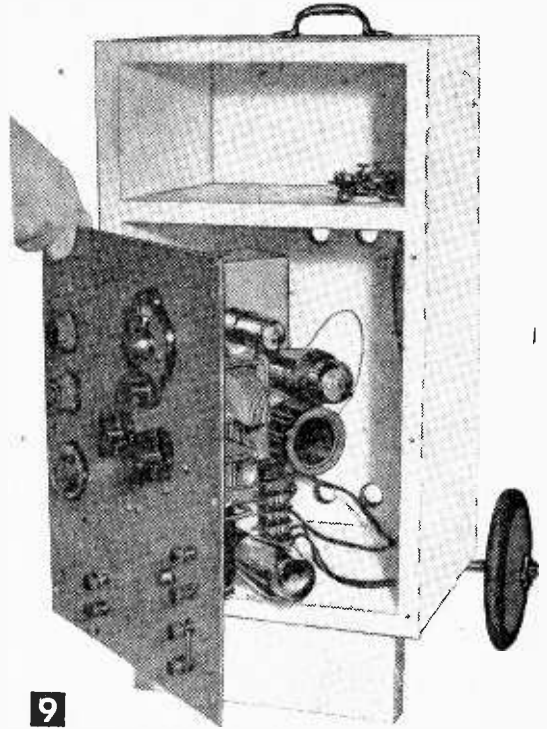
**Operating the Receiver.** After necessary external receiver connections have been made, set the regeneration control just beyond the edge of oscillation ("thud point") and set the main tuning control to 100 on the vernier dial. Adjust the bandset capacitor to the high-frequency edge of the amateur band. Then, by cautiously rotating the main tuning dial, the amateur band will be found to be "spread out" over it, making tuning much less critical and increasing the apparent selectivity.

For receiving radiotelegraph code signals the regeneration control should be set just slightly beyond the "thud point"; for voice reception, just below this point. Use a short (5 to 10 ft. length of wire) antenna, thrown on the floor or out the window. A longer wire may result in overloading, and shouldn't be used except by those who live in extremely poor reception locations. Tune slowly and carefully to pick out those weak, far-away signals. Don't expect this receiver to operate a loudspeaker. It may do so, but it is designed for use with either ordinary magnetic or (if you have them) crystal headphones.

## The Transmitter

**T**HE class of license you hold will determine which frequencies within this transmitter's range you may operate. Remember that *the crystal fixes the operating frequency of this transmitter.* If you have a *general or extra* class of license, you may use a quartz crystal on any frequency between 3500 and 3800 kilocycles.

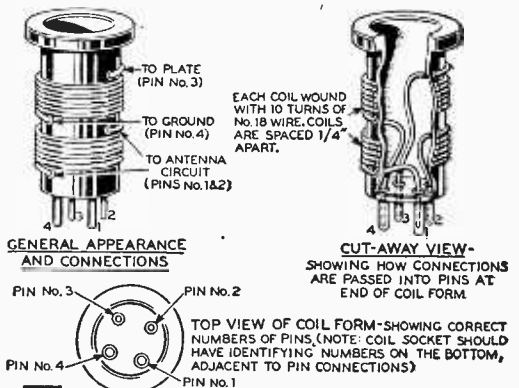
When you have your license, you are ready to build the transmitter. First, remove the panel from the chassis and carefully disconnect all wires and remove all parts from the panel to facilitate the further drilling that must be done. The transmitter's tank capacitor is placed immediately in front of the 6L6 socket and the coil socket (Fig. 4). Plug the coil form and 6L6 tube into their sockets before mounting the ca-



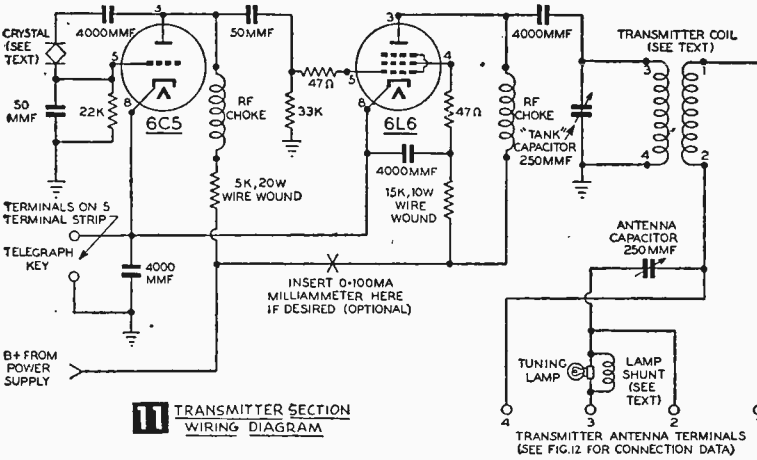
9

pacitor, to be sure that there is reasonable clearance between these and the back of the capacitor. Also, check to see that the 1/4-in. fiber shaft, which will extend from the end of the capacitor shaft to the knob on the front panel, will not interfere with the insertion of the 6C5 crystal oscillator tube in its socket near the front of the chassis.

To mount the variable tank capacitor, screw the two remaining angle brackets solidly to the chassis with 6-32 machine screws and nuts; then fasten other ends of brackets to the Carwell 250 mmf variable capacitor, using two frame screws directly below the two shaft bearings. After you have completed the job of mounting the tank capacitor, drill a 1/4-in. hole through the



10 TRANSMITTER COIL INFORMATION: USE 2 1/4 INCH DIAMETER "JUMBO" COIL FORM



drilling template included within the packing box of the capacitor.) Again referring to Fig. 7, page 97, drill holes for four transmitter antenna binding posts, and the tuning lamp socket. Pass the socket through its hole, with terminals to the rear, and cement it in place with radio service, model airplane or "Duco" cement.

When the cement is dry, re-install the receiver tuning capacitor, the dial and the headphone binding posts.

chassis under the stationary plate connection to pass the tank circuit lead.

Before drilling and re-installing the panel, complete as much chassis wiring as possible. Leaving coil socket terminals #1 and 2 blank for the time being, begin wiring at the transmitter coil socket and work backward through the 6L6 amplifier circuit (Fig. 11). To avoid short-circuits and incipient high frequency flashovers due to higher voltage levels involved in the transmitter, allow more space between leads than you did in the receiver section.

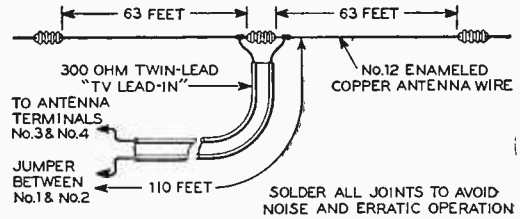
To complete the heater circuit wiring, connect pin 7 of both sockets together, and to the "hot" side of the 6.3 volt heater winding on the transformer. Then connect each pin 2 on both sockets to the chassis ground.

Next, wire in each of the other leads, working backward from the plate circuit of the amplifier. Remember to mark over each connection on the diagram with colored pencil as it is placed in the set, to avoid errors. Keep all high-frequency (plate, grid, or bypass capacitor) leads as short and direct as reasonable spacing permits and also make firm, short chassis grounds.

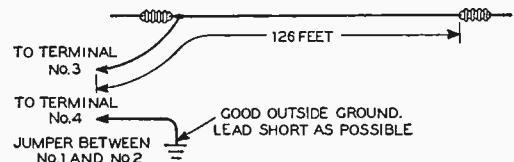
When connecting the stationary plates of the tank capacitor with the transmitter coil, wind several layers of plastic insulating tape around the area of the wire lead which passes through the chassis hole; the maximum transmitter output voltage exists at this point.

When you have completed and checked all transmitter wiring that can be done without the panel, remount the panel temporarily to the chassis, using the nuts on the potentiometer and receiver handset capacitor shafts to hold the two units together. Then sight along the extension fiber shaft for the tank capacitor to determine where it should pass through the panel, and mark this spot. Remove the panel and drill a 1/4-in. hole at this mark.

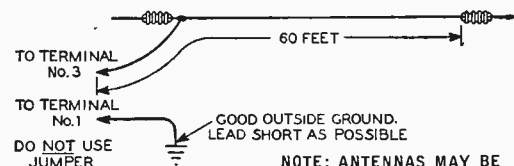
Next, drill the holes for mounting the 250 mmf antenna capacitor on the panel. (See Fig. 7 on page 97 for shaft hole location; the mounting holes should be laid out from the manufacturer's



**PREFERRED TYPE**



**SECOND CHOICE**



**FOR RESTRICTED SPACE**

NOTE: ANTENNAS MAY BE BENT TO FIT RESTRICTED SPACE

**12 ANTENNA ARRANGEMENT FOR TRANSMITTER**

Then mount the antenna tuning capacitor and the transmitter antenna binding posts. Then carefully re-install the panel on the chassis.

Mount the 5-prong base mounting crystal socket on the front panel as shown in Fig. 7, drilling the holes for the mounting screws right through both panel and chassis and fastening with 6-32 screws and nuts. Drill a hole alongside of the "P" and "K" terminals of the crystal socket for the leads.

With the crystal socket fastened firmly in place and all panel screws tightened, you are ready to reconnect the receiver wiring (to the tuning capacitor and headphone binding posts which were removed with the panel), and retest the receiver for normal operation. Complete the 6C5 crystal

oscillator wiring by connecting the crystal socket as in Fig. 11. Insert the crystal, the rectifier tube and the 6C5 crystal oscillator tube and connect the telegraph key to its terminals on the 5-prong terminal strip.

Now apply line power and allow a few minutes for the crystal oscillator tube to warm up. If it is a GT type tube, observe the glow. If a metal tube, the envelope should get noticeably, but not uncomfortably warm after about three minutes. Then close the key. Take the two watt neon bulb, and, grasping it by the glass bulb (careful!), touch the small tip to Pin 3 on the 6C5 socket. If the crystal oscillator is operating properly, you'll see an orange-red glow within the bulb.

With the crystal oscillator working properly, begin winding the transmitter coil in accordance with Fig. 10. Be sure connections to base pins from the coil ends are correct and are well-soldered. The 1/4-in. between the tank and antenna coil must be maintained if you want proper transfer of energy to the antenna.

range of from 0 to 100 *milliamps*, connect it in series with the B Plus lead to the 6L6 amplifier (at point marked "X" in Fig. 11). Simultaneously with the appearance of glow in the neon bulb, the dc current flowing should markedly decrease.

To complete wiring, the tuning lamp, in series with antenna terminal 3, is shunted by a small coil of No. 22 wire. Take eight inches of this wire and wind it into a little "scramblewound" coil around a pencil. Withdraw the pencil and "dope" the coil with radio service cement. When dry, connect it directly across the lamp socket terminals exactly as shown in Fig. 11; otherwise, you may not be able to tune your antenna system later. Complete the wiring of the antenna tuning system following one of the suggested arrangements shown in Fig. 12.

Finally, fasten the flexible coupling on the tank capacitor shaft, along with the 1/4-in. fiber rod that has first been passed through the panel hole drilled for it. Tighten the set screws, then saw shaft to proper length with a hacksaw and place a knob on each shaft.

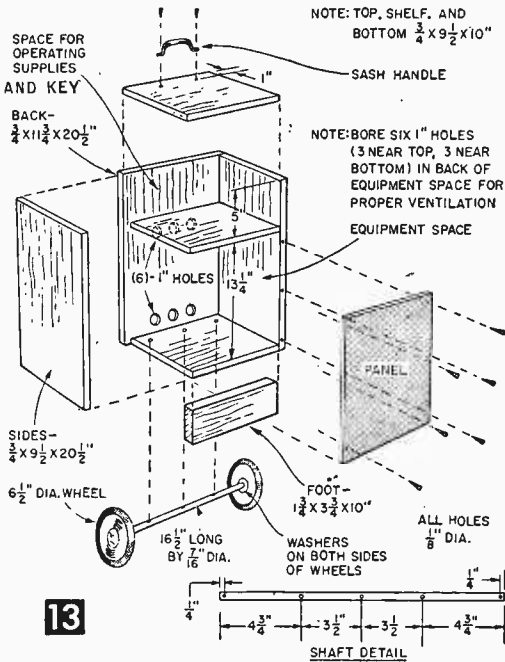
**Tuning the Transmitter.** With antenna disconnected, apply power. After making sure crystal is in its socket and tubes are warm, press the key. Rotate the tank capacitor until a neon bulb held against the tank coil glows brightly (which should occur with tank capacitor plates about half-meshed). Then release key and connect antenna leads to the appropriate terminals. Now connect antenna according to directions in Fig. 12 for type you erected. Next, press the key and turn the antenna capacitor carefully until the tuning lamp lights most brightly. Then readjust tank capacitor for maximum brilliance. The transmitter is now tuned.

When you have become thoroughly familiar with the operation of this station, you can make consistent contacts with other stations within a 50 mile radius during daylight and a 300 mile radius at night.

**Building the Cabinet.** First saw three pieces 3 1/4 x 9 1/2 x 10 in. for the top, bottom and shelf, and two 3/4 x 9 1/2 x 20 1/2-in. pieces for the sides. Sand off the saw marks, glue meeting edges and assemble, nailing through the sides into the ends and shelf with 2-in. long finishing nails. Then cut a 3/4 x 11 3/4 x 20 1/2-in. piece for the back and glue and nail it in place. A 10-in. long piece of "two by four" (actually 1 5/8 by 3 5/8 in.) is nailed in place for the foot.

Set all nail heads with a nail-set, and fill these holes and any other fissures with wood putty. Drill a 1/4-in. hole in the shelf near the right-hand rear corner to pass the leads for the telegraph key using a 1-in. auger bit; bore at least 6 one inch holes—three near the upper end of the equipment space and three near the bottom, to provide sufficient ventilation for the tubes.

While the wood putty is drying, cut and drill the 7/16 in. dia., 16 1/2-in. long shaft for the wheels, as shown in Fig. 13. The end holes are for screws to hold on the wheels, while the three center holes are for nails to fasten the shaft to



13

Plug the wound coil and the 6L6 tube into their respective sockets, and apply power. When the tubes are warm, close the telegraph key. Holding the neon lamp by its base, press the glass bulb against the tank coil. Then grasp the tank capacitor shaft and rotate it from maximum to minimum capacity. (You can't be shocked, since the capacitor shaft is at chassis potential). At somewhere between one-third and two-thirds of maximum capacity, depending upon crystal frequency, the neon lamp should burst into a bright orange-red glow, indicating the presence of RF energy. If you have a dc. milliammeter with a

the bottom of the cabinet. This shaft should be nail-fastened to the bottom, parallel to the back of the cabinet and  $\frac{1}{2}$  in. from back edge of bottom piece.

Finish the cabinet with paint or walnut or mahogany stain, followed by two coats of spar varnish. When the finish is dry, put on the wheels, with a washer in front and back of each. Fasten each wheel in place with a 6-32 machine screw passed through the end holes and secure with a nut. Then screw the sash handle to the top center of the cabinet one inch from the back.

Screw the telegraph key to the shelf near the right-hand edge and with the knob near the front edge (Fig. 9), "skin-back" 18 in. of POSJ line cord, and clamp under the terminals of the

key. Then pass the other end through the  $\frac{1}{4}$ -in. hole in the shelf.

Pass the line cord, and about 5 ft of insulated wire (for receiver antenna) through one of the lower holes in the back of the cabinet. Now connect the line cord, the telegraph key leads, and the receiving antenna lead each to the proper terminal on the five terminal Cinch-Jones strip on the chassis.

Slide the set into the cabinet as shown in Fig. 9 and fasten the unit in place with six 1-in. long No. 6 roundhead wood screws. Use the shelf space for storage. When ready to operate, wheel the unit beside your favorite chair, connect the antenna, plug in the power cord, and you're on the air!

## Small-Fry Television Silencer

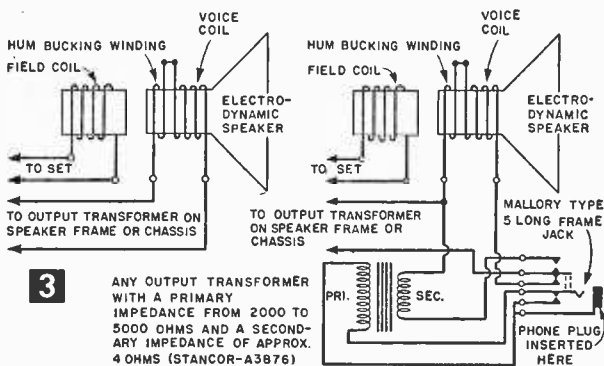
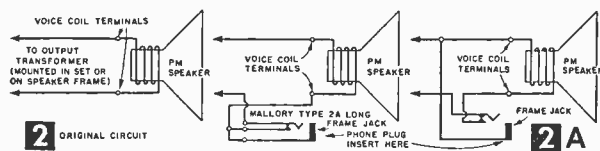
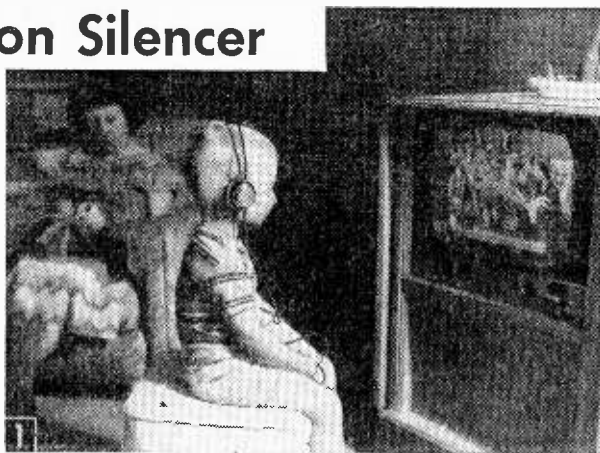
THE small-fry TV programs need not be an annoyance to adults, if a simple provision is made for plugging in a headset. A youngster can watch and listen to the sound through headphones without bothering others in the room. The only materials required are a pair of magnetic (wire-wound) headphones and a closed circuit phone jack for most TV sets.

With only two wires connecting to a permanent magnet (PM) type speaker, follow the diagram in Fig. 2. Disconnect one of the two leads near the speaker and connect an additional length of wire to the speaker terminal. The remaining ends of these two wires connect to phone jack. If the jack is correctly connected, the television set should function normally if the phones are not connected. Plugging in the headphones should silence the speaker and the signal should be heard in the headphones.

Although it will work either way, if you prefer that the phones not be in series with the speaker, use the alternate hookup shown in Fig. 2A.

Some TV sets in use today have four wires connecting to the speaker. On these sets one side of the power line cord is usually connected to the chassis and a shock hazard will exist if one side of the speaker voice coil is connected to the chassis. For this type of set connect the phone jack as shown in Fig. 3.

If there is any doubt about how your TV set's speaker is wired use the diagram shown in Fig. 3. It is absolutely safe regardless of the type of speaker. The jack can be fitted into a  $\frac{3}{8}$ " hole in the TV cabinet, or secured to the back with a small angle bracket. The connections and the rear of the phone jack should be covered or else the jack installed so



the back of the jack is not exposed.

Voltages involved are entirely harmless, so Junior can do his own plugging in without danger to himself or the set. All switching is accomplished automatically.—ELBERT ROBERSON.



# Transistors Make Ideal Electric Eyes and Photo Timers

By THOMAS A. BLANCHARD



Fractional timer (A) and photoelectric eye (B) which use transistors require a minimum of parts and a single battery voltage source unlike identical but more complex vacuum tube devices.

**F**OUR types of transistors are now available: The Point Contact P-N-P and N-P-N, and the Junction P-N-P and N-P-N. Making the Point Contact transistors involves a delicate positioning of the tungsten *emitter* and *collector* "cats-whiskers" on a pinhead sized germanium wafer—a costly operation.

The Junction transistor, on the other hand, consists of a minute wafer of germanium of one potential sandwiched between two wafers of opposing potential. Thus a P-N-P transistor has a negative wafer flanked on each side with positive germanium wafers; the N-P-N transistor is the reverse combination. This simple construction makes the Junction type the least expensive of all transistors, and thus the type we will use in these electric eye and timer projects.

More specifically, we will build these units using a P-N-P Junction transistor (Radio Receptor

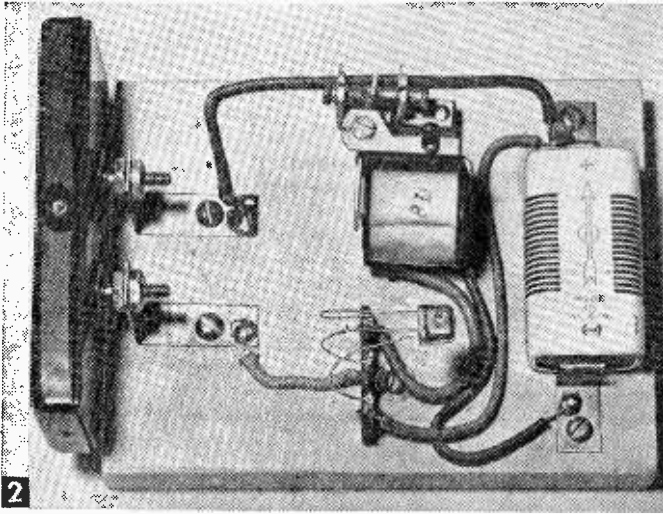
Co's. Type RR-38) which is hermetically sealed in a miniature metal jacket, and requires no tiny hard-to-mount sockets. It is fitted with phosphor bronze pigtail leads so spaced that, by merely clipping them short, they become pins for plugging into standard size transistor sockets found in hearing aids and other miniature apparatus.

The pigtail locations on the RR-38 transistor we will use correspond with the pin spacing on RCA and some other transistors. But many transistors still have the now-outmoded pin or pigtail design which uses one or more lacquered dots on the transistor to identify its three elements: *Collector*, *Base* and *Emitter*. The experimenter should therefore refer to the schematic packed with the transistor if pin or pigtail spacings differ from those in Fig. 6.

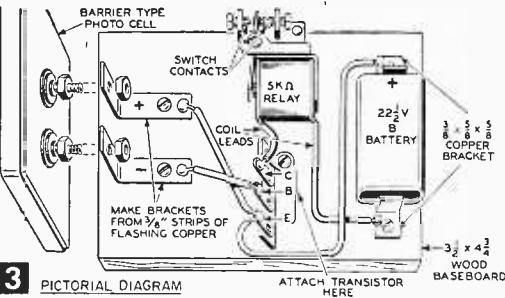
The unique features of the transistor are its size and small power requirements. Its function is the same as a triode type vacuum tube. The P-N-P junction transistor can be compared with a 6J5GT triode vacuum tube because it will do about the same job, with a fraction of the power

## MATERIALS LIST—TRANSISTOR ELECTRIC EYES AND PHOTO TIMERS

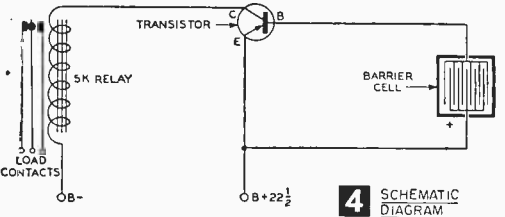
- 2 wood baseboards size  $\frac{3}{4} \times 3\frac{1}{2} \times 4\frac{3}{4}$  in.
  - 1 Sigma 5K ohm type 4F relay, or Potter-Brunfield 5K ohm Type LM-5
  - 1 radio receptor #RR-38 P-N-P transistor (or 2N34, or CK-722)
  - 1 double pole-double throw toggle switch
  - 1 50 to 500 mfd., 25 w.v. electrolytic capacitor
  - 1 100K (100,000) ohm linear carbon potentiometer and bar knob
  - 1 Barrier layer type selenium photocell (Bradley Labs, Inc., Meadow St., New Haven, Conn.)
  - 1 22½ v. hearing aid type B battery Eveready #412 or #412E
- Miscellaneous scrap, flashing copper for brackets and clips, ½ in. rh wood screws and hook-up wire.



**2** Photoelectric cell at left is a selenium "barrier" type (an inexpensive version of famous solar battery). Light striking cell causes relay contacts to close and operate lights, bells or motors.



**3** PICTORIAL DIAGRAM



**4** SCHEMATIC DIAGRAM

the tube requires. The P-N-P transistor's *Emitter* corresponds with the Cathode of the 6J5GT; the *Base* functions as does the tube's grid, and the *Collector* is equivalent to the vacuum tube's plate. Where heat is necessary to move electrons off the tube's cathode, none is required with the transistor; therefore it has no heater or filament. The P-N-P has one other marked difference. Its low voltage positive potential is applied to the Emitter (cathode) whereas with the vacuum tube *plus* voltage is applied to the plate. (In passing, note that on N-P-N type transistors the N-P-N Emitter functions as *grid*, Base as *cathode*, and Collector as *plate*.)

**Transistor Photoelectric Eye** (Figs. 2 and 3). A Sigma sensitive relay with a 5,000-ohm coil is wired to the transistor collector and B *minus* of

a 22½-volt hearing aid battery. B *plus* connects to the transistor's emitter. At this point nothing happens, but now apply a minute voltage (such as from an almost-dead penlite battery) from the transistor base to emitter. Instantly, current from the 22½-volt battery flows from the emitter to collector and closes the relay's contacts, which may be wired to turn on or off lights, bells, motors and the like.

Now let's replace the nearly-exhausted penlite cell you used to test the contacts with a simple "solar battery" of the selenium photovoltaic type used in photographic exposure meters. This cell consists of a strip of soft iron which is polished, sprinkled with a goodly coating of selenium powder and placed in an oven until the selenium melts and flows over the plate like sealing wax.

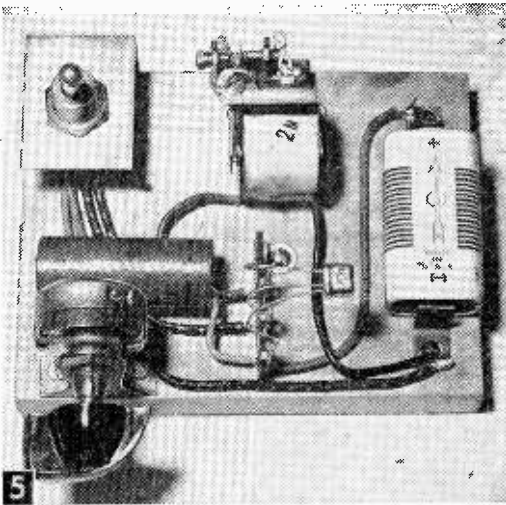
When cool, the selenium-coated iron plate is electro- or vapor-vacuum plated so as to deposit a semi-transparent layer of silver or other metal over the selenium. When a lead is connected to the iron plate and a spring brass clip pressed firmly in contact with the edges of the selenium surface, a voltage is developed when the selenium side of the iron plate is exposed to light.

A selenium cell of this type is known as a "barrier layer" photocell. A disc or plate only 1½ in. sq. will generate 100 microamperes or more with a 100-watt lamp 1 foot from the cell. However, only a couple microamperes are needed to trip the relay making the control sensitive to daylight or flashlight.

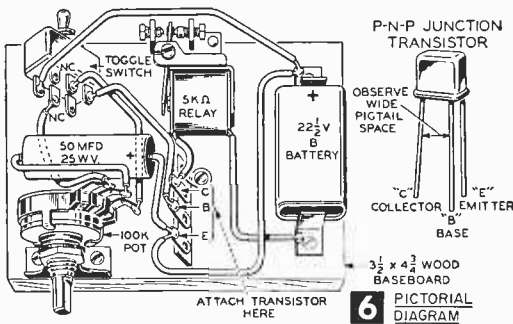
Unmounted barrier layer cells are available from many radio supply houses at low cost. The mounted cells, like the Bradley Luxtron shown here, are more expensive. The dull side of the barrier cell is the light sensitive side (—), while the iron base is often a silvery finish.

Remember that the cell you want should be clearly marked as a "barrier layer" type. There is another type—a selenium *photo-conductive* cell, formed by flowing selenium on a group of isolated wires. When exposed to light, the resistance of the selenium coating drops, causing an increase of current to flow through the cell. Such a unit, however, is *not* suitable for the project we are describing here.

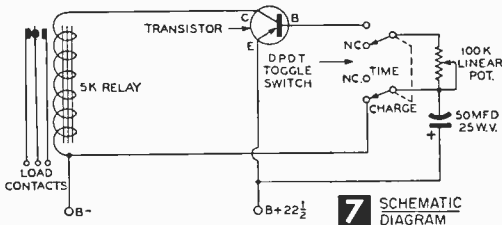
Because the RR-38 transistor is rated minus 25 volts at minus 5 milliamperes, a sensitive relay such as the Sigma type should be used, since both armature tension and contact spacing are fully adjustable. However, the inexpensive Potter and Brumfield #LM-5 with 5K-ohm coil operates at 4.5 m.a. You can use it, by bending its contacts and stretching the fixed spring somewhat, to provide sensitive operation required by this particular type of circuit.



The transistor fractional timer is actually the same basic circuit as the electric eye. Electrolytic capacitor and potentiometer determine the "hold-in" time of relay contacts. Device may be used for photo-printing.



6 PICTORIAL DIAGRAM



7 SCHEMATIC DIAGRAM

**Transistor Timing Control** (Figs. 5 through 7). This circuit is very similar to the Photo Control circuit. However, instead of creating a voltage with light, we charge up a capacitor from the 22½-volt battery, then switch the charged capacitor across the base and emitter of the transistor. As long as a slight charge remains in the capacitor, the relay remains energized. When the charge is finally dissipated, the relay drops out, opening its switch contacts.

The rate of discharge is controlled by a 100,000-ohm linear potentiometer. The higher its resistance setting, the longer it will take the condenser to discharge (or decay) and so long as a charge remains, the relay will hold in.

In the breadboard model shown in Figs. 1 and 5, we have used a 50 mfd., 25 w.v. electrolytic capacitor. This size is suitable for photo printing and enlarging, but for longer periods (not exceeding 5 minutes) 25 w.v. capacitors up to several 100 microfarads are available at modest cost.

The timer operates in this manner: When the toggle switch is in "idle" or "charge" position, the capacitor accumulates a charge from the 22½-volt battery. When snapped to "time" position, the charged capacitor is automatically connected across base and emitter of the transistor. Instantly, the relay pulls in and remains closed until no charge is left in the capacitor.

The potentiometer can be calibrated against an electric clock with a sweep second hand if put to practical use. Because most electrolytic capacitors are subject to some leakage, the battery should be removed from the unit when not in use.

Assemble both controls on baseboards cut from ¾-in. pine. Each measures 3½ by 4¾ in. Battery clips and mounting brackets were cut from strips of copper because it bends, drills, and cuts easily, though other metals can also be used.

Tack solder the transistors into the circuits by terminating base, emitter, and collector connections to 3-lug tie strips. Thus you can remove the transistor when you want to use it again in another circuit.

### The Radioman's Third Hand

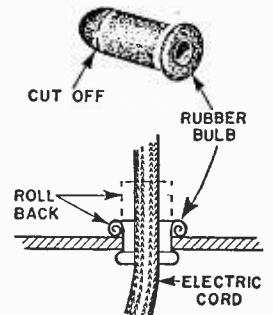
• The soldering of small parts such as eyelets, terminals and lugs is simpler and speedier with this small vise. Simply attach a suction cup to



a wooden clip-type clothespin, and fasten to any smooth surface.—L. J. DOWNES.

### Improved Rubber Grommets

• A rubber medicine-dropper bulb makes a handy rubber grommet for use where an electric cord passes through a metal radio chassis. Cut off the tip, insert the bulb through the hole in the chassis, and roll back the projecting end as shown in order to provide a flange for holding the grommet securely in place.—JOHN A. COMSTOCK.



# Two-Tube FM Receiver

Pick up those nearby FM stations with this ultra-simple high-frequency receiver. Small in size, light in weight and equal in fidelity to a five-tube AM superhet receiver, it utilizes only two tubes for top-flight FM reception via earphones

By BRUCE DEUTSCH and JOE STITT

WITH the increasing number of frequency modulation type broadcast stations in the U.S.—over 620 are now “on the air”—you may want to build this simple high-frequency receiver which will pick up the FM stations in your locality. You can build this 2-tube *ac-dc* FM circuit from a handful of easy-to-obtain parts. Of course, something must be sacrificed in such a simple set. It uses earphones—but that is quite suitable when the baby is sleeping or neighbors complain about the volume of your loudspeaker set. Further, it lacks the high fidelity inherent in multi-tube FM designs, though its fidelity is still the equal of the popular 5-tube superhet AM receiver.

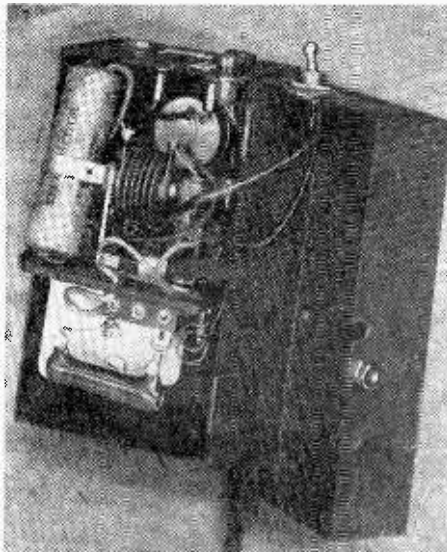
## Set Construction

Two miniature high-frequency pentode tubes are used in this circuit. This compact model is assembled on a  $\frac{1}{8}$  in. Masonite base and housed in a 3 x 5 in. dime store metal card filing case (metal cabinet shields tuned circuit from detuning effects of body capacity). Carefully isolate cabinet from all circuit components so there will be no shock hazard for persons operating the set.

Since electrically identical radio components of different manufacture may vary greatly in physical size, only a general layout is suggested in Fig. 2. Use non-conducting Masonite

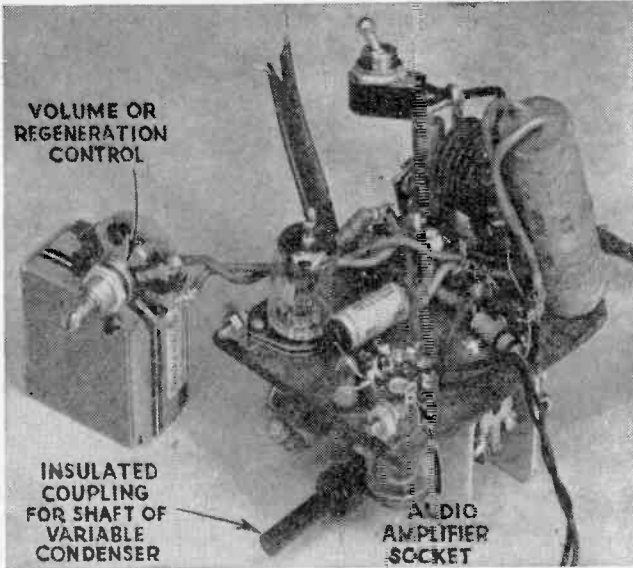


Tuning in the Deutsch-Stitt FM receiver.

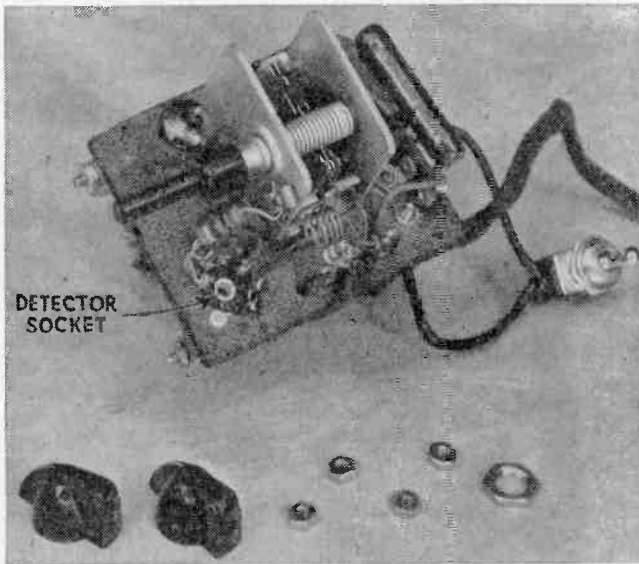


Rear view showing chassis mounted in case.

or plastic for your chassis or base, and cut it to fit your cabinet. Locate holes for mounting tuning condenser (C1), which goes upside-down beneath the base, allowing it a minimum of  $\frac{3}{8}$  in. clearance with the cabinet, with added space on one side to mount coils L1 and L2, and space between condenser and front of chassis to mount two 7-prong miniature tube sockets. Condensers of larger capacity may be trimmed to 15 mmf by removing some of the plates. Mount  $1\frac{1}{2}$  x  $1\frac{1}{2}$  in. angle bracket



Top front view showing wiring of power supply components and audio amplifier socket. Box holding up regeneration control is merely a support used by the photographer.



Bottom-front view showing wiring of detector socket and mounting of coils.

so electrolytic condenser and selenium rectifier it supports will clear chassis-mounted parts and metal cabinet. Pass a 1½ in. 6-32 bolt through holes in rectifier core and condenser mounting strap to hold these parts in their place on the bracket.

Lugs lettered A through F on 6-lug mounting strip (Fig. 2) serve as connecting points for correspondingly-lettered points in Fig. 1. Mounting strip which mounts both ends of C3, E3, and R5, is a convenient place to start the wiring. Wiring should proceed from mounting strip to detector tube, audio tube, and line cord, in that order.

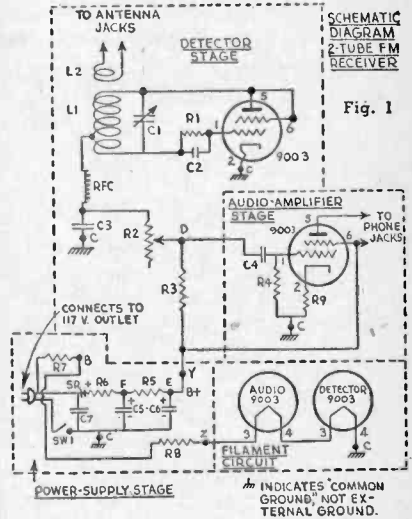


Fig. 1

Give special attention to the super-regenerative detector stage, where joints should be soldered securely and leads between parts kept as short as possible to avoid radio-frequency losses.

Form the coils L1 (5 turns) and L2 (1 turn) by winding #18 bare copper wire around a 3/8 in. drill bit shank or dowel. Mount the L1 directly between rotor and stator connections on side of tuning condenser (C1). Solder rf choke lead to L1 at a point one turn from its grid end. Mount antenna coil (L2) on a 2-lug terminal strip attached to chassis and oriented at the plate end of L1, so that L1 is about 1/8 in. from L2 with their axes coinciding. Then link 2 ends of L2 with antenna tip jacks or binding posts by a length of 300-ohm twin-lead conductor lead-in. Attach regeneration control (R2) to flexible leads mounting apart from the chassis.

Wiring audio-amplifier stage is simplified by mounting the audio tube in an inverted position. In wiring power-supply section, be sure to connect selenium rectifier and filter condenser (C5-C6) with polarity as shown in Fig. 1. To operate tube filaments at their rated 6.3 volts from a 117-volt line they must be connected in series with the line and resistance totaling 710 ohms. Providing this resistance total is the 560-ohm resistance element of a resistance line cord (R7, which has the usual 2 leads plus a resistance lead), in series with a 150-ohm 10-watt resistor (R8) mounted on a 2-lug mounting strip beneath the base and behind the tuning condenser. The resistance line cord is used to dissipate outside of the cabinet part of the heat of the filament voltage-dropping resistance. No

## MATERIALS LIST—FM RECEIVER

- C1—15-mmf. chassis-mounting miniature tuning condenser  
 C2—50-mmf. mica condenser  
 C3, C4—.002-mfd., 200-volt paper condenser \*  
 C5, C6—20-20-mfd., 150-volt dual electrolytic condenser  
 C7—.01-mfd., 200-volt paper condenser \*  
 R1—10-megohm, ½ watt carbon resistor  
 R2—50,000-ohm potentiometer  
 R3—15,000-ohm, ½ watt carbon resistor  
 R4—2.2 megohm, ½ watt carbon resistor  
 R5—2,200-ohm, 1 watt carbon resistor  
 R6—100-ohm, 1 watt carbon resistor  
 R7—560-ohm line cord resistor  
 R8—150-ohm, 10 watt wire-wound resistor  
 R9—220-ohm, ½ watt carbon resistor  
 L1—5 turns #18 wire, ⅜" diameter, ¼" between turns  
 L2—1 turn #18 wire, ⅜" dia.  
 SR—65 milliamp selenium rectifier  
 RFC—miniature very high frequency choke (Ohmite Z144, recommended)  
 SW1—Single-pole, single-throw toggle switch

Two 9003 tubes, two 7-prong miniature sockets, 4 phone tip jacks, 6 lug mounting strip, two 2 lug mounting strips, insulated shaft extension, angle brackets, nuts and bolts.

\* Condensers of larger voltage rating may be used.

710-ohm line cords are manufactured, hence our combination of line cord and resistor is used.

This circuit may be easily adapted to battery operation by omitting the power-supply stage and substituting batteries supplying *A* and *B* potentials. Connect 90 volts positive at point *Y* in Fig. 1 and 12 volts positive at *Z*; or the tube filaments may be wired in parallel for 6-volt operation. Connect negative leads from batteries to *C*. A battery pack consisting of 3 series-connected 30-volt hearing aid batteries (Burgess U2OE or equivalent) for *B* supply and 4 series-connected, 1 in. dia. flashlight cells for *A* supply may be housed in back of cabinet. Batteries of larger dimensions may be used, of course, outside the cabinet for *A* and *B* supply. The *B* drain in the circuit is low, but the *A* is rather high (.3 amps for parallel-connected filaments).

Using bottom of card-filing case as the front

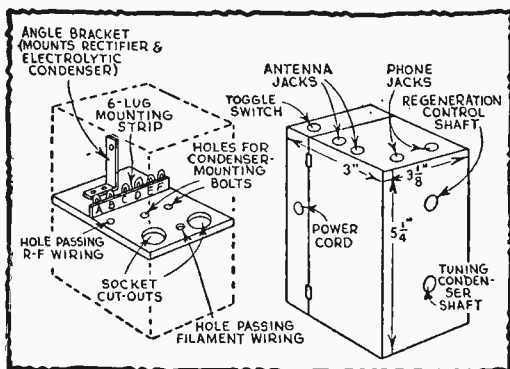


Fig. 2. Chassis and cabinet layout.

of your cabinet, drill holes for antenna and phone tip jacks, on-off switch, and tuning and regeneration controls according to general layout in Fig. 2. Locate on-off switch (SW1) at rear of top of cabinet to isolate its line voltage from *rf* components at front of chassis. Mount assembled chassis unit in cabinet on ½ x ½ in. angle brackets. Use insulated shaft extension to extend tuning condenser shaft through front panel. Clamp regeneration control to cabinet front with two hex nuts on projecting shaft bushing.

This receiver operates well with any of the usual FM antennas employing twin lead-ins, one going to each of the receiver antenna tip jacks. For strictly local reception, use a single 5 ft. length of insulated wire for an antenna. Test it on each tip jack to determine with which one best reception is obtained. Good distance reception is obtainable with an indoor folded dipole antenna. No external ground connection should be made to the receiver.

Tune receiver with regeneration control in minimum resistance position. You'll hear a hissing noise in the earphones (high impedance phones give best results) when tuning condenser is in a between-stations position. When condenser is rotated to a spot where it "pulls in" a station, regeneration hiss fades out. Adjustment of regeneration control varies volume and fidelity. For critical fidelity and sensitivity, adjust position of antenna coil (L2) after receiver is put into operation and tuned to a weak-signal station. With set thus tuned, note changing signal volume and fidelity in earphones as you slowly bend L2 on its leads, moving it to and from L1. Leave L2 in a position where a suitable volume-fidelity compromise is obtained. No re-adjustment will then be necessary unless an antenna change is made.

If your tuned circuit is not aligned with the 88-108 megacycle FM band, realignment is simple. If tuning condenser does not tune stations on the low-frequency end of the band, compress coil L1 (decrease spacing between coil turns) until complete band can be tuned. If high-frequency stations are cut off, expand L1 (increase spacing between turns). If the set fails to produce a regeneration hiss, check wiring for correct connections and short circuits. If tubes don't light up there is something wrong in filament circuit—possibly a burned out filament. As a last resort to obtain regeneration, replace R1 with other resistors on the order of 7 to 15 megohms.

## Static Problem?

Free the tuning capacitor's plates from heavy dust for better reception; use a clean paint brush. Many radios that are serviced today, because of static and poor reception, are found to be in good condition upon removing the thick layers of dust from the capacitor's plates. Care must be taken not to loosen connections during the cleaning process.—ALBERT E. FENN.

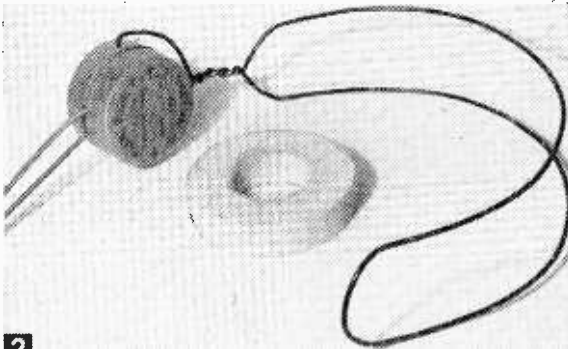
# Having Fun With "Talking Coils"

Musical card tables, the world's simplest dynamic earphone and under-the-pillow speakers are just a few of the simple but intriguing and inexpensive projects this article shows you how to make

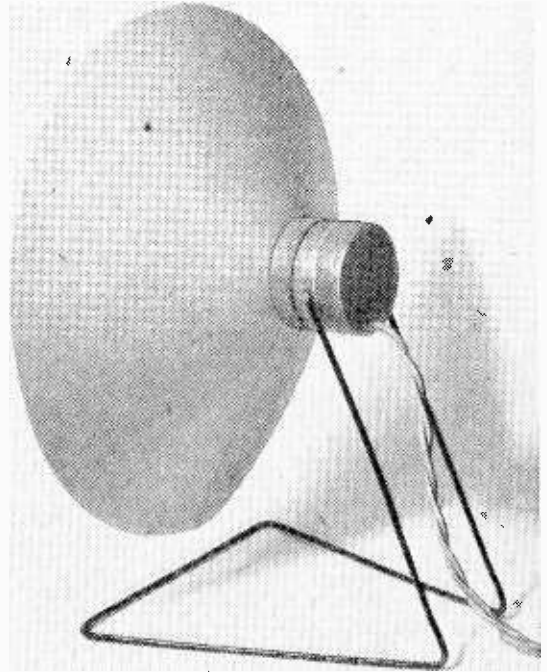
By ARTHUR TRAUFFER

**Y**OU can get a good workout reading about the theory of dynamic loudspeakers in textbooks. But it is far more fun to actually perform some experiments that show you how they work. That's the purpose of this article, and Figs. 1 through 3 show some of the projects we will build.

The construction of a typical PM (permanent-magnet) dynamic loudspeaker such as you have in your radio, is shown in Fig. 4. This drawing shows an Alnico slug used to supply the necessary magnetic field. Some dynamic speakers, however, use a field-coil consisting of many turns of small enameled copper wire surrounding an iron core. Direct current passing through the coil creates a magnetic field within the iron core. For economy and to simplify construction problems, such a field-coil is often made to double as a choke-coil in the power supply of a radio.



**2** Dynamic earphone with flexible cords, and headband bent from a wire clothes hanger. Sponge powder puff, when cemented to box top, cushions and holds the vibrating box top slightly off the ear. Two of these phones may be connected in series to form a double headset.

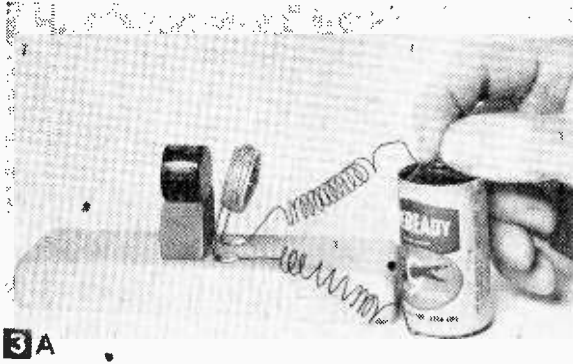


**1** This simple 8-in. PM dynamic speaker cost less than a dime, yet its reproduction is surprisingly clear.

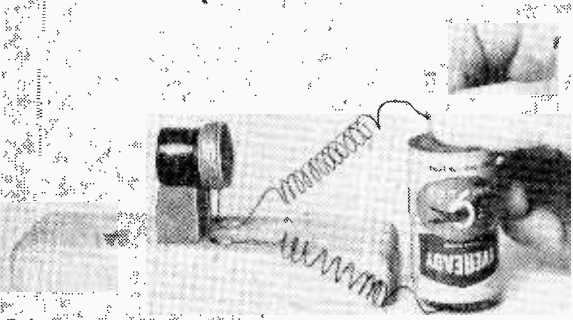
Note in Fig. 4 that the North pole of the Alnico slug forms the center pole of the magnetic field, while the South pole flux passes through both sides of the iron frame towards the North pole. Since like poles repel and unlike poles attract, a powerful magnetic field is created in the air-gap between the poles. This air-gap, purposely shown enlarged in Fig. 4, is actually made as small as possible in order to intensify the magnetic field.

The voice-coil, usually consisting of a number of turns of fine enameled copper wire around a thin paper collar, is centered and held within the magnetic field air-gap by a flexible support called a "spider." This spider is usually a corrugated disc made of material which is very flexible in the longitudinal direction, but stiff in the transverse direction.

Thus the spider allows the voice-coil to move freely forwards and backwards, but prevents it from side-to-side. The cone (also called a "diaphragm" or "piston") is formed from treated paper. Its apex is cemented to the voice-coil, and its outer edge is supported in the ring of the



3A



3B

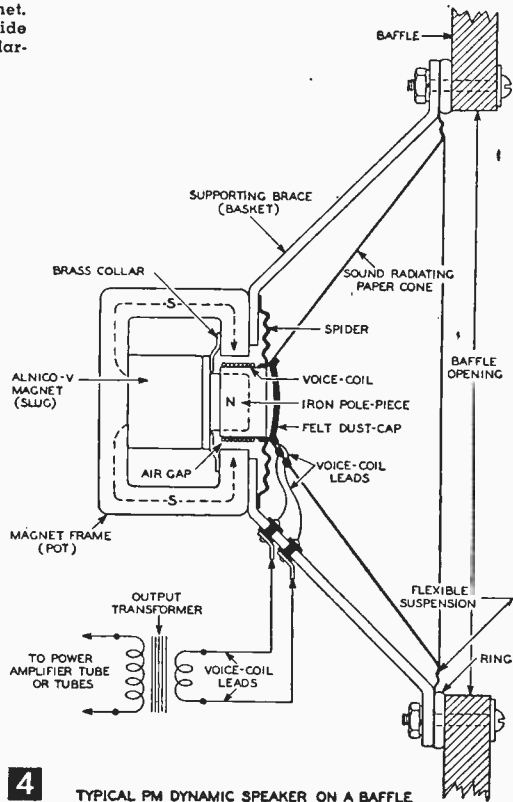
(A) Coil repels magnet and pulls away from it because its magnetic field polarity is the same as that of the magnet. (B) With battery connections reversed (battery now upside down), coil clings to magnet because its magnetic field polarity is now opposite that of the magnet.

“basket” by a flexible suspension, usually consisting of corrugations in the outer edge of the paper cone itself. As audio-frequency alternating currents flow through the radio’s output transformer and through the speaker voice-coil, magnetic fields of rapidly varying polarity, strength and frequency are set up within the voice-coil. These voice-coil magnetic fields are alternately attracted or repelled by the powerful magnetic field in the air-gap, thus causing the voice-coil to vibrate forwards and backwards at the audio rate. And since the voice-coil carries the cone along with it, the cone sets up sound waves which are a reasonable facsimile of the sound waves that enter the microphone at the broadcasting station. That, in brief, is the basic theory. Now let’s test it out with the first construction project we will show you how to build.

**Simple Voice-Coil Experiment.** To see how a coil with a magnetic field of changing polarity behaves when placed close to a strong magnetic field, rig up the simple device shown in Fig. 3. Mount an Alnico slug on top of an Artgum eraser and bind these parts together with Scotch tape. Wind about 40 turns of #28 insulated copper wire around a small paper or cardboard tube, or plastic top from a talcum can, and coat the coil with glue or with Duco cement so it won’t

unwind. The coil is supported by its two leads so it stands in mid-air about ¼ in. away from the end of the magnet, using thumbtacks stuck in the wood base as shown. A and B in Fig. 3 show what happens when a 1½-volt flashlight cell is momentarily connected to the coil. If you should connect the battery and coil to a DPDT knife-switch, the polarity of the connections from battery to coil can be reversed by throwing the switch from side to side. Thus you can make the coil move forwards and backwards as fast as you can operate the switch! In other words, you make the coil vibrate by alternating the current flowing through it; the same effect takes place in a loudspeaker although the method of producing the alternating current is different. The tone generated by a speaker cone depends on the number of times the cone vibrates per second, while the tone intensity depends on how far the cone moves during the vibrations.

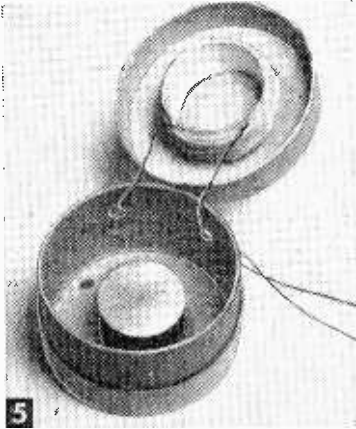
Thus, a loud bass tone is produced by slow but vigorous excursions of the cone, while soft treble tones are produced by very rapid but feeble excursions. Because a large cone is too heavy to vibrate efficiently at the very high frequencies, and a small cone cannot push enough air to fill a



4

TYPICAL PM DYNAMIC SPEAKER ON A BAFFLE





**5** Interior view of simple dynamic earphone. This also provides driving unit for dynamic speaker of Fig. 1. Leads were India-inked to show in photo.



**6** Under-the-pillow speaker built from a plastic stickpin case. Coil is wound on a plastic tube, and connecting cord plugs into the phone-tip-jacks.



**7** Under-the-pillow speaker, built in a 1¼x2½x3½-in. dime-store soap case, showing cord and plug attached to that unit. Magnet and coil are inside case.

room with bass, hi-fi units often combine the two to reproduce the entire musical range. This hi-fi combination of "woofer" and "tweeter" units as they are called, is known as a coaxial speaker.

To get back to the setup in Fig. 3, you could actually connect the coil to the output transformer of your radio (Figs. 4 and 10) and hear the broadcast program. But due to the poor sound radiating ability of the coil, and the poor magnetic coupling between the coil and the magnet, the sound output is so low you will have to put your ear very close to the coil in order to enjoy it!

**World's Simplest Dynamic Earphone.** If you have an Alnico slug, the earphone shown in Figs. 2 and 5 should cost you nothing to make, yet you will be pleasantly surprised by its performance. While its efficiency and tone quality cannot equal that of commercial dynamic earphones, it is good enough to use for late evening listening without disturbing those who have retired. Its impedance of around 6-ohms makes it a good match for the secondary of the output transformer on your radio and Figs. 4 and 11 show how this connection is made after you have built the earphone.

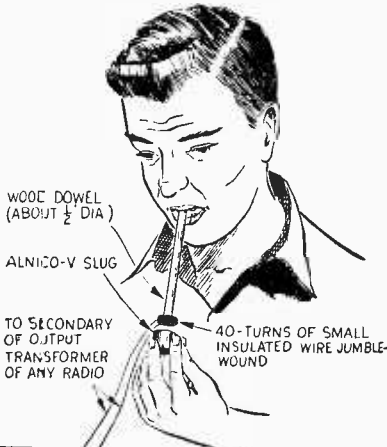
The writer used a 7/8-in. diameter Alnico-V slug 3/4 in. long salvaged from a junked 5-in. PM speaker. The slug was cemented to the inside center of a round 1¼ x 1-in. paper thumbtack box using DuPont Duco cement. For the voice-coil, 40 turns of #28 Cottenamel copper wire were jumble-wound around a 1-in. diameter, 1/2-in. long paper collar. Duco cement applied to coil kept it from unwinding. The voice-coil and magnet were cemented to the exact center of the box lid, so that when box was closed, the coil encircles the top edge of the Alnico slug *without actually touching it*. If it does touch, you'll get a raspy tone. Punch wire lead holes in box as shown (Fig. 5). Figure 2 shows completed earphone with a headband bent from a wire clothes hanger. Flexible rubber-covered wires soldered to voice-coil leads and secured to inside of box

keep the voice-coil from being damaged by pulling on the cords. Since the voice-coil vibrates the box lid, making the lid a sound-radiating diaphragm, it's best to hold the phone off the ear slightly while listening. To do this, cut a large hole in the center of a dime-store foam-rubber powder puff (Fig. 2). Then cementing the puff onto the outer edge of the box top with rubber cement. Remember, the stronger the magnet used, the closer you get the voice-coil to the magnet without touching it, and the larger the box top diameter—the greater will be the sound output of this simple dynamic earphone.

**Under-the-Pillow Dynamic Speakers.** With one of the simple dynamic speakers shown in Figs. 6 and 7 placed underneath your pillow, and with your ear on the pillow directly over the speaker, you can listen to late programs without disturbing others. Both pillow speakers are built in exactly the same way as the dynamic earphone of Fig. 5; in fact, they are simply enlarged earphones with a larger sound-radiating surface. To extend the magnet so that it will reach into the voice-coil, cement an iron pole-piece to the slug. Our pole-piece was salvaged from an old speaker, but a slug of iron rod of the required diameter will do. Or make the voice-coil form long enough to allow the coil to encircle but not touch top edge of magnet.

Before cementing slug and voice-coil to plastic, clean and scrape plastic surface so cement will hold. Use light-weight plastic-covered lamp cord for this speaker. Tie a knot in the cord and Duco-cement this to the inside of the case. Solder voice-coil leads to ends of lamp cord.

In the second pillow speaker project (Fig. 6), the voice-coil was wound on a plastic tube, and connections are made to the speaker through two phone-tip-jacks fastened through sides of the plastic compact. The soap-case speaker (Fig. 7) gives a little more volume than the plastic-compact speaker (Fig. 6) because of its thinner lid of

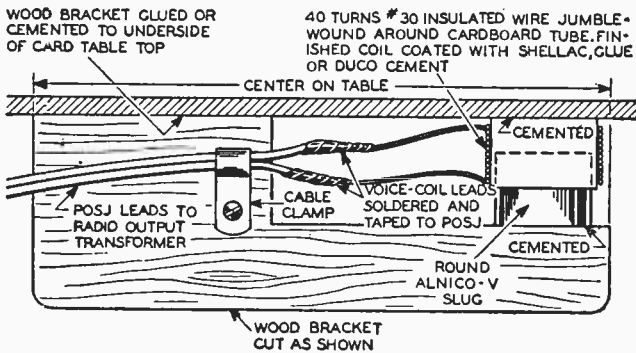


**8** LISTENING BY BONE CONDUCTION

as shown, and make the connections from the voice-coil to your radio's output transformer using a short length of POSJ lamp cord. Bring cord off the table at a corner so it won't be too much in the way. This musical card table works on exactly the same principle as the projects previously described, but you will hear more bass because of the larger radiating area of the table top. Use the most powerful magnet you can get, and place the coil as close as you can to the slug, without actually touching it

**Simple PM Speaker.** It cost me less than 10¢ to make the simple 8-in. PM dynamic speaker shown in Fig. 1. Of course, its efficiency and tone quality does not equal that of a factory-made speaker, but it reproduces clearly and has enough volume for a small-size room. To build this speaker, first make a phone unit as in Fig. 5. Then form an 8-in. diameter cone from a sheet of double-weight paper (poster or construction paper), cut the tip off the cone's apex, and then cement the cone to the center of outside of box lid as shown.

The box lid now acts as a spider and the cone radiates sound waves by acting as a piston. To make the spider more flexible you can punch or burn small holes in a circle around the outer edge of the box top, but leave the box top stiff enough to support the cone and voice-coil so they won't tilt. Bend a stand from a wire clothes hanger as shown, or make an angle-bracket from wood and glue back or paper box onto wood upright.



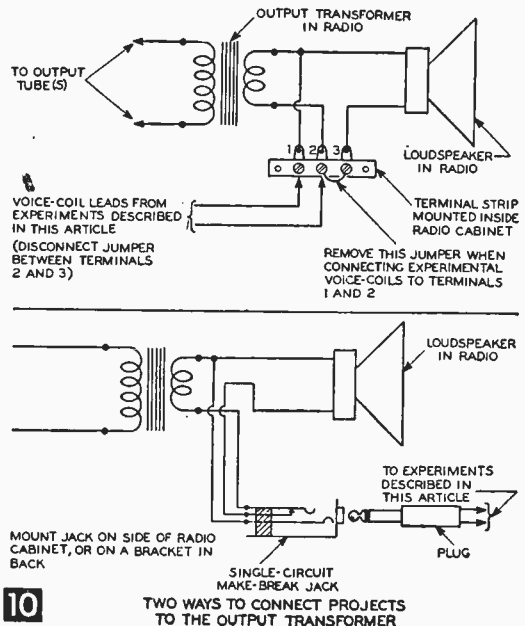
**9** MUSICAL CARD TABLE

somewhat larger surface area. But both perform surprisingly well for such simple devices.

**Listening by Bone Conduction.** For this experiment, jumble wind about 40 turns of #28 or #30 insulated copper wire around the end of an 8-in. long piece of 1/2-in. wood dowel (Fig. 8). Wind wire tightly, as close to the dowel end as possible, then coat with glue, or Duco cement to keep it from unwinding. Connect leads of coil to output transformer of your radio, hold wood dowel in your teeth as shown, and then hold an Alnico slug close to the coil. As the voice-coil vibrates at the audio rate in the magnetic field of the slug, the vibrations pass through the dowel, through your teeth and skull, and excite your auditory nerves, thus giving you the sensation of sound. If you turn up volume control, you will hear the music and understand the spoken words. Bone-conduction hearing aids work in this way.

**Musical Card Table.** Entertain your friends by having their favorite radio programs radiate right off the center of the card table top while you play cards! Figure 9 shows the simple setup. Secure the familiar magnet-and-coil combination to the underside center of the card table top

**Connections to Your Radio.** To use the projects described in this article, you must connect them to the output transformer secondary winding in your radio. The output transformer (see Fig. 4) is usually mounted right on the frame of the speaker,



**10** TWO WAYS TO CONNECT PROJECTS TO THE OUTPUT TRANSFORMER

and the two short wires from the transformer to the speaker voice-coil are the ones you want. Disconnect one of the leads, using a soldering iron if necessary. But don't disturb the long leads from the transformer to the output tube(s) plates. For temporary hook-ups, use alligator clips. For longer lasting, neater looking connections, use one of the methods in Fig. 10. None of the dynamic units in this article will work with crystal sets, because the voice-coil impedances are too low, but they do match the

output transformer in your receiver. Ask local radio service shops for junked PM speakers they intend to throw out. You can remove the Alnico slugs and iron pole-pieces by sawing through frames and prying frames apart to release the magnets. Or ask these firms for prices on round Alnico slugs such as PM speakers use: Park Magnets, 1557-A Greenbay Rd., Highland Park, Ill.; Miami Magnet Co., 3240 N.W. 27th Ave., Miami 42, Fla.; Leotone Radio, 67 Dey St., N. Y. 7, N. Y.

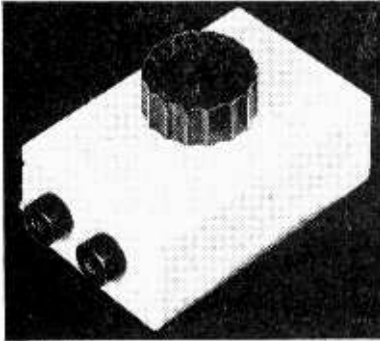


Fig. 2. Control built into small plastic box which used to house a small safety razor.

**TV** SET owners with children have a universal complaint: "The noise of those cowboy movies drives us crazy!" But try to pry the youngsters away with a crowbar—it can't be done! This attachment (Fig. 1) for any make or size TV set not only allows the kids to listen without disturbing you, but also permits you to either increase or decrease the set's volume by remote control from your easy chair. And if there is a member of the family who is hard-of-hearing, he can enjoy the program with you without blasting others out of the house.

You need no radio or TV knowledge to construct this control, nor will you be involved with any high voltages or internal wiring, since the point of connection is to one of the speaker wires. The control consists of a small plastic or wooden box just large enough to contain 2 earphone tip jacks and a 2000 ohm potentiometer (volume control). The plastic box shown here (Fig. 2) was designed to hold a safety razor and measures  $1\frac{3}{4} \times 2\frac{3}{4} \times 1\frac{1}{8}$  in. deep.

In the center of the bottom of box we drilled a  $\frac{1}{4}$  in. hole, then reamed it out to  $\frac{3}{8}$  in. to accept the potentiometer. Two  $\frac{1}{4}$  in. holes were drilled in the end of the box to accept 2 earphone tip-jacks (Figs. 3 and 4). A single  $\frac{1}{4}$  in. hole was drilled in the opposite end of box for

## 3-in-1 TV Control

Fig. 1. Below, a pair of standard 2,000 ohm headphones plugged into this control, and only you or the youngster can hear that noisy TV show.

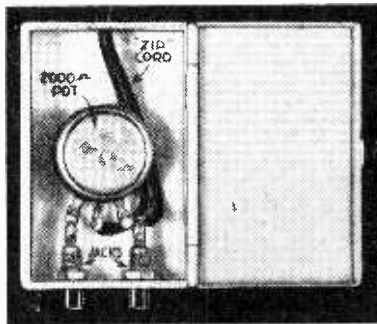


Fig. 3. Unit contains 2000 ohm volume control (center) and 2 phone tip jacks. When used as a remote control, phones are disconnected from unit.

passage of the connecting cord. This cord is a suitable length of ordinary plastic or rubber fixture wire known as "zip-cord."

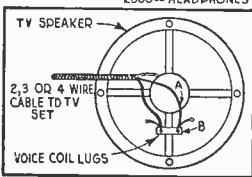
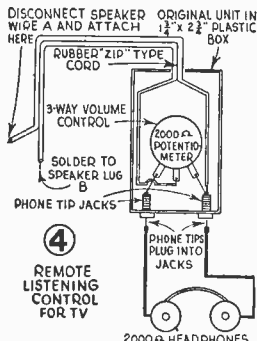
When the control is merely for earphone use, this cord need not be more than a couple of feet long. If, however, the control is used without the earphones for remote volume regulation, a length of 300 ohm TV

lead-in wire may be used instead of "zip-cord." The lead-in wire, being flat, may be laid under a rug without causing a bulge.

With components mounted in the box, refer them according to Fig. 4. Note that there are only 5 soldered connections in the box. To connect the control permanently to the TV set, remove back cover (if any) and locate the 2, 3, or

## MATERIALS LIST: TV CONTROL

- 1 small plastic or wooden box (see text)
- 2 earphone tip jacks (American Radio Hardware, etc.)
- 1 suitable length fixture "zip" cord, or 300 ohm TV lead-in wire
- 1 2000 ohm IRC, Mallory, or Ohmite-Bradley potentiometer
- 1 plastic knob for potentiometer (set-screw type)
- 1 pair 2000 ohm headphones (two youngsters may listen by removing 1 phone from headband)



4-wire cable from set to speaker. Most TV sets employ the revived electro-dynamic type speaker which hasn't been seen on radio sets for more than 10 years. The field coil of the dynamic serves as the low voltage filter choke and thus saves space on the TV chassis.

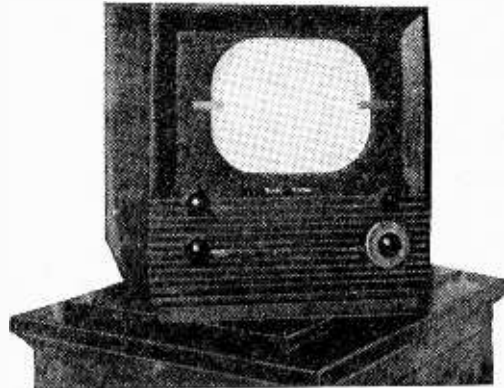
Inspect the speaker carefully and note that the speaker cable terminates at the center core as well as at 2 soldering lugs leading from the speaker cone (paper diaphragm). One of the cone lugs connects back to the center core (field) winding. With a soldering iron, disconnect the cable wire which connects directly and *only* to the voice coil diaphragm lug. This wire is often *white*.

The remote control is then attached by connecting one of its wires to the speaker lug. The other control wire is connected to the disconnected cable wire, and taped. In simple terms, the control has been connected in series with the voice coil of your TV speaker. If more convenient, the control may be installed at a more accessible point simply by noting the color of the voice coil lead, and inserting it in series with, let's say, the white wire near speaker plug.

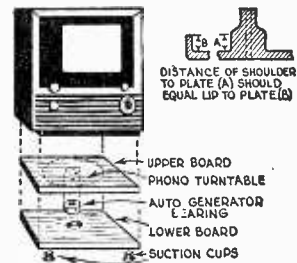
To adjust the volume control, turn the control knob to the extreme left, making sure earphone volume off and speaker is on full. Then advancing knob to the right will reduce speaker volume and gradually build up the earphone volume. At a point about  $\frac{1}{3}$  from left, speaker and phones will receive equal sound. To use the control for earphone reception only, turn knob all the way to right and regulate volume with the usual control on set. Also, remember to adjust the set's volume control to the desired level when using the accessory only as a remote volume regulator. The unit will then never increase volume beyond the point at which the TV set is adjusted.

The TV set should not be turned on full volume because "sound bars" may appear. This is a normal condition caused by overloading and happens on strong TV stations with or without the use of this adapter.

## Build a Turntable For Your TV Receiver



• To get more use from your table model TV set, try this turntable designed by Richard Heid of West Allis, Wis. Get an old automobile generator bearing ( $\frac{1}{2}$  in. wide,  $1\frac{1}{2}$  in. O.D.,  $\frac{5}{8}$  in. I.D.) an old phonograph turntable, 4 suction cups, four  $\frac{1}{2}$  in. screws, and 2 pieces of  $\frac{5}{8}$  in. wood, same size as bottom of set. Countersink bearing in center of one piece of wood; on opposite side place suction cups 2 in. from corners. Grind down center rod of

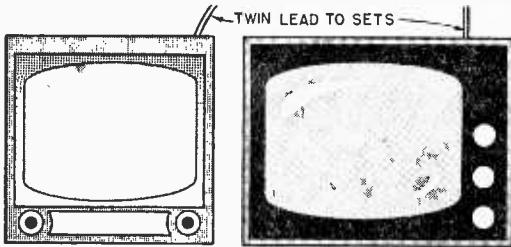
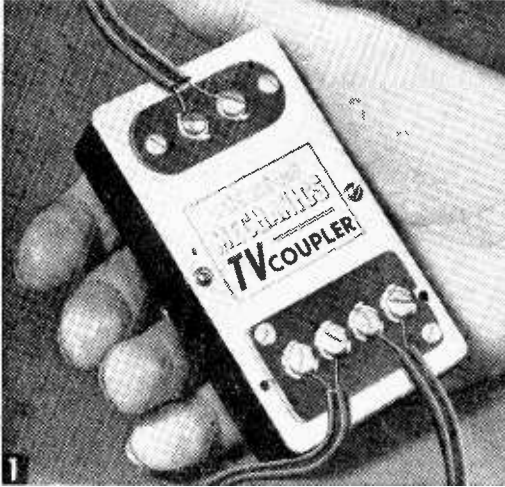
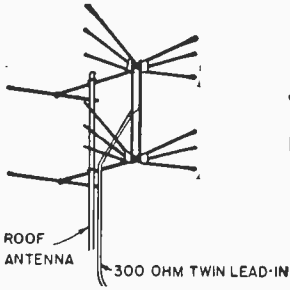


turntable to a press fit into bearing ( $\frac{5}{8}$  in.), leaving a slight shoulder about the same distance from turntable as lip at its rim. Drill 4 holes in turntable and fasten it to top board with  $\frac{1}{2}$  in. screws.

Place board with suction cups where you want your TV set to be; insert rod into bearing, and place set on board top. If you ground down too much shoulder, soap lower board where rim hits and it will work. Finish wood to match set and your television turntable is then complete.—LYMAN LINDAS.

# TV Antenna Coupler

You can operate two or more TV sets from a single roof antenna with this simple R.F. coupling transformer



IF YOU have two television sets, this simple coupling device will enable you to operate them from a single roof antenna. Fig. 1 shows a two-set coupler; however, by constructing four R.F. coupling transformers as shown in the schematic (Fig. 2), 3 or 4 sets can use the same antenna.

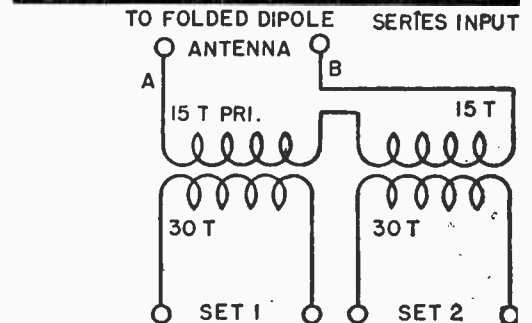
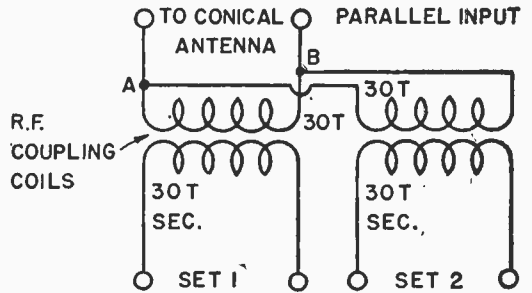
Actually, when several sets are operated off a single antenna, performance is often better than that obtained with a separate antenna on the roof for each set. The coupler reduces interaction between TV sets operated in close proximity of each other. Tests with this unit showed no loss in signal strength either at the high end (Channel 13) or low end (Channel 2) of the TV bands.

The aluminum panel (Figs. 1, 3 and 4) is slotted to clear the soldering lugs of a 2- and 4-screw terminal strip. The R.F. coupling coils are wound on a single coil form for convenience and

soldered to the terminal lugs in self-supporting fashion (Fig. 3). A coil form salvaged from a discarded I.F. transformer is long enough for both, or they may be wound on individual forms of  $\frac{3}{16}$  in. diameter.

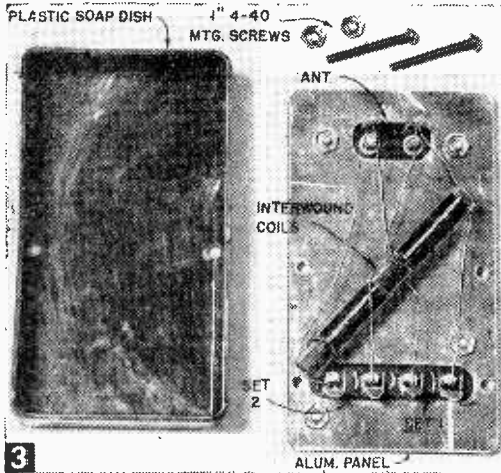
The primary and secondary windings of the R.F. couplers (about 30 turns each) are both wound in a single operation. Cut off two 34 in. lengths of magnet wire, and dip the ends of one piece in colored nail polish. When dry, secure an end of each wire in a small hole pierced in the coil form. Apply Duco or similar cement to the coil form and wind the dual lengths of magnet wire in a tight, even layer. Allowing  $2\frac{1}{2}$  in. of wire at the end for making connection to terminal lugs, anchor these leads in another pierced hole and set coil aside until cement has set.

Wind the second R.F. coupling transformer in the same manner. When both coils are dry, scrape insulation from the ends of the plain wires and solder to the 4-post terminal strip as shown in pictorial plan (Fig. 4). The primary wires are easily identified by the nail polish. Scrape the insulation from the right-hand red-tipped leads of each coil. Twist these together



UP TO 4 TV SETS MAY BE ATTACHED TO CONICAL ANTENNA USING ABOVE CIRCUIT IN TANDEM

## 2 SCHEMATIC PLANS



3

## MATERIALS LIST—TV ANTENNA COUPLER

- 1 plastic soap case (dime store)
- 1 aluminum panel, 2 $\frac{3}{8}$  x 4"
- 1 2-post terminal strip
- 1 4-post terminal strip
- 1  $\frac{1}{4}$  lb. spool #28 enameled magnet wire
- 1 length  $\frac{5}{16}$ " dia. paper or plastic tubing or wood dowel
- 2 1" 4-40 machine screws with matching nuts

and solder to one of the lugs of the 2-post terminal strip. Now scrape off insulation from the two remaining red-tipped coil leads, twist together and solder to remaining terminal strip lug.

After attaching panel to plastic box with two 1 in. 4-40 machine screws and nuts through bottom of the plastic box, the coupler is ready for use. Attach set lead-in to the 2-post terminal strip. Run a short length of 300-ohm lead-in from first set to terminals marked Set 1 on coupler. A longer length of lead-in is then connected from Set 2 on coupler to the second TV set.

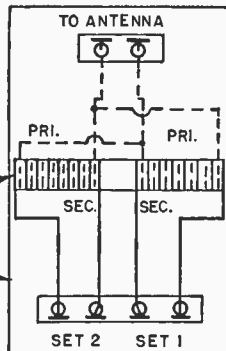
The coupler hook-up illustrated is for use with conical or X-type antenna only, which will match any lead-in wire and input (balanced or unbalanced) of any TV set. However, this coupler hook-up should be used only with sets having a 300-ohm input.

The primaries of the coupling coils are connected in parallel. This cuts the input to about 150 ohms for the 2-set coupler, and down to 75 ohms when a 4-set cou-

PL. 30 INTERWOUND  
TURNS #28 ENAMELED  
WIRE ON  $\frac{5}{16}$ " DIA. TUBE

2 $\frac{3}{8}$  X 4" ALUMINUM PANEL

## 4 PICTORIAL PLAN



pler is employed. There were no noticeable objections to this, but two series units in tandem are best.

If you wish to invest a little more time for a more closely matched antenna input, carefully unwind 7 $\frac{1}{2}$  turns from each end of the primary coils. This will leave a 30-turn secondary with a 15-turn interwound primary in the center. Now connect the end of the first coupler primary to one of the 2-post terminal strip lugs. Solder the remaining end of this coil to the start end of the second coupler primary. Now solder the finish end of the second coil to the remaining terminal lug. The coils are thus wired in series to provide a 300-ohm match approximately. This hook-up is advised when using the 2-set coupler with a folded dipole or dipole type antenna requiring connection to a 300-ohm input.

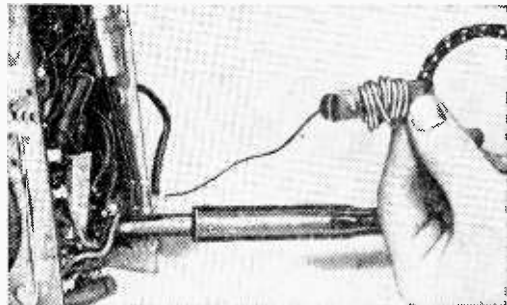
To operate sets with 72-ohm coaxial fed inputs, a single coupler transformer with a tapped secondary winding will provide a match to the popular 300-ohm twin lead and conical antenna. Wind a coupler coil with two lengths of magnet wire as previously described. After winding 15 turns, twist a small loop in the red-tipped wire, and complete the windings.

Unwind turns from each end, leaving 15 turns with the loop-tap point in center. Connect the 30-turn coil to antenna posts on coupler. Connect one end of 15 turn coil to first screw of 4-post strip. Clean insulation from tap and solder to terminals 2 and 3. Connect remaining end of coil to terminal 4.

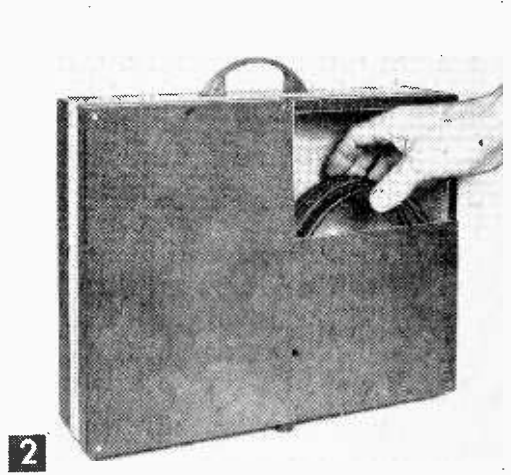
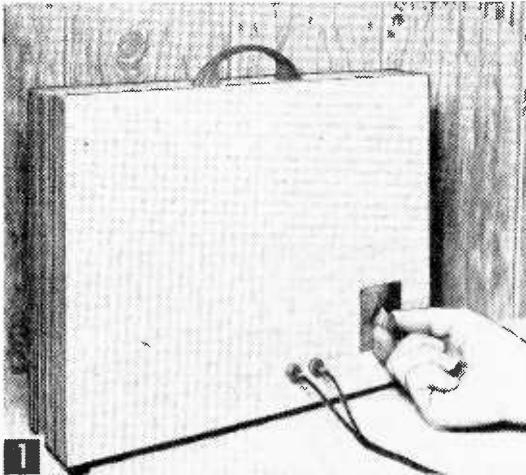
When attaching sets with coaxial lead-in to this coupler, the outer cable shields connect to terminals 2 and 3. The inner insulated wires connect to terminals 1 and 4, respectively.

Where a make-shift or hasty 2-set installation is desired, we suggest capacity coupling. Connect the roof antenna to the weaker of the two sets. Now attach a length of 300-ohm twin lead-in to the second set, and tape 3 or 4 feet of wire parallel with the roof antenna lead-in. Although there is no actual connection between second set and roof antenna, results are frequently very satisfactory.

## Solder Clipped to Iron Cord



• You'll have no trouble keeping track of rosin core solder if you will purchase a trouser clip at a bicycle store, slip it over the iron cord and wind solder around clip so it can't come off.—H. L.



Left, By winding the loop over the bare wood of the case and then applying the self-adhesive plastic material (here, Con-Tact), the loop is concealed and protected from damage. Right, The cut-out in the back panel permits storage of phones. The loop of this set has been wound over the case covering.

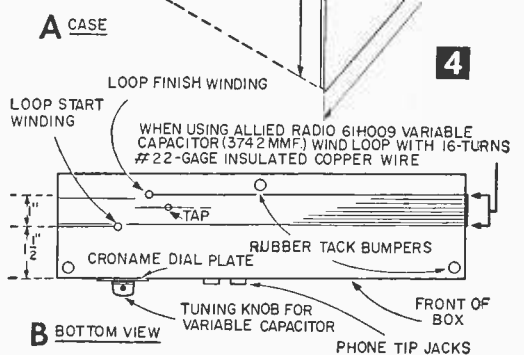
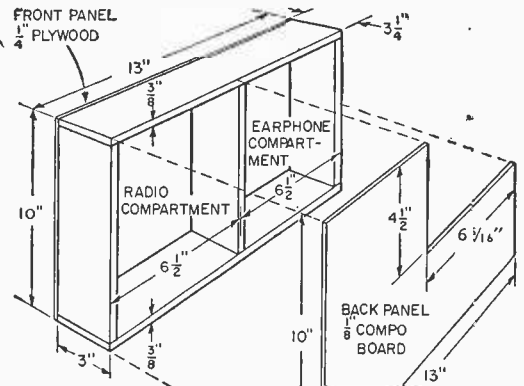
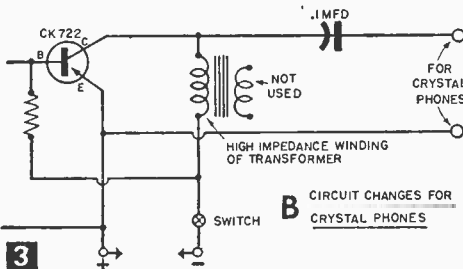
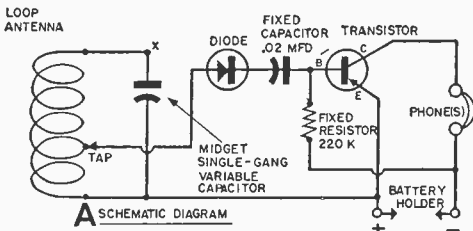
# Transistorized Loop Crystal Receiver

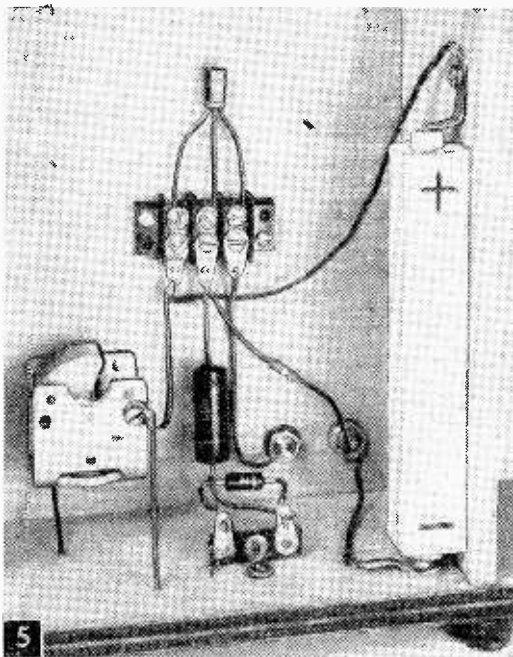
By ARTHUR TRAUFFER

**A**DDING a stage of transistor audio amplification to a loop crystal set provides a portable receiver that fills the bill nicely as either an emergency radio or an "extra" set for the youngsters. No conventional antenna or ground connections are needed, and the set is light enough to be carried easily from room to room. Volume is more than adequate from local stations, and selectivity is also excellent, due to the directional characteristics of the loop. Just aim the carrying case at a favorite station, zero in with the variable capacitor control, and enjoy yourself.

When tuning for maximum signal strength by

rotating the case, and thus the loop, you will notice a variation in volume in different rooms in the house, and even in different parts of a room. This is due to the effects of metal pipes and power lines within the walls, ceilings, and floors. Also, signal strength is usually greater





**5** There is plenty of room in the radio compartment of the case, and exact placement of parts is not critical, so don't crowd the circuit components. Cover all bare wires with spaghetti tubing.

3B. For this modification, any small transformer with a winding of about 100,000 ohms may be used. The other winding is not used. The switch in Fig. 3B removes battery voltage from the transistor when the set is not in use, and the .1 mfd low-voltage capacitor keeps d-c out of the crystal phones when it is in use.

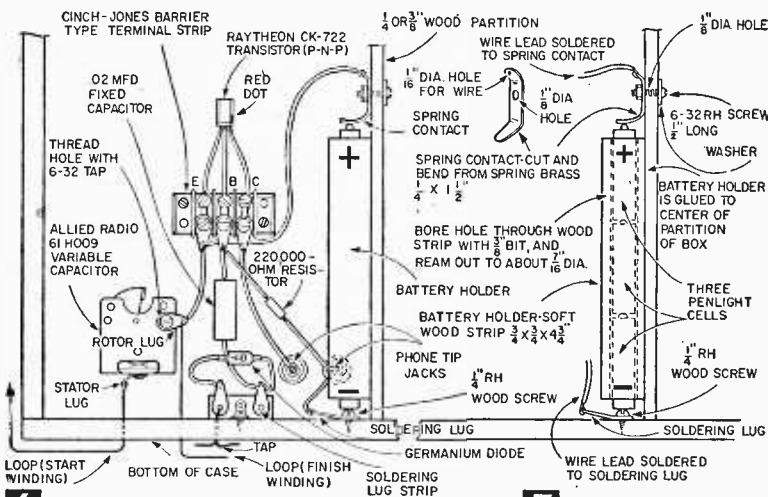
The carrying case is a 3 1/4 x 10 x 13-in. wooden box (it has a 1/4-in. plywood front panel; Fig. 4A and B). Assemble the top, bottom, sides, and partition with thin wire brads and glue. Sand all outside surfaces and round off sharp corners and edges. The size of the cut-out (Fig. 4B) for access to the phone storage compartment will depend on the size of your phones. If a back panel is not used, two or three bands of wide elastic tape stretched across the compartment will hold the earphones.

The case may be covered with a self-adhesive plastic material, as in Figs. 1 and 2, with the loop antenna wound over this covering (Fig. 2), or wound over the bare wood of the box with the plastic material applied directly over it to hide and protect it (Fig. 1). Cover the front of the case with a 13 1/2 x 10 1/2-in. piece of the plastic material (allow 1/4-in. overlap all sides); a 3 1/4 x 13-in. piece on the bottom; and a 3 1/4 x 34-in. piece top and sides (1/2-in. overlap on bottom). If you wind the loop over the covering material, you can protect the wires with 1/2-in.

*Mystik* tape which comes in many different colors.

Mount three large rubber tack bumpers on the bottom of the case (Fig. 4B), and fasten a plastic drawer-pull to the top for carrying. Mount the handle last and position it according to the distributed weight of the completed set. Do not damage the loop antenna wires when you mount the handle.

When using an Allied Radio #61H009 (374.2 mmf) variable capacitor and a 10 x 13 in. case, make the loop with 16



**6** PICTORIAL WIRING DIAGRAM

**7** BATTERY HOLDER

indoors than outdoors because the loop picks up radio-frequency energy from house wiring and pipes.

For best results, the earphones should be high-impedance magnetic units. Low-impedance magnetic and dynamic phones will usually require a matching transformer. Crystal phones must not be connected in series with the batteries (as are the phones in Fig. 3A). If you own a crystal hearing-aid type earpiece, or a pair of crystal headphones, and wish to use them, modify the circuit to that shown in Fig.

3A. Do not clip the diode's "pigtail" leads when related copper wire. Leave a small space between turns. To increase selectivity, put a tap on the loop winding at the 11th turn from the "start winding" end and connect the germanium diode directly to this tap (Fig. 3A). The "start winding" end of the loop is that which connects to the stator (stationary plate) lug of the variable capacitor. Selectivity can be further increased by tapping past the 11th turn, but sensitivity will suffer. If selectivity is no problem at your location, connect the diode to point "X" in Fig. 3A.



## MATERIALS LIST—TRANSISTORIZED LOOP CRYSTAL RECEIVER

## Receiver:

About 75-ft. #22-ga. cotton-covered enameled copper wire  
 One midjet single-gang variable capacitor (Allied Radio #61H009, 27-plate 374.2 mfm)  
 One .02 mfd low-voltage paper or ceramic fixed capacitor  
 One general-purpose germanium diode (Sylvania 1N34, Raytheon CK-705, G.E. 1N48, or equivalent)  
 One 220,000-ohm  $\frac{1}{2}$ -watt or  $\frac{1}{4}$ -watt fixed resistor  
 One P-N-P junction type transistor (Raytheon CK-722, Radio Receptor RR-38, RCA 2N34, or equivalent)  
 Two phone tip jacks  
 One 3-terminal Cinch-Jones barrier type terminal strip  
 One 2-terminal soldering lug strip  
 Five soldering lugs  
 Few feet insulated hook-up wire  
 About 16" small diameter spaghetti tubing  
 Two rh wood screws  $\frac{1}{4}$ -in. long, two  $\frac{3}{8}$ -in. long  
 Two small washers  
 One 6-32 rh machine screw  $\frac{1}{2}$ -in. long with hexagon nut to fit  
 One 6-32 rh machine screw  $\frac{1}{4}$ -in. long  
 Three 6-32 fh screws  $\frac{1}{4}$ -in. to  $\frac{3}{16}$ -in. long  
 One piece spring-brass  $\frac{1}{4}$ -in. wide and  $1\frac{1}{2}$ -in. long  
 One pointer-knob for variable capacitor (set-screw type for  $\frac{1}{4}$ -in. shaft)  
 One Croname type-406, 0-100 in 180-degrees, dial plate  
 One strip soft wood  $\frac{3}{4} \times \frac{3}{4} \times \frac{3}{4}$ -in. (for battery holder)  
 Three Eveready #912 penlight cells (or equivalent)  
 One pair head phones (any good quality high-impedance magnetic headset)

## Case:

One piece 10 x 13 x  $\frac{1}{4}$ -in. plywood  
 About five feet 3 x  $\frac{3}{8}$ -in. hardwood  
 One plastic drawer-pull handle  
 Three rubber tack bumpers  
 Wire brads, glue, etc.  
 Cover, one yard Con-Tact self-adhesive plastic (comes in 18-in. width)  
 Optional: One piece 10 x 13 x  $\frac{1}{8}$ -in. composition board for back panel

mounting. Use their entire length so you won't damage the crystal with soldering iron heat.

Run the two ends of the loop winding, and tap lead through small holes drilled through the bottom of the box (Fig. 4B). Mount the variable capacitor and the soldering lug strip *before* the loop is wound so you will have something to anchor the wire ends to. When mounting the variable capacitor, be sure the three 6-32 screws ends do not touch and bend the capacitor plates.

A Raytheon CK-722 P-N-P junction transistor was used by the writer, but any similar P-N-P junction type can be used in this circuit. For weaker or more distant stations, signal strength can be noticeably increased by using a CK-721 in place of the CK-722. Mount the transistor in a Cinch-Jones 3-terminal barrier strip (Figs. 5 and 6) so that connections can be made without the use of a soldering iron. (If you should solder transistor leads, be careful. Heat can easily ruin the internal connections of a transistor.) The barrier strip also allows the transistor to be removed easily when it is needed for other experiments. Mount the barrier terminal strip with  $\frac{3}{8}$ -in. rh wood screws and household cement.

To identify the leads on the CK-722, note in Figs. 3 and 6 that the center pigtail is B (base); the red dot pigtail is C (collector); and the third pigtail, E (emitter). The negative side of the batteries connects to C of the transistor, the positive side of the batteries connects to E. If you get the battery connections reversed, you



8 An MS-171 battery holder, sold by Lafayette Radio, screw-fastened to the wood partition separating the radio and phone compartments of the case.

may have to buy a new transistor; so if you buy a different make of transistor, be sure you get a diagram identifying the leads.

The .02 mfd low-voltage fixed capacitor (Fig. 3A) functions well in this circuit, but you could get slightly more bass by using a 10-mfd, 6-volt electrolytic capacitor such as the Sprague TE-1087. In this case be sure to connect the negative side of the capacitor to B of the transistor.

The battery holder (Fig. 7) was designed to hold three  $\frac{3}{8}$ -in. dia. penlight cells (Eveready #912) to give 4½ volts. If you want to use the next larger size cell (Eveready #915, size AA), increase the diameter of the hole and use a slightly longer wooden strip. To slip the cells in or out, simply move the top spring-contact to one side. The hole should be large enough so that any possible swelling of either wood or batteries will not cause the cells to stick, and the inside surface of the hole should be straight and smooth. You can bore all the way through the wooden strip from one end, or bore from both ends and meet in the middle. The hole can be enlarged to the correct diameter, and smoothed, by reaming it with a dowel wrapped with sandpaper.

If you prefer to buy a ready-made battery holder (Fig. 8), Lafayette Radio (100 Sixth Ave., New York, N. Y.) has placed various types on the market for transistor experimenters.

No power switch is used with the Transistorized Loop Crystal Receiver. Disconnecting the phones disconnects the batteries.

# Remote Control with Selsyn Motors

Tune your radio from your favorite chair, find out which way the wind blows without leaving the house. These motors make it possible

By THOMAS A. BLANCHARD



Author demonstrates how one Selsyn follows movement of mate.

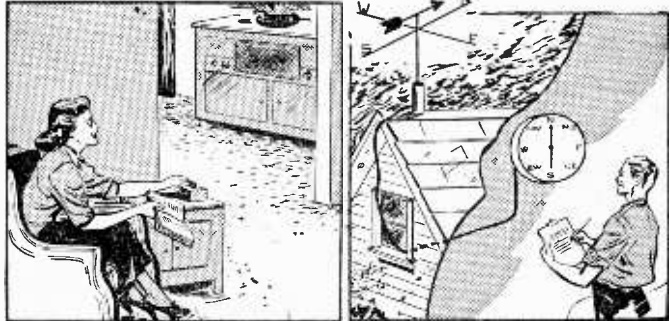
**T**HERE is nothing on the market that will provide as much electrical fun and practical use as a pair of selsyn motors.

The selsyn motor gets its name from the word *self* in a now obsolete English usage—meaning *same* or *identical*—and the Greek word *syn*, which means *together*. Thus selsyn means 2 identical things that work together.

The selsyn motors pictured here are surplus from military aircraft; you can probably buy a pair of them for less than \$10. The two G.E. type 2J1G1 units used were designed for a 57½ v. 400 cycle ac power source, but they may be operated on 110-125 house current, which is only 60 cycles. While many 400 cycle devices will burn up on 60 cycle current, these G.E. selsyns did not get as warm as a conventional small motor when left connected for an hour to the power supply. The uses here require only intermittent attachment to 110 in most instances.

When 2 selsyns are connected together each will imitate the action of the other. Connect them to a power line, then turn the shaft of one selsyn. Instantly, the other selsyn's shaft will rotate to the exact extent as the shaft you rotated manually. Now reverse the set-up and turn the shaft of the other selsyn; the shaft of the first selsyn will follow you every move. Thus, either unit can be a *transmitter* or *receiver* of mechanical movement. The remote control possibilities of these little devices are obvious.

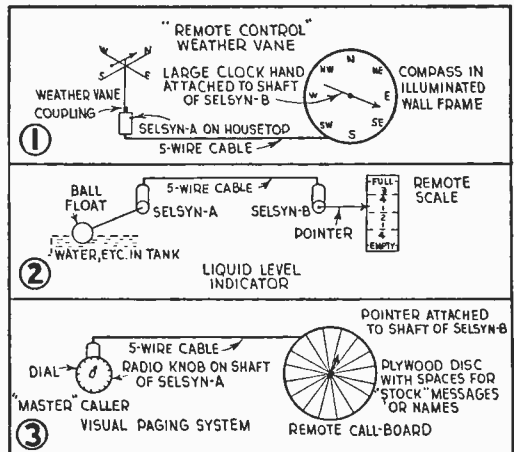
Selsyn units are supplied by surplus dealers minus the female AN connector, which resembles a giant radio tube base. This similarity was the key to a simple and convenient means for connecting the 5-wire cable needed to operate the units. The end of the selsyn has 5 coded pins. Soldering wires to these pins may be difficult,



or harmful to the unit. But as the pins are identical to GT radio tube pins, in diameter, we took a couple of discarded octal wafer radio tube sockets apart and used the metal connectors for cable terminations. These snap or slide on or off the selsyn motor pins with ease. Solder them to the 5-wire cord.

A regular 60 watt Mazda lamp provides the most economical voltage dropping resistance, both in operation and initial cost. When a more compact resistance is desired, use a regular radio type 150 or 200 ohm wire-wound resistor rated at 20 watts, and provide good ventilation for this re-

## Connections for Selsyn Motors



**SOURCES OF SUPPLY—2J1G1 SELSYNS**

**Name and Address**

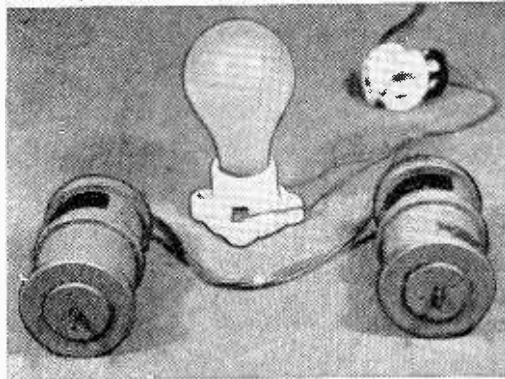
Instrument Associates Dept. J, 37 E. Bayview, Great Neck, L. I., N. Y.

TAB Electronics, Selsyn Div., 6 Church St., N. Y. 6, N. Y.

Pioneer Surplus Co., 331-M Canal St., N. Y. 13, N. Y.

G & G Radio Parts, 51-A Vesey St., N. Y. 7, N. Y.

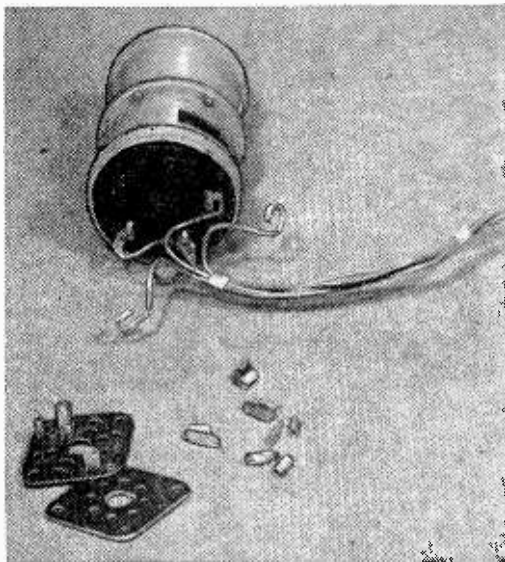
Palley Supply Co., Dept. G, 10460 S. Vermont Ave., Los Angeles, Calif.



A pair of \$1.98 Selsyn motors operating in series with 60 watt Mazda bulb is ready for workbench trial and experiment.

sistor. If selsyns are separated by some distance, the lower resistance value—150 ohm resistor or 75 watt lamp—may insure greater torque. At short distances, these lower values will give the units more driving power, but if there is any indication of motor frames becoming too warm, replace with the higher 200 ohm resistor, or the 60 watt lamp.

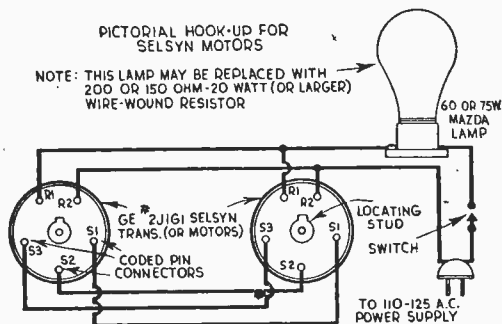
To protect the selsyn unit from atmospheric action, when used outdoors, cover it with a hood. A tall evaporated milk can is ideal, since it has



Old radio tube sockets provide perfect cable connectors for Selsyn motor pins. Break tube socket and remove the phosphor bronze clips. Solder clips to ends of 5-wire cable.

no flange in which rain can accumulate. Avoid fruit and vegetable cans which have flanges. Cut off top of can with tin-snips and pierce a hole in center of bottom. Ream hole to 1/4-in. dia. and insert a rubber radio grommet. The grommet hole will make a snug weather-tight fit over the selsyn shaft. To prevent hood from rusting, paint inside and out with auto-top dressing or asphalt roof paint.

A few of the selsyn's uses are described below.



Others will occur to you according to your needs.

1. *Remote Reading Weather-Vane.* Mount selsyn A on the roof-top. To its shaft (which is provided with a 6-40 thread) attach a weather vane. Run a special 5-wire outdoor-type cable to selsyn B. Attach a large clock hand to the shaft and mount unit in a frame carrying a reproduction of the compass points. Many of your auto road maps are illustrated with compass designs. Have a photocopy made in a suitable size, color the photocopy and install a 60 or 75 watt voltage drop bulb inside the frame to make a beautiful illuminated weather vane.

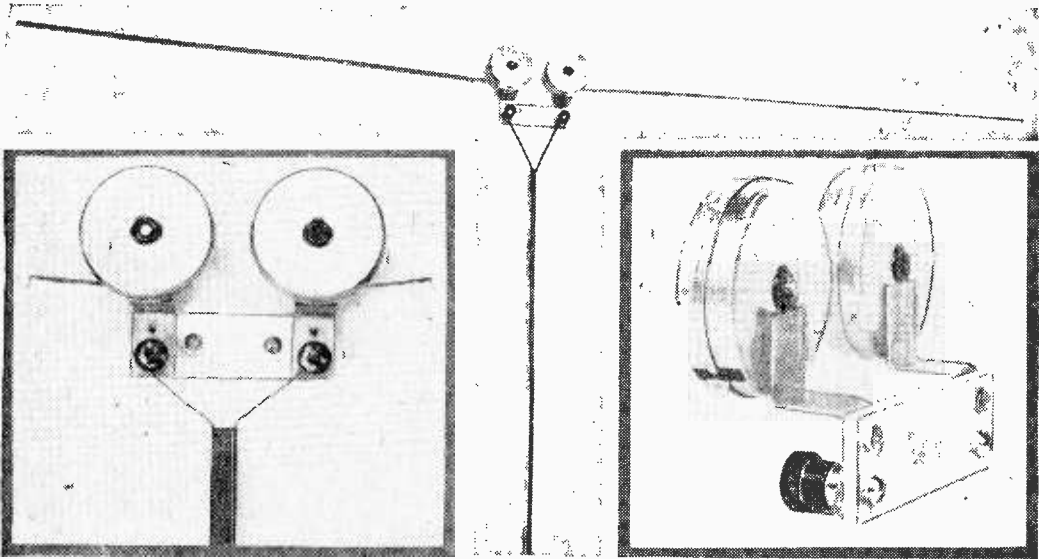
2. *Liquid Level Indicator.* Water, oil, etc., in storage tanks may be checked from distant points by fitting a copper ball float (as used in bath equipment) to shaft of selsyn A. Fashion pointer from sheet metal, or attach a regular clock hand to selsyn B. Make a calibrated remote scale for pointer, to indicate contents of tank from *empty* to *full*.

3. *Visual Paging System.* There are many places where the electronic "intercom" loud-speaker call system is worthless—boiler works, for example, or mills, farms, etc., where the persons being paged move about constantly. Fit selsyn A with an identification dial and radio pointer knob. Place selsyn B behind a large masonite or plywood dial divided into a suitable number of divisions for "stock" messages or individual's names. A large clock hand attached to selsyn B

will move to proper division on remote call board when the office clerk positions his *Master Caller* pointer to desired person or message.

A colored code-light system may be substituted for call board simply by removing the ball bear-

ing stop from a Mallory tap-switch so the switch turns from tap to tap without effort. Each tap turns on a different colored bulb assigned to a certain employee. A commercial outfit doing the same thing may cost up to \$1,000.



Left, front view of larger di-pole; right, rear view. Center, the large di-pole on the wall of the author's den. The elements are pulled out to 24 in. for the high end of the 88-108 megacycle FM band.

# Portable Di-Poles for TV and FM

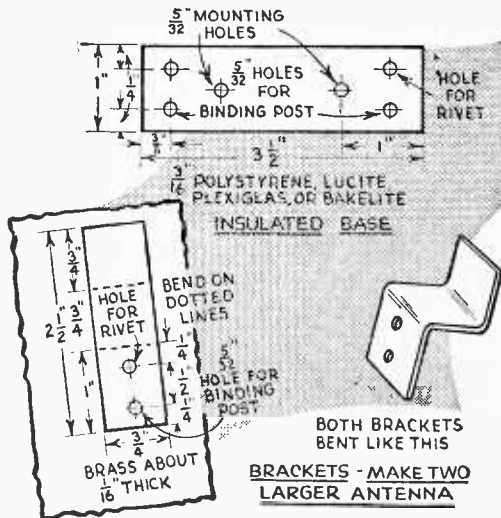
Here's how you can make a set of adjustable di-pole antennas

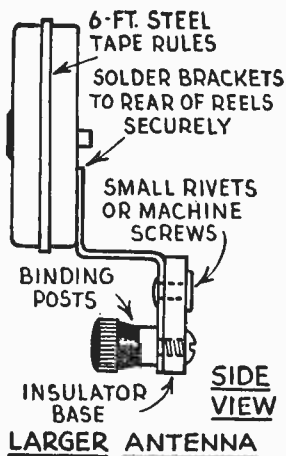
By ARTHUR TRAUFFER

HERE are just about the most compact, thoroughly portable and adjustable FM and television di-pole antennas ever developed. Both of these di-poles use common "roll up" steel tape rules, and the tapes themselves serve as the di-pole elements. When using the larger tapes, the elements or rules can be pulled out to any desired length up to 6 ft., and they will stay out until pressure on the release buttons snaps them back into the cases. Since the rules are calibrated in fractions of inches, you can easily balance each element electrically, that is, get both elements exactly the same length. It makes little difference whether the di-pole elements consist of tubing, solid rod, wire, or tape. The important thing is that the elements be metallic, and both the same length.

For portable FM and television receivers, these di-poles are ideal.

With the larger di-pole, the elements are self supporting up to 36 in., but beyond this, it is necessary to support the elements with string or other means. The smaller di-pole was intended for use with frequencies from 100-megacycles and up. The elements can be drawn out to





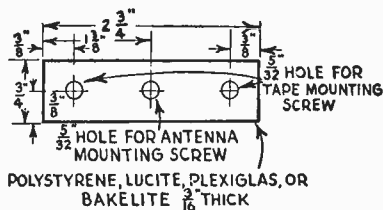
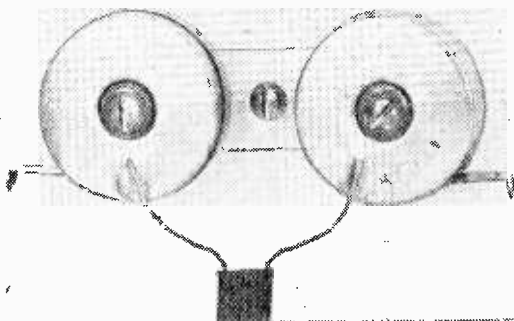
**MATERIALS LIST — PORTABLE DI-POLE ANTENNAS**

**Large Antenna**

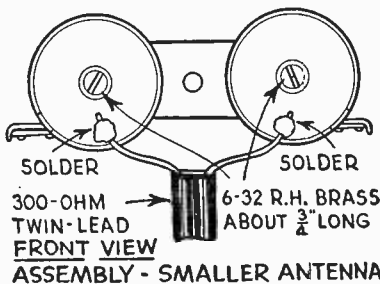
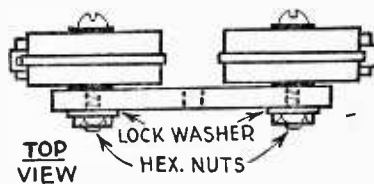
- 2—6 ft. Walsco metal-encased steel tape rules—about 45c each in all dime stores.
- 1—Length of 1"x $\frac{1}{16}$ "x12" Polystyrene strip—about 40c in radio stores. Sold only in 12" length. Lucite or Plexiglas can be used.
- 2—ICA Bakelite binding posts, about 12c each.
- 2—Flathead tubular rivets. Brass or copper about  $\frac{1}{16}$ " long. Sold in auto stores, or can be had in auto repair shops.
- 1—2"x3" piece of sheet metal for angle-brackets. Brass or steel about  $\frac{1}{16}$ " thick.

**Small Antenna**

- 2—"Little Pal" 3 ft. Walsco metal-encased steel tape rules. 20c each in dime stores. Polystyrene strip listed above can be used if desired, or buy a 12" strip  $\frac{3}{4}$ "x $\frac{1}{16}$ " for about 30c.
  - 2—Roundhead machine screws with hex. nuts, 6-32  $\frac{3}{4}$ " long.
- Note: Polyethylene ribbon twin-lead for above antennas can be any length within reason. 300 ohm twin-lead sells for about 3c per foot. Prices listed above are approximate.



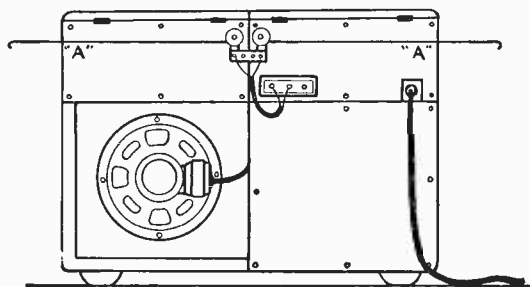
**INSULATED BASE - SMALLER ANTENNA**



36 in. and they are self-supporting up to 24 in. As the smaller steel tape rules contain no mechanism for locking the tapes when extended, it is necessary to push a small wedge between the tape and the opening in the case after the tapes are extended (wooden matches will do).

For the larger di-pole, mount the tapes on brackets with two bends in them in order to hold tapes out far enough so you can get at one of the tape-release-buttons with your finger. Use any good insulating material, Polystyrene, Lucite, Plexiglas, or Bakelite, for the insulator base, remembering that strength is perhaps more important than dielectric qualities because center of di-pole is at a low voltage node. A binding post and a small flat-head tubular copper or brass rivet hold each bracket securely to the insulator base. Binding posts make electrical contact with the tapes through the brackets

When attached to the rear of the radio-phonograph combination console, the antenna is almost hidden, the elements are easily adjusted for length, and the elements can be made to disappear when the cabinet must be moved.



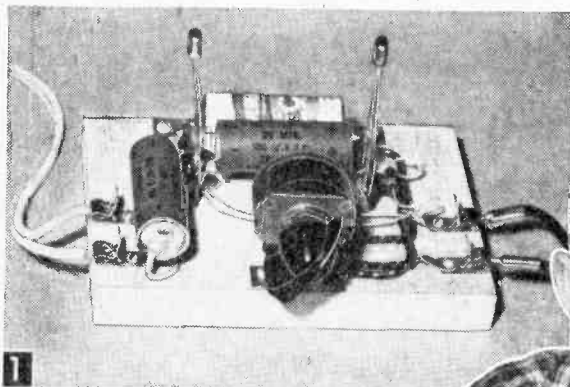
**SMALL INSULATED BRACKETS MOUNTED AT "A" ON CABINET WOULD PREVENT SAG IN THE TAPES WHEN EXTENDED**

which are soldered to cases of tapes. A 300 ohm ribbon lead-in is used to connect di-pole to antenna input of receiver. After holes are drilled in the bases, di-pole can be mounted on rear of receiver, on the wall, or onto a stake which has been driven into the ground. Wood-screws or machine-

screws are used depending on where you mount the di-pole.

In constructing the smaller di-pole, since there are no tape-release-buttons on these small tapes, it is not necessary to mount the tapes on brackets; tapes are simply attached to insulator base

with two round-head brass machine-screws, lock washers, and nuts. Then solder 300 ohm ribbon lead-in directly to tape cases as shown. After tapes have been drawn out to the desired length, lock them in position by pushing a match into the opening of each tape case.



Left, closeup showing transistors in place. Amplifier may be used with single or double headphones of 2,000 ohms or more, and it will serve as detectophone or a stationary hearing aid. Below, a 4-in. PM speaker and output transformer mounted in cabinet at left makes a wide range dynamic mike for this tiny but powerful 2-stage transistor amplifier.

**T**HIS simple breadboard layout will show you how you can adapt transistors to audio frequency amplifiers. In fact, the completed setup shown in Fig. 1 will serve you as a very sensitive detectophone and will pick up voice and music with surprising clarity and volume.

While transistor hearing aids use transformer-coupled amplifiers which provide somewhat greater gain and less distortion, we have found that the simple, inexpensive resistance-coupled circuit is excellent for experimental purposes. Moreover, its components are available at all radio parts suppliers, whereas few dealers stock the expensive sub-miniature components employed in hearing aids.

Vacuum tubes have high impedance inputs allowing crystal mikes or pickups to provide the grid signal. Transistors, on the other hand, have low impedance inputs making crystal mikes impractical. Transistor hearing aids, therefore, use a miniature moving coil magnetic mike known as the dynamic type, which is not easy for you to obtain at this writing. But your mike problem is easily solved by using an ordinary 4 or 5-in.



## Transistor Amplifier

Powered with just a penlite battery, this 2-stage amplifier demonstrates how to use transistors in a sensitive detectophone

By THOMAS A. BLANCHARD

PM speaker and a regular 2500-ohm output transformer. In this case, the output transformer is used as a "mike-to-grid" input transformer.

Although this amplifier can be reduced to less than half the size shown in Fig. 3, the 3½ x 5-in. baseboard mounting allows the parts to be 100% salvaged for re-use in other experiments. The two three-lug solder tie strips, mounted on the baseboard with ½-in. rh wood screws, serve to tie down resistors and capacitors as well as pro-

vide three lug points for terminating the transistor pigtail leads. Input and output amplifier connections are simple Fahnestock clips also secured to the base with 1/2-in. rh (round-head) wood screws. For the volume control mounting, use a window shade bracket with the 1/8-in. pin hole drilled out to 3/8 in. to take the threaded control bushing. Two small tin or copper brackets screwed to the base provide a mounting clip for the penlite battery which powers the amplifier.

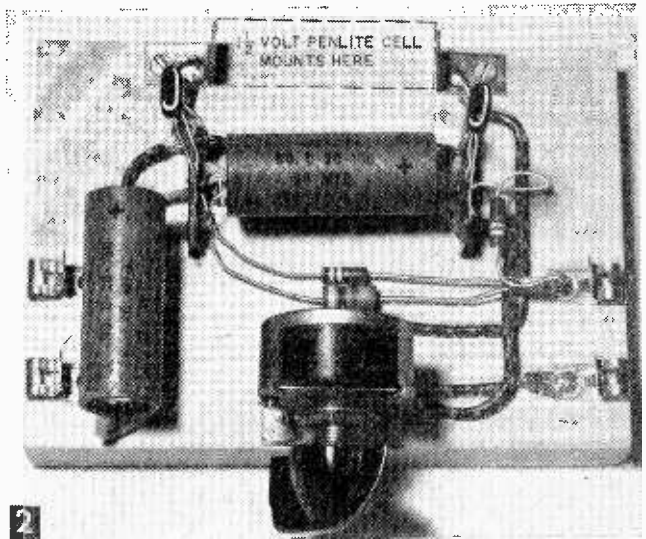
When wiring up the amplifier (Figs. 2 through 4), the transistors are not installed until the unit has been completed. When installing the transistors, hold a tiny wad of damp cotton on each pigtail lead to block transmission of soldering heat up into the transistor elements. Never apply heat to or near the transistor's metal jacket.

The transistor pin arrangement shown applies to units in current production. Some transistors may differ physically, so follow the instruction sheet furnished for the location of C (collector), B (base) and E (emitter). The RR-38 transistors shown here have dual purpose leads allowing direct pigtail connections. Or, with the leads cut short, transistors may be plugged

MATERIALS LIST—TRANSISTOR AMPLIFIER

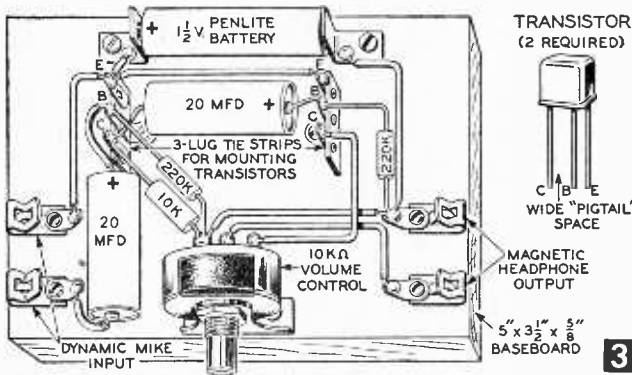
- 1 pc. wood about 5 by 3 1/2 by 3/8 in. for breadboard base
- 1 4 or 5-in. PM speaker
- 1 2500-ohm output transformer (commonly called 50L6 type)
- 2 RR-38 or CK-722 transistors or other P-N-P junction type
- 1 pair magnetic headphones, 2,000 to 4,000-ohms impedance
- 2 C-D (or equivalent) electrolytic capacitors, 20 mfd, 25 d-c w.v.
- 2 220K (220,000-ohm) 1/2-watt composition resistors
- 1 10K (10,000-ohm) 1/2-watt composition resistor (see note below)\*
- 1 10K Mallory or IRC linear potentiometer (volume control)
- 1 bar pointer knob for above
- 4 Fahnestock clips

\*Some transistors may require more collector current. If amplifier fails to work, switch transistors, or change 10K resistor to 3.9 or 4K.



2

Transistor amplifier assembled on 5 x 3 1/2-in. breadboard base. For greater output, extend battery clips and insert two penlite cells in series.



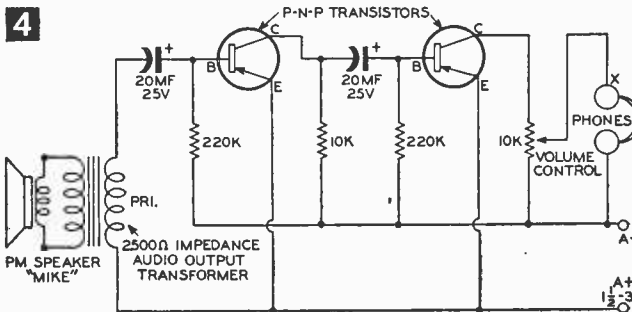
3

into 4-pin miniature sockets.

Note that the values of the coupling capacitors are two thousand times as great as those used in vacuum tube amplifiers; this is necessary because of the low impedance characteristics of the transistor.

Also note that the capacitors used in the model are of higher voltage rating than required only because we had them handy. Since the maximum voltage applied to this circuit will never exceed 3 volts, any working voltage above six will be sufficient, and the capacity may be as high as 40 mfd.

Having attached a pair of magnetic headphones to the output clips, advance the volume control. If all the wiring is okay, the pickup of minute sounds will surprise you. Remember to use headphones of 2,000 to 4,000-ohms resistance for best results; crystal headphones will not work!



4

The 10,000-ohm volume control in the output circuit will slightly reduce the maximum amplifier output. If you prefer to build the unit and leave the volume control out, then connect headphone lead marked X in Fig. 4 directly to C (the collector of the output transistor).

Some magnetic headphones may produce slight distortion when the volume control is retarded.

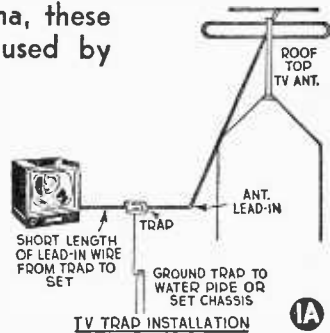
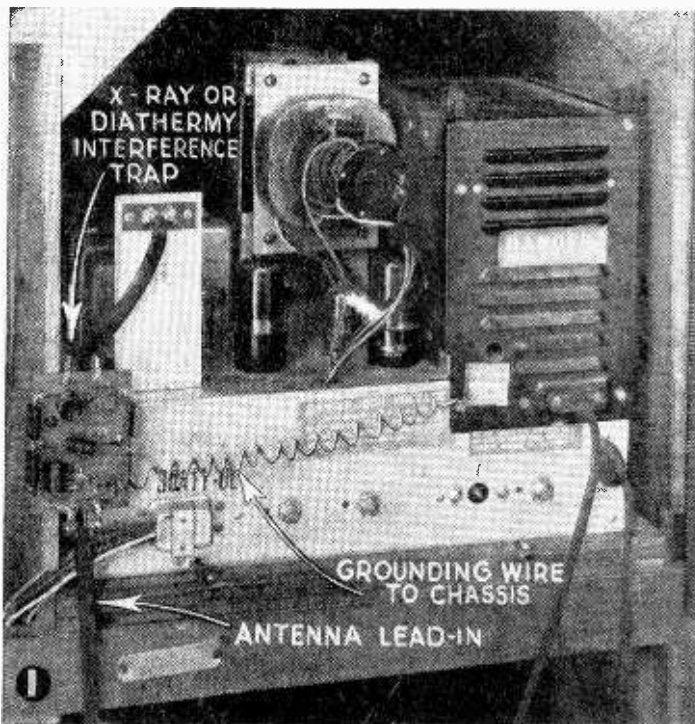
To correct this, insert a 20 *mfd* capacitor between the arm of the potentiometer (volume control) and the X phone lead.

A 50% gain in signal output is possible simply by increasing the voltage from 1½ to 3 volts. Two penlite batteries may be inserted between wide-spaced clips, with two strips of wood attached to the baseboard to form holding-cleats.

# Trapping That TV Interference

When installed between your TV set and its antenna, these traps can often eliminate picture interference caused by autos, X-ray and diathermy machines

By THOMAS A. BLANCHARD



## MATERIALS LIST

### AUTO IGNITION TRAP (Figs. 2 and 2A)

- 2 50 mmf. ceramic or mica capacitors
- 1 homemade coil (L1) see text
- 1 Bakelite or fiber plate  
( $\frac{1}{16} \times 1\frac{3}{4} \times 2$  in.)

### X-RAY OR DIATHERMY TRAP (Figs. 1 and 3)

- C1 & C2—20 mmf. ceramic or mica capacitors (or 50 mmf. trimmers)
- C3, C4, C5, and C6—10 mmf. mica or ceramic capacitors
- L1, L2, and L3—homemade coils (see text). Coils must be mounted juxtaposed—each in an opposing position (see picture plan)
- 1 Fiber or bakelite plate:  $\frac{1}{16} \times 3 \times 2\frac{3}{4}$  in.

and two 50 mmf. ceramic type capacitors, mounted on a Bakelite or fiber plate  $\frac{1}{16}$  in. thick by  $1\frac{3}{4}$  in. wide and 2 in.

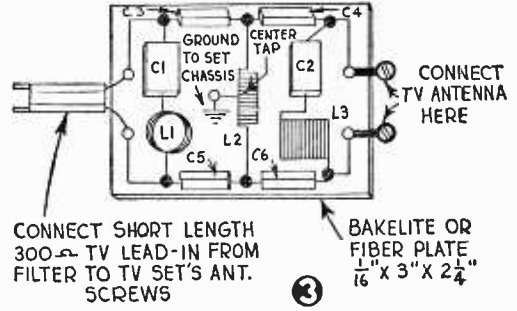
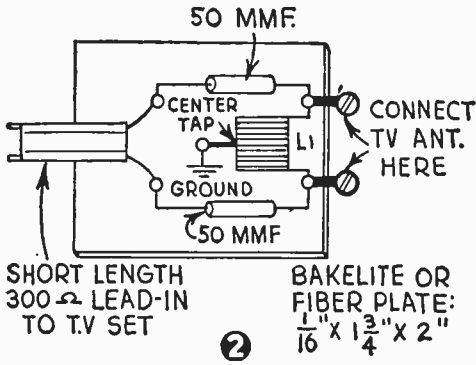
**N**O ONE TV interference eliminator is a cure-all. Here are 2 completely different TV units, both installed between the set and the antenna to "trap" and return to the ground signals generated by auto ignitions, some neon signs, X-ray machines and diathermy equipment. Perhaps one of these will cure the particular interference trouble you've been having—if those TV power line interference filters presented on pages 47-50 of this handbook don't do the job for you. They're intended to reduce or eliminate "hashed" pictures caused by electrical appliances.

The Ignition Trap (Figs. 2 and 2A) is extremely simple. It consists of a 10 turn inductance

long. Wind the coil (L1) of #20 enameled magnet wire on a wooden form  $\frac{1}{2}$  in. in diameter, with turns closely spaced. Scrape a small patch of enamel off the center turn with a razor blade and solder a short center-tapped ground connection at this point.

Use eyelets or small screws for junction points and connect the coil and 50 mmf. capacitors as shown in picture plan. Install the unit in your set by disconnecting the 300 ohm TV antenna and attaching the ignition trap between the TV set antenna binding posts and the outdoor lead-in. Ground the coil center-tap either to your TV set chassis or a convenient radiator or water pipe (Fig. 1). You can improve the ignition trap

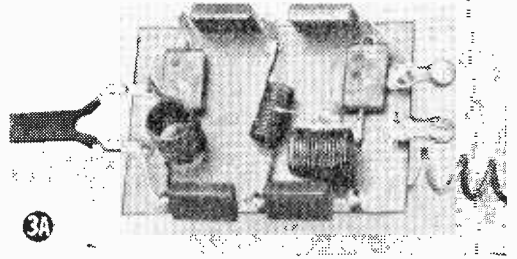




by connecting a mica trimmer capacitor across L1 coil so as to tune out some specific frequency. The trimmer should be a 50 mmf. size with the minimum value available—no more than 5 mmf. if possible.

The X-ray and diathermy filter (Figs. 1, 3, 3A) is just a more elaborate version of the ignition trap. But it should reduce or remove those horrible black smears running through the center of a TV picture that look so much like a fish after the cat has eaten off all the meat. For the X-ray filter, 3 coils and 6 capacitors are used. Components are mounted on a 1/16x1 1/4x3 in. fiber or Bakelite plate. The 3 coils are also wound of #20 enameled magnet wire. Coils L1 and L3 consist of 16 turns of wire on a 1/2 in. dia. form. Forms used for all coils may be any material since they are removed after coil is made. Each coil assumes a self-supporting spring shape.

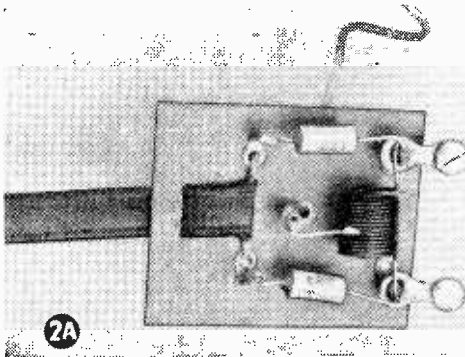
Coil L2 is of #20 wire but is wound on a 1/4 in. form with 17 turns. Remove enameled insulation from the ends of all coils with a razor blade, as well as a bit from the center of the L2 for soldering on the ground tap. Capacitors C1 and C2 are 20 mmf. while C3, 4, 5 and 6 are 10 mmf. each. You may substitute two 50 mmf. mica trimmer capacitors for the C1 and C2 if you wish. The screw adjustment of the trimmer may permit some specific local interference to be tuned out precisely. A plastic or other non-metallic screw-driver should be used to prevent effects from body capacitance (a makeshift screwdriver can be whittled from a meat skewer



or 1/4 in. wood dowel, if wood is thoroughly dry). Although TV interference stems from many varied sources there is a better than even chance that one or more of these units will cure your trouble.

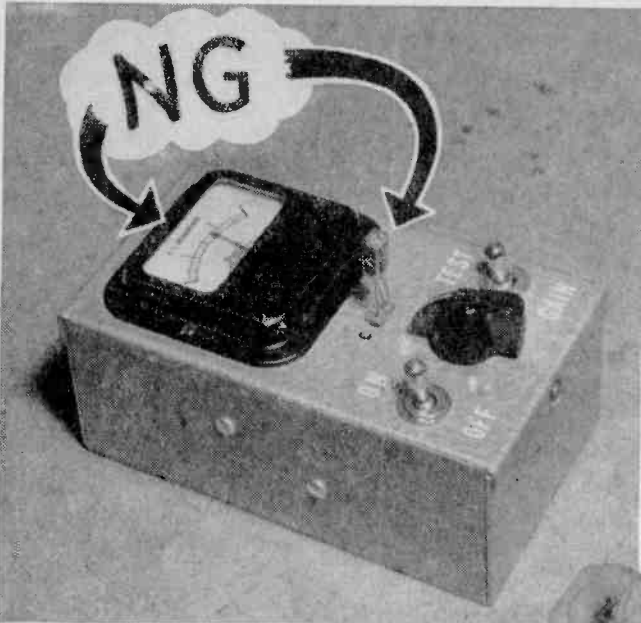
### When You're Done With Those Cleaners

• Save the instruction booklet which comes with your TV or radio set. It may be needed for tube replacement or operating instructions. A cardboard pipe cleaner holder pasted to the back or bottom of the receiver will accommodate such booklets. Do not cover ventilating holes in the radio or TV cabinet.—H. LEEPER.



### Iron Holder Makes Shop Accessory

• A discarded household iron holder will serve as a dual purpose radio servicing tool. Covering the top of the holder with asbestos paper equips it for holding the soldering iron as well as a handy container for the radio knobs and chassis screws for the set on which you are working.—H. LEEPER.



With power On, Test-Gain switch to Test, Selector switch to PNP, tester discloses that a CK721 transistor has a leakage current of over 1.8 milliamperes. Since a maximum of .5 milliamperes is all that a good transistor should show, this CK721 is bad.



**E**XPERIMENTERS in electronics working on projects that utilize transistors sooner or later find that a reliable means of testing these rugged little circuit components is a *must* in their work. Few such testers are yet available commercially, and those that are available are expensive. There is on the market, however, a kit (sold through Lafayette Radio, 110 Federal Street, Boston, Mass., and 100 Sixth Avenue, New York) which contains everything needed—except for hook-up wire and solder—to build an excellent junction-type transistor tester

(Fig. 1). It will test both P-N-P and N-P-N classes of transistors, and it sells for only \$7.95.

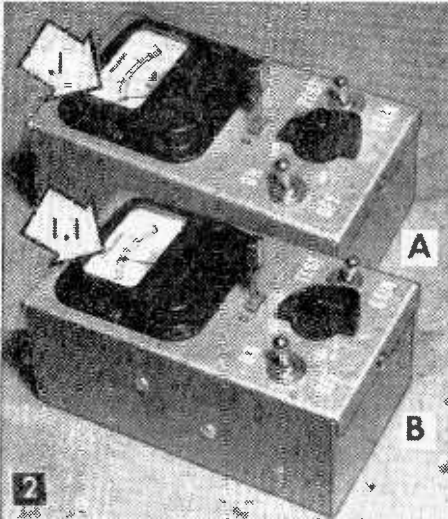
Tests with this unit (Figs. 1, 2, 3 and 4) start with a check on the transistor for leakage and shorts. If a transistor under test shows a reading on the meter in the leakage-short test that is not over 500 microamperes—.5 on the meter scale—the leakage is not excessive. (Very high or full-scale deflection of the needle indicates a short in the transistor.) The lower the leakage reading, of course, the better, since the transistor will operate at a lower noise level. When making the leakage-short test, watch the meter for several seconds. Sometimes the leakage of a transistor is

## Avoid "Built-In" Troubles— Use This Transistor Tester

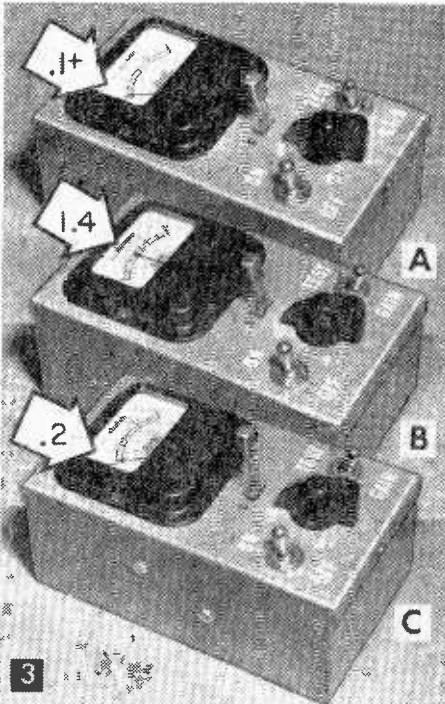
By HAROLD P. STRAND

not immediately apparent, but will begin to show itself—by way of a climbing needle—only after a few seconds. The highest meter reading indicates the leakage condition, if any.

If the leakage-short test is passed, a switch is thrown to give a meter reading of the transistor's "gain." This is expressed in d-c milliamperes on the meter and must be multiplied by 25 to get a figure to compare with the transistor's expected current "gain" (base current amplification factor) as given by the manufacturer. Table A gives these average expected gains for most of the popular transistors. While Table A shows typical values for the average transistor, due to manu-



A CK721 passes the leakage-short test with the needle only slightly off zero (A). With the Test-gain switch in the Gain position (B), however, it gives a meter deflection of only 1.1 milliamperes. Multiplying this by 25 gives 27.5, a figure far below the expected current amplification factor of 45 given by the manufacturer (See Table A). Therefore, this transistor, if used at all, should be used only in some portion of a circuit where high gain is unnecessary.



A CK722 checks out with low leakage on the leakage-short test (A), and a 1.4 deflection in the gain test (B), or a gain of 35. With 22 expected (see Table A), this is high gain. A second CK722 (C), already having passed the leakage test gives a meter deflection of only .2 in the gain test, a gain of only 5, or far too low to be used.

TABLE A—TRANSISTOR BASE CURRENT AMPLIFICATION FACTORS (GAIN)

TYPE	CLASS	GAIN	TYPE	CLASS	GAIN
General Electric			Raytheon		
2N81	P-N-P	60	2N63	P-N-P	22
2N107	P-N-P	25	2N64	P-N-P	45
2N135	P-N-P	20	2N65	P-N-P	90
2N136	P-N-P	40	2N106	P-N-P	25
2N137	P-N-P	60	2N112	P-N-P	45
General Transistor Corp.			2N113	P-N-P	45
GT-14	P-N-P	28	2N114	P-N-P	65
GT-20	P-N-P	45	2N130	P-N-P	22
GT-24	P-N-P	45	2N131	P-N-P	45
GT-34	P-N-P	15	2N132	P-N-P	90
GT-81	P-N-P	65	CK721	P-N-P	25
GT-83	P-N-P	45	CK722	P-N-P	45
GT-87	P-N-P	28	CK725	P-N-P	22
GT-88	P-N-P	65	CK727	P-N-P	90
GT-122	P-N-P	90			25
GT-760	P-N-P	30	Sylvania		
GT-761	P-N-P	60	2N34	P-N-P	40
GT-762	P-N-P	150	2N35	N-P-N	40
2N34	P-N-P	40	2N68	P-N-P	40
2N36	P-N-P	45	2N94	N-P-N	32
2N37	P-N-P	30	2N94A	N-P-N	32
2N38	P-N-P	15	Texas Instruments		
Germanium Products			201	N-P-N	19
2N97	N-P-N	15	202	N-P-N	49
2N98	N-P-N	40	300	N-P-N	9
2N99	N-P-N	40	301	N-P-N	19
2N100	N-P-N	140	Transitron		
2N103	N-P-N	4	2N34	P-N-P	40
Minneapolis Honeywell			2N36	P-N-P	45
H1*	P-N-P	14	2N37	P-N-P	30
H2*	P-N-P	54	2N38	P-N-P	15
H3*	P-N-P	18**	2N43	P-N-P	33
H4*	P-N-P	35	2N44	P-N-P	16
2N57*	P-N-P	28	2N45	P-N-P	9
* Class B-push pull			2N63	P-N-P	20
** Maximum value			2N64	P-N-P	30
			2N65	P-N-P	50
R.C.A.			Note: Data for transistors not listed above is obtainable from the manufacturer.		
2N104	P-N-P	40			
Westinghouse					
2N54	P-N-P	33.3			
2N55	P-N-P	19			
2N56	P-N-P	11.5			

facturing variations these should not be taken as exact values for every individual transistor. Some variation is to be expected. Generally, however, a reading close to the manufacturer's figure for that type indicates satisfactory gain. A higher reading than that given by the manufacturer indicates exceptional gain.

The tester's power source is a 15 v miniature "B" battery. Under normal use, this battery's use life should almost equal its shelf life. Battery voltage is supplied to the base and collector elements of a transistor under test through the On-Off switch. With the Test-Gain switch in the open position (Test), the transistor's base circuit is open. Thus, the only current indicated on the meter will be that which leaks across the base-emitter and base-collector junctions. If the transistor is defective, this will be indicated on the meter by a reading in excess of .5. With the Test-Gain switch closed (Gain), 40 microamperes of d-c is supplied to the transistor's base element through 375,000 ohms ( $R_1$  and  $R_2$  in Fig. 7). The meter now indicates amplified collector current, and when the meter reading is multiplied by 25 you have a figure which can be compared with the manufacturer's gain expectations as given in Table A. The Selector switch permits you to test either P-N-P or N-P-N type transistors.

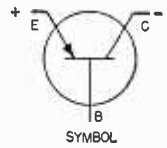
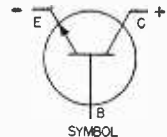
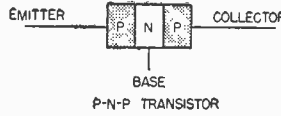
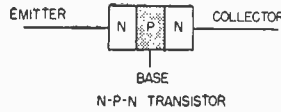
Figures 5 and 7 give wiring details of the tester. To

## TRANSISTORS—

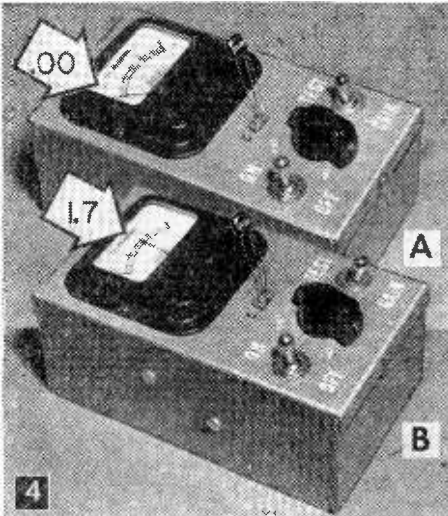
THE point-contact transistor was the first type of transistor developed, but because its manufacture entails more difficulty and, consequently, more expense than that of the junction-type transistor it has been largely superseded by the latter. A junction-type transistor consists of a minute wafer of germanium (a semi-conductor) of one potential sandwiched between two germanium wafers of opposing potential. A wire lead is attached to each of these wafers—which are known as the base, the emitter and the collector—and the completed transistor is hermetically sealed in a small casing and its three leads brought out through suitable insulation.

On some makes of transistors the collector element is identified by a red dot above its lead on the casing of the transistor; on other makes, the collector lead is wide-spaced from the base and emitter leads. A schematic is packed with each transistor sold, designating its three leads.

There are two classes of transistors, the P-N-P and the N-P-N. A P-N-P transistor has a negative wafer sandwiched by positive wafers; the N-P-N has the reverse combination. Both classes function in a circuit the same as would a triode vacuum tube—but at



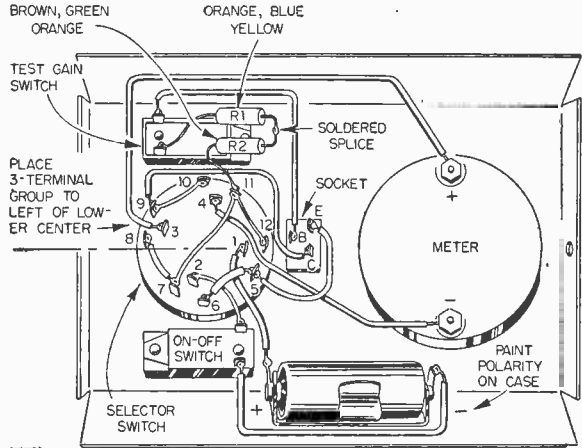
a fraction of the power a vacuum tube would need and without the necessity of a heater or filament. With P-N-P transistors, the emitter corresponds to the cathode of a vacuum tube, the base to the grid, the collector to the plate. On N-P-N transistors, the emitter functions as grid, base as cathode, collector as plate.



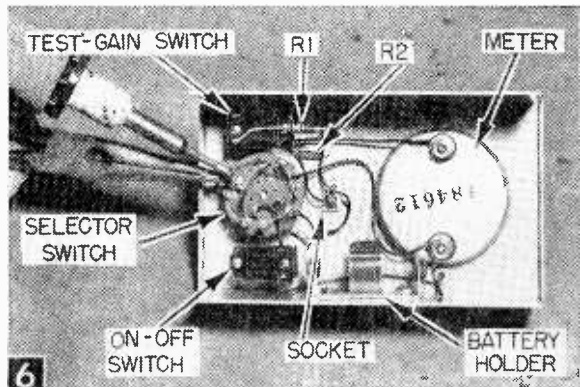
A 2N35 transistor passes the leakage test (A) and the gain test (B). In the gain test, the 2N35 registered 1.7 on the meter. This, multiplied by 25 gives a gain of 42.5, and only 40 is expected of this type (see Table A).

assemble, first try the transistor socket in its slot in the metal case. The slot may have to be filed out slightly for proper socket fit. The socket should be inserted from the front side and secured with its locking ring.

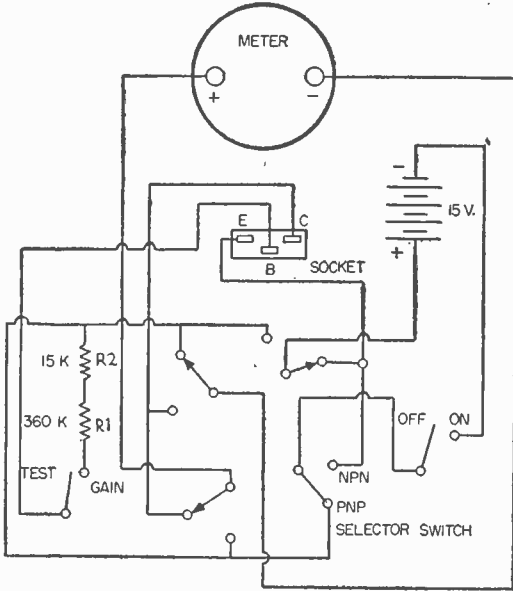
Next, insert the meter in its opening, fasten with the screws and nuts supplied, and cut the shaft of the Selector switch to 3/8 in. length and install this switch. The proper positioning for this switch is with one of its four groups of terminals located just to the left of lower center (Figs. 5 and 6). Lock the switch in this position with a nut behind and in front of the panel



5 WIRING PICTORIAL



Completing the wiring. Note that selector switch is positioned so that one group of three terminals is left of lower center. With wiring completed, ends of case are screw-fastened in place and unit is ready for use.



**7** SCHEMATIC

and setscrew-fasten the selector pointer so that in one position of the Selector switch it is at PNP, in the other at NPN.

Next, lock the toggle switches in their respec-

tive holes with the nuts provided. Note in Figs. 5 and 6 that the On-Off switch is placed with its terminals up, toward the meter, while the Test-Gain switch has its terminals down, away from the meter.

To wire the unit, use plastic covered flexible wire of about No. 26 gage with tinned conductors. Connect the bared ends of all conductors to their proper terminals by passing the wires through the terminal holes and bending the ends over. Then solder. The connections at the meter are made under the terminal nuts. They are not soldered.

The battery holder is mounted on the right side of the case. Mark a plus and minus sign opposite the battery terminals to make sure that when you replace the battery you observe the correct polarity. The last step in assembly is screw-fastening the ends of the case.

With the tester wired and assembled, the only thing left to do before you're ready to begin testing is to mark a small "C" on the front of the case to the left of the socket. This is for quick identification for insertion of the collector lead of a transistor. This lead always goes in the left (wide-spaced) socket hole. With some transistors, it may be necessary to use needle nose pliers or tweezers to start leads in the socket holes. If it is, be sure that the On-Off switch is in the Off position or you may short the leads and damage the transistor.

**Get This Valuable Book**

# FREE

*Applied Practical Radio-Television*  
on **7 DAY FREE TRIAL!**

Just For Examining COYNE'S New Set

Yes, you get this big, brand new book, "150 Radio-Television Picture Patterns and Diagrams Explained," absolutely FREE! Just off the press. Gives complete 11 x 22" Schematic Diagrams on leading models Radio and TV Sets. Easy-to-read, large 8½ x 11" pages, with full instructions on how to use the diagrams. A "must" in every repair kit. You get this book as a FREE Gift for asking to see Coyne's new 7-book set, "Applied Practical Radio-Television!"

**AT LAST! MONEY-MAKING "KNOW-HOW" ON TRANSISTORS, COLOR TV AND SERVICING**

Coyne's great 7-volume set gives you all the answers to servicing problems—quickly! For basic "know-how" that's easy to understand, you'll find everything you want in Volumes 1 to 5 on over 5000 practical facts and data. Every step from fundamentals to installing, servicing and troubleshooting all types of radio and TV sets. So up-to-date it covers COLOR TV, UHF and the latest on TRANSISTORS. All this plus Volume 6—NEW Coyne TECHNICAL DICTIONARY with over 4000 definitions of the latest terms, symbols and abbreviations in radio-TV, electronics and electricity.

**EXTRA! 900-PAGE TELEVISION CYCLOPEDIA INCLUDED** And then, for speedy on-the-job use, you get volume 7—the famous Coyne TELEVISION CYCLOPEDIA. It answers today's television problems on servicing, alignment, installation, etc. In easy-to-find ABC order, cross-indexed. Use this 7-volume TV-RADIO LIBRARY FREE for 7 days; get the valuable Servicing Book ABSOLUTELY FREE!

**NOW!**  
**7 BIG BOOKS**  
**IN ONE GREAT SET!**

SEND NO MONEY! Just mail coupon for 7-volume set on 7 days free trial. We'll include book of 150 TV-Radio Patterns and Diagrams. If you keep the set, pay \$2 in 7 days and \$2 per month until \$24.50 plus postage is paid. (Cash price, only \$22.95.) Or you can return the library at our expense in 7 days and owe nothing. YOU BE THE JUDGE. Either way, the book of TV-Radio Patterns is yours FREE to keep! Offer is limited. Act NOW!

**FREE BOOK—FREE TRIAL COUPON!**

Educational Book Publishing Division  
COYNE ELECTRICAL SCHOOL, Dept. 17-RE  
500 S. Paulina St., Chicago 12, Ill.

YES! Send 7-Volume "Applied Practical Radio-Television" for 7 days FREE TRIAL per your offer. Include TV-Radio Patterns & Diagram Book FREE.

Name ..... Age .....

Address .....

City ..... Zone ..... State .....

Where Employed .....

Check here if you want library sent C.O.D. You pay postman \$22.95 plus C.O.D. postage on delivery. 7-day money-back guarantee.

Educational Book Publishing Division

# COYNE

ELECTRICAL SCHOOL

500 S. Paulina St., Dept. 17-RE, Chicago 12, Ill.

# Make a Pair of Test Leads

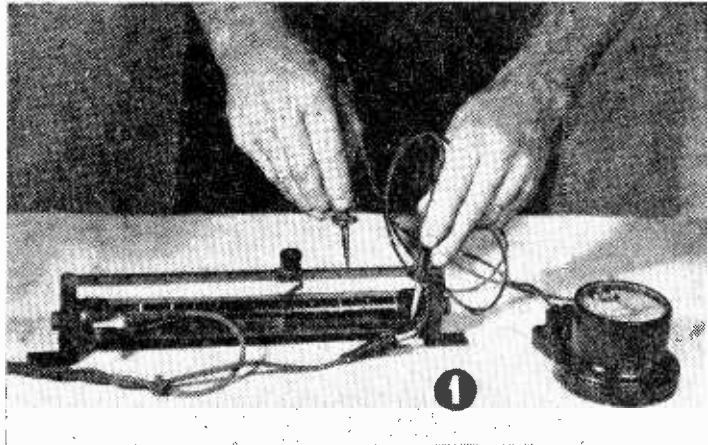
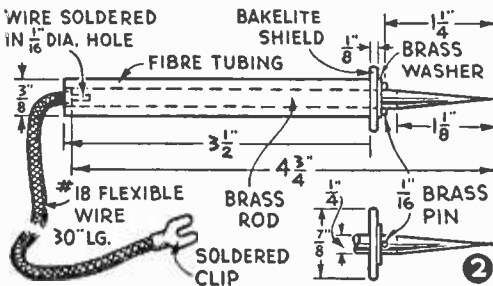
By HAROLD P. STRAND

PROFESSIONAL radio repair men and electrical testers will usually be observed using a set of test leads equipped with prods at the ends, which make test readings from various parts of a circuit easy and safe. The amateur, on the other hand, will often use some wire with crudely bared ends to do his testing with questionable results. Too often one of the wire strands happens to touch a part it shouldn't and a short circuit is created. It is easy to make a set of proper test leads and they are well worth the trouble.

Figure 1 shows the leads in use testing the voltage drop across a portion of a resistor.

Figure 2 drawing gives the necessary details for making the test prods; these materials are usually found in the average workshop. The main body is a piece of  $\frac{1}{4}$  inch round brass rod, turned in the lathe or ground to a point as shown;  $1\frac{1}{4}$  inch back from the point, a hole is drilled through the rod to receive a  $\frac{1}{16}$  inch brass pin, drive fit.

The lead wires should be flexible, rubber cov-



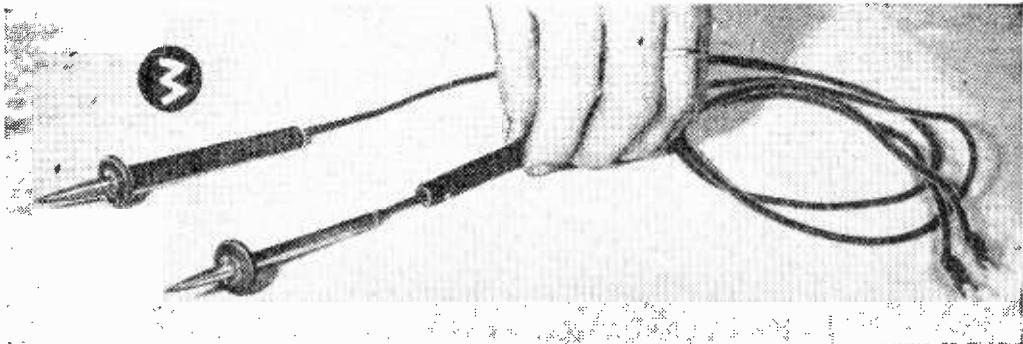
Testing is safe and easy with proper test leads.

ered No. 18 or No. 16 cable and the bared end is soldered in a hole which has been drilled in the end of the rod. To complete the test prod, a piece of fibre tubing with I.D. that will allow it to be pressed tightly over the brass rod is used as shown. First, however, a brass washer and Bakelite or fibre washer is placed over the rod, next to the pin, and the fibre tubing is then pressed in place against the Bakelite washer, holding the assembly tight.

The free ends of the lead cables are equipped with suitable clips or small soldered lugs for better connection to the instruments or other point of attachment.

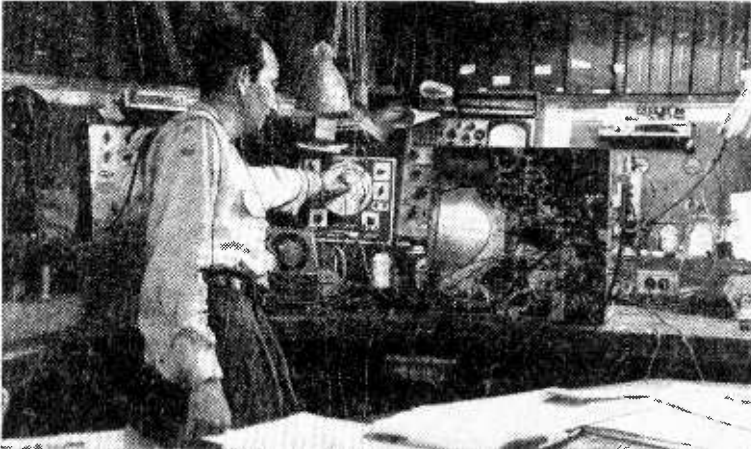
Made as described, these test leads will be found extremely useful in all service work. The large Bakelite washers provide shields against possible flashes from accidental wrong contacts. Ruggedly made, they should last indefinitely. In Fig. 3, the completed leads are shown with one of the fibre sleeves off to show the construction.

The completed leads with the fibre tube slipped off to show how the wire has been soldered in the end of the brass body.



# Radio-TV Servicing

## ELECTRONIC DOCTORING PAYS BIG FEES



A circular bench and a desk spread with circuit diagrams and work manuals form the complex heart of Jerry Newman's radio-TV service shop in Los Angeles.

**Y**OU may not think there's any joy in an inky TV screen or mute radio speaker, but it all depends on your point of view. From the back of a receiver chassis, such ailments look like \$30,000 a year to Jerry Newman, owner of a Los Angeles electronics service agency.

Enough cash was laid out last year for radio and television repairs to run the city of Chicago for more than a year or put up 200 Empire State Buildings. To get in on this whopping \$600,000,000 account, Newman, owner of *Jerry Newman's Television Service*, works long and steadily, nine hours a day, Monday through Saturday. But with nearly 40 million video receivers and over 110 million radios now burning brightly across the country, Newman figures he is building a solid business which will pay off more and more through the years.

Nor is the electronics field limited to radio and TV. Color TV is upcoming; since April 15 of 1956, NBC's Chicago television outlet, WNBQ, has



been telecasting all its programs in color. Hi-fi is a new and big-money word in the lexicon of electronics. Home-recorders, phonographs and portable radios have come to seem as much a part of the American way of life as the backyard barbecue.

Five years ago housing tract builders beckoned prospects with garbage disposers, but nowadays they may tout their room-to-room intercoms or radio-controlled garage doors.

Since the lifting of the FCC's 4-year freeze on new TV stations, telecasters have been spreading their coverage, beaming into even the farthest rural stretches.

And then there's the old familiar radio. Despite TV's coup of parlor entertainment, it's still a lusty audience puller, with more sets in service than ever before.

### Electronics servicing is

a business for the novice too, as well as the old-hand technician. The tenderfoot service-man must apprentice himself to an established maintenance shop, get the feel of the tools, familiarize himself with circuits, bone up at night school (if he lives in a city) or through correspondence

TABLE A  
FOR YOUR ELECTRONIC SHOP—8 MUSTS

1	Volt-ohm-millimeters, 20,000 ohms/volt	
	Simpson model 260.....	\$ 38.17
	Triplet 630.....	38.71
2	Vacuum-tube voltmeter (kit)	
	Heath V7A.....	24.50
	Knight 83F125.....	24.95
3	Tube checker, transconductance type	
	Hickok 600A.....	169.00
	B & K 500.....	107.75
4	AM signal and marker generator	
	Precision E200C.....	80.85
	Knight (kit) 83F145.....	19.75
5	Oscilloscope, 5", wide-band	
	Simpson 458.....	195.95
	Heath (kit) 0-10.....	69.50
6	FM, TV, sweep generator	
	Precision E400.....	142.10
	Hickok 695.....	284.00
7	Resistance-capacitance analyzer	
	Sprague TO-4.....	72.03
	Cornell Dubilier BF-60.....	42.85
8	6 Volt B eliminator (kit) for testing auto radios	
	Eico 1050-K.....	29.95
	Heath BE-4.....	31.50
Total.....		\$462.65 to \$1108.99

courses. For the industry is fast-paced, and you've got to keep abreast. According to Newman, the GI radar repairman of World War II or the Korean War probably would find himself hopelessly entangled in the 1956 TV circuits.

Actually, Newman, who is 41, doesn't expect to get rich in the business. Electronics repair, as far as he can see, hasn't spawned any millionaires, and it isn't going to. True, his gross, after 12 years in the business, is big, but it has to be. With two employees and one truck, he must gross that \$30,000 annually and spend an average 312-days a year at his workbench and in customers' homes to pocket a net profit of \$7,500 for himself.

"So you see it's not the \$1,500 you need to set yourself up in the electronics repair business that makes it rough," Jerry explains, "it's the long, rocky road, the time it takes to become established—and trusted—in your community."

The best way to see how Newman builds that customer trust is to visit his busy shop in Los Angeles.

**Newman's typical day begins** at 8:00 a.m. when he unlocks the shop, flips the *report* button of an electronic answering gadget which is hooked to his telephone. The electronic recorder, supplied by the telephone company for \$12.50 a month, is Newman's secretary. Whenever he leaves the shop, he records a message on its tape such as:

"Hello, Jerry Newman's Television Service. . . this is a recording. When you hear the signal, will you kindly leave your name and telephone number? We'll call you back just as soon as possible."

So, first thing each morning, Jerry takes messages from his vacuum-tubed secretary. On a normal morning, he'll get four to five repair calls to add to the 12 to 20 already scheduled. He works a 9 a.m.-to 6 p.m. home-call routine, and figures 45 minutes for the average in-home repair job.

In seven hours working *outside*, a repairman can handle about eight service calls, plus en route delivery of two or three repaired sets.

In general, Newman's operation is typical of the small but robust radio-TV repair shop. With 60% of his gross from TV repair, 25% from home radios, 10% from auto radios, and 5% from hi-fi, Jerry and two employees work from a 324-square ft. shop on Los Angeles' medium-busy Melrose avenue.

**Vortex of the shop's** 54-hour week (his two technicians work 40 hours each) is a circular bench, inset with an impressive array of tuners, signal generators and test gear. Close by are \$500 worth of spare parts, mostly the more common

tubes. Jerry stocks no picture tubes since he can count on one-day delivery from in-town suppliers.

For his 324-sq. ft., he pays \$50 a month rent. His hired technicians earn an average \$90 for a 40-hour week at \$2.25 per hour. They also get seven to eight cents a mile because both use their own cars.

Jerry admits he could work from his home, slicing that \$50 monthly shop rental from overhead.

"But when you're in business, you've got to operate like a business. Working from home just isn't the way."

His 1953 model panel truck, with a 24-ft. aluminum extension ladder riding its roof-rack, carries perhaps \$400 in quick-repair spares. Jerry and each of his repairmen make house calls armed with a "tube caddy," a special suitcase designed for holding upwards of 250 tubes—\$300 worth of the most commonly called for types. The caddy is essential because four out of five sets are repaired in the home, only the sickest are returned to the shop.

Customer building depends much upon the serviceman. You've got to be a salesman in the sense that you sell yourself as well as your service. One of the business' ironies is that personal appearance, the way you handle equipment and go about a home-repair, is often the only yardstick by which a client judges your technical know-how.

The serviceman who quick-scans an ailing TV, scratches his head and wonders aloud, "Now, what could the trouble be?" is ripe for a customer's reply, "You tell me!"

Paradoxically, the most inept repairman can

TABLE B	
Monthly Overhead for Newman's 3-man shop:	
Rent .....	\$ 50.00
Salaries (two repairmen) per month plus car allowance.....	800.00
Advertising (mostly listing and display ads in telephone book classified section).....	75.00
Telephone (including \$12.50 monthly for "electronic secretary") .....	37.50
Insurance (workman's comp., public liability property damage, truck insurance, 2 or 3 incidental policies).....	25.00
Equipment maintenance .....	3.00
Books and Manuals.....	20.00
Miscellaneous .....	50.00
Truck deprec. and upkeep.....	80.00
	<b>\$1140.50</b>



With TV a central factor in so many homes, this truly is an electronic age—24 hours a day. Newman's telephone recorder asks customers to leave their names and phone numbers, tapes this information; Newman jots down messages first thing each morning.



look like the best—in his customers' eyes—just because he dresses neatly, packs a good-looking tool kit, and gets to work pronto.

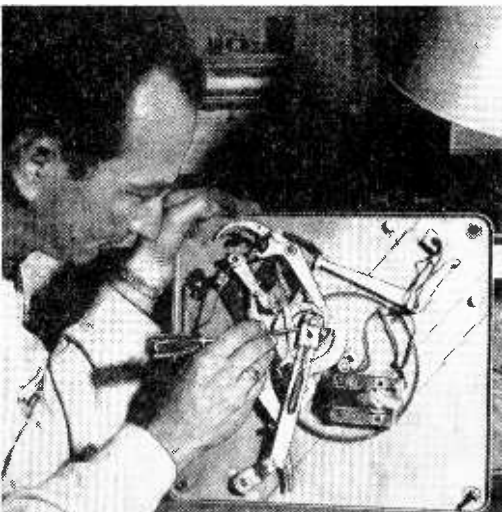
As Jerry leaves the shop and starts on his morning calls he carries into every home a neat tube-caddy and tool chest. Other essentials he leaves in the truck. He knows better than to blurt, "Never seen this make set before!" For that's an indecisive act. Customers assume the repairman has seen—and is familiar with—*every* set. They expect you to act *decisively*, and at \$5 a call, they've a right to expect it.

Jerry usually asks for trouble symptoms, although from long practice he can usually spot the probable fault after a few twists of the dials.

First, he clears the TV's top, being careful of vases and ornaments. Sometimes he asks the customer to remove valuable objects. After that, he plants a portable mirror in front of the screen, removes the set's back, and gets down to work. If it's tube trouble (and in 80% of the cases it is) he has spares aplenty in his caddy.

Before leaving he cleans the inside of the cabinet's glass, polishes the picture tube, buffs the tuner contacts with a clean, dry cloth, reducing tuner noise. And he leaves spent tubes with the customer—the tubes encased in the replacement cartons. It's a kind of silent reminder that here is a square-dealing repairman who leaves proof of tube changes.

And always, Jerry talks maintenance, preparing clients for future call backs. He explains that as of the moment, the set is in top condition. He hopes, aloud, there won't be further trouble. But he makes no unredeemable promises like, "Well, your set shouldn't need work for another year!" Such promises ricochet. Instead he's careful to emphasize that burn-outs aren't really "trouble"—just "normal maintenance."



Newman checks fit on bearing of cam and pickup actuating lever. The rocketing popularity of hi-fi is making phonograph repair a big source of servicing income.

Three general rules stand out in the success formulas of many experienced radio-TV servicemen:

1) Find out what your customer wants, and supply that want as economically as you can.

2) Don't run down your work by telling customers that the solutions to their problems are "really simple."

3) Try, by every means possible, to see the problem and your work as the customer sees them.

**Like other legitimate, square-dealing repairmen**—and there are plenty of them—Jerry is still living down the get-rich-quick sharpies who, just after World War II, smeared the service industry while fattening their own pockets. Many householders likely still remember that article in a large-circulation magazine warning them the radioman would gyp them if they didn't watch out.

In proof of such gyps, researchers, visiting Manhattan service shops with a gimmicked radio, found 17 out of 19 dishonest. In 1947, *Radio Daily*, a respected trade paper, reported the situation "simplified" although not improved: 20 out of 20 repairmen investigated proved cheaters.

In the intervening years, as the victims of these gyp artists have become wary, many cheaters have been weeded out and sent into bankruptcy. Yet ironically and even humorously TV's swarm of tubes and tricky circuits can sometimes make the most honest repairmen look like the fast buck boys. Why? You might blame it on the bit of prima donna in every TV set. While radios, once repaired, seldom go sour for another 24 months or so, there's no predicting trouble-prone TV. Only two things are sure:

The average TV set will need two or three new tubes every year and a new picture tube every three or four years. This is a big point in electronics servicing, too, and one you should remember and prepare for. Another thing to remember is that frequent call-backs bring complaints from your customers—even if you succeed in lighting the spark of life in their sets each time.

Newman discovered all this the hard way. For example, as TV hit the market, he sold year-long service contracts for \$45 to \$65, depending on screen size. It looked like security, an income he would be able to count on. In practice he almost foundered.

As each new TV station came on the air, he had to visit each of his 250 warranty holders, adjust their sets for the new channel. Over two short years he was forced to make six channel-adjustment calls on every warranted set (this besides routine repair visits). The chore all but drove him to the wall.

Today, although most manufacturers design their sets with full 12-channel reception, making new channel adjustments unnecessary, Jerry shuns warranties as basically unsound.

"Wouldn't take one on a bet," he says.

Actually, his anti-warranty stand contradicts some expert advice.

Paul Wendel, of Television Technicians Lecture

Bureau, contends "in the long run the continuance of the 12-month contract plan will give the public a much better type of television service than if it is permitted to drift into the category of prewar radio service."

Still, 175 service-installation contracts at, say \$60 annually, can guarantee the serviceman a \$10,500 gross. Latch onto 500 contracts, and you've laid a \$30,000 foundation under your business. But as Jerry Newman discovered, you've got to have a good sized shop before taking on this obligation.

Jerry, with perhaps \$1500 in equipment, manuals, and gear (not counting the truck) nets probably no more than 25% of what he and his two repairmen take in. His overhead runs between 60% and 75%. Most TV-electronics servicemen maintain that in their business overhead has to be high.

Admittedly, he might do almost as well as a one-man shop, but only at first. For Newman is well aware—and experts on service agency operation back him up—that the one-man operation is doomed.

**Soloing, a repairman spreads** his talents too thinly over the ever-widening range and complexity of electronic circuits. And since familiarity with circuits means fastest, most efficient repair—with a minimum of bench time—the solo operator can seldom specialize his way into profit-making efficiency.

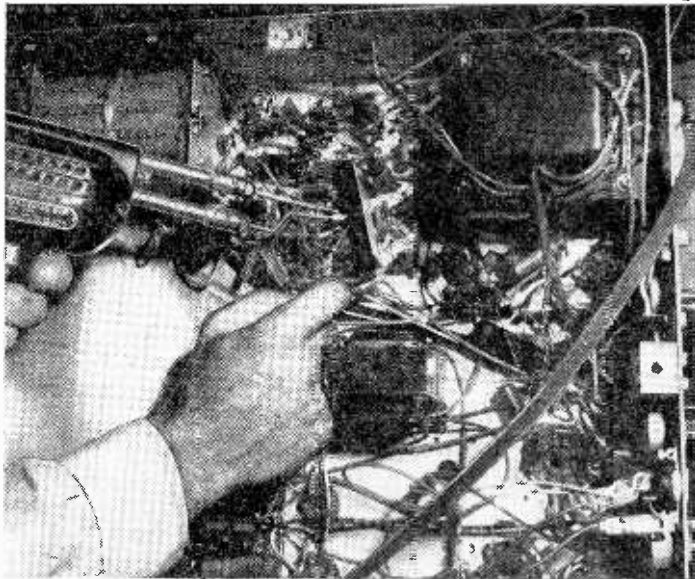
So, for the sake both of higher income and specialization, you need two, even four and some say upwards of seven employees, technicians like yourself. Each should work a limited number of circuits, each wringing maximum advantage from every minute spent at the bench.

**Viewers are far more critical** of their TV sets than they ever were of radio. A low sensitivity AM receiver was often overlooked. Nowadays the slightest blur, blip, wobble or peanut butter smeared on the screen sends them rushing to the telephone.

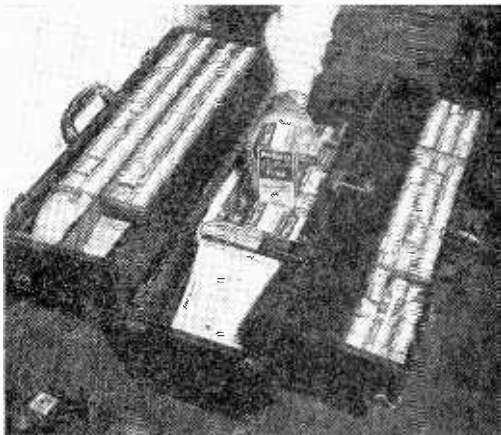
"And always," Jerry sighs, "it's an emergency . . . that's how people feel about their TV sets. Households revolve around TV as they never did around radio."

With it all, if ever there was a business with both a present and a future, it's TV-radio repair.

What should the repair jobs gross? Newman's standard rate for a home call is \$5 plus parts. Average total service bill runs \$8 to \$9. Probably half of all repairs involve routine tube changes, tubes retailing from \$1 to \$5 apiece; mark-up over list price is about 50%. If a picture tube is involved, Jerry feels justified in upping his labor



Television, radio, and other electronic appliances aren't getting any simpler. As in any technical or professional field, new developments and techniques in electronics equipment dictate that the electronics serviceman constantly study the current literature in the field. Newman spends \$250 annually for manuals and circuit diagrams.



Into each home where he makes service calls, Newman carries the electronic serviceman's black bag, the tube caddy. Chock full of 250 tubes, worth \$300, it is essential since most sets are repaired where they stand, and most repairs involve tube changes.

bill to about \$7.50 (because installation requires removal of chassis—more time).

Occasionally when the job is particularly complicated, the tube replacement labor bill jumps to \$12.50. As for tubes themselves, the customer pays about \$25 for a 7-incher, up to \$44 for a 21-incher.

Not considering profit from tube and parts replacement, Newman figures to gross about \$2.75 on every \$5 service call. But remember, servicemen earn \$2.25 for an hour's work (about the equivalent of one service call); gross isn't net profit, and Jerry's overhead runs high.

One of Newman's biggest expenses is circuit manuals. As a subscriber to Howard W. Sams Photofact Service, Jerry gets loose-leaf prints of every new manufacturer's circuit. Over the year he may spend \$250 for this up-to-the-minute information. For radio trouble shooting he has a complete set of Rider manuals. In addition, there are special manuals, issued by the manufacturers (Philco, RCA, etc.). His total library, which requires about 20-ft. of shelving, contains more than \$500 worth of books, costs \$150-\$250 a year to keep updated with current literature.

But the heart of his business—as well as yours—is equipment. Jerry figures he has the essentials, but none of the “ruffles,” for competently servicing radios, TV's, audio systems and phonographs.

And nowadays, Jerry, like many another small serviceman, is branching out. For the present, he's doing home intercom installations, with an eye to real estate developments with houses in the \$17,000 to \$21,000 range. But there are many other sidelines which can swell a service shop's gross:

1) *Renting Public Address Systems.* You can rent out public address components, including recorders, to wedding parties, backyard get-togethers, club dances. This is usually night or weekend work. For 3-hours, if you or a helper handles the equipment, you can charge \$25-\$30. If customer works the equipment, the charge is more likely \$10-\$15 for the evening.

2) *Antenna installation.* Specialized aerial work may bring more than \$100 a job. Some service shops specialize in antennas for fringe reception areas, away from a station. For proper and profitable diagnosis, you'll do well to buy a field strength meter (cost: about \$100).

3) *Big-screen Conversions.* This specialty has

a good future, what with advent of color television. Profit comes both from service-installation charges and from mark-up on conversion components.

4) *Specializing in tape recorders.* There are more than 1,000,000 tape recorders in American homes and new initiates are increasing by about 250,000 every year. With tape recorders priced as low as \$75, the market is swelling, and there's increasing need for specialists here.

5) *Color Television.* Color is still lagging, but this specialty with its new vocabulary—“gamma corrector,” “dynamic convergence” and “shadow mask”—should prove profitable in the years ahead.

6) *Hi-Fi*—now a \$300,000,000-plus annual industry and gaining adherents by the millions. But remember—there are two kinds of hi-fiers:

The casual consumer who wants more depth and better reproduction from his records; and the build-it-up-from-components bug, who works hard at high fidelity's complex vocabulary—and thinks \$500 cheap for the right components. This audiophile can be a tough and demanding customer. Many a repairman is riding this boom, finding more profit in assembling and servicing hi-fi than in doctoring TV and radio.

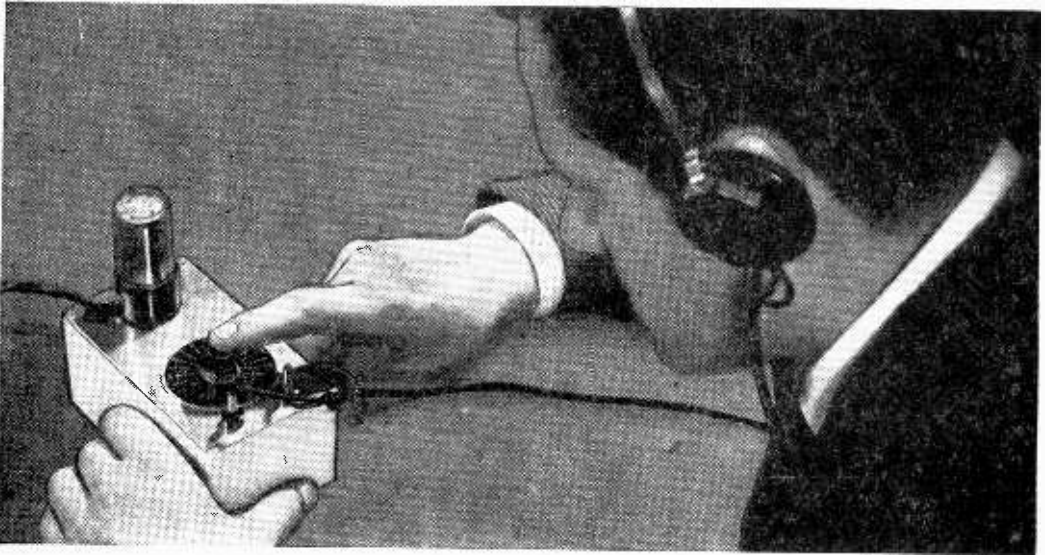
Regardless of your specialty though, there's only one way to become successful in electronics servicing, according to Newman. That's hard work. Any day of the week except Sunday, he's busy in his small shop, putting in 312 days a year, pocketing a good but hard-earned income.

“Room for newcomers?” he says. “Plenty.”

Then he cautions, “It's not the \$1500 it takes to set yourself up that's rough . . . it's the long rocky road—the time it takes to become established in your community.”



Cross-country from Los Angeles' Jerry Newman, another success in electronics is Mt. Vernon, Ohio's Roy L. Rockwell. Roy didn't know the first thing about radio or TV—couldn't tell a ham from a handset—when he enrolled in a correspondence repair course (via National Radio Institute) in 1945. Today, his appliance-repair store grosses \$72,000 yearly, a lot of it from radio-TV servicing. Roy's net worth in 1948 was \$3000; in 1955 he figured his assets at \$40,000.



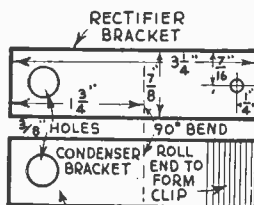
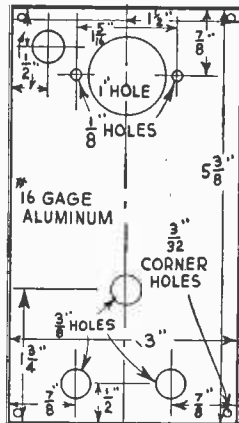
## One Tube Electronic Metronome

THE metronome is familiar to anyone who ever took a music lesson. The pyramid-shaped wooden box with its clock-spring works contains a pendulum which, as its swing is varied by adjustment of lever or knob, provides a suitable tempo for the student to follow. This electronic metronome produces the same type of beats without benefit of clockworks or other moving parts. The simple multi-vibrator-type circuit consists of 2 interlocked oscillators whose grids are made positive by a .1 mfd. paper capacitor which obtains its charge from the plate circuit. The grid leak bias to ground in one oscillator is fixed. In the other, the rate of discharge is variable through a 10 megohm potentiometer. As one circuit charges the other discharges; the rapidity of this action depending upon the setting of the potentiometer.

When used as a metronome proper, the student can plug in a pair of headphones, or, for room volume, connect metronome to phono jack of a radio, TV or audio amplifier set, using a length of mike cable with phone tips on one end and phono plug on the other.

Although this electronic device contains no moving parts, it beats out the rhythm you want just like a mechanical metronome

By THOMAS A. BLANCHARD



TIN, OR ANY LIGHT METAL

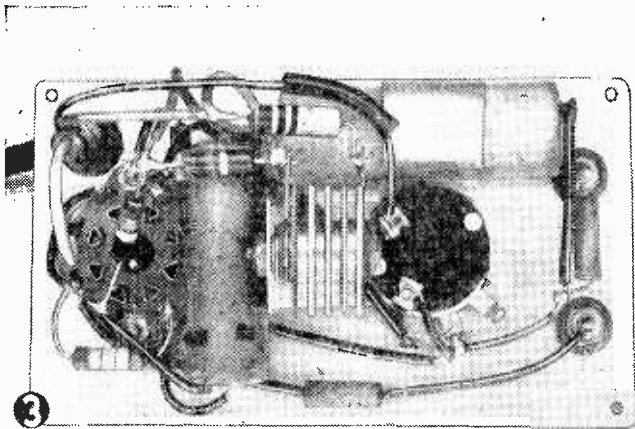
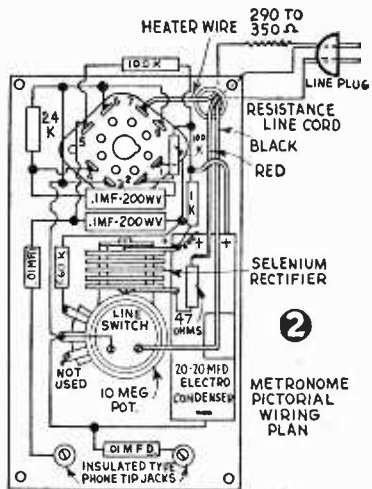
1 PANEL LAYOUT FOR METRONOME

### MATERIALS LIST—METRONOME

- 1 aluminum panel, 5 3/8" x 3"; #16 gage
- 1 octal water socket with 1 1/8" mounting centers
- 2 100K (100,000 ohms) 1/2 watt carbon resistors
- 1 560K (560,000 ohms) 1/2 watt carbon resistors
- 1 24K (24,000 ohms) 1/2 watt carbon resistors
- 1 1K (1,000 ohms) 1/2 watt carbon resistors
- 1 47 or 50 ohms 1/2 watt carbon resistors
- 1 10 meg. potentiometer
- 1 line sw. for above
- 1 resistance line cord 290-350 ohms (see text)
- 1 20-20 mfd., 150 v. electrolytic condenser (paper tube type)
- 2 .1 mfd., 150 or 200 v. paper capacitors
- 2 .01 mfd., 150 v. paper capacitors
- 1 65 or 100 ma. selenium rectifier (Federal, Sarkes-Tarzian, etc.)
- 2 insulated phone tip jacks
- 1 type 12SN7G7 dual-triode tube
- Miscellaneous: hook-up wire, dial plate (optional), 2 #4-40 x 3/8" rh screws and nuts, 4 small rh wood screws, and bar knob.

If device hums excessively, reverse phone tips on metronome jacks.

From an industrial viewpoint, this electronic metronome could, for example, be used to adjust clocks on a factory production line, provided there were no substantial line voltage fluctuation. First a specimen clock would



Above is an underneath view of the metronome showing parts wired in place. Check this against Fig. 2 for clarification.

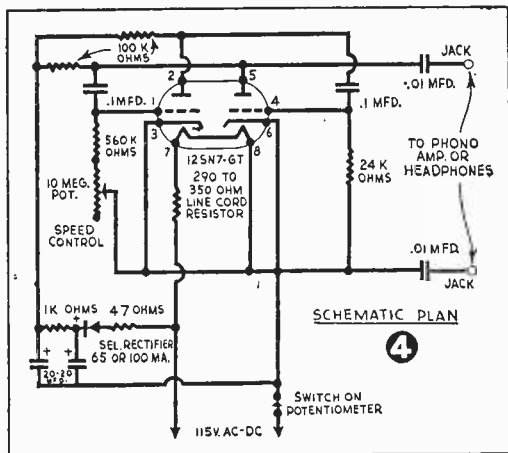
be adjusted and given a shelf test for accuracy. The electronic metronome, connected to a constant voltage power line, would be "tuned" until its beat corresponded to the tick of the clock. Thereafter, clocks on the production line would be adjusted so their click was synchronized with "standard" beat heard in metronome phones.

To use metronome with signal or alarm devices, connect sensitive type relay with a coil resistance between 2,000 and 5,000 ohms to Lug #5 and #8 of the 12SN7GT tube (thus bypassing the two .01 mfd. capacitors in the output). Wire relay contacts in series with a signal light, horn, bell or siren. The frequency of signal's sounding is adjustable by turning potentiometer knob.

You can alter the dimensions of this metronome as desired or even build it in a cigar box if you wish! The plastic case shown here measures 3 in. wide x 5½ in. long x 2¼ in. deep. Since there was no provision for panel mounting screws, 4 short lengths of ¼-round molding were cemented into box corners with Duco cement. Wood screws secure aluminum panel and components.

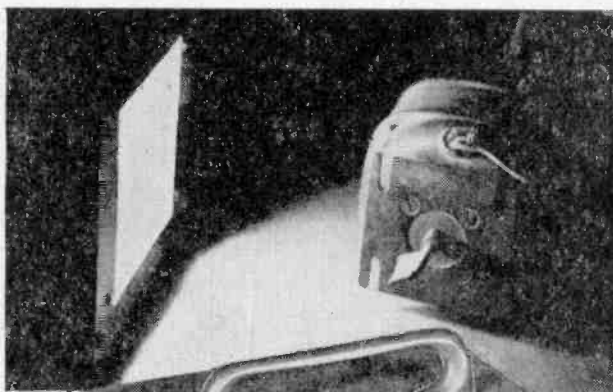
Cut metronome panel from #16 soft aluminum and provide with holes as shown. Form 2 metal brackets from #20 aluminum, copper or tin-can steel, support selenium rectifier and electrolytic condenser. These brackets require no special mounting provisions since both are slipped on potentiometer bushing and made rigid to panel upon tightening of potentiometer nut.

Inasmuch as the 12SN7GT dual-triode tube must obtain its heater supply from 115 volt ac-dc power line, a voltage-drop resistor, ballast tube or line cord resistor is required. For compactness, the latter was chosen. However, where metronome is constructed in larger quarters; either ballast or 50-watt wire-wound resistor of approximately 290-350 ohms may be used. The capacitors in the circuit need not be rated at more than 150 volts. Units rated at 400 or 600 volts may be used, but they occupy more space. The resistance line cord is shown in the pictorial



wiring diagram in semi-schematic form for clarification. In most cases, the black and red wires connect directly to the plug attached to the cord (like any fixture cord). But interwoven with the black and red leads, there is an asbestos cord carrying the heater resistance wire (usually white, gray or brown), which is connected to prong #7 of tube socket. Check cord connections carefully before turning on unit the first time, since a reversed connection will burn out a tube. In operation the fixture cord will become warm, but this is normal, and nothing to cause alarm. Never cut off or shorten this cord—or you will lower its resistance and burn out tube. Line cord resistor value depends upon line voltage furnished in your area. To determine correct ohm rating for cord, subtract 12 volts from your line voltage and divide the result by .3. Example: Line voltage is 115 volts; subtracting 12 leaves 103. Dividing .3 into 103 you get 343 ohms. Purchase cord which has nearest higher value, which is one rated 350 ohms.

Wire the metronome according to pictorial plan. Use 50-50 or not less than 60-40 rosin core radio solder, making good, firm connections.



Left, Under ordinary light, small motor running at 1800 rpm, with piece of adhesive tape attached to shaft, looks like this. But photo (right) shows you how motion of tape is "stopped" by synchronized flashes from stroboscope at left.

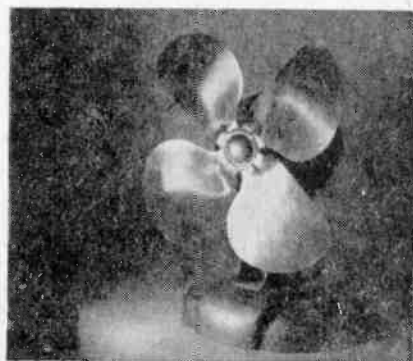
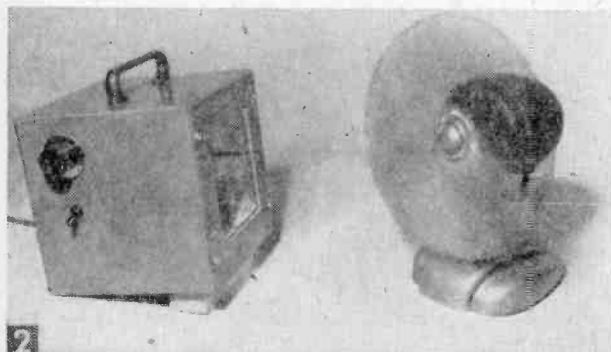
## Motion-Stopping Stroboscope

By HAROLD P. STRAND

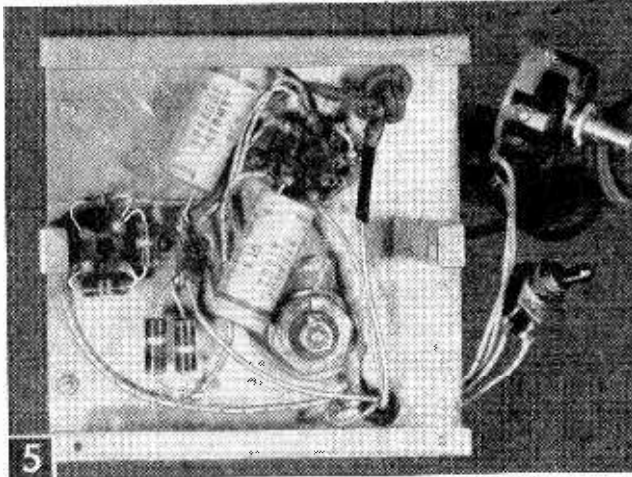
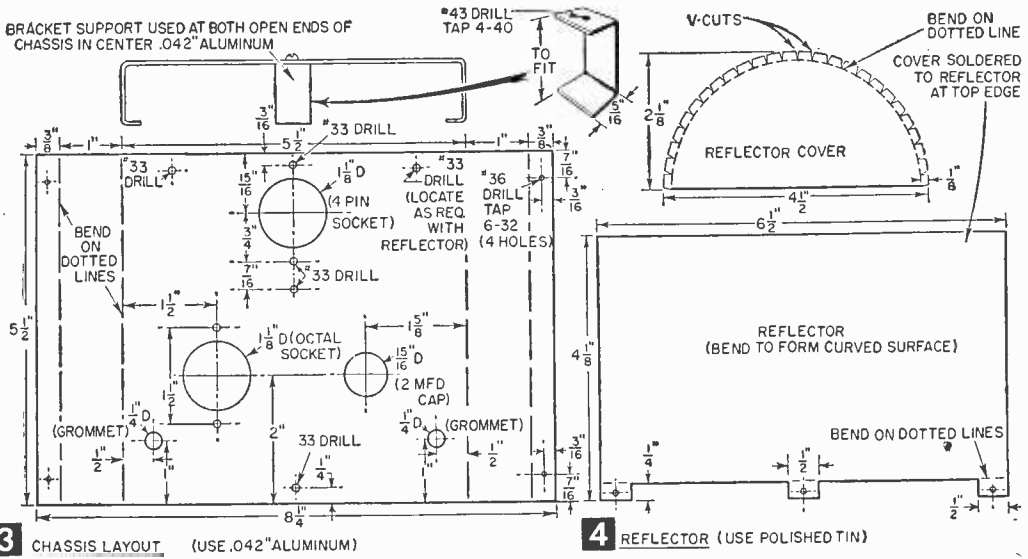
Craft Print Project No. 222

**T**HE trick to finding out what happens to a machine part that is moving at high speed—without turning off the motor—is to use a stroboscope. That's why you'll usually find a stroboscope in machine or automotive repair shops, test labs and other places where it is important to find out how rotating parts behave

Completed stroboscope employs a Strobotron tube which emits Neon-red flashes. Control knob (A) is used to synchronize frequency of these flashes with speed of moving part you want to inspect.



Left, Small fan moving at full speed. Right, Stroboscope flashes "stop" those blades for you, even though they are still moving at top speed.

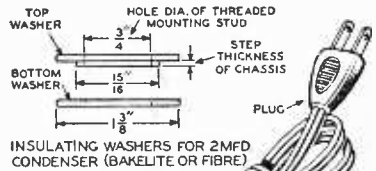


**5** Underneath view of mounted parts and wiring. Compare with Figs. 6 and 7.

may be used to study movements of parts in centrifugally-operated switches and clutches. Or to inspect the shifting structure of a solid piece under centrifugal force at various speeds. Or it can be used to read stampings or markings on the moving piece. Or to find out what may be causing unusual noises in motors and engines that are running.

But whether you can use it in your work, or just want to have fun experimenting with it, you'll find the unit shown is easy and economical

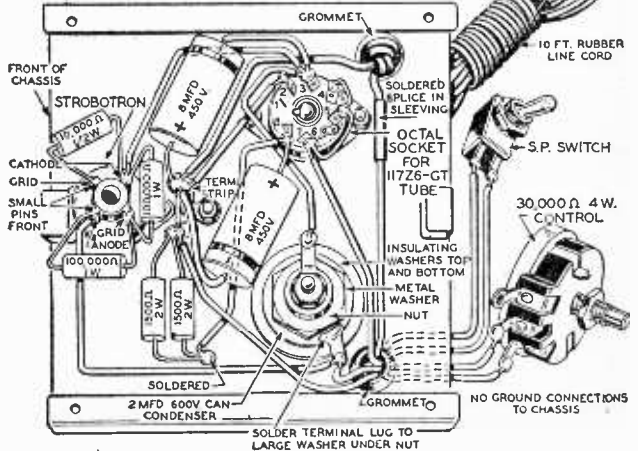
**6 PICTORIAL DIAGRAMS**



when under the stresses and strains of high speed movement and centrifugal forces.

Basically, a stroboscope emits a series of light flashes, and when the frequency of these flashes is synchronized with the speed at which the machine part is moving, that part appears to stand still (Fig. 1). Actually, what you are seeing is a rapidly repeated picture of the part in the same position each time it makes a complete revolution, or, at higher speeds, your flashes are catching it once every second, third or fourth revolution. Thus you can see the actual size, shape or position of the part under rotating conditions.

This ability to "stop" moving parts



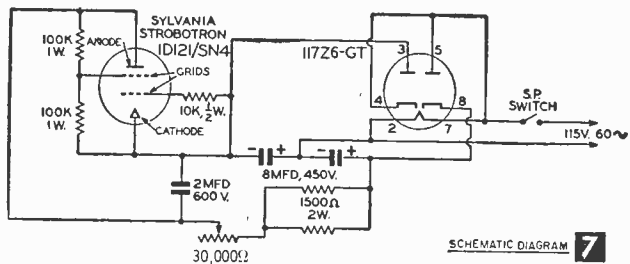
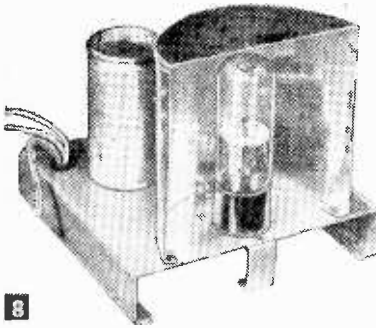
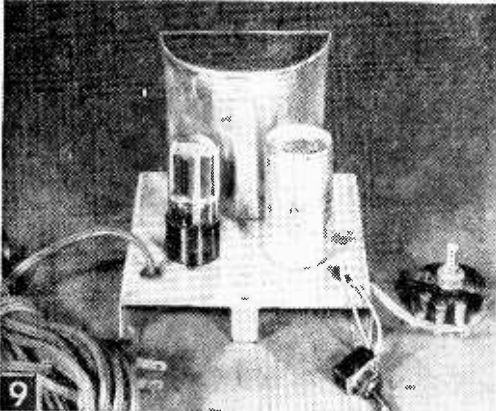


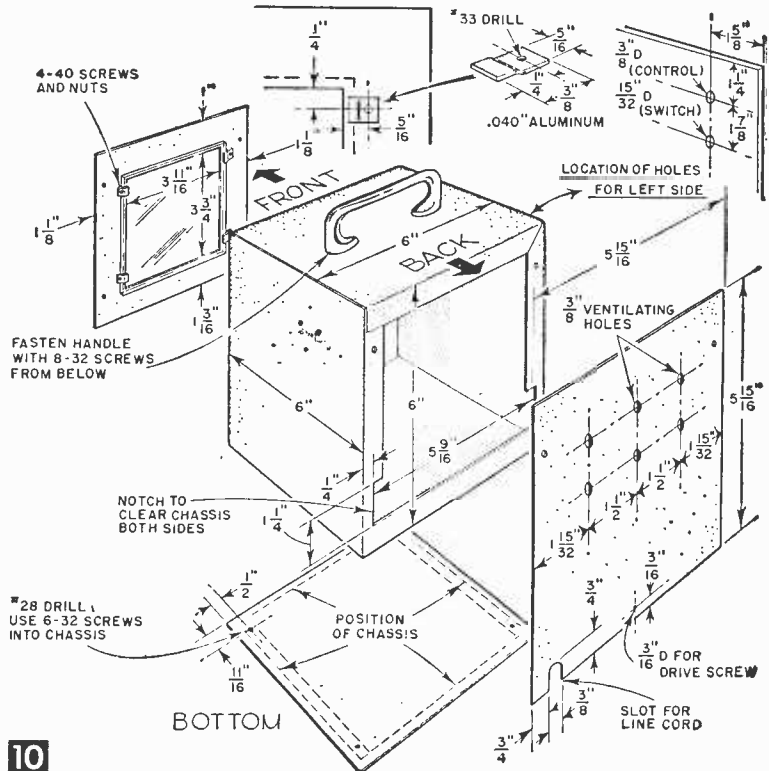
Fig. 8, top of stroboscope chassis with reflector and Strobotron tube mounted in place. Fig. 9, rear of chassis showing 117Z6-GT tube and can-mounted 2 mfd capacitor in position.



- MATERIALS LIST—STROBOSCOPE**
- 1 metal cabinet 6 x 6 x 6" aluminum gray, with removable front and back covers, type 29800 (Insuline Corp.)
  - 1 pc. sheet aluminum about .042" thick, 8 1/4 x 5 1/2", for chassis. Obtain from metal shop
  - 1 2 mfd 600-volt can-type condenser with 3/4" dia. threaded mounting bottom stud, and insulating washers. Not electrolytic (Cornell-Duhilier TLAG020-13G or equivalent)
  - 1 Bakelite or ceramic octal type socket
  - 1 4-pin Bakelite or ceramic socket
  - 1 30,000-ohm, 3-watt variable control (Clarostat 10-30K)
  - 1 toggle switch, single-pole, 6 amp 115 volt
  - 2 8 mfd 450-volt electrolytic cardboard cased condensers
  - 2 1500-ohm 2-watt carbon resistors
  - 2 100,000-ohm 1-watt carbon resistors
  - 1 10,000-ohm 1/2-watt carbon resistor
  - 1 two-terminal chassis terminal strip
  - 2 rubber grommets for 1/4" hole
  - 1 Sylvania 1D21/SN4 Strobotron tube
  - 1 117Z6-GT tube
  - 1 Bakelite knob with dial 0-10 to fit control. National H RS-3
  - 10 ft. flat rubber lamp cord; 1 attachment plug cap; #22 insulated hook-up wire; 1 metal cabinet handle; 1 pc. double-thick window glass 4 x 3 7/8"; 1 pc. shiny tin for reflector; miscellaneous screws, nuts, etc.

to build and use (parts cost about \$18).

It uses a Sylvania type 1D21/SN4 Strobotron tube in a circuit that provides adjustable timing of the frequency of flashes, and we have found it works well with speeds ranging from 250 rpm up to 10,000 rpm or more. Construction of this stroboscope starts with the chassis. Lay out the required holes and bend up the aluminum chassis as in Fig. 3. To support the center of the two open sides, make two bracket pieces and attach with screws as in Fig. 3. Next attach the octal socket, 4-pin socket and a 2 mfd 600-volt condenser in a can having a threaded lower end for mounting, at the correct chassis locations (Figs. 3 through 7). Mount the 4-pin socket for the Strobotron tube so the two small pin receptacles will face the

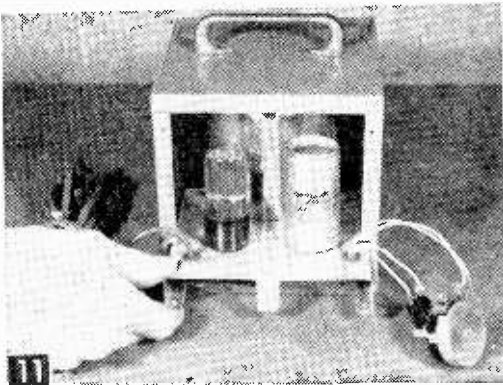
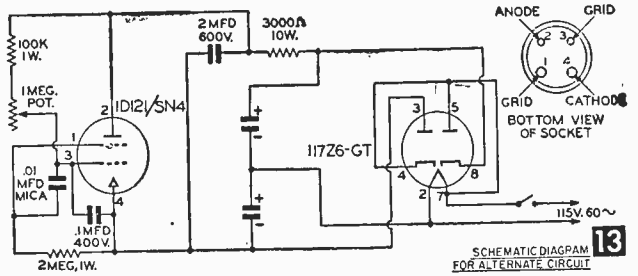




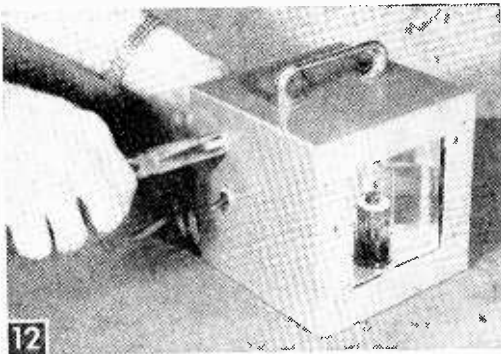
front edge of the chassis (Fig. 6).

When you connect the octal socket, note that terminal #1 is always the first to the left of the center notch (Fig. 6), when viewed from the bottom side with the notch in a center lower position. Insulating washers may be supplied with the 600-volt condenser, or its two terminals may be already insulated from the mounting stud; if not, be sure to add insulating washers.

Use #22 flexible insulated hook-up wire for the connections, and a chassis terminal strip (Fig. 6) for the junction points of the two group connections. Be sure to observe polarity shown (Figs. 6 and 7) with the two electrolytic condensers. Insert rubber grommets in the chassis



**11** Sliding chassis in through notches made in side of cabinet (see Fig. 10).



**12** Attaching control shaft and toggle switch to cabinet, using locknuts.

holes through which wires to the control and line switch, and wires to the line cord will be brought out.

Figures 8 and 9 show you top views of the chassis with components in place. To make that reflector for the Strobotron tube, cut and shape the reflector from a clean tin can or piece of shiny roofing tin (Fig. 4), solder the top cover to the body, then screw reflector to chassis.

To adapt the standard metal cabinet (see ma-

terials list) for this motion-stopping stroboscope, you will need to make several slight modifications. These changes are shown in detail in Fig. 10.

Figure 10 shows you how the double-thick window glass is held in place. After reassembling the cabinet sides, bottom and top, attach the front cover with four drive screws, and then slide the chassis into its case (Fig. 11). Next, secure the control and the toggle switch in their respective holes in the cabinet, using locknuts (Fig. 12). Then line up holes and screwfasten in the chassis with the bottom of the cabinet.

**To Use the Stroboscope,** first plug in the unit to 115 volts 60 cycles and throw on the switch. Wait 10 or 20 seconds for rectifier tube to heat up and then strobotron lamp should begin to operate with a continuous series of flashes, the flash frequency depending on the position of the knob on the control rheostat.

Test the unit by setting an electric fan close to the stroboscope in a darkened room, and then beaming the flashes onto the moving fan blades. Adjust the stroboscope control knob until the blades appear to stand still.

Where the rotation is not absolutely at a fixed speed, you may need to manipulate the control back and forth slightly in order to keep the lamp synchronized with the rotating member.

You'll find that several positions of the control knob will "stop" a moving part, but one particular position will give the best effect. This is because you can provide synchronizing multiples of the actual speed, which give you the same "stopping" action, even though the number of flashes don't match the revolutions of the part.

You can materially extend the life of the lamp by operating it only when you need it. If it begins to fail to flash when you adjust the control knob, or burns at a steady rate, it's time to replace the Strobotron tube with a new one.

For the true experimenter who likes to try out different circuits, Fig. 13 gives you an alternate circuit that also performs well.

• Craft Print No. 222, in enlarged size for building the Motion-Stopping Stroboscope is available at 50¢. SPECIAL QUANTITY DISCOUNT! If you order two or more craft prints (this or any other prints), you may deduct 10¢ from the regular price of each print. Hence, for two prints deduct 20¢; three prints, deduct 30¢, etc. Order by print number, enclosing remittance (no C.O.D.'s or stamps) from Craft Print Dept. R56, SCIENCE AND MECHANICS, 450 East Ohio Street, Chicago 11, Illinois. See coupon on last page of handbook.

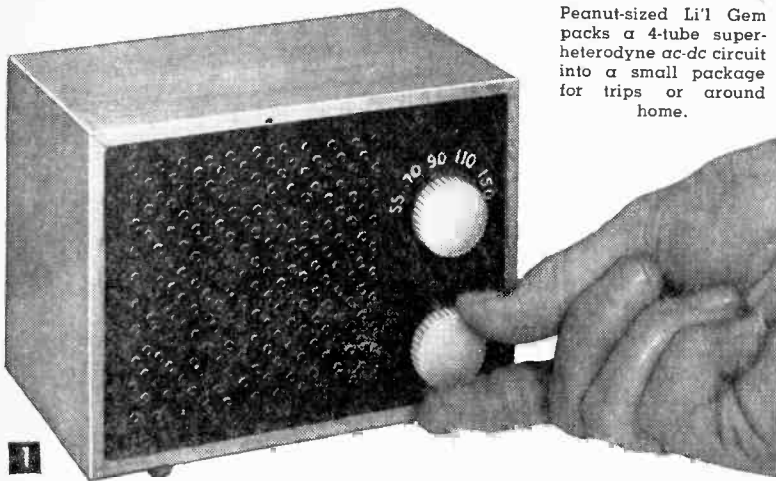
Peanut-sized Li'l Gem packs a 4-tube superheterodyne ac-dc circuit into a small package for trips or around home.

available from radio suppliers by mail, and construction is simple enough for a beginner.

An aluminum chassis (Fig. 4) is easier to form with hand tools, and you can ground connections through solder lugs placed under mounting nuts for the tube sockets. Before forming and cutting the chassis, assemble the parts and check dimensions.

Mount the miniature tube sockets first, with solder lugs under nuts as shown in Fig. 5. Mount the two I.F. transformers next with the two single lug terminal strips attached with the same nuts. Next come the volume control, tuning capacitor, and speaker.

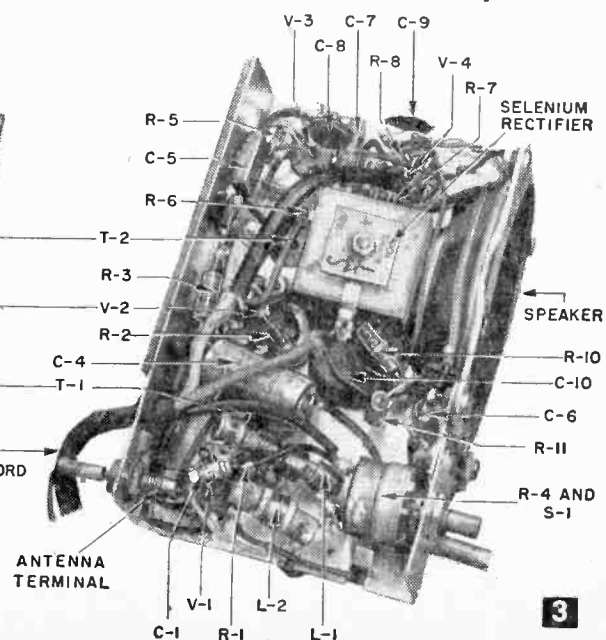
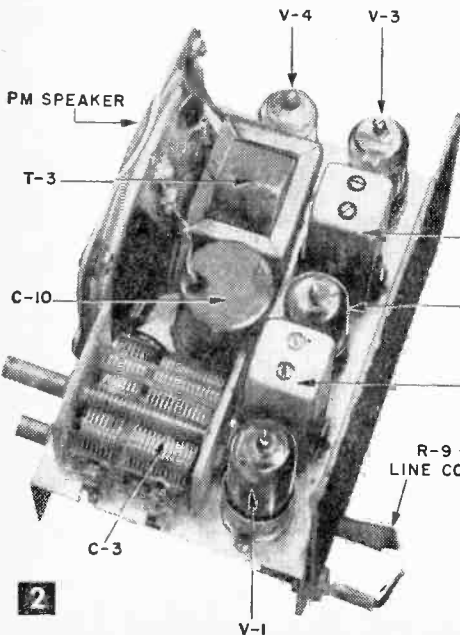
Only one corner of speaker is bolted to the chassis with two braces formed from coat hanger wire and a copper strip (Fig. 2) adding support. The output transformer is mounted by soldering it to a small bracket mounted on the remaining free mounting hole of the speaker (Fig. 2). Mounting ears on the transformer must be bent around the core of the transformer to keep it in place. The selenium rectifier is mounted by means of



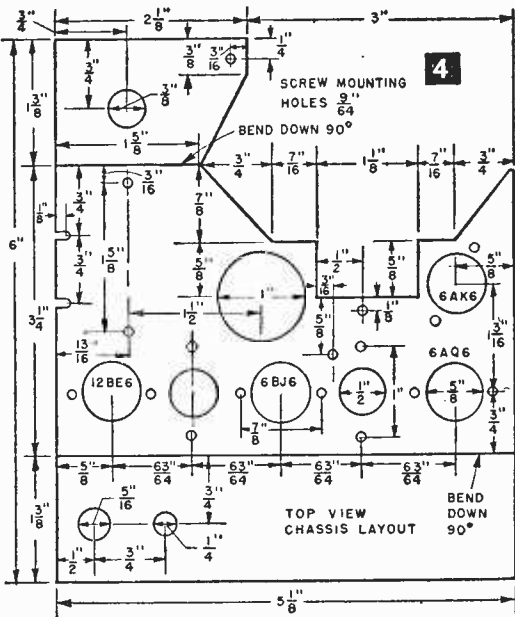
# LI'L GEM—4-Tube Receiver

By MAURICE B. LINDENAU and M. A. ADLER

COMBINING small size with top performance is a problem in any radio receiver, and vest-pocket sets usually pay for their small size with poor reception. *Li'l Gem* is compact (4x4x5½ in.), but it includes a 4-tube superheterodyne circuit for sharp performance with a cool-running selenium rectifier that operates on a-c or d-c power. It's mighty handy for tucking away in the corner of a suitcase or carrying around the house. All parts are standard and



Left, Top view of chassis. Parts call out symbols are: V for tubes, T for transformers, C for capacitors. See schematic and pictorial diagrams for circuit hook-up. Right, Underside of chassis with wiring complete.



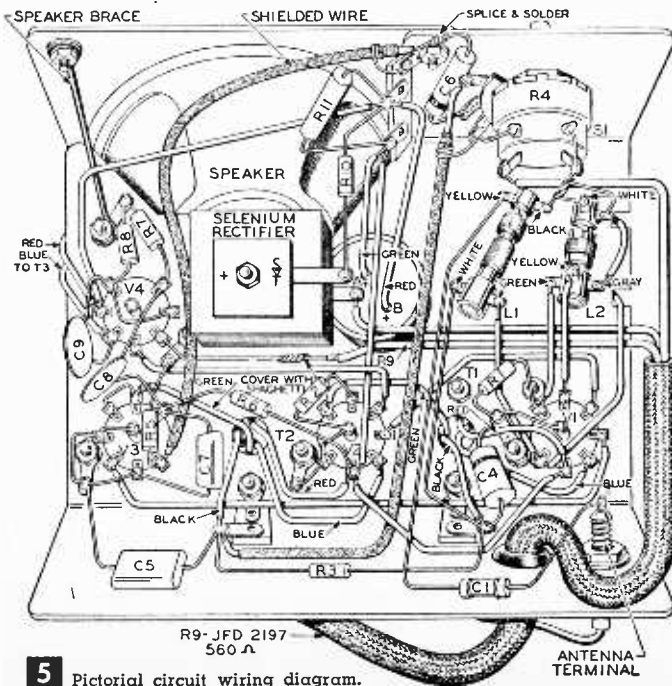
Flat pattern of chassis layout.

a long 6-32 machine screw and a 1/4-in. spacer to hold it away from the speaker and chassis.

Begin wiring with the tube heater (filament) circuit. Keep wires close to the chassis and as short as possible. I.F. transformer wires are next, and they should be as short as possible and kept close to the chassis to minimize howls and squeals. Before installing the electrolytic filter capacitor, remove the mounting bracket (fur-

**MATERIALS LIST—LIL GEM**  
Coils and Transformers

Code	Miniature antenna coil (Meissner 14-1071)
L2	Miniature oscillator coil (Meissner 14-1073)
T1	*456 K.C. air core I.F. inp. transf. (Meissner 16-6666)
T2	*456 K.C. air core I.F. outp. transf. (Meissner 16-6667)
T3	Output transformer 10,000 ohm to 3.2 ohm voice coil. (Burstein-Applebee Co. #18A1077)
	* Midget 456 K.C. iron core I.F. transformer (Meissner 16-6678) may be used for both T1 and T2
	Resistors
R1	22,000 ohms, 1/2 watt, carbon
R2	100 ohms, 1/2 watt, carbon
R3	3.3 megohms, 1/2 watt, carbon
R4	500,000 ohm volume control (Mallory type U-48)
R5	5.6 meg, 1/2 watt, carbon
R6, R7	470,000 ohms, 1/2 watt, carbon
R8	560 ohms, 1/2 watt, carbon
R9	560 ohm resistance line cord (J.F.D. type 2197)
R10	22 ohm, 1 watt, carbon
R11	680 ohm, 1 watt, carbon
	Capacitors
C1	30 or 33 mmf. 500 volts, tubular ceramic (Erie type G.P.)
C2, C3	Two gang cut plate tuning capacitor with trimmers. Allied Radio #61H008 (Rear Section 364 mmf, 27 plates; front section 132.6 mmf. 15 plates)
C4	.1 mfd., 200 volt, min. paper tubular (Sprague 68P17)
C5	250 mmf (.00025 mfd.) 500 volt molded mica
C6	.005 mfd., 200 volt, min. paper tubular (Sprague 68P11)
C7	150 mmf (.00015 mfd.) 500 volt molded mica
C8	.005 mfd., 500 volt, disc ceramic (Sprague 5HK-D5)
C9	.01 mfd.: 500 volt, disc ceramic (Sprague 5HK-S1)
C10	Dual 30-50 mfd., 150 volt tubular electrolytic (Sprague TVA2450)
	Tubes and Rectifier
V1	12BE6 mixer/oscillator
V2	6BJ6 i-f amplifier
V3	6AQ6 detector, AVC and 1st audio
V4	6AK6 audio output
SR	100 ma. selenium rectifier
	Miscellaneous
No. Reqtd.	
4	7 pin miniature tube sockets with shielded base (Amphenol 147-905)
1	attachable S.P.S.T. switch cover (Mallory US-26)
1	3/2" PM speaker Jensen "Viking" 35J4
2	single terminal tie lugs
1	double terminal tie lug
1	spade lug
1	chassis
1	Insulated tip jack



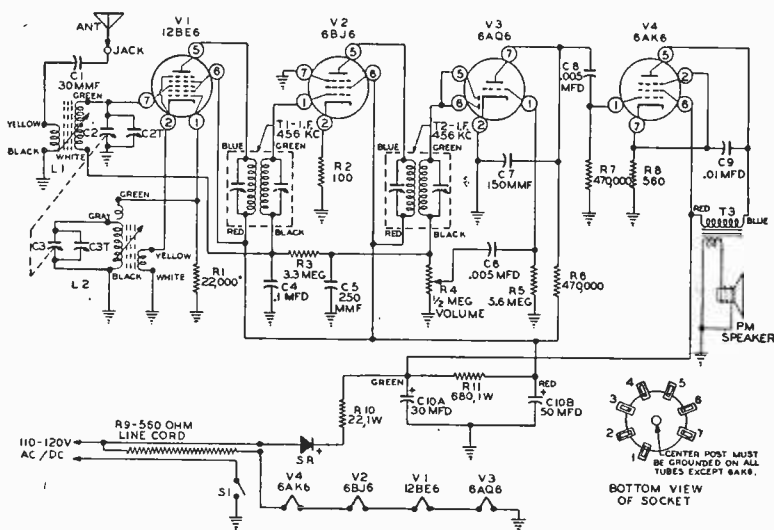
**5** Pictorial circuit wiring diagram.

nished by manufacturer) from around capacitor. Remove trimmer screws and small grounded plate for trimmers on filter capacitor side of the tuning capacitor. Two positive leads should come out on the underside of electrolytic capacitor. The two small Meissner coils are mounted by their leads, tilted for adjustment of their cores with a plastic screwdriver.

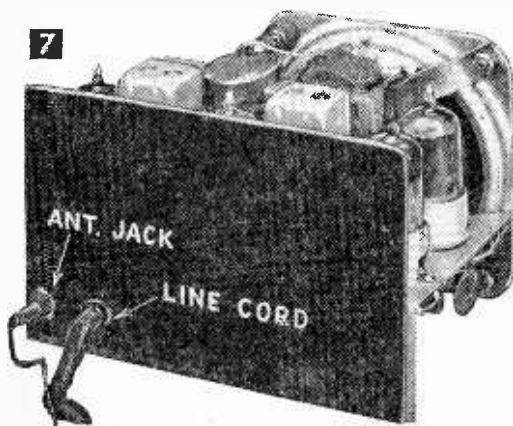
Before mounting the antenna jack, cut a cardboard back cover and cement it to the rear apron of the chassis (Fig. 7). Cut two holes through this back cover for the line cord and antenna jack. A resistance line cord is necessary to use lower voltage tubes that operate cool enough to be installed in such a small cabinet. Connect black wire of cord to switch (s-1) and white wire to negative side of selenium rectifier (see diagrams). Before soldering the last wire from line cord, slide a piece of insulating spaghetti

over it to prevent any accidental short circuits.

You're ready to turn the set *On* and see if everything is working right. With switch *On*, plug line cord into a 110-volt outlet. Tubes should light up to a dull red color. If tubes light up with a bright white light or the line cord or some other part starts to smoke, unplug the set immediately — quick action may prevent burning out a tube or some other component. Remember that one side of line cord is connected directly to chassis and any contact between



Schematic diagram of circuit.



Rear view showing line cord and antenna jack.

chassis and a grounded object may result in a severe shock or a burned-out fuse. The receiver is perfectly safe when operated inside the cabinet and fingers are kept out.

If tubes light up and you can receive at least one station by turning the tuning capacitor, you're ready for aligning the receiver. If the receiver refuses to operate when first turned *On*, DO NOT tamper with any of the adjustments on the I.F. transformers, oscillator coil, antenna coil or tuning capacitor. A wiring error or something else is wrong which must be corrected before attempting alignment of receiver. Select a station near the 1600-kc end of the band for adjusting I.F. transformers. The manufacturer adjusts the I.F. transformers to 456 kc and they need only a slight adjustment for maximum volume. Select one of the two adjustments on T-2, and do not, under any circumstances, change this adjustment from its original setting. Then adjust the second screw of T-2 and the two adjustments of T-1 for maximum volume.

Rotate the tuning capacitor until it is approxi-

mately 10-15 degrees from full closed position and adjust the oscillator coil (L-2) core until a station around 600 kc is received. Then adjust the antenna coil (L-1) core for maximum volume. Rotate the tuning capacitor in the opposite direction until it is approximately 5-10 degrees from full open and adjust the trimmer on the front section of the tuning capacitor until a station around 1500 kc can be received. At the same time, adjust the trimmer on the rear section of the tuning capacitor for maximum volume from this station. Rotate the tuning capacitor until the station can just be heard, and then adjust the trimmer on the front section for maximum volume as well as the trimmer on the rear section of the tuning capacitor. If these steps increase volume, repeat the above steps until the station comes in at maximum volume. If the above steps reduce volume, rotate the tuning capacitor in the opposite direction and adjust front and rear section trimmers for maximum volume. Repeat the adjustment of the cores in the antenna and oscillator coils as previously described and then repeat the adjustment of the trimmers on the tuning capacitor. Any type of single antenna may be used with this receiver. A 4-ft length of wire should be enough for local stations.

The cabinet is simple, butt joints glued and bradded together with a *Bakelite* or clear plastic, 3/16 or 1/4 in., painted black on inside front panel. Drill holes for the speaker and the shafts. Shellac, varnish or enamel the wood parts and drill a few 1/8-in. holes in the bottom of the cabinet for ventilation. The dial numbers were painted on with a small brush and a black stripe on the knobs indicate the dial setting. The chassis is held in the cabinet by the two set-screw knobs and requires no further fastening due to the close fit of the cabinet.

# FM Tuner for Use with TV, Radio or Phonograph

By THOMAS A. BLANCHARD

CIRCUITWISE, an FM receiver represents the R.F. (radio frequency) and I.F. (intermediate frequency) systems of a TV set. Its very high frequency range goes from 88 to 108 megacycles, the span between Channels 6 and 7 on your TV set. Except for a few of the early receivers, TV sets aren't built to receive FM radio programs. But, if your TV set, AM radio, or record player has an audio amplifier input jack (usually marked "phono") you can, with this tuner, receive and listen to FM programs through any one of these units and for about half the cost of an equivalent, commercially made tuner.

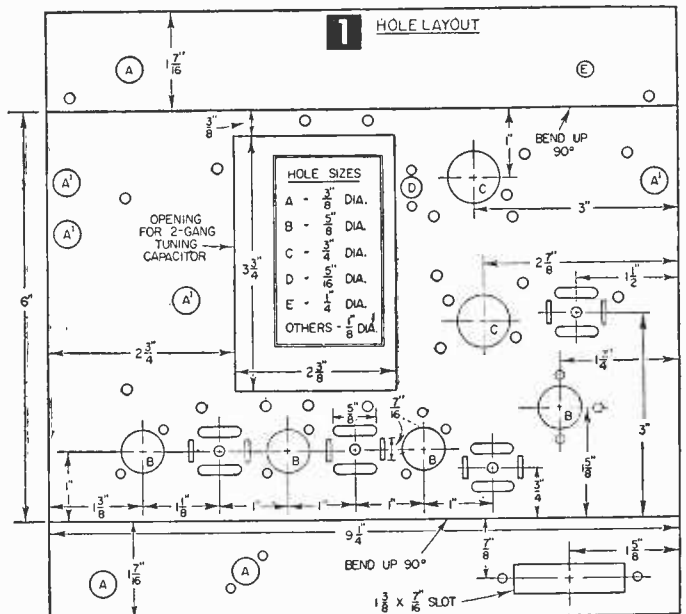
You may have noticed that during an electrical storm your TV set's sound is virtually immune to static, while crashes and bangs on your regular AM radio almost destroy reception. This is because ordinary radio signals are transmitted in the medium frequency band by amplitude modulation (AM), and television sound is transmitted in the very or ultra-high frequency bands and is frequency modulated (FM). Lightning interferes with AM, but scarcely affects FM. For good reception, then, your best bet is FM.

Program-wise, you'll benefit from FM, too. Not including the many independent FM stations, practically every large network-affiliated AM radio station simulcasts its programs via FM. Also, in some areas independent FM stations have teamed up to form co-op networks providing good, hi-fi quality music, plus farm news, and educational features not heard on regular AM radio. It's relatively simple as well as being cheaper, to build your own FM tuner to take advantage of what FM has to offer, and here's how you do it:

Figure 1 shows the locations of chassis holes. The opening for the 2-gang tuning capacitor is large enough to allow the capacitor to be moved forward or backward to engage other dial mechanisms than the type shown in Fig. 2 (between the pilot lamps). With chassis punches, punch out the holes and mount the miniature tube sockets with  $\frac{1}{4}$  in. #2-56 *rh* screws and nuts in



FM Tuner operates through audio amplifier of any radio, TV set or record player provided with a phono input jack; gives static-free, hi-fi reception.



holes B and C, Fig. 1. It's important that sockets are the low-loss, mica-filled bakelite type for high-frequency installations; don't use ordinary black bakelite or wafer type sockets. The 10.7 mc I.F. and discriminator transformers are the miniature K type which clip to the chassis by means of a spring brass mount. Before locking them to the chassis, check the green dots on the I.F. transformers and the red dot on the discrimi-

nator transformer to be sure they are positioned correctly.

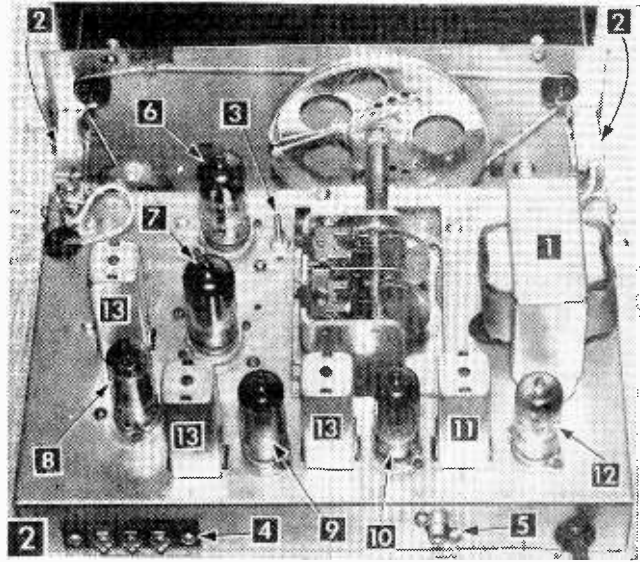
Now insert  $\frac{3}{8}$  in. rubber insulating grommets in the holes marked A<sup>1</sup> in Fig. 1 and mount the power transformer on the top of the chassis. Bring the transformer leads through the grommetted chassis holes, bolt the selenium rectifier, bakelite tie-strips, Ant.-Gnd. strip, and output jack to chassis and attach the wafer line switch to the front chassis apron. Finally, secure the six #6 ground lugs to the chassis, slip a knife blade under each secured lug, and bend up at right angles. The chassis is now ready for wiring. Wire electrically according to Fig. 3, physically according to Figs. 4 and 5.

First, wire in the power transformer leads, then connect the tube heaters and all point-to-point solid leads. These include all leads terminated on ground lugs. Cut all leads as short as possible, since the tuner works at very high frequencies. Some leads in Fig. 4 go around Robin Hood's barn, but this is for purposes of clarity. Your wiring should be more nearly like that shown in Fig. 5. The long plate voltage leads, and the leads connecting the transformer to the tube heaters are not critical as to length, but all wires carrying a.c. should be positioned as close to the chassis as possible.

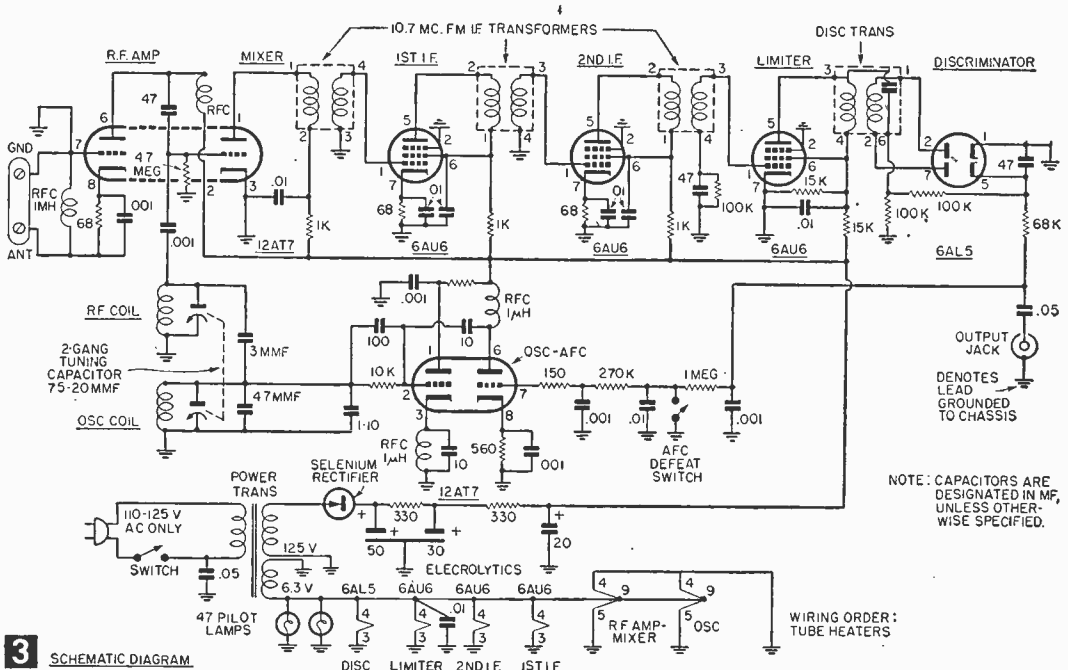
Resistors, R.F. chokes and disc ceramic capacitors are provided with pigtail leads averaging  $1\frac{1}{2}$  in. long. Before soldering these components

into their respective positions, cut off as much excess as possible. Not all, but most disc capacitors require pigtails only  $\frac{1}{2}$  in. long. Where the bare pigtail leads might create a short, use plastic "spaghetti" insulation. Be sure to insulate the bare pigtails of the 20 mfd. electrolytic capacitor; a short here could burn out the selenium rectifier.

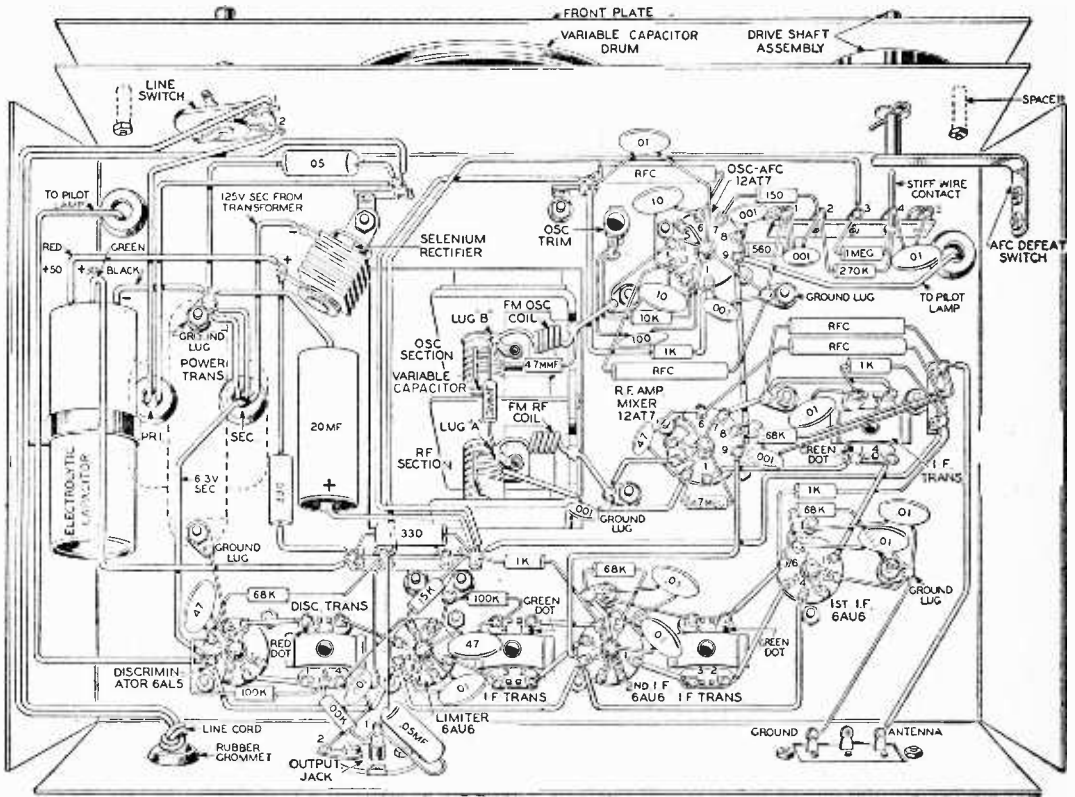
The R.F. and oscillator coils are wound with



Top view of chassis with tubes in place and dial mechanism assembled. Components shown are: 1) power transformer; 2) pilot lamps; 3) oscillator trimmer; 4) antenna-ground strip; 5) output jack; 6) oscillator-AFC 12AT7; 7) R.F. amplifier-mixer 12AT7; 8) 1st I.F. 6AU6; 9) 2nd I.F. 6AU6; 10) limiter 6AU6; 11) discriminator transformer; 12) discriminator 6AL5; 13) I.F. transformer.



3 SCHEMATIC DIAGRAM



**4** PICTORIAL DIAGRAM

**MATERIALS LIST**

- |                                                                                                                                                                                                                                                                                                                                                                                                                                                                                                                                                                                                                                                                                                                                                                                                                                                                                                                                                                                                                                                                                                                                                                                                                                                                                                                                                                                                                                                                                                                                                                                                                                                                                                                                                                                                                                                                |                                                                                                                                                                                                                                                                                                                                                                                                                                                                                                                                                                                                                                                                                                                                                                                                                                                                                                                                                                                                                                                                                                                                                                                                                                                                                                                                                                                                                                                                                                                                                                                                                                                                                                                                                                                                                |
|----------------------------------------------------------------------------------------------------------------------------------------------------------------------------------------------------------------------------------------------------------------------------------------------------------------------------------------------------------------------------------------------------------------------------------------------------------------------------------------------------------------------------------------------------------------------------------------------------------------------------------------------------------------------------------------------------------------------------------------------------------------------------------------------------------------------------------------------------------------------------------------------------------------------------------------------------------------------------------------------------------------------------------------------------------------------------------------------------------------------------------------------------------------------------------------------------------------------------------------------------------------------------------------------------------------------------------------------------------------------------------------------------------------------------------------------------------------------------------------------------------------------------------------------------------------------------------------------------------------------------------------------------------------------------------------------------------------------------------------------------------------------------------------------------------------------------------------------------------------|----------------------------------------------------------------------------------------------------------------------------------------------------------------------------------------------------------------------------------------------------------------------------------------------------------------------------------------------------------------------------------------------------------------------------------------------------------------------------------------------------------------------------------------------------------------------------------------------------------------------------------------------------------------------------------------------------------------------------------------------------------------------------------------------------------------------------------------------------------------------------------------------------------------------------------------------------------------------------------------------------------------------------------------------------------------------------------------------------------------------------------------------------------------------------------------------------------------------------------------------------------------------------------------------------------------------------------------------------------------------------------------------------------------------------------------------------------------------------------------------------------------------------------------------------------------------------------------------------------------------------------------------------------------------------------------------------------------------------------------------------------------------------------------------------------------|
| <p><b>Capacitors</b></p> <p>1 tuning capacitor; 2-gang FM type. Range: 7.5 to 18.7 or 20 mmf. DeLancey, G1 or RCC</p> <p>1 oscillator trimmer; screw-plunger type, 1-8 or 1-10 mmf. Erie type #532</p> <p>1 50-30 mfd. dual electrolytic; 150 V. paper tubular with mtg. strap</p> <p>1 20 mfd. 150 V. electrolytic</p> <p>2 .05 mfd. 400 W.V. paper capacitors</p> <p>7 .01 mfd. disc type ceramic capacitors (do not substitute other types)</p> <p>6 .001 mfd. disc type ceramic capacitors (do not substitute other types)</p> <p>1 100 mmf. disc type ceramic capacitor (do not substitute other types)</p> <p>3 47 mmf. disc type ceramic capacitors (do not substitute other types)</p> <p>2 10 mmf. disc type ceramic capacitors (do not substitute other types)</p> <p>1 4.7 mmf. disc type ceramic capacitor (do not substitute other types)</p> <p>1 3 mmf. (or 2 or 2.2) tubular ceramic (use disc if available)</p> <p><b>Resistors</b></p> <p>3 68 ohm 1/2 watt insulated resistor, IRC type</p> <p>1 150 ohm 1/2 watt insulated resistor, IRC type</p> <p>2 330 ohm, 1 watt insulated resistors, IRC type</p> <p>1 560 ohm, 1/2 watt insulated resistors, IRC type</p> <p>4 1K (1000) ohm 1/2 watt insulated resistors, IRC type</p> <p>2 15K (15,000) ohm 1/2 watt resistors, IRC type</p> <p>1 10K (10,000) ohm 1/2 watt resistor, IRC type</p> <p>1 68K (68,000) ohm 1/2 watt resistor, IRC type</p> <p>2 100K (100,000) ohm 1/2 watt resistor, IRC type</p> <p>1 1 megohm 1/2 watt resistor, IRC type</p> <p>1 4.7 megohm 1/2 watt resistor, IRC type</p> <p>1 270K (270,000) ohm 6 watt resistor, IRC type</p> <p><b>Coils/Transformers</b></p> <p>1 Power transformer. Primary: 110-120 V. Secondary: 125 V. @ 50 ma. plate and 6.3 V. fil. @ 2 amp. (Stanco #PA-8421)</p> <p>3 FM type I.F. transformers; 10.7 mc. Automatic #1606-1</p> | <p>1 FM discriminator transformer; 10.7 mc. Automatic #2607-1 or Miller #1464</p> <p>4 1 microhenry (<math>\mu</math>h) R.F. chokes; Insulated IRC type</p> <p>1 R.F. coil (See text. These are wound with #14 solid Osc. coil copper wire)</p> <p><b>Miscellaneous Components and Hardware</b></p> <p>1 metal chassis size: 9 x 6 x 1 3/4 stock size (furnished pre-punched with Arky kit)</p> <p>4 7-pin miniature tube sockets. Amphenol mica-filled Bakelite #147-913</p> <p>2 9-pin miniature tube sockets. Amphenol mica-filled Bakelite #59-410</p> <p>2 12AT7 Hi-Mu twin triode tubes</p> <p>3 6AUG6 sharp cutoff pentode tubes</p> <p>1 6AL5 twin diode tube</p> <p>2 #47 pilot lamps</p> <p>1 selenium rectifier; 50 ma.</p> <p>1 RCA type phono jack</p> <p>1 2 screw terminal strip (Ant.-Gnd.)</p> <p>2 1 insulated lug tie strips</p> <p>1 2 insulated lug tie strip</p> <p>2 3 insulated lug tie strips</p> <p>12 #2-56 machine screws, rh 1/4" long for mtg. sockets</p> <p>12 #2-56 machine nuts, rh 1/4" long for mtg. sockets</p> <p>6 #6 soldering lugs</p> <p>6 #4-40 x 1/4 in. screws and nuts (rh)</p> <p>7 #6-32 x 1/4 in. screws and nuts (rh)</p> <p>5 #8-32 x 1/4 in screws and nuts (rh)</p> <p>5 3/8 in. rubber grommets</p> <p>1 fixture cord</p> <p>1 wafer type rotary line switch</p> <p>10 ft. hookup wire (vinyl plastic #20 bell wire from dime store is excellent)</p> <p>1 slide rule type edge-lighted 88-108 MC dial assembly. (Furnished with Arky Kit. Otherwise use Crowe (Croname) #CR-1A preassembled dial.)</p> <p>A complete Arky FM Tuner Kit. #FM-6, with every component listed above except hook-up wire, can be obtained from Rose Electronics, Inc., 76 Vesey St., New York 7, N. Y. Net price js \$23.95, plus postage on 7 lb. parcel to your zone.</p> |
|----------------------------------------------------------------------------------------------------------------------------------------------------------------------------------------------------------------------------------------------------------------------------------------------------------------------------------------------------------------------------------------------------------------------------------------------------------------------------------------------------------------------------------------------------------------------------------------------------------------------------------------------------------------------------------------------------------------------------------------------------------------------------------------------------------------------------------------------------------------------------------------------------------------------------------------------------------------------------------------------------------------------------------------------------------------------------------------------------------------------------------------------------------------------------------------------------------------------------------------------------------------------------------------------------------------------------------------------------------------------------------------------------------------------------------------------------------------------------------------------------------------------------------------------------------------------------------------------------------------------------------------------------------------------------------------------------------------------------------------------------------------------------------------------------------------------------------------------------------------|----------------------------------------------------------------------------------------------------------------------------------------------------------------------------------------------------------------------------------------------------------------------------------------------------------------------------------------------------------------------------------------------------------------------------------------------------------------------------------------------------------------------------------------------------------------------------------------------------------------------------------------------------------------------------------------------------------------------------------------------------------------------------------------------------------------------------------------------------------------------------------------------------------------------------------------------------------------------------------------------------------------------------------------------------------------------------------------------------------------------------------------------------------------------------------------------------------------------------------------------------------------------------------------------------------------------------------------------------------------------------------------------------------------------------------------------------------------------------------------------------------------------------------------------------------------------------------------------------------------------------------------------------------------------------------------------------------------------------------------------------------------------------------------------------------------|

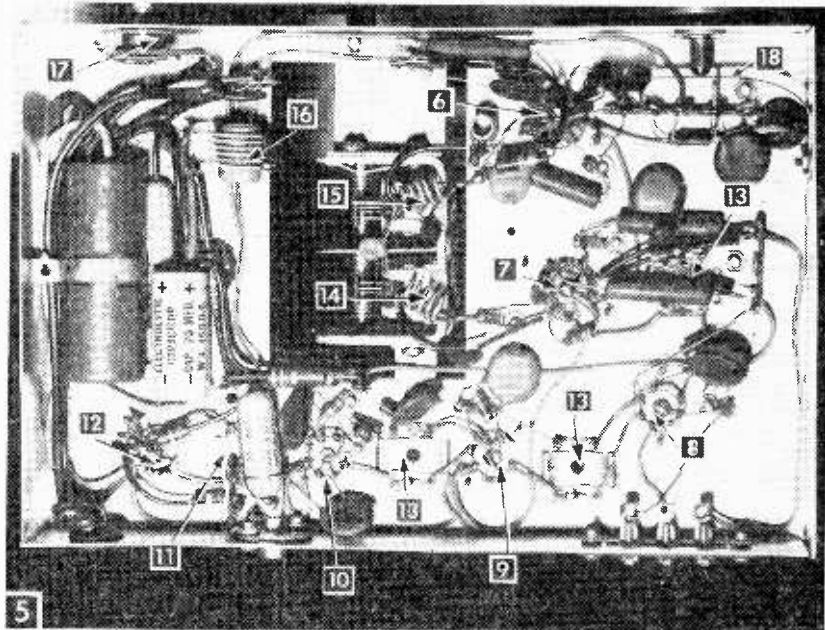
#14 solid copper wire; bare, tinned, or silver plated. For each coil, wind 5 turns on the shank of a  $\frac{7}{32}$  in. twist drill. Then remove the drill and space the turns to provide an air gap between each spiral equal to the thickness of the #14 wire. Both coils must be wound in the same direction. Insert one coil end into the stator lug hole of each tuning capacitor section and ground the opposite end to the frame of the tuning capacitor with a solid soldered connection. Bend the remaining end of the coil wire up and terminate on the adjacent chassis lug. After firmly soldering both ends of each coil, clip off any excess wire.

If the oscillator section of the tuning capacitor is provided with a trimmer screw adjustment, this may be used in place of the separate oscillator trimmer shown in Figs. 2 and 4. It is best to use the separate plunger trimmer, however, since it also serves as a rigid tie point for several critical components. The trimmer screw should be permanently removed from the tuning capacitor's oscillator section if you decide to use a separate one as shown.

With wiring completed, assemble the slide rule dial mechanism according to the instructions that come with these assemblies and insert the tubes in their sockets.

The R.F. front end of the tuner employs a low noise, grounded grid, unbalanced input. Usually a 5 ft. length of wire attached in a horizontal position to the Ant. terminal is all the antenna required. An indoor TV "Rabbit Ears" antenna can also be used, or in high noise or remote areas, use a rooftop dipole with a co-ax lead-in.

The oscillator and mixer circuits are not contained in the same tube envelope, thus improving circuit stability. In addition, drift is kept at the very minimum by automatic frequency control (AFC). A simple, momentary "defeat" switch, consisting of a strip of spring brass, closes by pressing in lightly on the tuning knob, and shorts out the AFC so that an FM station can be tuned in sharply. Once tuned in, the switch contacts open and AFC is restored, preventing signal drift.



Bottom view of completely wired chassis. Components shown are: 6) oscillator-AFC 12AT7; 7) R.F. amplifier-mixer 12AT7; 8) 1st I.F. 6AU6; 9) 2nd I.F. 6AU6; 10) limiter 6AU6; 11) discriminator transformer; 12) discriminator 6AL5; 13) I.F. transformers; 14) R.F. coil; 15) oscillator coil; 16) selenium rectifier; 17) line switch; 18) A.F.C. defeat switch.

To make tuner alignment as simple as possible, the circuit does not employ a ratio type detector. Instead, it has the discriminator detector developed in 1936 by the well-known electronics engineering team of D. E. Foster and S. W. Seeley. The Foster-Seeley circuit permits alignment with either a 10.7 mc. AM or FM signal provided by a suitable generator.

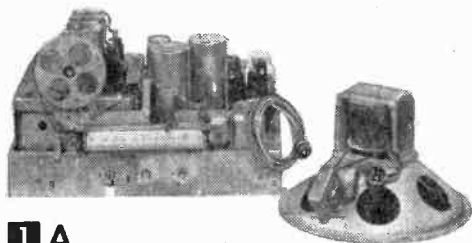
With tuner completed, make a short cord of single-conductor shielded lead and fit each end with a pin plug to connect tuner to the phono input jack of your audio amplifier. Attach a short antenna lead and—if all wiring is correct—the tuner should provide fair to medium reception as-is.

In most instances the I.F. and discriminator transformers are pre-adjusted at the factory. In constructing the set shown here, slight adjustments of the R.F. and oscillator trimmers resulted in the set operating at about 80 per cent efficiency prior to a complete alignment job.

This alignment job, for highest-quality reception, should be turned over to a good service man. Because of the instruments (such as the signal generator) and know-how involved, it is seldom that an experimenter can tackle it. An experienced radio technician, however, will align the tuner for you in about 15 minutes; and the small charge for his service is worth the expenditure tenfold.

You can incorporate your tuner in a hi-fi layout, or build a small cabinet to house it. It measures only  $9\frac{1}{2}$  in. wide,  $4\frac{1}{8}$  in. high, and  $7\frac{1}{2}$  in. deep—small enough to fit the narrowest bookshelf.





1A

from this-



Purchased for \$5 and put in working order for \$3 more, the set in 1A was transformed into the versatile Multi-Unit behind which the author's son is standing in 1B. The set restored to usefulness was a General Electric Model A-87. It could have been any other make or model a-c, superheterodyne receiver.



1B

## Resurrect That Old Superhet—Build an Electronic Multi-Unit

By ROBERT W. LUEBKE

**A**S A foundation unit for your test and experimental bench—particularly if you're a novice experimenter—here's a project that's simple to build, inexpensive and versatile. The set brought out of retirement by the writer was purchased in a second-hand store for \$5. But with a little attic prospecting you may be able to turn up an equally suitable receiver at no cost. The set used should be in working order, or easily made so, should be a-c only (*ac-dc* receivers are not isolated from the power line and are therefore dangerous for the novice experimenter to work with), and should be of the superheterodyne type.

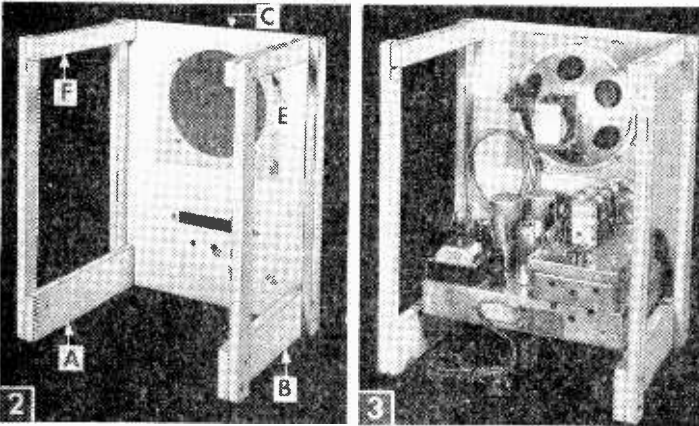
The first step in making an Electronic Multi-Unit is to remove the receiver you're going to use from its cabinet. Construction of a rack (Fig. 2) and mounting of the set in it (Fig. 3) are next. From then on, you construct as many—or as few—of the additional units as you wish.

**Constructing Rack and Mounting Receiver:** Two wooden rectangles and a panel (Fig. 2) make up the mounting rack. The receiver is mounted on the lower cross-pieces of the rec-

tangles (A and B, Fig. 2). Dimensions depend on the size of the set being used.

Measure the length and width of the set's chassis and cut the bottom cross-pieces from 1x4-in. ( $\frac{3}{4}$ x $3\frac{3}{8}$ -in.) stock to a length 3 in. longer than the width of the chassis. From 1x2-in. ( $\frac{3}{4}$ x $1\frac{5}{8}$ -in.) stock cut the two upper cross-pieces (E and F, Fig. 2) to the same length. The uprights of the rectangles are also made from 1x2's. Their length will depend on the size of the speaker used. With a 10-in. speaker cone (Fig. 3), the uprights were cut to 24 in. Screw-fasten uprights and cross-pieces with #10x $1\frac{1}{4}$ -in. *fn* wood screws, two to a corner, to form two rectangles, squaring the corners with a carpenter's square as you go along.

Next, fasten  $\frac{1}{2}$ x1-in. corner irons with  $\frac{3}{16}$ x $\frac{3}{4}$ -in. stove bolts flush with the bottom edge and 1



Completed rack ready for installation of set and speaker, Fig. 2. Upper cross-pieces (E and F) serve as handles if Multi-Unit is moved. Rear view of Multi-Unit with receiver mounted on rack, Fig. 3. Method of mounting leaves entire chassis open and accessible.

#### MATERIALS LIST—ELECTRONIC MULTI-UNIT

No.	Description
1	ac superhet receiver with speaker
	RACK
1 pc	1 x 4" x 3' pine
2 pcs	1 x 2" x 6' pine
1 pc	1/8" tempered masonite to size
16	#10 x 1 1/4" fh wood screws
4	1/2 x 1" corner irons
10	#6 x 1/2" fh wood screws
4	#8 x 5/8" fh wood screws
4	3/16 x 3/4" fh stove bolts
4	3/16 x 1/2" fh stove bolts
1 pc	screening to speaker size
	FUSE BLOCK
1	fuse holder (Buss type 4405)
1	box of 5 2-amp fuses (Buss type AGC)
	POWER OUTLETS
2	receptacles (2-pole female)
6-8'	#18, 2-conductor, insulated wire
	TIME SWITCH
1	time switch (Sessions unmounted, model RC-2B01, square face; or RA-2B03, round face)
25'	cellulose acetate hook-up wire—single, tinned copper conductor, solid or stranded (to be used with other additions also)
	RECORD PLAYER
1	record player (any type or kind with a crystal cartridge)
1	plug (Switchcraft "Littel Plugs" type 250)
1	jack (Switchcraft "Littel-Jax" phone jack type 11)
1	lever-action switch (Mallory type 6243)
15'	copper shielded hook-up wire (to be used with other additions also)
	REMOTE SPEAKER
30'	lamp cord wire (POSJ, Brown)
1	plug (Switchcraft "Littel Plugs" type 250)
1	jack (Switchcraft "Littel-Jax" phone jack type 11)
1	5" PM speaker (Jensen "Viking" 5J6, or equivalent)
1	lever action switch (Mallory type 6243)
4 pcs	1/2 x 3 x 7" scrap board (speaker enclosure)
1 pc	1/8 x 7 x 7" tempered hardboard (speaker enclosure)
1 ac	6 x 6" window screening (speaker enclosure)
	Miscellaneous screws, bolts, hook-up wire
	SPEAKER MIKE
1	5" PM speaker (Jensen "Viking" 5J6, or equivalent—1.47 oz. magnet or larger)
1	intercom transformer (Stancor type A4744)
1	jack (Switchcraft "Littel-Jax" phone jack type 11)
1	plug (Switchcraft "Littel Plugs" type 250)
6'	lamp cord wire (POSJ, Brown)
	SPEAKER ENCLOSURE
	materials same as for remote speaker
	miscellaneous screws, bolts, hook-up wire
	(Allied Radio, 100 N. Western Ave., Chicago 80, Ill., can supply all electronic parts for the Multi-Unit)

in. from the ends of both sides of the set chassis as in Fig. 3, set the receiver on the bottom cross-pieces and measure for the panel (C, Fig. 2). Again, the exact width of the panel will depend

on the width of the set being used.

The panel is cut from 1/8-in. tempered Masonite. After it is cut to size, holes for the set's control shafts are located by moving the set forward on the bottom cross-pieces toward the panel (held in place against the rectangles) until the shafts touch. Mark these locations and drill holes of the proper size in the panel. Now position the set on the bottom cross-pieces and screw-fasten through the corner irons with #8x5/8-in. fh wood screws.

With receiver secured in place, determine positioning of the speaker and with a compass saw cut a hole for it. Use coarse sandpaper held in place over a 4 or 5-in. cylinder (a tin can will do) to smooth sides of speaker hole. Place a square of window screening between speaker and panel, fasten speaker and screen in place with four 3/16x1/2-in. fh stove bolts, and screw-fasten the panel to the rectangles with 10 #6x1/2-in. fh wood screws, 5 on each side, countersunk into the panel.

**Fusing the Multi-Unit:** As a safety measure—one which will not affect the working of the set, but which may spare you the inconvenience of hunting for the household fuse panel and may also save a valuable part of the Multi-Unit if a wire should be connected incorrectly—the next step is installation of a fuse in the Multi-Unit's powerline. Bolt a small fuse holder on the underside of the set's chassis near the power wire and—with the set unplugged—cut one of the power wires. Solder the cut ends of this wire to the fuse holder terminals and insert a 2-amp fuse in the holder. Now, whatever power comes into the set will have to go through this fuse. If the current starts to go excessively high, as might happen if a short circuit developed within the set, the relatively small 2-amp fuse will blow; the household fuses will not be affected.

**Power Outlets** should be connected ahead of the On-Off switch in the receiver so that they can be used without first having to turn it on. The receptacles are wired in parallel with the receiver (Fig. 4), but will probably be most useful if installed (physically) on opposite sides of the panel. Since there will ordinarily be little tinkering done with the units plugged into the outlets (record player, tape recorder, small motors, etc.), the need for fusing them is not great.

**Adding a time switch.** Clock movements which will function at any pre-set time within a 12-hour period are available commercially for less than \$6 (see Materials List). To install such a movement on the Multi-Unit, pick a spot on the panel that is easy to see while still having sufficient clearance behind the panel for the works of the clock, and carefully mark out a circle with a com-

pass (if using the round-face time switch as we did, Fig. 5), to the size required. Cut the hole inside this marking with a compass saw and, with sandpaper held over a cylindrical surface slightly smaller than the hole being cut, finish it to the exact dimensions required. Insert the clock in this hole and fasten in place according to the manufacturer's instructions. Wire into circuit as in Fig. 4.

To use, turn receiver *Off-On* switch to *On*, turn time switch to *On* position, tune in preferred radio station (or set up station on TV set plugged into power outlet), and adjust volume. Now turn time switch to automatic position and set to time desired. The radio—and TV set (or toaster, or coffee-maker) plugged into power outlets—will disconnect and stay disconnected until the time switch turns them on automatically at the time set on the clock.

**Adding a Record Player.** Mount an open-circuit, two-conductor jack and a four-pole, three-position, non-shorting lever switch (switch Y, Fig. 5) on front panel of Multi-Unit. With jack and switch in place, wire a two-conductor plug to the record player's output.

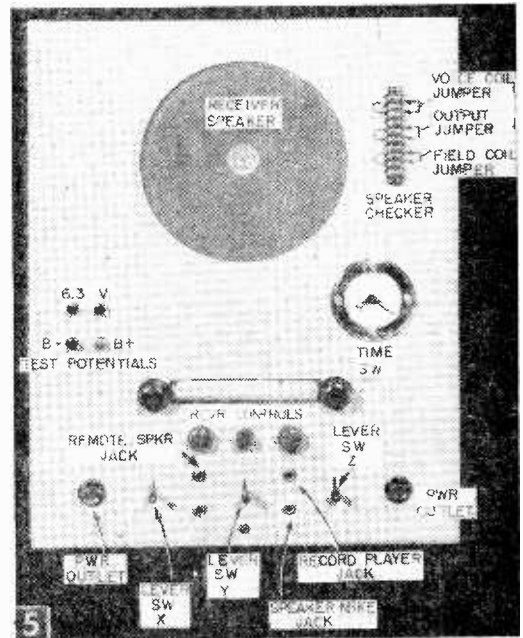
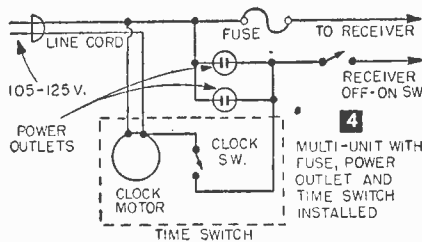
Now, locate the volume control of the receiver you are using. It will have three wires coming from it. One of these will go to ground, one will go to the grid of the audio amplifier tube. The third wire puts the volume control across the stage preceding the audio amplifier. Remove this wire and, using shielded wire (with shield grounded to chassis of set), extend it to the common "A" pole on the switch Y (see Fig. 6). Now connect a wire between the volume control terminal just vacated and terminal #2 of section "A," and to terminal #1 of switch section "B." Wire the ring connection (frame) of the phono jack to the chassis of the set, wire the insulated tip connection to common pole "B," and connect terminal #1 of section "A" to the chassis. This will ground the radio signal when the switch is in the record player position (switch lever pushed up). With the record player plugged into a power outlet, records will be amplified by the audio stage of the receiver and heard through its speaker. With the switch in its center position, the radio signal will be heard. The lower position of the switch is left open for future speaker mike connections.

**A Remote Speaker** can be wired permanently into the Multi-Unit, or set up for use with plug and jack. Build the speaker enclosure (3x7x7 in.) of apple-crate board sides, with a front panel of 1/8-in. tempered hardboard. The speaker itself is mounted behind a square of window screening placed over the 5-in. dia. opening cut into the front panel and the whole assembly is then screw-fastened together with four #6x1/2-in. sh wood screws.

To wire into the Multi-Unit for use with plug and jack, attach one end of a length of lamp cord to the voice coil of the speaker; attach the other end to a phone plug. Then install a lever switch (switch X, Fig. 5) and a jack in the Multi-Unit's front panel.

Now, find the voice coil leads of the set's speaker—they are the wires from the set's output transformer going to the speaker voice coil. Disconnect one of these leads from the transformer and resolder it to an insulated tie lug mounted near the output transformer. Connect a wire between this lug and the common "A" and "B" poles. Next, solder a length of hook-up wire from the voice coil terminal just vacated to terminals #2 and #3 of section "A" on switch X (see Fig. 7). Solder another length to the ring connection (frame) of the speaker jack and bring it to terminals #1 and #3 of switch X, section "B." Finally, bring a wire from the side of the output transformer which has been left intact to the insulated tip connection of the speaker jack. (To wire remote speaker permanently into Multi-Unit, simply bring tip and ring connections directly to remote speaker terminals, using lamp cord.)

With the remote speaker plugged in and the lever switch in its normal, center position, only the receiver's speaker will function; in the



Front panel of Multi-Unit with power outlets, various test potentials, speaker checker, time switch and operational controls and jacks available at front panel. Lever switch Z and two of the jacks are not in use, and there is still ample room on the panel for still further additions.

switch's Up, or #1 position, only the extension speaker will work; and with the switch in its Down, or #3 position, both speakers will be working. The remote speaker jack will also take earphones, and—in addition—can be used for making tape recordings directly, without using a mike. (Recording a radio program in this way eliminates the possibility of stray noise pickup which you would have using a mike.) When making tape recordings, the lever switch can be used in either its #1 or #3 positions. The #3 position is, perhaps, better, since it enables the operator to monitor what is being recorded through the receiver's speaker, and also places a load on the receiver's output transformer.

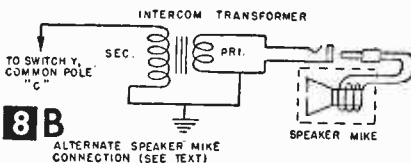
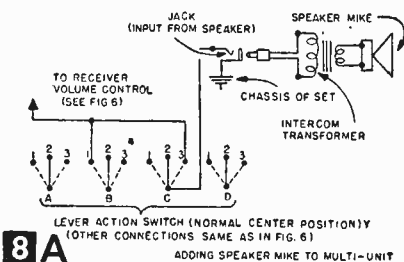
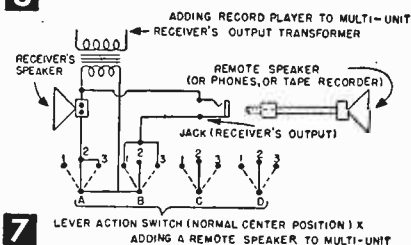
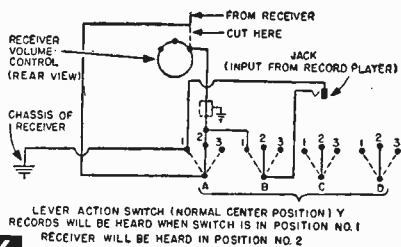
To attach a tape recorder to the Multi-Unit, use a convenient length of lamp cord. Attach a phone plug to each end of the cord and insert one plug into the jack used for the remote speaker, the other into the jack on the recorder marked "Radio." If hum is picked up with this connection, use shielded wire or reverse the line cord plug for the recorder.

#### Adding a Speaker Mike.

The use of a speaker mike operating via the remote speaker makes possible one-way communication into another room. A 5-in. PM speaker and an intercom transformer are used for the mike. Make the box to house them the same size as the one made for the remote speaker (3x7x7 in.), and of the same materials.

The voice coil of the speaker mike is connected to the voice coil side of the intercom transformer, the other side of which is connected through a 6-ft. length of lamp cord (or, if hum is too strong, through shielded wire) to a phone plug. Hum can also be eliminated by mounting intercom transformer behind front panel of Multi-Unit. (Using lamp cord, connect speaker mike voice coil to voice coil side of transformer through a jack, as in Fig. 8B. The transformer secondary is connected directly to chassis and to switch Y, common pole "C.")

A jack for the speaker mike plug is installed in the front panel of the Multi-Unit and connected (Fig. 8A) to the same input circuit used for the record player (see Fig. 6). The tip connection of the speaker mike jack is wired to the



common "C" pole of the record player lever action switch.

Connect the #3 terminal of section "C" to the #1 terminal of section "B." Now, with the speaker mike plugged in, the record player switch pushed down (its #3 position), and the receiver's volume turned up, you can talk over the set's speaker or over the remote speaker into another room. Volume, however, may not be high.

The advanced experimenter will have many other additions he will want to make to the Multi-Unit. If he tinkers with small radios requiring B-plus and 6.3 v. heater voltage, for instance, he may want to make these voltages available on the front panel of the unit. He can do this simply by tapping the potentials desired from the Multi-Unit's receiver and bringing them out to insulated binding posts on the front panel. Connecting in parallel to the filament or heater socket pins of a 6.3 v. tube in the receiver would provide the 6.3 potential, connecting to the B-plus side of the audio output transformer would provide a B-plus potential (on most older sets) somewhere around 250 v. Its exact value would be determined with a voltmeter and could be brought down to any value desired by means of a dropping resistor. B-minus would be brought out to the front panel by a connection to the set's chassis.

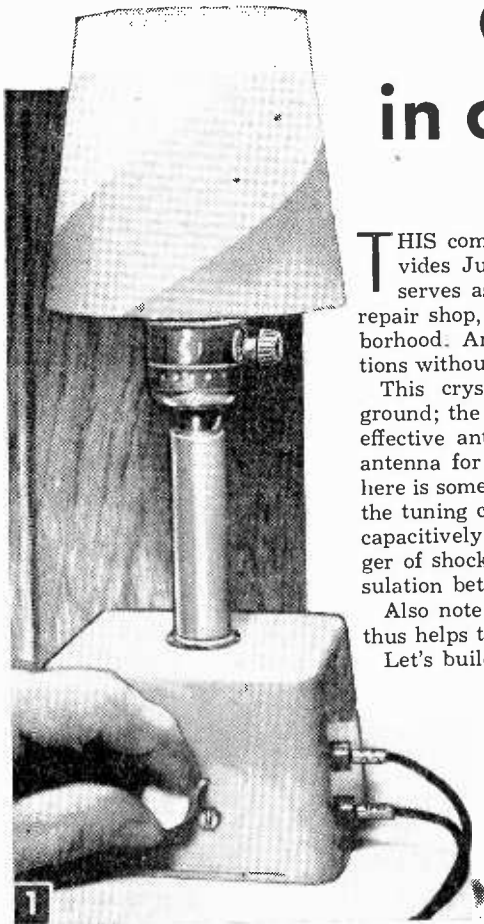
Another convenient facility the advanced experimenter may wish to add might be a speaker checker. A 10-terminal Jones series barrier terminal strip mounted on the Multi-Unit's front panel so that its lugs protruded back through the panel would form the basis of such a checker. Speaker leads from the unit's receiver would then be brought out in parallel, with appropriate jumpers (see Fig. 5), to the terminal strip. Tests could then be made on PM speakers or output transformers by connecting them to the appropriate terminals on the terminal strip.

Such are some of the many further, and advanced, additions which can be made to the Multi-Unit. Once he has the basic unit built, the experimenter will find many more himself; the applications to which such a unit can be put are limited only by its builder's ingenuity.

If you're tired of complaints from the rest of the family about your late-late radio listening, build this—

# CRYSTAL SET in a Bedside Lamp

By ARTHUR TRAUFFER



**T**HIS combination unit is not only useful as a lamp, but it provides Junior with a radio of his own. Being a crystal set, it serves as an emergency radio when your main radio is in the repair shop, or in the event of a power-line failure in your neighborhood. And it makes possible late evening listening to local stations without disturbing early-to-bed sleepy-heads.

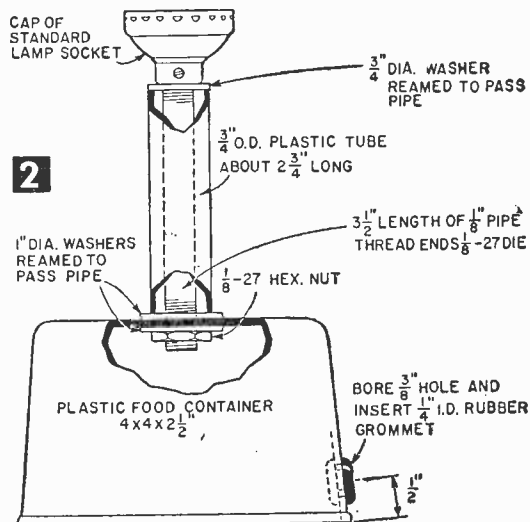
This crystal receiver requires no conventional antenna and ground; the same power-cord that feeds the lamp also serves as an effective antenna. Although the idea of using power lines as an antenna for a crystal set is not new, the coupling method shown here is somewhat unique. The lamp-cord is simply wrapped around the tuning coil to provide an antenna, coil which is inductively and capacitively coupled to the tuning coil. There is absolutely no danger of shock to the listener because there are several layers of insulation between the lamp-cord and the tuning coil.

Also note the tapped tuning coil which increases selectivity and thus helps to separate powerful local stations.

Let's build the lampstand first. Its base is a 4 x 4 in. by 2½ in. deep plastic food container (your super-markets, drug stores, or department stores will have one). The post of the lamp consists of a 2¾ in. length of ¾ in. O.D. plastic tubing, with a 3½ in. length of ⅜-pipe threaded both ends, passing through the plastic tubing to join the lamp socket, post, and base, securely together (Fig. 2). A rubber grommet with a ¼ in. opening is inserted into a ¾ in. hole drilled ½ in. from the edge of the box,

## MATERIALS LIST COMBINATION LAMP AND CRYSTAL SET

General Electric clamp-on type plastic lampshade  
Standard lamp socket with built-in rotary switch  
¾" O.D. plastic tube 2¾" long  
Plastic food container (2½" x 4" x 4")  
3½" length of ⅜-pipe (¾" O.D.) threaded both ends with ⅜-27 die. Hexagon nut to fit threads on ⅜-pipe  
One ¾" O.D. washer with hole reamed to pass ⅜-pipe  
Two 1" O.D. washers with holes reamed to pass ⅜-pipe  
Rubber grommet with ¼" inside-diameter hole  
10-ft. lightweight white plastic-insulated lamp-cord  
White plastic plug for lamp-cord  
Midget single-gang variable capacitor (11.2 to 381.4 mmf. Allied 61-009)  
100-ft. Belden No. 28 Cotenametal copper wire  
Hardwood tool handle 1⅜" diameter and 5" long for coil form  
Sylvania 1N34 germanium diode (or General Electric 1N51, or Raytheon CK705)  
Two tip jacks  
Small white pointer knob with set-screw and ¼" socket  
Two 1½" by 1½" by ½" brass angle-brackets  
Two steel rh wood screws ½" long (not brass)  
Six small lock-washers  
Five 6-32 rh machine-screws ¼" long  
Six small washers to fit 6-32 screws  
Few inches of hook-up wire, and few inches of spaghetti tubing  
One pair earphones, 2,000-ohms or more



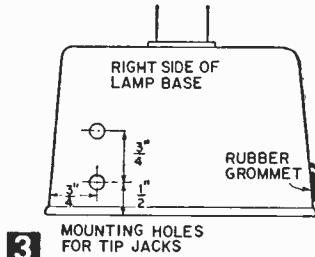
as shown. Before assembling the lampstand, you can "frost" the plastic tube and plastic container by rubbing them with Kitchen Kleenzer and a damp cloth. This takes the shine off the plastic and also removes any dirt or greasy deposits that might prevent the enamel from getting a good grip on the plastic surface. Now give the plastic post and base of the lamp a coat of good grade glossy pale-blue enamel to match the General-Electric blue plastic "clamp-on" lampshade which is used with this lamp, or color to match the shade you select. If you prefer, you can make the lamp base of  $\frac{3}{8}$  in. hardwood, but make the inside dimensions of the box the same as the plastic food container for a close fit.

Figs. 3 and 4 show locations for head-phone tip jacks and tuning-capacitor mounting holes. The capacitor mounting holes shown are for the 11.2 to 381.4 mmf. midget single-gang (Allied #61-009) used by the writer. If you use another make, locate these holes to fit it. For exact locations, it's a good plan to make a paper template off the condenser and then mark the plastic box off the template.

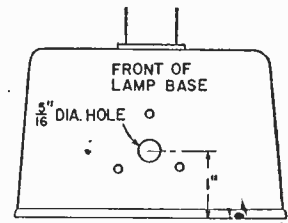
Fig. 5 shows the simple hook-up for the receiver, and Figs. 6 and 7 show how the parts are arranged inside the lamp base. The best procedure for installing and wiring the crystal receiver and lamp cord inside the lamp base is to first wind the tuning coil on a hardwood form. To make this form, cut a 2 $\frac{3}{8}$  in. length off a 1 $\frac{3}{8}$  in. diameter hardwood tool handle (sold at hardware stores) and give the wood form a couple of coats of shellac to moisture-proof it. On this form, wind 105 turns of #28 Belden Cotenamel wire, making a tap 30 turns from the right-hand end of the coil. Now give the coil a coat of shellac to moisture-proof it and to prevent it from unwinding. It's wise to give the ends of the coil a second coat of shellac. Let shellac dry.

Now mount the coil onto the rear of the tuning capacitor using two  $\frac{1}{2}$  x  $1\frac{1}{2}$  x  $1\frac{1}{2}$  in. brass angle-brackets (Fig. 6). To do this, you will have to thread two of the holes on the rear of the Allied 61-009 capacitor with a 6-32 tap for the two 6-32 rh mounting screws. Note also that the left-hand bracket is cut short on one side and drilled to pass a 6-32 screw. Now mount the coil onto the brackets with two  $\frac{1}{2}$  in. long steel rh wood screws (brass screws might twist in two when driven into the hardwood coil form). Two lock-washers on each end of the form keep it from turning on the brackets.

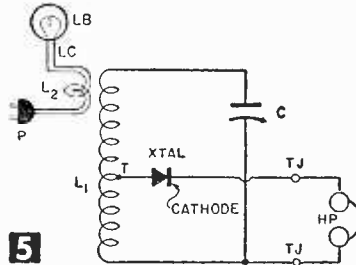
Pass the lamp-cord through the rubber grommet on the back of the lamp base, and wind a



3 MOUNTING HOLES FOR TIP JACKS

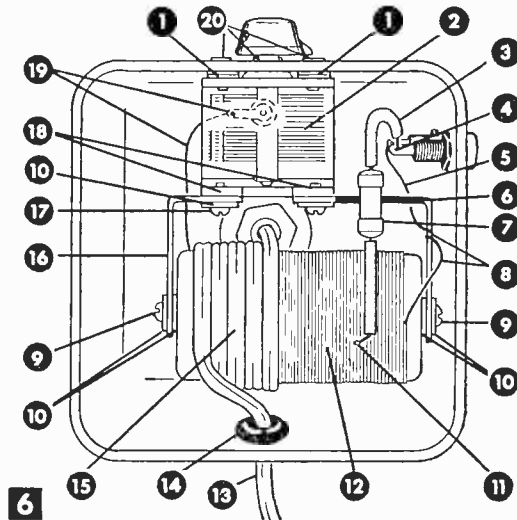


4 MOUNTING HOLES FOR MIDGET VARIABLE CAPACITOR



5

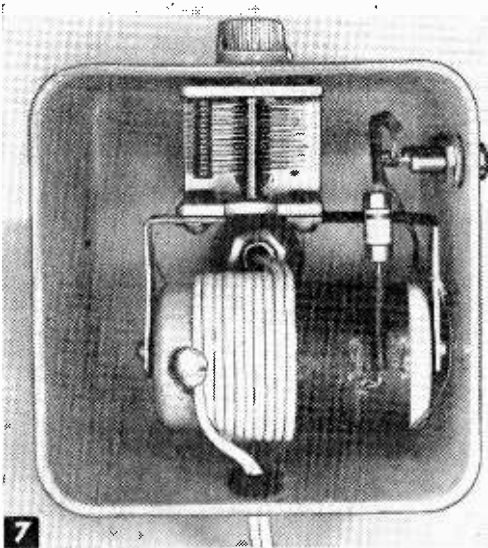
(C) Midget single-gang variable condenser 381.4-mmf. (Allied 61-009). (L1) Tuning coil, 105-turns No. 28 Belden Cotenamel on  $1\frac{3}{8}$  in. dia. wood form. (L2) Antenna coil, 2 to 5 turns of lamp-cord around L1 (see text). (T) Tap, 30-turns from end of L1 (see text). (XTAL) 1N34 germanium crystal diode. (TJ, TJ) Tip jacks for phones. (HP) Headphones, 2000-ohms or more. (LB) Lamp bulb and socket. (LC) Lamp-cord. Light-weight plastic-covered "zip cord." (P) Plug for wall outlet.



6

(1) Four washers. (2) Midget single-gang variable condenser, 381.4 mmf. Allied 61-009. (3) Spaghetti tubing on both leads of diode. (4) Cathode of diode connects to lower tip jack. (5) Lead from bracket to upper tip jack. (6) Tape on bracket. Prevents diode from shorting against bracket. (7) Germanium diode. (8) End of L1 soldered to bracket. (9) R.H. wood screws  $\frac{1}{2}$  in. long. (10) Lock-washers. (11) Tap, 30-turns from end of L1. (12) L1, 105-turns #28 Belden Cotenamel on  $1\frac{3}{8}$  by 2 $\frac{3}{8}$  in. round hardwood form. (13) Lamp-cord. (14) Rubber grommet. (15) L2, 2 to 5-turns of lamp-cord wound around end of L1. (16)  $1\frac{1}{2}$  x  $\frac{3}{4}$  x  $\frac{1}{2}$  in. brass angle-bracket. (17) R.H. 6-32 machine screw. (18) Holes threaded with 6-32 tap. (19) End of L1 connects to stator lug on bottom of condenser. (20) Round-heads on 6-32 screws filed flat.

few turns of the lamp-cord around the left-hand end of the tuning coil (Fig. 6). The number of turns of lamp-cord around the tuning coil will depend on the degree of sensitivity and selectivity required in your location. Few turns result in increased selectivity and lowered sensitivity, while a greater number of turns results in increased sensitivity but reduced selectivity. In my case, 3 or 4 turns did the trick, and that should be about right for most locations. To keep the turns from unwinding, coat the coil with plas-



tic cement and allow it to dry thoroughly. A thumbtack holds the left-hand end of the coil securely while the cement is drying, but you'll have to hold the other end of the coil by hand, or some other means, until the cement sets.

Referring to Fig. 6, note that the condenser-coil-assembly is mounted into the lamp base with three short 6-32 *rh* machine-screws, which have the heads filed flat so that the tuning knob can set close to the base without rubbing on the screw heads. There are two washers between the capacitor and the inside of the lamp base, on each of the three mounting screws. These washers fill the space so that the plastic will not bend too much when the screws are tightened. The right-hand end of the lamp cord antenna coil is slipped into the post of the lampstand at the same time that the coil-condenser-assembly is slipped into position in the base. Before installing the assembly into the lamp base, be sure to make the connection from the left-hand end of the tuning coil to the stator lug on the bottom of the capacitor. You cannot reach it later!

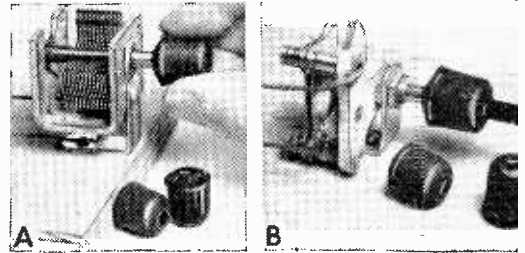
The next step is to connect the lamp cord to the terminals in the lamp socket. Solder the right-hand lead of the tuning coil directly to the right-hand angle-bracket, and from there to the upper tip jack on the right-hand side of the lamp base. Slip spaghetti tubing over both leads of the germanium diode, and solder the cathode lead of the diode to the lower tip jack. The wiring is completed by soldering the remaining lead of the diode to the 30-turn tap on the tuning coil. Remember that the purpose of this tap is to increase selectivity. If selectivity is not a problem in your area, you can increase sensitivity somewhat, especially at the low-frequency end of the band, by putting the tap in the center of the coil, or by connecting the diode directly to the stator lug on the tuning capacitor which is the same as connecting it to L.H. lead on the tuning coil.

If you enjoy fishing for more distant stations on cool evenings after the local stations have signed off, you can increase the sensitivity of this crystal radio by connecting a wire from the upper tip jack or phone tip, to a bed spring or other large metal object. Do *not* make a connection to a water pipe, or gas pipe, unless you make the connection through a good 600-volt fixed capacitor; and then the capacitor should be connected at the water pipe end of the wire.

The writer has used this lamp-radio as a crystal tuner, for local stations, by connecting the tip jacks directly into the *Phono* jack in a console model super-het receiver. In this case, the crystal diode jack goes to the "grid" in the phono jack, and the upper jack goes to the *Gnd* side of the phono jack. Shielded phono-cable should be used when making the connections to reduce hum pick-up. When using this crystal receiver as a *Hi-Fi* tuner, the lamp-cord on the crystal receiver should not be plugged into a wall outlet. The lamp-cord itself acts as the antenna for the crystal tuner.

### Fuller Balls Used in Radio Work

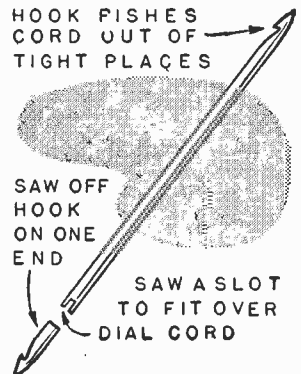
• Rubber "Fuller balls," available in several sizes from the hardware or plumbing shop, can be used as knobs (A) for the shafts of variable capacitors, volume controls, rotary switches, etc. They



will also serve as insulated shaft-couplings into which extension shafts of variable capacitors (B) can be set at a slight angle if necessary. Just slip them on the shafts.—ARTHUR TRAUFFER.

### Dial-Cord Tools

• When installing radio dial-cords, use plastic crochet hooks for getting into difficult places. Remove the hook on one end and saw a slot, as shown. The slot fits over the cord so the cord can be moved around. Heat and bend ends of the plastic rod to angle needed.—A. TRAUFFER.



# Portable SUPERHET

This 3-tube, superhet, battery receiver is ideal for your camping, biking or boating trips this summer

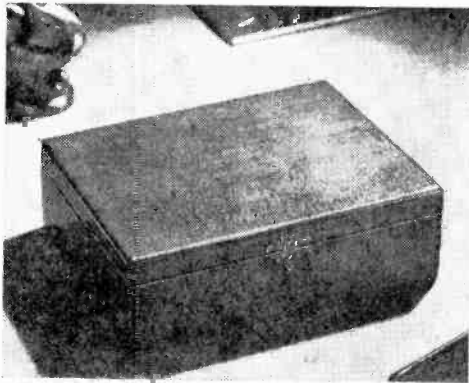
By MILO A. ADLER

**C**OMPACT and entirely self contained, this 3-tube receiver will even fit in a picnic lunch basket. Its performance is equal to that obtained from the average 5-tube table top radio. Since it is battery operated no rectifier tube (found in most table top models) is required, and the use of headphones eliminates the need for a power amplifier tube. Only the tubes needed for maximum sensitivity and selectivity are used. By eliminating the power tube, B battery drain is reduced from 12 ma. to about 3 ma. (milliamperes) and A battery drain from 250 ma. to 150 ma. This reduced battery drain greatly increases battery life and keeps cost of operation very low.

The receiver is built into a wooden cigar box which may be obtained from your corner cigar store. The box used here was a "Corina Larks" box with metal hinges and a catch to keep the cover closed. First remove printing stamped on the box by sanding until letters can no longer be seen. Next with a clean damp cloth, moisten outside of box



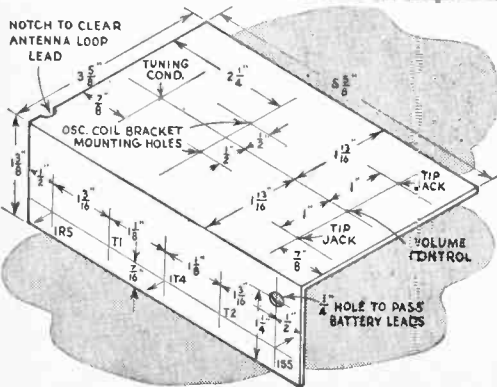
Tuning in the finished receiver.



Cigar box finished and ready for the receiver to be mounted in it.

and allow it to dry thoroughly. Then sand box smooth and moisten again. After drying, give box a final, thorough sanding, and then apply two coats of shellac, rubbing with fine steel wool after applying each coat. A final coat of paste wax will put a glossy surface on the box. Form the chassis from a 1/16 in. aluminum sheet, the surface of which is rubbed lightly with fine steel wool to produce a satin finish.

Tube sockets require a round 5/8 in. mounting hole and the I. F. transformers require square 5/8 in. holes which are notched in the corners to clear insulating studs protruding from transformers. The volume control requires a 3/8 in. mounting hole. Make hole for variable condenser large enough to allow condenser to mount flush on back of panel. For simplicity only the centers for various mounting holes are shown on chassis layout. Arrows pointing from centers for tube sockets indicate direction blank section on tube socket should point. When mounting I. F. transformers, rotate them so that



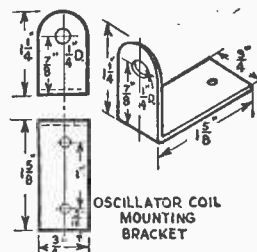
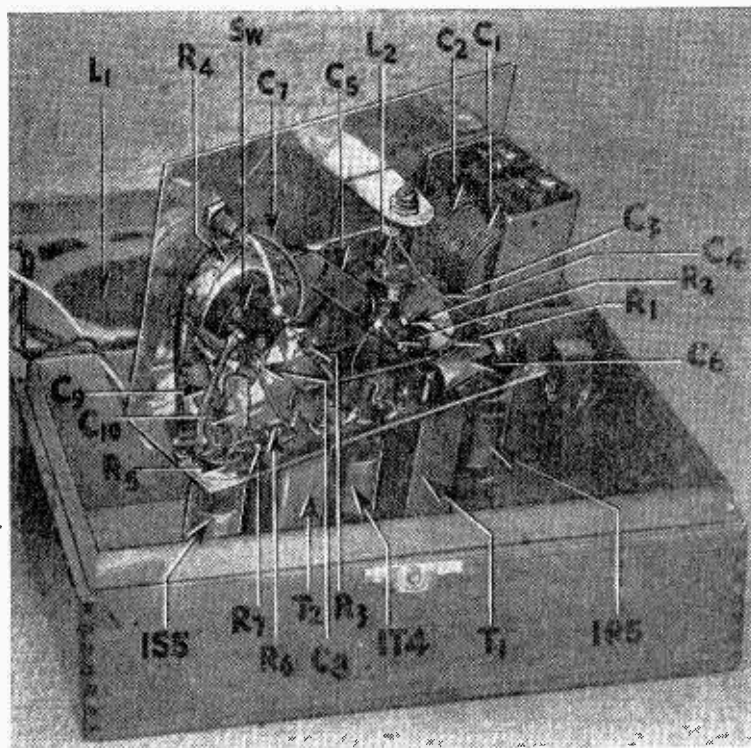


when terminals are bent they will almost reach correct terminals on tube sockets. Colors shown on schematic diagram are standard RMA color codes which identify 4 terminals of the I.F. transformers.

You can use any type standard loop antenna but loop should be small enough to fit into 5%

x6¼ in. cover of cigar box which has inside dimensions of 5⅞x6¼ in. You may obtain a new loop from a radio supply house or use the loop from a discarded radio receiver. One of the miniature loops now on the market may be used if desired. However, due to their extremely small size they do not have as much

signal pickup which will reduce the sensitivity of the completed receiver. The loop is mounted by cementing it to the inside of the box lid. Connections to loop may be made to tubular rivets mounted in the paper frame of the loop before cementing it in place.



At left, underneath view of receiver, showing wiring of components. Identify parts by referring to schematic diagram. Note wooden block in right hand corner on which receiver chassis rests. A similar block is cemented in front right hand corner.

**MATERIALS LIST—PORTABLE SUPERHET**

- C<sub>1</sub>-C<sub>2</sub> 2 gang cut plate variable condenser with trimmers (Allied Radio 61-008)
- C<sub>3</sub>—.00005 mfd. mica condenser
- C<sub>4</sub>-C<sub>6</sub>—.02 mfd. 400 volt condenser
- C<sub>7</sub>—.1 mfd. 200 volt miniature condenser
- C<sub>8</sub>—.0001 mfd. mica condenser
- C<sub>9</sub>—.005 mfd. 200 volt miniature condenser
- C<sub>10</sub>—.03 mfd. 150 volt miniature condenser
- C<sub>10</sub>—.01 mfd. 200 volt miniature condenser
- R<sub>1</sub>—100,000 ohms ½ watt resistor
- R<sub>2</sub>—10,000 ohms ½ watt resistor
- R<sub>3</sub>—3.3 megohm ½ watt resistor
- R<sub>4</sub>—1 megohm control (Mallory MR-53)
- R<sub>5</sub>—10 megohm ½ watt resistor
- R<sub>6</sub>—4.7 megohm ½ watt resistor
- R<sub>7</sub>—1 megohm ½ watt resistor
- L<sub>1</sub>—Loop Antenna
- L<sub>2</sub>—Meissner 14-1040 Universal Oscillator Coil
- T<sub>1</sub>-T<sub>2</sub>—Meissner 16-6758 Midget I.F. Transformers
- Sw.—DPST Switch mounted on R<sub>4</sub> (Mallory M27)
- Misc.—3 amphenol type 147-500 miniature 7 prong sockets  
2 phone tip jacks; hardware; wire; solder  
1 1R5 tube; 1 1T4 tube; 1 1S5 tube

Now for the receiver wiring. Oscillator coil is a universal type with an adjustable iron core which may be adjusted to match any type of cut plate tuning condenser. Terminal numbers on oscillator coil in schematic diagram may be determined by chart furnished with oscillator coil (see diagram). Condenser listed in parts list is recommended because of its small physical size.

Wire the filament circuit first. Next connect blue and green leads of I.F. transformers to correct terminals on tube sockets. By carefully bending terminals you can make them almost touch one another so that only a short connecting wire need be used. If these wires are longer than about ¼ in., either or both tube sockets and I.F. transformers have been mounted incorrectly.

All ground terminals are connected to soldering lugs on chassis; these, in turn, are wired together. Connecting grounds together in this manner keeps resistance in ground circuit at a minimum and assures maximum performance from the receiver. One phone tip jack is not insulated from chassis and the ground connections are made to this jack. Another solder lug is

mounted under one of the nuts holding oscillator coil bracket. A jumbo-type solder lug is slipped over mounting stud of oscillator coil before this coil is mounted in its bracket. One ground is made by soldering a wire on frame of tuning condenser. The round metal tube protruding from the bottom center of the tube sockets acts as a shield between the terminals and should also be grounded.

Make connections to B battery using snap-on connectors which may be obtained from any radio supply house. Solder the three A batteries together with a heavy copper wire which will hold them in place. Flexible leads from this heavy wire connect the batteries to the set.

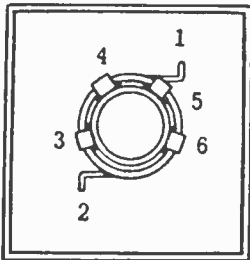
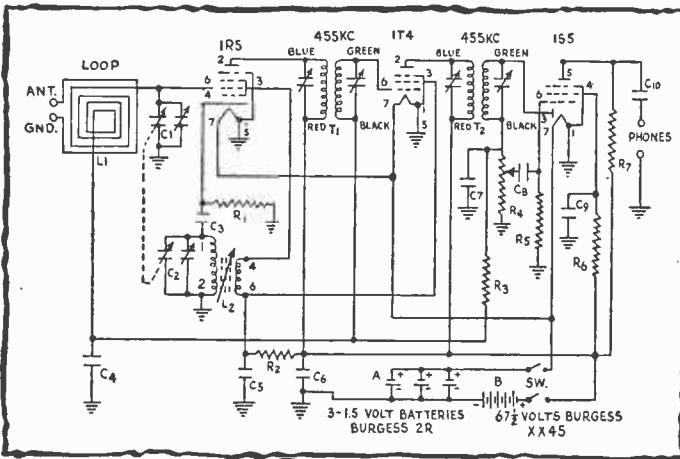
The receiver switch and tuning knobs must be extremely thin to allow lid of box to close. The large tuning knob was made from a piece of 1/4 in. tempered Masonite. The excess shaft cut from

the control was mounted in an electric drill and the Masonite blank for the knob was fastened to it. Knob was then "turned down" using the point of a sharp knife, and then hollowed out in back to clear heads of the three binder-head, 3/32x1/4 in. machine screws mounting the tuning condenser. Knob for volume control is made from a 1 in. plastic knob which is also "turned down" to reduce the knob thickness.

After the set has been completely wired and loop and batteries connected, it is ready for adjustment. Turn the set on and, with core of oscillator screwed completely in, turn tuning condenser until you hear a station. Then adjust I.F. transformer trimmers for maximum volume. These factory set transformers require little adjustment. If a signal generator is available, align I.F. transformers at 455 kilocycles. Next rotate tuning condenser until it is approximately 10 to

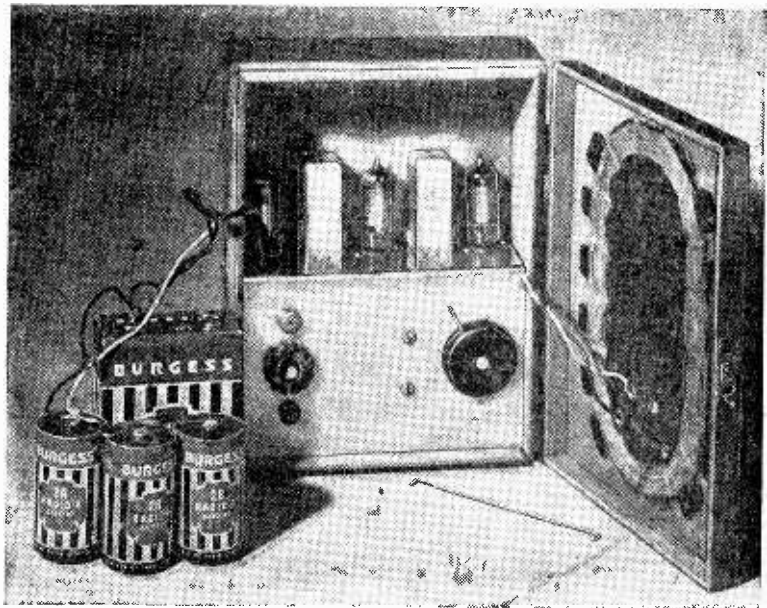
15° from the fully closed position. Now adjust oscillator coil core until local station nearest to 550 kilocycles can be heard.

Next rotate tuning condenser until local station at extreme high end of the band can be heard. Rotate tuning condenser until station can just be heard and then adjust padder condensers on oscillator or cut-plate section until station is received at maximum volume. If there has been an increase in volume repeat the above step until station is received with maximum volume. If the above steps reduce the volume, rotate tuning



Universal oscillator installation data. Note space between lugs 3 and 6.

At right, completely wired chassis is shown in place in cigar box with batteries removed to show tube arrangement. Cigar box lid is propped open with a wire bent at each end and inserted into brad holes drilled in lid and box side.

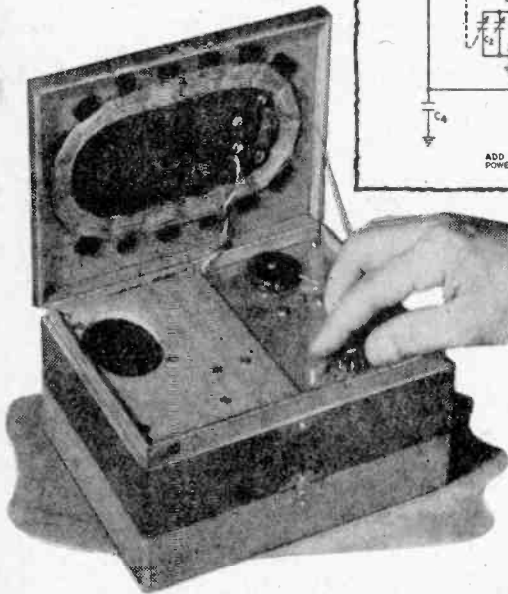
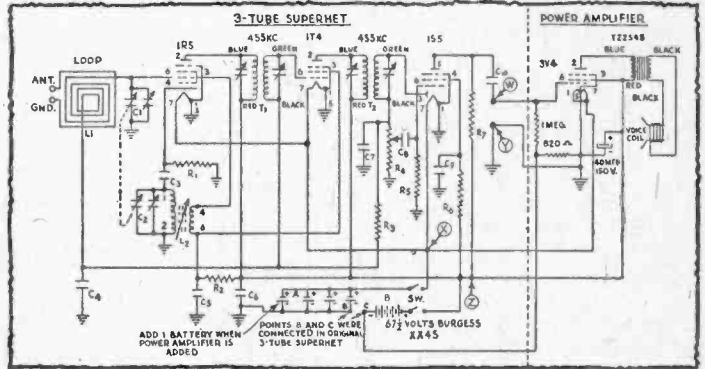


condenser in the opposite direction. Next adjust trimmers on large R.F. section of variable condenser for maximum volume. Then readjust core of oscillator coil as previously described and lock core in position. Then readjust oscillator and R. F. trimmers in the same manner as before.

Use headphones with a 2000 ohm or higher impedance. Loudest volume will be obtained from the phones with the highest impedance. If desired a paper dial may be mounted on the panel and the stations marked on the dial. However stations may be located without dial.

### Loudspeaker for Your Superhet

Here's a method of converting your 3-tube superhet, battery operated receiver into a portable loudspeaker set for less than \$6. To make this conversion you add to the original battery receiver (See Fig. 5 and schematic) a power amplifier stage and speaker for loudspeaker perform-



ance and increased sensitivity.

First secure another Corina Larks cigar box like the one which houses the original set. Remove the markings from the box as described in the preceding battery set article (Portable Superhet). Next pry off hinges and catch. Then cut bottom half of box down so that inside depth is 1 3/8 in. and sand edges smooth. Place box for the original 3-tube superhet on top of cut-down box, which is then marked and sanded so the two boxes match when fitted together. After fitting the two boxes, install hinges and catch so cut-down box is fastened to bottom of original box with both pairs of hinges and catches in line. Then finish bottom half of box to match top part. Start construction of power amplifier stage

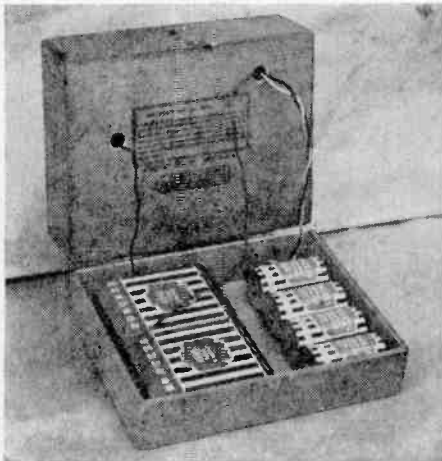


Fig. 1. Battery compartment showing extra 67 1/2 volt "B" battery and parallel connection of four 1 1/2 volt "A" batteries. Note holes for passing leads and space for extra batteries.

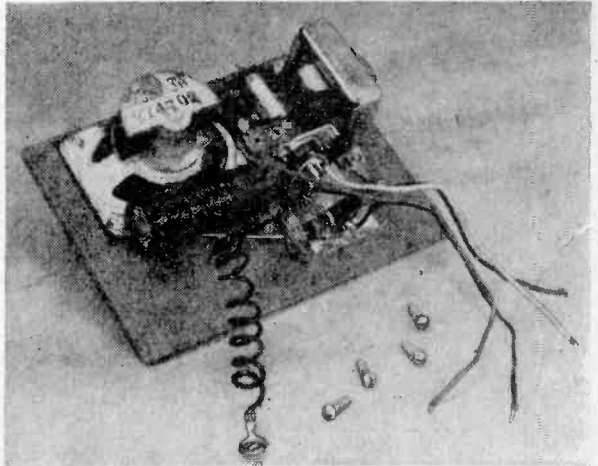
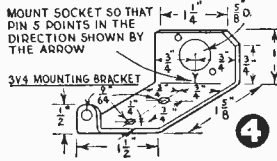
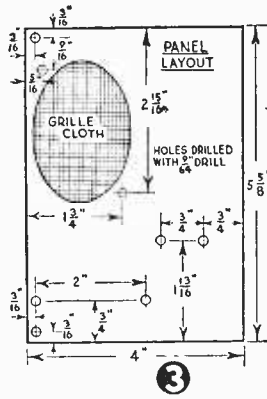


Fig. 2. Bottom view of power amplifier showing all new parts. The four wires are for connecting to points W, X, Y and Z. The coiled lead shown in the foreground is the negative lead for the 67 1/2 volt battery.

by making the front panel from the top of the dismantled box. Although dimensions in Fig. 4 are correct for items in the parts list, to insure proper clearance, check mounting position of each part as it is mounted. Install grille cloth or screen on front of speaker when it is mounted.

In wiring power amplifier make all leads as short and direct as possible and solder all connections carefully. Next remove all



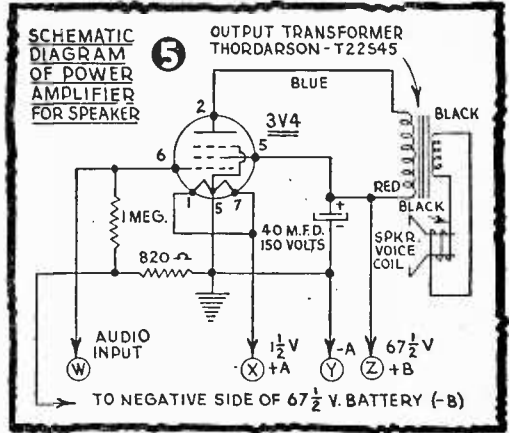
**PARTS LIST—SUPERHET LOUDSPEAKER CONVERSION**

- 1—2 x 3 in. oval type speaker (RCA type 423S1)
- 1—820 ohm 1/2 watt resistor
- 1—1 megohm 1/2 watt resistor
- 1—40 mfd. 150 v. elec. cond.
- 1—Thordarson T22S45 output trans.
- 1—3V4 Tube
- 1—7 prong miniature socket
- 2—Single insulated tie lugs
- 2—Solder lugs
- 3—6.32 x 3/8" machine screws
- 7—6.32 x 1/4" hex nuts
- 1—Corina Larks cigar box
- 1—3 1/8 x 1 1/2 x 1/8" piece of aluminum

battery leads from the original 3-tube receiver. Then pass 4 wires from power amplifier for connecting to points W, X, Y, Z through hole in chassis formerly occupied by battery leads. Connect proper wire to point W, the phone tip jack, which is not grounded. Point X is A+ which is the side of the switch connected to pin 7 of the 1S5 tube socket. Point Y is the phone tip jack, which is grounded. Point Z is B+ which is the side of switch connecting to +B terminal on output I.F. transformer.

Reconnect battery leads for A+, A-, and B+ as they were connected in the original set. The B- battery lead comes from power amplifier. Then pass battery leads through the two 1/2 in. holes drilled in bottom of box. Secure receiver and power amplifier in the case with No. 6 screws in the small blocks glued in all 4 corners. Drill two 3/4 in. holes for passing these screws in receiver panel. (Screws were not needed in headphone model since batteries held receiver in place.)

Connect loop antenna leads and battery leads and turn on receiver, which should play immediately without any adjustments. If it doesn't



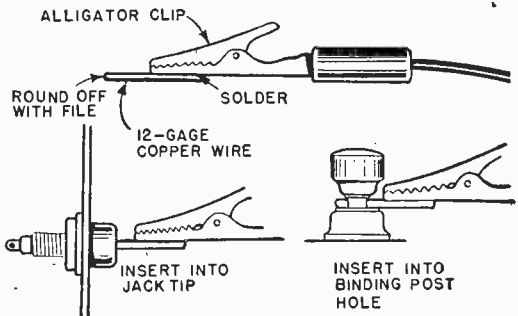
play, check all connections and be sure there are no short circuits. One of the I.F. transformer cans may be shorting a terminal in the power amplifier.

Since adding power amplifier stage increases battery drain, use at least 4 A batteries. Although only one 67 1/2 volt battery is needed, for maximum battery life 2 of these batteries can be connected in parallel. There is also more than enough room in the battery compartment for more than 4 A batteries. Movement of batteries within battery compartment can be prevented by stuffing with newspaper or any similar packing.

Output transformer used was selected to provide proper match for the tube and 11.75 ohm voice coil of the 423S1 RCA replacement speaker. If any other type of speaker is used select an output transformer with a 10,000 ohm primary and secondary to match the speaker used.

**Versatile Alligator Clips**

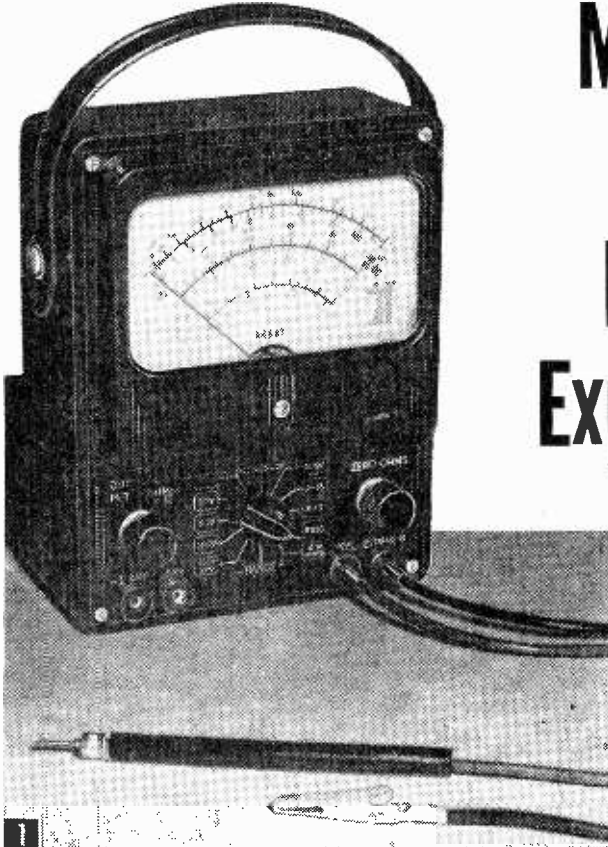
- You can increase the usefulness of your alligator clips by simply soldering 1 in. lengths of 12-gage copper wire to the back of one jaw of the



clips. Besides using the clips to snap on connections you can use them as test-prods, plug them into phone-tip jacks, or insert them into the holes in binding posts with non-removable screw-tops. —ARTHUR TRAUFFER.

This compact instrument checks *a-c* and *d-c* voltage, *a-c* and *d-c* current, resistance, output voltage and decibels

# Multi-Meter for Electronic Experimenters



This ultra-compact, versatile tester will ferret out those elusive electronic and electrical circuit "bugs." Its case measures (roughly) only 2 1/4 x 5 1/4 x 6 3/4 in.

**H**OUSED in a small case, but fitted with a giant 4 1/2-in. rectangular movement for easy reading, this multi-meter does for the electronic experimenter what a compass and sextant do for the mariner: It tells him, figuratively, where he is in a circuit—and what he's got. The meter movement is a remarkably well constructed imported unit. A "dampened" D'Arsonval movement (the moving coil type of meter movement that rides on jeweled bearings between the poles of a permanent magnet) produces a slow needle movement, without jump or jiggle, when voltage is applied.

This instrument does have one limitation: Its three resistance measurement ranges favor lower ohms readings, under 100,000 ohms. However, most resistance values come within this limit, especially those used in transistor circuits. And on Low Ohms, the Multi-Meter will actually measure the resistance of a piece of coathanger wire.

All parts (see Materials List), except the

movement itself, are available at local electronics suppliers. You'll have to send for the movement. A kit, with all components included, can also be obtained from most independent suppliers throughout the country. Arkay, Inc., 120 Cedar St., New York 6, N. Y., the supplier of the meter movement, will furnish the name of dealer in your locality.

To construct the Multi-Meter, drill and punch a standard 1/8x5x6 1/2 in. blank panel as in Fig. 2. Mount and wire circuit components as in Figs. 3 and 4. Mount the Range Switch so that its long, center-ring contacting lug (with wiper) is in exactly the Pole A position shown in Fig. 3. Note that lugs on the

top side of wafer (A-positions) alternate with lugs on the bottom side (B-positions). The switch lugs used, are labeled; the unlabeled lugs are left unconnected. Note also that two #8 soldering lugs are secured to the lower righthand meter screw. One of these serves as a miniature angle bracket for securing the meter rectifier, while the other serves as a tie-point for the yellow rectifier lead and the pigtail lead of the 540 ohm resistor.

A single 1 1/2 volt Penlite cell secured by a cartridge fuse clip for 220 v., 10 amp. industrial fuses, powers the Multi-Meter. To permit this cell to slip into the fuse clip, bend off the fuse retainer tabs found on one end of the clip. The clip is mounted on the panel with a 4-40x1/4 in. fh machine screw, countersunk so as not to interfere with mounting of the meter. The carrying strap on the meter case can be of vinyl plastic or leather. The vinyl strap shown in Fig. 1 is quite rigid and can be used as an easel support so that readings may be taken with the unit in

a slanting position. (The operating instructions which follow should be saved.)

**Operating Instructions**

For d-c voltage measurements: 1) Set the three-position Function Switch to "DC Ohms"; 2) rotate Range Switch to a voltage somewhat higher than you expect to measure and insert red test lead in red jack marked "Pos." (Positive). Insert black test lead in black jack marked "Common." Attach alligator clip on black lead to ground or negative side of circuit and establish positive contact with probe on red lead. If meter needle does not deflect sufficiently, back down to the next lower position on Range Switch. *Always start with a high voltage range, and work down until correct scale is obtained.* Excessive voltage on a low range may seriously damage meter. 3) When measuring voltages between 500 and 5000 volts, insert red test lead in red jack marked "5KV." (Black lead remains in "Common" jack.) Use extreme caution when measuring high voltages. Attach alligator clip with power off apparatus under test, and, of course, hold probe by plastic handle only. Stand on dry wood or rubber/plastic floor during high-voltage tests—never earth, steel, or concrete. Turn on power, take reading, then shut off power before touching or removing test clip, or probe.

All d-c voltages are read on the two black meter scales marked 0-100 and 0-50 DC. When using the 50 or 100 volt ranges, the reading is taken directly off the meter dial. To obtain a reading on the 0-1 volt range, divide the voltage shown on the 100 scale by 100. For the 0-10 volt range, divide reading on 100 volt scale by 10. To read 0-500 volts, read the 50 scale and multiply by 10. To read 0-5000 insert red test lead in red "5KV" jack, read needle deflection on 50 scale and multiply by 100.

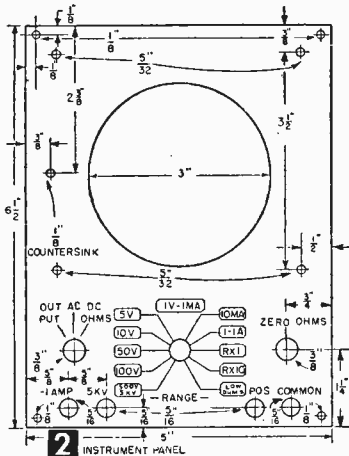
For a-c voltage measurements: 1) Set the Function Switch to center position ("AC"); and 2) proceed as when measuring d-c except that readings are taken off the red AC 0-50 and 0-100 scales. This applies to all voltages except those in the 0-1 v. range. Read 0-1 volts on the third red scale marked 0-10 which is calibrated in tenths of a volt. For instance, if needle swings to 8, this indicates  $\frac{8}{10}$  of a volt.

For d-c current measurements: 1) Set Function Switch in "DC Ohms" position and insert test leads in "Pos." and "Common" jacks. 2) Open one side of the circuit under test and insert test leads in series with this side. Use higher range first and work back to protect instrument from damage. Do not turn on power until correct range has been selected. 3) To read milliamperes, use the 0-100 DC scale for all ranges. For current measurements between

**MATERIALS LIST—MULTI-METER**

No.	Description
1	4 1/2" Arkay rectangular meter movement; 400µa, 60 mv. with multi-range scale (Arkay, Inc., 120 Cedar St., New York 6, N. Y.)
1	1/8 x 5 x 6 1/2" bakelite panel
1	2 5/16 x 5 5/32 x 6 13/16" O.D. molded bakelite meter case, (Dakaware or Waldm)
1	2-pole, 11-position switch (Centralab phenolic non-shorting #PA-1005)
1	2-pole, 3-position switch (Mallory non-shorting #3223-J)
1	600 ohm midget potentiometer (Centralab)
1	meter rectifier (Conant #160-BHS or Bradley #CX2E4U)
1	1 1/4" bar-pointer knob (Dakaware)
1	1 1/16" round knurled knob
1	1 1/16" round knurled pointer knob
2	red phone tip jacks (ICA)
2	black phone tip jacks (ICA)
pr	test leads with clip and probe
1	0.1 mfd. 400 v.w. paper capacitor
1	1/8 x 3/4 x 12" vinyl plastic carrying strap
2	10-24 x 3/4" rh screws with nuts (for attaching handle)
2	#10 brass eyelets
2	#10 flat washers
2	#10 lock washers
4	4-40 x 1/4" rh machine screws (for mounting panel)
4	4-40 x 1/4" fh machine screw with nut
1	1/2" cartridge fuse clip
2	#8 soldering lugs
2	2-56 nuts (for mounting rectifier)
1	Penlite battery (1 1/2v., size AA)
	hook-up wire and radio solder
	Resistors
1	4.3 megohm IRC Type BTB-2; 5% filament carbon (2 watts)
1	0.39 megohm (390K) Type BTS-1/2; 5% filament carbon
1	51K (51,000) Type BTS-1/2; 5% filament carbon
1	39K (39,000) Type BTS-1/2; 5% filament carbon
1	1200 ohm Type BTS-1/2; 5% filament carbon
1	5100 ohm Type BTS-1/2; 5% filament carbon
1	3900 ohm Type BTS-1/2; 5% filament carbon
1	*940 ohm Type BTS-1/2; 5% filament carbon
1	*540 ohm Type BW-1/2; 5% wire-wound
1	100 ohm Type BW-1/2; 5% wire-wound
1	*111.1 ohm IRC Type BW-1/2; 5% wire-wound
1	*9.09 ohm Type BW-1/2; 5% wire-wound
1	*1.01 ohm Type BW-1/2; 5% wire-wound

\*Specially selected values supplied by kit manufacturer. Two standard values can be wired in series to obtain special values. For example, 110 ohms plus 1.1 ohm unit equals 111.1 ohms



0-1 ma., set Range Switch to "1V-1MA" position and divide reading by 100. To read 0-10 ma., set Range Switch to "10MA" and divide reading by 10. To read 0-100 ma., turn Range Switch to ".1-1 AMP" and read directly. To read 0-1 ampere (1000 ma.) move black test lead from "Common" to "-1 AMP" jack. Read scale directly for hundredths of an ampere, or multiply by 10 for milliamps. 4) If meter needle deflects in reverse, switch test leads in jacks.

For a-c current measurements: 1) Set Function Switch to center "AC" position; use Range Switch as when measuring

d-c. 2) To read 0-1 ma., use the 0-100 red scale which is calibrated in fractional milliampere. Each major division on this scale is 1/10 ma. 3) For all other ranges, read red scale correctly positioned, 0-10 ma. is read directly; for 0-100 ma. multiply by 10; for 0-1 ampere,

multiply by 100 with black test lead in “-1 AMP” jack.

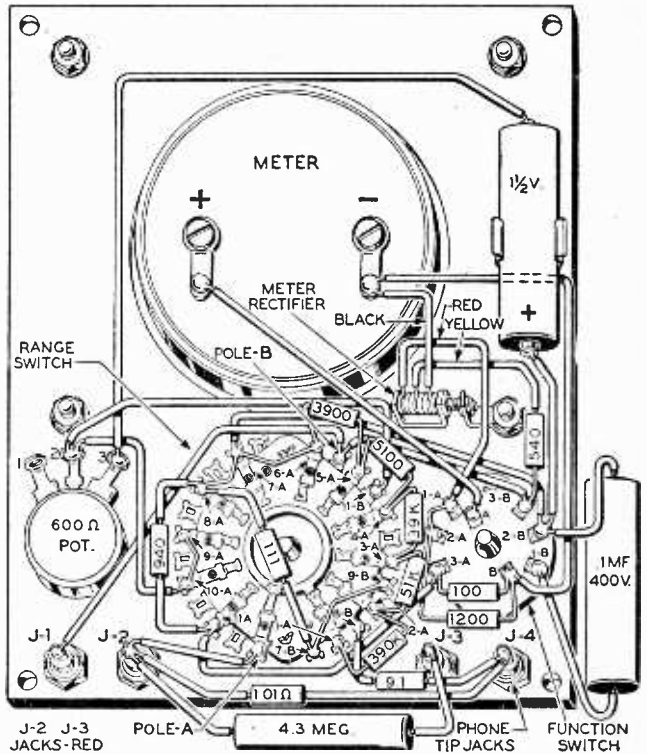
For resistance measurements: 1) Set Function Switch to “DC Ohms” position; 2) insert test leads in “Pos.” and “Common” jacks. 3) To measure resistance from 0-1000 ohms, set Range Switch to “Low Ohms,” causing needle to swing part-way across the dial, then turn “Zero Ohms” adjustment knob until needle reads full scale. When test leads are attached to unknown value, needle will back down the scale and indicate the resistance. Read “LO” scale. 4) To measure resistance from 0-10,000 ohms set Range Switch to “Rx1.” Short the test leads and adjust “Zero Ohms” knob for full-scale deflection of needle. Place test leads across unknown value and read resistance directly of “HI” scale in ohms. 5) To measure resistance from 0-100K ohms, set Range Switch to “Rx10.” With test leads shorted, readjust “Zero Ohms” knob for full-scale needle deflection. Place unknown resistance across test leads and read “HI” scale. Multiply value indicated by 10.

Always disconnect one side of resistance if it is wired in a circuit. Never make resistance measurements with power turned on in equipment. Discharge electrolytic capacitors by short circuiting with piece of wire.

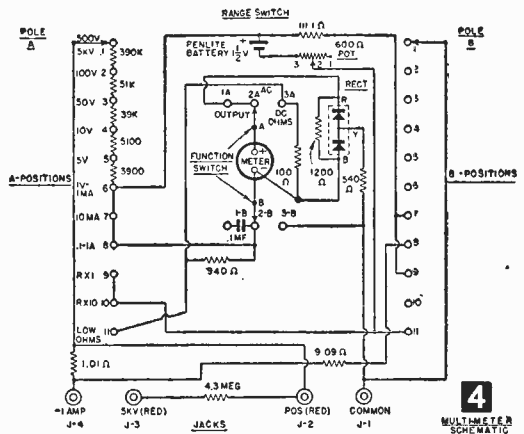
Voltage to operate ohmmeter ranges is provided by battery. When the meter needle can no longer be adjusted for full scale deflection, replace battery. To prolong battery life, do not leave instrument connected any longer than required to make the resistance measurement. When meter is not in use, set Range Switch at the “1V-1MA” position.

For output voltage measurements: 1) Set Function Switch to “Output” position; 2) follow same procedure as given above for measuring a-c voltages except that when measuring audio output of a radio or amplifier, note that: 3) because capacitive reactance increases as the frequency decreases, the 0-1 mf. blocking capacitor in the Multi-Meter’s input circuit will affect the voltage reading indicated on the meter scale. For example, at 600 cps the impedance of the capacitor results in the output voltage actually being 15% lower than that indicated on the meter. At 1000 cps the error will be down to 4%. On low frequencies such as 60 cps, the true voltage would be 10 times the value indicated on the meter. 4) Do not measure d-c voltages over 400 in the “Output” range unless a 0.1 mf. capacitor rated at 1000 v. is used.

For decibel measurements: 1) Set up switches the same as for output voltages. Readings are taken from the “DB” scale. 2) The correct db



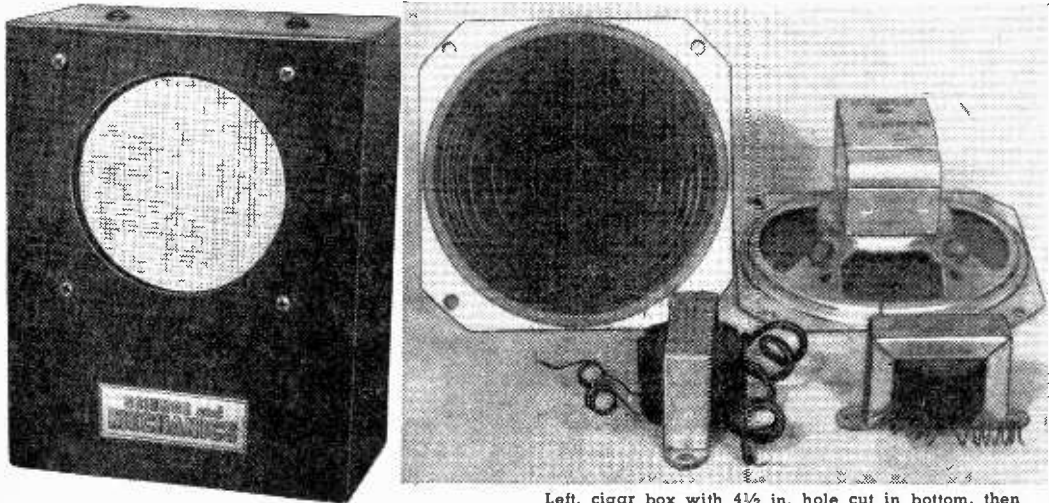
3 MULTI-METER PICTORIAL



value is determined by consulting the table in the lower righthand corner of the meter, thus:

AC VOLTS	ADD DB
5	0
10	6
50	20
100	26
500	40
5000	60

For example, if Range Switch is set at 100 volts and meter indicates +2 db the actual reading is 28 db (26+2). In the 10 v. range, a meter reading of -8 db would be -8+6, or actually, -2 db.—T. A. B.



Left, cigar box with 4½ in. hole cut in bottom, then covered with leatherette, makes neat cabinet. Above, pair of 4 in. PM speakers and two line transformers make up this interphone.

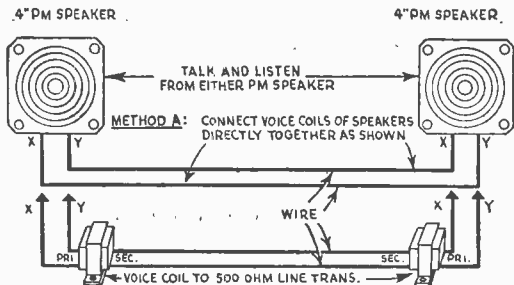
## Sound-Powered INTERPHONE

**T**HIS simple interphone system requires no electrical source of any kind to operate. The voice itself generates the necessary power to operate the two-way communicating system. Operation of the interphone is based on the fact that any moving coil, placed in a magnetic field, generates a small voltage which varies with the vibration or movement of the copper coil. A PM type radio loudspeaker is just such a moving coil device. And while intended to reproduce sound impulses, it will, by the same token, transmit them. Of course, the volume of this system is not to be compared with an interphone outfit operating through several stages of amplification and it is not advised for use in a factory or other noisy location. But it serves well otherwise.

The only materials needed for construction are a pair of 4 in. PM speakers, a suitable length of lamp cord or two conductor bell wire, and two voice coil to 500 ohm line speaker transformers. However, before even buying the line transformers, try the speakers connected *direct* to the line. You may not need the transformers. Since this system depends upon speakers with strong magnetic fields, use a pair of PM units with the largest size magnets you can buy. Standard PM speakers are available with a choice of magnet power ranging

from 0.68 to 1.47 ounces or more. The heavier the speaker magnet, the more volume you can expect from this interphone. Buy the *best!*

Each speaker is mounted in a small cabinet which may be a metal speaker box such as those sold by radio supply houses. Or this box can be home made (see photo). A pair of terminals at the bottom allow for easy connection to the line.—T. A. BLANCHARD.

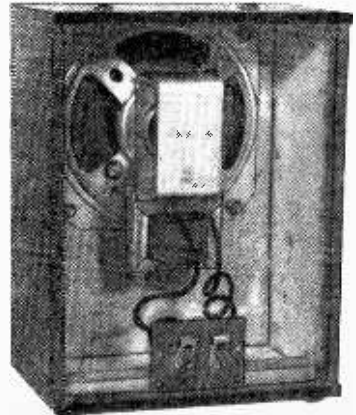


METHOD B: INSTALL LINE TRANSFORMERS BETWEEN SPEAKERS

### MATERIALS LIST SOUND-POWERED INTERPHONE

- 2 PM Radio Loudspeakers, 4 in. dia. Quam type 4A15, with 1.47 oz., #5 Alnico, 3-4 ohm voice coil
- 2 Line Transformers; Thordarson type 22S80 universal line-to-voice coil. 500 ohm primary and 3.2 to 4 ohm secondary connections
- 2 Commercial or homemade speaker cabinets
- 4 Terminal clips, or binding posts
- 8 Speaker mtg. screws (6-32 x ½ in.)
- 1 Suitable length of transmission line (#18POSJ lamp cord)

Note in rear view (right) that cabinet contains nothing but speaker, transformer, and line terminals or clips.





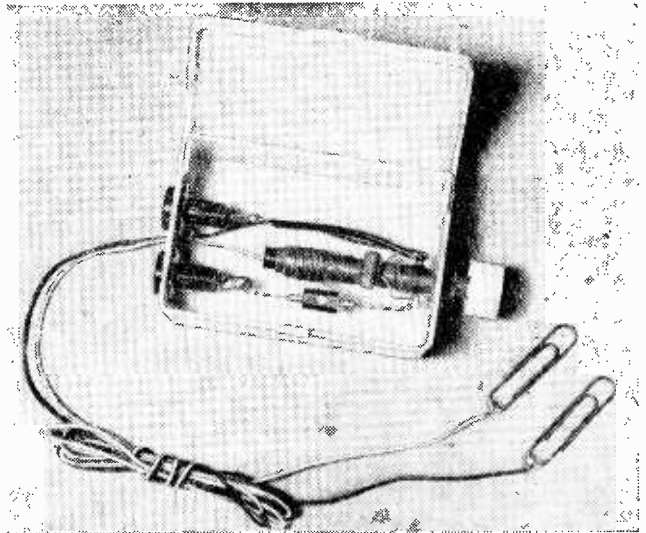
# Small Fry Crystal Set



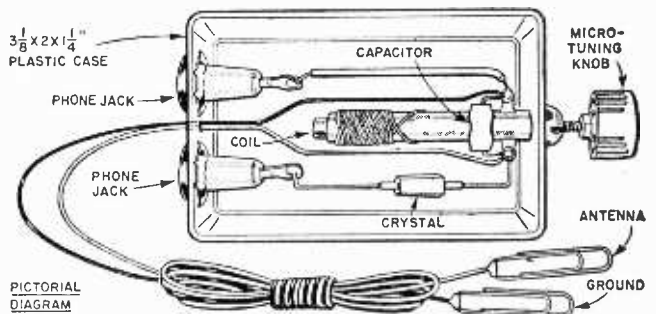
Single Alnico 2000-ohm phone may do but double headphone set of regular magnetic type gives better volume.

**T**HIS extremely simple, yet highly selective, crystal set would delight any youngster (not to mention those of us oldsters who still are amazed by these tubeless, powerless receivers).

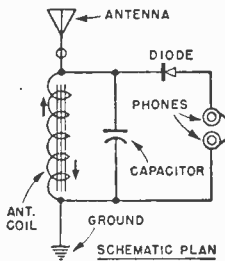
This set is housed in a  $1\frac{1}{4} \times 2 \times 3\frac{1}{8}$ -in. plastic pin or jewel box. Two  $\frac{3}{8}$ -in. holes are reamed in one end of the box with a rat-tail file and plastic phone jacks inserted. Just below these holes is a  $\frac{1}{8}$ -in. hole through which the antenna and ground leads pass. These flexible insulated wires have "frictioned" paper clips soldered to the ends for connecting set to antenna. The finger stop on a dial phone is an ideal antenna. Ground is not needed except



Although the case is tiny, there is no cramping of parts in it.



PICTORIAL DIAGRAM



SCHEMATIC PLAN

in outlying areas.

Ream a  $\frac{5}{16}$ -in. hole in the opposite end of the plastic box and, into this hole, snap a micro-tuning type ferrite antenna coil. Then attach a 4-40 threaded plastic knob to the coil screw, providing precision tuning that will not drift once set to a particular station. As most U.S. and Canadian stations are located below 1200 kc, a 150-mmf ceramic capacitor is connected across the coil lugs to tune from 1600 to 1200 kc. In large city areas where the powerful stations (with some exceptions) are between 1200 and 550 kc, use a 250-mmf ceramic capacitor. But with no capacitor, the set will often pick up amateur, police and fire signals. The detector employed in this rugged pocket set is a germanium type IN81.

Good reception and volume depend upon sensitive headphones, so use conventional magnetic or Alnico double headphones with a resistance of 2000 ohms or more for best results.—T. A. BLANCHARD.

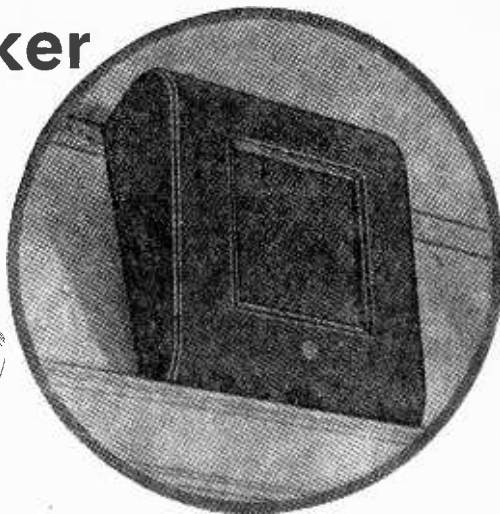
**MATERIALS LIST—SMALL FRY CRYSTAL SET**

- 1 plastic box. Original measured  $1\frac{1}{4} \times 2 \times 3\frac{1}{8}$  in.
- 1 IN81 germanium type crystal detector
- 1 150-mmf (or 250-mmf—see text) ceramic capacitor
- 1 micro-tuning type ferrite antenna coil
- 1 4-40 threaded plastic knob
- 1 magnetic or Alnico single or double headphones, 2,000 ohms or higher

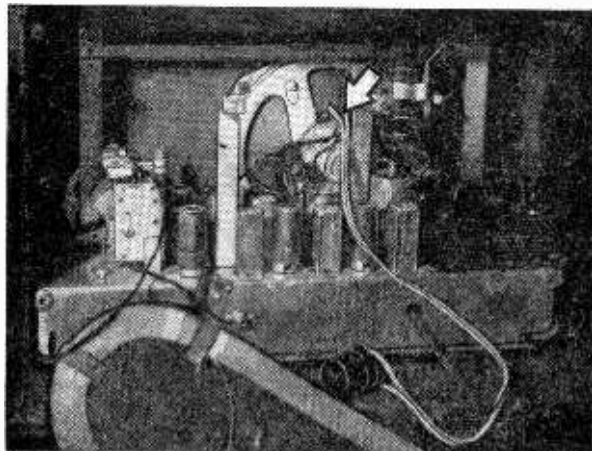
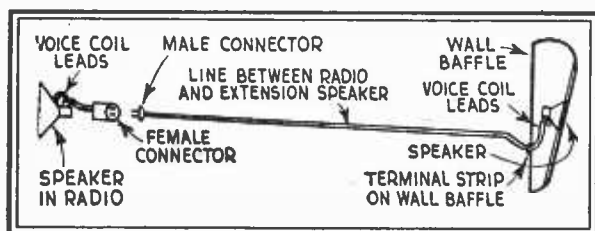
Flexible insulated antenna and ground lead wires, and two paper clips

Note: Complete kit for building this set, including plastic case, coil, knob, germanium detector, 2 ceramic capacitors, jacks, hookup wire and clips (but not headphones) may be obtained from Electro-Mite, P.O. Box 636, Springdale, Conn., for \$2.98 postpaid. Double set headphones are available at \$2.25 postpaid.

# Extension Speaker



Wall baffle mounted over door.



Connection to voice coil. Arrow points to leads.

5 in. PM speaker, with as large an Alnico V magnet as you can obtain, a wall baffle of the proper size for the speaker, a length of ordinary lamp cord to reach from the radio to the baffle, insulated staples for fastening connecting wire, picture hanging wire, a nail, and a 2-contact male and female cord connector.

Remove back cover from radio. Locate leads from voice coil which come from the cone close to the magnet and terminate on an insulated strip. Cut a piece of lamp cord long enough to reach from this strip to a point about a foot outside of the radio. Solder 2 wires from one end to voice coil terminals on insulated strip. To other end of wire attach female cable connector. Replace back cover of radio. These connectors allow you to detach line from the set so it can be moved.

Now mount your speaker unit with the wall baffle. With a short piece of lamp cord, make a connection between voice coil terminal strip and a dual terminal strip mounted on wall baffle. Plug in connectors and turn on radio to check the operation. After checking, turn off radio and disconnect the wire while you attach speaker. If you install it over a door, you can rest baffle

on top of door frame. Drill a nail part way into wall at the appropriate spot and use picture frame wire to support wall baffle in position. Adjust wire length to allow top of baffle to tilt slightly downward.

Starting at the radio end, fasten connecting wire along baseboard and door frame with insulated staples. Then cut end of wire nearest wall baffle to proper length and connect it to the terminal strip.—WILLIAM MARON.

**L**ISTENING to radio programs in a noisy kitchen, or the cellar, darkroom, laundry or playroom, isn't easy if the radio is located in another room. But one radio can serve 2 locations with the addition of another speaker.

For about 30 minutes of your time and something less than \$8 (or, if a homemade baffle is used, less than \$5), you can install an extension loud speaker at any location within about 25 feet from the radio. You'll need a good quality

Radio-TV-Electronic soldering requires just a few inexpensive tools. But they must be the right ones, and used correctly, to insure neat solid connections

## Solder It Right

**T**HERE is nothing difficult about electronic or electrical soldering. Strong, neat joints require only a fully heated iron with a *bright* tip, good solder, and clean working surfaces. In addition, most radio components are provided with pre-tinned lugs or leads, and standard hook-up wire is also tinned to insure proper fusion at connections. Yet "cold" joints, burned insulation, and actual parts damage are common results of soldering—improper soldering.

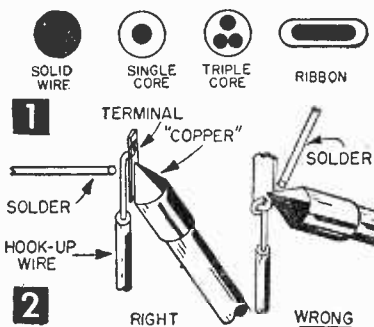
**Solder** used for electronic work must contain a large percentage of tin. Ordinary solders (typically, 30% tin and 70% lead) may be fine for a tinsmith working with a two-pound, gas-heated iron, but the high melting point of a solder which is 70% lead is out of reach of, say, a pencil-size electric soldering iron commonly used in electronic work. Before such a solder will flow, it would be necessary for the pencil iron to heat the joint to a temperature of nearly 500°F. Therefore, solder used in electronic work is generally 40 parts tin to 60 parts lead (Grade 40), or 50/50 (Grade 50), or 60/40 (Grade 60). Diameters of these solders range from  $\frac{1}{32}$  to  $\frac{3}{32}$  in., either solid or rosin core.

For electronic work, Grade 60, rosin triple core,  $\frac{1}{16}$  dia. solder is an ideal fusing agent; it is also more expensive than grades with less tin content. Diameter is another factor to consider when selecting a solder. Grade 40,  $\frac{1}{32}$  in. dia., for instance, may flow as easily as Grade 50 solder,  $\frac{1}{8}$ -in. dia. even though Grade 50 has a higher tin content than grade 40. Unfortunately, solders with a high tin content are not sold in low-cost spools or packets. The smallest standard package is 1 lb. Such a package, however, will last the average experimenter a long time. And sometimes dealers buy solder in large mill spools and sell it in smaller quantities either by the oz. or by the ft.

The four types of solder in general use are shown in Fig. 1. Solid-wire solder requires the use of an external flux. For this, non-corrosive paste flux should be on an experimenter's shelf.



Wire solder is best handled by cutting three ft. off the spool, winding it on a pencil, and fishing one end through the spiral. As it is consumed, more is pulled through.



But it should usually be used only in special cases, such as when making a connection to a chassis or other large surface or for tinning bare copper wires (such as ends of fixture cords) which are not pre-tinned at the wire mill. Non-corrosive paste fluxes cost as little as 12¢ for a can which will last five years. These paste fluxes consist of powdered rosin and sometimes zinc chloride suspended in a tallow or grease base. A very small amount of

paste spread thin on a joint is sufficient to insure a good bond. Paste *must* be used with solid-wire solder, and can be used with rosin core solders as a booster.

Core-type solders automatically dispense the fluxing agent contained in their cores as the solder flows on the joint being soldered. The purpose of flux is to dissolve the metallic oxides which form on a joint when heat is applied. Without flux, solder will not fuse. Triple-core solder is tops for electronic and electrical work and should be your first choice. Fluxes include rosin, borax, cryolite, sal ammoniac (ammonium chloride), zinc and sal ammoniac, and phosphoric acid. Sal ammoniac and phosphoric acid are

highly corrosive and should *never* be used in electronic work. Radio-TV electronic solders are clearly labeled "Rosin Core Filled," and no substitute should be accepted.

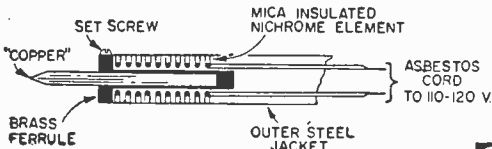
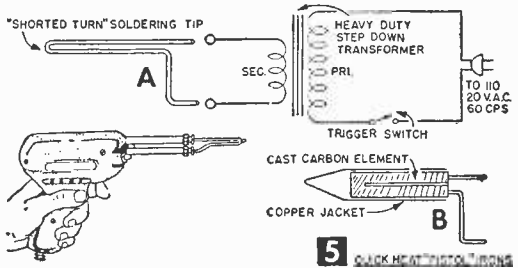
**The Iron.** Assuming that your solder is at least Grade 50, and that you are going to be doing light work such as wiring up a radio, a 20 w. pencil-size iron is large enough. Moreover, its compactness will permit you to work in tight places without burning the insulation of adjoining wires.

If the iron is new, the soldering tip (or "copper") must be tinned. If the iron is old and the tip is pitted and/or oxidized, it must first be cleaned, then re-tinned. A new tip may be cleaned with emery cloth, an old tip should be smoothed on a cast cement or glazed brick. A file could be used, but it would soon be ruined by solder and copper filling up its teeth. Bricks are cheaper than files and last indefinitely. Dipping a hot iron into sal ammoniac will also clean it of oxidation, but be sure to wipe off all the sal ammoniac.

To tin an iron, heat it to working temperature and melt a small amount of solder to form a

pool on a piece of tinplate (salvage from a tin can will do). Now rub each side of the tip on the tinplate until a bright coating of solder has been deposited on the copper. The iron is then ready for use.

The right and the wrong ways to apply solder to a joint are shown in Fig. 2. The right way is to insert the end of the hook-up wire in the lug, flatten with pliers, place the copper of the iron so that one of its chisel sides is flat against the work, hold the solder on the *opposite* side of the lug and wait for the metal to flow on the joint. The transfer of heat from iron, to lug, to hook-up wire insures an over-all, evenly dis-

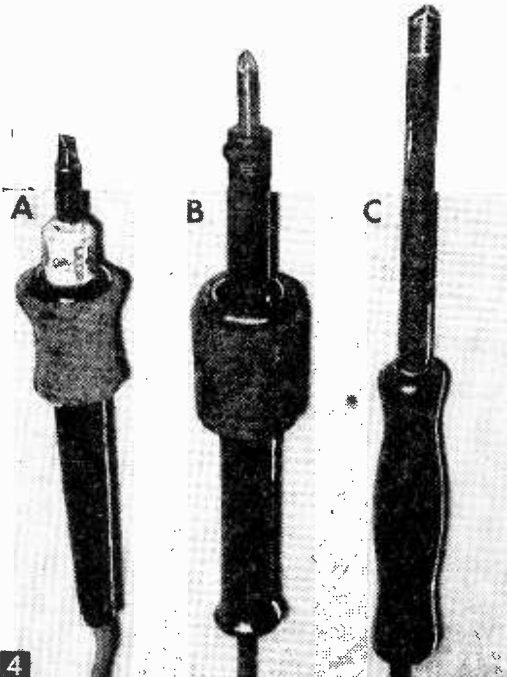


tributed 360°F. which is about the melting point of Grade 60 solder. Since the solder is the last to receive heat, a firm bonding to hook-up wire and lug is insured.

The wrong method is to make a hook joint and hold only the tip of the copper on the work, melting the solder directly and rolling it down on the connection. In addition to a cold joint, there will be inadequate surface contact between lug and wire, and, because of the hook joint, a difficult removal problem if you later discover that you have made a wrong connection. (It is true that hook joints are found in commercial apparatus but this is because one group of production workers merely installs wires while others on the assembly line do nothing but solder. Hooking is necessary to keep leads intact.)

Pencil irons are available in 20, 25 and 50 w. sizes and are not expensive. One make employs screw-in tips and heating elements so that the experimenter may select three tip sizes and two element sizes for combinations equalling six separate irons. For two years, we have been using an iron costing only 39¢ at a national auto supply chain and, because of proper care, it is still going strong. Proper care not only includes keeping the tip bright and free from excess solder at all times, but disconnecting the iron immediately after use. This not only prolongs the life of the tip, but that of the heating element as well.

In addition to the conventional electric irons (Figs. 3 and 4), instant and quick heating types are also available. While very good, they are expensive, sometimes easily broken if dropped, and cumbersome when compared with a pencil iron. The quick-heat irons usually have a heavy duty step-down transformer which lowers 110-



Conventional irons for electronic work: A) pencil iron with screw-in element and tip; B) heavy-duty pencil iron; C) lightweight iron bought for 39¢ by author, still in good condition after two years' heavy use.

120 v. line supply to 6 v. or less (Fig. 5). The low-voltage secondary of the step-down transformer is connected to a shorted-turn, alloy-wire tip (Fig. 5A), or to a cast carbon element contained in a copper-jacketed tip which outwardly resembles the tip of a conventional iron (Fig. 5B). Pressing a trigger switch in the primary side of the transformer causes these irons to reach working heat in as little as five seconds. Some irons of the instant type employ separate step-down transformers, while others are pistol-shaped with the transformer built into the grip. (For outdoor antenna or chassis work, of course, neither nichrome element nor instant irons are satisfactory because of the amount of heat dissipated either by the atmosphere or the large metal surface. Such work requires at least a heavy-duty 100-w. iron, or a self-generating, alcohol blow-torch.)

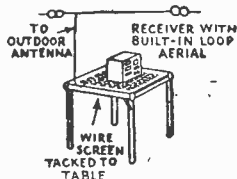
Once in a while, the experimenter may hit a snag attempting to solder aluminum, stainless steel, nickel, or chrome. Special fluxes and solders, or both, can do the job, but usually, the best procedure will be to bolt a soldering lug to such metals and solder leads to the lugs. All other metals, including tinplate, copper, brass, zinc, lead and bright steel, respond readily to rosin-core solder applied to adequately heated surfaces.

Electronic soldering requires such additional items as hook-up wire, a pair of flat nose pliers with side cutters, and a pen- or jack-knife for stripping insulation. Automatic wire stripping pliers are handy, but not essential, particularly since pocket wire strippers can be bought for less than 30¢. Jewelers' type, self-gripping pliers are useful for guiding wires into tight places and holding them in position while soldering, and diagonal cutters are also useful where space is cramped.

Hook-up wire, size 20, solid and stranded, is obtainable with wax-impregnated cotton insulation. Commonly known as "push-back" wire, no stripping is required. Best of all hook-up wire is the vinyl thermoplastic insulated type which comes in many different colors. Unlike rubber, the vinyl insulation does not rot, nor is there any odor or dripping if it is accidentally touched with a soldering iron.—T. A. B.

### Wire Screen Serves as Signal-Booster for Loop

• To increase signal pick-up when a portable receiver is being used in a steel building, connect a regular outdoor antenna to some large insulated metal surface in the room, such as to a copper screen placed under the rug, or to a piece of screen tacked under the table on which the receiver is most often used.



## SHOOT TV TROUBLE FAST

### With H. G. Cisin's Copyrighted RAPID "TV TROUBLE SHOOTING METHOD"

Without experience or knowledge, this guaranteed new method of servicing TV sets enables you to DIAGNOSE TV troubles as rapidly as an expert. **NO THEORY—NO MATH**—you can locate all faults in record-breaking time regardless of make or model. "TV TROUBLE SHOOTING METHOD" is the most valuable aid to TV servicing ever written. Be a TV Trouble Diagnostician. Increase your present earnings. Open your own Profitable Business or get a high-paying skilled job.

It's all in this book . . .

#### Nothing more to Pay—Nothing else to Buy

Alphabetically listed are 85 picture troubles, over 58 raster and 17 sound troubles. By this unique copyrighted method you know EXACTLY WHERE the trouble is; plus step-by-step instructions, including 69 RAPID CHECKS, enabling you to find the faulty part.

**13 IMPORTANT PRELIMINARY CHECKS NEED NO INSTRUMENTS!** Of the 69 Rapid Checks, **OVER 65 ALSO REQUIRE NO INSTRUMENTS!** Rapid checks include emergency checks for distorted pictures, defective tubes including IFT tube, plus 57 others. **ALL EXPLAINED IN SIMPLE LANGUAGE. PERFORMED WITHOUT INSTRUMENTS. MANY CHECKS USE THE PICTURE TUBE AS A GUIDE.**

H. G. Cisin, the author, is the inventor of the AC/DC midjet radio. He licenses RCA, AT&T, etc. He has also trained thousands of technicians now owning their own prosperous TV service organizations or holding highly paid TV positions. His years of experience are embodied in this remarkable new book.

Guaranteed Money Back in 5 Days if Not Satisfied!

**ABSOLUTELY FREE** with each order: H. G. Cisin's newest book "TV & RADIO TUBE SUBSTITUTION GUIDE" Gives direct replacements of set and picture tubes. Most valuable servicing aid! **ACT NOW—** get both books postpaid at cost of only one!

**\$1** Post-paid

#### RUSH COUPON NOW!

H. G. CISIN, CONSULTING ENGINEER, Dept. SM-11  
Amagansett, N. Y.  
Enclosed find \$1. Rush both books.

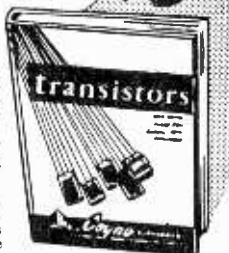
Name .....  
Address .....  
City ..... Zone ..... State .....

## Just Out! PRACTICAL REFERENCE BOOK ON TRANSISTORS

Every Radio-TV Serviceman and Technician Needs It!

Includes complete "how-to-do-it" wiring data on the use of Transistors in TV, Radio, Photo Cell Relays, Hearing Aids, Amplifiers, Oscillators. You learn how to install, test and service transistorized equipment. Contains the latest, practical information about this revolutionary new electronic development!

**SEND NO MONEY!** Just mail coupon. On delivery pay postman introductory price of just \$1.50 plus C.O.D. fee and postage. Or save postage by sending \$1.50 with coupon now. **Sole on 7-day money-back guarantee.** Be first with the latest "know-how." Order your Transistor book TODAY!



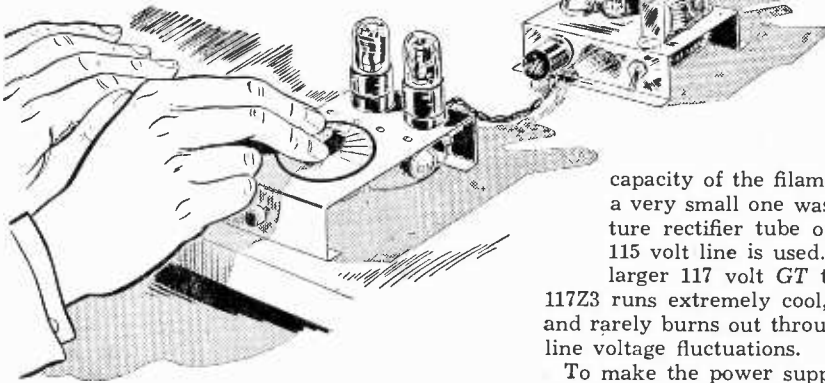
### RUSH THIS INTRODUCTORY OFFER COUPON

COYNE ELECTRICAL SCHOOL  
500 S. Paulina St., Dept. 17-RT, Chicago 12, Ill.  
YES! Rush your new book: "TRANSISTORS & THEIR APPLICATIONS," at \$1.50 plus C.O.D. and postage, on 7-day trial.

Name .....  
Address .....  
City ..... Zone ..... State .....

Check here if you are enclosing \$1.50. We pay postage. 7-Day Money Back Guarantee.

# Radio Experimenter's Power Supply



By T. A. BLANCHARD

**I**N TRYING out new circuits, and for many other purposes where a dc power source is needed, a self-contained power supply is a useful radio accessory for experimenting on or building sets, and will quickly pay for itself. The circuit employs a minimum number of components, yet the half-wave rectified dc is sufficiently free of ripple so that even when used with an earphone type set, little hum will be noticed. Radios attached to this power supply are automatically grounded via a power line. Do not attach a ground; merely reverse power line plug for best results.

In addition to furnishing 90 or more volts of B (or plate) supply, a small 6.3 volt filament transformer is incorporated in the circuit to handle the "heaters" of half a dozen of the new miniature tubes used in FM tuners, television boosters, and conventional radios and amplifiers. This power supply will handle up to 5 tubes rated at .3 amps. or 10 tubes rated at .15 amps., or combinations not exceeding 1.5 amps.

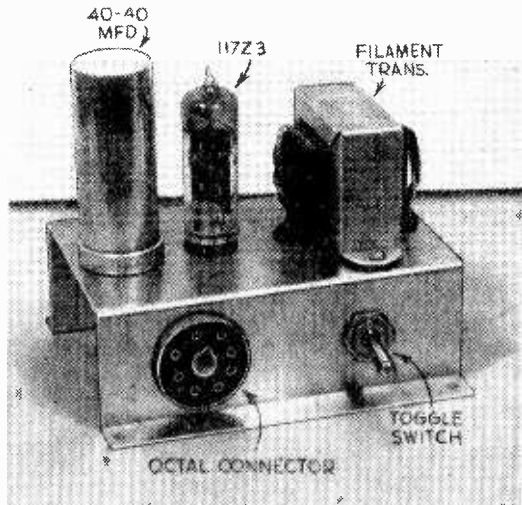
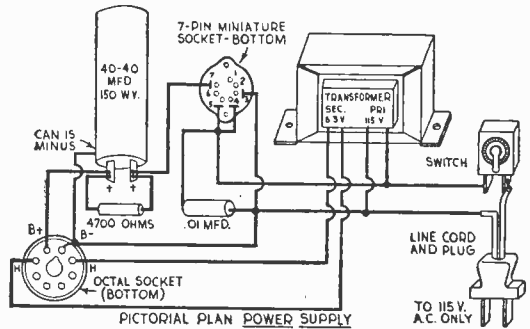
The built-in filament transformer permits parallel "heater" wiring and any combination of 6.3 volt tubes regardless of the individual current consumption of each type. Thus the bugaboo of series-wired "heaters," line-drop resistors, and the limitation of tubes to those with identical current characteristics, is eliminated.

This model was assembled on an aluminum chassis. The panel before bending measured  $4\frac{3}{4}$  by 7 in. After punching, and drilling to accept the components, the #18 gage plate was bent to form a chassis  $4\frac{3}{4}$  in. long,  $1\frac{1}{2}$  in. high, and 3 in. wide. You can use the two  $\frac{1}{2}$  in. outward bends at the bottom (see photo) for mounting the chassis. No hole dimensions for the chassis are given due to the variations in various

components. Our picture plan is arranged so that the constructor may use a "stock" chassis or cabinet from radio supply houses, an adapted dime store rectangular cake pan, or even a cigar box, etc.

In order to conserve the entire capacity of the filament transformer, since a very small one was used, a 117Z3 miniature rectifier tube operating right off the 115 volt line is used. Unlike many of the larger 117 volt GT tubes, the peanut-size 117Z3 runs extremely cool, draws little current, and rarely burns out through shock or moderate line voltage fluctuations.

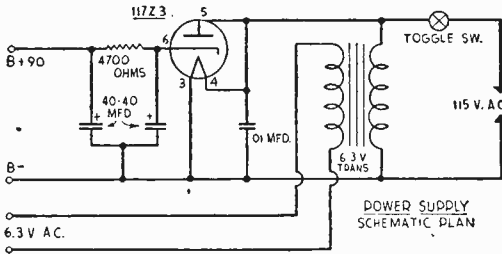
To make the power supply as flexible as possible, a plug-in power connector is used. For the connector, any octal tube socket may be employed. Voltage terminations are made to 4 of the socket lugs as shown. Four flexible leads are connected to the respective pins of an



octal plug or an octal tube base. For experimental uses, the ends of the flexible leads may be fitted with rubber hooded Muller clips so that instant connections can be made to experimental circuits. Several cord sets are useful, where permanent connections may be soldered to the apparatus, but still the power unit can be disengaged simply by pulling out the octal plug.

**Watch That Insulation!**

One word of caution: When constructing the power supply on a metal chassis, be sure the can of the 40-40 mfd. electrolytic condenser is insulated from the chassis. Most fabricated plate (commonly called "FP") condensers have a fiber



**MATERIALS LIST—POWER SUPPLY**

- 1 pc. #18 gage soft aluminum 4 3/4 by 7 in. for chassis (optional)
- 1 filament transformer: 6.3v., 1.5 amp. (or more) 115v. primary
- 1 40-40 mfd., 150 w.v. electrolytic condenser
- 1 7-pin miniature socket (wafer or molded type)
- 1 octal socket (wafer or molded type)
- 1 (or more) octal plugs or tube bases
- 1 4700 ohm, 1/2 watt resistor
- 2 .01 mfd. paper condensers, 150 (or more) w.v.
- 1 S.P.S.T. toggle switch
- 1 6 ft. line cord and plug
- Misc. hardware as required by components used

insulating ring included for this purpose. In most instances the minus connection and condenser case are common. While the condenser mounted directly to the chassis doesn't affect results, it does make the chassis "hot" or "alive." Should the device be placed on a grounded object, both a shock and blown fuse may result.

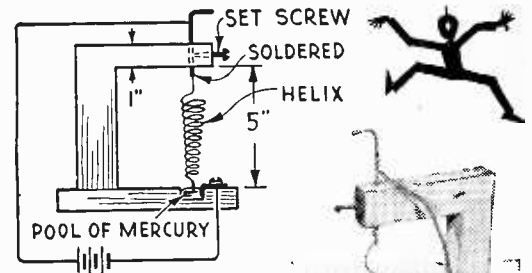
In instances where the electrolytic case has been insulated from the chassis, connect power supply chassis to B minus by connecting a .01 mfd. 400 to 600 volt paper condenser from the B minus socket lug to the chassis. This .01 mfd. unit isn't used when the power supply has been assembled in or on a non-metal object. The .01 mfd. shown in schematic and picture plans applies, of course, in all instances. Its purpose is to reduce line-noise. Remember that this device employs a transformer and is for ac power lines only. Transformer must be eliminated for use on direct current.

**Magnetic Jumping Jack**

ROGET, a French electrical experimenter of the 19th Century, developed this curious piece of equipment, a sort of electrical jumping jack which demonstrates the magnetic attraction that may exist between the convolutions of a helix carrying an electric current. Under the proper conditions, the magnetic attraction between such coils may be sufficiently great to pull or tend to pull the convolutions or turns of such a helix together. Thus if the end of the helix is arranged as illustrated with the tip of the end of the helix wire resting in a tiny pool of mercury, the tip will be pulled free of the pool of mercury and the electric current passing through the coil will be interrupted. This in turn cancels the magnetic attractions between the convolutions and the tip of the helix wire will again contact the mercury thus repeating the demonstration.

A bit of pine wood, a snifter of mercury, two binding posts and a foot or two of No. 26 copper wire is all that is needed to build it.

The spiral or helix of wire will require some experimentation before the instrument will func-



tion properly. One must regulate the space between the convolutions in the helix until just the proper distance between turns is had. Wind the helix on a slightly tapered wooden form.

The pool for the mercury is made by drilling a 1/4 inch hole in the base of the instrument. A small strip of brass or copper runs from this to the binding post. The other binding post connects with the top end of the coil.

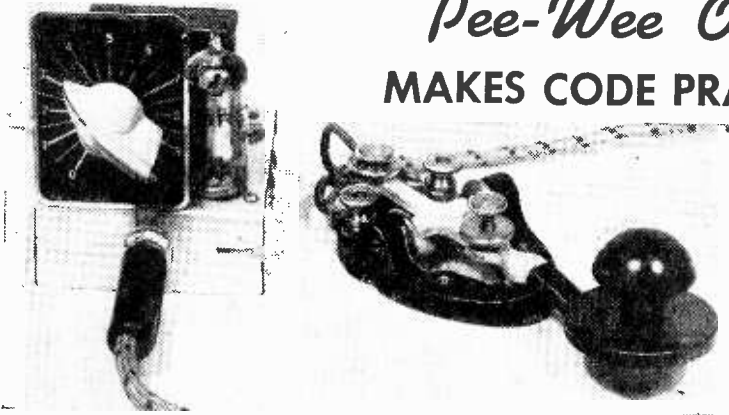
The current from one or two dry cells is sufficient to operate the device although it will be clear that the cells should not be left in the circuit too long. They will be almost immediately shortcircuited when current flows.

**Separate Loop Antennas**

When using a separate loop antenna with a portable receiver in a steel-frame building, place the loop near a corner of a window, not at the center. Try different loop positions with the set tuned to a weak station. The center of a steel-framed window is usually a signal dead-spot.

# Pee-Wee Oscillator

## MAKES CODE PRACTICE EASY



Pee wee code practice set is overshadowed by transmitting key at right. Complete outfit will fit in cigar box.

To join the "hams" and "get on the air," you must be able to send and receive code. This set makes code practice fun!

By THOMAS A. BLANCHARD

**H**ERE is a simple audio-tone code oscillator with which you can master code transmission. If you want to get on the air with your own amateur station, the Federal Communications Commission requires that you be able to send and receive the International Morse Code in order to get a license.

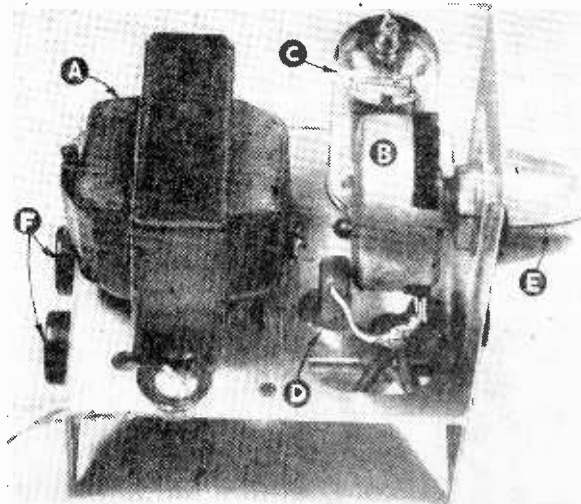
The tones of this oscillator are made variable by the high resistance potentiometer in the grid circuit of the 1T4 oscillator tube. Thus you can simulate the exact sound of a CW (continuous wave) transmitter as it would be heard on a shortwave receiver. This oscillator consists of a

few inexpensive and easily obtained components. Because it is battery powered, it is completely portable and may be packed along with key and headphones in a cigar box. The small current drawn by the miniature 1T4 pentode tube's filament permits a regular flashlight cell to furnish the A battery voltage. A small 22½ or 30 volt B battery will last for months.

The oscillator shown here was assembled on a 2½ in. square, 1 in. high metal chassis. But the components may be wired up on a wood base, inside a metal box, etc. if you prefer. Simply follow simplified picture wiring plan after parts have been mounted. The iron core oscillator coil is provided by a standard "push-pull" midget radio output transformer, the type used to drive PM speakers. The low impedance voice coil secondary is not used. The primary high impedance side is center-tapped. The resistance may be any value from 5 to 25 thousand ohms. A ⅜ in. hole is provided in the front right corner of the chassis for the 7 pin miniature tube socket. Drill a ⅜ in. hole in center of front chassis apron for key jack. Drill two ⅜ in. holes in rear apron for phone tip jacks. Make sure you provide insulation between

### MATERIALS LIST—PEE WEE OSCILLATOR

- 1 2½ x 2½ x 1" chassis (form from 2½ x 4½" piece of aluminum, steel, etc.)
- 1 Audio output transformer with C.T. Primary impedance from 5,000 to 25,000 ohms.
- 1 2 megohm potentiometer
- 1 250 mmf. mica condenser (capacitor)
- 1 7 pin miniature socket (Amphenol type 147-500)
- 1 Single pole, single throw toggle switch
- 2 Phone tip jacks
- 1 Key Jack
- 1 Dial plate (optional)
- 1 Bar pointer knob
- 1 1½ volt A battery (flashlight cell)
- 1 22½ or 30 volt B battery
- 1 1T4 miniature pentode tube
- Misc. hook-up wire and hardware

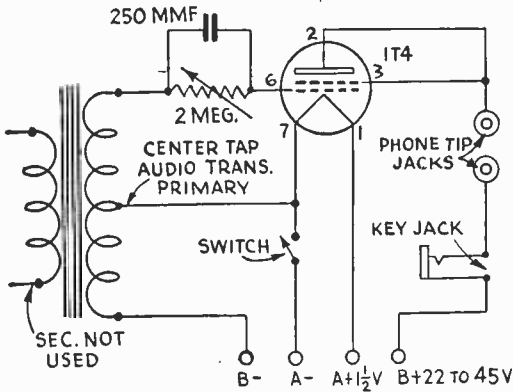


Closeup view of chassis: (A) transformer; (B) potentiometer; (C) 1T4 tube; (D) 250 mmf. condenser; (E) tone adjustment knob; (F) tip jacks.

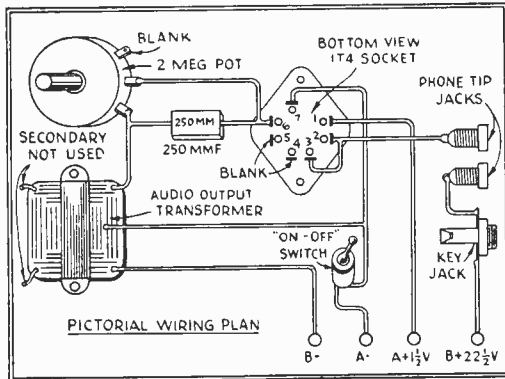


TABLE A—INTERNATIONAL MORSE CODE

A . . .	J . . . . .	S . . . . .	2 . . . . .
B . . . . .	K . . . . .	T . . . . .	3 . . . . .
C . . . . .	L . . . . .	U . . . . .	4 . . . . .
D . . . . .	M . . . . .	V . . . . .	5 . . . . .
E . . . . .	N . . . . .	W . . . . .	6 . . . . .
F . . . . .	O . . . . .	X . . . . .	7 . . . . .
G . . . . .	P . . . . .	Y . . . . .	8 . . . . .
H . . . . .	Q . . . . .	Z . . . . .	9 . . . . .
I . . . . .	R . . . . .	1 . . . . .	0 . . . . .
	PERIOD . . . . .		
	COMMA . . . . .		
	? MARK . . . . .		



SCHEMATIC - CODE PRACTICE SET

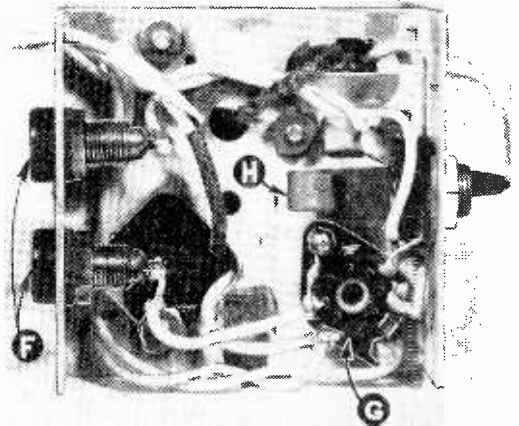


PICTORIAL WIRING PLAN

jacks and chassis when mounting.

Mount the 2 megohm potentiometer on a bracket which also supports the dial plate. This bracket may be purchased or fashioned from a strip of aluminum, etc. Because dimensions of components will vary, obtain parts first, so mounting holes may be drilled to fit.

Because the code practice set is battery powered, even a homemade transmitting key can be used without danger of shock. Or, you can buy the type shown here. The transmitting key is in series with the plate supply and phones, and acts as a momentary switch producing oscillation in headphones when key is closed. You can therefore insert an additional key and set of phones in series with the original for two-way code practice. When receiving, hold your key closed to estab-



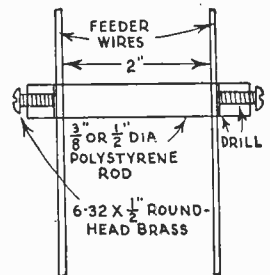
Bottom view of oscillator: (F) phone tip jacks; (G) tube socket; (H) key jack.

lish a circuit for the other operator. Likewise, his key must be held closed when you are transmitting. If key has a shorting switch on the base it is unnecessary to hold key down while your partner is sending.

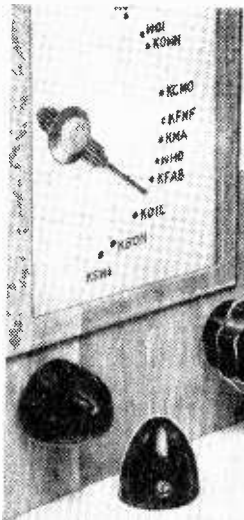
As many as five or six sets of phones and keys may be placed in series for group code practice. However, for this use it may be necessary to increase B battery voltage to 45 or 90 volts. For solo use, use headphones with a resistance of about 2000 ohms. Use two pairs of 1000 ohm headsets if you practice with a friend. For future reference and study, save the code chart which accompanies this article (Table A).

### Polystyrene Feeder Spreaders

• Radio amateurs who like to build everything themselves, can easily and cheaply make all their feeder spreaders. Use either 3/8 or 1/2 in. dia. round polystyrene rod. Standard sizes for feeder spreaders are 2, 4, 5, and 6 in. spacings between wires. Holes for wires should be slightly larger than the diameter of feeder wires used; space holes 1/2 in. from ends of rods. It isn't necessary to tap holes for 6-32 screws; simply use a drill slightly smaller in diameter than screws and twist screws into the holes; screws will thread themselves in securely. Ends of rods can be beveled on the edges with a file to improve the appearance. Sketch shows a 2 in. feeder spreader installed on the lines.—ARTHUR TRAUFFER.



# Dress It Up, For Convenience

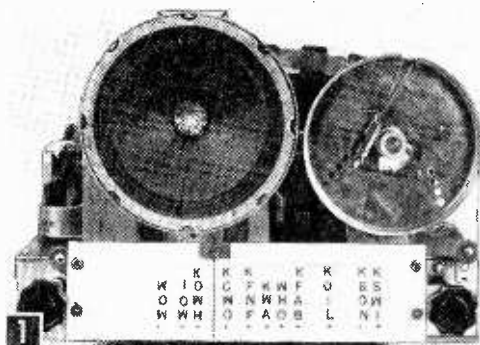


Replace the original dial plate with one that is custom call-lettered, and the original tuning knob with a spinner-type, and you've dressed up your radio as well as greatly adding to its convenience.

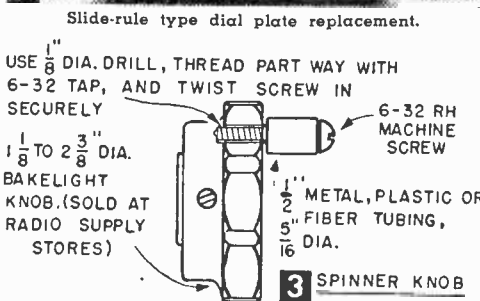
**I**F YOUR radio is not equipped with automatic tuning levers or pushbuttons, you'll appreciate the time-saving convenience of having the call letters of your favorite stations lettered on the dial plate so that you can tune to them quickly and accurately. (As radio servicemen and experimenters have discovered—to their profit—many people want and appreciate this added convenience.)

The radio's original dial plate is in no way defaced or spoiled. Instead, a duplicate dial plate is cut from Bristol board (a heavyweight drawing paper) and either replaces or is placed over the original plate, depending on the design of the radio. Thus, if you move to another part of the country where there are different stations with different call letters, you can make a different plate, or you can replace the original plate if you want to sell or trade-in the radio.

Figure 1 shows the chassis of a table radio (cabinet removed) with a slide-rule type dial. By pulling out the four snap-in trimounts, the original dial plate was removed and then replaced with a strip of Bristol board the same size. The call letters of the most-listened-to stations were



**2** Rotary-pointer type dial plate replacement.



rub one side briskly with a damp cloth and a little scouring powder.)

The perfect complement to a lettered dial plate is a spinner knob enabling you to "crank in" your favorite stations in a hurry. Figure 3 gives construction details of such a knob. The larger its diameter, the smoother and easier will be the spinning action. It should, of course, be used only with a drum-and-cord type of dial arrangement (the type most commonly used), since no advantage would be gained by installing it on sets without such a vernier arrangement, that is, sets in which the tuning knob is fastened directly to the capacitor shaft.—A. T.

then lettered onto the new dial plate with pen and India ink. Figure 2 shows the chassis of a table radio (cabinet removed) with a rotary-pointer type dial. An exact duplicate of the original dial plate was cut and punched from Bristol board and the desired station calls were lettered on it. (When working on an ac-dc chassis out of its cabinet, remember that it is likely to be "hot," so keep the radio disconnected when you are not actually tuning in stations for the purpose of spotting and lettering the stations on the new dial plate.)

Methods of fastening will, of course, depend upon the design of the radio. You can use small machine screws, thumb-tacks, Scotch tape, or even glue, providing you apply it where it will not show if you should ever remount the original plate. On sets where a dial lamp is mounted behind and glows through the dial plate, your new plate can be made from artist's tracing cloth, celluloid, thin plastic, or any other transparent or semi-transparent material that will take India ink. (Clear plastic can be given a dull finish on one side so that it will take India ink, if you

# SELECT ONE OF THESE PLANS FOR YOUR NEXT PROJECT

For our readers who enjoy building things in their workshops, we offer more than 150 plans covering a wide variety of subjects. Every project in our line of craft prints has been designed by a master craftsman. Special thought has been given to the design, its utility value and the ease of construction. Many of the plans are full-size patterns. Others give the neces-

sary parts in full-size to simplify construction. All of the projects listed in this catalog have been built. You can proceed with the assurance that your finished project will give complete satisfaction if you follow our easy-to-understand instructions. Keep this catalog for future reference for **SCIENCE AND MECHANICS** is Headquarters for the best in "Do-It-Yourself" Plans.

## Boat Building

**3. PORTABLE BOAT.** Easily built from plywood covered with leak-proof canvas. Weighs less than 125 pounds. Can be carried on the top of an automobile. Used for rowing, sailing, or with an outboard motor. Speeds of 5 to 35 miles an hour. Trolling speeds that delight the fisherman to speeds rivaling racing craft are possible with this type of boat. Length, 12 feet. Semi-Vee bottom. 50¢

**6. ATOMITE.** You can't beat this 9½-ft. hydroplane for speed and fun. While it is extremely fast, it is also highly maneuverable because of its special design. Uses outboard motors up to 15 hp. Plywood construction. 50¢

**11. BASS BOAT.** Ideal craft to reach the best bass fishing areas where the fish feed in shallow water among the spatter docks. There's no propeller to foul in water weeds and, with a flat bottom and a 4-ft. beam along its entire length, the draft is at a minimum. The little air-cooled engine is easy to install and it has paddle-wheel propulsion; no shaft log is required. Length, 15 ft. Plywood construction. 50¢

**13. ZIPP.** If you want a fast, sporty and highly maneuverable hydroplane, "Zipp" is your baby. Designed to be used with outboard motors of from 10 to 50 hp, it is a little over 13 ft. long and has a 59½-in. beam. "Zipp" seats two passengers in the small after-cockpit, and, if you have another intrepid pair of friends who want to come along, you can lift the forward hatch clear and take off as a foursome. Plywood construction. 50¢

**14. SEA GAL.** Tradition has it that it's the strong, broadbeamed heavyweights who are more stable when the going gets rough. Sea Gal's ample beam and 300 lb. weight make her ideal for the rough waters along the east or west coasts, the Gulf or Great Lakes. With a 14 hp outboard, this versatile utility boat will do

25 mph with one aboard and plane with three persons aboard. Construction is plywood over longitudinal framing for greater over-all strength. Length, 15 ft. 3 in. Beam, 5 ft. 4 in. Seating capacity 6 to 8 persons. 50¢

**15. FIRE BALL.** Want a high speed sportster that will cost about \$100.00 to build? Well, here's a boat that offers loads of fun, stability and service, yet it is easy on the pocketbook. It will seat four passengers and can use outboard motors of from 10 to 50 hp. Exterior waterproof plywood is used throughout to produce a sturdy craft in a minimum of time. Length, 13 ft. 4 in. 50¢

**18. LIVERY SCOOTER.** There's good money to be made in the renting of boats, providing you own the type of boat that meets the needs of a majority of the boating public. Here is a sturdy, dependable livery scooter that's ideal for fishermen and small family outings. It can be powered by a small, air-cooled inboard motor which is inexpensive and will operate all day long at 5 to 10 mph on a minimum of fuel. You'll find this boat easy to build for it is constructed of plywood. Length, 11 ft. 6 in. 50¢

**20. BLUE BIRD.** Most small dinghys do not sail well but this 10-ft. long dinghy is fast and points fairly well. It makes an excellent utility boat, and, if sailing equipment is not available, you can use the boat with a pair of 6½-ft. oars or with a long shaft Evinrude outboard motor of not over 3 hp. Difficult, joinery work of construction is eliminated. Constructed of mahogany, birch or exterior plywood. Suitable for car-top carrying. Length: 10 ft. Beam: 53 in. Depth: 18 in. Weight complete: 110 lbs. Sail area: 60 sq. ft. 50¢

**21. CASTABOUT.** For the beginning boat builder, here's an easy-to-build utility boat. You don't have to wait for this boat to swell after you put her over. She's dry from the minute she touches the water, and she stays dry because every seam is bonded with resorcinol resin.



Portable Boat—No. 3—50¢



Hydroplane Racer—No. 6—50¢



Sporty Hydroplane—No. 13—50¢



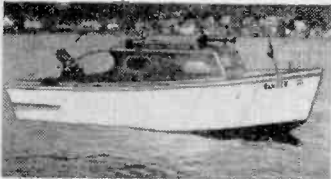
Utility Runabout—No. 14—50¢



Sailing Dinghy—No. 20—50¢



Livery Scooter—No. 18—50¢



Outboard Cruiser—No. 24—50c



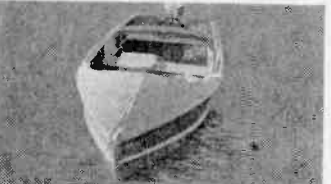
High Speed Sportster—No. 15—50c



Utility Boat—No. 21—50c



Outboard Hydroplane—No. 27—50c



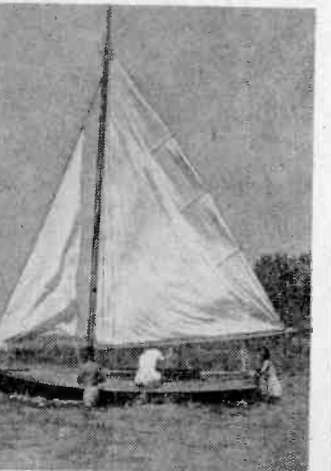
Outboard Runabout—No. 32—50c



Cruiserette—No. 38—50c



V-bottom Skiff—No. 44—50c



14 Ft. Sailboat—No. 30—50c

give that doesn't let go. A special feature of this boat is a flexible sheet plastic shelter that folds into a roll but can be erected in about two minutes if you get caught in a shower. Length: 14½ ft. Seats four people. 50¢

**22. CONVERTED FORD MODEL "A" ENGINE.** Looking for an automobile engine to convert for marine use? Here's how to do it! The converted engine develops about 45 brake hp at 2,400 rpm. It is ideal for a 16-ft. runabout. Our large pictorial plan shows how to do the complete job. 50¢

**24. RANGER.** All the facilities you need are wrapped up in this 17-ft. outboard cruiser. When powered with 35-50 hp outboard motors, "Ranger" will plane at speeds of 20 to 35 mph. She's easy on fuel and maintenance costs, too, and you can transport her most anywhere by trailer. Two persons may sleep aboard and there is room for a small stove and a few pots and pans with which to fry those fresh fish. Ideal for overnight trips, weekend cruises and general sports use. Construction is sawed wood frames planked with exterior plywood. 50¢

**27. METEOR.** If you like your sports speeds, build this lightweight, 12½-ft. outboard hydroplane. It's the type of boat that can be hauled anywhere by trailer. Propelled by 10 to 22 hp outboard motors, speeds up to 35 mph can be achieved. Seating capacity is four persons. Construction is plywood planking applied over a frame especially adopted to the use of plywood. 50¢

**30. FALCON.** As a general purpose sailboat, the "Falcon" is ideal for bay, lake and river sailing. It points closely and easily outdistances comparable one design class boats such as Snipe and Comet sailers. And she will pace neck and neck with 18 footers with considerably greater sail spread. The speed of this boat seems little affected by whether two or four passengers are aboard, which is unusual for most small sailboats. The construction is exterior plywood over a longitudinally stressed framework. The Semi-Vee bottom design of this boat was scientifically worked out using the same techniques of design used for schooners and large sailers. Weight complete is 475 pounds. Sail area: 118 sq. ft. Length: 14 ft. For those who want the very latest and best in sailing craft, here's your boat. 50¢

**31. WHIZZ.** This boat should appeal to those who want their cruisers fast, sporty and small enough to carry by trailer. It's a small cruiser designed for overnight trips or weekend cruises. You can sleep two persons on cruises and accommodate a party of four for afternoon ex-

cursion with a 50-60 hp inboard marine engine or converted automobile engine, speeds of 20 mph or better are possible. Construction is exterior plywood laid over a longitudinally stressed frame with sawed transverse frames. 50¢

**33. BUZZ.** Here's a versatile, planning outboard runabout measuring 11 ft. in length with a beam of almost 56 inches. It is lightweight with strong and sturdy constructional features, seats four passengers. Designed for use with 5 to 10 hp outboard motors, "Buzz" will plane a remarkable load at high speeds, equaling other boats with twice the hp. It also maneuvers well in rough or smooth waters, making turns easily at wide open speeds. As a lightweight, portable boat "Buzz" may be loaded atop any automobile for sport trips. Plywood construction. 50¢

**33. RAPID ROBERT.** This boat is a type known as a MacKenzie River Boat because it is designed for those wild rivers with fast, rough currents. It is a raked, smooth-bottomed, sturdy rowboat, able to twist and turn on a dime, with a high, buoyant stern that will shoot through rapids which would sink the best of other craft. You can also use this boat as an ordinary rowboat, and, for cruising on more gentle waters, a removable section of the high transom may be slipped out to attach an outboard motor. Seats four people. Construction is of exterior plywood. Length: 14 ft. 50¢

**36. CHUM.** This convex bottom runabout is 15½ ft. long and has a beam of 6 ft. and a maximum draft of 20 inches. You can use either a double cockpit or a single cockpit style for utility use. "Chum" was designed for use with a converted Jeep engine, although any 25-100 hp similar engine may also be used as long as the motor is of lightweight, high speed design. Plywood construction. 50¢

**38. SUN FISH.** The "Sun Fish" is an unconventional looking cruiserette which weighs only 375 pounds and is powered by an outboard. It can be transported easily and has accommodations for two persons for overnight trips. The scow-type bow allows it to be landed on shelving beaches which means dry feet for the passengers on embarking. Takes outboard motors up to 25 hp. Construction is simple. No difficult joinery work is necessary. Length: 15½ ft. 50¢

**43. KAYAK.** While this 10-ft. kayak is designed primarily for the 6- to 12-year-olds, it can be built to accommodate an adult by increasing the distance between the frames and using heavier battens, but retaining the same beam. It is by no means a toy. Its construction follows accepted practice. 50¢



Sport Cruiser—No. 31—50c



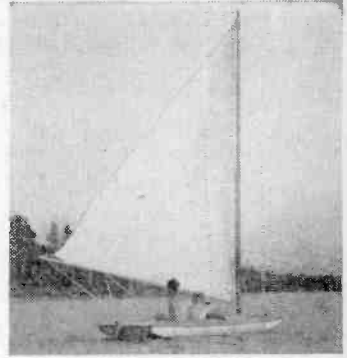
Outboard Hydroplane—No. 46—50c



Canoe—No. 60—50c



Car Top Boat—No. 54—50c



Sailboat—No. 67—50c

**44. DORETTE.** Another easily-built V-bottom skiff that is light in weight, strong and eminently seaworthy on most any waters. It may be powered with outboard motors up to 15 hp, used as a row-boat or fitted with a sail. It rides easily, carrying two passengers in rough waters and an additional pair on smooth water. Length: 13 ft. 50c

**46. DOODLE BUG.** You'll like this trim single cockpit, outboard hydroplane with a new type of convex bottom and non-tripping chines which combine to produce a remarkably fast boat with excellent maneuverability. Any outboard motor from 9 to 25 hp can be used to power "Doodle Bug" for thrilling speeds, miles faster than most present-day, factory-made craft. The design was evolved by selecting the best points from a series of small hydroplanes and combining them into this one boat. Before offering this boat to the public, we built and tested two of them, both of which perform beautifully. Length: 12 ft. Plywood construction. 50c

**47. WIDGETT.** Building "Widgett" requires only ordinary tools and no steam bending. It may be built in a fraction of the time required for ordinary utility boats. It is beamy and stable on any waters anywhere and, despite its simplified construction, is immensely strong and durable enough to give you real service. Length: 12 ft. Plywood construction. 50c

**53. GYPSY.** The design for this 24-ft. motor sailer includes the improvements tested and developed over a 6-year period on a motor sailer that covered more than 6,000 miles in all kinds of weather, under all manner of conditions, in the Gulf of Mexico. As a result, "Gypsy" offers an ideal design for the boat lover who wants a sea-going motor sailer. It will take 10 to 25 hp motors and will deliver speeds around 10 mph. With a sailing rig and a fair wind it will loaf along at 3 to 8 mph. Building "Gypsy" is really an ambitious undertaking. But the investment will pay handsome dividends over the years in relaxation, enjoyment, comfort and satisfaction. 50c

**54. CAR TOP BOAT.** If you're a fisherman who likes frequent changes of scenery, this lightweight car-top boat will permit you to drop a line in any body of water to which your car is able to transport you. Although an ideal two-person boat, the semi-V bottom and pram-type construction make possible the accommodation of three individuals without swamping. Boat weighs less than 100 pounds. Length: 8 ft. 50c

**55. FIRE FLY.** You can really go places with this speedy hydroplane for it was designed for the largest outboard motor available. A new but thoroughly proven

method of venting the step for top speed, and a new bottom design, make this sporty craft fast, efficient and seaworthy on smooth or rough water. With this hull, the Evinrude Big Four (50 hp), can plane six persons with ease, haul aquaplanes, and attain speeds approaching 60 miles per hour. Length: 14 ft. with a beam slightly over 5 ft. Weight about 275 lbs. Plywood construction. 50c

**59. JUNIOR.** This type of boat is usually known as a yacht dinghy, but there the comparison ends. "Junior" is of such ample dimensions and so carefully designed that it rows quite easily, carries three and even four adults, propels well with small outboards, and could even be sailed if fitted out with simple sailing equipment. Also, "Junior" makes an excellent car top boat for fishing or hunting since it is lightweight, leakproof and easily handled afloat or ashore. Length: 9 ft. Plywood construction. 50c

**60. LITTLE CHIEF.** So you've always wanted your own canoe? Here is a canoe with many virtues, ideally adapted to quick, easy construction. It has attractive molded lines and may be built either as a paddling model or, with slight changes, adopted for use with small outboard motors. Length: 14½ ft. 50c

**62. DOLPHIN.** This 16-ft. boat is especially designed for those who move their craft about by trailer. It will accommodate two persons for extended trips or a party of four for day cruises and do it comfortably. Construction and operating costs are low. Plywood is used throughout. The hull is designed to exact the utmost from low power motors. Inboard engines from 2½ to 8 hp will do or outboard motors can be used with slight transom adjustments. Construction of the "Dolphin" is not difficult. Each item has been simplified as much as possible. A splendid boat. 50c

**64. SEA SKIFF.** There have been sea skiffs and sea skiffs! But here is one that combines all of the best features of many types of skiffs in one boat based on years of actual experience. It is quickly built over an ingenious method of framing with exterior plywood that will retain its leakproof qualities even if left to dry in the sun for long periods. This sturdy skiff may be rowed, powered with air-cooled inboard motors or outboard motors, or rigged for sailing. As a sailer it is dry, light, and fast in a good breeze. Length: 13½ ft. For use in all types of water. 50c

**67. WINGS.** This 13-ft. scow sailing-craft is perhaps the most efficient hull form known, and one readily adapted to home construction. Anyone with the aid of ordinary carpenter's tools and a few



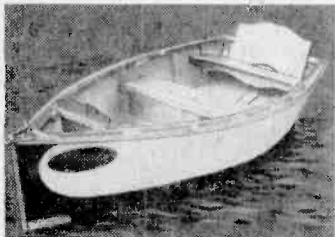
Cabin Cruiser—No. 78—50c



Knock-about Boat—No. 77—50c



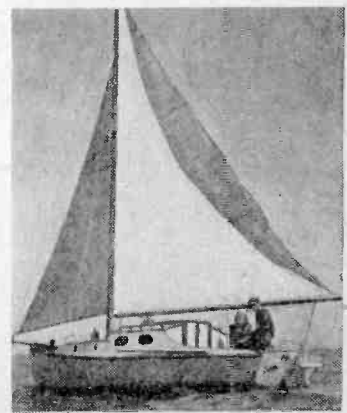
All-purpose Skiff—No. 64—50c



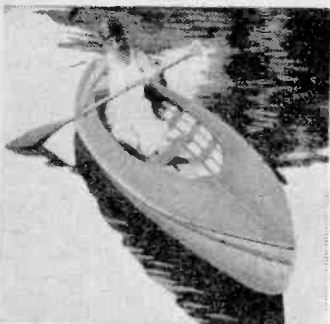
Utility Boat—No. 47—50c



Speedy Hydroplane—No. 55—50c



Motor Sailer—No. 53—50c



Kayak-Canoe—No. 80—50c



Utility Boat—No. 104—50c



Outboard Runabout—No. 112—50c



Multi-purpose Sloop—No. 106—50c



Utility Runabout—No. 79—50c



Hydroplane Racer—No. 161—50c

clamps can build this sailboat. It will furnish incomparable sport and compare favorably with other fast hulls. With a sail area of 110 sq. ft., it has shown an excellent turn of speed, the ability to point closely and is easily handled with one finger on the tiller. It is especially adapted to sailing on sheltered waters. Inexpensive to build! Lots of fun to sail! 50¢

**75. KINGFISHER.** Originally developed separately by Scandinavian fishermen and Dutchmen hundreds of years ago for use upon rough open waters of the Old World, the pram reflects the qualities of these hardy seafarers, for it is exceptionally practical and useful under all conditions. It rows easily, sails well and propels nicely with small outboard motors. It weighs only 90-100 pounds and therefore is easily handled and carried atop any auto for sports and adventure. Will seat three persons safely. All construction details have been simplified to permit easy fabrication of plywood. Length: 9 ft. 50¢

**76. DART.** This fast 13-ft. sailboat is designed for use on protected waters such as bays, lakes and rivers. Its construction will repay the builder handsomely and provide a fast sailing craft, light in weight, easily transportable and cheap to construct with all difficult joinery eliminated. Construction is exterior plywood over frame. Will seat two or three persons. It has a sail area of 100 sq. ft. Here is a sailboat with lots of action and thrills galore. 50¢

**77. WHITE DUCK.** Principally a knockabout boat for the summer cottage, or for fishing and hunting, this flat bottomed utility rowboat can be rowed or propelled by outboard motors of 1 to 6 hp. Its simple, inexpensive construction and substantial design make it a safe boat for sport or recreation anywhere. Construction is planking over frames. Length: 14 ft. Only ordinary tools are needed to build this fine boat. 50¢

**78. SPORTSMAN.** This unique 18-ft. cruiserette has a combination of runabout and cruiser features. It is a self-contained, seaworthy, open-water craft for weekend cruises or short overnight fishing trips that will accommodate a pal or the "missus." It may be transported by trailer wherever desirable. Designed to be powered with high speed converted auto or marine engines from 15 to 90 hp, "Sportsman" will go places in a hurry and provide protection during inclement weather. Weight about 1700 pounds. Construction is sawed wood frames, carved batten planked sides, lapped bottom. One of our most popular boats. 50¢

**79. SHORE LARK.** Fast, safe and seaworthy on almost any waters, this general utility runabout will afford long happy hours of sport and repay its construction many times. Adapted to the use of outboard motors from 1 to 24 hp, the utility runabout will plane safely, at speeds from 5 to 45 mph and easily carry four or five persons depending upon its power. Difficult joiner work has been eliminated. Hence, the "Shore Lark" is easy to build and presents a lightweight, sturdy hull that one can build for a fraction of the amount he would have to pay for a finished boat of this type. Length: 13 ft., 8 in.; beam: 56 in.; depth: 18 in.

Weight complete: 200 lbs. Construction is wood sawed frames, lapped plans. An excellent boat for fishing, hunting or knockabout usage. 50¢

**80. BLUE BILL.** Combining the features of both kayak and canoe, "Blue Bill" is offered to those out-of-door men who hunt or the sportsman who needs an ultra-lightweight portable boat for use upon any waters. Besides being usable for building a double-end paddling model, a few changes permit the plans to be used for making a canoe that will accommodate outboard motors up to 6 hp for swift, speedy transportation on any stream or waterway. Weighing only 75 lbs. complete, "Blue Bill" is easily transported atop an auto anywhere. Length: 13 ft. Seating capacity: 3 persons. Construction: wood frame canvas covered. 50¢

**81. ROCKET.** The "Rocket" is a 15-ft. inboard step hydroplane designed for those who like their boats fast and sporty but still inexpensive to build and operate. Any motor with or without reverse gear will power the "Rocket." Auto motors that develop more than 35 hp, if of lightweight, high speed design, will do nicely. Marine motors of similar high speed, lightweight design will perform even better. Construction of the "Rocket" is not difficult. She is built of plywood over an oak frame. 50¢

**104. BUDDY.** "Buddy," a general utility boat, was designed to meet the greatest possible variety of purposes and to serve each one well. With an overall length of 13 feet and a generous beam of 56 inches, the hull seats three or four passengers and performs with stability and seaworthiness in rough or smooth water. Outboard motors of 1 to 6 hp will propel this craft speedily and economically, while rowing it is easy. For those who love sailing, "Buddy" may be rigged as a sailboat and it will perform comparably with regulation sailing craft. The construction requires exterior plywood, making it easy to build, inexpensive and producing a craft that is light in weight, easily transported and permanently leakproof under all conditions. 50¢

**105. TORPEDO.** Fast, safe and comfortable is the "Torpedo," a distinctive 13-ft. runabout that skims over the water at race-boat speeds and carries four passengers in a capacious hull that will remain leakproof and light in weight during a lifetime of usage. Exterior plywood is used to cover the sides, bottom and deck, and besides dispensing with considerable labor in construction, the use of this material provides a boat that is strong and inexpensive to build and run. It is adapted to use with motors from 10 to 30 hp. 50¢

**106. PETREL.** 16-ft. multi-purpose centerboard sloop you can build as an open cockpit racing craft or as a cabin sailing model with accommodations for overnight trips and shelter on fishing excursions. Seats 4. Either model is constructed from the same basic design and possesses unusual seaworthiness, stability, trim attractive lines, speed and ability to handle well. Plywood construction. 50¢

**107. HANDY ANDY.** Outdoor sportsmen encounter numerous waterways or adverse conditions where it is impossible



High Speed Runabout—No. 154—50c



Duck Boat—No. 159—50c

to use the ordinary rigid boat or where its use is restricted, making it more of a liability than a convenience on a trip. This 10-ft. portable folding boat is not meant to dispense completely with the rigid boat, but to supplement its uses and to offer a ready means of water transportation where conventional type boats are excluded. Weighing only 80 lbs. and costing comparatively little for materials, simple and easy to construct, easily rowed or propelled with small outboard motors from 1 to 5 hp, this portable folding boat provides a lifetime of usage, under conditions unapproachable by conventional craft. The hull may be folded or unfolded in one minute's time. It will stow away inside any auto, airplane, house trailer or it may be packed under the arm and carried easily. 50¢

**112. VICTORY.** All requirements for an outboard runabout are met in the "Victory" sport runabout. Due to a new method of bottom design, the hull is fast, stable, handles well at all speeds with different sized motors, and has trim and attractive lines. Built of exterior marine plywood, the construction is simplified and produces a lightweight, strong hull suitable for many uses. To meet every possible requirement, the hull is designed so that it can be built in 12-14 or 16 ft. lengths by making a few simple changes in these plans. This boat is a good project for winter work. 50¢

**113. JAZZ BABY.** This 12-ft. multi-purpose boat is an excellent all-around boat for fishing or speed. It rows easily, has a trim design, and the ability to maneuver well with small outboard motors of 6 to 15 hp. Built-in beveled chines make this boat unusually safe while a new type bottom assures satisfactory operation at low or high speeds. Constructed of exterior marine plywood, the hull is easy to build, light in weight and permanently leakproof. The boat is seaworthy and stable. It is easily transported. 50¢

**138. SEA SCOUT.** "Sea Scout" is the type of boat its name implies—a small inboard 13½-ft. runabout with single cockpit destined for use by one or three persons and for fairly high speeds with comfort not found in outboards and convenience comparable to a coupe. 50¢

**150. NANCY JANE.** This all-purpose 19-ft. inboard open cockpit runabout is designed to fulfill a great variety of uses in one boat. With a length, beam and depth generous enough to be usable anywhere, this seaworthy design provides a craft that may be equipped with a marine or converted auto engine from 15 to 100 hp for speedy, stable riding service on open or sheltered waters. For fishing, hunting, surf board riding, and short pleasure trips, this boat would be difficult to surpass. If desirable, a cabin can be added. 50¢

**152. POLLY WOG.** Here is a planing-type, outboard utility boat that is unusually fast, weighs only 150 lbs., uses outboard motors up to 20 hp and is quite maneuverable at higher speed. Its ample beam and depth make it a good safe boat. In test runs, with a Mercury 10, "Polly Wog" has hit 34 mph. May be carried by lightweight high-speed trailers. Length: 11½ ft. Complete weight: 175 lbs. Seat-

ing capacity: 4 persons in smooth water, 2 persons in rough waters. Construction: bottom convex built for speed and maneuverability, non-tipping chines built in bottom. Plywood over a longitudinally stressed frame. 50¢

**154. MUSTANG.** You can't build three boats for the price of one, but you can take a sound, basic design and vary the dimensions to produce three boats whose sizes vary to meet different needs. This plan explains how to build this 10-ft. lightweight, speedy, outboard runabout, adapted to carrying atop an auto or by trailer. A minimum of frames are needed as the major portion of the bottom is constructed from one standard-size plywood sheet, which is stressed for maximum strength. These boats are designed to really ride on the propeller and a small amount of spray at high speeds. A sleek-looking job. 50¢

**155. MUSTANG.** With this plan, you can construct 12 and 14 ft. boats using the same basic design. The 12-ft. "Mustang" may be built as a standard freeboard model or as a low freeboard racer for high speed, lightweight outboards up to 25 hp. By making simple alterations the original 12-ft. "Mustang" may be lengthened to 14 ft. simply by adding 2 ft. to the original stern height and increasing heights of side frames as specified, but using the same transom for either length of boat. A terrific boat! 50¢

**157. SKEETER.** Here's a nautical "punkin seed" that will whip the pants off of many highly-touted commercial speedboats. In fact, she's just enough boat to support the driver and motor—the rest is pure flying. "Skeeter" is not designed for sanctioned races as she won't make their tight hairpin turns, but given a little space, she banks nicely without "tripping" or capsizing. You water bugs wanted speed and you'll find it in every line of this boat. Even though there are only three frames, the overall strength-to-weight ratio is high and "Skeeter" will withstand fast driving and indefinite pounding. Readily planes with as low as 5 hp motors and will take motors up to 10 hp and has done 40 mph. Easily constructed and quite inexpensive to maintain. 50¢

**159. PINTAIL.** As a duck boat, "Pintail" is small and able, leakproof, weighs only 60 lbs., can be handled by one man, and is versatile enough to serve as a year-round fun boat for both children and adults. It has a convex bottom for extreme strength with plywood covering. Bottom can be applied in one piece. Length: 10 ft. Can be built in one week. 50¢

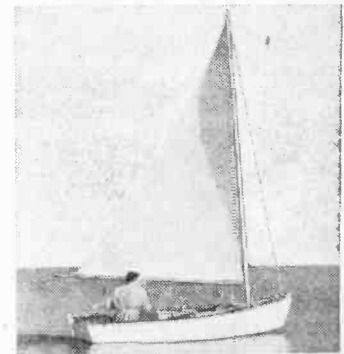
**161. HORNET.** This sleek 11-ft. hydroplane is several notches above more standardized models in terms of speed. You'll find she also requires a bit more skill in building. But that never stopped a dyed-in-the-wool craftsman. The secret of "Hornet's" speed lies in two things—the kind of bottom lines you give her and the motor angle. The design is adapted to any size motor for speeds up to 38 to 40 mph or, with special after-plane lines shown, for speeds well over 40 mph. Rounded stem fairing into streamlined body presents least wind resistance possible. Wide, non-tripping chines insure



Surf-Sail-Ice Boat—No. 170—50¢



Multi-purpose boat—No. 113—50¢



Sailboat—No. 182—\$1.00



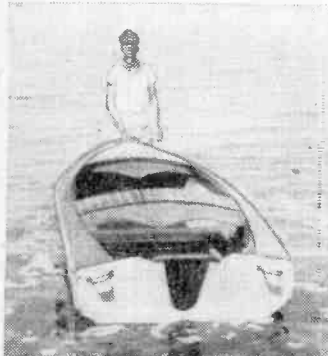
Motor Sailer—No. 188—\$2.00



"Hot Rod" Speedboat—No. 165—50¢



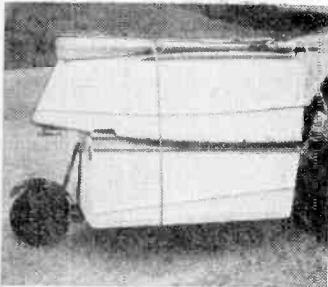
Inboard Runabout—No. 150—50¢



Outboard Runabout—No. 174—50c



Class B Racer—No. 185—50c



Trailer Boat—No. 192—\$1.00



Novel Catamaran—No. 199—50c



Scow Sailing Racer—No. 206—\$1.00

safety when making turns at high speeds. Complete instructions explain these details. 50¢

**165. YELLOW JACKET.** If you really want speed, here's a "hot-rod" speedboat that will do 39 mph with a Class A motor, or 45 mph with a Class B motor. "Yellow Jacket" weighs 100 pounds lake-side, not including steering wheel, throttle controls, and this brings it within the Class A racing requirements of a minimum 100-lb. hull weight. Also, to qualify for Class A racing, "Yellow Jacket" must be used with an outboard motor with a piston displacement of 10 but not over 15 cu. in. This design incorporates very low center of gravity, improved hull bracing and streamlining. Can turn at wide open speeds without tripping. Length: 8 ft. Construction: exterior plywood and fabric deck. 50¢

**170. SURF-SAIL-ICE BOAT.** Without a doubt you can have a whale of a lot of fun with this little craft, using it as a sailboat, paddleboard, sunbathing raft, aquaplane, and, yes, even as an iceboat. "Surf-Sail-Ice" boat handles like any sailboat. It tacks nicely, comes about readily, and points well into the wind. You'll find the "Surf-Sail-Ice" boat is easy to build and even with the iceboat frame and runners added, it should cost comparatively little, even if you add the iceboat conversion. The hull of the "Surf-Sail-Ice" boat is one big air cell with sail, centerboard and rudder. It can be sailed along leisuely in a light breeze or it will really cut the waves in a heavy blow. This little craft will do 5 to 6 mph and readily supports 300 lbs. 50¢

**174. BLITZEN.** The first "Blitzen" design we built was bought by a boat manufacturer who wanted to win some Class B runabout races. And, by golly, he did just that, with a speedometer clocked top speed of 47 mph, using a Mercury with a special lower unit. Actually, this "Blitzen" design makes either an ideal fast utility boat or a racer hydroplane for Class B competition for two hull styles are given. Performs well with outboard motors of from 10 to 25 hp. This design lends itself to quantity production in case you want to go into the boat-building business. Length: 11 ft.; seating capacity: 4 persons; weight: 185 lbs. Construction is exterior plywood over specially stressed framework using two frames and minimum number of joints. 50¢

**175. EAGER EVE.** From 50 feet away you'd swear that "Eager Eve" was a luxury inboard cabin cruiser. A cover hides the 25 hp outboard motor that drives this efficient cruiser fast enough to keep up with or outrun nine out of ten inboards. "Eager Eve" carries four persons in the cockpit or sleeps two and is just as maneuverable as an inboard cruiser without an inboard's high cost for building and operating. Without a heavy inboard engine, you can transport "Eager Eve" easily on a trailer and store it in a garage. Length: 18 ft.; beam: 6 ft., 1 in.; weight of hull: 600 lbs. Construction: exterior plywood planking, bottom vee-convex, developable surfaces. Just the boat for cruises, sports use or pulling water skiers. \$1.00

**179. DOLLY VARDEN.** Lakers will like the smooth lines of "Dolly Varden" that scoots along with any outboard in the under 7 hp class in choppy or smooth

waters. "Dolly" is a strip boat fashioned like the hundreds of similar boats built by craftsmen of the old school, and still being used because strip construction turns out a tight, durable, cheap and easy-to-build boat. About \$60 will pay for the materials to build either a 13 or 15½ ft. model, and if you can part with her, she'll market for \$225 to \$350. Either model will ride safely on top of a car as you take off for your favorite fishing grounds. Full instructions are given for steam bending, together with a complete materials list. 50¢

**182. BREEZE BABY.** Skimming off a brisk wind or with the wind abeam, "Breeze Baby," a 12-ft. saller, actually planes with one person aboard. Despite her rowboat lines, she handles easily under her simple sail, an ideal "first" boat. Simple lines are adapted to plywood construction that's strong, light and that keeps "Breeze Baby's" bilges dry. You can take her with you atop your car or on a lightweight trailer. \$1.00

**185. BLUE STREAK.** Prop riding on her hydro-conic bottom, "Blue Streak" takes Class B outboard motors for a merry spin in stock utility races. With a Mercury Hurricane motor, "Blue Streak" clocked 39 mph with one person aboard. Even higher speeds may be obtained with larger motors. The special design enables you to make fast turns for the upswep sides keep her plastered to the water surface. Plywood construction. Length: 11 ft.; beam: 4 ft. 6 in.; weight of hull: 130 lbs. A "hot" competitive racer. 50¢

**188. STAR-LITE.** Sporting an overall length of 27½ feet, "Star-Lite" accommodates four persons in 6 ft. 4 in. bunks with enough space for private "head" and a working galley. You can live on this boat if you wish. "Star-Lite" is a proved design, tested in Lake Michigan, the Mississippi River and the Gulf. She is a stiff and able saller, good for anything from an afternoon's sail to a 3-month stop-and-go trip around tropical isles. Every nook provides storage space for clothing, wet weather gear and food supplies. A 30-gal. tank under the aft cockpit stores fresh water. Interior space and accommodations are close to those found in the usual 34-ft. saller because of the short, forward overhang. Since "Star-Lite" is primarily a sailing ship, you'll need only a small auxiliary engine—not to exceed 100 cu. in. displacement. Building a big boat like "Star-Lite" is an ambitious undertaking but the joy and pleasure you will have with it for years will compensate for the time required to build it. Every detail is explained. \$1.50

**192. JUMP-N-JACK.** Fishermen! Campers! Here is your boat and trailer combined into one easy-to-build project. As a boat, you can use oars or outboard motor up to 5½ hp. Simply folding it over like a knife changes it into a one-wheel trailer for carrying your fishing or camping gear. But that's not all—slipping the wheel into the keel makes it easy to portage the whole unit right down to the water's edge, using the oars as handles. As a trailer, there's 40 cu. ft. of storage for fishing and camping gear, food and clothing. "Jump-N-Jack" is carefully designed to utilize maximum amount of plywood in 4 x 12 ft. panels \$1.00



Outboard Cabin Cruiser—No. 175—\$1.00



Utility Outboard—No. 179—50c



**199. SWIFT SWOOSIE.** An odd looking craft, the "Swoosie," but she'll do up to 45 mph; is stable as a church when heading into a stiff breeze full tilt. When planing, the "Swoosie" rides on 12 sq. in. of bottom, distributed between both hulls. It's the air flowing through the tunnel between catamaran hulls that lifts the "Swoosie" almost clear of the water and keeps water surface friction to a minimum. Overall length is 10 ft. Here's a boat that will give you a real thrilling ride. 50¢.

**201. PLAYBOY.** Sharp! Styled like a sporty inboard—that's "Playboy." From her wrap-around spray rails to the forward cockpit, "Playboy" simply exudes class—superior to any factory-built runabout in looks and performance. With a Johnson or Evinrude "25", "Playboy" will step around lively at 32 mph. Extras include a "glove compartment" for fishing gear, charts, odds and ends, smooth floor to save scrambling over frames and mahogany planking and deck. Ideal for sports, "Playboy" packs plenty of power for skidding aquaplanes or water skis or hauls up to six persons—seated. Even with the convex bottom, you can plank "Playboy" with plywood sheets that keep it dry and take all the punishment a fast ride on a choppy lake can dish out. It will cost about \$150-\$200 to build and you'd have to pay around \$650 for its equal. Length: 14 ft. \$1.00

**206. TERN.** Many a "stink pot" addict will take a second look at "Tern" because she planes in modest breezes, is easy to handle, and her streamlined prow and pod-shaped, "Inland scow" type hull offer slight-water resistance. Then, too, there's a charm about the tiller of a saller that's not matched by the wheel of a motor-powered boat. Part of it is the challenge of making the most of nature's free-wheeling breezes. Even with her 72 sq. ft. of sail, "Tern" is remarkably stable, and packs as many as four persons aboard. She's remarkably easy to build. Common hand tools are all you really need. You can build this 12-ft. flying saller in about 200 hours. And think of the fun you'll have! \$1.00

**209. SEA KING.** Built for salt-water fishing five to seven miles off shore, "Sea King" is a prime example of the African ski boat. Originally designed from the lines of the paddle skis used by life-saving patrols and African anglers who used to paddle out past the breakers to fishing shoals, the ski boats took their name because they ski down the breakers when coming in. "Sea King" is designed to take as much risk as possible out of an ocean-going small craft. It is easy to build because there are few difficult joints, fewer places to leak and the plywood deck and planking covers the simple frames with a minimum of work. "Sea King" has a self-draining deck with watertight compartment below which makes it practically unsinkable. Length: 16 ft. Uses 3½ to 10 HP. dual outboard motors. 50¢

**210. SEA BABE.** 15-ft. sports cruiser, ideal for extended trips in protected waters, hauling water skiers or aquaplanes and trolling or deep-water fishing. Seats two persons for overnight cruising or seats four persons. Construction: ¾ in. and ¼ in. plywood over single-curved bottom. Speeds up to 32 mph with a Johnson 25 outboard motor. Two plan sheets. \$1.00

**216. DRAGONFLY II.** 10-ft. hydroplane racer. A redesigned version of an exceedingly popular boat, this new model retains its planing shape, is faster, more maneuverable and smart appearing. Adapted to one-man operation upon smooth water. Construction: ¼-in. plywood over fir or spruce framework! Two plan sheets. \$1.00

**219. TOPPER.** 9½-ft. Runabout Car Top boat for campers, fishermen, sportsmen, anywhere an automobile can be driven. Designed to be handled by one man with special car-top carrier or by two men with a regular car-top carrier. Capacity: 2 persons, light model; 3 persons, standard model. Construction: plywood over a trussed bottom with seats bonded to bottom to form homogeneous hull. Weight: light model, 65 lbs.; standard model, 96 lbs. Uses motors from 3 to 10 hp. Two plan sheets. \$1.00

**221. PEDAL CAT.** A paddle-wheel driven catamaran which you operate much the same as a bicycle. It will navigate in about 3½ in. of water, is silent, and can be used upon protected waters anywhere. If you prefer to power it with a small outboard motor, the paddle wheel may be removed and the motor clamped to the engine support board. Construction: exterior fir plywood and pine, fir, or hemlock. Pontoons measure about 10 ft. in length. Easy to build. You can have hours of enjoyment with "Pedal Cat" or make money renting it. \$1.00

**223. TAILOR-MADE BOAT TRAILERS.** Whether you are looking for a light, fast trailer for your new 16- to 19-ft. cabin cruiser, or a serviceable small trailer for your outboard runabout, you will find the answer in one of the easy-built designs in this plan. Covers all construction details, bill of materials and step-by-step instructions. 50¢

**228. SEA LARK.** Designed for fishing, general utility and pleasure use, this all-purpose inboard-powered runabout, because of its hull lines, might be called a "small ship." Its developable-surface design makes possible a plywood planked hull with lines superior to most round bottom craft. Considerable flare to the forward top sides makes for great reserve stability. "Sea Lark" will give a fair turn of speed (10 to 20 mph) when powered with any one of the many marine engines from 10 to 25 hp. She is not a fast boat, but in her speed range she performs well in smooth or rough water and is sea kindly. Overall length: 14 ft. 6 in. Weight: 650 lbs. Seating capacity: 5 persons. An exceptionally seaworthy boat. \$1.00

**233. ACE.** Brand new hi-lift bottom design and hi-strength longitudinal beam construction makes "Ace" years ahead in outboard runabout speed and performance. Propelled with a 16 H.P. stock Evinrude, "Ace" has easily outrun conventional boats powered with 25 H.P. outboards. "Ace" is an ideal boat for backyard builders because no building form is required to make it. This feature also makes it an excellent boat for pre-cut boat kit sales if you are interested in going into the boat building business on a part or full time scale. Length: 12 ft. 4 in., beam: 5 ft. 9 in., Weight: 200 lbs. Capacity: 5 persons. Construction: new advanced hull design with plywood planking over frame. \$1.00.



Hydroplane Racer—No. 216—\$1.00



Sports Cruiser—No. 210—\$1.00



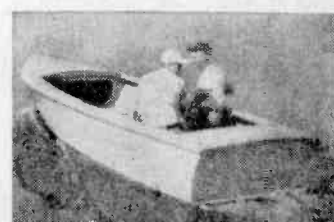
Car Top Boat—No. 219—\$1.00



Paddle Wheel Boat—No. 221—\$1.00



Boat Trailers—No. 223—50¢



Utility Runabout—No. 228—\$1.00



Inboard Fishing Skier—No. 260—\$1.00



Ski Boat—No. 209—50¢



14' Sports Runabout—No. 201—\$1.00



Outboard Runabout—No. 233—\$1.00



Supply Wagon—No. 172—50c



50 MPH Outboard Racer—No. 242—\$1.00

**239. SEA ROVER.** What's your cruising pleasure? Chances are this adaptable design has what you want, for "Sea Rover" can be built as a sports, utility or cabin model in either a 15 or 17 ft. length. The hull has ample beam and unusual depth for rough waters and may be used as a fishing boat, pleasure craft or to haul water skis and aqua-planes. Weight of hull: 350 lbs. Capacity: sports model seats three persons in forward seat and four persons in cockpit on aluminum folding chairs. Construction is exterior plywood over framework. The unusual design of this boat gives it excellent maneuvering qualities. \$1.50

**242. SPITFIRE.** If you're searching for that elusive extra mile an hour to put you ahead of competition with a small margin to spare, "Spitfire" is the boat for you. She is a step hydro, eligible for racing in sanctioned Class B regattas. She'll equal any three-point hydro with considerably better riding qualities. Hull rides well in rough water without excessive pounding and has beveled sides for taking turns at wide open speeds without tipping. Speeds up to 50 mph possible. Length: 9 ft. 10 in. Beam: 51 in. Weight: 100 lbs. without steering gear, fin, throttle control, etc. Plan includes outboard racing speed hints. \$1.00

**245. CAT'S PAW.** Old-time, dyed-in-the-wool sailors look askance at sailing catamarans because of their unorthodox design. But these same sailors are usually looking ahead at them in a race because of the cat's speed. An easy sailer, cockpit high and dry even in stiff breezes. Safe for older kids and for learning to sail. An ideal summer camp boat. It can be used as a swimming float between sailing jaunts. Designed for easy construction with flat sides and bottom. Hulls are constructed from 1/4 in. exterior-grade plywood. Length: 12 ft. Beam: 5 ft. 6 in. Depth: 21 in. Weight: 250 lbs. (twin hulls only). A boat you'll enjoy. \$1.00

**255. MINIMAX.** For minimum in cost and maximum in performance, you get both in "Minimax." Actually, "Minimax" was built in one day at a cost of about \$20.00. It will carry 2 people, take outboard motors ranging from 3 to 15 hp., has a water-tight air compartment that will support 900 lbs. even with the cockpit completely filled with water. As to performance, "Minimax" will plane a 165 lb. man up to 15 mph. with a 3 hp. outboard motor. With 10 hp. and over, the hull planing area diminishes until "Minimax" becomes air-borne and rides upon the motor's cavitation plate. Length: 8 ft.; Beam: 4 ft.; Weight: 68 lbs. Easy to build. 50c

**260. SEA MATE.** The design for "Sea Mate" was taken from proven sea skiffs used by fishermen for generations. Construction is side planking lapped and copper riveted with a plywood bottom. Design is of the displacement type, will not plane, but is efficient at speeds not exceeding 10 mph. Weight: complete with motor, 250 lbs. Seating capacity: 3 or 4 passengers, with 2 passengers safe upon any waters. Length: 15 ft. Beam: 5 ft. It is powered with a 1 3/4 hp., inboard, air-cooled engine. Uses a minimum of gas consumption and is ideal for trolling. \$1.00



Sailing Catamaran—No. 245—\$1.00



Outboard Hydroplane—No. 255—50c



Tri-model Outboard—No. 239—\$1.50

## Circus Equipment

**156. POLE WAGON FOR YOUR CIRCUS BIG TOP.** No model circus layout is complete without a pole wagon. It is the heaviest piece of equipment on the lot. It carries the big poles that support the tent. Complete materials list, easy-to-follow drawings and photos, show you exactly how to proceed. 50c

**163. STEAM CALLIOPE.** One of the most fascinating pieces of circus equipment. From this plan you can build an exact replica, true to scale, including boiler, pipes and keyboard. Detailed drawings and instructions explain how to cut the carvings, assemble the wagon, with a color scheme for painting and decorating. Complete materials list makes it easy to get started. Overall length, 12 1/2 in. 50c

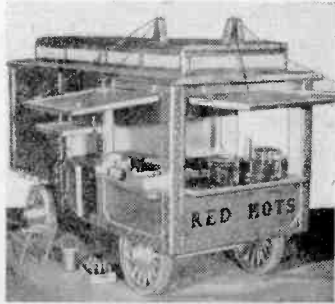
**172. CIRCUS SUPPLY WAGON.** This wagon is always on the first section of any circus train because it carries the "makings" for breakfast on arrival. Its cargo of miniature boxes, bags, crates and barrels add atmosphere to the completed model. You'll enjoy building this authentic 3/4 in. scale model. 50c

**178. HO GAGE CIRCUS TRAIN.** A colorful circus train will add interest to your model railroad layout. Our Craft Print gives complete instructions and plans for building the flat car used in transporting the canvas wagon, animal den, seat wagon and dressing wagon. Fascinating to build! A valuable addition to your model circus collection. 50c

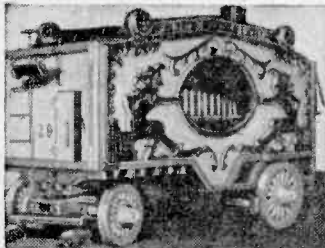
**189. HOT DOG WAGON.** No model circus layout is complete without a hot dog wagon offering pink lemonade and hot dogs to its patrons. Every detail is explained in our plans, including the mustard jar for hot dogs. 50c

**207. CARVED CIRCUS ANIMALS.** To recapture the memories of the circus, you need to include the elephants, zebras and draft horses. Our full-size plans give simple instructions for carving these animals, plus painting the models. There's realistic, authentic and fascinating carving projects. \$1.00

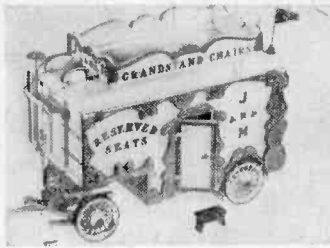
**211. GIRAFFE FOR YOUR MODEL CIRCUS.** The giraffe is a delicate animal in captivity. It is carried between circus



Hot Dog Wagon—No. 189—50c



Steam Calliope—No. 163—50c



White Ticket Wagon—No. 249—50c

lots in special padded wagons. Often he reaches a height of 18 ft. Our plans explain how to carve a giraffe to scale from a squared pattern and contour drawing. Step-by-step illustrations show you how to proceed. 50¢

**237. MODEL CIRCUS GORILLA.** The gorilla is generally rated the third most intelligent of the world's beasts, following the chimpanzee and the orangutan. A full grown male attains a height of 6 feet and weighs from 500 to 600 lbs. Your model circus should have a gorilla in the animal den and this plan will show you how to make one that is very realistic. 50¢.

**249. WHITE TICKET WAGON.** "Step right up and get your tickets!" What a familiar ring this cry has at the circus. And a model of the White Ticket Wagon is a "must" for your model circus layout. Our instructions include the carvings that decorate the wagon, all construction details explained with drawings and photos, and a complete materials list. 50¢

### Electrical Equipment

**191. TESLA COIL.** You'll get hours of satisfaction and thrills experimenting with this "Souped-up" Tesla Coil. You can perform more of the eerie electrical wonders than ever dreamed by Nicola Tesla in 1892. This coil develops 70,000 volts at 500,000 cycles per second frequency. Even though you'll be experimenting with 70,000 volts, the high frequency (500,000 cps) keeps it harmless. The original model of this project is on permanent display at the Museum of Science in Boston, Mass., where it is demonstrated daily. Complete instructions, diagrams and materials list are given. 50¢

**193. ELECTRIC FLOOR POLISHER.** A very powerful and efficient floor polisher can be built from an old Hoover motor and other discarded materials easily available. This polisher will save you hours of hard work and will put a beautiful polish on your floors. Complete instructions are given to put the motor in good working condition and to connect it to the polishing unit. The materials list shows parts needed and where to get them. You'll find this a handy appliance to have around the house. 50¢



Giraffe—No. 211—50c

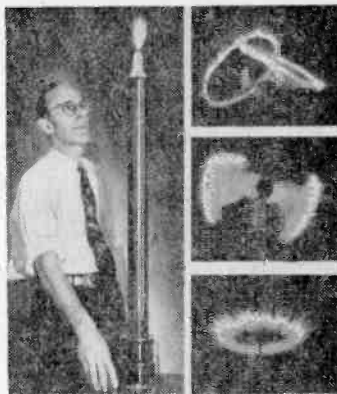
**197. VAN DE GRAAFF GENERATOR.** Every electrical experimenter will want to build an operating model of the full-size electrostatic generator that aided in the development of the atomic bomb. This model will perform a variety of fascinating experiments and develop up to 380,000 volts. Every construction detail is explained and the large, clear drawings make it an easy project to build. Two large plan sheets. \$1.00

**222. MOTION STOPPING STROBOSCOPE.** If you want to know what is happening to a machine part that is moving at high speed, without turning off the motor, use a stroboscope. The stroboscope can be used to "stop" moving parts and study the movements of the parts in centrifugally-operated switches and clutches, or to inspect the shifting structure of a solid piece under centrifugal force at various speeds, or to read stampings or markings on the moving piece, or to find out what may be causing unusual noises in motors and engines that are running. Easy to build, inexpensive and practical. 50¢

**224. FLY TRAP.** This electrical fly trap may be used anywhere but it is an especially efficient eliminator of disease-bearing insects when used outside near rubbish barrels and garbage pails. The neat housing contains two sloping screen wire grids charged with 3000 volts from a small neon sign transformer. The flies enter the holes on the sides to get at the bait. They walk down the inclined grids, spaced wide at the top. When they reach a point where the spacing is such that the current makes a quick pass through them, they fall dead into the bottom tray. Works like magic! Get rid of the pests around your home. Build this trap. Complete plans. 50¢

**227. REPULSION COIL FOR EXPERIMENTERS.** Many interesting experiments that demonstrate the laws of repulsion due to electromagnetic induction can be performed with this repulsion coil. For example, an aluminum ring can be shot into the air with considerable force. The ring can also be made to float in the air near the top of the center tube, apparently defying the force of gravity. In another experiment, the principle of a transformer can be demonstrated. The entire unit can be built in the home experimenter's shop for about \$18.00. Amaze your friends by doing stunts with this coil. 50¢

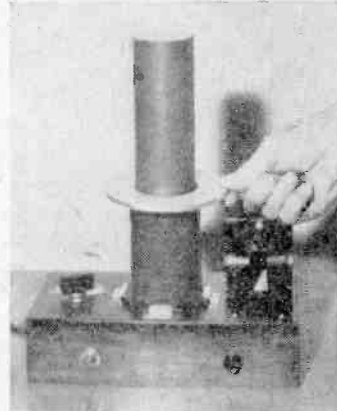
**246. AC TRANSFORMER ARC WELDER.** Once you have used an arc welder in your shop you will wonder how you got along without it. For making new things of metal or repairing old things it has no substitute. This welder is an AC transformer type rated at 150 amps when connected to a 220/240V, 60 cycle, single-phase circuit. Maximum output when operated wide open is 180 amps at 60V. It will handle welding electrodes (rods) up to and including 3/16 in. dia., which is large enough to weld steel several inches thick by the multipass method. By rearranging two connecting links, the welder can be used on 110/120V house current fused at 30 amps for use with 1/16 and 3/32 in. electrodes. Because of the hand-



Tesla Coil—No. 191—50c



Van De Graaff Generator—No. 197—\$1.00



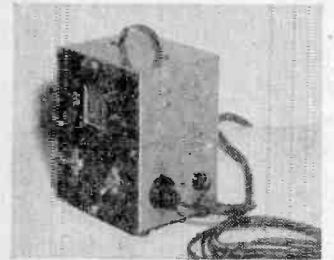
Repulsion Coil—No. 227—50c



Sun Powered Radio—No. 248—50c



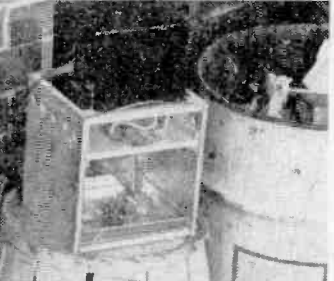
Arc Welder—No. 216—50c



Sun-Powered Relay—No. 258—50c



Selenium Rectifier Unit—No. 258—50c



Electrical Fly Trap—No. 224—50c



Miniature Furniture—No. 160—50c



Colt .44—No. 173—50c

wheel controlled, movable core-shunt transformer design, the welding-current setting can be regulated to a fraction of an ampere throughout the full welding range. Every construction step is fully explained with detailed drawings. 50c

**248. SUN-POWERED RADIO.** Now you can put sunlight to work as a source of power for your radio. A pocket-size portable receiver, with selenium photocells converts sunlight into electricity. Materials cost about \$12.00. Pictorial diagram and step-by-step instructions make this project ideal for radio experimenters. 50c

**250. MOBILE ARC WELDING SELENIUM-RECTIFIER UNIT.** By connecting this selenium-rectifier unit to an AC welder, you can use any type electrode of either straight or reverse polarity—the same as used with expensive DC motor-generator welders. Also, if this rectifier unit is connected to an AC welder, you can operate DC motors of 24 to 32 volts, pumps and the like up to 3 hp, if the voltage rating matches the output voltage of the rectifier. Our pictorial plan shows every construction detail. 50c

**251. SOLAR BATTERY AND MOTOR.** This solar battery captures sunlight and by the use of self-generating photo-electric cells produces sufficient electric power to run a small motor. In bright sunlight (10,000 foot candles), this battery produces an open-circuit voltage of about 1 volt, 180-190 milliamperes. Complete construction details are explained with pictorial drawings and photos. \$1.00

**258. SUN-POWERED RELAY.** This versatile relay turns lights, small motors, bells, buzzers, and a number of other types of electrical equipment on and off automatically—and it's activated solely by sunlight or by artificial light. As a control device, it has a wide variety of applications. Our plan explains how to put the sun to work and suggests many interesting experiments. A complete materials list, schematic diagrams and step-by-step instructions show you how to build the fascinating project. 50c

### Historical Models

**160. EARLY AMERICAN FURNITURE.** Set of 6 authentic pieces of 17th Century Colonial American Furniture—pine settle, six-board pine chest, trestle table, pine dresser, oak carver chair and a rod-back chair. Scale: 1 in. to 1 ft. Only simple hand tools needed. Makes an attractive collection. 50c

**166. WINCHESTER "73" CARBINE.** One of the most famous and colorful guns in American history, the Winchester "73" can be a prized addition to your model collection. Complete instructions for building and finishing the model are given. 50c

**173. COLT .44 SIX SHOOTER.** Probably the most famous firearm in history. Originally made by Col. Samuel Colt, who designed the world's first practical revolver. Today, the Colt .44 symbolizes the trigger-fast romance of the early West. Our plans are authentic in every detail. You'll enjoy building this fascinating project. 50c

**184. 1705 SPANISH MORTAR.** Authentic 1/16 in. scale model of a siege artillery piece used by Philip V of Spain's armies around 1705. They fired balls of stone or cases of small shot at a very

high angle at short range, dropping balls almost vertically behind enemy barriers. Splendid metal lathe job. Will be an eye-catching "conversation piece" for your mantle or den desk. 50c

**187. KENTUCKY PISTOL.** Recognized only recently as a distinct class of flint-lock hand arms. Most of these pistols were made by Kentucky rifle gunsmiths as a sideline or on special order. Rarely were two made alike as the gunsmiths were always trying to improve the mechanism and accuracy from gun to gun. Easy to make. A truly historical model to grace your mantle or den wall. 50c

**195. SPANISH MIQUELET PISTOL.** Named for the men who developed them, the Miquelets who were Spanish buccanniers and bandits. Used from about 1625 to 1850. They developed this flint and steel mechanism because the slow burning match which used to set off the earlier matchlocks would give away their presence on night raids. A very picturesque model to add to your collection. 50c

**213. 32-LB. COLUMBIAD CIVIL WAR GUN.** Many hours of fun can be had in building this authentic model of a cast iron, muzzle loading, 32-pound gun, used throughout the Civil War by both North and South, primarily as seacoast guns to defend cities and harbors. All construction details are explained with photographs and drawings. This project will make a real conversation piece for living room mantle or recreation room. 50c

### Home Furnishings and Equipment

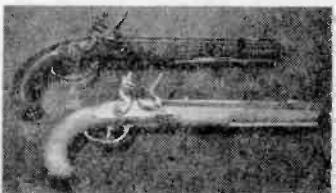
**139. TABLE WEAVING LOOM.** Weaving is one of the oldest arts of mankind. Beautiful patterns and fabrics up to 12 inches wide can be woven on this loom. This loom is easy to construct and will turn out work equal to professional jobs. You will find weaving fascinating and profitable. 50c

**153. FUNCTIONAL BEDROOM FURNITURE.** There's nothing quite so luxurious as reading in bed with all the comforts of home within easy reach. The double and twin-size bed shown on this plan are designed for individual comfort with back rests that tilt to 8 angles. Built into the headboard are concealed reading lights that automatically light when swung upward. Adjustable reflectors focus the light just where you want it. The footboard serves as a dressing seat. Matching cabinets hold your favorite books and have drop fronts at bed level that double for tables. The bed-side of the drop-front compartment is open and makes an excellent spot for a small radio. This plan triples the usefulness of your bed. 50c

**183. LAWN AND BEACH FURNITURE.** Planning on a summer of lazy lounging on the back lawn or at the beach? Then you'll enjoy making these three "built-for-comfort" gear. First, the 3-piece couch for sun-tanning keeps you off the sand and bugs and out of the dirt. It folds up like a suitcase. Second, the contour chair is just about the most comfortable chair you ever sat in. It is adjustable to several positions and when you stretch out—well, it's wonderful. Third, the wheeled lawn lounge can eas-



Spanish Miquelet—No. 195—50c



Kentucky Pistol—No. 187—50c

ly be moved from one place to another. The frame is covered with cord "upholstery" which affords service and comfort. Complete construction details, materials list and step-by-step instructions show you how to proceed. You'll enjoy these projects. Why not build them? 50c

**194. CONVERTIBLE SOFA-BED.** A handsome living room sofa that becomes a double bed six-footers can stretch out on comes in mighty handy for bedding down overnight guests or as a third bed in two-bedroom homes. Our plans give detailed instructions and step-by-step illustrations showing how to build this project. 50c

**204. MODERN BARN.** Size 36 x 50 ft. New design with laminated construction makes it easy to build and saves up to \$1,000. Includes built-in stanchions, box stalls, feed rooms, hay chutes and post-free hay mow that holds 50 tons. Two sheet plans. \$1.00

**217. MULTI-PURPOSE WORKBENCH.** Occupies a minimum of floor area, yet this workbench has more than 11 cu. ft. of space for storing all the hand tools you'll need, including small portable electric tools and appliances such as a drill, sander, glue pot and soldering iron. Special features are: a generous-sized linoleum-covered working surface with a shaving trough; a compartment for sandpaper and sanding blocks; 5 roomy drawers; 2 tool cabinets; file and screw-driver racks; shelves; magazine holder; built-in electrical outlets complete with pilot light; overhead adjustable lamp; a supporting device for holding long work and a 20 x 22 in. drawing board. The overall working surface is 62 by 26 inches. Never before has such a versatile workbench been designed. Two large plan sheets. \$1.00

**218. PORTABLE BEVERAGE BAR.** Ideal for home or small apartment use, this beverage bar can be folded up into four lightweight pieces and stored in a clothes closet or carried in your car to a friend's house. The bar is large enough to accommodate six people comfortably and will be the center of interest at any house party. It can be constructed of knotty pine, wall-panel type plywood, mahogany, oak, grooved or sandblasted fir plywood, whichever best harmonizes with the room walls. Every step needed to explain the construction is given in detail. 50c

**220. 3-IN-1 SAWHORSE.** This is not just another sawhorse, but a veritable workshop which will save you many steps around the house because it can be easily moved from one job to another. Hand tools can be stored in the space beneath the top, while bins located between the legs hold small portable electric tools. A shelf holds a carry-all tool box which, in addition to holding handsaws, plane irons and other hand tools, has a drawer for chisels, bits, screwdrivers and an assortment of nails and screws. The generous width of the top of the sawhorse provides a wide platform for use when painting walls and ceilings. Here is a sawhorse that should be a must in every home. 50c

**229. AUTOMATIC CLOTHES DRYER.** Now you can build a 110-volt automatic clothes dryer for approximately \$80.00. It

will simulate sunshine and destroy odors and bacteria. It will take about 9 lbs. of clothes and dry them in 45 minutes to 1½ hours depending upon the type and weight of clothing material. Complete instructions, bill of materials and detailed drawings show you how to build this useful home appliance. \$1.00

**231. MODERN MATCHING DESK AND CHAIR.** This artistically proportioned desk and chair of modern design is sturdy, functional and has a working-size top. Three drawers, one of filing-drawer type, provide plenty of storage for stationery, accounts and personal receipts, bills, etc. Construction is simplified by using large panels of veneered ¾-in. plywood which serve as both framing and covering material. Wrought iron legs and chair frame make this an interesting combination metal and woodworking project. 50c

**240. KITCHEN CABINETS.** Making and installing new natural wood finish kitchen cabinets and an over-the-range hood ventilator not only increases the value of your home but also gives your family the convenience of modern living at a low cost since you save by building the cabinets and base-cabinet fronts yourself. Five different types of wall and base or counter cabinets are used to transform and modernize the kitchen. Complete building plans for each basic cabinet are included in this kitchen modernization program. Cabinets are designed so that they may be altered to suit the particular size and shape of your kitchen. No detail is overlooked. \$1.00

**241. MULTI-PURPOSE ROOM DIVIDER.** Although this room divider has the appearance of a built-in unit, it is completely portable and may be moved about the same as other pieces of furniture. Its basic purpose is to separate two rooms but it can be used as a buffet for party snacks, a china cabinet, knick-knack display rack and storage unit for dishes, glassware and bottle goods. Helps to make your home more livable. 50c

**244. LIVING ROOM WORKBENCH.** What appears to be a piece of furniture is actually a self-contained workshop designed specifically for hobbyists living in small homes or apartments. It will accommodate a general assortment of hand and electric tools, plus containers for paints, screws, nails and model or craft parts and has a combination shaving trough and tool holder. Convenient table height. When folded up, it occupies only 11½ x 25¼ in. floor area. All construction details thoroughly explained. 50c

**252. CONCRETE STAIRS.** If you have always admired those neat concrete stairs with ornamental iron railings, here's how you can do it yourself at a big saving. You save in other ways too; the improvement will increase the resale value of your property and concrete stairs will never rot and need replacement or painting. This plan shows how to build the concrete foundation wall, prepare and pour the concrete mix, finish the surface, and install the iron railings. Add beauty to your home. 50c

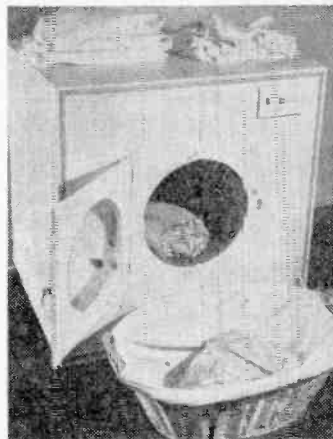
**253. ROLL-AWAY LAWN FURNITURE.** By carefully nesting all of the pieces of this project together, you can make a



Kitchen Cabinets—No. 240—\$1.00



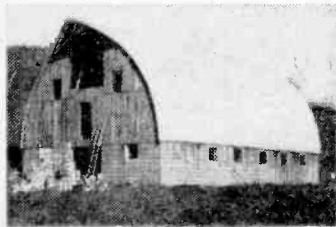
Portable Beverage Bar—No. 218—50c



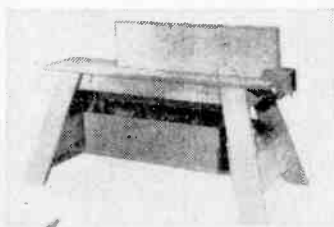
Automatic Clothes Dryer—No. 229—\$1.00



Multi-Purpose Workbench—No. 217—\$1.00



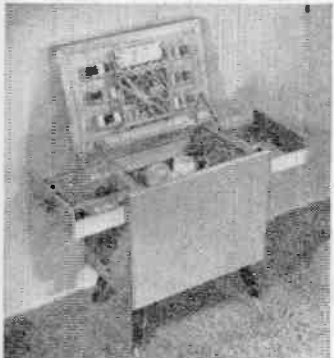
Modern Barn—No. 204—\$1.00



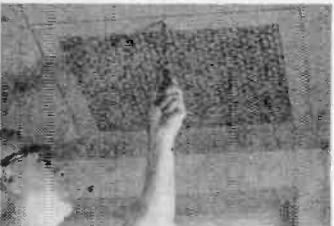
3-IN-1 Sawhorse—No. 220—50c



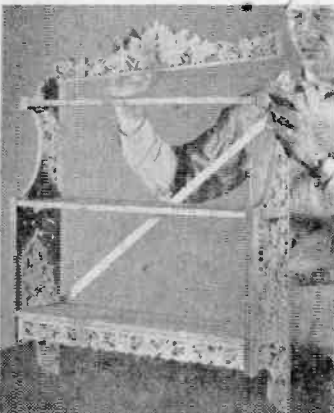
Lawn & Beach Furniture—No. 133—50c



Sewing Cabinet—No. 257—50c



Kitchen Ventilator—No. 254—50c



Wall Shelf—No. 24—50c



Convair XF-92A—No. 180—50c

cocktail table, two comfortable chairs and a chaise lounge from one sheet of plywood. A full-size pattern, plus detailed instructions for cutting, assembling and finishing this project are given. All you need do is to trace the pattern and start cutting the parts. Lightweight construction makes it easy to roll the entire set away for storage. \$1.50

**254. KITCHEN VENTILATOR.** You can now easily carry away cooking odors and grease-laden fumes with a kitchen ventilator installed to your exact requirements. Whether you need a ceiling ventilator, a cabinet ventilator or a wall ventilator, this plan will show you how to build it. Explains the basic needs for each type of ventilator and which one will give you the best results. Enjoy the added comforts a kitchen ventilator will give your family by installing one now. 50¢

**257. SEWING CABINET.** At first glance this project looks more like a chairside end table than a sewing cabinet for it makes an attractive addition to any living room. Yet, it contains two half-length, tray-drawers at the top, a lid that holds spools of thread and dress patterns, a large 6-in. deep storage cabinet, and a full-length drawer at the bottom. The arrangement of the cabinet is such that you get maximum use of the space. A detailed bill of materials, step-by-step instructions, and large, clear drawings make it an easy job to build this project. 50¢

### Jigsaw Projects

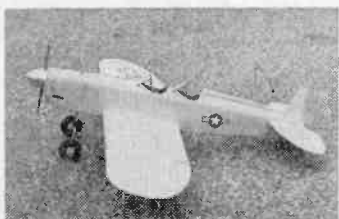
**26. 18th CENTURY WALL SHELF.** The scrolled grape leaf pattern of this shelf blends in with the design of this wall-piece for displaying figurines, vases and chinaware. It provides a project for the woodcraft hobbyist that may well be an heirloom in the years to come. Size: 23½ in. long by 26¾ in. high and 5½ in. deep. Full-size pattern. 50¢

**90. JIGSAWED WALL SHELVES.** Three full-sized patterns for making 1) a small shelf suitable for an electric clock or collector's items, 2) unique design of blond berries in relief, and 3) a lacy filigree design wall shelf that will add beauty and charm to any home. Complete instructions for making all 3 projects. 50¢

### Model Airplanes

**171. PULSE-JET MODEL AIRPLANE.** This model plane project uses what may be the smallest successful pulse-jet engine ever built. It was developed after scores of experiments by a guided-missile engineer. It can be built by any home craftsman who has a fair knowledge of metal working. The theory of jet propulsion is explained and every detail in the construction of the engine and the plane are shown, together with a materials list. For fun and real thrills, build this project. Two large plan sheets. \$1.00.

**180. CONVAIR XF-92A.** This plane is a model of Convair XF-92A which was the winner of the Air Force competition. It is a 20 in. span flying model and can be flown free-flight with a Jetex 200 or 150 solid fuel engine on U-control. Detailed drawings and step-by-step instructions show you exactly how to proceed. 50¢



Carrier Trainer—No. 186—\$1.00

**186. U. S. NAVY CARRIER TRAINER.** Designed especially for model airplane builders who wish to enter the U. S. Navy Carrier Event, sponsored by the U. S. Navy. This event has grown in popularity each year. Powered by a Fox .35 Glow-Plug engine, this model flew at a top speed of 71 mph and a low speed of 35 mph. Detailed drawings and instructions make it easy to build this model. \$1.00

**202. FREE-FLYING HELICOPTER.** This scale model takes off vertically, flies forward at reduced speeds, and slowly floats down when the gas runs out. It will teach you about rotary-wing aircraft and their problems. Complete with drawings and instructions. 50¢

### Model Boats

**29. MODEL MOTOR SAILER "STAR DUST."** This attractive 27 in. sloop will add nautical atmosphere to any recreation room or mantelpiece. Full construction details and bills of materials. 50¢

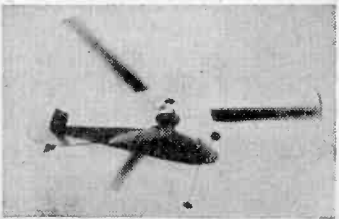
**37. MODEL YACHT "SEA BREEZE."** Model yacht racing is a sport every man and boy will enjoy. This trim model yacht is 36 in. long, has 487 sq. in. sail area, 42 in. mast, draws less than 6 in. of water, has deep fin keel and can be constructed of three-ply Weldwood. Designed for championship racing. 50¢

**58. COAST GUARD LIFEBOAT.** From Greenland to Panama hundreds of U. S. Coast Guard motor lifeboats are ready to aid seafarers in distress. When hurricane warning flags go up, the lifeboat crews of the Coast Guard put to the sea at a moment's notice. Breakers may completely swamp this unsinkable, self-balling lifeboat, but she was designed for jobs like that. The construction of a 9-3/16 in. scale model of this seagoing lady is quite simple. It will make a splendid conversation piece for your den or recreation room. Detailed drawings, list of materials and step-by-step instructions make it easy to build. Every model builder interested in the sea should build this project. 50¢

**181. COAST GUARD PATROL BOAT.** Model of YP class wooden hull patrol boat used in World War II along the shipping lanes along the Atlantic Coast to hunt Nazi submarines. Built to ¼ in. scale. Has forward anti-aircraft gun and dummy depth charges that operate by delayed action. You can install a small electric 6-volt motor or ½-A Class gas motor for power. Every step in construction clearly explained. Two large sheets. \$1.00

**196. DIXIE BELLE RIVER BOAT.** Now you can recapture a bit of Mark Twain's Americana by building an authentic 40 in. steam-powered operating model of a Mississippi Stern-Wheeler or a 20 in. shelf model. All construction details, materials list and procedure given. \$1.50

**205. SEA-SLED.** A streamlined airfoil-type hull enables this 14 in. racing boat to zoom over the water at a fast clip. Sea-Sled weighs only 5 oz. and, with a powerful Wasp or any .049 cu. in., gas engine, it will give hot competition to any boat on the lake. Construction is ultra-simple so you can build a Sea-Sled in one day and race it the next. Plans are full-size. 50¢



Free-Flying Helicopter—No. 202—50c

**214. LITTLE SQUIRT FIREBOAT.** This model is radio-controlled so that it can be maneuvered in the water by a remote transmitter. Even the water pump, which shoots a stream of real water through its gun-type nozzles, is remotely controlled. Two electric motors drive the boat at a fast clip as though it were in a hurry to get to a fire. Three large plan sheets explain every detail of construction. \$1.50

**256. HASTY HORNET, JR.** Weighing less than 16 ounces, this 16½-in. long, sleek model hydroplane with its battery-powered outboard motor will speed along at well over 30 scale miles per hour. It's a one-eighth scale model of our famous high-speed hydroplane "Hornet" (Craft Print 161) that has won so many races. Full-size plans make it easy for you to build this project. If you want speed, fun and thrills at your next model show, build "Hasty Hornet, Jr." 50¢

### Model Engines

**25. SPEED KING.** Designed for speed and power, this rugged little oscillating steam engine will appeal to the critical model builder. Due to its low center of gravity, this engine is ideal for installation in a model steam or other type of power boat. Develops speeds in excess of 3000 rpm. The machine work is of a type well within the construction capacity of the beginner who has learned to run a small metal cutting lathe. Plan includes materials list and detailed drawings. 50¢

**61. TWIN CYLINDER RACING GAS ENGINE.** There is something about the building of a high speed miniature racing engine that appeals to every model builder, even though the construction of a working model is a big undertaking. This twin cylinder water cooled gasoline engine has 1½ in. bore, 1 stroke. Length 6 in., width 4 in., height 5½ in. 50¢

**141. 4-CYCLE, SINGLE CYLINDER GAS ENGINE.** Here is a gem of a model air-cooled gasoline engine which develops approximately 1/3 H.P. at speeds ranging to 5,000 revolutions per minute with that smooth even flow of power which characterizes a 4-cycle engine. The engine is equipped with the latest in carburetors with slow and fast running jets, idling jets and both gas and air adjustments which may be manipulated so that the engine slowly "ticks" over or "roars" at full throttle. \$1.00.

**208. AIR PUP—MIDGET GLO-PLUG ENGINE.** For powering model planes up to 10 oz. in weight, "Air Pup" is a real air-gathering power plant. Operating with a glo-plug on a 2-stroke cycle, it is adapted for either control flying or free flight. Displacement .064 cu. in., bore .430, stroke .440, RPM 15,000, 6 in. Dia. 3 in. Pitch propeller 50¢

**225. CYCLONE 3 CYL. STEAM ENGINE.** If you are a model builder who enjoys making "live steam" engines, you'll find this high speed rotary engine an interesting challenge in model making. This little handful of dynamite is a beautiful and smooth-running machine that will tick over like a watch on five pounds of steam pressure and deliver a startling performance with a rating of about ¼ hp

on 100 to 125 pounds per square inch of moderately super-heated steam. The boiler is a slightly modified Scott marine-type boiler made entirely of copper. With its super-heater type it will deliver moderately dry steam. The engine is of the single-acting, rotary-type having three cylinders of ¾-in. bore and ¾-in. stroke. Crankcase, cylinders, pistons, connecting rods and drive shaft rotate around a combination main bearing and rotary valve so that perfect balance is maintained and no fly-wheel is necessary. Every construction step is explained so that you will have no difficulty in building this fine project. Complete materials list and source of supply are given for your convenience. \$1.00.

**259. MIDGET CENTRIFUGAL PUMP.** You can put this little pump to a variety of practical uses requiring a continuous flow of liquids from sources free of sand or other gritty substances. It is just the right size for a forced-coolant system on high-speed machine tools; for aerating small fish ponds or large aquariums; for window displays, or indoor or outdoor fountains. The output capacity of the pump will vary depending on its nearness to the liquid source, its operating speed and sizes of intake and output pipes. No castings are required to make this pump as all parts are machined from solid brass flats and rounds, except for the impeller shaft, which should be stainless steel to prevent rust. These plans are full-size to make it easy for you to construct this project. 50¢

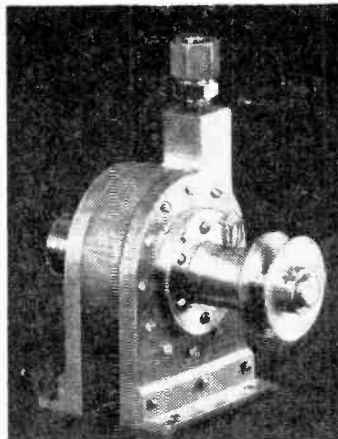
### Model Transportation

**23. MODEL OF 1850 HORSE-DRAWN STATION WAGON.** Here is a fashionable rig that Grandpa used for attending races, going to parties and meeting the trains. They were usually painted black with bright red upholstery, a lemon yellow undercarriage and bright red, rubber-tired wheels striped in black. You will find this an interesting project to build and one, if used as a mantle piece, that will cause plenty of comments. 50¢

**34. O-GAGE ELECTRIC LOCOMOTIVE.** Here's an O-Gage loco that's powerful, simple to make, and a gem for realism. No lathe work is necessary as the wheels and axles are available at most hobby shops. Our master plan is so complete and easy to follow that you should have no difficulty in building this project. 50¢

**45. TALLYHO COACH.** The original of this English Road Coach was built in London about 1850. It was still in general use after 1900 in this country and England. It offers you a project that will test your skill as a craftsman. Two large sheets, with large, clear illustrations, give you the dimensions, size and shape of every part in the construction. It's a project you'll enjoy and be proud of. \$1.00

**158. MODEL OF 1903 FORD.** The original Model A Ford Automobile was built in 1903, just seven years after Henry Ford constructed his first gasoline-powered vehicle. This authentic ¾ in. scale model is a must for your collection of antique automobiles. The full-size drawings and materials list enable you to build this model from scratch. 50¢



Midget Centrifugal Pump—No. 259—50c



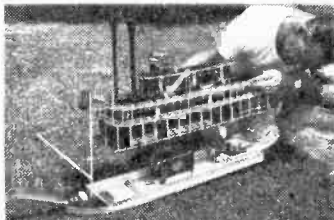
3-Cylinder Steam Engine—No. 225—\$1.00



1850 Station Wagon—No. 23—50c



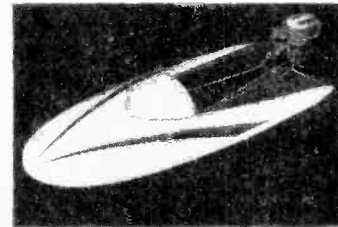
Stanley Steamer—No. 168—50c



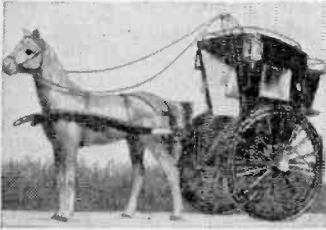
River Boat—No. 196—\$1.50



Sea-Sled—No. 205—50c



Model Hydroplane—No. 256—50c



Hansom Cab—No. 198—50c



Gage Electric Locomotive—No. 34—50c



Aquaplane and Surfboards—No. 203—50c



Powercycle—No. 215—\$1.50



Folding Camp Trailer—No. 200—\$1.00

**168. 1909 STANLEY STEAMER.** One of the fastest cars of its day. Broke the world's record with a speed of 127 mph in 1906. This 3/4 in. scale model is authentic in styling and detail. Complete materials list, step-by-step drawings explain how to build this model. 50¢

**190. LITTLE JOE.** This little HO GAGE locomotive—no larger than a pack of cigarettes—is modeled after one of the Baltimore & Ohio saddle-tank switches. This type of engine is used to shift cars, make up trains, and make short freight hauls. Easy to build. Makes an excellent project for the beginner. Complete materials list, plans and instructions simplify the making of this model. 50¢

**198. HANSOM CAB.** A low, 2-wheeled hackney carriage for one horse was invented and patented by Joseph Hansom in 1834, from whom it received the name of Hansom Cab. This carriage was used extensively in England and France and later came into use in the United States. All parts of this 3/4 in. scale model are numbered to simplify construction and each item is specified in the materials list, giving number required, size material and use. You'll enjoy building this project. 50¢

**235. MINIATURE MONORAIL.** Built to a scale of 3/16-in. to the foot, this miniature monorail train makes an excellent table-top toy for the youngsters. A battery powered 12-volt D. C. electric motor geared to a hard-rubber washer drives the car by friction against an overhead rail. The cars are made from balsa wood and given a metallic-like finish for realism. The track layout is mounted on a stock size 4 x 8 ft. sheet of plywood. Complete instructions with detailed drawings explain how to build this fascinating model project. 50¢

### Sports and Vacation Equipment

**50. CABIN TRAILER.** Ideal for week-ends, fishing or vacation trips. Compact rooms, comfortable; sleeps two people. Designed for all modern conveniences—sink, water tank and pump, stove, kitchen table, cupboard, clothes closet, drawer chest, storage space, electric lights, ventilator, etc. Sturdy, simple construction. Overall body length, 12 ft. 6 in., weight 1,100 lbs. Our master plan gives bill of materials, explains every construction detail. 50¢

**200. FOLDING CAMP TRAILER.** Camping out can now be a pleasure. With "Handy Andy," you can carry your tent with you (taking about 10 minutes to set up) in a light trailer that tows easily and also carries your boat. Inside there's sleeping room for three adults or two adults and three children. You also have space for cooking in bad weather. With its 20 in. road clearance, you can haul "Andy" any place you can drive a Jeep or pick-up truck—right back to where the trout are hungriest. Two large plan sheets show you how to build this trailer. \$1.00

**203. AQUAPLANE AND SURFBOARDS.** Water sport at high speed—that's the fun you'll have riding "Bobber" or "Flying Disc." There's plenty of variety too—from the slow, training rounded side of

"Bobber" the long board, to the skittish gyrations of "Flying Disc", that's strictly for the expert. For real water thrills here it is! 50¢

**215. SUITCASE-SIZE POWERCYCLE.** As an errand runner or for short distance commuting, this midget motorcar would be hard to beat. Designed so that the handle bars fold down and the foot pedals fold in, this powercycle will easily fit into the trunk of your car. You can build this pint-size powercycle for about \$110.00. Commercial powercycles regularly sell for over \$200 to \$400 and none of them fold up the way this one does. Three large plan sheets showing all necessary parts in full size, plus the step-by-step construction details simplify the building of this project. Nicky Frances, the famous clown, featured this powercycle recently on the famous Super Circus TV Show. Build one! You'll have hours of fun and enjoyment. \$1.50

**238. VACATION TRAILER.** You'll save money in two ways by building your own vacation trailer. First, because you can save one-half the cost of a comparably built and equipped new factory trailer. Second, because the two largest vacation expenses, lodging and meals, for you and your family will not be much more than if you stayed at home. The plus feature of having a vacation trailer is that even summer week-ends can become short-trip, fun-packed vacation days. You'll find real comfort, too, because this trailer provides sleeping, cooking and eating accommodations for a family of five, yet it is small enough to be towed by a modest family car. Plans provide for a 14 ft., 16 ft., or 18 ft. trailer. All construction details are explained, including electrical wiring, insulating and completing the exterior and interior. Sources of supply are given for all materials and parts to simplify construction. \$1.50

**247. BUILT-INS FOR TRAILERS.** These project ideas will add extra pleasure and convenience to trailer life and help put valuable space to use which may otherwise be wasted. Ideas include trailer name signs for identifying the occupants of trailers and the parking lot number, cupboard retainers to keep foodstuffs from toppling over or falling off the shelves while the trailer is in transit and a utility cabinet that holds toiletries and serves as a vanity. Drawings and photos show you how to do it. \$1.00

### Toys

**99. SCHNAPZY WIG-WAG DOG.** His tail wiggles and his body waggles as he walks. Just what that youngster of yours craves—action galore. Easily made from scrap lumber in one evening. Only simple tools needed. When finished, you have a toy that the kids will love. Full-sized pattern. 50¢

**134. ANIMATED GRASSHOPPER.** Here is a pull toy that will give your youngster a lot of happy hours. You can make it from scrap materials and when decorated will look like a professionally made toy. Grasshopper can be made to jump or walk, just as you wish. Full-sized pattern. 50¢

**145. "WIG-WAGGING" TURTLE.** Another action toy that thrills youngsters. The legs, front and back, as well as the tail move in a realistic manner. Easy to construct out of plywood. Full-size pattern gives all construction and assembly details. 50¢

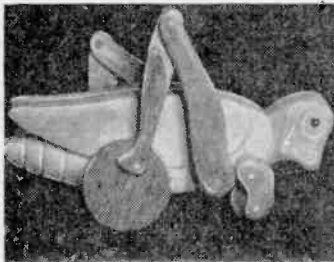
**147. BOUNCING BUNNY.** This pull toy produces lots of action. As your youngster pulls the bunny it stimulates a bouncing effect that reminds you of a rabbit scampering away in the garden. Children get a big kick out of it. Made of plywood. Full-size pattern. 50¢

**176. TOY CROSSBOW.** Youngsters will find this boy-size crossbow tops for target



Vacation Trailer—No. 238—\$1.50





Animated Grasshopper—No. 134—50c

practice and backyard "hunting". And with Junior in bed, dad and his pals will find the pistol-grip version a challenging substitute for darts in the game room. Full-size pattern and step-by-step instructions explain every construction detail. 50¢

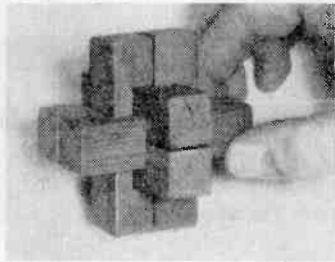
**212. MINIATURE SPEEDWAY.** Now you can have a miniature speedway and put on "races" that will simulate the Indianapolis races. The whole layout includes a race track for model Ferrari cars, grandstand, judge's stand, car pits for refueling (new batteries, that is), guard rails and the gay decorations that are always out for the race. You can mount the track on two 4 x 4 ft. pieces of plywood for easy storage. The two Italian Ferrari racers are built to a scale of 1/2-in. equals 1 ft. The HO-Gage brass rail down the middle of each track keeps the cars in line. You can have loads of fun simulating actual racing events. Full-size drawings are given for all necessary parts. Two large plan sheets make the construction details clear and easy. \$1.00

**226. FUN-ROOM CIGARETTE LIGHTER.** This is without doubt the goofiest, most complicated cigarette dispenser and lighter there is. It would probably come under the heading of Basement Game-room Gimmicks, although it could and has been used as a TV, office and party gag on many occasions. If you have the reputation of being an inventive or mechanically minded type of person, you'll have a lot of fun with it, offering your friends a cigarette and watching the look of amazement on their faces as the machine automatically goes through a series of mechanical movements with chain reaction regularity until a match is ignited. After a short pause, the match is extinguished with drops of water, again automatically controlled. You can find most of the material to make this gadget around the house. Have fun! 50¢

**230. ELEVEN TANTALIZING PUZZLES.** Do you like to work puzzles? If you do, this Craft Print gives plans in actual size for making 11 puzzles from bits of wire, wood, plastics, string or cardboard. They will give you endless hours of fun and enjoyment. Puzzles make excel-



Toy Crossbow—No. 176—50c



11 Tantalizing Puzzles—No. 230—\$1.00

lent gift items, or if you are going to have a dinner party, use puzzles as an "ice breaker" or offer prizes to those solving the puzzles first. They're loads of fun. You can also build up a profitable business by supplying puzzles to gift shops, cigar stores, etc. \$1.00

**234. ELECTRIC DART GAME.** You can really ring the bell with this dart game if your aim is good. The red-ringed bullseye circle in the center not only rings the bell when hit, but also lights up a red jeweled lamp. If your dart strikes one of the different colored circles surrounding the bullseye, a light of the same color will glow at the top of the target. A hit in the bullseye counts 50 points, and one in any of the surrounding circles counts 10 in scoring. Built from easily obtained materials. Pictorial wiring diagrams, drawings and photos show every step to make this fine game. 50¢

**236. MUSCLE-POWER MEASURER.** The way to get a good grip on yourself is to practice with this game room machine. Although built primarily for fun, it is an ideal hand exerciser. And your family and friends can have a whale of a time finding out who has the strongest grip from week to week. The machine registers 25, 50, 75 or 100-point grip. How strong are you? Test your grip with this muscle-power measurer. Our plan gives construction details, wiring diagram and complete materials list. 50¢

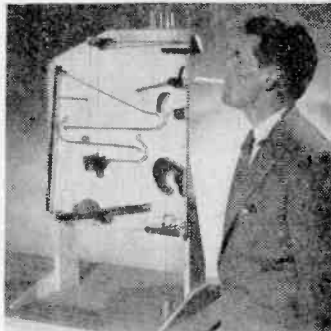
**243. TOY ELECTRIC MOTORS.** Toy electric motors come in two types—windmill and engine. This plan explains how to build BOTH types, and both will operate from a 3-volt battery. Detailed drawings, photos and materials list make it easy to build these toy motors. Not only will they furnish endless hours of enjoyment for your boy but they make an interesting project to demonstrate the conversion of magnetic energy directly to mechanical motion. \$1.00

Miscellaneous

**232. REBEC FIDDLE.** A sure-fire "conversation piece," this medieval-style fiddle makes a highly decorative wall ornament for the music or game room. More than just a piece of interesting bric-a-brac, this instrument can actually be played and has a very unique and pleasing musical quality. Brought to Europe during the middle ages by returning crusaders, it probably was the ancestor of today's violin. No special tools or skill needed to make this unusual musical instrument. Our plan gives all the construction details. 50¢



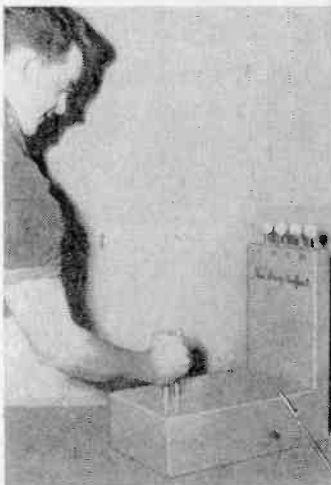
Wig-wag Dog—No. 99—50c



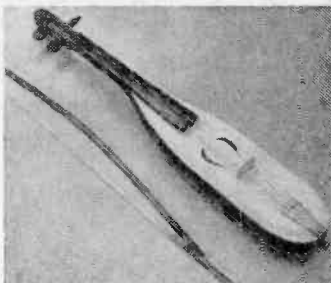
Cigarette Lighter—No. 226—50c



Miniature Speedway—No. 212—\$1.00



How Strong are You?—No. 236—50c



Rebec Fiddle—No. 232—50c

Use the handy  
Order form on  
the next page



# Use This Handy Order Form

## SCIENCE AND MECHANICS

450 East Ohio Street, Dept. R-571  
Chicago 11, Illinois

Enclosed is \$....., for which send me  
the Craft Prints I have circled below:

### These Plans are 50c each

3	6	11	13	14	15	18	20
21	22	23	24	25	26	27	29
30	31	32	33	34	36	37	38
43	44	46	47	50	53	54	55
58	59	60	61	62	64	67	75
76	77	78	79	80	81	90	99
104	105	106	107	112	113		
134	138	139	145	147	150		
152	153	154	155	156	157		
158	159	160	161	163	165		
166	168	170	172	173	174		
176	178	179	180	183	184		
185	187	189	191	193	194		
195	198	199	202	203	205		
208	209	211	213	218	220		
222	223	224	226	227	231		
232	234	235	236	237	241		
244	246	248	249	250	252		
254	255	256	257	258	259		

No C.O.D.'s or stamps please!  
Because of the excessive  
charge made by the U.S. Post  
Office on C. O. D. shipments  
(40c on orders of less than  
\$5), we recommend that you  
save this fee by sending your  
remittance with this order.  
We guarantee complete satis-  
faction or your money will be  
refunded immediately.

### These Plans \$1.00

45	141	171
175	181	182
186	192	197
200	201	204
206	207	210
212	216	217
219	221	225
228	229	230
233	240	242
243	245	247
251	260	

### These Plans \$1.50

188	196	214
215	238	239
253		

Please allow four weeks for delivery.

NAME .....

ADDRESS .....

CITY & ZONE .....

STATE .....

## SPECIAL QUANTITY DISCOUNT

If you order two or more  
Craft Prints at one time,  
you may deduct 10c from the  
regular price of each plan.  
Hence, if you order 2 plans  
you deduct 20c; 3 plans, 30c;  
4 plans, 40c; etc. Circle the  
numbers of the Craft Prints  
you want and enclose remit-  
tance with this order form.

# THE ONLY COMPLETE ELECTRONIC COURSE

# Learn TELEVISION, RADIO, RADAR, SONAR, ELECTRONICS

Only CTS offers you **COMPLETE** training in all phases of Electronics. Why be satisfied with less? The new Christy Shop-Method Home Training makes learning interesting and easy. You learn Radar, Sonar, Electronics, Radio, Television. No previous experience needed. You learn by working with actual equipment. Makes learning fun. Speeds your progress. Helps you understand quicker and remember longer.

You get comprehensive training starting with your first CTS lesson! The complete knowledge CTS provides you with, gives you a broader knowledge, a greater understanding which will mean more jobs and a higher income for you for the rest of your life.

## HOME LABORATORY SENT! 19 TRAINING INSTRUMENTS INCLUDED

With CTS **COMPLETE** Home Training Course, you receive a Home Laboratory to assemble, use and keep for years of peak performance. You receive a Multi-Tester, Oscillator, Signal Tracer, Oscilloscope, Signal Generator, Electronic Timer, Regenerative Radio, Giant-size Television Receiver (optional) as well as many other valuable electronic devices. With these you will be able to make hundreds upon hundreds of exciting experiments.

## EARN WHILE YOU LEARN! EARN \$5.00—\$6.00 PER HOUR

Or **MORE** while still studying! Almost from the very first you receive training that enables you to repair radios and television sets for friends and neighbors. To install and service electronic computers, communication equipment, protective equipment for police and fire departments, etc., etc.

## FREE BOOK—SAMPLE LESSONS SENT

Get all there is to know about the Christy **COMPLETE** Electronic Course in Radio-Television-Radar-Sonar, etc. A complete, colorful, illustrated book on Electronics sent without obligation.

Also, we will send you Two sample lessons showing how the new CTS Shop-Method Home Training Course will train you for making big money in your spare time and for building a bright future for yourself.

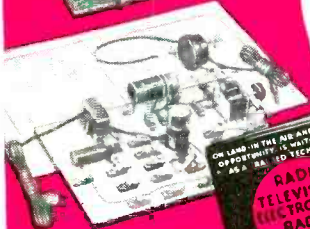
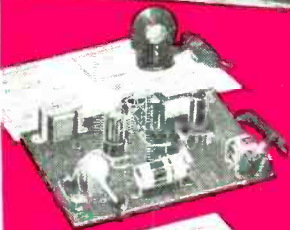
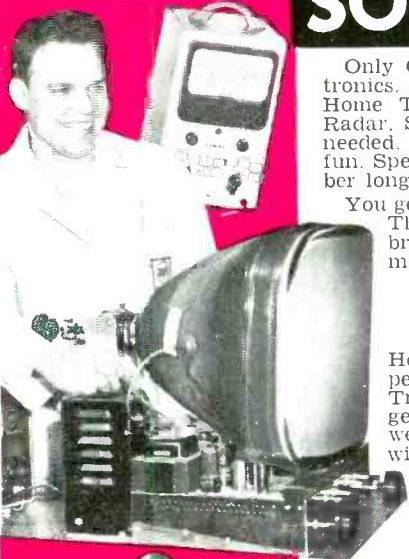
CHRISTY TRADES SCHOOL, Dept. T-209, 4804 N. Kedzie Ave., Chicago 25

## SIGN, MAIL FOR THREE BOOKS

Christy Trades School, Dept. T-209, 4804 N. Kedzie, Chicago 25, Ill.

Gentlemen:  
Please send me, without cost or obligation, two **FREE** lessons and the new 24-Page illustrated book telling all about the CTS Master Shop Method Home Training Course in Radar, Sonar, Television, Radio and Electronics, and the many opportunities this new field offers.

Name ..... Age.....  
Address .....  
City..... Zone..... State.....

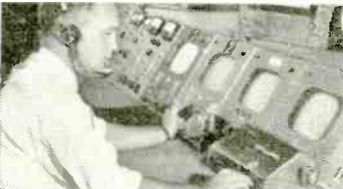
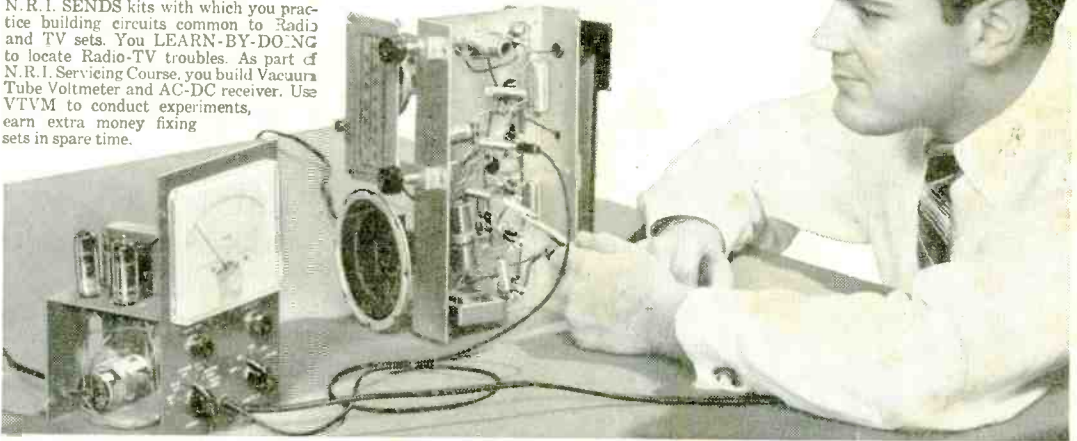


**MAIL COUPON TODAY FOR CATALOG!**

# Learn Radio-Television

## Servicing or Communications by Practicing at Home in Spare Time

N.R.I. SENDS kits with which you practice building circuits common to Radio and TV sets. You LEARN-BY-DOING to locate Radio-TV troubles. As part of N.R.I. Servicing Course, you build Vacuum Tube Voltmeter and AC-DC receiver. Use VTVM to conduct experiments, earn extra money fixing sets in spare time.



RADIO-TV BROADCASTING (see above) offers important positions as Operators and Technicians. RADIO-TV SERVICING Technicians (see below) needed in every community. Their services are respected, their skill appreciated.



## Fast Growing Field Offers You Good Pay, Success, Bright Future



J. F. SMITH  
Founder

Bigger than ever and still growing fast. That's why Radio-TV has special appeal to ambitious men not satisfied with their job and earnings. More than 4,000 Radio and TV stations. More than 150 million home and auto Radios, 40 million TV sets. Color TV promises added opportunities. For the trained man; there are good jobs, bright futures in Radio-TV Servicing or Broadcasting. Training PLUS opportunity is the ideal combination for success. So plan now to get into Radio-TV. The technical man is looked up to. He does important work, gets good pay for it. Radio-Television offers that kind of work. NRI can supply training quickly, without expense of going away to school. Keep your job while training. You learn at home in your spare time. NRI is the OLDEST and LARGEST home study Radio-TV school. Its methods have proved successful for more than 40 years.

### Added Income Soon - \$10, \$15 a Week in Spare Time

Soon after enrolling, many NRI students start to earn \$10, \$15 a week in spare time fixing sets. Some pay for their training and enjoy extra luxuries this way. Some make enough to start their own Radio-TV shops. NRI training is *practical*—gets quick results. Easy to understand, well illustrated lessons teach you basic principles. And you LEARN-BY-DOING by practicing with kits of equipment which "bring to life" things you study.

### Find Out What NRI Offers

NRI has trained thousands for successful careers in Radio-TV. Study fast or slow—as you like. Diploma when you graduate. Mail coupon now. Paste it on a postcard or mail in envelope. ACTUAL LESSON FREE. Also 64 page catalog that shows opportunities, shows equipment you get. Cost of NRI courses low. Easy terms. NATIONAL RADIO INSTITUTE, Dept. 6NB3, Washington 9, D. C.

### N.R.I. TRAINED THESE MEN FOR SUCCESS



"I was repairing Radios by 10th lesson. Now have good TV job." M. R. LINDEMUTH, Fort Wayne, Ind.



"Doing spare time repairs on Radio and TV. Soon, servicing full time." CLYDE HIGGINS, Waltham, Mass.

"I had a successful Radio repair shop. Now I'm Engineer for WHPE." V. V. WORKMAN, High Point, N. C.



"There are a number of NRI graduates here. I can thank NRI for this job." JACK WAGNER, Lexington, N. C.



### VETERANS Approved Under G. I. Bills

### SEND FOR BOTH FREE

#### National Radio Institute

Dept. 6NB3, Washington 9, D. C.

Mail me Sample Lesson and 64-Page Catalog FREE. (No salesman will call. Please write plainly.)

Name \_\_\_\_\_ Age \_\_\_\_\_

Address \_\_\_\_\_

City \_\_\_\_\_ Zone \_\_\_\_\_ State \_\_\_\_\_

Approved Member National Home Study Council

