

SERVICE DEALER

JULY
1956

50¢



and ELECTRONIC SERVICING



Photo Courtesy of Minnesota Mining & Mfg.

This Issue's Features:

Component Failures in Hi-Fi
Practical Scope Servicing
Modern Sweep Generator Design

Fuses for Radio & Television
Ruggedized VTVM
Auto Radios for 1956—Buick

a **VOM** ...plus a **VTVM** when you need it.

DOUBLE USE...HALF THE PRICE
TRIPLETT MODEL 631—In one year accepted as the
 standard **COMBINATION VOM-VTVM**



Battery operated

- 1** Just flip the switch.
- 2** Standard sensitivities as used in servicing manuals.
- 3** 34 ranges—with the famous Triplett single knob control.
- 4** Extra long scales—unobstructed visibility.

\$59.50

By using the Volt-Ohm-Mil-Ammeter for all general testing (90% of your testing) and the Vacuum Tube Voltmeter only when you need it, you have the advantage of a VTVM with extremely long battery life. Batteries are used only about one-tenth as much as in the ordinary battery-operated VTVM. Features: Ohms, 0-1500-15,000 (6.8-68 center scale. First division is 0.1 ohm.)

Megohms: 0-1.5-150 (6,800-680,000 ohms center scale.) Galvanometer center mark "—0+" for discriminator alignment.

RF Probe permits measurements up to 250 MC. \$7.00 net extra.

Featured by leading electronic parts distributors everywhere.

TRIPLETT

TRIPLETT ELECTRICAL INSTRUMENT COMPANY • 52 years of experience • BLUFFTON, OHIO

Triplett design and development facilities are available for your special requirements for meters and test equipment.

EDITORIAL STAFF

Sanford R. Cowan Publisher
 Samuel L. Marshall Editor
 Oscar Fisch Assistant Editor
 Charles W. Gardner, Jr. Editorial Production Manager
 San D'Arcy Contributing Editor
 Robert T. Dargan Contributing Editor
 Paul Goldberg Contributing Editor
 Elbert Robberson Marine Communications Editor
 Lawrence Fielding Hi-Fi & PA Editor

BUSINESS STAFF

Advertising Sales

New York and East	Richard A. Cowan Jack N. Schneider 67 West 44th Street New York 36, N. Y. MUrray Hill 7-2080
Chicago and Midwest	Jim Summers 400 North Michigan Ave. Chicago 11, Illinois SUperior 7-1641
West Coast	Ted E. Schell 2700 West 3rd Street Los Angeles 57, Calif. DUnkirk 2-4889

David Saltman Advertising Production Mgr.

CIRCULATION

Harold Weisner Circulation Manager
 Carol J. Binderman Ass't Circulation Mgr.
 Mady Weinbaum Circulation Processing

SERVICE DEALER and ELECTRONIC SERVICING (formerly Radio-TV Service Dealer) is published monthly by Cowan Publishing Corp., 67 West 44th Street, New York 36, New York, MUrray Hill 7-2080. Subscription Price: \$3.00 one year, \$5.00 two years in the United States, U.S. Possessions, Canada and Mexico. Elsewhere \$1.00 per year additional. Single copies 50¢. Second Class Mail privileges authorized at New York, N. Y.

POSTMASTER: SEND FORM 3579 TO SERVICE DEALER and ELECTRONIC SERVICING, 67 WEST 44th STREET, NEW YORK 36, N. Y.

SERVICE DEALER



and **ELECTRONIC SERVICING**

VOL. 17, NO. 7

Member

BPA

JULY, 1956

FEATURE ARTICLES

- | | |
|---|----|
| Practical Scope Servicing, Part 2 , by Allan F. Kinckiner | 4 |
| Additional valuable information on how the scope can aid you in your servicing problems. | |
| Modern Sweep Generator Design , by Dr. R. C. Langford | 8 |
| How new circuits and techniques can make your alignment easier and more accurate. | |
| Auto Radios for 1956 Buick , by Andrew V. Dopple | 12 |
| Removal hints and servicing information. | |
| Color Video I.F. Analysis , by Bob Dargan and Sam Marshall | 14 |
| Circuit analysis and alignment of the if sections of various color TV receivers. | |
| A Substitution Tester for Yokes and CRT's , by B. Yarmolow | 18 |
| New techniques in servicing with a brand new instrument that will save much valuable time, and do away with carting back and forth fragile picture tubes. | |
| Component Failures in Hi-Fi , by Lawrence Fielding | 28 |
| More new information on servicing hi-fi equipment. | |
| Miniature Meters with Full Size Features , by Peter Ruggiero | 32 |
| New design features in VTVM design that will add greater life to this indispensable piece of serviceman's equipment. | |
| Spurring Antenna Sales , by Fred Voorhaar | 34 |
| Valuable hints on how to increase your antenna sales. | |
| Fuses for Radio and Television , by J. C. Lebens | 42 |
| Little known facts about fuses, presented for the first time. | |

CIRCUIT AND SERVICE FORUM

- | | |
|---|----|
| The Answerman | |
| Philco TV440—vertical sketch | 21 |
| RCA KCS96—10w B plus | 21 |
| Service Dealer Complete Manufacturer's Schematics | |
| Emerson 1956 receivers | 23 |
| Video Speed Servicing Systems | |
| Admiral 19F1A | 37 |
| Emerson 120162A | 39 |
| Workbench | |
| Emerson Chassis 120 169-B, horizontal afc not function properly | 27 |
| Magnavox Chassis 103 Series, no horizontal and vertical sync | 27 |

DEPARTMENTS

- | | | | |
|----------------------------------|----|--------------------------------|----|
| S. R. Cowan Ad Libs | 2 | Trade Flashes | 31 |
| Association News | 20 | Rider Speaks | 41 |
| New Test Equipment | 22 | Buyer's Directory | 47 |
| Advertisers' Index | 49 | | |

Entire Contents Copyright 1956, Cowan Publishing Corp.

COWAN PUBLISHING CORP., 67 West 44th Street, New York 36. N. Y.

SERVICE DEALER and ELECTRONIC SERVICING • JULY, 1956

Sonotone's 2-model line simplifies cartridge replacement!

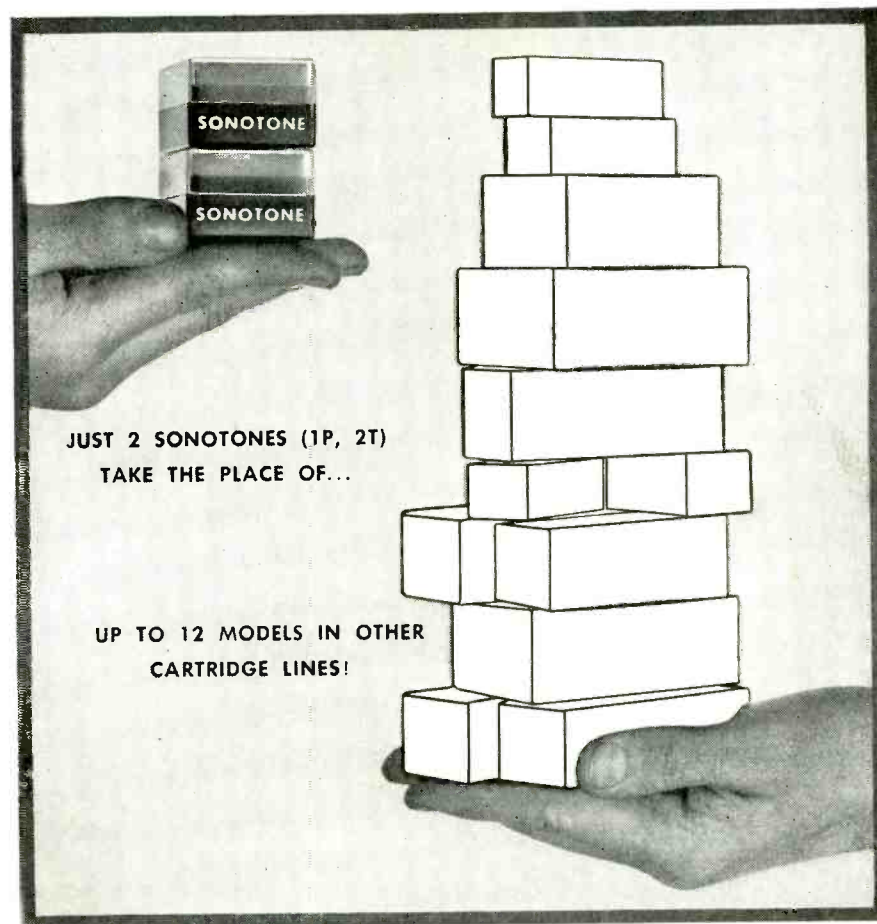

*You finish jobs faster, please customers more,
when you standardize on Sonotone Ceramics*

Why juggle a handful of different cartridges, when it's so much easier and faster to stick to just *two*! Sonotone single-needle 1P and turnover type 2T are all you need for over 90% of quality replacement jobs.

These two Sonotone cartridges fit practically any arm. They're quick to install. And remember, Sonotone cartridges are *more* than replacements. They'll give *better* response than original equipment...enhancing your reputation for quality work.

New standard of the phono industry

In more than half the quality phonographs made today by leading manufacturers, you'll find one of these Sonotone cartridges. All the more reason why you should standardize on Sonotone.

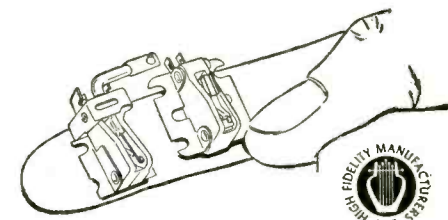

SONOTONE CERAMIC CARTRIDGES

ELMSFORD, N. Y.

In Canada, contact Atlas Radio Corp., Ltd., 50 Wingold Avenue, r



Service Dealers!

FOR YOU

From Your Raytheon **TUBE** **DISTRIBUTOR**

(ask for them!)

These and many, many other valuable sales and shop aids are available to you through your Raytheon Tube Distributor. Many items are free and the rest are priced well below normal cost. All of them are specially designed to help you stimulate sales and increase service business *volume*, and to help you work more efficiently and effectively.

The Raytheon Sales Promotion Booklet is bursting with a magnificent collection of wonderful sales helps.

Ask your Raytheon Tube Distributor for a free copy or write to Department "G", Raytheon Mfg. Co., Receiving and Cathode Ray Tube Operations, Newton 58, Massachusetts.



ILLUMINATED
OUTDOOR SIGNS



DEALERS NAME
TELEVISION & RADIO SERVICE
RAYTHEON
TELEVISION AND
RADIO TUBES



STATIONERY



QUICK ATTACHABLE
COLOR SPOT SIGNS

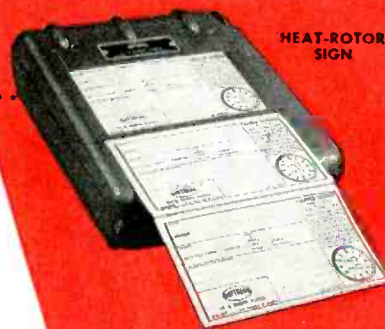

PHONE CALL
REGISTER



BUMPATEL SIGN



DISPLAYS



TUBE AND
TOOL
CARRYING
CASES



SHOP COATS
AND JACKETS



DISPENSER - AN AD
AND BOOK MATCHES



HEAT-ROTOR
SIGN



JOB
REPAIR TAGS



S. R. COWAN

Portable TV Service Contracts

When portable TV sets came on the market it seemed as though they would logically become the second and third sets in the average home and thus provide independent servicemen with more prospective service business in time to come. But such seems not to be the case because of a "gimmick."

The portable TV set manufacturers' basic idea in marketing the new sets was this: To open thousands of brand new retail outlets and thus keep production lines running. As a part of the package, and because most of the new retail outlets are drug, camera or specialty stores, that have no service departments of their own, the manufacturers offered buyers of the portables a very low-priced service contract which would be assumed by their distributors. Retailers who sell such distributor-handled service contracts get a small percentage or fee for handling the deal. But the average independent service firm or serviceman can't get in on the deal because it is too low-priced, and in most cases, for an independent, would probably result in their taking a loss. In fact, manufacturers claim their distributors are going along with the deal knowing in advance they will probably lose money on such all-inclusive low-priced service contracts, but they write this off as a part of their overall operation.

Frankly, speaking for all independent servicemen, I oppose all of these specialty service contracts that take potential service jobs away from servicemen and give the jobs to distributors. Distributors are wholesalers and they should never do any work at the retail level. That's just what distributors are now doing if they participate in these low-price service contract deals.

RAYTHEON MANUFACTURING COMPANY



Receiving and Cathode Ray Tube Operations
Newton, Mass. • Chicago, Ill. • Atlanta, Ga. • Los Angeles, Calif.

Excellence in Electronics

Ad Libs

If the nation's servicemen wanted "an excuse" or needed justification for a *solid* organization on a national basis, here it is. A law firm should be hired to investigate whether or not the law permits a wholesaler to do business as a retailer simultaneously. If the present laws do permit such double-dealings, then the lawyers should find ways of having new laws promulgated which will stop that insidious practice.

If the whole nation's service fraternity were solidly organized it could state its opposition to all manufacturer conceived deals that jeopardize their welfare. Now many servicemen are grumbling about this new low-cost service-through-distributor contract plan and to show their displeasure they are "knocking" the particular "brands" that are involved. Whether the manufacturers realize it or not this ever-increasing serviceman condemnation to prospective set buyers is a serious matter and it's going to hurt them plenty in time. So, Mr. Manufacturer, in light of developments, why not act now? Why not abandon these specialty-distributor service contracts and instead, find other means to promote the sale of your portable TV set lines?

The Parts Show in Review

The 1956 Radio-Electronic Parts & Equipment Manufacturers' Trade Show, held at Chicago May 21-25, was rated as a huge success by exhibitors, although, in my opinion, not a single truly revolutionary new item was displayed for the first time by any manufacturer. All the new products shown were modifications and improved versions of equipments already being marketed. Quite obviously manufacturers have tried to devise items that enable

[Continued on page 7]

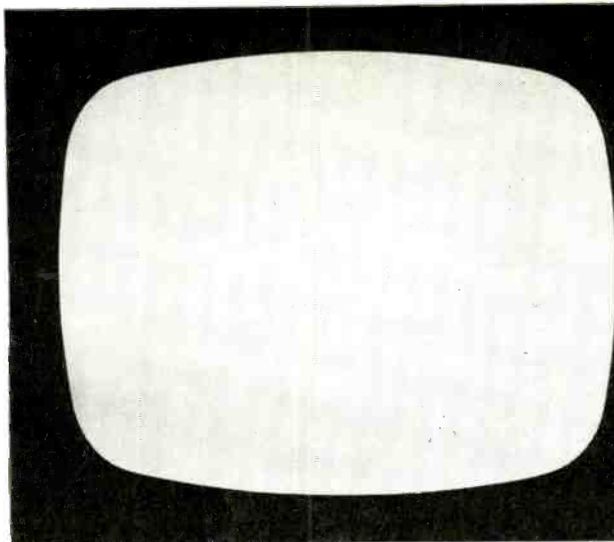

how long would it take you
to solve this service problem?

SYMPTOM:

No picture is obtained. Sound is distorted. Raster is okay.

There's no telling how long it might take to solve this problem with hit-or-miss methods or incomplete service data. With a PHOTOFACT Folder by your side, the job takes just minutes. Here's why:

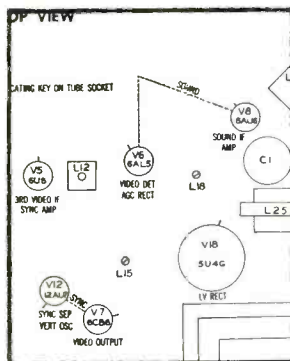

1. In just seconds, you locate the tubes most likely to cause this symptom by referring to the Tube Placement Chart* and Tube Failure Check Chart* you'll always find in each PHOTOFACT TV Folder.

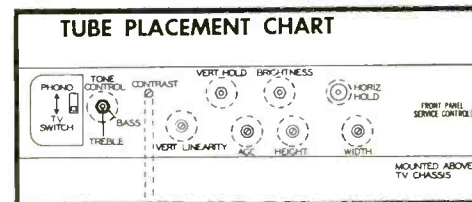

In this case the trouble wasn't caused by tube failure. So checking further...

2. Adjustment of the AGC Control caused a weak picture to appear. Operation of the contrast control had no effect (control identification and location appear right on the Tube Placement Chart*). Next logical step:

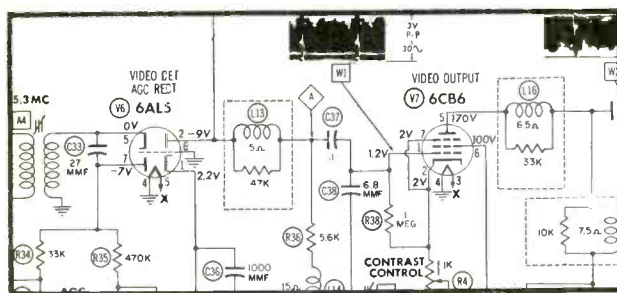

3. In just seconds, you refer to the Video and AGC circuits on the Standard Notation Schematic* featured exclusively in PHOTOFACT Folders. (Circuits are always laid out in the same uniform manner—easy to locate—easy to trace.) In a matter of minutes, you check waveforms and/or voltages—they're right on the schematic. In those same few minutes, you pinpoint the trouble. You make a resistance check using the handy Resistance Chart* and you have the answer to your problem in this case history: A cold solder connection at the center lug of the Contrast control.

*One of 32 features found exclusively in PHOTOFACT—the world's finest service data—the data that gives you the most for your money.

With PHOTOFACT by your side,
you solve your service problems in just minutes—you
service more sets and earn more daily!



**MONEY BACK
GUARANTEE!**

Got a tough repair? Try this—at Howard W. Sams' own risk: see your Parts Distributor and buy the proper PHOTOFACT Folder Set covering the receiver. Then use it on the actual repair. If PHOTOFACT doesn't save you time, doesn't make the job easier and more profitable for you, Howard W. Sams wants you to return the complete Folder Set direct to him and he'll refund your purchase price promptly. GET THE PROOF FOR YOURSELF—TRY PHOTOFACT NOW!

free



Send for Sams' INDEX TO PHOTOFACT FOLDERS—your guide to virtually any receiver model ever to come into your shop; helps you locate the proper PHOTOFACT Folder you need to solve any service problem on any model. You'll want this valuable reference guide. Send coupon now.

HOWARD W. SAMS & CO., INC.

Howard W. Sams & Co., Inc.
2209 E. 46th St., Indianapolis 5, Ind.

Send FREE Index to PHOTOFACT Folders
 I am a Service Technician: ___full time; ___part time.
 Student. Other: _____

Shop Name:

Attn.:

Address:

City: Zone: State:

Practical Scope Servicing

by ALLAN KINCKINER

PART 2

In this installment the author continues his discussion on the application of the scope in tracing down elusive troubles that crop up in TV receivers. Horizontal and vertical weave, as well as audio buzz are treated in detail.

THE two most common causes of horizontal weave, wave or hooking are sync compression or modulation on the sync envelope. These troubles by their very nature are most easily diagnosed by scope tracing. Sync

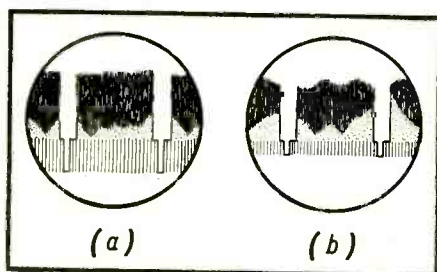

Fig. 1—(a) Relatively normal sync pulse amplitude is 25% of total height. (b) Compressed sync pulse.

compression may originate in the front end, the video amplifier or the sync section itself. Modulation of the sync envelope may occur not only in any of these stages but also in the vertical, audio and power supply sections of the set. Sync compression is the more common trouble and fortunately it is easier to detect and remedy. The points at which compression originates are listed below in the order of most frequent occurrence.

Sync Compression

Compressed sync pulses frequently originate in *agc* controlled stages. It is most often caused by the tube drawing grid current and is easily found by reading the voltage at each end of *agc* filter resistor. A difference in the reading indicates grid current flow. This condition is commonly accompanied by excessive contrast. A scope in combina-

tion with a demodulator probe will portray the compressed sync signal.

In *rf* or *if* stages not controlled by *agc*, the tube is again the chief culprit. Occasionally leaky coupling to the grid of the stage is responsible. In the case of the *if* stages, a low screen voltage, causing the tube to limit, will cause sync compression. In cascode circuits, voltage unbalance between the two stages has sometimes caused sync compression. In all of these cases, the scope in combination with a demodulator

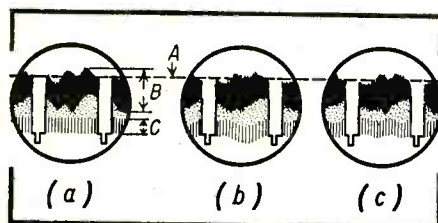

Fig. 2—Various forms of horizontal weave as observed on the scope.

probe can picture the compressed sync pulse, and thus quickly identify the defective stage. Fig. 1a shows the appearance of a normal sync pulse on the scope. A compressed sync pulse is shown in Fig. 1b.

Sync compression in the video amplifier is less common, and even easier to detect with the scope. First a scope reading of the detected signal is analyzed for proper sync to entire signal

ratio. The sync pulses, according to FCC standards, should be at least 25% of the total signal. If the scope does not show sufficient sync pulse amplitude at the output of the video detector, the waveform should be analyzed at the input to the detector, using a low impedance demodulator probe scope. Occasionally a bad germanium diode will compress sync. Scope tracing through the amplifier is continued with the idea in mind that the only changes in the waveform should be in amplitude while the signal to sync ratio remains constant. Faults which occur most often are due to faulty tubes, improper bias or low screen voltage.

Sync compression as a cause of horizontal weave, is not too common in the sync stages themselves. Generally,

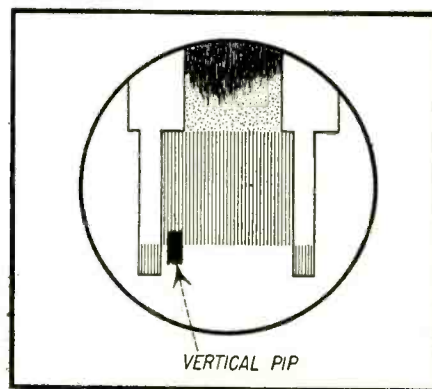

Fig. 3—Vertical pulse modulation of the horizontal sync pulse.

troubles in the sync stages cause more than just weaving or hooking. An exception to this is the case of the diode clipper used at the beginning of the sync circuit and is often used also as a restorer. This stage is found in some early models along with a synchrolock circuit and frequently caused hooking. The scope test here is for amplitude ratios, that is, the amplitude at the clipper output is roughly 10% of the input amplitude. A lower value than this will cause hooking.

Horizontal Weave

Horizontal weave caused by modulation of the sync as previously noted may originate in virtually any section of the set, and the modulation may take any one of many forms or frequencies such as 60 cycle, 120 cycle, vertical pip or audio pulse modulation. The 60 or 120 cycle forms of sync envelope modulation are perhaps the most common and generally easiest to trace with a scope.

The starting point of scope tracing is at the video detector. With the scope sweep set at 30 cycles the waveform should approximate that of Fig. 2a. Note that the top and bottom of the envelope are not perfectly flat as they would be in the ideal form. The variation should not be more than 10% of the sync envelope. Should the waveform show modulation as shown in

Fig. 2b, it would indicate 60 cycle modulation, which can be traced back through the preceding stages to its point of origin with a high sensitivity demodulator probe. This type of modulation is most often caused by heater-to-cathode leakage in the *rf*, *if* or local oscillator tube. It can also be caused by an open filament bypass capacitor in one of these stages. Fig. 2c indicates 120 cycle modulation and would probably be readable with the scope's direct probe at a filter condenser bypassing the supply for the defective stage. Actually the localization of these troubles should take less time than it took to read the above.

The modulation may also occur in the video or sync section. Recently, for example, a Motorola exhibited weave that was caused by a defective low capacity filter in the 130 volt B supply. Although the condenser was in the buss that fed the *if* stages the hum voltage did not modulate the sync until it got to the final sync amplifier stage.

In another case the modulation took place in the final video amplifier of a GE using a 12AT7 video amplifier. Here again the ripple that caused modulation was in a voltage line that fed previous stages.

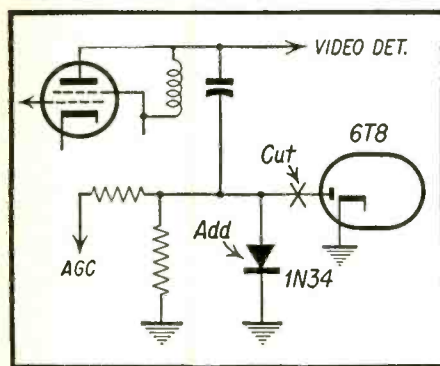

Fig. 4—Suggested repair for circuit described in text.

This 60 or 120 cycle modulation is easy to scope trace. It shows up in the picture by distorting what should be a straight vertical line, into an "S" shaped line in the case of 60 cycle modulation. In the case of 120 cycle modulation, the line which should appear vertical, weaves through two "S"s from top to bottom.

A more elusive type of horizontal weave is caused by vertical pulse modulation of the horizontal sync pulses. An illustration of this may be found in

RCA KCS 47. The observed waveform is shown in Fig. 3. A decrease in capacity of the $2\ \mu\text{f}$ bypass in the *agc* circuit was responsible for the trouble in this case. This condenser must be up to par since the *agc* is developed in one section of a twin triode, the other section of which is the vertical oscillator. The modulation creeps in as a vertical pip from this section which is not sufficiently bypassed.

In two other sets using keyed *agc* a similar condition has been noted where the keying pulse lags slightly and causes a pip on the sync envelope. The remedy lies in increased filtering of the *agc*

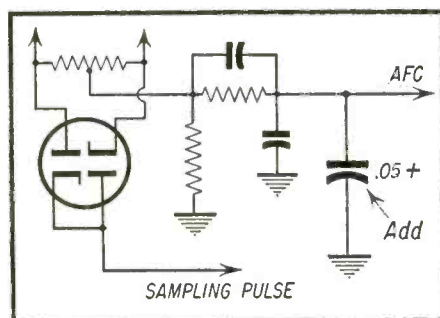

Fig. 5—Suggested repair for modulation fed back to *afc* circuit.

voltage. The aforementioned sets are Admiral and Westinghouse and the remedial changes are to be found in the pertinent manufacturers' notes.

Another set with horizontal weave due to pulse modulation of the sync is the GE where the condenser bypassing the B+ boost voltage supply to the vertical section decreases in capacity. As the capacity decreases the set first exhibits a weave and later the picture will lose height. The pip in this case will show on a waveform taken at the sync stage.

Another case of pulse modulated sync is encountered in a receiver using the circuit shown in Fig. 4. This receiver is sold under various names such as Philharmonic, Freed, Pathe, etc. It uses one diode plate of the 6T8 tube for *agc*. The remainder of the tube is a ratio detector and first audio. Leakage within the tube itself modulates the *agc* voltage. The best repair in this set is to use a 1N34 in place of the 6T8 diode, since the sets are quite critical as to 6T8 tubes. Fig. 4 illustrates the suggested repair remedy.

[Continued on next page]

TACO

TRAPPERS[®]

Taco Trappers are **DEPENDABLE**—day in, day out through all the seasons. You can count on the Trapper design to provide outstanding performance. We call it "staying power". Performance is our most important feature. However, this is only part of the story, for starting with the materials used and ending with the streamlined appearance when installed, the Trapper has no equal. For better pictures and satisfied customers, insist on the Taco Trapper design. You'll eliminate call backs.



SUPER TRAPPER
for extreme fringe area installations.



TRAPPER
for fringe and near-fringe installations.



TRAPPER ROYAL
for improved low-band performance.

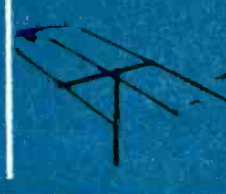

TRAPPER JR.
Modern antenna for high signal areas.

TACO

TECHNICAL APPLIANCE CORPORATION
SHERBURNE, N. Y.

In Canada: Hackbusch Electronics, Ltd., Toronto 4, Ont.

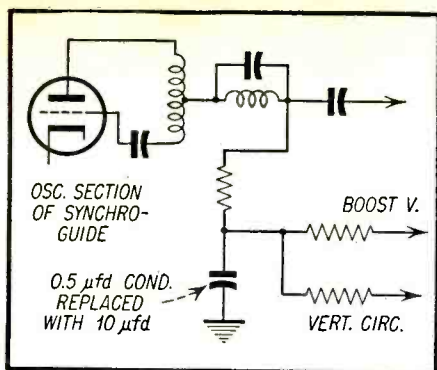

Fig. 6—Suggested repair for modulation picked up from B+ Boost.

A third form of horizontal weave takes place when the sync envelope seems to be in perfect shape. The modulation causing the weave or hook in this case is occurring in the horizontal circuit itself. The following are a few examples of their type of trouble.

1. Westinghouse had severe weave that looked like 120 cycle modulation. Removing the 6C4 tube and momentarily obtaining hold, showed the weave still present. Obviously the trouble was in the horizontal circuit itself. Tube substitution revealed a bad 6AU5. This is the only set of thousands the writer has worked on that showed a horizontal output tube in this condition.

2. An Admiral, using phase detector type of *afc*, exhibited weave accompanied by jitters. The trouble was caused by low capacity condenser at voltage side of ringing coil.

3. Department store sets sold under various names use a phase detector *afc* and the remedy for weave is the addition of an .05 μ f condenser across the developed control voltage. See Fig. 5. The modulation is picked up in the yoke and fed back through the sampling voltage to the *afc* circuit.

Recently two cases of weave were experienced that were different than any previously mentioned. The first, a synchroguide circuit that was fed by the B Boost voltage, picked up vertical pips from this B Boost. Since the filter in the vertical supply was only .5 μ f it was replaced with a 10 μ f electrolytic (See Fig. 6) and the trouble cleared up. The other case was a Motorola TS60. It exhibited weave with four cycles on the picture edge. Scope tracing indicated clean sync. Removing the sampling pulse made no difference, but with the

afc tube out the edge straightened. The trouble was finally found in an open condenser across the filter resistor feeding the corrective voltage to the control grid of the horizontal multivibrator. See Fig. 7.

In these cases the scope was used primarily to vindicate the properly operated stages, and focus attention to the point where the trouble originated.

Audio Buzz Tracing

Audio Buzz tracing is easily accomplished by the use of a scope, not only as a means of indicating the point of entry of the signal causing buzz, but also by the scope's ability to rapidly identify the transient unwanted signal causing the buzz. Two common buzz patterns are shown in Figs. 8a and 8b.

The scope pattern shown in Fig. 8a is the type present in the audio circuits, when the buzz is causing unwanted coupling of vertical sweep into the audio. This pulse when present will vary very little from set to set, and is easily recognized by its needle sharp spikes. The cure for this type of buzz is most often effected by lead dress of audio and vertical pulse carrying lead. Sometimes it may be necessary to add a small condenser from the plate of the vertical output tube to ground. In other cases, increasing the decoupling filter resistor in the vertical B supply may be helpful.

The scope pattern shown in Fig. 8b is more complex and will vary more from set to set. It is usually caused by the periodic high voltage rise under no drain conditions. This occurs during the raster blanking between succeeding frames. The defect causing this pulse is generally localized in the high voltage filter section. The outer aquadag coating of the pix tube is a most important filter. The cure for this buzz is the grounding of the aquadag at several points, and replacing the high voltage filter condenser, if necessary.

Another type of buzz is one which occurs when the contrast is operated at too high a level causing the video amplifier to limit or clip the signal. Operating the set this way is frequently a result of a weak picture tube and may sometimes be remedied by the picking off of the sound at the video detector rather than video amplifier output.

(This only when the sound *if* has enough amplification.) Misalignment in the video strip can also cause buzz. This occurs when the point on the response curve 4.5 mc below the picture *if* carrier is too high on the trace. The sound *if* frequency (4.5 mc from picture carrier) should be only 10% of maximum crest of the response curve.

One of the innovations in recently designed color sets uses variable absorption sound wave traps to accomplish this condition. Additional sound traps may well cure inter-carrier buzz where a realignment will not. An exception is to be found in those sets where the local oscillator is above the transmitted frequency on the lower channels, and below the station carrier on the high channels. On these sets it is extremely hard to align the *if* to obtain buzz free reception on both high and low channel stations. Fortunately, tuners of this design are no longer in vogue.

Another type of buzz originating in the sound circuit itself is that caused by an open reservoir condenser across the ratio detector. In these cases the "S" curve sought in ratio detector alignment is perfect but buzz will be present if this condenser has decreased appreciably in capacity.

The use of a scope will prove equally beneficial. In particular, the servicing of FM receivers, high power amplifiers, tape and wire recorders, etc., are facilitated by the use of a scope. On FM it assures proper alignment, as with TV. It will also assure proper alignment on communication receivers where the *if* must be needle-sharp and flat-topped for good tone and selectivity. On high power amplifiers it can readily check gain, frequency response, and the operation of tone controls or crossover networks. The simplest setup for checking amplifiers is to use a resistive load in place of the speaker; in this way the amplifier can be run at its full output without the annoyance of high sound.

Recently, in repairing a wire recorder which was a real puzzler, the scope won further respect from this writer. Considerable distortion was present in the recorder. Checking the preamp up to the head revealed no distortion. Checking from the head through the amplifier to the speaker also revealed no distortion. The scope was then used to look at the bias voltage where a severe-

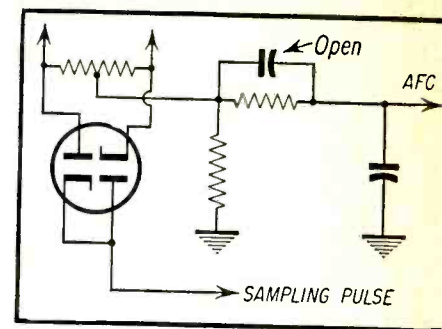

Fig. 7—Partial schematic of Motorola TS60 which exhibited weave of four cycles on picture edge. Trouble was open condenser.

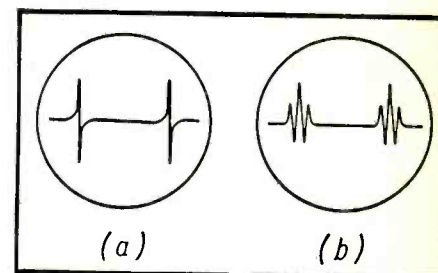

Fig. 8—Scope will indicate buzz patterns of various types where trouble of this nature exists.

ly distorted sine wave was noted, rather than the clean sine wave to be expected. Further circuit checking revealed an open decoupling filter. Replacing this condenser cleared the trouble.

Another case involved a set of nine intercommunication receivers which were to be overhauled. First, one receiver was put into top shape with respect to hum, amplification, frequency response and noise level. Then with a square wave generator at the input, a scope was used to trace the signal through the circuit. A series of standards were set up which had to be met by the other units. Time saved on each unit, and the scope revelation of hidden faults made the setup well worthwhile.

Don't sell your scope short. Not only is it extremely useful, but its usefulness increases more and more with your understanding and experience. ■ ■

MOVING?

Please Mail Us Your Change of Address 5 Weeks Before Moving

Also include old address and code line, if possible. Thanks.

**SERVICE DEALER
and ELECTRONIC SERVICING**
67 West 44 St., New York 36, N. Y.

AD LIBS

[from page 3]

servicemen who use them to do their work more efficiently, in less time. Price levels were static, neither up nor down appreciably as compared to last year's lines.

Regarding Future Parts Shows

As this year's Radio-Electronic Parts & Equipment Manufacturers' Show was closing, members of the executive committee polled exhibitors asking this question: "The 1956 Show ran 4 days—last year it ran 3 days—how many days should it run in 1957?" In answer to that question I'd suggest 7 days—and I'd like to explain why. The very first Parts Shows were launched so that manufacturers could show their new lines to servicemen *and also* to distributors. Attendance at the first shows was good but soon it became apparent that manufacturers preferred to talk to distributors (who they considered as mass buyers) rather than to servicemen. In time servicemen were excluded from the shows and only distributors were invited. Then, distributors formed an organization, and soon that organization, "feeling its oats," wanted the Parts Show executives to bar not only servicemen but also all distributors who were not members of their organization. Compromises were made. Meanwhile, engineers, manufacturers' reps, and surplus merchants were permitted to attend the show while servicemen were still blacklisted. So it went until this year.

Most manufacturers go to Chicago several days before the Show opens and they hold sales meetings for their reps. Then the Show opens and the manufacturers and reps try to do business with distributors. Strangely enough, there were more manufacturers and reps at this year's Show than distributors—a positive indication in my opinion that to some extent the Show is failing to perform its basic function—to wit, that of having all distributors see previews of what all manufacturers intend to make available to them so these items can be sold to servicemen. Stated another way, today there are more reps actively participating in Distributor Shows than distributors. ■ ■



**who sells
Mrs. America?**

Garry Moore, that's who!
He sells her because she likes him and has confidence in him. Nearly five million of her watch and listen to him weekdays on the CBS

Television Network. She *believes* what Garry says about his sponsors' products. And she buys them.

As a CBS tube dealer, you . . . yes, you . . . are one of Garry Moore's sponsors. He tells your customers that there are no better tubes made than your CBS tubes, and that they have the Good Housekeeping Guaranty Seal. He also tells the ladies about your technical training and equipment, and why they can rely on your expert service.

So remember, when you call at Mrs. America's home to repair her TV set, you . . . and CBS tubes . . . are welcome because Garry Moore has already convinced her that she can have confidence in both you and CBS tubes.

Show her the CBS carton with the Good Housekeeping Guaranty Seal.

CBS tube

CBS-HYTRON
Danvers, Massachusetts
A Division of Columbia Broadcasting System, Inc.



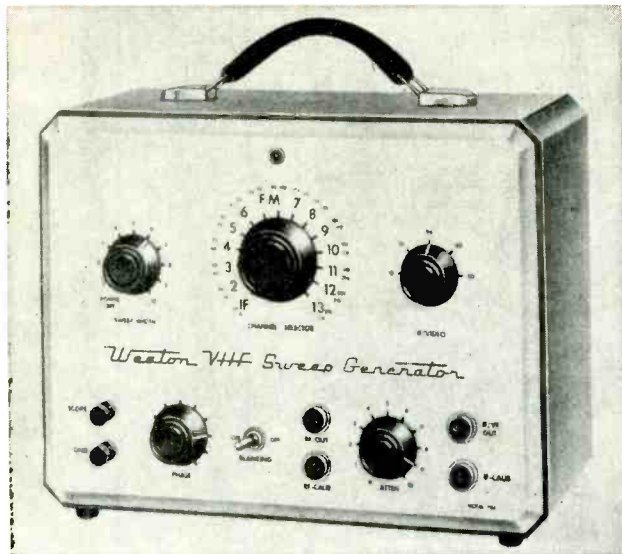

Fig. 1—Weston Model 984 VHF Sweep Generator

Modern Sweep Generator Design

Description of the circuitry and operation of a sweep generator of modern design. Methods of obtaining precision and stability are described.

by DR. R. C. LANGFORD

Weston Electrical Instrument Corp.

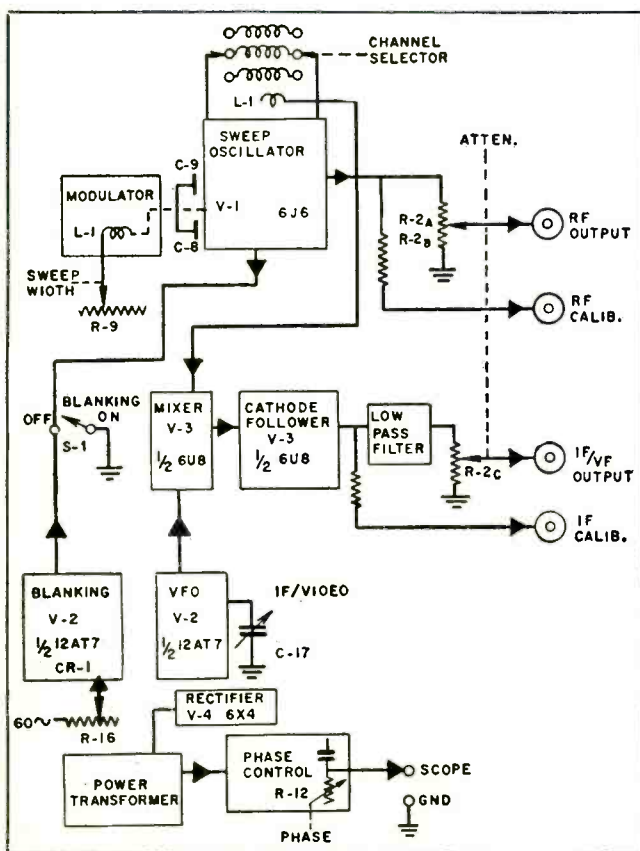

Fig. 2—Block diagram of Weston Model 984.

THE NEW Weston Model 984, shown in Fig. 1, is a sweep generator which has been designed to assist TV technicians in efficiently servicing color and monochrome television receivers. Its features provide for satisfactory methods of quickly detecting and correcting troubles in *rf* and *if* circuits, associated resonant trap filters, and alignment discrepancies in tuners and video amplifiers.

This generator was specifically designed to be used in conjunction with the Model 985 Calibrator and 983 Oscilloscope, in the new Weston Simplified Method of alignment.¹ Additionally, this sweep generator may be used separately, or in conjunction with existing test equipment in the conventional method of alignment. The unit comes supplied with its own matched cables, one a balanced 3 wire lead matched for 300 ohms impedance and the other a twin unbalanced lead matched for 100 ohms. The unit has its own self-contained power pack and full operation may be obtained by plugging into a 117 volt 60 cycle single phase wall socket.

General Features

The Model 984 Sweep Generator consists of 4 important sections:

1. Main Oscillator
2. Frequency Modulating Means
3. Blanking and Phase Shifting Means
4. Radiation Interference Elimination Means

A generalized or block diagram of the component entities is shown in Fig. 2. This gives the simple overall picture of the important sections listed above. Detailed wiring information is given in the schematic diagram of Fig. 3.

Main Oscillator

A 6J6 double-triode vacuum tube V1, is connected in a push-pull Colpitts oscillator circuit as shown in Fig. 3. The oscillating arrangement is connected as a tank circuit between the two anodes of the vacuum tube. This type of circuit eliminates feedback coils in the grid circuit and further has the unique property of summing all stray capacitance in the leads, etc. into the resonant tank circuit.

The tank inductors are arranged around the periphery of a low-loss Mycalex rotary switch as shown in Fig. 4. Inductors marked L7 to L14 in the tank circuit, (See Figure 3), are of the high Q type, being tuned by means of dust core tuning slugs located inside the phenolic tubes on which the coils are wound. Adjustment of the center frequency of oscillation, as may be seen in Fig. 4, may be made by screwing these dust cores in and out of the internally threaded tubes.

1. "New Weston Method of T.V. Receiver Alignment" Weston Engineering Notes Vol. 10 No. 1 May 1955. "Intensity Modulated Markers for Sweep Alignment" by Oscar Fisch—Service Dealer, Dec. 1955.

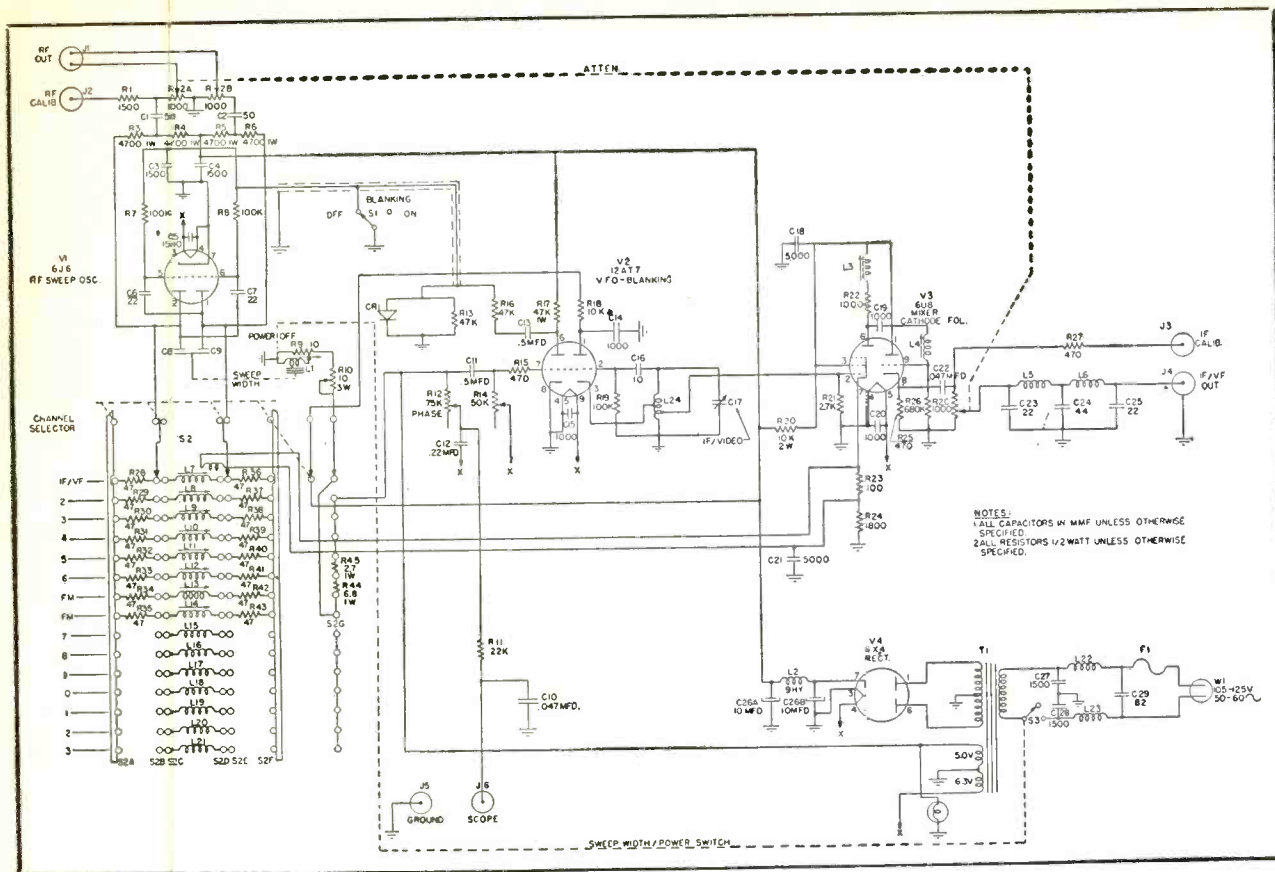

Fig. 3—Schematic diagram of Weston Model 984 VHF Sweep Generator.

The inductors for channels 7 to 13, being on the higher frequency ranges in the region of 200 megacycles, do not possess these dust cores, and adjustment of the center operating frequency is made by altering the pitch of the stiff wire coils by bending or spacing. This alters the mutual inductance between turns and hence effectively adjusts the overall inductance of the coil. The knob "Channel Selector" on the front panel then indexes these inductors and connects only one at a time into the tank circuit of the oscillator.

It will be noted that the tuning capacitance across each inductor, which provides effective capacitance for resonating the inductance, is composed of the stray capacitance across each inductor, the capacitance of the circuit through the Mycalex switch, and the capacitance of the split precision capacitor C8 and C9 of the modulator assembly. To prevent "suckout" points and spurious resonances in the frequency spectrum, inductors not in use and therefore not connected to the tank are short-circuited by additional switch elements on the Mycalex rotary switch. In particular the lower frequency inductors have additional series resistors. For example R28 and R36 are incorporated in the circuit to critically damp these coils electrically. By this means, stray resonant circuits are effectively removed from the oscillator network.

It will be seen that the output from the twin anodes of V1 is taken to a twin potentiometer R2A and R2B. This acts as an attenuator, and the output of all

radio frequency signals from channel 2 to 13 is controlled by this potentiometer. The signal is available as a balanced output to ground through a 3 wire cable matched to a load impedance of 300 ohms. Alternative matching to this cable is possible, as shown in Fig. 5, by inserting additional padding resistors. It will be noted also from Fig. 3, that the whole oscillator signal is decoupled through resistance R1 of 1500 ohms and is available through the knob on the front panel, "RF Calib". This signal is used to provide for the Weston simplified method of alignment.

When the channel selector is indexed to the position "IF/VF," Intermediate Frequency/Video Frequency, the center frequency of inductor L7 is tuned to 105 megacycles and this is relayed to the cathode of V3, the pentode mixer section of a 6U8 triode-pentode tube, by a pick-up loop located around the inductor L7. Tube V2, a 12AT7 double triode, is arranged so that the righthand half is employed as a

Top Right: Fig. 4—Low loss Mycalex rotary switch used with tank inductors.

Center: Fig. 5—Alternative methods of matching to cable using padding resistors.

Lower Right: Fig. 6—Coaxial capacitance vibrator—used to obtain frequency modulation.

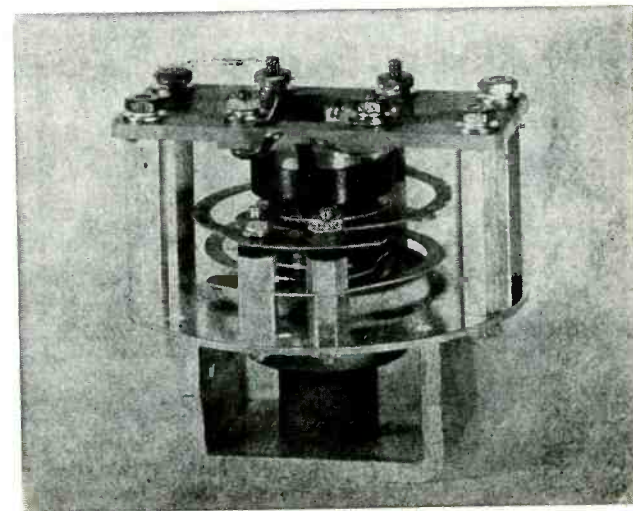
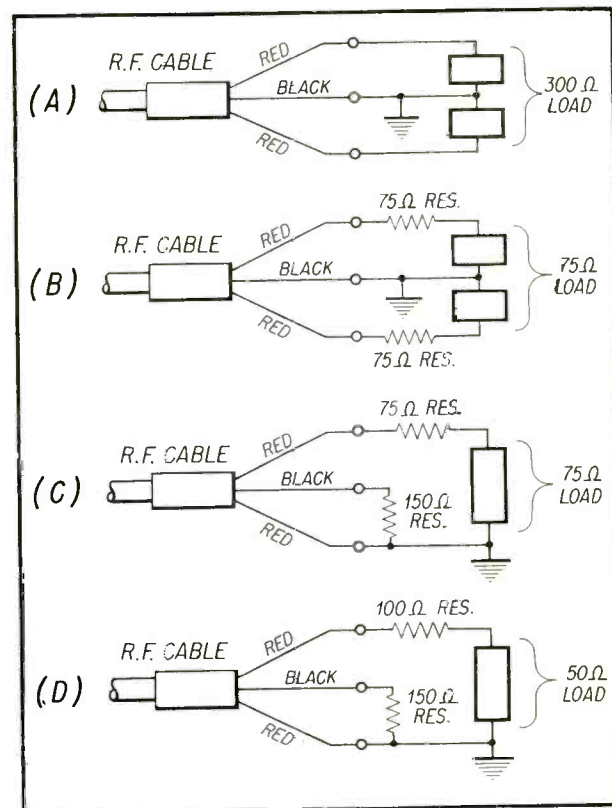
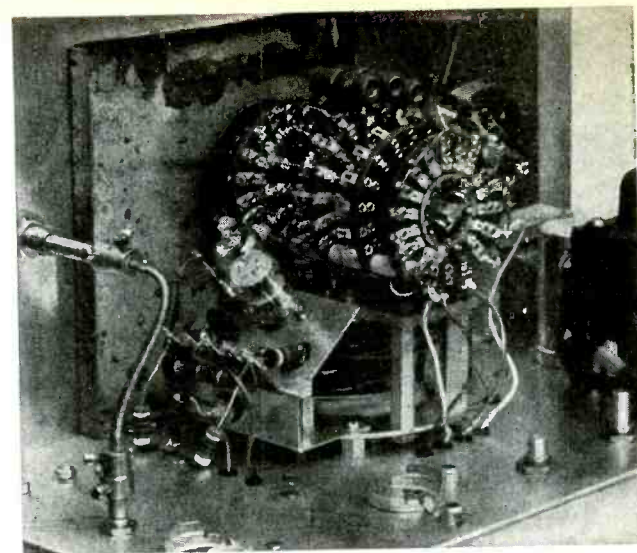

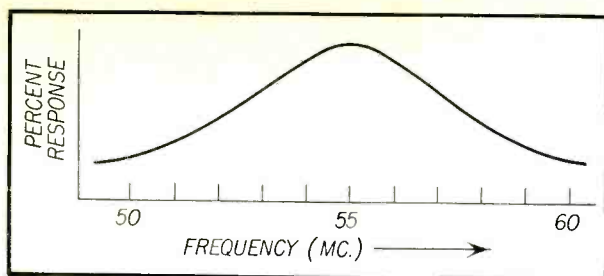

Fig. 7—Curve showing linear frequency response.

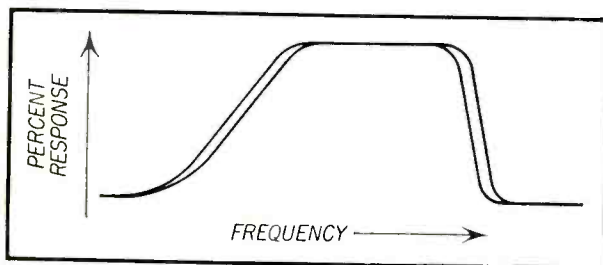

Fig. 8—Appearance of trace without blanking.

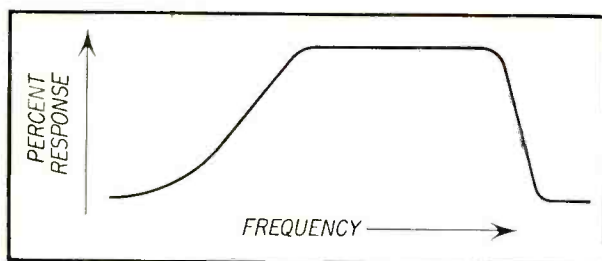

Fig. 9—Curves coincide when correctly phased.

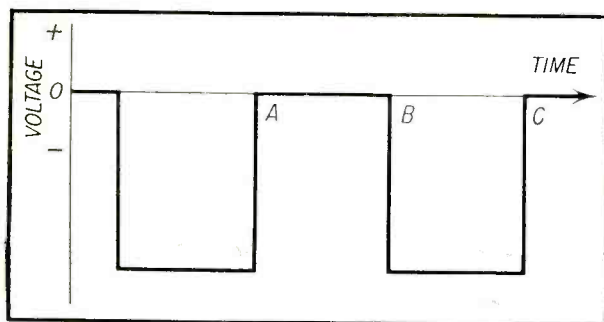

Fig. 10—Waveform of blanking signal

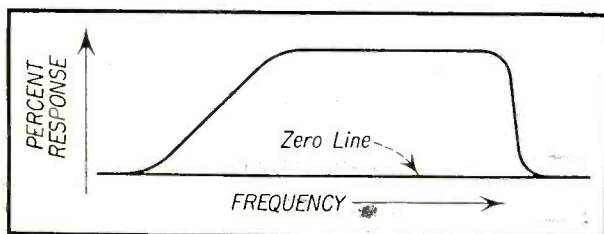

Fig. 11—Envelope of the blanked trace.

Hartley oscillator tunable through the frequency range of 105 to 155 megacycles by the variable capacitor *C17*. The shaft of this variable capacitor is connected to the front panel knob marked "IF/Video". The signal from the Hartley oscillator is fed to the grid of the pentode section of the 6U8 and the output of this pentode section is fed via the series shunt peaking network *L3*, *R22*, *C19* and *L4* to the triode section of the 6U8, which acts as a cathode follower.

A potentiometer *R2C*, which is the third element coupled on the attenuator shaft previously mentioned, receives the output of the cathode follower. By this means, both *RF* and *IF* signals can be attenuated by rotation of the same knob, the output signals emerging from different connectors. The output of the cathode follower will contain signals of 105 megacycles from the main push-pull oscillator; signals of from 105 to 155 megacycles from the Hartley oscillator, depending on the position of the tuning capacitor *C17*; and the sum and difference intermodulation product signals.

Since only the difference signals in the range of approximately 0-50 megacycles are of interest, a low-pass filter of *L5*, *L6*, *C23*, *C24* and *C25* is arranged to cut off all frequencies above 75 megacycles, for a match impedance of 100 ohms. This eliminates both original signals from the two oscillators as well as the upper side band of the intermodulation product frequencies since all are well over 75 megacycles. The output from the low pass filter therefore appears as an unbalanced signal to ground through the connector on the front panel marked "IF/VF", through the twin lead cable matched for 100 ohms impedance.

As before, the whole signal taken from the top of the potentiometer *R2C* is decoupled through 470 ohms to the connector on the front panel marked "IF/VF Calib.". This Z axis signal renders the Model 984 particularly suitable for using the Weston simplified method of alignment. By taking the whole signal in both *RF* and *IF* cases, we secure the advantage of constant intensity of the Z axis market pips on the oscilloscope, and independence of the level setting of the sweep generator attenuator.

Frequency Modulation

In the previous section it was shown that a *cw* signal is obtained for *rf* as well as *if* or *vf* signals and that it is made available at two separate front panel connectors.

To effect frequency modulation, the precision coaxial capacitance vibrator shown in *Fig. 6* is used. This capacitor *C8*, *C9* is a split balanced capacity device connected across the inductor selected by the channel selector switch for connection across the anodes of the Colpitts oscillator, *V1*. Variation in frequency of the oscillator at a time rate is achieved by varying the value of this capacitance at the given time rate. In particular, a shaping of the moving capacitor

plates is made such that a linear frequency deviation from the center frequency of oscillation is obtained per volt applied to the coil of the moving element. This feature permits a thoroughly linear presentation of frequency response curves which are free from distortion and cramping along the time axis, as illustrated in *Fig. 7*.

Synchronous variation of the capacitance is achieved by vibrating a precision multi-tongued coaxial capacitor in a precision concentric ring by a method somewhat resembling the operation of a loud speaker. The driving or moving coil is connected mechanically to the tongue and is fed with *ac* such that it moves in a unidirectional flux field of a permanent magnet. This causes the tongue to move in and out of the ring, at the frequency of the *ac* applied to the moving coil. In our case, this frequency is in the vicinity of 60 cycles per second or 3600 cycles per minute.

It should be noted that a very desirable feature for the moving element to possess is that the natural resonant frequency of the moving element should be far removed from the operating frequency range, in order that a flat displacement versus operating driving force curve may be obtained. If this were not true, small variations of the supply frequency to the moving coil could cause severe variations in the vibration amplitude. This in turn, would cause severe alterations in the band width of the swept frequency.

To secure this flat frequency band response, the moving element is made with the highest driving force to weight ratio possible. The moving capacitor tongue is made of magnesium, and the control springs of aluminum. By these means, it has been found possible to secure a high enough resonant frequency so that a variation from 50 to 70 cycles per second applied to the moving coil produces a substantially constant vibration amplitude. To prevent ingress of foreign matter into the small air gap of the moving coil, a restraining spider cover is made of fine nylon mesh and an internal gauze is fitted inside the phenolic tube. These may be seen in *Fig. 6* and it should also be noted that these have the double benefit of giving additional air damping to the moving element.

Indexing the "Channel Selector" knob causes different inductors to be connected in parallel with the vibrating capacitor. It will be noticed that the inductance to capacitance ratio of the tank circuit is progressively reduced as the frequency of the channel increases. This means that for the higher channels, smaller displacement of the moving element is required to give the same frequency band width of 10 megacycles.

The band width control *R9* appears on the front panel as a knob marked "Sweep Width" rotation of which alters the sweep width smoothly from 0 to 10 megacycles. To insure that the maximum setting of this knob actually gives 10 megacycles on all channels, an additional deck is fitted to the Mycalex switch so that additional resistors may be inserted in series with

the sweep width control, to correct the band width limit to 10 megacycles for all channels.

Note that on the *IF* channel the *FM* signal has a band width of 10 megacycles on the center frequency of 105 megacycles and is fed to the mixer, where it is mixed with the output of the Hartley oscillator. By this means, a frequency modulated *IF* signal is obtained, of center frequency capable of variation from approximately 0 to 50 megacycles, with a band width variable throughout this range of from 0 to 10 megacycles.

Blanking and Phase Shifting

Without blanking, the appearance of the envelope of nearly properly phased response curves would look like Figure 8 (on the oscilloscope cathode ray tube); the time base being the usual form of a 60 cycle sinusoid. When these traces are correctly phased, as described later, the two traces coincide as in Fig. 9. To obtain the maximum possible resolution on the face of the cathode ray tube, it is desirable to remove one of these traces. In Model 984, this is effected by applying a square wave at the power frequency and of large negative amplitude to the grids of the main oscillator tube V1. This is done via the blanking switch which appears on the panel as a toggle switch marked "Blanking". This blanking signal shown in Fig. 10, permits the oscillator to operate without hindrance during the interval from A to B when zero voltage is applied to the grids, but during the interval BC a large negative signal is applied to the grids of V1 thereby suppressing the oscillation.

The envelope of the blanked trace is shown in Figure 11, and it will be seen that the trace occurring during the period of suppressed oscillation in V1 corresponds to a zero line. This additionally provides an effective base for relative measurements of response curves.

As will be pointed out later, it is vitally important to phase this blanking signal correctly with respect to the *ac* signal on the capacitance modulator moving coil. For this reason an 11.3 volt 60 cycle signal is taken from the heater windings on the main transformer through an *RC* phase-shifting network of *R14* and *C11* to the grid of the left-hand section of V2, the 12AT7 double triode clipper tube. This tube turns the sinusoidal voltage appearing at the grid into a square wave at the plate. Grid limiting flattens out the positive portion of the cycle, and plate current cut-off eliminates the large negative portion of the original sinusoid. This square signal at the plate is then passed through a diode clamping network composed of *CR-1* and *C13* so that the most positive portion of the square surface clamps to zero potential as in Fig. 10.

In addition to the frequency deviation of the frequency modulation being dependent on the phasing of the *ac* voltage to the modulator, and the blanking

[Continued on page 44]

These 10 Types Offer Proper Replacement For Original Communication Equipment

Here is a 6 volt vibrator for EACH 6 volt operation and a 12 volt vibrator for EACH 12 volt operation!

Old Number	New Number	New Number
	6 volt	12 volt
55-5	5715	6715
55-8	5718	6718
*	5721	6721
*	5722	6722
*	5725	6725
5605	5805	6805
5620	5820	6820
5621	5821	6821
5622	5822	6822
*	5824	6824



THE RADIART CORPORATION
CLEVELAND 13, OHIO

VIBRATORS • AUTO AERIALS • TV ANTENNAS
ROTORS • POWER SUPPLIES

Auto Radios for 1956

BUICK



by
**ANDREW V.
DOPPLE**

Auto Radio Serviceman
Frank A. Reeve Co.

Of all the popular cars manufactured in 1956 "Buick" is the only one which still uses a radio of the single unit type. Two models are supplied by "The United Motors Service" for custom installation. They are interchangeable in all Buick models.

Basic Features

The "Sonomatic" model, part #981707 (see Fig. 1) employs a manual tuner, with five push buttons. It uses six tubes, plus a rectifier.

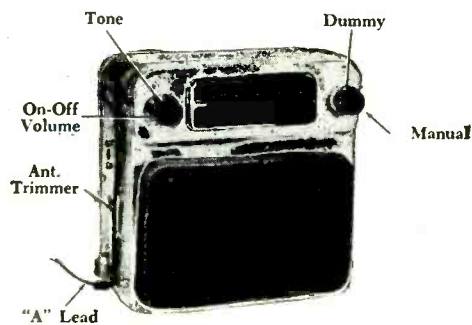

► Fig. 1—Sonomatic Model 981707 used in Buicks.

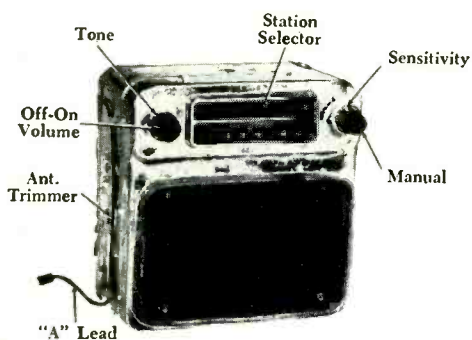

► Fig. 2—Selectronic Model 981708 used in Buicks.

The "Selectronic" model, part #981708 (see Fig. 2) is an electronic signal seeking receiver, using seven tubes, plus a rectifier. The circuit of the "Selectronic" model is identical with that of the "Sonomatic" except for the addition of a 12AU7 tube used to trigger the automatic tuning control. The "Buick" selectronic model differs from other signal seeking sets in that it has no provision for push button tuning. However, provision is made for manual tuning should the automatic feature fail.

The sensitivity control is located directly behind the manual tuning control. (See Fig. 2). This is a very important control on electronic tuners. It operates a four-position switch, which controls the sensitivity of the receiver. Clockwise rotation of the control increases the sensitivity. Should this control be set at the extreme counter-clockwise position in a weak signal area, no station would be received.

At the left end of the floorboard, near the brake pedal (See Fig. 3), is a foot switch similar to the head lamp dimmer switch, which, when depressed, triggers

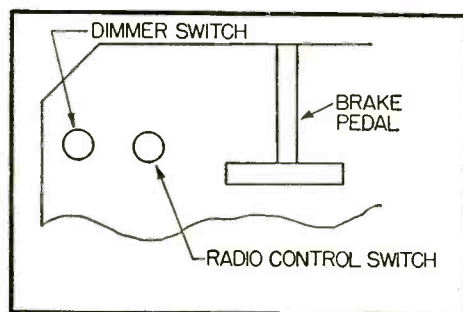

► Fig. 3—Automatic tuner switch on floorboard.

the automatic tuner. This enables the driver to change stations automatically without removing his hands from the wheel. Connection of the switch is made through a cable which terminates at the set in a three prong plug.

Manual and electric antennas are available and are mounted on the left front fender.

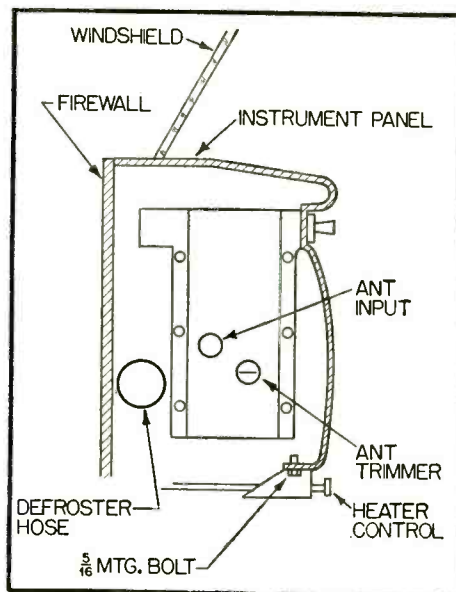

► Fig. 4—Cross section of instrument panel of Buick.

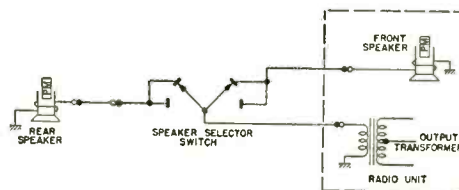

► Fig. 5—Rear speaker wiring diagram for Buick cars.

Removal of Unit

The unit is mounted directly behind the radio grille in the center of the instrument panel, (see Fig. 4), and its removal is one of the easiest of current models.

- 1) With a 7/16" wrench remove the heater control which is mounted directly below the radio grille (see Fig. 4) and drop the control down and out of the way. The wires and cables are long enough so that no other disassembly is necessary.
- 2) With a small screwdriver, release the springs holding the control knobs. Remove the knobs and controls.
- 3) Remove the two front panel mounting nuts with a 7/8" deep socket.
- 4) Disconnect the right-hand defroster hose and move it to one side to make the set accessible.
- 5) Disconnect the "A" battery lead at the cartridge fuse holder, fastened to the unit mounting bracket

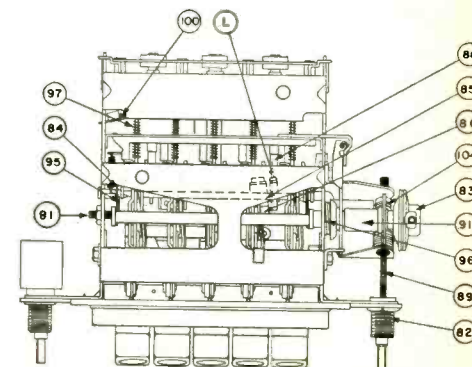

► Fig. 6—Adjustment points are shown in above diagram.

with a clip, and remove the 7.5 amp type AGW fuse.

- 6) Remove the antenna lead.
- 7) With a 7/16" wrench remove the two bolts holding the unit to the mounting bracket.
- 8) Move the unit forward until the unit controls clear the instrument panel. Then bring down toward the floor and out.

There is barely enough clearance between the hump of the floor board and the instrument panel for removal of the unit but a little pressure will compress the rubber cushion around the speaker grille and the unit can then be removed with little effort.

Installation Notes

Original equipment and all replacement distributor rotors are supplied with built-in resistors so that no other suppression at the distributor is necessary.

The usual condensers are necessary at the ignition coil, voltage control and generator. (See May, 1956 issue of [Continued on page 35])

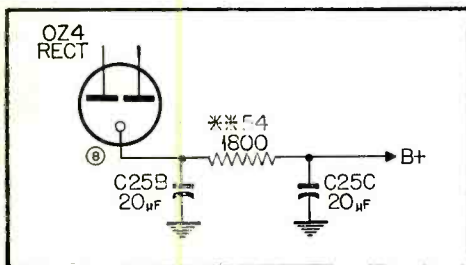

▶ Fig. 7—Partial schematic of rectifier filter section.

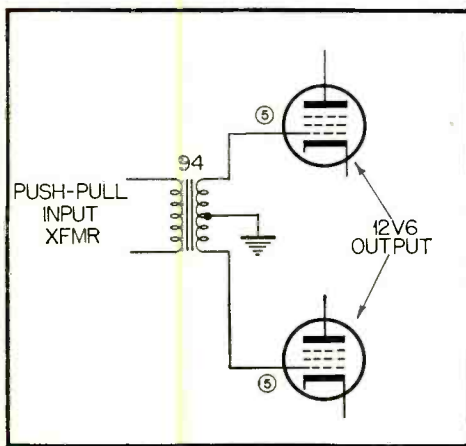

▶ Fig. 8—Partial schematic of push-pull input section.

Burton Browne Advertising

NEW *Hypex*
DRIVER UNITS
LIFETIME
GUARANTEED
BY
Jensen

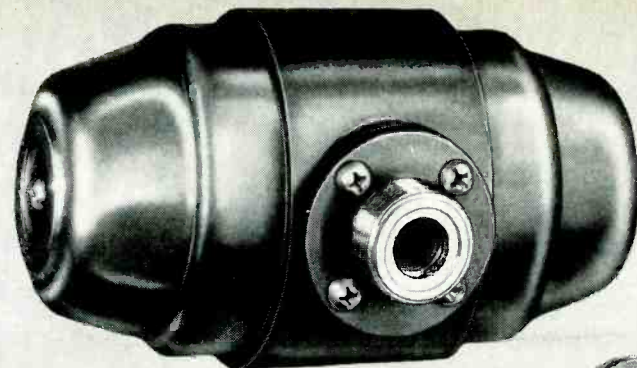

DD-100

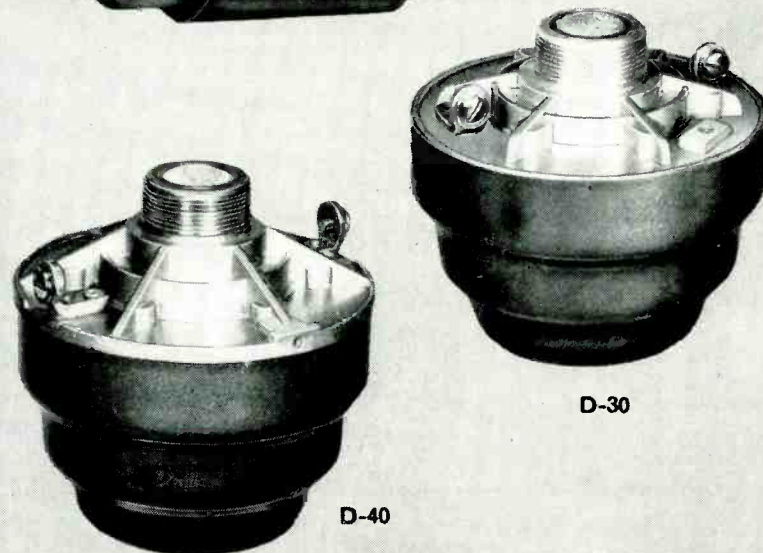

D-30

D-40

HIGHER POWER RATING...HIGHER EFFICIENCY, TOO!

Designed to pack a terrific sound "punch"...to penetrate high noise levels...to project sound over great distances, the new Jensen LIFETIME Driver Units will do the job better, more dependably, and more economically than ever before.

The D-30 (30 watts) and D-40 (40 watts) have higher power ratings than comparable previous units. This means that the projector can deliver more sound output and better coverage when called upon to do so. Moreover they are more efficient although their cost is approximately the same. This means more sound output per dollar...more sound output per watt input...saves amplifier power and cost too.

DD-100 Superpower Driver (100 watts) is a new advance in packaged sound power, for an integrated unit with such a high power rating has never been available before. It makes possible concentrated projector arrays

with a power capacity of 1600 watts or even more.

We are so confident of the excellence of design, skilled craftsmanship, precision materials and careful inspection that go into every Jensen Hypex Lifetime Driver unit that we are taking the unprecedented step of guaranteeing each and every one against electrical failure indefinitely. Should any Driver Unit fail at any time when used under normal operating conditions, we will either repair or replace it at our option without service charge.

Jensen LIFETIME Driver Units are standout members of the new Jensen Professional Series...a group of speakers covering every requirement for effective sound communication and entertainment in commercial, industrial and institutional sound systems. We'd like to send you Catalog 1070 which contains complete information.

SPECIFICATIONS						
MODEL	POWER RATING*	IMPEDANCE OHMS	FREQUENCY RANGE	LENGTH	DIA.	LIST PRICE
D-30	30 w.	16	75- 7,000	4 1/16"	4 1/4"	\$27.50
D-40	40 w.	16	75-10,000	4 1/16"	4 1/4"	\$36.00
DD-100	100 w.	3/32	75-10,000	5 5/16"	8 1/2"	\$96.50

*Integrated speech and music program material. For sine wave or siren signal input, reduce ratings one-half. Ratings apply only for frequencies above horn cutoff.

LIFETIME GUARANTEE
D-30; D-40 and DD-100 Lifetime Driver Units.
Every Lifetime Driver Unit is unconditionally guaranteed for life against failure when operated according to the instructions accompanying the unit.
Should any Lifetime Driver Unit become inoperative at anytime under these conditions, it will be repaired or replaced at our option entirely free from any service charge.
The instruction sheet supplements and is a part of the warranty under which the Lifetime Guarantee is extended.
JENSEN MANUFACTURING COMPANY

Jensen MANUFACTURING COMPANY

6601 S. Laramie, Chicago 38, Illinois • Division of The Muter Co. • In Canada, Copper Wire Products, Ltd. Licensee

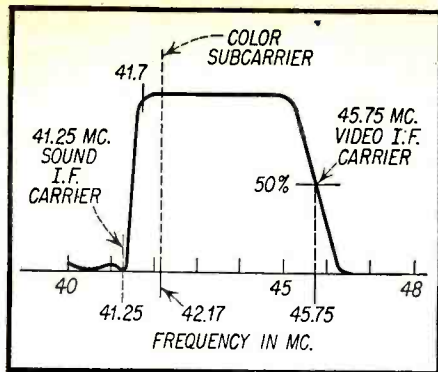

Fig. 1—Broad bandpass IF response curve.

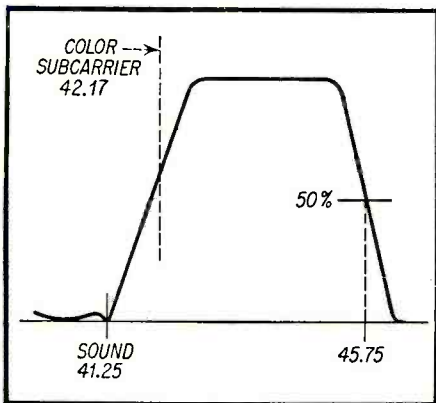

Fig. 2—Narrow bandpass IF response curve.

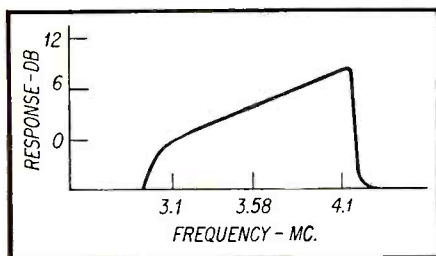

Fig. 2B—Chroma channel characteristic corresponding to Fig. 2.

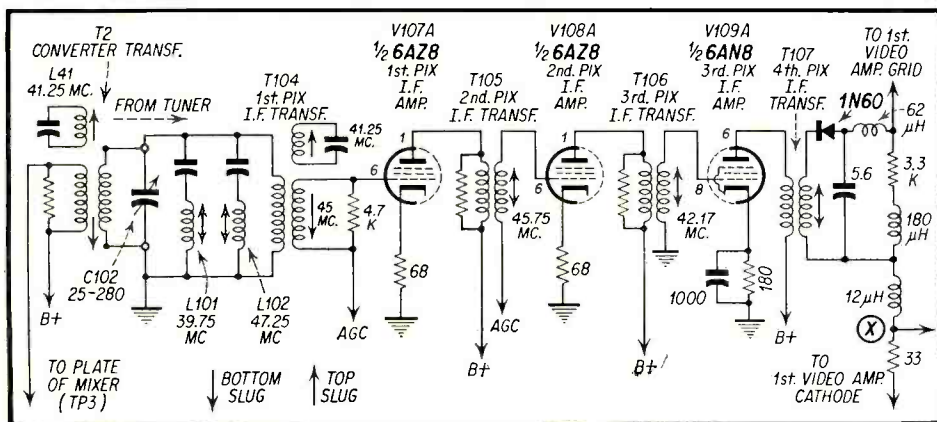

Fig. 3—Partial schematic of IF section of RCA 21CT660U Series.

As indicated at the outset of the discussion on RF-IF color circuitry, video *if* circuits in color TV receivers are essentially similar to those used in monochrome receivers except for added measures designed to process the color component contained in the overall *if* signal. These measures are primarily designed to effect a specific bandpass and to more effectively attenuate the sound signal contained in the overall *if* signal. In addition, provisions must be at the output of the *if* section to recover and channel off individually the five signal components contained in the overall *if* signal, these being, chrominance, luminance, sound, color burst and sync, both horizontal and vertical.

Generally, color *if* sections are designed to provide a flat response to all the video frequencies contained in the overall *if* signal. Since the tuner is similarly designed, the luminance-to-chrominance signal ratio at the output of the 2nd detector should be essentially the same as that of the transmitted signal. This ratio, if preserved up to the picture tube itself will result in correct color signals. If, for some reason, the *rf* response is such as to disturb the original luminance-to-chrominance signal ratio, measures have to be employed somewhere in the luminance or chrominance channels to restore the original ratio before the signals are applied to the pix tube. Unless this is done, incorrect color reproduction will result.

It will be recalled that the subcarrier frequency is located 3.58 *mc* above the *rf* carrier. Add to this the upper chroma

sideband frequencies (0.5 *mc*) and it will become evident that an extremely wideband *if* system is required; that is, one extending beyond 4 *mc*.

It was previously brought out that color *if* systems can be broadly divided into two basic types. In the first type, as shown in Fig. 1, the bandpass is es-

entially flat over the entire range of video *if* frequencies extending from the knee of the curve just above the 50% response point of the video carrier on to and slightly past the *rf* subcarrier. At this point the response drops very sharply in order to provide the necessary sound *if* attenuation. In line with the

COLOR VIDEO

This installment deals with the two basic types of video I.F. systems, narrow band and broad band. Alignment procedures are detailed for each in typical receivers.

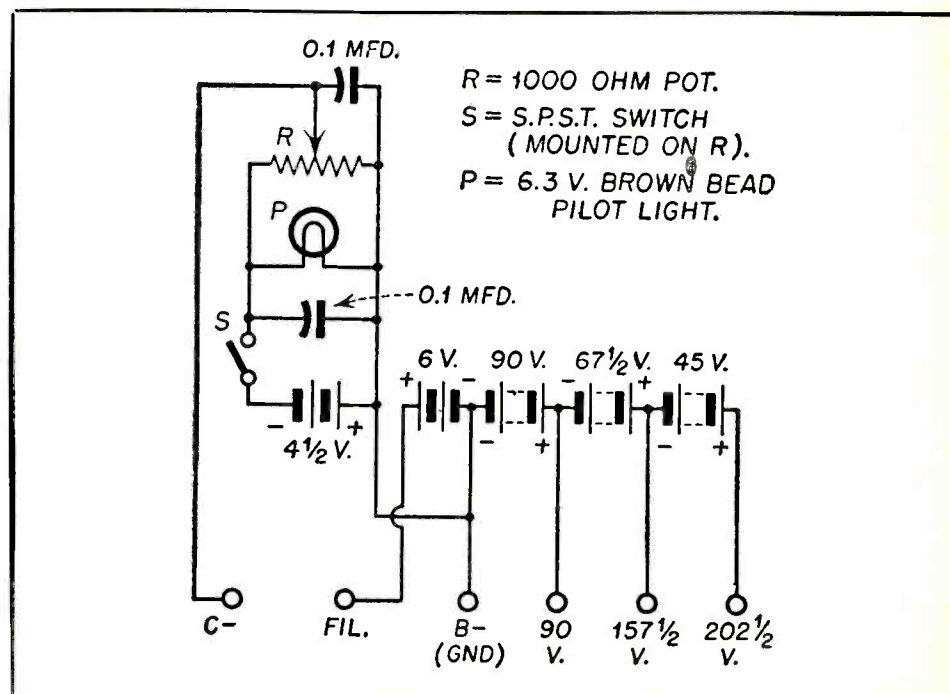

Fig. 4—Battery power supply for obtaining various values of "C" bias. Higher voltage "C" batteries may be substituted.

I.F. ANALYSIS

by **BOB DARGAN** and
SAM MARSHALL

From a forthcoming book entitled
"Fundamentals of Color Television"

latter it will also be recalled that the sound carrier must be highly attenuated in order to prevent the production of a 920 kc beat resulting from the interaction of the sound and chroma carriers:

$$4,500 \text{ kc} - 3,580 \text{ kc} = 920 \text{ kc}$$

In this type of *if* system the transmitted luminance-to-chrominance signal ratio is present at the detector output.

In the second basic type of video *if* circuit the response at the subcarrier frequency, as shown in Fig. 2, is down 50%. Notice that one sideband has little attenuation, and the other a great deal. All color systems have chrominance amplifier channels, but this one requires a complex frequency characteristic as

shown in Fig. 2B. Under these conditions the ratio of the relative luminance to chrominance signal values recovered at the detector will be in the order of 2 to 1. This apparent reduction of chroma signal with respect to luminance is subsequently compensated for in the chroma channel. Here the chroma signal is given an additional boost so that by the time the luminance and chrominance signals reach the picture tube they have again the original luminance-to-chrominance ratio contained in the transmitted signals.

In the system represented by the curve of Fig. 2 it is felt that the added task of including the chrominance amplifier

channel in the overall alignment is compensated for by the apparent narrower *if* bandpass requirements. Such a system lends itself to greater price economy which can be passed on to the consumer.

Typical IF Circuits—Narrow Band

Figure 3 is a simplified schematic of the *if* section of the RCA 21-CT-661U receiver which is of the narrow-band *if* type. In this circuit the subcarrier ampli-

tude is adjusted to the 50% level of the response curve and corresponds to the system indicated in Fig. 2. The converter transformer T2 provides the shaping of the shoulder around 42.75 mc and a sound trap for attenuation of the 41.25 mc signal. The first *if* transformer T104 provides the shaping of the knee of the curve around 45 mc, and includes a sound trap for attenuation of the 41.25 mc signal.

Additional traps L101 and L102 are

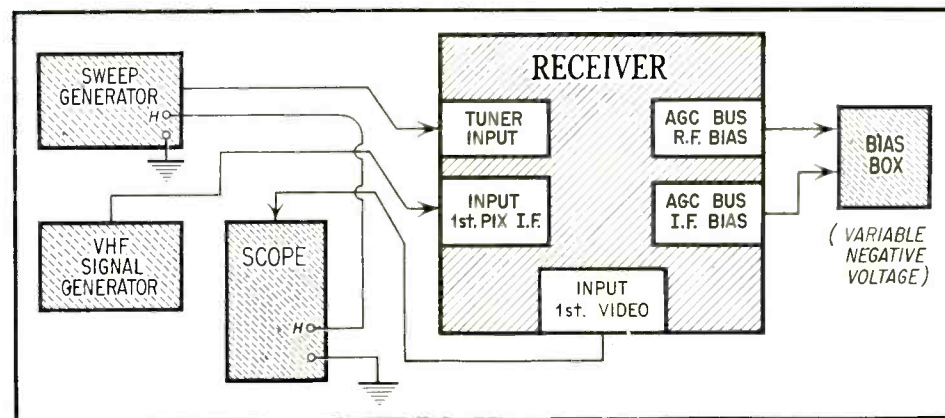

Fig. 6—Alignment test set up for IF sweep.

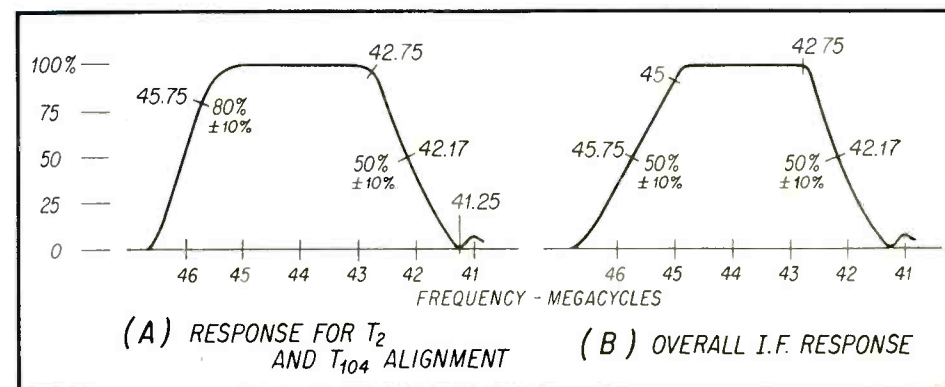

Fig. 7—Response curves (RCA) A and B.

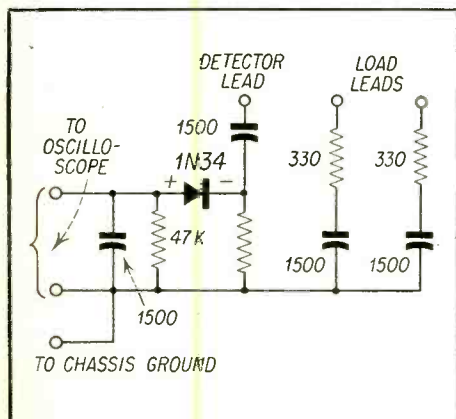

Fig. 5—IF test block.

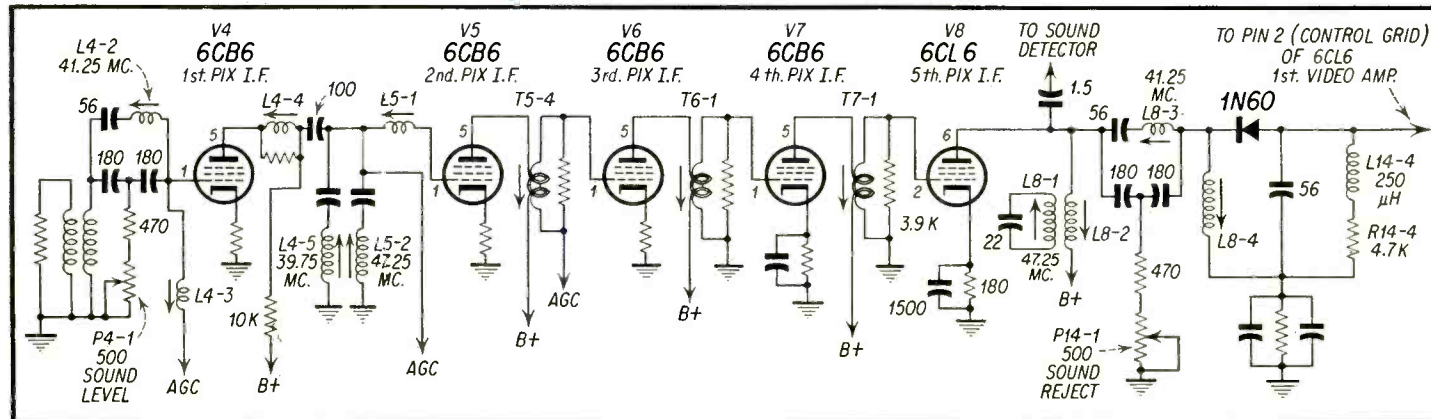

Fig. 8—Partial schematic of IF section of CBS-Columbia 205 Receiver.

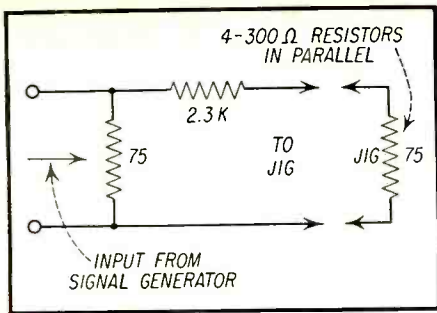

Fig. 9—30 db pad.

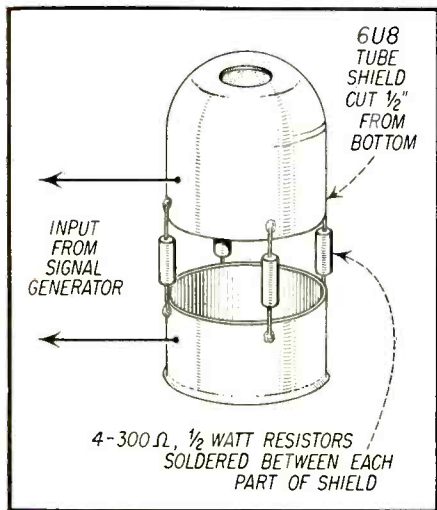

Fig. 10—Tuner coupling jig.

located between T2 and T104 to attenuate the adjacent channel sound and video carrier signals if present. Condenser C102 is effective in adjusting the overall bandwidth of the *if* response. Proceeding to the stagger-tuned transformer trio comprising T105, T106, and T107, T105 affects the curve response around the picture carrier (45.75 *mc*); T106 affects the curve response around the subcarrier (42.17 *mc*); and T107 tuned to 43.9 *mc* affects the overall tilt of the response curve.

Alignment of Narrow Band IF System

In line with our discussion pertaining to the relative level at which the subcarrier *if* response is adjusted, it is obviously necessary that extreme care be exercised in aligning the *if* section so that the correct response curve is obtained. Incorrect *if* slug adjustment can easily produce incorrect luminance-to-chrominance signal ratios and consequent color degradation. It can also affect the relative sound trap response,

resulting in a possible 920 *kc* beat and color degradation on this score alone.

The equipment required in performing the video alignment of this type of receiver is as follows:

1. Sweep generator.
2. Crystal controlled marker generator.
3. Wide Bandpass oscilloscope.
4. Low voltage *dc* bias power supply (See Fig. 4).
5. IF test Block (See Fig. 5).

Observation of an overall *if* response curve for adjustment and alignment purposes may be effected by connecting up the various components as shown in Fig. 6. It is most advisable to disable the *agc* voltage applied to the *if* slugs an increase in signal produces an increase in *agc* voltage. This in turn reduces the gain of the stage under observation and masks the condition where a sharp resonant increase in gain should be observable. The disabling action occurs automatically when connecting a low impedance bias supply across the high impedance *agc* circuit.

In order to provide a constant bias to the *if* tubes an external source of "C" bias is made use such as a "C" battery

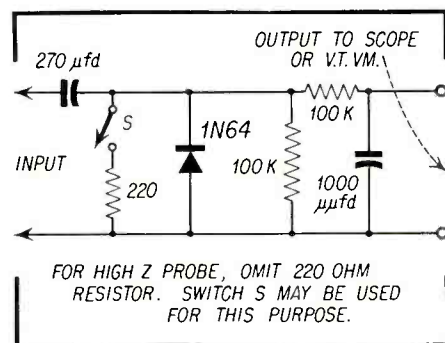

Fig. 11—Crystal diode probes—high frequency and low frequency.

power supply arrangement as shown in Fig. 4.

The initial adjustment in the alignment procedure involves aligning the mixer plate circuit. To effect this the following preliminary connections and adjustments are made.

1. The sweep generator is first injected into the mixer by converter shield injection. This involves pulling up the tube shield from its grounding clip, following which the signal generator is connected to the shield. This effectively produces capacity coupling to the converter plate.

2. The channel selector is set at channel 4.

3. C102 is preset to minimum capacity.

4. A 6 volt negative potential is applied to the *agc* point (+ 6V is connected to ground).

5. The "Load" leads from the *if* test block are connected to pin #1 of V108A, and pin #6 of V109A. The *if* test block provides a means of supplying a detector probe to the output of a stage being aligned so that the output of the stage may easily be observed with a scope. The load connections are provided to short out the signal in subsequent *if* stages.

6. The "Detector" lead from the *if* test block is connected to the plate of V107A, the 1st Pix IF Amp.

7. The oscilloscope is connected to "oscilloscope" lead of the test block.

8. The crystal controlled *vhf* signal generator is coupled loosely to the grid (pin 6) of V107 to obtain the required markers.

Step 1.

Following these preliminary connections and adjustments the bottom slug of T2 and T104 are adjusted so that 45.75 *mc* occurs at 70% of maximum

response (See Fig. 7A). C102 is then adjusted until the 42.17 *mc* marker is at 50% of the maximum response. The 42.75 *mc* point should fall at the shoulder of the curve on the low frequency side of the peak as shown in the figure. Readjustment of the trap and bandpass slugs in T2, T104 and the trimmer C102 are then made until the response curve obtained corresponds to Fig 7A.

Step 2.

The next set of adjustments involves aligning the bifilar transformers T105, T106 and T107. To do this the *if* test block is removed and the scope is connected directly to point X shown in Fig. 3. The sweep generator and crystal controlled signal generator are left connected as before with the output of the sweep generator adjusted so that the *rf* voltage present at point X never exceeds 8V. T105, T106 and T107 are then adjusted so that the overall response curve appears as in Fig. 7B.

Broad Band Video IF Circuits

More elaborate video *if* circuits than the one just described may be found in many color TV receivers. These use as many as four and five stages of video *if*. The latter are combinations of over-coupled and stagger-tuned stages.

An example of a receiver of this type is shown in Fig. 8 which illustrates a partial schematic of the *if* section of the CBS-Columbia Model 205 color TV receiver. Notice that the circuit between the tuner output and the first *if* grid consists of an adjustable sound level trap circuit of the type described in the May 1956 installment in this series. (See 4/56 RTSD, p. 32, Fig. 6).

Between the 1st pix *if* plate and the 2nd pix *if* grid we find a low impedance tuned circuit of the type also described in the previously referred-to installment.

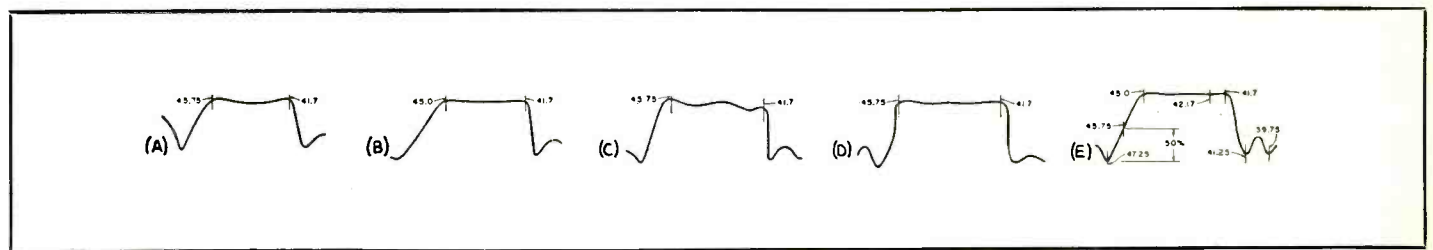

Fig. 12—IF response curves for different steps in alignment.

Included in this circuit are the adjacent channel sound and video carrier traps which are tuned to 47.25 mc and 39.75 mc respectively.

Three stagger tuned stages of *if* using bifilar wound coils follow V5. The output of V8, the fifth *if* tube, feeds into a crystal detector (1N60) which provides the sound signal, and into another 1N60 through a second sound-reject trap which provides the chrominance, luminance, color sync and black and white sync signals. Also contained in the output of V8 is an absorption trap tuned to 47.25 mc, the adjacent sound channel.

Alignment

The equipment required in performing the video *if* alignment in a receiver of the type just described is as follows:

1. Sweep generator.
2. Crystal controlled marker generator.
3. VTVM with high and low impedance crystal detector probes.
4. Wide bandpass oscilloscope.
5. Low voltage *dc* power supply.
6. 30 db pad (Fig. 9).
7. Tuner coupling jig. (Fig. 10).
8. Crystal diode probes—high frequency and low frequency (Fig. 11).

The VTVM is connected across the grid load resistor of the 1st video amplifier. During alignment the signal generator output is reduced so that the VTVM reading does not exceed 1-to-2 volts with the slugs properly adjusted.

Other preliminary connections are as follows. The crystal controlled *rf* generator is connected through a suitable double-terminated jig (see Fig. 10) which is slipped over the mixer tube. The channel selector switch is placed between channels to disable the local oscillator. A suitable bias (-4V) is applied to the *agc* bus at the junction of R5-2 and R6-2.

Step 1.

The adjacent channel traps L4-5, (39.75 mc) L5-2 (47.25 mc), L8-1 (47.25 mc), and L14-1 (41.25 mc) are adjusted in the order given for minimum deflection of the VTVM as the crystal controlled generator is switched through these various frequencies.

Step 2.

To adjust the sound reject control
[Continued on page 48]



You get dependable electrical protection — under all service conditions — with BUSS FUSES

To assure top quality and proper operation, — BUSS fuses are electronically tested. A sensitive device automatically rejects any fuse not correctly calibrated, properly constructed and right in all physical dimensions.

BUSS fuses, by their unflinching dependability, help safeguard your reputation for quality and service, — and BUSS fuses protect you and your customers against costly troubles.

When there is an electrical fault, BUSS fuses clear the circuit in time to prevent further damage to equipment. You are not faced with the problem of explaining to a customer why he has to replace a part that should not have been damaged.

And BUSS fuses eliminate needless blows. Your customers are not irritated by unneces-

sary shutdowns, — nor do you have to make time-wasting, costly call-backs because a faulty fuse has blown needlessly.

With a complete line of trouble-free BUSS fuses available in all sizes and types, — it is just good business to standardize on BUSS fuses.

For more information on BUSS and Fusetron small dimension fuses and fuseholders . . . Write for bulletin SFB.

Bussmann Mfg. Co.

(Div. of McGraw Electric Co.)

UNIVERSITY AT JEFFERSON, ST. LOUIS 7, MO.

Makers of a complete line of fuses for home, farm, commercial, electronic, automotive and industrial use.



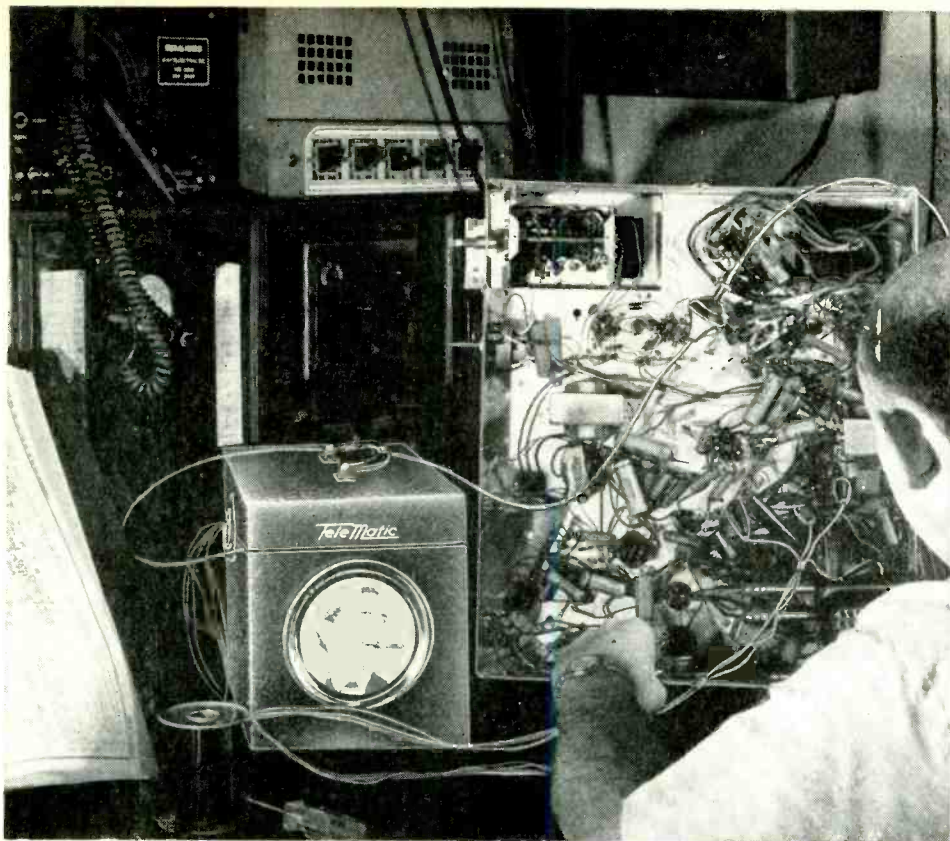

Fig. 2—Telecheck unit in actual use.

THE Telecheck unit is used to check, both quickly and accurately, whether or not the yoke or the picture tube of a TV set, regardless of its make or model, are defective. The unit consists of a 5AXP4 picture tube (CRT), a universal-type yoke, 6-foot CRT socket extension leads, and anode-yoke connecting leads, all of which are housed in a lightweight leatherette portable carrying case. See Fig. 1. The yoke is fused to prevent set damage.

Set yokes and cathode ray tubes may be checked by direct substitution of components when they are the same as those of the Telecheck unit. This permits many sets to be serviced directly in the customer's home and, even if a chassis must be taken to the shop, the CRT-yoke assembly may remain in the cabinet. Even in the shop, easy access to the CRT-yoke makes troubleshooting time-saving and less laborious. The 5AXP4, which is self-focusing and needs no ion trap, will substitute for all electromagnetic and electrostatic picture tubes.

The yoke in the unit is interchangeable with the one in the set, thus permitting a more accurate observation of a fault. The 6-foot CRT extension leads permit the unit to be placed in any convenient spot, such as on the TV cabinet, which enables the picture to remain in view at all times and with a minimum of space taken. This extension, as well as any other single part of the unit, may also be used for general TV service work, which gives the unit wide application. If both the CRT and yoke are faulty in a set, the unit will substitute both components to make sure that the set does not have any other troubles.

Preliminary Setup

The following procedure is used to operate the unit.

- 1) Plug anode lead of set into female plug of Telecheck anode extension.
- 2) Plug CRT socket of set into Telecheck CRT extension base.
- 3) Clip red and blue leads of Telecheck yoke extension leads across horiz. yoke leads of set.

A Substitution Tester For Yokes and CRTs

Description of a checker which saves time and labor by quickly localizing CRT or yoke troubles, by the method of substitution.

- 4) Clip black and tan leads of Telecheck yoke extension leads across vertical yoke leads of set.

To obtain more accurate results:

- 5) Disconnect horiz. and vertical yoke leads of set before doing 3 and 4.

To obtain greater picture accuracy (when the yoke is known to be good):

- 6) Substitute the set yoke for the Telecheck yoke.

How To Use the Telecheck

Consider a set which has no raster; the sound is normal. Adjustment of the brightness and contrast controls fails to bring back the raster. With a screw driver, draw an arc from the high-voltage lead (or measure the high-voltage, for accuracy) to determine whether the proper high-voltage is present. The Telecheck CRT is then substituted for the set CRT, and a normal raster appears. The trouble is obviously a faulty picture tube. If the raster still does not appear when the Telecheck CRT is substituted, then the trouble is in the circuit supplying the gun of the CRT.

Consider the case where there is no high-voltage output from the h-v supply. A shorted yoke, for example, could cause this condition. Substitution of the

Telecheck yoke for the set yoke would determine quickly whether or not the latter was defective.

Yoke Matching

A yoke is designed to match the impedance of a portion of the flyback transformer secondary. The yoke inductance and resistance determine its impedance. In a normally operating receiver when the yoke is properly matched to the flyback, a picture will result which fills out the entire picture tube screen and which is free of distortion, foldover, and non-linearity.

A replacement yoke must have the same inductance-resistance as the original in order for it to fulfill the requirements of the original. Most yoke manufacturers permit a tolerance of + or -5% for the horizontal windings and + or -10% for the vertical windings.

This unit uses a 10/40 yoke (10 mh horizontal winding and 40 mh vertical winding). Therefore, when this yoke is substituted for a 10/40 set yoke (or, even if the inductance of the set yoke falls within the allotted 5-10% tolerance), a normal full-sized picture is obtained. If, however, the set yoke has a different inductance, then a picture with short height or width, non-linearity



by **B. Yarmalow**
Chief Engineer Telematic Industries, Inc.

fore the Telecheck yoke was substituted for it. The horizontal and vertical windings of the Telecheck yoke may be connected in parallel with the respective windings of the set yoke, without first disconnecting the latter from the circuit. The resultant inductance, however, will be different. The inductance of the two inductors connected in parallel is calculated by using the formula $\frac{L1 \times L2}{L1 + L2}$, where $L1$ and $L2$ represent their respective inductances.

The following is an example of how this formula is used. A set yoke has 35/50 *mh* windings, which are connected in parallel with the corresponding 10/40 *mh* Telecheck yoke windings. The resultant horizontal inductance is $\frac{30 \times 10}{30 + 10}$, or roughly 8 *mh*, and the ver-

tical inductance is $\frac{50 \times 40}{50 + 40}$, or 22 *mh*.

Reference charts shown in Fig. 2 will show the type of picture which would be expected to appear. Note that the resultant 8 *mh* horizontal inductance is a fairly close match to the 10 *mh* Telecheck yoke. If the set inductance was much lower, say, 8 *mh*, and if it was connected in parallel with the Telecheck yoke, then a severe mismatch would occur, with the resultant inductance being 4.4 *mh*.

Determining Yoke Inductance

The need for using a yoke replacement with the same inductance as the original has been explained. The inductance of a yoke may be measured with an inductance bridge or Q-meter. Measurements must be made with the yoke disconnected from the circuit. It is not necessary to disconnect the balancing capacitor, which is connected across the horizontal yoke high-side, since it offers maximum reactance to the bridge frequency, which is generally 60 or 1,000 *cps*.

The inductance of the two horizontal yoke windings varies from about 8 to 30 *mh*. Typical inductance values are 8, 10, 12, 14, 17, 20, 25, and 30 *mh*. The *dc* resistance for this range runs from about 9 to 40 ohms. There is no positive way of correlating the inductance and resistance, since wire size varies



Fig. 1—Photo of Telecheck unit and accessories.

and/or foldover will result. The greater the mismatch, the more noticeable will be these effects. It would be impractical to include all of the various types of yokes used in TV sets since they are too numerous. To take into consideration mismatches which often exist when testing yokes with this unit, the charts below were made.

HORIZONTAL INDUCTANCE (mh)	APPROX. SCREEN WIDTH (%)	ABNORMAL INDICATIONS
8-10	Normal	Normal
15	95%	"
20	80%	"
25	75%	Reduced 2nd Anode Voltage
30	60%	Reduced 2nd Anode Voltage

VERTICAL INDUCTANCE (mh)	APPROX. SCREEN HEIGHT (%)	ABNORMAL INDICATIONS
3*	50%	Fold over at bottom
40	Normal	Normal
50	80%	"

*Direct-drive yokes

These charts should be used when there is doubt as to whether a yoke mismatch or an actual set fault exists. An even better way to dispel this doubt is to substitute the set yoke for the one in the Telecheck unit. In this way, no yoke mismatch can exist.

This discussion was based on the fact that the set yoke was disconnected be-

from yoke to yoke. However, it will be found that the *dc* resistance is always slightly higher (by about 1 ohm for inductances under 15 *mh* and up to 5 ohms for 30 *mh*) than the inductance. Thus, a *dc* resistance of 22 ohms for the horizontal yoke windings indicates an inductance of about 20 *mh*; an 8 *mh* yoke has a *dc* resistance of about 9 ohms, and the resistance of a 30 *mh* yoke is about 35 ohms.

With the exception of direct-drive yokes which use 25 to 30 *mh* horizontal windings, 70-degree yokes have inductance values of 8 to 20 *mh*. An inductance of 20 *mh* is used for 90 degree yokes.

With the exception of the 3 *mh* vertical winding inductance of direct-drive yokes, the inductance for the vertical windings ranges from about 30 to 50 *mh*. The relatively greater inductance of these windings, as compared to the horizontal, necessitates more winding turns and, hence, a greater *dc* resistance. The *dc* resistance ranges from about 45

to 65 ohms. Direct-drive yokes, however, have a resistance of about 4 ohms.

The vertical winding inductance may also be approximated from its *dc* resistance. The *dc* resistance is about 5 ohms greater than inductance values below 45 *mh* and up to 10 ohms greater for inductances of 50 *mh*. Thus, a *dc* resistance of 40 ohms indicates an inductance of 35 *mh*; 50 ohms indicates 45 *mh*; and 60 ohms, 50 *mh*.

The *dc* resistance measurement of the vertical windings may be made while the two damping resistors, one connected across each winding, remain connected, since their resistances are very much greater than those of the vertical windings.

Yoke Angle

The angle of a yoke indicates the angle of the CRT with which it must operate to produce the desired picture width. Earlier TV sets use deflection angles of 70-degrees, or less, for picture tubes up to 21-inches. The 90-degree

yoke became popular with the advent of 24 and 27 inch picture tubes. However, this yoke is also being used for some 21 inch tubes. Some 21 inch sets use a 74-degree yoke which has gained in popularity recently.

Seventy-degree yokes may be recognized by their relatively small winding flare (Fig. 3a), as compared to the very wide flare used in 90 degree yokes (Fig. 3b). Seventy-four degree yokes use a flare somewhere between that of the 70 and the 90 degree yokes.

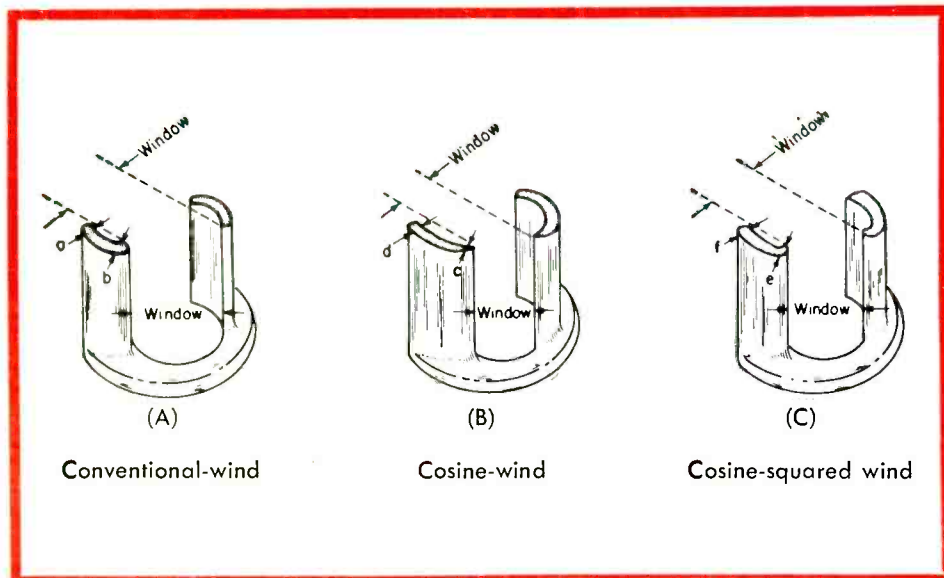

A replacement yoke should have the same deflection angle as the original. However, generally speaking, a 70 degree yoke may be substituted for a yoke with an angle of less than 70 degrees. The substitution of a 70 degree yoke for one with a higher angle will usually result in neck shadow. If space permits, and if insufficient or excessive width does not result, then a higher-angle yoke may be substituted for one with a lower-angle.

Yoke Winding Types

Besides having the same inductance and deflection angle, a replacement yoke should also have the same type of winding as the original, lest an unsatisfactory picture result. There are three types of yoke windings. These are the conventional yoke, cosine wound yoke, and cosine-squared wound yoke. They are shown in Fig. 3. Each winding has been cut at the top (darkened areas) to show its cross-section clearly. The differences in the shape may be noted by compar-

ing the shapes of the darkened areas.

The thickness of the darkened area of the conventional type is the same throughout (distance a equals b) and its window is relatively large. The darkened area of the cosine type takes the shape of a geometric cosine curve (hence, its name) and has a very narrow window (c is very much narrower than d). The cosine-squared type is a modification of the other two. Its winding and window are intermediate between the conventional and the cosine

types (e is somewhat narrower than f).

The conventional type is used only in the older sets, since its main disadvantage is non-uniform edge-to-edge picture focusing. Although the cosine-type results in the best edge-to-edge focusing, its disadvantage is that it usually results in a pincushion raster (caved-in sides). The cosine-squared type provides good edge-to-edge focusing with a minimum amount of pincushioning, thus, making it the most popular.

It is very important for the service technician to distinguish between the three types of windings, even though it is strictly a design detail. The reason is that an undesirable picture effect may result if an incorrect type of winding is used. The pincushioning effect was mentioned above. If a conventional type were substituted for the cosine, or cosine squared type, barrelling (picture sides bulge out) might occur. Also, two yokes, although with the same imped-

[Continued on page 45]

ASSOCIATION NEWS

by SAMUEL L. MARSHALL

Philadelphia Radio Service Men's Association, Inc. (PR SMA)

The last open meeting of PR SMA was held recently at the Franklin Institute. It featured Bill Powell of the RCA Service Co., who spoke on "Servicing Techniques on RCA Color Receivers." The meeting was sponsored by Raymond Rosen & Co.'s Electronic Parts Division in cooperation with PR SMA, NETSDA, TSDA of Delaware County, TSDA Allied TV Technicians of New Jersey, and TCA. Bill did a wonderful job, using slides to illustrate the circuits of which he spoke.

Television and Radio Association of Alameda County, Inc. (TRAAC)

The following is the Code of Ethics of the Television and Radio Association of Alameda County, Inc.

"It is our aim to serve the public and the trade with competent workmanship, with forthright, truthful information and honest values, and to avoid any misrepresentation or subterfuge in the solicitation or the performance of the work we do by

a) Stating clearly in advance the price of goods sold, or a reasonable estimate of work to be performed and probable time of completion.

b) Itemizing articles and services sold, actual work performed, all parts replaced, and any extras.

c) Returning to the customer, when practicable, all defective parts that have been replaced.

d) Co-operating with customer and manufacturer in properly observing existing warranties.

e) Stating clearly when new, rebuilt, or used merchandise is sold or installed.

f) Accepting responsibility for work performed, assuming liability for damage caused, and being prepared to make good on all promises made.

g) Refraining from deceptive advertising claims."

The last general meeting of May 5 held at Hotel Lamington, Oakland, was well attended despite unfavorable weather. Mr. Donald Johnson, training specialist for Westinghouse, outlined the new Westinghouse Silver Safe-Guard circuit.

Advancements in construction such as those outlined, show the trend in manufacturing ability to cut costs, leading to low cost color receivers.

It has been realized for some time TRAAC is in need of new emblem. Artist Leroy Lepeilbet has tackled the job with a vengeance. He says he will come up with something really good. We will be watching for it.

Television Electronic Service Association of St. Louis, Missouri (TESA)

St. Louis Board Chairman, Vince Lutz, and TESA member Charles Luensmann, attended the organizational meeting of a group of TV service shop owners in Flat River recently. Vince Lutz gave reasons for forming an association in the area and why it would be advantageous to be part of TESA—Missouri and NATESA.

The group elected the following temporary officers: Ed Engel, Crystal City, President; Frank Haggett, Des-Loge, Secretary; and Carl Warren, Flat River, Treasurer. Emmett Rusteberg, Elvins; and Ray Hellweg, Crystal City, were appointed to a committee to assist the temporary officers to draw up a Constitution and By-laws.

Efforts of Cyril Echele of Dennings Radio & TV, and Fred Mertens of Mertens Radio & TV, both of St. Charles, to form a TV Service Association have finally crystallized.

Vince Lutz also attended this meeting to explain the formation of a local group.

Fourteen shops were represented at

[Continued on page 40]

Dear Mr. Answerman:

In a Philco TV440 chassis a small amount of vertical stretch exists in the picture. The vertical linearity control does not completely correct the condition when adjusted. Everything in the vertical circuits tests normal and tubes and condensers have been checked. The voltages are close to normal. Evidently something has been overlooked in checking out this set but I have no idea what it can be. I know the receiver had normal vertical linearity originally as I had seen it in operation when the antenna was installed.

Is there anything unusual that might be causing the vertical stretch in the picture?

C. B.
Washington, D. C.

As will be noted in Fig 1 the vertical linearity control is located in the grid circuit of the horizontal output tube. This is not a very unusual place for this operating control. Other receivers have used the same point to obtain negative voltages for noise cancellation circuits and for other purposes. For circuits to work the way they are designed they must be supplied by the correct voltage at this point. As has happened in some cases the grid bias on the horizontal output tube can change somewhat and still the circuit will provide sufficient width and seem to function normally. This is especially true when the width control can be advanced if the width is abnormal.

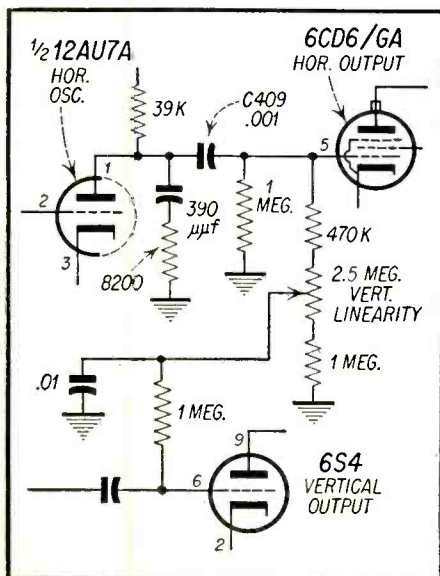

Fig. 1—Partial schematic of Philco TV440.

As can be seen in Fig. 1 the grid bias on the horizontal output tube is an important voltage since the vertical linearity control provides a portion of the negative voltage at this point for the bias arrangement on the vertical output circuit.

There are several things that will affect the bias voltage and cause it to be incorrect. The first is if the coupling condenser has slightly abnormal leakage. Unfortunately, all condensers have some leakage and what is important is whether the leakage present is significant in the circuit or not. Above tolerable leakage in the coupling condenser C409, .001 μ f will reduce the negative bias on the grid of the horizontal output tube and thus the bias applied to the vertical output tube via the vertical linearity control. Although it may seem strange at first, leakage in the coupling condenser of the horizontal oscillator stage can cause poor vertical linearity in a picture.

Naturally, this takes for granted that both the 6S4 and the 6CD6/GA tubes have been checked by substitution. No doubt it can be appreciated that if the horizontal output tube weakens the grid bias will be changed and can also cause this type of trouble.

Dear Sir:

I have a condition of low B plus voltage in an RCA KCS96 chassis. The voltage is not pulled down so low that the circuits do not operate but the picture and sound is weak. Where the B plus from the power supply should be 265 volts it is closer to about 240 volts. I finally decided, after making all other checks I could think of such as tubes,

THE ANSWERMAN

Inquiries Sent To The Answerman Will Be Acknowledged Only If Accompanied By Radio-TV Service Firm Letterheads Or Similar Identification.

BY SD AND ES TECHNICAL STAFF

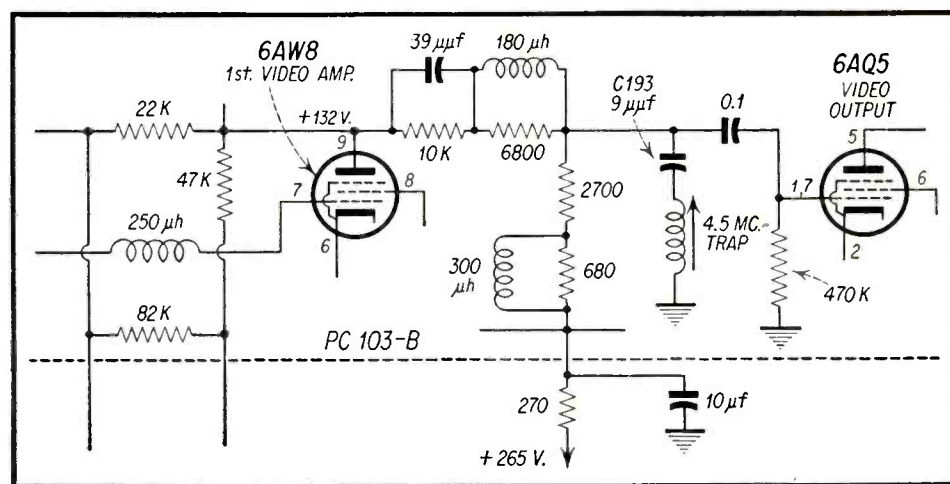

Fig. 2—Partial schematic of RCA KCS96 receiver.

measuring resistors, etc., to disconnect some of the B plus feed lines. I arrived at the conclusion that the reason for the loss in B plus voltage is in the video amplifier printed circuit panel PC103-B. When I removed the leads to this panel the positive voltage jumped up to about normal.

This would seem to have almost finished the job, but then when it came to determining what was causing the loss in positive voltage nothing showed up under my tests.

As usual in such cases everything checks normal, tubes, resistors, condensers, etc., but still when the voltage is applied to the panel the voltage drops too low. It sounds like a simple case of finding the reason for the leakage and the loss in voltage. However, there are quite a few components on this panel and as far as can be determined they are all correct in value.

What I have been wondering is whether it is possible that the leakage can be occurring in the material of the panel itself.

B. W.
San Diego, Cali.

Of course, it is possible that the material of the panel has developed a low resistance path but it is unlikely and hasn't been noted in any panels to our knowledge. Usually, if a low resistance path develops there is evidence of it in the form of burned or carbonized material where the low resistance is occurring. This type of failure occurred in some yoke plugs where the material of the plug did not have sufficient insulation qualities to withstand the high potentials existing across the plug pins. In these cases a black burned mark between the pins where the material [Continued on page 45]

SERVICE DEALER



and **ELECTRONIC SERVICING**

NEW TEST EQUIPMENT

FILAMENT CHECKER

A Series String Filament Checker, completely self-contained and battery-powered, has been introduced by the Precision Apparatus Company, Inc. This little instrument, the Model SS-10, provides a quick check of filament continuity for radio receiver tubes and TV picture tubes, checks TV and radio set fuse continuity, ac circuit continuity in TV sets, and pilot lamps. It also has built-in pin straighteners for miniature tubes.

(Check 701 on inquiry card for more information)



SCOPE PROBE AND HOOD

Two new accessories for cathode-ray oscillographs are made available by Allen B. Du Mont Laboratories, Inc. The Type 2613 is an attenuator probe with ten megohms input impedance for observation of signals in circuits with high source impedance. It is furnished with five feet of cable and three interchangeable tips. The Du Mont Type 2621 is a three-inch rubber viewing hood, furnished with a mounting clip.

(Check 702 on inquiry card for more information)

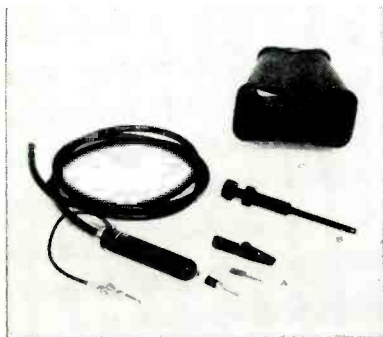

AUTOMATIC TUBE TESTER

The principles of automation are brought to the service technician's tool kit in the DynaMatic, a new automatic tube tester developed by TeleTest. It uses perforated plastic cards to automatically set up socket pin connections and test voltages. As fast as new tubes appear cards supplied by TeleTest will permit these tubes to be tested. It is a dynamic mutual conductance tube tester and permits testing a complete set of tubes in about 15 minutes.

(Check 703 on inquiry card for more information)



INTERMITTENT TESTER

The new Seco Monitron monitors signal paths without the constant attention of the service man, by producing an audio tone when a break occurs in such a path. Independent monitoring by an indicator lamp and an electric eye is also provided. It can be used to trace signals and localize intermittent problems on any steady signal carrying circuit, whether it be a receiver, transmitter or a similar device used in television or industrial application.

(Check 704 on inquiry card for more information)

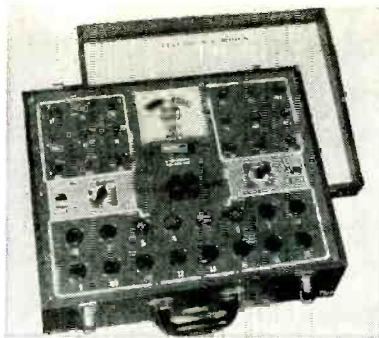
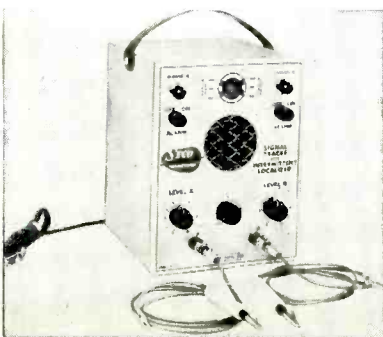

TUBE TESTER

American Scientific Development Co. announces their TV-340 tube tester. This new tester eliminates most selector switches and knobs. Setup procedures are simple and rapid. It is primarily a TV serviceman's instrument. Mounted in a portable case it gives a cathode-conductance test to some 400 popular tubes. It also detects the presence of shorted or gaseous conditions in these tubes.

(Check 705 on inquiry card for more information)



LINE CHECKING METER

A highly efficient line checking meter, Model 3000, is now being manufactured by the Triplet Electrical Instrument Co. The Line Chek provides an invaluable aid in checking the condition of the line under load and enables the user to connect an electrical load equal to the appliance to be installed on the line. The Triplet Line Chek measures 2 3/4" x 5 1/2" x 7 1/2" and weighs only four pounds.

(Check 706 on inquiry card for more information)

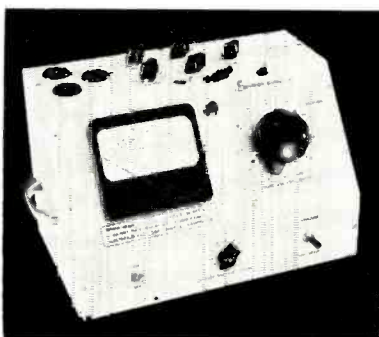

TUBE REACTIVATOR

An entirely new principle of reactivating cathode ray and receiving type tubes is used in a new instrument, the Electron-O-Vac, manufactured by the Electron-O-Vac Corporation. Its principle of reactivation is a controlled process which has proved successful in extensive tests both under laboratory and actual working conditions. The instrument incorporates circuitry for accurate checking of picture tubes before reactivation.

(Check 707 on inquiry card for more information)

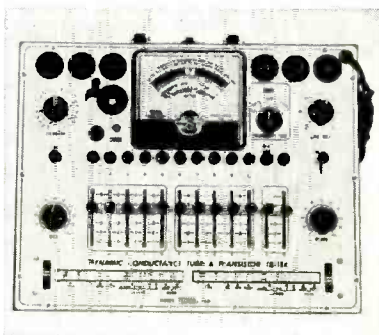

TUBE AND TRANSISTOR TESTER

The new EICO dynamic conductance tube and transistor tester #666 features speedy, simple operation, close simulation of actual tube operating conditions, thoroughness, sensitivity and accuracy of test and ruggedness. It checks n-p-n and p-n-p transistors, all receiving tubes including subminiatures, special purpose and series-string types, and Color and Monochrome TV picture tubes with an accessory adapter.

(Check 708 on inquiry card for more information)

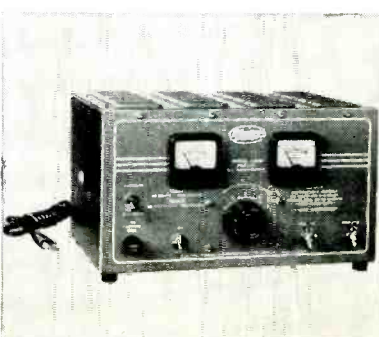

DC POWER SUPPLY

A new dc power supply, designed to operate, test and service transistor auto radios, is presented by Electro Products Laboratories. The Model D612T operates on ac input and handles 6/12 volt tube radios as well as the transistor models. A new filter circuit keeps ac ripple below the critical level for the testing of transistor auto radios. Heavy-duty fabrication and a patented cooling system provide a greater current carrying capacity.

(Check 709 on inquiry card for more information)

(Free Literature Request Form Appears on Page 36)

EMERSON MODELS 1108D, 1110D, 1112D, 1116D, 1120D, 1126D, 1138D, 1140D, 1150D, 1152D, 1154D, 1162D, CH. 120257-D; 1108F, 1126F, 1138F, 1140F, 1150F, 1152F, 1154F, 1162F, 1164D, CH. 120257-P; 1109D, 1111D, 1113D, 1117D, 1121D, 1127D, 1139D, 1141D, 1151D, 1153D, 1155D, 1163D, 1165D, CH. 120258-D; 1122D, 1124D, 1156F, CH. 120263-D; 1122F, 1124F, 1156D, 1160D, CH. 120263-P; 1123D, 1125D, 1157D, 1161D, CH. 120265-D; 1144D, CH. 120277-D; 120279-B; 1145D, CH. 120278-D; 120279-B; 1158A, CH. 120282-P; NOTE: FOR ADDITIONAL SERVICE DATA SEE PAGES 24, 25, AND 26.

Emerson

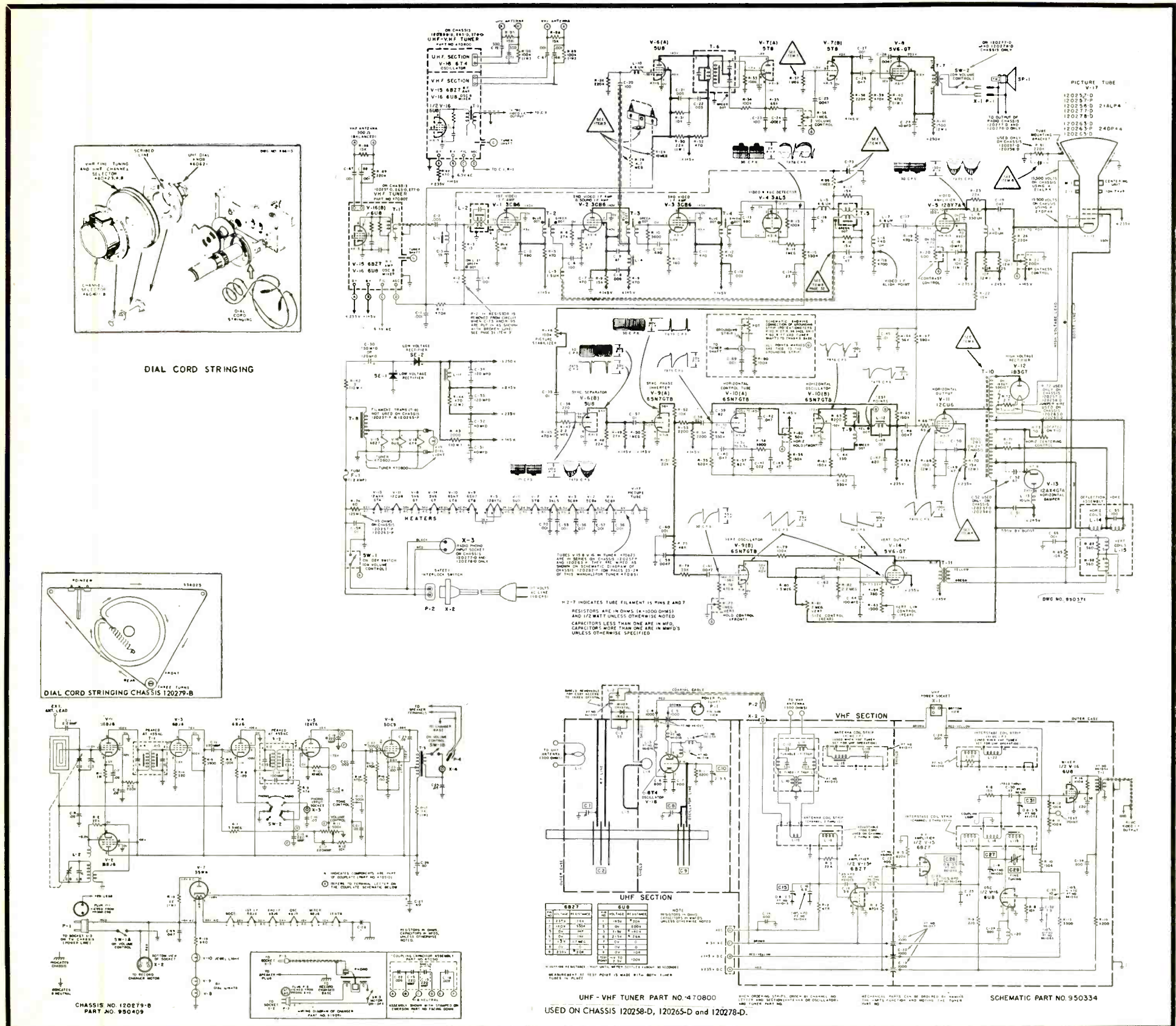

SERVICE DEALER & ELECTRONIC SERVICING COMPLETE MANUFACTURERS SCHEMATICS. An exclusive service of Cowan Publishing Corp. by special arrangement with John F. Rider, Publisher.

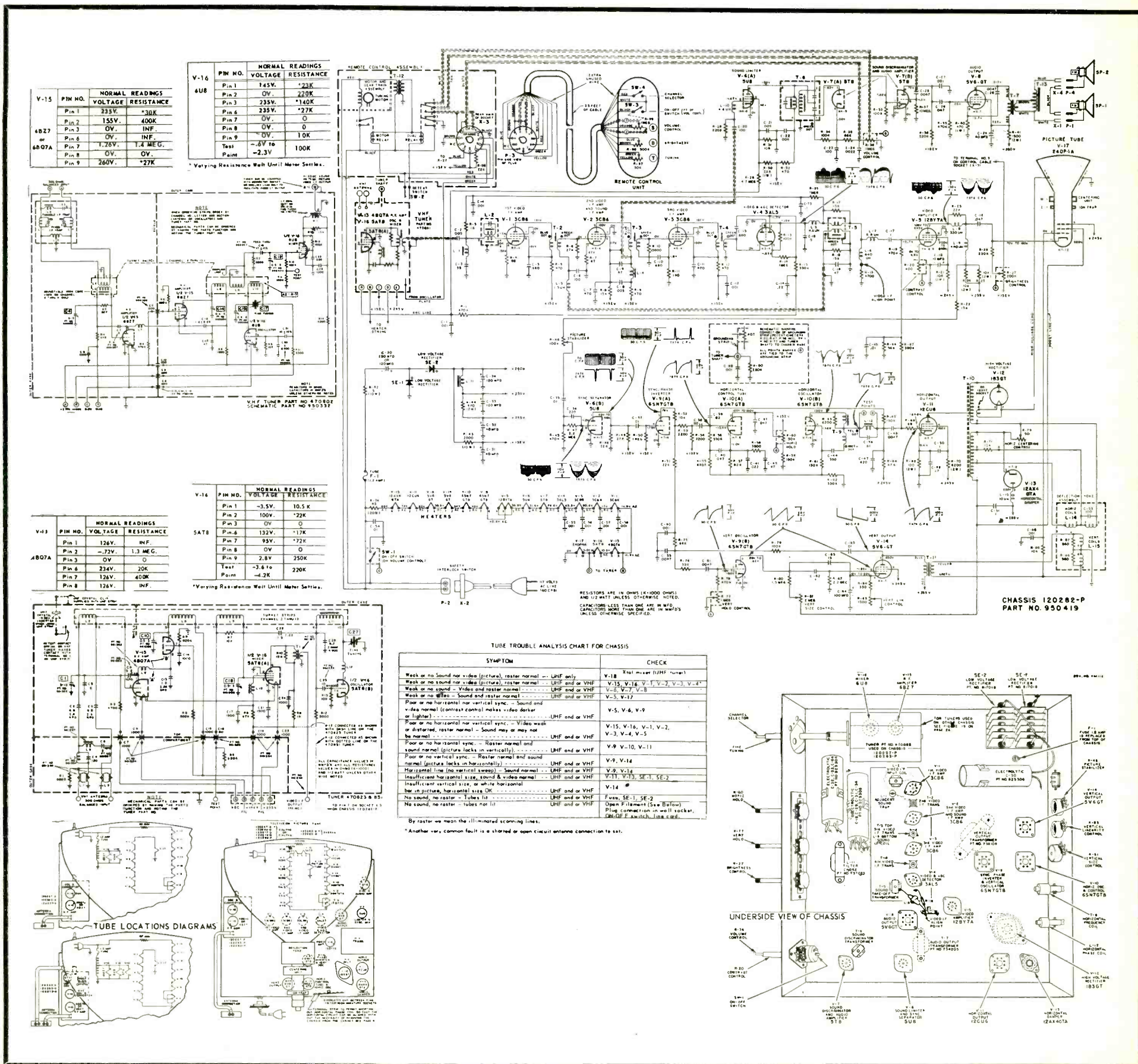

EMERSON MODELS 1062L, CH. 120245-N; 1102D, 1130D, CH. 120245-D; 1102F, 1130F, CH. 120245-N; 1102H, CH. 120245-H; 1104F, CH. 120245-D; 1104H, L, CH. 120256-H; 1104J, 1132F, CH. 120256-F; 1104N, CH. 120256-P; 1105D, CH. 120275-L; 1106H, J, CH. 120255-D; 1106L, N, CH. 120255-F; 1106P, R, CH. 120255-H; 1106T, V, 1118D, CH. 120255-P; 1107D, F, CH. 120269-L; 1114D, CH. 120259-D; 1114F, 1142D, CH. 120259-F; 1114H, CH. 120259-N; 1114J, 1142F, 1148D, CH. 120259-P; 1114L, CH. 120259-H; 1115D, 1143D, CH. 120276-L; 1119D, CH. 120269-L; 1128, CH. 120273-F, 120272-B; 1128H, CH. 120273-P, 120272-B; 1142H, 1148F, CH. 120259-D; 1146D, CH. 120244-P; 1149D, CH. 120276-L; 1168A, CH. 120288-N. NOTE: FOR ADDITIONAL SERVICE DATA SEE PAGES 23, 24, AND 26.

Emerson

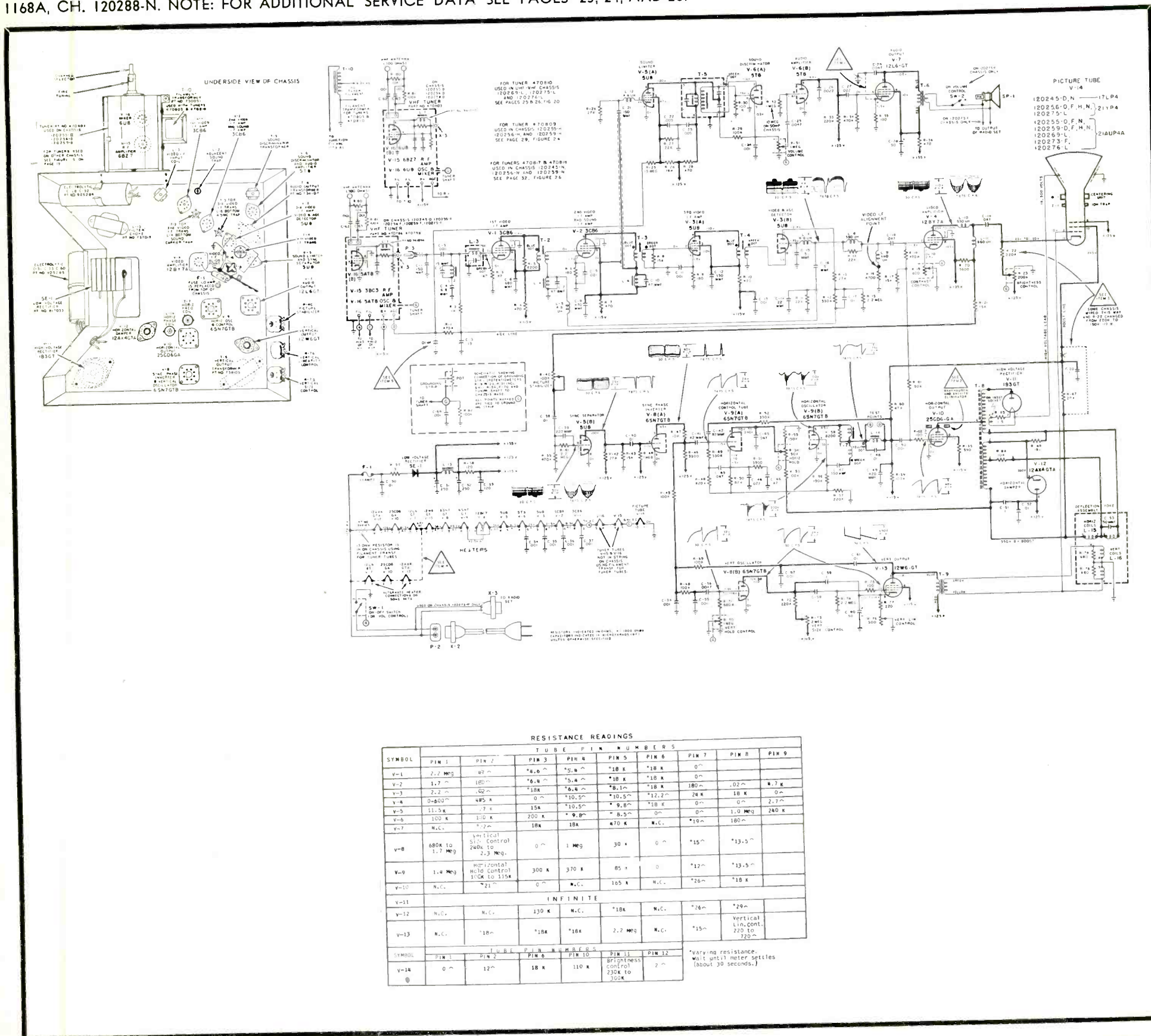

SERVICE DEALER & ELECTRONIC SERVICING COMPLETE MANUFACTURERS SCHEMATICS. An exclusive service of Cowan Publishing Corp. by special arrangement with John F. Rider, Publisher.

FIELD OSCILLATOR ALIGNMENT OF VHF SECTION OF 470810 TUNER

Ordinarily it is not necessary to adjust the tuners in the field. However, a change of mixer-oscillator tube might necessitate a slight readjustment of the VHF oscillator trimmer. This readjustment may be done without removing the chassis from cabinet. When replacing V-16, 6A8 mixer-oscillator by several, if possible, and select that tube which permits all channels to be within the range of the VHF fine tuning. If this does not prove possible because of wide variations in interelectrode capacitance of the new tube then readjustment of the oscillator section will be necessary as follows:

- 1- Set channel selector to the highest VHF station received between Channels 7 and 13. Set VHF fine tuning control shaft to that the list of the shaft faces the top of the tuner (this places the fine tuning at the center of its range).

2- Use a non-metallic screwdriver to adjust slug L-24 for best sound and picture (See Fig. 21). Check other channels between 7 and 13 to make sure that they are received within the VHF fine tuning range.

3- Set channel selector switch to the highest frequency station received between channels 2 and 6. With fine tuning control again set in center of its range, adjust slug L-23 for best picture and sound. As before, check remaining low frequency channels for coverage within the fine tuning range.

4- Re-check for reception of all channels within fine tuning range and, if necessary, trim slugs L-24 and L-23 again slightly for best overall range of fine tuning control.

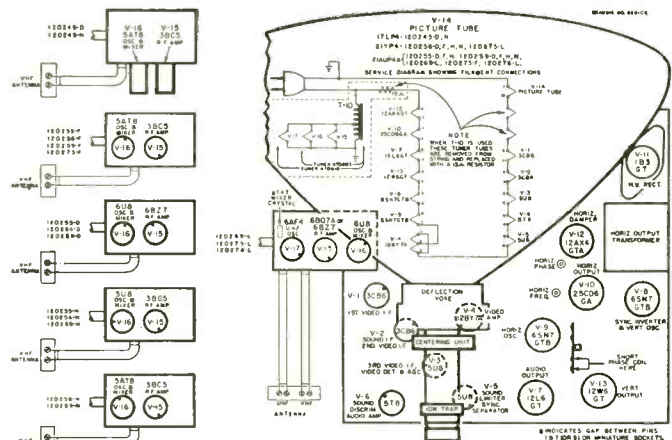

TUBE TROUBLE ANALYSIS CHART

SYMPTOM	CHECK
Weak or no sound nor video (picture), raster normal - UHF only	V-17, Crystal Mixer *
Weak or no sound nor video (picture), raster normal- UHF and or VHF	V-1, V-2, V-3, V-15, V-16*
Weak or no sound - Video and raster normal - UHF and or VHF	V-5, V-6, V-7
Weak or no video - Sound and raster normal - UHF and or VHF	V-4, V-14
Poor or no horizontal nor vertical sync - Sound and video normal (contrast control makes video darker or lighter) - UHF and or VHF	V-5, V-8
Poor or no horizontal nor vertical sync - Video weak or distorted, raster normal - Sound may or may not be normal - UHF and or VHF	V-1, V-2, V-3, V-4, V-15, V-16
Poor or no horizontal sync - Raster normal and sound normal (picture locks in vertically) - UHF and or VHF	V-9
Poor or no vertical sync - Raster normal and sound normal (picture locks in horizontally) - UHF and or VHF	V-8, V-13
Horizontal line (no vertical sweep) - Sound normal - UHF and or VHF	V-8, V-13
Insufficient horizontal size, sound & video normal - UHF and or VHF	V-9, V-10, V-12, SE-1
Insufficient vertical size, or white horizontal bar in picture, horizontal size O.K. - UHF and or VHF	V-13
No sound, no raster - tubes lit - UHF and or VHF	Fuse, SE-1
No sound, no raster - tubes not lit - UHF and or VHF	Plug connection in wall socket, ON-OFF switch, line cord, open filament in tubes
No sound, no raster - only tuner tubes lit - UHF and or VHF on chassis 120255-D, 120256-D, 120259-D, 120269-L, 120275-L, 120276-L	Open filament in unit tube string.

*By raster we mean the illuminated scanning lines.

*Another very common fault is a shorted or open circuit antenna connection to set.

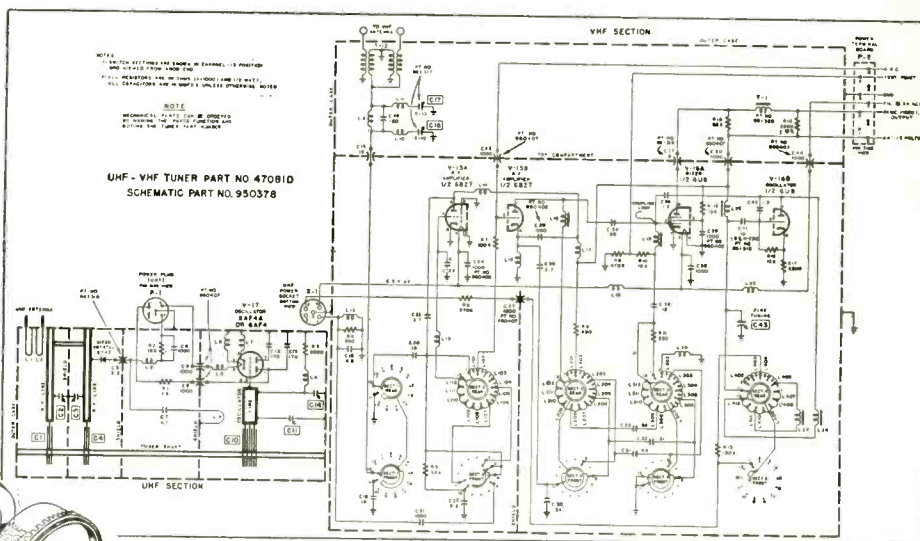

FIELD ALIGNMENT OF UHF SECTION OF 470810 TUNER

As in the case for the VHF section replacement of the 6A4 oscillator tube may require retuning of the oscillator. This readjustment may be done on side-tuned models without removing the chassis from cabinet. First try a few tubes and select the one which has the least shift from correct frequencies determined from either signal generator or known UHF channels. Field alignment is carried out as follows:

First set position of UHF dial by turning the UHF tuning knob to its maximum counter-clockwise position and place UHF dial so that the top portion of Channel 83 on the dial is opposite the pointer mark on the cabinet. Then turn tuning knob in maximum clockwise position. If correctly set the bottom portion of 14 on the UHF dial will now be opposite the pointer.

If your area has only UHF channels above Channel No. 50 set the UHF dial to the highest channel number received and adjust the lowest trimmer C-11 (See Figure 21) until correct frequency is received.

If only channels below Channel No. 50 are present then set dial to lowest UHF channel received in area and adjust the top trimmer C-14 (See Figure 21) until correct frequency is received.

If channels on the high end and also on the low end of the UHF band are present adjust the higher frequency first, then the lower frequency and again readjust on higher frequency.

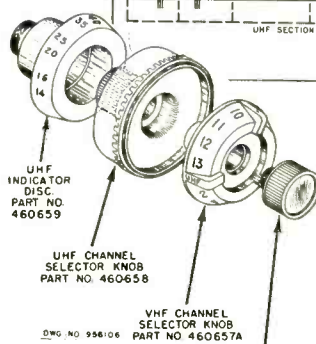

UHF CHANNEL SELECTOR KNOB PART NO. 460658
VHF FINE TUNING KNOB PART NO. 460656

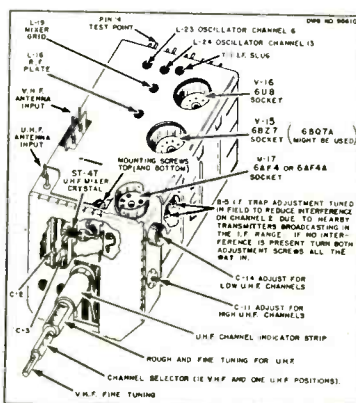

V-15	PIN NO.	NORMAL READINGS		POSSIBLE TROUBLES IF READINGS NOT NORMAL	
		VOLTAGE	RESISTANCE		
6B27	Pin 1	110 V.	*18K	(C-31, .44 MMF)	(C-32, .91 MMF) (C-33, .56 MMF) Shorted
	Pin 2	OV.	2.6 Meg	(C-26, 1000 MMF) Shorted, (R-7, 100 K) Open	
	Pin 3	OV.	.2	(L-15, Choke) Open	
	Pin 4	5.8 V. A.C.	.45	Open Filament Transformer	
	Pin 5	OV.	0	Cold Solder Joint	
	Pin 6	120 V.	*17K	(L-14) (L-17) Open, (C-29, 1000 MMF) Shorted	
	Pin 7	OV	2.6 Meg.	(C-23, 4 MMF) (C-22, 2.7 MMF) Shorted	
	Pin 8	OV.	0	Cold Solder Joint	
	Pin 9	OV.	0	Cold Solder Joint	

V-16	PIN NO.	NORMAL READINGS		POSSIBLE TROUBLES IF READINGS NOT NORMAL	
		VOLTAGE	RESISTANCE		
6U8	Pin 1	110 V.	*17K	(C-41), 10 MMF) (C-42, 1.5 MMF) Shorted	
	Pin 2	OV.	470K	(C-36, 1.2 MMF) (C-34, .39 MMF) Shorted	
	Pin 3	110 V.	*32K	(C-39, 1000 MMF) Shorted, (R-12, 15K) Open	
	Pin 4	5.8 V. A.C.	.45	Open Filament Transformer	
	Pin 5	OV.	0	Cold Solder Joint	
	Pin 6	110 V.	*19K	(C-37, 5 MMF) Shorted, (R-18, 2.2 K) Open	
	Pin 7	OV.	0	Cold Solder Joint	
	Pin 8	OV.	2K	(R-17, 2.2 K) Open	
	Pin 9	OV.	18K	(C-42, 1.5 MMF) (C-41, 10 MMF) Open	
Test Point	-2.5 to -3.5 V.		At test point - Tubes replaced in sockets.		

*Varying resistance - Wait until meter settles.

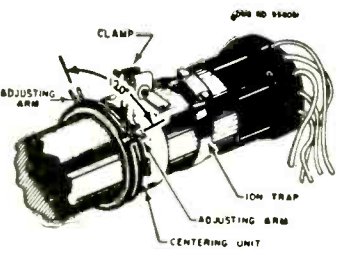
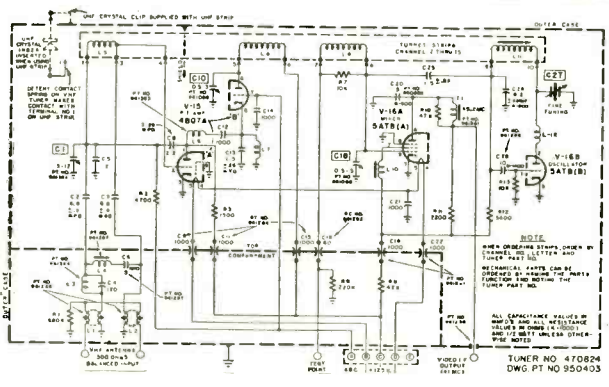
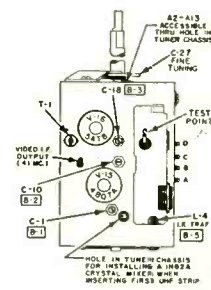

FIG. 8 - CENTERING UNIT LOCATION DRAWING



V-15	PIN NO.	NORMAL READINGS		POSSIBLE TROUBLES IF READINGS NOT NORMAL	
		VOLTAGE	RESISTANCE		
6B27	Pin 1	110V D.C.	18K	(C-31, 440MMF) (C-32, 910MMF) (C-33, 560MMF) Shorted	
	Pin 2	OV.	2.6MEG	(C-26, 1000MMF) Shorted, (R-7, 100K) Open	
	Pin 3	OV.	.2	(L-15, Choke) Open	
	Pin 4	5.8V. A.C.	.45	Open Filament Transformer	
	Pin 5	OV.	0	Cold Solder Joint	
	Pin 6	120V.	17K	(L-14) (L-17) Open, (C-29, 1000MMF) Shorted	
	Pin 7	OV.	2.6MEG.	(C-23, 4MMF) (C-22, 2.7MMF) Shorted	
	Pin 8	OV.	0	Cold Solder Joint	
	Pin 9	OV.	0	Cold Solder Joint	
V-16	Pin 1	110V D.C.	17K	(C-41), 10MMF) (C-42, 1.5MMF) Shorted	
	Pin 2	OV.	470K	(C-36, 1.2MMF) (C-34, .39MMF) Shorted	
	Pin 3	110V.	32K	(C-39, 1000MMF) Shorted, (R-12, 15K) Open	
	Pin 4	5.8V. A.C.	.45	Open Filament Transformer	
	Pin 5	OV.	0	Cold Solder Joint	
	Pin 6	110V.	19K	(C-37, 5MMF) Shorted, (R-18, 2.2K) Open	
	Pin 7	OV.	0	Cold Solder Joint	
	Pin 8	OV.	2K	(R-17, 2.2K) Open	
	Pin 9	OV.	18K	(C-42, 1.5MMF) (C-41, 10MMF) Open	
Test Point	-2.5 to -3.5 V.		At test point - Tubes replaced in sockets.		



THIS month's installment is concerned with Sync problems. A thorough knowledge of the receiver circuitry is necessary in solving these troubles. Proper utilization of the scope is also important.

Emerson — Chassis 120169-B

The receiver was turned on and it was observed that the receiver was far out of horizontal frequency range. The sync amp and horizontal Separator, 12AU7, V11, and the horizontal phase detector V12, 12AU7, and V13, the horizontal oscillator, 6SN7 were all replaced individually, but had no effect.

At this point the diagram was studied. This chassis uses a comparison of phase between sync signal and the generated saw-tooth as a basis for automatic frequency control (*afc*). A phase detector, V-12B, compares the difference in phase between the transmitted horizontal sync pulse and the horizontal saw-tooth voltage which is generated in the receiver.

Whenever the frequency of the horizontal multi-vibrator (V13) changes, the saw-tooth frequency generated by the tube also changes. This effect changes the phase between the sync and saw-tooth voltages which are detected by V-12 (horizontal phase detector).

When the frequency and phase of the sync and saw-tooth are correct, the negative grid voltage developed across R-66, (82K) is equal to the positive cathode voltage developed across R-65 (100K). Therefore the net output voltage to grid V13 (Horizontal Oscillator) is zero.

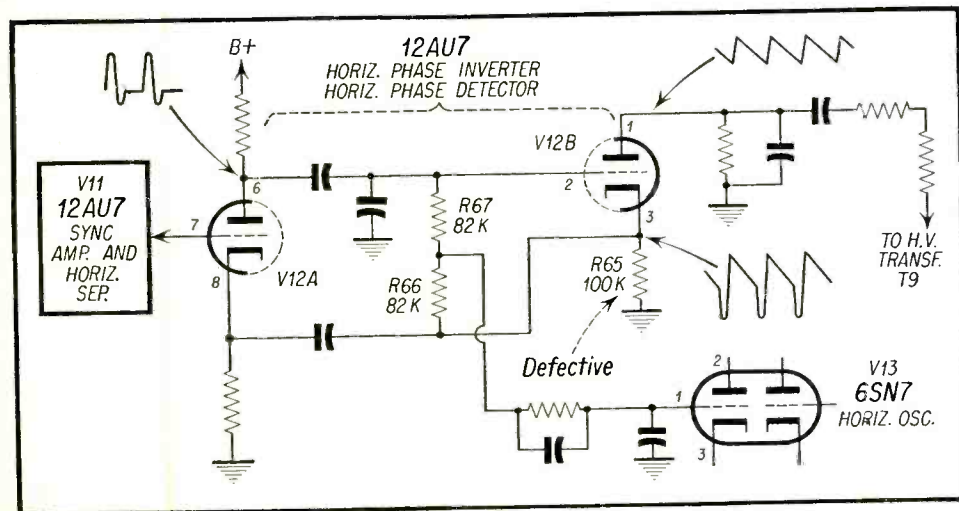

Fig. 1—Partial schematic of horizontal phase detector circuit of Emerson 120169B

THE WORK BENCH

Unusual Service Problems And Their Solutions

by PAUL GOLDBERG
Service Manager

Knowing these facts, the scope was set up and a few waveform checks were made. A waveform check was first made at #1 of V12B. The waveform measured fairly accurate at this point. Next a waveform check was made at pin #3, of V12B. Here the waveform was practically a straight line. Noting this incorrect waveform, the cathode circuit of V12B, pin #3 was investigated. R65, 100K was immediately observed to be burnt. Its resistance was then measured and was found to read only 100 ohms instead of 100K. R65 was then replaced with a new 100K and the receiver functioned properly.

Magnavox Chassis 103 Series

The receiver was turned on and it was observed that the picture was not holding horizontally or vertically. Because this was a composite sync problem, V113, and V112, 6SN7's were replaced but had no effect.

This Month's Problem:

The author analyzes two cases involving sync problems.

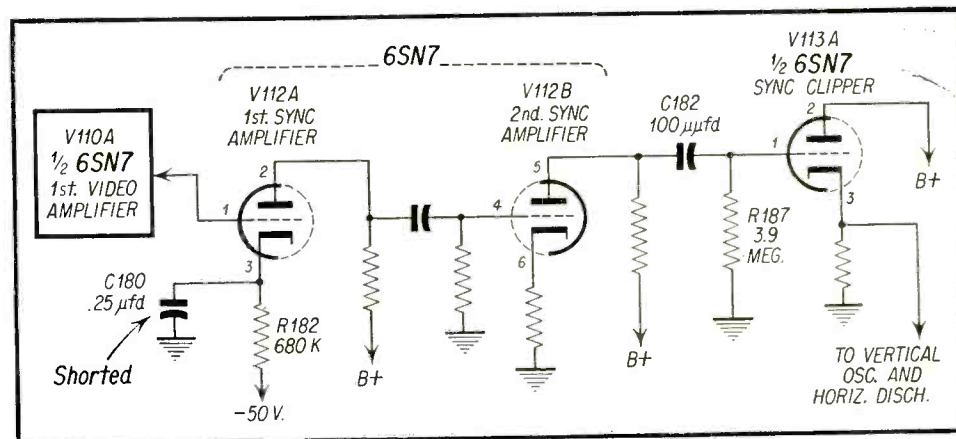

Fig. 2—Partial schematic of sync amplifier section of Magnavox Chassis 103. Sync signal for vertical oscillator and horizontal discharge is taken off the cathode of the sync clipper shown as tube V113A.

The diagram was next studied. It was noted that the positive going signal at the plate of this first video amplifier is sampled at the plate and applied to the grid of the 1st Sync Amp, V112A. This tube is biased so that the video portion of the signal falls below the knee of its characteristic curve and receives but little amplification. The sync pulses appearing on the linear portion of the curve are amplified.

The negative sync signal that is then fed to the second sync amplifier grid V112B is again amplified. This tube is also biased so that any noise on the crest of the pulses is removed, and any noise between the sync pulses is clipped. The signal is in the positive direction at the sync clipper grid V113A; and in that stage the lower half of the signal is removed. This is accomplished by the grid biasing effect of C182, 100 uuf condenser and R187, 3.9 meg.

Knowing these facts a quick voltage check was first made at the plate of

V112A, V112B, V113A. The voltage at pin #2 of V112A plate, measured about 65 volts positive instead of about 90 volts. With this clue in mind a voltage check was then made at pin #3 cathode, of V112A. The voltage at this point measured zero instead of about 6 volts positive. A resistance check was then made from pin #3 of V112A to ground. The ohmmeter measured zero ohms. C180, .25 uuf, was clipped out of the circuit and measured. It was found to be completely shorted. C180 was replaced with a new .25 uuf and the receiver functioned properly.

The important cathode bias which allows only the sync pulses to be amplified by V112A is developed across R182, 680K. When C180 shorts, the cathode bias is reduced to such a point that not only the sync pulses are amplified but the video information also. Thus, both the sync pulses and video signals trigger the vertical and horizontal oscillators producing the erratic sync. ■ ■

IN THE FIRST installment of this service we attempted to set forth the aims and objectives of the serviceman in extending his service to include high-fidelity systems. In the present installment we shall analyze some of the systems in popular use today. Procedures will be outlined for isolating some of the common faults peculiar to systems as a whole rather than to any one of the components. Recalling the rather elaborate block diagram shown in the previous article, it should be noted that most installations are not quite so complex. That is, a high-fidelity system may comprise but three or four of the elements previously shown.

Four of the most common approaches to the assembly of a high-fidelity system are illustrated in the block diagrams of Figs. 1 through 4. Fig. 1, for example, represents the most inexpensive method of achieving quality record reproduction at the outset. There is also reasonable provision for the eventual incorporation of additional elements in the system, such as a high quality FM-AM tuner, a tape recorder, etc. Let us use these simple systems to illustrate the types of complaints involving the overall installation. These general faults may be tabulated as follows:

1. Distortion when listening to recordings or other sound sources.
2. Poor frequency response
3. Noise
4. Hum
5. Hum accompanied by failure of the entire system
6. No sound from the system
7. Intermittent operation

Equipment for Service Calls

The minimum equipment necessary for a home service call involving any of the above symptoms would be an audio oscillator having a frequency range of at least 20 to 20,000 cycles, a good test recording, and an *ac* VTVM having a sensitivity of at least .03 volts full scale and a uniform frequency response between 20 and 20,000 cycles, plus or minus 1 db. Incidentally, it would be a good idea to use a meter which is calibrated in decibels (*db*) as well as volts. The reason for this will become apparent shortly. In addition to the above, an oscilloscope would be helpful if you have a small portable

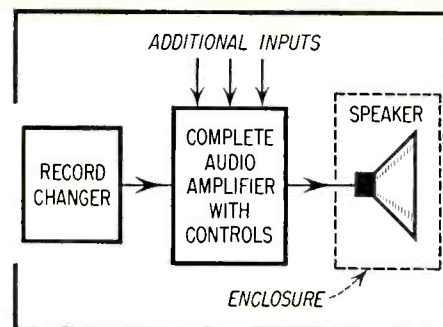

▶ Fig. 1—Basic hi-fi system using separate record changer, amplifier, and speaker.

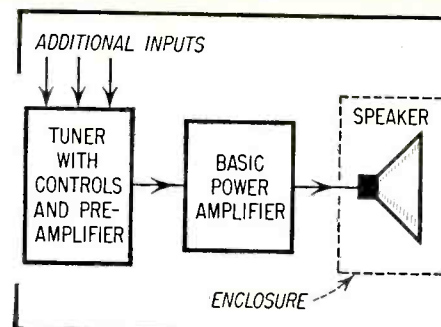

▶ Fig. 2—More elaborate system using tuner with controls and pre-amplifier.

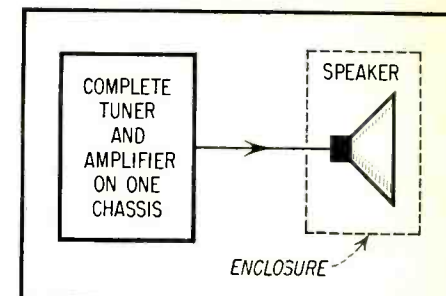

▶ Fig. 3—System using complete tuner and amplifier mounted on a single chassis.

type. Of course, the usual complement of replacement tubes is a must, as in any other type of service call. While it would be impossible to list *all* of the tube types common to high-fidelity equipment, Table 1 shows some of the more popular types found in the *audio* portion of a system. Tuners generally use tubes commonly found in TV receivers and should therefore present no special problem.

Other minor equipment required includes three wirewound resistors (of at least 50 watt rating) having values of 4, 8, and 16 ohms. These will be used as dummy loads to substitute for speakers when making dynamic tests of the complete electronic system. They are necessary because it would be virtually impossible to tolerate 15 or 25 watts of *continuous* sound from a speaker in a home installation. Our hearing is such that momentary peaks of great levels of power, as reproduced in musical crescendos are quite tolerable, whereas a single, sustained tone of equivalent amplitude would be deafening. In addition to the above, it is helpful to take along a simple R-C network on all Hi-Fi service calls. The network, shown in Fig. 5, should be suitably wired and mounted in a shielding can.

Distortion Troubles

Now, let us consider the first of the complaints mentioned earlier—distortion. A quick check for harmonic distortion can be made using an oscilloscope and an audio oscillator. Substitute a dummy load for the loudspeaker. (Choose a value equal to the nominal impedance of the loudspeaker.) If the system in question has a high-level in-

In this installment the author describes various types of failures that may occur in the hi-fi system and methods of testing that may be employed to track down the section in which the fault lies.

Component Failures in

put (such as is used for connection of a tuner, for example) connect the audio oscillator to this input and apply a signal at a frequency of about 1000 cycles. Turn all volume or level controls of the system up full. Increase the applied signal to obtain a voltage reading across the dummy load which corresponds to a power output equal to, or just under rated power of the amplifier. Table 2 lists voltages versus equivalent powers for various speaker impedances and is derived from the formula $W = E^2/R$ where W is power, in watts, E is the voltage across the load in volts and R is the speaker impedance, in ohms.

If "full power" voltage is unobtainable, the amplifier may very likely be responsible for the distortion. If proper audio voltage is achieved across the load, examine the appearance of the output sine wave on an oscilloscope. It should appear very much as shown in Fig. 6A. If such is the case, the ampli-

Table 1

Tube types common in high fidelity installations.

Low Noise - Preamplifier	Voltage Amplifier	Power Output Tubes
6SC7	6SN7	12AU7 EL-84 EL-37
12AN7	6SL7	12AT7 6V6 807
Z729*	6C4	ECC81* 6L6 KT-66*
12AY7	6AV6	5881 6AV5
12AD7	6CL6	6550 6AQ5
ECC83*	6S4	1614 2516
		6CM6 35L6
		EL-34 50L6

*Imported

Table 2

Equivalent voltages across speaker loads for various power levels.

Power (Watts)	Voltage (4 ohm load)	Voltage (8 ohm)	Voltage (16 ohm)
1	2.0	2.8	4.0
5	4.4	6.3	8.9
10	6.3	8.9	12.5
15	7.7	10.9	15.5
25	10.0	14.1	20.0
30	10.9	15.5	22.0
50	14.1	20.0	28.3

fier is not at fault and the trouble must then be isolated either in the preamplifier section of the system or in the cartridge or speaker components. The appearance of a waveform as shown in Fig. 6B indicates the presence of a great deal of second harmonic distortion. This usually indicates that one half of the push-pull system of the amplifier is, in some way, defective. The appearance of a waveform such as that shown in Fig. 6C means that the amplifier is clipping, or overloading. Reduce the level of the input signal until this situation clears up and note the wattage level at which this takes place. Obvious-

ly, if clipping occurs for input levels below the rated input voltage of the amplifier, the trouble is once again in this component and trouble shooting should proceed along these lines. Assuming that the power amplifier has been checked out and is found to be operating even at full power, check

HI-FI Systems

by LAWRENCE FIELDING

the preamplifier section of the chassis or the separate preamplifier. If a crystal or ceramic phone cartridge is used in the system being tested, you may apply a signal directly from the audio oscillator to the phone input and proceed as outlined above. If, however, a magnetic low level cartridge is employed, you may find that even at the lowest output setting of your audio oscillator you will overload the entire system. (Most magnetic cartridges produce only about 10 millivolts of signal.) In such cases, insert the little R-C network described earlier between your oscillator and the phono input of the system and proceed

to measure full output. If possible, examine the waveform as before. If this check proves that the preamplifier is not the culprit, the next point to check is the cartridge itself. The best means by which this may be accomplished is with the aid of a test-frequency recording.

Most record manufacturers now include such test recordings in their catalogs and you will find them very useful for both distortion and frequency checks. Use the 1000 cycle band for this check and turn the volume control of the amplifier up until previous "full power" conditions are duplicated. If this last check eliminates the cartridge, the fault definitely lies with the speaker system. Incidentally, do not be surprised if this check shows extraneous noise and hum on the oscilloscope. Although vinyl microgroove recordings have made vast strides over old fashioned, shellac discs, they are far from perfect. So long as the fundamental sine wave is "clean" as viewed across the dummy load, however, we may be reasonably certain that the cartridge, preamplifier, and power amplifier are functioning within ratings as far as distortion is concerned. Before leaving this subject, it should be pointed out that the average listener cannot detect distortion below 2% or so. This percentage of distortion can easily be discerned on the 'scope, so that expensive Intermodulation Analyzers and Distortion Meters are not necessary for such preliminary service calls. These refinements in testing procedures will be discussed in future articles and are best relegated to the shop service bench.

Loss of Frequency Response

Before checking any complaints involving loss of frequency response, examine *all* the controls of the system. Except for gassy power output tubes affecting low frequency response, it is usually unlikely that any electronic flaw will cause deterioration of frequency

response alone. Make certain that the tone controls have not been inadvertently rotated by a junior member of the family. Tone controls set fully counterclockwise are a sure means for transforming Hi-Fi back into Lo-Fi. If the speaker system has a separate attenuator pad for the "tweeter" (high frequency speaker) make certain that it has not been accidentally rotated counterclockwise. These precautions, though obvious upon reading, have often been overlooked by high-fidelity technicians and resulted in much wasted time. After these preliminary checks, use your test record and *ac VTVM* to check the response of the system. Be sure to set the record equalization selector to the correct response curve transcribed on your test record. (e.g. lp, RIAA, NARTB.)* If the response from 30 cps to 15,000 cps is reasonably flat, demonstrate that fact to your customer. He would like nothing better than to know, by metered proof, that his system is "flat". The procedure is identical for systems of Figs. 1, 2, 3 or 4. If a serious deficiency shows up in the above check, remove the cartridge plug and substitute your audio oscillator. Again, be certain to insert your R-C network in series if the cartridge is of the magnetic variety. This network now serves a second purpose. In addition to attenuating the output from your oscillator it approximates the response of a recording made to RIAA standards. We will have much more to say about this subject (equalization) in future articles. Suffice it to say at this point that magnetic cartridge preamplifiers are not built to have "flat" response, because recordings are deliberately made without a "flat" response. Preamplifier response is actually the inverse of the recording characteristic so that the sum of the two responses (cartridge and preamplifier) yields a net output which is "flat".

Make the test by sweeping the audio oscillator through the audible spectrum,

Fig. 4—In the system shown below a pre-amplifier and control chassis is used in conjunction with a separate basic power amplifier.

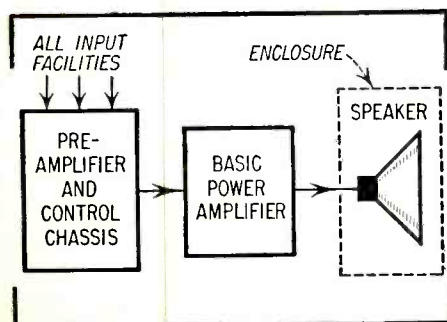

Fig. 5—The test jig shown below will come in handy in many of the tests and measurements made by the hi-fi serviceman in the field.

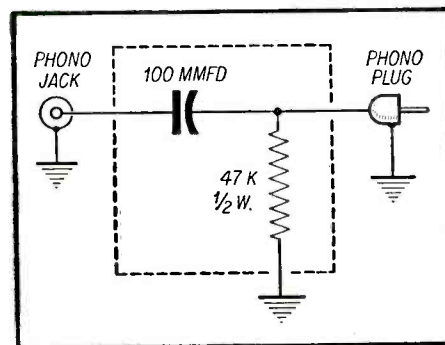
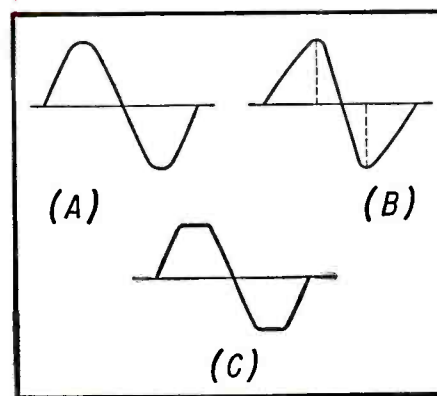

Fig. 6—Various waveforms observed on scope when testing for distortion.



*LP— The old recording response first used by Columbia in early long play records.

RIAA— The newly adopted Record Industry Association of America recording curve, now becoming standard throughout the industry.

NARTB—National Association of Radio and Television Broadcasters proposed recording curve, used now primarily for broadcast transcriptions only.

noting any deviations from flat response. Both the record and audio oscillator tests should be conducted with the speaker hooked up, rather than with the dummy load. The level should be appropriately low, so as to afford comfortable listening levels. The *ac* VTVM may be connected directly across the speaker terminals. This procedure has the added advantage of enabling the customer to test his hearing response, a test which most high fidelity enthusiasts vastly enjoy. If this latter test shows response flat within two *db* (the minimum perceptible audible difference) the trouble is with the cartridge. Otherwise, the trouble is again in the amplifier or preamplifier. Most often, however, the trouble in frequency response complaints is likely to be the education and sophistication of the recent purchaser of high fidelity equipment. Usually, the customer is initially enthused over the vast improvement in sound when he installs the equipment. Then, after listening to other superior speaker systems (and make no mistake about it, speakers are still the weakest link in the whole system), the frequency response of his own unit seems to contract before his very ears. This is a fact which will have to be dealt with by tact and diplomacy which most servicemen have had to develop through the years.

Noisy Systems

Noise troubles in any of the systems of Fig. 1 through 4 will usually be the result of tubes which have become noisy or microphonic with age. This is especially true of early preamplifier or voltage amplifier stages, where a few microvolts of noise is amplified many hundreds of times through the remaining stages of the system. Occasionally, noisy resistors in these early stages cause the trouble. Isolation of the faulty tube is made simple by checking the action of low-level inputs (cartridge, etc.) and high level inputs independently. In fact, such troubles, as well as any troubles peculiar to *one* service are more readily isolated than faults which are common to *all* services because of the "block" construction of most high fidelity installations. Other intermittent types of noise may sometimes be generated by faulty or dirty

volume controls, poor contact or selector switches, and, very rarely, poor connection of the twin-lead cable between the amplifier output terminals and the voice coil connections to the loudspeaker. Such defects can usually be detected visually or by manual operations of the controls involved.

Hum Troubles

The subject of hum is one which will recur many times in the course of this series. Hum, whether it be sixty cycle line frequency or one hundred twenty cycle power supply ripple or combinations of both is particularly objectionable in any high fidelity installation. This is so because the response to these frequencies is so much better in a good system than in the average table model radio. Again, we will need some limits as to what constitutes ac-

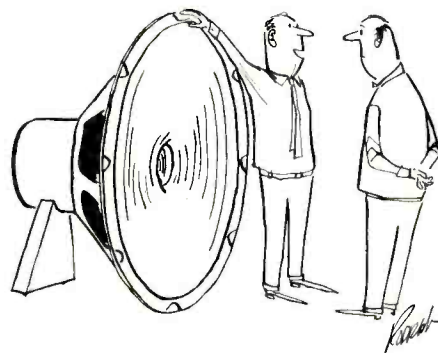

"Now to build a
1000 watt
amplifier!"

ceptable hum level. In general, 70 *db* below maximum sound level approaches acceptable hum for an overall system. We have measured systems whose overall hum exceeds this figure by as much as thirty to forty *db*. Of course, the nature of the hum must be considered. Our hearing is not as efficient at sixty cycles as it is at one hundred twenty cycles. Consequently, we can probably tolerate somewhat more of the former type of hum than of the latter.

Assuming that the hum complaint in this case is one peculiar to the system as a whole rather than to a component failure, a reasonable procedure for analysis would be the following: Apply a nominal signal to the input causing the trouble. A high level input usually has a rated voltage requirement of anywhere from .1 volt to 1

volt, depending upon whether or not a control chassis is included in the system. Low level cartridge inputs are usually checked by feeding a signal of about 10 millivolts into the input jack. Actual figures should be obtained by referring to the specification of input level requirements of the particular amplifier, preamplifier, or control chassis which heads the system in question. With nominal input applied, and using a dummy load instead of the speaker, set any master volume control for *full power output*, using the voltage-power table as before. Note the voltage reading in terms of relative *db*. Disconnect the signal source and insert a shorting plug in the input jack. (Use a standard phono plug, having its tip and sleeve shorted together by soldering.) Now reduce the scale of your meter, counting the number of *db* down until a readable

from the control chassis. However, such a signal input to the power amplifier would overload this component. A simple expedient would be to lower the input level control on the power amplifier about one half turn counterclockwise (assuming the resistance of the level control is linear) and *increase* the setting of the control chassis master volume control proportionately. This simple adjustment alone would result in a two to one improvement in hum, assuming nothing is really wrong with any of the components.

Most hum complaints, however, are associated with phonograph reproduction. This part of the system generally has the highest gain, and as such is the most sensitive with respect to hum. If the previous checks have shown the electronic part of the system to be performing within rated specifications, the trouble invariably lies somewhere between the stylus and the input jack of the preamplifier. Such troubles include improper grounding of one side of the cartridge, poor shielding of the shielded cable leading from the cartridge to the jack, lack of, or improper grounding of, the record changer frame to a good ground point on the amplifier chassis, etc. Secondary hum source include the presence of power transformers of other components too close to the pick-up arm, causing magnetic field induction in cartridge; aging and inefficient turntable motors radiating more intense magnetic fields than normal, etc. All of the above possibilities must be investigated carefully and systematically. It should be noted that extreme bass boost settings of the tone controls will naturally increase audible hum in any system, since we are once again emphasizing that portion of the audible spectrum wherein the hum frequencies are contained.

Interconnection Faults

The final "troubles" tabulated above as "Hum—No signal", "No Audio" and "Intermittent Audio" all fall into the same general category—poor interconnection between the "blocks" of the system. For several years now, the use of RETMA type phono plugs and jacks has been fairly standard in the high fidelity industry. Their simplicity, small

[Continued on page 45]

trade flashes

Manufacturers' sales of both receiving tubes and cathode ray tubes in April decreased from the March level. While receiving tube sales during the month declined from the April 1955 level; cathode ray tube sales showed a substantial increase over the same month a year earlier. Picture tube sales in April totaled 830,902 units valued at \$15,141,461 compared with 848,055 tubes worth \$15,714,365 sold in March. Sales in April 1955 had totaled 788,317 picture tubes worth \$14,620,075, RETMA said. The receiving tube sales report showed 35,184,000 tubes with a value of \$28,616,000 sold in April compared with 42,525,000 tubes worth \$34,849,000 sold in March. Manufacturers' sales of receiving tubes had totaled 35,426,000 units with a value of \$26,780,000 in April 1955.

CBS-Hytron, the tube manufacturing division of Columbia Broadcasting System, Inc., has expanded its facilities on the West Coast and is now offering complete sales and service to its distributor and equipment customers in this area.

With the appointment of Leonard M. Murchison as Equipment Sales Manager, West Coast, and William J. Anderson as Supervisor of Field Engineering, West Coast, CBS-Hytron can now provide sales and commercial engineering service to manufacturers of electronic equipment in the entertainment, industrial and military fields.

A handsome gold plaque was presented to Charles Golenpaul, retiring President, as the First Annual Award of the Radio Old Timers Club at its annual get-together during the Electronic Parts Convention in Chicago. The award is for the most outstanding contribution to manufacturer, distributor and representative relationship in the electronic industry.

M. D. Ercolino, president of Telrex, Inc., announces the signing of two more patent license agreements. These latest agreements are between his firm and J.F.D. Mfg. Co. and R.M.S. These firms now become licensed under Telrex's well-known patent on conical antennas.

Mr. Ercolino stated that Telrex is engaging in an intensive campaign to suppress unauthorized in-

fringements, and that new actions have been taken where infringers do not either stop their activities or take a license.

The General Electric Company announced the reorganization of its electronics businesses into three separate Divisions as a result of "rapid expansion and future growth prospects." C. W. LaPierre, executive vice president of the Company's Electronic, Atomic and Defense Systems Group, announced formation of the new Divisions. They are the Industrial Electronics Division; the Electronic Components Division; and the Defense Electronics Division.

DON'T BE FOOLED by the Joker in the Deck!



This effective mailing piece has been used successfully by Television & Appliance Inc., 4036 N. 36 St., Phoenix, Arizona.

General Electric Company broadened its national communication equipment service program by establishing a new sales policy under which the factory, for the first time, will accept mobile radio service contracts in a direct relationship with its customers. The announcement was made by George A. Svitek, newly-appointed national service manager for General Electric Communication Equipment.

"The trend is inescapable," he said, adding: "With more specialized types of radio units now being engineered, the purchaser has a right to be assured that he will be able to receive factory service, when necessary, on complex systems."

At a recent three-day international sales convention, Motorola Inc. unveiled its new 1957 lines of television receivers, radios and phonographs for some 900 distributors and sales personnel representing the company in the U.S. and nine foreign markets. Highlighting the meeting, Robert W. Galvin, executive vice-president, told the convention that the industry would attain an annual sales volume of over 9,000,000 television units within five years.

Reaction to new low-priced color television receivers has been so great that these sets may be in short supply before Christmas, Robert A. Seidel, Executive Vice-President, Consumer Products, Radio Corporation of America, said at a preview of RCA's 1956-57 consumer product lines.

"Our market surveys show that there are nearly one million persons who are ready and able to buy a color television set for their homes at the \$495 price level—now," said Mr. Seidel. "Since we announced RCA's new line of large-screen color television sets at nationally advertised prices ranging from \$495 to \$850 to our distributors two weeks ago, the response has been overwhelming."

Free courses in radio and television service will be offered by the Queens Evening Trade School located at 47th Avenue and 37th Street, Long Island City 1, N. Y. Registration for all classes will take place at the school on September 10 and 11, 1956 from 7:00 pm to 9:00 pm.

Raytheon Manufacturing Company has purchased a 15 acre site in Goleta, Calif., 5 miles west of Santa Barbara, for a new engineering laboratory to be used in the design and development of airborne electronics and infrared equipment.

Admiral Corporation has purchased the assets of the television and radio operations of Raytheon Manufacturing Company. Terms of the transaction were not disclosed. The new acquisition will be operated as the Belmont Division of Admiral. Included in the transaction are two plants in Chicago, the inventory of finished television and radio receivers, and plant

[Continued on page 36]

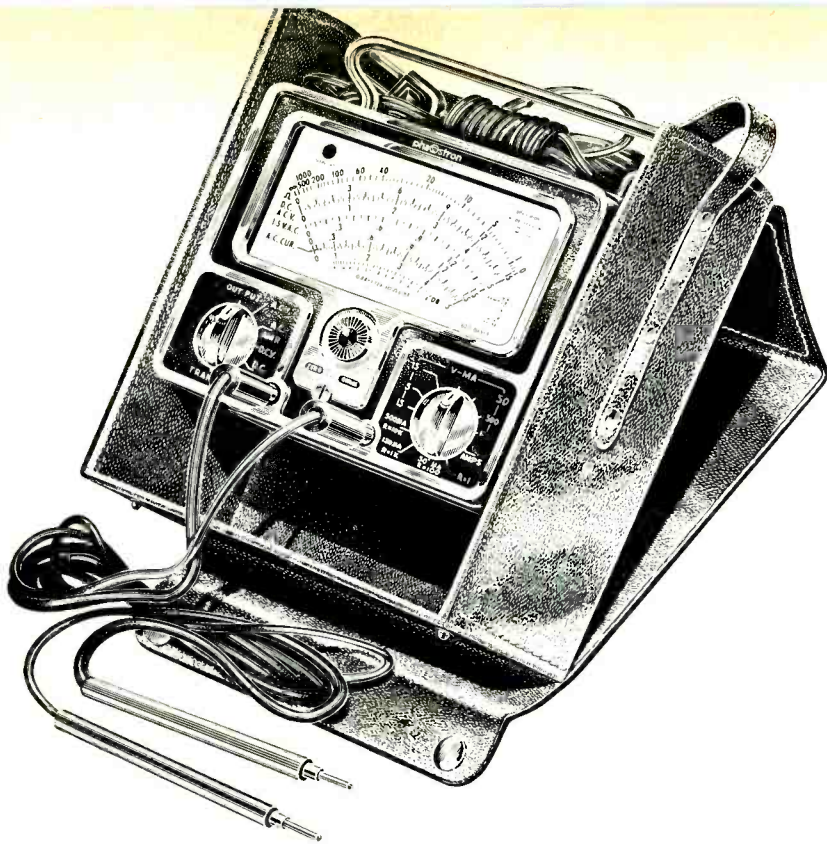

Fig. 1A—Phaostron Model 666 Volt-ohm-Milliammeter

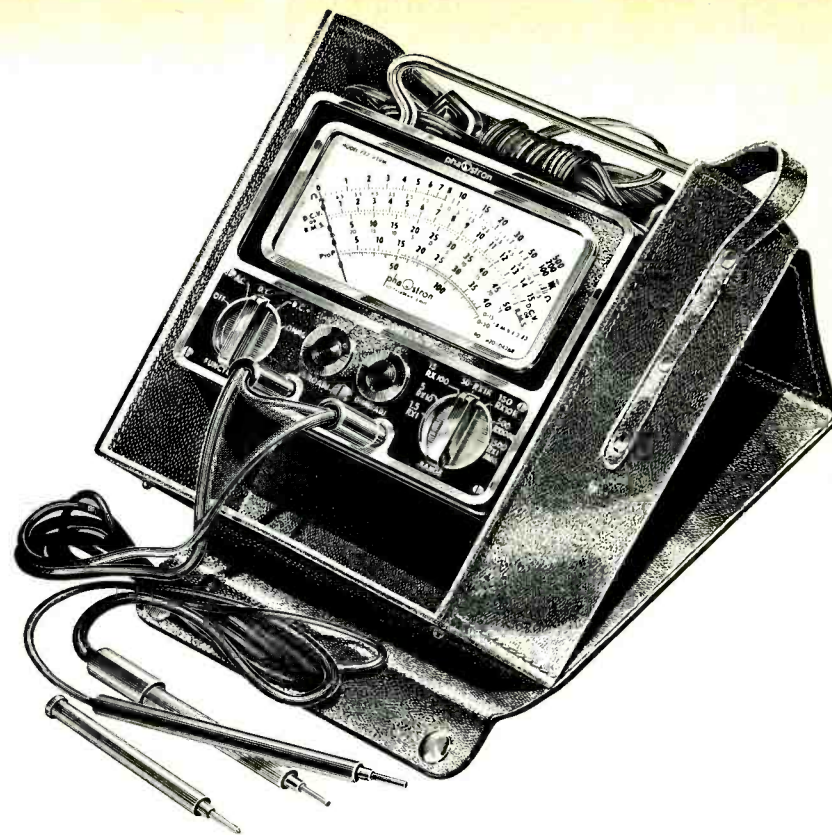

Fig. 1B—Phaostron Model 777 Vacuum Tube Voltmeter

Compact Meters with Full Size Features

Two new meters are described in this article, one a 20,000 ohm per volt meter and the other a V.T.V.M., both containing unique features.

by PETER RUGGIERO

TWO VERY attractively styled meters have recently been made available to the service industry. Both are manufactured by Phaostron Instrument and Electric Company and incorporate many novel features, both electrically and style-wise.

The first, Model 666, is a self contained volt-ohm-milliammeter having a

total of 37 different usable ranges. A photograph of this unit is shown in *figure 1*. The instrument, supplied with a leather carrying case, measures only 3¾" by 6⅝" by 7½" including the case and weighs only 4 lbs. 4 oz. Despite its compact and integrated design it features an expanded meter scale nearly 5 inches in length, making readings extremely simple.

The meter movement has a basic sensitivity of 50 microamperes (20,000 ohms per volt) and can, therefore, be used to measure reasonably high impedance circuits without affecting their operation or causing severe loading common with meters having lower sensitivity. The *dc* current ranges available are from 0 to 50 microamperes full scale all the way to 0 to 15 amperes in eleven convenient over-

lapping ranges. Thus, it is always possible to obtain a reading on the upper two thirds of the meter scale, where greatest accuracy is afforded.

A copper-oxide rectifier is used in the *ac* measurement circuit for both current and voltage readings. All shunt resistors and multipliers for all functions are 1% precision carbon, deposited or wire-wound for greatest accuracy. Maximum voltage scales are 0-1500 volts for both *ac* and *dc* measurements.

Meter Illumination

Many portable multimeters have a serious drawback in that it is virtually impossible to read the meter indication in some of the tight, dark corners in which it must often be placed. Usually, a flashlight in such instances would re-

quire a "third hand" for its efficient use. The Model 666 solves this problem by incorporating two, 60 volt pilot lamps in series for connection to any 115 volt line (*ac* or *dc*). Furthermore, as shown in *Fig. 2*, the lamps are completely independent of the rest of the circuit and are automatically turned off when the function switch is returned to the "transit" position. Thus, if lighting is adequate and a receptacle is inconvenient, the 666 may be operated without connecting the pilot lamp plug at all. On the other hand, for locations where the visibility is zero, one can always resort to the use of this convenient feature.

Protective Features

A meter movement as sensitive as the one contained in this unit requires over-

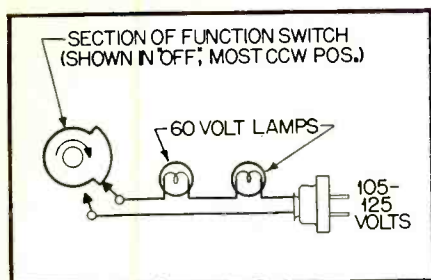

Fig. 2—Meter illumination diagram.

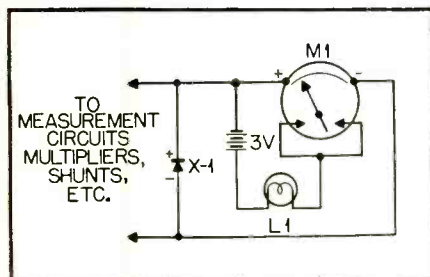

Fig. 3—Diode connected across meter affords transit protection.

load protection that is foolproof and positive acting. In addition to conventional fusing of the various circuits as well as that of the movement itself, the manufacturers of this instrument have gone to special pains to make it unnecessary to replace burned out fuses except in rare cases of overload.

The meter movement is electrically protected by placing a special diode across it, as seen in Fig. 3. This diode has a very high resistance at the normal operating voltage of the meter, but the resistance drops very rapidly as the voltage is increased, thus giving in effect, a variable shunt across the meter. Due to this unique property, it is possible to give a high degree of protection to the meter movement. Protection well up to 500 times the full scale current is provided.

In addition, the unit features a warning signal light which indicates to the operator that the unit is being subjected to an overload or that he had applied reverse polarity. The pointer cross is used as a moving contact to activate a signal light. To insure a good electrical contact part, the pointer and the stationary contacts in the instrument are gold plated.

Transit Protection

While most of us exercise caution
[continued on page 46]



Radio - TV Hi Fi-Audio Communications Electronics

SERVICEMEN

SERVICE DEALER

 and ELECTRONIC SERVICING

is YOUR magazine.

Subscribe to it now. Reap its benefits!

Now every serviceman engaged in every phase of radio-TV
and Industrial Electronics servicing will find:

SUBSCRIPTION RATES: 12 Issues \$3; 24 Issues \$5 (In the U.S.A., U.S. Possessions, Canada and Mexico). Elsewhere add \$1 per year.

COWAN PUBLISHING CORP.

67 W. 44 St., New York 26, N.Y.

NEW RENEWAL

Sirs: I remit herewith \$..... Enter a subscription for..... years as follows:

Name.....

Address.....

City..... Zone..... State.....

Name of firm.....

Firm's business address.....

City..... Zone..... State.....

CHECK YOUR CLASSIFICATION

- | | |
|--|---------------------------------------|
| <input type="checkbox"/> Independent Radio-TV Serviceman | <input type="checkbox"/> Owner |
| <input type="checkbox"/> Radio-TV Service Organization | <input type="checkbox"/> Employee |
| <input type="checkbox"/> Retail Store having Service Department | <input type="checkbox"/> Service Mgr. |
| <input type="checkbox"/> Industrial Electronic Service Firm | <input type="checkbox"/> Student |
| <input type="checkbox"/> Firm having electronic equipment which I service and maintain | |

If some other type of company describe:.....

A TYPICAL ISSUE COVERS

- Latest TV Installation and Maintenance Techniques for VHF and UHF
- Auto Radio Installation and Service
- Mobile Communications, 2-Way Radio, Ship-to-Shore Radio Installation and Service Techniques
- Industrial Electronics Equipment Servicing Data
- Advanced Data on New Circuitry
- Production Changes and Field Service Data on Receivers
- New Tubes
- New Test Equipment, Operation and Application Data
- P.A. Installation and Service
- Hi-Fi Installation and Service
- New Developments, Such As Transistors, Color, UHF, etc.
- News of the Trade
- Service Short Cuts and Shop Notes
- Explanation of Difficult Circuits
- M'fgr's Complete Line of TV Schematics
- Video Speed Servicing Systems

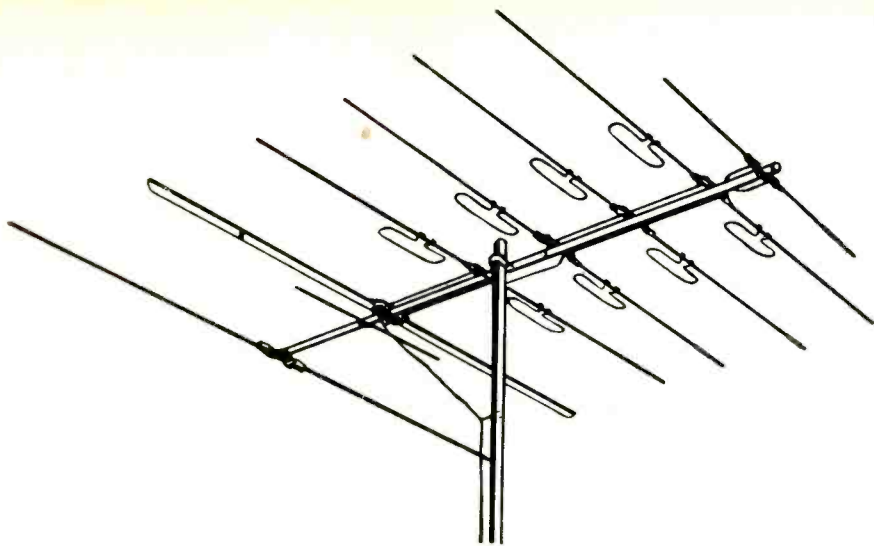

Spurring Antenna Sales



by FRED VOORHAAR

Sales Promotion Manager
Taco Appliance Corp.

A FARMER friend was approached by an itinerant book salesman who had a line of books "guaranteed to double the farmer's income by proper farming." I'll always remember my friend's answer to the sales pitch. "I know what I must do to double my income. What I need is somebody to make me do the things I know how to do." We all know that this is true.

It is possible for you to increase your 1956 income by following a planned program and in this article we will give you some business building suggestions. The suggestions are not listed in any particular order though somewhere in these paragraphs there is at least one which will bring added business and profit.

1—When an antenna has outlived its usefulness—there are millions in this country that have—sell the replacement in a modern antenna. When you replace an obsolete design with another of the same general construction, your customer can reasonably question whether there was any reason for making the replacement. In no other industry does a dealer make a replacement sale of an item that looks like the outmoded product.

2—Picture deterioration does not happen over night. In most instances quality drops from day to day until ultimately the picture may still be satisfactory to the customer because he has become accustomed to seeing a poor picture. When you are called to make repairs

on a 'dead' set, there is a great improvement when you get it operating. But you know that further improvement can be made by the replacement of transmission line, adjustment of the antenna installation by orientation, guying, etc., and very definitely by replacing with an antenna of modern design. After all, there are stations now on the air which were not available when the original antenna installation was made. Your sales pitch is not a hard one because you are selling a *modern* antenna to replace one that has outlived its effectiveness. Remember, *automobile dealers would starve if they only sold a new car when the customers old betsy failed completely.*

3—About indoor antennas. There are many cases where because of the overall cost, the dealer did not sell an outdoor antenna when he installed the set. When you make your service calls, these are the sets that you can improve tremendously by providing enough signal to give good sharp pictures. It won't cost the customer less today than it would have when he bought the set, but chances are that he is better able to consider the installation of an antenna today. Don't overlook these indoor antenna users, for they number in the millions, each ready to accept improved satisfaction for themselves and increased profits for you.

4—There are many good accessories, each having a definite place in your installation set-up. Take for instance an antenna installed in high signal areas, where the signal pick-up in transmission line is so great that annoying ghosts are present. They may not trouble the customer because he has become used to them, but you know that he is

not getting the best possible picture. Here is a case where you can install a coupler at the antenna to convert from a balanced line to an unbalanced coaxial line which is not susceptible to signal pick-up. With another coupler at the set to return to the 300 ohm input of the set, the improvement will be tremendous. The same clean signal which is picked up at the antenna is delivered to the set providing improved ghost free pictures.

5—Another accessory which can be easily checked and installed while making service calls is a signal attenuator of the switch type. With this unit excess signal which overdrives the set causing the picture to 'tear-out' can be reduced by the selection of the proper amount of attenuation to bring the signal down to a usable level. One such unit has two attenuation steps plus a 'feed-through' position where signal level does not require attenuation.

This coming summer your customers are going to be using their sets to a much greater extent than in the past. Finally, more and more homes are being air conditioned. This means that the social life will be kept in the home as it is during the winter-time, rather than as in the past being brought to the outdoors. We may not agree that this is the best thing for people but it is a fact that air conditioning will bring about increased use of television receivers and this in turn means that many sets which in the past have not been used during the hot summer months will be used to a greater extent than heretofore.

The business is there for you and these suggestions will increase your participation in this additional business. It's waiting for you. ■ ■

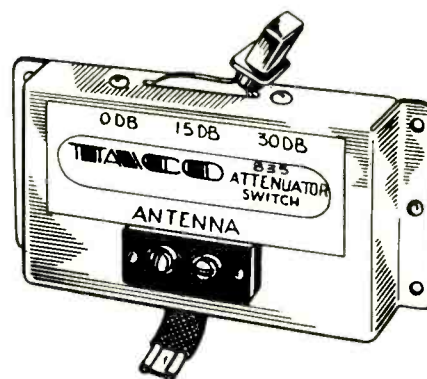

Variable attenuator switch.

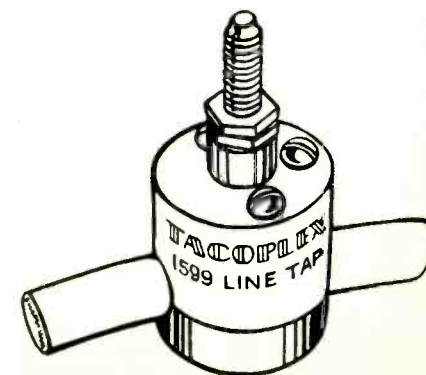

Coaxial cable line tap.

SPECIAL OFFER TO OUR READERS!

By special arrangement with John F. Rider Publisher, Inc., SERVICE DEALER and ELECTRONIC SERVICING now brings you a COMPLETE diagram service to help you do a faster, easier servicing job!

**ALL COMPLETE! ALL FACTORY
PREPARED! ALL FACTORY
AUTHORIZED!**

✓ Just \$1.25 for COMPLETE SERVICING INFORMATION on any TV receiver . . . any year, any make, any model . . . from 1946 on!

✓ Just 75¢ for COMPLETE SERVICING INFORMATION on any radio . . . any year, any make, any model . . . from 1941 on!

**TAKE ADVANTAGE OF THIS SPECIAL
OFFER . . . MAIL THE COUPON TODAY!**

COWAN PUBLISHING CORP.
67 W. 44 Street, New York 36, N. Y.
Please RUSH me the the following diagrams:

TV DIAGRAMS @ \$1.25 EACH		
CHASSIS #	MAKE	MODEL #

RADIO DIAGRAMS @ 75¢ EACH		
CHASSIS #	MAKE	MODEL #

MAKE CHECKS & MONEY ORDERS PAYABLE TO
COWAN PUBLISHING CORP.

(For all New York City orders, please submit additional 3% sales tax.)

Name _____

Address _____

City _____ State _____

TRADE FLASHES

[from page 31]

equipment. The two plants include a total of approximately 430,000 square feet of space.

C. F. Adams, Jr., president of Raytheon, said that Raytheon's major operations, which are concentrated in the greater Boston area and which include the company's picture tube and receiving tube business, will not be affected.

• • •

"Ten Top Tubes" is the title of a new concept in tube packaging announced here today by the Westinghouse Electric Corporation. Under a new plan, dealers and distributors are now able to buy in a single package the 10 highest volume types of receiving tubes listed by Radio-Electronics-Television Manufacturers Association in 1955.

The new Westinghouse package contains 50 tubes—five of each type, according to J. C. Lane, Jr., advertising and sales promotion manager of the electronic tube division. In addition, each TTT package contains, as a premium, a thermal picnic bag. The TTT pack, Mr. Lane explained, has a double handle built into the box to permit the service dealer to carry these high volume types on home service calls when his "over-worked" tube caddy is filled with test equipment, tools, other tube types, and so on.

• • •

Donald J. Hughes has been named advertising manager of the Electronic Products Sales Department of Sylvania Electric Products Inc., it has been announced by George C. Isham, general merchandising manager of electronic products.

In his new position, Mr. Hughes will be responsible for advertising plans and programs for electronic products, including both distributor and equipment sales. He will be located at the company's executive offices in New York.

Prior to assuming his new position, Mr. Hughes was advertising and sales promotion supervisor for electronic products. He joined the Sylvania organization in 1954 after extensive experience in trade publication and advertising fields. He was assistant advertising manager of Tide Water Associated Oil Co. before joining Sylvania.

• • •

A new, electrostatic "Cathedral" speaker for true high-fidelity instruments and capable of covering a frequency range between 2,000 and 20,000 cycles per second, has been developed by Philco Corporation engineers and will be featured in the new full line of Philco musical instruments.

High-fidelity electrostatic speakers, radically different in design from conventional cone speakers, were first introduced to the general public by Philco in its 1955 line of phonographs and radio-phonograph combinations.

The 1955 electrostatic speaker, while providing an upper limit of 20,000 cycles, had a lower limit of 7,000 cycles. The range of the new "Cathedral" speaker has been extended to a low of 2,000 cycles, well into that covered by many "woofer" loudspeakers.

The new speaker provides a 180 degree arc of sound transmission, whereas the conventional cone speaker, or "tweeter," tends to radiate sound in a narrow beam, restricting high-frequency sound reception to persons directly in front of the loud-speaker.

• • •

Development of a compact, professional-quality hi-fi magnetic tape recorder utilizing transistors and printed circuitry—the first of its kind—was announced by J. F. O'Brien, Manager, RCA Theatre and Sound Products Department.

FREE LITERATURE REQUEST FORM

Valid for 6 weeks only, expires 8/1/56
Business Card MUST be attached

Circle numbers for Free Technical Literature or Information on New Equipment:

701	702	703
704	705	706
707	708	709

If you want more details on products advertised in this issue fill in below:

Page _____ Product _____

Page _____ Product _____

Page _____ Product _____

Name _____

Title _____

Company _____

Co. Address _____

City _____ Zone _____

State _____

NEW PRODUCTS, ROOM 510, 67 WEST 44 ST., NEW YORK 36, N.Y.

Merit

FIRST IN EXACT REPLACEMENT.

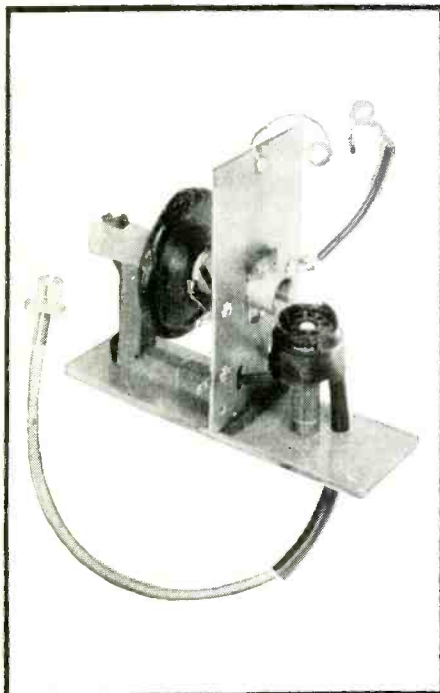

HVO-37 FOR EXACT REPLACEMENT IN over 125 models . . . CROSLY, HALLICRAFTERS, SENTINEL, SILVERTONE. Another in the complete Merit line of exact and universal transformers, yokes and coils. Merit is the only manufacturer of transformers, yokes and coils who has complete production facilities for all parts sold under their brand name.

Merit

MERIT COIL & TRANSFORMER CORP.
4427 N. CLARK ST., CHICAGO 40, ILL.

Mfg: Admiral Chassis No. 19F1A

Card No. AD19F1A-1

Section Affected: Raster

Symptom: No raster, no H.V.

Cause: Defective component.

What To Do:

Replace: C411B (10-160 $\mu\mu\text{f}$), which is shorted.

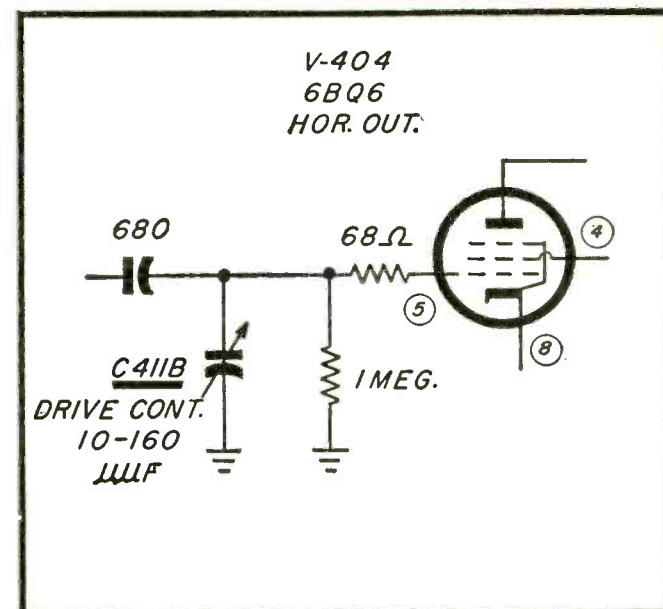

Mfg: Admiral Chassis No. 19F1A

Card No. AD19F1A-2

Section Affected: Raster and sound.

Symptom: No $\exists+$

Cause: Defective component.

What To Do:

Replace: Entire speaker; field is open.

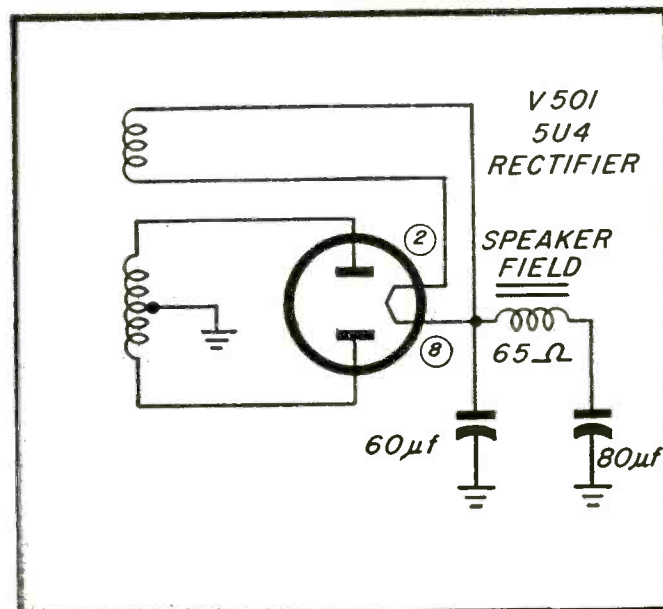

Mfg: Admiral Chassis No. 19F1A

Card No. AD19F1A-3

Section Affected: Sound.

Symptom: No sound.

Cause: Defective component.

What To Do:

Repair or replace: L201 (4.5 mc trap) which is open.

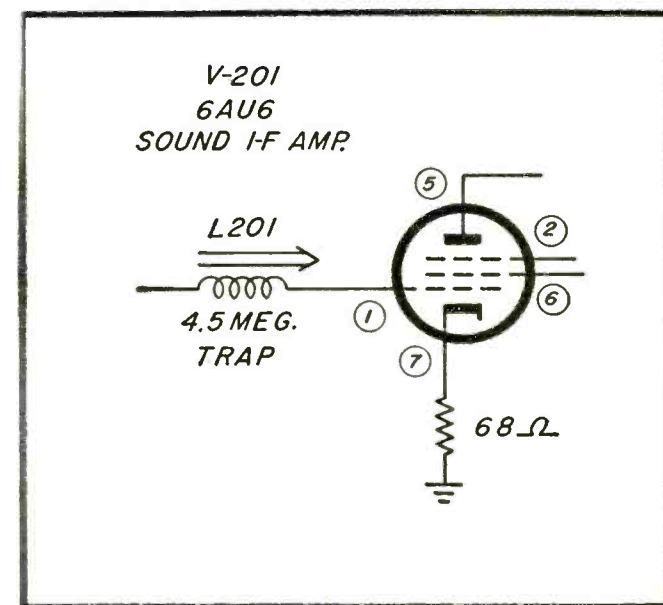

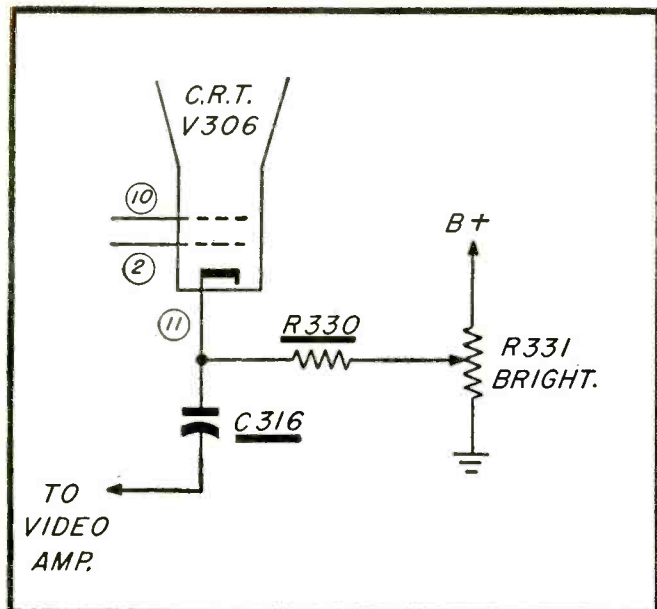

Mfg: Admiral

Chassis No. 19F1A

Card No. AD19F1A-4

Section Affected: Pix.

Symptom: Not enough brightness.

Reason For Change: Modification to increase brightness.

What To Do:

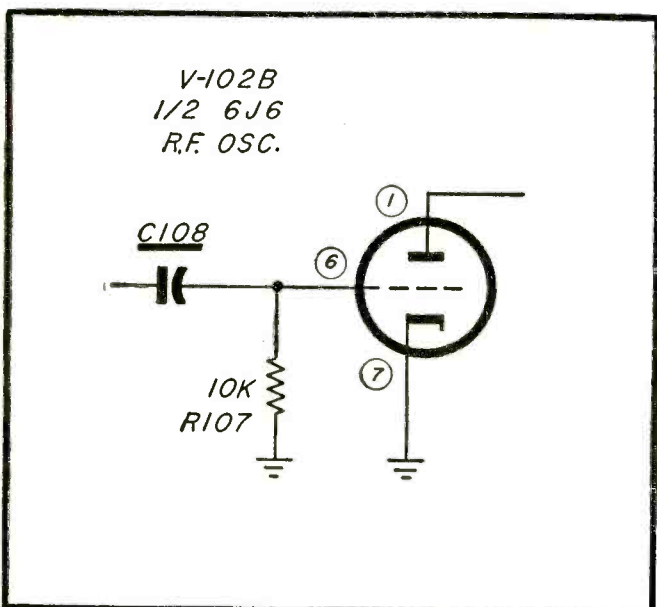
Change: R330 (470K) to 180K; also C316 (.01 μ f) to .22 μ f.

Mfg: Admiral

Chassis No. 19F1A

Card No. AD19F1A-5

Section Affected: Pix

Symptom: Stations drift off frequency.

Cause: Defective component.

What To Do:

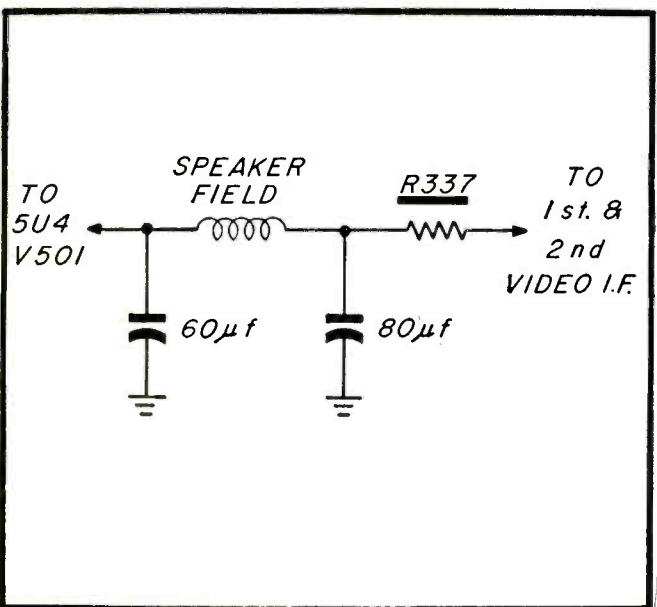
Replace: C108 (10 μ f), which has changed value.

Mfg: Admiral

Chassis No. 19F1A

Card No. AD19F1A-6

Section Affected: Pix and sound.

Symptom: No B+ to first and second video if.

Cause: Defective component.

What To Do:

Replace: R337 (4.5K), which is open.

SPECIFY NORELCO

*F.R.S.

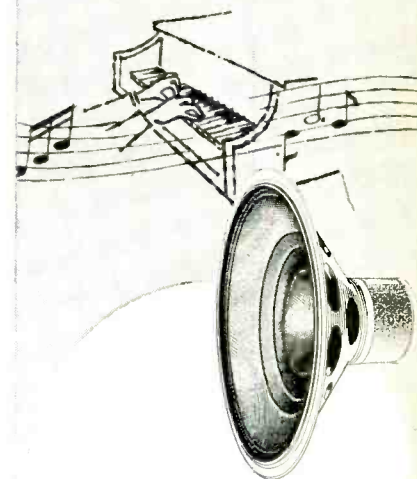
for Top Performance
speaker replacements

Based on economy alone, any one of the Norelco FRS twin-cone speakers is your best choice.

Aside from price, these speakers have been designed and manufactured by audio craftsmen—to produce unexcelled sound qualities. In a single FRS speaker, sound is reproduced so perfectly that listeners have difficulty in distinguishing recorded performance from those which are live.

FRS Twin Cones are both operated by the same magnet and voice coil. The smaller cone radiates frequencies above 10,000 c/s and diffuses lower frequencies. Frequencies below 10,000 c/s are generated by the larger cone while reflecting frequencies above this frequency.

Price from \$59.98 to \$6.75 in all standard impedances and sizes from 12 inches to 5 inches.

ADD TO... and improve any
sound system with **Norelco**[®]
*FULL RESONANCE SPEAKERSSend to Dept. E-7 today
for more details.North American Philips Co., Inc.
100 East 42nd Street
New York 17, N. Y.

LOOK FOR THIS RACK

at your Jobber . . .

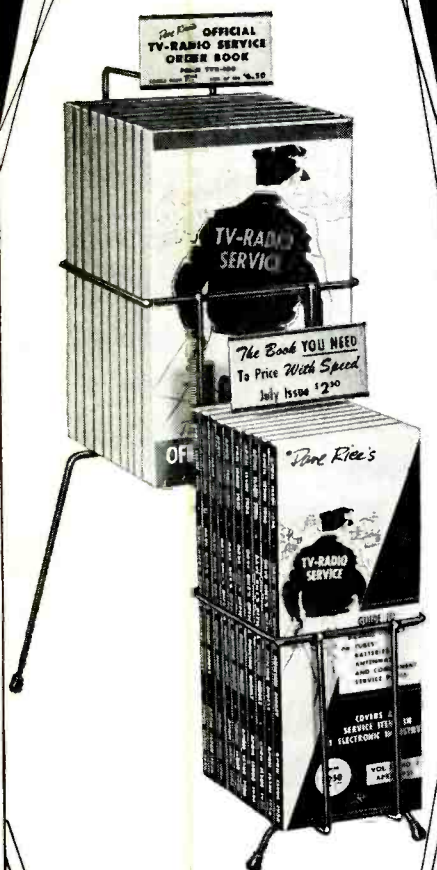

In this rack you will find
The Biggest Service Help
The Largest Value
In These Perfect Partners

Dave Rice's Official Pricing Digest
—a quick check for over 60,000
prices—revised 4 times every year.
Pocket sized.

and
Dave Rice's Official TV-Radio
Service Order Book which pro-
vides separate listings for picture
tubes, receiving tubes, parts and
components, serial numbers, labor
and state and local taxes. 5½x8½
—50 sets of triplicate orders—
carbons bound in.

ELECTRONIC PUBLISHING CO. INC.
180 North Wacker Drive Chicago 6, Illinois

Mfg: Emerson

Chassis No. 120162-A

Card No. EM162-1

Section Affected: Raster

Symptom: Vertical jumps.

Cause: Defective component.

What To Do:

Replace: R67 (vertical linearity control 5K ohms), which is arcing.

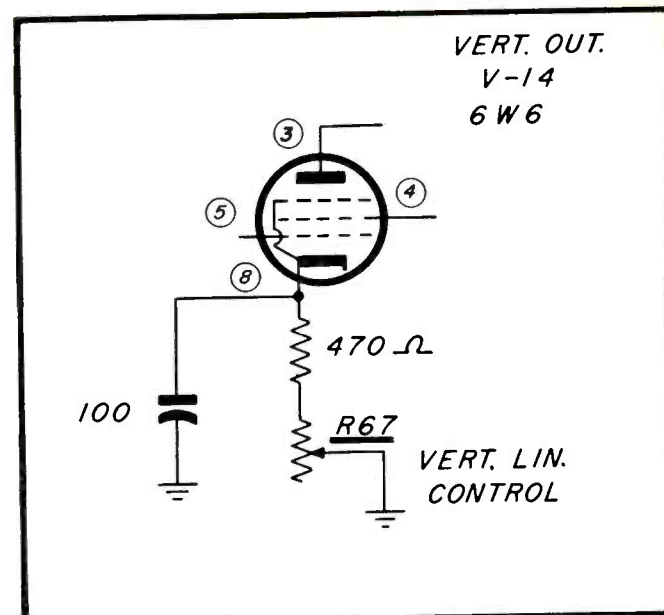

Mfg: Emerson

Chassis No. 120162-A

Card No. EM162-2

Section Affected: Raster

Symptom: H.V. Ticking.

Cause: Defective component.

What To Do:

Replace: C-69 (500 μ f), which is breaking down.

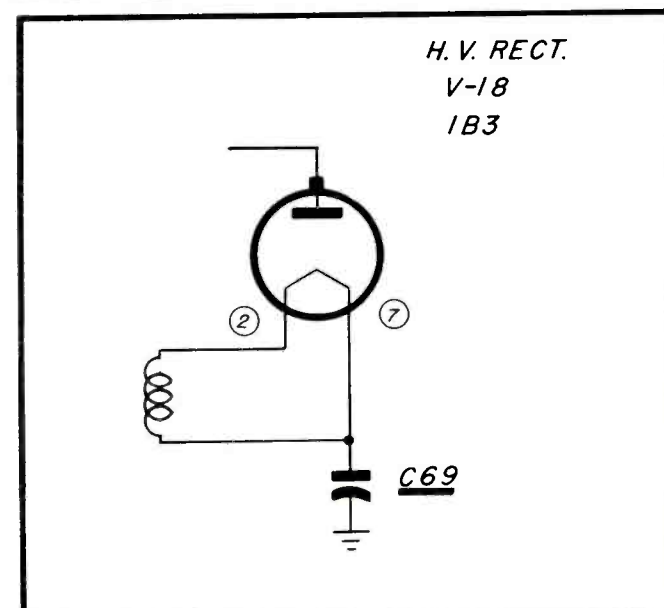

Mfg: Emerson

Chassis No. 120162-A

Card No. EM162-3

Section Affected: Raster

Symptom: Intermittent raster and intermittent H.V.

Cause: Defective component.

What To Do:

Replace: R86 (100 ohms), which opens inter-
mittently.

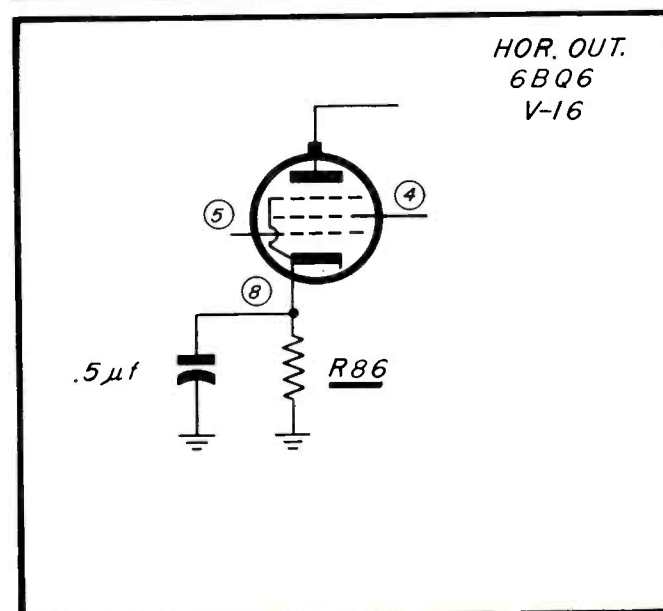

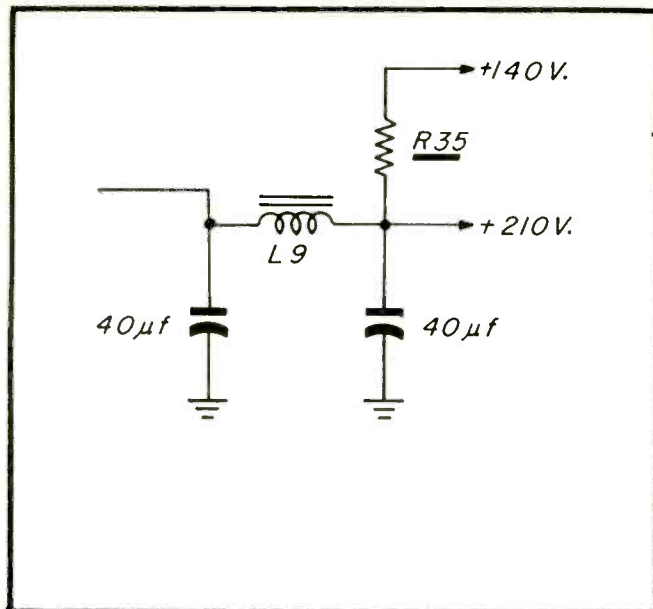

Mfg: Emerson

Chassis No. 120162-A

Card No. EM162-4

Section Affected: Pix and sound.

Symptom: No pix and sound.

Cause: Defective component.

What To Do:

Replace: R35 (1.2K), which is open.

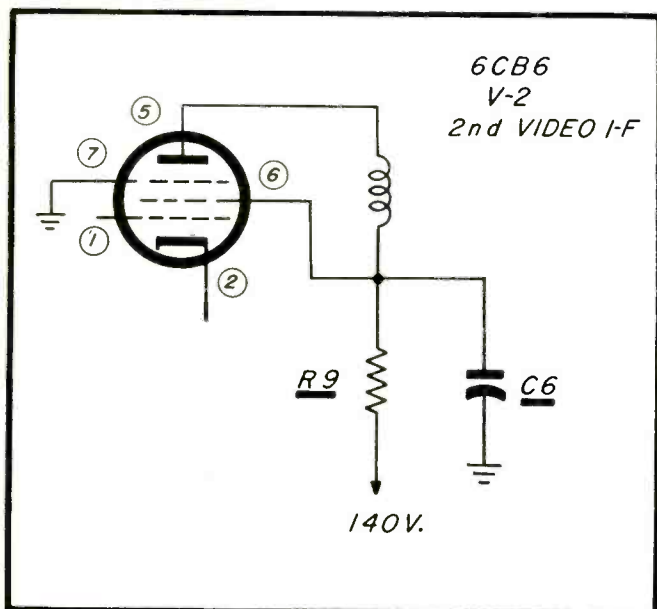

Mfg: Emerson

Chassis No. 120162-A

Card No. EM162-5

Section Affected: Pix and sound.

Symptom: No video, no sound.

Cause: Defective component.

What To Do:

Replace: C6 (1500 µmf), which is shorted, and R9 (470 ohms), which is burned.

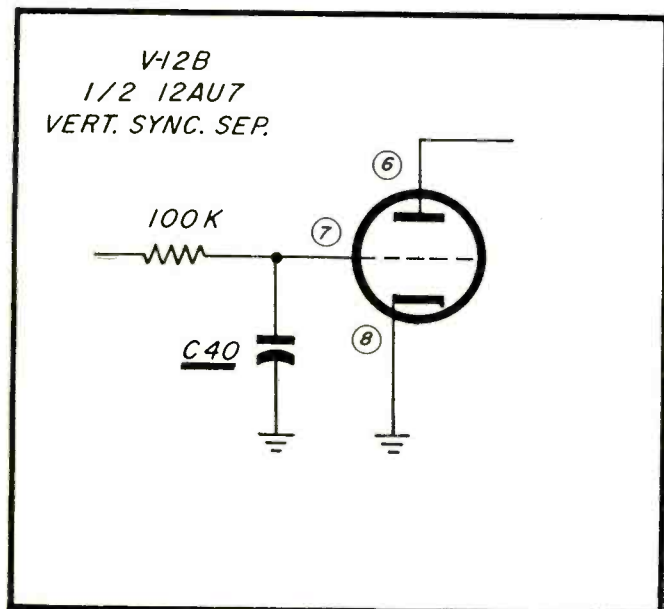

Mfg: Emerson

Chassis No. 120162-A

Card No. EM162-6

Section Affected: Sync.

Symptom: Horizontal pulling, and vertical rolling.

Cause: Defective component.

What To Do:

Replace: C40 (47 µmf), which is leaking.

ASSOCIATION
NEWS

[from page 20]

the meeting. A committee was selected to draw up a constitution and By-laws.

Temporary officers were elected to serve until organization is completed as follows: Fred Mertens, Pres.; Mel Cullom, Vice Pres. and Treasurer; Cyril Echele, Secretary; Tom Ginnener and Wm. Vogt, Directors.

All of St. Charles County is to be included in the association. Several shop owners were from the city of St. Charles, and men from O'Fallon, Old Monroe, Winfield and Wentzville attended.

This enthusiastic group of men believe they will have their Constitution and By-laws in final form and permanent officers elected very shortly. The group is expected to submit application for membership in TESA—MISSOURI and NATESA very soon.

Electronic Technicians Association
of Denver, Colorado (ETA)

The general meeting recently held by ETA of Denver was a huge success due mainly to an address given by Mr. Frank J. Moch as guest speaker of the evening. After Mr. Moch's address, the meeting was opened for a question and answer session, and every question was answered capably and fully. The meeting was also attended by NATESA's Jim Failing, Western Vice-President, and a number of men from his area in Northern Colorado.

Radio Television Guild of
Long Island

Last month the executive board launched one of its most ambitious projects. Using the I.R.E. convention as a model, the board appointed a committee to draft plans for an electronics fair. Scheduled to be held this fall at the New York State University at Farmingdale, December 6, 7, and 8, the fair will embrace all phases of the service industry.

Under the heading of Electronics Fair, booths will be set up for the use of manufacturers. In these booths animated displays will illustrate and explain the parts or products involved.

Among the devices illustrated will be transistorized radios, printed circuit television receivers and amplifiers, test equipment, the new fall line of color receivers, as well as many other electronic devices related to the serviceman.

In addition to the parts exhibition, and under the heading of Color Symposium, the committee has arranged for a slate of lectures on color television. There will be approximately twenty technical papers given covering such topics as the latest color tube developments, receiver circuits, the newest test equipment, the fastest alignment techniques, as well as a host of other service industry topics.

California State Electronics Association (CSEA)

Harry Coolidge president of the Pasadena RTA and Chairman of the Presidents Council of greater Los Angeles was elected President of the CSEA. Larry Schmitt President of the Santa Clara RTA was elected Vice President. Re-elected secretary was Jim Wakefield, president of the Central RTA.

John Blackwood President of the TSEA of Kern County, was elected treasurer. Mr. Blackwood reported that the convention was a great success, attendance was high.

The newly elected board of directors of the CSEA are Herb Sulkin of Los Angeles, Leland Johnson of the Long Beach RTA, Art Blumenthal, president of the San Mateo Association, Rex Yeager, president of the San Francisco Guild, Jack Holloway of San Diego, and Arnold Meyer of the Society of Radio and Television in Los Angeles.

Television Servicemen's Association of Connecticut (TELSA)

A very effective campaign is being planned by the Waterbury Chapter to enroll more members. Potential members will be contacted personally and brought over to the next meeting.

Yellow page ads will be contracted for to list all the Waterbury Chapter members under the TELSAs emblem, as was done last year.

We will be 13 Chapters strong when the last 3 chapters return their contracts.

RIDER SPEAKS



JOHN F. RIDER

COLOR TV is causing quite a fuss. It looks like the strongest proponent (and we don't have to mention the name) is determined. Maybe they're right.

The price pattern for the color TV receivers to be sold this fall and winter is a minimum of about \$495 and a number of manufacturers are very reluctantly going along with the production of their own models to be marketed at similar prices, or perhaps a little bit higher. It is very doubtful if anyone has the courage to offer a lower priced receiver. The reluctance on the part of numerous manufacturers to produce color TV receivers is very great; nevertheless the consensus indicates that 200,000 or 300,000 color receivers will be sold during the forthcoming season. Whether or not this number will be a successful kick-off for the color TV receiver sales in 1957 is something no one wants to say. The greatest worry seems to be the inability to earn a profit on a color TV receiver which is marketed around the \$495 figure, especially in the light of the relatively limited production which most of the manufacturers anticipate. Much of the success depends, of course, on the amount of color programming. In this respect the effort has to be much stronger than the weekly big show, numerous commercials and a few 15-minute spots.

Related to the color scene are two other situations. Many manufacturers feel that the push to color is very adversely affecting the table model black-and-white receiver, of which it is said that between 2,200,000 and 2,500,000 are in inventories.

No doubt there is much truth in this statement but it cannot be denied that the appearance of the portable black-and-white TV receiver, which has proven a walloping success, has also affected the sale of the conventional table model and may even prove to be more devastating than color TV.

All manufacturing eyes seem to be focused on the portable receiver with picture tube sizes ranging from a little more than eight inches to as high as seventeen inches. The excellent performance of these units under the most adverse conditions can't help but lead to the portable rather than the conventional table model being the second receiver in the home.

It has been said that almost 2½ million TV receivers are discarded each year because of old age. How many have already been brought in 1956? Are they the "main receivers in the home" or are they the "second receivers"? Which category of use and replacement covers the receivers in inventory today?

We don't think that anybody doubts the eventual disposal of these receivers before the year ends but even if they are to replace the "first" receiver in the home, service income from installation will benefit very little. Similarly, the purchase of portable TV receivers cannot benefit service from installation in any way at all. Thus the servicing industry must examine its income sources and look around for new ways of deriving income when trends in manufacturing and sales form new patterns.

There is another very interesting situation which may develop in connection with the portable receiver. They are well made, but being portable they are going to be moved around and so will be subject to shocks and jars which the table model and console model have never experienced. Such use will, more than likely, develop business for the service technician. The compactness of the portable TV receiver and the increased difficulty in gaining access to some units will, we hope, reduce self-service by the public. The ease with which the public removed tubes from table models, for that matter, the ease with which they were able to identify the tube locations of these different receivers, is not duplicated in all port-

ables. It is too bad that it is not so in all of them. It isn't that we want to deny the public the right to do with their possessions as they please, but it would be a good thing if servicing remained the province of the servicing business.

There is something else we can't help but think about—the effect which the low sales price of the portable will have on the ease of getting just service charges. The very compactness of the receiver and the need for working in close quarters will aggravate the servicing operations tending to make them more time-consuming than on larger receivers. With time being a major item sold by the servicing group, it is to be expected that the public will once more forget that the low sales price is a matter of production line technique, but the service operation is a custom job—that this is done on a one-at-a-time basis.

This carries us back to the appearance of the table model receiver many years ago. The public was ready to pay a price for the servicing of consoles but just couldn't see their way clear to paying an equal price for the repair of table radios.

Anyway, there is a saving grace in the portable TV receiver. Being portable, it can be brought to the service shop, and the portal-to-portal service charge is saved. This should attract service business and should increase tube sales through service channels. The fact that an effective repair in the shop can be demonstrated to the customer when he picks up his receiver also should prove helpful.

All in all, the servicing industry has a few things to think about. Is this new? ■ ■

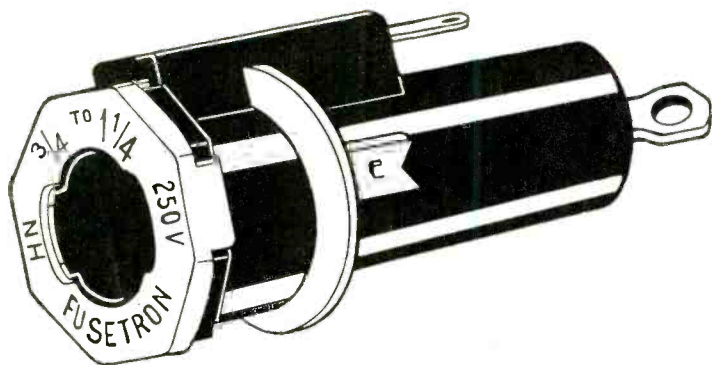

Fuses for Radio and

Discussion of the how and why of various types of fuses. Voltage and current ratings of fuses are defined. In addition, Dual-Element and fast-acting fuses are explained with respect to operation.

Ask the old time radio repair man what he thinks of fuses for the protection of radios and television receivers and you will probably get little more than a snort of scorn—a snort which the art justly deserved some fifteen years ago.

Prior to the last war most electronic devices were relatively simple, large, but with small power requirements. Few operated automatically and, in most cases, reliability was of minor importance. If the radio failed to play, it was not a catastrophe. As a result, if fuses were applied at all, the 32 volt glass tube fuses $\frac{1}{4}$ " in diameter and $1\text{-}1\frac{1}{4}$ " long were used for short circuit protection. Little else was available that was not too large for the devices.

Such fuses performed satisfactorily on battery operated radio receivers even though they were used on voltages higher than their rating. However, when the size of the power pack of the radio was increased, the condition no longer was safe even though the voltage was not increased. Unfortunately, the radio designers selecting the fuses did not realize the meaning of the voltage rating of the fuse and unwittingly created this unsafe condition.

In the blowing of the fuse it is the current flowing through it which causes it to melt. Once it melts, the fuse must extinguish the arc established by the line voltage. Obviously the higher the voltage, the greater the arc and the more difficult it is to clear the circuit. It is for this reason that the voltage rating of the fuse always is given as "32 volts or less," "125 volts or less," or "250 volts or less." The voltage indicates the maximum voltage the fuse can interrupt safely and it can be used on any voltage less than this value.

As a general rule the higher the voltage, the larger and more expensive the fuse. A 4 ampere fuse with an ordinary glass tube having dimensions of $\frac{1}{4}$ " diameter and $1\frac{1}{4}$ " long is rated 32 volts. This same fuse requires a heavier, more expensive tube for 250 volt rating.

If this were the complete story, fuses seldom would be misapplied. However, the performance of the fuse also is affected by the amount of current which can flow when trouble develops. On the old battery-powered radio sets, the voltage was considerably higher than 32 volts but a dead short circuit on the battery produced a maximum current of less than 50 amperes. Under such conditions, the 32 volt fuse was able to interrupt safely the higher voltage. Hence, to prevent misapplication, the voltage rating must be defined more specifically.

The Underwriters' Laboratories, Inc. established the voltage rating of fuses on a *dc* circuit capable of delivering 10,000 amperes at the voltage for which the fuse is rated. When the fuse is blown on such a system, the fuse must remain intact and open the circuit without emitting sufficient flame or molten metal to ignite surgical cotton entirely surrounding it. This test establishes that the fuse will perform satisfactorily without creating a fire hazard at rated voltage under the most severe conditions. It is then the responsibility of the circuit designer to select the fuse with the proper ampere and voltage rating for his application. If his device is listed by the Underwriters' Laboratories, the accuracy of his choice is checked by them in their tests of the complete unit.

The stimulant of the demands of the armed services for smaller, better protection of electronic equipment caused rapid strides in the development of small dimension fuses. New tubing material such as ceramic and glass filled melamine were applied, higher voltage ratings were realized with improved design and construction but, equally important, fuses with long time lag were developed in the small dimension fuses.

Fuses with long time lag, or dual-element fuses, have a fuse link which operates only on the high overloads or short circuits and have a thermal cutout which operates at the lower overloads to give the required time lag. These fuses are furnished in the same physical dimensions as the fast acting fuses even though they combine the two elements in a single fuse casing.

At the lower overloads, both the dual-element and the fast acting fuses act the same. Also under short circuit conditions both clear the circuit with approximately the same speed. However, between 200% and 500% loads, the real difference between the two types is apparent. In this range of loads, the dual-element fuse holds on without blowing much longer than the fast acting fuse. Hence, it can be used to protect cir-

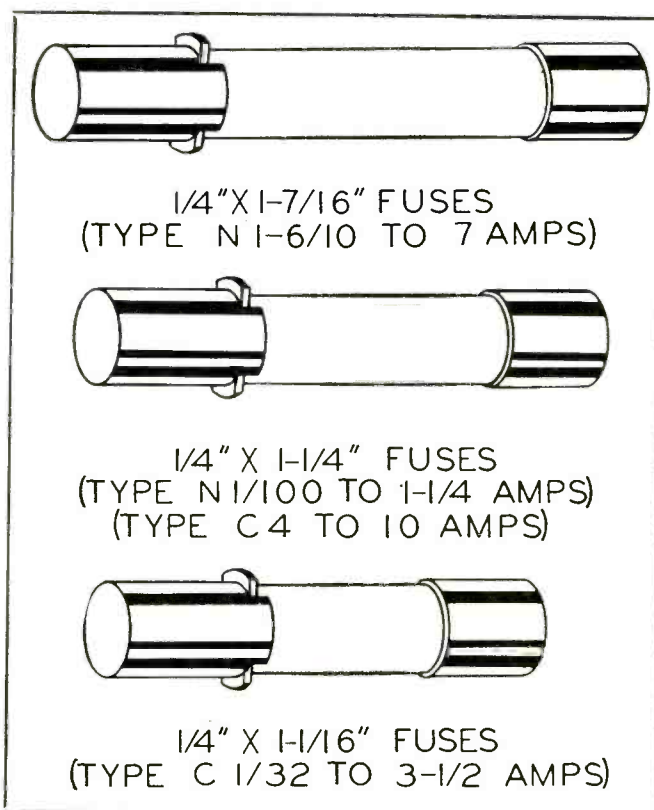
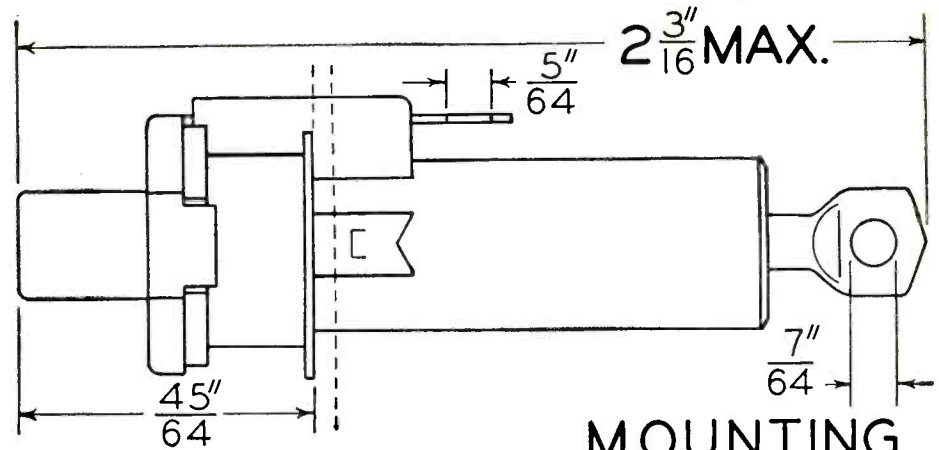
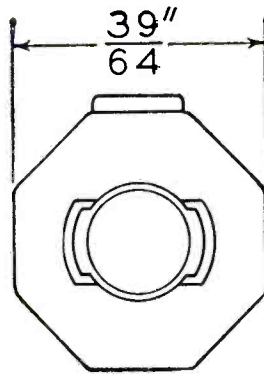

Fig. 2—Fuses are furnished in three lengths.

Television

by J. C. Lebens

Vice President in Charge of Engineering
Bussmann Mfg. Co., St. Louis, Mo.



MOUNTING
HOLE

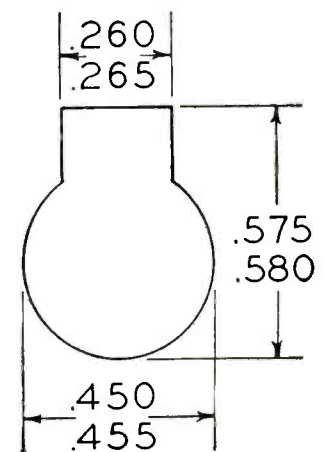

Fig. 1—Dimensional details of Type HC and HN fuseholders.

cuts which may develop such harmless surges in the normal operation of the device.

To illustrate a 1 ampere fuse of either the dual-element or fast blowing type will carry 1.1 amperes, and open at 1.35 amperes within one hour. However, at 3 amperes, the dual-element fuse will hold for 8 seconds before blowing whereas the fast acting fuse opens in approximately 0.1 seconds. If the circuit can withstand the 3 amperes for 8 seconds, the dual-element fuse can be used and will carry the harmless

transient currents which would blow the fast-acting fuse but, if the overload is caused by some faulty condition, the fuse will blow to clear the circuit before it can be damaged.

From this, it is seen that the circuit designer not only must select a fuse of the proper ampere rating but, equally important, he must select the proper voltage rating and type. When this fuse blows, it must be replaced with the proper one by the radio or television serviceman if the protection is not to be destroyed.

To simplify the replacement problem and make certain that the proper replacement fuse is installed, the type C and N fuses with the HC and HN fuseholders shown in Fig 1, were developed. The type C fuse is fast acting and the type N is the dual element type with time lag.

The bakelite bodies of the HC fuseholder for the type C fuse and the HN fuseholder for the type N fuse are the same. A spring steel fastener is mounted on the shank of the fuseholder at the factory so that it can be snapped into a key-hole in the chassis of the television or radio receiver without the use of special tools. Since the body is the same for both types of fuses, the ampere rating or type of fuse can be changed by replacing the holder without changing the hole in the chassis but, unless the holder is changed, the size or type of fuse cannot be altered.

The shoulder on the body of the fuseholder seats on the top of the chassis and both terminals are on the underside. One terminal is an extension of the bayonet socket at the top of the holder and the other an extension of the movable contact, surrounded by a coil spring, at the bottom of the holder. The bakelite key which prevents the holder from rotating in the key-hole in the chassis surrounds the side terminal and insulates it from the chassis.

The spring and movable contact are designed so that the fuseholder will take fuses 1-1/16" long, 1/4" long and 1-7/16" long but only one length will fit a

particular holder. In other words, fuses 1-1/16" long will not make circuit in the fuseholder designed for 1/4" fuses. Hence, one means of separation is obtained by the rejection feature resulting from the use of fuses of three different lengths.

To obtain greater separation, the width of the slots in the bayonet socket on the fuseholder is varied. By varying the width of the slots from 0.060" to 0.180" in steps of 0.020," seven additional means of separation results.

As shown in Fig 2, the fuses are furnished in three lengths and the ferrule on one end is provided with ears ranging in width from 0.060" to 0.180" which engage the bayonet socket in the fuseholder. Fuses having ears wider than the slots in the bayonet socket will not enter. Hence, the ears on the fuses do not provide complete separation but, if the narrower ears are used for the fuses of lower rating, the condition results that the radio and television serviceman can insert a smaller fuse in the fuseholder but never a larger one. This will never create a hazard and only

[Continued on next page]

FUSETRON Type N Fuses are time-delay type		BUSS Type C Fuses are "quick-blowing" type	
Fuses Symbol & Amperes	Fuseholders Symbol & Range	Fuses Symbol & Amperes	Fuseholders Symbol & Range
N 1/100	HN 0 to 3/10	C 1/32	HC 0 to 3/10
N 1/32		C 1/16	
N 1/16		C 1/8	
N 1/10		C 3/16	
N 15/100		C 1/4	
N 2/10		C 3/10	
N 1/4		C 3/8	
N 3/10		C 1/2	
N 1/2		C 3/4	
N 1		C 1	
N 1 1/4	HN 3/10 to 1 1/2	C 1 1/4	HC 1/2 to 3/4
N 1 1/2		C 1 1/2	
N 2		C 1 3/4	
N 2 1/2		C 2	
N 3		C 2 1/2	
N 3 1/2		C 3	
N 4		C 3 1/2	
N 5		C 4	
N 6		C 5	
N 7		C 6	
N 8	HN 1 1/2 to 3/4	C 7	HC 3/4 to 1 1/4
N 9		C 8	
N 10		C 9	
N 11		C 10	
N 12		C 11	
N 13		C 12	
N 14		C 13	
N 15		C 14	
N 16		C 15	
N 17		C 16	
N 18	HN 3/4 to 1 1/4	C 17	HC 1 1/4 to 1 3/4
N 19		C 18	
N 20		C 19	
N 21		C 20	
N 22		C 21	
N 23		C 22	
N 24		C 23	
N 25		C 24	
N 26		C 25	
N 27		C 26	
N 28	HN 1 3/4 to 2 1/2	C 27	HC 1 3/4 to 2 1/2
N 29		C 28	
N 30		C 29	
N 31		C 30	
N 32		C 31	
N 33		C 32	
N 34		C 33	
N 35		C 34	
N 36		C 35	
N 37		C 36	
N 38	HN 2 1/2 to 3 1/2	C 37	HC 2 1/2 to 3 1/2
N 39		C 38	
N 40		C 39	
N 41		C 40	
N 42		C 41	
N 43		C 42	
N 44		C 43	
N 45		C 44	
N 46		C 45	
N 47		C 46	
N 48	HN 3 1/2 to 5	C 47	HC 3 1/2 to 5
N 49		C 48	
N 50		C 49	
N 51		C 50	
N 52		C 51	
N 53		C 52	
N 54		C 53	
N 55		C 54	
N 56		C 55	
N 57		C 56	
N 58	HN 5 to 7	C 57	HC 5 to 7
N 59		C 58	
N 60		C 59	
N 61		C 60	
N 62		C 61	
N 63		C 62	
N 64		C 63	
N 65		C 64	
N 66		C 65	
N 67		C 66	

Table 1—Various types of N and C fuses.

will result in greater protection or, at worst, unnecessary fuse blowing.

As shown in *Table I*, the fast-acting, or type C, fuses are furnished in ratings of 10 amperes, or less, at 250 volts or less. Fuses rated at 3½ amperes or less are 1-1/16" long and fuses from 3-6/16 to 10 amperes are 1¼" long. Ten type HC fuseholders cover the range for the type C fuses. All have the same body but rejection is obtained by the fuse length and width of the ears on the fuse ferrule.

The dual-element, or Type N, fuses are furnished in ratings of 1¼ amperes, or less, at 250 volts or less, and from 1-3/10 to 7 amperes rated at 125 volts or less. The fuses 1¼ amperes or less, are 1¼" long and fuses from 1-6/10 to 7 amperes are 1-7/16" long.

Nine Type HN fuseholders cover the range for the type N fuses. The intermediate steps are obtained by varying the width of the slot in the bayonet socket of the fuse holder and the width of the ears on the fuse ferrule.

Positive identification of the fuseholder and fuse is provided by stamping the type and ampere range on the socket of the fuseholder and the type and ampere rating on the end of the fuse eared cap. In other words, the socket of the fuseholder for the 1¼ to 1¾ ampere fast-acting fuses is stamped "HC 1¼ to 1¾" and the 1¾ ampere fast-acting fuse has its eared cap stamped "C 1¾" on its end.

Since the eared cap projects from the fuseholder, above the chassis, when the device is installed in the set, the re-

placement problem is simple. Both the rating of the fuse and the fuseholder are readily determined before removing the fuse and, if the improper fuse which may create a hazard is substituted in spite of the marking, it will not fit.

Since the "hot" ferrule of the fuse is exposed, the circuit must be shut off or an insulated tool used to remove the fuse if the voltage is dangerous. However, the "hot" ferrule provides a convenient test point in shooting trouble on the radio or television receiver.

From the above, it is seen that the Type H and C fuses with the type HC and HN fuseholders offer real electrical protection for radio and television receivers. The serviceman will see more and more of these devices in the years to come. ■ ■

NEW PROFIT MAKER...

Electenna

AUTO RADIO REPLACEMENT ANTENNA

Here's sales potential! Millions of car owners will welcome new Electenna... first and only replacement antenna that installs fast, using present mounting and wiring. Boosts radio reception; up to 100% gain over standard 54" antenna fully extended. Beautiful design, chrome finish. Short height avoids damage.

Retails profitably
for you at..... **\$5.95**

COILTENNA
Coil only without antenna. Easily installed. Gives same improved performance. Packed in colorful self-service counter display container. Retails at only \$3.95.



ELECTENNA DISPLAY BOARD
Large, colorful counter display given to dealer does outstanding self-service selling job!

Dealers! Jobbers! Write today!

Another Quality Product of

Electrend

PRODUCTS CORPORATION
St. Joseph, Mich.
Electronic Division



IDEA OF THE MONTH

Saves Time Handling Service Calls

No. 120 RADIO-TV SERVICE ORDER SIZE 4" x 7¼"

SUPPLIED WITH OR WITHOUT IMPRINT **\$2.95**

In triplicate with hard 3rd copy and one-time throw away carbons in each set. Ask for prices with your imprint. See them at your parts jobber. PER 100 SETS (no imprint)

WELL, don't just sit there...

WRITE FOR THE FREE STUFF NOW!

OELRICH PUBLICATIONS
4308 N. MILWAUKEE AVE. CHICAGO 41, ILL.

Send me FREE Service Order File, Sample Form, and Complete Catalog.

Name _____

Address _____

City _____ Zone _____ State _____

MODERN SWEEP GENERATOR DESIGN

[from page 11]

signal being dependent on its phase to the *ac* signal from the heater, it will be recalled that an *ac* signal is required to drive the horizontal time base of the oscilloscope used. This signal is available on the front panel connector marked "Scope" and is obtained from the heater supply referred to previously via another phase shifting device.

It will be seen then that these *ac* signals must be correctly interphased so that the pattern of *Fig. 9* is obtained. The phase shift produced by *C11* and *R14* is set and positively locked at the factory to insure that the blanking signal is correctly phased with respect to the signal on the modulator. The other phase shift may be adjusted by the panel knob marked "Phase." To determine the correct position for this control, the blanking switch should be turned to the "Off" position so that a trace similar to *Fig. 8* is obtained, and then the knob marked "Phase" should be rotated until a single trace is obtained. When this is done, the blanking switch should be turned to the "On" position to obtain the final desired signal response curve as in *Fig. 11*.

**The New NO-NOISE
TUNER TONIC**

with PERMA-FILM

Cleans, lubricates, restores all tuners including wafer type.

Won't change or affect capacities, inductance or resistance. Won't harm insulations or precious metals, nor attack plastics. For television, radio and FM. Eliminates all noise, oxidation and dirt indefinitely.

Non-toxic, non-inflammatory, insures trouble-free performance.

Net to servicemen **\$3.25**

Extra economical because a small amount does the job!



"NO NOISE"

Volume Control and Contact Restorer with Perma-Film

\$2.25

Cleans, lubricates, protects... Net to not a carbon-tet solution. Still service- available in the new 6 oz. men spray can.

2 oz. bottle \$1.00 Net to servicemen Also available in 8 oz. bottles and quart cans.

At your nearest distributor

ELECTRONIC CHEMICAL CORP.
813 Communipaw Avenue, Jersey City 4, N.J.



COMMUNITY CAMPAIGNS

Give... the United way

DON'T JUST SAY CAPACITORS

Ask For Sprague By
Catalog Number

Know what you're getting... get exactly what you want. Don't be vague... insist on Sprague. Use complete radio-TV service catalog C-610. Write Sprague Products Company, 71 Marshall Street, North Adams, Massachusetts.

SPRAGUE®

WORLD'S LARGEST
CAPACITOR MANUFACTURER

The NEW YEATS "Shorty" STATION WAGON & PANEL PICK-UP APPLIANCE DOLLY

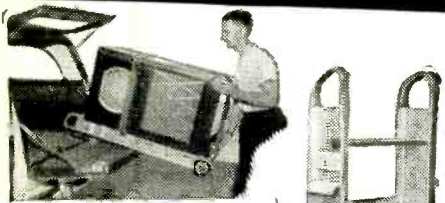

Only 47" tall, this new Yeats dolly is designed for TV and appliance men who make deliveries by station wagon or panel delivery. No need to detach appliance for loading... the YEATS "Shorty" will slide into your vehicle with ease. Has same aluminum alloy frame, 30 second strap ratchet and caterpillar step glide as the standard size YEATS dolly! See your dealer today!

YEATS "Everlast" COVERS & PADS



Furniture Pad

Washer Cover

SEND postcard for full information on our complete line TODAY!

YEATS appliance
dolly sales co.

2133 N. 12th St.

Milwaukee 5, Wis.

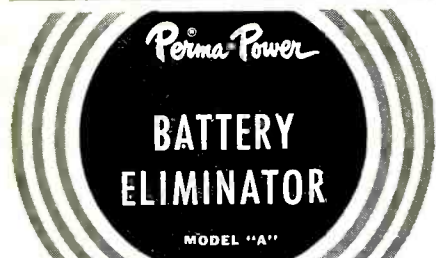

**Converts Battery Radio
to Electric Operation!**

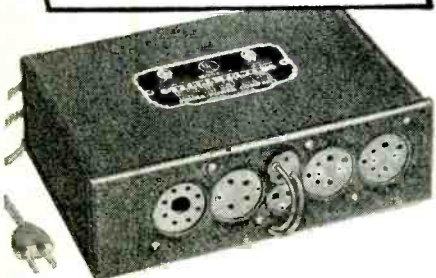

At All Distributors

manufactured by

Perma-Power COMPANY

4727 N. Damen Ave., Chicago 25, Ill.

manufacturers of electronic equipment since 1928

Export: SCHEEL INT., Chicago

Radiation Interference Elimination Means

To secure adequate operation as a sweep generator, the model 984 has been designed to minimize the chief causes of radiation interference. These radiations occur through the line cord and through the case. Radiation through the line cord is lowered to an effectively safe value by the insertion of a low pass filter in the two leads using C27, C28, L22, L23 and C29. To keep radiation through the case at the minimum possible level, the main oscillator compartment has its own separate inner shield fabricated of iron and all leads going through this inner shield to the oscillator are made by lead-through capacitors. By heavily plating this inner shield with copper, the effectiveness of the outer case of the instrument is also materially increased. ■ ■

SUBSTITUTION TESTER

[from page 20]

ance, might result in a mismatch (possibly causing ringing or foldover), if each had a different type of winding. The latter condition results from different stray-distributed capacitances for the yokes, thus, changing the inherent resonant frequency and operation of the flyback circuit. The best way to identify the type of yoke winding is to note the size of its window as indicated in Fig. 3.
(To Be Continued)

ANSWERMEN

[from page 21]

was breaking down was visible. However, this is unlikely in printed circuit panels and, as has been stated, evidence of panel material breakdown hasn't been seen and isn't expected.

You might inspect the printed circuits for a small piece of solder that has fallen and connected two or more portions of the printed wiring. However, even this is unusual.

In examining the schematic of the printed circuit panel PC103-B there is one component that could easily cause this difficulty. This component is shown

in a partial schematic of PC103-B, Fig. 2. In association with the 4.5 mc coil is a series resonating capacitor, C193, 9 μf . If this condenser were to develop a low resistance the exact symptoms as you are experiencing would occur. This condenser is a good choice for the cause because it most probably hasn't been checked, not being a likely suspect. Since it goes to ground through the coil from the plate voltage point it has sufficient potential across it to be a very good possible cause of the difficulty.

In fact, after investigating further it has been found that to prevent this possibility the voltage rating of this condenser has been increased. The condenser to be used in the circuit is a ceramic 9 $\mu\text{f} \pm 5\%$, 1000 volt rating. It has been noted that if this condenser should develop a complete short it might cause damage to the panel requiring its replacement.

HI-FI

[from page 30]

size and ease of soldering cannot be denied. Unfortunately, however, they have no provision for making a "locked" connection as do their senior XL and AN counterparts. As a result, the sleeves of these little connectors will often be found pulled part way out of the jack, causing an enormously high level of hum, enough to mask even the ungrounded audio signal. This symptom will usually be present if the "disconnect" has occurred in an early stage or component such as a preamplifier. Complete absence of sound with all electronic components working individually means, of course, a disconnect either at the input to the power amplifier or between amplifier and speaker terminals. A somewhat less likely cause would be an open speaker voice coil. This can be easily checked by applying two leads from a small flashlight battery to the speaker terminals. A sharp pop indicates that the voice coil is continuous. Intermittent interruption of audio. If not due to faulty components or switch contacts, will usually turn out to be faulty cabling between elements of the system. Do not overlook the possibility of a *short* between the outer and inner conductors of shielded cable, es-

TELE-SCOPIC PRODUCTS, INC.
215 W. 33rd St. • New York 1, N.Y.

Send checks or money orders only



**ABLE
3rd ARM
ADJUST-
FOR HOLDING
CHASSIS IN
POSITION ON
WORK BENCH**

\$5.50
each

BONUS DOLLARS
on every service call

carry a



TV LISTENER

IN YOUR TRUCK!

Increase your profits on every residential TV service call! Just put a Telex TV Listener in your kit or tool box and during the call, take out the Listener and tell Mrs. Housewife "Here's a wonderful little gadget that will give you some peace and quiet while the Kids are watching noisy Westerns". Explain how the TV Listener allows individual listening for one or two persons. How it doesn't disturb the picture. How the main speaker can be turned on and off. How the Listener is equipped with a 14' cord to allow normal viewing distance. And be sure to mention that by installing it NOW she can save an additional service call. Retail at only \$12.50 (list) complete with one earset. Additional earset at \$7.50 (list).

It's your key to BONUS DOLLARS on every service call. Use the handy coupon below and order a supply today.

TELEX, Inc., Dept. EA-118
Telex Park, St. Paul 1, Minn.

Send me TV Listeners, complete with one earset at \$7.50. Also send additional earsets at \$4.50.

My check for \$..... is enclosed. Ship postpaid.
 Ship C.O.D. I'll pay postage and charges.

NAME.....

ADDRESS.....

CITY and STATE.....

for service and lab. work

Heathkit PRINTED CIRCUIT OSCILLOSCOPE KIT FOR COLOR TV!

① Check the outstanding engineering design of this modern printed circuit Scope. Designed for color TV work, ideal for critical Laboratory applications. Frequency response essentially flat from 5 cycles to 5 Mc down only 1½ db at 3.58 Mc (TV color burst sync frequency). Down only 5 db at 5 Mc. New sweep generator 20-500,000 cycles, 5 times the range usually offered. Will sync wave form display up to 5 Mc and better. Printed circuit boards stabilize performance specifications and cut assembly time in half. Formerly available only in costly Lab type Scope. Features horizontal trace expansion for observation of pulse detail — retrace blanking amplifier — voltage regulated power supply — 3 step frequency compensated vertical input — low capacity nylon bushings on panel terminals — plus a host of other fine features. Combines peak performance and fine engineering features with low kit cost!

Heathkit TV SWEEP GENERATOR KIT ELECTRONIC SWEEP SYSTEM

② A new Heathkit sweep generator covering all frequencies encountered in TV service work (color or monochrome). FM frequencies too! 4 Mc — 220 Mc on fundamentals, harmonics up to 880 Mc. Smoothly controllable all-electronic sweep system. Nothing mechanical to vibrate or wear out. Crystal controlled 4.5 Mc fixed marker and separate variable marker 19-60 Mc on fundamentals and 57-180 Mc on calibrated harmonics. Plug-in crystal included. Blanking and phasing controls — automatic constant amplitude output circuit — efficient attenuation—maximum RF output well over .1 volt—vastly improved linearity. Easily your best buy in sweep generators.

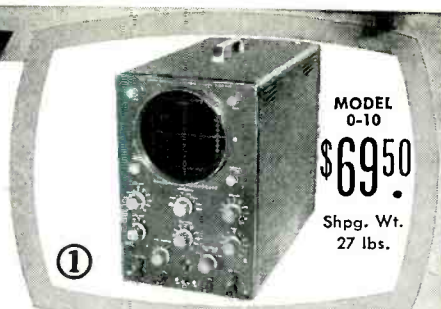

MODEL
0-10
\$69.50
Shpg. Wt.
27 lbs.



MODEL
TS-4
\$49.50
Shpg. Wt.
16 lbs.



As easy to use as a pencil

WALL

INDUSTRIAL
SOLDERING IRONS
give you

More
BTU's...

Faster
HEAT...

Higher HEAT
CONTINUITY

than ANY OTHER
soldering irons of equal tip size

Proved 4 times faster on the production lines of America's leading electronics firms. Complete range of sizes... scientifically designed... individually tested... for easier, surer precision work or heavy duty soldering. Operate on 110-120 volts, AC or DC! Model 18T illustrated, \$6.25 list.

Write for FREE Catalog

Exclusive
THERMOSTATIC ACTION...

Guaranteed for the life of the iron!
Prevents excessive tip burning!

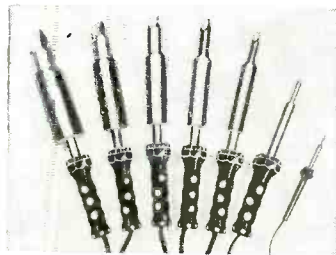

WALL MANUFACTURING CO.
Grove City, Pennsylvania

OVER 20,000,000 SOLDERING PRODUCTS SINCE 1864

pecially at the point of entry to the pin plug. Repeated removal and insertion of these pin plugs has a tendency to fray the insulation, especially if the customer pulls on the cable instead of on the plug when patching in various elements of his system.

Having discussed in this issue several and varied system types and faults very generally, we shall get down to specific components in the next installment, which will analyze "Separate Phonograph Preamplifiers—The First Step Towards Hi Fi". ■ ■

COMPACT METERS

[from page 33]

when actually using a piece of precision test equipment, we seldom realize the amount of bouncing around that the equipment takes when being transported from one job to the next. When the function switch is returned to the "transit" position after use, a complete short circuit is placed across the meter movement, which has the effect of damping or stiffening the action of the meter pointer, so that it does not move excessively with the vibration encountered in transit. The action can be readily understood if one considers the meter movement to be a small *dc* generator. Mechanical motion of the meter coil (affixed to the pointer) through the permanent magnet field surrounding it tends to generate a small voltage. Placing a short across this voltage is the same as loading the generator very heavily, or trying to draw infinitely large currents from it. Attempting to do so would require that more force be applied to move the armature (in this case the meter pointer). This means, in effect, that the pointer can take much more vibration for less actual movement.

The Model 777 VTVM

The vacuum tube voltmeter also shown in Fig. 1 is identical in size to the Model 666 described above. It, too, is supplied in a leather carrying case and has the same large, easy to read, meter face. Transit protection is afforded in this instrument when the function switch is in the "off" position. This unit has no less than 42 useful ranges including two zero-center scales for *fm* discriminator alignment. Of additional help to the serviceman is the inclusion of two peak-to-peak scales on the meter face. These scales are based upon the fact that a sine wave is 2.83 times as great in amplitude when measured from the most positive peak to the most nega-

tive as compared with the *rms* readings which are usually obtained with conventional meter movements. Fig. 5 illustrates this point. A sine wave having a peak amplitude of 10 volts, when measured with conventional meters will indicate a reading of 3.54 volts, *rms*. This reading is quite correct as far as Ohm's law and power calculations are concerned. Often, however, it is desirable to know the peak to peak value of a sine wave, or one that does not differ too much from the sinusoidal shape. For such applications, the necessity of

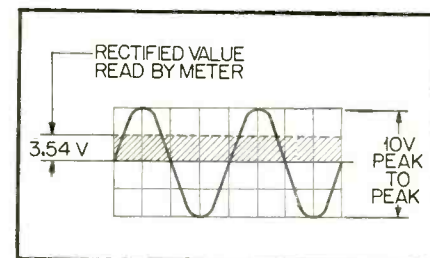

Fig. 5—Sine wave with peak value of 10 volts provides 3.45 V. rms.

multiplying by the inconvenient factor of 2.83 is eliminated.

Like its non-electronic mate, this unit has a fully illuminated meter face, easy-to-use chrome bar knobs and only two jacks for all measurements. All necessary accessories, including probes and line cord are neatly tucked into the carrying case, making the units ideally suited, singly or as a pair, for all outside work as well as for bench jobs. The circuit includes a time-proven balanced-bridge dual triode (12AU7) for the meter circuits and a dual-diode (12AL5) for rectification of *ac* voltage prior to application to the metering circuits.

Construction of both units represents advanced modular techniques and miniaturization carried out sensibly and without sacrificing good design and meter accuracy. ■ ■

AMPLIFIERS—(Audio, Hi-Fi, P. A.)

Allied Radio Corp.	100 N. Western Ave., Chicago 80, Ill.
Blonder-Tongue Labs, Inc.	526 North Ave., Westfield, N. J.
Bogen & Co., Inc., David Transvision, Inc.	29 Ninth Ave., New York 14, N. Y. 360 North Ave., New Rochelle, N. Y.

ANTENNAS

Amphenol Electronics Corp.	1830 S. 54th Ave., Chicago 50, Ill.
Channel Master Corp.	Ellenville, New York
Clear Beam Antenna Corp.	Canoga Park, Calif.
Cornell-Dubilier Electric Corp.	South Plainfield, New Jersey
Electrend Products Corp.	St. Joseph, Mich.
Finney Company, The	4612 St. Clair Ave., Cleveland 3, Ohio
Hi-Lo TV Antenna Corp.	3540 N. Ravenswood Ave., Chicago 13, Ill.
Holloway Electronics Corp.	Fort Lauderdale, Fla.
JFD Manufacturing Co., Inc.	6127 16th Ave., Brooklyn 4, N. Y.
Philco Corp.	Philadelphia 34, Pa.
Radiart Corp.	3455 Vega Ave., Cleveland 13, Ohio
Radio Merchandise Sales, Inc.	2016 Bronxdale Ave., New York 60, N. Y.
Snyder Mfg. Co.	22nd & Ontario Sts., Philadelphia 40, Pa.
Technical Appliance Corp.	919 Taylor Ave., Rockford, Ill.
Telec Electronics Mfg. Co.	Asbury Park, N. J.
Telrec, Inc.	Asbury Park, N. J.
Walco Electronics Corp.	3602 Crenshaw Blvd., Los Angeles 16, Cal.
Winegard Company	3000 Scotten Blvd., Burlington, Iowa

ANTENNA ACCESSORIES

Alliance Manufacturing Co.	Alliance, Ohio
Amphenol Electronics Corp.	1830 S. 54th Ave., Chicago 50, Ill.
Blonder-Tongue Labs, Inc.	526 North Ave., Westfield, N. J.
Channel Master Corp.	Ellenville, New York
General Cement Mfg. Co.	919 Taylor Ave., Rockford, Ill.
I. E. Manufacturing Co.	325 N. Hoyle Ave., Chicago 12, Ill.
JFD Manufacturing Co., Inc.	6127 16th Ave., Brooklyn 4, N. Y.
Jontz Manufacturing Co.	1101 E. McKinley Ave., Mishawaka, Ind.
Kenwood Engineering Co.	265 Colfax Ave., Kenilworth, N. J.
Mosley Electronics	8622 St. Charles Rock Rd., St. Louis 14, Mo.
Mueller Electric Co.	1583 E. 31st Street, Cleveland 14, Ohio
Philco Corp.	Philadelphia 34, Pa.
Radiart Corp.	3455 Vega Ave., Cleveland 13, Ohio
Radio Merchandise Sales, Inc.	2016 Bronxdale Ave., New York 60, N. Y.
South River Metal Products Co., Inc.	South River, New Jersey
Superex Electronics Corp.	6 Radford Place, Yonkers, N. Y.

BATTERIES

Burgess Battery Co.	Freeport, Illinois
RCA, (Tube Div.)	Harrison, New Jersey

BOOKS & MANUALS

Cisin, Harry G.	Amagansett, N. Y.
Cowan Publishing Corp.	67 West 44th Street, New York 36, N. Y.
Electronic Publishing Co.	180 N. Wacker Drive, Chicago 6, Ill.
Rider, John F. Publisher	480 Canal Street, New York 13, N. Y.
Sams, Howard W. & Co., Inc.	2201 E. 46th Street, Indianapolis 5, Ind.
United Catalog Publishers	110 Lafayette Street, New York 13, N. Y.

BUSINESS ORDER FORMS

Electronic Publishing Co.	180 N. Wacker Drive, Chicago 6, Ill.
Oelrich Publications	4308 N. Milwaukee Ave., Chicago 41, Ill.

CAPACITORS

Aerovox Corp.	New Bedford, Mass.
Astron Corp.	255 Grant Ave., East Newark, N. J.
Centralab, Div. of Globe-Union	900 E. Keefe Ave., Milwaukee 1, Wisc.
Cornell-Dubilier Electric Corp.	South Plainfield, New Jersey
Eric Resistor Corp.	Eric, Pa.
Illinois Condenser Co.	1616 N. Throop St., Chicago 22, Ill.
Planet Sales Corp.	225 Belleville Ave., Bloomfield, N. J.
Pyramid Electric Co.	1445 Hudson Blvd., North Bergen, N. J.
Sprague Products Co.	71 Marshall Street, North Adams, Mass.

CHEMICALS, SPRAYS, LUBRICANTS

Electronic Chemical Corp.	813 Communipaw Ave., Jersey City 4, N. J.
General Cement Mfg. Co.	919 Taylor Ave., Rockford, Ill.
Great Eastern Mfg. Co.	165 Remsen Ave., Brooklyn 12, N. Y.
Krylon, Inc.	Ford & Washington Sts., Norristown, Pa.
Quietrol Co., Inc.	Spartanburg, South Carolina
Superex Electronics Corp.	6 Radford Place, Yonkers, N. Y.
Telematic Industries, Inc.	16 Howard Ave., Brooklyn 21, N. Y.
Walco Electronics Corp.	3602 Crenshaw Blvd., Los Angeles 16, Cal.

CHOKES, COILS & TRANSFORMERS (RF)

Aero Electric Corp.	468 Water Street, Cuba, New York
Chicago Standard Transformer Corp.	3501 Addison Street, Chicago 18, Ill.
Merit Coil & Transformer Corp.	4427 N. Clark Street, Chicago 40, Ill.
Miller, J. W. Company	5917 S. Main Street, Los Angeles 3, Cal.
Superex Electronics Corp.	6 Radford Place, Yonkers, N. Y.
Triad Transformer Corp.	4055 Redwood Ave., Venice, Calif.

CHOKES, COILS & TRANSFORMERS (Audio and Line Freq.)

Aero Electric Corp.	468 Water Street, Cuba, New York
Chicago Standard Transformer Corp.	3501 Addison Street, Chicago 18, Ill.
Delco Radio (Div. of General Motors Corp.)	Kokomo, Indiana
Merit Coil & Transformer Corp.	4427 N. Clark Street, Chicago 40, Ill.
Perma-Power Company	4721 N. Damen Ave., Chicago 25, Ill.
Triad Transformer Corp.	4055 Redwood Ave., Venice, Calif.

CHOKES, COILS & TRANSFORMERS (Deflection & Focusing)

Aero Electric Corp.	468 Water Street, Cuba, New York
Chicago Standard Transformer Corp.	3501 Addison Street, Chicago 18, Ill.
Great Eastern Mfg. Co.	165 Remsen Ave., Brooklyn 12, N. Y.
Merit Coil & Transformer Corp.	4427 N. Clark Street, Chicago 40, Ill.
Perma-Power Company	4721 N. Damen Ave., Chicago 25, Ill.
Ram Electronic Sales Co.	Irvington, New York
Superex Electronics Corp.	6 Radford Place, Yonkers, N. Y.
Triad Transformer Corp.	4055 Redwood Ave., Venice, Calif.

CONNECTORS, PLUGS

Blonder-Tongue Labs, Inc.	526 North Ave., Westfield, N. J.
Cannon Electric Co.	P. O. Box #75, Los Angeles 31, Calif.
Eby Sales Co. of N. Y.	130 Lafayette Street, New York 13, N. Y.
General Cement Mfg. Co.	919 Taylor Ave., Rockford, Ill.
Mosley Electronics	8622 St. Charles Rock Rd., St. Louis 14, Mo.
Radio Merchandise Sales, Inc.	2016 Bronxdale Ave., New York 60, N. Y.

FUSES

Bussmann Mfg. Co.	University and Jefferson, St. Louis 7, Mo.
Littelfuse, Inc.	4751 N. Ravenswood Ave., Chicago 40, Ill.

BUYER'S DIRECTORY OF ADVERTISED PRODUCTS

• This department is an additional service to our readers and advertisers. It is not intended to cover all products in all categories, nor is it intended to cover all products made by any manufacturer.

• The classifications are broad. Under each is listed the name and address of only those manufacturers who have, in the recent past, or who are currently advertising these particular products in this publication.

• This service is not a part of the advertiser's contract. The listings may change in future issues. Every reasonable precaution is taken to avoid errors and omissions.

HARDWARE

I. E. Manufacturing Co.	325 N. Hoyle Ave., Chicago 12, Ill.
Kenwood Engineering Co.	265 Colfax Ave., Kenilworth, N. J.
Mueller Electric Co.	1583 E. 31st Street, Cleveland 14, Ohio
South River Metal Products Co., Inc.	South River, New Jersey
Television Hardware Mfg. Co.	919 Taylor Ave., Rockford, Ill.
Walco Electronics Corp.	3602 Crenshaw Blvd., Los Angeles 16, Cal.

MICROPHONES, Stands & Accessories

American Microphone Co.	370 S. Fair Oaks Ave., Pasadena 3, Cal.
Atlas Sound Corp.	1446 39th Street, Brooklyn 18, N. Y.
Shure Bros., Inc.	222 Hartrey Avenue, Evanston, Ill.

PHONOGRAPH NEEDLES

Jensen Industries, Inc.	342 S. Wood Street, Chicago 12, Ill.
Permo, Inc.	6415 N. Ravenswood Ave., Chicago 26, Ill.
Recoton Corp.	52-35 Barnett Ave., Long Island City 4, N. Y.
Walco-Electrovox Co., Inc.	60 Franklin Street, East Orange, N. J.

PHONOGRAPH PICKUPS & CARTRIDGES

American Microphone Co.	370 S. Fair Oaks Ave., Pasadena 3, Cal.
Electro-Voice, Inc.	Buchanan, Michigan
Shure Brothers, Inc.	222 Hartrey Avenue, Evanston, Ill.
Sonotone Corp.	Elmsford, New York

POWER SUPPLIES (Converters & Inverters)

American Television & Radio Co.	300 East First St., St. Paul 1, Minn.
Electro Products Labs, Inc.	4501 N. Ravenswood Ave., Chicago 40, Ill.
Perma-Power Company	4721 N. Damen Ave., Chicago 25, Ill.
Vokar Corporation	Dexter 2, Michigan

RESISTORS & CONTROLS

Aerovox Corp.	New Bedford, Mass.
Centralab, Div. of Globe-Union	900 E. Keefe Ave., Milwaukee 1, Wisc.
Clarostat Mfg. Co., Inc.	Dover, New Hampshire
Delco Radio, Div. of General Motors Corp.	Kokomo, Indiana
Eric Resistor Corp.	Eric, Pa.
International Resistance Co.	401 N. Broad St., Philadelphia 8, Pa.

SEMI-CONDUCTORS

CBS-Hytron	100 Endicott Street, Danvers, Mass.
Federal Telephone & Radio Corp.	100 Kingsland Road, Clifton, N. J.
General Electric Co.	Schenectady, New York
Philco Corp.	Philadelphia 34, Pa.
RCA, (Tube Div.)	Harrison, New Jersey
Raytheon Mfg. Company	Newtown, Mass.
Tarzian Inc., Sarkes	415 N. College Ave., Bloomington, Ind.
Tung-Sol Electric, Inc.	95 Eighth Ave., Newark 4, N. J.

SERVICING AIDS

Allied Radio Corp.	100 N. Western Ave., Chicago 80, Ill.
American Phenolic Corp.	1830 S. 54th Ave., Chicago 50, Ill.
Belden Manufacturing Co.	4647 W. Van Buren St., Chicago 80, Ill.
Blonder-Tongue Labs, Inc.	526 North Ave., Westfield, N. J.
Colman Tool & Machine Co.	P. O. Box 7026, Amarillo, Tex.
Columbia Wire & Supply Co.	2850 Irving Park Road, Chicago 18, Ill.
Deep River, Conn.	Deep River, Conn.
Electronic Publishing Co.	180 N. Wacker Drive, Chicago 6, Ill.
General Cement Mfg. Co.	919 Taylor Ave., Rockford, Ill.
Mall Tool Company	7740 South Chicago Ave., Chicago 19, Ill.
Oelrich Publications	4308 N. Milwaukee Ave., Chicago 41, Ill.
Quietrol Co., Inc.	Spartanburg, South Carolina
Ram Electronic Sales Co.	Irvington, New York
Telec Products, Inc.	215 W. 33rd Street, New York 1, N. Y.
Ungar Electric Tools, Inc.	P. O. Box 312, Venice, Calif.
United Catalog Publishers	110 Lafayette Street, New York 13, N. Y.
Vaco Products Co.	317 E. Ontario Street, Chicago 11, Ill.
Wall Mfg. Co.	Grove City, Pa.
Wen Products, Inc.	5806 Northwest Highway, Chicago 31, Ill.
Xcelite, Inc.	Thorne Ave. and Bank St., Orchard Park, N. Y.
Yeats Appliance Dolly Sales Co.	2133 N. 12th Street, Milwaukee 5, Wisc.

SPEAKERS (including phones)

Atlas Sound Corp.	1446 39th Street, Brooklyn 18, N. Y.
Delco Radio, Div. of General Motors Corp.	Kokomo, Indiana
Jensen Mfg. Company	6601 S. Laramie Ave., Chicago 38, Ill.

North American Philips Co., Inc.	100 East 42nd Street, New York 17, N. Y.
Oxford Electric Corp.	3911 S. Michigan Ave., Chicago 15, Ill.
Philco Corp.	1247 Belmont Ave., Chicago 13, Ill.
Quam-Nichols Company	Marquette Rd. & Prairie Ave., Chicago 37, Ill.
Telex	Telex Park, St. Paul, Minn.
University Loudspeakers, Inc.	80 S. Kensico Ave., White Plains, N. Y.

SPEAKER ENCLOSURES

Jensen Mfg. Company	6601 S. Laramie Ave., Chicago 38, Ill.
Transvision, Inc.	460 North Ave., New Rochelle, N. Y.
University Loudspeakers, Inc.	80 S. KENSICO AVE., White Plains, N. Y.

TEST EQUIPMENT & INSTRUMENTS

American Scientific Development Co.	334 S. Main St., Fort Atkinson, Wisc.
B & K Manufacturing Co.	3731 N. Southport, Chicago 13, Ill.
Central Electronics, Inc.	84 Withers Street, Brooklyn 11, N. Y.
Electronic Instrument Company (EICO)	13224 Livernois Avenue, Detroit 38, Mich.
Electronic Test Instrument Corp.	Whitewater, Wisc.
General Electronic Research Co.	Benton Harbor, Michigan
Heath Company, The	10533 Dupont Ave., Cleveland 8, Ohio
Hickok Electrical Instrument Co.	320 S. Arroyo Parkway, Pasadena, Calif.
Hycos Electronics, Inc.	16 S. Patterson Blvd., Dayton 2, Ohio
Jackson Electronic Instrument Co.	326 Lincoln St., Manchester, N. H.
Leitch Engineering Co.	38 Murray Street, New York 7, N. Y.
Moss Electronic Distributing Co., Inc.	151 Pasadena Ave., South Pasadena, Calif.
Phastron Company	Philadelphia 34, Pa.
Precision Apparatus Co., Inc.	70-31 84th Street, Glendale 27, L. I., N. Y.
Proscope Co.	44-05 30th Ave., Long Island City 3, N. Y.
Radio City Products Co., Inc.	Centre & Glendale Sts., Easton, Pa.
Research Inventions & Mfg. Co.	617 F Street, N. W., Washington 1, D. C.
Seco Mfg. Co.	5015 Penn Avenue South, Minneapolis, Minn.
Simpson Electric Company	5200 W. Kinzie Street, Chicago 44, Ill.
Superior Instruments Co.	2435 White Plains Rd., New York 67, N. Y.
Telematic Industries, Inc.	16 Howard Ave., Brooklyn 21, N. Y.
Teletest Instrument Corp.	31-01 Linden Place, Flushing 54, N. Y.
Triplet Electrical Instrument Co.	Bartton, Ohio
Weston Electrical Instrument Corp.	614 Frelinghuysen Ave., Newark 1, N. J.
Winton Electronics, Inc.	4312 Main Street, Philadelphia 27, Pa.

TOOLS

Electric Soldering Iron Co.	Deep River, Conn.
General Cement Mfg. Co.	919 Taylor Ave., Rockford, Ill.
Ohmite Manufacturing Co.	3640 W. Howard Street, Skokie, Illinois
Philco Corp.	Philadelphia 34, Pa.
Krauter & Co., Inc.	583 18th Avenue, Newark, N. J.
Mall Tool Company	7740 S. Chicago Ave., Chicago 19, Ill.
Tele-Scopic Products, Inc.	215 W. 33rd Street, New York 1, N. Y.
Ungar Electric Tools, Inc.	P. O. Box 312, Venice, Calif.
Vaco Products Co.	317 E. Ontario St., Chicago 11, Ill.
Wall Mfg. Co.	Grove City, Pa.
Walco Electronics Corp.	3602 Crenshaw Blvd., Los Angeles 16, Cal.
Wen Products, Inc.	5806 Northwest Highway, Chicago 31, Ill.
Xcelite, Inc.	Thorne Ave. and Bank St., Orchard Park, N. Y.

TUBES—CRT & RECEIVING

Barry Electronics Corp.	512 Broadway, New York 12, N. Y.
CBS-Hytron	100 Endicott Street, Danvers, Mass.
Ceco Electronics Co.	100 Endicott Street, Danvers, Mass.
Delco Radio, Div. of General Motors Corp.	Kokomo, Indiana
Federated Television Mart	513 Rogers Ave., Brooklyn 25, N. Y.
General Electric Co.	Schenectady, N. Y.
Philco Corp.	Philadelphia 34, Pa.
RCA, (Tube Div.)	Harrison, N. J.
Raytheon Mfg. Company	Newtown, Mass.
Tung-Sol Electric, Inc.	95 Eighth Ave., Newark 4, N. J.

VIBRATORS

American Television & Radio Co.	300 E. First Street, St. Paul 1, Minn.
Cornell-Dubilier Electric Corp.	South Plainfield, New Jersey
Delco Radio, Div. of General Motors Corp.	Kokomo, Indiana
Radiart Corp.	3455 Vega Ave., Cleveland 13, Ohio
Vokar Corporation	Dexter 2, Michigan

WIRE—CABLE—HARNESSES

American Phenolic Corp.	1830 S. 54th Ave., Chicago 50, Ill.
Belden Manufacturing Co.	4647 W. Van Buren St., Chicago 80, Ill.
Columbia Wire & Supply Co.	2850 Irving Park Road, Chicago 18, Ill.
Eby Sales Co. of N. Y.	130 Lafayette St., New York 13, N. Y.
Federal Telephone & Radio Corp.	100 Kingsland Road, Clifton, N. J.
Jersey Specialty Co.	Burgess Street, Mountain View, N. J.

**DON'T JUST SAY
CAPACITORS**

Ask For Sprague By
Catalog Number

Know what you're getting . . .
get exactly what you want.
Don't be vague . . . insist on
Sprague. Use complete radio-
TV service catalog C-610. Write
Sprague Products Company,
71 Marshall Street, North
Adams, Massachusetts.

SPRAGUE
WORLD'S LARGEST CAPACITOR MANUFACTURER

Only the 5 TOP-QUALITY brands of

STANDARD BRAND TUBES

AT SENSIBLE PRICES

• 90 Day RETMA Guarantee • Brand New
• 1st quality only • Individually boxed

FREE! Newest handy air-mail order form for your ordering convenience.—Free!
• Lists ALL popular TV & radio types.
• Makes mail-ordering a real pleasure.
• Orders over \$25.00 (with remittance) postpaid

024	.60	6AS6	2.25	7F8	1.20
1AX2	1.15	6AS8	1.20	7G7	1.15
1B3GT	.95	6AT6	.60	7H7	.85
1H5GT	.80	6AT8	1.10	7J7	1.35
1L4	.85	6AU4GT	1.10	7K7	1.20
1L6	1.10	6AU5GT	1.25	7L7	1.15
1LA4	1.00	6AU6	.75	7N7	.95
1LA6	1.00	6AU7	.90	7Q7	1.00
1LB4	1.00	6AV5GT	1.20	7R7	1.30
1LC5	1.00	6AV6	.60	7V7	1.30
1LC6	1.00	6AW8	1.20	7W7	1.30
1LD5	1.00	6AX4GT	.90	7X7	1.00
1LE3	1.00	6AX5GT	.90	7Y4	.70
1LG5	1.00	6BA6	.70	7Z4	.70
1LH4	1.00	6BA7	.90	2A4	.85
1LN5	1.00	6B4	1.00	2A5	.70
1N5GT	.95	6BC5	.75	2AQ5	.75
1Q5GT	1.15	6BC7	1.25	2AT6	.65
1R4	1.00	6BD5	1.40	2AT7	1.00
1R5	.85	6BD6	.75	2AU6	.70
1S4	.90	6RE6	.75	2AU7	.85
1S5	.75	6BF5	.90	2AV6	.65
1T4	1.00	6BF6	.70	2B7	1.35
1T5GT	1.05	6BG6G	.85	2AW6	1.00
1U4	.80	6BH6	.90	2AX4GT	1.00
1U5	.75	6BJ6	.85	2AX7	.90
1V2	.95	6BK5	1.15	2AY7	1.75
1X2B	.70	6BK7A	1.15	2AZ7	.95
2A4A	1.00	6BL7GT	1.25	2BA4	.90
2D21	1.00	6BN6	1.40	2BA6	.70
2X2	.50	6BQ6GTA	1.45	2BA7	.75
3A3	1.10	6BX7GT	1.30	2BD6	.75
3A4	.55	6BY5G	1.25	2BE6	.75
3A5	.75	6BZ6	.80	2BF6	.70
3AL5	.70	6BZ7	.80	2BH7A	1.00
3AU6	.75	6C4	1.35	2BQ6GTB	1.45
3AV6	.65	6C5	.80	2BX7	.90
3BA6	.75	6CB5	4.50	2BY7A	1.05
3BC5	.80	6CB6	.75	2BZ7	1.10
3BE6	.75	6CD6G	1.90	2CA5	.80
3BN6	1.35	6CF6	.90	2CUG	1.45
3BY6	.90	6C7	.90	2L6	.80
3BZ6	.80	6CL6	1.20	2SA7GT	1.00
3CB6	.85	6CM6	.85	2SC7	.80
3CF6	.85	6CS6	.75	2S17	.75
3CS6	.80	6CU6	1.45	2SK7GT	.80
3L4	1.20	6DC6	.95	2SL7GT	1.00
3Q4	.85	6DE6	.80	2SN7GT	1.10
3Q5GT	1.00	6FF5	.85	2SQ7GT	.75
3S4	.80	6F6G	.80	2V6GT	.80
3V4	.85	6H6	.75	2W6GT	.95
4BQ7A	1.30	6J4	3.95	4A4	1.00
4BZ7	1.35	6J5	.75	4A5	1.50
5AM8	1.05	6J6	.70	4A7	.85
5AN8	1.10	6K6GT	.75	4A7F	1.00
5AQ5	.75	6K7	.90	4B6	.85
5AS8	1.10	6K8	1.25	4C7	1.00
5AT8	1.10	6L6GA	1.30	4E6	1.20
5AY8	1.15	6L6M	1.75	4E7	1.30
5AW4	1.15	6N7	1.20	4F9	1.00
5AZ4	.60	6O7	1.00	4H7	1.00
5BK7	1.10	6S4	.70	4N7	1.00
5J6	.95	6S8GT	1.10	4N7	1.00
5T4	1.75	6SA7GT	.90	4Q7	.95
5T8	1.10	6SC7	1.00	4R7	1.30
5U4G	.70	6SF5	.75	4S7	1.25
5U4GB	.75	6SF7	.95	4S7	1.25
5UB	1.10	6SC7	.95	4T8	1.20
5V4G	1.00	6SH7	1.00	25AV5GT	1.30
5V6GT	.70	6SJ7M	.85	25AX4GT	1.10
5W4GT	.70	6SK7GT	.85	25BK5	1.10
5X4G	.80	6SL7GT	1.00	25BQ6GTB	1.45
5Y8	1.05	6SN7GT	.90	25CD6GA	1.85
5YGT	.60	6SO7GT	.75	25CUG	1.45
5Y4G	.65	6ST7	.75	25LGT	.75
5Z3	.80	6T4	1.30	25W4GT	.85
5Z4	1.25	6T8	1.10	25Z5	.80
6AGT	1.10	6U8	1.10	25Z6GT	.85
6AB4	.70	6V3A	1.50	35A5	.75
6AC5GT	1.15	6V6GT	.75	35B5	.70
6AC7	1.15	6V8M	1.35	35C5	.70
6AD7G	1.55	6W4GT	.80	35L6GT	.65
6AF4	1.35	6W6GT	.95	35W4	.55
6AF6G	1.20	6X4	.55	35Y4	.75
6AG5	.80	6X5GT	.55	35Z5	.60
6AG7	1.35	6X8	1.20	41	.85
6AH4GT	1.00	6Y6G	.95	42	.75
6AH6V	1.05	7A5	.95	43	.85
6A15	1.75	7A6	.80	50A5	.75
6AK5	.80	7A7	.85	50B5	.75
6AK6	.80	7A8	.80	50C5	.75
6AL5	.65	7A7	1.00	50L6GT	.75
6AL7GT	1.65	7AH7	1.00	50X6GT	.90
6AM4	1.55	7B4	.80	50Y6GT	1.00
6AM8	1.15	7B5	.70	50Y7GT	.90
6AN4	1.50	7B6	1.00	70L7GT	1.55
6AN5	3.50	7B7	.80	80	.65
6AN8	1.20	7B8	.90	117L7GT	2.50
6AQ5	.75	7C5	.80	117N/P7	2.00
6AQ6	.60	7C6	1.00	11Z3	.80
6AQTGT	1.25	7C7	.85	11Z4GT	1.15
6AR5	.75	7Z7	1.20	11Z6GT	1.15
6AS5	.80	7F7	.90	5642	1.00

We stock over 1000 types including Diodes, Transistors, transmitting and Special Purpose types.

TERMS: 25% with order, balance C.O.D. All merchandise guaranteed. F.O.B., N.Y.C.

BARRY ELECTRONICS CORP.
Dept. SD
512 Broadway, N. Y. 12, N. Y.
Call us day or night
24-hour telephone service
Walker 5-7000

COLOR VIDEO IF ANALYSIS [from page 17]

P14-1 (41.25 mc). L4-2 (41.25 mc) is detuned several turns to allow sufficient 41.25 mc signal to reach the 2nd detector and P14-1 is adjusted for minimum VTVM deflection. Now the VTVM is reconnected through a high impedance crystal probe (Fig. 11) to pin 5 (plate) of V7 and L4-2 is retuned for minimum VTVM deflection.

Step 3

To adjust the sound level pot P4-1, a 43.4 mc signal is fed into the mixer jig through a 30 db pad (Fig. 9) and the signal generator output is adjusted so that the VTVM reading is $-3V$. (Note exact value of reading). If sufficient signal strength cannot be obtained for this reading then dispense with the mixer jig and feed the pad directly in at the mixer grid.

Now the frequency of the signal generator is switched to 41.25 mc, the pad removed, and with the signal generator output settings unchanged the pot is adjusted for the same VTVM output as before ($-3V$). Thus, the sound level pot is made to provide an attenuation of 30 db to the 41.25 mc sound signal.

Up to this point we have made adjustments designed to attenuate the undesired adjacent channel signals and the associated sound signal. In the following steps which involve the shaping of the *if* bandpass, the oscilloscope deflection should not exceed 5V p-p. If greater deflections are observed the signal generator output should be reduced accordingly.

Step 4

The sweep generator (and marker) set at 41.7 mc to 45 mc, with a sweep covering the range between 40 mc and 50 mc is connected to pin 2 (control grid) of V8. The high side of the scope is connected at the junction of L14-4 and R14-1 and the low side to ground.

Step 5

We now proceed to align the *if* bandpass of the last stage L8-4 and L8-2 are adjusted to obtain the curve shown in Fig. 12A. If a flat top cannot be obtained, the amplitudes of the points of the curve at 45.75 mc and 41.7 mc should be as high as possible *but equal*.

Step 6

Advancing to the three bifilar stages preceding the last *if* stage, the sweep and marker signals are fed into pin 1 (control grid) of V5 and the slugs of T6-1, T5-4, and T7-1 are adjusted to obtain the curve shown in Fig. 12B. Again, as in the previous adjustment, if a flat top cannot be obtained the 41.7 mc and 45.75 mc points should be adjusted for maximum and equal amplitudes.

Step 7

We are now ready to align the *if* stage preceding the bifilar trio. First the scope is connected through a low impedance crystal probe to pin 5 (plate) of V5 (2nd pix IF amp). Then the sweep and marker are fed into pin 1 (control grid) of V4 the 1st pix IF amp., and L4-4 and L5-1 are adjusted to obtain the curve shown in Fig. 12C.

Step 8

With the scope connected as above the sweep generator is connected to the jig which is placed over the mixer tubes. L4-3 is now adjusted to obtain the curve shown in Fig. 12D.

Step 9

The final response shown in Fig. 12E is obtained by reconnecting the scope across R14-1 (the sweep and marker generator connections remain unchanged) and retouching the bifilar transformer slugs T6-1, T5-4, and T7-1.

It is customary, for best results to repeat steps 2 and 3 involving readjustment of L4-2 and the sound level trap in the *if* section located between the tuner and V4 the 1st pix IF amp. The video *if* alignment is now complete.

The reader should be cognizant of the fact that different receivers will require different procedures and techniques. However, the general overall principles of alignment are essentially the same as those covered in the preceding discussion. It might also be pointed out that a wideband *if* system is obviously much more complex than a narrow one. For this reason the added complexity of a compensating chroma channel appears to be economically feasible.

for all your
**Exact Replacement
TV TRANSFORMERS**

Specify Stancor

FREE
STANCOR TV Transformer Replacement Guide listing over 8000 models and chassis of 117 manufacturers... also STANCOR Auto Radio Replacement Guide with replacement data on over 540 auto radios of 40 manufacturers. Available from your distributor or by writing Chicago Standard.



**CHICAGO STANDARD
TRANSFORMER CORPORATION**
3586 Elston Avenue • Chicago 18, Illinois

QUICK-CHANGE 5AXP4 HOLDER

Permits
Speedy
Yoke
Changing

\$3.25
each

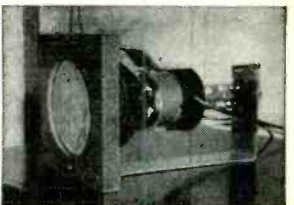

TELE-SCOPIC PRODUCTS, INC.
215 W. 33rd St. • New York 1, N. Y.

DON'T JUST SAY CAPACITORS

Ask For
Sprague
By Catalog
Number

Know what you're getting
get exactly what you want
Don't be vague... insist on
Sprague. Use complete radio-
TV service catalog C-610. Write
Sprague Products Company,
71 Marshall Street, North
Adams, Massachusetts.

SPRAGUE

WORLD'S LARGEST
CAPACITOR MANUFACTURER

Advertisers' Index

Barry Electronics Corp.	48
Bussmann Manufacturing Co.	17
CBS-Hytron	7
Chicago Standard Transformer Corp.	48
Electrend Products Corp.	44
Electronic Chemical Corp.	44
Electronic Publishing Co.	39
Heath Company	46
Jensen Manufacturing Co.	13
Merit Coil & Transformer Corp.	37
North American Phillips Co., Inc.	38
Oelrich Publications	44
Perma-Power Company	45
RCA Batteries	Cover 3
RCA Tubes	Cover 4
Radiart Corporation	11
Raytheon Manufacturing Co.	2
Sams, Howard W & Co.	3
Sonotone Corporation	1
Sprague Products Company	44, 47, 48
Technical Appliance Corp.	5
Telex, Inc.	45
Triplett Electrical Instrument Company	Cover 2
Wall Manufacturing Co.	46
Yeats Appliance Dolly Sales Co.	45



Get in the swim for bigger profits...

STOCK AND SELL RCA RADIO BATTERIES

Your customers are going "on vacation" every day now—and wherever they go, along go their portables! Catch this rising tide of portable battery business—stock, promote, and sell RCA Radio Batteries. RCA offers you the brand-name customers go out of their way to buy—a famous emblem that pre-sells *for you*. RCA backs you up with the most extensive sales promotion program in the radio-battery industry, featuring the powerful theme: "PORTABLES COME TO LIFE WITH RCA BATTERIES... *radio engineered for extra listening hours.*" Your RCA Distributor is ready now to help you make this your biggest battery season ever. See him soon. He'll get you right in the swim for bigger profits—with RCA Batteries.



RADIO BATTERIES

RADIO CORPORATION OF AMERICA • HARRISON, N. J.



Quiet!
RCA
Salesman
at
work



(Frames from the famous
RCA "SILVERAMA Song"
TV Commercial now
showing on such top
TV programs as
Martha Raye, Milton
Berle and the NBC
Spectaculars—in color!)

How RCA pre-sells your customers on

RCA Silverama SUPER-ALUMINIZED
PICTURE TUBES

Millions of TV listeners see and hear about RCA's great super-aluminized SILVERAMA line on TV, radio—in Life, Saturday Evening Post, TV Guide—week in and week out.

That's why your customers, who want the best, expect you to install SILVERAMA when their picture tubes need replacement. They've been told about RCA's "Advanced Technique" Aluminizing, RCA's super-phosphors, RCA's pin-point focus electron gun—and they know there is a SILVERAMA made to fit virtually every make and model TV.

If you believe in making satisfied customers, just as RCA does, don't let 'em down. Install the tube that provides maximum light output and picture clarity—an RCA SILVERAMA. *They'll* be glad you did!



PICTURE TUBES

Radio Corporation of America • Harrison, N. J.

COWAN PUBLISHING CORP., 67 West 44th Street, New York, 36, N. Y.

SERVICE DEALER
and **ELECTRONIC SERVICING**

44 16 MAY 57 A
PROP
MICH