

SEPTEMBER, 1954

SEP 24 1954

*Radio-Television*  
**SERVICE  
DEALER**

**TV - AM - FM - SOUND**

*Includes*  
3  
*Sections*

- 1. VIDEO SPEED SERVICING SYSTEMS**
- 2. TV FIELD SERVICE DATA SHEETS**
- 3. COMPLETE TV SERVICE INFORMATION SHEETS**



**The Professional Radio-TVman's Magazine**  
Reaching Every Radio TV Service Firm Owner in the U.S.A.



your **IRC** distributor can

# Save

you over

# 50%



on IRC Type BT 1/2 Watt and 1 Watt Resistors  
in new handy RESIST-O-CARD form

*if you buy now!*

*Here's your special price selection*

| ASSORTMENT NUMBER | IRC RESISTOR TYPE | QUANTITY ON CARD              | BALANCED ASSORTMENT OF | COST IF BOUGHT SINGLY | SPECIAL DEALER PRICE |
|-------------------|-------------------|-------------------------------|------------------------|-----------------------|----------------------|
| Resist-O-Card #15 | BTS<br>1/2 watt   | 100<br>most popular resistors | 20<br>values           | \$12.00<br>net        | <b>\$5.95</b>        |
| Resist-O-Card #16 | BTS<br>1/2 watt   | 100<br>often needed resistors | 57<br>values           | \$12.00<br>net        | <b>\$5.95</b>        |
| Resist-O-Card #17 | BTA<br>1 watt     | 74<br>most popular resistors  | 20<br>values           | \$13.32<br>net        | <b>\$6.59</b>        |
| Resist-O-Card #18 | BTA<br>1 watt     | 74<br>often needed resistors  | 45<br>values           | \$13.32<br>net        | <b>\$6.59</b>        |

For a Limited Time Your IRC Distributor has popular, balanced assortments of BTS and BTA resistors in handy RESIST-O-CARD form. IRC RESIST-O-CARDS SAVE YOU OVER 50% of the regular cost of IRC resistors.

**Distributor RESIST-O-CARD Stocks are Limited. Order now and save real money!**

- ✓ Choose from 4 Resist-O-Card assortments. In combination they give complete coverage.
- ✓ Resist-O-Cards are factory-packed from current IRC production.
- ✓ Handy card-mounted stocks. Hang right at service bench ready to use.
- ✓ Individual ranges and RETMA Color Code Chart on each card.



INTERNATIONAL RESISTANCE COMPANY  
Wherever the Circuit Says 413 N. Broad St., Philadelphia 8, Pa.

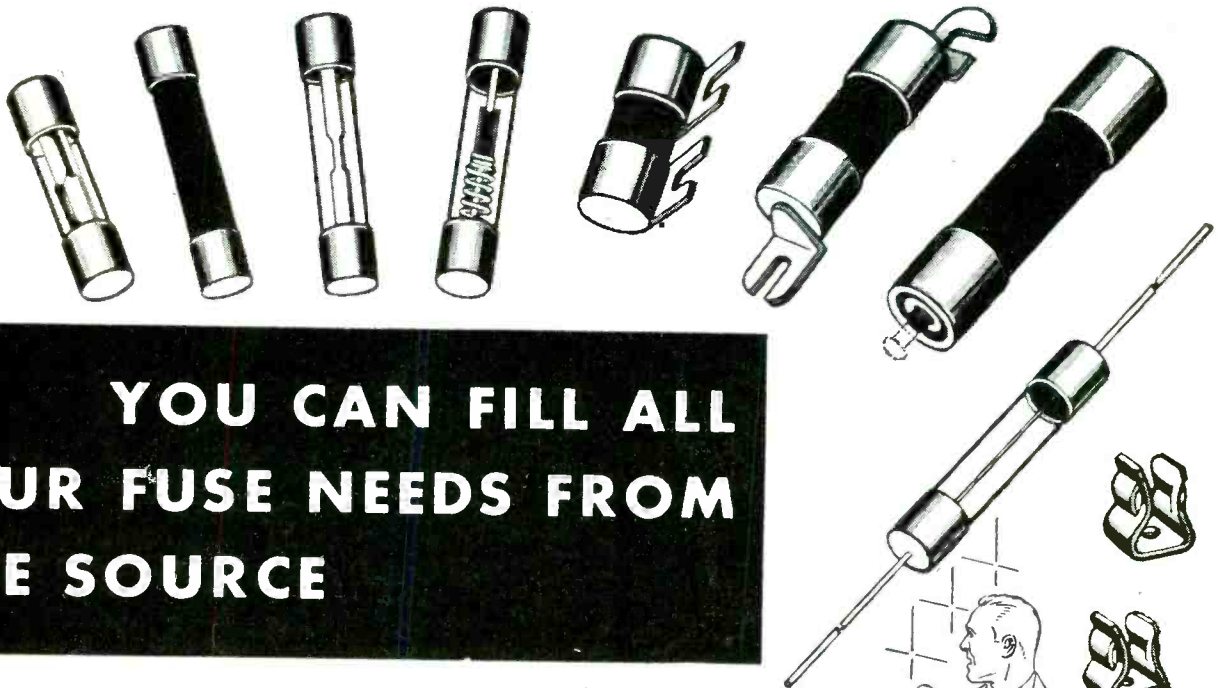

# YOU CAN FILL ALL YOUR FUSE NEEDS FROM ONE SOURCE

## ... by Standardizing on *BUSS FUSES*

Just turn to *BUSS* for all your fuse requirements in any size from 1/500 ampere up. The line is complete:—standard type, dual-element (slow blowing), renewable and one-time types . . . plus a companion line of fuse clips, blocks and holders.

You'll find that by obtaining all your fuses from one source you can save time and money by simplifying your purchasing, stock handling and records.

*Why BUSS fuses give "trouble-free" protection.*

To make sure of dependable electrical protection under all serv-

ice conditions, — every *BUSS* fuse normally used by the Electronic Industries is tested in a sensitive electronic device that rejects any fuse not correctly calibrated, properly constructed and right in all physical dimensions.

*In sales and service* — *BUSS* is the fuse your customer knows. In the past 39 years millions and millions of fuse installations for home, farm and industry have firmly established the *BUSS* trademark. So when you furnish a *BUSS* fuse the quality is never questioned. That's why you'll find it's just good business to handle only genuine *BUSS* fuses.



BUSSMANN Mfg. Co. (Div. McGraw Electric Co.)  
 University at Jefferson, St. Louis 7, Mo.  
 Please send me bulletin SFB containing facts on *BUSS*  
 small dimension fuses and fuse holders. SD-954

Name.....Title.....  
 Company.....  
 Address.....  
 City & Zone.....State..... 954

**FOR MORE INFORMATION MAIL THIS COUPON**

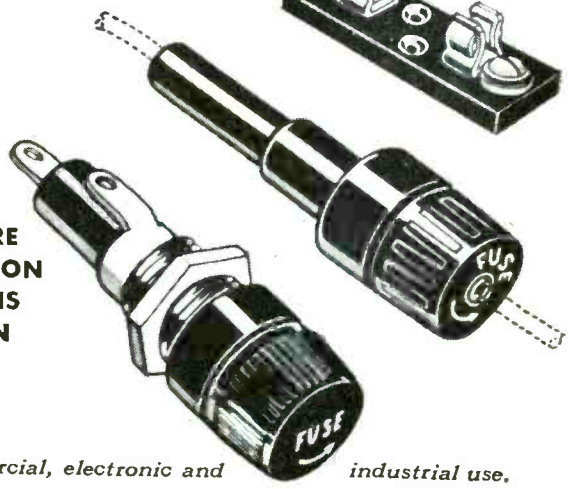

*Makers of a complete line of fuses for home, farm, commercial, electronic and industrial use.*

NEW  
MERIT FLYBACKS  
GIVE YOU

**exact replacement** FOR  
**1,252 tv set models**

MANUFACTURED BY **RCA**

**PHILCO**

*Emerson*

**MUNTZ**



**SILVERTONE**

**Motorola**

HVO-15  
PHILCO



HVO-21  
PHILCO

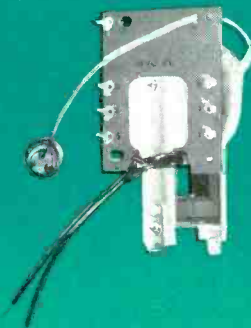

HVO-24  
ADMIRAL

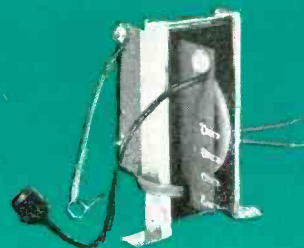

The only transformer line designed exclusively for service—Merit since 1947 has made available to you a complete line of exact replacement transformers.

Merit's 3 plants are geared to supply your TV transformer needs when you need them—on the spot for black and white and color with exact or universal replacement flybacks.

# MERIT

**MERIT COIL & TRANSFORMER CO.**

4427 N. Clark Street • Chicago 40, Illinois

Ask your jobber, or write for, your copy of Merit 1955 Replacement Guide #407 listing up-to-date replacement components for all models and chassis of TV receivers.

Burton browne advertising

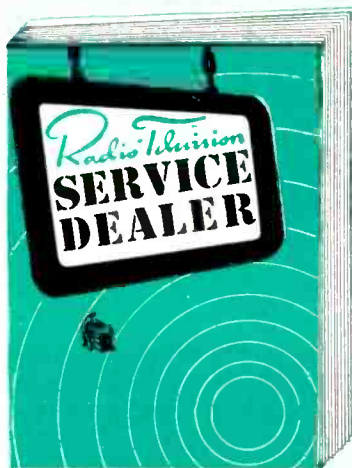

**Every Service Firm Owner in the U.S.A.  
Receives SERVICE DEALER Monthly  
DISTRIBUTION THIS ISSUE OVER 65,000**

**COWAN PUBLISHING CORP., 67 West 44th Street, New York 36, N. Y.**

VOL. 15, NO. 9

SEPTEMBER, 1954

**EDITORIAL STAFF**

*Publisher*

**SANFORD R. COWAN**

*Editor*

**SAMUEL L. MARSHALL**

*Editorial Production*

**ROBERT CAMPBELL**

*Contributing Editors*

**LEONARD LIEBERMAN**

**ROBERT T. DARGAN**

**PAUL GOLDBERG**

**MARVIN KLEIN**

**SAN D'ARCY**

**BUSINESS STAFF**

*Advertising Director*

**SANFORD L. CAHN**

*Advertising Manager*

**HARRY N. REIZES**

*Advertising Sales*

**LAWRENCE STEINER**

*Production Manager*

**DAVID SALTMAN**

*Circulation Manager*

**HAROLD WEISNER**

*Ass't Circ. Mgr.*

**C. J. BINDERMAN**

**BRANCH OFFICES**

**LOS ANGELES**

**TED E. SCHELL**

2700 West Third Street

Dunkirk 2-4889

**CLEVELAND**

**RICHARD E. CLEARY**

Commercial Bank Bldg.

Berea, Ohio

BErea 4-7719

**FEATURE ARTICLES**

|   |           |
|---|-----------|
| <b>Block Diagram Analysis of Color Transmission and Reception, Part 1,</b><br><i>by Bob Dargan and Sam Marshall</i> ..... | <b>9</b>  |
| Transmission and reception principles, basic requirements of the color systems, and comparisons of color and B&W systems. |           |
| <b>Curing TVI in AM Radios, by Steve Travis</b> .....   | <b>21</b> |
| Service hints to help eliminate noises caused by TV sets that plague the AM receiver.                                     |           |
| <b>A Revolutionary Method of Antenna Coupling, by Harold Harris</b> .....   | <b>24</b> |
| A coupling device, which, by virtue of its extreme efficiency, may well be a milestone in this field.                     |           |
| <b>TV Instrument Clinic, Part 4, by Robert G. Middleton</b> .....   | <b>29</b> |
| A perceptive discussion of test problems involving identification of simple and complex waveforms.                        |           |
| <b>CBS Color tube</b> .....   | <b>31</b> |
| Functional details and comprehensive diagrams are presented in this article on the "Colortron 205."                       |           |
| <b>"Lead Dress" Problems, by Paul Goldberg (a Workbench feature)</b> .....  | <b>32</b> |
| A study of techniques utilized in tracking down trouble sources due to defective insulation and wiring methods.           |           |
| <b>RC Circuits, Part 4, by Cyrus Glickstein</b> .....   | <b>34</b> |
| Helpful rules-of-thumb which may be applied to complex RC circuits, as well as typical circuit analyses.                  |           |

**CIRCUIT AND SERVICE FORUM**

|   |    |
|---|----|
| <b>The Workbench—"Lead Dress" Problems</b>                            |    |
| DuMont RA-105—Pix and Sound Fades Out.....                            | 32 |
| Admiral 22M1—Smear Pix.....   | 33 |
| Freed Model 55—Hum.....   | 33 |
| <b>Answer Man</b>   |    |
| DuMont RA-306—Intermittent Pix Shrinkage.....                         | 36 |
| Crosley Model 10-416—Audio Modulation of Pix.....                     | 36 |
| Traveler Model 64R50—Intermittent Channel 7 and 13 Reception.....     | 36 |
| <b>Rider TV Field Manual Service Data Sheets</b>                      |    |
| Aimcee Model 1C23 Ch. T.D.....  | 45 |
| General Electric, Models 17C125, 20C107, 21C201, etc.....             | 47 |
| Westinghouse, Chassis V-2233-1, Models H740T21, H742K21, H743K21..... | 49 |
| <b>Video Speed Servicing Systems</b>                                  |    |
| Crosley Model 10-419MU.....   | 37 |
| Hallcrafters Model HA 861-1.....                                      | 39 |
| Sentinel Model 1U425.....   | 41 |

**DEPARTMENTS**

|                                |           |                             |           |
|--------------------------------|-----------|-----------------------------|-----------|
| <b>Editorial</b> .....         | <b>4</b>  | <b>The Work Bench</b> ..... | <b>32</b> |
| <b>Trade Flashes</b> .....     | <b>16</b> | <b>Answer Man</b> .....     | <b>36</b> |
| <b>Association News</b> .....  | <b>27</b> | <b>New Products</b> .....   | <b>52</b> |
| <b>Advertising Index</b> ..... | <b>64</b> |                             |           |

RADIO-TELEVISION SERVICE DEALER is published monthly by Cowan Pub. Corp., 67 West 44th St., New York 36, N. Y. Subscription price: \$1 for 2 years in the United States, & U.S. Poss. Elsewhere \$1 per year additional. Single Copies 25c. Reentered as second class matter Sept. 25, 1950 at the Post Office at New York, N. Y. under the Act of Mar. 3, 1879. Copyright 1954, Cowan Publishing Corp.

POSTMASTER: SEND FORM 3579 TO RADIO-TELEVISION SERVICE DEALER, 67 WEST 44th ST., NEW YORK 36, N. Y.



# EDITORIAL...

by S. R. COWAN  
PUBLISHER

## CURRENT PRODUCTION & SALES FIGURES

During the first 6 months of 1954, according to RETMA reports, 2,845,147 television and 4,886,559 radio receivers were manufactured. Compared to figures for the corresponding period of 1953 this year's TV receiver production was down 26% while radio production was down over 30%. Incidentally, only 8,394 color TV sets were produced during the first half of this year.

However, from the same reliable source comes offsetting good news to the effect that during the first 6 months of this year 2,805,760 TV sets moved through retail outlets whereas only 2,775,900 were sold in the like period of last year. 1954 radio receiver sales volume for the first half hit 2,410,893 units contrasted to 3,017,196 for 1953.

Thus we have gone through a production-sales leveling period. Last year, during the first half, distributor-dealer receiver inventories were far too high. This year a more justifiable ratio of production-to-sales was maintained. Eventually it will be a big factor in eliminating "dumping" or the failure of weak-sister manufacturers and consequently prices will remain firmer.

## CHANGING SERVICE DEALER TRENDS

Early last year we compiled a list that included the name and address of every Service Firm and Service Dealer establishment in the USA. In May of this year we did the same thing and were astounded to note that there was a sharp drop-off of Service Dealers (firms that sell radio-TV at retail besides operating a service department) in certain key cities. For example, in New York City, Philadelphia, Chicago, Detroit and Los Angeles the number of dealers dropped from 10% to 28%. In contrast, the number of firms engaged solely in service work increased from 8% to 24%. Our records also showed that in other major cities such as Kansas City, Portland, Houston, etc., where TV only became a factor during 1953, the number of pure service firms increased while the number of Service Dealers increased, too.

At first we were perturbed and almost came to the conclusion that our statistics might have been in error. Then, happily, the August 9, 1954 issue of "Life" came along and the article, "Discount Houses Stir Up a 5 Billion Dollar Fuss," gave us the clue which enabled us to reconfirm our findings. Yes—in many major cities the impact of some large discount houses had forced many former re-

tail stores to drop their fast becoming unprofitable dealer activities so they could concentrate on the service angle which showed handsome returns. We suggest that you read the "Life" article referred to. It shows that discount selling is being overdone, but is here to stay. It also shows that a firm that renders good service to its customers can maintain its position as a retailer.

## WE CAUSED A FURORE

Our July issue story on how to sell and service radio controlled garage door operators caused quite a furore. Many readers liked the suggestion, writing that they're going to explore its possibilities.

However, several firms that manufacture radio-controlled garage door opening devices, other than the particular firm mentioned in our story, have written that some of the sales figures we quoted in our story were not quite accurate. For example, H. W. Crane Company, a Maywood, Illinois firm, contends that at present over 200,000 operators are now in use whereas we said that only 20,000 were in use. That being so—there's that much extra *immediate* potential service business to go after. Also, we are now informed that several brands of radio controlled garage door operators can be purchased by Service Dealers for about \$140.00 net so they can be sold and installed profitably in the \$225.00 price range.

## OUR NEW REGULAR TV SERVICE INFORMATION SECTION

Bound into this issue, at the rear, is an eight-page form representing the latest, absolutely COMPLETE TV Service Information available on certain Sylvania receiver and chassis models. All future issues of "Service Dealer" will have a similar *complete* TV service information section devoted to one of the leading TV brands now in use and now most needed by the service fraternity. Some of these sections will be 8 pages—others larger, depending upon the receiver in question. All of these *complete* TV service information sections are being prepared for "Service Dealer" exclusively by arrangement with John F. Rider, Publisher. Note: Our new TV service section is NOT a mere digest. Instead, each is legibly printed and complete in every detail. They may be assembled alphabetically in standard binders so in time a complete working file will be obtained.

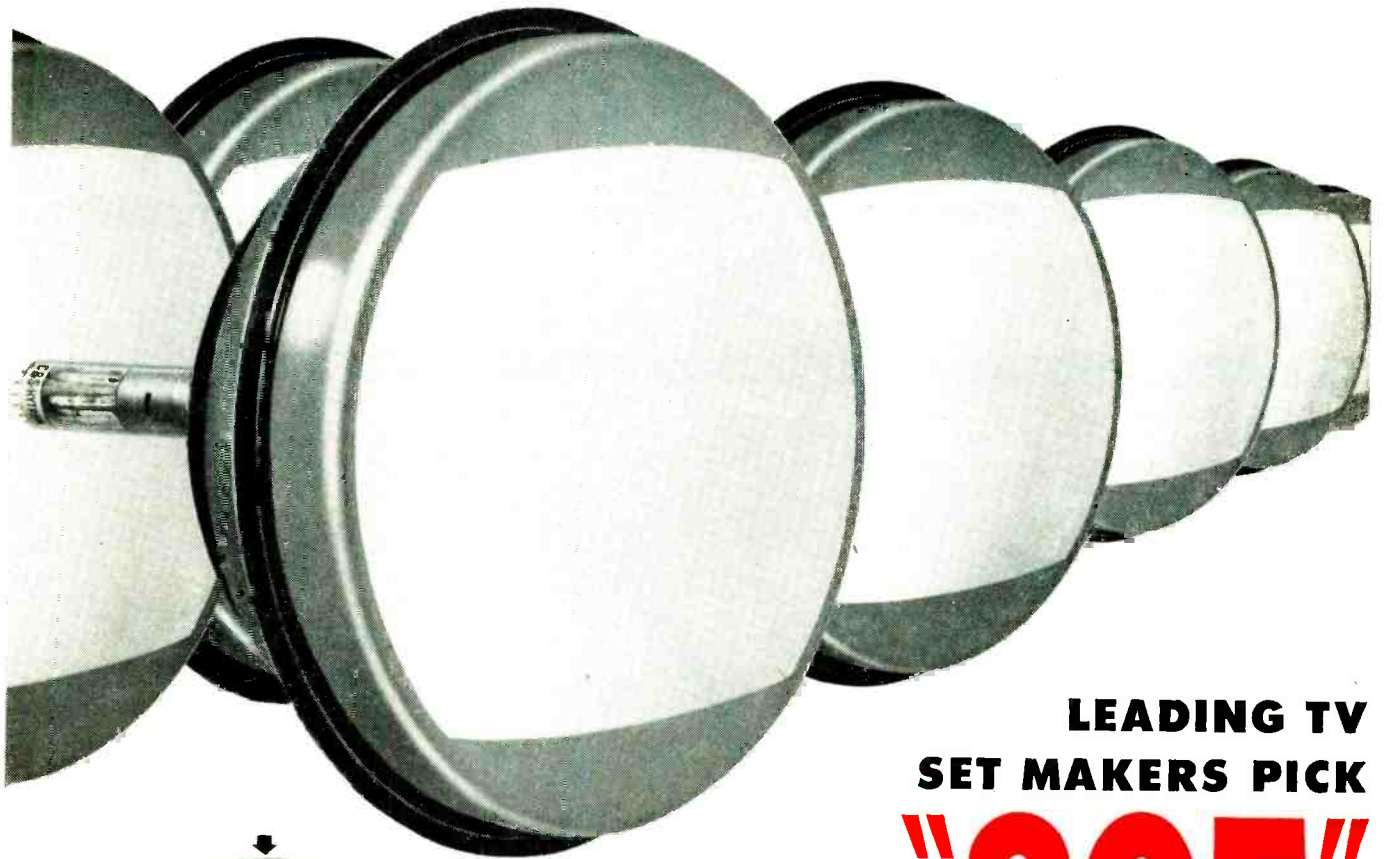

**LEADING TV  
SET MAKERS PICK**

**"205"**

**CBS-COLORTRON**

**LEADING BIG-SCREEN COLOR TUBE**

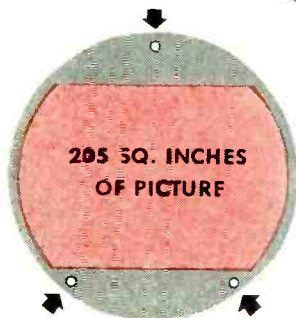

**HOW "205" ACHIEVES BIGGEST PICTURE**

As its name implies, picture area of "205" is a big 205 square inches. The "205" achieves this maximum utilization of screen area: 1. By photographic printing of tricolor screen directly on inside of curved face. 2. By using a simple, light-weight shadow mask. 3. By positioning the three mask supports above and below the desired screen area . . . where the screen is masked off anyway by the set maker to obtain the desired 4 x 3 aspect ratio. This permits full lateral use of screen.



**IT'S CBS-HYTRON FOR NEW  
COLOR RECEIVING TUBES TOO**

| TYPE             | DESCRIPTION                                      |
|------------------|--|
| CBS-Hytron 3A3   | Half-wave, high-voltage rectifier                |
| CBS-Hytron 6AM8  | Diode, sharp-cutoff pentode                      |
| CBS-Hytron 6AN8  | Medium-mu triode, sharp-cutoff pentode           |
| CBS-Hytron 6BD4A | Sharp-cutoff beam triode, high-voltage regulator |
| CBS-Hytron 6BD6  | Sharp-cutoff r-f pentode color demodulator       |
| CBS-Hytron 6B17  | Triple-diode d-c restorer                        |

- ... for *Biggest Picture*
- ... for *Superior Performance*
- ... for *Delivery NOW!*

The CBS-Colortron "205" is *today* traveling in freight cars and trucks to the nation's leading TV set manufacturers. It was chosen by them, because of: The "205's" larger 205-square-inch screen. The "205's" over-all superior performance. The "205's" easier circuit adjustments. The "205's" absence of "pincushioning" and other distortion. And the "205's" availability in production quantities now!

**BIG-SCREEN COLOR TV IS HERE . . . today . . . at CBS-Hytron.** Original . . . simple . . . functional . . . advanced design of the "205" made this possible: 1. With its curved screen-mask construction. 2. With its maximum use of the screen area. 3. With its electromagnetically converged three-beam electron-gun assembly. And CBS-Hytron's huge, new Kalamazoo plant stands ready to step up the "205's" availability when needed. Yes, you can look to CBS-Hytron as the leader . . . and major producer of big-screen color picture tubes.

**NEW . . . FREE "205" DATA**

Keep abreast of big-screen color TV. Four-page sheet on CBS-Colortron "205," RETMA type 19VP22, contains complete data on: Construction . . . operation . . . application . . . installation . . . adjustment . . . electrical and mechanical characteristics. Write for Bulletin E-227 today!



**CBS-HYTRON** Main Office: Danvers, Massachusetts

A Division of Columbia Broadcasting System, Inc.  
A member of the CBS family: CBS Radio • CBS Television • Columbia Records, Inc. • CBS Laboratories  
CBS-Columbia • CBS International • CBS-Hytron

RECEIVING • TRANSMITTING • SPECIAL-PURPOSE • TV PICTURE TUBES • CRYSTAL DIODES AND TRANSISTORS

RADIO-TELEVISION SERVICE DEALER • SEPTEMBER, 1954

See For Yourself!



*New!*

**PHILCO**

**SUPER PERFORMANCE**

**TV**

**ANTENNAS**



RADIO-TELEVISION SERVICE DEALER • SEPTEMBER, 1954



# GUARANTEED TO OUTPERFORM ANY EQUIVALENT TYPE ANTENNA OR YOUR MONEY and LABOR COSTS BACK!

There's been enough words written about TV antenna performance. Now . . . *see the facts for yourself!* Compare any of the new PHILCO Super-Performance TV Antennas with any equivalent type on the market. If the new PHILCO does not give you the finest picture possible, your money back for the antenna *plus* your labor costs up to \$10.00. Ask your PHILCO Distributor for complete details on this amazing offer!

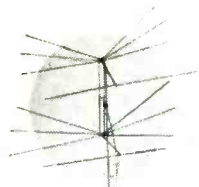

**PHILCO VHF  
SUPER CONICAL**

#### **PHILCO TWO-BAY SUPER CONICAL ALL-CHANNEL ANTENNA**

Strong signal pickup on VHF channels 2 through 13 . . . UHF channels 14 through 83 . . . ideal for fringe area reception . . . all-aluminum construction with dowelled elements; Part No. 45-3096-2. Rugged single bay design; Part No. 45-3096.

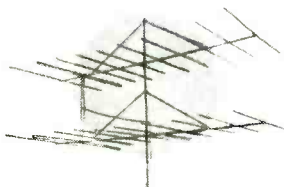

**PHILCO VHF  
LOW BAND YAGI**

#### **PHILCO TWO-BAY VHF LOW BAND YAGI ANTENNA**

10 elements . . . all-aluminum . . . factory pre-assembled. Top performance on channels 2 through 6 . . . 13 db to 15 db gain on various channels. Single bay Part No. 45-3112-2 through 6. Stacked version harness Part No. 45-3267.

#### **PHILCO GOLDEN YAGI UHF ANTENNA**

Designed for 300 ohm operation . . . all metal construction . . . 11 db to 12 db gain on various channels. "Cronak" coated components resist salt air . . . humidity. Six models cover entire UHF spectrum: Basic Part No. 45-1996.

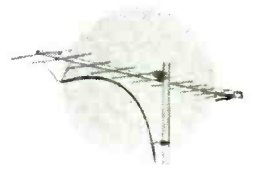

**PHILCO UHF  
GOLDEN YAGI**

#### **PHILCO PARAFLECTOR ALL-CHANNEL UHF ANTENNA**

Pre-assembled, all-aluminum . . . 8 to 10 db gain . . . outstanding fringe area performance . . . immediate mounting on existing masts. Part No. 45-3071. Bow Tie, Part No. 45-3069 and Bow Tie with reflector, Part No. 45-3070 give top quality pictures in many UHF areas.



**PHILCO UHF  
PARAFLECTOR**

## **PHILCO CORPORATION ACCESSORY DIVISION**

'A' AND ALLEGHENY AVE. • PHILADELPHIA 34, PA.

RADIO-TELEVISION SERVICE DEALER • SEPTEMBER, 1954



offers

50

SALES AND SHOP AIDS

to help YOU make more money!



**ILLUMINATED "SERVICE DEPT." SIGN**

Dress up your shop with this easy-to-hang direction sign. Supplied ready to hang.



**TUBE and TOOL CARRYING CASE**

Holds 137 tubes and necessary repair tools — all tubes are in full view.



**RAYTHEON ConvertTV Seats**

Ideal for shop or home use, or as incentive gifts on TV set sales.

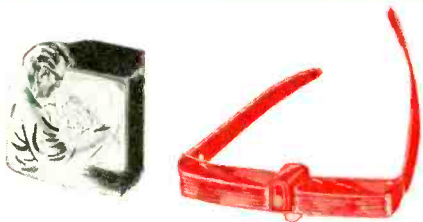

**RAYTHEON BROWLITE**

A new kind of flashlight that frees both hands for service work.



**ILLUMINATED OUTDOOR SIGN**

Double sided, — formed plastic face sign for outdoor use. 36" x 24". A real traffic stopper.



**PRESSURE-SENSITIVE REPAIR STICKERS**

Stick to any surface without moistening. Packaged in handy dispenser box.

**OUTDOOR THERMOMETER**

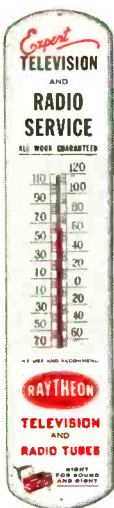

**COLOR SPOT SIGNS**

A brand new set of transparent window signs every service shop needs.



**TRANSPARENT PLASTIC WINDOW STREAMER**

**TUBE SHELF IDENTIFICATION LABELS BOOK**



Labels for over 480 current Raytheon Radio and TV tube type designations. Easy to apply.



**WINDOW DISPLAYS**

Bright, full color displays to sell your service. Both are varnished and easel.



**They're all in this FREE BOOKLET! It's yours for the asking**

You'll find many more money-making sales stimulators and time-saving shop aids in this booklet — all designed to help you make more money by increasing service business and saving valuable time. Many are free and others are made available through your Raytheon Tube Distributor at less than cost. To get a copy of the booklet write to Raytheon Manufacturing Company, Receiving and Cathode Ray Tube Operations, 55 Chapel Street, Newton 58, Mass. Department G.



Excellence in Electronics

**RAYTHEON MANUFACTURING COMPANY**

Receiving and Cathode Ray Tube Operations  
Newton, Mass., Chicago, Ill., Atlanta, Ga., Los Angeles, Calif.

RAYTHEON MAKES ALL THESE:

RECEIVING AND PICTURE TUBES • RELIABLE SUBMINIATURE AND MINIATURE TUBES • SEMICONDUCTOR DIODES AND TRANSISTORS • NUCLEONIC TUBES • MICROWAVE TUBES

# Block Diagram Analysis

of

## COLOR TRANSMISSION

and

## RECEPTION

By **BOB DARGAN**  
and **SAM MARSHALL**

From a forthcoming book entitled  
"Fundamentals of Color Television."

### Part 1

**T**HE basic NTSC color TV system is illustrated in block diagram form in Fig. 1. In general, color TV utilizes the same general principles of transmission and reception as black and white (B & W) TV. In the conventional B & W signal the brightness information of the areas being scanned makes up the video signal. In color transmission two video signals are employed. The first is a color signal which contains the hue and saturation information of each color in the scene, and

the second is a B & W signal which contains the brightness information. The latter is made up of fixed percentages of the red, green, and blue signals as defined in Chapter 1.

#### Transmission

At the transmitter a scene in color is picked up by a color camera which is actually a combination of three cameras in one. By a system of mirrors and filters the scene is usually separated into three individual and simultaneous

images, one for each color, red, green, and blue, which are then directed on to three separate camera tubes.<sup>1</sup>

Referring again to Fig. 1, the outputs of these camera tubes, which contain the three primary color signals in approximately equal amplitude levels, are

<sup>1</sup>RCA has under development a single camera tube that puts out three signals simultaneously. CBS has developed a pick-up system called, Chroma-Coder which involves a single camera tube, a sequential color scanner, and a system for converting the resulting signal into a simultaneous NTSC color signal.

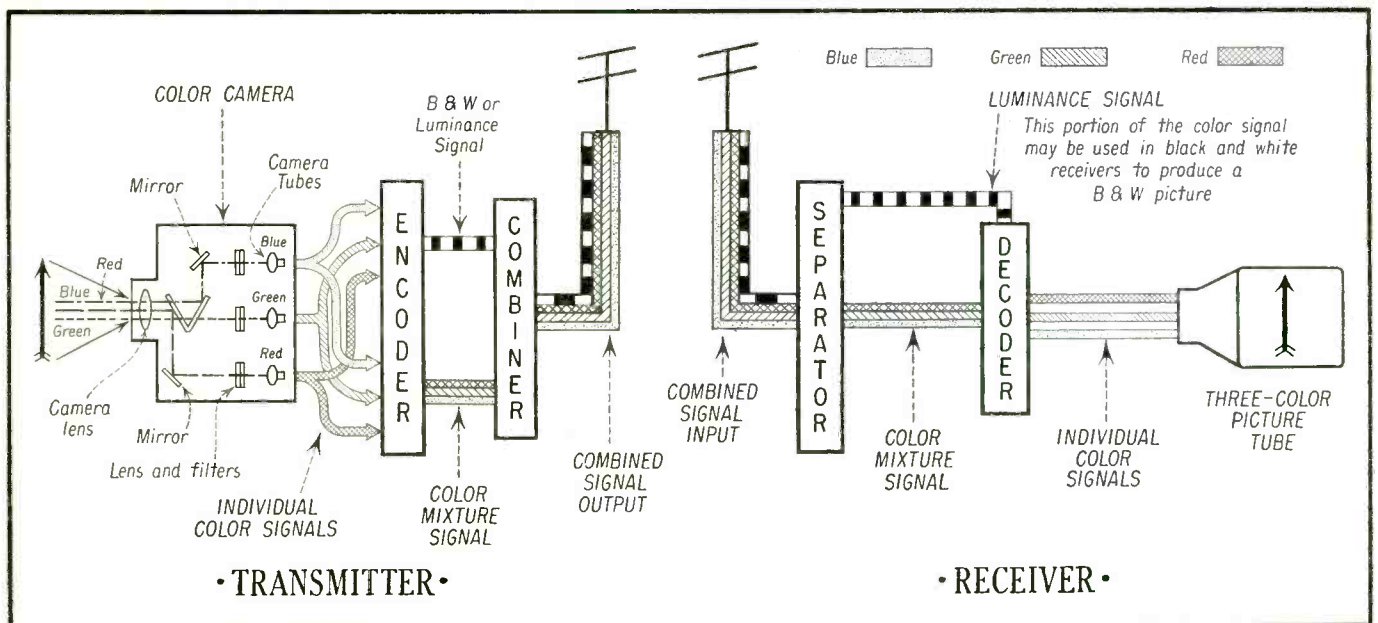
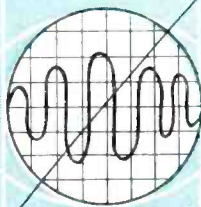
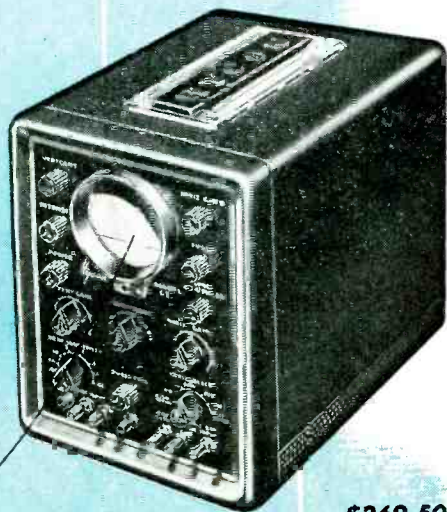

Fig. 1—Simplified block diagram of color TV system.

**FULL VIEW FULL VALUE**



WITH A  
**HYCON  
OSCILLOSCOPE  
MODEL 617**



**\$269.50**

SHARP UNDISTORTED TRACE EDGE TO EDGE

You get *more* for your scope dollar in a Model 617 Oscilloscope, because Hycon's special flat face 3-inch tube eliminates fringe distortion. You pay for a 3-inch scope—you get 3 inches of sharp, usable trace.

And this precision scope meets all requirements for color TV servicing. So before you buy any scope, compare it to the Model 617 feature by feature.

For full view—full value you'll buy Hycon . . . setting the standards "where accuracy counts."

- 4.5 MC BANDPASS WITHIN  $\pm 1$  DB (VERTICAL AMPLIFIER)
- HIGH DEFLECTION SENSITIVITY (.01 V/RMS PER INCH)
- INTERNAL CALIBRATING VOLTAGES
- EDGE LIGHTED BEZEL
- STURDY, LIGHTWEIGHT CONSTRUCTION



See Hycon's line of matched, bench-stacking test instruments at your Electronic Parts Jobber's.



Service facilities in your area.

**Hycon Mfg. Company**

2961 EAST COLORADO STREET PASADENA 8, CALIFORNIA

"Where Accuracy Counts"

then sent into two separate sections of an "encoder". For our purposes, we will define an "encoder" as the section of a transmitter which converts the three primary color signals leaving the camera into separate B & W and color mixture signals suitable for modulating the channel carrier of the station.

One section of the encoder extracts certain required percentages of the three primary color signals for the B & W or "luminance" signal. A second section produces a color mixture signal which provides the necessary color information for transmission. Both B & W and color signals are then made to modulate a *vlf* channel carrier in a section labelled in the figure as a "combiner." The combiner actually is the section in which all of the various signals connected with the entire broadcast are made to modulate the station carrier. The signal leaving the combiner is the complete composite amplitude modulated *rf* signal of the color broadcast. Although not shown in the illustration, the sound carrier with its FM modulated sound signal is also sent along as a separate signal on the same channel.

**Reception**

At the receiving end, this composite signal permits a color receiver to reproduce the broadcast signal in its entirety, and a B & W receiver to reproduce the luminance portion of the broadcast signal.

The incoming color signal first enters the color receiver in a unit which, for convenience, we will call a "separator". This section directs the luminance and color signals into their respective circuit sections. The combined color signals plus the luminance signal then enter a "decoder" which processes the transmitted color information so that again the three original red, green, and blue color signals are reproduced. These color signals when directed on to the screen of a special color picture tube, light up the corresponding color phosphors of the picture tube, and a scene which is an excellent replica of the original one at the studio is produced.

**Basic Requirements of a Color System**

Basic requirements of color transmission and reception as set forth by the Federal Communications Commission are:

1. Black and white receivers should be able to produce satisfactory B & W pictures from color broadcasts without the need for auxiliary equipment or any modification to the receiver.

2. Color receivers should similarly be able to produce satisfactory B & W

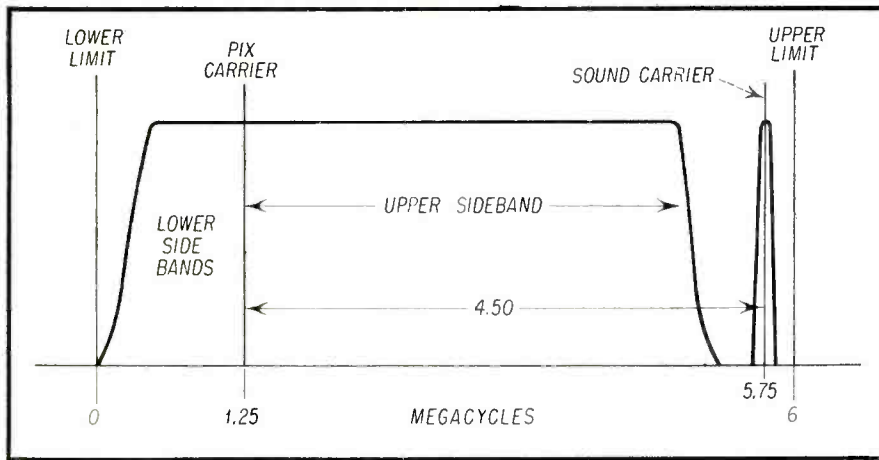

Fig. 2—Frequency distribution of video and sound signals of black and white channel.

pictures from normal black and white broadcasts.

The above requirements are in addition to the normal reproducing functions of B & W and color receivers, and embody the meaning of the word "compatibility" as it applies to color TV. Under the conditions outlined above a smooth transition from black and white to color transmission and reception is made possible without making existing black and white transmitters and receivers obsolete.

One of the conditions for meeting the above requirements is that the color signal must be contained within the six-megacycle frequency limits of the present black and white channel. Recalling that apparently full utilization is already made of the six-megacycle channel by the black and white signal, as shown in Fig. 2, it would seem that such a requirement might be improbable of fulfillment. Up to very recently such thoughts were shared by many. However, new circuit developments and systems, plus a more advanced knowledge of how the human eye-brain combination reacts to various colors of small areas, have made techniques possible which permit transmission of two signals on the same frequency. These, and other developments, particularly advances in the art of manufacturing color picture tubes, have climaxed and brought forward this new twentieth century marvel.

### Comparison Between B & W and Color System

Aside from the addition of a "color sync" signal the horizontal and vertical sync system used in color is the same as that employed in B & W transmission and reception.<sup>2</sup> This additional signal is commonly referred to as a "color

<sup>2</sup>The horizontal frequency is 15,734,264 cps. The vertical frequency is 59.94 cps. The reason for these values as compared to the B&W values of 15,750 cps and 60 cps will be explained further on in the text.

burst," the purpose of which is to synchronize and set into operation various

As shown in Fig. 3, the basic color and white system consists of a camera color circuits in the color receiver. Thus, it may be considered that a color system is essentially a B & W system to which a color video signal and a color sync burst signal have been added.

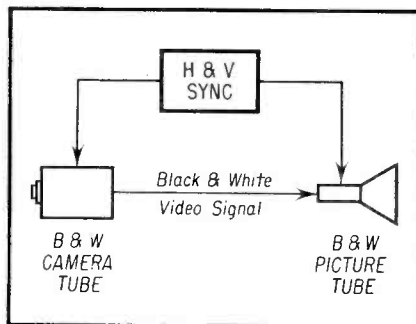

Fig. 3—Basic B & W TV system.

tube, a picture tube, and a sync system which controls the horizontal and vertical sweeps. The camera tube converts brightness information into a video signal voltage. Conversely, the picture tube

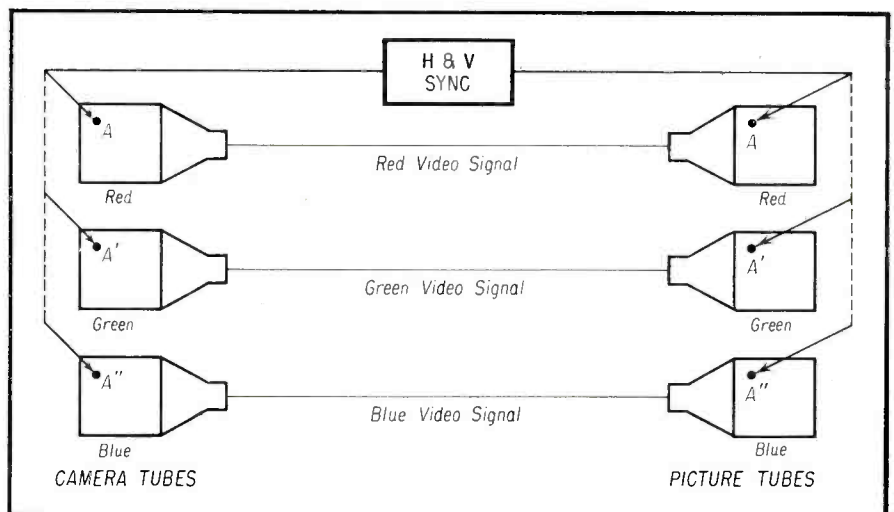

Fig. 4—Basic color TV system.

converts the video signal voltage into brightness information. Finally, the sync section provides identical scanning of the horizontal and vertical sweeps in both camera and picture tubes.

In comparison with the black and white system, the basic color system is illustrated in Fig. 4. Here we have three color camera tubes; one providing a red output signal, the second a green signal, and the third a blue signal. The three color signals appear at the output terminals of the three color pickup tubes at the same instant, so that the system is referred to as a "simultaneous" one.

It is obvious that in the system shown a single transmission line cannot be connected to all of the output terminals of the three camera tubes. Doing this would cause all three signals to interfere with each other, thereby resulting in a confused mixture of all color signals. For this reason the system shown uses three separate transmission lines, one at each output terminal of the camera tubes.

As far as the receiver is concerned, let us assume for the present that three electron guns are used in the picture tube, each gun exciting a separate color phosphor. Also, because of the nature of the transmitted signals, we will assume that the color signal voltages are applied simultaneously to the three guns of the picture tube. This system is used by RCA, CBS and others in conjunction with the so-called "three-gun shadow mask" tubes which are described in another chapter. In contrast with the three-gun tube is another type, using a single gun, called a "Chromatron". Here, the use of a single gun requires that one color signal at a time be fed into the electron beam of the gun. It also requires a synchronized switching circuit so that the various color signals reach only their correct phosphors. The system analysis as de-

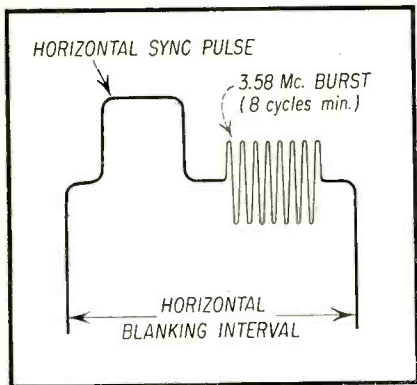

Fig. 5—Waveform of 3.58 mc color sync burst signal.

scribed in this chapter can easily be applied to the single gun tube described in a later chapter.

As mentioned previously, the horizontal and vertical sweep system used in color TV is the same as that used in black and white. In the color camera tube the sweep action takes place simultaneously across all three camera tubes. Thus, when point A (Fig. 4) on the red tube is being scanned, point A' on the green tube is also being scanned, as is point A'' on the blue tube. All of these points correspond to the same relative locations on the three tube faces. That is, if all of the images on these tube faces were superimposed on each other by the use of mirrors, all of these points would coincide.

### Color Burst Signal

Introductory reference has been made to the color sync signal, or burst, which sets into operation various color circuits in the receiver. In Fig. 5 it will be observed that this color sync signal is located on the back porch of the horizontal sync pulse, this being the most suitable position for this signal.

### Expanded Block Diagram—Transmission

A somewhat expanded block diagram of the color TV system which is designed to show how the color sync signal affects the transmitter and receiver is shown in Fig. 6. At the left we find the color camera tubes contributing their color signals,  $E_R$ ,  $E_G$ , and  $E_B$ . These signals, as in the previous block diagram, enter an encoder section which develops a luminance signal and a color video signal preparatory to modulating the rf channel carrier in the combiner stage.

Notice that a 3.58<sup>3</sup> mc signal generator is included which provides the 3.58 mc signals for the color encoder and the horizontal and vertical sync and sweep circuits of the transmitter. The reason why a 3.58 mc signal is fed into the horizontal and vertical circuits is twofold. First, it is the standard frequency from which the horizontal and vertical sweep frequencies must be derived. Second, it combines with the horizontal sync pulse so that the color burst signal is positioned on the back porch of each horizontal sync pulse as shown in Fig. 5. The color burst signal consists of eight cycles of the 3.58 mc signal.

Further examination of Fig. 6 will reveal that the horizontal and vertical sync pulses as well as the color burst signal are fed into the combiner. Here they are added to the color and luminance signals where they form a composite video signal before modulating the rf carrier. Notice that the luminance or black and white signal is also referred to as the "Y" signal. This reference is common practice and will be used extensively throughout this book.

<sup>3</sup>The actual value of the color sub-carrier is 3.579545 mc.

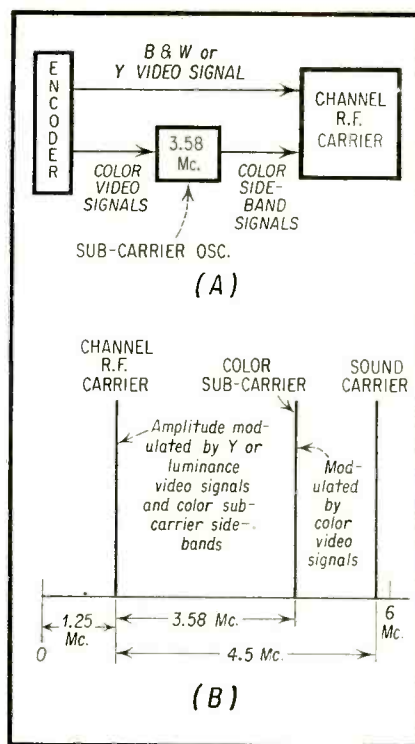

Fig. 7—(A) Y signal from encoder modulates channel rf carrier. Color video signals modulate 3.58 mc sub-carrier oscillator producing sidebands with 3.58 mc as a center frequency. These sidebands then modulate the channel rf carrier. (B) Location of rf, color, and sound carriers on typical 6 mc rf channel.

Let us now return to the 3.58 mc signal which is fed into the encoder. This signal becomes the color carrier or "sub-carrier" as it is commonly called. The sub-carrier eventually is modulated by the color video signals developed in the camera tube, producing

[Continued on page 62]

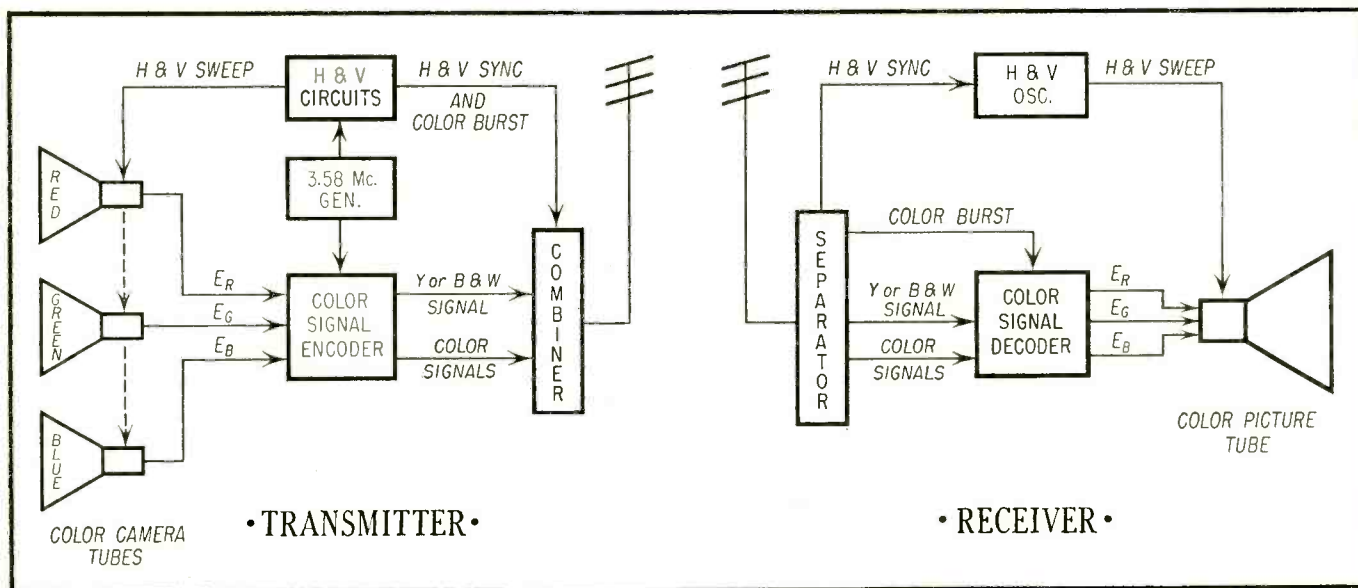
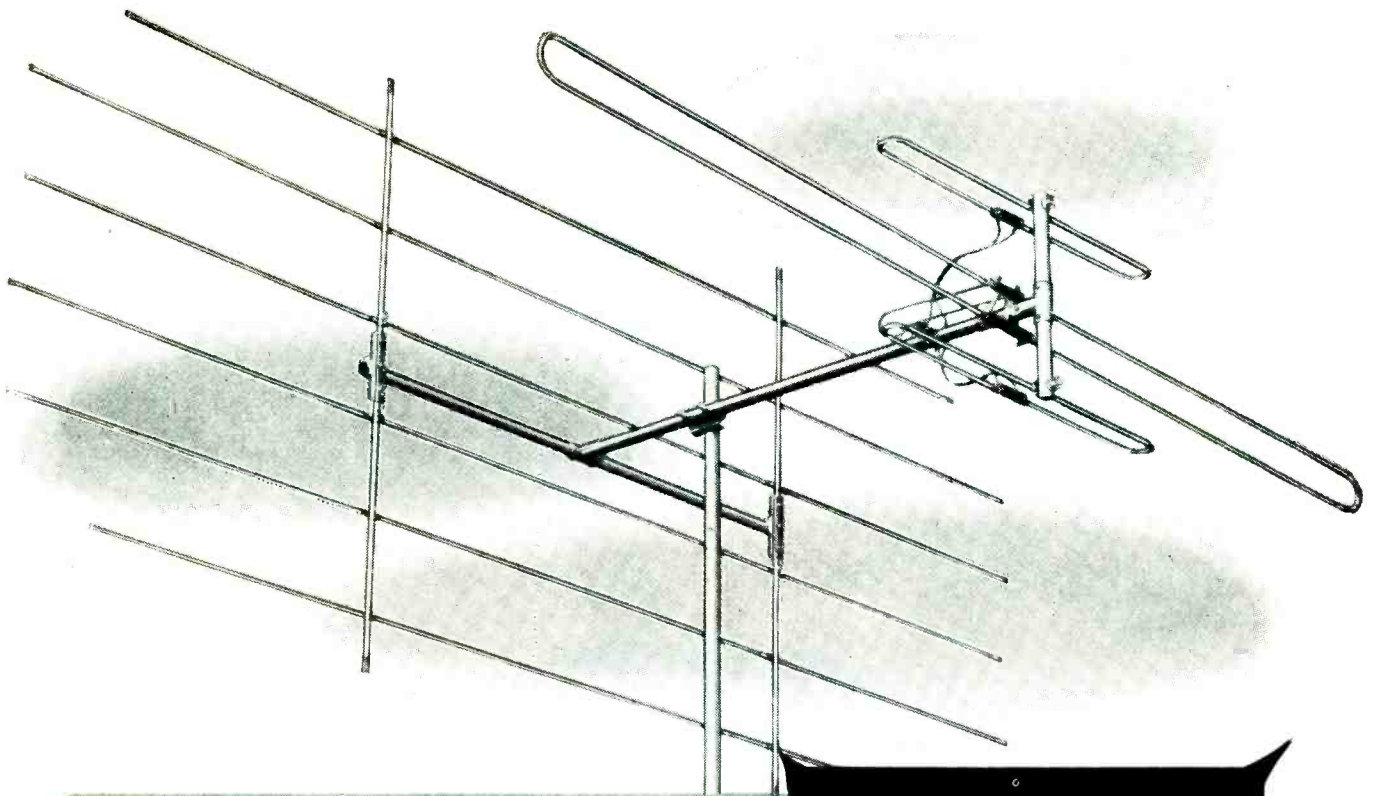

Fig. 6—Block diagram of color TV system with sync information added.



**RADIART**  
**ULTAMATIC**  
**All-Channel TV Antenna**

for the  
**FIRST** time  
 ...the **FIRST**  
**Antenna with**  
**which You Can**  
*See the*  
*Difference*  
 perfectly synchronized for  
 monochromatic and color TV

THESE QUALITIES HAVE BEEN COMBINED INTO THIS SINGLE ANTENNA — THE ULTAMATIC . . .

- ★ **LOW VOLTAGE STANDING WAVE RATIO** . . . the mis-match between antenna and transmission line is lower than four competitive types tested, an attribute to its broad band quality.
- ★ **FRONT-TO-BACK RATIO** . . . higher than multi-element, yagi-type antennas, minimizing co-channel interference.
- ★ **GAIN** . . . expressed in decibels, is a ratio of signal voltage developed by an antenna over that of reference folded dipoles. It is not a quality sold by the pound or achieved by the addition of meaningless elements. The curves shown accurately describe the gain of the Ultamatic. Loss of sound or picture due to erratic antenna response is eliminated.

**MECHANICAL FEATURES**

- ★ Aluminum screen reflector of exclusive fold-out design, assembled in seconds with adequate stability for years of trouble-free service. Longer elements insure maximum front-to-back ratio on channels 2-6 and are more closely spaced for increased performance on channels 7-13.
- ★ Dipole and boom assembly are of heavy gauge, seamless tubing. Dipoles fold out and are rigidly supported and reinforced to minimize sag and sway.
- ★ Specifically designed mechanically by stress analysis of each unit and sub-assembly to provide a low vibrational period of all elements — your assurance of trouble-free installations.

**MODEL UM-213 . . . double stacked UM-213-2**

**Most Uniform Gain Response** The gain response **DOES NOT VARY MORE THAN 3 D.B. ON ANY CHANNEL** across the band. This quality is exceedingly important in color reception to insure adequate color synchronization without resetting.

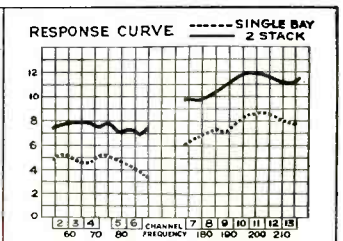
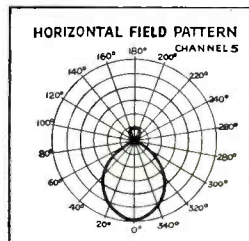

A SUBSIDIARY OF **THE RADIART CORPORATION**  
 CLEVELAND 13, OHIO

TV ANTENNAS \* AUTO AERIALS \* VIBRATORS \* ROTORS \* POWER SUPPLIES

# It's New! It's Here!



# SILVER

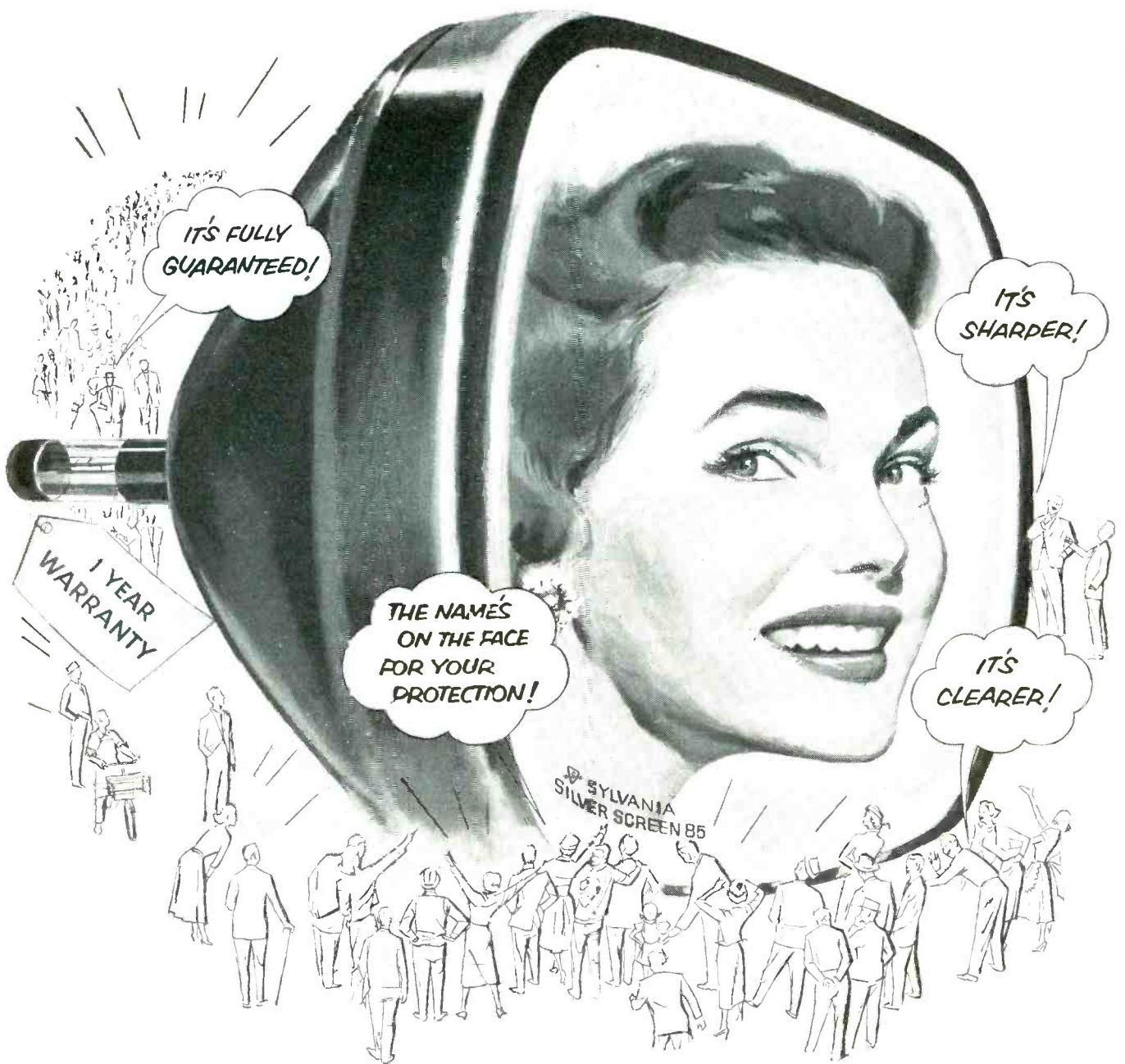

IT'S FULLY  
GUARANTEED!

IT'S  
SHARPER!

THE NAMES  
ON THE FACE  
FOR YOUR  
PROTECTION!

IT'S  
CLEARER!

SYLVANIA  
SILVER SCREEN 85

1 YEAR  
WARRANTY



# IT'S SYLVANIA'S SCREEN 85"

**The Picture Tube with three amazing design features!**

**SILVER-ACTIVATED SCREEN...SUPER ALUMINIZED REFLECTOR  
PRECISION-FOCUS ELECTRON GUN**

**YOU CAN BE PART OF THE  
BIGGEST PICTURE TUBE  
CAMPAIGN IN THE INDUSTRY!**

All this promotion material  
is yours **FREE**  
—All you have to do is ask for it!

- attractive window streamers . . .
- colorful counter and window displays . . .
- radio and TV commercials for you to use on your local stations . . .
- newspaper mats . . .
- publicity releases . . .
- postcards . . .
- envelope stuffers . . .
- a brand new booklet to describe the revolutionary "Silver Screen 85" to your customers . . .



Here is a truly great achievement in television picture tubes! Sylvania's "SILVER SCREEN 85" is the last word in design and engineering perfection. It's the picture tube with the SILVER-ACTIVATED SCREEN, to produce television's sharpest, clearest pictures; the SUPER ALUMINIZED REFLECTOR to catch and use all available light, giving pictures more depth, more dimension than ever before; the PRECISION-FOCUS ELECTRON GUN that scans every inch of the screen, making images stand out in pinpoint detail.

From foreground to background, pictures are razor-sharp, crystal clear! Blacks are *really* black—whites are *true* white. Only professional movies can duplicate

the "Silver Screen 85" picture. It's a SUPER ALUMINIZED PICTURE TUBE, designed to give top performance, made to the highest quality standards, and backed by the world's most experienced manufacturer of picture tubes!



**24 MILLION PEOPLE—INCLUDING YOUR CUSTOMERS—WILL HEAR ABOUT THE "SILVER SCREEN 85" EVERY WEEK ON "BEAT THE CLOCK"! 80 STATIONS NOW REACH 93% OF THE TV HOMES IN THE COUNTRY.**

Right in your own town! That's where Sylvania will help you sell the "Silver Screen 85"! Hard-selling commercials will tell millions of people every week that you're the man to see for a new "SILVER SCREEN 85."

**YOUR SYLVANIA  
DISTRIBUTOR HAS THE  
"SILVER SCREEN 85" NOW!  
MAKE SURE YOU ARE PART  
OF THIS PROFIT-PACKED  
PROMOTION—CALL HIM,  
WRITE HIM, SEE HIM TODAY!**

# SYLVANIA



Sylvania Electric Products Inc., 1740 Broadway, New York 19, N. Y.

In Canada: Sylvania Electric (Canada) Ltd., University Tower Building, St. Catherine Street, Montreal, P. Q.

**LIGHTING • RADIO • ELECTRONICS • TELEVISION**

# THE *American* IDEA

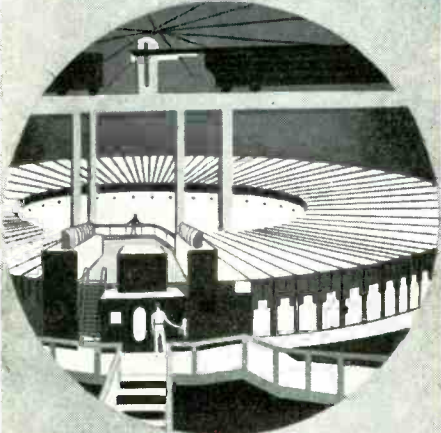

"To find and follow the better way"... Gigantic offspring of the cyclotron, the Bevatron—world's greatest magnet—can send masses of protons hurtling around its 135'-diameter race track at almost the speed of light. "Idea", to penetrate deep into the atomic nucleus, where lie secrets of matter and energy.

With us, the "American Idea" is, by directed effort and applied know-how, to continue to lead in bringing you electronic products of the highest quality.

Complete line of "Full Vision" Microphones  
D33 Broadcast  
D-22 Public Address

Replacement Phonograph Cartridges

INSIST ON AMERICAN FOR QUALITY  
Send for FREE Catalog 47

merican microphone co.  
370 South Fair Oaks Ave. • Pasadena, 1, Calif.

## TRADE FLASHES



Douglas Carpenter, Chief Engineer, JFD, shows response curves to Harry (Service Dealer) Reizes in newly opened JFD Penthouse Antenna Laboratory. The



Laboratory facilities include signal generators, sweep generators, field strength meters, oscillo-synchrosopes, and a polar recorder, used in recording the polar pattern of an antenna.

Television training schools for dealer service have been held in the San Antonio and Corpus Christi, Texas, areas the first week of August, according to Max Schinke, national service manager of Admiral Corporation. The two-day refresher courses are designed to acquaint service personnel with the newest engineering advances in the company's black and white television receivers, latest servicing techniques, and circuitry differences between the new 1955 sets and last year's models. The courses are conducted by Hugh Wyeth and Ed Koehler, Admiral TV engineers.



Mr. Lawrence Steiner joins the staff of "SERVICE DEALER." Formerly with the advertising staff of Variety Magazine and prior thereto, a 1st Lieutenant in the Adjutant General's Corps of the U. S. Army, Mr. Steiner has a fine public relations background.

[Continued on page 54]

## A NEW KIND OF BOOK FOR TV SERVICEMEN

by MILTON S. KIVER

### "Analyzing and Tracing TV Circuits"

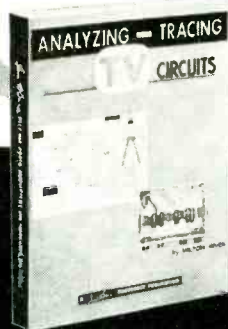

**YOU'LL  
MASTER  
ANY TV  
CIRCUIT**

the book that gives you all  
the knowledge you need and  
shows you HOW TO APPLY IT

A BASIC  
BOOK

for EXPERTS  
or  
BEGINNERS

Written by an authority who gives you all the facts about every TV circuit and then actually tells you how to apply the knowledge for everyday Service SUCCESS and PROFITS. This book spells out in simple, easy-to-understand language the rules a technician must follow to become top-notch in his work—the rules you need for assured Service SUCCESS. It's the one "must" book for every Service Technician.

**CONTENTS:** Chapt. 1: Things You Should Know About Every Circuit. Chapt. 2: From the General to the Specific. Chapt. 3: Differences Between Schematics and Actual Sets. Chapt. 4: Following the D.C. Power Lines of a Set. Chapt. 5: Where the Boost B+ Fits In. Chapt. 6: The A. G. C. System—From Beginning to End. Chapt. 7: In and Around the Deflection Systems. Chapt. 8: First Things First. Chapt. 9: What To Do When You Meet an Unfamiliar TV Circuit. Chapt. 10: Summary.

168 PAGES, 8½ x 11" \$3.00

**ORDER  
TODAY**

HOWARD W. SAMS & CO., INC.

Order from your Parts Jobber today, or write to Howard W. Sams & Co., Inc., 2209 East 46th St., Indianapolis 5, Ind.

My (check) (money order) for \$..... enclosed. Send ..... copy(ies) of "Analyzing & Tracing TV Circuits" (JA-1, \$3.00).

Name.....

Address.....

City..... Zone..... State.....  
(outside U.S.A. priced slightly higher)

# Today, the Best Dressed **RADIO-TV SERVICE MEN** are the Ones who Wear

**Geo. Master**  
ADVERTISING WORK UNIFORMS

**They serve a Two-fold Purpose. First, they IDENTIFY and ADVERTISE Your Company. Second, they PROTECT and DRESS UP Your Representatives.**



Trim, smart Geo. Master Advertising Work Uniforms are the kind your men will be proud to wear—the kind that will convince your customers that they're dealing with a progressive company.

That's why managers of the sales and service personnel of such industrial giants as GE, Ford, Standard Oil, Goodyear, Canada Dry, Borden, Philco and hundreds of others depend on Geo. Master Uniforms to build good will and send the sales curve upward.

Shrewd buyers know that proper fitting garments wear longer and look better. It is to assure proper fit that Geo. Master garments are sold only by authorized dealers who come to your place of business and give personal measurement service to your men. We serve every type of business from the smallest to the largest.

## **FOUR FABRICS . . . HUNDREDS OF STYLES & COLORS**

### **ORLON**

DuPont's new miracle fabric—an all-winter, year-round cloth that looks like wool and wears like iron. Crease resistant and easy to clean.

### **COTTON**

The old standby—trim, neat, washable and ever popular cotton. Geo. Master Advertising Uniforms of cotton are washable and low in price.

### **NYLON woven with COTTON**

An amazing fabric that wears up to 50% longer than ordinary cotton. Newest addition to the famous Geo. Masterline. Nothing else like it.

### **WOOL**

All styles and colors in built-for-work wool. Always popular—always practical. The Geo. Master line is the most complete in America.

**HOW TO GET THESE SALESMAKING UNIFORMS FOR YOUR MEN.** If you have not yet seen our current styles write us today. We will send our local representative to show you fabrics, styles, prices, and examples of the kinds of advertising monograms that we embroider on these fine garments. His call will not put you under the slightest obligation. You will find him courteous, helpful and ready to give you the kind of service that has made Geo. Master a "buy" word among the nation's leading advertisers. Write today for prices and full particulars. Complete information will be supplied without obligation.

**The Geo. MASTER GARMENT DIV. LIGONIER, INDIANA**

WESTON INTRODUCES NEW LINE OF INSTRUMENTS THAT SIMPLIFY

AND SPEED-UP SERVICING AND ALIGNMENT OF ALL TV RECEIVERS

INCLUDING COLOR. PRECISION BUILT-- DESIGNED TO DEFEAT

OBSOLESCENCE -- PRICED RIGHT FOR SERVICEMEN

# WESTON 980 LINE TV TEST EQUIPMENT

In the new 980 Line, WESTON offers TV technicians not only a group of superior, up-to-the-minute instruments, but a new, *greatly simplified* and *time-saving method* of TV receiver alignment as well.

The instruments in this line represent a completely new approach in test equipment design and operation . . . instruments that set entirely new standards in *performance* . . . in *operating simplicity* . . . in *value!*

In the new simplified method of alignment which they provide, it is no longer necessary to connect the calibrator to the receiver. This simplified hook-up eliminates the spurious markers and receiver oscillations encountered with conventional hook-ups. Further, there is no disappearance of markers at trap resonant frequencies. And there are many other advantages, too; all enabling you to do a *better alignment job*, in *one-half the usual time*, and at *far higher profit*.

980 Line instruments are available to TV technicians through leading distributors. Literature giving complete information gladly sent on request. Return the coupon today.



**MODEL 985**  
**CALIBRATOR**

—a time-saving instrument for TV shop, engineering laboratory, and industrial alignment applications. Negative and positive Z-axis markers are provided for wave-form pattern analysis. Extremely useful for making linearity adjustments, calibrating signal generators, and determining signals of unknown frequencies. Generated markers are visible even at sound trap frequencies. Generated frequencies are *fundamentals* . . . not harmonics. Simultaneous multiple marker insertion . . . no distortion of response curve . . . fewer connections to TV receiver.

**MODEL 983**  
**OSCILLOSCOPE**

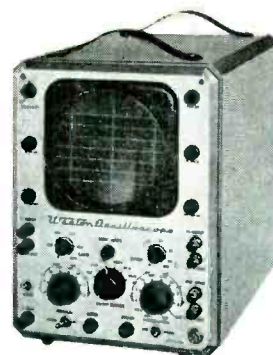

—a high gain, wide band oscilloscope. Band width of 4.5 megacycles allows accurate display of video frequencies, including pulse wave forms and color synchronizing bursts. High sensitivity of 17 millivolts per inch makes it ideal for setting resonant traps, as a general null indicator, signal tracing in low level stages, phase measurements as well as for sweep frequency visual alignment of TV receivers. Has provisions for internal calibration, internal phased sine wave, and Z-axis intensity modulation. Reversal of polarity of both horizontal and vertical signals accomplished by means of toggle switching. Identical vertical and horizontal amplifiers . . . direct coupling used throughout.



**MODEL 984**  
**SWEEP**  
**GENERATOR**

—for efficient trouble shooting and lab practice in problems of sound and video IF circuits, associated trap circuits, TV tuners, video amplifiers and all-purpose

visual alignment. RF OUTPUT: Frequency modulated signal, TV channels 2 to 13 inclusive, complete FM coverage available by means of two preset selector positions. FREQUENCIES ARE FUNDAMENTALS OF THE OSCILLATOR FREQUENCY. IF/VIDEO OUTPUT: Frequency modulated signals ranging to 50 megacycles, continuous tuning, signals free from harmonics. SWEEP WIDTH: Full 10 megacycles on all channels. OUTPUT VOLTAGE (RMS): 0.1 Volt, sweep is linear. Output is essentially flat.



**MODEL 981**  
**PROPORTIONAL**  
**MUTUAL CONDUCTANCE**  
**TUBE CHECKER**

—provides meter measurement of leakage resistance as high as 5 megohms between tube elements . . . nine single circuit, twelve position selector switches protect against obsolescence . . . three toggle switches

make it possible to check and compare sections of twin-section tubes at only one setting of selector switch. Transconductance measurements high as 30,000 micromhos with filtered d-c plate, screen grid, and control grid potentials. Precision voltage divider network and switch provides signal voltages of 0.65, 1.3, 2.6, and 5.2 volts peak to peak at a frequency of 5000 cycles. Tubes checked more closely to circuit operating conditions. Better Gm accuracy obtained.

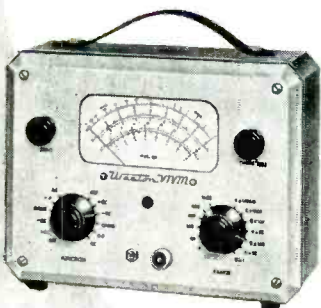

**MODEL 982**  
**VACUUM TUBE**  
**VOLTMETER**

—a self-contained, battery operated Vacuum Tube Voltmeter, particularly adaptable to the Radio-TV service

industry where the requirements of peak to peak measurements of a-c voltages exclude the use of conventional meters. Makes possible quantitative measurement of all complex wave form voltages utilized in video, sync and deflection circuits with no a-c line interference in critical measurements. Battery operation affords complete isolation from spurious response due to stray a-c fields and circulating ground currents. *Circuit loading on peak to peak measurements eliminated.*

**MODEL 980**  
**ANALYZER**



—highly versatile, accurate and rugged volt-ohm-milliammeter with a combination of functional ranges which provide a wide range of test measurement applications in the electronic field. D-c sensitivity of 20,000 ohms/volt, a-c sensitivity 1000 ohms/volt. Accuracy 2% d-c, 3% a-c. Range and functional switching greatly simplified by use of a single dial for all ranges and functions.

for TV it's the 980 Line  
**WESTON**  
test equipment

WESTON Electrical Instrument Corporation  
614 Frelinghuysen Ave., Newark 5, N. J.

Send copy of bulletin SD

Name \_\_\_\_\_

Address \_\_\_\_\_

City \_\_\_\_\_ State \_\_\_\_\_

**Now!**

# Telrex

**gives you the most  
TECHNICALLY  
PERFECTED  
TV ARRAY  
in the entire world!**

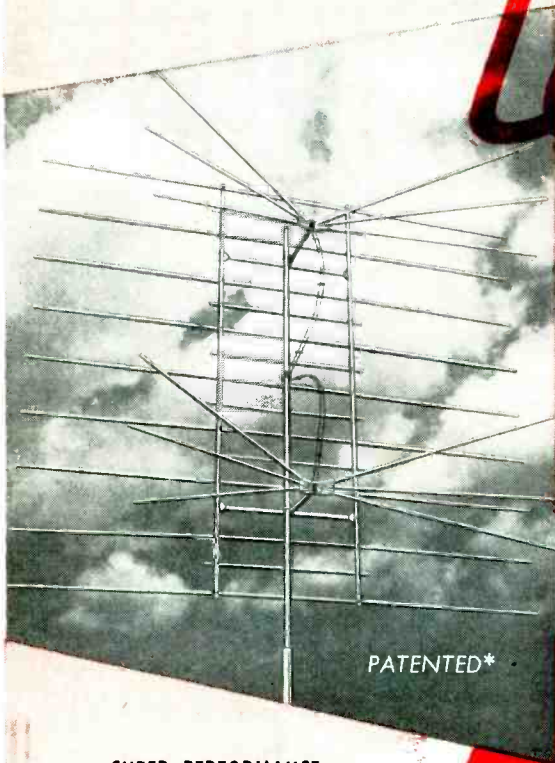

**SUPER PERFORMANCE  
ON VHF — EXCELLENT  
PERFORMANCE ON UHF**

**"CONICAL-V-BEAM" DIPOLES  
FOR BEST AND MOST UNIFORM  
MATCH TO 300 OR 200 OHM  
LINE ACROSS ENTIRE BAND**

**FULLY PRE-ASSEMBLED —  
INSTALLS QUICKLY AND  
PERMANENTLY**

**NO PHASING (PHASE SHIFT)  
TRANSFORMERS ATTACH 300  
OHM LINE OR 200 OHM  
LOW LOSS LINE**

**ALL ALUMINUM CONSTRUCTION  
LIGHTWEIGHT — DURABLE  
NO RIVETS TO WORK LOOSE  
AND BECOME NOISY!**

THE NEW  
VHF  
**KING  
PIN!**

**— designed to obsolete all  
existing TV arrays, provides maximum  
gain, maximum F/B ratio, minimum  
spurious lobes, no phase shift  
— best for B&W or Color TV**

The best S/W/R, S/N/R and H-E plane pattern TV Array ever devised. Utilizes the Patented "Conical-V-Beam" theory to perfection. "Conical-V-Beam" dipoles provide true broad-band characteristics with maximum gain and signal to noise ratio with NO PHASE SHIFT. New transmission line and spline back provide the perfect pattern on all channels. If you've tried the rest — Now! Try the best!

**LIST PRICES:**

- Model 201 (Single Bay) \$26<sup>50</sup>**
- Model 202 (2 Bays Stacked) \$57<sup>00</sup>**
- Model 204 (4 Bays Stacked) \$124<sup>00</sup>**

**AMERICA'S  
OUTSTANDING  
TELEVISION  
BEAM**

**Telrex INC.**

**"CONICAL-V-BEAMS"®**

**ASBURY PARK 5  
NEW JERSEY**

*\*"Conical-V-Beams" are produced under U. S. Patent No. 23,346, Canadian Patent No. 500,436 and British Patent No. 691,485 — other patents pending. Sold only through authorized distributors.*

# Curing

# TVI

# in AM Radios

Service hints to help eliminate noises caused by TV sets that plague the AM receiver.

by **STEVE TRAVIS**  
Service Consultant

**T**HE purpose of this article is to help avoid TV interference in home radios by considering some of the causes of TVI and methods of eliminating it. It is up to the TV technician to be able to remedy the situation when it occurs.

The whistles and birdies that are characteristic of TVI come about in two ways. First, they may result from radiation of magnetic fields from TV chassis. Second, they may be produced by the feeding of parasitic voltages from the TV chassis into the power lines which then convey the obnoxious signals to the innocent radio. (See Fig. 1.)

The horizontal deflection systems in television receivers develop high deflection currents and voltages. The horizontal sweep voltage of 15,750 cps itself is not important. It is the production of harmonics of this deflection frequency that cause the disturbing signals in radio sets.

Radiated voltages which may be present in the radio antenna and power supply cause the annoying squeals heard from the radio speaker. In tuning, the interference may be noticed every 15,750 cycles over the radio tuning dial.

This type of interference can be experienced as far away as 60 or 70 feet from some TV receivers. On occasion, it has been heard at a distance of over

100 yards from the TV receiver and can be experienced at any AM signal level. Usually the interference is more pronounced in those signal areas where the AM radio signals are not very strong. Also it is particularly noticeable when the radio is operated with a built-in antenna which most radios use today.

### Outdoor Antenna Recommended

The use of an outdoor antenna is highly recommended in such cases of TVI when the radio is being operated with a built-in aerial. The outdoor aerial will deliver more AM signal strength and therefore the signal to interference ratio will usually be increased. Hence, the use of an outdoor antenna is very important and should not be overlooked in the correction of this trouble.

It usually strikes the television set owner as rather strange that service work has to be performed on his television receiver when it is working so beautifully and he is not anxious to have it touched. It is most important to determine positively that the suspected TV receiver is causing the whistles and birdies. Rotation of the horizontal hold control should change the pitch of the whistle in the radio. Another way of determining that the particular TV receiver is the offender is to turn off the TV set. The whistles should be eliminated.

Horizontal interference escapes from the TV receiver through two paths. Since the horizontal output tube and horizontal damper tube develop large rf voltage containing the interfering harmonics, any cables associated with these tubes will radiate the signals (as

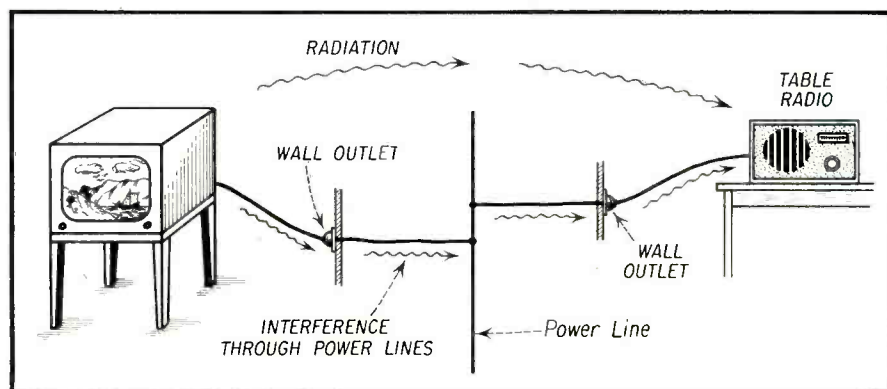

Fig. 1—Two paths for interference signals: power lines and via the air.

well as the tubes themselves). The capacitance between the filament and cathode in the tubes will permit the signals to appear on the filament line of the tubes. These signals are then capacitively coupled from the secondary of the filament or power transformer to the primary from where they are fed to the power line and thereby coupled to radios on the same power line.

A three way portable radio can be used to determine if the annoying signals are being transferred through the power lines. If the portable radio has the same amount of interference when operated on battery as when con-

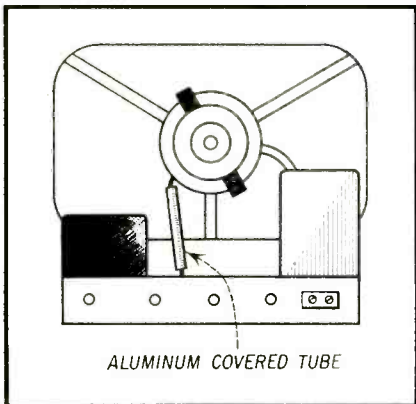

Fig. 2—The deflection cable is enclosed in an aluminum covered tube to prevent radiation from the cable.

nected to the ac power line in the location of the interfered radio, then most of the interference is being radiated through the air.

Many cases of this type of interference will be found to be due to TV receivers converted for larger picture tubes. Some conversions generate such strong 15,750 cycle pulses that these pulses are often audible in the room to people with a sharp sense of hearing.

Since the radiation can occur due to exposed cables, transformers and tubes, these items should be the first to be investigated.

Most TV manufacturers have tackled this problem by more careful receiver design. Radiation has been greatly reduced by housing the entire horizontal deflection system in a high voltage cage or shield which includes the horizontal output tube and damper tube and the transformer. Another help has been to encase the deflection cable in a cylinder of aluminum or covered with aluminum tape (see Fig. 2). Tin foil can be wrapped around the deflection cable if the aluminum tape is not readily available. This will measurably reduce the radiation and should be one of the first steps in affecting a cure. Shielding the horizontal output and damper tube with wire screen, thus permitting sufficient air to circulate through the shield to

remove the tube heat, should be another step taken. It may even be necessary to shield the picture tube aquadag coating with tin foil or aluminum paper.

It is advisable to find out whether .01  $\mu f$  line-bypassing condensers are at the ac input to the chassis. The .01  $\mu f$  condensers may have been omitted by the manufacturer and the installation of the condensers may very possibly reduce the radiation down to a tolerable degree.

Since the interference can reach the power lines and travel along them to the radio, an ac power line filter may be of some help in reducing interference. A filter as shown in Fig. 3 will aid in this blocking action. Experience has shown that most of the radiation comes through the air and the complete correction cannot be expected from the filter. This does not mean that the possibility of improvement with a filter should be

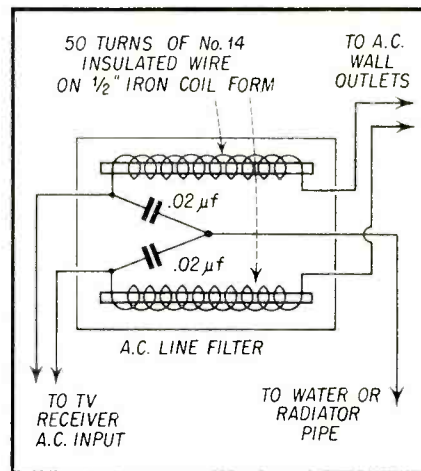

Fig. 3—Mount at back of cabinet. Keep ac line from receiver to ac line filter as short as possible.

overlooked as it certainly will aid in many cases. Excellent ac line filters to eliminate interference have been made available by various manufacturers.

#### Using the AC Line Filter

When using the ac line filter, mount the filter as close to the chassis as possible, but do not physically connect it to the TV chassis. When this type of filter is used, remove any existing ac line filter condensers in the TV chassis that may be located at the power input. Connect the ground or outside connection of the filter to an external water or radiator pipe. The filter is most effective if used at the TV receiver rather than at the radio.

In extreme cases it may prove necessary to provide a different power transformer with shielding between the damper tube winding and the other windings of the transformer.

Concerning the radio interfered with,

ac bypassing condensers in the radio chassis will help filter the ac line. They should be installed if they are not already in the radio. In using bypass condensers from each side of the ac line it is not advisable to use any larger size than .04  $\mu f$  at the radio or TV chassis as this will increase the shock hazard, and larger values will probably not provide any additional improvement.

As was previously pointed out, some of the interference can originate in the filament supply leads from the horizontal output and damper tubes. The addition of an rf choke in the filament leads to the tubes will help block the radiation of these pulse voltages.

With receivers that use permanent magnet focusing it may be necessary to connect a .01  $\mu f$  condenser in parallel with a 500K ohm resistor between the permanent magnet focuser and the yoke housing. This applies only to those receivers that make use of selenium rectifiers in a line connected arrangement. With this type of design the yoke housing is usually connected to the chassis and the focusing assembly is insulated from the yoke housing. This arrange-

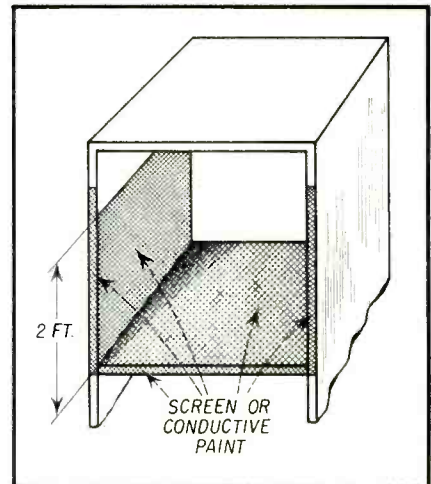

Fig. 4—Cover the interior with copper screening of conductive paint. Also, paint or shield the back panel.

ment protects the customer, when adjusting the focus, from being exposed to the potentials of the line-connected chassis.

#### Wire-Dress of Antenna

Another important item in the elimination of the whistles and birdies is the wire-dress of the antenna lead-in. The antenna lead-in should be positioned as far as possible away from the deflection section. This applies not only in the cabinet but externally as well. If permissible, the lead-in on the floor at the TV set should be located as far as

[Continued on page 59]





# A first PERFORMANCE

Introducing the longest line of replacement loud speakers with the lowest inventory requirement.

The highest performance in replacement loud speakers at the lowest cost.

## THE NEW Viking Replacement Speakers by JENSEN.

Completely redesigned for all today's requirements, the new Viking speakers are completely streamlined both for stocking, selling and performance. Viking is the most complete line for radio, TV, replacement and general purpose applications—there are 13 models including 3 ovals

### **BUT**

because of the ingenuity of the Jensen design, you need only one universally applicable model in each speaker size. Your inventory requirements are lower than for any other speaker line—your stock investment is cut to the bone.

And the Viking speakers are universal. The new Viking design is the most compact, has the least depth of all the replacement speakers. They'll fit into even the most crowded sets. And with the most compact design Viking has introduced greatly improved efficiency, heavier magnets, truly permanent alignment, at no increase in price in all models 6" and smaller.

Free with all sizes from 3" to 6" Viking speakers new free, easy-mount combination transformer and chassis mount bracket.

# Jensen

MANUFACTURING COMPANY

Division of The Muter Company  
 6601 South Laramie Avenue • Chicago 38, Illinois  
 In Canada: COPPER WIRE PRODUCTS, LTD., Licensee

# A Revolutionary

# Method of

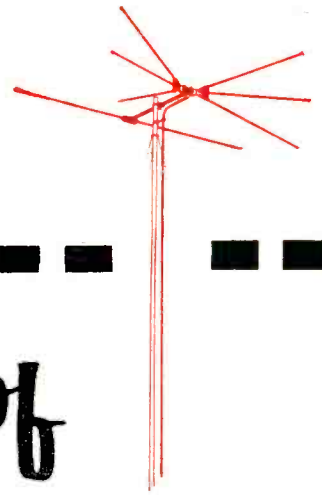
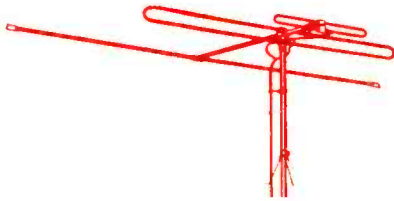

by **HAROLD HARRIS**  
 Vice President, Sales & Engineering,  
 Channel Master Corp.

FROM the geographical aspect of TV transmission, the situation of overlapping coverages and extended transmission range ultimately resulted in the memorable freeze, which was lifted after completely new channel allocations failed to reduce the problems presented. These re-allocations have not reduced the great distances that TV stations reach out to—and as a result practically every community in the country receiving TV signals gets them from more than one channel and from more than one direction.

Until now, the problem of receiving TV reception from a number of different directions has been met by three general methods:

1. The use of a rotator in conjunction with a broad band antenna. This, by far, is the most common approach to the problem.
2. The use of two or more Yagis, independently oriented in conjunction with a manually operated antenna selector switch located at the set.

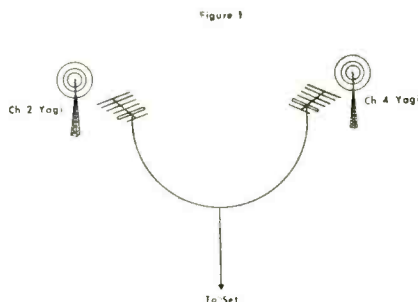

3. The use of so-called omni-directional antennas, consisting of a series of straight or conical dipoles which can be connected in different combinations by a manually operated, antenna selector switch at the set.

The purpose of this article is to describe an additional method of solving this problem. This new method, developed by the Channel Master Laboratories after years of research, is called the SelecTenna Coupling System. The SelecTenna system permits up to seven separate vhf Yagi antennas to be coupled, on the mast, to a single transmission line, provided there is at least one channel separation between them (or the guard band between channels 4 and 5). This method the author believes will eliminate the use of compromise antenna types, extra tuning equipment and the extra manual operation at the set when switching channels.

The system consists of a series of very narrow bandpass filters having a 300 ohm impedance at resonance and an impedance of several thousand ohms off resonance. The number of filters used bears a general relationship to the

number of channels to be received.

Let us illustrate the most simple installation problem of this type. Assume that Channels 2 and 4 lie in different directions and that reception is desired from each of them. The ideal solution would be to couple Channel 2 and Channel 4 Yagi antennas together and run one lead down to the set. However, difficulties may arise when we attempt to do this. Until now the hookup shown in Fig. 1 has been technically impossible for the following reasons:

The VSWR (Voltage Standing Wave Ratio) curve of an antenna is such that it reaches its lowest value at resonance and climbs sharply at either side of resonance (Fig. 2). The VSWR is a function of the impedance of the antenna. At resonance, the VSWR is at its minimum value and the impedance is purely resistive. The capacitive and inductive reactances cancel each other out. Off resonance, the antenna becomes highly reactive.

When the Channel 2 and Channel 4 antennas are tied together through a length of transmission line, serious losses occur because one antenna shunts the other. In addition, spurious Channel 2 pickup from the Channel 4 antenna is introduced, and this further degenerates the performance of the

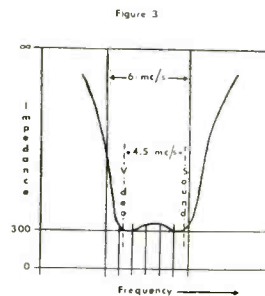
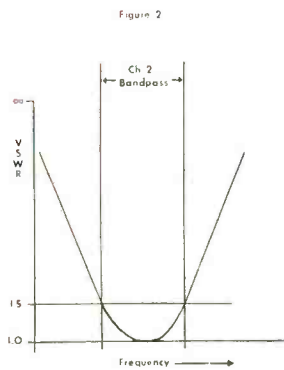

# ANTENNA COUPLING

Channel 2 antenna. The same thing is true if we consider the effect of a Channel 2 antenna on Channel 4 reception.

An ideal solution would be to put a bandpass filter, one channel wide, in series with each antenna. This filter would have a 300 ohm impedance at resonance and an impedance of several thousand ohms on either side of its selected channel. (See Fig. 3). This system would then permit the channel being received to go through its respective filter unimpeded. The other filter isolates the inoperative antenna and prevents it from interfering with the one in operation. The outputs of the bandpass filter for each respective channel would be tied in parallel and one line could be brought down to the set (Fig. 4). After almost two years of development the circuits shown in Figs. 5A and 5B were developed. Fig. 5A shows the circuit for the low band. Fig. 5B shows the circuit for the high band.

In operation, these two circuits are virtually the same. Capacitive isolation instead of inductive isolation is used in the high band because the required value of inductance resonated with the distributed capacity of the coils at high

Figure 4

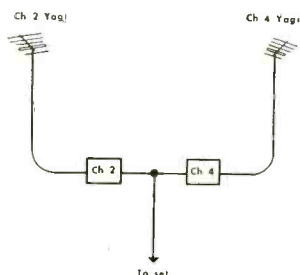
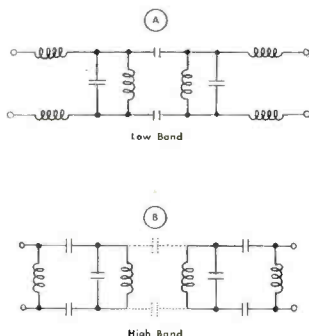

Figure 5



band frequencies. A compensating inductance was also put across the high band terminals to compensate for stray capacitances resulting from the size of components, hardware, and placement of parts. This inductance corrects the skirt impedance off resonance and prevents it from being low in magnitude and from appearing capacitive.

The operation of the filter can be readily explained by breaking it into two parts. Fig. 6A shows that the heart of the filter is essentially a double tuned transformer consisting of two parallel resonant circuits at the desired mid-band frequency, with two coupling capacitors added to provide necessary band width.

The impedance curve of this type of circuit alone is not suitable for our purposes because the impedance is extremely high at resonance and drops sharply off on either side of resonance (Fig. 6B). The demands of our filter are just the opposite. We need a 300 ohm impedance at resonance and an extremely high impedance either side of resonance.

Figure 7A shows one half of a filter circuit with the parallel tuned circuit, described above, replaced by a resistance.

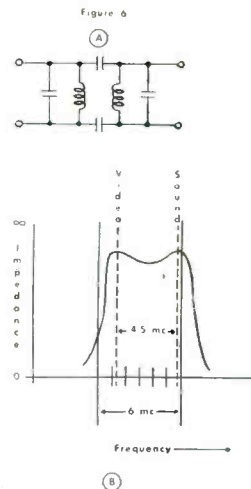

At resonance, the impedance of a tuned circuit is purely resistive. The dotted capacitor is common to the parallel resonant circuit and to the series resonant circuit. The explanation is as follows:

The two inductances and the capacitor are tuned to the bandpass frequency. Therefore, we have a series resonant circuit acting as an impedance transformer. The effect of this series resonant circuit is to appear as a 300 ohm impedance at resonance, and as an extremely high impedance—several thousand ohms—either side of resonance.

The impedance characteristics of the circuit was being aimed at a filter circuit having a band width of one channel, very sharp skirt selectivity, an impedance of 300 ohms at resonance, and an impedance of several thousand ohms off resonance.

The physical layout was extremely critical, and in order to get capacitors of the proper Q, metal stampings were used on the high band couplers as capacitor plates. Fig. 8A shows the physical placement of components for the high band coupler. The total effect of these electrical and mechanical considerations is to give us couplers having standing wave ratios of under 1.5:1, and having insertion losses of under

Figure 7

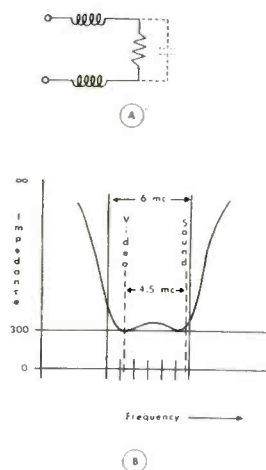

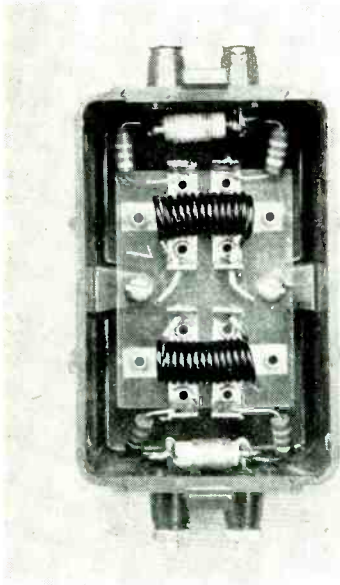

Fig. 8A—Physical placement of coils for high band coupler.

1 db on the low band and under 1½ db on the high band.

Since two or more couplers will be used in each installation, a simple method of mast mounting had to be developed. An ingenious system was devised in which each coupling unit could be snapped onto the next, resulting in an interlocked stack of couplers (Fig. 8B). It will also be noted that since the circuits are completely symmetrical, it makes no difference which end is used for the input and which end is used for the output. This simplifies the installation.

Since it is not possible to maintain the high impedance of the high band couplers on low band frequencies, it is necessary to use a high-low coupler of special design when coupling high and low band antennas through this system. Fig. 9A shows the hookup when two antennas in the same band are coupled together. Channels 3 and 6 are used as examples.

Figure 9B shows a case where a broad band Yagi is used to provide pickup from Channels 2 and 4 from one direction, and a separate Yagi is used to provide Channel 6 signal from another direction. It will be noted that both the inputs and outputs of the Selectenna Couplers can be used in parallel.

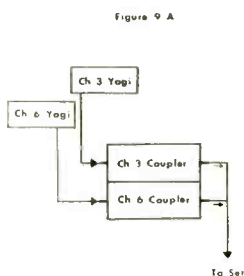
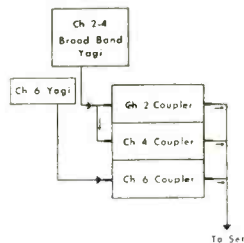

Figure 9C shows a case where two low band Yagis are coupled to one high band Yagi. Separate couplers are used for the low band channels and since Channel 10 is the only high band channel being received in this installation, the high-low filter provides adequate isolation. No separate Channel 10 coupler is required in this application. In this case, it should be noted that an all-channel high band antenna could have been used instead of a single channel high band antenna. This of course would provide reception on all channels of the high band which were on the air in the area.

Figure 9D shows the case where four separate Yagis are used—two for the high band and two for the low band. The combined outputs of the low band and the combined outputs of the high band are fed into a high-low filter and combined. The single transmission line carrying all four channels runs from the high-low filter to the set.

Figure 9E shows a common situation: Reception is obtained from one direction, on both high and low bands, by use of a broad band antenna such as the conical. It is desired to tie in to

Figure 9 B



this system a separate high band Yagi. In this example, the conical receives Channels 3, 6, and 10. The Yagi is to receive Channel 12.

Two high-low filters must be used in this application. The first filter reverses its usual application; it now separates the highs from the lows. The low band output from this filter is fed directly to the low band input of the second high-low filter. The high band output which now carries the channel 10 signal is fed to a Channel 10 coupler. The signal from the Channel 12 Yagi is fed to a Channel 12 coupler. The outputs from the Channel 10 and the Channel 12 couplers are then tied in parallel and fed to the second high-low coupler. Here these signals are combined with the low band signals and fed to the set via a single transmission line.

Figure 9F shows how *uhf* can be tied into any of the above examples. The single line from the Selectenna System carrying the *vhf* signals is fed into the *vhf* input of a *vhf-uhf* coupler

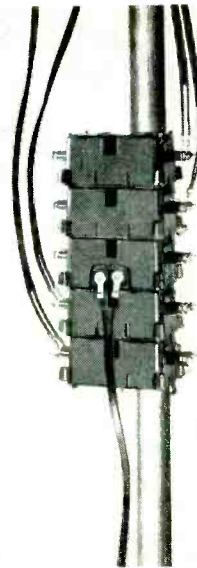

Fig. 8B—Couplers may be stacked on mast as shown above.

such as the Channel Master "Ultra-Tie". *UHF* signals are fed to the *uhf* terminals, and the combined output carrying both *uhf* and *vhf* is fed down to the set, using only a single transmission line.

It should be noted from the illustrations that the channels of higher frequency on both the high band and the low band should be the ones closest to the line—or high-low coupler—running directly to the set.

It may be seen from the above illustrations that a quite versatile antenna coupling system has been devised covering every conceivable combination of antennas. The advantages claimed for this system as compared to a rotator are as follows:

1. No moving parts.
2. No waiting for antenna to come about when changing channels.
3. Specific high gain Yagi antennas can be used for each channel instead of compromise broad band types.
4. Eliminates extra manual operation at set when changing channels.
5. Eliminates extra cabinet on top of set.
6. Single down lead (no rotor wire).

Figure 9 C

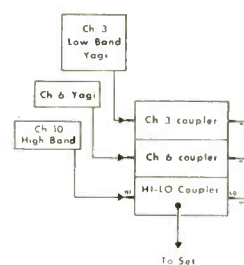
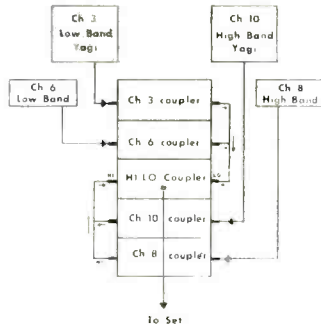
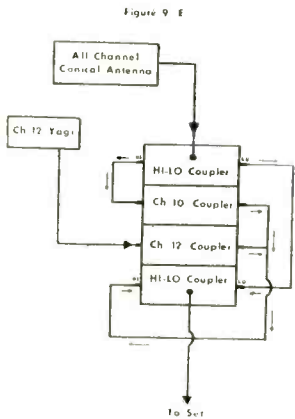

Figure 9 D



7. No possibility of antenna being off orientation.
8. Lower cost in many cases.

The claimed advantages of the Selectenna Coupling System as compared to coupling Yagi antennas together with double throw or triple throw switches at the set are as follows:



1. Eliminates switching operation.
2. Eliminates selector switch from wall or top of set.
3. Couplers have less insertion loss than switch.

Where manually operated switches are already in use, they may be replaced by the Selectenna Coupling System. This would be an unusual application

Figure 9 F

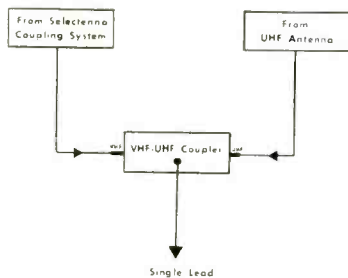

in that the coupling units would be located down at the set instead of up on the mast.

In light of the above advantages and in consideration of the simplicity and economy of installation, this system should be a welcome innovation to TV installers.



# Association News

## NATESA—Chicago, Ill.

The National Alliance of Television and Electronic Service Associations—NATESA—will hold its Fifth Annual National Convention at the Morrison Hotel in Chicago on Sept. 24, 25, 26, 1954. NATESA has gone all out to assemble a stellar staff of experts in the various fields to make this year's convention a criterion for the future. The Seminar speakers will be men of stature in the TV Industry, and they will lecture on topics of current importance to all branches of the Industry. There is still some booth space available, and they invite all Service Organizations, manufacturers, jobbers, etc. to participate. Address all booth reservations to NATESA, 5908 S. Troy Street, Chicago 29, Illinois.

## ARTSD—Columbus, Ohio

An obviously justifiable gripe was registered recently in an issue of the ARTSD NEWS in reference to the fact that, when the picture signals of two large Columbus, Ohio, TV stations dropped out and left only the sound, the stations' refusal to make an announcement of this broadcasting deficiency precipitated a deluge of calls from set owners to servicemen, and hours of wasted time and effort among the whole service community.

## Eastern TV Conference

The Eastern Television Service Conference, Inc., which is composed of 37 television service associations on the Eastern Seaboard, has filed incorporation papers in the State of New Jersey.

Harold B. Rhodes, of Paterson, N. J., is chairman of the group, Bert Bregenzer, of Pittsburgh, is vice-chairman, John Rader, of Reading, Pa., is treasurer, Ferdinand J. Lynn, of Buffalo, N. Y., is secretary, and J. Palmer Murphy is executive director.

## LIETA—Long Island

We see by the LIETA "Guild" News that the association has elected to campaign for full cooperation with Sarkes Tarzian in that company's rectifier recovery program, which was announced in the June issue of this magazine, and which was inaugurated to offset the critical shortage of selenium, recently made more acute by increased military demands upon the already fixed and limited supply. The "Guild" also announces that a business group will be set up within the Guild, composed of Guild members who are shop owners or self-employed servicemen, who will expedite their public relations program. To be eligible for participation in this program, members will have to meet stiff minimum requirements based on business integrity.

## FRSA—Williamsport, Pa.

The delegates from federation chapters met in Williamsport for their regular monthly meeting. Mr. Charles Knoell of TSDA of Philadelphia was appointed chairman of a committee to prepare the forms and outlines now being used successfully in Philadelphia for the procedure of investigating of part time service men employing technicians who do night and Sunday work, back alley operators and service shops who ignore city, state and federal tax and business licenses and users of bait advertisements. The committee will show how to gather needed information and prepare reports for the local state sales tax offices, mercantile or business tax headquarters, income tax bureau and other interested agencies. This committee will prepare and supply each group with copies of an anti-bait advertising ordinance for presentation to local municipalities for enactment.

**HERE'S WHY!**

# **ALLIANCE develops and markets NEW OUTSTANDING ANTENNA**

*After staying out of the antenna business these many years...  
Alliance has now entered the field because...*

TV servicemen and engineers the country over demanded a complete, all-purpose, high-gain antenna to meet today's needs. So Alliance research and development, after exhaustive design tests, and satisfied with nothing short of the best, has at long last produced this... the ultimate in an all-channel, high-performance antenna... the **ALLIANCE TRICEPTOR!**

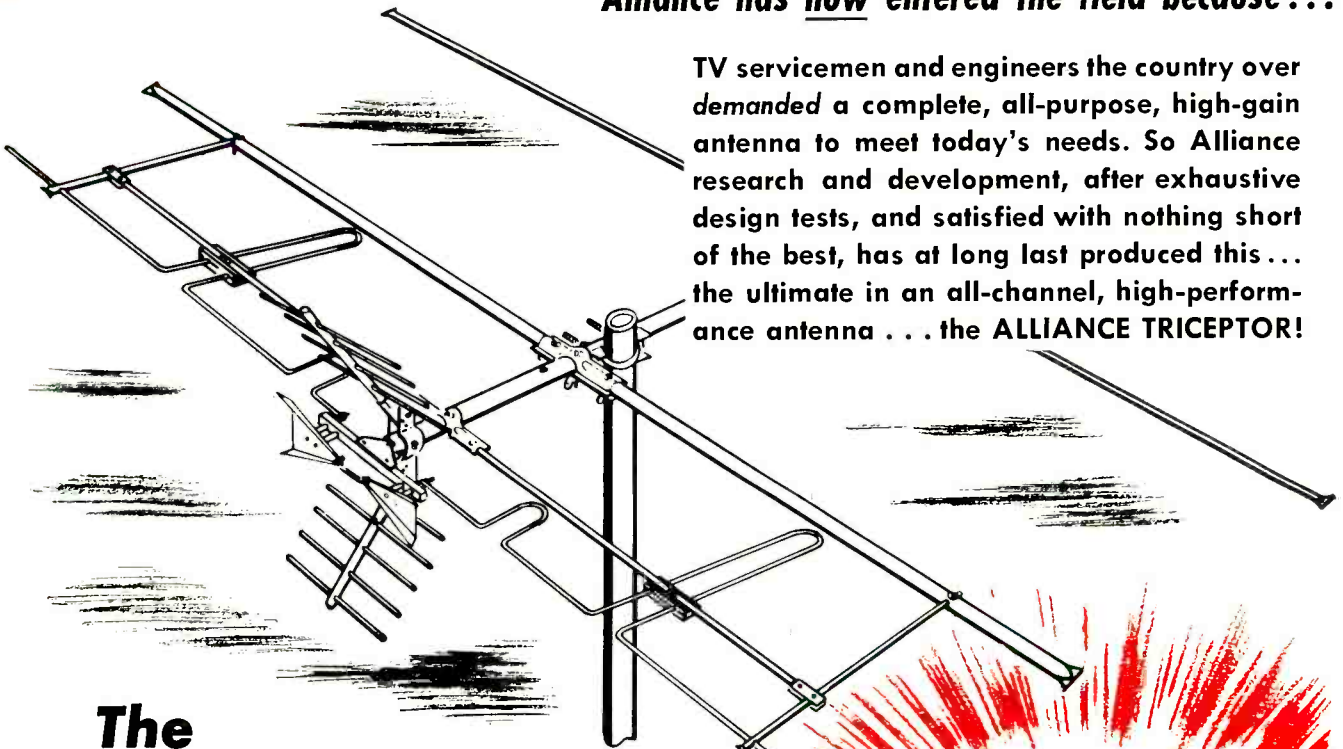

## **The ALLIANCE TRICEPTOR**

*The Antenna you asked for—  
**ALL VHF UHF CHANNELS**  
A Revolution in Design!*

A totally new and different UHF-VHF all channel antenna. Adds gain of VHF antenna to UHF antenna for unusually high, uniform gain and top performance on all channels!

*Where the ultimate in directivity is required, especially in fringe, multiple station and overlapping areas, the famous Alliance Tenna-Rotor used as an accessory with the Alliance Triceptor, makes the ideal combination for 'peak' reception.*

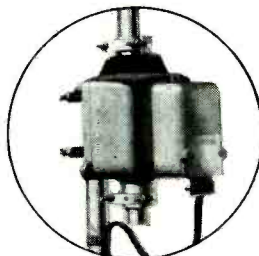

## THE *Monolober*

(Model TC-2 single bay UHF-VHF)  
New Alliance Antenna designed for all channel reception.

Price **\$2295**

**HIGH UNIFORM GAIN** on all UHF-VHF channels. No dropouts—no channels sacrificed to improve others.  
**MINIMIZES OR ELIMINATES INTERFERENCE.** Co-channel interference, ghosts, airplane flutter, auto ignition, neon, etc., greatly reduced or eliminated!

**HIGH DIRECTIVITY** with a MONOLOBE pattern.  
**PRE-ASSEMBLED "SNAP-OUT" DESIGN** units for fast easy installations.

**NO SPARE PARTS BAG!**

**ALL-WEATHER CONSTRUCTION**—structurally sound, rigid, sturdy, compact and lasting. Wind tested, light weight, no tying needed.

*Meet the changes in Television with Alliance Triceptor antennas.*

**THE ALLIANCE MANUFACTURING CO., Alliance, Ohio**  
**MAKERS OF THE FAMOUS ALLIANCE TENNA-ROTOR**

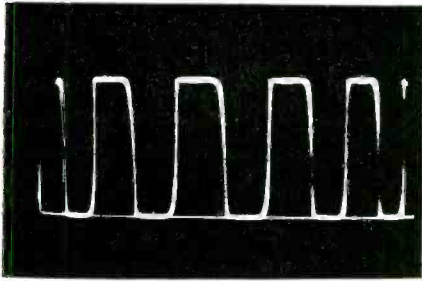

Fig. 1—Example of comparatively fast rise time.

Q. What is the meaning of "rise time" in the reproduction of a square wave?

A. The rise time of a square wave is the time which is required for the voltage to rise from 10% to 90% of its final value. Rise time accounts for the elapsed time in developing 80% of the leading edge of the wave. This convention is adopted in the trade in order to avoid confusion which would be caused by widely variable end effects during the initial and final 10% of the leading-edge excursion. Fig. 1 shows a reproduced

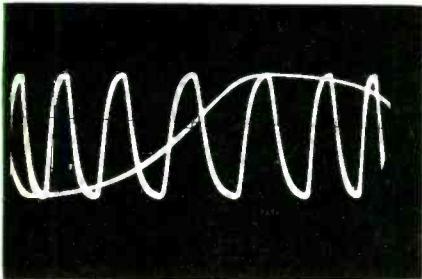

Fig. 2—Example of comparatively slow rise time.

square wave with a faster rise time than appears in Fig. 2.

Q. Why would the top of a square wave appear thicker than the bottom of the square wave?

A. This situation is shown in Fig. 3. It is due to the presence of spurious voltages in the reproduced square wave, such as noise voltages, combined with non-linear operation of

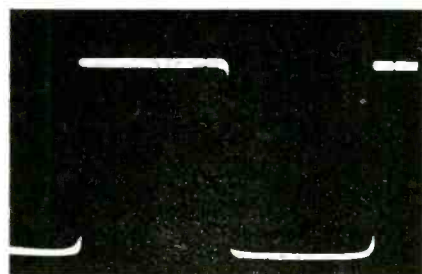

Fig. 3—Example of variation in trace thickness.

# TV INSTRUMENT CLINIC

## PART 4

*Based on CHALLENGE CLINIC demonstrations, this new series discusses many measurement and test problems raised by service technicians.*

By **ROBERT G. MIDDLETON**

*Field Engineer,  
Simpson Electric Co.*

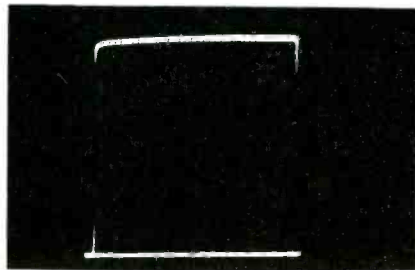

Fig. 4—Waveform without standing waves.

the video amplifier. That is, when the gain of the video amplifier is greater at the top of the waveform, the noise voltages are amplified more, and the trace appears thicker.

Q. Can a square-wave test of a video amplifier be made without the use of a square-wave generator?

A. Yes. A 60-cycle square-wave test can be easily made by setting up a sweep generator as the i-f alignment, and connecting the scope at the output of the video amplifier. The sweep generator is tuned to the center frequency of the i-f amplifier, and the sweep width is reduced almost to zero. A very good 60-cycle square-wave voltage is then applied.

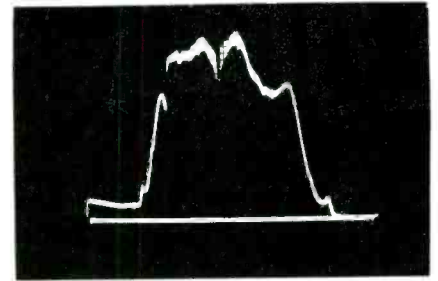

Fig. 5—True image is not obtained in this waveform.

Q. What type of pattern is obtained during an impedance check of an antenna, if the antenna matches the impedance of the lead-in?

A. If a demodulator-probe check is being made of the standing-wave pattern on the lead-in, the match condition is indicated by the lack of standing waves, as illustrated in Fig. 4.

Q. When sweeping a video amplifier through zero frequency, what would cause the curves on either side of zero frequency to fail to match each other as true mirror images?

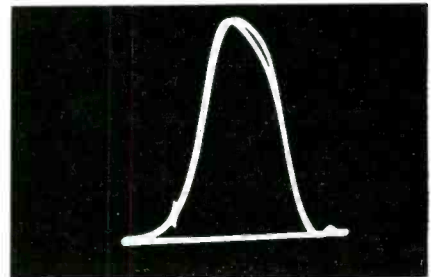

Fig. 6—Appearance of waveforms that jump up and down.

A. This type of difficulty is illustrated in Fig. 5. It is caused by regenerative instability, either in the video amplifier or in the test set-up.

Q. Why does a visual-response curve sometimes jump up and down slightly on the scope screen?

A. This jumping, illustrated in Fig. 6, is usually the result of line-voltage [Continued on page 58]

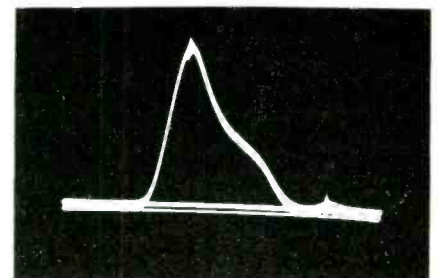
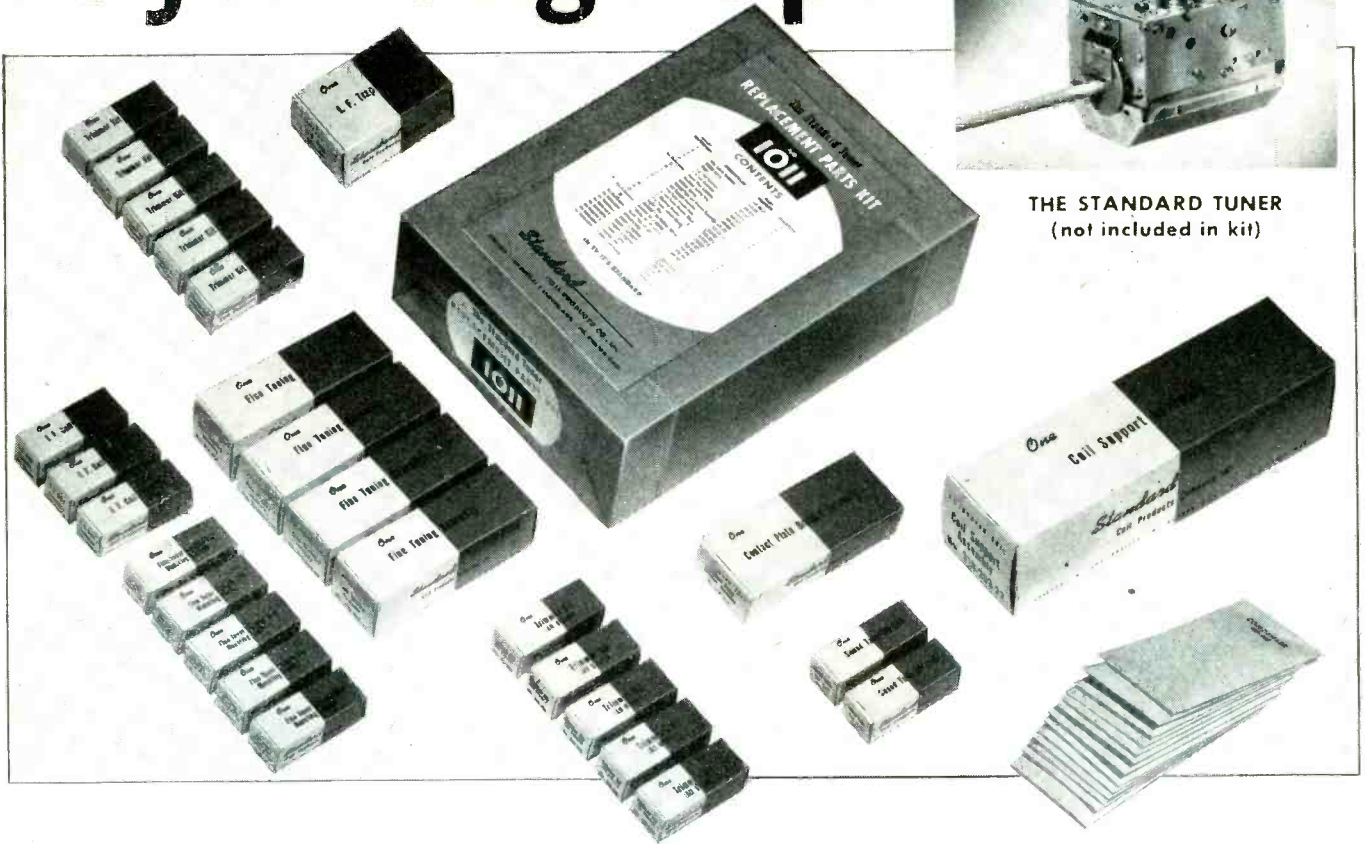

Fig. 7—Fuzzy wave caused by cross-talk.

# LOOK! 104 TV tuner parts at your fingertips!



THE STANDARD TUNER  
(not included in kit)

Use the handy, all-new

## STANDARD Tuner Replacement Parts Kit

No. 1011

IN TV IT'S STANDARD

*Standard*

COIL PRODUCTS CO., INC.

CHICAGO LOS ANGELES BANGOR, MICH.  
NO. DIGHTON, MASS.

Export Agent:

Rocke International Corporation, 13 E. 40th St., New York City

Get your most called for parts servicing Standard tuners series TV-200, TV-1500, TV-2000 and TV-2200. All are now conveniently packaged in this low-cost Standard replacement parts kit—sturdy, compact, fully labeled for quick reference. Each item is individually boxed, except the very small.

**More Profit**—Kit costs only \$22.50, contains parts retailing at \$41.30.

**Save Time**—Hard-to-find tuner parts right at hand for quick, sure selection.

**Build Customer Goodwill**—Replace tuner parts direct from your Standard kit, so your customer will *know* each part is completely new.

Plan now to speed up your service work, bring new order and efficiency to every job. Get your Standard tuner replacement parts kits today! Call, write or wire your parts jobber, or address Standard Coil Products Co., Inc., 2085 N. Hawthorne Ave., Melrose Park, Ill.



# CBS

## COLOR TUBE

Prepared by the Commercial Dept.  
CBS-Hytron

**T**HE CBS-Colortron "205" is a 19-inch, aluminized, glass-envelope, tri-color picture tube designed for use in color television receivers. By utilizing the CBS-Hytron method of applying the phosphor dots to the inner surface of the face plate, the "205" provides truly large-screen color television. The actual useful screen area of this 19-inch CBS-Colortron is 205 square



Fig. 1—The CBS "Colortron 205."

inches. In addition to the large-screen surface, the CBS-Colortron "205" incorporates an electromagnetic convergence system that eliminates the high-voltage problems associated with electrostatic convergence.

### Electron-Gun Assembly

The electron-gun assembly of the "205" contains three matched electron beam sources arranged in a triangular configuration. Each of the three beam sources is tilted toward the common tube axis. This tilted structure provides proper convergence of the beams at the center of the screen. The electron-gun assembly of the "205" contains three pairs of pole pieces mounted  $120^\circ$  apart above the anode.

### Phosphor Screen and Shadow Mask

By a new method of screen processing, the tri-color, phosphor-dot screen is placed directly on the inside surface of the spherical face plate of the CBS-Colortron. In addition to achieving simple construction and high-quality reproduction, many electrical and structural advantages are realized, because of this advanced design. Dynamic con-

vergence requirements are reduced; sharper, brighter pictures result; adjustment time is reduced to a minimum; and a simple, stable over-all tube construction is attained.

The phosphor screen of the CBS-Colortron contains some 300,000 phos-

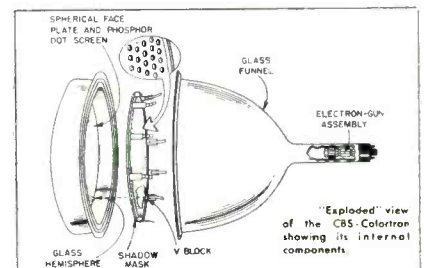
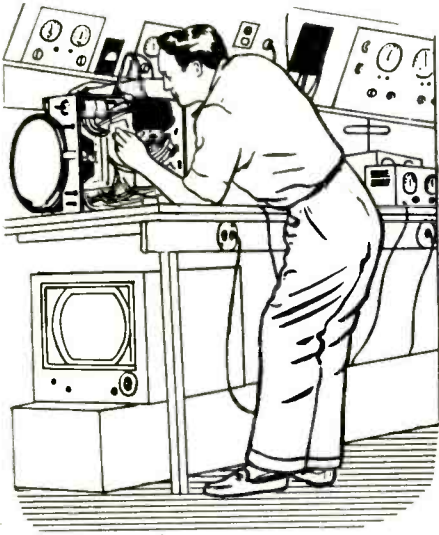

Fig. 2—Relationship of shadow mask assembly to body structure.

phor dots of each primary color, a total of 900,000 phosphor dots. These dots are arranged in 300,000 triangular groups, or triads. Each triad contains one red, one blue, and one green phosphor dot.

Another component of the CBS-Colortron is the shadow mask. See Figure 2. This thin, arched mask is

[Continued on page 55]



# The Work Bench

by PAUL GOLDBERG

This Month:

## "LEAD DRESS" PROBLEMS

THREE "lead dress" problems have been chosen for this installment. Due to the fact that there are no meter checks that can be made, manufacturers' modifications usually have to be referred to for trouble solution in many cases.

### DuMont RA-105—Pix and Sound Fades Out

The receiver was turned on and after playing properly for about an hour, the picture and sound faded out completely, leaving only the raster. We deduced from this that the trouble was either in the first *i-f* video, the tuner, or the *agc* system. Replacing V201 and the three tubes in the tuner individually, had no effect. The *agc* control R251 was likewise adjusted with no effect.

The receiver was next turned on its side and a check of the *agc* system was made. The *agc* lead was clipped at point "X," thus removing the *agc* voltage to the video *if* and *rf* tubes. As soon as this was done, the picture and sound came in. The *agc* circuit was therefore definitely at fault. Point "X" was then joined and re-soldered, and V209, 6AT6, and V204, 6AL5 were replaced individually without effect.

A voltage check made at point "X" measured -9.5 volts negative. This bias is enough to cut off picture and sound. Voltage checks were then made on plates 7 and 5 of V209 but they seemed to check normally. As soon as the volt meter probe was placed on pin #1 of the 6AT6 grid, the picture and sound came in. When the probe was removed the picture and sound disappeared.

The receiver had not been turned off for fear the trouble would not recur immediately. Therefore, resistance checks could not be made at this moment. However, voltage leakage checks were made of all condensers in the

6AT6 *agc* circuit. C228-.005  $\mu$ f, which had given us trouble on other sets, checked okay.

At this point, the receiver was finally turned off and all resistors were measured; especially R249, 100K, a trouble maker on other occasions. All resistors read OK.

A study of the diagram was then made and it was noted that if pin #2 plate, of V204, goes positive, current flows from ground through R345, R355, and R218 to the cathode of V204, pin #5. Thus, an incoming signal causes a varying positive voltage to appear on the grid of V209, pin #1, resulting in an increase and decrease in negative *agc* voltage.

It was now decided to see if there was any *agc* modification in the DuMont manual that could cover this condition. Thankfully, there was. From pin #5 of V204, 6AL5, the blue lead enters a cable of about fifteen wires which is positioned around the chassis. The blue lead then emerges to tie in at a terminal strip to R218, 1.2 meg. In humid weather this blue lead picks up enough voltage in the cable to result in an abnormal negative *agc* voltage, killing sound and picture.

The modification states, "Remove the blue lead from the cable and run it from pin #5 of V204 as short as possible through a hole in a stand up bracket to R218." (Refer to Fig. 1.)

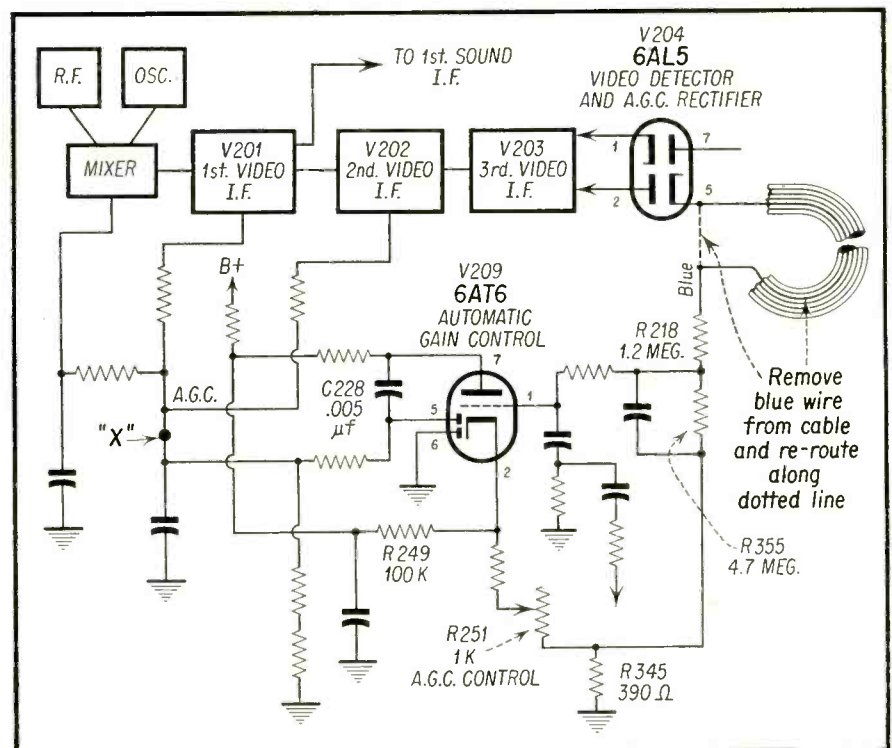

Fig. 1—Partial schematic, DuMont RA-105.

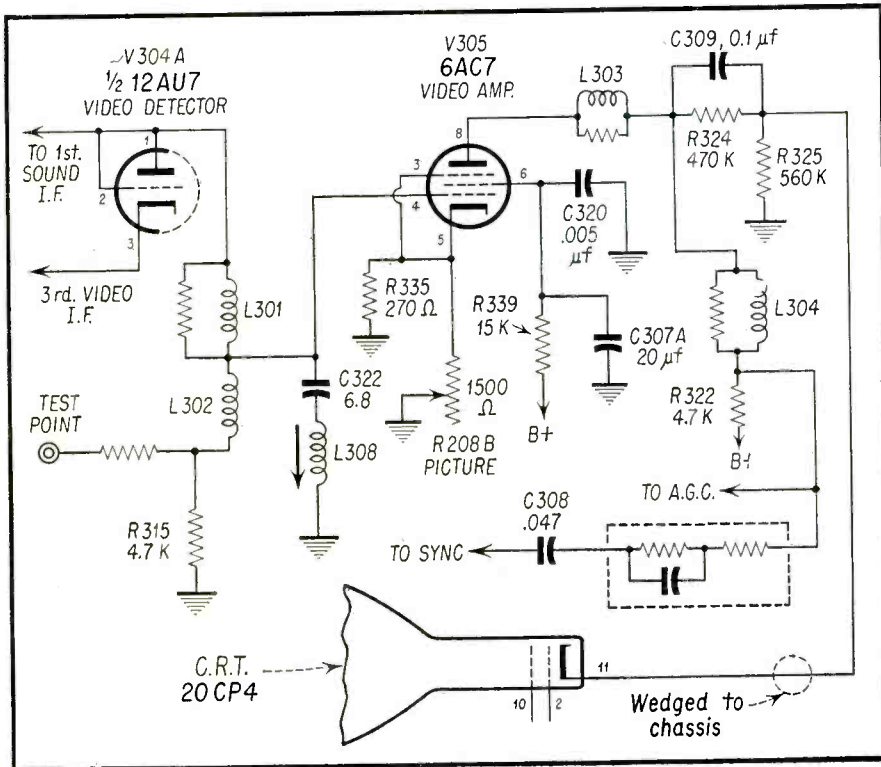

Fig. 2—Partial schematic, Admiral 22M1.

This was done and immediately picture and sound came in. The modification also states that a number of condensers and resistors are changed to reduce the impedance of the 6AT6 grid circuit and provide better stability. Before changing the recommended components, we checked the receiver for three days and it functioned properly. Thus, the re-routing of the blue lead was the direct answer to the problem. We then changed the necessary components to complete the modification.

It is extremely difficult for a serviceman to keep up with modifications as they come out. In this case, knowing about the modification beforehand would have saved us much time and many grey hairs. Thus, it is obvious that an informed serviceman makes a better serviceman.

#### Admiral 22M1—Smeard pix

When the receiver was turned on a very bad video smear was observed. As usual, before any further checks were made, the tubes V305, 6AC7 and V304, 12AU7, were replaced individually. However, these tubes were not at fault. We then proceeded with the under chassis checks.

A bad smear usually means an open peaking coil. Therefore, all peaking coils were resistance checked, but were found to be OK. Voltage, leakage measurements were next taken of several likely video condensers. These were C309, C308, C307A, and C320. All

checked OK. Voltage readings were then taken at the plate, screen, grid, and cathode of the 6AC7. All measured normal.

A resistance check was next made of all resistors in the video detector and video amplifier circuit, especially the 6AC7 load resistor, R322—4.7K. If R322 decreases in value, you will get greatly reduced low frequency response. If it increases in value, you will get excessive low frequency response and smearing. However, all resistors measured properly.

At this point the picture tube became the object of suspicion. Removing the C. R. T. socket, a high resistance check was made of the C. R. T. elements. First grid to cathode, then screen to grid, cathode to filament, etc. But this check also met with no success.

Before replacing the picture tube the socket was re-plugged on the C. R. T. and the receiver was turned on again. To our amazement the picture now was clear as a bell. We gently tapped the neck of the tube but could not reproduce the trouble. However, when the socket leads were rattled the trouble reappeared.

The cathode lead which carries the video information was traced down through a small hole in the chassis and it was found that the insulation was cracked and wedged to chassis. The smear effect was produced by this high resistance short. The cathode was then taped at the crack and rerouted through a larger hole in the chassis. The receiver now functioned properly.

Very often leads are forced through too small a hole in the chassis, causing this type of trouble. Yoke leads especially should be free of any chance of arcing through to the chassis. The lead carrying the video information to the picture tube should always be run separately from the other C. R. T. leads. Even the C. R. T. screen lead should be run separately, especially when it carries the blanking pulses. If this is not done, black bars on the left side of the raster may result.

#### Freed Model 55—Hum

The customer complained of a background hum, ever since he had bought [Continued on page 61]

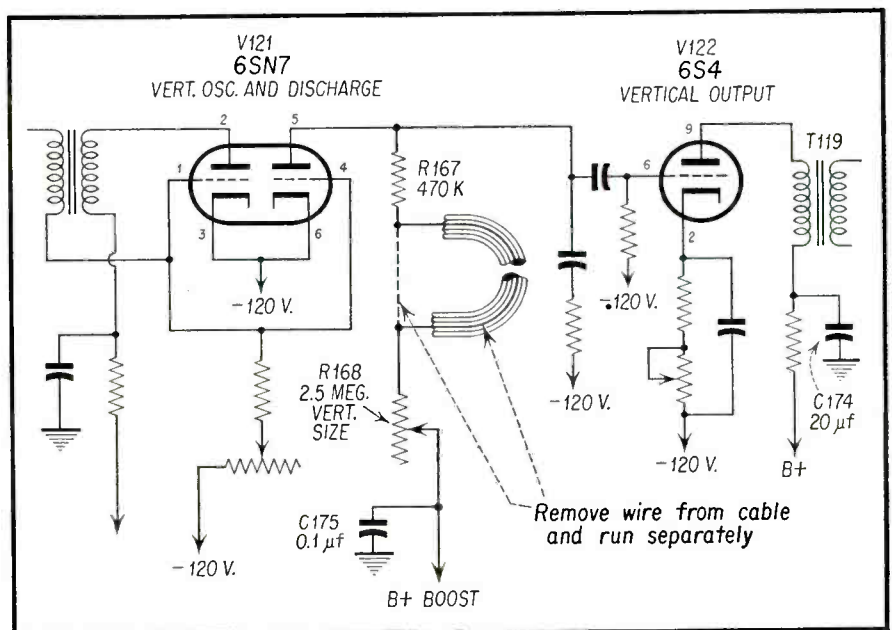

Fig. 3—Partial schematic, Freed Model 55.

**I**N an integrating circuit the time constant of the circuit is large compared to the frequency of the incoming signal and the output is taken off the condenser. If parallel resistor  $R_1$  is quite large compared to series resistor  $R_2$ , a normal integrated waveform is obtained, Fig. 19e, since the condenser tries to charge up to practically the peak source voltage, but can charge up to only a small portion of it in the available time. However, if  $R_1$  is small compared to  $R_2$ , then the condenser can only charge up to an even smaller part of the actual source voltage. The output is still integrated, but reduced, and is similar to the output of a series RC circuit with an even longer time constant. The waveforms taken off either the series resistor or parallel RC branch are typical for integrating circuits, regardless of the comparative value of  $R_1$  and  $R_2$ .

In integrating circuits, therefore, the relative values of  $R_1$  and  $R_2$  affect only the *amplitude* of the output waveform, not the waveshape; in differentiating circuits, the relative values of  $R_1$  and  $R_2$  affect both the *shape* and the peak-to-peak *amplitude* of the output waveform. (In differentiating circuits, the voltage the condenser charges to in series with the applied voltage is applied across the series resistor.)

In the series-parallel circuit we have been discussing, the larger parallel resistor  $R_1$  is compared to series resistor  $R_2$ , the less effect there is on the typical output waveform in either differentiating or integrating circuits.

In a simple series RC circuit, reducing the value of either  $R$  or  $C$  reduces the time constant; increasing the value of either increases the time constant. The same holds true if the value of any resistor or condenser is changed in a more complex circuit. However, when a resistor or condenser is added or taken away to make a different type of complex circuit, the effect on the time constant may not be too apparent. Some helpful rules-of-thumb can be applied to most complex RC circuits to clarify the effect on the action:

1) Any circuit change in an RC circuit which reduces the final voltage to which the condenser charges (while the same battery voltage is used) reduces the time constant, if the initial charging current is not also reduced. Example: Placing  $R_p$  across  $C$  in Fig. 17 reduces the voltage to which  $C$  would charge, as compared to a simple series circuit, without reducing the initial charging current. Adding a resistor across the condenser therefore reduces the time constant of the circuit.

2) Any change in an RC circuit which reduces the initial charging current while the condenser charges to

# RC CIRCUITS

by Cyrus Glickstein

Helpful rules-of-thumb which may be applied to complex RC circuits are outlined in this fourth installment, as well as typical applications in cathode bypass and sync separator circuits.

the same value of battery voltage, increases the time constant of the circuit.

For both rules mentioned above, the reverse is also true, of course. It is important to remember that changing the battery voltage alone has no effect on changing the time constant of the circuit. Time constant depends only on the values of  $R$  and  $C$ . A higher battery voltage will increase the initial charging current, but it also increases the voltage to which the condenser must charge. It therefore takes the condenser the same time as before to reach full charge, or 63% of full charge, etc.

### Cathode Bypass Analysis

Our analysis up to this point throws some interesting sidelights even on such familiar operations as cathode bypass action in an amplifier stage. Figure 20a shows a typical audio amplifier stage.  $R_k$  is the cathode resistor and  $C_k$  the cathode bypass condenser. The function of the cathode bypass condenser, of course, is to keep the cathode voltage steady as signals come in. This action prevents degeneration—loss of gain. Figure 20b shows an equivalent form of the amplifier circuit. The tube is represented as a variable resistor,  $R_x$ . The load resistor is  $R_l$ .

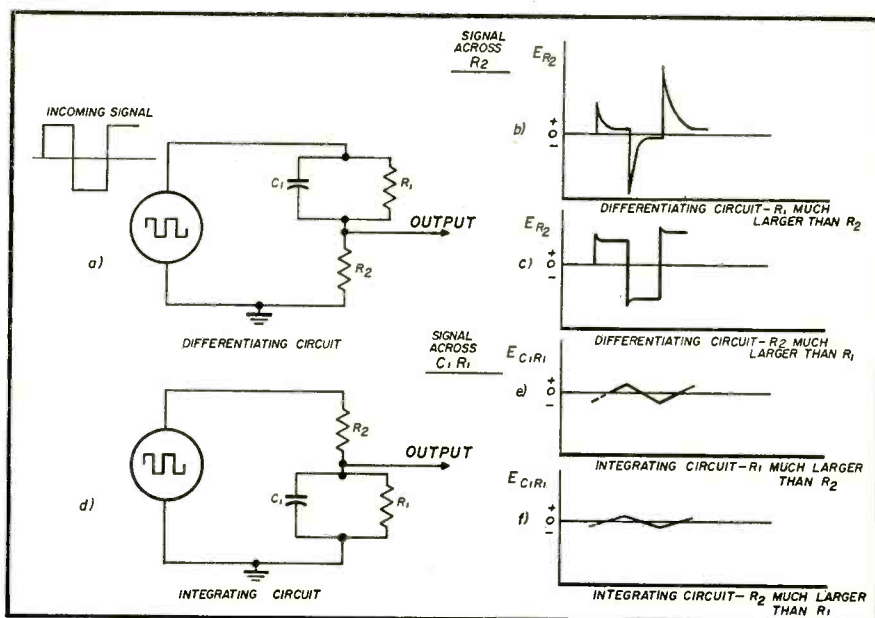

Fig. 19—Differentiating and integrating action in a series-parallel R-C circuit (parallel RC shown in series with  $R$ ). Note different "output" points.

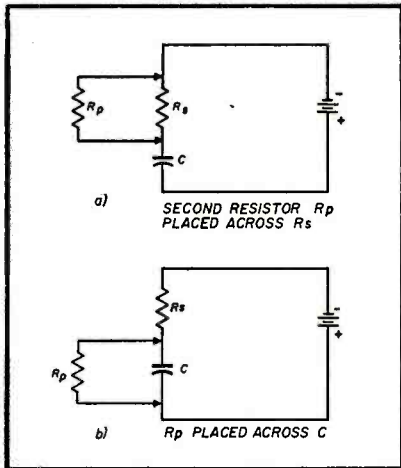

Fig. 17— $R_p$  has same effect on time constant whether put across  $C$  or  $R_s$ .

As can be seen, the equivalent circuit represents a series-parallel RC circuit. The time constant, from the standpoint of time required for the cathode condenser to charge, is therefore  $Ck \times Rk$  in parallel with  $Rx + Rl$ . Since  $Rk$  is so much smaller than  $Rx + Rl$ , the time constant for the charge circuit is effectively  $Ck \times Rk$ . The discharge path for  $Ck$  is only through  $Rk$ . Current can flow only in one direction through the tube. The time constant for the discharge path is also  $Ck \times Rk$ .

With no signal, there is a steady current through the circuit and  $Ck$  charges up to the voltage across the cathode resistor as determined by the voltage divider action in the circuit. When signals are applied to the grid, the tube resistance can be considered to change instantaneously—a negative signal increasing tube resistance, and a positive signal decreasing tube resistance. As the tube resistance changes, there is a redistribution of voltage—

less across the tube, and more across the load resistor (or vice versa, depending on the polarity of the signal). Without  $Ck$ , the voltage across  $Rk$  would also change. However, this voltage cannot change until  $Ck$  either charges or discharges to a new value. Before  $Ck$  can do this, the polarity of the signal on the grid changes. To keep the cathode voltage steady, therefore, a large enough value of  $Ck$  is selected to give a long time constant compared to the lowest expected incoming signal frequency. In the same way, a screen bypass condenser is used in the screen circuit of a pentode amplifier stage to keep the screen voltage steady.

### Sync Separator Analysis

Another application of the series-parallel RC network discussed above is in a sync separator circuit used in some older models, Fig. 21. A composite video signal, generally a video *if* signal, is applied across a diode in series with the RC circuit. The time constant of the charge circuit is comparatively small. The condenser charges through  $R2$  and the diode. The time constant of the discharge circuit is high, since the condenser can discharge only through  $R1$ .  $C1$  charges up to practically the peak value of the incoming signal. This is represented by the positive sync pulses. Connected as shown in Fig. 21, the diode does not conduct on negative alternations.

When the diode conducts, a small portion of the input voltage is developed across  $R2$ . After the first few cycles,  $C1$  is charged up to most of the applied voltage. Following the sync pulse, the video information in the rest of the horizontal line has a smaller amplitude.  $C1$  discharges slowly through  $R1$  and this maintains the cathode of the diode at a positive po-

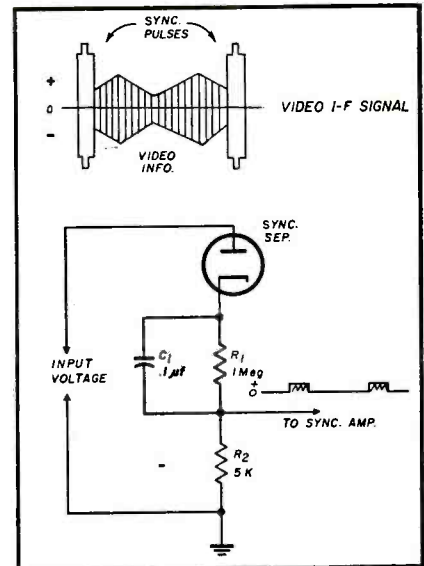

Fig. 21—Typical sync separator circuit used in TV receivers.

tential. The diode will not conduct until a large enough positive signal comes in to overcome this voltage. This occurs only when the next sync pulse comes in. The circuit functions as a diode detector for the sync pulses only. The pulsating *dc* voltage across  $R2$  represents the clipped sync pulses, which are then fed to the sync amplifier stage. A comparatively steady *dc* voltage is maintained across  $C1$ ,  $R1$ . If  $C1$  opens, synchronization is upset since video information also is rectified and passed along to the sync amplifier.

### CRT Input Analysis

In some cases, a circuit may look like the one we have been discussing but turns out to be somewhat different on further examination. For example, Fig. 22a shows a video amplifier stage direct-coupled to the cathode of the CRT. Direct coupling avoids the need for *dc* reinsertion.  $C1$ ,  $R1$ , and  $R2$  form a series-parallel RC network. However, this is not the entire circuit at this point. Another component, not indicated in the schematic, is  $Ck$ , the interelectrode capacitance between the cathode of the CRT and the other electrodes. This is shown by the dotted lines placing  $Ck$  in parallel with  $R2$ , Fig. 22b.

$R1$  and  $R2$  function as a voltage divider so the *dc* voltage at the cathode of the CRT is less than the full plate voltage of the video amplifier. This reduces the potential between the filament and the cathode of the CRT and so reduces the possibility of a breakdown between these elements. However, if only  $R1$  and  $R2$  were used without  $C1$ , the high-frequency response of the video system would be impaired. The reactance of  $Ck$ , ef-

[Continued on page 62]

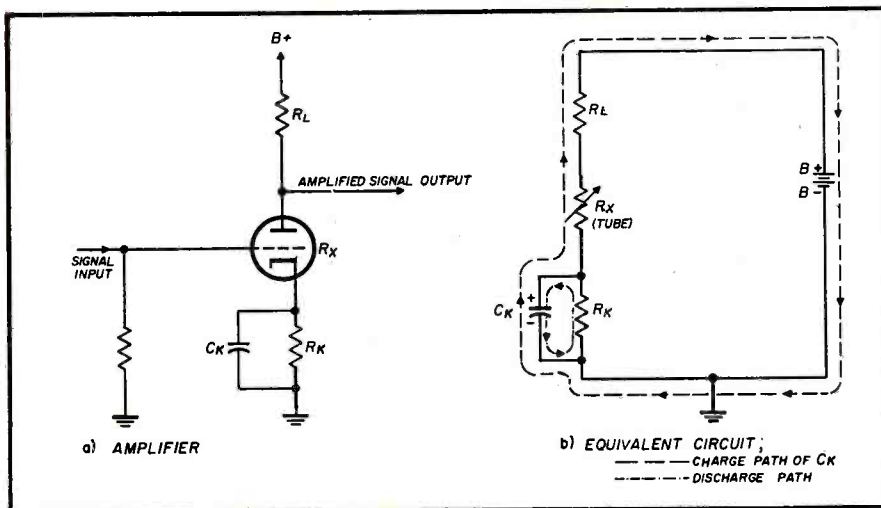

Fig. 20—(a) Typical audio amplifier, and equivalent circuit.

**DuMont RA-306  
Intermittent Pix Shrinkage**

Dear Answerman:

I have a DuMont RA-306 that has been causing me a considerable amount of trouble. The problem is the picture intermittently shrinks vertically. Naturally, the 12AT7 vertical oscillator and the 6S4 vertical output tubes have been replaced and this seemed to clean up the vertical shrinkage for a period of time but the trouble is now occurring more frequently than before. I have changed such components as the vertical coupling condenser, the charging condenser and others but haven't been able to actually put my finger on the defective component that is causing this intermittent shrinkage.

Have you any suggestions?

D.S.  
Washington, D.C.

Dear D. S.

The boost voltage is used in this receiver to operate the vertical oscillator and this is sometimes a source of vertical difficulties. A check of the boost voltage circuit may reveal that this is the cause of the vertical shrinkage. However, it is unlikely that useful information can be obtained by just measuring

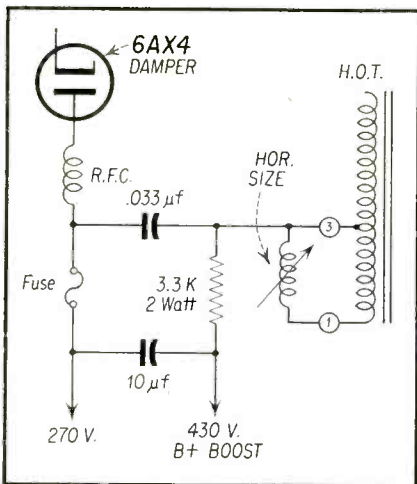

Fig. 1—Breakdown of 3.3K, 2 watt resistor causes intermittent vertical shrinkage in the DuMont RA306.

the boost voltage as it will be difficult to determine which component is breaking down and causing the fluctuation of the boost voltage.

The intermittent vertical shrinkage is probably caused by the 3.3K-2 watt resistor as shown in Fig. 1 which feeds the boost voltage to the vertical circuit from the boost condenser. It is not likely to be the boost condenser itself as this would affect the width of the raster.

More than likely there will be no evidence that the resistor is breaking



by **BOB DARGAN**

**Do you have a vexing problem on the repair of some radio or TV set? If so, send it in to the Answer Man, care of this magazine. All inquiries acknowledged and answered.**

down or increasing in value. Break down of resistors in this manner usually doesn't show with an ohmmeter measurement. The best procedure is to substitute another 3.3K resistor for the one in the receiver.

In many cases it is cheaper to replace components such as this one rather than waste time. The cost of the resistor is usually far less than the cost of the labor that is often wasted before such a replacement is made.

**Crosley Model 10-416  
Audio Modulation of Pix**

Dear Answerman:

I have a Crosley Model 10-416 in which when the volume control is rotated past the center the picture shakes so badly that it can't be watched. This shake or modulation of the picture is in unison with the audio that is being heard.

B.A.  
Shaker Hts 20, Ohio

Dear B.A.

This type of trouble is usually due to an open bypass condenser, 40 uf as shown in Fig. 2. When this condenser is open the audio signals appear on the B plus line and cause the horizontal oscillator voltage to be modulated with the audio signals. In some cases even the vertical deflection can be affected.

Some receiver designs have barely enough filtering at this point and when the volume is advanced to a loud level the picture will shake and pull even with a good filter condenser in the circuit. In these cases if it is desired to correct or improve this condition additional filtering is required.

**Trav-ler Model 64R50  
Intermittent Channels 7 and 13  
Reception**

Dear Answerman:

I am having a bit of difficulty with a Trav-ler Model 64R50. This receiver uses a one tube 12AT7 tuner. At all times I can receive Channel 4 but Channels 7 and 13 are very intermittent.

In the shop when I place my meter probe to either the plate or the grid of the 12AZ7 tube Channel 7 and 13 pop in and play fine for hours. Then, the next day they won't come in at all.

What do you think can be the cause of this and how do I go about servicing this intermittent condition?

Z.E.S.  
Albuquerque, N. Mex.

[Continued on page 58]

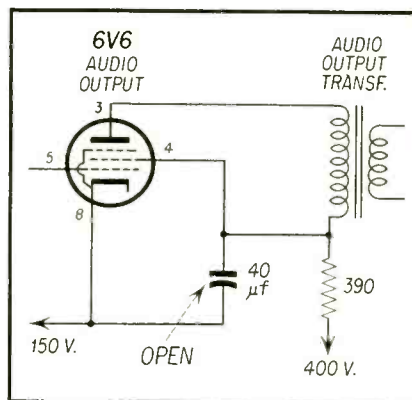

Fig. 2—When this bypass condenser is open the 400V B+ line contains the audio signal that modulates the horizontal oscillator and causes horizontal shaking of the picture.

A service record unmatched  
in the history of television!

# CROSLEY SUPER-V *is a service man's dream!*

"No more groping and twisting"

"Entire chassis accessible for service"

*Just look at what  
service men say!*

"By removing the cabinet back, every tube is right in front of one's eyes. No more groping and twisting to relocate tube-socket pins. The separate diagram showing the actual filament wiring makes the search for an open filament a matter of seconds."  
**L. B. Hallberg, Hardware Products Co., Sterling, Ill.**

"The Crosley Super-V is a service man's dream; the new vertical chassis allows the changing of tubes in a few minutes. When service of a more complicated nature is required, the cabinet can be removed by loosening 6 screws; this leaves the entire chassis accessible for service."  
**Roy R. Thompson, Saginaw Distributors, Inc., Saginaw, Mich.**

*Just look inside  
a Super-V!*

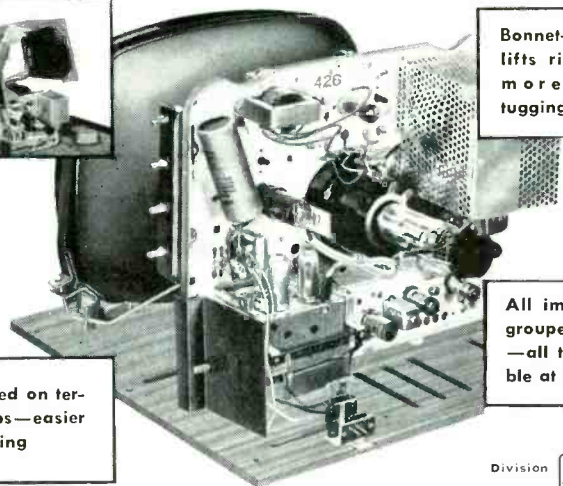



Bonnet-type cabinet lifts right off—no more chassis tugging



All important parts grouped in one plane—all tubes accessible at rear

Points wired on terminal strips—easier circuit tracing

Division **AVCO** Cincinnati 25, Ohio

**ou can sell them better on a Crosley**

As a  is 2 a 

or a  is 2 a 

or a  is 2 a 



the  is 2 U!

MODEL 631 VOM-VTVM \$59.50 NET

*Because—it's TWO-in-One for the price of one! It's a VTVM—It's a VOM with just the flip of a switch!*

This one combination instrument will be the serviceman's most frequently used piece of test equipment. No need to invest in two separate testers when one will do his work at half the price—\$59.50 net.

Flip the switch, it's a VTVM (completely portable; battery operated—VTVM accuracy not subject to line voltage fluctuations — Input Impedance of 11 megohms).

Flip the switch and it's a VOM (with the sensitivity to match readings in all the service manuals—20,000 ohms per volt DC, 5,000 ohms per volt AC).

Ranges entirely adequate for servicing needs. All 34 ranges selected by one knob control—minimizes incorrect settings and burnouts. Unbreakable clear plastic meter case front floods light on long, readable scales.

*Triplet Model 631 is sold by leading distributors everywhere.*

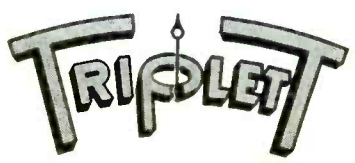

TRIPLETT ELECTRICAL INSTRUMENT CO., Bluffton, Ohio



# AIMCEE

Model IC23CH. T.D.

## TUBE LIST

| SYMBOL TYPE                                | CIRCUIT FUNCTION                    |
|--|-------------------------------------|
| V1 6BC5 or 6CB6                            | RF Amp.                             |
| V2 6J6                                     | Osc. Mixer                          |
| V3 6BA6                                    | 1st Sound IF Amp.                   |
| V4 6AU6                                    | 2nd Sound IF Amp.                   |
| V5 6AL5                                    | Sound Disc.                         |
| V6 6AV6 or 6TA6                            | 1st Audio—AGC Clamp                 |
| V7 6K6GT                                   | Audio Output                        |
| V8 6CB6                                    | 1st Pix and Sound IF                |
| V9 6CB6                                    | 2nd Pix IF Amp.                     |
| V10 6CB6                                   | 3rd Pix IF Amp.                     |
| V11 6CB6                                   | 4th Pix IF Amp.                     |
| V12 6AL5                                   | Video Det. A.G.C. and Sync. Limiter |
| V13 12AU7                                  | Video Amp.                          |
| V14 { 17BP4A/<br>17BP4A<br>20CP4/<br>20DP4 | Picture Tube                        |
| V15 6SN7GT                                 | Noise Limiter & Vert. Sync. Amp.    |
| V16 6SN7GT                                 | Sync Amp.                           |
| V17 6BL7GT                                 | Separator                           |
| V18 6SN7GT                                 | Vert. Osc., Output                  |
| V19 6BG6C                                  | Hor. Osc. and AFC                   |
| V20 1B3GT                                  | Hor. Output                         |
| V21 6W4GT                                  | H.V. Rect.                          |
| V22 5U4G                                   | Damper<br>Power Rect.               |

### KEY VOLTAGES

B+, plate of damper, V21 pin 5 240 VDC  
 Boosted B+, cath. of damper, V21 pin 3 520 VDC  
 Plate of Vert. Osc., V17 pin 2 —36 VDC  
 Plate of Vert. Out., V17 pin 5 275 VDC  
 Plates of Hor. Osc. and A.F.C., V18 pin 5 175 VDC  
 pin 2 —18.5 VDC  
 Grid of Hor. Out., V19 pin 5 —95 VDC

All voltages are measured with a VTVM connected between the tube pins and chassis.

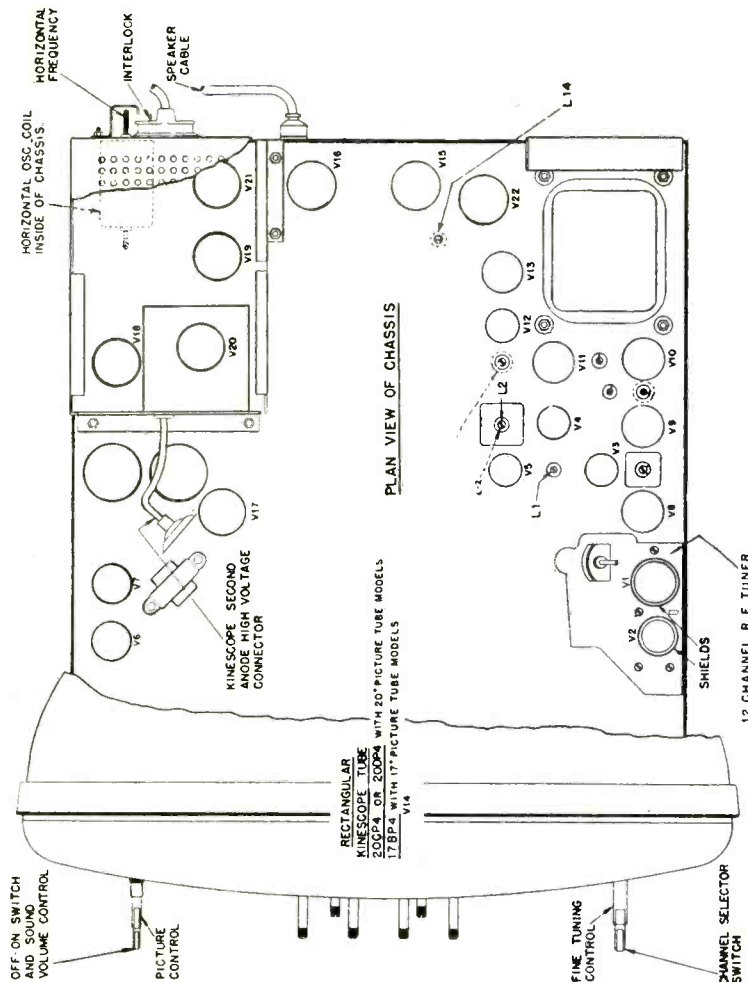
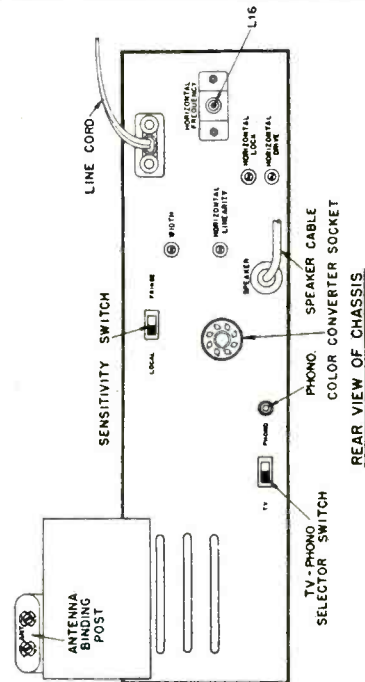
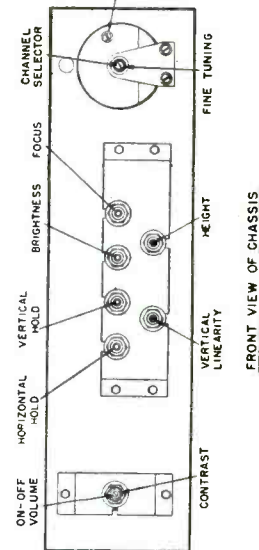
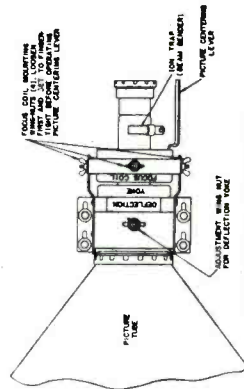

### CHECK OF HORIZONTAL OSCILLATOR ALIGNMENT

(Any adjustments or check of horizontal oscillator alignment should be made after a fifteen to thirty minute chassis warm-up period.)

Obtain a test pattern and turn the horizontal hold control to the extreme clockwise position. The picture should remain in synchronization or shift slightly to the right with the blanking bar becoming visible. The blanking bar may be unstable and move from side to side. Turn hold control counter-clockwise and the picture should remain in synchronization unless the signal is weak and in which case 3 or 4 bars may be seen sloping downward to the left.

If the receiver behaves in this manner and the test pattern is normal and stable, the horizontal oscillator is properly adjusted. Skip the "Adjustment of Horizontal Oscillator" and proceed with Height and Vertical Linearity adjustments.

### HORIZONTAL OSCILLATOR

The horizontal oscillator is adjusted at the factory to provide the conventional wave shape obtained with this Osc. and normally can be adjusted by means of the horizontal frequency threaded brass screw (L16) at rear of chassis, and by means of the horizontal lock trimmer. (a) Turning the horizontal lock trimmer clockwise decreases the range of the horizontal hold control, and turning the trimmer counter-clockwise increases the range of the hold control. Normal setting is about one turn counter-clockwise from the tight position. In "Fringe" or weak signal areas the trimmer may be set two turns counter-clockwise from the tight position resulting in somewhat better range on the hold control.

(b) Turning the horizontal frequency screw (L16) clockwise lowers the frequency, (bars sloping downward to left). Turning the screw counter-clockwise increases frequency (bars sloping downward to right).

NOTE: Some manufacturers' types of 6SN7GT may perform better than others in the horizontal oscillator socket and excessive drift of the horizontal oscillator circuit may be caused by a weak or defective 6SN7GT tube.

After the horizontal oscillator circuit has been adjusted in the manner outlined above, any subsequent touch-up may be made with the horizontal frequency screw L16.

Caution: It is important that the picture be centered in the mask properly with the horizontal hold control in the mid-position, otherwise the set user may attempt to center the picture by means of the hold control. Under this condition the control may be on "edge" and impulse noise or change of camera will cause the picture to fall out of synchronization.

### WIDTH, DRIVE AND HORIZONTAL LINEARITY

Turn the width control (accessible through a hole in the rear of chassis) clockwise until the picture fills the entire width of the tube. Adjust the trimmer "horizontal drive" (rear of chassis) to give the best degree of brightness and linearity. Adjust the horizontal linearity control (rear of chassis) for best linearity of the right half of the picture. Readjust the width control until the picture fills the mask and again adjust the focus coil lever to align the picture within the mask.

NOTE: It is advisable to adjust both the height and width of the picture to a size slightly larger than the mask opening so that during periods of low line voltage or subsequent aging of tubes adequate deflection to fill the mask opening is obtained.

IMPORTANT: The horizontal oscillator frequency must be checked for proper range of horizontal hold control after any adjustment of horizontal drive and horizontal lock trimmers. Some interaction is present between these trimmers and any adjustment of either one will usually require resetting of the horizontal frequency adjustment screw.

### SENSITIVITY SWITCH

A two-position switch is provided at the rear of the chassis for increasing the gain of the receiver which may be required for proper operation in fringe areas. Where sound and picture reception is weak with the sensitivity switch set in LOCAL position, switching to "FRINGE" position will improve the performance of the receiver.

### PHONO-TELEVISION SWITCH

A two-position slide switch is provided at the rear of the chassis together with a pick-up socket for plug-in of an external record changer.

### RASTER BLOOMING

Hor. Drive control V14, V18, V19, V20, V21, V22  
Check HV filter cap.  
Check 1 meg  $\Omega$  res. connected to HV filter cap.

### INSUFFICIENT RASTER WIDTH

Hor. Drive and Width controls V19, V21, V22  
Check 0.005 mf cap. connected to terminal "D" of Hor. Osc. Trans.  
Check 0.05 mf cap. 4.7K  $\Omega$  res. connected to pin 4 of V19  
Low line voltage  
Hor. Out. Trans.

### INSUFFICIENT RASTER HEIGHT

Height and Vert. Lin. controls V17, V22  
Check 0.05 and 0.25 mf caps. connected to red lead of Vert. Osc. Trans.  
Vert. Out. Trans.  
Low line voltage

### NO VERT. DEFL.

V17  
Check 0.05 and 0.25 mf caps. connected to red lead of Vert. Osc. Trans.  
Vert. Defl. yoke  
V. O. T. and Vert. Osc. Trans.

### NO VERT. SYNC.—HOR. SYNC. OK

Vert. Hold control  
V16, V16, V17  
Check Vert. Int. Network  
Check 0.0047 mf cap. connected to pin 1 of V17

### NO HOR. OR VERT. SYNC.—PIX SIGNAL OK

V14  
Check 0.05 mf cap. connected to pin 1 of V16  
Check 220 mmf cap. connected to pin 4 of V16

### NO HOR. SYNC.—VERT. SYNC. OK

Hor. Hold and Lock controls  
Hor. Osc. adj.  
V14, V16, V17  
Check 150 mmf cap. connected to pin 4 of V18

### DISTORTED SOUND

Tuner fine tuning  
V2, V8, V4, V6, V6, V7  
Check 0.01 mf cap. connected to pins 5 of V7  
Sound and Vid. IF alignment L-5, L-1  
Det. alignment L-2, L-3

### NO SOUND—PIX OK

Tuner fine tuning  
Volume control  
V3, V4, V5, V6, V7  
Speaker (open voice coil or defective connection)  
Sound and Vid. IF alignment L-5, L-1  
Det. alignment L-2, L-3

### WEAK SOUND—PIX OK

Tuner fine tuning  
Volume control  
V2, V3, V4, V5, V6, V7  
Sound and Vid. IF alignment L-5, L-1  
Det. alignment L-2, L-3

### NOISY SOUND—PIX OK

Volume control  
V3, V4, V5, V6, V7  
Check sound system for loose connections  
Speaker  
Sound IF and Det. alignment L-1, L-2, L-3, L-5

### SOUND BARS IN PIX

Tuner fine tuning  
Check alignment of L-14  
V1, V2, V8, V9, V10, V11, V12  
IF and RF alignment

### VERT. BARS

Hor. Drive control  
V19, V21  
Check 47 mmf cap. connected to terminals 1 and 2 of yoke  
Defl. yoke ringing

### PIX BENDING

Hor. Hold and Lock controls  
Contrast control  
V15, V16, V18  
Check 0.02 and 0.25 mf caps. connected to pin 3 of V18

### NO RASTER—SOUND OK

Brightness control  
Check HV Fuse (0.25 Amps)  
Ion trap  
V14, V18, V19, V20, V21  
HV xformer Hor. Yoke CRT connections

### POOR HOR. LIN.

Hor. Lin. and Drive controls  
V19, V21  
Check 0.035 and 0.05 mf caps. connected to Hor. Lin. coil  
Hor. Out. Trans.

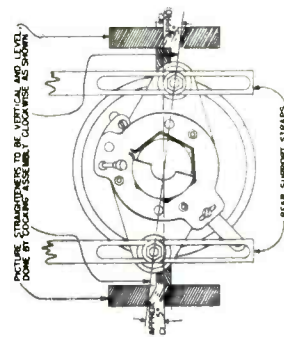
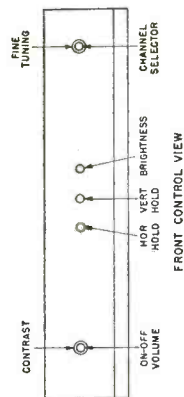
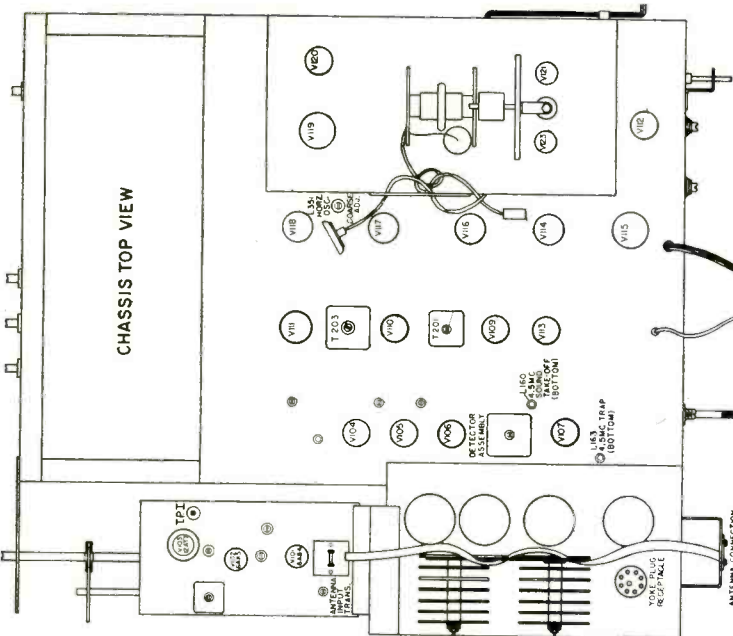

REAR VIEW, 21-INCH MODELS (LATE PRODUCTION)

V202 6BK7-A Cascade Amplifier (UHF Models)  
 Y151 RED-001 Video Det. Diode  
 Y200 IN72 UHF Conv. Diode

Plate(s) of VERT. OSC., V114 pin 1 33 vdc  
 pin 6 25 vdc

Plate of Vert. Out., V115 pin 2 and 5 240 vdc  
 Plate(s) of Hor. Osc. (and control), V118 pin 6 160 vdc  
 pin 1 150 vdc

Grid of Hor. Out., V119 pin 5 —50 vdc

(All voltages are measured with a 20,000Ω per volt meter connected between the tube pins and chassis.)

### KEY VOLTAGES

B+, plate of damper, V120 pins 2, 7, 9 250 vdc  
 Boosted B+, cath. of damper, V120 cap. 600 vdc

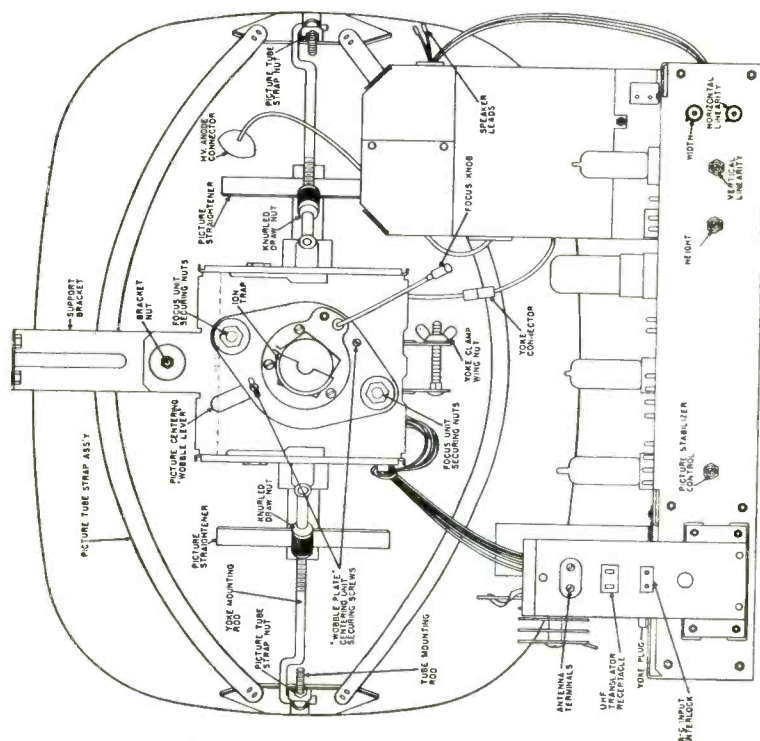

CHASSIS AND 21-INCH PICTURE TUBE ASSEMBLY REAR VIEW (EARLY PRODUCTION) AND REAR CONTROLS

## GENERAL ELECTRIC

Models 17C125, 20C107, 21C201, 21C202, 21C204, 21C206, 21C208, 21C208U, 21C210, 21C214, 21T1, 21T1U, 21T3, 21T6

### TUBE LIST

| SYMBOL | TUBE    | CIRCUIT FUNCTION                   |
|--------|---------|------------------------------------|
| V101   | 6AB4    | 1st R-F Amp.                       |
| V102   | 6AK5    | 2nd R-F Amp.                       |
| V103   | 12AT7   | Mixer-oscillator                   |
| V104   | 6CB6    | 1st I-F Amp.                       |
| V105   | 6CB6    | 2nd I-F Amp.                       |
| V106   | 6CB6    | 3rd I-F Amp.                       |
| V107   | 12BH7   | Video Amp.                         |
| V107   | 6BK7-A  | Video Amp.                         |
| V108   |         | Picture Tube                       |
| V109   | 6CB6    | Audio I-F Amp                      |
| V111   | 6T8     | Ratio Det., Audio Amp.             |
| V112   | 6AQ5    | Audio Output                       |
| V113   | 12AT7   | Sync Amp., Noise Inv.              |
| V114   | 12BH7   | Vert. Oscillator                   |
| V115   | 6BX7-GT | Vert. Amp.                         |
| V116   | 12AX7   | Sync Clip., Hor. Blank.            |
| V117   | 12AU7   | Hor. Phase Det. & Discharge Tube   |
| V118   | 12AU7   | Hor. React. & Osc.                 |
| V119   | 25AV5   | Hor. Output (early)                |
| V119   | 25BQ6   | Hor. Output (late)                 |
| V120   | 6V3     | Hor. Damper                        |
| V121   | 1X2A    | H. V. Rect.                        |
| V122   | 1X2A    | H. V. Rect., (21-inch models only) |
| V123   | 1X2A    | H. V. Rect.                        |
| V201   | 6AF4    | UHF Osc.                           |

**THE PICTURE TUBE ASSEMBLY**

Two basic types of picture tube assemblies have been used in the production of the STRATOPOWER family of receivers. Both assemblies are similar in that the picture tube is held forward against the mask by a strap assembly which, in turn, is secured to the cabinet or mask assembly. The yoke and focus unit are held in position against the bell of the picture tube by side rods which engage the picture tube strap assembly. The yoke and focus assembly is also top supported by a bracket or, in the "late" unit, by two vertical straps. Note that the picture tube need not be removed when the yoke is removed for service, providing that the picture tube strap assembly is properly tightened.

In order to avoid neck shadow, the focus unit in both the "early" and "late" assembly must be perpendicular to the picture tube neck and concentric about it. Also, the deflection yoke must be properly positioned in the "early" unit, as described below.

Since the picture tube in 21-inch models is of the "cylindrical face" type, picture straightening magnets are used to avoid a "pincushioning" effect in the raster. These magnets should be perfectly vertical in their position and be centered about the center line of the picture tube. Failure to properly position these magnets will result in either a "pincushioning" or "parallelogramming" of the picture.

**HEIGHT AND VERTICAL LINEARITY**

These controls should be adjusted simultaneously to provide proper picture height consistent with good vertical linearity. The final adjustment should extend the picture approximately  $\frac{1}{8}$  inch beyond the mask limits.

**HORIZONTAL SIZE (WIDTH) & HORIZONTAL LINEARITY**

These controls should be adjusted simultaneously to provide proper picture width, consistent with good horizontal linearity. The adjustments, when completed, should extend the picture approximately  $\frac{1}{8}$  inch beyond the mask limits.

**ADJUSTMENT OF THE AGC & SYNC GAIN CONTROL. (EARLY AND MID-PRODUCTION)**

This control is located at the rear of the receiver and should be adjusted at the time of the receiver installation. On some receivers, it is labeled "Signal Control," "Signal Strength Compensator," or "Picture Stabilizer."

Adjust this control so that the strongest signal to be received does not cause picture sync distortion. The extreme clockwise "switch" position of the control should be used in the weaker signal areas to improve the sync stability in the presence of ignition and similar interferences.

**HORIZONTAL HOLD**

The coil, L351, should be adjusted so that the horizontal sync will remain locked over the entire range of the horizontal hold control. Also, the "pull-in" range of sync should be evenly distributed on each end of the horizontal hold control range. This may be checked by switching off and on at a station and observing the "pull-in" ability at either extreme of the control.

**SYNC GAIN CONTROL**

Late production Stratopower receivers incorporating "Delayed AGC" are equipped with a simple two-position rotary switch instead of the above mentioned control. This switch (Normal-Fringe) increases or decreases the sync gain thus permitting optimum sync system operation under strong or weak signal conditions.

**OVER-LOAD PROTECTION**

A "slow-blow" 1.6 ampere fuse is incorporated in this receiver to protect the power supply rectifiers from overload. Should the receiver fail to operate, the fuse should be checked and the cause of overload remedied. This fuse is wired into the power supply compartment beneath the chassis.

**FOCUS UNIT**

Loosen the focus unit securing nuts and laterally adjust the focus unit. Make sure the circular focus magnet remains concentric about and perpendicular to the tube neck. Tighten the focus unit securing nuts. Adjust the focus control for best focus.

**PICTURE CENTERING**

The wobble plate lever which is located on the forward end of the focus unit is the centering control. Loosen its two securing screws and move the lever in a restricted circular path until the picture is centered. Readjust the focus knob if the picture centering process disturbed the focus adjustment.

**PICTURE STRAIGHTENERS**

These are the two anti-pincushioning magnets mounted near the bell of the picture tube. Adjust these magnets as follows:

- (a) Reduce the picture size so that the raster edges are visible.
- (b) Adjust the straightening magnets so that the raster edges are perfectly straight. These magnets will have an effect upon the width, but their important function is to keep the raster edges from being "bowed" in or out.
- (c) Return picture to normal size with the size controls.

**ENGRAVED EFFECT IN PIX**

Tuner fine tuning  
Contrast con.  
V103, V104, V105, V106, V107, V108  
Check Vid. Det. xtal 1N64 (Part of Det. Assembly)  
Check Vid. Det. and Amp. peaking coils

**WEAK OR NO PIX—SOUND WEAK—  
RASTER OK**

Tuner fine tuning  
V101, V102, V103, V104, V105, V106  
Check Vid. Det. xtal 1N64 (Part of Det. Assembly)  
RF and IF alignment

**INSUFFICIENT RASTER WIDTH**

Hor. Drive and Width con.  
V117, V118, V119, V120  
Check 0.0047  $\mu$ f and 300  $\mu$ f caps. connected to pin 1 of V117  
Hor. Out. trans.  
Low line voltage

**INSUFFICIENT RASTER HEIGHT**

Vert. Size and Lin. con.  
V114, V115  
Check 0.01 and 0.047  $\mu$ f caps. connected to pin 4 of V115  
Check 0.1  $\mu$ f cap. connected to vert. size con.  
Vert. Out. trans.  
Low line voltage

**NO VERT DEFL.**

V114, V115  
Check 0.01 and 0.047  $\mu$ f caps. connected to pin 4 of V115  
Check 0.1  $\mu$ f cap. connected to vert. size con.  
Vert. Defl. coils (yoke)  
Vert. Osc. con.

**NO VERT. SYNC.—HOR. SYNC. OK**

Vert. Hold con.  
Vert. Int. network  
V114, V115  
Check 0.056  $\mu$ f cap. connected to pin 7 of V114  
Check 0.004  $\mu$ f cap. connected to pin 6 of V114

**NO HOR. OR VERT. SYNC.—PIX SIGNAL OK**

V119, V116  
Check 0.01  $\mu$ f cap. connected to pin 1 of V113  
Check 0.1  $\mu$ f cap. connected to pin 7 of V113

**NO HOR. SYNC.—VERT. SYNC. OK**

Hor. Hold and Osc. con.  
V117, V118, V119  
Check 470  $\mu$ f cap. connected to pin 1 of V118  
Check 0.0018  $\mu$ f cap. connected to pin 7 of V118

**DISTORTED SOUND**

Tuner fine tuning  
V103, V109, V110, V111, V112  
Check Vid. Det. xtal 1N64 (Part of Det. Assembly)  
Sound and Vid. IF alignment L160, T201  
Det. alignment T203

**WEAK SOUND—PIX OK**

Tuner fine tuning  
Vol. con.  
V103, V109, V110, V111, V112  
Sound and Vid. IF alignment L160, T201  
Det. alignment T203

**SYNC. BUZZ IN SOUND**

Tuner fine tuning  
V103, V109, V110, V111  
Sound IF and Det. alignment L160, T201, T203

**NO RASTER—NO SOUND**

Check Line fuse F401 (1.6 Amp "Slow Blow")  
Power input circuit  
Check 300  $\mu$ f cap. connected to selenium rectifier  
Check selenium rectifiers

**POOR HOR. LIN.**

Hor. Lin. con.  
V119, V120  
Check 0.0047  $\mu$ f cap. connected to pin 4 of V119  
Check 0.25  $\mu$ f cap. connected to terminal 8 of Hor. Out. trans.  
Hor. Out. trans.

**POOR VERT. LIN.**

Vert. Size and Lin. con.  
V114, V115  
Check 0.01 and 0.047  $\mu$ f caps. connected to pin 4 of V115  
Check 100  $\mu$ f Elec. cap. connected to pin 3 of V115  
Vert. Out. trans.  
Check 0.1  $\mu$ f cap. connected to pin Vert. Size con.

# WESTINGHOUSE

Chassis V-2233-1  
 Models H-740T21  
 H-742K21  
 H-743K21

## TUBE LIST

| SYMBOL | TUBE TYPE | CIRCUIT FUNCTION               |
|--------|-----------|--------------------------------|
| V1     | 6BZ7      | * RF Amp.                      |
| V2     | 6X8       | HF Oscillator and Mixer        |
| V3     | 6CB6      | 1st IF. Amp.                   |
| V4     | 6CB6      | 2nd IF. Amp.                   |
| V5     | 6CB6      | 3rd IF. Amp.                   |
| V6     | 12BY7     | Video Output                   |
| V7     | 21FP4A    | Picture tube                   |
| V8     | 6AU6      | Sound IF. Amp.                 |
| V9     | 6BN6      | FM Det.                        |
| V10    | 6BK5      | Audio Output                   |
| V11    | 6AU6      | Keyed AGC                      |
| V12    | 12AT7     | Sync Amp. and Sync Control     |
| V13    | 6AU6      | Sync Separator                 |
| V14    | 6SN7GT    | Vertical MV                    |
| V15    | 12BH7     | Vert. Output and Noise Clipper |
| V16    | 6AL5      | Hor. AFC                       |
| V17    | 12AU7     | Hor. MV.                       |
| V18    | 6BQ7GT    | Hor. Output                    |
| V19    | 1B3GT     | HV Rectifier                   |
| V20    | 6AX4GT    | Hor. Damper                    |
| V21    | 5U4GT     | L.V. Rectifier                 |
| V22    | 5U4GT     | L.V. Rectifier                 |

## KEY VOLTAGES

|                       |           |         |
|-----------------------|-----------|---------|
| B+ plate of damper,   | V20 pin 5 | 280 VDC |
| Plates of Vert. MV.   | V14 pin 2 | 80 "    |
|                       | pin 5     | 205 "   |
| Plates of Vert. Out., | V15 pin 6 | 420 "   |
| Plates of Hor. MV.    | V17 pin 1 | 85 "    |
|                       | pin 6     | 165 "   |
| Grid of Hor. Out.,    | V18 pin 5 | —15 "   |

All voltages are measured with a VTVM connected between the tube pins and chassis.

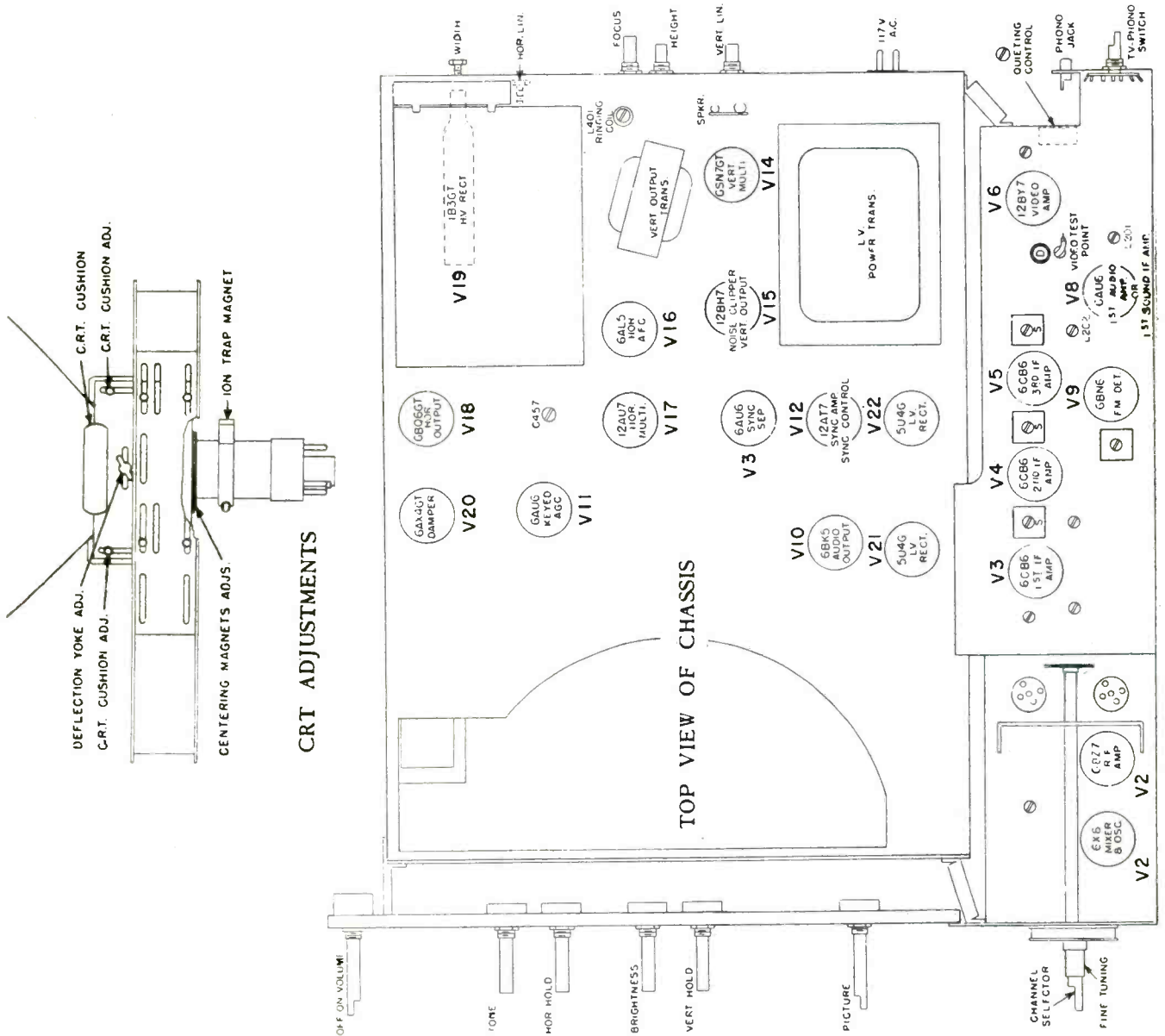

## ADJUSTMENTS

## CATHODE RAY TUBE CUSHION

The CRT cushion must fit snugly against the flare of the CRT in order that the rear of the tube will be supported firmly. If this condition is not obtained, loosen the CRT cushion adjustment screws and the deflection yoke adjustment screw, slide the CRT cushion forward as far as possible, and re-tighten the screws.

## DEFLECTION YOKE

The deflection yoke must be positioned as close as possible to the flare in the CRT. If adjustment is required, loosen the deflection yoke adjustment screw, slide the deflection yoke forward as far as possible, and re-tighten the screw. Note that the CRT cushion must fit snugly against the CRT flare as described previously.

The deflection yoke adjustment screw also permits the picture to be rotated to make it square with respect to the mask. To rotate the picture, loosen the deflection yoke adjustment screw and move it to the left or right. The picture will tilt to the left or right with the movement. Tighten the screw when the picture is squared in the mask.

## FOCUS

The focus control is located on the back of the chassis. With the brightness and picture controls set at their normal operating positions, the focus control should be adjusted for best focus.

## QUIETING CONTROL

The quieting control is located at the lower left on the back of the receiver and is adjusted by means of a screwdriver inserted through the hole in the back cover. This control, which determines the AM rejection characteristics of the sound system, is normally adjusted during alignment of the sound system as described under SOUND ALIGNMENT PROCEDURE and will not ordinarily require further adjustment. In very weak signal areas, however, a reduction in noise or hiss on the sound may be obtained by slightly re-adjusting the control.

## CENTERING

Centering is accomplished by rotating the centering magnet adjusting rings clockwise or counterclockwise as required. The two adjusting rings are located on the back of the deflection yoke. A tab projection on each of the rings serves to facilitate adjustment.

If difficulty is experienced in centering the picture or eliminating "neck shadows," make certain the CRT cushion is tight against the flare in the CRT. Also make certain that the deflection yoke is as far forward as possible.

## ION TRAP MAGNET

*It is extremely important that the ion trap magnet be correctly adjusted immediately after the set is first turned on during installation.* This is true even though the set appears to be operating satisfactorily. When the magnet is not correctly oriented, the electron beam strikes the edge of the aperture in the anode top disc instead of moving cleanly through the hole. The resultant heat vaporizes the metal of the disc, thus releasing gas which has a harmful effect on the tube. Some of the vaporized material may be deposited on the screen of the tube and be apparent as darkened area. An excessively high setting of the brightness control will aggravate this condition. From this it is apparent that the brightness control should never be turned up to compensate for an incorrectly adjusted ion trap magnet. The tube can be ruined in a very short time under this condition.

To adjust the ion trap magnet, position the magnet with the color code mark facing upward, then rotate the magnet and move it forward and backward until the position is found where the picture is brightest. If the brightness peaks at two positions of the magnet, the position nearer the base of the tube is the correct one. Never move the ion trap magnet to remove a shadow from the raster if the brightness is decreased by so doing. Shadows should be removed by adjusting the position of the deflection yoke. *The ion trap magnet must always be adjusted for maximum picture brightness.*

## WESTINGHOUSE TROUBLE SHOOTING CHART

## NO RASTER—SOUND OK

Brightness control  
Ion trap  
V7, V17, V18, V19, V20  
HV Fuse F401 (0.25 Amp.)  
HV xformer Hor. yoke CRT connections

## WEAK PIX—SOUND AND RASTER OK

Tuner fine tuning  
Contrast con.  
V2, V3, V4, V5, V6  
Check vid. det. xstal (1N60 or 1N64)

## POOR HOR. LIN.

Hor. Lin. con.  
V18, V20  
Check 0.04 and 0.06 MFD caps. connected to hor. lin. coil  
H.O.T.

## POOR VERT. LIN.

Vert. Lin. and Height con.  
V14, V15

Check 0.1 MFD cap connected to pin 7 of V15  
Check 0.05 MFD cap connected to pin 5 of V14  
Check 150 MFD EL. cap connected to pin 8 of V15  
V.O.T.

## PIX JITTER SIDEWAYS

Hor. Ringing coil adj.  
V16, V17, V18  
Check 890 and 680 MMFD caps connected to pin 7 of V16

## SMEARED PIX

Tuner fine tuning  
Contrast con.  
V2, V3, V4, V5, V6  
Check vid. det. xstal (1N60 or 1N64)  
Check vid. det. and amp. peaking coils  
IF and RF alignment

## POOR PIX DETAIL

Tuner fine tuning  
V3, V4, V5  
Check vid. det. xstal (1N60 or 1N64)  
Check vid. det. and amp. peaking coils  
IF and RF alignment

## SOUND BARS IN PIX

Tuner fine tuning  
V2, V3, V4, V5  
Check alignment of 4.5 mc trap connected to pin 7 of V6  
Check vid. det. xstal (1N60 or 1N64)  
IF and RF alignment

## SNOW IN PIX

V1, V2, V3, V4, V5, V11  
Antenna and transmission line

## ENGRAVED EFFECT IN PIX

Contrast con.  
Tuner fine tuning con.  
V2, V3, V4, V5, V6, V7  
Check vid. det. xstal (1N60 and 1N64)  
Check vid. det. and amp. peaking coils

## VERT. BARS

V18, V20  
Check 51 MMFD cap connected to defl. yoke  
Defl. yoke ringing

## PIX JITTER UP AND DOWN

Vert. hold and contrast con.  
V11, V14, V15

## PIX BENDING

Hor. hold con.  
Hor. ringing coil (L401) adj.  
V16, V17, V18

## DISTORTED SOUND

Tuner fine tuning  
Tone con.  
V2, V8, V9, V10  
Check 0.02 MFD cap. connected to vol. con.  
Sound and Vid. IF alignment L201  
Det. alignment L203 and L204

## NO SOUND—PIX OK

Tuner fine tuning  
V8, V9, V10  
Speaker (open voice coil or defective connection)  
Sound and Vid. IF alignment L201  
Det. alignment L203 and L204

## WEAK SOUND—PIX OK

Tuner fine tuning  
Vol. and tone con.  
V2, V8, V9, V10  
Sound and Vid. IF alignment L201  
Det. alignment L203 and L204

## NOISY SOUND—PIX OK

Vol. tone and quieting con.  
V8, V9, V10  
Check sound system for loose connections  
Speaker  
Sound IF and Det. alignment L201, L203, L204

## SYNC. BUZZ IN SOUND

Tuner fine tuning  
Quieting con.  
V8, V9  
Check vid. det. xstal (1N60 or 1N64)  
Sound IF and Det. alignment L201, L203, L204

## WEAK OR NO PIX—SOUND WEAK—RASTER OK

Tuner fine tuning  
Contrast con.  
V1, V2, V3, V4, V5, V6  
Check vid. det. xstal (1N60 or 1N64)  
RF and IF alignment

# SPECIAL OFFER TO OUR READERS!

By special arrangement with John F. Rider Publisher, Inc., RADIO-TV SERVICE DEALER now brings you a COMPLETE diagram service to help you do a faster, easier servicing job!

**ALL COMPLETE!**

**ALL FACTORY PREPARED!**

**ALL FACTORY AUTHORIZED!**

✓ Just 70¢ for COMPLETE SERVICING INFORMATION on any TV receiver . . . any year, any make, any model . . . from 1946 on!

✓ Just 50¢ for COMPLETE SERVICING INFORMATION on any radio . . . any year, any make, any model . . . from 1941 on!

**TAKE ADVANTAGE OF THIS SPECIAL OFFER . . . MAIL THE COUPON TODAY!**

Radio-TV Service Dealer, 67 W. 44 Street, New York 36, N. Y.

Please RUSH me the following diagrams:

| RADIO DIAGRAMS @ 50¢ EACH |      |         |
|---------------------------|------|---------|
| YEAR                      | MAKE | MODEL # |
|                           |      |         |
|                           |      |         |
|                           |      |         |
|                           |      |         |
|                           |      |         |
|                           |      |         |
|                           |      |         |
|                           |      |         |

| TV DIAGRAMS @ 70¢ EACH |      |         |
|------------------------|------|---------|
| YEAR                   | MAKE | MODEL # |
|                        |      |         |
|                        |      |         |
|                        |      |         |
|                        |      |         |
|                        |      |         |
|                        |      |         |
|                        |      |         |
|                        |      |         |
|                        |      |         |

MAKE ALL CHECKS & MONEY ORDERS PAYABLE TO Radio-TV Service Dealer  
(For all New York City orders, please submit additional 3% sales tax.)

Name .....

Address .....

City ..... State .....

# New

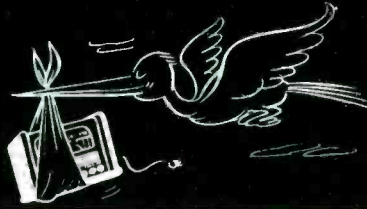

# Products

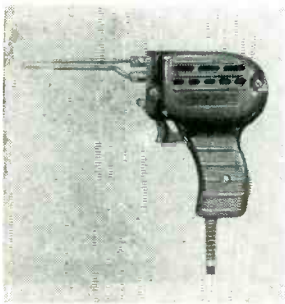

### "Quick-Hot" Soldering Gun

The WEN Model 199 features extremely light weight, only 1½ lbs.—speed, working-hot in 2½ seconds—new type extra long reach, extra long life tips—balance, that makes it handy to use, accurately, without tiring.



### Pickering Diamond-Sapphire Stylus Turnover Pickup

Pickering & Company, Inc., Oceanside, Long Island, N. Y., announces that their Model 260 Turnover Pickup Cartridge is now available with a diamond stylus for long-playing recordings and a sapphire stylus for standard 78 recordings. The diamond stylus is of .001" radius for long-playing records and the sapphire stylus is of .0027" radius for standard groove 78 RPM records.

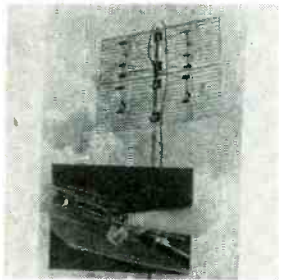

### JFD Tunable 8-Bow Antenna

JFD engineers have unveiled a new 8-bow antenna with an exclusive calibrator. This calibrator is a graduated slide. It connects the bow to the screen element. Easy to peak for any particular UHF channel, or group of UHF channels. It adjusts the wavelength between bows and grids. This provides higher signal-to-noise ratio, and better selectivity.

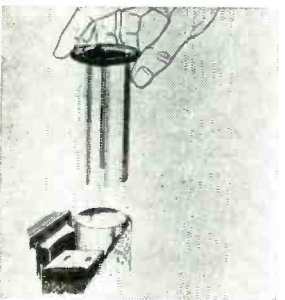

### James Vibrator Puller

The JAMES Vibrapower Company of Chicago has introduced a new vibrator puller, the Model C-905. The JAMES puller was designed to automatically release the vibrator ground clamp, grip the can firmly and permit easy removal from the most confined auto radio chassis. The new pullers are available through JAMES vibrator distributors at a dealer's net cost of \$.99. They may also be obtained in a special promotional sales package with auto and communications vibrators.

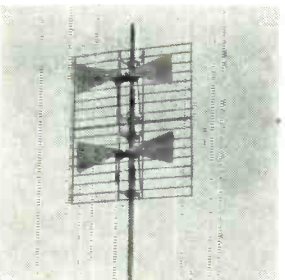

### Channel Master UHF Array

Channel Master Corporation, El-len-ville, N. Y., has announced production of the ECONO-BOW, Model No. 418, an all-channel *uhf* antenna designed for primary and secondary reception areas; the ECONO-BOW, when stacked, is spaced at a full wavelength, providing highest stacking gain. Channel Master's exclusive 2-stage stacking transformers maintain a constant impedance, which delivers the high stacking gain across the entire band width.

### ITI Field Strength Meter

The newest version of the ITI Field Strength Meter, the Model IT-136R, features continuous *uhf* tuning, Standard Coil *uhf* tuner, preselection stage for maximum selectivity, and freedom from spurious response.

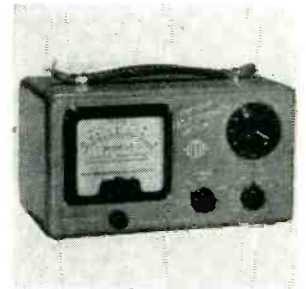

### Merit Exact Replacement Transformers

Three new horizontal output transformers designed as exact replacements for similar Admiral units are being manufactured by the Merit Coil and Transformer Corp. of Chicago. The new units, models HVO-22, HVO-23 and HVO-24, all have mounting brackets, mounting centers, terminal boards and terminal locations exactly comparable to the Admiral television transformers they are designed to replace.

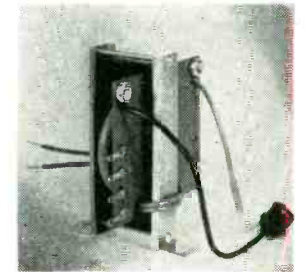

### Littelfuse Improves TV Snap-On Mounting

A marked improvement in the design of the TV snap-on mounting has been introduced by Littelfuse, Inc. of Des Plaines, Ill. and consists of substantial cut-outs on each side of the holder, facilitating quick and easy replacement of fuses. The blown pigtail fuse can be readily snapped on one side; the regular replacement fuse inserted on the other.



### Rohn Roof Mounts and Bases

The new Rohn Model TMB (deluxe) roof mounts, Model ETMB (standard) roof mounts and the Model GTMB drive-in type ground mount base accommodate all masts from 1" to 2¼" diameter including the ETM and TM telescoping mast series, and can be installed on peak roofs, side walls or any horizontal surface. The Rohn Model GTMB is suitable for use on 30-50' masts; it is driven into the ground and mast affixed to the protruding portion.

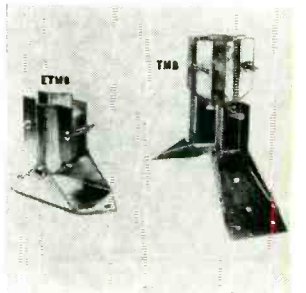

### Regency High Pass Filter

A high pass filter, Model HP-45, which reduces television interference caused by interfering transmitters is now being manufactured by Regency. The new Regency unit is a constant "K" type filter with a cut-off frequency of approximately 45mc in a 300 ohm balanced line. Attenuation at 29mc. is approximately 20db. At frequencies of 14mc. and below, the attenuation is 40db or more. Signals above 55mc are passed through the filter without loss.

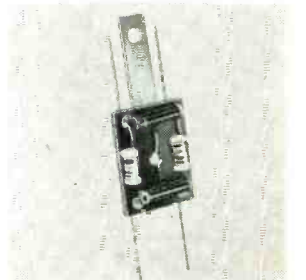



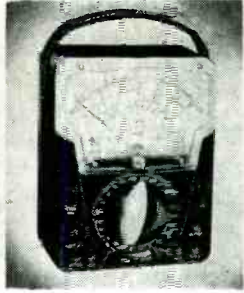

### Triplet Model 631 Combination V-O-M and VTVM Unit

A tester that combines a volt-ohm-millammeter and a vacuum tube voltmeter in a single unit—Model 631—has been introduced by the Triplet Electrical Instrument Company. Outstanding characteristics of the new Triplet Model 631: 34 ranges; C-O-M: 10 A.C.-D.C. volts; six direct current; resistances from 0.1 ohms to 150 megohms; decibel and output readings. VTVM: four, including 1.2 volt range for grid voltage and accurate discriminator alignment.

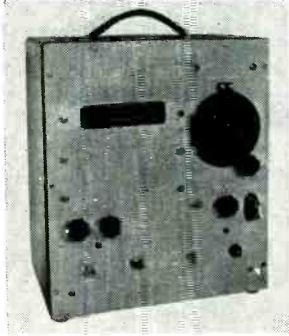

### Kollman Sweep Generator

A Sweep Generator, covering its complete frequency range in a single sweep without tuning, has been developed by Kollman Instrument Corporation. This instrument generates a sweep frequency signal with which bandpass and frequency response, standing wave ratio, and attenuation can be measured in conjunction with a detector and an oscilloscope. It comes in three frequency ranges, with each range covered in a single sweep.



### Blonder-Tongue UHF Converter

Blonder-Tongue Laboratories, Inc., Westfield, New Jersey, has announced the new Ultraverter Model BTU-2, featuring dual-speed tuning. The Ultraverter is fully compensated to guarantee frequency stability even under the weakest signal conditions. The converter is turned "on" and "off" automatically by means of the patented Thermo Relay, controlled by the TV set power switch.

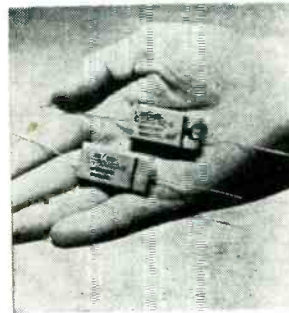

### Condenser Products Postage Stamp Capacitor

Condenser Products Company has introduced a new molded postage stamp type capacitor with a temperature range of up to 100 degrees C. with a full rated voltage. The Mylar dielectrics have an insulation resistance of 50,000 megohms minimum. They have 300 percent more capacity than JAN-C-91 and equal or exceed all other electrical requirements in JAN-C-91.



### Telrex "King Pin" Screen Array

Telrex, Inc., Asbury Park, announces its "KING PIN" 2-bay "Conical-V-Beam" Screen Array, which exhibits a measured gain on the low VHF channels of 7½ to 8½ db.; and 15 to 17 db. at the upper VHF channels. Excellent performance is also obtained on UHF, without modification. Through the use of "Conical-V-Beam" dipoles, uniform match is obtained to 300 ohm line, or 200 ohm low-loss line over entire band.

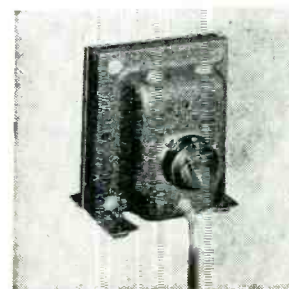

### Regency's VB-1 Voltage Booster

Full-size television pictures in areas where low line voltage shrinks the picture size have been assured through use of the new Regency VB-1 voltage booster, which can maintain a 117 volt power supply to any TV set regardless of line voltage variations from 90 to 120 volts. It may be used on any TV set or electrical device drawing 350 watts or less.

### Sound-System Control Installations

Simplified installation of sound-system controls is now assured by wiring instructions, dial plate and bar knob, packed with each Clarostat constant-impedance attenuator. Wiring instructions indicate not only the schematic diagram for the control circuitry, but also the actual connections to and bussing of terminals. The circular dial plate is marked in even divisions from 0 to 100, and used in conjunction with the pointer of the bar knob included in the package.

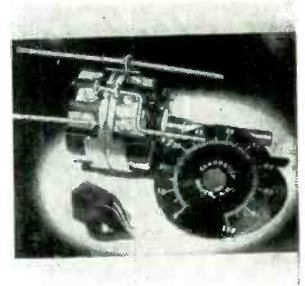

### Clear Beam Radar Array

A super version of Clear Beam's previously announced two bay TRI-KING antenna is now available in the new Clear Beam Super TRI-KING. The new Super TRI-KING incorporates a large full radar-type screen behind each tri-pole for better ghost rejection and improved re-radiation. The antenna provides up to three db more gain on the low band and one db more gain on the high band than the standard two-bay model.

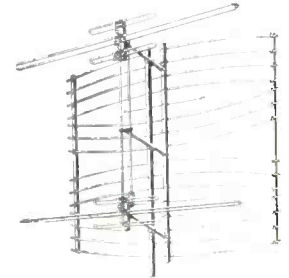

### Jensen Tri-Plex 3-Way Reproducer

The Jensen TP-200 series has a frequency range rating of -8 LIM; input impedance, 16 ohms; power rating, 35 watts maximum speech and music signal input. The components include: high channel: RP-302 ultra high frequency unit; mid-channel, RP-201 high frequency unit; low channel, P15-LL low frequency unit, A-402 crossover network (4000 cycles) and A61 crossover network (600 cycles).



### Jackson Color Bar, White Dot Generator

A new color television test instrument, designed to produce color bars, white dots, or a crosshatch pattern has just been announced by the Jackson Electrical Instrument Company of Dayton, Ohio. Designated the Model 712, the generator is entirely self-contained, and provides a complete NTSC system color difference signal as well as all required synchronizing signals.



### Astron Blue Point Capacitors

BLUE POINT molded plastic paper capacitors are designed for continuous operation at 85°C without derating, and up to 100°C with derating, wherever small size, capacitance-temperature stability and moisture resistance are prime factors. The use of a unique solid thermosetting impregnant results in highly stable capacitance characteristics, with low power factor and high insulation resistance over the entire temperature range of -40°C to +85°C.

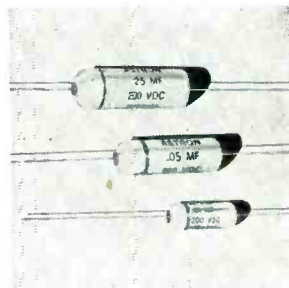

### ASD Tube Tester

The American Scientific Development Co., of Fort Atkinson, Wis., has announced its TV-20 tube tester. Features: No roll chart to turn, negligible set-up, dynamic conductance, 4½-inch meter, automatic "line" compensation, high sensitivity to leakage, positive "gas" detection circuit, portability, and good appearance. Guaranteed not to damage good tubes by overloading.



# WHOA, Mr. Serviceman!

DON'T JUST REPLACE—

# MODERNIZE

with wide-range, high-compliance

# SONOTONE

TITONE  
CERAMIC CARTRIDGES



Always install a Sonotone, the original ceramic cartridge—your customers will love you for it. It will start them on the road to high-fidelity—and additional new business for you!

**Write for free Sonotone manual today!**

New Sonotone Phonograph Modernization Manual includes an up-to-date cross reference and phonograph model index, fully explains how to use Sonotone Ceramic Cartridges. Send coupon below for your free copy, now!

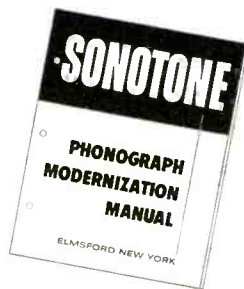

ELECTRONIC APPLICATIONS DIVISION

## SONOTONE CORPORATION

Elmsford, New York

SONOTONE CORPORATION  
Elmsford, N.Y.

Dept. D

Please send me a free copy of the Sonotone Phonograph Modernization Manual

Name \_\_\_\_\_

Address \_\_\_\_\_

City \_\_\_\_\_ State \_\_\_\_\_

## TRADE FLASHES

[from page 16]

Dr. W. R. G. Baker, GE vice president, avers that plans for large quantity production of the transistors have been made possible through development of a "rate-grown" method of mass producing essential transistor elements. The rate-grown process appears to be the only technical process which shows any promise of a low cost device of this quality. Dr. Baker further stated that, as a result of the huge quantities of uniform transistor elements it is now possible to produce by the rate-grown process, prices of the transistors should become competitive with vacuum tubes.

A word on FCC policy; from the policy adopted by the Commission regarding "UHF Television Stations Proposing No Local Live Programming," we have the dissent of Commissioner Frieda B. Hennock:

"What is happening to UHF is the most serious blow to the public interest which I have witnessed in over six years of Commission membership. And this announced policy is the last of a series of blows against UHF from which I fear it may never recover.

The Commission's ruling, taken without the opportunity for public scrutiny and comment, has two immediate and dangerous effects:

- 1) it delivers the final mortal blow to UHF which the Commission for years has stated to be the only hope for the full development of TV, and
- 2) it encourages and invites monopolistic control over TV, the most important medium of mass communications ever devised.

The policy will permanently endanger the future of TV. Instead of the harmful decision announced by the Commission, I propose an 11 point action program which will protect TV, both for the public and broadcaster alike, and will assure a nationwide competitive TV system."

Henry Pope, who for the past nineteen years has served National Union Radio Corp. as its Credit Manager and Asst. treasurer, announces his resignation of both posts effective immediately. Mr. Pope, one of the electronic industry's better known executives, also served as chairman of the credit committee of RETMA for the two year period ending June, 1954.

Factory production of television receivers increased sharply in June from the May level and also remained higher than June a year earlier, the Radio-Electronics-Television Manufacturers Association reports. The total number of radios manufactured in June also increased from May although average weekly production was slightly lower.

A special pro rata warranty policy which provides one-year protection from date of installation on all RCA black-and-white television picture tubes purchased for replacement service in home receivers has been announced by the Tube Division, Radio Corporation of America. The policy grants credit adjustments to distributors, service dealers, and consumers, based on the length of time the tubes are in service.

LaPointe Electronics Inc., Rockville, Conn., has started production on a second shift for their VEE-D-X division to speed up production of this division's television antennas and accessories. For the past month, VEE-D-X has been working at full capacity on one shift but found it necessary to add the second shift to keep pace with the accelerated demands for their products.

## CBS COLOR TUBE

[from page 31]

located between the phosphor screen and the electron-gun assembly. It contains approximately 300,000 uniform-size, round holes, one for each triad on the screen. Since the position of these holes relative to the triads is of paramount importance for proper tube operation, the mask is accurately positioned with relation to the triads and is approximately 0.4 inch behind the phosphor screen.

### Mask-and-Screen Assembly

As can be seen in Fig. 2, the entire mask assembly is exceedingly simple. It consists of the curved mask with spring clips to hold it in place. This assembly is mounted on three hemispheres, which are raised points of glass molded around the edge of the face plate, beyond the picture area.

The mask contains three "V"-shaped surfaces which rest over the hemispheres and make use of the kinematic principle of precise location. Since the mask is unstressed, it is free to expand and contract. This combination of a curved face plate and a curved, un-

[Continued on next page]

# DEALERS! SERVICEMEN!



Make Money  
by REMOTE CONTROL  
for  
Television Sets  
with the NEW  
*Remot-o-matic*

- Most complete remote control!
- Simplest installation! !
- Lowest retail list! ! !

Here it is at last! The lowest retail-priced remote control unit in the world . . . to create more traffic in your store . . . more profit in your pocket.

Now priced so that it is within the means of almost every TV set owner. REMOT-O-MATIC has arrived.

## NATIONALLY ADVERTISED

REMOT-O-MATIC advertising is nation wide . . . on television, in newspapers and in magazines. Point of sale dealer aids, brochures and display materials are already doing a tremendous sales job all over the country. Service men are doubling their incomes.

### The *Remot-o-matic* DeLuxe

With this unit, you can control the sound, turn the set on or off, change channels, control the brightness, control contrast, take the control from the set to the hand unit or back to the set . . . as you choose. This DeLuxe model retails for only..... **\$39<sup>95</sup>**

### The Regular *Remot-o-matic*

With this unit you completely control the sound and have a perfect channel changer. The Regular retails for only..... **\$19<sup>95</sup>**

Your discounts and installation profits . . . plus the increased TV set business which results from handling REMOT-O-MATIC are the reasons why you should immediately contact your local jobber or write to us for literature and discounts.

## REMOT-O-MATIC SALES, INC.

8747 SUNSET BOULEVARD, LOS ANGELES 46, CALIFORNIA

There are more C-D capacitors in use today than any other make.

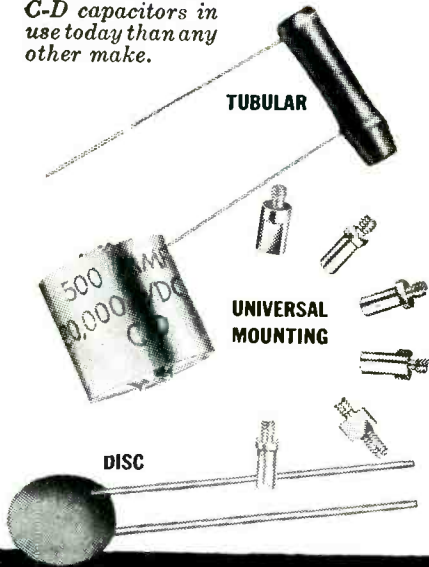

There's a C-D ceramic with the "Million Dollar Body" for every requirement



### Every one a winner

A line of the most popular, fast-moving sizes, in both general purposes and temperature compensating types. Try your C-D jobber about them today! He's listed in your local Classified Telephone Directory. For catalog write to Dept. RS94, Cornell-Dubilier Electric Corp., South Plainfield, New Jersey.

CONSISTENTLY DEPENDABLE  
**CORNELL-DUBILIER**  
CAPACITORS



PLANTS IN SO. PLAINFIELD, N. J.; NEW BEDFORD, WORCESTER AND CAMBRIDGE, MASS.; PROVIDENCE AND HOPE VALLEY, R. I.; INDIANAPOLIS, IND.; SANFORD AND FUQUAY SPRINGS, N. C. SUBSIDIARY: RADIANT CORP., CLEVELAND, OHIO

[from preceding page]

stressed mask automatically permits expansion and contraction without misregistration.

### Principles of Tube Operation

A logical starting point to discuss tube operation is the electron-gun assembly made up of three identical electron beam sources arranged in a triangular configuration. The resultant beams are also in the same triangular arrangement relative to the tube axis.

Each of these beams is individually modulated by a composite voltage that consists of color and brightness information. By utilizing a separate composite signal for each beam source, the individual beams are modulated in accordance with the transmitted signal, and are of the proper intensities for their respective colors.

The modulated beams are also focused by their respective beam sources.

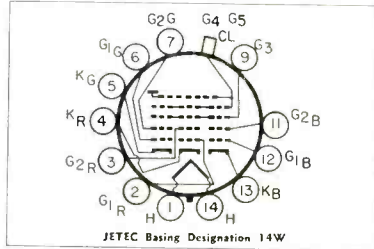

**Pin Connections of CBS "Colortron 205"**

|  |  |
|--|--|
| Pin 1: Heater                          | Pin 7: Grid No. 2 of green beam source |
| Pin 2: Grid No. 1 of red beam source   | Pin 8: Grids No. 3                     |
| Pin 3: Grid No. 2 of red beam source   | Pin 9: Grid No. 2 of blue beam source  |
| Pin 4: Cathode of red beam source      | Pin 10: Grid No. 1 of blue beam source |
| Pin 5: Cathode of green beam source    | Pin 11: Cathode of blue beam source    |
| Pin 6: Grid No. 1 of green beam source | Pin 12: Cathode of blue beam source    |
| Pin 13: Cathode of blue beam source    | Pin 14: Heater                         |

Metal Flange: Anode

Fig. 3—Pin connections of CBS "Colortron 205."

This focusing, similar to that in conventional black-and-white tubes, is accomplished by the electrostatic lens formed by grids 2 and 3. Since the focusing electrodes (grid 3 of each of the three beam sources) are internally connected together, a common focusing voltage may be used. This feature simplifies the associated circuitry. See Fig. 3 for pin connections.

The three electron beams are then acted upon by the magnetic fields created by three external electromagnets mounted on the tube neck. The electron-gun assembly contains three sets of pole pieces mounted above the anode. Magnetic fields, created by three electromagnets on the tube neck, are induced in these three sets of pole pieces and provide dynamic convergence control of each of the three electron beams. Small d-c fields may also be induced in these pole pieces to compensate for slight manufacturing variations that might otherwise impair proper mechanical static convergence.

## a bear for punishment

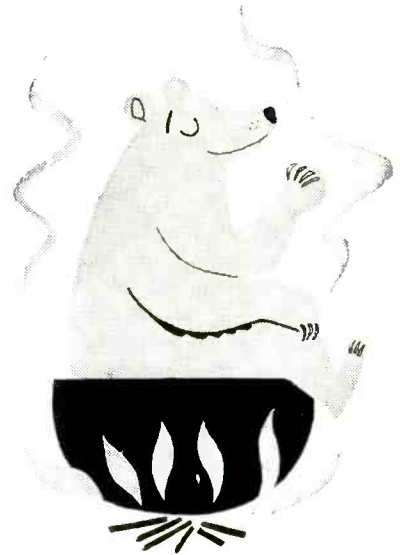

## C-D does it again with its new Cub

Outperforms any other molded tubular



- \* A better-looking tubular with
- \* A better humidity seal.

Get more for your money by insisting on C-D's new "CUB-KIT".

For your nearest C-D authorized jobber see the Yellow Pages of your Classified Phone Book. Write for Catalog to Dept. RS94, Cornell-Dubilier Electric Corporation, South Plainfield, New Jersey

CONSISTENTLY DEPENDABLE  
**CORNELL-DUBILIER**  
CAPACITORS



There are more C-D capacitors in use today than any other make.

PLANTS IN SO. PLAINFIELD, N. J.; NEW BEDFORD, WORCESTER AND CAMBRIDGE, MASS.; PROVIDENCE AND HOPE VALLEY, R. I.; INDIANAPOLIS, IND.; SANFORD AND FUQUAY SPRINGS, N. C. SUBSIDIARY: RADIANT CORP., CLEVELAND, OHIO

These electromagnets provide radial adjustment of each of the three beams. Since it may not always be possible to converge properly the three beams by radial adjustment only, an external blue-beam positioning magnet is used to provide tangential movement of the blue beam. The combination of the three external electromagnets and the blue-beam positioning magnet insures the realization of center convergence.

The dynamic convergence produced by the electromagnetic fields varies the point of convergence in accordance with the position of the beams as they scan the phosphor screen. The spherical shape of the mask and screen of the CBS-Colortron reduces the dynamic-convergence requirements and facilitates easy convergence adjustment in the receiver.

In the ideal case, the three beams leave the magnetic convergence fields so aligned that, when deflected, they approach the shadow mask at the correct angles properly converged. In the prac-

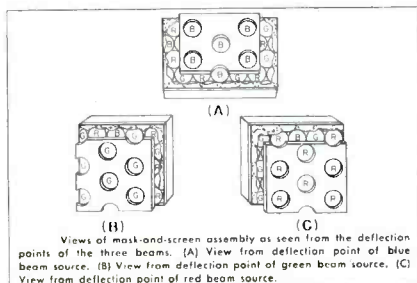

Fig. 4—Shadow mask assembly views.

tical case, however, this is not always true. For this reason, it is necessary to employ external components to align properly the three beams.

Two of these external components, the blue-beam positioning magnet and the magnetic convergence coils, have already been described. The other external component necessary for proper beam alignment is the color-purifying coil. The magnetic field produced by this coil is perpendicular to the tube axis. This field acts upon the three beams simultaneously and, by proper adjustment of its strength, and its axial and rotational position, the common axis of three beams can be positioned to achieve optimum color purity. The coil is located on the neck of the tube in the region of grids 2 and 3. The construction of the coil should allow it to be rotated and moved along the neck of the tube.

After the beams have been acted upon by the alignment components and the magnetic convergence fields, they enter the deflection area. Here, the deflection yoke provides the required uniform magnetic fields that simultaneously deflect the three beams.

As in black-and-white tubes, the deflection yoke consists of four electromagnetic coils. These coils function in pairs, each coil of a pair located diametrically opposite the other. Since this deflection yoke acts simultaneously on three beams, the electromagnetic field requirements are more stringent than those in black-and-white tubes. In particular, a more uniform field is required for deflection in the tri-color tube.

The electron beams travel in straight line paths from the deflection area to the screen. Between the phosphor screen and the deflection area is the

shadow mask. This mask is positioned so that, when viewed from the deflection point of any of the beams, only the dots of a single color can be seen through the perforations in the mask. Fig. 4 illustrates this condition.

With the mask in the position described above, one beam will strike only the red dots, another beam will strike only blue dots, and the third beam will strike only green dots. This mask, consequently, allows the three beams to reproduce the exact hue present in each portion of the televised scene.

**Ready  
NOW!**

**completely NEW  
STANCOR TV  
TRANSFORMER  
REPLACEMENT  
GUIDE**

The new 1954 Stancor TV Replacement Guide and Catalog is a fully revised, up-to-the-minute listing of accurate transformer replacement data. Every recommendation has been rechecked against the latest information obtainable.

This Stancor reference lists over 6800 TV models and chassis of 115 manufacturers, including hard-to-locate information on "private label" sets.

To make your servicing easier, *virtually all flybacks, yokes and power transformers listed are exact replacements.* Where an exact replacement unit is not available, reference is made to the circuit or terminal changes required.

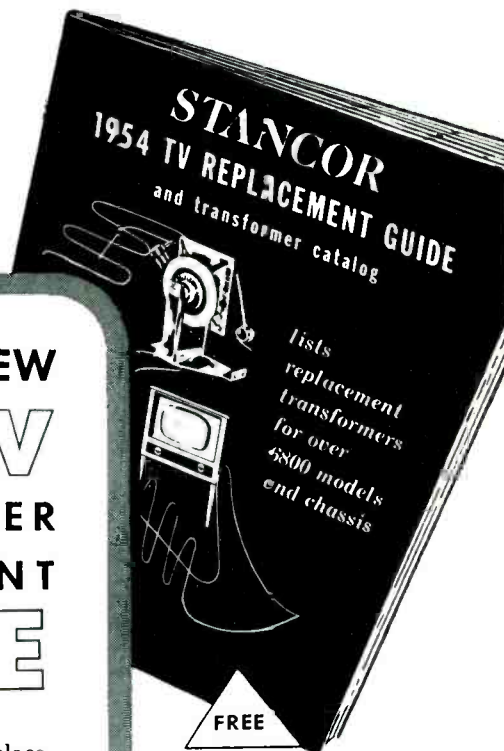

**FREE**

If you haven't received your copy, see your Stancor distributor, or write us directly.

**STANCCR-WILLIAMSON  
ULTRA-LINEAR  
HI-FI amplifier bulletin 479**

Build your own ultra-linear hi-fi amplifier using Stancor high fidelity output transformer A-3072 (\$15.00 net). You can also use A-8072 to convert your present Williamson amplifier to ultra-linear operation. Bulletin 479, available FREE, contains performance curves, schematics, parts lists, chassis layouts and other helpful construction and conversion information.



Stancor transformers are listed in Photofact Folders and Counterfacts.

**CHICAGO STANDARD  
TRANSFORMER CORPORATION**  
3586 Elston Avenue Chicago 18, Illinois

EXPORT SALES: Roburn Agencies, Inc., 39 Warren Street, New York 7, N. Y.

# 7 RIDER BOOKS JUST PUBLISHED!

## ADVANCED TELEVISION SERVICING TECHNIQUES

by RETMA Teaching Staff! Tells step-by-step how to service every section of a TV receiver . . . how to use all kinds of test equipment in servicing (sweep generators, signal generators, vacuum tube voltmeters, scopes, ohmmeters.)

176 (8½x11") pages, soft cover.

Only \$3.60

## LABORATORY WORKBOOK

for use with main book.  
32 (8½x11") pps.

Only \$ 9.95

## SPECIALIZED

### AUTO RADIO MANUALS

VOL. 4-A: covers Chrysler, DeSoto, Dodge, Dodge Trucks, Plymouth  
VOL. 5-A: INDEPENDENT CAR MANUFACTURERS — Henry-J, Hudson, Kaiser-Frazer, Nash, Studebaker, Willys  
Complete installation, removal and servicing information on factory-installed car radios (1950-1954) . . . parts lists, schematics, tube layouts, dial stringing.

Vol. 1-A: covers Ford, Lincoln, Mercury  
Vol. 2-A: covers Buick, Cadillac, Oldsmobile  
Vol. 3-A: covers Chevrolet, Pontiac, GMC Trucks, Chevrolet Trucks  
each volume 8½x11", soft cover.  
Vol. 3-A \$1.80; all others \$3.00

### COLOR TV DICTIONARY

More than a dictionary! Complete explanation of new color TV terms and definitions —over 50 illustrations. Vital for everyone interested in color TV.

72 (5½x8½") pages, soft cover.

Only \$1.25

### R-C and R-L TIME CONSTANT

First in a new review series on difficult technical subjects. Covers practical applications of Time Constant and how it affects circuit operation.

48 (5½x8½") pages, soft cover.

Only \$ 9.90

### TV FIELD SERVICE MANUAL—

#### Vol. 2

Most marvelous guide to in-the-home servicing—spiral bound, lies flat for easy reference! Troubleshooting, tube layouts, picture adjustment, dial stringing. VOL. 2 covers Bendix, Capehart, CBS Columbia, Crosley, DuMont. VOL. 1 covers Admiral, Affiliated Retailers (Artone), Aimee (AMC), Air King, Air Marshall, Allied Purchasing, Andrea, Arvin and Automatic.

VOL. 2—160 (5½x8½") pages, soft cover.

Only \$2.40

VOL. 1—128 (5½x8½") pages, soft cover.

Only \$2.10

### OBTAINING AND INTERPRETING TEST SCOPE TRACES

Key to successful use of oscilloscope. Covers radio, audio, TV, transmitters. More than 500 waveforms.

Over 140 (5½x8½") pages, soft cover.

Only \$2.40

### HOW TO SERVICE TAPE RECORDERS

How to troubleshoot and service all kinds of tape recorders. Explains drive mechanisms, recording heads, electronic circuits. Also tells how to set up a tape recorder repair shop.

5½x8½" Soft cover.

Only \$2.90

In Canada, all prices approximately 10% higher.

SEND FOR COMPLETE NEW RIDER CATALOG

Write for information on all RIDER books.

Buy these books now from your jobber . . . bookstore

If not available from these sources, write to:

**JOHN F. RIDER**

PUBLISHER, INC.

480 Canal Street, New York 13, N. Y.

## INSTRUMENT CLINIC

[from page 29]

variations, which can be stabilized by operating the receiver and test instruments from an automatic line-voltage regulating transformer.

Q. What is the cause of a thickened fuzzy appearance in a visual-response curve?

A. This condition, shown in Fig. 7, is usually the result of cross-talk between the horizontal sweep circuit and the signal circuits in the receiver, or in some cases, due to cross-talk from the high-voltage power supply or the picture tube. The operator sometimes falls into error by using exposed test leads to the scope, which are susceptible to stray-field pick-up.

## ANSWERMAN

[from page 36]

Dear Z. E. S.

This intermittent condition on the high channels can be due to a number of possible causes. Considering these causes in the order of the most frequent occurrence:

1. Replace the 12AT7 *rf*, oscillator and mixer tube.

2. Clean the entire tuner with a contact cleaner fluid, particularly taking care of the switch contacts and the variable condenser plates in this case.

3. Inspect the tuner for broken contacts or leads that have parted from their junction. Particularly inspect such items as are brought into play when the high band is in operation such as the tuner band switch.

4. In the inspection look for connections that might be cold solder joints, particularly the coils that are used in the high band reception. In fact an easy way to service this trouble might be to resolder all the connections in the tuner that could possibly bring this about.

5. It would be desirable to know whether the oscillator is in operation when the picture cuts out. This could be easily determined in most cases by measuring the grid to cathode voltage. However, since the tuner is intermittent and would probably cut in when the meter connection is made, this would be rather difficult. What might be attempted is to connect a meter in the grid circuit and leave it there during the servicing and testing process. If the signals should cut out while the meter is in the circuit it will be evident whether the local oscillator is operat-

## NEW Reproducer

sounds like

\$200 —

COSTS

LESS

THAN

\$60†

Now you can enjoy high fidelity without high prices



**What Is It?** A new Argos sound enclosure—handsomely styled—built with "Craftsmanship in Cabinets"—plus a Jensen speaker and tweeter.

**How Does It Work?** It uses the Jensen Duette\* principle—which in effect gets double the use out of the internal air mass. It gives big-speaker fidelity in half the space.

**How Can I Hear It for Myself?** Ask your Argos—or Jensen—Parts Distributor. Your ears cannot be deceived. It *does* sound like \$200.

†Argos AD-1 Cabinet . . . . . \$21.50

Jensen KDU-10 speaker and tweeter components kit . . . . .

Total . . . . . Under \$60.00

Prices may vary West and South.

\*TM of and Licensed by Jensen Mfg. Co.

Also see new matching cabinets for Record Player and Tuner or Amplifier.



ing by the meter voltage reading. This confirms whether or not the oscillator is working.

6. Of course the trouble might be in the tube socket. A tube pin may not be making proper contact in the socket. Probably twisting and pushing the tube in the socket will introduce the trouble if it is due to poor contact in the socket.

7. With an insulation rod, the components in the tuner can be pushed and probed until the defective component or connection is located. In many of these intermittent tuner cases the trouble can be located in this manner. However, realize that the position of tuner components are sometimes critical and important.

8. It may be desirable to replace some condensers such as the very small ones with values of 3.35 uuf, 3 uuf and 2.2 uuf.

For additional information on tuner servicing see the first section of "TV Troubleshooting With Key Test Points" in the December 1953 issue.

## CURING TVI

[from page 22]

possible from the deflection side of the cabinet. It may also be desirable to

dress the antenna lead inside of the cabinet along the side of the cabinet away from the high voltage cage. This will help prevent radiation from occurring on the TV transmission line which would cause the antenna and lead-in to perform as a transmission system. If the station signal strength is high and the TVI strong, the transmission line should be changed to coaxial cable. An impedance matching transformer located at the TV tuner can be employed to permit grounding the coaxial cable shield to a water pipe when used with a line-connected receiver. Some technicians have resorted to shielding the 300 ohm lead-in with heavy braid tubing which is grounded to a water or radiator pipe. This may be helpful, provided the capacity introduced by this arrangement does not reduce the television signal strength to an intolerable degree.

Shielding may not only be used in the lead from the tuner but may extend from the back of the receiver a number of feet to prevent the pickup of the deflection voltage signals. This aspect of the correction of radiation problems has not been fully explored and therefore may prove very helpful in certain

[Continued on next page]

# "FREE"

## PERMO DIAMOND NEEDLES

for DEALERS and DEALER Personnel

Sell 4 Permo Diamond Needles and get one "free." Send postal card for complete details.

Special promotion for September, October and November

**PERMO** **PERMO** **PERMO** **PERMO**

**PERMO, INC.**  
6415 Ravenswood Avenue  
Chicago 26, Illinois

# Windsor

RADIO & TV RECEIVING

## TUBES

### GUARANTEED ONE FULL YEAR

...FOR PEAK PERFORMANCE!

| Type  | Each | Type   | Each |
|-------|------|--------|------|
| 0A2   | .98  | 1S3    | .52  |
| 0B2   | .88  | 1T4    | .62  |
| 0C3   | .95  | 1U4    | .61  |
| 1A7GT | .87  | 1U5    | .51  |
| 1AE4  | .90  | 1V2    | .45  |
| 1B3GT | .89  | 1X2A   | .74  |
| 1H5GT | .51  | 2X2    | 1.43 |
| 1J6   | .83  | 3A5    | .90  |
| 1L4   | .63  | 3LF4   | .76  |
| 1L8   | .66  | 3Q4    | .66  |
| 1LA4  | .82  | 3Q5GT  | .72  |
| 1LA8  | .80  | 3S4    | .61  |
| 1LB4  | .82  | 3V4    | .62  |
| 1LC5  | .80  | 3R4GY  | 1.00 |
| 1LD6  | .80  | 5U4G   | .48  |
| 1LD5  | .80  | 5V4G   | .83  |
| 1LE3  | .80  | 5Y3Q   | .37  |
| 1LG5  | .80  | 5Y3GT  | .42  |
| 1LH4  | .80  | 5Y4G   | .43  |
| 1LN5  | .80  | 6A8GT  | .66  |
| 1N34  | .90  | 6A8A   | .51  |
| 1N43  | .90  | 6A85GT | .82  |
| 1N5GT | .83  | 6AC7   | .90  |
| 1N64  | .75  | 6AF4   | 1.10 |
| 1R4   | .85  | 6AG5   | .59  |
| 1R5   | .82  | 6AH4   | .68  |
| 1S4   | .67  | 6AH6   | .89  |

**THERE'S NO SUBSTITUTE FOR EXPERIENCE!**  
And thousands of Service Dealers throughout America now know, FROM EXPERIENCE, that you can depend on Windsor Tube Quality. That's why we can safely guarantee each and every tube we ship, for **ONE FULL YEAR!** That's why the famous Green & Black Windsor Tube Carton is now accepted everywhere, as a symbol of **QUALITY and DEPENDABILITY!**

| Type   | Each | Type   | Each | Type   | Each | Type    | Each |
|--------|------|--------|------|--------|------|---------|------|
| 6AK5   | 1.05 | 6B16   | .53  | 6E4    | .51  | 7A4/XXL | .57  |
| 6AL5   | .44  | 6BK5   | .76  | 6S8GT  | .75  | 7A5     | .70  |
| 6AN8   | .95  | 6BK7   | .97  | 6SA7GT | .57  | 7A6     | .57  |
| 6AQ3   | .51  | 6BL7GT | .94  | 6SC7   | .63  | 7A7     | .58  |
| 6AQ6   | .47  | 6BN6   | .98  | 6SD7   | .55  | 7A8     | .58  |
| 6AQ7   | .75  | 6BQ6GT | .98  | 6SF5GT | .66  | 7AD7    | 1.05 |
| 6AR5   | .42  | 6BQ7   | .92  | 6SG7   | .55  | 7AF7    | .63  |
| 6AS5   | .55  | 6BY5G  | .85  | 6SH7GT | .52  | 7AG7    | .65  |
| 6AS7G  | 4.50 | 6BZ7   | 1.09 | 6SJ7GT | .52  | 7AH7    | .65  |
| 6AT6   | .42  | 6C4    | .41  | 6SK7GT | .55  | 7AJ7    | .70  |
| 6AUSGT | .85  | 6C5GT  | .80  | 6SL7GT | .68  | 7B4     | .54  |
| 6AU6   | .47  | 6C6B   | .58  | 6SN7GT | .59  | 7B5     | .51  |
| 6AV5   | .85  | 6C6B6  | 1.57 | 6SQ7GT | .46  | 7B6     | .52  |
| 6AV6   | .41  | 6C6S6  | .72  | 6T8    | .85  | 7B7     | .58  |
| 6B5GT  | .93  | 6E5    | .63  | 6U4    | .80  | 7C4     | 1.05 |
| 6BA6   | .50  | 6F5GT  | .54  | 6U5    | .72  | 7C5     | .56  |
| 6BA7   | .66  | 6H6GT  | .55  | 6V3    | 1.09 | 7C7     | .58  |
| 6BC5   | .58  | 6J5GT  | .44  | 6V6GT  | .51  | 7E5     | .85  |
| 6BCT   | .78  | 6J6    | .68  | 6V8    | .85  | 7E6     | .85  |
| 6BD5GT | .98  | 6J7    | .70  | 6W4GT  | .50  | 7E7     | .85  |
| 6BD6   | .54  | 6K6GT  | .45  | 6W6GT  | .63  | 7F7     | .69  |
| 6BE6   | .51  | 6K7    | .70  | 6X4    | .37  | 7F8     | .97  |
| 6BF5   | .66  | 6L6G   | .88  | 6X5GT  | .36  | 7G7     | .85  |
| 6BF6   | .43  | 6L6GA  | .88  | 6X8    | .82  | 7H7     | .61  |
| 6BG6G  | 1.47 | 6Q7GT  | .55  | 6Y6G   | .64  | 7J7     | .85  |
| 6BH6   | .63  | 6R7    | .75  | 6Z5    | .60  | 7K7     | .85  |



| Type    | Each | Type    | Each |
|---------|------|---------|------|
| 12BF6   | .50  | 19T8    | .87  |
| 12BH7   | .69  | 25A5    | .85  |
| 12BY7   | .77  | 25B6GT  | .98  |
| 12J5GT  | .48  | 25L6GT  | .53  |
| 12SA7GT | .57  | 25W4GT  | .53  |
| 12SF5GT | .85  | 25Z6GT  | .46  |
| 12SH7GT | .67  | 35A5    | .55  |
| 12SK7GT | .55  | 35B5    | .53  |
| 12SL7GT | .67  | 35C5    | .53  |
| 12SN7GT | .59  | 35L6GT  | .52  |
| 12SQ7GT | .46  | 35W4    | .43  |
| 12V6    | .51  | 35Y4    | .48  |
| 14A7    | .58  | 35Z3    | .48  |
| 14AF7   | .68  | 35Z5GT  | .43  |
| 14B6    | .50  | 50A5    | .55  |
| 14C5    | .85  | 50B5    | .52  |
| 14C7    | .70  | 50C5    | .52  |
| 14E6    | .70  | 50L6GT  | .52  |
| 14E7    | .80  | 50X6    | .55  |
| 14F7    | .69  | 50Z3    | .43  |
| 14T8    | .99  | 117Z3   | .43  |
| 14N7    | .75  | 117Z6GT | .75  |
| 14Q7    | .62  |         |      |
| 14R7    | .85  |         |      |
| 14S7    | .80  |         |      |
| 19BG6G  | 1.53 |         |      |

### WINDSOR WONDER-BEAM 3-WAY INDOOR ANTENNA

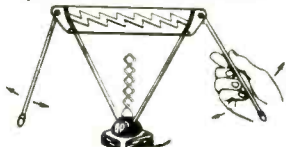

A real performer, this antenna works where others fail! Adjustable arms, for Average Areas, Fringe Areas, and UHF. Features new electronic wonder-switch: no need to rotate antenna, just turn wonder-switch for best results with each individual station! Works with any TV set.

**SPECIAL PRICE \$5.69**  
Lots of Six each \$14.95  
Singly \$5.95 each

25% Deposit with Order. All merchandise F.O.B. NYC. For orders less than \$10, add \$1 handling cost. Deduct 2% if full remittance accompanies order. All merchandise subject to prior sale and price changes without notice.

### FREE! WINDSOR TUBE CADDY

Most practical service-aid ever designed for Radio & TV repairmen! Now offered **FREE** with every purchase of \$160.00 or accumulated purchases totalling \$160.00 within 90 days (You get Caddy credit memo with each purchase).

- Carries approximately 125 Tubes, including meters and tools.
- 16 1/4" long, 8 1/4" wide, 13 3/4" high. Weighs only 9 lbs.
- Ruggedly constructed with heavy leatherette covering, strong plastic handle, nickel plated hardware, and reinforced with metal clamps.

WINDSOR TUBE CADDY may also be purchased outright for \$14.95

Note to our Latin-American Friends: "SE HABLA ESPANOL"



### WINDSOR BROW-LITE



- Leaves Both Hands Free to Work!
- Wear it on your Brow.
- Adjustable angle of Beam.
- Ideal for Radio & TV Repairmen.
- Uses standard penlite batteries and bulb.
- Won't Interfere with glasses.

Complete with Batteries. \$4.95

**Windsor ELECTRONIC TUBE CO.**  
2612-D NOSTRAND AVENUE, BROOKLYN 10, N. Y.

WRITE FOR ADDITIONAL TUBE TYPES AND PRICES. We also stock Special Purpose and Transmitting Tubes at similar savings Dept. D-9.

# SOUND-SYSTEM

## Controls

Clarostat self-compensating volume controls provide any attenuation from full volume down to a mere whisper—without distortion.

Series CIL L-pads and CIT T-pads handle up to 10 watts audio. Continuous range from 0.5 to 30 db attenuation in 90% rotation. Last 10% affords infinite attenuation.

Also Series CIB output attenuator handling up to 30 watts audio. Linear attenuation in 3 db steps up to 24, then 30, followed by infinity.

### Ask for DATA...

Descriptive literature from your Clarostat distributor or from us. Remember, for "tops" in audio controls, you can rely on Clarostat!

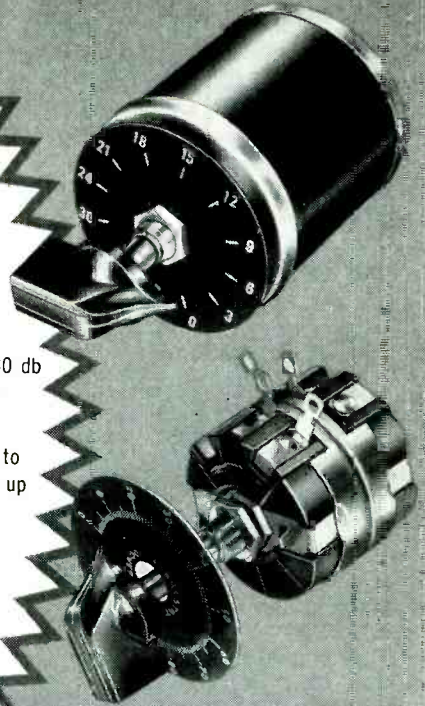

*Controls and Resistors*

CLAROSTAT MFG. CO., INC. DOVER, N.H.

your customers want the BEST!...the "ORIGINAL"

## MOSLEY

Wall

Thru

To Get The ORIGINAL,  
Ask For It By Name!

TAKES ALL  
POPULAR LINES!  
RUBBER GROMMET  
SEALS OUT  
MOISTURE!

POLYSTYRENE  
THRU-OUT! FULL  
1/8" THICK WALL  
— BEST FOR UHF,  
VHF, COLOR

CONVENIENT  
LOW LOSS SOCKET  
MAY BE INSTALLED  
ON INSIDE PLATE

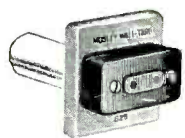

Cat. No. 625  
MOSLEY WALL-THRU,  
in brown or ivory.  
List Price \$1.95

Cat. No. 625-PK  
WALL-THRU, with  
Universal TV Socket  
& mating Plug.  
List Price \$3.00

Write for free copy of MOSLEY Condensed Catalog, Form D-1. Tells — How To Make More Installation Profits!

**Mosley**  
Electronics, Inc.  
8622 ST. CHARLES ROCK ROAD  
ST. LOUIS 14, MISSOURI

### A Word Of Caution!

Because there are numerous imitations, similar in appearance to the popular Wall-Thru, the TV installer is cautioned to ask for the Original MOSLEY Wall-Thru — by name!

For Quality, Value, Practical Design — insist upon the MOSLEY Wall-Thru... Another PREMIUM QUALITY MOSLEY Accessory for Better, More Profitable TV Installations!

[from preceding page]

cases along with other changes mentioned here to achieve the complete elimination of the condition.

Shielding with wire screen of the entire cabinet has on many occasions proved very effective as a cure. However, this is expensive. It requires the complete coverage of the interior side walls and breadboard on which the chassis rests as well as the cabinet back and cup assembly. A liquid graphite solution is now available with which an easier job can be performed. Very recently, conductive paint was introduced for the painting of the inside of the cabinet and back and cup assembly for shielding purposes.

In painting the interior of the cabinet it is first necessary to clean out all of the dust and dirt in the cabinet and from the cup and back assembly. The conductive graphite paint should be mixed thoroughly before the coating operation is begun. In the painting of the interior of the cabinet, care should be taken against allowing any of the paint to spill or spot the finish of the outside surface of the cabinet. The area in the cabinet that is to be covered is the breadboard on which the chassis will rest and the sides and back and cup assembly. There should be no paint at any part of the breadboard that will touch the chassis if it is of the line connected type. The inside cabinet corners should form a definite connection with the paint between the breadboard and the cabinet sides. The interior sides of the cabinet should be painted up to about two feet from the breadboard. Most important, the outside edges should also be painted at the back of the cabinet (see Fig. 4). The back and cup assembly is also painted on the inside except for within an inch of where the antenna lead-in enters. When the back is fastened to the rear of the cabinet it will make definite contact with the edges of the cabinet. Therefore the chassis will now have a complete shield around the entire back of the receiver.

The graphite conducting paint usually takes about an hour to dry but it might be well to allow the paint to set for 5 or 6 hours after which time the technician can return and install the chassis.

When the chassis has been installed in the cabinet a continuity check should be made between the chassis and the conductive paint in the interior. There should be infinite resistance between the two if it is a line-connected receiver to prevent the possibility of shock hazard to the customer at the exposed line filter used in conjunction with the shielding.

The internal coating should be con-



nected to an earth ground such as a radiator or water pipe. This can easily be accomplished by connecting a piece of braid strap between the graphite coating inside the cabinet and the terminal point on the power line filter. From this terminal another lead can be run to a water or radiator pipe.

In radiation of this type each chassis and cabinet will present a slightly different problem. The strength of the interference will determine the extent to which the technician will have to go to sufficiently eliminate the whistles. Most of the radiation will have to be licked by shielding, because very little interference gets into the power lines when ac line filter condensers are used in the chassis.

## THE WORKBENCH

[from page 33]

the set. When the set was brought into the shop, the first thing that was done was to determine what type of hum it was. When the volume control was turned up, you could hardly hear the hum, but at a normal setting it could be heard rather clearly. Varying the contrast control had practically no effect on the hum. By varying the vertical hold control, a variation in the tone of the hum was affected. The volume control was then turned down to a point where this vertical hum could be heard best.

Replacing V121, and V122, the vertical oscillator and output tubes had no effect. Next, filter leak checks were made. With the ear to the speaker, filters were paralleled individually. C174, the most probable cause of this trouble, was found to be okay. Next a filter was paralleled individually with all the filters in the receiver. But this proved unsuccessful. A voltage leakage check was next taken of C175—1  $\mu$ f, the bypass on the vertical size control, but it checked OK.

It was then that we noticed that when a wire cable assembly was moved the vertical hum got louder. It was observed further that the lead to the vertical size control was among the wires in this cable. (Ref. to Fig. 3). Pulling this lead somewhat out of the cable, had a tremendous effect on the volume of the vertical hum. This cable consisted of about ten wires. Among them, audio wires from the sound discriminator, audio amplifier and the volume control. Here was a perfect cause of trouble. The vertical lead was next taken out of the cable and re-routed away from the audio circuit. The set now functioned properly without any hum.

# THANK YOU, Mr. Serviceman

for naming



## your preferred brand!

In a recent nationwide survey\*, radio and TV servicemen were asked this question: "What brand of replacement speakers do you prefer? Why?" QUAM was first in number on mentions—almost 30% more than the next most preferred brand.

\* Conducted by Brand Name Surveys of Chicago, Illinois, May 1954.

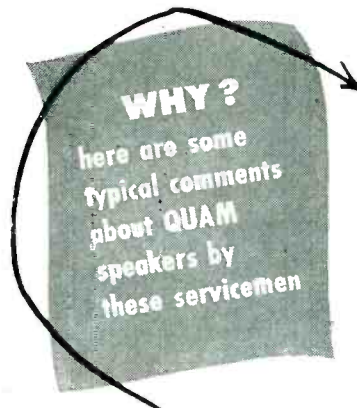

- "Adjust-a-Cone feature-ruggedness"
- "Complete range of sizes and types"
- "Stand up best in service"
- "Include hardware for easier installation"
- "Good construction"
- "Listed in Sams' Photofacts"
- "Heavier magnets"
- "Good quality at a reasonable price"
- "Always satisfactory"

ask for **QUAM** the quality line, for **ALL** your speaker needs

## QUAM-NICHOLS COMPANY

238 EAST MARQUETTE ROAD • CHICAGO 37, ILLINOIS

Eliminates Small Catalogs and Loose Literature

### Faster, Easier, more PROFITABLE Operation

**Get into the MASTER habit!**

Brings you the product data of the industry in one handy book—all products vital to your daily sales and service operations. In the customer's home, across the counter or on the bench, you'll value the MASTER'S thoroughly complete descriptions, specs, illustrations and prices . . . all systematically organized in 18 big sections. Over 1300 pages of unabridged catalog data direct from the manufacturers. Keeps you abreast of all latest electronic products. Increase your sales and speed-up your buying—the MASTER way.

As **\$1.95** at your parts distributor. Publisher's price **\$6.50**.

Get your MASTER now from leading parts distributors or write to: United Catalog Publishers, Inc., 110 Lafayette St., N. Y. 13

OFFICIAL BUYING GUIDE OF ELECTRONICS-TV-RADIO INDUSTRY

- 1370 pages
- 8" x 11"—5 lbs.
- Over 8,000 illus.

Just a few of the more than 85,000 items included:

Tubes—Transmitters  
Test Equip.—Receivers  
Transformers  
Capacitors—Antennas  
Resistors—Wire & Cable  
Coils & Relays  
Recording & PA  
Hardware & Tools

**5**  
CORES  
OF  
ERSIN  
FLUX

in **ERSIN**  
*Multicore*  
WORLD'S FINEST  
CORED SOLDER  
ON WOODEN SPOOL

ASK FOR  
**NEW**  
**50c**  
SERVICE  
PAK

Ready Now  
ON YOUR  
JOBBER'S  
COUNTER

EXTRA VALUE! Unlike other low cost, haphazard solder packages, the MULTICORE SERVICE PAK features a convenient wooden spool, and—important to you—length of wire, alloy and gauge is clearly marked on every 50c SERVICE PAK!

MULTICORE SALES CORPORATION, 164 Duane St., New York 13, N. Y.

**They Come! They Listen! . . . and then They Buy!**

# Audiorama 1954

Presented by THE AUDIO FAIR

Sponsored by



**Creates demand for the Products YOU SELL**

More than 25,000 Hi-Fi Consumers Will Come to See, Hear and Learn! Jobbers, Dealers, Servicemen—Get to Know the Products Your Customers will ask for. Attend Audiorama 1954. BE SURE YOUR MEN ATTEND!

AUDIORAMA 1954 will attract at least 25,000 serious Hi-Fi customers—Broadcast Engineers, Governmental, Military and Municipal Agencies—Representatives of Foreign Governments and Businesses—Sound-on-Film Men—Business and Industrial Purchasing Agents—Hobbyists—etc.

AUDIORAMA 1954 is the starting gun for the Fall, Winter and Holiday Hi-Fi selling season. Everybody waits for "What's new" at

Audiorama. Audiorama advertising and publicity . . . the added excitement and the 'audio' talk . . . all mean more business activity for you.

More than 125 manufacturers, from all over the world, will exhibit and demonstrate their products—and will be in attendance to help you. Here is one grand opportunity to get the manufacturer's point of view . . . first hand.

Remember—this is AUDIORAMA 1954, produced by the original AUDIO FAIR in New York City. Audiorama is business to you! It's your business to attend!

**NO ADMISSION CHARGE—You Are Invited**

**FOUR DAYS** . . . . . October 14, 15, 16, 17  
**FOUR FLOORS** . . . . . 5th, 6th, 7th, 8th  
**Hotel New Yorker** . . . . . New York City

Daily from  
1 P.M. to 10 P.M.  
Sunday from  
12 Noon to 6 P.M.

AUDIORAMA 1954 is presented by THE AUDIO FAIR,  
Harry N. Reizes, Managing Director, 67 W. 44th St., N. Y., N. Y.

An AUDIO FAIR-  
VIDEO FAIR, INC.  
Project

## RC CIRCUITS

[from page 35]

fectively in parallel with  $R_2$ , goes down as the frequency goes up. The higher the video frequencies, the more signal voltage appears across  $R_1$  and the less across  $R_2$ ,  $C_k$ . It is the voltage across,  $R_2$ ,  $C_k$  which is the signal applied to the CRT cathode.

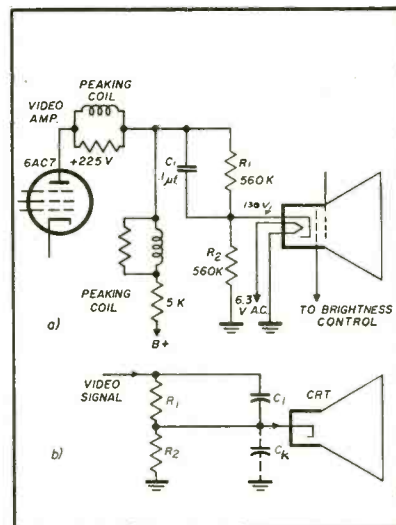

Fig. 22—Typical cathode-fed, direct-coupled CRT circuit.

By placing a comparatively large condenser across  $R_1$ ,  $C_1$  and  $C_k$  act as a capacity voltage divider for the ac (signal) voltage. Practically all of the a-c voltage appears across the smaller condenser  $C_k$  at all frequencies. That is, for ac the parallel impedance value of  $R_2$ ,  $C_k$  is much better than  $R_1$ ,  $C_1$ , and therefore substantially all of the signal is applied to the CRT. If  $C_1$  opens, both the contrast range (video signal amplitude) and the picture quality (high-frequency response) are impaired.

We will find that other types of complex RC circuits act quite differently from the one discussed in this article.

[To Be Continued]

## BLOCK DIAGRAM ANALYSIS

[from page 12]

ing color sub-carrier sidebands which in turn modulate the channel carrier.

### Reception

At the receiver the separator block shown in the expanded block diagram of Fig. 6 is actually made up of many

[Continued on page 64]

# 2-Year Subscription only \$100



## NOW AVAILABLE TO . . .

1. Servicemen who are employed by Service Organizations.
2. Servicemen employed by radio/TV Dealers.
3. Independent servicemen who do not have business establishments.
4. Employees of Distributors.
5. Students enrolled in accredited Radio/TV Schools, Colleges, etc.
6. Hobbyists and Experimenters.

## A TYPICAL ISSUE COVERS

- Video Speed Servicing Systems
- Rider's "TV Field Service Manual" data sheets
- Latest TV Installation and Maintenance Techniques for VHF and UHF
- Auto Radio Installation and Service
- Advanced Data on New Circuitry
- Production Changes and field service data on receivers

- New Tubes
- New Test Equipment, operation and application
- Hi-Fi Installation and service
- New developments, such as transistors, color, UHF, etc.
- News of the trade
- Service Short Cuts & Shop Notes
- Explanation of difficult circuits

**and many more  
EXCLUSIVE . . .  
ORIGINAL . . .  
AUTHORITATIVE . . .  
TIMELY . . .  
FULLY ILLUSTRATED  
subjects that  
can ONLY  
BE READ IN  
"SERVICE DEALER"**

RADIO-TV SERVICE DEALER

67 W. 44 St., New York 36, N.Y.

NEW  RENEWAL

Gentlemen: Here is \$1.00 for which enter my 2-year subscription. (This rate applies in USA only. Elsewhere add \$1 per year)

Name .....

Address .....

City ..... Zone ..... State .....

Employed by (Name of firm) .....

Firm's business address .....

City ..... Zone ..... State .....

Your Position or Title .....

Check whether firm is:  Service Organization or  Dealer having Service Dept.

If some other type of company describe: .....

IF STUDENT, Name of School .....

[from page 62]

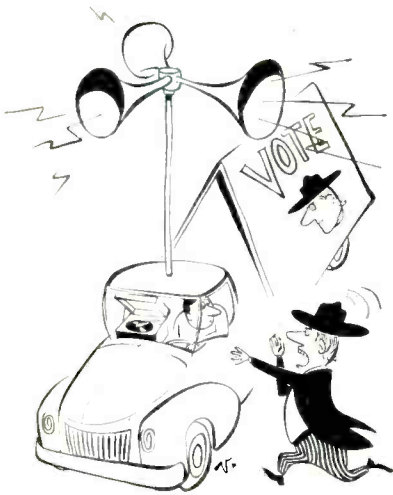

"If you want me to win this election, you'd better get a JENSEN NEEDLE."

circuits. The outputs of these circuits provide the horizontal and vertical sync signals, the 3.58 mc color sync burst, the Y or luminance signal, and the color signals. The horizontal and vertical sweep circuits are mostly conventional. As in the previous block diagram (Fig. 1) the color information and luminance signals are fed into the decoder from which the red, blue, and green voltage signals are derived. These signals are then fed into their respective picture tube guns. Notice that the color sync burst is fed into the decoder where it synchronizes and sets into operation the color circuits contained therein.

### Video Frequencies in Color Transmissions

Our experience in B & W transmission has taught us that we require about 4 mc for good detail of the transmitted picture. Applying this to color, and with the knowledge that the luminance signal is made up of the three primary color signals, red, green and blue, we would expect that both the color signals and the luminance signal would be wide-banded. We find, however, that physiological experiments indicate that the eye does not perceive color in very small detail areas. As a consequence the transmission of the color signal information does not require as wide a band of frequencies as does the luminance signal. As a matter of fact, the NTSC specifications provides a total bandwidth of 2 mc for the color information transmission. This includes the upper and lower sidebands on both sides of the 3.58 mc sub-carrier. This does not apply to the luminance signal which still requires a 4 mc bandwidth for clear cut pictures.

Although the Y signal modulates the channel carrier directly, the color signal, as indicated in Fig. 7A, does not. Instead, it first modulates the 3.58 mc color sub-carrier. Color video sidebands are then produced which modulate the channel carrier. The net result is a set of modulating color signals centered around a frequency 3.58 mc higher than the channel carrier.

The relative positions of the three carriers used in a color transmission are also shown in Fig 7B. It should be emphasized at this point that the color sub-carrier is suppressed at the transmitter in order to minimize interference from this source. For this reason the actual color video frequencies which are transmitted are the sidebands formed by the color video signals around the sub-carrier as a center frequency.

[To Be Continued]

## Advertising Index

|  |         |
|--|---------|
| Alliance Manufacturing Co.....           | 28      |
| Allied Radio Corp.....                   | 64      |
| American Microphone Co.....              | 16      |
| Argos Products Co.....                   | 58      |
| Audio Fair, The.....                     | 62      |
| Bussmann Mfg. Co.....                    | 1       |
| CBS-Hytron.....                          | 5       |
| Chicago Standard Transformer Corp.....   | 57      |
| Clarostat Mfg. Co., Inc.....             | 60      |
| Cornell-Dubilier Electric Corp.....      | 56      |
| Crosley Div., Avco Manufacturing Co..... | 43      |
| Hycon Mfg. Co.....                       | 10      |
| International Resistance Co.....         | Cover 2 |
| Jensen Industries.....                   | 64      |
| Jensen Mfg. Co.....                      | 23      |
| Master, George Garment Div.....          | 17      |
| Merit Coil & Transformer Corp.....       | 2       |
| Mosley Electronics.....                  | 60      |
| Multicore Sales Corporation.....         | 62      |
| Permo, Inc.....                          | 59      |
| Philco Corporation.....                  | 6, 7    |
| Quam-Nichols Company.....                | 61      |
| Radiart Corporation.....                 | 13      |
| Raytheon Mfg. Co.....                    | 8       |
| RCA Manufacturing Co.....                | Cover 4 |
| Remot-O-Matic Sales, Inc.....            | 55      |
| Rider, John F. Publisher.....            | 51, 58  |
| Sams, Howard W. & Co., Inc.....          | 16      |
| Snyder Manufacturing Co.....             | Cover 3 |
| Sonotone Corporation.....                | 54      |
| Standard Coil Products Co., Inc.....     | 30      |
| Sylvania Electric Products, Inc.....     | 14, 15  |
| Telrex, Inc.....                         | 20      |
| Triplett Elec. Instrument Co.....        | 44      |
| United Catalog Publishers.....           | 61      |
| Weston Elec. Instrument Corp.....        | 18, 19  |
| Windsor Electronic Tube Co.....          | 59      |

**FREE**

**1955**  
**308-PAGE**  
**ALLIED**  
**ELECTRONIC**  
**SUPPLY**  
**CATALOG**

Send for it

*Everything in Electronics*  
**For Service Technicians and Engineers**

Get the complete, up-to-date 1955 ALLIED Catalog. It's packed with the world's largest selection of TV and radio parts and accessories, test instruments, Hi-Fi systems and components, P. A. systems, tubes, tools—everything for service work and industrial electronic application. Depend on ALLIED for fast shipment from the world's largest stocks—save time and money. Send today for your FREE 308-page ALLIED Catalog.

ALLIED RADIO CORP., Dept. 26-J-4  
100 N. Western Ave., Chicago 80, Ill.

Send FREE 1955 ALLIED Catalog

Name \_\_\_\_\_

Address \_\_\_\_\_

City \_\_\_\_\_ Zone \_\_\_\_\_ State \_\_\_\_\_

## MOVING?



Please  
Mail Us  
Your Change  
of Address  
Today

Also include old address and code line, if possible. Thanks.

**RADIO-TELEVISION  
SERVICE DEALER**

67 West 44 St., New York 36, N. Y.

**VIDEO IF, 4.5MC TRAP AND SOUND ALIGNMENT PROCEDURES**

**VIDEO IF ALIGNMENT**

| STEP   | ALIGNMENT SETUP NOTES  | TEST EQUIPMENT HOOKUP  | ADJUST   |
|--|--|--|--|
| <p><b>PREALIGNMENT INSTRUCTIONS READ CAREFULLY</b></p> <p>1. Stand chassis on side with high voltage shield down for under chassis adjustments.</p> <p>2. Set Fringe (AGC) switch to fully counterclockwise position (normal or "non-fringe" position).</p> <p>3. Ground all test equipment unless otherwise stated.</p> <p>4. Keep detector circuit leads as short as possible.</p> <p>5. Use non-metallic alignment tools for powdered iron cores. Metallic screwdriver may be used for brass screw adjustments.</p> |  |  |  |
| 1.   | Connect 3V. battery (-) terminal to junction of C130 (.33 mfd.) and R145 (220K) and connect (+) terminal to chassis.<br><br>Set VHF tuner to signal-free channel with minimum interference.  | <b>MARKER GENERATOR</b> - to ungrounded tube shield on Osc. Mixer tube on VHF tuner.<br><br><b>VTVM - D.C.</b> Probe to junction of L58 peaking coil and R147 (4.7K).  | L84 (top core) for MIN. at 39.75 MC.<br>T55 (top core) for MIN. at 41.25 MC.<br>L55 for MIN. at 41.25 MC.<br>T56 (top core) for MIN. at 47.25 MC.<br><br>Use sufficient marker generator output for satisfactory VTVM reading. |
| 2.   | Same as 1.   | Same as 1.   | T58 for MAX. at 44.0 MC.<br>T57 for MAX. at 42.0 MC.<br>T56 (bottom core) for MAX. at 45.2 MC.<br>T55 (bottom core) for MAX. at 43.2 MC.<br><br>Adjust marker generator output to keep VTVM reading between 1 and 2 volts.     |
| 3.   | Repeat step 1 trap adjustments.  |  |  |
| 4.   | Remove 3V. AGC battery.<br><br>Disconnect T55 lead from pin 5 of V1 (6CB6). Connect 330 ohm resistor from R128 (1K) to pin 5 of V1.<br><br>Set VHF tuner to any signal-free high channel on SARKES TUNER chassis. OR Between any two channels on G.I. tuner chassis. | <b>SWEEP GENERATOR</b> - to looker point "B" on SARKES TUNER. OR to pin 5 of 6B8 tube on G.I. tuner. Set to 45.5 MC with 10 MC sweep.<br><br><b>MARKER GENERATOR</b> - loosely couple to sweep generator lead.<br><br><b>OSCILLOSCOPE</b> - through detector circuit to pin 5 of V1 (6CB6).          | <b>SARKES TUNER CHASSIS ONLY:</b><br>L54 (bottom core) and T1 (VHF tuner) for response curve shown:<br><br><b>G.I. TUNER CHASSIS ONLY:</b><br>L54 (bottom core), L1 (VHF tuner) and L83 for response curve shown:<br><br>      |
| 5.   | Repeat step 4 adjustments until response curve is flat with 42.1 MC and 45.75 MC markers on corners.   |  |  |
| 6.   | Connect 3V. battery (-) terminal to junction of C120 (.33 mfd.) and R145 (220K) and connect (+) terminal to chassis.<br><br>REMOVE 330 OHM RESISTOR AND RECONNECT T55.<br><br>Set VHF tuner to signal-free channel with minimum interference.                        | <b>SWEEP GENERATOR</b> - to ungrounded tube shield on Osc. Mixer tube on VHF tuner. Set to 43.5 MC with 10 MC sweep.<br><br><b>MARKER GENERATOR</b> - loosely couple to sweep generator lead.<br><br><b>OSCILLOSCOPE</b> - through 330 ohm resistor to junction of L58 peaking coil and R147 (4.7K). | Retouch T56, T57, T56 (bottom core) and T55 (bottom core) if necessary to obtain response curve shown:<br><br>   |

**4.5MC TRAP ALIGNMENT**

| STEP | ALIGNMENT SETUP NOTES                | TEST EQUIPMENT HOOKUP  | ADJUST           |
|------|--------------------------------------|--|------------------|
| 1.   | Short pin 1 of V4 (6CB6) to chassis. | <b>SIGNAL GENERATOR</b> - to pin 2 of V5 (12BY7). Set to 4.5 MC.<br><br><b>VTVM - R.F.</b> Probe to pin 1 of V20 (Picture Tube); Ground Lead to chassis. | L61 for MINIMUM. |

**SOUND ALIGNMENT**

| STEP | ALIGNMENT SETUP NOTES  | TEST EQUIPMENT HOOKUP   | ADJUST  |
|------|--|---|---|
| 1.   | Set VHF tuner to signal-free channel with minimum interference.<br><br>DO NOT GROUND VTVM                                      | <b>MARKER GENERATOR #1</b> - through 1K resistor to pin 1 of V1 (6CB6). Set to 45.0 MC.<br><br><b>MARKER GENERATOR #2</b> - through 1K resistor to pin 3 of V1 (6CB6). Set to 4.5 MC.<br><br>OR<br><b>MARKER GENERATOR</b> - through 1K resistor to pin 1 of V1 (6CB6). Set to 45.0 MC with a crystal controlled 4.5 MC marker.<br><br>ALSO<br><b>VTVM - D.C.</b> Probe to pin 5 of V7 (6AL5); Ground Lead to pin 7 of V7 (6AL5). | T52 (both cores) for MAXIMUM L82 for MAXIMUM.<br><br>Repeat adjustments until maximum reading is reached.   |
| 2.   | Same as 1.   | USE SAME MARKER GENERATOR HOOKUP AS IN STEP 1.<br><br><b>VTVM - D.C.</b> Probe to junction of two matched 100K resistors connected in series across R104 (68K); Ground Lead through 100K resistor to terminal 5 of T52.   | T52 (top core) for ZERO.<br><br>Use lowest VTVM scale set to zero center. At correct core setting, a slight turn of core will give either a positive or negative reading. |
| 3.   | Remove test equipment and resistors; then, tune in a weak station and adjust T52 (top core) for optimum signal-to-noise ratio. |   |   |

**ALTERNATE SOUND ALIGNMENT**

| STEP | ALIGNMENT SETUP NOTES  | TEST EQUIPMENT HOOKUP   | ADJUST  |
|------|--|---|---|
| 1.   | Connect a good antenna installation to receiver.<br><br>Set VHF tuner to a strong station.<br><br>DO NOT GROUND VTVM           | <b>VTVM - D.C.</b> Probe to pin 5 of V7 (6AL5); Ground Lead to pin 7 of V7 (6AL5).  | T52 (bottom core) for MAXIMUM. L82 for MAXIMUM.<br><br>Repeat adjustments until maximum reading is reached.   |
| 2.   | Same as 1.   | <b>VTVM - D.C.</b> Probe to junction of two matched 100K resistors connected in series across R104 (68K); Ground Lead through 100K resistor to terminal 5 of T52. | T52 (top core) for ZERO.<br><br>Use lowest VTVM scale set to zero center. At correct core setting, a slight turn of core will give either a positive or negative reading. |
| 3.   | Remove test equipment and resistors; then, tune in a weak station and adjust T52 (top core) for optimum signal-to-noise ratio. |   |   |

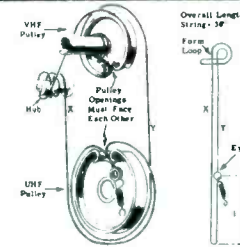
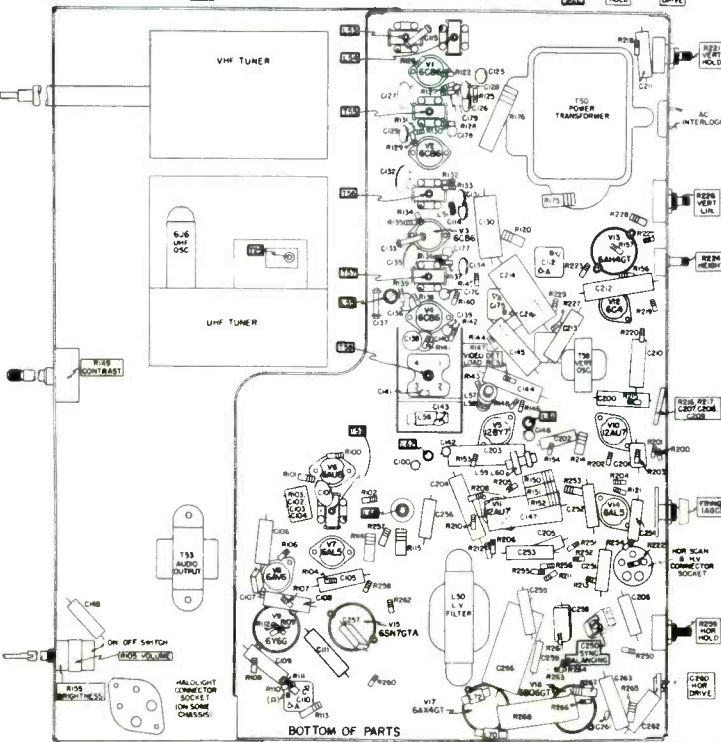
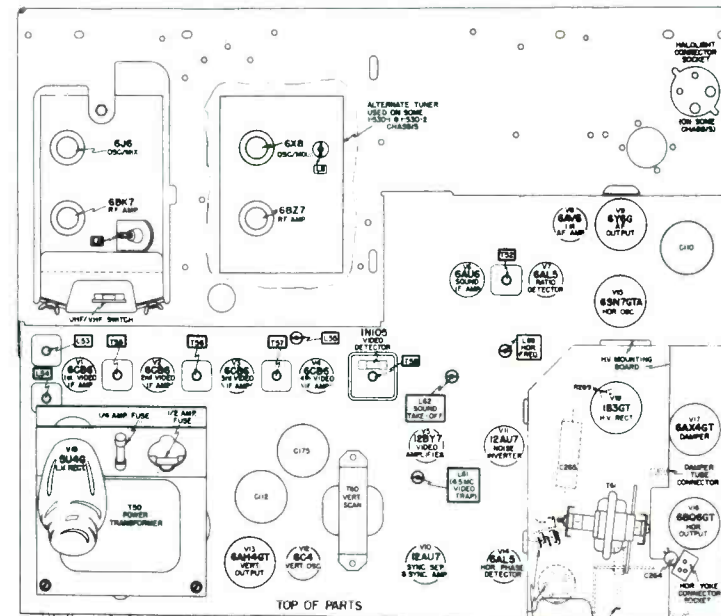
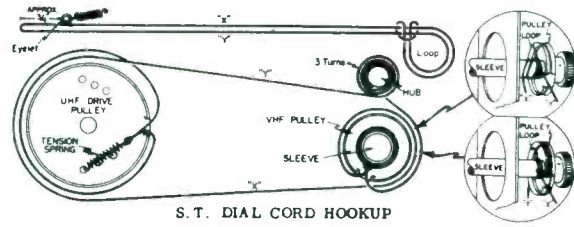

**G.I. UHF/VHF SWITCH ASSEMBLY**

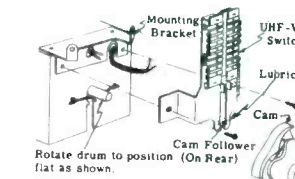

**G.I. UHF/VHF SWITCH ASSEMBLY**

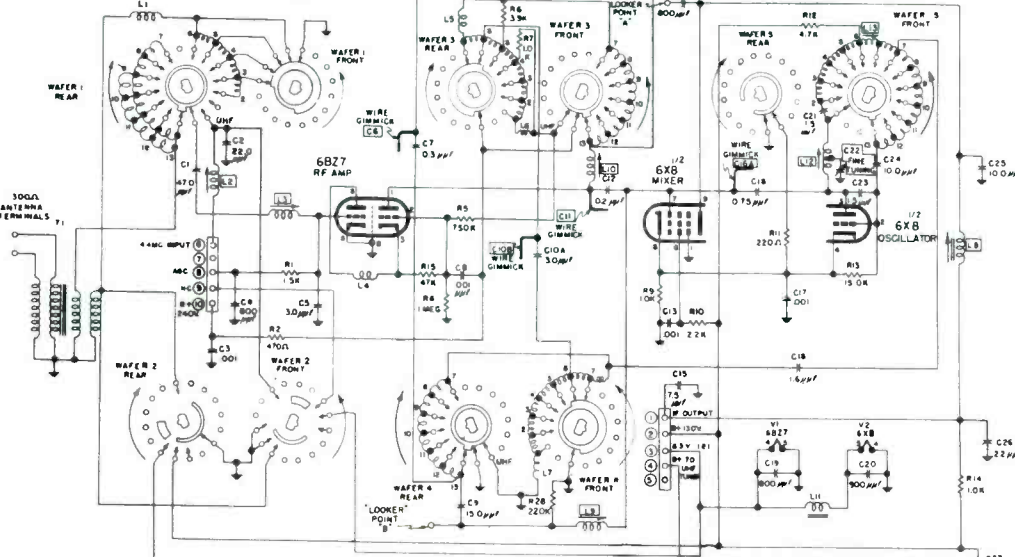

ARROWS INDICATE ROTATION TO CHANNEL 12, 11, ETC. NUMBERS AT WAFER TERMINALS INDICATE CHANNEL POSITIONS. WAFER SWITCH SHOWS CHANNEL POSITION.

**SARKES TARZIAN (S.T.) TYPE TUNER**

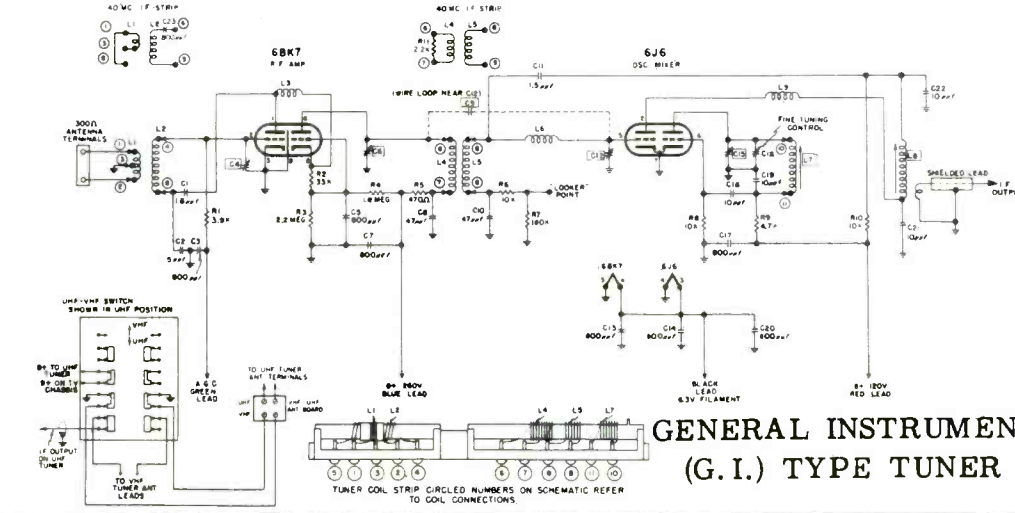

**GENERAL INSTRUMENT (G.I.) TYPE TUNER**

| STEP   | TUNER SET TO CHANNEL                    | SWEEP (10 MC) | GENERATORS IF MARKER  | RF MARKER                      | SCOPE SWITCH POSITION | ADJUST                                     | ACCEPTABLE RESPONSE CURVES                | COMMENTS   |
|--|---|---------------|---|--------------------------------|-----------------------|--|---|--|
| 1  | Channel 4<br>69 MC                      |               |   | 67.25 MC (P)<br>71.75 MC (S)   | RF Output             | C12, C8, C4<br>then C9 wire loop near C12  | 30% deviation permissible as shown below: | Connect 300 ohm resistor across Antenna Leads. Passband should be somewhat broader than that with antenna circuit operating and with picture marker inside.  |
| 2  | Channel 13<br>213 MC                    |               |   | 211.25 MC (P)<br>215.75 MC (S) |                       | See "Comments" and note at bottom of chart |   | Interstage band width is adjusted by C9. When proper band width cannot be obtained by adjustment of C9, it may be necessary to move C8 and C10 slightly farther apart. Overall band width also depends on antenna selectivity. Interstage band width should be adjusted so that proper overall band width occurs with antenna circuit aligned. |
| 3  | Channel 4<br>69 MC                      |               |   | 67.25 MC (P)<br>71.75 MC (S)   |                       | C4 Antenna Trimmer                         |   | Obtain symmetrical response curve.   |
| 4  | Set VHF tuner between any two channels. |               | Connect a sweep generator set to 43.25 MC (sweeping 10 MC) thru hole in VHF tuner cover to pin 5 of 616 Osc./Mixer tube. Inject 42.1 MC and 45.75 MC markers. |                                |                       | L8, then L54 and L53 (both on TV Chassis)  |   | Adjust for symmetrical overcoupled, double peaked response curve with markers on peaks. L8 and L54 determine position of 45.75 MC marker. L53 determines band width or position of 42.1 MC marker.   |
| 5  | Channel 4<br>69 MC                      |               | 45.75 MC  | 71.75 MC                       |                       | C15  |   | If C15 cannot be made to track properly, L7 is out of adjustment and must be tuned as in step 8.   |
| 6  | Channel 2<br>57 MC                      |               |   | 55.25 MC (P)<br>59.75 MC (S)   |                       | L7   |   | Check RF Passbands on each channel. If necessary slightly readjust C15, C12, C8 and C4 for satisfactory compromise on all channels.  |
| 7  | Channel 3<br>63 MC                      |               |   | 61.25 MC (P)<br>65.75 MC (S)   |                       | L7   |   |  |
| 8  | Channel 4<br>69 MC                      |               | Alternate 42.1 MC and 45.75 MC or two Markers   | 87.25 MC (P)<br>91.75 MC (S)   | IF Output             | L7   |   | See note below.  |
| 9  | Channel 5<br>75 MC                      |               |   | 77.25 MC (P)<br>81.75 MC (S)   |                       | L7   |   |  |
| 10   | Channel 6<br>81 MC                      |               |   | 83.25 MC (P)<br>87.75 MC (S)   |                       | L7   |   | Picture Marker 5-SOUND MARKER  |
| 11   | Channel 7<br>177 MC                     |               |   | 175.25 MC (P)<br>179.75 MC (S) |                       | L7   |   |  |
| 12   | Channel 8<br>183 MC                     |               |   | 181.25 MC (P)<br>185.75 MC (S) |                       | L7   |   | Same as for steps 6 through 18.  |
| 13   | Channel 9<br>189 MC                     |               |   | 187.25 MC (P)<br>191.75 MC (S) |                       | L7   |   |  |
| NOTE: If one or more coil strips cannot be made to track properly, replace strips. Do not peak coils to correct passbands. If Channels 7 and 8 show deep valley, adjust L9 as in step 18. If this does not correct conditions change the 616 Oscillator/Mixer tube. This will necessitate repetition of steps 1 through 5. |   |               |   |                                |                       |  |   |  |
| 14   | Channel 10<br>195 MC                    |               |   | 193.25 MC (P)<br>197.75 MC (S) |                       | L7   |   | Check Passbands on each channel. If necessary slightly readjust C15, C12, C8 and C4 for satisfactory compromise on all channels.   |
| 15   | Channel 11<br>201 MC                    |               |   | 199.25 MC (P)<br>203.75 MC (S) |                       | L7   |   |  |
| 16   | Channel 12<br>207 MC                    |               | Alternate 42.1 MC and 45.75 MC or two Markers   | 205.25 MC (P)<br>209.75 MC (S) | IF Output             | L7   |   | See curves above.  |
| 17   | Channel 13<br>213 MC                    |               |   | 211.25 MC (P)<br>215.75 MC (S) |                       | L7   |   |  |
| 18   | Channel 13<br>213 MC                    |               |   | 211.25 MC (P)<br>215.75 MC (S) |                       | L7   |   | A valley that is too deep can be flattened by adjusting turns spacing on L9.   |

\*In order to adjust C8, C9, C10 and L9, it is necessary to remove side cover of tuner. Remove side cover by means of a small wrench and slide cover out between chassis and tuner. The above mentioned adjustments may then be made through hole in chassis opposite tuner. Replace cover when adjustments are complete.

**UHF TUNER ALIGNMENT**

| STEP | SIGNAL GENERATOR Connection   | Freq.             | SWEEP GENERATOR Connection           | Freq.                  | VTVN CONNECTION   | OSCILLOSCOPE CONNECTION | ADJUST  | OUTPUT READING             | COMMENTS   |
|------|---|-------------------|--------------------------------------|------------------------|---|-------------------------|---|----------------------------|--|
| 1    | PERFORM "OSCILLATOR ALIGNMENT" ONLY IN CASES OF POOR UHF TUNER TRACKING   |                   |                                      |                        |   |                         |   |                            |  |
|      | UHF RF gen. to UHF ant. terminals. (SEE COMMENTS)   | 896 MC            |                                      |                        | Across video detector load resistor, R147 4.7K.           |                         | C28   | Max.                       | Turn UHF tuning shaft until tuning capacitor plates are fully unmeshed. If UHF RF generator is not internally terminated to 300 ohms, use matching pad in Fig. B.  |
| 2    | Check Video IF bandpass response as outlined in step 2 of "Video IF Alignment". Leave detector circuit connected for use in following step 3. |                   |                                      |                        |   |                         |   |                            |  |
| 3    | IF marker to test point on UHF tuner.   | 42.1 and 45.75 MC | IF sweep to test point on UHF tuner. | 43.25 MC (10 MC sweep) |   | See preceding step 2    | T25   | Response curve in Fig. A.  | Set VHF tuner to "UHF" position. Maintain marker generator coupling as small as possible to prevent loading and distortion of response curve.  |
| 4    | IF marker to test point on UHF tuner.   | 42.1 and 45.75 MC | UHF sweep to UHF ant. terminals.     | 464 to 896 MC          | Pin 5, 1st Video IF Amp. thru detector circuit in Fig. C. |                         | C37, C38, C39* (C39 adjustment very critical at high end. | Response curves in Fig. D. | Tune UHF sweep generator and UHF tuner simultaneously across UHF band. Adjust C37, C38 and C39* for best compromise on dip, tilt and amplitude. Additional adjustment may be accomplished by a slight bending of rotor plates. |

CAUTION: Do not attempt to correct for excessive dip or tilt in overall UHF response curves by adjusting bandpass circuit (L8, L53, L54). Readjustment of these circuits will adversely affect VHF reception of receiver.

\*NOTE: As a double check for proper C39 adjustment, connect microammeter from UHF tuner test point to chassis. Tune through range; current will vary slightly with frequency. However, improper adjustment of C39 may cause current to drop to 0 on high end of range, while on low end operation is satisfactory.

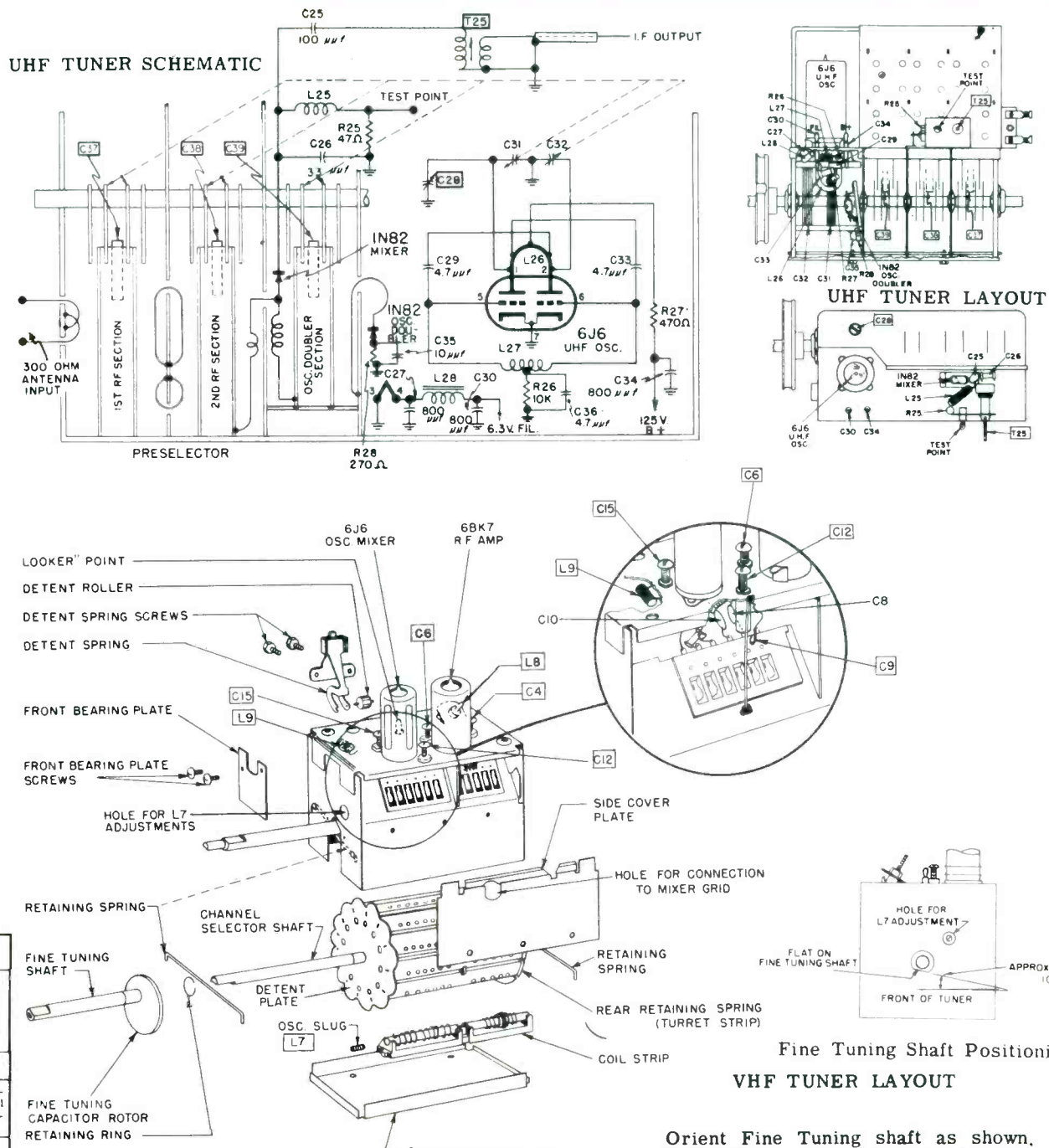
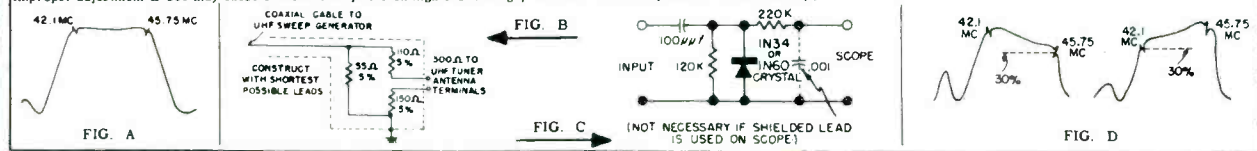

| STEP  | TUNER SET TO CHANNEL | SWEEP (10 MC) | GENERATORS IF MARKER | RF MARKER | SCOPE SWITCH POSITION | ADJUST                     | ACCEPTABLE RESPONSE CURVES    | COMMENTS  |
|---|----------------------|---------------|----------------------|-----------|-----------------------|----------------------------|-------------------------------|---|
| 1   | Channel 13<br>213 MC |               | 48.75 MC             | 211.25 MC | RF Output             | L12 Screw                  | See Curves below              | Coincide Markers as shown.  |
| NOTE: Refer to VHF Tuner Layout and VHF Tuner Schematic for location of specified Wafers, Coil Increments, and Screw Adjustments mentioned in the following steps. As Channels 12 to 7 and 5 to 2 are aligned by means of consecutive coil increments, the aligned increments that precede must not be disturbed. |                      |               |                      |           |                       |                            |                               |   |
| 2   | Channel 12<br>207 MC |               | 45.75 MC             | 205.25 MC | RF Output             | Channel 12 Loop on Wafer 5 | TYPICAL CURVES IF BRF MARKERS | Squeeze or spread loop for Channel 12 on Wafer 5 to coincide Markers as shown.  |
| 3   | Channel 11<br>201 MC |               | 45.75 MC             | 199.25 MC | RF Output             | Channel 11 Loop on Wafer 5 |                               | Adjust each succeeding HI-Channel Loop on Wafer 5 (steps 3 to 7) to coincide appropriate Markers for that Channel.<br><br>Note: Curves may not be symmetrical until RF alignment is complete. |
| 4   | Channel 10<br>195 MC |               | 45.75 MC             | 193.25 MC | RF Output             | Channel 10 Loop on Wafer 5 |                               |   |
| 5   | Channel 9<br>189 MC  |               | 45.75 MC             | 187.25 MC | RF Output             | Channel 9 Loop on Wafer 5  |                               |   |
| 6   | Channel 8<br>183 MC  |               | 45.75 MC             | 181.25 MC | RF Output             | Channel 8 Loop on Wafer 5  |                               |   |
| 7   | Channel 7<br>177 MC  |               | 45.75 MC             | 175.25 MC | RF Output             | Channel 7 Loop on Wafer 5  |                               |   |

**RADIO-TELEVISION SERVICE DEALER  
COMPLETE TV SERVICE INFORMATION SHEETS**

**SYLVANIA**

Models: 410, 514, 525, 529 Series  
Chassis: 1-530-1, -2, -3, -4, -5, -6

An exclusive service of Cowan Publishing Corp. by special arrangement with John F. Rider, Publisher

**LOW BAND OSCILLATOR ALIGNMENT**

|    |   |                    |          |          |           |                           |                  |                            |  |  |
|----|---|--------------------|----------|----------|-----------|---------------------------|------------------|----------------------------|--|--|
| 8  | 6 | Channel 6<br>85 MC | 45.75 MC | 83.25 MC | RF Output | L13 screw                 | See Curves above | Coincide Markers as shown. |  |  |
| 9  | 5 | Channel 5<br>79 MC | 45.75 MC | 77.25 MC | RF Output | Channel 5 Coil on Wafer 5 |                  |                            | Squeeze or spread turns of Channel 5 Coil on Wafer 5 to coincide Markers as shown. |  |
| 10 | 4 | Channel 4<br>89 MC | 45.75 MC | 87.25 MC | RF Output | Channel 4 Coil on Wafer 5 |                  |                            |  | Adjust each succeeding Lo-Channel Coil on Wafer 5 (steps 10 to 12) to coincide appropriate Markers for that Channel. |
| 11 | 3 | Channel 3<br>83 MC | 45.75 MC | 81.25 MC | RF Output | Channel 3 Coil on Wafer 5 |                  |                            |  |  |
| 12 | 2 | Channel 2<br>57 MC | 45.75 MC | 55.25 MC | RF Output | Channel 2 Coil on Wafer 5 |                  |                            |  |  |

**HIGH AND LOW BAND RF ALIGNMENT**

|    |    |                      |                                |           |   |                        |           |  |
|----|----|----------------------|--------------------------------|-----------|---|------------------------|-----------|--|
| 1  | 13 | Channel 13<br>213 MC | 211.25 MC (P)<br>215.75 MC (S) | RF Output | L3, L9, L10<br>Screws                       | 212.5 MC               | 215.75 MC | Adjust L3 for maximum mid-band height regardless of skirt. Adjust L10 for proper skirt flaring. Adjust L9 for flat top. Picture carrier must be at 100% sound carrier may ride down 30%.   |
| 2  | 13 | Same as 1            | 45.75 MC and<br>42.1 MC        | IF Output | L8 on Tuner<br>and L54 on<br>main Chassis   | 42.1 MC                | 45.75 MC  | Adjust for response curve shown.   |
| 3  | 13 | Same as 1            | 211.25 MC (P)<br>215.75 MC (S) | RF Output | L9 Screw                                    | 211.25 MC              | 215.75 MC | Touch up for flat top if necessary. There must not be more than 5% dip.  |
| 4  | 12 | Channel 12<br>207 MC | 205.25 MC (P)<br>209.75 MC (S) | RF Output | Channel 12 Loops<br>on Wafers 1, 3<br>and 4 | PICTURE<br>100%        | SOUND     | Squeeze or spread loops for Channel 12 to acquire acceptable response curve. Loop on Wafer 1 adjusts mid-band amplitude. Loop on Wafer 3 adjusts skirt frequency. Loop on Wafer 4 adjusts for flat top. Align each succeeding channel (steps 5 to 14) adjusting inductances of appropriate loops or coils on Wafers 1, 3, and 4. Refer to VHF Tuner Schematic and Parts Layout for locations of specified loop increments. Picture and Sound carriers must remain on top of curve. |
| 5  | 11 | Channel 11<br>201 MC | 199.25 MC (P)<br>203.75 MC (S) | RF Output | Channel 11 Loops<br>on Wafers 1, 3<br>and 4 | PICTURE<br>OR<br>SOUND |           |  |
| 6  | 10 | Channel 10<br>195 MC | 193.25 MC (P)<br>197.75 MC (S) | RF Output | Channel 10 Loops<br>on Wafers 1, 3<br>and 4 | PICTURE<br>OR<br>SOUND |           |  |
| 7  | 9  | Channel 9<br>189 MC  | 187.25 MC (P)<br>191.75 MC (S) | RF Output | Channel 9 Loops<br>on Wafers 1, 3<br>and 4  | PICTURE<br>OR<br>SOUND |           |  |
| 8  | 8  | Channel 8<br>183 MC  | 181.25 MC (P)<br>185.75 MC (S) | RF Output | Channel 8 Loops<br>on Wafers 1, 3<br>and 4  | PICTURE<br>OR<br>SOUND |           |  |
| 9  | 7  | Channel 7<br>177 MC  | 175.25 MC (P)<br>179.75 MC (S) | RF Output | Channel 7 Loops<br>on Wafers 1, 3<br>and 4  | PICTURE<br>OR<br>SOUND |           |  |
| 10 | 6  | Channel 6<br>86 MC   | 83.25 MC (P)<br>87.75 MC (S)   | RF Output | Channel 6 Coils<br>on Wafers 1, 3<br>and 4  | PICTURE<br>OR<br>SOUND |           |  |
| 11 | 5  | Channel 5<br>79 MC   | 77.25 MC (P)<br>81.75 MC (S)   | RF Output | Channel 5 Coils<br>on Wafers 1, 3<br>and 4  | PICTURE<br>OR<br>SOUND |           |  |
| 12 | 4  | Channel 4<br>89 MC   | 87.25 MC (P)<br>91.75 MC (S)   | RF Output | Channel 4 Coils<br>on Wafers 1, 3<br>and 4  | PICTURE<br>OR<br>SOUND |           |  |
| 13 | 3  | Channel 3<br>83 MC   | 81.25 MC (P)<br>85.75 MC (S)   | RF Output | Channel 3 Coils<br>on Wafers 1, 3<br>and 4  | PICTURE<br>OR<br>SOUND |           |  |
| 14 | 3  | Channel 3<br>57 MC   | 55.25 MC (P)<br>59.75 MC (S)   | RF Output | Channel 3 Coils<br>on Wafers 1, 3<br>and 4  | PICTURE<br>OR<br>SOUND |           |  |

NOTE: As each Channel is aligned by adjustment of its inductance increments in the order listed in steps 4 to 14, care must be exercised not to disturb the aligned increments preceding the one being adjusted.

15. Recheck all channels for flat top response curve, touching up L9 for Chan. 13 and appropriate coil increments for other channels. Up to 10% Dip is permissible for all channels. If bandwidth on any channel is insufficient after these adjustments, touch up by bending trimmer capacitors C8, C10B and C11 towards or away from C7, C10A and C12, respectively.

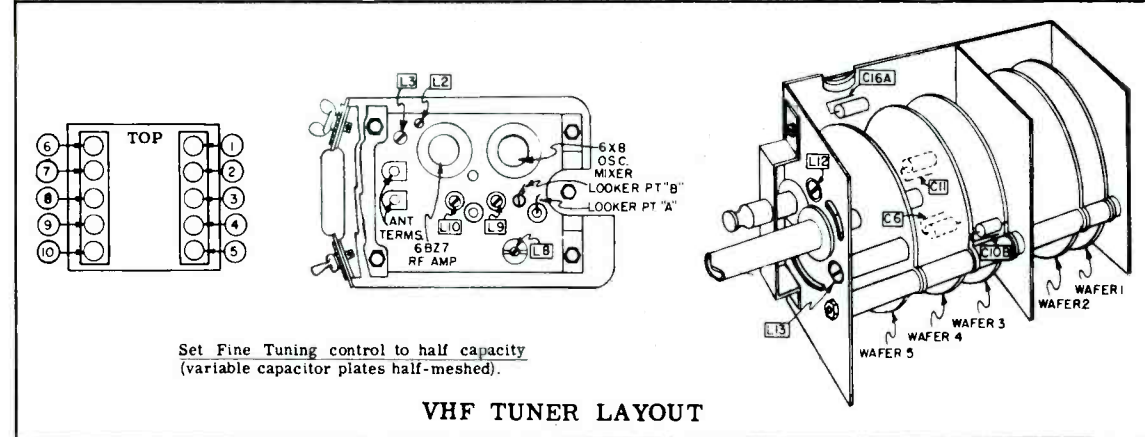

Set Fine Tuning control to half capacity (variable capacitor plates half-meshed).

**VHF TUNER LAYOUT**

**REPAIR PARTS LIST**

| SCHEMATIC LOCATION | SERVICE PART NO. | DESCRIPTION                                   |
|--------------------|------------------|---|
| C100               | 166-0010P        | 10 Mmfd. - 500V. - Ceramic                    |
| C101               | 168-0011D        | .0047 Mfd. - 500V. - Dual Ceramic             |
| C102, C103, C104   |                  | Listed under "Miscellaneous Electrical Parts" |
| C105               | 161-1001         | 2 Mfd. - 50V. - Electrolytic                  |
| C106               | 160-0411         | .01 Mfd. - 400V. - Molded Paper               |
| C107               | 163-0100         | 100 Mmfd. - 500V. - Mica                      |
| C108               | 160-0611         | .01 Mfd. - 600V. - Molded Paper               |
| C109               | 161-1001         | 2 Mfd. - 50V. - Electrolytic                  |
| C110A              | 161-3017         | Three Section Electrolytic                    |
| C110B              |                  | 20 Mfd. - 300V.                               |
| C110C              |                  | 100 Mfd. - 200V.                              |
| C110D              |                  | 100 Mfd. - 200V.                              |
| C111               | 160-0611S        | .015 Mfd. - 600V. - Molded Paper              |
| C112A              | 161-2005         | Two Section Electrolytic                      |
| C112B              |                  | 40 Mfd. - 400V.                               |
| C114               | 166-4700D        | 100 Mfd. - 50V.                               |
| C115               |                  | .0047 Mfd. - 500V. - Ceramic                  |
| C116               | 166-0270N        | 270 Mmfd. - 500V. - Ceramic                   |
| C117               | 166-0001P        | 1 Mmfd. - 500V. - Ceramic                     |
| C118               | 166-0033P        | 33 Mmfd. - 500V. - Ceramic                    |
| C125               | 166-4700D        | .0047 Mfd. - 500V. - Ceramic                  |
| C126               | 166-4700D        | .0047 Mfd. - 500V. - Ceramic                  |
| C127               | 166-0011D        | .0047 Mfd. - 500V. - Dual Ceramic             |
| C128               | 166-4700D        | .0047 Mfd. - 500V. - Ceramic                  |
| C129               | 166-4700D        | .0047 Mfd. - 500V. - Ceramic                  |
| C130               | 162-0202         | 22 Mfd. - 200V. - Paper                       |
| C131               | 166-4700D        | .0047 Mfd. - 500V. - Ceramic                  |
| C132               | 168-0011D        | .0047 Mfd. - 500V. - Dual Ceramic             |
| C133               | 166-0270N        | 270 Mmfd. - 500V. - Ceramic                   |
| C134               | 166-4700D        | .0047 Mfd. - 500V. - Ceramic                  |
| C135               | 166-0011D        | .0047 Mfd. - 500V. - Dual Ceramic             |
| C136               | 166-0043P        | 43 Mmfd. - 500V. - Ceramic                    |
| C137               | 166-0270N        | 270 Mmfd. - 500V. - Ceramic                   |
| C138               | 166-4700D        | .0047 Mfd. - 500V. - Ceramic                  |
| C139               | 168-0008N        | 4.7 Mmfd. - 500V. - Ceramic                   |
| C140               | 166-4700D        | .0047 Mfd. - 500V. - Ceramic                  |
| C141               | 166-0010P        | 10 Mmfd. - 500V. - Ceramic                    |
| C142               | 168-0008N        | 4.7 Mmfd. - 500V. - Ceramic                   |
| C143               | 166-0010P        | 10 Mmfd. - 500V. - Ceramic                    |
| C144               | 160-0201         | 1 Mfd. - 200V. - Molded Paper                 |
| C145               | 162-0202         | 22 Mfd. - 200V. - Paper                       |
| C146               | 168-0008N        | 4.7 Mmfd. - 500V. - Ceramic                   |
| C147               | 168-06022        | 22 Mfd. - 600V. - Molded Paper                |
| C148               | 160-0411         | .01 Mfd. - 400V. - Molded Paper               |
| C149               | 161-2004         | Two Section Electrolytic                      |
| C175A              |                  | 40 Mfd. - 400V.                               |
| C175B              |                  | 80 Mfd. - 400V.                               |
| C176               | 166-1000D        | .001 Mfd. - 500V. - Ceramic                   |
| C177               | 166-1000D        | .001 Mfd. - 500V. - Ceramic                   |
| C178               | 166-1000D        | .001 Mfd. - 500V. - Ceramic                   |
| C179               | 166-1000D        | .001 Mfd. - 500V. - Ceramic                   |
| C200               | 160-04147        | .047 Mfd. - 400V. - Molded Paper              |
| C201               | 163-0220         | 220 Mmfd. - 500V. - Mica                      |
| C202               | 160-04247        | .047 Mfd. - 400V. - Molded Paper              |
| C203               | 160-0601         | 1 Mfd. - 600V. - Molded Paper                 |
| C204               | 160-0611         | .01 Mfd. - 600V. - Molded Paper               |
| C205               | 160-0411         | .01 Mfd. - 400V. - Molded Paper               |
| C206               | 162-06233        | .0033 Mfd. - 600V. - Paper                    |
| C210               | 162-0622         | .0022 Mfd. - 600V. - Paper                    |
| C211               | 162-0623         | .0022 Mfd. - 600V. - Paper                    |
| C212               | 160-0401         | 1 Mfd. - 400V. - Molded Paper                 |
| C213               | 162-06147        | .047 Mfd. - 600V. - Paper                     |
| C214               | 161-1010         | 10 Mfd. - 500V. - Electrolytic                |
| C216               | 160-06247        | .047 Mfd. - 600V. - Molded Paper              |
| C250               | 172-0032         | Trimmer: 70-470 Mmfd.                         |
| C251               | 160-0421         | .001 Mfd. - 400V. - Molded Paper              |
| C252               | 160-0421         | .001 Mfd. - 400V. - Molded Paper              |
| C253               | 160-0421         | .001 Mfd. - 200V. - Molded Paper              |
| C254               | 162-04247        | .047 Mfd. - 400V. - Paper                     |
| C255               | 160-0411         | .01 Mfd. - 400V. - Molded Paper               |
| C256               | 160-06247        | .06247 Mfd. - 500V. - Mica                    |
| C257               | 163-0330         | 330 Mmfd. - 500V. - Mica                      |
| C258               | 163-0680         | 680 Mmfd. - 500V. - Mica                      |
| C259               | 166-1000P        | .001 Mfd. - 500V. - Ceramic                   |
| C260               | 172-0032         | Trimmer: 70-470 Mmfd.                         |
| C261               | 166-1000D        | .001 Mfd. - 500V. - Ceramic                   |
| C262               | 161-1001         | 2 Mfd. - 50V. - Electrolytic                  |
| C263               | 160-0601         | 1 Mfd. - 600V. - Molded Paper                 |
| C264               | 174-0056         | 56 Mmfd. - 2,000V. - Ceramic                  |
| C265               | 160-0601         | 1 Mfd. - 600V. - Molded Paper                 |
| C266               | 160-06022        | 22 Mfd. - 600V. - Molded Paper                |
| L50                | 145-0004         | Coil - B- Filter                              |
| L51                | 147-0014         | Coil - Heater                                 |
| L53                | 115-0001         | Coil - Link Shunt                             |
| L54                | 119-0002         | Coil - Tuner Coupling                         |
| L55                | 118-0011         | Coil - Cathode Trap                           |
| L56                | 118-0010         | Coil - Filter                                 |
| L57, L58           | 131-2003         | Coil - Dual Peaking                           |
| L59, L60           | 131-2008         | Coil - Dual Peaking                           |
| L61                | 130-0001         | Coil - 4.5 MC Trap                            |
| L62                | 130-0001         | Coil - Sound Take-off                         |
| L64, L65           | 100-0009         | Yoke - Deflection - Vertical                  |
| L66, L67           |                  | Yoke - Deflection - Horizontal                |
| L88                | 132-0001         | Coil - Horizontal Frequency                   |
| L69                | 118-0010         | Coil - Filter                                 |
| L70                | 118-0010         | Coil - Filter                                 |
| L71                | 132-0005         | Coil - Horizontal Size Adjustment             |
| L72                | 118-0010         | Coil - Filter                                 |
| T30                | 141-0030         | Transformer - HaloLight Power                 |
| T50                | 141-0039         | Transformer - Power - 117V. 60 Cycle          |
| T52                | 128-0008         | Transformer - Sound Discriminator             |
| T53                | 143-0023         | Transformer - Audio Output                    |
| T55                | 119-0003         | Transformer - 1st Video IF                    |
| T56                | 119-0004         | Transformer - 2nd Video IF                    |
| T57                | 119-0005         | Transformer - 3rd Video IF                    |
| T58                | 126-0001         | Transformer - Video IF Output                 |
| T59                | 242-0002         | Transformer - Vertical Oscillator             |
| T80                | 241-0008         | Transformer - Vertical Scan                   |
| T81                | 241-0019         | Transformer - Horizontal Scan                 |

|       |           |                                   |      |           |                                      |
|-------|-----------|-----------------------------------|------|-----------|--------------------------------------|
| C115  | 166-0270N | 270 Mmfd. - 500V. - Ceramic       | R10C | 181-0473  | 47,000 Ohm - 1/2W.                   |
| C116  | 166-0270N | 270 Mmfd. - 500V. - Ceramic       | R101 | 181-0101  | 100 Ohm - 1/2W.                      |
| C117  | 166-0001P | 1 Mmfd. - 500V. - Ceramic         | R102 | 181-0102  | 1,000 Ohm - 1/2W.                    |
| C118  | 166-0033P | 33 Mmfd. - 500V. - Ceramic        | R104 | 181-0683  | 68,000 Ohm - 1/2W.                   |
| C125  | 166-4700D | .0047 Mfd. - 500V. - Ceramic      | R106 | 181-0156  | 15 Megohm - 1/2W.                    |
| C126  | 166-4700D | .0047 Mfd. - 500V. - Ceramic      | R107 | 181-0224  | 220,000 Ohm - 1/2W.                  |
| C127  | 166-0011D | .0047 Mfd. - 500V. - Dual Ceramic | R108 | 181-01045 | 1,000 Ohm - 1/2W. - 5%               |
| C128  | 166-4700D | .0047 Mfd. - 500V. - Ceramic      | R109 | 181-0104  | 100,000 Ohm - 1/2W.                  |
| C129  | 166-4700D | .0047 Mfd. - 500V. - Ceramic      | R110 | 181-01845 | 180,000 Ohm - 1/2W. - 5%             |
| C130  | 162-0202  | 22 Mfd. - 200V. - Paper           | R111 | 182-0680  | 68 Ohm - 1W.                         |
| C131  | 166-4700D | .0047 Mfd. - 500V. - Ceramic      | R112 | 181-0470  | 47 Ohm - 1/2W.                       |
| C132  | 168-0011D | .0047 Mfd. - 500V. - Dual Ceramic | R113 | 182-0103  | 10,000 Ohm - 1W.                     |
| C133  | 166-0270N | 270 Mmfd. - 500V. - Ceramic       | R114 | 183-0681  | 680 Ohm - 2W.                        |
| C134  | 166-4700D | .0047 Mfd. - 500V. - Ceramic      | R115 | 183-0681  | 680 Ohm - 2W.                        |
| C135  | 166-0011D | .0047 Mfd. - 500V. - Dual Ceramic | R120 | 183-0272  | 2,700 Ohm - 2W.                      |
| C136  | 166-0043P | 43 Mmfd. - 500V. - Ceramic        | R121 | 181-0683  | 68,000 Ohm - 1/2W.                   |
| C137  | 166-0270N | 270 Mmfd. - 500V. - Ceramic       | R122 | 181-0272  | 2,700 Ohm - 1/2W.                    |
| C138  | 166-4700D | .0047 Mfd. - 500V. - Ceramic      | R125 | 181-0222  | 2,200 Ohm - 1/2W. (1-530-1, -2 only) |
| C139  | 168-0008N | 4.7 Mmfd. - 500V. - Ceramic       | R126 | 181-0102  | 1,000 Ohm - 1/2W.                    |
| C140  | 166-4700D | .0047 Mfd. - 500V. - Ceramic      | R127 | 181-0102  | 1,000 Ohm - 1/2W.                    |
| C141  | 166-0010P | 10 Mmfd. - 500V. - Ceramic        | R128 | 181-0102  | 1,000 Ohm - 1/2W.                    |
| C142  | 168-0008N | 4.7 Mmfd. - 500V. - Ceramic       | R129 | 181-0102  | 1,000 Ohm - 1/2W.                    |
| C143  | 166-0010P | 10 Mmfd. - 500V. - Ceramic        | R130 | 181-0102  | 1,000 Ohm - 1/2W.                    |
| C144  | 160-0201  | 1 Mfd. - 200V. - Molded Paper     | R131 | 181-04705 | 47 Ohm - 1/2W. - 5%                  |
| C145  | 162-0202  | 22 Mfd. - 200V. - Paper           | R132 | 181-0472  | 4,700 Ohm - 1/2W.                    |
| C146  | 168-0008N | 4.7 Mmfd. - 500V. - Ceramic       | R133 | 181-0102  | 1,000 Ohm - 1/2W.                    |
| C147  | 168-06022 | 22 Mfd. - 600V. - Molded Paper    | R134 | 181-0152  | 1,500 Ohm - 1/2W.                    |
| C148  | 160-0411  | .01 Mfd. - 400V. - Molded Paper   | R135 | 181-0181  | 180 Ohm - 1/2W.                      |
| C175A |           | 40 Mfd. - 400V.                   | R136 | 181-0102  | 1,000 Ohm - 1/2W.                    |
| C175B |           | 80 Mfd. - 400V.                   | R137 | 181-0102  | 1,000 Ohm - 1/2W.                    |
| C176  | 166-1000D | .001 Mfd. - 500V. - Ceramic       | R138 | 181-0152  | 1,500 Ohm - 1/2W.                    |
| C177  | 166-1000D | .001 Mfd. - 500V. - Ceramic       | R139 | 181-0331  | 330 Ohm - 1/2W.                      |
| C178  | 166-1000D | .001 Mfd. - 500V. - Ceramic       | R140 | 181-0102  | 1,000 Ohm - 1/2W.                    |
| C179  | 166-1000D | .001 Mfd. - 500V. - Ceramic       | R141 | 181-0103  | 10,000 Ohm - 1/2W.                   |
| C200  | 160-04147 | .047 Mfd. - 400V. - Molded Paper  | R142 | 181-0682  | 6,800 Ohm - 1/2W.                    |
| C201  | 163-0220  | 220 Mmfd. - 500V. - Mica          | R143 | 181-0123  | 12,000 - 1/2W.                       |
|       |           |                                   |      |           |                                      |

**RADIO-TELEVISION SERVICE DEALER  
COMPLETE TV SERVICE INFORMATION SHEETS**

**SYLVANIA**

Models: 410, 514, 525, 529 Series  
Chassis: 1-530-1, -2, -3, -4, -5, -6

An exclusive service of Cowan Publishing Corp. by special arrangement with John F. Rider, Publisher

**SCHEMATIC DIAGRAM FOR I-530 TV CHASSIS**

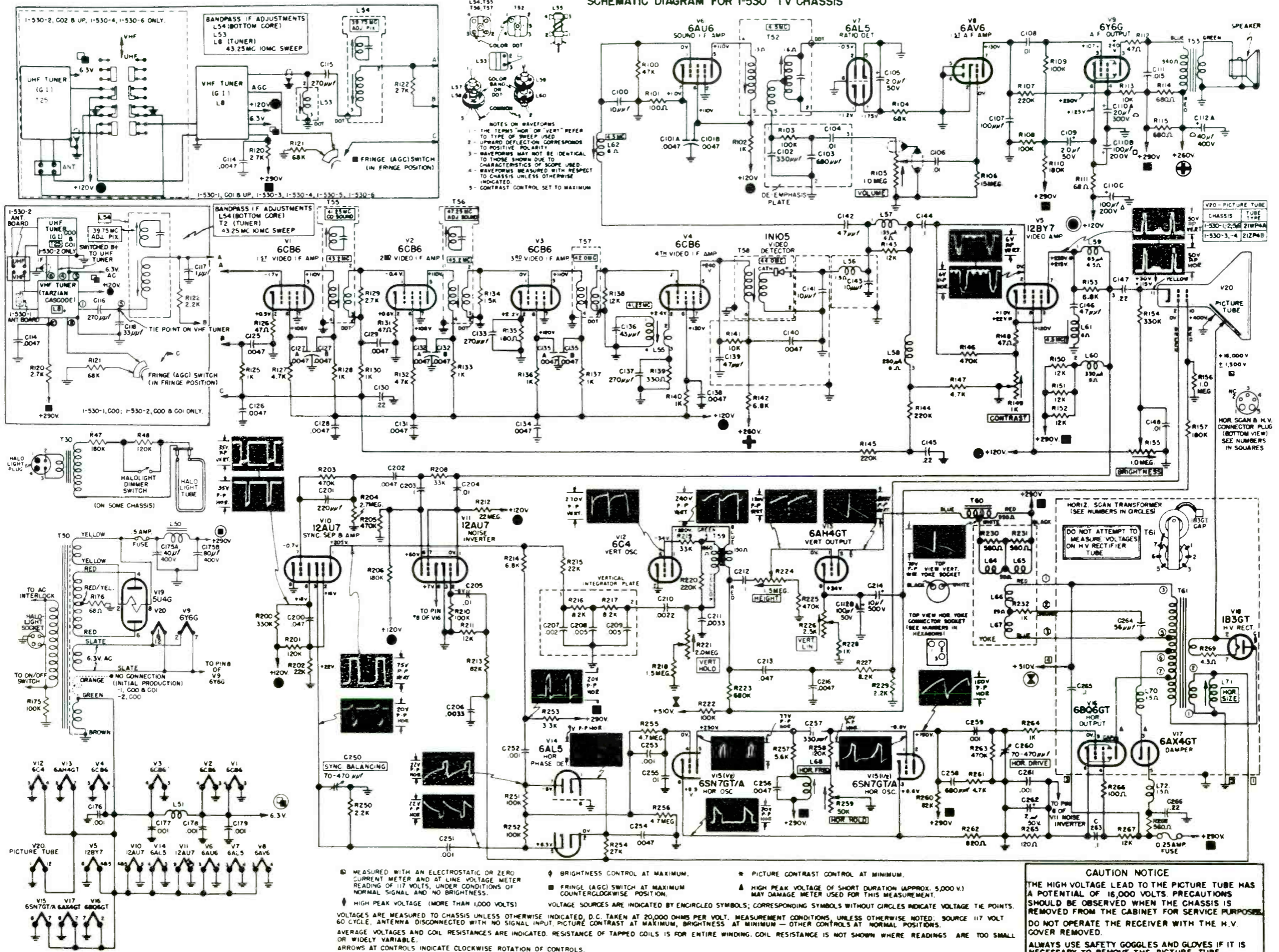

MEASURED WITH AN ELECTROSTATIC OR ZERO CURRENT METER AND AT LINE VOLTAGE METER READING OF 117 VOLTS, UNDER CONDITIONS OF NORMAL SIGNAL AND NO BRIGHTNESS.

BRIGHTNESS CONTROL AT MAXIMUM.

FRINGE (AGC) SWITCH AT MAXIMUM COUNTERCLOCKWISE POSITION.

HIGH PEAK VOLTAGE (MORE THAN 1,000 VOLTS)

VOLTAGES ARE MEASURED TO CHASSIS UNLESS OTHERWISE INDICATED. D.C. TAKEN AT 20,000 OHMS PER VOLT. MEASUREMENT CONDITIONS UNLESS OTHERWISE NOTED: SOURCE 117 VOLT 60 CYCLE, ANTENNA DISCONNECTED WITH NO SIGNAL INPUT. PICTURE CONTRAST AT MAXIMUM, BRIGHTNESS AT MINIMUM - OTHER CONTROLS AT NORMAL POSITIONS.

AVERAGE VOLTAGES AND COIL RESISTANCES ARE INDICATED. RESISTANCE OF TAPPED COILS IS FOR ENTIRE WINDING. COIL RESISTANCE IS NOT SHOWN WHERE READINGS ARE TOO SMALL OR WIDELY VARIABLE.

ARROWS AT CONTROLS INDICATE CLOCKWISE ROTATION OF CONTROLS.

PICTURE CONTRAST CONTROL AT MINIMUM.

HIGH PEAK VOLTAGE OF SHORT DURATION (APPROX. 5,000 V.) MAY DAMAGE METER USED FOR THIS MEASUREMENT.

**CAUTION NOTICE**

THE HIGH VOLTAGE LEAD TO THE PICTURE TUBE HAS A POTENTIAL OF 16,000 VOLTS. PRECAUTIONS SHOULD BE OBSERVED WHEN THE CHASSIS IS REMOVED FROM THE CABINET FOR SERVICE PURPOSES. DO NOT OPERATE THE RECEIVER WITH THE H.V. COVER REMOVED.

ALWAYS USE SAFETY GOGGLES AND GLOVES IF IT IS NECESSARY TO REMOVE THE PICTURE TUBE.



**Snyder**  
PHILADELPHIA

# TV ANTENNAS

*sell quickly.  
stay sold!*

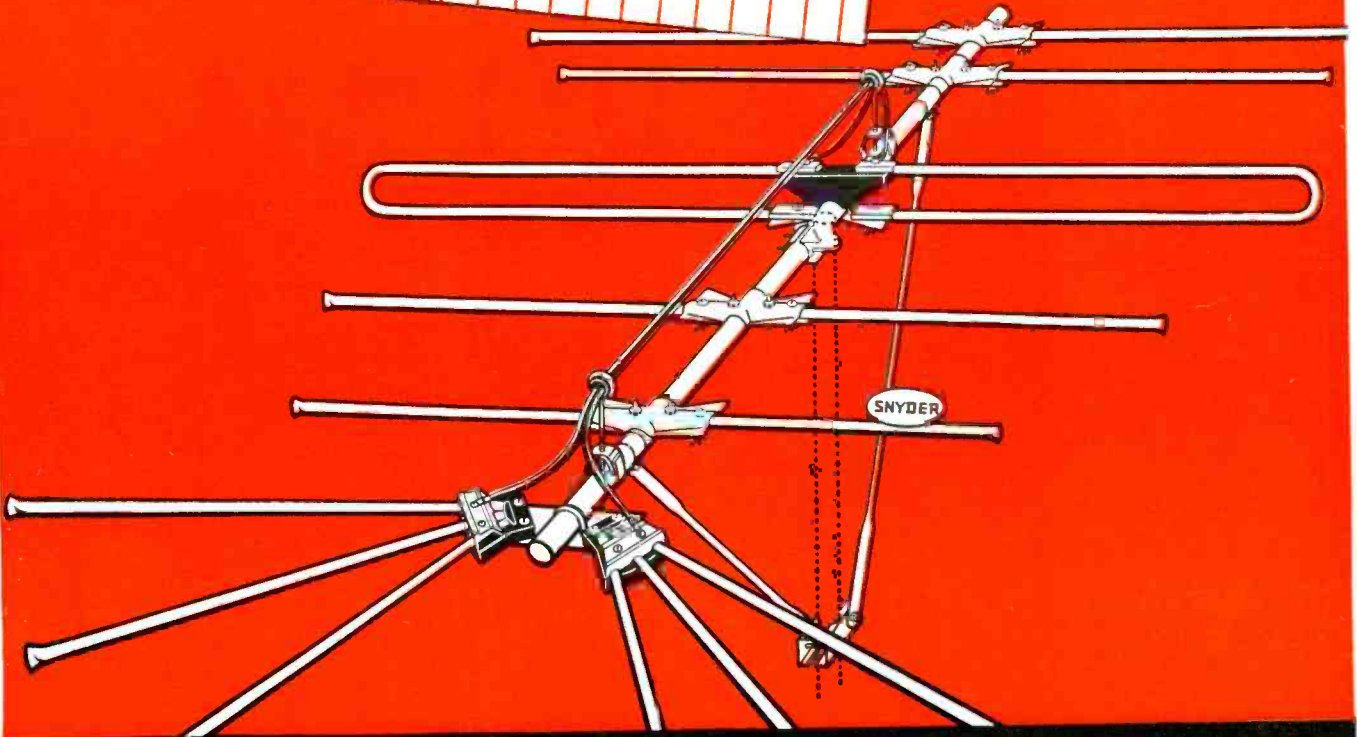

## THE **Long Ranger**

LO-BAND COMBINATION

**CONICAL YAGI**

# SNYDER

SNYDER MFG. CO., PHILADELPHIA 40, U.S.A. • BELLEVUE TUBE MILL, INC., PHILADELPHIA  
SNYDER ANTENN-ENGINEERS LTD., TORONTO 14, CANADA • WORLD EXPORT: ROBURN AGENCIES, INC., N.Y.

ALEX RADIC LAB  
 A PLAKALIS PROP  
 1771 W 25TH ST  
 CLEVELAND OHIO

MAY 58

# FOR COLOR SERVICING

Add These Two New  
 RCA Test Instruments  
 to Your Present  
 B & W Equipment

The RCA WR-61A Color-Bar Generator and RCA WR-36A Dot-Bar Generator plus proper test facilities for servicing b & w receivers give you complete test equipment for servicing color receivers.



\$247.50  
 (Suggested User Price)

### RCA WR-61A COLOR-BAR GENERATOR

Generates signals for producing 10 bars of different colors simultaneously (without manual switching), including bars corresponding to the R-Y, B-Y, G-Y, I, and Q signals, for checking and adjusting phasing and matrixing in all makes of color sets. Crystal-controlled oscillators (color sub-carrier, picture carrier, sound carrier, bar frequency, and horizontal sync) ensure accuracy and stability. Luminance signals at bar edges for checking color "fit" or registration. Adjustable sub-carrier amplitude for checking color sync action. Lightweight and compact.



\$147.50  
 (Suggested User Price)

**RCA WR-36A DOT-BAR GENERATOR.** Provides pattern of optimum-size dots for adjusting convergence in color receivers. H- and V-Bar patterns for adjusting linearity in both color and b & w sets. RF output on channels 2-6. High-impedance video output (plus and minus polarities). Choice of internal 60-cps vertical sync, or external sync. Number of dots and bars is adjustable, 8 to 15 horizontal bars, 10 to 13 vertical bars. Lightweight, compact for home and shop use.



**RCA WO-88A (5") and WO-56A (7") Oscilloscopes**

—essentially flat response to 500 Kc—excellent for most color servicing. For certain applications, such as measurement of 3.58-Mc signals, the new WO-78A wideband scope is recommended.

**RCA WR-89A Crystal Calibrator**

provides the accuracy essential for color work. Continuous frequency coverage from 19 to 260 Mc with built-in 2.5-Mc crystal calibrator and 4.5-Mc crystal oscillator.

**WR-59C Sweep Generator**

includes the essential video sweep range, down to 50 Kc for checking and adjusting video and chrominance circuitry and band-pass filters. The new accessory WG-295A Video MultiMarker provides 5 simultaneous markers, with finger-touch identification.

**RCA VoltOhmysts\***

with high-impedance inputs and isolating probes are tops for color. Accessory high-voltage probes extend range to 50,000 volts. Accessory demodulator probe extends frequency range to 250 Mc.

Now off the press—RCA's new enlarged, 2nd edition of "Practical Color Television for the Service Industry." Price: \$2.00—from your RCA Tube Distributor.



**RADIO CORPORATION of AMERICA**

TEST EQUIPMENT

HARRISON, N. J.

\*TMK Reg.