

AUGUST, 1954

Radio-Television
**SERVICE
DEALER**

TV - AM - FM - SOUND

Includes: **"VIDEO SPEED SERVICING"**
& **"TV FIELD SERVICE"** *Data Sheet Sections*



The Professional Radio-TVman's Magazine
Reaching Every Radio TV Service Firm Owner in the U.S.A.



The Complete Line

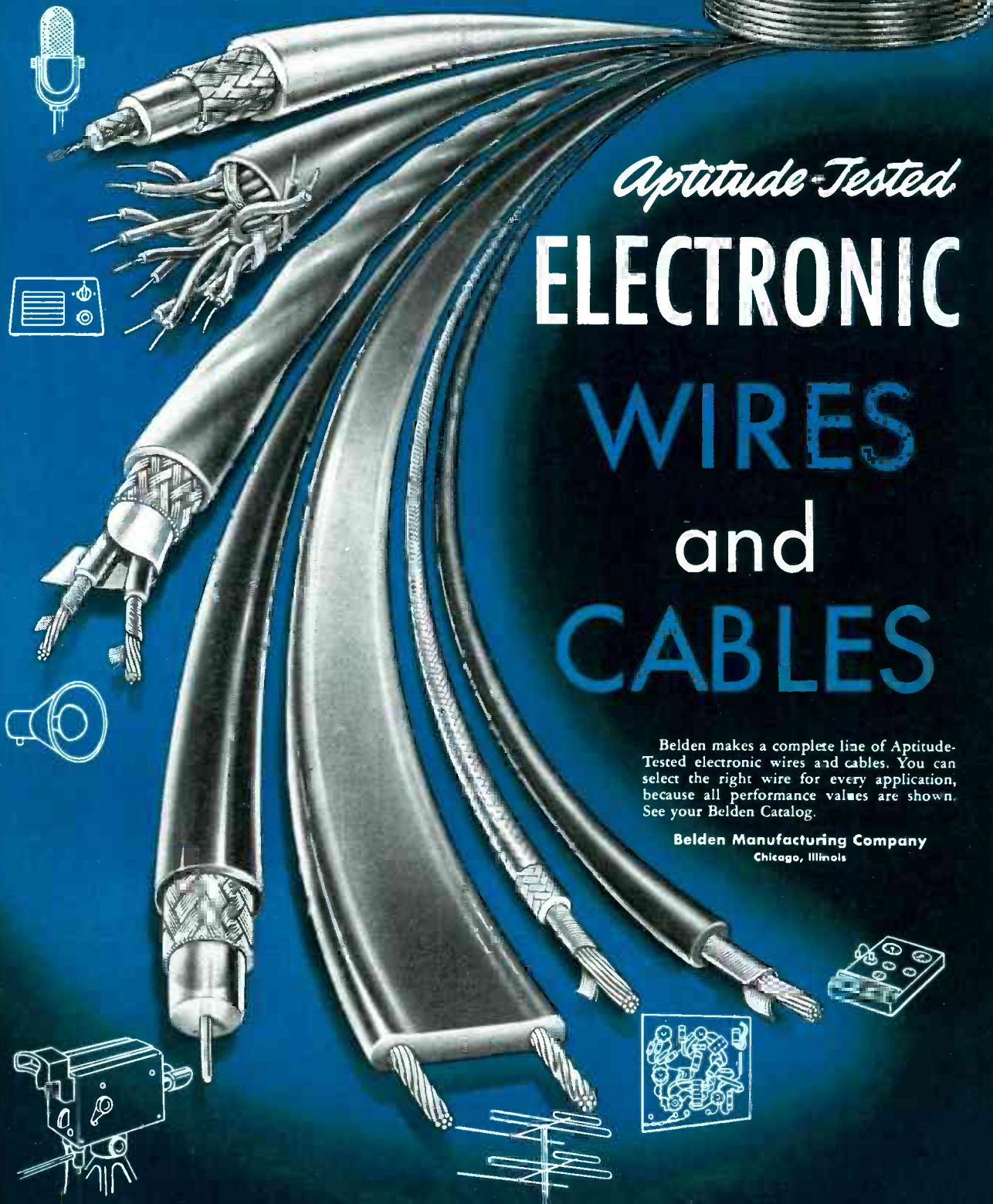

Aptitude-Tested
ELECTRONIC
WIRES
and
CABLES

Belden makes a complete line of Aptitude-Tested electronic wires and cables. You can select the right wire for every application, because all performance values are shown. See your Belden Catalog.

Belden Manufacturing Company
Chicago, Illinois

Belden

**WIREMAKER
FOR INDUSTRY**



Every Service Firm Owner in the U.S.A.
Receives SERVICE DEALER Monthly
DISTRIBUTION THIS ISSUE OVER 65,000

COWAN PUBLISHING CORP., 67 West 44th Street, New York 36, N. Y.

VOL. 15, NO. 8

AUGUST, 1954

EDITORIAL STAFF

Publisher

SANFORD R. COWAN

Editor

SAMUEL L. MARSHALL

Editorial Production

ROBERT CAMPELL

Contributing Editors

LEONARD LIEBERMAN

ROBERT T. DARGAN

PAUL GOLDBERG

MARVIN KLEIN

SAN D'ARCY

BUSINESS STAFF

Advertising Director

SANFORD L. CAHN

Advertising Manager

HARRY N. REIZES

Advertising Sales

LAWRENCE STEINER

Production Manager

DAVID SALTMAN

Circulation Manager

HAROLD WEISNER

Ass't Circ. Mgr.

C. J. BINDERMAN

BRANCH OFFICES

LOS ANGELES

TED E. SCHELL

2700 West Third Street

Dunkirk 2-4889

CLEVELAND

RICHARD E. CLEARY

Commercial Bank Bldg.

Berea, Ohio

Berea 4-7719

FEATURE ARTICLES

Solving Sweep Alignment Problems, Part 3, by Robert G. Middleton	10
Methods of localizing regeneration in <i>if</i> stages are discussed in this third installment.	
Antenna Check, by Fred Voorhaar	14
A summertime-service item, which, with proper promotion, can be a boon to both serviceman and set owner.	
A New Deal For Hi Fi, by Noel Namtro	17
Methods of exploiting the fertile but commonly neglected field of Hi Fi sales and service.	
Servicing Remote Tuners, by Woodrow W. Smith	18
Important considerations in the installation and servicing technique applied to remote TV tuners.	
Horizontal and High Voltage Color Circuitry, Part 4, by Bob Dargan and Sam Marshall	20
High voltage regulation and Victoreen tube functions.	
Horizontal Frequency Troubles by Paul Goldberg (A Work Bench Feature)	36
Various problems involving horizontal frequency circuits, and their solutions.	

CIRCUIT AND SERVICE FORUM

Video Speed Servicing Systems	
DuMont RA-306	23
Philco R191, D191	25
Answer Man	
Replacing 10BP4 with 10RP4	27
AC Voltage on Antenna	27
Montgomery Ward 2WA—Weak	47
Rider TV Field Service Data Sheets	
Sentinel, Models LU500, 510, 511, etc.	29
RCA, Chassis KCS-81, Models 305, 305U, 317, 317U, etc.	31
The Work Bench	
Admiral 22M1—Horizontal Drift	36
DuMont RA-103C—Horizontal Frequency out of Range	36

DEPARTMENTS

Editorial	4	The Work Bench	36
Answer Man	27	Trade Flashes	42
New Products	34	Advertising Index	48

RADIO-TELEVISION SERVICE DEALER is published monthly by Cowan Pub. Corp., 67 West 44th St., New York 36, N. Y. Subscription price: \$1 for 2 years in the United States, & U.S. Poss. Elsewhere \$1 per year additional. Single Copies 25c. Reentered as second class matter Sept. 25, 1950 at the Post Office at New York, N. Y. under the Act of Mar. 3, 1879. Copyright 1954, Cowan Publishing Corp.

POSTMASTER: SEND FORM 3579 TO RADIO-TELEVISION SERVICE DEALER, 67 WEST 44th ST., NEW YORK 36, N. Y.

SCIENTIFICALLY DESIGNED...

FOR BETTER TV RECEPTION

... BETTER PICTURE QUALITY



Scientifically designed to give top performance, Philco television antennas are products of extensive research into receiver requirements in all types of locations. Field tested electrical and mechanical designs provide

proper gain, directivity, bandwidth and impedance... long life and ease of installation. Now a wide choice of Philco television antennas give you better picture quality... build complete customer satisfaction... more sales for you!

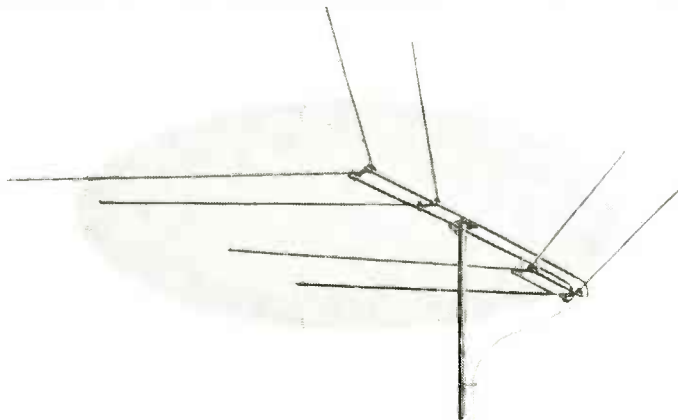

PHILCO ALL-CHANNEL UHF-VHF TROMBONE ANTENNA: The ideal antenna for areas having both UHF and VHF stations. The Philco Trombone can be stacked for VHF fringe area use. Completely pre-assembled at the factory... all-aluminum construction with dowelled elements: Part No. 45-1880.

PHILCO TWO-BAY SUPER CONICAL ALL-CHANNEL ANTENNA: Strong signal pickup on VHF channels 2 through 13, UHF channels 14 through 83... ideal reception in fringe areas... all-aluminum: Part No. 45-3096-2. Fringe area single bay design: Part No. 45-3096.

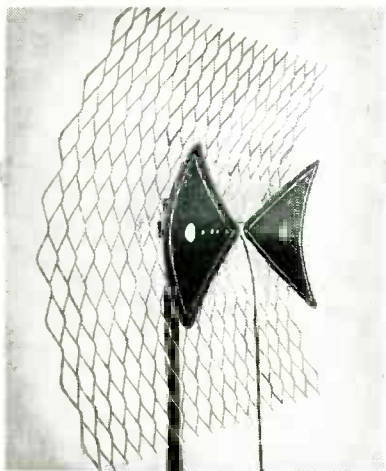
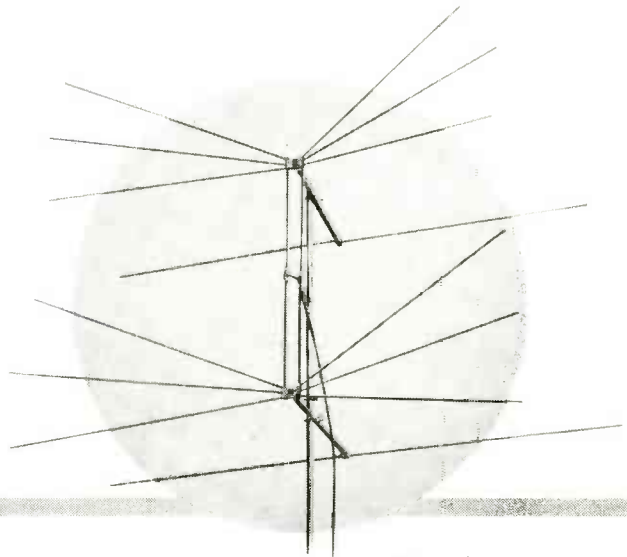

PHILCO PARAFLECTOR ALL-CHANNEL UHF ANTENNA: Pre-assembled, all-aluminum... 8 db to 10 db gain... outstanding fringe area performance... immediate mounting on existing masts: Part No. 45-3071. Bow Tie, Part No. 45-3069 and Bow Tie with reflector, Part No. 45-3070 provide top quality pictures in many UHF areas.

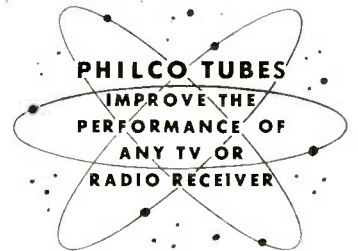

PHILCO CORPORATION

PHILCO

... SUPER PERFORMANCE

TV ANTENNAS

PHILCO VHF "V" ANTENNA: Adequate reception on all VHF channels in most localities . . . heavy chrome plated three-section brass tubing . . . weighted plastic base holds antenna fully extended in any direction: Part No. AD-2643. Also available with aluminum tubing "V": Part No. AD-2643-1.

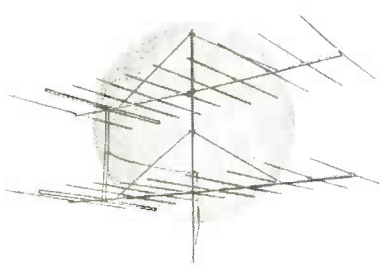

PHILCO TWO-BAY VHF LOW BAND YAGI ANTENNA: 10 elements . . . all-aluminum . . . factory pre-assembled. Top performance on channels 2 through 6 . . . 13 db to 15 db gain on various channels. Single bay Part No. 45-3112-2 through 6. Stacked version uses stack-harness Part No. 45-3267.

PHILCO HIGH BAND VHF YAGI ANTENNA: Pre-assembled, all-aluminum, 10 elements . . . high gain in fringe areas on channels 7, 8, 9, 10, 11, 12, or 13 . . . 10 db to 12 db gain on various channels . . . eliminates co-channel station interference: Part No. 45-3112-7 through 13.

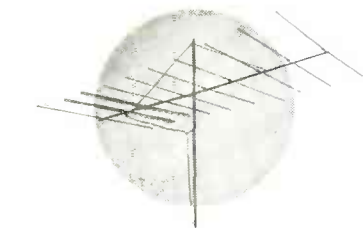

PHILCO BROAD BAND VHF YAGI ANTENNAS: All-aluminum, factory assembled for quick installation . . . high gain plus adequate band width. Three broad band models cover channels 2 to 6 . . . 4, 5, 6 . . . or 7 through 13: Basic Part No. 45-3112.

PHILCO GOLDEN YAGI UHF ANTENNA: Designed for 300 ohm operation . . . all steel construction . . . 11 db to 12 db gain on various channels . . . "Cronak" coated components resist salt air . . . humidity . . . six models cover entire UHF spectrum: Basic Part No. 45-1996.

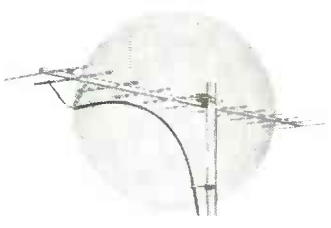

← **PHILCO HEAVY DUTY ANTENNA ROTORS:** →

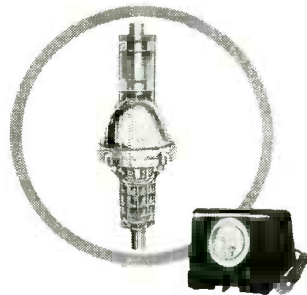

PHILCO MODEL P-4: Supports antenna installations weighing up to 150 pounds . . . completely weather sealed . . . factory lubricated for life . . . uses 4-wire rotor cable . . . modern direction meter control cabinet: Part No. 45-1974.

PHILCO MODEL P-11: Easily handles two-bay arrays . . . mounts on masts up to 1 5/8" in diameter . . . accurate direction control . . . heavy duty motor . . . streamlined design . . . uses 4-wire rotor cable . . . modern direction meter control cabinet: Part No. 45-1994.

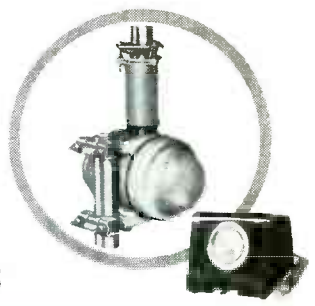

A complete line of powerful Philco TV antenna rotors as low as **\$39.95**

ACCESSORY DIVISION
 "A" AND ALLEGHENY AVE. • PHILADELPHIA 34, PA.



EDITORIAL...

by S. R. COWAN
PUBLISHER

LEGAL VERDICTS OF INTEREST

Last month an interesting legal ruling was issued concerning a Canadian case involving a commercial sponsor of telecasts.

We review the highlights of the Canadian case because of its uniqueness. The decision was premised by all fundamental English law—and frequently American law is also so predicated. If such an American case ever comes about it could have grave repercussions.

In the telecast case the sponsor contracted to pay for certain live telecasts of a certain football team as the games were played, and the sponsor obtained further rights to re-telecast the same games at a later date by means of film recording or kinescope. To protect his "property" the sponsor obtained a copyright registration on all of the live telecasts as well as film presentations. The broadcast station in question not only telecast the live games, but also contracted to retelecast the same games on film at a later date. It so happens that the broadcast station in question also has certain "direct line" subscribers who receive this station's programs in their homes. Actually these subscribers do not get a direct line service but they do rent sets from the broadcasting station and these receivers are tuned solely to that station's video frequency. At the same time this broadcast station maintains a viewing studio where, by direct wire, prospective subscribers to the video rental system have demonstrated for them the broadcasts going on.

The sponsor objected to having his program go to the people who receive their programs by "direct line," meaning over the rented receivers. The sponsor also objected to the broadcast station showing his programs to an audience in the viewing studio. The reasons for this are not important.

In summary, the sponsor claimed that under his exclusive copyright privileges he not only controlled the transmission of live telecasts but also the subsequent film viewings. The court issued a very unusual verdict that was predicated upon a combination of copyright law as well as "an understanding of the difference between a public showing and a private showing of material regardless of whether or not it was subject to copyright."

The court held that all of the live talent broadcasts could not be copyrighted at all because they were not preconceived artistic presentations under the current copyright laws. That being so, the court held that the viewers of the program who received the signal on rented sets were not infringing on

the sponsor's rights. These "direct line" subscribers were considered a part of the overall viewing public. But, the court also held that when the broadcast station demonstrated their rental service receivers to an audience in the viewing studio, the broadcast station did violate the sponsor's rights because he used the sponsor's personal property for a private showing. Quite intricate, eh what!

All of the sponsor's rights to film telecasting were upheld so that has no part in this discussion.

But getting back to the other angle, here in effect we have a case where a broadcast station is held liable because of a private audience arrangement as contrasted to a general public audience. In other words, to make a simile of this case, if a radio dealer owns a TV set and allows his guests to watch a program coming over it in his home he is not violating any copyright laws because he is participating in a "public showing." But, by the same token, under a strict interpretation of the Judge's ruling in the Canadian case, if that same dealer were to own a television set and have it in his store, he is not permitted to allow a prospective customer to view a copyrighted program on it because in such an instance the dealer has participated in a "private showing" of the program.

We merely cite this case because at some future date, without question, certain firms are going to telecast by means of coded signal to a selected audience who will be its subscribers. Undoubtedly ordinary taxpayers here and there will sue these programmers on the premise that they are being discriminated against—and it is the general consensus, and is now common law that all radio frequencies under assignment by the international body which controls them, actually, in effect, belong to all stations of the respective countries under the international pact. Stated another way, it would seem that "closed circuit" telecasting and "blackouts" of certain sporting events in certain localities may find themselves facing legal action by objectors thereto.

SCARCE METAL SHORTAGE

A manufacturer of selenium rectifiers has learned that the shortage of selenium is so acute, and the sales of selenium rectifiers increasing in such great volume, that it would pay to try to get back all burned out rectifiers so that the selenium returned can be reclaimed and re-used. We are for that type of reclamation project just as we favor the turning in of TV tube envelopes which can be reclaimed and re-used by tube manufacturers.

The BACKSTOP

STOPS co-channel and adjacent-channel interference caused by rear signal pick-up!

- Highest front-to-back ratio ever built into an antenna!
- No rear pick-up; eliminates "venetian blinds"!
- Largest screen area: 70 square feet!
- Very high all-channel gain. Incorporates basic Champion design, including Tri-Pole, with additional elements!
- Completely preassembled!

Table of Front-to-Back Ratios (Relative Voltage)

Channels	Front-to-Back Ratios
2	9:1
3	10:1
4	11:1
5	20:1
6	18:1

Only Low Band channels shown, since co-channel interference is not encountered on High Band channels.

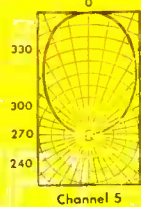

IMPORTANT . . . don't be misled by polar patterns representing relative POWER. Remember, power is the square of voltage. All Channel Master polar patterns are presented in relative VOLTAGE.

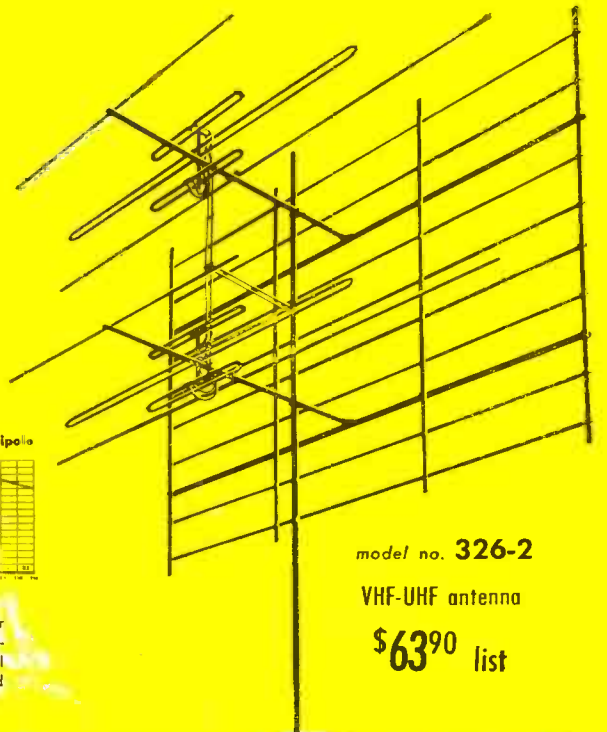
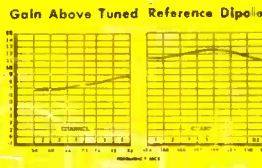

model no. 326-2

VHF-UHF antenna

\$63⁹⁰ list

2 radical new antennas by CHANNEL MASTER

The most beautiful antenna ever made! The only indoor antenna featuring powerful outdoor design principles — Bow-Tie and Screen.

Wonder Bow

* VHF-UHF indoor antenna

DESIGNED FOR POWER!

On **UHF**: For primary and secondary areas. In many cases, performance is equal to actual outdoor installations. Good directivity on all channels.

On **VHF**: Ideal in areas of strong VHF signals.

STYLED FOR BEAUTY!

Designed by a well-known industrial designer, the **WONDER BCW** is proof that indoor antennas can be beautiful as well as powerful. Wins customer approval on beauty alone!

The first gain figures ever to be published for an indoor antenna!

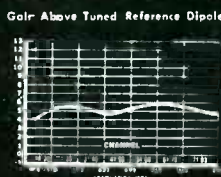

Gold and black
model no. 416

Silver and black
model no. 417

\$8³⁵ list



CHANNEL MASTER CORP. 111 N. WILLE, N. Y.

The World's Largest Manufacturer of TV Antennas

Write for complete technical literature.

Copyright 1954, Channel Master Corp.

*Pat. No. D-171560

"Wish someone had thought of the vertical chassis before"

CHARLES W. RHODES

"Back-breaking chassis tugging belongs to the past"

L. B. HALLBERG

"Another wonderful feature—easier circuit tracing"

ROY R. THOMPSON

CROSLEY SUPER-V IS A SERVICE MAN'S DREAM

—read these letters

"The Super-V is not only a low-priced set, but a set that can be maintained at a low price, which is equally important. I only wish that someone had thought of the vertical-chassis arrangement for a TV set before. To me, there is nothing more annoying than fishing around blindly trying to get a miniature tube back into its socket on a conventional chassis."

Charles W. Rhodes, Electronic Service Mgr.
Robert L. Rice & Co., Portland, Oregon

"By removing the cabinet back, every tube is right in front of one's eyes. No more groping and twisting to relocate tube-socket pins. Back-breaking tugging of the chassis belongs to the past. If a repair or check of chassis components is necessary, a few screws are removed and the cabinet lifts off like a bonnet. The separate diagram showing the actual filament wiring makes the search for an open filament a matter of seconds."

L. B. Hallberg, Manager, Service Dept.
Hardware Products Co., Sterling, Ill.

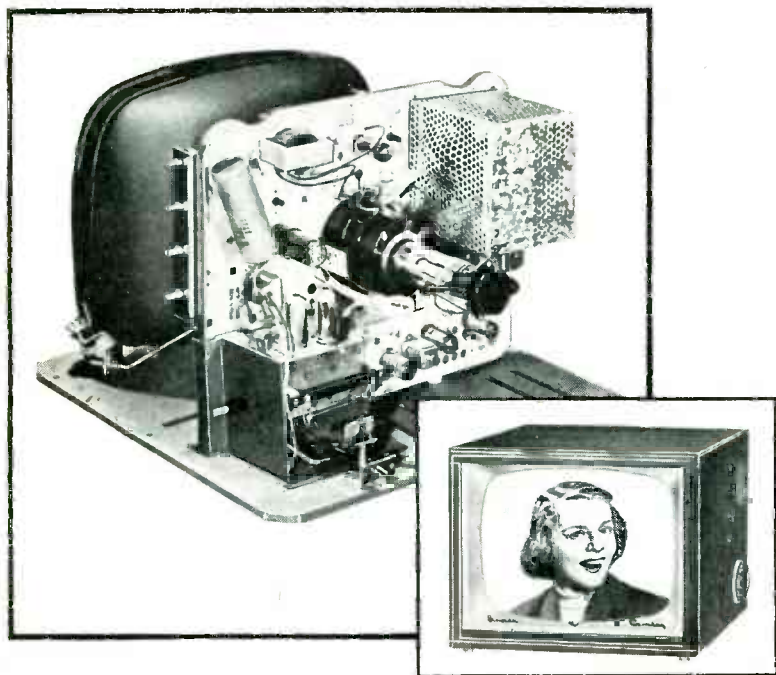

"The Crosley Super-V is a service man's dream; the new vertical plane chassis allows the changing of any tubes in a very few minutes. When service of a more complicated nature is required, the entire cabinet can be removed by loosening 6 screws; this leaves the entire chassis accessible for service. Another wonderful feature is that the picture-tube chassis and bracket are incorporated in one common mounting board along with the points wired on terminal strips for easier circuit tracing."

Roy R. Thompson, General Service Manager
Saginaw Distributors, Inc., Saginaw, Mich.

Crosley
Division



Cincinnati
25, Ohio

For "Trouble-Free" Electrical Protection



You can rely on BUSS FUSES!

Accuracy and dependability are built in every BUSS fuse at the factory and will be there no matter when the fuse is called upon to operate.

For every BUSS fuse normally used by the Electronic Industries is tested in a sensitive electronic device that rejects any fuse that is not properly constructed, correctly calibrated and right in all physical dimensions.

Proper construction prevents poor contact heating, correct calibration makes certain that the fuse will carry its rated current.

This insistence on perfection results in quality, 'trouble-free' fuses. That's why manufacturers and service organizations rely on BUSS fuses for dependable electrical protection under all service conditions.

And to your customer too, the BUSS trademark stands for fuses of unquestioned dependability and high quality. For the BUSS reputation has been built on millions and millions of installations for home, farm and industry over the past 39 years. So be doubly safe, protect the product and your reputation . . . furnish only genuine BUSS fuses.

For More Information • Mail this Coupon ▶

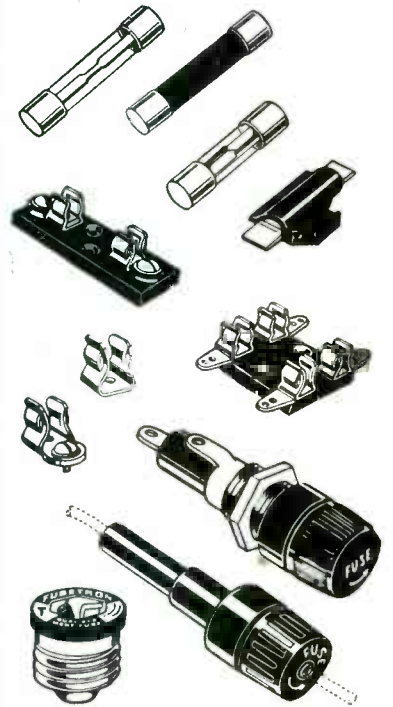

BUSSMANN Mfg. Co. SD-854
(Division of McGraw Electric Co.)
University at Jefferson, St. Louis 7, Mo.

Please send me bulletin SFB containing facts on BUSS small dimension fuses and fuse holders.

Name _____

Title _____

Company _____

Address _____

City & Zone _____ State _____ 854

*Sensationally
New!*

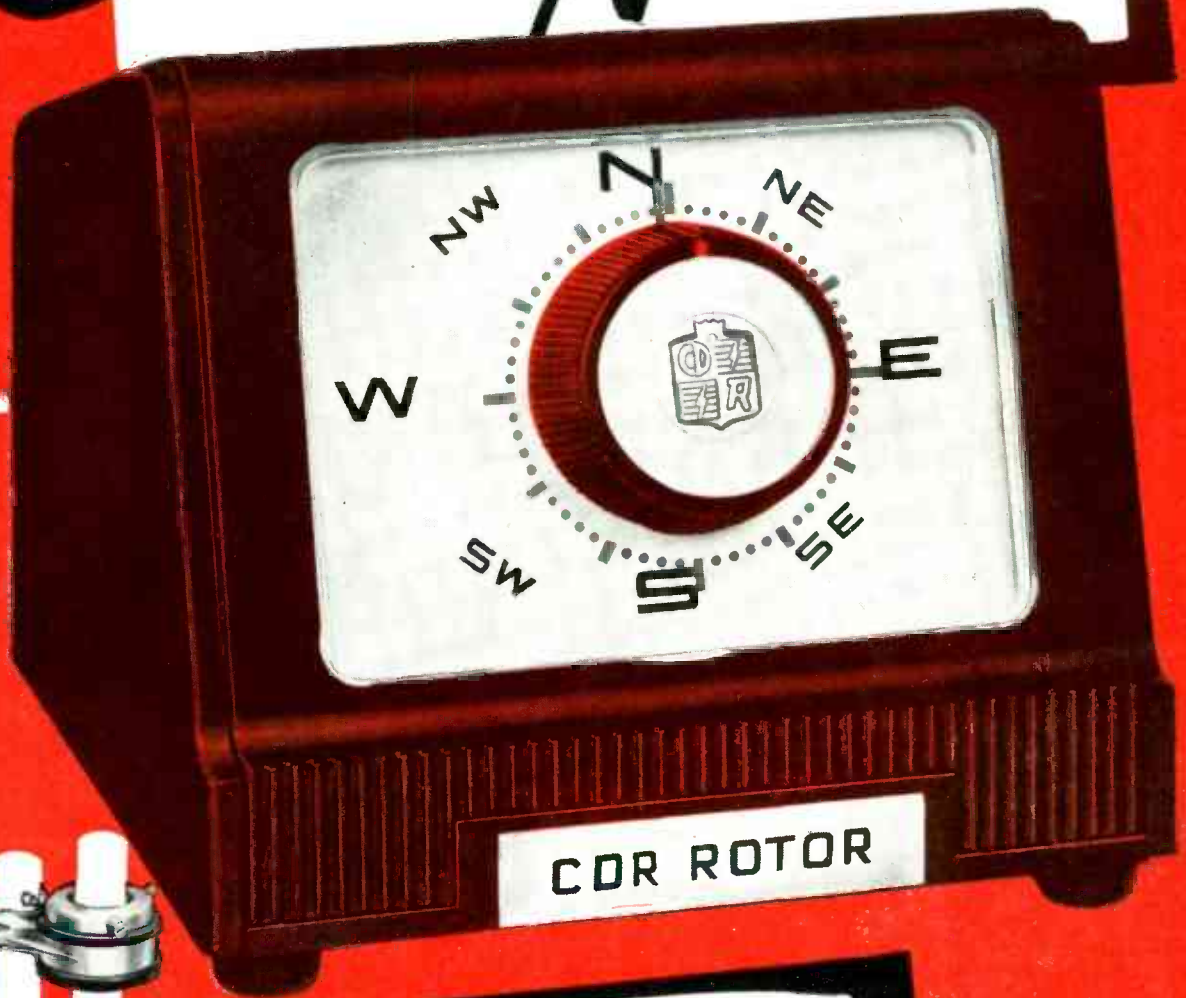

Pre-Sold to consumers in every leading TV market area with saturation TV spot announcements as well as newspaper advertisements. These further helps — animated point-of-sale display... newspaper mats ... envelope enclosures... window streamers.

Models AR-1 and AR-2

CDR AUTOMATIC ROTOR

40% sharper tuning
than any other
AUTOMATIC ROTOR

They said it couldn't be done — never thought it possible — but HERE IT IS! The AR-1 and AR-2... the sharpest tuning AUTOMATIC ROTORS in the world. Superior construction and quality manufacture are featured in these as in the other CDR ROTORS, plus a handsome NEW MODERN DESIGN CABINET styled along lines for gracious, contemporary living. An added feature is a MECHANICAL BRAKE THAT IS RELEASED MAGNETICALLY! Here, truly, is the ultimate in rotors — handsome design, accurate, pinpoint, automatic performance easier to set and adjust — and CDR dependability!

Model AR-2

... complete, AUTOMATIC rotor with THRUST BEARING... and handsome modern design plastic cabinet, uses 4 wire cable..... **47.95**

Model AR-1

... same as AR-2, without thrust bearing..... **44.95**

Model TR-2

The heavy-duty rotor with plastic cabinet featuring "Compass Control", illuminated "perfect pattern" dial, uses 8 wire cable

Model TR-4

The heavy-duty rotor complete with handsome, modern design cabinet with meter control dial, uses 4 wire cable.

Model TR-11

The same as the TR-12 without thrust bearing, complete with meter control dial cabinet, uses 4 wire cable

Model TR-12

A special combination value consisting of complete rotor including thrust bearing. Handsome modern cabinet with meter control dial, uses 4 wire cable



CORNELL-DUBILIER
SOUTH PLAINFIELD, N. J.



THE RADIART CORPORATION
CLEVELAND 13, OHIO

Solving

Sweep - Alignment

Problems

PART 3

Methods of localizing regeneration in *if* stages are discussed in this third installment.

by Robert G. Middleton, Field Engineer, Simpson Electric Co., and author of "TV Troubleshooting and Repair Guidebook," Vols. I & II, and co-author (with Alfred A. Ghirardi) of "TV Test Probes," published by John F. Rider.

REGENERATION often occurs in a single *if* stage, so that relatively simple test methods suffice to localize the trouble. When the regeneration is quite strong, and the stage is on the verge of oscillation, the method shown in Fig. 1 is quite useful; this method is applicable also to the localization of an oscillating stage which causes a negative picture, or complete cessation of receiver operation.

Localization of Regeneration In I-F Amplifier Stages

A sweep-frequency signal is applied at the input terminals of the receiver, or at the mixer tube. A low-impedance

demodulator probe is then used to trace this sweep signal from stage to stage; the probe is used with a *dc* scope, and as the probe passes a point in the circuit which generates an *if* voltage, the trace is deflected off-screen, and the scope screen becomes dark. A suitable low-impedance demodulator probe for this test is illustrated in Fig. 2. While a low-impedance probe of this type is less sensitive than the more conventional types of signal-tracing probes, it has an important advantage in that it does not partially detune the circuit across which it is applied; partial detuning often suffices to throw an otherwise normal stage into oscillation, thereby misleading the operator.

In order to obtain a usable deflection on the scope screen, particularly at the input *if* stage, it is often found advantageous to apply the sweep-frequency signal at the antenna-input posts of the receiver, so that the gain of the front end can be taken advantage of, and the signal level built up considerably greater than is the case when an *if* sweep signal is applied by means of a floating tube shield over the mixer tube. The use of

a sensitive scope is also helpful in this regard.

It will be apparent that when an *if* stage is on the verge of oscillation, or has broken into continuous oscillation, that the *if* voltage which is generated passes through the remaining stages to the picture detector, so that the presence of the unstable stage can be determined by applying a *dc* voltmeter at the output of the picture detector. In normal operation noise voltages will cause an indication of approximately 0.6 volt, but when regenerative instability or oscillation is present, this voltage rises to a maximum of from 5 to 10 volts. Merely determining that the amplifier is generating a spurious *if* voltage, however, is not sufficient; the operator must next determine the source of the spurious voltage—hence the regeneration-tracing test discussed above.

Regeneration or Oscillation May Not Be Confined to One I-F Stage

The foregoing test is based upon the case in which the regenerative trouble is confined to a single stage. Of course, situations arise also in which the fault extends over more than one *if* stage, as indicated in Fig. 3. In such case, a different type of test is required to trace out the regenerative loop. Such a test is

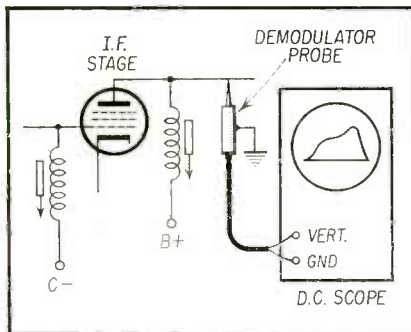

Fig. 1 — Useful method of locating source of strong regeneration in an *if* amplifier, when a *dc* scope is available. The signal is traced from stage to stage with a low-impedance demodulator probe; as the regeneration source is passed, the response curve disappears from the scope screen, the trace being deflected off-screen by the rectified oscillatory voltage from the probe.

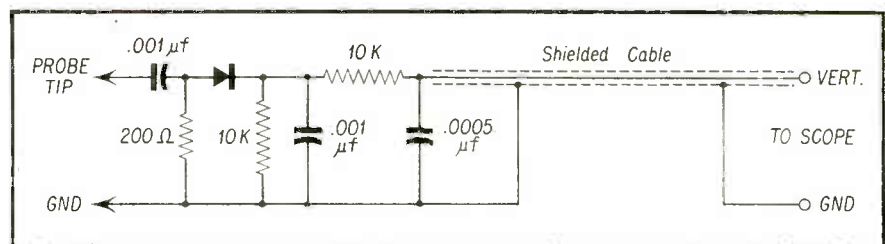

Fig. 2—Low-impedance signal-tracing demodulator probe is useful because it does not partially detune the circuit across which the probe is applied. Because the sensitivity of the probe is relatively low, however, it is essential to apply the sweep signal suitably, and to use a sensitive scope in test work.

made as indicated in Fig. 4. The output from a sweep generator is applied across the input of the picture detector, and a sensitive scope is connected across the picture-detector load resistor. It will be seen that the pattern obtained on the scope screen is basically the response of the tuned circuit at the detector input; however, the essential feature of the test set-up from the standpoint of regeneration testing is the isolating resistor R , shown in Fig. 4. This resistor is made as large as is possible, to still permit satisfactory deflection on the scope screen. The purpose of isolating resistor R is to decouple the sweep generator from the *if* circuit insofar as possible, because it is desired that any feedback voltage, if present, proceed through the last *if* stage undisturbed, as indicated in Fig. 3. If such is the case, it is clear that any feedback voltage which is contributed by earlier *if* stages will add to the height of the response curve on the scope screen—and that any means which is utilized to interrupt the flow of feedback voltage will cause the height of the curve to diminish.

To make the feedback test a 0.01 μf bypass capacitor is utilized. This capacitor is applied between the grid of each preceding *if* tube and chassis, thus grounding the grid for *if* voltages. It is clear that any feedback voltage which is flowing through a preceding *if* stage will be "killed" by means of this test, and the result will be seen on the scope screen as a decrease in height and change in shape of the response curve. As the operator proceeds with the test from tube to tube, he eventually moves out of the feedback loop, after which no further effect is seen in the shape and height of the response curve when the bypass capacitor is applied to the tube in question. In this manner, the stages which are involved in the feedback loop are quickly "buzzed out."

The test set-up shown in Fig. 4 is based upon the assumption that the feedback is taking place from the last *if* stage to some earlier *if* stage. This is

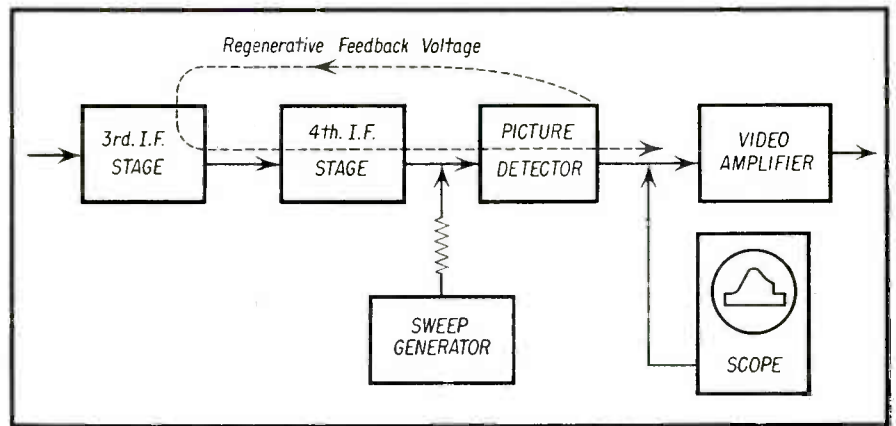

Fig. 3—A regenerative loop may extend over several *if* stages, as shown above. If the loop can be mapped out by regenerative signal tracing, the troubleshooting job is considerably eased. Such a test is readily made with a sweep generator and scope, as shown in Fig. 4.

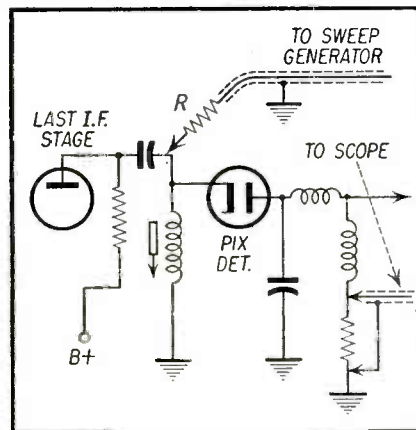

Fig. 4—Basic test set-up for tracing a regenerative signal through the *if* amplifier. A sweep signal, partially decoupled by R , is applied at the output of the *if* amplifier. Feedback often occurs from the highest-level signal point (output of last *if* stage) to some earlier *if* stage. Presence or absence of feedback is then determined by applying a by-pass capacitor between grid and chassis of each *if* tube. The text explains the details of the test.

usually a reasonable assumption for initial testing, because the *if* signal is amplified to maximum voltage at the last *if* stage, and it is more probable that a portion of the output high-level voltage will escape via some circuit fault to an earlier low-level stage. However, the assumption is *not always true*, and if the results of the test illustrated in Fig. 4 are negative the search must be conducted further.

The next step, in such case, is to move the sweep-injection point back one stage, to the plate of the next-to-the-last *if* stage. The regeneration test is then made in the same manner as before, with the bypass capacitor being shunted first from the grid of the next-to-the-last *if* tube to chassis, then from the grid of the preceding *if* tube to chassis, etc.

The question is sometimes asked why this regeneration test is made with a sweep-frequency generator, rather than with a conventional signal generator; the reason for use of the sweep generator is that regeneration takes place, as has been noted, at some particular frequency within the *if* pass band. At the outset, the operator does not know whether the regeneration is taking place

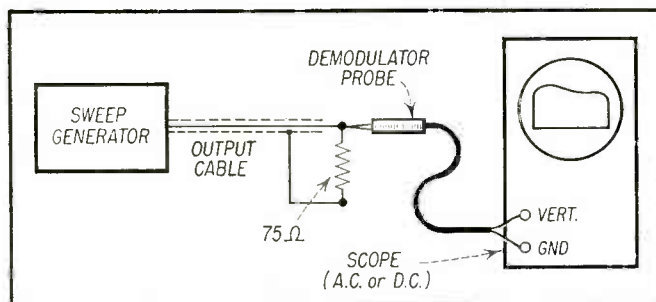

Fig. 5—Checking the output from a sweep generator for output voltage, and for uniformity of output over the swept band. Typical service sweep generators are rated at 0.1 volt output (measured on a calibrated scope from the top to the bottom of the pattern), and are rated at plus-or-minus 10% uniformity of output.

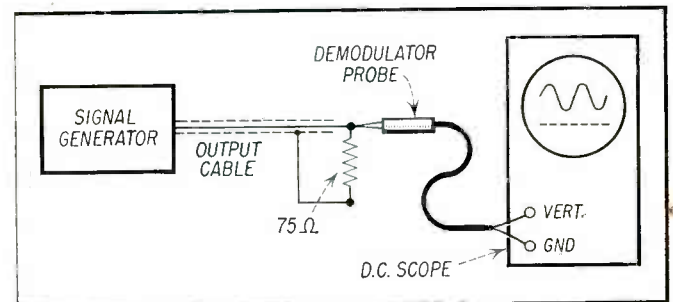

Fig. 6—Measuring the percentage modulation of the output from a signal generator is accomplished with a demodulator probe and a dc scope. The test also shows the value of the output voltage from the generator when a calibrated scope is used in the test. The example illustrated shows approximately 30% modulation.

Dictate Reports Accurately-Promptly!

**make your car,
boat or plane
a "rolling
office"**

with

ATR

INVERTER

for changing your storage battery current to A. C. Household ELECTRICITY

Anywhere . . .

in your own car!!

ATR INVERTERS . . . especially designed for operating standard 110 volt A. C. . . .

- TAPE RECORDERS
- WIRE RECORDERS
- DICTATING MACHINES
- ELECTRIC RAZORS

for

- EXECUTIVES
- SALESMEN
- PUBLIC OFFICIALS
- POLICEMEN
- FIREMEN
- OUTDOOR MEN
- REPORTERS
- FIELD INSPECTORS
- DOCTORS
- LAWYERS, ETC.

See your jobber or write factory

NEW MODELS ✓ NEW DESIGNS ✓ NEW LITERATURE
"A" Battery Eliminators, DC-AC Inverters, Auto Radio Vibrators

AMERICAN TELEVISION & RADIO CO.

Quality Products Since 1931

SAINT PAUL 1, MINNESOTA — U. S. A.

ATR

**EASY TO INSTALL
EASY TO OPERATE**

**mounted
out of sight
under dash
or in trunk
compartment!**

at the low-frequency end of the band, at mid-frequency, or at the high-frequency end of the band. Accordingly, several tests would have to be made if an *if* signal generator were used in the test, and the dial would have to be reset a couple of times and the test repeated to make certain that the pass band had been reasonably well explored. A sweep generator, on the other hand, explores the entire pass band in one operation, by developing a complete response curve. Accordingly, the test is speeded up considerably by use of a sweep generator.

Distorted Responses Can Be Caused By Equipment Faults

An unjustified assumption is sometimes made by the beginner that any distortions which are observed in response curves are necessarily the consequence of receiver circuit faults. It should be apparent, however, that test instruments will develop faults upon occasion, just as receiver circuits. Tubes may weaken in a generator, capacitors may become leaky, or may open up, resistors may change value, switches and connectors may become defective, etc. For this reason, when the test results do not seem "to make sense," it is a good plan to check the operation of the generator.

Figure 5 shows a simple test which can be quickly made of a sweep generator using a demodulator probe and scope, to determine whether output voltage is present, or weak, or absent, or perhaps erratic. Typical sweep generators develop approximately 0.1 volt output when in good operating condition, and this value can be checked on a calibrated scope. The output voltage is measured between the zero-volt reference (or base) line of the pattern, and the swept trace. The zero-volt reference line is developed by the internal blanking function of the sweep generator, and is provided on almost all modern instruments.

The output from the sweep generator should evidently be uniform, within plus-or-minus 10% over the swept band, if there is no defect in the operation of the instrument. The calibration of the instrument is of less importance, and a sweep generator may drift several megacycles off calibration without posing any problem to the operator. If the output voltage from the generator should vary two-to-one or three-to-one over the swept band, the technician should change tubes in the instrument, check the output cable for poor grounds or breaks, and check the capacitors and resistors in the oscillator circuits for faults, exactly as would be done in the

[Continued on page 48]

A new
dimension
in price and
performance

WALSCO

Scotty

377

LIST

GUARANTEED FOR 1 YEAR

**Greatest Antenna
Value in America**

The new "Scotty" has every quality feature necessary for crystal-clear reception in metropolitan and suburban areas. Good gain and directivity on all VHF channels. Used effectively for UHF, or as a combination antenna. Tested and approved for color reception

COMPARE

WALSCO "Scotty"	3.77
Antenna B	7.50
Antenna C	4.86
Antenna D	5.40
Antenna E	4.60

Place your order today

Easily
stacked for
semi-fringe
reception

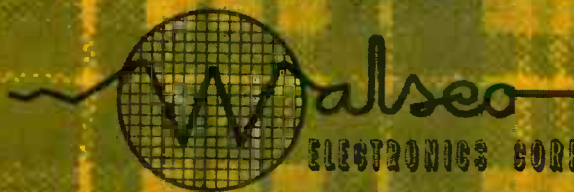

ELECTRONICS CORPORATION

3602 Crenshaw Boulevard, Los Angeles 36, California

Export Distributor:

AD AURIEMA, Inc., 89 Broad St., New York 4, N.Y.

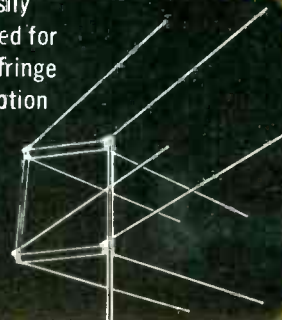

Antenna Check

by **FRED VOORHAAR**
Chief Sales Engineer,
Technical Appliance Corp. (TACO)

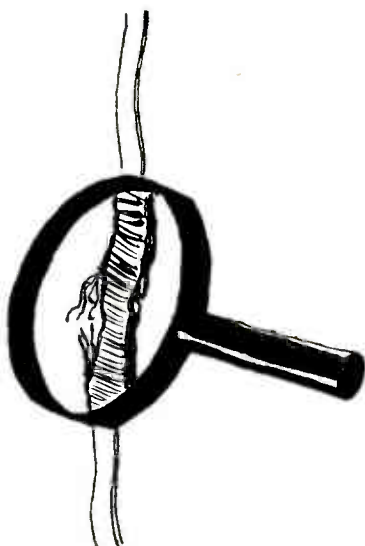

with his ball game than he can in the winter when he looks out the window and sees it for free. Anyway, he usually holds back on TV repairs until Fall. The thought has occurred to us that you would like to make a few extra bucks this summer, and the way to do it is to find the jobs that fit in with summer weather better than other seasons. The answer is obvious—antenna repairs and new installations. . . .

There is no magical formula for selling new antenna installations. All it requires is a little initial push to get it rolling, the backing of a product manufacturer, and a ladder. I know a serviceman who tours his village every morning after a windstorm or after the local cider party and barn dance. He rings the doorbells of the homes on which he spots broken or bent antennas. It's surprising how much business he has picked up, and not at all surprising that he is now the leading serviceman of his community.

Your antenna distributor has a lot of ammunition that will help you sell an-

[Continued on page 46]

NOW is the time to speak of antennas, transmission line and accessories for the television installation.

It's no push-over to sell a replacement antenna installation. About the only time you get a buzz from the customer is when his antenna has been bent into a pretzel shape or when it is laying in ma's petunia bed with a cricket band playing Mozart's Fifth Movement.

Why is it that Joe TV Fan doesn't call you and ask you to check his antenna installation—especially when he'll drive in to the local gas dispensary and order the finest white wall tires for the family cream puff? Or again, when some poor little family of bugs decides to rent a nice green flat in his favorite maple, he'll call up the squirt boys to evict them.

Let's face it . . . television is an electronic miracle that entertains him by the hour and as long as the set has a big screen with the latest super-doooper youdoitmatic tuning and a ghostamatic crystal-clear screenanylizer — the heck with the antenna. Poor fellow, he doesn't know what he's missing.

Take a gander around your own neighborhood. How many of those antennas are four, five or more years old? Take a closer look—see that transmission line waving and flapping like a sailor on shore leave? Feel that transmission line. It feels like Spaghetti Joe's spaghetti—before he cooks it. The terminals of the antenna are rusty, while the transmission line is sometimes broken down to a single strand of copper still wrapped around the terminal. The terminals are usually crossed by the neatest carbon resistor (without the coding bands) formed by soot deposits. Then take a look at the standoff insulators. How many are still holding up their share of the transmission line? Notice the insulated eyes—they look like the morning after the night before.

Now you probably want to know "What's the pitch? Why are you telling

me these things that I know so well? What are you trying to sell me?" O.K., so I'll tell you . . .

Despite all the logical reasons working against it, the TV servicing business seems to fall off over the summer. Maybe Joe TV Fan can stand more snow

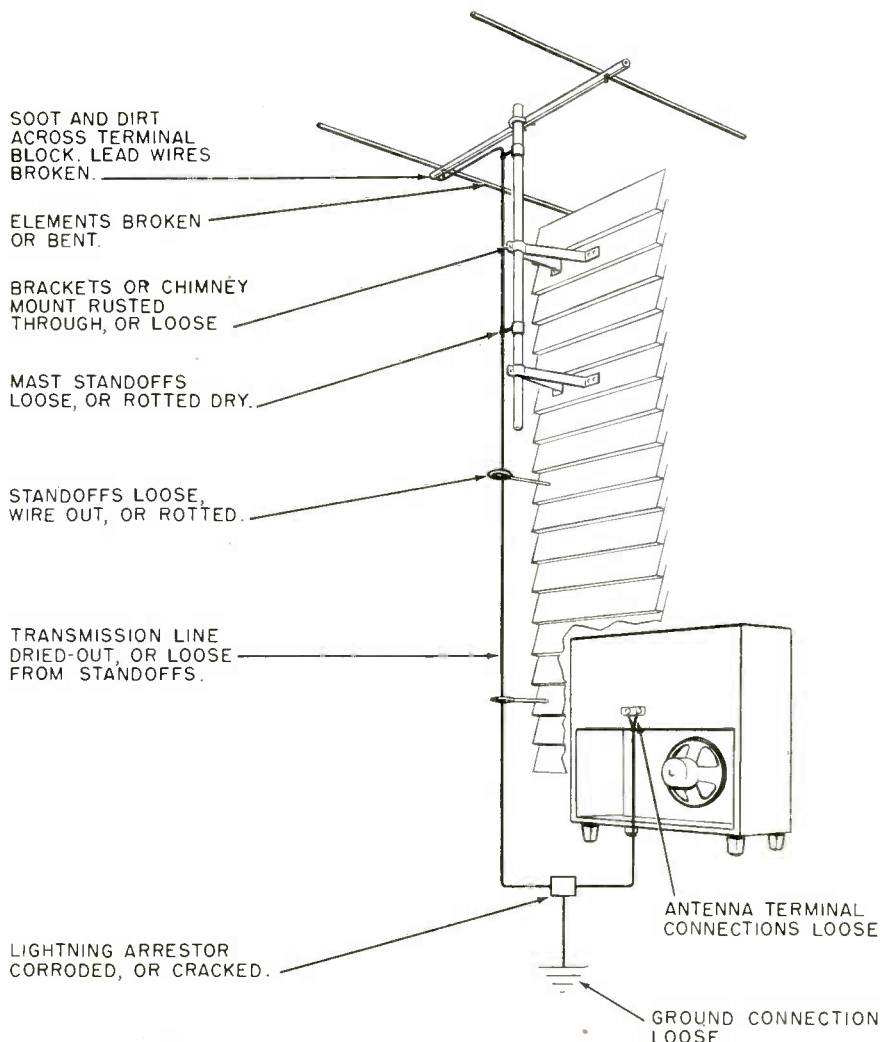

A diagram illustrating the chief check points to be observed in any antenna checkup procedure



Duette

Treasure Chest

FIRST to give you the real high fidelity of a two-way speaker system in a small package—the Jensen "Duette" won your acclaim.

Now the Jensen Duette "Treasure Chest" model is an elegant compliment to your decor whether traditional or modern. The handsome versatile chest design is available in either selected mahogany or blonde oak veneer with genuine matching hardwood trim.

The "Treasure Chest" Duette fits on your book shelf or in a small table area. Measures only 11" by 2 1/4" by 10". The "Treasure Chest" may be made into a graceful free-standing piece by the addition of modern wrought iron legs—available separately.

Duette "Treasure Chest" gives the full performance of the true two-way system with its special 8-inch woofer and compression driver tweeter in an unusually compact scientifically designed acoustic enclosure. Ideal for

small space hi-fi system, excellent as an improvement addition for true hi-fi from existing radio, TV, phonograph or tape recorder. Capable of adequate bass reproduction even at low listening levels. Clean, smooth response with the unmistakable presence of the true two-way reproducer.

The Jensen "Treasure Chest" Duette in either blonde oak or mahogany is an extraordinary value at **\$76⁵⁰ net.**

ST-862 Wrought iron leg set, \$4.25

Also see the "Duette DU-201" in Dupont Fabrikoid finish at a new low price

\$62⁵⁰ net.

And the "Duette Portable" in black leatherette carrying case at only

\$77⁵⁰ net.

Jensen has been the world's quality standard in loudspeakers for more than a quarter of a century.

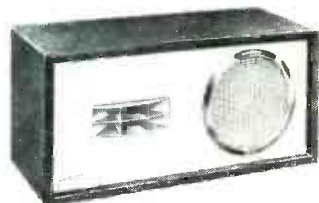

DUETTE DU-201



DUETTE PORTABLE

Jensen

MANUFACTURING COMPANY

Division of The Muter Company
 6601 South Laramie Avenue • Chicago 38, Illinois
 In Canada: COPPER WIRE PRODUCTS, LTD., Licensee

Mr. Service Dealer:

THIS RAYTHEON AD IS YOUR AD

More than twenty-six million people will read about you and the good work you are doing, in the September 13th issue of LIFE Magazine. We at Raytheon are publishing this advertisement because we believe you deserve a public pat on the back for the successful way you have met every challenge of the Radio and Television Service industry. We

are telling you about it in advance so that you can take full advantage of its appearance to help increase your volume and profit. It's our way of saying thank you for using and recommending Raytheon Quality Radio and Television Tubes.

RAYTHEON MANUFACTURING COMPANY

Receiving and Cathode Ray Tube Operations
 Newton, Mass., Chicago, Ill., Atlanta, Ga., Los Angeles, Calif.

RAYTHEON MAKES ALL THESE:

RECEIVING AND PICTURE TUBES • RELIABLE SUBMINIATURE AND MINIATURE TUBES • SEMICONDUCTOR DIODES AND TRANSISTORS • NUCLEONIC TUBES • MICROWAVE TUBES



Excellence in Electronics

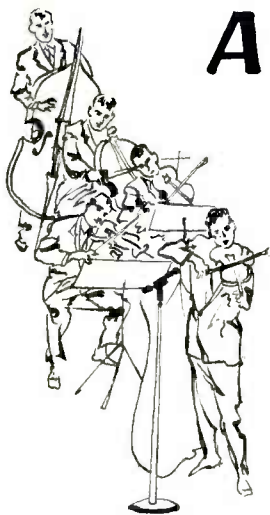

A New Deal



by **NOEL NAMTRO**
Sales Consultant

HIGH FIDELITY! Everybody's talking about High Fidelity. Go to a trade show of record, radio, phonograph and TV set manufacturers and what's the chatter all about? Where's the excitement? Where's the crowd? Why, at the Audio Fairs and High Fidelity exhibits, you bet! Everybody's selling High Fidelity equipment. Everybody but the one guy who's 100% in the right spot to do a 100% job with it. You're the 100% guy, you the radio, phonograph and TV service dealer, the man with the know how. Now RCA, Jensen, Regency, Newcomb and others have begun to promulgate new plans of distribution in order to provide the profit margin for the Service Dealer.

What a fabulous advantage you hold for manufacturers of High Fidelity equipment over every other High Fidelity dealer! Compare your situation with those businesses which must spend hundreds of millions of dollars every year trying to get the attention of the housewife and the breadwinner, trying to untie the household "purse strings." Millions of dollars are spent every year on newspaper and magazine advertising, direct mail, radio and TV advertising, specialty salesmen pounding pavements and ringing doorbells, using all sorts of gimmicks to get into the home, to make the buyers on the inside listen to and remember the sellers on the outside. But you, the Service Dealer, are among the very few people who are actually asked to come inside that sanctum behind the private front door. Your clients actually

contact you and *invite* you to come over. And when you come, they stand by and they listen closely when you talk, giving you an ideal chance to "sell" them.

What a break this can be for you . . . and for Hi-Fi equipment manufacturers! Lots of people would give their right arms to be in your shoes at that moment. Because, whether or not you get the service call, you do get the ideal time to talk to the prospective customer, in his own home where, strangely enough, he is less suspicious of the salesman, more positive and friendlier in his attitude. Those who are now handling High Fidelity would give almost anything to be in your place then. And, to make the situation even more unbelievable to the other salesmen, you get at least two chances to "sell," one when you make the call and do the pickup, the second when you deliver. And sometimes you make additional calls for the radio or the phono-



graph. These are extra invitations for you to talk to the people, in their own homes, about High Fidelity.

The manufacturers are realizing that, in order to build their own businesses and industry to the giant volume which has been predicted, they must get much more exposure for their products. One of the elements most necessary to their growth is increasing distribution and dealerships so that many more people will see their items. In this way more people will learn that there is such a thing as High Fidelity and eventually become purchasers and customers.

High Fidelity is not a monster, requiring monstrous sales staffs or gigantic inventories. A sample setup for demonstrations in the home or in your store can be made with small capital. You may not have to stock furniture or walnut cabinets. A decorative wall display of photographs can be made up or put up in an album in jig-time. All manufacturers have collections of photographs and can supply them to you at cost. These can be used to illustrate how smart a home installation of High Fidelity equipment can look. You should put in a rack, a small one will do for the literature supplied by manufacturers, usually free of charge. Keep the rack full and make certain that everyone who comes into your shop takes an assortment of pamphlets with him. Carry some literature with you on your service calls. Also carry a small photo album of typical installations. If you don't have time to stop and chart about High Fidelity then, leave some folders behind and call back when you have some time to fill in with. If you are one of those few who mails the bills or mails a statement, include some descriptive literature with the mailing. Go through your customer list and make your own direct-mailing of literature. Most manufacturers cooperate in this and other advertising efforts, offering advice, some even writing your letter which should go along with the literature, others even supplying the letter or sharing some of the costs of the mailing. Simple though this may sound, don't forget to stamp or imprint your name and number on the literature. It's amazing the numbers of dealers who do overlook this small but all-important detail, expending money and effort only to lose the sale to some one who did remember to include his name and number.

Since High Fidelity is relatively new and relatively more expensive than a table model radio, don't expect to make High Fidelity sales without having to expend relatively more time on them. It's worth it. The dollar sales and dollar

[Continued on page 48]

Servicing

Another unit in this series on remote tuners is described by

WOODROW W. SMITH

Gonset Company

THE Gonset DeLux Remote Control is designed to permit remote channel selection (at viewing distance) on practically any model TV receiver. Also provided are control of audio volume and contrast. The unit is so designed that it may be operated resting on its back in cases where that position is a more convenient one. Headphone output is provided, together with a speaker muting switch, in order to permit listening late at night, in the sick room et cetera without disturbing other people.

Employing the latest type Standard Coil cascode tuner, the unit actually will improve the performance of many of the older receivers, making it possible in many cases to dispense with a separate booster in fringe areas.

The unit can also serve as a *uhf* converter by simply substituting the necessary *uhf* coil strips available from most radio parts jobbers.

Design of the unit is such that on practically all receivers complete installation can be made from the top of the chassis, making it unnecessary to remove the receiver chassis from the cabinet.

An incidental advantage of the unit is that the load on the receiver power transformer is lessened by from 10 to 15 watts, and drain on the rectifiers lessened by from 15 to 20 ma. The reduction in drain is not enough to upset the voltage balance on the receiver circuits, but will substantially prolong the life of power supply rectifiers which are running at full rating (in some cases even overloaded) and likewise permits the power transformer to run cooler, lessening the possibility of failure on transformers which are being "crowded."

The remote unit is completely "float-ed" by means of isolating condensers so that there is no dangerous shock hazard

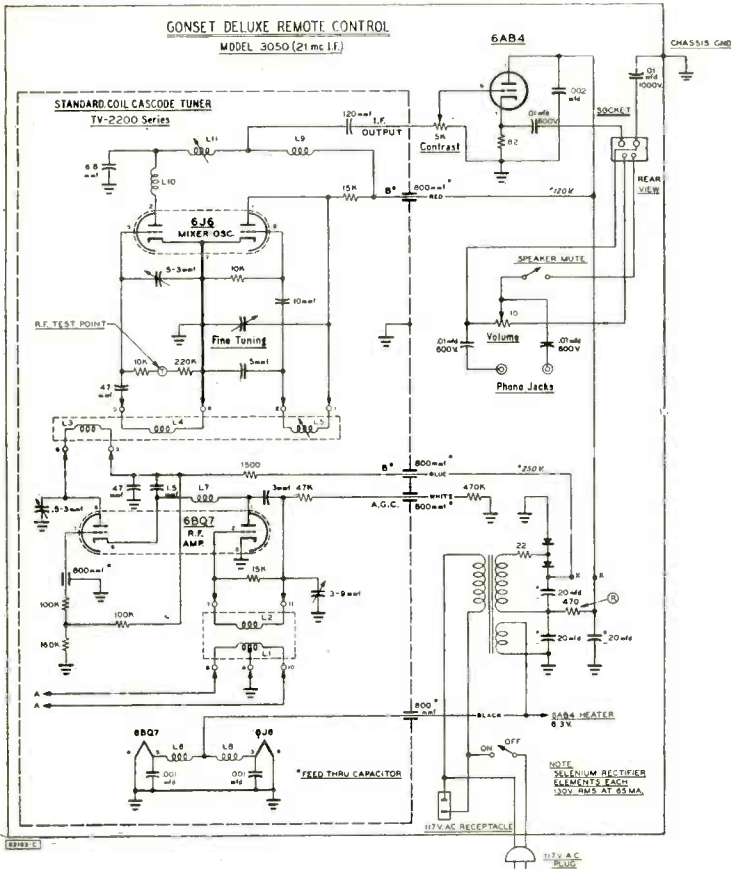

Schematic of Gonset DeLux Remote Control, Model 3050 (21 mc if).

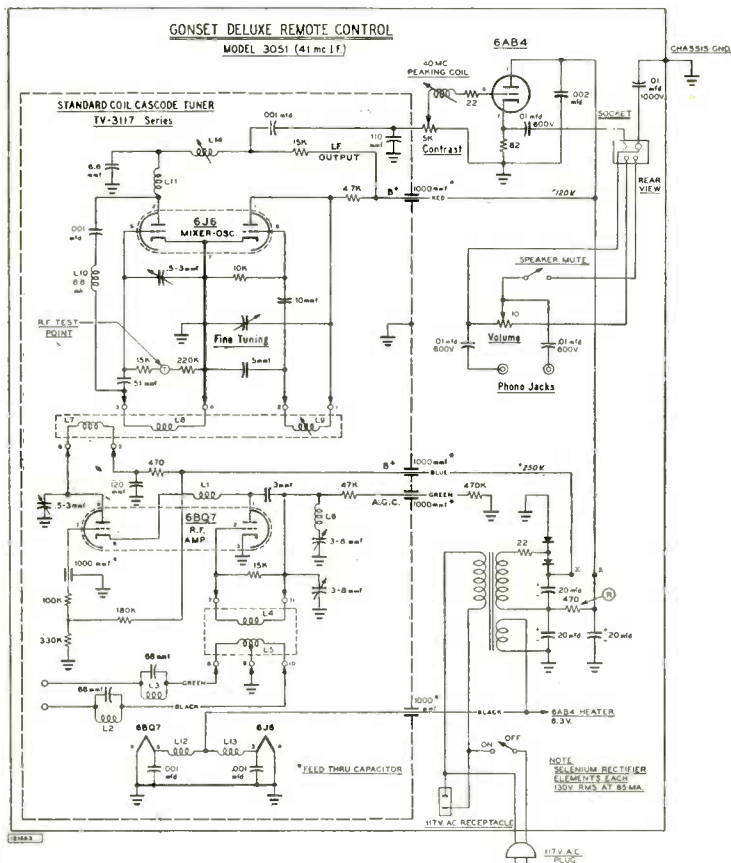

Schematic of Gonset DeLux Remote Control, Model 3051 (41 mc if).



Remote

Tuners

when the unit is employed with a "hot chassis" receiver.

Installation

Installation should be attempted only by a qualified serviceman who is familiar with the necessary precautions which must be taken against the dangerous high voltages which exist inside the cabinet of a TV receiver. The instructions immediately following apply to receivers in which the tubes in the tuner section are not part of a series

heater string. If the receiver employs a series heater arrangement, refer first to the supplementary instructions at the end.

Initial "set up" adjustments are made easier by temporarily locating the remote unit right at the receiver, then moving it to the desired remote location for the permanent installation. Be sure the receiver has the same *if* as the model remote unit you are installing (21 or 40 *mc.*).

Refer to step-by-step installation procedure in Fig. 1 for proper method of

attaching the unit. With regard to step #2, note that socket connections are shown in Fig. 2 for the common mixer tubes. In the case of dual triodes, it may be necessary to try both pairs of elements to determine which half is the mixer. Both leads from the coupling unit are isolated for *dc* with series condensers; so no damage to the receiver will occur if wrong connections are made. Fig. 3 is a diagram of the connections made in Fig. 1.

After step #4 is completed, plug in and turn on remote unit (thus turning on receiver). Turn contrast control on Remote unit full on and, using the contrast control on the receiver, tune in a channel for preliminary check and possible adjustment of the focus control and horizontal and vertical lock controls on rear of receiver chassis or under front "trap door." On some sets these controls may need slight readjustment because of the reduction in drain on the "B stick" to which the original tuner was connected.

Next, adjust the slug on the mixer plate coil in the original tuner for greatest contrast compatible with good definition (contrast control turned down). This should be checked again after the Remote Unit is adjusted. On most receivers this is the only *if* readjustment that need be made. However, if the *if* oscillates and/or ringing "ghosts" are present a slight readjustment of the first *if* transformer in the *if* strip may be necessary.

The *if* coil in the tuner of the Remote Unit (mixer plate) is very broad, but may require readjustment on some sets. The 40 *mc* remote unit has an additional peaking coil (not on the tuner frame) which should be adjusted for maximum contrast with the contrast control on the remote unit full on and
[Continued on page 41]

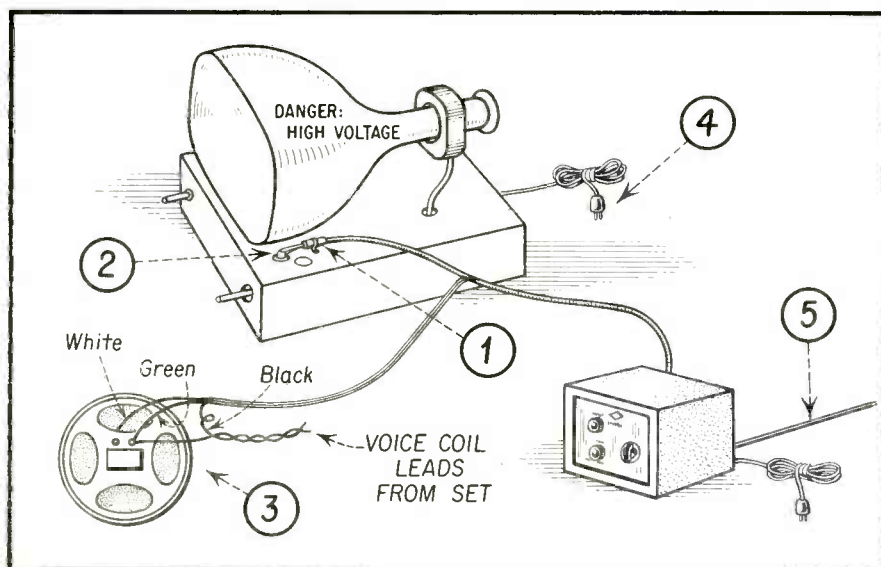

Fig. 1 — Installation procedure: (1) Remove all tubes in TV tuner. Securely fasten coil can clamp under chassis screw, or solder to chassis tab close to mixer tube socket. (2) Insert pin with blue lead in proper pin socket for mixer plate. Plug pin with yellow lead to a cathode or ground pin socket. (3) Disconnect one voice coil lead from speaker ("hot" lead if one side is grounded) and make connections as shown (Solder and tape splice). Attach strain relief clamp for main cable at convenient point on chassis. (4) Run ac extension cord (furnished) from TV set to ac receptacle on rear of remote control unit if desired.

Horizontal and High Voltage

By **BOB DARGAN** and **SAM MARSHALL**

From a forthcoming book entitled
"Fundamentals of Color Television."

The High Voltage Bleeder

A bleeder network is connected from the high voltage output circuit to maintain a minimum operating load on the high voltage supply. It provides a means of obtaining the convergence dc voltage, and the high voltage regulation adjustment. This network is made up of very large resistors in series as shown in Fig. 27. The resistors in the network total up to more than 100 megohms, which include the high voltage regulation potentiometer and the convergence voltage potentiometer. The convergence voltage is obtained at a point on the bleeder which provides 9.5 to 10.5 KV.

High Voltage Regulation

Changes in picture luminance levels from dark to bright produce corresponding variations in the beam current of the picture tube. Since there is no control over the amount of brightness signal within its dynamic range that may be transmitted in a scene, great difficulty would arise in convergence and

focusing within the picture tube unless proper voltage regulation were incorporated. If the picture tube current were to change without holding the high accelerating voltage fairly constant, problems such as blooming, fringing, improper convergence and general color misregistration could easily develop. In high voltage systems for color picture receivers it is extremely important to hold the high voltage applied to the ultor, convergence, and focus anodes within 2% for all load conditions.

To accomplish this job, a high voltage regulator tube is connected across the output of the high voltage supply. Such a tube may be a triode with its bias adjusted to conduct a definite amount of current for a particular value of high voltage (20 KV) applied to the plate of the tube.

As an example of the operation of this circuit let us examine the voltages on certain key points before a change of picture conditions takes place. We will assume that the high voltage con-

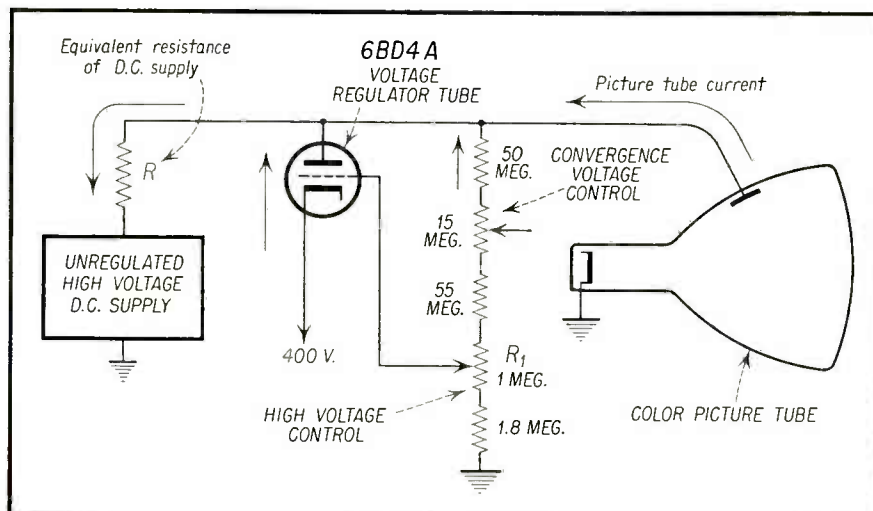

Fig. 27 — The equivalent voltage regulator circuit.

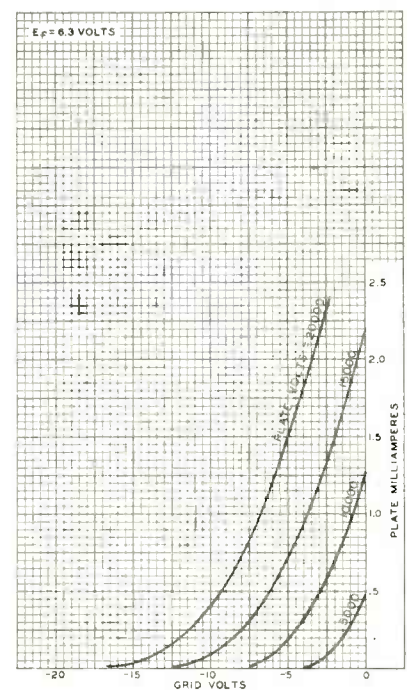

Fig. 28 — Average transfer characteristics curves of the high voltage regulator tube, 6BD4.

control (Fig. 27) has been set at some point, which, in this case could be 392 volts. Since the cathode of the 6BD4A tube connects to 400 volts on the "B" supply, the grid is $400 - 392 = 8$ volts minus with respect to the cathode. We will also assume that the voltage output of the unregulated terminals produces a regulated voltage output of 20 KV at the above settings and circuit conditions. This would correspond to a current drain of about 600 μ amp. See Fig. 28, which shows the operating characteristics of this tube.

If the picture tube brightness, and therefore its current, increases, a greater voltage drop occurs across R, the internal resistance of the high voltage

Color Circuitry

PART 4

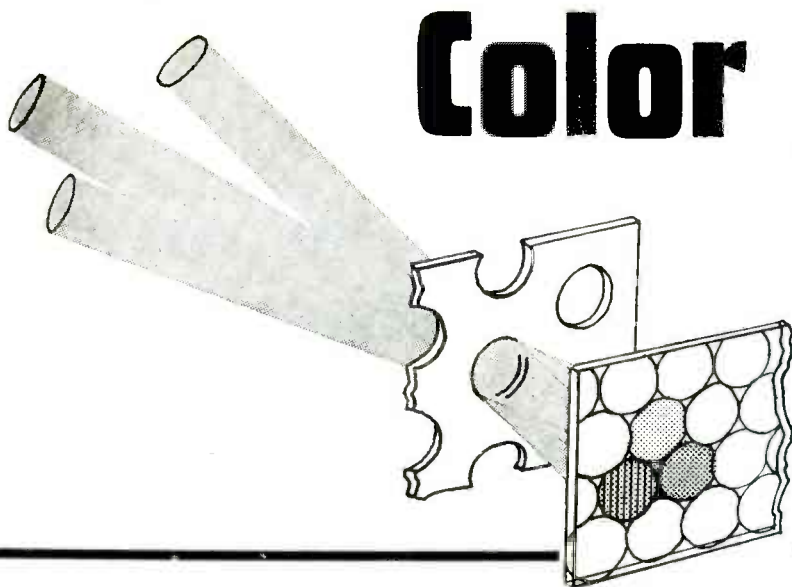

supply. This will produce a momentary reduction in high voltage. This reduced voltage will cause the current drain through the bleeder network to decrease. The 392 volt point now assumes some lower value such as 390 volts, thus increasing the bias on the regulator tube (cathode is always at 400 volts). The increased bias reduces the current flow in the tube and hence through *R* by an amount almost equal to the increase caused by the brighter picture. The voltage drop across *R* is now practically the same as it was before, and the voltage across the picture tube assumes a value almost equal to its original value of 20 KV. A similar analysis for a picture decreasing in brightness may be made with the same end results.

Fig. 29 indicates that this system is capable of 2% regulation, or a change of only 400 volts from no load to full load.

A high voltage regulator tube used for this purpose is the 6BD4A tube. The socket connections for this tube are shown in Fig. 30. This tube is a

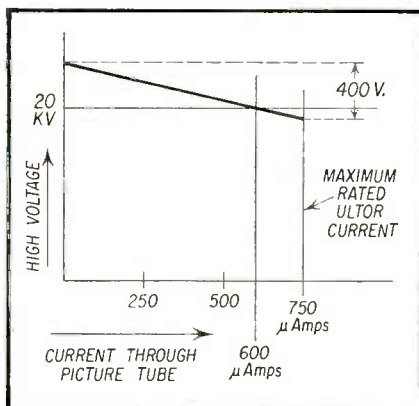

Fig. 29 — Regulation curve of high voltage system.

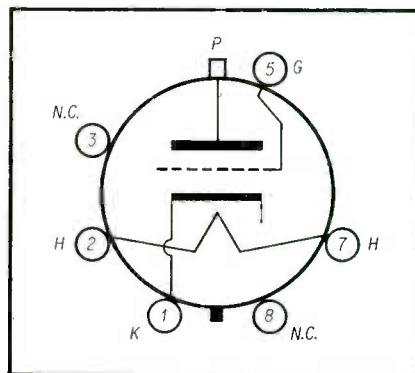

Fig. 30 — The socket connections for the 6BD4A high voltage triode regulator tube.

low current, sharp cutoff type that has been specially designed to withstand the voltages developed between the plate and cathode elements.

One characteristic of the 6BD4A tube is that the plate in the glass envelope exhibits a dull red color when operated at plate dissipation ratings that are near the maximum operating conditions. A blue glow visible in the upper portion of the tube is normal in the operation of this tube. The blue glow is the result of fluorescent gas and it should not be mistakenly assumed that the tube is defective because of this blue glow.

The high voltage is adjusted to 19.5 or 20 kilovolts depending on the particular color receiver. This is done by varying the 6BD4A bias (*R1*—Fig. 27) while observing the ultor voltage with a *vvm*. The ultor current drawn should never exceed 750 microamperes average current.

The Victoreen High Voltage Regulator Tube

The Victoreen (Fig. 31) is a gas filled tube, usually hydrogen, which is

designed to accomplish the same job as performed by the 6BD4A high voltage regulator triode. It will maintain the voltage across the high voltage supply at a constant predetermined value, just as the high voltage regulator tube does. The Victoreen tube conducts when high voltages of more than 20 KV are applied to it. At higher potentials the gas in the tube ionizes and the tube draws current until the voltage is brought back to the 20 KV level.

If the picture tube current increases, the high voltage is reduced and the Victoreen tube draws less current. This is illustrated in the voltage regulation curve of Fig. 32. The sum of the three currents (see Fig. 33), the current through the high voltage bleeder I_1 , the Victoreen tube current I_2 , and the picture tube current I_3 , always remains constant. When the electron flow through the picture tube increases, the current through the Victoreen tube and bleeder decreases, so that the sum of the three currents always totals a fixed amount, thereby maintaining the high voltages constant under different load conditions.

[Continued on page 39]

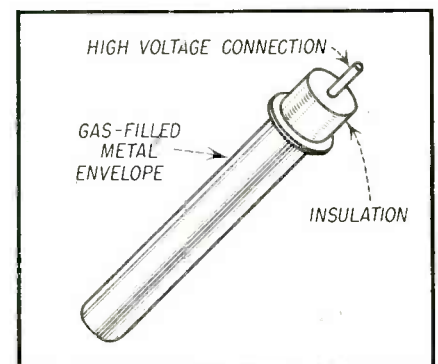
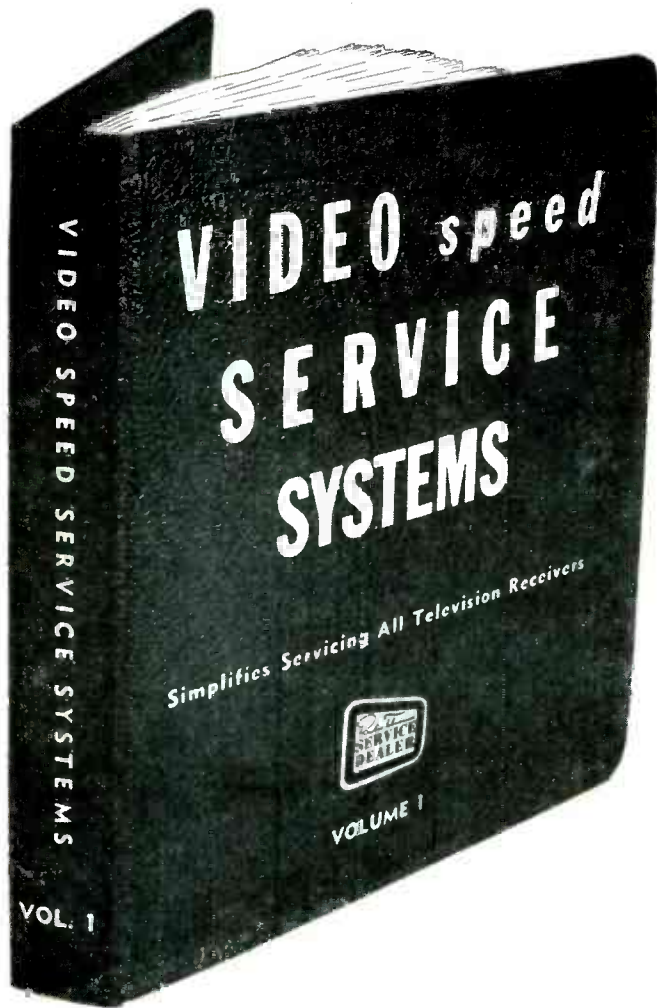

Fig. 31 — The Victoreen tube.

FOR GREATER PROFITS



SPEED UP YOUR SERVICING with THIS NEW BOOK

which shows you how to take care of and repair in the quickest possible time:

- Common troubles characteristic of certain receivers
- "Bugs" which might take you hours to find
- Factory and field service changes

SET UP SO THAT YOU CAN MAKE THESE REPAIRS IN THE SHOP OR IN THE FIELD WITHOUT REFERENCE TO ANY OTHER SOURCE.

Contains over 600 Service Items representing over 1000 of the most-serviced Television models now in use. Over 25 different manufacturers' lines are covered.

\$4.95
postpaid

(Add 3% Sales Tax in New York City)

DISTRIBUTORS—ORDER YOUR SUPPLY NOW!

Service Dealers—get your copy of VSSS from your Distributor. If he can't supply you, order direct by mail from us.

Video Speed Servicing Systems IS GUARANTEED to Simplify Servicing All TV sets. A number of new Data Items are published in every issue of "Radio-Television Service Dealer" as a regular monthly feature.

TEAR OFF AND MAIL NOW

RADIO-TELEVISION SERVICE DEALER

67 West 44th Street, New York 36, N. Y.

Please send me post-paid VIDEO SPEED SERVICING SYSTEMS Volume 1. Enclosed herewith is

my check money order for \$_____ for _____ copies at \$4.95 each. (Add 3% Sales Tax in New York City)

Name

Address

City

Zone

State

Mfr: Du Mont Chassis No. RA-306

Card No. DM 306-1

Section Affected: Pix

Symptom: Weak video with possible smear

Cause: Defective component

What to Do:

Repair open coil, L203

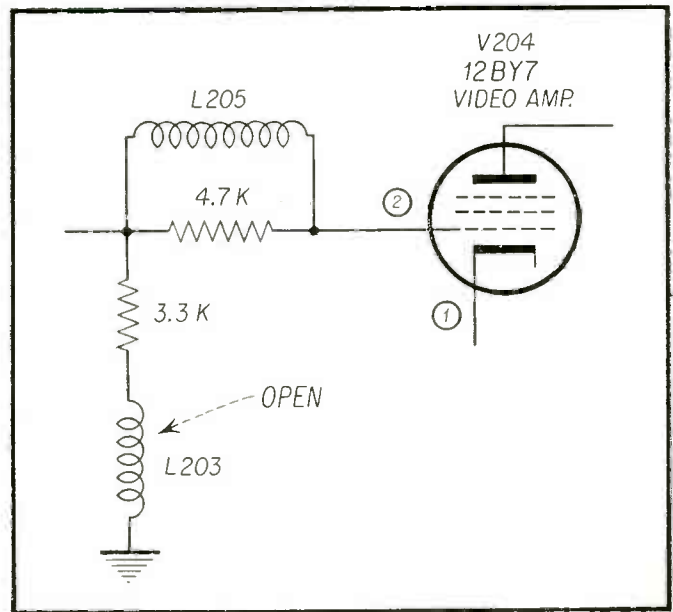

Mfr: Du Mont Chassis No. RA-306

Card No. DM 306-2

Section Affected: Sound

Symptom: Horizontal sound bars in Pix

Cause: Defective components

What to Do:

Replace: C292C (40 μ f)—open

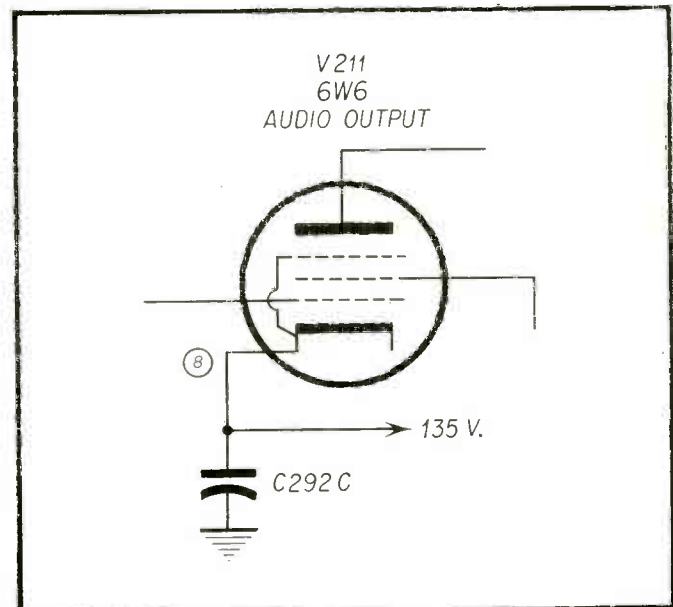

Mfr: Du Mont Chassis No. RA-306

Card No. DM 306-3

Section Affected: Raster

Symptom: Poor vertical linearity

Cause: Defective component

What to Do:

Replace: C292D (10 μ f)—open

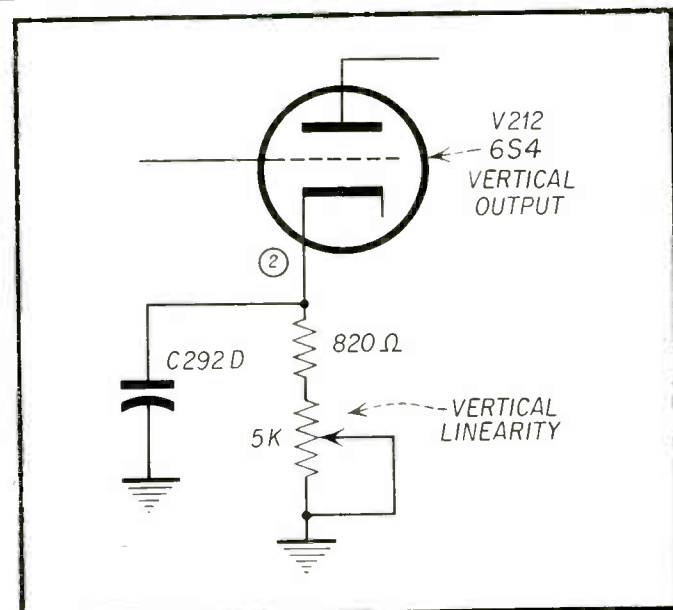

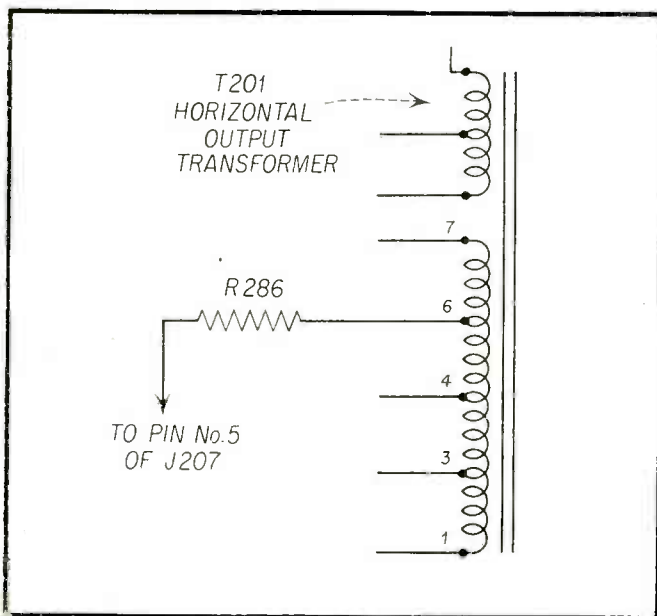

Mfr: Du Mont

Chassis No. RA-306

Card No. DM 306-4

Section Affected: Raster

Symptom: Right side of Raster out of focus

Cause: Defective component

What to Do:

Replace: R286 (15K, 2 watt)—decreased in value

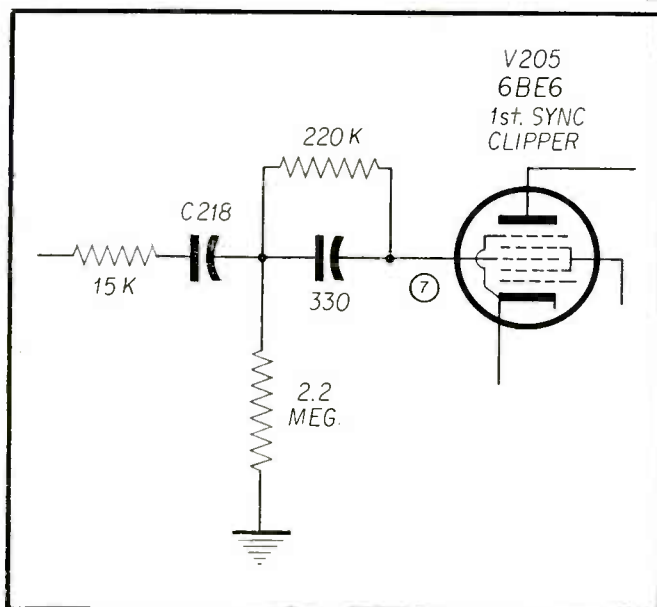

Mfr: Du Mont

Chassis No. RA-306

Card No. DM 306-5

Section Affected: Sync

Symptom: Horizontal wiggle

Cause: Defective component

What to Do:

Replace: C218 (.022 μ f)—leaky

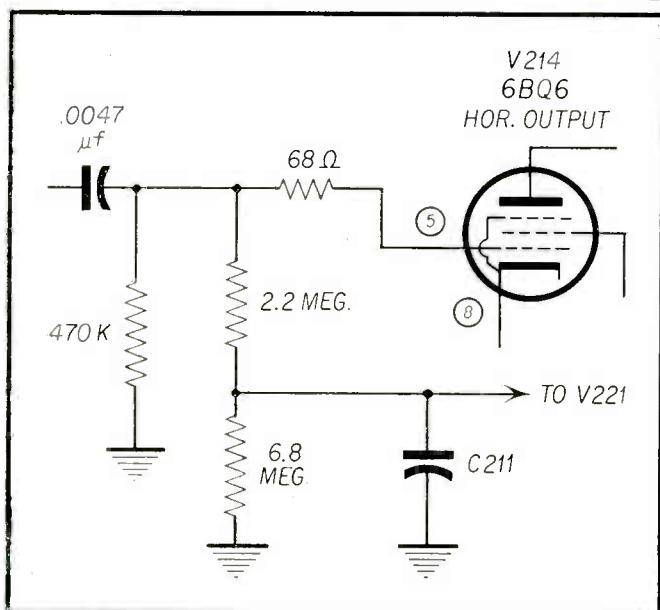

Mfr: Du Mont

Chassis No. RA-306

Card No. DM 306-6

Section Affected: Sync

Symptom: Severe hook at top of pix with critical sync

Cause: Defective component

What to Do:

Replace: C211 (.01 μ f)—shorted

Mfr: Philco Chassis No. R191, D191

Card No. PH 191-1 Code No. 140

Section Affected: Pix

Symptom: Picture blops in and out

Cause: Oscillations in video if strip

What to Do:

Dress B+ lead to screen of 2nd video if tube outside of if shield and away from crystal detector

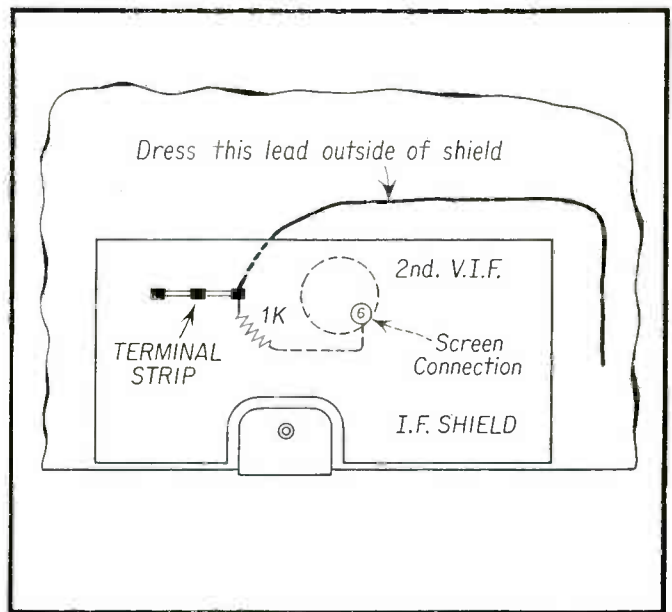

Mfr: Philco Chassis No. R191, D191

Card No. PH 191-2 Code No. 140

Section Affected: Sound

Symptom: Low audio

Reason for Change: Circuit improvement

What to Do:

- Remove: 6.8K resistor
- Replace: 125 μ h coil with a 65 μ h adjustable coil
- Add: 18 μ mf condenser across 65 μ h coil
Also, 10K resistor across 65 μ h coil
- Adjust: coil for maximum audio output

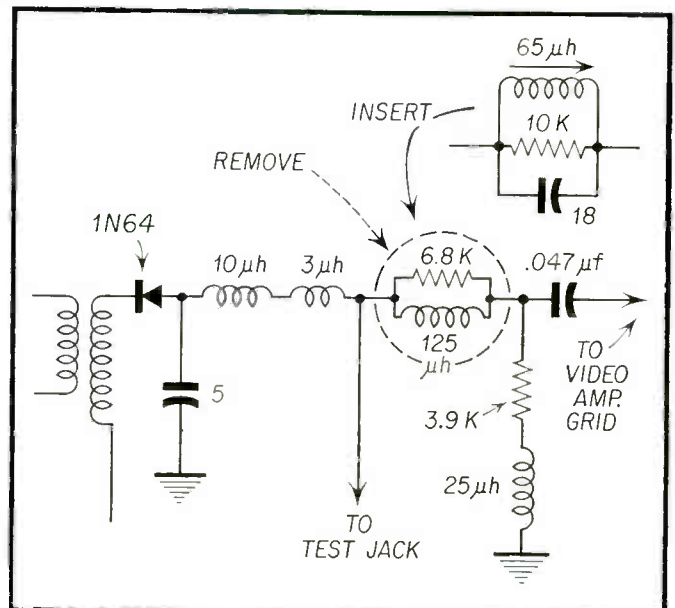

Mfr: Philco Chassis No. R191, D191

Card No. PH 191-3 Code No. 140

Section Affected: Sync

Symptom: Poor lock-in of picture

Cause: 680K resistor has increased in value

What to Do:

- Replace: 680K resistor
- Change: 27K resistor to 15K (circuit improvement)
- Also, .047 μ f condenser to .15 μ f

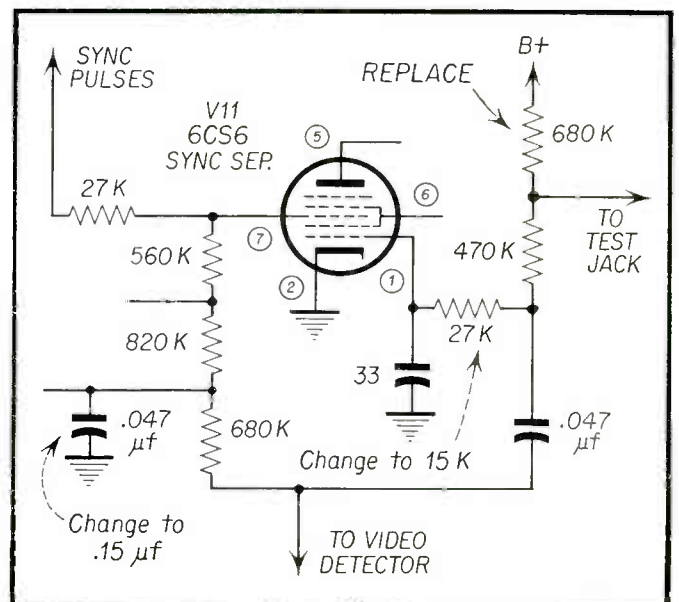

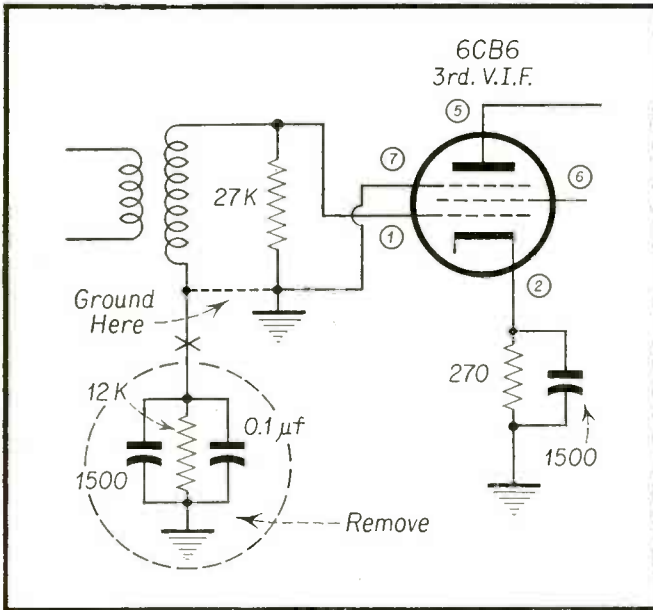

Mfr: Philco Chassis No. R191, D191
 Card No. PH 191-4 Code No. 140
 Section Affected: Pix
 Symptom: Low if sensitivity
 Reason for Change: To improve if sensitivity and prevent sync clipping
 What to Do:
 Remove: 1500 μf condenser, .1 μf condenser and 12K resistor
 Ground: bottom of transformer and pin #7 on 3rd video if tube socket

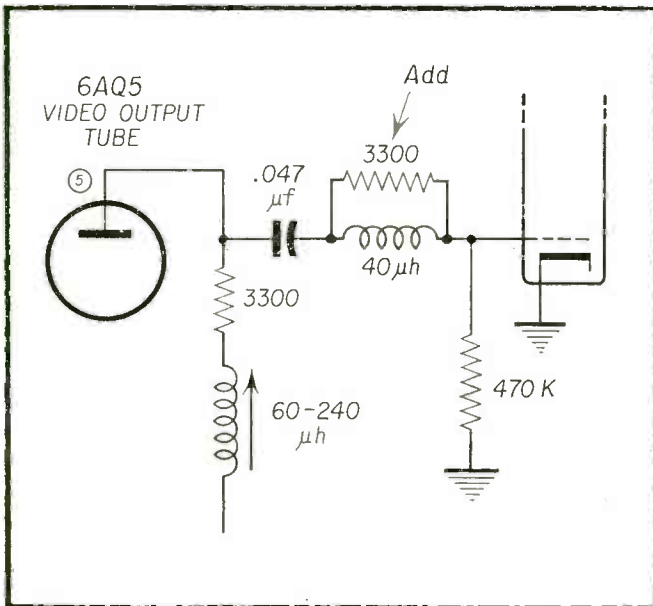

Mfr: Philco Chassis No. R191, D191
 Card No. PH 191-5 Code No. 140
 Section Affected: Pix
 Symptom: Oscillations in picture at different contrast control settings
 Reason for Change: To damp coil and circuit
 What to Do:
 Add: 3.3K resistor across peaking coil

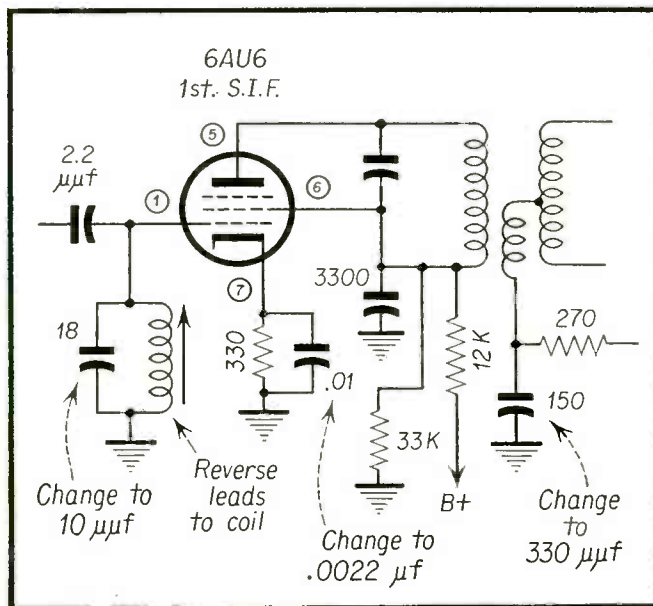

Mfr: Philco Chassis No. R191, D191
 Card No. PH 191-6 Code No. 140
 Section Affected: Sound
 Symptom: Low audio with buzz
 Reason for Change: Improve AM filtering
 What to Do:
 Change: 18 μf condenser to 10 μf
 Also, .01 μf condenser to .0022 μf
 Also, 150 μf condenser to 330 μf
 Reverse: Connection on coil in grid of 1st Sound if tube

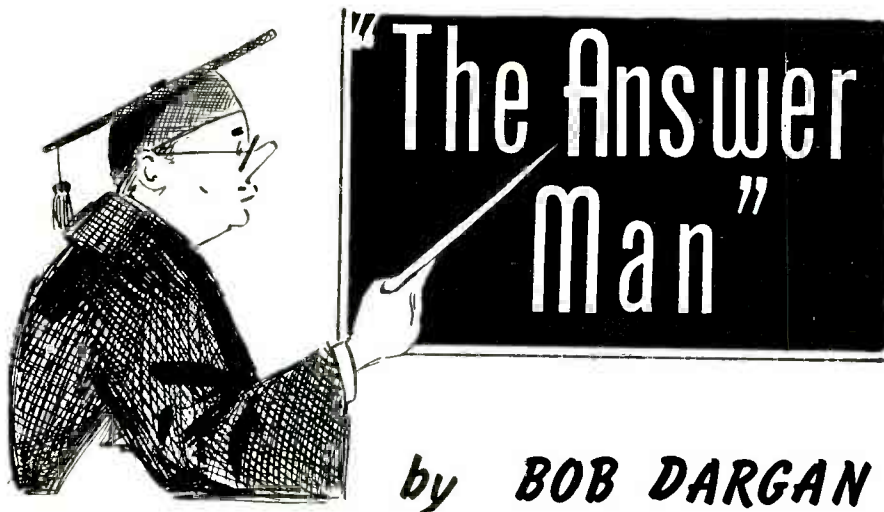

by **BOB DARGAN**

Do you have a vexing problem on the repair of some radio or TV set? If so, send it in to the Answer Man, care of this magazine. All inquiries acknowledged and answered.

Replacing 10BP4 with 10RP4

Dear Answer Man:

I have an R.C.A. 8T24 television receiver which uses a 10BP4 picture tube. I have replaced it with a Zenith 10RP4 picture tube. The picture has a compression on the left side. Can you tell me what is possibly wrong? Do you think it was proper to replace the 10BP4 tube with a 10RP4 tube? Would you kindly advise if any changes are necessary?

J. K.
Mt. Vernon, N. Y.

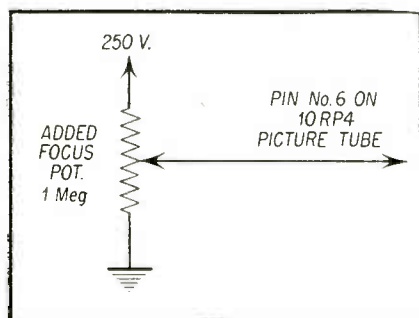

Fig. 1 — A focus pot must be added to provide focus voltage to the 10RP4 picture tube.

Dear J. K.:

In your letter it is not stated whether in the replacement of the 10BP4 picture tube with a 10RP4 provisions have been made for an adjustable electrostatic voltage for the focusing of the 10RP4 picture tube. This is necessary to operate the tube properly as a replacement for the 10BP4 picture tube.

This picture tube was originally used in the CBS color system. Requiring no ion trap, the 10RP4 white face picture

tube has a built in anode for low voltage electrostatic focus. Pin #6 at the tube base provides access to the focusing anode.

A variable *dc* voltage must be made available in the chassis to permit adjustment of the focus of this tube. This *dc* voltage should be adjustable over a range of 50 to 250 volts. A one megohm potentiometer should be connected between a B plus point and ground to provide this voltage as shown in Fig. 1. The variable arm of the potentiometer is connected to pin #6 of the picture tube.

Since the original focus coil is not to be used it can be replaced by an equivalent resistance which will probably eliminate further difficulties. If it is not replaced with a resistor it is necessary to position the focus coil away from the picture tube so that the strong magnetic fields associated with the focus coil will not affect the electron beam in the picture tube. Any serviceman who has played with a permanent magnet near a picture tube knows the amount of distortion that can be introduced in the sweep of a picture tube with a small magnet. In fact, in certain cases, magnets have been used to expand the width of pictures. As much as two inches or more in additional width on each side can be achieved with permanent magnets if correct polarity is observed. Incorrect polarity of the magnet will cause compression of the picture.

The magnet field from the focus coil is very strong, and it is possible that in your case the focus coil is located too near the picture tube on the left side, thus causing the compression you speak of.

If this is not the cause, it is more than likely that this compression existed in the horizontal sweep previous to the changing of the picture tube. Ordinary servicing procedure should be used in this case to correct the compression. This consists of substitute replacement of the horizontal tubes, particularly the damper tube, and checking the horizontal oscillator and output waveforms for clues as to circuit component breakdowns.

AC Voltage On Antenna

Dear Answer Man:

I have an RCA model 9TW309 TV receiver that has voltage on the antenna system and dipole. It can deliver quite a jolt, being an *ac* voltage that measures about 90 volts. Can you explain this voltage on the antenna system?

W. T.
Los Angeles, Cal.

Dear W. T.:

It is normal to be able to draw small sparks from a dipole or the antenna lead-in when it is touched to a good ground such as a metal pipe. However, if a substantial *ac* voltage can actually be measured between a dipole and a ground the condition should be investigated.

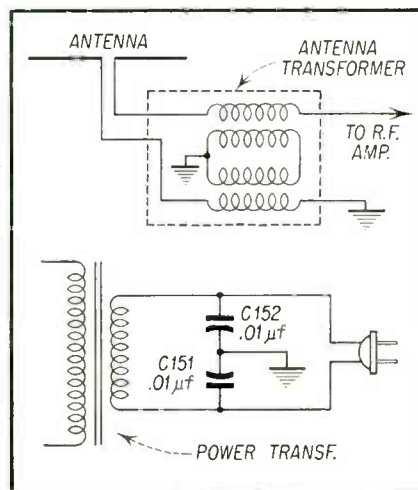

Fig. 2 — If either of the two 0.01 μ f condensers short to chassis ground, the *ac* voltage will be present at the antenna dipole through the common chassis ground to the antenna transformer.

In your case, the power supply is conventional and the most likely cause of voltage appearing on the antenna system is the leakage of one of the .01 μ f *ac* line bypass condensers. A shorted condenser *ac* live condenser will cause little difference in the operation of the chassis except that an *ac* potential will occur across chassis and ground. Inasmuch as one side of the antenna transformer is connected to chassis as shown in Fig. 2 the *ac* voltage will be applied

[Continued on page 47]



NOW! Any TV serviceman may
ADD \$60, \$100 OR MORE A
WEEK TO GROSS PROFITS!

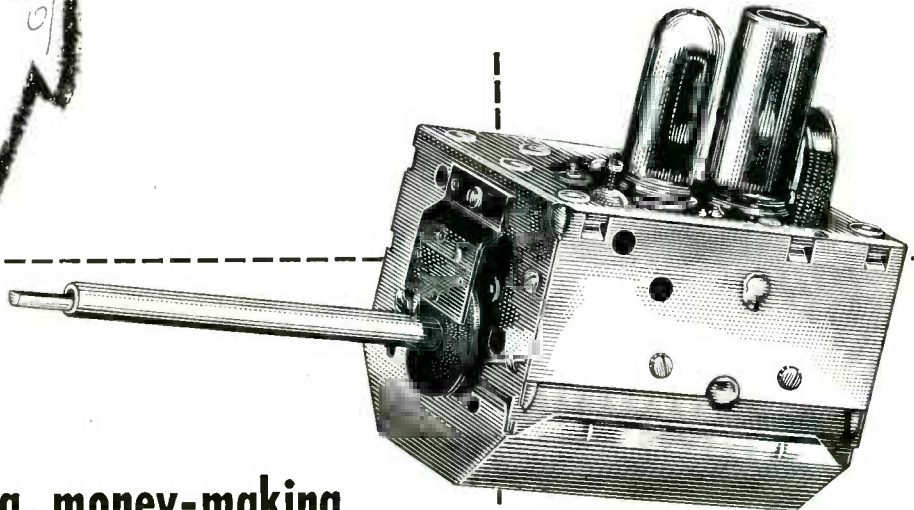

Share in the big, money-making tuner replacement market!

Hundreds of TV set owners in your community will welcome the sharper, stronger pictures afforded by newer, more powerful Standard cascode and pentode tuners. And a completely new Standard replacement tuner often costs your customer *less* than the parts and labor required for a major repair to the original tuner.

Approved Standard Tuners Install Faster, Easier!

Standard replacement tuners have shafts and leads easily cut to fit any set. In most jobs the tuner mounts into the space occupied by the original tuner with no alteration of the cabinet front.

Get Extra Profits Through Easy Conversion to UHF!

Set owners demand adaptability to UHF—and get it when you install Standard replacement tuners. Standard UHF conversion strips are priced to sell, permit easy, perfect tuning, and require no outside cabinet, adjustments, wires or extra parts of any sort.

Sell Approved

STANDARD TV REPLACEMENT TUNERS TV-2232—TV-1532

Super cascode and pentode models
designed and built *especially* for the
replacement market

STOP COSTLY CALLBACKS!

Install only APPROVED Standard TV replacement tuners. Non-approved tuners often *can not* be adapted to a particular set with satisfactory results. Each approved Standard tuner comes individually boxed, complete with circuit diagrams and installation data. Accept no substitutes!

Standard
COIL PRODUCTS CO., INC.

CHICAGO • LOS ANGELES • BANGOR, MICH. • NO. DIGHTON, MASS.

Export Agent: *Rocke International Corporation, 13 E. 40th Street, New York City*

Get set for bigger profits with Standard Coil's line of TV replacement tuners. Call your jobber today or write Standard Coil Products Co., Inc., 2085 North Hawthorne Avenue, Melrose Park, Illinois.

In TV it's Standard

ADJUSTMENTS

REPOSITIONING LOOSE OR REPLACED PICTURE TUBE

The rubber gasket around edge of Deflection Yoke mounting bracket supports the picture tube. It should be pressing very firmly against the bell of the tube, otherwise the picture tube may move and cause corner shadow or shift of pattern on screen.

To position, loosen the Deflection Yoke mounting screw "A" and 2 wing nuts "B" and the 4 Phillips screws "C". Push the complete Bracket Assembly forward so that the rubber gasket fits snugly around the bell of picture tube. Tighten the 4 Phillips screws "C" firmly. If the foregoing procedures have been followed correctly the picture tube should now be held firmly in place. Gently push the Deflection Yoke forward and tighten the 2 wing nuts "B". Before tightening screw "A" make sure that pattern is not tilted.

PEAKING THE INDIVIDUAL VHF OSCILLATOR TRIMMERS

(A) Set channel selector knob to the desired channel.

(B) Set the FINE TUNING CONTROL to the center position.

(C) Remove the channel and fine tuning knobs. This will expose the individual channel adjustment screw opening just to right of the channel shaft.

(D) Use a non-metallic screwdriver such as polystyrene or nylon. Adjust the individual oscillator screw for best picture detail. A slight adjustment in either direction is all that is necessary. **CAUTION: DO NOT ADJUST IN-DISCRIMINATELY. THIS MAY CAUSE THE ADJUSTMENT SCREW TO FALL FROM ITS LOCKED POSITION.**

ADJUSTMENT FOR STATION BUZZ

If station buzz is excessive and NOT DUE to "contrast control" being advanced too far in a clockwise direction or the locality adjuster control in the incorrect position, adjust the ratio detector secondary adjustment screw located on top of the ratio detector for minimum buzz. **MAKE SURE THAT THIS POSITION IS BETWEEN THE TWO MAXIMUM** buzz peaks that will be noticed when adjustment screw is turned to the right or left of the minimum buzz position.

VERTICAL AND HORIZONTAL CENTERING

Adjust the two centering rings located on the back of the Deflection Yoke assembly so that pattern is centered both horizontally and vertically.

ELIMINATING SEMI-CIRCULAR CORNER SHADOW OF PATTERN OR PICTURE

Use same procedure as listed above on horizontal and vertical centering.

CAUTION: DO NOT USE ION TRAP TO ELIMINATE CORNER SHADOW OF PATTERN IF BY SO DOING THE INTENSITY OF RASTER IS DECREASED.

RATIO DETECTOR AND SOUND I-F ALIGNMENT

In most cases only the secondary of the ratio detector coil will require adjustment. This can be done simply by adjusting the top adjustment screw of the ratio detector for minimum buzz with the sound carrier of a tv station.

SENTINEL TROUBLE SHOOTING CHART

NO SOUND—NO RASTER

Power input circuit
V17
Check AC line fuse F-1 (3 Amp.)

NO RASTER—SOUND OK

Brightness control
V9, V17, V13, V14, V15
Ion trap
C.R.T.
HV x-former Hor. yoke CRT connections

WEAK PIX—SOUND AND RASTER OK

Tuner fine tuning
Contrast control
Locality Adj. Switch
V2, V3, V4, V5, V6
Check Vid. Det. crystal 1N60 (Part of T-5)

POOR VERT. LIN.

Vert. Lin. and Size controls
V16
Check 0.047 mf cap. connected to pin 1 of V16
Check 20 and 30 mf ELEC. caps. connected to Vert. Lin. control
Vert. Out. Trans.

PIX JITTER SIDEWAYS

Hor. Hold control
V9, V12
Check 470 mmf cap. connected to pin 4 of V9
Check 0.0033 and 0.01 mf caps. connected to pin 1 of V12

SMEARED PIX

Tuner fine tuning
Contrast and Locality Adj. Switch
V2, V3, V4, V5, V6
Check Vid. Det. crystal 1N60 (Part of T-5)
Check Vid. Det. and Amp. peaking coils IF and RF alignment

NO HOR. SYNC.—VERT. SYNC. OK

Hor. Hold control
V9, V12
Check 330 mmf cap. connected to pin 4 of V12

NO VERT. SYNC.—HOR. SYNC. OK

Vert. Hold and Contrast controls
V11, V16
Check 0.0047 mf cap. connected to pin 5 of V11

POOR PIX DETAIL

Tuner fine tuning
Focus Control
V3, V4, V5
IF and RF alignment

VERT. BARS

V14, V15
Check 47 mmf cap. connected between terminals 3 and 2 of yoke
Def. yoke ringing

PIX JITTER UP & DOWN

Vert. Hold and Contrast controls
Locality Adj. Switch
V9, V11, V16

DISTORTED SOUND

Tuner fine tuning
V2, V7, V8, V9, V10
Check Vid. Det. crystal 1N60 (Part of T-5)
Check 0.0047 mf cap. connected to pin 5 of V10
Sound and Vid. IF alignment T-7
Det. alignment T-8

SYNC. BUZZ IN SOUND

Tuner fine tuning
Contrast control
Vid. Det. crystal 1N60 (Part of T-5)
V6, V7, V8
Locality Adj. Switch
Sound IF and Det. alignment T-7, T-8

INSUFFICIENT BRIGHTNESS

Ion trap
Brightness control
V13, V14, V15, V17
Low line voltage

INSUFFICIENT RASTER WIDTH

Hor. Size control
V12, V14, V15, V17
Check 630 mmf cap. connected to pin 5 of V12
Check 0.005 mf cap. connected to pin 5 of V14
Check 0.1 mf cap and 15KQ res. connected to pin 4 of V14
Low line voltage
Hor. Out. Trans.

INSUFFICIENT RASTER HEIGHT

Vert. Size and Lin. controls
V16, V17
Check 0.047 mf cap. connected to pin 1 of V16
Vert. Out. Trans.
Low line voltage

ENGRAVED EFFECT IN PIX

Tuner fine tuning
Contrast Control
Locality Adj. Switch
C.R.T. V2, V3, V4, V5, V6
Check Vid. Det. crystal 1N60 (Part of T-5)
Check Vid. Det. and Amp. peaking coils

R. C. A.

CHASSIS KCS-81

MODELS 21-D—

- 305, 305U, 317, 317U
- 326, 326U, 327, 327U
- 328, 328U, 329, 329U
- 330, 330U

TUBE LIST

SYMBOL/TUBE	CIRCUIT FUNCTION
V1	6X8 Osc. & Mixer
V2	6BQ7A RF Amp.
V101	6AU6 1st Sound IF Amp.
V102	6AU6 2d Sound IF Amp.
V103	6AL5 Rat. Det.
V104	6AU6 1st AF Amp.
V105	6AQ5 AF. Out.
V106	6AU6 1st Pix IF Amp.
V107	6CB6 2nd Pix IF Amp.
V108	6CB6 3rd Pix IF Amp.
V109	6CB6 4th Pix IF Amp.
V110	6CL6 Vid. Amp.
V111	12AU7 AGC Amp., Vert. Sync. Sep.
V112	12AU7 Hor. Sync. Sep., Hor. Sync. Amp.
V113	6SN7-GT Vert. Sync. Amp., Vert. Osc.
V114	6AQ5 Vert. Out.
V115	6SN7-GT Hor. Osc., Hor. Osc. Control
V116	6CD6-G Hor. Out.
V117	1B3-GT HV Rect.
V118	6W4GT Damp.
V119	6W4GT Damp.
V120	21AP4A Picture Tube
V121	5U4-G Rect.
V122	5U4-G Rect.

KEY VOLTAGES

- B+, plate of damper, V118 and V119 pin 5 350 vdc
- Boosted B+, cath of damper, V118 and V119 pin 3 640 vdc
- Plate of VERT. Osc., V113 pin 5 200 vdc
- Plate of Vert. Out., V114 pin 5 330 vdc.
- Plates of Hr. Osc. (and control), V115 pin 5 184 vdc. pin 2 188 vdc.
- Grid of Hor. Out., V116 pin 5 —30 vdc.

All voltages are measured with a VTVM connected between the tube pins and chassis.

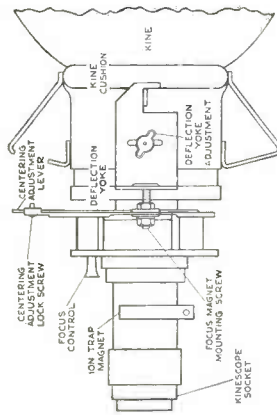

Yoke and Focus Magnet Adjustments

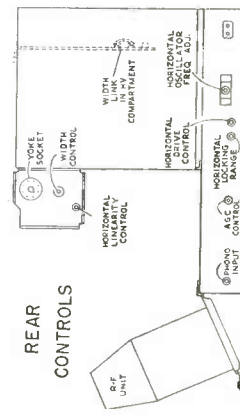

REAR CONTROLS

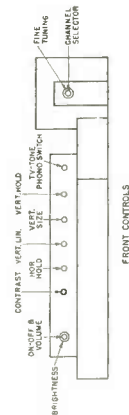

FRONT CONTROLS

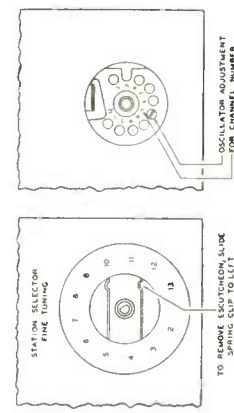
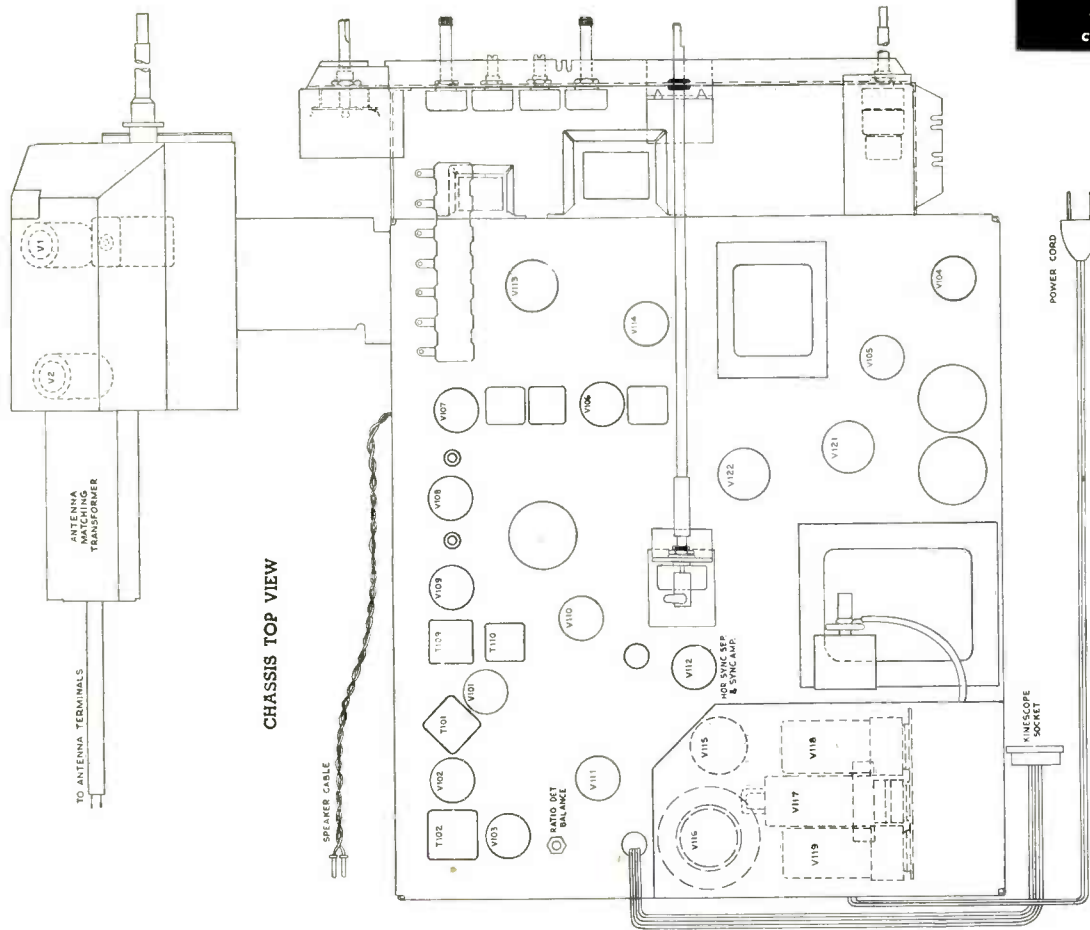

AGC THRESHOLD CONTROL

The AGC Threshold Control R180 is adjusted at the factory and normally should not require readjustment in the field.

To check the adjustment of the AGC Threshold Control, tune in a strong signal and sync the picture. Momentarily remove the signal by switching off channel and then back. If the picture reappears immediately, the receiver is not overloading due to improper settings of the AGC control. If the picture requires an appreciable portion of a second to reappear, or bends excessively, this control should be readjusted.

Turn the AGC control counter-clockwise. The raster may be bent slightly. This should be disregarded. Turn control clockwise until there is a very, very slight bend or change of bend in the picture. Then turn control counter-clockwise just sufficiently to remove this bend or change of bend.

If the signal is weak, the above method may not work as it may be impossible to get the picture to bend. In this case, turn the AGC control clockwise until the snow in the picture becomes more pronounced, then counter-clockwise until the best signal to noise ratio is obtained.

The AGC control adjustment should be made on a strong signal if possible. If the control is set too far clockwise on a weak signal, then the receiver may overload when a strong signal is received.

ALIGNMENT OF HORIZONTAL OSCILLATOR

If in the above check the receiver failed to hold sync with the hold control at the extreme counter-clockwise position or failed to hold sync over 90 degrees of clockwise rotation of the control from the pull-in point, it will be necessary to make the following adjustments.

Horizontal Frequency Adjustment—Turn the horizontal hold control to the extreme clockwise position. Tune in a television station and adjust the horizontal frequency adjustment at the rear of the chassis until the picture is just out of sync and the horizontal blanking appears as a vertical or diagonal black bar in the raster. Then turn the core until the bar is just visible at the extreme left side of the picture.

Horizontal Locking Range Adjustment—Set the horizontal hold control to the full counter-clockwise position. Momentarily remove the signal by switching off channel then back. The picture may remain in sync. If so turn the rear core slightly and momentarily switch off channel. Repeat until the picture falls out of sync with the diagonal lines sloping down to the left. Slowly turn the horizontal hold control clockwise and note the least number of diagon-

al bars obtained just before the picture pulls into sync.

If more than 2 bars are present just before the picture pulls into sync, adjust the horizontal locking range trimmer slightly clockwise. If less than 2 bars are present, adjust this trimmer slightly counter-clockwise. Turn the horizontal hold control counter-clockwise, momentarily remove the signal and recheck the number of bars present at the pull-in point. Repeat this procedure until 2 or 3 bars are present.

Repeat the adjustments under "Horizontal Frequency Adjustment" and "Horizontal Locking Range Adjustment" until the conditions specified under each are fulfilled. When the horizontal hold operates as outlined under "Check of Horizontal Oscillator Alignment" the oscillator is properly adjusted.

CHECK OF HORIZONTAL OSCILLATOR ALIGNMENT

Turn the horizontal hold control to the extreme counter-clockwise position. The picture should remain in horizontal sync. Momentarily remove the signal by switching off channel, then back. Normally the picture will be out of sync. Turn the control clockwise slowly. The number of diagonal black bars will be gradually reduced and when only 2 or 3 bars sloping downward to the left are obtained, the picture will pull into sync upon slight additional clockwise rotation of the control. Pull-in should occur before the control has been turned 70 degrees from the extreme counter-clockwise position. The picture should remain in sync for approximately 90 degrees of additional clockwise rotation of the control. At the extreme clockwise position, the picture should just begin to show a black bar in the picture on the left side.

FOCUS MAGNET ADJUSTMENTS

The focus magnet should be adjusted so that there is approximately three-eighths inch of space between the rear cardboard shell of the yoke and the flat of the front face of the focus magnet. This spacing gives best average focus over the face of the tube.

The axis of the hole through the magnet should be parallel with the axis of the kinescope neck with the kinescope neck through the middle.

ION TRAP MAGNET ADJUSTMENT

Set the ion trap magnet approximately in the position shown in figure. Starting from this position immediately adjust the magnet by moving it forward or backward at the same time rotating it slightly around the neck of the kinescope for the brightest raster on the screen.

SMEARED PIX

Tuner fine tuning
Contrast con.
V106, V107, V108, V109, V110, V111
Check Vid. Det. and Amp. peaking coils
Check 5 μ f Elec. cap. connected to pin 8 of V110 through a 220 Ω res.
IF and RF alignment
Check Vid. Det. Xstal CR101 (Part of T109)

POOR PIX DETAIL

Tuner fine tuning
Focus adj.
V106, V107, V108, V109, V111
Check Vid. Det. and Amp. peaking coils
IF and RF alignment

NO VERT. SYNC.—HOR. SYNC. OK

Vert. Hold con.
Vert. Int. network
A.G.C. Con.
V111, V112, V113, V114
Check 0.047 μ f cap. connected to pin 7 of V111

INSUFFICIENT RASTER WIDTH

Hor. Drive and Size con.
V116, V118, V119
Check 0.001 and 0.0013 μ f caps. connected to terminal "D" of hor. osc. trans.
Hor. Out trans.
Low line voltage

VERT. BARS

Hor. Drive con.
V116, V118, V119
Check 56 and 10 μ f cap. connected to yoke terminals 1, 2, 3, and 7
Defl. yoke ringing

PIX BENDING

Hor. Hold and Req. Con.
Hor. Locking Range
V115, V116
Check 0.022, 0.047 and 0.47 μ f caps. connected to pin 3 of V115

WEAK OR NO PIX—SOUND WEAK—RASTER OK

Tuner fine tuning
A.G.C. con.
V2, V106, V107, V108, V109, V111
Check Vid. Det. Xstal CR101 (part of T109)
RF and IF alignment

INTERMITTENT RASTER—SOUND OK

Brightness con.
V115, V116, V117, V118, V119, V120
Hor. Out. trans.

INSUFFICIENT BRIGHTNESS

Ion trap
Brightness and Hor. Drive con.
V116, V117, V118, V119, V120, V121, V122
Low line voltage

NO HOR. SYNC.—VERT. SYNC. OK

Hor. Hold and Req. Con.
Hor. Locking Range
V111, V115, V116
Check 270 μ f cap. connected to pin 4 of V115

DISTORTED SOUND

Tuner fine tuning
V2, V101, V102, V103, V104, V105
Check Vid. Det. Xstal CR101 (Part of T109)
Check 0.01 μ f cap. connected to pin 1 of V105
Sound and Vid. IF alignment T110, T101
Det. alignment T102

NO SOUND—PIX OK

Tuner fine tuning
Vol. con.
Speaker (open voice coil or defective connection)
Sound and Vid. IF alignment T110, T101
Det. alignment T102
V101, V102, V103, V104, V105

NOISY SOUND—PIX OK

Vol. con.
V101, V102, V103, V104, V105
Check sound system for loose connections
Speaker
Sound IF and Det. alignment T101, T102 and T110

NO RASTER—SOUND OK

Brightness con.
Check HV Fuse F101 (0.25 Amps.)
Ion trap
V111, V115, V116, V117, V118, V119, V120
HV trans. Hor. yoke CRT connections

POOR HOR. LIN.

Hor. Lin. and Drive con.
V116, V118, V119
Check 0.047 μ f cap. and 22k Ω res. connected to pin 8 of V116
Hor. Out. trans.

POOR VERT. LIN.

Vert. Size and Lin. con.
V113, V114
Check 0.1 and 0.22 μ f caps. connected to pin 5 of V113
Check 100 μ f Elec. cap. connected to pin 2 of V114
Vert. Out. trans.

ENGRAVED EFFECT IN PIX

Tuner fine tuning
Contrast and A.G.C. con.
V2, V106, V107, V108, V109, V110, V111, V120
Check Vid. Det. Xstal CR101 (Part of T109)
Check Vid. Det. and Amp. peaking coils

without equal **FOR** **PERFORMANCE!**

Telrex 4-BAY
"CONICAL-V-BEAMS"®

The finest long distance array
ever produced . . . for the ultimate
in fringe area reception

Guaranteed to outperform
any antenna or combination
of cut-to-frequency antenna.

When used with Telrex Duo-Band
splines, the 8X-TV comprises the
finest in reception on channels 2 to
83. This famous Telrex antenna has
proven unequalled for performance
for distances up to 200 miles. When
you check the facts on antenna,
you'll agree that Telrex is
BEST BY EVERY TEST!

Every genuine Telrex antenna
features rugged all-aluminum,
all-weather construction

Over 60 different models for every installation
need, near or far, are included in the new Telrex
catalog. Ask for your copy, today!

"Conical-V-Beams" are produced under U. S. Patent No. 23,346, Canadian Patent No. 500,436 and British Patent No. 691,485 — other patents pending. Sold only through authorized distributors.

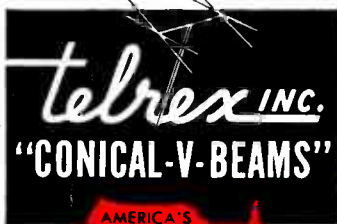

AMERICA'S
OUTSTANDING
TELEVISION
BEAM

**ASBURY PARK 5
NEW JERSEY**

MAKERS OF THE FAMOUS "BEAMED POWER" COMMUNICATION ROTARIES

New



Products

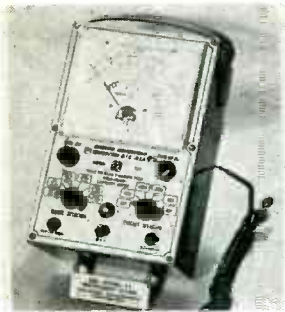

New EMC VTVM

Electronic Measurements Corporation, 280 Lafayette Street, New York, N. Y., has announced the VTVM, Model 107, which directly measures capacity, resistance and complex waveforms peak-to-peak. The manufacturer states that this new meter will not burn out. The Model 107 is offered in two different forms. Wired and tested complete with leads, in kit form complete with leads, and with two accessory probes also available.

ITI UHF Converter

The Industrial Television, Inc., Model IT-150R ULTRA-TUNER features micrometric, direct drive tuning with no sliding contacts, precision capacitors and conservative design for long tube life. ITI's exclusive "channelok" circuit accepts only the desired *uhf* signal and automatically rejects unwanted channels, *vhf* signals and other sources of interference.



High Efficiency Color Yoke

A new magnetic deflection yoke for 19-inch, three-gun color TV tubes, with extraordinarily close convergence characteristics, has been introduced by General Instrument Corporation. The yoke is suitable for the three major types of color tubes; the planar mask type, the mono-convergence shadow mask type, and the type in which the color phosphors are applied directly to the curved face.

JFD Indoor Antenna

The JFD "Super-Beam" TA131 indoor television antenna has a dome-shaped mahogany-grained plastic base containing two pressure-swivel spheres that lock the dipoles in position without any screws, nuts or other tool-actuated adjustments. This dipole housing joins with a tip-proof weighted base. The two telescoping dipoles adjust to the half-wave length of TV channels 2 to 13 and FM frequencies.



Walsco "Scotty"

With a sudden, explosive campaign, Walsco Electronics Corporation just introduced their new "Scotty" antenna. It is described as an "excellent model specially designed for metropolitan and suburban areas" . . . capable of producing a strong signal 20 to 30 miles from the transmitter. The "Scotty," however, can be readily stacked for semi-fringe reception. The Walsco "Scotty" is said to provide good gain over the entire VHF spectrum.

Raytheon Portable Radio-Direction Finder

A new portable radio, the "GM 114A," which serves also as a marine direction finder to help boatmen determine their positions at sea, was just announced by Raytheon Manufacturing Company. It receives the regular AM "broadcast" band, and also "Marine" and "Beacon" bands. A flat, knob-like antenna projects only two inches above the case.



Quam AS-3 Speaker

Quam-Nichols Company, Chicago, has introduced the AS-3 Rear-Seat Auto Speaker Kit. A new 5 x 7" model with a 1.47 oz. Alnico V magnet, the AS-3 has a 3/4" voice coil and will handle the complete undivided output of any conventional auto set. Ford, Chrysler, Studebaker, Hudson and other models have baffle openings for the AS-3 size unit.

Federal "S-C-S" Diodes

The Federal Telephone and Radio Co. is now marketing their single crystal stabilized, hermetically sealed germanium diodes for replacement needs. Ceramic-to-metal construction provides hermetically-sealed, fully insulated cases. The "S-C-S" diode is capable of withstanding repeated temperature and humidity cycling without adverse effects on its top electrical characteristics.



South River EM-48 Eave Mount

The South River Metal Products Co., Inc., of South River, New Jersey, has announced production of an eave mounting for antenna installations, the EM-48, made of heavily embossed steel to provide strength and rigidity, and hot dip galvanized to prevent rust. The lower member is one piece and has a 48" spread, permitting installation on the eaves of varied pitched roofs, and is also available in 60" spread dimensions.

Walsco's "Window Thru" Bushing

Walsco's new "Window Thru" bushing now allows servicemen to bring lead-in antenna wires into a home without drilling holes. It eliminates the mess of drilling through walls or woodwork, ends wasted installation time, is durable and attaches to any type window in only a few minutes. The bushing is effective for VHF and UHF. Its weatherproof capacitor discs are easily attached to the window pane.

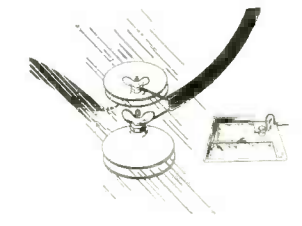

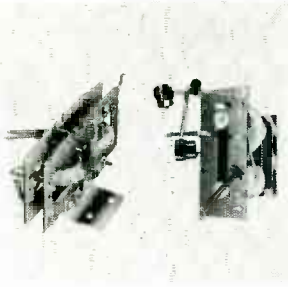

Stancor Replacement Flybacks

The Stancor Division of Chicago Standard Transformer Corporation has announced the addition of exact replacement flybacks for Motorola and Muntz. Stancor flyback A-8239 is an exact replacement for Motorola part Nos. 24K792753 and 24K701099. A-8239 has application in over 100 Motorola models and chassis. A-8240, exact replacement for Muntz, replaces part #TO-0036.

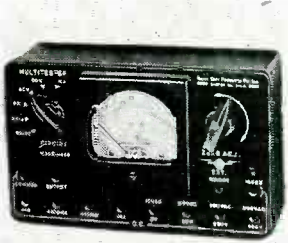

New Multitester Model 480

Radio City Products Company, Inc., Easton, Pennsylvania, announces its NEW Model 480 ac-dc Multitester. The D'Arsonval meter movement is 800 microamperes, which gives full 1000 ohm per volt sensitivity in the circuit for all dc measurements. The copper oxide rectifier has excellent characteristics and the entire circuit is extremely stable. Operating features include circuit and range selection by selector switch and jacks.

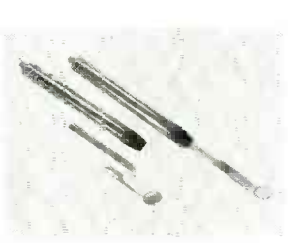

3-Way Probe Inspection Light

With mirror and plastic probe removed the handle of the instrument provides a powerful insulated top flashlight. When the probe is inserted the light is beamed to the probe tip which offers a flood of light at the tip end. When you slide the 1 1/2 x mirror on the probe, a powerful illuminated reflection permits ready inspection of tight wiring. New 3-Way Light is available through Moore Manufacturing Company, Swedesboro, New Jersey.

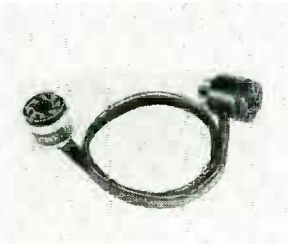

Vidaire Tube Tester

The newest addition to Vidaire TV accessories is the Vidaire ADAP-TEST. ADAP-TEST has dual sockets with 20 inches of lead extensions; used with any voltmeter, the serviceman can reach remote and inaccessible tube sockets in any chassis. Test points are clearly numbered for easy identification. The ADAP-TEST, available at all distributors.

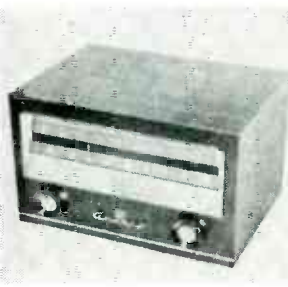

Quality UHF Converters

To provide finest reception in fringe areas—plus exceptional eye appeal—new Model DUC "De Luxe" is announced by Granco Products, Inc., 36-17 20th Ave., Long Island City 5, N. Y. The Granco three-cavity coaxial tuner covers the entire UHF band, and eliminates wiping contacts and related noises. This exclusive feature is combined with Cascode amplification for an overall gain of better than 13 to 15 db, and the lowest noise figure.



"Precision" Multi-Range Test Set

A new 20,000 ohms per volt dc, 5,000 ohms per volt dc, multi-range test set has been introduced by Precision Apparatus Co., Inc., Elmhurst, New York. The new Model 120 has 44 self-contained ranges which start extra-low and go extra-high: an extra-low resistance range affords a 2-ohm center scale; an extra-low voltage range offers 1.2 volts full scale, both ac and dc; an extended low dc current range starts at 0-60 microamperes.

EBY Subminiature Pocket Tester

The EBY Sales Co. of New York has announced the availability of their new pocket tester which exhibits the following characteristics: Low voltage tester (0-1000) ac or dc, high voltage tester (50kv); signal tracer, audio oscillator, condenser tester, agc substitution voltage supply, visual output meter, and continuity tester.



Ceramic-Case Sealed Precision Resistors

A ceramic-case version of the Carbofilm precision resistor is announced by the Hi-Q Division, Aerovox Corporation, Olean, N. Y. Designated as Type CPC, the new Carbofilm unit is housed in a ceramic tube with metallized ceramic end-seals for complete and permanent hermetic sealing. There is no capacitance effect between element and casing. The longest leakage path is provided.

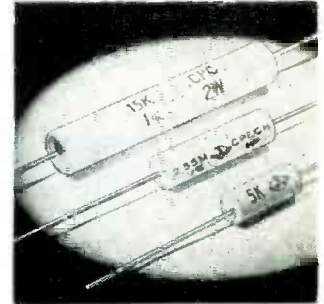

Brach Auto Aerials

Two new Universal auto aerials, Model 473, Speedmount, and Model 501, Fendermount, have been announced by Brach Manufacturing Corporation, of Newark, N. J. Each unit has a three section triple chrome-plated admiralty brass mast, automatic ground connection, and a rugged, adjustable (0-32 degree) insulator.

Catalog and specification sheets are available on request.

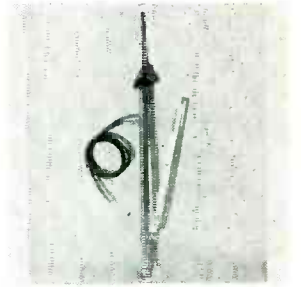

Authorized CRT Tube Tester

Authorized Manufacturers Service Co. of Brooklyn is producing a lightweight, portable Cathode Ray Tube Tester, the Model 101, designed to provide positive test indication within 90 seconds for continuity and emission.

All phases of potential trouble and breakdown are clearly outlined on the front panel. No additional computations are necessary.

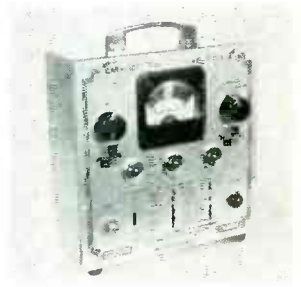

CBS-Hytron Pliers Kit

CBS-Hytron, a Division of Columbia Broadcasting System, Inc., has announced a new Pliers Kit available free to service-dealers with the purchase of CBS-Hytron receiving tubes, from July 1 through August 31. The Kit consists of a set of three pliers of drop-forged tool steel packed in a plastic carrying case. Two of the pliers are unique and all three are "musts" selected by a panel of servicemen.



Astron Capacitors Use Impregnant X-250

An exclusive impregnant developed by ASTRON—X-250—is being used in the construction of Astron Corporation's METEOR line of capacitors. The exclusive ASTRON developed impregnant X-250 provides exceptionally high capacitance stability, low power factor, low resonance loss and high test voltage. The capacitance versus temperature curve of Meteor capacitors is practically flat from -40°C to +125°C.



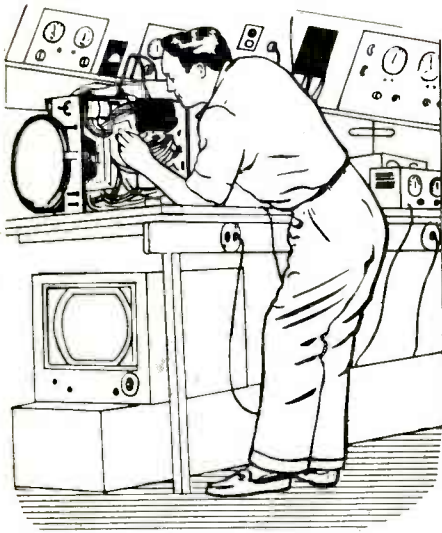

The Work Bench

by PAUL GOLDBERG

This Month:

HORIZONTAL FREQUENCY TROUBLES

THE following installment deals with three horizontal frequency problems. Each of these problems will involve a different horizontal oscillator system. The following case histories are typical examples.

Admiral 22M1—Horizontal drift

The receiver was turned on and after a couple of minutes the horizontal frequency proceeded to go more and more out of range. The 6SN7 horizontal oscillator was immediately replaced but this had no effect. The 6AL5 sync discriminator was next pulled. This was done to determine whether the trouble was due to the malfunctioning of this circuit. The voltage developed across R429, 4.7 meg, is proportional to the phase difference between the transmitted sync pulse voltage and the horizontal sweep reference voltage which is fed back from the horizontal output transformer. When the frequency and phase relationship is correct, normal operating bias is developed across R429 which is supplied to the control grid (Pin #1) of the horizontal oscillator. The horizontal oscillator is a modified multi-vibrator whose feedback is obtained by the common cathode resistor R432. Knowing these facts it was observed after pulling the 6AL5 that the horizontal frequency was still far out of range.

Trouble therefore was probably limited to the horizontal oscillator circuit. The 6AL5 was then replaced anyway, and with no effect. Next, the receiver was turned on its side and the lead to Pin #1 of the 6SN7 was clipped as a positive check on the latter assumption. The horizontal frequency still remained far out of range. Adjusting the horizontal lock, L401, and R434 the horizontal hold, did not help.

It was thus established that the trouble was definitely in the horizontal oscillator. C419, the grid leak condenser of the 6SN7, was clipped off at Pin

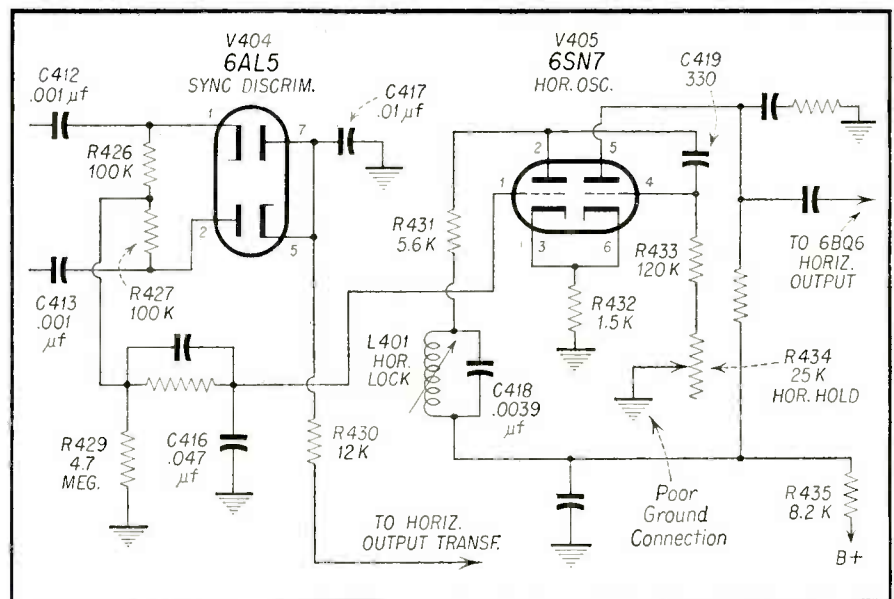

Fig. 1 — Partial schematic, Admiral 22M1.

#4. A voltage leakage check proved that C419 was ok. Next, a resistance reading was taken from Pin #4 to ground. The resistance measured was 2.5 megohms. Referring to the diagram it was noted that the most it should have read was 145K (R433 + R434). R433 was next resistance checked and found ok. R434, the horizontal hold, was then resistance checked to ground and was found to measure 2.5 megohms. It was at this point that we discovered that the ground connection from the center arm of the horizontal hold control was poorly soldered. After re-soldering, a measurement was taken from the horizontal hold to ground and it was found to read the correct value, 25K. The receiver now operated properly.

Du Mont RA-103C—Horizontal frequency out of range

The receiver was turned on and it was immediately observed that the re-

ceiver was far out of horizontal frequency range. Adjusting the horizontal oscillator hold (Z204) would not bring the frequency back into range. The 6K6, and 6AL5 were then replaced individually but without effect. Referring to the diagram, it was noted that the receiver used the common "Hartley-oscillator-reactance tube-sync discriminator" system. The 6AC7 which is the reactance tube, will change its transconductance with a change in the *dc* voltage output of the 6AL5, sync discriminator. This *dc* output voltage is fed to the 6AC7 control grid. The 6AC7 is connected as a reactance tube across the 6K6 oscillator coil (Z204 primary). When the 6AC7 transconductance changes, the frequency of the oscillator will change. Thus, if the oscillator shifts in phase with respect to the horizontal sync pulse, it will produce a corresponding change in the *dc* voltage from the sync distributor. This will

Right now

..... IS THE TIME TO
REPLACE THAT OUT-MODED
AND WORN OUT TV ANTENNA

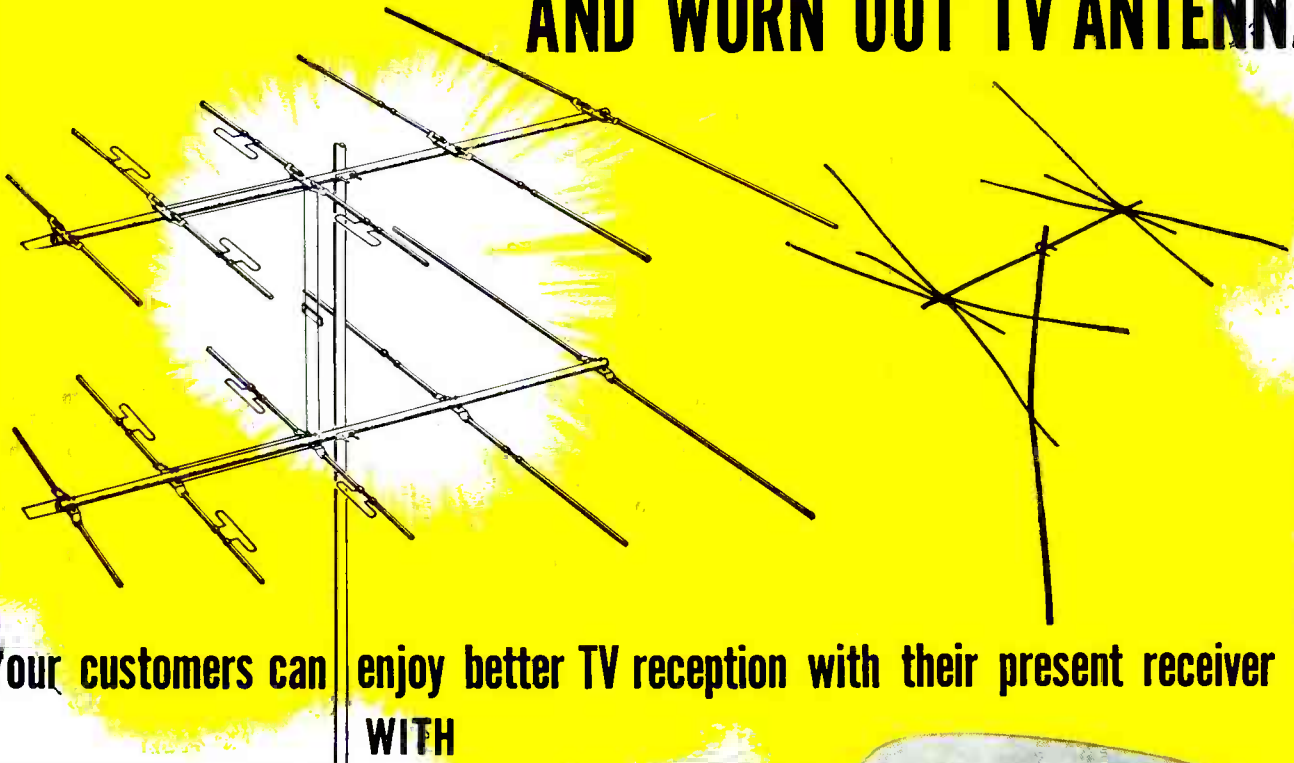

Your customers can enjoy better TV reception with their present receiver
WITH

BRIGHTER, CLEARER, SHARPER PICTURES

Provide your customer with greater enjoyment with his present TV receiver—put new life into the pictures on the screen—supply him with the equipment necessary to bring in all the available channels better, clearer...with the installation of a new Taco antenna.

We all know that there is a tremendous amount of replacement antenna and installation business to be had. The next few months will have a great effect on your overall business for the year.

**SEE YOUR TACO DISTRIBUTOR—HE WILL
TELL YOU WHAT TACO IS DOING FOR YOU.**



Mr. Serviceman:

Postcards with your message directed to your customers and bearing your imprint and telephone number are available through your Taco distributor. Your customers will thank you for sending him this reminder that he needs television antenna service.

ESPECIALLY WITH A GENUINE

TACO

HIGH-GAIN ANTENNA

Technical Appliance Corporation, Sherburne, N. Y.

In Canada: Hackbusch Electronics, Ltd., Toronto 4, Ontario

NOW!



COLOR TV

COVERAGE IN

PHOTOFACT!

FIRST COLOR TV FOLDER

the **RCA Model CT-100**

OVER 40 FACT-PACKED PAGES

It's a terrific **FIRST**—complete data based on actual analysis of the production model...full schematics, block diagrams, parts lists, tube placement, alignment, wave forms, set-up adjustments—*everything* you want to know about this actual color set—information you want and need to get out in front on Color TV!

here's how to get it!

1 Included with Photofact Folder Set No. 252—out Sept. 1st. You get it in *addition* to over 100 pages of regular Photofact TV-Radio coverage. Get the Color TV Folder at the regular price of the complete Set. .Only \$1.75!

2 You can buy the Color TV Folder separately if you wish. Available from your distributor for only \$1.00!

GET IT EITHER WAY FROM YOUR PARTS DISTRIBUTOR

HOWARD W. SAMS & CO., INC.
2209 East 46th Street
Indianapolis 5, Indiana

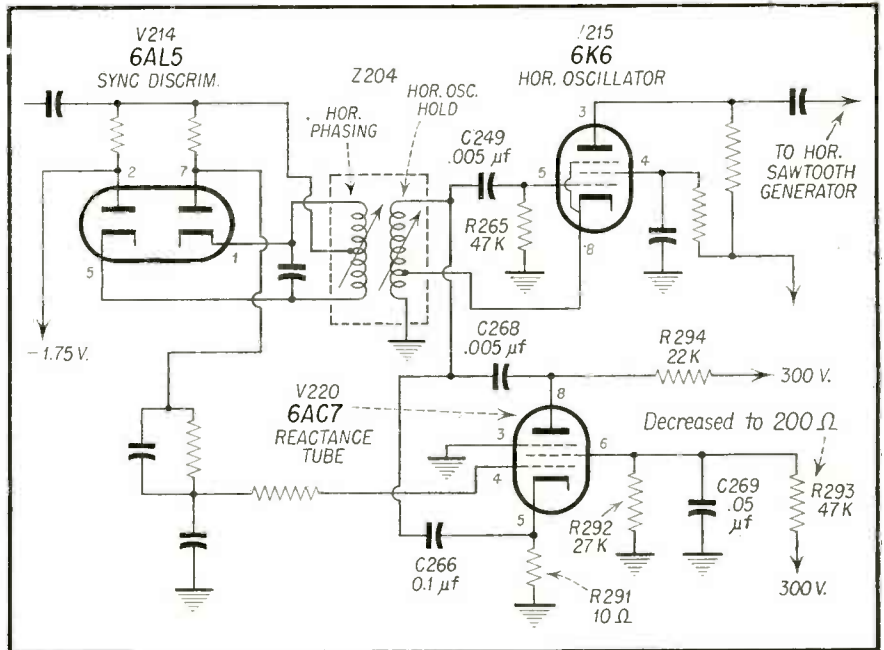

Fig. 2 — Partial Schematic, DuMont RA103C.

bring the oscillator back into the correct phase.

With these facts in mind the 6AC7 was pulled out to see if the frequency would come back into range. As soon as this was done, the picture naturally remained out of horizontal hold, but

now an adjustment of Z204, the horizontal hold, brought the frequency back into range. Thus, it was assumed that the trouble was in the reactance circuit. The 6AC7 was next replaced, but again the horizontal frequency drifted far out [Continued on page 45]



The
ASD
TELEVISION
Tube Tester

NET \$124.50

HERE IT IS

- NO ROLL CHART
- PRACTICALLY NO SET-UP
- 20 CONNECTED SOCKETS
- LARGE 4½" METER
- HIGH GAS SENSITIVITY

The tube tester designed especially for the television serviceman. With this tester you can test an entire set of TV tubes in a few minutes. This means less time spent per job, more profit, more tube sales and fewer call-backs.

Write for Details or See Your Distributor.

Developed and Manufactured by
AMERICAN SCIENTIFIC DEVELOPEMENT CO.
334-336 S. Main St., Ft. Atkinson, Wisc.

[COLOR from page 21]

The high voltage value is adjustable by controlling the screen voltage on the horizontal output tubes and thereby the amplification of the tube. This permits control of the drive of the horizontal output transformer and also the high voltage flyback pulses.

In combination with high voltage regulation, some color receivers make use of a regulator tube such as the OB3 tube to maintain "B" supply voltages constant with fluctuations in ac line voltage or other circuit values. Regulation of the 400 volt supply with the Victoreen is necessary in order that the variation of picture size with line voltage shall not be excessive. This would occur because variations in line voltage, while not affecting the 20 KV ultor potential, does affect the sweep energy,

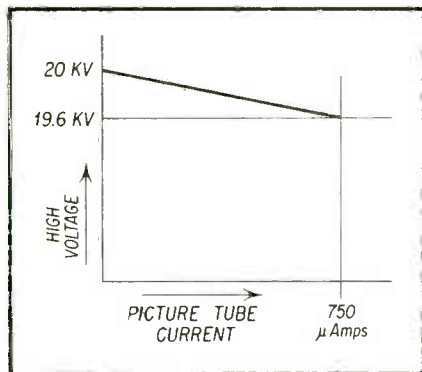

Fig. 32 — High voltage regulation curve for Victoreen tube.

variations in which would result in changes on picture size.

The 6BD4A on the other hand does not require a regulated 400 volt supply because the ultor voltage, although constant to within 2% for any given line

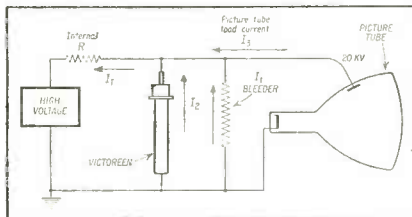

Fig. 33—Currents flowing in a high voltage system using a Victoreen tube.

voltage, will change its reference value as the line voltage changes. This means that if the line voltage falls 10% the sweep energy will also fall 10%, tending to make the picture smaller. However, the high voltage will also fall from 20 KV to 18 KV. Thus, a compensating increase in picture size will occur. This compensation is not perfect, a net decrease in picture size resulting. However, the overall decrease in picture size will not be intolerable.

3 SHURE CRYSTAL PICKUP CARTRIDGES

replace the 192

cartridges you are most likely to encounter in your service work!



-
- TECHNICAL DATA AND REPLACEMENT CHART IS ENCLOSED.
- Lists 192 Crystal Cartridges manufactured by
- five leading cartridge manufacturers.
-

Lowest investment for broadest coverage! The RK-54 is beyond all doubt the *most practical* Replacement Kit on the market! Proof? Simply this—you get the broadest coverage at the lowest investment—only \$22.55 list! Think of it—3 Crystal Cartridges replace 192 of those specific Cartridges most likely to be in need of replacement! Two of the Cartridges consistently have been "best sellers" in the Shure line—as established by actual sales to Servicemen! The Cartridges are: Model W22AB, 3-Speed, 2-Needle Cartridge—Model W26B, All-Purpose, Single-Needle Cartridge—Model W78, 78 RPM, Dual-Volt, Dual-Weight Cartridge. Model W78 is the new, versatile Cartridge that replaces 149 other Cartridges! This Cartridge alone will become a sensation overnight! Order a Replacement Kit from your Distributor today—once you have worked with this practical kit you will find that these three Cartridges are dependable replacements—will make your service work faster, easier and more profitable!



TRANSPARENT PLASTIC BOX IS FREE!

This Handy Box is 5" long, 3½" wide, 1¼" deep.

SHURE — The Mark of Quality

2-Year Subscription only \$1.00



NOW AVAILABLE TO . . .

1. Servicemen who are employed by Service Organizations.
2. Servicemen employed by radio/TV Dealers.
3. Independent servicemen who do not have business establishments.
4. Employees of Distributors.
5. Students enrolled in accredited Radio/TV Schools, Colleges, etc.
6. Hobbyists and Experimenters.

A TYPICAL ISSUE COVERS

- Video Speed Servicing Systems
- Rider's "TV Field Service Manual" data sheets
- Latest TV Installation and Maintenance Techniques for VHF and UHF
- Auto Radio Installation and Service
- Advanced Data on New Circuitry
- Production Changes and field service data on receivers
- New Tubes
- New Test Equipment, operation and application
- Hi-Fi Installation and service
- New developments, such as transistors, color, UHF, etc.
- News of the trade
- Service Short Cuts & Shop Notes
- Explanation of difficult circuits

**and many more
EXCLUSIVE . . .
ORIGINAL . . .
AUTHORITATIVE . . .
TIMELY . . .
FULLY ILLUSTRATED
subjects that
can ONLY
BE READ IN
"SERVICE DEALER"**

RADIO-TV SERVICE DEALER

67 W. 44 St., New York 36, N.Y.

NEW RENEWAL

Gentlemen: Here is \$1.00 for which enter my 2-year subscription. (This rate applies in USA only. Elsewhere add \$1 per year)

Name

Address

City Zone State

Employed by (Name of firm)

Firm's business address

City Zone State

Your Position or Title

Check whether firm is: Service Organization or Dealer having Service Dept.

If some other type of company describe:

IF STUDENT, Name of School

REMOTE TUNER

[from page 19]

the contrast control on the main receiver turned way down. On the average receiver the factory adjustment of these *if* slugs on the Remote Unit will be found satisfactory, but they nevertheless should be checked for best operation.

Next check oscillator slug adjustment on all channels in the area, to make sure that the fine tuning adjustment hits at about half the total travel.

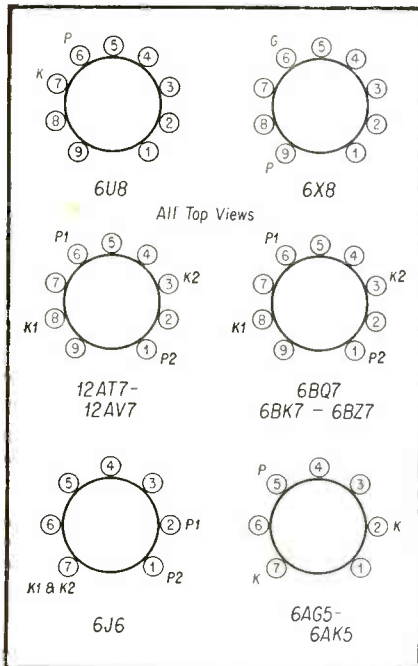

Fig. 2 — Socket connections for the common mixer tubes.

To adjust the receiver controls for remote operation on all stations, turn the contrast and audio volume controls on the Remote Tuner full on, and tune in the weakest channel received in the area. Adjust the contrast and brightness

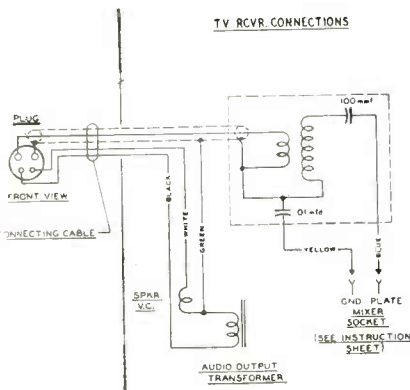

Fig. 3 — Schematic of the connections referred to in Fig. 1.

more servicemen prefer

STANCOR

REPLACEMENT TRANSFORMERS

than all other brands combined*

because they like the . . .

- ease of installation
- completeness of the Stancor line
- availability of accurate replacement information
- rugged, breakdown-proof construction
- quick delivery from distributor's stock

Brand Name Surveys, Chicago, Illinois; brand preference survey of electronic replacement components, May, 1954. Answered by servicemen from all over the U.S.

FREE NEW STANCOR GENERAL CATALOG listing over 500 transformers for TV, radio, high fidelity, communications and other electronic applications. Available from your local Stancor distributor or by writing Standard Division, Chicago Standard Transformer Corporation.

Stancor transformers are listed in Photofact Folders and Counterfacts

CHICAGO STANDARD TRANSFORMER CORPORATION
 3586 ELSTON AVENUE • CHICAGO 18, ILLINOIS

EXPORT SALES: Roburn Agencies, Inc.
 431 Greenwich Street, New York 13, N. Y.

controls on the receiver to the proper level for average room brightness. Adjust the audio volume control on the receiver to a level slightly higher than would ordinarily be used. All further adjustments of contrast and audio volume level are then accomplished at the Remote tuner.

The customer should be instructed as to how to make the adjustments in the preceding paragraph in case the controls on the receiver are unintentionally moved.

UHF Operation

To receive *uhf*, remove a pair of unused "coil strips" from the tuner in the Remote Unit (they are marked with channel numbers). These snap out or in after relieving the pressure exerted by the spring spider at each end of the

tuner. Replace with a pair of *uhf* strips for the desired *uhf* channel, making sure that the letter subscript (such as "Q", etc.) is the same as on the *uhf* strips which were removed.

Headphone Operation

Headphone operation is accomplished simply by inserting the phone tips in the tip jacks on the rear of the Remote Unit, and throwing the "speaker-phones" slide switch to the proper position.

Miscellaneous Notes

A 15 foot extension cable is available on special order for connection between the Remote Unit and TV receiver for use in unusual cases where the cable supplied will not reach due to the necessity for taking a devious route with the

[Continued on page 44]

TUNG-SOL TUBE QUALITY PAYS OFF IN SALES!



Black and White Picture Tubes

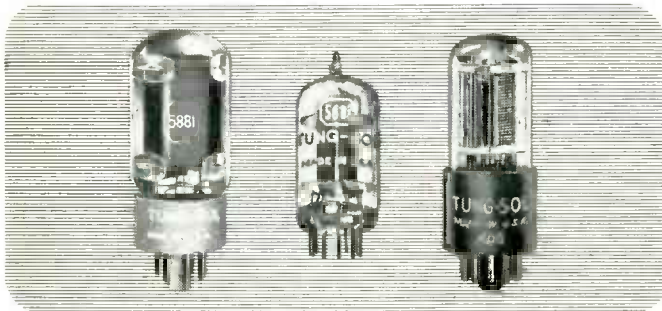

Special Purpose Tubes

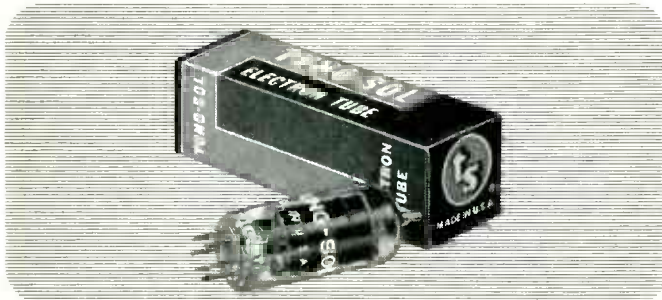

Radio and TV Receiving Tubes

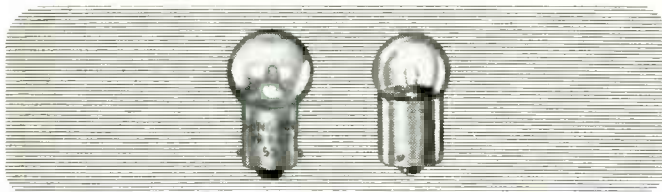

Dial Lamps

The performance quality of Tung-Sol Tubes will keep customers convinced that you're the best serviceman in the business. Tung-Sol Tubes meet highest set manufacturers' specs—protect you against call-backs. Tell your supplier you'd rather have Tung-Sol

TUNG-SOL ELECTRIC INC., Newark 4, N. J.

Sales Offices: Atlanta, Chicago, Columbus, Culver City (Los Angeles), Dallas, Denver, Detroit, Newark, Seattle

TUNG-SOL *dependable*
ELECTRON TUBES

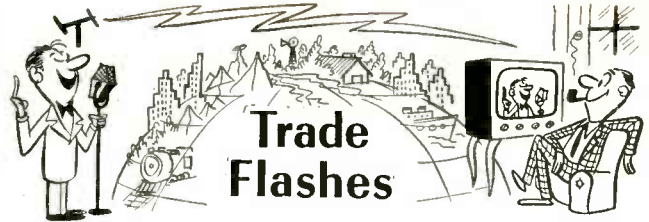

More than 1,800 radio-television service dealers already have qualified for a color television training course offered by the Tube Division of the Radio Corporation of America, with purchases of RCA electron receiving tubes, Harold F. Bersche, manager of distributor sales, revealed recently. The current promotion, announced late in May, continues until November 15, 1954, and provides service dealers and technicians with a nine-lesson color television receiver home study course, obtainable on the basis of their purchases of RCA receiving tubes from RCA distributors.

Du Mont's 19-inch Chroma Sync color television picture tube was demonstrated recently to a large group of receiver manufacturers at Du Mont's newly dedicated Tele-Centre in New York City. Color motion pictures from the new Du Mont Color Multi-Scanner were presented on the large-screen Du Mont color tube, so that observers could gauge the excellent color saturation and sharpness of reproduction achieved by the Du Mont color tube development and the color television motion picture reproduction equipment. Color broadcasts from Du Mont's New York station, WABD, are scheduled to begin in September.

CBS-Hytron, a Division of Columbia Broadcasting System, Inc., announced another in its growing series of aids for the service-dealer. The latest is a new CBS-Hytron Service Coat with a tailored look. This coat has achieved several desired features without sacrificing any of its practicality. A good-looking coat, it avoids that "uniform look." It offers square shoulders, sweeping lapels, and an easy drape. Its powder-blue herringbone is both flattering and easy to keep clean thus cutting down on laundry bills. The nicely embroidered CBS-Hytron emblem on the breast pocket adds a colorful, casual appearance and shuns the printing sometimes plastered across the back of a service coat.

A new, complete line of quality-controlled cables for audio, intercommunication, microphone, television camera and other applications, has been introduced by Federal Telephone and Radio Company, Clifton, New Jersey, a division of International Telephone and Telegraph Corporation.

The 16 types of communication cable making up the Federal line are made with polyethylene insulation to insure low loss, long life, good flexibility and high dielectric strength. Non-marring Chrome Vinyl jackets, durability, minimum maintenance and ease of stripping, are the new line's outstanding features.

The first TV chassis ever built around a printed circuit is featured in the 1955 line of Admiral television receivers, according to Joe Marty, Jr., general manager of the company's electronics division. "This will go a long way toward eliminating the problem of vibration and thus cut down the possibility of circuit trouble," the Admiral official pointed out. "Printed circuits also will make possible better quality control in TV set production."

An important industry first was established recently by the General Electric Co. with an announcement that its standard 90 day factory warranty on radio receivers has been extended to include labor charges as well as parts. William L. Parkinson, product service manager of the company's radio and television department, stated that the new parts and labor warranty will give effective assistance to those retail radio outlets which need independent service organizations to make repairs. The new warranty, he thinks, will solve the retailers' in-warranty consumer service problem. Mr. Parkinson revealed that "effective June 1, 1954, the G-E radio warranty includes labor for 90 days as well as parts for the same period." The new warranty, he said, will apply on all current radio models in distributor and dealer inventories as well as on new models to be introduced in the future.

Channel Master Corporation, Ellenville, N. Y., has reported that it has successfully concluded negotiations with the Nikoh Tube Co. to market a major portion of Nikoh "TELE-TUBE," electric welded steel tubing for TV masts. Two major advantages to distributors and dealers were pointed out. First, all "TELE-TUBE" masting will be shipped F.O.B. Chicago. This centrally located shipping point will mean faster delivery and reduced freight charges, a major factor in masting costs. Second, the arrangement makes Channel Master a one-stop source for all types of masting, by rounding out its line with a series of 5- and 10-foot mast sections.

Color television sets with pictures as large as 21 and 24 inches will appear on the American market for about \$500 before the end of next year, Barney Balaban, president of Paramount Pictures Corp., told stockholders at the corporation's annual meeting recently. Balaban said the present 15-inch color tube "is as obsolete as the 10-inch picture in black and white. Twenty-one and 24-inch Chromatrons are now sufficiently developed to provide the popular sized larger pictures, to which the public is accustomed, in high quality color," he said.

The National Union Electric Corporation will be the official name, effective immediately, of the National Union Radio Corp. The new name was announced by C. Russell Feldmann, president and chairman of the board of National Union, in personal letters to all stockholders. "National Union was organized more than a quarter of a century ago," Mr. Feldmann said. "In recent years, activities of the company have been diversified beyond the limits of radio tube manufacture. The new name reflects the broader nature of the company's current activities. We look forward to providing our old customers and a growing list of new ones with a broadening line of quality products."

The Electronics Components Division of RCA, Harrison, N. J., has issued a series of colorful, hard-hitting promotion circulars, with streamers, designed to emphasize to the TV consumer the importance of the midsummer-TV set and antenna checkup procedure. The streamers, along with snappy direct-mail postcards, are available to the service dealer by writing to the Radio Corporation of America, Electronic Components Division, Harrison, N. J. The RCA lightning arrestors are specifically highlighted in this campaign; their utility is heightened by vividly illustrated lightning-strike streamers. (See article, "Antenna Check," this issue, Page 14.)

TUNG-SOL TECHNICAL DATA PAYS OFF IN SERVICE!

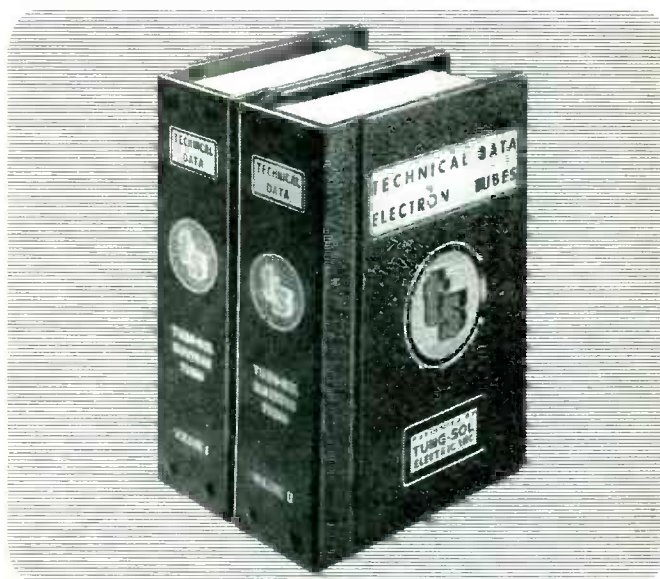

T-58 700 pages—600 tube types



NEW! 1954 Edition! T-70 160 pages of data on CR tubes, receiving and special tubes, dial lamps



T-31 300 blueprint base diagrams for 1100 tube types

Here's the most practical set of tube reference books in the industry—all the information you need for everyday jobs! They're easy to read—easy to use (always lie flat when open.) You'll get work done faster with Tung-Sol Technical Data Books. Ask your tube supplier about them.



TUNG-SOL makes All-Glass Sealed Beam Lamps, Miniature Lamps, Signal Flashers, Picture Tubes, Radio, TV and Special Purpose Electron Tubes and Semiconductor Products.

TUNG-SOL® *easy reference* TECHNICAL DATA

SERVICING'S EASY WITH RIDER BOOKS!

**RETMA EXPERTS TELL ALL
ABOUT TV SERVICING!**

**ADVANCED
TELEVISION SERVICING
TECHNIQUES**

written by the RETMA (Radio Electronic Television Manufacturers' Association) Pilot Training School Teaching Staff.

A completely NEW approach to books for TV service technicians. Written by experts who are teaching every day. The contents have been tried and proven to be the finest ever written. Completely practical. A step-by-step approach to how to service every section of a TV receiver with every kind of test equipment—by resistance measurement, by voltage measurement, by means of the scope. It explains the uses of test equipment of all kinds in connection with TV receiver servicing, such as sweep generators—signal generators—vacuum tube voltmeters—scopes—ohmmeters!

This is not a theory book! It is a book which every technician can use on the bench—and every student in a TV school can use, because it tells what to do and how to do it!

Never a book like this. Words alone can't describe it—you have to see it to believe it!

175 (8½ x 11") pages. Soft Cover. \$3.60 In Canada, all prices approximately 10% higher.

Write for complete 32 page
NEW RIDER CATALOG



**COMPLETE
EXPLANATION
COLOR TV TERMS
AND DEFINITIONS!**

**COLOR TV
DICTIONARY**

by
J. R. Johnson

This is more than a dictionary! Over 50 illustrations. Of vital concern to everyone—engineers, service technicians, students, amateurs—interested in color television. Approx. 72 (5½ x 8½") pp. Paper cover

\$1.25. In Canada, all prices approximately 10% higher

Write for complete
32 page RIDER catalog



**RADIO-TV
THEORY
REVIEW
SERIES**

R-C & R-L

TIME CONSTANT

edited by A. Schure, Ph.D., Ed.D. This is the first in a new series of books to help the student or technician brush-up on difficult subjects. Supplements courses on technical institute level. 48 (5½ x 8½") pp. Paper cover. \$.90 In Canada, all prices approximately 10% higher

Write for complete 32 page
RIDER catalog



Buy these books now from your jobber... bookstore... If not available from these sources, write to:

JOHN F. RIDER PUBLISHER, 480 Canal St., INC. New York 13, N. Y.

REMOTE TUNER

[from page 41]

cable. To use, simply remove the back from the Remote Tuner, giving access to the control cable plug and receptacle.

On a very few receivers the cathode of the mixer is "hot" and better results will be obtained if the yellow wire is connected to the chassis rather than the mixer cathode pin. If one side of the heater is grounded, as may be determined by a continuity check, the yellow wire may be inserted in this pin socket as a convenient way of picking up ground.

If no sound is obtained from the speaker, the chances are that the "speaker-phones" switch on the rear of the Remote Unit is in "phones" position.

Because of the small amount of resistance in the leads in the connecting cable loudspeaker volume cannot be reduced completely to zero by means of the volume control on the Remote Unit, but only to a very low volume level. This is normal and should be explained to the customer. If for any reason it is desired to mute the speaker completely, as when answering a telephone at the viewing position, the "speaker-phones" switch on the rear of the unit can be thrown to "phones."

In a location very close to a powerful transmitter it may be found that the station overloads the tuner, making it impossible to reduce contrast sufficiently from the remote position, or causes the picture to tear. When this occurs it will be necessary to remove the rf board for that channel from the tuner (the rear board) and solder a 1200 ohm, ¼ or 1/3 watt, composition resistor across the two outside terminals, laying the resistor parallel to and against the coil form.

Receivers Employing Series Heaters

If the tubes in the tuner of the receiver happen to be part of a series heater string, a resistor load must be substituted for the heaters of the tube(s) which are removed. A 4 or 5 watt insulated resistor of proper value may be substituted for each tube removed. The correct resistance value may be determined by application of Ohm's Law. The resistor or resistors may be soldered directly to the heater connections on the tube sockets. Inspection of the receiver schematic and reference to the heater ratings of the tubes to be removed will make it obvious what is required. It is possible to avoid substituting a resistor for the rf stage tube by simply snipping off the plate and screen pins and reinserting the tube in its socket.

SAVE 2-WAYS

WITH

**University
DRIVER UNITS
& TRUMPETS**

1. Higher Conversion Efficiency
Lowers Amplifier Costs
2. Highest Quality Eliminates
Maintenance Expense

**RUGGEDIZED
TRUMPETS**



UNIVERSITY trumpets are built to the highest standards in the industry—by the pioneers of the reflex trumpet. They are completely weather-proof, super conditioned for any locale or climate. Achievement of highest attainable conversion efficiencies reduce amplifier requirements. Get the facts.

* Less Driver Unit

MODEL	GH	LH	PH	SMH
Low Frequency Cutoff	85 cps.	120 cps.	150 cps.	200 cps.
Sound Distribution	65°	75°	85°	95°
Air Column Length	6½ ft.	4½ ft.	3½ ft.	2½ ft.
Bell Diameter	30¾"	25¾"	20¼"	16¼"
*Horn Length	27¾"	19"	15¾"	12"
*Shipping Weight	25 lbs.	20 lbs.	11 lbs.	9 lbs.

HIGH EFFICIENCY DRIVER UNITS



MODEL SA-HF — Workhorse of the sound industry for general PA and Industrial use. Very high efficiency delivers extra punch to cut through heavy noise. Response to 10,000 cps.—ideal for both speech and music. Tropically and hermetically sealed for trouble-free service anywhere.

MODEL MA-25 — A low cost unit for use where response to 6000 cps. meets requirements. No compromise in quality — incorporates all the famous UNIVERSITY quality features — high efficiency magnet structure, tropicalized full size 2" voice coil, rim-centered break-down proof bakelite diaphragm, etc.



MODEL PA-30 — A "de-luxe" unit incorporating every advance design feature including famous University W Alnico 5 Magnet and built-in transformer with terminals available thru housing base. For all amplifiers including 70 volt systems. Response 80-10,000 cps. with 30 watt cont. power.

MODEL SA-30 — Similar to the SA-HF in response and efficiency but includes a multi-impedance line matching transformer with taps accessible through water-tight cover. Taps designated in impedance values and watts for "constant voltage" lines. Die-cast aluminum housing affords lasting protection.



Write for catalog describing the complete line of University Hi-Fi and PA reproducer equipment, including Radial Type Projectors. Address Desk 24-H

**University
LOUDSPEAKERS INC**
80 SO. KENSICO AVE., WHITE PLAINS, N. Y.

WORK BENCH

[from page 38]

of range. Therefore, because the 6AL5 had already been replaced with no effect on this circuit, trouble-shooting was initiated in the reactance circuit.

The plate voltage of the 6AC7 was measured and found to be a little low. The screen voltage was next measured at about 280 volts to ground. The diagram however, called for 105 volts. Going no further, the receiver was turned off and a resistance check was made of R293, and R292. R292 checked okay, but the resistance of R293 checked about 200 ohms instead of 47K. The receiver was then turned on and C269, .05 mf., the screen bypass, was next checked for voltage leakage. However, it showed no leakage. Following this, R293—47K, was replaced. The receiver's horizontal hold was adjusted, the horizontal phasing checked and the receiver now functioned properly.

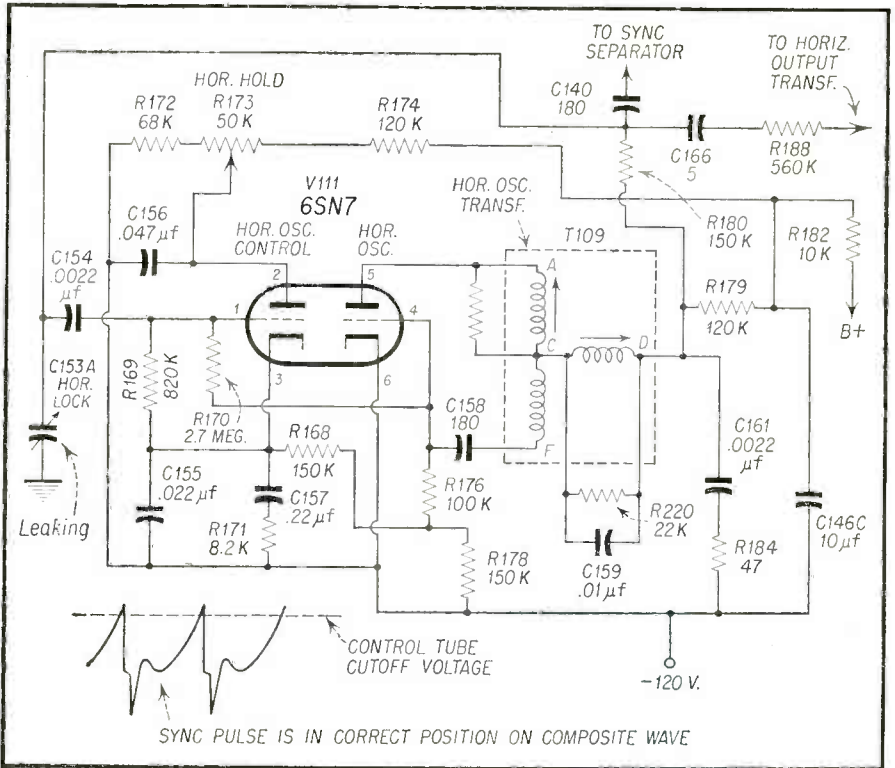

Fig. 3 — Partial schematic, RCA 8TV321.

RCA 8TV321—Horizontal drift

The receiver was turned on and after about twenty minutes the horizontal frequency drifted out of range. Replac-

ing the 6SN7 horizontal oscillator had no effect. Before proceeding any further, it is important to note here that

this is a syncro-guide type horizontal oscillator circuit. This circuit eliminates the use of a sync discriminator such as

Windsor

RADIO & TV RECEIVING

TUBES

GUARANTEED ONE FULL YEAR

... FOR PEAK PERFORMANCE!

Type	Each	Type	Each
0A2	.99	1U4	.61
0B2	.88	1U5	.51
0C3	.95	1V2	.45
1A7GT	.87	1X2A	.74
1AE4	.90	2X2	1.43
1B3GT	.69	3A5	.90
1H5GT	.51	3LF4	.76
1J6	.93	3Q4	.66
1L4	.63	3Q5GT	.72
1L6	.66	3S4	.61
1LA4	.82	3V4	.62
1LA8	.80	5R4GY	1.00
1LB4	.82	5U4G	.49
1LC5	.80	5V4G	.83
1LC6	.80	5Y3GT	.37
1LD5	.80	5Y3GT	.42
1LE3	.80	5Y4G	.43
1LG5	.80	6A8GT	.68
1LH4	.80	6AB4	.51
1LN5	.80	6AC5GT	.82
1N34	.90	6AC5GT	.90
1N48	.50	6AF4	1.10
1N5GT	.83	6AG5	.59
1N64	.75	6AH4	.68
1R4	.85	6AH6	.89
1R5	.82	6AK3	1.05
1S4	.87	6AC5GT	.44
1S5	.52	6AN8	.95
1T4	.62	6AQ5	.51

Thousands of Service Organizations and Dealers send us REPEAT ORDERS month after month—they KNOW you can depend on the WINDSOR promise of PEAK PERFORMANCE. Every tube we ship is first carefully tested in our labs, for maximum functioning characteristics, right in a radio or TV Set—under actual operation conditions. Each tube is attractively packaged in the famous green and black WINDSOR carton that has earned consumer acceptance throughout America!

Type	Each	Type	Each	Type	Each	Type	Each	Type	Each
6AQ6	.47	6BL7GT	.94	6SA7GT	.57	7A5	.70	7L7	.85
6A7	.75	6BN6	.98	6SC7	.63	7A6	.58	7N7	.62
6AR5	.42	6BQ6GT	.98	6SD7	.55	7A7	.57	7Q7	.62
6AS5	.55	6BQ7	.92	6SF5GT	.66	7A8	.56	7S7	.90
6AS7G	4.50	6BY5G	.85	6SG7	.55	7AD7	1.05	7V7	.92
6AT6	.42	6BZ7	1.09	6SH7GT	.52	7AF7	.63	7X6	.62
6AU5GT	.85	6C4	.41	6SJ7GT	.52	7AG7	.65	7Y4	.45
6AU6	.47	6C5GT	.60	6SK7GT	.55	7AH7	.70	7Z4	.50
6AV5	.85	6CB6	.58	6SL7GT	.58	7AJ7	.54	12A6	.60
6AV6	.41	6CD6G	1.57	6SN7GT	.59	7B4	.54	12AL5	.44
6AX4	.72	6CS6	.56	6SQ7GT	.46	7B5	.51	12AT6	.53
6BB6	.93	6D9	.63	6T8	.85	7B6	.58	12AT7	.75
6BA7	.50	6E5	.72	6U4GT	.60	7B7	.65	12AUG	.47
6BA7	.66	6F5GT	.54	6U5	.76	7C4	1.05	12AU7	.75
6BC5	.58	6H6GT	.55	6U6	.86	7C5	.56	14A7	.41
6BC7	.78	6J5GT	.44	6V3	1.09	7C6	.50	14B7	.62
6BD5GT	.98	6J6	.68	6V6GT	.51	7C7	.58	14C7	.75
6BD6	.54	6J7	.70	6V8	.85	7E5	.85	14D7	.62
6BE6	.51	6K6GT	.45	6V4GT	.50	7E6	.65	14E7	.59
6BF5	.60	6K7	.70	6W6GT	.63	7E7	.85	14F7	.50
6BF6	.43	6L6G	.88	6X4	.37	7F7	.69	14G7	.75
6BG6G	1.47	6L6GA	.88	6X5GT	.36	7F8	.97	14H7	.75
6BH6	.63	6Q7GT	.55	6X8	.82	7G7	.85	14J7	.62
6BJ6	.53	6R7	.75	6Y6G	.64	7H7	.61	14K7	.80
6BK5	.76	6S4	.51	6ZY5	.60	7J7	.85	14L7	.62
6BK7	.97	6S8GT	.75	7A4/XXL	.57	7K7	.85	14S7	.80
								14T7	.50
								14U7	.62
								14V7	.62
								14W7	.62
								14X4	.72
								14X7	.72
								14Y7	2.15
								12A27	.78
								12B4	.66
								12BA6	.50
								12BA7	.66
								12BD6	.51
								12BE6	.52

WINDSOR WONDER-BEAM 3-WAY TV ANTENNA

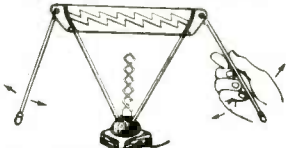

Has adjustable arms, and new electronic wonder-switch, for maximum reception in Fringe Areas, Average Areas, and for UHF. It's a real performer—works where others fail!

SPECIAL PRICE \$5.69
Lots of Six each
Singly \$5.95 each

FREE! WINDSOR TUBE CADDY

Most practical service-aid ever designed for Radio & TV repairmen! Now offered FREE with every purchase of \$160.00 or accumulated purchases totalling \$160.00 within 90 days (You get Caddy credit memo with each purchase).

- Carries approximately 125 Tubes, including meters and tools.
- 16 3/4" long, 8 1/2" wide, 13 3/4" high. Weighs only 9 lbs.
- Ruggedly constructed with heavy leatherette covering, strong plastic handle, nickel plated hardware, and reinforced with metal clamps.

WINDSOR TUBE CADDY may also be purchased outright for \$14.95

Note to our Latin-American Friends: "SE HABLA ESPANOL"

Windsor ELECTRONIC TUBE CO.
2612-D NOSTRAND AVENUE, BROOKLYN 10, N. Y.

WINDSOR BROW-LITE



Leaves Both Hands Free To Work!

Ideal for Radio & TV Repairmen! Puts light right where you need it. Uses standard penlite batteries and bulb. Does not interfere with glasses, rides over the brow. Order yours TODAY... you'll never want to be without it!

\$4.95
Complete with Batteries.

WRITE FOR ADDITIONAL TUBE TYPES AND PRICES. We also stock Special Purpose and Transmitting Tubes at similar savings! Dept. D-8

Snyder
PHILADELPHIA

**AUTO
RADIO
ANTENNAS**

**THE
ONLY
COMPLETE
LINE**

SNYDER

SNYDER MFG. CO., PHILADELPHIA 40, U.S.A.
BELLEVUE TUBE MILL, INC., PHILADELPHIA
SNYDER ANTENN-GINEERS LTD., TORONTO 14
WORLD EXPORT: ROBURN AGENCIES, INC., N.Y.



the 6AL5. One 6SN7 type tube does the entire job. The horizontal oscillator may be called a free running blocking oscillator. The coils of T109, A to C, and C to F, make up the blocking oscillator transformer section.

The stabilizing tuned circuit between C and D is shock excited into sine wave oscillation by pulses of plate current. These sine wave pulses and the saw tooth pulses manufactured by the blocking oscillator add to each other. Thus, that at the junction of C140 and R180, you will find these pulses fed by R180; the horizontal sync pulse fed by C140; and the partially integrated pulse fed by C166 from the horizontal output transformer.

All are fed to the grid of the control tube (Pin #1) through C154. A portion of the bias from the blocking oscillator is applied to the grid of the control tube through R170, which is sufficient to cut off the control tube.

Now, if the oscillator drifts after the latter pulses add correctly, or after the horizontal sync pulse is in the right position on the sino-sawtooth wave (Fig. 3A), the control tube will conduct. When the control tube conducts, the cathode condensers C155, and C157 charge up. This potential is applied as a bias to the oscillator grid (Pin #4) through R168 thus shifting the oscillator frequency and pulling it back into phase with the horizontal sync pulses.

Knowing these important facts, a few components were next voltage-leakage checked. The receiver had been left on now for about a half hour and the horizontal frequency had drifted far out of range. The grid leak condenser of the oscillator C158 was first checked but it was found to have no leakage. The plate condenser of the control tube C156 was next checked but it was also found to be ok. C154, the control tube coupling condenser off Pin #1 was also ok. C153A was next clipped of its ground connection and it was found to be leaking badly. This condenser, you will notice, is the horizontal lock adjustment and naturally will have a tremendous effect on the oscillator frequency. C153A was replaced and the receiver now functioned properly.

ANTENNA CHECK

[from page 14]

tenna checkups and new installations over the summer months. He can supply you with postcards that carry the sales message from you to your customers, window posters that will catch the attention of the passerby, and best of all . . . new antennas, transmission line, standoffs, and accessories.

The pitch to the customer from you

SERVICEMEN

Here it is . . .

Columbia's
DELUXE
Television
Service Lite



**Handier than a
flashlight!**

Now . . . with complete swivel for better lighting and easier servicing!

EVERY SERVICEMAN, experimenter, model-maker, needs this handy item. No need to work in the dark . . . ample light is provided by a 7½ watt, 110 volt bulb that remains cool at all times.

Scientifically - designed, unbreakable aluminum reflector directs maximum light to point of work . . . A REAL TIME AND LABOR SAVER.

Carried by Leading Jobbers!

Have you seen our other TV service aids . . . "TV Service Cord" and "TV Picture Tube Extension Cable", Extension Cords, Hook-up Wire Assortment, TV Transmission Lines, Etc.

Columbia
WIRE & SUPPLY CO.
2850 Irving Park Road • Chicago 18, Ill.

is simply this: "Antennas don't last forever. In spite of the fact that most TV stations have upped their power over the last few years, you can enjoy better reception with a good antenna installation. Right now—in the good old summertime, I can do the job better, faster, and maybe at a little better price because working conditions up in the wild blue yonder are better than in the cold weather." Once you have reminded the customer that the antenna installation is so very important, he'll look at his. If you are with him, show him all the points at which he is losing signal strength. Show him how the transmission line is almost as good as a Key West sponge when it comes to soaking up and holding moisture. Point out the rusted terminals on his antenna. Show him the bent or broken antenna elements and then stress the importance of sufficient signal strength to the receiver. Then the climax . . .

You can sell *better than new* reception by installing one of the newer types of antennas with increased gain, better directivity and better all-around performance. This can be a hot-shot yagi for the single or few channel areas, or a streamlined, broad-band antenna design. Tell him the advantages over the antenna he now has—some things improve with age, but not antennas!

All you have to do is get started on this summer sales program. The rest comes easy. The only catch is that you probably won't get a summer vacation as the cash register will require your constant attention ringing up the receipts—and when you are not doing that, you'll be working as a Wells Fargo man carrying your money to the bank. Just get the scoop from your jobber . . .

ANSWER MAN

[from page 27]

to the antenna leadin. This is also true in cases of other types of antenna input systems, where the input to the *rf* stage connects to chassis directly or through a by-pass condenser.

Montgomery Ward 2WA—Weak

Dear Answer Man:

I am having trouble with a Montgomery Ward TV 21" receiver, the Airline, Series 2WA.

This set is about one year old. It operated satisfactory until lately. We have a local *uhf* channel No. 39 and *vlf* channel No. 13, both with strong signals, as well as some weaker channels. Now the receiver will not pick up any of the weaker stations.

I have tried different tubes. Some-

THIS VOLTAGE ADJUSTOR

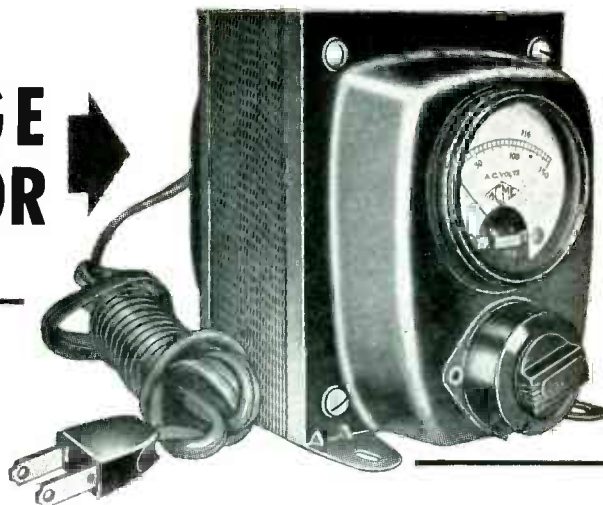

T-8394M MANUAL
VOLTAGE ADJUSTOR

IS EASY TO USE ON SERVICE CALLS

Where low voltage is affecting TV reception the serviceman can detect the conditions immediately with a T-8394M Acme Electric Voltage Adjustor.

To determine line voltage, set the tap switch at 115 volts. The meter reading will show the exact incoming line voltage.

REPRODUCING LOW VOLTAGE EFFECT

The T-8394M Voltage Adjustor can also be used to reproduce the operating condition about which the customer complained. For example, the customer complains that evening program pictures flicker and shrink but daytime pictures are alright.

This indicates low voltage conditions in the evening. By adjusting the tap switch to 97 volts the condition may be duplicated. This quickly convinces the set owner that good performance can be sustained with a T-8394M Voltage Adjustor. A sale is made.

NOT A GADGET

The T-8394M Voltage Adjustor is small and compact. It is supplied with a primary cord and a secondary receptacle. Just plug the cord into any convenient outlet — then plug the television cord into the secondary receptacle. No tools are necessary.

The Acme Electric T-8394M Voltage Adjustor is a high quality variable voltage type transformer that has been on the market for 25 years. Regulation is adjustable over a range from 95 to 125 volts. It is a dependable, low cost voltage regulator that can adjust voltage to the exact amount necessary for top TV performance. Write for Bulletin VVA-190.

ACME ELECTRIC CORPORATION



MAIN PLANT: 468 Water Street • Cuba, N. Y.
West Coast Engineering Laboratories:
1375 West Jefferson Boulevard • Los Angeles, Calif.
In Canada: Acme Electric Corp. Ltd.
50 North Line Road • Toronto, Ontario

times the receiver works for a few minutes but if switched over to strong signal stations and back there is no picture and very faint sound. Would there be overloading on some part or is there some new tube that could be substituted to correct this?

R. H.
Freeport, Ill.

Dear R. H.:

The Airline TV receiver, Series 2WA, uses a standard coil tuner and the poor reception condition that is being experienced on the weaker chan-

nels can be due to a number of reasons.

Probably the most obvious reason has been checked, namely the *rf* amplifier tube. However, don't overlook the mixer-oscillator tube and any of the *if* tubes inasmuch as they could also cause this type of trouble.

Assuming that the tubes and the antenna is o.k., the next possibility is the contacts between the tuner and its coils. The metal contacts on the block may be dirty or may not be touching turret coil contacts. Wash the turret contacts and the block contacts with a good contact cleaner fluid.

NEW! **EICO**
Laboratory Precision at lowest cost

FLYBACK & YOKE TESTER KIT

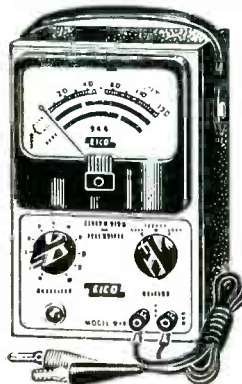

Model
944 KIT
\$23.95
Wired
\$34.95

Checks all flybacks & yokes
instantly—in or out of set!

- Detects even 1 shorted turn!
- Exclusive separate calibration for air & iron-core flybacks for accurate testing of all types.
- Tests continuity of coils, speakers, switches, etc.
- Large 4½" meter, 3 colored scales.
- Complete with easy instructions.
- Compact, rugged, smartly styled.

See it at your jobber today. Write for FREE Catalog D-8 describing EICO's 38 Kits and 42 Wired Instruments. Prices 5% higher on West Coast.

EICO ELECTRONIC INSTRUMENT CO., Inc.
84 Withers Street, Brooklyn, N. Y.
© 54

Preferred for
Original Equipment
Proven for
Replacement

O
X
F
O
R
D

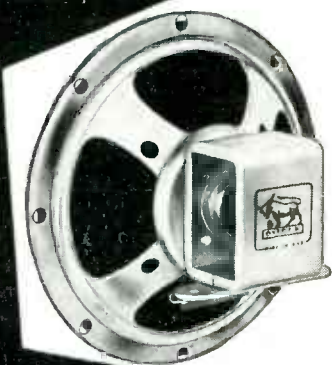

Speakers

Available from leading jobbers!

OXFORD ELECTRIC CORP.
3911 S. Michigan Ave., Chicago 15, Ill.
EXPORT: ROBURN AGENCIES, N. Y. C., N. Y.
In Canada: Atlas Radio Corp., Ltd., Toronto

A NEW DEAL for HI-FI

[from page 17]

profits are also relatively higher and can be made in three directions: Sales, Installation and Service. The last two directions are "old hat" for you. The first direction is newer, but the sale always begins with a contact between the seller and the buyer. And who has closer or more frequent contact with the "purse strings" than you, the radio and television service dealer. The manufacturers need you to help them get the added exposures they need to build new business. You need them to build new income. This could be a happy wedding!

SWEEP ALIGNMENT

[from page 12]

case of a receiver which produces a badly distorted picture.

In a somewhat similar manner, the operator can easily check the output voltage from a signal generator, and check the percentage of modulation at various settings of the modulation control, as shown in Fig. 6. In this test, it is essential to use a *dc* scope, since use is made of the *dc* voltage component in measuring modulation percentage. To conduct the test, first observe the resting position of the scope trace when no input signal is applied to the scope. This level is indicated by the dotted line on the scope screen in Fig. 6. Next, apply the output from the signal generator to the demodulator probe, and observe the pattern which is obtained; a sine wave will appear on the scope screen, and this sine wave will rise up above the reference level as shown in Fig. 6, to indicate the percentage of modulation. At 100% modulation, the lower troughs of the sine wave will touch the zero-volt reference line. At 0% modulation, the sine wave flattens out to a straight line; the output voltage of the signal generator is measured on a calibrated scope by the displacement between this straight line and the reference level. Scope calibration can be carried out by various methods, which would exceed the space limitations of this article, and are reserved for later discussion.

FOR SALE OR RENT

Very small service shop with quarters, in California's best climate. Good for elderly man wishing to "ease-off". Details write RADIO, Route 1, Box 76, Elsinore, California.

Advertising Index

Acme Electric Corp.....	47
American Scientific Development Co.....	38
American Television & Radio Co.....	12
Belden Manufacturing Co.....	Cover 2
Bussmann Manufacturing Co.....	7
Channel Master Corp.....	5
Chicago Standard Transformer Corp.....	41
Columbia Wire & Supply Co.....	46
Crosley Div., Avco Mfg. Co.....	6
Electronic Instrument Co., Inc. (EICO)	48
Jensen Manufacturing Co.....	15
Oxford Electric Corp.....	48
Philco Corporation	2, 3
Precision Apparatus Co., Inc.....	Cover 3
Radiart Corporation.....	8, 9
Radio	48
Raytheon Manufacturing Co.....	16
RCA Batteries.....	Cover 4
Rider, John F., Publisher.....	44
Sams, Howard W. & Co.....	38
Shure Brothers, Inc.....	39
Snyder Manufacturing Co.....	46
Standard Coil Products Co., Inc.....	28
Technical Appliance Corp.....	37
Telrex, Inc.	33
Tung-Sol Electric, Inc.....	42, 43
University Loudspeakers, Inc.....	44
Walsco Electronics Corp.....	13
Windsor Electronic Tube Co.....	45

MOVING?



Please
Mail Us
Your Change
of Address
Today

Also include old address and
code line, if possible. Thanks.

**RADIO-TELEVISION
SERVICE DEALER**

67 West 44 St., New York 36, N. Y.

the NEW **PRECISION** 120

MODEL

*Gives You
What You Wanted
in a*

HIGH SENSITIVITY MULTI-RANGE TEST SET

**20,000 OHMS PER VOLT D.C.
5,000 OHMS PER VOLT A.C.**

You wanted...

MORE RANGES — The '120' gives you 44... which start lower and go higher... to outrange any professional V.O.M. of similar size or type.

AN EXTRA-LOW RESISTANCE RANGE — The '120' gives you a 2-ohm center scale range, powered by long-lived, internal 1.5 volt battery source.

AN EXTRA-LOW VOLTAGE RANGE — The '120' gives you 1.2 volts full scale, A.C. and D.C.

AN EXTENDED LOW CURRENT RANGE — The '120' gives you a 60 microampere first D.C. current range.

A LARGER AND EASIER READING SCALE FACE — The '120' gives you a new, extra-large 5 1/4" meter with full 4 3/4" extra-wide window for greater visibility.

SIMPLE, POSITIVE RANGE SELECTION — The '120' gives you an 18-position, positive-detenting, master range selector with low resistance, dependable, silver-plated contacts.

RUGGED, POSITIVE CONTACT JACKS and PLUGS — The '120' gives you specially designed, low resistance, solid brass, banana type plugs and jacks.



**Compare
These
Wide-Spread
Ranges
and
Special
Features:**

- ★ **8 DC VOLTAGE RANGES:** 20,000 ohms per volt. 0-1.2-3-12-60-300-600-1200-6000 volts.
- ★ **8 AC VOLTAGE RANGES:** 5,000 ohms per volt. 0-1.2-3-12-60-300-600-1200-6000 volts.
- ★ **8 AC OUTPUT RANGES:** same as AC volt ranges. With built-in 600 volts blocking capacitor.
- ★ **7 DC CURRENT RANGES:** 0-60-300 Microamperes. 0-1.2-12-120-600 Ma. 0-12 Amperes.
- ★ **5 RESISTANCE RANGES:** self-contained batteries. 0-200-2000-200,000 ohms. 0-2-20-megohms.
- ★ **8 DECIBEL RANGES:** from -20 to +77 DB. 0 DB = 1 Milliwatt, 600 ohms.
- ★ **EXTRA LARGE 5 1/4" RUGGED 'PACE' METER:** 40 microamperes sensitivity, 2% accuracy.

- ★ **1% MULTIPLIERS and SHUNTS:** wire-wound and high stability deposited-film types employed throughout.
- ★ **ONLY 2 PLUG-JACKS SERVE ALL STANDARD RANGES:** separately identified and isolated jacks provide for extra-high ranges.
- ★ **"TRANSIT" SAFETY POSITION:** on master range selector protects meter during transportation and storage.
- ★ **CUSTOM-MOLDED PHENOLIC CASE and PANEL:** set a new standard for compact, efficient, laboratory instrument styling. Deeply engraved panel characters afford maximum legibility throughout the life of the instrument.

MODEL 120: complete with internal ohmmeter batteries, banana-plug test leads and operating manual. Over-all case dimensions: 5 3/8 x 7 x 3 1/8"Net Price: **\$39.95**

ACCESSORIES FOR THE MODEL 120

TV-2B — 30 kilovolt safety probe.....\$14.75 net
LC-3 — Custom, leather instrument case 9.50 net
ST-1 — Snap-on foldaway tilt-stand..... 1.00 net



PRECISION Apparatus Company, Inc.
92-27 HORACE HARDING BLVD., ELMHURST 6, N. Y.

Export Division: 458 Broadway, New York 13, U.S.A. Cables: Morhanex
Canada: Atlas Radio Corp., Ltd., 560 King Street W., Toronto 2B

46 284 14 JAN 56

ANTHONY C JANKOWSKI
14119 JENNE AVE
CLEVELAND 10 OHIO

"Selling

RCA BATTERIES

5

was a 'natural' for me,"



says **GEORGE S. SRDJAK** of the **Maple Heights Record Center, 15815 Libby Road, Maple Heights, Ohio**

"MY WHOLE SERVICE business benefited when I started promoting RCA Batteries—the radioman's battery," Mr. Srdjak said, "My customers recognize the famous monogram on the RCA Battery carton. This makes selling this quality product that much easier."

"The Radio Battery for the Radio Trade" is popular with radio dealers and technicians everywhere. Reason is simple. Radio dealers and technicians build repeat business selling RCA Batteries. Take advantage of the merchandising magic of the popular RCA monogram found on every RCA Battery carton. You'll find your customers stray less to other outlets for battery replacements when they know you sell RCA Batteries.

The strong RCA Battery sales volume you can build at your store will produce an extremely favorable inventory turnover picture on your books.



Ask your RCA Distributor salesman to give you a copy of the new "1954 RCA Battery Sales Planner" booklet. Then order a good stock of the ten top-volume types and start enjoying *plus profits* selling RCA Radio Batteries.

Here's how RCA helps you sell more Radio Batteries



● NATIONAL TV and RADIO ADVERTISING



● POWERFUL SALES PROMOTION



● COMPLETE LINE



● GREATEST NAME IN RADIO



● RADIO TRADE DISTRIBUTION



RADIO CORPORATION of AMERICA

RADIO BATTERIES

HARRISON, N. J.