

JUNE, 1954

Radio-Television SERVICE DEALER

TV - AM - FM - SOUND

JAN 56
48 284 14
ANTHONY C JANKOWSKI
14119 JENNE AVE
CLEVELAND 10 OHIO

Includes: **"VIDEO SPEED SERVICING"**
& **"TV FIELD SERVICE"** Data Sheet Sections



The Professional Radio-TVman's Magazine
Reaching Every Radio TV Service Firm Owner in the U.S.A.





YAGIS



DELTA MATCH

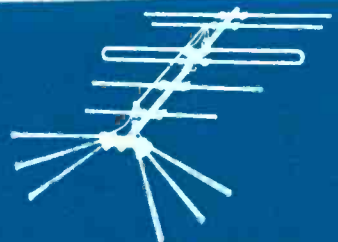

CON-YAGI COMBINATION

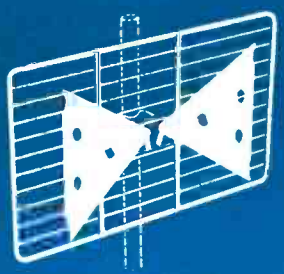

UHF

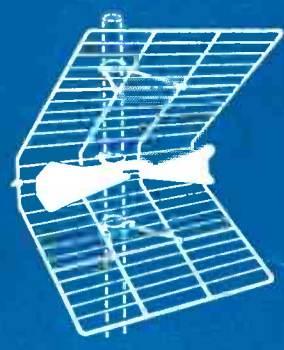

UHF

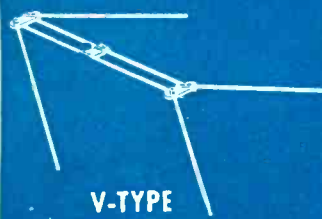

V-TYPE

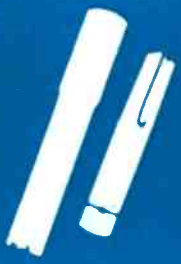

*BELLEVUE TV MASTS



INDOORS

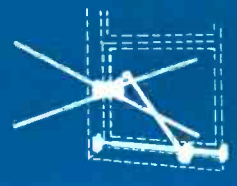

WINDOW

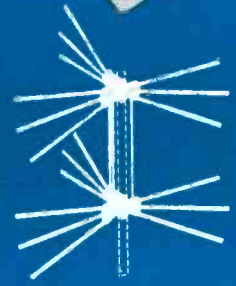

Directronic

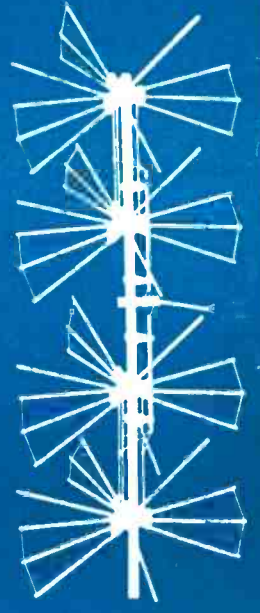

Directronic



LINE-UP



SNAP-UP

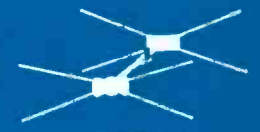

CONICAL

Snyder
PHILADELPHIA

The Only
Complete
TV ANTENNA
LINE

SNYDER MFG. CO.

ANTENN-GINEERS® PHILADELPHIA, U.S.A.

*BELLEVUE TUBE MILL, INC., PHILADELPHIA, A *Snyder* AFFILIATE
 SNYDER ANTENN-GINEERS LTD., TORONTO, CANADA, A *Snyder* AFFILIATE
 WORLD EXPORT: ROBURN AGENCIES, INC., NEW YORK 7, N.Y.

MANUFACTURERS START TO FINISH

ASTRON
capacitors for real...



GUTS

(*stamina as in Astron capacitors)



TWO basic conditions must be filled by capacitors to satisfy the need of service technicians:

Have they got GUTS? Yes—no one can look inside a capacitor and see how long it will stand up; or how much of a beating it will take over a long period of time. But you can put your trust in Astron for behind each Astron capacitor is the meticulous quality control that insures staying power. No call-back when you install an ASTRON!

Is there an ASTRON CAPACITOR for this job? Yes—there is an Astron capacitor built especially to fill the specific, exacting replacement requirements of any job you tackle.

See your local jobber today and ask for ASTRON!



Export Division: Rocke International Corp.
13 E. 40 St., New York, N. Y.

In Canada: Charles W. Pointon
6 Alcina Ave., Toronto 10, Ontario

ASTRON

C O R P O R A T I O N

225 GRANT AVENUE, E. NEWARK, NEW JERSEY

©NTI

"...and all I did was install a
WALSCO antenna"

Buyers are getting wiser. The quality of *their* TV reception is *your* responsibility . . . and they'll hold you to it! For *your* protection, sell and install
WALSCO, the finest antennas ever built for VHF and UHF.

WALSCO IMPERIAL CONICAL (all-channel VHF)

Featuring the new, exclusive "Barrier Disc" Insulator to prevent shorts and maintain lasting high gain performance anywhere. Designed for color as well as black and white. Not affected by dirt, moisture, salt . . . will not rust. Stainless steel hardware prevents corrosion losses *permanently*. Pre-assembled . . . guaranteed 3 years!

Single Bay . . . only \$9.95 List. Also available in Dual and 4 Bay Stacks.

WALSCO CORNER REFLECTOR (UHF)

No other UHF antenna so effectively combines all three . . . (1) extra high gain; (2) all-channel reception; (3) sharp vertical and horizontal directivity. Features the hollow, unbreakable X-77 Insulator . . . silicone treated to shed dirt and moisture . . . not affected by extreme heat, cold or wind.

Single Bay . . . \$10.95 List. Also available in 2 and 4 Bay Stacks.



3602 Crenshaw Boulevard, Los Angeles 36, California

Branch: 315 West Walton, Chicago, Illinois

Overseas Distributor: Ad Auriema, Inc., 89 Broad St., New York 4, N.Y.

Canadian Factory Distributor: Atlas Radio Corp., Ltd., 560 King St. West, Toronto 2-B.



Every Service Firm Owner in the U.S.A.
Receives SERVICE DEALER Monthly
DISTRIBUTION THIS ISSUE OVER 65,000

COWAN PUBLISHING CORP., 67 West 44th Street, New York 36, N. Y.

VOL. 15, NO. 6

JUNE, 1954

EDITORIAL STAFF

Publisher

SANFORD R. COWAN

Editor

SAMUEL L. MARSHALL

Editorial Production

ROBERT CAMPBELL

Contributing Editors

LEONARD LIEBERMAN

ROBERT T. DARGAN

PAUL GOLDBERG

MARVIN KLEIN

SAN D'ARCY

• •

BUSINESS STAFF

Advertising Director

SANFORD L. CAHN

Advertising Manager

HARRY N. REIZES

Advertising Sales

LAWRENCE STEINER

Production Manager

DAVID SALTMAN

Circulation Manager

HAROLD WEISNER

Assistant Circulation Manager

EDWARD J. HARMAN

• •

BRANCH OFFICES

LOS ANGELES

TED E. SCHELL

2700 West Third Street

Dunkirk 2-4889

CLEVELAND

RICHARD E. CLEARY

Commercial Bank Bldg.

Berea, Ohio

BErea 4-7719

FEATURE ARTICLES

Solving Sweep Alignment Problems, Part 1, by <i>Robert G. Middleton</i>	7
How video oscillation can affect the response curve in the alignment process; and steps to be taken in pinpointing the source of this oscillation.	
Oscilloscope Y-Axis Pre-Amplification, by <i>Harry Casey</i>	10
Description of an auxiliary piece of test equipment to be used in conjunction with the scope for increasing its range.	
Horizontal and High Voltage Color Circuitry, Part 2, by <i>Bob Dargan and Sam Marshall</i>	14
Analysis of damper circuit operation.	
Auto Inverters, by <i>San D'Arcy</i>	23
This accessory provides a source of income to the service technician both from the sales and the service angles.	
Servicing Marine Radio, Part 1, by <i>Marvin Klein</i>	24
Introduction to the marine radio servicing and sales business, an excellent source of income in areas where such activities exist.	
Get Started in P.A., Part 2, by <i>Gene Hessel</i>	30
Description of a typical P.A. installation in an amusement park.	
A.G.C. Problems, by <i>Paul Goldberg (A Work Bench Feature)</i>	32
Various service problems involving agc circuits.	
A Versatile VTVM, by <i>R. Blitzer</i>	44
Description of a new VTVM.	
Du Mont Chroma-Sync Teletron	51
Description of a new three-beam electron gun, shadow mask type of color tube.	

CIRCUIT & SERVICE FORUM

Answer Man	
Adjacent Channel Interference	29
44 mc Band for TV Receivers	29
Rider TV Field Manual Service Data Sheets	
Hallcrafters Models 1067, 1068, CH L1100D, Runs 1 & 2	33
Motorola Models 17F13C etc.	37
Video Speed Servicing Systems	
Capehart CX-33DX	45
Du Mont RA-164	47
The Workbench	
Admiral 22A2: Video Overload	41
Emerson Model 654B, Chassis 120118B: Video Overload	41

DEPARTMENTS

Editorial	5	Trade Flashes	50
Answer Man	29	Association News	53
The Work Bench	32	Book Reviews	56
New Products	42	Advertising Index	64

RADIO-TELEVISION SERVICE DEALER is published monthly by Cowan Pub. Corp., 67 West 44th St., New York 36, N. Y. Subscription price: \$1 for 2 years in the United States, & U.S. Poss. Elsewhere \$1 per year additional. Single Copies 25c. Reentered as second class matter Sept. 25, 1950 at the Post Office at New York, N. Y. under the Act of Mar. 3, 1879. Copyright 1954, Cowan Publishing Corp.

POSTMASTER: SEND FORM 3579 TO RADIO-TELEVISION SERVICE DEALER, 67 WEST 44th ST., NEW YORK 36, N. Y.

The BACKSTOP

STOPS co-channel and adjacent-channel interference caused by rear signal pick-up!

- Highest front-to-back ratio ever built into an antenna!
- No rear pick-up; eliminates "venetian blinds"!
- Largest screen area: 70 square feet!
- Very high all-channel gain. Incorporates basic Champion design, including Tri-Pole, with additional elements!
- Completely preassembled!

Table of Front-to-Back Ratios (Relative Voltage)

Channels	Front-to-Back Ratios
2	9:1
3	10:1
4	11:1
5	20:1
6	18:1

Only Low Band channels shown, since co-channel interference is not encountered on High Band channels.

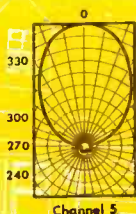

Gain Above Tuned Reference Dipole



IMPORTANT . . . don't be misled by polar patterns representing relative POWER. Remember, power is the square of voltage. All Channel Master polar patterns are presented in relative VOLTAGE.

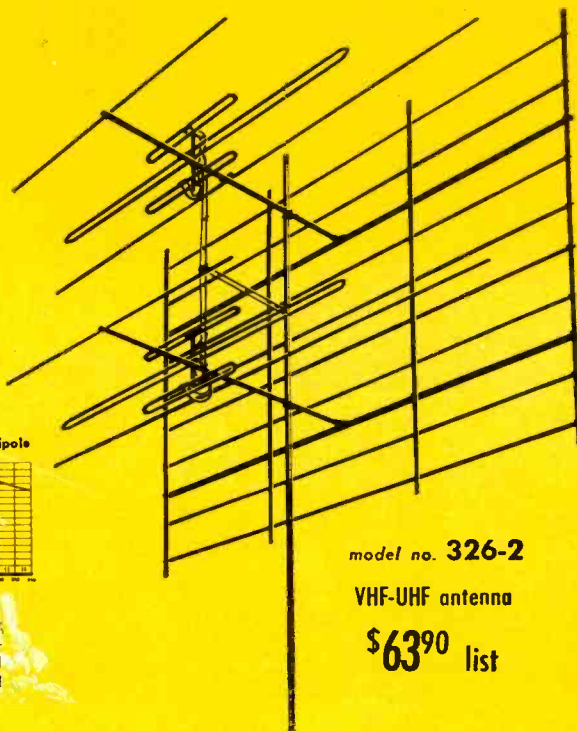

model no. 326-2

VHF-UHF antenna

\$63⁹⁰ list

2 radical new antennas by CHANNEL MASTER

The most beautiful antenna ever made! The only indoor antenna featuring powerful outdoor design principles — Bow-Tie and Screen.

DESIGNED FOR POWER!

On **UHF**: For primary and secondary areas. In many cases, performance is equal to actual outdoor installations. Good directivity on all channels.

On **VHF**: Ideal in areas of strong VHF signals.

STYLED FOR BEAUTY!

Designed by a well-known industrial designer, the WONDER BOW is proof that indoor antennas can be beautiful as well as powerful. Wins customer approval on beauty alone!

Wonder Bow * VHF-UHF indoor antenna

The first gain figures ever to be published for an indoor antenna!

Gain Above Tuned Reference Dipole

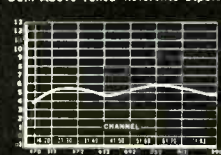

Gold and black

model no. 416

Silver and black

model no. 417



\$83⁵ list



CHANNEL MASTER CORP. ELLENVILLE, N. Y.

The World's Largest Manufacturer of TV Antennas

Write for complete technical literature.

Copyright 1954, Channel Master Corp.

*Pat. No. D-171560



EDITORIAL...

by S. R. COWAN
PUBLISHER

THE READERS WRITE

Our daily mail, especially since November 1953, has been gratifyingly heavy with favorable comments from readers in regard to the articles and feature departments which are appearing in our monthly issues. We say this, not to boast, but rather to point out that most radio-TV servicemen readers are discerning. They can and do evaluate the text content of a technical publication in a blunt and positive manner.

It is a simple thing every month for any magazine editor to obtain many more articles than he can possibly publish in the space allotted to him for his next issue. The big decision which every managing editor must make, is this: Which of the articles contain the subject matter and authenticity worthy of selection for publication in the next issue?

To publish material merely as filler, or because it has a "cute or intriguing title" — or to accept articles on auto radios in the summer, or on TV antennas in the fall — simply because they are available and in season, is not the answer to good publishing practice. Not in a highly technical field like this where space is limited and every word published must have point and meaning. Our primary evaluation of selected articles is the extent to which they can help a serviceman do a quicker and better job, and make more money doing so.

For example, let us tell you, in candid fashion, about some intimate decisions that took place here in our office recently. At the staff meeting one of our advertising salesmen told the managing editor that "as long as 15,000 of our readers are located in non-TV areas, we should run more articles than we do on servicing ordinary radios such as ac/dc sets, portables, auto radios and the like." Then two of our advertising salesmen mentioned that another serviceman's publication has been running just such a series — and that fact having been stressed by our competitor's representatives favorably impressed some advertising prospects. But no! Our managing editor bluntly replied, "I read those articles carefully and I say to you in no uncertain terms — that series was loaded — it was nothing but tripe and full of errors that the service fraternity quickly recognized and scoffed at." Then, our managing editor stressed what I have said many times, "Our text material, first and always, must be armed to help professional servicemen and service shop owners."

Our mail from you readers confirms the managing editor's views 100%. It's nice to know that you fellows are aware of what's going on — not only in our magazine's text pages, but also in the columns

of contemporary publications. But as we have often said, we always welcome constructive suggestions and criticism from our readers and if there is ever any subject about which you feel more material should be published, never hesitate to make that fact known to us so that we can work to our mutual advantage.

NEW DISCOUNTS OPEN HI-FI TO SERVICEMAN

Inasmuch as I was co-founder and the first publisher of the magazine "Audio Engineering" I may justifiably claim a wee bit of fundamental *know-how* relative to the high fidelity and sound business.

Since the inception of this fabulous, fast-growing market that today is popularly called "High Fidelity" or "Hi-Fi"—there has been a serious and fundamental fault with the manufacturers' pricing and discount structure. The "fault," as I term it, locked out professional radio servicemen and service dealers. Heretofore, for example, a speaker or amplifier manufacturer established a list (or selling) price for his product. The Parts Jobber or Sound Distributor got his professional trade discount, but the Serviceman or Service Dealer, just like any Tom, Dick, or Harry, was supposed to pay list price. Naturally, customers who contemplated buying or who wanted to assemble various components to establish a Hi-Fi installation were reluctant to call in a professional serviceman because they could buy the basic components for the same price. On the other hand, service dealers didn't feel justified in trying to push their way into the sale of Hi-Fi equipments knowing in advance that they had no profit markup or profit margin on which to work, and could only rely on service, if any, for their profit.

Even worse was the fact that the old "net price" trade policy made several jobbers become retailers in effect—a position that they, being wholesalers, should never have been put into at the outset.

Happily a step in eliminating this discount impasse has been taken very recently. Already several of the leading Hi-Fi equipment manufacturers (such as Regency, Jensen, and RCA, to name but a few) have announced that without changing their list price structure, professional service dealers are now to be given their trade discounts at distributor levels. This plan will undoubtedly be followed by all the other manufacturers in short order. Welcome news it is, for it now opens vast new sales vistas to service dealers everywhere. Now service dealers will no longer be reluctant to get into Hi-Fi and sound equipment sales because they know that they are no longer to be discriminated against discountwise.

SUPER-PERFORMANCE

...THAT COSTS NO MORE!

MAKE THE SCREEN TEST!

1. Measure the space between reflector elements of any other big screen antenna.
2. Note that the TRI-KING has closer spacing between reflector elements for improved performance. The TRI-KING's element spacing is the proven maximum for a full $1/10$ wave length.

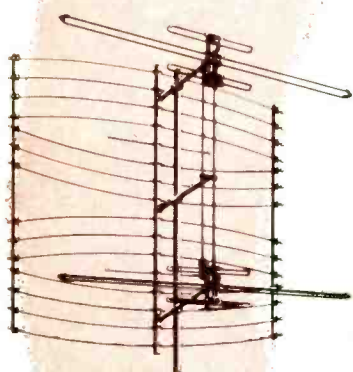

SUPER TRI-KING Model TK1800

WIND TUNNEL TESTED to exacting aircraft standards. Test results prove that a full size TRI-KING antenna can withstand 30% higher wind velocities than any other large screen antenna.

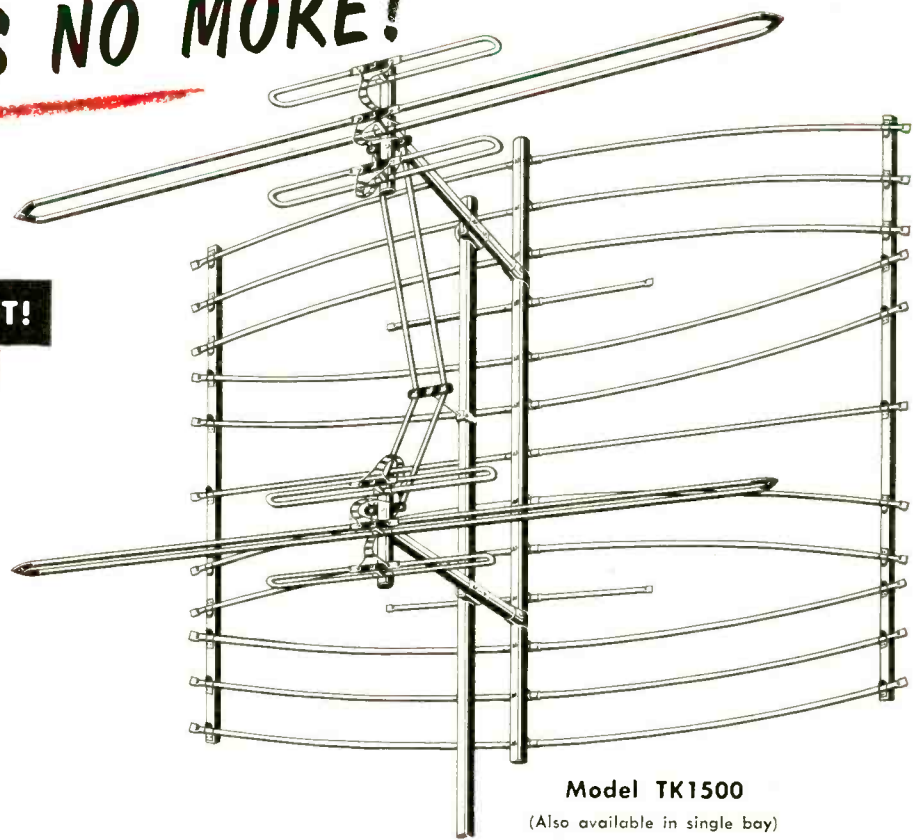

Model TK1500
(Also available in single bay)

CLEAR BEAM'S TRI-KING

Patent Applied For

POSITIVE GHOST REJECTION! Clear Beam proudly announces the new TRI-KING, combining for the first time a Radar-type reflector screen with the improved TRI-KING dipole assembly. A real champion with many Clear Beam features including rugged, quality construction and Quik-Rig assembly that outsells all other big screen antennas. Sold on a money back guarantee.

WRITE FOR COMPLETE INFORMATION TODAY

Clear Beam Antenna Corp.



100 PROSPECT AVENUE • BURBANK, CALIFORNIA
THornwall 2-4886 • VIctoria 9-2141

ORDER NOW - IMMEDIATE DELIVERY!

CLEAR BEAM PRICES	
Model TRI-KING TK1500	List Price \$44.50
Super TK1800	\$52.95

WAREHOUSES IN: San Francisco • Portland • Seattle • Chicago • Kansas City • Detroit • Dallas • Baltimore

Solving

Sweep-Alignment

Problems

PART 2

Regeneration in video amplifiers can be difficult to trace. This article points up a few methods.

by Robert G. Middleton, Field Engineer, Simpson Electric Co., and author of "TV Troubleshooting and Repair Guidebook," Vols. I & II, and co-author (with Alfred A. Ghirardi) of "TV Test Probes," published by John F. Rider.

THE symptoms of regeneration in *if* amplifier circuits are those caused either by:

1. Distortion of the response curve, or,
2. Introduction of spurious beat waves.

It was learned in the preceding article that regeneration causes the response curve to become distorted into various shapes at different values of grid bias. It is for this reason that a regeneration check may be conveniently made by adjusting the value of additional or over-ride bias up and down, to observe whether an appreciable change takes place in the shape of the sweep-response curve. Such changes are usually most apparent at low values of grid bias, where the gain of the amplifier is greater and the feedback more pronounced.

It may readily be appreciated that if the *if* amplifier has a good response curve at high values of over-ride bias, but has a badly distorted response curve at low values, receiver response on weak signals will be impaired. This impairment results from the fact that a weak signal develops less *agc* bias voltage than does a strong signal.

Symptoms which result from regenerative distortion of the response curve are the same as symptoms which result from misalignment of the tuned circuits in a stable receiver. For example, regeneration usually increases the gain at the frequency of maximum feedback, but reduces the gain at frequencies off maximum. The result appears as a response curve having abnormal height, and subnormal bandwidth. In consequence, when the fine-tuning control is adjusted during reception of a TV signal in such a

manner as to place the picture-carrier frequency half way up the side of the response curve, the sound-carrier frequency will fall far out along the base line where the response is practically zero, with the result that the sound signal disappears from the loudspeaker. Conversely, when the fine-tuning control is adjusted so as to place the sound-carrier frequency 5% up the side of the

response curve, the sound signal becomes audible as usual, but the picture-carrier frequency will then fall far out along the base line where the response is practically zero, with the result that the picture disappears from the screen of the picture tube.

This is a situation termed "separation of picture and sound", and although it can be caused by any circuit fault which results in subnormal bandwidth, it is most often caused by regeneration in the *if* amplifier. Regeneration should be strongly suspected when there is separation of picture and sound on weak signals only.

Receivers with response curves of subnormal bandwidth will have poor-quality picture reproduction. Even if the amount of regeneration present is not sufficient to cause separation of sound and picture, it will show up as increasingly poor picture quality on weaker signals. Deterioration of picture quality usually appears as loss of detail, and smearing of some picture elements. When regeneration also places a very sharp peak in the response curve, as is sometimes the case, additional picture deterioration becomes noticeable as "repeats" or electrical echoes; these are circuit ghosts, which result from ringing of the *if* circuits whenever a side-band frequency equal to the sharp peak-frequency response passes through the *if* amplifier.

Regeneration also causes the appearance of *rf* interference in the picture when the regeneration is strong enough to cause a condition where the circuit is on the verge of breaking into oscillation. This situation produces a beating of the borderline oscillation frequency with the picture-carrier frequency, and produces wavy wandering bars and herringbone patterns in the picture which are sometimes confused with outside interference; however, trapping the lead-in is of course futile in such case, and it will be observed that neighboring receivers are not similarly afflicted.

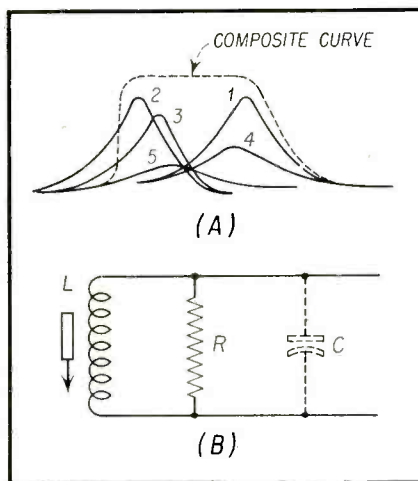

Fig. 1 — A composite *if* response curve is the product of the individual tuned-circuit responses, as indicated. The numbers indicate the consecutive tuned circuits in the *if* amplifier; "1" is the mixer-output coil, "2" is the 1st *if* output coil, etc. (B) Each *if* tuned circuit comprises an inductance *L*, stray circuit capacitance *C*, and a damping resistor *R*; the damping resistor is required to lower the circuit Q and to increase the bandwidth sufficiently that a flat-topped composite curve can be obtained.

When regeneration becomes so strong that the circuit oscillates continuously, it becomes impossible to receive weak signals at all, because the oscillating *if* tube is blocked by the strong oscillations. Weak oscillations sometimes become subject to negative modulation by a TV signal, causing the development of a negative picture on the screen of the picture tube. Strong oscillation causes operation to cease abruptly. Oscillation encountered during sweep-alignment procedures becomes apparent as a sudden collapse of the distorted response curve. Just before collapse, the incipient oscillation appears as strong spurious markers on the response curve. After collapse, the screen of a *dc* scope appears dark due to deflection of the beam off-screen by the rectified voltage at the output of the detector. If an *ac* scope is used in the sweep-alignment procedure, the beam is not deflected off-screen when the *if* amplifier breaks into oscillation. However, the curve collapses and only the base-line trace of the scope appears. A check with a *dc* voltmeter will then show the presence of a steady *dc* voltage at the output of the picture detector, which may range from 5 to 10 volts.

How the Response Curve Becomes Distorted by Regeneration

Figure 1 shows a complete *if* response curve; this curve is termed a "composite" because it is comprised of the product of the individual stage responses. In the example illustrated, four single-stage responses (composed of five tuned-coil responses) combine to develop the flat-topped composite *if* response curve.

The circuit of an *if* tuned coil is shown in Fig. 1A, from which it is seen that the circuit is comprised of an inductance L , shunted by the stray circuit capacitance, C , and a damping resistor. The damping resistor is required in order to lower the Q of the tuned circuit

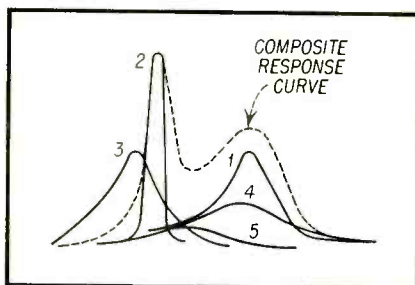

Fig. 2 — When a damping resistor opens up across an *if* coil, the stage gain becomes very great, and the bandwidth becomes seriously reduced, as indicated as "2," above. This situation has a semblance to regenerative distortion, but does not vary with the value of over-ride bias, as does regeneration.

sufficiently so that a flat-topped composite *if* curve can be obtained. In case the damping resistor opens up, the gain of the associated stage becomes very high, the bandwidth becomes very narrow, and the contribution of the faulty stage to the composite response curve is no longer correct. In consequence, the response curve becomes distorted as shown in Fig. 2.

An important point to fix in mind is that when regeneration is present, the effect is the same as that of an open damping resistor. That is, regeneration causes the stage response to become excessive at the expense of bandwidth, so that the composite response becomes distorted; just as if a damping resistor had opened. The essential difference between the two situations is that the regenerative stage operates in a normal manner if the over-ride or *agc* bias is high, but shows characteristics of distortion when the bias falls to a low value. On the other hand, an open damping resistor produces just as much distortion at high bias levels as at low bias levels. It is for this reason that one of the most useful tests for regeneration consists of varying the *agc* over-ride bias from a high level to a low level.

Another very practical conclusion that can be arrived at from this discussion is that when a regenerative amplifier is to be aligned, it is advantageous to apply a very strong sweep signal as well as a high value of over-ride bias. Then, after the stage has been restored to normal operation, the over-ride bias can be reduced to a nominal value of -3 volts. Otherwise, the operator may find the adjustments difficult or impossible to handle.

Why Regenerative Distortion Increases at Low Values Of Grid Bias

The reason that regenerative distortion is increased at low values of grid bias is illustrated in Fig. 3. Such a circuit arrangement will always exhibit symptoms of regeneration when the grid and plate coils L_G and L_P are tuned to nearly the same frequency. Regeneration takes place because there is always some residual interelectrode and stray capacitance, which may be represented as C , as shown in Fig. 3. It should be borne in mind that there is some capacitance between the grid and plate lead wires in the stem of the tube and between the grid and plate terminals of the tube socket. Screen grids are not 100% perfect, so that there is a certain small amount of capacitance present between the grid and plate elements of the tube. Also, there is a small capacitance between the leads from the coils to the grid terminal and to the plate terminal of the tube socket. There may even be a small stray capacitance between the

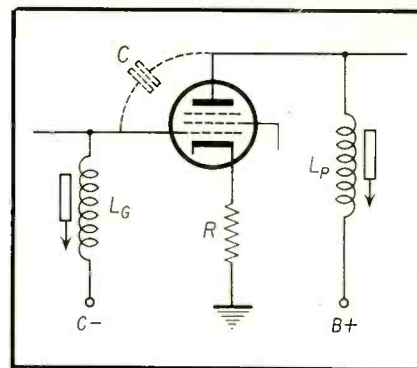

Fig. 3 — There is always a certain residual plate-grid capacitance in a picture *if* stage, as indicated above by C . This capacitance is composed of numerous small capacitances, as explained in the text. Provided the grid and plate circuits are staggered sufficiently far apart in frequency, the regeneration which results from feedback through C will be negligible.

grid coil and the plate coil. Although these capacitances are individually small, it should be apparent that together they can add up to an appreciable value. This total capacitance provides the capacitive coupling from the plate to the grid circuit of the *if* stage.

Under normal circumstances, this capacitance does not lead to trouble. However, consider a situation in which coils L_G and L_P are tuned to the same frequency (Fig. 3), instead of being staggered 2 or 3 *mc* apart. Stagger-tuning the grid and plate circuits of course results in an increase of bandwidth and a corresponding reduction in gain. But peaking the grid and plate circuits to the same frequency results in a decrease of bandwidth and a corresponding increase in gain. Increased gain results in more signal voltage being developed across L_P , the increased signal voltage causing more feedback of signal through the stray capacitance C . This increased feedback results in regeneration, which has the effect of further narrowing the bandwidth of the stage response. The narrowing of bandwidth results in a further increase of gain, since the product of gain times bandwidth is found to be a fixed constant. The practical result of this regenerative process, brought on by peaking grid and plate coils to the same frequency, is a highly distorted composite *if* curve.

Leaving the circuit in its regenerative state, let us now turn our attention to the effect of varying the grid bias $-C$, shown in Fig. 3. Reducing the grid bias has the practical effect of increasing the G_m of the tube, thereby increasing the stage gain. This increase in gain means that we now have a greater signal voltage at the output, or, an increased signal voltage across L_P .

(Continued on page 62)

without equal **FOR PERFORMANCE!**

Telrex 4-BAY
"CONICAL-V-BEAMS"®

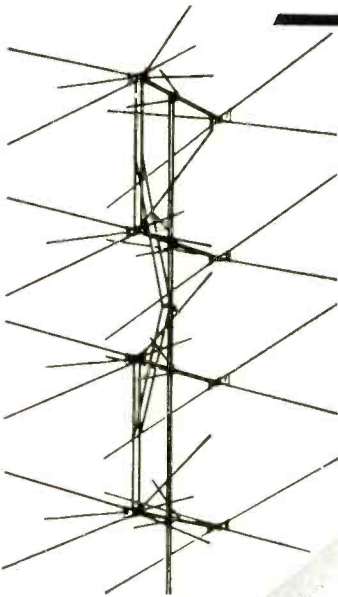

The finest long distance array
ever produced . . . for the ultimate
in fringe area reception

Guaranteed to outperform
any antenna or combination
of cut-to-frequency antenna.

When used with Telrex Duo-Band
splines, the 8X-TV comprises the
finest in reception on channels 2 to
83. This famous Telrex antenna has
proven unequalled for performance
for distances up to 200 miles. When
you check the facts on antenna,
you'll agree that Telrex is
BEST BY EVERY TEST!



Every genuine Telrex antenna
features rugged all-aluminum,
all-weather construction

Over 60 different models for every installation
need, near or far, are included in the new Telrex
catalog. Ask for your copy, today!

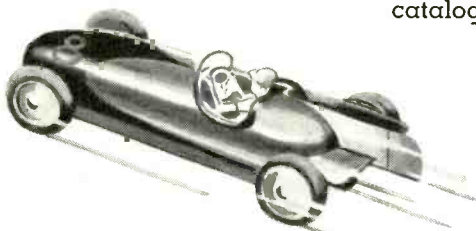

"Conical-V-Beams" are produced under U. S. Pat-
ent No. 23,346, Canadian Patent No. 500,436
and British Patent No. 691,485 — other patents
pending. Sold only through authorized distributors.



AMERICA'S
OUTSTANDING
TELEVISION
BEAM

**ASBURY PARK 5
NEW JERSEY**

MAKERS OF THE FAMOUS "BEAMED POWER" COMMUNICATION ROTARIES

Oscilloscope Y-AXIS Pre-Amplification

by Harry Casey

Chief Engineer, Kirby Products Corp.

TWENTY years ago Servicemen considered the oscilloscope a luxury item to be enjoyed and used only by engineers in research and development laboratories. Today there is an oscilloscope on almost every service bench. This wide acceptance establishes the fact that instruments such as this are service necessities.

Extends CRO Gain

The benefit which a serviceman derives from an investment of this type is determined by his ability to use the equipment and the variety of circumstances under which it may be of use to him. Many thousands of oscilloscopes, satisfactory for general work a few years ago, now represent a non-paying investment on the service bench due to poor sensitivity. These instruments may be modernized by the addition of a companion unit—an oscilloscope pre-amplifier. To illustrate, suppose you have an oscilloscope which has a voltage gain, from input terminals to deflection plates, of 100. An oscilloscope pre-amplifier with an additional gain of 100 coupled to the input terminals of the oscilloscope raises the overall voltage gain of the system, from input terminals of the pre-amplifier to deflection plates, to 10,000.

Similarly, servicemen who have purchased oscilloscopes in kit form may extend the usefulness of this purchase by taking advantage of the abilities of the oscilloscope pre-amplifier. It should not be inferred from this that equipment of this type is useful only to owners of oscilloscopes with inherent low gain.

Many higher priced oscilloscopes which in themselves have fairly high gain still require additional amplification in certain applications where extremely low level signals must be viewed.

In sweep alignment of various tuned amplifier circuits in which the response curve is to be viewed on an oscilloscope, the strength of signal which must be applied to the input of the amplifier in order to present a reasonably sized pat-

ter overdriven amplifier is certainly not capable of normal alignment.

VHF Tuner Applications

In particular, alignment of *vhf* tuners is complicated by the fact that much higher signals than normal must be applied in order to see the response curve on the oscilloscope. These strong signals, applied to a low level unit such as this, produce such a distortion of the response curve that it is difficult to align the circuits involved accurately. Even so-called high gain oscilloscopes fall down in this respect when visual alignment is attempted on present UHF tuners. It is almost mandatory that oscilloscope pre-amplification be used in work of this type.

A unit of this type which is the Kirby Products Corp. Model SA-103 Oscilloscope Pre-Amplifier is illustrated in Fig. 1. Features of this instrument include voltage regulation in the power supply, and hum balancing and low frequency phase correction controls which are conveniently placed for accessibility. The unit features a voltage gain of from zero to 100, controllable from the front panel. At extremely high gain, such as when the pre-amplifier is used in conjunction with an oscilloscope which has a built-in voltage gain of 1000, providing a total gain of 100,000, mechanical vibrations become a factor and shock mounting of tubes is used to overcome this. With voltage gains of this magnitude involved it was necessary to include voltage regulation in the power supply (see Fig. 2) to prevent the waveform viewed on the oscilloscope from bounc-



Fig. 1 — View of Kirby Model SA-103 Oscilloscope Pre-Amplifier Unit.

tern on the oscilloscope is important. If the oscilloscope has low vertical gain, this must be compensated for by increasing the signal input to the amplifier. But if it is necessary to apply a much stronger signal than the amplifier is normally designed to handle, what happens to the response curve? An

WHEN THE



**BONDED
ELECTRONIC TECHNICIAN**

PROGRAM

**REMOVES
THIS
CHIP...**



You're in the chips!



Customer confidence in you and your way of doing business is the greatest single business asset you can have. The *RAYTHEON Bonded ELECTRONIC TECHNICIAN* program, now in its 10th year, has helped and continues to help many thousands of Radio and Television service dealers break down the barrier of public mistrust. And in so doing increases the volume and profit of these Raytheon Bonded Technicians.

Ask your Raytheon Tube Distributor if you can qualify for this priceless sales asset. If you can, the program costs you not one cent, it's Raytheon's investment in *your* future.



RAYTHEON MANUFACTURING COMPANY

Receiving Tube Division
Newton, Mass., Chicago, Ill., Atlanta, Ga., Los Angeles, Cal.

RAYTHEON MAKES ALL THESE:

RECEIVING AND PICTURE TUBES • RELIABLE SUBMINIATURE AND MINIATURE TUBES • SEMICONDUCTOR DIODES AND TRANSISTORS • NUCLEONIC TUBES • MICROWAVE TUBES



Excellence in Electronics

LOOK TO THE LITTLE INDIAN  FOR

THE **BIGGEST** VALUE IN

MOLDED PAPER TUBULAR CAPACITORS

the Sangamo

Telechief®



The Telechief will outlive all other tubulars! Major manufacturers' test and stamp of approval prove that

Telechiefs have longer life. They have a final insulation resistance value 10 to 15 times greater than any other paper tubular—because they're molded in HUMIDITITE!



The Telechief outperforms all other molded paper tubulars in moisture resistance... in high temperature operation... in holding its rated capacity under all conditions.



EXTRA VALUE AT NO EXTRA COST! This amazing new capacitor—that meets specifications so tough that no previously existing paper tubular could approach them—is a *premium* tubular at the price of an ordinary one. See your Sangamo Distributor today!

Those who know  choose Sangamo

SANGAMO ELECTRIC COMPANY

SC 54-11

MARION, ILLINOIS

ing due to slight changes in the output of the power supply.

Low Frequency Response Requirements

The majority of alignment work involves viewing of a 60 cycle sweep signal. In order for the amplifier to pass this sweep pattern without introducing any tilt or malformation into the curve, the pre-amplifier was designed to pass cleanly a 30 cycle square wave.

On the other hand the serviceman is often called upon to look at other pulse,

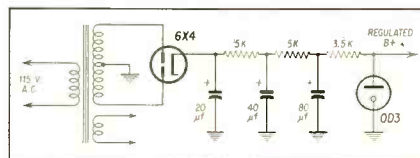

Fig. 2 — Voltage-Regulated power supply used in Kirby Model SA-103.

sawtooth, differentiated or integrated waveforms. Square waves of frequencies up to 15 kc may be passed by the pre-amplifier with negligible deterioration of the leading and trailing edges.

Gain Calibration

One important and useful feature of the instrument is the gain calibration. Each unit is individually calibrated so that the front panel gain control provides an accurate indication of the input to output voltage gain of the unit.

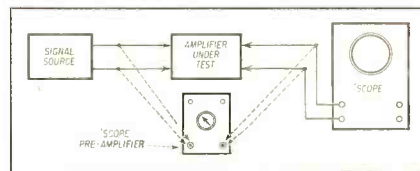

Fig. 3—Set-Up used to test power amplifier with Kirby Model SA-103.

This can be used, for example, to check the gain of a power amplifier stage (see Fig. 3). A signal may be applied to the amplifier under test and the scope connected to the output of the stage. The scope can then be adjusted so that this output produces, for instance, 3 inches of deflection.

The same test signal can now be applied to the oscilloscope pre-amplifier input and the scope connected to its output. The gain control on the pre-amplifier is now adjusted until 3 inches of deflection is produced on the scope and the gain of the unknown amplifier can then be read directly from the dial indication on the pre-amplifier.

Signal Tracing Applications

Many servicemen use diode probe signal tracing with various amplifying units. The oscilloscope pre-amplifier (Continued on page 61)

THE GREATER TRI-PLEX

BY JENSEN

The new TRI-PLEX is the result of further research directed toward the enhancement of all the qualities for which this famed Jensen 3-way system has been noted.

Musicians, record collectors, sound engineers and laymen contributed to the concept and participated in the five years acoustical research and exhaustive psycho-acoustic tests. Even the slightest false coloration effects have been eliminated—there is no raucous tinkle or exaggerated percussion, stridency is missing from the violins. And there is an extreme smoothness of response and a precisely adjusted intrarange balance—the individual instruments stand out in true dimensional separation. The vocalist steps out in front of the musicians. You're bound to agree that here is the listening indeed.

At \$312.70 net the TRI-PLEX in mahogany factory assembled complete with individual certificate of performance—in korina blonde \$316.80 net. Jensen back-loading improved bass cabinets only—Model BL-220 (12-inch speakers) mahogany \$89.50 net, korina blonde \$92.50 net—Model BL-250 (15-inch speakers) Mahogany \$128.00 net, korina blonde \$130.90 net.



Burton Browne Advertising

Jensen

MANUFACTURING COMPANY
DIVISION OF THE MUTLÉ COMPANY

6301 S. LARAMIE AVENUE, CHICAGO 38, ILLINOIS
IN CANADA: COPPER WIRE PRODUCTS, LTD., LICENSEE

Horizontal and High Voltage

By Bob Dargan and Sam Marshall

From a forthcoming book entitled
"Fundamentals of Color Television."

Horizontal Centering, Width and Linearity Circuits

A typical horizontal output deflection circuit is shown in Fig. 9. This schematic shows the control for adjusting the horizontal centering of the picture, as well as the picture width and horizontal linearity. These are important adjustments and are usually completed before any other set-up operations are attempted, such as convergence and purity. This is necessary because going back to these controls will usually disrupt other adjustments which are affected by the preliminary adjustment of horizontal centering, width and linearity.

Horizontal Centering

Modern B & W television receivers in general make use of mechanical cen-

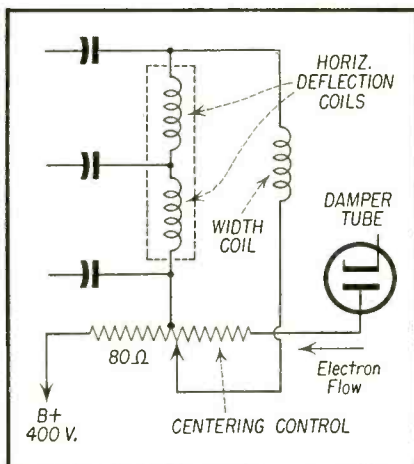

Fig. 10 — The equivalent horizontal deflection circuits. No dc flows through the horizontal deflection coils with the variable arm in this position.

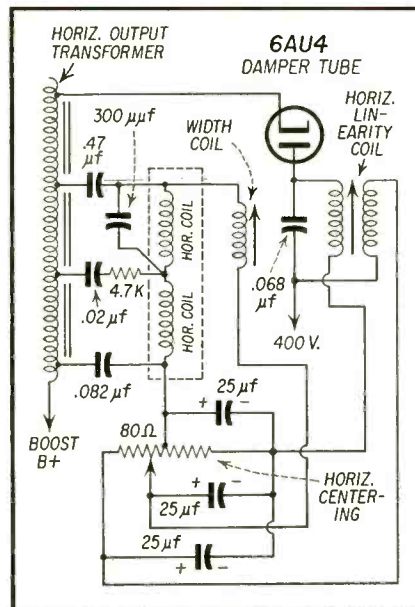

Fig. 9 — Controls in the horizontal output stage of color receiver for adjustment of width, horizontal linearity and horizontal centering.

tering of the picture and the electron beam. This is done by adjusting an external plate which affects the focus magnetic fields and influences the direction of the electron beam. This focus or wobble plate is moved vertically to accomplish a horizontal movement of the picture and vice versa. After completion of the mechanical adjustment it is fastened securely by wing nuts or screws. This type of centering has superseded an earlier system which used potentiometers to vary dc current through the horizontal and vertical deflection coils, thereby establishing an

adjustable magnetic field for positioning the picture both horizontally and vertically.

This same system is now used in color TV receivers because the use of magnetic or mechanical techniques would conflict with the purity adjustments of the yoke.

A schematic using this system is shown in Fig. 9. Fig. 10 shows a simplified version of this circuit involving only the horizontal centering control and associated components. It should be noted that any dc current flowing through the horizontal deflection coils from the tap on the centering control returns to the variable arm of the centering control through the width coil. All other paths are blocked with condensers. The electron flow through the control is from the damper plate to the B plus supply of 400 volts and the deflection coil and width are in parallel with a portion of the centering control.

Fig. 11 shows the variable arm of the

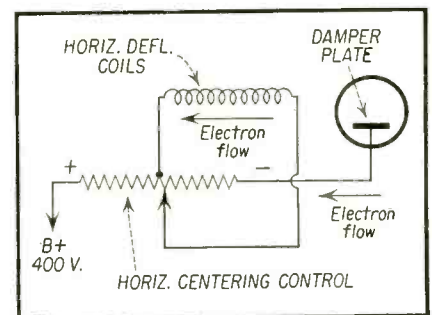
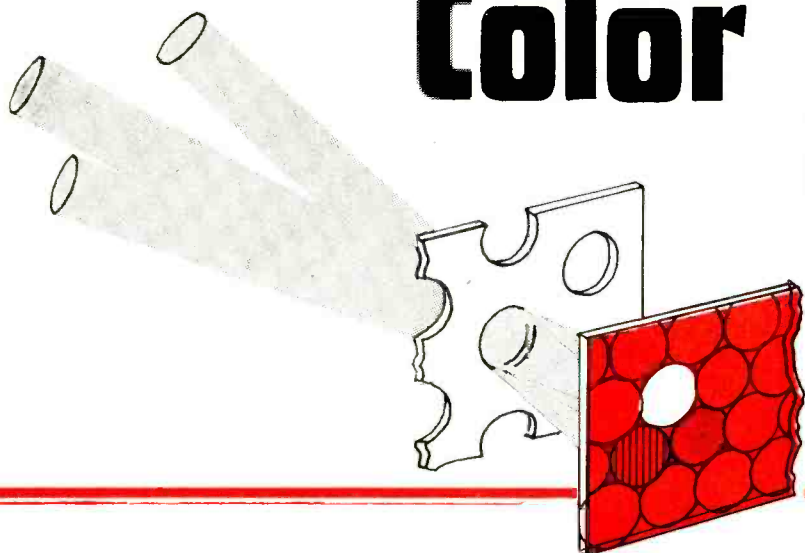

Fig. 11 — No electron flow occurs in horizontal deflection coils since both ends of coil are at the same potential. The width coil has been omitted purposely for simplicity.

Color Circuitry



PART 2

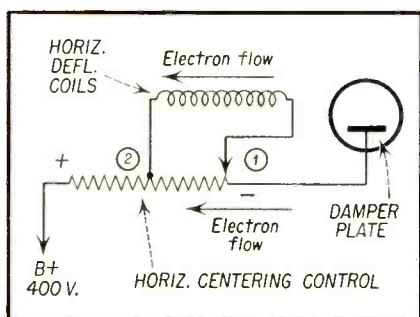

Fig. 12 — The electron flow occurs from terminal 1 on the horizontal deflection coil to terminal 2 when the horizontal centering control is positioned in the manner shown.

potentiometer at the middle point of the control in contact with the center tap. When the adjustable arm is positioned at this point there is no *dc* difference of potential between the ends of the horizontal deflection coils and therefore no electron flow takes place.

However, if, as in Fig. 12, the control arm is moved to some position on the right of the center tap, where one side of the yoke is connected, electrons will flow in the direction shown through the horizontal deflection coils. This *dc* current will establish a magnetic field that will cause the electron beam or picture to be moved horizontally from its original position.

When the control setting is as shown in Fig. 13 the *dc* current flow will be in the opposite direction, thereby causing the electron beam to be moved in a direction opposite to the one corresponding to Fig. 12.

Thus, the beam or picture can be positioned toward either side of the cen-

ter by varying the centering control. The centering adjustment of the picture vertically is achieved in a similar manner and will be dealt with under the discussion of vertical circuits.

Width Control Circuits

From an examination of Fig. 14 it can be noted that the width coil is connected in parallel with the horizontal deflection coils. Therefore, the deflection currents applied to these coils divides up, one portion flowing through the width coil and the balance flowing through the deflection coils. The amplitude of the currents in each of these two branches is inversely proportional to the inductive reactances in the branches.

When the iron core of the width coil is moved away from the center of the width coil the inductive reactance of the coil is reduced. This reduction permits more of the available deflection current to flow through the width coil

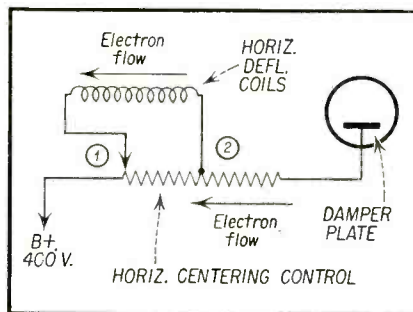

Fig. 13 — The direction of electron flow in the horizontal deflection coils is from terminal 2 to terminal 1 when the centering control is positioned in the manner shown.

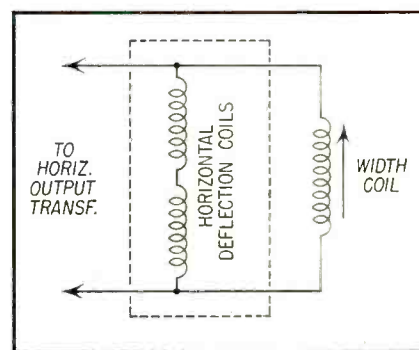

Fig. 14 — The width coil is effectively connected in parallel with the horizontal deflection coils, and the total inductance of the two parallel components is thus made adjustable.

with a resultant decrease of current through the deflection coils. The available current that divides up between the coils is supplied by a system that may be considered a constant current source. The decrease in deflection current through the deflection coils with its corresponding decrease in magnetic energy causes less horizontal deflection of the beam and a narrower picture results.

It can also be seen that increasing the picture width may be accomplished by positioning the core in the width coil more towards the center so that the inductance is increased, thereby causing the width coil to absorb less current. In adjusting the width of color receivers it is customary to set it for at least a 1/4 inch of picture overscan.

The width coil inductance in a typical color receiver varies between 20 to 70 millihenry between the positions of

"FUSES?"



There's BUSS — the one Source for all FUSES."

For your exact fuse needs, there's a BUSS fuse. A complete line of fuses for the Electronic Industries — in sizes from 1/500 amperes up . . . plus a companion line of fuse clips, blocks and holders.

Besides meeting your specifications, BUSS fuses are known for their ability to give accurate and dependable electrical protection under all service conditions.

To make sure that a BUSS fuse will never let you down — every BUSS fuse normally used by the Electronic Industries is tested in a sensitive electronic device that rejects any fuse that

is not correctly calibrated, properly constructed and right in all physical dimensions.

That's why manufacturers and service organizations throughout the nation rely on BUSS as the one source for fuses of unquestioned high quality.

And in sales and service, furnish the fuse your customer knows. The BUSS trademark has been firmly established by the millions and millions of installations in home, farm, and industry. Sales are easier and there won't be customer "kicks" caused by faulty fuses. It's just good business to handle only *genuine* BUSS fuses.

Makers of a complete line of fuses for home, farm, commercial, electronic and industrial use.



For more information
mail this Coupon ▶

BUSSMANN Mfg. Co. (Division of McGraw Electric Co.) SD-654
University at Jefferson, St. Louis 7, Mo.

Please send me bulletin SFB containing facts on BUSS small dimension fuses and fuse holders.

Name _____

Title _____

Company _____

Address _____

City & Zone _____ State _____ 654

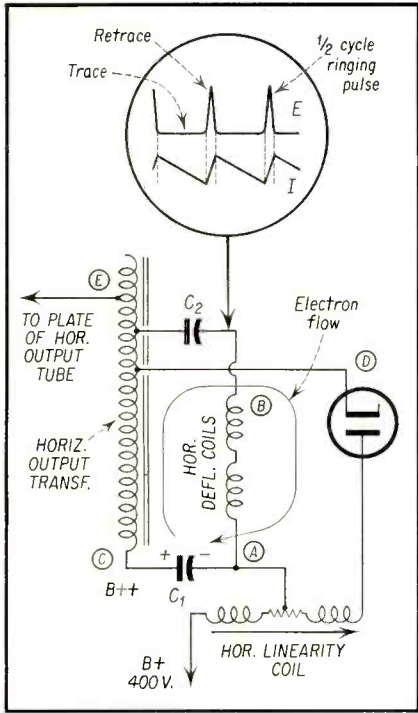

Fig. 16 — Current and voltage waveforms in a deflection system. The condenser, C_1 , has electrons removed from the side marked (+), thereby making this side of the condenser positive, which becomes $B++$.

the core fully out and the core in the center of the coil.

The Damper Circuit

The damper circuit used in color TV is much the same as that used in B & W receivers except that it must handle higher voltages and be able to withstand greater peak inverse voltages. As an example, the damper tube and socket are subjected to a spike pulse of 3,500

volts from the horizontal output transformer as compared to about 2,000 volts in a B & W receiver. In Fig. 15 it will be noted that a tap on the horizontal auto-transformer connects to the cathode of the damper tube. Also, the plate of the damper tube is connected to $B-400\text{ V}$ through the horizontal linearity and centering circuits.

A simplified version of Fig. 15 for the purpose of studying the damping action is shown in Fig. 16. The damper circuit primarily rectifies and smoothes out the undesired transient voltages that are set up in the deflection system immediately following retrace time. In review, this action is as follows. When the signal at the grid of the horizontal output tube goes sharply negative as shown between t_2 and t_3 in Fig. 17 (A) the corresponding plate current drops sharply as shown in (B). Notice that the plate current of the tube is cut off and remains that way during the retrace period. This sharp drop in plate current induces a high positive pulse of several thousand volts at the plate of the output tube as shown between t_2 and t_3 in (C). The amplitude and phase of this pulse is shown with reference to the 600 volt dc potential applied to the plate.

The cessation of plate current produces a corresponding collapse of current in the horizontal yoke. In a purely resistive circuit this current would reach zero and remain at zero. However, the entire horizontal circuit comprising the H.O.T. primary, the yoke, the various inductances and the associated fixed and distributed capacitances, form a resonant circuit which is shock-excited into oscillation by the collapse of the magnetic fields in the yoke and horizontal transformer. For this reason the plate

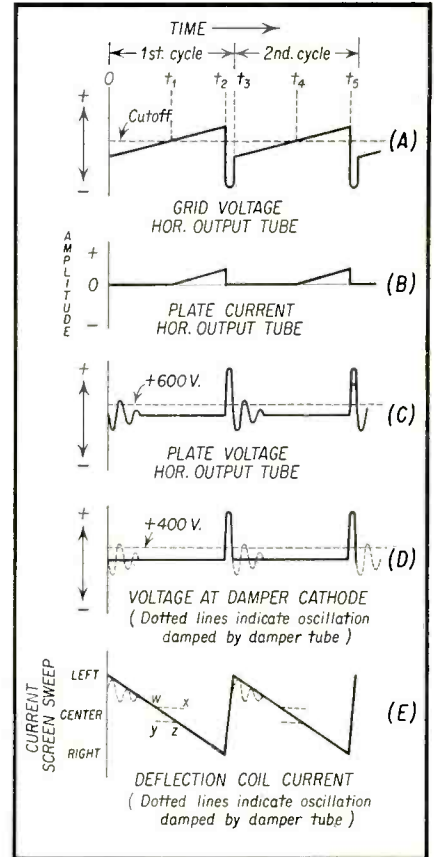

Fig. 17 — Waveforms for cycle of events taking place at various points in the horizontal output circuit of a typical color receiver. Notice saw-tooth current waveform in deflection coils shown in (E) of diagram.

voltage pulse, referred to in the previous paragraph, is oscillatory in nature as shown by wavy lines following the initial high voltage spike in (C).

The first portion of this oscillation cycle causes the current in the yoke to reverse itself. Thus, the electron beam in the picture tube is brought back to the left side of the face as shown at (E). Inasmuch as the entire system is made to resonate at 72 kc, which corresponds to a time interval of about 14 μsec per cycle, and since the retrace action takes place in less than $\frac{1}{2}$ cycle (interval between t_2 and t_3) or less than 7 useconds, the action is fast enough to take care of the minimum retrace time requirement which is 7 μsec .

Reference to Fig. 16 will indicate that the yoke is connected effectively across a portion of the horizontal output transformer through C_2 . Similarly the damper tube is effectively in parallel with both components.

The waveform at tap E on the output transformer is shown in Fig. 17 (C). Since the damper tube is across the same transformer, on a somewhat lower tap, its waveform will be similar and is shown as (D) in Fig. 17. The relative

[Continued on page 20]

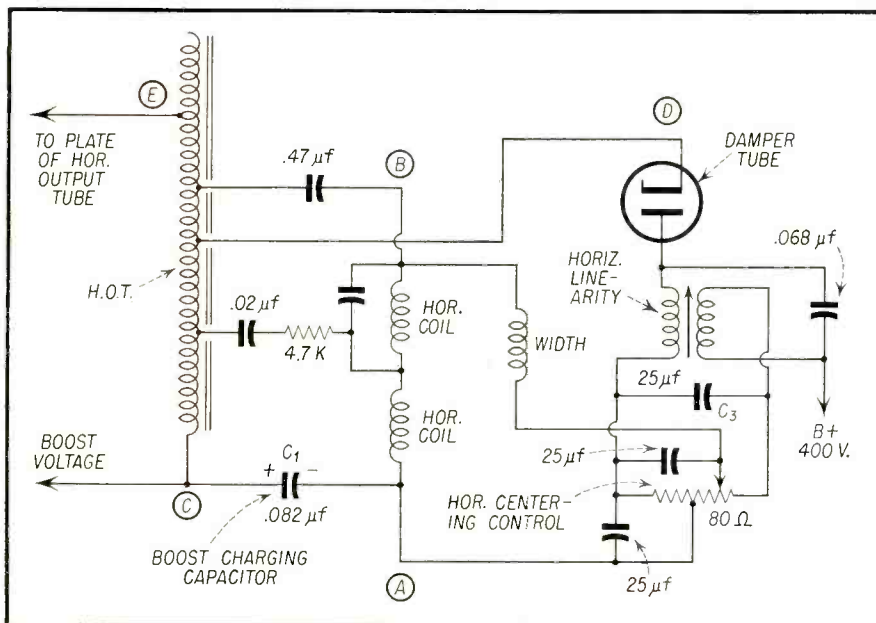

Fig. 15 — Partial schematic of a damper circuit in a typical color receiver.

2-Year Subscription only \$100



NOW AVAILABLE TO . . .

1. Servicemen who are employed by Service Organizations.
2. Servicemen employed by radio/TV Dealers.
3. Independent servicemen who do not have business establishments.
4. Employees of Distributors.
5. Students enrolled in accredited Radio/TV Schools, Colleges, etc.
6. Hobbyists and Experimenters.

A TYPICAL ISSUE COVERS

- Video Speed Servicing Systems
- Rider's "TV Field Service Manual" data sheets
- Latest TV Installation and Maintenance Techniques for VHF and UHF
- Auto Radio Installation and Service
- Advanced Data on New Circuitry
- Production Changes and field service data on receivers
- New Tubes
- New Test Equipment, operation and application
- Hi-Fi Installation and service
- New developments, such as transistors, color, UHF, etc.
- News of the trade
- Service Short Cuts & Shop Notes
- Explanation of difficult circuits

**and many more
EXCLUSIVE . . .
ORIGINAL . . .
AUTHORITATIVE . . .
TIMELY . . .
FULLY ILLUSTRATED
subjects that
can ONLY
BE READ IN
"SERVICE DEALER"**

RADIO-TV SERVICE DEALER

67 W. 44 St., New York 36, N.Y.

NEW RENEWAL

Gentlemen: Here is \$1.00 for which enter my 2-year subscription. (This rate applies in USA only. Elsewhere add \$1 per year)

Name

Address

City Zone State

Employed by (Name of firm).....

Firm's business address.....

City Zone State

Your Position or Title.....

Check whether firm is: Service Organization or Dealer having Service Dept.

If some other type of company describe:.....

IF STUDENT, Name of School.....

Performance! Profits! Packages!

GET THE BEST IN ALL 3 WITH THE NEW

Federal S-C-S DIODES



GERMANIUM

Highest quality diodes for every replacement need...packed for economy buying...in the service industry's MOST USEFUL PACKAGE LINE!

Servicemen! Federal's "S-C-S" Germanium Diode Packaging Program is the hottest news in diode purchasing!

You get top performance and attractive profits in handy packages you can use for many practical purposes.

You can buy single units in cellophane-wrapped packages . . . you can buy 5-unit and 10-unit packages in the form of clear plastic cases with hinges and snap-lock. You can buy boxes of 50 single-unit packages . . . at a substantial saving!

Look for "S-C-S" Diodes in Federal's Store Dispensers!

When you're shopping at your Federal Distributor — look for these two types of dispensers: (A) counter dispenser with single-, five- and ten-unit packages; (B) wall dispenser with single-unit packages. Serve yourself . . . save time! Watch for them in stores . . . in golden yellow and brilliant red!

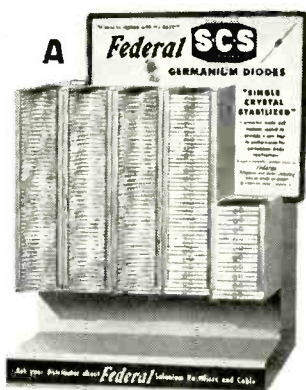

10-UNIT PACKAGE
—economy-size clear plastic hinged utility case.

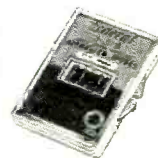

5-UNIT PACKAGE
—clear plastic hinged utility case.

SINGLE-UNIT PACKAGE
—cellophane-wrapped.



50-UNIT PACKAGE
—large-economy-size, combination dispenser-container . . . a real money-saver!



CHECK the quality and performance features of Federal's new design achievement in diodes! You'll agree that Federal is your best bet for profitable, customer-satisfying diode servicing!

Federal Telephone and Radio Company

A Division of
INTERNATIONAL TELEPHONE AND TELEGRAPH CORPORATION
COMPONENTS DIVISION, 100 KINGSLAND ROAD, CLIFTON, N. J.
In Canada:
Federal Electric Manufacturing Company, Ltd., Montreal, P.Q.
Export Distributors:
International Standard Electric Corp., 67 Broad St., N. Y.

Federal "S-C-S" Diodes ARE TOPS!

SINGLE-CRYSTAL GERMANIUM—the best for reliable performance
MOISTURE-PROOF—vacuum-sealed, all-ceramic construction
EVERY DIODE TESTED for all characteristics
COMPLETELY INSULATED CASE
POLARITY clearly identified
HEAT SINKS protect during soldering
SMALL SIZE ($-\frac{1}{4}$ " diameter, $\frac{1}{2}$ " long)
FLEXIBLE LEADS for easy mounting
NO FILAMENT—no heater power drain or hum
LOW SHUNT CAPACITY (average 1 rmf.)
SELF-HEALING for temporary overloads
NO CONTACT POTENTIAL
WITHSTAND adverse temperature and humidity cycling
INSURE many thousands of hours of dependable performance

PACKAGES YOU CAN USE!

Be sure to save Federal's 5-unit and 10-unit packages of clear plastic. They're hinged . . . they snap-lock . . . they open easily. Excellent for storing small parts . . . carrying in pocket or kit or filing in shop cabinets. They're a plus value you get with Federal quality-controlled "S-C-S" Diodes!

Ask your Federal Distributor or write to Dept. R-385

ATR

INTRODUCES

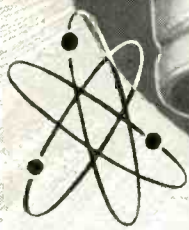
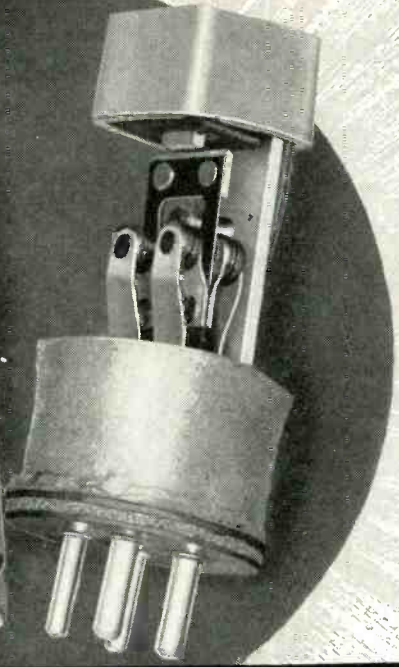
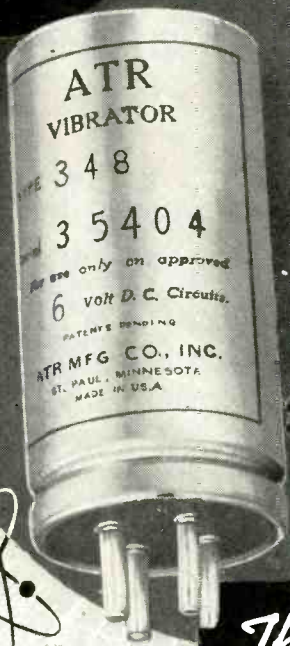

The World's Finest Communication VIBRATORS

featuring:

- CERAMIC STACK SPACERS
- 1/4" DIAMETER POWER CONTACTS
- DRIVER-TYPE COIL CONSTRUCTION
- SPECIAL REED HINGE and WIRING
- POWER CAPABILITY UP TO 15 AMPERES

A COMPLETE LINE OF REPLACEMENT

ATR VIBRATORS

FOR AUTOMOTIVE, HOUSEHOLD and TWO-WAY COMMUNICATION SETS

ATR VIBRATORS are proven units of the highest quality, engineered to perfection. They are backed by more than 23 years of vibrator design and research, development and manufacturing.
ATR pioneered in the vibrator field.



FREE - Just off the Press!
1954 ATR VIBRATOR
MASTER MANUAL

See your jobber or write factory today
for complete information

ATR

AMERICAN TELEVISION & RADIO Co.
Quality Products Since 1931
SAINT PAUL 1, MINNESOTA - U. S. A.



COLOR

[from page 17]

amplitudes of this waveform are shown with reference to a 400V reference line, this being the B+ voltage connected to the plate of the damper. A similar waveform for the horizontal coils is shown in Fig. 16.

At time t_2 , in Fig. 17, the cathode of the damper, which is connected to the output transformer, goes positive by several thousand volts on the upward swing of the initial oscillation. These oscillations would continue were it not for the fact that as soon as the cathode reaches a potential of less than +400 volts on the negative swing of the oscillation, the damper tube conducts. Thus, the oscillations are rapidly damped out. The dashed line following the solid spike return waveform in (D) indicates the transient oscillations damped out by the damper tube action.

It will be observed in Fig. 16 that C1 is connected effectively through the H.O.T. to the cathode of the damper. Due to the rectifying action by the damper tube of the transient oscillations a dc voltage is built up across this condenser. Simple electron flow analysis indicates that the cathode side of the condenser takes on a positive charge. Thus, between point C and ground we have in effect two sources of dc in series, the 400 volt "B" supply and the voltage across C1. The total voltage at point C may be in the vicinity of 600 volts and is referred to as the B++ point or boost voltage to distinguish it from the normal B+ point. The B++ point is a key test point in most TV receivers and may be used as a quick check on the operation of the horizontal output system.

Reference to Fig. 17 (D) indicates that during the trace period the voltage remains substantially constant. Constant voltage in an inductive circuit produces a sawtooth current waveform as shown in (E).

Observe, in Fig. 17, that during the first half of each sweep cycle, corresponding to the intervals t_2-t_3 and t_4-t_5 , the output tube is cut off. During these intervals the sweep energy is supplied by the decay of energy in the horizontal output resonant circuit. Up to point w in waveform (E) this decay is linear, after which it tapers off non-linearly to x. However, just at about this time the horizontal output tube starts conducting again. In the time interval corresponding to y-z its conduction is non-linear as shown. However, if the circuit constants are properly proportioned, the combined effects of

[Continued on page 63]

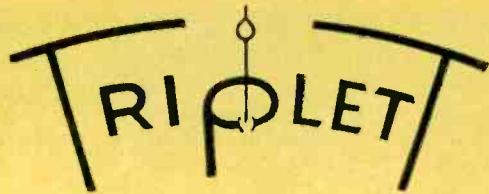

exclusive much longer scale PL (clear plastic) panel meters

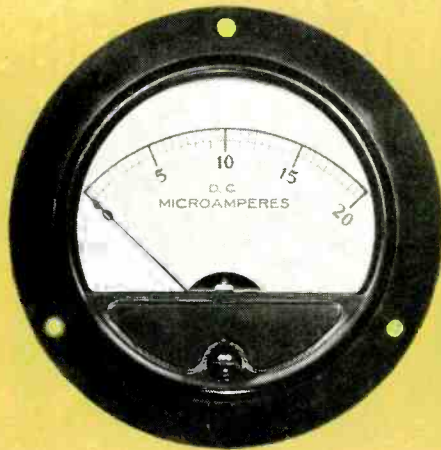
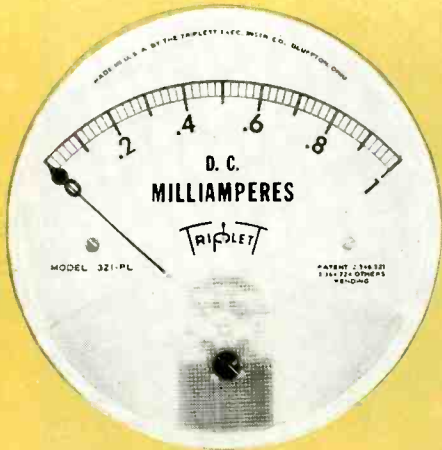

visibility unlimited

Entire dial face encased in transparent non-breakable plastic. Entire dial is exposed to viewing.

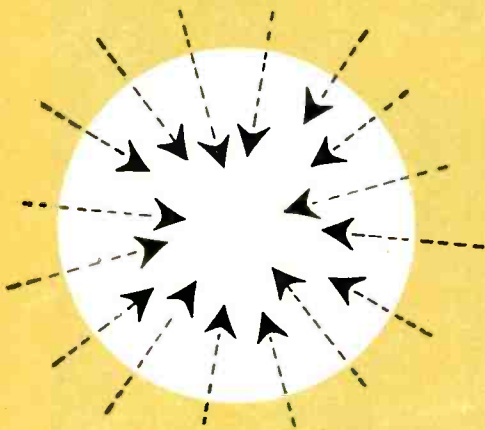

light unobstructed

Full natural lighting from top, sides and bottom. No bezel or case rim interrupts the light from any angle.



readability extended

Full open face on round meters allows much longer scale than conventional types for quicker easier readings from much greater distances.

interchangeability—universal

Longer scale length, yet the mounting makes it readily interchangeable with all conventional round meters of the same size. The panel space occupied is exactly the same.

appearance revolutionized

These handsome modern streamlined Triplet PL Panel Meters with clear plastic fronts will make an amazing improvement in the appearance of your equipment panels in addition to contributing greatly to reading accuracy. An additional advantage is the unbreakable crystal.

Write for full information on Triplet PL Panel Meters. Available for immediate delivery in 2" and 3" round types and 4" square types. 2" and 3" square types will be available soon.

Burton Browne Advertising



TRIPLETT ELECTRICAL INSTRUMENT COMPANY BLUFFTON, OHIO

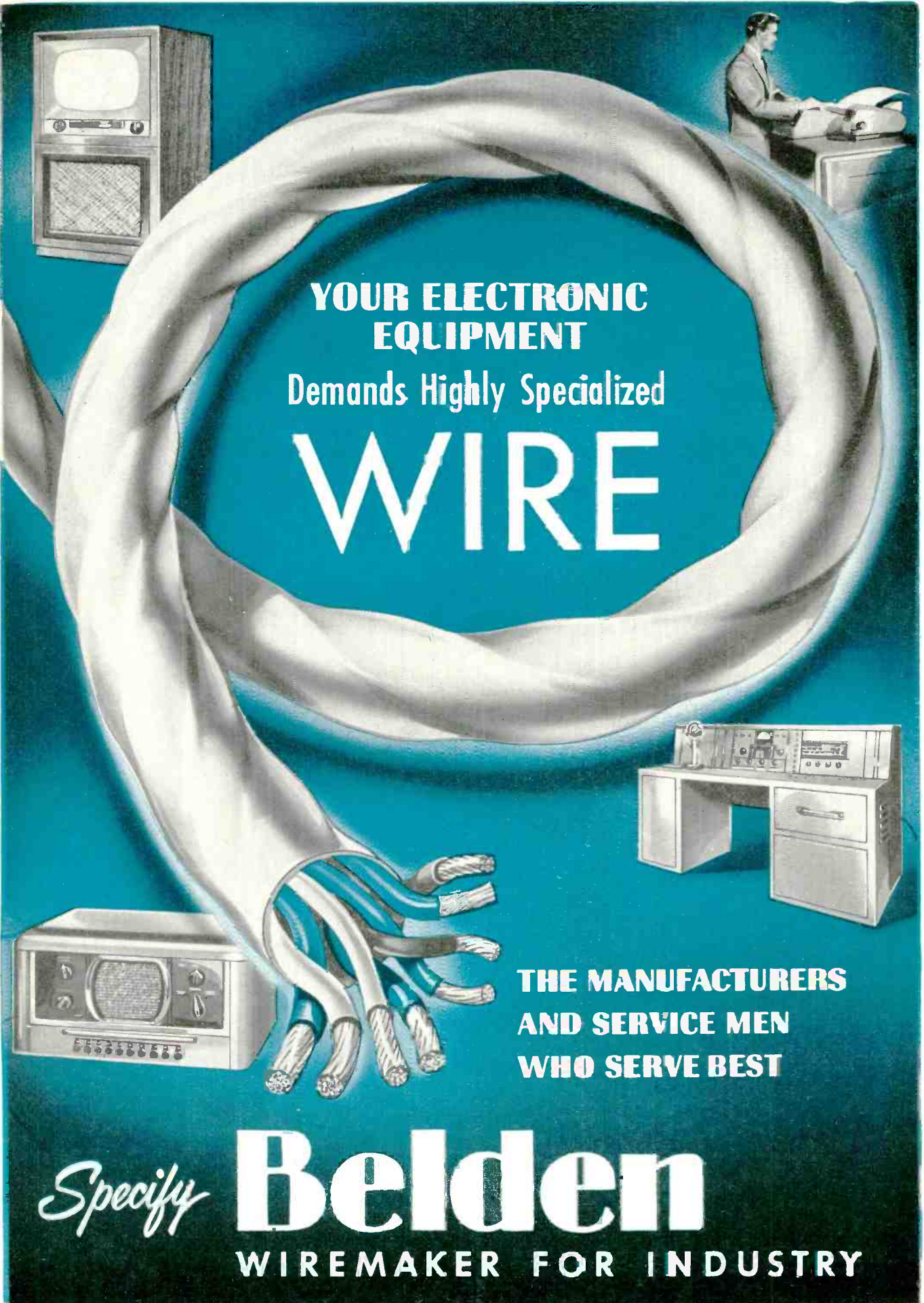

**YOUR ELECTRONIC
EQUIPMENT**
Demands Highly Specialized
WIRE

**THE MANUFACTURERS
AND SERVICE MEN
WHO SERVE BEST**

Specify **Belden**
WIREMAKER FOR INDUSTRY

AUTO inverters

by **SAN D'ARCY**

The Author draws his sights upon the fertile Inverter market, and on a promising unit which virtually drips with installation profit.

FOR the benefit of all service dealers, regardless of where situated, we are presenting a merchandising idea that has already proven sound. The "secret"—and frankly we don't want it to remain a secret any longer—is to convert as many automobiles as possible with an electrical power conversion unit which will enable the car owner to operate in his car, even while driving, such commonplace electrical devices as tape recorders, dictating machines, electric razors, small radios, public address systems, etc. In fact, the conversion unit we have in mind can easily, and profitably, be installed in many other mobile conveyances such as small boats and private planes. Such units can also be sold to operators of commercial mobile units such as passenger planes, busses, etc.

There are several types of inverters on the market. One such unit, the



Fig. 2 — The ATR 12-RSE tape recorder inverter, designed to operate anything from recorders to mixmasters on automotive dc. The unit may be purchased with mounting hardware, extension cables and/or a remote control system.



Fig. 1 — A bracket-mounted 12-RSE drives Mr. Latimer's tape recorder.

ATR Model 12-RSE, recently got worldwide publicity when it was written up in a "slick" magazine by its user, R. A. Latimer, a well-known professional writer who makes a practice of dictating his stories into a tape recorder while travelling from one assignment to another. In Fig. 1, Mr. Latimer is shown seated in his car, with his complete rig, consisting of a Pentron multi-speed tape recorder, a mike, and the ATR inverter. Fig. 2 is a closeup view of the inverter itself.

Let's be downright commercial and point out how much profit (and labor) is involved in such a mobile installation by the service dealer who handled it. The service fee for labor was \$15.00. Less than 40 minutes of installation time was required by the technician, who admitted that he was slowed down because it was his first attempt at that kind of job, so the gross profit ran close to \$10.00. The inverter itself sold for \$69.95, on which the service dealer's gross was nearly \$25.00. So, in less than an hour the deal rang up approximately \$35.00 profit. Not bad! 2 or 3 such jobs each week make nice going.

The ATR Model 12-RSE Inverter is shown schematically in Fig. 3, is a heavy, compact unit which mounts under the dash. Supply cords from the inverter to the battery pass through a half-inch hole in the firewall of the car. One cord is grounded to the engine block, and the other permanently attached to the battery terminal by means of a clamp pin and a hole drilled through the lead battery post. A switch on the inverter itself provides 110-volt current for operating the recorder, while a four-position knob varies the output as required, for dictating when the engine is off, or when in transit.

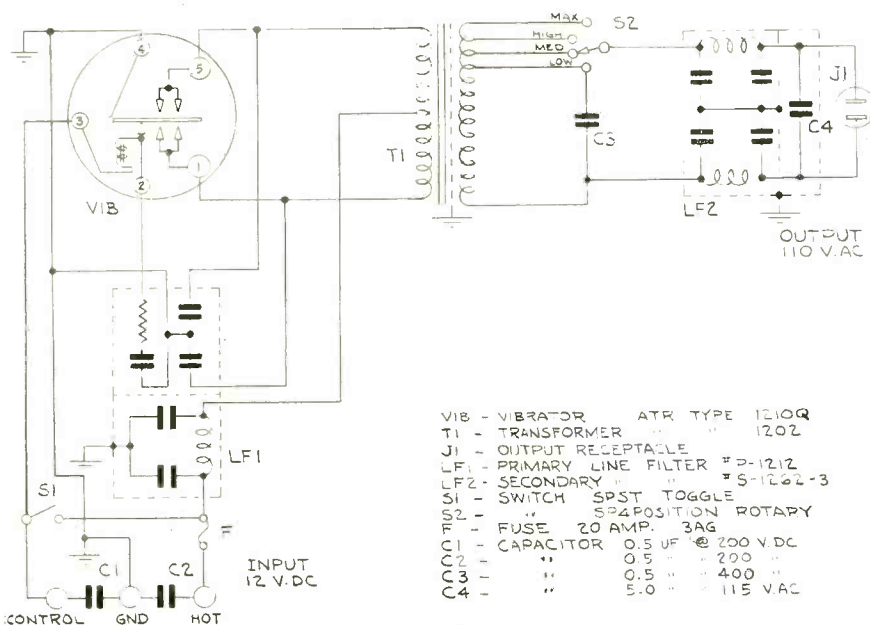
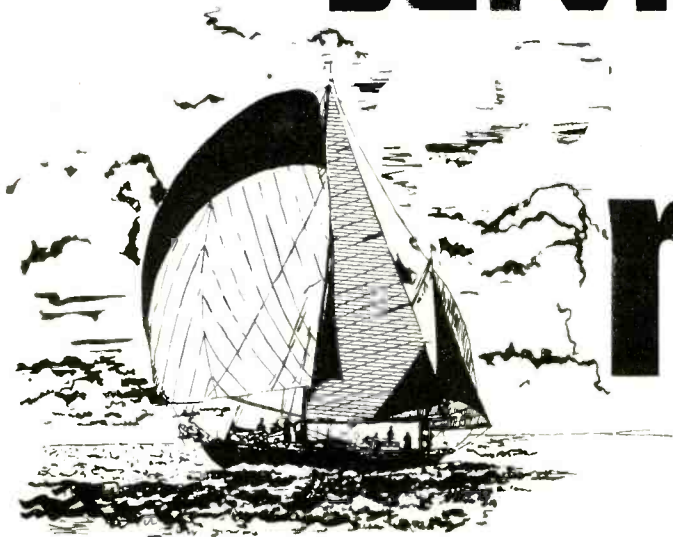

Fig. 3—Schematic and parts list for the ATR 12-RSE inverter.

Servicing



MARINE

by MARVIN KLEIN

HOW many of you get annoyed every time that you think of the "Good Old Summer Time"? You know—the time of the year when your customer is having a wonderful time at the beach instead of staying home and fretting because you haven't had time to get over to his house and fix his defective television set five minutes after it broke down. Of course, you did sell him those batteries for his portable, but it would take more batteries than you could sell in a month of Sundays to make up for that big unprofitable hole in your service department.

Well, if you live near the ocean, a river, or near one of the Great Lakes, and if you or one of your employees has the proper type of F.C.C. license, such as a second class phone or telegraph ticket, you can stop worrying about the so-called slack season. The installation, maintenance, and service of marine radio and navigational equipment can become a very profitable branch of radio repair. Furthermore, cruising around to test out this equipment is a very pleasant way to spend a hot summer afternoon.

It is the intention of these articles to acquaint the reader with whatever information is necessary to get him started in this extremely lucrative field. Because of the necessarily specialized nature of marine equipment and the large amount of information that should be imparted, it has been thought advisable to split the material into two sections. Thus, installment I will concern itself with a general description of the equipment, the uses of such equipment and the types of vessels and installations normally encountered. In addition, there will be a discussion

of the frequencies involved, the costs of such equipment, since some service organizations may wish to secure various sales franchises, and a description of the various necessary accessory equipment such as antennas, power supplies and the like.

Nature of Marine Electronic Equipment

In almost every case the communication equipment installed on small and medium size boats consists of a separate low power transmitter, and a separate communication receiver all enclosed

in a single cabinet. These units are carried today by almost all such craft as private yachts, commercial fishing boats, police boats, and tugs or pilot boats. Unlike combination units used in some ham and military mobile equipment, however, this equipment almost always consists of separate transmitters and receivers. Such an arrangement usually permits of much greater flexibility and usually results in more efficient and reliable operation.

The more common uses of a boat's radio-communication equipment can be tabulated as follows:

(1) The calling for aid when a vessel is in distress. Inasmuch as sudden squalls are much more dangerous to small craft than to the large ocean liners or Great Lake freighters, good reliable sending and receiving equipment is of vital importance to the prompt summoning of aid. A great many sales of this equipment have been made solely by stressing its usefulness in such emergencies.

(2) The use of the radio equipment to obtain needed navigational information, such as the weather reports supplied by the various coast guard facilities. These might include the usual advance warnings of an impending storm. In addition, there is a great deal of important commercial information such as the location of good fishing grounds.

(3) General ship-to-shore telephone. A great many persons carry on their business while on a cruise by direct communication with their office through a special tie-in service to the Bell system. In addition, police boats, fire boats and tugs are constantly communicating with shore installations for guidance and information.

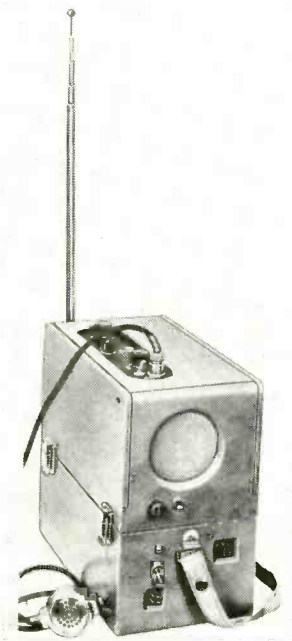

The Sonafone transmitter, which operates from 2 to 3 mc and on the 2812 kc distress frequency.

RADIO

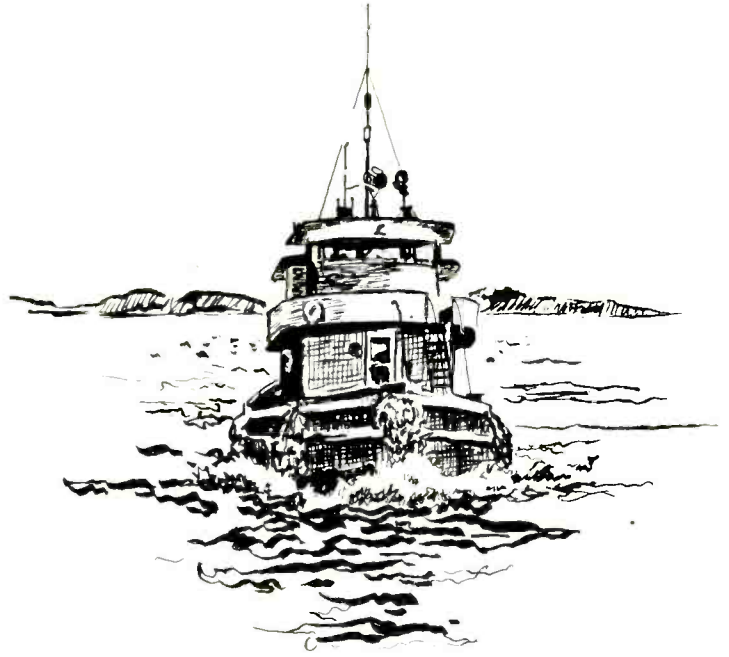

PART I

Frequency Assignments

As compared to the equipment used in large liners or freighters, the radio gear used on small boats is rather simple. In the first place, transmission and reception are mainly on fixed frequencies, which are crystal-controlled. These frequencies, usually falling between 2 and 3 *mc* are assigned by the Federal Communication Commission according to the section or region involved. A typical group of assignments are those used in the New York City Harbor area:

- (1) Ship-to Shore 2.198 *mc*
- (2) U. S. Coast Guard 2.670 *mc*
and Emergency
- (3) Ship-to-Ship. This service is normally very crowded and is therefore allotted two frequencies, 2.638 *mc* and 2.738 *mc*.

There are other differences between this equipment and that used on the large ships. Transmitters carried by large vessels are high-powered units employing either phone-modulated or keyed, unmodulated CW and requiring the attendance of trained personnel licensed by the F.C.C. On the other hand, equipment used on small craft is relatively simple. It employs transmission of the straight-forward voice-modulated type, and it requires no special training or license for its operation. Of course, there are certain precautions such as warm-up time of the transmitter itself etc., but anyone may be easily taught proper handling of the gear in a few minutes.

Because of the strict frequency assignments involved, any marine-radio installation must have a station call and be assigned a F.C.C. license. Furthermore, each equipment must have an

F.C.C. type approval to make sure that the equipment will operate only on the assigned frequencies without generating spurious signals which might interfere with other services.

Circuitry

This necessity for type approval has some merit from the serviceman's viewpoint. The technician servicing ordinary broadcast radios or television sets is very often confronted with some queer looking circuitry, especially in the case of some of the off-brand sets or "custom" installations. Since, there are no schematics available for many of these sets, the serviceman really has to "sweat it out" at times. On the other hand, the type of circuitry used in the F.C.C.-approved, commercial units used on small boats is standard. The number of different manufacturers is fairly

small, and the power output of the various transmitters usually vary between 5 watts in the case of the smallest units to 100 watts for what are probably the elaborate equipments used in the larger commercial fishing boats. As a matter of fact, the equipment sold by the manufacturers listed below comprise probably the bulk of the sets available at present:

All-Tronics-Telecolor
Ray-Jefferson
Hudson-American
Hallicrafters
RCA
Raytheon
Sonar Radio Corp.
Fisher Research

As is usually the case with transmitting equipment, the price is related to the output power radiated. A 5 watt unit might cost approximately \$300.00 plus installation and antenna, whereas a representative price for a 25 watt unit would be \$500.00 plus installation and antenna. Of course, prices will vary with the manufacturer.

In the matter of power supplies, marine radio gear resemble most other mobile units, in that they are usually derived from *dc* storage battery, charged by a *dc* generator. There is some difference, however. Whereas the average car radio, for instance, might be supplied from a 6 or 12 volt source, the marine units, especially some of the older ones, might be actuated by a 6, 12, 24, or 32 volt source. It is true that many of the newer units seem to be standardizing on 12 volts, but there are enough of the other installations in operation to make it imperative that the serviceman have all the various supply voltages available.

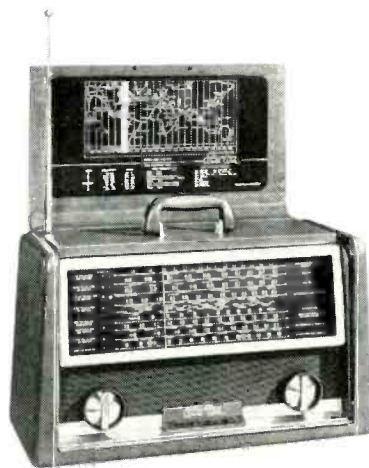

The Hallicrafters TW 2000 portable, with three antennas which cover the LW, broadcast and short wave bands.

Antennas

With regard to a further similarity between this equipment and other mobile rigs, the average serviceman has had some experience with the automobile radio antenna, a somewhat crude version of the vertical end-fed whip or "Marconi" antenna used in marine installations. However, where the former is a mechanically weak, and relatively electrically inefficient unit which is designed for an inexpensive, permanent installation, the latter is a very expensive unit, combining several features, both mechanical and electrical.

Location of Equipment

In concluding the description of the

communication equipment itself, mention should be made of the location of such equipment on the vessel. In the case of small craft, it is usually located in the cabin, whereas it is located in the pilot room of commercial vessels. The antenna itself is located externally to the control room in such a manner as to allow of easy swivelling to a horizontal position. Fig. 3 is a photograph of a section of the Corsair III, a commercial ocean fishing vessel, moored to its dock at Freeport, New York. It will be noticed that its very high, center-loaded antenna is mounted alongside of the pilot house.

As was mentioned earlier in this article, the maintenance and installation of navigational equipment is another

potential source of income to the strategically located service organization. This equipment is extremely expensive, in the main, and will usually be found only on the commercial vessels such as the fishing boats, tugs, salvage vessels and the like.

Types of Equipment

Present-day navigational equipment can be roughly divided into three classes. The oldest and best known of course, is the D.F. or direction-finding equipment. This is used to get a bearing in degrees on two or more known fixed stations operating in any given area. The position of the boat can then be determined by triangulation techniques.

GENERAL INSTRUMENT
all channel UHF converter

there's an extra profit incentive when you sell General Instrument

New exclusive features with sensational improved **tuning element**

GREATER PERFORMANCE, simpler construction, better design . . . these features place the new Model 66 General Instrument converter far out front as the favored unit with dealers, jobbers, service technicians. In UHF converters, the tuning element makes the difference . . . and General Instrument Corporation is a leader in the design and manufacture of UHF tuners! **JOBBERS:**—Some choice territories still remain open. Write for details about territories and extra profit.

General Instrument & Appliance
CORPORATION
Subsidiary of GENERAL INSTRUMENT CORPORATION • 829 Newark Avenue • Elizabeth 3, N. J.



The typical marine end-fed Marconi antenna. Its rugged construction is a prerequisite for all-weather operation. Note that the mast is swivel-mounted, an expedient which allows it to be lowered while passing under low-clearance bridges.

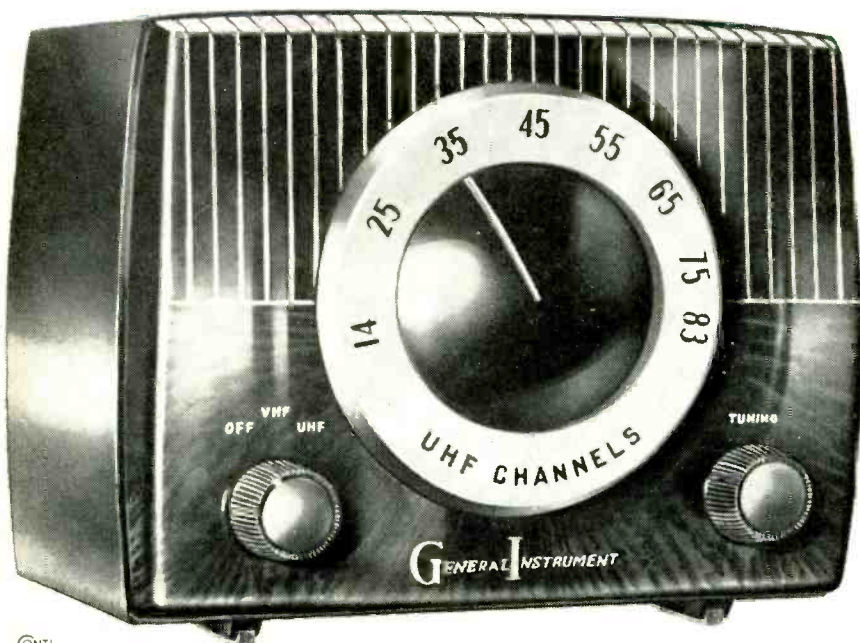

The usual well-established type of marine D.F. equipment operates in the low and medium frequency band ranging from 200 *kc* to 2 *mc*. It is a receiver, equipped with a differential antenna of the loop type, which is manually rotated to give a null or minimum response in an earphone detector. Inasmuch as a null or minimum can be obtained at two positions located at 180° apart, a "sense" antenna which is completely non-directional is also switched in during the taking of a bearing. Its contribution will aid the signal coming from the proper direction, and thus enable the operator to determine which of the two nulls is the correct one. The bearing is usually read on a circular scale, divided into 360°, which forms part of the rotatable loop mount.

The D.F. equipment usually has a self-contained power supply of the Vibrapack type. Since it is just a receiver, its power consumption is nominal.

The second type of navigational equipment that will be discussed is ex-

[Continued on page 59]

Here's the most terrific Time and
Trouble saver you've ever seen

the **CLASSY CHASSIS CARRIER!**



TAKES MOST OF
THE LIFT AND LUG FROM
TV REPAIR WORK!

Carries up to 27" tube
and chassis easily!

\$19⁹⁵
A VALUE...
YOURS FREE WHEN
YOU BUY SYLVANIA
TUBES

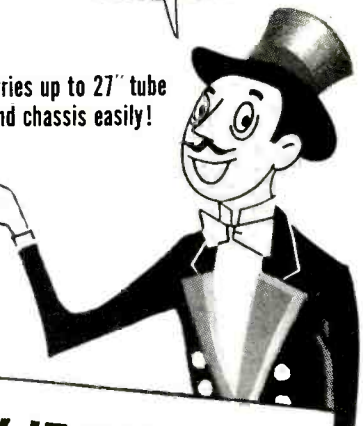

- SEE HOW IT SAVES!**
1. Saves effort and energy... a breeze to wheel... a snap to carry!
 2. Saves extra steps and extra labor. Carries your TNT Kit... everything all at once.
 3. Saves valuable service time... permits more calls per day... you make more money.
 4. Prevents damage to tubes, wiring and set.
 5. Prevents damage to customers' furniture, woodwork and floors.

THE GREATEST
WORK-SAVER EVER
OFFERED TO SERVICE
DEALERS!

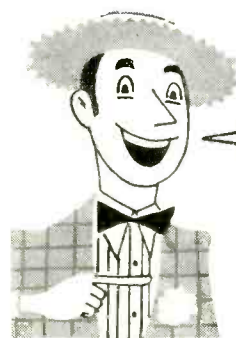

You'll say it's stupendous... the greatest and most valuable helper a TV Serviceman ever had!

An easy-wheeling, aluminum carrier that lets you move a heavy TV chassis (up to 27-inch tube) anywhere... with no lugging, no straining, no bumping. And no risk to tubes, floors, or polished surfaces. You save time, save money, save effort, and win renewed confidence from your customers.

Yours FREE!

This sensational work-saver now yours FREE with your purchases of Sylvania Tubes.

But don't delay! Offer expires August 31st. So, order your Sylvania Tubes and get your carrier reservation in NOW! Call your Sylvania Distributor for full details *today!*

SYLVANIA ELECTRIC
PRODUCTS INC.
1740 BROADWAY
NEW YORK 19, N. Y.

SYLVANIA



In Canada:
Sylvania Electric
(Canada) Ltd.
University Tower Bldg.
St. Catherine St.
Montreal, P. Q.

LIGHTING • RADIO • ELECTRONICS • TELEVISION

PHILCO

announces
3 new
super-performance

TV

antennas

The finest TV antennas in their class... designed by the world famous Philco Laboratories after thorough research into receiver requirements in all types of locations... designed to give complete customer satisfaction... to meet competition on any level!

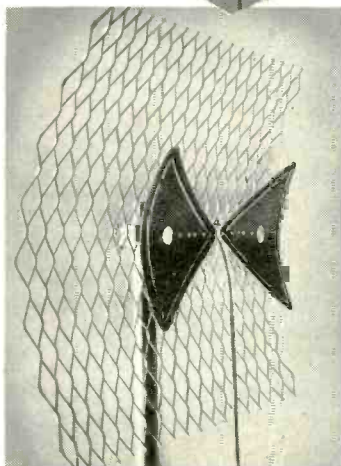
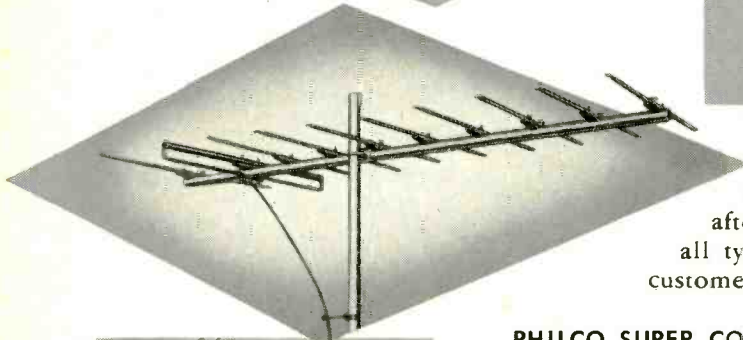
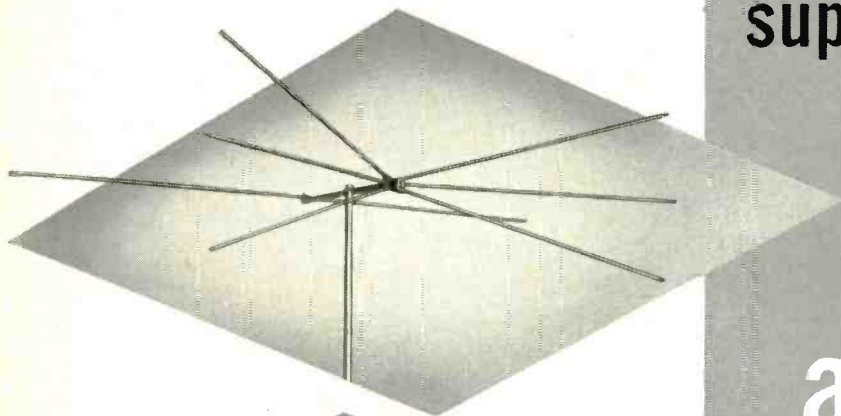

PHILCO SUPER CONICAL UHF-VHF ALL-CHANNEL ANTENNA

Full 45" dowelled aluminum antenna elements and full 53" dowelled aluminum reflector assure strong signal pickup on VHF channels 2 through 13... top quality performance on UHF channels 14 to 83.

Single or stacked array Super Conicals produce new balanced performance... super picture quality plus high gain. All-aluminum construction in the Super Conical... it's easy to erect: Part No. 45-3096.

PHILCO SUPER YAGI VHF ANTENNAS

Quick-rig model with ten elements gives top fringe-performance on VHF channels 2 through 13. Excellent front to back ratio (6 to 1). This Super Yagi eliminates ghosts in strong signal areas... selects signals

from adjacent weak area channels or co-channel stations. 10 db to 12 db gain depending on channel. Strong, all-aluminum: Part No. 45-3112. (Single channel 2 thru 13 and broadband 2 thru 6; 7 thru 13; 4, 5, 6).

PHILCO PARAFLECTOR ALL-CHANNEL UHF ANTENNA

Light weight pre-assembled all-channel UHF antenna. Outstanding performance in far-fringe areas. High gain... 8 to 10 db. Exceeds gain of corner reflector of like dimensions. Impedance matched to 300

ohm line. Completely assembled, all-aluminum construction... can be mounted on existing masts for immediate use... all-channel paraflector weighs only 1½ lbs: Part No. 45-3071.

See them today at your Philco Distributor



PHILCO CORPORATION

ACCESSORY DIVISION

"A" and Allegheny Ave., Philadelphia 34, Pa.

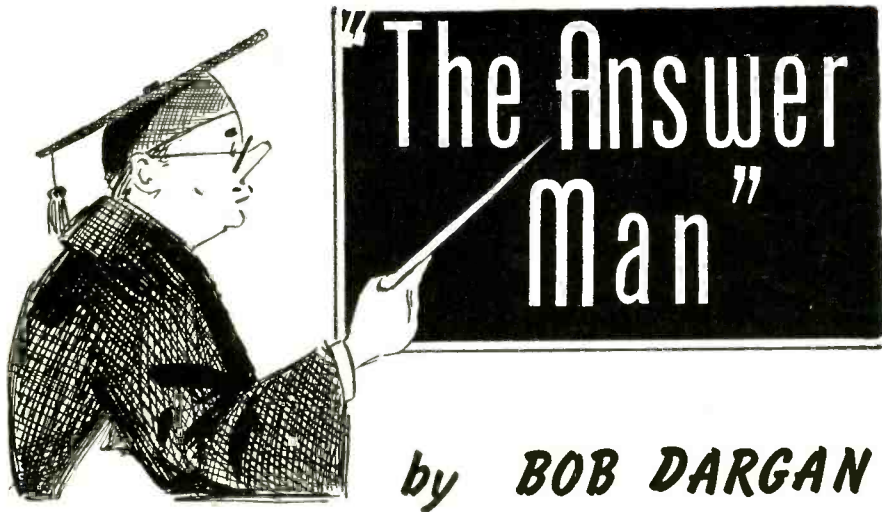

Do you have a vexing problem pertaining to the repair of some TV set? If so, send it in to the Answer Man, care of this magazine. All inquiries acknowledged and answered.

Adjacent Channel Interference

Dear Answer Man:

Could you give me some suggestions and ideas to combat adjacent channel interference? We have a bad case of interference from a local Channel 5 and a Channel 6 fringe station. A scattered few receivers have little trouble while most others have considerable difficulty. In the really bad ones the sound and picture are both blotted out on Channel 6. So far none of the local technicians have been able to cure or to alleviate this interference problem.

A. E. R.
Saginaw, Michigan

Dear A. E. R.:

As you are undoubtedly aware, the problem of adjacent channel interference is prevalent in many reception areas where one TV channel interferes with an adjacent channel. This difficulty is usually found in those areas where a channel received from a distant

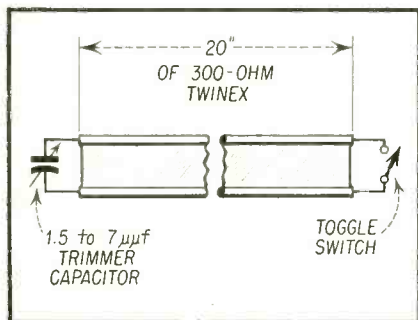

Fig. 1 — This arrangement with 20 inches of 300 ohm line is very effective as an adjacent channel trap for Channels 2 through 6.

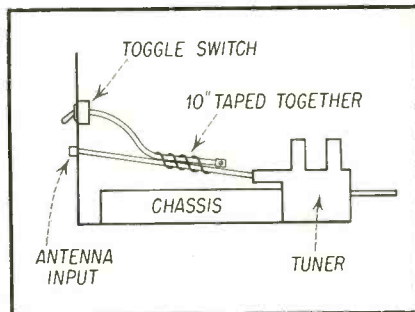

Fig. 2 — The adjacent channel trap is taped to the antenna input lead in the cabinet for added strength.

station is interfered with by a local strong adjacent channel. There are a number of steps that can be taken to correct this interference problem. One of the easiest and quickest is to incorporate a stub or trap arrangement to eliminate the strong adjacent signals.

One favorite type of trap is made up of twinex as shown in Fig. 1. For the channels from 2 to 6, a length of about 20 inches of the 300 ohm twinex is about correct. An adjustable trimmer condenser of 1.5 to 7 μmf is connected to one end of the twinex. Connected across the open end of the twinex is a toggle switch. About 10 inches of twinex is taped to the antenna lead-in as close to the tuner as is practical, with the trimmer condenser end at the TV tuner. The other end of the twinex containing the switch is mounted on the cabinet so that the knob extends through the cabinet back and is accessible to the customer.

As shown in Fig. 2, the receiver is turned on after the trap has been installed, and the channel interfered with is selected. The switch on the rear is

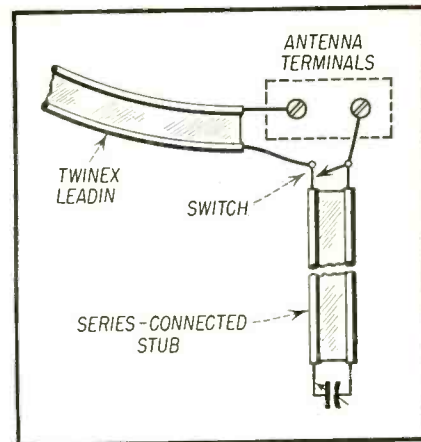

Fig. 3 — When the switch is in the open position the absorption trap will help to reduce standing waves and mismatch for the one channel.

closed, and the trimmer condenser adjusted to remove the interference from the picture and sound. As the interfering signal is tuned for a minimum with the trimmer condenser, the hand must be kept as far away as possible from the twinex to prevent incorrect adjustment. When the customer desires to receive the channel interfered with he merely places the toggle switch in the closed position after turning the channel selector to this channel. If more alleviation is desired, it may be necessary to add additional stubs of the same design.

Of course, the twinex tuned stub may be mounted on the back of the cabinet. However, for the maximum results it is best to put the trap as close to the tuner as possible.

The trap can be used equally well for the high channels from 7 to 13 by decreasing the length of the twinex to about 17 inches. The length of the twinex may have to be reduced or increased for the most effective elimination of the interfering station if the trimmer condenser does not provide the necessary peak.

Another use of the above described absorptive trap is to reduce standing waves on a transmission line causing reflections or ghosts. The trap can either be taped to the transmission line or connected in series with one side of the transmission line as shown in Fig. 3. When the switch is closed, the transmission line is normal. When the standing waves are to be eliminated, the switch is opened thereby series-stubbing the transmission line and balancing out the reactive component.

44 MC Band for TV Receivers

Dear Answer Man:

Why did the television industry recently change the *if* frequency of re-

[Continued on page 57]

Get Started

in

P.A.

by **GENE HESSEL**

PART 2

Chief Engineer, Air Tone Sound and Recording Co.

I NSTALLATION and servicing of P.A. in amusement parks, swimming pools, etc., is a widespread and lucrative branch of the electronics industry. This article describes an interesting operation of this type in Woodside Park, Philadelphia. Techniques described in the following paragraphs should prove of value to those presently engaged and those who are about to engage in P.A.

The system, shown in block form in Fig. 1 consists of fifteen (15) outdoor diffraction projector horns spotted along the midway and throughout the park area to give adequate coverage to even the most remote location. The horns are mounted on buildings or utility poles already planted and in use. They are connected in three (3) sets of five (5) horns each with the appropriate number of matching transformers. Each set operates from a separate circuit thus giving the added advantage of individual section control, and allowing the possibility of cutting off any section of the park whenever desired and deemed necessary. Each speaker in any group can be pre-adjusted so that it will suit its particular location with regard to surrounding noise conditions.

Although the system provides high quality background music at all times, one of the most important applications for which it was designed was to allow split-second paging facilities. This paging can be accomplished from any one of the three locations, a checking booth, the main office, and a cloak room. The

operator simply speaks into the microphone from any of these locations and by so doing actuates a voice-operated relay which automatically replaces the

existing program with the desired announcement, and then after a 5 second delay, permits the resumption of the regular program. The installation of a voice-operated relay of this type does away with the necessity of running thousands of feet of relay wire and makes, in the long run, for a more economical setup. Needless to say, a feature of this sort lends to the effectiveness of such a system one hundredfold.

The installation is powered by three (3) 50-watt bridging amplifiers designed for continuous duty with long life components consisting of separate plate and filament transformers, individual volume indicator and volume controls. The Amplifiers are rack-mounted and located in the cloak room which location serves as operations center.

The programs emanating from Sylvan Hall, an outdoor auditorium situated in the park, can be channeled through and subsequently distributed throughout the entire park area, thereby replacing the continuous background music regularly obtained either from record programs or taken direct from radio. This gives the added advantage of broadcasting such live shows with their on-the-spot spontaneity and lends a distinct air of versatility to the system.

The amplifiers are driven by two (2) pre-amps, each of which includes a microphone input with base attenuating tone control and mixing volume con-

[Continued on page 60]

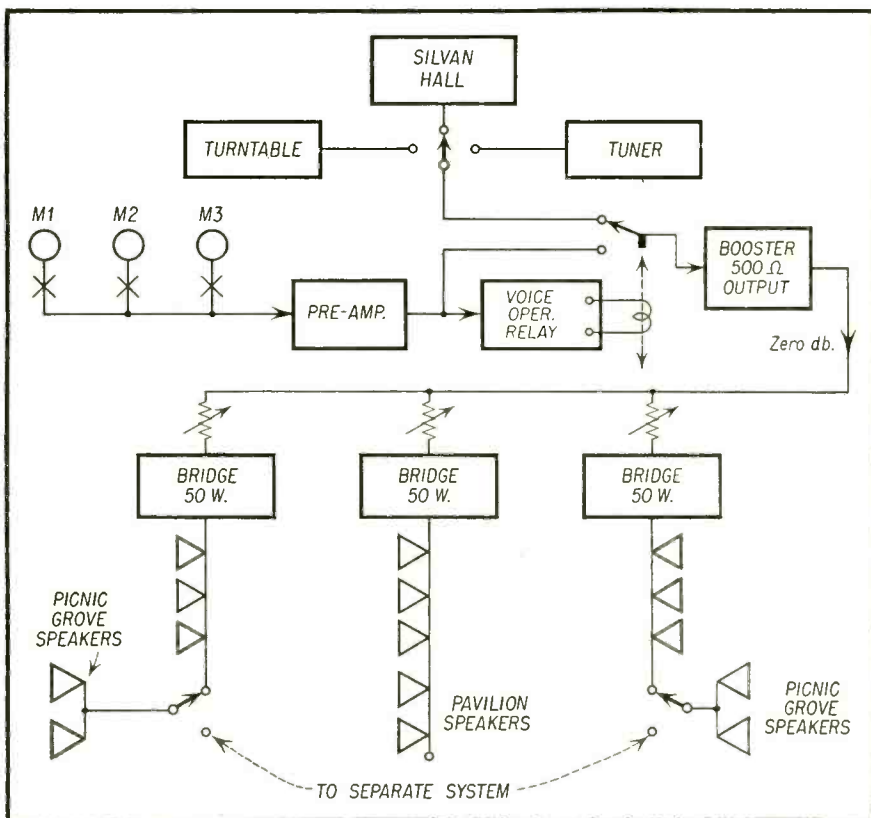

Block diagram of an efficient amusement park system.

They're Hot Packed



DELCO RADIO CANS ITS POWER TRANSFORMERS TO PROTECT THEIR QUALITY AND PERFORMANCE

If you want a part made *right*, you've got to be able to control all phases of its production. That's why Delco Radio exercises strict quality control over all its parts—for service use as well as for original equipment.

Let's look at some new power transformers for auto radios: The laminated core inserts are stamped out of low-loss silicon steel, then heat treated to insure retention of desired magnetic properties. Skilled operators use special machines to wind the primary and secondary coils. On the production line, laminations and coils are assembled and, with other parts, placed in a metal can. Finally, a hot asphalt compound is poured into the shield can. On cooling, it becomes a solid mass that holds all components in position, transfers heat and protects the transformer's quality and performance.

Satisfied customers are the basis of a good service business, and Delco Radio service parts assure customer satisfaction. Delco Radio service parts are available through your UMS Delco Electronic Parts Distributor.



Potting power transformers. The transformer can is filled with an asphalt compound which helps to protect the transformer and transfer heat from the transformer to the can for better heat dissipation.



A GENERAL MOTORS PRODUCT   A UNITED MOTORS LINE

DISTRIBUTED BY ELECTRONICS WHOLESALERS EVERYWHERE

DELCO RADIO

DIVISION OF GENERAL MOTORS CORPORATION, KOKOMO, INDIANA

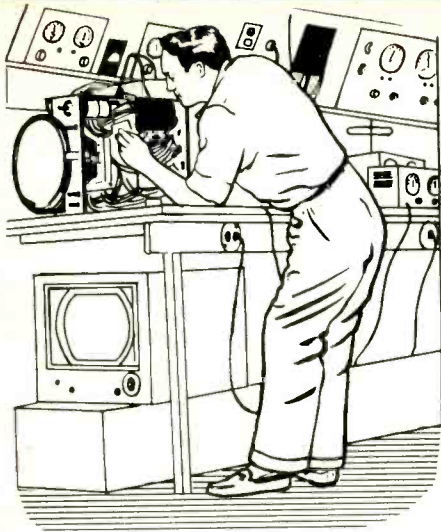

The Work Bench

by PAUL GOLDBERG

This Month:

A.G.C. CIRCUIT TROUBLES

THREE *agc* circuit troubles have been chosen for this installment. Much useful information can be obtained in analyzing them as the troubles occur in three different types of *agc* systems.

Admiral 22A2 Using TV Cascode Tuner 94D45-I

The customer complained of what was evidently a video overload after about an hour of playing the receiver. The immediate symptom being an increase in contrast. After another fifteen minutes the video overloaded completely and the picture disappeared entirely.

Not taking anything for granted, we started replacing tubes individually. Referring to Fig. 1, V307, 6AU6, the gated *agc* tube, was first replaced but to no avail. The video *if* tubes were next replaced individually, but this also had no effect. Finally, V101, (6BQ7) the amplifier in the tuner was replaced, also without result.

Turning the set on its side, we measured the *agc* voltage from test point

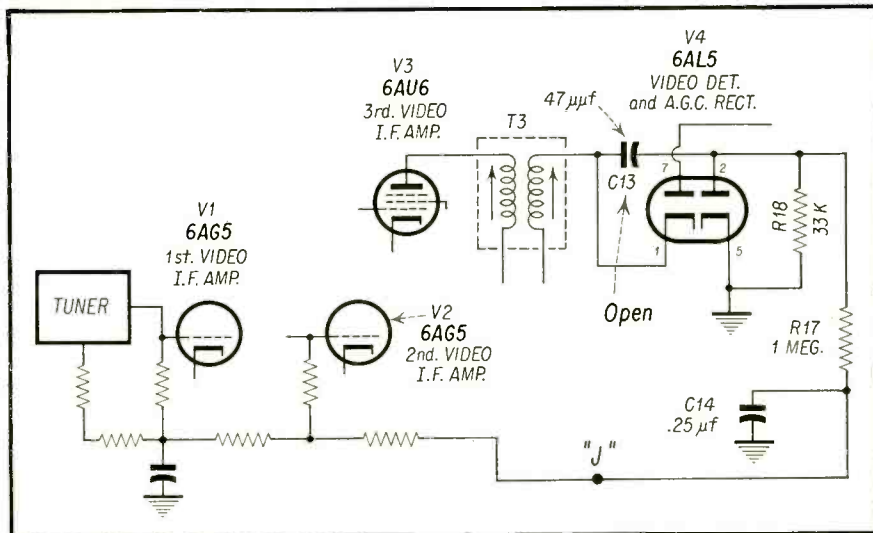

Fig. 2 — Partial schematic, Emerson 654B.

“T” to ground and found it to be about 3 volts positive. Inasmuch as coupling condenser C314 often develops leakage, causing overload of this type, the con-

denser was clipped open on the grid side in order to take a voltage leakage measurement. It was found okay.

Before going any further we decided to localize the trouble as much as possible. The *agc* lead coming from V307, was first clipped at point “X.” Again the voltage at test point “T” was checked to ground, and again, it measured 3 volts positive.

The *agc* lead coming from the tuner was next clipped at point “W.” This time the voltage measurement taken at test point “T” measured zero. A voltage reading was next taken from the *agc* lead of the tuner to ground and it measured 3 volts positive. The trouble was evidently in the tuner.

From the diagram, it can be seen that the only possible way +3 volts can appear at the tuner *agc* lead is if C120, the 2.2 μf neutralizing condenser, develops leakage.

The side metal cover of the tuner was first removed. C120 is located behind the antenna lead near the spring contact terminals. This condenser was then clipped where it was connected to C102, a variable slug condenser, and

[Continued on page 57]

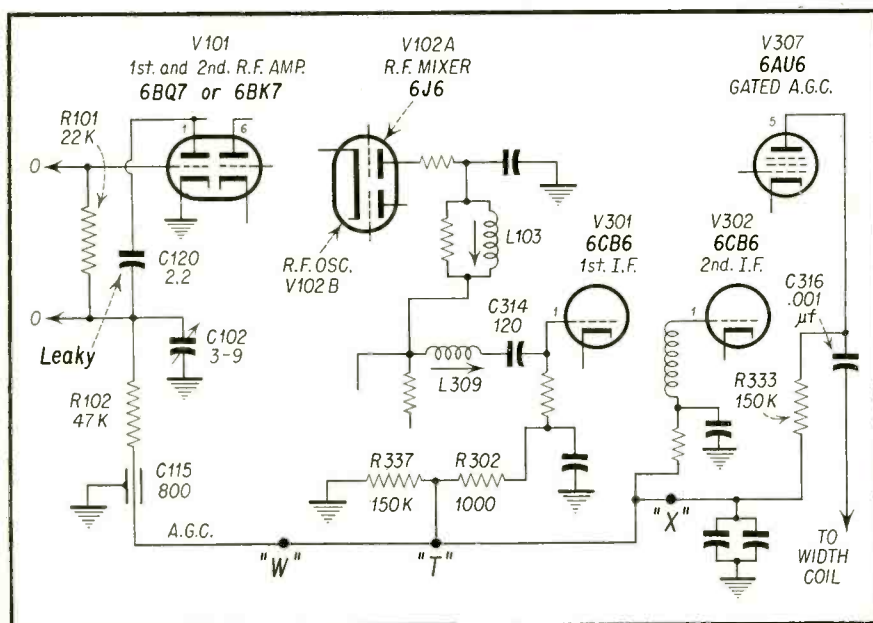

Fig. 1 — Partial schematic, Admiral 22A2.

HALLICRAFTERS

MODELS 1067, 1068, CH. L1100D, RUNS 1, 2

TV FIELD SERVICE

Pre-published from Rider "TV Field Service Manuals"

by Rider & Alsberg

Copyright 1954, John F. Rider Publisher, Inc.

TUBE COMPLEMENT

V 1	6BK7 or 6BQ7	RF AMPLIFIER
V 2	6J6	OSCILLATOR-MIXER
V 101	6CB6	1ST I-F AMPLIFIER
V 102	6CB6	2ND I-F AMPLIFIER
V 103	6CB6	3RD I-F AMPLIFIER
V 104	6AL5	VIDEO DETECTOR
V 105	6AH6	VIDEO AMPLIFIER
V 106	*12AU7 or 6SN7GT	SYNC AMP & SEP
V 107	6SN7GT	SYNC CLIPPER & VERTICAL OSC
V 108	6AV5	VERTICAL AMPLIFIER
V 109	6AU6	AUDIO I-F AMPLIFIER
V 110	6AL5	AUDIO DETECTOR
V 111	*6AV6 or 6SQ7	1ST AUDIO AMP.
V 112	6AQ5	AUDIO OUTPUT
V 113	6AX5GT	LV RECTIFIER
V 114	5U4G	LV RECTIFIER
V 115	6SN7GT	HORIZONTAL OSCILLATOR
V 116	6CD6	HORIZ. AMP.
V 117	6V3	DAMPER
V 118	1B3GT	HV RECTIFIER
V 119	27EP4	PICTURE TUBE

* These tubes are not directly interchangeable. For socket wiring of each type refer to the Schematic Diagram. When tube replacement is required use the same tube types found in the receiver chassis.

Key Voltages

All voltages are measured with a VTVM connected between the tube pins and chassis.

B+ plate of damper V117 pins 2, 7 and 9	250V DC
Plate of Vert. Osc., V107 pin 5	63V DC
Plate of Vert. Out., V108 pin 5	235V DC
Plates of Hor. Osc., V115 pin 2	135V DC
pin 5	160V DC
Grid of Hor. Out., V116 pin 5	-8.0V DC

SERVICE ADJUSTMENTS

NOTE: The sequence of "SERVICE ADJUSTMENTS" outlined herein is suggested as a convenient method of approach and is not an arbitrary procedure. Variations of the procedure are permitted to obtain the desired final results. The operating and auxiliary controls, located on the front panel, should be set for as good a pattern as possible before making any of the following adjustments. **CENTERING:** Loosen the centering lock nut, and adjust the centering lever until the picture is properly centered. Moving the centering lever through the horizontal slot will center the picture vertically. For centering the picture horizontally, grasp the top of the lever, and raise or lower it. If the picture cannot be correctly adjusted by these operations, additional range may be gained by adjusting the screws on each side of the PM focus device. Retighten all adjustment screws and nuts after proper centering has been accomplished.

FOCUS: With the channel selector control tuned to a free channel, adjust the focus control until the lines of the raster are clearly visible. If this operation does not achieve proper focus, the whole PM focus assembly may be moved either backwards or forward by adjustment of the mounting bracket adjustment screws on each side of the rear tube support brackets. Retighten screws after adjustment.

Adjust the height and width controls so that the picture fills out the dimensions of the screen. A slight readjustment of the centering control may then be necessary.

Adjust the horizontal drive by advancing the control clockwise until a vertical white line appears in the pattern. Turn the control in the opposite direction a little further beyond the point at which the line disappears. If a white line does not appear leave the control set to the extreme clockwise position. If, after setting the drive control, the horizontal hold control on the front panel fails to restore synchronization it will be necessary to adjust the horizontal oscillator as described under "HORIZONTAL OSCILLATOR ADJUSTMENT." Adjust the horizontal and vertical linearity controls for a symmetrical pattern. A slight readjustment of the height and width controls may then be necessary.

HORIZONTAL OSCILLATOR ADJUSTMENT

If the horizontal hold control on the front panel fails to restore synchronization, the horizontal range adjustment should be reset. Procedure for this adjustment is as follows:

1. Turn the horizontal hold control to the full clockwise position. Adjust the horizontal range adjustment until a vertical bar appears in the pattern.
2. Turn the horizontal hold control to the full counter-clockwise position. Momentarily set the channel selector to an adjacent channel, and then return it to the original channel being used for adjustment. The resulting picture may or may not be in horizontal synchronization. If it is not in sync., four or less horizontal bars should then appear on the screen.
3. If more than four bars appear in step 2, repeat steps 1 and 2.
4. Check the action of the front controls. If the horizontal oscillator is properly adjusted it should be possible to obtain a stable picture on all active channels.

TV TUNER ALIGNMENT (OSC. CIRCUIT)

1. Set the FINE TUNING control at the approximate midpoint of its tuning range.
2. Place a non-metallic screwdriver through the openings provided in the front of the chassis and the tuner assembly and adjust the oscillator coil slug for each active channel to give the best possible picture.

(Continued on page 36)

HALLICRAFTER TROUBLESHOOTING CHART

NO SOUND—NO RASTER

Power input circuit
AC line fuse F103 (4 Amps)
V113, V114
B+ fuse F104 (0.3 Amps)

NO RASTER—SOUND OK

Brightness control
V105, V115, V116, V117, V118, V119
Ion trap
HV xformer Hor. yoke CRT connections

WEAK PIX—SOUND AND RASTER OK

Tuner fine tuning
Contrast control
V2, V101, V102, V103, V104, V105

POOR HOR. LIN.

Hor. Lin. and Drive controls
V116, V117
Check 0.047 mf caps. connected to Hor. Lin. coil
Hor. Out. Trans.

POOR VERT. LIN.

Vert. Lin. and Height controls
V107, V108
Check 0.1 mf caps. connected to pin 5 of V107
Check 75 mf Elect. cap. connected to pin 3 of V108
Vert. Out. Trans.

PIX JITTER SIDEWAYS

Hor. Hold control
Hor. Osc. Trans. adj. (Hor. Range control)
V107, V115, V116
Check 2-82 mmf caps. connected to pin 1 of V115

SMEARED PIX

Tuner fine tuning
Contrast control
V2, V101, V102, V103, V104, V105
Check Vid. Det. and Amp. peaking coils
Check 0.1 mf cap. connected to cath. of CRT. (#11)
IF and RF alignment

POOR PIX DETAIL

Tuner fine tuning
Check adjustment of focus device
V101, V102, V103, V104
Check Vid. Det. and Amp. peaking coils
IF and RF alignment

SOUND BARS IN PIX

Tuner fine tuning
Check alignment of T104
V1, V2, V101, V102, V103, V104, V105, V109, V110
IF and RF alignment

SNOW IN PIX

V1, V101, V102, V103, V104
Antenna and transmission line

AC IN PIX (DARK HOR. BAR)

V1, V2, V101, V102, V103, V104, V105

ENGRAVED EFFECT IN PIX

Tuner fine tuning
Contrast control
V2, V101, V102, V103, V104, V105, V119
Check Vid. Det. and Amp. peaking coils

VERT. BARS

Hor. Drive control
V116, V117
Defl. yoke ringing

PIX JITTER UP & DOWN

Vert. Hold and Contrast controls
V107, V108

PIX BENDING

Hor. Hold and Contrast controls
Check Hor. Osc. adjustment
V115, V116

AUDIO HUM IN SOUND

V109, V110, V111, V112

DISTORTED SOUND

Tuner fine tuning
V2, V109, V110, V111, V112
Check audio coupling network
Sound and Vid. IF alignment L-106
Det. alignment T-108

NO SOUND—PIX OK

Tuner fine tuning
V109, V110, V111, V112
Speaker (open voice coil or defective connection)
Sound and Vid. IF alignment L-106
Det. alignment T-108

WEAK SOUND—PIX OK

Tuner fine tuning
Volume control
V2, V109, V110, V111, V112
Sound and Vid. IF alignment L-106
Det. alignment T-108

NOISY SOUND—PIX OK

Volume control
V109, V110, V111, V112
Check sound system for loose connections
Speaker
Sound IF and Det. alignment L-106 and T-108

SYNC. BUZZ IN SOUND

Tuner fine tuning
Contrast control
V2, V104, V105, V109, V110
Sound IF and Det. alignment L-106 and T-108

WEAK OR NO PIX—SOUND WEAK—RASTER OK

Tuner fine tuning
 Contrast control
 V1, V2, V101, V102, V103, V104, V105
 RF and IF alignment

INTERMITTENT RASTER—SOUND OK

Brightness control
 V115, V116, V117, V118, V119
 HV xformer

RASTER BLOOMING

Hor. Drive control
 V113, V114, V116, V117, V118, V119
 Check 1 meg res. connected to HV filter cap.
 Check HF filter cap.

INSUFFICIENT BRIGHTNESS

Ion trap
 Brightness and Hor. Drive controls
 V113, V114, V116, V117, V118, V119
 Low line voltage

EXCESSIVE RASTER (PIX SIZE)

Hor. Drive, Width and Height controls
 V116, V117, V118, V119

INSUFFICIENT RASTER WIDTH

Hor. Drive and Width controls
 V113, V114, V116, V117
 Check 820 and 2200 mmf cap. connected to terminal "D" of Hor. Osc. Trans.
 Hor. Out. Trans.
 Low line voltage

INSUFFICIENT RASTER HEIGHT

Height and Vert. Lin. controls
 V107, V108, V113, V114
 Check 2-0.1 mf caps. connected to pin 5 of V107
 Vert. Out. Trans.
 Low line voltage

NO VERT. DEFL.

V107, V108
 Check 2-0.1 mf caps. connected to pin 5 of V107
 Vert. Defl. yoke
 Vert. Out. Trans. and Vert. Osc. Trans.

NO VERT. SYNC.—HOR. SYNC. OK

Vert. Hold control
 V106, V107, V108
 Vert. Int. Network

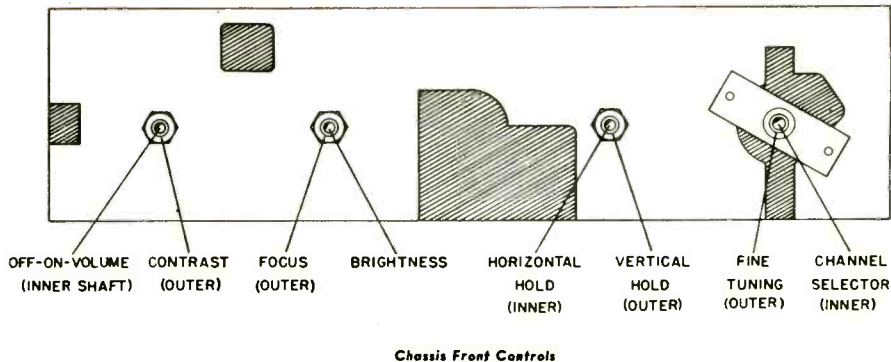

Chassis Front Controls

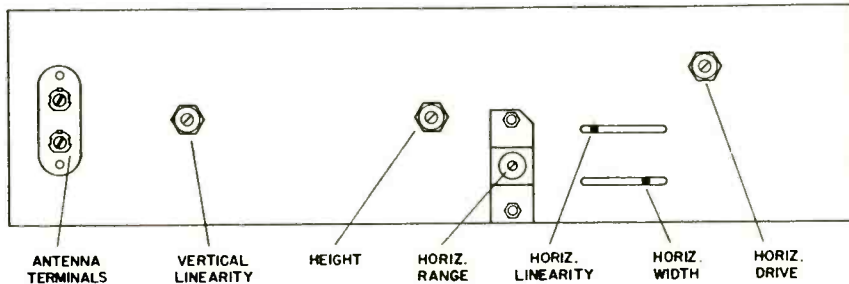

Chassis Rear Controls

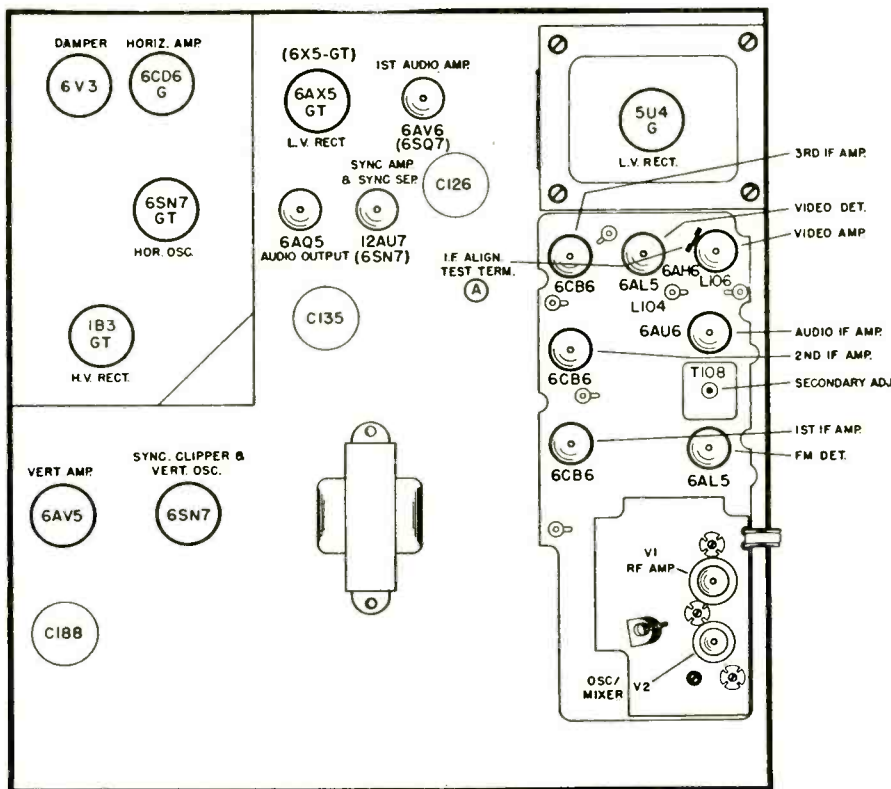

Top View

NO HOR. OR VERT. SYNC.—PIX SIGNAL OK
 V106, V107

INTERMITTENT SOUND—PIX OK
 V109, V110, V111, V112
 Poor connections in sound system

REMOVAL OF PICTURE TUBE MOUNTING FROM CABINET

1. Remove the 5 Phillips head screws which fasten cabinet back to cabinet. Swing cabinet back open slightly guiding focus control knob through hole in shield cup. Remove internal antenna lead from hole in cabinet back. Swing cabinet back full open.
2. Loosen 6 screws which hold picture tube baseboard to cabinet shelf. (An offset screw driver or other suitable tool will be required to loosen the 2 screws located under the main chassis.)
3. Slide the board out of the cabinet, being careful to protect the tube. (The tube weighs about forty-five pounds.)

NOTE: If no suitable tool is available for loosening the two screws located under the main chassis in the limited clearance available, it will be necessary to remove the chassis. This can be done by pulling off the front knobs, removing the speaker plug, yoke plug, high voltage lead, ground wire lug (black wire) and removing the four screws which hold the chassis mounting board to the side of the cabinet. The chassis can then be pulled back and removed. It can then be replaced after the picture tube adjustment is made.

REMOVAL OF THE PICTURE TUBE

1. Remove the picture tube from the cabinet according to instructions above.
2. Disconnect the anode plug (PL-105) from the side of the tube and short the plug to the chassis to insure discharge of the high voltage filter capacitor. Discharge the aquadag coating by shorting the anode contact of the tube to the outer tube coating.
3. Remove the anode lead keeper by unhooking the attached springs.
4. Remove the tube socket from the base of the tube.
5. Remove the ion trap from the neck of the picture tube.
6. Remove the two rear support adjustment screws closest to the front of the picture tube.
7. Loosen the two remaining rear support adjustment screws by nine complete turns each but leave them in place.
8. Loosen the three screws which hold the deflection yoke mounting bracket.
9. Loosen the screws for the picture tube mounting strap.
10. Remove mounting strap and rubber strip.
11. Carefully lift tube upward to clear picture tube stop brackets, raising the rear picture tube support to provide enough clearance for the neck. DO NOT FORCE NECK.
12. Move tube forward gently until neck of tube emerges from deflection yoke and rubber collar. Slight twisting motion may be necessary to free neck from the rubber collar.

INSTALLATION AND ADJUSTMENT OF THE PICTURE TUBE

1. With the tube in position so that the anode lead will be located on the right side when viewed from the front face, place the rubber strip across the top and sides along the front rim of the tube.

2. Slide the neck of the picture tube through the rubber collar and the deflection yoke.
3. Seat the tube on the pad so that the face rests against the rubber stop pads, not the brackets for the pads.
4. Place the mounting strap around the rubber strip and tighten the mounting strap screws.
5. Move the rear support so that the rubber collar rests firmly against and supports the cone of the tube. Tighten the rear support adjustment screws.
6. Tighten the three screws on the deflection yoke mounting bracket.
7. Slip the ion trap over neck of tube.
8. Connect the picture tube socket and anode plug (PL-105) and turn on receiver.
9. With the brightness control turned up, adjust the ion trap both along the length of, and around, the neck of the tube. Turn brightness control down as maximum point is approached.
10. With slightly more than normal brightness and the channel selector tuned to a free channel, adjust the focus control until the lines of the raster are most clearly visible. If good focus cannot be obtained in this manner, loosen screws on PM focus mounting bracket, move this bracket forward or back and again adjust the focus control lever. Tighten screws again when perfect focus is obtained.
11. Readjust the brightness control for normal brilliance and touch up ion trap setting.
12. Connect the antenna and tune in a test pattern, if possible.
13. Readjust the contrast control until different shades of gray scale are clearly visible.
14. If the pattern is off center or shadowed at the corners, loosen the centering lock and nut and adjust the centering lever. Rotating this lever through the horizontal slot centers the picture vertically. For moving the picture to right or left, raise or lower this lever. If greater range of adjustment is needed, loosen the screws to the right and left of the focus magnet. Retighten nut and screws after adjustment.
15. If the lines of the raster are not horizontal or square with the escutcheon, loosen the deflection yoke adjustment nut and rotate deflection yoke until proper raster position is obtained. Tighten thumb screw after adjustment.
16. Follow the procedure under "SERVICE ADJUSTMENTS" and make any minor adjustments necessary to obtain properly adjusted pattern.

PICTURE TUBE ANODE HIGH VOLTAGE MEASUREMENT

The second anode potential will be approximately 13,000 volts or higher in a receiver that is functioning properly. If it is possible to obtain good picture brilliance, the second anode potential is correct and need not be measured.

If it is necessary to measure the voltage present on the second anode, a meter specifically designed for high voltage measurements should be used. The contrast and brightness controls should be rotated to the minimum position and PL-105 should be connected to the picture tube. Under these conditions the test meter will load the high voltage power supply approximately the same amount as the picture tube would during normal operation.

MOTOROLA

MODELS: 17F13C, 17F13BC, 17K14C, 17K14BC,
17K14WC, 17K15C, 17K15BC, 17K16C,
17T11C, 17T11EC, 17T12C, 17T12WC

RADIO CHASSIS HS-319
RECORD CHANGER RC-40

TV FIELD SERVICE

Pre-published from Rider "TV Field Service Manuals"

by Rider & Alsberg

Copyright 1954, John F. Rider Publisher, Inc.

TUBE COMPLEMENT

SYMBOL	TUBE	FUNCTION
V-1	6BZ7	RF Amplifier
V-2	6U8	Mixer-Oscillator
V-3	6CB6	1st IF Amplifier
V-4	6CB6	2nd IF Amplifier
V-5	6CB6	3rd IF Amplifier
V-6	6AH6	Video Amplifier
V-7	6AU6	FM Driver
V-8	6AU6	FM Limiter
V-9	6AL5	Ratio Detector
V-10A	1/2 6SN7GT	1st Audio Amplifier
V-10B	1/2 6SN7GT	Phase Detector
V-11	6W6GT	Audio Output
V-12	6SN7GT	1st & 2nd Clippers
V-13A	1/2 12BH7	Vertical Blocking Oscillator
V-13B	1/2 12BH7	Vertical Output
V-14	6SN7GT	Horizontal Oscillator
V-15	6BQ6GT	Horizontal Output & High Voltage Generator
V-16	6AX4GT	Damping Diode
V-17	1B3GT	High Voltage Rectifier
V-18	17LP4	Picture Tube: rectangular; glass; electrostatic focus; cylindrical face

Key Voltages

All voltages are measured with a VTVM connected between the tube pins and chassis.

B+, plate of damper, V16 pin 5	250V DC
Boosted B+, cath. of damper, V16 pin 3	480V DC
Plate of Vert. Osc., V13 pin 6	102V DC
Plate of Vert. Out., V13 pin 1	*480V DC
Plates of Hor. Osc., V14 pin 2	118V DC
pin 5	205V DC
Grid of Hor. Out., V15 pin 5	-29V DC

*Varies with control settings.

ADJUSTMENT OF THE ION TRAP

Under conditions of rough shipment, it is possible for the ion trap to become mis-adjusted. To prevent serious damage to the picture tube, the following method of adjustment should be used.

Place the magnet on the neck of the tube so that it is positioned over the slash in the gun structure. (The slash is the separation between grids #1 and #2.) With the BRIGHTNESS control at low intensity, move the magnet a short distance forward and backward, at the same time rotating it, to obtain the brightest raster. If, in obtaining the brightest raster, the magnet has to be moved more than 1/2" forward from the slash, it is probably weak and should be replaced. Never correct for a shadowed raster

with the ion trap magnet if such correction results in decreased brightness. The ion trap is always adjusted for maximum brightness and, if shadows occur at this setting, they should be eliminated by adjusting the magnetic centering device on the neck of the tube, or by changing the position of the yoke.

Caution: Keep the BRIGHTNESS control at low intensity until the ion trap is properly set.

CENTERING

Note: The ion trap should be properly adjusted before centering or focusing is attempted.

It is important, in achieving correct centering and good focus, that the magnetic centering device be properly adjusted. The centering device used with the electrostatically focused picture tube consists of two magnets arranged in such a way that the magnetic field intensity can be varied in angle or direction by means of the two projecting arms and by rotating the device about the tube neck. When the arms are superimposed, the fields of the two magnets cancel. Moving the arms progressively farther apart in a given direction, with respect to each other, will produce an increasing field intensity of a given polarity. If the arms are moved apart in the other direction, a field of opposite polarity will result. This controllable magnetic field, acting on the beam, normally provides a means of centering the picture vertically when the arms are initially at either side, and by rotation to a vertical arm position, it will also produce horizontal centering. Horizontal centering by means of the magnetic centering device should be held to a minimum because of the danger of defocusing and shadow.

To center the picture correctly, follow these steps:

1. Reduce the size of the picture so that all four edges are visible. Tune in a station; do not attempt centering with an uncontrolled raster.
2. Start with the magnetic centering device arms together and turned so they are horizontal. The device should be positioned as close to the yoke as possible without causing any part of it to slip inside the yoke opening.
3. Adjust the electrical horizontal centering control on the back of the chassis for best horizontal centering obtainable within the range of the control.
4. Separate the arms of the centering device in the proper direction to center the picture vertically.
5. If full horizontal centering was not obtained in step 3, complete the horizontal centering by slightly rotating the magnetic centering device as a unit one way or the other. It may then be necessary to readjust vertical centering by slightly changing the relative position of the arms.
6. Recheck adjustment of ion trap after centering is completed.

MOTOROLA TROUBLE SHOOTING CHART

NO SOUND—NO RASTER

Power input circuit
Check B+ Selenium Rectifier

NO RASTER—SOUND OK

Brightness con.
V14, V15, V16, V17
Ion trap
C.R.T.
HV xformer Hor. yoke CRT connections

WEAK PIX—SOUND AND RASTER OK

Tuner fine tuning
Contrast Con.
Area Selector Switch
V3, V4, V5, V6
Check Vid. Det. xtal (Part of T-6)

POOR HOR. LIN.

V15, V16
Check 0.15 mf cap. connected to Hor. Cent. Con.

POOR VERT. LIN.

Vert. Lin and Size con.
V13
Check 0.047 mf cap. connected to pin 6 of V13
Check 30 mf EL. cap. connected across Vert. Lin. Con.

PIX JITTER SIDEWAYS

Hor. Hold and Osc. Con.
V10, V14
Check 0.001 and 0.002 mf caps connected to pin 5
of V10

SMEARED PIX

Tuner fine tuning
Contrast Con.
Area Selector Switch
Check Vid. Det. and Amp. peaking coils
V3, V4, V5, V6
Check Vid. Det. xtal (Part of T-6)
IF and RF alignment

POOR PIX DETAIL

Tuner fine tuning
Focus Con.
V3, V4, V5
Check Vid. Det. and Amp. peaking coils
IF and RF alignment

SOUND BARS IN PIX

Tuner fine tuning
Check alignment of L-17
V2, V3, V4, V5
Check Vid. Det. xtal (Part of T-6)
IF and RF alignment

SNOW IN PIX

V1, V2, V3, V4, V5
Antenna and transmission line

INSUFFICIENT BRIGHTNESS

Ion trap
Brightness con.
V6, V15, V16, V17
C.R.T.
Low line voltage

EXCESSIVE RASTER (PIX SIZE)

Hor. Size and Vert. Size
V15, V17

INSUFFICIENT RASTER WIDTH

Hor. Size con.
V15, V16
Check B+ Selenium Rectifier
H.O.T.
Low line voltage

INSUFFICIENT RASTER HEIGHT

Vert. Size and Lin. con.
V13
Check 0.047 mf cap. connected to pin 6 of V13
V.O.T.
Low line voltage

NO VERT. DEFL.

V13
Check 0.047 mf cap. connected to pin 6 of V13
Vert.
Defl. yoke
V.O.T. and Vert. Osc. Transformer

NO VERT. SYNC.—HOR. SYNC. OK

Vert. Hold con.
Check R-C network connected between Vert. Hold Con.
and pin 5 of V12
V12, V13

ENGRAVED EFFECT IN PIX

Tuner fine tuning
Contrast con.
Area Selector Switch
V2, V3, V4, V5, V6
Check Vid. Det. xtal (Part of T-6)
Check Vid. Det. and Amp. peaking coils

VERT. BARS

V15, V16
Check 47 mf cap. connected to terminals of deflection
yoke
Defl. yoke ringing

PIX JITTER UP & DOWN

Contrast con.
Area Selector Switch
V12, V13

PIX BENDING

Hor. Hold and Osc. Con.
V10, V14, V15
Check 0.01 mf cap. connected to pin 4 of V14

**NO HOR. OR VERT. SYNC.—
PIX SIGNAL OK**

V12
Check Vid. Det. xtal (Part of T-6)

NO HOR. SYNC.—VERT. SYNC. OK

Hor. Hold and Osc. con.
V10, V14, V15
Check 390 mmf cap. connected
between pins 1 and 5 of V14

DISTORTED SOUND

Tuner fine tuning
V2, V7, V8, V9, V10, V11
Sound and Vid. IF alignment L-20,
L-21
Det. alignment T-7

NO SOUND—PIX OK

Tuner fine tuning
Vol. con.
V7, V8, V9, V10, V11
Speaker (open voice coil or defec-
tive connection)
Sound and Vid. IF alignment L-20,
L-21
Det. alignment T-7

WEAK SOUND—PIX OK

Tuner fine tuning
Vol. con.
V2, V7, V8, V9, V10, V11
Sound and Vid. IF alignment L-20,
L-21
Det. alignment T-7

NOISY SOUND—PIX OK

Vol. con.
V7, V8, V9, V10, V11
Check sound system for loose con-
nections
Speaker
Sound IF and Det. alignment

SYNC. BUZZ IN SOUND

Tuner fine tuning
Area Selector Switch
V7, V8, V9
Check Vid. Det. xtal (Part of T-6)
Sound IF and Det. alignment L-20,
L-21, T-7

INTERMITTENT SOUND—PIX OK

V7, V8, V9, V10, V11
Poor connections in sound system

**WEAK OR NO PIX—SOUND WEAK
—RASTER OK**

Tuner fine tuning
V1, V2, V3, V4, V5
Check Vid. Det. xtal (Part of T-6)
RF and IF alignment

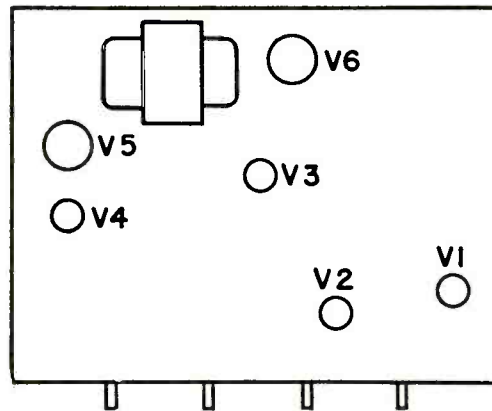

**TUBE LOCATIONS
OF RADIO CHASSIS**

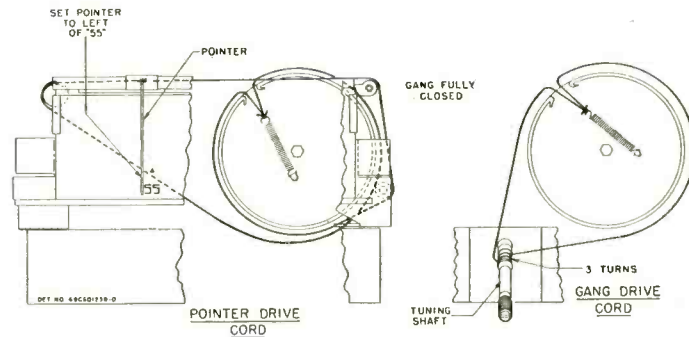

**RADIO CHASSIS
DIAL STRINGING**

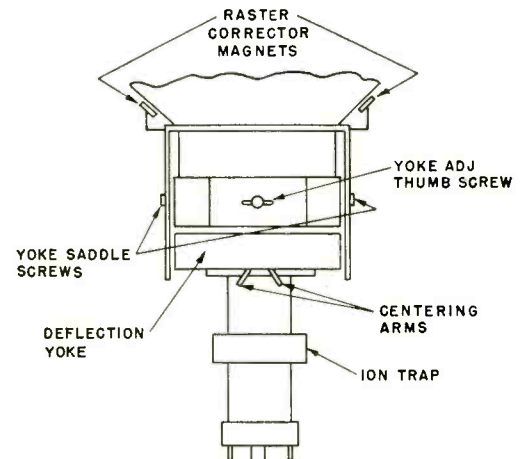
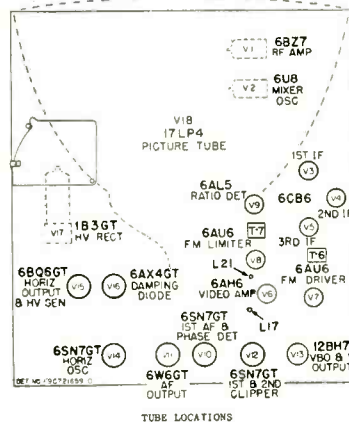

PICTURE TUBE ADJUSTMENT

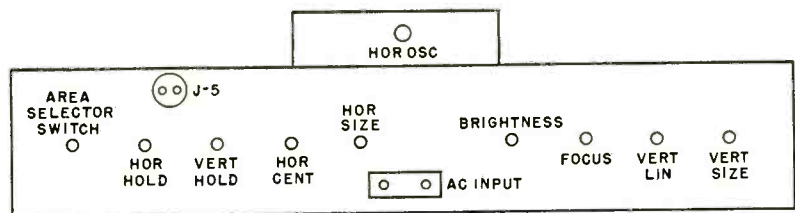

SERVICE ADJUSTMENT CONTROLS

DEFLECTION YOKE ADJUSTMENT

If the deflection yoke shifts, the picture will be tilted. To correct, loosen the thumbscrew on top of the deflection yoke and rotate yoke until the picture is straight. Before tightening the thumbscrew, make certain that the deflection yoke is as far forward as possible to prevent shadow.

If the yoke support and the picture tube have shifted in transit or, if for any reason, these parts have been removed and replaced, it is best to do a complete job of repositioning. The picture tube should be mounted so that the front of the tube rests against the brackets on the front of the chassis. The clamp around the front of the tube should then be tightened. (NOTE: This applies only to the glass tubes. The position of the metal picture tubes is fixed by the front brackets.) The picture tube rear support bracket mounting screws should be loose enough to permit sliding the bracket forward until it fits snugly up against the flare of the tube. Loosen the yoke adjustment thumbscrew and yoke saddle screws and push the yoke up against the flare of the tube. CAUTION: Do not use force in sliding the bracket. If too much force is applied, a strain will be placed on the neck of the tube when the support bracket mounting screws are tightened, or the yoke may be forced out of position. The opening in the yoke should be concentric with the neck of the tube.

FOCUS

The zero focus type of electrostatically focused tube used in these chassis requires a fixed potential applied to the focusing anode which is supplied through the focus control potentiometer. This control, in effect, provides a means of compensating for differences in gun structure between tubes, but is far less critical in adjustment than was the focus control in the electromagnetically focused tubes. By carefully turning the control through its range, a point of adjustment will be found where optimum focus is obtained, but no misadjustment of the control will result in the extreme defocusing which resulted from the off-focus range in the control of electromagnetically focused tubes. In some tubes, the effect of the focus control is so slight as to lead the serviceman to believe that a fault exists in the circuit. The control should be adjusted to the point where the line structure is distinguishable over a 90% area of the screen.

Due to differences in gun structure between tubes mentioned above, it may be found that in some picture tubes better overall focus is obtained with the arms of the magnetic centering device pointing in a particular direction. If, after the magnetic centering device has been adjusted as in the paragraph on centering, good overall focus is not obtained, rotate the magnetic centering device 180° and repeat the centering procedure.

RASTER CORRECTOR MAGNETS

On chassis having a cylindrical face picture tube, there is a magnet on each side of the rear support bracket to straighten the raster sides, if necessary. They are correctly set at the factory but if moved in shipping or, if the yoke has been replaced, they may require readjustment. To do so:

1. Reduce raster size so that its sides are just visible.
2. Move corrector magnet forward or backward so that sides are straight.

HORIZONTAL HOLD ADJUSTMENT

The HORIZONTAL HOLD control should have a sync range of approximately 50°. If the control is too critical, adjust as follows:

1. Shunt the HORIZONTAL OSCILLATOR coil L-23 to ground with a .25 mf 400V capacitor. This may be done with the chassis in the cabinet by placing the capacitor across the two-pin receptacle (J-5).
2. With the HORIZONTAL CENTERING control, move the picture to the left so that the right edge of the raster can be seen, as viewed from the front of the set. Adjust the HORIZONTAL HOLD control for about 1/16" of sync pulse. (The sync pulse appears as a darker gray bar at the right edge of the blanking pulse. The blanking pulse is the gray bar at the right edge of the raster.)
3. Remove the .25 mf capacitor from across the HORIZONTAL OSCILLATOR coil.
4. Adjust the HORIZONTAL OSCILLATOR coil until the same amount of sync pulse can be seen as was noted in step 2.

HORIZONTAL SIZE

Adjust the HORIZONTAL SIZE control until the picture fills the mask horizontally. As this control also affects vertical size, it may be found necessary to readjust the VERTICAL SIZE control.

AREA SELECTOR SWITCH

A three-position AREA SELECTOR switch, located on the back of these chassis, permits them to be adapted to varying receiving conditions found in different localities.

The LOCAL, SUBURBAN, and FRINGE positions correspond approximately with the setting required for strong medium, or weak signals, respectively.

In the LOCAL position, AGC is applied to the RF amplifier, mixer, and the first two IF stages. In the SUBURBAN position, AGC is removed from the RF and mixer stages. In the FRINGE position, the AGC applied to the IF stages is reduced 50% and the video amp grid resistor is returned to ground to improve noise limiting.

Since the AREA SELECTOR switch allows the receiver to operate under best conditions for the signal strength at your location, an incorrect setting may give poor picture quality, instability, or a buzzing sound in the speaker. Set this switch in the position which gives the clearest and most stable picture.

tone control linkage setting

If, for any reason, it becomes necessary to replace the tone control linkage, the following procedure should be followed:

1. Set the tone control potentiometer at zero ohms (maximum counterclockwise).
2. Place the linkage over the TONE and CONTRAST-VOLUME shafts in such a manner that the arms and link are below the shafts.
3. Move the arms counterclockwise as far as possible and tighten the setscrew on the TONE shaft.

VERTICAL HOLD

Adjust the VERTICAL HOLD control for the center of the vertical sync lock-in range.

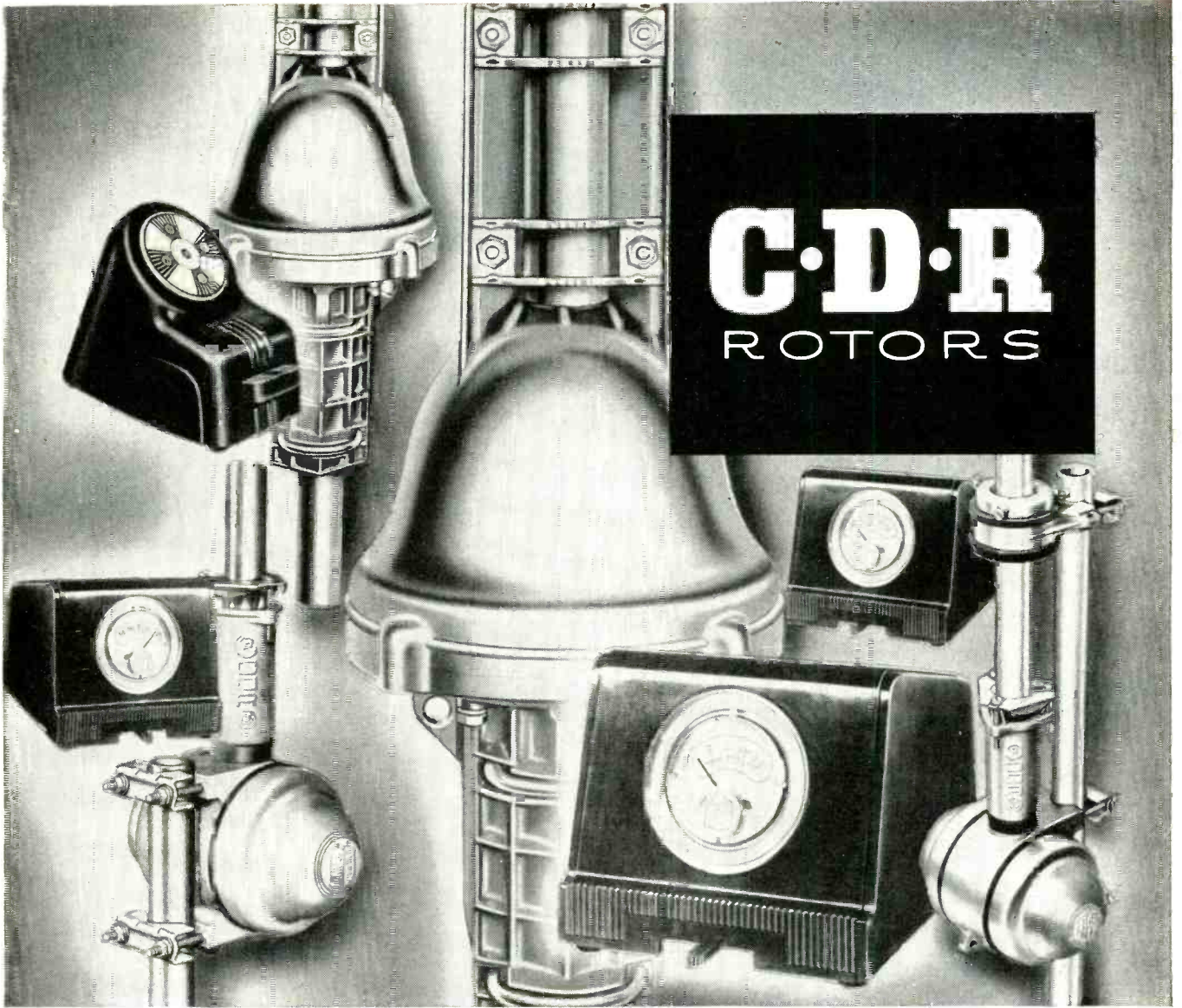

no other rotor offers SO MUCH

a complete line

TR-2 the heavy duty rotor with compass control dial cabinet.

TR-4 the heavy duty rotor with meter dial cabinet.

TR-11 all purpose rotor with meter dial cabinet.

TR-12 all purpose rotor for large TV antenna arrays with meter dial cabinet.

widely promoted on TV!

widely promoted to consumers on TV... ALL CDR ROTORS are PRE-SOLD for you through an extensive campaign to millions every week exploiting the advantages of the CDR.

completely merchandised

completely merchandised... the easiest to sell... in addition to the TV spot coverage... there are newspaper ads, window streamers, envelope enclosures... and an animated point of sale display... all the tools you need to sell the BEST SELLING ROTOR!

CORNELL-DUBILIER
SOUTH PLAINFIELD, N. J.



THE **RADIART** CORPORATION
CLEVELAND 13, OHIO

New



Products

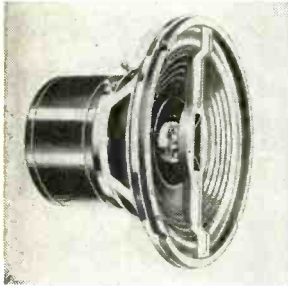

E-V 12" and 15" Triaxial Speakers

New concentric-type 12" and 15" TRX TRIAXIAL high-fidelity loudspeakers are announced by Electro-Voice, Inc. These new Triaxial reproducers combine the E-V super-Sonax Very High Frequency Driver, Radax, Treble Propagator, and bass cone with magnet in one concentric assembly. Adjustable brilliance control for remote mounting which allows matching to room acoustics. Response is 30-15,000 cps in recommended enclosures. Full 1/2 section M-derived crossover network minimizes distortion.

Sylvania Color TV Dot Generator

Sylvania Electric Products, Inc., announced production of color TV dot generators. To achieve precise register of colors on the television screen, the electron beams from each of three guns must converge to a single point exactly at the hole in an aperture mask between the guns and the tube face.

The Sylvania color dot generator introduces on the color screen a large number of rectangles of light, large enough to show the degree to which the electron beams are out of proper convergence.

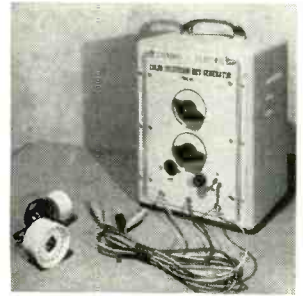

Belden Cellulose Lead-In

A highly efficient, 300-ohm *uhf*-*vhf* TV lead-in with a moistureproof cellulose polyethylene core which eliminates moisture and maintains constant characteristics, has been announced by Belden Manufacturing Company, Chicago.

The new 8275 Cellulose Lead-In has been thoroughly tested and proved stable, efficient, water-, sun-, wind-, and abrasion-resistant. No end seal is required, and conductor spacing is constant at all times.



Taco Multi-Set TV Couplers

Technical Appliance Corporation, Sherburne, N.Y., announces the availability of a complete line of multi-set couplers, of the high-efficiency, signal-splitting design.

Measuring 2 1/4" x 4 1/4" x 3/4" deep, the units may be installed in a few minutes. Connections of the transmission line is to captive screw terminals in a high quality terminal strip.

Currently available in three different models, No. 820-2 divides the signal equally to two receivers, while 820-3 and 820-4 provide service to three or four receivers as required.

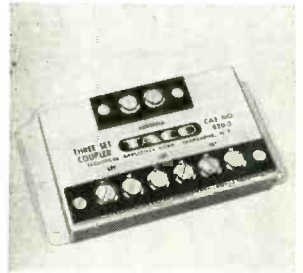

Cornell-Dubilier "Ultamatic" Antenna

The Cornell-Dubilier Electric Corporation of South Plainfield, New Jersey, announces a new television antenna, the "Ultamatic", an all-channel type to be perfectly synchronized for both black and white and color reception, and has gain response that does not vary more than 3 db on any channel across the band—a quality exceedingly important in color reception to insure adequate color synchronization without resetting.

Revolutionary Flyback Tester

TeleTest Instruments Corp. has introduced an amazing new Flyback Tester, which purportedly tells exactly what condition any flyback is in. It not only checks continuity... it also checks yokes, width coils, and linearity coils for shorted turns. The TeleTest instrument checks the flyback under the full operating voltage. The Tester is portable and compact, and has a convenient leather carrying strap. The dial is clear and easy to read... the control panel is simply and efficiently designed. Perfect operation is guaranteed on a money-back basis.

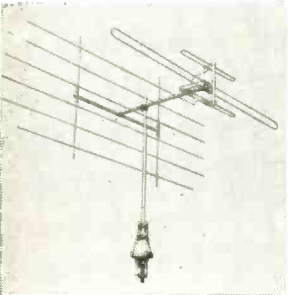
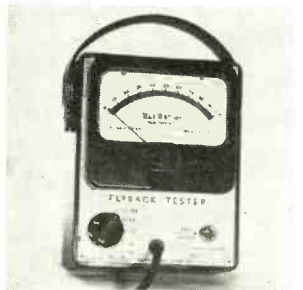

TV Antenna Filter by Radiart

Radiart has announced the Model UAK-1 Filter Network for TV antenna installations. This network contains coils and capacitors, no resistors, and therefore functions as a low loss filter. Features: Sealed polystyrene case, molded "standoffs", maximum signal rejection ratio insuring minimum signal interaction, easy installation, positive gripping, for use in normal 300 ohm installations, and no ghosts or images because of minimum reflection loss. It is ideal for segregating *vhf* and *uhf* at the set, and is guaranteed to work with *uhf*.

New IRC Miniature Resistor

A new 1/4 watt high frequency miniature resistor, type HFR, has been introduced by International Resistance Company, Philadelphia. Constructed of solid ceramic rods to which a thin resistive film is permanently bonded, this unit, featuring axial leads is entirely coated with a moisture resistant protective coating, and is recommended for use in circuits requiring excellent wide range frequency response and where low shunt capacity is desirable.

For further information, write International Resistance Company, 401 North Broad Street, Philadelphia 8, Pennsylvania—specify bulletin F-3.

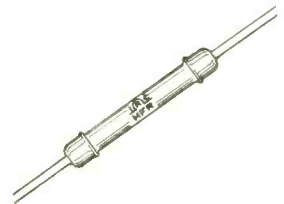

General Instrument Combination Tuner

A new combination all-channel *vhf*-*uhf* tuner has been perfected by General Instrument Corporation. The Model 80 combination *vhf*-*uhf* tuner features a tri-concentric shaft arrangement. The inner shaft tunes Channels 2-13 (*vhf*) by turret-detent action; the middle shaft operates *vhf* fine tuning and all *uhf* tuning; the outside shaft operates the dial. In the 13th position, it switches to *uhf*, and Channels 14-83 then tune continuously on the vernier section of the knob.

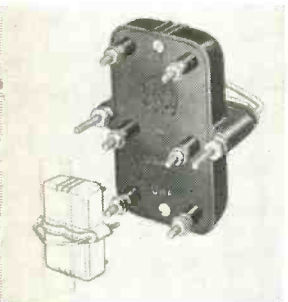
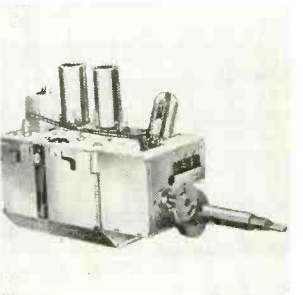

CBS-Hytron Solder Dispenser

CBS-Hytron is now offering service-dealers a new solder-dispenser which does away with haywire coils of solder. The operator's thumb on the knurled control wheel of the unique Solder-Dispenser feeds solder and retracts it neatly when the job is done. A one-hand tool, the Dispenser holds 72 inches of solder (a full month's supply) and is compact, light, and pencil-like with a handy pocket clip.

RCA Wide-Range Sweep Generator

A wide-range sweep generator for *uhf* TV equipment has been announced by the Radio Corporation of America.

The compact, lightweight, and portable instrument (WR-86A) is engineered for the requirements of both color and black-and-white *uhf* television equipment, and supersedes RCA's two popular laboratory-type *uhf* sweep generators.

The instrument comes complete with a 50-to-300-ohm padded balun for matching the sweep generator to loads of 300 ohms, a four-foot *rf* cable, and an instruction booklet.

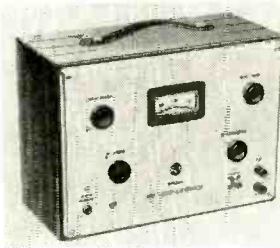

Chicago Transformer BO-13

A new high fidelity output transformer, BO-13, specially designed for ultra-linear operation, has been announced by the Chicago Division of Chicago Standard Transformer Corporation. Featuring Chicago's "sealed-in-steel" construction, its drawn steel case measures only 3 11/16" x 3 5/16" x 4 11/16" high, with pin-type terminals and studs for flush chassis mounting.

For details, write for Chicago Bulletin No. 33 to the Chicago Division, Chicago Standard Transformer Corporation, 3501 Addison Street, Chicago 18, Illinois.

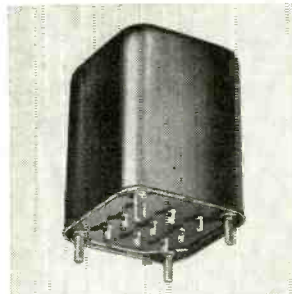

Jensen Announces "Treasure Chest" Models

The addition of two new "Treasure Chest" furniture models to the "Duette" line of two-way high fidelity loudspeaker systems, one in mahogany and the other in blonde oak, has been announced by the Jensen Manufacturing Company of Chicago.

Wrought-iron legs to fit all "Duette" models are also available. The "Duette" features an 8" heavy duty "woofer", a multicell "tweeter", a built-in dividing system and a full 20-watt power rating.

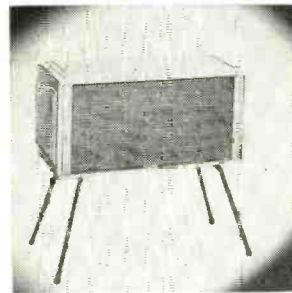

New Auto Speakers

Oxford Electric Corporation, 3911 S. Michigan Ave., Chicago, Ill., is introducing a new line of rear deck speaker kits, in two models; RD-69, which employs the 6" x 9" elliptical speaker, and RD-57, which has a 5x7" elliptical speaker. The 5"x7" is suited to late model cars equipped with cut outs for this size unit. Both speakers have sufficient power handling capacity for the most powerful car radios.

The kits, complete with all necessary hardware and grille plates, are finished in a neutral grey, and are also boxed in a display type carton.

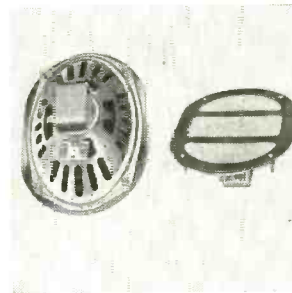

Amphenol Lightning Arrestor

A lightning arrestor for UHF/VHF TV is in production by the American Phenolic Corporation of Chicago.

Affording complete protection in both frequencies, plus the lowest possible measurable loss in signal strength, it also handles flat, tubular or open wire transmission line with equal facility. Installation is quick and simple, as all lead-ins are inserted in a vertical position. This lightning arrestor, the 114-328 is the resistor type with the cavity around the resistors filled with a unique compound giving perfect seal with practically no loss of signal strength.

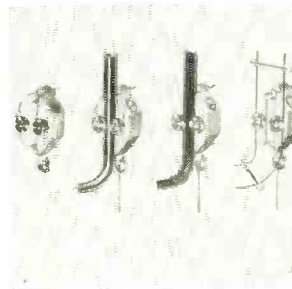

Anchor UB-160 Britener

Anchor Wire Products, Chicago, announces its new line of Heavy Duty Briteners. Star of the line is the UB 160 "quick change" universal Britener of unique design which increases the voltage to 7.8 V britening CR tubes—in either series or parallel wired filaments. Incorporating an isolation transformer, Anchor's UB 160 set to normal 6.3 V will relieve internal cathode to filament shorts of CR tubes for either series or parallel wired filaments. Information on request from Anchor Wire Products, 2712 W. Montrose Avenue, Chicago 18, Illinois.



The TARZIAN TUNER

UV 13

All Channel
Combination UHF-VHF

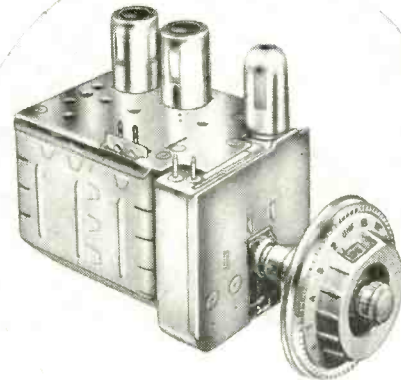

● A compact, combination tuner (the world's smallest) for covering the entire UHF-VHF bands.

● Straight line electrical sequence of compartmented circuits.

● Simple, coaxial tuning.

● Stage shielded.

● OVERALL PERFORMANCE MAKES ANY SET A BETTER SET.

Write for folder covering complete description and performance data.



SARKES TARZIAN, Inc.

Tuner Division

Bloomington, Indiana

A VERSATILE VTVM

by R. BLITZER

A description of a new bridge-type VTVM which adequately meets the modern TV serviceman's complex and exacting requirements.

IN addition to the normal function of a vtvm as an instrument that measures sine wave values of ac, and dc with minimum loading of the circuit being measured, its ability to measure peak-to-peak values of nonsinusoidal voltages permits it to be usefully employed in signal tracing sync pulses, video signals, deflection signals, etc.

One of the more versatile instruments of this type is the Radio City Products Model 655 Do-All vtvm. The description of its circuitry and operation should be of interest to the servicing technician

insofar as it will enable him to understand more readily its applications in more effective servicing. The complete unit is shown in Fig. 2, with the schematic diagram given in Fig. 1.

Switching

Basically, the circuit is a bridge type vtvm. A 500 μ amp meter is connected between the cathodes of a 12AU7 duotriode. The conductivity of each of these tubes is adjusted by means of their cathode bias resistors so that the cathode voltages are equal. A zero reading is

now indicated on the meter. By applying the voltage to be measured (through circuits herein described) to the grid of one triode, a difference in plate current between the two tubes is produced with a resulting difference in their cathode voltages. The meter, connected between the cathodes, shows this voltage difference.

Referring to Fig. 2, the five position switch shown on the front panel at the left is called "Circuit," and selects the operation of the unit for -DC Volts, [Continued on page 54]

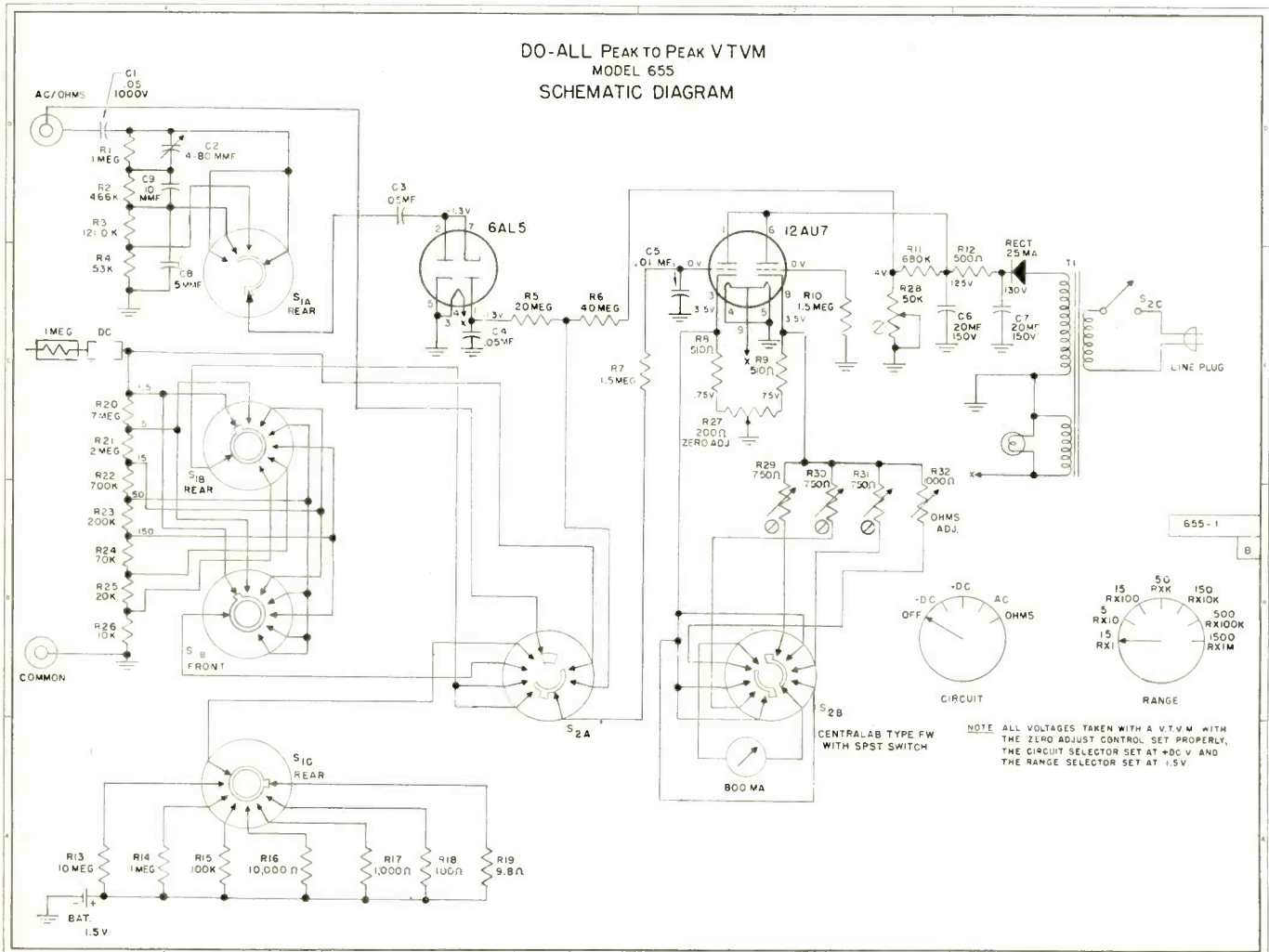

Fig. 1—Schematic diagram of Radio City Products Model 655 VTVM.

Mfr: Capehart Chassis No. CX-33DX

Card No. CA33-25

Section Affected: Pix

Symptom: Pix instability

Reason for Change: To eliminate *if* harmonic feedback

What to Do:

Add: L219 (2.7 μ h) between T203 and -90V point

Connect: C209 (5 μ f) as shown

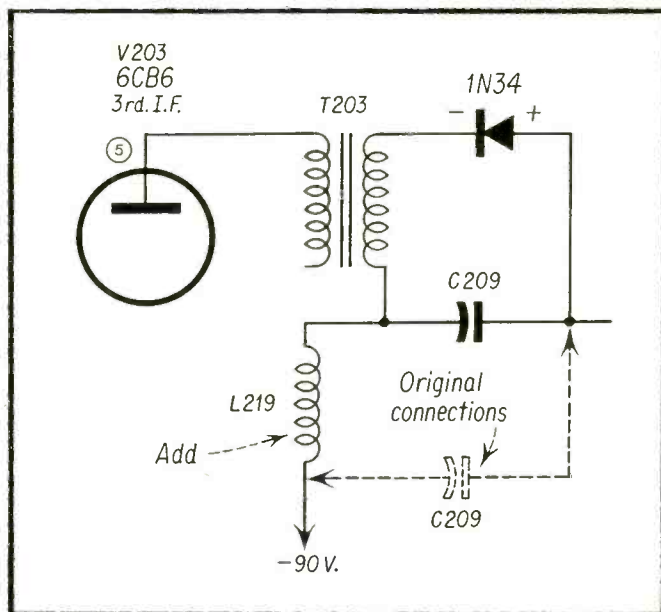

Mfr: Capehart Chassis No. CX-33DX

Card No. CA33-26

Section Affected: Sync

Symptom: Critical vertical hold

Reason for Change: To improve vertical stability

What to Do:

Replace: C244 (.0012 μ f)

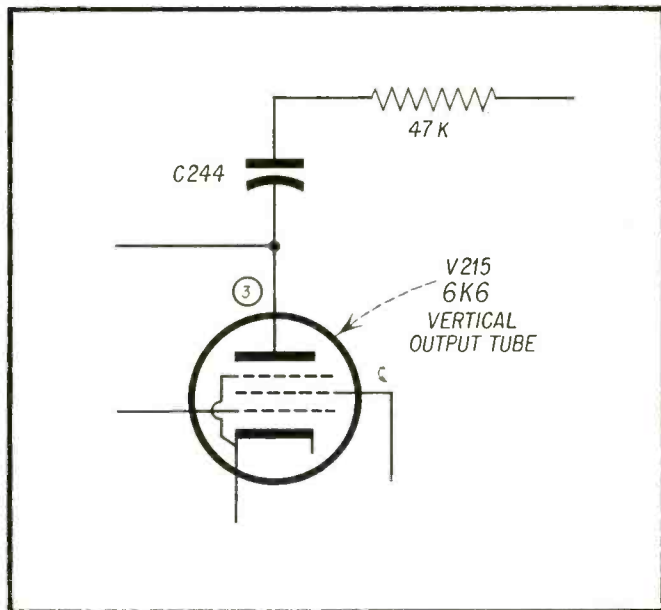

Mfr: Capehart Chassis No. CX-33DX

Card No. CA33-27

Section Affected: Pix

Symptom: Critical operation of *agc* set control

Reason for Change: To smooth operation of *agc* set control

What to Do:

Change: R243 from 330K to 1 meg

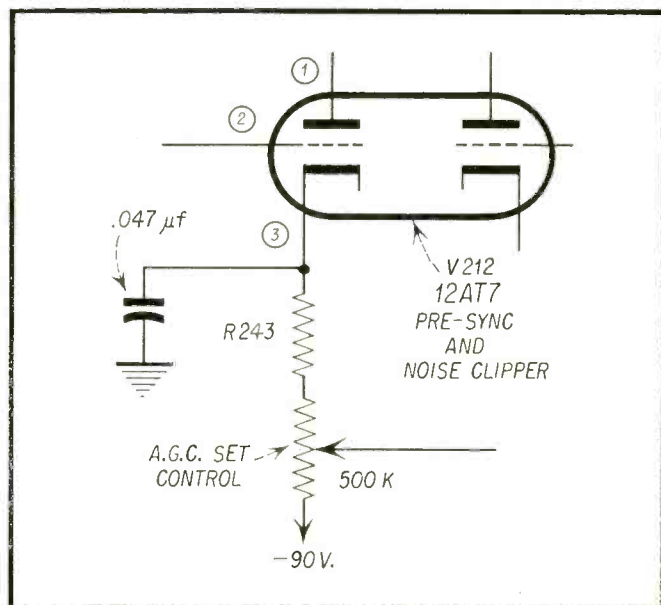

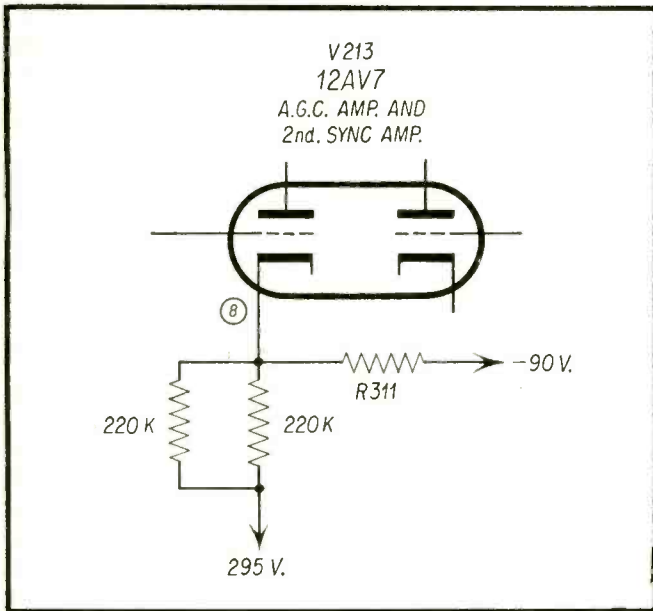

Mfr: Capehart

Chassis No. CX-33DX

Card No. CA33-28

Section Affected: Pix

Symptom: Critical *agc* operation

Reason for Change: To improve *agc* operation

What to Do:

Change: R311 from 10K to 8.2K

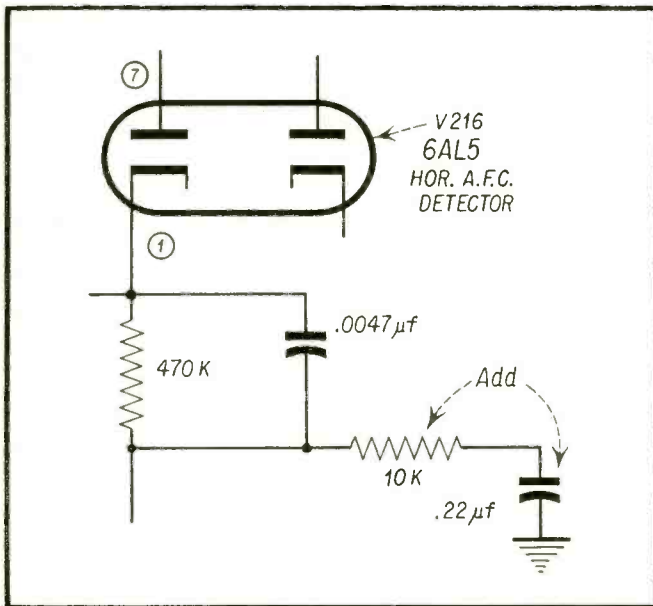

Mfr: Capehart

Chassis No. CX-33DX

Card No. CA33-29

Section Affected: Sync

Symptom: Hooking and bending at top of pix

Reason for Change: To eliminate hooking and bending at top of pix

What to Do:

Add: 10K, ½W resistor and .22 µf condenser as shown

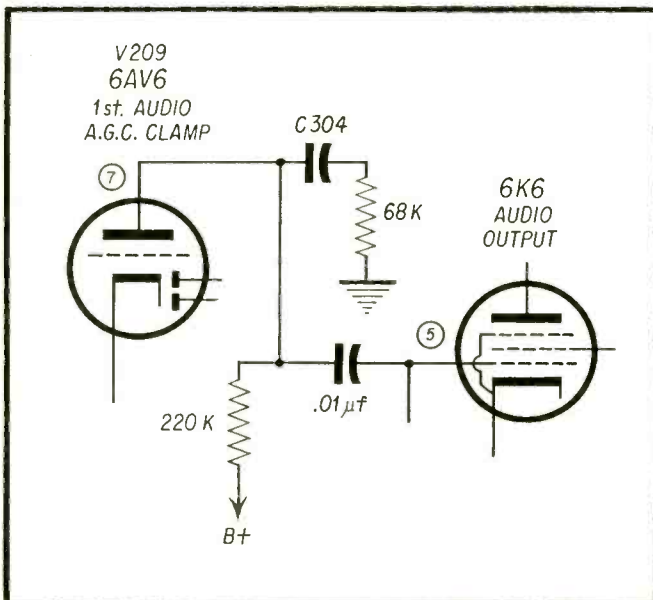

Mfr: Capehart

Chassis No. CX-33DX

Card No. CA33-30

Section Affected: Sound

Symptom: Sound weak and possibly distorted

Cause: Component failure

What to Do:

Replace: C304 (.0047 µf)

Mfr: Du Mont Chassis No. RA-164

Card No. DM 164-7

Section Affected: Sync

Symptom: Critical vertical hold

Cause: Component failure

What to Do:

Replace: C221 (.01 μ f)

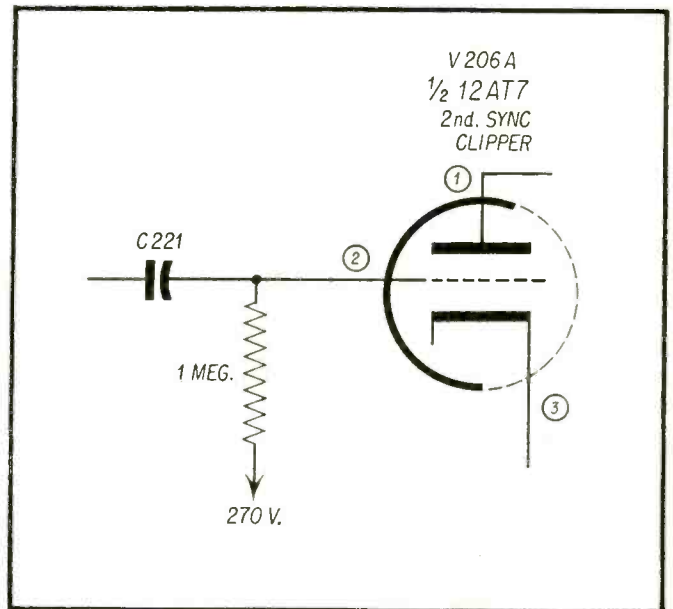

Mfr: Du Mont Chassis No. RA-164

Card No. DM 164-8

Section Affected: Sync

Symptom: Horizontal hold control does not hold through complete range

What to Do:

Replace: either R237 or R236 (100K), whichever has changed value

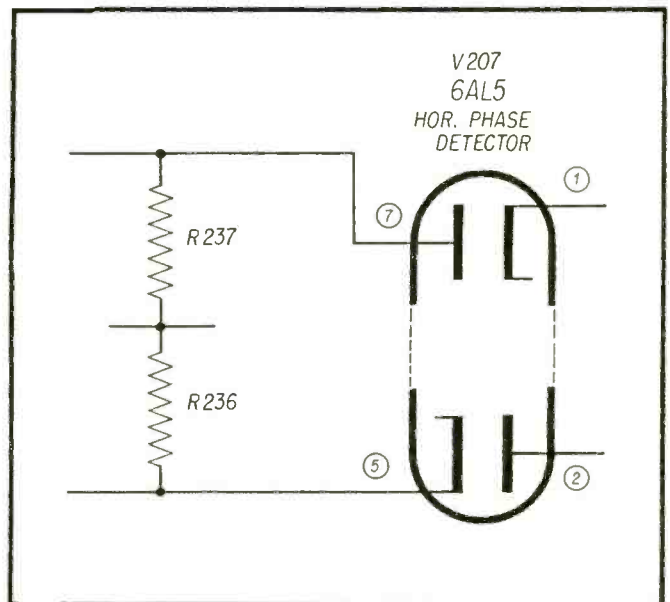

Mfr: Du Mont Chassis No. RA-164

Card No. DM 164-9

Section Affected: Raster

Symptom: Insufficient brightness

Cause: Defective component

What to Do:

Replace: C289 (.01 μ f)

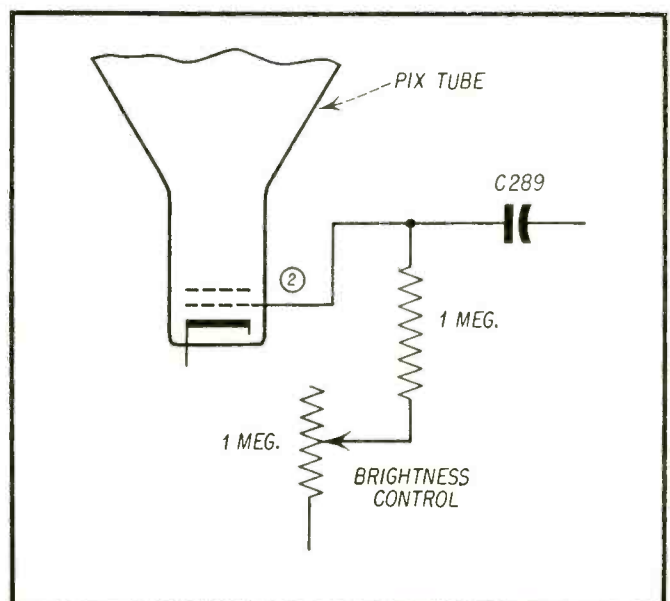

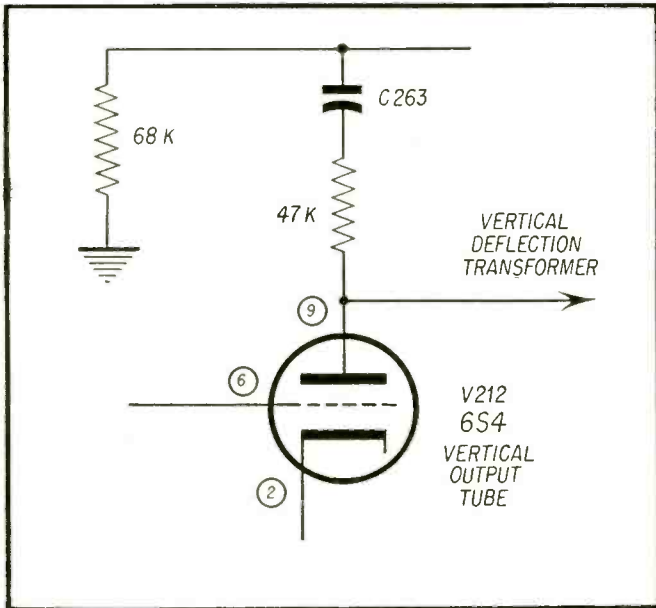

Mfr: Du Mont Chassis No. RA-164

Card No. DM 164-10

Section Affected: Sync

Symptom: Vertical hold range drifts

Cause: Defective component

What to Do:

Replace: C263 (.01 μ f)

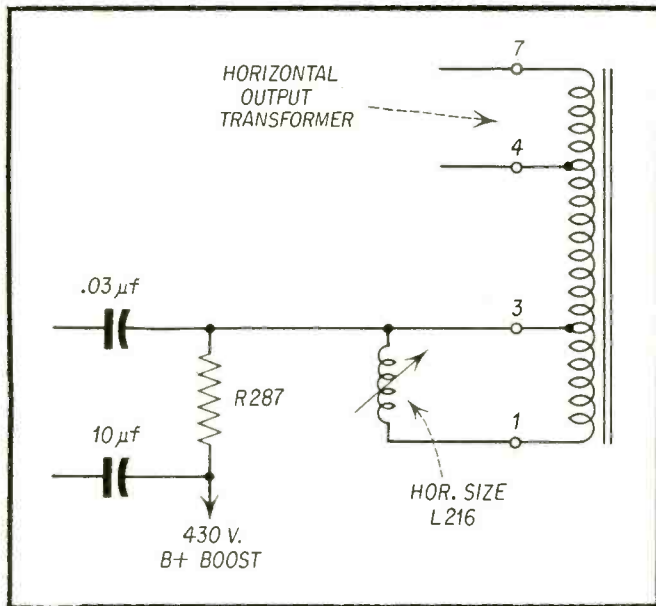

Mfr: Du Mont

Chassis No. RA-164

Card No. DM 164-11

Section Affected: Raster

Symptom: Insufficient height

Cause: Defective component

What to Do:

Replace: R287, 3.3K-2W resistor which has increased in value

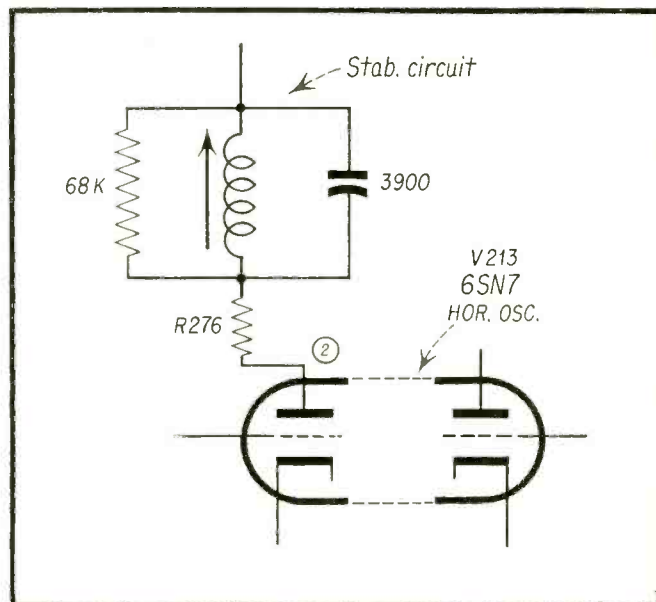

Mfr: Du Mont

Chassis No. RA-164

Card No. DM 164-12

Section Affected: Raster

Symptom: Intermittent high voltage

Cause: Component failure

What to Do:

Replace: R276 (8.2K)

"Customers Bring own sets in for service"

CHARLES W. RHODES

"Back-breaking chassis tugging belongs to the past"

L. B. HALLBERG

"Another wonderful feature—easier circuit tracing"

ROY R. THOMPSON

CROSLEY SUPER-V IS A SERVICE MAN'S DREAM

—read these letters

"I now find many customers bring their own sets in for service because the Super-V has reversed the trend toward heavy, bulky sets. I can service more sets per day, and my overhead is less by truck expenses. The Super-V is not only a low-priced set, but a set that can be maintained at a low price, which is equally important."

Charles W. Rhodes, Electronic Service Mgr.
Robert L. Rice & Co., Portland, Oregon

"By removing the cabinet back, every tube is right in front of one's eyes. No more groping and twisting to relocate tube-socket pins. Back-breaking tugging of the chassis belongs to the past. If a repair or check of chassis components is necessary, a few screws are removed and the cabinet lifts off like a bonnet. The separate diagram showing the actual filament wiring makes the search for an open filament a matter of seconds."

L. B. Hallberg, Manager, Service Dept.
Hardware Products Co., Sterling, Ill.

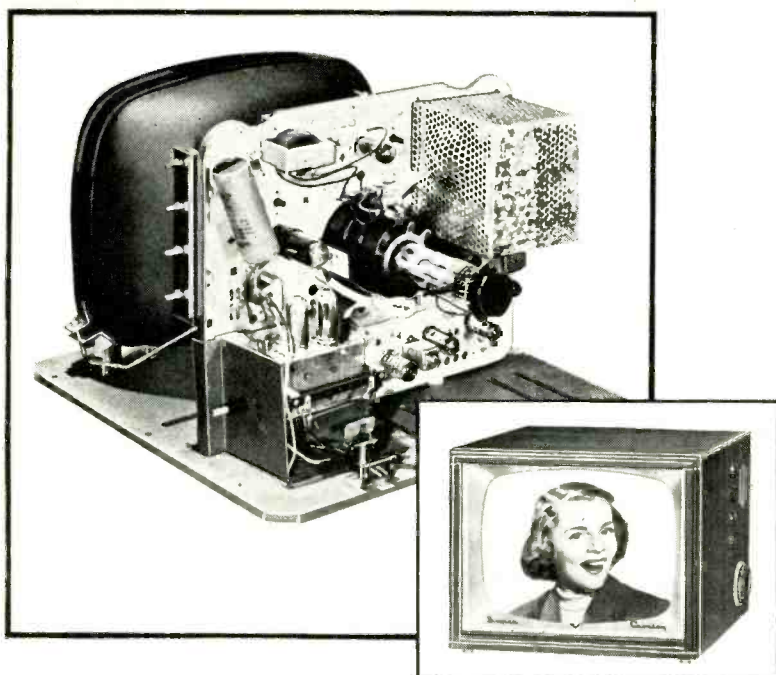

"The Crosley Super-V is a service man's dream; the new vertical plane chassis allows the changing of any tubes in a very few minutes. When service of a more complicated nature is required, the entire cabinet can be removed by loosening 6 screws; this leaves the entire chassis accessible for service. Another wonderful feature is that the picture-tube chassis and bracket are incorporated in one common mounting board along with the points wired on terminal strips for easier circuit tracing."

Roy R. Thompson, General Service Manager
Saginaw Distributors, Inc., Saginaw, Mich.

Crosley Division  Cincinnati 25, Ohio

Revolutionary Electronic "DO-ALL" by RCP

62

INDIVIDUAL
ELECTRONIC
RANGE

MEASUREMENTS



MODEL 657

Never before has there been engineered one instrument to sell for under \$100 that can possibly match the versatility, efficiency and speed of measurement built into this latest RCP design. Here are combined in one instrument five independent instruments—Capacity Meter, High Range Ohmmeter, R.M.S. V.T. Voltmeter, Peak-to-Peak V.T. Voltmeter, Inductance Meter—(by reference to charts)—essential in service—production—development. Outstanding in performance, measuring low frequency sinusoidal and both low and high repetition rate non-sinusoidal waveform.

D.C. Voltage: 16 Ranges $0 \pm 1.5 \pm 3 \pm 6 \pm 30 \pm 150 \pm 600 \pm 1500 \pm 6000$
 D.C. Voltage: Zero center 14 ranges $\pm .75 \pm 1.5 \pm 3 \pm 15 \pm 75 \pm 300 \pm 750$
 A.C. Voltage: Peak-to-Peak 7 ranges $0-4.2-8.5-17-85-420-1700-4200$
 A.C. Voltage: RMS—7 ranges $0-1.5-3-6-30-150-600-1500$
 A.C. High Voltage: RMS—Range 0-6000 Volts.
 Ohmmeter: 8 ranges— $0-1,000-10,000-100,000$ ohms. $0-1-10-100-1,000-10,000$ megohms. Center Scale 10.
 Capacity meter: 6 ranges 1 micro-microfarad to 1,000 microfarads; 1-100uf.; .00001-.001 mfd.; .0001-.01 mfd.; .001-.01 mfd.; .1-10 mfd.; 10-1000 mfd.

Years Ahead In Design —

- $8\frac{1}{2}$ " Easy-to-View Meter provides instant measurement recognition of the several scales.
- Simplified Controls save time. Illuminated individual settings of function and range.
- Carrying Handle serves as inclinable rest—tilts the instrument for maximum readability. **\$99 85 net**

The New RCP FLYBACKER Model 123

Extremely sensitive, the Model 123 Flybacker immediately shows up a single shorted turn in a flyback transformer or yoke. Its light, portable design serves to advantage in the shop and in the home.

All tests can be carried out with the components in place in the TV receiver, and call-backs can be prevented by checking all flyback transformers and yokes in stock for opens, shorts, etc.

Flybacker tests are also applicable to inductive windings on any transformer, choke speaker, solenoid, relays, etc. where the impedance is not relatively low. In fact the instrument may be used as a proportional AC Ohmmeter.

So Easy to Operate!

Minimum of connections necessary. All you do is remove flyback plate caps—set switches—apply leads and then read meter. The slightest change in inductance due to a shorted turn or the effect of intermittents shows up on the meter immediately as "BAD".



Quickly . . .
Accurately . . .
Check the Horizontal Output Circuit of All TV Receivers

The answer to fast, reliable testing of Flyback Transformers and Yokes

Only **\$39 75 net**

See your local parts distributor or write Dept. SD-6 for RCP Catalog.

RADIO CITY PRODUCTS CO.
EASTON, PENNSYLVANIA

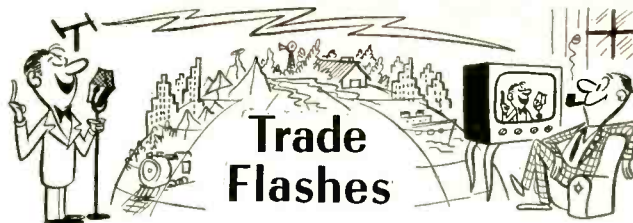

Experimental field tests of a method to extend coverage of ultra high frequency (UHF) television stations to "shadowed" areas are being prepared by the Radio Corporation of America. The company is requesting temporary authority from the Federal Communications Commission to conduct the tests for a period of 90 days. The system, Mr. Watts explained, utilizes a low-powered auxiliary transmitter developed by engineers of the David Sarnoff Research Center of RCA, Princeton, N. J. Under present plans, the newly-developed equipment will be installed near Vicksburg, Mississippi, some 37 miles from the station's main transmitter. Use of the system is expected to provide Grade "A" service for WJTV's signal in that area, where reception now is "shadowed" by geographic elevations.

Harold H. Rainier, right, manager, distributor sales, Electronic Products Sales, Sylvania Electric Products Inc., receives the annual "NATESA Friends of Service Manage-



ment" plaque for 1953. The award, made annually by the National Alliance of Television and Electronic Service Association, is presented to that company, which in the judgment of NATESA, rendered services beyond normal functions during the year.

Future uses of electronics in industry and in the home will be so many and so widespread that even today's universal use of radio and TV will seem small by comparison, Harvey W. Harper, chairman and founder of Tung-Sol Electric Inc., declared at a dinner honoring his 50 years of pioneer engineering and production achievements in the electrical lamp and electron tube fields. The dinner, attended by more than 300 leaders in the automotive, electronic, and other industries which Tung-Sol supplies, observed the half-century business association of Harper and Louis Rieben, president of Tung-Sol. Guests at the dinner honoring Harper and Rieben included E. C. Anderson, vice-president, Radio Corporation of America; M. F. Balcom, Director, Sylvania Electric Products, Inc.; Allan B. Dumont, Allan B. Dumont Laboratories, Inc.; J. B. Elliott, executive vice-president, Radio Corporation of America; A. B. Hunt, Director of Electronics Branch, Dept. of Defense Production, Dominion of Canada; Don G. Mitchell, chairman of the board, Sylvania Electric Products, Inc.; B. W. Cooper, general manager, Delco Radio Division, General Motors; F. R. Lack, vice-president, Western Electric Co.; Lyman A. Wine, vice-president, Electric Auto-Lite Company.

Factory production of both radio and television receivers in the first quarter of this year was at approximately the
[Continued on page 52]

THE Du MONT CHROMA-SYNC TELETRON

A new 3-beam shadow mask tube

THE Du Mont Chroma-Sync Teletron, Type Dev.-B1103, is a shadow mask type of color picture tube using a three-beam electron gun. In the Du Mont Color Teletron the color phosphors are applied directly to the curved face plate of the tube envelope by a photographic process, and the electron shadow mask has the similar curvature, and is positioned immediately behind the face plate. The size of the color picture available on the Du Mont Color Teletron is 12 9/16" by 16 9/16", which gives a useful picture of 185 square inches on a 19-inch round color envelope. Over 1,300,000 individual color dots of red, green, and blue phosphor have been deposited upon the screen, and are arranged in triad form.

The shadow mask has the curvature similar to that of the face plate itself. It is rigid and self-supporting. It does not require the use of tension for accuracy of alignment.

A new Mono convergence three-beam electron gun, developed by Du Mont, contributes considerably to the performance and design of the tube. A 60 degree deflection angle has been achieved which contributes to the short over-all length of the tube. The Du Mont 19-inch Color Teletron is three quarters of an inch shorter than the 15-inch type color tube familiar to the trade, nearly two inches shorter than a 19-inch tube of the planar-mask type. The Du Mont tri-beam electron gun has been so designed that there is a simple common convergence of all three electron beams. This eliminates the need for individual dynamic beam convergence and associated circuitry in the receiver. As a result, the Du Mont 19-inch Chroma-Sync Teletron is essentially interchangeable in receiver circuits with the older 15-inch types these being the first types of color tubes to appear on the present color TV scene.

COLOR PICTURE TUBE SIZE COMPARISON

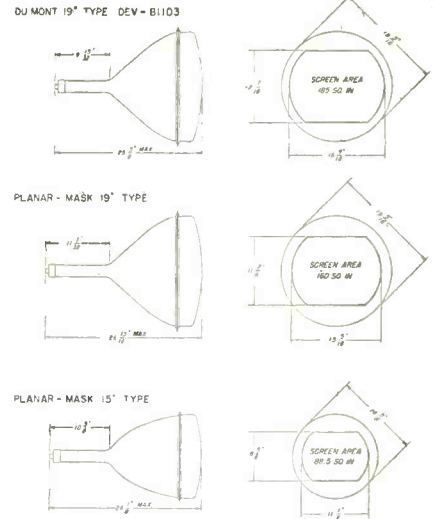

In the figure above, Du Mont indicates relative screen area sizes of various types of color TV tubes of the shadow mask type.

Future Outlook

The tube is simple in concept with high quality performance. However, there is still the qualification that present manufacturing techniques are costly. Thus, color television receivers of large screen size, priced for volume sale, are still some time in the future.

Windsor RADIO & TV RECEIVING TUBES GUARANTEED ONE FULL YEAR ... FOR PEAK PERFORMANCE!

Type	Each	Type	Each
0A2	.99	1U4	.61
0B2	.88	1U5	.51
0C3	.85	1V2	.74
1A7GT	.67	1X2A	.45
1AE4	.90	2X2	1.43
1B3GT	.69	3A5	.90
1H5GT	.51	3LF4	.76
1J6	.93	3Q4	.66
1L4	.63	3Q5GT	.72
1L6	.86	3S4	.61
1LA4	.82	3V4	.62
1LA6	.80	5R4GY	1.00
1LB4	.82	5U4G	.44
1LC5	.80	5V4G	.83
1LC6	.80	5Y3G	.37
1LD5	.80	5Y3GT	.32
1LE3	.80	5Y4G	.43
1LG5	.80	6A8GT	.68
1LH4	.80	6AB4	.51
1LN5	.80	6AC5GT	.82
1N34	.90	6AC7	.90
1N48	.50	6AF4	1.10
1N5GT	.63	6AG5	.59
1N64	.75	6AH4	.68
1R3	.85	6A8G	.89
1R5	.62	6AK5	1.45
1S4	.67	6AL5	.44
1S5	.52	6AN8	.95
1T4	.62	6AQ5	.51

Thousands of Service Organizations and Dealers send us REPEAT ORDERS month after month—they KNOW you can depend on the WINDSOR promise of PEAK PERFORMANCE. Every tube we ship is first carefully tested in our labs, for maximum functioning characteristics, right in a radio or TV Set—under actual operation conditions. Each tube is attractively packaged in the famous green and black WINDSOR carton that has earned consumer acceptance throughout America!

Type	Each	Type	Each	Type	Each	Type	Each	Type	Each
6AQ6	.47	6BL7GT	.94	6SA7GT	.57	7A5	.85	7K7	.85
6AQ7	.75	6BN6	.98	6SC7	.63	7A6	.57	7L7	.85
6AR5	.42	6BQ6GT	.98	6SD7	.55	7A7	.58	7N7	.62
6AS5	.55	6BQ7	.92	6SF5GT	.66	7A8	.56	7Q7	.62
6AS7G	4.50	6BY5G	.85	6SG7	.55	7AD7	1.05	7R7	.70
6AT6	.42	6BZ7	1.09	6SH7GT	.52	7AF7	.63	7S7	.90
6AU5GT	.85	6C4	.41	6SI7GT	.52	7AG7	.65	7V7	.92
6AU6	.47	6C5GT	.60	6SK7GT	.55	7AH7	.65	7W7	.62
6AV5	.85	6CB6	.58	6SL7GT	.68	7A17	.70	7Y4	.45
6AV6	.41	6CD6G	2.04	6SN7GT	.59	7B4	.54	7Z4	.50
6AX4	.72	6D6	.63	6SF7GT	.46	7B5	.51	12A6	.60
6BBG	.93	6E5	.72	6T8	.85	7B6	.52	12AL5	.44
6BA6	.50	6F5GT	.54	6U4GT	.60	7B7	.58	12AT6	.53
6BA7	.66	6H6GT	.55	6U5	.72	7C4	1.05	12AT7	.75
6BC5	.58	6J5GT	.44	6UR	.86	7C5	.56	12AU6	.47
6BD5GT	.98	6J6	.68	6V3	1.09	7C6	.50	12AU7	.58
6BD6	.54	6J7	.70	6V6GT	.51	7C7	.58	12AV6	.41
6BE6	.51	6K6GT	.45	6W6GT	.63	7E6	.85	12AV7	.87
6BF5	.66	6K7	.70	6W6GT	.63	7E6	.65	12AX4	.72
6BF6	.43	6L6G	.88	6X4	.37	7E7	.85	12AX7	.67
6BG6G	1.47	6L6GA	.88	6XS5GT	.36	7F7	.69	12AY7	2.15
6BH6	.63	6Q7GT	.55	6XR	.95	7F8	.97	12B4	.68
6BJ6	.53	6R7	.75	6Y6G	.64	7G7	.85	12BA6	.50
6BK5	.76	6S4	.51	6ZY5	.60	7H7	.61	12BA7	.66
6BK7	.97	6S8GT	.75	7A4/XXL	.57	7J7	.85	12BD6	.51

Type	Each	Type	Each
12BE6	.52	25A5	.85
12BH7	.69	25BQ6GT	.98
12BY7	.77	25L6GT	.53
12J5GT	.48	25W4GT	.53
12SA7GT	.57	25Z6GT	.46
12SH7GT	.67	35A5	.55
12SK7GT	.55	35B5	.53
12SL7GT	.67	35C5	.53
12SA7GT	.57	35L6GT	.52
12SH7GT	.67	35W4	.33
12SK7GT	.55	35Y4	.48
12SL7GT	.67	35Z4	.48
12SA7GT	.57	35Z5GT	.33
12SH7GT	.67	50A5	.55
12SK7GT	.55	50B5	.52
12SL7GT	.67	50C5	.52
12SA7GT	.57	50L6GT	.52
12SH7GT	.67	50X6	.55
12SK7GT	.55	117Z3	.43
12SL7GT	.67	117Z6GT	.75

WINDSOR WONDER-BEAM 3-WAY TV ANTENNA



Has adjustable arms, and new electronic wonder-switch, for Maximum reception in Fringe Areas, Average Areas, and for UHF. It's a real performer—works where others fail! Attractively styled, ruggedly made. Lots of Six, Each \$5.69. Singly, each \$5.95.

FREE! WINDSOR TUBE CADDY

Most practical service-aid ever designed for Radio & TV repairmen! Now offered FREE with every purchase of \$160.00 or accumulated purchases totalling \$160.00 within 90 days (You get Caddy credit memo with each purchase).

- Carries approximately 125 Tubes, including meters and tools.
- 16 1/2" long, 8 1/2" wide, 13 3/4" high. Weighs only 9 lbs.
- Ruggedly constructed with heavy leatherette covering, strong plastic handle, nickel plated hardware, and reinforced with metal clamps.



WINDSOR TUBE CADDY may also be purchased outright for \$14.95

Note to our Latin-American Friends: "SE HABLA ESPANOL"

Windsor ELECTRONIC TUBE CO.

2612-D NOSTRAND AVENUE, BROOKLYN 10, N. Y.

WINDSOR BROW-LITE



Leaves Both Hands Free To Work!

Ideal for Radio & TV repairmen! Puts light right where you need it. Uses standard penlite batteries and bulb. Does not interfere with glasses, rides over the brow. Order yours TODAY! ... you'll never want to be without it! Complete with Batteries \$4.95

WRITE FOR ADDITIONAL TUBE TYPES AND PRICES. We also stock Special Purpose and Transmitting Tubes at similar savings! Dept. D-6

ONE WORRY A SERVICEMAN DOESN'T HAVE . . .



Tung-Sol makes the kind of tubes servicemen know they can rely on for profitable service work without callbacks.

TUNG-SOL® dependable **PICTURE TUBES**



TUNG-SOL ELECTRIC INC., Newark 4, N. J.
Sales Offices: Atlanta, Chicago, Columbus,
Culver City (Los Angeles), Dallas, Denver,
Detroit, Newark, Seattle.

TRADE FLASHES [from page 50]

same level as the same 1952 period—a year when over six million TV sets and nearly 11 million radios were produced—as reported by the Radio-Electronics-Television Manufacturers Association. During the first 13 weeks of this year, 1,447,110 TV receivers and 2,581,565 radios were manufactured, RETMA reported. This compares with production of 2,259,943 television sets and 3,834,784 radios in the first 1953 quarter and 1,324,831 video receivers and 2,668,197 radios manufactured in the first 13 weeks of 1952.

1500 Service dealers attended RAYTHEON "Service Saver" meetings held recently throughout the Northwest. The "Service Saver" meetings were conducted by RAYTHEON TV's lecturer Bill Ashby who gave a slide-illustrated presentation of the "Service Saver" plan developed around the consumer TV Owner's Guide and the dealer's companion "Service Saver" Manual and Wall Chart. He developed many practical hints on how to conduct a service firm in a profitable manner, and presented the practical aspects of color TV servicing and what to expect when it arrives.

"Mass production of color television receivers is probable within two years," says Dr. Allen B. Du Mont, president, Allen B. Du Mont Laboratories, Inc. "Our company has demonstrated a large-screen color picture tube that we believe can be manufactured economically. It has a picture size almost as large as a 19-inch black-and-white picture tube. I think that a major step has been taken to break the log-jam with the introduction of Du Mont's 19-inch color tube. We expect to have Du Mont color receivers using this tube by the fall. Initial prices probably will be around \$1,000 each."

Robert C. Sprague, Chairman of the Radio-Electronics-Television Manufacturers Association's Board of Directors, will be awarded the "Medal of Honor" for his outstanding contributions to the radio-electronics and television industry during the RETMA annual convention in Chicago, Ill., June 15-17. Mr. Sprague was chosen unanimously by the RETMA Board of Directors. Long active in affairs of the electronics industry, Mr. Sprague was elected RETMA President in 1950 and became its first Board Chairman in 1951. Since that time he has devoted much of his time and energy towards improving the Association's relations with government and in increasing its representation of the mushrooming electronics industry.

"The Vital Link," a motion picture about TV antennas, has been completed and is now available for television and club promotion. Filmed by Channel Master Corporation, Ellenville, New York, the 13-minute sound movie describes how antennas function, why different antennas are necessary, and how antennas can reduce "snow," "ghosts" and other reception problems. Free 16mm prints are available from Association Films, New York City.

In January 1949, Clarostat Mfg. Co., Inc., manufacturer of resistors, controls, switches and resistance devices, transplanted its operations from Brooklyn to Dover, N. H., where everything could be concentrated under one roof. Over 34 truckloads, each weighing 10 tons, transported Clarostat equipment some 300 miles. Only half of each department in Brooklyn was dismantled and moved at first, so that the other half could remain in production, thereby insuring a steady flow of orders. As the Dover half got rolling, the remaining half was moved up. In the intervening five years Clarostat has taken firm root in Dover, and in many ways the community has benefited from the advent of Clarostat in its midst, with employment provided for some 1500 or more.

ASSOCIATION NEWS

RTTG of Gadsden, Ala.

The Radio and Television Technician's Guild of Gadsden, Alabama rounded out its fourth successful year recently. Plans are under way for filing incorporation papers. A TV Antenna Clinic is scheduled. Sessions will be held in the association's new meeting hall which seats 250. New officers of the group are: F. F. Hall, president; Nelson D. Harde- man, vice-president; Guy Brooks, secretary; and Arthur A. Godwin, treasurer.

ARTS-Men of Chicago

A new service group, the Associated Radio and Television Service Men, has been organized in Chicago, it was announced by Howard Wolfson, presiding chairman of the group. According to Mr. Wolfson, "Chicago servicemen have never had an organization. It is our intention to provide those things that the independent serviceman has always found lacking in previous attempts at group activity." Other officers are Clifford L. Anderson, vice-chairman; and Thomas H. Craig, secretary-treasurer.

Eastern TV Service Conference, Inc.

Incorporation papers were filed recently in Trenton, N. J. for the Eastern Television Service Conference, Inc., which is composed of 37 television service associations on the eastern seaboard.

Formation of the corporation was authorized at the second annual sessions of the Conference in the Bellevue-Stratford Hotel, Philadelphia, last weekend, and the following officers were elected: Harold B. Rhodes, of Paterson, N. J., chair- man; Bert Bregenzer, of Pittsburgh, Pa., vice-chairman; John Rader, of Reading, Pa., treasurer; and Ferdinand J. Lynn, of Buffalo, N. Y., secretary.

Trustees of the corporation will be Roger K. Haines, of Haddonfield, N. J.; Albert M. Haas, of Philadelphia; and Max Leibowitz, of New York. Haines, Haas, Leibowitz, Rhodes, and Charles Pierce of Miami, Florida, are the incorporators of the group. Office of the Corporation will be at 45 Church Street, Paterson, New Jersey, with Attorney Jerome J. Gelman as registered agent.

RTG of Long Island Hits "Below List" Sales

The Radio Television Guild of Long Island has taken a firm stand on the controversial issue of distributors selling parts "below list price" to private consumers. In a recent issue of *The Guild News*, the feature story relates two incidents that rate "high on the list of headaches that . . . plague . . . the serviceman . . ." The article states that distributors who retail parts to home set owners are like members of a team who are breaking up a healthy relationship. The distributor can undersell the service dealer, states the story, and still show a profit. The service dealer cannot do this.

UETA of Kingston, N. Y.

The Ulster Electronic Technicians Association of King- ston, New York were sponsors of a technical lecture on UHF installation and repair techniques, during May 12, 1954, given by the Zenith Television Co. The meeting was very successful and interesting since channel 66 went on the air recently in that area. UETA are members of the Empire State Federation of Electronic Technicians Association.

THE SET OWNER WHO USES TUNG-SOL TUBES!

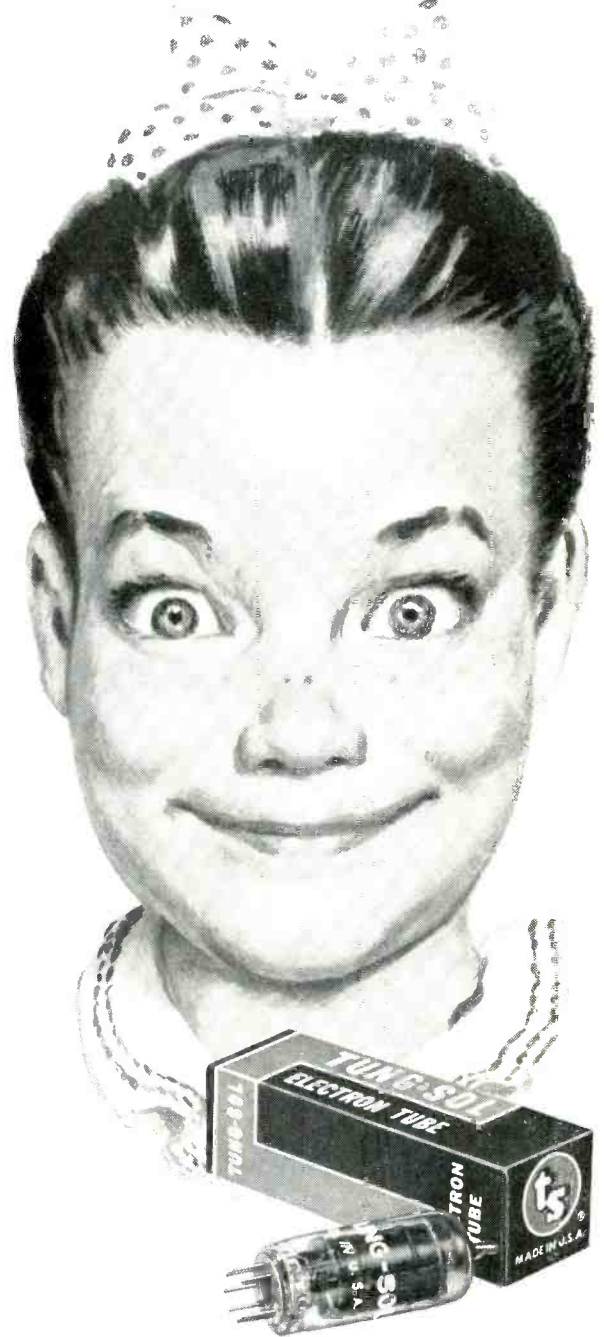

Tung-Sol Tubes have a long record of per- formance dependability. Servicemen can build a reputation on Tung-Sol quality.

TUNG-SOL® dependable TUBES-DIAL LAMPS

TUNG-SOL makes All-Glass Sealed Beam Lamps, Miniature Lamps, Signal Flashers, Picture Tubes, Radio, TV and Special Purpose Electron Tubes and Semiconductor Products.



After They
Tried Them All
**THIS IS THE ONLY
FLYBACK TESTER USED
BY SERVICE MEN AT:**

**JOHN WANAMAKER
SUNSET APPLIANCES
WINSTON APPLIANCES
AND MANY OTHERS**

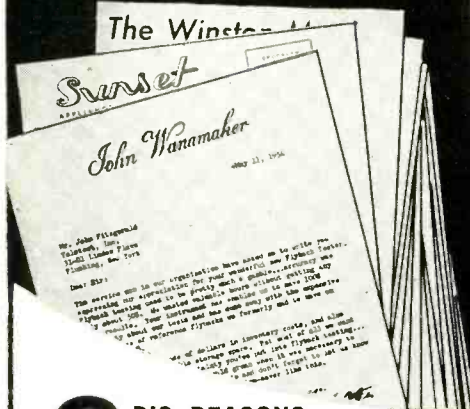

With other
flyback testers
you can be sure
only 50% of the time

AMAZING NEW

TELETEST
INSTRUMENT CORP.

**FLYBACK TESTER
IS 100% ACCURATE**

*A great new step
forward in elec-
tronic testing!
Now for the first
time, a flyback
tester that tests
GOOD flybacks
as well as bad!*

**6 BIG REASONS
WHY TELETEST IS BEST**

1. It's reliable... previous testers often gave bad readings on a good flyback transformer. Now Teletest indicates the exact condition of a transformer: good or bad. **2.** It checks continuity AND tests yokes, width coils, and linearity coils for *shorted turns*. **3.** It checks flyback under full operating voltage without danger of shock. On previous testers, shorts that occurred at operating voltage might not show at 100V. **4.** It needs no reference flyback... other testers need a known good reference flyback of the exact type as the one being tested. **5.** It tests color flybacks without a reference unit... other testers need an expensive color flyback as a reference. **6.** No calibration adjustment is required.

\$44.95

TELETEST
INSTRUMENT CORP.



**31-01 Linden Place
Flushing, New York**

Write today for detailed information.

A VERSATILE VTVM

[from page 44]

+DC Volts, AC Volts, and Ohms. The seven position switch at the right, on the front of the instrument, is called "Range." It selects the desired voltage and resistance measuring ranges.

Figure 1 shows the position of these switches in the schematic. "Circuit" switch is shown as a two wafer rotary marked "S2A" and "S2B" and an on-off switch section, "S2C." "Range"

switch is shown as a four section rotary at the left, indicated by "S1A rear", "S1B rear", "S1B front", and "S1C rear".

In the diagram both S1 and S2 switches are shown in their extreme counter-clockwise position; "Circuit" switch S2 is in the "OFF" position, and "Range" switch S1 is in the "1.5" (volts) and "RX1" (ohms) position.

Power Source

First let us consider the power source for this vtvm. A half-wave rectifier power supply is used, employing a power transformer (to isolate the instrument chassis from the hot side of the ac line voltage) and a selenium rectifier. Filtered dc is provided by the two 20 μ capacitors, C6 and C7, for the plates of the double-triode 12AU7.

The two triodes of the 12AU7 and their cathode resistors, R8, R9 and R27, make up the bridge circuit. Balance of the bridge is accomplished by proper setting of R27, the "Zero Adjust" control on the front panel.

Voltage Measurements

The meter is connected through switch S2B to the cathodes of the triodes. Provision is made for measuring dc voltage of either positive or negative polarity without the necessity of removing and reversing the test leads. Switch S2B reverses the meter connections itself. For example on "-DC" operation of the "Circuit" switch, the rotor blades of S2B are moved one position clockwise from that shown. The left side of the meter now connects to the triode cathode on the left. This is accomplished when the left side of meter, which is permanently connected to S2B stator (11 o'clock position), now connects through the rotor of S2B to the stator (at 7 o'clock). This stator permanently is joined to the cathode on the left. The right side of the meter is connected to the triode cathode at the right through S2B stator (at 5 o'clock), the rotor, stator (1 o'clock), and the calibration potentiometer R29.

For "+DC" measurements the "Circuit" switch S2 is turned two positions clockwise from that shown. The meter now connects to the triodes' cathodes oppositely from the previous operation; the left side of meter now connects to the right-side cathode through S2B stator (11 o'clock position), the rotor, stator (8 o'clock), and the calibration potentiometer R30. At this same time the right side of meter connects to the left-side cathode through S2B stator (5 o'clock), the rotor, and stator (2 o'clock).

To measure a dc voltage the two leads marked "Common" and "DC" are placed across the unknown voltage as usual. This voltage now appears across the voltage divider resistors, R20 to R26, at the left side of the schematic Fig. 1. Switch S1B rear selects a portion of this voltage, depending on the operating range, and connects it to the control grid of the left half of the 12AU7. This is accomplished via switch S1B rear stator (at 11 o'clock), its rotor, the stator (at 8 o'clock), switch S2A stator (7 and 8 o'clock, for -DC or

+DC), its rotor, and stator (5 o'clock) which leads to the triode grid. Connections through S2B were previously described as connecting the meter to the triodes' cathodes in the bridge circuit. The bridge becomes unbalanced when a voltage is applied to the triode grid.

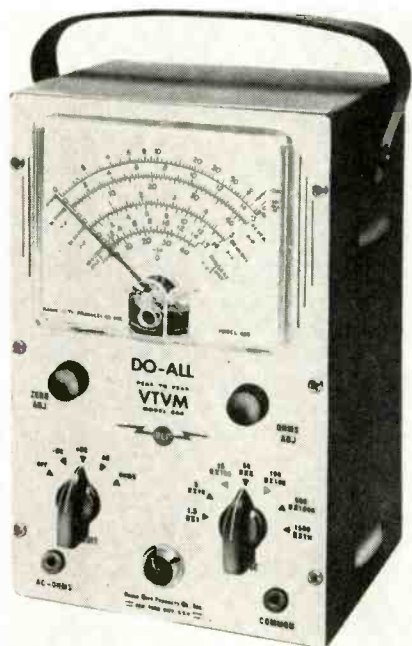

Fig. 2—Frontal view of the unit, showing panel switch positions.

Measuring an ac voltage is attained in a novel manner. A duo-diode tube, a 6AL5, is employed in a voltage doubler circuit using capacitors C3 and C4. The complete schematic Fig. 1 and the simplified schematic of Fig. 3 show this.

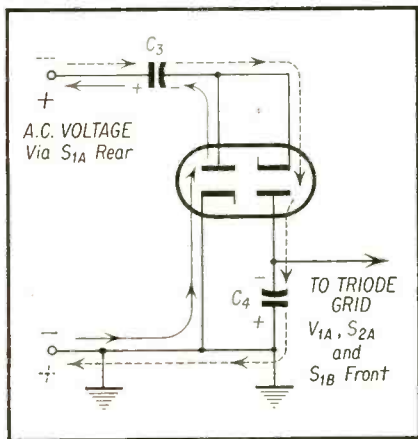

Fig. 3—AC voltages are measured using a duo-diode in the illustrated voltage-doubling circuit.

On the positive portion of the ac voltage to be measured, the left diode conducts, charging up C3 to the peak of this voltage. When the ac reverses polarity, the voltage across C3 adds to the negative-polarity of the ac. The right diode now conducts charging C4

Ready NOW!

completely NEW STANCOR TV TRANSFORMER REPLACEMENT GUIDE

The new 1954 Stancor TV Replacement Guide and Catalog is a fully revised, up-to-the-minute listing of accurate transformer replacement data. Every recommendation has been rechecked against the latest information obtainable.

This Stancor reference lists over 6800 TV models and chassis of 115 manufacturers, including hard-to-locate information on "private label" sets.

To make your servicing easier, *virtually all flybacks, yokes and power transformers listed are exact replacements.* Where an exact replacement unit is not available, reference is made to the circuit or terminal changes required.



Stancor transformers are listed in Photofact Folders and Counterfacts.



CHICAGO STANDARD TRANSFORMER CORPORATION
3586 Elston Avenue Chicago 18, Illinois

EXPORT SALES: Roburn Agencies, Inc., 39 Warren Street, New York 7, N. Y.



FREE
If you haven't received your copy, see your Stancor distributor, or write us directly.

STANCOR-WILLIAMSON ULTRA-LINEAR HI-FI amplifier bulletin 479

Build your own ultra-linear hi-fi amplifier using Stancor high fidelity output transformer A-8072 (\$15.00 net). You can also use A-8072 to convert your present Williamson amplifier to ultra-linear operation. Bulletin 479, available FREE, contains performance curves, schematics, parts lists, chassis layouts and other helpful construction and conversion information.

to this sum voltage. A negative dc voltage, equal to the peak-to-peak value of the ac voltage, regardless of waveform, now appears across C4. This voltage is applied via switches S2A and S1B front to the grid of the triode in the bridge circuit. An unbalance is caused exactly as if a negative dc voltage were being measured. On "AC" operation the "Circuit" switch S2 is rotated three positions clockwise from that shown in the schematic, Fig. 1, and the voltage across C4 reaches the left triode grid in the following path: from the top of C4 through R5 (20 Meg), through S2A

stator (3:30 o'clock), small rotor section (which has been moved three positions clockwise), stator (2:30 o'clock), and to the voltage divider resistors, R20 to R26. All, or a portion of this voltage across these resistors, depending on the operating range, is tapped off by the rotor of S1B front and connected through its stator (9 o'clock), to S2A stator (9 o'clock) through its rotor (which has been moved three positions clockwise), and finally through the stator (5 o'clock) and R7 to the triode grid.

The operating range for ac voltage

BOOK REVIEWS

• • •

David Fidelman, *Guide to Audio Reproduction*, John F. Rider Pub. Inc., New York, 1953. (232 pp., Price \$3.50).

Many books and articles have been published on the subject of High Fidelity since it swooped down on us about five years ago. Some of them are quite theoretical and concern themselves with elaborate circuit derivations, complex acoustical principles and lengthy mathematical formulas. Others stress the practical side of the subject and deal mostly with the layout and construction of amplifiers, speaker enclosures and the like, with no regard for the basic principles of audio design. A compromise between these two extremes would clearly be a contribution to the field, and this book appears to fill this need.

After presenting an interesting introductory section, which delves just deeply enough into the theory of acoustics and into the mysteries of the ear (a most important but often neglected link in the audio chain), the author goes on to cover systematically each component part of the complete high fidelity system from the point of view of design, layout, and construction techniques. While somewhat technical, this book can be of great use to amateurs and laymen who have a basic familiarity with electronic circuits. Also, for those concerned primarily with learning what to look for when choosing one commercial unit over another, a section is included on complete systems with regard to overloading problems, duplication of controls, room location of equipment and other such considerations. Finally, there is a discussion of the techniques of performance measurements. This chapter includes methods of determining frequency response, noise level, distortion and other standards of operation connected with audio reproduction.

—Gil Tint

Dial Cord Stringing Guide, compiled and published by Howard W. Sams & Co., Inc., Indianapolis, Ind. (vols 3 and 4, \$1.00 each).

Volumes 3 and 4 of this valuable series are now available, containing complete descriptions and illustrations for stringing dial cords of all makes of sets. Vol. 3 contains a preface with remarks on dial drive cords which should prove of value and interest to all servicemen. A special feature of Vol. 4 is its complete index for all the volumes in the series.

5

**CORES
OF
ERSIN
FLUX**

in **ERSIN**

Multicore

**WORLD'S FINEST
CORED
SOLDER**



*Ready
Now*



**ON YOUR
JOBBER'S
COUNTER**

ASK FOR

NEW

**50c
SERVICE
PAK**

5 CORES—50 CENTS! Unlike other low-cost, haphazard solder packages, the MULTICORE SERVICE PAK features a convenient wooden spool. Furthermore—and important to you, the extra value is there on every 50¢ SERVICE PAK marked for you to read—in terms of length of wire, alloy and gauge.

WHY YOU SHOULD USE

ERSIN

Multicore

**WORLD'S FINEST
SOLDER**

Only Multicore has Ersin Flux—high grade water-white rosin, homogeneously activated. Non-corrosive even after long exposure to humidity.

Ability to tin rapidly produces perfect joints with less solder. Greater coverage per pound.

Thin wall 5-core construction assures flux continuity... prevents "dry" joints. Contains only Virgin tin and lead. Tin: 99.75% pure. Lead: 97.97% pure.

Wets metal rapidly due to reduced surface tension. Vigorous fluxing action.

Leaves only pure rosin after soldering. Perfect joints on difficult metals and alloys even if oxidized.

Total % flux to solder less than many single cored solders. Rigid quality control insures same standards in every Multicore Pak

MULTICORE SALES CORPORATION 164 DUANE STREET, NEW YORK 13, N. Y.

measurements is determined by the settings of S1A rear and S1B front. S1A rear, on the 500 Volt and 1500 Volt ranges, selects a portion of the *ac* voltage which it then connects to the diode doubler circuit. S1B front selects a portion of the rectified peak-to-peak C4 voltage which it then connects to the triode grid.

Resistance Measurements

Resistance measurements are taken on "Ohms" operation of the "Circuit" switch, S2. The resistor to be measured is placed between the "Common" and "AC-ohms" leads. A 1.5 volt dry cell

sends current through this resistor to S2A stator (11 o'clock), through its rotor (which has been moved four positions clockwise), to stator (10 o'clock), then to S1C rear stator (10 o'clock), through it rotor and any one resistor, R13 to R19 (depending on the ohmmeter range), and back to the battery. The voltage developed across the resistor under measurement connects through the S2A rotor, stator (5 o'clock), and R7 to the triode grid. An unbalance of the bridge, causing a meter reading is thus produced on ohmmeter operation in the same manner as on *dc* and *ac* voltage operation.

WORK BENCH

[from page 32]

measured for leakage under load. It read 3 volts positive. On replacement of this condenser the receiver functioned properly. This trouble could occur in any receiver using this particular type of cascode tuner.

Emerson—Model #654B Chassis #120118B

Just like the previous receiver, this one also exhibited contrast overload. All the video *if* tubes were replaced one by one but with no effect. The *if* tube in the tuner was replaced, also, with no effect. V4 the 6AL5, video detector and *agc* rectifier was then replaced, also without effect. Turning the chassis on its side, an *agc* voltage check was made at point "J" to ground. The *agc* voltage measured was slightly negative; in fact it was almost zero. See Fig. 2.

A resistance measurement was then taken from point "J" to ground. It read a little over 1 meg., which was close enough to be correct.

A voltage measurement was next taken at pin #2 of V4 to ground (across R18). The meter read again ever so slightly negative. From the diagram it can be seen that C13 feeds the half of V-4 which develops the *agc* bias. The greater the energy that C13 transfers to the *agc* rectifier, the greater the negative voltage drop across R18 (33K).

It was decided at this point to check the video information being transferred to pin #2 of V-4 with the scope. A reading between pin #2 and ground revealed nothing but a straight horizontal line. When a scope measurement was taken on the other end of C13 the proper video information was seen. C13 was then clipped where it was connected to pin #2; and as a final check the open end of this condenser was checked with the scope to ground. A straight horizontal line again appeared on the scope. Thus, C13 (47 μ f) was definitely open. It was then clipped out of the set and examined. At once, it was seen that it was cracked through the center. As this condenser is used in this *agc* circuit with no B+ voltage applied to it, only on very rare occasions could something like this occur. C13 was then replaced with a new 47 μ f and the receiver functioned properly.

ANSWER MAN

[from page 29]

ceivers from 21 *mc* to 44 *mc* when they surely knew that the F.C.C. has assigned the 42.02 *mc* to 45.98 *mc* to

EVERY
SERVICEMAN
NEEDS THIS
VOLTAGE
ADJUSTOR

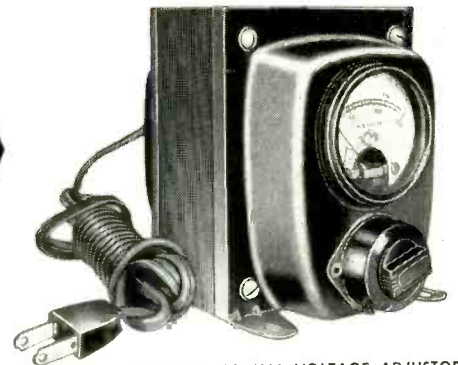

T-8394M MANUAL VOLTAGE ADJUSTOR

Where low voltage is affecting TV reception, the service man can detect the condition at once with a T-8394M Acme Electric Voltage Adjustor. And by a simple demonstration he can sell a Voltage Adjustor to the TV set owner. Sales are easy to make because demonstration while servicing a set quickly convinces its owner that the voltage regulation is essential to good TV reception.

How To Use The T-8394M VOLTAGE ADJUSTOR on Service Calls

With the tap switch set at 115 volts, the meter reading will show incoming line voltage. Thus it can be instantly determined if line voltage is lower than normal required for good TV set performance.

The T-8394M Voltage Adjustor can also be used to reproduce the operating condition about which the customer complains by turning tap switch to the voltage which simulates such condition. For example, customer complains that evening program pictures flicker and shrink. When service man calls next day all operation appears normal — voltage tests out properly. But, by adjusting voltage to 97 volts the condition about which the complaint was made is reproduced. This indicates low voltage condition during evening that can be corrected with a T-8394M Voltage Adjustor.

Not A Gadget — A High Quality Unit You'll Be Proud To Use

The T-8394M Voltage Adjustor can be installed instantly, no tools needed. Just plug into most convenient outlet. Then plug television cord into secondary receptacle on Voltage Adjustor.

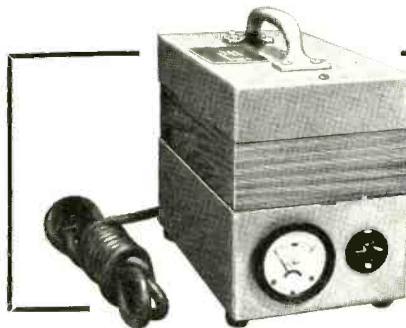

FOR COMPLETELY AUTOMATIC VOLTAGE CONTROL

Regardless of line voltage supply, the Automatic Voltrol corrects voltage fluctuation over a range from 95 to 130 volts. The voltmeter supplied indicates secondary voltage while unit is in operation. A built-in relay automatically disconnects circuit when set is turned off.

Acme  Electric
TRANSFORMERS

ACME ELECTRIC CORPORATION
MAIN PLANT: 466 WATER STREET • CUBA, N. Y.
West Coast Engineering Laboratories:
1375 West Jefferson Boulevard • Los Angeles, California
In Canada: Acme Electric Corp. Ltd.
50 North Line Road • Toronto, Ontario

the State Police for high power communications? 42.02 *mc* to 45.06 *mc* can employ powers up to 5,000 watts.

We have been receiving constant complaints from customers purchasing the 1953-54 models using the 44 *mc if* that they get interference from the State Police transmitters. This comes in even when the set is tuned to a local *uhf* station. The State Police transmitters have been checked by the TVI committee and the F.C.C. and found to be operating perfectly and to have the required harmonic filters and modulation limiters.

The State Police plan to increase power from 250 watts to 3,000 watts in

the near future and this matter is very vital to all TV users in this area.

W. T. G.
Baton Rouge, La.

Dear W. T. G.:

The television industry has been working towards the ideal *if* frequency band of 40 to 45 megacycles because it will remedy a serious problem that exists in every city receiving television. The greatest interference experienced in TV reception is local oscillator radiation. The radiation from the oscillator circuit can pass through the capacitance of the *rf* stage and appear on the antenna which will then perform

New RIDER Books Make Servicing Easy!

INTRODUCTION TO COLOR TV

by KAUFMAN & THOMAS

Here is the complete story about color television—all types of receivers—all types of picture tubes—all types of circuits—written in a clear, understandable language without mathematics. The most complete book on the subject. Easy to understand! A "must" for all technicians, engineers and students. Over 140 (5½x8½") pages. Soft cover \$2.10

TECHNICIAN'S GUIDE TO TV PICTURE TUBES

by IRA REMER

A picture tube servicing guide for the television installation and repair man. Covers the care, methods of handling, replacement, maintenance and repair of the picture tube. It is written for the technician who desires basic and specific information on the picture tube and its accessories (including conversion) without wading through reams of technical data, complicated circuit explanations. 140 (5½x8½") pages. Soft cover.....\$2.40

HOW TO INSTALL AND SERVICE AUTO RADIOS

by JACK DARR

An expert gives practical, detailed instructions on how to install and service all types of automobile radios. Not a schematic book. Shows where to run lead-ins, how to install antennas, eliminate noise and gives methods for vibrator testing. Furnishes a complete list of tools, spare parts and other equipment and how to set up an auto radio service business.

128 (5½x8½") pages. Soft cover.....\$1.80

SERVICING TV VERTICAL AND HORIZONTAL OUTPUT SYSTEMS

by HARRY THOMAS

Complete. Easy-to-understand. Discusses all types of vertical and horizontal output circuits used in TV receivers—recognition of trouble—how to locate faults and their repairs. No other book in print offers equivalent coverage of the subject or explains details as clearly.

176 (5½x8½") pages. Cloth cover.....\$2.40

TV FIELD SERVICE MANUAL, VOLUME I

Edited by HAROLD ALSBERG

The finest practical data for in-the-home servicing. Tube layouts; picture tube adjustments; rear and front controls; tube compartment; tuner and horizontal oscillator adjustments; key voltages; tuner dial stringing; trouble symptoms; chart with tubes and parts to check; series filament wiring. Book lies flat, spiral binding. Covers 1947 through 1953.

Volume I covers: Admiral, Affiliated Retailers (Artone), Aimee (AMC), Air King, Air Marshal, Allied Purchasing, Andrea, Arvin and Automatic.

128 (5½x8½") pages. Cloth cover.....\$2.10

OUT IN JUNE

Rider TV MANUAL, VOL. 13

Write for information on all RIDER books. Buy these books now from your jobber . . . bookstore . . . if not available from these sources, write to:

JOHN F. RIDER PUBLISHER, INC.
480 Canal Street, New York 13, N. Y.

as a transmitting antenna. This occurs with a cascode dual Triode *rf* stage as well as with pentode *rf* stages.

When the oscillator frequency beats with the *rf* signal in the mixer circuit to reduce the *rf* signal to a 20 megacycle *if* frequency it is mathematically possible that the oscillator is operating at a frequency within the frequency band of one of the *rf* channels. Since the antenna will radiate this frequency, any other antennas in close proximity will receive the interference signal along with the channel in which it falls.

When a 45 megacycle video *if* carrier frequency is used, the local oscillator will operate at 45 megacycles above the channel frequency being received and mathematically it will be impossible to have the local oscillator operate at a frequency that will fall in the band of any of the existing chan-

Channel	Video Carrier Freq.	+ I.F. Freq.	= Local Oscillator Freq.	Channel Interfered With
2	55.25	+ 26.6	= 81.85	5
3	61.25	+ 26.6	= 87.85	6
7	175.25	+ 26.6	= 201.85	11
8	181.25	+ 26.6	= 207.85	12
9	187.25	+ 26.6	= 213.85	13

Channel	Video Carrier Freq.	+ I.F. Freq.	= Local Oscillator Freq.	Channel Interfered With
2	55.25	+ 45.75	= 101.0	None
3	61.25	+ 45.75	= 107.0	None
7	175.25	+ 45.75	= 221.0	None
8	181.25	+ 45.75	= 227.0	None
9	187.25	+ 45.75	= 233.0	None

Chart illustrating channels interfered with for various *if* values.

nels. Therefore, using *if* frequencies of 40 to 45 megacycles will cause the local oscillator to operate at frequencies that can not interfere with other television receivers.

This is the answer to the removal of interference problems where the roofs are covered with antennas, in some cases located as close as 10 feet from each other. It is acknowledged that other services are assigned to the frequencies between 40 and 45 megacycles but the overall benefit of the change greatly outweighs the disadvantages.

In those areas where interference is experienced the answer is to shield the cabinet of the TV receiver, use a low pass filter in the power line to the receiver and a high pass filter in the antenna leadin. Under extreme conditions even this will not completely eliminate the feeding through of the 45 *mc* interference.

It should be pointed out that many TV manufacturers still make available one chassis in their line with a 20 to 26

Mr. Serviceman

OXFORD'S

NEW

REAR DECK SPEAKERS

mean MORE
PROFITABLE
AUTO RADIO
WORK for
YOU!

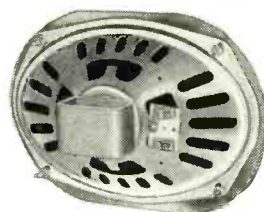

Model
RD-69
6" x 9"
\$13.40

Suggested list price:

Preferred for
Original
Equipment —
Proven for
Replacement



Model
RD-57
5" x 7"
\$12.15

Suggested list price:

Sold Through Recognized Jobbers Only!

**OXFORD
ELECTRIC
CORPORATION**



3911 SOUTH MICHIGAN AVENUE
CHICAGO 15, ILLINOIS
EXPORT — ROBURN AGENCIES, NEW YORK CITY
IN CANADA — ATLAS RADIO CORP. LTD., TORONTO

THE BIG 3
of SALES SUCCESS
WITH **BUXTON**
POWER-VUE
ANTENNAS

We give the trade

1. WHAT THEY WANT
2. WHAT THEY CAN SELL
— PROFITABLY
3. WHAT PERFORMS BEST
IN THEIR AREAS

FOR EXAMPLE:

COBRA* CONE (Conicals)

PROVED UNIVERSALLY HIGH GAIN for practically all areas. WINNING UNQUESTIONED APPROVAL wherever used. . . An EXCLUSIVE KEY FEATURE: Quick-Lock "2 BOLT" COBRA HEAD (Greater element separation achieves longer, cleaner, clearer signal.) Other important features, too.

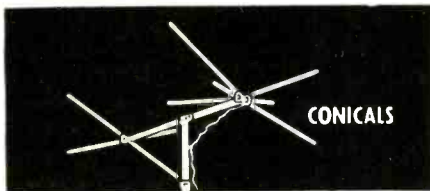

NO. 3cc POWER-VUE COBRA CONE
(An outstanding sales number)

The PLAIN FACTS about BUXTON POWER-VUE YAGIS

1. MAINTAINED HIGH GAIN via correct design.
2. APPROVED PHYSICAL STRENGTH
Aluminum alloys, Steel Support brackets, non-break insulators.
3. "E-Z UP" ASSEMBLY. Either pre-assembled Snap-Out, or One-Piece, Elements.

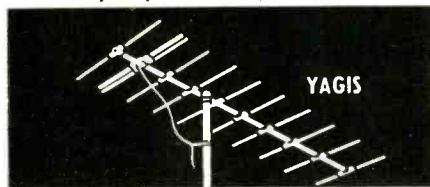

A FULL LINE OF YAGI TYPES
Broad Band, Delta Match, etc.

BUXTON ALSO BUILDS: Power-Vue Straight Dipoles, Arrows, V Stacks, Diamondbacks, Folded Dipoles and Fringe Area Antennas. And Accessories. *A Buxton Name

SOLD NATIONALLY THROUGH JOBBERS

BUXTON INDUSTRIES, INC. SD-1
88 North Fair Oaks Ave., Pasadena, California

PLEASE SEND INFORMATION AS CHECKED:

- FULL INFORMATION & PRICES.
 Name & Address of NEAREST JOBBER

Name _____
Street _____
City _____ Zone _____ State _____

megacycle if frequency. In those areas where this problem is serious it would be sensible to advocate the purchase of only those receivers with the 20 to 26 megacycle if strip.

MARINE RADIO

[from page 26]

tremely recent in development as compared to the D.F. equipment discussed above. It is Sonar, an equipment, which like so many others originally developed for military use, has brought great benefit to civilian life. Its very name which is a contraction of "Sounding and Ranging", indicates its first use, which was to locate submerged submarines. Most present-day commercial Sonars generate an ultrasonic signal which will produce an echo when hitting some type of obstruction. This echo is picked up by a receiver which is an integral part of the sonar gear, and translated by some device into an indication of the distance of the obstruction from the vessel. This display usually consists of a "blip" on a cathode-ray oscilloscope screen which is calibrated in yards.

The sonar is a complex unit as compared to the communication or D.F. equipment and is usually carried only by the larger commercial vessels, such as the fishing boats. Its main uses are:

(1) To make soundings so as not to run aground on submerged shoals or sand bars when entering strange waters. In connection with this use, it should be stated here that there are "Fathometers", as some of these sonars are called, which will electronically actuate the pen of a continuous paper chart recorder to give a permanent record of a given area of ocean bed.

(2) To locate the positions of wrecks during salvage operations.

(3) To locate schools of fish. In this regard, it should be mentioned that many a depth charge was wasted during the war on so-called submarines which turned out to be some very inoffensive whales.

In general, sonar equipment requires some appreciable power ranging from 50 to 100 watts. Both Vibrapack and dynamotor types of supplies are used. Such supplies are very similar to those used with most battery-operated mobile equipment of any appreciable size.

The last, least-common, and most expensive of the various navigational equipment used aboard ship is, of course, the radar. It will not be found on any of the pleasure craft except the most luxurious, and it is hardly even found on the smaller commercial craft.

A great many of the larger commercial fishing ships, however, are installing radars for safer navigation under bad

**SERVICE TECHNICIANS:
FOR YOUR SHOP!**

THE COMPLETE

PHOTOFACT
SERVICE DATA LIBRARY

(world's best TV-Radio service data)

in this one handy
file cabinet

YOURS FOR ONLY

\$25 DOWN
NO CARRYING CHARGES

1. If you now own some Sets of PHOTOFACT Folders, you can COMPLETE your present library this EASY-PAY-WAY
2. If you've never used PHOTOFACT, you've never realized your full earning power. Put this file cabinet with its 220 Sets of PHOTOFACT Folders to work . . . starting right NOW!

YES, ONLY \$25 DOWN PUTS THE COMPLETE PHOTOFACT LIBRARY IN YOUR SHOP . . .

COVERS OVER 17,000 TV, RADIO, RECORD CHANGER, RECORDER AND AMPLIFIER MODELS

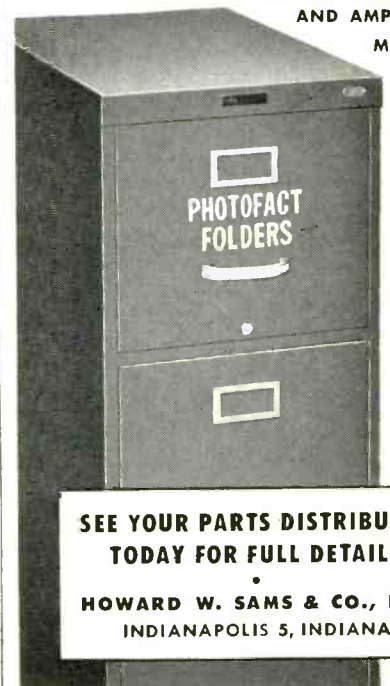

SEE YOUR PARTS DISTRIBUTOR TODAY FOR FULL DETAILS

HOWARD W. SAMS & CO., INC.
INDIANAPOLIS 5, INDIANA

Convenient to Buy . . . Convenient to Use . . .
LYNN Lightning Solderless Terminals

by **VACO**



Vari-Board Display

- The clean, modern way to apply terminals to wire
- No soldering necessary
- Choice of all popular numbers in handy \$ Paks
- Plastic service kit contains crimping tool and complete selection of terminals for on-the-job use

3 Ways to Buy Supplies of "Refills"



New \$ Pak with life size terminal illustration for easy identification



New "100" Pak contains 100 terminals per box at quantity lot prices



"250" Pak contains 250 terminals per box at volume lot prices

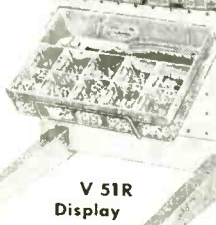
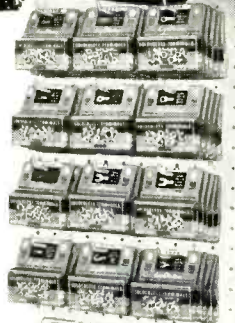

V 51R Display

Look for the Convenient Lynn Lightning Display on Your Jobber's Counter

VACO PRODUCTS COMPANY

In Canada: Vaco-Lynn Products Co., Ltd.

317 E. Ontario St.
 Chicago 11, Illinois

atmospheric conditions such as the presence of heavy fog. A scope display presents each obstruction as a "blip", enabling the pilot to safely avoid them. Some types of scope displays, known as the P.P.I. or "Plan-Position-Indicators", actually show an approximate map of the entire channel or harbor on the screen.

Although all the equipments mentioned so far seem to have little resemblance to the television set or car-radio so familiar to the average service dealer, they all have three things in common: they are complex electronic devices requiring installation by skilled personnel; they break down, thus requiring repairs by experienced technicians; and, last, but not least, they are constantly being changed or modernized requiring all types of conversion techniques by the same type of personnel described above. Therefore, future articles will deal with the common techniques utilized in the installations, maintenance, and conversions of the various equipments discussed so far.

P.A.

[from page 30]

trols along with one phonograph or line input with treble attenuating and mixing volume control. All of the amplifying equipment is broadcast standard throughout and is designed for ultimate flexibility and dependability. The system has the added feature that complete failure is virtually impossible in view of the fact that any one component is capable of assuming the entire work load whenever required.

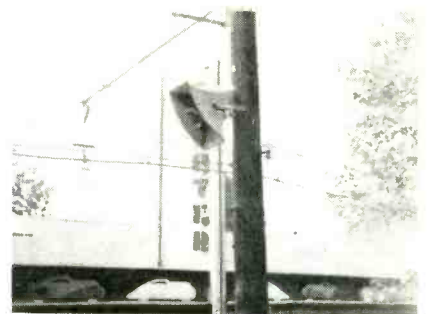

The rugged and versatile diffractor-projector. Its wide tone range facilitates articulation.

The three mikes used in the system are low-impedance 50 ohm microphones designed primarily for dependable, consistent, and general-purpose use. They have a substantially flat response of 65-7,500 cps. and are used, of course, principally for making announcements, paging, etc. The important thing to remember when working an installation of this nature is that special care must

KENCO KATE SAYS

"NO INSTALLATION PROBLEMS when you use KENCO MOUNTS"

KENCO 6"

Aluminum Snap-In Wall Bracket

Made of heavy gauge high strength aluminum alloy. Snap-in feature eliminates holding of mast while applying hardware. Carriage bolts throughout for easy installation. Full thread hex head lag screws permit use of ratchet or speed wrench.

6W-AL (less tripod legs)
 6W1-AL (1-tripod leg)
 6W2-AL (2-tripod legs)

For information on the complete Kenco line write Dept. W.

KENWOOD ENGINEERING CO., INC.
 Kenilworth, New Jersey

RMC DISCAPS PROTECT YOUR SERVICE PROFITS

The Ceramic Capacitors TV Manufacturers Depend on

With RMC DISCAPS you install 1000 V.D.C.W. capacitors at the cost of ordinary units, but the higher voltage ratings mean fewer callbacks. DISCAPS are packaged in clear plastic reusable boxes so you can determine contents and ratings at a glance. Their rugged mechanical construction makes them easy to install. Asking your jobber for RMC DISCAPS is your best insurance of service profits.

RADIO MATERIALS CORPORATION
 Factories at CHICAGO, Ill., and ATTICA, Ind.
 For the name of your nearest RMC jobber contact:

JOBBER SALES COMPANY
 National Distributors for RMC DISCAPS
 P. O. Box 695 FAIRLAWN, N. J.

be taken to keep your mike lines away from any other power lines, and, thus minimize the danger of picking up hum or other interference. This is particularly important if the lines are to be run for any appreciable distance.

While on the subject of important considerations, it might be well to mention at this point the necessity of keeping the speakers in phase. Upon this consideration will ultimately depend whether or not the speakers will operate at a maximum of efficiency, because, as you are probably well aware, speakers out of phase have a tendency to cancel out each other and can thereby ruin the effect of an otherwise excellent job.

With regard to speakers, I'd like to point out that we discovered that the speakers which seem to be best adapted to an installation of the Amusement Park type is the diffractor projector. Their light-weight, versatility, and ruggedness coupled with their very impressive wide tone range made them the ideal horn to be used exclusively in those areas of the Park along the Midway, around the concession stands.

The speakers covering the picnic area are connected to a double-pole, double-throw switch in order that they might be connected to a separate Public Address system for private functions whenever desired. Further, in those areas where large crowds congregate and there are concentrations of people, it was felt that the large WLC 2-way speaker systems would be better employed, the system is made up of a combination of the cone Type speaker and the re-entrant type horn. Treating the installation in this manner guaranteed the finest possible results in system fidelity and the maximum in life-like reproduction quality.

The interesting part of the whole thing is the fact that all the equipment and tools used in the installation and maintenance of this system are exactly the same as those used in every good radio repair shop and service bench throughout the country every day. The only extra ingredient, and it's a very necessary one, is the willingness to get outside the shop and concentrate on outdoor amplification.

Y-AXIS PREAMP

[from page 12]

may be used as a unit to provide additional gain for this type of work, allowing the serviceman to trace into circuits where the signal is so weak that he normally would get no results. In an arrangement of this type the diode probe would be connected to the input terminals of the pre-amplifier and the

In this day and age with almost everyone shouting that his product is best, we would like to say . . . quietly and confidently . . .



just try

AEROVOX CAPACITORS

THE NEW MODEL TV-11

TUBE TESTER



- Uses the new self-cleaning Lever Action Switches for individual element testing.
- Because all elements are numbered according to pin number in the RMA base numbering system, the user can instantly identify which element is under test. Tubes having tapped filaments and tubes with filaments terminating in more than one pin are truly tested with the Model TV-11 as any of the pins may be placed in the neutral position when necessary.
- Uses no combination type sockets. Instead individual sockets are used for each type of tube. Thus it is impossible to damage a tube by inserting it in the wrong socket.
- Free-moving, built-in roll chart provides complete data for all tubes.
- Phono Jack on front panel for plugging in either phones or external amplifier detects microphonic tubes or noise due to faulty elements and loose external connections.

EXTRA SERVICE—The Model TV-11 may be used as an extremely sensitive Condenser Leakage Checker. A relaxation type oscillator incorporated in this model will detect leakages even when the frequency is one per minute.

Operates on 105-130 Volt 60 Cycles A.C. Hand rubbed oak cabinet complete with portable cover **\$4750**

SHIPPED ON APPROVAL
NO MONEY WITH ORDER — NO C. O. D.

Try it for 10 days before you buy. If completely satisfied send \$11.50 and pay balance at rate of \$6.00 per month for 6 months. **No Interest or Carrying Charges Added.** If not completely satisfied, return to us, no explanation necessary.

MOSS ELECTRONIC DISTRIBUTING CO., INC.
Dept. D-38, 3849 Tenth Ave., New York 34, N. Y.
Please rush one Model TV-11. I agree to pay \$11.50 within 10 days after receipt and \$6.00 per month thereafter.

NAME
ADDRESS
CITY ZONE STATE



From
AMERICA'S
MOST COMPLETE

WIRE LINE

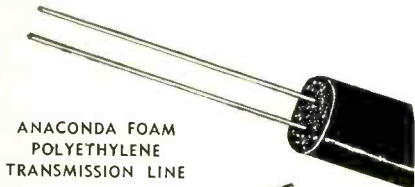

ANACONDA FOAM
POLYETHYLENE
TRANSMISSION LINE



COLUMBIA
TELEVISION
TRANSMISSION LINES



MULTI PAIRED
INTERCOM
CABLES



MICROPHONE
CABLE



ROTATOR
CABLE



DELUXE TELEVISION
SERVICE LITE



ALUMINUM GROUND
WIRE

Special Wire & Cable to
Your Specifications

Sold Through Jobbers

ORDER TODAY!

New! Catalog #104—Just off the
Press, write for your copy TODAY.

Columbia
WIRE & SUPPLY CO.
2850 Irving Park Road • Chicago 18, Ill.

output of the pre-amplifier connected to the signal tracer.

The serviceman may also signal trace circuits of various types using his oscilloscope and pre-amplifier. Using a diode probe, very weak signals may be traced through *if* strips and without the probe, through video amplifiers and sync circuits. This arrangement is extremely helpful in cases where sync trouble is suspected and the sync pulses may be traced through the successive amplifier and clipper stages. With some oscilloscopes it is difficult to view the sync as it comes out of the vertical integrator, but the addition of the pre-amplifier raises this to a usable level.

Extending Range of AC Meters

An interesting possibility is the use of the pre-amplifier to extend the low range of an *ac* voltmeter (see Fig. 4). Suppose the full scale range at the lowest setting of your *ac* voltmeter is

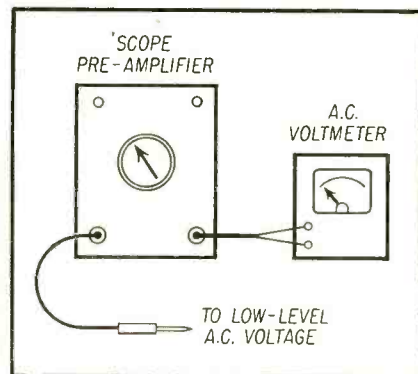

Fig. 4 — Use of Y-Axis Pre-Amp to extend low range of *ac* voltmeter.

1 volt. If the voltmeter is connected to the output of the scope pre-amplifier, unknown voltages as low as 10 millivolts applied to the pre-amplifier input will produce full scale deflection on the meter.

The Kirby Oscilloscope Pre-Amplifier operates from 115 volts, 60 cycle AC and consumes less than 15 watts of power. The hum and noise level of the unit is equivalent to an input of 36 microvolts and it can handle a maximum input signal of .3 volts. The power supply is completely self-contained and no batteries are used. Tubes used in the unit are 12AX7, 12AU7, OD3 and 6X4. Input impedance is .2 megohm.

Color Applications

The development of color TV will, no doubt, produce further need for equipment of this type. Visual observation of the 3.58 mc color burst sync will be necessary and the shapes of other pulses will be more critical. Aside from this, low level work of any type demands equipment fitted to the job.

SWEEP-ALIGNMENT

[from page 8]

opment of this increased output voltage provides a higher value of feedback voltage through C to the grid of the tube, and hence an increased amount of regeneration occurs. Increased regeneration results in a further narrowing of the stage bandwidth, and a further increase in the stage gain. It is for this reason that the response curve "goes to pieces" at low values of grid bias.

Regeneration can of course be countered by degeneration. It is a simple matter to develop degeneration in an amplifier circuit. Many methods are possible, and are used in various designs, but the oldest and still the most widely used method is shown in Fig. 3. Here, the cathode resistor R is un-bypassed, and in consequence develops a certain amount of current (negative) feedback, determined by the value of the resistor. By aligning the receiver

*Pat. Pending

THE NEW TV DYNATRACER

ONLY \$495 *
*Prd. or C.O.D. + Chgs.

- TRACES TV SIGNALS AND VOLTAGES
- LOCATES DEFECTIVE COMPONENTS
- REQUIRES NO ADDITIONAL EQUIPMENT

Ideal for trouble-shooting television sets in home or shop. Out-performs more expensive testers and pays for itself on the very first repair.

A "Must" for Every TV Technician

The "DYNATRACER" is a self-powered quality test instrument that traces TV signals through any Video, Sound, Sync, AFC, Horizontal or Vertical Sweep Circuit — isolates trouble to a stage or component. Traces voltages (50/500 V. AC/DC). Also locates open, shorted, intermittent or leaky (up to 20 MEGOHMS) condensers, resistors, coils, Xformers, etc.

Complete with instruction Manual and Repair Guide
10 DAY MONEY-BACK GUARANTEE

With each new order we'll include a unique **FREE** "TV High Voltage Indicator" useful in your testing work.

Cut out advertisement . . . attach name and address with \$5.00 bill, check or money order and mail to

Century ELECTRONICS CO.

211-04 99th Ave., Dept. 406, Queens Village, N. Y.

MOVING?

Please
Mail Us
Your Change
of Address
Today

Also include old address and code line, if possible. Thanks.

RADIO-TELEVISION SERVICE DEALER

67 West 44 St., New York 36, N. Y.

SAVE 2-WAYS WITH *University* DRIVER UNITS & TRUMPETS

1. Higher Conversion Efficiency Lowers Amplifier Costs
2. Highest Quality Eliminates Maintenance Expense

RUGGEDIZED TRUMPETS



UNIVERSITY trumpets are built to the highest standards in the industry—by the pioneers of the reflex trumpet. They are completely weather-proof, super conditioned for any locale or climate. Achievement of highest attainable conversion efficiencies reduce amplifier requirements. Get the facts.

*Less Driver Unit

MODEL	GH	LH	PH	SMH
Low Frequency Cutoff	85 cps.	120 cps.	150 cps.	200 cps.
Sound Distribution	65°	75°	85°	95°
Air Column Length	6 1/2 ft.	4 1/2 ft.	3 1/2 ft.	2 1/2 ft.
Bell Diameter	30 3/8"	25 3/8"	20 3/8"	16 1/4"
*Horn Length	27 3/8"	19"	15 3/4"	12"
*Shipping Weight	25 lbs.	20 lbs.	11 lbs.	9 lbs.

HIGH EFFICIENCY DRIVER UNITS



MODEL SA-HF — Workhorse of the sound industry for general PA and Industrial use. Very high efficiency delivers extra punch to cut through heavy noise. Response to 10,000 cps.—ideal for both speech and music. Tropicallized and hermetically sealed for trouble-free service anywhere.

MODEL MA-25 — A low cost unit for use where response to 6000 cps. meets requirements. No compromise in quality — incorporates all the famous UNIVERSITY quality features — high efficiency magnet structure, tropicalized full size 2" voice coil, rim-centered break-down proof bakelite diaphragm, etc.



MODEL PA-30 — A "de-luxe" unit incorporating every advance design feature including famous University W Alnico 5 Magnet and built-in transformer with terminals available thru housing base. For all amplifiers including 70 volt systems. Response 80-10,000 cps. with 30 watt cont. power.

MODEL SA-30 — Similar to the SA-HF in response and efficiency but includes a multi-impedance line matching transformer with taps accessible through water-tight cover. Taps designated in impedance values and wafers for "constant voltage" lines. Die-cast aluminum housing affords lasting protection.



Write for catalog describing the complete line of University Hi-Fi and PA reproducer equipment, including Radial Type Projectors. Address Desk 24-F

University
LOUDSPEAKERS INC
80 SO. KENSICO AVE., WHITE PLAINS, N. Y.

properly, and choosing a suitable value for the cathode resistor, the regeneration which is present can be effectively balanced out. This is what the receiver design engineer does at the factory. It will be apparent that such compensation is suitable only for the intended tube type, and that if the technician substitutes another tube type having higher Gm, the result will be an unstable stage.

Regeneration in Stages Not Controlled by AGC

Inspection of the schematic diagram for a modern TV receiver usually shows that while the earlier stages in the receiver are *age* controlled, later stages are not. Since regeneration can occur in any *if* stage, the problem which presents itself concerns the localization of regeneration in a stage not under *age* control. Adequate test methods are available for attacking regeneration problems in this portion of the *if* amplifier, but require some detailed discussion. For this reason, consideration of such tests is reserved for treatment in the next article.

COLOR

[from page 20]

w-x and *y-z* is a straight current line as shown. In this manner a smooth transition is effected between the end of the damper circuit contribution to the sweep and the start of the output tube contribution.

- The following résumé briefly outlines the damper circuit action.
- 1—At the conclusion of positive grid voltage swing (*t1*) the grid goes sharply negative (*A*).
 - 2—Plate current in the horizontal output tube is cut off (*B*) causing collapse of the yoke and transformer magnetic fields.
 - 3—Plate voltage rises sharply followed by a reduced transient oscillation which dies out gradually (*C*).
 - 4—Similar voltage waveforms appear across the horizontal output transformer section connected to the damper. The damper action smooths out the oscillations (*D*).
 - 5—The constant voltage waveform of (*D*) results in the sawtooth current waveform of (*E*).
 - 6—Non-linear portions at the end of the damper waveform and the beginning of the output tube sweep waveform combine to produce a linear waveform at the center of sawtooth (*E*).
 - 7—Decay of energy in the horizontal coils rectified by the damper produces an additional voltage across *C1* which is added to the "B" supply voltage. The sum of both voltages results in the boost or *B+* voltage.

4 NEW RIDER BOOKS for JUNE

ADVANCED TELEVISION SERVICING TECHNIQUES

written by the RETMA (Radio Electronic Television Manufacturers' Association) Pilot Training School Teaching Staff.

A completely NEW approach to books for TV service technicians. Written by experts who are teaching every day.—The contents have been tried and proven to be the finest ever written. Completely practical. A step-by-step approach to how to service every section of a TV receiver with every kind of test equipment—by resistance measurement, by voltage measurement, by means of the scope. It explains the uses of test equipment of all kinds in connection with TV receiver servicing, such as sweep generators—signal generators—vacuum tube voltmeters—scopes, ohmmeters!

This is not a theory book! It is a book which every technician can use on the bench—and every student in a TV school can use, because it tells what-to-do and how-to-do-it. Never a book like this. Words alone cannot describe it. You have to see it to believe it! Approx. 175 (8 1/2 x 11" pages), Soft cover, \$3.60

ATTENTION TEACHERS:—the main book above and a laboratory manual for it as well as the Teacher's Guide also are available. Write for details.

SPECIALIZED AUTO RADIO MANUALS

Cover 5 years production (1950 thru 1954) of factory installed car radios. Identical data from other sources is just not available! Each volume contains: Parts List Schematics, Tube Layout, Voltages, Trimmer Location, Chassis Views, Chassis Pictures, Dial stringing and complete installation and removal information.

- VOL. 1-A (Released in May)..... \$3.00
- VOL. 2-A
Buick . . . Cadillac . . . Oldsmobile
200 (8 1/2 x 11") pages, Soft cover \$3.00
- VOL. 3-A
Chevrolet, Pontiac, GMC Trucks, Chevrolet Trucks—128 (8 1/2 x 11") pages, Soft cover\$1.80

COLOR TV DICTIONARY

by J. R. JOHNSON

First complete explanation of new color TV terms with their definitions that everyone—service technicians, students, engineers, amateurs—interested in color television must be familiar with. This is more than a dictionary! Over 50 illustrations. Approx. 72 (5 1/2 x 8 1/2") pages, Soft cover.....\$1.25

R-C & R-L TIME CONSTANT

edited by

ALEXANDER SCHURE, Ph.D., Ed.D.

FIRST IN A SERIES of review books written expressly for the student who is studying electronics or the technician who has studied electronics and wishes to understand Time Constant (R-C and R-L) more clearly. It supplements the contents of courses in textbooks which are on a technical institute level. Covers practical applications of Time Constant and how it affects circuit operation. About 48 (5 1/2 x 8 1/2") pages, Soft cover \$ 90

write for complete 32 page
NEW RIDER CATALOG

Buy these books now from your jobber, bookstore—if not available from these sources, write to:

JOHN F. RIDER Dept. SD6
PUBLISHER, INC.
480 Canal Street, New York 13, N. Y.

NEW! **EICO**
Industry Precision at Lowest Cost

FLYBACK & YOKE TESTER KIT

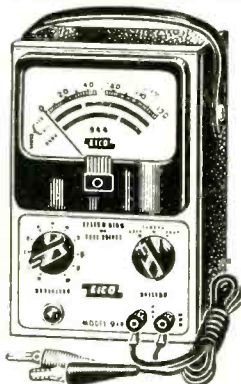

Model
944 KIT
\$23.95.
Wired
\$34.95

Checks all flybacks & yokes
instantly—in or out of set!

- Detects even 1 shorted turn!
- Exclusive separate calibration for air & iron-core flybacks for accurate testing of all types.
- Tests continuity of coils, speakers, switches, etc.
- Large 4½" meter, 3 colored scales.
- Complete with easy Instructions.
- Compact, rugged, smartly styled.

See it at your jobber today. Write for FREE Catalog D-6 describing EICO's 38 Kits and 42 Wired Instruments. Prices 5% higher on West Coast.

EICO ELECTRONIC INSTRUMENT CO., Inc.
84 Withers Street, Brooklyn, N. Y.
© 54

South River ★ ★ NEWS ★ ★

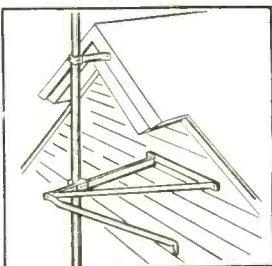

Combination Steel Adjustable Wall Bracket—Model ST3-18A

All steel construction; hot-dip galvanized to prevent corrosion. 18" lower bracket features embossed steel bracing leg; is adjustable for vertical mast mounting under eave. 3" embossed steel top bracket—Spintite for nut tightening. Spintite for nut tightening.

Write for Catalog

In Canada: A.T.R. Armstrong Ltd., Toronto

**SOUTH RIVER METAL
PRODUCTS CO., INC.**
SOUTH RIVER, N. J.

PIONEER AND OUTSTANDING PRODUCER
OF FINEST LINE OF ANTENNA MOUNTS

Advertising Index

Acme Electric Corp.....	57
Aerovox Corporation.....	61
American Television & Radio Co.....	20
Astron Corporation.....	1
Belden Manufacturing Co.....	22
Bussmann Manufacturing Co.....	16
Buxton Industries, Inc.....	59
Century Electronics Co.....	62
Channel Master Corp.....	4
Chicago Standard Transf. Corp.....	55
Clear Beam Antenna Corp.....	6
Columbia Wire & Supply Co.....	62
Crosley Div., Avco Mfg. Co.....	49
elco Radio.....	31
Electronic Instrument Co., Inc. (EICO).....	64
Federal Telephone & Radio Corp.....	19
General Instrument & App. Corp.....	26
Jensen Industries, Inc.....	64
Jensen Manufacturing Co.....	13
Kenwood Engineering Co.....	60
Moss Electronic Dist. Co., Inc.....	61
Multicore Sales Corp.....	56
Oxford Electric Corp.....	58
Philco Corporation.....	28
Precision Apparatus Co., Inc.....	Cover 3
Radiart Corporation.....	41
Radio City Products Co., Inc.....	50
Radio Materials Corp.....	60
Raytheon Manufacturing Co.....	11
RCA Batteries.....	Cover
Rider, John F. Publisher.....	58, 63
Sams, Howard W. & Co.....	59
Sangamo Electric Company.....	12
Sarkes-Tarzian.....	43
Snyder Manufacturing Co.....	Cover 2
South River Metal Prods. Co.....	64
Sprague Products Co.....	64
Sylvania Electric Products, Inc.....	27
Tele Test Instrument Corp.....	54
Telrex, Inc.....	9
Triplett Elec. Instrument Co.....	21
Tung-Sol Electric, Inc.....	52
University Loudspeakers, Inc.....	63
Vaco Products Co.....	60
Walsco Electronics Corp.....	2
Windsor Electronic Tube Co.....	51



"I believe all your troubles
would vanish, Mrs. Kosgriff,
if you'd simply get a
JENSEN NEEDLE!"

FIND THE RIGHT TV Yoke Capacitor IN A JIFFY!

SPRAGUE TV YOKE CAPACITOR
REPLACEMENT KIT
ALL DISTRIBUTORS
EVERYWHERE, U.S.A.

Just try the different ceramics in this Sprague TV Yoke Capacitor Replacement Kit until you get a good picture. That's all there is to it! 36 famous Sprague Cera-Mite® Capacitors, in eight different values selected and proportioned on the basis of actual need, providing complete coverage of fractional values between 33 mmf and 82 mmf. The tiny ceramic discs fit any yoke assembly . . . stand up under the toughest service . . . are excellent replacements for any 2000 volt capacitor which may appear in original equipment. Complete instructions are on the face of the tough, paper-board card, conveniently punched for hanging over the service bench. Get yours now! Ask your distributor for Sprague Kit CK-1. Only \$12.60 List!

SPRAGUE PRODUCTS COMPANY
Distributors' Division of the Sprague Electric Co.
NORTH ADAMS, MASS.

You'll Find a
PRECISION E-200

in Every Other Service Lab in the Country!

THIS FAMOUS SIGNAL GENERATOR provides — at a practical, sensible price — the accuracy, stability, range, functions and long-lived reliability that are so necessary to the efficient Service-Lab.

THIS FAMOUS SIGNAL GENERATOR has consistently set unparalleled standards of performance and value.

THIS FAMOUS SIGNAL GENERATOR, along with the other instruments in the PRECISION line, has kept pace with the ever-increasing requirements of modern servicing and maintenance, AM-FM-TV.

E-200-C

The Modern Multi-band
SIGNAL-MARKING GENERATOR

for TV-FM-AM Alignment

- ★ Frequency Coverage: 88 KC to 240 MC (To 60 MC on fundamentals)
- ★ Direct Reading in 9 bands on easy-reading 6½" dial.
- ★ 1% Accuracy and exceptional stability on all bands assured through use of the famous PRECISION "Unit-Oscillator" construction.
- ★ 0-100% Modulation controlled at front of panel.
- ★ AGC-AVC Substitution voltage, continuously variable on expanded scale from 0-50 volts D.C.
- ★ Hand Calibrated: each instrument is individually calibrated against 'PRECISION' standards.



NET PRICE: \$78.50 complete with tubes, RG type coaxial output cable and 96 page operating text 'Servicing by Signal Substitution'. Black ripple-finished, portable, steel case, 10½" x 12" x 6".



PRECISION Apparatus Company, Inc.

92-27 HORACE HARDING BLVD., ELMHURST 6, N. Y.

Export Division: 458 Broadway, New York 13, U.S.A. Cables: Morhanex
Canada: Atlas Radio Corp., Ltd., 560 King Street W., Toronto 2B

**"A little attention
on my part increased
my Battery Sales**

62% "



says—

**FRED WHEELER of
Wheeler Radio Service,
117 East Main Street,
Monroe, Washington**

"BY KEEPING a fresh stock of RCA Batteries clearly priced in neat arrangement and by reordering promptly, my sales of RCA Batteries have increased 62%. This, of course, has meant a great deal in increasing my dollar profits."

Yes, a little more attention to the battery business by radio dealers and service technicians pays handsome dividends. Enterprising battery dealers don't just order... they *sell* RCA Batteries.

Step by step you can build the foundations of a profitable radio battery business such as Mr. Wheeler enjoys in Monroe, Washington. Your RCA Battery Distributor Salesman will help you to analyze your current neighborhood potential and to prepare an order for batteries which will produce top profit results.

As your initial stock starts to move, he'll remind you to place the new stock at the rear of your shelves, thereby assuring every customer of fresh new RCA Batteries and eliminating your spoilage problems.

If your store is not already equipped with a useful RCA Battery Tester (WV-37A), ask about its remarkable selling power. Thousands of dealers all over the country have found that it's good to do business with an RCA Battery Distributor.

Be sure to ask for copy of: "The 1954 RCA Battery Sales Planner."



Here's how RCA helps you sell more Radio Batteries



● NATIONAL TV and RADIO ADVERTISING



● POWERFUL SALES PROMOTION



● COMPLETE LINE



● GREATEST NAME IN RADIO



● RADIO TRADE DISTRIBUTION



RADIO CORPORATION of AMERICA

RADIO BATTERIES

HARRISON, N. J.