

MARCH, 1954

Radio-Television
**SERVICE
DEALER**

TV - AM - FM - SOUND

Includes: **"VIDEO SPEED SERVICING"**
"TV FIELD SERVICE" *Data Sheet Sections*



The Professional Radio-TVman's Magazine
Reaching Every Radio TV Service Firm Owner in the U.S.A.



NO. 1

CHOICE

of service technicians for

TV CONTROLS*



*Not Claims! Not Predictions!
But Plain Facts! More Service
Technicians prefer IRC TV Controls
than the next 2 brands combined.
Proved by unbiased, authoritative,
independent surveys.*

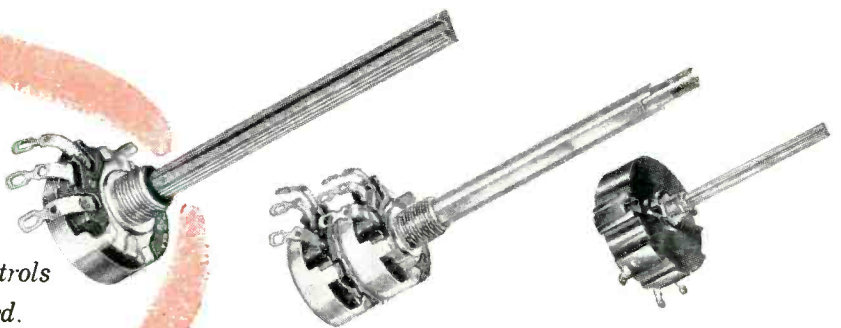

**ASK FOR *IRC* TV CONTROLS...
MOST SERVICE TECHNICIANS DO!**



INTERNATIONAL RESISTANCE COMPANY

413 N. Broad Street, Philadelphia 8, Pa.

In Canada: International Resistance Co., Ltd., Toronto, Licensee

Wherever the Circuit Says 

Insulate tools the easy way!

Just dip tools in insl-x tool dip for maximum protection

**NO MORE
TEDIOUS
TAPING OF
TOOL HANDLES**



Insl-x Tool Dip, the same material used by major utility companies for insulating power linemen's tools, is now available in a handy six-ounce container to the electrical trade.

Simply dip the tool into the Insl-x container, withdraw, and you have a smooth, tough coating that gives more than adequate protection.

Any desired thickness for use of tools on high voltage circuits may be built up by dipping in INSL-X.

The Insl-x coating is bright red so you can spot your insulated tools at a glance. Also available in black.



USE INSL-X INSULATING SPRAYS FOR ELECTRICAL AND TELEVISION INSULATION



List \$1.79
12 oz. Packed
12 to case

Insl-x E-16 for the television serviceman and Insl-x E-26 for the electrical trade are both quality insulating sprays of extra high dielectric strength that are guaranteed to completely insulate, rustproof and waterproof.

Packaged in aerosol containers, Insl-x is easy to apply. Just press the button and spray.



List \$1.79
12 oz. Packed
12 to case

\$1.19
LIST
6 oz. Packed
12 to case

See your jobber or write for complete technical data, Dept. 303

INSL-X SALES COMPANY, 26 RITTENHOUSE PLACE, ARDMORE, PENNSYLVANIA

Insl-x Products are available in bulk for spray, dip, and brush application.

CALL BACKS COST MONEY...

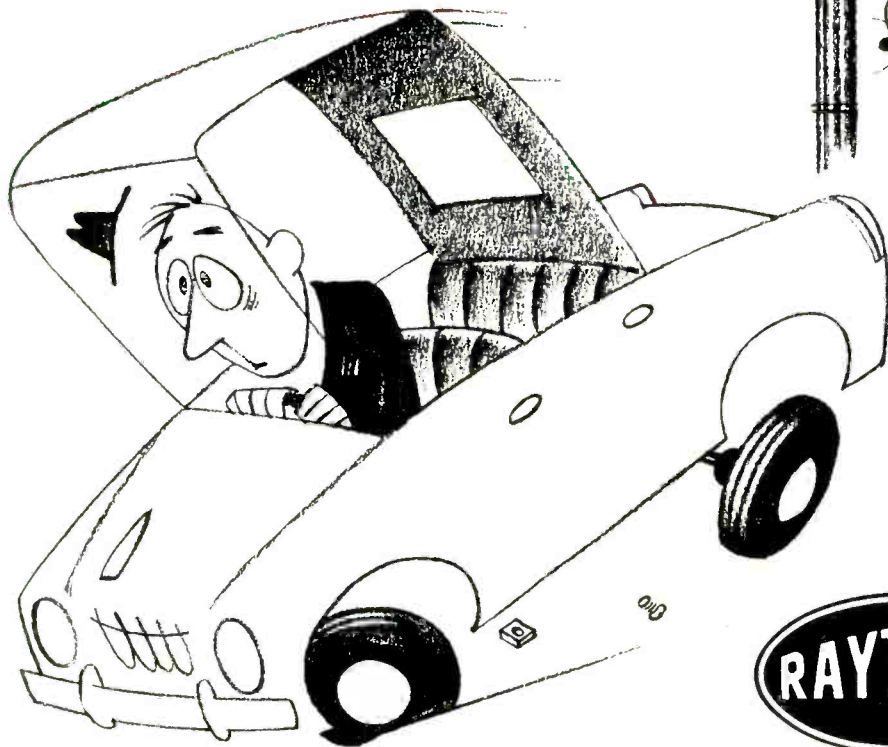

**AVOID
THEM
WITH
THE**



SERVICE SAVER PLAN

available through your **RAYTHEON TUBE DISTRIBUTOR**

The Raytheon Service Saver Plan, which permits customers to identify about 85% of all the troubles that may occur on the screen of a defective TV receiver — *and accurately transmit this information to the Service Dealer via telephone* — is helping to minimize costly call-backs two ways.

First, when a Service Dealer goes on a call knowing in advance what ails a TV receiver (thanks to Raytheon's Service Saver Plan), he goes completely equipped to do

the job — no more running back to the shop for tubes or parts.

Second, customers frequently call about TV receiver trouble when a minor control adjustment is all that is needed to correct the fault. The Raytheon Service Saver Plan helps Service Dealers avoid these needless, unprofitable calls.

Ask your Raytheon Tube Distributor to tell you how to put the Raytheon Service Saver Plan to work for you.

RAYTHEON RADIO AND TELEVISION TUBES cut call-backs, too! Their outstanding quality reduces early tube failures to a minimum. Use them. You'll find them Right . . . for Sound and Sight . . . and *you!*



RAYTHEON MANUFACTURING COMPANY

Receiving Tube Division
Newton, Mass., Chicago, Ill., Atlanta, Ga., Los Angeles, Cal.



Excellence in Electronics

RAYTHEON MAKES ALL THESE:
RECEIVING AND PICTURE TUBES • RELIABLE SUBMINIATURE AND MINIATURE TUBES • SEMICONDUCTOR DIODES AND TRANSISTORS • NUCLEONIC TUBES • MICROWAVE TUBES



Every Service Firm Owner in the U.S.A.
Receives SERVICE DEALER Monthly
DISTRIBUTION THIS ISSUE OVER 65,000

COWAN PUBLISHING CORP., 67 West 44th Street, New York 36, N. Y.

VOL. 15, NO. 3

MARCH, 1954

EDITORIAL STAFF

Publisher
SANFORD R. COWAN

Editor
SAMUEL L. MARSHALL

Assistant Editor
NORMAN EISENBERG

Contributing Editors
LEONARD LIEBERMAN
ROBERT T. DARGAN
RUDOLF F. GRAF
MARVIN KLEIN
SAN-D'ARCY

BUSINESS STAFF

Advertising Director
SANFORD L. CAHN

Advertising Manager
HARRY N. REIZES

Production Manager
DAVID SALTMAN

Circulation Manager
HAROLD WEISNER

Assistant Circulation Manager
EDWARD J. HARMAN

BRANCH OFFICES

LOS ANGELES
TED E. SCHELL
 2700 West Third Street
 Dunkirk 2-4889

CLEVELAND
RICHARD E. CLEARY
 Commercial Bank Bldg.
 Berea, Ohio
 B Erea 4-7719

FEATURE ARTICLES

Color Oscillator and Control Circuits, <i>by Bob Dargan and Sam Marshall</i>	19
Lucid explanation of circuit action in color TV receiver.	
Video Amplifier Servicing Hints, <i>by Robert G. Middleton</i>	27
Unusual but effective trouble-shooting techniques for the serviceman.	
Enterprising TV Serviceman Brings Shop to Customer	30
The "Ryan Mobile-Kar," first rolling repair shop.	
Universal Test Bench Connectors, <i>by Irving Tepper</i>	31
Using test connectors for speed in servicing.	
Vertical Hold Problems, <i>by Paul Goldberg</i>	33
A Work-Bench feature.	
Torture Test for TV Rotators, <i>by Herbert G. Koenig</i>	41
A TV rotator is subjected to a series of tests to insure against mechanical defects.	
Rhombic Antennas	53
An Answerman feature.	

CIRCUIT & SERVICE FORUM

Work Bench	
Philco model 52-1882-121 RF chassis 44.....	33
Deflection chassis D4: Vertical roll.....	34
Du Mont RA 164: critical vertical hold.....	34
G.E. 10T-1: critical vertical hold.....	34
Video Speed Servicing Systems (VSSS)	
Emerson chassis no. 120066-B, model no. 571.....	35
Motorola chassis no. TS32B, model no. 12VT13.....	37
Westinghouse chassis no. V2150-101.....	39
Rider TV Field Manual Service Data Sheets	
Admiral TV chassis nos. 22C2; 22E2.....	43
Capehart model 12F272M, TV chassis CT-74.....	47
Circuit Court	
Du Mont RA-160: vertical amplifier.....	52
Capehart CX36: sync system.....	52
Answer Man	
Rhombic Antennas.....	53
Philco 51-T1606: pix pulls.....	53
Portable Field Strength Meter.....	54

DEPARTMENTS

Editorial	6	Circuit Court	52
Trade Flashes	8	Answer Man	53
Association News	14	New Products	56
Work Bench	33	Advertising Index	64

RADIO-TELEVISION SERVICE DEALER is published monthly by Cowan Pub. Corp., 67 West 44th St., New York 36, N. Y. Subscription price: \$1 for 2 years in the United States, & U.S. Poss. Elsewhere \$1 per year additional. Single Copies 25c. Reentered as second class matter Sept. 25, 1950 at the Post Office at New York, N. Y. under the Act of Mar. 3, 1879. Copyright 1954, Cowan Publishing Corp.

POSTMASTER: SEND FORM 3579 TO RADIO-TELEVISION SERVICE DEALER, 67 WEST 44th ST., NEW YORK 36, N. Y.

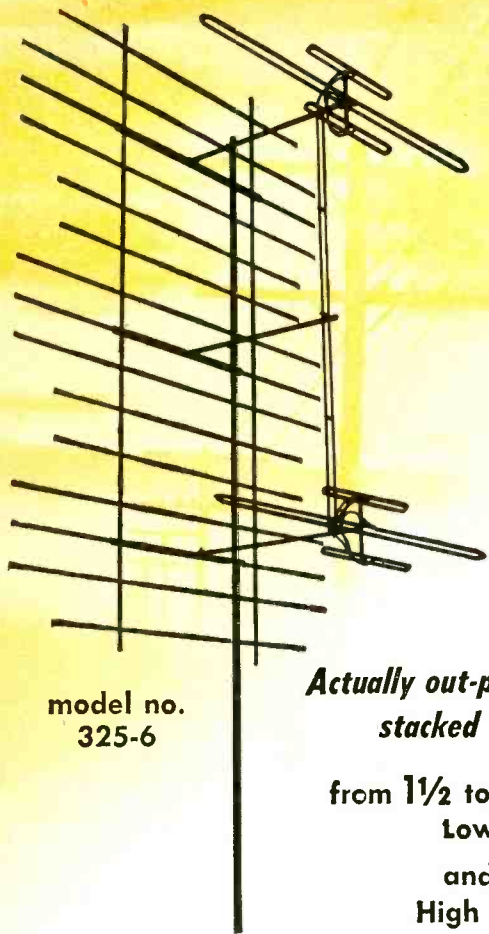

model no.
325-6

CHANNEL MASTER'S *new* SUPER CHAMP

featuring wide-spaced stacking of Tri-Pole assemblies

*Actually out-performs the
stacked CHAMPION*

from 1½ to 3 DB more
Low Band gain
and 1 DB more
High Band gain!

Channel Master proudly introduces the SUPER CHAMP — the newest addition to the Champion antenna family. The Super Champ is a super-powerful antenna that provides extraordinary VHF-UHF reception at greater distances than has ever before been possible.

How it Works:

The Tri-Pole assemblies of the stacked Champion have been wider-spaced by the addition of a third reflecting screen between the antennas. These antennas are joined with a newly-designed half-wave stacking harness. The result: Tri-Pole assemblies are spaced a full half-wave on the Low Band, increasing both Low and High Band gain.

Champion Performance on UHF

In addition to its sensational VHF performance, Channel Master's entire Champion series — including the Super Champ — has been carefully designed to provide excellent reception on the UHF band. Write for complete technical details.

AVAILABLE TWO WAYS:

1. As a complete antenna, model no. 325-6

Consists of two Tri-Pole assemblies, three reflecting screen assemblies and a special stacking harness for wide-spaced Tri-Pole. **\$54¹⁷**
list

2. As a Conversion Kit, model no. 325-7

For converting standard 2-bay Champions into Super Champs. Consists of reflecting screen and specially-designed stacking harness. **\$14⁵⁸**
list

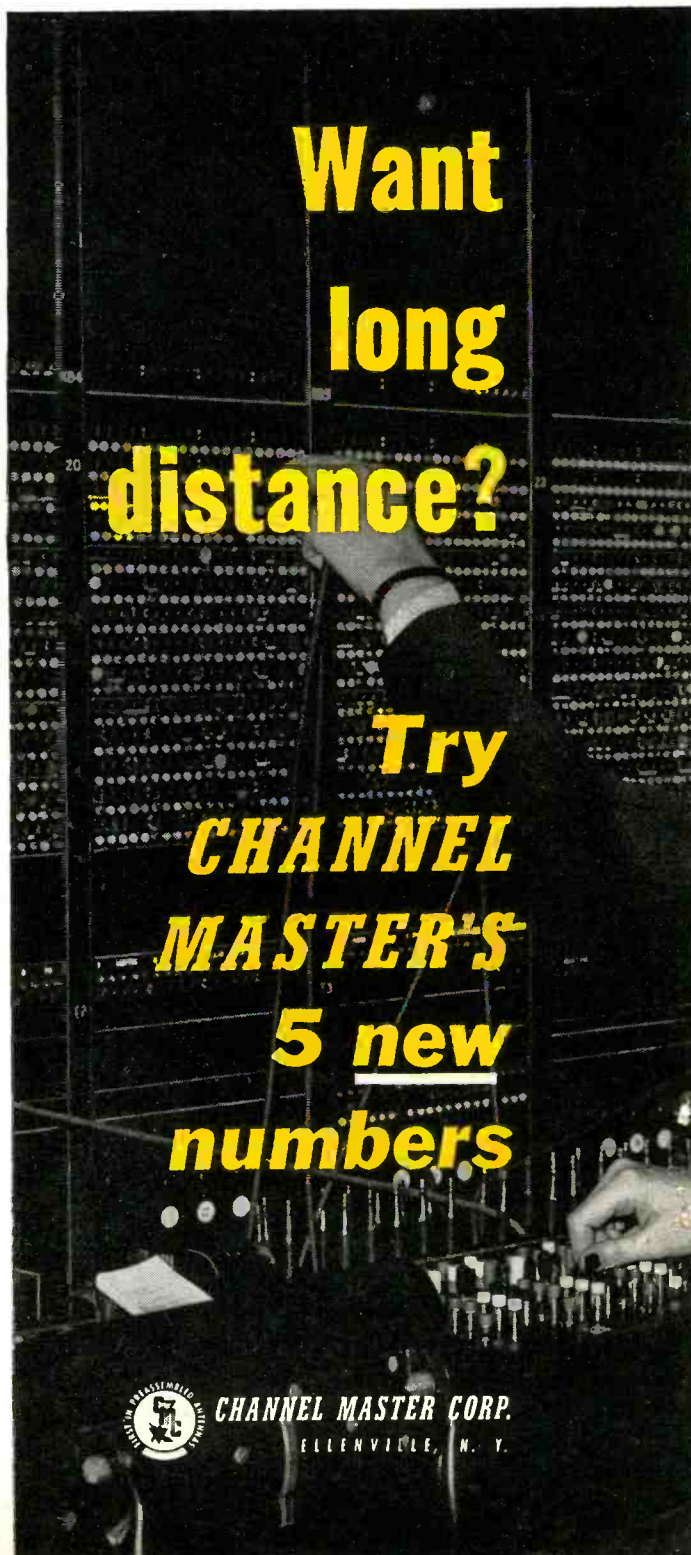

Want
long
distance?

Try
**CHANNEL
MASTER'S**
**5 new
numbers**



CHANNEL MASTER CORP.
ELLENVILLE, N. Y.

Designed for **POWER!** Low Priced for **ACTION!**

These new antennas are the most sensitive of their type — feature Channel Master's famous built-in quality at remarkable low prices, to help you meet competition on any level.

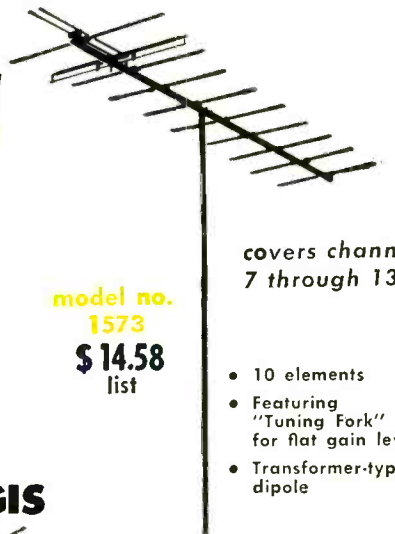

model no.
1573
\$14.58
list

covers channels
7 through 13

- 10 elements
- Featuring "Tuning Fork" for flat gain level
- Transformer-type dipole

CHALLENGER BROAD BAND YAGIS

Here's Broad Band coverage with the high gain and directivity of the Yagi. Ideal for areas served at present by two or more VHF stations on the same band and areas where new VHF stations are being added to present ones, on the same band. Feature 100% aluminum construction; are completely preassembled. They give high gain across the band; high front-to-back ratio. Can be stacked for extra sensitivity.

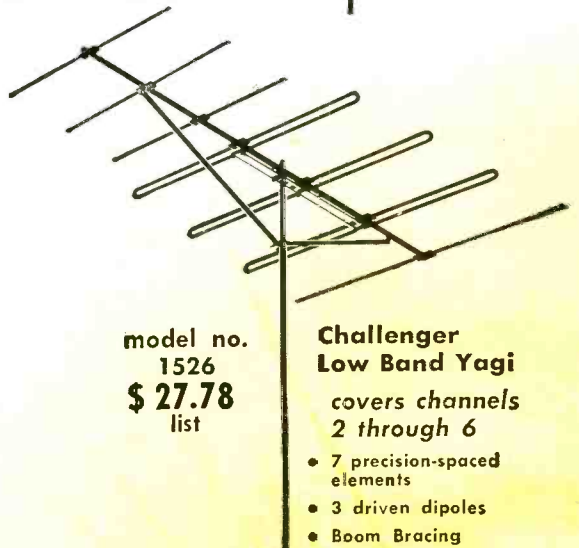

model no.
1526
\$27.78
list

Challenger Low Band Yagi

covers channels
2 through 6

- 7 precision-spaced elements
- 3 driven dipoles
- Boom Bracing

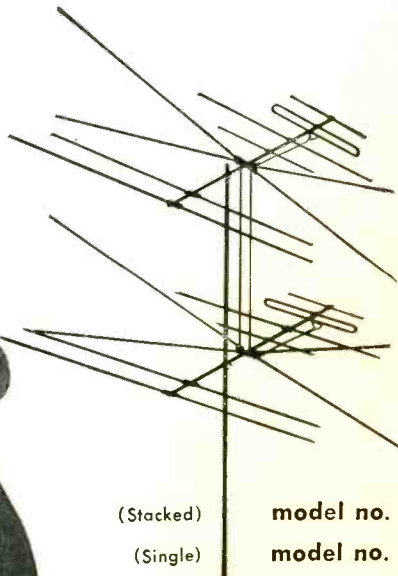

(Stacked)

model no. 321-2 **\$25.97** list

(Single)

model no. 321 **\$12.64** list

GLOBE TROTTER

- All-channel VHF *fringe area* coverage.
- All-channel UHF *primary area* coverage.
- 100% aluminum construction.
- Completely preassembled — no loose hardware.

MULTI-BOW

covers channels 14 through 83

- Outstanding fringe area reception.
- All-aluminum, solid sheet elements.
- "Free-Space" terminals.
- Heavy-duty welded wire screen, bright zinc electroplated.

model no.
410
\$11.11
list

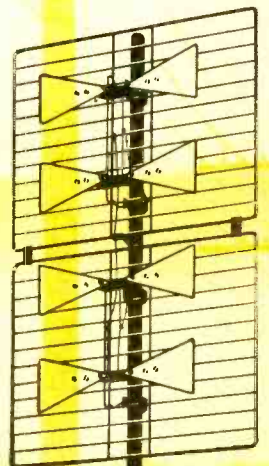

The World's Largest Manufacturer
of Television Antennas

Copyright 1954 Channel Master Corp.



EDITORIAL...

by S. R. COWAN
PUBLISHER

BEWARE OF FAKE SUBSCRIPTION SALESMEN!

WE HAVE been gratified to find that thousands of service shop owners have gone along with our recommendation that each of their employed technicians should individually subscribe to "Service Dealer" so that every man will have his own personal file of "Video Speed Servicing Systems" and "TV Field Servicing" data sheets.

However, there's a fly in the ointment! Of late, men who purport to be our subscription sales agents, (and particularly a guy who uses the name R. H. Brown), have tried to bilk unsuspecting service shopowners into buying a subscription to "Service Dealer." Remember—while we do have field subscription salesmen out—they are *not* authorized to sell subscriptions to any full-time independent serviceman, or to any service shop owner, or to any retail store owner who operates his own service department. Our field salesmen have proper credentials and they are authorized to sell subscriptions only to technicians who are employed by service organizations and service dealers. *Caveat Emptor!*

WE APOLOGIZE!

OUR MAIL last month was chock full of inquiries from subscribers wanting to know why, in our January issue, did we run less than "the usual number" of pages allocated to "Video Speed Servicing Systems" and to "Rider's TV Field Service" data sheets.

Our only excuse was that we were forced by space limitations to sacrifice some regular departments, and we chose "VSSS" and "TV Field Service" knowing that we would be able, in subsequent issues, to make up for that deficiency.

In other words, during the months ahead, additional pages of "VSSS" and "TV Field Service" data sheets will appear in certain issues over and above the regular number that would normally be scheduled to appear.

Incidentally, John F. Rider just advised us that his first complete volume of "TV Field Service Manuals" has been shipped to jobbers and is now in distribution... but we assure you that none of the items that we have published in "Service Dealer" are included in that Rider book.

Also, although we continuously receive here at this office orders from servicemen for Volume I of "VSSS" we would prefer to have our subscribers buy this volume and all of their other books from their regular distributors. Ask your jobber first—then if he can't serve you—order from us.

OPTIMISTS ARE WE!

MUCH AIR time used by commentators, and much space allocated by newspapers, at present, is devoted to business conditions and the number of people who are gainfully employed. It is all timely and relevant to the conflict of opinion as to whether or not this country is now in a general business slump, or whether the proper steps are being taken by executives to prevent our country from heading into such a slump. Mark Twain is credited with opining that "while many people talk about the weather, none of them seem to do anything about it!" Regarding the trend of business, it seems to me that many people—and particularly the President of the United States—are at present not only talking, but they are also doing many things in an effort to forestall and prevent a falling-off of business and employment. Mark us down as being among the optimists.

It is axiomatic that when radio and television sales are at high levels the servicing industry is likewise at a proportionately high level. The two seem to tie in somewhat.

But, by the same token, when new receiver sales taper off because of general business conditions or even localized conditions, servicing activities continue to expand. Many people who refrain from buying new items such as television sets, because of economic factors, naturally have repair work done on old items that otherwise would have been traded in or disposed of.

Checking with our readers in all parts of the country, in an effort to get an overall view of business conditions, we now happily report that the consensus is: that Service Dealers are now doing quite well and in general are running approximately the same sales volume as at this time last year. Independent servicemen seem to be running around 13% ahead of last year in dollar billing while contractors and service organizations report their volume up five to seven percent over last year. The biggest cities, where television has been firmly established, report less optimistically than in the new territories where television is for the first time making inroads. Summarized—1954 looks like another record-breaking year for the servicing profession as a whole.

Service dealers and service organizations situated in "average-sized" cities throughout the country would be particularly astute if they were to re-examine now the service potential afforded rather than to worry too much about the sales potential of new equipment.

New CBS-Colortron

NOW IN MASS PRODUCTION

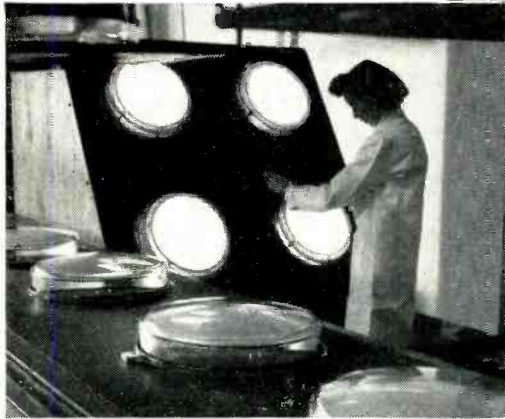

Unique photographic process, like photoengraving, uses aperture masks as negatives to print consecutively the red, green, and blue phosphor dots (250,000 of each) on CBS-Colortron screens.

After tri-color screens are printed, aperture masks are temporarily removed and face plates move on to critical inspection for screen imperfections.

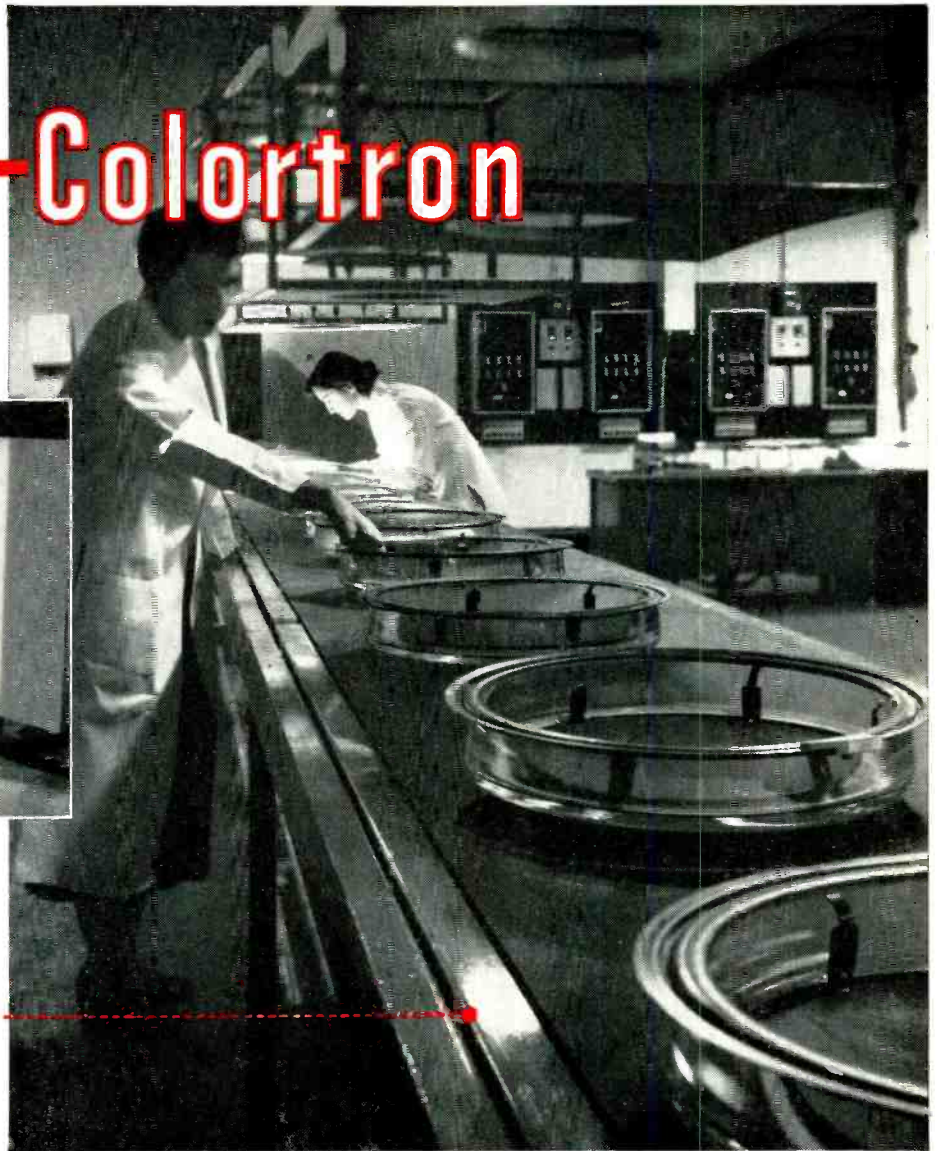

COLOR TV IS COMING . . . faster than you think. The revolutionary new CBS-Colortron . . . a practical color picture tube . . . hastens the day. Already it is in lower-cost, mass production . . . made possible by its simplified, advanced design.

As in black-and-white tubes, the CBS-Colortron's screen is deposited directly onto the inside of its face plate. A unique photographic technique makes this possible. Because each aperture mask serves as a negative to print its tri-color screen, perfect register of mask and screen is automatically achieved

and maintained. The rugged, simple, light-weight mask sharply reduces assembly and exhaust problems. And the spherical design of mask and screen simplifies convergence circuitry and adjustment.

The CBS-Colortron is now a 15-inch, round tube. But, as soon as tooling is completed, it will be made in larger sizes. Watch for the new CBS-Colortrons. You'll see plenty of them soon. And you'll be sold on sight by their logical simplicity . . . their superior performance . . . their many advantages.

CBS-Colortron OFFERS MANY ADVANTAGES

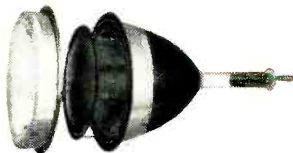

Cross-section (face plate, aperture mask, funnel, tri-color electron gun) shows simplicity of CBS-Colortron and its adaptability to low-cost, mass production.

Spherical screen and aperture mask of CBS-Colortron simplify convergence and focus. Electron beams remain in focus over entire surface of screen.



Light-weight (6 oz.), rugged, simple aperture mask of CBS-Colortron minimizes problems of exhaust, handling, and assembly.

COMPLETE CBS-Colortron DATA FREE!

Take a look into the future. Write today for complete information on CBS-Colortron 1511122: Construction . . . operation . . . application . . . installation and adjustment . . . electrical and mechanical data. Four packed pages . . . free!



CBS-HYTRON, Main Office: Danvers, Massachusetts

Manufacturers of Receiving Tubes Since 1921

A Division of Columbia Broadcasting System, Inc.

A member of the CBS family: CBS Radio • CBS Television • Columbia Records, Inc. • CBS Laboratories • CBS-Columbia • and CBS-Hytron

RECEIVING • TRANSMITTING • SPECIAL-PURPOSE • TV PICTURE TUBES • GERMANIUM DIODES AND TRANSISTORS

RADIO-TELEVISION SERVICE DEALER • MARCH, 1954

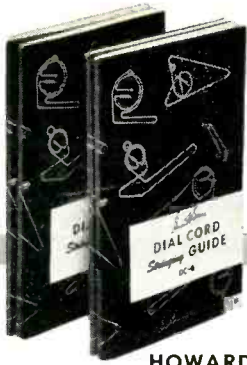

**NEW
VOLS.
3 & 4**

HOWARD W. SAM'S

**"DIAL CORD
STRINGING GUIDES"**

**Shows you the ONE right
way to string any dial
cord in just seconds . . .**

There is only ONE RIGHT WAY to string a radio receiver dial cord, and these are the *only* books that show you how. They cover thousands of receivers, clearly illustrating each dial cord system in a legible diagram that shows you how to solve the knottiest stringing problem in seconds. You'll say goodbye to trouble when you own these invaluable guides—they pay for themselves in the time you save!

VOL. 4. Latest volume includes dial cord stringing diagrams for hundreds of radio and TV-radio receivers produced from mid-1951 through 1953. Includes cumulative index to all 4 volumes. 96 pages. 5½" x 8½".
ORDER DC-4. Only.....\$1.00

VOL. 3. Includes dial cord stringing diagrams for radio receivers produced from 1950 through mid-1951, as well as TV-radio receivers produced from 1946 through mid-1951. 96 pages. 5½" x 8½".
ORDER DC-3. Only.....\$1.00

VOL. 2. Covers dial cords used in receivers produced from 1947 through 1949. Indexed for quick reference. 96 pages. 5½" x 8½".
ORDER DC-2. Only.....\$1.00

VOL. 1. Complete dial cord stringing data for hundreds of receivers produced from 1938 through 1946. 112 pages. 5½" x 8½".
ORDER DC-1. Only.....\$1.00

**OWN ALL 4—LUCK ANY DIAL CORD
STRINGING PROBLEM IN SECONDS**

HOWARD W. SAM'S & CO., INC.

Order from your Parts Jobber today, or write to Howard W. Sams & Co., Inc., 2209 East 46th St., Indianapolis 5, Ind.

My (check) (money order) for \$..... enclosed. Send the following books:

- DC-4 (\$1.00) DC-2 (\$1.00)
- DC-3 (\$1.00) DC-1 (\$1.00)

Name.....

Address.....

City..... Zone..... State.....
(Outside U.S.A. priced slightly higher)

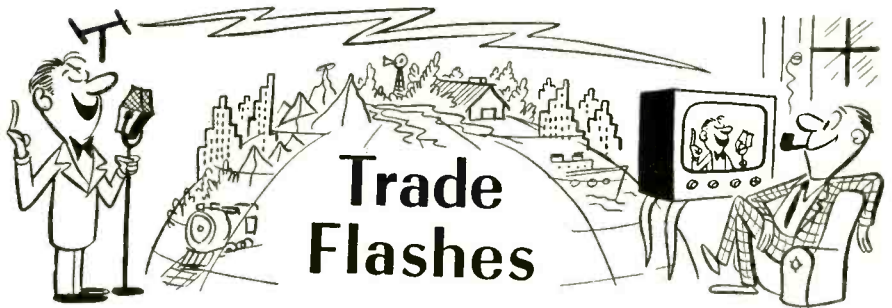

Servicemen Receive Awards

Two top winners in RCA Service Company "Man of the Hour" sales contest for TV service technicians are shown receiving awards for their record



sales of TV service contracts over a three-month period. Above, William A. Jackson, San Francisco, Western Area winner, receives trophy from Donald H. Kunsman, vice president, consumer products division, RCA Service Co. Below, Kunsman presents award to Robert Goldman, New York Eastern Area winner.

Scott Lowers Prices

Price reductions averaging twenty-five percent were announced today for Scott high fidelity equipment.

John Meek, president of Scott Radio Laboratories, Inc., Chicago, stated these reductions are made possible by the mushrooming growth of the high fidelity market. No changes of specifications accompanied these price adjustments said Meek.

G. E. Explains Color TV

W. L. Parkinson, General Electric's television product service manager, at the left, introduces a representative group of company service personnel and technicians to color television. This group was among 200 TV distributor and dealer servicemen who recently attended a week-long color TV seminar at Electronics Park, Syracuse. The technicians went through thirty-five hours of intensive indoctrination into



all phases of color TV alignment and service. With Mr. Parkinson, from the left, are R. L. Cam, R. Cooper, Jr., Chicago; A. B. Sherwood, General Electric Supply Co., Los Angeles; Arthur D. Schulze, Schulze Radio Service, Richmond, Texas; Richard Goins, GESCO, Houston, Texas; Robert K. Yeaton, GESCO, Boston; and Paul I. Bayless, GESCO, Jacksonville, Fla.

RCA Tube Contest

A \$50,000 contest which will award 400 prizes to radio-TV service dealers offering the best reasons for using and recommending RCA kinescopes and receiving tubes was announced today by the Tube Department of the RCA Victor Division, Radio Corporation of America.

The "Tell and Sell" prize contest, open to all radio and TV service dealers, requires the completion in 25 words or less of the sentence beginning, "I use and recommend RCA tubes because . . ." Winners will be selected on the basis of originality and aptness by an independent, nationally-known judging organization. The contest closes midnight, April 30, 1954. Official entry blanks are available from RCA tube distributors.

[Continued on page 12]

\$5000 IN PRIZES

... easy to win

503 PRIZES!

\$2000 - 1st prize

\$500 - 2nd prize,

\$100 - 3rd prize

100 - \$10 prizes,

400 - \$5 prizes

HOW TO WIN

To win one of these 503 prizes all you have to do is complete in 25 words or less "I like Pyramid capacitors because _____" You fill in this statement on a Pyramid contest entry blank which can be obtained from any electronic parts jobber selling Pyramid capacitors. You have this entry blank countersigned by your jobber or one of his salesmen and forward it to us attached to a Pyramid Dry Electrolytic Capacitor box top—the top being the part which carries the description of the item. There is no limit to the number of entries which you may make in this contest but each entry must be accompanied by a box top. Full rules for the contest appear on the entry blank.

It's so easy. Here is the kind of statement that might win:

"I like Pyramid capacitors because they always check out perfectly and don't deteriorate and so I know I won't have to call back at my expense."

"I like Pyramid capacitors because the line is so complete that I can always get what I need and don't have to worry about an off-brand capacitor."

PYRAMID



PYRAMID FEATURES:

- 1 Only one quality—the best at no premium. All Pyramid capacitors are made of materials commanded by rigid military specifications.
- 2 All Pyramid capacitors are non-hygroscopic.
- 3 Highest quality insulator material used in all production results in low leakage factor.
- 4 Exclusive non-contamination technique guarantees close tolerances and no deterioration. Peak performances for life.
- 5 Pyramid capacitors operate unchanged at ambient temperature of 85° centigrade.
- 6 Designed by service technicians across the country for their requirements.
- 7 Individually packaged for protection.
- 8 Permanently legible, high visibility ratings on each item.
- 9 100% absolute electronic inspection before shipment.

Pyramid is in its 10th year as a leading manufacturer of high-quality capacitors.

PYRAMID ELECTRIC COMPANY
1445 HUDSON BOULEVARD
NORTH BERGEN, N. J.

Before you install another antenna

take this

Irving Rose, prominent Chicago designer and president of Voice and Vision, noted television and high fidelity center, takes the “**look test**” of fringe reception from Milwaukee.



using JFD Super JeT antenna

using antenna A



1. Four TV receivers of one brand, same model, same production run were set up. Technicians went over these sets to make sure they were identically aligned.

2. Three other leading high gain TV antennas were installed—each oriented for maximum performance. Each antenna was connected to a set by identical type lead-in.

3. Each receiver was tuned with infinite care to the same channel to make certain the reception was as good as possible. The picture is the proof—the result can be immediately seen—the JFD Super JeT outperformed all others.

4. The chart shows why the “Look-test” is your proof positive of sharper, clearer, more brilliant pictures . . . in Black and White or Color on all channels present and future.

JeT 213 (single Bay) \$18.70

JeT 213S* (2-Bay) \$38.35

*complete with stacking transformer

"look-test"

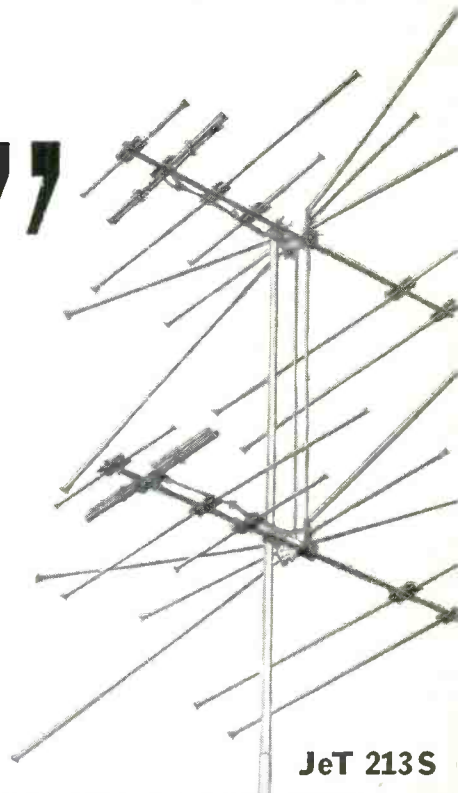

Here is your clinical proof that only the **JFD Super JeT TV antenna Out-Performs** all others on all channels

JeT 213 S

using antenna B

using antenna C

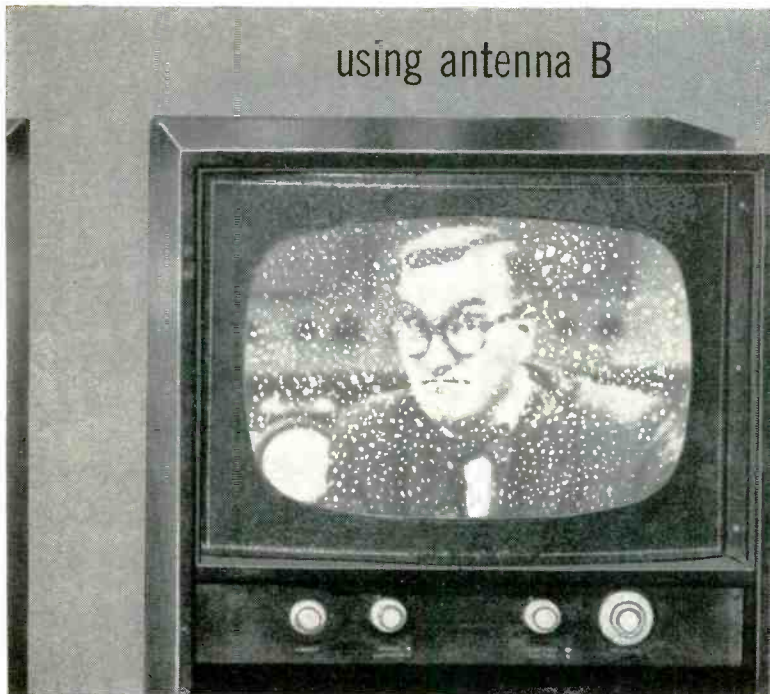

Burton browne advertising

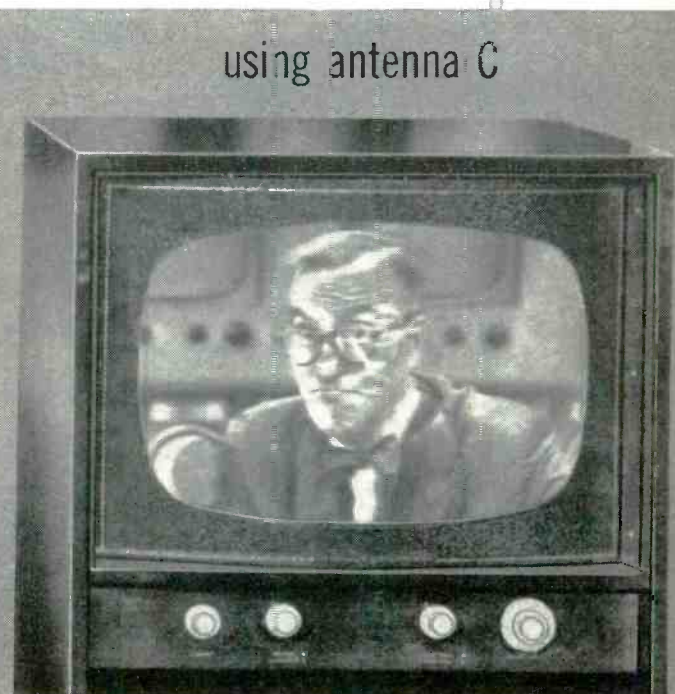

ANTENNA LIST

CHANNELS

		2	3	4	5	6	7	8	9	10	11	12	13
Competitor A Radar Screen with 3 dipoles (2-bay) Partly Pre-Assembled	\$42.36	4.5	4.3	7.3	7.0	7.0	10.00	10.75	11.5	11.7	11.0	11.5	11.6
Competitor B Radar Screen with 2 dipoles (2-bay) Not Assembled	\$34.95	0.75	3.25	4.5	3.5	3.5	6.0	7.0	6.5	7.75	8.0	7.5	6.0
Competitor C Bedspring (4-bay) Pre-Assembled	\$55.00	4.0	5.0	7.0	6.25	5.0	5.25	6.0	5.25	7.25	9.25	6.5	7.0
JFD Superjet Model JeT 213 S (2-bay) Pre-Assembled	\$42.50	6.5	7.5	9.5	8.5	8.5	11.0	11.0	12.0	12.0	11.25	11.75	12.0

DB GAIN



**JFD Manufacturing Company,
Brooklyn 4, N.Y.**

World's largest manufacturers of TV antennas and accessories

Write for Bulletin #230

TRADE FLASHES

[from page 8]

The grand prize is a choice of a 1954 DeSoto hard-top convertible automobile or a 1954 Dodge panel truck, plus a full set of RCA test Equipment.

Simpson TV "Challenge Clinics"

Television service men, in increasing numbers, have requested that industry service meetings be conducted on a practical basis, and Simpson Electric Co. will accede to these requests in its 1954 series of television service meetings. These meetings will feature "Challenge Clinics," to which television service men are invited to bring their "dog" receivers for diagnosis and repair by a field engineer.

The challenge Clinics are conducted



by Bob Middleton, a "service man's service man," known throughout the United States and Canada as a speaker, demonstrator, and author of best-selling books on television troubleshooting.

Because technical audiences often re-

quest that proceedings of service meetings be made available in printed form, Simpson Electric Co. has inaugurated a new house organ entitled *The Technicians Timesaver*, an easy-to-read four-page publication which points out profitable shortcuts to faster TV servicing. Each issue covers, in part, the formal discussions and demonstrations made at the meetings.

Raytheon "Service Saver" Meetings

Carroll Hoshour, director of service and sales for Raytheon's television and radio division, explains some of the fine points of "Service Saver." It's the ingenious new TV trouble-shooting method which was enthusiastically received by more than 1,000 of Greater New York's television dealers and repairmen assembled on January 13 at Manhattan Center, New York City. L. to R.: Adolph Langer, H. L. Dalis Co.; Bill Marcus, John F. Rider Publications; Carroll Hoshour; John F. Rider, John F. Rider Publications; Syd Fink, H. L. Dalis Co.; Bob Dalis, H. L. Dalis Co.; F. E. Anderson, Manager Replacement



and Export Sales, Raytheon Manufacturing Co., Receiving Tube Division.

Over 600 service dealers attended recent "Service Saver" meetings held in Florida, Georgia and South Carolina. Attending dealers were most enthusiastic in their response to the informative and educational talk presented by Bill Ashby, RAYTHEON TV's popular staff lecturer.

Over 400 service dealers attended the recent RAYTHEON Bonded Electronic Technician meeting held in Buffalo, N. Y., while approximately 500 service dealers attended "Service Saver" meetings held in Reading and Wilkes-Barre, Pa. and Hagerstown, Md.

First TV For Wyoming Town

A new milestone in television was reached when the people of Casper, Wyoming, second largest city in the state, received television for the first time recently. The programs come from Denver, Colorado via a unique closed circuit community television system which uses microwave facilities for the first time in such a system.

[Continued on page 51]

QUAM

the Quality line

When you specify Quam products you are assured of components that are carefully checked and tested for top performance and dependability . . . delivered when you need them . . . at the right price.

manufacturers of

QUAM Adjust-a-Cone[®] Speakers for television, radio, high fidelity, public address, outdoor use, replacement and many other applications.

QUAM Focalizer Units for TV picture tube focusing . . . use Alnico V permanent magnets . . . eliminate troubles inherent to wire-wound focusing devices.

QUAM Ion Traps for any size or type of TV picture tube.

QUAM Tru-Match Output Transformers, designed to get the best performance from your speaker.

QUAM-NICHOLS CO.

Marquette Road and Prairie Avenue
Chicago 37, Illinois

Cash-in on the "do-it-yourself" trend!

STOCK and SELL Admiral ANTENNA KITS

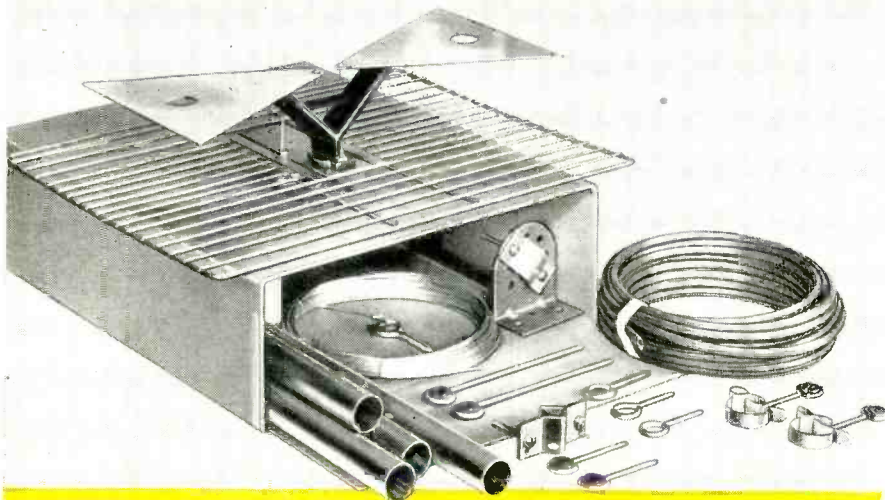

NINE KITS...for UHF, VHF and UHF-VHF areas

Each kit complete with mast, mounting accessories, step-by-step instruction sheet and antenna as follows...

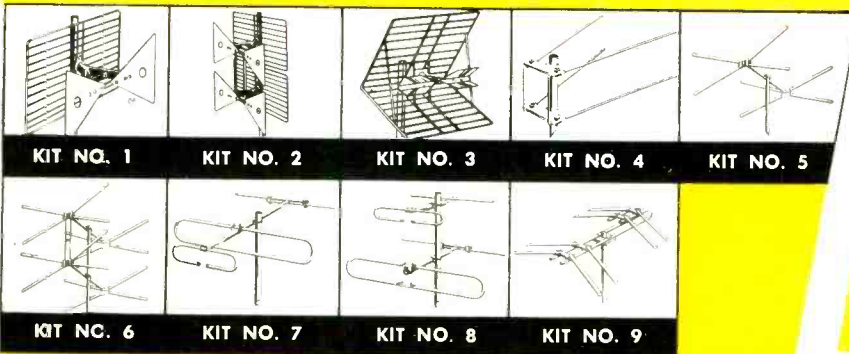

Pre-packed for easy, over-the-counter sale. Liberal dealer discounts enable you to sell at "wholesale" prices yet earn big profits. All kits available with any one of four different mast mounts as follows:

- Add "A" to Kit No. for Mast Base Mount (flat or sloping roof)
- " " " " " Chimney Mount
- " " " " " Roof Ridge Mount
- " " " " " Side or Flat Wall Mount

SUGGESTED LIST PRICES	KIT NO. 1	KIT NO. 2	KIT NO. 3	KIT NO. 4	KIT NO. 5	KIT NO. 6	KIT NO. 7	KIT NO. 8	KIT NO. 9
	\$13.95	16.75	19.50	\$14.95	13.95	21.95	\$15.95	15.95	21.95

Admiral Corporation, Accessories and Equipment Division, Chicago 47, Illinois

INSTALL IT Yourself and SAVE!

YOU CAN GET 25 to 40% BETTER RECEPTION on your present TV Set... and you're READY FOR COLOR!

ANTENNA KITS FROM Admiral
WORLD'S LARGEST TELEVISION MANUFACTURER

Priced from **\$13.95** LIST
at your Admiral dealer

UHF Kits
VHF Kits
All-Channel Kits

Kits contain everything needed... antenna, mast, mast mount, guy wires, insulators, lead-in... down to the last screw-eye. Step-by-step instructions are easy to follow. No experience or special tools needed. No gain antennas get excellent reception. Highest quality, tested and guaranteed by Admiral. Buy from your Admiral dealer.

Nationally Advertised in
POPULAR MECHANICS
MECHANIX ILLUSTRATED
POPULAR SCIENCE

Sangamo Dry Electrolytics

Live many seasons
for heap good
reasons



these wire lead
tubular capacitors
will not deteriorate
with age

Use Sangamo dry tubular electrolytics for trouble-free replacements. You don't have to worry about premature failure. Long life is really built into these capacitors. They have exceptional staying power because:

- 1 A super-seal keeps the electrolyte from evaporating even under the toughest conditions of heat and humidity.
- 2 All these capacitors are aged at 85° C to build a tough dielectric film that will stand up under high heat.
- 3 All aluminum container prevents the "creeping" corrosion that occurs in capacitors when any other metal is permitted to contact the electrolyte.
- 4 Sangamo electrolyte is really pure. Continuous laboratory control of every batch keeps the chlorine ion concentration to less than 10 parts per million. That's 99.999% pure, or better!
- 5 No lead breakage. Sangamo uses a special wire that resists bend fatigue. A specially designed rivet that "cradles" the lead gives additional protection.

P. S. These wire lead tubulars fit those tight corners— Their compact design gives maximum capacity in minimum space. See your Sangamo Distributor for all your capacitor replacement needs.

Those who know



choose Sangamo

SANGAMO ELECTRIC COMPANY

MARION, ILLINOIS

SC54-4

ASSOCIATION NEWS

I.R.E. Convention

The 1954 National Convention of the Institute of Radio Engineers will be held on March 22-25 at two locations in New York City—the Waldorf-Astoria Hotel and the new exhibit site, the Kingsbridge Armory.

Meetings and social features will take place at the hotel. The Convention will open with the Annual Meeting of the Institute at 10:30 am on March 22.

An outstanding feature of the Convention will be the 600-exhibit Radio Engineering Show to be housed on one floor in the Armory. The extensive technical program of 51 sessions and 242 technical papers will include a Medical Electronics Symposium, as well as an Audio Seminar on hi-fi, both to be held on the evening of March 23.

Members of the I.R.E. and guests may register either at the Waldorf-Astoria or at the Kingsbridge Armory. Fee is \$1.00 for I.R.E. members and \$3.00 for non-I.R.E. members.

LIETA Prexy and Staff In Shop

LIETA president, William A. Carey, takes a break in his repair shop in Garden City, L. I., N. Y. with his staff of technicians, all LIETA members.



Left to right: Mr. James Sedden, Mr. Carey (better known as Dick); Mr. Napoleon Revels; Mr. William H. Cully.

SARTA

The San Antonio (Texas) Radio and Television Association reports interesting technical sessions on color TV. Recent guest speaker was Mr. C. R. Bowman of the P. R. Mallory Co. SARTA has increased membership dues to \$4.50 a month, which includes a 50 cent contribution to their state organization, Texas Electronic Association (TEA). SARTA's business meeting

[Continued on page 17]

it's new
it's new
it's new

It's What You've Been Asking For!

it's new

it's new
it's new
it's new
it's new
it's new
it's new

the TR-4 **C•D•R** Rotor

still the most powerful TV rotor, enough power to turn any array.

**NOW... With Meter Cabinet
Using 4-Wire Cable**



Model TR-4

the de-luxe HEAVY DUTY ROTOR complete with modern design meter control dial cabinet, using 4 wire cable.

\$53.95

also these models **TR-2 • TR-11 • TR-12**

CORNELL-DUBILIER
SOUTH PLAINFIELD, N. J.



THE RADIART CORP.
CLEVELAND 13, OHIO

TELL YOUR CUSTOMERS THIS TV TRUTH

"Why pay more? You don't have to buy a new set. You don't have to pay a high premium for UHF reception on a new set. On your present set you can get ^{all} UHF Channels for ONLY \$19.95 with a genuine Regency CONVERTER - no costly installation - perfect reception with a Regency \$19.95 CONVERTER."

Learn this TV truth yourself - there's more profit in low cost, volume conversion.

ASSOCIATION NEWS

[from page 14]

this month features a tape recording of Al Robertson's speech made at the TEA clinic and Fair held last summer at Fort Worth. In addition to the technical forums being sponsored by SARTA, this association is also giving a business course for servicemen which is sponsored by General Electric, Modern Radio, and SARTA.

NARDA (Newport, R.I.)

The National Appliance and Radio-TV Dealers Association is organizing a group in the Newport, R. I., area, to be headed by George Ganong of T & C Radio, Newport.

Other Newport stores participating are Bob Nass's, Newport TV Service Center, Richards Radio & TV Service, Ace Television, Radio Shack, Henry's Radio Service, Leo Kain's TV, and Shumaker & Evans Radio.

Middletown, R. I., stores participating include Radio & Appliance Center and Bestoso TV.

ARTSNY

At a meeting held by the Associated Radio TV Servicemen of N. Y. at their headquarters on Thursday, Feb. 4th, Bob Dargan, chief instructor, Philco Distributors, L. I. City, N. Y., assisted by Don Sabatini, presented an interesting lecture on the new Philco chassis. Servicing techniques were demonstrated with the aid of a scope and various types of probes.

Eastern TV Conference

The Eastern Television Service Conference, composed of service associations on the eastern seaboard, will hold its annual session in the Bellevue-Stratford Hotel, Philadelphia, on April 2, 3, and 4, in connection with the Color Symposium to be held at the same time and place.

The Color Symposium is being arranged by the major manufacturers, and is sponsored by the manufacturers and distributors in the Philadelphia area, and by the Council of Radio and Television Service of Philadelphia, which will also act as host for the Eastern Conference.

All persons connected with the television or radio industry, whether affiliated with an association or not, are welcome to attend the symposium and the conference sessions.

Harold B. Rhodes, of Paterson, N. J., president of the Radio and Television Servicemen of New Jersey, Inc., and Eastern Secretary of N. A. T. E. S. A., was re-elected chairman of the conference at a meeting of the Conference Executive Committee in Philadelphia January 31. Groups represented at the meeting, and who will join in sponsoring

8 vertical outputs
1 deflection yoke
1 filter choke
5 width and linearity controls
17 exact replacement flybacks
23 TV power transformers

55 NEW TV REPLACEMENT COMPONENTS HAVE BEEN ADDED TO THE STANCOR LINE

STANCOR YOUR MOST COMPLETE SOURCE OF TV REPLACEMENT TRANSFORMERS

28 flybacks (27 exact duplicates)
55 TV power transformers
8 deflection yokes
9 width and linearity controls
15 vertical outputs
8 blocking oscillators
3 focus coils
5 filament transformers
22 filter chokes
19 audio outputs

NOW 172 TV REPLACEMENT COMPONENTS ARE IN THE STANCOR LINE

Ask for Stancor's new TV Replacement Guide listing replacement applications for these transformers in 6800 TV models and chassis. FREE from your local Stancor distributor, or from Chicago Standard Transformer Corporation.

Stancor transformers are listed in Sams Photofact Folders and in Counterfacts.



CHICAGO STANDARD TRANSFORMER CORPORATION

3586 ELSTON AVE. • CHICAGO 18, ILL.
EXPORT SALES: Roburn Agencies, Inc., 39 Warren Street, New York 7, N.Y.

the Eastern Conference sessions were: N. A. T. E. S. A., N. E. T. S. D. A., A. R. T. S. N. Y., Philadelphia Radio Servicemen's Association, Federation of Radio Service Associations of Pennsylvania, Council of Radio and Television Service of Philadelphia, Mid-State Radio Servicemen's Association of Harrisburg, Pennsylvania, Radio and Television Servicemen of New Jersey, Inc., Allied TV Technicians of New Jersey, Long Island TRT Guild, Empire State Federation of Electronic Technicians, Radio Technicians Guild of New England, Television Service Dealers of Philadel-

phia, Television Service Dealers Association of Delaware County, Pennsylvania, and Radio and TV Servicemen's Association of Pittsburgh.

RTASV

Russel L. Dovel has been elected president of the Radio and Television Association of Springfield (Ohio) and Vicinity. He succeeds Jack Carpenter. Anthony Petrausky will serve as vice-president, while Walt Kugler, treasurer and Paul Boller, secretary, have both been re-elected for another term.

[Continued on page 58]



Speaking of Speakers...

DELCO RADIO CAREFULLY CONTROLS THE MANUFACTURING OF ITS SPEAKERS TO ASSURE HIGHEST POSSIBLE QUALITY

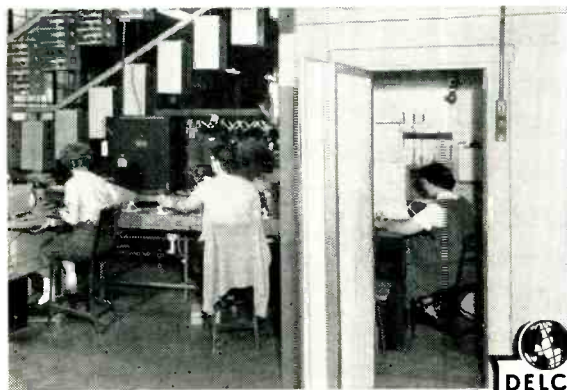

In the audio test booth, the speaker is checked for its ability to deliver good listening. In the background you can see a small section of the speaker production line.



High quality in the final product can be had only through rigid quality control. Take speakers, for example. Speaker baskets are formed in our stamping department. Special machines wind the voice coils. On the assembly line the cones are secured to the voice coils and then assembled with the basket. All along the line inspectors have been checking and rechecking. Then, the speaker is magnetized and goes into a specially designed sound booth for a final check.

This continuing quality control is one important reason why Delco Radio replacement parts assure customer satisfaction. Made by the world's largest manufacturer of auto radios, they are available from your UMS Delco Electronic Parts Distributor.

**DISTRIBUTED BY
ELECTRONICS
WHOLESALEERS
EVERYWHERE**

DELCO RADIO

DIVISION OF GENERAL MOTORS CORPORATION, KOKOMO, INDIANA

A GENERAL MOTORS PRODUCT   A UNITED MOTORS LINE

COLOR OSCILLATOR and CONTROL CIRCUITS

From a forthcoming book
entitled "FUNDAMENTALS
OF COLOR TELEVISION"

by **BOB DARGAN**
and **SAM MARSHALL**

COLOR receivers will require an understanding of many new electronic concepts and a mastery of new adjustments relating to color balance in the various circuits associated with the color picture tube. With regard to the new electronic concepts, the most intriguing are the principles and operation of color encoding and decoding circuitry. In the transmitter the sections relating to this function are the color matrixing and multiplexing circuits which are often referred to as the color encoding sections. In the process of matrixing we cross-mix the primary colors to produce the luminance signal plus the two chrominance signals. Following this operation we make possible the transmission of these three signals on a single channel which is called multiplexing.

In the receiver, color decoding involves:

1. The Color Sync Section
2. The Color Demodulation Section
3. The Color Matrixing Section

This chapter is primarily concerned with the color sync section. It describes the action taking place in the color oscillator and control circuits, and the progress of the transmitted sync signal as it influences and combines with other developed signals in this important section of the color receiver.

The Color Sync Section which involves the Color Oscillator and Control Stages is positioned between the Video

Amplifier and the Q and I Demodulator Sections as shown in the block diagram of Fig. 1.

A block diagram of a typical color oscillator and control circuit is shown in Fig. 2. As can be seen, the Burst Amplifier is supplied with two signals, the horizontal deflection spike and the reference burst from the transmitted video signal. This combination results in passage and amplification of only the 8-cycle reference burst. This burst signal enters a phase detector which is used to compare the phase of the burst with that of a 3.579545 mc crystal oscillator commonly referred to as 3.58 mc. Any difference of phase in this circuit produces an error voltage which is coupled to a reactance tube for the purpose of accurately re-phasing the crystal oscillator in sync with the incoming burst.

Typical commercial color sync circuits are shown in Figs. 3 and 4. Except for a slight difference in tube type used by RCA in the phase detector, Fig. 3 illustrates the circuitry used in the CBS and RCA receivers. Fig. 4 is the system used by Emerson. Notice that in this receiver no crystal is used in the oscillator circuit, sufficient frequency stability being obtained with the particular circuit used.

The Burst Amplifier

Coming back to the first video amplifier as shown in Fig. 2, it should be

noted that a tuned circuit resonant at 3.58 mc is used to remove the E_v signal component and pass only the burst and color information. The 3.58 mc signal developed across the tuned circuit is then coupled to the grid of the Burst Amplifier.

Referring to Fig. 5 which is a partial schematic of the RCA Burst Amplifier circuit, we observe that in the 6U8 burst amplifier tube the cathode is connected through a 220 ohm resistance to the junction of the 12K and 220K voltage divider network between B plus and ground. This places a relatively high negative bias between grid and cathode causing tube cut-off.

Along comes the sync pulse followed immediately by the 8-cycle color burst (see Fig. 2). A simultaneous action occurs on the tube whereby the negative going sync spike from the horizontal output transformer (Fig. 5) is injected into the cathode circuit, thereby neutralizing the positive voltage on the cathode and driving the tube into conduction. Just at that moment the 8-cycle color burst enters the grid of the tube and is amplified. These two actions are such that at the termination of the spike no further color burst signal occurs, and the tube goes back into cutoff again. In this manner no spurious signals which could disrupt the color demodulation action can pass through the burst amplifier.

The relative phase positions of the horizontal sync pulse, the spike and the color burst are shown in Fig. 6. The 8 cycle burst is then amplified in the tube and passed on to the Phase Detector through the tightly coupled transformer in the plate circuit. The circuit constants are so proportioned as to produce a negative spike which opens up the burst amplifier wide enough to permit passage of the full 8 cycles of the color burst.

Another method of gating the burst amplifier used in some commercial receivers is to maintain the tube in a non-conducting condition by applying a large negative voltage to the screen grid. See Fig. 7. At the time when the tube is

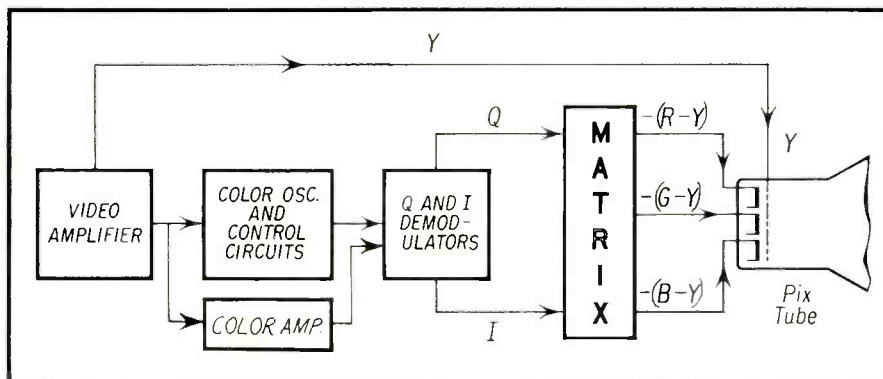

Fig. 1—Color oscillator and control circuits follow video amplifier.

to be made to conduct a positive horizontal spike from the horizontal output transformer is coupled to the screen grid. This temporarily removes the blocking potential and permits the tube to conduct, thereby resulting in amplification of the 8 cycle 3.58 mc burst.

The horizontal pulse for the gating of the burst amplifier is obtained in most cases from a separate small winding on the horizontal output transformer.

Automatic Phase Control

It will be recalled that the purpose of the phase detector is to lock the crystal oscillator with the color burst. This is shown in block diagram form in Fig. 2.

Referring to Fig. 3, a correction voltage is derived from the phase detector which is fed to the grid of the reactance circuit tube in case the incoming color and the crystal oscillator are out of phase. A portion of the crystal frequency is fed to the color phasing amplifier the output of which is fed into the phase detector. At the same time the color burst is applied to the phase detector from the burst amplifier. Thus, the Phase Detector is able to compare the burst phase with the crystal oscillator phase. If the correct phase relationship exists between them no correction voltage will be applied to the reactance tube. On the other hand should there be a phase shift in the crystal oscillator frequency, for some reason or another, this change will be transmitted through the color phasing amplifier to the phase detector where an unbalance in the conduction of the diodes will re-

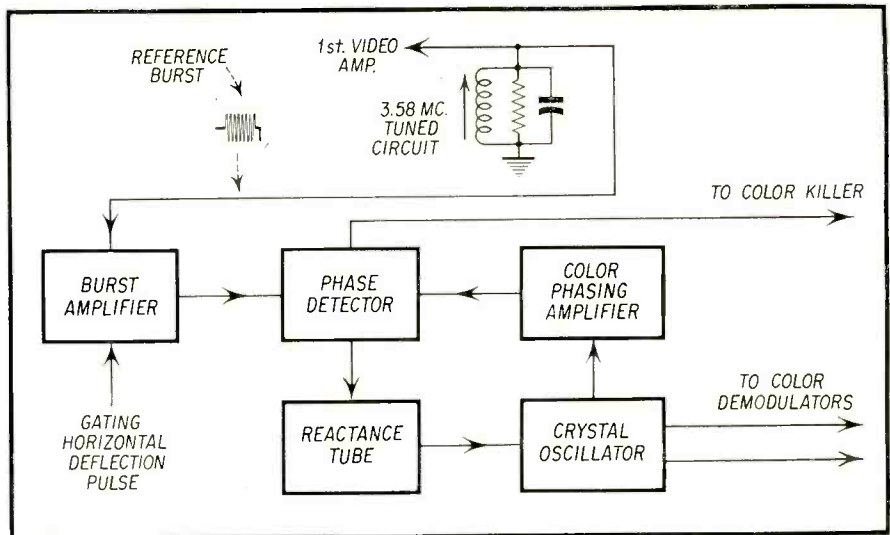

Fig. 2—Block diagram of color oscillator and control section.

sult, causing a correction voltage to be applied to the reactance tube. The latter will then convert this correction voltage into a capacitance change across the tank circuit of the oscillator bringing the latter into proper phase relationship with the burst signal.

A circuit balancing potentiometer of 50,000 ohms is usually made use of to permit manual balancing of the inequalities that may result in the Phase Detector circuit components and tubes. A center tap on the secondary of the Phase Detector transformer is connected to the variable arm of the balancing potentiometer. It is from this point that the pulses charge the filter network, the purpose of which is to provide an RC

time constant slow enough to absorb noise pulses that manage to get through the previous circuits and fast enough to permit reactance tube control.

Reference to Fig. 3 will reveal that the balance potentiometer affects the balance currents in the Phase Detector and therefore affects the correct phasing of the 3.58 mc oscillator. This, in turn affects the color registration so that this control is one of the controls used in obtaining proper color register.

The quartz crystal signal is not fed directly to the Phase Detector but is applied through the Color Phasing Amplifier which permits adjustment of the phase of the oscillator frequency. If there is a lead or lag in phase of the local oscillator signal with respect to the burst signal, a dc error voltage is developed in the phase detector circuit which is supplied to the reactance tube through the filtering or integrating network. The voltage obtained from the Balanced Detector corresponds directly to the phase difference between the two signals. A phase difference of plus or minus 5 degrees between the burst and the oscillator frequency is the maximum tolerable phase shift that will produce negligible change in color fidelity.

Reactance Tube Circuit

The reactance tube circuit provides a means of correcting the phase of the 3.58 mc color oscillator signal should its phase be different than that of the color burst signal. In effect it is equivalent to adding or subtracting inductances or capacitances (depending on the type of circuit used) across the tank circuit of an oscillator. In this manner the frequency or phase of the oscillator tank may be varied. For example, the reactance tube connected in Fig. 5 keeps the phase of the 3.58 mc crystal oscillator locked in phase with the incoming color burst signal.

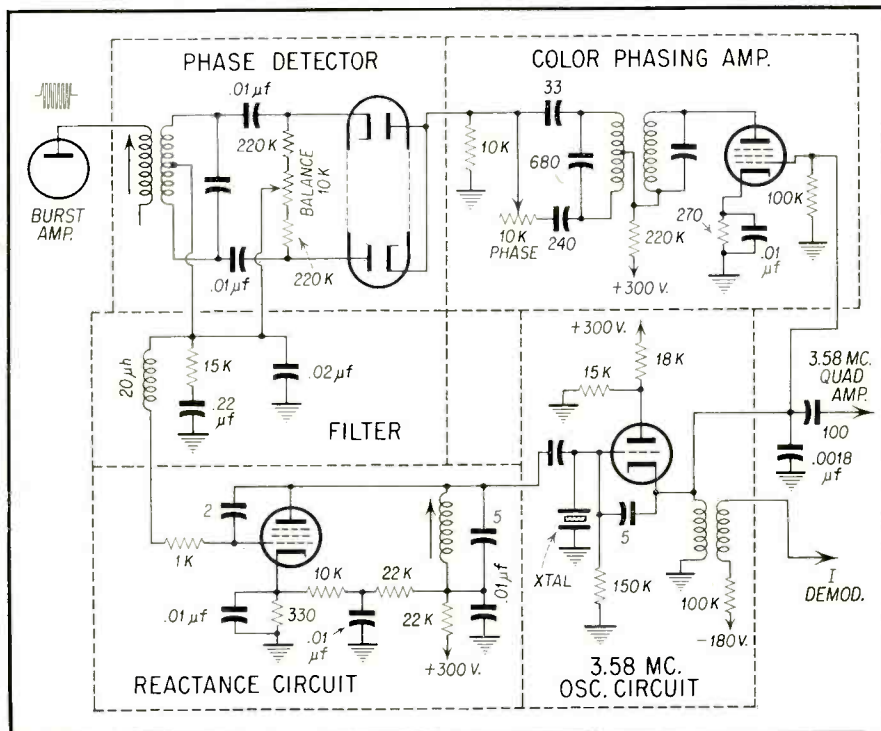

Fig. 3—Basic color oscillator and control circuit.

Now a

COLOR

TELEVISION

HOME STUDY COURSE

by RCA Institutes



"Color Television is here—not around the corner, or in the developmental labs, but here! The big question now is . . . Are You ready for Color TV?"

"You may now have a successful TV servicing business. When color sets come to your bench for servicing, will you be able to handle them?"

"Color Television is a vast new field, embodying entirely new concepts . . . principles of light and vision, radically new circuitry."

First Home Study Course in Color TV

Now is the time to prepare. Now, for the first time, you can train yourself for the

opportunities in this brand-new field. The just-announced RCA Institutes Home Study Course is the *first* home study course covering all phases of color television. Offered only to those already experienced in radio-television servicing, it explains the "why" of basic theory, as well as the "how-to-do-it" of servicing techniques.

Planned and written by RCA instructors, the entire course is based on the practical experience of RCA engineers—the men who have pioneered in the research and development of color television since the very first color experiments, many years ago.

Remember when black-and-white television first became a reality? Overnight, the demand for men who knew television grew. Even now, a shortage of qualified servicemen exists. Think, then—of the even greater demand for servicemen who will understand the many additional problems of color reception!

Costs so little to gain so much

RCA Institutes makes it easy for you to prepare yourself now for color television. Not only is the cost of the home study course for qualified servicemen extremely low, but you pay for the course on a pay-as-you-learn basis.

RCA Institutes conducts a resident school in New York City offering day and evening courses in Radio and TV Servicing, Radio Code and Radio Operating, Radio Broadcasting, Advanced Technology. Write for free catalog on resident courses.

Send for FREE Booklet—Mail the coupon, today. Get complete information on the RCA INSTITUTES Home Study Course in Color Television. Booklet gives you a general outline of the course lesson by lesson. See how thoroughly you can learn Color TV. Mail coupon in envelope or paste on postal card.



MAIL COUPON NOW!

RCA INSTITUTES, INC., Home Study Dept. RT354
350 West Fourth Street, New York 14, N. Y.

Without obligation on my part, please send me copy of booklet "RCA INSTITUTES Home Study Course in COLOR TELEVISION." (No salesman will call.)

Name _____ (please print)

Address _____

City _____ Zone _____ State _____



RCA INSTITUTES, INC.

A SERVICE OF RADIO CORPORATION of AMERICA
350 WEST FOURTH STREET, NEW YORK 14, N. Y.

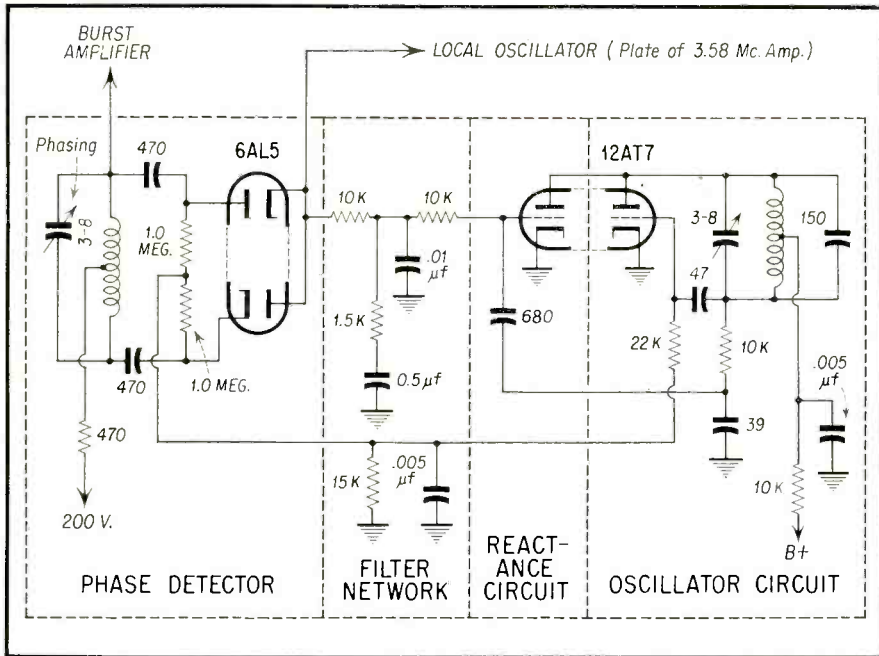

Fig. 4—Color sync circuit used by Emerson.

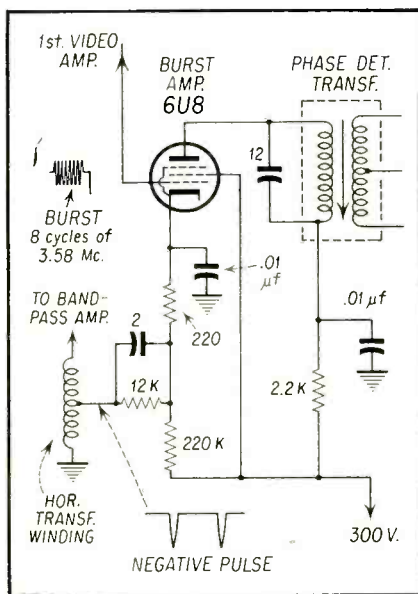

Fig. 5—Burst amplifier circuitry.

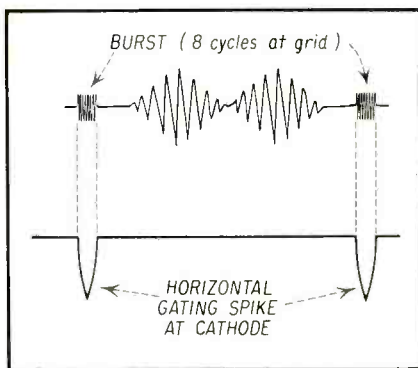

Fig. 6—Comparative burst signal and horizontal gating spike phase relations.

The current in an *ac* circuit containing resistance only is in phase with the applied voltage, E , as shown in Fig. 8. Conversely when the current is in phase with the applied voltage, the circuit is resistive.

If a condenser is connected in an *ac* circuit as shown in Fig. 9, the current leads the applied voltage. Conversely, when the current leads the applied voltage, a circuit is said to be capacitive.

If a coil is connected in an *ac* circuit as shown in Fig. 10, the current lags the applied voltage. Conversely, when the current lags the applied voltage E , a circuit is said to be inductive.

The manner in which a reactance tube circuit takes on the property of inductance is shown in Fig. 11. The following step by step analysis refers to the circuit action that takes place.

1. A voltage E , from the oscillator tank is sent through C_1 (low reactance) and appears across R_1 and C_1 .

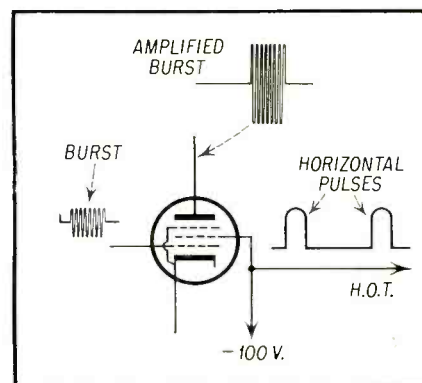

Fig. 7—Alternate method used in gating the burst amplifier.

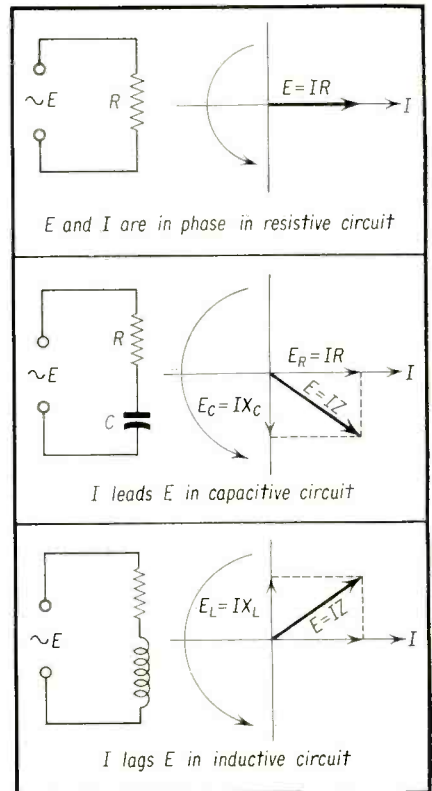

Fig. 8—(top)—Resistive circuit.
Fig. 9—(middle)—Capacitive circuit.
Fig. 10—(bottom)—Inductive circuit.

2. A current I flows as a result of this voltage.

3. R_1 is made very much higher than X_{C1} , so that the circuit may be considered resistive and I is in phase with E .

4. The current I produces a voltage drop, E_{C1} , across C_1 . E_{C1} lags I by about 90 degrees.

5. Since E_{C1} lags I it will also lag E .

6. The voltage E_{C1} is in phase with the plate current I_p as a natural result of triode tube action.

7. Therefore I_p lags E which is the equivalent of Fig. 10; so that the reactance tube circuit of Fig. 11 represents an inductive load across the tank.

8. Variation of the grid bias on the tube affects its operation so that by introducing a variable *dc* bias on the tube we can vary the amount of equivalent inductance connected across the tank circuit or its frequency. Thus, if the grid bias is very high the tube is cut off and no inductive effect is observed.

The manner in which a reactance tube circuit takes on the property of capacitance is shown in Fig. 12. The following step by step analysis refers to the circuit action taking place:

1. A voltage E from the oscillator tank appears across C_1 and R_1 .

[Continued on page 25]



PRECISION-EERED

to save you time and money

N.U.

ELECTRONIC GUN

Precision-eering is the *plus* sales and profit builder you get from the National Union engineering principle of custom designing each electronic gun for a particular type of cathode ray tube. Naturally, such precision manufacturing reduces time and money spent on installation adjustment and speeds up service calls.

It is this custom designing of all component parts that gives National Union Videotron® picture tubes their reputation for reliability... for meeting the strictest service requirements in the renewal field.

NATIONAL UNION RADIO CORP.

HAYBORO - PENNSYLVANIA

21YP4

2-Year Subscription only \$100



NOW AVAILABLE TO . . .

1. Servicemen who are employed by Service Organizations.
2. Servicemen employed by radio/TV Dealers.
3. Independent servicemen who do not have business establishments.
4. Employees of Distributors.
5. Students enrolled in accredited Radio/TV Schools, Colleges, etc.
6. Hobbyists and Experimenters.

A TYPICAL ISSUE COVERS

- Video Speed Servicing Systems
- Rider's "TV Field Service Manual" data sheets
- Latest TV Installation and Maintenance Techniques for VHF and UHF
- Auto Radio Installation and Service
- Advanced Data on New Circuitry
- Production Changes and field service data on receivers

- New Tubes
- New Test Equipment, operation and application
- Hi-Fi installation and service
- New developments, such as transistors, color, UHF, etc.
- News of the trade
- Service Short Cuts & Shop Notes
- Explanation of difficult circuits

**and many more
EXCLUSIVE . . .
ORIGINAL . . .
AUTHORITATIVE . . .
TIMELY . . .
FULLY ILLUSTRATED
subjects that
can ONLY
BE READ IN
"SERVICE DEALER"**

RADIO-TV SERVICE DEALER

67 W. 44 St., New York 36, N.Y.

NEW RENEWAL

Gentlemen: Here is \$1.00 for which enter my 2-year subscription. (This rate applies in USA only. Elsewhere add \$1 per year)

Name

Address

City Zone State

Employed by (Name of firm)

Firm's business address

City Zone State

Your Position or Title

Check whether firm is: Service Organization or Dealer having Service Dept.

If some other type of company describe:

IF STUDENT, Name of School

COLOR

[from page 22]

2. A current I flows as a result of this voltage.

3. X_{c1} is made very much higher than R_1 so that the circuit is capacitive. I leads E by approximately 90 degrees.

4. The current I produces a voltage drop E_p across R which is in phase with I .

5. Since E_p is in phase with I it leads E .

6. Since I_p is in phase with E_p , I_p leads E and the circuit is capacitive.

Thus the reactance tube circuit presents an equivalent capacitive effect across the tank circuits. This equivalent capacitance may be varied by varying the grid bias on the tube. Reference to the Reactance Circuit in Fig. 3 will reveal the similarity between this circuit and Fig. 12. C_1 and R_1 in Fig. 12 correspond to the 2 uuf condenser and the

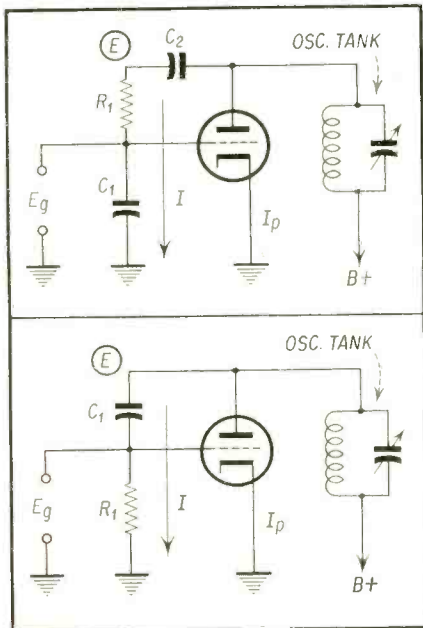

Fig. 11—(top)—Inductive circuit.

Fig. 12—(bottom)—Capacitive circuit.

1K resistor in the Reactance Circuit of Fig. 3.

The correction voltage from the Phase Detector is applied to the grid of the Reactance tube. If the incoming burst phase signal is in phase with the crystal controlled oscillator no correction voltage is developed. On the other hand, should the crystal controlled oscillator shift phase in either direction a correction voltage from the phase detector will be applied to the grid of the reactance tube. The latter will then take on the properties of a variable capacitance which will retune the crystal controlled oscillator back to the correct phase; that is, the phase that produces no correction voltage in the Phase Detector output.

new! designed for UHF

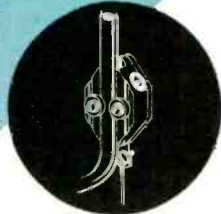

model 114-328

actual size

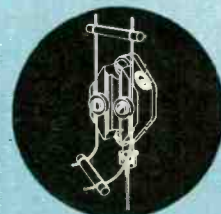
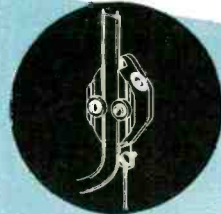
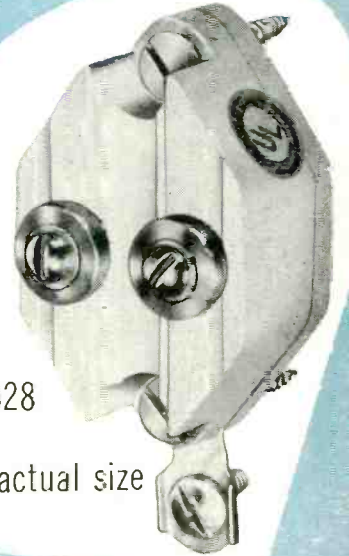

Insertion Characteristics Chart

universal LOW-LOSS LIGHTNING ARRESTOR

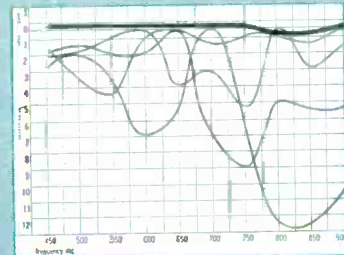

LOWEST LOSS—The chart above gives the characteristics of the AMPHENOL model 114-328 and four competitive lightning arrestors. The superiority of the AMPHENOL arrester is obvious—negligible losses over UHF frequencies. The same standard measurement procedures applied to four competitive lightning arrestors illustrate the high loss on UHF resulting in poor pictures at the receiver.

FROM THE LABORATORIES OF AMPHENOL COMES a new concept in lightning arrestors, designed not only to protect the television receiver from the hazards of lightning but to give *full protection to the signal strength* as well. This is the new model 114-328 AMPHENOL Lightning Arrester, the result of long months of research by skilled engineers. This Arrester's *low-loss* performance means better picture quality—VHF or UHF. Its unique design assures easy installation—a *sure-grip* of flat, tubular or open-wire lead-in.

AMERICAN PHENOLIC CORPORATION
chicago 50, illinois



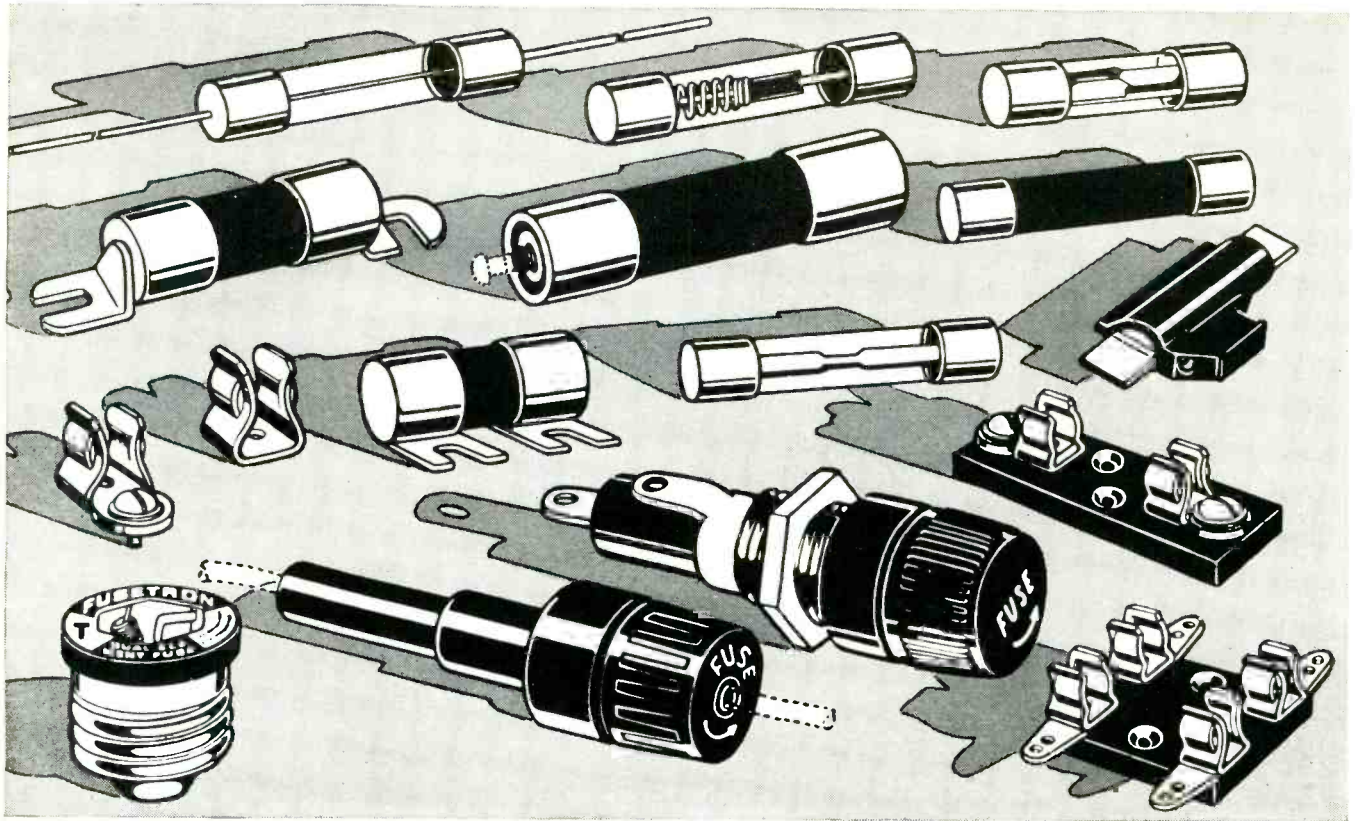

WHY YOU WILL FIND IT PROFITABLE to STANDARDIZE on BUSS FUSES



BUSS OFFERS A COMPLETE LINE OF FUSES

It is easy and economical for you to choose the exact fuse for your requirements. Select from dual-element (slow blowing) renewable and one-time types . . . in sizes from 1/500 ampere up, plus a companion line of fuse clips, blocks and holders.

A fuse is a small but significant component part — for a faulty fuse that fails to protect — or a fuse that blows needlessly may reflect, in your customer's mind, on your product or service.

Dependable electrical protection is not an accident with BUSS fuses.

The makers of BUSS fuses maintain rigid quality control by testing every fuse in a sensitive electronic device that rejects any fuse not properly calibrated, properly constructed and right in all physical dimensions.

That is why you can be sure that a BUSS fuse will always operate as intended under all service conditions.

"Trouble-free" BUSS fuses can help protect your goodwill, reputation and profits.

Then be profit wise, change your buying and stock records today — to standardize on genuine BUSS fuses.

In sales and service capitalize on the BUSS trademark.

Millions and millions of BUSS fuse installations in homes, on farms and in industry have firmly established BUSS as the known brand. When you furnish a BUSS fuse your customer accepts it as the best possible fuse. So let the BUSS trademark help, in its own little way, to build your reputation for quality and service.



Makers of a complete line of fuses for home, farm, commercial, electronic and industrial use

For more information mail this Coupon ▼

BUSSMANN Mfg. Co. (Division of McGraw Electric Co.)
University at Jefferson, St. Louis 7, Mo.

SD-351

Please send me bulletin SFB containing facts on BUSS small dimension fuses and fuse holders.

Name _____

Title _____

Company _____

Address _____

City & Zone _____ State _____ 354

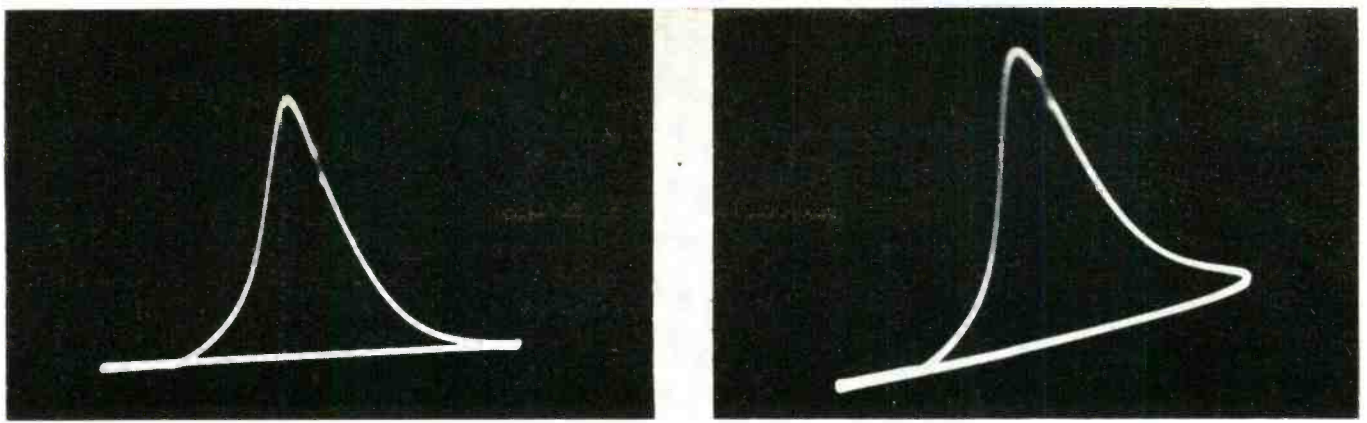

Fig. 1—(left)—I-F response curve with scope connected at output of picture detector. (Right)—Moderate distortion (tilt) of response curve with scope connected at output of video amplifier. Such distortion is usually caused by coupling or decoupling condensers too low in value. Close examination reveals that some 60-cycle hum is also apparent.

VIDEO AMPLIFIER Servicing Hints

By **ROBERT G. MIDDLETON**

Field Engineer, Simpson Electric Co. Author of *TV Troubleshooting Guide, Vols. I and II*, and co-author of *TV Test Probes* with Alfred A. Ghurdi, published by John F. Rider

Servicemen may use the scope as a tool to detect elusive video amplifier troubles. Certain patterns showing up on the scope indicate specific circuit faults. Some of these are discussed in this article.

The video-amplifier section of the receiver is an important link in the reproduction of a distortionless picture. Because the video amplifier "looks simple," it is often neglected during servicing of the signal circuits, with the result that although the *rf*, mixer, and *if* circuits are in proper alignment, picture quality is poor. The points noted below will serve to point out the more important of these difficulties, and explain how to correct them at the bench.

Sixty-Cycle Phase Distortion in Video Amplifier Changes Shape (Tilt) of I-F Response Curve

As shown in Fig. 1, the *if* response curve may have a different appearance at the output of the video amplifier as compared to the output of the picture detector. For the record, the curve should have the same appearance in either case, and if a difference is found, the difficulty is due to low-frequency phase distortion. Low-frequency phase distortion produces a background smear, or change in shading from top to bottom of the picture, which may be confused with *de* restorer trouble, or possibly with 60-cycle hum in the video signal. Of course, combinations of

Fig. 3—(Left)—Undistorted passage of 60-cycle square wave through video amplifier. (Right)—Tilt introduced into reproduced square wave by phase distortion. Amplitude distortion is also present, causing the tilt to develop in an unsymmetrical manner. Speed and accuracy in interpreting TV receiver video waveforms of this type comes with practice.

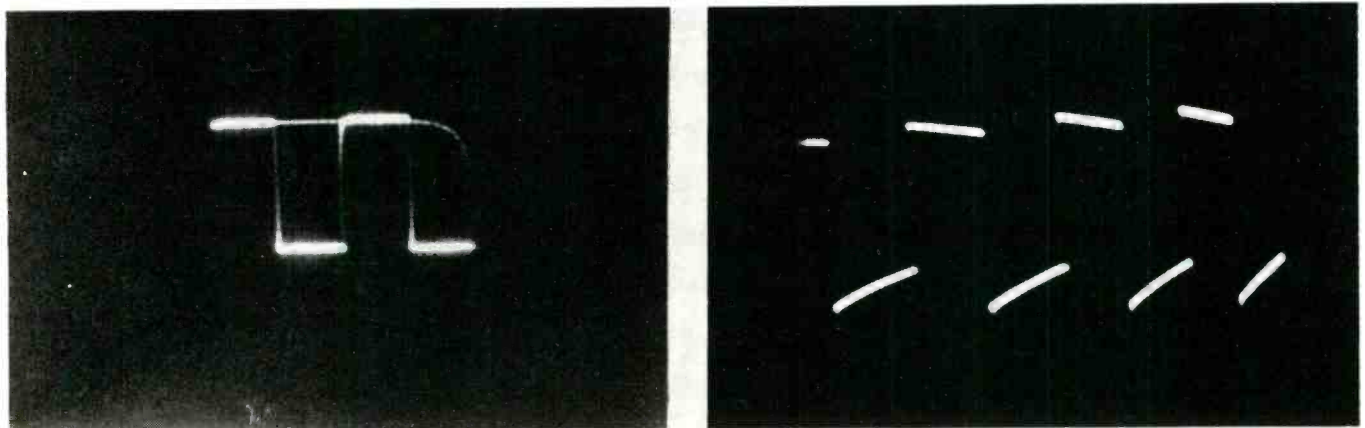

NEW for TV

NOW

operate 2 TV sets from
1 antenna at same time
(VHF-UHF)

**WITH BOOST
IN
SIGNAL STRENGTH**

WALDOM Electronic

Duo-Tenna

TV DISTRIBUTION AMPLIFIER



Install
anywhere indoors.

- Booster effect improves picture quality in "fringe" as well as metropolitan areas.
- Reduces existing noise and "snow" conditions.
- When used with single UHF Converter, converts TWO sets to UHF.
- Broad band width. (Ideal for color telecasts.)
- Save cost and installation of second antenna.
- Easily installed.

It will PAY you to get the
whole story . . . Write fo

**WALDOM
ELECTRONICS INC.**

909D Larrabee St., Chicago 10, Ill.

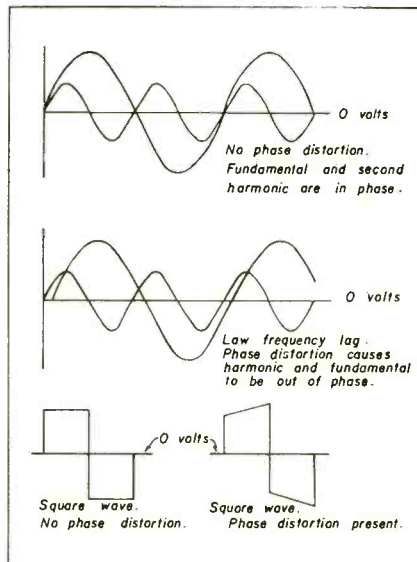

Fig. 2—Practical pointers on phase distortion. See text for details.

these difficulties are responsible for poor background rendition in some cases, but of these, phase distortion is most likely to be overlooked.

Phase distortion is usually caused by coupling or decoupling capacitors in the video-amplifier circuit which are too low in capacitance. Electrolytic capacitors, such as used in the low-frequency compensation circuit are frequent offenders. The nature of phase distortion is shown in Fig. 2, from which it is seen that phase distortion means that the high frequencies do not travel through the circuit at the same speed as the low frequencies. When high frequencies arrive at the picture tube out-of-step with low frequencies, typi-

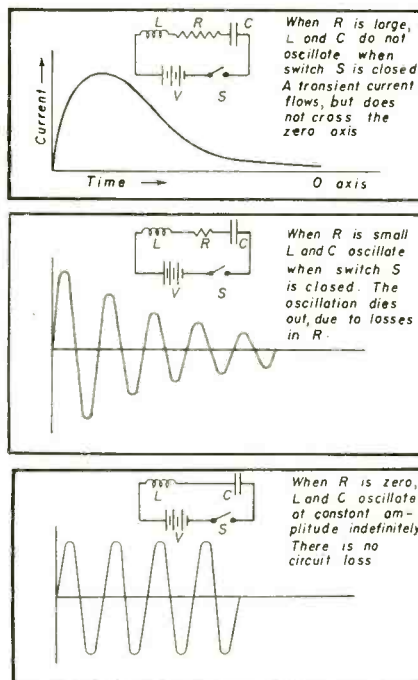

Fig. 5—Circuit responses showing overdamping and underdamping.

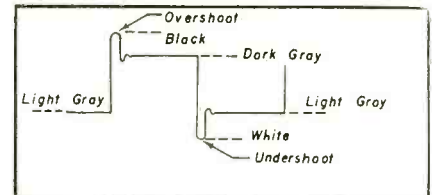

Fig. 4—Over- and undershoot result from too high values of damping resistors across peaking coils.

cal smear and phase distortion become apparent.

Why does the *if* response curve show the presence of phase distortion? It does so, because the *if* response curve is a member of the generic family which includes a 60-cycle square wave. When a square wave is passed through a video amplifier with phase distortion, tilt is introduced into the square wave, as shown in Fig. 3. Likewise, phase distortion in a video amplifier must introduce tilt into the *if* response curve, as seen in Fig. 1.

Overshoot of Square Wave Causes Trailing Reversal in Picture

As shown in Fig. 4, overshoot and undershoot cause trailing reversal in the picture. Trailing reversal causes the edge of a light-gray object to be outlined with a black line, and causes the edge of a dark-gray object to be outlined with a white line. This distortion has the effect of crisping the picture somewhat in a low-definition receiver, and some technicians adjust the damping resistors across the peaking coils to obtain a certain amount of overshoot in the square-wave response.

Whether or not overshoot develops in a video amplifier depends upon whether the L and C in the amplifier is overdamped or underdamped, as shown in Fig. 5. In this respect, the plate-load resistors and the plate resistance of the video-amplifier tubes exert damping influence upon the peaking coils. The capacitance associated with the peaking coils is distributed between winding capacitance, lead capacitance, and interelectrode capacitance of the tubes.

Insofar as picture quality is con-

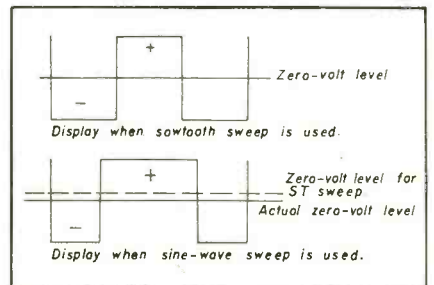

Fig. 6—Square-wave swept with sine-wave instead of sawtooth voltage: center expands; ends compress.

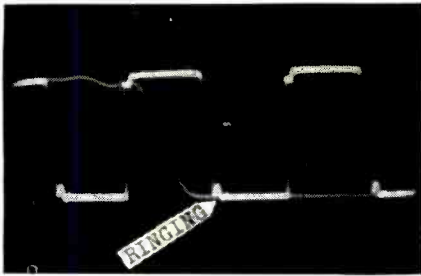

Fig. 7—Ringing in the first video stage, followed by rounded corner in second video stage, produces a notched corner (lack of crispness).

cerned, it is found that the phase characteristic of the video amplifier is of more importance than the frequency characteristic. For this reason, more informative data are obtained from a square-wave test of the video amplifier, than from a sweep-frequency test. Although it is possible to determine the phase characteristic of a video amplifier from a study of the frequency characteristic, the determination is somewhat difficult, and the square-wave test is much more practical.

It is found in practice that the picture quality developed by a video amplifier is not necessarily better because the frequency-response characteristic is made quite flat. On the other hand, a trailing video-amplifier characteristic provides the best square-wave response. However, if the *if* response is quite poor, the technician may be forced to use high-frequency peaking of the video amplifier to build up some of the high-frequency losses in the video amplifier. Accordingly, practical situations usually call for some compromises.

Use of 60-Cycle Sine-Wave Sweep Instead of Sawtooth Sweep Changes Display

Because 60-cycle sine-wave sweep is practically standard when running frequency-response curves, the technician often utilizes 60-cycle sine-wave sweep when running a 60-cycle square-wave test of a video amplifier. It is immaterial whether sine-wave or sawtooth sweep is utilized, but the operator must recognize the characteristic change in the horizontal development of the display, as shown in Fig. 6.

Tilt and Overshoot Are Independent of Square-Wave Frequency

Overshoot of a reproduced square wave may occur either at low frequencies or at high frequencies. If overshoot is developed at high frequencies, it is also present when a low-frequency square wave is passed through the video amplifier; however, the overshoot may

be invisible when a low-frequency square-wave test is made, because the details of the leading and trailing edges become so highly compressed at low repetition rates.

Furthermore, it is not always true that a low-frequency square wave will ring the high-frequency video circuits to the same degree as will a high-frequency square wave. There are several reasons for this situation; first, the rise time of a square-wave generator is not always as fast at low frequencies as it is at high frequencies (although some generators develop the same rise time at any repetition rate). Second, the har-

monics of a square wave drop off in voltage with the order of the harmonic. The 20th harmonic is only 1/20 as strong as the fundamental, and the 50th harmonic is only 1/50 as strong. Hence, even if the output waveform from the square-wave generator is practically perfect, the ringing circuits have more voltage applied to them at their resonant frequency when the square-wave repetition rate is high.

Tilt remains constant in percentage as the frequency of the square-wave test is varied, but tilt developed at low frequencies may be overlooked during

[Continued on page 60]

BEST ALL-AROUND TESTER ON THE MARKET

USE IT FOR:

- TV SETS
- RADIOS
- TRANSMITTERS
- BROADCASTING EQUIPMENT
- HOME APPLIANCES
- TWO-WAY RADIO COMMUNICATIONS SYSTEMS
- PHONE LINES
- AIR CONDITIONING SYSTEMS
- STARTER CONTROLS
- AUTO IGNITIONS, GENERATORS, BATTERIES
- MOVIE EQUIPMENT
- PANEL INSTRUMENTS
- TV CAMERAS
- AUTO LIGHTING SYSTEMS
- GENERATORS
- VOLTAGE SOURCES
- "HAM" RADIO EQUIPMENT
- CABLES
- CONNECTORS
- AUDIO FREQUENCY SOUND CURRENTS

... and write for your complimentary copy of "1001" Uses for the Simpson Model 260"

RANGES:

20,000 OHMS PER VOLT DC
 1,000 OHMS PER VOLT AC
 VOLTS, AC AND DC: 2.5, 10, 50, 250, 1,000, 5,000
 OUTPUT: 2.5, 10, 50, 250, 1,000
 MILLIAMPERES, DC: 10, 100, 500
 MICROAMPERES, DC: 100
 AMPERES, DC: 10
 DECIBELS (5 RANGES): -12 TO +55 DB
 OHMS: 0-2000 (12 OHMS CENTER), 0-200,000 (1,200 OHMS CENTER), 0-20 MEGOHMS (120,000 OHMS CENTER)

SIMPSON ELECTRIC COMPANY
 5200 W. Kinzie St., Chicago 44 • ESTbrook 9-1121
 In Canada: Bach-Simpson, Ltd., London, Ont.

Simpson
Model 260
 VOLT-OHM-MILLIAMMETER



Enterprising T.V. Serviceman Brings Shop To Customer

A TRUCK that is capable of servicing a majority of television complaints at the home of the set owner is the "Ryan Mobile-Kar."

The first of its kind in the United States, this rolling TV repair shop was designed and built by H. Michael Ryan of 1310 W. Broad St., Richmond, Virginia. The idea is to increase the convenience of servicing sets both from the customer's viewpoint and the serviceman's.



Serviceman at work inside the Mobile-Kar. Note location of test panel and AC receptacles.

According to Ryan, his Mobile-Kar is ideally suited for suburban areas. It can be parked practically on the customer's doorstep. This, says the inventor, brings the serviceman closer to the consumer helping to increase confidence in the serviceman. It also serves as a free advertising campaign for the serviceman, since his trade-name and insignia print-

ed on the truck would be plainly visible to all. Another factor: with a repair shop doing reliable work and capable of coming to a community that is relatively remote from the main shopping area, many potential customers may be encouraged to bring their sets over to the truck. Repair jobs that might have



H. Michael Ryan designed and built the Mobile-Kar, first of its kind.

gone undone because of the inconveniences of time and distance would now be facilitated.

Power Plant

The "Ryan Mobile-Kar" is equipped with a self-contained 110 volt, 60 cycle, 1000 watt power plant that runs off the truck engine. Its interior is fitted with work benches, storage cabinets containing adjustable shelves, tube compartments, and test panels that will accommodate all standard types of test

equipment. There are start and stop switches for the power unit as well as a meter for maintaining the 60-cycle, 110 volt output. After long research, the power plant has been made virtually noiseless and vibrationless.

Work-benches and test panels are equipped with 110-volt receptacles. In addition, there is an overhead ventilator and rubber-lined floor.

Built onto the chassis of a standard Chevrolet panel delivery truck, the pilot model shown at the top of this

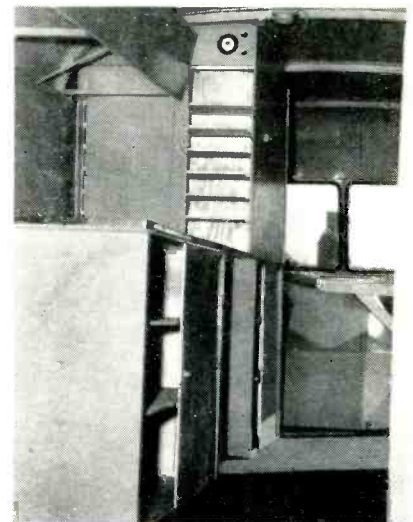

Interior showing work - bench, storage area, 60 cps meter, start-stop switch, test panel.

page is the result of nine months study and research.

Physical Features

In addition to the rear doors, Ryan has developed two side doors that open to four feet wide to permit easy access of equipment to and from the sidewalk. Body length from the back of the driver's seat is 12 feet. Inside width is 6 feet, 3 inches. Inside height is such that a man as tall as 6 feet, 3 inches can stand erect and move about in comfort. The front of the truck has been modified as shown in the photo; in addition it contains clearance lights, front and rear turn signals, and triple side-view mirrors.

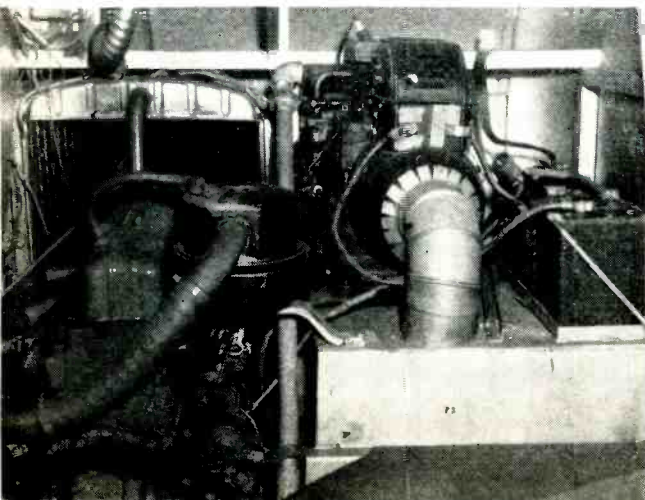

Generator (right) puts out 110 volts at 60 cps, is vibrationless, runs off truck engine (left).

UNIVERSAL TEST-BENCH CONNECTORS

BY IRVING TEPPER

The illustrations shown at the left were made available through the courtesy of: Amphenol, EBY, EPCO, Insuline, JFD, and Telematic.

This article illustrates many types of connectors that may be used by the serviceman to speed up his work.

SAVING time pays dividends in service efficiency and increased customer satisfaction. If repair time can be reduced for the individual television receiver without impairing the quality of the service then the serviceman can realize a greater return for his time. A simple device such as a test speaker can save time for both the bench man and outside man. If the outside man knows that all speakers of certain types can be provided for in the shop he will not spend the time necessary to remove it. This article will attempt to show some of the many time savers used by the servicemen in the field. These are:

- (1) test speaker and leads

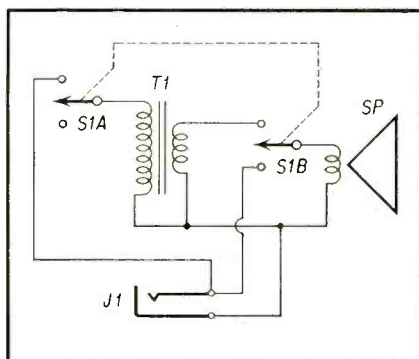

Fig. 1—Test speaker circuit. SP—largest PM available. S1 (A & B)—DPDT toggle. T1—Stancor A 2313. J1—I.C.A. 1870 open circuit jack.

- (2) special extension leads
- (3) device for rapid parts substitution
- (4) antenna system for the service bench

Test Speaker

All universal test speaker designs ever seen by the author have been very complex because they attempt to make provisions for all voice coil impedances, output transformer impedances and field coil resistances. This always presents construction complications and application problems. Evaluating all types of speakers encountered we find the popularity rating as follows:

- (1) PM speaker

- (2) PM speaker and output transformer
- (3) field coil type

A simple test speaker can be made if no provisions are made for field coils or different impedances of output transformers. The average impedance of the TV output transformer is from 5,000 to 7,000 ohms, and should have a wattage rating of at least 7 watts. When selecting a speaker for the test unit it should be a PM type of the largest size possible so that it will stand up under the abuse it is bound to receive. Fig. 1 shows the diagram of the test speaker circuit. Even a simple test speaker has little value unless it is easily connected to the set under test. For this purpose

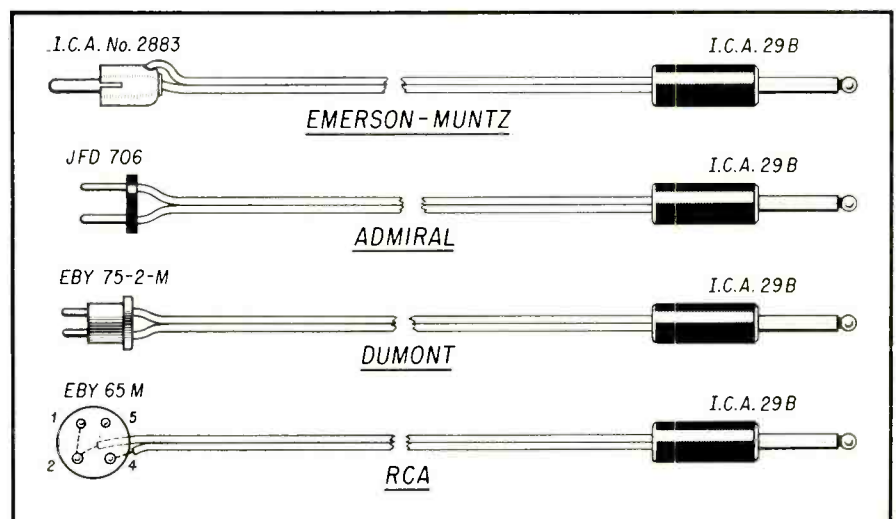

Fig. 2—Sets of leads for typical sets.

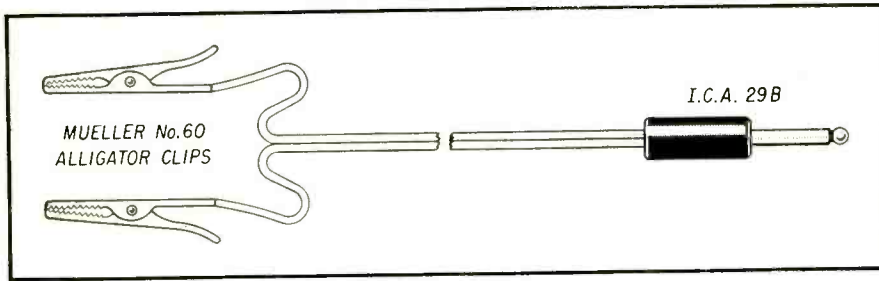

Fig. 3—General purpose leads using any type wire.

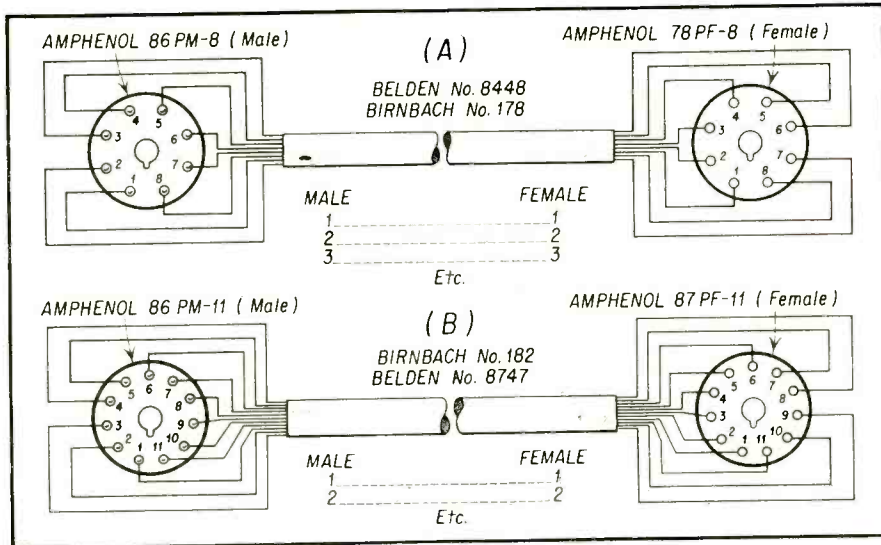

Fig. 4-A shows octal extension; B eleven prongs.

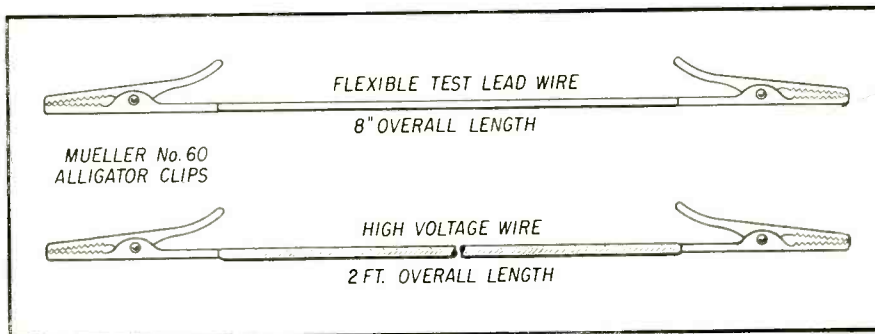

Fig. 5—General purpose extension leads.

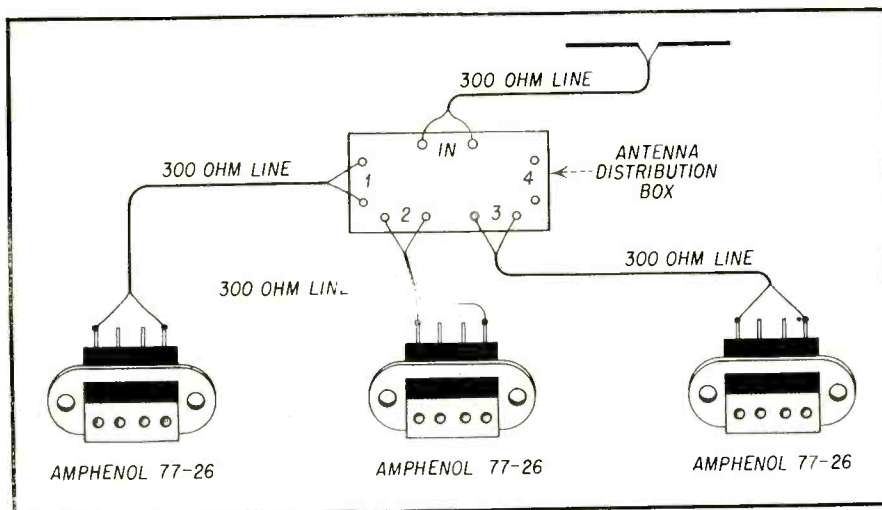

Fig. 7—Bench antenna system.

a set of leads were made to fit the more popular television sets. These leads are shown in Figs. 2 and 3. If other type sets are encountered frequently appropriate sets of leads can be made in much the same manner.

Extension Leads

The need for extension leads of special types have been so evident that several manufacturers do produce the most necessary types. These are:

- (1) CRT extensions
- (2) H.V. extensions
- (3) octal plug extensions

The CRT and high voltage extensions are simpler bought than made because of the difficulty in getting the proper fittings for them. However the octal extension can very easily be assembled with readily available parts. This cable is shown in Fig 4A. The cable may be used for setting up receivers for test on the bench when the cables are too short. Some typical examples are the Philco split chassis receivers and the RCA KCS47 and KCS49. For the Freed Eisman Model

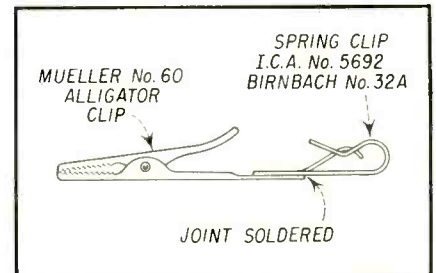

Fig. 6—Substiting clips.

1620 an 11 prong cable of the same type is almost a necessity. This cable is shown in Fig. 4B. These cables serve a specific purpose. There is a crying need for general purpose extension leads. These can be made up in varying lengths and special wire for each application. These are shown in Fig. 5.

Rapid Parts Substitution

When servicing we very often come upon situations where new parts are needed but the values for some reason are in doubt. Determining the correct value part usually entails a trial and error procedure. With several values to be tried, time is lost soldering and unsoldering. Even if the parts are only crimped into place it is time consuming. This type of job can be done in much less time if the device shown in Fig. 6 is made. The shank of the alligator clip is flattened in a vise and then tinned. The spring clip is then soldered to the alligator clip shank with a heavy iron. With a pair of these clips, condensers or resistors can be connected into a circuit with ease. The serviceman should

[Continued on page 63]

THE WORK BENCH

BY PAUL GOLDBERG

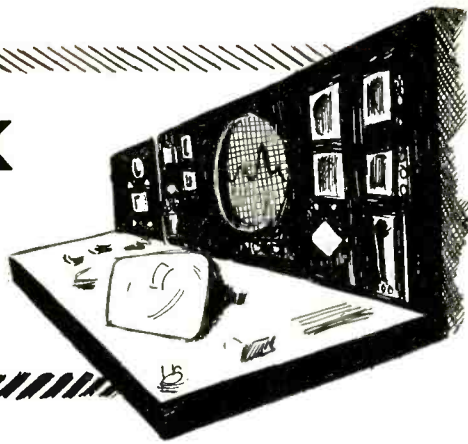

Vertical Hold Problems in Three Sets

THREE vertical hold problems have been chosen for our discussion. These should prove exceedingly interesting as they are rather odd.

Philco Model 52-1882-121, RF chassis 44, Deflection Chassis D4—Vertical Roll

The set was turned on and the picture immediately began to roll. The vertical hold was adjusted and the vertical range was found to be satisfactory, but the picture could not be brought into sync. The set was acting as if no vertical sync pulses were reaching the vertical generator. However, when the contrast control was turned to maximum, the vertical did make a feeble attempt to go into sync but immediately

began to slip out of sync again. All the tubes that might affect the vertical sync (V1, V2, V3 and V4) were changed, but none of these seemed to solve the problem.

It was then decided to set up the oscilloscope and check a few waveforms to see if the trouble could be localized to a single stage. The waveform was first checked at point "W," the point at which the vertical sync pulse enters the vertical generator. It seemed a good idea to start here and work back. The waveform showed the vertical sync pulse riding on a vertical generator wave, but the sync pulse was exceedingly small. Before going further, however, the horizontal hold control was carefully checked to deter-

mine whether the horizontal sync circuits were functioning properly. Since they were O.K. the sync amplifier circuits of V1B, V2A, and V2B were eliminated as possible sources of trouble as these circuits would also affect the horizontal sync. Also eliminated was the grid circuit of V4A for the same reason.

Well, where did this leave us? It left us at the plate circuit of V4A, the sync inverter tube (7N7). The scope was set aside and the plate voltage was measured. It was exactly what the diagram called for. The vertical range of the oscillator was okay; therefore, it seemed improbable that C700, C606, and C605 could cause the trouble. The resistance values of R613, R614, and R615 were checked and found to be satisfactory.

Here was a baffling case to say the least. It was recalled that in many sets, a grid to cathode leak in the picture tube could cause the vertical to slip. However, in those cases, the sync pulses were fed to the sync amplifiers from the plate circuit of the video output tube [what we can consider the input circuit of the picture tube], while in this receiver the sync pulses are taken off in the plate circuit of the first video amplifier, V1A (12AV7).

This gave us an idea. It was decided to check the first video amp for a defective component that could affect the vertical sync pulse without affecting the picture quality. (From a visual inspection, the picture quality seemed to be satisfactory.) The circuit was studied

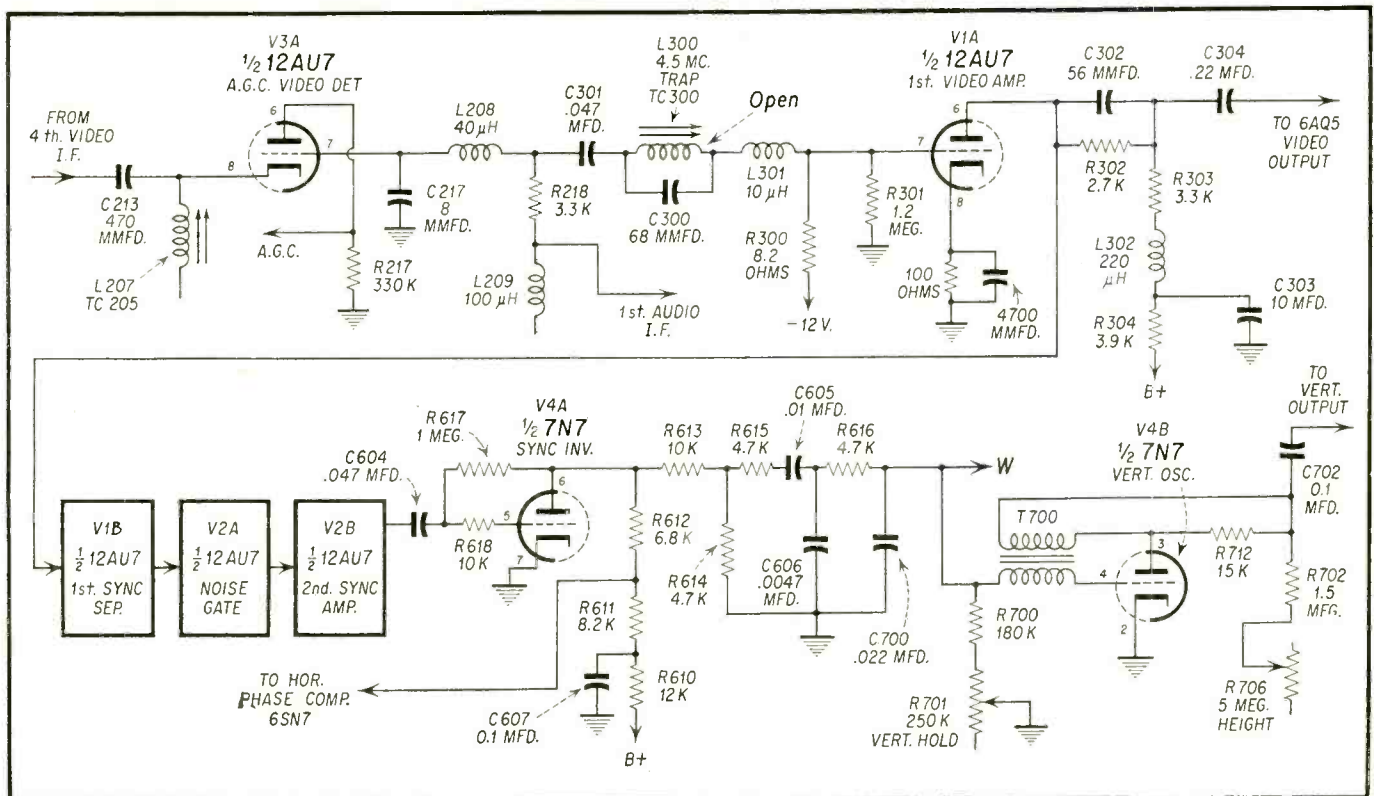

Fig. 1—Simplified schematic, Philco model 52-1882-121, RF chassis 44, Deflection D4.

carefully with the idea of picking some component that would meet these qualifications. It was observed that any defective component in the plate circuit of V1A would most certainly affect the picture quality. However there was a possibility of just such a component in the grid circuit. At this point the resistance of L300 was checked and found open.

One can see that the 68 uuf condenser, C300, in parallel with the open L300, can easily transfer to V1A the video information, the horizontal sync pulses, but *not the vertical sync pulses*. The reactance of a 68 uuf condenser to the 60 cycles sync pulse is so high that very little of this signal can get through indeed. Now, very rarely do coils open. In most cases, the pigtailed of the coils have been poorly soldered. This case was no different. The pigtail of L300 was resoldered and it read its normal resistance of 2 ohms.

L300 and C300 act as a 4.5 mc trap. It was noticed now, with the 4.5 mc trap functioning properly, a slight amount of herringbone was removed from the picture. We wish now that we had noticed this slight amount of herringbone at first; it might have saved us a lot of time. Oh well! All in a day's work.

Du Mont RA164—Critical Vertical Hold

The vertical hold was found to be very critical, although the vertical range

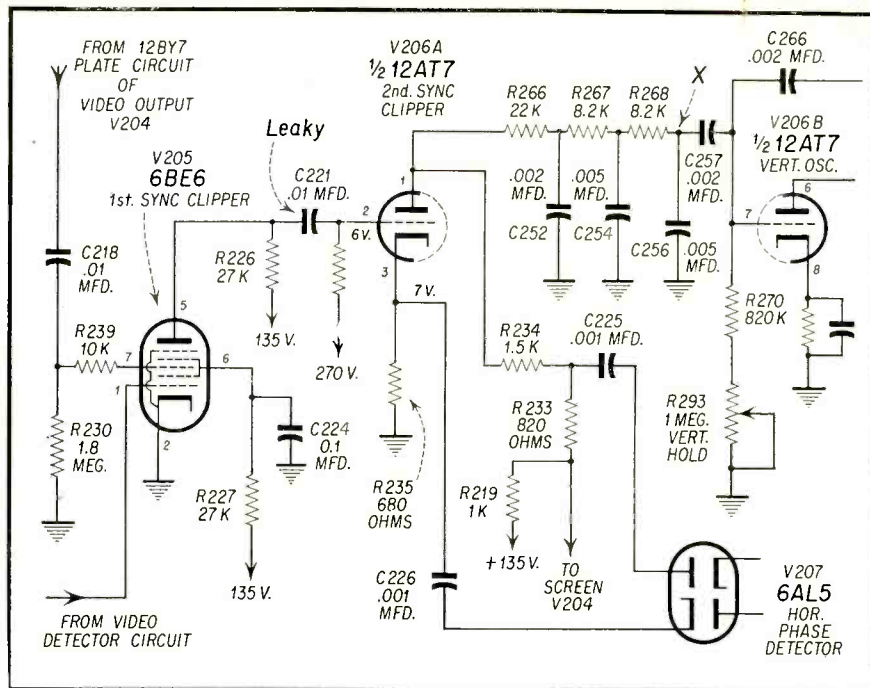

Fig. 2—Simplified schematic, Du Mont RA-164.

seemed fine. The horizontal hold was then varied to check its operation and found satisfactory. The picture quality and gain were also okay.

First replaced were the sync amp tubes V205, V206; but this did not cure the trouble. The scope was then set up and a waveform check at point "X" was taken. Here we found the vertical sync pulse exceedingly small. C252, C254 and C256 were then checked for leak-

age, but these condensers were perfect. The resistors in this integrator network, R266, R267, R268, also checked satisfactory.

Now, normally any defective component in the clipper circuits (V205) 6BE6, and (V206A) 1/2 12AT7, should affect the horizontal syncs, but the horizontal sync was okay. Not to overlook any possibility, however, we measured the plate voltage of V206A, 1/2 12AT7. It was 50 volts, while the diagram called for 100 volts to ground. The next move was to check the grid of V206; and it measured about 20 volts. Here the diagram called for 6 volts to ground. C221, .01 mfd, was then clipped at the grid and checked for leakage. We were not surprised to find it leaking badly. It measured about 50,000 ohms.

After replacing a new 600 volt, .01 uf condenser the vertical hold was no longer critical. The odd thing about this trouble was that the leaky condenser did not seem to affect the horizontal sync. So to prove a point, we placed a shorting bar across C221 and turned the set on. The set now would not hold vertically and the horizontal hold only in the center of the horizontal hold control range; whereas before the horizontal hold control would hold over its entire range. This seems to prove that different amounts of condenser leakage can cause different results, especially in sync clipper circuits where the tubes are biased so critically.

G.E. 10T1—Critical Vertical Hold

Although the vertical hold in this set was critical, the horizontal hold seemed satisfactory. Furthermore, at a normal

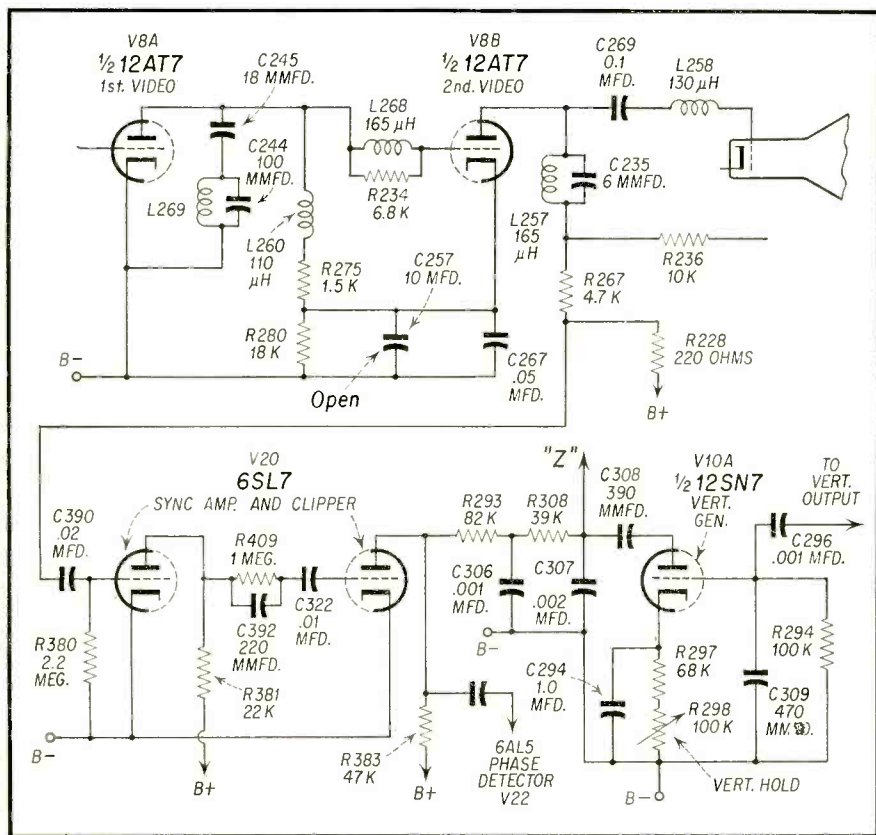

Fig. 3—Simplified schematic, G.E. 10T1.

[Continued on page 62]

Mfr: Emerson Chassis 120066B

Card No. EMO66-1 Model No. 571

Section Affected: Raster

Symptom: White vertical lines on left side and horizontal linearity

Cause: Open resistor in damper circuit

What To Do:

Replace: R94 (7.5K)

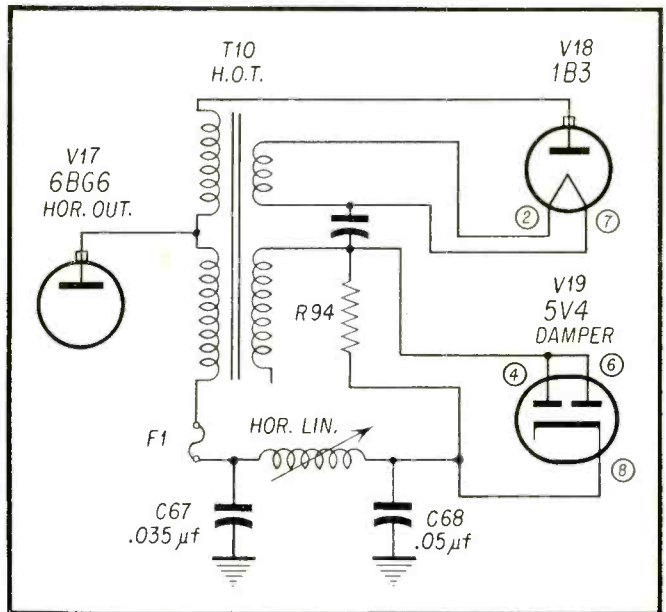

Mfr: Emerson Chassis No. 120066B

Card No. EMO66-2 Model No. 571

Section Affected: Sync.

Symptom: Vertical hold out of range

Cause: Leaky Condenser

What To Do:

Replace: C51 (.003 μf)

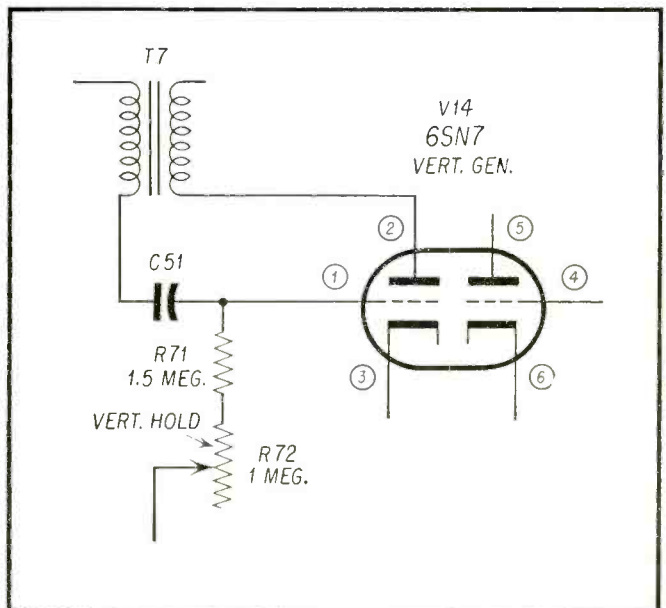

Mfr: Emerson Chassis No. 120066-B

Card No. EMO66-3 Model No. 571

Section Affected: Pix

Symptom: Video overload

Cause: Leaky coupling condenser

What To Do:

Replace: C3 (270 μμf)

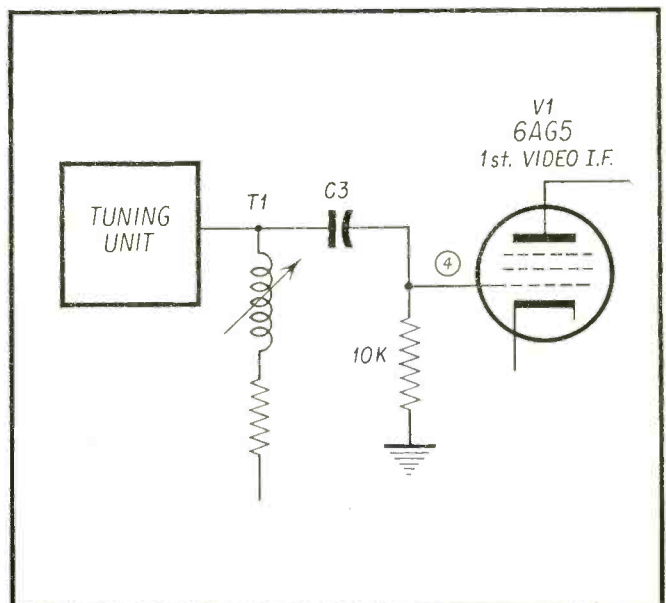

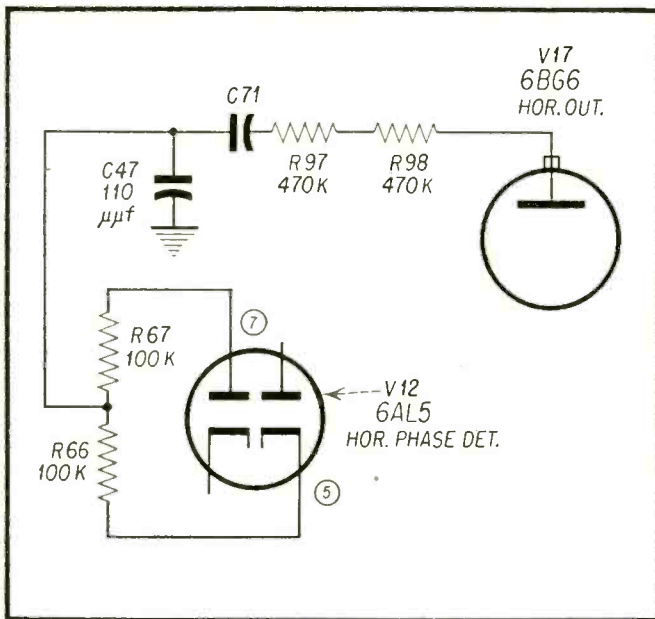

Mfr: Emerson Chassis No. 120066-B

Card No. EMO66-4 Model No. 571

Section Affected: Sync

Symptom: Horizontal tearing

Cause: Defective component

What To Do:

Replace: C71 (.005 μf)—Leaky
Also R97 (470K)—probably in-
creased in value and burned

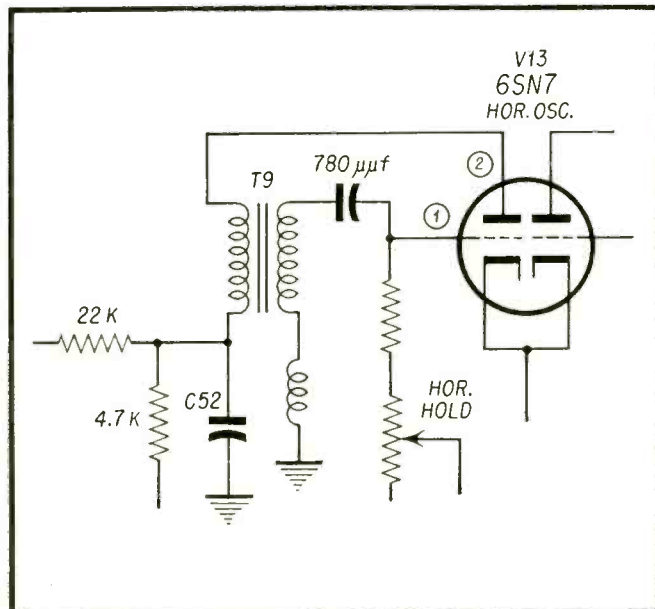

Mfr: Emerson Chassis No. 120066-B

Card No. EMO66-5 Model No. 571

Section Affected: Sync

Symptom: Horizontal Frequency far out of range

Cause: Leaky condenser

What To Do:

Replace: C52 (8 μf)

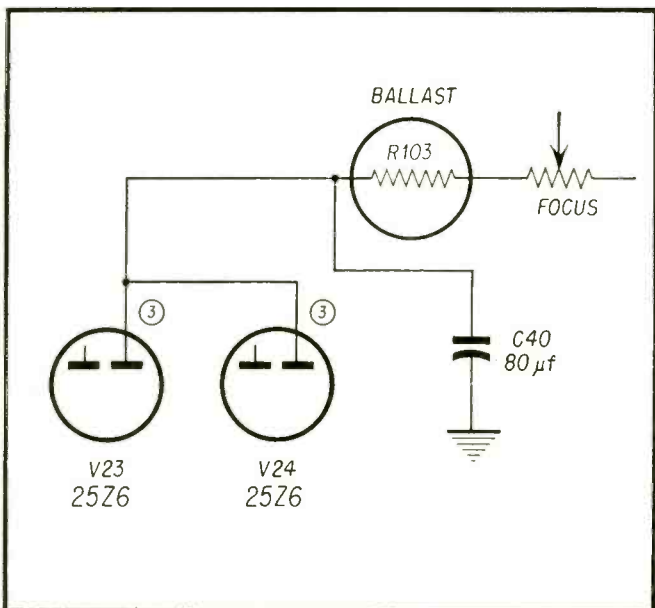

Mfr: Emerson Chassis No. 120066-B

Card No. EMO66-6 Model No. 571

Section Affected: Raster

Symptom: No raster

Cause: Open filter condenser

What To Do:

Replace: C40 (80 μf)

Mfr: Motorola Chassis No. TS23B

Card No. MO23-1 Model No. 12VT13

Section Affected: Raster and Pix

Symptom: Poor vertical linearity—not enough height

Cause: Defective component

What To Do:

Replace: C47C (100 μ f)—opens up

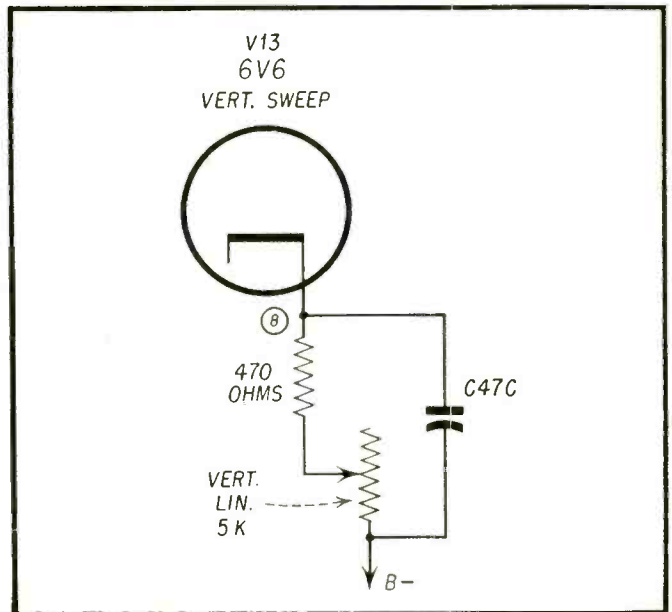

Mfr: Motorola Chassis No. TS23B

Card No. MO23-2 Model No. 12VT13

Section Affected: Sync

Symptom: Vertical and horizontal instability

Cause: Defective component

What To Do:

Replace: C63 (.001 μ f)—leaky

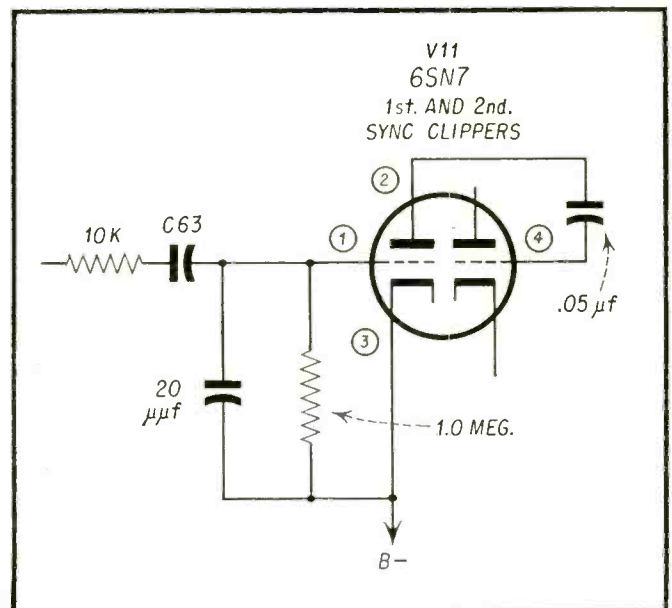

Mfr: Motorola Chassis No. TS23B

Card No. MO23-3 Model No. 12VT13

Section Affected: Raster

Symptom: Filaments light—No. B+

Cause: Defective component

What To Do:

Replace: R95 (7.5 ohms)—open

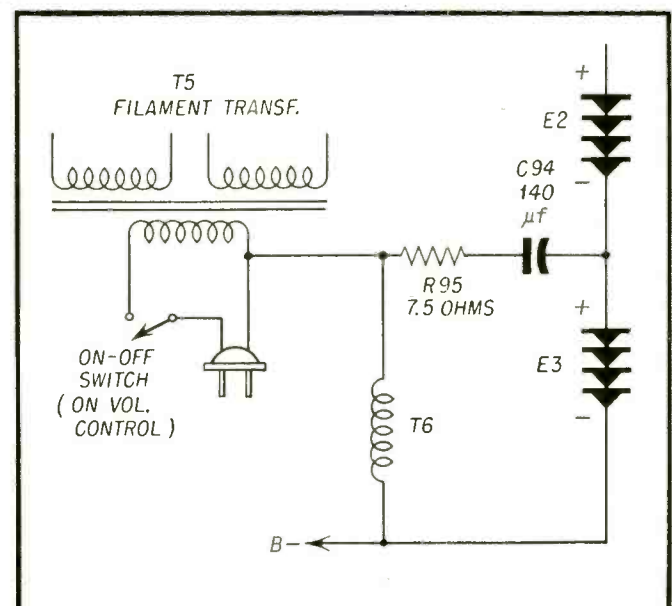

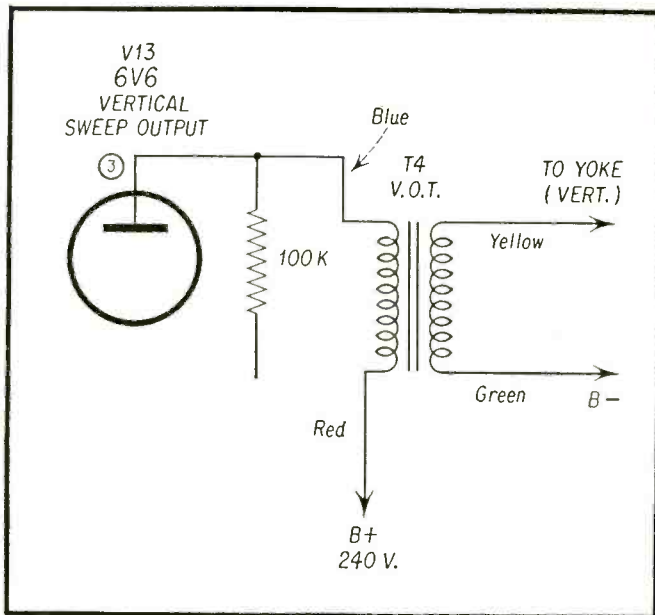

Mfr: Motorola Chassis No. TS23B
 Card No. MO23-4 Model No. 12VT13
Section Affected: Raster
Symptom: Vertical shrinking
Cause: Defective component
What To Do:
 Replace: Vertical output transformer (T4)

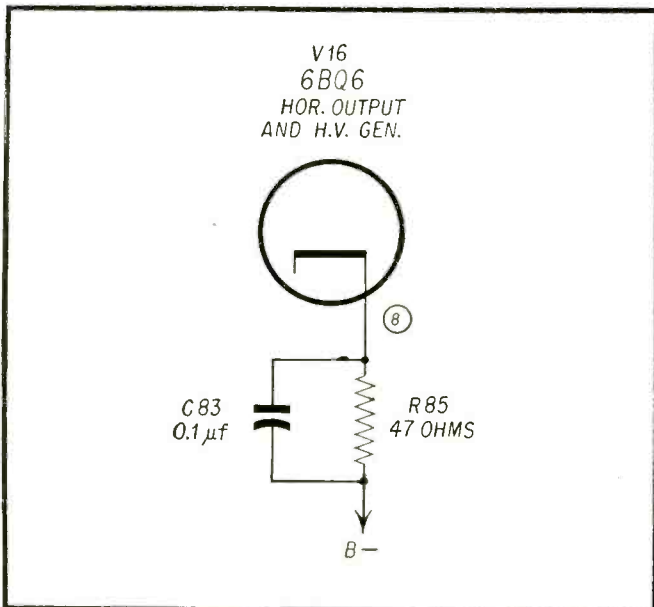

Mfr: Motorola Chassis No. TS23B
 Card No. MO23-5 Model No. 12VT13
Section Affected: Raster
Symptom: Intermittent raster
Cause: Defective component
What To Do:
 Replace: R85 (47 ohm—½ W) with 47 ohm—
 1 watt; opens intermittently

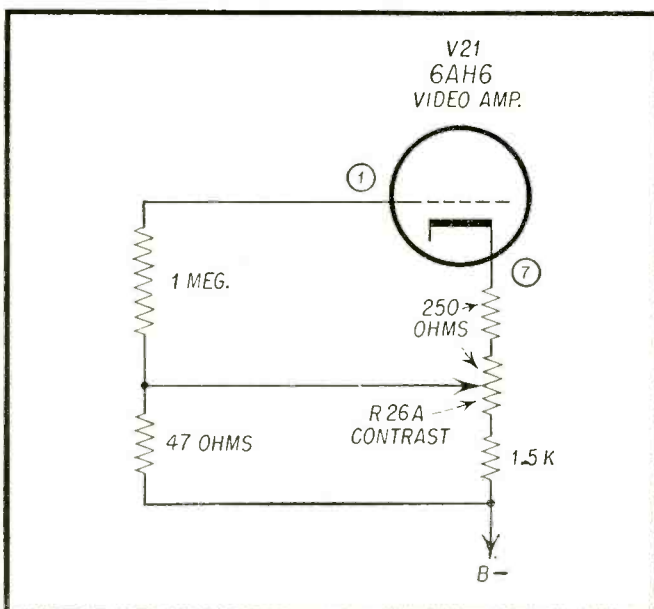

Mfr: Motorola Chassis No. TS23B
 Card No. MO23-6 Model No. 12VT13
Section Affected: Pix
Symptom: No pix
Cause: Defective component
What To Do:
 Replace: Contrast control R26A (250 ohms)—
 opens up

Mfr: Westinghouse Chassis No. V2150-101

Card No. WE2150-1

Section Affected: Raster

Symptom: No raster, no sound, 5U4's get red

Cause: Shorted condenser

What To Do:

Replace: C422 (.1 μ f)

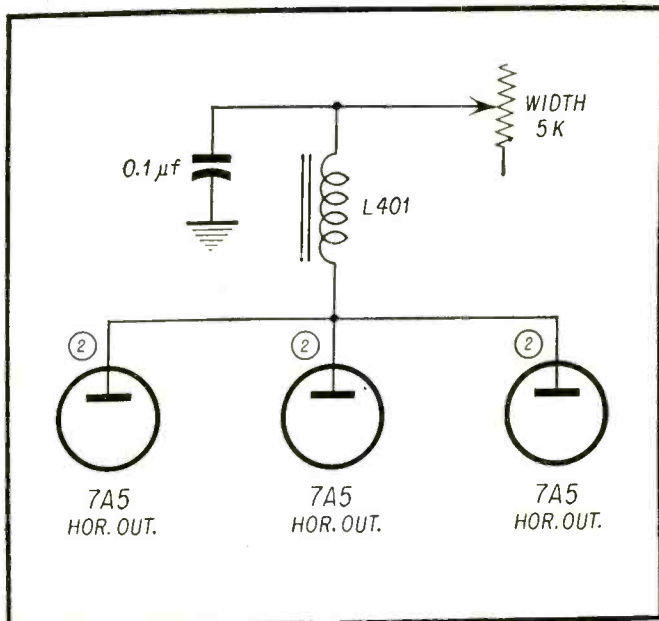

Mfr: Westinghouse Chassis No. V2150-101

Card No. WE2150-2

Section Affected: Raster

Symptom: Horizontal flashes—L 401 burning

Cause: L 401 arcs internally

What To Do:

Replace: L 401

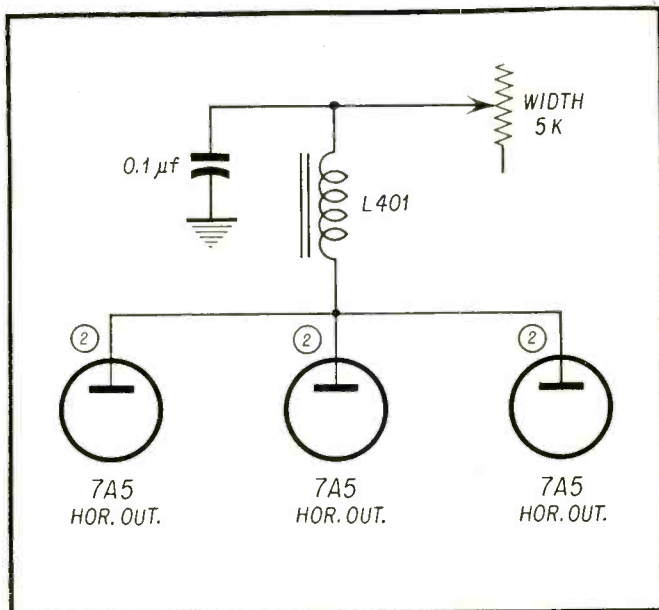

Mfr: Westinghouse Chassis No. V2150-101

Card No. WE2150-3

Section Affected: Raster

Symptom: No hi-voltage

Cause: Shorted condenser

What To Do:

Replace: C506 (.05 f) also, R502 (68 ohms)—burned

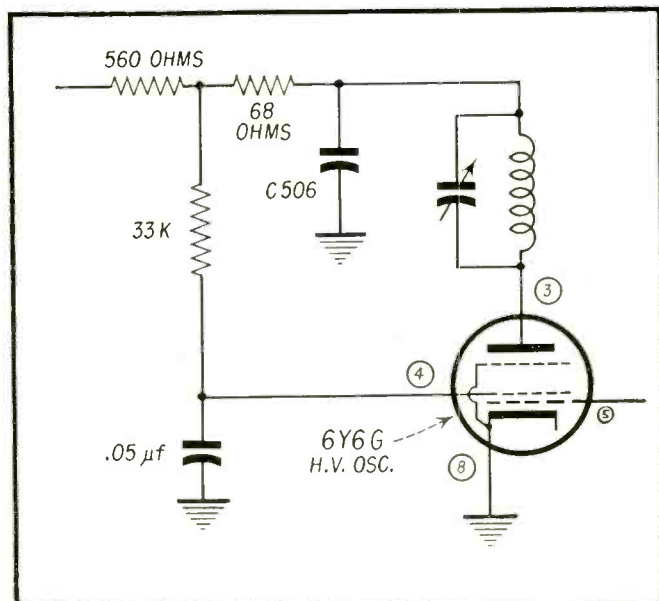

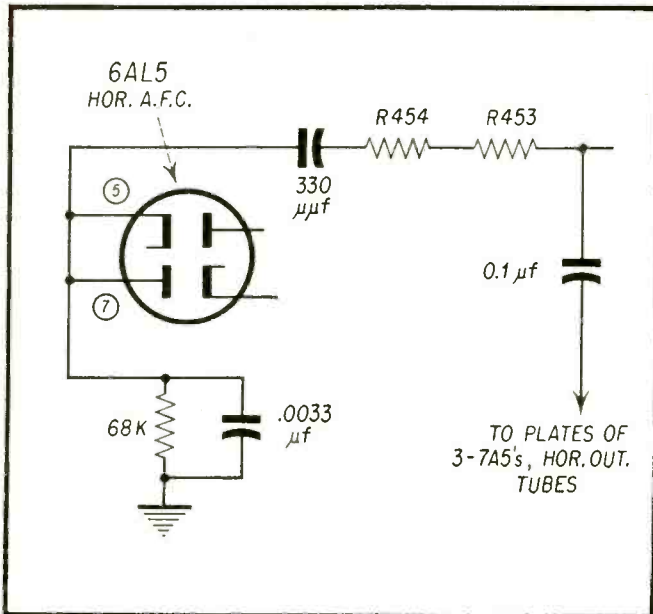

Mfr: Westinghouse Chassis No. V2150-101

Card No. WE2150-4

Section Affected: Sync

Symptom: Critical horizontal sync

Cause: Resistors increased in value

What To Do:

Replace: R453 and R454 (both 220K)

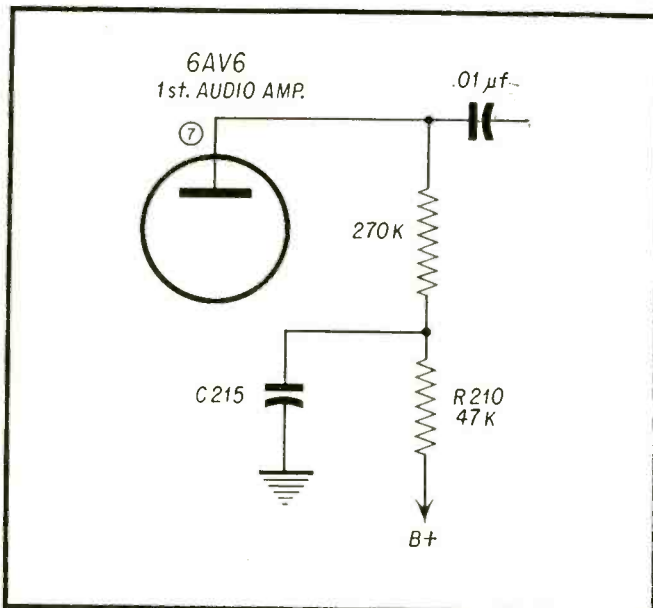

Mfr: Westinghouse Chassis No. V2150-101

Card No. WE2150-5

Section Affected: Sound

Symptom: No sound—R210 burned

Cause: Shorted condenser

What To Do:

Replace: C215 (.1 μf)

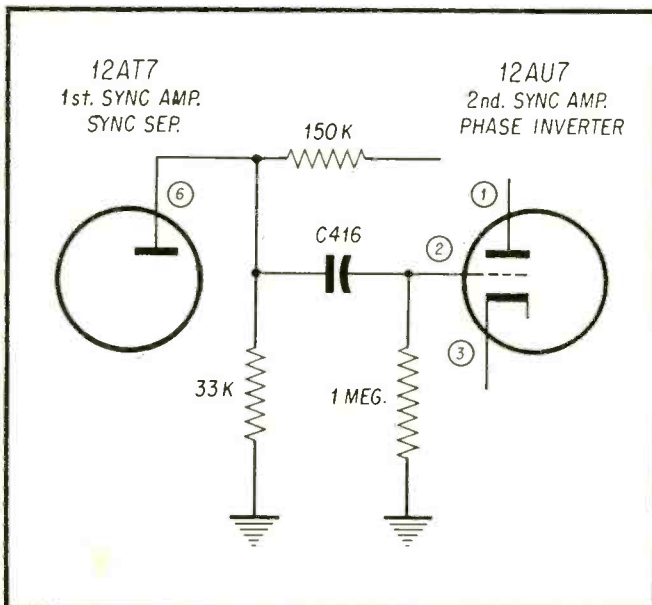

Mfr: Westinghouse Chassis No. V2150-101

Card No. WE2150-6

Section Affected: Sync

Symptom: No vertical and horizontal hold

Cause: Shorted condenser

What To Do:

Replace: C416 (.05 μf)

Torture Test FOR TV ROTATORS

by HERBERT G. KOENIG

Design Engineer, Rotator Division
Trio Manufacturing Company

Fig. 1—Close-up of cold chamber when opened, following minus 50° F. exposure. Note icing.

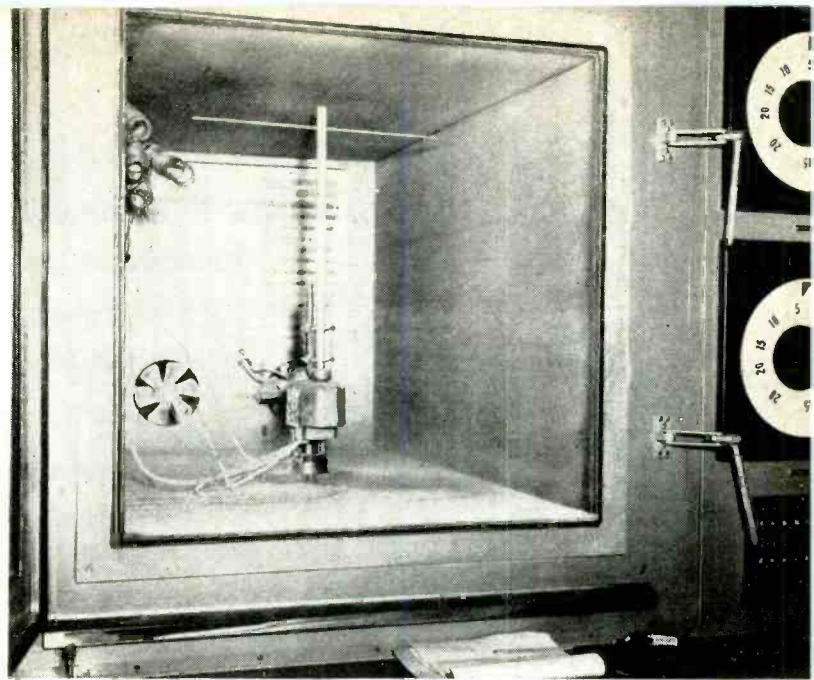

TV ANTENNA rotators are wonderful things—when they work!

Any TV viewer will heartily agree, since rotator failure, for whatever cause, usually calls for service work that is expensive to the customer—and not particularly profitable for the serviceman dealer.

Because of rotator's location high on the tower where it is difficult to service and where it is constantly exposed to the worst the elements have to offer, it is of great importance that complete dependability be engineered into the unit.

After a rotator has been designed and built, actual testing under every conceivable simulated weather and load condition is indicated to prove whether the engineer's theories are correct.

One manufacturer uses a test set-up (see Fig. 1) which provides degrees of stress and strain up to five times greater than those encountered by a rotator supporting a Channel 4 Yagi in an average installation.

The rotator shown is a Trio (Fig. 2)

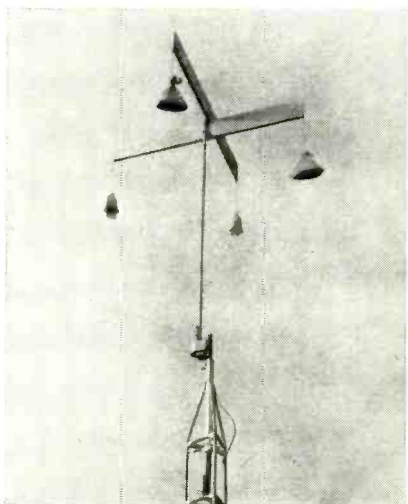

Fig. 2 — Test set-up to simulate stress and strain conditions.

which is supporting a 9 foot mast at the top of which are two wooden cross arms, each 85 inches long by 8 inches wide. Two 8 pound and two 4 pound weights are hung 8 inches down from the wooden cross arm ends, providing an unbalanced load.

The wooden cross arms offer wind resistance approximately four-times greater than a Channel 4 Yagi. The loosely hanging weights apply a constantly shifting load equal to an 8 stacked Channel 4 Yagi. The uneven weight distribution provides the excessive bending moment.

The rotator shown has been in constant operation—the equivalent of 15 years normal use!

This particular test provides the engineer with conclusive proof as to whether his rotator will stand up under heavy, bulky arrays, and in high winds during actual use. Actually, this test exerts stresses and strains far greater than any rotator will be subjected to in normal usage.

Another important rotator test was taken to the Electronic Parts Show in Chicago this spring and put on display there. A standard rotator was operated continuously, turning to the end of rotation in one direction, then to the other, while supporting four swinging weights totalling 200 pounds. Tests such as these have guided us in constantly improving performance, by increasing the rating or design of individual components when indicated.

Part II of the rotator "torture" test involves rotator dependability during extremes of temperature. Equipment used in this test was a Bowser environmental test chamber. See Fig. 3.

This particular test consisted of placing a rotator in the chamber, hooking it up, and then operating it at various degrees of temperature. The rotator was checked for rotation in both

directions (the Trio has two motors—one for each direction of rotation.) at 0°, -10°, -20°, -30°, -40°, and -50°. At -50° a vacuum was applied to the entire chamber to simulate the conditions of a 15,000 ft. altitude!

Throughout the test, the rotator did not falter. There was no appreciable slowing up of the operation nor, at anytime, was the accuracy of direction in any way impaired. When the temperature reached -50°, heavy ice and frost formed on the antenna, rotator housing, lead wires, etc.

To make the test even more accurate and fool-proof, the rotator was not operated continuously. For example, when -10° was reached, the rotator was stopped and allowed to "freeze-up" if it could. This procedure was followed for every 10° drop in temperature. Happily, even after a "freezing-up" wait at the -50° mark, when the rotator was turned on, it broke the encasing ice and functioned perfectly.

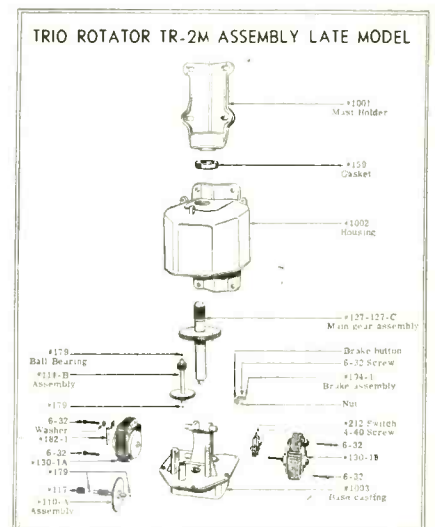
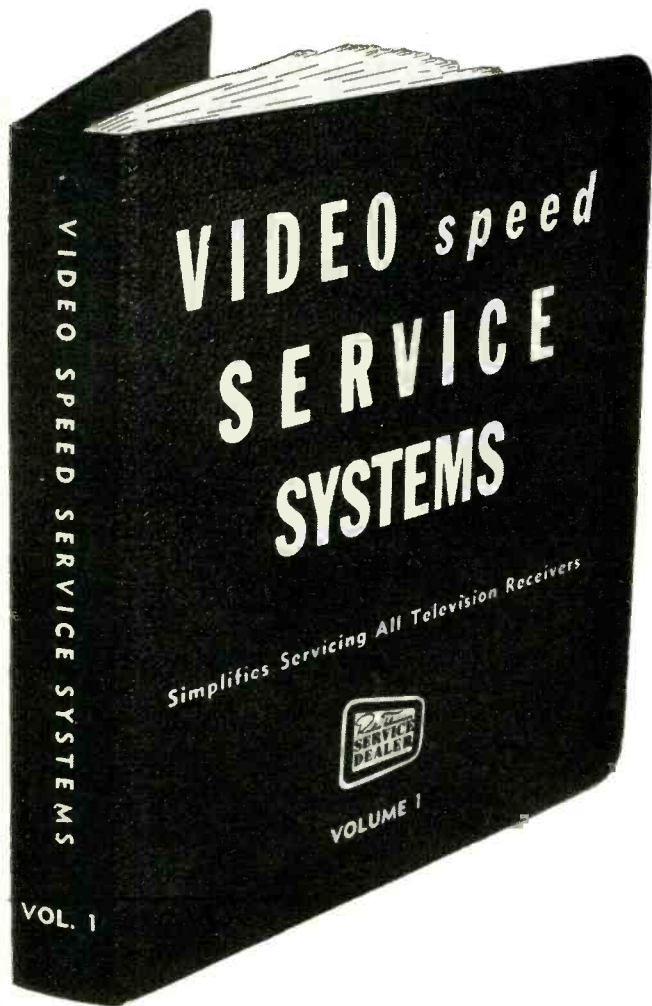

Fig. 3—Exploded view of Rotator mechanism showing internal parts.

FOR GREATER PROFITS



SPEED UP YOUR SERVICING with THIS NEW BOOK

which shows you how to take care of and repair in the quickest possible time:

- Common troubles characteristic of certain receivers
- "Bugs" which might take you hours to find
- Factory and field service changes

SET UP SO THAT YOU CAN MAKE THESE REPAIRS IN THE SHOP OR IN THE FIELD WITHOUT REFERENCE TO ANY OTHER SOURCE.

Contains over 600 Service Items representing over 1000 of the most-serviced Television models now in use. Over 25 different manufacturers' lines are covered.

\$4.95
postpaid

**DISTRIBUTORS—ORDER
YOUR SUPPLY NOW!**

Service Dealers—get your copy of VSSS from your Distributor. If he can't supply you, order direct by mail from us.

Video Speed Servicing Systems IS GUARANTEED to Simplify Servicing All TV sets. A number of new Data Items are published in every issue of "Radio-Television Service Dealer" as a regular monthly feature.

TEAR OFF AND MAIL NOW

RADIO-TELEVISION SERVICE DEALER

67 West 44th Street, New York 36, N. Y.

Please send me post-paid VIDEO SPEED SERVICING SYSTEMS Volume 1. Enclosed herewith is

my check money order for \$_____ for _____ copies at \$4.95 each.

Name

Address

City Zone State

ADMIRAL

MODEL NUMBERS Model numbers may have suffix letter "N"	TV Chassis	Picture Tube	Record Changer	Radio	Tone Control
222DX15S, 222DX16, 222DX17	22C2	21EP4A	Yes
222DX26, 222DX27	22C2	21EP4A	Yes
222DX48, 222DX49	22C2	21EP4A	Yes
322DX16	22E2	21EP4A	RC600	Built-in AM	Yes

TUBE COMPLEMENT

V101	6BZ7	RF Amplifier
V102	6J6	Oscillator and Mixer
V201	6AU6	Sound IF
V202	6AL5	Ratio Detector
V203	6AV6	{ AM Detector, AVC Sound Amplifier
V204	6V6GT	Sound Output
V301	6CB6	1st IF
V302	6CB6	2nd IF
V303	6AG5	3rd IF
V304	*12AU7 or 12AT7	{ Video Detector 1st Sound IF
V305	6AC7	Video Amplifier
V306	21EP4A	Picture Tube
V307	6AU6	Gated AGC
V401A	6SN7GT	{ Vertical Oscillator
V401B		{ Sync Inverter
V402	6S4	Vertical Output
V403	12AU7	Sync Separator and Clipper
V404	6AL5	Sync Discriminator
V405	6SN7GT	Horizontal Oscillator
V406	6CD6G	Horizontal Output
V407	1B3GT	2nd Anode Rectifier
V408	6W4GT	Damper
V501	5U4G	Rectifier
V701	6BE6	Converter (AM Radio)
V702	6BA6	1F Amplifier (AM Radio)

* Tubes not directly interchangeable

Key Voltages

All voltages are measured with a VTVM and in respect to chassis ground.

B+ voltage, fuse holder (M401)	265V DC
Boosted B+ voltage, cathode of damper tube V408 pin 3	400V DC
Plate voltage of Vert. Osc., pin 2 of V401	150V DC*
Plate voltage of Vert. Out. Tube, pin 9 of V402	375V DC*
Plate voltage of Hor. Osc. pin 2	300V DC
pin 5	180V DC
Grid voltage of Hor. Out. Tube, pin 5 of V406	-30V DC

*This voltage varies widely with control setting.

All tube filaments are connected in parallel.

ADJUSTMENTS

DX Range Finder Adjustment

Incorrect adjustment of this control in a strong signal area may result in bending of the picture, excessive contrast and poor sync.

In normal signal strength areas, the DX Range Finder Control will generally be set at the "0" position. In intermediate areas, where the TV signal strength is lower and the noise level is higher, the DX Range Finder control will generally be set within the 10 to 150 position. In fringe areas or areas where long distance "DX" reception is possible, the DX Range Finder control will generally be set within the 150 to 300 position. In weak signal and high noise level areas, adjust the DX Range Finder for minimum noise (snow) and flashing in the picture.

Adjust the DX Range Finder as follows:

- Rotate the DX Range Finder control fully to the left (to the "0" setting).
- Tune in a picture, preferably on the strongest TV channel.
- Set the Picture (contrast) control fully to the right (clockwise).
- While observing a test pattern or picture, slowly rotate the DX Range Finder control to the right for best contrast with a minimum of snow and flashing in the picture.

Check for bending of vertical objects (overloading) in the picture. Also check to see that the picture locks in sync properly when switching off and on channel. If necessary, rotate the DX Range Finder control to the left or to the right until the operation is satisfactory.

In some fringe areas where long range reception is possible, TV signals may be subject to excessive fading. This may vary with season and time of day. If the signal in the area concerned is subject to excessive fading and the Range Finder is adjusted during the time the signal is weakest, overloading (picture bending) will take place when the signal is stronger. For this reason be sure that the customer is instructed on the adjustment of this control for periodic variations in signal strength.

[Continued on page 46]

ADMIRAL TROUBLE SHOOTING CHART

NO SOUND—NO RASTER

Power input circuit
V501
Check line cord and connector
Phono-Radio-TV Switch

NO RASTER—SOUND OK

Check HV Fuse M401 ($\frac{1}{4}$ Amp)
Brightness control
Ion trap
V305, V306, V405, V406, V407, V408
HV xformer Hor. yoke CRT connections

WEAK PIX—SOUND AND RASTER OK

Tuner fine tuning
Picture control
V101, V102, V301, V302, V303, V304, V305, V306,
V307
DX Range Finder control

POOR HOR. LIN.

Hor. Lin. and Drive controls
V405, V406, V408
Check 0.02 mf, 0.047 mf and 0.25 mf caps. connected
to Hor. Lin. coil

POOR VERT. LIN.

Vert. Lin. and Height controls
V401, V402
Check 0.1 mf and 0.047 mf caps. connected to pin 6 of
V402
Vert. Out. Trans.

PIX JITTER SIDEWAYS

Hor. Lock and Hold controls
DX Range Finder control
V401, V404, V405, V406
Check 0.01 mf and 12K res. connected to pins 5 and 7
of V404

SMEARED PIX

Tuner fine tuning
Picture control
V102, V301, V302, V303, V304, V305, V307
Check Vid. Det. and Amp. peaking coils
IF and RF alignment

POOR PIX DETAIL

Tuner fine tuning
Focus control
V102, V301, V302, V303, V304
IF and RF alignment

SOUND BARS IN PIX

Tuner fine tuning
V101, V102, V301, V302, V303, V305, V307
Check adjustment of L-301
IF and RF alignment

SNOW IN PIX

V101, V102, V301, V302, V303, V304, V307
DX Range Finder control
Antenna and transmission line

AC IN PIX (DARK HOR. BAR)

V101, V102, V301, V302, V303, V304, V305, V307

ENGRAVED EFFECT IN PIX

Tuner fine tuning
Picture control
DX Range Finder control
V102, V301, V302, V304, V305, V306, V307

VERT. BARS

Hor. Drive and Width controls
V406, V408
Check 47 mmf. cap. and 1K Ω res. connected between
terminals 1 and 2 of yoke
Defl. yoke ringing

PIX BENDING

Hor. Hold and Lock controls
DX Range Finder control
V307, V404, V405, V406
Check 0.047 mf cap. connected to pin 1 of V405

AUDIO HUM IN SOUND

V201, V202, V203, V204, V304

DISTORTED SOUND

Tuner fine tuning
V102, V201, V202, V203, V204, V304
Tone control
Check Printed ckt connected to pin 5 of V204
Sound and Vid. IF alignment L-202, L-203
Det. alignment T-201

NO SOUND—PIX OK

Tuner fine tuning
V201, V202, V203, V204, V304
Volume control
Speaker (open voice coil or defective connection)
Sound and Vid. IF alignment L-202, L-203
Det. alignment T-201

WEAK SOUND—PIX OK

Tuner fine tuning
Volume and Tone control
V102, V201, V202, V203, V204, V304
Sound and Vid. IF alignment L-202, L-203
Det. alignment T-201

NOISY SOUND—PIX OK

V201, V202, V203, V204, V304
Volume and Tone controls
Check Sound System for loose connections
Speaker
Sound IF and Det. alignment L-202, L-203, T-201

SYNC. BUZZ IN SOUND

Tuner fine tuning
DX Range Finder control
V201, V202, V304, V307
Check 500 mmf cap. connected to pin 2 of V202
Sound IF and Det. alignment L-202, L-203, T-201

INTERMITTENT SOUND—PIX OK

V201, V202, V203, V204, V304
Poor connections in sound system

WEAK OR NO PIX—SOUND WEAK—RASTER OK

Tuner fine tuning
Picture and DX Range Finder controls
V101, V102, V301, V302, V303, V304, V307
RF and IF alignment

INTERMITTENT RASTER—SOUND OK

Brightness control
V404, V405, V406, V407, V408
HV xformer

RASTER BLOOMING

Hor. Drive control
V306, V406, V407, V408, V501
Check HV Filter cap.
Check 470K res. connected to HV
Filter cap.

INSUFFICIENT BRIGHTNESS

Ion trap
Brightness and Hor. Drive controls
V305, V306, V406, V407, V408,
V501
Check 3.3K res. connected in series
with a 82 res. to pin 6 of V406
Low line voltage

EXCESSIVE RASTER (PIX SIZE)

Hor. Drive, Width and Height
controls
V406, V407

INSUFFICIENT RASTER WIDTH

Hor. Drive and Width controls
V405, V406, V408, V501
Check 330 and 680 mmf caps.
connected to pin 5 of V405
Low line voltage

INSUFFICIENT RASTER HEIGHT

Vert. Lin. and Height controls
V401, V402, V501
Check 100 mmf cap. connected to
pin 2 of V402
Check 0.1 and 0.047 mf caps. con-
nected to pin 6 of V402
Vert. Out. Trans.
Low line voltage

NO VERT. DEFL.

V401, V402
Check 0.1 mf and 0.047 mf caps.
connected to pin 6 of V402
Vert. Defl. yoke
V. O. T.

NO VERT. SYNC.—HOR. SYNC. OK

Vert. Hold control
Check Vert. Int. Network
Check 0.0047 mf cap. connected
to yellow lead of Vert. Osc. Trans.
V307, V401, V402, V403
DX Range Finder control

**NO HOR. OR VERT. SYNC.—PIX
SIGNAL OK**

V101, V401, V403
Check 0.01 mf cap. connected to
pin 4 of V401

NO HOR. SYNC.—VERT. SYNC. OK

Hor. Hold and Lock controls
V101, V301, V302, V303, V307,
V404, V405, V406
Check 330 mmf cap. connected be-
tween pins 2 and 4 of V405

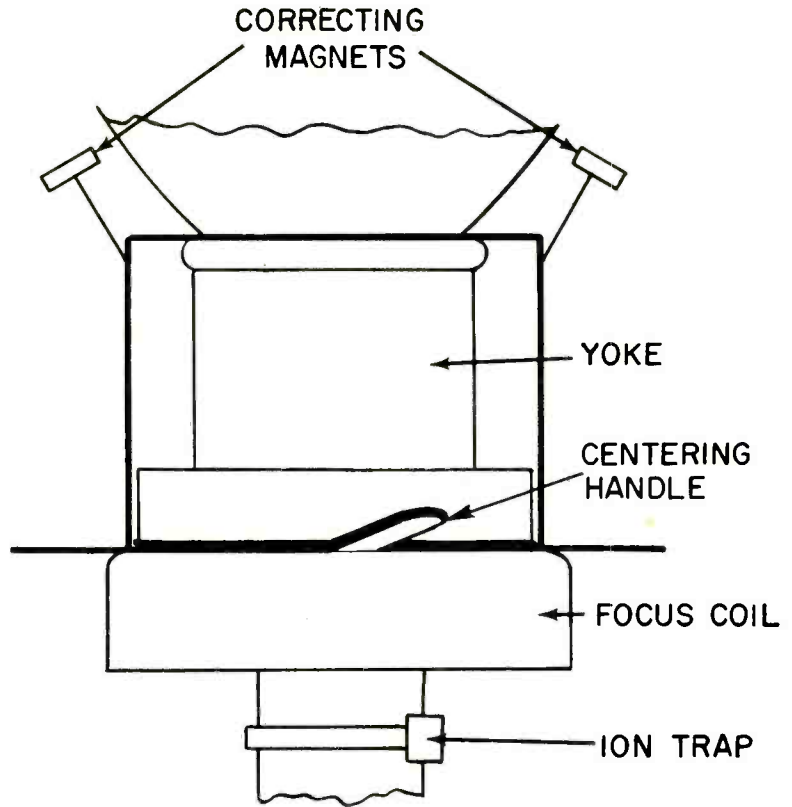

PICTURE TUBE ADJUSTMENTS

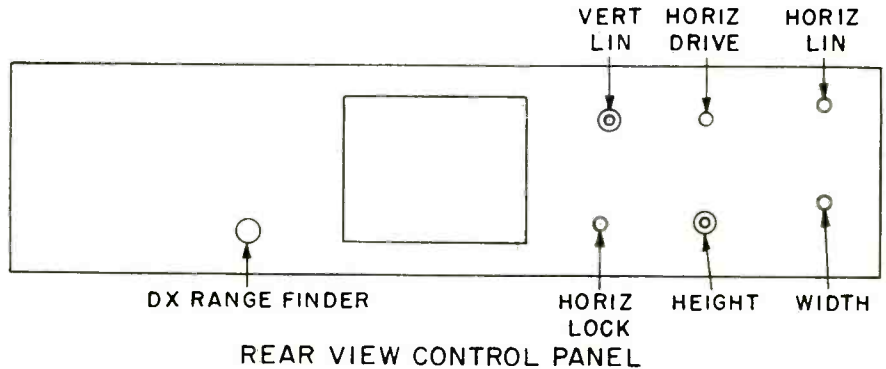

**22C2 CHASSIS
DOES NOT USE RADIO CHASSIS**

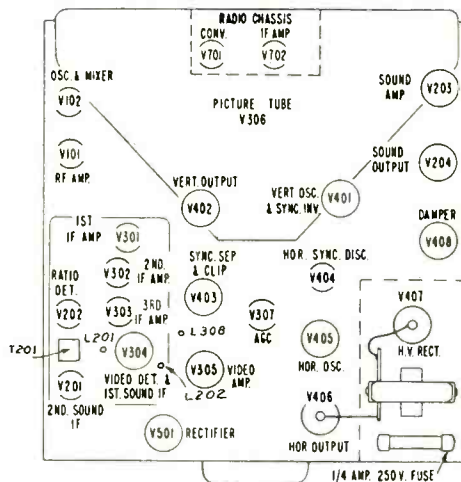

**Top View of 22E2 & 22C2 Chassis.
(V701 and V702 are accessible from
underside of chassis).**

[from page 43]

Individual Channel Slug Adjustment Using a Television Signal

Individual channel oscillator adjustment of every receiver should be checked upon installation or servicing. If this adjustment is properly made, it is possible to tune from one station to another by merely turning the CHANNEL control. With correct oscillator channel adjustment, best picture will be located at the approximate center of the range of the TUNING control. However, this may not necessarily be maximum sound output.

Channel slug adjustment can be made without removing the chassis from the cabinet. Adjust as follows:

- Turn the set on and allow 15 minutes to warm up.
- Set the CHANNEL knob for a station in operation. Set all other controls for a normal picture.
- Set TUNING control at center of its range by rotating it approximately half-way.
- Remove the CHANNEL and TUNING knobs.
- Insert a $\frac{1}{8}$ " blade, NON-METALLIC screwdriver in the $\frac{1}{4}$ " hole adjacent to the channel tuning shaft. For each channel in operation, carefully adjust the channel slug for best picture with clear detail. Be sure that the Tuning control is set at the center of its range before adjusting each channel slug. Only slight rotation of the slug will be required; turning the slug in too far will cause it to fall into the coil. (If the slug falls into the coil, remove the coil, move the retaining spring aside, lightly tap the open end of the coil until the slug slips out. Replace slug and reset retaining spring.)

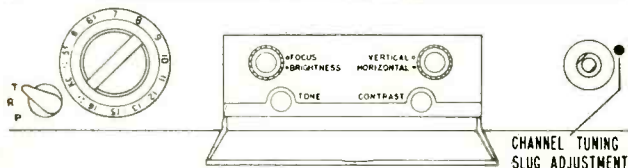

Control Panel in 22E2 Sets. Channel and Tuning Knobs Removed.

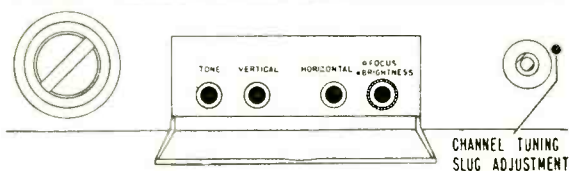

Control Panel in 22C2 Sets. Channel and Tuning Knobs Removed.

Touch-Up of Ratio Detector Secondary Using Television Signal (Bottom Slug of T201)

*This adjustment is accessible through the $\frac{1}{4}$ " hole (just below T201) in bottom of the cabinet or the chassis mounting shelf, located toward the left side facing the rear of the set. Removal of the chassis is therefore not required. Adjustment need be made on one channel only. Proceed as follows:

- Turn set on and allow about 15 minutes for warm up.
- Tune set for normal picture and sound.
- Carefully insert a non-metallic alignment tool through the opening in cabinet bottom below T201. An align-

ment tool with a screwdriver blade or hexagonal end is required depending on the transformer used, see note below. When the alignment tool engages the bottom tuning slug, adjust the slug for best sound with minimum buzz level. Do this carefully as only slight rotation in either direction will generally be required. Correct adjustment point is located between the two maximum buzz peaks that will be noticed when turning the slug back and forth about $\frac{1}{4}$ to $\frac{1}{2}$ turn.

- If necessary, repeat individual channel slug adjustment and conclude with retouching the ratio detector secondary. Note: If oscillator adjustment is required for other channels, it will *not* be necessary to repeat the ratio detector secondary adjustment after *once* correctly adjusting it.

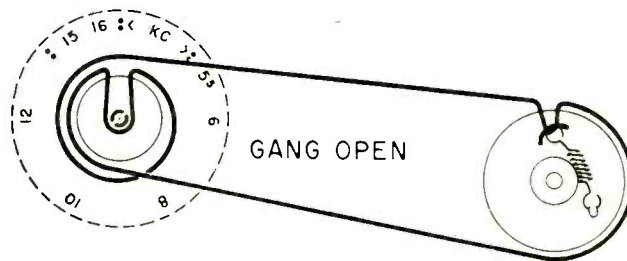

Dial Stringing for the 22E2 Chassis.

Adjusting Curvature Correcting Magnets for Sets Using a 21EPA (21") Picture Tube

If either side of the picture has excessive curvature (pin cushion effect) or if corners of the picture are bent inwardly, this can be minimized by adjustment of the correcting magnets located on the yoke bracket. Either side of the picture can be adjusted individually by using the magnet on that side of the picture tube. A picture or test pattern having straight vertical lines near the sides can be used for making adjustment; the pattern from a cross-hatch generator is preferable. IMPORTANT: A cross-hatch generator which is not capable of locking the picture in both horizontal and vertical sync is not suitable. Adjust as follows:

- Set the receiver control for normal picture. Be sure that the picture is centered properly and vertical linearity adjustment is made.
- Check the radial position of the magnet brackets. The magnet brackets are generally set so that the mounting screw is centered in the curved slot. It should only be necessary to change from this setting if the curvature at the side of the picture is not centered with respect to the side of the picture tube.
- Move the correcting magnet against the deflection yoke bracket. While observing the vertical lines on the same side of the picture that the magnet is located, slowly move the magnet forward until curvature of vertical lines near the side is minimized. If the magnets are moved too far forward, the corners of the picture will bend inwardly or become shaded.

Servicing Radio Tubes and Dial Light in 22E2 Sets

The radio tubes can be serviced without removing the TV chassis from the cabinet. The radio tubes can be reached through the opening in the underside of the chassis shelf.

The dial light can be serviced by removing the tuning knobs and plastic control panel.

CAPEHART

MODEL 12F272M

TV CHASSIS CT-74

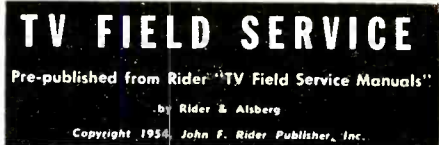

TUBE COMPLEMENT

REF. NO.	TYPE	FUNCTION
V101	6BQ7	R. F. Amplifier
V102	6J6	Osc. & Mixer
V201	6CB6	1st I.F. Amplifier
V202	6CB6	2nd I.F. Amplifier
V203	6CB6	3rd I.F. Amplifier
V204	6CB6	4th I.F. Amplifier
V205	6X8	Triode Section, 1st Video Amplifier Pentode Section, 1st Sound I.F. Amplifier
V206	6AQ5	Video Output
V208	27GP4 or 27EP4	Picture Tube
V301	6AU6	2nd Sound I.F. Amplifier
V302	6AL5	Ratio Detector
V303	6AV6	1st Audio Amp. & AGC Clamp
V304	6AQ5	Audio Output
V401	6AU6	Keyed A.G.C. Amplifier
V402	6BA6	Sync Amplifier
V403	6BE6	Sync Sep. & Noise Clipper
V404	12AT7	1st Triode, Sync Clipper 2nd Triode, Reactance Tube
V501	6AL5	Horizontal A.F.C.
V502	12AU7	1st Triode, Horizontal Oscillator 2nd Triode, Horizontal Discharge
V505	1B3	H.V. Rectifier
V506	6C4	Vertical Multivibrator
V508	6CD6	Horizontal Output
V509	6AX4	Damper
V510	6AX4	Damper
V511	6AV5	Vertical Output
V601	5U4	L. V. Rectifier
V602	5U4	L. V. Rectifier
CR201	1N64	Video Detector (Germanium Diode)

Key Voltages

All voltages are measured with a VTVM connected to the tube pin and chassis.

B+ voltage, HV Fuse	300V DC
Boosted B+ voltage, cathode of damper tube V509 pin 3	540V DC
Plate voltage of Vert. Osc., V506 pins 1 and 5	5.2 to 140V DC
Plate voltage of Vert. Out., V511 pin 5	280V DC
Plate voltage of Hor. Osc. V502 pin 6	260V DC
Grid voltage of Hor. Out. V503 pin 5	-23V DC

Filament Wiring

All tube filaments are connected in parallel.

ADJUSTMENTS

Oscillator Adjustment Using a Television Signal

1. Turn set on and allow sufficient time for set to reach normal operating temperature.

2. Turn Channel selector to the channel to be adjusted and adjust Shading, Contrast and Volume controls for normal sound and picture. Set the Fine Tuning control to the midpoint of its range.
3. Remove Channel and Fine Tuning knobs and adjust the oscillator slug for that channel, using a small non-metallic screwdriver. When the CHANNEL selector is set for a particular channel, the oscillator "slug" for that channel is accessible through a small hole in the front of the tuner chassis.

Adjust the oscillator slug for the clearest and sharpest detail in the picture. At this point the sound should be best, but not necessarily the loudest.

NOTE: BE CAREFUL NOT TO TURN THE SLUG TOO FAR, AS IT MAY FALL COMPLETELY OUT OF ITS MOUNTING.

Beam Corrector Magnet Adjustment

Adjust the Height Control so that the top and bottom edges of the raster are just visible and check to see if the raster lines near the top and bottom are sufficiently straight. If the lines are bent adjust the two Beam Corrector Magnets (attached to the CRT metal support ring, one above and the other below the bell of the CRT) to remove the bend. These magnets are adjusted at the factory and should not require re-adjustment unless they have been accidentally bent out of position.

These magnets can be adjusted by moving them closer to or further from the bell of the CRT or by moving them from side to side. As the magnet is moved closer to the tube, the raster lines will be pulled toward the magnet. Likewise as the magnet is moved away from the tube, it will have less effect on the raster lines. If the magnets have been shifted either to the left or right, an irregular bend may appear in the raster lines near the top or bottom.

Adjustment of Horizontal A.F.C. Circuit

There is no Horizontal Hold front panel control provided on this chassis. The picture should lock in synchronism automatically when switching from channel to channel. In event, however, that adjustment of this circuit is required, because of tube or component replacement, the following procedure should be followed:

1. Remove the Horizontal A.F.C. Detector Tube (6AL5) from its socket and adjust the Horizontal Frequency slug until the picture is synchronized horizontally. When properly adjusted the picture will move slowly back and forth horizontally with one vertical blanking bar.
 2. Re-insert the 6AL5 tube, and as soon as the tube reaches its normal operating temperature, the picture should fall in sync.
 3. After making the frequency adjustment, check the horizontal phasing. This can best be done by decen-
- [Continued on page 50]

CAPEHART TROUBLE SHOOTING CHART

NO SOUND—NO RASTER

Power input circuit
V601, V602

NO RASTER—SOUND OK

Brightness control
HV Fuse (F502 2/10 Amp)
Ion trap
V208, V404, V501, V502, V503, V505, V509, V510
HV xformer Hor. yoke CRT connections

WEAK PIX—SOUND AND RASTER OK

Tuner fine tuning
Contrast control
A.G.C. Set control
V102, V201, V202, V203, V204, V205, V206, V208,
V401
Check Vid. Det. crystal CR201 (1N64 Part of T205)

POOR HOR. LIN.

Hor. Drive control
V503, V509, V510
Check 0.1 mf cap. connected to HV Fuse

POOR VERT. LIN.

Height and Vert. Lin. controls
V506, V511
Check 100 mmf cap. connected to pin 3 of V511
Check 0.1 and 0.033 mf caps. connected to pins 1-5
of V506
Vert. Out. Trans.

PIX JITTER SIDEWAYS

Hor. Hold and Phasing controls
V404, V501, V502, V503
Check 0.0047 mf cap. connected to pin 1 of V501
Check 100 mmf cap. connected to terminal "E" of
Hor. Osc. Trans.

SMEARED PIX

Tuner fine tuning
Contrast and A.G.C. Set. controls
V102, V201, V202, V203, V204, V205, V206, V401
Check Vid. Det. crystal CR201 (1N64 Part of T205)
Check Peaking Coils
IF and RF alignment

POOR PIX DETAIL

Tuner fine tuning
V201, V202, V203, V204, V205, V206, V208, V401
Check Vid. Det. & Amp. Peaking Coils
Check Vid. Det. crystal CR201 (1N64 Part of T205)
IF and RF alignment

SOUND BARS IN PIX

Tuner fine tuning
V102, V201, V202, V203, V204
Check Vid. Det. crystal CR204 (1N64 Part of T205)
Check alignment of L208 and L215
IF and RF alignment

SNOW IN PIX

V101, V102, V201, V202, V203, V204, V401
Antenna and transmission line

AC IN PIX (DARK HOR. BAR)

V101, V102, V201, V202, V203, V204, V205, V206,
V401

ENGRAVED EFFECT IN PIX

Tuner fine tuning
Contrast and A.G.C. Set control
V102, V201, V202, V203, V204, V205, V206, V401
Check Vid. Det. crystal CR201 (1N64 Part of T205)

VERT. BARS

Hor. Drive control
V503, V509, V510
Check 47 mmf cap. and 39Ω res. connected across
terminals 1 and 2 of yoke
Defl. yoke ringing

PIX BENDING

Hor. Hold and Phasing controls
V401, V404, V501, V502, V503
A.G.C. Set control

AUDIO HUM IN SOUND

V205, V301, V302, V303, V304

DISTORTED SOUND

Tuner fine tuning
V102, V205, V301, V302, V303, V304
A.G.C. Set. control
Sound and Vid. IF alignment L1301
Det. alignment T-301

NO SOUND—PIX OK

Tuner fine tuning
Volume control
V205, V301, V302, V303, V304
Speaker (open voice coil or defective connection)
Sound and Vid. IF alignment L-301
Det. alignment T-301

WEAK SOUND—PIX OK

Tuner fine tuning
Volume and A.G.C. Set. controls
V102, V205, V301, V302, V303, V304
Sound and Vid. IF alignment L-301
Det. alignment T-301

NOISY SOUND—PIX OK

Volume control
V205, V301, V302, V303, V304
Speaker
Sound IF and Det. alignment L-301, T-301

SYNC. BUZZ IN SOUND

Tuner fine tuning
A.G.C. Set. control
V102, V205, V301, V302
Check Vid. Det. crystal CR201 (1N64 Part of T205)
Sound IF and Det. alignment L-301, T-301

INTERMITTENT SOUND—PIX OK

V205, V301, V302, V303, V304
Poor connections in sound system

WEAK OR NO PIX—SOUND WEAK—RASTER OK

Tuner fine tuning
Contrast and A.G.C. Set control V102, V201, V202,
V203, V204
Check Vid. Det. crystal CR201 (Part of T205)
RF and IF alignment

**INTERMITTENT RASTER—
SOUND OK**

Brightness control
V404, V501, V502, V503, V505,
V509, V510
HV xformer

RASTER BLOOMING

Hor. Drive control
V502, V503, V505, V509, V510,
V601, V602
Check HV Filter cap.
Check 1 Meg res. connected to HV
Filter cap.

INSUFFICIENT BRIGHTNESS

Ion trap
Brightness and Hor. Drive controls
V203, V502, V503, V505, V509,
V510, V601, V602
Low line voltage

EXCESSIVE RASTER (PIX SIZE)

Hor. Drive, Width and Height
controls
V503, V505
Check 0.047 mf cap. and 12K Ω
res. connected to series res. on
pin 3 of V503

INSUFFICIENT RASTER WIDTH

Hor. Drive and Width controls
V203, V503, V509, V510, V601,
V602
Check 0.001 and 0.0082 mf caps.
connected to pin 1 of V502
Check 120 mmf cap. connected to
terminals 1 and 3 of Hor. Out.
Trans.
Low line voltage

INSUFFICIENT RASTER HEIGHT

Height and Vert. Lin. controls
V506, V511, V601, V602
Check 0.1 and 0.033 mf caps. con-
nected to pins 1 and 5 of V506
Vert. Out. Trans.
Low line voltage

NO VERT. DEFL.

V506, V511
Check 390 mmf cap. connected to
pin 5 of V506
Check 0.1 and 0.033 mf cap. con-
nected to pins 1 and 5 of V506
Vert. Defl. yoke
V. O. T.

NO VERT. SYNC.—HOR. SYNC. OK

Vert. Hold control
Vert. Int. Network
V401, V403, V404, V506, V511
A.G.C. Set control
Check 0.001 mf cap. connected to
pin 6 of V506

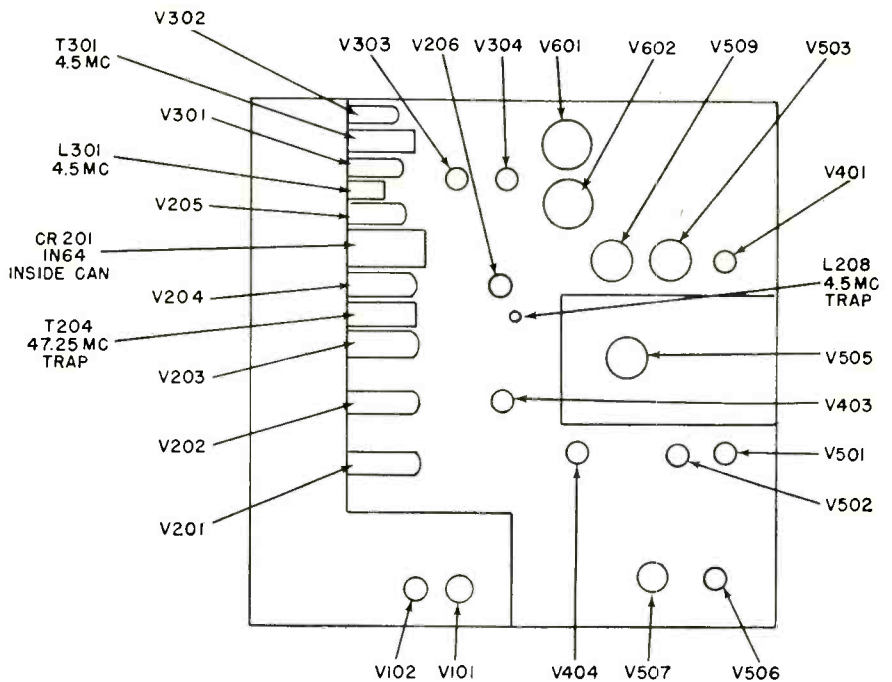

**TOP VIEW CHASSIS LAYOUT
CT-74
Location of Components, Tubes and Alignment Adjustments**

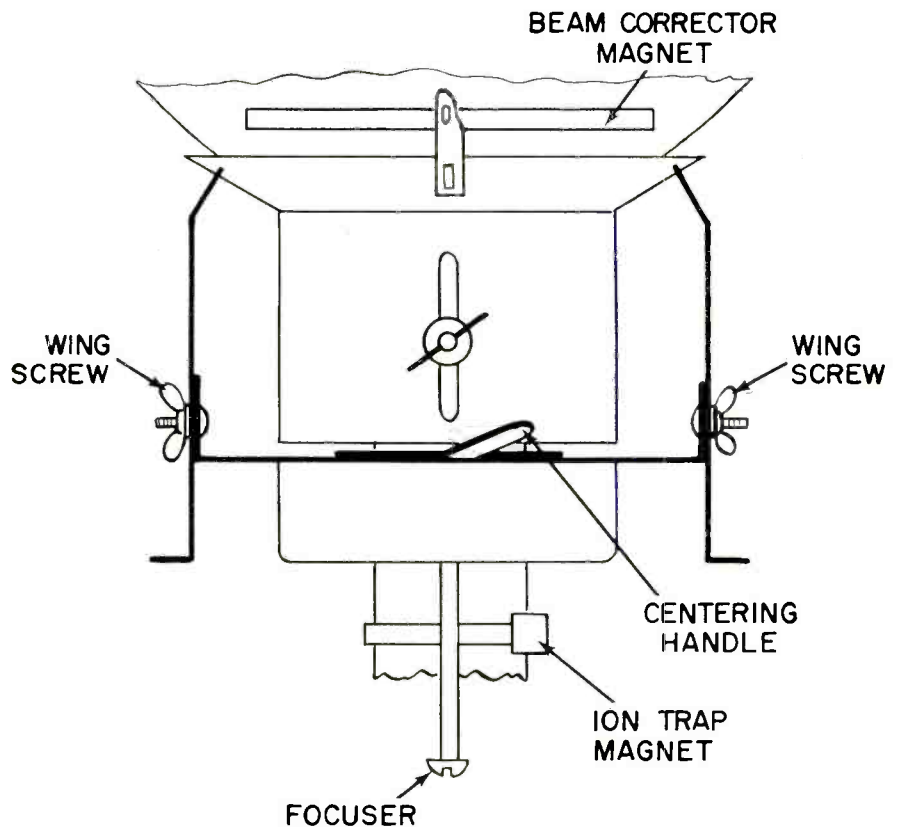

PICTURE TUBE ADJUSTMENTS

NO HOR. SYNC.—VERT. SYNC. OK

Hor. Hold and Phasing controls
A.G.C. Set. controls
V404, V501, V502, V503
Check 0.001 mf, 1100 mmf and
1200 mmf caps connected to

pin 1 of V404

**NO HOR. OR VERT. SYNC.—
PIX SIGNAL OK**

V303, V401, V402, V403, V404
Check 0.047 mf cap. connected to
pin 5 of V403

[from page 47]

tering the picture so that the right hand edge of the raster is visible. Adjust the Shading control for maximum brilliance and reduce the Contrast control until the raster edge can be seen. There should be approximately 3/16 inch between the edge of the raster on 17 inch tubes and 1/4 inch on 21 inch tubes. If the picture is out of phase, adjust the Horizontal Phasing "slug" on the rear of the chassis.

If considerable amount of change is required in the phasing adjustment, it may be necessary to re-adjust the horizontal frequency as in Step 1, above.

Picture Size and Linearity:

Adjust the Horizontal Drive and Width controls to obtain the proper picture width and horizontal linearity. The Horizontal Drive control should be adjusted first to provide maximum scan and then the Width control should be used to adjust for the proper horizontal size. If a vertical white line (or lines) appears in the picture, back off the Horizontal Drive control slightly.

Adjust the Height and Vertical Linearity controls to obtain proper height and vertical linearity. It may be necessary to adjust the Vertical Hold control while making these adjustments, if the picture should roll.

Final Check:

In sequence, set the Channel knob to all channels on which reception is obtained. Adjust the receiver for operation as outlined in the Owner Operating Instructions. Check the quality of reception, picture and sound on all available TV stations in the area.

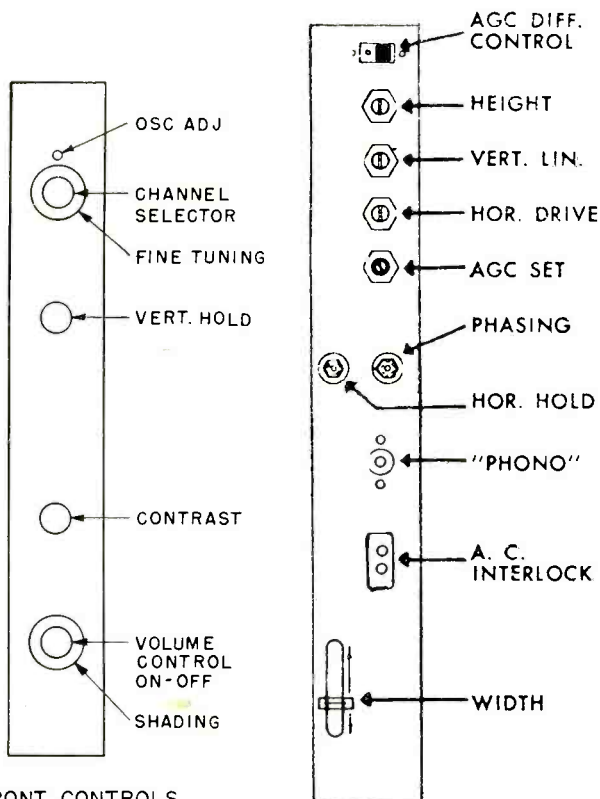

FRONT CONTROLS

REAR CONTROLS

NOTE: If a degree of "background noise" is noticed on moderate signals the AGC Differential Control (switch on rear chassis apron) should be placed in the DOWN position. If no background noise is apparent with the switch in the UP position, it should be left in this position.

Recheck the focuser adjustment and Ion Trap Magnet setting for good picture focus.

Check to see that the best reception is obtained on all channels with the Fine Tuning control set to the approximate center of its range. This can be obtained by making the adjustments outlined under "Oscillator Adjustments Using a TV Signal."

Remove the "cheater cord" and replace the cabinet back.

OPERATION AND INSTALLATION

Removing the Picture Tube From the Cabinet

To remove the CRT:

1. Remove the cabinet rear door assembly (held in place by twelve (12) wood screws).
2. Remove the CRT socket from the CRT base.
3. Disconnect the Deflection Yoke Cable.
4. Disconnect the H.V. Anode Connector from the CRT.
5. Remove the rear braces from the deflection yoke support assembly.
6. Remove the four (4) nuts which fasten the front CRT strap assembly to the cabinet. **NOTE:** Unless the instrument is in the face down position (as described above) the CRT should be supported from the rear while the mounting nuts are being removed.
7. Lift the tube out of the cabinet tilting it slightly to avoid striking the H.V. Section of the TV Chassis.

After removing the CRT assembly from the cabinet place it face down on a pad (to protect the CRT face) and remove the Ion Trap, Focus Magnet and Deflection Yoke. When installing a new CRT be certain that the rubber collar, which is used to hold the deflection yoke in place against the bell of the tube, is solidly in place.

Removing the Chassis From the Cabinet

The chassis used in this model is bolted to a sliding skid which fits in grooves provided in the cabinet construction. For maintenance the chassis can be removed from the rear of the instrument as follows:

1. Remove the control knobs from the front of the instrument.
2. Remove the cabinet rear door assembly (held in place by twelve (12) wood screws).
3. Remove the Antenna Terminal strip (fastened to cabinet by two (2) wood screws).
4. Remove the CRT Socket from the CRT base.
5. Disconnect the Deflection Yoke Cable.
6. Disconnect H.V. Anode Connector from the CRT.
7. Remove the Speaker plug from the TV chassis.
8. Remove the wood screws which fasten the chassis mounting skid to the cabinet (four screws at the rear and one at the front near the R-F Unit).
9. Slide the chassis on the sliding skid from the rear of the instrument.
10. Remove the wooden skid from the chassis to facilitate service.

TRADE FLASHES

[from page 12]

The system was engineered and installed by Jerrold Electronics Corporation of Philadelphia, Pa., manufacturers of television master antenna systems. This new type of public service facility in Casper is operated by a group of local businessmen who have formed Community Television Systems of Wyoming, Inc.

Book-Naming Prize Contest

H. G. Cisin, Publisher of Amagansett, N. Y. announces a new book-naming prize contest in connection with his newest TV service book now in preparation. If the name suggested is selected as the title of this new book, the winner will receive a one hundred dollar cash award. In addition, there will be fifty consolation prizes including cash, test instruments, subscriptions to TV magazines and other valuable prizes.

This contest is open to everyone, with the exception of employees of H. G. Cisin or of his advertising agency. As many names as desired may be submitted. To participate, write to the publisher.

Westinghouse Holds Color TV Service School

Westinghouse is staging a color television service school to review the unique problems of maintaining and servicing color TV receivers, according to A. H. Kuttruff, Television-Radio Division service manager, who is in



charge of the intensive two-week training program here.

All key Westinghouse field service engineers are taking part in the classroom and laboratory sessions. Subjects discussed include: colorimetry, the study of colors; composite color signals and their function; transmitter requirements and variables; basic color TV receiver design requirements; and adjustment of color receivers.

May Parts Show Has Sellout

The 1954 Electronic Parts Show management received a total of 215 contracts for the 202 Exhibition Hall booths available at the Conrad Hilton, May 17-20th.



HAROLD J. SCHULMAN

NATIONAL SERVICE
MANAGER

of

DU MONT

and

CHAIRMAN,
SERVICE COMMITTEE,

RETMA

SAYS:

"...a product as complex as a television receiver cannot possibly be maintained satisfactorily without timely, understandable and helpful service information.

"Every manufacturer tries in his own way to develop service helps that will keep his product performing the way in which it was designed to perform. But in the final analysis, it is only through the efforts of the experts in the field, like yourself, that servicemen can expect a steady flow of all-inclusive service information.

"We have found your publications to be consistently high in quality and integrity. We particularly single out your current Parts Replacement Information program as a service to the industry.

"We hope you continue to help the service technician service our products intelligently and well through your fine service publications."

RADIO MANUAL 23 NOW AVAILABLE

Up-to-the-minute information
on all home AM, FM radios
built during 1952 and 1953.
(Place your order with your jobber)

Tek-File
is now only \$1.50 per pack



..... AVAILABLE *NOW* - TV 12!

For easier radio servicing... use Rider's 23 AM-FM Radio Manuals

JOHN F. RIDER

PUBLISHER, INC.
480 Canal Street, New York 13, N. Y.

In Canada,
Mr. Charles W. Pointon
1926 Gerrard Street, East
Toronto, Ontario

Export Agent:
Roburn Agencies, Inc.
39 Warren Street
New York 7, New York

West Coast Office:
4216-20 W. Jefferson Blvd
Los Angeles, California

Cable Address:
Roburnage N. Y.

CIRCUIT COURT

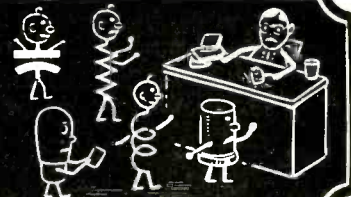

Du Mont RA 160—Vertical amplifier

The video amplifier of the Du Mont RA 160 chassis (Fig. 1) has many interesting features. In addition to being direct coupled in both the input and output circuits, this chassis has a most unusual compensated contrast control.

The video signal is, as indicated previously, applied to the grid across the video detector load circuit which makes up the grid d-c return to ground. This signal is coupled to the grid across L208 which acts as a high frequency peaking network. This coil is damped by R224 to prevent excessive peaking and the "ringing" in the picture which this can cause. In the amplifier plate circuit we find first L207 which is another damped peaking coil. L205 shunted by C217 serves two purposes. Its natural resonance is 4.5 mc and presents a high impedance to any 4.5 mc intercarrier sound beats which might be present in the video signal. In addition, L205 serves as another peaking coil.

Beside the series peaking coils just mentioned, L209 acts as a shunt peaking coil. L209 is in series with R221, the plate load resistor. R227 is connected at the junction of L209 and R221. This resistor acts to directly couple the video signal to the sync and age circuits.

The output frequency response of any uncompensated amplifier varies with the tube gain. As a result, when an uncompensated contrast control is varied from max. gain to min. gain, the video response curve will tilt on either the high frequency or low frequency side. Because of this, many methods of

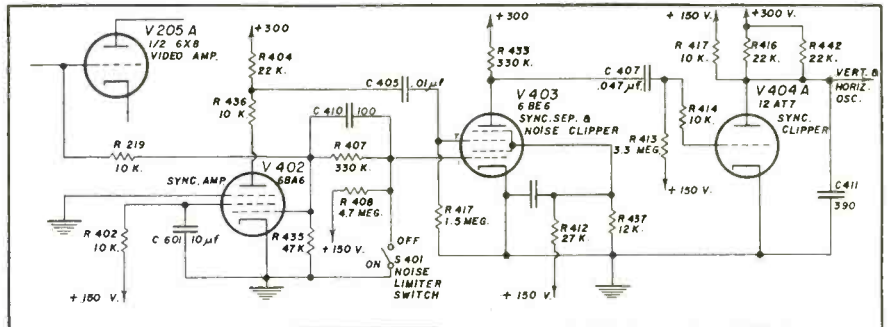

Fig. 2—Capehart CX-36, sync system.

contrast compensation are employed in order to get a uniform response at all gain levels.

The method used in this model consists of a tapped control which is partially across the plate load circuit. By moving the control center arm, a portion of the signal can be picked off. Connected across the taps are C252, C235 and C270. When the center arm is moved, different combinations of these three condensers are connected across the control, and in this way the control compensation for different signal levels are provided.

In order to establish the dc voltage at the cathode of the CRT, which sets the bias for the tube, the cathode is returned to a B+ voltage. This is accomplished by returning the cathode through R222 and the contrast control to a point on a voltage divider consisting of R292 and R258. These two resistors go from +145 to +230. The bias is established by returning the grid to a less positive voltage through R225 to the voltage divider R226 and R257, and the brightness control.

Capehart CX36—Sync System

The Capehart CX36 uses a 6BA6 sync amplifier, a 6BE6 sync separator and 1/2 of a 12AT7 sync clipper for the multiple purpose of separating the video information from the sync, shaping and amplifying the sync pulses and to eliminate any noise pulses whose amplitude is greater than that of the sync pulse. These noise pulses could upset the sweep stability.

The video signal for the 6BA6 stage is directly coupled from the grid of the first video amplifier through R219. This signal is fed to the sync amplifier in sync phase negative.

The output of the sync amplifier is a signal which is sync phase positive. This signal is coupled to the second control grid (pin 7) of the 6BE6 sync stripper. The coupling condenser C405 charges to the peak value of the sync pulse, through R417, the grid leak resistor. The time constant of this combination permits only a small part of this charge to trickle off before the next sync pulse arrives. This charge keeps the tube in a cutoff condition. In this way, the only signal presented to the grid is the peak of the sync pulses, which brings the tube into conduction.

The characteristics of the 6BE6 are such that once the tube is in conduction, the second control grid is the grid which controls the plate current flow. The first control grid (pin 1) by its location close to the cathode can also, however, cause the tube to be cut off. This grid is directly coupled to the grid of the sync amplifier through R407. The signal present on the grid of the sync amplifier is, of course, 180° out of phase with the signal at the tube plate. The signals on grid #1 and grid #7 of the sync stripper are, therefore, 180° out of phase. The bias of grid #1 is so set that any signal whose amplitude is

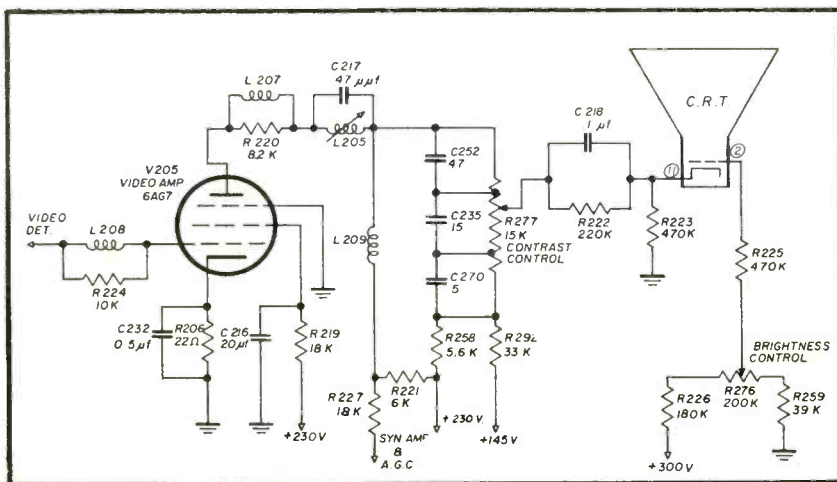

Fig. 1—Du Mont RA 160, video system.

Rhombic Antennas

Dear Answer Man:

Your article on page 40 of the October issue, answering R.W.B. interests me very much as we are fully 200 miles from our closest stations (Bismarck & Billings) which have just come on the air. Of course I have been experimenting with different aerials two-stacked vagsis with open lead-in, etc., with meager occasional results.

Could you send me a rough sketch with details for a Rhombic antenna for Channel 5? On my lot I have about 50 to 75 feet of available space and if the Rhombic might do the job I would just as soon experiment on it. I would like to know also if I should use aluminum tubing or if it can be made from wire; I also realize that it may require several poles. Anyway, any data you can send me as to aerials for extreme fringe areas will be highly appreciated . . . Channels 2 to 6.

E. T.
Glendive, Montana

Dear E. T.:

The Rhombic antenna is a sensitive type that is unidirectional and has excellent broadband characteristics. See "TV Installation Techniques" by S. L. Marshall, published by John F. Rider. One disadvantage is the input impedance which is about 700 ohms. However this can be overcome through the use of a matching stub of one-half wavelength connecting the rhombic to the transmission line. The other end of the diamond is in the direction of the station transmissions to be received and is terminated with a 680 ohm resistor. The rhombic has a broad band-pass characteristic with excellent gain over a frequency range of 2 to 1. For this reason it can be employed for either the upper or lower television channels. Notice in Fig. 1 how the four lobes all point in the forward direction. Rhombic antennas can achieve a gain of 18db.

The three variables concerned with in the construction of a rhombic are the leg length, the angle of the legs and the slope with respect to the ground of the rhombic.

Concerning the leg length it can be

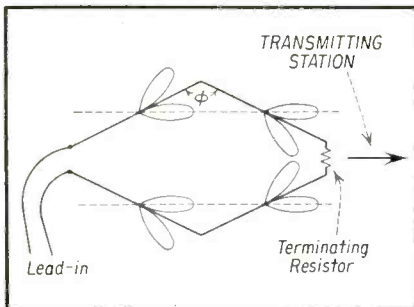
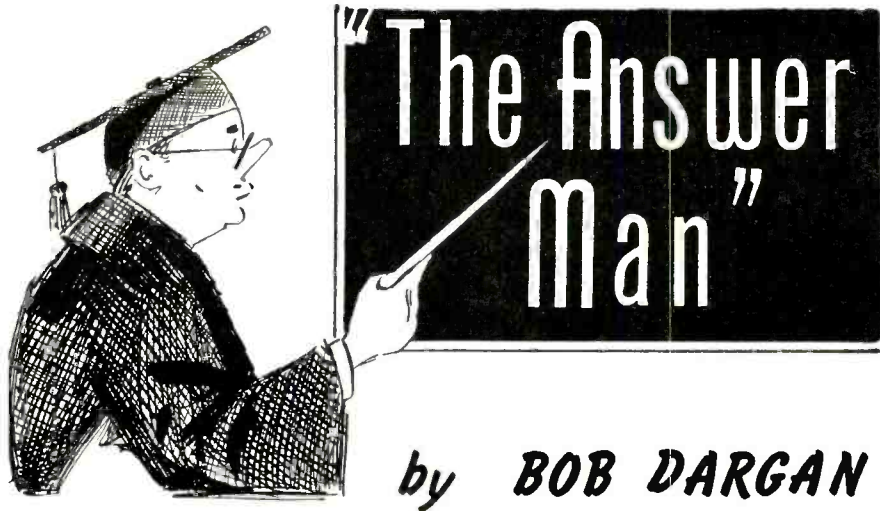

Fig. 1—Four lobes rhombic antenna.



Do you have a vexing problem pertaining to the repair of some TV set? If so, send it in to the Answer Man, care of this magazine. All inquiries acknowledged and answered.

seen that this length can be any multiple of the wavelength desired to be received. The limiting factor here is the practical length that can be strung. Once the length of the leg has been decided upon, and this generally does not exceed ten wavelengths, the other variables become fixed. The angle be-

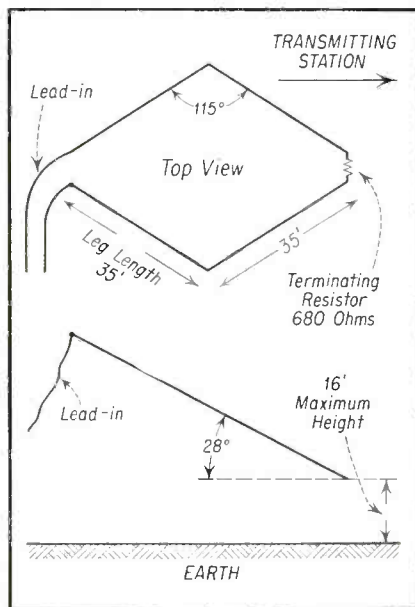

Fig. 2 — Dimensions for constructing rhombic antenna for channel 5.

tween the legs and the slope angle is then designated and fixed as well as the possible gain.

In the design of this particular rhombic as shown in Fig. 2 a leg length of three wavelengths has been

chosen as this is the largest that can fit in the area specified. Using the formula, whereby wavelength in feet equals 936 divided by the frequency in megacycles it is found that for Channel 5 which has a frequency band of 76 to 82 megacycles the approximate corresponding wavelength is about 11.6 feet.

A leg length of three wavelengths will just fit within the small side dimension of the property. This is therefore three times 11.6 feet or about 35 feet for each leg of the diamond. This leg length specifies the angle of the legs at about 115 degrees and the slope angle at about 28 degrees.

Naturally four poles will be required, one for the support of each point of the diamond. A terminating resistor must be employed of about 680 ohms. Of course the terminating resistor can be divided in half and the junction of the two resistors grounded which will then balance the arrangement to ground. The wire used to form the diamond can be number 12 size or larger. The matching stub can be made by taking two pieces of number 12 wire and connecting them at the rhombic with a separation of about 2½ inches. This stub can be tapered so that at one half wavelength from the antenna it will be about the separation of the leads in the 300 ohm twinex. The length of the one-half wave stub is about 5.8 feet.

Philco 51-T1606—pix pulls

Dear Sir:

Can you advise me about a Philco 51-T1606, code 122 TV set? I am having trouble with the picture pulling

such as a man's nose will pull away out, or his eyes or stomach. Any small section of the picture pulls. I have changed the tubes in the horizontal section.

H. E. R.
Havertown, Pa.

Dear H. E. R.:

The trouble you describe is caused by video information passing through the sync clipper stages and therefore modulating the horizontal oscillator so that portions of the picture are pulled. The sync circuits are not performing their designed function of separating the signal voltage and passing only the sync pulses on to lock in the horizontal and vertical oscillators. This can be caused by two reasons: either the grid bias or the plate voltage has changed value.

As in all cases of sync trouble the first check is the tubes and in this case the most common offender is the 12AV7 sync separator tube. This tube should be checked by substitution with a good tube.

Following this step if the trouble is still present the condensers feeding the information into the grid of the 12AV7 sync separator tube should be changed. This condenser is .022 μ f and is shown in Fig. 3. A small intermittent leak in this condenser will be difficult to find. This condenser can cause this type of difficulty very easily as it is in the stage in which a great deal of the sync clipping is performed. It will probably be less expensive to change the condenser than to spend time trying to determine if the condenser is intermittent.

There is one other condenser of this same type that should also be changed and that is the .015 μ f condenser that couples the signal from the noise gate circuit. It may pay to change this condenser also as a matter of course.

From the plate of the 2nd sync separator

tube to the grid a 6.8 megohm resistor is connected which can cause this trouble if it has changed value and therefore this resistor should be checked by substitution.

Portable Field Strength Meter

Dear Answer Man:

Would you please send me information about converting a 7" portable television receiver into a field strength meter? If I am not mistaken I have read an article to that effect in one of your magazines at one time, but I have checked thru all issues from Dec. 1951 thru the latest issue and I can't seem to find the article.

Any information you can give me will be greatly appreciated.

M. E.
Rossmoynne, Ohio

Dear M. E.:

In the October, 1953 issue of *Radio Television Service Dealer* there is an excellent article dealing with the Philco field strength meter. Otherwise, there has been no other article in this magazine covering field strength meters or converting a 7 inch portable television receiver into a field strength meter.

A 7 inch portable TV receiver can easily be used to obtain a relative signal strength indication by measuring the *age* voltage. The *dc* voltmeter is connected to the *age* line as in Fig. 4 and the negative voltage generated due to the signal is the relative indication of the strength of the signal.

Of course the TV receiver can be calibrated with a generator that has provisions for indicating the amount of signal output voltage. The calibration can also be accomplished by measuring the signal strength with a field strength meter and then drawing up a chart that will show microvolts field strength obtained with the field strength meter versus *age* voltage obtained on the TV

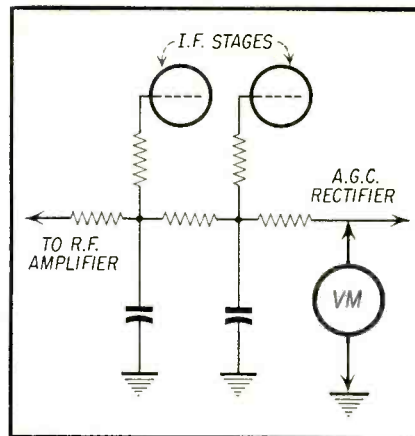

Fig. 4—The AGC voltage is used to indicate signal strength.

receiver. There is one disadvantage to this method, and that is the negative *dc* voltage will be a rather rough indication because a change in signal strength of several thousand microvolts will not cause an appreciable change in *age* voltage. A circuit can be added to the receiver so that the negative *dc* voltage when applied to the tube grid will allow plate current to flow. In the plate circuit the current can pass through the meter which will reveal an indication corresponding to the negative grid voltage. Thus a high impedance circuit can be achieved and by

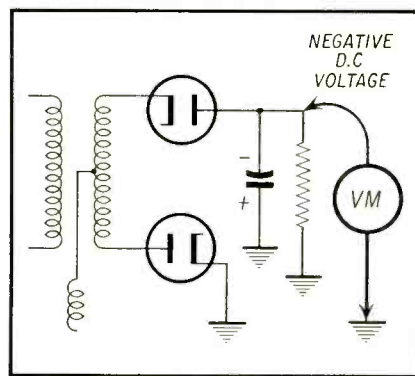

Fig. 5—The FM detector output is used to indicate signal strength.

the choice of a good tube the meter will indicate small changes in plate current due to different *age* voltages. The small changes of negative *age* voltage will provide a better indication and the meter in the plate circuit can then be calibrated in microvolts.

There is one other way in which a comparative voltage indication can be obtained easily. This is by making use of the FM detector voltage which can be made to vary directly with signal strength. The advantage of using this voltage is that a wider range of voltages will be obtained as the result of the

[Continued on page 61]

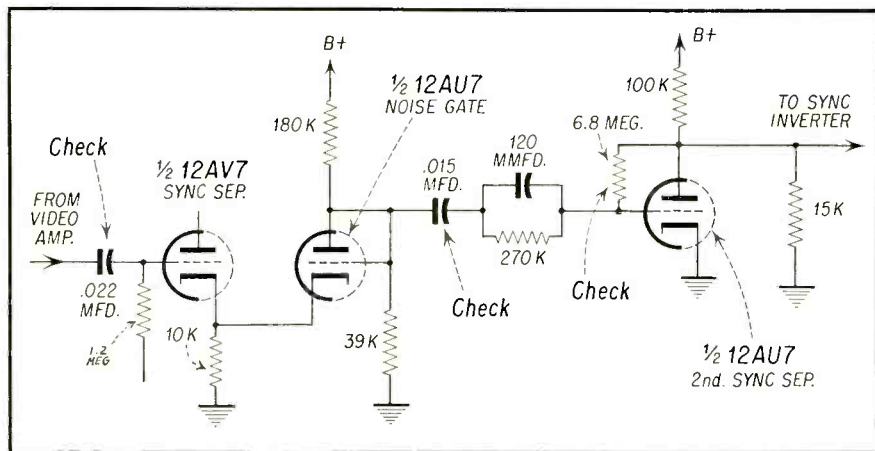

Fig. 3 — Sync circuits, Philco 51-T1606 chassis showing points to be checked to correct pix pull.

NOW! Use Your Present Signal Generator

NEW! *For UHF!*

PHILCO Signal Generator Adapter

(VHF to UHF)



Individually Calibrated For Extreme Accuracy

Now produce UHF signals for TV receiver tests at a fraction of the cost of a UHF generator. Individual calibration guarantees extreme accuracy of UHF frequency. Any VHF signal generator output at 60 MC is converted by the PHILCO Model G-8000-C to UHF. The VHF sweep or marker signal beats against the UHF oscillator, producing UHF signals with the same characteristics as the VHF input signal. It's economical . . . it's a PHILCO exclusive!

VHF INPUT
60 MC

UHF OUTPUT
SIGNAL

5" High Gain Oscilloscope Model S-8202.

Gives rugged, general purpose performance. 60 CPS phasing of sweep generator presentations. Wide sweep range (up to 100KC) gives extreme flexibility in sweep circuit trouble shooting.

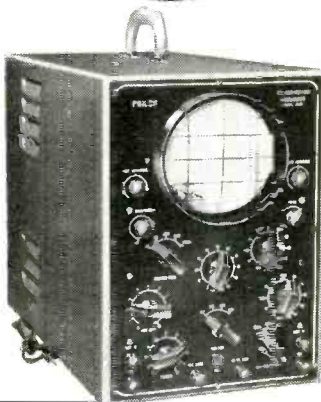

Look at These Philco Features . . .

- 1 The VHF signal generator output attenuator controls the UHF output signal level.
- 2 Precision Vernier Dial for accurate re-settings.
- 3 Each unit is hand calibrated.
- 4 Functions as an external UHF converter by connecting UHF antenna transmission line to generator's output terminal and connecting lead to TV receiver tuned to 60 MC Channel 3.
- 5 High UHF levels, excellent stability, no drift.

**AVAILABLE THROUGH YOUR PHILCO DISTRIBUTOR
ON A NEW SPECIAL PAYMENT PLAN**



Take advantage of the great
SHARE and PROFIT Program

on Philco Receiving Tubes
Parts and Accessories

NOW AT YOUR PHILCO DISTRIBUTOR



New



Products

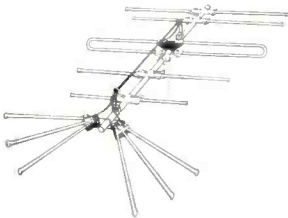

Snyder's New Conical-Yagi

Snyder's new conical-yagi combination TV antenna (the "AX-670") is designed for ultra-fringe area reception and may be used for V VHF and UHF when stacked with a UHF antenna. Recommended stacking is Snyder model UHF-6 Corner Reflector together with crossover network. Literature on the AX-670 may be obtained by writing to Dick Morris, Snyder Mfg. Co., Philadelphia 40, Pa.



Stancor Flybacks

These exact replacement flybacks, A-8227, A-8228, A-8229, cover almost 90% of all Sylvania production up to 1953. They are supplied as coil and core for installation to the original brackets which are a permanent part of the chassis. Stancor Bulletin 478 lists over 170 Sylvania models and chassis using these transformers. Available from Chicago Standard Transformer Corp., Standard Division, Addison and Elston, Chicago 18, Ill.

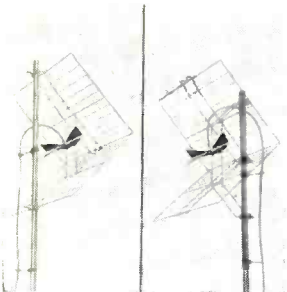

Channel Master Corner Reflectors

Model No. 409 can be adapted to any UHF installation with or without VHF. It installs instantly on any type structure and has high gain across the entire UHF band. The twin corner reflector, Model No. 406 can now be stacked because of a new Z-matching system with high gain over a greater band width than is possible with conventional stacking rods. (Channel Master Corp., Ellenville, N. Y.)

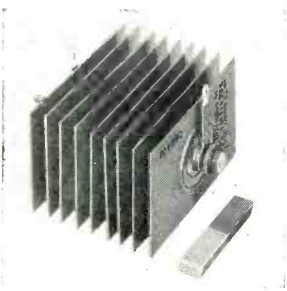

Color TV Rectifiers

I.R.C. announces a series of selenium rectifier stacks for color TV sets. The photo shows Type RS609S which is rated for 195 volts RMS input and 600 ma output. Bulletin ER-178 Supplement covers electrical and mechanical specifications of all the units in this series. Write to International Rectifier Corp., 1521 E. Grand Ave., El Segundo, Calif.

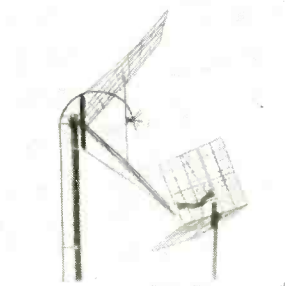

JFD "Golden Rig"

JFD announces the new "Golden Rig" Corner Reflector for UHF channels 14 to 83 in fringe areas. Designated Model UHF415, the "Golden Rig" is braced four ways to eliminate ghost-producing vibrations. Pre-assembled construction permits 35-second average installation time. The "Golden Rig" is gold colored due to JFD "Bronzidite" anti-corrosion plating. (JFD Mfg. Co., Inc., Bklyn, N. Y.)

Bogen "G-Line" for U.H.F.

The "G-Line," a single-wire transmission line consists of an impedance-matching unit at each end called "Launchers" which match the usual 300-ohm balanced line connection at the antenna to the single wire which carries the signal to the TV set. Near the TV set, usually at the window a second launcher matches the single wire to a short length of 300-ohm twin line which is attached to the receiver. The "G-Line" will greatly extend the range of UHF television because it exhibits unusually-low losses. It has very-low radiation and conversely it is not susceptible to noise. Swinging of the line does not affect the signal so intermediate supports are unnecessary. Frequencies below 100 mc are attenuated highly because of the design characteristics — this further reduces noise pickup. David Bogen Co., Inc., 29 Ninth Avenue, New York 14, N. Y.

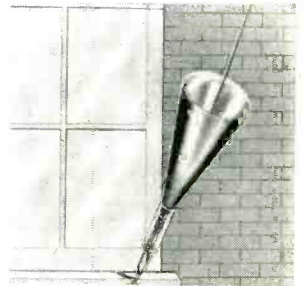
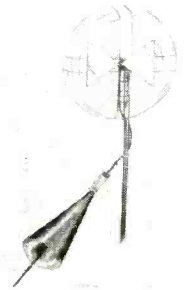

White-Dot Generator For Color TV

The Model 650C Hickock Universal Video Generator provides accurate registration adjustment of the three color guns in the tube of new color TV receivers, as well as the means for other adjustments in color and black-and-white TV. Complete details are available from The Hickock Electrical Instrument Co., 10533 Dupont Ave., Cleveland 8, Ohio.

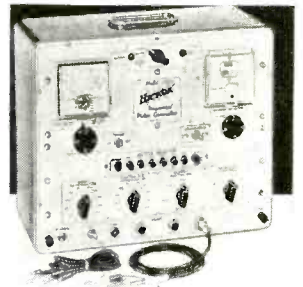

TV Antenna "Orienter"

As an aid in TV installation, the "Orienter" permits the single transmission line to carry the signal to the TV set and return the video signal whose strength can then be read on an ordinary volt-ohmmeter. Requires no power and is easy to use. Descriptive folder, Form 903, is available from Mosley Electronics, Inc., 8622 St. Charles Rock Road, St. Louis 14, Missouri.

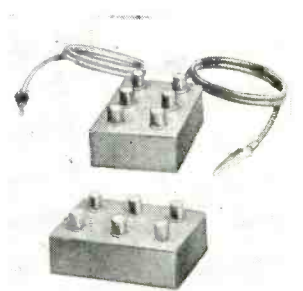

Perma-Power Horiz. Bar Generator

The new Horizontal Bar Generator provides a series of equally spaced horizontal lines to indicate picture frame linearity. The "HBG" provides precise setting of yoke, accurate positioning of focus coil or magnet and quick adjustment of vertical linearity, height and centering. For details, contact the Perma-Power Co., 4727 North Damen Ave., Chicago 25, Ill.



Another Outstanding Service Success Story...

with **SYLVANIA!**

From Basement Repair Shop
to prosperous Service Business...
featuring Sylvania Tubes, Parts
and Promotion Programs!

The steady and substantial growth of the Ball Television and Radio Service, from basement shop to the large handsome brick building, shown below, is a tribute to the fair practices and alert policies of the owner, Mr. Ted Ball.

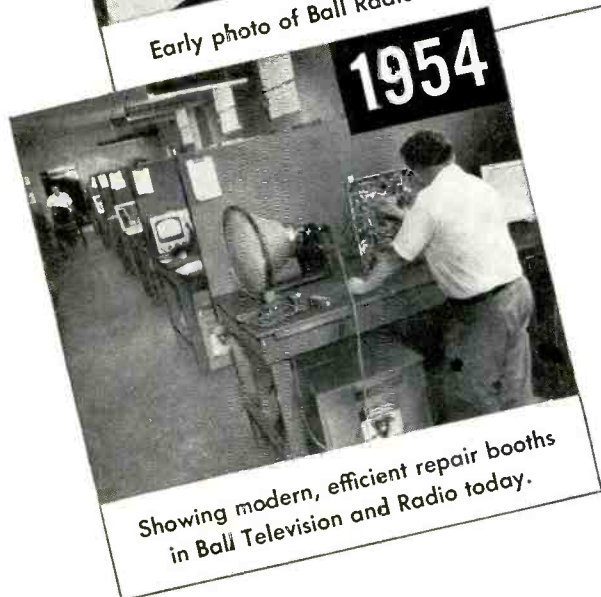

Says Mr. Ball: "My men are as skilled and experienced as any you'll find anywhere, and each is instructed to do the best job possible with the best of parts... and that, of course, includes Sylvania Tubes."

Ted Ball is another important Radio-TV Service Manager that appreciates the quality performance, dependability, and the nation-wide high reputation of Sylvania products.

Mr. Ball also knows about the business-boosting power of Sylvania's promotion and display offers. Find out how Sylvania can step up *your* business. Your friendly Sylvania Distributor is ready and anxious to give you full cooperation. Call him today.

SYLVANIA

Sylvania Electric Products Inc., 1740 Broadway, New York 19, N. Y.



In Canada: Sylvania Electric (Canada) Ltd., University
Tower Bldg. St. Catherine St., Montreal, P. Q.

LIGHTING • RADIO • ELECTRONICS • TELEVISION

ASSOCIATION

{from page 17}

CRTSA (Phila.)

The Council of Radio and Television Service Associations has elected Albert Haas, of the Television Contractors Association, as President. Mr. Haas succeeds Samuel Brenner, President of the Philadelphia Radio Servicemen's Association, the group's temporary President.

Other officers, elected to serve one year terms, were: Vice-President, Ray

Cherrill of the Northeast Television Service Dealers Association; Secretary, William Wile, Jr. of the Television Service Dealers Association of Philadelphia; Treasurer, Louis J. Smith of the Television Service Dealers Association.

Mr. Haas reviewed the progress made by the Council, especially its public relations program over station WFIL and WFIL-TV here. Council is in process of completing arrangements with TV Guide magazine in promoting the Council's public relations program. Dave Krantz was named chairman of the Public Relations Committee.

NATESA Awards President's Cup

First annual award of the President's Cup of the National Alliance of Television-Electronics Service Associations goes to Fred Colton, chairman of the board of the Associated Radio & Television Service Dealers of Columbus, Ohio, shown receiving the coveted cup



from Frank J. Moch (right) of Chicago, president of NATESA, at a luncheon in Colton's honor.

The NATESA President's Cup, to be awarded annually hereafter at the Alliance's conventions, was presented to Colton "because of his zealous work on behalf of NATESA during the year 1953, especially for his efforts in the interest of the NATESA annual convention in Chicago," Moch said.

Colton, who is Eastern Central Vice President of NATESA, headed the largest visiting delegation to the Convention.

ARTSD (Columbus, O.)

Installation of new officers for the Associated Radio-Television Service-Dealers of Columbus, Ohio, took place recently. 1954 officers are: President, Fred Oberle; Vice-President, Harry Walcutt; Treasurer, Jim Cumbow; Secretary, Bob Duckworth.



PRE-INVENTORY CLEARANCE-SPECIALS!

G.E. VARIABLE REL. CART. & TONE ARM



Lists at \$19.95. New with GE Var. Rel. cart. & permanent sapphire stylus. For 10" & 12" LP records. Buy for cartridge only..... ea. **\$2.95**

TV TRAP. Lots of 10, 29c ea.



Top quality TV trap. Primarily used as antenna loading coil for GI TV front end tuner. Brass slug tuned. 3/8" dia. coils of 7 turns ea. Ideal for interference trap on your television. 10 for **\$2.90**

WIDTH CONTROL. Lots of 10, 29c ea.

Width control equivalent to RCA #201R2 for use with TV sets using tubes with 30 KV. Anode sup. 10 for **\$2.90**



VERTICAL OUTPUT TRANSFORMER



Philco 32-8154-1 electrically similar to RCA 204D9 Pri. to Sec. turns ratio 10.9 to 1. Size: 2 1/2" x 3 1/4" x 1 1/2". Mtg. ctr. 27%. **79c ea.**

FILTER CHOKE

7 Henry 150 Ma. 200 ohm DC res. Size overall 4" x 2 1/2" x 2". **\$1.29 ea.**



6V VIBRATOR TRANSFORMER



Philco 32-8313-1 6 V. Vibrator transformer 280 V. output @ 60 ma. Size 2 1/2" x 2-3/16" x 2" half shell chassis mtg. **95c ea.**

RELAYS AC 24 V. or 110 V.

110 Volt AC relay with two sets of SPDT contacts and one set of SPST contacts. 24 Volt AC relay with 4 SPST contacts. Mfg. by Leach. **79c Choice ea.**

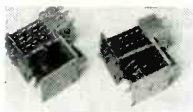

DC HERMETICALLY SEALED RELAY



Potter Brumfield MT2128-5 relay. 365 ohm coil pull in at 12-15 volts DC. 4 SPDT twin palladium contacts hermetically sealed in the 31 can with 3 stud only and 14 pin solder terminal header. Relay tested at 100 vibration at 5-60 CPS. **79c Brand new ea.**

GUY WIRE—5,000' SPOOL— \$1.95 PER 1,000'

Extra strong snarl, and rust resistant cable. Originally used for aircraft control cable, has 21 strands alloy brass plated to resist corrosion. 350 lbs. breaking test. OD 3/64". Ideal TV Antenna guy wire. Wound on Wood & metal spool of 5,000' length. Per spool **\$9.75**



RCA TV IF XFORMER. Lots of 10, 29c ea.



RCA Part #71507 TV IF transformer 21 Mc. Used as 1st IF in many popular TV receivers such as Radio Craftsman, TRAD, etc. 10 for **\$2.90**

ZENITH COBRA ADAPTER

Play 33-1/3 & 45 RPM records on your old 78 rpm player. Complete with Cobra cartridge & adapter wire & plug. Only 97 in our inventory. New, boxed. **\$2.95 ea.**



AN SWITCHES



AN switches similar to one pictured in DPDT, SPST, DPST, etc. momentary and regular types, some new, some used. Hi current capacity. Misc. assortment cannot be split. 10 for **\$2.95**

12 V. VIBRATOR TRANSFORMER

300 V. @ 65 Ma. output. Ideal for your new car receivers. High quality type transformer designed originally for aircraft. Size overall 2 1/2" x 2 1/2" x 2 1/2". **95c ea.**



CH PRESSURE SWITCH



Controls pressure within any setting from 50-250 lbs./sq. in. with a differential of 20-75 lb./sq. in. Use for any motor up to 1 HP. @ 110 V. or 1.5 HP. @ 220 V. AC or DC. Has also manually operated push-pull on-off switch Cutler Hammer. Bulletin 9505. BRAND **\$1.75 NEW ea.**

110 V AC SOLENOID

New 110 V. AC solenoids with 3/8" dia. steel plunger with 3/8" travel. The terrific pull on this plunger makes it ideal for door locking mechanisms. Only 200 in our inventory..... ea. **95c**



All Merchandise Guaranteed. If not satisfied, return prepaid & cash will be refunded.

ESSE RADIO CO. 40 WEST SOUTH STREET INDIANAPOLIS 25, IND.

SERVICE MAN'S DREAM

... the most compact TV set ever made!

(Yet easily accessible)

CROSLLEY SUPER-V IS DRAMATICALLY DIFFERENT INSIDE

Here's one set that is designed with the TV service man in mind. Removing the back of the Super-V plainly exposes all secondary controls and every tube in the set. And as you know, 9 out of 10 service calls merely require the change of a tube.

For any other service job, it's as simple as opening the hood of your car, no chassis to pull, just slide the entire Super-V cabinet up off the chassis. More repairs can be made in the home. You can get at the works immediately and without obstruction, service the Super-V in lots less time than you'd spend on an ordinary set.

The Super-V is a cinch to install. It's compact, weighs only 53 pounds. And in many places, you'll find its built-in antenna is all you need for perfect reception. Service men who've seen the Super-V call it the greatest forward step ever taken in TV chassis design.

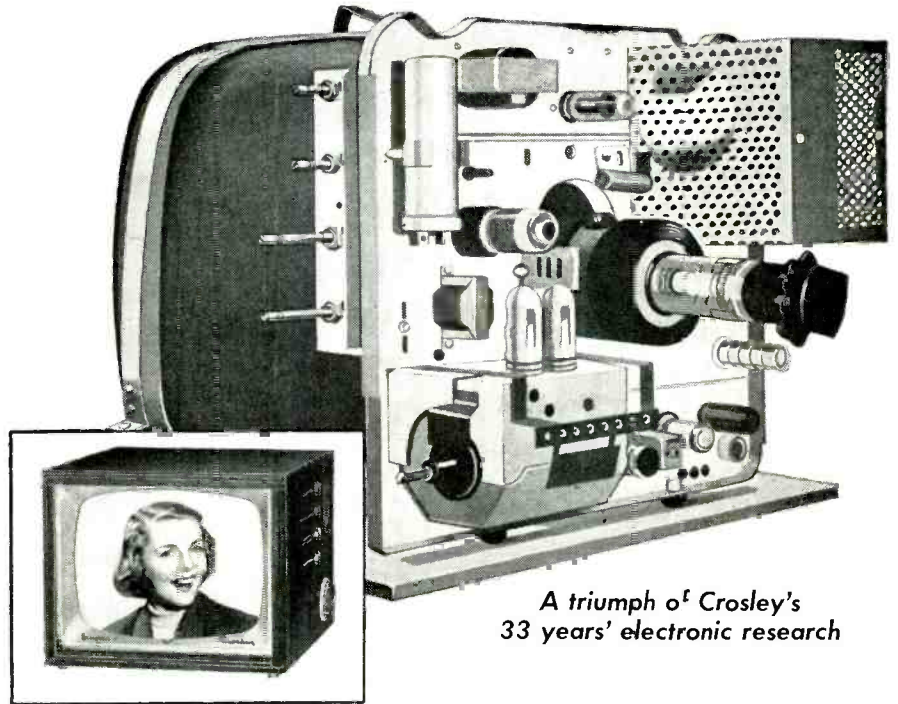

A triumph of Crosley's
33 years' electronic research

CROSLLEY

17-INCH

Super-V

- TAKES UP TO $\frac{1}{3}$ LESS SPACE THAN OTHER 17" TVs—FITS WHERE OTHER SETS WON'T
- FRONT ALL SCREEN—CONTROLS ON THE SIDE
- CHOICE OF THREE FINISHES (MAHOGANY, WALNUT, BLOND)
- FULL-YEAR WARRANTY ON PICTURE TUBE—90 DAYS ON CHASSIS PARTS
- ROLLING OFF CROSLLEY PRODUCTION LINE IN VOLUME—PRICED FOR PROFIT AND ACTION NOW!

FOR MORE INFORMATION ON THE SUPER-V
CALL YOUR CROSLLEY DISTRIBUTOR NOW!

Suggested retail prices start at

\$ **139** ⁹⁵
coast to coast

(Walnut-finished)

You can **SELL** them better on a **CROSLLEY**

Division **AVCO** General
33, Ohio

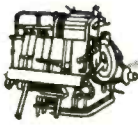

JUST OFF THE PRESS!

1954 CLAROSTAT CATALOG

Packed with data on standard radio and electronic controls and resistors. Concise descriptions . . . photo illustrations . . . dimensional drawings . . . listings . . . prices . . . standard packings. Also the new C-Line and other "industrial" controls.

For the latest in controls and resistors, be sure to include this latest literature in your data file.



Ask your Clarostat distributor for your copy of Clarostat Catalog No. 54. Or write us.



Controls and Resistors

CLAROSTAT MFG. CO., INC., DOVER, N. H.

In Canada: CANADIAN MARCONI CO., LTD., Toronto, Ont.

South River NEWS

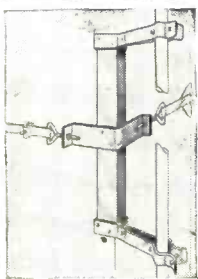

**CHIMNEY
UNI-MOUNT
Model
UM-1**

Riveted, heavy-gauge, galv. steel with wide, flared-lip, snap-in mast holders. 18" spacing between mast holders for firm support. Available with one heavy-gauge stainless steel strap, Kwik-Klip banding closure and Chimney Corner Guards.

Model UM-2 . . . same as UM-1 with 2 heavy-gauge stainless steel straps.

Send for catalog

In Canada

A. T. R. Armstrong Ltd., Toronto

**SOUTH RIVER METAL
PRODUCTS CO., INC.
SOUTH RIVER, N. J.**

PIONEER AND OUTSTANDING PRODUCER
OF FINEST LINE OF ANTENNA MOUNTS

HICKOK

Model 665

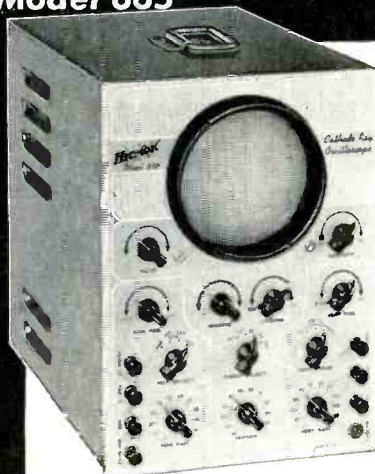

**TV TECHNICIANS'
5" SCOPE**

- Frequency: 0.5 cycles to 700 KC.
- Push-Pull Amplifier
- Sensitivity: 20 M.V. per inch.
- Excellent Square Wave Response.
- Stable, dependable, built-in trace.
- Write for technical details . . .

THE HICKOK ELECTRICAL INSTRUMENT CO.

10533 Doront Ave., Cleveland 8, Ohio

VIDEO AMPLIFIERS

[from page 29]

high-frequency tests, simply because the top of the reproduced square wave then represents such a small section of the tilted waveform, that a cursory glance leads to the conclusion that tilt is absent.

These are the chief reasons why video-amplifier tests must be carried out at a minimum of two square-wave frequencies, such as 60 cps, and 100 kcs. It is understood that in tests at any frequency, the rise time of the square-wave generator must be faster than the rise time of the video amplifier. In practical work, this means that the generator should have a rise time of not more than 0.05 microsecond. All good service generators meet the risetime requirement.

It is usually considered that a video amplifier which develops more than 10% overshoot at a square-wave repetition rate of 100 kc is unsuitable for good-quality picture reproduction. When two video stages are cascaded, the overshoots are additive, and the overshoot of each stage must be held to 5%. It sometimes happens that the first stage develops overshoot, while the second stage develops a rounded corner; in such case, the combined response is that of a notched corner, as seen in Fig. 7.

Horizontal Pull Can Be Caused by Cross-Talk of Video Amplifier With Sweep Circuit

Horizontal pull is sometimes observed in the picture when the cage is open to the high-voltage compartment, which permits the strong fields from the sweep-circuit network to escape and energize the grid or cathode leads of the picture tube. The sweep-circuit voltages are picked up by stray coupling, enter the output circuit of the video amplifier, and thence travel to the sync circuits, where the spurious waveforms in the phase-detector circuit cause horizontal pull.

Picture hooking is a closely related type of trouble, and consists of a displacement of the top of the picture (not the raster), and is usually caused by overload in the video amplifier, with resulting sync compression. In consequence, the sync circuits are forced to operate with subnormal sync-voltage, as well as being subjected in many cases to spurious transients from clipped pedestals and camera-signal peaks, as well.

In the majority of cases, this difficulty can be overcome by reducing the signal to the video amplifier by changing the *age* threshold level. However,

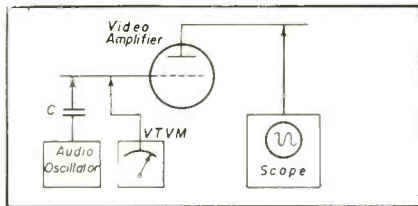

Fig. 8—To check operating point of video amplifier tube, apply audio signal to grid via blocking condenser. Advance audio oscillator output until distortion appears in display. Adjust operating point for maximum undistorted output.

in some cases, the signal level from the antenna may be uncontrollable. Pads should be switched into the *hf* input circuit in such case, to attenuate the signal to a usable level. If printed-circuit H pads are used, they can be permanently installed inside the tuner turret, and automatically switched in or out, as required.

Overload Distortion in Video Amplifier Must Be Checked with Audio Oscillator

It is apparent that the overload-voltage point of a video amplifier is a matter of some concern, not only from the standpoint of obtaining adequate picture contrast without tonal distortion in the gray ranges, but also to avoid certain types of sync trouble. It would be convenient if an overload check could be made as part of the square-wave test, or as part of a sweep-frequency test. However, due to the somewhat limited output of most square-wave and sweep-frequency generators, an audio oscillator is usually found better adapted to this test, as shown in Fig. 8.

A picture detector develops from 1 to 2 peak-to-peak volts output, in normal operation. The output from the audio oscillator can be readily measured with the aid of a peak-to-peak indicating VTVM, as shown in Fig. 8, and the output waveform should not show distortion when this value of input voltage is utilized.

It is just as important that when the video amplifier does finally drive into overload, that it do so in a symmetrical manner: if the waveform becomes flattened on the bottom, for example, but not on the top, the full signal-handling capability of the video amplifier is not being realized. The grid bias should be adjusted so that flattening appears simultaneously at the top and bottom of the reproduced sine wave, when driving into overload.

**SUPPORT THE
RED CROSS**

ANSWER MAN

[from page 54]

different signals. The *age* system can be switched and grounded so that it does not limit or govern the amplification of the FM signal. The output voltage of the FM detector can then be used as the signal strength indication as shown in Fig. 5. The advantage of using this voltage is that larger voltages are provided that will reveal more indication of different signal levels.

If only a field strength meter is used to measure signal strength there is no means of determining the quality of

the picture. Standing waves on the antenna transmission line, noise and ghosts can cause a false indication as to the correct antenna orientation. Therefore it is very desirable to view the picture at the same time as measuring the signal strength. A 7 inch portable TV receiver converted to function as a field strength meter is a very desirable piece of equipment. It can be transported easily to the roof where the orientation is being performed and the picture watched as the job is being done. At the receiver the amount of pickup in the antenna lead-in can be determined by disconnecting the antenna on the roof and measuring the signal at the receiver end.

PROFIT-WISE TV DEALERS

DON'T—Send 2 Men To Do A 1 Man Installation Job!

DON'T—Risk Costly Equipment On A Roof-top!

DO—Send 1 Man, A Pocket Meter* and

The NEW MOSLEY "ORIENTOR"

for FAST, ACCURATE ORIENTATION OF ANY UHF/VHF TELEVISION ANTENNA

If TV antenna orientation is a problem in your area, here is a piece of equipment that pays for itself every day it is used. It's the new MOSLEY "ORIENTOR"—a simple-to-use, compact and low cost device that enables the installer on the roof to know, instantly and unerringly, just what is occurring in the TV set.

HERE'S HOW THE "ORIENTOR" SAVES TIME AND MONEY...

- ✓ Permits ONE MAN To Do The Job Formerly Requiring Two!
- ✓ Makes Possible Use Of Low Cost, Portable VOM* To Read Relative Video Signal Strength!
- ✓ Eliminates Need For Extra Wires From Set To Roof!
- ✓ Use To Determine Best Lateral, Vertical and Directional Orientation Of Antenna!
- ✓ Aids In Determining If Transmission Line Is Functioning Properly!

Try it on your next installation job. You'll quickly see why the MOSLEY "ORIENTOR" has been termed "The TV Installers' Handiest Tool Since The Step-ladder...!"

THE NEW MOSLEY "ORIENTOR", includes dual isolation network units, ready-to-use leads for connecting unit to set without removing chassis and complete instructions. Catalog 903, Dealer Net, just \$7.50. Descriptive Folder, Form 903, Sent Upon Request.

The NEW MOSLEY "ORIENTOR"

Write for your free copy of this catalog.

Mosley Electronics, Inc.

8622
St. Charles Rock Road
St. Louis 14, Missouri

TELEVISION ACCESSORIES
ELECTRONIC COMPONENTS

Service Men!

THE GUARDIAN SERIES 200 RELAY...

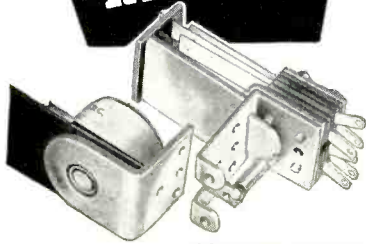

Interchangeable COIL and CONTACT SWITCH ASSEMBLIES Save Time—Cut Costs!

★ Coil assembly includes coil and field piece. Contact assembly consists of switch blades, armature, return spring and mounting bracket. Standard and Midget contact assemblies in either S.P.D.T. or D.P.D.T. are interchangeable and can be used with any of 13 coils described below.

CONTACT SWITCH ASSEMBLIES

CAT. NO.	TYPE	AMPS	COMBINATION
200-1	Standard	8 amps	Single Pole Double Throw
200-2	Standard	8 amps	Double Pole Double Throw
200-3	Standard Contact Switch Parts Kit with complete assembly and wiring details		
200-4	Standard	12.5 amps	Double Pole Double Throw
200-5	Standard	8 amps	Four Pole Double Throw
200-M1	Midget	8 amps	Single Pole Double Throw
200-M2	Midget	8 amps	Double Pole Double Throw
200-M3	Midget Contact Switch Parts Kit with complete assembly and wiring details.		

13 COILS ASSEMBLIES

A.C. COILS*		D.C. COILS	
CAT. NO.	VOLTS	CAT. NO.	VOLTS
200-6A	6 A.C.	200-6D	6 D.C.
200-12A	12 A.C.	200-12D	12 D.C.
200-24A	24 A.C.	200-24D	24 D.C.
200-115A	115 A.C.	200-32D	32 D.C.
		200-110D	110 D.C.
		200-5000D	for current type

*All A. C. coils available in 25 and 60 cycles

GUARDIAN ELECTRIC

1606-C W. WALNUT STREET CHICAGO 12, ILLINOIS
A COMPLETE LINE OF RELAYS SERVING THE RADIO INDUSTRY

for like - new performance

replace with original ROGERS full-focus deflection yokes

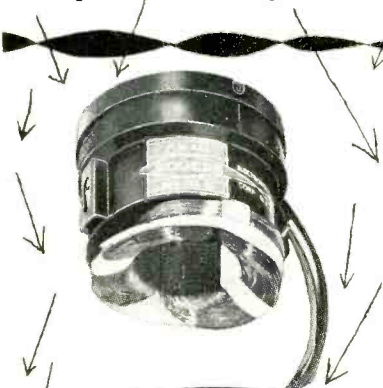

Since most of the better TV sets are made with ROGERS Deflection Yokes, this same top quality yoke should be used for replacement. With over 25 years of electronic know-how, ROGERS Precision Engineered Products make TV sets perform like new.

ROGERS Full-Focus Deflection Yoke assures double brilliance with knife-edge sharpness over the entire screen. Each ROGERS yoke—precision tested for perfect focus—is designed for peak performance and extra long life.

"the eye tells why"

packaged individually—attractively

ROGERS ELECTRONIC CORP. 43-49 Bleecker St. New York 12, N. Y.

FREE: Send for new catalog "B" listing TV set models and ROGERS Yoke and Flyback replacements, or see your jobber.

MOVING?

When you change your address please notify our circulation department as soon as possible. This is to your advantage, since it takes approximately 5 weeks to have your stencil changed and duplicate copies cannot be sent. Be sure to give your old as well as your new address.

RADIO-TV SERVICE DEALER 67 West 44th St. New York 36, N. Y.

ONLY \$495
Pd. or C.O.D. + Chgs. L.



THE NEW TV DYNATRACER

- TRACES TV SIGNALS AND VOLTAGES
- LOCATES DEFECTIVE COMPONENTS
- REQUIRES NO ADDITIONAL EQUIPMENT

This sensationally new piece of test equipment is ideal for trouble-shooting television sets in the home or in the shop. The "DYNATRACER" will outperform more expensive testers and should pay for itself on the very first repair.

A Must for Every TV Technician
SPECIFICATIONS: The "DYNATRACER" is a self-powered quality test instrument designed to trace TV signals through any Video, Sound, Sync, A.F.C., Horizontal or Vertical Sweep Circuit—will isolate trouble to a stage or component.

ADDED FEATURE: The "DYNATRACER" will also trace voltages (50/500 V. AC/DC) and instantly locate open, shorted, intermittent or leaky (up to 20 MEGOHMS) capacitors, resistors, coils, XFormers, etc.

Instruction and Trouble-Shooting Book Enclosed
10 DAY MONEY-BACK GUARANTEE
Cut out advertisement, attach name and address with \$5.00 bill, check or money order and mail to

Century ELECTRONICS CO.

8509-21st Ave., Dept. 403, Brooklyn 14, N. Y.

WORK BENCH

[from page 34]

setting of the contrast control, as the vertical sync held momentarily, the vertical sync and blanking pulses were visible beneath the picture portion.

First we changed all the tubes that affected the vertical sync, namely 6SL7 (V20) 12 SN7 (V10). This did not cure the trouble. We then took a waveform check with the scope at point "Z" and found the vertical sync pulse very weak. All components in the integrating network were found to be functioning properly. We then measured voltages at the 6SL7 sync amp and clipper tube. The voltages were also correct. As the sync pulses were taken off at the plate of V8B, 12AT7, there was a possibility of a defective CRT. A new pix tube was substituted, but this did not solve the problem.

We then studied the diagram in order to find a component in the video amp that might squash the vertical sync pulses without affecting pix quality and horizontal sync. There was a possibility that C257, 10 mf, could cause the trouble. Sure enough, on substituting a new 10 mf condenser, the vertical sync immediately popped in and that was that. In checking the bad one, we found it to be open.

In analyzing this problem, we see that C257 is the normal path from B-minus for the vertical sync pulses. With C257 open the 60 cycle vertical sync pulses are forced to choose the comparatively high reactance of C267, .05 mf in parallel with the resistance R280 (18K). Naturally, to the horizontal sync pulses and video information, these components offer low impedance. Thus with C257 open, the remaining impedance is high enough to attenuate the vertical sync pulses.

CIRCUIT COURT

[from page 52]

greater than that of the sync pulse will drive this grid beyond cutoff. When this grid is biased beyond cutoff, the entire plate current is cutoff and the signal on grid #7 of course is not present in the output. In this way, any signal whose amplitude is greater than the sync pulse, which might result in starting the sweep oscillators at the wrong time, is kept out. The result is greater stability of the set in the presence of heavy noise in the signal.

When the set is operated in areas of strong signal strength the possibility of strong noise pick-up is unlikely. Since

in these areas the sync pulse itself might be strong enough to drive the first grid into cutoff, a "local-distance" switch is incorporated. In this set, the switch is called a "Noise Limiter." In local reception areas, this switch is turned to the "off" position. In this position, the first grid of the 6BE6 is grounded and its noise inverting function is eliminated.

The output of the sync stripper stage is fed to the grid of the 12AT7 triode sync clipper. The output of this stage is applied to the horizontal and vertical sweep circuits.

TEST CONNECTORS

[from page 32]

be sure to remove all the clips from the set before returning it to the customer. We have lost two sets of clips in this manner.

Bench Antenna System

A proper antenna system for the service bench should provide two immediate services.

- (1) It should enable rapid connection of the television set to the antenna.
- (2) It should provide for simultaneous operation of at least 3 sets.

When an antenna is available we can expand it with an efficient multi-set antenna coupler. Several units were tried amongst which we selected an

EPCO 4 set coupler Model #TS4. We only use three of the taps for the service bench and the fourth for the shop set. The arrangement for the bench wiring is shown in Fig. 7.

The three antenna plugs are strategically located on the bench. The connecting cables for the sets were made to fit as many types of receivers as possible. Only two special connectors were made. One for the Dumont line includes a matching transformer. This is optional, for very little improvement has been noticed with it. The second is for the early Philco receivers. These are shown in Fig. 8. The connectors most often used are the clothespin connector and a pair of alligator clips which can be connected to almost any receiver.

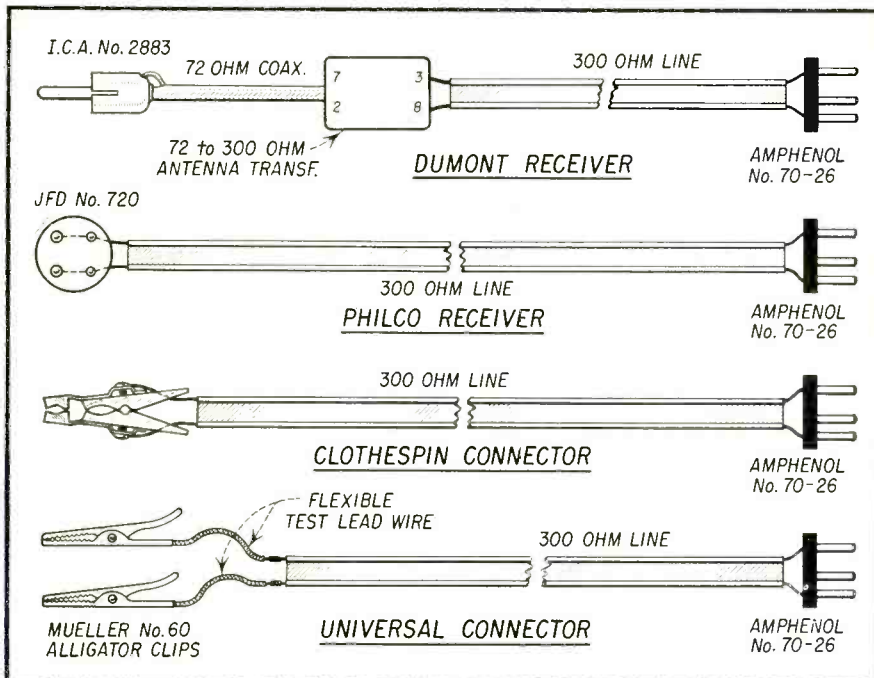

Fig. 8—Universal connectors.

"TIP WRENCH"

GETS NUTS, BOLTS AND SCREWS
Into "Hard-To-Get-At" Places—

HOLDS THEM FIRMLY

WHILE TIGHTENING

Or, "TIP WRENCH" goes in and un-loosens them and takes them OUT. "TIP WRENCH" is built to work in deep. Holds Nuts, Bolts and Screws where fingers can't hold them. With "TIP WRENCH" you can stop fumbling and save valuable minutes in either REPAIR or LINE PRODUCTION WORK . . . In total, it SPEEDS THE JOB—SAVES THE COST MANY TIMES OVER.

"TIP WRENCH"
SOCKET
POCKET-WRENCH

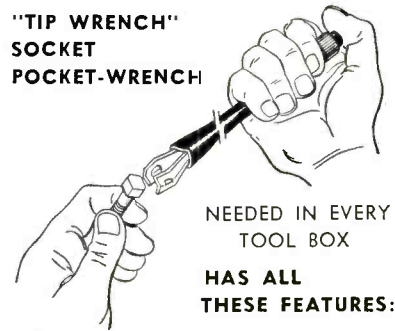

NEEDED IN EVERY
TOOL BOX

HAS ALL
THESE FEATURES:

1. It grips—starts—tightens (or loosens). Just one setting.
2. It GRIPS FIRMLY. A nut or bolt won't slip or turn. For screws, the screw driver blades—one in each jaw—engage the slot in the screw head.
3. By thumb pressure on the plunger head, the Jaws slide out and OPEN, the nut, bolt or screw is inserted, gripped firmly, and the user is ready to go in and complete the job.
4. "TIP WRENCH" is a TOUGH TOOL—for TOUGH JOBS. Built of finest materials and precision manufactured . . . It's RUST PROOF, too.
5. SHOCKPROOF. Has a tough Vinylite insulated shank.
6. Knurled—Hardened Steel Jaws slide in form-fitting barrel which "take the pressure" when tool is in use.
7. Capacity: No. 2 to No. 12 Nut or Screw.

THREE
CONVENIENT
SIZES:

No. 1 Capacity:
No. 2 to No. 8
Nut or Screw . . . 8 1/2"



No. 2 Capacity:
No. 6 to No. 12
Nut or Screw . . . 8 5/8"
No. 3 Capacity:
No. 6 to No. 12
Nut or Screw . . . 4 1/2"

EACH \$1.35

ORDER
A SET

ORDER THROUGH YOUR JOBBER . . .
If he cannot supply immediately, ORDER
DIRECT—but GIVE US YOUR JOBBER'S
NAME . . . SAVE MONEY & TIME—with
"TIP WRENCH." Write for Literature.

Sold on A Money-Back Guarantee

Address: "TIP WRENCH" DIVISION
SMITH HEAT TREATING CO.
5865 Wilmington Ave., Los Angeles 1, Cal.

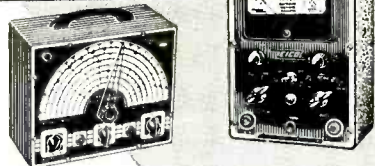

KITS-WIRED INSTRUMENTS

Give you
HIGHEST QUALITY!
SAVE OVER 50%!*

World-famous performance-proved EICO Kits and instruments are designed from YOUR point of view—with the best of circuitry and the finest components. Because you do the easy assembly of EICO Kits in just one evening, you get a fine precision instrument and SAVE 50% and more!

See the complete EICO line of VTVMs, scopes, generators, V-O-Ms, tube testers, battery eliminators, decade boxes, etc., at your local jobber today. Write NOW for FREE Catalog D-3

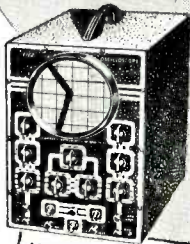

425K 5" PUSH-PULL
SCOPE KIT \$44.95
WIRED \$79.95.



EICO ELECTRONIC INSTRUMENT CO., Inc.
84 WITHERS STREET, BROOKLYN 11, N. Y.

AUDEL'S TV-RADIO SERVICE LIBRARY

HERE IS LATE INFORMATION IN A HANDY FORM FOR RADIO AND TELEVISION REPAIRMEN, SERVICEMEN AND STUDENTS

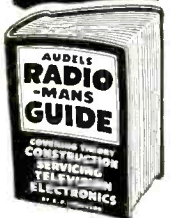

2 VOLS. \$6 COMPLETE \$1 A MONTH.
AUDEL'S T.V.-RADIO SERVICE LIBRARY—Highly Endorsed—1001 Facts—Over 1552 Pages—625 Illustrations, Diagrams of Parts. Presents Important Subjects of Modern Radio, Television, Industrial Electronics, F.M., Public Address Systems, Auto, Marine & Aircraft Radio, Phonograph Pick-Ups, etc.

IT PAYS TO KNOW!

The Basic Principles—Construction—Installation—Operation—Repairs—Trouble Shooting. Shows How to get Sharp, Clear T.V. Pictures. Install Aerials—How to Test, Explains Color Systems, Methods of Conversion, Terms, etc. Includes Ultra High Frequency (U.H.F.)—Valuable for Quick Ready Reference & Home Study. Tells How to Solve T.V. & Radio Troubles—Answers Your Questions.

Get this Information for Yourself.
7 DAY TEST—ASK TO SEE IT!

MAIL ORDER

AUDEL, Publishers, 49 W. 23 St., N.Y. 10, N.Y.
Mail AUDEL'S T.V. RADIO SERVICE LIBRARY 2 Vols. \$6 on 7 days free trial. If O. K. I will remit \$1 in 7 days and \$1 monthly until \$6 is paid. Otherwise I will return them.

Name _____
Address _____
Occupation _____
Employed by _____ **SD**

Advertising Index

Admiral Corporation	13
American Phenolic Corp.	25
Audel Publishers	64
Bussmann Manufacturing Co.	26
CBS-Hytron	7
Century Electronics Co.	62
Channel Master Corp.	4, 5
Chicago Standard Transf. Corp.	17
Clarostat Mfg. Co., Inc.	60
Crosley Div., Avco Mfg. Co.	59
Delco Radio	18
Electronic Instrument Co. Inc. (EICO)	64
Esse Radio Company	58
Guardian Elec. Mfg. Co.	62
Hickok Electrical Instrument Co.	60
Insl-X Sales Company	1
International Resistance Co.	Cover 2
Jensen Industries, Inc.	64
JFD Manufacturing Co., Inc.	10, 11
Mosley Electronics	61
National Union Radio Corp.	23
Noll, Edward M.	64
Philco Corporation	55
Pyramid Electric Company	9
Quam-Nichols Company	12
Radiart Corporation	15
Raytheon Mfg. Company	2
RCA Institutes, Inc.	21
RCA Tube Dept.	Cover 4
Regency	16
Rider, John F. Publisher	51
Rogers Electronic Corp.	62
Sams, Howard W. & Co.	8
Sangamo Electric Company	14
Simpson Electric Company	29
Smith Heat Treating Company	63
Snyder Manufacturing Co.	Cover 3
South River Metal Prods. Co.	60
Sylvania Electric Products, Inc.	57
Waldom Electronics	28



"Oh, boy!
JENSEN NEEDLES"

FREE FREE INFORMATION

EXCEPTIONAL LOW-COST ONE
MEGACYCLE MARKER
GENERATOR

YOU HAVE NEVER HAD SUCH
SIMPLE AND ACCURATE
MARKERS BEFORE

A new single-tube circuit that provides *One Megacycle Markers* over entire I.F. and VHF Ranges along with key calibration markers. System designed by Edward M. Noll and Earl Gross.

Write for information (schematic, construction, how to use system) on this simple, accurate, and most effective marker method. Some initial units to be available in kit form.

EDWARD M. NOLL Box 94, Hatboro, Pa.

Mail free information to:

Name _____
Address _____
City _____ State _____

Snyder

PHILADELPHIA

DIRECTronics build SALES

Fringe Area VHF/UHF
SUPER Directronic®
TV ANTENNA SYSTEM

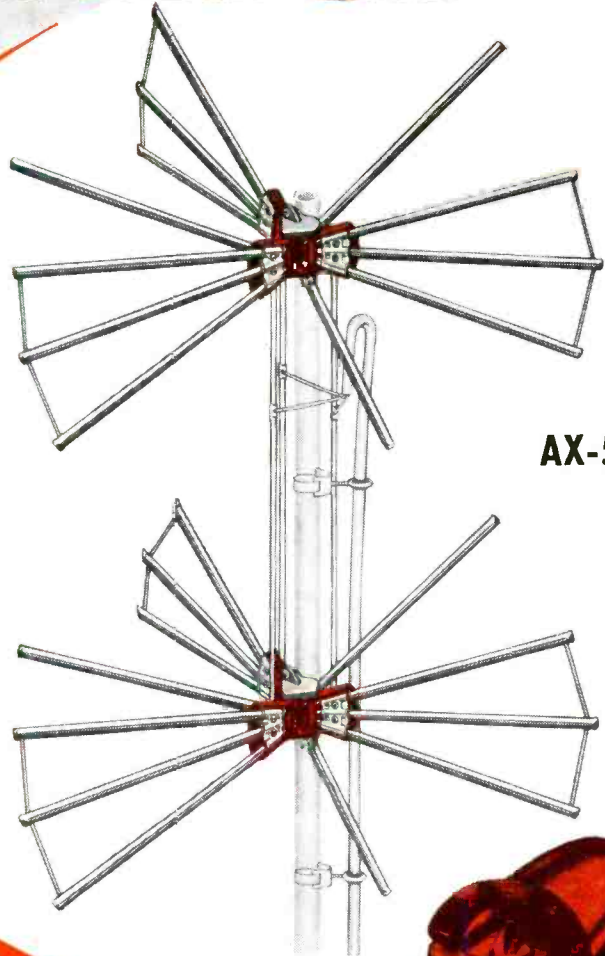

AX-524

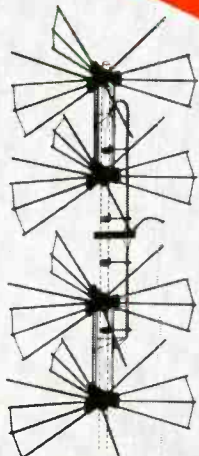

AX-548

ULTRA-FRINGER

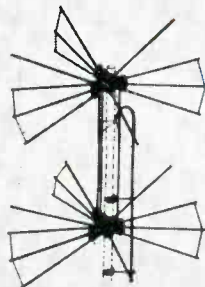

AX-524

FRINGE-AREA

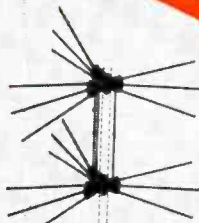

AX-599

FRINGE-AREA



AX-56

METROPOLITAN



Directronic®
6-Position BEAM SELECTOR

SNYDER

SNYDER MFG. CO., PHILADELPHIA 40, U.S.A. • BELLEVUE TUBE MILL, INC., PHILADELPHIA 40, U.S.A.
SNYDER ANTENN-GINEERS LTD., TORONTO, CANADA • WORLD EXPORT: ROBURN AGENCIES, INC., N.Y.

Anthony C. Jankowski
 14119 Jenne Ave.
 Cleveland 10, Ohio

"50,000" "TELL & SELL" CONTEST

400 FABULOUS PRIZES

For Dealers and Servicemen* who use RCA Tubes

1954 Dodge, Deluxe 1/2-Ton Panel Truck
 —complete with "Truck-o-matic" transmission, radio, heater and accessories . . . plus a full set of RCA Test Equipment, aluminum ladder, and winner's business name and address on truck panel.

1st prize
 (your choice)

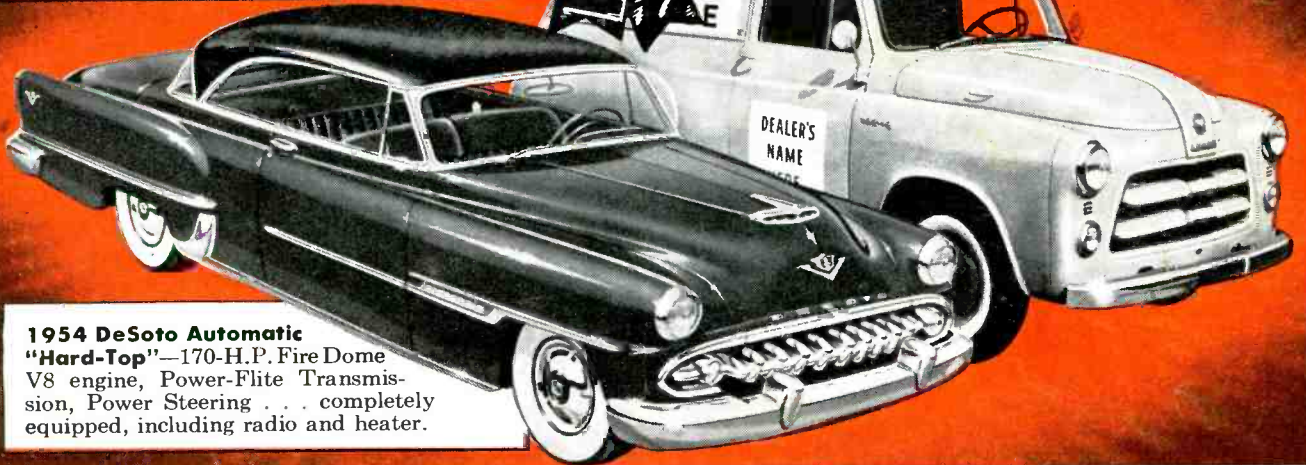

1954 DeSoto Automatic "Hard-Top"—170-H.P. Fire Dome V8 engine, Power-Flite Transmission, Power Steering . . . completely equipped, including radio and heater.

HURRY, HURRY, HURRY . . . contest closes April 30, 1954. See your RCA Distributor Salesman right away, and get your copy of the "clue book" that includes complete contest rules, official entry blank, and clues that will help you win.

* Your RCA Distributor Salesman will be glad to help you . . . because if you win, he wins a duplicate prize!

PLUS Powerful promotion campaign to help you sell more in '54

The RCA "Tell and Sell" campaign was designed to help you sell your service on a local level. Everything you need, from giant illuminated signs and window displays, to a consumer booklet that will give your customers the facts of TV servicing—is available from your RCA Distributor. See him today!

Consumer Booklet

Tells the customer what is needed to bring him expert service. Points you out as "the man who keeps the show going."



1954 RCA BABY DISPLAY



NEW GIANT OUTDOOR SIGN



NEW RCA SERVICE DECAL



RCA DOOR-BELL FLIPPER



DRAMATIC "EDGE LIT" SIGN



RCA TUBE RACK



RADIO CORPORATION of AMERICA
 ELECTRON TUBES
 HARRISON, N. J.