

NOVEMBER, 1953

*Radio-Television*  
**SERVICE  
DEALER**

**TV - AM - FM - SOUND**

*Includes:* **"VIDEO SPEED SERVICING"**  
**"TV FIELD SERVICE"** *Data Sheet Sections*



**The Professional Radio-TVman's Magazine**  
Reaching Every Radio TV Service Firm Owner in the U.S.A.



# FOR ALL OF TODAY'S REPLACEMENT CONTROL NEEDS



IRC Volume Control Plant, Asheville, North Carolina.

Name your requirement; it's in full production now at IRC's new volume control manufacturing plant. From no other single source can you get such wide replacement coverage. And no other replacement control gives you the IRC combination of easy installation and trouble-free performance.

Compare IRC's Replacement Control Line with any other:

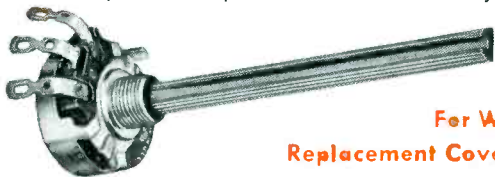

## For Widest Replacement Coverage Type Q Volume Control

82 values—7 tapers—give greatest TV, AM, FM coverage with least stock. Flatted, knurled and slotted Knobmaster Fixed Shaft fits most knobs without alteration. 13 Interchangeable Fixed Shafts give fast conversion to "specials" with fixed shaft security. Small  $\frac{1}{4}$ " long bushing and compact  $\frac{3}{8}$ " design ideal for small sets—yet handle large set needs as well. Cushioned-turn rotation. Quiet element. Handsome appearance.

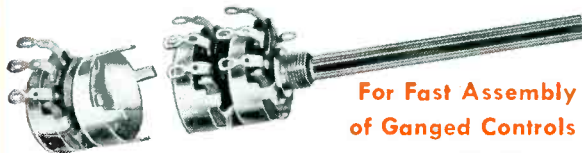

## For Fast Assembly of Ganged Controls IRC MULTISECTIONS

In just a few minutes you can assemble standard duals, triples, even quadruples—with IRC Multisections and Q Controls. Simply remove control cover and attach Multisection. Over 15,000,000 combinations. 20 resistance values. Switches can be added. Use to provide low-cost L Pads and T Pads.

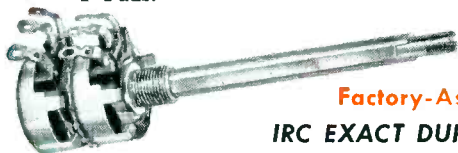

## Factory-Assembled IRC EXACT DUPLICATES

IRC's complete line includes 492 Factory-Assembled Exact Duplicate Concentric Duals. Mechanical fit and electrical operation double-money-back guaranteed—specifications are based on set manufacturers' procurement prints. Resistance values are matched; tapers are closely followed; shaft lengths are never less than manufacturers' nominal—never more than  $\frac{1}{2}$ " longer. Cover more than 5,000 TV sets. Carbon and wire wound.



## For Concentric Duals in Less Than A Minute IRC CONCENTRIKITS

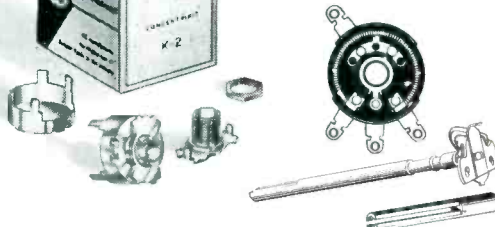

Here's coverage of more than 5,000 TV models. Revolutionary 4-piece Universal Concentrikits assemble with shafts and elements in less than a minute to give you the exact duplicate replacement control you want. Mechanical fit and electrical operation double-money-back guaranteed. Assemble both carbons and wire wounds. Fewer inventory problems.

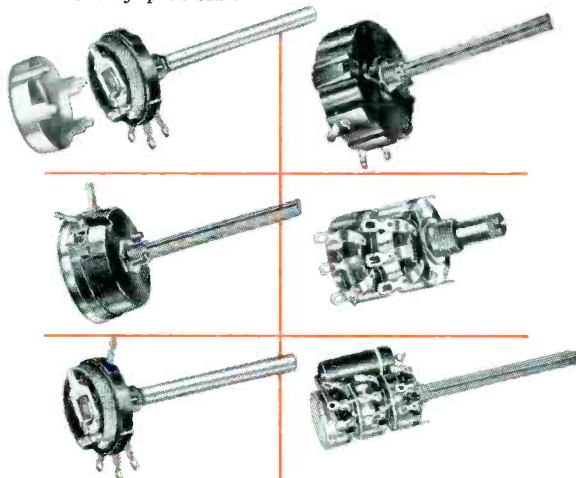

## For Special Purpose Controls IRC's Complete Line

2-Watt Wire Wounds—2 styles, full rounded shaft and Knobmaster shaft. High Voltage Controls—2-watt carbon-element control with Knobmaster shaft. 4-Watt Wire Wounds—2 styles, short, knurled and slotted shaft or Knobmaster shaft. TV Attenuators—Carbon-element control for adjustment of signal input. TV Centering Controls—2-Watt Wire Wound Control with centering tap. Loudness Controls—Continuously variable, bring higher fidelity to ordinary audio.

No other brand of replacement controls offers you wider variety—greater efficiency. Send for New IRC Control Catalog DC1D.

For one-source-service on all your control requirements, order from your IRC Distributor.

**INTERNATIONAL RESISTANCE COMPANY**

413 N. Broad Street, Philadelphia 8, Pa.

In Canada: International Resistance Co., Ltd., Toronto, Licensee

Wherever the Circuit Says



For TELEVISION-RADIO-RADAR INSTRUMENTS

**REMEMBER  
ONE  
NAME . . .**

# BUSS FOR FUSES

THE INDUSTRY'S *Most Complete* LINE

Here's why it pays to get **all** your fuses from this one reliable source:

More than a third of a century of service stands behind every fuse that bears the BUSS trademark. Your customers have faith in BUSS fuses. They know that the BUSS name represents fuses of unquestioned high quality.

To maintain these high standards, each BUSS fuse is **electronically tested** for correct calibration, construction and physical dimensions.

- **BE DOUBLY SAFE . . .** install BUSS fuses. They protect the product and your reputation. Your customers know BUSS fuses — famous for dependable protection in homes, industry and on the farm, ever since 1914.

 **FOR MORE INFORMATION**  
*mail this coupon today*

FOR EVERY CIRCUIT PROTECTION PROBLEM

CONTROLS-AVIONICS

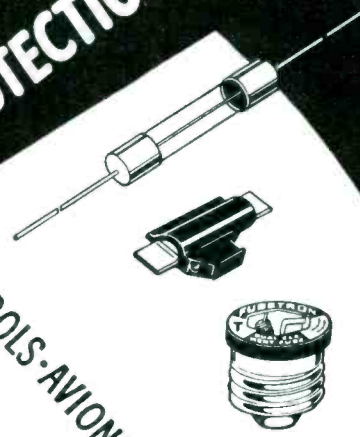

*Plus* A COMPLETE LINE OF FUSE CLIPS, BLOCKS AND HOLDERS

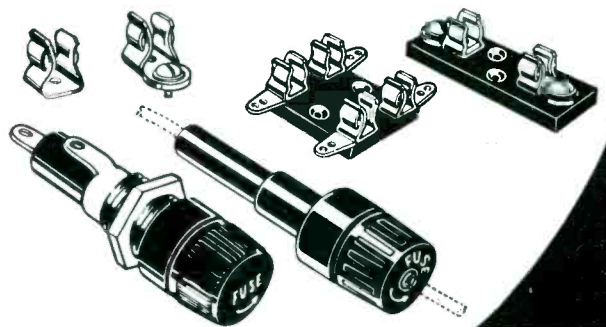

Bussmann Mfg. Co., University at Jefferson  
St. Louis 7, Mo. (Division of McGraw Electric Co.)

SD-1153

Please send me bulletin SFB containing facts on BUSS small dimension fuses and fuse holders.

Name .....

Title .....

Company .....

Address .....

City & Zone ..... State ..... 1153

# 2 NEW SERVICE AIDS . . .

# DESIGNED

BY AND FOR

# YOU!

## New CBS-HYTRON Tube-and-Tool Caddy ▶

Another Tube Caddy? Yes, but *you* service-dealers helped us design this one. Helped us throw out a dozen almost-right designs. Stayed with us until the CBS-Hytron Tube-and-Tool Caddy became *your* Caddy. Built the way *you* want it.

Your new Caddy has literally dozens of features . . . many unique. Here are only a few: *Roomy* . . . holds 218 tubes! Also all your necessary tools. Small parts, volt-ohmmeter, flashlight, and reference data. *Compact* . . . functional design wastes not one inch of space. *Accessible* . . . everything in sight and reach. *Rugged* . . . strong, tip-proof — used safely as seat. *Test Mirror* . . . reversible for protection — mounted in cover supported by adjustable friction hinge.

Sorry, there's just not enough space to tell all. But *see* your new Caddy yourself at your CBS-Hytron distributor's. He has a red-hot deal for you. He'll show you how *amazingly easy* it is for you to own this unique CBS-Hytron Tube-and-Tool Caddy. See him today.

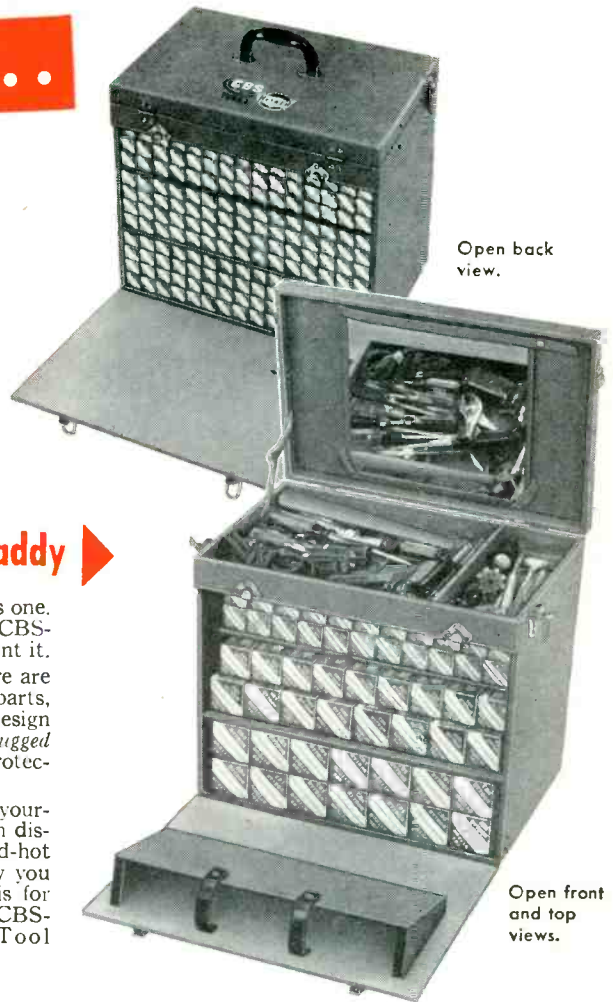

Open back view.

Open front and top views.

## ◀ New CBS-HYTRON Twin Pin Straightener

Ever wished you had a combination 7-Pin and 9-Pin Straightener? One that was handy, compact, light? But also a precision job, just like CBS-Hytron's original 7-Pin and 9-Pin Straighteners?

Here it is: The new CBS-Hytron Twin Pin Straightener, SH79. Same life-time, wear-and-corrosion-resistant steel dies. Same individually drilled, precision pin-circle holes. Same absence of guide-posts, permitting that final touch of sidewise straightening. The "Twin" is also roll-proof.

And the Twin is only 98¢ net. Get at least two . . . for pocket, tool kit, bench. Call your CBS-Hytron distributor today. Yes, he still has the famous individual CBS-Hytron 7-Pin and 9-Pin Straighteners at only 65¢ each net. Get them, too.



## CUTTING YOUR CALL-BACKS WITH CBS-HYTRON CTS-RATED\* 5AW4 and 6CU6?

They're the most talked-about tubes in TV today. CBS-Hytron CTS-Rated 5AW4 and 6CU6 are both rated for dependable Continuous Television Service. Heavy-duty work horses, they replace the 5U4G and 6BQ6GT respectively.

Brand new designs, not just improved tubes, the 5AW4 and 6CU6 have big safety factors. Give you long . . . long trouble-free life. Loaf in those hard-working, heavily

loaded rectifier and horizontal amplifier sockets . . . even in 21-inch jobs.

Start slashing your call-backs with these tubes right now. 5AW4 and 6CU6 are available only from your CBS-Hytron distributor. See him today. Ask for complete 5AW4 and 6CU6 data. Or write direct. Above all, don't let another day slip by without trying these wonderful, new CBS-Hytron CTS-Rated tubes.

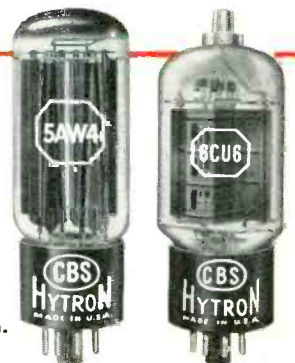

\*Rated for Continuous Television Service

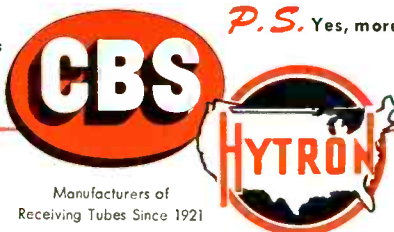

Manufacturers of Receiving Tubes Since 1921

*P.S.* Yes, more CBS-Hytron CTS-Rated tubes are coming. Watch for them.

CBS-HYTRON Main Office: Danvers, Massachusetts

A Division of Columbia Broadcasting System, Inc.

A MEMBER OF THE CBS FAMILY: CBS Radio • CBS Television • Columbia Records, Inc. CBS Laboratories • CBS-Columbia, Inc. • and CBS-Hytron

RECEIVING . . . TRANSMITTING . . . SPECIAL-PURPOSE AND TV PICTURE TUBES • GERMANIUM DIODES AND TRANSISTORS



*Every Service Firm Owner in the U. S. A.*  
**Receives SERVICE DEALER Monthly**  
**DISTRIBUTION THIS ISSUE OVER 63,000**

**COWAN PUBLISHING CORP., 67 West 44th Street, New York 36, N. Y.**

**EDITORIAL STAFF**

*Publisher*

**SANFORD R. COWAN**

*Editor*

**SAMUEL L. MARSHALL**

*Assistant Editor*

**NORMAN EISENBERG**

*Contributing Editors*

**LEONARD LIEBERMAN**

**ROBERT T. DARGAN**

**RUDOLF F. GRAF**

**MARVIN KLEIN**

**SAN D'ARCY**

**BUSINESS STAFF**

*Advertising Director*

**SANFORD L. CAHN**

*Advertising Manager*

**HARRY N. REIZES**

*Eastern Adv. Sales*

**JACK N. SCHNEIDER**

*Production Manager*

**DAVID SALTMAN**

*Circulation Manager*

**HAROLD WEISNER**

**BRANCH OFFICES**

**CHICAGO**

**HAROLD F. MANN**

333 No. Michigan Ave.

Franklin 2-7100

**LOS ANGELES**

**TED E. SCHELL**

2700 West Third Street

Dunkirk 2-4889

**FEATURE ARTICLES**

Horizontal Sweep & Deflection Systems, Symposium Series No. 9, <i>by Matthew Mandl</i> .....	18
Summary of modern circuitry.	
R.C. Circuits, Part I, <i>by Cyrus Glickstein</i> .....	21
An original approach to this subject.	
CBS Colortron, Part I .....	27
Explanation of new CBS color tube.	
A New Tandem 40 MC I.F. Amplifier .....	31
This amplifier will be used shortly by many manufacturers.	
Color TV, Part I, <i>by Leonard Lieberman</i> .....	33
Simplified approach to color TV.	
TV Sound Circuits, Part 2, <i>by Rudolf F. Graf</i> .....	43
Ratio detector explained.	
How To Sharpen Carbide-Tipped Drills .....	53
Manufacturers' Service Aids .....	55

**CIRCUIT & SERVICE DATA**

Video Speed Servicing Systems Data Sheets (VSSS) .....	60
Admiral Chassis No. 22F2, 22M2, 22P2	
Hoffman 180 Series	
Philco 1954 "B" Line	
Stromberg-Carlson 116 Series	
Rider TV Field Service Manual Data Sheets .....	70
Crosley Chassis Nos. 402, 403, 404	
Philco Chassis Nos. D-181, R-181	
Zenith Chassis Nos. 19L25, 19L26, 19L27, 19L28	

**DEPARTMENTS**

Editorial .....	6	Circuit Court .....	51
Guest Editorial .....	8	Shop Notes .....	57
Association News .....	33	New Tubes .....	59
The Answer Man .....	39	New Products .....	85
Advertisers' Index .....	96		

RADIO-TELEVISION SERVICE DEALER is published monthly by Cowan Pub. Corp., 67 West 44th St., New York 36, N. Y. Subscription price: \$1 for 2 years in the United States, & U.S. Poss. Elsewhere \$1 per year additional. Single Copies 25c. Reentered as second class matter Sept. 25, 1950 at the Post Office at New York, N. Y. under the Act of Mar. 3, 1879. Copyright 1953, Cowan Pub. Corp.

POSTMASTER: SEND FORM 3579 TO RADIO-TELEVISION SERVICE DEALER, 67 WEST 44th ST., NEW YORK 36, N. Y.



# **CHANNEL MASTER**

*introduces a*

**basically new type**

**of VHF antenna**

the **CHAMPION\***

**the highest gain  
all-channel VHF antenna  
ever developed!**

*Featuring the unique new "Tri-Pole"*

#### **TRIPLE-POWERED DIPOLE**

The "Tri-Pole" is a new antenna system in which the Low Band folded dipole also functions as three folded dipoles tied together in phase on the High Band. This is the heart of the Champion, the secret of its phenomenal performance on all 12 VHF channels.

# the **CHAMPION** is the most sensitive all-channel VHF antenna ever designed!

Stacked **CHAMPION** provides:  
11-13 D B High Band gain  
6½-7½ D B Low Band gain

Here is a totally NEW kind of antenna, completely different — in principal and performance — from any VHF antenna you've ever seen! Since the lifting of the TV freeze means a gradual disappearance of the single-channel VHF area, the VHF antenna of the future will be a *multi-channel* antenna. Prepare now for outstanding reception on *all* VHF channels — present and future — with Channel Master's super-sensitive **CHAMPION**! Outperforms every all-channel VHF antenna made today — and many Yagis, too!

## COMPARE these features with the antenna you are now using:

- Folded dipoles throughout — give close to 300 ohms impedance across the entire band.
- Screen-type reflector provides high uniform gain on every channel, 2 through 13. Not frequency sensitive — this reflector provides more than twice as much extra gain as straight bar reflectors.
- Phase-correcting harness is built-in and fully assembled; the only wiring you do is to attach the lead-in.
- All-aluminum construction . . . lightweight, durable, non-corrosive.

### MARVEL OF PRE-ASSEMBLY

assembles faster than a  
5-element yagi!

Collapsed "Pop-Up" screen opens instantly — no loose rods, elements or hardware. "Tri-Pole" assembly features automatic Spring Lock Action — all dipoles snap permanently into place without wing nuts or any other hardware.

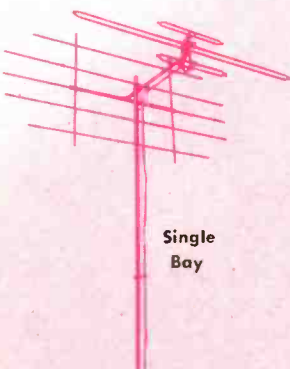

Single  
Bay

It's a **CHAMPION** in any area!

- 1-bay—local areas
- 2-bay—secondary and fringe areas
- 4-bay—super-fringe areas

## THIS ANTENNA...

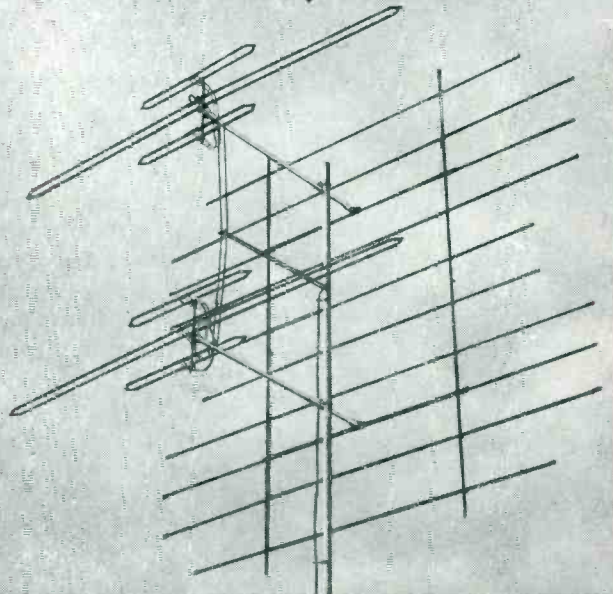

## OUT-PERFORMS:

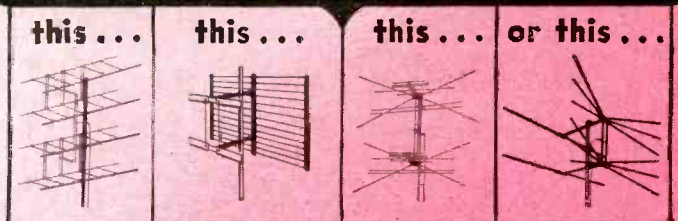

The 2-Bay **CHAMPION** actually  
gives you the performance of:

- Separate 5-element Yagis for every Low Band channel!
- Separate 10-element Yagis for every High Band channel!

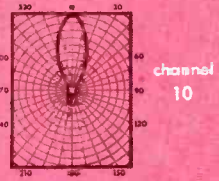
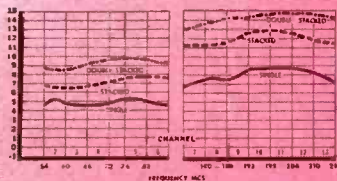

Model No.		List Price
325	Single Bay	\$20.83
325-2	2-Bay	\$42.36
325-4	4-Bay	\$88.89
Separate Stacking Harness		
325-3	2-Bay Harness	\$ 2.08
325-5	4-Bay Harness	\$ 4.15

Send for complete technical literature.

**CHANNEL MASTER CORP.**

ELLENVILLE, N. Y.





# EDITORIAL...

by S. R. COWAN  
PUBLISHER

## Defining A New Policy

A copy of this issue of *Service Dealer* has been sent to the owner of every firm in the U.S.A. that does either radio or TV servicing. Our future issues will be sent to them too. Full details about our new Controlled Circulation policy are given on pages 47-50 in this issue. However, we are not infallible and inadvertently perhaps we have slipped up on a shop owner's name here or there. If any shop owner has been overlooked all he need do is tell us and the omission will be corrected promptly.

In sending *Service Dealer* gratis to owners of established service organizations while requiring part-time and employed technicians to pay the nominal sum of \$1 for a 2-years' subscription (24 issues) we are not discriminating nor do we proceed on the premise that the employee is less deserving than the shop owner. One must understand that heretofore we solicited subscriptions from shop owners and we made little or no effort to obtain subscriptions from their employees. That's why our current ABC Publisher's Statement credits us with almost 25,000 paid subs from shop owners compared to less than 4,000 from employed technicians.

Our about-face in subscription-selling policy is predicated on the fact that until now many employed technicians had no aspiration to become shop owners. Furthermore, this journal could not benefit many servicemen whose efforts were solely confined to repairing AM/FM receivers, until TV got "the green light."

From a text point of view, as you can readily see for yourself, this and future issues of *Service Dealer* includes features and departments or sections which are of such vital worth to all men engaged in radio and TV servicing that each shop owner and technician will want for himself his own set of file copies. These files will, as they accumulate, provide invaluable data for present and future reference. The progressive shop owner and employed technician alike have a single aim: that of finding ways and means of doing better work, in less time, by easier means, and at greater financial reward. These are also the basic aims of *Service Dealer* in working with and for the Service Profession as a whole.

## Servicing — The Nation's Big Business

Until not very long ago, the average manufacturer of radio tubes, parts and accessories said to himself, (and some said it aloud), that the servicing part of the radio industry was a relatively small and insignificant segment com-

pared to the set manufacturing phase. Frequently prospective advertisers told us that the replacement market potential is "peanuts" and that those who lived with servicemen (meaning us) were like the tail wagging on the end of a dog.

But times have changed! Today in dollars and cents the Servicing Business means as much, if not more, to most tube and component makers than the "big boys" — meaning receiver manufacturers. Let's review this a moment! This year, if 7 million new TV sets are made they will require 7 million pix tubes as original equipment to be shipped with sets as they are sold. But, this year service firms will also buy just a few thousand under 7 million pix tubes to be used as replacements for old, defective tubes. Taking the discount differential (Mfgs get 60-10 while Parts Distributors get 50-10) into consideration, we find that service firms will pay picture tube manufacturers almost \$30 million more for tubes this year than will the manufacturers of new receivers. Recently a volume control manufacturer told us that servicemen will buy 3½ times as many controls this year as will set manufacturers.

Slowly but surely our profession is winning respect and recognition not only by set owners but also by die-hard manufacturers. Servicing is big business now, but today it is small business compared to what it will be in a few more years. It's a cozy thought.

## Our New Features

We welcome aboard our new section called "TV Field Service Data Sheets." By pre-publishing these data sheets, provided by John F. Rider, Publisher, we both believe that a truly great contribution is made to the servicing industry. The great secret of many service firms successes lies in their ability to do most TV set repair jobs quickly while at the customers' homes. Time lost in pulling a chassis out of a cabinet or console, time wasted taking the chassis to shops, returning them to the owners' homes and reinstalling them in the cabinets is money irrevocably lost. By eliminating this money-costing evil to the greatest possible extent the average service shop benefits from the additional profit-making jobs that can be attended to in the time saved. We feel fortunate indeed that *Service Dealer* alone will provide the service field with "TV Field Service Data Sheets" which will speed up and simplify doing repairs in the field, as a regular monthly feature in the interim between the new editions of the book by the same name which John F. Rider will publish.







This is the first in a series of guest editorials by representative Service Technicians and Service Managers of TV and Radio receiver manufacturers. We feel that this service will help solve the mutual problems that are shared by service technicians and manufacturers.

#### What Is That In Thine Hand?

This question was first asked thousands of years ago. Many are now asking another question, "What future is there in TV?" These questions are related. The answer to the second depends on you, the servicing fraternity. In our opinion you not only have a wonderful opportunity but a grave responsibility.

It is not our purpose to present charts and figures to picture the future of TV service. We need but look back a few years to see how far we have come; look at the open spaces on the television station map and visualize the long list of stations planning to open to realize what the future holds for you—for us.

Then there is color. Color, the engineers tell us, is as much an advance over black and white television as TV is over radio. The advent of color will open a new vista that will dwarf anything we have seen so far.

But we must be ready to take advantage of it. If we are not making the most of the situation now the advent of color will not help but rather complicate our problem. A wise successful business man was once asked for his formula to success. He said, "Like your work; do it well; prepare for the job ahead." We can think of no more applicable counsel.

Service, more than any other business grows on its reputation; it builds up slowly but surely and then "snow-balls" as it goes along. But it can be quickly ruined by poor workmanship. You have a wonderful opportunity because every job done well brings others.

You have a grave responsibility of which we as manufacturers are particularly cognizant. Whenever you do a good repair job it enhances not only your reputation but also that of the set and the prestige of the manufacturer. If you do a poor job not only you but the set and the manufacturer share the blame and we sometimes reap the lion's share of discredit.

If you have any constructive criticism or suggestions we are always glad to get them. We have often told servicemen that they can help improve the product by their suggestions. Some younger men have felt that if they helped to improve the product too much they would work themselves out of a job. We always replied, facetiously, that this was impossible because each year new models are introduced and the serviceman is back in business.

Seriously though, no product is perfect. The very warranty we so proudly quote merely admits that in spite of all we can do there is the possibility of failure of a part since both the materials and workmanship are the product of human hands which are not infallible.

There will always be service. People do not expect perfection but they do expect prompt, intelligent, and courteous service when their sets need attention. That is where we must depend on you.

What is the future of television? It is unlimited and it is literally in your hands. Please handle it as the most cherished and valuable possession we own. You owe it to yourself to make the most of it for us all.

R.H.S.



# FALCON

# Introduces -

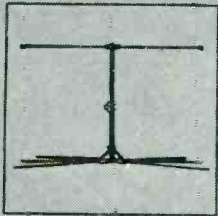

Channels 2-13, peaked for low channels (2 thru 6)

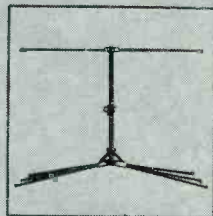

Channels 2-13, normal position, peaked for all VHF channels (2 thru 13)

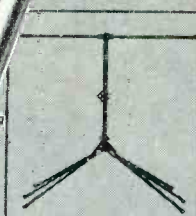

Channels 2-13, peaked for high channels (7 thru 13)

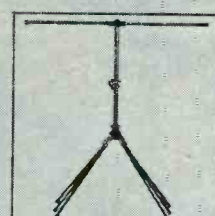

Channels 2-83, peaked for UHF channels

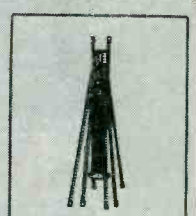

Falcon "VARI-CON" folded for packing

Model VC-1



Model VC-2



Model VC-4

Stack them for added gain.

## FALCON

easiest of all antennas to assemble merely open like an umbrella and tighten wing nuts

There is NO ASSEMBLY problem with a FALCON "VARI-CON". It takes longer to explain the operation than to accomplish it! Your FALCON "VARI-CON" comes folded into one compact unit. You need only swing the reflector into position and tighten the wing nuts. Move the sliding sleeve to the calibrated channel setting you desire and tighten. The butterfly springs snap the elements into position and lock them securely. The FALCON "VARI-CON" is ready to install, ready to provide peak performance. Changing the channel peaking of the "VARI-CON" is just as simple and easy as making the original setting. No tools are needed for either operation.

## THE HEART OF THE "VARI-CON"

Above is a view of the new mechanism which enables anyone to adjust the peaking of the FALCON "VARI-CON" to any range of channels desired. The sliding sleeve, on the calibrated boom, automatically fans out the elements to their correct position.

A simple, trouble-proof, snap-action spring in the

butterfly keeps the elements solidly in place. The insulated hinge assembly is extremely strong, durable and weather-resistant and has an extra long leakage path. Weight has been kept to a minimum, strength at a maximum in order to assure long life and freedom from wind and weather damage. A heavily plated mast clamp is supplied.

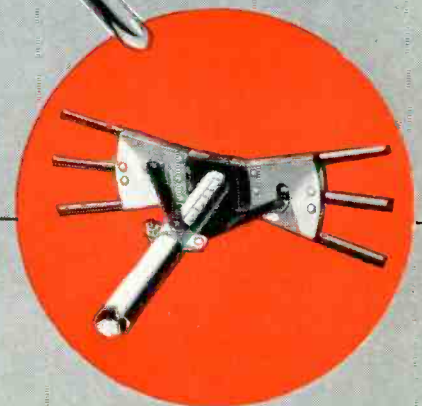

Calibrated sleeve for quick peaking of antenna.

# the "VARI-CON"

(The conical that's variable)

*Provides all Channel Performance...*

**Yet can be Peaked for Increased Gain on any Channel Range**

The FALCON "VARI-CON" was designed for today, tomorrow and years to come. Its unusual construction permits setting the "VARI-CON" for all-channel performance peaked to provide the additional gain needed on special channels. In addition, the variable patterns obtainable are of great value in ghost elimination.

There is no guess work; no tedious assembly; no field strength equipment needed to peak the "VARI-CON" for high-gain, sharp pattern performance in your area. It's as simple and easy as opening an umbrella. Here's all you do: Unpack the "VARI-CON"—Slide the adjusting sleeve to the calibrated marking on the boom for the best reception of channels in your area—Fan out the reflector elements—Tighten the locking wing nuts. The "VARI-CON" is

automatically peaked WHERE YOU WANT IT and ready to install. It is the only conical that enables you to provide a custom-made installation resulting in higher gain and increased customer satisfaction.

The NEW FALCON "VARI-CON" is ruggedly constructed. Heavy-duty heads will not crack or break. The steel spring snap-action butterfly assemblies are unbreakable. Full length, 48 inch, elements are used. One of the most capable engineering staffs in the industry has worked out every last detail of this truly remarkable TV antenna. To the high gain all-channel performance and excellent line match of the conical, FALCON engineers have added the "plus" feature—adjustable, calibrated channel range peaking!

## FALCON

The new "VARI-CON" is one of the most significant additions to antenna design. Watch for the other new FALCON antennas which will be announced in the near future! Each will represent the most advanced, most efficient antenna design of its type.

**WRITE FOR ILLUSTRATED FOLDER AND PRICES**



**FALCON ELECTRONICS COMPANY • 2003 CEDAR ST. • QUINCY, ILLINOIS**



## NATIONAL ADVERTISING TO BACK NEW FALCON "VARI-CON"

To stimulate sales on all levels, FALCON is conducting one of the most aggressive advertising campaigns in the industry. Full two-page color spreads are appearing regularly in many of the nation's top trade and consumer publications.

The only lightning arrester with the strain relief LIPS is  
 manufactured by JFD. *A patent is its proof!*  
 The twin-lead will bend only at a point separate from your contact—  
 therefore, your twin-lead cannot break away.



Only the exclusive JFD strain relief lip prevents the  
 contact washers used in all arresters from ripping your lead-in  
 apart, strand by strand until the wire is torn through and  
 the picture on your screen obliterated. Write for Form 84.

**FOR RIBBON TWIN-LEAD**

No. AT105 ("Little Giant" with hardware for wall  
 or window sill mounting) List \$1.25

No. AT105S ("Little Giant" with UL approved stainless  
 steel strap for pipe mounting) List \$1.50

No. AT102 ("Jumbo" with UL approved stainless steel  
 strap for Universal Mounting) List \$2.25

**FOR TUBULAR TWIN-LEAD**

No. AT103 ("Jumbo" with UL approved stainless steel  
 strap for Universal Mounting) List \$2.25

Available with four color, sales producing counter display, on request

**JFD MFG. CO.**

BROOKLYN 4, N.Y.  
 BENSONDURST 4-9200

World's Largest Manufacturer  
 of TV Antennas and Accessories

*the secret is in the lips*

"Little Giant" Lightning Arrester  
 U.S. Pat. No. D-4664



**the secret is in the lips**

*the secret is in the lips*

ONLY JFD OFFERS YOU A **FULL-YEAR "GOLD SHIELD" GUARANTEE AGAINST RUST!**

Every screw, nut, bolt, washer and bracket in JFD's new "Gold Shield" UHF antennas is "Bronzidite" plated! Only these spectacular performing antennas carry a full year's guarantee against damaging rust. Safeguard your antenna installation and your reputation... depend on the new JFD "Gold Shield" gold-colored UHF antennas.

See them at your jobber or write for brochure #219.

Model UHF411-GOLDEN BRIDGE

\$11.75 list

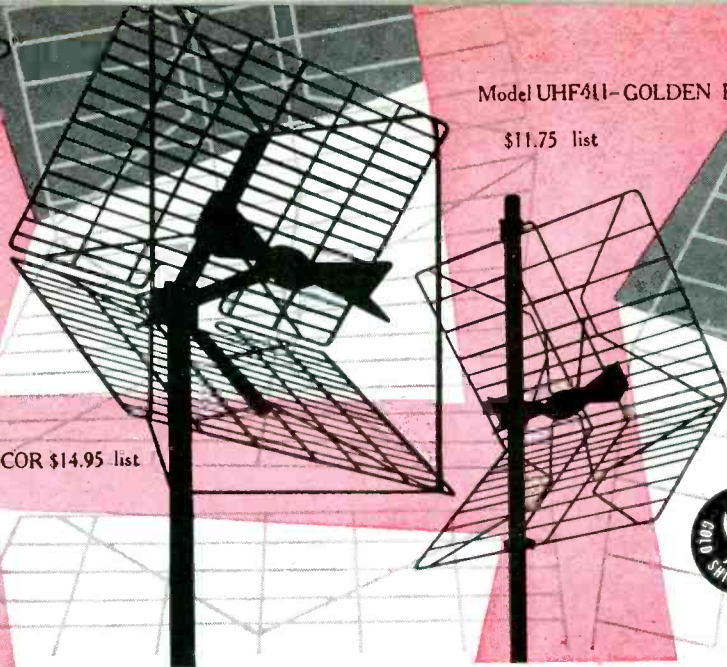

Model UHF401-GOLDEN MAX-COR \$14.95 list

**JFD**

JFD MFG. CO., BROOKLYN 4, N.Y.  
World's largest manufacturer of TV antennas and accessories



## NEW JFD "3-in-one" LIGHTNING ARRESTER

No. AT110 with hardware for wall or window sill mounting, \$1.50, list.

No. AT110S with stainless steel strap for pipe mounting, \$1.75 list.

Both feature the patented JFD strain-relief lips which prevent contact washers from ripping the lead-in wires apart!

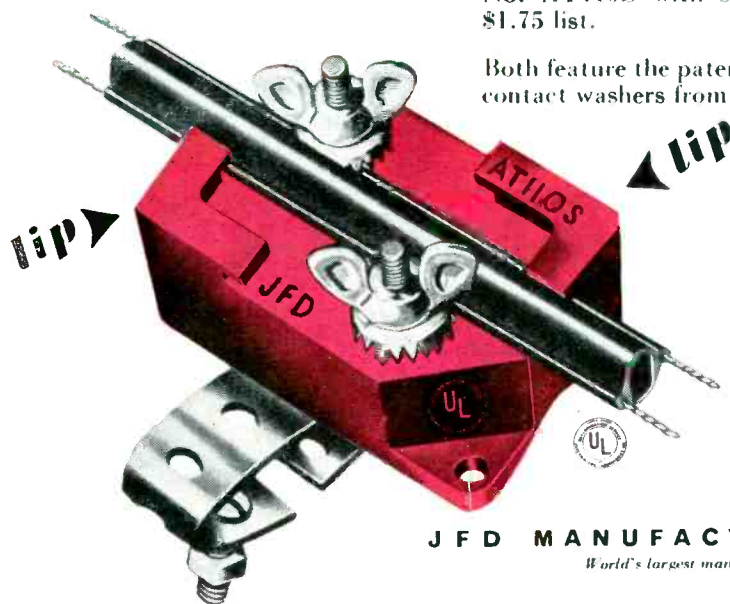

one for all... all for one

for UHF or VHF tubular twin lead  
for VHF flat twin lead  
for VHF or UHF open wire



Barton Brown Advertising

**JFD MANUFACTURING COMPANY, INC.**

World's largest manufacturer of tv antennas and accessories; Brooklyn 4, New York



The JFD Golden "Para-Bow" delivers the performance of two antennas because it actually is two sensitive antenna designs combined into one powerful array: the radar parabola and the time-tested bowtie.

Guaranteed for a full year against rust with BRONZIDITE, the "Gold Shield" gold colored Para-Bow is the finest UHF antenna you can offer your customers. It's completely preassembled, too.

**UHF900-\$14.95 LIST.**

Write for bulletin 231.

## SENSITIVE AS RADAR

JFD MANUFACTURING COMPANY, Brooklyn 4, N.Y.  
World's largest manufacturer of TV antennas and accessories



CUSTOMERS EVERYWHERE KNOW  
 SYLVANIA TUBES JUST  
 CAN'T BE BEAT FOR QUALITY!



## WHY SYLVANIA PRODUCTS MEAN BETTER BUSINESS!

**Y**OU'RE really on board the *better-profit* special when you feature Sylvania Picture Tubes and Receiving Tubes.

Your customers know Sylvania as a pioneer in the development of fine radio and television products. From the very beginning, the name Sylvania has stood for the highest possible quality. And, as the industry has progressed and expanded, Sylvania has taken great care to maintain its recognized leadership.

*Now, due to advanced manufacturing techniques and precision testing methods, Sylvania tubes can point to outstanding records, both in long life and fine performance. Today 7 of the 10 leading set manufacturers use Sylvania Picture Tubes and Receiving Tubes.*

So, if you want *recognized quality* working on your side . . . *sell Sylvania!* Call your local Sylvania Distributor for the latest fall prices and money-making promotion offers, or write to: Sylvania Electric Products Inc., Dept. 3R-2211, 1740 Broadway, New York 19, N. Y.

**Television keeps telling  
 about Sylvania quality**



Sylvania's popular nation-wide television show "Beat the Clock" continues to tell millions of your customers week after week, all through the year, about the unbeatable quality of Sylvania products.

# SYLVANIA

**LIGHTING • RADIO • ELECTRONICS • TELEVISION**

In Canada: Sylvania Electric (Canada) Ltd.  
 University Tower Bldg., St. Catherine Street, Montreal, P. Q.

RADIO-TELEVISION SERVICE DEALER • NOVEMBER, 1953





## “CALL-BACKS?

# Can't Remember a MALLORY Capacitor Ever Letting Me Down...”

When a service man makes a statement like that, you can be sure he depends on Mallory for all his capacitors. Mallory FP Capacitors are engineered to duplicate the electrical characteristics of the original part in any TV or radio set. However, dependability is only part of the story. Mallory Capacitors will give performance that is equal to... and often better than... the original equipment.

Mallory FP Capacitors are the only fabricated plate capacitors available to the replacement market. They will give long lasting performance at higher temperatures and greater ripple currents ... even at 185° F. (85° C.).

The next time you order capacitors, ask for Mallory FP's. They will put an end to time wasting call-backs. The best costs no more.



For your plastic tubular requirements, be sure and specify Mallory Plascaps®. You can depend on them to end troubles with premature shorts ... leakage ... off center cartridges ... and unsoldered leads.

P. R. MALLORY & CO., Inc.  
**MALLORY**

CAPACITORS • CONTROLS • VIBRATORS • SWITCHES • RESISTORS  
RECTIFIERS • POWER SUPPLIES • FILTERS • MERCURY BATTERIES  
**APPROVED PRECISION PRODUCTS**

**P. R. MALLORY & CO., Inc., INDIANAPOLIS 6, INDIANA**

*Depend on Mallory  
for  
Approved Precision Quality*

# NORTH, EAST, SOUTH, WEST...

## Federal has a lead-in

Whatever the area or atmosphere... city or fringe... rain, snow ice, heat, dust, salt spray, polluted air or radiation... you'll find the answer in these quality-controlled cables by Federal —

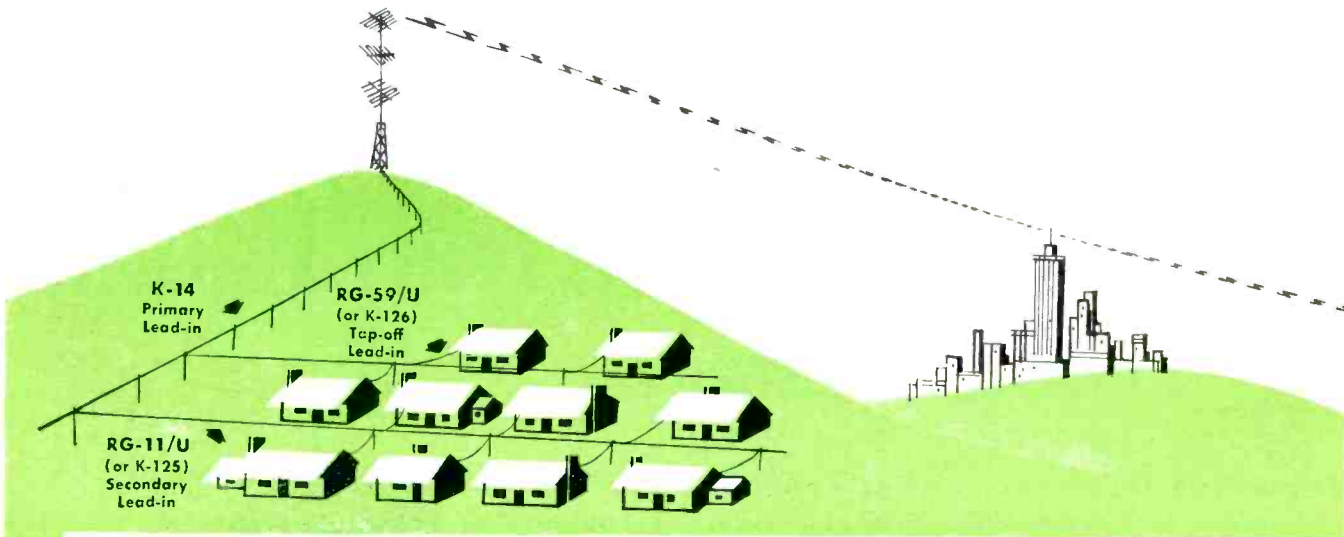

### FOR COMMUNITY TV IT'S *Federal's* "BIG 5"



**K-14**—71-ohm shielded primary transmission line for community distribution systems. Famous for lowest line loss, long cable runs and fewer amplifiers required. Capacitance: 21.5 mmf/ft. Attenuation DB 100/ft: .57—50 Mc; .90—100 Mc; 1.42—200 Mc; 2.3—400 Mc.



**RG-11/U**—75-ohm shielded low-loss coaxial. One of the best small-diameter cables. Tops as a community TV secondary lead-in. Seven strands #26 tinned copper. Capacitance: 20.5 mmf/ft. Attenuation DB 100/ft: 1.5—50 Mc; 2.15—100 Mc; 3.2—200 Mc; 4.7—400 Mc.



**RG-59/U**—73-ohm coaxial TV lead-in cable. Highly efficient as a community system pole-to-house tap-off. Meets all needs wherever a high-grade installation is a must. Capacitance: 21 mmf/ft. Attenuation DB 100/ft: 2.7—50 Mc; 4.0—100 Mc; 5.7—200 Mc; 8.5—400 Mc.

Use these 2 for Community TV radiation:

### FOR URBAN CENTERS



**K-111**—300-ohm shielded, balanced TV lead-in developed by FTR. Minimizes noise, snow, ghosts due to transmission line pick-ups. Ideal for many areas where good TV was impossible before. Capacitance: 4.2 mmf/ft. Attenuation DB 100/ft: 3.4—100 Mc; 6.6—400 Mc.



**TV-1184**—300-ohm dumbbell-shaped TV lead-in. A standard low-cost lead-in for areas without unusual conditions. Cinnamon-brown color is highly resistant to ultraviolet. Two conductors: 7/#28. Capacitance: 4 mmf/ft. Attenuation DB 100/ft: 1.28—100 Mc; 3.0—400 Mc.



**TV-1182**—300-ohm deluxe type heavy-duty TV lead-in with 90 mil. web. Insulated with "silver" polyethylene, Federal development that provides maximum weather protection and long life. Capacitance: 4 mmf/ft. Attenuation DB 100/ft: 1.22—100 Mc; 2.85—400 Mc.

### Non-Radiating Lead-ins for MULTIPLEX TV SYSTEMS



**K-125**—75-ohm coaxial TV lead-in cable. Double-shielded and jacketed. Formerly listed as SP-75.



**K-126**—73-ohm coaxial TV lead-in cable. Double-shielded and jacketed. Formerly listed as SP-76.

K-125 alternates for RG-11/U as secondary lead-in  
K-126 alternates for RG-59/U as tap-off lead-in

Wherever there are TV customers...

for the finest VHF-UHF

Federal's TV-1185

... "PIPELINE" of the Air!

300-OHM  
ALL-CHANNEL  
TWIN-LEAD  
THAT LAUGHS  
AT WEATHER

FOR FRINGE AREAS

**TV-1182**—Provides remarkably low line loss in fringe areas. Outstanding for resistance to weather and sunlight. Silver-colored insulation blends with any color scheme in home decoration.

**K-200 (RG-86/U)**—200-ohm heavy-duty ultra low-loss lead-in. Particularly adaptable to remote-area installations—especially long runs and multi-stack antennas. Also used with rombics.

See your local  
Federal Distributor  
or write to  
Federal direct  
Dept. D-985

TV-1185's "Silver" pigmentation lets you  
**INSTALL IT and FORGET IT!**

FEDERAL's TV-1185 is virtually a "pipeline" for better-than-ever TV reception... VHF or UHF. Insulated with the revolutionary Federal-developed "silver" polyethylene, TV-1185 is amazingly tough, flexible and efficient.

TV-1185 leads in Weatherometer tests... fights heat, resists moisture and other destructive deposits... minimizes deterioration due to sunlight.

TV-1185 keeps the energy field inside the weather-proof sheath... providing exceptionally low loss... more constant impedance... a better TV picture regardless of area or length of lead. It's easy to install and tight-seal against all atmospheric conditions.

There's no finer tubular lead-in of its type on the market today!

Capacitance: 4 mmf/ft. Attenuation DB 100/ft:  
0.5—10 Mc; 0.95—50 Mc; 1.25—100 Mc; 1.7—200 Mc;  
2.6—400 Mc; 3.0—500 Mc; 4.5—1000 Mc.

Product of America's leading producer of solid dielectric coaxial cables



Federal Telephone and Radio Company

SELENIUM-INTELIN DEPARTMENT

100 KINGSLAND ROAD, CLIFTON, N. J.

In Canada: Federal Electric Manufacturing Company, Ltd., Montreal, P. Q.

Export Distributors: International Standard Electric Corp., 67 Broad St., N. Y.

# Horizontal

# SWEEP & DEFLECTION

## Systems

SYMPOSIUM SERIES No. 9

A summary of modern horizontal sweep and deflection systems, and an explanation of the circuitry involved.

by MATTHEW MANDL

THE horizontal sweep systems of modern television receivers are not only used for deflection purposes, but also generate the high voltage for the second anode of the picture tube as well as boost the plus B applied to several other circuits. Because a special type of sync lock system is necessary, the horizontal system is one of the most complex sections in the entire television receiver. It is small wonder that a greater portion of receiver troubles originate in the horizontal sweep and deflection system. For this reason servicing is expedited if the technician is generally familiar with typical types used as well as variations encountered among different models.

For a clearer understanding by the newcomer or to refresh the fundamental principles for the working technician, the block diagram of Fig. 1 will prove helpful. This shows the circuits involved in virtually all modern receivers. Because the horizontal sweep oscillator is more immune to noise pulses, one of several lock systems is employed. By making phase comparisons between the oscillator output and the sync signal, direct synchronization of the sync oscillator by the horizontal sync is avoided. This minimizes the tendency for noise impulses upsetting horizontal sweep. The most commonly used systems are the phase detector, the synchrolock, and the synchroguide system. The phase detector system is the least used circuit, with the synchroguide holding the edge over the synchrolock in terms of the number of receivers using it.

The horizontal sweep generator consists of the oscillator which is locked in by the synchronizing system as well as the discharge circuit which forms the sawtooth. In some instances a separate discharge tube is used, while in

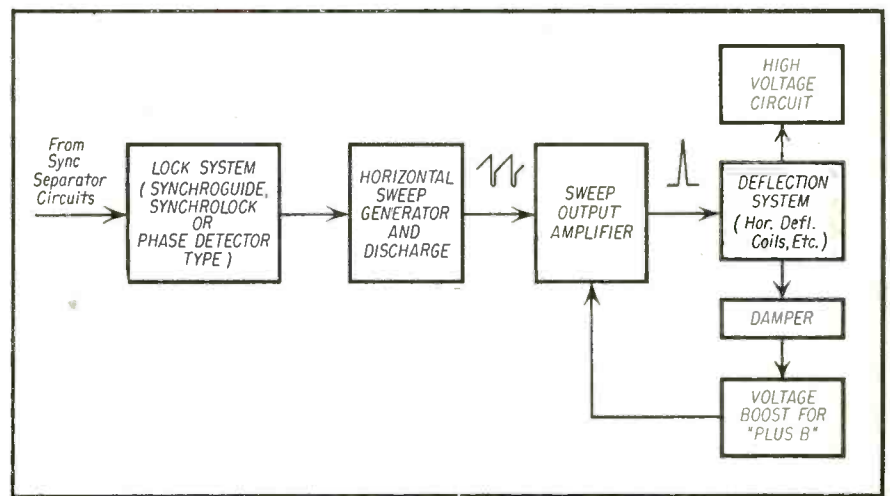

Fig. 1—Modern horizontal sweep and high voltage system.

many other instances the discharge circuit merely consists of an R-C network following the oscillator. The capacitor charges gradually to form a sawtooth while the series resistor develops a square wave voltage during the discharge to produce the modified waveform shown in Fig. 2. (A modified waveform of voltage is necessary to produce a sawtooth of current in deflection coils having both inductance and resistive components.)

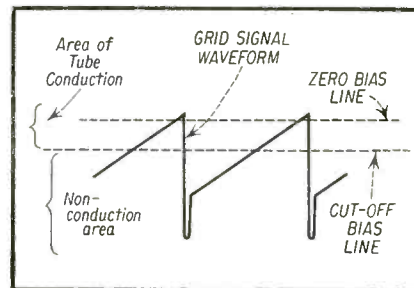

Fig. 2—Grid signal of horizontal sweep amplifier.

The modified sawtooth shown in Fig. 2 is applied to the grid of the horizontal output sweep amplifier. As can be seen from this illustration the horizontal output tube conducts only for a short interval after which the grid signal drives the tube beyond cut-off. The sawtooth developed in the horizontal deflection coils is shown in Fig. 3. During the sudden decline of the sawtooth at the end of the horizontal trace the collapsing field of the coils produces transient oscillations. The negative alternation of the transient voltage appears across the secondary of the horizontal output transformer, and this in turn is transferred to the primary as a sharp positive spike of voltage averaging 6,000 volts peak to peak or more, depending on the size of the picture tube. This sharp pulse has a frequency of 15,750 cps, and is rectified by the high voltage power supply and converted to dc for application to this picture tube.

When the positive alternation of the transient voltage appears as shown by

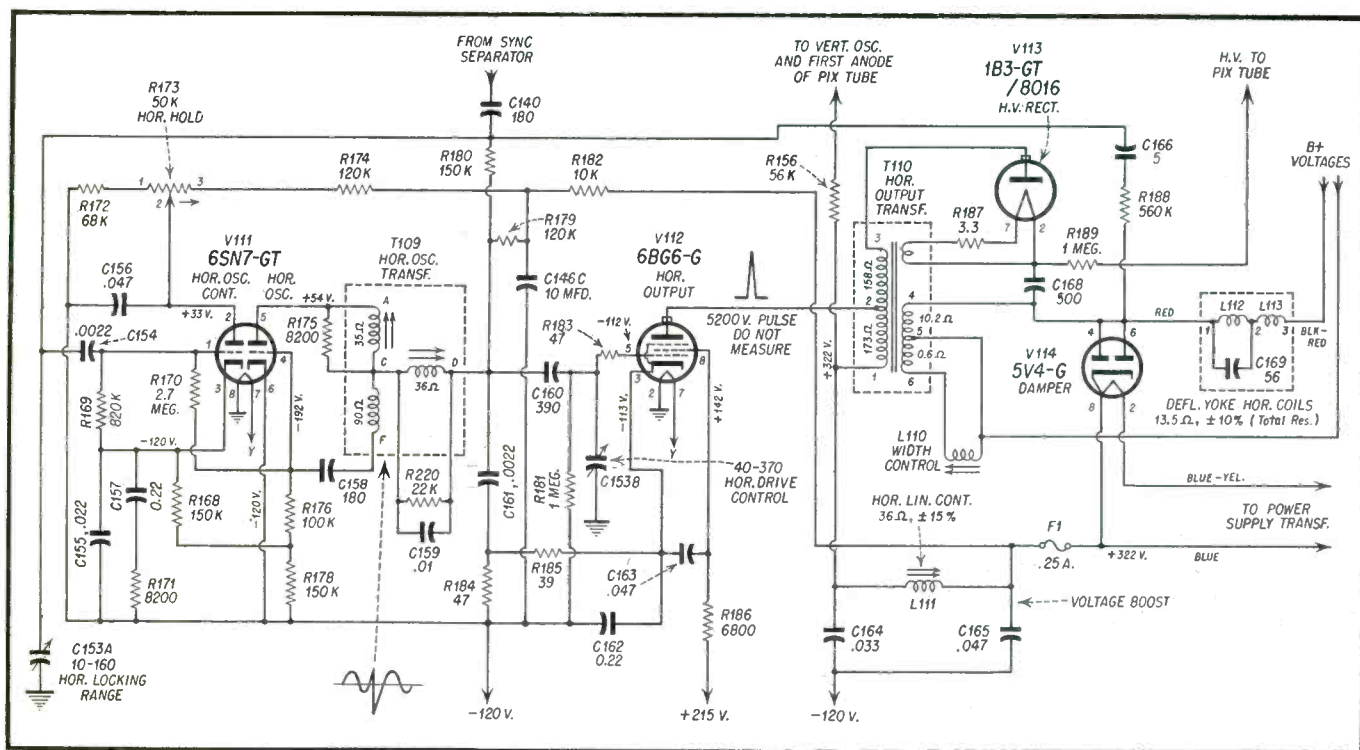

Fig. 4—Horizontal system used in RCA 8T241 receivers.

the dotted lines of Fig. 3, the damper tube conducts and prevents the transient from going through periodic sine wave motions. Instead, the voltage decays over a period of time set by the R-C constant of the circuit. This voltage decay is actually the initial sawtooth waveform and occurs during the time the horizontal output tube is in a non-conducting state. Thus, part of the horizontal sweep is furnished by the energy dissipated in the damper tube.

Because the horizontal output tube is in a non-conducting state when the high positive pulses appear at its plate, tube damage is avoided. The energy developed during conduction of the damper tube is utilized to boost the plus B voltage derived from the power supply. Thus, voltages from 50 to 200 can be secured in modern voltage boost systems utilizing the flyback principle. Utilization of such energy means a saving in the size of the power supply. The voltage boost is often fed to the plate of the horizontal output amplifier only, though in many other instances the voltage boost potentials are also applied to other circuits such as the horizontal oscillator, the vertical oscillator, vertical output, etc.

Because of the inter-relationship which is established among the various circuits by the voltage boost system, defects in the horizontal sweep system can also influence other circuits. Thus, vertical and horizontal instability could be caused by an improper potential

fed from the voltage boost system. On the other hand this would also mean that a defect in the horizontal sweep oscillator can influence many other circuits because it will influence the horizontal sweep and thus the voltage boost. It is for this reason that after the obvious cause and effect factors have been eliminated from circuits fed by the voltage system the latter should be checked as well as the horizontal system for symptoms which might affect circuits fed by the boost voltage.

#### Typical Commercial System

A representative commercial version of a modern horizontal deflection sys-

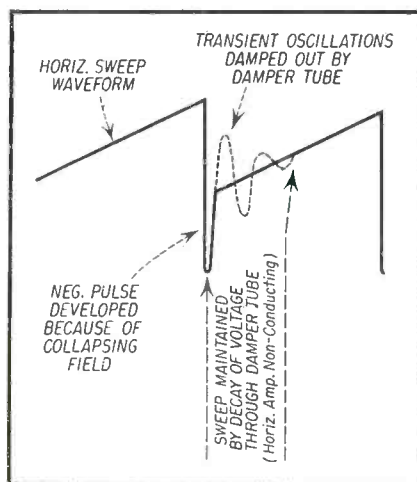

Fig. 3—Deflection coil sweep waveform.

tem is shown in Fig. 4. This is the sweep section used in the RCA 8T241 receivers, though similar circuits will be found in many other receivers. A conventional synchroguide system is used here and one half of the 6SN7-GT tube is used for a horizontal oscillator control, while the triode section is used as a stabilized blocking oscillator. Primary factors to learn in servicing this circuit are:

1. Use factory recommended replacement parts,
2. Use an oscilloscope at junction "C" during complete readjustment procedures,
3. Try several 6SN7-GT tubes if minor sync instability is present.

Exact replacement parts are recommended because many are close-tolerance parts or temperature compensated components. The usage of ordinary parts will affect final results. The synchroguide is the only horizontal lock system which requires the use of an oscilloscope for peak performance. The oscilloscope is used to check that the broad and narrow peaks of the waveform at junction C are equal in amplitude. The procedures given in the service notes for the particular receiver under repair must be followed for best results. Procedures are not simple but rather lengthy if properly done.

Inasmuch as the amount of conduction of the horizontal output tube depends on the amplitude of the input signal it is necessary that the drive con-

control be adjusted properly. An excessively high driving signal amplitude will cause the tube to operate under conditions similar to that of Class C. This will overload the circuit, increase the high voltage to the point of corona or arcing, and may also blow the protective fuse (F1 in Fig. 4). Excessive drive will elongate the picture at the left and cause center compression. The drive control should be set at a point just below where these symptoms appear.

With insufficient drive the bias on the tube is reduced and current flow through the tube is increased. This, as with excessive drive, can cause shortened tube life and overheating of parts. Insufficient drive will decrease the amount of high voltage obtainable which causes picture blooming because the beam velocity has been reduced and is more easily influenced by the fields of the deflection coils.

As indicated in Fig. 4, the positive pulse present at the plate of the 6BG6-G tube has a peak to peak amplitude of 5,200 volts. This is stepped up by the auto-transformer arrangement in the primary and applied to the plate of the 1B3-GT high voltage rectifier. A 500  $\mu\text{mf}$  capacitor and a one megohm resistor comprise the filter section for the high voltage system. This represents an adequate filtering because the ripple frequency is high (15,750 cycles).

A 4.7 ohm resistor can be used in place of the 3.3 ohms for a greater limiting effect on filament potential. Where variations exist, the larger value resistor may reduce the possibility of repeated high voltage rectifier failure. The one megohm resistor also reduces the danger of high voltage shock to some extent. A load placed on the high voltage system will increase the current through the one megohm series resistor and a large voltage drop will occur across it. This, in turn, reduces the potential of the high voltage system and also protects the transformer and tube to some extent.

The secondary of the horizontal output transformer feeds the sawtooth signal to the horizontal deflection coils while the damper reduces the transient oscillations as previously detailed. A filter network is placed in the cathode circuit of the damper tube which will smooth the ripple components of the energy developed by the damper during conduction. The voltage developed here is applied to the plus B voltage which is delivered to the transformer secondary circuit. The voltage boost thus secured is applied to the horizontal output tube plate via the lower half of the horizontal output transformer primary. This same voltage is

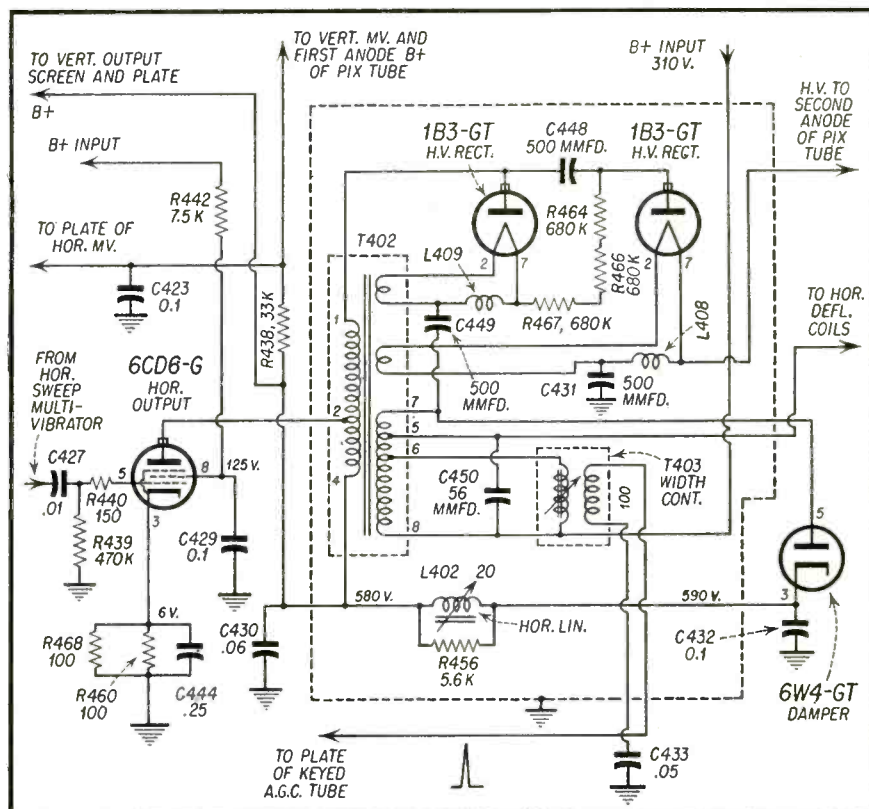

Fig. 5—Horizontal system used in Westinghouse H-653K24.

also used for the vertical oscillator and the first anode of the picture tube as indicated. A portion of the secondary is shunted with an additional inductance. The amount of shunt is established by the variable core and this controls the width of the sweep waveform. The filter choke in the voltage boost system will also affect linearity when the movable core slug is adjusted inasmuch as it affects the amount of transient voltage decay present in the damper system. The linearity of the initial portion of the sawtooth trace is adjusted by this control.

In the RCA version the cathode and negative section of the voltage boost are not placed at chassis ground but are returned to the minus 120 volt section of the bleeder system in the low voltage power supply. Voltage differences between tube elements are then established by relative allocation of potentials.

The 47 ohm resistor in the grid circuit of the horizontal output tube is for the purpose of reducing Barkhausen oscillations which are sometimes generated in the 6BG6-G. The oscillations would produce one or more black vertical bars toward the left of the screen.

To balance the capacity in the horizontal deflection coils, C169 is placed across one-half of the coil section. This prevents the left side of the screen from developing distortion because of non-

linear initial sweep.

#### Circuit Variations

Among commercial systems there are numerous variations. Some of these consist of additional windings on the secondary for voltage doubling or for the purpose of securing a pulse for keyed *agc* systems. The circuit shown in Fig. 5 is representative of the differences which sometimes exist. This shows the horizontal output and high voltage system of the Westinghouse Model H-653-K24 series of receivers. A 21AP4 picture tube is used in these receivers, which means that a greater amplitude of high voltage is required than can be procured from a single high voltage rectifier using conventional circuits. Thus, two 1B3GT tubes are used in a voltage doubler system to secure the required amplitude for the second anode of the picture tube. For this reason, two filament secondaries must be incorporated in the horizontal output transformer to accommodate the filaments of the two rectifiers. This receiver has an additional winding on the width control section so that a positive pulse can be secured for application to the plate of the keyed *agc* rectifier tube. In contrast to the circuit previously described, a 6W4GT damper is used instead of the 5V4-G. This tube, as well as the 6CD6G horizontal output tube provides greater efficiency in the horizontal deflection

[Continued on page 89]

# RC CIRCUITS

by Cyrus Glickstein

In this first installment resistor-condenser networks are discussed showing their operation and application to television and electronic circuits.

**L**OOK at any radio or TV schematic. A substantial part of the receiver consists of RC (resistor-condenser) circuits, some series and many series-parallel. In TV, especially in the sync. horizontal *afc* (automatic frequency control), and sweep sections, the circuits are largely RC.

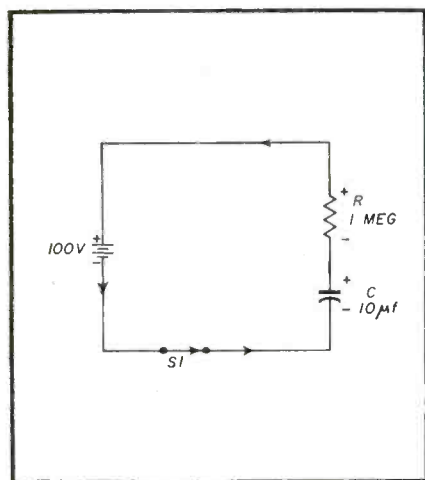

Fig. 1—Simple series RC charge circuit.

Yet, in most text-books for technicians, basic RC circuit theory is either ignored completely or touched on lightly—with only simple series RC circuit theory discussed. The assumption seems to be that once series RC circuits are understood, more complex RC circuits can be readily analyzed. *This is simply not the case.* The amazing fact

is that series-parallel RC circuits do *not* act the same as series circuits, although there are certain family resemblances. Even more surprising is the fact that each basic type of series-parallel RC circuit acts differently from the rest.

The object of this series is to provide a comprehensive survey of how the basic types of series-parallel RC circuits in radio and TV operate. Theoretical analyses will be combined with practical trouble-shooting applications, so the reader will have a foundation for analyzing the exact action of most RC circuits, which in turn will help simplify trouble-shooting problems.

As an introduction to more complex circuits, let's review briefly how series RC circuits work.

Suppose a series RC circuit is placed across a battery and the switch is closed, Fig. 1. The condenser naturally charges up to the battery voltage if the switch is kept closed for a long enough time. The time it takes the condenser to charge up depends on the value of the resistor and condenser—that is, the resistance of the resistor and the capacity of the condenser. Notice that the time it takes the condenser to charge up to the battery voltage has nothing to do with the amount of voltage in the battery. It would take the condenser in Fig. 1 the same time to charge up to the source voltage whether there is a 1-volt or a 100-volt battery in the circuit.

Let's examine the action in detail. When the switch is closed, the entire source voltage is across the resistor.

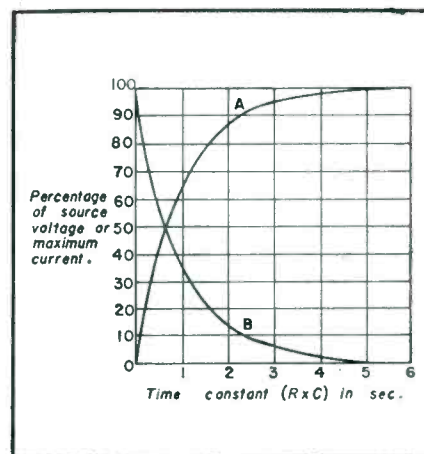

Fig. 2—Universal RC charge and discharge curves.

Curve A — Exponential rise — Condenser voltage during charge period.  
Curve B — Exponential decay —

1. Resistor voltage during condenser charge period.
2. Circuit current during condenser charge period.
3. Condenser voltage, resistor voltage and circuit current during condenser discharge period.

There is no voltage across the condenser because condenser voltage depends on charge and the condenser is just beginning to charge. The initial current is maximum and depends on the source voltage and the resistor.

As the condenser charges, the voltage in the condenser begins to buck the source voltage. A charged condenser

# SERVICEMEN NOW... you can have your own needle inspection Kit... FREE!

Here's a chance to have the new 50 Power large field hand microscope for nothing... a scope with a wide angle lens which makes it easy to examine needles—no difficulty in bringing the needle into view quickly to tell if it is worn! But that's not all! You also receive a plastic carrying case; a new

amazing ELECTRO-WIPE cloth; a professional tool for quickly replacing needles. All of this is free if you accept a real bargain, DUOTONE's offer of \$25.00 worth of needles for only \$12.50. Place your order today direct with your jobber!



replacement needles —	\$25.00
one microscope —	5.00
one electro-wipe cloth —	1.50
one plastic kit —	.50
one professional tool —	.50
	<del>\$32.50</del>
	<b>ONLY \$12.50</b>



## DUOTONE

KEYPORT, NEW JERSEY

Canadian Representative: CHARLES W. POINTON, TORONTO, CANADA  
Export Division: AD. AURIEMA, INC., NEW YORK CITY, N. Y.

Terrific  
wide angle  
50 power scope  
makes it easy to  
examine needles  
without even  
removing them  
from the  
cartridge!

acts like a battery, as practically anybody who has touched one can testify. Now, the current in the circuit begins to decrease. As the condenser voltage goes up, the resistor voltage drops in proportion.

An interesting point to remember is that during the entire time the condenser is charging, the voltage across the condenser ( $E_c$ ) and the voltage across the resistor ( $E_r$ ) add up to the source voltage ( $E_b$ ). This is not surprising since in any series circuit the voltage drops around the circuit add up to the source voltage.

If the condenser is allowed to charge up long enough, it will charge up to the full battery voltage. The condenser voltage is then equal in value but opposite in sign to the battery voltage. The two voltages are bucking, thereby preventing any current flow in the circuit. There is therefore no voltage drop across the resistor.

The time it takes the condenser to charge up to a certain definite percentage (63%) of the source voltage is called the time constant of the circuit. (Time constant also applies to a certain percentage when the condenser is dis-

charging, as will be seen shortly.) An available formula makes this very simple to compute:

$$T = R \times C$$

$T$  is the time constant in seconds,  $R$  is the resistance in ohms, and  $C$  is the capacity in farads.

The time constant of any circuit can be found by multiplying the value of  $R$  in the circuit by the value of  $C$ .

*Example:* What is the time constant of a series  $RC$  circuit if  $R$  is 1 megohm and  $C$  is 10  $\mu\text{f}$ ?

$$\begin{aligned} T &= R \times C \\ &= 1 \times 10^6 \times 10 \times 10^{-6} \\ &= 10 \text{ seconds.} \end{aligned}$$

This means it would take 10 seconds for the condenser to charge up to 63% of the source voltage regardless of the amount of source voltage.

Figure 2a shows the universal charge curve for a condenser, indicating how the voltage across a condenser rises during the charge period. Figure 2b shows the universal curve indicating how both the voltage across the resistor and the current in the circuit drop during the charge period. These curves show the percentage of source voltage (or maximum current) plotted against time (that is, time constant:  $R \times C$ ). It will be seen shortly that these curves apply also to discharge circuits. Because of their shape and mathematical characteristics, these curves are called *exponential*. Fig. 2a shows an exponential rise and Fig. 2b an exponential drop or decay.

In 5  $RC$ , the condenser in a charge circuit can be considered fully charged (see Fig. 2a). Therefore, in the example given above, if the time constant ( $R \times C$ ) is 10 seconds, the condenser would be fully charged to the battery voltage in 5  $RC$  ( $5 \times 10$  seconds) or 50 seconds.

All of the above figures which apply to a condenser charging apply in a similar fashion to the voltage across the resistor and to the current in a charge circuit. There is only a slight modification in the sign of the percentage, as is to be expected on the basis of the circuit operation. That is, in  $RC$  time, since the condenser gains 63% of the source voltage, then the voltage across the resistor falls 63%—or to 37% of the battery voltage. As was noted before, the voltage across the condenser and the voltage across the resistor must always equal the source voltage. In the same way, the current in a charge circuit which starts at maximum or 100% falls to 37% of the initial current in  $RC$  time.

One point previously mentioned may not be too clear. It may be wondered why, when a larger source voltage is used across the same  $RC$  circuit, the condenser still takes the same time to



reach full charge (or any given percentage of the full charge). This is quite understandable when the action is analyzed carefully.

When a larger battery is used, more current flows at the instant the switch is closed and throughout the charge period. Therefore a half of  $RC$  time, or  $RC$  time, or at full charge, the condenser has more voltage when the battery is bigger—but the *percentage* of total voltage is the same at any given instant. The following figures might clarify this. Suppose in *Fig. 1*, a battery of 6V is used. In  $RC$  time (10 seconds), the condenser would charge up to 63% of 6V or 3.78V. On the other hand, if a 100V battery is used across the very same circuit, in  $RC$  time the condenser would still charge up to 63% of the source voltage; amount of the voltage (not the percentage) would be greater—63% of 100V is 63V.

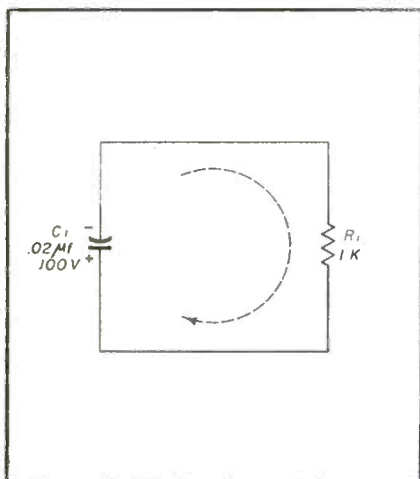

Fig. 3—Charged condenser discharging through resistor.

Now let's examine a condenser discharging through a resistor. The charged condenser in *Fig. 3* can be considered a battery—more exactly, a battery that is running down as it discharges. Just as in any simple circuit, the initial discharge current is determined by: a) the voltage across the condenser, and b) the value of resistance. However, the *time* it takes the condenser to discharge is something else again. This is determined by the time constant ( $R \times C$ ), not by the voltage across the condenser. The time it takes  $CI$  in *Fig. 3* to discharge would be exactly the same whether it started with a 1-volt charge or a 500-volt charge.

As the condenser discharges in the circuit of *Fig. 3*, the following happens: the voltage across the condenser drops; the current in the circuit therefore decreases, since less voltage across the same value of resistance gives less cur-

rent. The value of resistance of course, does not change during the discharge period.) The voltage across the resistor decreases. This must follow for two reasons: the condenser, acting as the circuit battery, is running down—therefore there is less voltage across the condenser and across the resistor; also, since the current in the circuit is decreasing because of the decreasing condenser voltage, there is less voltage drop across the resistor. Actually this is saying the same thing in two different ways. In discharge circuits of this kind, the voltage across the condenser must always equal (since it provides)

the voltage across the resistor throughout the discharge period. From the moment the switch is closed in the discharge circuit, the voltage across the condenser, the voltage across the resistor, and the current in the circuit all decrease steadily from the initial value to zero.  $E_c$ ,  $E_r$ , and  $I$  in a discharge circuit are all represented by the exponential decay curve shown in *Fig. 2b*.

The length of time it takes the condenser to discharge depends on  $RC$ . For discharge,  $RC$  is defined as the time it takes the voltage across the condenser (or the voltage across the re-

## New New New FASTER TUBE TESTING!

Now! fast testing in Plate Conductance with convenient ohms readings for leakage and shorts with the new Simpson Model 1000

- tests any tube—including 9 pin miniatures and subminiatures—for plate conductance. Dial shows percentage of rated plate conductance for more positive, accurate results.
- tests are made under conditions simulating actual use in radio, TV, hearing aids and other electronic circuits.
- gives you reliable short tests because the Simpson 1000 quickly and conveniently shows you the exact ohms values for inter-element leakage and tube shorts.
- Simpson's roll chart service makes a new roll chart available each year and complimentary roll chart supplements are provided at regular intervals.
- and—the Simpson 1000 is as handsome as it is useful. Front panel is finished in non-glare grey hammerloid. Rich burgundy carrying case looks like expensive luggage. Comes complete with Operator's Manual—all for only \$135.00, net.

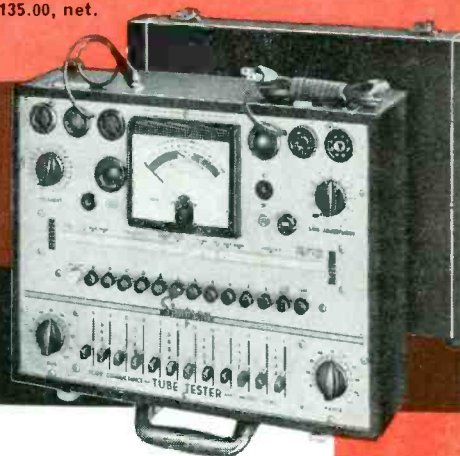

# Simpson MODEL 1000

SEE IT AT YOUR PARTS JOBBER

## SIMPSON ELECTRIC COMPANY

5200 West Kinzie Street, Chicago 44, Illinois  
ESTebrook 9-1121

IN CANADA: Bach-Simpson, Ltd., London, Ontario

FLAT  
TUBULAR  
OVAL  
ROUND  
AND OPEN  
WIRE LINES

now one lightning arrester  
takes 'em all!

AM FM UHF VHF



MODEL ULA  
shown actual size

ANNOUNCING THE ONE AND ONLY  
**UNIVERSAL  
LIGHTNING ARRESTER**

ANOTHER  
GREAT FIRST BY

**VEE-D-X**

**VEE-D-X** proudly presents the first and only Universal Lightning Arrester. Now, with this one lightning arrester, you can make any type of installation — UHF, VHF, AM, FM and with any popular type of transmission line. Sounds fantastic . . . but it's true. It all started with the advent of UHF and the many complications with various types of transmission lines. It was then that the VEE-D-X engineering staff set as its goal the perfection of a single lightning arrester that would be adaptable for any type of installation. The Universal Lightning Arrester is the result . . . compact, clean-cut, inexpensive and designed to give complete protection, providing a discharge gap, resistance suppression and high inductive impedance. What's more, it is the first lightning arrester that is hermetically sealed, using a printed circuit, and designed to accommodate 150, 300, 350, 450 ohm line. It is the first lightning arrester that can be used as a termination block. When mounted on window sill, it provides a simple and convenient means of terminating tubular line to flat line for indoor use. Check every one of its additional features below, and you will agree that the Universal Lightning Arrester obsoletes all others.

**FEATURES**

- Takes flat, tubular, oval and open wire lines.
- Encased electrodes, hermetically sealed against weather. Fully moisture-proofed for stable operation at UHF.
- Low-loss, homogeneously moulded case of flame-resistant plastic. No wax to chip or crack. No pitch compound to melt away.
- Form-fitted channels assure positive anchorage for all popular type lines. No need for improvised or haphazard connections that will loosen or break away in storms.
- Small, compact size — only 2" x 2½" x 1½" — inconspicuously mounted on boom, mast, window sill or water pipe.
- Quick installation without wire-stripping, cutting or wire separation.
- Ample teeth on terminal cleats for positive "bite" on all types of transmission lines.
- Unaffected by climatic and temperature changes.
- Maintains proper line impedance for all lines.
- Positive line connectors are protected under cover, applying constant pressure for permanent electrical continuity.
- Can be used with either TV, FM or AM radio set installations.
- Double ground connections for either wire or pipe termination.
- Adaptable to mast diameters ranging from ¼ inch to 1½ inch.
- Approved fire-resistant plastic case.
- UL approved.
- Universal mounting—mast strap or window sill in any position best suited to lead direction.
- Individually boxed — 25 to reshipment cartons — 100 in master carton.

*LaPointe* ELECTRONICS INC.  
ROCKVILLE, CONNECTICUT

sistor or the current in the circuit) to decrease by 63% from the initial value at the instant the switch was closed—that is, in the case of the condenser, the time it takes to discharge down to 37% of the voltage it had when it first started to discharge.

*Example:* In the circuit of Fig. 3, how long does it take  $C$  to discharge to 37% of the original voltage across it if  $C$  is .02  $\mu\text{f}$  and  $R$  is 1K?

$$T = R \times C = 1000 \times .02 \times 10^6 \\ = 20 \times 10^{-6} \text{ seconds} = 20 \mu\text{sec}$$

We are now ready to consider some practical circuit applications before going on to more complex circuits. Although we have discussed how long it takes a condenser to charge and discharge completely, it would be a serious error to think the object of all RC circuits is to charge up a condenser completely across a  $dc$  source voltage.

RC circuits are used in  $ac$ ,  $dc$ , and pulsating  $dc$  (combination of  $ac$  and  $dc$ ) circuits. In all cases, the charge and discharge action of a condenser is basically the same. In some circuits where there is pulsating  $dc$ , condensers are allowed to charge up completely to the source voltage. This is done in most filter circuits, such as those used in power supplies or in bypass circuits (cathode bypass and screen bypass condensers). In this type of filtering, the condenser charges up to a given voltage and tends to maintain this value of voltage even when the source voltage changes instantaneously. This is usually accomplished by placing the condenser *across* (in parallel to) the point being filtered. Also, in certain  $ac$  (differentiating) circuits, which will be discussed shortly, the condenser is allowed to charge up to the source voltage.

In other circuits where there is pulsating  $dc$ , condensers are used to block out the  $dc$  and allow only the  $ac$  to pass through. A common example of this is the RC interstage coupling circuit in an audio amplifier. This action is accomplished by placing a series RC circuit across the point where there is pulsating  $dc$  (coupling condenser in series with a grid return resistor). The condenser charges up to the  $dc$  voltage and keeps this from being applied across the resistor, once the condenser has reached the full  $dc$  source voltage. However, when  $ac$  variations are superimposed on the  $dc$  level, the  $ac$  voltage is applied across both the resistor and condenser.

In other applications, the series RC circuit is placed across a  $dc$  source and the condenser is allowed to charge to a small part of the source voltage. A common example is the TV sweep circuit.

The RC charge circuit in a TV sweep

# MEET *Telechief!*<sup>®</sup>

**SANGAMO'S NEW PREMIUM TUBULAR**

**CAPACITOR** — designed to give

better TV performance!



Sangamo combines an amazing new molding compound with a new impregnant to bring you a completely new paper tubular capacitor—developed by request to meet rigid specifications so tough that no previously existing paper tubular could approach them.

Thousands of Telechiefs have been tested under actual service conditions... have proved their ability to outlast and outperform all other tubulars.

The new molding compound, Sangamo Humiditite, greatly

lengthens capacitor life. It has been proved, by severe tests, to give the best seal against moisture of any molding compound in the industry.

The new Sangamo impregnant holds rated capacity under all conditions and makes the Telechief really rugged.

Because we know that service men want only the *best* replacement parts—the new Telechief has been released to the service trade. Get in touch with your Jobber.

*Those who know... choose Sangamo*



**SANGAMO ELECTRIC CO.** MARION ILLINOIS

generator is used to generate a sawtooth or a modified sawtooth voltage for sweeping the beam of the picture tube vertically and horizontally. In a sawtooth generator, the condenser charges only during the initial part of the charge curve, which is the linear portion of the exponential curve. The condenser charges slowly through a large resistor, but the charging action is stopped before the condenser accumulates more than 20% of the source voltage. Then the condenser is discharged rapidly through a small resistor (usually a tube which is made to

conduct). The discharge path is a small time constant compared to the charge path. Therefore, the discharge is more rapid than the charge, to provide fast retrace of the beam. When the action is repeated regularly, the result is a typical sawtooth waveform. The charge and discharge of the condenser is accomplished automatically by appropriate sawtooth oscillator circuits—blocking oscillators or multivibrators. The basic charge and discharge paths and the resulting waveform are shown in Fig. 4.

[Continued on page 90]

PHILCO TEST EQUIPMENT SPECIFICALLY DESIGNED FOR THE SERVICEMAN

# AGAIN PHILCO LEADS THE INDUSTRY

## *Serviceman's needs seen as Philco's Engineering Goal*

This new Philco VHF to UHF adapter pioneers a whole new approach to service problems and at the same time is the most economical and practical unit ever offered. Servicemen are taking full advantage of the introductory demonstrations of this amazing piece of equipment now offered by Philco distributors coast to coast.

### **The First and Only VHF to UHF Signal Generator Adapter**

Continuing its engineering program designed to provide the serviceman with the best possible test equipment Philco Corporation now offers at a fraction of the usual cost an exclusive highly specialized adapter unit for converting the output of VHF TV servicing test equipment to UHF.

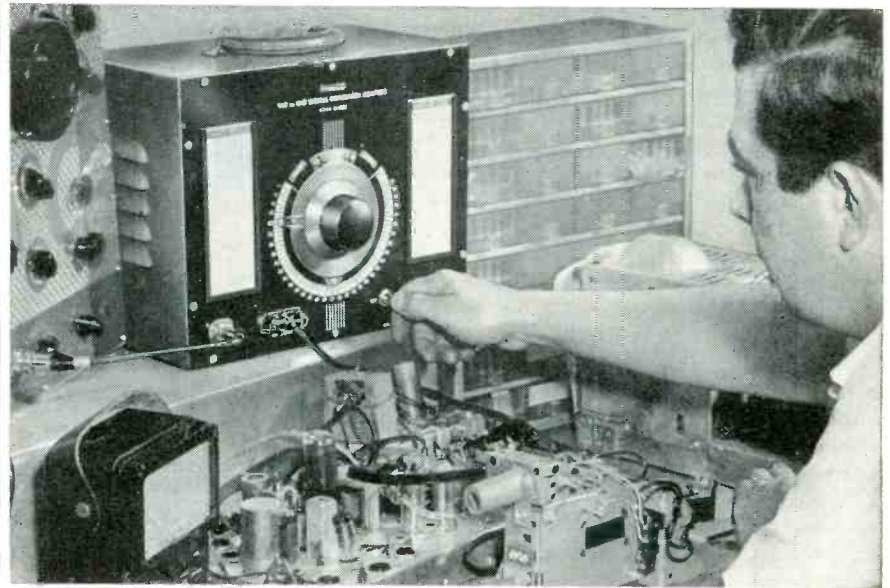

Under the trained eye of a Philco Serviceman the amazing model G-8000 VHF to UHF signal generator adapter is shown in action.



### **One of the Finest Vacuum Tube Voltmeters ever Designed**

Facing up to the task of measuring high impedance circuits where loading effect must be kept to a minimum Philco has again designed a unit which meets the most rigid engineering specifications. All reports indicate this unit is unexcelled for complete and accurate measurements.

### **Practical Portable 3-inch Television Oscilloscope**

The tremendous growth of television requires the most practical and versatile types of equipment to answer service needs. Philco has such equipment, particularly in its 3" scope which is 2½ times smaller than other 3" units, making it adaptable to either bench use or field servicing. High sensitivity and wide response make it ideal for TV work.



"Philco Test Equipment Specifically designed for the serviceman!" That's the theme of Philco's engineering program. A program which you, the serviceman, can depend upon to supply the very finest in service test equipment. Discover how easy it is to own a complete Philco Test Equipment Laboratory. Your Philco Distributor is eager to serve you by offering his new special payment plan to best accommodate your needs. Fill out the attached coupon as shown and mail to Philco Accessory Div.

#### **PHILCO CORPORATION**

Accessory Division  
Allegheny Ave. & "A" St., Phila. 34, Pa.

I am interested in the Philco Test Equipment shown here. Please send me details of your SPECIAL PURCHASE PLAN for obtaining these units.

Please send FREE copy of your new booklet on Philco Test Equipment.

NAME .....

ADDRESS .....

CITY ..... STATE .....

# CBS COLORTRON



Through the courtesy of CBS we are pleased to bring to our readers the first article on the new CBS color picture tube, the "Colortron."

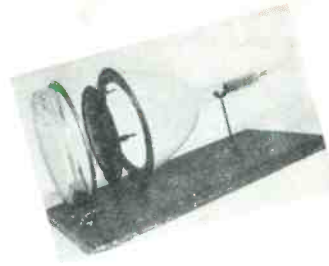

## Part 1

**T**HE CBS-Colortron is an aluminized, direct-view, tri-color picture tube designed for use in color-television receivers. Electromagnetically deflected and electrostatically focused, the CBS-Colortron has a deflection angle of 45 degrees, and an over-all length of 26 $\frac{1}{8}$  inches. It provides a choice of full-color or black-and-white pictures on a screen area of approximately 104 square inches.

This tube employs an all-glass construction and incorporates a unique mask-and-screen assembly. The simplicity of this assembly facilitates the use of low-cost mass-production techniques, and enhances the operational quality of the tube.

### Electron-Gun Assembly

The electron-gun assembly contains three matched, electrostatic-focus electron guns, each similar to the gun used in the 5TP4 projection-type black-and-white tube. The three guns are arranged in a triangular configuration, with each gun aligned parallel to and equidistant from the tube axis. The guns are also displaced from each other by an angle of 120°, measured in a plane perpendicular to the tube axis.

### Phosphor Screen And Aperture Mask

By a unique method of screen proc-

essing, the tri-color, phosphor-dot screen is placed directly on the inside surface of the spherical face plate of the CBS-Colortron. In addition to achieving simple construction and high-quality reproduction, many electrical and structural advantages are realized, because of this advanced design. Dynamic focusing and convergence requirements are reduced to a minimum; sharper, brighter pictures result; adjustment time is reduced to a minimum; and a simple, stable overall tube construction is attained.

The phosphor screen of the CBS-Colortron contains some 250,000 phosphor dots of each primary color, a total of 750,000 phosphor dots. These

dots are arranged in 250,000 triangular groups, or triads. Each triad contains one red, one blue, and one green phosphor dot.

Another component of the CBS-Colortron is the aperture mask. This thin, arched mask is located between the phosphor screen and the electron-gun assembly. It contains approximately 250,000 round holes, one for each triad on the screen. Since the position of these holes relative to the triads is of paramount importance for proper tube operation, the mask is accurately positioned with relation to the triads and is approximately 0.4 inch behind the phosphor screen. *Figure 1*, graphically illustrates the orientation of the holes in the mask with the triads on the screen.

### Mask-And-Screen Assembly

As can be seen in *Fig. 2*, the entire mask assembly is the ultimate in simplicity. It consists of the curved mask with spring clips to hold it in place. This assembly is mounted on three hemispheres, which are raised points of glass molded around the edge of the face plate, beyond the picture area.

The mask contains three "V"-shaped surfaces which rest over the hemispheres and make use of the kinematic principle of precise location. Since the mask is unstressed, it is free to expand and contract. This combination of a curved face plate and a

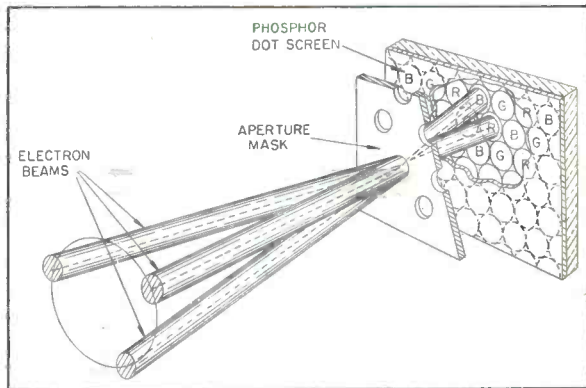

**Fig. 1**—Diagrammatic illustration of the mask and screen showing the convergence of the three beams at a single hole in the aperture mask. Note that the converged beams pass through the hole and strike their respective phosphor dots.

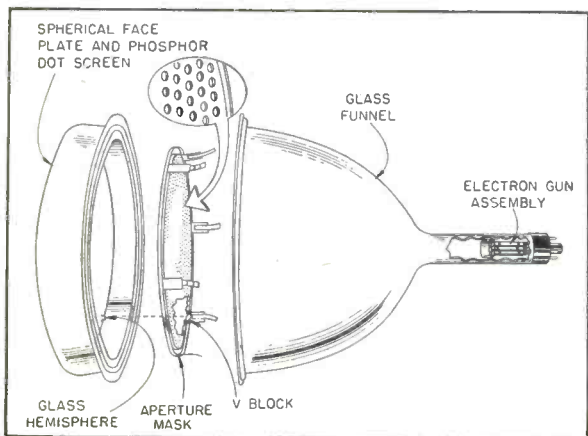
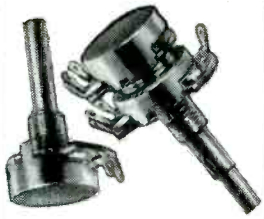

**Fig. 2**—"Exploded" view of the CBS-Colortron showing its internal components.

**1 CONTROLS**



Model B16 Radiohm®  
Miniature



Twin and dual concentric  
Radiohms

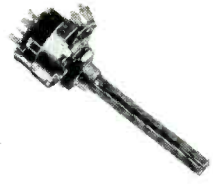

Model B Blue Shaft®  
Radiohms



Type AB Adashaft®  
Radiohms



Compentrol†  
Infinitely variable  
loudness control

**2 SWITCHES**

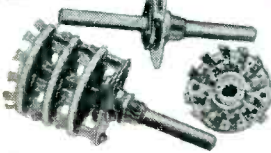

PA-2000 Miniature Rotary,  
Steatite Insulation

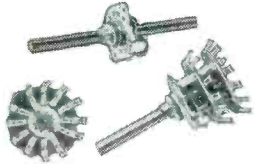

2500 Series Standard  
Rotary,  
Steatite Insulation



Ham Type

**3 CAPACITORS**

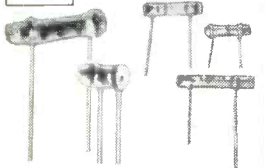

BC Tubular TC Tubular

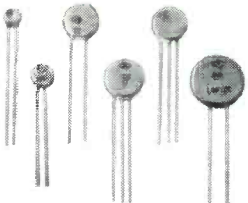

BC Discs



TV HI-VO-KAPS®



Transmitting Capacitors

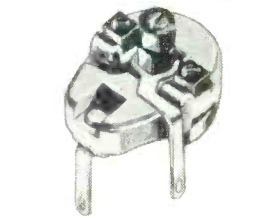

Ceramic Trimmers

**4 P.E.C.**

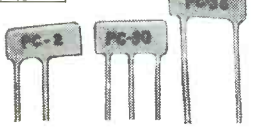

Miniature Resistor and  
Resistor-Capacitor  
Units

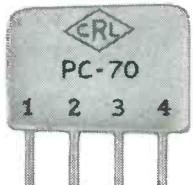

Standard Triode  
Coupler®

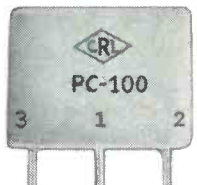

Vertical Integrator

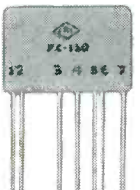
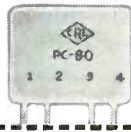

Audet®  
Audio-detector plate



Ampec®  
standard and miniature  
3-stage amplifiers



P. E. C. Kits

# FOR SALE!

**These and 100,001 other Centralab quality electronic components**

HERE'S a perfect check list to determine your electronic needs. And there are hundreds of variations available to you. Whether you need a few items or dozens — no other single manufacturer can offer you such a wide choice of standard fastest-for-servicing parts. That's why Centralab is the industry's No. 1 electronic component source . . . and keeps your distributor supplied with the latest develop-

ments in the fast-changing electronics field.

You know CRL parts are your best value because each is backed by a written guarantee. That means they're safest for servicing. And you'll agree that's mighty important for building consistent customer satisfaction.

So when you need parts, look for the familiar blue and white CRL package — the product inside is the result of more than 30 years of electronic experience. This experience has pioneered many profit-building "firsts" for you! For complete performance data and engineering specifications mail coupon.

† Trademark  
P.E.C.—Printed Electronic Circuits

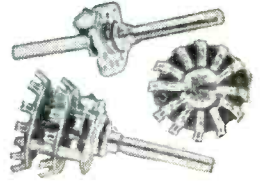

1400 Series, Standard  
Rotary, Phenolic  
Insulation



Small General  
Purpose and tone



Complete Switch Kits

## Centralab

A Division of Globe-Union Inc.  
944-K E. Keefe Ave., Milwaukee 1, Wis.  
804 Mt. Pleasant Road, Toronto 12, Ontario

Please send me Catalog 28 with information on Centralab products.

Name.....  
Title.....  
Company.....  
Address.....  
City.....Zone.....State.....

curved, unstressed mask automatically permits expansion and contraction without misregistration.

### Principles of Tube Operation

A logical starting point to discuss tube operation is the electron gun. As was previously stated, the CBS-Colortron contains three identical electron guns arranged in a triangular configuration. It follows that the resultant beams are also in the same triangular arrangement relative to the tube axis.

Each of the three electron beams is individually modulated by a composite voltage that consists of color and brightness signals. This voltage is applied between the control grid and cathode. The proper color signal is applied between the control grid and ground; the common brightness signal is applied between all cathodes and ground. By utilizing this method, the individual beams are modulated in accordance with the transmitted signal,

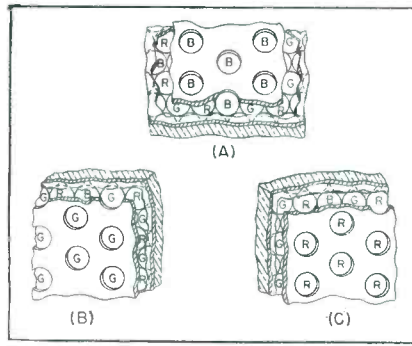

Fig. 3—Views of mask-and-screen assembly as seen from deflection points of three beams. (A) View from blue gun. (B) View from green gun. (C) View from red gun.

plied to the convergence electrode. This voltage is a combination of a static voltage and a dynamic voltage derived from the horizontal and vertical-deflection circuits. It varies the focal length of the convergence lens in accordance with the position of the

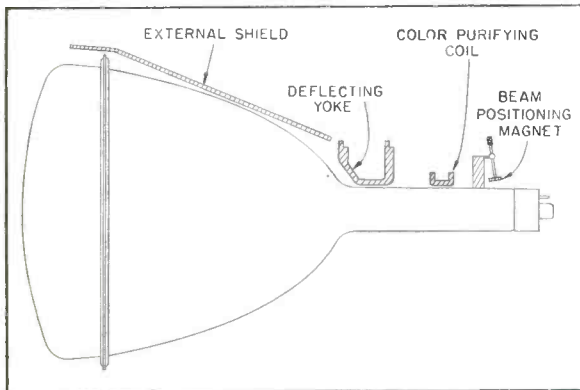

Fig. 4—Cross-sectional view of external components used with tri-color tube. Note the arrangement of these components.

and are of the proper intensities for their respective colors.

The modulated beams are also focused by their respective guns. This focusing, similar to that in conventional black-and-white tubes, is accomplished by the electrostatic lens formed by grids 2 and 3. (See Fig. 5) Since the focusing electrodes (grid No. 3 of each of the three guns), are internally connected together, a common focusing voltage may be used. This feature simplifies the associated circuitry.

As the three electron beams emerge from the convergence electrode (grid No. 4), they are acted upon by the electrostatic convergence lens. This lens is formed by the potential gradient that exists between the convergence electrode and the inner conductive coating in the neck of the tube. This conductive coating is electrically part of the accelerating anode. It is the function of this lens to converge the three beams at the aperture mask. Convergence is necessary to insure that the three color images will be superimposed.

Adjustment of convergence is accomplished by varying the voltage ap-

plied to the convergence electrode. This voltage is a combination of a static voltage and a dynamic voltage derived from the horizontal and vertical-deflection circuits. It varies the focal length of the convergence lens in accordance with the position of the beams as they scan the phosphor screen. The spherical shape of the mask and screen of the CBS-Colortron reduces the dynamic-convergence voltage and facilitates easy convergence adjustment in the receiver.

In the ideal case, the three beams leave the convergence lens so aligned that, when deflected, they approach the aperture mask at the correct angles properly converged. In the practical case, however, this is not always true. For this reason, it is necessary to employ external components to align properly the three beams.

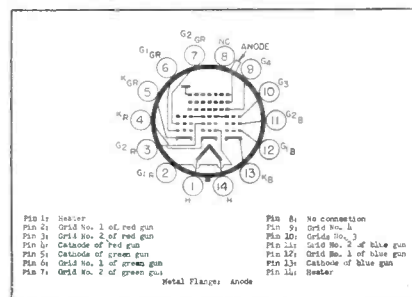

Fig. 5—Basing diagram.

The first of these external components is a combination of three small, movable permanent magnets, one for each beam. These magnets provide for adjustment of each of the beams, so that they will be properly acted upon by the convergence lens. The three magnets are mounted nominally 120° apart on the circumference of a non-ferrous ring. The ring is located approximately 1½ inches from the tube axis in the grid-No. 2 region.

The other external component necessary for proper beam alignment is the color-purifying coil. (See Fig. 4) The magnetic field produced by this coil is perpendicular to the tube axis. This field acts upon the three beams simultaneously and, by proper adjustment of its strength, and its axial and rotational position, the common axis of three beams can be positioned to achieve optimum color purity. The coil is located on the neck of the tube in the region of grids 2 and 3. The construction of the coil should allow it to be rotated and moved along the neck of the tube.

After the beams have been acted upon by the alignment components and the convergence lens, they enter the deflection area. Here, the deflection yoke provides the required uniform magnetic fields that simultaneously deflect the three beams.

As in black-and-white tubes, the deflection yoke consists of four electromagnetic coils. These coils function in pairs, each coil of a pair located diametrically opposite the other. Since this deflection yoke acts simultaneously on three beams, the electromagnetic field requirements are more stringent than those in black-and-white tubes. In particular, a more uniform field is required for deflection in the tri-color tube.

The electron beams travel in straight line paths from the deflection area to the screen, as seen in Fig. 1. Between the phosphor screen and the deflection area is the aperture mask. This mask is positioned so that, when viewed from the deflection point of any of the beams, only the dots of a single color can be seen through the perforations in the mask. Figure 3 illustrates this condition.

With the mask in the position described above, one beam will strike only the red dots, another beam will strike only blue dots, and the third beam will strike only green dots. This mask, consequently, allows each beam to reproduce the exact hue of one of the primary colors present in each portion of the televised scene. The combination of the three primary colors recreates the color scene in full color.

[To be continued]

# THE *American* IDEA



"To find and follow the better way"... Out of the vision of Dr. George Ellery Hale came the great "American Idea" that resulted in the creation of the "Glass Giant of Palomar"—world's largest telescope—to gather new light from the farthest stars for the searching eye of science.

With us, the "American Idea" is, by directed effort and applied know-how, to continue to lead in bringing you electronic products of the highest quality.

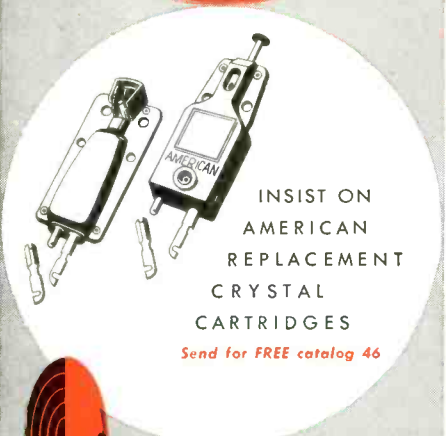

INSIST ON  
AMERICAN  
REPLACEMENT  
CRYSTAL  
CARTRIDGES

Send for FREE catalog 46



*American* microphone co.

270 South Fair Oaks Ave. • Pasadena, 1, Calif.

## Service Technicians!



**NOW** you can own  
the invaluable  
**PHOTOFACT Library**  
this **EASY** way!

- ✓ Own the COMPLETE Library
- ✓ Fill in your present Library

Yes, now you can get through your PHOTOFACT Distributor, the complete PHOTOFACT Library (200 Sets of Folders) for only \$25.00 down and 18 full months to pay! Or you can fill in your present library and bring it up-to-date on the same amazing terms. Absolutely no interest and no carrying charge! You get immediate *prepaid* delivery of the world's finest service data. You use it *now*. It earns for you while it *pays for itself*! See your PHOTOFACT Distributor today!

**YES ONLY \$25<sup>00</sup> DOWN!**  
**UP TO 18 MONTHS TO PAY**  
**No Interest • No Carrying Charge**

**PLUS** the ultimate in  
filing convenience. Your choice of:



**BINDERS:** Handsome, sturdy permanent binders that make up into handy volumes of 10 sets of Folders each. Order 20 for the 200 set Library or as many as you need to fill in. Shipped prepaid.



**FILING CABINET:** Sturdy 4-drawer file cabinet to hold your PHOTOFACT Library in ship-shape, easy-reference order. Shipped FOB factory.

Yes, you get either Binders or File Cabinet with your PHOTOFACT Library under the same Easy Terms—the entire deal for just \$25.00 down, up to 18 months to pay!

**ORDER TODAY!**

**PAY AS YOU PROFIT with  
The World's Finest Service Data**

See your PHOTOFACT Distributor for full details. If you don't know his name, write us for it. Address: HOWARD W. SAMS & CO., INC., 2201 E. 46th St., Indianapolis 5, Ind.

## TV Voltage Trouble?

TeleVolt **AUTOMATICALLY**  
Provides Constant Voltage  
For Proper  
**TV PERFORMANCE** and  
**SET PROTECTION**



Bad voltage from overloaded lines shifts TV tube operating points and often causes distortion, fuzzy pictures and jitters; high voltages damage components. The SOLA "TeleVolt" Constant Voltage Transformer automatically stabilizes voltage within  $\pm 3\%$ . It automatically protects costly components against high voltage surges while it enables any TV set to deliver peak performance. It is an automatic voltage stabilizer... not a voltage booster.

Actual line voltage may vary  $\pm 15\%$  or more over nominal value

The Sola Tele Volt automatically stabilizes voltage within  $\pm 3\%$

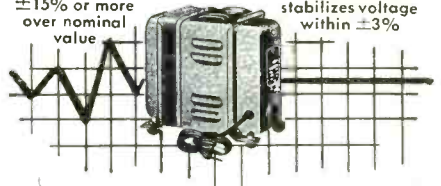

Write today for Bulletin AC-CV-175 or see your electronic distributor

**SOLA Tele Volt**  
Automatic Constant Voltage  
**TRANSFORMERS**

**SOLA ELECTRIC CO.**  
4633 W. 16th St. Chicago 50, Ill.



# A New Tandem 40 MC. I.F. AMPLIFIER

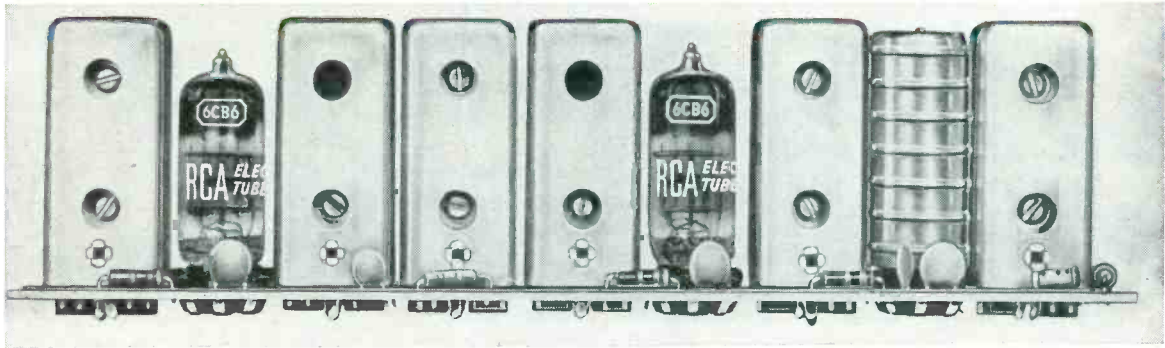

Reprinted by permission of RCA, copyright proprietor

THE RCA-207E1 is a prealigned *if* amplifier designed for use in TV receivers utilizing intercarrier-sound systems having picture-*if* and sound-*if* carriers of 45.75 *mc* and 41.25 *mc*, respectively. It employs printed-circuit *if* transformers, coils, and traps arranged in tandem, with three 6CB6 amplifier tubes and a 1N64 type crystal on a panel 8-25/32" long by 1-15/32" wide. As illustrated in the photograph above.

The inductances of the printed-circuit *if* transformers, coils, and traps employed in the 207E1 are in the form of flat inductors having rectangular windings. The inductors are made by accurately producing the windings on low-loss plastic strips by the RCA photo-etched copper-foil process. Each inductor strip is housed in a shield can 7/8" square by 2 1/4" high; adjustments are made by means of aluminum screw disks accessible from one side of the can. This arrangement permits all alignment adjustments to be made above the chassis.

The resistors and capacitors used in the 207E1 are uniquely mounted on top of the amplifier panel with their leads inserted through the panel and connected into the circuitry by printed wiring.

When the 207E1 is attached to the TV chassis, an excellent grounding connection is mechanically effected between the two units by means of flat solder areas around the amplifier-mounting holes. Terminals are provided on the 207E1 for input, output, B+, *agc*, and heater.

The new RCA printed-circuit type, prealigned, full 4-mc bandpass, 40-mc *if* amplifier with 40 uv sensitivity.

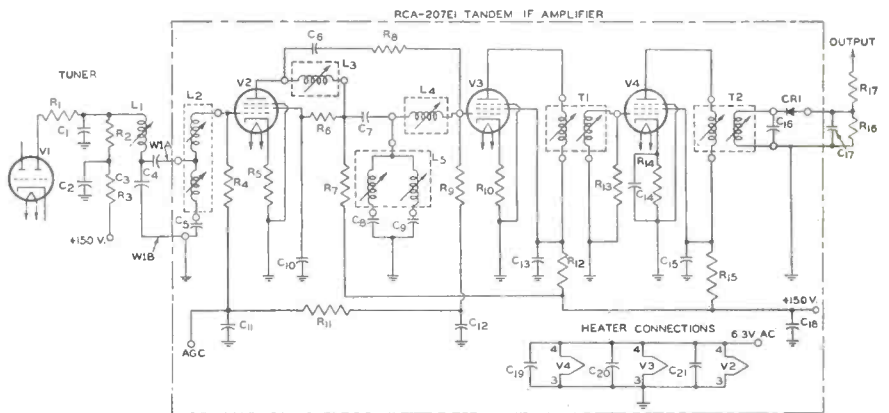

- C1: 10  $\mu\text{mf}$ , 400 v.
- C2: 1500  $\mu\text{mf}$ , 400 v.
- C3: 82  $\mu\text{mf}$ , 400 v.
- C4: 1500  $\mu\text{mf}$ , 400 v.
- C5: 9  $\mu\text{mf}$ , 400 v.
- C6 C7: 870  $\mu\text{mf}$ , 400 v.
- C8: 12  $\mu\text{mf}$ , 400 v.
- C9: 5  $\mu\text{mf}$ , 400 v.
- C10: 470  $\mu\text{mf}$ , 400 v.
- C11: 1500  $\mu\text{mf}$ , 400 v.
- C12: 1500  $\mu\text{mf}$ , 400 v.
- C13: 470  $\mu\text{mf}$ , 400 v.
- C14: 1500  $\mu\text{mf}$ , 400 v.
- C15: 470  $\mu\text{mf}$ , 400 v.
- C16: 4  $\mu\text{mf}$ , 400 v.
- C17: 15  $\mu\text{mf}$ , 400 v.
- C18 C19 C20 C21: 1500  $\mu\text{mf}$ , 400 v.

- CV1: 1N64 Type Crystal
- L1: Converter plate coil with adjustable powdered-iron core; center frequency, 43.5 Mc
- L2: 1st picture-*if* grid-circuit filter coils
- L3: 1st picture-*if* plate-circuit coil
- L4: 2nd picture-*if* grid-circuit coil
- L5: 1st & 2nd picture-*if* filter trap coils
- R1: 22 ohms, 0.5 watt
- R2: 8200 ohms, 0.5 watt
- R3: 15000 ohms, 0.5 watt
- R4: 10000 ohms, 0.5 watt
- R5: 47 ohms, 0.5 watt

- R6: 2200 ohms, 0.5 watt
- R7: 1200 ohms, 0.5 watt
- R8: 24000 ohms, 0.5 watt
- R9: 22000 ohms, 0.5 watt
- R10: 47 ohms, 0.5 watt
- R11: 2200 ohms, 0.5 watt
- R12: 1000 ohms, 0.5 watt
- R13: 10000 ohms, 0.5 watt
- R14: 82 ohms, 0.5 watt
- R15: 1000 ohms, 0.5 watt
- R16: 5600 ohms, 0.5 watt
- R17: 4700 ohms, 0.5 watt
- T1: 2nd picture-*if* transformer
- T2: 3rd picture-*if* transformer
- V1: RCA-6J6
- V2 V3 V4: RCA-6CB6 up to 10" in length

Fig. 1—Typical circuit using the RCA-207E1 amplifier

The entire amplifier panel is impregnated with a special compound to provide high resistance to moisture absorption.

### Electrical Features

Designed to operate with a diode load resistance of 5600 ohms, the 207E1 amplifier provides high gain,

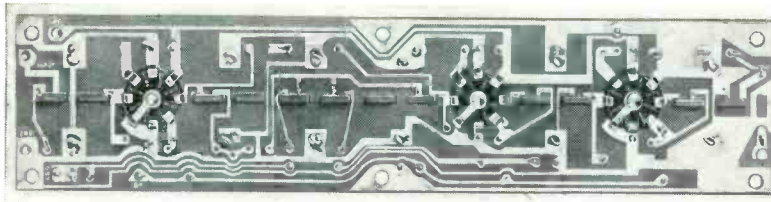

Bottom view of RCA-207E1.

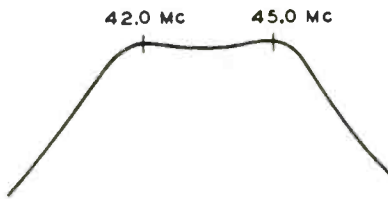

Fig. 3—Response curve for T2, L5, T1, and T2.

full bandpass response, and excellent skirt selectivity. It has an overall sensitivity of 40 microvolts\* at 44 megacycles and passes a bandwidth of 4 megacycles measured at two times down as indicated on the attenuation curve shown in Fig. 2. When the 207E1 is used in conjunction with a cascade type tuner, a voltage of only 6.5 microvolts as midband is required at the input of the tuner to provide a dc voltage increase of 1 volt at the output of the amplifier.

The coupling circuit of Fig. 1, between the tuner and the 207E1, includes L1 and L2 and constitutes an M-derived bandpass filter. The characteristics of this filter provide high attenuation at 39.75 mc for rejection of the adjacent-channel picture-*if* carrier signal. A low-impedance line, up to 10" in length, can be used for link-coupling the tuner to the *if* amplifier.

L3, L4, and L5 of Fig. 1 are used in a double-tuned, double-cutoff, M-derived filter section between the V2 and V3 tubes. The characteristics of this filter section provide efficient coupling between the first and second *if* stages, essentially flat bandpass response, desired attenuation at 41.25 mc of the accompanying-sound signal, and maximum attenuation at 47.25 mc for rejection of the adjacent-channel sound signal.

T1 of Fig. 1 is a double-tuned mutually coupled transformer between the

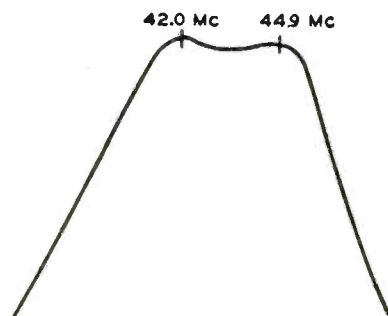

Fig. 4—Response curve for T1 and T2.

V3 and V4 tubes. It provides a flat bandpass response at a center frequency of 43.5 mc.

T2 of Fig. 1 is a double-tuned mutually coupled transformer. Used between the V4 tube and the CR1 crystal-diode detector, it provides a flat bandpass response at a center frequency of 43.5 mc.

#### Suggested Alignment Procedure

1. Connect a wide-bandwidth oscilloscope such as an RCA-WO-56A or WO-88A to the output of the circuit of Fig. 1.

2. Detune the primary winding of T1 by connecting an alligator clip to the plate of V3. Connect a 1000- $\mu$ f mica capacitor in series with the out-

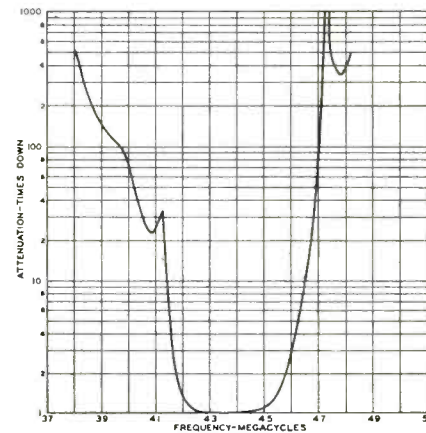

Fig. 2—Overall attenuation characteristic.

put lead of a TV sweep generator such as the RCA-WR-59C and connect to grid-No. 1 of V4. Set the output level of the sweep generator to produce a 1-volt output at the second detector. Loosely couple the output of a TV marker calibrator, such as the RCA-WR-39C, to the sweep-generator lead. Adjust the primary and secondary inductances of T2 to obtain the response curve shown in Fig. 3.

3. Remove the alligator clip from the plate of V3. Connect the sweep generator through the 1000- $\mu$ f mica capacitor to grid No. 1 of V3. Loosely couple the output of the marker calibrator to the sweep-generator lead. Adjust the primary and secondary inductances of T1 to obtain the response curve shown in Fig. 4.

\* Measured at the grid of the converter tube. Forty microvolts at this point will produce a dc output of 1 volt across the load resistor of the second detector with zero external bias and the oscillator developing a converter-grid bias of approximately 2.5 volts.

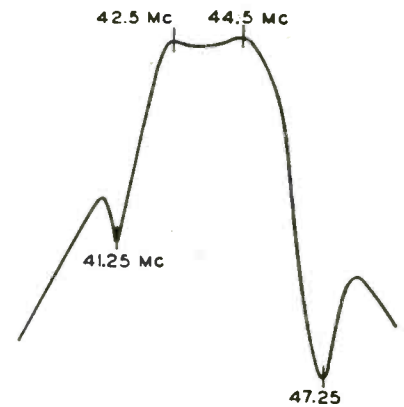

Fig. 5—Response curve for L3, L4, L5, T1, and T2.

4. Connect the sweep generator through the 1000- $\mu$ f mica capacitor to grid No. 1 of V2. Modulate the marker calibrator and loosely couple its output to the sweep-generator lead. Adjust the upper screw disk of L5 for minimum response of the modulated signal at 47.25 mc. Adjust the lower screw disk of L5 for minimum response of the modulated signal at 41.25 mc. Remove the modulation and adjust the inductances of L3 and L4 to obtain the response curve shown in Fig. 5.

5. Connect the sweep generator through the 1000- $\mu$ f mica capacitor to grid-No. 1 of V1. Modulate the marker calibrator and loosely couple its output to the sweep-generator lead. Adjust the lower screw disk of L2 for minimum response of the modulated signal at 39.75 mc. Remove the modulation and adjust the upper screw disk of L2 as well as the inductance of L1 to obtain the response curve shown in Fig. 6.

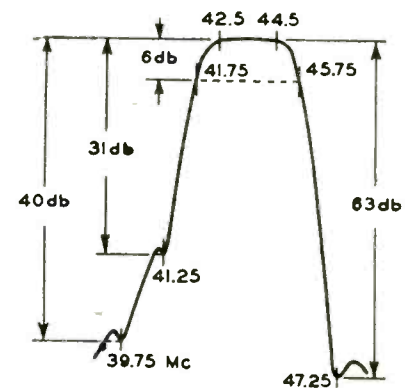

Fig. 2—Overall attenuation characteristics.

# ASSOCIATION NEWS

## NETSDA

The National Electronic Technician And Service Dealers Association (NETSDA) met in Trenton, N. J., October 4th, 1953, in the Stacy-Trent Hotel. President Roger Hains of Haddonfield, N. J. presided. Among the items of business conducted were: Plans for the proposed Eastern Conference which is scheduled for Philadelphia, Pa., in early February at a date to be announced. Samuel Brenner, President of PRSMA, associating with the newly formed Philadelphia Council was appointed Chairman of the conference arrangements for NETSDA. Max Leibowitz, President of the New York State Federation was appointed Co-chairman.

## FRSAP

Chairman Milan Krupa presided at the State Federation (FRSAP) meeting held Sunday, September 13, at the Sheraton Hotel, Pittsburg, Pa. It was decided that final action would be taken at the October session to change the present chartered title of the organization to "The Federation Of Television-Radio Service Associations of Pennsylvania" (FTRSAP).

At this session it was decided to promote activity to encourage and uphold the validity of the Dealers Franchise. The co-operation of the parts and set jobbers will be sought in the project.

## NATESA

The National Alliance of Television & Electronic Service Associations plan a comprehensive three-point industry relations program for the coming year, Frank J. Moch, president announced following the fourth annual TV-Radio Service Industry Convention and Show held in Chicago, October 9, 10 and 11. The convention brought delegates from thirty-eight states and Canada to view the thirty-two manufacturers' displays and to attend the seminars, color-television symposium and discussion groups and the gala annual NATESA banquet.

## Cincinnati Group Joins NATESA

The Association of Television Service Companies, Cincinnati, has joined the National Alliance of Television and Electronic Service Associations, Frank J. Moch, NATESA president, disclosed recently.

BEST ALL-AROUND TESTER ON THE MARKET

### USE IT FOR

- TV SETS
- RADIOS
- TRANSFORMERS
- BROADCASTING EQUIPMENT
- HOME APPLIANCES
- TWO-WAY RADIO COMMUNICATIONS SYSTEMS
- PHONE LINES
- AIR CONDITIONING SYSTEMS
- STARTER CONTROLS
- AUTO IGNITIONS, GENERATORS, BATTERIES
- MOVIE EQUIPMENT
- PANEL INSTRUMENTS
- TV CAMERAS
- AUTO LIGHTING SYSTEMS
- GENERATORS
- VOLTAGE SOURCES
- "HAM" RADIO EQUIPMENT
- CABLES
- CONNECTORS.
- AUDIO FREQUENCY SOUND CURRENTS

... and write for your complimentary copy of "1001 Uses for the Simpson Model 260"

### RANGES:

20,000 OHMS PER VOLT DC  
 1,000 OHMS PER VOLT AC  
 VOLTS AC AND DC: 2.5, 10, 50, 250, 1,000, 5,000  
 OUTPUT: 2.5, 10, 50, 250, 1,000  
 MILLIAMPERES, DC: 10, 100, 500  
 MICROAMPERES, DC: 100  
 AMPERES, DC: 10  
 DECIBELS (0 RANGES): -12 TO +55 DB  
 OHMS: 0-2000 (12 OHMS CENTER), 0-200,000 (1,200 OHMS CENTER), 0-20 MEGOHMS (120,000 OHMS CENTER)

SIMPSON ELECTRIC COMPANY

5200 W. Kinzie St., Chicago 44 • ESTbrook 9-1121

In Canada: Bach-Simpson, Ltd., London, Ont.



Simpson  
**Model 260**  
 VOLT-OHM-MILLIAMMETER

Barton Browne Advertising

## LIETA

The Long Island Electronic Technicians Association reports that a Technical Forum was held Oct. 8th, at the Masonic Club, Willis Ave., Williston Park, N. Y. Mr. James Seddon, coordinator of our technical committee opened the meeting showing problems associated with basic alignment. A simple and practical method of making money was advanced by Mr. Gerry Goldberger from Precision Apparatus, Elmhurst, N. Y. Mr. Victor Robinson, Mr. Julius Futterman, and Mr. Howard Coleman, of Precision.

## TEA

The next trade show of the Texas Electronics Association will be a regional trade show, attended by servicemen from Texas, Arkansas, Oklahoma, New Mexico, and Louisiana. Leonard R. Smith, president, TEA, revealed that the date of the next show has not been set, but the association will meet to discuss plans for it at the Stephen F. Austin Hotel, Austin, Dec. 6. It is hoped that the eventual outcome of a regional trade show will be a regional service association.

ONLY FOR THOSE WHO WANT THE BEST

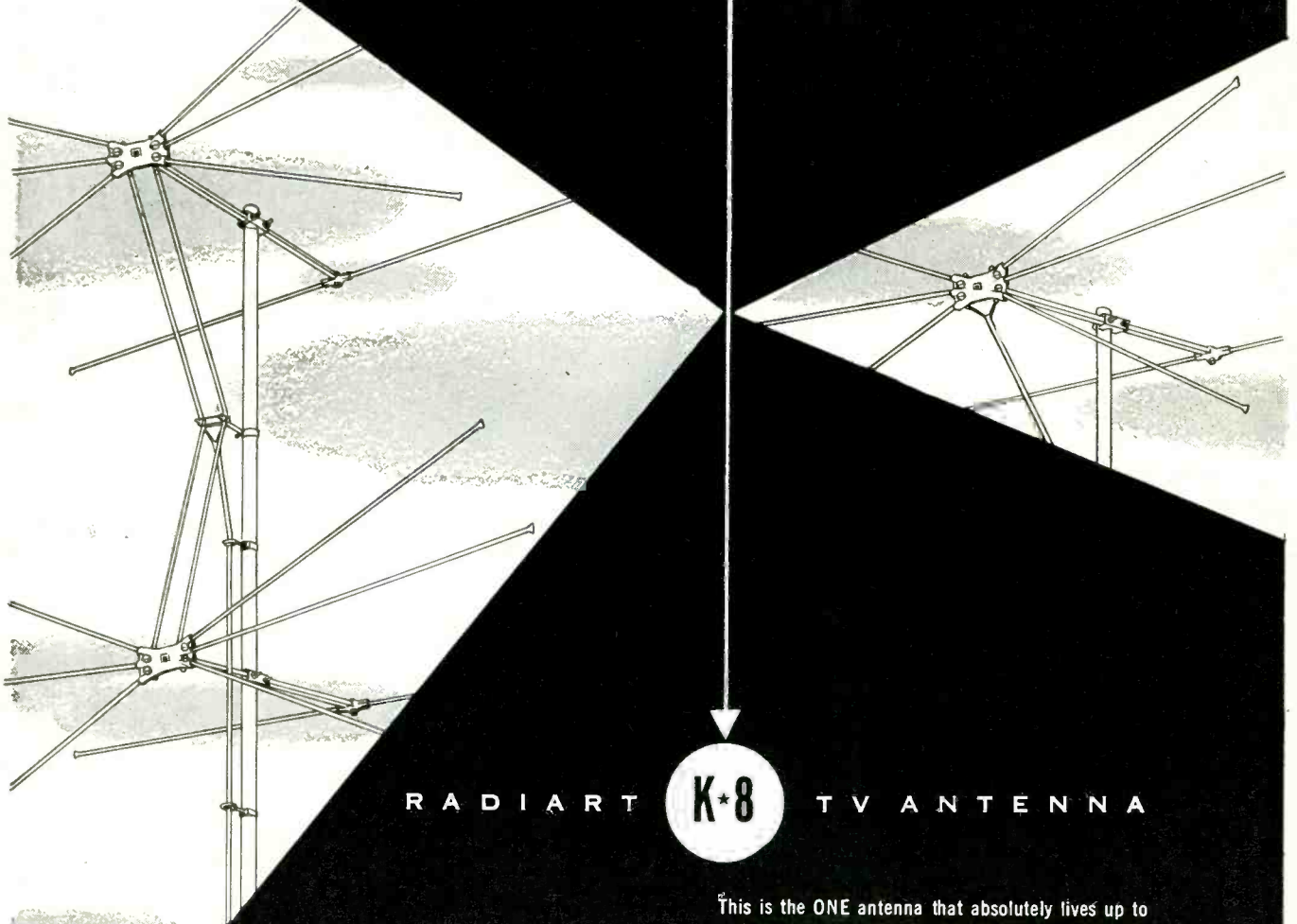

RADIART **K\*8** TV ANTENNA

This is the ONE antenna that absolutely lives up to and completely merits the superlatives and all claims made for other type antennas! Here's why:

- Field tested for two years — proving its ability to get all VHF channels exceedingly well.
- Superior construction throughout featuring ½" seamless aluminum elements.
- Exclusive, patented, quick-rig, cam action locking device for positive speedy assembly.
- Extra heavy moulded plastic insulators with precision machined brackets as well as costly die cast fixtures.
- Double stacked array eliminates fringe area reception problems.



THE **RADIART** CORP.  
CLEVELAND 13, OHIO

VIBRATORS • TV ANTENNAS • AUTO AERIALS • ROTORS • POWER SUPPLIES

# COLOR TV

by LEONARD LIEBERMAN

THE petition of the National Television System Committee to the FCC for a re-opening of the FCC's color system standards marks a turning point in the development of this branch of the electronics art. The agreement by CBS with the findings of the industry-wide NTSC makes the adaptation of the "compatible" color system a certainty. As far as the average serviceman is concerned, this means several things. First, wide scale mass sales are several years away. Second, he can continue to sell monochrome (black and white) sets since these sets will not become obsolete when color programs are broadcast. Third, he should start educating himself in the theoretical concepts governing color TV, so that, when color sets are mass-produced, he will be able to understand their operation. The reason for this lies in the fact that while

This article begins a new series on color TV. The approach is primarily directed to the servicing technician.

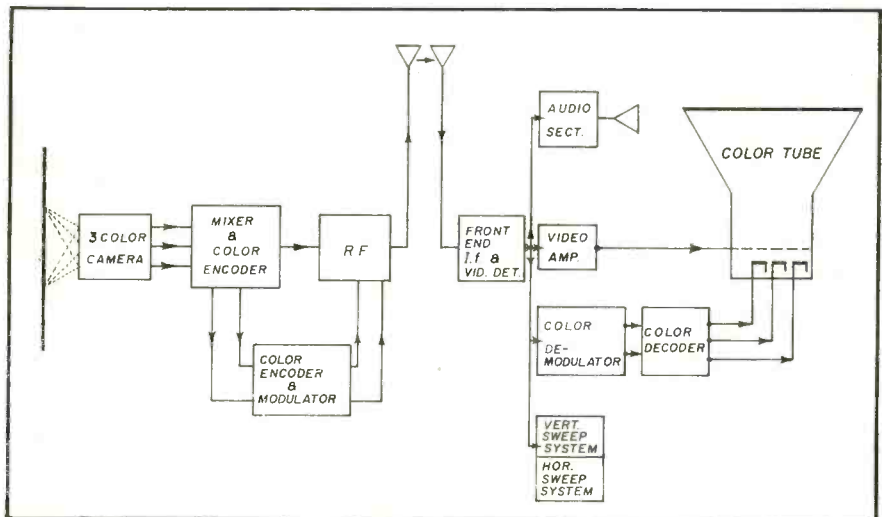

Fig. 1—Partial block diagram of NTSC color system.

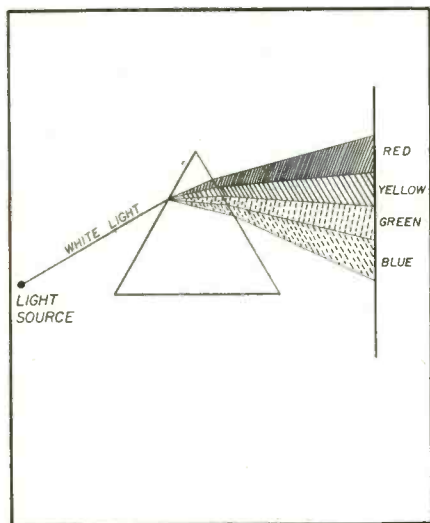

Fig. 2—Color spectrum created by passing white light through prism.

the color TV set resembles the monochrome set in many respects, the new circuits and techniques to learn are many.

Experience in servicing monochrome receivers will make color TV servicing easier but unless a strenuous effort is made to understand *Color TV principles*, servicing of these sets will be exceedingly difficult. Not only are new circuits and tube applications involved, but also new non-electronic concepts are being used. Not only will the serviceman have to become familiar with such terms and ideas as synchronous demodulators, burst amplifiers, adders, matrixing, delay lines and other new electronic devices, but he will also have to be more than a little familiar with such terms as *C.I.E.*, *chrominance*, *saturation* and

other terms involved with the actual physical properties of color.

It is the purpose of this series of articles to bring to the serviceman an understanding of the principles underlying the NTSC system. To do this properly, it will be necessary to examine some of the principles and characteristics of color itself as well as the methods of measuring color (colorimetry). This results from the fact that the design of the color TV set is governed by the characteristics of color itself as well as the physiological reaction of the human eye to color.

After the discussion of color principles, we will examine how the image or picture is picked up, transmitted and redisplayed on the receiver screen. We will then analyze the circuitry

**A**gain proving  
tube-design  
leadership...

## 40% OF 1952'S NEW RECEIVING TUBES WERE G-E DEVELOPMENTS... TWICE ANY OTHER MAKE

**F**OURTEEN out of thirty-five registered *new* receiving-tube designs—40%—were G-E, in the last calendar year, 1952. As still further proof of leadership... new G-E types numbered more than twice those of any other manufacturer!

Outstanding research and development by General Electric have given to the TV-radio industry its newest, most advanced tubes. You can be sure, when servicing latest-model receivers, that G-E tubes are available for every need—that G-E leadership

in tube development brings you the finest obtainable product. Every working day, you will receive extra dividends in superior performance and reliability.

*You can expect more new and improved tubes from General Electric in the months ahead—types that will make your work easier and cut callbacks. Keep in touch with your G-E tube distributor for forthcoming new-tube announcements, each with a profit message for you! Tube Dept., General Electric Co., Schenectady 5, N. Y.*

SHOWN BELOW: a few of the many new G-E tubes that are making money for service dealers.



6AM4

6BK5

6BK7-A

25W6-GT

*You can put your confidence in—*

**GENERAL  ELECTRIC**

161-1A8

used in the reproduction of the NTSC system picture at the receiver.

The receiver design may seem very cumbersome and complex. It is advisable to recall that color TV is much more complex than monochrome. In addition, there is no doubt that by the time color sets are mass-produced, new and more efficient tubes will have been designed and new, simpler circuits will have been designed.

### Color and Colorimetry

Color is specified by three characteristics:

1. Brightness
2. Hue
3. Saturation

*Brightness* is the characteristic of the amount of light given off by an object which is measureable on a photometer. Quantitatively, this is different from the sensation of brightness experienced by a viewer. *Hue* is what we know as the color of an object, that is, its blueness, greenness, etc. *Saturation* is a measure of the purity of the color. The more saturated a color is, the less there is present of any other color. Non-technically this quality is usually referred to as the shade of a color: e.g., pastels, aquamarine, etc.

In any color reproducing system, the color response of the human eye is, of course, the final criterion of the reproduction accuracy. There are certain characteristics of the eye which are useful in this respect. The first of these is the same persistence of vision which is made use of in monochrome TV. In this case, if several different individual colors are brought to one spot in rapid succession, persistence of vision causes it to look like the individual colors are being shown simultaneously. We will see later how this important feature of the eye makes it possible to use just a few

colors to achieve all visible colors.

The second color characteristic of the eye is its ability to act as a null indicator, that is, while it cannot tell the *degree* of difference between two colors which are side by side, it can tell if the colors are the same. The eye can distinguish in direct contrast, between hundreds of hues, dozens of degrees of saturation and a large number of degrees of brightness. However, if there is nothing which can be used for direct contrast, the eye cannot tell if any particular hue is the correct one or whether any two small adjacent areas are exactly alike. In measuring by direct contrast a certain color is flashed on a screen and another color is placed right next to it for visual comparison. If, however, only one color is placed on the screen, the eye cannot tell if it is the exact reference color or not.

The last major eye characteristic is in relation to the variation of sen-

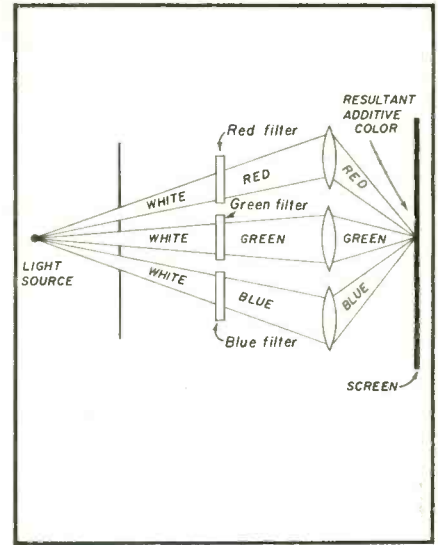

Fig. 4—Additive color mixture system.

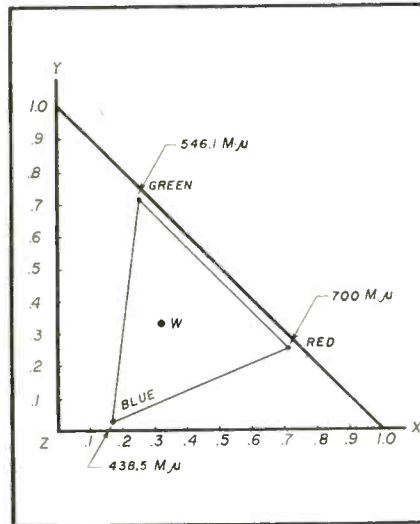

Fig. 3—CIE chromaticity diagram (XYZ triangle).

sitivity to color distortion of different colors. That is, it will notice small distortions in certain colors while in other colors there can be large distortions without the same awareness by the eye. On the other hand, minute changes or distortions in the brightness are immediately noted. Thus, the brightness of each point scanned by the camera must be accurately reproduced.

While a complete exact analysis of the eye's reaction to color has never been accomplished, it is known that there are three color-sensitive sections in each of the bundles of nerves from the eye to the brain. These nerve sections are each responsive to red, green or blue.

The visible color spectrum can be created by taking a standard white light and shining it through a prism. (Fig. 2) As a result of the different wavelengths of each color, their speed through the prism is different and they appear individually on the other side. Because of the three color-sensitive response characteristic of the eye, known as the *tri-stimulus effect*, the saturated green, blue and red are called the primary colors. Mixtures of any two saturated primaries are called *saturated secondaries*. One of the characteristics of color is that by combining the three primary colors in varying percentages and degrees of hue and saturation, any color in the visible spectrum can be reproduced.

Since any color can be specified in a specific frequency and wavelength, it becomes possible to establish a numerical standard for measurements. There is an international organization *Commission Internationale de* [Continued on page 88]

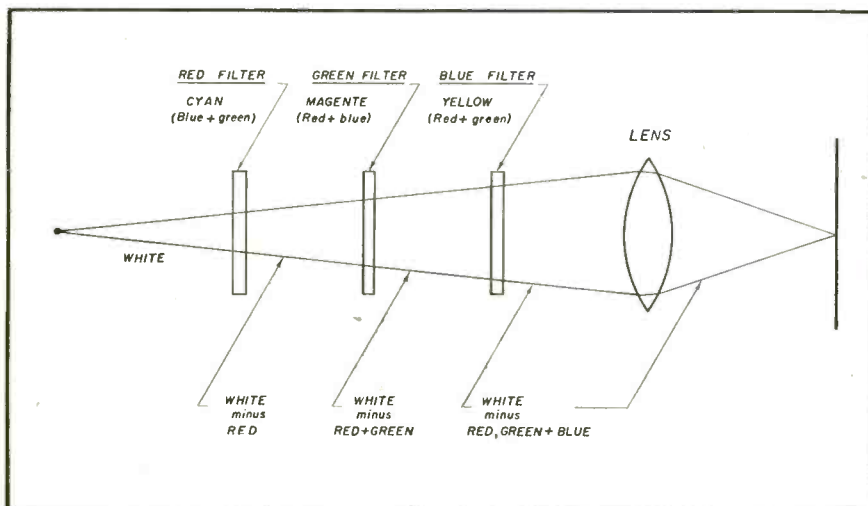

Fig. 5—Subtractive color mixture system.

## ASTRON SM\* CAPACITORS

These SAFETY MARGIN capacitors offer the assurance of greater all-around built-in dependability because of the most exacting engineering specifications. To you, as it does to thousands of other service men, SM\* means absolute customer satisfaction.

### ASTRON SM\* TWIST PRONG

dry electrolytics are individually tested and guaranteed. They have earned wide acceptance by original equipment manufacturers. For quality replacement, you can rely on Astron's high standards of quality manufacture. Your jobber stocks all popular replacement ratings. Catalog AC-3A lists all available SM twist prong ratings.



### ASTRON SM\* BLUE-POINT\*

fabulous new member of the Astron line, offers the "tightest seal and toughest shell" in molded plastic paper capacitors. They give outstanding performance under the most adverse temperature and moisture conditions. Look for the eye-catching yellow jacket with the easy-to-spot Blue-Point end seal. Write for Bulletin AB-20A for the complete story.

\*Trade Mark

PATENT  
PENDING



DEPEND ON — INSIST ON

# ASTRON

*Manufacturers of a complete line of capacitors and filters for every television, radio and electronic application.*

ASTRON CORPORATION

255 GRANT AVE., EAST NEWARK,



NEW JERSEY

In Canada: Charles W. Pointon, 1926 Gerrard St. East, Toronto





picture is brought into sync in the center of the range of the horizontal hold control and breaks out of sync in either extreme rotation of the control.

\* \* \*

Dear Answer Man:

In the February 1953 edition, an article by Leonard Lieberman discussing intercarrier sound systems makes the statement that as long as the picture remains there is sound present.

Now I have an Admiral, Model 19B1, in which this does not hold true. Lots of times we have a very good picture and the sound fades away entirely. I have changed the sound take-off from the video detector to the first video amplifier which has raised the volume some but does not stop the fading.

Whether I am overlooking some other detail contributing to this trouble I do not know. Is there something that I can do to eliminate this trouble?

We are receiving Jacksonville on Channel 4, our only station in range (about 120 miles), with good reception 65% to 70% of the time, using a yagi antenna (8 element) with no booster.

Leesburg, Fla.  
R. W. B.

Dear R. W. B.

In the February 1953 edition of Radio-Television Service Dealer, Mr. Leonard Lieberman states in his article "Sound Systems in TV" in discussing the intercarrier sound system as follows:

"The sound in the intercarrier system is not fixed in the *if* amplifiers, but remains the constant 4.5 mc away from the video carrier. Therefore, if the oscillator is detuned either intentionally or by drift, as long as the picture remains, there is sound present."

To amplify the above excerpt in the light of the problem it must first be accepted that the antenna is supplying the TV receiver with the FM signal and that the receiver alignment is proper. The possibility of the FM signal not being delivered to the receiver will be discussed later.

The important basic difference and advantage of the intercarrier system over the conventional sound system is the fact that with the intercarrier sound system there is no separate sound *if* circuit with a specific sound *if* frequency to which the local oscillator must reduce the received FM signal. With no separate sound *if* strip the local oscillator can drift or change from the optimum position and the resultant audio will not be

appreciably affected. Neither will the picture be affected if the change is not of any appreciable amount.

This is not true with the conventional sound system. If the local oscillator changes frequency the resultant *if* frequency will not be the frequency

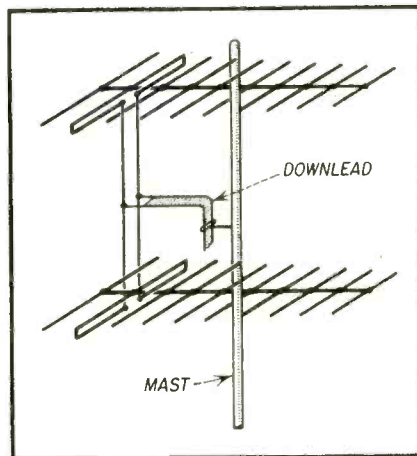

Fig. 2—10 Element stacked yagi recommended for fringe areas.

to which the sound *if* circuits are adjusted to. Also the FM detector circuit will not respond favorably to the incorrect sound *if* frequency. The total result is inferior audio from the conventional sound system receiver.

If the television picture is normal it is extremely unlikely that anything has occurred in the common intercarrier *if* system to cause the FM signal not to be present at the video detector. It is in the video detector circuit that the two signals, the FM sound carrier and the video carrier, mix and the resultant difference between the two carriers, which is fixed by the transmitter, is 4.5 mc, still FM modulated with a little AM modulation from the video *if* carrier. The 4.5 mc FM signal is independent of any exact local oscillator setting because it depends upon the difference between the two carriers sent out by the television station.

In considering this difficulty of the sound fading it is unlikely that the fading is occurring in the intercarrier system. If it is occurring in the TV receiver itself, the first obvious check is the tubes through which the FM signal must pass. Check them by substitution with tubes known to be good. This is of particular importance since the fading could be due to an intermittent filament in some tube in the audio-FM circuits.

Usually, it is not advisable to alter circuits engineered by a television manufacturer such as has been performed with the sound take-off. More

trouble can be introduced than the good that will derive from such changes.

In the light of the problem it is felt that the real trouble is in the antenna system or a combination of the antenna system and the alignment.

Considering the antenna system, the 8 element yagi is not usually satisfactory, in itself, for fringe area reception of 120 miles away from the transmitter. In this area something more powerful is desirable and usually necessary. It is suggested that another 8 element yagi be stacked with the existing one, tying the two of them together with stacking bars. A 10 element stacked yagi is about the best type of antenna that can be employed for single channel fringe reception.

An improvement can very definitely be accomplished by using open wire transmission line with matching stubs at the stacked yagi antenna and at the TV receiver. Be very careful of avoiding mismatch and standing waves. Since only one channel is of any concern matching the lead-in will not be difficult. In reference to the lead-in, to repeat, the best that can be employed in this problem is open wire transmission line. It has never been fully appreciated as a means of delivering signals to the receiver in fringe areas.

No doubt the possibility has been investigated of the existing yagi being out of orientation. The orientation is important because of the sharp directivity of the yagi type of antenna. If the antenna is slightly out of orientation it could help bring about this situation of fading sound. Normally, it has been found that the video information will fade out when reception difficulties are experienced before the sound fades but the possibility certainly does exist of the sound fading and the picture remaining relatively good.

There are many boosters available now which will do an excellent job in fringe areas. A booster should be employed in a case such as this.

Fringe area alignment, if it hasn't already been done will unquestionably improve the picture and reception. In fact, along these lines, there are many things which can be done to any receiver to improve its operation under special conditions. The *if* response curve can be narrowed which will increase the gain. The detector load resistors and video amplifier load resistors can be doubled in their resistance value which will improve the results obtainable.

• • •

# 272 NEW DRY ELECTROLYTICS!

*Greatly Expanded Pyramid  
Capacitor Replacement Line*

*Now Listed in Free  
Supplement DE*

featuring  
an entirely new  
hermetically sealed  
tubular with 6" flexible  
insulated leads

**TYPE TDL**

*Write for Free Catalog DE*

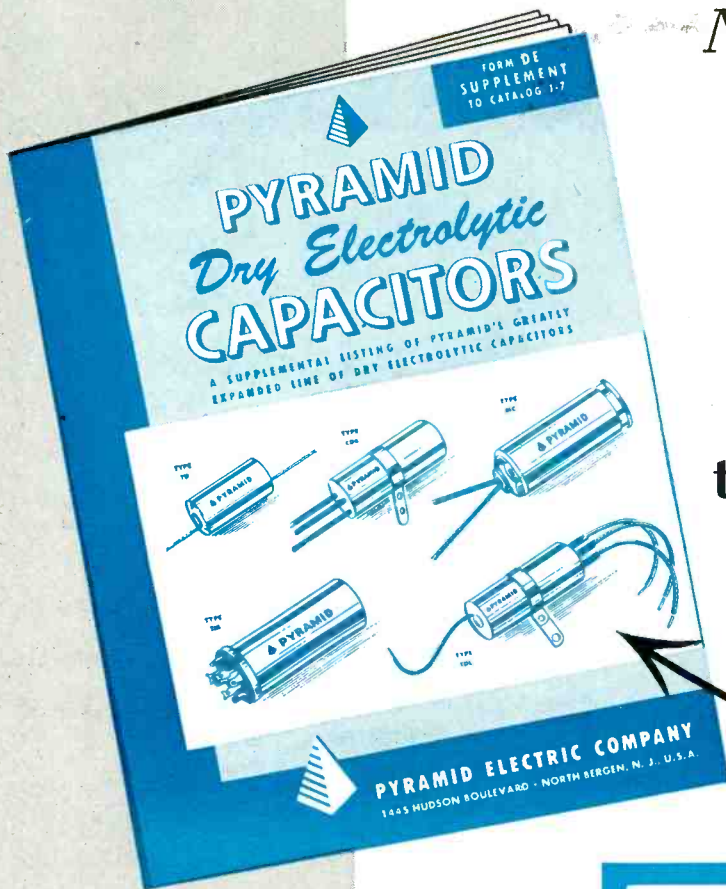

**FREE**

## *Mr. Serviceman:*

Get this handy wrench for locking or unlocking the mounting ears of Pyramid's Twist-Mounts. See your distributor today and take advantage of this exceptional offer.

**PYRAMID ELECTRIC COMPANY**

1445 HUDSON BOULEVARD, NORTH BERGEN, N. J.

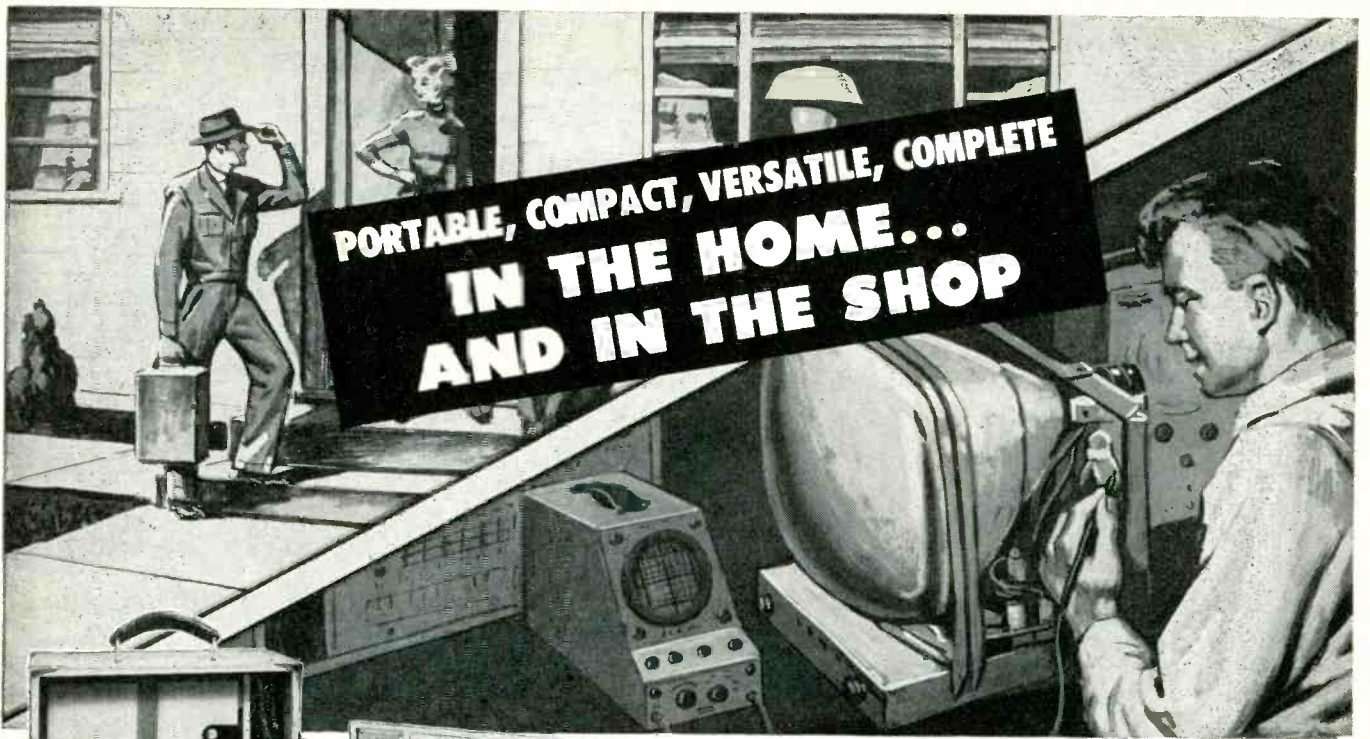

**PORTABLE, COMPACT, VERSATILE, COMPLETE  
IN THE HOME...  
AND IN THE SHOP**

# RCP

## "DO-ALL" Servishop Sets You Up In Business

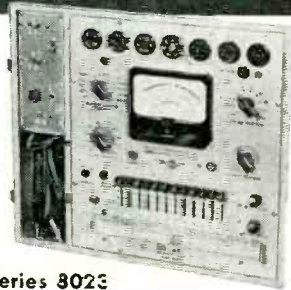
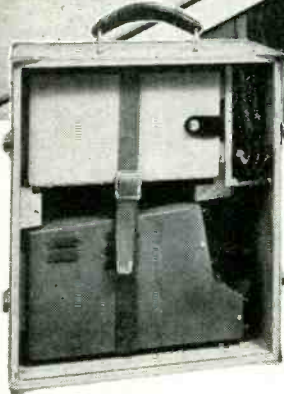

Series 8023



**Model 750**  
"DO-ALL" TV Signal  
Generator

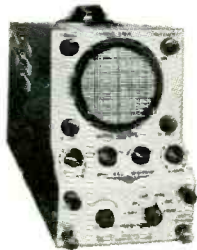

**Model 533M**  
The Midgetscope



**Model 730**  
Universal Signalizer

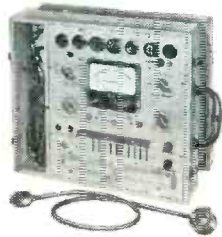

**Model 808A**  
"DO-ALL" Tube and  
Set Tester

With the RCP Servishop you can check, test and align set from antenna to picture tube. Whether it be AM-FM or TV—UHF or VHF—there is nothing that does the complete job as expertly and professionally as the RCP Servishop.

Series 8023 includes:

1. **Model 750**—for UHF and VHF... serves as signal, marker and pattern generator.
2. **Model 533M**—a portable 3" scope with high sensitivity and wide band response.
3. **Model 808A**—a tube and set tester which also serves as cathode ray tube tester and reactivator plus a vacuum tube voltmeter with ohmmeter.
4. **Model 730**—AF-AM (RF) FM signal generator—easily aligns and checks all circuits in AM and FM receivers.
5. **Model HVMP-1**—Hi-Voltage Multiplier Probe. Complete, including all necessary leads. **\$341.00 Net.**

Series 8020—Same as the 8023

less Model 730 Signalizer.

Complete **\$310.00 Net.**

**Model 8873A**—Servishop—A compact, convenient service package to meet your AM-FM, and TV test needs... includes 808A "DO-ALL" Tube and Set Tester and Model 730 Signalizer AF-AM (RF) FM Signal Generator. Complete with tubes, batteries and leads. **\$139.95 Net.**

### TIME PAYMENT PLAN

Ask your local distributor about the new RCP Finance Plan... Gives you 1 year to pay and allows you to buy the equipment package you need to do the complete job.

See Your Local Parts Distributor Or Write For New RCP Catalog Department SD-11

**RADIO CITY PRODUCTS CO., Inc.**  
152 WEST 25th STREET • NEW YORK 1, N. Y.



# Symposium Series No. 8

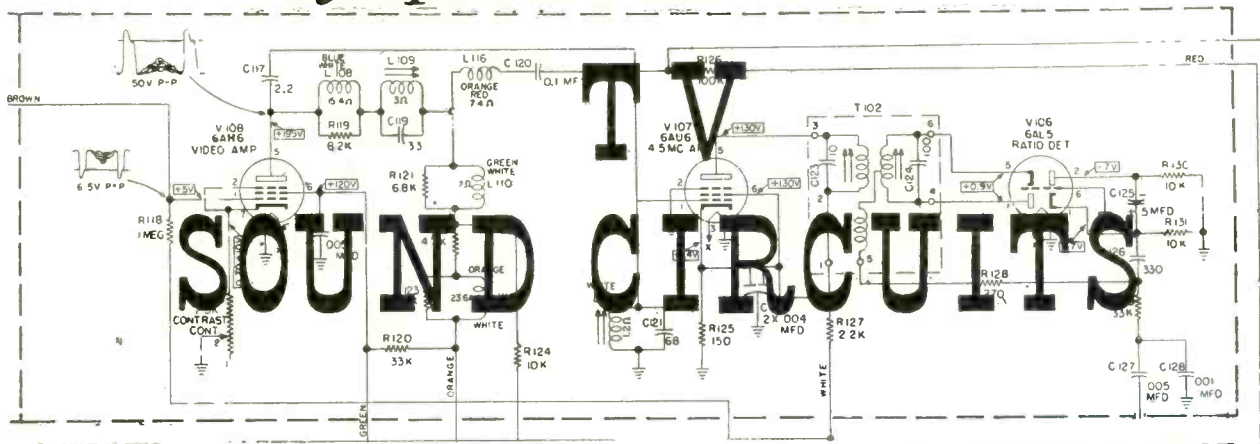

PART 2

by RUDOLF F. GRAF

Part 2 of this symposium series chapter deals with the theory and applications of the ratio detector. Also discussed is a suggested procedure for the alignment of the gated beam detector using an on-the-air signal.

IN the first part of this symposium we discussed the operation of the gated beam detector and the Foster Seeley discriminator. We will now discuss the operation of the third of the popular FM detectors, namely the Ratio Detector as well as the methods used in aligning these circuits.

## Ratio Detector

This circuit uses a dual diode and is used in many receivers including Du Mont, General Electric, Philco, RCA, and Motorola. The most commonly used tube employed in this circuit is the 6AL5, which is a miniature tube containing two independent diodes in one envelope. The Ratio Detector differs from the Foster Seeley discrimina-

tor in that it is essentially immune to any amplitude variations, such as noise pulses, in the incoming signal. This characteristic does away with the need for a limiter stage that would otherwise be required to eliminate AM interference. Thus, the signal need not be amplified as much as for a Foster Seeley discriminator where a limiter is required. Let us now see how this circuit operates, and why it is not sensitive to amplitude modulated signals.

For purposes of discussion let us refer to the circuit of the Foster Seeley discriminator shown in Fig. 6. The tubes in this circuit are so connected that the currents through the two resistors  $R_1$  and  $R_2$  are in opposite directions. Thus, the net output voltage across both resistors is the output of

the circuit. It will always be the algebraic sum of these two voltages. At the center or *if* frequency, the voltages across the resistors will be equal. For the sake of discussion, let us assume that each resistor has 3 volts across it. The net output voltage is, of course, zero. As we deviate from the center frequency, the currents through both tubes will not be the same any more and the voltages across the two resistors will also be different from each other. With the same carrier amplitude and at some frequency other than the *if*, we may have 2.5 volts across  $R_1$  and 3.5 volts across  $R_2$ . Thus, there will be a difference or output voltage of 1 volt. Now let us see what happens if we increase the strength of our carrier and then again frequency modulate our signal.

Assume that the signal strength is momentarily increased so that the signal and output voltages are exactly twice what they were before. At the center *if*, the voltages across each of the resistors would be 6 volts and the net output voltage would again be zero. With the same frequency deviation as before, the voltage across  $R_1$  would have increased to 5 volts and the voltage across  $R_2$  would now be 7 volts. With the same frequency deviation as before, we now get an output of 2 volts instead of the 1 volt we had before. Thus, the output voltage in the Foster Seeley discriminator is not only dependent on the frequency deviation of the incoming signal, but it is also affected by its amplitude. That of course, is the reason why we must use a limiter with this circuit so that all signals

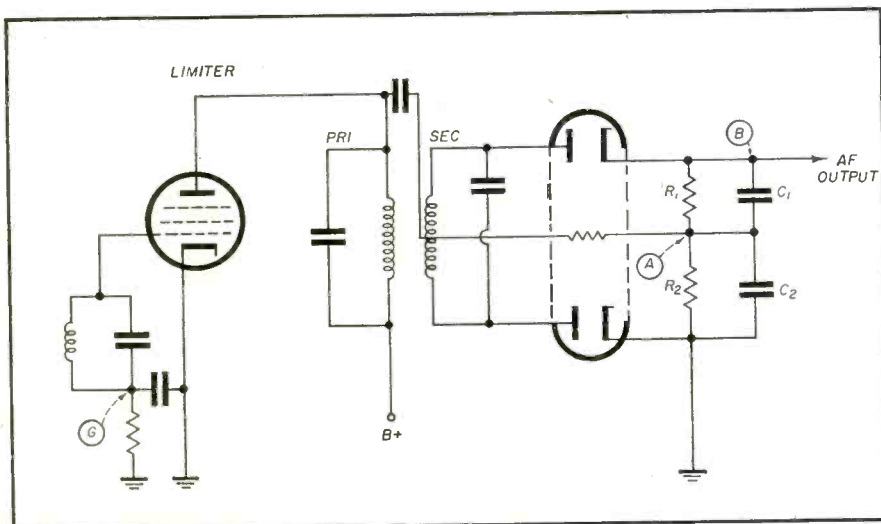

Fig. 6—Foster-Seeley discriminator with all test points indicated in the diagram.

**LADIES GENTLEMEN!**

*with your kind permission . . .*

**Regency**

**PRESENTS**

**THE**

**"FABULOUS FIVE"**

**QUINTUPLET UHF CONVERTER**

This fall, a huge promotional program is directing thousands of customers to Regency!

Stand-out advertising in **LIFE, HOUSE BEAUTIFUL, HOUSE AND GARDEN, ATLANTIC MONTHLY, SATURDAY**

**REVIEW, HARPER'S** and Nation-wide **TELEVISION** will effectively sell your customers on Regency. Take advantage of it! Fifty million

customers will see it! Make sure you can offer them the only converter ever made that utilizes any of 5 VHF channels in converting to UHF! Don't take chances!

Other converters work on only 2 channels! Insure your customers against image interference, obsolescence . . . sell them **REGENCY'S**

fabulous, profit-fetching Quintuplet Converter! . . . at \$49.95 list there's extra profit for you!

**Regency**

Division of I. D. E. A., Inc., Makers of VHF Boosters, FM Boosters, UHF Converters, Professional High Fidelity Equipment and Television Remote Control.

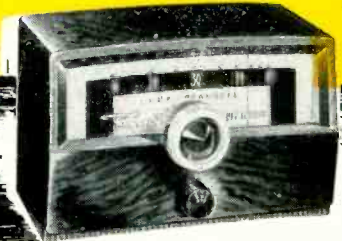
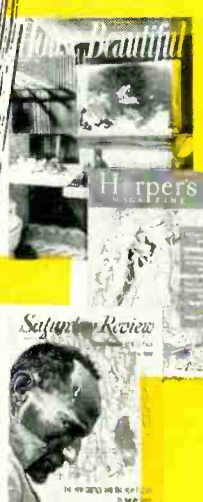

come to the detector at the same relative amplitude.

Let us however, look at another interesting point that is brought to light by this little example. If we consider the ratio of the voltages across  $R_1$  and  $R_2$  for the two conditions illustrated, we note something very important. In the first case the ratio is 2.5 to 3.5. When we allowed the carrier strength to increase, the ratio became 5 to 7 which is, of course, the same as 2.5 to 3.5. All we have to do now is construct a circuit which responds only to these voltages *ratios* but is insensitive to rapid fluctuations in signal amplitude and we have no more need for the limiter. This has been accomplished in the Ratio Detector.

There are two basic types of Ratio Detectors used today. One is called the balanced Ratio Detector and is shown in Fig. 7, and the other is the unbalanced Ratio Detector and is shown in Fig. 8.

Let us first consider the balanced detector in Fig. 7. At first glance this circuit looks very much like the Foster Seeley discriminator. However, there is one very important difference. The diodes are connected in *series*, and the voltages across the two resistors are now additively in series. As soon as a signal is applied to the circuit there will be a flow of current through  $V_1$ ,  $R_1$ ,  $V_2$  and  $R_2$ . A voltage will be developed across the two resistors and condensers  $C_1$ .  $C_2$  and  $C_3$  will be charged. Condenser  $C_1$  is a large electrolytic condenser, which usually has a capacity between 4 to 10  $\mu f$ . Together with the two resistors,  $C_1$  makes up a long time constant circuit. Because such a circuit is not able to follow momentary amplitude changes of the signal, such as those caused by noise pulses, the circuit is essentially im-

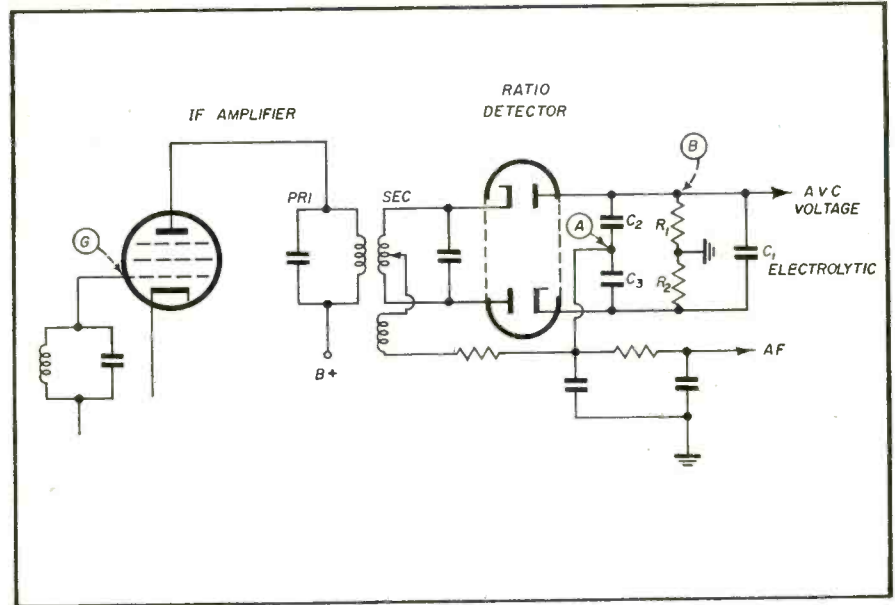

Fig. 7—Schematic diagram of balanced ratio detector with test points indicated. The audio signal is taken from point A.

immune to any noise. Thus a limiter is not needed.

At the center, or *if* frequency the voltages applied to both tubes are the same. There will be a flow of current which will develop a voltage across  $C_1$  which is equal to the average of the incoming signal. Since this voltage is negative with respect to ground and dependent on the average of the signal, it is sometimes a source of *avc* voltage. This same voltage will also appear across  $R_1$  and  $R_2$  as well as across  $C_2$  and  $C_3$ . Since  $C_2$  and  $C_3$  are of the same value, and since  $R_1$  and  $R_2$  also have the same resistance, there will be no difference of potential between points A and ground. In other words, there will be no output. If the signal deviates from its center frequency the

tubes will receive different voltages and the voltages across  $C_2$  and  $C_3$  will not be equal any more. The voltage across the two resistors does not vary, since the voltage across  $C_1$  remains unchanged. Thus, a difference of potential is developed between points A and ground and an output voltage results. Momentary noise pulses will not be noticed in the output, since such brief disturbances are not sufficient to change the charge on condenser  $C_1$  and hence the voltage across  $C_1$ . Since condenser  $C_2$  and  $C_3$  are in parallel with  $C_1$ , the sum of the voltages across the two condensers must always be equal to the voltage across  $C_1$ . Frequency changes will only alter the proportionality or *ratio* between the voltages across  $C_2$  and  $C_3$ , but they do not affect the sum. That is why this detector is called a Ratio Detector.

Several modifications of the basic detector have been developed. The most common of these is the unbalanced ratio detector, the circuit of which is shown in Fig. 8. The resistors  $R_1$  and  $R_2$  of the balanced detector have now been combined into one resistor. This modification does not lessen the efficiency of this circuit, but it does enter into the picture when we go ahead and align these circuits.

#### Aligning The Gated Beam Detector

Here is a simple method of aligning this detector circuit. It utilizes an actual "on the air" signal from a TV station. It is necessary, however, to be able to lower the signal input to the receiver to such a degree that the voltage at the 6BN6 limiter grid is below the limiting level. When we reach this

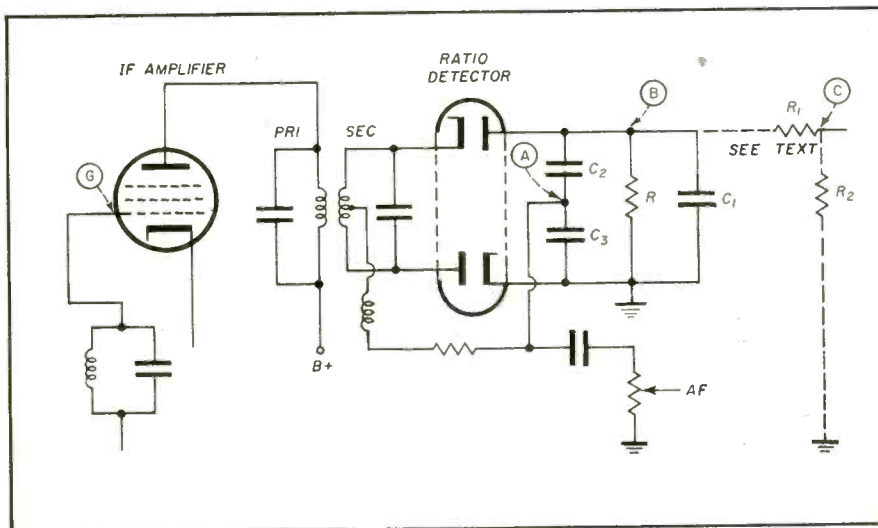

Fig. 8—Schematic diagram of an unbalanced ratio detector with test points indicated.

level a definite hiss will be heard through the loud speaker.

In order to lower the signal input to the receiver, the signal from the antenna, must be attenuated with either a commercially available signal attenuator such as a Centralab model PCH-4 or an IRC model QJ-3. If neither of these two is available, a simple and effective attenuator can be made by using a few resistors. The circuits shown in Fig. 9 are suitable for this purpose. Two or more may be used in series if greater attenuation is desired. Several of these pads can be made up and held aside for use anytime the signal from an antenna must be attenuated. The resistors should be within 5% of the values indicated on the charts.

The procedure is as follows:

1. Adjust the sound traps and sound if coils for maximum sound signal through the speaker. If any of these adjustments makes the signal much louder and the hiss disappears, readjust the signal attenuator in the antenna circuit to make the hiss appear again. See Fig. 3

2. Remove the attenuator from the antenna circuit to deliver maximum signal to the 6BN6 so that the signal goes above the limiting level. (In order to get optimum alignment with this method, it is best to use a TV station

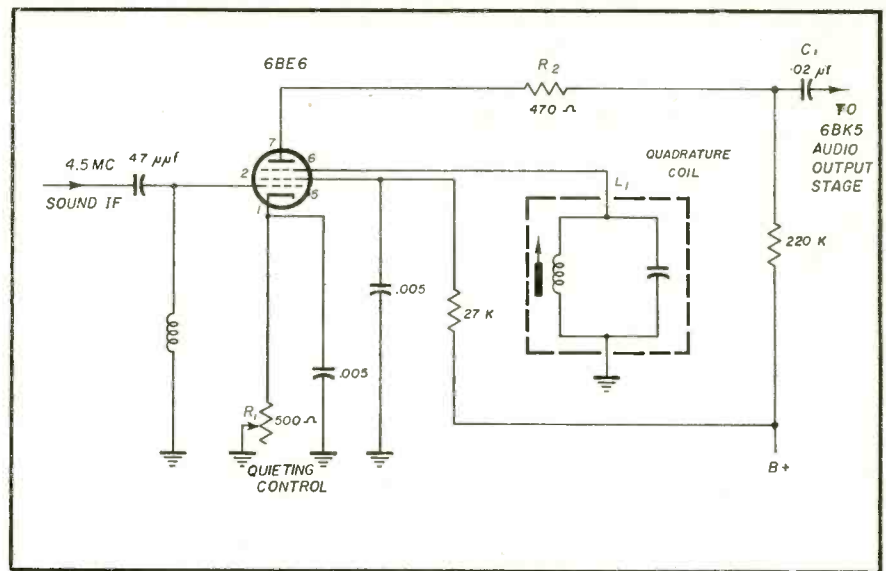

Fig. 3—Gated Beam Detector used in Westinghouse V2233-1.

signal which has average strength considering the final location of the receiver.)

3. Adjust the Quadrature coil  $L_1$  for maximum signal output.

4. Now adjust the 6BN6 bias with the AM rejection or Quieting control  $R_1$ , until there is a minimum of background noise and intercarrier buzz.

5. Readjust  $L_1$  for clearest sound. If necessary, repeat the adjustment of  $R_1$  and  $L_1$  for best results.

If an "on the air" signal is not available or is not convenient to use, another method may be employed. This method requires the use of an oscilloscope or an ac voltmeter, an FM signal (deviation approximately 7.5 kc) and an AM signal (modulation approximately 30%). Both of these signals must be at the exact sound if of the receiver. If we are dealing with an intercarrier set, the if is 4.5 mc.

1. Connect the scope or ac voltmeter (on low range) across the volume control.

2. Apply the frequency modulated ( $\pm 7.5$  kc) if signal to the grid of the video amplifier if the set is of the intercarrier type. Otherwise apply the signal to the grid of the last if amplifier stage.

3. Use the lowest signal that will still give a meter reading or scope indication and adjust all sound if circuits for maximum output. As the meter reading increases, lower the generator output, rather than go to a higher meter range.

4. Now use a strong signal (increase meter range) and adjust the quadrature coil  $L_1$  for maximum output.

5. Then apply the amplitude modulated (30%) if signal to the grid of the video amplifier. (Remove FM signal applied in step 2.)

6. Starting with a very low generator signal, increase the output gradually. At the same time adjust the 6BN6 bias with the AM rejection control  $R_1$ .

7. "Rock" the control ( $R_1$ ) and adjust the signal level until you reach the point where the meter reading or scope indication drops to zero. This zero will be at a position where either clockwise or counter-clockwise rotation of  $R_1$ , will give an increase in reading. Leave the AM rejection control set exactly at this "zero" position. Alignment is now complete.

[To be Continued]

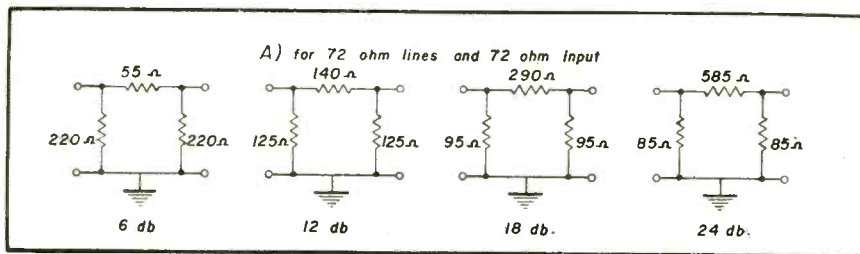

Fig. 9a—Attenuator pad: 72 ohm line, 72 ohm input.

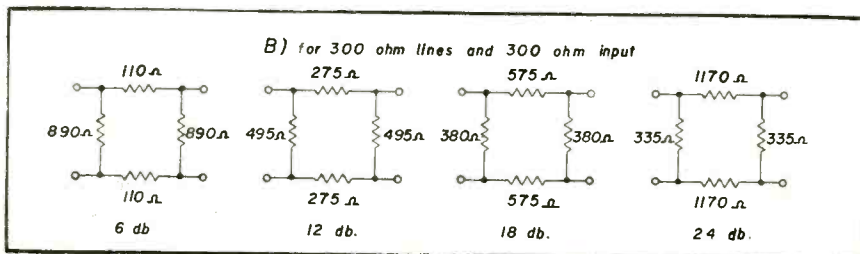

Fig. 9b—Attenuator pad: 300 ohm line, 300 ohm input.

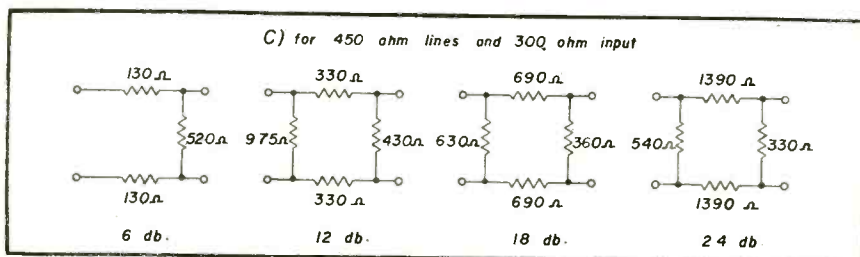

Fig. 9c—Attenuator pad: 450 ohm line, 300 ohm input.



# Our New Publishing Policy Affects YOU!



It has long been our ambition not only to reach every service organization and service dealer in the country, but also to have *SERVICE DEALER* read by every serious-minded employed serviceman.

To that end we have made a master mailing list. On it is the name of every service organization and dealer (having a service department) that has a listing under the "TV Service" classification of Classified Directories issued by the Telephone Companies for every city in the U.S.A. Also on that list are names of thousands of bona-fide service firms who, for one reason or another, are not listed in Telephone Company Classified Directories. Many thousands of dollars, and almost one year of constant research and compilation effort, have gone into this undertaking.

Effective with our November 1953 issue, it will be our policy to send, every month, and *without cost or obligation*, a copy of *SERVICE DEALER* to the owner of every established firm and full-time independent serviceman engaged in doing radio-TV service work.

On the other hand, we will continue to seek and we will be happy to accept paid subscriptions from all employed servicemen, part-time independent servicemen, employees of distributors, students and others interested in service work—and, effective in November 1953, such paid subscribers will only be asked to pay the nominal sum of \$1.00 for a 2-year (24 issues) subscription. The \$1.00 fee required for the 2-year subscription represents just about what it will cost us for postage to send such paid subscribers their 24 copies. Our prime aim is to reach all employed servicemen in the U.S.A. as well as shop owners—and we're making it as painless (financially) as possible—that's why our new 2-year subscription rate is, effective November 1st, 1953, only \$1.00. (1-year subs. for 50c will NOT be accepted.)

Service organization owners would be wise to consider buying (or paying part of the cost of) a *SERVICE DEALER* subscription for each employed serviceman so that every technician may maintain his own personal file of time-saving data sheets such as VSSS, TV Field Service Data Sheets, Shop Notes, etc., that appear in every issue.

## Our New, Expanded Editorial Policy!

*SERVICE DEALER* now has a larger and more experienced staff of editors and assistants than any other publication catering to radio-TV servicemen.

Under the capable guidance of these practical men, most of whom have years of actual experience as servicemen, and who have spent many years teaching radio-TV to thousands of vocational school students—a new publishing vista is to be opened.

Effective with our November issue, we will great-

ly expand our editorial services. Every issue of *SERVICE DEALER* will consist of many more pages of informative text than heretofore. Every article will be aimed at keeping you abreast of the latest servicing techniques, and our basic publishing policy—that of showing radio-TV servicemen how to do their work more efficiently, in less time, and at greater profit—will remain in effect. Read the next two pages carefully for more pertinent facts in this regard.

# Don't Miss

## ANY ISSUE OF RADIO-TV SERVICE DEALER



To Help You Repair Old and New Receivers  
Easier, in Less Time and Greater Profit

### A TYPICAL ISSUE COVERS

- Video Speed Servicing Systems
- Rider's "TV Field Service Manual" data sheets
- Latest TV Installation and Maintenance Techniques for VHF and UHF
- Auto Radio Installation and Service
- Advanced Data on New Circuitry
- Production Changes and field service data on receivers
- New Tubes
- New Test Equipment, operation and application
- Hi-Fi installation and service
- New developments, such as transistors, color, UHF, etc.
- News of the trade
- Service Short Cuts & Shop Notes
- Explanation of difficult circuits

and many more  
**EXCLUSIVE ...**  
**ORIGINAL ...**  
**AUTHORITATIVE ...**  
**TIMELY ...**  
**FULLY ILLUSTRATED**  
subjects that  
can **ONLY**  
**BE READ IN**  
**SERVICE DEALER**

### HIGHLIGHTS OF THE NOVEMBER ISSUE:

#### New Rider TV Field Service Data Sheets

By exclusive arrangement with John F. Rider, Publisher, now every issue of **SERVICE DEALER** will carry a complete section of specially prepared service information sheets which were compiled for the use of field TV technicians.

They are a part of a new series of Rider publications which will be titled: "TV Field Service Manuals."

Crammed with vital information the prime objective of these data sheets is to enable field service technicians to make light repairs in the set-owners' homes with a minimum expenditure of time.

The TV Field Service data sheets scheduled to appear in **SERVICE DEALER** monthly will always relate to the newest and current TV set models and should prove to be one of the most valuable working aids ever made available to field service technicians.

#### Video Speed Servicing Systems (VSSS)

Each issue of **SERVICE DEALER** contains 24 new VSSS data sheets. These are troubles, "bugs," and other types of receiver headaches that take up so much of the technician's time, and which are pinpointed for him in such a manner as to enable him to recognize the symptom and effect the cure in the quickest possible time.

Each item is accompanied by a partial schematic, thereby making it so much easier to identify and locate the components involved in the repair.

This material has been obtained from manufacturers' and distributors' service departments, independent servicing organizations, and practising servicing technicians. Before presentation to our readers it is carefully selected, analyzed, and simplified so that optimum benefits are obtained from the material and its presentation.

#### Servicing Video I-F Systems

by Matthew Mandl

**RADIO-TV SERVICE DEALER** spares no expense in bringing to its readers authoritative articles by top writers in the field.

This article is one in a series titled, "Symposium," in which each section of the TV receiver is given individual treatment from the point of view of the various types of circuits being used to date. In this manner the practising TV technician knows what to expect in the field.

This feature is presented monthly, and has found widespread acceptance among our readers. Read the Symposium series and keep up to date on TV circuitry.

# THE MOST SENSATIONAL RADIO-TV SERVICEMAN'S MAGAZINE OFFER IN THE INDUSTRY!

## 2-Year Subscription only



**24 issues of "SERVICE DEALER"—THE BETTER—BIGGER MAGAZINE WITH MORE TIMELY, AUTHORITY TECHNICAL ARTICLES THAN ANY OTHER TECHNICAL MAGAZINE FOR SERVICEMEN IN THE FIELD!**

2-YEAR SUBSCRIPTION AT \$1 AVAILABLE ONLY TO . . .

1. Servicemen who are employed by Service Organizations.
2. Servicemen employed by radio/TV Dealers.
3. Independent servicemen who do not have business establishments.
4. Employees of Distributors.
5. Students enrolled in accredited Radio/TV Schools, Colleges, etc.

### FOR YOUR SERVICE DEPARTMENT EMPLOYEES

As owner of a Service Dealer firm or Service Organization, undoubtedly you want your employees to be thoroughly familiar with the most up-to-date repair methods and techniques to help them to get more work done—in less time—with less effort!

Giving your men an opportunity to read Service Dealer is good business for you! Your personnel will appreciate receiving a full 2-years' subscription—(24 issues—cost only \$1.00). We suggest that you buy them each a subscription as a bonus . . . and the cost of the subscription is a tax deductible business expense. In any event, tell your men of our new low subscription rate. When your employees read Service Dealer every month, it is your assurance of having them informed of the new advances in the industry! It will pay you and them to read Service Dealer—America's foremost professional Radio-TV servicemen's magazine—first with authentic, accurate and timely news!

### TO SUBSCRIBERS

IF YOUR FIRM IS A SUBSCRIBER NOW . . . your FREE COMPANY SUBSCRIPTION will automatically go into effect upon the expiration of your present paid subscription.

If you are an employed serviceman or student subscriber now, your subscription will be adjusted and extended to afford you the same low subscription rate now being put into effect for those who do not qualify as FREE SUBSCRIBERS.

### FREE SUBSCRIPTION QUALIFYING FORM

If your name is not already on our free list, to qualify for a FREE SUBSCRIPTION, you must send us one of the following—in addition to the coupon at right:

1. The page from your Classified Telephone Directory showing the listing of your company under the "TV Service" classification (or a photostatic copy of that page).
- or . . . 2. An old receipted bill from your parts distributor.
- or . . . 3. A letterhead or business card of your firm.

RADIO-TV SERVICE DEALER  
67 W. 44 St., New York 36, N. Y.

Gentlemen:

Here is \$1.00 for which enter my 2-year subscription.

Name .....

Address .....

City ..... Zone..... State.....

Employed by (Name of firm).....

Firm's business address .....

City ..... Zone..... State.....

Your Position or Title .....

Check whether firm is:

Service Organization or  Dealer having Service Dept.

If some other type of company describe:  
.....  
.....

STUDENTS: .....

Name of School .....

RADIO-TV SERVICE DEALER  
67 W. 44 St., New York 36, N. Y.

Sirs:

Enter our FREE SUBSCRIPTION to Service Dealer. Attached herewith is one of the required company identifications.

Name of Firm.....

Your Name..... Your Position.....

Firm's Business Address.....

City ..... Zone..... State.....

Type of Business: (check the one which applies to your firm)

Service Organization  Dealer Operating Own Service Department

**DON'T DELAY—MAIL COUPON TODAY!**

# Radio-Television Servicing

is now

## Big Business

and

## Getting Bigger Every Hour

well over  
\$1,000,000,000  
a year!

For every \$1 worth of parts, tubes and accessories bought annually by servicemen for replacement use or for new installations, an average of \$2 in labor fees will be charged to set owners. Thus, in 1954 the Nation's radio-TV set owners will pay over \$2,400,000,000 to servicemen—servicemen will gross over \$1,000,000,000 in salaries—Parts Distributors will sell servicemen over \$1,000,000,000 worth of merchandise for new installations and replacement use.

Statistics Compiled by Radio-TV Service Dealer—August 11, 1953

### I. Facts and Figures:

1941—80,000,000 receivers in use. (No TV)  
Replacement Market in \$:  
\$ 44,000,000 replacement parts  
42,000,000 replacement tubes  
\$ 86,000,000 Total\*

\*In all cases these are net \$ values received by mfrs., not retail list prices.

Bulk of this \$ volume was done by:

14,000 service organizations  
16,000 service dealers  
30,000 Total

10-12,000 independent servicemen were relatively unimportant factors.

1946—90,000,000 receivers in use. (No TV)  
Replacement Market in \$:  
\$ 60,000,000 replacement parts  
51,000,000 replacement tubes  
\$111,000,000 Total

Bulk of this \$ volume done by:

17,000 service organizations  
8,000 service dealers\*  
25,000 Total

\*War (shortages had depleted the ranks of service dealers.)

1950—96,000,000 receivers and 5,000,000 TV sets in use.  
Replacement Market in \$:  
\$100,000,000 replacement parts  
62,000,000 associated equipment such as TV accessories, rotors, antennas, boosters, etc.  
270,000,000 replacement tubes\*  
\$432,000,000 Total

\*Includes picture tubes.

Note that a radical change took place, accounted for by the advent of TV, i.e.: 1) through the GI training many independent servicemen came into the field, 2) TV specialty service contractors obtained a very large share of \$ billing.

Bulk of this \$ volume done by:

20,000 service organizations who did \$120,000,000  
17,000 service dealers " " 175,000,000  
970 TV specialty contractors " 95,000,000  
15,000 independent servicemen " 42,000,000  
52,970 firms and individuals \$432,000,000

1953—98,000,000 receivers and 27,000,000 TV sets in use.

Replacement Market in \$:

\$265,000,000 replacement parts  
86,000,000 associated equipment, antennas, boosters, etc.  
320,000,000 replacement receiver tubes  
220,000,000 replacement picture tubes  
\$891,000,000 Total\*

\*Remember these are net prices by mfrs., not retail list prices. Associated equipment such as antennas, boosters, etc., while for new installations, are called part of the "replacement market," because Parts Distributors sold them to servicemen.

Bulk of this \$ volume done by:

32,000 service organizations who did \$273,000,000  
23,000 service dealers " " 410,000,000  
2,450 TV specialty service contractors 165,000,000  
30,000 independent servicemen 43,000,000  
87,450 firms and individuals \$891,000,000

### II. Conclusion:

- A. The vast increase in replacement \$ volume is primarily accounted for by the increased number of TV sets being used, and conversions being done.
- B. Every time 5,000,000 additional TV sets go into regular use, the annual replacement market \$ volume increases by approximately \$140,000,000. In other words, statistics given above indicate that the average TV set in use requires \$27 worth of replacement tubes and/or parts per year, while the average radio receiver requires \$1.80 worth of replacement and/or tubes per year for maintenance outlay.

# CIRCUIT COURT

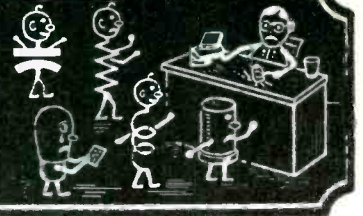

## Du Mont RA 164 Horizontal Phase Detector

The horizontal oscillator is kept in phase by means of a phase detector circuit. (Fig. 1) This circuit compares the incoming sync signal with a reference voltage pulse from the horizontal oscillator. The comparison is such that if the two are in phase there is no change in voltage on the oscillator control grid. If there is a difference, a grid voltage change is produced which brings the oscillator in phase with the sync signal.

In Fig. 1 the signal on pin #7 of the 6AL5 and the one on pin #5 are 180° out of phase. If there were no reference signal on pins #1 and #2, the positive signal on diode section #1 plate would cause this diode to conduct through R237 and R240 to ground. At the same time the negative signal at pin #5 would cause diode section #2 to conduct from the ground through R240 and R236 to pin #5. As the amplitude of the sync signals are identical both sections will conduct equally. It is just as evident that the currents through R240 will buck each other out.

If diode #1 should conduct more heavily than diode #2 it can be seen that the voltage at the junction of R240, R241, etc. will become more negative because of the current flow through R240 to ground. On the other hand if the reverse were true and diode #2 were to conduct more heavily than diode #1 the voltage at the junction would become more positive.

Now let us see what happens when the reference voltage is present. This reference voltage consists of a sawtooth pulse from the horizontal oscillator. Figure 2A shows the relationship that exists when the sync and oscillator are in phase. Note that the sync pulses on the two diodes arrive as the sawtooth is passing through its a-c zero level. It can be seen that both diodes will conduct equally.

Figure 2B shows the case when the oscillator is higher in frequency than the incoming signal. While the signals on the sync side of the diode remain the same, the conditions on the reference side have been changed, the cathode of section #1 now has 1 volt

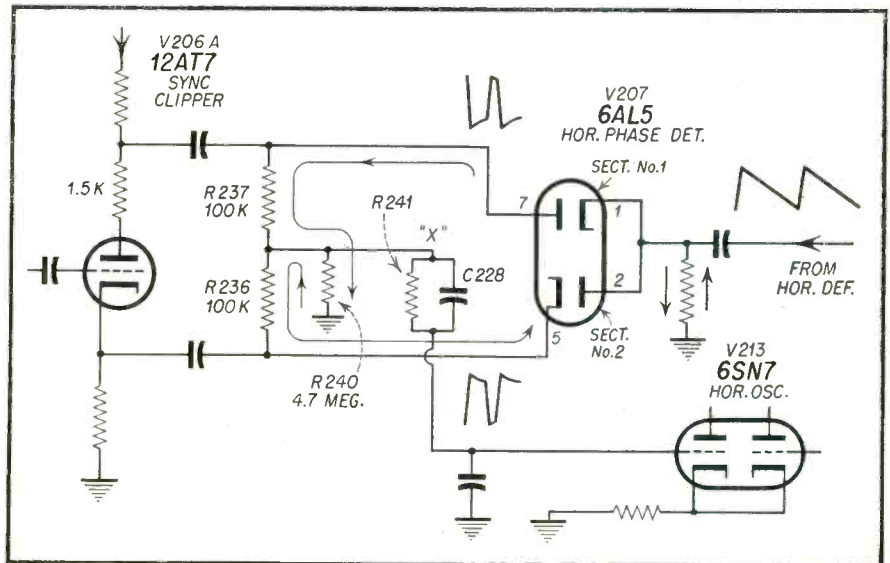

Fig. 1—Partial Schematic of the Du Mont RA 164 Horizontal Phase Detector.

positive on it. This makes the plate to cathode difference 4 volts. At the same time the conditions in diode #2 find the plate to cathode voltage to be 6 volts; section #2 will, therefore, conduct more heavily than section #1. This, as was pointed out before, will make the voltage at point "X" move in a more positive direction. Figure 2C shows the conditions that exist when the oscillator frequency is slight-

ly lower than that of the incoming sync signal.

The input circuit of the horizontal oscillator is such that there is a slight negative voltage on it when the sync and horizontal output are in phase. The *afc* action causes this voltage to become more or less negative, thereby synchronizing the horizontal oscillator frequency with the incoming sync pulse.

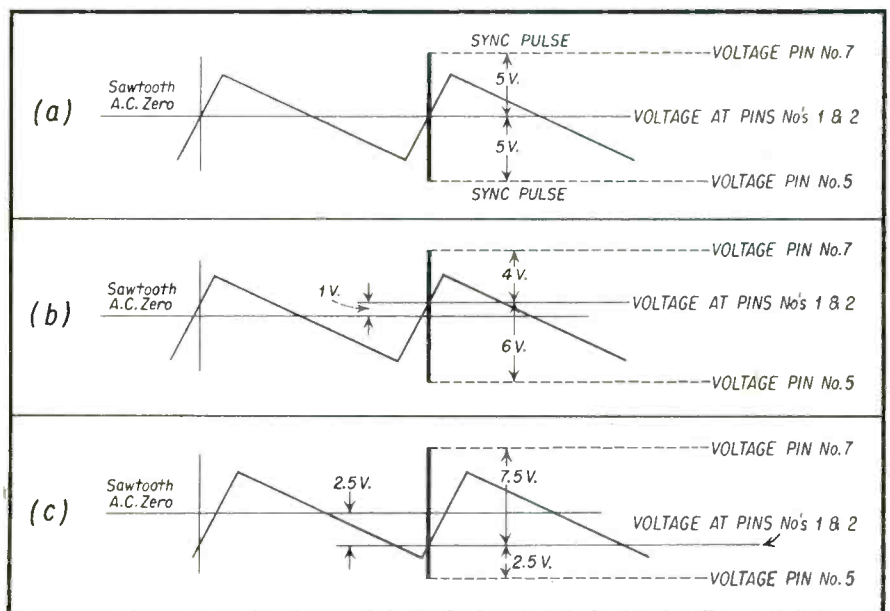

Fig. 2—Simplified Analysis of Circuit Action of the Du Mont RA 164 Horizontal Phase Detector.

DISCOVER WHAT **GOLD**

AND 2 INCHES OF AIR

DO FOR

**2**

NEW

**WALSCO ANTENNAS**

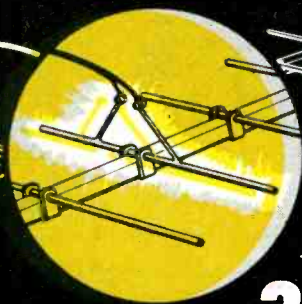

AMAZING  
**3 YEAR**  
GUARANTEE

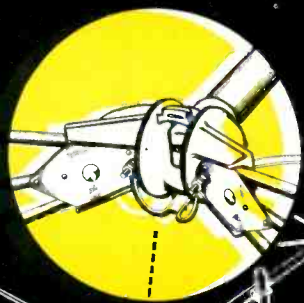

● **NEW WALSCO GOLD DIPOLE YAGI (UHF)**

No less than *24 kt. gold* plating on the receiving dipole of this great, new, 10 element Yagi. Why *gold*? Because *gold* resists corrosion better than any other metal... and *gold* is an excellent conductor. Like the most powerful *radar* antennas, the Walsco *Gold Dipole Yagi* guarantees *permanent high gain* in any location, under all weather conditions. It's custom-made for each location. The *only* Yagi that carries a *3 year unconditional guarantee!* And it costs no more than conventional Yagis.

● **NEW WALSCO IMPERIAL CONICAL (VHF)**

Here's the first radical improvement in Conicals. A new insulator which utilizes "barrier discs" and *2 inches of air space* between the terminals prevents "shorts." Soot deposits, dirt, moisture, salt, etc., *cannot* affect the insulator. This great, new Conical will therefore maintain high gain performance under any and all weather conditions. Front-end hardware is *stainless steel* to prevent corrosion losses permanently. Takes only 2 minutes to assemble because there's *no loose hardware*. Nothing compares to the Walsco Conical at any price...and it's backed by the *only 3 year unconditional guarantee!*

Write for complete information

**WALSCO ELECTRONICS CORPORATION**

3602 Crenshaw Boulevard, Los Angeles 16, California

# HOW TO SHARPEN

## CARBIDE TIPPED MASONARY DRILLS

CARBOLOY DEPT., G.E. Co.

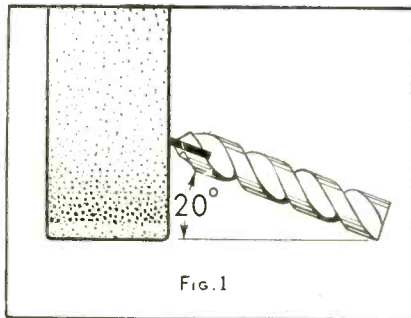

FIG. 1

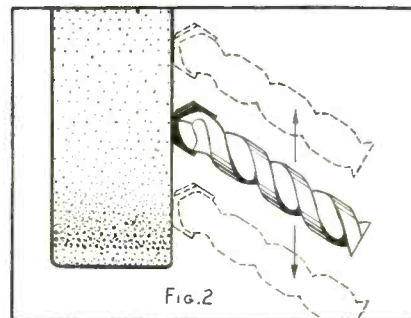

FIG. 2

**F**OUR steps to sharpening carbide tipped masonry drills have been outlined by the Carboloy Department of General Electric Company in Detroit.

The Department recommends using a silicon carbide wheel (C100-18V or C80-18V), for use in resharpening the drills and restoring the original 118 degree included angle. The drills should be sharpened when a 1/64 inch or more flat develops on the cutting edge. The steps:

1. Bring the drill against the side of the grinding wheel at a 20 degree angle as shown in *Fig. 1*. This 20 de-

gree angle should be maintained, otherwise the drill will not cut properly.

2. Using moderate pressure, move the drill back and forth across the wheel to avoid overheating (*Fig. 2*). (If overheating should occur, do not drop the drill into liquids to cool.)

3. Keep the two cutting edges of the drill of equal length while sharpening (*Fig. 3*). If one edge varies in size, the drill will make oversized cuts.

4. Repeated resharpening of the drill will reduce the clearance between the carbide tip and the steel shank.

When necessary, grind away the steel from behind the carbide tip so the steel is nowhere closer than 1/32 inch to the working surface of the carbide blank. (*Fig. 4*)

The Carboloy Department said that the drills can be sharpened on either a pedestal or bench type grinder. If the drill must be sharpened while on the job, a portable drill can be mounted on a stand and a small silicon carbide wheel used.

The new Carboloy masonry drill is being used extensively in all types of masonry products, including brick, plaster, concrete, etc.

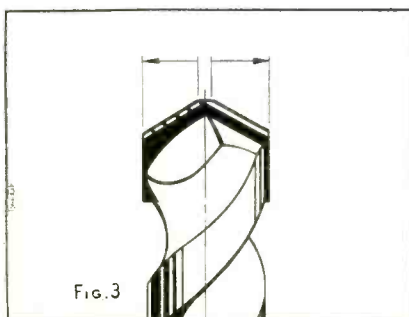

FIG. 3

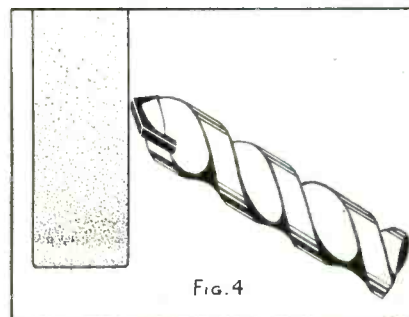
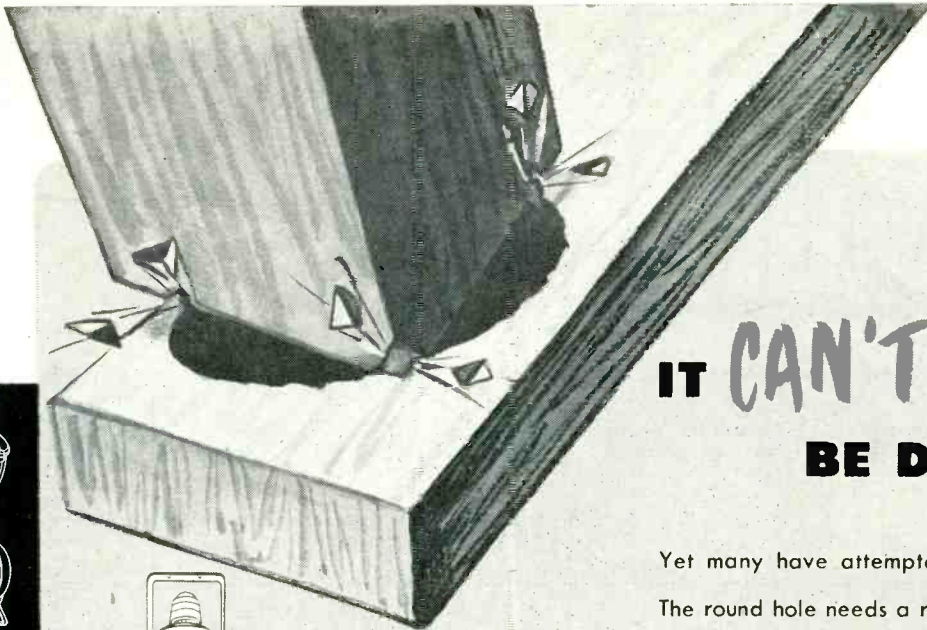

FIG. 4



# IT CAN'T BE DONE!

Yet many have attempted to try it.

The round hole needs a round peg—custom-fit to meet the need. In the choice of a speaker, just as in the choice of the peg, the point of application should be the governing factor.

So why waste loudspeaker capacity and amplifier power using the wrong speaker for the job? University makes available over 50 different models of speakers, each designed to meet a particular requirement most efficiently. University loudspeakers are *application engineered* to provide optimum performance with maximum economy—technically and cost-wise.

Whether the need is for music or voice, or both—for either indoor or outdoor use; whether in a fixed position in a factory or for mobile use on a vehicle, boat, train or airplane... there's a University speaker that can do the job best. *Don't spend more for more than you need... CHECK UNIVERSITY FIRST!*

Radial type projectors and paging speakers with 360° dispersion for maximum coverage at lowest cost and ease of installation.

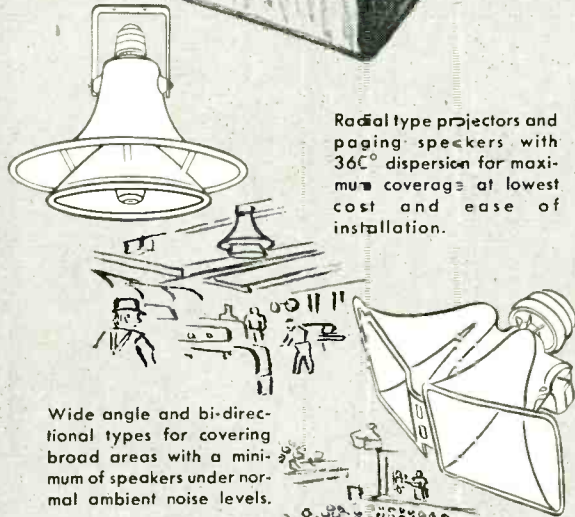

Wide angle and bi-directional types for covering broad areas with a minimum of speakers under normal ambient noise levels.

Reflex trumpets in various sizes for incomparable efficiency, distance and noise penetration.



**FREE**—new 1953 copy of the University Technilog • Complete up-to-date manual of sound theory, application and installation requirements • SEND for your copy today.



**UNIVERSITY LOUDSPEAKERS • INC.**  
80 SOUTH KENSICO AVENUE WHITE PLAINS, N. Y.





The Serv-U-Fact binder fits well on the technician's bench, as shown by the illustration on the right. Note the convenient manner of referring to charts.

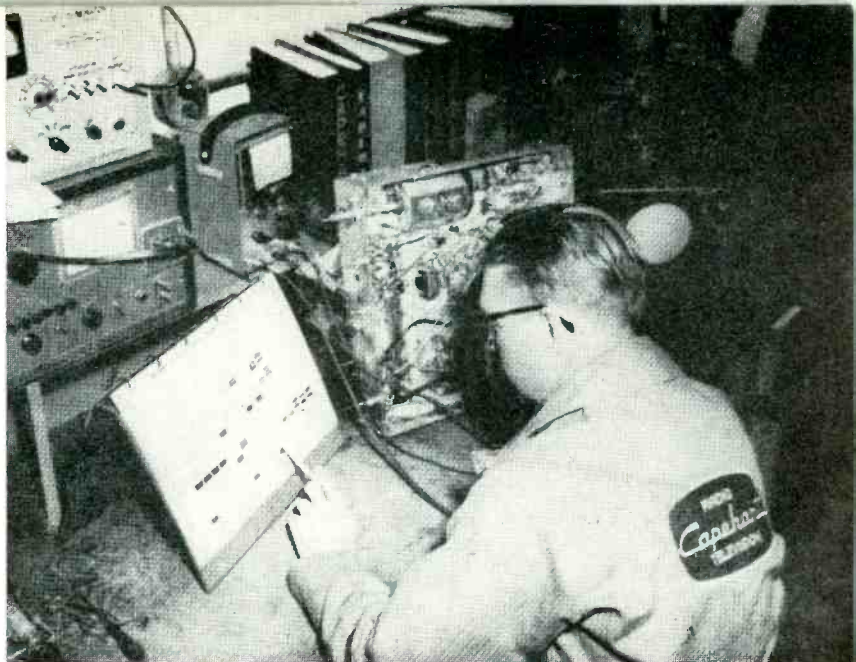

# MANUFACTURERS' Service Aids

We take our hats off to the two manufacturers whose service aids are described on this page. From time to time we will be happy to do the same for others.

The effort expended by the manufacturer in making his service in-

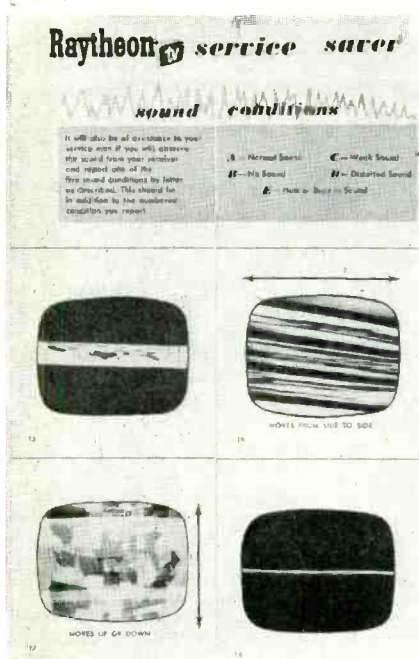

structions as lucid as possible is reflected in the type of service a technician can render, and the good will of the buying public. Shown on this page are two excellent service aids prepared by manufacturers.

The Capelhart "Serv-U-Facts" book is a compilation of service charts mounted in a sturdy easel-type binder. These charts contain circuit diagrams, alignment data, tube types and locations, voltage readings and waveforms for most Capelhart TV receivers.

The "Raytheon Service Saver" is a unique gimmick whereby the owner of a TV set is given a booklet containing certain pictorial patterns which represent faulty operating conditions in his receiver. Each picture is numbered, so that when the owner calls up his serviceman he merely indicates the symptom by referring to that number. The serviceman has a complementary booklet with the same numbers. However, his manual contains all the technical information he requires to

correct the indicated fault in the quickest possible time.

A sample page of the booklet given the owner is shown at the left. A sample page of the booklet given to the serviceman is shown at the right.

**V. Hold:**  
The Vertical Hold control should be adjusted when the picture is rolling or slipping up or down. The proper setting of the vertical hold control is that point where the picture is moving slowly upward and just back into place. At this control setting, noise will have the least tendency to lateralize vertical type.

**V. Size and V. Linearity:**  
The vertical size and linearity controls should be adjusted while a test pattern is being received. The beauty appeal effect: the upper portion of the picture, while the size control affects the overall size especially the lower portion of the picture. Adjust both controls simultaneously until the test pattern is symmetrical and fill the entire screen vertically. Readjust the vertical hold control if necessary.

**VERTICAL DEFLECTION SCHEMATIC**

**NO VERTICAL SWEEP**  
This condition is generally caused by a defective tube or component in the vertical deflection circuit.

**CHECK:**  
 V-15B Vertical Blocking Oscillator (12AU7)  
 V-16 Vertical Output (6X4)  
 T-202 Vertical Blocking Oscillator Transformer  
 T-203 Vertical Output Transformer  
 T-205 Deflection Yoke  
 C-238-23424 Coupling Capacitor  
 R-200 Vertical Size Control

**NOTE:** Check Vertical Size control for proper setting. One method of setting the deflection stage is to apply a 40 cycle 0.3 filament voltage through a 3 MFD capacitor to various points in the vertical deflection circuit. If an increase of vertical deflection is not observed on the 40 cycle voltage it applied the defect is located between the point tested and the deflection yoke.

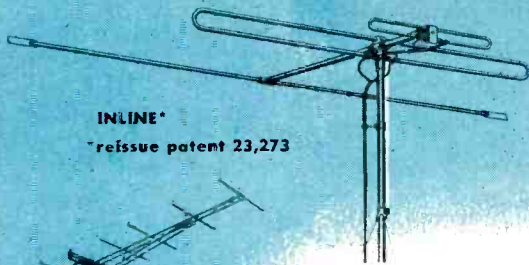

INLINE\*  
reissue patent 23,273

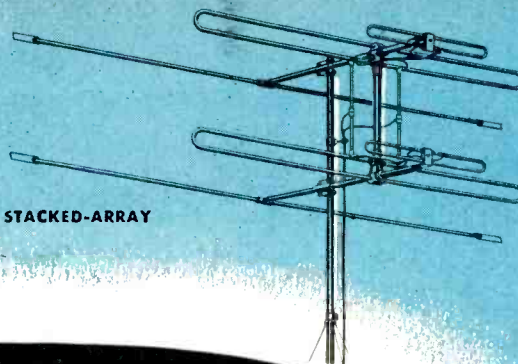

STACKED-ARRAY



YAGI



CORNER REFLECTOR

# Better Installations



BO-TY

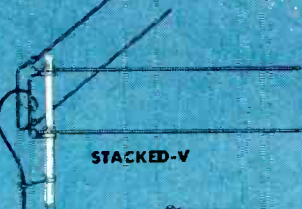

STACKED-V



RHOMBIC

have you seen it?

the **UHF VHF**  
 AMPHENOL  
 television  
 antenna story

## with **AMPHENOL** TELEVISION ANTENNAS

AMPHENOL antennas have many features of value to servicemen and installers. Because each AMPHENOL antenna is designed with the installer in mind, the entire line of UHF and VHF antennas incorporate *easy-to-install* construction and are factory pre-assembled into an absolute minimum of parts. Because each AMPHENOL antenna is designed with the serviceman also in mind, they feature *stay-up* construction. Craftmanship care in manufacture and the use of fine materials insure longer lasting antenna performance—in all kinds of weather. Finally, the superb electrical characteristics of all AMPHENOL antennas mean better TV picture quality and therefore *customer satisfaction*.

AMPHENOL antennas: *easy-to-install, stay-up* construction and *customer satisfaction*—points to remember in every new or replacement antenna installation.

Now being shown to enthusiastic audiences of dealers and servicemen—installers all over the country, AMPHENOL's "The UHF-VHF Television Antenna Story" is a film that you won't want to miss. It fully explains the technical details of UHF—makes it easier to understand by comparing the characteristics of UHF and VHF—and gives, as well, full antenna data. Contact your AMPHENOL distributor for details and be sure and see "The UHF-VHF Television Antenna Story."



the Amphenol  
"TVAntenna  
Folio"

### A NEW KIND OF PRACTICAL AID FOR TELEVISION SERVICEMEN

Designed to furnish every installer-serviceman with helpful information on UHF/VHF television and thus further aid him in making better antenna installations, the brand new AMPHENOL "TVAntenna Folio" has just been published. It contains a concise resume of television facts and is illustrated with actual Kodachromes from the AMPHENOL film "The UHF-VHF Television Antenna Story." It also contains the latest AMPHENOL antenna and accessories catalog sheets.

**AMERICAN PHENOLIC CORPORATION**  
 1830 South 54th Ave., Chicago 50, Illinois

Please send me my free copy of the "TVAntenna Folio"

NAME \_\_\_\_\_  
 COMPANY \_\_\_\_\_  
 ADDRESS \_\_\_\_\_  
 CITY \_\_\_\_\_ ZONE \_\_\_\_\_ STATE \_\_\_\_\_



Fill in the coupon and send to AMPHENOL for your free copy of the "TVAntenna Folio."



antennas for Better TV Pictures



Write up any "tricks-of-the-trade" in radio servicing that you have discovered. We pay from \$1 to \$5 for such previously unpublished "SHOP NOTES" found acceptable. Send your data to "Shop Notes Editor."

### Airline 3 speed changer—slow speed

Airline 3-speed changers. RCA Victor changers #930409 series, and other changers using same mechanism: tend to run slow speed, especially on 12 in. records. This may be present to some

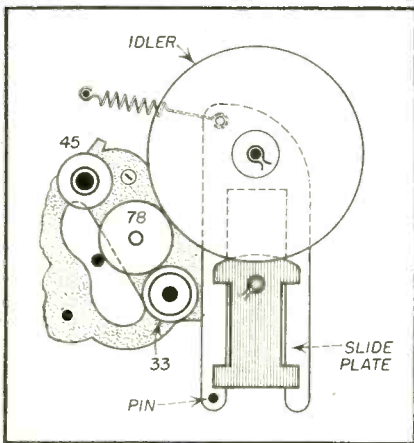

Details of three-speed changer mechanism showing idler and pin.

extent on all speeds due to pin stopping the slide before idler wheel is in full contact with turntable rim. Remove pin and discard. Smooth down surface to prevent sticking.

M. G. Goldberg  
St. Paul, Minn.

### Sylvania Model 508—Retrieving Slug

I don't believe anyone will admit pulling a dinghammer or a boner such as I did the other day. I have a Sylvania 508 TV receiver and I was touching up the controls a bit and wasn't watching too closely being somewhat distracted by my own bad temper and some yaking from my wife and I'll be a so&so if I didn't back off and loose the Osc. slug L7 in the VHF tuner. (L9 in some chassis.) If I'd of had a bottle I believe I would have had a hangerover the next day, as it was I left the set and got very busy servicing radios.

The next day after much thought about pulling the chassis and removing the tuner unit I came up with the following idea, it may have whiskers on it, but it was new to me and it may keep some guy from self destruction if the idea were in print.

This is it, use a Big Stretch or similar aligner and file the end down thin, thin, thin, then apply a drop of good fast drying service cement and reach in from the front of set and place end of alignment tool in slot in Osc. slug, do this a couple of times to get a well cemented slot, then leave the aligner in the slot for an hour or so to let the cement set. Then very carefully pull the slug forward, you can watch it and when you come up against the threads start turning counterclockwise using just a little pull and if it works for you as it did for me you got it, and the world isn't such a terrible place after all. A couple words of caution, use very little cement so it won't run off the slug and cement it to the tube of the coil strip, if that should happen your "it." After slug is recovered use another aligner with a wee bit of cotton on the tip and a wee bit of solvent to loosen the cement to remove the first tool from the slug. Another caution, use a pair of pliers on the tip of the filed down tool to test the twist you can put on it. If this won't work you are no worse off than when you started, and if it does work for you, you have saved a couple of hours at least.

W. D. Houde  
Eureka, Mont.

### Save Some of Those Picture Tubes

Some sets use the bias of sync separator tube for dc restoration (Fig. 1). Slight grid to cathode leakage of the picture tube will change the grid bias of the sync separator causing poor synchronization. As a result, even the slightest grid to cathode leakage of

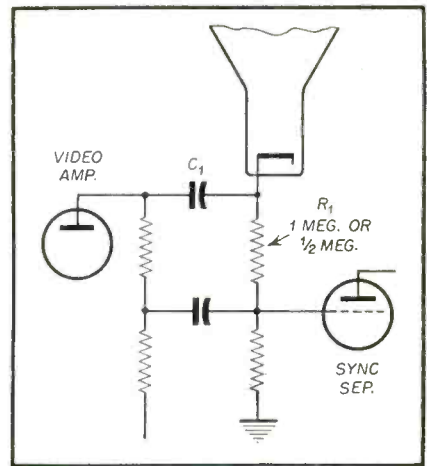

Fig. 1—Partial schematic of sync separator tube (R1 to grid). the picture tube (which might otherwise be perfectly satisfactory) requires replacement.

A way to save that good picture tube is to remove R1 from the grid of the

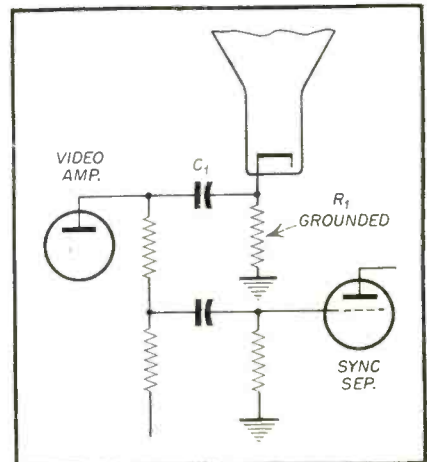

Fig. 2—Partial schematic of sync separator tube (R1 grounded).

sync separator and ground it (Fig. 2). Average dc voltage will now be developed across R1 as a result of the time constant of C1 and R1.

F. S. Mattioli  
Racine, Wisc.

### TVI

Occasionally one may be called upon to service a radio receiver in which is present a continuous and never ending buzz similar to that of a horse-fly, and consisting of long and short buzzes.

The cause is difficult to locate. Under these conditions it is suggested that the serviceman inquire of the superintendent of the apartment building if any tenants have fish aquariums.

Usually the trouble will be found here. The noise is caused by the electrical heating device which operates like a thermostat to maintain an even water temperature.

G. W. Heath  
B'klyn, N. Y.

# Admiral TV TABLE SELLS EXTRA SETS

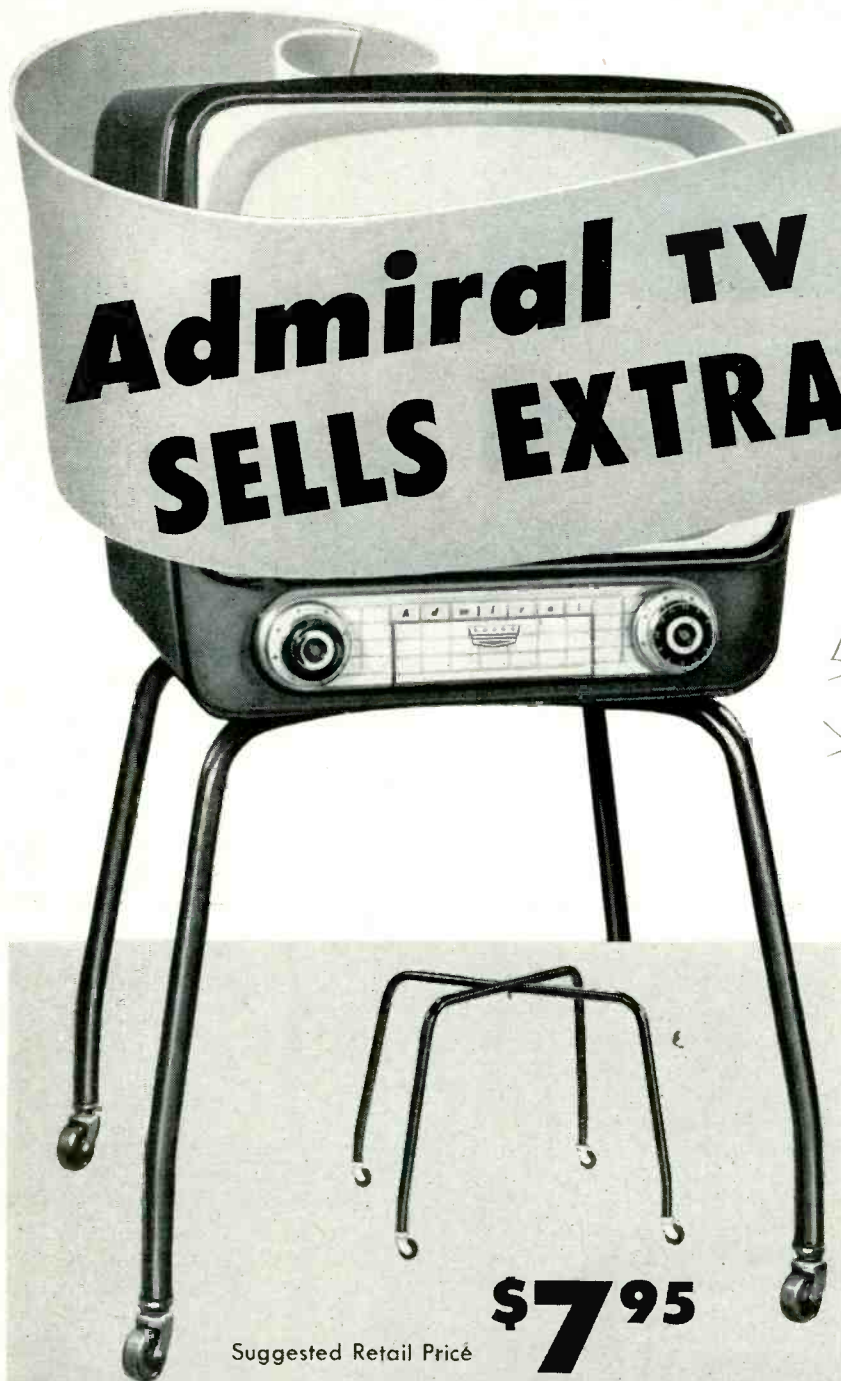

**\$7<sup>95</sup>**

Suggested Retail Price

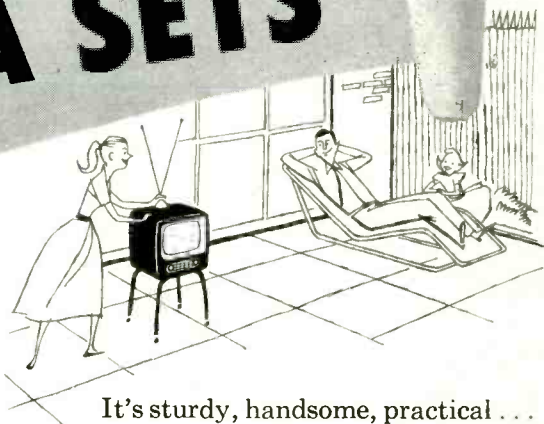

It's sturdy, handsome, practical . . . and priced *really low*. In fact, the low price will often help you clinch the sale of a TV receiver.

Show your prospect how easily this table enables him to wheel his set (with indoor antenna) to another room, the porch or terrace. In effect, it makes a portable of every table TV!

Seamless steel tubing construction supports up to 500 pounds . . . no glue joints to loosen. Admiral Silent-glide casters. Mahogany or ebony finish. Just one size fits all current Admiral table television models and many other makes . . . no multiple models to stock. Order from your Admiral distributor by part number PT100M (Mahogany) or PT100E (Ebony).

Sell a matching base with every Admiral table model . . . and take the extra profit.



**PT106**—Matching base for Admiral models, T1812, T1822, 17DX12, 17" screen. Wood, mahogany finish, casters included. Suggested list price \$17.50

**PT106A**—Same as above, ebony finish, for Admiral models T1811 and 17DX11. Sug. list price \$17.50



**PT107**—Matching base for Admiral models T2212, T2222, 121DX12, 21" screen. Wood, mahogany finish, casters included. Suggested list price \$22.50

**PT108**—Matching base for Admiral models T2232 and 122DX12, 21" screen. Wood, mahogany finish, casters included. Suggested list price \$22.50



**PT104**—Wrought iron stand for Admiral models T2212, T2222, T2232, 21" screen. Suggested list price \$9.95



**PT103**—Black wrought iron radio-phono and album stand for Admiral models 5D31, 5D32, 5D33. Sug. list price \$9.95

Admiral Corporation, Accessories and Equipment Division, Chicago 47, Ill.

# NEW TUBES

## Sylvania Tetrode Transistor

Sylvania has developed a so-called "tetrode transistor" and now is making final tests on a so-called "pentode transistor" that is expected to become commercially available later this year. Development of the tetrode and the pentode transistors, complements Sylvania's work in triode transistors, which the company is now producing commercially.

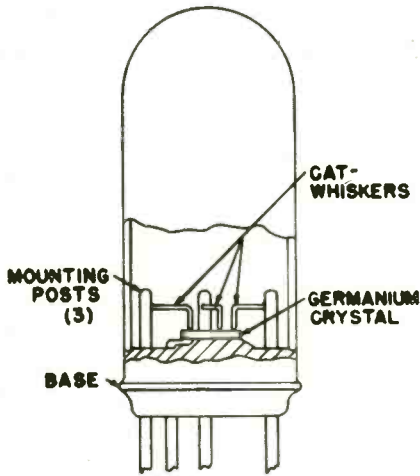

Construction of a Sylvania Crystal Tetrode Transistor.

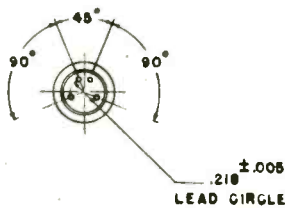
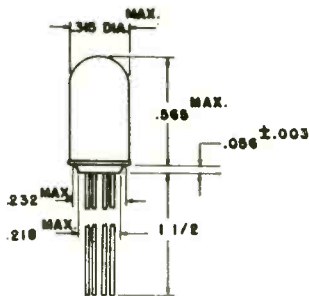

Mechanical Dimensions of the Sylvania Tetrode Transistor.

## RCA - 12X4

The 12X4 is a full-wave vacuum rectifier tube of the 7-pin miniature type intended especially for use in vibrator-type power supplies of automobile radio receivers operating from a 12-volt storage battery.

Rated to withstand a maximum peak inverse plate voltage of 1250 volts, the 12X4 can supply a maximum peak plate current per plate of 210 milliamperes. When operated in a full-wave circuit with capacitor input to filter, and an *ac* plate-to-plate supply voltage of 650 volts, the 12X4 can deliver about 300 volts *dc* to filter at a load current of 70 milliamperes. With choke-input filter and an *ac* plate-to-plate supply voltage of 900 volts, it can deliver approximately 370 volts to filter at a load current of 70 milliamperes.

### Electrical:

Heater, for unipotential cathode:		
Voltage (AC or DC)	12.6	volts
Current	0.3	ampere

### Typical Operation as Full-Wave Rectifier

with Capacitor-Input to Filter:		
AC Plate-to-Plate Supply Voltage (RMS)	650	volts
Filter Input Capacitor	10	$\mu$ f
Effective Plate-Supply Impedance per Plate*	520	ohms
DC Output Voltage at Input to Filter (Approx.):		
At half-load current of 35 ma.	360	volts
At full-load current of 70 ma.	300	volts
Voltage Regulation (Approx.):		
Half-load to full-load current	60	volts

### Typical Operation as Full-Wave Rectifier

with Choke-Input to Filter:		
AC Plate-to-Plate Supply Voltage (RMS)	900	volts
Minimum Filter Input Choke	10	henries
DC Output Voltage at Input to Filter (approx.):		
At half-load current of 35 ma.	385	volts
At full-load current of 70 ma.	370	volts
Voltage Regulation (Approx.):		
Half-load to full-load current	15	volts

\* Higher values of capacitance than indicated may be used but the effective-plate supply impedance should be increased to prevent exceeding the maximum rating for peak plate current.

Characteristics of the RCA 12X4 Rectifier.

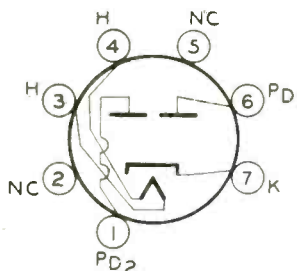

Tube Base Diagram, RCA 12X4.

## CBS-Hytron Type 1N133

The CBS-Hytron type 1N133 is a germanium diode which has been especially manufactured and tested to meet the requirements for mixer applications in the *uhf* television spectrum of 470 to 890 megacycles. The device is application tested at *uhf*.

Among other features are its glass-filled phenolic case and special impregnation which assure optimum performance under adverse humidity conditions.

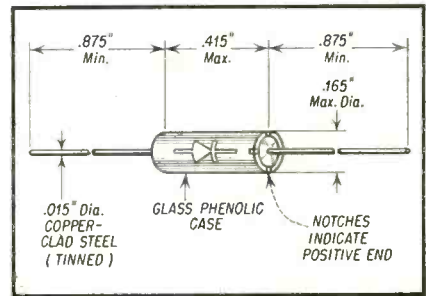

Mechanical Dimensions of the CBS-Hytron Type 1N133 Diode.

### ELECTRICAL DATA

Rating - Absolute Maximum - 25° C

D. C. Inverse Voltage	5 volts
Max. D. C. Current (Average)	50 ma.
Max. D. C. Peak Current	150 ma.
Surge Current (1 sec. duration)	500 ma.

Characteristics (at 25° C)

Maximum Reverse Current @ -0.6 volts	0.3 ma.
Minimum Forward Current @ +0.5 volts	3.0 ma.
Shunt Capacitance (average)	0.3 $\mu$ f.
Peak Inverse Voltage	8 volts

Mixer Characteristics - UHF TV (in circuit shown)

Oscillator Injection	1.0 ma.
Frequency	850 mc.
Conversion Gain (average)	0.5
Noise Figure (average)*	18 db.

\*Based on classic equation

$$N. F. db = 10 \log \frac{1}{K} \left( \frac{E}{f} \right)^2$$

E: Signal voltage required to double noise power output  
 K: Boltzman's constant  
 T: 290° Kelvin  
 f: 3.5 mc.

Characteristics, 1N133 Diode.

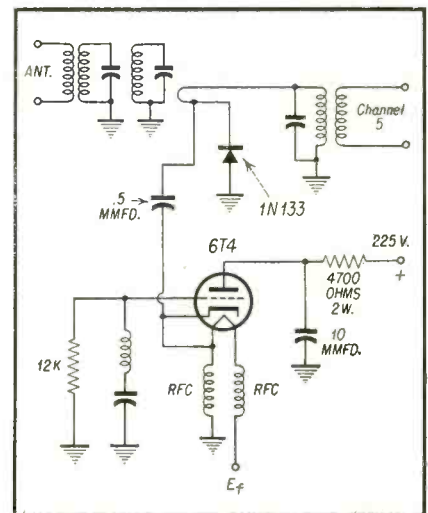

Typical Circuit Showing 1N133 Diode Used as Mixer in UHF TV.

# VIDEO SPEED SERVICING SYSTEMS 14th INSTALLMENT

## INDEX FOR SEPTEMBER, OCTOBER and NOVEMBER ISSUES

<i>Mfr.</i>	<i>Chassis No.</i>	<i>Section Affected</i>	<i>Month</i>	<i>Page</i>	<i>Card No.</i>
Admiral	19 Series	Sync	Sept.	39	AD19-1
Admiral	19 Series	Sync	Sept.	39	AD19-2
Admiral	19 Series	Pix and Sound	Sept.	39	AD19-3
Admiral	19 Series	Sync and pix	Sept.	40	AD19-4
Admiral	19 Series	Pix	Sept.	40	AD19-5
Admiral	19 Series	Sound	Sept.	40	AD19-6
Admiral	Model No. 19 Series	Pix	Oct.	47	AD19-7
Admiral	Model No. 19 Series	Sound	Oct.	47	AD19-8
Admiral	Model No. 19 Series	Pix	Oct.	47	AD19-9
Admiral	Model No. 19 Series	Pix	Oct.	48	AD19-10
Admiral	Model No. 19 Series	Sync	Oct.	48	AD19-11
Admiral	Model No. 19 Series	Raster	Oct.	48	AD19-12
Admiral	22F2, 22M2, 22P2	Pix and Sound	Nov.	61	AD22-1
Admiral	22F2, 22M2, 22P2	Sound	Nov.	61	AD22-2
Admiral	22F2, 22M2, 22P2	Sound	Nov.	61	AD22-3
Admiral	22F2, 22M2, 22P2	Sound, pix and sync	Nov.	62	AD22-4
Admiral	22F2, 22M2, 22P2	Pix	Nov.	62	AD22-5
Admiral	22F2, 22M2, 22P2	Pix	Nov.	62	AD22-6
Crosley	385, 386, 387, 393, 394	Sync	Oct.	49	CR386-1
Crosley	386, 387, 393, 394	Pix	Oct.	49	CR386-2
Crosley	386, 387 (21 inch)	Pix	Oct.	49	CR386-3
Crosley	386, 387	Pix	Oct.	50	CR386-4
Crosley	386, 387	Pix	Oct.	50	CR386-5
Crosley	386, 387	Pix	Oct.	50	CR386-6
Crosley	386, 387	Pix	Nov.	63	HO180-1
Hoffman	180	Pix	Nov.	63	HO180-2
Hoffman	180	Sound	Nov.	63	HO180-3
Hoffman	180	Pix	Nov.	64	HO180-4
Hoffman	180	Sound	Nov.	64	HO180-5
Hoffman	180	Pix and raster	Nov.	64	HO180-6
Hoffman	180	Raster	Nov.	65	PH54B-1
Philco	1954 "B" Line	Video output	Nov.	65	PH54B-2
Philco	1954 "B" Line	Raster	Nov.	65	PH54B-3
Philco	1954 "B" Line	Pix	Nov.	66	PH54B-4
Philco	1954 "B" Line	Horizontal output	Nov.	66	PH54B-5
Philco	1954 "B" Line	Pix	Nov.	66	PH54B-6
Philco	G1 Deflect., Code No. 124	Pix	Oct.	51	PHG1-1
Philco	G1 Deflect., Code No. 124	Sync	Oct.	51	PHG1-2
Philco	G1 Deflect., Code No. 124	Pix	Oct.	51	PHG1-3
Philco	G1 Deflect., Code No. 124	Sync	Oct.	52	PHG1-4
Philco	G1 Deflect., Code No. 124	Pix	Oct.	52	PHG1-5
Philco	G1 Deflect., Code No. 124	Pix	Oct.	52	PHG1-6
Philco	G1 Deflect., Code No. 124	Sync	Oct.	53	SE412-19
Sentinel	Model No. 412	Sync	Oct.	53	SE412-20
Sentinel	Model No. 412	Sync	Oct.	53	SE412-21
Sentinel	Model No. 412	Sound and Raster	Oct.	54	SE412-22
Sentinel	Model No. 412	Raster	Oct.	54	SE412-23
Sentinel	Model No. 412	Raster	Oct.	54	SE412-24
Sentinel	Model No. 454, 5, 6, 7	Sync	Sept.	41	SE454-1
Sentinel	Model No. 454, 5, 6, 7	Pix, or pix and sync	Sept.	41	SE454-2
Sentinel	Model No. 454, 5, 6, 7	Pix	Sept.	41	SE454-3
Sentinel	Model No. 454, 5, 6, 7	Pix	Sept.	42	SE454-4
Sentinel	Model No. 454, 5, 6, 7	Sound	Sept.	42	SE454-5
Sentinel	Model No. 454, 5, 6, 7	Sync	Sept.	42	SE454-6
Sylvania	1-274	Audio	Sept.	43	SY274-1
Sylvania	1-274	Pix	Sept.	43	SY274-2
Sylvania	1-274	Sync	Sept.	43	SY274-3
Sylvania	1-274	Pix	Sept.	44	SY274-4
Sylvania	1-274	Audio	Sept.	44	SY274-5
Sylvania	1-274	AM/FM Radio	Sept.	44	SY274-6
Sylvania	1-437	Pix	Sept.	45	SY437-1
Sylvania	1-437	Audio	Sept.	45	SY437-2
Sylvania	1-437	Pix	Sept.	45	SY437-3
Sylvania	1-437	Audio	Sept.	46	SY437-4
Sylvania	1-437	Pix	Sept.	46	SY437-5
Sylvania	1-437	Sound	Sept.	46	SY437-6
Stromberg-Carlson	116 Series	Pix	Nov.	67	SC16-7
Stromberg-Carlson	116 Series	Pix	Nov.	67	SC16-8
Stromberg-Carlson	116 Series	Pix	Nov.	67	SC16-9
Stromberg-Carlson	116 Series	Pix	Nov.	68	SC16-10
Stromberg-Carlson	116 Series	Pix	Nov.	68	SC16-11
Stromberg-Carlson	116 Series	Pix	Nov.	68	SC16-12

Mfr. Admiral Chassis No. 22F2, 22M2, 22P2

Card No. AD22-1

Section Affected: Pix and sound

Symptom: No pix, no sound in weak signal area; white flashes across pix; pix bending; excessive contrast; poor sync.

Cause: Incorrect adjustment of DX range finder; 5 meg. control which provides *agc* to *if* and *rf* grids.

What To Do:

In strong signal areas range finder should be in zero position. In weak and medium signal areas advance range finder to a point of optimum reception.

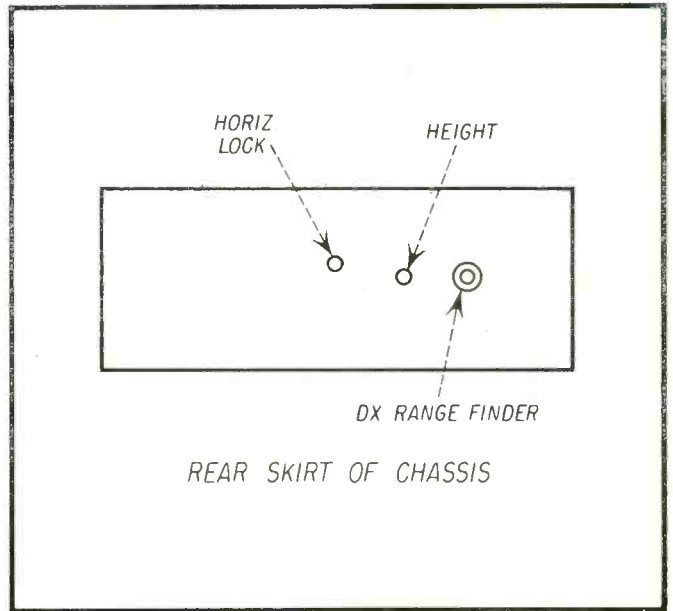

Mfr. Admiral Chassis No. 22F2, 22M2, 22P2

Card No. AD22-2

Section Affected: Sound

Symptom: Distorted or weak sound.

Cause: Frequency drift of ratio detector transformer.

What To Do:

Connect: 20  $\mu$ f-750 TC condenser in parallel with C204 (180  $\mu$ f).

Realign: T201—See card No. AD22-3.

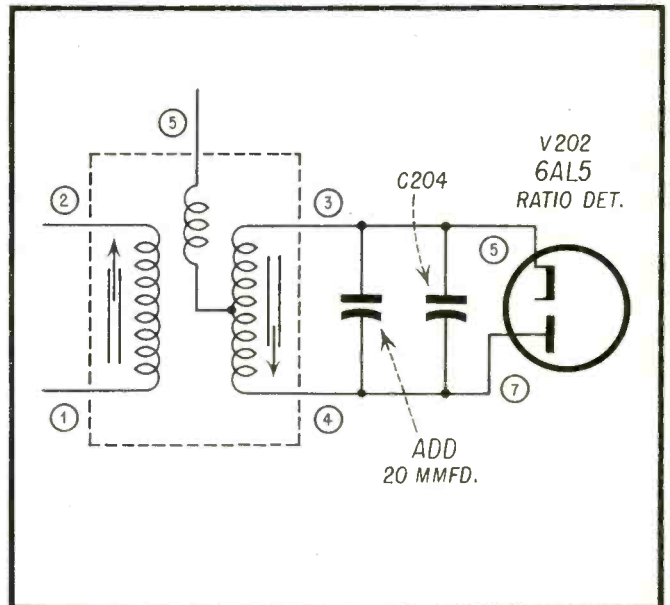

Mfr. Admiral Chassis No. 22F2, 22M2, 22P2

Card No. AD22-3

Section Affected: Sound

Symptom: Distorted on weak sound.

Cause: Ratio detector needs alignment.

What To Do:

Align: Ratio detector secondary on TV station as follows:

1. Allow set to warm up 15 minutes.
2. Tune in station.
3. Check individual channel slug adjustment.
4. Adjust A12 through hole in bottom of cabinet. Correct adjustment point as occurs between two maximum buzz peaks.

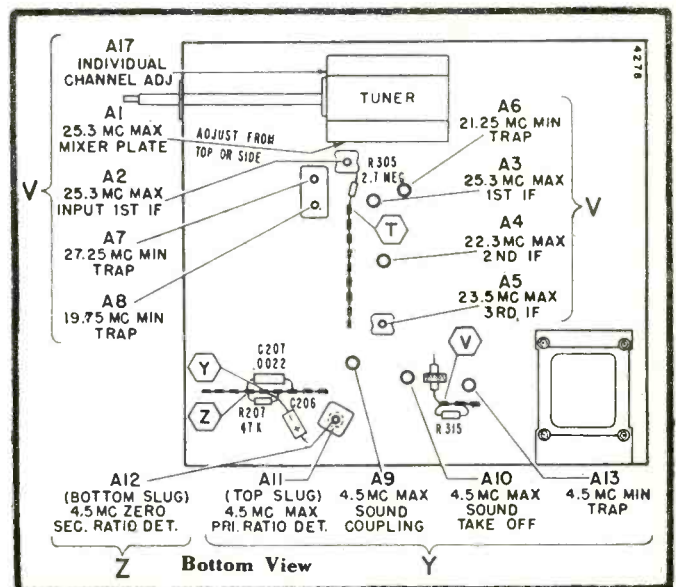

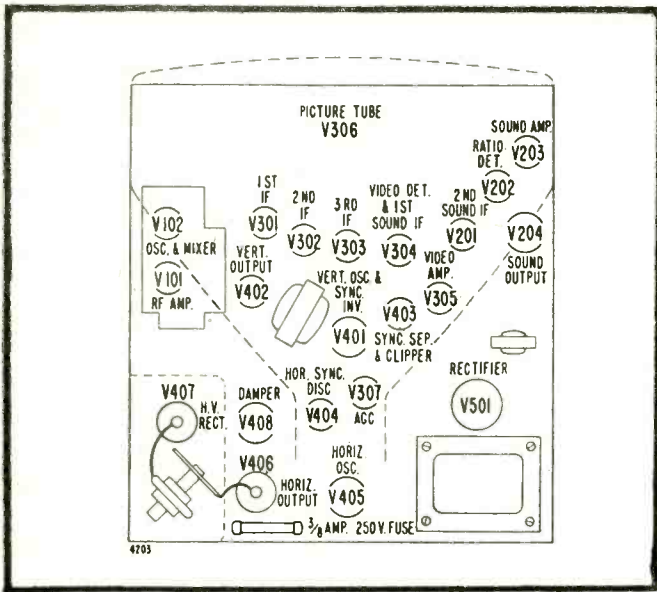

Mfr. Admiral Chassis No. 22F2, 22M2, 22P2

Card No. AD22-4

Section Affected: Sound, pix and sync

Symptom: See below.

Cause: See below.

What To Do:

1. Pix and sound may be separated due to *if* oscillation; check 6CB6 and 6AG5 (or 6AU6) *if* tubes by substitution.
2. Picture bending may be caused by leakage between tube elements. Check 6CB6, *if* amp. and 6BZ7, 1st and 2nd *rf* amp.
3. Washed out pix. Check 6CL6 video amp.

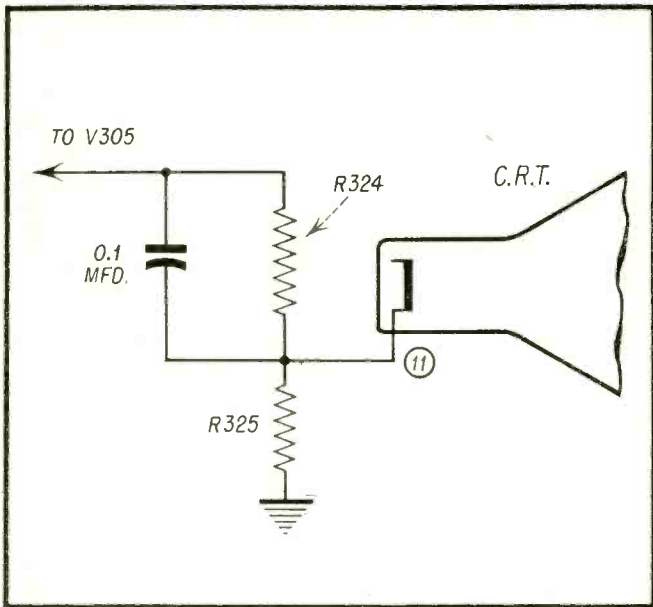

Mfr. Admiral Chassis No. 22F2, 22M2, 22P2

Card No. AD22-5

Section Affected: Pix

Symptom: Inadequate brightness level.

Reason For Change: Circuit improvement.

What To Do:

- Replace: R324 (680K) with 270K.  
Also, R325 (560K) with 1 meg.

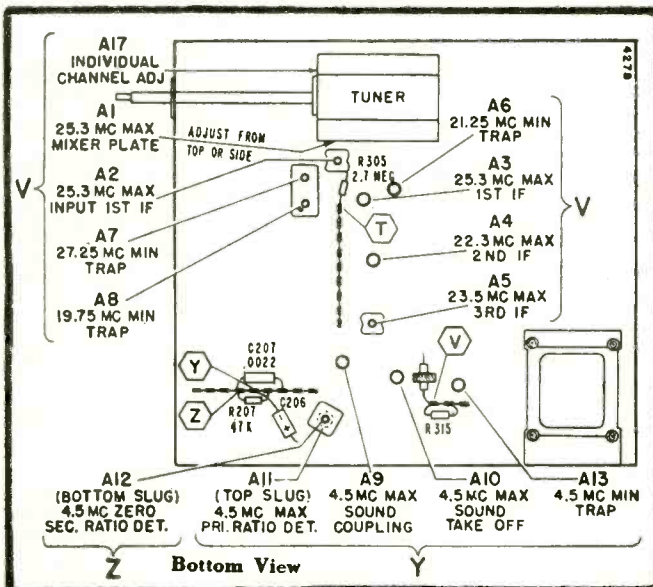

Mfr. Admiral Chassis No. 22F2, 22M2, 22P2

Card No. AD22-6

Section Affected: Pix

Symptom: 4.5 mc. interference. Pattern varies with sound.

Cause: Beat frequency (4.5 mc.) interference.

What To Do:

- Adjust: Slug A13 for minimum interference.



Mfr. Hoffman Chassis No. 180

Card No. HO180-1

Section Affected: Pix

Symptom: Vertical roll after set warms up.

Cause: Component defect.

**What To Do:**

Check: R601 (1 meg.). Resistor changes value.

Replace: With 1 meg 1 watt resistor.

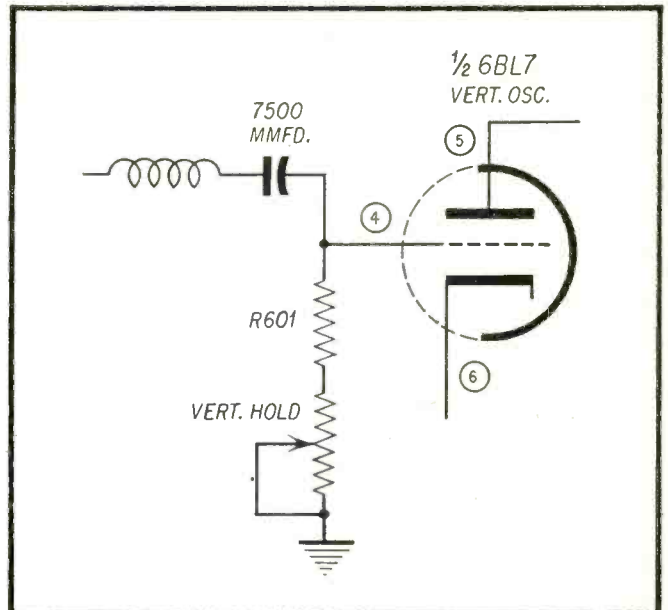

Mfr. Hoffman Chassis No. 180

Card No. HO180-2

Section Affected: Pix

Symptom: Weak vertical hold in fringe area.

Reason For Change: Fringe area performance improvement.

**What To Do:**

Change: R303 (47K) to 10K.  
Also, C501 (220 μmf) to .001 μf;  
Also, R501 (10 meg) to 1.5 meg.

Add: 47 μmf from pin #1 V501 (6AU6) to ground.

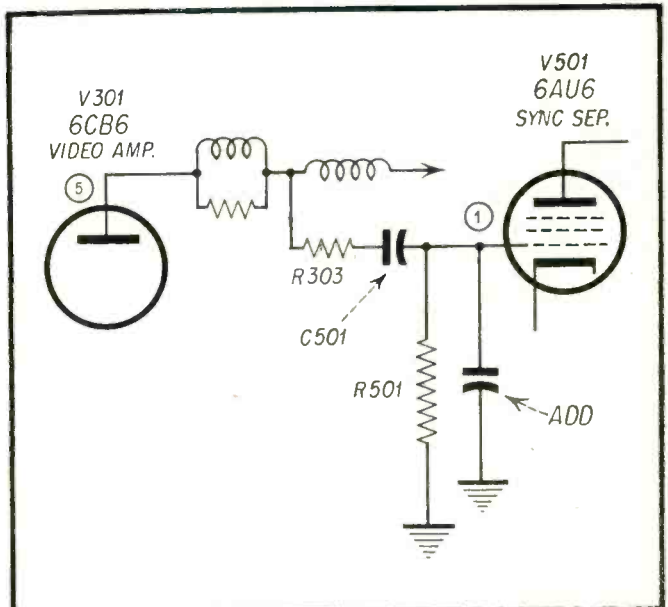

Mfr. Hoffman Chassis No. 180

Card No. HO180-3

Section Affected: Sound

Symptom: Buzz.

Reason For Change: Circuit improvement.

**What To Do:**

Change: C402 (.005 μf) to .22 μf.

Note: If hum still persists, change C402 to 2 μf.

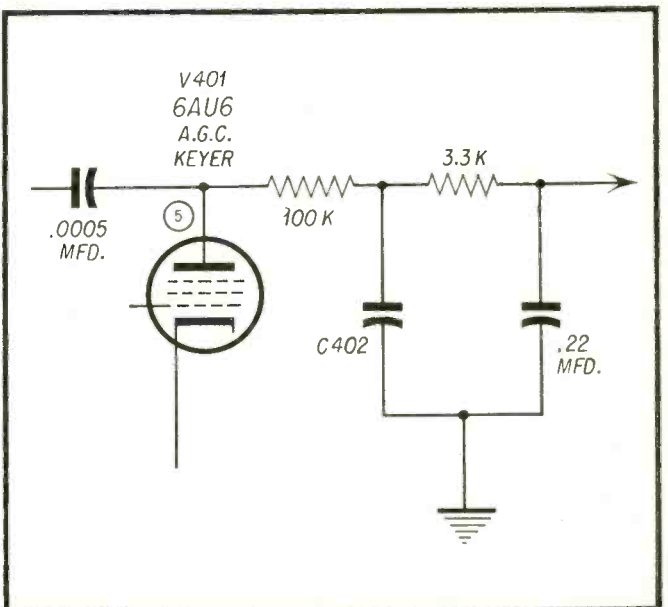

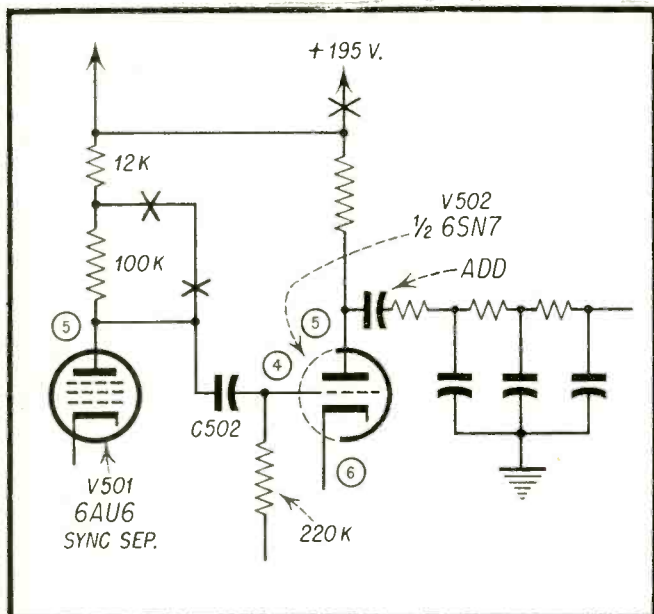

Mfr. Hoffman Chassis No. 180

Card No. HO180-4

Section Affected: Pix

Symptom: Weak vertical hold in normal areas.

Reason For Change: Circuit improvement.

What To Do:

Add: .005  $\mu$ f between pin #5 V502 (6SN7) and integrator network.

Reconnect: C502 (.047  $\mu$ f) to pin #5 V501 (6AU6);  
Also, R507 (6.8K) from +195 VDC to +140VDC.

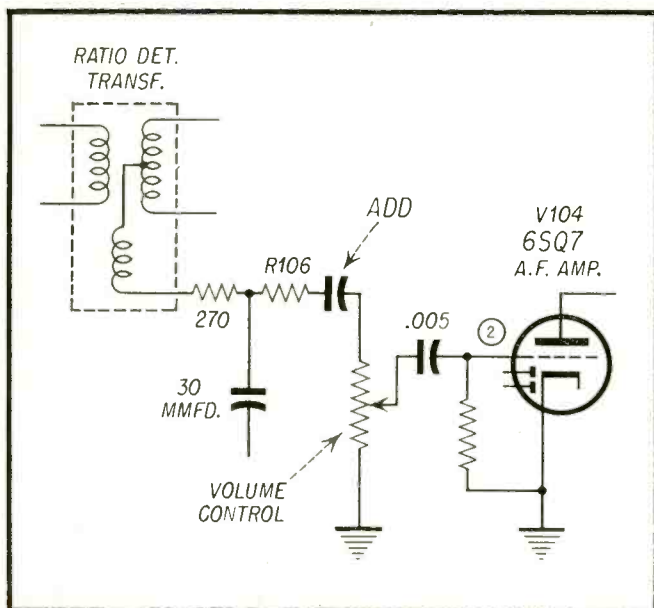

Mfr. Hoffman Chassis No. 180

Card No. HO180-5

Section Affected: Sound

Symptom: Volume control gets noisy very soon after cleaning.

Cause: DC passes through control.

What To Do:

Add: A .0047  $\mu$ f condenser between volume control and R106 (15K).

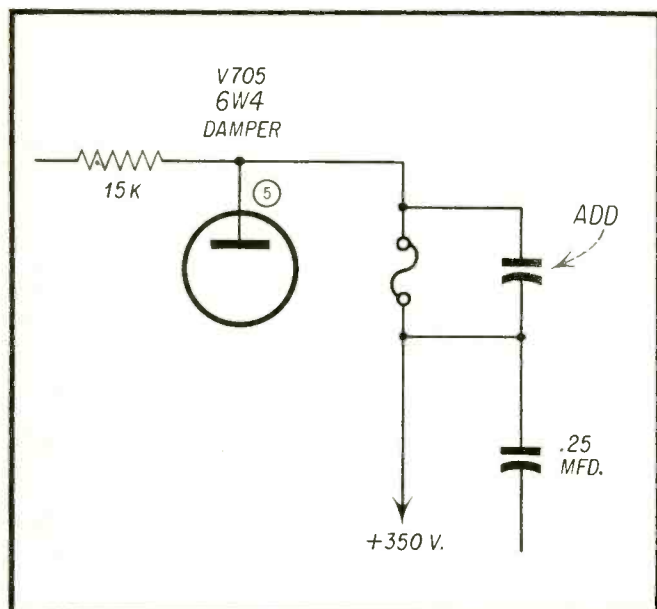

Mfr. Hoffman Chassis No. 180

Card No. HO180-6

Section Affected: Pix and raster

Symptom: Excessive failure of hi-voltage fuse.

Cause: Transient current surge peaks.

What To Do:

Add: A .22  $\mu$ f 400 volt molded condenser across fuse.

**Mfr. Philco** Chassis No. 1954 "B" Line.  
All series, TVI81, TVI91 & HF200.  
**Code No.** All Codes, 130, 140, 147,  
150, 157, 158

**Card No.** PH54B-1

**Section Affected:** Raster

**Symptom:** Repeated failure of 1B3 high voltage rectifier.

**Cause:** Excessive filament voltage.

**What To Do:**

**Replace:** R103, 4.7 ohm resistor with a 5.6 ohm, 1/2 watt, resistor.

**Note:** Do not over scan as this will increase the filament voltage.

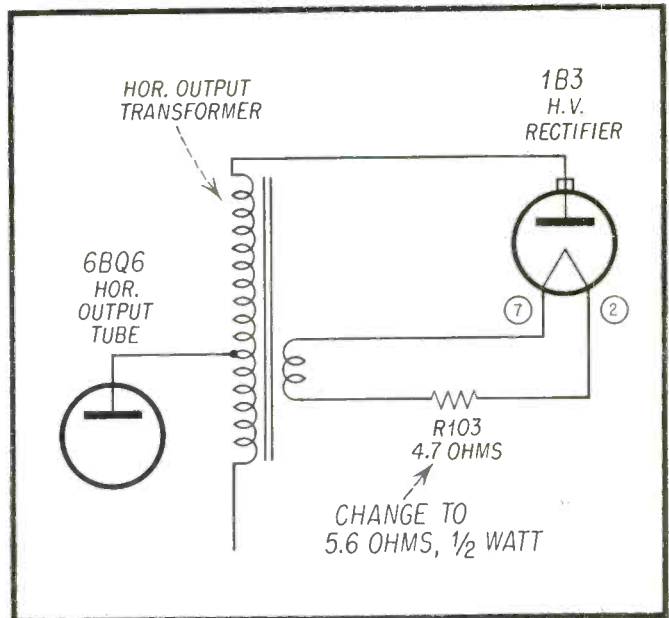

**Mfr. Philco** Chassis No. 1954 "B" line  
TVI91 and HF200 series.  
**Code No.** 140, 147, 150, 157, 158

**Card No.** PH54B-2

**Section Affected:** Video output

**Symptom:** Improper operation of contrast control —spotty or open.

**Cause:** Momentary short internally of the 6AQ5 video output tube between the suppressor and screen grids causes excessive current flow through contrast control damaging it.

**What To Do:**

**Replace:** Contrast control.

**Add:** 1.8K ohm resistor in screen grid circuit of 6AQ5 tube.

**Note:** This can occur with any 6AQ5 tube and once it has happened it is not likely to recur. It is therefore more desirable to leave the old tube in the set if it is functioning properly than to replace it. If a new tube is used the inclusion of the 1.8K ohm resistor is desirable.

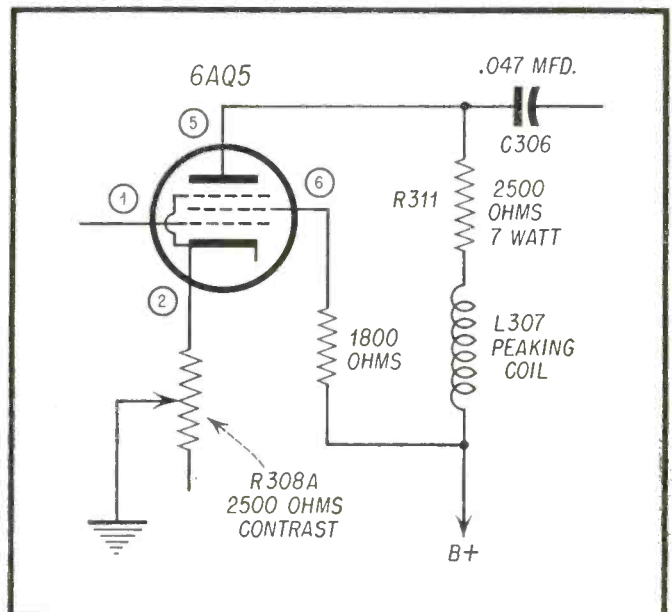

**Mfr. Philco** Chassis No. 1954 "B" Line,  
HF200 series. **Code No.** 150

**Card No.** PH54B-3

**Section Affected:** Raster

**Symptom:** No vertical sweep.

**Cause:** Open resistor in cathode of vertical output tube, 12B4. The cathode resistor opens because of too much plate current which is caused by grid emission in the 12B4 tube.

**What To Do:**

**Replace:** 470 ohm cathode resistor with a two watt type of the same resistance value.

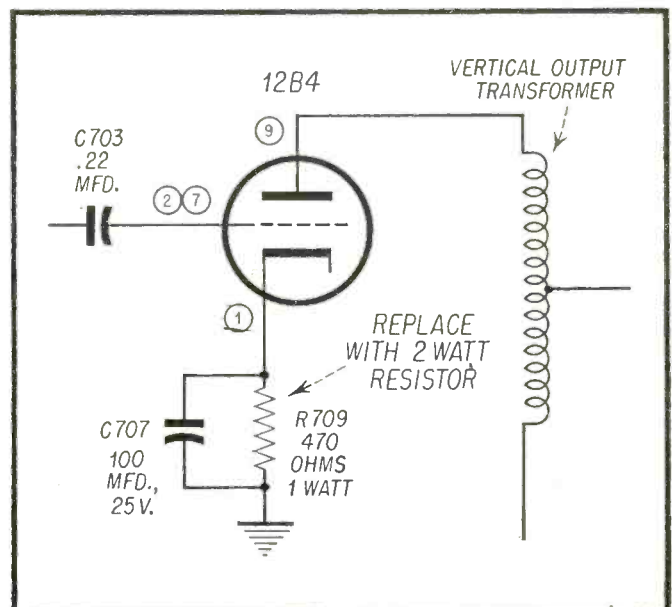

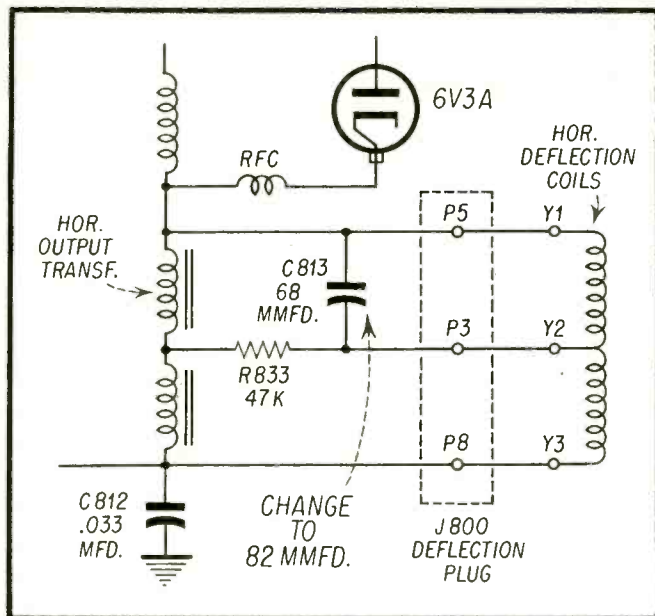

Mfr. Philco Chassis No. 1954 "B" Line, D-208.  
Code No. 158

Card No. PH54B-4

Section Affected: Pix

Symptom: Insufficient width.

Reason For Change: To reduce slightly the drive into the horizontal deflection coils.

What To Do:

Change: 68  $\mu\text{f}$ , 5000 volt condenser to 82  $\mu\text{f}$ , 5000 volt. This condenser is located across the connections to the upper horizontal coil in the power chassis.

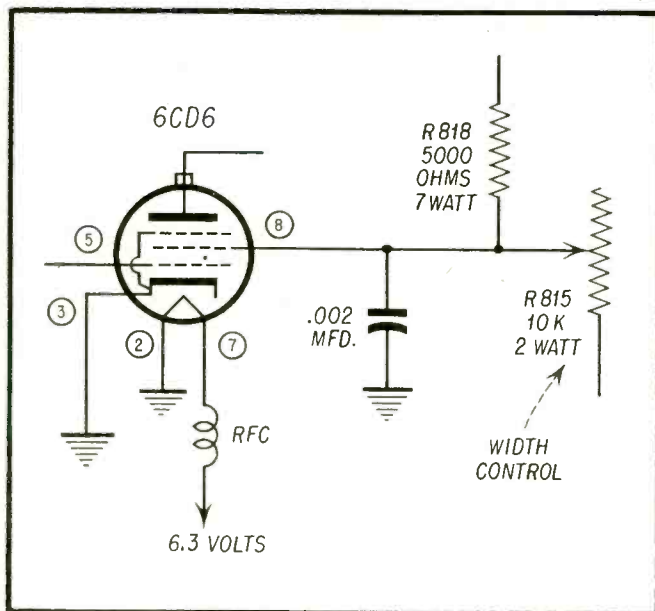

Mfr. Philco Chassis No. 1954 "B" Line, D-208.  
Code No. 158

Card No. PH54B-5

Section Affected: Horizontal output

Symptom: Vertical lines in picture.

Cause: Barkhausen oscillations are developing in the horizontal output circuit and tube.

What To Do:

Add: A .002  $\mu\text{f}$ -400 volt capacitor from screen to chassis.  
Also, an *rf* choke in series with the filament lead to the 6CD6 horizontal output tube.

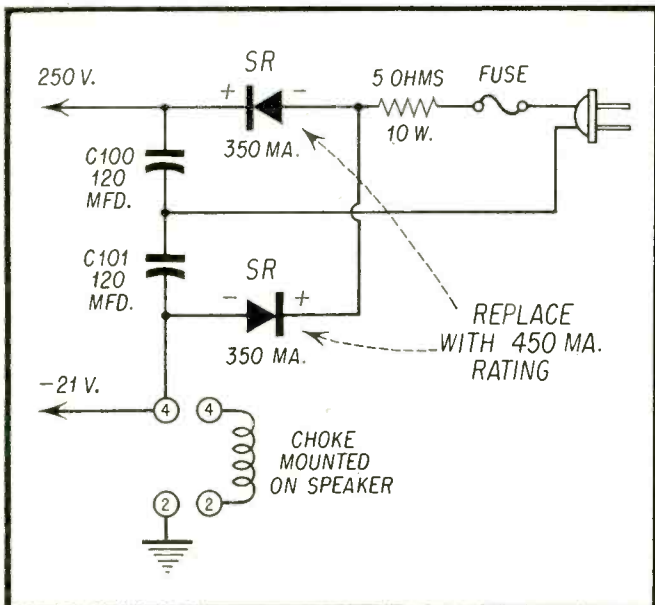

Mfr. Philco Chassis No. 1954 "B" Line, TVI81, TVI91 and HF200 series.  
Code No. All combo radio-phonograph TV models

Card No. PH54B-6

Section Affected: Pix

Symptom: Reduced picture width and/or 60 cycle pull in picture.

Cause: Loss of rectifying efficiency of one or both of the selenium rectifiers.

What To Do:

Replace: Selenium rectifiers with 450 ma rating rectifiers.

Mfr. Stromberg-Carlson Chassis No. 116 series

Card No. SC16-7

Section Affected: Pix

Symptom: "Loose" vertical hold.

Cause: Osc. transformer "Q" too high.

What To Do:

Add: A 10K resistor across plate winding of vertical osc. transformer.

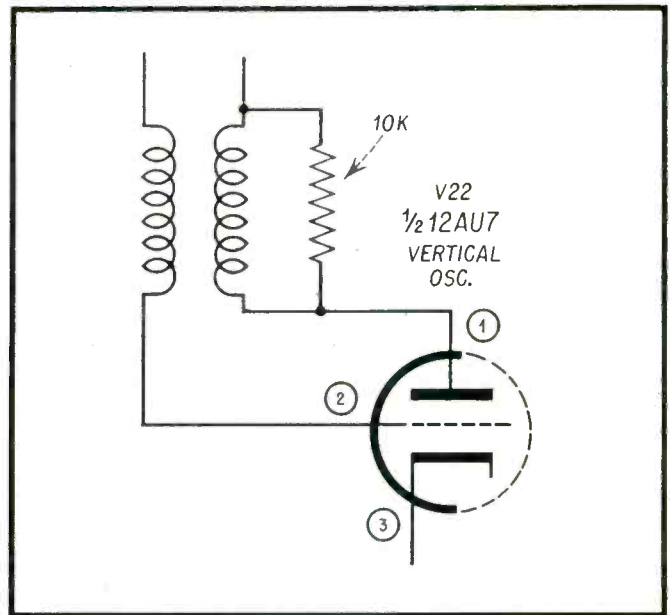

Mfr. Stromberg-Carlson Chassis No. 116 series

Card No. SC16-8

Section Affected: Pix

Symptom: Unstable horizontal sync.

Reason For Change: Circuit improvement.

What To Do:

Change: R59 from 2.2K to 8.2K-1 watt.

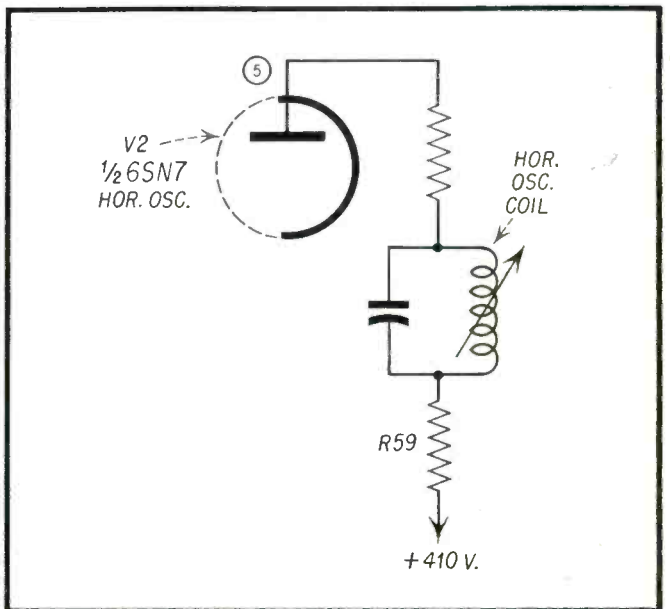

Mfr. Stromberg-Carlson Chassis No. 116 series

Card No. SC16-9

Section Affected: Pix

Symptom: Picture "blooms" when brightness control is advanced.

Reason For Change: Circuit improvement.

What To Do:

Add: 100K 1/2W resistor between CRT cathode and arm of brightness control.

Remove: R72 (18K) between end of brightness control and ground.

Reconnect: End of brightness control to ground.

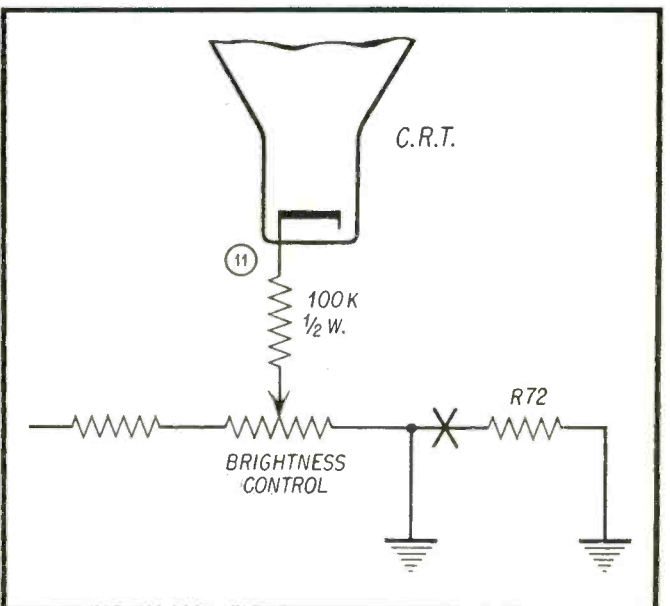

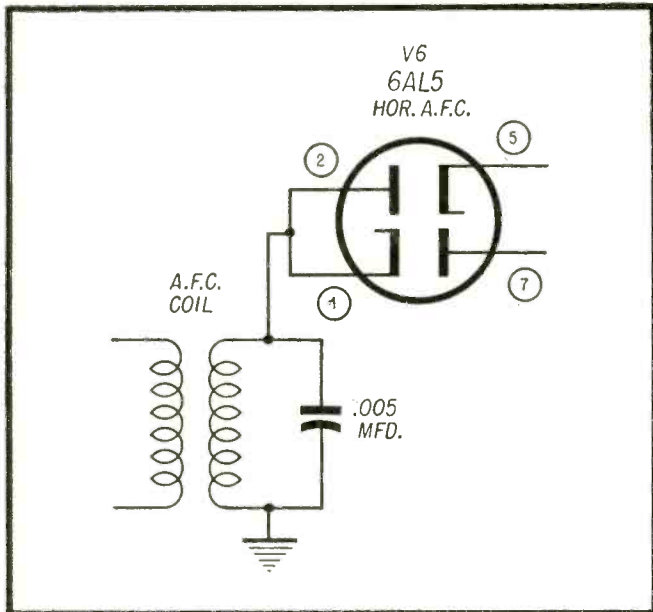

Mfr. Stromberg-Carlson Chassis No. 116 series

Card No. SC16-10

Section Affected: Pix

Symptom: Poor horizontal centering.

Reason For Change: Circuit improvement.

What To Do:

Add: .005  $\mu$ f condenser across *afc* coil.

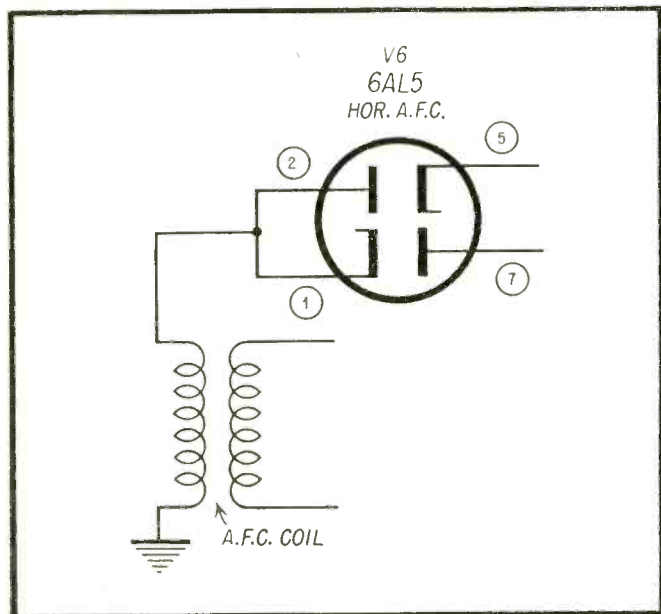

Mfr. Stromberg-Carlson Chassis No. 116 series

Card No. SC16-11

Section Affected: Pix

Symptom: No horizontal sync or blanking bar in center of pix.

Cause: Component defect.

What To Do:

Check: *AFC* feedback coil for shorted turns.

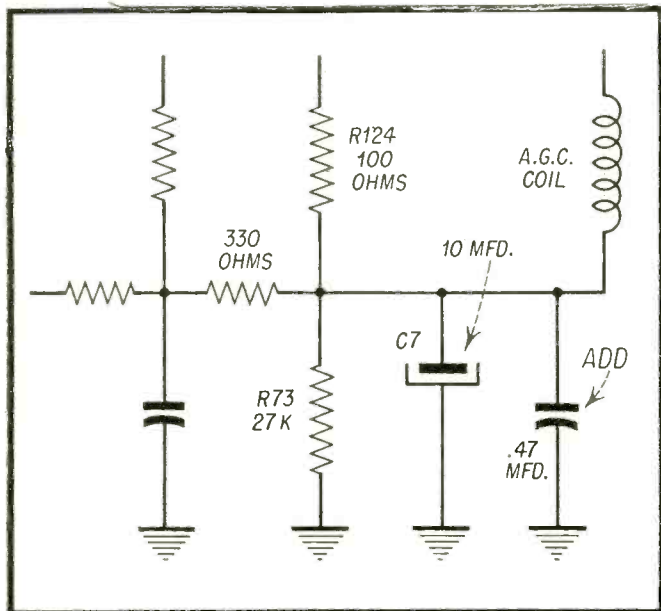

Mfr. Stromberg-Carlson Chassis No. 116 series

Card No. SC16-12

Section Affected: Pix

Symptom: Horizontal pull, jitter or weaving.

Cause: Insufficient *agc* filtering.

What To Do:

Add: A 47  $\mu$ f condenser across the *agc* filter network.

# FOR GREATER PROFITS

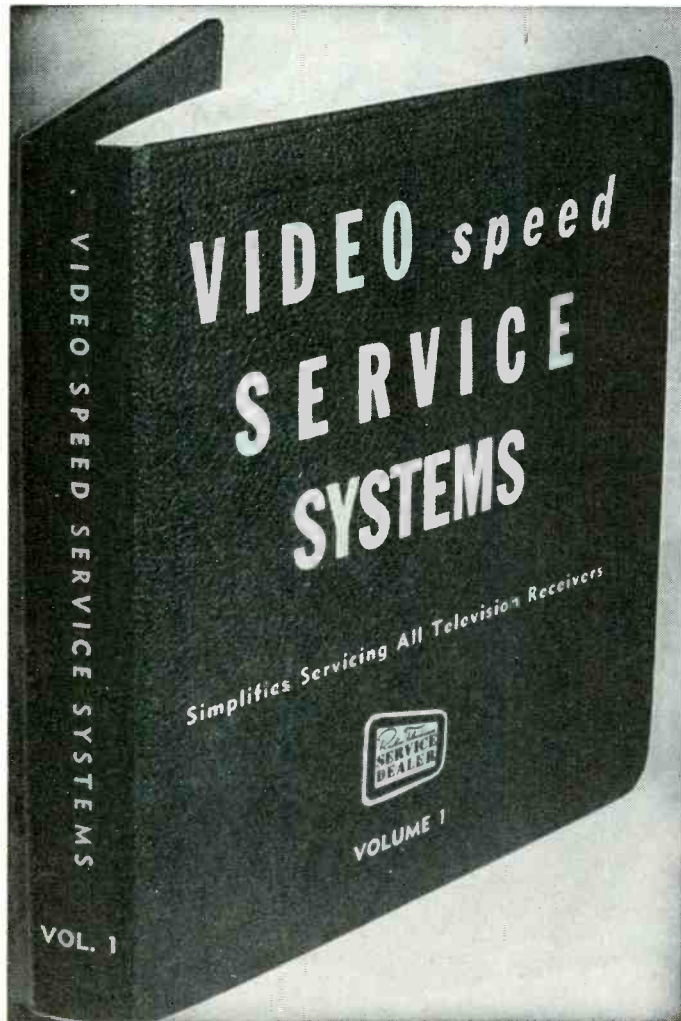

## SPEED UP YOUR SERVICING with THIS NEW BOOK

which shows you how to take care of and repair in the quickest possible time:

- Troubles commonly found in certain receivers
- "Bugs" which might take you hours to find
- Factory and field service changes

SET UP SO THAT YOU CAN MAKE THESE REPAIRS IN THE SHOP OR IN THE FIELD WITHOUT REFERENCE TO ANY OTHER SOURCE.

**\$4.95**  
• (postpaid)

Distributors—order your supply now!

Service Dealers—get your copy of VSSS from your Distributor. If he can't supply you, order direct by mail from us.

Contains over 600 Service Items representing over 1000 of the most-serviced Television models now in use. Over 25 different manufacturers' lines are covered.

Video Speed Servicing Systems IS GUARANTEED to Simplify Servicing All TVsets. 24 (or more) new Data Items are published in every issue of "Radio-Television Service Dealer" as a regular monthly feature.

### TEAR OFF AND MAIL NOW

RADIO-TELEVISION SERVICE DEALER  
67 West 44th Street, New York 36, N. Y.

Please send me post-paid VIDEO SPEED SERVICING SYSTEMS Volume 1. Enclosed herewith is

my  check  money order for \$\_\_\_\_\_ for \_\_\_\_\_ copies at \$4.95 each.

Name .....

Address .....

City ..... Zone ..... State .....

# Introducing!

# TV FIELD SERVICE MANUAL DATA SHEETS



John F. Rider  
"Dean of Servicemen"

Here is the first set of TV Field Service Manual Data Sheets, a new exclusive feature of "Service Dealer" magazine. The author, an outstanding figure in the service industry, explains below why this service was conceived.

THE tremendous appeal which television has for the viewing public is having a tremendous effect on the activities of the television servicing industry. By and large, the public is very reluctant to part with its receivers for any prolonged period of time. In the event of any trouble in the equipment, the preference of the public is that the service be done in the home.

It is understandable that the amount of service which can be rendered in the home is limited. There are many conditions which make it very difficult for a service facility to carry out major trouble diagnosis and major repairs in the customer's home. The kinds of troubles which may develop in a television receiver are myriad and it is extremely difficult for the itinerant service technician to carry with him, even in a rolling parts supply truck, the complete variety of components which he may need to complete every conceivable type of repair. However, operations in the home do lend themselves to certain kinds of trouble diagnosis and to light repairs.

Such troubles usually revolve around tubes. However, it is not impossible that minor components such as resistors and capacitors be changed in the home, especially when it is not too convenient, because of the distance involved, to remove a chassis from the shop, and then return it several days later. It is with the realization that more and more servicing *must* be done in the home that the field service data given in the pages which follow was conceived. The material presented was chosen after a great deal of deliberation and consultation with practicing service technicians. The consensus of opinions resulted in the selection of the data given.

It is realized that all service technicians do not agree on what information is required in a home for light television servicing. What is presented in these pages reflects the data desired by all. This includes those references to the components other than tubes which might have become defective and require replacement. It is to be noted that the location of these components in the chassis is described in

terms of where they are connected. This is an alternative to the inclusion of schematic information.

Investigations have disclosed a particular type of public reaction to the handling of service information by the visiting technician. The public is ready to accept the service technician who brings reference information into the home, but develops misgivings when they see an individual turning pages back and forth or examining a large schematic in their presence. It is for this reason, and because it would mean added bulk to the data carried by the technician, that schematics are omitted and a particular type of organization is used in presenting these data. We are referring to the troubleshooting information and the tube locations and related data on facing pages. This permits utmost utility of the data without need for turning over the pages.

It is hoped that the service industry will view these data with favor. In the meantime, comments and suggestions are solicited, because the intention is to make these data sheets as useful as possible.



# CROSLEY

**TV FIELD SERVICE**

Pre-published from Rider "TV Field Service Manuals"

by Rider & Aisberg

Copyright 1953, John F. Rider Publisher, Inc.

## CHASSIS AND MODEL NUMBERS

CHASSIS NOS.	MODEL NOS.
402	F-17TOLH
402	F-17TOLBH
403	F-21TOLH
403	F-21TOLBH
404	F-21COLH
404	F-21COLBH
404	F-21CDLH
404	F-21CDLBH
402-1	F-17TOLU
402-1	F-17TOLBU
403-1	F-21TOLU
403-1	F-21TOLBU
404-1	F-21COLU
404-1	F-21COLBU
404-1	F-21CDLU
404-1	F-21CDLBU

## TUBE COMPLEMENT

SYMBOL	TUBE	FUNCTION
V1	6BC5	R-F Amplifier
V2	6J6	VHF Oscillator and Mixer
V101	6CB6	1st I-F Amplifier
V102	6CB6	2nd I-F Amplifier
V103	6CB6	3rd I-F Amplifier
V104	12BH7	Vertical Oscillator and Output
V105	6SN7GT	Sync Clipper and Sync Output
V106	6AL5	Ratio Detector (Sound)
V107	6AU6	Sound Detector Driver (4.5 mc)
V108	6AH6	Video Amplifier
V109	6AL5	Horizontal A.F.C.
V110	6C4	1st Audio Amplifier
V111	6W6GT	Audio Output
V112	6AX4	Horizontal Damper
V113	6SN7GT	Horizontal Oscillator
V114	6BQ6GT	Horizontal Output
V115	1B3GT	H.V. Rectifier
V116	17HP4	Picture tube (chassis 402-1)
V116	21MP4, 21AP4	Picture tube (chassis 403-1)
V116	21ZP4A	Picture tube (chassis 404-1)

This receiver employs only parallel filaments.

### Key-Voltages

(Chassis 402, 403, 404, 402-1, 403-1, 404-1)

All voltages are measured with respect to chassis:

B+	voltage, plate of the Damper tube V112,	pin 5	260VDC
Boosted B+	cathode of Damper tube V112,	pin 3	520VDC
Plate voltage of Vert. Osc., V104,	pin 6		100VDC
Plate voltage of Vert. Output Ampl., V104,	pin 1		500VDC
Plate voltage of Hor. Osc., V113,	pin 5		200VDC
	pin 2		132VDC
Grid voltage of Hor. Output tube, V114,	pin 5		—25VDC

## ADJUSTMENTS

### Focusing Magnet Adjustment (403 and 404 chassis)

This bracket should be adjusted so that the magnet is centered around the neck of the picture tube. Do not remove the cardboard spacer between the neck of the tube and the magnet. Adjustment can be made after loosening the two screws in the slotted holes of the bracket on either side of the magnet housing.

### Centering Raster

If the picture is off center and/or has neck shadow on receivers using the 402 chassis, rotate either or both CENTERING MAGNET levers to the left or right until the picture is centered on the screen and is free of neck shadow. The CENTERING MAGNET is located on the back cover of the DEFLECTION YOKE. On receivers using the 403 or 404 chassis, move the centering lever (wobble arm) up or down to the right or left. Some of the Focusing Magnet Brackets have a slotted head screw or a wing screw to lock lever in position. Before adjusting, loosen the screw, retighten screw after adjustment is made. To determine the correct picture centering, it may be necessary to reduce the size of the picture with the HEIGHT and WIDTH adjustments. After making adjustment of CENTERING MAGNET, readjust ION TRAP.

### Local-Distance (AGC) Switch

The LOCAL-DISTANCE SWITCH can be set to prevent the receiver from overloading in strong signal areas or to reduce "snow" in the picture in weak signal areas. In strong signal areas, the "LOCAL" (counter-clockwise)

[Continued on page 74]

## CROSLEY TROUBLE SHOOTING CHART

### NO SOUND—NO RASTER

Power input circuit  
Check B+ output of Selenium rectifiers (B+ 260VDC to Chassis)

### NO RASTER—SOUND OK

Brightness con.  
V109, V112, V113, V114, V115, V116  
Ion trap  
HV Xformer Hor. yoke CRT connections

### WEAK PIX—SOUND AND RASTER OK

Tuner fine tuning  
Contrast con.  
Local-Distance Switch (Noise gate con.)  
V2, V101, V102, V103  
Check Vid. Det. Xtal (1N64 Part of T-101)

### POOR HOR. LIN.

V112, V114  
Check 0.005 MFD cap. connected to pin 5 of V112.

### POOR VERT. LIN.

Vert. Lin. and Height con.  
V104  
Check 0.047 MFD cap. connected to pin 2 of V104.

### PIX JITTER SIDEWAYS

Hor. Hold and Stabilizer con.  
V109, V113, V114  
Check 0.006 MFD and 0.001 MFD caps connected to pin 5 of V109.  
Local-Distance-Switch (Noise gate con.)

### SMEARED PIX

Tuner fine tuning  
Contrast con.  
Local-Distance-Switch  
V108  
Check Vid. Det. Xtal (1N64 Part of T-101)  
Check Vid. Amp. and Det. peaking coils  
IF and RF alignment

### POOR PIX DETAIL

Tuner fine tuning  
Focus con. (on 402-1 Chassis only)  
V101, V102, V103  
Check Vid. Amp. and Det. peaking coils  
IF and RF alignment

### SOUND BARS IN PIX

Tuner fine tuning  
V2, V101, V102, V103  
Check Vid. Det. Xtal (1N64 Part of T-101)  
IF and RF alignment L-109, L-112

### SNOW IN PIX

V1, V2, V101, V102, V103  
Antenna and transmission line

### AC IN PIX (DARK HOR. BAR)

V1, V2, V101, V102, V103, V108

### ENGRAVED EFFECT IN PIX

Tuner fine tuning  
Contrast con.  
Local-Distance Switch  
V2, V101, V102, V103  
Check Vid. Det. Xtal (1N64 Part of T-101)

### VERT. BARS

V112, V114  
Check damping cap. connected to terminals 3 and 7 of yoke.  
Defl. yoke ringing

### PIX BENDING

Hor. Hold and Stabilizer con.  
V109, V113, V114  
Local-Distance Switch (Noise gate con.)

### AUDIO HUM IN SOUND

V106, V107, V110, V111

### DISTORTED SOUND

Tuner fine tuning  
V2, V106, V107, V110, V111  
Tone con.  
Sound and Vid. IF alignment L-112  
Det. alignment T-102

### NO SOUND—PIX OK

Tuner fine tuning  
V106, V107, V110, V111  
Vol. con.  
Speaker (open voice coil or defective connection)  
Sound and Vid. IF alignment L-112  
Det. alignment T-102

### WEAK SOUND—PIX OK

Tuner fine tuning  
V2, V106, V107, V110, V111  
Vol. and Tone con.  
Sound and Vid. IF alignment L-112  
Det. alignment T-102

### NOISY SOUND—PIX OK

V106, V107, V110, V111  
Vol. and Tone con.  
Check sound system for loose connections.  
Speaker  
Sound IF and Det. alignment

### SYNC. BUZZ IN SOUND

Tuner fine tuning  
Contrast con.  
Local-Distance Switch  
V106, V107  
Sound IF and Det. alignment L-112 and T-102

### INTERMITTENT SOUND—PIX OK

V106, V107, V110, V111  
Poor connections in sound system

### WEAK OR NO PIX—SOUND WEAK—RASTER OK

Tuner fine tuning  
Contrast con.  
Local and Distance Switch  
V101, V102, V103, V108  
Check Vid. Det. Xtal (1N64 Part of T-101)  
Check Vid. Amp. and Det. peaking coils.  
RF and IF alignment

**INTERMITTENT RASTER—  
SOUND OK**

Brightness con.

V109, V112, V113, V114, V115,  
V116

Check 0.005 MFD cap. connected  
to pin 2 of V104.

HV Xformer

**RASTER BLOOMING**

V114, V115, V116

Check 390 MMF cap. connected to  
pin 2 of V113.

**INSUFFICIENT BRIGHTNESS**

Ion trap

Brightness con.

V114, V115, V116

Check 0.1 MFD cap. connected to  
pin 11 (yellow lead) of V116.

Low line voltage

**EXCESSIVE RASTER (PIX SIZE)**

Width and Height con.

V113, V114, V115

**INSUFFICIENT RASTER WIDTH**

Width con.

V113, V114

H.O.T.

Check 560 MMF cap. connected  
to pin 5 of V114.

Low line voltage

**INSUFFICIENT RASTER HEIGHT**

Vert. Lin. and Height con.

V104

Check 0.047 MFD cap. connected  
to pin 2 of V104.

Low line voltage

**NO VERT. DEFL.**

V104

Check Vert. Height con.

Defl. yoke

V.O.T.

**NO VERT. SYNC.—HOR. SYNC. OK**

Vert. Hold con.

Check 0.0047 MFD cap. connected  
to pin 5 of V104.

V105

**NO HOR. OR VERT. SYNC.—  
PIX SIGNAL OK**

Local-Distance Switch

V105

**NO. HOR. SYNC.—VERT. SYNC.  
AND PIX SIGNAL OK**

Hor. Hold and Stabilization con.  
V109, V113, V114

Check 0.01 MFD cap. connected  
to pin 4 of V113.

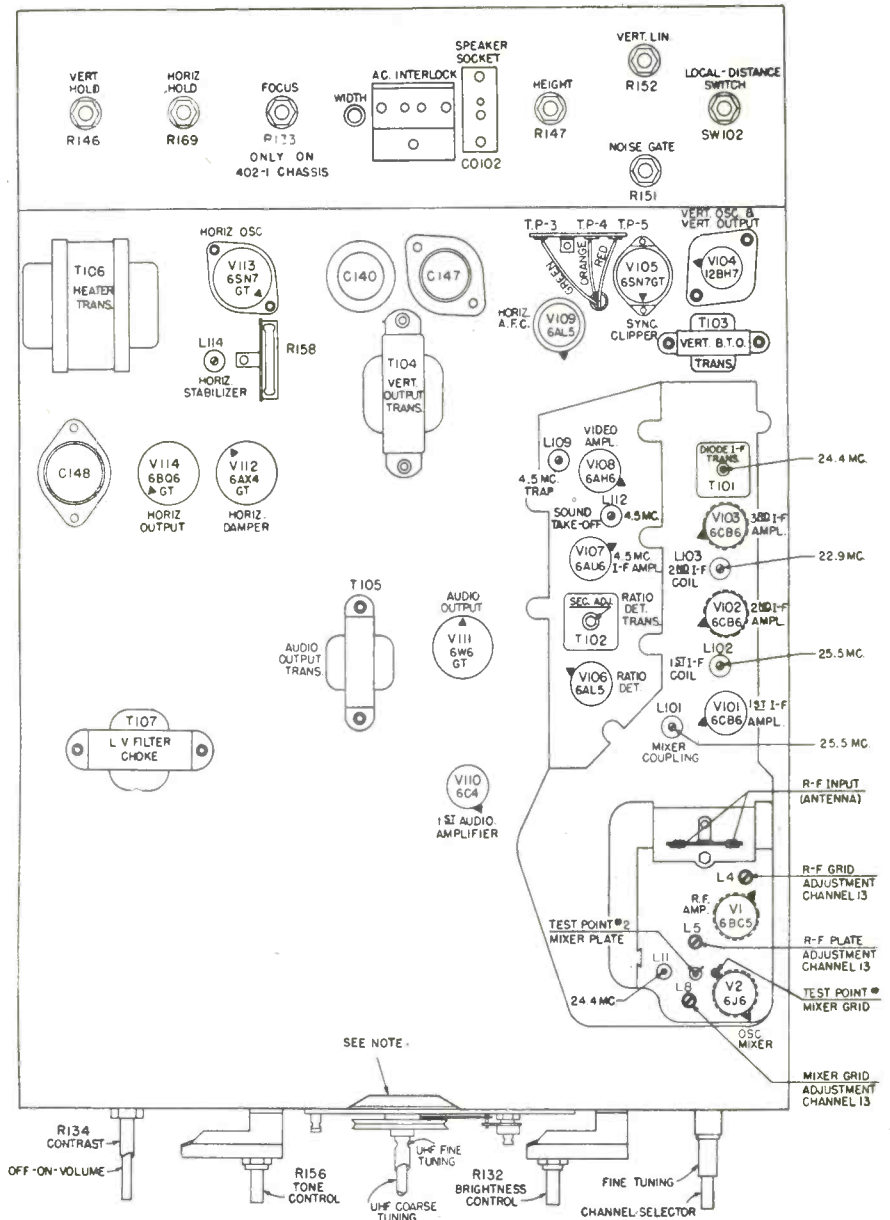

**TOP VIEW 402-1, 403-1, 404-1 CHASSIS**

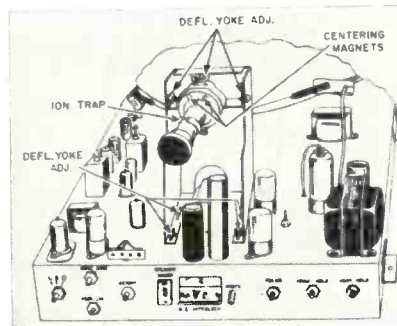

**REAR VIEW, CHASSIS 402, 402-1**

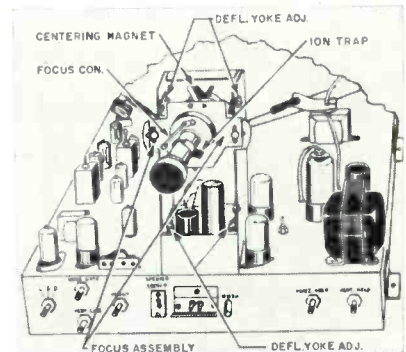

**REAR VIEW, CHASSIS 403, 403-1,  
404, 404-1**

position of the switch must be used. The second and third positions "SUBURBAN" and "DISTANCE" are to be used in medium to weak signal areas. Use the position with which the best picture is obtained with a minimum of overloading of the receiver when the CONTRAST control is advanced.

#### Noise Gate Control

This control makes it possible to obtain improved picture stability in the presence of electrical interference (noise), when the LOCAL-DISTANCE switch is in the "SUBURBAN" or "DISTANCE" position. When the control is turned completely counter-clockwise, it is out of the circuit and has no effect. Adjust the control by turning it clockwise until the picture is stable. The limiting factor of this adjustment is the buzz or noise that may be introduced, if the control is turned too far in the clockwise direction.

#### Oscillator Adjustment Using a Television Signal

Do not make any adjustments on the two oscillator adjusting screws unless the FINE TUNING control range is insufficient to properly tune-in the station. The adjusting screws are accessible through holes in the front of the chassis after the tuning knobs are removed.

To make the adjustment, proceed as follows:

- (a) Turn the receiver on and allow a warm-up period of approximately five minutes.
- (b) For stations from channel 13 to channel 7, set the Station Selector Switch to the highest channel received and adjust the Contrast and Volume control for normal sound and picture. Set the Fine Tuning Control in the center of its range.
- (c) Using a small non-metallic screwdriver, adjust the slotted head brass screw located above and to the right of shaft and above the fiber disc for the clearest and sharpest detail in the picture. This adjustment will be effective on all channels between 13

and 7. If other stations are operating in this range, it may be necessary to compromise slightly on the high channel adjustment so the other channels may be properly tuned-in.

- (d) For Stations on channel 6 and below, set the station Selector Switch to the channel received closest to channel 6 and adjust the Contrast and Volume control for normal sound and picture. Set the Fine Tuning control in the center of its range.
- (e) Using a small non-metallic screwdriver, adjust the slotted head brass screw located below the shaft for the clearest and sharpest detail in the picture. This adjustment will effect all channels between 6 and 2.

#### Horizontal Hold Adjustment

1. Tune in a local television signal and adjust contrast control for normal picture.
2. Connect electronic voltmeter between TP-3 (green lead) and chassis.
3. Short TP-4 (orange lead) to chassis and adjust electronic voltmeter to zero.
4. Remove short from TP-4. Do not change zero on electronic voltmeter.
5. Connect a 0.1 mfd., 600 volt capacitor between TP-5 (red lead) and chassis.
6. Adjust Horizontal Hold control for zero reading on the meter.
7. Remove the 0.1 mfd. capacitor from TP-5 and chassis. Do not disturb setting of Horizontal Hold control.
8. Adjust Horizontal Stabilizer coil (L114) for zero reading on the meter.
9. Remove electronic voltmeter from TP-3.
10. Check horizontal pull-in range. The pull-in range should be approximately 50° of the controls rotation.

# PHILCO

## TV FIELD SERVICE

Pre-published from Rider "TV Field Service Manuals"

by Rider & Alberg

Copyright 1953, John F. Rider Publisher, Inc.

### MODEL, CHASSIS & CODE NUMBERS

MODEL NOS.	CHASSIS NOS.	CODE NO.
B-1887	D-181; R-181	130
B-1888	D-181; R-181	130
B-3000	D-181; R-181	130
B-3001	D-181; R-181	130
B-3100	D-181; R-181	130
B-3102	D-181; R-181	130
B-4000	D-181; R-181	130
B-4100	D-181; R-181	130
B-4101	D-181; R-181	130
B-4303	D-181; R-181	130

### TUBE COMPLEMENT

RF-CHASSIS R-181			DEFLECTION CHASSIS D-181		
SYMBOL	TUBE TYPE	FUNCTION	SYMBOL	TUBE TYPE	FUNCTION
V1	6B27	RF-Amplifier	V12	12BH7	Vertical Oscillator
V2	12A27	Oscillator-Mixer	V13	12B4	Vertical Output Amplifier
V3	6CB6	Video IF Amplifier	V14	6AL5	Horizontal Phase Comparer
V4	6CB6	Video IF Amplifier	V15	12AU7	Horizontal Oscillator
V5	6CB6	Video IF Amplifier	V16	6BQ6GT	Horizontal Output Amplifier
V6	12B47	Video Output Amplifier	V17	6AX4GT	Horizontal Damper
V7	6AU6	Sound IF Amplifier	V18	1B3GT	High-Voltage Rectifier
V8	6T8	Ratio Detector, First Audio, and tuner A.G.C. Clamp	The filaments of all tubes in this receiver are wired in parallel.		
V9	6K6GT	Audio Output			
V10	6U8	Sync Amplifier and Sync Generator			
V11	6BE6	Sync Separator			
V19	17YPA or 21ZP4A	Picture Tube			

#### Key-Voltages (Chassis R-181 and D-181):

All voltages are measured with respect to chassis.

B+ voltage, plate of hor. Damper tube	V17 pin 5	230VDC
Boosted B+ Terminal T1 of H.O.T.		360VDC
Plate voltage of Vert. Osc. (V12) pin 1		75VDC
pin 6		80 to 120VDC*
Plate voltage of Vert. Output Amplifier (V13) pin 9		225VDC
Plate voltage of Hor. Osc. (V15) pin 6		125VDC
pin 1		137VDC
Grid voltage of Hor. Output Ampl. (V16) pin 5		-27VDC

\*Voltage varies with Vert. Hold Settings.

## PHILCO TROUBLE SHOOTING CHART

### NO SOUND—NO RASTER

Power input circuit  
Check B+ Fuse (1.6 Amps) connected to selenium rectifiers.  
Check Filament Fuse (F101)

### NO RASTER—SOUND OK

Brightness con.  
V14, V15, V16, V17, V18, V19  
Ion trap  
HV Xformer Hor. yoke CRT connections

### WEAK PIX—SOUND AND RASTER OK

Tuner fine tuning  
Contrast con.  
Check Vid. Det. X-stal (1N64) connected to T202  
V2, V3, V4, V5, V6

### POOR HOR. LIN.

Width con.  
V16, V17  
Check 0.047 MFD cap. connected to "T1" of H.O.T.

### POOR VERT. LIN.

Height and Vert. Lin. con.  
V12, V13  
Check 0.1 MFD cap. connected to center tap of Vert. Lin. Con.  
Check 0.015 MFD cap connected to pin 9 of V13.

### PIX JITTER SIDEWAYS

Hor. Hold and Centering con.  
Check TC800 (Hor. Freq.) adjustment  
V14, V15  
Check 15K $\Omega$  Res. connected to pin 7 of V15.  
Check 1000 MMF cap. connected to pin 7 of V15.

### SMEARED PIX

Tuner fine tuning  
Contrast con.  
V2, V6  
Check adjustment of L-214 and L-302  
Check Vid. Det. Xtal (1N64) connected to T202  
IF and RF alignment

### POOR PIX DETAIL

Tuner fine tuning  
V2, V3, V4, V5, V6  
Check adjustment of L-214 and L-302  
Check Vid. Det. and ampl peaking coils  
Check Vid. Det. Xtal (1N64) connected to T202  
IF and RF alignment

### SOUND BARS IN PIX

Tuner fine tuning  
Check alignment of TC300  
V3, V4, V5  
Check Vid. Det. Xtal (1N64) connected to T202  
IF and RF alignment

### SNOW IN PIX

V1, V3, V4, V5  
Check Fringe-Local Switch  
Antenna and transmission line

### AC IN PIX (DARK HOR. BAR)

V1, V2, V3, V4, V5, V6

### ENGRAVED EFFECT IN PIX

Tuner fine tuning  
Contrast con.  
V2, V3, V4, V5, V6, V11  
Check Vid. Det. Xtal (1N64) connected to T202

### VERT. BARS

V16, V17  
Check Hor. Damping network in yoke.  
Check 0.047 MFD cap. connected to terminal T1 of H.O.T.  
Defl. yoke ringing

### PIX BENDING

Hor. Hold and Centering con.  
Check TC800 (Hor. Freq.) adjustment  
V14, V15 and V11  
Fringe-Local Switch

### AUDIO HUM IN SOUND

V7, V8, V9

### DISTORTED SOUND

Tuner fine tuning  
V2, V7, V8, V9  
Sound and Vid. IF alignment TC400  
Det. alignment Z400 (TC401 and TC402)

### NO SOUND—PIX OK

Tuner fine tuning  
V7, V8, V9  
Speaker (open voice coil or defective connection)  
Sound and Vid. IF alignment TC400  
Det. alignment Z400 (TC401 and TC402)

### WEAK SOUND—PIX OK

Tuner fine tuning  
V2, V7, V8, V9  
Vol. con.  
Sound and Vid. IF alignment TC400  
Det. alignment Z400 (TC401 and TC402)

### NOISY SOUND—PIX OK

V7, V8, V9  
Vol. con.  
Check sound system for loose connections  
Speaker  
Sound IF and Det. alignment

### SYNC. BUZZ IN SOUND

Tuner fine tuning  
V2, V6, V7, V8  
Check Vid. Det. Xtal (1N64) connected to T202  
Contrast con.  
Sound IF and Det. alignment TC400, Z400, (TC401 and TC402)

### INTERMITTENT SOUND—PIX OK

V7, V8, V9  
Poor connections in sound system

### WEAK OR NO PIX—SOUND WEAK—RASTER OK

Tuner fine tuning  
Contrast con.  
Fringe-Local Switch  
V1, V2, V3, V4, V5, V6  
Check Vid. Det. Xtal (1N64) connected to T202  
RF and IF alignment

**INTERMITTENT RASTER—SOUND OK**

Brightness con.  
V14, V15, V16, V17, V18, V19  
HV Xformer

**RASTER BLOOMING**

V15, V16, V18, V19

**INSUFFICIENT BRIGHTNESS**

Ion trap  
Brightness and Width con.  
V16, V18  
Low line voltage

**EXCESSIVE RASTER (PIX SIZE)**

Width and Height con.  
V16, V18

**INSUFFICIENT RASTER WIDTH**

Width con.  
V15, V16  
Low line voltage

**INSUFFICIENT RASTER HEIGHT**

Height and Vert. Lin. con.  
V12, V13  
Low line voltage

**NO VERT. DEFL.**

V12, V13  
Check 0.1 MFD cap. connected to pin 2, 7 of V13  
Check 0.047 MFD cap. connected to pin 6 of V12  
Defl. yoke  
V.O.T.

**NO VERT. SYNC.—HOR. SYNC. OK**

Vert Hold con.  
Vert. Int. Network  
Check 8200 MMF cap. connected to pin 1 of V12  
V11, V12

**NO HOR. OR VERT. SYNC—PIX SIGNAL OK**

Check Vid. Det Xtal (1N64) connected to T202  
V10, V11

**NO HOR. SYNC.—VERT. SYNC. AND PIX SIGNAL OK**

V14, V15, V16  
Hor. Hold and Centering con.  
Adjust TC800 (Hor. Freq.)  
Check 390 MMF cap. connected to pin 6 of V15  
Check 0.01 MFD cap. connected to pin 7 of V15

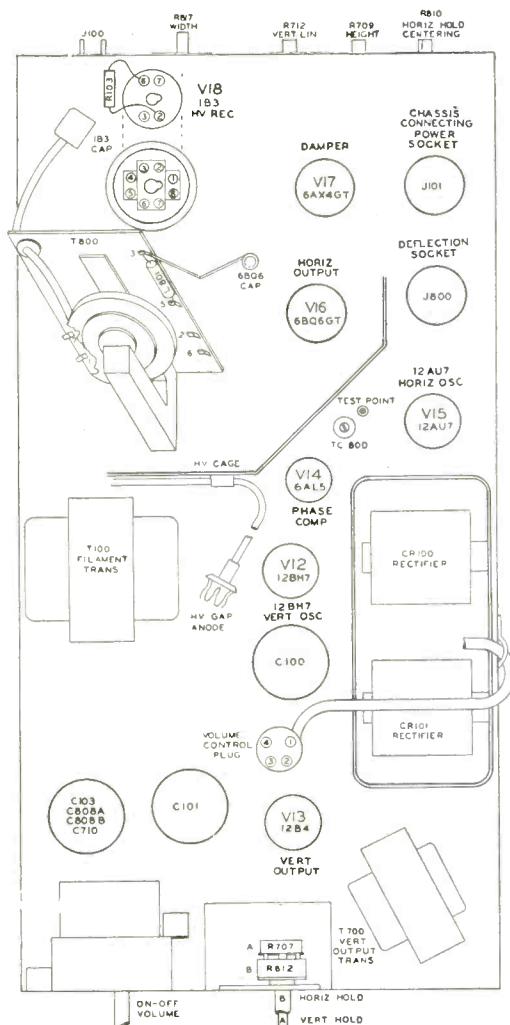

Deflection Chassis D-181: Tube Layout, Functions and Control Locations.

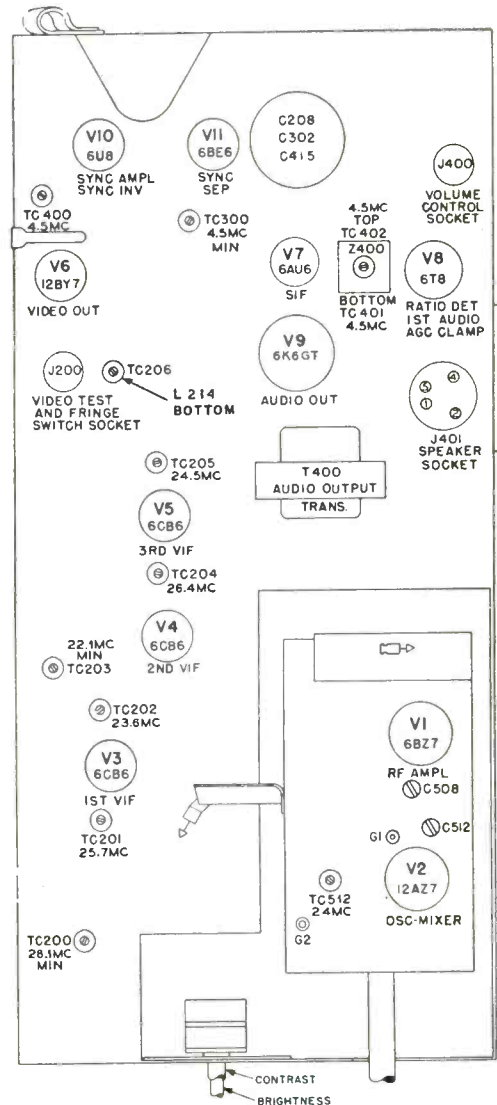

R-F Chassis R-181: Tube Layout, Functions and Control Locations.

## ADJUSTMENTS

### Oscillator Alignment—General

Tuning cores are provided in the oscillator coils at channels 13, 11, 9, 7, 6, and 4. By adjusting these tuning cores, all channels may be placed on frequency. This procedure should be carried out with the highest-frequency channel first, since the alignment of each channel affects the alignment of all the channels below it in frequency. The channel adjustments are so arranged that, with one exception, each adjustment corrects the tuning of more than one channel. The coverage of the various adjustments is as follows:

Channel Adjustment	Channels Corrected By Adjustment
13	13 and 12
11	11 and 10
9	9 and 8
7	7 only
6	6 and 5
4	4, 3, and 2

The FINE TUNING cam should be preset for all adjustments by placing the stop on the FINE TUNING cam between the Channel 7 and 8 holes on the front plate of the tuner. See figure showing locations of adjustments.

### Procedure Using Station Signal

The following simplified procedure may be used to align the oscillator when the television i-f alignment is satisfactory and a station signal is available:

1. Mechanically preset the FINE TUNING cam to the center of its range (see tuner adjustments).
2. Tune in the highest-frequency channel to be received.
3. Adjust the tuning core for that channel, or the next highest channel, for the best picture; that is, starting with sound in the picture, turn the tuning core until the sound disappears. Repeat for each channel received in the area.

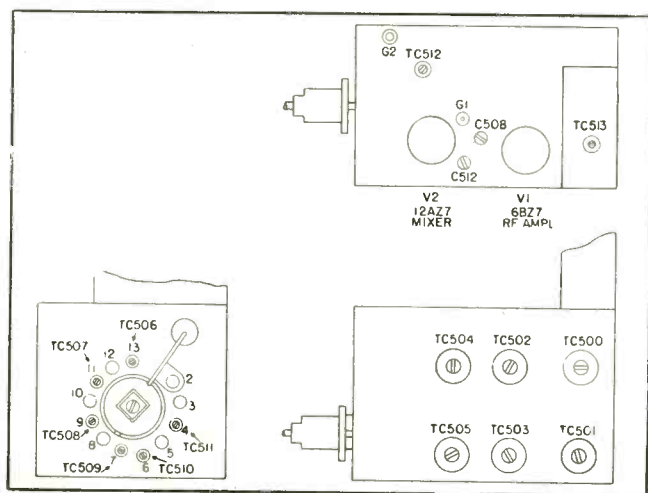

Television Tuner, Showing Locations of Adjustments.

### Horizontal-Oscillator Adjustment

To adjust the horizontal-oscillator circuit, tune in a station and proceed as follows:

1. Reduce the width of the picture until approximately 1 inch of blank screen appears at the right-hand and left-hand sides of the picture.
2. Increase the BRIGHTNESS control setting until the blanking becomes visible. This will appear as a dark vertical bar on each side of the picture.
3. Connect a .1- $\mu$ f. condenser from the test point, adjacent to TC800, to ground. (The plate side of the horizontal ringing coil, L800, is connected to the test point.)
4. Set the HORIZONTAL HOLD control to the approximate center of its mechanical rotation.
5. Adjust the HORIZ. HOLD CENTERING control until equal portions of the blanking bar appear on both sides of the picture.
6. Remove the .1- $\mu$ f. condenser from the test point.
7. Adjust the horizontal ringing coil, L800, until equal portions of the blanking bar again appear on both sides of the picture.
8. Rotate the HORIZONTAL HOLD control through its range. The picture should fall out of sync on both sides of the center of its rotation. If the picture does not fall out of sync on both sides, readjust the HORIZ. HOLD CENTERING control.

9. Rotate the HORIZONTAL HOLD control through its range, and observe the number of diagonal blanking bars that appear just before the picture pulls into sync. The pull-in should occur with from 1 to 2 diagonal bars when the sync position is approached from either direction. If proper pull-in is not obtained, repeat the above procedure.

### Video-Detector Peaking-Coil Adjustment

The video-detector peaking coil, L214, is adjusted at the factory for proper transient response of the video circuit. Ordinarily, this coil will require no further adjustment by the serviceman. On any station where excessive overshoot or excessive smear is present, a slight adjustment of L214 may improve the picture quality on that station; however, this adjustment may sacrifice the quality on other channels. If L214 is replaced in servicing, adjustment will be required.

Before adjusting L214, check the tuner alignment and i-f alignment. (Never adjust L214 until the alignment of the receiver is correct.) Then tune in a station and adjust L214 until there are no trailing whites or smear in the picture. Turning TC206 clockwise reduces trailing whites and overshoot; turning TC206 counterclockwise reduces picture smear and increases trailing whites. The proper position is the point where no smear or trailing whites appear in the picture.

The above procedure for adjustment of TC206 applies to a particular station exhibiting smear or overshoot. After TC206 is adjusted, reception on all the other stations should be checked, to make certain that the adjustment has not impaired the picture quality.



# ZENITH

**TV FIELD SERVICE**  
 Pre-published from Rider "TV Field Service Manuals"  
 by Rider & Alberg  
 Copyright 1953, John F. Rider Publisher, Inc.

## MODEL AND CHASSIS NUMBERS

MODEL	TYPE	SCREEN	TV CHASSIS	RADIO CHASSIS
L1812E or R	Table	17" Rectangular	19L26	None
L1820E or R	Table	17" Rectangular	19L26	None
L1846E or R	Console	17" Rectangular	19L25	None
L2229E or R	Table	21" Rectangular	19L28	None
L2235E or R	Table	21" Rectangular	19L28	None
L2236E or R	Table	21" Rectangular	19L27	None
L2258E or R	Console	21" Rectangular	19L27	None
L2262C	Console	21" Rectangular	19L27	None
L2262R	Console	21" Rectangular	19L27	None
L2281 or E	Combination	21" Rectangular	19L27	4L03
L2281R	Combination	21" Rectangular	19L27	4L03
L2285R	Combination	21" Rectangular	19L27	8L20

Suffix "U" following the model numbers indicates a receiver equipped with Zenith UHF continuous tuner.

## TUBE COMPLEMENT

SYMBOL	TUBE	FUNCTION
V1	6BK7A	RF Amplifier
V2	6U8	V2A Mixer
V3	6CB6	V2B RF Oscillator
V4	6CB6	1st IF Amplifier
V5	6CB6	2nd IF Amplifier
V6	12BY7	3rd IF Amplifier
V7	6AU6	Video Amplifier
V8	6BN6	Sound Limiter
V9	6BK5	Audio Detector
V10	12AX7	Sound Output
V11	6BE6	V10A AGC Amplifier
V12	6AH4GT	V10B Vertical Oscillator
V13	6AQ7GT	Sync Clipper
V14	6SN7GT	Vertical Output
V15	6BQ6GT/G	V13A Horiz. Phase Detector
V16	1B3GT	V13B Horizontal Control
V17	6AX4GT	V14A Horizontal Oscillator
V18	5U4G	V14B Horizontal Discharge
V19	17LP4	Horizontal Output
V19	21YP4	High Voltage Rectifier
		Damper
		Low Voltage Rectifier
		19L25 and 19L26 Chassis
		19L27-19L28 Chassis

The filaments of all tubes in this receiver are in parallel.

## ADJUSTMENTS

### Fringe Lock Adjustment:

1. Turn the fringe lock control fully clockwise and then back it off approximately 1/4 turn. Adjust the vertical and horizontal hold controls and check operation of the

receiver to see that it syncs normally when the turret is switched from channel to channel.

2. If the picture jitters or shows evidence of delay, tearing, split phase, etc., back down the fringe lock control further, a few degrees at a time, each time readjusting the hold controls and switching from channel to channel until normal sync action is obtained. It will be found that under normal signal conditions, the correct adjustment will be near the counterclockwise position of the control.

3. In fringe and noisy areas, the best adjustment will be found at or near the maximum clockwise position of the control; however, do not automatically turn the fringe lock fully clockwise in fringe areas as has been done on previous models. Always follow the procedure outlined.

### Corrector Magnet Adjustment:

Two corrector magnets (see tube layout) are used in all chassis to obtain straight, sharply focused sweep lines across the face of the picture tube. The corrector magnets are mounted on the deflection coil mounting brackets and can be moved in and out or up and down by bending the flexible arms which support them. The corrector magnets are adjusted at the factory and should not require re-adjustment unless accidentally bent out of position. If this occurs, adjustment can then be made as follows:

1. With the vertical and horizontal size controls, reduce the size of the picture to a point where the four corners and sides of the picture are visible. (In some receivers it may not be possible to reduce the picture size sufficiently to see all sides and in this case it may be necessary to shift the picture with the centering control to view one side at a time.)

2. Bend the corrector magnet arms until the corners

## ZENITH TROUBLE SHOOTING CHART

### NO SOUND—NO RASTER

Power input circuit  
V18

### NO RASTER—SOUND OK

Brightness con.  
Check H. V. Fuse (0.2 Amps)  
Ion trap  
V13, V14, V15, V16, V17, V19  
HV Xformer Hor. yoke CRT connections

### WEAK PIX—SOUND AND RASTER OK

Tuner fine tuning  
Contrast and A.G.C. Delay con.  
V2, V3, V4, V5, V6, V10  
Check Vid. Det. Xtal X1 (Part of T-4)

### POOR HOR. LIN.

Hor. Drive Aud. Lin. con.  
V15, V17  
Check 0.1 MFD and 0.15 MFD caps connected to Hor.  
Lin. Coil

### POOR VERT. LIN.

Vert. Lin. and Size con.  
V10, V12  
V.O.T.  
Check 0.1 MFD cap. connected through a 100 $\Omega$  Res.  
to pin 1 of V12

### PIX JITTER SIDEWAYS

A.G.C. Delay and Fringe Lock con.  
Hor. Hold con.  
V13, V14, V15  
Check 56 MMF cap. connected to pin 2 of V13

### SMEARED PIX

Tuner fine tuning  
Contrast and A.G.C. Delay con.  
V6, V10  
Check Vid. Det. Xtal X1 (Part of T-4)  
Check Vid. Ampl. and Det. peaking coil  
IF and RF alignment

### POOR PIX DETAIL

Tuner fine tuning  
Focus Adjustment  
V2, V3, V4, V5, V10  
Check Vid. Det. Xtal X1 (Part of T-4)  
A.G.C. Delay con.  
IF and RF alignment

### SOUND BARS IN PIX

Tuner fine tuning  
V3, V4, V5  
Check Vid. Det. Xtal X1 (Part of T-4)  
IF and RF alignment

### SNOW IN PIX

V1, V2, V3, V4, V5, V10  
A.G.C. Delay con.  
Antenna and transmission line

### AC IN PIX (DARK HOR. BAR)

V1, V2, V3, V4, V5, V6, V10

### ENGRAVED EFFECT IN PIX

Tuner fine tuning  
V2, V3, V4, V5, V6, V10  
A.G.C. Delay con.  
Check Vid. Det. Xtal X1 (Part of T-4)

### VERT. BARS

Hor. Drive con.  
V15, V17  
Check damping cap. in yoke  
Defl. yoke ringing

### PIX BENDING

A.G.C. Delay con.  
Hor. Hold and Fringe Lock con.  
V13, V14, V15

### AUDIO HUM IN SOUND

V7, V8, V9

### DISTORTED SOUND

Tuner fine tuning  
V2, V7, V8, V9, V10  
Buzz con.  
Sound and Vid. IF alignment L-19  
Det. alignment L-22 and L-23

### NO SOUND—PIX OK

Tuner fine tuning  
V7, V8, V9, V10  
Vol. and Buzz con.  
Speaker (open voice coil or defective connection)  
Sound and Vid. IF alignment L-19  
Det. alignment L-22 and L-23

### NOISY SOUND—PIX OK

V7, V8, V9  
Vol. con.  
Check sound system for loose connections  
Speaker  
Sound IF and Det. alignment

### WEAK SOUND—PIX OK

Tuner fine tuning  
V2, V7, V8, V9, V10  
Vol. and Buzz con.  
Sound and Vid. IF alignment L-19  
Det. alignment L-22 and L-23

### SYNC. BUZZ IN SOUND

Tuner fine tuning  
V7, V8  
Buzz con.  
Vid. Det. X1 (part of T-4)  
Sound IF and Det. alignment L-19, L-22 and L-23

### INTERMITTENT SOUND—PIX OK

V7, V8, V9  
Poor connections in sound system

### INSUFFICIENT BRIGHTNESS

Ion trap  
Brightness and Hor. Drive con.  
V6, V15, V16, V18, V19  
Low line voltage

**WEAK OR NO PIX—**  
**SOUND WEAK—RASTER OK**  
 Tuner fine tuning  
 V1, V2, V3, V4, V5, V6  
 Vid. Det. X1 (part of T-4)  
 A.G.C. Delay con.  
 Contrast con  
 RF and IF alignment

**INTERMITTENT RASTER—**  
**SOUND OK**  
 V13, V14, V15, V16, V17, V19  
 Brightness con.  
 HV Xformer

**RASTER BLOOMING**  
 Hor. Drive con.  
 V15, V16, V18, V19  
 Check 680 MMF cap. connected to pin 2 of V14

**EXCESSIVE RASTER (PIX SIZE)**  
 Hor. Drive and Width con.  
 Vert. Size con.  
 V14, V15, V16

**INSUFFICIENT RASTER WIDTH**  
 Hor. Drive and Width con.  
 V14, V15, V18  
 Check 2-18K $\Omega$  Res. connected to pin 4 of V15.  
 Check 270 MMF cap. connected to pin 2 of V14.  
 Low line voltage

**INSUFFICIENT RASTER HEIGHT**  
 Vert. Line and Size con.  
 V10, V12, V18  
 Check 0.001 MFD cap. connected to pin 5 of V12.  
 Check 0.1 MFD cap. connected to pin 1 of V10.  
 Low line voltage

**NO VERT. DEFL**  
 V10, V12  
 Defl. yoke  
 V.O.T.

**NO VERT. SYNC.—HOR. SYNC. OK**  
 Vert hold con.  
 Vert. Int. Network  
 V10, V11, V12  
 A.G.C. Delay con.

**NO HOR. OR VERT. SYNC.—**  
**PIX SIGNAL OK**  
 A.G.C. Delay and Fringe Lock con.  
 V10, V11

**NO. HOR. SYNC.—VERT. SYNC.**  
**AND PIX SIGNAL OK**  
 V13, V14, V15  
 A.G.C. Delay and Fringe Lock con.  
 Hor. Hold con.  
 Check 0.001 MFD cap connected through a 100 $\Omega$  res. to pin 4 of V13.

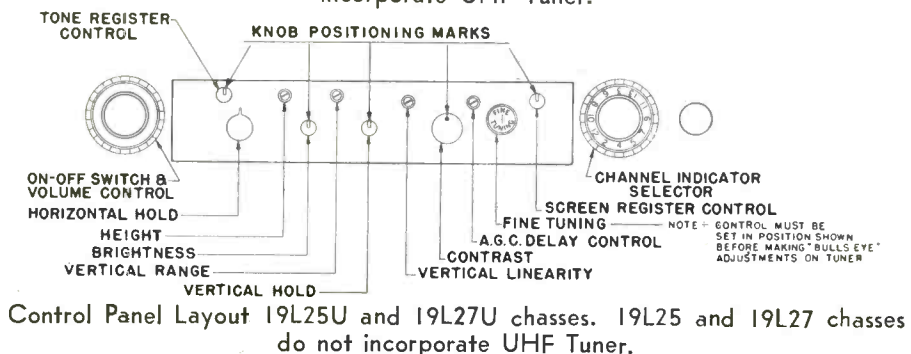
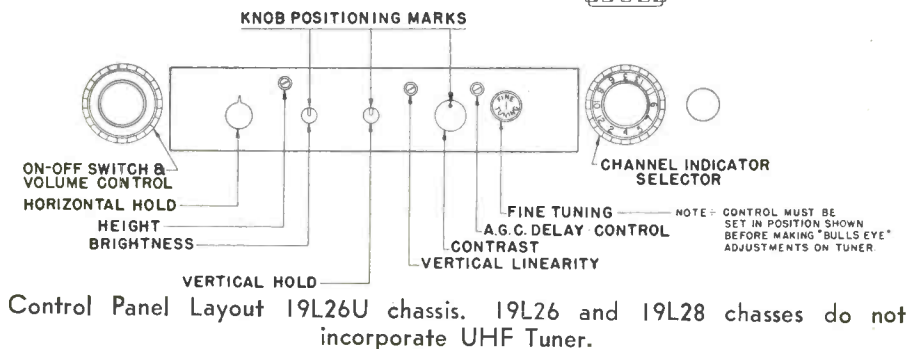
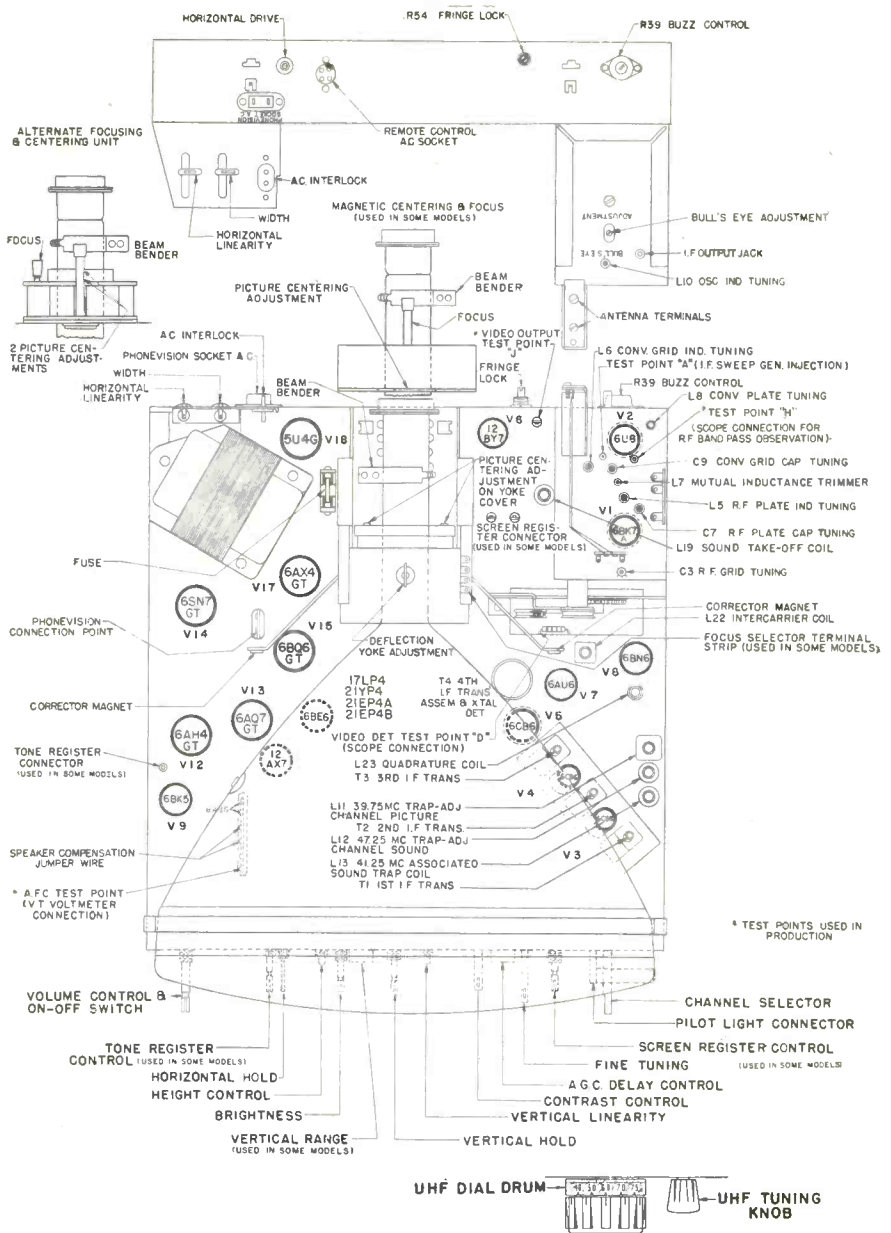

become right angles and the top of the raster is parallel with the bottom and the left side is parallel with the right side. After adjustment, the picture should be restored to normal size.

*NOTE: Mis-adjustment of the corrector magnets may cause pincushioning, barreling, keystoneing, poor linearity, etc.*

**Horizontal Oscillator Adjustment:**

The AFC adjustment can effectively be made by setting the horizontal hold control L26 to a position where it is virtually impossible to "throw" the receiver out of horizontal sync when switching from channel to channel.

**AGC Adjustments:**

**IMPORTANT: THE AGC CONTROL CANNOT BE USED IN ANY WAY TO IMPROVE THE RECEIVER SENSITIVITY.** The sole function of this control is to set the level applied to the video amplifier (12BY7) tube so that the output of this tube is approximately 100 volts peak (100% modulated video signal) for application to the picture tube cathode.

Satisfactory adjustment can be made by observing the picture and slowly turning the AGC delay control from its maximum clockwise position, counterclockwise until a point is reached where the picture distorts and buzz is heard in the sound. The control should then be turned slowly clockwise and set at a point comfortably below this level of intercarrier buzz, picture distortion and

improper sync.

**CAUTION:** Misadjustment of the AGC delay control can result in a washed-out picture, distorted picture, buzz in sound OR COMPLETE LOSS OF PICTURE AND SOUND.

**Sound Alignment:**

Proper alignment of the 4.5 MC intercarrier sound channel can only be obtained if the signal to the receiver antenna terminals is reduced to a level below the limiting point of the 6BN6 Gated Beam Detector. This level can be easily identified by the "hiss" which then accompanies the sound.

Using an active channel adjust the sound take-off coil L19 (top and bottom slugs), intercarrier coil L22, quadrature coil L23 and buzz control R39 for the cleanest sound and minimum buzz. It must be remembered that any of these adjustments may cause the "hiss" to disappear and further reduction of the signal will be necessary so that the "hiss" does not disappear during alignment. If intercarrier buzz is in evidence, after all normal sound adjustments have been made, the cause may be attributed to one or more of the following:

1. Improper adjustment of the AGC delay controls.
2. Defective 6AU6 sound limiter.
3. Extremely high signal levels which require attenuation in the antenna circuit.
4. Transmitter over-modulation.

Radio Chassis 4L03

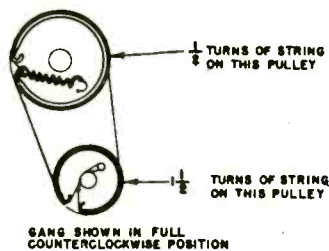

**DIAL CORD DRIVE**

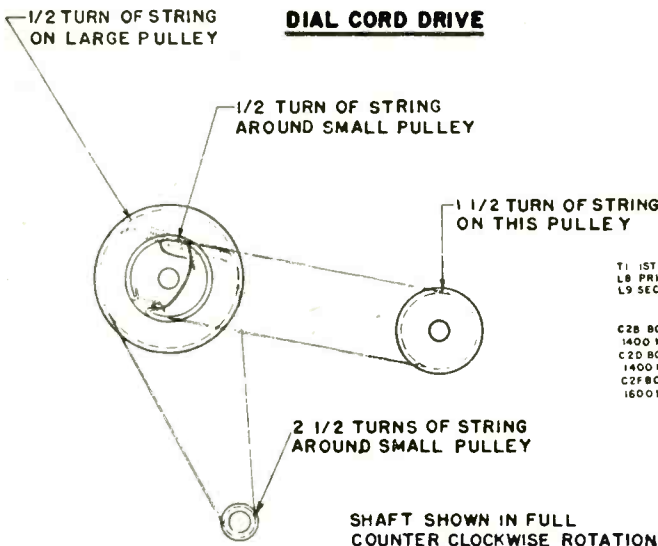

Radio Chassis 8L20

**DIAL CORD DRIVE**

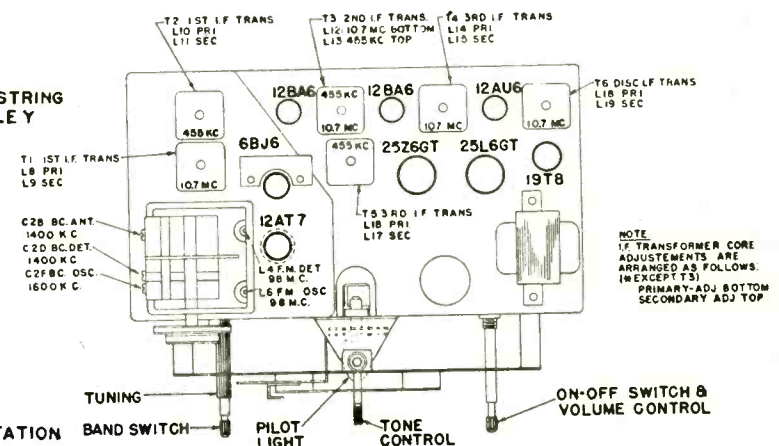
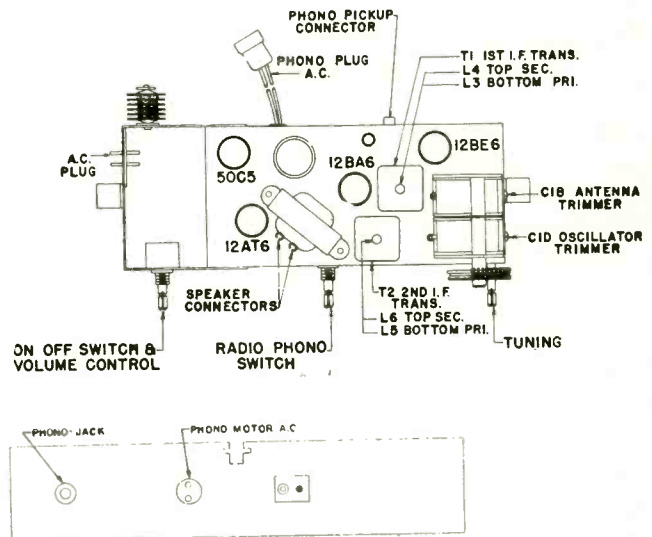

**TUBE AND TRIMMER LOCATION**

# RIDER TEK-FILE\*

**NOW...  
ONLY \$1.50  
PER PACK!**

## packaged tv service information

(Schematics on all production runs. Voltage data. Waveforms. Alignment. Chassis views. Installation. Chassis removal, etc.)

**factory-  
authorized**

**factory-  
approved**

**for easy TV  
servicing...**

**tailor-made  
for more than  
3000  
receiver models.  
NOW ONLY  
\$1.50 per pack**

(at your jobbers)

Try a pack. If you're not satisfied,  
return the pack within 7 days and  
your money will be refunded.

\*Dependable TV replacement  
parts listings starting  
with pack 57

## JOHN F. RIDER

Publisher, Inc.  
480 Canal Street  
New York 13, N. Y.

## EASIEST USING, EASIEST READING VACUUM TUBE VOLT-OHM METER



Model 709

## New TELE-VOLTER by Jackson

The **BIGGEST** little  
instrument of its kind

The 7"-square meter, with hair-line pointer, provides all the voltage (AC-DC) and ohm ranges you could possibly want or need. Meter is electronically protected against overload.

Controls consist of on-off circuit switch, zero adjust, ohms adjust, besides switches built into probes for changing from DC to AC or ohms.

High voltage accessory probe gives readings to 30,000 volts DC.

**Dealer net price ... \$95.00**

Ask your electronics distributor for information, or write us.

# JACKSON

JACKSON ELECTRICAL INSTRUMENT CO.  
DAYTON 2, OHIO

"SERVICE ENGINEERED" TEST EQUIPMENT

IN CANADA: THE CANADIAN MARCONI CO.



### CBS-Columbia Announces Service Clinic Program

The Field Engineering Department of CBS-Columbia, Inc., has begun a series of 19 service clinics in 9 different distributor areas in the South and Southwest. Robert E. Savold, Field Service Manager, announced recently. The series, conducted by Morton S. Klein, CBS-Columbia field service engineer, started in New Orleans, La., under the auspices of Interstate Electric Company. Clinics will be held in Tampa, Miami, Atlanta, Knoxville and Johnson City, El Paso, Albuquerque, Phoenix, Houston, San Antonio and Dallas, in conjunction with CBS-Columbia distributors.

### RCA Service Reveals Plans For Color Training Courses

RCA will conduct intensive training courses on color television throughout the country for servicemen if color

television is approved by the Federal Communications Commission, Dan R. Creato, vice-president, RCA Service Co., told the National Alliance of Television and Electronic Service Associations convention. Basis of the course will be a book now being completed, "Practical Color Television for the Service Industry." Details of the training program must wait upon FCC action.

### TV Service Group Advised To Broaden Their Horizons

All electronic maintenance work and repair of home appliances was the income-building recommendation of John F. Rider, president, John F. Rider Publisher, Inc., New York technical publisher, to the Greater Chicago Television Service Industry Group. Television service firms, Mr. Rider said, have not reached for additional business possible in repair of record players, high fidelity equipment, auto radios, ham equip-

ment, home radios, electronic organs and such appliances as room air conditioners. Some 10 million outdoor television antennas, he estimated, are currently in need of repair. Television service gets you into the home, and once you are in the home, you have the opportunity for many other service sales. A repeat call, he suggested, is the time to ask the set owner about the condition of any radios in the home.

### NATESA Aims Educational Consumer Campaign

The National Alliance of Television and Electronic Service Associations is formulating plans for a nationally coordinated consumer education campaign, to be financed partly by NATESA and partly by member associations. Target date for start of the campaign, details of which have not been finalized, is in 90 days.

Actions of NATESA at the convention included establishment of an industry relations committee to effect closer harmony between the manufacturer and service man and a blast at factories whose distributing branches use returned warranty cards to promote consumer service sales.

### Philco Presents Service Awards

Over 100 servicemen from Connecticut and western Massachusetts recently attended a Philco TV service meeting held at the Roskin Auditorium, East Hartford, Conn. Some 53 TV servicemen and firms in the territory were honored with individual service achievement plaques for maintaining high standards in the service field. Eighteen of the group had won service citations for the second year, while 35 others were cited for the first time. Sam Roskin, president of Roskin Distributors, Inc., was awarded the first Philco national distributor service award.

### Kaye-Halbert TV Service Clinic

Kaye-Halbert Television of Culver City, California, held their first Fall TV Service Clinic for servicemen of the Southern California area recently. New television service manuals containing latest schematics and service hints on chassis were distributed at the meeting, followed by a general discussion on the proper servicing of Kaye-Halbert receivers.

### GM Offers Service Training

United Motors Service Division of General Motors will offer a series of electronics service classes for distributors and the service personnel of their dealer accounts. The new Detroit GM Training Center is the first of 35 such training schools.

# Now...

multi-moded, all channel  
tele-beam antenna

For UHF or VHF or both... close-in or fringe... under any receiving conditions, the TELE-BEAM MULTI-MODED ANTENNA will guarantee your customers top reception on all channels.

Basic single Sabre Comet unit can be built up to meet any need: Add snorkel for an increase on VHF highs, stack these for more on all VHF channels; use diamond stacking bars for increase VHF and UHF gain; add UHF reflectors to increase the UHF gain and directivity.

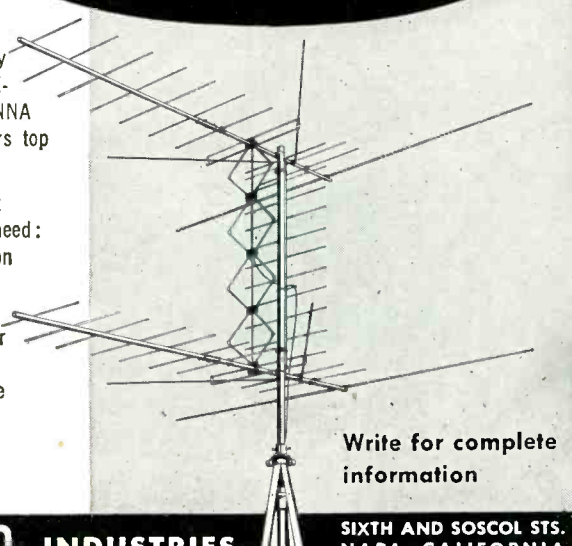

Write for complete information

tele-beam INDUSTRIES

SIXTH AND SOSCOL STS.  
NAPA, CALIFORNIA

# New



# Products



### Twin Pin Straightener

The Twin Pin Straightener, has been developed by CBS-Hytron for radio-and-TV service-dealers. It is compact and ideal for pocket or tool box. Pin straightening of 7-pin and 9-pin miniature tubes is safe, fast, economical. "Twin" offers many advantages: Lifetime, wear-and-corrosion-resistant steel dies; precision pin-circle holes individually drilled to close tolerances; and an absence of guide posts.

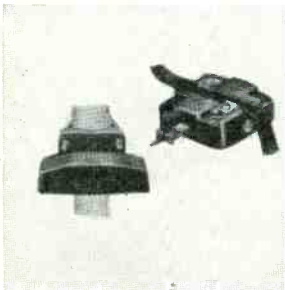

### New Amphenol Products

American Phenolic Corp., Chicago, Ill., has introduced a Lightning Arrestor for flat twin-lead that makes it unnecessary to strip off the insulation from the twin-lead—merely slip the line in and tighten the two contact teeth. The new Amphenol Isonet is a matching network designed to connect a uhf and vhf antenna to the receiver with only one lead-in. It uses a highly efficient lumped constants filter network and operates with very low signal loss.

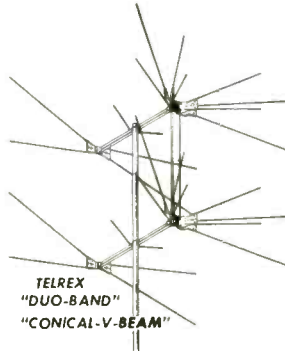

TELREX  
"DUO-BAND"  
"CONICAL-V-BEAM"

### New Duo-Band Series

Telrex, Inc. of Asbury Park, N.J., announce the Series of Duo-B and "Conical-V-Beam" Models #520-540-580 for optimum reception on Channels 2 to 83, with one transmission line. A practical lightweight uhf-vhf array with one major in-line lobe, with perfect match constant center impedance, it provides extremely high gain, high signal-to-noise performance. The transition from vhf to uhf is automatic.

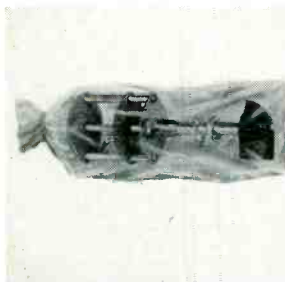

### Rotary Selector-Lever Switches

A new full line of rotary selector and lever switches has been announced by Erie Resistor Corp. New design features the flat rivet or "Wedgelock" which fastens the contact to the stator and prevents loosening or rotating due to soldering heat; a rugged construction in which the rotor blades do not support the assembly; the use of superior grades of phenolic sheet for insulation. Each Erie switch is sealed in a durable plastic bag.



### Mallory Unit — LVA2

Radio-television service shops will find this unit most useful for applications requiring line voltage adjustment, line isolation, low voltage, or high current output. The case dimensions are 7 7/8" high x 5 3/4" deep x 6 1/2" wide. More information may be obtained by contacting P. R. Mallory & Co. Inc., Distributor Division, P.O. Box 1558, Indianapolis, Indiana.

### Paper Tubular Capacitors

Cornell-Dubilier Electric Corp., South Plainfield, New Jersey has developed the "Budroc" steatite-cased paper tubular capacitor. It is of a non-inductive sturdy construction housed in a ceramic (steatite) tube with Polykane end seals. This combination protects the capacitor sections against heat and humidity; provides a rigid support for the lead wires; and assures a permanent seal under any operating temperature.

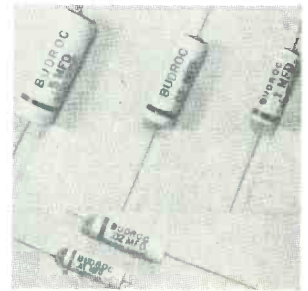

### Stylus-Disk

The Audak Company has developed the Stylus-Disk which makes home-checking of any jewel-point very simple. With the Stylus-Disk you can detect stylus wear at its inception and protect your records before they are ruined. Neither the cartridge nor the stylus need be removed for the test, nothing need be disturbed. It will be sold for \$3.90 net. For further information write to Audak Company, 500 Fifth Avenue, New York 36, N.Y.



### Triple-Tie Cross-Over Filter

A new triple-tie cross-over filter is available from TV Products Co. ("TESCON"), Springfield Gardens, New York. Model UV-3 employs a printed circuit to eliminate the need for two down leads when both a uhf and vhf antenna are in operation. UV-3 is impregnated before encasement to make it moisture-proof and fungus-proof that eliminates possibility of any drift or shorting of components.

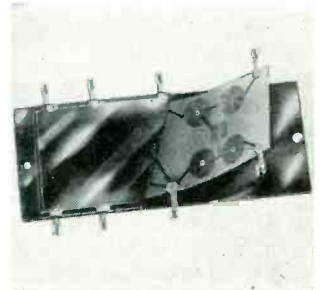

### Indoor TV Antenna

Indoor TV antenna with a single knob has two 3-section telescopic elements set in a large ball molded of Bakelite phenolic plastic. With one 3-section element standing straight up and the other parallel to the base, antenna resists tipping even when pushed. Adjustment of the knob makes the desired frequency to produce the maximum signal output on each channel. Model SV-T3 Tunable Indoor Antennas is produced by Radio Merchandise Sales, Inc. 2016 Bronxdale Ave., New York 62, N. Y.



### VHF Antenna Coupler

A new Taco vhf antenna coupling device providing best impedance matching and maximum signal transfer is announced by Technical Appliance Corp., Sherburne, N. Y. The Magi-Mix may be employed in any combination of high-band and low-band antennas to feed a single transmission line to the receiver. A companion unit is enclosed.

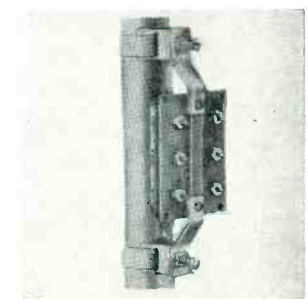



my Radio  
and **T.V.**  
**REPAIR SECRET?**

**OHMITE®**  
**DEPENDABLE REPLACEMENTS**

**Little Devil®** COMPOSITION RESISTORS



Tiny, yes . . . but what dependability, ruggedness, and stability! And they provide an extra margin of safety—being rated at 70C rather than 40C. Completely sealed and insulated by molded plastic, they meet all JAN-R-11 requirements . . . are available in 1/2, 1, and 2-watt sizes in all RTMA values.

**TYPE AB NOISE-FREE POTENTIOMETERS**

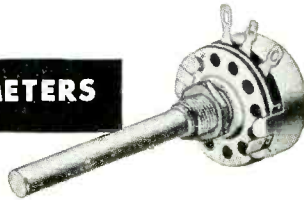

Because the resistance material in these units is solid-molded—not sprayed or painted on—continued use has practically no effect on the resistance. Often, the noise-level decreases with use . . . and they provide exceptionally long, trouble-free service. Rated at 2 watts, with a good safety factor.

**BROWN DEVIL® AND DIVIDOHM® RESISTORS**

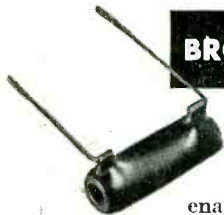

BROWN DEVIL fixed resistors and DIVIDOHM adjustable resistors are favorite vitreous-enameled units! DIVIDOHM resistors are available in 10 to 200-watt sizes; BROWN DEVILS in 5, 10, and 20-watt sizes.



**WRITE FOR  
STOCK  
CATALOG**



**OHMITE MFG. CO.**  
3440 Howard St.  
Skokie, Illinois  
(Suburb of Chicago)

Be Right With . . .  
**OHMITE**

**RHEOSTATS • RESISTORS • TAP SWITCHES**

## "HOW TO" BOOKS

Simple and Practical



### HOW TO TROUBLESHOOT A TV RECEIVER

by J. R. Johnson

A step-by-step guide for newcomers to rapid systematic troubleshooting. Read this book and start out on the right foot!

Over 120 (5 1/4 x 8 1/4") pp. . . . . \$1.80

### HOW TO USE SIGNAL AND SWEEP GENERATORS

by J. R. Johnson

First book on all types of signal and sweep generators. Gives test uses and discusses problems and their solutions in using this equipment. Applications of all signal and sweep generators in AM, FM radio and TV servicing.

Over 140 (5 1/2 x 8 1/2") pages. . . . . \$2.10

### POSITIVE CURES FOR TV TROUBLES

#### TV MANUFACTURERS' RECEIVER TROUBLE CURES VOL. 1, VOL. 2, VOL. 3 and VOL. 4

Positive cures for TV troubles! Gives you exact directions for correcting TV receiver performance "bugs". Each cure is official, factory-authorized, direct from the receiver's manufacturer. Listings by manufacturer and model or chassis number. Helps correct the most difficult faults—picture jitter, hum instability, buzz, tearing, etc.

Vol. 1, 115 pages (5 1/4 x 8 1/4") . . . . . \$1.80

Covers 12 brands, Admiral through Dumont

Vol. 2, 117 pages (5 1/4 x 8 1/4") . . . . . \$1.80

Covers 11 brands, Emerson through Jackson

Vol. 3, 119 pages (5 1/4 x 8 1/4") . . . . . \$1.80

Covers 16 brands, Kaye-Halbert through Philco

Vol. 4, Over 115 pages (5 1/4 x 8 1/4") . . . . . \$1.80

Covers 10 brands, Philharmonic through Shaw TV

VOLUME 5 COMING SOON!

Prominent manufacturers not in first 4 volumes

One Service Job Will More Than Pay

The Cost of This Series of Books!

### UHF TELEVISION ANTENNAS AND CONVERTERS

by A. Lytel

Latest information on all types of converters, antennas, transmission lines. Valuable for UHF installation techniques.

Over 128 (5 1/4 x 8 1/4") pp. . . . . \$1.80

### GUIDE TO AUDIO REPRODUCTION

by David Fidelman

A to Z explanation of the reproduction of sound, design, construction, assembly and testing of sound systems and their components. Valuable for service technicians, engineers, amateurs.

Over 250 (5 1/2 x 8 1/2") pp., illus. . . . . \$3.50

### OBTAINING AND INTERPRETING TEST SCOPE TRACES

by J. F. Rider

Over 500 actual photographs of test scope traces. Shows how to use scopes and what traces mean. Valuable for servicing TV receivers, FM and AM radio receivers, audio systems and test equipment. Specific test equipment set-ups shown with each application. No other book like it! Over 140 pages. . . . Only \$2.40

### TV SWEEP ALIGNMENT TECHNIQUES

by Art Liebscher, Test Equipment Specialist

Never before has there been a book such as this on TV sweep alignment! An expert gives you accurate time-saving methods—and tells you how they work. Introduces the new Supermark method. Chock-full of sweep curve pictures. Valuable for servicing in UHF signal areas. 123 (5 1/2 x 8 1/2") pp., illus. . . . . \$2.10

Write for complete RIDER catalog

Buy these books now from your jobber . . . bookstore

. . . If not available from these sources, write to:

**JOHN F. RIDER PUBLISHER, INC.**  
480 Canal Street, New York 13, N. Y.

SD-11



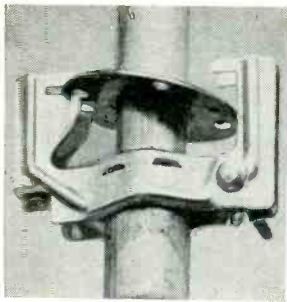

### New Antenna Mast

An all-new antenna mast, featuring a unique safety device called the "Third Hand," which permits one-hand extension, has been developed by Channel Master Corporation. Another feature is the Step-Up Key, a metal stamping that makes for fast, simple mast indexing. This key automatically extends each mast section for elevation. Beaded safety rings keep the mast sections completely inter-locked and concentric at all times.

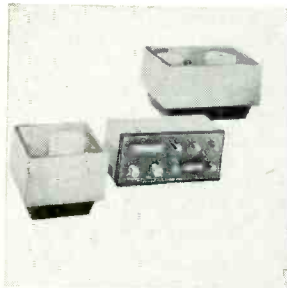

### New Hi-Fi Ensemble

Regency has introduced a new professional high fidelity ensemble that consists of three separate units: a pre-amp-equalizer, a power amplifier and the power supply. All units are non-hygroscopic, providing complete protection against all adverse effects of moisture. Each unit is individually calibrated and each has an individual response curve which is supplied with the ensemble.

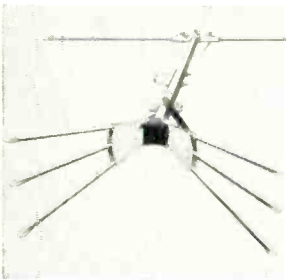

### "Vari-Con" TV Antenna

Falcon Electronics, Co., 2003 Cedar Street, Quincy, Ill., announces an antenna so constructed that it provides all channel coverage, yet is easily peaked for top performance on any channel range, vhf or uhf. Easy to assemble, one need only open the antenna like an umbrella and tighten the wing nuts. Butterfly springs snap the elements into position and lock them securely.

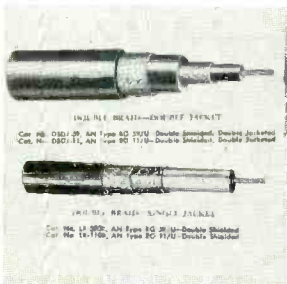

### "Rotaxial" Cables

Community TV systems require cables which give exceedingly low radiation losses and consistent peak performance over the entire vhf range. Rotaxial cables are constructed for this use in both Double Braid—Single Jacket, and Double Braid—Double Jacketed Types. For advice on how to properly use "Rotaxial" cables, and prices, write to U.S. Wire and Cable Corp., Progress & Monroe Streets, Union, New Jersey.

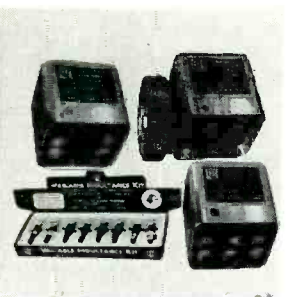

### UTL Products For Radio-TV

United Technical Laboratories introduces a TV Cross Over Network designed to permit the use of uhf and vhf antennas with a single lead-in; an Interference Filter of the 3-section high pass type for use between the transmission line and a TV receiver. A 2 receiver coupler for operation of 2 TV receivers from a single antenna; and a variable Inductance Kit, consisting of 8 permeability tuned coils, calibrated within 5% limits.

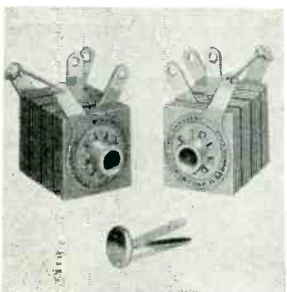

### Rectifier-Magnetic Devices

A small, compact and inexpensive single phase bridge rectifier, Type D-3575, has been developed by International Rectifier Corporation, El Segundo, California, for the operation of magnetic devices such as relays, solenoids, and electric counters. The unit is designed for use directly from 117 volt AC systems and is rated to deliver an output of 9 watts at 90 volts DC, continuous duty.

### New Front End Chassis

Granco Products, Inc. announces the production of new front end chassis for all-channel uhf reception. Termed "Hideaway" unit, it is adaptable to any TV chassis for the purpose of obtaining built-in uhf reception. The Model UJ5, is recommended for fringe area reception, tunes the entire uhf band utilizing three coaxial tuned cavity elements, two as preselectors and one controlling the local oscillator.

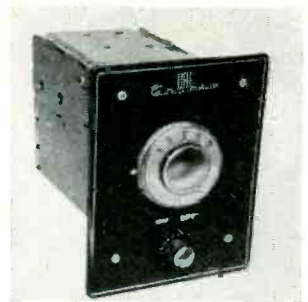

### Reversing Polarity Switch

Pomona Electronics Company has introduced the Peco Model MS-1 Meter Reversing Polarity Switch to assist the radio and electronics technician. It is designed to reverse polarity when making circuit tests without removing test lead to meter and can be instantly attached by plugging into test lead holes on Simpson Tester Model 260 for which it is exclusively designed.



### Toroids

F. W. Sickles announces that their long experience in coil production techniques are now being applied to toroidal winding problems. Sickles facilities are offered to industry for high volume winding of toroidal coils to tight inductance, balance and "Q" tolerances; precision wave filters on communication networks; pulse transformers; magnetic memory units and magnetic amplifiers.

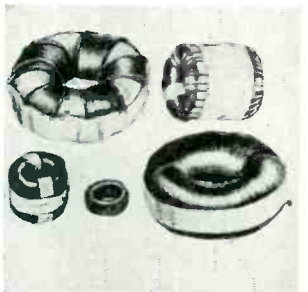

### Circuit Testing Clip

A fully-insulated alligator clip that greatly facilitates the testing of live circuits in television and radio receivers has been brought out by the Insuline Corporation of America, 3602—35th Avenue, L.I.C. 1, N.Y. The spring-loaded jaws, which are actuated by a thumb button in the body of the clip, hold firmly on conductors up to 1/4 inch in diameter. Connection to the clip is made with standard banana plugs.

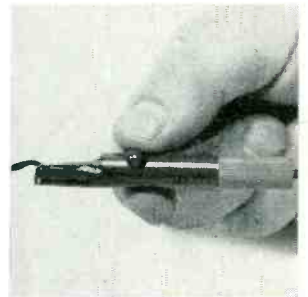

### All-Purpose Microphone

Shure Brothers announces the new, all-purpose Model 777 "Slim-X" Crystal Microphone. Designed to provide good-quality voice and music reproduction, it can be used: on desk or floor stand, mounted on a swivel adapter; in the hand; around the neck, with a lavalier. Technical information: smooth frequency response—60 to 10,000 c.p.s.; special-sealed crystal element—for long operating life; high impedance; 7' single-conductor cable, disconnect type.

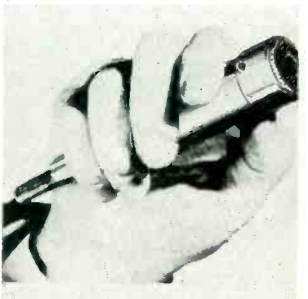

### New Rotator Connectors

A new series of plugs and sockets for connecting 4, 5 and 8-wire rotator cables is now offered the trade by Mosley Electronics, Inc. The rotator connectors are precision molded of polystyrene and are solderless and, in addition, the line plugs and sockets possess a unique design feature that eliminates the need for individual set screws. Connectors are designed for either flat or round multi-wire cable.

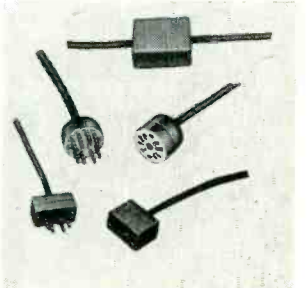

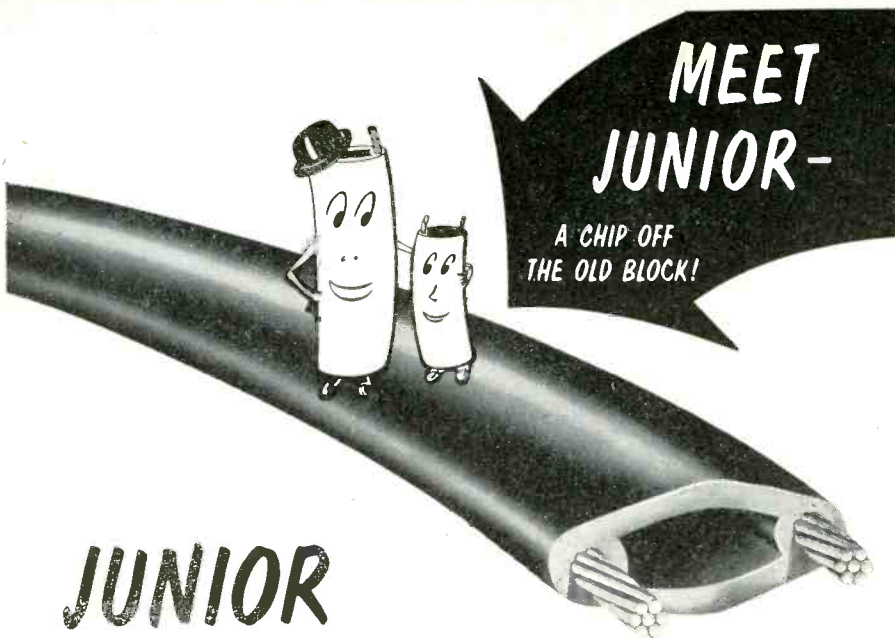

# JUNIOR OVALTUBE

## Low Priced version of the famous Synkote "Ovaltube"

Designed to meet the demand for a lower cost air dielectric lead-in when the *super* performance of our sensational Ovaltube is not essential.

Manufactured by Plastoid with the same precision standards that govern all Synkote wire and cable, JUNIOR OVALTUBE gives excellent all-around reception on VHF and UHF. Write *today* for samples and low prices.



"Manufactured by the mile - tested by the inch"

**PLASTOID**  
Corporation 42-61 24th St., Long Island City, N.Y.



## MOVING?

When you change your address please notify our circulation department as soon as possible. This is to your advantage, since it takes approximately 5 weeks to have your stencil changed and duplicate copies cannot be sent. Be sure to give your old as well as your new address.

## RADIO-TV SERVICE DEALER

67 West 44th St.  
New York 36, N. Y.

## COLOR TV

[from page 37]

*L'Eclairage* (CIE) or International Committee on Illumination which has set these standards. These standards on color are used by many industries concerned with color or color matching such as color printing, paints, color photography, dyes, etc. As a part of these standards the CIE established as saturated red, the red color whose wavelength is 700 milli-microns (Mu). 1 Mu equals  $10^{-7}$ cm. The saturated green is 596.1 Mu and the blue is 546.1 Mu. The CIE has established a means by which any color's chromaticity and saturation can be determined by specifying two of the three primaries in the correct proportion. By means of the so-called XYZ triangle (*Fig. 3*) it is possible to specify any color by locating its "x" and "y" coefficient on this chart. It is possible to eliminate the variable of brightness from the calculations because of the fact that if all the primaries used to create another color have their brightness multiplied by a constant factor, the over-all brightness is multiplied by the same factor. As for example, if the brightness of the red, blue and green are doubled the resultant color remains the same as it would have been but it has double the brightness.

To satisfy the mathematical requirements of the CIE, the XYZ triangle contains colors which do not exist in nature. The main visible colors are located in the inserted triangle. The point "W" is called the point of "equal-energy-white." This is the white which would result if all the colors in the spectrum were added together with each color having the same energy.

### Additive and Subtractive Matching

There are two systems for matching or creating a color from other colors. In one system only the desired color in a white light is passed through a filter. (*Fig. 4*) In the other system, the color which would be added to the desired color to make the white is filtered out. (*Fig. 5*) The output, therefore, contains all the colors needed to make the desired color. The first system is called the additive method of matching and it permits the addition of selected primaries to be added together to match the required color. It is this system in conjunction with the previously mentioned persistence of vision of the eye that permits the individual primaries to be flashed on the TV screen separately, and added as a single color blend by the eye.

[To be continued]

# HORIZONTAL DEFLECTIONS SYSTEMS

[from page 20]

system necessary for larger screen tubes.

It will be noted that the voltage boost systems feed a number of other circuits. One branch feeds the plate of the horizontal multivibrator and from the same terminal voltage is also applied to the vertical multivibrator as well as the first anode of the picture tube. Besides these circuits, the voltage boost also feeds the vertical output amplifier screen and plate elements. As previously mentioned, a deficiency

type of sweep used in the Hallicrafters, Models 811, 820, 860 series receivers. This uses no secondary for application of the sweep waveform to the deflection coils. Rather, the primary functions in similar fashion to an auto-transformer and the deflection coils are in reality, in series with the primary winding. The high efficiency is procured by careful design and proper calculation of the distributed constants in the circuit. To make up the required capacity, one leg of the damp-

ing because of the lack of secondary winding. With this system the only secondary winding is that used for the filament of the high voltage rectifier. When replacement of components is necessary, it is important that exact values be utilized because the efficiency of the system can be upset easily by off-value parts.

A considerable amount of voltage boost can be secured by high efficiency systems. As with previous circuits, the booster voltage is not only applied to the horizontal output amplifier plate but also to other circuits. In the system shown in Fig. 6 the voltage boost is also fed to the vertical oscillator anode as well as the output amplifier.

## Service Factors

With many of the systems discussed, replacement of either the horizontal output transformer or yoke requires that a factory recommended replacement be utilized. It is necessary that the output transformer and yoke match each other for peak efficiency. Mismatch may result in poor linearity, insufficient width, poor brilliancy, raster pin-cushioning, and corner shadows. RCA has brought out a universal type of horizontal flyback transformer. This is their Model 211T5 and can be used for all tubes having a deflection no greater than 65 degrees.

When defects occur, voltage checks can be made at the screens and plates of all tubes preceding the horizontal output tube. With the latter, the amount of grid drive can be measured with a peak reading oscilloscope or *vtvm*, while screen and cathode voltages can be checked with a conventional *vtvm*. No attempt should be made to read the plate voltage of the horizontal output tube with ordinary equipment. The applied plate voltage as well as the boost voltage can be read with a *vtvm* applied at the lower terminal of the transformer primary. This will also indicate the approximate voltage applied to the plate inasmuch as there is little drop through the transformer winding.

Care should be exercised in servicing the high voltage compartment of any receiver because of the high amplitude voltages which are present. When using an ohmmeter to check for continuity or resistance values, make sure the receiver is disconnected from the power mains. Also discharge the high voltage filter capacitors by shorting them with a length of wire.

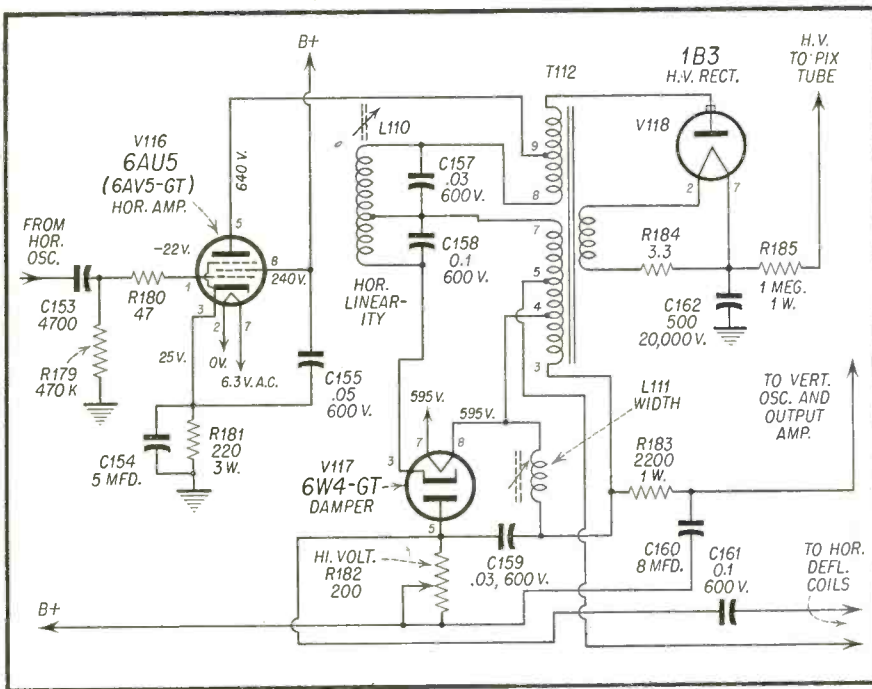

Fig. 6—The high efficiency type of direct drive horizontal output system used in the Hallicrafters Model 811, 820 and 860 series receivers.

in the boost voltage will have a serious effect on the performance of both vertical and horizontal sweep. Thus, if both horizontal and vertical sync instability is not caused by defects in the sync separator system, the amount of voltage boost potential should be ascertained by using a VTVM to check the voltage against the value given in the schematic. A decline of voltage may mean a defective damper tube or a decline in the output of the horizontal amplifier circuit. If tube replacement does not help, component parts should be checked as well as the amount of grid drive signal to the 6CD6.

## The Direct Drive System

The high-efficiency type of direct drive horizontal output amplifier is shown in Fig. 6. This indicates the

er tube is applied to a special tap in the transformer. For this reason the interelectrode capacity of the damper affects the efficiency of performance. A decline of high voltage or sweep width can, therefore, be caused by defects arising in the damper tube. The horizontal deflection coils are of the high impedance type to match the plate impedance of the horizontal output tube. This is in contrast to the low impedance horizontal deflection coils utilized with the systems previously discussed. In the latter, the secondary winding of the horizontal output transformer has a step-down ratio to provide a match between the relatively high plate impedance of the output tube and the low impedance coils.

It will be noted that a special coil section is again utilized for linearity adjustments, though in this instance it is incorporated in the primary wind-

## RC CIRCUITS

[from page 24]

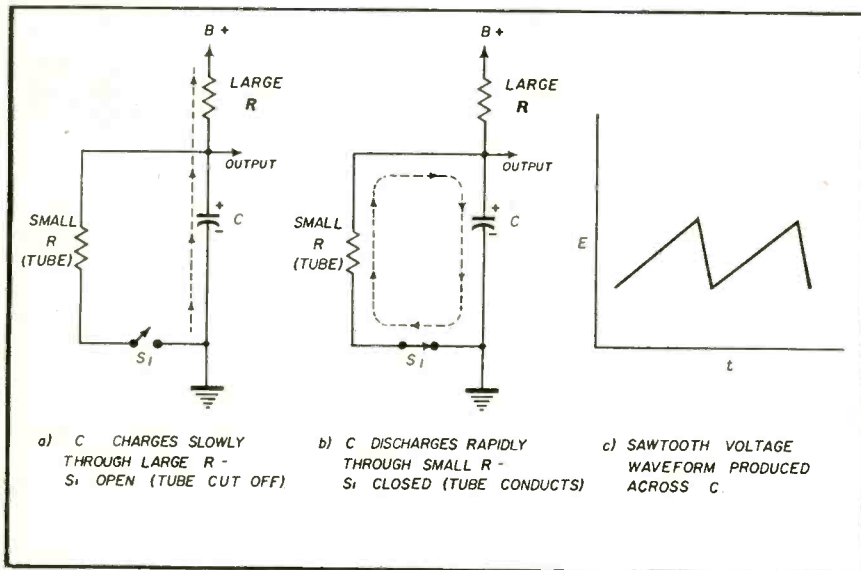

Fig. 4—Equivalent circuit of sawtooth generator. Note charge and discharge paths, and resultant waveform.

Since these sawtooth oscillator circuits are generally familiar to most technicians, they will not be discussed in detail here. From the standpoint of trouble shooting, if the charge condenser is allowed to charge to too great a percentage of the source voltage, the generated sawtooth becomes

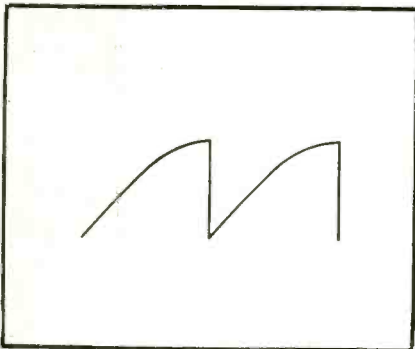

Fig. 5—Non-linear sawtooth waveform.

non-linear (Fig. 5). The result is a non-linear picture (one end stretched or crowded), either vertically or horizontally, depending on whether the sawtooth is being generated in the vertical or horizontal sweep circuit. However, in most cases, a non-linear sawtooth is caused by a circuit defect—such as a leaky charge condenser to the next (output) stage, where the sawtooth voltage is amplified. When the top of the sawtooth waveform is flattened, non-

linearity or foldover is observed on the screen.

For magnetic deflection, it is usually necessary to use a modified sawtooth (trapezoidal) waveform. This is required because the deflection coil is actually a combination of inductance and resistance. A combined sawtooth and square wave is usually needed to produce the desired sawtooth current through the deflection coil. This trapezoidal waveform is easily secured through the addition of a small resistor ( $R_1$ ) in series with the charging condenser ( $C_1$ ), and taking the output waveform from across the two, Fig. 6  $R_1$  is called a peaking resistor. This comparatively minor modification of simple series circuit action is described in detail in few texts. Yet a complete analysis of the action is very helpful in understanding all types of RC circuits.

In the circuit of Fig. 6, the charge condenser  $C_1$  charges up through two resistors,  $R_1$  and  $R_2$ . The general charging action is the same as in the simple RC circuit. In the simple series circuit, the source voltage is entirely across the resistor at the first instant of charge. In this circuit, when the switch is closed the source voltage divides across the two resistors  $R_1$  and  $R_2$  in proportion to their resistance, and there is no voltage across the condenser,  $C_1$ .

Since  $R_1$  is much smaller than  $R_2$ , only a small part of the battery voltage is across  $R_1$ . The rest of the battery

# FASTER STURDIER

## Lower Installed Cost

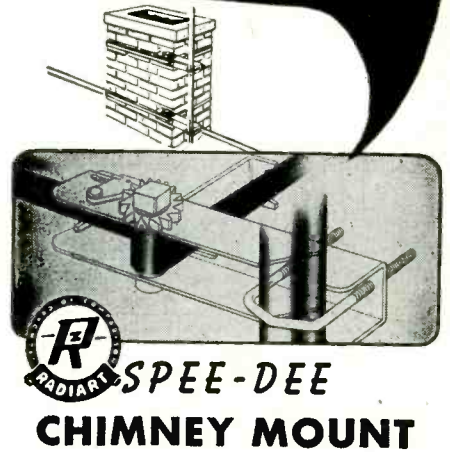

**Model AK 85** The fastest-installed chimney mount ever devised for TV antennas! Rugged in design—simple to install. Simply thread strapping through ratchet, around chimney and back through ratchet—wind up ratchet tight—and the job's done! Heavy gauge, zinc-plated steel with large "U" bolt for up to 1 3/4" O.D. mast and full length galvanized steel strapping.

**THE RADIART CORPORATION**  
CLEVELAND 13, OHIO

More Satisfied  
**CUSTOMERS**

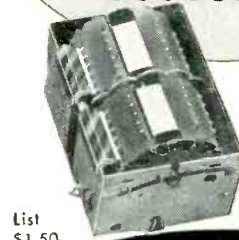

List  
\$1.50

with the  
**NEW  
CONRAC**

**Tuner-Kleen'r**

Over 30,000 installed in the first 30 days. The new Conrac "Tuner-Kleen'r" is easily snapped into position in all standard tuners to perpetually clean all the stationary and revolving contact points for clearer television reception. Every turn of the tuner puts the Conrac "Tuner-Kleen'r" to work. Put it to work for you for extra profits and more and more satisfied customers. SEE YOUR PARTS JOBBER TODAY!

**CONRAC, INC.** SINCE 1939  
GLEN DORA, CALIFORNIA

# "TIP WRENCH"

**GETS NUTS, BOLTS And SCREWS**  
Into "Hard-To-Get-At" Places—  
**HOLDS THEM FIRMLY**  
**WHILE TIGHTENING**

Or, "TIP WRENCH" goes in and un-  
loosens them and takes them OUT. "TIP  
WRENCH" is built to work in deep.  
Holds Nuts, Bolts and Screws where  
fingers can't hold them. With "TIP  
WRENCH" you can stop fumbling and  
save valuable minutes in either REPAIR  
or LINE PRODUCTION WORK . . . In  
total, it SPEEDS THE JOB—SAVES THE  
COST MANY TIMES OVER.

"TIP WRENCH"  
**SOCKET**  
**POCKET-WRENCH**

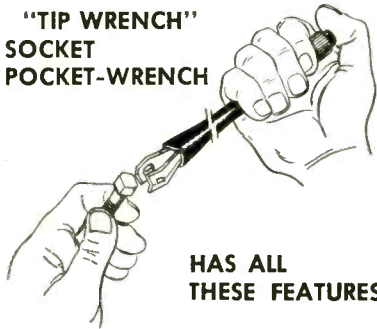

**HAS ALL  
THESE FEATURES:**

1. It grips—starts—tightens (or loosens). Just one setting.
2. It GRIPS FIRMLY. A nut or bolt won't slip or turn. For screws, the screw driver blades—one in each jaw—engage the slot in the screw head.
3. By thumb pressure on the plunger head, the Jaws slide out and OPEN, the nut, bolt or screw is inserted, gripped firmly, and the user is ready to go in and complete the job.
4. "TIP WRENCH" is a TOUGH TOOL—for TOUGH JOBS. Built of finest materials and precision manufactured . . . It's RUST PROOF, too.
5. SHOCKPROOF. Has a tough Vinylite insulated shank.
6. Knurled—Hardened Steel Jaws slide in form-fitting barrel which "take the pressure" when tool is in use.
7. Capacity: No. 2 to No. 12 Nut or Screw.

**THREE  
CONVENIENT  
SIZES:**

No. 1. Capacity:  
No. 2 to No. 8  
Nut or Screw . . . . . 8 1/2"

No. 2. Capacity:  
No. 6 to No. 12  
Nut or Screw  
. . . . . 8 3/4"

No. 3. Capacity:  
No. 6 to No. 12

Nut or Screw . . . 4 1/2"  
EACH — \$1.35  
ORDER  
A SET



ORDER THROUGH YOUR JOBBER . . .  
If he cannot supply immediately, ORDER  
DIRECT—but GIVE US YOUR JOBBER'S  
NAME . . . SAVE MONEY & TIME—with  
"TIP WRENCH"

**Sold on A Money-Back Guarantee**

Address: "TIP WRENCH" DIVISION  
**SMITH HEAT TREATING CO.**  
5865 Wilmington Ave., Los Angeles 1, Cal.

## Solutions for RADIO-TV Service Business Problems

Now at your Radio-TV Parts Distributor



### 104 TV SERVICE CALL BOOK



50 Triplicate sets of invoices  
for use on service calls in sales-  
book form with space for dealer  
rubber stamp. Also available  
with dealer 4-line imprint.

Ask your distributor for details  
and special imprint order form.

See our complete line of job tickets,  
service contracts, service systems, ser-  
vice reports, guarantee forms, call  
routers, collection systems at your  
Parts Distributor.



Write for Catalog RT

**OELRICH PUBLICATIONS**  
4135 N. Lawler Ave. Chicago 41, Ill.



for Hi Fi Conversions,  
New Installations



### AMPLIFIER

You can change an outmoded radio, phono-  
graph or TV receiver into a high fidelity  
instrument with a VC-6 amplifier. Low cost,  
yet supplies more power than required by the  
largest size house . . . so simple to install,  
anyone can do it. The VC-6 is made for quick,  
easy mounting. It's compact, light weight,  
No extensive cabinet alterations. R.T.M.A.  
guarantee.

Service! The VC-6 cuts your conversion  
costs — makes more jobs more profitable.  
Matching speaker systems available.

Push-pull power output—6 watts.  
Frequency response 50 to 30,000 c.p.s.  
Bass boost of 6DB or treble boost of 6DB  
from single control.  
Impedance—8 ohms  
Self-contained power supply,  
110 V., 60 cycles, A.C. only  
Size 1 3/8" x 3 1/8" x 11" long  
Ship. Weight 3 lbs.

ONLY  
**\$26.95**  
F. O. B. N. Y. C.



Order your VC-6 Amplifier Today!  
Quantity Discounts.

**VIDEO CORPORATION OF AMERICA**  
229 West 28th St., New York 1, N. Y.

**EICO**



### KITS—WIRED INSTRUMENTS

Give you  
**HIGHEST QUALITY!**  
**SAVE OVER 50%!**

World-famous performance-proved EICO Kits and instruments are designed from YOUR point of view—with the best of circuitry and the finest components. Because you do the easy assembly of EICO Kits in just one evening, you get a fine precision instrument and SAVE 50% and more!

See the complete EICO line of VTVMs, scopes, generators, V-O-Ms, tube testers, battery eliminators, decade boxes, etc., at your local jobber today. Write NOW for FREE Catalog D-11.

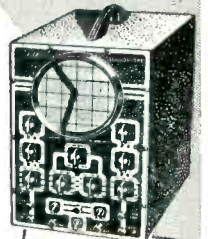

425K 5" PUSH-PULL  
SCOPE KIT \$44.95  
WIRED \$79.95.



**EICO** ELECTRONIC INSTRUMENT CO., Inc.  
84 WITHERS STREET, BROOKLYN 11, N. Y.

by  
every  
test

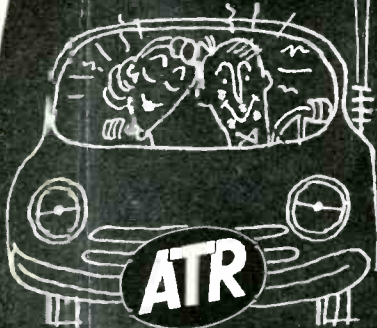

**ATR**  
is BEST!



**ATR** AUTO  
RADIO  
**VIBRATORS**

Have Ceramic Stack Spacers

A COMPLETE LINE  
OF VIBRATORS

Designed for Use in Standard  
Vibrator-Operated Auto Radio  
Receivers. Built with Precision  
Construction, featuring Ceram-  
ic Stack Spacers for longer  
Lasting Life. Backed by more  
than 22 years of experience in  
Vibrator Design, Develop-  
ment, and Manufacturing.

Free

"A" Battery Eliminators, DC-AC  
Inverters, Auto Radio Vibrators



NEW MODELS    NEW DESIGNS    NEW LITERATURE

See your jobber or write factory

**AMERICAN TELEVISION & RADIO CO.**  
Quality Products Since 1931  
SAINT PAUL 1, MINNESOTA—U. S. A.

[from page 90]

voltage is across  $R_2$ . The initial volt-  
age across  $R_1$  is shown by the sharp  
rise in the leading edge of the wave-  
form (points  $A$  to  $B$ , Fig. 7). This wave-  
form represents the voltage measured  
at the plate of  $V_2$  (combined voltage  
of  $IC$  and  $R_1$ ). Then  $C_1$  begins to  
charge. As  $C_1$  charges, the voltage  
across both resistors begins to drop.  $C_1$   
gains the voltage of  $V_2$  rises. So  
the plate voltage of  $V_2$  rises. It may  
seem surprising that the plate voltage  
of  $V_2$  goes up even though the voltage  
across  $R_1$  falls. But remember that the  
voltage across  $C_1$  rises faster than the  
resistor voltage falls, and that plate  
voltage is the sum of the voltages across  
 $C_1$  and  $R_1$ .  $C_1$  is gaining the voltage as

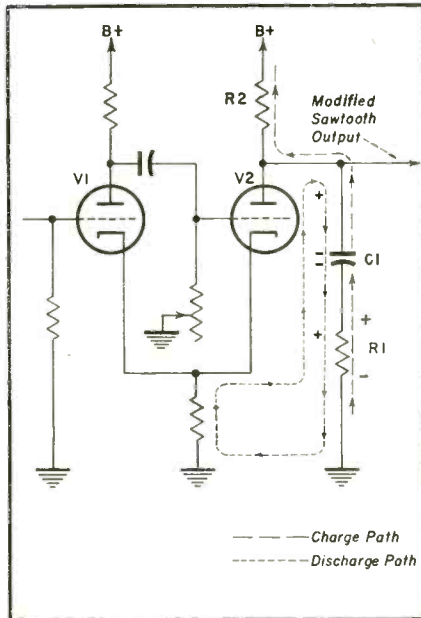

Fig. 6—Simplified multivibrator os-  
cillator circuit for generating a mod-  
ified sawtooth output.

both resistors are losing. When the  
plate voltage of  $V_2$  is positive enough  
to overcome the negative voltage on the  
grid, the tube conducts (point  $C$ , Fig.  
7). To give a concrete illustration of  
what actually happens, let's assume  
that at the instant before the tube con-  
ducts, there is 50V across  $C_1$  and 10V  
across  $R_1$ , or a total of 60V from plate  
to ground.

When the tube conducts,  $C_1$  starts  
to discharge through  $R_1$  and the tube.  
Current takes the dotted path shown  
in Fig. 6. The discharge path has less  
resistance than the charge path, so the  
condenser discharges at a faster rate  
than it charged.  $C_1$ , in discharging,  
acts like a battery. A very interesting  
voltage redistribution takes place. The  
50V across  $C_1$  divides across the peak-  
ing resistor  $R_1$  and the tube including  
the cathode resistor (Fig. 6). Assuming,

[Continued on page 95]

Brach...  
exclusives!  
3-D line

**FREE!**  
write for 3-D  
counter display  
with glasses

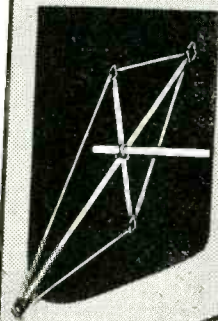

uhf diamond rhombic No. 496

- D**evelops highest gain
- D**oesn't flicker
- D**esigned for service

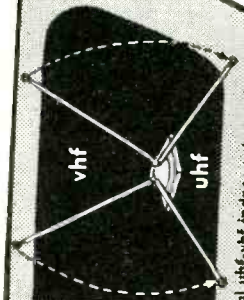

universal uhf-vhf indoor antenna No. 482

- D**iversiform peaks on 82 TV channels
- D**evised eccentric joint does it all
- D**esigned to reduce uhf skin losses



**Manufacturing Corp.**  
Div. of General Bronze Corp.  
200 CENTRAL AVE.,  
NEWARK 3, N. J.

**UNDER-COUNTER CASH DRAWER** \$26<sup>50</sup>

6 coin tills, 5 currency compartments.  
Warning bell and disc tumbler lock.  
Made of Indiana hardwoods. Smooth  
lacquer interior. Natural lacquer  
or office gray exterior (specify).  
Size 18 3/4" W x 14 3/4" D x 4 1/2" High.  
STANDARD WITH MOST CHAIN  
STORES. Order or write today!  
**INDIANA CASH DRAWER CO.**  
P.O. Box 236 A, Shelbyville, Ind.



Mfrs. Cash Drawers  
for over 31 years

**WANTED:**

Manufacturers Representatives, Jobbers and Dealers  
to handle our UHF All Channel Antennas, Made  
of All Aluminum.

AECO Channel Queen Corner Reflector  
AECO Channel King Bo-Tie  
And VHF AECO Sky Sweeper, All Channel Aerial.  
These antennas are priced so there is a nice profit.

**AERIAL ELECTRONICS CO.**

220 Washington St, Phone 1415 Beardstown, Ill.

# NEW RMS "PRE-FAB"

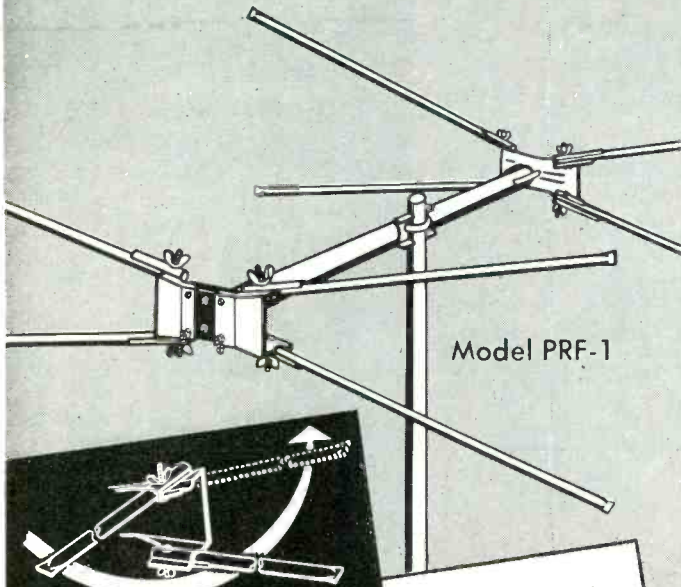

Model PRF-1

**SWING OUT - INSTALL... THAT'S ALL!**

the lowest priced—most rugged completely

## PREASSEMBLED CONICAL on the market!

This is not an economy model... it is virtually a deluxe 4-front-4-back conical being massed produced by RMS in such vast quantities that costs are lowered... not quality!

- Rugged brackets hold elements securely—are triple-thick plated.
- 3/8" aluminum elements with pinched ends.
- Standard 36" aluminum crossarm dowel-reinforced at both ends and at the U-bolt.
- Tenna-Tek for signal terminal protection with each antenna.
- Six to the carton. Available in stacked and 4-bay.

AVAILABLE ALSO WITH STEEL CROSSARM

See your local RMS Jobber

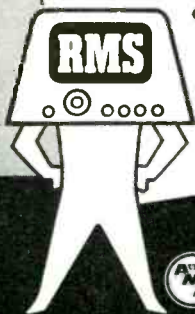

In Canada, MJS TV Accessories Co.  
Mexico: Industrias Comerciales

RMS. NEW YORK 62, N. Y.

**! NOW VIKING SELLS DIRECT !**  
**"THERE'S NO SALE LIKE WHOLESALE"**  
**70% TO 90% OFF LIST**

### VEE BOXED—BRANDED—TUBES FULLY GUARANTEED

1B3	..... \$ .63	6BA6	..... \$ .45	12AT6	..... \$ .43
1R5	..... .56	6BC5	..... .53	12AT7	..... .68
1S4	..... .61	6BE6	..... .46	12AU6	..... .43
1S5	..... .47	6BG6	..... 1.34	12AU7	..... .53
1T4	..... .56	6BJ6	..... .48	12AV6	..... .37
1U4	..... .55	6BK7	..... .88	12AV7	..... .79
1U5	..... .46	6BQ6	..... .89	12BA6	..... .45
1X2	..... .67	6BQ7	..... .98	12BE6	..... .47
3Q4	..... .60	6C4	..... .37	12BH7	..... .63
3Q5	..... .65	6CB6	..... .53	12SA7	..... .52
3S4	..... .55	6CD6	..... 1.85	12SK7	..... .50
3V4	..... .56	6J5	..... .40	12SN7	..... .54
5U4	..... .40	6J6	..... .62	12SQ7	..... .42
5V4	..... .73	6K6	..... .41	19BG6	..... 1.39
5Y3	..... .29	6S4	..... .46	25BQ6	..... .89
6AB4	..... .46	6SA7	..... .52	25L6	..... .48
6AC7	..... .75	6SK7	..... .50	25W4	..... .48
6AG5	..... .54	6SN7	..... .54	25Z6	..... .42
6AK5	..... .95	6SQ7	..... .42	35L6	..... .47
6AL5	..... .40	6T8	..... .77	117Z3	..... .39
6AQ5	..... .46	6V6	..... .46	35Z3	..... .18
6AT6	..... .38	6W4	..... .45	35Z5	..... .30
6AU5	..... .78	6W6	..... .57	50B5	..... .47
6AU6	..... .43	6X4	..... .34	50C5	..... .47
6AV5	..... .78	6X5	..... .33	50L6	..... .47
6AV6	..... .37			35W4	..... .30

All Orders sent C.O.D. plus Postage Quantities limited. Minimum order \$5. Prices subject to change.



ORDERS SHIPPED PREPAID IF CHECK IS ENCLOSED.

112-07 FRANCIS LEWIS BOULEVARD, DEPT. SD11  
QUEENS VILLAGE 29, N. Y.

Service Men!

## THE GUARDIAN SERIES 200 RELAY...

*Interchangeable*  
**COIL and CONTACT SWITCH ASSEMBLIES**  
*Save Time—Cut Costs!*

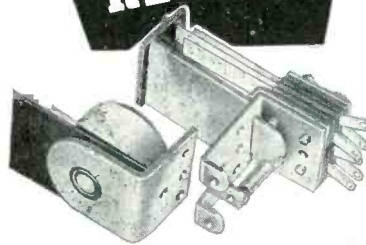

★ Coil assembly includes coil and field piece. Contact assembly consists of switch blades, armature, return spring and mounting bracket. Standard and Midget contact assemblies in either S.P.D.T. or D.P.D.T. are *interchangeable* and can be used with any of 13 coils described below.

#### CONTACT SWITCH ASSEMBLIES

CAT. NO.	TYPE	COMBINATION
200-1	Standard	8 amps Single Pole Double Throw
200-2	Standard	8 amps Double Pole Double Throw
200-3	Standard	8 amps Contact Switch Parts Kit with complete assembly and wiring details
200-4	Standard	12.5 amps Double Pole Double Throw
200-5	Standard	8 amps Four Pole Double Throw
200-M1	Midget	8 amps Single Pole Double Throw
200-M2	Midget	8 amps Double Pole Double Throw
200-M3	Midget	Contact Switch Parts Kit with complete assembly and wiring details.

#### 13 COILS ASSEMBLIES

CAT. NO.	A.C. COILS*	VOLTS	CAT. NO.	D.C. COILS	VOLTS
200-6A	6 A.C.	6 D.C.	200-6D	6 D.C.	6 D.C.
200-12A	12 A.C.	12 D.C.	200-12D	12 D.C.	12 D.C.
200-24A	24 A.C.	24 D.C.	200-24D	24 D.C.	24 D.C.
200-115A	115 A.C.	32 D.C.	200-32D	32 D.C.	32 D.C.
		110 D.C.	200-110D	110 D.C.	110 D.C.

\*All A. C. coils available in 25 and 60 cycles

**GUARDIAN ELECTRIC**  
1606-M W. WALNUT STREET CHICAGO 12, ILLINOIS  
A COMPLETE LINE OF RELAYS SERVING THE RADIO INDUSTRY



# I've switched to **ERIE** SWITCHES

*They're in the BAG!*



The new, full line of ERIE rotary selector and lever switches includes twenty-five item numbers. They are made in four styles, in single or multiple sections, shorting and non-shorting types. ERIE switches meet existing R.E.T.M.A. requirements. For protection against the corrosion of heavy silver plated contacts, each switch is sealed in a durable plastic bag and then boxed for convenient stocking.

*Descriptive literature is available at your distributors, or write Dept. C for your copy.*

*ERIE components are stocked by leading electronic distributors everywhere.*



**ERIE**  
RESISTOR CORP.

ELECTRONICS DISTRIBUTOR DIVISION  
**ERIE RESISTOR CORPORATION**

Main Office: ERIE, PA.  
Factories: ERIE, PA. • LONDON, ENGLAND • TORONTO, CANADA

# HICKOK

## Model 610A



### TELEVISION SWEEP - ALIGNMENT GENERATOR

- The most widely used popularly-priced TV sweep generator.
- Complete I.F. Marker Range.
- Covers all channels: 2 to 13 on fundamentals, and UHF on harmonics.
- Write for technical details . . .

**THE HICKOK ELECTRICAL INSTRUMENT CO.**  
10533 DUPONT AVE., CLEVELAND 8, O.

for **like - new** performance

replace with original **ROGERS** full-focus deflection yokes



Since most of the better TV sets are made with ROGERS Deflection Yokes, this same top quality yoke should be used for replacement. With over 25 years of electronic know-how, ROGERS Precision Engineered Products make TV sets perform *like new*.

ROGERS Full-Focus Deflection Yoke assures double brilliance with knife-edge sharpness over the entire screen. Each ROGERS yoke—precision tested for perfect focus—is designed for peak performance and extra long life.

**“the eye tells why”**

packaged individually—attractively

**ROGERS ELECTRONIC CORP.** 43-49 Bleecker St. New York 12, N. Y.

FREE: Send for new catalog “B” listing TV set models and ROGERS Yoke and Flyback rep'acements, or see your jobber.

# South River

## ★★ NEWS ★★

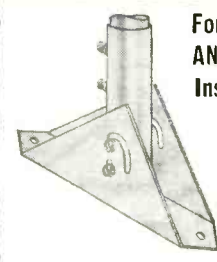

For ONE-MAN  
ANTENNA Roof  
Installations

### ROOF MOUNT

Model  
RM-15

Newly improved model enables installation man to “walk up” antenna and mast from horizontal to vertical position where they then drop and lock securely. Man is then free to guy the mast on any 10 ft. or less installation. (May also be used for higher installations.) Features 5½” long, heavy gauge steel mast holder to accommodate masts up to 1½” O.D. Embossed at all critical points for extra strength.

Heavily plated for rust resistance.  
Write for new 1953 catalog.  
In Canada A. T. R. Armstrong Co., Toronto

**SOUTH RIVER METAL PRODUCTS CO., INC.**  
SOUTH RIVER, N. J.

PIONEER AND OUTSTANDING PRODUCER OF FINEST LINE OF ANTENNA MOUNTS



for the sake of simplicity, that the resistances of  $R1$  and the conducting tube are approximately equal, there are 25V across each. This means that *instantaneously* the voltage of the tube from plate to ground drops from 60V to 25V. This is shown at points C and D, Fig. 7. Note that when  $C1$  discharges, the current through  $R1$  is in the reverse direction compared to the charge period. Therefore, during discharge, the voltage across  $R1$  subtracts from the voltage across  $C1$ , when a voltage measurement is made from plate to ground. This accounts for the sharp, instantaneous drop in plate voltage as soon as  $C1$  starts to discharge.  $C1$  proceeds to

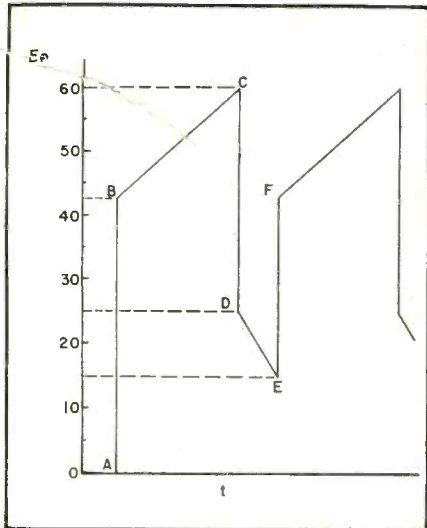

Fig. 7—Trapezoidal waveform generated at the plate of multivibrator (V2, Fig. 6).

discharge through  $R1$  and the tube. As  $C1$  discharges, the voltage across  $C1$  and  $R1$  (from plate to ground) decreases. Plate voltage becomes less positive. Since this occurs for a relatively short time, the voltage decrease is linear (points D to E, Fig. 7). Let's assume the condenser discharges from 50V to 30V. When there is 30V across  $C1$ , there is 15V across  $R1$ , the peaking resistor, and 15V across the tube. Therefore, during the discharge, the actual plate voltage drops from 25V to 15V. However, before  $C1$  can lose too large a portion of charge, the cathode bias of the multivibrator is sufficient to cut the tube off with such a low plate voltage on V2.

$C1$  then starts to charge again. The voltages across  $C1$  and  $R1$  are now series aiding. Let us assume that there is 12V across  $R1$  and 30V across  $C1$ . Then plate voltage goes instantaneously from +15V to +42V (points E to F, Fig. 7). And the cycle repeats. This is the sequence of events in a multivibrator type of oscillator.

[To be continued]

# ALL-CHANNEL UHF CONVERTER

**Model BTU-2**

## Ultrawerter

**Ultra POWERFUL**

**Ultra DEPENDABLE**

**MORE POWER**

**GREATER STABILITY**

**EASIER TUNING**

Employing the newly developed B-T Ultratuner, the B-T Ultrawerter, Model BTU-2, provides for reception of all UHF channels on any TV set with quality unmatched by any converter, regardless of price. 'On/off' operation is automatically controlled by the power switch on the TV receiver. Terminals are provided for both VHF and UHF antennas.

Advanced circuit design assures high gain, high stability, and lowest noise performance. A high ratio vernier knob permits easy, accurate tuning on UHF channels from 14 through 83. Tube complement: 6T4/6AF4, 6AB4, and Germanium Diode, 1N72.

**\$39.95**

**B-T LABS**

**BLONDER-TONGUE LABORATORIES\***

Manufacturers of TELEVISION AMPLIFIERS, UHF CONVERTERS, MIXERS, DISTRIBUTION UNITS and TV ACCESSORIES. WESTFIELD, N. J.

## MOSLEY ROTATOR CONNECTORS

- Models For EVERY Rotator!
- Line Plugs—Line Sockets—Base Sockets—Flush Mounted Sockets!
- Solderless!
- Precision Molded Polystyrene!

Available at Radio & Television Parts Distributors—everywhere.

Write For Folder 1002:

### MOSLEY Electronics Inc.

8622 St. Charles Rock Road      St. Louis 14, Missouri

● **ADVERTISING INDEX** ●

**FREE!  
NEW '54  
EDITION**

**SIMPLIFIES  
TV ANTENNA  
INSTALLATIONS  
AND SALES**

**TV UHF VHF**

**'TENNA TIPS**

**INCLUDES  
LATEST UHF/VHF  
DATA & EXCLUSIVE  
"ANTENNA SELECTOR"**

Completely revised by TV authorities Matt Mandl and Ed Noll, this essential pocket size manual includes the exclusive "Antenna Selector", Directronic Antennas, Dimension Guide, Channel Frequencies, Proper Feed Methods, Helpful Hints... everything about every type of TV antenna.

**FREE To TV Servicemen,  
Service Dealers,  
Dealers, Distributors, Hams,  
Salesmen, Manufacturers**

**Publication Price \$1.  
Yours free if you write at once.  
-MAIL THIS COUPON TODAY-**

**SNYDER MFG. CO., Dept. "B"**  
22nd & Ontario Sts., Phila. 40, Pa.  
Please send free copy of TV 'TENNA TIPS

Name \_\_\_\_\_  
Address \_\_\_\_\_  
City \_\_\_\_\_ Zone \_\_\_\_\_ State \_\_\_\_\_

Admiral Corporation ..... 58 Agency: <i>Cruttenden &amp; Eger Assoc.</i>	Mosley Electronics ..... 95 Agency: <i>Rudolph Bartz Adv. Agency</i>
Aerial Electronics Co. .... 92	Oelrich Publications ..... 91 Agency: <i>Sander Rodkin Adv. Agency</i>
American Microphone Co. .... 30 Agency: <i>John A. Ripley Advtg.</i>	Ohmite Manufacturing Co. .... 86 Agency: <i>The Fensholt Adv. Agency</i>
American Phenolic Corp. .... 56 Agency: <i>Burton Browne Advtg.</i>	Philco Corporation ..... 26 Agency: <i>Hutchins Adv. Co.</i>
American Television & Radio Co. .... 92 Agency: <i>Firestone-Goodman Adv.</i>	Plastoid Corporation ..... 88 Agency: <i>Byrde, Richard &amp; Pound</i>
Astron Corporation ..... 38 Agency: <i>Salow &amp; Associates</i>	Pyramid Electric Company ..... 41 Agency: <i>Sylvan A. Wolin &amp; Assoc.</i>
Blonder-Tongue Laboratories, Inc. .... 95 Agency: <i>Shappe-Wilkes, Inc.</i>	The Radiart Corporation ..... 34, 90 Agency: <i>Stern &amp; Warren</i>
Brach Mfg. Corp. .... 92 Agency: <i>FAA Advertising</i>	Radio City Products Co., Inc. .... 92 Agency: <i>George Gero Advtg.</i>
Bussmann Mfg. Co. .... 1 Agency: <i>Henderson Advertising Co.</i>	Radio Corp. of America ..... Cover 4 Agency: <i>J. Walter Thompson Co.</i>
Centralab ..... 28 Agency: <i>Klau-Van Pietersom-Dunlap Assoc.</i>	Radio Merchandise Sales, Inc. .... 93 Agency: <i>Reid Associates</i>
Channel Master Corp. .... 4, 5 Agency: <i>Duso Advertising, Inc.</i>	Raytheon Mfg. Co. .... 7 Agency: <i>Walter B. Snow &amp; Staff, Inc.</i>
Conrac, Inc. .... 90 Agency: <i>Ford C. McElligott &amp; Associates</i>	Regency ..... 44 Agency: <i>Burton Browne Advtg.</i>
Duotone Company ..... 22 Agency: <i>Conti Advertising Agency, Inc.</i>	John F. Rider Pub., Inc. .... 83, 86 Agency: <i>Conti Advertising Agency, Inc.</i>
Electronic Instr. Co., Inc. (Eico) ..... 91 Agency: <i>Krate-Basch Associates</i>	Rogers Electronics Corp. .... 94 Agency: <i>A. D. Adams Advtg.</i>
Erie Resistor Corp. .... 94 Agency: <i>W. S. Hill Company</i>	Howard W. Sams & Co., Inc. .... 30 Agency: <i>George Brodsky Advtg.</i>
Falcon Electronics Co. .... 10, 11 Agency: <i>Rudolph Bartz Adv. Agency</i>	Sangamo Electric Company ..... 25 Agency: <i>Arthur R. Mogge, Inc.</i>
Federal Telephone & Radio Corp. .... 16, 17 Agency: <i>J. M. Mathes, Inc.</i>	Walter L. Schott Co. .... 52 Agency: <i>Tilds &amp; Cantz</i>
General Electric Co. .... 36 Agency: <i>Maxon, Inc.</i>	Simpson Electric Co. .... 23, 33 Agency: <i>Burton Browne Adv.</i>
Guardian Elec. Mfg. Co. .... 93 Agency: <i>Kennedy &amp; Company</i>	Smith Heat Treating Co. .... 91 Agency: <i>Clark Collard Adv. Agency</i>
Hickok Electrical Instrument Co. .... 94 Agency: <i>Ritchie &amp; Sattler, Inc.</i>	Snyder Mfg. Co. .... 96, Cover 3 Agency: <i>Brooks &amp; London</i>
Hytron Radio & Electronics ..... 2 Agency: <i>Bennett, Walther &amp; Menadier, Inc.</i>	Sola Electric Co. .... 30 Agency: <i>Sidney Clayton &amp; Associates</i>
Indiana Cash Drawer Co. .... 92 Agency: <i>Jacobson &amp; Tonne Adv.</i>	South River Metal Products Co. .... 94 Agency: <i>Art-Copy Advertising Agency</i>
International Resistance Co. .... Cover 2 Agency: <i>John Falkner Arndt &amp; Co., Inc.</i>	Sylvania Electric Products Inc. .... 14 Agency: <i>Cecil &amp; Presbrey, Inc.</i>
Jackson Electrical Instr. Co. .... 83 Agency: <i>Parker Advtg. Co.</i>	University Loudspeakers, Inc. .... 54 Agency: <i>George Homer Martin Adv.</i>
JFD Manufacturing Co., Inc. .... 12, 13 Agency: <i>Burton Browne Advtg.</i>	Video Corp. of America ..... 91 Agency: <i>The Wexton Company</i>
LaPointe Electronics Corp. .... 24 Agency: <i>F. W. Prella Company</i>	Viking Electronics Corp. .... 93
Littelfuse, Inc. .... 9 Agency: <i>Burton Browne Advtg.</i>	
P. R. Mallory & Co., Inc. .... 15 Agency: <i>The Aitkin-Kynnett Company</i>	

**REPRESENTATIVES WANTED**

with wide acquaintance among jobbers throughout U. S. and Canada to handle new Adjustable Socket Pocket-Wrench which holds nuts, bolts and screws in tip—for hard-to-get-at places in assembly and repair work. Three sizes in popularly priced line, advertised and properly displayed. Write giving full particulars, references, and other data to Box 1153, Radio-TV Service Dealer, 67 West 44th St., New York 36, N.Y.

**Snyder**  
PHILADELPHIA

**SUPER**  
**Directronic**

**ULTRA-FRINGE**

**TV AERIAL SYSTEM**

Designed to give the finest reception in ultra fringe areas where signals arrive from more than a single direction... without motors, moving parts or electric power.

**\$100** COMPLETE WITH  
"AIR-CORE" TRI-TUBE  
TRANSMISSION LINE

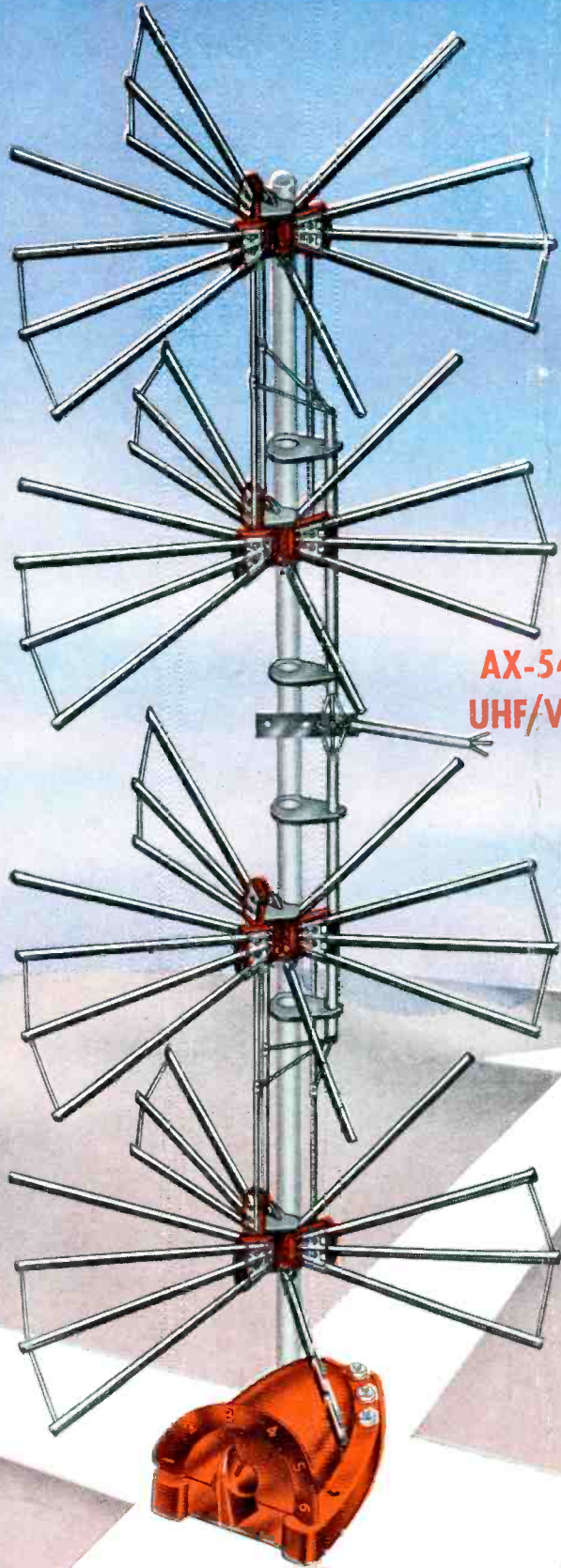

**AX-548**  
**UHF/VHF**

**SNYDER MFG. CO.**

ANTENNA ENGINEERS®  
**PHILADELPHIA**

Let's face it...

... the best tube you can buy  
is your best buy

When it comes to anything so important in radio and television servicing as a receiving tube, *performance* means much more than *price*.

After all, when you purchase a receiving tube, you are not buying just glass and metal. Your reputation and your profit depend on the *performance* that tube will provide!

If you try to cut corners by buying "seconds" . . . or by using "just any tube brand," you may be in for trouble. Unnecessary callbacks alone can eat up all your profit. That's why we think you'll be interested in these two facts about RCA Receiving Tubes . . .

**First Fact:** There is no such thing as a "second" RCA Receiving Tube that can find its way to market. If an RCA Tube fails to pass its final test, it is not only rejected . . . *it is broken up, dumped into a "meat chopper" and ground up into so much hash.*

**Second Fact:** The quality of RCA Receiving Tubes is continually being "upgraded." For instance, when television came, you asked for an improved 6SN7-GT. As a result, RCA's 6SN7-GT is a far better tube than the 6SN7-GT of yesterday. You see, we guard our reputation as zealously as you guard yours.

**So let's face it . . .** you just can't afford to buy anything less than the best in receiving tubes—and that's RCA.



To be sure you're getting unused, factory-fresh RCA Tubes, buy them only in the familiar red, white and black RCA Tube cartons through your authorized RCA Tube Distributor.



**RADIO CORPORATION of AMERICA**

ELECTRON TUBES

HARRISON, N. J.