

APRIL, 1953

Radio-Television
**SERVICE
DEALER**

N28 A 2K-952 MAR 57
ROBERT G. WALRAVEN
GREEN BAY WISC
134 BADER ST



The Professional Radio-TVman's Magazine

IN THIS ISSUE:

Video Amplifier Techniques
(TV Symposium Series)

A Precision Transistor Oscillator

Horizontal Sync & Sweep Servicing, Part 1

Your Hi-Fi Market, Part 6

Video Speed Servicing Systems

AM-FM-TV-SOUND

The only lightning arrester with the strain relief LIPS is manufactured by JFD. *A patent is its proof!*
The twin-lead will bend only at a point separate from your contact—therefore, your twin-lead cannot break away.

Only the exclusive JFD strain relief lip prevents the contact washers used in all arresters from ripping your lead-in apart, strand by strand until the wire is torn through and the picture on your screen obliterated. Write for Form 84.



FOR RIBBON TWIN-LEAD

No. AT105 ("Little Giant" with hardware for wall or window sill mounting) List \$1.25

No. AT105S ("Little Giant" with UL approved stainless steel strap for pipe mounting) List \$1.50

No. AT102 ("Jumbo" with UL approved stainless steel strap for Universal Mounting) List \$2.25

FOR TUBULAR TWIN-LEAD

No. AT103 ("Jumbo" with UL approved stainless steel strap for Universal Mounting) List \$2.25

Available with four color, sales producing counter display, on request

JFD MFG. CO.

BROOKLYN 4, N.Y.
BENSONHURST 6-3200

World's Largest Manufacturer
of TV Antennas and Accessories

the secret is in the lips



"Little Giant" Lightning Arrester
U.S. Pat. No. D-4664

the secret is in the lips

the secret is in the lips

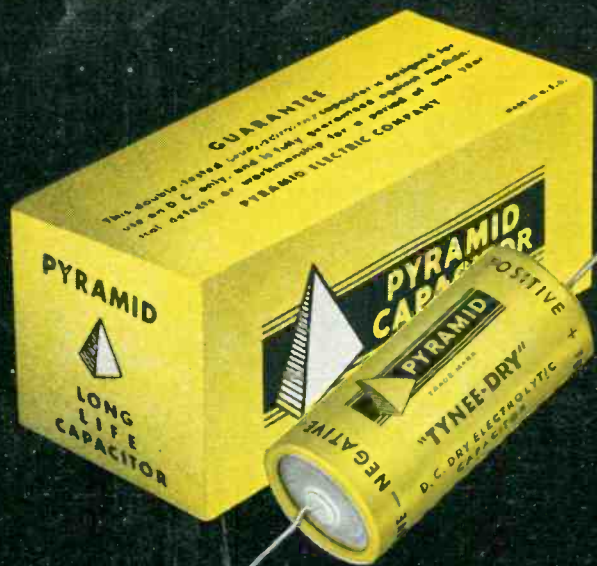

*In capacitors, your best bet,
your best buy, is*



PYRAMID

PYRAMID ELECTRIC COMPANY
NORTH BERGEN, NEW JERSEY

Write for free literature

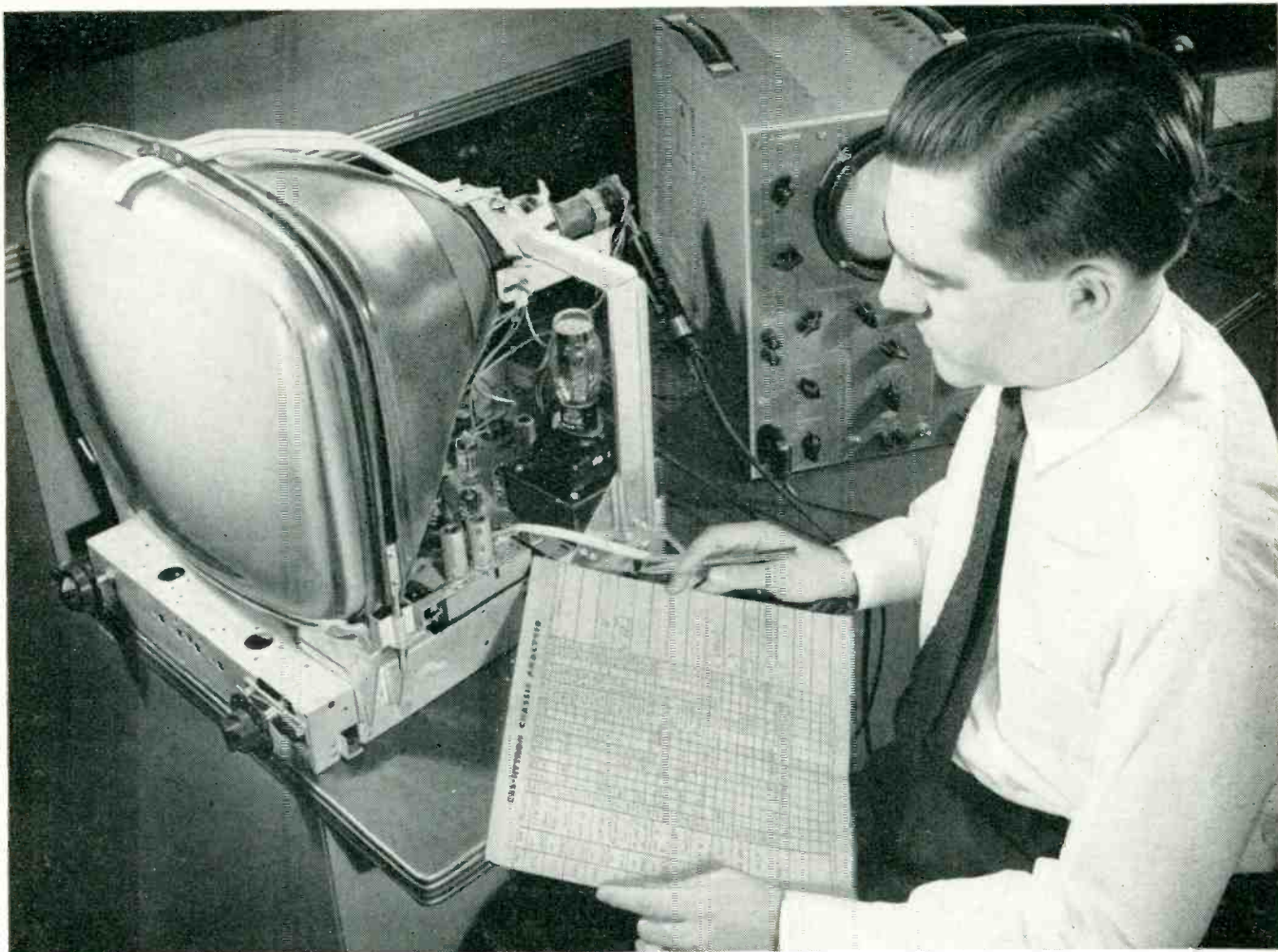

Bring back that New-Set Sparkle with **Performance-Tested Tubes**

Meet John Cunningham, a CBS-Hytron Commercial Engineer. John is beginning at the beginning for you. Socket by socket, he is analyzing the tube requirements of a brand-new TV set design.

John knows the superior performance demanded. He concentrates his know-how on insuring top tube operation within standard specification limits. He tests sample tubes . . . checks analysis data. Working hand-in-glove with the set designer . . . and with CBS-Hytron engineers . . . he assures control of the characteristics of all tubes for this new chassis. Finally he achieves . . . from rectifiers to picture tube . . . the perfect performance all of this engineering team (and you) seek.

Constantly CBS-Hytron carries on teamwork like this. Socket by socket analysis. Day in, day out — with 9 out of 10

leading TV set makers. Both tube and set engineers pool their specialized skills. Scores of the nation's foremost TV set engineers help make endless CBS-Hytron improvements. Help assure you of unsurpassed performance in virtually *all* leading TV sets.

Small wonder that your CBS-Hytron replacement tubes recapture that new-set sparkle. Please *your* customers. Cut *your* call-backs. Profit more. Take advantage of CBS-Hytron engineering. Demand CBS-Hytron . . . your logical replacement tube, because it is performance-tested all the way . . . from original to replacement.

**NEW... BIGGER... BETTER
FREE!**

6th Edition

**CBS-HYTRON
Reference Guide
for
Miniature Electron
Tubes**



- A CBS-Hytron original . . . it's unique.
- All miniatures, regardless of make.
- 250 miniature types . . . 87 new.
- 111 basing diagrams . . . 34 new.
- Similar larger prototypes indicated.
- 8 packed pages of data you need daily.
- And it's FREE!

Get your copy of this old friend brought up to date now. Ask your CBS-Hytron jobber or write direct . . . today!



MANUFACTURERS OF RECEIVING TUBES SINCE 1921
HYTRON RADIO AND ELECTRONICS CO.

A Division of Columbia Broadcasting System, Inc.
Main Office: Danvers, Massachusetts

EDITORIAL

by S. R. COWAN

Controls Are Off

As an avid advocate of free enterprise we rejoice at the new administration's price decontrol policy. Of course, there will be a certain amount of price incline and decline, but the premise is that eventually products and services will be sold at the levels where they belong, and not at levels where politicians said they should be. Remember, in a free democracy no one can make you buy something you can't afford, and by the same token, no administration should be permitted to force you to sell a product or service for less than it costs.

Now, with decontrol, service dealers and service organizations can govern their own destinies, succeeding or failing, on their own merits.

During the past two years we have addressed over 150 groups of servicemen in all parts of the country. Most service shops were handling capacity business, but could not make normal profits or enjoy normal growth and expansion. Why? Because they were forced to live within obsolete regulations propounded by politicians who went "by the book" and who did not take cognizance of the fact that radio and TV servicing is a new art which had to be learned, and paid for at the prevailing cost scale, which was *not* under control. Our lectures were titled: "How To Determine What Prices *Must* Be Charged For Your Services." The common-sense facts brought out in the lecture were sometimes counteracted by the fact that price controls prevented a shop from raising its labor charges by price control regulations. Unfortunately, those shops that charged prices which were too low when regulations became effective had no "out." Some sought relief but did not get it. As one Wit stated: "Truman's administration started as a New Deal, became a Raw Deal, and bogged down into a No Deal." That's behind us. Now all service shops should review their costs, wage and price scales. Corrective measures should be made immediately so that no job is ever undertaken unless it is known definitely in advance that a profit will ensue.

Five-City Slump

It is reported that TVset sales have tapered off a bit in New York, Chicago, Detroit, Cleveland and Philadelphia, but offsetting this, where new *uhf* and *vhf* stations are now on the air, the demand for sets exceeds the supply. It is a normal, temporary trend and should not worry servicemen. Most have more work now than they can handle. What the service profession needs is information that will help technicians do their work more efficiently and in less time. That's just what Video Speed Service Systems, a monthly feature of Radio TV Service Dealer, does. Try it and prove it to yourself!



Stanford R. Cowan
EDITOR & PUBLISHER

SAMUEL L. MARSHALL
MANAGING EDITOR

ADOLPH SUCHY
LEONARD LIEBERMAN
Contributing Editors

COWAN PUBLISHING CORP.
67 WEST 44TH ST.
NEW YORK 36, N. Y.



Vol. 14, No. 4

APRIL, 1953

Editorial	3
Trade Flashes	6
Sync Pulses, <i>by San D'Arcy</i>	12
Trade Literature	18
Video Amplifier Techniques (TV Symposium Series), <i>by Edward M. Noll</i>	23
Modern trends in video amplifier circuitry.	
A Precision Transistor Oscillator	26
Description of transistor oscillator developed by the U.S. Bureau of Standards.	
Horizontal Sync & Sweep Servicing, Part I, <i>by Leonard Lieberman</i>	30
Beginning a 3-part series on this most troublesome section of the TV receiver.	
Your Hi-Fi Market, Part 6, <i>by Charles B. Graham</i>	33
This installment deals with loud speaker applications.	
Circuit & Service Data of Emerson Chassis 120166D	36
Video Speed Service Systems Data Sheets (VSSS)	38
Information this month covers the Airline 84HA3010, Arvin TE290, Philco 51T1433B, Magnavox CT219.	
Circuit Court	48
CBS-Columbia Models No. 817 and 820-Sync. G.E. Model 21T4-Noise reduction circuit.	
Association News	49
Shop Notes	50
Tube News	52
New Products	54
Advertisers' Index	76

SANFORD L. CAHN, Advertising Director

HARRY N. REIZES, Advertising Manager

DAVID SALTMAN, Production Manager

NATHAN BOYCE, Circulation Mgr.

TED E. SCHELL, 2700 West 3rd St., Los Angeles 5, Calif., Dunkirk 2-4889

HAROLD F. MANN, Mid-West Sales, 333 No. Michigan Ave., Chicago. Franklin 2-7100
RADIO-TELEVISION SERVICE DEALER is published Monthly by Cowan Pub. Corp., 67 West 44th St., New York 36, N. Y. Subscription price: \$2 per year in the United States, U.S. Poss. & Canada: elsewhere \$3. Single Copies 25c. Reentered as second class matter Sept. 25, 1950 at the Post Office at New York, N. Y. under the Act of Mar. 3, 1879. Copyright 1953, Cowan Pub. Corp.

New! another Channel Master development!

beats 'em all on **UHF!**

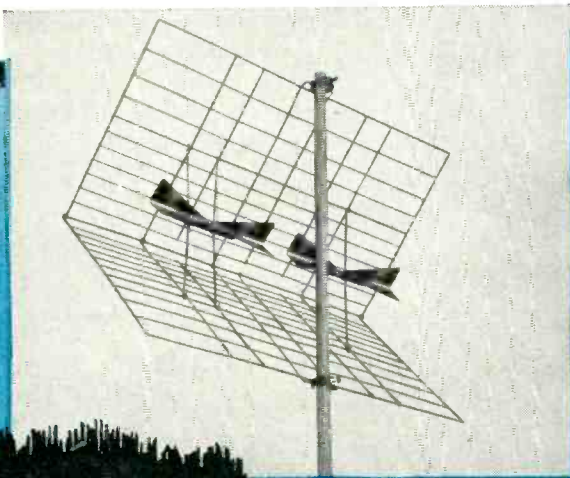

CHANNEL MASTER'S **TWIN CORNER REFLECTOR**

Model No. 406

Gives the brilliant performance of **2** antennas!

up to **16** db gain

THE MOST SENSITIVE UHF ANTENNA EVER DEVELOPED!

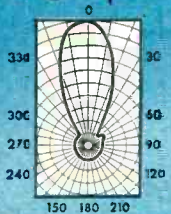

Extremely narrow forward lobe, with no side lobes and negligible rear lobe

Twice the gain of the BEST standard UHF Corner Reflector

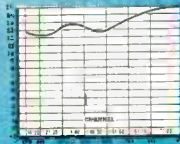

Excellent 300 ohm impedance match over the entire UHF range, provided by built-in, pre-cut matching harness

because Channel Master's Twin Corner Reflector really is **2** antennas . . .

stacked side by side into one simple structure

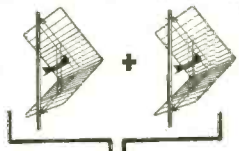

exclusive **DUBL-DIPOLE** design



- 2 antennas, electrically
- 1 antenna, mechanically
- One simple structure . . . one simple installation . . . highest gain, all-channel UHF coverage!

In any area you pick, the Twin Corner Reflector will out-perform any other antenna available today!

Ties together all 3 TV reception bands!

"Free space" terminals. Impossible for dirt or rainwater to accumulate between the terminals, which can short out the picture. Assures you of brilliant, steady reception in ANY KIND OF WEATHER!



CHANNEL MASTER'S **New!** **TRIPLE-TIE** model no. 9035

electronic inter-action filter

Combines up to 3 antennas with only 1 lead to the set.

1. Low Band VHF
2. High Band VHF
3. All UHF (Broad Band or Yagi)

Eliminates inter-action between all 3 antennas.

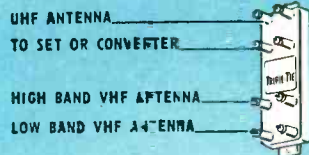

Designed to adapt a HI-LO VHF installations to UHF — quickly and economically

- SINGLE LEAD • NO SWITCHING
- ELIMINATES INTER-ACTION • NO SIGNAL LOSS ON VHF OR UHF

ULTRA FAN series — Complete VHF-UHF coverage

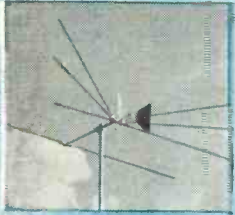

single bay — model no. 413

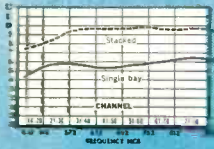

Today's most sensitive All-VU* antennas! The Ultra Fans actually operate on three separate electronic principles — automatically:

1. Low Band VHF (Channels 2-6) ... Conical antenna with parasitic reflector
2. High Band VHF (Channels 7-13) ... Large diameter V antenna
3. UHF (Channels 14-83) ... Triangular dipole with sheet reflector

One set of All-VU* stacking rods provides highest VHF and

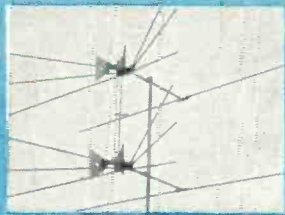

stacked — model no. 4132

UHF gain. Each Ultra Fan has its own 2-stage interaction filter, so that only one transmission line to the set is required.

*All VHF, all UHF

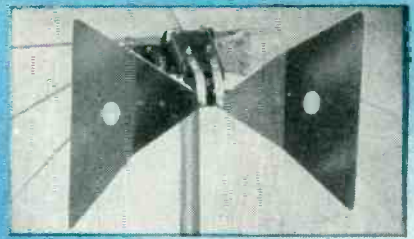

ULTRA DAPTER
model no. 414

Instantly converts all Channel Master Super Fans into high gain, all-channel, VHF-UHF antennas. Features a built-in interaction filter.

Your best bet for UHF!

CHANNEL MASTER Ultra-Tennas

America's most complete — most effective — UHF antenna line.

Channel Master's advanced engineering pays off again! While rain caused hundreds of UHF antennas to FAIL recently in Portland, not one Channel Master antenna dimmed or shorted out a picture! The facts speak for themselves: Rain or shine, Channel Master antennas outperform all others.

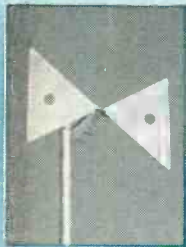

ULTRA BOW
model no. 401

The basic UHF antenna for primary signal areas, and the outstanding member of the bow-type antenna family.

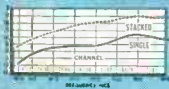

Only Channel Master Antennas are designed to eliminate the "TWIN TERRORS" OF UHF RECEPTION:

- Vibration, which causes picture flicker.
Eliminated by Channel Master's Ultra-Rigid construction and advanced mechanical design.
- The accumulation of dirt or moisture around the antenna terminals, which dims and eventually shorts out the TV picture.
Eliminated by Channel Master's sensational "free-space" terminals which prevent the accumulation of foreign deposits at the feed points.

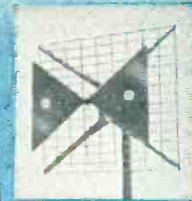

ULTRA BOW
with
SCREEN REFLECTOR
model no. 403

Can be stacked in 1, 2, and 4 bays. High, all-channel UHF gain, excellent front-to-back ratio.

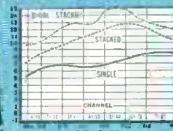

ULTRA VEE
model no. 404

- Good UHF gain
- Low VHF gain
- The most rigid UHF antenna of its type and size.

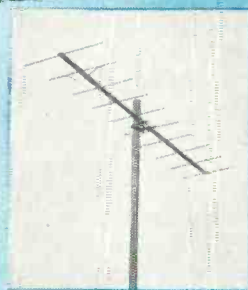
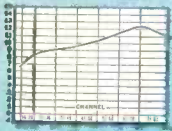

Gain: 11 DB, single
14 DB, stacked

DELTA WELD

Wide Band 10 Element UHF Yagi

Custom-designed for full coverage of your specific area! Brilliant high gain performance across as many as 23 different channels.

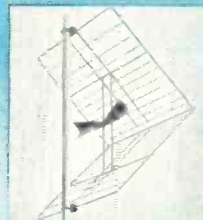

CORNER REFLECTOR
model no. 405

The outstanding all-channel UHF FRINGE antenna.

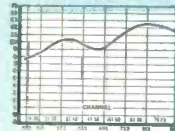

MEMBER



Sold through the nation's leading distributors

CHANNEL MASTER CORP.
ELLENVILLE, N. Y.

Write for complete technical literature



ULTRA-TIE model no. 9034

Electronic Inter-Action Filter

JOINS separate antennas into a single VHF-UHF antenna system, for use with a single transmission line

SEPARATES VHF and UHF signals at the set or converter where separate inputs are provided

The only filter with "free-space" terminals.

get Milton S. Kiver's
IMPORTANT
NEW BOOK ON

**"UHF antennas,
converters
and tuners"**



A "Must" for Every TV Service Technician

136 pages
5 1/2 x 8 1/2"

Fact-Packed To Give You All The Answers on These Vital UHF Subjects:

UHF Antennas: Full coverage of UHF TV antennas, including Fan Dipole, double-"V", rhombic, parabolic reflector, yagi, corner reflector, horn and helical types. Analysis of each array — design, operation, directional characteristics, input impedance, gain. Tells you type best suited for any given conditions.

Transmission Lines, Matching Networks: Tells how to select proper transmission line to deliver maximum signal to the receiver for best quality picture — a full discussion of this important subject.

UHF Installation Practices: Practical advice on proper antenna location and routing of transmission line to set. Describes accurate method of checking for antenna mismatch and determining whether system is properly installed.

UHF Converters: Detailed analysis of existing converters, ranging from UHF turret tuner strips to all-channel self-contained converters. Helps you understand converter design and operation.

UHF Tuners: Full analysis of tuner design and operation, ranging from parallel-wire to "butterfly" types. Absolutely essential data for the TV Service Technician.

This book keeps you ahead in TV, makes you a UHF expert, brings you extra business and profits. Get your copy today.

ORDER UHF-1. Only \$1.50

HOWARD W. SAMS & CO., INC.

Order from your Parts Jobber, or write direct to Howard W. Sams & Co., Inc. 2209 E. 46th St., Indianapolis 5, Ind.

Send.....copy (ies) of "UHF Antennas, Converters & Tuners", \$1.50 per copy.

Name.....

Address.....

City..... State.....

ORDER TODAY

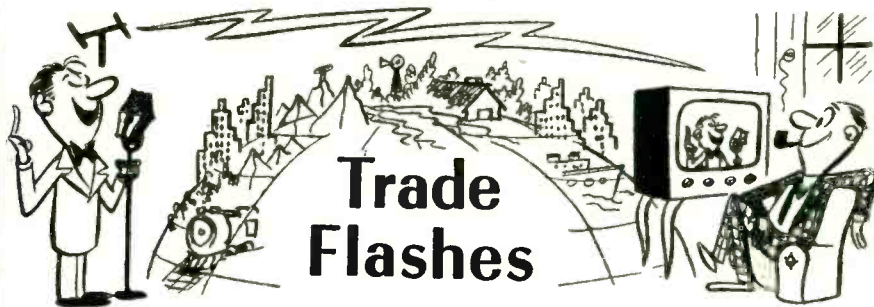

Trade Flashes

Electronics Parts Show

With a sellout of all display room and Exhibition Hall space assured for the 1953 Electronic Parts Show to be held at the Conrad Hilton Hotel here May 18th-21st, plans are now being completed for a condensed educational program to supplement the record number of displays and exhibits, Kenneth C. Prince, Show manager, announced recently.

Statistically, the Show will have 203 booths in Exhibition Hall, as compared with 164 booth in 1952, and a capacity of 177 display rooms on the fifth and sixth floors, as compared with 165 rooms last year. Advance registrations for hotel accommodations as of February 23rd were approximately twenty-two per cent greater than as of the same date last year, with the Show housing committee literally swamped with requests for accommodations.

Vin K. Ulrich of National Union Radio, Hatboro, Pa., chairman of the Show educational program committee, said that one morning of seminar sessions is being planned, with one program for management personnel and another for sales personnel, both to be held Wednesday morning, May 20th at the Conrad Hilton.

RTMA Statistics

Retail sales of both radio and television sets declined seasonally in January from the high level of December, the Radio-Television Manufacturers Association reported recently.

An estimated 640,073 television receivers and 414,726 radios, excluding automobile sets, were sold at retail during January. RTMA estimated that 1,049,770 TV sets and 1,514,688 radios had been sold through retail outlets during December 1952.

However, television set production in January topped all previous records for that month. TV output for the month was reported as 719,234 sets compared with 404,932 TV receivers produced in January 1952 and

650,700 sets manufactured in the same 1951 month.

Total radio production for January was estimated by RTMA as 1,093,142 sets. This compares with 632,455 radios manufactured in January 1952 and 1,202,503 receivers produced in January 1951.

Over 37 million receiving tubes and 900,000 cathode ray tubes were sold by manufacturers in January.

During the month, 988,316 cathode ray tubes valued at \$23,892,982 were sold by manufacturers. RTMA reported that 37,343,081 receiving tubes worth \$25,688,914 also were sold in January.

Clarification of TV Tube Excise Taxes

Due to widespread confusion with respect to the application of the radio-TV manufacturers' excise tax on the rebuilding of television picture tubes, the RTMA Committee, under Chairman A. M. Freeman, has obtained the views of the Bureau of Internal Revenue.

Chairman Freeman and his Committee developed the following questions and answers with respect to rebuilt TV tubes after informal discussions with Bureau officials.

1. Q. Under what circumstances is a rebuilt television picture tube "manufactured or produced?"

A. If a used tube is not opened or disassembled but is merely subjected to a reconditioning electrical treatment, there is no manufacturing process and no tax applies to the reconditioning. If used tube is opened, new or reconditioned parts installed in the used or reconditioned shell, and the tube reexhausted and resealed, the process is a manufacturing operation and the rebuilt tube so produced is a taxable article under Section 3404(b) of the Code.

2. Q. Who is the manufacturer or producer for excise tax purposes?

A. The rebuilder is liable for this tax. It will be presumed that the re-

Depend on Mallory
for
Approved Precision Quality

RIGHT The First Time!

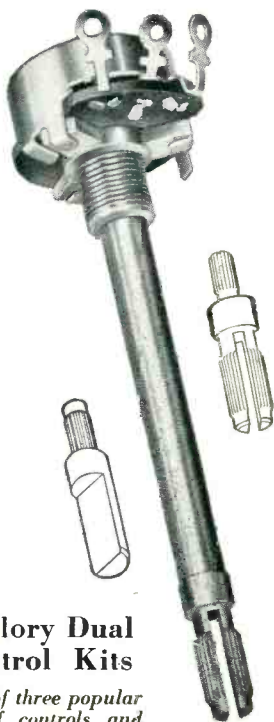
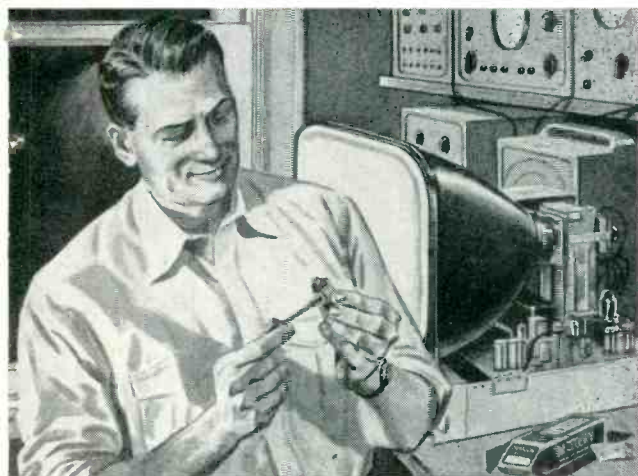

Mallory Dual Control Kits

Each of three popular kits of controls and switches will service over 50 different models of radio and TV sets. Housed in an attractive 3-drawer metal cabinet. You pay only for the controls and switches; the cabinet is yours at no additional charge. Details available from your Mallory distributor.

THE Mallory Midgetrol in his hand is the answer . . . the answer to long, dependable service for the set he is working on. Mallory Midgetrols® are engineered to match the electrical characteristics of the original equipment in any TV or radio set. From the standpoint of performance and long life, they are equal to . . . and often better than . . . the original control. Midgetrols are designed to save you precious time.

Round tubular shafts are built for fast, accurate cutting . . . fit split-knurl and flatted-type knobs.

AC switches may be attached instantly without disassembling the control.

Their unique design simplifies inventory problems . . . always available from your Mallory distributor.

Be sure *every* job is right the first time . . . use Mallory Midgetrols for *all* your service work.

Here is another time saver. The Mallory Control Guide is a complete cross reference between set manufacturers' part numbers and the equivalent Mallory control. Ask your distributor for your copy.

P. R. MALLORY & CO. Inc.
MALLORY

CAPACITORS • CONTROLS • VIBRATORS • SWITCHES • RESISTORS
• RECTIFIERS • VIBRAPACK* POWER SUPPLIES • FILTERS

*Reg. U.S. Pat. Off.

APPROVED PRECISION PRODUCTS

P. R. MALLORY & CO. Inc., INDIANAPOLIS 6, INDIANA

The world's most desirable oscilloscope for TV service.



JACKSON

MODEL CRO-2

Proved by the hundreds in use by TV manufacturers' and dealers' technicians

Judging by ratio of sales to market potential, this laboratory grade 5" oscilloscope is preferred by the great majority of television and electronic technicians. The specifications explain why such is the case.

Specifications

Vertical Amplifier—Push-pull amplifiers provide flat response within 1.5 db from 20 cycles thru 4.5 Mc.

Sensitivity Ranges—The sensitivity ranges are .018, .18, 1.8, .25, 2.5, 25 RMS volts-per-inch.

Horizontal Amplifier—Push-pull with sensitivity of .55 RMS volts-per-inch.

Input Impedances—Vertical 1.5 megohms shunted by 20 mmfd. Direct to plates, balanced 6 megohms shunted by 11 mmfd. Horizontal: 1.1 megohms.

Linear Sweep Oscillator—Saw tooth wave 20 cycles to 50 Kc in 5 steps. 60 cycle sine wave also available as well as provision for using external sweep.

Input Voltage Calibration—Provides a standard voltage against which to measure voltages of signal applied to vertical input

Vertical Polarity Reversal—For reversing polarity of voltage being checked or for choosing either positive or negative sync. voltages.

Return Trace Blanking—Electronic blanking provides clear, sharp trace to prevent confusion in waveform analysis.

Synchronizing Input Control—to choose among INTERNAL, EXTERNAL, 60 CYCLE, or 120 CYCLE positions.

Intensity Modulation—60 cycle internal or external thru front panel binding posts.

Accessory—Model CR-P Probe for demodulating RF and IF voltages.

Prices: Model CRO-2, Users' Net \$197.50
Model CR-P Probe, Users' Net \$9.95

See your electronics distributor for more information, or write

JACKSON ELECTRICAL INSTRUMENT CO. • DAYTON 2, OHIO
"Service Engineered" Test Equipment
IN CANADA: THE CANADIAN MARCONI CO.

builder of the tube is the "manufacturer" unless the rebuilder establishes that by agreement with the customer or dealer, ownership remained in the customer and the customer understood that he, not the rebuilder, is the manufacturer of the rebuilt tube and therefore liable for the tax applicable to the sale or use by manufacturers of tubes.

3. Q. What is the selling price on which tax is based?

A. Where tax applies, the selling price on which the tax is based is the gross price for the rebuilt tube before any allowance or credit which may be given for a used or defective tube which may be turned in. For example, if the price of a rebuilt tube is \$40 without trade-in of an old tube and \$25 if an old tube is traded in, the tax is based on the price of \$40.

Since this is a manufacturers' excise tax, where the rebuilder makes both wholesale and retail sales, the tax on a retail sale may be based upon established wholesale prices in accordance with Reg. 46, Sec. 316.15.

Exposition Progress

The rush for display space in the first International Sight and Sound Exposition and Audio Fair in Chicago, to be held at the Palmer House September 1, 2 and 3, indicates an early sellout.

Among those who contracted for space by first return mail are General Electric; Motorola; Hallicrafters; Jensen Mfg. Co.; Electro-Voice; Revere Camera; Magnecord; British Industries; Voice & Vision; Newcomb Audio; Audak; Permoflux; Ampex; Reeve Soundcraft; Bell Sound; Newark Electric; Allied Radio; Masco; IDEA-Regency; Contemporary American Furniture; High Fidelity Magazine; Down Beat Magazine; University Loudspeakers; Disc Records; Thordarson-Meissner; Boulevard Electronics; Station WFMT; The Radio Craftsmen, Pentron and others now being processed.

Plan For Better Public Relations Outlined

Plans for combating unfair propaganda now directed at the TV-Radio servicemen were suggested by L. B. Calamaras, executive vice president of the National Electronic Distributors Association, while addressing a meeting of independent servicemen in Dallas, Tex., February 23.

Calamaras emphasized that taking the real story to the public is the most effective way of discouraging the unfair propaganda now resulting in the move to license these businessmen,



Mr. Newton Cook

Manager, -Standard Products Section

CHICAGO TRANSFORMER

says: "You can see the difference with the Regency Booster"

Regency

largest selling Booster at any price.

Latest TV Data!

JUST OUT

RIDER'S TV 11

with

**dependable
replacement parts
listings**

**THE standard reference
for TV service technicians**

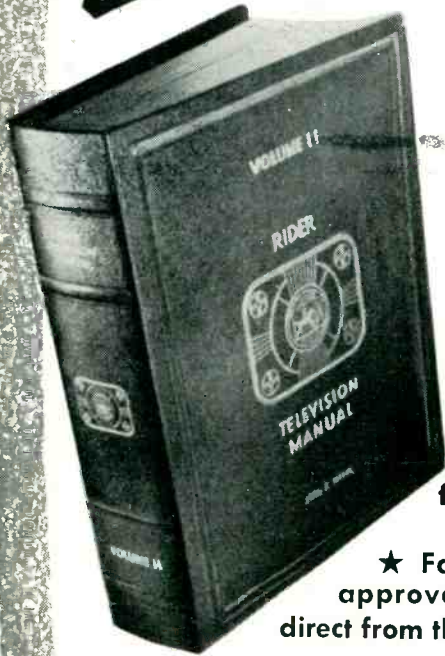

- ★ Factory-authorized! Factory-approved! ★ Servicing data—direct from the manufacturer! ★ Now sectionalized for most up-to-date coverage!
- ★ Schematics . . . waveforms . . . chassis views . . . circuit changes . . . different production runs! ★ Cumulative replacement parts listings include cross-reference by chassis and models! ★ Over 2,500 (8 1/2 x 11") pages in a (12 x 15") durable binder! Only \$24.00!

Order from your jobber today!

TEK-FILE

Packaged TV service information—the same as in the Rider Manuals—tailor-made for easy TV servicing...over 2800 models...new Packs monthly...try a TEK-FILE Pack at \$2.00 each. If you're not completely satisfied, return to us within 7 days and we'll refund your money!



- ★ Dependable replacement parts listings beginning with Pack 57

For easier radio servicing...use Rider's 22 AM-FM Radio Manuals

JOHN F. RIDER PUBLISHER, INC.
480 Canal Street, New York 13, N. Y.

West Coast Office:
4216-20 W. Jefferson Blvd.
Los Angeles, California

Export Agent:
Roburn Agencies, Inc.
39 Warren Street
New York 7, New York

In Canada:
Charles W. Peinton
1926 Gerrard Street, East
Toronto, Ontario

Cable Address:
Roburnage N. Y.

and he outlined a program which included formation of a committee from broadcasting stations, parts distributors, and servicemen to go on the air periodically over a period of months and tell the story of television servicing to the American public. He recommended that this be followed by a careful cooperative effort with the Better Business Bureau and other institutional organizations in the area which would follow up any complaints against servicemen and ascertain the truth or falsity of such complaints. The ultimate objective of the campaign, Calamaras pointed out, is to have the public come to consider the TV serviceman a friend and responsible businessman.

RCA Drive Helps Service Dealer

The Tube Department of RCA Victor has launched a national advertising and sales promotion campaign to enhance the prestige of the local radio-television service dealer and help him create additional sales of RCA electron receiving tubes and television picture tubes.

Directed at the consumer market, the campaign seeks to create a demand for RCA receiving tubes and kinescopes among radio and television set owners, and to identify and publicize the local servicemen who use them, according to H.S. Stamm, advertising manager of the RCA Tube Department. Heart of the program is a personalized identification plaque which spotlights dealers as local headquarters for radio-TV service and users of RCA electron tubes.

Admiral & Du Mont Serializing Sets

Admiral Corporation is taking an important step in its newly declared war against transshipping of television receivers to New York and other markets. The company has started to affix permanent type serial numbers to all television receivers. These numbers appear on small metal plates which are riveted to the set.

Similarly, Allen B. Du Mont Laboratories, Inc., has struck a blow to transshipping practices by stamping serial numbers directly on to its television receiver chassis, Irving Rosenberg director of operations for Du Mont's receiver and cathode-ray tube divisions, disclosed recently.

North Jersey's First UHF Station

North Jersey's first ultra high frequency commercial television station, on Channel 58, will have the call letters "WRTV."

The Atlantic Video Corporation of Asbury Park, announced that the

[Continued on page 14]

**BUILDING BOATS
IN BOTTLES
IS A CINCH...**

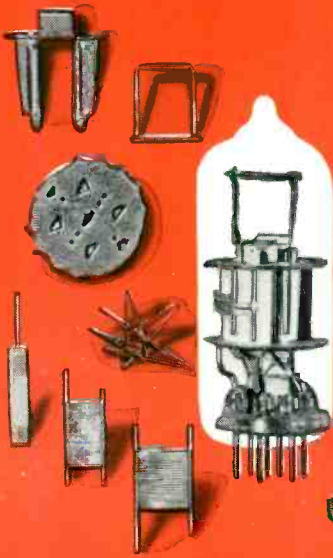

COMPARED TO

**ASSEMBLING
RECEIVING
TUBES**



Assembling the components of Raytheon Electron Tubes is a thousand times more exacting than building boats in bottles, yet Raytheon has hundreds of skilled technicians who (we think) assemble tubes better than anyone else in the world.

They do it better because Raytheon has specialized in the design, development and *manufacture* of highest quality Electron Tubes for *thirty years*. The skill, experience and "know-how" gained through dealing with every phase of quality tube production have been passed on to make these highly trained technicians the best in the business.

This precision assembly is a mighty important reason why Raytheon Radio and Television Tubes are Right for Sound and Sight!



RIGHT... FOR SOUND AND SIGHT

RAYTHEON MANUFACTURING COMPANY

Receiving Tube Division
Newton, Mass., Chicago, Ill., Atlanta, Ga., Los Angeles, Calif.

RAYTHEON MAKES ALL THESE:

RECEIVING AND PICTURE TUBES • RELIABLE SUBMINIATURE AND MINIATURE TUBES • GERMANIUM DIODES AND TRANSISTORS • NUCLEONIC TUBES • MICROWAVE TUBES



Excellence in Electronics

SYNC

by

Yours truly travelled—almost 8,000 miles between January 21st and February 25th, visiting key cities from coast-to-coast. The object to ascertain first-hand how business conditions are where new *uhf* or *vhf* stations have either gone on the air recently, or where such an event is about to transpire.

Without exception, wherever TV has come into being, or where it is about to touch, there is a business boom and all technicians and Service Dealers are breaking records. The greatest complications is the shortage of some item or items. For example, in some cities there is a dearth of TVsets, and in other cities the shortage of antennas is holding up profitable installations that Service Dealers have booked. (Fella, how's your inventory?)

Receiver line franchises are being sought by many well-established service organizations who heretofore did not sell at retail, but who now wish to do so because of TV. The old and recognized top-brand lines of receivers are and have been tied up in most cities where TV is just starting to touch. Naturally these lines are not being made available to service shops that now want to become dealers—and by the same token, smart servicemen are not willing to take on "just any" line of TVsets merely because the franchises are offered. Consequently, a behind-the-scenes warfare exists and potential set buyers are bearing the brunt of the brickbats. For example, only a small number of prospective set buyers are willing to invest in a TVset until after they have asked their serviceman, "What do you think of Such and Such Brand?" Many servicemen have knocked certain Brands because they haven't been able to get a dealership for that brand for themselves and the result is that the potential set buyer often switches to a lesser known or inferior brand. Such captious practice on the part of servicemen is neither good business nor is it justified. But it has resulted in sales swings that TVset manufacturers are having a tough job overcoming. After all, when a person invests several hundreds of dollars in a TVset they are sold for a long period of time, taking them out of the prospect class. Cognizant of the situation, some of the Brand Name set makers are starting to cultivate the good will of technicians, for they have learned that the recommending power of most technicians is such as to be able to make the difference between their getting a sale or having it go to some competitive set manufacturer.

Single TV Transmitter Cities are still the big problem. Take St. Louis, Mo. for example. Now only one *vhf* station is operating. Soon three *uhf* stations are slated to go on the air there, or nearby. There are approximately 450,000 *vhf* sets in use, and when *uhf* hits there will be a demand for converters so great that chaos will reign. Not only will there not be enough converters to go around, but there will also be a shortage of man-power to make the necessary conversions and installations. Look what happened at South Bend, Indiana! Long a fringe TV town to Chicago, with DX reception ranging from poor to bad, South Bend only had about 30,000 TVsets in use on February 1st. Then, on that day the South Bend *uhf* station put out its own regularly scheduled commercial programming the signal was so good, that people flocked to their dealers to buy sets. We're told that upwards of 50,000 TV antennas alone are now on back-order by the jobbers serving the territory, and that close to 80,000 converters have been ordered. And that's only the beginning!

UHF stations open new fringe areas in exactly the same manner that new *vhf* stations do, or that *vhf* stations with increased power does. When WCBS-TV New York upped its power to full rating recently the surge of buyers reached as far as Hartford, Conn. and Albany, N.Y.

Opposition to TV is rife in several parts of the country where there are lobbies or interests who oppose competition for a prospect's time or money. Las Vegas, Nevada, is a

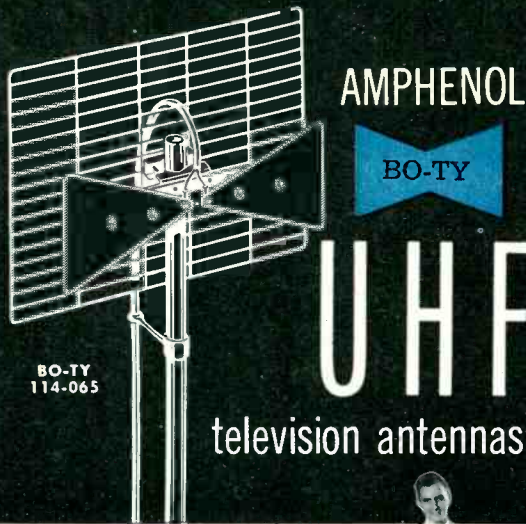

now packaged
preassembled



The AMPHENOL 300 ohm BO-TY Antenna, 114-065, is a UHF antenna and reflector that intercepts any of the UHF channels, 14 through 83. High signal gains of 5 db to 8 db plus excellent front-to-back ratio make the BO-TY Antenna ideal for both strong and weak signal areas. For extremely weak signal areas, two BO-TYs can be easily stacked. One stacking rod is provided with each 114-065 BO-TY making the necessary pair when two are bought for stacking.

All components of the AMPHENOL 114-065 BO-TY Antenna are completely preassembled for quick and easy mounting on the mast. Installation is a simple matter of tightening two wing nuts.

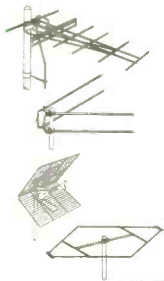

OTHER UHF TYPES AVAILABLE SOON. Designed and field tested by the same engineers who developed the famous INLINE VHF Antennas, the UHF Antennas previewed here will shortly be added to the AMPHENOL line. **YAGI** UHF Antenna for high gain on specific channels. **STACKED-V** combination UHF and VHF Antenna. **CORNER REFLECTOR** all-channel, high gain UHF Antenna. **RHOMBIC** Antenna for high gain, broadband UHF reception.

U.S. Pat. No. 2,543,696

AMPHENOL tubular twin-lead

Moisture, one of the greatest enemies of UHF signal strength, does not materially affect the impedance or electrical efficiency of AMPHENOL Tubular Twin-Lead. As illustrated, the concentrated field of energy is largely contained and protected by the tubular construction. Because flat twin-lead does not afford this protection, it is not recommended for UHF installations.



AMPHENOL

AMERICAN PHENOLIC CORPORATION *chicago 50, illinois*

PULSES

SAN D'ARCY

case in point. The big business in "Lost Wages," Nevada is gambling. Naturally, if TV comes into that town a certain number of people are going to spend some time watching it, and the time thus spent would not be free for the gamblers. Result: Metcalf the distributor in L.V. and Goldie Goldsmith, one of the better service dealers, are busy as all get-out workin' on super-hets and battery portables, but they "don't expect to see no TV thar fer quite a spell." And, in contrast to Las Vegas, which is admittedly just a small town, we have the big city of Kansas City, Mo. almost as badly tied up because of friction and scraps for the assigned frequencies. Imagine, at this late date only one station in K.C.!

Los Angeles has been TV Booming for the past year, and now expects to add further woes because wlf is coming along for early operation. The mountainous terrain there and along the Southern California coast is giving technicians more than their share of trouble. Imagine how the signals bounce! It is commonplace to see high gain antennas, yagis, corner antennas and stacked arrays on roofs of houses situated only 2 miles from, and in direct line of sight with the TV transmitter. Blotting out ghosts, trying to wade past other signals coming from the same direction, and trying to pick up skips or reflected signals is the order of the day in California. But, they have nice weather there!

More standardization—and fewer types—of phonograph pickups and needles are being sought by both Service Dealers and Manufacturers. At present there are scores of types of pickup arms and cartridges, with the result that hundreds of types of needles and playing stylii are required to round out a complete replacement inventory. This seems silly. Today's phonographs and record players work on 78, 45 and 33 1/3 rpm. It would be fitting and proper for the various manufacturers, especially of receivers and record-players, to cut to a minimum the number of types of needles to fit the grooves. A half dozen universal-type and interchangeable cartridges and stylii would be a boon to the service profession for it would enable technicians to carry a small kit to meet all requirements. Imagine how a serviceman feels when he suggests to a customer that he be allowed to repair a defective record-player, and then, finding that a new needle will round out the job, is embarrassed to discover that this particular job needs some weird size and shape needle,—a type that is the exception, and most of them are.

Predictions we made regarding TVset production are being borne out. The RTMA figures on 1952 radio receiver production show that 7,066,794 radios went into the hands of dealers compared to 7,588,810 in the like period of 1951. In contrast, TVset production hit an all time high, and considering government regulations and other restrictions imposed by a shortage of components, would have been much higher than the 6 million mark which was passed. In other words, in 1952, just as many TVsets were made as radio sets for home use, for the 7 million plus figure used by RTMA for radio production includes auto radios, FM tuners, and the like.

Astute service dealers will carefully note the trend of radio receiver sales as a guide towards their future commitments. For example, in 1952 not a single state in the U.S. bought a million radios, with New York being on top, with 827,256, Pennsylvania second with 524,971 and California third with 506,562. These figures contrast greatly with pre-war figures when New York alone would require upwards of 2 million new radios, even during a mild depression year like 1947, right after the end of War II. The big trend now in old, established TV sections is for customers to hold on to their obsolete 7", 10", 12" and 14" TVset, using it as a second or third set-in-the-home, while buying a modern 21" or 24" model for general use.

AMPHENOL

—INLINE—

VHF

television antennas



INLINE
114-302
STACKED

proven 10 ways better . . .

- 1 Wide, single forward lobe.
- 2 High front-to-back and front-to-side ratios.
- 3 No lobes off the sides—negligible ones off the back.
- 4 Uniformity of lobes at all frequencies.
- 5 High, uniform gain.
- 6 300 ohm impedance.
- 7 All-aluminum antenna construction.
- 8 3/4" Thinwall galvanized steel conduit mast.
- 9 Quick-Up assembly takes three minutes to erect.
- 10 Conveniently packaged with everything needed for the installation—antenna, mast, insulators, guy ring, mounting bracket and Twin-Lead (two bays and connecting rods included with stacked arrays).

*Reissue Pat. No. 23,273

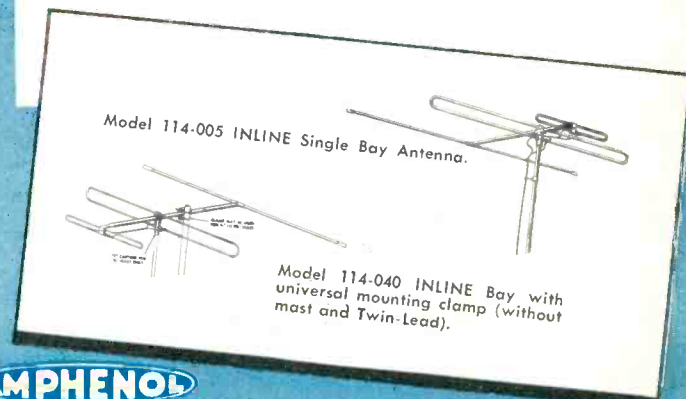

AMPHENOL

AMERICAN PHENOLIC CORPORATION *chicago 50, illinois*

for extreme
accuracy
and
stability...

AEROVOX
Carbofilm
RESISTORS

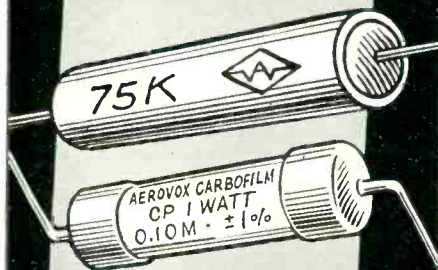

Made under Western Electric license agreement, these carbon-deposit resistors serve a real need in test equipment and laboratory-grade instruments. Packed and sealed in plastic tubes to insure quality-control accuracy. 1/2, 1 and 2 watts.

Also available in metal-cased hermetically-sealed construction for superlative stability under the most adverse climatic conditions. 1/2, 1 and 2 watts.

Aerovox also offers popular resistor types such as insulated-molded carbons and wire-wounds.

Ask your Aerovox distributor for Carbofilm precision resistors, as well as popular insulated-molded carbons and wire-wounds. Stocked for your convenience!



FOR RADIO-ELECTRONIC &
INDUSTRIAL APPLICATIONS
AEROVOX CORPORATION
NEW BEDFORD, MASS., U.S.A.

In Canada: AEROVOX CANADA LTD., Hamilton, Ont.
Export: 41 E. 42nd St., New York 17, N. Y.

TRADE FLASHES

[from page 10]

Federal Communications Commission Washington, D.C., had approved "WRTV" for the station, which will be known as the "Walter Reade Theatre of the Air."

GE Tube Dep't Plans

L. A. Warehouse

General Electric's Tube Department today announced plans for a new electronic tube warehouse in Los Angeles to meet what was termed "a major expansion of the far west electronics market."

The 25,000-square-foot building will be built at 11840 West Olympic Boulevard by motion picture actor James Stewart. It will be built to G-E specifications and occupied by G.E. under long-term lease.

The new plant will house tube sales office headquarters for far western states, and an extensive commercial engineering laboratory and commercial service offices, in addition to warehouse facilities.

Westinghouse Plans To Purchase WPTZ

E. V. Huggins, President, Westinghouse Radio Stations, Inc., and James H. Carmine, Executive Vice-President, Philco Corporation, announced jointly that Westinghouse had arranged to purchase television station WPTZ, Philadelphia, from Philco. It was stated that approval of the Federal Communications Commission would be sought immediately.

Sidney Gernsback Passes Away

Sidney Gernsback, former vice president of Gernsback Publications, Inc., New York City, died at the Alexian Brothers Hospital on February 18th after a short illness. He was 77 years old.

Mr. Gernsback is survived by his younger brother, Hugo Gernsback, and his two adopted children, George Gernsback and Marguerite Fleggenheimer, all of New York City.

Hytron Plans New Plant

Plans for the construction of an ultramodern television picture-tube plant and warehouse in Kalamazoo, Michigan, were announced by Bruce T. Coffin, president of Hytron Radio & Electronics Co. The new manufacturing facilities form part of the company's expansion plans to answer the growing demands of the television industry.

The city of Kalamazoo was selected as the site for the new plant, because of its strategic location in the heart



L. Veltri, busy service-dealer of Westchester, N. Y., reports:

I SAVED \$940*
by making a \$59 INVESTMENT
in a Transvision
FIELD STRENGTH METER

* Says Mr. Veltri: "... The way I figure, in the last 6 months I saved that much money in installation time alone ..."



FIELD STRENGTH METER
Saves 50% of Installation Cost
Pays for itself on 3 or 4 jobs

NO TV SET NEEDED

Works from antenna . . .

Measures actual picture signal strength directly from antenna. Shows antenna orientation maxima. Compares gain of antenna systems. Measures TVI on all channels. Checks receiver re-radiation (local oscillator). Permits one man antenna installation.

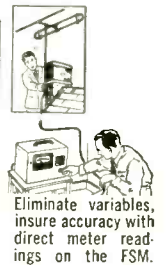

Eliminate variables, insure accuracy with direct meter readings on the FSM.

PREVENT WASTE OF SERVICING TIME! By checking antenna performance with the *Field Strength Meter*, the serviceman can determine whether the TV set or antenna, or both, are the source of trouble. Call backs are eliminated.



Don't lug sets. The Transvision FSM makes installation easy.

Wide range: Measures field strength from 10-50,000 microvolts. Has *Fringe Area Switch* for weak signal areas. 13 channel selector. Individually calibrated on every channel.

ADAPTABLE for HFM

Model FSM-2, for 110V AC only. Complete with tubes. Wt. 13 lbs. net \$59.

Model FSM-3B, for 110V AC and Battery Operation (all batteries and cables included). Wt. 22 lbs. net \$79.

Order direct from factory:

TRANSVISION INC., NEW ROCHELLE, N. Y.

FREE: Sample copy of "TV and Electronics Notes". Or send 50¢ for year's subscription.



10 DAY TRIAL

Buy and try this fine instrument for 10 DAYS. Then, if you wish, you may return it. Your purchase price less 10% (our cost of handling and re-packaging) will be promptly refunded.

TRANSVISION, INC.
NEW ROCHELLE, N. Y.

DEPT. SD-4

() Send me _____ Model FSM-2; _____ FSM-3B

() Enclosed find \$ _____ deposit. Balance C.O.D.

() Enclosed find \$ _____ in full.

I accept your 10 Day Trial terms.

Name _____

Address _____

City _____ State _____

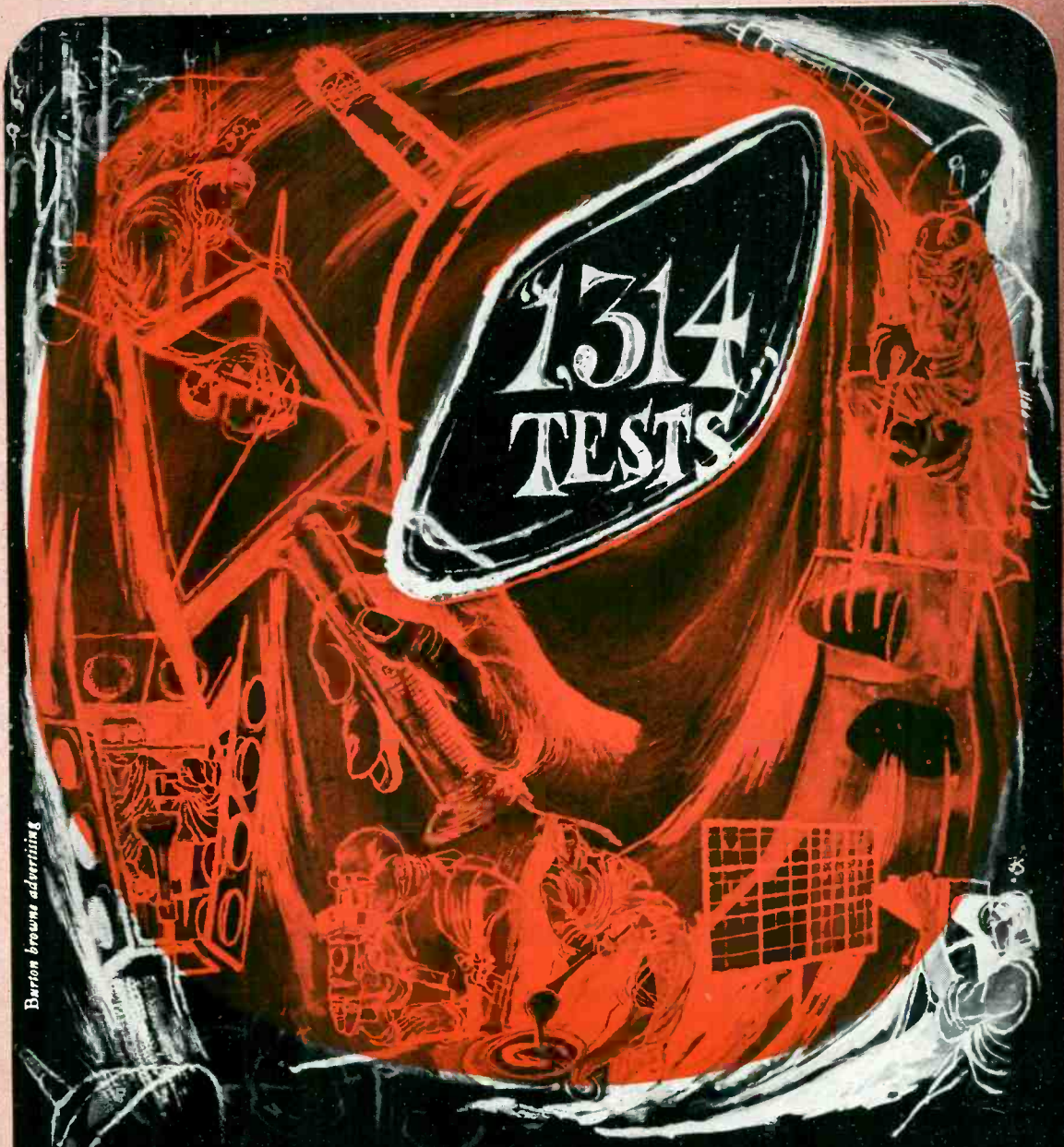

Burton Brown Advertising

Quality-checks are a full-time job with Rauland—all the way down the line. From spectographic analysis of tube components to ionization test for vacuum—1,314 tests are your assurance that Rauland meets the highest engineering standards. Test-proved in our factories and laboratories, performance-proved in countless homes...it's plain to see why Rauland is the *proved* profit-getter, too. *The Rauland Corporation, 4245 N. Knox Avenue, Chicago 41, Illinois—Mulkerry 5-5000.*

ZENITH Subsidiary

RAULAND

PERFECTION THROUGH RESEARCH

ATR

Makes it easy to
DEMONSTRATE and TEST
D.C. apparatus from A. C. lines
with "A" BATTERY
ELIMINATORS



for
**Demonstrating
and Testing
Auto
Radios**

6 volt
or 12 volt

See your jobber
or write factory

New Models . . . Designed for testing
D.C. Electrical Apparatus on Regular A.C. Lines.
Equipped with Full-Wave Dry Disc Type Rectifier,
Assuring Noise-less, Interference-Free Oper-
ation and Extreme Long Life and Reliability.

- ✓ NEW MODELS
 - ✓ NEW DESIGNS
 - ✓ NEW LITERATURE
- "A" Battery Eliminators, DC-AC
Inverters, Auto Radio Vibrators

ATR

AMERICAN TELEVISION & RADIO Co.

Quality Products Since 1931

SAINT PAUL 1, MINNESOTA—U. S. A.

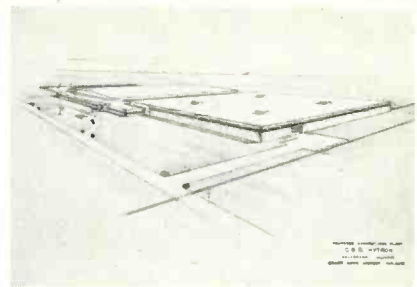

New Hytron Plant

of the television manufacturing industry of the Middle West, and because of the speed and economy in transportation of raw materials and finished products that this location makes possible.

Standard Coil UHF Strips Being Shipped

Standard Coil Products Co., Inc. has begun shipping *uhf* strips covering a number of television channels now operating or soon to go on the air, Oden F. Jester, Standard Coil's distributor sales manager, announced. Shipments are now being made of strips for channels 25, 27, 28, 34, 43, 46, 48 and 61, and strips for other channels will follow as rapidly as possible, he said.

In a letter to distributors of the Standard tuner, he said, "It's difficult to predict how big this UHF strip market is going to be, but a great percentage of the 8,000,000 owners of Standard tuners will want to convert to UHF reception in some manner at some time."

UCP Celebrates Birthday

At the birthday cake celebration in honor of the third year of the *Pricing Service*—which provides up-to-date resale prices for distributors of Radio-TV-Electronic Parts and Equipment—Sam Roth, President of United Catalog Publishers, 110 Lafayette Street, New York, announced plans to further increase the speed and efficiency of this service. Specially designed collating machinery is now being installed in new and larger quarters.

TV Passes Phones & Bathtubs In Chicago

The Chicago area now has more television sets in use than home telephones or bathtubs. W. C. Johnson, vice president-sales of Admiral Corporation disclosed the latest TV census showed 1,360,000 receivers in use in the Chicago viewing area.

Sylvania Plans New Lab.

The Radio Tube Division of Sylvania Electric Products Inc. today announced plans to construct a 120,-

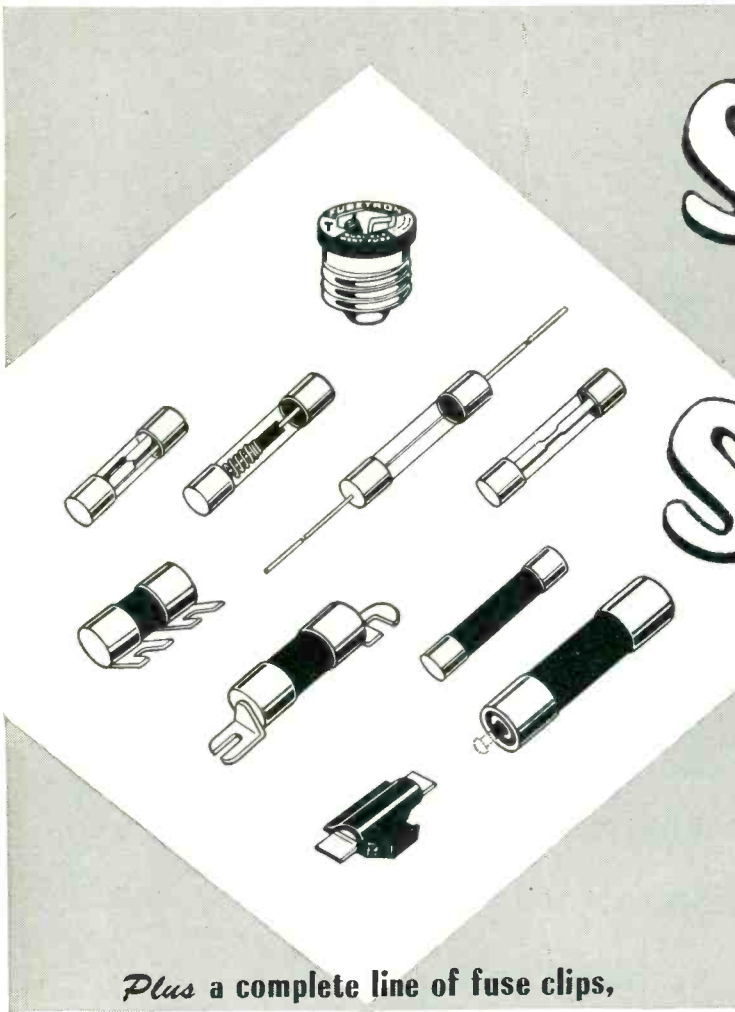

Plus a complete line of fuse clips,
blocks and fuse holders

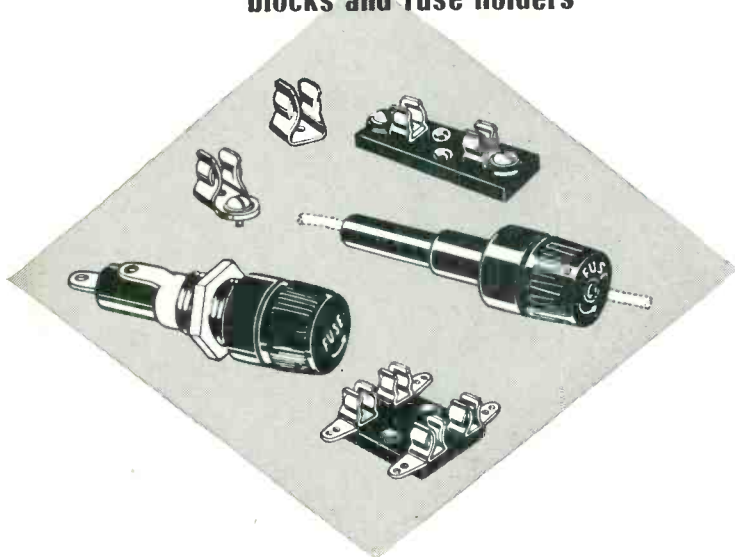

GIVE YOUR CUSTOMERS high quality fuses to match high quality workmanship. Install BUSS Fuses . . . famous for dependable protection in homes, on farms and in industry for 39 years.

BUSSMANN Mfg. CO., Division of McGraw Electric Co.
University at Jefferson, St. Louis 7, Missouri

RADIO-TELEVISION SERVICE DEALER • APRIL, 1953

Simplify

Your Search for the
Right Protection

Standardize

on BUSS Fuses . .

the complete line for
Television • Radio • Radar
Instruments • Controls
and Avionics

Whatever your protection requirements, you'll find the right fuse faster when you look first to BUSS. All types and sizes, from 1/500 ampere up, are included in the complete BUSS line. This can simplify your purchasing and stock handling.

To assure protection to both the product and your good name, every BUSS fuse is tested on a sensitive, electronic device for correct construction, calibration and physical dimensions.



BUSSMANN Mfg. Co. (Division of McGraw Electric Co.) ED-454
University at Jefferson, St. Louis 7, Mo.

Please send me bulletin SFB containing facts on
BUSS small dimension fuses and fuse holders.

Name _____

Title _____

Company _____

Address _____

City & Zone _____ State _____ 453

000-square-foot facility in Williamsport, Pa., to house a group of divisional engineering laboratories.

Matthew J. Burns, general manager of the Radio Tube Division, said the research and development work of the new laboratories will augment that now being carried on in divisional engineering laboratories in Emporium, Pa., headquarters of the Radio Tube Division.

RCA Offer Sales Incentives

A six-month sales incentive program which will enable service dealers to earn valuable premiums with

their purchases of RCA service parts, electronic components, speakers, lightning arresters, and accessories was announced by the Tube Department of RCA Victor.

Under the program, purchasers of RCA stock-numbered or type-numbered parts, components, and accessories will receive from their distributors an RCA premium coupon for each dollar of purchase. A special catalog illustrating the premiums and listing their coupon values will be available from RCA parts distributors.

[Continued on page 74]



**NOW ..Wire Lead Micacs
with 500 times better
moisture resistance
than ever before!**

Sangamo HUMIDITITE* Mica Capacitors

When you use Sangamo HUMIDITITE molded Mica Capacitors, you gain all the advantages of an amazing moisture seal that offers previously unheard-of moisture resistance characteristics for compression molded plastic-encased mica capacitor components.

***what is HUMIDITITE?**

Humiditite is a remarkable new plastic molding compound, developed by Sangamo, that

gives Sangamo Mica Capacitors moisture resistance properties far superior to any others on the market.

HERE'S THE PROOF . . . The standard moisture resistance test described in MIL-C-5A (proposed) Specification requires mica capacitors to offer at least 100 megohms of insulation resistance after ten 24 hour cycles in a humidity chamber at 90% to 95% relative humidity. The best competitive micacs barely meet this requirement . . . but Sangamo HUMIDITITE Micacs, under the same conditions, all tested in excess of 50,000 megohms! Continued tests, over and above requirements, with the same HUMIDITITE Micacs, proved them capable of withstanding from 21 to 52 cycles (from the smallest sizes to the largest) before failure.

Humiditite is just another example of the advanced engineering that enables Sangamo to meet the existing and future needs of the electronic industry. For additional information about HUMIDITITE, write for Engineering Bulletin No. TS-111.

Those who know...  choose Sangamo

**SANGAMO
ELECTRIC COMPANY**
MARION, ILLINOIS



The RCA Tube Department has just brought out a revised edition of the quick-reference booklet "RCA Receiving Tubes for AM, FM, and Television Broadcast"—popular for so many years with servicemen, technicians, engineers, students, amateurs, and others technically interested in receiving tubes.

This new, 24-page booklet covers more than 495 RCA receiving tubes including 45 picture tubes. It provides quick and easy reference to the characteristics and socket connections for each tube type, as well as a classification chart which facilitates the selection of the proper tube type for a desired purpose.

The new RCA Receiving Tubes Booklet (Form 1275-F) can be obtained from RCA Tube Distributors, or by sending 15 cents to Commercial Engineering, RCA Tube Department, Harrison, N. J.

* * *

CBS-Hytron Reference Guide for Miniature Electron Tubes is both original and unique. First of the miniature guides, it attempts to list all miniatures to date, regardless of make.

Pertinent characteristics data are given for 250 miniatures, 87 of them new since the fifth edition. The guide also includes 111 basing diagrams and indicates similar larger prototypes. Data is as complete as possible and include numerous operating conditions for individual tube types. The electronic technician and serviceman will find the basing diagrams particularly helpful.

* * *

The facts of television service life will be called to the attention of the television-owning public through a new booklet prepared by General Electric's Tube Department.

The pocket-sized eight-page booklet, measuring only four by five inches, discusses in simple, non-technical

SC53-5A



THE BIGGEST THING
IN **UHF**
ALLIANCE TENNA-ROTOR



Alliance Tenna-Rotor opens up the UHF television market. Meet the coming changes in TV with this top TV accessory. UHF is critical—more directional! For good reception from many stations—many channels, Tenna-Rotor, properly installed with a directional all-channel antenna is the **answer!**

The Buying Impulse is there—why not Tap it?

Alliance TV spots Convince, Demonstrate and pre-sell! Newspaper ads fit each market! Alliance TV products are sold the most because they're seen the most!

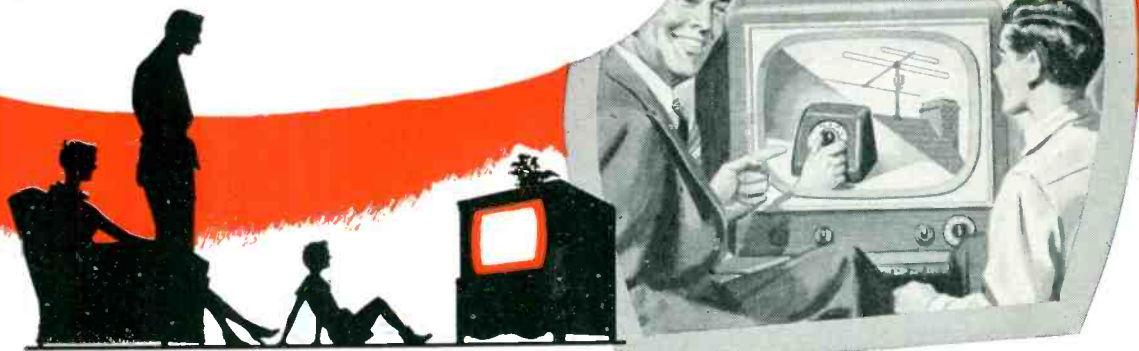

Important Notice: Changes in television demand changes in antennas. New UHF and VHF stations mean more channels! Current FCC rulings changing channels on nearly 1/3 of existing VHF stations—make many 'stay-put' single channel antennas obsolete! Turning your antenna with Tenna-Rotor eliminates alterations—assures universal, high-gain reception from many stations!

Place your orders now for the NEW Alliance Cascamatic Booster with the Famous "California Circuit!"

This Fully Automatic, 3-tube TV Booster pre-tuned to all VHF channels mounts instantly on back of set—another companion item to Alliance Tenna-Rotor and Tenna-Scope, the selective, single-control Booster.

Sold by Television Dealers Everywhere

ALLIANCE MANUFACTURING COMPANY • ALLIANCE, OHIO

language the complexity of the television receiver, the implosion and high-voltage dangers involved when unskilled persons tamper with a set, and reasons for calling a skilled service technician when repairs are necessary. One page is devoted to hints to the set owner on the care of his set.

The booklets are suitable for distribution by the service dealer to the set owner at the shop or on home service calls and may also be used as direct mail pieces. Space for imprinting the service dealer's name and address has been reserved on the back cover. Copies of the *booklet* (ETR-

641) are available free of charge through General Electric tube distributors.

* * *

Ultra-high frequency converters—how they are designed and how they work is the subject of a new book, *UHF Converters*, (UC-1), published by Howard W. Sams & Co., radio and television service data publishers, of Indianapolis.

The book, publication data of which is April 1st, gives a detailed description of the design and operation of the new *uhf* converters and tuners; describes all the popular con-

verter designs and how they work with present *uhf* sets. List price is \$1.00 a copy.

Forty-four pages, 8½ by 11 in., the book covers twenty-one converters of the following makes: Arvin; Crosley; DuMont; General Electric; Mallory; Motorola; RCA; Raytheon; Regency; Sarkes-Tarzian; Standard Coil; Stromberg; Sutco and Sylvania.

Described as a must for a thorough understanding of *uhf* converters, the book gives the "know-how" on all popular converters on the market.

* * *

The *2nd Edition* of the *Clarostat TV Control Replacement Manual* just issued simplifies and expedites television control replacement. With over 262 pages of factual control replacement information, this book lists replacement controls by set model and chassis designation, set manufacturer's part number, Clarostat catalog number, function and description. Several cross indexes serve as additional checks in determining the right replacement. The "Frequency of controls used by models and chassis" can guide the distributor and serviceman in stocking the most likely replacements for any given locality or trade.

The Manual sells for \$1.00 list either from the distributor or from Clarostat Mfg., Co., Inc., Dover, N.H. Supplementary Sheets appear regularly in leading service papers or can be obtained from company or distributor, in keeping a Manual up to date.

* * *

Rider Television Manual Volume 11, the latest edition in the series of factory-authorized television servicing information, will be available at the distributors of John F. Rider Publisher, Inc., 480 Canal St., New York 13, N. Y., in April.

Over 55 manufacturers' products are made available in four separate sections. This sectionalization permits the organization to publish information practically up to the time the volume is released. It makes for a thoroughly up-to-date publication.

The fifth section of the volume continues the feature started with Rider's TV 10—dependable replacement parts listings. The replacement parts listed conform with the physical and electrical requirements of the original parts used in the receiver. Eleven prominent parts manufacturers' replacements are given. The listings are cumulative for Rider's TV 10 and TV 11. They also include cross references to receiver chassis and model numbers. A

[Continued on page 70]

Silverline

all channel UHF converter

- Receive ALL STATIONS in your community.
- Built-in low noise I.F. amplifier.
- Low loss, double tuned Pre-selector reduces interference.
- Self-contained—own power supply and built-in antenna.
- Simple to install: plug SILVERLINE into wall, then TV set into SILVERLINE.

For the finest-UHF converter—SILVERLINE!



Features straight-line frequency dial calibration... completely eliminates channel "bunching"

General Instrument & Appliance
CORPORATION

Subsidiary of GENERAL INSTRUMENT CORPORATION 829 Newark Avenue Elizabeth 3, N. J.

Be Sure of Your Installations . . . Use

Aptitude-Tested

MULTIPLE CONDUCTOR

CABLE

⊗ You know what you are doing when you use Belden Multiple Conductor Cables — they're aptitude rated. They are designed to provide desirable electrical characteristics, and rigid control assures constant quality.

Specify Belden Radio Wires.

Belden Manufacturing Co., 4639 W. Van Buren St., Chicago 44, Ill.

To You, Belden's Golden

Anniversary Means

—product performance that can come only from a "know-how" that has grown through actual service since the inception of Radio.

—an ability to co-operate in pioneering new wires to meet or anticipate industry's growing needs.

In the years that follow

This Belden Program Is—

— TO BE CONTINUED

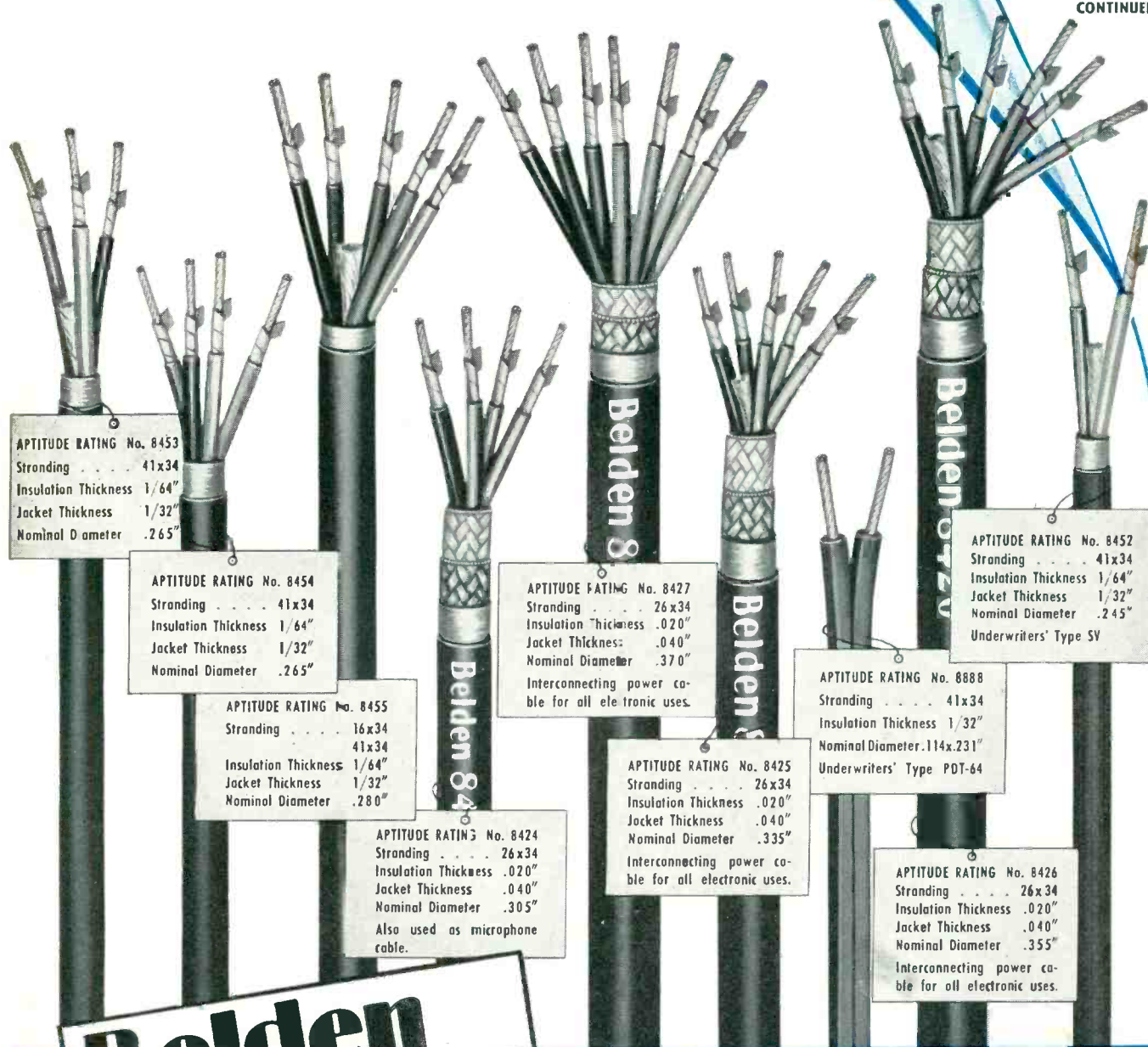
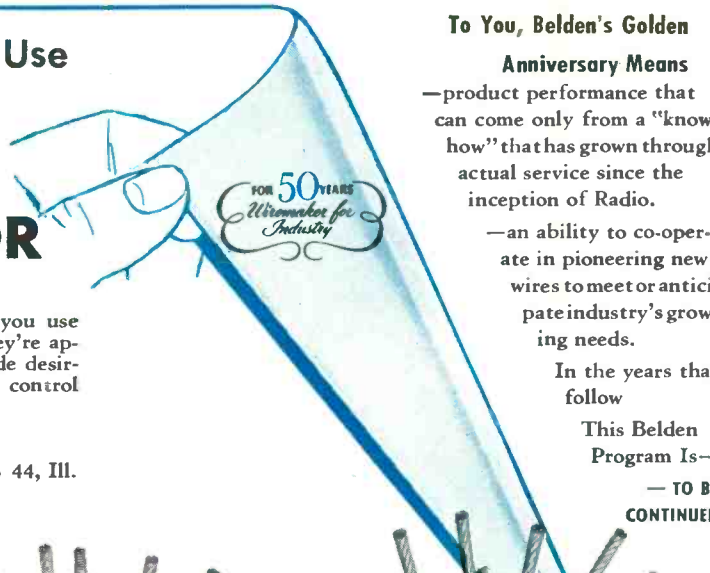

APTITUDE RATING No. 8453
Stranding 41x34
Insulation Thickness 1/64"
Jacket Thickness 1/32"
Nominal Diameter .265"

APTITUDE RATING No. 8454
Stranding 41x34
Insulation Thickness 1/64"
Jacket Thickness 1/32"
Nominal Diameter .265"

APTITUDE RATING No. 8455
Stranding 16x34
 41x34
Insulation Thickness 1/64"
Jacket Thickness 1/32"
Nominal Diameter .280"

APTITUDE RATING No. 8424
Stranding 26x34
Insulation Thickness .020"
Jacket Thickness .040"
Nominal Diameter .305"
Also used as microphone cable.

APTITUDE RATING No. 8427
Stranding 26x34
Insulation Thickness .020"
Jacket Thickness .040"
Nominal Diameter .370"
Interconnecting power cable for all electronic uses.

APTITUDE RATING No. 8425
Stranding 26x34
Insulation Thickness .020"
Jacket Thickness .040"
Nominal Diameter .335"
Interconnecting power cable for all electronic uses.

APTITUDE RATING No. 8888
Stranding 41x34
Insulation Thickness 1/32"
Nominal Diameter .114x.231"
Underwriters' Type PDT-64

APTITUDE RATING No. 8452
Stranding 41x34
Insulation Thickness 1/64"
Jacket Thickness 1/32"
Nominal Diameter .245"
Underwriters' Type SV

APTITUDE RATING No. 8426
Stranding 26x34
Insulation Thickness .020"
Jacket Thickness .040"
Nominal Diameter .355"
Interconnecting power cable for all electronic uses.

Belden
Radio WIRE

The *Aptitude-Tested* **LINE**

Snyder
PHILADELPHIA

**UHF
BROADBAND
YAGI**

**PINPOINT
TO
PROFIT**



PACKAGE TO POLE! READY FOR INSTALLATION

Exclusively Yours



**Model A - CHANNELS 14 to 48
Model B - CHANNELS 27 to 62
Model C - CHANNELS 47 to 83**

SNYDER MFG. CO.

ANTENNA - ENGINEERS[®]

PHILADELPHIA

WORLD EXPORT: ROBURN AGENCIES, INC., 39 WARREN ST., N.Y. 7, N.Y.
CANADIAN DISTRIBUTOR: VAN DER HOUT ASSOC., LTD., NEW TORONTO

TV SYMPOSIUM

SERIES—No. 4

This fourth article in the popular symposium series deals with the requirements of the video amplifier of a TV receiver. Modern video techniques are discussed, including the application of a variable video peaking circuits.

VIDEO AMPLIFIER TECHNIQUES

BY EDWARD M. NOLL

THE video amplifier of the modern television receiver has numerous functions. It must not only have a satisfactory frequency and phase response in its own right but is often planned to correct for frequency and phase deficiencies that occur in earlier portions of the receiver. Additional duties of the video system are to increase the level of the video signal after detection and to retain adequate relative levels of amplification of light and dark portions of the screen. Video amplifier must be able to accommodate weak and strong signals without overloading, reduce impulse noises for all signal levels, and retain proper average brightness levels.

The amplitude of the signal at the output of the video detector must be increased in level for satisfactory excitation of the control grid of the picture tube. Large screen picture tubes require a peak signal amplitude in the order of 100 volts to attain full brightness range between brightest bright and darkest dark. Thus, the video amplifier must have a gain of some 35-40 times. A two stage video amplifier is generally required to provide suitable signal strength.



Fig. 1—New video amplifier tube.

New Video Amplifier Tube

A new video amplifier tube of high *gm* and high gain has been developed for video amplifier use. This tube, the

RCA 6CL6, Fig. 1 permits a single stage gain of some 40-45, thus providing enough amplification to employ just a single video amplifier stage in a modern television receiver. A typical video stage using this tube, Fig. 2, has a bandwidth of 4 mc and sufficient gain to amplify a 3 volt signal at video detector to about 130 volts peak for delivery to the picture tube grid. We may expect widespread application of this tube in the future in video systems.

Amplification of Dark and Bright Ranges

In the composite video signal, Fig. 3, the dark portions of the picture approach the blanking level while the bright components are concentrated at the opposite voltage end of the signal. In video amplifier design the white portions of the scene must not be compressed but should be amplified in the same proportion as the dark region. Should compression occur a non-linear amplification of half-tone levels will result. This defect may be further emphasized by the fact that the average televisioner sets his contrast too high.

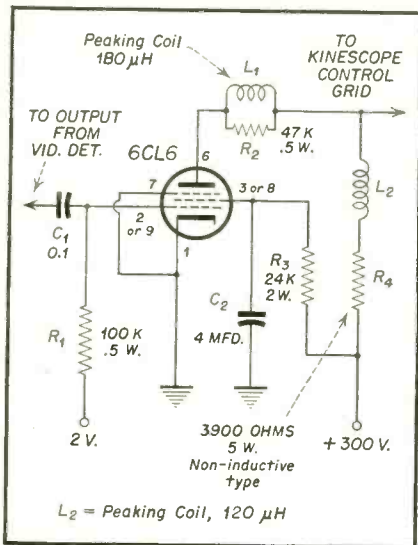

Fig. 2—Typical video stage.

In the design of a video amplifier some of the advantages gained by linear amplification or with even some limited compression of darks are:

1. Half-tone rendition appears more realistic.
2. High brightness gradations are emphasized to compensate to a degree for the fact that the eye is least sensitive to change in white than changes in black.
3. Some emphasis of whites improves apparent picture clarity and crispness because of sharper white gradations. Noise impulses swinging largely toward black are de-emphasized—a boon to fringe area reception.

Generally, white compression is caused by operation on non-linear portions of the video amplifier tube transfer characteristics. This condition is at times difficult to overcome if the amplifier is to give peak results on a weak signal and still not overload or compress on a very strong signal. This will certainly become more and more of a consideration as more stations come on the air and resulting in an availability of both local and fringe signals.

White compression is most often caused by bias shifts that occur with changes in average brightness when the positive sync pulses reach up and draw grid current and charge the grid capacitor negative. This charge often sets the bias too far negative causing picture whites to lie in the compressed area of the tube transfer characteristic Fig. 3. Noise pulses can create the same disturbance, that is by driving the whites into compression and making noise more apparent on the picture because the dark range is emphasized.

A basic approach, Fig. 4, in the prevention of white compression is the use of a single stage video amplifier with proper signal amplitudes. Another approach is the use of proper circuits to minimize bias shifts detrimental to picture fidelity. In a single stage video amplifier, a sync-negative signal can be taken from the video detector and applied to the grid of the video amplifier. In this arrangement the sync is negative-going and cannot draw grid current to upset bias relations. At the same time noise impulses drive the tube beyond cut-off and are clipped. Positive-going signals at the plate of video amplifier requires that the signal be coupled to the cathode of the picture tube for proper picture phase.

In a two stage video amplifier the use of d-c coupling and/or low impedance bleeder bias for grid and screens can minimize the above distortion. Low impedance bias sources either by tube current regulation or by dc voltage changes that are a function of received signal levels can change the video stage operating potentials and transfer characteristic to hold whites on the linear portions of the curve regardless of the signal level and composition. Direct coupling eliminates the long time constants across RC combinations that are charged by noise and sync pulse sweeps, and which drive the tube bias into the grid current range.

Signal Levels and Noise Rejection

The modern television receiver is expected to give peak performance on weak or strong signals. A receiver must be able to handle a strong signal without sync clipping or serious compression of whites or darks; and with good noise rejection. The very same video amplifier must be able to give full amplification to a weak signal and, at the same time, offer thorough

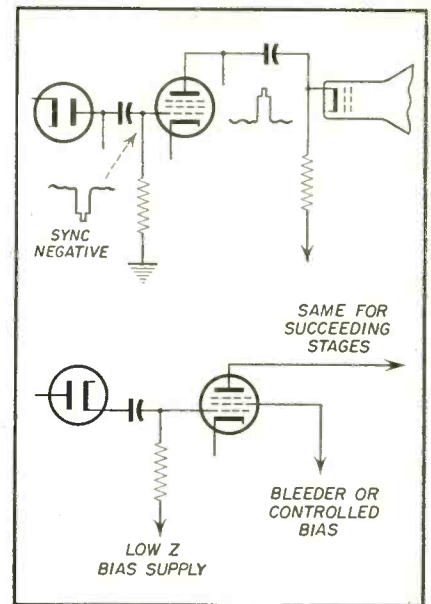

Fig. 4—Circuit used to prevent white compression.

noise rejection to this lower level signal. Fortunately, a good *agc* system in the receiver helps to equalize to a degree the signal levels at the output of video detector.

In the utilization of a strong signal, it must be made to fit the video amplifier tube transfer characteristic so that the sync does not swing far enough negative to clip (Fig. 5) and upset stable synchronization of the signal. At same time it must be brought near enough to cut-off so that noise bursts are clipped off by the cut-off action of the tube. In addition, there must be a minimum of dynamic compressed areas so that true tone gradation of the picture is retained.

When a weak signal is received it must also fit into the dynamic characteristic in much the same manner and with same noise rejection action. Under this condition, however, we have

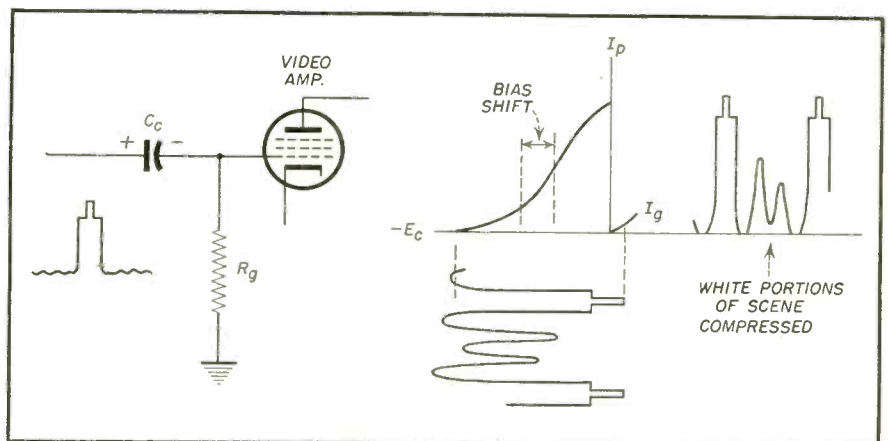

Fig. 3—Composite video signal. Dark portions of signal approach blanking level.

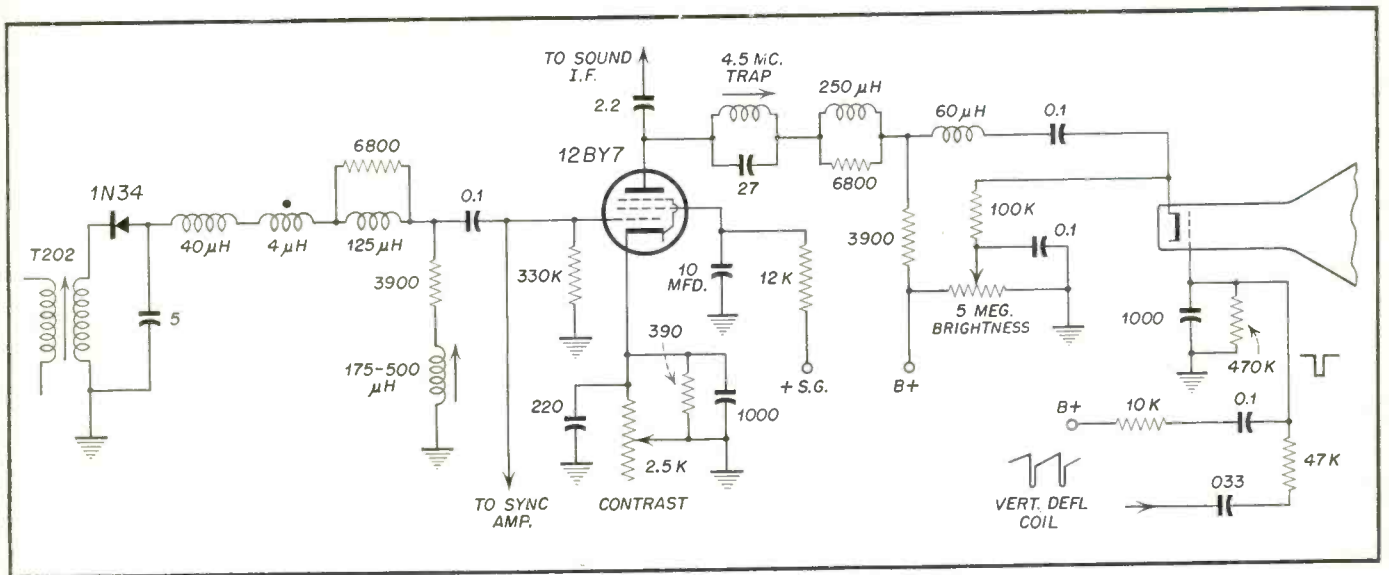

Fig. 6—Circuit diagram of Philco video amplifier with variable series—shunt peaking to compensate for average deficiencies of transmission.

a much weaker signal, and the grid swing required between cut-off and the top of the characteristic curve must be less if noise pulses are to be removed by cut-off action. This means cut-off must occur earlier. If the tube were operated with an early cut-off for strong signal however, the sync would be clipped. Consequently, a means for changing video tube transfer characteristic is expedient for peak performance on weak and strong signals.

One method employed in Fig. 5, is to utilize the *agc* to also regulate one or more video amplifier tube potentials so that the transfer characteristic expands and compresses as a function of the signal level. For example, by changing the plate and/or screen

voltage on a given video amplifier tube, the bias of cut-off can be moved up and down to meet the amplitude needs of the signal to be received.

Video Amplifier Response

There are many points in a television system where the video bandwidth can be impaired so that trends toward a receiver with an adjustable video amplifier response are inevitable. Some of the many factors that influence bandwidth are:

1. Transmitted signal. There are variations from station to station.
2. Conveyance of signal along coaxial or microwave links.
3. Receiving antenna and transmission line response. Antenna orientation.
4. Tuner response and alignment.

5. *IF* amplifier response and alignment. Response restrictions of the inter-carrier system.

Video amplifier response can be altered with adjustable peaking coils or by controlled cathode frequency degeneration. It could be a rear chassis or a customer controlled adjustment so he could set the picture for the very best clarity as a function of screen size and viewing distance.

The Philco video amplifier (Fig. 6) using a high gain 12BY7 is excited by a sync-negative composite video signal from crystal video detector. Consequently, white compression is absent. The positive-going signal at the plate of video stage is applied to the cathode of the picture tube (Fig. 6).

A series-shunt peaking arrangement exists at the output of the video detector with means for controlling the series and shunt elements. This plan permits response correction in the video amplifier to compensate for average deficiencies at some other section of the transmission system.

Contrast is controlled in the cathode circuit of the video amplifier by bias and degeneration control. Effective cathode resistance is variable from near 390 ohms to zero. Resistance increase is fast initially and slows down to permit smooth contrast control for weak or strong signals.

Retrace blanking is applied to the grid of picture tube by shaping a pulse from the sawtooth across the vertical deflection coils. In developing the blanking pulse, the amplitude of the sawtooth is reduced and differentiated to emphasize the sharp retrace portion; at same time the sharp transient spike is suppressed.

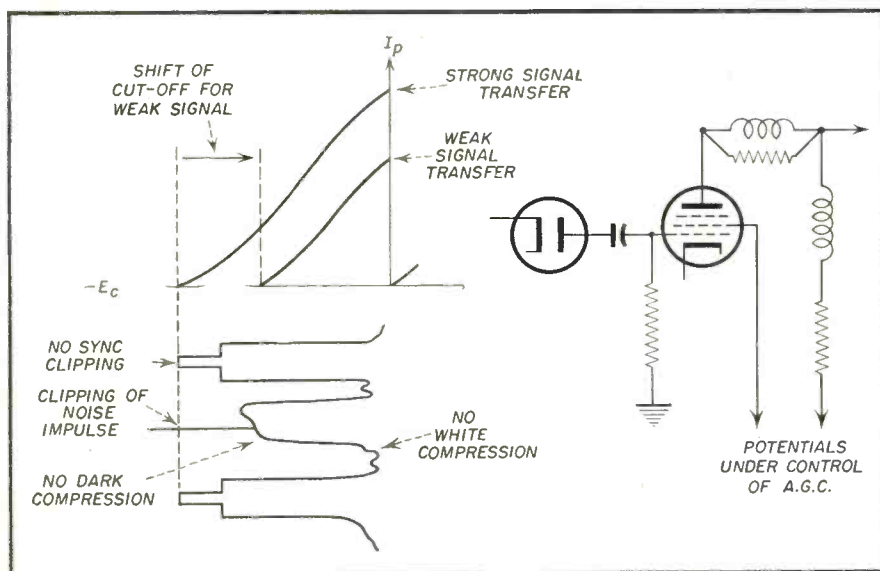

Fig. 5—Utilization of *agc* to regulate tube potentials so that variable transfer characteristic is obtained.

A PRECISION TRANSISTOR OSCILLATOR

The manner in which transistor applications are forging ahead in the electronic world is illustrated by use to which it has been put by the United States Bureau of Standards as a precision oscillator.

AS part of a program devoted to the improvement of measuring and calibrating standards, the National Bureau of Standards has developed a crystal oscillator that is small, portable, dependable, and accurate over long periods of time. The new oscillator unit, developed by Peter G. Sulzer of the NBS staff, utilizes a junction transistor as the source of driving power for a high-stability quartz crystal unit. All components of the circuit, including the power supply, fit into a metal tube less than 2 inches in diameter and about 7 inches long. At an operating frequency of 100 kc, the long-period drift in the first model was about 3 parts in 10^9 per day.

Basic to most work in research, development, and engineering is an accurate reference or standard to which time-intervals and frequencies may be precisely compared. In an attempt to reach a majority of the investigators who need these references, the National Bureau of Standards maintains radio stations WWV (Washington, D. C.) and WWVH (Territory of Hawaii), which transmit standard frequencies (2.5, 5, 10, 15, 20 and 25 mc) and standard time intervals continuously, night and day. The frequencies that are transmitted to 2 parts of 10^8 , and constant to better than 1 part in 10^9 per day.

To obtain the most precise operation of conventional laboratory type frequency standards, the signals from WWV or WWVH are used in the calibration procedure. The greatest continuous accuracy is achieved by

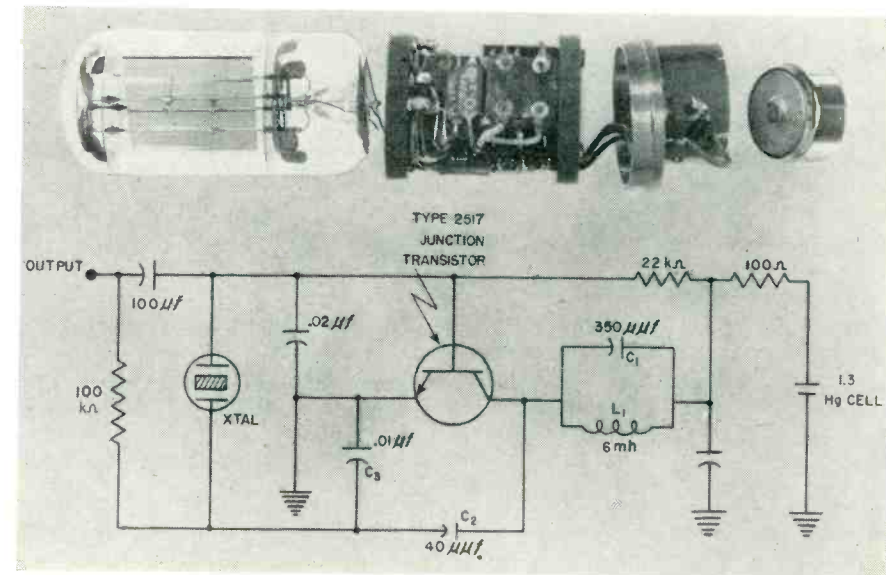
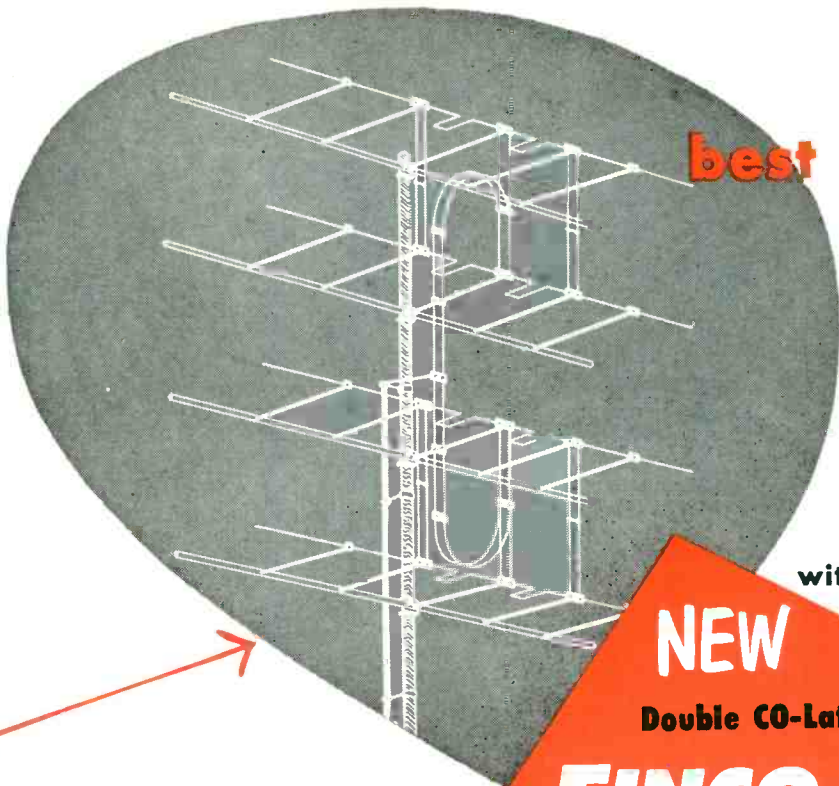

Fig. 1—Exploded view and circuit diagram of the new transistor oscillator developed by the National Bureau of Standards. This new oscillator fits into a metal tube less than 2 inches in diameter and about 7 inches long. A Mercury cell (right), with a life of about 5 years, supplies all the power to the unit—1.35 volts at 100 microamperes. The circuit components, including the transistor, are lumped together in a bakelite form (center), which may be "potted" in a casting resin for greater rigidity. The GT-cut quartz crystal unit is placed in an evacuated envelope (left). The new oscillator has a short-time stability of about 3 parts in 10^{10} and a long-time accuracy (per 24 hour day) of 3 parts in 10^9 . The schematic diagram below the exploded view shows the various resistor, capacitor, and inductive components of the transistor oscillator.

making the calibration at those times when the received standard frequencies are most efficiently propagated by the ionosphere. But laboratory type standards of the highest stability are

expensive to buy and to operate, and their use has been generally limited to the larger laboratories and research centers. In addition, these standards normally involve such auxiliary equip-



best possible

**Fringe area
installation**

with the remarkable

NEW

Double CO-Lateral

FINCO 400-A

**ALL Channel UHF and VHF Antenna
for excellent reception 120 to 150 Miles from stations**

32 Driven Elements

Here is one truly great antenna for the fringe area market — an antenna that can give YOUR installations recognition in the community. The new 400-A was tested all over the country under all types of conditions. Reception was the finest — we can prove this! The traditionally superb Finco engineering is evident in the performance and symmetrical design. One antenna — one transmission line. All-aluminum construction — rugged, lightweight, completely pre-assembled. Total weight only 8 lbs.

Fringe area TV buyers demand Quality installations... FINCO is Quality!

Fringe area buyers more and more ask for the FINCO by name. Let them know you handle the best—advertise the low cost way with Finco co-op ad mats—tie-in with LIFE—watch your sales soar! Get the complete story from your jobber or write direct.

TO PUT THE **FINCO** NAME BEFORE YOUR CUSTOMERS WE ARE ADVERTISING IN . . .

LIFE

RADIO

TELEVISION

LOCAL NEWSPAPERS

FARM MAGAZINES

Tie-In With This Program

The Finney Co.
Dept. S-1
4612 St. Clair Ave.
Cleveland 3, Ohio

RUSH

- Information on the new 400-A and UHF Conversion Kit No. 12
- FREE LIFE merchandising display material.
- Co-op newspaper ad mat brochure.

NAME

COMPANY NAME

ADDRESS

CITY ZONE STATE

**the
FINNEY
COMPANY**

Dept. S-1 • 4612 St. Clair Ave. • Cleveland 3, Ohio

ment as lead-acid batteries, voltage regulators, power supplies, a multiplicity of components, complex temperature controls, and also require large floor space and highly trained operating personnel. The use of transistors in oscillators, counters, amplifiers, etc., shows great promise of making a high precision frequency standard and crystal clock available when needed. With the development of the transistor oscillator, that part of a compact, high-precision crystal clock is now a reality.

The major components of the NBS transistor oscillator are a type 2517 junction transistor, a high-precision 100 kc GT-cut quartz crystal unit,* and a long-life mercury cell. The dry cell supplies power to the whole unit (1.35 volts at 100 microamperes), and has an active life, under these conditions, of five or more years.

Two of the requirements that must be met in developing a high-stability crystal oscillator are constancy of phase shift in the feedback loop associated with the crystal and constancy of the amplitude of oscillation. A constant phase shift is obtained by using large, stable "swamping" capacitors at both crystal connections and by using highly stable components in the remainder of the circuit. Excellent amplitude stability is achieved by operating the transistor in such a manner that collector-voltage limiting is produced.

The transistor is used in the NBS oscillator in the grounded-emitter connection. It produces an output of 0.8 volt across a tuned circuit connected to the collector electrode. The tank circuit, composed of a 350 μmf capacitor and a 6 *mh* coil, is designed to oscillate at 100 *kc* however, the magnitude of the voltage is too high to be applied directly to the crystal unit. Consequently, the voltage is reduced by means of an attenuator, which consists of a 40 μmf and a 0.01 μf capacitor in series from the collector electrode to ground. The driving current (less than 100 microamperes) for the crystal is taken from the junction between these capacitors. The crystal voltage is coupled to the output through a 100 μmf capacitor.

Over half of the space in the 1 $\frac{3}{4}$ -inch diameter by 7-inch metal tube is consumed by the crystal, which is mounted in an evacuated glass envelope. The transistor, coil, capacitors, and resistors are supported in a bakelite frame that may be "potted" in casting resin to add to the rigidity of the section. The mercury cell, only about one-half inch deep, is at the

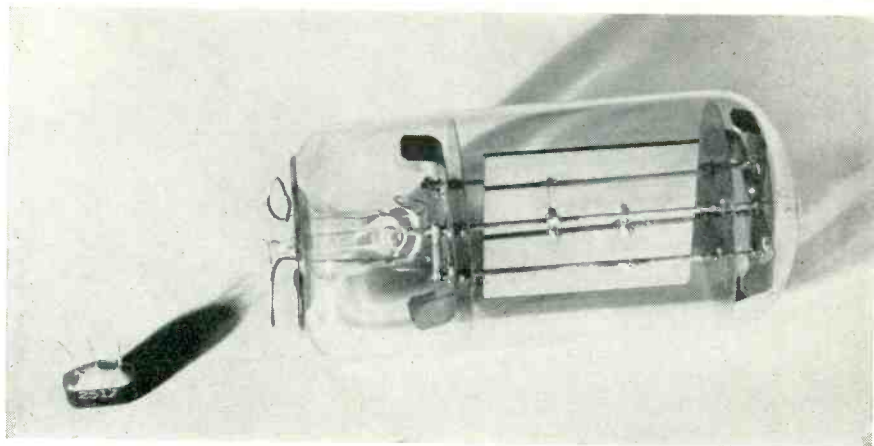

Fig. 2—Basic components of the new transistor oscillator developed by the National Bureau of Standards. The driving power for the unit is obtained from a type 2517 junction transistor (left). This power is applied to a precise GT-cut quartz crystal unit, which is enclosed in an evacuated glass envelope (right). The new oscillator has a short-time stability of about 3 parts in 10^{10} . The complete unit is enclosed in a tube 1 $\frac{3}{4}$ inches in diameter and 7 inches long, which includes the power supply for all the components.

base of the assembly and is insulated from the metal "can" by a bakelite shield.

Determinations of the frequency stability with changes in temperature and supply voltage have indicated that the frequency varies approximately 1 part in 10^8 per degree C, and 1 part in 10^8 per 0.10 volt. The transistor oscillator was also compared with the standard oscillators controlling the transmissions of WWV. Short time variations were about ± 3 parts in 10^{10} and the long interval drift—in days—indicated changes of about 3 parts in 10^9 per 24 hours. These figures are comparable to those obtained from vacuum tube standard oscillators, particularly at the time of their initial installation. Fortunately, frequency drift in the quartz-crystal unit of a conventional type standard oscillator normally decreases with age. It should also be noted that because the NBS transistor oscillator has just recently been developed, no data exist in regard to long-time stability in terms of years.

The compactness of the NBS transistor oscillator lends itself to more convenient and portable temperature control measures. Heretofore standard quartz oscillators or quartz clocks have required relatively complex temperature control apparatus (operating at temperatures up to 60°C) and special high-reliability power sources.

Tests were conducted on the new transistor oscillator with the complete unit operating at 0°C. Reasonable temperature stability was achieved by merely placing the oscillator in a Dewar flask containing crushed clear ice. Among the results was an indication that the reduced temperatures were responsible for reducing drift and increasing the Q of the quartz crystal unit. Thus, it now becomes possible to make available a readily portable continuously-oscillating frequency standard that may be carried to all parts of the world.

* High stability quartz crystal unit for frequency standards, J. P. Griffin, Bell Lab. Record 30, No. 11 (1952).

TECHNICAL ARTICLES WANTED on

TV, AM RADIO, FM RADIO, PHONO MECHANISMS, HI-FI AUDIO, AUTO RADIO, TEST EQUIPMENT, ANTENNAS

pertaining to their

Theory, Installation, Application, Service & Maintenance

submit manuscripts to Managing Editor

RADIO-TELEVISION SERVICE DEALER

67 West 44th Street

New York 36, N. Y.

SUPERIOR PERFORMANCE

OF SYLVANIA PICTURE TUBES

NOW PROVED BEYOND ALL DOUBT

HERE'S THE
FULL REPORT!

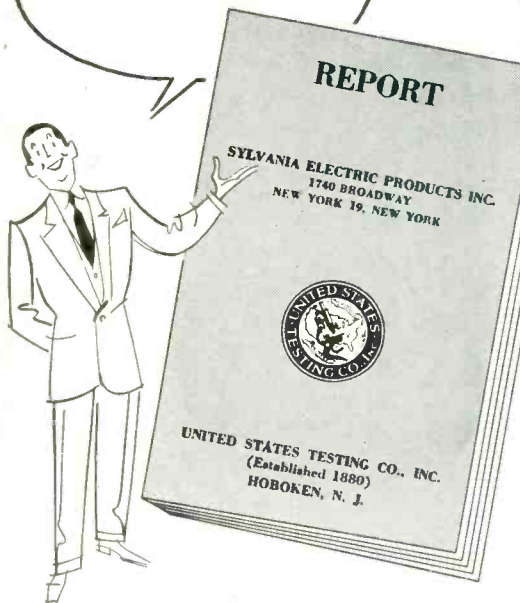

LIFE TEST MAGNETIC TUBES United States Testing Company Hoboken, N. J.			Test No. E-5526 Date 10-11-52 Engineer A.S.M.
Mfr.	Tubes Tested	Tubes Failed	Point Quality
A	8	3	76
B	8	4	79
C	8	6	62
D	8	4	74
E	8	4	67
F	8	5	42
G	8	4	52
H	8	5	30
SYLVANIA	8	0	93

Exhaustive tests by United States Testing Company prove Sylvania Picture Tubes out-last, out-perform all others tested!

• Hour after hour for over 1,400 consecutive hours, Sylvania Picture tubes were tested side by side with tubes of 8 other manufacturers. The chart at right tells the remarkable performance record. Note that only Sylvania Picture tubes showed no failures. Here's the conclusion of the U. S. Testing Company Report: "On the basis of an ultimate Life Test Evaluation of the eight tubes of each brand tested, it can be

concluded that the averaged overall qualities measured on the Sylvania Tubes were superior to the averages of the other brands tested."*

*United States Testing Company, Inc., Test No. E-5526.

We'll be glad to send you full details of this report. Send your request to Sylvania Electric Products Inc., Department 3R-2204 1740 Broadway, New York 19, N. Y.

HERE ARE
THE
CONCLUSIONS!



SYLVANIA



RADIO TUBES; TELEVISION PICTURE TUBES; ELECTRONIC PRODUCTS; ELECTRONIC TEST EQUIPMENT; FLUORESCENT LAMPS, FIXTURES, SIGN TUBING, WIRING DEVICES; LIGHT BULBS; PHOTOLAMPS; TELEVISION SETS.

RADIO-TELEVISION SERVICE DEALER • APRIL, 1953

HORIZONTAL SYNC & SWEEP SERVICING

PART 1

BY LEONARD LIEBERMAN

THE section of the television set which has caused more hair pulling on the part of the practicing serviceman is the horizontal sync and sweep system. From the number of different trouble sources, it is small wonder that on hearing that a set has horizontal trouble, the average serviceman groans. However, with a thorough understanding of the oscillator and sweep circuits plus the correct use of the usual shop equipment, the amount of time lost trying to locate the source of trouble can be reduced considerably.

For the purpose of analysing the horizontal system, this series will be broken into the following main sections:

1. The horizontal oscillator
2. Afc systems
3. The horizontal output section

The block diagram is shown in *Fig. 1*.

In order to get a clear picture of the functioning of the individual sections, it might be in order to review the overall operation of the horizontal system. The FCC standards call for 525 lines per field. Since there are two fields per frame, and 30 frames per second, the product of $525 \times 2 \times 30$ is 15,750 cps.

At the camera, the scene is, therefore, scanned horizontally at a 15.75 kc rate. In order for the receiver to be swept at the same rate and in the same sequence, a horizontal sync pulse is transmitted by the station at the start of each horizontal line. This sync pulse goes through the receiver, is separated from the video in the sync stages and is then fed to the system which originates the receiver horizontal sweep.

The oscillator which starts the horizontal sweep has a free-running fre-

Beginning a series on the horizontal sync and sweep systems used in TV receivers. The treatment is elementary, each circuit being explained clearly, following which the basic servicing knowledges are outlined.

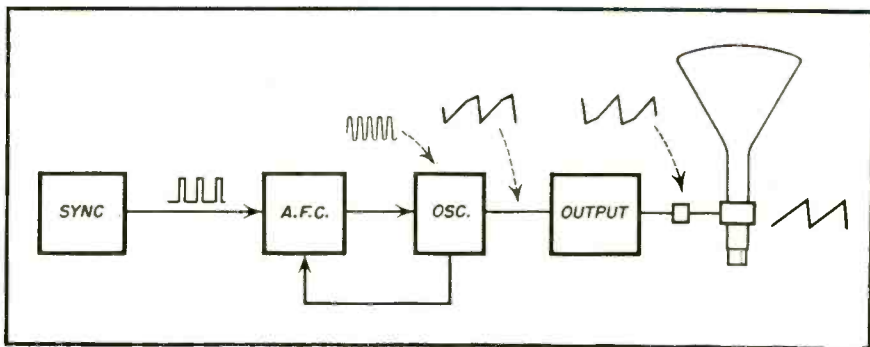

Fig. 1—Block diagram of horizontal sync and sweep TV system, including afc.

quency at or about 15.75 kcs. This frequency is usually adjustable by one or more controls. The sync pulse is used to trigger the oscillator or to time the oscillator so that the receiver horizontal sweep starts at the same time that the transmitter sweep does.

Types of Horizontal Oscillators

There are three popularly used types of horizontal oscillators. Each of the oscillators can be used with any type of automatic frequency control systems. In practice, however, they are each more popularly associated with a particular type of afc. *Fig. 2A* shows the oscillator used in the circuit, popularly known as the "syncro-lock." The entire system is shown in *Fig. 2b*. This oscillator is a simple Hartley oscillator. The energy to keep the oscillator going is developed between the cathode and ground.

Fig. 3a is the oscillator most commonly associated with the afc system known variously as the "syncro-guide," "pulse width," or "pulse phase afc." shown in *Fig. 3b*. *Fig. 4a* is the oscillator most commonly associated with the phase detector afc system (*Fig. 4b*).

The "syncro-lock" oscillator is as mentioned previously a straightforward Hartley type oscillator. The other two oscillators, however, require some more detailed examination. The "syncro-guide" oscillator (*Fig. 3a*) is a combination of the double tuned plate oscillator and the blocking grid oscillator. The plate circuit section "A" to "B" is tuned to 15.75 kcs. The grid section "B" to "C" is tuned by the plate. As the plate current increases, the inductance causes a change in the voltage from "A" to

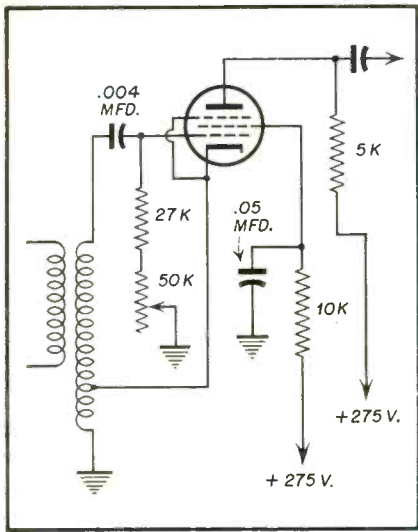

Fig. 2A—Syncro-lock oscillator circuit used in horizontal.

"C", which is a function of the rate of plate current change. This voltage appears at "C" 180° out of phase with the voltage at "A." It can be seen that as the plate current increases, the voltage at "A" decreases. However, due to the phase reversal, this appears at "C" as a voltage increase. This drives the grid more positive. The result is an increase in plate current, a decrease in plate voltage at "A" and an additional positive voltage at "C." This action rapidly drives the tube to plate saturation. When plate saturation occurs, there is no further increase in plate current. Due to the reduction in the rate of current increase, the coil from "B" rapidly reverses polarity and the grid starts in a negative direction (negative in the sense that it starts getting less positive). When this occurs, the plate current starts decreasing. With the decrease in plate current, the plate vol-

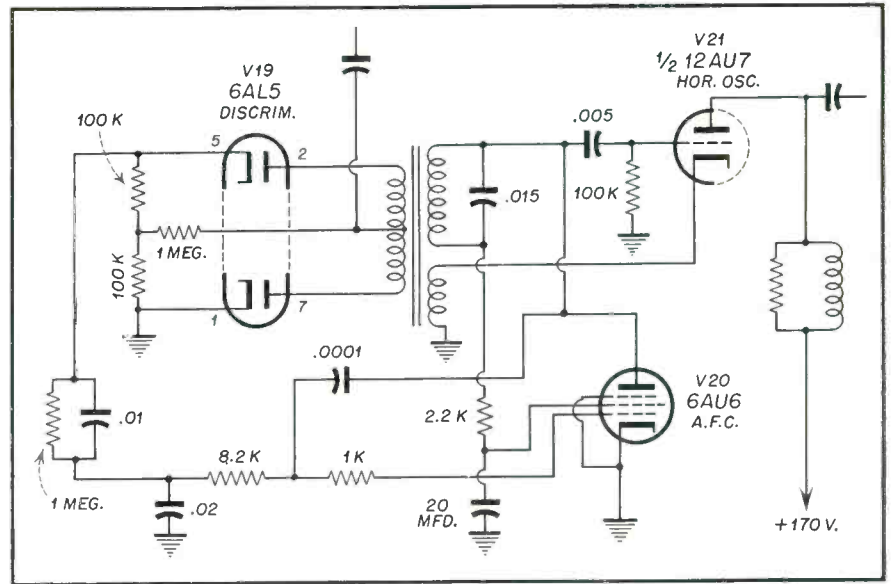

Fig. 2B—Complete syncro-lock system with afc.

tage starts getting more positive, the grid goes still more negative. This continues until the grid is driven beyond cut-off. The RC time of C_1 , R_1 , and R_2 determines when the tube comes out of cut-off into conduction again.

The tuned circuit at "B" and "D" is called the stabilizing winding. This winding is an LCR tuned network tuned to 15.75 kcs. Since it is not dependent on tube characteristics, it can be shock excited into oscillation by sudden pulses. If it were shocked by only a single pulse the result would be a damped out wave train as shown in Fig. 5. However, the pulses shock exciting it occur at the resonant frequency of 15.75 kcs. The result is a sine wave output. The "fly-wheel" action of this winding tends to keep the horizontal output constant in spite of a momentary disruption of the sync input due to noise, change of cameras

at the studio, or for any other cause. We will discuss the methods of keeping the oscillator in step with the sync transmitted by the studio, later.

The Sine Wave Stabilized Multivibrator

The sine wave stabilized multivibrator (Fig. 4a) is becoming more and more popular with the design engineer, the manufacturer and the service man. The reasons are slightly different but the net effect is that this circuit is appearing in more and more sets. The engineer prefers it because the circuit has the advantages of the inherently better stability of the multi-vibrator, is not as critical as to component variations, is simpler, and the "fly-wheel" action of the tuned circuit gives good immunity to noise.

The manufacturer prefers it for the obvious reason of fewer and less expensive parts, and the economy of

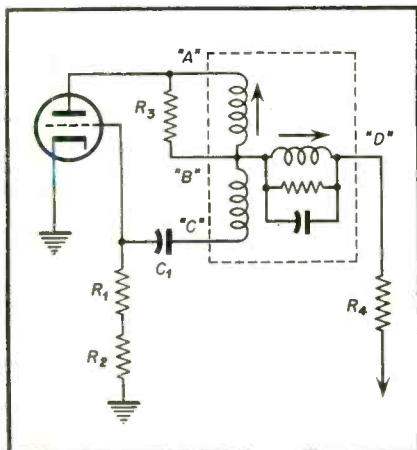

Fig. 3A—Basic syncro-lock oscillator circuit used in most TV receivers using this circuit.

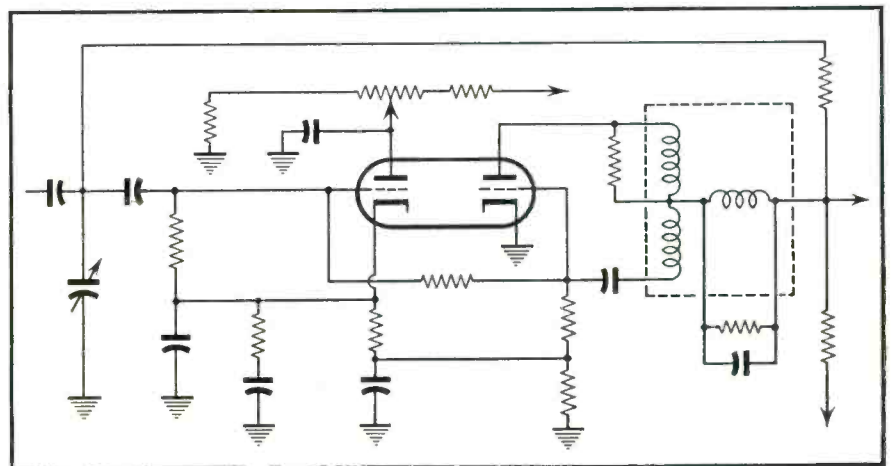

Fig. 3B—Basic complete afc circuit using syncro-guide system. Other names by which this system is known are: "pulse width" and "pulse-phase."

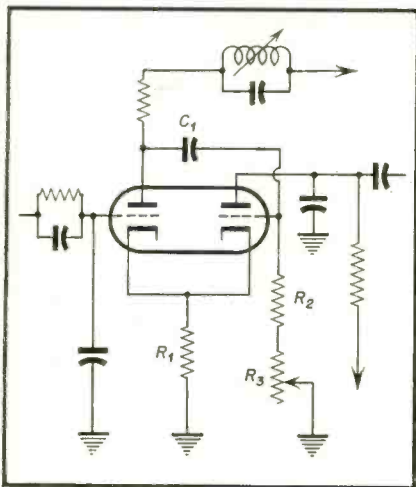

Fig. 4A—Basic sine wave stabilized multivibrator oscillator.

larger tolerance parts. The service man prefers it because of the fact that there is only one rear panel adjustment. This permits complete horizontal adjustment without removing the chassis from the cabinet. The other oscillators have two coil adjustments. This means that for a completely accurate adjustment of the horizontal oscillator, the chassis must be taken out of the cabinet to get to the bottom coil adjustment.

The commonly used type of circuit shown in Fig. 4a is the cathode coupled multi-vibrator. Let us assume that at some time (t), the second section is conducting. With no bias on the grid of the first tube, the current through R, the cathode resistor will develop a bias so that the first section will be driven to cut-off. The plate voltage of the first section will, of course, then rise to the value of the supply voltage. If, when this condition exists, a positive pulse is applied to the grid of the first section, this section will start conducting.

The conduction pulse of the first section will drive its plate voltage down. This decrease in plate voltage will appear through C, at the grid of the second stage as a negative pulse. To operate properly, this negative pulse is of a sufficient amplitude to drive the second section to cut-off. The result is then a positive going pulse at the plate of the second section. The tuned circuit in the plate of the first section is an LC network whose resonant frequency is adjusted to 15.75 kcs. It is shock-excited when the first section is cut-off and then follows the fly-wheel action previously discussed. The *afc* system generally applied to this type of oscillator will be discussed in the section devoted to the various *afc* systems.

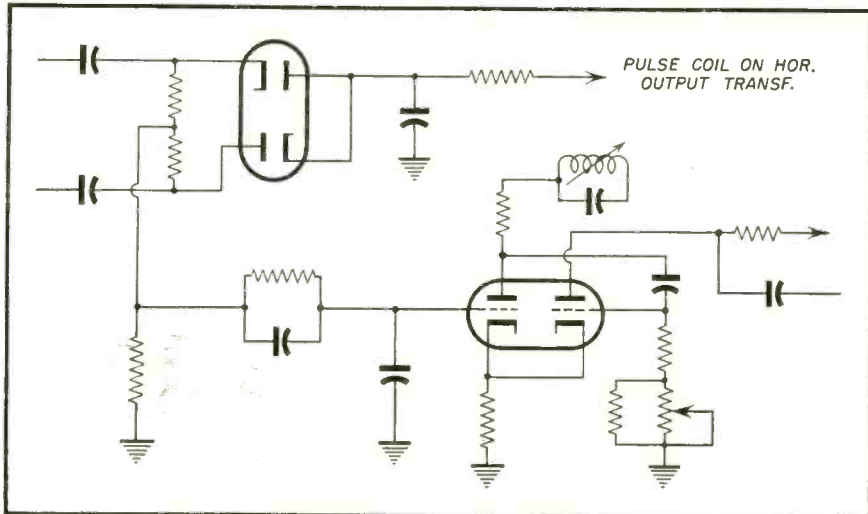

Fig. 4B—Complete afc circuit using the sine wave stabilized oscillator.

Servicing the Horizontal Oscillator

The problem of servicing the horizontal oscillator itself as distinguished from the *afc* and output circuits, usually falls into two categories. The first of these seems extremely simple, namely; the oscillator tube. This, is, however, not as simple as it appears at first glance. In the syncro-guide and the multi-vibrator, in spite of the stabilizing circuit, the tube characteristics, play an important part in the oscillator operation. It should be noted that if both sections of the twin triodes have dissimilar characteristics, the circuit would not function properly. For example, if each section's characteristics were within the allowable tolerances, but one was on the plus side by say, 20% and the other on the minus side by 20%, the difference between the sections would be 40%. Under these conditions, the circuit would be extremely critical. To be on the safe side, it is sometimes advisable to try several tubes before tearing into the circuit components.

Another factor to be taken into consideration is the tube characteristics when the tube is hot. When a horizon-

tal trouble occurs to a set in the shop and the tube is one of the replacements, allow the set to run for an hour or so in a part of the shop with little air motion before returning it to the customer. This precaution may save the need for a call-back to replace the tube as a result of variations in operating characteristics when hot.

Components

It is in the horizontal oscillator section that the serviceman will run into the most aggravating type of component trouble, the intermittent. The villain in the piece is something which is usually mentioned in elementary radio theory and then forgotten—heat!

The horizontal oscillator is generally located in the high-voltage cage or close to the horizontal output amplifier. This tube and the output circuit dissipate a large amount of power in the form of heat. Due to the general close quarters, this heat is usually concentrated close to the components of the horizontal oscillator. These components more specifically, the resistors, are generally small ($\frac{1}{2}W$), of critical values, and important in determining the oscillator frequency. In the case of the syncro-lock, this is generally *not* the case. But in the syncro-guide and sine wave multi-vibrators, the RC time is of great importance.

What happens, is that as the resistors get hot, their resistance goes up. (In the experience of the author, this change can be as high, as 40% in some cases and is usually between 25% to 30%.) This change in value of the frequency determining resistors, will change the recovery time of the oscillator. It will, of course, become

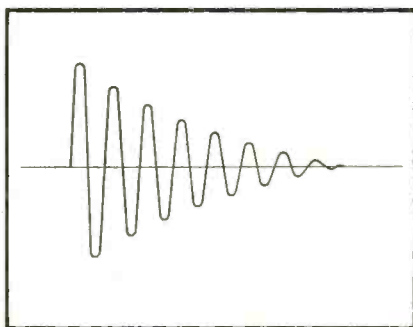

Fig. 5—Damped wave train that normally results from single impulse in a circuit.

[Continued on page 76]

YOUR Hi-Fi MARKET

PART 6

by CHARLES B. GRAHAM

This installment deals with speakers used in high fidelity installations. Speaker construction and requirements, as well as a discussion of cross-over networks in conjunction with these speakers are treated.

IN contrast to the big strides made in the past few years in audio amplifier circuitry and performance, there has been somewhat less progress in loudspeaker improvement, and even less change in speaker design. The amplifier is the best part of most reproducing systems, and can fairly easily be made to deliver 15 or 20 watts at distortion figures of 1 or 2%. This is certainly not the case with loudspeakers. The most expensive loudspeakers, can be counted on for at least 3 to 5 times as much comparable distortion. (These are *good* loudspeakers, too! Cheap ones may deliver as high as 30% or 40% distortion at rated input!) In other words, we've learned how to amplify sound electronically pretty well, but in making use of it mechanically there's still a long way to go.

The following comparisons can be made between typical good amplifiers

and typical present-day high-grade loudspeakers:

1—Efficiency—15% to 35% for amplifiers; 3% to 6% for speakers.

2—Linearity—within 1 db, 20 to 20,000 cps for amplifiers; 5 db, 50 to 15,000 cps for speakers (unusually good).

3—Distortion at 1/2 to 2/3 rated power—1% harmonic and, about 4% IM for amplifiers; speakers give rarely better than 5% harmonic and 10% IM.

It is a far cry from early speakers to the complex high quality coaxial loudspeakers used today. In *Figs. 1 and 3* are shown two very high quality speaker mechanisms. *Fig. 1* shows a three way speaker which uses two small horn-type drivers for the middle and high ranges and a 15 inch cone for the lows. *Fig. 3* pictures a two way speaker employing a 15 inch cone as the "woofer" and a two inch cone for the highs. These two speakers, and a few similar, competitive units selling for from \$150 to \$300 are among the best that have been designed and produced until now.

Today the "loudspeaker" indicates the loudspeaker mechanism, which we call the *driver*, since it *drives* the air, plus the *enclosure*. Even the best driver mechanism cannot do much at the low frequencies in an inadequate enclosure. Peculiarly, a very good enclosure often helps the performance of an inferior or medium grade loudspeaker driver. Since the term "speaker" has for so long been taken to mean the driver mechanism only we will use it that way, bearing in mind that the driver *alone* will be of little use in a high quality sound setup.

The job of the (complete) loudspeaker is to convert electrical audio energy into audible sound energy.

The principle by which it does this is very simple. The dynamic loudspeaker is a simple electric motor. Instead of an armature and a field the speaker has a voice coil and a field. Instead of changing electrical energy into energy which does work such as lifting or transporting, the speaker motor changes electrical energy into sound waves.

When *ac* is sent through the voice coil the coil moves within the magnetic field. If the speaker has an elec-



Fig. 1A—Photo shows cutaway view of Jensen Hi-Fidelity Triaxial three way loudspeaker. Letters "A" and "B" indicate the horns which couple the high range and middle range metal diaphragms to the air load. Refer to Fig. 1B for drawing of this speaker.

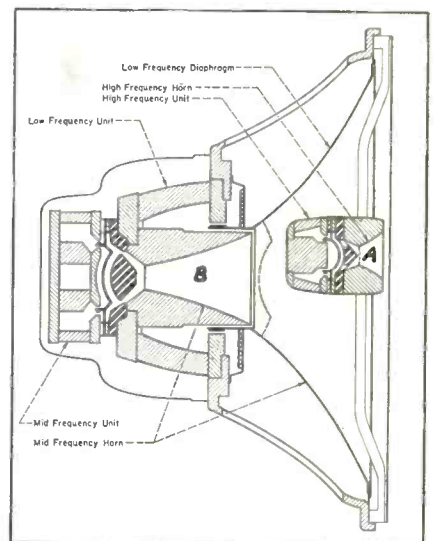

Fig. 1B—Cross section of Jensen Hi-Fidelity Triaxial three way loudspeaker showing the high frequency tweeter horn (A) and mid-range tweeter horn (B). Note that the Low frequency woofer cone (diaphragm) acts as a continuation of the mid-range horn. It may be seen that the thin metal diaphragm for the high speaker is convex shaped (looking into horn from front) while the mid-frequency one is convex.

tromagnet providing its field energy and the energizing current for the field is not present there will be no motion of the voice coil. When the voice coil flux (constantly changing, since the sound currents are *ac*) opposes or aids the field flux the voice coil is forced back and forth in sync with the *ac* currents being sent out by the amplifier.

The loudspeaker's job of making sound out of electrical energy is accomplished by means of the motion imparted to air when a diaphragm moves back and forth. This diaphragm is most commonly a paper cone, but is sometimes a small metal dome, usually of thin aluminum or duraluminum. If a small cone area attempts to move a large body of air it will be successful only if it moves at very high frequencies. This is because there is a direct relationship between the wavelength of sounds and the size of the instrument which produces these sounds. In other words, an instrument (in this case, the loudspeaker) whose dimensions (cone area, or more simply, diameter) are small can only efficiently produce sounds of small (short) wavelength.

Low frequency sounds, that is long wavelengths, can most efficiently be produced by cones having diameters of 12 or 15 inches. The diaphragm (cone) is a means for coupling (transmitting) the movement of the voice coil to the air. If the cone is large it will move more particles of air, and will therefore be a more efficient sound (re) producer. If there were no other considerations than this involved there would be no reason for small diameter speakers, nor for metal diaphragm horn speakers. But a large heavy cone cannot move back and forth at high frequencies. Therefore, we use small diaphragms for high frequencies and larger ones for lower frequencies.

The component parts of a loudspeaker are illustrated in *Fig. 2*. It will be noticed that the structure of this typical speaker mechanism has not changed much in the last decade.

Loudspeakers can be divided into two types—cone speakers and horn type speakers. Actually, they are all cone types, but in the horn types the driver usually has a metal horn as an integral part of its construction. These are usually used in public address or in the manufacture of high-fi tweeters. Horn speakers may have efficiencies as high as 15 or 20%, which is much higher than the 3% to 5% which most cone speakers deliver. As we will show later, a cone

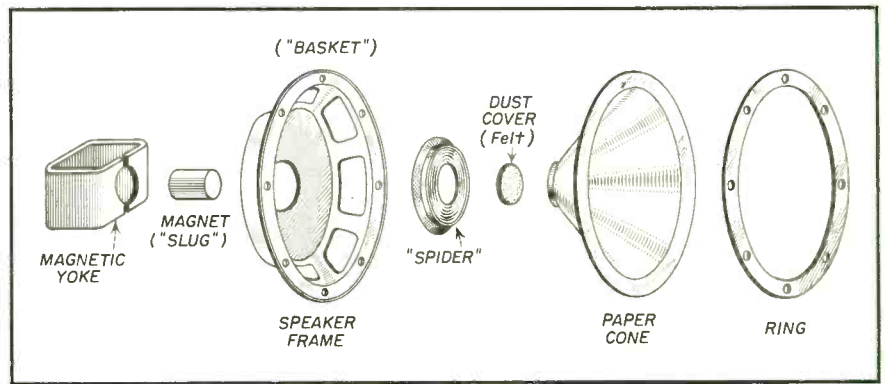

Fig. 2—The basic components of an ordinary cone speaker are shown above in exploded view. The construction of high quality woofers follows this general construction. Details of spider and magnet are the most common deviations from above.

woofer may have a large horn as its enclosure; in this case its efficiency may rise to 10%-20%.

The cardboard *ring* (see *Fig. 2*) has not changed much for many years. It is still used to provide a slightly compressible packing between the speaker proper and the board it is mounted on. The felt *dust cover* has only one purpose—to keep small stray foreign particles, especially tiny bits of magnetic metal, away from the strong magnetic flux which the magnetic field places around the voice coil.

The *cone* is usually made of special paper, and it is desirable that it be fairly rigid except at its outward edge, where it is necessary that it be flexible. Some manufacturers have solved this problem by using cloth or felt circular segments, or "surrounds" around the outside of the cone. These segments connect the cone to the speaker frame. Other manufacturers have used paper cones which are heavy and stiff in the center, near the voice coil, and have tapered the thickness of the paper thinner as the outer rim is approached. Years ago thin leather was employed as the surround on some of the more expensive speakers.

The cone is driven back and forth by the motion of the *voice coil* in the magnetic air gap. The voice coil is wound around a thin non-metallic ring whose diameter is from one to four inches and whose length is usually less than a half inch. This ring is rigidly cemented to the center, or apex of the cone and may be treated as part of the cone.

The voice coil may be wound from either copper or aluminum (the latter, or some alloy of it is almost universally employed today in high-quality speakers.). It is held in place in the magnetic gap both by the cone, which is supported at its outer edge by the rim of the speaker frame (the frame

is called the "basket") and by a *spider* which allows comparatively free motion of the voice coil back and forth, but not from side to side or up and down. The spider must be firmly fixed to the frame of the speaker of course.

Finally, we find the magnetic structure at the rear of the basket or *frame*. This may be an iron casting from three to five inches in diameter (or square), or a heavy metal frame containing a round magnet slug (see *Fig. 5*), or a large coil of heavy wire, if the speaker employs an electromagnetic field. Whether the field is an electromagnetic or a permanent magnet (most top grade loudspeakers use permanent magnets) does not affect the quality of reproduction, if the magnetic flux created in the air gap is the same in both cases. It is difficult to make a permanent magnet

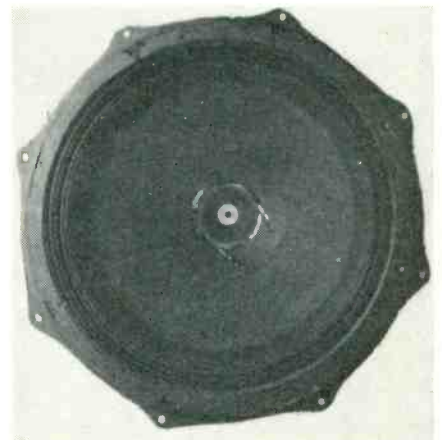

Fig. 3—RCA high fidelity loudspeaker Model LC-1A, employing both 15" and 2" paper cones. This speaker is widely used in broadcast stations and recording studios. Although it is the only present day high quality speaker using a coaxial paper tweeter, many engineers consider it an outstanding loudspeaker mechanism. It is called the "Olson" speaker, after its designer, Dr. Harry Olson.

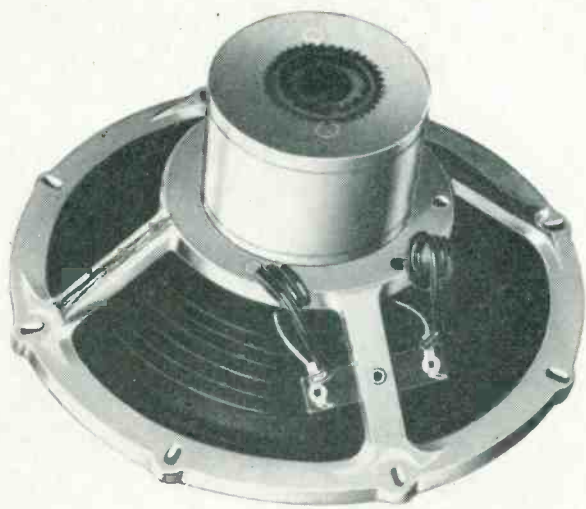

Fig. 5—Eight inch high-quality loudspeaker shows heavy Alnico V "pot" (magnetic structure). Magnetic flux created in the voice coil gap is the 10,000 gauss of this speaker. (Courtesy of British Industries.)

structure for loudspeaker mechanisms much beyond 15,000 to 18,000 gauss—therefore, extremely special speakers may employ special field coils. The average good quality speaker may have a flux density in its magnetic air gap from 9,000 to about 14,000 gauss.

In general, the weight of a speaker is some index to the magnetic flux density it can produce if it is a truly modern speaker. There are two different magnetic materials which are often used in the various magnetic structures of speakers. They are Alnico III an alloy of aluminum, nickel and cobalt, which we have had around for some years, and Alnico V, a considerably superior material.

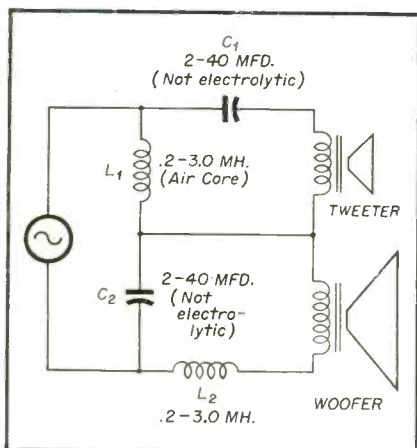

Fig. 4—Typical crossover network for sending lows to woofer and highs to tweeter is diagrammed here. The values of the chokes and condensers will vary according to the desired crossover frequency (usually from 500 to 3000 cps) and with the nominal impedance of the speakers.

Were it not for the cold war it is probable that Alnico V would have superseded Alnico III entirely in loudspeaker manufacture. As a point of comparison an Alnico III speaker magnetic weighing 3½ lbs is less effective than a similarly constructed Alnico V magnet of only 1½ lbs.

Another usual index of a superior speaker is the amount of stray magnetism which it does not have. This can be tested by holding a screwdriver near the rear and sides of the "pot" (Fig. 5), as the round magnetic structure is called. If the screwdriver is strongly attracted it usually indicates a structure with considerable flux leakage. If there is little attraction of the screwdriver, it means that most of the magnetic flux paths have been concentrated where they should be: into the magnetic gap where they can control the voice coil.

Naturally, a cheap speaker with a small weak magnet will offer very little attraction to the screwdriver, even though it has a badly built structure. This test therefore properly applies only to the grades of speakers supposed to be high-fidelity, and whose prices range roughly from \$20 and up.

It has been found that truly wide range reproduction cannot be accomplished with a single loudspeaker. Coaxial speakers may be considered two separate speaker mechanisms combined for reasons of economy, acoustics, or both.

For the sake of description, reproducers for the higher notes are called "tweeters" and low frequency reproducers are called "woofers." All

woofers are cone speakers, employing paper cones usually 12" or 15" in diameter. There are also 18" woofers made by two manufacturers; and one manufacturer has in the past made a few special 27" woofers. Tweeters are made in many varieties of sizes, shapes, and designs. They are more often horn speakers, similar in a general way to PA trumpet speakers, but they may be small paper cone speakers of special construction.

Some high quality speaker systems employ three separate loudspeakers, two of them being tweeters for the middle and top ranges. See Fig. 1. There are even a few extremely expensive four and five way systems, which have two or three horn tweeters with one, two or three different sized cone speakers for mid- and low-frequency ranges. It has not been demonstrated to the satisfaction of many system designers, however, that these justify the enormous increases in cost which they entail over three-way or even two-way loudspeakers.

Of the roughly ten or so top cost dual loudspeaker combinations presently available and built in the United States, almost all employ 15" woofers. Of these only two have cone type tweeters. All others have short metal horns with metal diaphragms of less than 1" diameter. Over half of these are small tweeters which are (or may be) mounted coaxially inside the big cone woofers. When they are thus built together there is a dividing network incorporated as part of the system, usually physically mounted on the main frame. These networks direct the high notes into the tweeter and the low notes into the woofer.

The crossover network at its simplest is a condenser of from 1 to perhaps about 10 microfarads (not electrolytic, since these circuits handle only ac). This is actually only a blocking condenser to keep the low tones out of the tweeter, which would be ruined by the heavy currents and large movements involved were there no filtering out of the lower frequencies.

The more complex crossover networks may contain more than one condenser and one choke. A typical crossover network is shown in Fig. 4. Examination of the signal paths shown will reveal the function of each of the four components readily. C1 is a condenser in series with the high-frequency voice coil. It passes the higher frequencies into the tweeter, but fails to pass the lower frequencies. L1 also in the tweeter circuit is

[Continued on page 64]

CIRCUIT & SERVICE DATA OF EMERSON CHASSIS 120166D

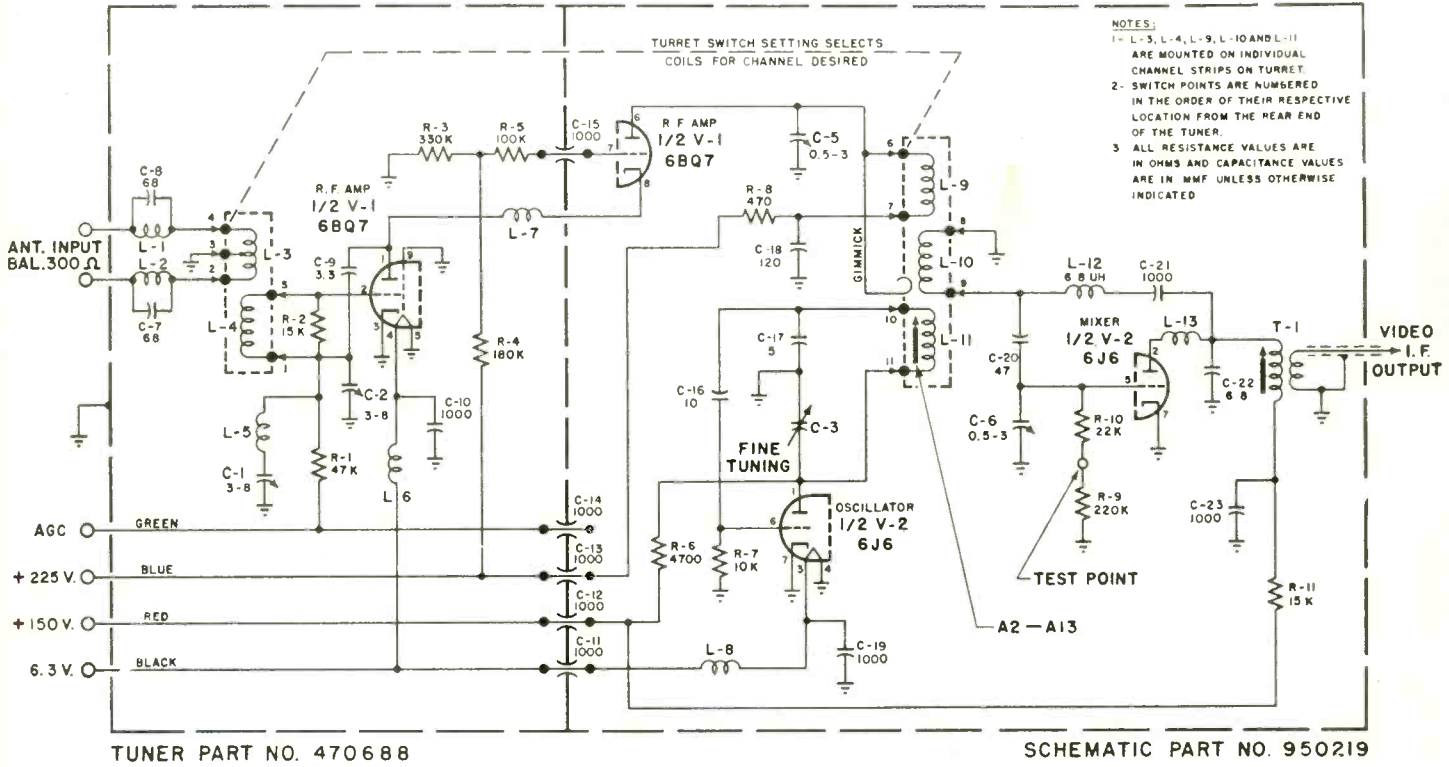

Fig. 1 - Schematic Diagram of Turret Type Tuner #470688 used on Chassis 120166-D

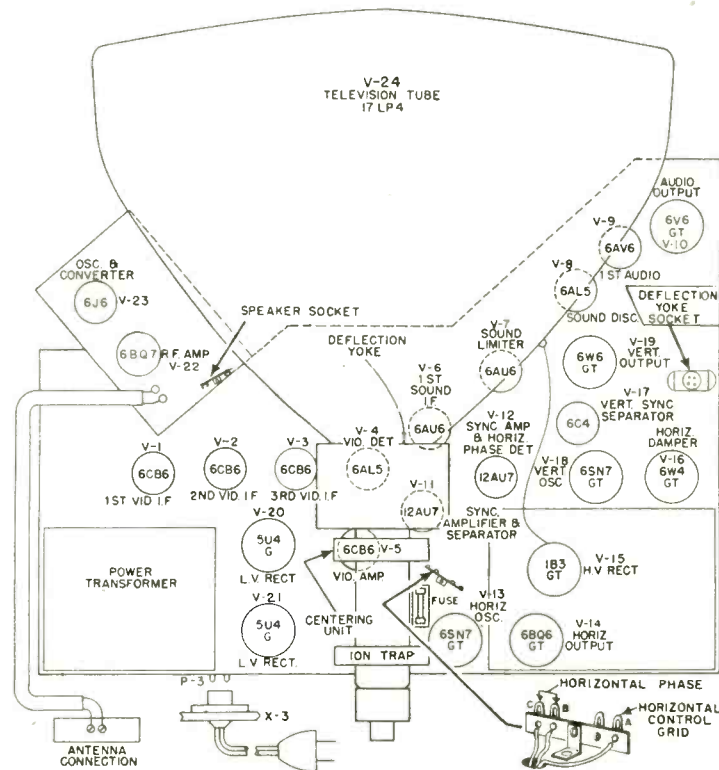
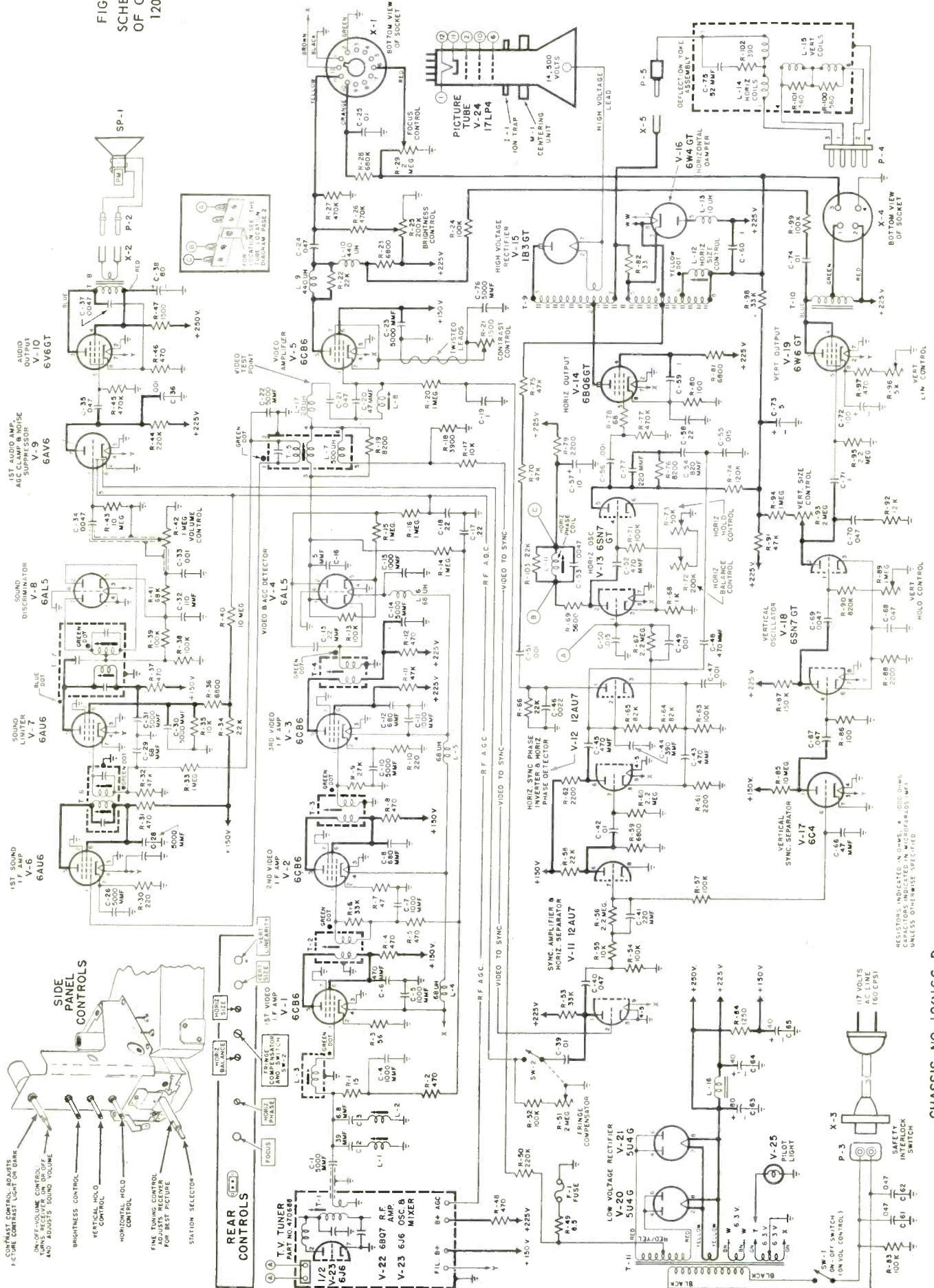

Fig. 2 - Tube Locations Diagram for Chassis 120166-D

FIGURE 3
SCHEMATIC
OF CHASSIS
120166-D



RADIO-TELEVISION SERVICE DEALER ● APRIL, 1953

PART NO 950230

CHASSIS NO 120166-D

VIDEO SPEED SERVICING SYSTEMS

Error Correction:

In Feb. 1953 issue, page 43, Card No. C-2, C28 should be C278.
In March 1953 issue, pages 47 and 48, diagrams in Cards No. SE412-15 and SE412-17 should be interchanged.

CUMULATIVE INDEX

Mfr.	Model	Section Affected	Page	Card No.
Admiral	20A-1	Pix	Jan. 31	20-1
Admiral	20A-1	Sound	Jan. 31	20-2
Admiral	20A-1	Sync	Jan. 31	20-3
Admiral	20A-1	Sound	Jan. 32	20-4
Admiral	20A-1	Raster	Jan. 32	20-5
Admiral	20A-1	Raster	Jan. 32	20-6
Admiral	20A1 (chassis)	Pix and Sound	Mar. 45	A20-7
Admiral	20A1 (chassis)	Pix and Sound	Mar. 45	A20-8
Admiral	20A1 (chassis)	Pix	Mar. 45	A20-9
Admiral	20A1 (chassis)	Pix	Mar. 46	A20-10
Admiral	20A1 (chassis)	Pix	Mar. 46	A20-11
Admiral	20A1 (chassis)	Sound	Mar. 46	A20-12
Airline	84HA3010	Pix	April 39	AI3010-1
Airline	84HA3010	Pix	April 39	AI3010-2
Airline	84HA3010	Pix	April 39	AI3010-3
Airline	84HA3010	Raster	April 40	AI3010-4
Airline	84HA3010	Sync	April 40	AI3010-5
Airline	84HA3010	Pix	April 40	AI3010-6
Arvin	TE-290	Sound	April 41	AR290-1
Arvin	TE-290	Raster	April 41	AR290-2
Arvin	TE-290	Sync	April 41	AR290-3
Arvin	TE-290	Pix	April 42	AR290-4
Arvin	TE-290	Pix and Sound	April 42	AR290-5
Arvin	TE-290	Sound	April 42	AR290-6
Capehart	CX-33	Sound and Pix	Feb. 43	C-1
Capehart	CX-33	Pix	Feb. 43	C-2
Capehart	CX-33	Pix	Feb. 43	C-3
Capehart	CX-33	Raster	Feb. 44	C-4
Capehart	CX-33	Raster	Feb. 44	C-5
Capehart	CX-33	Pix	Feb. 44	C-6
CBS	700-10	Raster	Jan. 33	A-1
CBS	700-10	Pix	Jan. 33	A-2
CBS	700-10	Pix	Jan. 33	A-3
CBS	700-10	Pix	Jan. 34	A-4
CBS	700-10	Pix	Jan. 34	A-5
CBS	700-10	Sync	Jan. 34	A-6
Emerson	120118	Pix	Jan. 35	E-1
Emerson	120118	Pix	Jan. 35	E-2
Emerson	120118	Pix	Jan. 35	E-3
Emerson	120118	Pix	Jan. 36	E-4
Emerson	120118	Pix	Jan. 36	E-5
Emerson	120118	Pix	Jan. 36	E-6
Magnavox	CT219	Sound	April 43	MA219-1
Magnavox	CT219	Pix	April 43	MA219-2
Magnavox	CT219	Pix	April 43	MA219-3
Magnavox	CT219	Pix	April 44	MA219-4
Magnavox	CT219	Pix	April 44	MA219-5
Magnavox	CT219	Pix	April 44	MA219-6
Olympic	TA	Sound	Feb. 45	C-1
Olympic	TA	Raster	Feb. 45	C-2
Olympic	TA	Pix and Raster	Feb. 45	C-3
Olympic	TA	Pix	Feb. 46	C-4
Olympic	TA	Pix	Feb. 46	C-5
Olympic	TA	Pix	Feb. 46	C-6
Philco	49-1040	Sound	Feb. 47	49-B-1
Philco	49-1240	Pix and Sound	Feb. 47	49-B-2
Philco	49-1040	Pix	Feb. 47	49-B-3
Philco	49-1040	Sync	Feb. 48	49-B-4
Philco	49-1040	Pix	Feb. 48	49-B-5
Philco	49-1040	Sound	Feb. 48	49-B-6
Philco	51T1433B (Code 121, 122)	Sync	April 45	PH1433-1
Philco	51T1433B (Code 121, 122)	Raster	April 45	PH1433-2
Philco	51T1433B (Code 121, 122)	Pix	April 45	PH1433-3
Philco	51T1433B (Code 121, 122)	Pix	April 46	PH1433-4
Philco	51T1433B (Code 121, 122)	Pix	April 46	PH1433-5
Philco	51T1433B (Code 121, 122)	Pix	April 46	PH1433-6
Sentinel	412-1	Raster	Jan. 37	412-1
Sentinel	412-1	Raster and Pix	Jan. 37	412-2
Sentinel	412-1	Raster	Jan. 37	412-3
Sentinel	412-1	Pix	Jan. 38	412-4
Sentinel	412-1	Raster	Jan. 38	412-5
Sentinel	412-1	Raster	Jan. 38	412-6
Sentinel	412, 413, 415	Raster	Feb. 49	412-7
Sentinel	412, 413, 415	Raster	Feb. 49	412-8
Sentinel	412, 413, 415	Raster	Feb. 49	412-9
Sentinel	412, 413, 415	Raster	Feb. 50	412-10
Sentinel	412, 413, 415	Raster	Feb. 50	412-11
Sentinel	412, 413, 415	Raster	Feb. 50	412-12
Sentinel	412, 413, 415	Raster	Mar. 47	SE412-13
Sentinel	412, 413, 415	Raster	Mar. 47	SE412-14
Sentinel	412, 413, 415	Pix and Sound	Mar. 47	SE412-15
Sentinel	412, 413, 415	Pix and Sound	Mar. 48	SE412-16
Sentinel	412, 413, 415	Sync	Mar. 48	SE412-17
Sentinel	412, 413, 415	Sync	Mar. 48	SE412-18
Stromberg-Carlson	119 Series	Pix	Mar. 49	SC119-1
Stromberg-Carlson	119 Series	Pix	Mar. 49	SC119-2
Stromberg-Carlson	119 Series	Pix	Mar. 49	SC119-3
Stromberg-Carlson	119 Series	Pix	Mar. 50	SC119-4
Stromberg-Carlson	119 Series	Pix	Mar. 50	SC119-5
Stromberg-Carlson	119 Series	Pix	Mar. 50	SC119-6
Sylvania	1-186 (chassis)	Pix	Mar. 51	S186-1
Sylvania	1-186 (chassis)	Pix	Mar. 51	S186-2
Sylvania	1-186 (chassis)	Pix	Mar. 51	S186-3
Sylvania	1-186 (chassis)	Pix	Mar. 52	S186-4
Sylvania	1-186 (chassis)	Pix	Mar. 52	S186-5
Sylvania	1-186 (chassis)	Sync	Mar. 52	S186-6

Mfr. Airline Model No. 84HA3010

Card No. AI3010-1

Section Affected: Pix

Symptom: Bulge on left side of pix.

Reason For Change: Improvement of horizontal linearity.

What To Do:

Add: 25K-10W resistor between (pin #8) and (pins #4 and #6) of V20.

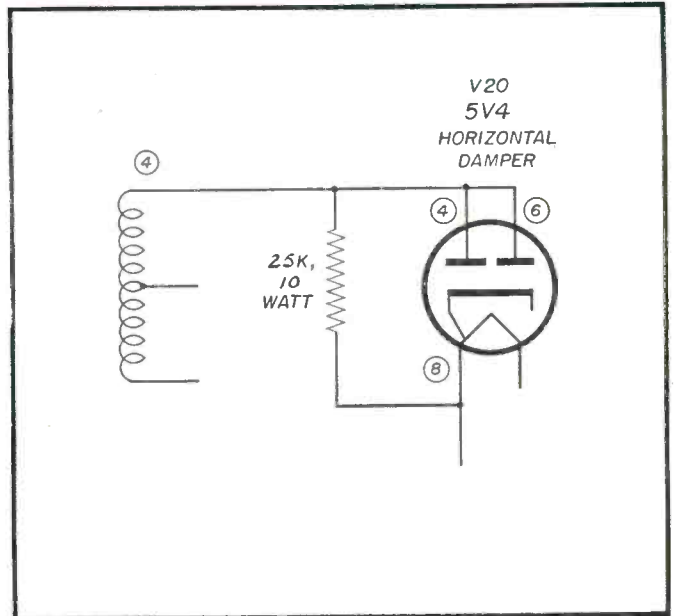

Mfr. Airline Model No. 84HA3010

Card No. AI3010-2

Section Affected: Pix

Symptom: Insufficient contrast.

Reason For Change: To improve black to white ratio.

What To Do:

Add: 2.2K- $\frac{1}{2}$ W resistor. Between L29 and R67 (4.7K) (Fig A).

Replace: R40 (4.7K) with 2.2K- $\frac{1}{2}$ W resistor. (Fig. B).

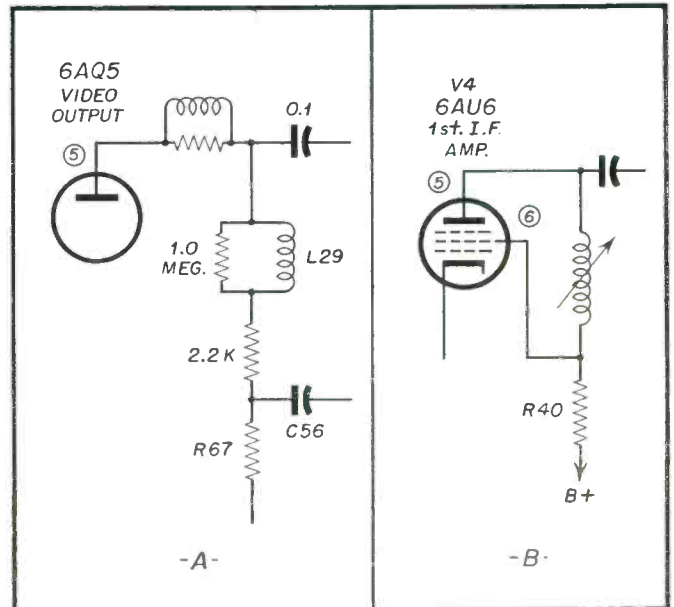

Mfr. Airline Model No. 84HA3010

Card No. AI3010-3

Section Affected: Pix

Symptom: Snow on high frequency stations.

Reason For Change: Increase sensitivity on high band channels.

What To Do:

Remove: Ground leads from pin #4 of V1 and pin #7 of V2 (6AK5 mixer) and re-ground directly to chassis. Also, C9 (4.7 μ f).

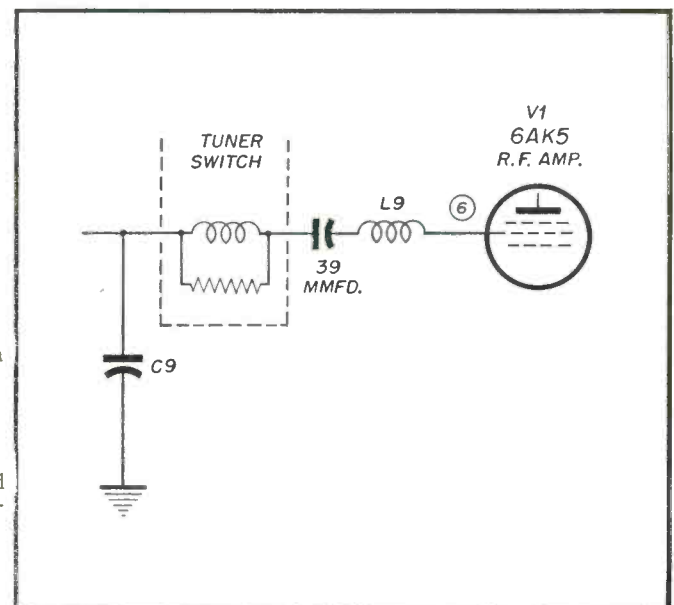

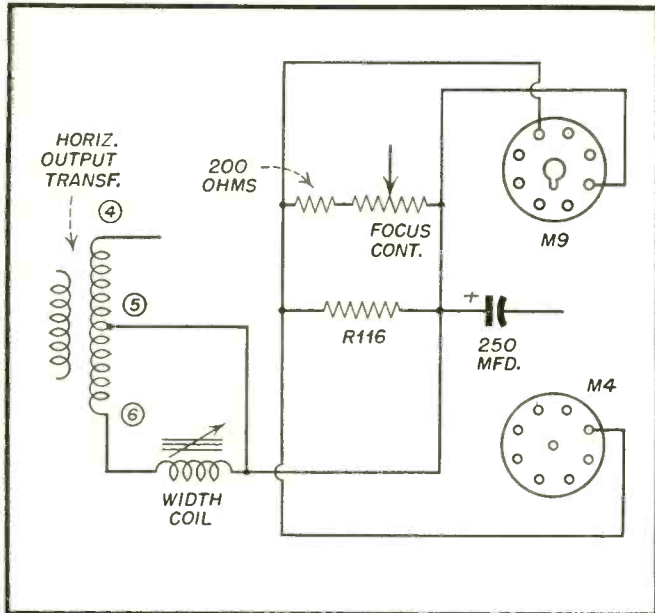

Mfr. Airline Model No. 84HA3010

Card No. AI3013-4

Section Affected: Raster

Symptom: Insufficient range of focus control.

Reason For Change: Increase range of focus control.

What To Do:

Remove: R116 (1.8K).

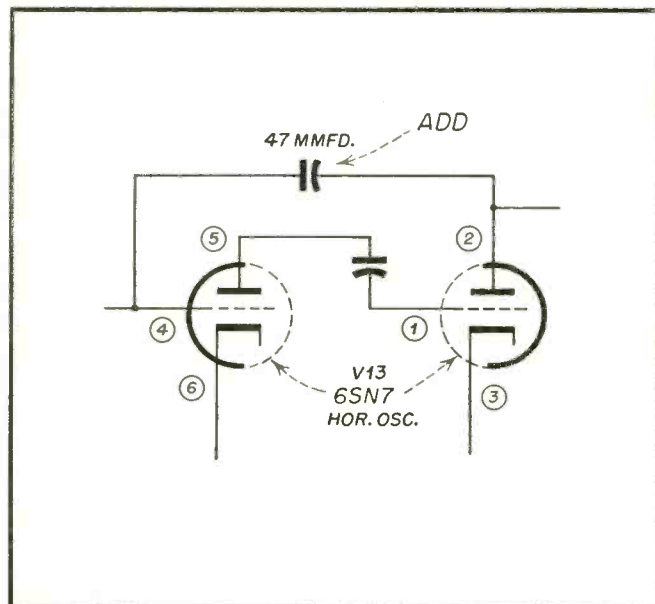

Mfr. Airline Model No. 84HA3010

Card No. AI3010-5

Section Affected: Sync

Symptom: Inadequate horizontal sync.

Reason For Change: Circuit improvement.

What To Do:

Add: C97 (47 μf) capacitor between pin #2 and pin #4 of horizontal oscillator tube (V113).

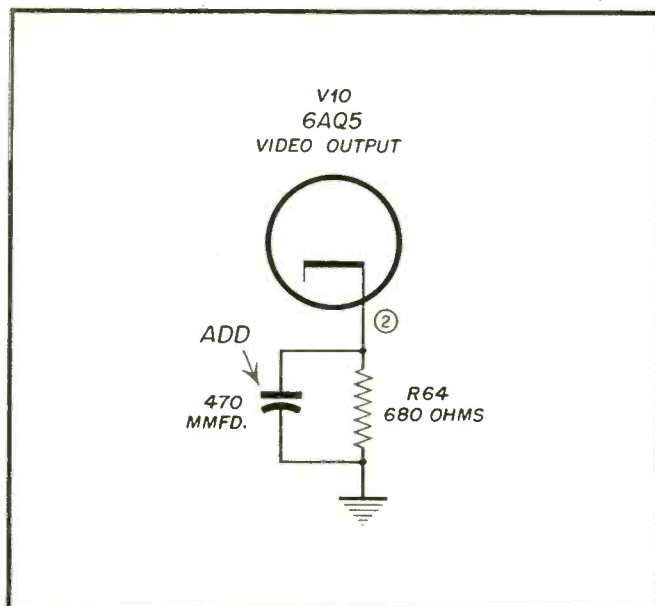

Mfr. Airline Model No. 84HA3010

Card No. AI3010-6

Section Affected: Pix

Symptom: Insufficient definition.

Reason For Change: To improve pix resolution.

What To Do:

Add: C51 (410 μf) in parallel with R64 (680 ohms) from pin #2 of V10 to ground.

Mfr. Arvin Model No. TE 290

Card No. AR290-1

Section Affected: Sound

Symptom: Weak sound and buzz.

Reason For Change: Trap connections reversed.

What To Do:

Reverse: L120 (4.5 mc trap) connections and realign.

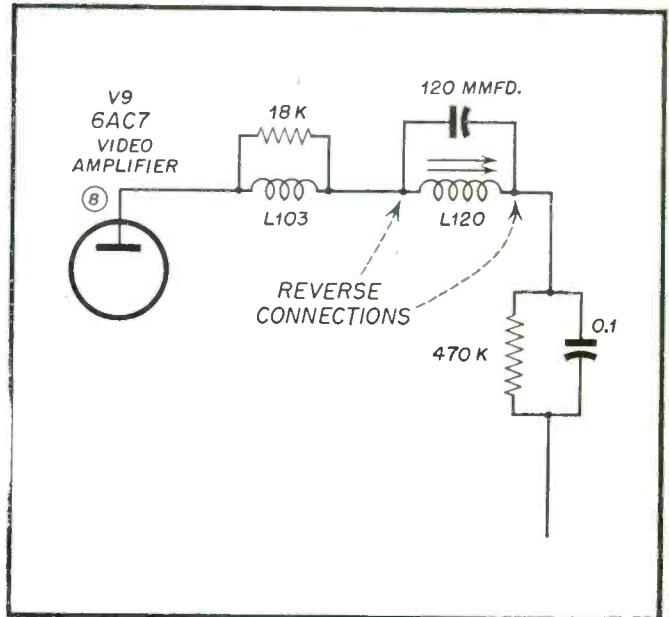

Mfr. Arvin Model No. TE 290

Card No. AR290-2

Section Affected: Raster

Symptom: Raster ringing.

Cause: Variations in capacity winding to ground of horizontal deflection yoke #AC23816-2.

What To Do:

Add: C169 as shown. Try various values between 22 and 47 $\mu\mu\text{f}$.

Note: When yoke #AC24292 is used, C162 should be 47 $\mu\mu\text{f}$.

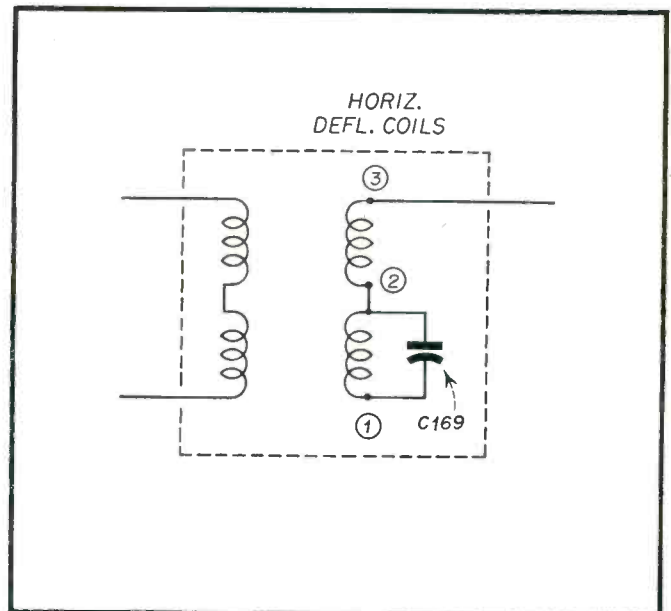

Mfr. Arvin Model No. TE 290

Card No. AR290-3

Section Affected: Sync

Symptom: Unstable vertical. Tends to roll under noise impulse conditions such as are found in fringe areas.

Reason For Change: Circuit improvement.
(This change was included in chassis TE 290-3)

What To Do:

Change: R154 (15K) to 47K.

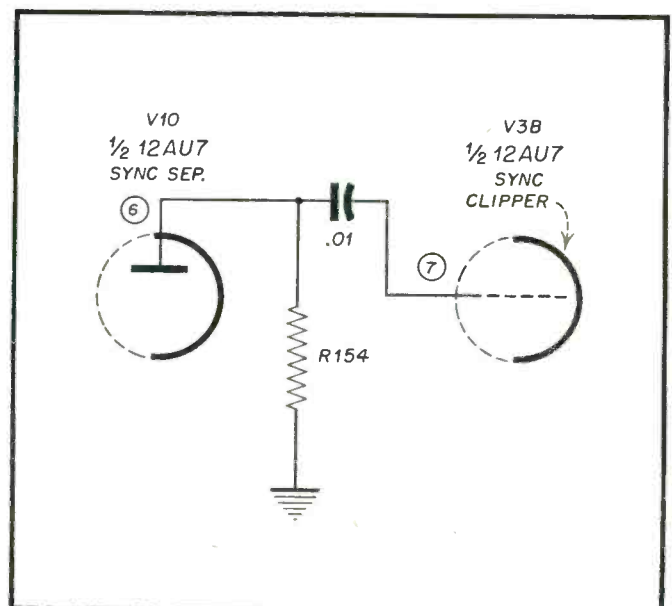

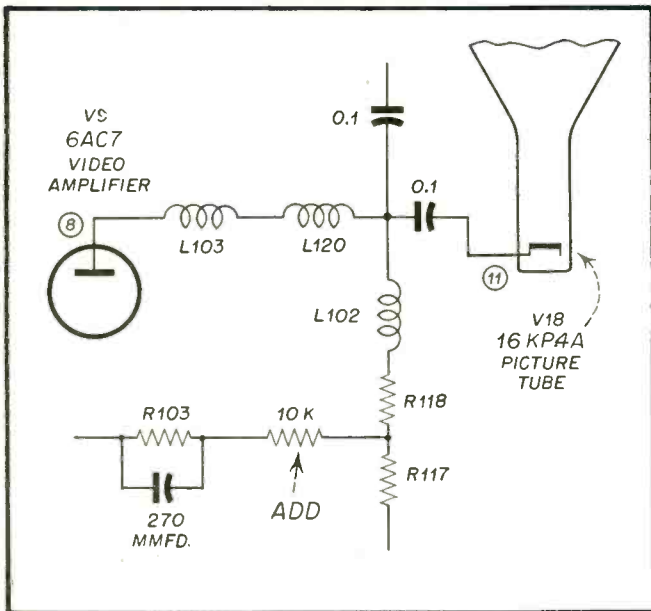

Mfr. Arvin Model No. TE 290

Card No. AR290-4

Section Affected: Pix

Symptom: Pix breakup due to noise impulses, especially in fringe areas.

Reason For Change: To reduce effect of noise impulses on pix stability.

(This change was included in chassis TE 290-3)

What To Do:

Add: 10K resistor between R103 (270K) and junction of R117 (3.3K), R118 (2.2K).

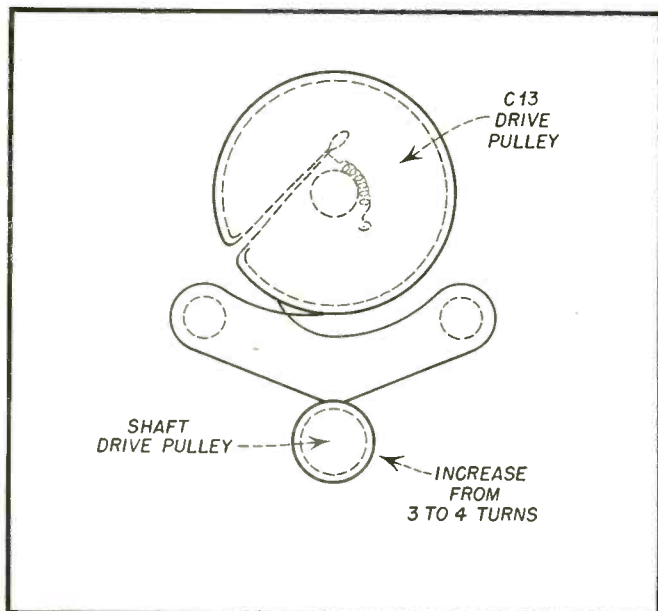

Mfr. Arvin Model No. TE 290

Card No. AR290-5

Section Affected: Pix and Sound

Symptom: Difficulty in tuning Channels 6 and 13.

Cause: Inadequate dial rotation.

(This change was included in later production)

What To Do:

Add: One extra turn of dial string around shaft of drive pulley, making a total of four turns. The drive pulley controls the rotation of the oscillator capacitor C13.

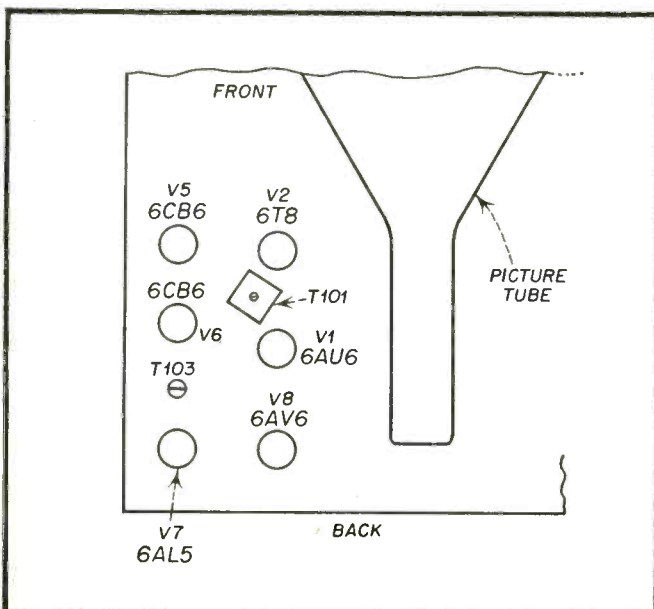

Mfr. Arvin Model No. TE 290

Card No. AR290-6

Section Affected: Sound

Symptom: Sync buzz.

Cause: Sound if requires adjustment.

What To Do:

Perform the following operations:

1. Turn tuning control clockwise until pix begins to deteriorate; then turn carefully counterclockwise for best pix setting.
2. Adjust top of ratio detector transformer T101 for minimum buzz, maintaining reasonably strong sound.
3. If buzz is still present, adjust the first if transformer T103 for minimum buzz maintaining reasonably strong sound. (Do not turn slug more than one turn in either direction.)

Mfr. Magnavox Chassis No. CT 219

Card No. MA219-1

Section Affected: Sound

Symptom: No sound; or "hash" in sound.

Cause: Component failure.

What To Do:

Check: C48 (.001 μ f) for short or leak.

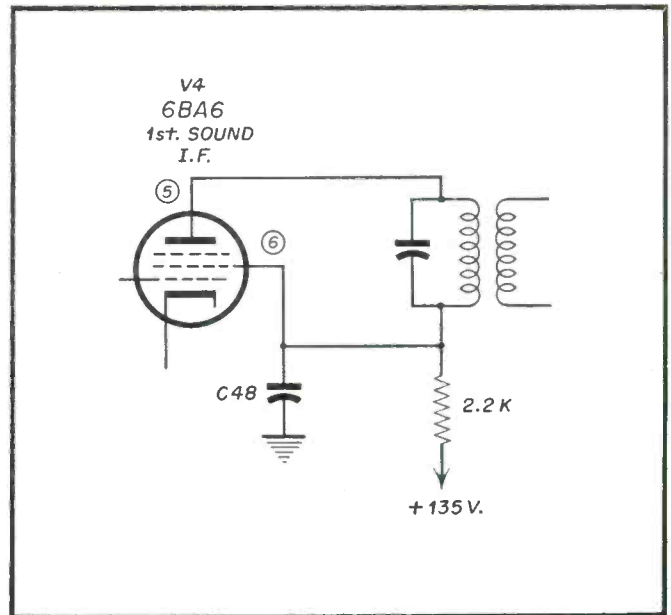

Mfr. Magnavox Chassis No. CT 219

Card No. MA219-2

Section Affected: Pix

Symptom: Double pix overlapping.

Cause: Component failure.

What To Do:

Check: R182 (100K) temperature compensating resistor for change in value.

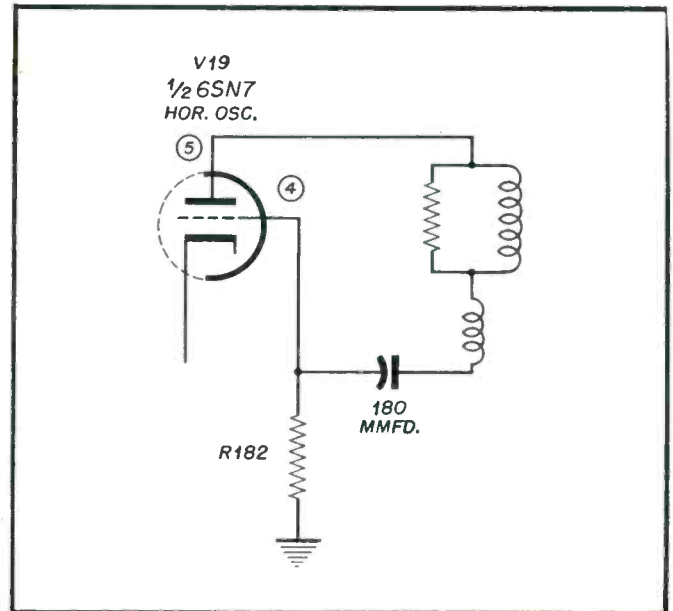

Mfr. Magnavox Chassis No. CT 219

Card No. MA219-3

Section Affected: Pix

Symptom: No pix. Blanking pulse on raster.

Cause: Component failure.

What To Do:

Check: L19 for open.

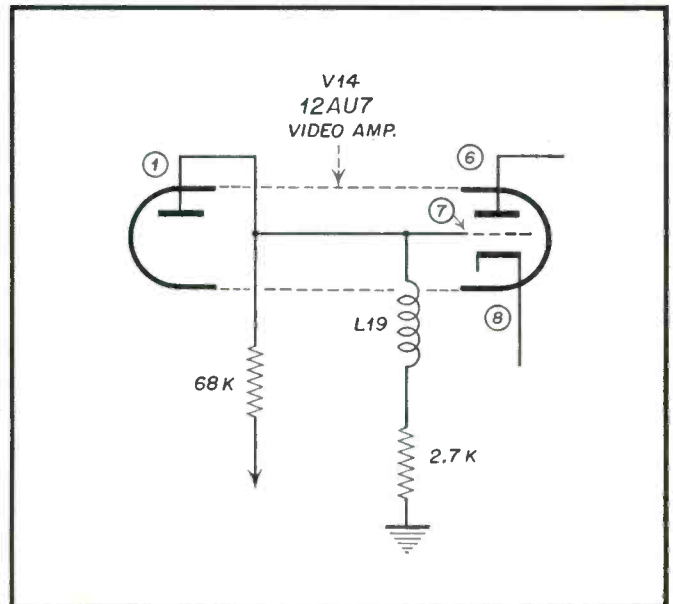

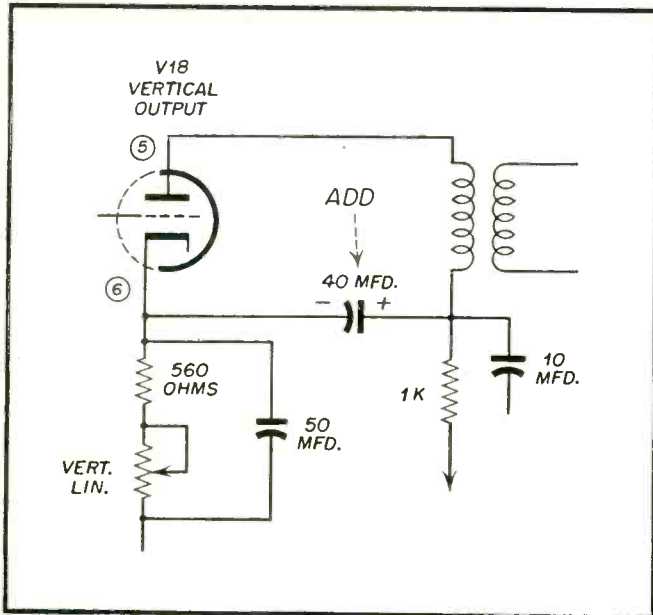

Mfr. Magnavox Chassis No. CT 219

Card No. MA219-4

Section Affected: Pix

Symptom: Compression of pix on top and bottom.

Reason For Change: Circuit improvement.

What To Do:

Add: 40 μ f-475V condenser between pin #6 V18 and B plus side of vertical output transformer.

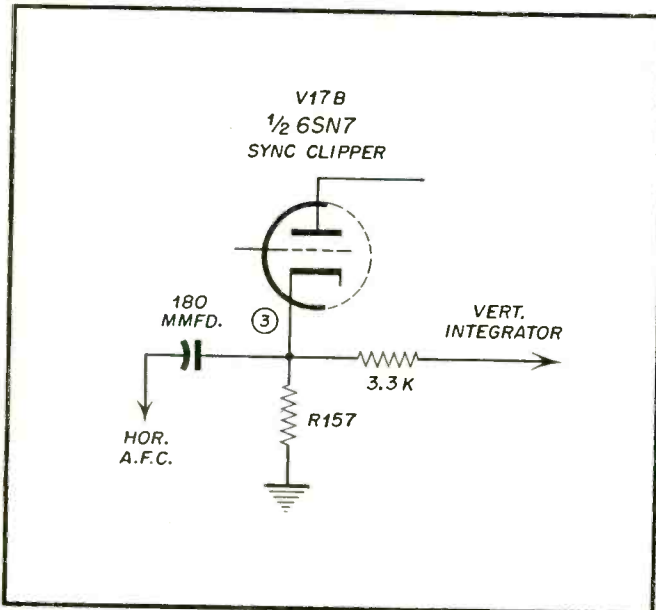

Mfr. Magnavox Chassis No. CT 219

Card No. MA219-5

Section Affected: Pix

Symptom: Pix "hooks" to right at top.

Cause: Vertical pulse feedback to horizontal control circuit.

What To Do:

Change: R157 (6.8K) to 2.2K.

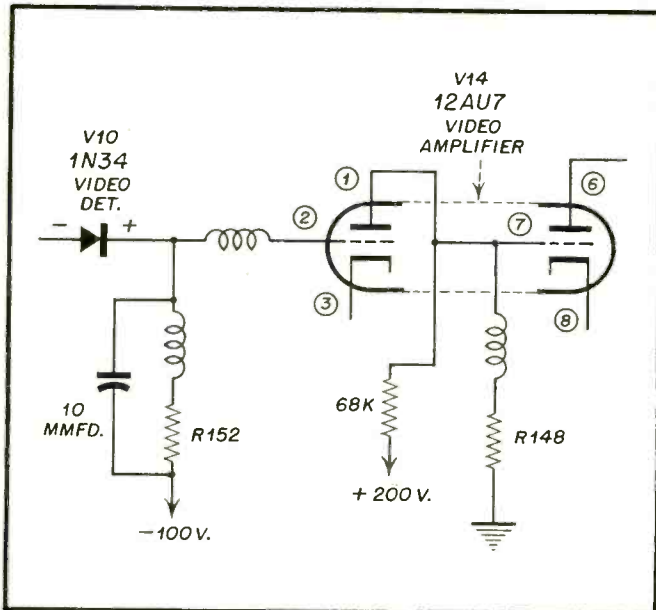

Mfr. Magnavox Chassis No. CT 219

Card No. MA219-6

Section Affected: Pix

Symptom: Pix smeared.

Cause: Component failure.

What To Do:

Check: R152 (4.7K) for change in value. Also, R148 (2.7K) for change in value.

Mfr. Philco Model No. 51T1433B

Card No. PH511443-1 Code No. 121 and 122

Section Affected: Sync

Symptom: Inadequate horizontal sync stability.

Reason For Change: Circuit improvement.

(This change was included in chassis beginning with run #4)

What To Do:

Change: R635 (39K) to 68K.

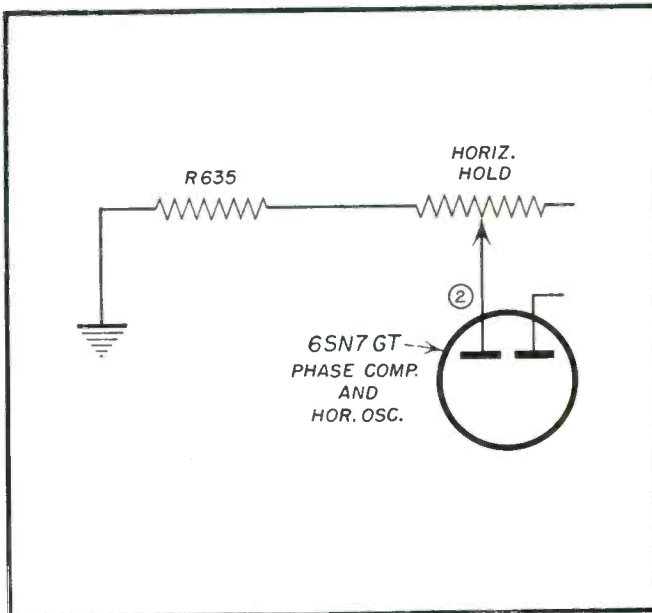

Mfr. Philco Model No. 51T1433B

Card No. PH511443-2 Code No. 121 and 122

Section Affected: Raster

Symptom: Inadequate vertical centering range; also neck shadow.

Reason For Change: Circuit improvement.

(This change was included in chassis beginning with run #3)

What To Do:

Disconnect: Low end of L101 and black lead of T601 from ground.

Connect: Above-mentioned leads through a 3.3 ohm resistor to ground.

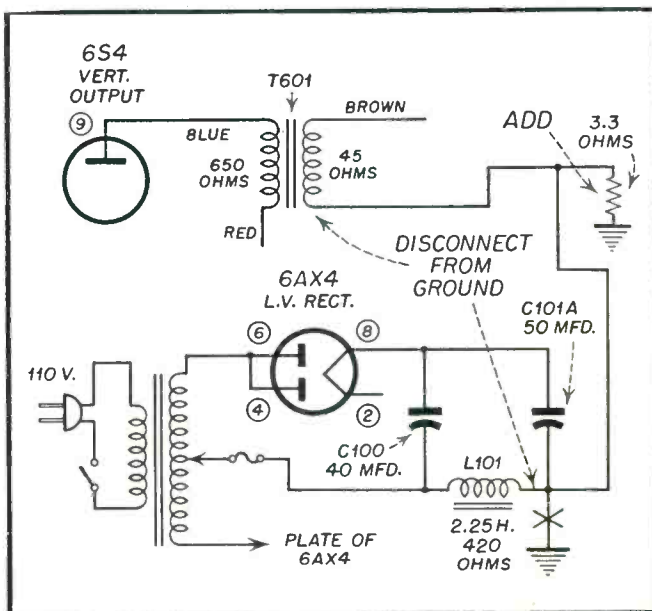

Mfr. Philco Model No. 51T1433B

Card No. PH511443-3 Code No. 121 and 122

Section Affected: Pix

Symptom: Inadequate horizontal linearity.

Reason For Change: To improve horizontal linearity.

(This change was included in chassis beginning with run #2)

What To Do:

Change: C624 (.082 μ f) to .068 μ f.
Also, C619 (680 μ f) to 270 μ f.

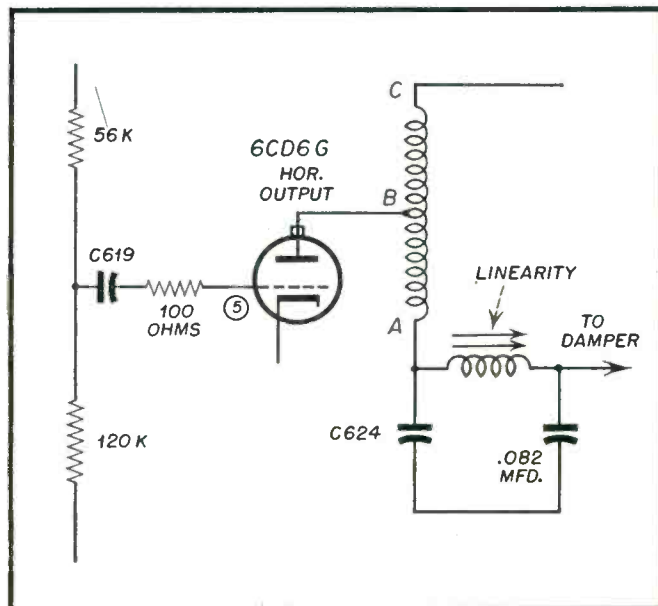

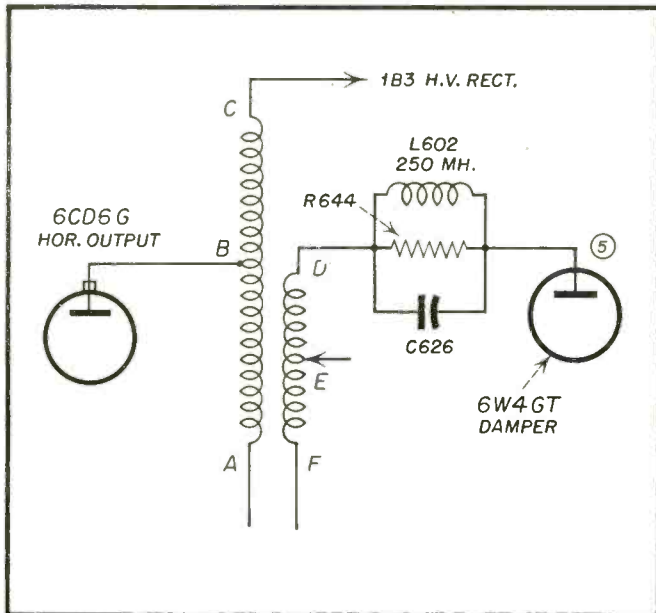

Mfr. Philco Model No. 51T1433B

Card No. PH511443-4 Code No. 121 and 122

Section Affected: Pix

Symptom: Shadow, bars on left side of raster.

Reason For Change: To dampen horizontal retrace sweep.

(This change was included in chassis beginning with run #2)

What To Do:

Change: C626 (.0033 μ f) to .004 μ f.
Also, R644 (470 ohms) to 330 ohms.

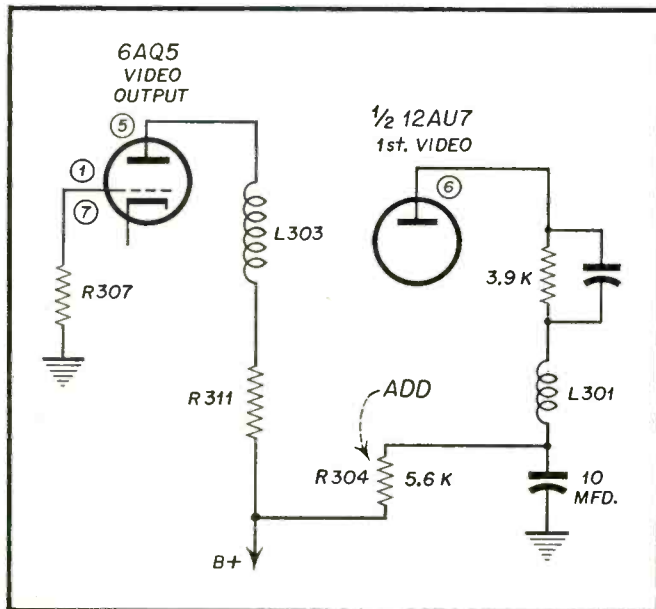

Mfr. Philco Model No. 51T1433B

Card No. PH511443-5 Code No. 121 and 122

Section Affected: Pix

Symptom: Inadequate pix quality.

Reason For Change: Circuit improvement.

What To Do:

Change: R307 (470K) to 1.2 meg.
Also, R311 (1.8K) to 2.7K.
Add: R304 (5.6K) in plate return lead of 1st video amplifier tube.

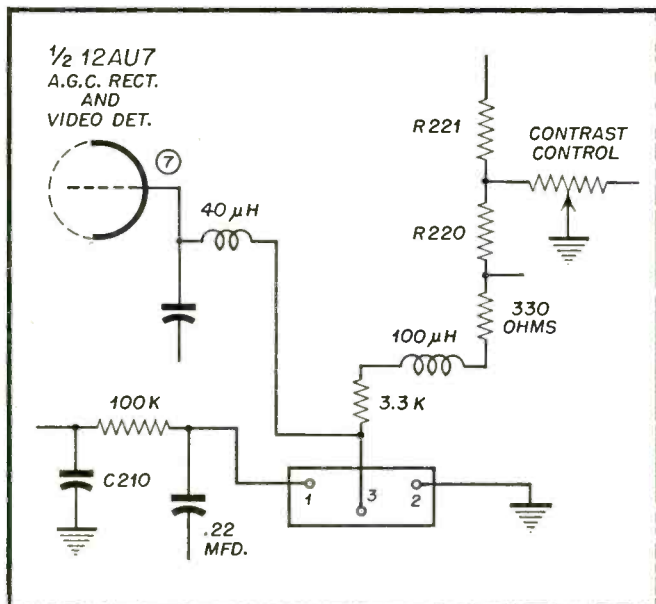

Mfr. Philco Model No. 51T1433B

Card No. PH511443-6 Code No. 121 and 122

Section Affected: Pix

Symptom: Pix bounces.

Reason For Change: To reduce pix bounce.

(This change was included in chassis beginning with runs #2 and #3)

What To Do:

Change: R220 (3.3K) to 1K.
Also, R221 (120K) to 150K.
Also, C210 (.22 μ f) to .47 μ f-400V.

Radio Television Service Dealer magazine wishes to thank RCA for permission to reproduce this excellent safety and first aid chart which appeared in the July-August 1950 issue of AM-FM-TV Broadcast News, an RCA publication.

YOUR OWN LIFE MAY DEPEND ON THIS!

(Why Not Post This or Enlargements Near Your Transmitter and Other Equipment)

WARNING!

Operation of Broadcast Radio and Television equipment involves the use of high voltages which are dangerous to life. Operating personnel must at all times observe all safety regulations. Do not change tubes or make adjustments inside the equipment with voltage supply on. Under certain conditions dangerous potentials may exist in circuits with power controls in the off position due to charges retained by capacitors, etc. To avoid casualties always discharge and ground circuits prior to touching them.

ABOUT FIRST AID

Personnel engaged in the installation, operation and maintenance of this equipment or similar equipment are urged to become familiar with the following rules both in theory and in the practical application thereof. It is the duty of every radioman to be prepared to give adequate First Aid and thereby prevent avoidable loss of life.

PRONE-PRESSURE METHOD OF RESUSCITATION

1. PROTECT YOURSELF with dry insulating material.
2. BREAK THE CIRCUIT by opening the power switch or by pulling the victim free of the live conductor.

DON'T TOUCH VICTIM WITH YOUR BARE HANDS UNTIL THE CIRCUIT IS BROKEN.

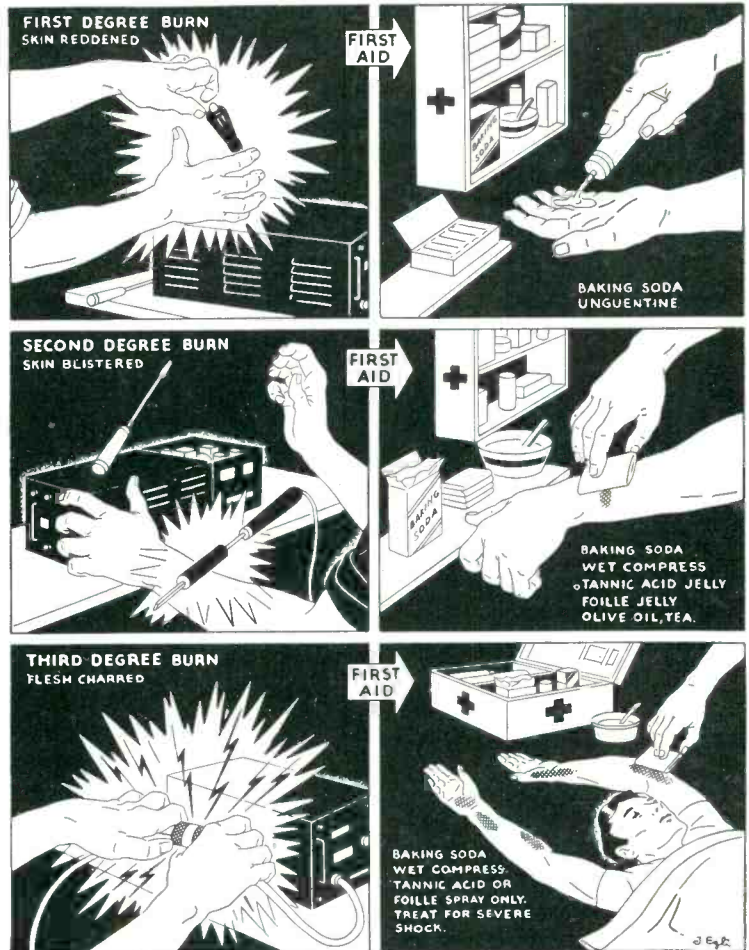

(A)



(B)

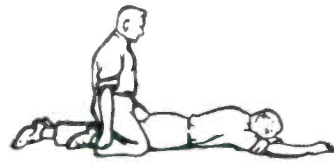

(C)

3. LAY PATIENT ON STOMACH, one arm extended, the other arm bent at elbow. Turn face outward resting on hand or forearm.
4. REMOVE FALSE TEETH, TOBACCO OR GUM from patient's mouth.
5. KNEEL STRADDLING PATIENTS THIGHS. See (A).
6. PLACE PALMS OF YOUR HANDS ON PATIENT'S BACK with little fingers just touching the lowest ribs.
7. WITH ARMS STRAIGHT, SWING FORWARD gradually bringing the weight of your body to bear upon the patient. See (B).
8. SWING BACKWARD IMMEDIATELY to relieve the pressure. See (C).
9. AFTER TWO SECONDS, SWING FORWARD AGAIN. Repeat twelve to fifteen times per minute.
10. WHILE ARTIFICIAL RESPIRATION IS CONTINUED, HAVE SOMEONE ELSE:
 - (a) Loosen patient's clothing.
 - (b) Send for doctor.
 - (c) Keep patient warm.
11. IF PATIENT STOPS BREATHING, CONTINUE ARTIFICIAL RESPIRATION. Four hours or more may be required.
12. DO NOT GIVE LIQUIDS UNTIL PATIENT IS CONSCIOUS.



CIRCUIT COURT



Circuit Court Editor
Radio-TV Service Dealer
Dear Sir:

Reference is made to an article which appeared in "Circuit Court" in your February issue of the Radio-Television Service Dealer, describing the functions of CBS-Columbia models No. 817 and 820 sync amplifying systems. Since the circuit analysis furnished in that article is not quite correct, we are wondering whether you might not wish to publish a correction at a later date.

Referring to our sync amplifiers in CBS-Columbia 817 and 820, it is not quite accurate to describe Tube "A" and Tube "B" as separate amplifiers for the horizontal and vertical sync circuits.

Basically, Tube "A", with a specially selected grid in-pur circuit, operates as a sync separator and amplifier for both horizontal and vertical sync pulses.*

If Tube "B", with its grid circuit consisting of $C209$ and $R207$, were completely removed, the over-all sync separating system would still function almost as normally as before, in the absence of strong impulse noise.

However, especially in weak signal areas and in the presence of strong

The following letter was received by us from the service department of CBS Columbia. In essence it presents a somewhat different version of operation of the sync amplifying system used in the Columbia Models 817 and 820 receivers. In the interest of a better understanding of the operation of this circuit on the part of readers we herewith present this version.

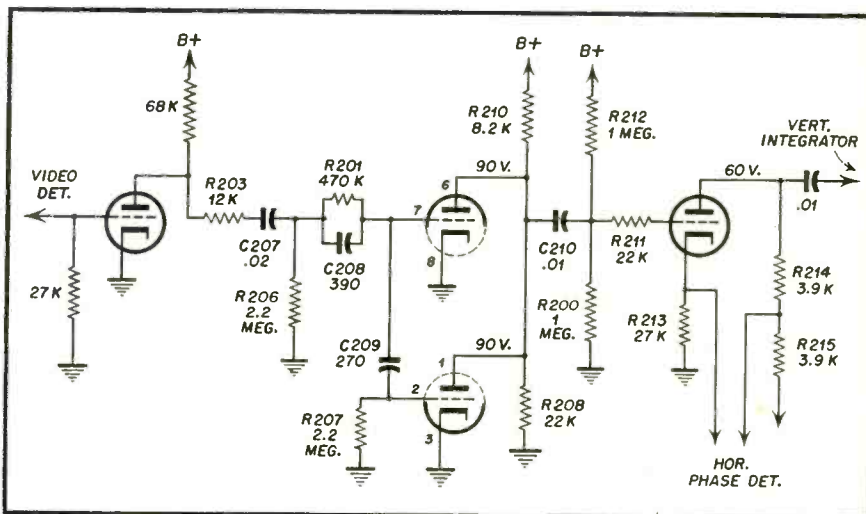

Fig. 1—Separate sync. amplifiers used in C.B.S. Columbia Models 817, 820.

impulse noise, while the double time constant grid input circuit of Tube "A", possesses a high degree of noise immunity, eventually $C207$ will charge up with noise and cut-off the tube. During the time the noise charge leaks off $C207$ through its relatively long time constant, Tube "A" will be wholly or partially inoperative.

If Tube "B" is now put back into the circuit, it is apparent that while Tube "A" remains cut-off due to the noise voltage existing across $C207$, Tube "B" is still operative. Sync pulses appearing at the input to the system will continue to operate Tube "B" providing synchronizing information to the common plate load. While it is true that the relatively small value of $C209$ will result in somewhat better horizontal than vertical sync information appearing at the plate load resistor when Tube "B" alone is operating, the performance of the over-all system in the presence of severe noise is significantly improved over that of the Tube "A" circuitry alone. The small value of

$C209$ is, of course, essential to insure that Tube "B" never remains cut-off for any length of time.

The actual values of the circuit elements have been carefully chosen so that under equilibrium conditions in the absence of impulse noise, the relative contributions of Tubes "A" and "B" result in stable horizontal and vertical operation, while in the presence of severe noise, optimum noise immunity is obtained.

In any further questions concerning this circuit, please do not hesitate to contact the writer.

Very truly yours,
CBS-Columbia Inc.
Edward F. Morgan
Service Manager

* White and Avins; RCA LB-813: "Improved Sync Separation in Television Receivers in the Presence of Impulse Noise."

G. E. Model No. 21T4—
Noise Reduction

Dear Sir:

The G.E. model #21T4 (Fig. 3) uses two plate circuits with common

(Continued on page 68)

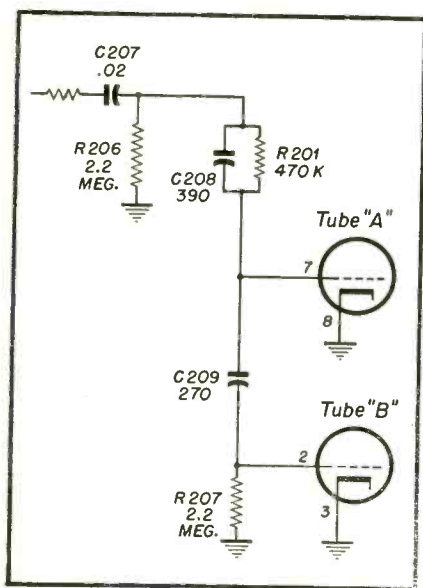

Fig. 2—Partial schematic showing method of sync voltage distribution.

ASSOCIATION NEWS



Television Servicing Dealers Association, Phila.

Aims and Purposes for the Organization of The Television Servicing Dealers Association are as follows:

I. To promote the welfare and mutual interests of the servicing industry.

A. Public confidence by the use of the various mediums in our city: Press, Radio, Television, Mail.

B. Cooperation with the Better Business Bureau and Municipal Departments.

C. Cooperation with other business and civic organizations.

D. To build public confidence and acceptance of our membership.

II. Elevation of standards.

A. Create a code of ethics for their servicing industry.

B. Design a uniformity of suggested rate schedules.

C. Mutual assistance among membership: Exchange of information, both technical and business. Exchange of materials where surplus and special parts are needed.

D. Maintenance of competent servicing departments.

III. Promote public relations.

A. Education at consumers level: What is a service charge. Whys and reasons for a service charge and what it covers. What is a guarantee and its coverage. Why there may be repeat calls and the necessity for charge.

IV. Business promotions.

A. Provide improvements in business methods.

B. Simplified service records.

C. Business bookkeeping for small shops.

D. Simple standardization of forms and records.

E. Phone personality.

F. Sales promotional materials:

Displays—manufacturers, distributors. Advertising methods—mailing, newspapers and publications.

G. Service and technical information as needed for daily operation.



Seated, left to right: Harry E. Ward, Gen. Chairman Public relations; Marilyn Cochems, Secretary; Joe Martin, President; Fred Abrams, Vice-President; Clarence Spencer, Treasurer. Standing, left to right: Richard Harding, Ass. Ch. Public Relation; Hal Myers, Customer Relations. Les Huckins, Director of the board.

Long Beach Radio Technicians Association Inc. (Calif.)

The above picture is of the new officers of Long Beach Radio Technicians Association, Inc.

LBRTA is endeavoring to introduce a television licensing bill into our State legislature.

Radio Television Technicians Guild (Boston)

The RTTG represented the servicemen of Boston at a meeting of the Boston Better Business Bureau to formulate plans to make Boston a cleaner TV place to live.

At the Wednesday (Feb. 25th) meeting a lecture on Philco Film and sound was presented which featured the following 1) Practical trouble shooting on the latest Philco TV-90 2) Use of test equipment in television service. And 3) A.G.C. and noise inverter circuits.

National Association of TV Electronics Service Association

On April 10, 11, 12, 1953—Television Service Engineers, Inc. of Greater Kansas City will be host to NATESA (National Association of Television & Electronics Service Association) for the annual convention.

Over 300 attendance is anticipated from NATESA affiliate members at this early date from all sections of the United States. Genuine interest is dominant as this meeting is the one source for vital information for management and service organizations.

The headquarters for the convention is the Continental Hotel, as it is outstanding in meeting rooms, exhibitors' space and visitors accommodations. Two complete floors of privacy have been reserved for this event.

April 10th, Friday, is registration day and the opening of exhibits. A cocktail party will be given at 4:30 P.M. by the host. T.S.E.

April 11th, opening of the meeting by Frank Moch, National President. Discussions, Luncheon, UHF Authority, Management, Service, Banquet and Entertainment.

April 12th, Ranch Style Breakfast, address by outstanding speaker, convention reports, final day of exhibits.

Phila. Radio-Servicemen's Association

On Thursday, February 19, 1953, P.R.S.M.A. and Beetem and Brody, Inc., presented Lee Sigmund, Chief Engineer, and Harold Dittenhoffer, Service Manager of the Olympic Radio and Television Company, who spoke on the servicing of new and old Olympic TV receivers. Mr. Sigmund went over the circuit of the latest model Olympic receiver from beginning to end explaining about each circuit along the way.

Over one hundred men attended this meeting and were supplied wiring diagrams with which to follow Mr. Sigmund during his talk.

Willis L. Ashby, Sales Engineer, Raytheon, lectured on "How to Interpret What You See in UHF," at the TV service meeting held at the Franklin Institute February 26, 1953. Mr. Ashby has been in on the ground floor of UHF experimentation.

[Continued on page 62]

SHOP NOTES

Write up any "tricks-of-the-trade" in radio servicing that you have discovered. We pay from \$1 to \$5 for such previously unpublished "SHOP NOTES" found acceptable. Send your data to "Shop Notes Editor."

Zenith Model 29G20-Oscillation

A Zenith Model 29G20 was brought in with parasitic oscillations on channels 11 & 13. (These are similar in appearance to Barkhausen Oscillations.) This model has two 6BG6G tubes in parallel for the horizontal

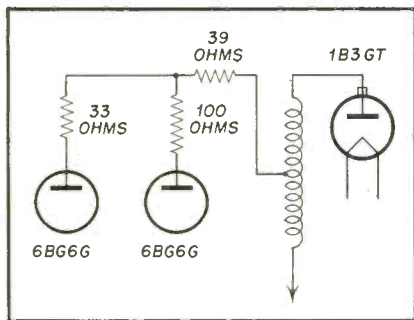

Fig. 1—Curing oscillation in Zenith Model 29G20.

sweep output stage. Substitution of at least half a dozen new tubes and the use of all types of magnets and ion traps did not help. The trouble was finally cured by a suppressor circuit composed of three resistors as shown in the diagram.

John Wizeman
New York, N. Y.

Universal Cheater Cord

Shown in Fig. 2 is a universal cheater cord which plugs into the one removed from the set to eliminate "socket hunting." An adaptor is taped

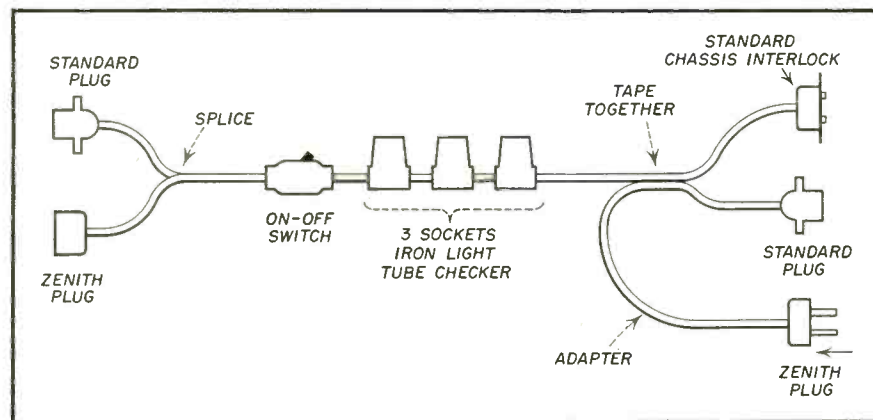

Fig. 2—Universal cheater cord.

in to accommodate Zenith plugs. Three sockets take care of soldering gun, trouble light, and tube checker or other test equipment. An on-off switch provides a means for turning off the set other than pulling the plug. Two female sockets to fit standard or Zenith sets complete the gadget.

Elmer Fischer
Parma, Ohio

Connecting External Antenna To Loop Set

Even though many radios serviced today have loop antennas, we still get many to which an external antenna must be connected. I solder a Fahnstock clip to the antenna lead leaving the radio, leaving the clip portion for quick attachment of an external antenna.

In fact, I have done this to loop antenna radios where the people used an external antenna. On sets having a screw for antenna attachment, I have used a spade lug on a piece of ten inch wire, with the clip available for customer attachment of the external antenna. It eliminates the use of a screwdriver and prevents attaching the antenna to the ground screw.

Joseph M. Stefanko
West Allis, Wis.

Motorola Model 61K22—Intermittent

Have run across several cases of intermittent reception now in these

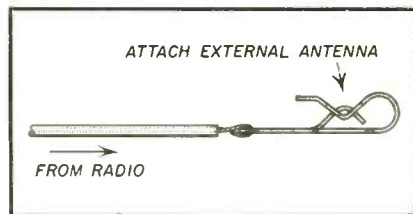

Fig. 3—Convenient loop receiver antenna attachment.

sets. Will play for 10 to 20 minutes, then goes dead. All tubes check good. In shop on service bench set played fine (for five days on one occasion), but a few days later, it was back at the old tricks. Replacing 6T5 oscillator tube was cure needed, although tube checked good in tester.

Shingler Radio-TV Labs
McVeytown, Penna.

Westinghouse V2162-Loss of Horizontal Sync

Westinghouse V-2162 Chassis. Complaint; after on 1/2 hour; set completely loses horizontal sync. Remedy: Turn off set, and immediately check keyed *agc* winding on the width coil. It will check open, however if allowed to cool, the coil will check continuity. Replace coil.

E. White Plains, N.Y.
A. Pratesi

Ford Model M1 (8A-18805A) Auto Set

In auto, set cut off and on intermittently, mostly after being played a few minutes. On service bench set played good.

Finally located trouble in oscillator coil which was shorting out. At bottom of coil is a sleeve to which coil ends and connecting wires are anchored by means of small staples. A staple had penetrated through to the coil and was shorting it out. Removal of staple, placing sleeve lower to get it off the coil wire, and cementing in place with coil cement remedied completely.

Shingler Radio-TV Labs
McVeytown, Penna.

Chrysler 1951 Auto Sets

To whip stubborn cases of blowing fuses in the 1951 series Chrysler auto sets manufactured by Philco for all four Chrysler cars, separate fuse holder and install battery lead in set. Solder lead to spark plate post in radio instead of just plugging it in. The tip on these leads is very light metal and will not keep any tension on post of spark plate. When loose, fuse will blow when set is turned off.

Kenneth Futrell
Muncie, Ind.

See YOUR ANSWER

WITH THE **PRECISION ES-500A**

HIGH SENSITIVITY — WIDE RANGE **5" OSCILLOSCOPE**

PUSH-PULL VERTICAL AND HORIZONTAL AMPLIFIERS
20 MV PER INCH "V" SENSITIVITY — 150 MV PER INCH "H" SENSITIVITY

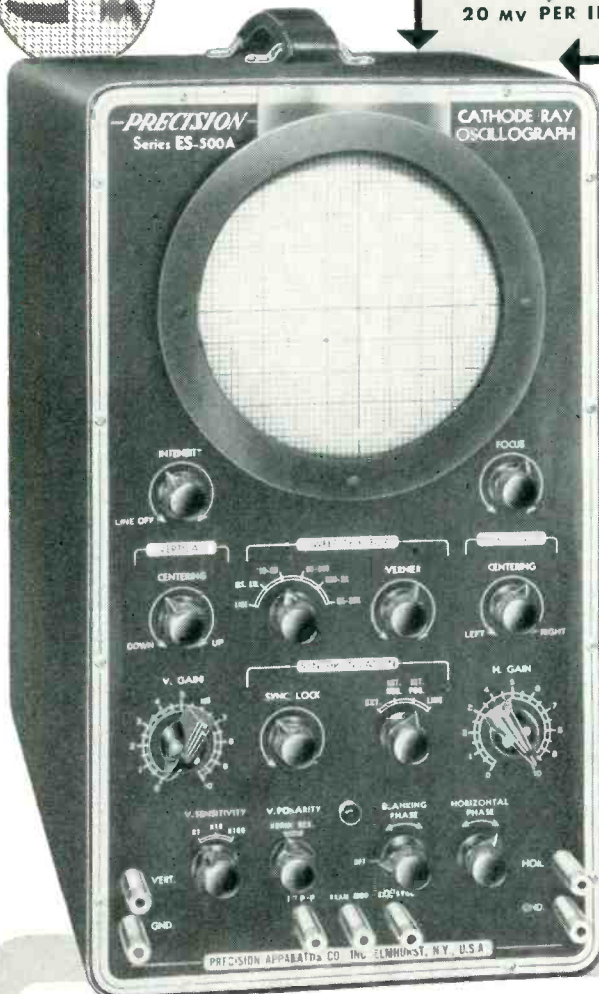

SERIES ES-500-A affords the ultimate in performance, visibility and operational flexibility at moderate cost. **PRECISION** engineers have incorporated every necessary feature which they found to be required to meet the needs of the rapidly advancing art of electronics, A.M., F.M., and TV.

SUMMARY OF IMPORTANT FEATURES

- ★ **Push-Pull Vertical Amplifier — High Sensitivity, Wide Range, Voltage Regulated.** 20 millivolts (.02v.) per inch deflection sensitivity. 10 cycles to 1 MC. response. 2 megohms input resistance. Approx. 22 mmf. input capacity.
- ★ **Compensated Vertical Input Step Attenuator—X1, X10, X100.**
- ★ **Direct Peak to Peak Voltage Checks** thru use of internal, semi-square wave, regulated voltage calibrator.
- ★ **Vertical Phase-Reversing Switch.** Non-frequency discriminating.
- ★ **Push-Pull, Extended Range, Horizontal Amplifier—150 Millivolts (.15 v) per inch deflection sensitivity.** 10 cycles to 1 MC response at full gain. 1/2 megohm, approx. 20 mmf. input.
- ★ **Linear Multi-Vibrator Sweep Circuit—10 cycles to 30 KC.**
- ★ **Amplitude Controlled, Four Way Synchron. Selection:** Internal Positive, Internal Negative, External and Line.
- ★ **"Z" Axis Modulation** input facility for blanking, timing, etc.
- ★ **Internal, Phasable 60 cycle Beam Blanking** for elimination of alignment retrace; clean display of synchron. pulses, etc.
- ★ **Sweep Phasing Control** for sinusoidal line sweep usage.
- ★ **Direct Horizontal and Vertical Plate Connections.**
- ★ **High Intensity CR Patterns** through use of adequate high voltage power supply with separate 2X2 rectifier.
- ★ **The Circuit and Tube Complement:** 6C4 "V" cathode follower. 6CB6 "V" amplifier. 6C4 "V" inverter. Push-Pull 6J6's "V" driver. 7N7 "H" amplifier and inverter. Push-Pull 6AU6's "H" driver. 7N7 Multi-vibrator, linear sweep oscillator. 5Y3 low voltage rectifier. 2X2 high potential rectifier. VR-150 regulator. 5CP1/A CR Tube.
- ★ **Four-Way, Lab-Type Input Terminals—**Take banana plugs, phone tips, bare wire or spade lugs. Matches SP-5 Probe Set cable connector.
- ★ **Light Shield and cross-ruled Mask,** removable and rotatable.
- ★ **Extra Heavy-Duty Construction and components.**
- ★ **Heavy Gauge, Etched-Anodized, No-Glare, Aluminum Panel.**
- ★ **Fully Licensed under Western Electric Co. patents.**

Series ES-500A: In louvered, black-ripple, heavy gauge steel case. Size 8 1/4" x 14 1/2" x 18". Complete with light shield, calibrating mask and comprehensive instruction manual. **NET PRICE \$173.70**

Series SP-5 — OSCILLOSCOPE TEST PROBE SET

FOR TV SIGNAL TRACING, ALIGNMENT,
TROUBLE SHOOTING AND WAVEFORM ANALYSIS

- ★ Specifically engineered for use with **PRECISION** Cathode Ray Oscilloscopes, Series ES-500 and ES-500A.
- ★ Includes **four of the most important test probes** for general purpose, as well as specialized use:
 1. **HIGH IMPEDANCE—LOW CAPACITY PROBE**
 2. **SIGNAL TRACING—CRYSTAL PROBE**
 3. **RESISTIVE—ISOLATING PROBE**
 4. **SHIELDED—DIRECT PROBE**
- ★ Each probe is specifically engineered for efficient application to the special test problems requiring its use.
- ★ Distinctively colored heads and individual labelling permit positive identification of each probe.
- ★ A single, universal, coaxial cable accommodates each probe through a quick-change, self-shielding connector.
- ★ A specially-designed, shielded plug provides for positive cable attachment to the ES-500 and ES-500A Vertical input posts.
- ★ Each probe head terminates in a patented clip-on tip which frees both hands of the operator.



Series SP-5, in custom-designed, vinyl-plastic, carrying case, complete with four probe heads, universal coaxial cable, and detailed operating instructions. **NET PRICE \$21.50**

TV • AM • FM • TV • AM • FM

PRECISION APPARATUS COMPANY, INC.

92-27 HORACE HARDING BLVD. • ELMHURST, L. I., N. Y.

EXPORT DIVISION: 458 BROADWAY, NEW YORK CITY U.S.A. • CABLES—MORHANEX
CANADIAN SALES DIVISION: ATLAS RADIO CORP. LTD., 360 KING ST. W. TORONTO 28, ONTARIO

See the ES-500A Oscilloscope and the Series SP-5 Test Probe Set at leading Radio Parts & Equipment Distributors.

NEW TUBES

GE 6AH4-GT Vertical Amplifier

The type 6AH4-GT, a vertical deflection amplifier, is expected to be particularly useful in receivers with large-deflection-angle picture tubes.

The tube utilizes relatively low plate voltages at high plate currents to fully deflect wide-angle picture

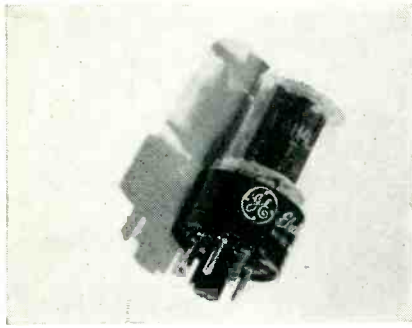

tubes. It is capable of withstanding the high pulse voltages normally encountered in this application.

Typical operating characteristics with 250 volts on the plate include: heater voltage 6.3 volts; grid voltage, -33 volts; plate current, 30 milliamperes; transconductance, 4,500 micromhos; amplification factor, 8.0; and plate resistance, 1,780 ohms.

Sylvania 6U8

A new miniature nine-pin, triode-pentode receiving tube designed primarily for service in *fm* and television receivers as an oscillator mixer has been announced by the Radio Tube Division of Sylvania Electric Products, Inc.

Designated the 6U8, both sections of the new tube are electrically independent and adequately shielded,

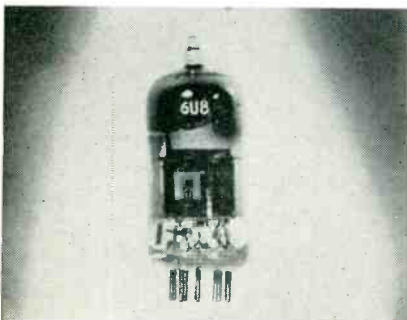

CHARACTERISTICS AND TYPICAL OPERATION

	Triode	Pentode	
Heater Voltage (ac or dc)	6.3		Volts
Heater Current	450		Ma.
Plate Voltage	150	250	Volts
Screen Voltage		110	Volts
Cathode Resistor	56	68	Ohms
Plate Current	18	10	Ma.
Screen Current		3.5	Ma.
Transconductance	8500	5200	
Amplification Factor	40	0.4	Megohms
Plate Resistance	.005		Volts
Grid Voltage for $I_b = 10 \text{ ma}$	-12	-10	

voltage of only about 12 volts. These

and both have demonstrated exceptional performance on the higher frequencies. The completely independent sections permit a high degree of flexibility in circuit design.

The pentode section provides excellent gain with a low local oscillator voltage which minimizes oscillator radiation. The pentode section may also be used as an *if* amplifier, video amplifier, sound limiter or sync separator. The triode performs satisfactorily as a horizontal or vertical oscillator, or sync clipper.

RCA-12V6-GT

RCA-12V6-GT is a beam power tube of the heater-cathode type intended primarily for use in the output amplifier of automobile radio receivers operating from a 12-volt storage battery.



GENERAL DATA

Electrical:	
Heater, for unipotential cathode:	
Voltage (ac or dc)	12.6 volts
Current	0.225 ampere

SINGLE-TUBE CLASS A₁ AMPLIFIER

Maximum Ratings, Design-Center Values:	
Plate voltage	315 max. volts
Grid-No. 2 (Screen) supply voltage	315 max. volts
Grid-No. 2 voltage	See rating chart
Plate dissipation	12 max. watts
Peak heater-cathode voltage:	2 max. watts
Heater negative with respect to cathode	90 max. volts
Heater positive with respect to cathode	90 max. volts

Typical Operation:	
Plate Voltage	180 250 315 volts
Grid-No. 2 voltage	180 250 225 volts
Grid-No. 1 voltage	-8.5 -12.5 -13 volts
Peak AF Grid-No. 1 voltage	8.5 12.5 13 volts
Zero-Signal Plate Current	29 45 34 ma.
Max-Signal Plate Current	30 47 35 ma.
Zero-Signal Grid-No. 2 Current (Approx.)	3 4.5 2.2 ma.
Max-Signal Grid-No. 2 Current (Approx.)	4 7 6 ma.
Plate resistance (Approx.)	50000 50000 80000 ohms
Transconductance	3700 4100 3750 umhos
Load Resistance	5500 5000 8500 ohms
Total harmonic distortion	8 8 12 per cent
Max-Signal Power Output	2 4.5 5.5 watts

The application of directed electron beam principals in the design of this tube make it capable of producing relatively high power output with high power sensitivity. For example, a single 12V6-GT operated with a plate and grid No. 2 voltage of 250 volts can deliver a maximum-signal power output of 4.5 watts with a driving voltage of only about 12 volts. These

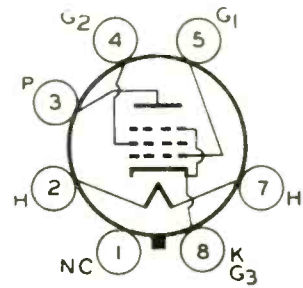

Basing diagram

features together with relatively low plate-current drain make the 12V6-GT especially suitable for use in the output stage of automobile receivers.

Rauland 21YP4, 21ZP4A

The Rauland Corporation, Chicago, announces the production of two new 21" rectangular television picture tubes with spherical faceplates.

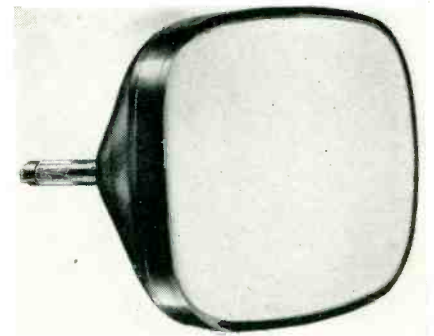

The 21YP4 had electrostatic focus and magnetic deflection requiring a focusing voltage from -0.4 to -2.2% of the anode voltage. The 21ZP4A has magnetic focus and magnetic deflection.

Both tubes have gray filter faceplates which improve picture contrast. Each type tube has external conductive coating which acts as filter capacitance. Each tube employs the Rauland indicator ion trap gun which provides outstanding picture quality with a minimum of installation servicing time. Pictured above is the 21YP4 tube.

Hytron 21YP4

The Hytron type 21YP4 is a 21" rectangular, picture tube. The face

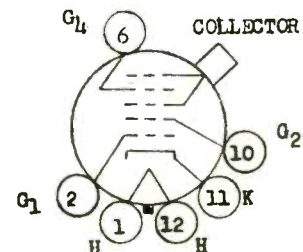

Basing diagram

[Continued on page 62]

for the
new 12 volt
auto circuit

RADIART

announces its
6300 series...

an addition
to the full line of

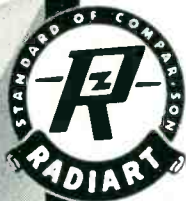

Seal-Vent
RED SEAL VIBRATORS

Faster Starting

The exclusive RADIART design permits the briefest possible "Warm-up" period, thereby making the RADIART vibrators practically instantaneous starting. This added feature means greater performance.

Longer Life

There's more for your money in every RADIART vibrator—they last longer! Precision manufacture, using only the finest materials, assures long lasting, trouble-free performance.

Complete Replacement Line

RADIART has a CORRECT replacement vibrator for every original equipment vibrator. 12 Radiart vibrator types serve over 89% of all popular replacements. NOW...THE NEW 6300 SERIES IS READY FOR THE NEW '53 car MODELS with radios having 12 volt circuits.

Seal-Vented

Sealed at the factory to prevent the formation of an insulating film on the points while the vibrator is on the shelf...the sealed vent automatically opens when put in use to allow the vibrator to "breathe".



SUBSIDIARY OF



preferred by Servicemen Everywhere

THE RADIART CORPORATION CLEVELAND 13, OHIO

VIBRATORS • AUTO AERIALS • TV ANTENNAS • ROTORS • POWER SUPPLIES

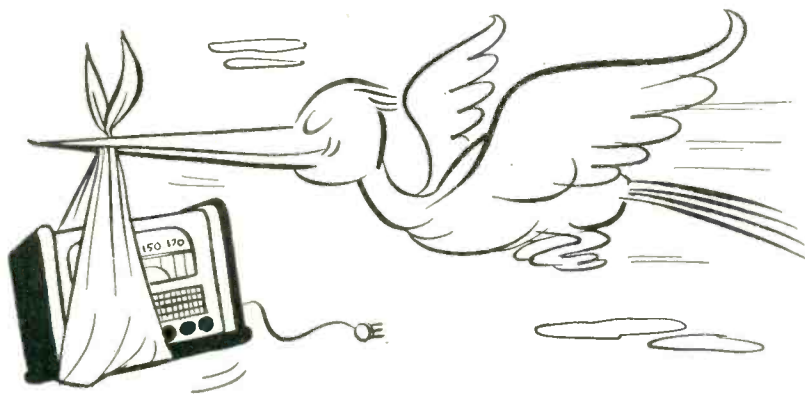

New Products

CONICAL TV AERIAL

A new conical television aerial has been placed on the market by Snyder Manufacturing Company of Philadelphia, it has been announced by company sales manager Dick Morris.

Bearing the code number AX-622, the new Snyder television aerial features Speed Clip Construction for easy and permanent installation. Described by the slogan "Open! Snap! It's Up!", the AX-622 comes completely pre-assembled and requires only that the elements be snapped into position on the superstructure locking plate where they are held firmly and permanently.

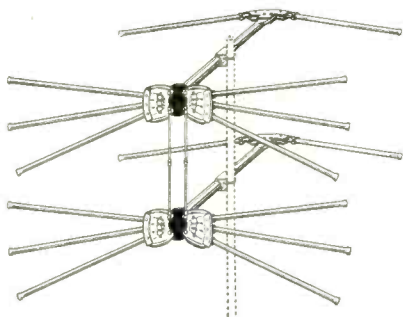

For high and low band reception, the Snyder AX-622 is a dual bay aerial of 16 dowel reinforced aluminum elements, with genuine Hi-Paq insulator and heavy duty weatherproof assembly brackets.

Catalogs on the Snyder AX-622 and AX-620 Single Bay may be obtained by writing to Snyder Manufacturing Company, Philadelphia 40, Pa.

GERMANIUM RECTIFIERS

The General Electric Company has announced new diffused junction germanium rectifiers for use in computers, magnetic amplifiers, television receivers and telephone switchboards. The new series includes four models, 4JA1A1, 4JA1A2, 4JA1A3 and 4JA2A4. They are hermetically sealed and extremely small in size. Forward resistance of the new units is very low, less than two ohms at rated load. Back resistance and peak inverse voltages are high. Glass-to-metal seals are used to hermetically seal the units against deteriorating elements. Originally developed for military applications, the rectifiers meet stringent humidity, shock and vibration requirements. Peak inverse voltages range from 100 to 400 volts. DC output currents into a resistive load range from 75 to 500 milliamperes. Full load voltage drop is 0.5 in three



models and 0.7 in the fourth. All ratings are at ambient temperatures up to 55 degrees centigrade.

Further information on the new germanium rectifiers is available from Dept. N-13, Inquiry Section, of the G-E Electronics Division at Electronics Park, Syracuse, N. Y.

TV ANTENNA CONNECTOR

Channel Master Corp., Ellenville, N.Y., has announced the development of the Triple-Tie, Model No. 9035, a brand new inter-action filter which ties together all three TV reception bands. Developed in the Channel Master Laboratories, the Triple-Tie permits the use of up to 3 individual antennas with only one lead to the TV set or converter. Separate terminals are provided for a Low Band vhf antenna (Channels 2-6), a High Band vhf antenna (Channels 7-13), and a uhf antenna (broad band or Yagi). All 3 are joined into 1 single simple antenna system with the Triple-Tie. The Triple-Tie features "free space" terminals. These prevent the accumulation of dirt, ice, or rainwater between the terminal points which can actually short out the TV picture.

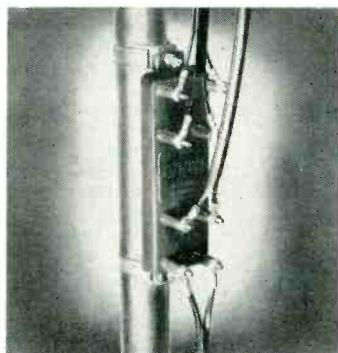

Designed to adapt all Hi-Lo vhf installations to uhf quickly and economically, the Triple-Tie is recommended for all Hi-Lo vhf areas which either now have uhf or which are getting uhf in the future. The Triple-Tie eliminates inter-action between any of the antennas in the system and accomplishes this with absolutely no signal loss.

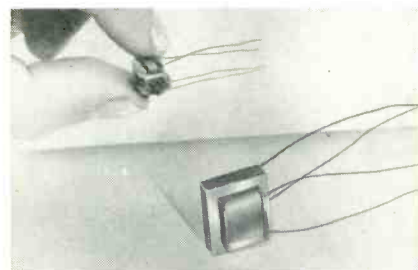

TRANSISTOR TRANSFORMER

Described as the world's smallest transformer, an ultra-miniature transistor transformer has been introduced by the Standard Transformer Corporation, Chicago.

Weighing less than one-tenth of an ounce, the tiny Stancor transistor transformers measure as little as one-fourth by three-eighths by three-eighths of an inch and are no larger than the transistors they are designed to power. While they are intended primarily for transistor audio applications, the ultra-miniature transformers can be used wherever low power is involved, Stancor engineers said. Useful below 1 mw level, they are constructed of extremely fine wire, wound on molded nylon bobbins, with special nickel alloy steel laminations.

UHF ANTENNA

Telrex, Inc., Asbury Park, N. J. has announced the introduction of the Ultra "Bow Tie" Series of uhf Antennas. These antennas feature high gain, directivity, and excellent impedance characteristics over the entire uhf band. By means of "sectionalized" design, the basic "Bow Tie" dipole assembly can be employed as a primary area antenna without further accessories. The same basic unit can also be incorporated into a single screen reflector array, a stacked "Bow Tie" screen reflector array, and into the exclusive Telrex

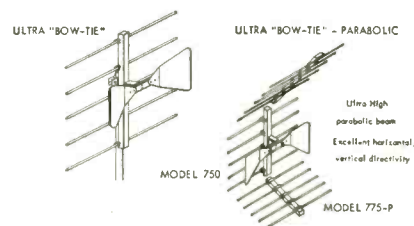

Parabolic Beam array. These elaborations are easily achieved by the use of a Telrex Modification Kit or by the addition of standard Telrex components which are available for initial or field installation.

TV TRUCK COMPARTMENT

Service-Twins, newly designed tool and material compartments, for 1/2 and 3/4 ton pick-up trucks are now being produced by McCabe-Powers Auto Body Company. The compartments are shipped in pairs, completely painted inside and out. The finish, in medium-dark green, is baked on synthetic enamel that resists rust and chipping. Compartment doors are of double-panel construction and are completely weathertight. Slam action catches are

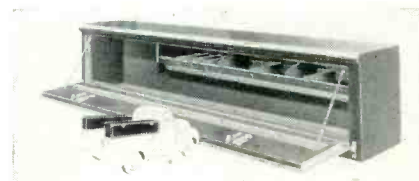

NOW! ULTRA-HI "CONICAL-V-BEAMS"

by *telrex*

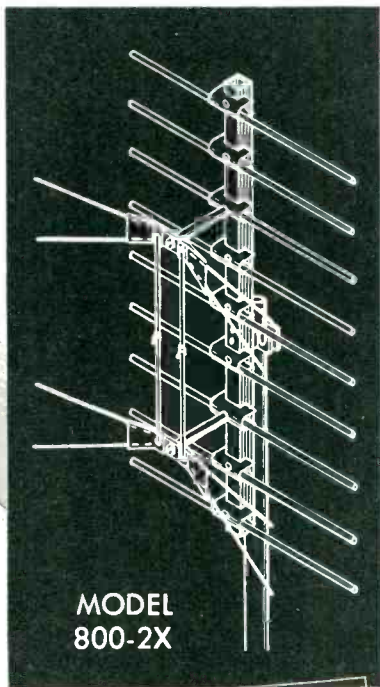

MODEL
800-2X

Outstanding Broadband UHF Antennas featuring—

- **STACKED HI-GAIN "CONICAL-V-BEAM" DIPOLES**—Ultra sensitive stacked array with excellent directivity for clean, snow-free, ghost-free long distance reception.
- **BROADBAND**—Stacked "CONICAL-V-BEAM" dipoles insure flat hi-gain response with full video and tone fidelity on any UHF channel, plus freedom from flicker or flutter!
- **HURRICANE DESIGN — FACTORY ASSEMBLED**—Light weight, ruggedized construction of the finest, most durable materials available today. Easily installed in a minimum of time.

NEW!

ULTRA "BOW-TIE" SERIES

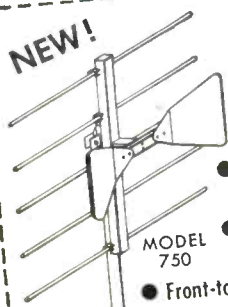

MODEL
750

- Peak efficiency — no "dead" spots
- Gain over 13db (stacked)
- Front-to-back ratio over 25db
- Simplicity of installation
- Rugged, all aluminum "Hurricane" construction
- Sectionalized design — basic units interchangeable for single bay, stacked or parabolic assembly

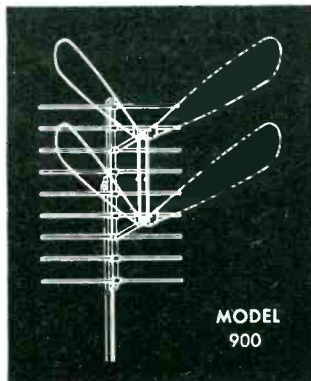

MODEL
900

OTHER MODELS AVAILABLE for every ultra-hi frequency need in every price range—write for catalog.

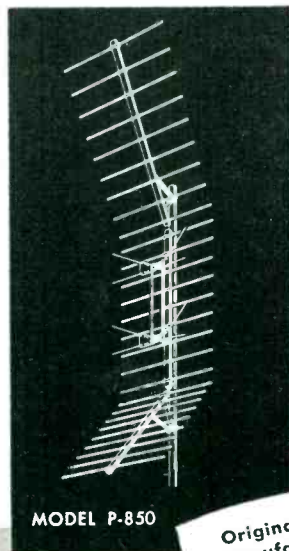

MODEL P-850

TELREX — TESTED, TRIED AND PROVEN FOR EVERY RECEPTION AREA, NEAR OR FAR!

"CONICAL-V-BEAMS" are produced under Re-issue Patent Number 23,346.

telrex INC.
CONICAL-V-BEAMS

AMERICA'S
OUTSTANDING
TELEVISION
BEAM

Originators and
Manufacturers of
"CONICAL-V-BEAMS"
— insist on
the Original!

ASBURY PARK 5, N. J.

recessed for safety and appearance. Cylinder locks, provided on each door, are keyed alike for convenience. Parts bins are provided for each compartment as standard equipment. Bins are equipped with removable dividers.

Service-Twins are available in 74" and 84" lengths for installation on 1/2 and 3/4 ton pick-up trucks respectively. They can be mounted in a few minutes using only a drill and wrench. An overhead rack, with adjustable ladder brackets, is optional. For descriptive bulletin and name of nearest distributor, write McCabe-Powers Auto Body Company, 5900 N. Broadway, St. Louis 15, Missouri.

UHF TV CONVERTER

A new Model 3300 continuously tuned UHF TV CONVERTER is announced by Electro-Voice, Inc., Buchanan, Michigan. Research-engineered by E-V and thoroughly field-proved,

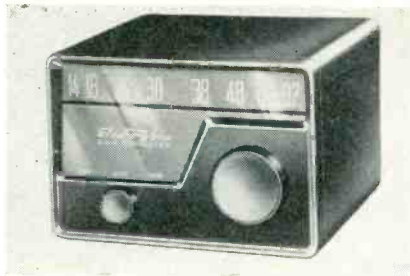

the "3300" Converter readily adds all UHF channels to VHF television sets. Installations is quick and easy—connects to antenna input of the VHF TV set and just plugs into the a.c. electrical outlet.

Utilizes channels 5 or 6 of VHF TV set as IF. Does not affect VHF reception. Housed in smart compact dark brown cabinet—size 7 3/4" wide, 5 1/4" high, 6 1/4" deep. Operates from 105-125 volts, 50-60 cycles AC. Input and output impedances, 300 ohms. Quality built throughout for picture precision and trouble-free service. List price \$49.50. For further information, write for Bulletin 182 to Electro-Voice, Inc., Buchanan, Michigan.

TV "A DO ALL" GENERATOR

The now famous TV "DO-ALL" GENERATOR Model 740 has proved to be an extremely versatile instrument by performing extremely well as a UHF Signal Generator. Radio City Products has recently announced that the unit has been further improved to give even better performance and has been designated the Model 740A.

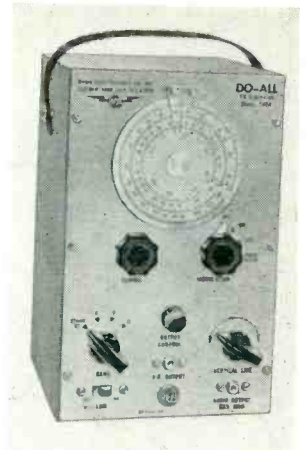

The new Model #740A is now being shipped on all orders for the Model 740 at no increase in cost. Sales of this instrument had far outstripped production causing short delays in delivery but expanding facilities are easing this situation.

UHF-VHF COUPLER

The JFD Manufacturing Company, Inc., of Brooklyn has announced development of the JFD JeTie Electronic Coupler for UHF and VHF antenna installation. The JeTie is a silver printed circuit contained in an hermetically sealed Butyrate case.

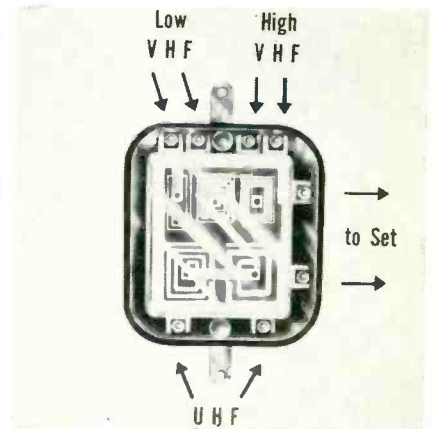

The JeTie can be very simply attached to any television mast by use of the JFD NUT Stand-Offs which are packaged with the coupler in an attractive, laminated box. The JeTie, of course, is the electronic divider network which will be packaged with the JeT283 antenna, for combination VHF-UHF reception. For complete information on the JFD JeTie, write for literature to the JFD Manufacturing Company, Inc., 6101 Sixteenth Avenue, Brooklyn 4, New York.

IT'S HERE!

The NEW IMPROVED DAVIS SUPER-VISION

**ALL-CHANNEL TELEVISION ANTENNA
For FRINGE AREA and DX**

*Brings in the Signals STRONG
and CLEAR up to 125 Miles and
More Away from the Station*

The NEW DAVIS
SUPER-VISION
has been
WIND-TESTED
and
WEATHERIZED

...STURDY BUILT and
STRENGTH-INCREASED
so it will stand the gaff in
any part of the country

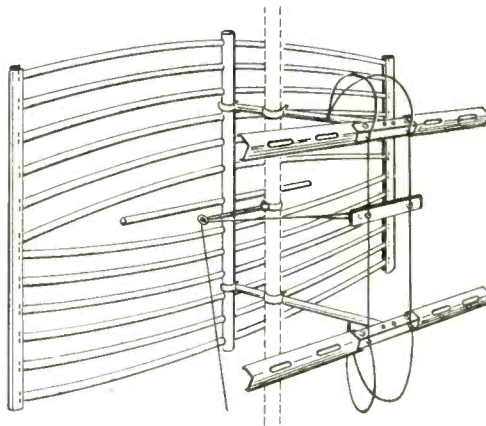

"The Original Antenna Sold With A
Money-Back Guarantee"
Built By America's Fastest Growing
Antenna Manufacturer

AT YOUR JOBBERS —
"THE BACKBONE OF YOUR INDUSTRY"

... or MAIL COUPON TO:

DAVIS ELECTRONICS SD-1
4313 West Magnolia Blvd., Burbank, California
SIRS: RUSH INFORMATION TO ME AS CHECKED
BELOW:

Send Free Technical Data on new SUPER-VISION ANTENNA.
 Send Name and Address of NEAREST JOBBER.

Name _____
Street _____
City _____ State _____

HAVE A DATE

WITH DAVIS

BOOTH 977

CHICAGO ELECTRONICS SHOW





ONLY THE PHILCO TUBE CHECKER

Tests 'Em All!

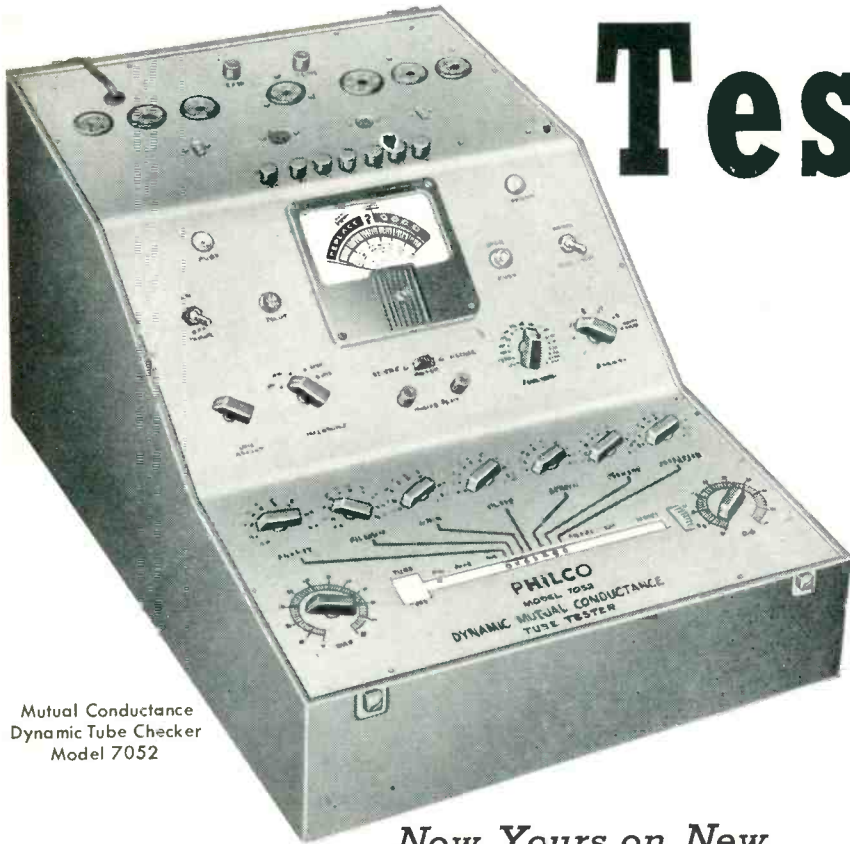

Mutual Conductance
Dynamic Tube Checker
Model 7052

Now Yours on New
SPECIAL PAYMENT PLAN



CATHODE RAY TUBE CHECKER

MODEL 7053. From Philco, the *only* emission CRT checker containing a built-in neon bulb calibrator for individual calibration of bulb sensitivity... for pin point accuracy and finest sensitivity each unit is individually calibrated... tests all picture tubes.



3-INCH OSCILLOSCOPE

MODEL 7020. The ultimate in portability... this Philco scope is 2½ times smaller than other 3" units... adaptable for bench use or field servicing... now, avoid guesswork with *pre-set* horizontal and vertical sweep rates. Provide measurements accurate to within 5%.

Here's Philco's answer to your tube checking problems... a mutual conductance tube checker that tests 'em all from subminiature to acorn low power transmitting tubes... featuring the most sensational roll chart yet designed for efficiency and speed of operation. Its compact design, finished in beautiful grey leatherette with blue panel, makes it adaptable for both portable and counter top use. *Size—17" W x 18½" L x 10" D. Weight—21 lbs. (Shipping Wt. 24 lbs.). Operating Voltage—105-130 volts AC.*

- ✓ Most complete, easiest to use roll chart ever designed.
- ✓ Mutual conductance readings given directly in Microhms.
- ✓ Forecasts remaining tube life!
- ✓ Checks shorts and leaks between elements of tubes.
- ✓ Determines noise characteristics and gas content of tubes.

**FILL OUT AND MAIL COUPON OR
SEE YOUR PHILCO DISTRIBUTOR NOW**

**PHILCO CORPORATION, Accessory Division
Allegheny & "A" Sts., Philadelphia, Pa.**

I am interested in the Philco Test Equipment shown here. Please send me details of your **SPECIAL PURCHASE PLAN** for obtaining these units.

Please send **FREE** copy of your new booklet on Philco Test Equipment.



NAME.....

ADDRESS.....

CITY..... STATE.....

PHILCO Test Equipment

SPECIFICALLY DESIGNED FOR THE SERVICEMAN

12 VOLT VIBRATOR

The special requirements of automobile radio sets designed to operate on 12-volt systems have been met by a new vibrator announced by P. R. Mallory & Co. Inc. of Indianapolis.

The new vibrator is the G874, produced as a replacement for original equipment vibrators in auto radio sets used in 1953 Cadillacs, Buicks, Oldsmobiles and GMC Trucks.

The G874 measures 1½" x 3¼" and has a unique pin arrangement which serves as a guide for quick insertion of the vibrator into the set. It also prevents it from being plugged into a 6-volt set by mistake. The pins are arranged in a triangle formation with the longer pin connected to the reed.

Engineering tests have proved the Mallory G874 vibrator to be capable of extensive ser-

vice when correctly installed as a replacement for the following original equipment part numbers:

Cadillac	7263525	1953
	7263545	1953
	7262675	1953
Buick	981231	1953
Oldsmobile	982990	1953
	983004	1953
GMC Trucks	2233338	1953

UHF ANTENNAS

A new line of high quality, low cost UHF antennas has been added to the well known TRIO VHF line. These new UHF antennas feature two general types, the proven bow-tie with reflector design and the familiar yagi type.

The bow-tie with reflector type is avail-

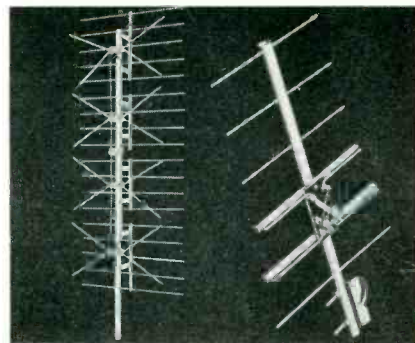

able in 3 all-channel models; a single stack, a two stack and a four stack. Assembly consists only of fastening on reflector, swinging bow-tie-elements to correct position and tightening wing nuts.

UHF CONVERTER-BOOSTER

Blonder-Tongue Laboratories of Westfield, New Jersey, announces the "Ampliverter," an original single-channel UHF converter with more than 17 db gain and a remarkably low noise factor. This compact unit, Model BTU-1, operates automatically with the TV set and is easily mounted on the back of the cabinet, flush with the top. It will produce clear, sharp, snow-free pictures.

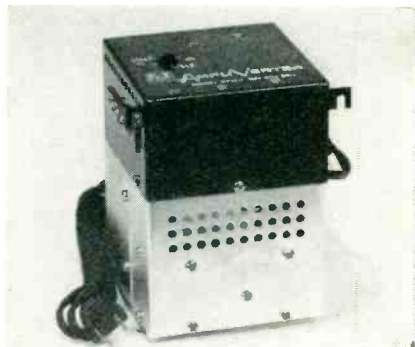

Listing at \$47.50, the new model features three tubes (6AF4, 6BK7A, and 6CB6), a germanium mixer and a self-contained power supply.

10-ELEMENT YAGI

The new Delta X, 10 element Yagis series is now being distributed throughout the country, it was announced this week by LaPointe Electronics Inc., (formerly The LaPointe-Plasco-mold Corp.).



On the high channels, the Delta X has wide element spacing, which results in greater gain. All aluminum construction makes the Delta X lighter. All models of the Delta X, both high and low channels, are provided with boom struts. All low channel booms use 1¼" drawn aluminum tubing while the high channels use lock seam tubing made from new Reynolds Television Alloy #41.

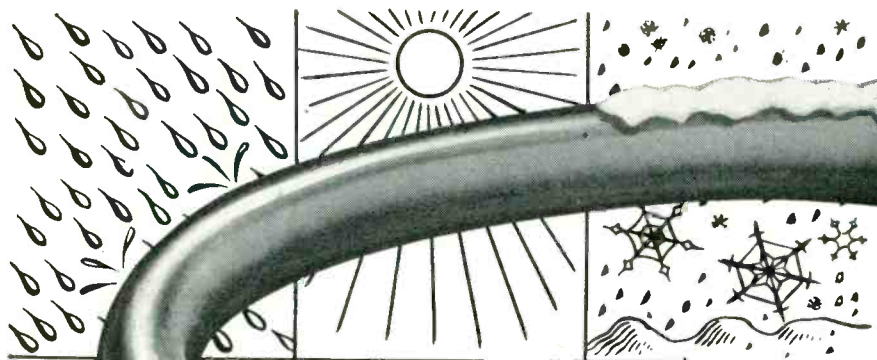

Sheath-Leed the all-weather lead line for finest TV reception

SHEATH-LEED—the DON GOOD super-fine leadline is built for use wherever tough weather conditions prevail. It's especially recommended for use in coastal areas where salt spray encrusts the regular leadline and devitalizes it. And also in hot humid areas, where much alternate rainfall and strong sunlight prevails, and where leadlines are subjected to frost, snow and icy conditions.

- PURE POLYETHYLENE TUBING — ENCASING GOODLINE AIRLEAD
- TWO COLORS — STANDARD BROWN or SILVER-GRAY TUBING
- RECOMMENDED FOR FINEST VHF or UHF RECEPTION
- GIVES MAXIMUM LONG-LIFE SERVICE VS WEEKS OF SERVICE WHERE A REGULAR TYPE LEADLINE IS USED

Goodline Airlead — Nationally Accepted as the Basis of Finest Television Reception

- 80% OF LOSS PRODUCING DIELECTRIC WEB IS REMOVED
- CORRECT IMPEDANCE FOR SHARP, CLEAN, "SNOW-FREE" PICTURES
- PACKAGED: 100'—250'—500'—1000'—2500'

GIVE TELEVISION SETS A CHANCE TO GIVE YOU FINEST RECEPTION
INSIST ON SHEATH-LEED or GOODLINE AIRLEAD

Don Good, INC.

SOLD BY LEADING
JOBBER & DEALERS

Send coupon NOW for complete information. Get samples "in your hands" —you'll realize why Goodline Products give the finest possible in television reception.

DON GOOD, INC. SD-1
1014 Fair Oaks Ave., So. Pasadena, Calif.
Please rush Samples and Complete Information covering Sheath-Leed and Goodline Airlead.

Name _____

Street _____

City _____ State _____

ASTRON

SAFETY MARGIN



CAPACITORS

Cut Callbacks!

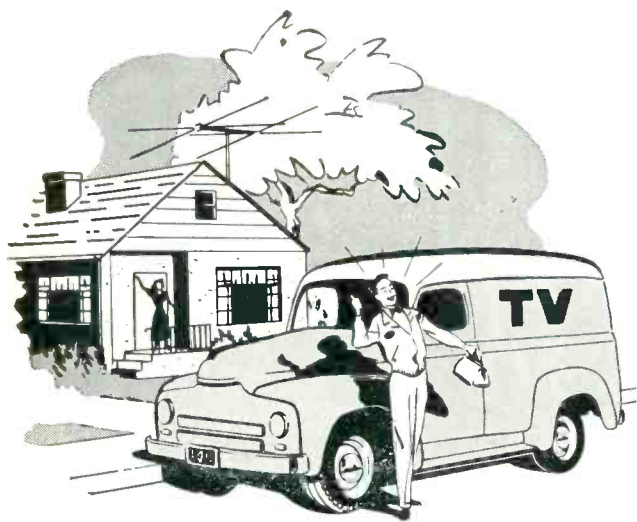

When you install ASTRON Capacitors, you're insuring against call-backs, building your reputation for *reliable* service.

Through the use of an improved electrolyte, and an exceptionally high-purity anode foil—plus rigid quality control and exhaustive multiple testing techniques—ASTRON electrolytic SAFETY-MARGIN capacitors mean longer life and maximum performance under every condition. Unexpected surges of voltage, undue heat or moisture—conditions that might spell failure in an ordinary capacitor—rarely affect an ASTRON.

So next time ask for ASTRON—the capacitor with the "safety margin" that protects your service reputation. And ask for Astron Type AM molded paper tubular capacitors to complete your service job. *Individually tested—individually guaranteed.*

Depend On—Insist On



Write for Catalog AC-3 and
Name of Jobber Nearest You

ASTRON

CORPORATION

255 Grant Avenue, E. Newark, N. J.



UHF-VHF ANTENNA CONNECTOR

Only one lead-in for separate uhf and vhf antennas is now possible with the new Ward Diplexer, Ward Products announced today. Developed for Ward, a division of The Gabriel Co., by The Gabriel Laboratories, the Diplexer has three major applications.

First, it is used in conversions of present VHF installations for UHF, where there are separate UHF and VHF antennas, and only one lead-in to the set is desired. Second, since many sets and converters have separate UHF and VHF terminals, the Diplexer can be

used with only one antenna lead-in. Third, when necessary to have individual UHF and VHF antennas in fringe areas, the Diplexer again permits but one lead-in.

The Diplexer is a printed circuit, using a "Twin-Tee" filter on which a patent is pending. This circuit gives a uniform response over all TV channels, both VHF and UHF, and keeps insertion loss at a minimum. Less than two inches square, the DIPLEXER is purposely small to prevent resonance on short UHF wavelengths. Factory sealed in a waterproof plastic case, it is free from the affect of moisture. A mast mounting strap is included with each unit.

On the Ward Diplexer there are three terminals—"UHF", "VHF" and "Common." The lead-in from the VHF antenna is attached to the "VHF" terminal, from the UHF antenna to the "UHF" terminal and the lead-in to the set runs from the "Common" Terminal.

SPEED HANDLING OF TINY PARTS WITH NEW LITTLE GEM* CABINETS

Ideal for storage of capacitors, condensers, phonograph needles, chokes, nuts, bolts, screws, and lock washers.

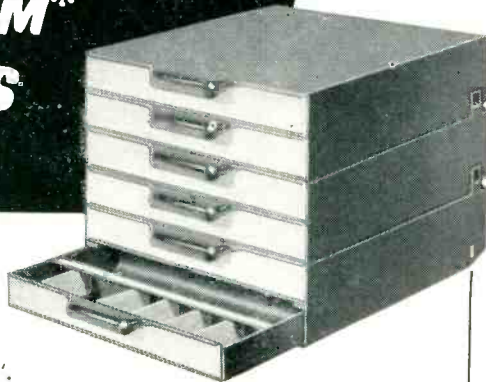

The Little Gem is a ruggedly-built, all-steel two drawer storage unit that measures 11" x 11" x 3 1/4".

Each drawer may be divided into as many as 28 instantly adjustable compartments through use of flush-fitting dividers. Sides and bottom are fully enclosed to prevent escape of even the tiniest parts. Front of compartment is curved for easy removal of parts... rear has 3/4" overhang to prevent mixing of items when drawer is jerked open or slammed shut. Easily visible label holders on every

compartment permit quick identification of all parts.

The Little Gem may be used individually, in stacks, under counters, on shelving, or in countless other locations. Anchoring tabs keep units securely in place no matter how assembled. Matching units may be added as storage needs expand. See these amazing new cabinets at your Equipto distributor or write us for free catalog.

*Trade Mark, Patent Pending

Equipto

Division of Aurora Equipment Company
810 Prairie Avenue, Aurora, Illinois
Steel Shelving . . . Parts Bins . . . Drawer Units

SCOPE KIT

Electronic Instrument Co., Inc. (EICO), Brooklyn, N. Y., has just announced production of the new EICO Model 470, 7-inch Oscilloscope in Kit and Wired Form. Model 470-K. KIT, sells for \$79.95; model 470, factory wired, is \$129.50.



As with all EICO Kits and Instruments, the Model 470 is supplied complete with all parts and Super-Simplified Assembly and Application Instructions. For further information on the 470 and the rest of the complete EICO line, write directly to Electronic Instrument Co., Inc., 84 Withers Street, B'klyn 11, N.Y.

SELENIUM KIT

A new "build-your-own" selenium rectifier kit that enables the assembly of a wide range of selenium rectifier stacks at substantially reduced costs has made its appearance in the electrical-radio-television market.



A product of Federal Telephone and Radio Corporation, Clifton, N. J. associate of International Telephone and Telegraph Corporation, the new kit is designed to meet the rectifier requirements of a variety of users, from radio Hams and hobbyists to service repairmen and electrical technicians. Included in the compact, self-contained unit are all the necessary components for assembling any one of four different types of selenium rectifiers—half-wave rectifier, full-wave center-tap rectifier, full-wave bridge type and full-wave battery charger.

TOOL KIT

Originally assembled in response to requests from radio and TV servicemen for a compact, all-purpose screw and nut driver kit, Vaco's RT-14 driver set has proved to be an unusually popular item with the trade.

The RT-14 Kit includes 7 nut drivers, 2 Phillips and 3 regular drivers with shank design for interchangeable use in one common handle. An extension piece included in the set lengthens the "reach" of any of the drivers by 5 inches. The extended "reach" has proved to be one of the most desirable features of the set.

In addition, servicemen like the conservation of space and ready accessibility of tools

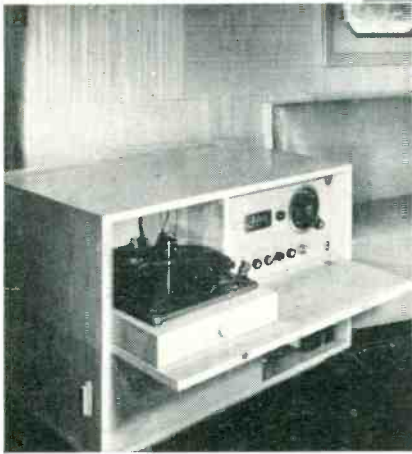

Approach listening perfection...

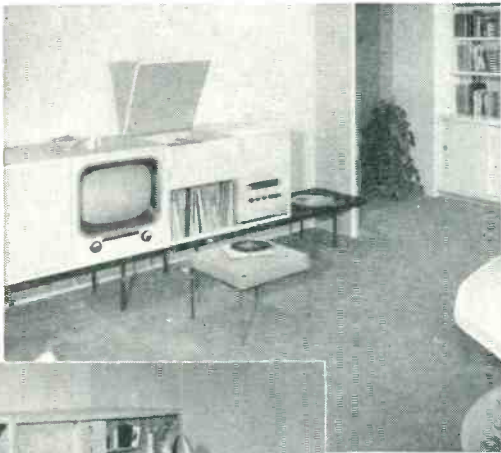

put a Webcor "HF" Diskchanger
in every high-fidelity installation

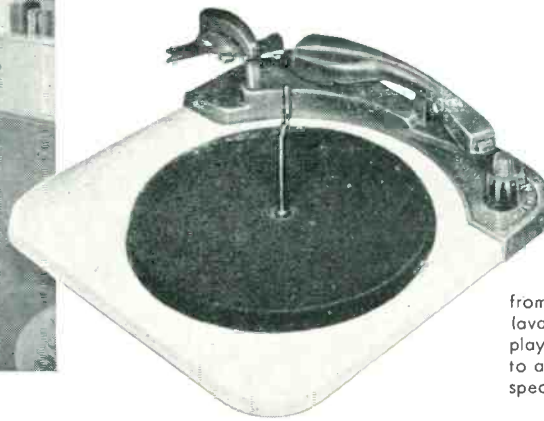

from \$4950
available with G. E. triple
play cartridge or equipped
to accommodate your own
special cartridge)



The Webcor 3-speed high-fidelity diskchanger provides super-accurate tracking with absolute minimum "rumble," "wow" and "hum." Changes precious records quickly, gently. Gives up to four hours of supreme listening pleasure. Easily installed in any custom installation . . . with or without a base pan.

See and hear a Webcor diskchanger at your music dealer today!



A Webcor Diskchanger is the  of every High-Fidelity Installation



Webcor®

by Webster-Chicago — Chicago 39, Illinois

© w/c 1953 4275

designed and installed by Voice and Vision

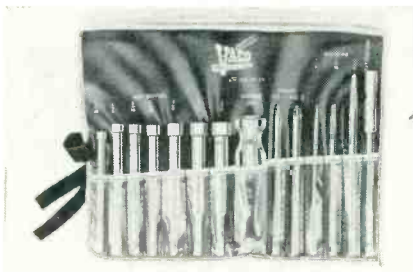

TUBE NEWS

[from page 52]

plate is of spherical shape and the tube is of all-glass construction.

Other features of the tube are:

1. Low voltage electrostatic focus.
2. Single ion-trap gun design.
3. External coating.
4. Filter-glass face plate.

provided by the compact roll. All drivers are of high quality steel, and the handle is of Vaco's exclusive break-proof, shock-proof Amberyl plastic. The leatherette roll has ties attached for keeping kit rolled up when not in use.

Characteristics of Hytron 21YP4 →

GENERAL DATA

Heater voltage	6.3 10½ volts
Heater Current	0.6 ampere
Average direct interelectrode capacitances	
Grid No. 1 to all other electrodes	6 puf
Cathode to all other electrodes	5 puf
External conductive coating	750 max. uuf
	500 min. uuf
Phosphor	No. 4
Fluorescence	white
Persistence	medium
Focusing method	electrostatic
Deflection method	magnetic
Deflection angle (approx.)	diagonal 70 horizontal 66
Face plate light transmission	66%
(Neutral density filter)	

MECHANICAL DATA

Overall length	37 3/8"
Outside diameter	21 7/32"
Useful screen width	19 1/8" min.
Useful screen height	13 7/8" min.
Cap	Recessed small cavity (J1-21)
Base	Small shell duodecal 6-pin (BG. 63)
Heating	JETEC designation 12L
Mounting position	any

ELECTRICAL DATA

Maximum Ratings (Design-Center Values)

Collector voltage	18,000 d-c max. volts
Grid-No. 4 voltage	1800 d-c max. volts
	500 d-c max. volts
Grid-No. 2 voltage	500 d-c max. volts
Grid-No. 1 voltage:	
Negative bias value	125 d-c max. volts
Positive bias value	0 d-c max. volts
Positive peak value	2 d-c max. volts
Peak heater cathode voltage:	
Heater negative with respect to cathode (note A)	180 max. volts
Heater positive with respect to cathode	180 max. volts
Grid-No. 1-circuit resistance	1.5 max. meg.

*Internal black, grid #3, grid #5, all connected together to be known as Collector.

JETEC Test Conditions

Collector voltage	12,000 d-c volts
Grid No. 4 voltage	-50 to 400 d-c volts
Grid No. 4 current	-15 to 25 d-c ua
Grid No. 2 voltage	300 d-c volts
Grid No. 1 voltage (Note B)	-33 to .77 d-c volts
Ion-trap current (Note C) (approx.)	75 50% d-c ma

Note A: A value of 410 max. volts is allowed during equipment warm-up period not to exceed 15 seconds.

Note B: Visual extinction of undeflected focused spot.

Note C: As measured with single-field beam bender, JETEC #111.

KNOWS HIS BUSINESS

Yes, this Service Man knows his business—knows that he must be sure replacement transformers will perform superbly and reflect favorably his reputation as a highly skilled service technician.

He doesn't gamble with mediocre transformers, he installs the choice of leading set manufacturers—Utah. Don't hazard your reputation with unproven parts, specify "Utah" Transformers and be sure of a job well done.

POWER TRANSFORMERS • VERTICAL OUTPUT TRANSFORMERS • FILTER CHOKES
VERTICAL BLOCKING OSCILLATORS • AUDIO OUTPUTS

Free WRITE TODAY FOR Complete TRANSFORMER INFORMATION, UTAH TRANSFORMER DIVISION, CATALOG T-100

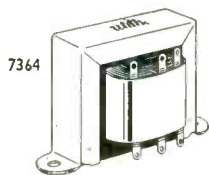
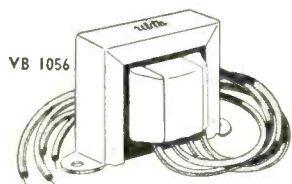

Speakers . . . Transformers

Export Dept. Rocke International Corporation, N. Y. C.

RADIO PRODUCTS CO., INC.
HUNTINGTON, INDIANA

A WHOLLY OWNED SUBSIDIARY OF NEWPORT STEEL CORPORATION

ASSOCIATIONS

[from page 49]

This meeting, open to all TV servicemen, was the third in the current series of educational TV service programs sponsored by the Joint Electronics and Radio Committee on Service, in cooperation with the Philadelphia Radio Servicemen's Association and the Television Contractors' Association.

Texas Electronics Technicians Inc.

This item appeared in the Houston Post, Thursday, March 5, 1953:

At a meeting sponsored by the Texas Electronics Technicians Inc., the city's television repairmen and technicians—an overflow crowd of 500—got the latest word on the four TV stations boosting Houston's television picture Wednesday night.

They heard the managers and chief engineers of each of the stations, KPRC-TV and the three others scheduled to go on the air before July, outline the hopes and policies of each channel, and got the chance to ask questions of them later.

The men heard that:

KPRC-TV, Channel 2, represented by Vice President and General Manager Jack Harris and Chief Engineer Paul Huhndorff, would go on the air from its new million-dollar Post Oak Road plant with a two-thirds increase in power on March 29, and that power would be boosted to a full 100,000 watts shortly after that.

KUHT, Channel 8, represented by George Arms and Paul Owens, both producers and directors, and Chief

from
Admiral
ALL-CHANNEL
ANTENNAS
 for high gain
 on both ...

VHF
UHF

These two new antennas will help you sell TV sets now ... especially if you expect new stations or channel changes in your area. Elements are adjustable to three positions ... (1) VHF only, (2) VHF-UHF and (3) UHF only. Thus the *same* antenna may be installed to deliver high gain on any currently operating station ... and will give top performance on *all new stations*, either VHF or UHF.

Admiral antennas are built to minimize call-backs. Sharp directivity reduces ghosts and interference. Seamless aluminum elements, doweled for sturdiness. Completely preassembled for quick, easy installation ... no lost parts. See these and other Admiral Antennas when you visit your Admiral distributor.

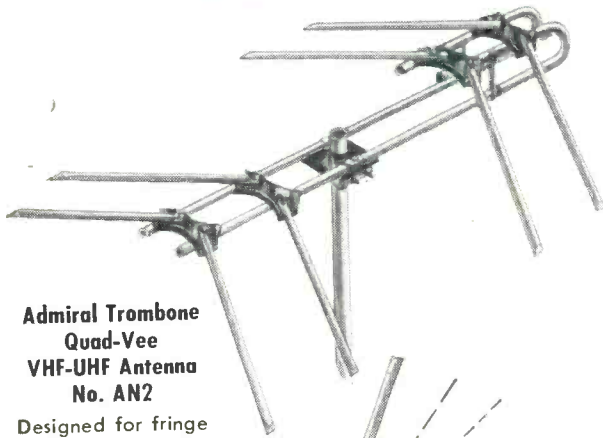

**Admiral Trombone
 Quad-Vee
 VHF-UHF Antenna
 No. AN2**

Designed for fringe areas. Stacking kit available for extreme fringe areas.

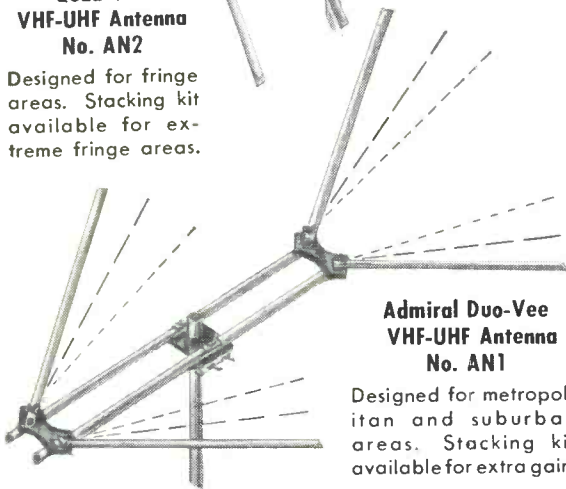

**Admiral Duo-Vee
 VHF-UHF Antenna
 No. AN1**

Designed for metropolitan and suburban areas. Stacking kit available for extra gain.

See your Admiral distributor for
 Antenna masts and tower equipment. Mounting hardware and accessories. Tubular steel TV tables.

Admiral Corporation

Accessory and Equipment Division
 Chicago 47, Illinois

**A COMPLETE LINE OF ADMIRAL TV ANTENNAS ...
 NOW AVAILABLE FROM YOUR ADMIRAL DISTRIBUTOR**

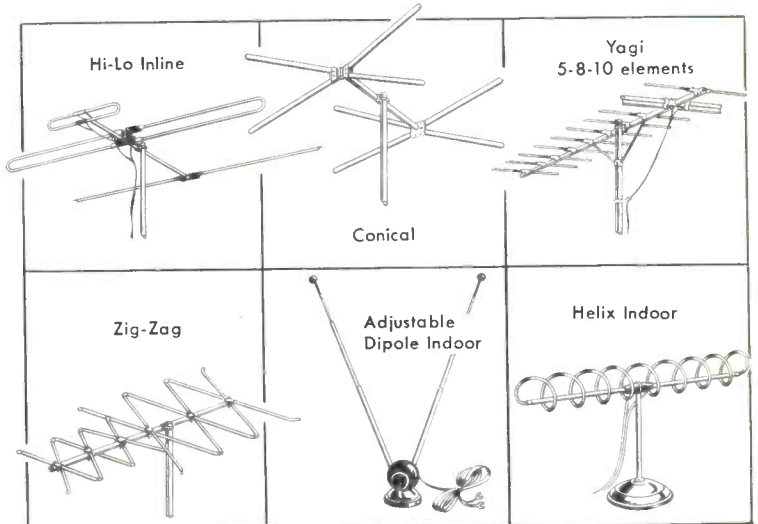

Engineer Bill Davis, will go into its 20-hour broadcast week on March 20.

KGUL-TV, Channel 11 in Galveston, represented by President Paul Taft and Chief Engineer George Smith, would be sending out a test pattern by March 15 and will be on the air March 22 as a basic CBS-TV affiliate.

KNUZ-TV, UHF Channel 39, represented by Dave Morris, vice president and general manager, and Chief Engineer Orville Crossland, is aiming to begin telecasting as an independent station from the Texas Television Center on July 4, and that its signal should cover all of Houston and

Harris County.

The men also learned that converters and antennas would be needed on the TV sets now in operation in this area before they would be able to receive UHF Channel 39, and were instructed on how the installations should be made.

Dr. Frank Logan of Chicago, laboratory engineer from the Raytheon Television Corp., instructed the men not to install UHF antennas without a test pattern to work by.

Also, the men were told by Jules Cohen of Washington, DC, consulting engineer for KGUL-TV, that some sets in the area might need dif-

ferent antennas to pick up transmissions on Channel 11.

Mr. Harris said the new KPRC-TV operation, which will be "unexcelled by any independent station in the country," could go on the air March 29 with full 100,000 watts' power, but is waiting for a specially built antenna that will not send signals skipping over sets in the stations immediate area.

Also presented was a skit by Bill Babcock of the TET, in which he told the servicemen that the TET was outlining a program of good practices through which Houston servicemen may be able to avoid city governmental controls that have been set up in other cities.

Ed. Note:

It would be nice if I could get this info first hand instead of second hand. How about it fellers.

HI-FI MARKET

[from page 35]

selected so that frequencies above the crossover point cannot pass through it. The lower frequencies are bypassed to the woofer circuit. *L2* is in series with the woofer, having little effect on the low frequencies, while blocking the highs effectively. Meanwhile *C2* shunts the highs across the woofer section and directs them into the tweeter circuit.

The crossover network for coaxial speakers is usually designed so that the crossover point is nominally 1000 cycles or higher. In general, the more expensive a system, the lower will be its crossover point. This is because a low crossover point infers the use of a large tweeter in order to handle lower notes. Many two way systems crossover at 1800 to 3500 cycles with very good results, of course.

Horn tweeters for frequencies (from 8 to 20KC at the top and) down to below 1000 cycles must be mounted outside the woofer. 800, 500, and even some 400 and 350 cycle crossovers are handled by tweeters mounted separately from the woofers. Cone tweeters and midrange speakers can easily handle such low frequencies. Woofers for such systems should be used in special enclosures, to make the low frequency reproduction as strong as possible, otherwise the sound will be mostly from the tweeters. Future installments will discuss means of getting the most out of woofers by means of various types of enclosures which, with the loudspeaker driving mechanism makes up the loudspeaker as a unit.

ALL IN 1 YEAR—

Why?

100,000 BOUGHT AND IN USE
BIG PLANTS SPECIFY

RADIO-TV REPAIR AND SERVICE MEN BUY
THOUSANDS SOLD ABROAD

914 DISTRIBUTORS CARRY

EVERYBODY WANTS ONE



UNDERWRITERS' APPROVED

50,000 DEALERS SELL THEM
THOUSANDS OF HOUSEHOLDERS BUY

WEN
"QUICK-HOT"
**ELECTRONIC
SOLDERING
GUN**

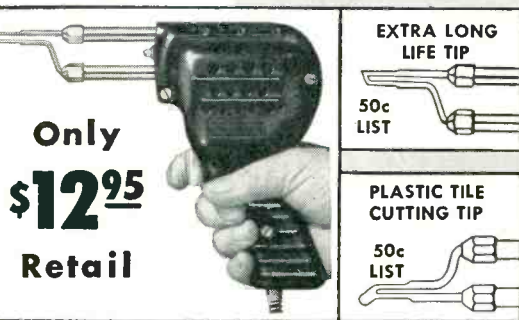

Only
\$12⁹⁵
Retail

You owe it to yourself to find out what it is about this sensational new soldering device that has won it such tremendous acceptance in a single year. Brother, we've got something here—

and you should get one! Then there's the new "Feraloy" LONG LIFE TIP that lasts 20 times as long as conventional types—and one that cuts plastic tile. Order a Wen Gun with special tips.

Try it yourself and See!

WEN PRODUCTS, INC.
5806 NORTHWEST HIGHWAY • CHICAGO 31, ILL.
(Export Agents, Scheel International, Inc. • Chicago 18, Ill.)

Order Your Copy

NOW!

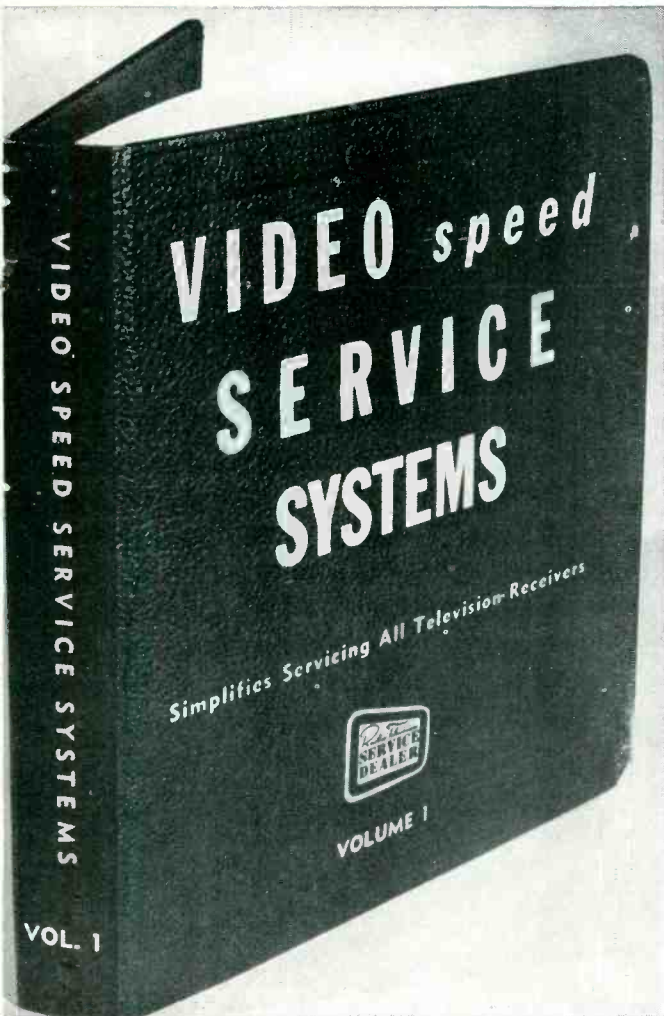

Volume 1 goes on
Sale May 1st, 1953

\$ **4** **.95**
POSTPAID

Send your order to Cowan Pub. Corp.
if your Distributor can't supply you

Over 600 Different Data Sheets Over 220 pages: Size 9 x 12"
Over 2,500 Different TV Models Over 25 Top TVset M'fgrs Brands

Thousands of TV technicians discovered that the Video Speed Servicing System Data Sheets which appear exclusively each month in "Service-Dealer" are so valuable in pin-pointing TVset faults, simplifying servicemen's problems and saving their time that they asked us to assemble immediately a comprehensive file of additional Data Sheets and publish same in a single volume. This has been done! Now Vol. 1 of VSSS is ready for release in a limited first edition of 20,000 copies. The price is so low that every technician wants a copy for

his own exclusive use. Think of it—over 600 different Data Sheets, covering over 2,500 different TV models, together with a very fine leather binder which is large enough to accommodate another full year's supply of Data Sheets, when they are assembled to cover the faults of the TVset lines now, or soon to be manufactured.

Full details about Video Speed Service Systems Vol. 1 are given—read the next 2 pages!

Video Speed Service Systems is published by the Cowan Publishing Corp., (67 West 44th St., New York 36, N. Y.)—publishers of Radio-Television Service Dealer, the leading technical monthly journal for professional Radio-TV Servicemen and technicians.

Radio-Television
**SERVICE
DEALER**

Facts about VIDEO speed

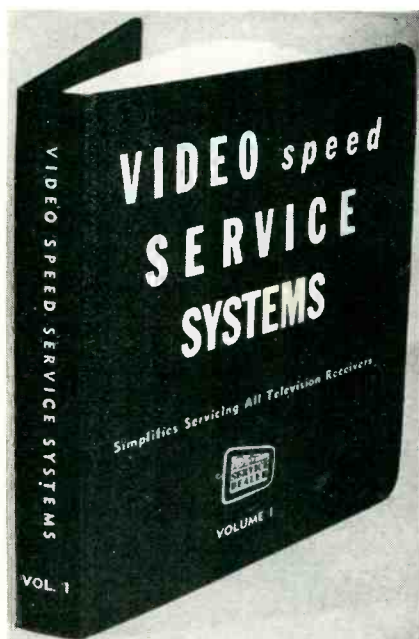

Video Speed Servicing Systems is a Reg. Trade Mark and is fully covered by Copyright 1953 in the U.S.A. and elsewhere by Cowan Publishing Corp. Printed in U.S.A. All publishing rights reserved. Reproduction or reprinting of any VSSS data sheet prohibited.

Contents:

A compilation of specific receiver service repairs, "bugs", chronic troubles, field circuit changes, manufacturers' production revisions, etc. The compilation enables the service technician to pin-point what is wrong with any given TV set and to correct the fault in the shortest possible time.

Sources:

The material was obtained directly from manufacturers, distributors' service departments, TV service organizations, and top TV Service-dealers throughout the country. Furthermore—all material has been checked carefully to assure dependability and accuracy.

Uses:

The VSSS data sheet for any particular TVset maker's model or chassis number gives: 1—the section of the set affected; 2—the symptom; 3—the cause of complaint; 4—the solution, in simple, understandable and usable form.



Over 25 leading, nationally known television receiver manufacturers' lines are represented.

More than 600 different speed service data sheets, which account for the fast-servicing of over 2500 different TVset models, are included.

All data sheets are folio'd, indexed and cross-indexed to simplify reference to them by brand, model or chassis.

All data sheets have an accompanying schematic of the segment of the circuit involved.

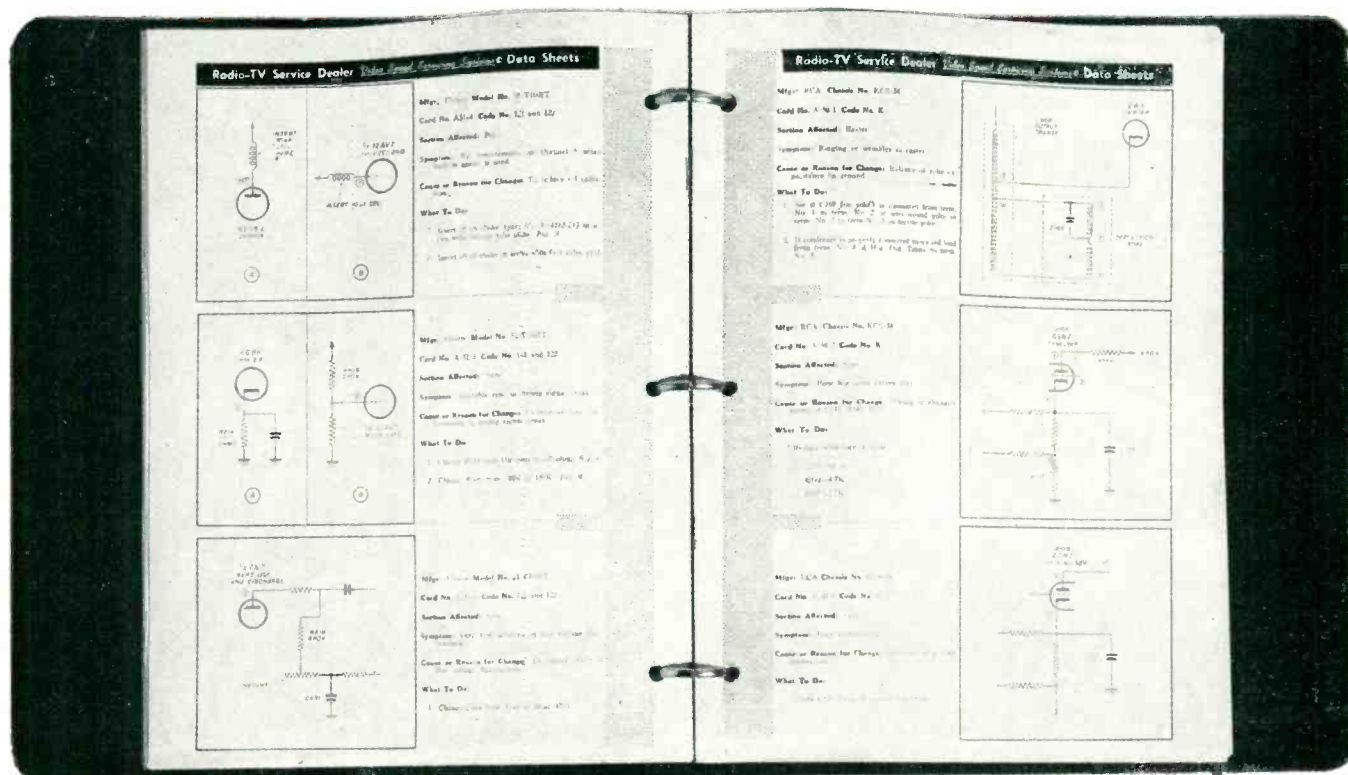

Video Speed Servicing Systems Vol. 1 consists of more than 220 pages printed on fine quality stock. Each sheet is 8½ x 11 inches (ring-hole punched), and collated in proper sequence. The 9 x 12 inch rounded corner 3-ring binder has fibre safety tabs. The binder itself is the finest quality available, of simulated leather (called Black Levant Grain), with reinforced hinges and with inside cloth strip. The book, when opened, lies flat on the service bench so

Data Sheets are fully exposed. Metal rings are triple-plated nickel, 1 inch diameter, and are large enough to accommodate additional VSSS Data Sheets.

Each page in VSSS, and its back-up sheet, refers to one TVset manufacturer's chassis. This make-up allows for future insertion in their proper place of subsequent VSSS Data Sheets for that particular manufacturer's chassis.



Thousands of VSSS Users say they are the perfect answer to all TV troubleshooters' problems. VSSS pin-points the fault and furnishes the answer. Every Serviceman saves so much time by using VSSS he can't afford to be without his own copy.

Read what TV technicians say about **VIDEO speed SERVICING SYSTEMS**

Thousands of unsolicited complimentary testimonial letters have been received from TV technicians and TV Service Organization managers from all parts of the U.S.A. Here we quote verbatim from just a few taken at random to give you a cross-section-of-the-country consensus.

Enclosed find MO for VSSS Vol. 1 and a post card to use to advise me that you received the order. Of all the good things I have gotten from "Radio-Television Service Dealer," this (VSSS) tops them all. I want to be the first to receive your publication as it is indispensable. *R.L.K., Des Moines, Iowa.*

The Video Speed Service Systems in your magazine is the tops—the best I have found yet! By putting these speed datas in a volume—well, here's my order! *V.E.S., Red Bud, Illinois.*

After receiving your magazines with the trouble-shooting bulletins on TV sets (VSSS) I would appreciate having the issues in which they started—and bill me for a full year. Also want them for my three technicians. We finally repaired an Admiral by using your VSSS. Rush the issues and our check will be sent. *A.C.E., New Orleans, La.*

I would never hesitate to recommend your publication to anyone. It is the most informative Radio and TV Serviceman's periodical on the market, and I mean this most sincerely. It is the one magazine that continually sticks to its fine line of interesting, up-to-date, and informative articles on pertinent subjects of the day.

I could go on raving for a long time about your fine publication, but I'm sure you hear this all the time. At least, I want you to know how I feel.

When you started your Video Speed Service Systems department in "RTSD," you really hit the jackpot for all of us TV servicemen. This material is exactly what we technicians have needed so much. If you get a whole lot of VSSS material together and put out a book, you'll make a fortune. Every one of the 19 servicemen who work for me here agree. All of us now subscribe to "RTSD," and we're for you 100%. What about a book on VSSS, and how soon can we buy them?

S.A.G., Chicago, Illinois.

Enclosed is my check for \$28 to cover 14 two-year subscriptions to your excellent magazine. All of us are radio technicians employed by—. The Video Speed Service Systems has attracted a great deal of interest here because it is *just what we trouble-shooters need*. We hope you will bring out a book with all sets covered. VSSS is a "must" for TV servicemen.

R.A., Detroit, Michigan.

We have read and seen your "Radio-Television Service Dealer" magazine, and even if it only had one department like Video Speed Service Systems, it would be worth buying. Here is a check for my subscription and for one other fellow's renewal, and for two other fellow's new orders.

J.C., Ft. Worth, Texas.

Received the October-November issues of "RTSD" and am writing to say I truthfully believe yours is truly the one and only serviceman's trade journal worthwhile reading. The VSSS section is just the ticket and it is just what we fellows who must do quick TV trouble-shooting have wanted for such a long time. Keep up the good work and pass on more of this type info. In fact—why not publish a whole book of it? I'll gladly pay any price you name. *D.E.B., Pittsburgh, Pa.*

I hope you don't mind hearing from me about your fine magazine. It is a God send to servicemen like me. I don't see how any technician can do his work right without it. Those Video Speed Service Sheets are also wonderful. Why did it take you so long to get them into "RTSD?" I'm going to tell all the fellows who belong to our local association about your magazine. I simply would not want to be without it.

J.F.W., Hagerstown, Md.

I like your magazine and especially the new service on the common defects of certain makes and models of television receivers (VSSS). Your efforts are a great help so we can give better service on these particular sets. The clues are there for quickly locating the cause of the trouble. I like the information in the form of a file-card system, and put mine in a loose-leaf notebook as it is very convenient for us when seeking information. *C.E.S., Columbiaville, Mich.*

I wish to take this opportunity to express my thanks for your magazine's fine articles on radio and television servicing. October's issue with recurrent troubles (video speed servicing) was tops. Most magazines do not give circuits when they say resistor R3 causes vertical foldover, then the poor serviceman has to pour over a set of Riders' or Sams' diagrams to figure out whether the R3 they have listed is the same one the magazine article referred to. Your VSSS with circuits makes it ducksoup for the serviceman. *A.W.S., Jr., Norfolk, Va.*

I am a former subscriber to your magazine. About one year ago I decided to drop it because I got so many magazines and I was too busy to read them all. Then a few days ago I was speaking to another fellow while at work here, and he talked about how good your magazine is—and he said it was better than all of the others put together. Before I knew it, there were 12 other fellows here who also wanted to subscribe to it because we studied all the other so-called serviceman's magazines and agreed that yours is really the one for us. It is good and it doesn't cost much money. Enclosed is a check for \$26 and a list of the 13 two-year subscribers including myself. By the way—that Video Speed Service Systems department alone is worth more than \$2.00. *V.A.W., San Jose, California.*

STANDARD BRAND TUBES

Individually Boxed . . . at **SLASHED PRICES**

These are STANDARD BRANDS—No Seconds—No Rejects—No “Pulls”—No War Surplus or Rebrands

Every tube is genuinely first quality, and is sold with full RTMA Guarantee. We have and ship promptly the types listed. We do NOT switch to offbrands or “hold back” on any item offered.

0Z4	.49	6AV6	.44	6S4	.61	12AV7	.97
1B3	.85	6AX4GT	.82	6SA7	.66	12BA6	.63
1S4	.87	6BA6	.61	6SK7	.63	12BE6	.65
1U5	.62	6BC5	.73	6SN7GT	.73	12BH7	.87
1X2B	.84	6BE6	.63	6SQ7	.55	12SA7	.65
5U4G	.54	6BG6G	1.72	6T8	.89	12SK7	.63
5Y3GT	.45	6BH6	.77	6V6GT	.64	12SQ7	.54
6AB4	.62	6BN6	.97	6W4GT	.62	25BQ6GT	1.17
6AC7	1.00	6BQ6GT	1.15	6W6GT	.77	25L6GT	.63
6AF4	1.40	6C4	.51	12AT6	.52	35W4	.42
6AG5	.72	6CB6	.72	12AT7	.92	35Z5GT	.42
6AH6	.88	6J5G	.54	12AU6	.59	50A5	.65
6AK5	1.31	6J6	.82	12AU7	.74	50B5	.63
6AU6	.57	6K6GT	.57	12AV6	.52	50L6GT	.62

Minimum order \$20.00. Terms: 25% with order, balance C.O.D. Orders shipped promptly F.O.B. New York City. Prices subject to change without notice. All tubes sold on Money-Back Guarantee. For prices of other tubes not listed above, write.

Elek-Tronic Bargain House

2 Embassy Court Great Neck, Long Island, N. Y.

SERVICE DEALERS! SERVICE-MEN! Here is your opportunity to buy only standard brand, individually boxed tubes at better than 60% off list. Save money—order by mail today!

RUSH Your order for a copy of VSSS Vol. 1,—only 20,000 copies of this edition will be published.

 Use the coupon below so we can mail your copy as soon as it comes off the press. 

---TEAR OFF AND MAIL NOW---

RADIO-TELEVISION SERVICE DEALER
67 West 44th Street, New York 36, N. Y.

S-43

Please send me post-paid VIDEO SPEED SERVICING SYSTEMS Volume 1 as soon as available. Enclosed herewith is

my check money order for \$_____ for _____ copies at \$4.95 each.

Name

Address

City Zone State

PREFERRED

because of their
dependable service
and overall economy



RADIO and TV PRODUCTS



Uniform **COPPER COVERING** gives you

RESISTANCE
REACTANCE
IMPEDANCE
CAPACITANCE

Same as copper at Radio Frequencies

also RUST-RESISTANCE and SOLDERING QUALITIES of Copper

Cut-away section of Copperweld Wire

Tough **STEEL CORE** adds HIGH STRENGTH
MINIMUM ELONGATION
RESISTANCE TO FATIGUE

Perfect interlocking **MOLTEN-WELD** between the copper and steel eliminates electrolytic action.

NO OTHER WIRE HAS THIS MOLTEN-WELD

Write today for further details.

COPPERWELD STEEL COMPANY • Glassport, Pa.
SALES OFFICES IN PRINCIPAL CITIES

Copperweld GUY STRAND
ANTENNA WIRE • GROUNDING WIRE
GROUND RODS AND CLAMPS . .

also HOOK-UP WIRE, TWIN-LEAD AND COAXIAL CABLES,
AND MANY OTHER ELECTRONIC WIRE PRODUCTS

THIS IS IT! THE RELAY WITH Interchangeable Coil FOR A WIDE RANGE OF RADIO APPLICATIONS

GUARDIAN Series 200

Interchangeable
COIL and CONTACT
Switch Assembly



Two basic parts—a coil assembly and a contact switch assembly—comprise this simple, yet versatile relay. The coil assembly consists of the coil and field piece. The contact assembly consists of switch blades, armature, return spring and mounting bracket. The new Guardian Midget Contact Assembly which is interchangeable with the Standard Series 200 coil assembly, is also available in either single pole, double throw; or double pole, double throw.

CONTACT SWITCH ASSEMBLIES

CAT. NO.	TYPE	COMBINATION	
		Single Pole	Double Pole
200-1	Standard	Single Pole	Double Throw
200-2	Standard	Double Pole	Double Throw
200-3	Contact Switch Parts Kit		
200-4	Standard	Double Pole	Double Throw
200-M1	Midget	Single Pole	Double Throw
200-M2	Midget	Double Pole	Double Throw
200-M3	Midget Contact Switch Parts Kit		

13 COIL ASSEMBLIES

A.C. COILS*		D.C. COILS	
CAT. NO.	VOLTS	CAT. NO.	VOLTS
200-6A	6 A.C.	200-6D	6 D.C.
200-12A	12 A.C.	200-12D	12 D.C.
200-24A	24 A.C.	200-24D	24 D.C.
200-115A	115 A.C.	200-32D	32 D.C.
		200-110D	110 D.C.

*All A.C. coils available in 25 and 60 cycles

GUARDIAN ELECTRIC

1606-D W. WALNUT STREET

CHICAGO 12, ILLINOIS

A COMPLETE LINE OF RELAYS SERVING RADIO AMATEURS

TRADE LIT

[from page 18]

single index covering all models in the eleven Rider Television Manuals makes all information accessible instantly. Rider's TV 11 contains more than 2,500 (equivalent of 8½ x 11") pages in its 12 x 15" binder. It is priced at \$24.00.

* * *

"Taco Presents UHF," a new brochure offered by Technical Appliance Corporation, Sherburne, N.Y., contains up-to-the-minute tips on the "do's" and "don'ts" for the TV technician in *uhf* areas. The new brochure is a 12 page, pocket-size two-color booklet profusely illustrated for quick, easy review by the busy technician.

An introductory section reviews the basic characteristics of *uhf* transmission and reception. Specific installation problems are illustrated and described. Transmission line handling—both tubular and flat—is fully reviewed with recommendations. All recommendations and installation tips are based on experience.

* * *

Output versus bias current curves for "Scotch" brand magnetic recording tapes are discussed in "Sound Talk" bulletin No. 21 recently announced by Minnesota Mining and Manufacturing Co., 900 Fauquier Street, St. Paul, Minn.

Graphs are included on which the curves of 12 different "Scotch" brand magnetic tapes are shown, representing four basic tape constructions. The bulletin is available upon request from the manufacturer.

* * *

A brochure on an *Assembly Kit* is made available by Federal Tel. and Radio Corporation, 100 Kingsley Road, Clifton, New Jersey. This Brochure describes various applications of Selenium Rectifiers.

* * *

An outstanding time-saver for service technicians is *form #33*, the four schematics now provided by Merit Coil & Transformer Corp., 4427 N. Clark St., Chicago. If totalled today, the number of "flybacks" in use by the many set manufacturers would probably exceed 300. Yet only four basic types are in use; therefore the fundamental knowledge and service help needed can be reduced to the application of these four—(1) transformer, covering 85% of the total

[Continued on page 74]

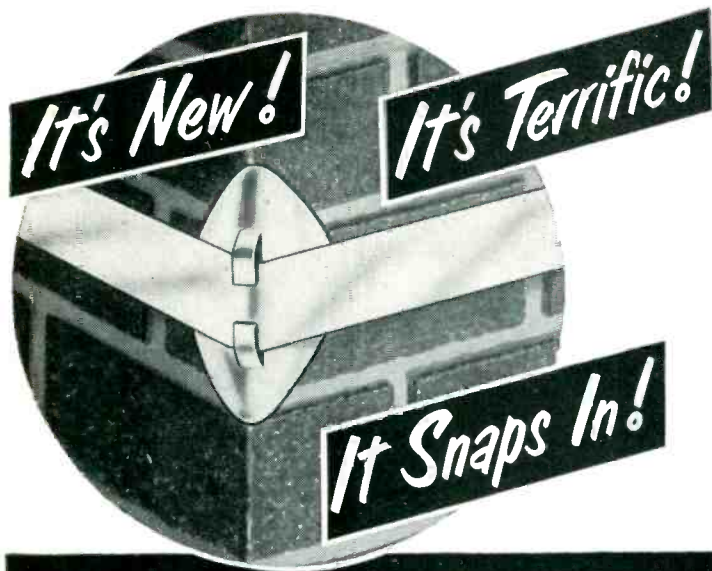

SOUTH RIVER CHIMNEY
CORNER-GUARD®

For every chimney . . . old or new . . . it safeguards mounting equipment, strengthens installations, permits uniform tightening of banding, enables you to make a trouble-free installation on any chimney without fear of chimney-chipping.

MOST IMPORTANT! For a thoroughly practical, protective device, it's so inexpensive, you can't afford to overlook its possibilities. It's a "natural" for building customer goodwill . . . and guarding your own reputation, too.

Protect Every Installation—Guard Your Reputation with

SOUTH RIVER CHIMNEY
CORNER-GUARD®



Box of 6
On Your
JOBBER'S
COUNTER **49¢** List

Service men everywhere are praising this bright, new idea for chimney and installation protection. It's the newest in a long line of South River devices created and manufactured to benefit you, the service man.

South River
METAL PRODUCTS CO., INC.
SOUTH RIVER, NEW JERSEY



Booth 780—Display Room 632A, Chicago Show

Preferred
for Original
Equipment

Proven
for
Replacement

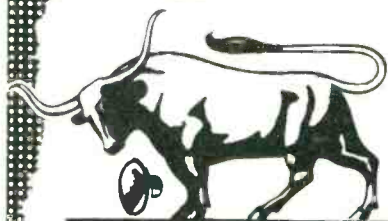

OXFORD

Speakers

There is an application for every Oxford Speaker . . . and an Oxford Speaker for every application.

**OXFORD
ELECTRIC
CORPORATION**

3911 S. Michigan Ave.
Chicago 15, Illinois

EXPORT: ROBURN AGENCIES,
NEW YORK CITY

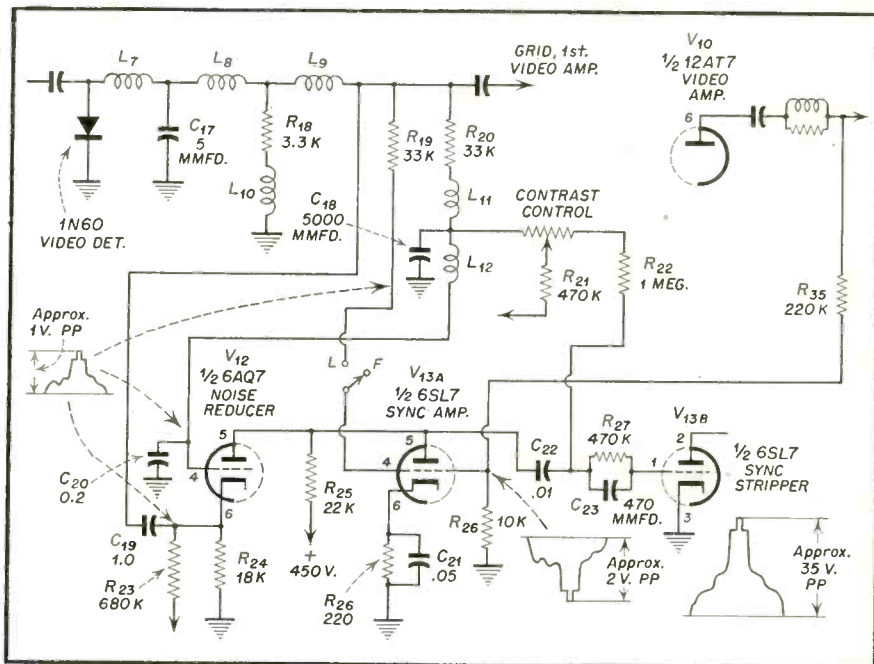

Partial schematic G.E. noise reducer circuit.

load resistor to cause noise to be bucked out. This circuit operates in the following manner: $\frac{1}{2}$ of V12 (6AQ7 and $\frac{1}{2}$ of V13 (6SL7) have R25 as a common load resistor. V12 cathode and grid are both connected to the output circuit of the 1N60 video detector. The cathode is directly connected to the output through C19 (1 μ f). The grid is connected to the top of the *agc* network which consists of R20, L11, L12, the contrast control, and C20. The grid bias will, therefore, be set up by the full *agc*. The *agc* system is of the average type and contains some noise power in its output.

The cathode bias will be set-up by the low frequency component of the signal which permits some plate current to flow through R24. Sharp noise pulses, however, appear at the top of R24 in their entirety. They flow to ground through R24. This causes the cathode voltage to drop and thus reduces the grid-to-cathode bias for the duration of the pulse. The result is a sharp increase in the plate current. The plate waveform then contains a large spike in the negative direction.

At the same time the grid of V13A is being fed a composite video signal from the plate of the second video amplifier through R35. The signal is fed sync phase negative. The plate waveform is sync phase positive. When there is no noise present, the only effect of the noise reducer is a slight reduction of the gain of the sync amplifier output. When the sharp noise spike appears in a negative direction in the plate of the 6AQ7 it

results in a sharp reduction in the sync amplifier gain at this point. The noise pulse which caused this spike is present in the output of the sync amplifier in a limited form. This is due to the limiting in the video amplifier. This limiting reduces the pulse amplitude to that of the sync pulse.

When the noise reducer pulse is introduced into the common load resistor the sync amplifier noise pulse amplitude is reduced by the extent of the amplitude of the noise reducer pulse. Instead of a noise pulse whose amplitude is as great as the sync pulse we now have a "hole."

To insure that the sync amplifier would not overload in strong signal areas a "local-fringe" switch is used. An overloaded sync amplifier would permit incomplete clipping of the video portion of the composite signal. The switch is hooked up so that when it is in the "local" position, the video signal which is at the video detector is applied to the grid of V13A. This signal is sync phase positive and approximately 1 Volt p-p. The signal from the video amplifier is sync phase positive and 2 volts p-p. The resulting bucking keeps the input down.

The sync stripper (V13b) grid is biased by the *agc*. Since the signal is fed sync phase positive, when we have a strong signal and, therefore, more *agc*, the tube is more heavily biased. The video information falls in the tube's cut-off region. The top of the sync signal is compressed by the limiting action of the tube.

SAVE Up to \$1.00 each.

Form a Group.

Subscribe to "RTSD"—



'The Professional Radio-Television man's Magazine'—published monthly. All articles are exclusive and timely. Practically every issue is worth what an entire 1 year subscription costs.

The more in a group the bigger the savings. 6 men in a group save \$1.00 each; 4 men groups save 80c per man. Present "RTSD" subscribers may participate in or form a group with co-workers, or even competitors. Still active subscriptions are automatically extended 2 years. Start a Group today! The timely and exclusive technical data appearing in future issues of "RTSD" will make this the best investment you ever made. The special Group Rate offer may be withdrawn at any time—so hurry.

Use This Coupon For Convenience

(The coupon below can be used for from 1 to 6 subscription orders. Use it today!)

TEAR OUT — MAIL TODAY

RADIO-TELEVISION SERVICE DEALER
67 West 44th Street, New York 36, N. Y.

Please enter 2 years subscription orders for the names given below. Our remittance is enclosed.

NOTE: If you do not wish to tear this order blank out, just print or type the information on a single sheet of paper, following the style given. Each subscriber's occupation must be clearly described.

<input type="checkbox"/>	One 2-year subscription	In U.S.A. \$3.00
<input type="checkbox"/>	Two 2-year subscriptions each	2.50
<input type="checkbox"/>	Three 2-year subscriptions, "	2.30
<input type="checkbox"/>	Four 2-year subscriptions, "	2.20
<input type="checkbox"/>	Five 2-year subscriptions, "	2.10
<input type="checkbox"/>	Six 2-year subscriptions, "	2.00

Name

Address

City Zone State

Describe Title or Position and Type of Business

State whether a New Subscriber or Renewal Order

Name

Address

City Zone State

Describe Title or Position and Type of Business

State whether a New Subscriber or Renewal Order

Name

Address

City Zone State

Describe Title or Position and Type of Business

State whether a New Subscriber or Renewal Order

Name

Address

City Zone State

Describe Title or Position and Type of Business

State whether a New Subscriber or Renewal Order

Name

Address

City Zone State

Describe Title or Position and Type of Business

State whether a New Subscriber or Renewal Order

Name

Address

City Zone State

Describe Title or Position and Type of Business

State whether a New Subscriber or Renewal Order

These practical books make TV servicing EASY



TV MANUFACTURERS' RECEIVER TROUBLE CURES VOL. 1., VOL. 2. AND VOL. 3

A brand new series of practical books. Gives you exact directions for correcting TV receiver "bugs". Each cure is official, factory-authorized, direct from the receiver's manufacturer. It is positive! Helps correct the most difficult faults—picture jitter, hum, instability, buzz, tearing, etc. Vols. 1 to 3 cover approx. 40 different manufacturers. One service job will more than pay the cost of these books!

Vol. 1 over 120 pages (5¼ x 8¼").....\$1.80
Vol. 2 over 120 pages (5¼ x 8¼").....\$1.80
Vol. 3 coming soon.....\$1.80

TV SWEEP ALIGNMENT TECHNIQUES

by Art Liebscher, *Test Equipment Specialist*
Never before has there been a book such as this on TV sweep alignment! Exclusive information not generally available to service technicians. Introducing the new Supermark method. Simplified procedures...time-saving...eliminates dual set-ups. Over 100 (5¼ x 8¼") pp., illus. \$2.10

UHF PRACTICES AND PRINCIPLES

by A. Lytel

New, up-to-the-minute. Clear, easy-to-understand book covers both theory and applications of UHF. TV devices, converters, UHF test equipment, circuit components, tubes. 390 (5½ x 8½") pages. Cloth cover.....\$6.60

TV TROUBLESHOOTING AND REPAIR GUIDE BOOK

by R. G. Middleton

The finest practical book to make your TV servicing easy. Spot TV receiver troubles rapidly. Includes receiver waveforms, visual alignment, test equipment kinks, etc. 204 (8½ x 11") pages.....\$3.90

VACUUM-TUBE VOLTMETERS

by J. F. Rider

Completely revised. Covers theory, operation and application — also probes, calibration and testing. Illus. with 432 (5½ x 8½") pages. Cloth cover.....\$4.50

ENCYCLOPEDIA ON CATHODE-RAY OSCILLOSCOPES AND THEIR USES

by Rider & Uslan

Covers practically every 'scope manufactured during the past 10 years — and applications. 992 (8½ x 11") pages. 3,000 illus. Cloth cover.....\$9.00

FM TRANSMISSION AND RECEPTION

by J. F. Rider & S. D. Uslan

This 2nd edition covers FM from start to finish, including receiver servicing. 460 (5½ x 8½") pages. Cloth cover.....\$4.95

Buy these books now at your jobbers... leading bookstores... or —

JOHN F. RIDER PUBLISHER
INC.
Dept. 4SD 480 Canal Street, New York 13, N. Y.

TRADE LIT

[from page 70]

units in use, (2) autoformer, requiring exact replacement, amounting to 10% of the present sets in use, (3) direct drive (air core and iron core) and (4) adjustable air gap. 3 and 4 represent about 5% of the sets in use and require exact replacements or extensive circuit modifications.

Form #33 comes packed with both the HVO-7 and HVO-X7. Additional forms are also available for general distribution by the jobber by writing Merit Coil & Transformer Corp., 4427 N. Clark Street, Chicago 40, Illinois.

* * *

The RCA Tube Department has recently made available to equipment manufacturers a new series of printed-circuit *if* components—RCA-209K1, RCA-210K1, RCA-211K1, RCA-212K1, RCA-213K1, and RCA-214K1—designed for use in television receivers utilizing intercarrier-sound systems and having picture-*if* and sound-*if* carriers of 45.75 mc and 41.25 mc, respectively.

Employed in properly designed circuits, these printed-circuit *if* components feature high gain, full bandpass response, and excellent skirt sensitivity. They can provide an overall sensitivity of 70 microvolts at 44 Mc with accurate control of the response-curve shape.

A copy of the 8-page booklet describing these new printed-circuit components may be obtained on request from Commercial Engineering, RCA Tube Department, Harrison, N. J.

TRADE FLASHES

[from page 18]

Although the program ends on July 31, the coupons can be redeemed at any time up to Sept. 1, 1953.

Allied Radio Corp. Expands

Now under construction and soon to be ready for occupancy is the Allied Radio Corp's new building. Located



at Western Ave. at Washington Blvd. in the geographical center of Chicago, with over 150,000 square feet of floor

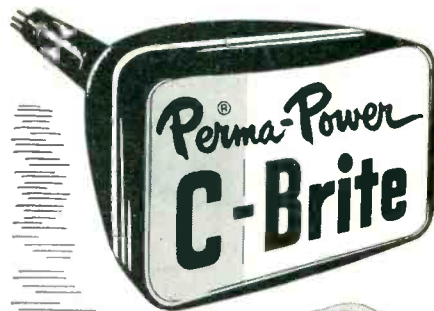

to add increased
brilliance to any
TV PICTURE TUBE

manufactured by

Perma-Power COMPANY

Chicago 25, Illinois

Manufacturers of Electronic Equipment Since 1928

ILLINOIS CAPACITORS
HAVE BEEN SERVING
SERVICEMEN FOR OVER
19 YEARS



TYPE IHT

The complete dependability of ILLINOIS electrolytic capacitors has made them a favorite with servicemen everywhere!

For over 19 years, ILLINOIS CONDENSER COMPANY has been producing quality capacitors—and during this time has been responsible for many important advancements in electrolytic capacitor construction. Millions of ILLINOIS capacitors, now in service, are proving their absolute dependability.

Used as original equipment by leading TV and radio manufacturers, ILLINOIS electrolytics are "first choice" of servicemen for all replacements!

Write for new Catalog!



ILLINOIS CONDENSER CO.
1616 NORTH THROOP STREET • CHICAGO 22, ILL.

A Full Size
LIGHTNING ARRESTER
at the Price of a Midget



LIGHTNING ARRESTER

MODEL TA5 Real protection against lightning and static charges — the RADIART Lightning Arrester has all the features! Fits anywhere... inside or out... handles standard or jumbo leads... no wire stripping necessary... does not unbalance the line... low internal capacity... no loss of signal... internal resistance "leaks off" static discharges! UNDERWRITERS LABORATORIES APPROVED.

THE RADIART CORPORATION
CLEVELAND 13, OHIO

FREE

FREE — the latest issue of our "TV and ELECTRONICS NOTES". It presents

IMPORTANT FACTS EVERY SERVICEMAN MUST KNOW about

UHF

Vital Serviceman's information regarding Installation, Reception, Converting existing Sets, Timers, etc.

FRINGE AREA RECEPTION

How to get best results at lower costs, improve performance, AND—

OTHER IMPORTANT SUBJECTS

Get this special FREE copy, or for regular subscription to "TV and Electronics Notes" send 50c.

RUSH THIS COUPON NOW

TRANSVISION, INC., NEW ROCHELLE, N. Y. Dept. SD

Send FREE, the latest issue of "TV and Electronics Notes" on UHF, Fringe Area Recep., etc.

Enclosed find 50c for regular subscription.

Name _____

Address _____

City _____ State _____

area, the building at a cost of \$2,000,000, will carry an inventory of 19,000 items worth more than \$25,000,000.

DuMont Promotions

Norman Skier has been named merchandise manager of the Receiver Sales Division. Kenneth A. Hoagland chief engineer of the cathode-ray tube division, and Alfred Y. Bentley has been named chief engineer of the receiver division, Allen B. Du Mont Laboratories, Inc., it was announced by Irving Rosenberg, director of operations for the receiver and cathode-ray tube divisions. The appointments are effective immediately.

Homes Using Multiple TV Receivers

Definite signs of a trend to two and three television receivers in homes were reported by Dan D. Halpin, general sales manager of the receiver division, Allen B. Du Mont Laboratories, Inc.

Of an estimated 22 million sets, 2 to 3 million already are second sets in the homes, Halpin said. Television's popularity with children and the present wide variety of programming now available were given by Halpin as reasons for the trend.

United Motors Expands Parts Lines

Expanded distribution of radio and television service parts and additions to these lines was announced by W. N. Potter, general manager of United Motors Service Division of General Motors Corporation.

Television antennas and picture tubes will be marketed under the Delco name and sold through electronics parts distributors by United Motors, parts sales company for GM.

Raytheon Appoints Donald Tait

The appointment of Donald W. Tait as manager of sales promotion has been announced by James J. Tynan, sales manager, Equipment Sales division, Raytheon Manufacturing Company. Mr. Tait has a broad background of experience in advertising, merchandising and sales promotion.

Sprague Appoints Podolsky

Mr. Leon Podolsky has been appointed to the newly created post of Technical Assistant to the President at Sprague Electric Co., North Adams, Massachusetts, it was announced by Julian K. Sprague, president. Mr. Podolsky was formerly Manager of Field Engineering.

Herrick Made Sales Mgr.

Raymond W. Herrick has been named sales manager of Admiral Corporation's radio division, Wallace C. Johnson, vice president-sales, announced recently.

ANACONDA UHF LINE

was adapted for use because it was found to be the most reliable available; had lowest losses under adverse weather conditions...
 ● high-strength conductor
 ● unique inner construction
 ● reliable over the entire range of both VHF and UHF channels
ORDER TODAY! Carried by leading jobbers.

Manufactured by Anaconda
... supplied by "Columbia"

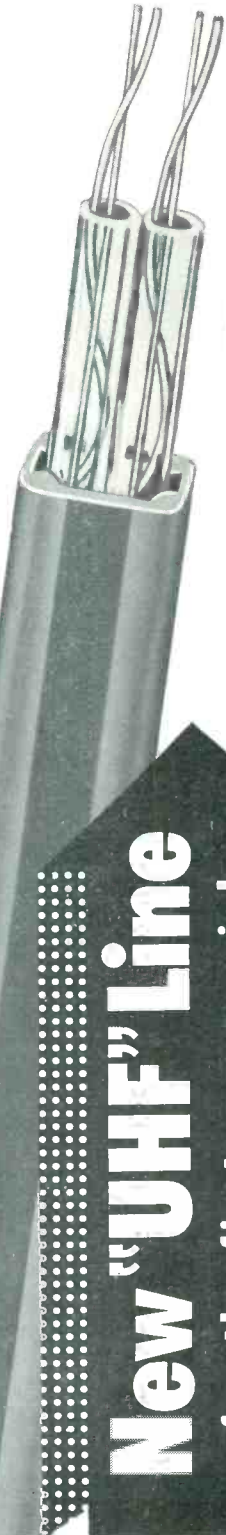

National distributors and warehouse for ANACONDA densthech television and radio wires and cables

Columbia

WIRE & SUPPLY CO. 2850 Irving Park Road Chicago 18, Illinois

New "UHF" Line
for the first commercial
UHF Telecasts

Compare!

PROVE
EMC
SUPERIORITY!

MODEL 205 tube tester

• Tests all tubes including Noval and sub-miniatures • Completely flexible lever type switching arrangement • Tests all tubes from .75 volts to 117 filament volts by standard emission test • Tests all cold cathode, magic eye, voltage regulator and ballast tubes • Has pilot light indicator • Line voltage control compensates for line variations between 105 and 135 volts • Checks for shorts and leakages • Three-color hammerstone panel.

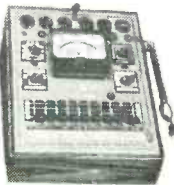

MODEL 205C— Sloping Counter Case—illustrated . . \$46.50
MODEL 205P— With hand-rubbed oak carrying case . . \$47.50

MODEL 204 tube-battery-ohm capacity tester

Tests all tubes including Noval and sub-miniature • Tests all batteries under rated load • Emission testing method gives easy, direct readings • Tests resistance to 4 megohms • Tests condensers from .01 to 1 mfd • Uses four-position lever type switches • Checks condenser leakage.

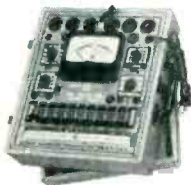

MODEL 204— Portable oak case, removable cover . . \$55.90

MODEL 206 Mutual conductance tube tester

• Checks mutual conductance on calibrated microhmo scale • Checks tubes for gas content • Detects both shorted and open elements • Tests all tubes from .75v to 117 filament volts • Tests all octal, octal and miniature tubes • Checks individual sections of multi-purpose tubes. Built-in roll chart. Uses lever type switches.

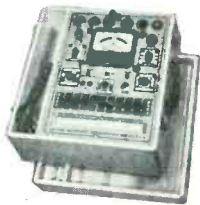

MODEL 206— Sloping Counter Case . . \$79.50
MODEL 206P— With hand-rubbed oak carrying case . . \$83.50

Write Dept. SD4 for Free Catalog



Electronic Measurements Corp.
280 Lafayette Street New York 12, N. Y.
Export Dept., 303 W. 42nd St., N. Y. C.

TECHNICAL ARTICLES WANTED

on

TV, AM RADIO, FM RADIO, PHONO MECHANISMS, HI-FI AUDIO AUTO RADIO, TEST EQUIPMENT, ANTENNAS

pertaining to their

**Theory, Installation, Application,
Service & Maintenance**

submit manuscripts to
Managing Editor

Radio-Television Service Dealer

67 West 44 Street New York 36, N. Y.

HORIZONTAL SYNC & SWEEP

(from page 32)

impossible to sync the picture if the change is large enough. The usual symptom for this type of trouble occurs in the set whose picture starts drifting as the set warms up. Generally in these cases after about an hour, the horizontal hold control cannot be made to bring the picture in. To determine if this is the case, a number of simple shop test set-ups can be devised. One way is to cover the chassis completely with a carton from a table model set. Place the chassis on a large level surface, set up the horizontal oscillator as per the manufacturer's instructions, put the carton over the chassis, completely covering it and allow the chassis to run for an hour or two. If the picture has fallen out of sync, it is advisable to start looking for components. Some other ways of heating the circuits quickly, are by directing a hot air blower of the hair dryer type or an infra-red lamp focused close to the circuit.

Once all the signs point to resistor variations under heat, the problem can be handled in one of two ways: first depends on the fact that the really critical resistor values are in the RC networks and second, that temperature compensating condensers are commercially available. With these two premises, change $C1$ in the syncro-guide and $C1$ in the multi-vibrator to the same value of capacity with a negative temperature co-efficient type. The reasoning for this lies in the fact that as the resistor goes up in value with heat, the condenser will go down in capacity. The effective RC time will remain comparatively constant.

The other trouble shooting device can be used if the value change does not take place in the RC network. In this method, the horizontal oscillator is set as per manufacturer's instructions. The horizontal hold control is adjusted so that the blanking bar is in the middle of the screen. The chassis is laid on a side and a hot high-voltage soldering iron is brought next to each suspected resistor. When it is found that the heat of the iron next to one or more of the resistors causes the blanking bar to drift these resistors should be replaced by others of the same value and tolerance but of the one or two watt size. These larger resistors, due to their larger radiating surface will resist the effect of heat much more successfully.

(To be Continued)

Advertising Index

Admiral Corporation	63
Aerovox Corporation	14
Alliance Manufacturing Company.....	19
American Phenolic Corp.....	12, 13
American Television & Radio Co.....	16
Astron Corporation	59
Balden Manufacturing Co.....	21
Bussmann Manufacturing Co.	17
Channel Master Corp.	4, 5
Columbia Wire & Supply Co.....	75
Copperweld Steel Co.	70
Electronic Measurements Corp.	76
Equipto	60
Finney Company, The	27
General Instrument Co.	20
Good, Don, Inc.	58
Guardian Elec. Mfg. Co.	70
Hytron Radio & Electronics Co.....	2
Illinois Condenser Co.	74
Jackson Electrical Instrument Co.....	8
JFD Manufacturing Co., Inc.....	Cover 2
Mallory, P. R. & Co., Inc.....	7
Oxford Electric Corporation	72
Perma-Power Company	74
Philco Corporation	57
Precision Apparatus Co., Inc.....	51
Pyramid Electric Company	1
Radiart Corporation	53, 75
Rauland Corporation	15
Raytheon Manufacturing Co.	11
RCA Tube Dept.	Cover 4
Regency	9
Rider, John F. Publisher, Inc.....	10, 74
Sams, Howard W. & Co., Inc.....	6
Sangamo Electric Company.....	18
Snyder Manufacturing Co.	22
South River Metal Prods. Co.....	71
Sylvania Electric Products, Inc.....	29
Telrex, Inc.	55
Transvision, Inc.	14, 75
Trio Manufacturing Co.	Cover 3
Utah Radio Products Co., Inc.....	62
Webster Chicago Corp.	61
Wen Products, Inc.	64

MAGNESIUM LADDERS

World's Lightest Structural Metal—33% Lighter Than Aluminum 5 Times Lighter Than Wood Stronger, Tougher than Aluminum or Steel, pound for pound Magnesium or Aluminum Step, Extension and Straight Ladders

INDUSTRIAL

MAIL ORDER CO.
131 West 53rd Street
New York 25, N. Y.

Phone: JUdson 6-0116, 0117

Mechanic & Homeowners. Visit Our Showrooms



Free
Folder
and
Prices



The Picture Tells the Story

TV Antennas exist for one reason — to provide a clear, strong, sharp picture!

TRIO ZIG-ZAG* TV Antennas perform so well in this all important respect that they are America's most wanted.

Yes, a picture — the TV picture — tells the TRIO story more eloquently than anything else! Where all other antenna designs fail, high gain TRIO ZIG-ZAG TV Antennas consistently lock in sharp, clear pictures — from Maine to Texas, in city or country!

TRIO TV antennas look different, work different — provide a magnificent DIFFERENCE in picture quality!

*Patent Pending



Also in the Picture

The TRIO Rotator and Direction Indicator are the most dependable ever built. Developed after \$50,000 research. Fully guaranteed for a FULL two years!

*New insulating sleeve, with longer leakage path and elimination of slit, does away with assembly errors — elements cannot short out. For maximum strength, new steel, electro-plated element clamps have been introduced.

Best Buy in UHF Antennas LOW IN COST — HIGH IN PERFORMANCE

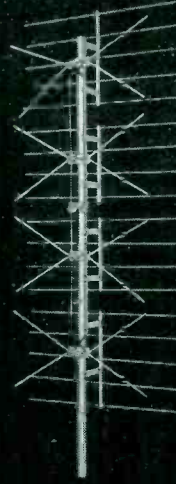

Model UBT-1
Supplied With
2 Foot Mast

NEW TRIO UHF BOW-TIE with reflector

Sturdy, broadband antennas of uniformly high gain that have been thoroughly field tested. Phasing strips installed, pre-assembled — a jiffy to attach reflector screen. Available in one, two and four bay models. Usual high-quality TRIO construction.

Model UBT-4
Supplied With
4 Foot Mast

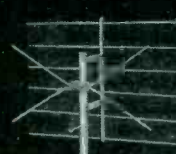

Model UBT-2
Supplied With
3 Foot Mast

NEW TRIO UHF MULTI-CHANNEL YAGI ANTENNAS

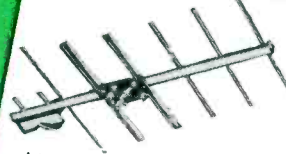

- Model 6-UBY 14-26 for Channels 14-26
- Model 6-UBY 27-42 for Channels 27-42
- Model 6-UBY 43-60 for Channels 43-60
- Model 6-UBY 61-83 for Channels 61-83

Broadband yagis developed by TRIO now successfully applied to UHF. Four models cover all UHF channels, require more than two needed for any one area.

These high gain six element yagis have sharper directivity, thereby eliminating ghosts. Thoroughly field tested. Entire antenna mounted in front field of reflectors or antenna elements. Mast clamp supplied. Completely assembled.



TRIO MANUFACTURING CO.

GRIGGSVILLE, ILLINOIS

A good name to live by...

THIS COULD BE YOUR SHOP . . . and your good name on the Dealer Identification Plaque—for everyone to see.

And this could be a *new* customer at the door—confident that, in dealing with you, his set will be in good hands.

And, he would be right . . . because you've learned from experience that the superior quality of RCA receiving tubes and kinescopes is your best measure of protection against premature tube failures.

Helping to safeguard *your* good name is a vital, everyday service of RCA Tubes. And that protection is yours at no extra cost.

Learn from your *RCA Tube Distributor* how *two* good names can prosper together . . . how *you* can qualify for a Registered Dealer Plaque.

DYNAMIC NEW PROMOTION PLAN TO HELP YOU BUILD YOUR BUSINESS

Ask your RCA Tube Distributor for a copy of the colorful, 16-page booklet "A Magic Pass-Key to Customer Confidence." A brand-new campaign is outlined, illustrated, and described in full detail. Be sure to get your copy. It's free!



RADIO CORPORATION of AMERICA
ELECTRON TUBES

HARRISON, N. J.