

AUGUST, 1952

Radio-Television
**SERVICE
DEALER**

WILLIAM HOBETZKO
2123 W SUPERIOR ST
CHICAGO 12 ILL
NIA-489 55-2C-1373



The Professional Radio-TVman's Magazine

IN THIS ISSUE:

- New Antenna Design
- A New U-H-F Tuner
- Factory and Service Bench Trouble-Shooting
- Miniature Test Probes
- Modern FM Equipment
- Test Equipment Notes

AM-FM-TV-SOUND



Got "Dual Control
headaches?"

**MALLORY
MIDGETROLS®**
will cure them!

Why wait for delivery—why scour distributors' stocks for special controls? You can replace *any* dual control in only a few minutes, by assembling the *exact* combination you need with Mallory Midgetrol Companion Units.

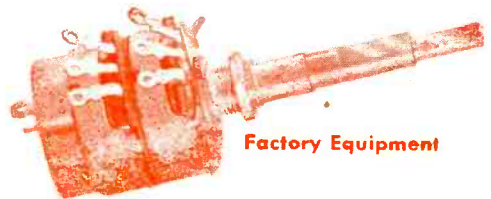

Factory Equipment



Mallory Replacement

Here's how easy it is to get an *exact replacement* for the original control. You just combine the Mallory factory-assembled front and rear control sections... add the easily attached switch... insert the shaft tip. The job takes less than five minutes. No soldering, no special tools.

Quick—sure—economical. Here's the way to get the control you need, with these features:

- **Exact match**, electrically and mechanically, for original components.
- **Highest quality**—quiet, drift-free resistance elements, accurate tapers, wobble-free, two-point suspension.

Best of all, you won't have to carry big inventories. A small selection of standard sections will equip you to service all the popular radio and TV sets. Your Mallory distributor has a complete stock of control sections, switches and hardware ready for immediate delivery. See him today!

P. R. MALLORY & CO. Inc.
MALLORY CAPACITORS... CONTROLS... VIBRATORS...
 SWITCHES... RESISTORS... RECTIFIERS...
 VIBRAPACK* POWER SUPPLIES... FILTERS
*Reg. U.S. Pat. Off.

APPROVED PRECISION PRODUCTS

P. R. MALLORY & CO., Inc., INDIANAPOLIS 6, INDIANA

*Make Sure...
Make it Mallory*

Rauland Tubes give you a prettier profit picture



Rauland picture tubes are first choice of an ever growing number of service dealers and men. First, because of the completeness of the Rauland replacement line.

Second, because you get the benefit of acknowledged leadership in picture tube engineering. Rauland research has developed more picture tube improvements since

the war than any other company.

You get quality you can count on, too. Rauland production employs machines unique in the industry—many of them designed by Rauland engineers and built in Rauland's own plant.

And finally, you get assurance of customer satisfaction beyond

what any other line can give you. Installation and adjustment of Rauland tubes is faster and better. The Indicator Ion Trap gives you the surest known protection against ion burn and shortened tube life.

Specify Rauland—deliver Rauland—and assure yourself of pleased picture tube customers.

THE RAULAND CORPORATION



Perfection Through Research

4245 N. KNOX AVENUE • CHICAGO 41, ILLINOIS



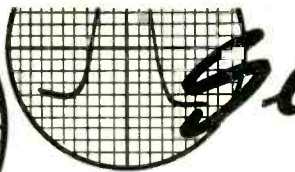
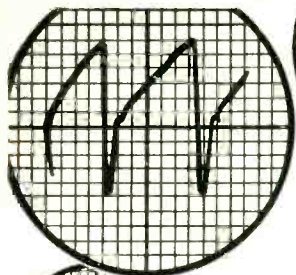

See YOUR ANSWER

WITH THE

PRECISION ES-500A

HIGH SENSITIVITY—WIDE RANGE

5" OSCILLOSCOPE

PUSH-PULL VERTICAL AND HORIZONTAL AMPLIFIERS

20 MV PER INCH "V" SENSITIVITY—150 MV PER INCH "H" SENSITIVITY

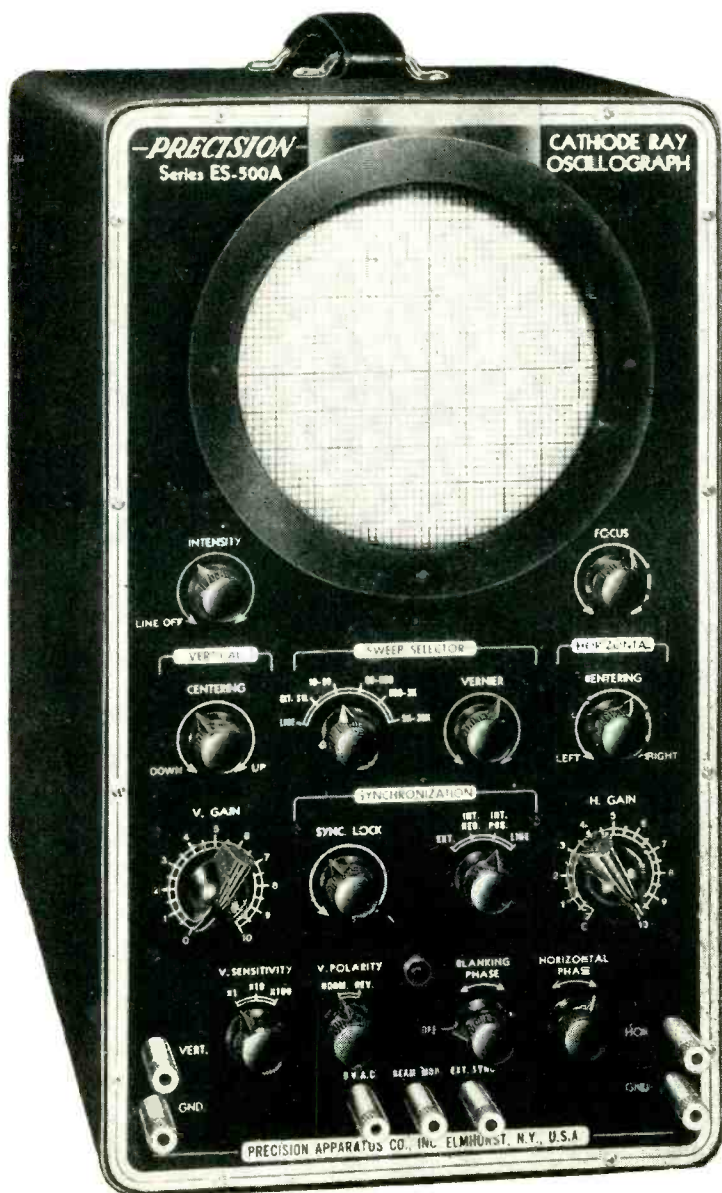
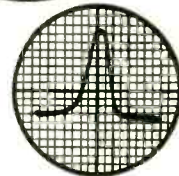
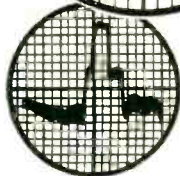
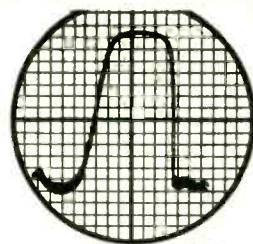

SERIES ES500A affords the ultimate in performance, visibility and operational flexibility at moderate cost. "Precision" engineers have incorporated every necessary basic feature which they have found to be required to meet the needs of the rapidly advancing art of electronics, A.M., F.M., and TV.

Series ES-500A provides an unparalleled combination of high sensitivity, extended frequency range and other essential operating features specifically desired for experimental and commercial visual circuit analysis.

SUMMARY OF IMPORTANT FEATURES

- * High Sensitivity, Extended Range, Voltage Regulated Push-Pull Vertical Amplifier—20 MV (.02 V) per inch deflection sensitivity, 10 cycles to 1 MC response, 2 megohms input resistance, Approx. 22 mmfd. input capacity.
- * Frequency Compensated Vertical Input Step Attenuator—X1, X10, X100 plus continuous variable gain control in cathode follower input stage.
- * Vertical Phase-Reversing Switch permits inversion of all patterns at will. Non-frequency discriminating.
- * Extended Range, High Sensitivity Push-Pull Horizontal Amplifier—150 MV (.15 V) per inch high deflection sensitivity adequate for most all "H" drive purposes, 10 cycles to 1 MC response at full gain. 1/2 megohm input resistance. Approx. 20 mmfd. input capacity.
- * Linear Multi-Vibrator Sweep Circuit—10 cycles to 30 KC plus line and external sweep.
- * Amplitude Controlled, 4-Way Synch. Selection—Internal Positive, Internal Negative, External and Line.
- * "Z" Axis Modulation input facility for blanking, timing, etc.
- * Internal, Phasable 60 cycle Beam Blanking for elimination of alignment retrace; clean display of synch. pulses etc.
- * Sweep Phasing Control for sinusoidal line sweep usage. Wide angle bridge circuit.
- * Direct H and V Plate Connections and Audio Monitoring phone jacks at rear. All four plates accessible.
- * High Intensity CR Patterns through use of adequate high voltage power supply with 2X2 rectifier.
- * The Circuit and Tube Complement—6C4 Vertical input cathode follower, 6CB6 first "V" amplifier, 6CA "V" phase inverter, Push-Pull 6AU6's vertical CR driver, 7N7 first "H" amplifier and phase inverter, Push-Pull 6AU6's horizontal CR driver, 7N7 Multi-vibrator internal linear sweep oscillator, 5Y3 low voltage rectifier, 2X2 high potential rectifier, VR-150 voltage regulator, 5CP1/A CR Tube.
- * 7 Four-Way Lab. Type Input Terminals—Take banana plugs, phone tips, bare wire or spade lugs.
- * Light Shield and Mask removable and rotatable.
- * Extra Heavy-Duty Construction and components to assure "Precision" performance.
- * Heavy Gauge, Etched-Anodized, No-Glare, Aluminum Panel.
- * Fully Licensed under Western Electric Co. patents.

* **Series ES-500A** In louvred, black ripple, heavy gauge steel case. Size 8 1/4" x 14 1/2" x 18". Complete with light shield, calibrating mask and instruction manual.
NET PRICE \$173.70

See the ES-500A Oscilloscope on display and available at leading Radio Parts & Equipment Distributors.

AM • FM • TV



PRECISION APPARATUS CO., INC.

92-27 Horace Harding Boulevard, Elmhurst 6, New York
Export Division: 458 Broadway, New York, U.S.A. • Cables—Morhanex
In Canada: Atlas Radio Corp., Ltd., Toronto, Ontario

Convenient "PRECISION" Purchase Terms can be arranged with your local favorite authorized "PRECISION" Distributor.

AM • FM • TV

EDITORIAL

by S. R. COWAN

The Heat Got Us

In June "SERVICE-DEALER" on page 18 appeared Chart 1 which has a caption to the effect that "the following 40 TV picture tube faults are of such nature that the manufacturer (Rauland Corporation) offers no compensation if they occur." Actually, just the opposite is true, and these are the 40 possible faults for which Rauland *does* give full and complete redress whereas the 8 possible defects enumerated at the bottom of the Chart are the ones for which a manufacturer can assume no responsibility as such defects would result from improper handling of the tube in use.

On page 29 of this issue is published the corrected Chart showing accurately which faults are, and which are not covered by manufacturer guarantee. We take this action to protect Rauland against any possible loss. Their products are of recognized top quality and their guarantee is as sound and broad as that of any other top-rated TV picture tube producer.

New UHF Station Allocations

Amongst the first 14 UHF allocations are stations in the following cities: Denver, Col., Bridgeport, Conn., New Britain, Conn., New Bedford, Mass., Springfield-Holyoke, Mass., Flint, Mich., Youngstown, Ohio, Portland, Ore., and York, Penna. Additional allocations are expected from FCC weekly but at this writing no one can predict with certainty as to just when the UHF stations will go into actual operation. Guestimates in this regard vary from 90 days to six months. The bottleneck is transmitting apparatus, of which there is a short supply.

The New Fair Trade Law

On July 14th President Truman signed the "Fair Trade" Act which restored the price-fixing authority of 45 States. The authority had been nullified in May 1951, by a Supreme Court decision which precipitated price-cutting wars in many sections of the country.

Under the new Act (House Resolution 5767), a manufacturer may fix the price of a trade-mark or brand-name item when signing a contract with one or more retailers, and such action automatically requires ALL other retailers to sell the product at the price fixed regardless of whether or not they sign such an agreement. Penalties for failure to abide by such price structures are severe so be careful if you are a dealer.

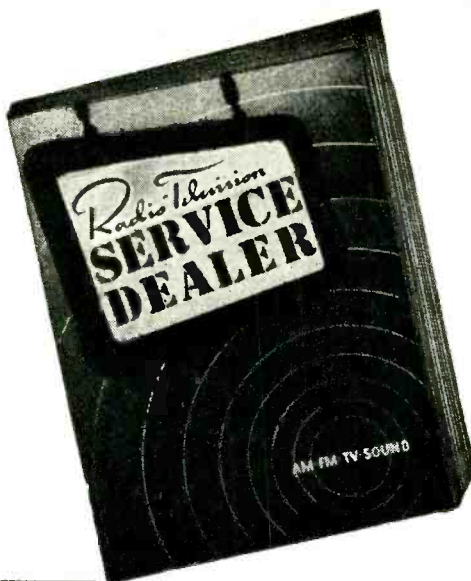

Sanford R. Cowan
Editor & PUBLISHER
SAR
MA

cowan
hall
NEW

Vol. 13 NO. 8

AUG

Editorial	3
Association News	12
New Antenna Design, by Douglas H. Carpenter	17
Design factors entering into the evolution of various types of antennas used in TV.	
A New U-H-F Tuner, by Allan Lytel	20
Describing an u-h-f tuner of unique design.	
Factory and Service Bench Trouble Shooting, by Leonard Lieberman	22
How TV receivers are tested on the factory service bench, and how these techniques may be applied to the technician's service bench.	
Miniature Test Probes	24
Describing 2 new miniature test probes developed by the National Bureau of Standards, and which may be applied to Radio and TV testing.	
Modern FM Equipment, by C. A. Tutthill	25
A description of modern AM/FM tuners and their associated equipment.	
Circuit Court	27
Arvin 5024CM—A-G-C system	
Trade Literature	27
Shop Notes	28
Crosley 1952 20 or 21 inch receiver. General service hints. Vertical instability of 17AY212 Raytheon and Truetone D2149. Motorola Model 61K22—intermittent. Majestic Model 5LA50—no reception. Westinghouse Models H-324T7 and H-325T7—increasing FM sensitivity.	
Test Equipment Notes, by Jack Whiteside & L. J. Austin	29
Voltage dividers for oscilloscope inputs	
New Products	30
Ad Index	40

SANFORD L. CAHN, Advertising Director HARRY N. REIZES, Advertising Manager
DAVID SALTMAN, Production Mgr. NATHAN BOYCE, Circulation Mgr.

TED E. SCHELL, 2700 West 3rd St., Los Angeles 5, Calif., Dunkirk 2-4889
RADIO-TELEVISION SERVICE DEALER is published Monthly by Cowan Pub. Corp., 67 West 44th St., New York 36, N. Y. Subscription price: \$2 per year in the United States, U.S. Poss. & Canada: elsewhere \$3. Single Copies: 25c. Reentered as second class matter Sept. 25, 1950 at the Post Office at New York, N. Y. under the Act of Mar. 3, 1879. Copyright 1952, Cowan Pub. Corp.

PHOTOFACT ADVERTISERS

elicited letters tell
s finest Radio & TV
to Service Technicians



Ray Krischke
Edinburg Radio Lab.
609 E. Harriman Blvd.
Edinburg, Texas

"Thanks for Sam's PHOTOFACT—the best service in electronics."



F. Josephs
165 Sherman Ave.
New York 34, N. Y.

"Since purchasing Volume 16 with the voltages at the pins and the wave forms, there is no question in my mind as to which manuals I should get. The information on the schematics saves a lot of time, and I want to thank you."



L. G. Patrick
Patrick Electro Serv.
1509 W. Hillsboro Ave.
Tampa 3, Florida

"We have all your Folders to date and would like to state they are worth every cent we have paid for them."

NOW! GET THE PROOF FOR YOURSELF!

FREE

We'll send you a Free Photofact Folder on any receiver listed in "PF Index & Technical Digest."

Learn for yourself—at our expense—how PHOTOFACT pays for itself by earning bigger repair profits for you! Select any Folder from the PF Index (if you haven't an Index, get a free copy from your distributor). When you write us for your Free Folder, be sure to state Photofact Set and Folder Number as shown in the Index. Get your Free Folder now. Examine, use, compare—see why you can't afford to be without PHOTOFACT!

HOWARD W. SAMS & CO., INC.
2201 East 46th Street • Indianapolis 5, Indiana

TRADE FLASHES

A "press-time" digest of production, distribution, and merchandizing activities

TV & Radio Production Drops

Production of television receivers showed a slight decline in May, but the radio output was reduced substantially under the May 1951 output, the Radio-Television Manufacturers Association reported today.

RTMA's estimates showed the manufacture of 309,375 TV sets compared with 339,132 in May 1951. The radio output was estimated at 748,344 units in May compared with 1,372,609 sets in the corresponding 1951 month.

A breakdown of the May radio output showed 288,927 home radios manufactured, 128,351 portables, 215,478 auto radios and 115,588 clock radios. Home sets with FM facilities totaled 35,102 units in May. In addition, 7,432 television receivers with FM facilities were produced during the month.

Tube Sales For May

May sales of television picture tubes to receiver manufacturers increased above the sales in the corresponding 1951 month, the Radio-Television Manufacturers Association announced today. May sales, however, fell below sales in April.

RTMA's report showed 247,724 TV picture tubes sold to set manufacturers in May compared with 229,250 units in the same 1951 month. April sales totaled 270,781 units.

Sales of receiving tubes in May declined from the level of the previous month and from May 1951, according to reports from member-companies to the Radio-Television Manufacturers Association. May sales totaled 23,636,484 units valued at \$17,037,274 compared with 26,247,258 tubes valued at \$19,801,541 sold in April. In May 1951 there were 34,074,356 receiving tubes sold.

For the first five months of this year, 135,818,064 tubes were sold with a value of \$97,890,279.

A breakdown of the May report showed sales of 21,463,911 receiving tubes of the entertainment type and 2,172,573 of the allied or non-entertainment type. A total of 15,807,449 tubes were sold for new equipment, 4,178,292 for renewals, 1,217,135 for export and 2,433,605 were sold to the government.

NEDA Conference

Mayor Joseph Altman, of Atlantic City, will officially welcome members and guests of the National Electronic Distributors Association at NEDA's third annual Convention and Manufacturers Conference September 22-25, by proclaiming the convention-conference dates as "Electronics Week in Atlantic City," the mayor advised NEDA national headquarters.

Raytheon Dedicates New Plant

An expanded program of research and development was launched today by Raytheon Manufacturing Company, Waltham, Mass., with the dedication of a new building on Seyon Street. The plant, which will be used by the Research Division in carrying on a major portion of Raytheon's \$2,000,000 transistor program, will also be utilized for engineering and manufacturing activities by the company's Equipment Divisions.

DuMont New Warranty

A new warranty policy on replacement cathode-ray television picture tubes, extending the warranty period from six to twelve months, from the date of installation in the consumer's home receiver, was announced by Bill C. Scales, general sales manager, Cathode-ray Tube Division, Allen B. DuMont Laboratories, Inc., Clifton, N. J.

The new policy is effective immediately.

An improved two-card system instituted with this new policy, simplifies registration of DuMont cathode-ray tubes used for replacement, and will make it easier for authorized dealers and service contractors to take full advantage of the warranty period, Scales said.

Clinic for Servicemen Held in Washington

A "TVI Clinic" on "TVI" for television servicemen in the Washington, D. C. area was conducted two nights under the auspices of the Radio-Television Manufacturers Association, a local committee of amateurs and the Electric Institute of Washington. The two-day clinic, June 11-12, featured talks each evening by P. S. Rand, Laboratory of Advanced Re-

HIS CHOICE IS

Regency

LARGEST
SELLING
VHF
BOOSTER
AT ANY PRICE!

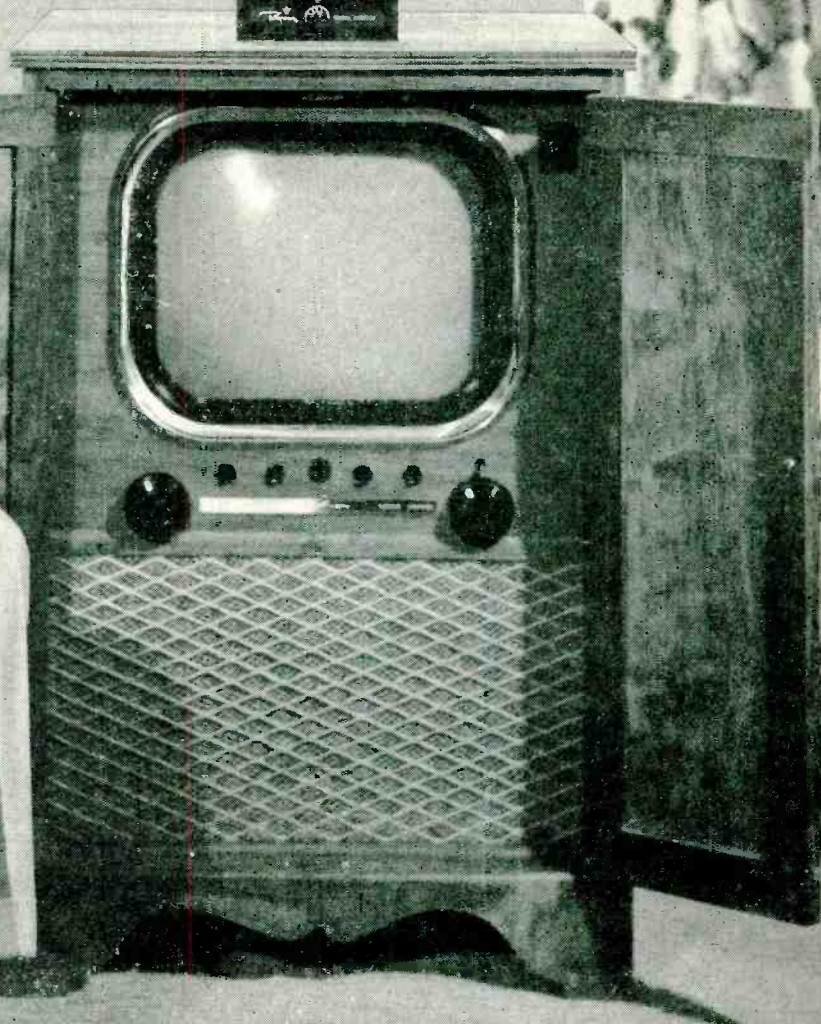

JOHN GILTNER TWIST, SALES MANAGER
CAPACITOR DIVISION
SANGAMO ELECTRIC COMPANY
MARION, ILLINOIS
PHOTOGRAPHED IN HIS HOME

ALSO MAKERS OF THE

Regency

 UHF CONVERTER

 ★ Get window-size
 ★ reprints of this ad
 ★ free from your
 ★ Sprague distribu-
 ★ tor, or send 10c to
 ★ Sprague to cover
 ★ handling costs.
 ★ *****

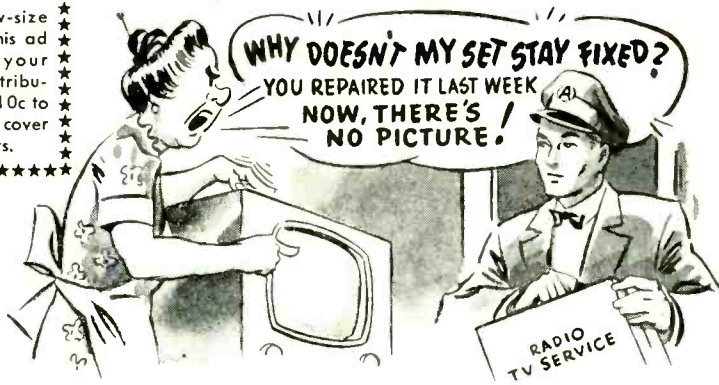

HERE'S YOUR ANSWER, MR. AND MRS. SETOWNER!

999 times out of a thousand, when this happens . . . *don't blame your service technician!*

The repair to your television receiver made several days ago or even several months ago probably had no relation to the new trouble that developed today.

Actually, there are more than 300 electrical parts in even a small table model television receiver. Trouble in any one of them might cause the picture or sound to disappear or to be received poorly.

Take your automobile for instance. Tuning up the motor today is no guarantee against a tire blowout tomorrow!

Such a thing is easier to understand because most of us are more familiar with automobiles than with today's highly complicated TV and radio sets. But such unconnected troubles occur in TV and radio nevertheless—and because they are so

hard to explain in non-technical terms, it is always embarrassing to your service technician when they do.

His continued business existence is based on gaining the full confidence of you and other set owners like you. He isn't in business to "gyp" you or to overcharge you. His success is based on doing each and every job to the level best of his ability, at a fair price for his skilled labor. It's only when you patronize the shops that feature "bargains" at ridiculously low prices that you need worry. Good radio and TV service can't be bought on the bargain counter! Set owners who recognize this aren't likely to get "gypped."

Sincerely yours,

(HARRY KALKER, President)

SPRAGUE PRODUCTS COMPANY
 (Distributors' Division of the Sprague Electric Company)
 71 Marshall Street
 North Adams, Massachusetts



WORLD'S LARGEST MANUFACTURER OF ELECTRIC CONDENSERS

search, Remington Rand, Inc., and an authority on television interference problems.

RCA Service Aid Features CRT Carton Carrying Strap

A grip-tight, self-adjusting carrying strap especially designed to make safe and easy the hand-carrying of a kinescope in its carton was announced by the Tube Department of RCA Victor. Designed to fit the largest

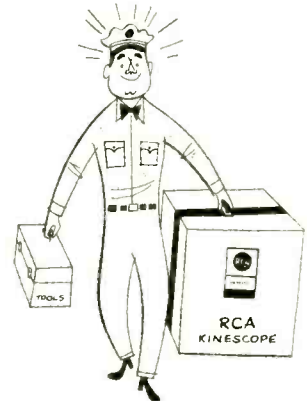

RCA television picture tube carton, the 120-inch strap will enable the technician to carry a kinescope comfortably and safely with one hand. The strap has a grip-easy plastic handle. This new service aid is now available to radio service dealers and television technicians through their RCA kinescope distributors.

Predicts 40 Million TVs By 1957

Celebrating Philco Corporation 60th Anniversary at its national Distributor Convention at the Waldorf-Astoria, William Balderston, president, predicted that 40 million television sets will be in use and served by 600 stations by 1957.

Triplett Celebrates 50th Anniversary

Mr. R. L. Triplett, president of the Triplett Electrical Instrument Co., Blugton, O., is shown receiving a handsome gold watch from his sales force, commemorating his fiftieth year in the electrical measuring instrument



industry. Making the presentation is E. K. Seyd, left, Andover, Conn., 20 year veteran of the Triplett sales organization. Looking on is A. D. Plamondon, Jr., president of Indiana

Turn to **BUSS**

THE ONE SOURCE FOR ANY

FUSE..

From 1/500 Amp. Up

BUSS offers the most complete line of fuses for Television...Radio...Radar... Instruments...Controls...Avionics... in standard types and dual-element (slow blowing) types.

By using BUSS as your one source for fuses you simplify your buying, stock handling and records.

Every BUSS Fuse is Electronically Tested...

in a sensitive device that rejects any fuse that is not correctly calibrated, properly constructed and right in all physical dimensions. This means every BUSS Fuse is a good one.

Manufacturers and servicemen throughout the country have learned that they can rely on BUSS fuses for dependable protection.

For Sales and Service...

it will pay to standardize on BUSS Fuses. They protect your profits and your reputation. How can you afford to take a chance on anything less than BUSS quality?

Send the Coupon
FOR MORE FACTS...

BUSSMANN MFG. CO. *Division McGraw Electric Company.*
University at Jefferson, St. Louis 7, Mo.

RADIO-TELEVISION SERVICE DEALER • AUGUST, 1952

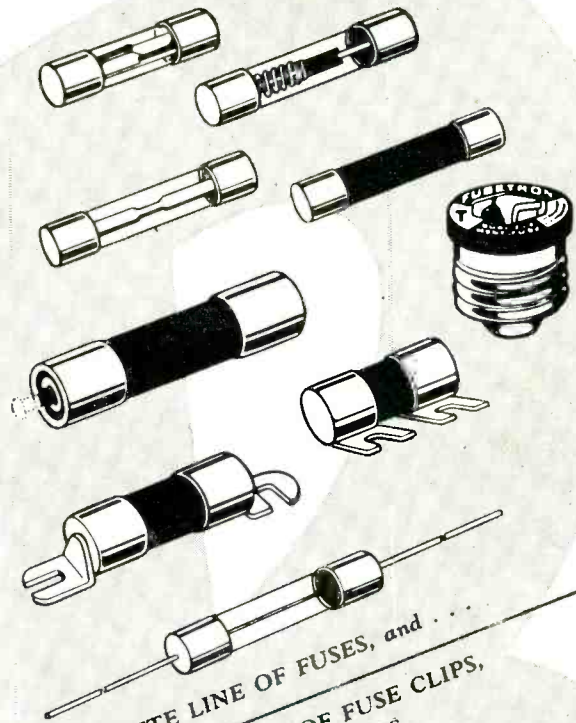

A COMPLETE LINE OF FUSES, and . . .
A COMPANION LINE OF FUSE CLIPS,
BLOCKS AND FUSE HOLDERS.



BUSSMANN Mfg. Co. (Division of McGraw Electric Co.) SD-852
University at Jefferson, St. Louis 7, Mo.

Please send me bulletin SFB containing complete facts on BUSS small dimension fuses and fuse holders.

Name _____

Title _____

Company _____

Address _____

City & Zone _____ State _____ 852

10,000,000* Waiting to be SOLD!

**Perma-Power
TV TUBE
BRITENER**



* Over 10,000,000 television sets were purchased prior to 1954. Each of these has a picture tube which is getting dimmer . . . 10,000,000 set owners need the "TV TUBE BRITENER."

- Prolongs tube brilliance; fully automatic
- Isolates filament; relieves cathode—filament shorts
- Eliminates nuisance calls
- Protects tube guarantee
- Made to sell; packaged to sell
- Producing sales everywhere



"TV TUBE BRITENER" was designed by engineers to produce sales for television servicemen. Adds brilliance to any picture tube; extends useful life of tube far year or more; adaptable for all tubes with duodecal base. Write or complete, illustrated literature. SOLD through recognized wholesalers ONLY. ORDER TODAY!

Perma-Power COMPANY
4721 N. Damen Ave., Chicago 25, Ill.

"Manufacturers of electronic equipment since 1928"

Steel Products, Co., Valparaiso, Ind., and vice-president of Radio-Television Manufacturers, who voiced congratulations of the industry upon completion of Mr. Triplett's half-century of achievements in a field which has increased tremendously in importance since the turn of the century.

CBS-Columbia Meeting Huge Success

"The most successful sales meeting in the history of the company."

That is the way David H. Cogan, President of CBS-Columbia Inc., manufacturing subsidiary of the Columbia Broadcasting System, summed up the sales meeting at which his company unveiled three new, separate television set lines to representatives of 60 distributing companies from all over the United States, South America, Europe, Canada, and the press at the Waldorf-Astoria Hotel, New York.

More than 200 distributors attended the meeting which started in the morning, continued through the afternoon and concluded with dinner and a gala show by headliners from the CBS-Television Network.

Baker Predicts 53 Million TV Sets Soon In Use

A prediction that 53,000,000 television sets will eventually be in use in the United States was voiced here June 12 by Dr. W.R.G. Baker, General Electric vice president and general manager of the G-E Electronics Division.

He spoke at the dedication of General Electric's new \$6,000,000 Aniston Tube Works. The new electron tube plant was dedicated by G-E President Ralph J. Cordiner and opened to the public at an open house program following dedication ceremonies.

Dr. Baker called the estimate of the television receiver market "conservative and realistic." He said that 2,000 stations will eventually be on the air as compared with a current total of about 110.

LaPointe Plascomold Expands

VEE-D-X has again found it necessary to move to larger quarters, this was announced by Jerome E. Respass, President of The LaPointe Plascomold Corporation. All facilities for the manufacture of VEE-D-X antennas and accessories, formerly located in Windsor Locks, Conn., have been transferred to the New Rochelle plant which has been occupied by Press Wireless Manufacturing Co., Inc. since its purchase. The official VEE-D-X address is now: 155 West Main

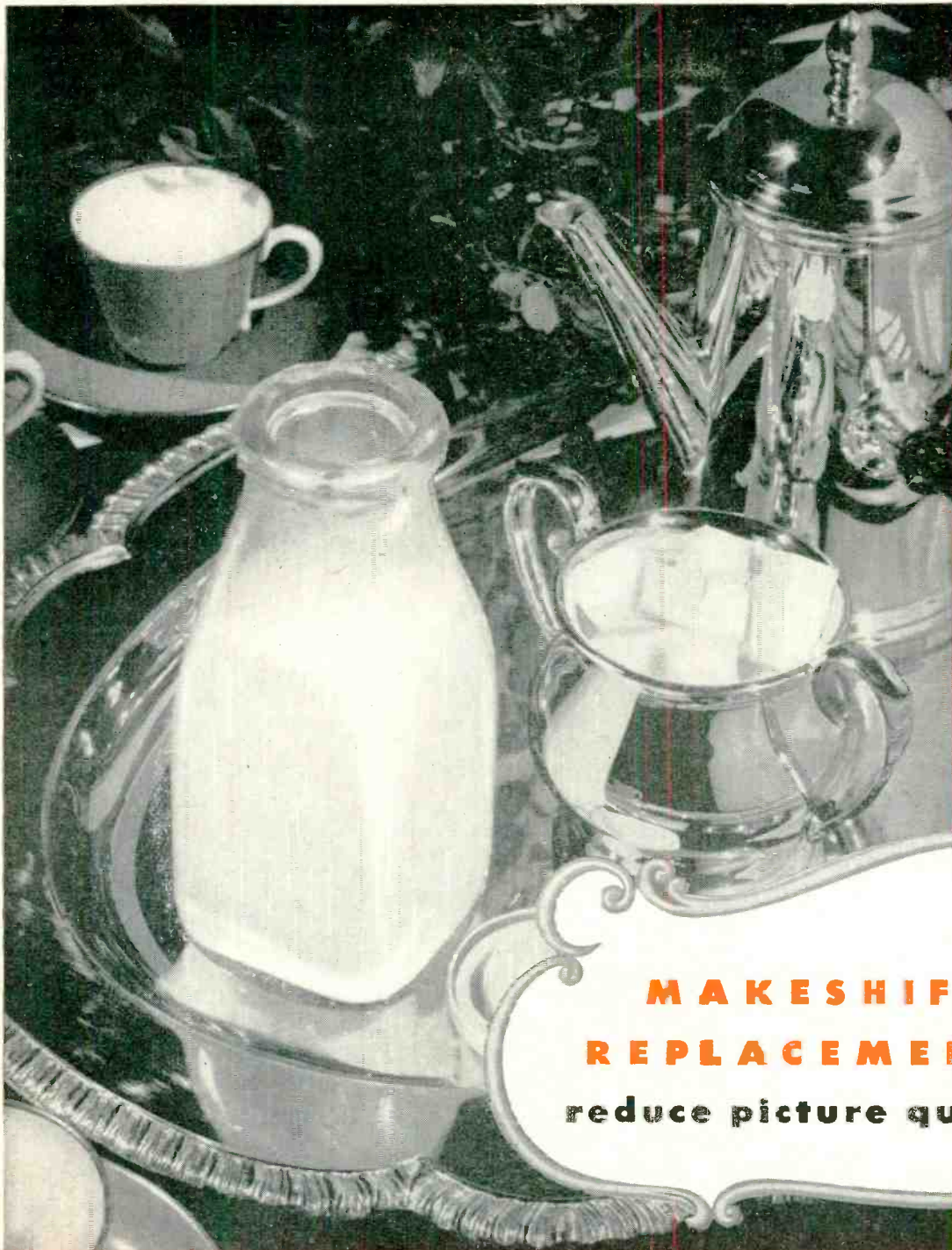

**MAKESHIFT
REPLACEMENTS**
reduce picture quality

Right
for
Sight

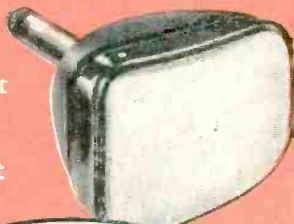

Replacements with
Raytheon Television Tubes
assure picture quality



Excellence in Electronics

RECEIVING AND PICTURE TUBES • RELIABLE SUBMINIATURE AND MINIATURE TUBES • GERMANIUM DIODES AND TRANSISTORS • RADIAC TUBES • MICROWAVE TUBES

Remember! Raytheon Picture Tubes with Corona Inhibitor
give constant picture clarity whatever the weather.

RAYTHEON MANUFACTURING COMPANY

Receiving Tube Division

Newton, Mass., Chicago, Ill., Atlanta, Ga., Los Angeles, Calif.

RADIO-TELEVISION SERVICE DEALER • AUGUST, 1952

This instrument provides complete sweep and marker frequencies

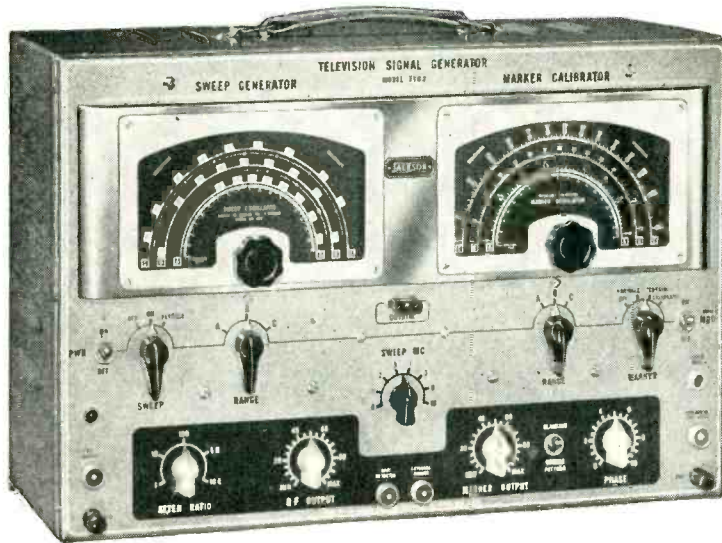

Jackson Model TVG-2 Television Generator

Both industrial and service technicians the world over use the Model TVG-2. Years of experience have proved that Jackson Signal Generators STAY accurate. Just ask the "ole timer" who owns one.

Continuously variable sweep frequencies over all TV and FM bands . . . Reversible single response pattern with base line or double pattern . . . Adjustable sweep width from 100 KC thru 18 MC . . . Marker Calibrator continuously variable from 100 KC thru 216 MC . . . Separate Crystal Oscillator for use either as a marker or calibrator . . . Video Modulation Jack provides for picture or pattern

modulation . . . Marker Calibrator IF frequencies all on highly stable fundamentals . . . RF Output completely controllable with variable and step attenuator . . . Multiple shielding of attenuators and circuits insures low leakage . . . Complete Sweep and Marker Generators in one beautiful instrument . . . Styled to match the famous Jackson Model CRO-2 Oscilloscope.



MODEL CRO-2
OSCILLOSCOPE

**Two Other Fine
Jackson Instruments**

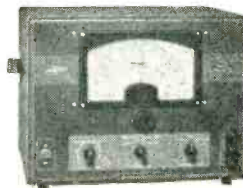

MODEL 655
AUDIO OSCILLATOR

5-inch oscilloscope having a vertical sensitivity of .018 RMS v.p.i. and band width flat within 1.5 db from 20 cycles thru 4.5 Mc. Linear saw-tooth sweep oscillator 20 cycles thru 50 KC per second in 5 steps. A standard voltage provided for determining unknown Peak to Peak potentials of all waveforms. Has reversible vertical polarity and return trace blanking.

Sine-wave 20 cycles to 200,000 cycles. Less than 5% harmonic distortion between 30 cycles and 15,000 cycles. Frequency calibration accurate within 3% or 1 cycle. Hum level down more than 60 db of maximum power output. Output impedances of 10, 250, 500, 5000 ohms or Hi Z resistive output.

See your electronics distributors for more information, or write

JACKSON ELECTRICAL INSTRUMENT CO.

"Service Engineered"
Test Equipment

DAYTON 2, OHIO

In Canada:
The Canadian Marconi Co.

Street, Rockville, Connecticut. Telephone: Rockville 5-3351.

Radion Celebrates 2 and One-Half Millionth Antenna

May 15th marked the production of Radion's 2½ millionth antenna. Willbur Burge owner of Radio TV Supply, 4343 West Armitage Avenue, Chicago, was presented with the gold-plated 2½ millionth unit by Ralph Leonard, President of Radion. In September, 1948, Mr. Burge was the first distributor in the country to place an order with the infant company. At that time he was associated with Walker-Jimieson, Inc., the Chicago Parts Jobber. His first order was for 300. The following year he sold more than 12,000. Radion now has two plants and produces some 30 items for the electronics market.

Walsco Unveils New Line

The formal unveiling of the new Walsco "50 Line" received a sudden and enthusiastic response from the thousands of jobbers attending the Parts Show in Chicago. Exceeding the expectations of Walter Schott, President, Walsco sales representatives were able to sell the new merchandising deal to 220 jobbers during the first 3 days of the Show.

Acquisition of new and larger quarters was announced by Sidney Pariser, President of RMS, manufacturers of TV antennas, accessories and electronic equipment.

The new RMS plant is located at 2016 Bronxdale Ave., and is a modern structure providing approximately 45,000 sq. ft. of space for the firm's production of electronic products. The company's Antenna Division will remain at West Farms Road in the Bronx, and their former plant building and general offices are to be retained as a warehouse.

J. F. Arndt & Co. Expands

John Falkner Arndt & Company, Inc., is celebrating its 28th anniversary by moving into its own building at 160 North 15th Street, Philadelphia 2, Pennsylvania. (New phone LOcust 4-4400)

Beginning 28 years ago with a 10 x 20 foot rent-free office and one hundred dollars (borrowed), two Arndt brothers pooled their initiative and set out in the agency business.

Today, the Arndt organization ranks among the first sixty agencies in the country, serving many leading companies in a wide variety of Industries.



MAXIMUM STRENGTH
 in the
PARALLELOGRAM OF FORCES
 featuring built-in thrust-bearing to take up down thrust

Sturdy

...to support any antenna array

Power

...more than you'll ever need

all yours in the **MODEL TR-12**
the CDR Rotor

All you could ask for in an antenna-turning device... the TR-12 CDR ROTOR is the last word in streamlined efficiency! It will support and turn with ease any antenna array—even 4-stack designs... you just can't beat it! Some of the features include: speedy installation, no loose parts to assemble—quick-mounting antenna mast collet—dependable, trouble-free, fool-proof operation!

- MODEL TR-12**... Complete rotor with handsome modern design plastic cabinet and meter control dial—fingertip lever—using 4-wire cable **\$47.95**
- MODEL TA6**... thrust-bearing accessory, separately **\$4.95**
- MODEL TR-11**... same as TR-12 without thrust-bearing **\$44.95**

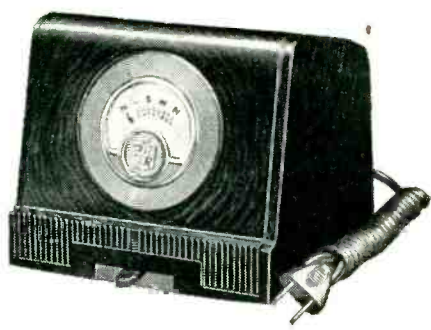

THE RADIART CORPORATION CLEVELAND 13, OHIO

VIBRATORS • AUTO AERIALS • TV ANTENNAS • ROTATORS • POWER SUPPLIES

VITALITY



for
CRT
•
P.U.T
NEW
LIFE

into weak
Picture Tubes
with the famous

TRANSVISION

TESTER-REACTIVATOR

EARN UP TO \$100 A WEEK
part time — more full time—
with this great instrument!

- *Renews Brightness, Sharpness, and Detail of Old Dim CR Tubes. Results are truly astounding.*
- You *don't* remove tube from set, or from its carton. No time lost.
- **It's also an accurate TESTER:**

Again, without removing the Picture Tube from set or carton, use this fine instrument to *measure Cathode emission, locate shorts between elements, locate high resistance shorts or leakage as high as 3 megohms. 110V-60 cycles; wt. 3 lbs. It's a rugged, dependable, effective instrument. So get the genuine—order direct from TRANSVISION today!*

(Pat. Applied For)

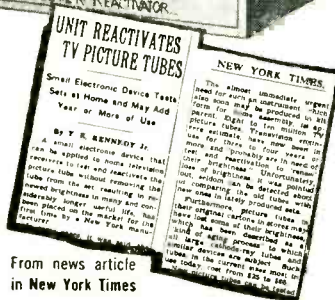
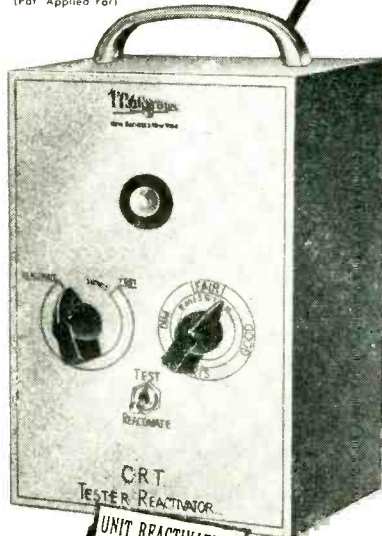

From news article
in New York Times

TRANSVISION, INC. • NEW ROCHELLE, N. Y.

SATISFACTION GUARANTEED
or money refunded if you return
the instrument in 10 days in good
condition. **\$19.95** NET

—RUSH THIS COUPON—
TRANSVISION, INC.
DEPT. SD-8V NEW ROCHELLE, N. Y.

() Send me _____ CR Tube Tester-Reactuator(s).
() Enclosed find \$_____ deposit Balance C.O.D.
() Enclosed find \$_____ in full. Send prepaid

Name _____
Address _____
City _____ State _____

ASSOCIATION NEWS

Phila. Radio Servicemen's Association

Our last open meeting was held June 3rd, 1952 at KYW in Studio 'A' and was sponsored by Albert Steinberg and Co. of Philadelphia, who presented Roy Berger of the Federal Telephone and Radio Corp. who spoke very ably on Federal's miniature selenium rectifiers, followed by a question and answer period.

Sam Jefferies of Littelfuse, Inc. was also a speaker at this double header meeting spoke on fuses and their very important part electronics, radio and television. Sam also entertained a question and answer period, and all who attended this meeting were given descriptive literature by both speakers published by their respective companies.

The program was part of a series of lectures sponsored by area parts distributors for service groups in an effort to keep local technicians informed of the latest developments in radio and television.

This June 3rd meeting is the last one until September and it is probable that the September meeting will be held September 9th (Tuesday) due to the first Tuesday being the day after Labor Day, and being so, it makes it hard to get speakers to come to Philadelphia when they would have to leave on a holiday to arrive here.

The September 9th meeting is to be a great affair and will be sponsored by the Almo Radio Co. Watch for notices of this meeting. It is a must.

It is rumored that a new service organization for Radio and Television service technicians will be started in Delaware County soon.

Television Installation Service Associations—Chicago

Another death was caused as a result of work on a television set. The death of Frank Freudinger was attributed to contact with the high voltage system of a television set upon which he was working. This again, reemphasizes the warnings issued by The Television Installation Service Association (TISA), an association of ethical TV service companies in the Chicago area on the dangers present in servicing television equipment. TISA has warned, particularly

\$4⁰⁰ opens up
A NEW BUSINESS
FOR YOU...



**GOLDEN OPPORTUNITY FOR ALERT SERVICEMEN
 TO TURN \$4.00 INTO HUNDREDS**

The market is wide-open... a ready market... an actual \$70,000,000 Phono-Cartridge Replacement market. Facts and figures prove it! What an opportunity for you and every serviceman to get new business, profitable business you're not getting now!

ELECTRO-VOICE SHOWS YOU HOW... AND PAVES THE WAY E-V helps you with everything you need to build a money-making Professional Phono Service business—New Sales Aid Kit, Manufacturer's Set Model Replacement Guide, Dramatic Direct Mail Campaign including Post Cards and Stuffers, Handbook on Cartridge Sales and Service, Professional Phono Service Sign, Window and Wall Streamers, Service Tags, etc. With these sales tools you can easily turn that \$4.00 into HUNDREDS.

The E-V Basic 6 Preferred Type Cartridges enable you to make over 92% of all cartridge replacements and give immediate replacement service. Not only that... every E-V Cartridge now comes like a jewel in a new golden yellow, self-stacking plastic box.

It's the most powerful, most effective merchandising plan ever conceived in the phono service field!

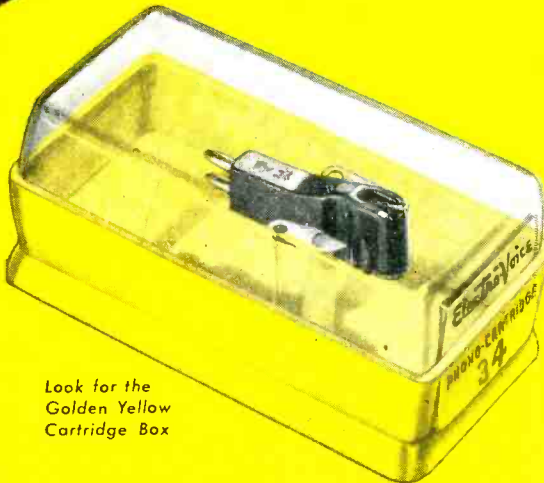

Look for the Golden Yellow Cartridge Box

FREE

Send Now for Bulletin CP-1. Gives You the E-V Plan—Tells you How to Make \$4.00 Open New Business for You.

ELECTRO-VOICE, INC.
 412 CARROLL STREET
 BUCHANAN, MICHIGAN

Please Rush FREE Bulletin CP-1

Electro-Voice

412 CARROLL STREET • BUCHANAN, MICHIGAN
 Export: 13 East 40th St., New York 16, U.S.A. Cables: Arlab
 PHONO CARTRIDGES • MICROPHONES • HI-FI SPEAKERS • TV PRODUCTS

NAME _____
 ADDRESS _____
 CITY _____ ZONE _____ STATE _____

MY DISTRIBUTOR'S NAME _____

1 for the money . . .

2 for the show . . .

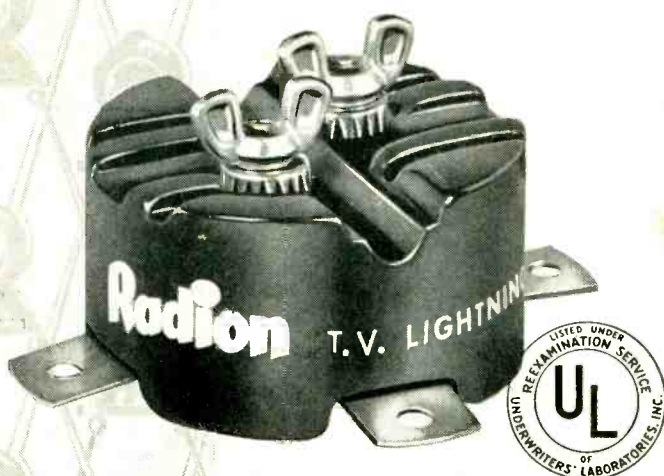

1 **ARRESTER** is all you need!
Simplifies inventories and installations because it fits *all* types of twin lead*—mounts *anywhere!*

2 **MODELS** that show top profit—each is all-purpose, complete with mounting strap, screws, individually packaged.

The Champion, in high di-electric porcelain, Model QLA-2 \$1.50 list

The Challenger, in low-loss phenolic, Model LA-2 \$1.00 list

Write now for free bulletin.

*Pat. pending.



The Radion Corp., 1130 W. Wisconsin Ave., Chicago 14

against the use of fix-it-yourself books which encourage service by laymen not familiar with the dangers involved. In this latest case, the victim was apparently at least partially qualified to work on TV.

As far as the uninitiated person is concerned, he should be aware that he is working with a device which contains voltages far in excess of those used in the electric chair for the purposes of execution. He should remember that merely shutting the set off or removing the plug does not of necessity eliminate the danger. Picture tubes have been known to retain a charge of electricity for as long as six months and more. Periods of high humidity are extremely dangerous. Another danger that can not be discounted is the possibility of implosions of the picture tube. These dangers are known and anticipated by trained television technicians. They know exactly what to look out for and take proper steps to protect themselves. In the event of an accident, good service companies protect the customer against law suits resulting from the accident by proper insurance coverage.

Again TISA warns: "Don't save a dollar at the possible expense of your life. Your life is worth much more."

Central Television Service has been expelled by this association by unanimous vote at the regular TISA meeting of July 2, 1952.

Henceforth, they are to be accorded none of the privileges accruing from membership.

Radio & Television Technicians Guild of Florida, Inc.

A series of lectures on UHF and the various Tuners is being planned for the Serviceman in the Miami area. They will be the very best bet Service-wise on how to maintain the UHF Converters.

A vote of thanks to Sea Coast for arranging to have the RCA Service Clinic come to Miami and give the timely information that they need so much on UHF. Just wondering how long it will be before other manufacturers will be doing the same thing.

Radio-TV Servicemen's Ass'n. of Pittsburgh, Inc.

Following is a list of the newly elected Officers and Directors of the above Association.

President: George V. Sharpe, S & B Radio Service, 710 Warrington Ave., Pgh. 10, Pa. Ist Vice Pres.: Stephen Mykita, Mykita Radio &

[Continued on page 35]

Bill Clemens says—
 Midget Radio Service (a 3-Man Shop)
 129 S. Elizabeth St., Lima, Ohio

**"TRIPLITT 660 saves us
 50 to 100 man hours
 per month."**

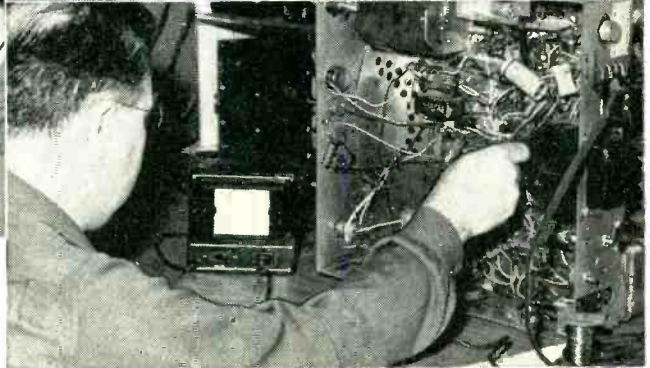
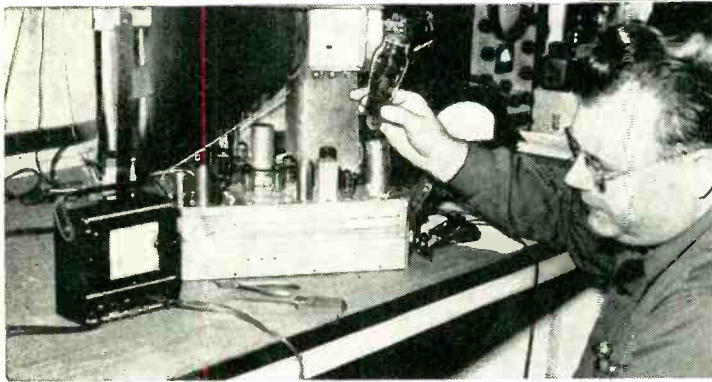

1. ISOLATING THE TROUBLE—Plug the power cord of the chassis into LOADCHEK and note the reading. With your eye on the large meter remove the rectifier tube and you can tell immediately which side of the tube the trouble is on. You have already eliminated 50% of your probing time.

2. LOCATING THE SHORT—With Loadchek you can quickly check the shorted side, part by part, without laying down tools or picking up test leads. Here, the trouble was a short in the transformer, spotted without having to warm up set. Overloads are found the same way.

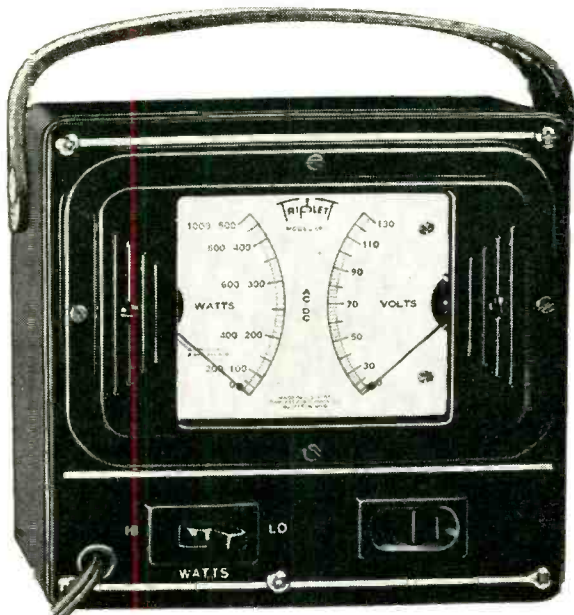

Locates trouble in a hurry

The above pictures illustrate but one of the many time-saving uses of Triplitt 660 Loadchek. This versatile instrument accurately measures power consumption, enables you to see instantly any deviation from normal load, without disconnecting a single part... finds trouble in a hurry.

For Radio and TV servicing—for almost any kind of electrical trouble-shooting—LOADCHEK saves hours of painstaking work every day. At its moderate cost no service technician can afford to be without it. Try one today—and see! Write for free booklet.

TRIPLE ELECTRICAL INSTRUMENT CO., BLUFFTON, OHIO, U.S.A.



Triplitt

Suggested U. S. A. DEALER NET \$29.50
 Prices subject to change without notice.

102 BILLION

FREE SALES BOOSTS A YEAR FOR YOU!

NEW
CBS-HYTRON
BRAND
gives you:



Acceptance



1,973,326,000 times a week! 102,612,952,000 times a year! The magic letters "CBS" are seen and heard on radio and TV station breaks. Impact is terrific. An average of 13 sales impressions weekly for every man, woman and child in the country. Every one of your customers knows CBS. Knows he can depend upon CBS. Consumer acceptance of your CBS-Hytron brand grows hourly.

Engineering



As a division of the Columbia Broadcasting System, Inc., CBS-Hytron commands tremendous engineering resources for you. Because CBS embraces the field of electronic entertainment: Radio broadcasting. TV broadcasting. Radio, television, and phonograph sets. Records. Electronic research laboratories. And CBS-Hytron tubes.

Leadership



For example, CBS-Hytron originated: the GT tube . . . the subminiature tube . . . the rectangular picture tube . . . specialized, low-cost TV receiving tubes. CBS-Hytron's new picture-tube and miniature-tube plants are the most modern in the world. Such aggressive leadership guarantees you the newest and best in tubes.

YOU CAN'T BUY BETTER

Demand the CBS-Hytron brand. You get the finest electron tubes that progressive engineering skill and craftsmanship can make. You get the brand known and respected by every one of your customers. You get the brand they see and hear the most . . . CBS-Hytron.



MAIN OFFICE: SALEM, MASSACHUSETTS

NEW ANTENNA DESIGN

by DOUGLAS H. CARPENTER

The author provides a basic discussion of TV antenna elements and their effects on the overall antenna system. Gain figures for various conditions of stacking and the addition of directors and reflectors are also given.

SINCE the television antenna has become an important factor in the installation budget of the service technician, a healthy interest has been exhibited in the principles controlling operation of individual arrays. This is particularly true in the so-called "fringe", or areas of weak signal level. It would be impossible to analyze each type of antenna system in an article of this length. It is practical, however, to present a fairly comprehensive explanation of the important systems used where high gain, and high signal to noise are mandatory. Although the following explanations refer primarily to high gain antennae, the basic theory governs the operation of any antenna employing driven elements with parasitic reflectors or directors.

Radiator

The first element to consider in any television receiving system is the radiator, or that portion of the antenna connected directly to the transmission line. In order to fully appreciate the function of the radiator, it is necessary to understand the "capture area" or signal acceptance coverage of this element. When any resonant receiving element intercepts a wave front, voltage is induced, and a field will exist at right angles to the greatest element dimension. The total energy intercepted by the "capture area" of the antenna cannot be delivered to the transmission line because of the re-radiation characteristics of any dipole. Only 50% of the total induced voltage can be recovered as useful signal. The wasted, or re-radiated portion of the wave

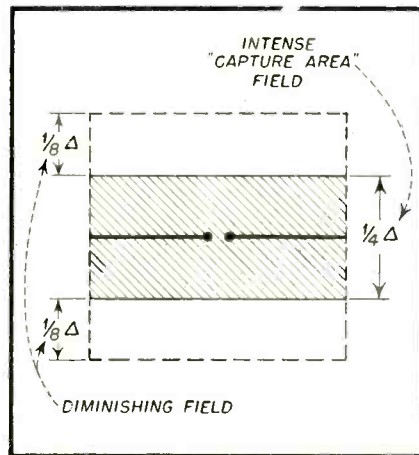

Fig. 1. Field diagram of dipole.

front, establishes a field of diminishing intensity at right angles to the plane of the receiving element. The center impedance of the radiator can be computed if it is assumed that this element is located in free space and clear of any metallic object. The "capture area", or fixed field of the antenna drops off rapidly after $1/8$ wave length but still has noticeable coupling effect up to $.7$ wave length. This is illustrated in *Fig. 1*. If another receiving element was located in this field, two separate things would happen. The fields of the two elements would inter-couple, and the effective field alteration would be inversely proportional to the spacing between the two elements. The center impedance of the elements would

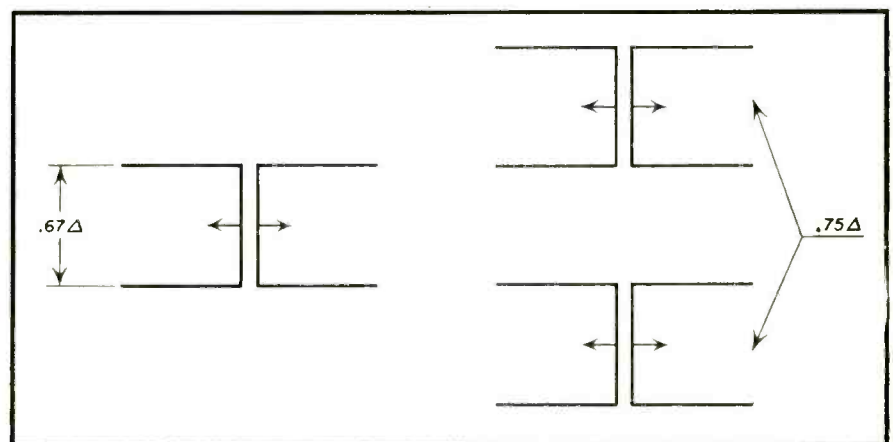

Fig. 2. Arrows indicate feedpoints to common harness.

Spacing	Gain (Db)
.67	4.9 (two bay)
.5	3.6
.36	2.0
.25	1.0

change in like manner due to variation in the current and voltage distribution. This fixed field is probably the most important single factor governing the design of multi-element and stacked arrays.

Stacking

Figure 2 depicts a horizontally stacked half wave dipole array. Neglecting the impedance change as seen at the center feed points, the chart of Fig. 2a gives an accurate account of gain vs spacing over a single element. If more than two horizontal elements are stacked in the vertical plane, the maximum spacing increases to .75 wave length with other gain points proportional. A practical spacing of .5 wave length is generally used by antenna manufacturers. This is done in the interest of mechanical support rather than an attempt to squeeze the last bit of gain from a stacked array. When horizontally polarized antennas are stacked in the vertical plane, the vertical pattern is noticeably changed. In the case of two-half wave dipoles stacked in this plane, sharp vertical nulls will occur. High vertical angle reception will be minimized, and the lobe response will be augmented in the direction of the horizon. As additional elements are stacked, these lobes become sharper and consequently more directional. The horizontal directivity response of a vertically stacked array remains unchanged as more elements are added, the only pattern variation occurring in the plane of stacking. A vertical angle of 50 degrees can be achieved by stacking two dipoles. This angle may be divided by two as the number of elements comprising the array is doubled. Gain figures of Fig. 2a are theoretically optimum values, but a rule of thumb can be employed which is surprisingly ac-

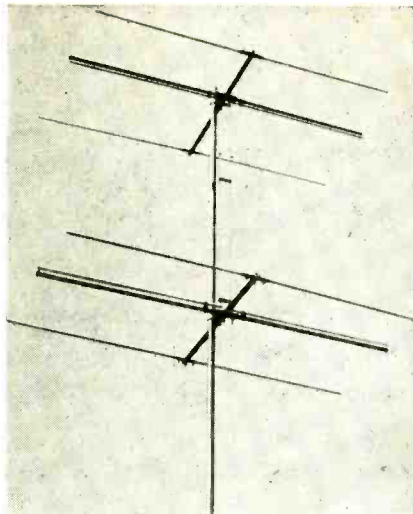

(Courtesy VEE-D-X)

Fig. 4. Typical stacked antenna, (two bay) each bay containing a driven element, director and reflector.

curate. If we double the number of elements in any stacked array at half wave length spacing, an average increase in gain of 3 db can be expected.

If it is desired to stack dipoles in the horizontal plane, we have the reverse electrical situation as compared to the vertical arrangement. In this case the vertical pattern of the total array remains unaltered, as additional elements are added. The horizontal beam width is, however, appreciably sharpened. Again the distance between the individual dipole sections must be maintained at fixed values if optimum gain is to be expected. Fig. 3 illustrates a colinear dipole stack of this type. Fig. 3a, the horizontal beam width to be expected as the number of elements in the array is increased. Gain as in the case of the vertical stack is increased approximately 3 db as the number of elements are doubled.

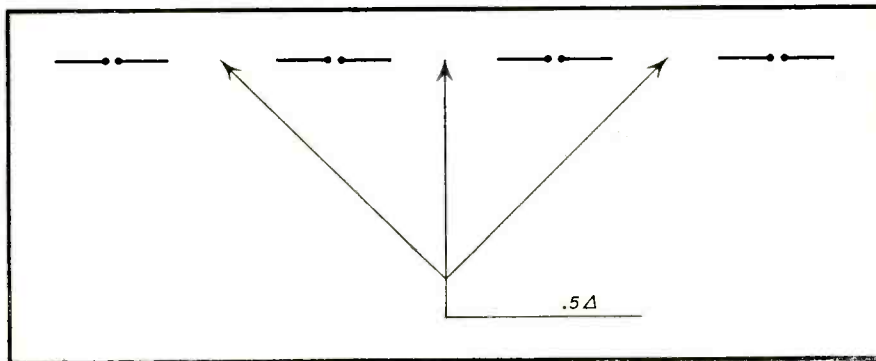

Fig. 3. Horizontal Beam Angle

Elements	Angle
1	76°
2	34°
4	16°
8	8°

Directors and Reflectors

The foregoing discussion has been purposely limited to the simple half wave dipole. The operation of any antenna system employing parasitic elements (directors and reflectors) is exactly the same with two fixed differences. The impedance of the receiving element is changed by the association of the additional elements, and power gain per antenna section (bay) is higher. The action of a reflecting element is to cancel the back pickup of the dipole and to increase the total amount of usable signal voltage available at the transmission line feed points.

A reflector will re-radiate the energy that it intercepts from the signal field. If the reflector is placed in proper proximity to the receiving dipole, this re-radiated energy will augment or add in phase to the energy collected by the receiving element. This phenomena is accomplished by adjusting the length of the reflector so that a time lag occurs between the induced and re-radiated voltage. The spacing of the reflector from the radiator and the ratio of these element lengths determine the exact in phase addition of voltages across the receiving dipole.

As indicated in Fig. 1, we now have the condition of a dipole with an additional element interposed in the "capture area." In this case, we are not attempting to extract energy from the secondary element by direct connection, but rather to take advantage of the re-radiated component. Fig. 1 also explained why practically no reflector action can be observed as the distance between the receiving element and parasitic element is increased over one-half wave length.

A good question might be asked at this point. Why isn't the picture as observed on the television screen displaced in direct ratio to the two voltage components since one is delayed in time? This can be explained by the wide separation of the transmitted (RF) portion of the television signal as compared to the modulation component. The demodulated intelligence of the signal is delayed only an infinitesimal fraction of one cycle even though the carrier wave may be delayed many times this value.

The action of a director is similar to the reflector just described. The director represents an additional element located in the "capture area" of the radiator section. The function of the director is to collect and re-radiate energy in the direct line of the signal. This component adds to the voltage existing on the receiving

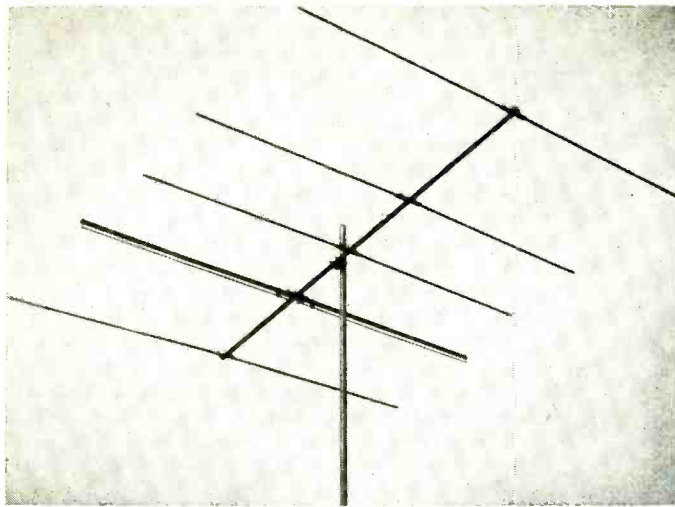

(Courtesy VEE-D-X)

Fig. 5. Typical 5-element yagi containing three directors, one reflector, and a "stepped-up" driven element.

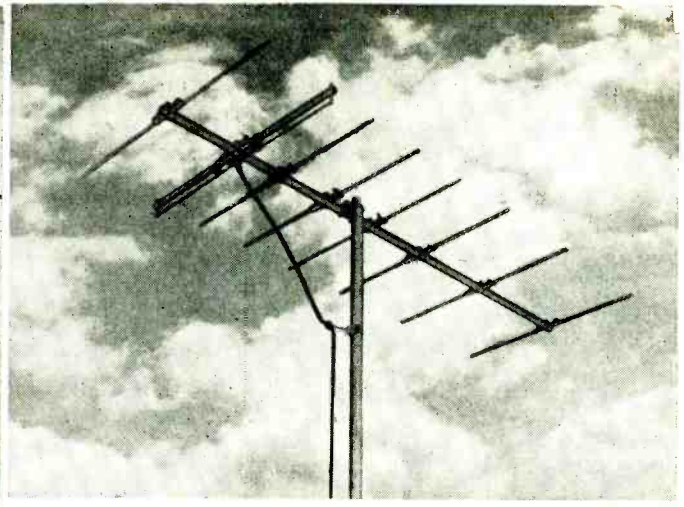

(Courtesy VEE-D-X)

Fig. 6. This 8-element yagi contains six directors, one reflector, and a "stepped-up" driven element.

element, and in turn raises the gain and horizontal directivity of the entire assembly.

Fig. 4 is a typical antenna employing the essential components of reflector, driven element and director. Although rather simple in appearance, the three element beam is really a rather complicated arrangement. The re-radiated components of both the reflector and director not only add to the voltage present on the receiving element, but affect each other because of the close inter-coupled spacing. Fortunately the only element that must be considered from a design standpoint is the radiator itself, as the total action is composite. Optimum design points of spacing are calculated for the maximum addition of in phase voltage at the receiving dipole.

Impedance

The impedance change at the center of a half wave dipole when parasitic elements are added, is similar in action to tuned circuit theory. As additional elements are electrically coupled to the receiving element, "loading" of this section occurs with a subsequent lowered impedance. It can be appreciated that if the transmission line was matched to the receiving element, addition of the parasitic section would mismatch this termination and cause a high standing wave ratio. To compensate for such a condition, some sort of transformer action is necessary between the line and antenna feed points. Commercial practice is to design the receiving element to have an impedance step-up ratio. The critical dimensions are the diameters of the upper and lower tubular sections of the radiator, and the spacing between

them. These dimensions remain fixed vs frequency, the only variation occurring in the length of this section as different frequencies are considered. The receiving element in the photograph of Fig. 4 is typical of this type of construction. In simple beam, or yagi design, it is possible to increase the gain of the antenna by resorting to wider spacing. Interaction between the elements comprising the array is reduced resulting in smaller voltage cancellations. With wider spacing, the transformer impedance is not affected to the same degree as in close spaced beams, and the design of more efficient transformer sections is possible.

Antenna Types

In so-called "fringe" areas, it has been pretty well conceded that the yagi does an outstanding job. There are several reasons why a selective or single channel antenna will outperform the broadband types and a comparison of signal to noise pickup illustrates this advantage.

Broadband antennas are designed to cover the entire VHF television spectrum, and in stacked form can exhibit excellent gain and sharp directivity. A yagi type of comparable gain and directivity will always deliver a cleaner picture at the design channel. The reason for such a difference lies in the fact that the bandwidth of the yagi can be controlled. In the case of the broadband types, it is necessary to rely on the selectivity of the receiver front end to minimize noise voltage existing at the channel edges. Such antennae amplify these voltages at the same level as the desired signal. The yagi on the other hand, has a fixed bandwidth and will attenuate these undesired interfer-

ence components by several db.

The field of yagi antenna design has been pretty well standardized with the five element close spaced beam entrenched as the most popular type, both in single and stacked arrangements. Fig. 5 is a photograph of such an antenna employing a "stepped-up" driven element. All five element yagi antennas consist of three directors and a reflector in combination with the receiving section. The latest additions available to the service technician are the eight and ten element types. In the case of the eight element yagi, six directors are used, and eight directors in the ten element combination. It might be well to review the operation of these multi-element types, and to present measurement data for the single and stacked versions of these two systems. When dealing with the commercial versions of the eight and ten element yagis, it is well to remember that the gain will vary in both cases as we consider the low or high frequency segment of the television spectrum. The reason for this condition is the difference in wave length spacing of the parasitic sections for the high and low TV channels. The problem is actually mechanical in nature and spacing is limited by the rigidity of the supporting boom extension.

If we consider the familiar five element yagi as a standard reference, we have a level of plus 8 db for a properly constructed close spaced beam. Such a figure is derived by comparison to a tuned folded dipole cut for the center of the measurement frequency band. The gain figure is also based on the fact that a band of frequencies is available from the

{Continued on page 37}

A New U - H - F T U N E R

by **ALLAN LYTEL**

(Author of *UHF Principles and Practices*)

Describing a uniquely designed tuner for u-h-f reception

MANY of the new UHF tuners utilize the transmission line as a tuned resonant circuit; this tuner is an example of a compact design based on the variable length transmission line. As discussed in earlier articles in this series, transmission lines can be used advantageously for UHF tuned circuits. A quarter wave short circuited transmission line, for example, provides a high input impedance at the operating frequency. This high input impedance results from the high voltage and low current characteristics across the input terminals. As the shorting bar is moved, it changes the length of the line and hence the operating frequency.

Using the basic relation between wave length and frequency and velocity the length of the quarter wave line may be established quite simply. At 470 mc or the low end of the UHF-TV band, a quarter wave length is about 16 cm or 6½ inches. At the high end of the band or 890 mc, a quarter wave length line is about 8 cm, or 3¼ inches. Capacitive loading which is usually used to allow frequency adjustment, shortens these lengths somewhat. A view of this compact tuner is shown in *Fig. 1* in which the dial cord drive can be seen connected to the upper and lower transmission line elements. As the tuning dial is rotated, the shorting bar moves around the circular shape of the bent transmission line changing its electrical and physical length.

In Part A of *Fig. 2* a quarter wave transmission line short circuited at the load end is illustrated. Across the short circuit there will be a condition

of current maximum and voltage minimum. At the sending end or 90 degrees away from the load end, there will be a current minimum and voltage maximum. Looking in at the sending end will produce a high impedance since the input impedance is voltage divided by current which is in this case high voltage divided by low current hence a high impedance or parallel resonance.

This basic transmission line section is the fundamental device used to tune virtually all UHF converters. However, in actual practice several modifications are made. One of these modifications as in the tuner under discussion involves bending the transmission line in a semi-circular shape. Other modifications are shown in part

B of *Fig. 2*. The transmission line is shortened so that it will occupy less space and a trimmer capacitor is used to replace a portion of the line. This trimmer allows a shorter line section and also provides for adjustments of the operating frequency. Tuning is accomplished by the moveable shorting bar. As this shorting bar position is changed the line length is varied which changes the operating frequency to provide for tuning over the entire range.

Kingston Tuner

Figure 1 is the compact transmission line tuner designed by the Kingston Products Corporation; it is four inches in diameter and three inches deep. As shown, it is a continuous tuning type of device with a dial drive shaft covering the entire UHF band in 340 degrees of rotation. The two tuned lines are used to tune the pre-selector stage and the oscillator stage. A crystal is used for the mixer, a 6AF4 for the local oscillator and a 6BK7 for the intermediate frequency amplifier. *Fig. 3* is a schematic of the entire tuner.

The functional operation of this device is easily understood once the tuned lines have been replaced by tuned circuits in the mind of the technician. The input signal is inductively coupled by means of the loop through the tuned pre-selector to the mixer crystal. A second tuned circuit ganged with the first adjusts the local oscillator frequency. Output signal from the oscillator is capacitively coupled to the mixer. There are two stages of i-f amplification with the plate of the first tube being capacitively coupled to the cathode of the second. The grid of the second

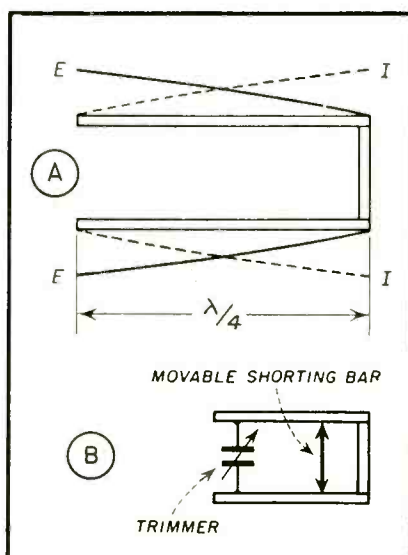
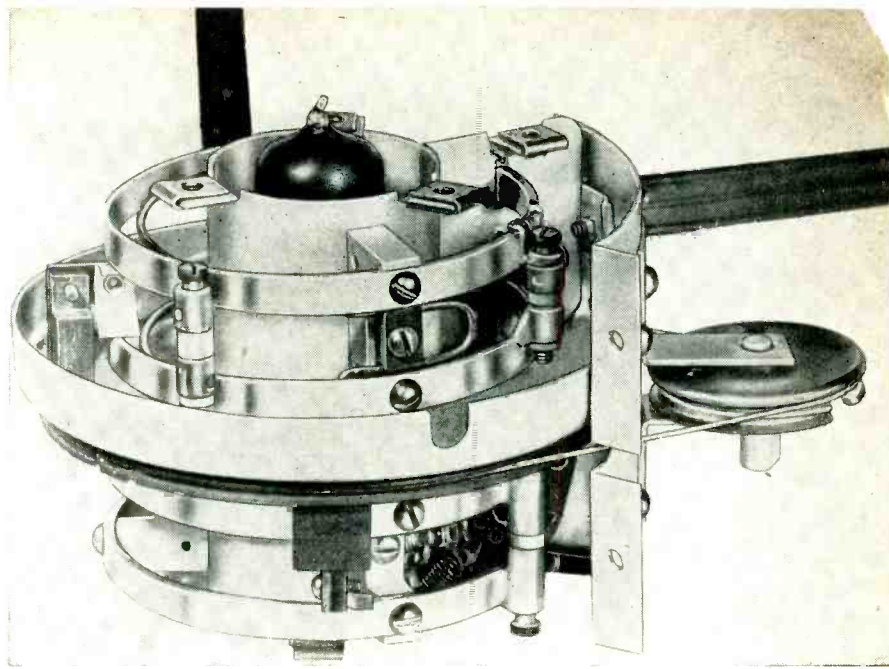

Fig. 2. Shorted $\frac{1}{4}$ wavelength bar looks like high impedance at open end. In B the trimmer serves to shorten line.

Fig. 1. Transmission line tuning elements of new u-h-f tuner.



tube is grounded and it operates as a grounded grid i-f amplifier.

Applications

The manufacturer suggests four possible applications for this tuning device. First the entire unit can be used in its attractive cabinet as shown together with any existing television receiver, and the output of the UHF tuner would be fed to the input of the VHF tuner.

In the second application, this tuner could be installed without the cabinet directly on the chassis of the TV receiver operating on the present VHF channel. The VHF tuner would be switched to the appropriate channel and the i-f output adjusted by means

of the trimmer control on the oscillator. In this way, the UHF tuner would be a part of the present television receiver.

A third possibility would be the UHF tuner using a 40 megacycle i-f output; this could be coupled directly to the 40 megacycle i-f amplifier system of the existing television receiver. In this case, either the UHF tuner or the VHF tuner would be used depending upon the appropriate channel desired. A final possibility involves a tuner designed to cover both the VHF and the UHF ranges in one complete unit.

Figure 4 illustrates the cabinet when this tuner is used as an auxiliary



Fig. 4. Tuner enclosed in cabinet.

of the present television receiver. The three controls which are becoming standard for such units involve first the station selector, second the fine tuning and third a combination switch which is used for the ON-OFF power and the antenna changeover from UHF to VHF. This cabinet is 8 1/8th inches wide, 5 3/4 inches high and 4 1/2 inches deep.

The transmission lines of this tuner are one-quarter inch wide curved parallel strips of silver plated brass; a moveable shorting bar arrangement and capacitive trimmers are used as suggested in Fig. 2. The transmission line coupling loop is coupled to the preselector line by locating the loop closer to the preselector line at the high frequency end than it is at the low frequency end to provide almost constant loading. Two trimmer capacitors are used for tracking on the preselector lines. One trimmer is used for the high frequency end and the other is used for the low frequency end. The preselector is a half wave transmission line (except for the effect of the capacitive trimmers which

[Continued on page 36]

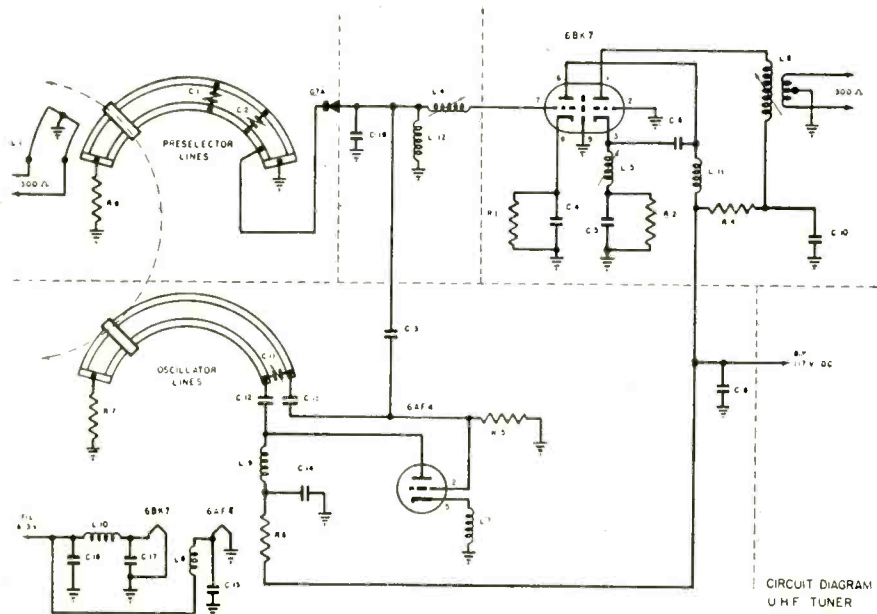

Fig. 3. Circuit diagram of Kingston u-h-f tuner.

FACTORY AND TROUBLE-

by LEONARD LIEBERMAN

It may come as a surprise to the average bench service man to learn that the factory trouble-shooter can trouble-shoot and repair between 15 and 20 sets in one 8 hour day. It is true that they work on only one make set and a certain portion of their work is of the simplest type. While this is true, it is also true that they run into troubles which are not found outside the factory. Wrong components or even missing ones are things not ordinarily found outside the factory.

An important cause for this accomplishment is organization of the work by the following items:

1. Systematic trouble-shooting.
2. Familiarization with the many uses of their test equipment.
3. Use of specially devised accessories. Some variations of these factory techniques can be applied to service bench operation. This should make the operation more efficient and, therefore, more profitable.

Factory Systems

Let us briefly examine the system used by several manufacturers and see how parts of it can be utilized in the service shop. The new set after it has been wired and received its complement of tubes is brought to a test position. The first test position is usually *i-f* alignment. In some factories each stage is individually aligned by means of a signal generator and a meter. The set is then sent to a position where the *i-f* is swept and the curve is adjusted by means of an oscilloscope to correspond to the proper shape. In other factories, the curve position is also the one in which each stage is aligned. In this position any trouble caused by defects in the *i-f*'s or the tuner show up. These troubles are accurately noted by the tester on a card. The set is then sent to a trouble-shooter. This illustrates the first part of systematic trouble-

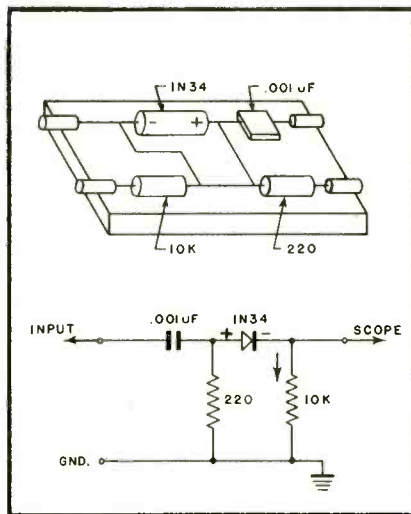

Fig. 1. Diode probe detector.

shooting. Note the complaint accurately.

Noting the complaint accurately in a service organization is the responsibility of the outside serviceman. His report on a set brought into the shop should be brief and precise in describing the complaint. Just saying poor sync does not give the benchman sufficient information. Is it on all stations? Is it horizontal or vertical or both? Is it a steady condition or does it vary? If it varies, how? All these things enable the benchman to get to the source of the trouble at a saving of time. The savings in the benchman's time is greater than the time required to write out a satisfactory field report.

After the *i-f* test position, the set at the factory goes to various other test positions where the tuner alignment, sweeps, high voltage, pix, sound and sync are tested. At each of these positions, a reject requires the same type of procedure as in the *i-f*'s. The troubles require concise, accurate description. In this manner, when

the trouble-shooter picks up a set, he does not have to look all over the set for a generalized complaint. The testers use the screen of the CRT to a large extent as a trouble source indication device. By properly interpreting what the screen says, it is possible to isolate the section causing the trouble.

Section Block Trouble Shooting

This illustrates the second part of a systematic trouble-shooting procedure; *Section-Block trouble-shooting*. By this is meant when trouble-shooting a set, isolate the section of the receiver which is most likely to cause that type of trouble. For instance, if the complaint is lack of both vertical and horizontal sync, the first place to look is at the stages preceding the inter-sync separation. While the horizontal or vertical stages could cause the trouble, the trouble is more likely in the sync separators or the video amplifier. This putting first things first is a necessity under mass production and should be just as much a *must* in the service shop.

After a set goes to a trouble-shooter,

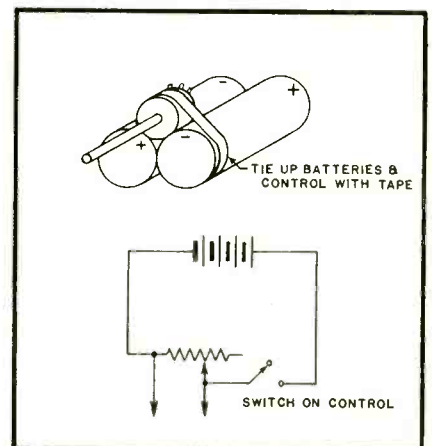

Fig. 2. Bias battery.

SERVICE BENCH SHOOTING

Practical pointers on how a set is serviced in a factory, together with illustrations explaining how the serviceman can duplicate these tests.

the first thing he does before he picks up a tool is to look for signs of trouble in the components in the section giving trouble. Burnt or blown-up resistors, condensers with wax leaking out, are spots, etc. are very likely sources of the trouble. Before replacing a burnt resistor, especially if it is a plate or screen resistor, he will check the bypass and coupling condensers in the circuit. When the cathode bias resistor and the plate load resistor are burnt or look defective there is the possibility of the tube being gassy or shorting.

The next item of information which the factory trouble-shooter has working for him is the knowledge of the pin connections of the tubes most commonly used in commercial receivers. This may seem to be a simple thing, but in actual practice, it is surprising how many servicemen couldn't tell you, right off the bat, which is the plate pin of a 6CB6,

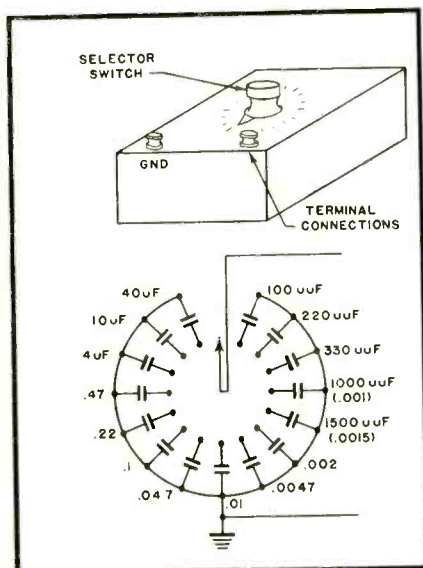

Fig. 3. Condenser substitution box.

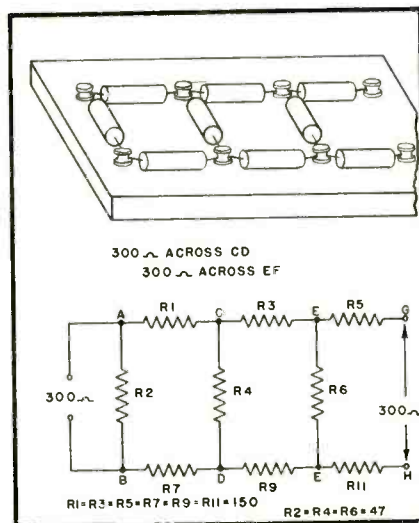

Fig. 4. Antenna attenuator pad. Attenuation is 20 db per step.

the grid pin of a 6AC7, or the plates of a 6AL5. This knowledge is the difference between being able to pick up a meter and rapidly making a check of the voltages around a circuit or starting to hunt through a stack of schematics to enable one to make these checks. While reference to the manufacturer's voltage chart is essential for accurate servicing, the quick check helps reduce the time required to find the stage which is defective.

Knowledge of the abilities and limitations of his test equipment is important to the trouble shooter since he is then enabled to evaluate his readings. If, for instance, he knows that it is easy to overload the i-f curve with too much marker signal, when he sees a distorted curve, he will remove the marker generator to see if that is what is doing it. He will not start immediately realigning the i-f's. If he knows that the genera-

tor which puts out the 4.5 signal is "hot," he will reduce its output to a minimum before he starts aligning the sound system. While all these instructions are usually in the service manual, unlike the average serviceman, the trouble-shooter at the factory has supervisors, quality control men, engineers who will not let him disregard these instructions.

Use of the oscilloscope at the factory is not an unusual operation but one which occurs as often as the use of the meter. The factory man knows by experience that the scope will give him more information, more quickly than the meter will, in many circumstances. For instance, he knows that in trouble-shooting, the horizontal sweep and high voltage troubles putting the scope on a few selected points at the oscillator and output tube will give him more useful information quicker. Most servicemen will take voltage and resistance measurements and then refer to the schematics rather than interpret what is on the screen of the scope. The reason for this is that they are more than a little bit leery of this versatile instrument.

Another instrument that should be used a good deal more frequently than it usually is employed is the sweep generator and its associated marker generator. Alignment of most stagger tuned sets is so simple that with a little practice, it can be done in less than five or ten minutes. Since it can be done so simply, alignment of stagger tuned sets should be as routine a part of bench servicing as cleaning off the face of the CRT.

Special Tools

One of the advantages that the factory man does have is the availability of a number of specialized accessory tools. This, however, should

[Continued on page 38]

MINIATURE TEST PROBES

Describing two new test probes devised by the National Bureau of Standards which may well be adapted for use by the practicing servicing technician.

TWO types of miniature test probes recently devised at the National Bureau of Standards are being used to speed development and testing in the NBS radar miniaturization laboratory. Light and compact, the probes are designed to cling to the test point without danger of contacting adjacent leads. Intended particularly for use with miniaturized electronic equipment, the new probes offer possible advantages for use with conventional-sized devices as well.

One of the probes is a push-on type, with a very small tapered jaw that is simply pressed onto the wire under test. The jaw is of hardened beryllium copper, silver-plated for good electrical contact. It grips the wire with a slight spring action until sufficient pull is exerted to remove it. The jaw screws into an insulating handle, made of lucite or of material like fiber having greater mechanical strength and heat resistance. The handles now being used at NBS are $\frac{1}{4}$ inch in diameter and $3\frac{1}{2}$ inches long. Color-coding of transparent-handled probes is accomplished by using colored lead wires, while colored bands are placed in grooves in the fiber-handled probes. Only about $\frac{1}{16}$ inch of the metal jaw protrudes from the insulating handle, so that the danger of shorting to nearby components is minimized.

The other probe is a lock-on type, designed so that it cannot be removed from the wire until a release button on the side of the probe is pressed. A small hook mechanism at the end of the probe remains open only while the button is pressed, and tightens on the wire when the button is released. In other respects, including size, the lock-on probe is similar to the push-on model. Like the push-on model, the lock-on probe is designed to accommodate wires varying considerably in diameter. Although several moving parts are required, manufacture of the lock-on probes is straightforward.

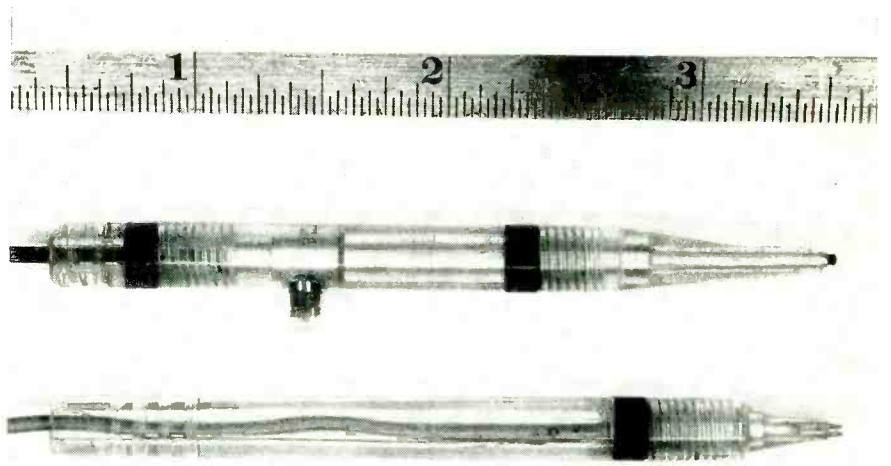

Fig. 1. Two miniature test probes recently developed by the National Bureau of Standards are particularly useful in servicing miniature electronic equipment. A push-on type (top) is designed to grip the wire on which it is pressed until pulled away. A lock-on probe (bottom) has a small hook in its tip, controlled by a button on the side of the probe.

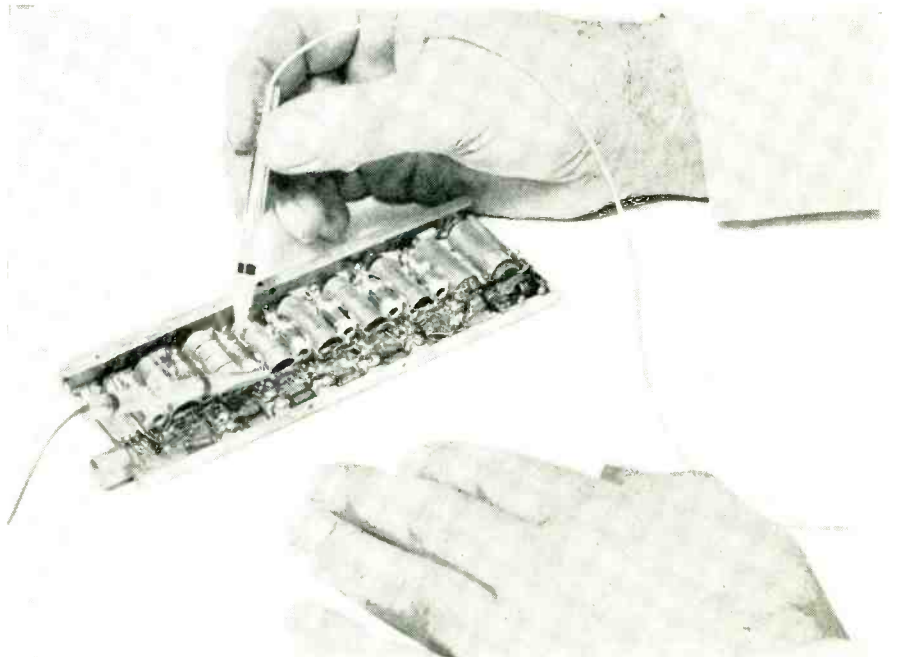

Fig. 2. Two of the new NBS miniature test probes are here being used to check a resistor in a diminutive 8-tube intermediate-frequency amplifier, also developed at NBS.

Modern FM EQUIPMENT

by C. A. TUTHILL

AN excellent example of recent FM equipment is the *Radio Craftsmen C-10* tuner. Figure 1 shows a functional block diagram for this combination FM/AM tuner. The FM channel covers the 88-108 megacycle band. The AM channel tunes 535 through 1620 kilocycles. Continuously variable controls provide ample choice of tone compensation. A 16 db boost or 14 db attenuation at 60 cycles and a 15 db boost or a 15 db drop at 10,000 cycles is available. Or, controls may be set for a flat response between 20 and 20,000 cycles. The variable possibilities are shown in Fig. 2. This unit incorporates ideas solicited from owners of an earlier model.

Inputs

Either a 300 ohm or 72 ohm FM transmission line may be used. Similarly, for AM, a high grid input or a low impedance transformer input is provided. Noise reduction loops are effective for both channels. FM and AM sensitivities are both below five microvolts. There is 30 db of quieting for a five microvolt signal input to the FM channel.

A phono input includes a 12AX7 preamplifier stage having a gain of 31 db plus 22 db boost at 30 cps for record compensation when variable reluctance pickups are used. Finally there is a TV input jack which may be switched through a volume control to a 12AX7 cathode follower. When the selector switch is positioned for either Phono or TV, power is reduced to all but the active audio tubes so to extend the life of inactive tubes. Power is derived from one 6X5GT and its circuitry. Total power consumption for the complete unit is 50 watts at 105/125 volts, 60 cycles. This is of significance for custom installations since the ventilation requirement is less than for larger dissipation.

Audio Channel

Signal path for the AM channel is through one 6CB6 r-f stage to the

This article describes the circuitry of one of the newer AM/FM tuners that is available on the present market, and should be of interest to the hi-fi service dealer.

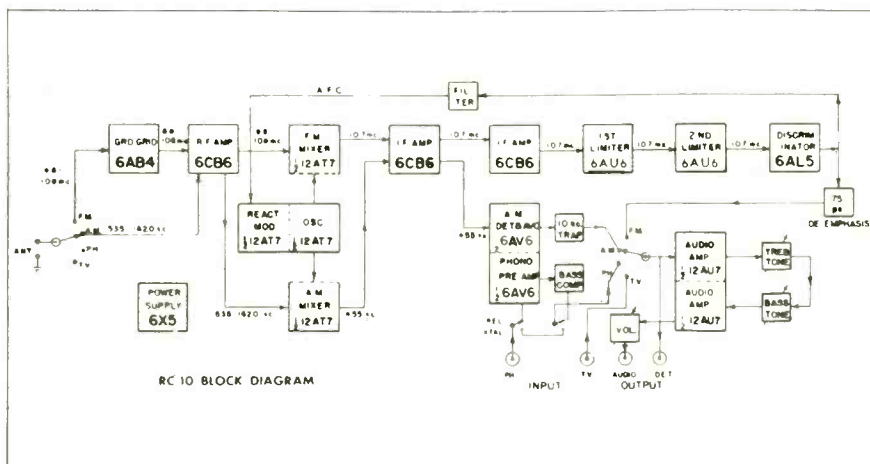

Fig. 1. Block diagram of Craftsman C-10 combination tuner for AM and FM reception.

AM mixer ($\frac{1}{2}$ 12AT7). As indicated by the block schematic (Fig. 1), this unit has automatic frequency control for stability. Following the AM mixer, there is one 6CB6 intermediate stage (455 kc) preceding the 6AV6 detector and AVC tube. Next there is inserted a 10 kc filter which provides 25 db rejection of inter-station whistle.

The AM signal path continues through the selector switch and volume control to a cathode follower stage whose output is made immedi-

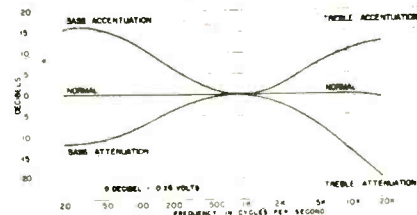

Fig. 2. Tone compensation curves of tuner.

ately available at a detector output jack or, the signal passes to the treble and bass equalizer. Flexibility of tone compensation is shown by the curves of Fig. 2.

Beyond the dual equalizer there is one 6AV6 stage of audio amplification and its output is varied by a ganged second section of the volume control mentioned earlier. Finally there is a 12AX7 cathode follower output stage capable of producing a signal of two volts with less than one half per cent distortion. This output is intended for high or low gain amplifiers having an input impedance of 10,000 ohms or greater.

FM Channel

When the selector switch is positioned at FM, the 88-108 mc signals first enter the 6CB6 r-f stage then the triode FM mixer ($\frac{1}{2}$ 12AT7). Mixer output enters the first of two 6CB6 and 10.7 mc i-f stages having

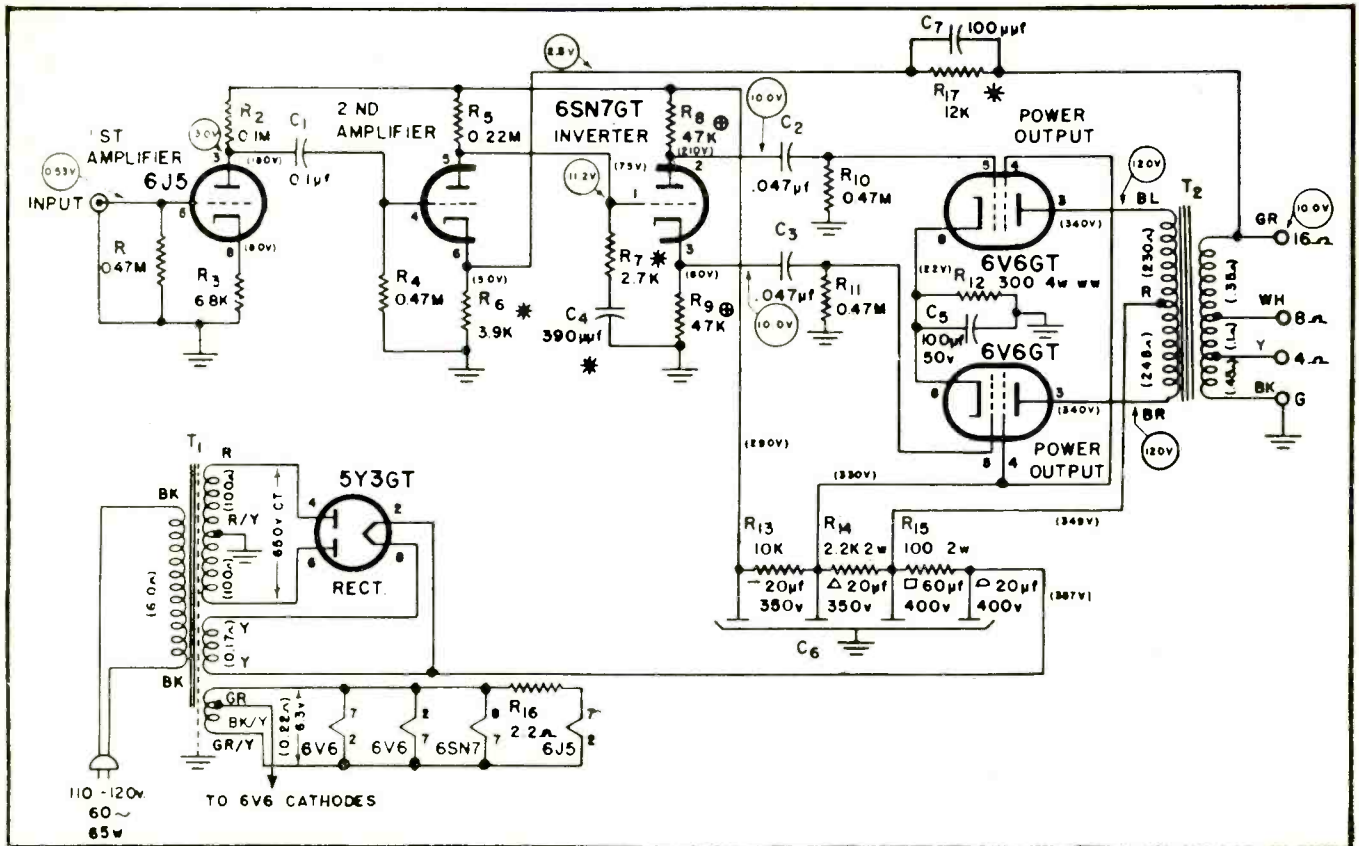

Fig. 3. Circuit diagram of Craftsman 400 amplifier.

the wide band width of 190 kc. High fidelity results from such treatment.

Twin cascade limiters (2-6AU6s) remove amplitude disturbances. Adequate gain ahead of this point assures complete limiting action. Reception of distant or weak FM stations is improved by the extreme sensitivity of this channel. Noise peaks are clipped to the same amplitude as the limited carrier. This limiter reacts to both rapid and slow variations in amplitude, which, if allowed to reach the discriminator, would cause distortion, noise, or both. Optimum reaction at the second 6UA6 grid is designed for a wide range of signal strength excitation. Additive results

of the two limiters mean a far more constant output than is possible with one limiter.

The 6AL5 discriminator translates frequency variations to amplitude variations. The relationship between frequency and output voltage amplitude is kept linear over the entire i-f bandwidth. An automatic frequency loop is tapped off from the discriminator output, filtered, and returned to the 12AT7 reactance modulator. FM tuning is simplified to the point that no tuning eye is required. Pulling between stages is reduced and annoyance due to station drift is eliminated.

Discrimination output is also fed through an RC deemphasis filter hav-

ing a time constant of 75 microseconds. This unit compensates for the standard high frequency preemphasis introduced at the FM radio transmitter stations.

The FM signal path is continued through the second section of the selector switch and the volume control to the 12AX7 cathode follower. From the switch forward the signal path is identical to that previously described for the AM channel. The five front panel control knobs are, from left to right,—bass, off-on-volume, selector switch, tuning, and treble.

Amplification

To derive full benefit from the capabilities of this tuner, a truly high quality amplifier can not be too strongly recommended. To meet FM standards the response should be linear from 50 cps through the upper activity limit of the speaker system employed. Power output requirement will be determined by room size and acoustics. For living room home use, a 10 watt output is generally adequate. The Craftsman 400 model is a typical amplifier for this function. The schematic of this unit appears in Fig. 3. Its high impedance input is directly coupled to the grid of triode 6J3. Signal from this tube is

[Continued on page 36]

Use of 13½ db inverse feedback around the entire amplifier results in a 4:1 output damping factor or an output internal impedance of 2 ohms at the 8 ohm tap.

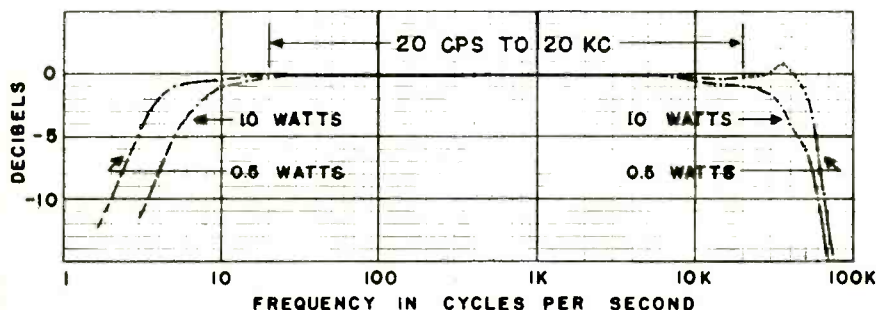
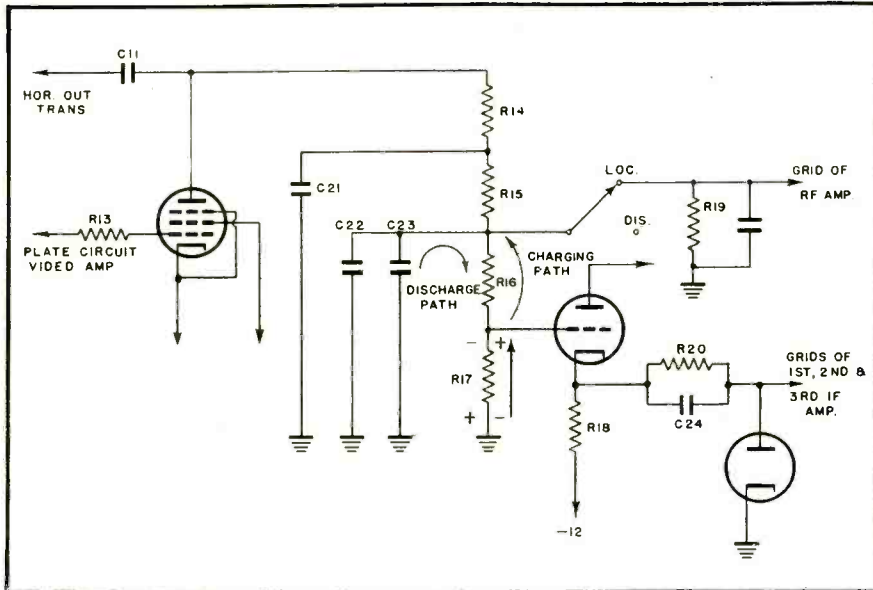

Fig. 4. Performance curves of Craftsman 400 amplifier illustrating frequency response characteristics.

TRADE LITERATURE



Arvin—5204CM keyed a-g-c system.

CIRCUIT COURT

Arvin 5204CM—A-G-C System

The Arvin 5204CM keyed a-g-c operates through a cathode follower amplifier. This system of operation permits the a-g-c output to be amplified so as to provide a wider range of a-g-c voltages to be presented to the grids of the controlled tubes. By means of this system, the tuner a-g-c can be tapped down in comparison to the i.f.'s for better operating conditions of the r-f amplifier.

The a-g-c voltage is derived in the conventional manner. *V1* plate is connected with the a-g-c coil in the horizontal output transformer through *C11*. The cathode and suppressor are connected to B+. The grid is connected to the plate circuit of the video amplifier through *R13*. The voltage relations between grid and cathode are such that the cathode is more positive than the grid. This keeps *V1* plate current in a normally cut-off condition. The arrival of a positive going sync signal at the grid will cause the tube to conduct if the plate is unblocked by the simultaneous arrival of a positive pulse from the horizontal output transformer. When the two pulses arrive in sync *V1* conducts through *R14*, *R15*, *R16* and *R17* to ground. Since the direction of cur-

rent flow is to ground, the top end of each resistor is negative with respect to ground. *C21*, *C22* and *C23* filter out any a-c component in the signal. *C21* responds to fast frequency changes. *C22* and *C23* in parallel respond to slow frequency changes. Since the time constant of *C22*, *C23*, *R16* and *R17* is long the d-c voltage will remain relatively constant until the next sync pulse arrives. The voltage on the plate of *V1* is, therefore, negative. *V1* will then conduct only at the peaks of the succeeding sync pulses.

V2 is a d-c amplifier. That is, there is a constant plate current flowing through it. The cathode of *V2* goes to -12 volts, the plate goes to B+. The amount of plate current flow is a function of the grid bias. If *V1* input signal does not cause plate current flow in *V1* due to the fact that the signal strength has gone down, *C22* and *C23* will charge through *R16* and *R17*. This reduces the bias on *V2*. Reduction of the bias on *V2* will cause the tube to conduct more heavily. The heavier *V2* conducts, the higher the cathode of *V2* through *R18* goes in a less negative direction. Thus by taking off the i-f bias from

[Continued on page 35]

Volume III of the RCA Television Pict-O-Guide, unique illustrated guide to the solution of everyday television service problems by screen-image analysis, was announced recently by the Tube Department of RCA Victor.

The new volume, prepared by John R. Meagher, RCA's noted television service specialist, is available immediately to television service dealers and technicians as a bonus with each order for 75 RCA receiving tubes or three RCA kinescopes they place with RCA tube and parts distributors. The bonus program will be continued until August 31. Volumes I and II of the Pict-O-Guide series will be made available on the same basis, as alternatives to Volume III, during the period of this promotion.

In addition, purchasers of the specified numbers of tubes will receive a bonus copy of "TV Servicing Supplement," a new booklet by Mr. Meagher on television trouble-shooting. This booklet concentrates on the handling of "tough" service problems.

* * *

Oxford Electric Corporation's new catalog has just been released. Containing complete information on all of the Oxford Speakers including the new Hi-Fidelity Speakers and speakers for Auto, P. A., Inter-com, Outdoor and Radio & Television, Portables and permanent magnet and electro-dynamic applications.

The 3-colored catalog includes complete information which answers all questions. Illustrations of the various speakers are also included.

The modern design of the cover is eye-appealing with room on the back cover for imprinting. Copies are available from the firm at 3911 South Michigan Ave., Chicago, Illinois.

* * *

Standard Transformer Corporation's new, completely revised 24-page catalog and replacement guide is now in the hands of distributors.

This enlarged edition contains over five hundred separate listings of transformers and related components, and has been revised to include a separate television component section,

[Continued on page 35]

SHOP NOTES

Write up any "tricks-of-the-trade" in radio servicing that you have discovered. We pay from \$1 to \$5 for such previously unpublished "SHOP NOTES" found acceptable. Send your data to "Shop Notes Editor."

Crosley 1952 20 or 21 Inch Receivers

In the schematic wiring diagram of bulletins 434 and 438, the wire marked Green from the Focus Coil (L119) to the right hand pin of P105 should be marked "Yellow." The wire marked Yellow connected to the left hand pin should be marked "Green." This is a correction to the schematic wiring diagram only.

If it becomes necessary to increase the range of the Focus control on the 20 or 21 inch models of 1952, connect the Focus Coil (L119) as shown in sketch and explained below.

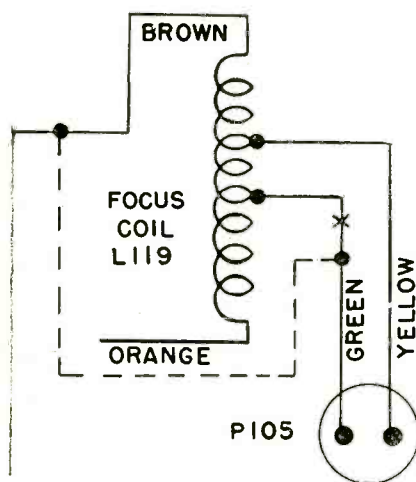

1. Cut the Green wire at "X" and tape the bare end of the portion of wire that remains on the Focus coil. Be sure to allow enough wire to remain on the coil just in case it is ever necessary to reconnect it in its original manner if for any reason the picture tube must be replaced at a later date.

2. The portion of Green wire that remains on P105 should be spliced to the Brown wire of the Focus coil as shown by the dotted line.

Crosley Service Dep't.

General Service Hints

A 100 watt goose-neck or sun lamp is beamed on TV sets that break down after a couple of hours operation. By sectionalizing the heat application, the

defective component can be located in a shorter time.

Partial rejuvenation of various types of phono crystals can be made by freezing them for about three hours and then playing them. Some respond, others may not, however, a couple of treatments have brought up the output considerably.

When starting to use a cleaning or polishing fluid on a plastic cabinet, test it on a spot on the bottom or inside. Some cleaning fluids will work ok on some plastic cabinets, but may eat into the high finish of others. It may take weeks to get a new cabinet.

If correct buffers tend to blow in an auto set which is installed against a fire wall that gets very hot on long trips, suggest that a high voltage transmitting type of mica condenser will permanently cure the trouble.

A customer bought and installed a portable battery pack during the last hurricane alert and the "B" section immediately went weak in his defective set after several hours of operation. He returned sad looking and I rigged up a 250 MA selenium rectifier with a bleeder and recharged the "B" section of the pack at approximately three times the rate of total set "B" current drain. After approximately 10 hours, the "B" section came up to 87 volts and the battery lasted throughout the storm with a satisfied customer who didn't have to buy a new battery pack after his set was repaired. During hurricane warnings in Miami, portable batteries become scarce.

*Submitted by:
J. Perkinson, Jr.
Miami, Fla.*

Vertical Instability of 17AY212

Raytheon & Truetone D2149

Instability of the vertical oscillator especially during warm-up has been traced in these sets to at least three different defective components.

When servicing these sets with the above symptom it is a good idea to replace resistors R76 & R78. C116 vertical decoupling filter should be replaced at least temporarily until it

can be determined if there is improvement in the performance.

If trouble still persists replace all resistors in the circuit that are of foreign manufacture and check hold control as well as height control.

The resistors of foreign manufacture in this set are notorious offenders. They may read very nearly correct when not passing current but change value considerably under actual working conditions.

*Submitted by:
Wayne E. Lemons
Buffalo, Mo.*

Motorola Model 61K22—Intermittent

Have run across several cases of intermittent reception now in these sets. Will play for 10 to 20 minutes, then goes dead. All tubes check good. In shop, on service bench, set played fine (for five days on one occasion). But a few days later (*in home*) it was back at old trick. Replacing 6T5 oscillator tube was cure needed, although tube checked good in tester.

Seems that when tube reaches a certain temperature it stops working.

Majestic Model 5LA50—

No reception

Defect: No reception. Look for voltage on output tube plate. If none, check output transformer for poor soldered connection made at factory. Carefully tear paper insulation back to where you can see where coil ends are soldered to heavier hook-up wires. You'll find it not soldered at all, or a very poor job. Clean wire good, and resolder, and radio is repaired.

*Submitted by:
Shingler Radio-TV Labs.
McVeytown, Pa.*

Westinghouse-Radio Models

H-324T7 and H-325T7—Increasing FM Sensitivity

The FM sensitivity of early production chassis can be increased by making the following changes:

1. Replace the 1.5 mmf capacitor (C24) which is connected between the top of the FM-RF coil and the top of the FM oscillator coil with a 0.68 mmf capacitor. The Westinghouse part number of the 0.68 mmf capacitor is V-5658-4.

2. In some early production chassis, the bottom turn of the primary winding of the FM RF coil (L2) is partially folded back on itself. Where this is the case, the bottom turn should be continued in a clockwise direction around the coil. This will add two thirds of a turn to the coil.

3. Make certain that the reactor (L9) which is connected to pin #6 of the 12AT7 tube is dressed away from the chassis is so that it is suspended in space.

TEST EQUIPMENT NOTES

by **JACK WHITESIDE**
& **L. J. AUSTIN**

Engineers, Simpson Electric Co.

MANY oscilloscope input circuits are ruined by service and laboratory personnel who forget that there is a maximum voltage which may safely be applied to the input terminals. All oscilloscopes are rated by their manufacturers as to the maximum allowable voltage which their input circuits will allow, and the majority of these ratings lie in the range around 500 volts a.c., r.m.s.

With television servicing, and particularly in observing wave shapes in the horizontal and vertical deflection circuits, voltages much higher than the rated maximum input voltage are encountered. For these, the man who wishes to preserve his equipment will build voltage dividers which will allow him to apply only a fraction of the actual circuit voltage to the oscilloscope terminals, and still preserve the wave shape which he is observing.

High impedance circuits are necessary for these dividers to prevent any loading effects on the circuits. These objectives can be met easily with simple materials at hand in any service shop. For the high frequency circuits, a capacity divider is more appropriate, while for low frequency circuits, a resistance divider works better.

In a capacity divider for high frequencies, such as the horizontal deflection frequency in a television set, the voltages appear across the capacitors in inverse ratio to their capacities. So use a low capacity in series with a high capacity, and the high voltage will appear across the low capacity while the lower voltage will appear across the high capacity. Referring to *Fig. 1*, connect a used high voltage rectifier tube (may be burned out but not shorted) for *C1*. This can be a 1B3 or a 1X2. Connect both filament leads as a single connection out the bottom (leave the filament cold), and

CORRECTION NOTICE

We wish to call our readers attention to an error made in the heading and caption of Chart I on page 18 of the June, 1952 issue of Radio TV Service Dealer Magazine. This chart appeared in the article, "Picture Tube Failures," by David Gnessin, and was supposed to list picture tube faults for which the manufacturer (Rauland) DOES GRANT compen-

sation. Both caption and heading indicated that these were faults for which NO compensation can be granted, which is not the case. The corrected chart appears below. Note that the only items for which the manufacturer does not grant compensation are those listed on the bottom of the chart, beginning with: A. Scratched face, etc.

PICTURE TUBE FAULTS FOR WHICH COMPENSATION CAN BE GRANTED

- | | |
|---|---|
| <p>I. Electrical Defects</p> <ul style="list-style-type: none"> A. Shorted elements B. Open or intermittent connection to elements C. Excessive element leakage D. Current out of limits (ion trap, focus coil, second grid, heater) E. First grid cut-off voltage out of limits F. Element breakdown under high voltage G. Low emission H. Arcing and singing (poor internal anode coating) I. Beam improperly centered J. Magnetized metal cone <p>II. Physical Defects</p> <ul style="list-style-type: none"> A. Air leaker B. Gassy tube C. Neck shadow D. Broken tube if caused by defective glass E. Defective outside paint F. Loose elements in tube G. Physical dimensions out of limits H. Incorrect type marking <p>III. Base Defects</p> <ul style="list-style-type: none"> A. Loose base if due to poor cementing B. Cracked base C. Improper base orientation D. Defective pin soldering | <p>IV. Screen Defects</p> <ul style="list-style-type: none"> A. Uniformity of color out of limits (including streaks, watermarks, blue areas, dark areas, dark edges, etc.) B. Insufficient screen area C. Holes and cracks in screen out of limits D. Dark or discolored spots in screen if out of limits E. Dirt and lint marks out of limits F. Excessive aluminum areas showing through screen G. Ion burn out of limits H. Excessive screen burn <p>V. Glass Face Defects</p> <ul style="list-style-type: none"> A. Blisters (large bubbles) out of limits B. Seeds (small bubbles) out of limits C. Chill wrinkle out of limits D. Mold mark out of limits E. Excessive impact marks F. Excessive cords G. Stones, scale, knots and embedded dirt out of limits H. Rouge, rust and unglazed scale out of limits I. Shear marks, scum and spew out of limits J. Dirt on mold marks, oil spots and cold glass marks out of limits |
|---|---|

Following is a list of possible defects for which the manufacturer cannot accept responsibility when these conditions appear on picture tubes:

- | | |
|---|--|
| <ul style="list-style-type: none"> A. Scratched face B. Patterns or holes burned in screen C. Broken tubes caused by mishandling D. Base loose due to mishandling | <ul style="list-style-type: none"> E. Bump checks in glass tube F. Base pins bent due to mishandling G. Base broken due to mishandling H. External coating defaced due to handling |
|---|--|

Chart I. List of picture tube faults for which compensation can be granted. (Rauland)

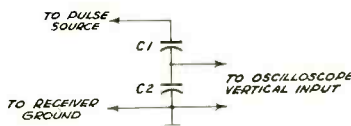

Fig. 1. Capacitor type of voltage divider.

connect a piece of lead not more than 8 inches long from the plate cap and use this as the "hot" probe. The capacity of the tube will provide about 1 to 1.5 μmf for *C1*, and it will withstand upwards of 15000 volts. Then connect

a ceramic, mica, or air dielectric capacitor with a value of 200 to 400 μmf as *C2*. Only a small fraction of the circuit voltage will appear across *C2*, and this can be safely connected as the oscilloscope input.

In a resistance divider for low frequencies, such as the vertical deflection frequency in a television set, the voltages appear in direct proportion to the resistances. Connect three resistors in series as shown in *Fig. 2*. Resistors *R1* and *R2* can be 10 megohms each, and *R3* can be 100K. Most

[Continued on page 35]

NEW PRODUCTS

SWITCH KIT

Centralab, a division of Globe-Union Inc., Milwaukee 1, Wisconsin, announces the availability of its newly revised 414 and 419 complete switch kits. These kits contain the latest Centralab switch parts in an attractive metal cabinet, furnished at no charge with the purchase of the parts. The cabinet size is 17" wide, 11-15/16" deep and is designed to fit standard steel shelving.



Both the 414 kit of phenolic switch parts, and the 419 kit of steatite switch parts contain Centralab's "De Luxe" or "DD" section and index construction. This construction has long been recognized as the most reliable in its class due to the one piece construction of knob shaft, index, and rotor shaft, and the extremely close tolerances possible in shaft manufacture. The 414 kit contains 111 phenolic switch sections, 31 index assemblies, and complete hardware, brackets, knobs, and dial plates. Its list price is \$175.00. The 419 kit contains 81 steatite-ceramic switch sections, 27 index assemblies, and complete hardware and etc. The 419 list price is \$185.00. These kits are available through any authorized Centralab distributor. For further information write for bulletin number 42-138.

TV CONVERSION KIT

A special "Converkit" containing RCA Victor's first "universal" horizontal-deflection-output and high-voltage transformer and a ferrite-core deflecting yoke, designed for converting small-screen television receivers to use kinescopes up to 21-inches in size, has been announced by the company's Tube Department.

The new transformer (RCA-231T1) and yoke (RCA-211D2), the latter an "anastigmatic" type, are immediately available from RCA parts distributors, either as independent products or combined in the handy "Converkit" package (RCA 201Y1). Both transformer and yoke can be used for either replacement or conversion service.

Heart of the "Converkit" is the special RCA "universal" horizontal-deflection-output and high-voltage transformer, which is designed for replacement use in TV receivers utilizing transformers which have isolated secondary windings, or for general conversion service. This transformer covers a high-voltage range of 10 to 15 KV.



Of special interest to service dealers and technicians is the transformer's universal-type bracket, which permits mounting the unit on the chassis of virtually all types and makes of television receivers.

Numerous secondary-winding taps are provided on the RCA transformer to facilitate the securing of an accurate match between the driver tube and any yoke having a horizontal-coil inductance from 8 to 30 millihenries.

The transformer's primary winding is tapped to take care of "B" supply voltages from 250 to 350 volts and accommodate all standard driver tubes. With the transformer's unique electrical construction, the damper tube is always connected across the entire secondary winding, and thus provides maximum damping.

The "anastigmatic" deflecting yoke (RCA-211D2) included in the "Converkit" features a ferrite core for high deflection sensitivity, distributed windings of a modified cosine design for sharp corner focus, and negligible pattern distortion. It is supplied complete with 12-inch leads, two vertical damping resistors, and a neutralizing network for the horizontal coils.

5 ELEMENT YAGI

Channel Master Corp., Ellenville, New York, has announced its entry into the low-priced Yagi field with the introduction of the Challenger 5 Element Yagi Antenna, Series 550.



Designed for the extra-price-conscious installation man who nevertheless demands top antenna quality, the Challenger is a highly sensitive and ruggedly built antenna. It produces over 7 DB gain on the single bay, matches 300 ohm line, and has a 5.1 front to back ratio. Noise interference is minimized.

Among the built-in quality features of the Challenger Yagi is the Uni-Fold Dipole, a transformer-type folded dipole made in one single assembly for extra strength and rigidity. The director and reflectors, made of reinforced aluminum, are completely pre-assembled, and the 1" cross arm has plugged ends.

SUBMINIATURE CAPACITORS

Availability of Astron type AQ capacitors, a new type of subminiature paper capacitor specifically designed for operation at temperatures through 125°C, was announced by the Astron Corporation 255 Grant Ave., E. Newark, N.J., manufacturers of fixed capacitors and RF interference filters.

Incorporating the use of Astron's newly developed X-250 high temperature impregnant, type AQ capacitors offer excellent capacitance stability over a wide temperature range from -65°C. to +125°C., without derating, plus high insulation resistance, low power factor and high test voltage.

Having excellent operating characteristics on both AC and DC voltages, and offering the lowest possible resonance losses, type AQ capacitors are supplied in the extended foil, non-inductive type construction. They are capable of meeting all military requirements, and are especially recommended for use under adverse operating conditions.

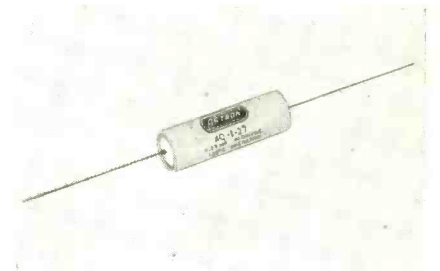

Hermetic sealing is provided by use of glass-to-metal seal terminals. Available in a variety of hermetically sealed metal tubular cases and construction styles.

SERVICEMAN'S AID

A new and unique premium for dealers and distributors of radio and television picture tubes has been announced by Sylvania Electric Products Inc.



A folding aluminum and sailcloth stool in a zippered carrying case, called the "Sit-N-Fixit", is being offered during July and August as a servicing aid to Sylvania dealers who order a given number of radio tubes or television picture tubes.

The folding stool was designed for on-the-spot home servicing of radio and television sets and is equipped with a zippered side pocket for screwdrivers, alignment tools,

HERE YOU ARE, SERVICEMEN!

Win \$5,000.00

in cash prizes!

Jensen
NEEDLE'S

"WIN
A GRAND"
CONTEST



\$1000 FIRST PRIZE!

187 WINNERS!

187
CASH PRIZES

1st Prize	\$1000.00
2nd Prize	500.00
3rd Prize	250.00
Next 10 Winners . . . each	100.00
Next 25 Winners . . . each	50.00
Next 50 Winners . . . each	10.00
Next 100 Winners . . . each	5.00
Total Prizes	\$5000.00

Contest Closes
DEC. 31, 1952

Special Prize
FOR EARLY BIRDS!

A precision quality, high powered Jensen Needle Microscope will be given to each of the first 500 servicemen to send in a completed Official Entry Blank. \$5.00 value. Handy pocket size to take on your service calls.

Start saving those packages . . . get your entry in soon!

RULES OF ENTRY

1. **What You Have To Do** . . . Jensen Phonograph Needles are packaged two ways—on a card or in a plastic box. Every time you sell or install a Jensen Needle during this contest, save the card or colored insert in the box (not the instruction sheet). Collect as many as you can during the contest period. Prizes will be awarded to the 187 servicemen sending in the most empty Jensen Needle packages.

2. **When Is The Contest** . . . The Jensen "Win a Grand" Contest opens September 1, 1952 and closes at midnight December 31, 1952.

3. **Who Is Eligible** . . . This contest is open to every bona fide radio-television serviceman in continental United States. This includes employees as well as employers, anyone who is actively engaged in this work during the period of the contest. No employee of Jensen Industries, Inc. or its advertising agency is eligible.

4. **How To Enter** . . . To be eligible for one of the 187 cash prizes, you must send in one completed Official Entry Blank (available at your regular Parts Distributor) together with all the empty Jensen Needle packages you have collected during the period of the contest. All Jensen Needle packages, EXCEPT the Jensen "Symphonette" and Jensen Coin Machine Needles, are acceptable.

5. **15-Word Statement** . . . On the Official Entry Blank, you will find a sentence beginning, "I Sell Jensen Needles Because . . ." Just complete this sentence in 15 words or less. As a suggestion, you might say, "I Sell Jensen Needles Because they are easier to install." (5 words).

6. **Where To Send Entries** . . . All entries to be considered for prizes must be sent, accompanied by a completed Official Entry Blank, direct to:

Jensen Contest Headquarters, 329 South Wood St., Chicago 12, Illinois

Do not send your entry to your Parts Distributor. You may hold your entry until the last day or send it in as often as you like, but be sure you have a suitable means of identification with each shipment (such as your original Official Entry Blank). REMEMBER: All entries must be postmarked before Midnight, December 31, 1952, to be eligible.

7. **Duplicate Prizes** . . . In the event of a tie, duplicate cash prizes will be awarded to all tying contestants.

8. **Judges' Decision Final** . . . Decision of the judges, chosen by Jensen Industries, Inc., will be final. All entries become the property of Jensen Industries, Inc., and none will be returned.

9. **Only Entry Itself Counts** . . . Only the total number of empty Jensen Needle packages, together with the completed Official Entry Blank, counts toward the prizes. Neatness, spelling, grammar or packing of entry do not count.

10. **Winners To Be Announced** . . . Winners in the Jensen Contest will be notified as soon after the contest closes as possible.

HERE'S ALL YOU HAVE TO DO! . . .

It's Easy! Simply save the cards and colored inserts from all the Jensen Phono Needles you sell or install from now 'til the end of the year. Pick up an Official Entry Blank at your regular Parts Distributor, complete the sentence, "I Sell Jensen Needles Because . . ." and mail this with your packages direct to Jensen Contest Headquarters before Midnight December 31st. That's all there is to it . . . the radio-TV serviceman sending in the most Jensen packages wins \$1000 cash. It might be you!

WHY JENSEN SPONSORS THIS BIG CONTEST!

Every radio-television serviceman can get a lot more business for himself without additional tools, equipment or labor simply by just replacing worn-out phonograph needles. That's why Jensen sponsors this unique contest—to show you how easy it is . . . and profitable, too. And Jensen supplies every assistance you need, with a precision made needle for every type of record player and complete easy-to-follow instructions.

Jensen INDUSTRIES, INC.
342 South Wood Street, Chicago 12, Illinois

JENSEN . . . Oldest name in Sound Engineering

Sell a **JENSEN NEEDLE** on Every Service Call!

soldering iron and other equipment, and open flaps on the other side for tool kits and manuals. The case opens for use as a drop cloth to prevent damage to customers' rugs and floors from tools, tubes and parts.

Dealers earn one "Premium Token" from their Sylvania distributors by ordering one picture tube or 25 receiving tubes. Sixteen tokens are required for the new servicing aid. The new premium is available to dealers only through authorized Sylvania tube distributors, and not directly through the company.

TWIN-DRIVEN 6-ELEMENT YAGI

Because of the extremely favorable response and the high rate of re-orders on its new 6-element Twin-Driven "Fishbone Jr.," pro-

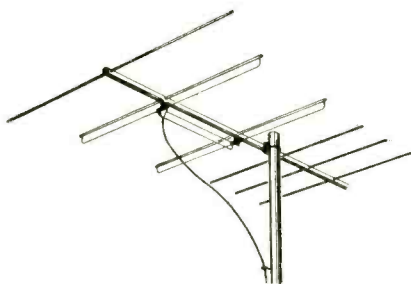

duction schedules are being stepped up six weeks ahead of time. The "6-element TV" Series features 3 directors spaced at one-tenth wavelength, two high impedance dipoles driven 90 degrees out of phase and full electrical quarter-wave spaced, with 15 wavelength spaced parasitic reflector.

Both forward gain and front to back ratio are extremely high, exceeding that of most 8-element beams, and comparable to many 10-element beams on the market today. Notwithstanding customized manufacturing methods which assures optimum performance of all Telrex Antennas, these rugged precision built units are competitively priced. Write for literature to: Telrex, Inc., Asbury Park, N. J.

BALLAST RESISTOR

The Clarostat TV Ballast is designed primarily to be plugged in between TV set and electric receptacle, for use in areas where line voltage tends to increase up to 140 volts.

This unit operates on the ballast principle, whereby, as voltage increases, the resistance

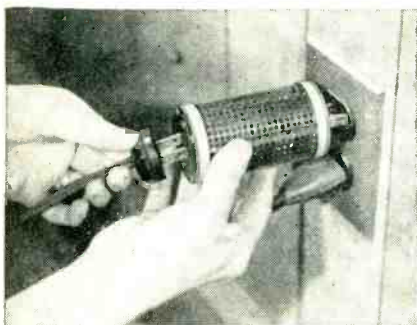

increases, giving an increased drop across the resistance, thus allowing a lower potential to be applied to the TV set. At 110 volts and under, the voltage drop is negligible; but with increases up to 140 volts, the voltage applied to the TV set will not normally increase much above 115 volts, depending, of course, on the load applied.

These units are designed so that one unit can be plugged into another, or two or more can be operated in series to obtain greater voltage drops in applications where needed.

Clarostat TV Ballasts, manufactured by Clarostat Mfg. Co., Inc., Dover, N. H., are available in Type TVA, 200 to 300 watts; and Type TVB, 300 to 375 watts.

GERMANIUM DIODE CHECKER

A germanium diode checker, for use in laboratories, quality control groups, service shops and wherever a need exists for checking static characteristics of diodes, has been announced by the General Electric Company here.

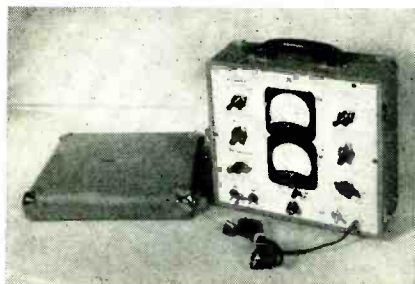

The new unit, type ST-12-A, has test clips for diodes having leads, and for those with pins on each end. Should test clips be shorted on any range, the circuit is designed to prevent instrument damage.

Diode resistance is checked by placing a variable, accurately metered DC voltage across the diode. The resulting current appears on a second meter. The forward and inverse circuits are entirely separate. A diode may be checked to test limits in both the forward and back direction by moving a lever switch; thus eliminating both reversal of the diode in the clips and any major readjustments of controls.

A three-inch voltmeter and three inch current meter permit voltage and current to be metered simultaneously. All voltage ranges are continuously variable.

A chart of manufacturer's limits for about 40 of the most commonly used diodes is secured in the cover of the new unit.

The ST-12-A is only 10-inches high, 11-inches wide and six inches deep. It weighs about eight pounds.

Further information is available from Dept. N-12, Inquiry Section, G-E Advertising Division, Electronics Park, Syracuse, N. Y.

TV WALL-THRU

A new weather-proof TV or FM lead-in wall entrance that can be quickly installed in any wall up to 13" thick has been announced by Mosley Electronics, Overland, Missouri.

The new Wall-Thru consists of precision molded polystyrene inside and outside wall plates combined with a sturdy 14" extruded polystyrene tube, 3/4" OD. Both wall plates are designed to accommodate either standard flat 300 ohm transmission line or RG-59/U

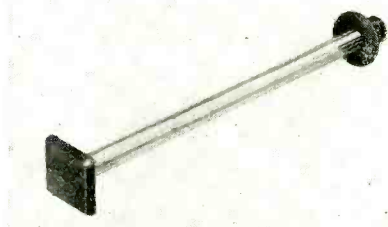

co-axial cable and are readily adapted for use with tubular type 300 ohm line. The Wall-Thru is ideal for bringing in transmission line from ham dipole antennas.

The new Wall-Thru is available separately or may be purchased complete with socket and mating plug. For further information about the Wall-Thru, see nearest radio parts jobber or write Mosley Electronics, 2125 Lackland Road, Overland 14, Missouri.

VHF-UHF COMBINATION ANTENNA

The new Vee-D-X Ultra Q-Tee, a new VHF-UHF combination highly efficient antenna has been released by The LaPointe-Plasco-mold Corporation. Covering the entire television spectrum from VHF Channel 2 to UHF Channel 83, this antenna was designed so that it may be installed now, yet be ready for UHF as these stations come on the air.

Designed for all television areas from primary to fringe this antenna may be installed singly, two-stacked or four-stacked.

Listing for only \$14.25, the All Channel (2-83) Ultra Q-Tee has already been accepted by Parts Jobbers throughout the country as a feature antenna for the fall season.

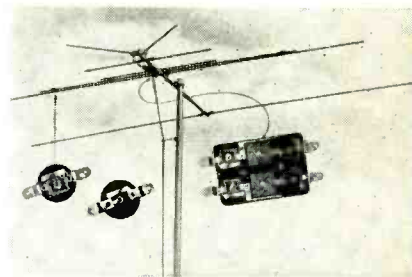

The VHF portion of the Ultra Q-Tee is similar to the Vee-D-X Q-Tee, the new VHF broad band antenna introduced by Vee-D-X a few months ago. For the addition of the Ultra high frequency portion of this antenna, a six circuit filter is employed (see cut) between the common VHF and UHF transmission line feed points.

UHF CONVERTER

A new Regency converter for adding ultra-high frequency station reception to any TV set is announced by The Regency Division of I.D.E.A., Inc., Indianapolis. Its sleek cabinet has been designed by the firm of Painter, Teague and Petertil, Chicago.

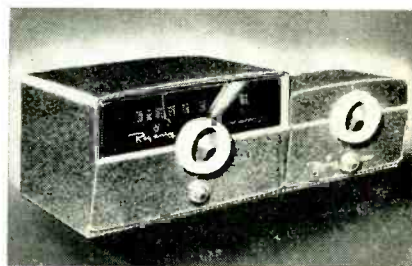

The cabinet, a companion in style to the Regency television signal booster, complements either period or contemporary television cabinets. Color and finish blend well with either blonde or dark furniture.

The new Regency UHF Converter, according to Mr. Richard Mitchell, sales manager, will be ready for instant distribution as soon as advanced market information warrants.

TV ANTENNA ROTATOR

Redesigned at a cost in excess of \$50,000.00, the new Trio Rotator is said to possess ability to function under the most severe weather extremes and to have superior structural strength. The manufacturer bases this claim on the results of tests that included operating the rotator and control unit in an environmental test chamber where temperature was

SYLVANIA
PRECISION

FREE!

The following manufacturers' products are cataloged in the 128 page Instrument & Test Equipment Section.



EMCO JACKSON

Chicago

ELECTRONIC MEASUREMENTS

SUPERIOR

BEAM

SUPREME

BARBER & WELLS AMSON



marion

STERLING

Industrial Instruments

precise

HICKOK

SHALLCROSS

RADIO CITY PRODUCTS

JAMES MILLEN

Darlington

BOONTON RADIO

FREED

Weston

Shurite

Triplet



BROWNING

MEASUREMENTS CORPORATION



JBT

Simpson

These manufacturers do not catalog test equipment in Radio's Master. Separate catalog sheets will accompany each booklet.

Clippard Instrument Lab.
Dumont Laboratories, Inc.
Galvanic Products Corp.
Heath Company

National Union Radio Corp.
Oak Ridge Products
Panoramic Radio Products
Transvision, Inc.



RADIO-TELEVISION SERVICE DEALER subscribers can receive, without cost or obligation, a complete 128 page catalog section on Test Equipment and Instruments, as reprinted from the 1200 page RADIO'S MASTER, the Industry's Official Buying Guide.

This section catalogs in detail the products of the leading Instrument and Test Equipment manufacturers—all in 1 handy booklet. It is complete with descriptions, specifications and illustrations as written by each manufacturer. You will find this large catalog section extremely helpful and a handy reference.

This FREE offer is made possible by a special arrangement between RADIO-TELEVISION SERVICE DEALER and the publishers of RADIO'S MASTER. Be sure to get your copy . . . just mail coupon NOW.

GET YOUR FREE 128 page CATALOG

RADIO-TELEVISION SERVICE DEALER
67 WEST 44th STREET, N. Y. 36, N. Y.

Please send, without cost or obligation, the 128 page Instrument and Test Equipment Catalog as reprinted from Radio's Master.

Name.....
Address.....
City..... Zone..... State.....

OF COURSE IT'S

AEROVOX

FOR ALL TYPES
OF MICAS!



Yes sir, it's still the most complete line. Including types that meet JAN specs. Pick just the right mica capacitor from over two dozen different types.

Postage-stamp or tiny wafer types; high-voltage heavy-duty types in different terminals and mountings; silver micas; porcelain-cased types; etc. Choice of tolerances.

Don't fumble, fuss or fume! Let Aerovox micas fit your particular needs.

Ask your distributor for Aerovox mica capacitors — the outstanding selection of types.



FOR RADIO-ELECTRONIC &
INDUSTRIAL APPLICATIONS

AEROVOX CORPORATION
NEW BEDFORD, MASS., U. S. A.

In Canada: AEROVOX CANADA LTD., Hamilton, Ont.
Export: 41 E. 42nd St., New York 17, N. Y.

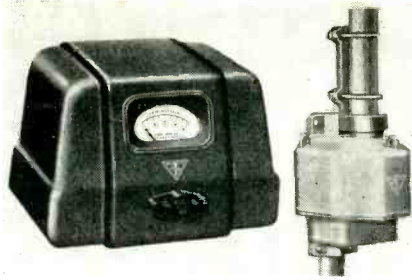

dropped to -50°F . and a partial vacuum applied to equal atmospheric pressure at a 15,000 foot altitude.

The Trio Rotator was found to operate perfectly under these conditions which closely simulate those usually encountered at the peak of Mt. Whitney! Other successfully completed tests included: Supporting a 50 pound vertical load in 100 MPH gales during continuous operation; operating with 600 inch pounds bending moment applied; operating while surrounded by water in temperatures of zero and below, a rigid vibration test, and other tests, the manufacturer states. Each unit, before shipment, is subjected to an extended life test and a final torque test.

For complete information describing the many improved features of the new TRIO Rotator, write Trio Manufacturing Company, Griggsville, Illinois.

VTVM

The Electronic Instrument Co., Inc., 84 Withers Street, Brooklyn 11, N. Y., designers and manufacturers of the famous EICO line of Kits and Wired Instruments, has just announced production of their new Model 214 Vacuum Tube Voltmeter. This model incorporates a large, rugged $7\frac{1}{2}$ -inch meter movement for faster, easier reading and is constructed in the new "horizontal-type" layout.

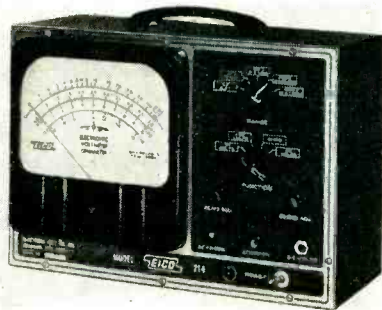

Especially designed for laboratory precision at lowest cost, the Model 214 offers many outstanding features, among which are the following: 15 different ranges. All multiplier resistors possess 1% or better accuracy. AC/DC ranges: 0-5, 10, 100, 500, 1000 volts (30 KV with the EICO HVP-1 High Voltage Probe). Measures to 200 MC with EICO P-75 Radio Frequency Probe. 5 ohms ranges from 0.2 ohms to 1000 megohms. DB scale. (-20 to +55 db) Double-triode balanced bridge circuit. 26 megohms DC input impedance. Tube complement: 6SN7, 6H6, 6X5, 3-color etched rubproof front panel; rugged steel case. Power supply rating: 110-130 V., 50/60 cycles.

Model 214-K, KIT, is only \$84.95. Model 214, factory wired, is \$54.95.

5 INCH SCOPE

Permits visual testing and alignment of amplitude and frequency modulated receivers and television equipment, when used with a frequency modulated RF Oscillator or sweep generator. Contains DC Amplifiers to provide

excellent square wave response on both high and low frequency.

This 'scope, Model 670, is built to provide a sensitivity of 10 millivolts RMS per inch. This extra sensitivity will permit the proper viewing of TV response curve—even on receivers that are far out of alignment. A good vertical amplifier in the 670, amply provides for the viewing of TV frequencies—DC range to 500 KC and usable to beyond 2 megacycles.

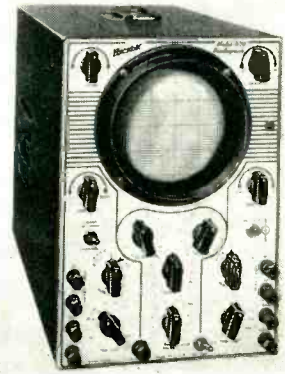

This new 'scope is an excellent test instrument to measure voltages of AC signals, or hum, gain and distortion in audio amplifiers. Permits the study and analysis of wave forms or other electric and magnetic phenomena. A recent design astigmatic focus control provides a new standard in trace sharpness, and patterns are easier to view more accurately. Provision for direct connection to both horizontal and vertical plates of the cathode ray tube is another desirable feature offered by the 670.

Line phasing control negative and positive synchronizing, reversing switches for both horizontal and vertical deflection and provision for "Z" axis modulation are also provided in this new high value 'scope.

Complete information is available on request. The Hickok Electrical Instrument Company, 10533 Dupont Avenue, Cleveland 8, Ohio.

COUNTER DISPLAY

Striking a new note in the realm of self-selling, Vaco Products Company, 317 E. Ontario St., Chicago 11, Ill., announce their powerful 2-color Kit Counter Display which holds a complete service kit in its plastic box and pictorially describes the products' uses.



This Counter Kit display is made of heavy cardboard and has a base measurement of 7" x 14", with an upright panel in back that reaches a height of 14". The front is tilted and decorated with illustrations of various terminal types, and has a cut-out $8\frac{3}{8}$ " x 6" which holds the complete service kit.

TRADE LIT.

[from page 27]

among other new features. A numerical index and price list; classified index, and separate sections for high fidelity; input and interstage; output; driver; modulation; power; filter chokes; filament; plate; isolation and autoformers are contained in the book. Seventy classifications are indexed in the catalog. Also included is an output transformer chart, matched power supply chart and data on the Stancor-Williamson Amplifier.

Handsomely bound in Stancor colors, the catalog covers transformers for all television, radio, industrial and other electronic applications.

CIRCUIT COURT

[from page 27]

the top of *R18* we get an amplified a-g-c which is proportional to the sync amplitude. An additional advantage of using a cathode follower is that the grid returns look into an a-g-c impedance source which is more like the tube design requirements called for than that presented by the conventional a-g-c network.

An additional feature in this model's a-g-c system is a "local/distance" switch. In the "local" position, the r-f amplifier grid is tapped directly into the unamplified a-g-c network of *V1*. In the "distance" position the r-f amplifier grid is returned to ground through *R19* and develops some grid leak bias. *V3* is a diode whose function it is to prevent the top of *R18* from ever going positive.

TEST EQUIPMENT

[from page 29]

of the input voltage will appear across *R1* and *R2*, and the small portion across *R3* can then be connected as the vertical input to the oscilloscope.

Caution: For safety, always turn the

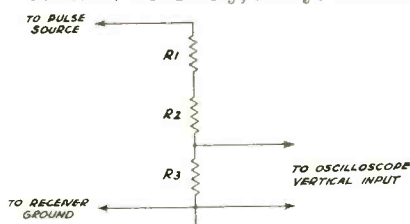

Fig. 2. Resistance divider.

television set OFF to connect or disconnect the probes. Turn the set on only while making the observations.

ASSOCIATIONS

[from page 14]

T. V. Service, 217 Third St., Carnegie, Pa.

2nd. Vice Pres. & Secretary: Kenneth C. Kegg, Keggs TV Service, Perrysville, Pa. Treasurer: E. A. Roberts, S & B Radio Service, Pgh. 10, Pa. Board Of Directors: C. W. Bachman, B. A. Bregenzer, W. J.

Gerhold, T. Ging, J. P. Malone, W. B. McGonigal, G. Washil.

The Association, one of many years standing, was re-activated two years ago when Mr. Sharpe took his first term as President, along with his very competent Board of Directors. Their first job was to increase the membership. Through lack of interest, activity, etc., the membership had fallen to a very low number. Instituting a very aggressive membership drive it now stands at 250 paid-up members.

RTSA is affiliated with the state

the BIG 10

fabulous
10 element
Yagi

- The highest gain Yagi in TV history: 12 DB single, 14½ DB stacked (78% stacking gain).
- "Boom Braced" (low band) to prevent picture flicker.

600 Series

5 element
Yagi

- Highest gain of any 5 element Yagi: over 9 DB single, 12 DB stacked.
- Full 100% stacking gain!

4

4

4

4

4

do
you
get
these

Major Benefits

in your present TV installations?

1. Adjustable impedance eliminates mismatch to 300 ohm line in single and stacked arrays.
2. Wider spaced elements, on longer cross-arms, for still higher gain.
3. Up to 100% additional gain in stacking.
4. And you don't pay for stacking bars!

4 major benefits are provided by Channel Master Z-Match Yagis which are essential to better, more profitable fringe installations. No other Yagi gives you any of them! However, in the Z-Match Yagi, you get all 4 features — at no extra cost.

List Prices

Ch.	600	BIG 10
7-13	7.65	13.89
2-3	17.65	31.94
4-5	16.67	28.47
6	16.67	25.69

Write for new catalog

MEMBER

CHANNEL MASTER CORP.

ELLENVILLE, N. Y.

ATR

Makes it easy
to DEMONSTRATE
AND TEST
D.C. APPARATUS
FROM A.C. LINES



"A" BATTERY ELIMINATORS

For DEMONSTRATING AND TESTING
AUTO RADIOS

New Models . . . Designed for testing D.C. Electrical Apparatus on Regular A.C. Lines. Equipped with Full-Wave Dry Disc Type Rectifier, Assuring Noise-less, Interference-Free Operation and Extreme Long Life and Reliability.

✓ NEW MODELS
✓ NEW DESIGNS
✓ NEW LITERATURE

"A" BATTERY ELIMINATORS
DC-AC INVERTERS
AUTO RADIO VIBRATORS

See your jobber or write factory

AMERICAN TELEVISION & RADIO CO.
Quality Products Since 1931
SAINT PAUL 1, MINNESOTA-U. S. A.

and national Associations and its Members operate under (1) a code of ethics designed to protect the public and members from incompetent contemporaries; (2) are subject to policing by fellow members; (3) charge a just and fair price for sat-

isfactory service; (4) will not engage in unethical practices; (5) promote technical education.

The Association, as of this date, is sponsoring the circulation of a petition to the Public for additional TV Channels in the Pittsburgh Area.

MODERN FM EQUIPMENT

[from page 26]

applied doubly, through a split load arrangement, to the two grids of a twin triode 6SN7GT. The first triode adds further gain while the second 6SN7 triode functions as a phase inverter for the pushpull 6V6GT power output stage. Maximum power output is 10 watts.

Use of a 13½ db inverse feedback loop results in a four to one output damping factor. Or, stated differently, there is an internal output impedance of only two ohms at the eight ohm output tap. Speaker outputs of four, eight and sixteen ohms are provided.

A built-in power unit is served by a 5Y3GT. The entire amplifier requires 65 watts at 110-120 volts 60 cps. Frequency response for the entire unit is plus or minus 1 db from 10 to 30,000 cps at ½ watt output, and, plus or minus 1 db from 15 to 20,000 cps at the full rated output of 10 watts. Descriptive performance curves appear in Fig. 4. There is less than 1% distortion of mid-frequencies at full output. Hum and noise level is attenuated 70 db. Input sensitivity

of 0.7 volt rms is to be expected for the rated output together with an intermodulation distortion factor of less than 5% at 10 watts for frequencies between 60 and 7000 cps. These are all statements from the manufacturer but listed to give an example of modern performance. The complete unit weighs 12 pounds and measures 14 x 4½ x 5¼ inches. It is streamlined for custom or rack installation.

Preamplifiers

Presently the use of equalized and self-powered preamplifiers is very popular. Such units offer flexibility to individualized installations. One well designed unit is the model PR-4 of Fisher Radio Corporation. It is designed especially for low level magnetic pickups such as the G-E., Pickering, Audak, and Clarkson types. It serves equally well as a microphone preamplifier. The equalized circuitry of this unit appears in Fig. 5.

Two stages of amplification from a double triode result in high gain. For phonograph work, an input of 20 millivolts (.02 volts) will produce an output signal of one volt. This

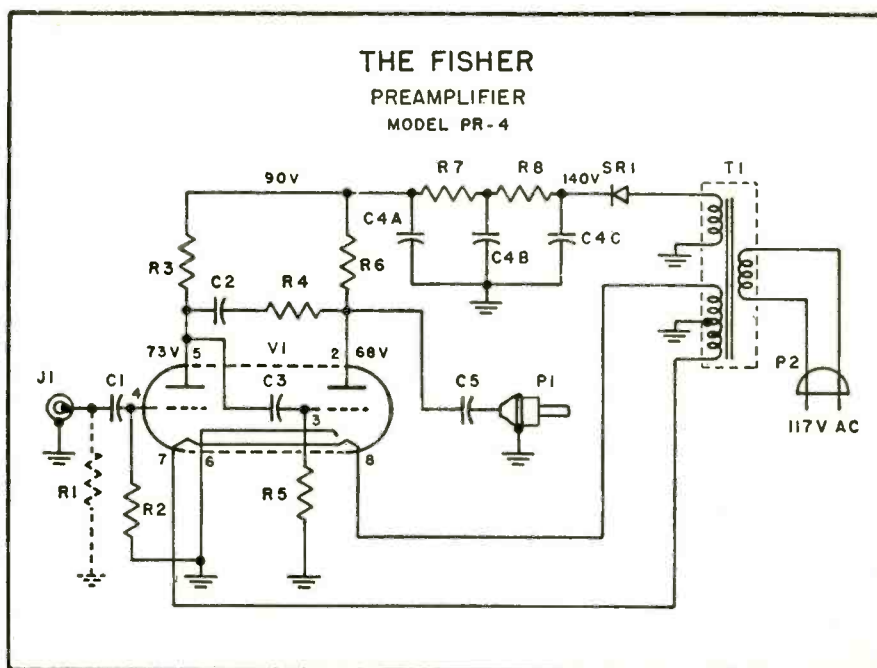

Fig. 5. Fisher Preamplifier schematic.

amounts to a voltage gain of 50. With a microphone input of 5 millivolts (.005 volts), a one volt output is derived. This amounts to a voltage gain of 200. An output cable of 50 foot length may be used for remote possibilities.

Frequency response is uniform within 2 db from 30 to 20,000 cycles for all applications. An exclusive feedback circuit has been developed with a turnover at 500 cycles. It is claimed that the low frequency equalization requirement has been fully covered. The complete preamplifier measures less than four inches in any dimension.

This same corporation is about to release a new FM tuner, about mid-August. It will embrace greater equalization facilities than their earlier models. There will be a companionate 30 watt amplifier. This equipment will be described in a subsequent article.

NEW ANTENNA DESIGN

[from page 19]

transmitting standard covering exactly the design bandwidth of the yagi. It is true that some point may be found where the yagi has higher gain than this figure, but when considering an antenna for TV reception, we are interested in the average gain across a single channel. If three directors are added to the five element beam, the useful signal as seen at the feed terminals will be increased by 2 db. If five directors were added, the useful signal would be increased by 2.8 db. It is assumed in both cases that the spacing between the directors is .1 wave length. The small fraction of gain difference is negligible, and not worth considering from a performance standpoint.

A popular version of the eight element yagi is illustrated in the photograph of Fig. 6. The only approach to increased gain in a single bay is of course, to add to the number of director elements. We are again faced with the same basic problem as in the case of stacked vertical or horizontal arrays. There has to be twice as much material actively incorporated into the receiving system if a gain of 3 db is to be expected. If we employ eight elements in a yagi type antenna, it would be foolish to add two more elements if a noticeable increase in gain is desired. A twelve element yagi on the other hand, would increase the gain some 2 db over the eight element type and would cer-



"CONICAL-V-BEAMS"

*REGISTERED TRADE MARK

3 BIG REASONS WHY

Telrex

is your logical ANTENNA CHOICE!

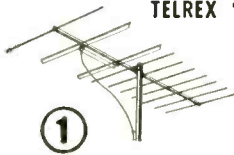

①

TELREX "FISHBONE" WITH TEN WORKING ELEMENTS GUARANTEED TO OUTPERFORM ANY YAGI ANTENNA! Recommended for superior reception in suburban and outlying areas, the "Fishbone" is constructed for lasting, trouble-free installations.



②

"BAT WING" the finest top-of-set antenna made REQUIRES NO TUNING, PRUNING OR ADJUSTMENTS! Outperforms any other indoor type and features modern, rich styling to harmonize with finest furnishings.

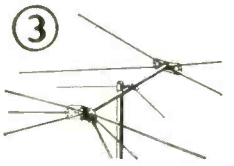

③

UNIVERSAL SERIES "CONICAL-V-BEAMS" WITH HI-V-REFLECTOR AVAILABLE NOW CUSTOMIZED FOR YOUR OWN RECEPTION AREA! These famous-for-superior-performance antennas are supplied to your distributor custom-cut for best reception in your particular location.

NOW! THE DUAL-DRIVEN FISHBONE JR.
FOR ALL VHF CHANNELS — New six element TV series. Extremely high forward gain and front to back ratio exceeds most 8 element beams — compares favorably with many 10 element antennas. Supplied to distributors custom cut.

"CONICAL-V-BEAMS" are covered by Patent No. 23,346
 CANADIAN and FOREIGN PATENTS PENDING



CONICAL-V-BEAMS

AMERICA'S
OUTSTANDING
TELEVISION
BEAM

Be sure it's a
"CONICAL-V-BEAM"
— look for the
Telrex
TRADEMARK

ASBURY PARK 5, N. J.

NEW! MOSLEY WALL-THRU

For TV, FM and Amateur Transmission Line



Cat. No. 625
List Price \$1.95

Cat. No. 625-PK
WALL-THRU, complete with
MOSLEY Universal TV Lead-in
Socket and Plug.
List Price \$3.00

- Fits Any Wall Up To 1 1/2" Thick!
- Completely Weather-Proof!
- For Standard Flat 300 Ohm Line or RG-59/U Co-ax Cable!
- MOSLEY Lead-In Socket Can Be Mounted Direct To Inside Plate!
- Precision Molded Polystyrene End Plates!
- Easily, Quickly Installed!

MOSLEY ELECTRONICS

2125 LACKLAND ROAD OVERLAND 14, MISSOURI

SMASH HIT!

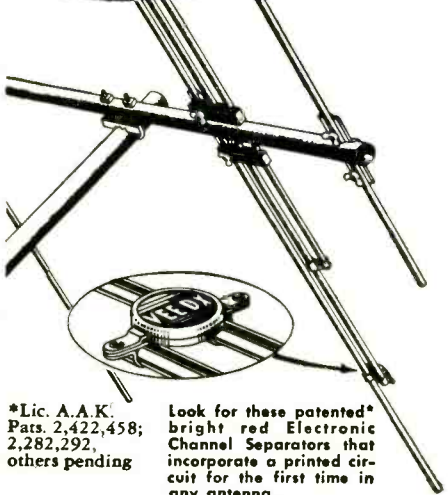

*Lic. A.A.K. Pats. 2,422,458; 2,282,292, others pending

Look for these patented* bright red Electronic Channel Separators that incorporate a printed circuit for the first time in any antenna.

REVOLUTIONARY



WITH PATENTED* BUILT-IN

Channel Separators

Here it is—the antenna that is taking the TV industry by storm. With its sensational Electronic Channel Separators employing a printed circuit for the first time in antenna history, the Q-Tee is fast replacing other types of all-channel antennas. With its powerful performance, clean-cut silhouette, light weight, and pre-assembled construction, the Q-Tee incorporates everything the finest all-channel antenna should have. Available in three series for every reception need — Q-TEE Single Bay — for primary areas; Q-TEE Double — two-bay array for near-fringe areas; Q-TEE Quad—four-bay stacked array for fringe areas.

VEE-D-X makers of the world's most powerful TV antenna systems

THE LaPOINTE-PLASCOMOLD CORP. N7
Rockville, Connecticut

Gentlemen:

Send complete Q-Tee literature

Send copy of new Vee-D-X catalog

Name

Street

City Zone.....State.....

tainly be worth-while. If sixteen elements were used in the horizontal plane, a 3 db increase over the eight element type would be realized. If an additional 3 db was required, it would be necessary to either increase the number of elements to thirty-two, or to stack two, sixteen element types at .5 wave length.

These relative gain figures are based on increased voltage recovery as compared to a five element close spaced beam, and it is assumed that the multi-element yagis employ the same spacing. If wide spacing is used (.2 wave length) the eight element type would show an increase of 3.5 db over the five element close spaced beam and .7 db greater than a ten element close spaced type. It is interesting to note the affect on beam angle between close and wide spaced parasitic elements.

The chart of Fig. 7 shows the maximum increases in gain that can be expected from various multi-element yagis, and Fig. 7a the variation in beam angle vs spacing for the eight element type. It can be seen that wider spacing not only increases the gain of the antenna, but narrows the beam angle resulting in excellent rejection of undesired voltages existing to the sides of the directivity pattern.

Unfortunately there is no standard measurement method that is followed by all antenna manufacturers, and published gain figures are many times based on widely differing test procedures. This author can recall reading specifications that used a standard

Figure 7a

Beam angle vs spacing

% wave length	Angle
10	76°
15	60°
20	40°
25	30°

Fig. 7a. Beam angle vs. spacing data.

reference dipole cut at a mean frequency between the high and low television spectrums. The information that was compiled showed outstanding gain and almost unbelievable directivity. This data was, of course, quite useless and could not provide any basis for comparison with similar types.

There is a standard measurement procedure recommended by RTMA which provides a basis for comparison of all antenna systems. This method has been adopted by the larger antenna manufacturers whose prime interest is to present factual data from which the service technician can make proper comparisons. If two similar antenna systems are advertised by different manufacturers, it is pretty certain that the one claiming lowest gain is using recommended testing procedures. If the service technician will consider the operational principles described in the early part of this article in conjunction with the gain figures given for the several antennas discussed, he should be in an excellent position to make up his own mind as to the virtues of all new antenna systems.

Figure 7

Elements	Spacing	Gain
5	.1	8 DB
5	.15	8.5 "
5	.2	9 "
8	.1	10 "
8	.15	10.5 "
8	.2	11.5 "
10	.1	10.8 "
10	.15	11.3 "
10	.2	12.3 "

Fig. 7. Gain characteristics of Yagis.

TROUBLE SHOOTING

[from page 23]

not stop the field serviceman since most of these are easily constructed. The special tools which cannot be home-made are usually available from the manufacturer.

One of the special tools which can be made by the serviceman is a diode head for the oscilloscope (Fig. 1). This tool is very handy in signal tracing the i.f.'s and also the video

amplifier. Another piece of equipment which gets a lot of use from the factory trouble-shooters is a battery for variable bias. This little device (Fig. 2) is very helpful in i-f alignment and in determining if certain intermittent conditions occur as a result of weak signals.

Intermittents

One of the most troublesome servicing problems arises from "intermittents." The intermittents which are particularly annoying are those which may or may not show up while the outside man is in the customer's house. When the set is then brought into the shop, no trouble shows. The set is returned and immediately the complaint arises again. One of the prime sources of this particular trouble is a fluctuating line voltage at the customer's house. A very handy object to have at the bench is a variable power line transformer. This device while comparatively expensive, will pay for itself in the reduced number of call-backs which these intermittents cause. Another use to which the line transformer can be put is to cause components which pop under surge, and then cure themselves, to pop for good. This can be accomplished by running the line voltage up to 125-130 volts and letting the set cook at this line voltage for five or ten minutes. Doing this also enables the serviceman to track down the intermittent corona points so that he can paint the points with corona dope. There are a number of metered line transformers on the market.

Another simple testing device which can be home-made is a condenser substituting box (Fig. 3). Leaking condensers are difficult to check except under operating conditions. By taking the commonly used values in the substitution box, it becomes a simple job to check suspected leaking condensers by direct substitution in the set.

Figure 4 shows the lay-out of a little device which is very convenient for duplicating weak signal conditions found in the customer's house when the service shop reception is strong. Since a number of set difficulties may show up under weak signal conditions, this attenuator pad is found to be very convenient in duplicating these conditions.

As stated before, the factory man does have a slight advantage over the serviceman in the matter of time required to service a set. This is due to the fact that he is working with one manufacturer's set. This leads to familiarization with that one set's



the solution for *all* your high voltage TV filter replacement problems

This package contains six (6) Style 413 Erie Universal High Voltage TV Filter Ceramicon and an assortment of 14 adapter terminals.

Carry one of these handy package assortments with you on all your TV service calls. You are assured of having, at all times, the CORRECT RE-

PLACEMENT UNIT for any receiver rated at 20 KV or lower.

If your requirements are for all of one combination of terminals, the Style 413 may also be obtained in handy plastic kits of ten HV Ceramicon bodies. Adapter terminals are supplied in packets of five each of a type.

Order through your jobber.



ERIE RESISTOR CORPORATION . . . ELECTRONICS DIVISION

Main Offices: ERIE, PA.

Sales Offices: Cliffside, N.J. • Philadelphia, Pa. • Buffalo, N.Y. • Chicago, Ill. • Detroit, Mich. • Cincinnati, Ohio • Los Angeles, Calif.

Factories: ERIE, PA. • LONDON, ENGLAND • TORONTO, CANADA

THIS IS IT! THE RELAY
WITH *Interchangeable Coil*
FOR A WIDE RANGE OF RADIO APPLICATIONS

GUARDIAN Series 200

Interchangeable COIL and CONTACT Switch Assembly

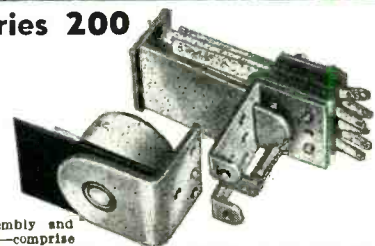

Two basic parts—a coil assembly and a contact switch assembly—comprise this simple, yet versatile relay. The coil assembly consists of the coil and field piece. The contact assembly consists of switch blades, armature, return spring and mounting bracket. The new Guardian Midget Contact Assembly which is interchangeable with the Standard Series 200 coil assembly, is also available in either single pole, double throw; or double pole, double throw.

CONTACT SWITCH ASSEMBLIES

CAT. NO.	TYPE	COMBINATION	
		Single Pole	Double Throw
200-1	Standard	Single Pole	Double Throw
200-2	Standard	Double Pole	Double Throw
200-3	Contact Sw. with Parts Kit	Double Pole	Double Throw
200-4	Standard	Double Pole	Double Throw
200-M1	Midget	Single Pole	Double Throw
200-M2	Midget	Double Pole	Double Throw
200-M3	Midget Contact Switch Parts Kit	Double Pole	Double Throw

13 COIL ASSEMBLIES

A.C. COILS*		D.C. COILS	
CAT. NO.	VOLTS	CAT. NO.	VOLTS
200-6A	6 A.C.	200-8D	8 D.C.
200-12A	12 A.C.	200-12D	12 D.C.
200-24A	24 A.C.	200-24D	24 D.C.
200-115A	115 A.C.	200-32D	32 D.C.
		200-110D	110 D.C.

*All A.C. coils available in 25 and 60 cycles

GUARDIAN G ELECTRIC
1606-J W. WALNUT STREET CHICAGO 12, ILLINOIS

A COMPLETE LINE OF RELAYS SERVING RADIO AMATEURS

**A Full Size
LIGHTNING ARRESTER
at the Price of a Midget**



LIGHTNING ARRESTER

MODEL TA5 Real protection against lightning and static charges — the RADIART Lightning Arrester has all the features! Fits anywhere... inside or out... handles standard or jumbo leads... no wire stripping necessary... does not unbalance the line... low internal capacity... no loss of signal... internal resistance "leaks off" static discharges! UNDERWRITERS LABORATORIES APPROVED.

THE RADIART CORPORATION
CLEVELAND 13, OHIO

6x20 awg.

galvanized steel

WIRE STRAND

wound on 1,000 foot
spools

(no deposit—no return)

Delivery from stock!

\$4²⁵

Per M Feet

F.O.B. Factory

Write for free samples
and quantity discounts

Spencer Wire Co., Inc.
West Brookfield, Mass.

peculiarities. However, the average trouble-shooter can take advantage of service clinics offered by many manufacturers and within a very short period of time become just as familiar with the second set. What is sorely needed is more of these service clinics by more manufacturers.

UHF TUNER

[from page 21]

shortens the line) and it has a characteristic impedance of 125 ohms. To cover this frequency range there is a 4 inch travel of the movable shorting bar. Ceramic stand off insulators are used to mount this flattened transmission line. The crystal mixer is coupled directly to the output of the lines and the antenna is coupled to the input.

The local oscillator operates below the signal frequency to prevent inverting the relation between the sound and picture carriers. To cover the entire range from 470 to 890 megacycles, this local oscillator using a 6AF4 tube, tunes a range from 275 to 695 megacycles, assuming the VHF receiver is tuned to Channel 10. The transmission line associated with the oscillator is an electrical quarter wave length long. Again this means it is physically less than a quarter wave length long but together with the trimmer capacity and the tube capacity, a resonant condition is created which is the electrical equivalent of a quarter wave short circuited line. The oscillator design is a shunt-fed tank circuit between the grid and the plate circuit. The B supply is filtered and fed through a radio frequency choke. The warm-up drift of the local oscillator ceases after approximately five minutes and good circuit stability is obtained after this time.

A two-stage cascode i-f amplifier is used following the crystal mixer. The tube is a 6BK7 dual triode whose frequency of operation is VHF Channel 10 (195 megacycles). Signal input is obtained on the first grid which is coupled to the crystal mixer. The plate of the first amplifier stage is capacitively coupled to the cathode of the second amplifier stage. This second stage is a grounded grid amplifier whose plate is transformer coupled to a balanced 300 ohm output feeding the standard VHF receiver.

This tuner requires an external power supply with the requirement of 0.9 amperes at 6.3 volts ac for the filament supply and 250 volts dc at 25 milliamperes for the plate supply.

\$1.00 to \$5.00 PAID "for SHOP NOTES"

Write up any "kinks" or "tricks-of-the-trade" in radio servicing that you have discovered. We will pay from \$1 to \$5 for such previously unpublished "SHOP NOTES" found acceptable. Send your data to "Shop Notes Editor," RADIO-TELEVISION SERVICE DEALER, 67 West 44 St., New York 36, N. Y. Unused manuscripts cannot be returned unless accompanied by stamped and addressed return envelope.

TECHNICAL ARTICLES WANTED

on

TV, AM RADIO, FM RADIO, PHONO MECHANISMS, HI-FI AUDIO, AUTO RADIO, TEST EQUIPMENT, ANTENNAS

pertaining to their

**Theory, Installation, Application,
Service & Maintenance**

submit manuscripts to
Managing Editor

Radio-Television Service Dealer
67 West 44 Street New York 36, N. Y.

AD INDEX

Aerovox Corporation	34
American Television & Radio Co.	36
Bussmann Manufacturing Co.	7
Channel Master Corp.	35
Electro-Voice, Inc.	13
Erie Resistor Corp.	39
Guardian Elec. Mfg. Co.	39
Hytron Radio & Electronics Co.	16
Jackson Electrical Instrument Co.	10
Jensen Industries, Inc.	31
JFD Manufacturing Co., Inc.	Cover 3
LaPointe-Plascomold Corp.	38
Mallory, P. R. & Co., Inc.	Cover 2
Mosely Electronics	37
Perma-Power Company	8
Precision Apparatus Co., Inc.	2
Radiart Corporation	11, 40
Radian Corp., The	14
Rauland Corporation	1
Raytheon Mfg. Co.	9
RCA Tube Dept.	Cover 4
Regency Div., I.D.E.A. Inc.	5
Sams, Howard W. & Co., Inc.	4
Spencer Wire Co., Inc.	40
Sprague Products Company	6
Telrex, Inc.	37
Transvision, Inc.	12
Triplett Elec. Instrument Co.	15

the greatest Yagi of them all

JFD 10-ELEMENT "Baline" YAGI

* **12 db** (gain of stacked JFD BALINE over a tuned folded dipole)

* **9½ db** (gain of single JFD BALINE over a tuned folded dipole)

*These figures have been verified by the Hazeltine Corporation, world famous research laboratory. All JFD gain figures are based on a reference tuned folded dipole. Beware of exorbitant gain figures which are not based on any reference level.



Illustrated: JFD No. 10Y2S-10Y6S Low Band Stacked Baline Yagi

ACTUAL FIELD TESTS PROVE IT

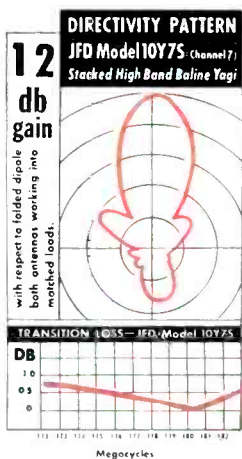
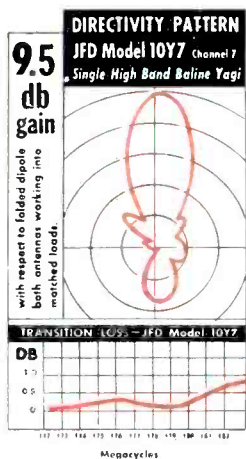

Single JFD High Band BALINE Yagis

Channels	Models	List Price
7-13	10Y7-10Y13	\$13.85

Stacked JFD BALINE Yagis

Channels	Models	List Price
2	10Y2S	\$63.70
3	10Y3S	63.70
4	10Y4S	56.90
4-5	10Y45S	67.80
5	10Y5S	56.90
6	10Y6S	51.40
7-13	10Y7S-10Y13S	27.70

Include JFD Baline matching transformers at no extra charge

Single JFD Low Band BALINE Yagis

Channels	Models	List Price
2	10Y2	\$31.85
3	10Y3	31.85
4	10Y4	28.45
4-5	10Y45	33.90
5	10Y5	28.45
6	10Y6	25.70



The antenna sensations of the Nation!

JETENNA... the conical with jet-action assembly
...no other fan conical assemblies so fast, performs so well!

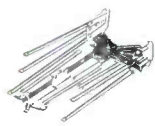

1. Pre-assembled JFD JeTenna as packaged. Note its compactness of construction and craftsmanship of design.

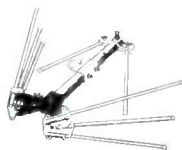

2. As the JeTenna swings open, dipole elements fan instantly into exact position by riding along unique fulcrum indices.

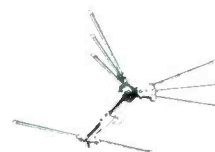

3. JeTenna elements lock into position effecting 35° forward inception angle and 40° dipole angulation for greater signal pickup. Reflectors snap into place for quick tightening by wing nuts.

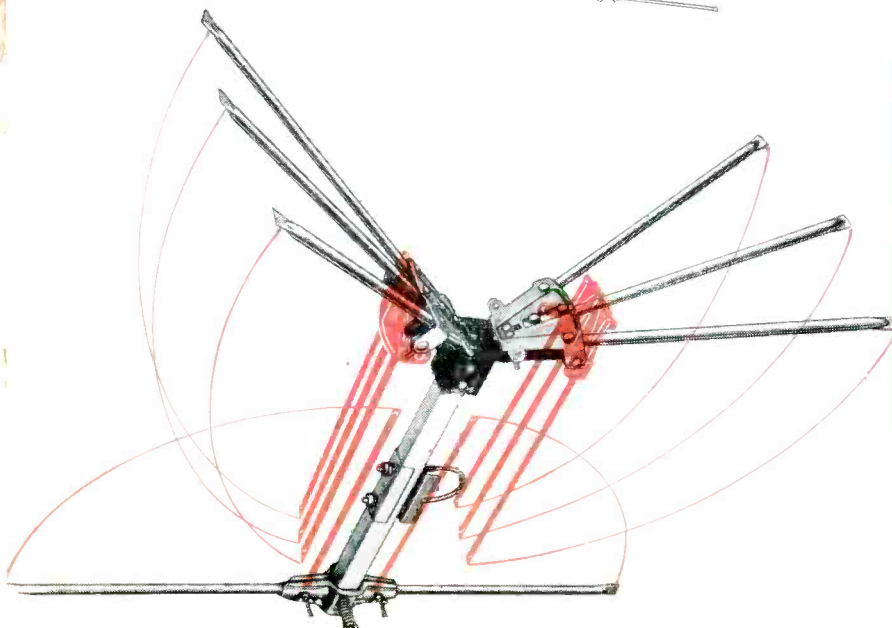

Series with 1" seamless aluminum square crossarm and seamless aluminum elements reinforced with Fibreglas dawels.

No. JET160	Single Bay	Up to 8.8 db*	\$12.50 list
No. JET161	2 Bay	Up to 12.5 db*	\$26.40 list
No. JET164	4 Bay	Up to 15.5 db*	\$56.80 list

Series with 1" seamless square aluminum crossarm and wood-doweled butt-seam aluminum elements.

No. JET660	Single Bay	Up to 8.8 db*	\$ 9.75 list
No. JET661	2 Bay	Up to 12.5 db*	\$20.70 list
No. JET664	4 Bay	Up to 15.5 db*	\$45.40 list

*Performance tested and figures verified by the Hazeltine Corporation, Little Neck, N.Y. World Famous Research Laboratory.

JFD MFG. CO.
BROOKLYN 4, N. Y.
BENSONHURST 6-9200





Quality control by feedback ...the secret of RCA tube performance

FOR MANY YEARS, RCA has employed a system, which might be called "feedback" control, in the manufacture of RCA Tubes. This system is recognized by industry as a most effective method for achieving superior product quality. Here's how it works . . .

Test positions are set up at every important production point . . . from raw materials to the finished tube. Tests are made periodically at each point, and the data transmitted to a central supervisory

group of quality-control engineers. This group immediately spots any deviations from prescribed quality standards, and corrects them on the production line almost before they happen! Result . . . *inferior tubes never reach your shop.*

RCA's constant vigilance at all stages of manufacture is your assurance that only uniform, top-quality RCA Tubes leave the factory. In this way, RCA closely guards its own reputation . . . *and yours as well.*



FINISHED PRODUCT

With RCA Kinescopes, as well as with RCA Receiving Tubes, **TOP-QUALITY CONTROL** makes the difference.



RADIO CORPORATION of AMERICA
 ELECTRON TUBES

HARRISON, N. J.

Trmk. ®