

MARCH, 1952

Radio-Television SERVICE DEALER



The Professional Radio-TVman's Magazine

IN THIS ISSUE:

Servicing TV Oscillator Circuits
Using the Oscilloscope, Part 1
A.G.C. In TV, Part 3
Let Your Sales Slip Sell The Job
Selenium Rectifiers For TV
Looking For Trouble? No. 8

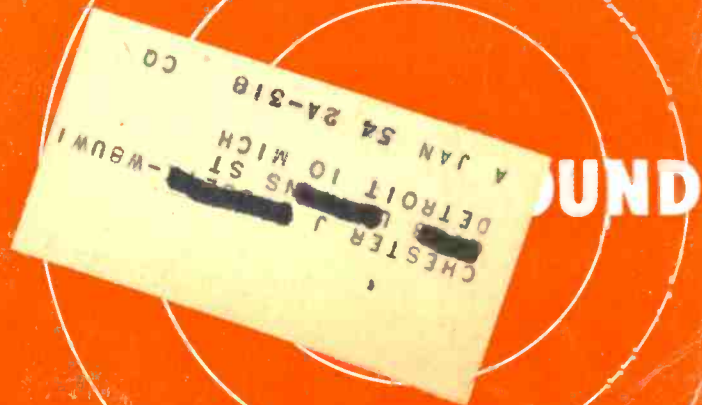

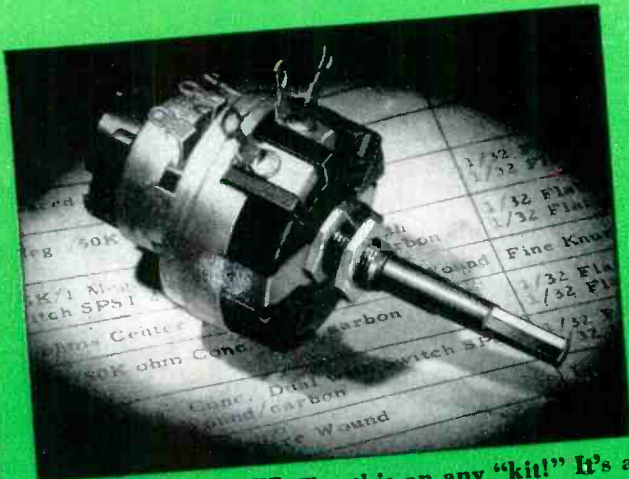

EXACT DUPLICATE: Try this on any "kit!" It's a wire-wound, carbon and switch combination. Only the Clarostat RTV (Exact Duplicate) number will do.

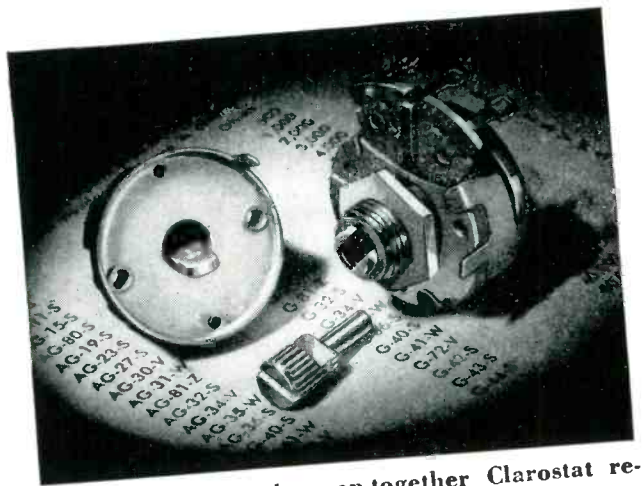

STANDARD: Simple snap-together Clarostat replacement—Series AG "15/16" control with Series SWB Ad-A-Switch and Series FKS-1/4 fine knurled slotted Pick-A-Shaft.

Exact Duplicate OR Standard Type

EITHER WAY
you can stand pat with

CLAROSTAT

Controls

Which? Well, some replacement jobs call for exact duplicates. No standard controls will do. Especially so with those concentric-shaft duals. And you just can't afford to lose time, patience, money and even reputation trying to assemble tricky combinations from old-fashioned "kits." Your best bet is Clarostat's RTV program—Exact-Duplicate numbers—almost 300 types—covering 2700 TV models of approximately 100 set manufacturers.

In the many applications where standard controls will do, Clarostat offers you the outstanding selection of 1 1/8" and 15/16" sizes. More than that, you can have Ad-A-Switches and Pick-A-Shafts to assemble simple combinations.

Best of all, your Clarostat distributor stocks them! Ask him about it.



The Clarostat TV Control Replacement Manual (and supplements) tells you what control to use. Ask your distributor for it!

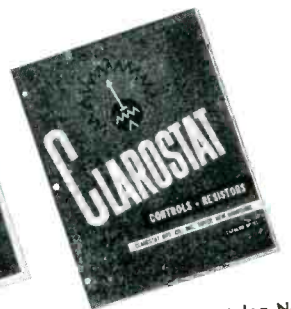

Clarostat's latest catalog No. 51 lists the greatest choice yet of controls and resistors. Ask your distributor for your copy!

Controls and

CLAROSTAT MFG. CO., INC.,
DOVER, NEW HAMPSHIRE

CLAROSTAT



Resistors

In Canada:
Canadian Marconi Co., Ltd.,
Toronto, Ontario

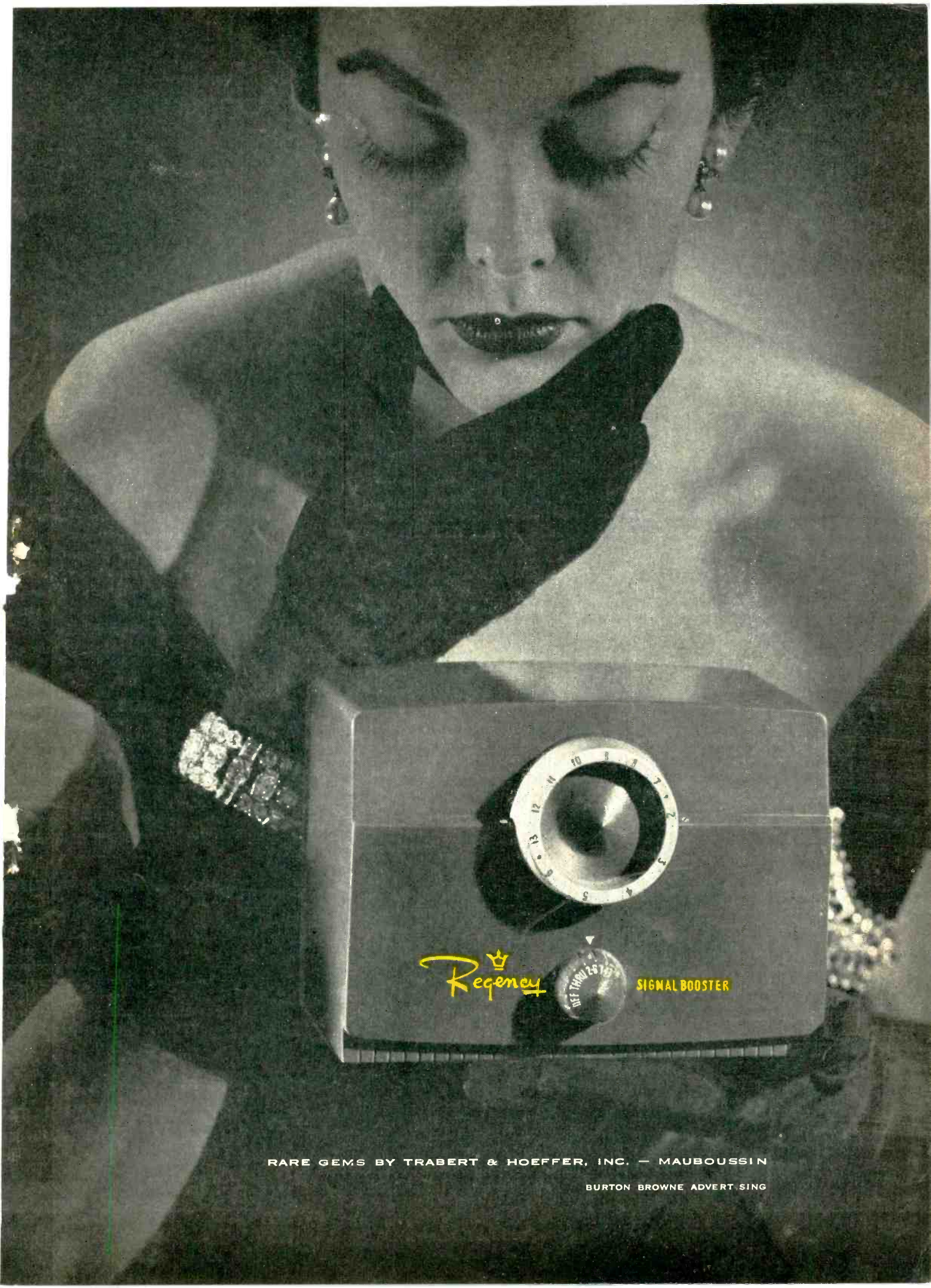

RARE GEMS BY TRABERT & HOFFER, INC. — MAUBOUSSIN

BURTON BROWNE ADVERTISING

STIKIT-UP!

*the NEW
AMAZING*

INDOOR Directronic TV AERIAL SYSTEM

- ALL CHANNELS
- ANYONE CAN INSTALL
- ADHERES TO ANY SURFACE
- 360° ELECTRONICALLY-SWITCHED BEAM
- FLICK OF SWITCH CLEARS PICTURE

995
LIST



SNYDER MFG. CO.

PHILADELPHIA

DALIS, New York • ALMO, Philadelphia • RADIO PARTS, Chicago

FRESHMAN, Cleveland • WHOLESALE RADIO, Baltimore • KAEMPER & BARRETT, San Francisco

VAN DER HOUT, Canada • Export: ROBURN AGENCIES, New York • AND OTHER DISTRIBUTORS, EVERYWHERE

RADIO-TELEVISION SERVICE DEALER • MARCH, 1952

CLOSETS

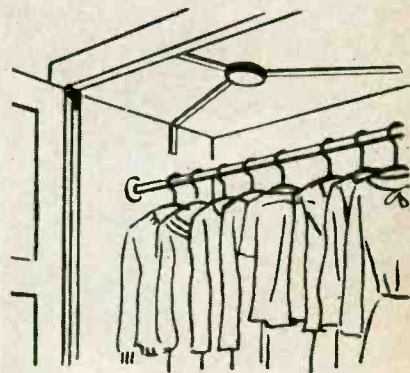

ATTICS

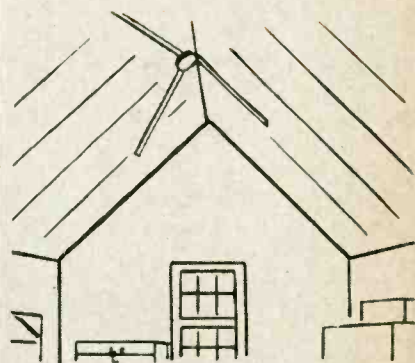

CEILING

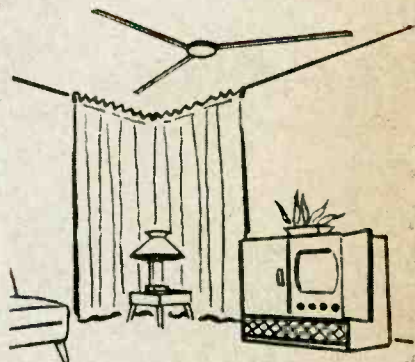

EDITORIAL

by S. R. COWAN

Is The Freeze Thawing?

An FCC commissioner opines that unless some unforeseen difficulty arises, quite likely the freeze on TV construction, operations expansion, etc., will thaw by mid-March, 1952. However, even if 90 new station permits were granted, many months will pass before any appreciable number can get into actual operation. It takes time, often many months, to build transmitters and at present there is a serious shortage of both manpower and materials. Were half of the new stations VHF and half UHF, most likely the VHF program would be given preference so that smaller communities could get in on the TV boom.

On the surface that would seem to the uninitiated to mean a big broadening of TV population coverage but such would not be the case, for most of the VHF stations would be in areas that are now covered as fringe by existing UHF stations. Yet we, and all radiomen, would welcome the end of the freeze and the resumption of TV station construction. This is particularly true in the larger cities where now but one station is in operation, and by thus enjoying a partial if but temporary monopoly, they are taking advantage of the public by giving poor programs and generally bad coverage. So, in coming to the climax of the impending thaw, let the FCC weigh carefully the merits of the CP applicant stations in big cities who are awaiting the green light. If an appreciable number of them get under way the competitive spirit will improve the TVset owning public's investment.

Percentage of Radio vs TV Service Potential

Over 100 million radio sets of all types, 15 million TVsets, and 12½ million public address systems (including jukeboxes) are now estimated to be in daily use. Besides there are millions of other electronic circuit devices, such as phono players with amplifiers, industrial electronics safety and control devices. All are subject to constant maintenance. No wonder the so-called electronics industry as a whole is now one of this nation's most important factors in the economy. Think of it! Every new passenger plane that is built, and in particular, every new military plane coming off the production line represents almost as much, investment-wise, from an electronics point of view, as does the rest of the plane's overall cost. Yes, electronics is BIG business, and yet, it is still in its early stage of infancy. Today less than 70,000 technicians of all calibres are engaged in all phases of maintenance. The industry could use double that number and still suffer from a man-power shortage.



Sanford R. Cowan
EDITOR & PUBLISHER

Samuel L. Marshall
MANAGING EDITOR

COWAN PUBLISHING CORP.
67 WEST 44TH ST.
NEW YORK 36, N. Y.



VOL. 13, NO. 3

MARCH, 1952

| | |
|---|----|
| Editorial | 3 |
| Trade Flashes | 6 |
| Sync Pulses, by <i>San D'Arcy</i> | 8 |
| Servicing TV Oscillator Circuits, by <i>Matthew Mandl</i> | 19 |
| How to identify and trouble-shoot oscillator troubles in TV receivers. | |
| Using the Oscilloscope Part I, by <i>Allan Lytel</i> | 22 |
| Beginning a 2-part article on the applications of the scope in various types of measurements. | |
| A.G.C. in TV, Part 3, by <i>Leonard Lieberman</i> | 26 |
| Concluding installment deals with Keyed A.G.C., its explanation, and various applications. | |
| Let Your Sales Slip, Sell The Job, by <i>Walter J. Swontek</i> | 28 |
| How to prepare a bill that will make your customer happy. | |
| Selenium Rectifiers For TV, by <i>Daniel Lerner and Rob't Dargun</i> | 29 |
| An easy-to-follow explanation of the design, construction, and applications of selenium rectifiers in TV receivers. | |
| Looking For Trouble? No. 8, by <i>Cyrus Glickstein</i> | 32 |
| Trouble shooting a Sentinel Model 412 receiver in an educational style. | |
| Association News | 36 |
| Shop Notes | 38 |
| DuMont RA 109-113, various service hints. Emerson TM-655B series, 6S8GT substitution. Barkhausen Oscillation Effect. Philco Auto Radio, Model PD4908 or Mopar Model 803, replacing on-off switch. Cadillac Model 7258865 Car Radio, signal seeking tuner troubles. Rheostat Varies Line Voltage. Admiral 20T1, 20V1, focus adjustment in sets having a PM focus assembly. Admiral 20T1, 20V1, picture centering in sets having a PM focus assembly. Saving Fuses. Traveler TV Model A-16-T, no vertical or horizontal sync. | |
| Trade Literature | 39 |
| New Developments | 40 |
| Third dimension hearing. Raytheon develops miniature transmitter-receiver. | |
| Circuit Court | 41 |
| Motorola Model 19F1, video output circuit. | |
| Personnel Notes | 42 |
| New Products | 44 |

SANFORD L. CAHN, Advertising Director HARRY N. REIZES, Advertising Manager
DAVID SALTMAN, Production Mgr. CHARLES LO CICERO, Circulation Mgr.
TED E. SCHELL, 112 West 9th St., Los Angeles 15, Calif., VANDIKE 8921

RADIO-TELEVISION SERVICE DEALER is published Monthly, by Cowan Pub. Corp., 67 West 44th St., New York 36, N. Y. Subscription price: \$2 per year in the United States, U.S. Poss. & Canada; elsewhere \$3. Single Copies: 25c. Reentered as second class matter Sept. 25, 1950 at the Post Office at New York, N. Y. under the Act of Mar. 3, 1879. Copyright 1952, Cowan Pub. Corp.

SAVE TUBES- WITH G.E.'S NEW



TUBESAVER

Says Al Mirus of Mirus TV Service Shop (left), 6579 Glenway Ave., Cincinnati, O.: "Our G-E Tubesavers do just what the name says. That's why we have one at every bench. A Tubesaver holds up to 52 tubes in their proper sequence, gripping the tubes so tightly they can't fall out. Built-in pin-straighteners help, too. The best and most practical device we've seen!"

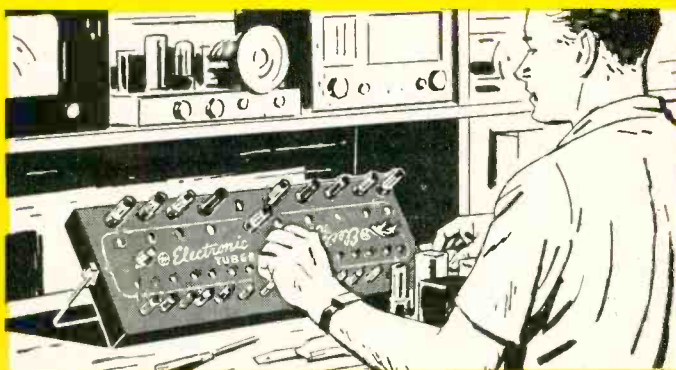

← **NO MORE WORRY ABOUT PUTTING TUBES BACK IN THE WRONG SOCKETS!...** The systematic layout of the G-E Tubesaver keeps tubes in their exact order. Moreover, they stay that way because rubber inserts keep them from dropping out—even if you tip the Tubesaver sharply! With its convenient handle design, the Tubesaver can be laid flat on the bench, angled, or hung on the wall nearby.

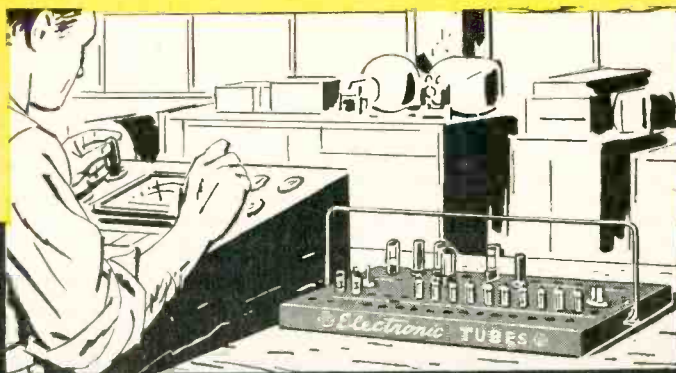

NOW YOU CAN TEST TUBES FAST AND ACCURATELY!... Place tubes in the inner holes of the G-E Tubesaver. Test them one-by-one. Put the good tubes in the outer set of holes, and return rejects to the inner set. Interruptions are no handicap—the Tubesaver keeps tubes correctly arranged till you resume work. In their proper order you now show the full tube complement of the receiver — which tubes are usable, which not!

**SEE YOUR G-E
TUBE DISTRIBUTOR
FOR FULL DETAILS!**

SAVE TIME- SERVICE AIDS!

PICTURE-TUBE CARRIER

Here's a practical aid that enables you to carry a cartoned picture tube safely and easily with one hand, leaving the other free for service equipment. Heavy canvas straps—quickly adjusted—hold the tube carton firmly. Rounded leather grip fits snugly in the hand. Blue and yellow colors are attractive. Save extra steps with this new convenience!



DROP-CLOTH

Use this handy G-E drop-cloth to cover fine rugs or cabinets. It's durably woven, with a soft texture that won't harm the most delicate surface. A plastic top coating takes hard wear, resists hot solder, can be wiped clean in a jiffy. Customers will appreciate your protecting their furnishings from dust, grime, and stray particles of metal!

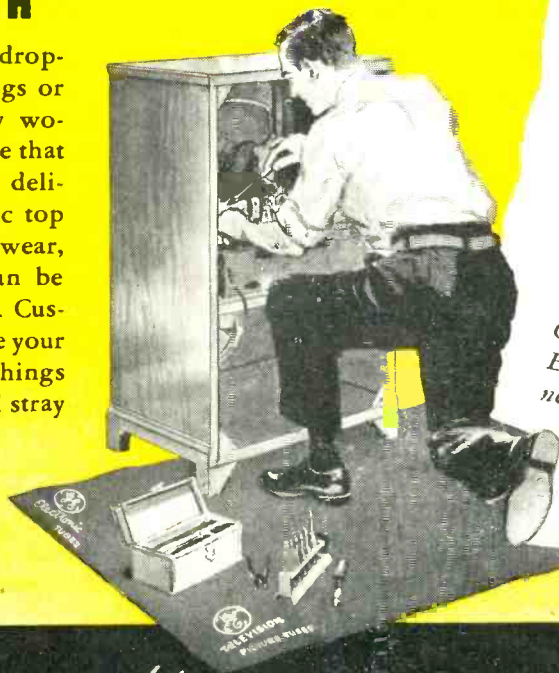

MAKE MORE CALLS PER DAY

... with these G-E-tube service aids! They cut time and costs, build customer goodwill. Your General Electric tube distributor will be glad to help you obtain them. Phone or write him today!
*General Electric Company,
Electronics Division, Schenectady 5, New York.*

161-1A1

You can put your confidence in—

GENERAL  ELECTRIC

PHOTOFACT Users Write Our Best ADS!

Hundreds of unsolicited letters tell what the world's finest Radio & TV Data means to Service Technicians



Ronald W. Heckbert
30 Magoun Ave.
Medford, Mass.

"I have recently purchased some of your books and in my opinion they are priceless. They certainly cut down the service time on any job. I want to pass along a slogan you could rightfully use: 'More for your money than you expect!'"



J. T. Cookson
Lock Box O
Puxico, Mo.

"I wouldn't part with PHOTOFACT for anything. For a fellow like myself who has most of his brains in his hands and eyes, they are a great help."



R. F. Dietz
1027 S. Main
Berger, Texas

"We have your complete set of PHOTOFACT, and we are convinced they are the best. We even prefer them above factory data. The TV data given in them is tops."

NOW! GET THE PROOF FOR YOURSELF!

FREE

We'll send you a Free Photofact Folder on any receiver listed in "PF Index & Technical Digest."

Learn for yourself—at our expense—how PHOTOFACT pays for itself by earning bigger repair profits for you! Select any Folder from the PF Index (if you haven't an Index, get a free copy from your distributor). When you write us for your Free Folder, be sure to state Photofact Set and Folder Number as shown in the Index. Get your Free Folder now. Examine, use, compare—see why you can't afford to be without PHOTOFACT!

HOWARD W. SAMS & CO., INC.
2201 East 46th Street • Indianapolis 5, Indiana

TRADE FLASHES

A "press-time" digest of production, distribution, and merchandizing activities

RTMA President Discusses Outlook For Television Industry in 1952

From the text of an address, "The Outlook for the Television Industry in 1952," given by Glen McDaniel, President of the Radio-Television Manufacturers Association, at a session of the National Appliance and Radio Dealers Association, January 15, at the Conrad Hilton Hotel, Chicago; the following viewpoints of trade authorities were excerpted:

"Ben Abrams, President of Emerson Radio and Phonograph Corp., who is noted for his merchandizing astuteness, took a rather dim view of 1952 set production. He estimated that not more than 4 million television receivers and 8 million home radio sets will be produced. As a result, he said, there will be a severe shortage of receivers this year.

"Frank Folsom, President of RCA, was a little more optimistic. He foresaw a 1952 output of between 4 and 4½ million television sets and 9 to 10 million radios.

"John Craig, Vice President and General Manager of the Crosley Division, Avco Mfg. Corp., who is Chairman of our Set Division, predicted that television receiver production will approximate 4½ million units and radio set manufacturing about 11 million in 1952.

"Bill Halligan, President of The Hallicrafters Company, foresaw an output of about 4 million television receivers and 10 to 11 million radios.

"Dr. W. R. G. Baker, Vice President of General Electric Company, made no television predictions of his own but called attention to the fact that NPA officials have indicated that metals available to the industry will allow the manufacture of from 3½ to 4 million television receivers. He estimated that material restrictions will reduce radio set production to approximately 6 million home and portable radios.

"Dick Graver, Vice President of Admiral Corp., took a more optimistic view. He said that production in 1952 should be approximately as high as in 1951.

"Bob Sprague, who is Chairman of our Board of Directors, while not

a set manufacturer, has a remarkably good record for forecasting set production. His year-end statement, however, allowed for a wide margin of error. He estimated 1952 set production at a minimum of 4 million and a maximum of 5 million units."

Commenting on NARDA-RTMA cooperation, Mr. McDaniel continued,

"We in the manufacturing side of the industry have enjoyed excellent cooperation from organized dealers as represented by NARDA. Your officers, Mort Farr and Al Bernsohn, have been extremely helpful in joining dealer forces with the manufacturers in such important industry undertakings as that of effecting modification of Regulation W and defeating the proposed increase in excise taxes. These two activities alone have amply illustrated the strength of our industry when all forces unite.

"I regret that we cannot comply with NARDA's request that RTMA adopt a suggested form of warranty clause for television sets. Your objections to the warranty practices which have grown up in the television field have been very ably expressed to us and I have investigated the problem thoroughly. I have sought the best legal advice that could be found and upon that advice I have taken the position that RTMA must adhere to the statement that I originally made on this matter at the Trade Practice Conference conducted by the Federal Trade Commission last June 21. I said then that the field of warranty practices and pricing practices are areas in which a trade association such as RTMA should not function. RTMA will scrupulously avoid any activity in those areas.

"That is not to say, however, that RTMA is not vitally interested in the problems of providing good service to television set owners. As you probably know, our Board of Directors authorized in September the employment of a service manager to devote full time to these problems. As UHF service and color television begin to grow, service problems are likely to become even more difficult; and well qualified service technicians will be more scarce

[Continued on page 12]

Fast Fit for the Job at Hand . . .

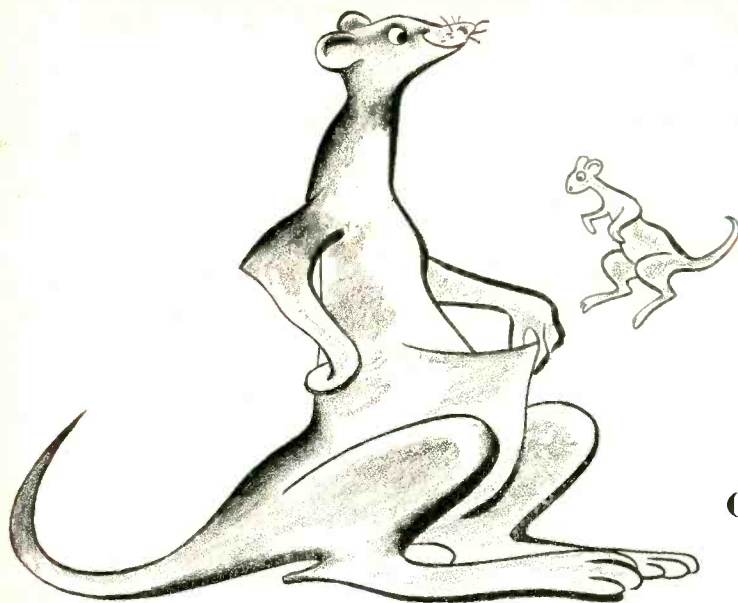

MALLORY MIDGETROL®

Round-Shaft Volume Controls

START FAST . . . FINISH FAST . . .

- Because of the wide and easy adaptability of Mallory Midgetrols, it's easy to stock—or get fast from your distributor—just what you need to do your job.
- Round tubular shaft designed and built for fast, easy and accurate cutting.
- Factory-tested AC switch may be attached instantly without disassembling control.
- Speedy adaptability to both split-knurl and flatted type knobs.

CUSTOMER-PLEASING RESULTS . . .

- Longer lasting resistance elements even in extremes of temperature and humidity.
- Better and more accurate taper curves resulting from precision processing methods.
- No pigtail connections to break—thanks to Mallory's exclusive sliding contact that gives EXTRA quiet operation.
- Minimum wobble with Mallory exclusive two-point shaft suspension.



So Versatile are Mallory Midgetrols—both standard and dual—that they reduce by 40% the cost of inventory needed to service the 10 most popular makes of radio and TV sets.

**Make Sure!
Make it Mallory!**

Every Mallory Midgetrol is packed with two shaft ends to make it easy for you to use either split-knurl or flatted type knobs. The Mallory Midgetrol line, in addition to round shaft standard controls, includes dual concentric controls that offer fast, easy assembly in five steps *without* special tools. Front and rear sections are factory assembled and inspected. AC switch attachment is easy.

P. R. MALLORY & CO. Inc.
MALLORY

CAPACITORS • CONTROLS • VIBRATORS • SWITCHES • RESISTORS
• RECTIFIERS • VIBRAPACK* POWER SUPPLIES • FILTERS

*Reg. U.S. Pat. Off.

APPROVED PRECISION PRODUCTS

P. R. MALLORY & CO., Inc., INDIANAPOLIS 6, INDIANA

LOOK CLOSELY...

and you'll see why
They outperform all others!

OHMITE *Little Devil* INSULATED COMPOSITION RESISTORS



COMPACT SIZE

Extremely small for their current capacity—ideal for the smallest equipment.

TEMPERED COPPER LEADS IMBEDDED DEEP IN THE BODY

Differential tempering of *locked-in* leads prevents sharp bends and resistor damage.

INDIVIDUALLY MARKED AND COLOR-CODED

Quick, positive identification is easy. No guesswork or mistaken identity!

RATED AT 70C (158F)

Withstand extremes of heat, pressure, and humidity without deterioration.

MOLDED PLASTIC COMPLETELY SEALS AND INSULATES

Have high mechanical and insulating strength. Meet JAN-R-11 requirements.

When you use OHMITE *Little Devils* on your repair jobs, you can be sure of dependable resistor performance. That's because these tiny, rugged units are designed and built to high standards unmatched by any other composition resistor. Little Devils come in 1/2-, 1-, and 2-watt sizes in $\pm 5\%$ or $\pm 10\%$ tolerances, in standard RTMA values from 10 ohms to 22 megohms. In the 1-watt size, $\pm 10\%$ tolerance, values as low as 2.7 ohms are available.



OHMITE MANUFACTURING COMPANY
4846 Flournoy Street, Chicago 44, Illinois

WRITE FOR
BULLETIN 135

Be Right with **OHMITE**
RHEOSTATS • RESISTORS • TAP SWITCHES

TRADE FLASHES

[from page 6]

than ever. E. W. Merriam served as our service manager during the fall on a temporary basis to get the program started. On January 28 Albert Coumont of General Electric, who has been appointed RTMA service manager, will undertake his duties. He will actively promote the RTMA plan for expanding and strengthening the training of television technicians in the 2500 vocational training schools throughout the country. This program will produce more technicians at the time the severest need for them is likely to begin. He will work with the servicemen and with you dealers on the many problems besetting the industry at present and he will coordinate efforts being made by the individual manufacturers to improve television service. He will also keep on the lookout for moves in city governments and state legislatures to require the licensing of servicemen. We are opposed to licensing bills because they will not correct the evil at which they are aimed. Instead they will only make matters worse by making it more difficult for younger men to enter the service field.

"It is a pleasure to report that the New York City Board of Estimate last week sent back to Committee a licensing bill that has been pending for some months. This action was taken despite earlier passage of the bill by the City Council by a large majority. The remanding of the bill to Committee was done on motion by the Mayor after the presentation of a case against it by representatives of RTMA and the National Electronic Distributors Association."

Albert Coumont Appointed Service Manager of RTMA

Glen McDaniel, president of the Radio-Television Manufacturers Association, appointed *Albert Coumont*, formerly Sales Manager, Electronics Section, International General Electric Co. Inc., as RTMA Service Manager. The position was created by the RTMA Board of Directors early last fall to coordinate the Association's activities aimed at improving industry practices and policies on TV set servicing. The post previously was held by E. W. Merriam on a temporary basis.

Mr. Coumont has had diversified experience in the radio and television industry and has been with General Electric since 1935. Mr. Coumont's entire business career has been spent in the radio and television field, be-

[Continued on page 14]



for greater speed and
accuracy of TELEVISION INSTALLATIONS
in any locality use the new

Simpson

MODEL 488

TV FIELD STRENGTH METER

In addition to location of maximum signal areas, the Simpson Model 488 Television Field Strength Meter is also ideal for antennae orientation, comparison of antennae systems, adjustment of TV signal boosters and checking antennae and lead-in installations to list but a few of the many functions available . . . THE 50 MICROVOLT FULL SCALE RANGE IS AN OUTSTANDING FEATURE FOR THOSE CONCERNED WITH FRINGE AREA INSTALLATIONS WHERE MAXIMUM EFFICIENCY MUST BE ATTAINED . . . The 500, 5,000 and 50,000 microvolt ranges extend the usefulness of the Simpson Model 488 into areas of higher signal strength. The large 4½-inch modernistic meter is easily read from a considerable distance and all controls and connections are arranged for greatest accessibility. Model 488 is housed in a beautiful gray hammerloid finished case for greater portability. LINE VOLTAGE: 105-125 volts, 50-60 cycles. SIZE: 8" x 11" x 8½".

WEIGHT: 11½ lbs. Shipping weight 15 lbs.
DEALER'S NET PRICE, including operating instructions and shoulder strap . . . \$89.50

SIMPSON ELECTRIC COMPANY

5200 WEST KINZIE STREET, CHICAGO 44, ILLINOIS

Phone: COLUMBUS 1-1221

In Canada: Bach-Simpson, Ltd., London, Ontario



Some Plain Talk about Making More Money

HOW WE CAN HELP

...with the **RCA Battery Line**

As **Radio** men, we can do it by **working together**

Here's how we'll help you build a more profitable business with **RCA BATTERIES**:



1 We will advertise you, the *Radio Service-Dealer* on national network radio and TV programs. We'll tell millions of listeners that you are best qualified to sell and install RCA Radio Batteries.



2 We will help you advertise for repeat sales on the RCA Battery carton. Millions of volume-type RCA Batteries will carry a printed message directing the user to come back to you for replacements. Below this message will be a space where you can stamp your own name with a personalized stamp which you may obtain from your RCA Battery Distributor.

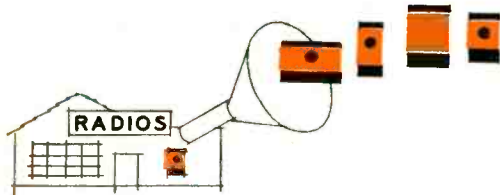

3 We will continue to channel our principal battery distribution to you as a *Radio Dealer and Serviceman* which means that you get profitable repeat business with RCA BATTERIES.



4 We will continue to provide speedy, dependable service backed by the only nation-wide warehousing and distribution organization geared to the needs of the radio trade.

DOESN'T THIS MAKE SENSE TO YOU?

As a *Radio* man, you should handle the *Radio* Battery line of the *Radio* Company that wants to help you prosper. By doing this, you get extra help . . . four-way help. And you make more money. It's as simple as that.

for Local Radio Dealers and Servicemen:

YOU MAKE MORE MONEY

With the RCA line you get ALL THESE EXTRA BENEFITS, TOO

You get **TREMENDOUS BRAND ACCEPTANCE** . . . because RCA is the best-known, most-advertised name in the radio field. This means your battery sales are fast, easy, profitable with RCA.

You get **COMPETITIVE PRICES**. RCA Batteries are priced to sell against the toughest competition.

You get **TERRIFIC SELLING AIDS** . . . signs, banners, displays, kits, merchandisers that are unique . . . to mark your store as headquarters for RCA Batteries.

You get **RADIO-ENGINEERED BATTERIES** . . . power-packed for *extra* listening hours . . . and built to exacting standards of quality. They represent the combined skills of both battery engineers and radio engineers.

You get a **ROUNDED LINE** to fill virtually every portable and farm radio requirement. Seven popular types will fill about 80% of your needs. You cut down on stocking problems . . . are sure to have the right batteries on hand—at the right time!

Get started with RCA Batteries . . . NOW

Let us help you make this your banner year for battery sales. Call your RCA Battery Distributor right now. Get set with the *Radio Battery* for the *Radio Trade* . . . RCA. And *let us help you make more money . . . starting TODAY.*

Why YOU are so important to us.

You're in the *Radio Business*. So are we.

You're interested in promoting the sale and use of *Radio products*. So are we.

If you prosper, so do we!

That's why we channel our battery distribution to *you as a Radio outlet*.

That's why we advertise *you, the Radio-Service Dealer* on national radio and TV programs. That's why we help promote your store right on the actual RCA Battery.

*You're a Radio Man.
We're a Radio Company.
Let's prosper together!*

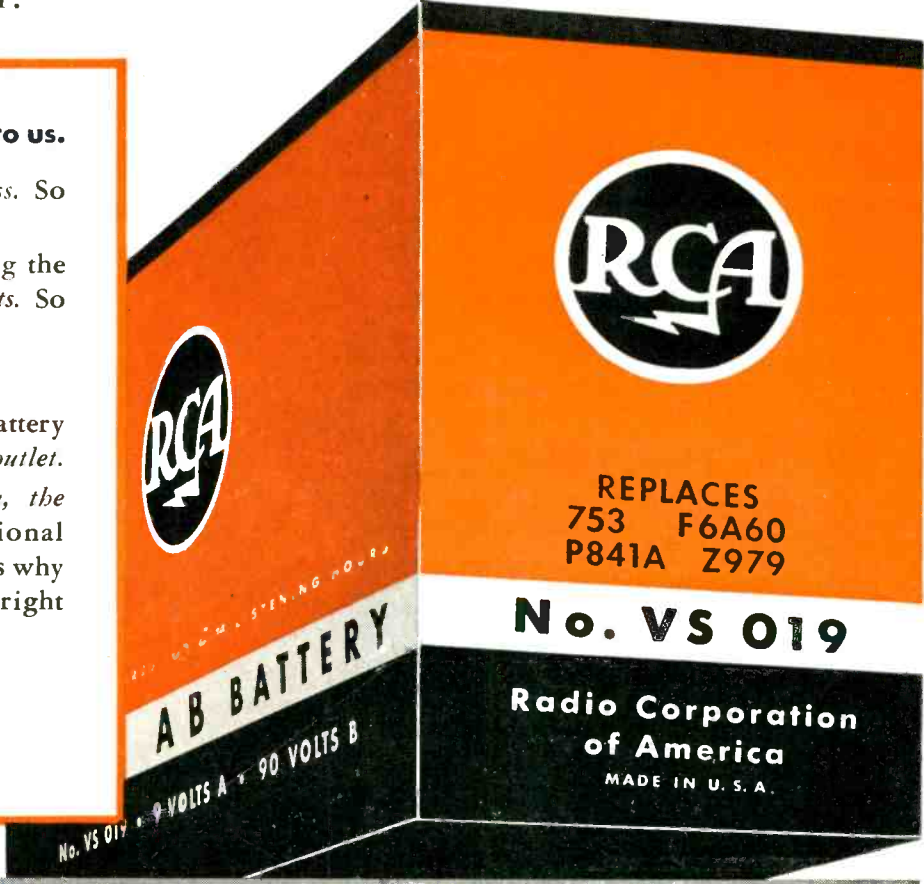

RADIO CORPORATION of AMERICA

RADIO BATTERIES

HARRISON, N. J.

SYNC PULSES

by San D'Arcy

N. Y. TV License Bill Snagged — On December 20th, 1951 New York City's Council planned to enact a bill that would have required TV dealers, contractors and servicemen to be licensed to do business. The bill's outline was in part drafted by the N. Y. C. association of radio-TV servicemen (ARTSNY) and in itself was acceptable, and probably would have been the pattern for all other license bills to follow. However, at the very last minute action to vote on the bill was deferred at the request of the city's License Commissioner. He claimed that his department, which was to be the one responsible for enforcement of the bill's provisions, was not properly staffed or equipped to handle the assignment. The department has 42 inspectors and supervises some 60 different types of businesses.

The Commissioner stated: "We are in favor of the principle of licensing these people and regulating them but we have suggested that some other city department with a larger inspection department should handle it." As of February 20th no further action on the license bill had taken place. At that date it was estimated that in metropolitan New York upwards of 2,600,000 TV-sets were in use, with approximately 6,000 service organizations, dealers and servicemen available (and subject to licensing), to maintain them. Mathematically that means that every technician had a potential average of 433 TV-sets to service. Bright outlook, eh what?

Promote Preventive Maintenance — On previous occasions we have lauded Nassau TV & Electronic Lab, a Long Island New York service dealer, for the constructive job done by their monthly letter to customers called "Tele-News." Opportunity for praise comes again for the current issue's item tritely titled "An Ounce of Prevention" which says, in part:

"All television receivers, and for that matter most of man-made objects, are at best a compromise; concerning tolerances of parts, construction, and alignment, when manufactured.

"In operation the TV receiver begins to deteriorate when subjected to humidity, dust heat and use. By the time a failure occurs there are many points that are below optimum performance. The front-end becomes dirty, the video strip drifts out of alignment, the video amplifier becomes unpeaked, the sync circuits are less sensitive, the horizontal drive circuits become weak and dirty and permit corona discharge, the ion trap grows weaker, sound discriminators shift, leaks develop in coupling condensers, bypass and filter condensers open up, and tubes, which before produced good emission and linearity, change.

"Now, when the failure occurs, the defective part or parts must, of course, be replaced but EQUALLY as important, numerous points must be checked, cleaned and adjusted to bring back optimum performance of the receiver. Experience and equipment go hand in hand to accomplish the desired result and a more lasting satisfaction for the set owner."

Such a clearly stated opinion cannot be misunderstood by people of even low intelligence level, and without doubt, it makes a favorable impression on all readers. That's why Nassau TV is thriving. Have you done any such progressive promotional work lately? Preventive maintenance jobs are worth having.

RADIO-TELEVISION SERVICE DEALER • MARCH, 1952

AMPHENOL

— IN LINE —

ANTENNA

Be Sure
ANTENNA INSTALLATIONS
are *Safe*

Safety is a factor too often overlooked in many TV antenna installations. Bent or broken antennas are a constant menace and antennas that break off or topple over under any undue strain can cause serious damage. Installing an Amphenol Inline Antenna is your guarantee of all-around quality! Not only does the Inline Antenna present the best possible TV picture, but it is safe! The Inline Antenna is constructed of aluminum for light weight and strength, and is engineered to withstand winds up to 70 miles per hour. In addition, it will bear up to one-half inch annular ice loadings without bending or breaking.

LIGHTNING ARRESTOR

Using an Amphenol Lightning Arrestor on the lead-in from your Inline Antenna makes your antenna installation secure in all ways. It provides real protection to your home and TV set from lightning damage and carries off the minor static discharges which interfere with good picture reception. The Amphenol Lightning Arrestor is of the type approved by the National Electric Code and is also approved by the Underwriters' Laboratories.



See your regular Amphenol Distributor now for your copy of this 20-page book containing all the factors which determine Better TV Picture Quality and safe antenna installation.

AMERICAN PHENOLIC CORPORATION
1830 SOUTH 54th AVENUE • CHICAGO 50, ILLINOIS

AMPHENOL



Be Sure of Your Installations

Get the *Aptitude-Tested*
**RG/U TRANSMISSION
 LINE CABLES**

• You know what you are doing when you use Belden RG/U Transmission Line Cables—they're aptitude rated. They are designed to provide desirable electrical characteristics, and rigid control assures constant quality. Specify Belden Radio Wires.
 Belden Manufacturing Co., 4639 W. Van Buren St., Chicago 44, Ill.



To You,
 Belden's Golden Anniversary Means

—product performance that can come only from a "know-how" that has grown through actual service since the inception of Radio.

—an ability to co-operate in pioneering new wires to meet or anticipate industry's growing needs.

In the years that follow

This Belden Program Is—

—TO BE CONTINUED

| APTITUDE RATING No. 8236 | | APTITUDE RATING No. 8237 | | APTITUDE RATING No. 8238 | | APTITUDE RATING No. 8239 | | APTITUDE RATING No. 8241 | |
|-----------------------------|------------------------|-----------------------------|------------------------|-----------------------------|------------------------|-----------------------------|------------------------|-----------------------------|------------------------|
| Frequency (Mc) | Attenuation per 100 ft | Frequency (Mc) | Attenuation per 100 ft | Frequency (Mc) | Attenuation per 100 ft | Frequency (Mc) | Attenuation per 100 ft | Frequency (Mc) | Attenuation per 100 ft |
| 100. | 2.65 | 100. | 2.10 | 100. | 1.90 | 100. | 3.10 | 100. | 3.75 |
| 200. | 3.85 | 200. | 3.30 | 200. | 2.85 | 200. | 4.40 | 200. | 5.60 |
| 300. | 4.80 | 300. | 4.10 | 300. | 3.60 | 300. | 5.70 | 300. | 7.10 |
| 400. | 5.60 | 400. | 4.50 | 400. | 4.35 | 400. | 6.70 | 400. | 8.30 |



Belden
Radio WIRE

The
Aptitude-Tested **LINE**

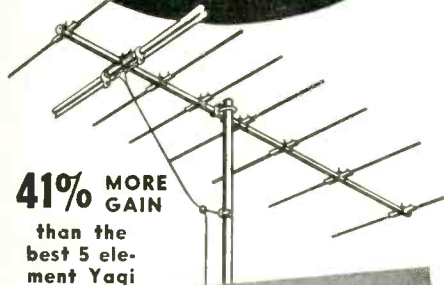

41% MORE GAIN
than the best 5 element Yagi

GIVES EQUAL GAIN TO A DOUBLE-STACKED 5 ELEMENT YAGI ARRAY

at lower cost!

MODEL LJ **\$12.50** LIST
for Channels 7-13

COMPARE THESE TIME AND MONEY SAVING FEATURES

- Faster, easier to install than stacked arrays
- Better roof-top appearance
- Higher front-to-back ratio eliminates co-channel interference
- Full 6 megacycle band width
- Rugged pre-assembled construction
- Low channels (2-6) have 1 1/4" reinforced boom of highest quality aluminum tubing and extra rugged VEE-type clamp (CL-10) which allows use of mast up to 2" diameter

Another Great Product by **VEE-D-X**
Originators of the World's Most Powerful TV Antenna Systems

THE LaPOINTE-PLASCOMOLD CORPORATION
Windsor Locks, Connecticut

Gentlemen:
Send me complete information on Long John

Name _____
Street _____
City _____ Zone _____
State _____

Check here if technician

[from page 8]



Albert Coumont

ginning in 1932. His experience includes the operation of his own home radio repair company and an active participation in the home radio service divisions of manufacturing companies.

One of the first tasks to be undertaken by Mr. Coumont will be to promote training courses for service technicians in the nation's trade and vocational schools. A recommended agenda for a training course has been prepared by the RTMA Service Committee, under Chairman R. J. Yeranko, of the Magnavox Co., and has been distributed among trade and vocational schools.

To further this program RTMA has engaged the RCA Institutes, Inc., to write a three-year vocational high school syllabus on radio and television and a 10-12 months syllabus for adult educational institutions. The courses are being edited by Gilbert Weaver, Training Director of the New York State Board of Education.

1952 Audio Fair To Be Held In Chicago

The 1952 Audio Fair In Chicago will be held at the Conrad Hilton Hotel here May 23rd and 24th.

To give manufacturers and distributors an opportunity to reach the huge audio-high fidelity market in the middle west, the Audio Fair In Chicago, counterpart of the Audio Fair held annually in New York in conjunction with the Audio Engineering Society convention, is being set up to immediately follow the 1952 Electronic Parts Show here, Harry N. Reizes, Fair manager announced.

In setting the Chicago dates for the Friday and Saturday immediately following the 1952 Electronic Parts Show, Reizes said that the Audio Fair In Chicago will occupy the fifth, sixth and seventh floors of the Conrad Hil-

[Continued on page 50]

SO IMPORTANT — it was
Featured in Special Article
in
The New York Times

Jan. 28, 1952
FREE copy
of article on request

UNIT REACTIVATES TV PICTURE TUBES

Small Electronic Device Tests Sets at Home and May Add Year or More of Use

By T. R. KENNEDY Jr.
A small electronic device that can be applied to home television receivers to test and reactivate the picture tube without removing it from the set, resulting in renewed brightness in many a receiver, has been placed on the market for the first time by a New York manufacturer.

In some cases, it was said, the picture tube may be made almost as good as new and given as much as a year's useful life before replacement is necessary.

The instrument is small and compact. It weighs three pounds and is as large as the average lunch box, costs little and is simple to operate. Picture tubes, some of them new and never in a receiver, have shown remarkable improvement in brilliance and definition after a few minutes of reactivation here in the last few days.

Although the principle of its operation is not new—cathode-ray tube manufacturers have used it for years in the initial making of picture tubes—the incorporation of a small reactivator in a home television set is a new development.

The almost immediate urgent need for such an instrument, which also soon may be produced in kit form for home assembly, is apparent. Eight to ten million TV picture tubes, Transvision engineering estimates, have now been in use for three to four years or more, and "probably are in need of test and reactivation to renew their brightness." Unfortunately, loss of brightness, it was pointed out, seldom can be detected short of comparing the old tubes with new ones in lately produced sets.

Furthermore, picture tubes in their original cartons in stores may have lost some of their brightness, which has been described as a "kind of aging process" to which all large cathode-ray tubes and similar devices are subject. Such tubes, in the current sizes most in use today, cost from \$25 to \$65.

New picture tubes can be tested and reactivated without removing them from their cartons, and tubes in TV sets without removing them from the receivers. It is done by attaching a standard picture-tube socket to the tube, linked by wires from the instrument, to a switch on the tester-reactivator, and noting the glow of a small neon bulb as a condition of the tube is indicated directly on a dial of an AC home electric socket. The receiver, meanwhile, is not turned on.

In some cases the test and reactivation is accomplished in less than two minutes.

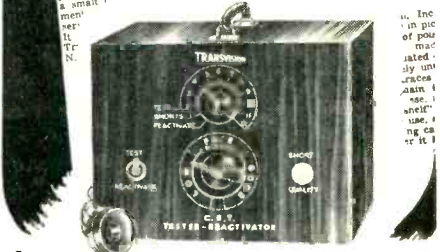

TRANSVISION CR TUBE TESTER - REACTIVATOR

performs 2 vital functions:

- Tests Picture Tubes
- Renews Brightness of Many Dim Picture Tubes

It's a **TESTER**:

Without removing picture tube from set, you apply this precise instrument to:—

- Measure Cathode emission
- Locate shorts between elements
- Locate high resistance shorts or leakage as high as 3 megohms

It's a **REACTIVATOR**

for dim CR Picture Tubes

Revives dim TV Picture Tubes, without removal of tubes from sets. Works on a great many tubes with low light output, if there's no mechanical defect in tube. 110 V—60 cycles. Portable, weighs only 3 lbs. One or two applications pays for instrument.

SATISFACTION GUARANTEED or money refunded if you return the instrument in 10 days in good condition. **\$19.95 NET**

RUSH THIS COUPON

TRANSVISION, INC.
DEPT. SD3 NEW ROCHELLE, N. Y.

() Send me CR Tube Tester-Reactivator(s).
() Enclosed find \$___ deposit. Balance C.O.D.
() Enclosed find \$___ in full. Send prepaid.

Name _____
Address _____
City _____ State _____

“When we think of V-R tubes, we think of **CBS-HYTRON**”

TUBES ARE KNOWN BY THE COMPANY THEY KEEP

It's automatic with scores of top-flight manufacturers. They turn to CBS-Hytron for the miniature OA2, OB2 and standard OC3, OD3.

That's only natural. They know CBS-Hytron has the know-how... know-how gained from making over 15,000,000 voltage regulators. They know CBS-Hytron supplies these apparently simple tubes to either JAN or commercial specifications. (In fact, CBS-Hytron's factory tests of VR tubes are much tougher than JAN.) And they know CBS-Hytron... top producer of VR tubes... can be depended upon for prompt delivery.

Follow the leaders yourself. Buy the best. Order your gaseous voltage regulators from CBS-Hytron.

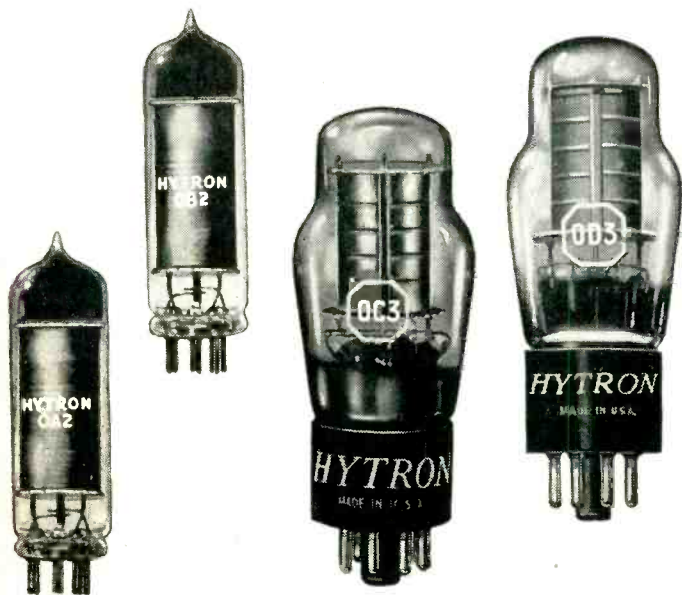

Write for Complete Free Data on
CBS-HYTRON voltage-regulator tubes



MAIN OFFICE: Salem, Massachusetts

Reads like the blue book of electronics...

this list of famous companies who from long experience buy the best in voltage-regulator tubes... CBS-Hytron.

Admiral Corporation • Airborne Instruments Lab., Inc. • Aircraft Armaments, Inc. • Aircraft Radio Corp. • Airesearch Mfg. Co. • Applied Physics Corp. • Applied Research Laboratories • Arma Corporation • A.R.F. Products, Inc. • Atomic Instrument Co. • Audio Products Corp. • Ballantine Laboratories, Inc. • Arnold O. Beckman, Inc. • Bell Aircraft Corp. • Bell Telephone Laboratories, Inc. • Bellaire Electronics, Inc. • Bendix Aviation Corp. • Berkeley Scientific Corp. • Bill Jack Scientific Instrument Co. • Bright Radio Laboratories • The Brinnell Co. • Browning Laboratories, Inc. • J. H. Bunnell & Co. • Cambridge Instrument Co., Inc. • The Allen D. Cardwell Mfg. Corp. • CBS-Columbia, Inc. • CBS Television • Collins Radio Co. • Connecticut Telephone & Electric Corp. • Consolidated Vultee Aircraft Corp. • Cornell-Dubilier Electric Corp. • Crosley Division, Avco Mfg. Corp. • DDD Manufacturing Co. • Douglas Aircraft Co., Inc. • Allen B. DuMont Laboratories, Inc. • Edo Corporation • Eicor, Inc. • Electro-Physical Laboratories, Inc. • Electrotech Corp. • El-Tronics, Inc. • Fada Radio and Electric Co., Inc. • Fairchild Guided Missiles Div., Fairchild Engine and Airplane Corp. • Federal Manufacturing and Engineering Corp. • Federal Telecommunication Laboratories, Inc. • Federal Telephone and Radio Corp. • Ford Instrument Co., Div. of Sperry Corp. • Gaveco Laboratories, Inc. • General Communication Co. • General Precision Laboratory, Inc. • General Radio Co. • Gilfillan Bros., Inc. • Gosnet Company • The Gray Mfg. Co. • The Hallicrafters Co. • The Hammarlund Mfg. Co., Inc. • Harvey-Wells Electronics, Inc. • Hazeltine Electronics Corp. • Hewlett-Packard Co. • Hickok Electrical Instrument Co. • Hoffman Radio Corp. • Hubbell & Miller Co. • Industrial Control Co. • Industrial Development Engineering Associates, Inc. • Jack & Heintz, Inc. • Jackson Electrical Instrument Co. • Kepco Laboratories, Inc. • Lavoie Laboratories, Inc. • Lear, Incorporated • Lewyt Corporation • Link Radio Corp. • Loral Electronics Corp. • Lyman Electronic Corp. • Lysco Mfg. Co., Inc. • P. R. Mallory & Co., Inc. • The Glenn L. Martin Co. • The W. L. Maxson Corp. • McDonnell Aircraft Corp. • McElroy Manufacturing Corp. • Melpar, Inc. • Midwest Engineering Development Co., Inc. • Minshall-Estey Organ, Inc. • Motorola, Inc. • National Company, Inc. • National Electrical Machine Shops, Inc. • National Research Corp. • National Research Council, Canada • New London Instrument Co. • Nuclear Measurements Corp. • Nutone, Inc. • Photobell Co. • Pilot Radio Corp. • Portable Electric Tools, Inc. • Precision Apparatus Co., Inc. • Press Wireless Mfg. Co., Inc. • Radiation, Inc. • Radio Development & Research Corp. • Radio Engineering Laboratories, Inc. • Rauland-Borg Corp. • Raymond Rosen Engineering Products, Inc. • Raytheon Mfg. Co. • Reed Research, Inc. • Sanborn Company • Sangamo Electric Co. • Schuttig & Company, Inc. • Sentinel Radio Corp. • Servomechanisms, Inc. • Setchell Carlson, Inc. • Shallcross Mfg. Co. • F. W. Sickles Div., General Instrument Corp. • Sierra Electronic Corp. • A. F. Smuckler & Co., Inc. • Sonar Radio Corp. • Spencer-Kennedy Laboratories, Inc. • The Stamford Electronics Co. • Fred Stein Laboratories • The Superior Electric Co. • The Technical Materiel Corp. • Telechrome, Inc. • Tel-Instrument Co., Inc. • Times Facsimile Corp. • Tracerlab, Inc. • Trad Television Corp. • Transducer Corp. • United Scientific Laboratories, Inc. • Varo Mfg. Co., Inc. • Wells-Gardner & Co. • Western Electric Co. • Western Sound & Electric Labs., Inc. • Westinghouse Electric Corp. • Weston Electrical Instrument Corp. • Weston Laboratories • Wilcox Electric Co., Inc. • Witco Mfg. Co.

In addition to many other prominent manufacturers, the U. S. Army, Navy, Air Force, Coast Guard, AEC, CAA, FCC, National Bureau of Standards, government development laboratories and other government agencies, well-known research laboratories and universities, foreign countries, and the nation's leading electronic parts distributors.

UHF



*All UHF channels...
for all TV sets*

MALLORY UHF CONVERTER

The Mallory UHF converter is right for *all* your TV customers because it can be used with *any* TV set... in *any* UHF broadcast area. And it's easy to install—no adjustments or connections to make in the TV set... just connect power lines and antenna leads.

These Mallory features mean real customer satisfaction... real sales for you in the new UHF market—

- Reception of all UHF channels
- No sacrifice of VHF channels
- Built-in UHF antenna
- High quality picture definition
- Fast, easy installation

No larger than a small portable radio, the Mallory UHF converter is precision-built for long, trouble-free service. Get complete details today on the Mallory UHF converter from your Mallory distributor.

P. R. MALLORY & CO. Inc.

MALLORY CAPACITORS... CONTROLS... VIBRATORS...
SWITCHES... RESISTORS... RECTIFIERS...
VIBRAPACK* POWER SUPPLIES... FILTERS
*Reg. U.S. Pat. Off.

APPROVED PRECISION PRODUCTS

P. R. MALLORY & CO., Inc., INDIANAPOLIS 6, INDIANA

*Make Sure...
Make it Mallory*

Servicing TV Oscillators

CIRCUITS

by MATTHEW MANDL

This article discusses troubles which might occur and their causes in various types of oscillators in TV receivers. These oscillators are the r-f, horizontal, vertical, and high voltage r-f. Typical symptoms are illustrated in most cases.

INASUCH as most television receivers use three (and sometimes four) oscillator circuits, it is well worthwhile for the technician to investigate similarities in such circuits and evaluate common symptoms. This is particularly useful when one considers that well over 50% of the trouble can be caused by some defective tube or component in one of the oscillator circuits. Symptoms include:

1. Picture and sound loss
2. Vertical instability
3. Horizontal instability
4. Horizontal sync loss
5. Vertical sync loss
6. Pulling
7. Hum Bars
8. Picture and sound distortion
9. Loss of raster

Functionally, the various oscillators in the receiver resemble each other because they are "generators." The function of each is to produce a specific frequency and for this reason common electrical symptoms occur when defects exist. Their individual tasks differ, however, and thus the visible and audible symptoms for a specifically defective oscillator will

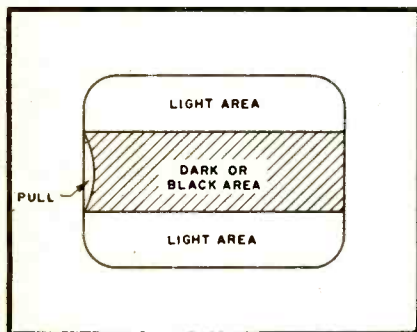

Fig. 1. Hum bar present on pix tube screen (60 cycle).

have definite identifying characteristics.

Familiarization with the common troubles and symptoms will expedite repairs. For this reason an analysis of the various types follows.

Local Oscillator Defects

The local oscillator of the tuner is a source of many common troubles as well as occasionally developing unusual defects. Because the production of the i-f frequency depends on proper oscillator function, however, troubleshooting is often expedited because the symptoms are peculiar to this stage. If, for instance, a heater-cathode short develops in this tube, it will produce a hum bar on the screen similar to that shown in Fig. 1. Inasmuch as the hum is introduced in a stage prior to sync take-off, a bending at the edge of the raster will also occur.

Localization of this defect to the oscillator tube in the tuner is facilitated because the hum bar will only be present when a station is tuned in. This comes about because the hum present in the oscillator cannot reach the i-f stages unless the mixing process is present to produce the intermediate frequency. Thus, when switching to a channel which has no station, the hum bar would not be present on the raster. If, however, a heater-cathode short existed in one of the tubes in the picture i-f or video amplifier section, the hum bar would be present whether or not a station were tuned in.

When a defect occurs in the local oscillator which will cause this stage to become inoperative, certain symptoms can again be evaluated to indicate that it is the oscillator stage which would not short the power sup-

ply but which would prevent oscillations, the mixing process would not, of course, occur and since no i-f frequencies are produced there would be no picture or sound. The set, however, would still be "alive" as evidenced by the presence of the raster, residual hum from the speaker, and the presence of slight tube noises if the volume control is turned on full. If the chassis is on the workbench, a voltage check would also indicate normal voltages. If additional checks were made, signal tracing would, for instance, establish the normal operation of the r-f and picture i-f stages. A simple means for definitely establishing whether or not the oscillator is generating signals, however, is to place a vacuum-tube voltmeter across the grid-leak as shown in Fig. 2.

The presence of bias would indicate an oscillating circuit, while the absence of bias indicates a non-oscillating state. (In an oscillator of this type, the feedback signal to the grid is instrumental in establishing bias by driving the grid positive and causing conduction. The grid capacitor is charged and discharges across the grid

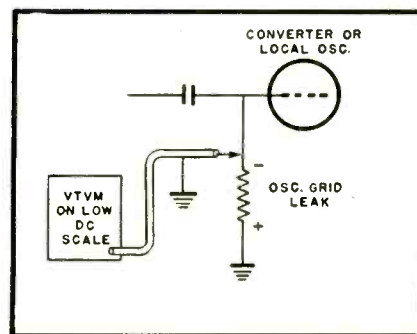

Fig. 2. Presence of bias indicates oscillator operation.



Fig. 4. Typical picture that may result because of vertical jitter.

leak establishing the requisite negative potential at the grid.)

Insufficient oscillations caused by a low emission tube or defective components sometimes reduces picture gain, particularly at the higher frequencies. The efficiency of the local oscillator is prone to be less on the higher channels and thus the symptoms would be more in evidence than they would be for the lower channels. When this is suspected, it is best to try a new local oscillator tube by direct substitution, because tube checkers will not always disclose the relative inefficiency which exists when the tube is used in an oscillating circuit. Off-value resistors are also a common offender and efficiency can be decreased appreciably by a change in value by the resistors. When replacing these, use close tolerance units. Capacitors, too, are frequent offenders and can cause intermittent operation or pronounced frequency drift during the warm-up. When replacing these, make sure that exact duplicates are secured because occasionally the negative-coefficient temperature compensated types are used. Replacement with other than a similar type will not cure the original trouble and will still cause pronounced drift in oscillator frequency. This would mean constant readjustment of the fine tuning during an evening's reception.

Vertical Oscillator

Most technicians are already familiar with the more common troubles which are caused by the vertical oscillator. These would include general

vertical instability as manifested by vertical roll, constant readjustment of the vertical hold control, or inability of the vertical hold control to re-establish synchronization.

Other troubles, however, often are produced and can give rise to various symptoms. Such troubles can be caused by a defective tube, a defect in the low-pass filter network (integrator) preceding the oscillator, and defects in various capacitors, including the coupling capacitor to the next stage as shown in *Fig. 3*. Improper sync separation prior to the vertical oscillator, or defective capacitors and resistors in the low-pass filter can permit spurious signals to arrive at the vertical oscillator besides the required sync pulses. There have been occasions when improper sync separation has allowed sufficient video information to arrive at the oscillator and cause vertical jitter or jump. This can be an intermittent condition depending on the type and amplitude of the undesired signals which arrive with the sync. Often, sync is not lost but only disturbed. The disturbance is sometimes rapid enough so that the vertical jump almost resembles a smear such as shown in *Fig. 4*.

Loss of interlace can also occur and for a more detailed description as well as illustrations of this defect, refer to an earlier article by the writer in the *December 1951* issue of *Radio Television Service Dealer*. "Troubles in Television RC Networks."

A leakage in the coupling capacitor to the output tube can also cause serious troubles, the primary symptom being vertical foldover or overlap along the bottom of the picture. A leaky coupling capacitor will also re-

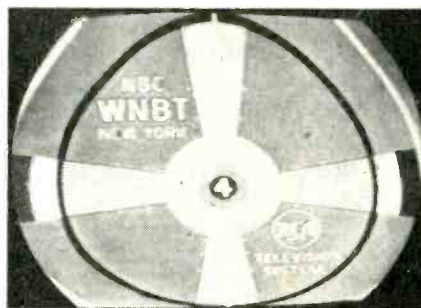

Fig. 5. Vertical non-linearity may result because of leakage in capacitors connected in the vertical circuit.

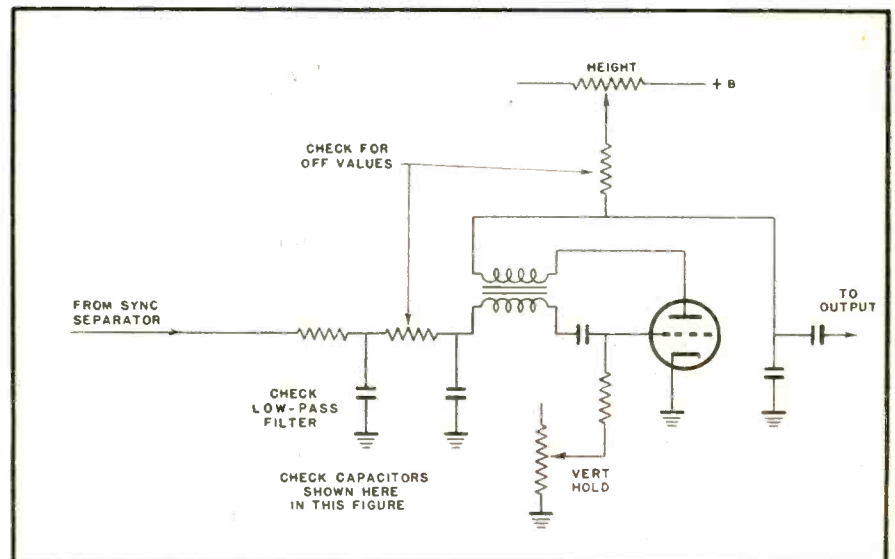

Fig. 3. Typical vertical oscillator circuit and servicing check points.

duce the bias to the vertical output tube and increase its emission beyond normal. This would result in poor linearity. If the leakage is small, foldover may not be present but the bottom of the circle of a pattern would start to flatten and the top to elongate as shown in Fig. 5.

If the output amplitude of the vertical oscillator drops below normal because of a low emission tube or because of other defects, it can cause a decline in height which would be very similar to troubles occurring in the vertical output stage. A defective vertical output tube could cause a decrease in sweep amplitude as shown in Fig. 6, but this could also occur because of insufficient drive to the vertical tube from the oscillator output.

For any of the aforementioned symptoms, voltage checks should be made and the ohmic values of resistors checked. Capacitors can be checked for leakage with the R x 1 meg. scale of a vacuum-tube voltmeter with the capacitors disconnected from the circuit. Scope analysis can also be made and for a more thorough discussion of this topic, refer to the June 1951 issue of *Radio Television Service Dealer*, "Scope Analysis of TV Sweep Defects."

Horizontal Oscillator

In the horizontal sweep oscillator, common defects also occur with respect to sync instability etc. These can be caused by a misadjusted horizontal lock system which can be corrected by following the step-by-step procedures in the service notes for the particular receiver in question. The more uncommon types of troubles also include foldover, insufficient drive, and general instability because of low amplitude sync input, etc.

Foldover, as with the vertical system, can be caused by defective coupling capacitors or damping circuit defects. In the horizontal system, however, it could also occur because of a change in relative timing of the sync versus blanking. In the transmitted signal the sync pulse is mounted approximately over the center of the blanking pulse so that the screen is blanked out before and after retrace. Since most horizontal sweep systems have automatic lock controls, however, the oscillator is no longer triggered directly by the sync pulses but is controlled by a reactance tube or other type of control tube. Thus, the relationship between sync and blanking can easily be upset. This can be caused by a misadjusted phase control in the lock system or by a defective tube or component part. This will disturb linearity as shown in Fig. 7

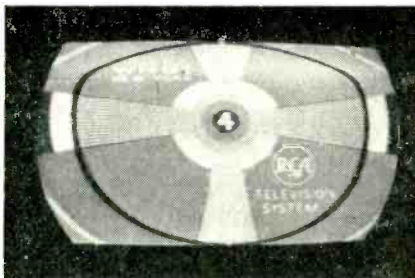

Fig. 6. Typical pix resulting from insufficient vert. drive.

and foldover will be present to the degree by which sync versus blanking has been shifted. Note the beginning of foldover on the right of pattern circle of Fig. 7. It must be remembered, however, that a similar condition can also be caused by a combination of improperly set width, drive, and linearity controls.

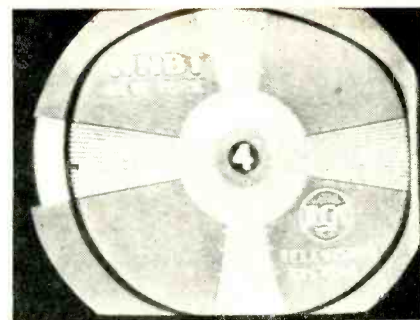

Fig. 7. Beginning of foldover at the right.

These controls should be adjusted initially before going to the trouble of checking all component parts. If the width and drive controls (in combination with horizontal linearity) cannot correct this condition, check the alignment adjustments of the lock system. Also try a new oscillator-control tube and if this fails to correct the condition, check for defective components. Here again, close tolerance resistors and negative-coefficient capacitors may be encountered and exact replacement parts should be used.

High Voltage RF Oscillator

The fourth type of oscillator is only encountered on occasion in modern receivers. This is the type of oscillator circuit used when the r-f type of high voltage supply is employed in the receiver instead of the flyback type. A typical circuit is shown in Fig. 8. Earlier 7" receivers such as Hallierafers and Motorola used this system, and some later Westinghouse 10, 12 and 14 inch receivers also employed this system.

When this oscillator ceases to function the high voltage will be lost and no raster will appear as with conventional high voltage supplies. These types depend for maximum efficiency on the circuit being resonant at the proper frequency. For this reason decreased high voltage can be reestablished to a normal level by adjusting the trimmer capacitor shown.

When this type of oscillator is employed a symptom sometimes occurs which is peculiar to this type of receiver. This consists of a bright vertical bar as shown in Fig. 9. This indicates loss of horizontal sweep with high voltage still present. The high voltage permits the vertical sweep to be visible as shown. In the flyback type of high voltage system, failure of the high voltage oscillator would obliterate the raster and the vertical sweep would not be visible. Such bright bars, whether vertical or hori-

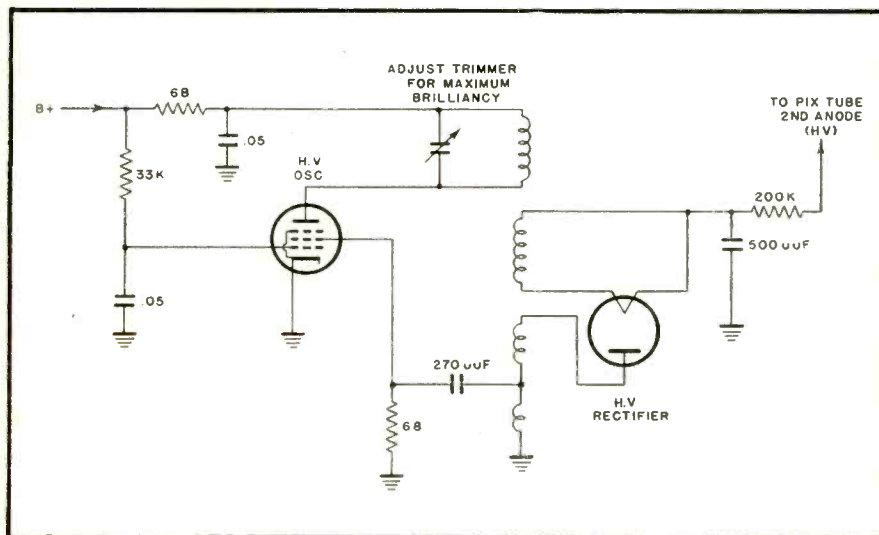

Fig. 8. Typical r-f high voltage power supply.

[Continued on page 60]

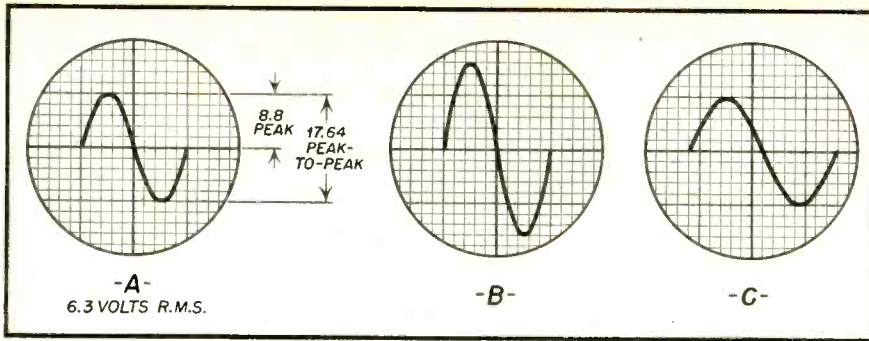

Fig. 1. Various examples of calibrated voltage scales.

Using the OSCILLOSCOPE

by **ALLAN LYTEL**

(Author of *UHF Principles*)

Part I

The cathode ray oscilloscope when used in conjunction with auxiliary apparatus may perform many versatile measurements such as voltage, time calibration wave comparisons, a-f and r-f visual observation and alignment.

THE versatile oscilloscope can have its usefulness extended by the addition of auxiliary equipment. Calibrating devices allow the oscilloscope to be used as either a peak reading voltmeter or an r-m-s voltmeter although the actual oscilloscope indication is always a peak-to-peak reading. A time calibrator may be used to indicate the exact time duration of any input signal.

Audio signal generators and square wave generators are useful together with the oscilloscope in checking fre-

quency response in amplifiers. But the greatest and most important use of this instrument is unquestionably visual alignment of wide band circuits. In this application, the sweep signal generator usually supplies the horizontal signal for the oscilloscope.

Calibrated Voltage Scales

A cathode ray oscilloscope may be used as a peak reading voltmeter since the trace upon the screen, if a sine wave is used upon the input signal, will show the complete sine wave from peak to peak. An a-c voltmeter will

usually read root-mean-square voltage, since it is calibrated for this purpose. Whenever voltage readings are taken from the face of the cathode ray tube, peak readings must always be used. For example, a 10 volt reading on an a-c voltmeter meter indicates a sine wave whose potential difference between the positive maximum and the negative maximum is 28.28 volts. The 10 volt reading on the meter is an r-m-s value which must be multiplied by 1.414 to obtain the peak value. This figure is again multiplied by a factor of 2 in order to obtain the peak-to-peak value. If a peak-to-peak voltage is given, this value is divided by 2.828 to obtain the effective or rms value.

In order to obtain comparisons between various voltages, some method of direct reading is needed. Calibrated scales which are circular discs with equally spaced rulings, are available to fit over the outside of the fluorescent screen. The usual scale is calibrated in tenths of an inch and once the calibration for an oscilloscope has

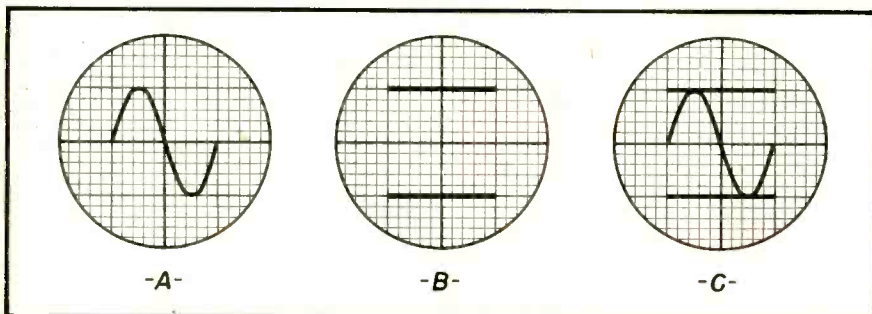

Fig. 3. Direct reading voltage calibration.

Fig. 2. The DuMont Type 264 Voltage Calibrator.



been set, it may be used as a peak reading voltmeter.

A 6.3 volt a-c signal as in *Fig. 1A* is conveniently used for a sine wave calibration since it is either available on the front panel of the oscilloscope as a test signal, or it may be easily obtained from a filament winding on a power transformer. This signal is applied to the vertical binding post with the synchronization selector switch turned either to the Internal or 60 cycles per second position. By means of the Coarse and Fine Frequency control, a single pattern is obtained on the screen and any motion of the pattern is stopped by advancing the Synchronization amplitude. One single cycle of the 60 c-p-s signal should now be present on the screen and its amplitude may be varied by the Vertical Gain control. Several sine waves may be used rather than one since in this case, the number of cycles on the pattern is not important. Since the 6.3 volt a-c signal has a peak-to-peak amplitude, of 17.64 volts, the vertical gain control is rotated until the sine wave fills some convenient unit on the calibrated screen.

A signal of unknown amplitude may now be measured provided only that the vertical gain control is not changed. The unknown signal is now applied to the vertical input terminals and it is not necessary for the unknown signal to be synchronized to measure its amplitude, although this may be done by means of the coarse

and fine frequency adjustments. The scale calibration is now read directly and the value of the unknown voltage calculated. There is a direct relation between the number of calibrated units covered by the unknown voltage and the number of units covered by the 6.3 volt a.c.

Although the oscilloscope is essentially a peak reading device voltage

this manner and it is possible to compare the gain of an audio amplifier by finding the voltage relations between the input and output of one or more stages.

Voltage Calibrators

In order to read the voltage of the signal present on the oscilloscope screen, some method of calibration is necessary since a motion of the vertical gain control would destroy the effectiveness of the preceding method. If the calibrated screen is adjusted for a particular value of signal with the 6.3 volt a.c. used as a reference, it is difficult to measure large values of voltage since the top and bottom of a large signal would be off the screen. Adjusting the vertical gain control to obtain the entire pattern on the tube face, would of course, destroy the voltage calibration which is effective for only one setting of the gain control. The most direct method for obtaining voltage calibration would be to connect a high resistance voltmeter, preferably a vacuum tube voltmeter, across the vertical input terminals. This does not use the characteristics of the cathode ray tube as a measuring device but it does allow a reading of voltage to be obtained for any signal present on the screen.

A voltage Calibrator (DuMont Type 264-A) is available to read the direct peak-to-peak value of any applied signal. As shown in *Fig. 2*, this instrument has two controls and four binding posts. The input is connected between the signal input terminal and ground: Vertical deflection from the oscilloscope is obtained from the output. A calibrated scale reading in units of 10 from 0 to 100, is used with a multiplier: A calibrated square wave is also available as the output of this unit.

When this is connected as above, the Output Multiplier Switch is turned to signal Output Position so that the vertical signal to the oscillo-



Fig. 4. Time Calibrator; Owen Model 160.

calibrations may be carried out on the basis of r-m-s value. If, for example, the 6.3 volt a-c signal covers 20 small units on the calibrated screen, the unknown signal may be directly compared. A test signal occupying 10 units must be 3.15 volts a.c., or an unknown signal occupying 40 units must be 12.6 volts a.c. Voltage measurements may be made directly in

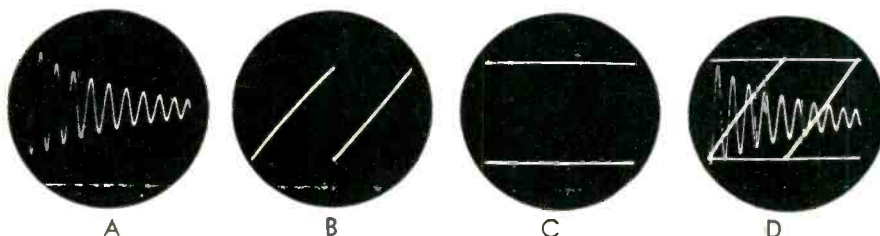

Fig. 5. Sine wave time calibrations.

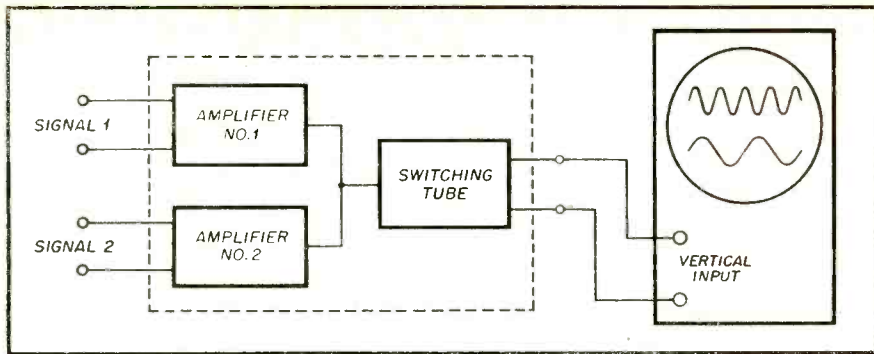

Fig. 6. Use of the electronic switch.

scope passes directly through the calibrator without being affected. A convenient adjustment of the vertical control on the oscilloscope is made so that an entire pattern is visible on the screen as in *Fig. 3A*. The signal is synchronized by means of the oscilloscope controls so that a stationary pattern results.

Without changing the setting of the vertical gain control on the oscilloscope, the Output Multiplier Switch of the calibrator is rotated to any convenient position. The continuously calibrated dial is then carefully adjusted until the square wave from the calibrator, which is now on the oscilloscope screen or *Fig. 3B* occupies exactly the same vertical spaces as did the original signal. By means of the multiplier and the continuous control, an exact voltage reading, which is the peak-to-peak voltage, may be obtained. For example, if the multiplier is in the 0 to 10 volt position, and the continuous control is in the 50 position, the peak-to-peak voltage is exactly 5 volts. This represents a convenient method for reading the peak-to-peak voltage of any size signal using the characteristics of the oscilloscope directly. Both the sine wave signal and the square wave calibration are shown together in *Fig. 3C*.

Time Calibration

Where precise measurements of the duration of a particular signal is necessary, a time calibrator as in *Fig. 4* may be used conveniently. This is essentially a resonant circuit in series with the vertical input signal. A sine wave is produced whose exact frequency and time duration is fixed. This signal is compared to the unknown test signal whose time duration may then be exactly calibrated in terms of the fixed frequency circuit, of the time calibrator.

The use of a time calibrator is shown in *Fig. 5*. Part *A* illustrates the output of the calibrator which is a damped sine wave. A portion of the vertical signal input is applied across the tuned circuit. This circuit pro-

duces a sine wave voltage output and since the exact value of the component in the tuned circuit is precisely fixed, the time between any successive peaks of the damped sine wave is known. In part *A* the time interval between crests of these waves is 100 microseconds.



Fig. 7. Commercial electronic switch.

Part *B* shows the two cycles of a sawtooth test signal whose horizontal deflection is the same as in part *A*.

Where the saw-tooth signal is to be measured, either a voltage calibration or a time calibration method may be used. A voltage calibrator is used to

measure the peak-to-peak voltage as shown in part *C*. Output from the voltage calibrator is adjusted until the same vertical deflection is obtained as was obtained with the test signal in part *B*. All three of these signals are present on the oscilloscope face in part *D*. Each of the cycles of the sawtooth test signal requires approximately $5\frac{1}{2}$ cycles of the time calibration sine wave. Since each cycle of the sine wave represents 100 microseconds, each cycle of the saw-tooth is $5\frac{1}{2}$ times this, or 550 microseconds. This represents an accurate method establishing the time duration of an unknown signal.

Since the same vertical deflection is obtained from the voltage calibrator and the saw-tooth voltage, a direct reading from the calibrator dial will indicate the peak-to-peak voltage of the unknown signal. In this case, a peak-to-peak voltage reading of 26 volts is obtained. Through a combined use of time and voltage calibration, the exact time duration and peak-to-peak voltage of the unknown sawtooth signal is established.

The Electronic Switch

There are occasions where it is desirable to compare two simultaneous signals. This may be done by one of several different methods: if one signal is used for the vertical input and the other signal is used as the horizontal input, certain complex screen patterns result. In laboratory work, where two signals must necessarily be compared quite often, a dual-beam oscilloscope is used which is essentially a cathode ray tube with two complete electron guns and deflection systems. Each electron beam may then have a separate and individual signal applied to it and both signals may be presented on the same fluorescent screen. The electronic switch whose block diagram in *Fig. 6*, represents

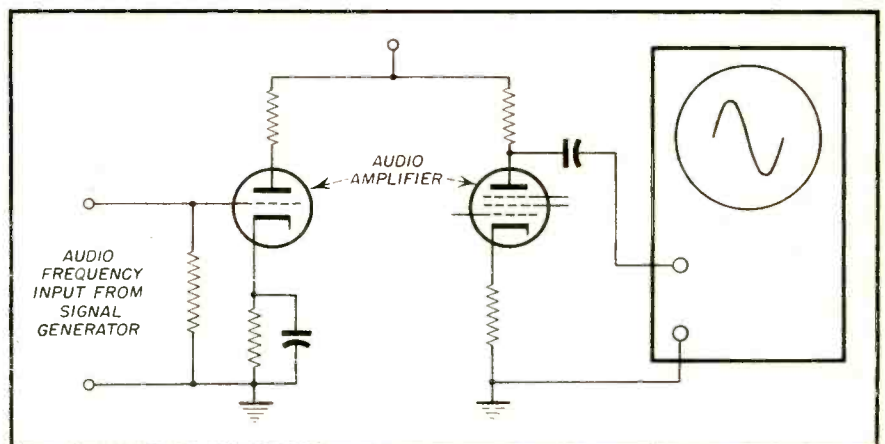

Fig. 8. Measuring a-f response with scope.

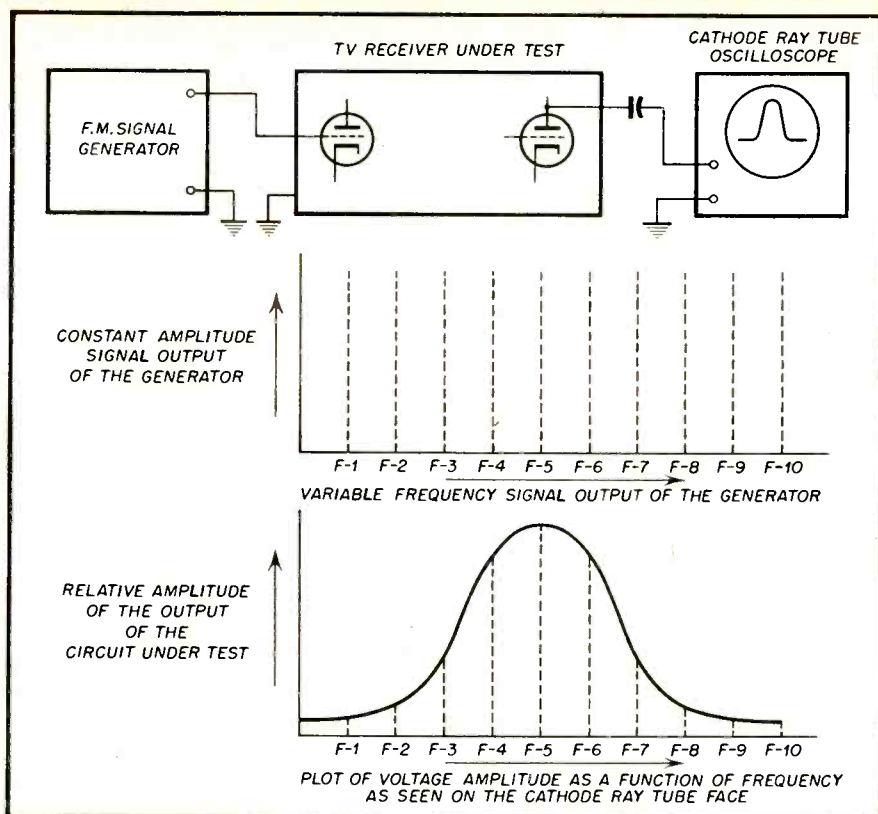

Fig. 9. Visual plotting of information on the cathode ray tube screen.

the third method of presenting two signals simultaneously. Its circuit is essentially a square wave generator whose output is feed to two amplifier tubes. Each of the two amplifier tubes has a separate individual signal applied to the grid. By means of the square wave, only one amplifier tube is allowed to conduct at a time; while one tube is conducting, the other tube is cut off and the situation then reverse. The vertical input to the oscilloscope is the combined output of the two amplifier tubes of the electronic switch. In this way, the vertical input oscilloscope receives the signal from each amplifier alternately.

When these are presented as a visual trace on the fluorescent screen, the switching action is of a sufficiently high frequency to make it appear that both signals are present simultaneously. In this manner, two signals may be compared in frequency and amplitude. An electronic switch has certain limitations but may be used to present two signals at the same time when a direct comparison is necessary and desirable. Fig. 7 is the DuMont Electronic Switch Type 185A—a commercial example of this device.

The Audio Frequency Signal Generator

Audio frequency signal generators may be used with an oscilloscope to check the response of an amplifier. A

generator of this type usually has a frequency output from 60 cps up to and including 20,000 cps. The signal generator may be one of several different varieties. If it is a Beat Frequency Oscillator, the oscilloscope may be conveniently used for calibration. A 60 cps signal is applied to the vertical input of the oscilloscope; this signal is synchronized so that one complete cycle appears on the screen. The BFO is then used as a vertical input signal with its dial calibration set to 60 cps. A frequency adjustment is made so that the BFO output is exactly one complete pattern just as the 60 cps test pattern was. Thus the a-f oscillator is calibrated for 60 cps.

Figure 8 illustrates one of the possible uses of the audio frequency signal generator as a test instrument. A sine wave signal of known frequency is applied to the input of the amplifier. An oscilloscope reads the voltage across the output load resistor. Distortion of the output sine wave may be read from the oscilloscope pattern provided its internal amplifiers are not overloaded. The vertical gain control is helpful in preventing this overloading of the oscilloscope amplifiers. As the test oscillator is adjusted over the audio frequency range, the peak amplitude of the signal on the oscilloscope is an indication of the gain of each of these input frequencies. Dis-

tortion of the audio output signal may be clearly observed by use of the oscilloscope pattern.

An audio amplifier may also be tested for 60 cycle hum since the oscilloscope will indicate not only the amplitude but the frequency of its vertical input signals. Any hum coming from poor filtering in the power supply, or possibly a filament to cathode short in the amplifier, will appear as a 60 cycle signal on the oscilloscope. Its presence may be ascertained by adjusting the oscilloscope controls to synchronize with the line frequency. If the test oscillator is adjusted for 1000 cycles, any large 60 cycle signal present on the oscilloscope screen will indicate hum. Some signal from the power supply is almost inevitably present unless carefully shielded leads are used. The outer braid of the shielded lead should be grounded both at the amplifier and at the oscilloscope.

A square wave generator extends the use of the audio frequency range in testing an audio amplifier. A square wave requires an audio amplifier several times its fundamental frequency in order that the square wave output appear to be undistorted. A complete frequency and phase response of an audio amplifier may be obtained by the use of square wave testing.

Visual Alignment

Television receivers require more exacting methods for alignment and servicing than ever were needed with ordinary broadcast band AM radios. The use of a sweep signal generator and cathode ray tube oscilloscope in visual alignment and trouble shooting techniques is not only vital to proper television servicing, but its use can also be extended to AM and FM radios.

The cathode ray tube which is the indicating device for the oscilloscope is also used although in a somewhat different form for the picture tube in television receivers. The cathode ray tube actually paints a visible picture of electrical information on a fluorescent screen. By comparing this information with the published data, supplied by the television receiver manufacturer, the service technician has a convenient and rapid method for aligning and servicing television receivers. Since the cathode ray tube uses an electron beam as an indicator, it is capable of covering a very great range of frequencies without serious limitations because the electron beam is virtually weightless.

In its most general use, the oscilloscope has a horizontal deflection voltage which moves the electron beam

[Continued on page 62]

A.G.C.

in

TV

Part 3

by Leonard Lieberman

IN the development of a-g-c circuitry, it was found that even with the improvements and modifications of the peak type a-g-c (discussed in the February issue of RTSD). The basic faults were not completely eliminated. These were:

1. Noise on the sync pulse which caused the peak reading to be higher than the actual carrier level.
2. Airplane "flutter" caused by the inability of the a-g-c system to follow very rapid variations in sync level.

Keyed A.G.C.

This inability to recover rapidly is due to the long time-constant of the a-g-c network. The reason this long

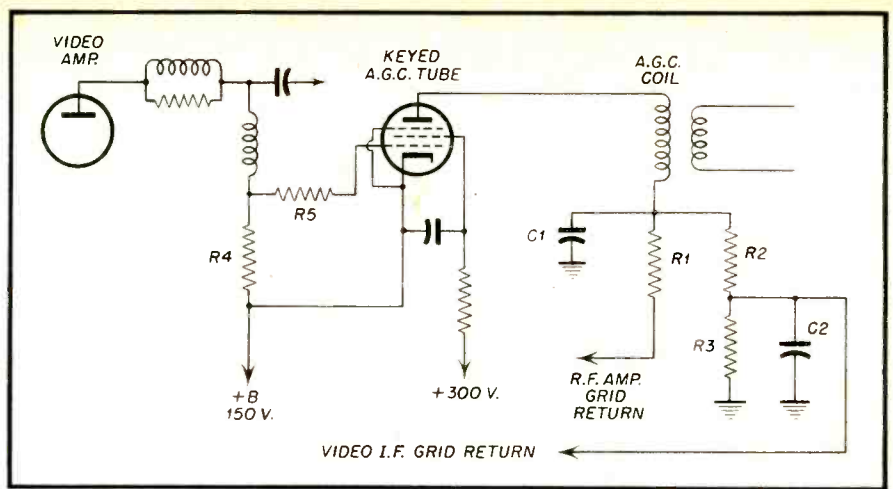

Fig. 15B. Typical keyed a-g-c circuit.

time-constant is necessary is due to the fact that the network must filter out the lowest frequency in the signal. Because of the blanking pulse in the

vertical sync, this cut-off frequency has to be below 60 cycles. As a result, the RC time of the peak type a-g-c filter is in the order of 100,000 to 125,000 micro-seconds.

It was felt that if the sync pulses could be sampled, at a higher rate, this RC time could be brought down with the result that we would have a better response to rapid variations in sync level that might be caused by airplanes. At a faster sampling rate, it would also be possible to overcome the cumulative effect of noise on the sync pulses adding to the a-g-c voltage.

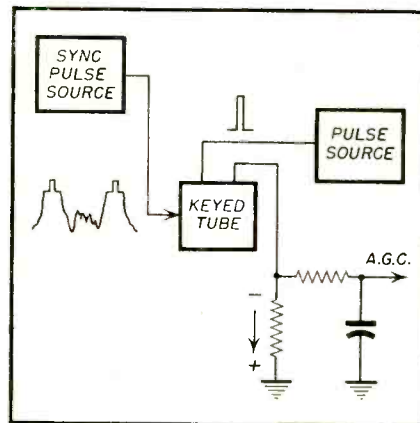

Fig. 15A. Block diagram.

The block diagram for one such circuit is shown in Fig. 15A. In this system, the signal is taken off the video amplifier. It is fed into the grid of a tube whose plate current is cut off. The tube only conducts when a positive going pulse taken off the horizontal output transformer is applied to the plate. The plate load resistor is connected to ground. Therefore, when the tube conducts, the plate current develops across this load resistor a voltage which is negative with respect to ground. This voltage is then filtered and the resulting negative voltage is applied either directly to the grids of the controlled tubes or is amplified and then fed to the controlled tube grids.

Either triodes or pentodes can be used as the keying tube. The Crosley Model 10-419MU (Fig. 16) is an example of the use of triodes. However, the 6AU6 pentode amplifier is the most commonly used tube, for this type of circuit.

In Fig. 15B we can examine the general operation of this circuit in greater detail. It can be seen from the diagram that the grid of the pentode is directly coupled to the video amplifier output through R5. The video amplifier tube current flowing through

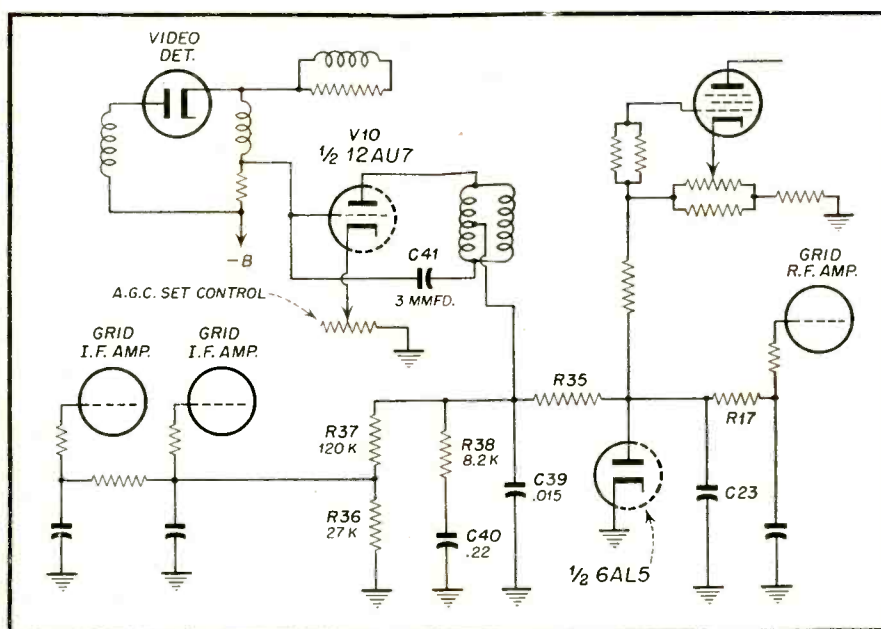

Fig. 16. Keyed a-g-c circuit used in Crosley 10-419MU.

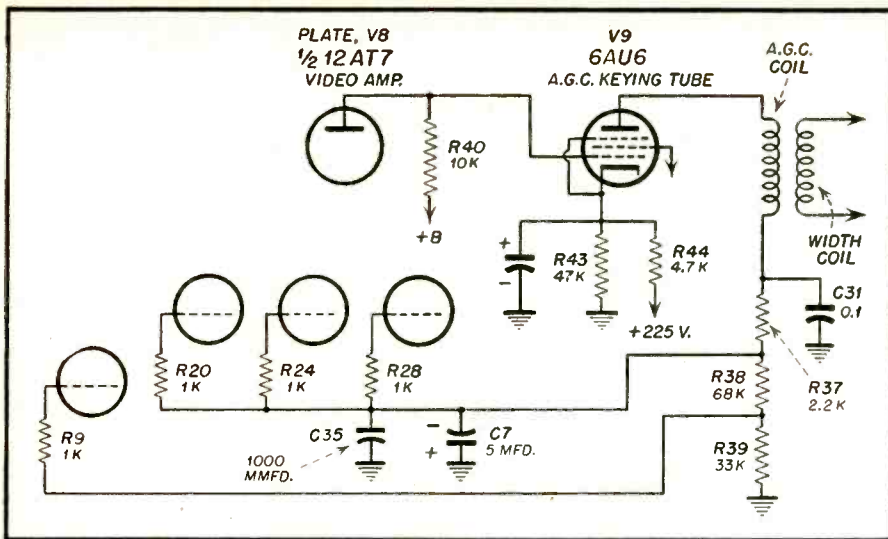

Fig. 17. Keyed a-g-c circuit used in Coronado 05TV1. Pentode is used as the keying tube.

R4 is sufficient to keep the keyed tube at cut-off. The plate is fed a positive going pulse in the order of 350 to 500 volts. This pulse is derived from the damper tube circuit, and is in sync with the horizontal sync pulse. The tube, therefore, will conduct at the time that the horizontal sync pulse is at its grid. The amplitude of this sync pulse will determine the amount of plate current which the tube will draw.

The plate current flows to ground through R2 and R3. C1 is the filter capacitor in the a-g-c system. The time-constant of the network C1, R2, R3 is generally in the order of 40,000 to 50,000 micro-seconds. Thus, the system is able to react from two to three times faster than the peak a-g-c system to variations in sync level. Capacitor C2 which is a filter in the video i-f branch has an even shorter RC time than the main system and will react even faster.

The plate pulse is obtained in several ways:

1. Capacity coupling from the plate of the horizontal output tube;
2. Inductively coupled by means of a properly phased winding on the width coil;
3. Direct connection to the winding of the width coil.

All the systems of obtaining this pulse have these major requirements:

- (a) the pulse be positive going
- (b) it must be of the proper amplitude to start the keying tube conducting
- (c) it must be a part of the horizontal output circuit

In the Crosley-Model 10-419MU (Fig.16), we find an example of the use of a triode as a keyed a-g-c am-

plifier and the use of the a-g-c transformer directly connected to the terminals of the width coil. In this circuit the plate of V10 (1/2 12AU7) conducts when the horizontal output pulse appears on the width coil. When the tube conducts, the plate current goes to ground through R37 (120K) and R36 (27K). This places a negative voltage at the junction of R37 and R36. Capacitor C39 (.015 mfd) acts as the filter condenser. The network of R38 and C40 is the filter which

by-passes short duration noise pulses to ground.

The diode is so connected that it prevents the a-g-c line from going positive. It also puts a delay on the r-f amplifier a-g-c. The purpose of this is to reduce the amount of a-g-c on the r-f amplifier when weak stations are being received. The control in the cathode of V10 determines the cut-off voltage of the tube. The grid of V10 has bias voltage applied to it through C41 (3 mmf) Thus V10 will conduct only at the peaks of the sync pulses. Noise on the sync pulses, as explained previously, are by-passed by the very short RC time of R33 and C40.

Coronado Model 05TV1

Coronado Model 05TV1 (Fig. 17) is an example of the straightforward use of a pentode as the keying tube. V9 (6AU6), the keying tube, is kept at cut-off due to the positive voltage on the cathode through R44 (4.7K). The plate voltage appears across the a-g-c coil at retrace time. Since this occurs in the same time relation with the arrival of the positive going sync pulse at the grid, the tube conducts. The d-c path for plate current is through R37, R38 and R39 to ground. The a-g-c for the i-f tube grids is taken off at the junction of R37 and R38. It is more negative than the r-f

[Continued on page 60]

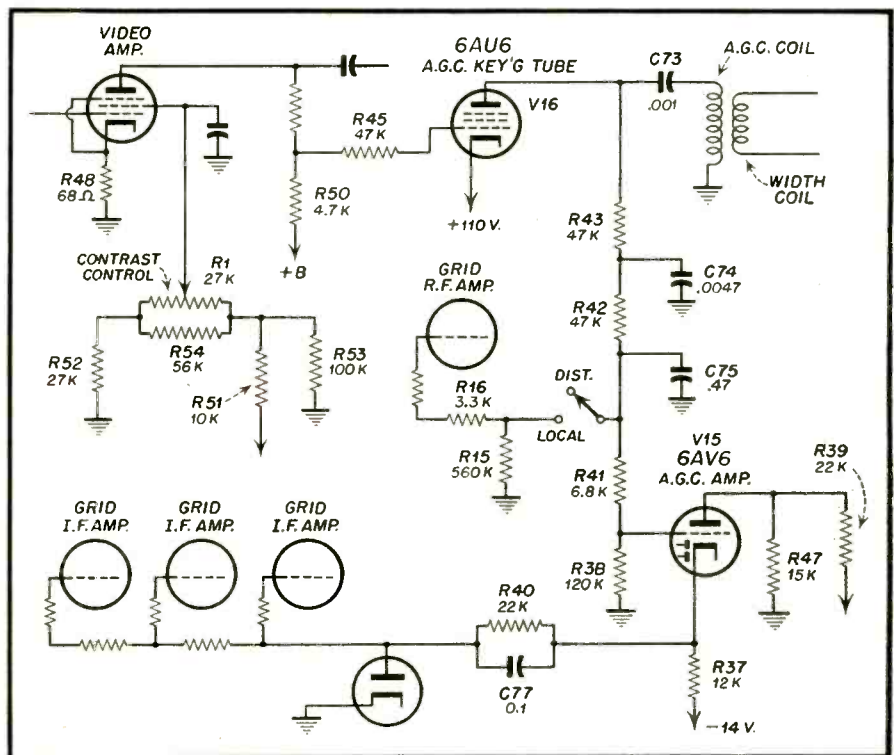

Fig. 18. Keyed a-g-c system used in Arvin Model 4162. This circuit employs amplified a-g-c., V15-6AV6 being the tube used for this purpose.

Let Your Sales Slip

SELL THE JOB!

by Walter J. Swontek

ONE of the worst headaches in the Radio-TV service business is Johnny Q. Public's impression that it is a "racket". The explanations for this belief are many and varied. After a great deal of thinking on this subject, the writer has come to the conclusion that a primary factor in producing this undesirable impression is the usual sales slip.

The average serviceman, having worked on a customer's TV set for two hours, will write out a sales slip saying:

| | |
|-------------------------------------|---------|
| 1 .001 μ f 6,000 volt condenser | \$ 2.95 |
| Service | \$15.00 |
| Total | \$17.95 |

When the customer sees this, he gets a feeling of emptiness. Since this is an average, or below average bill, he may not squawk, but—he has the feeling, at best, of being mildly "taken". Many will argue immediately that this is wrong on the part of the customer, that he is not buying a piece of paper, but should look at the operation of the set. True enough, but not many people got rich by complaining that their customers were wrong.

The sad part of this situation is that many otherwise honest servicemen, in order to avoid a squabble at the presentation of the bill, pad the parts list to make the labor smaller. Listing parts that were not used is, of course, highly unethical. In addition, this bit of dishonesty—which the serviceman can readily justify by the customers' reactions to an honest bill—has a strong tendency to disrupt his integrity and self-respect. Soon, the padding grows larger and larger, and the serviceman soon becomes caloused in this respect.

In those cases where parts are in warranty, but labor is COD, this particular method is not available, and all that the serviceman does is take the headaches. If particularly con-



scientious, he may explain the situation to the customer, but this takes time and results in loss of profits, forcing the bill up higher for more squawks.

Now, let's suppose that the same sales slip had been written out like this:

| | |
|--|---------|
| 1 .001 μ f 6,000 volt condenser | \$ 2.95 |
| Checked Hi-voltage oscillator tube, ok. | |
| Checked all voltages in oscillator. | |
| Checked Hi-voltage rectifier tube, ok. | |
| Checked all resistors in Hi-voltage bleeder circuit. Checked all Hi-voltage coupling condensers, replaced leaky one in vertical. Dusted chassis, cleaned pix tube face. Air checked, sound and pix ok on all channels. Focus ok, width ok, height ok. Sync and linearity ok. | |
| Service | \$15.00 |
| Total | \$17.95 |

And what happens? The customer, subconsciously perhaps, is left with a happy feeling of having got a lot for his money!

Moral: Be Honest, Be Truthful. *But write down every single thing you did to that set!*

Ok! Ok! I can hear you from here! Sure, I know that the customer doesn't know what you're talking about. But, what's the difference? Look at the prestige doctors build by writing prescriptions so nobody but the pharmacist can read them!

Oh! The other argument—You can't afford the time it takes to write this kind of bill? Try this then: Time yourself as to how long it takes to write it, figure the time at your usual hourly rate, and add it to the labor charge! I've tried it and the customers pay the slightly increased bill happily.

Here's a little kink that may help you get the bills written up right. Keep a little sheet of paper with the set, and as fast as you check or replace anything, write it down. Then, when the job is done, you won't have forgotten any work. Incidentally, this also seems to speed up trouble-shooting, as it helps to keep the work proceeding in a logical manner.

On straight warranty work; that is, labor is also no-charge, the situation is a little different, but a little thinking will keep everybody happy. If it's a brand-new set, the almost empty return slip is ideal. The customer gets the impression that not much was wrong with his set, and that keeps the dealers happy. If the warranty is almost out, though, give the details. Then the customer gets a double impression: 1) He got his money's worth out of the warranty. 2) You must be a conscientious outfit, as even on warranty you didn't just *fix* it, you did a *good job*. This will pay off on repeat calls, COD of course!

In conclusion, one other bit of psychology to keep them happy. After you have been using this type of sales slip long enough to have a good idea of how much space you need to write your piece, have the next batch of sales slips printed with just one line less than you need. Then, on most of your slips, the service description will be cramped a little, or run over onto the blank paper. This is a wonderful little gimmick, as the customer will subconsciously get the impression that maybe *his* set took just a *little* more work than the average.

ALTHOUGH selenium rectifiers began to show promise as far back as 1938, it was not until 1946 that they were adopted commercially to any extent in the United States.

Because of their many advantages, selenium rectifier circuits are now employed in many television receivers. Commercially, selenium rectifiers are used in such high current applications as electroplating, because the maintenance required is small and the reliability under heavy duties great.

It might be predicted that the trend will be toward adoption of selenium rectifiers in television receivers, because of their great advantages over the old power transformer, vacuum diode tube type of rectifier circuit. With the modern selenium rectifier, it is anticipated that less trouble will develop than with the conventional rectifier system. Selenium rectifiers may have to be replaced on occasion, but it must be remembered that replacement of vacuum tube diodes and transformers is also occasionally necessary in television receivers.

Application

Devices called rectifiers present a high resistance to the flow of electrons through them in one direction with much lower resistance to the electrons in the other. When alternating voltages are applied to the device, maximum current will flow in the direction of the least resistance and a small electron flow will develop in the other direction.

Selenium rectifiers are being employed where diode vacuum tubes were formerly used to develop d-c power from an a-c voltage, and have become widely accepted in half and full-wave rectifier circuits as power converters.

Construction

One cell of a selenium rectifier consists of an aluminum plate coated on one side with a crystalline material called selenium. Over the selenium is spread a layer of dielectric material. On top of the dielectric, a metallic alloy is sprayed, the type employed being determined by the particular manufacturer. The use of a dielectric between the selenium material and the alloy or counter-electrode helps to create an artificial barrier which improves the inverse voltage rating of the rectifier. The entire unit is sprayed with a protective coating to prevent the effects of moisture, etc. See *Fig. 1*.

With aluminum as the base plate, light weight construction is achieved at no sacrifice of ruggedness. Aluminum is corrosion resistant, and will provide a more uniform surface temperature.

SELENIUM RECTIFIERS for TV

by **DANIEL LERNER** and **ROBT. DARGAN**

The theory of operation, construction, and applications of selenium rectifiers are described in this straightforward article on this subject.

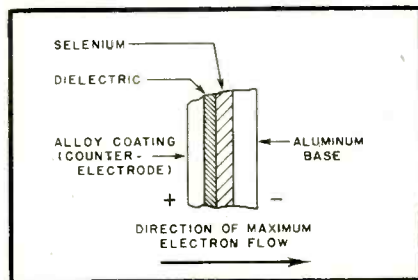

Fig. 1. Constructional details of a selenium rectifier.

A number of cells are coupled together to form the selenium rectifier into a unit. The cells are joined together on an insulated sleeve which is rolled over at each end, holding the cells together. A bolt may be inserted through the sleeve for mounting purposes. See *Fig. 2*.

The condition of the contact of the surfaces and their pressure on each other is very important. The conduction and efficiency of the rectifier can be altered by changing the pressure of the plates and the area of the contact. With insufficient pressure a higher resistance to electron flow can be caused.

One or more conducting washers are placed between each cell to permit air circulation about the individual plates thus allowing the heat to be carried away. The aluminum discs serve

to radiate the heat developed. The plates are usually mounted vertically to provide a good upward circulation of air between them.

Operation of Selenium Rectifiers

By joining two dissimilar materials—a metal and a metallic crystalline salt—an invisible, theoretical barrier is formed. This is much the same as the effect of placing two different metals together, in that a contact potential is developed. If the circuit is closed, electrons will flow from one metal to the other because of the voltage difference.

The theory of operation of a selenium rectifier is somewhat similar. An imaginary, so-called barrier or thin film at the junction of the surfaces of the alloy and the selenium is formed. In the film, the molecules are polarized or oriented so that electrons will flow in one direction with much greater ease than in the other.

From the alloy coating to the base plate is what may be called the forward resistance, the impedance to the electrons being less in that direction. High resistance is encountered by the electrons in the reverse direction, from the aluminum base plate through the selenium rectifier to the alloy or counter-electrode. The larger the resistance ratio, the more efficient the unit.

For an example, one cell might have a reverse voltage rating of 26 volts.

r.m.s. This is considered the maximum continuous operating voltage with the rectifier under load. By adding, in series the proper number of cells a complete rectifier can be assembled to handle the RMS voltage desired.

The reverse voltage rating of 26 volts r-m-s per cell, with the unit under load drawing the proper d-c current, is the maximum continuously operating a-c voltage permissible. This is the maximum reverse voltage that can be applied to the cell without drawing too much reverse current. With no load applied the cell can withstand a greater amount of voltage indefinitely and can handle large momentary surges of current without damage.

Some of the first selenium rectifier cells were rated for a maximum inverse voltage of 14 volts. Research developed better barrier layers, with manufacturers now claiming r-m-s inverse voltage ratings of as high as 50 volts for their cells. The increase in the inverse voltage rating of the rectifier can be attributed to the dielectric layer between the selenium and the alloy, which if used, gives higher ratings than can be obtained without this artificial barrier.

The space requirements for mounting selenium rectifiers are much less than usually occupied with a power transformer and rectifier tubes. Therefore, a lighter more compact unit can be produced and the heat from the power transformer and rectifier tubes eliminated.

With no rectifier tube filaments to heat, as much as 5 watts per rectifier can be saved. In addition, doing away with the power loss in the power transformer can provide a total reduction in power consumed of as much as 20 watts.

Comparing the voltage regulation between vacuum rectifier tubes and selenium rectifiers, it is found that selenium rectifiers are between 5 and 15% better, resulting in higher efficiency. The internal resistance in the maximum conducting direction is much lower than with vacuum diodes. The voltage drop across the selenium rectifiers can be as low as 5 volts with full load.

Other advantages are increased ruggedness, reduced cost, and almost instantaneous operation.

With no transformer to isolate the chassis, most television receivers employing selenium rectifier circuits use certain safety precautions. All television receivers are equipped with back panels incorporating safety devices designed to prevent the consumer from injuring themselves. Circuit

changes with the use of selenium rectifiers cause no particular concern. Front and back adjustment controls are insulated from the chassis, as are parts into which the hold down bolts in the bottom of the cabinet are screwed.

Classifying Selenium Rectifiers

Selenium rectifiers are classified according to the current that can safely be conducted through them at a particular input a-c voltage. The amount of current which the rectifier can conduct is determined by the power the rectifier can dissipate. Increasing the area of the selenium coating, but maintaining the same plate area, will not increase the current capacity of the rectifier.

By increasing the current through the rectifier with the same input a-c voltage, the power dissipation requirement of the rectifier is increased. If a manufacturer wishes to increase the heat dissipation ability of a rectifier,

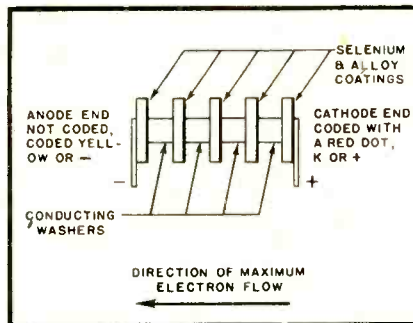

Fig. 2. Constructional details of selenium rectifiers in series.

the area of the plates, or the distance between the plates can be increased to permit convection of heat. A conducting washer is placed between the plates. Sometimes two washers are used to give greater separation allowing more heat to be removed. The permissible current in milliamperes depends upon the square inches of radiating surface of the plate and the separation between the plates. There is always a certain amount of reverse current flow which causes a major portion of the heat generated in the unit. This is power wasted.

In the construction of banks of selenium rectifiers it would be supposed possible to employ, for a greater input a-c voltage, a corresponding increase in the number of cells. However, there is a limit to the number of cells that can be placed in series. With each cell added, more forward resistance is included which will limit the forward current. It would be necessary to connect the rectifiers in a series-parallel combination if sufficient current can

not be obtained in just a series arrangement.

If a rectifier rated to deliver 450 ma is substituted for a rectifier rated at 400 ma, the unit will operate cooler with less possible breakdown.

A selenium unit rated for 130 volts input a.c. operating into a capacity filter charges up the capacitor to approximately the line peak voltage during the conduction half cycle if there is no load on the unit. With a load the voltage will be lower. The charge on the condenser during the negative half cycle is in series with the a.c. voltage and the rectifier must be able to withstand the two voltages which are effectively in series.

Current Limiting Resistors

When a television set is switched into operation, time is required for the formation of the barrier between the selenium and the alloy. This may take as long as several minutes. Large reverse currents may flow during the formation.

Resistors are usually inserted in series with the selenium rectifiers to limit the initial charging current each time the set is turned on. The filters are usually large and can take a large charge. Therefore, on peak voltages, the current can be very high. With series resistors the surges are limited until the barrier restricting the reverse currents is formed.

The current limiting resistor, of 7.5 to 60 ohms, functions also as a fuse, in that it will blow open if excessive current is drawn through the rectifiers. Therefore, if a short circuit occurs in the chassis, the resistor or fuse should open up before damage occurs to the rectifiers. The resistor also protects the set under high line voltage conditions.

The size of the filter condenser must be limited so that peak voltages will not draw electrons from the capacitor too rapidly, or the selenium will be damaged. During the initial period these capacitors are subject to severe reverse currents, possibly causing overheating of the condenser.

In full wave voltage doubler circuits, each of the condensers charge to the a-c line voltage peak alternately while the other condenser is discharging through the load circuit.

To simplify circuit analysis, and because of their similarity in purpose, a selenium rectifier may be considered as a vacuum diode, in that it may be thought of as having a cathode and an anode (plate), the same as a diode.

As with a diode, electrons flow from the cathode to the anode in a selenium cell. On the schematic symbol, the

[Continued on page 60]

Rauland—the Original

LOW FOCUS VOLTAGE ELECTROSTATIC TUBE

**Perfected in Rauland Electronics Laboratories,
this tube that gives edge-to-edge sharpness of focus
without coils and magnets is proved and ready
as the materials pinch becomes painful**

BETTER in all ways! Gives better over-all focus—hair-line sharpness from edge-to-edge—with NO critical materials for focusing . . . and **STAYS SHARP** under considerable variation in line voltages.

REQUIRES NO re-engineering of present television chassis . . . NO added high voltage focus circuit . . . NO added receiver tubes . . . NO additional components except an inexpensive potentiometer or resistor.

FOCUSES by using D.C. voltage already available in the receiver.

ELIMINATES focusing coils and magnets . . . saves critically scarce copper and cobalt.

• • •

This new Rauland development is now available in substantial quantities in 17 and 20 inch rectangular tubes. For further information, address . . .

THE RAULAND CORPORATION



Perfection Through Research

4245 N. KNOX AVENUE • CHICAGO 41, ILLINOIS



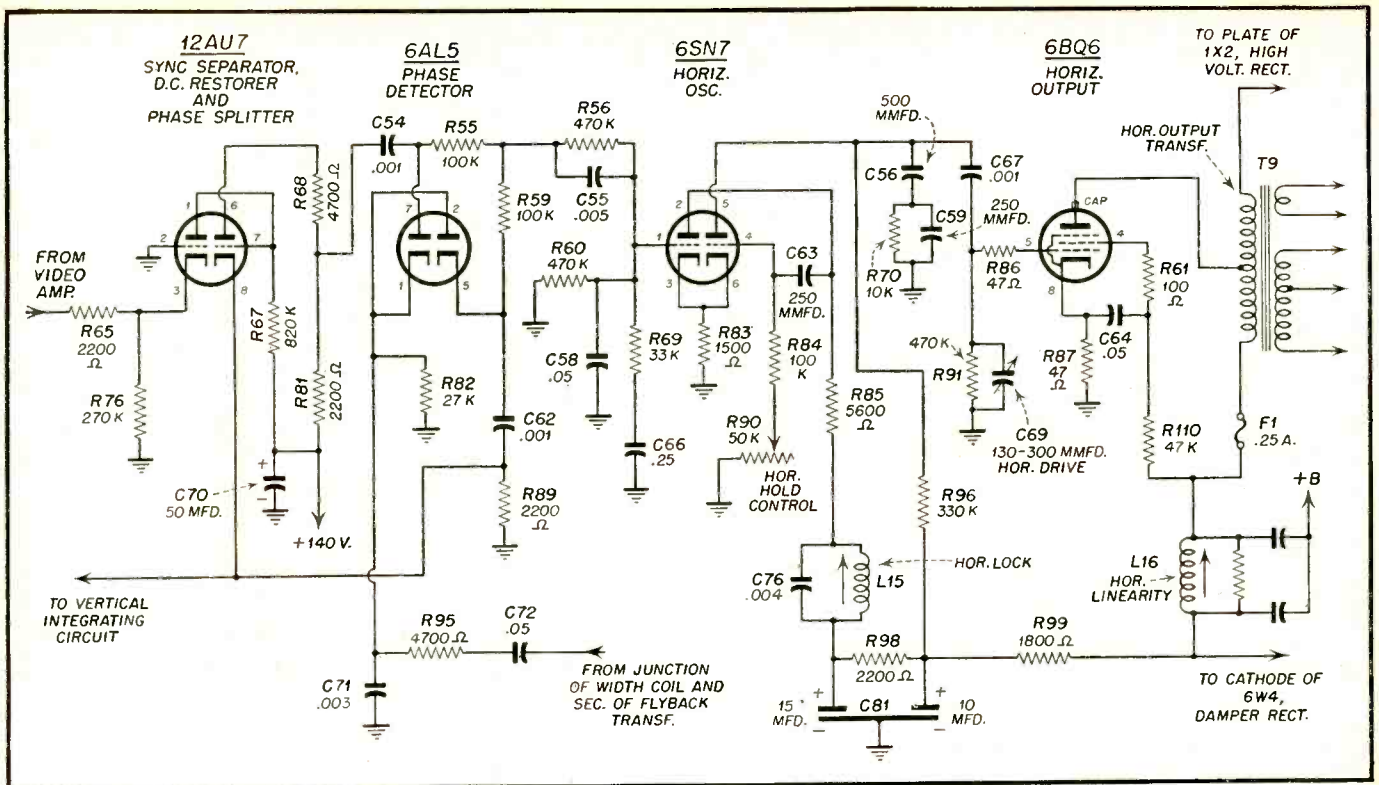

Fig. 1. Sentinel Model 412, phase detector and horizontal sweep circuits.

A defective receiver is on the bench for servicing. Join in the search for trouble by answering the questions in this TV trouble-shooting quiz. Answer each question before going on to the next one, since the following question usually contains the answer to the question before. Some questions may have more than one correct answer. If so, indicate all correct choices. Answers and discussion follow directly.

Receiver: Sentinel, Model 412; a-c, transformer type low voltage supply; kickback high voltage system; inter-carrier sound.

Trouble: Pix is out of sync horizontally, but is steady vertically. Sound is o.k. and picture information seems normal.

1. Loss of horizontal sync indicates that trouble may be present in the following circuit(s):

- (a) Front end or video strip
- (b) Horizontal a-f-c (automatic frequency control) circuit
- (c) Horizontal sweep circuit
- (d) CRT
- (e) Sync section

2. To narrow down the possibilities where the trouble might be found, various controls are rotated to check the effect on the picture. The horizontal hold control is unable to stop the picture at any setting. Varying the control has some effect in changing the number of slanting black lines—horizontal blanking bars—in the pic-

ture. Turning the contrast control varies the picture information. Although the pix is broken up horizontally, it is possible to see the areas of light and shade vary normally as the control is rotated. The setting of the control has no effect on stopping the pix horizontally.

The brightness control varies the intensity normally and complete counter-clockwise rotation blanks out the screen.

The vertical hold control is rotated through its range. On one side of the center, the vertical blanking bars can

be seen moving down the screen. For some additional angle of rotation, the picture syncs vertically and remains in vertical sync. As the vertical control is rotated still further, the picture goes out of vertical sync in the opposite direction. The picture, of course, continues to remain out of horizontal sync during this check.

The channel selector and fine tuning controls are checked. Fine tuning has the usual effect in tuning in the sound and picture but does not affect the horizontal sync. This is true on all channels.

LOOKING for TROUBLE?

No. 8

by Cyrus Glickstein

(Instructor, American Radio Institute)

On the basis of the information produced by the manipulation of the controls, trouble is indicated in the following circuits (s):

- (a) Front end or video strip
- (b) Horizontal a-f-c circuit
- (c) Horizontal sweep circuit
- (d) CRT
- (e) Sync section

3. The defect appears to be either in the horizontal a-f-c or horizontal sweep circuits. The following tubes are changed, *Fig. 1*: 12AU7, sync separator and phase splitter; 6AL5, phase detector; 6SN7, horizontal oscillator; 6BQ6, horizontal output; and 6W4, damper. No improvement is noted.

To narrow down the defect to either the horizontal sweep or the horizontal a-f-c (phase detector) circuits, the following check can be made:

- (a) Take voltage readings around the phase detector and horizontal oscillator stages.
- (b) Take resistance readings around the phase detector and horizontal oscillator stages
- (c) Use a scope for signal tracing around the phase detector and horizontal oscillator stages
- (d) Check the alignment of the horizontal oscillator by varying the horizontal lock control
- (e) Feed sync pulses directly to the horizontal oscillator

4. With the horizontal hold left in the center of rotation, the horizontal lock control, *L-15*, in the plate circuit of the horizontal oscillator (*Fig. 1*), is varied and the picture pulls into horizontal sync. However, the pix jitters horizontally and will not become steady at any setting of the lock control. Varying the lock control to any extent on either side of this setting causes the picture to lose horizontal sync completely.

The horizontal lock is left in the best position and the horizontal hold control is varied. The hold control is very critical and a slight rotation on either side causes a complete loss of sync. It is noted that a) when the horizontal controls—hold and lock—are varied, they are able to change the frequency of the horizontal oscillator, and b) although the picture now jitters horizontally, it has the correct horizontal frequency since there is just one picture which is not broken up horizontally. The horizontal linearity of the pix is normal and no other type of horizontal distortion is noticeable. This indicates the horizontal saw-tooth waveshape is normal. On

| SOUND | PIX INFO | LOSS OF SYNC | SECTION IN WHICH TROUBLE MOST LIKELY IS LOCATED | NOTES |
|-------------------------------|--|------------------------------------|---|---|
| o. k. | very black | v or h or both | video strip (video i-f, video amp., a. g. c., etc.) | too much signal. Check operation and setting of contrast control; also a. g. c. control, if any |
| " | normal | v and h | sync section (possibly in video strip) | both hold controls not operating normally. (check for field blanking pulses in pix - see RTSD, Look. for Trouble, Dec. '51) |
| " | " | v | integrating ckt or vert. osc. | hor. hold operating normally - vert. hold not working. |
| " | " | h | hor. a-f-c or hor. sweep ckt. | vert. hold operating normally. Hor. hold not working. |
| " | normal or weak | v or h or both | CRT - cath-grid short | brightness control cannot blank out screen at any position. |
| " | weak | v or h or both | antenna or video strip | a) break in one antenna line may give good sound, poor pix on some channels. b) defect in video strip can cause low amplitude video signals & sync pulses. |
| weak | weak | v or h or both | front end, antenna | weak sound and video signals, resulting in poor sync |
| o. k. or noisy when pix jumps | jumpy or tears. Ignition type interference may show on screen intermittently | intermittent loss of v &/or h sync | sparking in high voltage | |

the basis of this information, it is reasonable to assume that the horizontal oscillator is running at the correct frequency and producing a normal waveshape but is not being synchronized correctly by the phase detector circuit.

Waveforms are taken around the pins of the 6AL5, phase detector stage, *Fig. 2*.

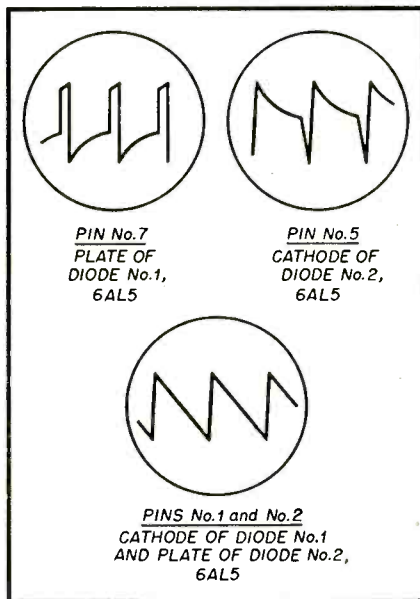

Fig. 2. Waveforms observed on oscilloscope around 6AL5, phase detector stage.

Voltage and resistance readings are taken around tube socket. There are no abnormal voltage readings. The resistance readings are:

- Cathode, pin 1, 6AL5, 29 k
- Plate, pin 7, " 1 meg
- Cathode, pin 5, " 1 meg
- Plate, pin 2, " 29 k

On the basis of the waveforms, and the voltage and resistance readings, the most likely trouble is:

- (a) *C-55* (.005 to pin 1, 6SN7, hor. osc.) open
- (b) *R-60* (470 k from pin 1, 6SN7, hor. osc.) changed values
- (c) *C-66* (.25 connected to *R-69* going to pin 1, 6SN7, hor. osc.) shorted
- (d) *C-62* (.001 to cathode, pin 5, 6AL5) open
- (e) *C-54* (.001 to pin 7, plate, 6AL5) leaky

ANSWERS AND DISCUSSION

1. a, b, c, d, e

Horizontal (and vertical) sync trouble can originate in almost any section of the television receiver. The first step in tracing the defect is close observation of the type and amount of horizontal trouble. The main types can be classified as:

- 1. Some bending at the top or elsewhere in the picture. The picture remains locked in horizontally.
- 2. Intermittent tearing while the picture is locked in most of the time.
- 3. Picture completely out of sync

horizontally and can't be locked in with the horizontal hold control. Bending and/or intermittent tearing will be considered separately in the next article in this series. Complete loss of horizontal sync may be due to a defect in a) the horizontal sweep circuit or b) one of the circuits which feeds a synchronizing signal to the horizontal oscillator. Horizontal sync pulses generally pass through all the video signal stages and the sync amplifier and clipper circuits before arriving at the horizontal a-f-c system. The phase detector then compares the phase relationship between the horizontal sync pulses and the horizontal sawtooth and supplies a correction voltage, if necessary, to the horizontal oscillator.

Loss of horizontal sync can therefore originate anywhere in the video signal circuits (front end, video strip): the sync section (sync amp. and sync clipper); the horizontal a-f-c circuit (phase detector in this receiver); the horizontal sweep circuit; and the CRT. There have been many cases where a defective CRT (cathode-to-grid short or partial short) affected the peaks of the composite video signal and deformed the sync pulses. The composite signal usually goes from the last video amplifier to both the CRT and the sync circuits.

Although there are many differences in the design of various receivers, the basic sources of sync trouble are common for most models. It is possible to obtain a great deal of information on the most likely source of trouble by noting carefully the information on the screen, the sound, and the sync symptoms. This is then supplemented by noting the effect of various controls. *Table 1* outlines the most common sources of trouble associated with various symptoms as indicated in the sound, pix, and sync condition.

2. b,c

Varying the contrast control and obtaining a normal variation of picture information indicates the video strip is operating normally from the standpoint of signal amplification. It may seem impossible to tell the pix situation when the pix is completely out of sync horizontally. However, even under such conditions, the black and white areas of the picture vary in shade as the contrast control is rotated, if the video strip is normal. A possibility to keep in mind is that even with video information apparently normal, the sync pulses may be distorted in the video strip either through limiting action or through improper frequency response in the video i-f or video amplifier stages. A check for this is the rotation of the

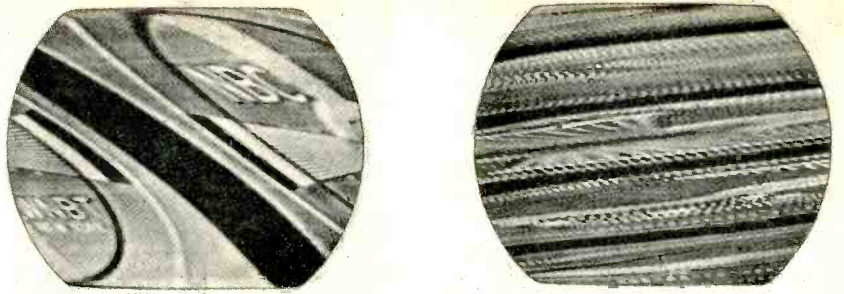

Fig. 3. The number of line blanking bars shows how close pix is to horizontal sync. Left—pix almost in sync; horizontal freq. too high. Right—pix further away from sync., hor. freq. too low.

vertical hold control. Since this control is acting normally (see *Looking for Trouble*, #7. *RTSD*, Dec. 1951), then it can be assumed that normal vertical sync pulses are coming into the vertical oscillator. It can therefore be further assumed that all of the sync pulses are passing through the video strip and the sync section without major distortion.

If the brightness control varies the brilliance normally, then the CRT can be ruled out as a source of trouble. A shorted or partially shorted cathode to grid in the CRT causes, among other things, a loss of control over brilliance. It is impossible to blank out the screen on any position of the intensity control.

On the basis of the above checks, therefore, the trouble is most likely in either the horizontal a-f-c stage or the horizontal sweep circuit.

3. d

The horizontal oscillator circuit can be responsible for the loss of horizontal sync if one or more of the frequency-determining components changes value sufficiently. If the horizontal oscillator is too far off frequency, the a-f-c circuit cannot bring it back to the correct frequency. On the other hand, the a-f-c system can cause a loss of horizontal sync by not providing the required correction voltage for the horizontal oscillator.

At this point in trouble-shooting, the next step is to find which circuit is at fault. By previous checks, it was found the horizontal hold control (*R-90*, *Fig. 1*) cannot stabilize the picture. The hold control is set at the mid position and the horizontal lock (*L-15*, plate of hor. osc., pin 2, 6SN7, *Fig. 1*) is rotated through its range. The starting position is noted so the setting can be returned to the original position if the adjustment is not successful. It is possible that the loss of sync is due merely to the aging of the tube and other components, causing

a critical change in the horizontal frequency. If this is the case, a simple adjustment of the horizontal lock control may lock in the picture and eliminate the trouble. If the lock adjustment brings the picture into sync and it holds on all channels, then a simple realignment of the horizontal oscillator is all that is necessary to correct the trouble. It should be noted that *C-69*, the horizontal drive control, has some effect on horizontal frequency as well as the usual effects on drive, linearity and brightness.

While the horizontal lock is being adjusted, the picture should be examined to see if the adjustment is bringing the pix nearer to horizontal sync. It is usually possible to tell this by the number of black diagonal lines—horizontal blanking bars—in the picture. When fewer blanking bars are seen, the picture is being brought closer to horizontal sync, *Figs. 3* and *4*. If the lock adjustment is turned and the number of blanking bars increases, the screw is being turned in the wrong direction. Simply reverse the direction of rotation. It might be noted for reference that blanking bars slanting down to the right indicate too high a horizontal frequency: When blanking bars slant down to the left, the horizontal frequency is too low.

Sometimes the picture can be brought close to horizontal sync but cannot be made to sync even when the maximum adjustment of the lock is reached. This usually indicates a) some change of value in one or more of the horizontal circuit components b) a change in the supply voltage to the horizontal oscillator or c) an abnormal voltage, either a-c or d-c — on the first grid, pin #1, of the horizontal oscillator. The first two are defects in the horizontal sweep circuit. The last is usually caused by a defect in the a-f-c circuit.

When the lock adjustment cannot

ASSOCIATION NEWS

Local, State, and National Associations are urgently requested to send in news of their activities so that we may print them in these columns.

National Alliance of TV & Electric Service Associations

It is now obvious that most TV manufacturers will continue to sell parts warranties under one scheme or another. This will deprive service companies of the sale of parts for the nine months extension period even though service must shoulder the cost of handling parts.

Thus far service has labored under the delusion that the parts warranty was a temporary thing and its abuse by manufacturers and their distributors was tolerated in the hope that the whole thing would soon end. Many attempts at solution through individual manufacturers and RTMA have failed miserably. It now behooves every service company executive to review this policy which apparently must be assumed to be a permanent change in industry practices.

Every service operator has suffered great loss through failure of distributors to fully honor their warranties, through long delays at parts counters, through the distributors failure to stock parts, through the call backs due to back orders, and above all, loss of prestige due to backing up distributors. No longer can you be blind to these costs. If distributors insist on selling parts warranties, they must also accept the responsibilities. Service, to stay financially sound, must take the added costs of handling parts warranties into account when billing customers. We, therefore, suggest that the customer be billed for the normal mark-up on any part or tube you replace and that your billing show this charge is definitely made to cover cost of obtaining replacements. Although this mark-up will not fully compensate you due to high cost of handling, the customer will at least be informed. We further advise that under no condition should *any* component be replaced under terms of war-

ranty *except* when the component, to your knowledge, will be replaced without question by the particular distributor. Unless you follow this billing procedure, the costs of handling will of necessity have to be concealed in your service charges or absorbed by you. The first alternative is dishonest, the second is business suicide. In either case, no one will mourn your passing.

Frank J. Moch, President

National Electronic Technicians & Service Dealers Associations

The February meeting of NETSDA dealt with matters of National Importance policies were formulated to handle these problems. A report was made on the progress of Radio-TV Licensing in the City of New York and in the State of Pennsylvania.

The meeting was held at Maurice's Restaurant, 211 Quince St. (rear of Forrest Theatre, 1114 Walnut St., Philadelphia, Pa.) on Sunday, February 3, 1952.

Richard G. Devaney

Empire State Federation of Electronic Technicians Associations

A meeting of the Empire State Federation of Electronic Technicians Associations (ESFETA) was held in Smith Brothers restaurant, Poughkeepsie, New York on Sunday, January 27th. Present were delegates and guests from seven associations of New York State. Several excellent suggestions regarding methods of increasing interest of servicemen in existing associations and in forming new associations within the State were made. Exchange of ideas was urged and invitations extended to the secretaries of all the associations within the state and of federations of other states to write to Mr. Ed. Fisk, 234 Knickerbocker Avenue, Rochester, New York. Sec'y of ESFETA for further exchange of ideas relating to

a more closely knit and active fraternity of electronic technicians. The next annual meeting will be held in the Hotel Arlington, Binghamton, April 27th.

Federation Of Radio Servicemen's Association Of Penna.

Federation monthly meeting was held in Steelton, Pa. with the Mid-State Radio Servicemen's Association under the guidance of its newly elected President, George Hardy, who was host to the delegations from our many Chapters. This meeting was considered by the body as one of the most important meetings in the existence of the Federation. The meeting which started at 1 P.M. lasted long into the evening. Many important issues were decided on, among them were the following:

1. The final vote on the recipient of the Federation's annual plaque was announced by the committee after three months of voting at all Chapters.
2. Arrangements were made for the presentation of the plaque to be held on March 16th at the Hotel Harrisburger in Harrisburg, Pa. The Federation has invited many representatives of the Electronic Manufacturing, Distributing, Broadcasting and Publishing Industries. In addition, invitations were extended to the officers of all Radio and Television Technicians and Service Dealers Associations in the surrounding states to attend this presentation.
3. The Lecture Bureau reports that the Capehart-Farnsworth technical meetings which were presented to all Chapters, were considered one of the finest service meetings held in the state for the benefit of the Chapter members. Meetings are scheduled for the following months are Howard W. Sams and Co., Inc.

[Continued on page 57]

SHOP NOTES

Write up any "tricks-of-the-trade" in radio servicing that you have discovered. We pay from \$1 to \$5 for such previously unpublished "SHOP NOTES" found acceptable. Send your data to "Shop Notes Editor."

DuMont RA 113, RA 109-113 — Various Service Hints

Symptom—Intermittent overload of pix.

Remedy—This trouble can be traced to the narrow band sync. circuit. When changing the sync tubes has no effect, check the peaking coil in the grid circuit of the sync amplifier. This coil sometimes opens up intermittently when the set is in operation a few hours. Replacement of this peaking coil (L213) cured the intermittent overload condition. Be sure to replace with manufacturers recommended coil, as this circuit is critical.

Symptom—No high voltage.

Remedy—Remove the damper tube (6W4) from its socket while set is on. If raster appears with heavy foldover lines on it, the trouble can be traced to a leaky capacitor .02 μ f which is the boost capacitor. (This is capacitor #C291 on the schematic.) Replace with a 600 volt working condenser to prevent further breakdown.

Symptom — Pix gets snowy after several hours of playing.

Remedy—If checks of all tubes in the video i-f amplifiers and components, do not reveal any defects, then open up the inputuner and check the ten thousand ohm (10K) resistor which is the plate load of the r-f amplifier (6J6). This resistor has a tendency to increase several times its normal value, in which case the amplifying properties of the 6J6 are nullified. However, the lows might be snowy, but the highs might come through with fairly good signal strength, due to the h-f signal being coupled through the capacity of the tube and the stray wiring capacity of the circuit.

Symptom — Flashes on Screen, (similar to ignition noise).

Remedy — Sometimes the coupling condenser, which is located in the i-f can, which consists of a standard strand of wire in an insulated sleeve internally shorts to ground. Replace this coupling with a 1.5 μ f condenser, keeping leads as short as possible.

Symptom—No high voltage, RA111.

Remedy—After checking all components in output (6BQ6) circuit and it seems normal, disconnect the lead on pin 1 of flyback, then check to see if B plus is present on pin 1. If B plus is present replace the flyback since a short between primary and secondary of transformer is indicated.

Submitted by:
J. T. Smith
Bronx, N. Y.

6S8GT Substitution

In the Emerson TM - 655 B series, the 6S8GT tube is becoming hard to replace. Also we found that this tube did not stand up well. Here is the procedure we have taken to replace the 6S8 tube with a 6SQ7GT and a 1N35 GE Diode. See Fig. 1.

Remove 110 μ f cond., 68K resistor, 100K resistor from pin 5, bring these to one tie point. Remove connection from disc. coil to pin 3, remove ground (common) lead from pin 2 and rewire to pin 3. Connect a 1N35 G.E. diode cathode to tie point of 110 μ f, 68K and 100K resistor, con-

nect plate side to disc. coil secondary originally going to pin 3. Remove lead from pin 1 and rewire to pin 5. Splice shielded grid wire and connect hot side to pin 2; connect shield to pin 3. Realign discriminator coil in normal procedure.

Submitted by
Joseph F. Valenti
Webster Radio-Television
Bronx, N. Y.

Barkhausen Oscillation

Many cases of what appears to be Barkhausen Oscillation on 16" through 20" TV sets can be either eliminated or minimized by careful positioning of the antenna lead in wire away from the neck of the "kine" and away from any a-c line cords going to boosters or sets.

It is also wise to demonstrate the effect of moving the ant lead in around to your customer so that he can see the actual effect on the Barkhausen oscillation lines. Then if any cleaning is done in the rear of the set no "call back" will result.

Of course in the real stubborn cases the usual magnet on the horizontal output tube may be necessary.

Submitted by:
Robt Snow
Milford, Conn.

Philco Auto Radio Model PD4908 or Mopar Model No. 803

Replacing on-off switch.

These switches are not on a shaft, but operate with push button. Switch is mounted exactly as an FP condenser, with tabs through slots on a

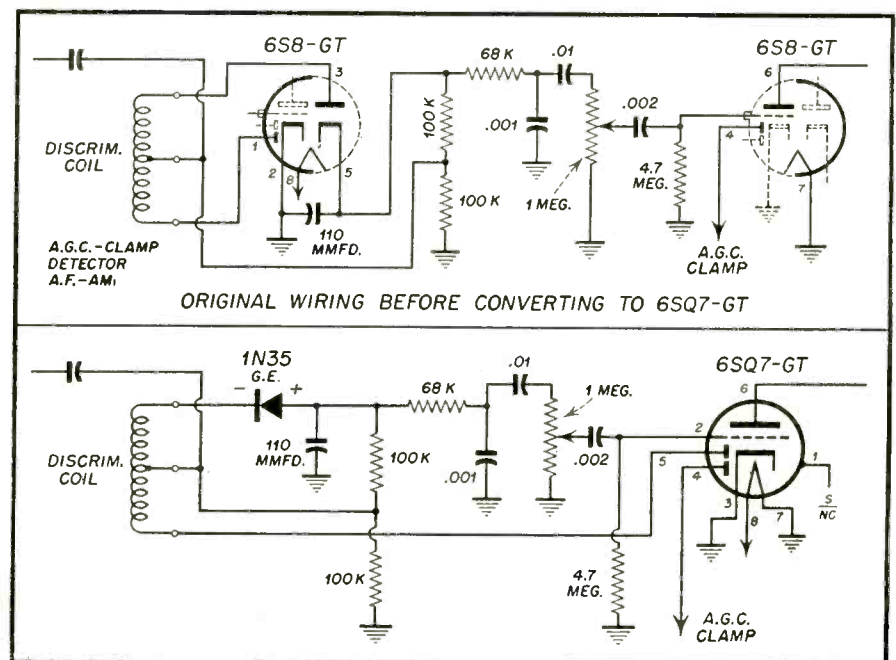

Fig. 1. Converting from 6S8GT to 6SQ7 and 1N35.

metal plate, and bent over on under side. Impossible to get at them without much and very careful dis-assembling of delicate parts.

Studying the problem, to avoid not necessary work, I decided to very carefully, with proper tool, attempt to pry up the switch, thus straighten out the holding tabs. It worked. After we had unsoldered the wires from the four switch terminals. The new switch was set into the clean slots, and three neat spots of solder hold it to the mounting plate. Removal, if again necessary, will be easy. No damage to any part, and Oh! the time and labor we saved.

*John Kadletz
Chatfield, Minn.*

Cadillac Model 7258865 Car Radio

Trouble may be found in Cadillac Model 7258865 or other G.M. sets using their signal seeking tuner. These sets will occasionally get so they will only stop at one place, approximately 550 kc. If replacing 12AU7 trigger tube and checking alignment does not correct this condition, the 2nd i-f transformer is defective (Pt #1219-602). It is very difficult to check this transformer. Replacement is the cure.

*Submitted by:
Kenneth Futrell,
Muncie, Ind.*

Rheostat Varies Line Voltage

Many technicians have found the advantages of being able to vary the line voltage when working on electronic devices.

If you have \$8.00 or \$10.00 for a special transformer (more with a built-in meter) fine, if not, this device does the same job, does it better; and costs \$1.00 or less.

My main use is checking for cutouts on portable or a-c/d-c radios with weak converter tubes due to low line voltages. Also with battery eliminators

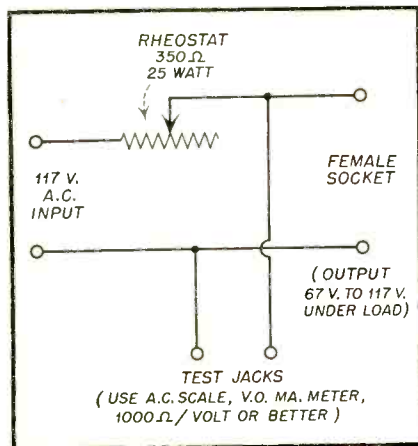

Fig. 2. Connecting up rheostat to vary line voltage.

to find weak or sticky vibrators in auto radios.

Get a small metal box, 350 ohms -25 watt rheostat, knobs, 2 insulated test jacks, female socket, a-c lead and plug. Assemble as per diagram. Hook up your V.O. Ma meter to test jacks. Switch to a-c scale and you are set to work.

*Submitted by
C. F. Elgassei Jr.
San Diego, Calif.*

Admiral 20T1, 20V1, 3C1 — Focus Adjustment in Sets Having a PM

Focus Assembly

To adjust the focus, set the PICTURE control for normal picture and the BRIGHTNESS control at slightly above average brightness.

Slight rotation in either direction of the "Focus Adjustment" (see Fig. 3) should generally bring the picture into focus. An ordinary screwdriver can be used in sets having a brass adjustment slug; a non-magnetic screwdriver is preferable for sets having a steel adjustment slug. If the picture was greatly off focus, readjust the ion trap as instructed in Service Manual No. S338.

Admiral 20T1, 20V1, 3C1 — Picture Centering in Sets Having a PM

Focus Assembly

If the picture is off center, it can be centered by using the picture positioning lever, and when necessary, repositioning the PM focus assembly around the picture tube neck. Follow the instructions given below.

Centering the Picture

- Adjust ion trap as instructed on page 5 of Service Manual No. S338.
- Center the picture by adjusting the picture positioning lever. Note that the picture positioning lever can be moved sideways, and up and down. It may be necessary to reduce picture height and width to determine correct centering unless a test pattern is used.
- Readjust the ion trap and check focus adjustment.

Difficulty in Centering the Picture

- Adjust ion trap as instructed on page 5 of Service Manual No. S338.
- Slightly loosen the two screws which mount the PM focus assembly to the yoke bracket. Facing the back of the chassis, move the PM focus assembly fully to the left while rotating it counter-clockwise (to the left) as far as possible; then tighten the two mounting screws.
- Center the picture with the picture positioning lever. If the pic-

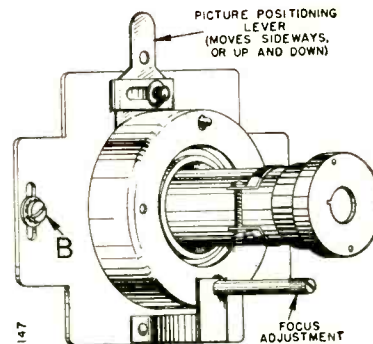
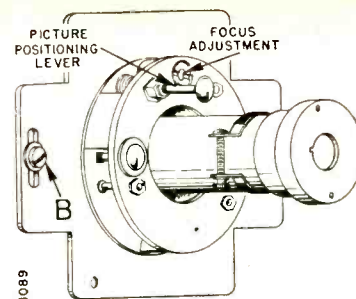

Fig. 3. Focus adjustment and centering Admiral 20T1 and 20V1.

ture cannot be centered with the lever, it may be necessary to repeat step "b", this time setting the focus assembly in another position and then centering the picture with the picture positioning lever.

- Readjust the ion trap and check focus adjustment.

Admiral Service Dept.

Saving Fuses

After blowing a couple of pigtail fuses in trouble shooting a troublesome HV circuit, I used the following kink.

I connected a pilot lamp, blue lead, to a pair of leads with alligator clips on the leads.

This was then bridged across the fuse, thus when power was turned on, it could be seen the short still existed. However, the power could be killed before any damage to the bulb resulted.

Using this kink the circuit is still protected and a lot of trouble is saved.

*John H. Cook
Narragansett, R. I.*

Trav-ler TV, Model A-16-T

No vertical or horizontal sync

After all components had been checked the trouble was found to be a hot short between cathode and grid of picture tube. Sync is taken off plate of d-c restorer. The short caused full video to be fed into sync separator.

*Don Shapiro
Akron, Ohio*

TRADE LITERATURE

The 16th edition of *Radios' Master, Official Buying Guide of the Radio—Electronic—Television Parts and Equipment Industry* is now available through local Radio Parts Distributors **ONLY** at the special price of \$1.95.

In this 1951-52 edition (which regularly sells at the publishers' price of \$6.50) 90% of the parts and equipment manufacturers catalog their products. Prices are at list, with confidential code for those entitled to trade discounts.

Over 7000 illustrations, with detailed descriptions and specifications for approximately 75,000 items are included in this permanently bound volume. Hard covers measure 8 $\frac{3}{4}$ x 10 $\frac{3}{4}$. Shipping weight 5 lbs.

For further details write: United Catalog Publishers, 110 Lafayette Street, New York 13, New York.

* * *

Rider *Tek-File*, the monthly packaged service data of *John F. Rider Publisher, Inc.* 480 Canal St., New York 13, N. Y., now lists 32 different TV TEK-FILE Packs. The latest releases, Packs 17 through 32, are now being shipped to the organization's distributors.

The publishing organization has in production 16 new Packs of television servicing data containing information on current receivers, including those in the 1952 lines, and data for receivers produced during the past few years. The new Packs contain complete manufacturers' data on 734 models not previously published in TEK-FILE form. This brings the total TV coverage to 1974 models in 48 Packs. Rider distributors will receive Packs 33 through 48 the latter part of February.

* * *

A new plastic *Ohm's Law Calculator* has just been announced by Ohmite Manufacturing Company, Chicago, manufacturers of electrical rheostats, resistors, and tap switches.

The new plastic calculator is identical to the popular, varnished cardboard calculator, of which nearly three-quarters of a million have been distributed, except that it is made of durable, dimensionally stable vinylite. It answers the demand for a deluxe calculator of greater durability and longer life.

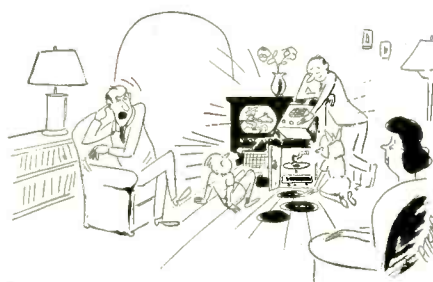

"Before we bought this Combination Radio, Television and Record Player, why didn't you tell me they'd always insist on playing all three at once?"

Price of the new plastic Ohmite Ohm's Law Calculator is \$1.50 net. The varnished cardboard calculator is priced at 25c. Both are available through Ohmite jobbers, or directly from *Ohmite Manufacturing Company*, 4937 W. Flournoy Street, Chicago 44, Illinois.

* * *

Containing a wealth of concise and practical technical data, the "*Technilog*", a new 28 page general catalog announced by University Loudspeakers, Inc. will be of special value to everyone interested in public address and high fidelity equipment.

Both product and application data are presented in simple to understand language and in such manner as to provide the answer to most problems confronting the sound technician and custom installer. Scores of curves, tables, charts, typical circuitry and practical discussions on such subjects as overload protection of loudspeakers, impedance matching, speaker baffles, phasing, reverberation, etc., are included.

Easy to file, this important new reference book may be obtained through most radio distributors, or by writing to the factory at 80 South Kensico Avenue, White Plains, New York.

* * *

The Recording and Reproduction of Sound, by *Oliver Read*, 2nd expanded edition, 800 pp. Published by *Howard W. Sams & Co., Inc.*, Indianapolis 5, Indiana. Price \$7.95.

With the growing interest in matters pertaining to Audio, the recording and reproduction of sound as well as sound distribution, Servicemen and Service Dealers could find this book a great help as a complete reference on all phases of Audio Problems pre-

sented to servicemen and Service Dealers by the ever increasing number of purchasers of quality equipment could be solved by reference to this substantial volume. It presents the subject and equipments in clear and understandable language. The treatment of Sound from the fundamental History, through basic recording and reproduction as well as handbook type of information should provide the right answers to queries likely to be presented to the Servicing Fraternity in increasing numbers. A timely publication, fulfilling a need for today and many tomorrows.

* * *

Complete specifications for solderless cable connectors are given on a new *catalog sheet* prepared by *The Workshop Associates*, Division of The Gabriel Company.

Describing the models W-50, W-60, W-80 and W-100 for RG-8/U, RG-11/U and RG-59/U cable, the sheet gives dimensions and electrical characteristics. A free copy, Form WA 54-164, may be secured from The Workshop Associates, Division of The Gabriel Company, 135 Crescent Road, Needham, Mass., or from radio parts distributors.

* * *

In answer to many inquiries by people outside the electronic industry, particularly in government circles, as to *What Constitutes An Electronic Parts Wholesaler*, *National Electronic Distributors Association* has prepared a four-page brochure outlining the basic structure and functions of electronic parts distributors.

Covered in the pamphlet are sources of supply, material handled, customers served, type of employees, services rendered, status of electronic parts distributor and functions in wartime.

* * *

The teleset service control department, *Allen B. Du Mont Laboratories, Inc.*, has published a 115 page manual titled, "*Service Operations of the Du Mont Distributor*", it was made known yesterday. The manual, most complete of its kind yet offered in the television industry, covers every facet of distributor service activities.

In announcing the availability of this volume to Du Mont distributors,

[Continued on page 54]

NEW DEVELOPMENTS

Third Dimension Hearing

The Permoflux Corporation, a leading manufacturer of electronic components, announce the availability of a Binaural (third dimension hearing) Headset.

Binaural recording and reproduction of sound (also referred to as stereophonic or third dimension) is the latest and possibly the most important step ever taken in the search for complete realism in reproduced sound. Stereophonic reproduction is not actually new to the audio art. It was first demonstrated by the Bell Telephone Laboratories as early as 1933, but due to technical difficulties, it was not developed to any extent until the arrival of tape. This highly versatile recording medium made binaural reproduction commercially feasible and accounts for its sudden spurt to a position of prominence in the audio field.

The theory of binaural sound is quite simple: For many years it has been known that the slightly different length of the paths taken by a sound travelling from its source to each of our ears accounts for our ability to determine the direction and distance of the sound. If we cannot sense the location of the sound, it does not seem natural to us. In an artificial "hearing system", such as the conventional monaural recorder, only one microphone channel or "ear" is used and the sense of sound location is lost, thereby robbing the sound of its naturalness.

To overcome this defect, audio engineers took the obvious approach. They used two microphones spaced about eight inches apart, just as the human ears are. (See diagram.) Each microphone, of course, receives the same intelligence that the individual ears of a human listener would pick up. The extreme versatility of present day recording tape makes it possible to record the output of each of these mikes simultaneously, but separately. Standard quarter-inch recording tape is used and the output of each mike occupies one-half of the width of the tape and remains completely isolated from the other half.

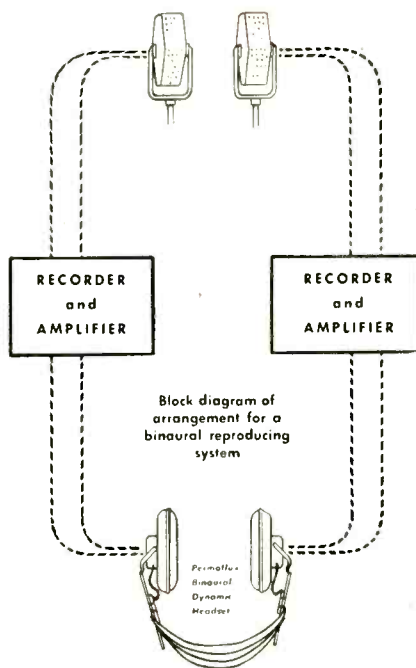

These two sound channels when played back through separate amplifiers and separate earphones, bring the sound to the listener just as he would have heard it had he been present at the recording scene. Effectively, the listener's ears are transported by means of the recording play-back system to the position occupied by the two microphones.

Just as stereophonic photography makes each element of the picture stand out in proper relationship to the surrounding elements, so does the binaural system allow each instrument in an orchestra to be heard in its proper relationship to the other instruments. In a sense, it photographs a three-dimensional sound picture.

Reproduction of stereophonic sound is possible with two properly balanced loudspeakers in an acoustically treated room, but to get the full benefit of the binaural effect, headphones such as the Permoflux BDHS-17B should be used. Listening to the binaural recording through headphones gives a sense of realism that is startling. The first impression is that the sound is not being heard from the earphones at all, and the listener has the urge to look around the room for the source.

Raytheon Develops Miniature Transmitter-Receiver

The Armed Forces are far ahead of the marvel of the comics!

The lightest and most compact hand radio transmitter-receiver ever developed—smaller than a loaf of bread—was shown publicly recently by Raytheon Manufacturing Co., Waltham, Mass., during a plant tour arranged for members of the press. Largely developed by Raytheon with the Signal Corps Engineering Laboratories in 1948, the new equipment was the first communications equipment to utilize tiny subminiature tubes on a mass production basis. It is a complete one-package transmitter, receiver, battery power-source and antenna, designed for a specific, highly essential purpose: to link front-line troops with other men and other units.

There were "handie-talkies" in World War II, of course, but the new model demonstrated—officially designated the AN/PRC-6—has a number of outstanding advantages over its predecessor. With most of its metal parts built of magnesium and aluminum, the unit weighs but 6½ pounds, including a 3½-pound battery—only half as heavy as the former 11-pound model. The tiny set can be held comfortably in the palm of one hand when it is taken out of its case. It uses FM and can be adjusted in the field to any one of 44 frequencies. It can be used over distances greater than the World War II model. In the roughest terrain it can operate effectively up to one mile, and has a normal range of one to three miles, depending on terrain conditions. The old handie-talkies, Raytheon engineers pointed out, had a reliable range of less than one mile.

The unit is rugged enough to withstand submersion indefinitely in water as deep as three feet, and to operate in temperatures from minus 40 degrees Fahrenheit to plus 131 degrees. During today's demonstration at Raytheon's Special Products plant at Brighton, in suburban Boston, sets were actually plunged into a tank of water to demonstrate their resistance to submersion, and later placed in a huge refrigerator where they underwent extreme low temperature tests.

The subminiature tubes used in the equipment are produced by Raytheon at its Receiving Tube Division plants located at Newton and Quincy, Mass. These tubes, which made possible the development and production of the new hand communications unit, are so tiny that operators must use microscopes in assembling them, it was revealed.

CIRCUIT COURT

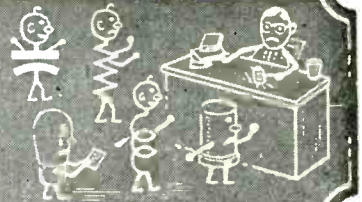

Motorola Model No. 19 F 1

In this model, (Fig. 1) we find an interesting video output circuit. By the use of *V9*, this circuit accomplishes three objectives:

1. d-c restoration.
2. permits the use of a contrast control in the last video stage.
3. permits variation of contrast control without affecting stage gain.

The reasons that the last two observations are worthy of comment are: that by inserting the contrast control in the last stage video response non-linearity can be compensated for irrespective of contrast setting. The previous video amplifiers can be designed so that noise pulses can be clipped by grid cut-off or plate saturation operation. The slight distortion resulting from these two operations can then be corrected in *V9*.

The reason the contrast control is usually in one of the low level stages is due to the fact that the amplifier tube is usually mounted close to the rear of the chassis and the control is on the front panel. As a result, the lead from the control to the amplifier is "hot". If it is connected to a high level stage, there would be considerable "spraying" of the horizontal and vertical sync pulses. This would result in pix and sound disturbances. The explanation of the circuit which will shortly follow describes how this difficulty is overcome.

The second design consideration of note is the fact that variations of the contrast does not change the operating conditions of *V9*. In the usual contrast control arrangement, the control acts to vary the tube plate current by changing either the cathode bias resistor value or the screen $B+$. This change causes the linearity of the tube response to vary. The result is that in order not to ruin the picture resolution over the entire range of the contrast control, the designer compromises his response curve. In this circuit, the only thing that the contrast control arm does is to vary the amount of signal taken off *R1*. This does not change any of the tube's operating characteristics.

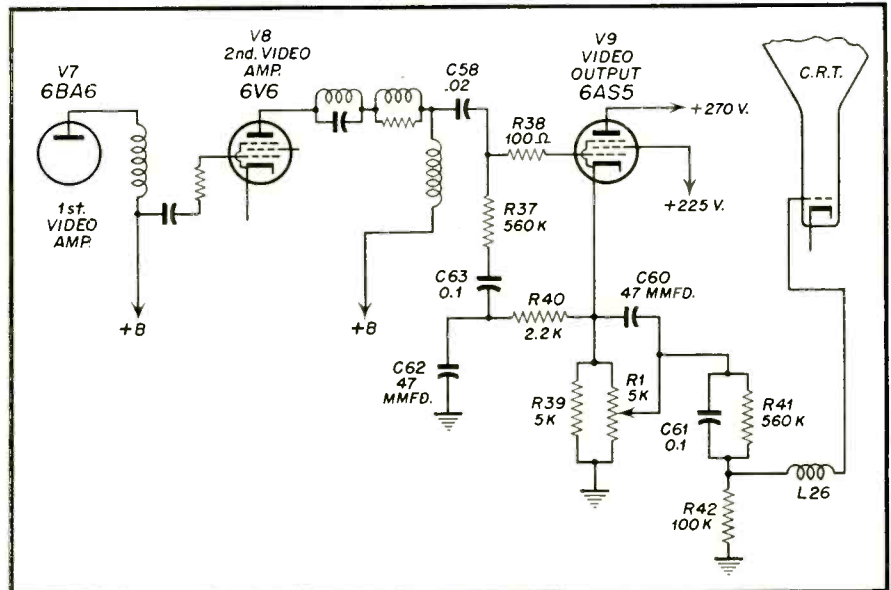

Fig. 1. Partial schematic of Motorola 19F1 output circuit.

Now, let us analyse the operation of the circuit. Since *V9* is a cathode follower, there is a loss in gain. Therefore, prior to it, we have two video amplifier stages, *V7* and *V8*. The signal from *V8* is quite substantial with

a maximum swing of approximately 90 v. peak-to-peak, appearing across *C58*. By means of *R37*, *C63*, *C62* and *R40*, the bias between cathode and grid of *V9* is established. This bias also performs the function of d-c restoration. The reason for this is that the long RC time of *R37*—*C63* attenuates the blanking and sync pulses across the voltage divider *R37*, *C63*, *C62*. However, the high frequency component (video signal) develops most of its drop across *C62*. Since *C62* discharges through *R40*, the bias between cathode and grid is determined by *C62* and will vary with the pix information level which is what a d-c restorer does.

The signal is fed to the grid of *V9* and causes the current across *R1*—*R39* to vary at the picture rate. Thus, the video signal appears across *R1* and the position of the arm of the control determines the amplitude of the picture signal to be taken off and fed to the grid of the CRT. The reason that the position of the arm does not cause the tube operating conditions to change is that it goes to ground through *R41* and *R42*. The value of these two resistors is so high in comparison to the part of *R1* which is going to ground that they have little shunting effect on it.

[Continued on page 54]

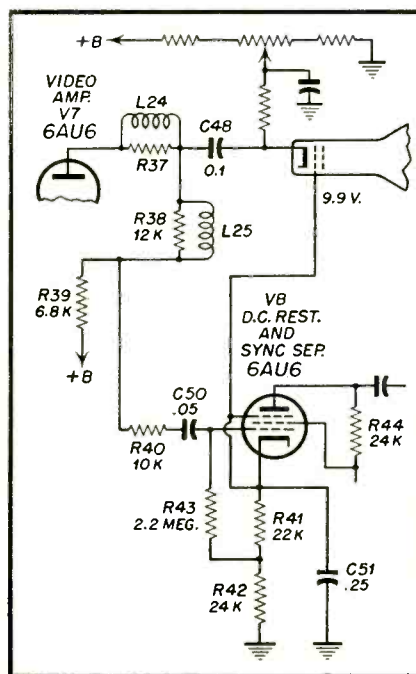

Fig. 2. Shunt capacitance of shielded lead in cathode circuit has little effect.

PERSONNEL NOTES

• • •

Nicholas DeFalco has been appointed manager of the receiver quality control department of Allen B. Du Mont Laboratories, Inc., it was announced by Stanley F. Patten, Vice-President.

Sylvania Electric Products Inc. has set up a new executive department to supervise the planning of plant expansion and has placed Vice President *C. A. Haines* in charge as director of Facilities Planning, it was announced by H. W. Zimmer, Executive Vice President. *Matthew D. Burns* has been appointed General Manager of the Radio Tube Division of Sylvania Electric Products Inc.

From the Home Instrument Department of RCA we hear that *Raymond W. Saxon*, formerly staff assistant to J. B. Elliott, vice president in charge of consumer products, has been appointed general sales manager of the department. *Allan B. Mills*, former sales manager, assumes the post of manager of the merchandising division of the Home Instrument Department, in which he will be responsible for the coordination of sales and styling and for the analysis of consumer trends. In addition, a new product development division was created, with *H. M. Rundle* as manager. Mr. Rundle, who was formerly manager of the merchandising division, will be responsible for general product development and styling.

Hugh P. McTeigue, manager of training for the RCA Service Company for the past three and a half years, has been appointed to direct the company's accelerated military electronics training program, it was announced today by P. B. Reed, vice president in charge of the company's Government Service Division.

Recognizing the growing importance of the West Coast area as a market for electronic equipment and electron tubes, the equipment sales section of the RCA Tube Department announced the assignment of *D. R. Yoder*, a veteran of RCA engineering and sales activities, to its Los Angeles



"Notice too, sir, how the giant 140 square inch screen unfolds, with unmatched brilliance and clarity, all the many wonders of television"

office to augment its West Coast field sales force.

Hugo Sundberg, vice-president and general manager of Oxford Electric Corporation, Chicago speaker manufacturer, will personally direct future sales policies in addition to his other executive duties.

Walter J. Fitzpatrick has been appointed central regional sales manager for General Electric replacement tubes, *Gordon E. Burns*, field sales manager of replacement tubes for the C-E Tube Department announced.

Irving G. Rosenberg has been appointed Director of Operations, responsible for Allen B. Du Mont Laboratories, Inc.'s television receiver and cathode-ray tube divisions, it was announced by Dr. Allen B. Du Mont, president. *Fritz P. Rice* has been named manager of the cathode-ray tube division, of Allen B. Du Mont Laboratories, Inc., it was announced by Irving G. Rosenberg, Director of Operations. *Kenneth A. Hoagland* has been appointed assistant engineering manager of the Cathode-ray Tube Division.

Irwin Weinstein, has joined the staff of Electronic Devices, Inc., as assistant sales manager. Mr. Weinstein has actively engaged in the design and sales of many types of rectifiers used both in commercial production and governmental work.

Mr. Harry R. Ashley, President of Electronic Instrument Co., Inc., released the news of the appointment of

Jack Brown as the authorized Sales Representative for the territory of Upper New York State.

Steven E. Lasewicz has recently been appointed Production Manager of The LaPointe Plascomold Corporation, it was announced by M. M. Hancock, General Manager. *Thomas Lamont* has been appointed Assistant Publicity Director of The LaPointe Plascomold Corporation, it was announced by Jerome E. Respass, VEE-D-X President. His duties will also include advertising and public relations work.

Charles P. Cushway, formerly executive vice-president of Webster-Chicago Corp., has joined Crescent Industries, Inc. of Chicago as vice-president and chairman of the advisory board, it was announced recently.

Richard F. Dooley, vice president of Admiral Corp. will retire February 15 after serving the company since its founding in 1934, *Ross D. Siragusa*, president and board chairman, announced recently. Dooley will continue as a director and will be called on for counsel as the need arises, he said. The retiring executive has been with Admiral since its organization with a capital of \$3400 in the depth of the depression. His association with Siragusa dates back to World War I years when they were classmates in grammar school in Chicago.

Henry C. Roemer, executive vice president of Federal Telephone and Radio Corporation, Clifton, N. J., since September 1950, has been elected president of that manufacturing associate of the International Telephone and Telegraph Corporation, it was announced.

The appointment of *Paul Gaynor* as Vice-President in Charge of Merchandising of CBS-Columbia Inc., effective February 1st, 1952 was announced by Mr. David H. Cogan, President of the firm.

Also announced was the appointment of *Albert Axelrod* as Senior Engineer in the Advanced Development Laboratories.

← there's something missing here



but the **RADIART ANTENNA LINE** has **EVERYTHING**

From conicals to yagis . . . from indoor "rabbit-ears" to hi-los and strate-lines — RADIART has everything **good** to be had in antennas! There's nothing missing in your antenna "picture" when you handle RADIART because there is a type and model for every need . . . quality engineered for peak performance . . . and made to outlast them all! **GET RADIART** — because it means you've got the best!

AND . . . don't forget our quality antenna accessories . . . like the "hottest" lightning arrestor on the market . . . the "SPEE-DEE" chimney mount . . . and our famous TELE-ROTORS!

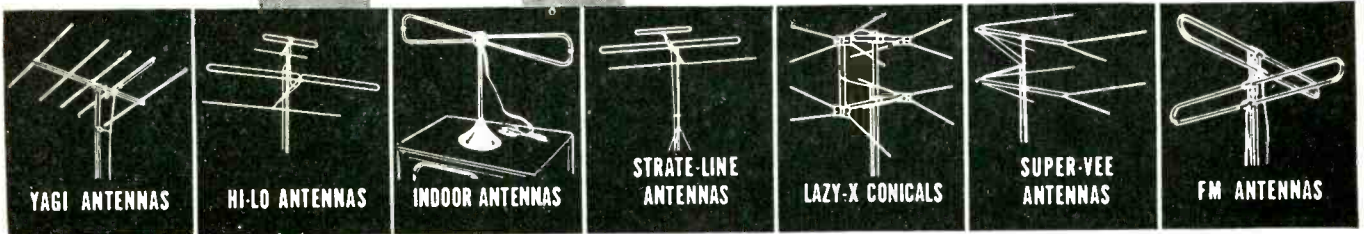

SUBSIDIARY OF



THE RADIART CORPORATION CLEVELAND 13, OHIO

VIBRATORS • AUTO AERIALS • TV ANTENNAS • ROTATORS • POWER SUPPLIES

NEW PRODUCTS

HYTRON TYPE 17QP4

The Hytron type 17QP4 is a 17" rectangular, all-glass, picture tube incorporating a cylindrically shaped face plate designed to eliminate annoying specular reflection.

In addition to this outstanding feature, the tube is magnetically focussed and deflected and, also, incorporates the following features:

1. Single ion-trap gun design.
2. Neutral density face plate for better contrast.
3. External conductive coating for increased anode supply filtration and radiation shielding.

For further technical information, write Hytron Radio & Electronics Co., Salem, Mass.

PICKUP CARTRIDGES

A revolutionary new design principle for turnover pickup cartridges has been developed by engineers of The Astatic Corporation, Conneaut, Ohio.

The new Astatic development called the "Twin CAC," is described as two complete cartridge assemblies, mounted back to back, on a common plate.

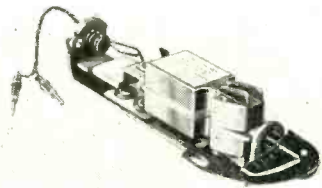

Output of the Twin CAC is 0.8 volt at 1 kc. on the Audiotone 78-1 test record and 0.7 volt on the RCA 12-5-31-V. The frequency range is 30 to 11,000 cycles.

The cartridge is furnished complete with turnover bracket and knob assembly, with standard 1/2-inch mounting holes. The wiring terminates in pin connectors which are graduated for the two dimensions now standard on lead wire connectors. It installs without soldering. The needles used are the Astatic Type Q (3 mil) and Type Q-33 (1 mil), sapphire tipped.

Two standard size pickups and one transcription pickup, the Astatic Studio Master "400", now come equipped with the new turnover cartridge. The 9-D Pickup is the new cartridge and turnover assembly mounted in the V-M Style 950 Tone Arm, with replacing of the entire pickup recommended in the case of these changers, for speed and ease of replacement with negligible added cost. The new Astatic 7-CAC-D Pickup has the new cartridge, and the arm will be recognized as the curved, cast aluminum Model 7-D, in light brown Hammerlin finish.

NEW OXFORD COAXIAL SPEAKER

Oxford Electric Corporation, manufacturers of fine speakers for over twenty-six years, announces its newest development . . . a 12" coaxial speaker.

The new speaker, Model CO12JB, designed for quality AM, FM and TV receivers, as well as monitoring, recording applications and other sound installations . . . is an excellent quality speaker.

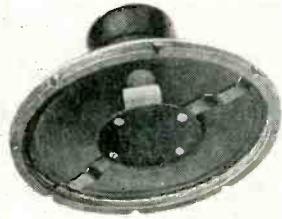

The frequency range is 65 to 15,000 C.P.S.; the network-crossover at 4,000 cycles; power rating 10 to 12 watts; input impedance—8 ohms; size and magnet weight: Woofer -12" —6.8 oz. Alnico V, Tweeter -3"—1.47 oz. Alnico V. The finish is a luxurious silver hammertone.

Technical literature, and other information are available upon request. Write: Oxford Electric Corporation, 3911 South Michigan Avenue, Chicago 13, Ill.

NEW INDOOR DIRECTRONIC

Snyder Manufacturing Company of Philadelphia, through company salesmanager Dick Morris, has announced production on its brand new Indoor Directronic TV Aerial System.

As in the outdoor model, the Indoor Directronic is an all-channel aerial offering a combination of elements for perfect picture clarity on each channel and full 360° orientation without the use of motors or electric power. A Directronic Beam Selector mounted on or near the television set, gives remote control of element combinations. By a single flick of the Selector Switch, the clearest picture on each channel is obtained instantly.

Instead of rigid elements, however, the Indoor Directronic has flexible tape elements which adhere in a horizontal position to any ceiling. This aerial has been designed for concealed installation as in closets or attics or maybe sealed to the ceiling of a room.

FOLDER CORNER SPEAKER

High fidelity enthusiasts were recently introduced to the ROYAL—a new Klipsch-licensed, moderately-priced Folded Corner Horn Enclosure designed by Electro-Voice for 15"

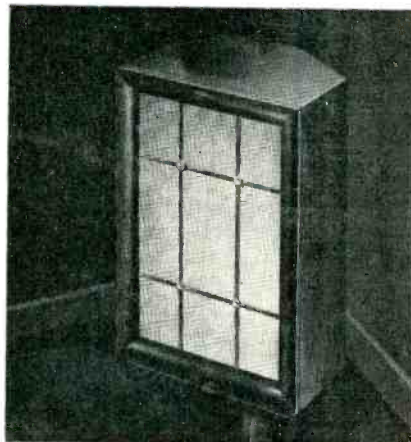

coaxial speakers and for 800 cps separate 2-way and 3-way speaker systems.

Employing the walls of the room as an extension of the exponential air load on the driver, this beautiful corner cabinet provides new purity of bass reproduction down to 30 cps with unprecedented efficiency. (Laboratory flatness ±5 db to 30 cps.) Upper register response is more pleasing, too, because of proper overall musical balance.

Dimensions: 37" high, 20 1/2" deep, 23 3/4" wide. Net wt., 69 lbs. Shpg. wt. 79 lbs. Mahogany, less speaker, list price \$180.00. Smart Blonde Korina, less speaker, list price \$190.00.

For full details, write for free Bulletin No. 183 to Electro-Voice Inc., Buchanan, Michigan.

UHF SWEEP GENERATORS

Tube Department, Radio Corporation of America, Harrison, N. J. announces two new UHF Sweep Generators—the WR-40A and the WR-41A—of particular interest to research workers and engineers engaged in the development of uhf television receivers and other uhf equipment.

Both instruments feature continuous tuning from 470 to 890 mc and operation entirely on fundamental frequencies—no beat notes or harmonics are used. They have a continuously variable sweep width from 0 to 45 mc with

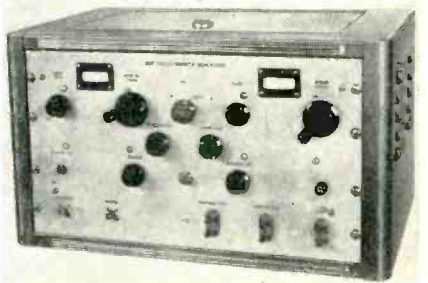

an amplitude variation of 0.1 db per mc or less throughout the swept range. The maximum output level of the sweep oscillator is 0.5 volt across a 50-ohm load. Facilities are also provided for matching to either a 72- or a 300-ohm load.

This instrument has a built-in crystal calibrator and variable-frequency marker oscillator. The sweep-frequency oscillator and the variable-frequency marker oscillator each employs an RCA-5675 pencil triode.

Other features of the WR-40A include front-panel attenuator controls for individually varying the amplitude not only of the sweep output but also the amplitude of the response input, the marker pips, and the calibrating pips; a built-in detector with matched load for direct monitoring of the sweep oscillator output on an oscilloscope; a front-panel blanking control; and a system of marker injection which prevents distortion of the response curve.

The WR-41A has the same sweep-generator mechanism used in the WR-40A but does not include the laboratory-type calibrator or marker circuit. This instrument is most useful in factory operations.

TELREX V-BEAM

Telrex, Inc., Asbury Park, N. J., manufacturers of "Conical-V-Beams" is now making deliveries of its new "Telrex V-Beam", it was announced by Ralph Ercolino, Sales Manager.

"The "Telrex V-Beam" fills a long felt need for a low cost, medium range TV antenna suitable for metropolitan and suburban area installations.

Unlike conventional designs, the Telrex V-Beam provides all-channel coverage in a single unit, requires no high frequency head, or dual

For
Dependable
Electrical
Protection...

RELY ON
**BUSS
FUSES**

Companion lines for
FUSETRON and BUSS small
dimension fuses are BUSS Fuse
Clips, Blocks and Fuse holders.
They are made in many types
and sizes to make it easy to
select the fuse and fuse mount-
ing needed to give the required
protection.

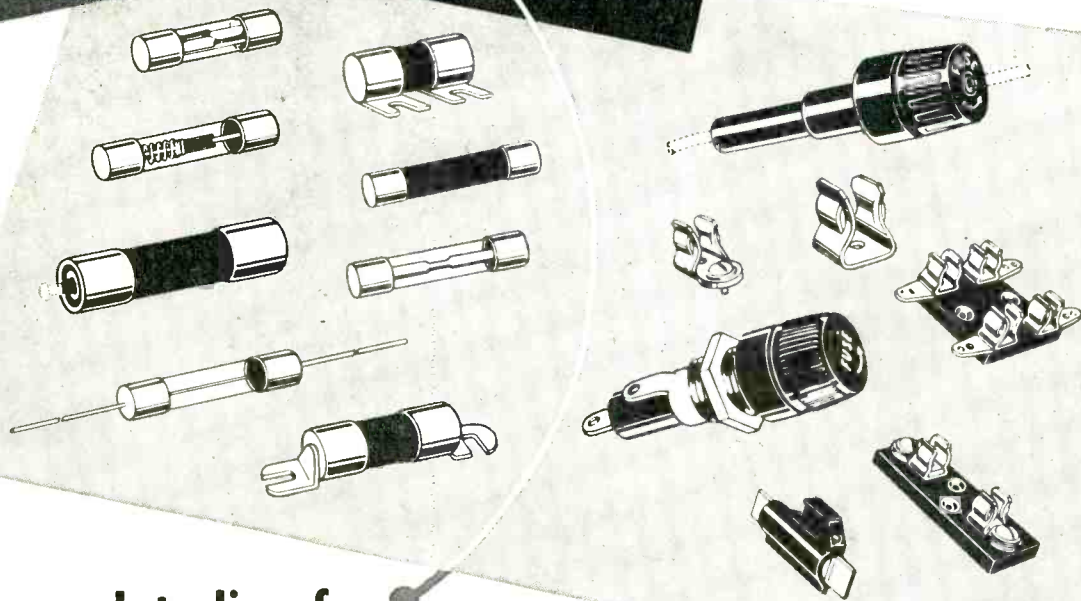

**The complete line for
Television • Radio • Radar
Instruments • Controls • Avionics**

Buss is the one source for any fuse you need: — standard type, dual-element (slow blowing), renewable and one-time types . . . in sizes from 1/500 ampere up.

Manufacturers and service men the country over have learned that they can depend on BUSS Fuses for dependable protection under all service conditions. The name BUSS has meant unquestioned high quality for more than 37 years.

To make sure that quality is always maintained, EVERY BUSS FUSE IS ELECTRONICALLY TESTED. The sensitive testing device rejects any fuse that is not correctly calibrated, properly constructed and right in all physical dimensions.

That's why you can handle BUSS Fuses with complete confidence. You know that you will have no irritating, costly "comebacks."

That's why it pays to standardize on BUSS Fuses.

And when you handle only BUSS fuses it keeps your stocking problem simpler.

BUSSMANN MFG. CO. **St. Louis 7, Mo.**
Division of McGraw Electric Company

Manufacturers of a complete line of fuses for home, farm, commercial and industrial use.

SEND THE COUPON for Complete Facts

Bussmann Mfg. Co., University at Jefferson
St. Louis 7, Mo. (Division McGraw Electric Co.)

SD 352

Please send me Bulletin SFB on BUSS Small
Dimension Fuses and Fuse Holders.

Name _____

Title _____

Company _____

Address _____

City & Zone _____ State _____ 352

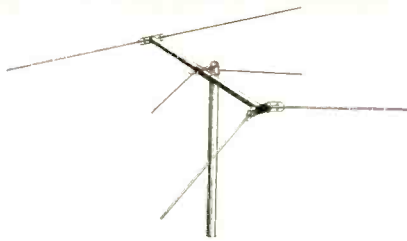

transmission line. This is achieved by employing forward tilted dipoles, made popular in Telrex "Conical-V-Beams", to obtain perfect and automatic transition from low to high channel operation. A well controlled uni-directional reception pattern is thereby maintained on both low and high frequencies, greatly simplifying antenna orientation.

The "Telrex V-Beam" will be available with the new Telrex "Hi-V-Reflector" as standard equipment. The "Hi-V-Reflector", which is a supplementary parasitic element, is designed to improve high channel directivity for areas where noise and secondary reflections (ghosts) are exceptionally troublesome.

CR TUBE TESTER & REACTIVATOR

Transvision Inc., of New Rochelle, N. Y., announces release to the television industry of its new CR Tube Reactivator.

Weighing only 3 lbs., this portable instrument plugs into any convenient 110 V receptacle. It is self-powered and completely self-contained and independent.

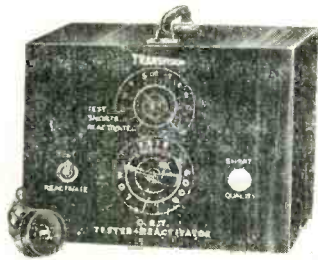

The reactivation of the CR Tube can be done in the customer's home, if necessary, without removing the picture tube from the TV set. In the majority of cases the reactivation is complete and permanent, amounting to a virtual rejuvenation. Light emission increases, brightness goes up, and detail is enlivened. It must be noted, however, that the reactivator will not work on broken filament, broken glass, or shorted components.

Further information may be obtained by writing to Transvision, Inc., Dept. DG, New Rochelle, N. Y.

MASTER ANTENNA COUPLER

A master TV antenna system coupler for use in conduit installations in new-construction work is now available from Technical Appliance Corporation, Sherburne, N. Y., manufacturers of the Tacoplex Master Antenna System. The new coupler is designed to fill the



need for a tap-off device along the main transmission lines housed in conduits.

As a tap-off device, the Tacoplex Cat. No. 1582 provides the necessary isolation between receivers and at the same time provides proper attenuation to maintain a constant level of signal strength throughout the system. By means of three resistors wired in parallel, the proper attenuation is obtained by clipping out one or two of the resistors. Complete instructions accompany the unit.

The coupler is designed to be housed in a standard electrical outlet box. Connection to the receiver is made by means of a polarized plug that is supplied with each unit. A standard-size flush cover plate is available as Cat. No. 1581 which identifies the outlet as a TV signal source.

ANTENNA MASTS

The JFD M110 mast, produced by Republic Steel and called the JFD "Dura-Mast", is a seamless steel unit. It is electro-galvanized with the exact same process as EMT conduit

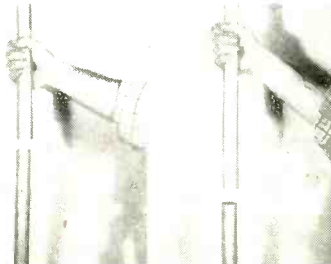

and its 6" fitted joints provide an inter-lock grip which guarantees against any separation.

The Jones & Laughlin mast, made of Permatube, is a seamless piece too. Like the M110, this mast—the M108 has 3" fitted joints. Its corrosion-resistant coating is Vinsynite. Both masts are available in 10 foot lengths.

These masts are packaged 14 to a carton, providing for easy stacking and excellent inventory control for both distributor and dealer. This method of packaging, too, insures receipt of the masts in top condition.

Literature on the JFD antenna mast line may be speedily obtained by writing the JFD Manufacturing Co., Inc. 6101 16th Avenue, Brooklyn 4, New York.

AMPLIFIED TV DISTRIBUTION UNIT

Blonder-Tongue Laboratories, Inc. at 38 North Second Street, Mt. Vernon, New York is now delivering this two outlet Distribution

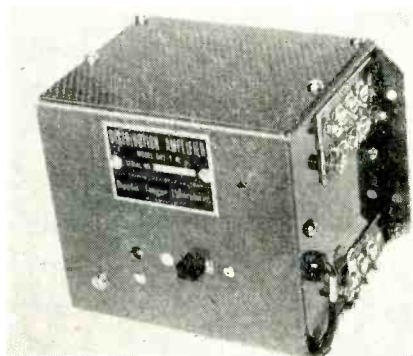

Amplifier. Featuring two isolated TV set outlets and a through line output, it can be used in Master Antenna Systems of any size or as a complete system for the two set home.

Providing full electronic isolation and amplifying all channels simultaneously to each TV set, these units may be used in a series by inter-connecting them with 75 ohm line. Simple screw terminals provide for speedy economical

installation. Employing two 6BC5 tubes, Model DA2-1-M amplifies all-channels without loss to each TV set outlet and in addition has correct impedance matching at each terminal for 75 and 300 ohm lines. Maximum input and output signal voltages are .5 on 75 ohms and 1.0 volt on 300 ohms.

Listing at only \$39.50. Model DA2-1-M is available nationally through electronic wholesalers.

ZERO-VOLTAGE ELECTROSTATIC TUBES

The General Electric Company's Tube Department today announced three additions to its new zero-voltage electrostatic tube line.

The new tubes embody the same principles which have proven highly successful in the company's 17RP4/17HP4, General Electric's first commercial zero-voltage tube, which was placed on the market in August.

These tubes contain the electron gun developed by G-E engineers which makes possible important savings of copper, nickel, and cobalt through elimination of the focus coil. Elimination of the focus coil has also resulted in significant cost savings for receiver manufacturers.

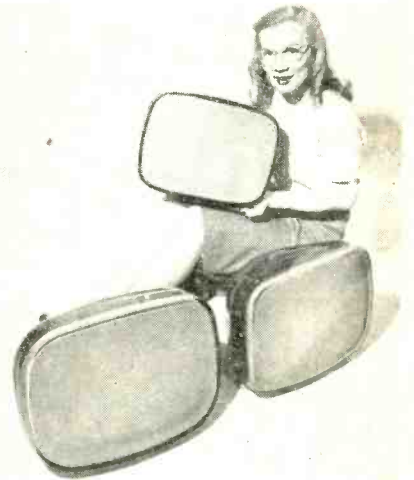

The three new tubes are the 17VP4, a 17-inch tube; the 20HP4-A/20LP4, a 20-inch tube, and the 21FP4-A, a 21-inch tube. All are space saving glass rectangular tubes. The 17-inch and 21-inch tubes have cylindrical faces.

JENSEN BACK-LOADING FOLDED HORN

Jensen Manufacturing Company, Chicago, is offering without charge blueprints and instructions for building the new backloading folded horn which was demonstrated in conjunction with the Jensen G-610 Triaxial loud-

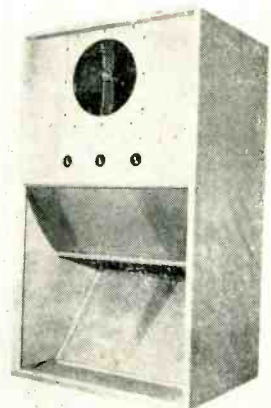



NANTOOK MOOK WALSCO ONKO

(translation)

'BETTER FRINGE AREA RECEPTION WITH WALSCO MODEL M ANTENNA'

There's a magical difference in WALSCO Model M Signal King performance almost *anywhere*. In the fringe areas, or wherever weather is the roughest, the Model M will out-perform, out-last any competitive antenna.

Once you install... *that's all*. No costly call-backs that steal your profit. Model M is guaranteed sturdier, more dependable in *any climate*.

Chromate-coated magnesium cross-arms have a structural strength almost equal to steel, yet $\frac{1}{3}$ lighter than aluminum. Positive corrosion resistance even in severest weather. Elements are made of high-conductivity, super strength aluminum alloy, reinforced with Swiss "Permalum." WALSCO Model M is quality you can trust *anywhere*.

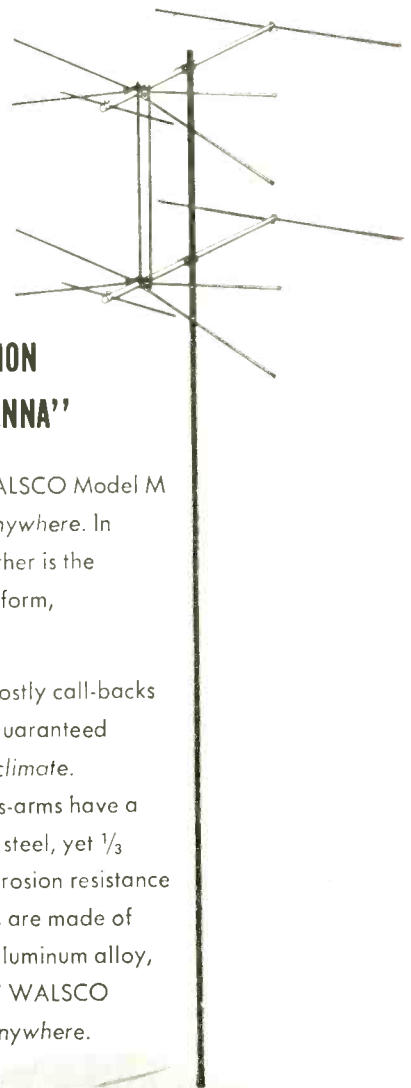

WALSCO

Walsco quality earned its reputation

WALTER L. SCHOTT CO.

3225 Exposition Place, Los Angeles 18, Calif.
Branch: Chicago 6, Illinois

IT'S CARTRIDGE

Check-up TIME!

REPLACE INEFFICIENT PHONO-CARTRIDGES NOW with Modern, Lightweight, Compliant E-V CARTRIDGES



DETERIORATED



OBSOLETE

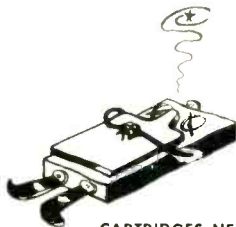

WORN OUT

CARTRIDGES NEED NOT
BE COMPLETELY DEAD
TO NEED REPLACEMENT

This is a good time to contact record-player owners and check the condition of their phono-cartridge. If it is not reproducing properly or is causing excess record and needle wear, chances are the cartridge has deteriorated or is obsolete—and should be replaced. You'll make new replacement sales, and open the way to other service business, too! A modern, lightweight, compliant E-V cartridge will give fullest record enjoyment and longer record life. You can demonstrate the difference. Remember, you can make most replacements with fewer E-V models!

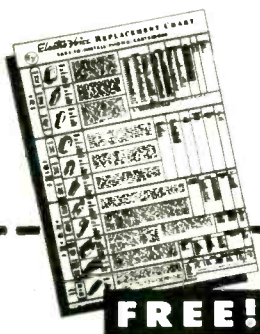
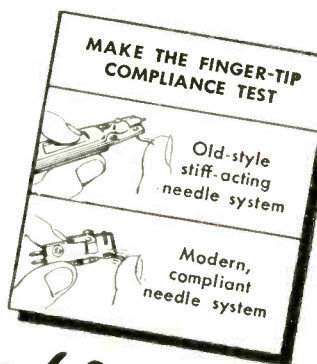

REPLACEMENT CHART
Large, Complete Replacement Chart. Gives handy cross-reference and valuable data. Tells when to replace a phono-cartridge. Ask your E-V Distributor or send for it now.

Electro-Voice INC.

412 CARROLL STREET • BUCHANAN, MICHIGAN
Export 13 East 40th St., New York 16, U.S.A. Cables: Arlab
TV BOOSTERS • MICROPHONES • HI-FI SPEAKERS • PHONO-PICKUPS

Electro-Voice, Inc., Dept. T3-52
412 Carroll St., Buchanan, Michigan

Send FREE Cartridge Replacement Chart.

Name..... (PLEASE PRINT)

Address.....

City..... Zone..... State.....

Service-Technician Dealer Record Fan

speaker at the Audio Fair held in New York City in November.

This 30 cubic foot enclosure, developed and presented by D. J. Plach, Physicist and P. B. Williams, Senior Engineer of Jensen Manufacturing Company is of special interest to professional sound men and high fidelity enthusiasts alike since it is easily constructed of plywood panels at moderate cost.

Compactly arranged in a cabinet 5' x 3' x 2', this new horn design reduces loudspeaker resonant frequency by almost one octave, increases efficiency 4 to 6 db over the entire piston range, improves transient performance and allows doubling the loudspeaker power rating for a given amount of distortion. For further information write: Jensen Mfg. Co., 6601 South Laramie Ave., Chicago 37, Ill.

LOW-LOSS TWIN LEAD

"SpaceLine", a revolutionary new and improved type of TV twin lead which is claimed to eliminate at least 50% of the signal loss, is now available for immediate delivery through legitimate Clearbeam distributors at the same low price as ordinary twin lead.

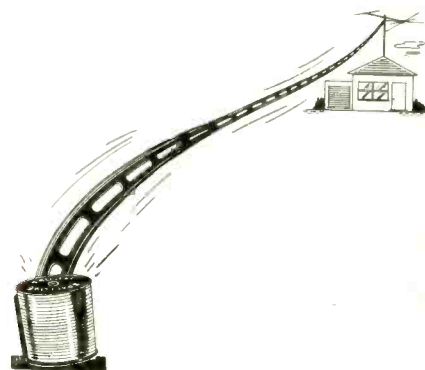

According to Clearbeam polyethylene, which is a normal low loss conventional plastic insulation for TV leadin, has a loss of 4.0 DBs per 100 feet at the high TV frequencies. By eliminating a substantial portion of the polyethylene, Clearbeam engineers claim to have slashed TV signal loss by at least half!

Clearbeam's SpaceLine is made of a tough 20-gauge copper wire and pure 55 mil Polyethylene.

DEFLECTION YOKE

This new Cletron Universal Television Deflection Yoke is designed with anastigmatically corrected coils to provide a sharper focus over the entire picture are. Easily installed

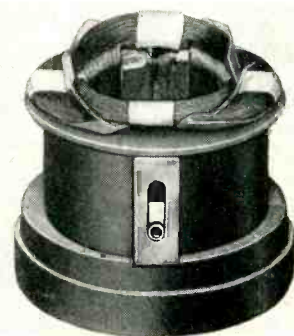

with a floating type cage nut that permits rapid and accurate adjustment. Simplifies large picture tube conversions of older TV receivers with minimum circuit revision. Made in 4 standard models that provide for direct replacement in over 80% of all TV receivers. Manufactured by Cleveland Electronics, Inc., 6624 Euclid Avenue, Cleveland 8, Ohio.

Your dollar buys
more "instrument"
... in our Model



630

by R. L. Triplett
PRESIDENT

Because we build every major part of our instruments the quality is carefully controlled. For example, we know we have more torque driving our pointers because we designed and built the complete instrument. We know we have sustained dependence in the shafts and switch contacts of our test equipment for the same reason. Cycle tests for switches exceed several times the rigid requirements of the armed forces.

There is another important value to you. Because we make our own components we eliminate the profit another manufacturer would make in selling them to us. And this "profit" is passed on to you.

Consider these features of Model 630 V.O.M., for example—

One Hand Operation—One switch with large recessed knob has a single position setting for each reading. Leaves one hand free. Eliminates switching errors, trouble, saves time.

Ranges—AC-DC Volts: 3-12-60-300-1200-6000 (AC, 5000 Ohms/Volt; DC, 20,000 Ohms/Volt). 60 Micro-Amps. 1.2, 12, & 120 Mil Amps. DB scales at 1.73V on 500 Ohm line, 0-66 DB output.

Highest Ohm Reading—To 100 Meg. in steps of 1000-10,000-100,000 Ohms—100 Megohms.

Yes, with us it's a matter of personal pride to make "Triplett" stand for better construction and more service for your test equipment dollar.

R. L. Triplett

PRESIDENT

TRIPLETT ELECTRICAL INSTRUMENT CO.
Bluffton, Ohio

Model # **630**

Volt-Ohm-Mil-Ammeter

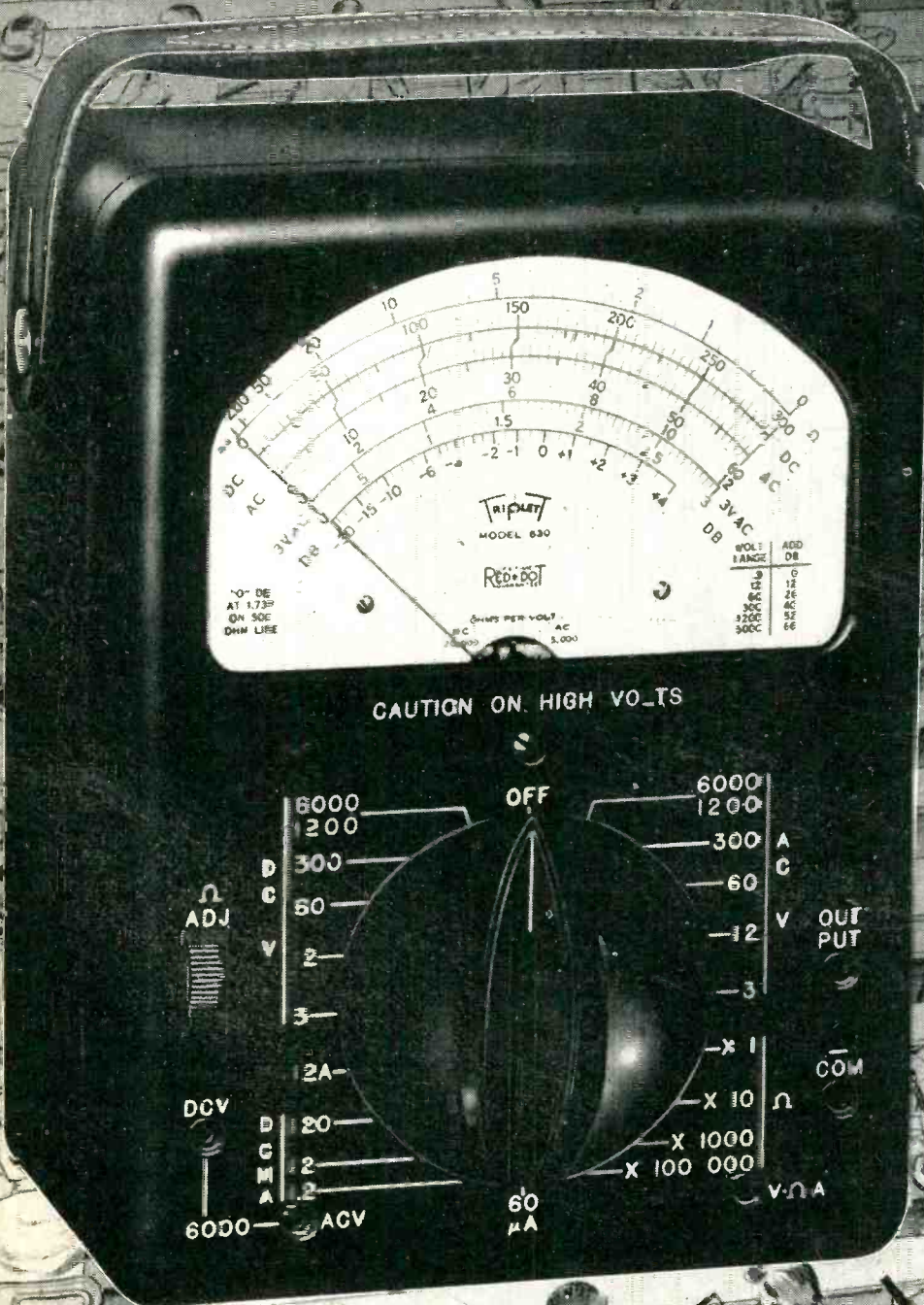

For service, accuracy, highest dependability, buy

Triplett



TRADE FLASHES

[from page 14]

ton. Manufacturers who participate in the Parts Show early in the week may remain in their fifth and sixth floor display rooms for the Audio Fair at a reduced participation fee, he said. Manufacturers and distributors who do not exhibit in the Parts Show may reserve display rooms in the Audio Fair on the seventh floor of the hotel.

The Audio Fair In Chicago, Inc., is being incorporated in Illinois, with Chicago offices at One North LaSalle

St., and New York offices at 67 W. 44th St., to sponsor the Fair, which is expected to feature displays on May 23 and 24 by the industry's leading audio, sound and high fidelity equipment makers and distributors.

While the Electronic Parts Show attendance is restricted to qualified distributors during the first three days, and to the distributors, industrial buyers, engineers and government agencies on Thursday, the Audio Fair In Chicago will be open to service technicians, sound specialists and the public during its two-day displays

Friday and Saturday at the Conrad Hilton, Reizes said.

The sound industry, newest market in the electronics field, already is a three-quarter billion dollar enterprise, Reizes said, covering all types of equipment for reproducing music and other sound, including high-fidelity amplifiers, tape and wire recorders, speakers, microphones, component parts, cabinets and allied products—a field which already has attracted a tremendous market of audio enthusiasts, and has developed into an industry employing an estimated 100,000 persons in the United States.

All Audio Fair exhibits will be displayed in rooms and suites on the fifth, sixth and seventh floors of the Conrad Hilton. Space reservations are being made by the Audio Fair In Chicago, Inc., One No. LaSalle St., Room 815, Chicago 2, or by Harry C. Reizes, 67 W. 44th St., Room 510, New York 17, N. Y.

Cathode Ray Tube Sales Totalled 4.4 Million in 1951

Sales of television picture tubes to receiver manufacturers in 1951 totaled 4,434,126 units valued at \$106,150,834, the Radio-Television Manufacturers Association announced.

Rectangular tubes 16 inches and larger in size accounted for 88 percent of the 1951 sales. In 1950 tubes of this category consisted of only 34 percent of manufacturers' purchases. Picture tube sales to manufacturers in 1950 aggregated 7,473,614 units valued at \$198,737,428.

In 1951 sales of picture tubes for all purposes, including new sets, renewals, U. S. government, and export, amounted to 5,135,799 units valued at \$122,224,186.

The Radio Parts & Electronic Equipment Shows, Inc. Combats Licensing

The Radio Parts & Electronic Equipment Shows, Inc., sponsors of the annual Electronic Parts Show would take an active part in behalf of the nation's servicemen-dealers in the fight against discriminatory licensing laws and restrictive ordinances, as part of an educational program proposed in a resolution approved by the Show board of directors at its last meeting and now being referred to the five co-sponsoring associations for ratification.

The five co-sponsoring groups to which the resolution has been referred for approval are the Radio-Television Manufacturers Association; the National Electronic Distributors Association; the Association of Electronic

Consumer Demand

Makes The Turner TV Booster



a RED HOT profit item!

When Jack Jones installs a Turner Booster in a fringe-area home it doesn't take long for the word to get around . . . "Jack Jones has the best reception in town!" When that happens, brother, make sure you're stocked up on the Turner Booster!

Simple but effective word-of-mouth advertising will sell more Turner Boosters for you than all the direct mail, newspaper space or radio time you can buy.

In city after city, TV installers are turning to the Turner Booster — recommending it to solve their knottiest fringe area reception problems. They have discovered that Turner's low-noise-level Cascode circuit stabilizes the picture, reduces noise and snow to a minimum, and produces a good picture when many other boosters are unable to even lock the picture in!

Place an order with your Jobber or write direct. You'll soon be convinced that the Turner Booster is the hottest profit item in your store.

List Price..... **\$57.50**

THE TURNER COMPANY

937 17th Street N. E. Cedar Rapids, Iowa

IN CANADA:
Canadian Marconi Co., Ltd., Toronto, Ont., and Branches

EXPORT:
Ad. Auriema, Inc., 89 Broad St., New York 4, N. Y.





IMPORTANT ANNOUNCEMENT TO SERVICE DEALERS!

**Your used
PICTURE TUBES are
now worth \$2.25 to \$5.25**

Sylvania Tube Distributors offer trade-in allowance on more than 40 picture tube types . . . of any make.

Here's the best picture tube news you ever heard. It's the Sylvania GLASS ALLOWANCE PROGRAM. You can make \$2.25 to \$5.25 more on every picture tube you sell.

You also protect your reputation by installing only new, fully guaranteed Sylvania Picture Tubes in your customers' sets. The process is simple! No strings attached!

Here's all you do!

1. Return old picture tubes to your Sylvania tube distributor. Sylvania has made it possible for him to give you a GLASS ALLOWANCE CREDIT of from \$2.25 to \$5.25 per used tube on the purchase of any new Sylvania picture tube.
2. Return tubes may be of ANY MAKE but must be types shown on the suggested Sylvania Glass Allowance Price List. (See list below.)
3. Returned tubes must be under vacuum and free from chips, scratches, etc.
4. New tubes purchased need *not* be the same as those returned. You may choose any type Sylvania has for sale.

Sylvania reserves the right to change cash values or tubes shown on the suggested Glass Allowance Price List. **SO ACT NOW.** Take your used picture tubes to your Sylvania Dis-

tributor . . . TODAY! For further details call your Sylvania Representative or Sylvania Electric Products Inc., Glass Department, Seneca Falls, New York.



Here's your Suggested Glass Allowance PRICE LIST

(Clip this list and keep it handy)

| | | | | | |
|--------|--------|--------|--------|--------|--------|
| 12KP4A | \$2.25 | 17AP4 | \$2.25 | 20CP4 | \$4.25 |
| 12LP4A | 2.25 | 17BP4 | 2.25 | 20CP4A | 4.25 |
| 12VP4A | 2.25 | 17BP4A | 2.25 | 20DP4 | 4.25 |
| | | 17BP4B | 2.25 | 20DP4A | 4.25 |
| 16JP4A | 3.25 | 17FP4 | 2.25 | 20FP4 | 4.25 |
| 16KP4 | 3.25 | 17FP4A | 2.25 | 20GP4 | 4.25 |
| 16KP4A | 3.25 | 17HP4 | 2.25 | 20HP4 | 4.25 |
| 16LP4A | 3.25 | 17JP4 | 2.25 | 20HP4A | 4.25 |
| 16QP4 | 3.25 | 17KP4 | 2.25 | 20JP4 | 4.25 |
| 16RP4 | 3.25 | 17LP4 | 2.25 | | |
| 16TP4 | 3.25 | 17QP4 | 2.25 | 21EP4 | 5.25 |
| 16UP4 | 3.25 | 17RP4 | 2.25 | 21EP4A | 5.25 |
| 16XP4 | 3.25 | 17SP4 | 2.25 | 21FP4 | 5.25 |
| 16ZP4 | 3.25 | | | 21FP4A | 5.25 |
| | | | | 21KP4 | 5.25 |
| | | | | 21KP4A | 5.25 |

SYLVANIA



RADIO TUBES; TELEVISION PICTURE TUBES; ELECTRONIC PRODUCTS; ELECTRONIC TEST EQUIPMENT; FLUORESCENT TUBES, FIXTURES, SIGN TUBING, WIRING DEVICES; LIGHT BULBS; PHOTOLAMPS; TELEVISION SETS

Parts and Equipment Manufacturers; the Sales Managers Club Eastern Group and the West Coast Electronics Manufacturers Association.

With the approval of these co-sponsoring groups, the Show Corporation president, Charles A. Hansen, of Jensen Mfg. Co., Chicago, would then name the Serviceman-Dealer Advisory Committee, to which would be allocated funds with which to carry on the fight and the educational program. It was contemplated that this committee would then appoint a "task force" empowered to apply itself immediately to any situation or locality where

unfair licensing laws are threatened, and to alert the public and officials to the inherent dangers in such restrictive legislation.

Snyder Begins New Ad Campaign

As a continuation of its consumer advertising campaign, launched for the first time last fall on behalf of its line of TV aerials, Snyder Manufacturing Company of Philadelphia will spot test new media in the next few months.

The new Snyder advertising will be in the nature of news articles written for the layman and informing him of the function of the antenna in tele-

vision reception. The article will be written by Edward M. Noll, consulting engineer to Snyder Mfg. and a faculty member of the Technical Institute of Temple University. The first series of articles will be run in a local television publication as a test. Further expansion of the campaign will be considered after a study of the results.

Large Quantity of 300

Ohm Line Stolen

December 13th is a day that will long be remembered by Columbia Wire and Supply Company, 2850 Irving Park Road, Chicago 18, Illinois.

This large supplier of wire and cables, cord sets, harnesses, etc., had a robbery on the 13th during which the thieves took approximately \$10,000.00 worth of material which included in the most part 300 ohm line and RG8U cable.

It is interesting that the robbers were intelligent enough regarding scarcity of certain critical materials as they ignored large quantities of less critical merchandise in order to take away the aforementioned 300 ohm line and the RG8U cable.

In view of the supply situation of these materials the industry should make certain that they are buying from regular, recognized sources of supply.

RCA Tube Dept. Announces All-Purpose "Master" VoltOhmyst and Two UHF Sweep Generators

An all-purpose all-electronic voltmeter, designed to provide radio service dealers, television receiver manufacturers, and industrial laboratories with a test and measurement instrument capable of performing many major electronic tests, was announced by the RCA Tube Department.

Designated the WV-87A Master VoltOhmyst, the instrument includes facilities for the direct measurement, on separate scales, of peak-to-peak voltage values of complex wave-forms and the rms voltage values of sine waves. It also reads d-c voltage, resistance, and direct current. Vacuum tubes are employed in all functions except current measurement to insure good sensitivity and stability.

Anticipating market needs for specialized UHF-TV test equipment which will develop with the opening of the ultra-high frequency band, the RCA Tube Department also disclosed that it will soon put into production two newly developed UHF sweep generators. Initial units are expected to be available early in the Spring.

The new instruments are a UHF sweep-marker generator (WR-40A),

Especially Designed for Radio & TV!

LYNN *Lightning* SOLDERLESS WIRE TERMINAL REPAIR KIT

NO. 2195
SERVICE KIT

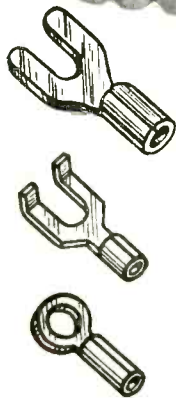
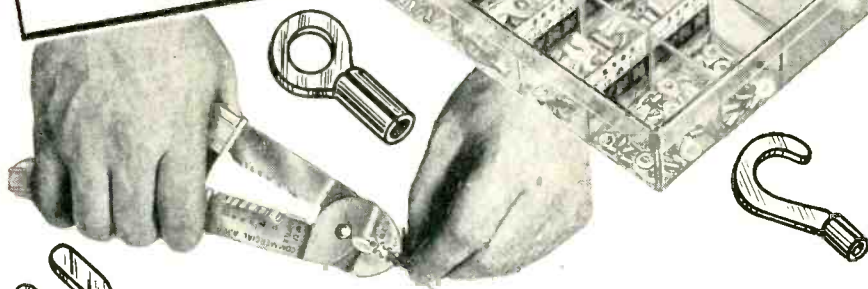

Now you can get a positive, trouble-free connection on every terminal... as fast as you can close your hand. No messy soldering or waiting for an iron to heat! With a Lynn *Lightning* service kit you just strip primary wire from 10 to 22 gauge with handy, combination stripping and crimping tool... select the proper terminal... then *crimp* it on. Every job quick, clean, professional-looking! Kit comes complete with crimping tool, 10 different types of terminals in 11-bin, clear plastic box. Only \$8.50

Two New Television Screw Drivers

Reach hard-to-get-at spots with the new Vaco AT 510 non-metallic, fiber shank driver for critical tuning and aligning work... the 10" blade gives you all the length you need. Adjust the new type focalizers with specially designed Vaco Beryllium-copper drivers... non-magnetic, yet nearly as hard as steel for adequate torque without interference with the Ion trap field. Full information on other aligning tools, nut setters and special radio tool kits on request. Write for FREE catalog.



317 E. Ontario St., Chicago 11, Ill.
In Canada: Vaco-Lynn Products Co., Ltd.
204 Laurier Ave. W., Montreal 8, Que.

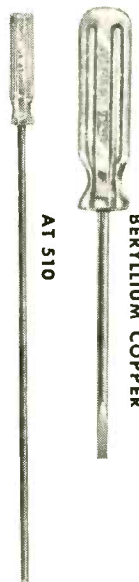

designed for engineers developing UHF circuitry for home television receivers, and a UHF sweep generator (WR-41A), intended for use as test equipment in factory production of UHF equipment. The frequency range of both instruments is from 470 megacycles to 890 megacycles, which includes the new UHF band for TV. Both are continuously tunable over the entire range, and operate entirely on fundamental frequencies, obviating the need for use either beat notes or harmonics.

Vee-D-X Products In Full Production

The VEE-D-X "Long John" and the VEE-D-X "Rocket" Booster are now in full production, it was announced by Milby M. Hancock, General Manager of the LaPointe Plascomold Corp. These two new products, separately or in combination, are the VEE-D-X answer to the need for still better fringe area reception, he stated.

The "Long John", a new 8-element Yagi, offers up to 41 per cent gain over the best 5-element Yagi, and is claimed to be the most powerful antenna for single channel reception commercially available today, Mr. Hancock stated.

Another accessory that will be beneficial in promoting sales in the difficult areas is the "Rocket" Booster. This pre-amplifier is a single channel, mast mounted model that boosts the signal before line loss occurs and before line noise is picked up.

Vee-D-X engineers have announced that the "LJ" antenna and the "Rocket" Booster is a formidable combination that will help eliminate "snow" and "flop-over", both of which have been major obstacles in fringe area selling.

Sylvania Announces TV Tube Glass Allowance Program

Radio-TV Service Dealers will be given a trade in allowance of from \$2.25 to \$5.25 on used television picture tubes, under terms of a new Glass Allowance Program, announced by H. H. Rainier, Manager of Distributor Sales for Sylvania Electric Products, Inc.

The program will be operated through Sylvania's 450 radio and television tube distributors who will grant dealers allowances on more than 40 different picture tube types. Returned tubes of any make are being accepted, provided they are among the types listed on a suggested Glass Allowance List.

To obtain the trade in credit, dealers are asked to purchase one new

Sylvania Picture Tube of any type for each used tube returned. In announcing the Glass Allowance to dealers, Mr. Rainier pointed out that Sylvania was accepting only tubes under vacuum and free from glass defects such as scratches, chips, bruises and other indications of physical abuse. Glass quality must be such that when reduced to a raw bulb, the quality is equal to that of a brand new raw bulb purchased from glass manufacturers, he explained.

DuMont Stresses Importance of UHF TV

The importance of UHF television

to retail TV dealers and the need for dealers to get behind UHF now was pointed out in a speech by TV scientist Dr. Allen B. Du Mont, president of Allen B. Du Mont Laboratories, Inc., at the annual convention of the National Appliance and Radio Dealers Association at the Conrad Hilton Hotel here.

Dr. Du Mont declared that UHF television was much closer than many realize because intensive research and experimental work in the past three years of the "freeze" have lifted UHF from the laboratory stage to that of a proven art.

BY ACTUAL COUNT...

THE LARGEST AND MOST COMPLETE TV GUIDE IN THE INDUSTRY!

NEW 10th EDITION OF THE
STANCOR
TV TRANSFORMER
REPLACEMENT GUIDE
and CATALOG

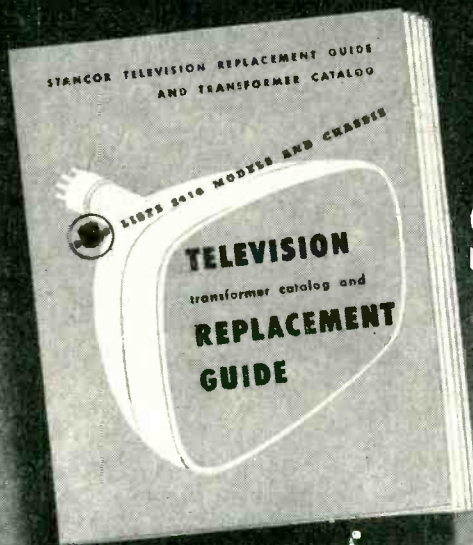

NEW... Stancor Part Nos. A-8133 and A-8134

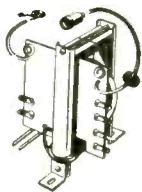

"Flyback" transformers—exact replacements for Admiral #79C30-1, 79C30-3, 79C30-4 in 80 Admiral TV models. See Stancor Bulletin #391.



This big new reference book lists transformer replacement information on 2416 TV models and chassis made by 82 manufacturers. The catalog section carries detailed electrical and physical specifications on 106 Stancor TV Replacement Transformers. A frequency chart shows the number of chassis that use each component.

To save your valuable time, this Guide lists all models and chassis components in numerical order under each manufacturer's name. Every replacement recommendation is listed with the manufacturer's part number for instant identification.

Get this up-to-the-minute TV Guide from your Stancor distributor now—or write directly to Stancor.

STANDARD TRANSFORMER CORPORATION
3586 ELSTON AVENUE • CHICAGO 18, ILLINOIS

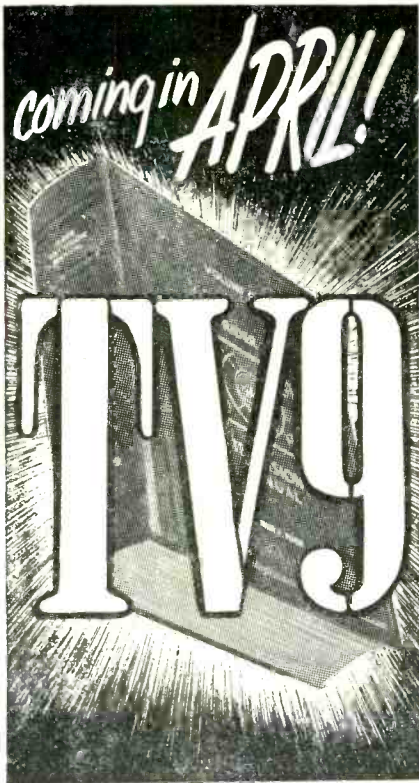

The newest Rider TV Manual covering the very latest complete, factory-issued TV receivers servicing data for all prominent manufacturers. Make sure you get your copy. Order from your jobber — today!

TV8 and Vol. 22

TV8. The largest TV manual ever published by Rider. Covers the products of 52 TV manufacturers. Contents include chassis views, voltages, resistance



readings, troubleshooting test patterns, waveforms, complete parts lists and values plus coverage of all models and circuit changes . . . and much, much more. Equivalent of 2694 pp. 8½x11" . . . \$24.

Vol. 22. Covers all AM-FM production runs of 62 manufacturers. Contents include all factory-issued servicing data on AM-FM receivers, auto radios, record changers, tuners and recorders . . . plus a cumulative index for vols. 16 through 22. 1520 pp. 8½x11" . . . \$18.

Make all your servicing easier — be sure your Rider Manual library is complete. Now available, Rider TV Manuals 1 through 8. AM-FM Manuals up to 22.

Get them from your jobber—today!

JOHN F. RIDER
PUBLISHER, INC.
480 Canal St., N. Y. 13, N. Y.

CIRCUIT COURT

[from page 41]

It is the network *R41*, *R42* and *C61* which enables the control contrast arm lead to be shielded. Referring to a previous paragraph, it was pointed out that the contrast control is usually in the first video amplifier cathode. Let us see why the contrast control can be located in the final stage in this circuit. It can be done because the leads to the control can be shielded. *Fig. 2* shows the usual circuit and the effect that the use of a shielded

lead would have. The shunt capacity to ground in *Fig. 2* would have a marked degenerative effect on the high frequency response. Since *V9* is a cathode follower, however, the tube sees only the effective output impedance which is the impedance of the network comprised of *R41*, *R42* and *C61*. *C60* and *L26* are in the circuit to compensate for any frequency discrimination. *R42* is also the grid return resistor for the CRT.

TRADE LIT

[from page 39]

Harold J. Schulman, department manager under whose direction the manual was prepared, declared,

"The purpose of this guide is to acquaint new Du Mont distributors with their service responsibilities as well as to suggest methods for handling these responsibilities. It will also provide a source of ideas for improving existing distributor service operations.

* * *

Calibration of Commercial Radio Field-Strength Meters at the National Bureau of Standards, by Frank M. Greene, National Bureau of Standards Circular 517, iii, 5 pages, 10 cents (order from Government Printing Office, Washington 25, D. C.).

Among the services offered by the National Bureau of Standards is the calibration of certain types of radio field-strength meters in the frequency range 10 kc to 300 mc. This Circular described briefly the standards and methods used in such calibration.

* * *

A new house organ entitled "*Mighty Monarch*" has been published by *Majestic Radio & Television*, Division of The Wilcox-Gay Corporation for distribution to their 1,000 employees. The first issue of the paper was written and edited by students of the Graduate School of Journalism at Columbia University. Professor John Foster, Faculty Advisor, supervised the editorial staff.

* * *

The first edition of "*Raytheon News*," published by *Raytheon Manufacturing Co.*, Waltham, Mass., was distributed today. A revival of an earlier publication bearing the same name, which was discontinued in 1945, the new company newspaper will be issued monthly. Riley Hampton, who headed the editorial staff of the old "*Raytheon News*," is editor.

Designed to provide employees with up-to-date information concerning the company's operations and progress, each issue will feature a timely personal message by Charles F. Adams, Jr., president of Raytheon.

* * *

"*Application of the Electronic Valve in Radio Receivers and Amplifiers*," Volume II. 450 pages, size 6 x 9", 343 drawings. Price: U.S. \$7.75.

This second part of the trilogy planned by the publisher deals with a-f amplification, the output stage, and the power supply.

These books are intended for radio technicians and radio engineers, for students in radio engineering and those attending secondary and high schools and technical universities, in fact for all who are interested in radio development.

As complete and comprehensive a treatment of these subjects as one could desire. The mathematical treatment is kept as simple as possible.

Phillips Technical Press, U. S. representative Elsevier Press Inc., 402 Lovett Blvd., Houston 6, Texas.

* * *

"*Transmitting Valves*" by P. J. Heyboer and P. Zijlstra. 308 pages, sizes 15½ x 23½ cm, 256 ill. Price: U.S. \$6.25.

The present book deals thoroughly with the various aspects of the practical use of transmitting valves, such as amplification, modulation, oscillation and frequency multiplication. The most important data for each particular case have been derived partly by calculation and partly by graphical means from the characteristics.

Furthermore, separate chapters have been devoted to the technology of transmitting valves and some particular factors playing a part in transmit-

[Continued on page 57]

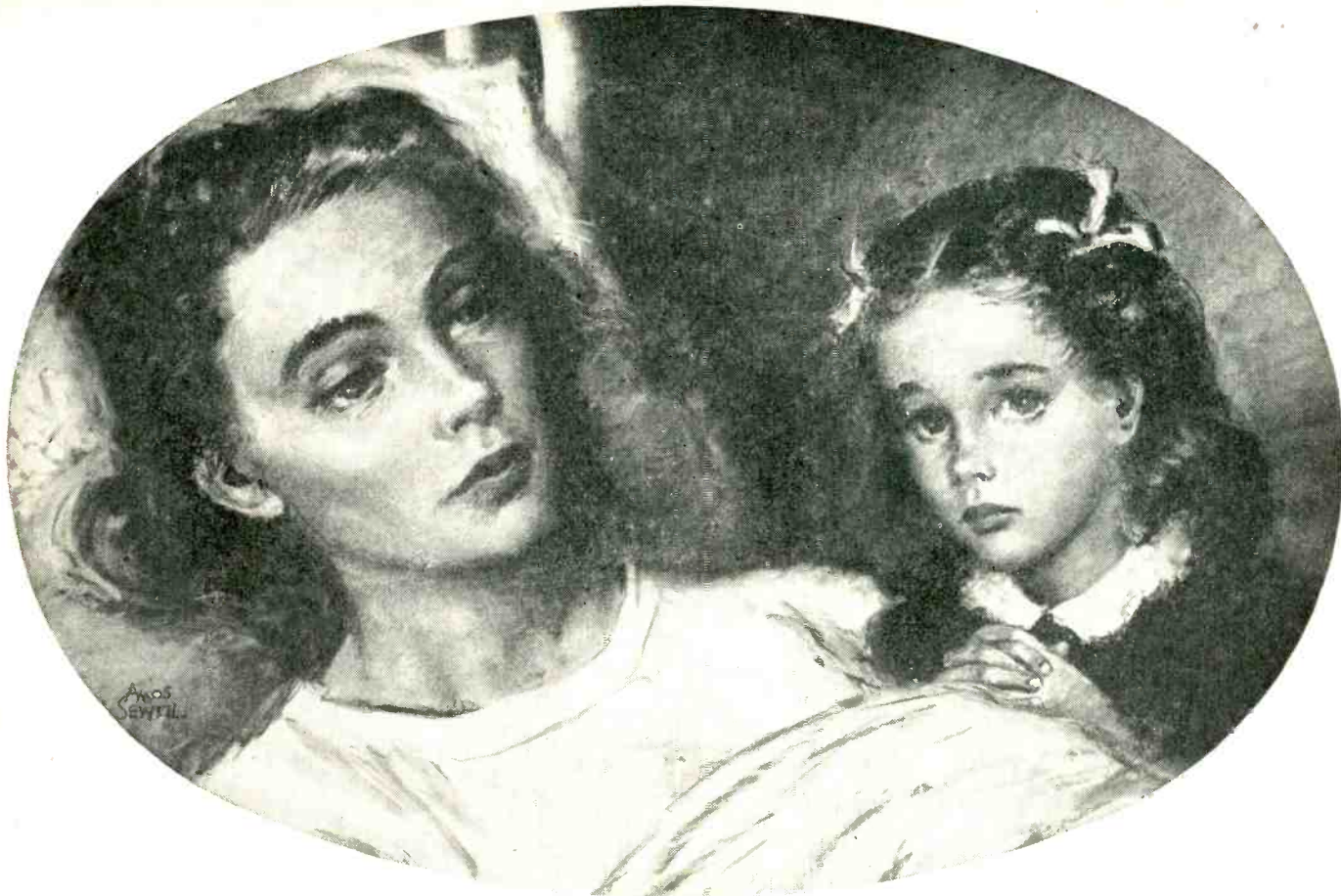

“THANK YOU FOR THE CHANCE to watch my daughter grow up”

I don't think I would have known how to say good-bye to my little girl. Thank you for the chance to watch her grow up . . . The doctors tell me that now all the disease in me has been destroyed. I'm going to live.

I'm one of the lucky ones—one of the 70,000 saved each year from cancer. *There should be more of us . . .*

When I was helping raise funds last April for the Cancer Crusade I never thought I was really working for myself—never dreamed cancer would strike me.

The dollars you give to the American Cancer Society mean so much to those of us who face cancer. Those dollars paid for the leaflet that

sent me to my doctor . . . He told me yesterday they paid for his training on an American Cancer Society fellowship.

Yes, I am one of the lucky ones. With your help there will be many more . . . thousands more. Won't you show you care with a generous gift? Thank you, thank you very much.

CANCER STRIKES ONE IN FIVE!
Strike back — give to conquer cancer



MAIL THIS COUPON TO "CANCER" C/O YOUR LOCAL POST OFFICE

AMERICAN CANCER SOCIETY

GENTLEMEN:

PLEASE SEND ME FREE LITERATURE ABOUT CANCER.

ENCLOSED IS MY CONTRIBUTION OF \$..... TO THE CANCER CRUSADE.

Name.....

Address.....

City..... State.....

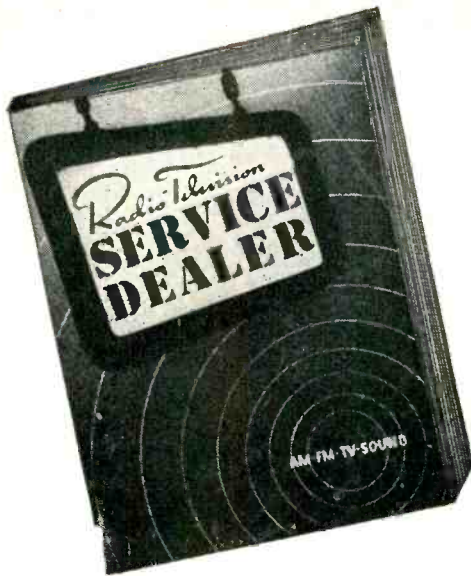

SAVE Up to \$1.00 each.

Form a Group, Service Dealers

Subscribe to "RTSD" -

"The Professional Radio-Television man's Magazine"—published monthly. All articles are exclusive and timely. Practically every issue is worth what an entire 1 year subscription costs.

The more in a group the bigger the savings. 6 men in a group save \$1.00 each; 4 men groups save \$.75 per man. Present "RTSD" subscribers may participate in or form a group with co-workers, or even competitors. Still active subscriptions are automatically extended 1 year. Start a Group today! The timely and exclusive technical data appearing in future issues of "RTSD" will make this the best investment you ever made. The special Group Rate offer may be withdrawn at any time—so hurry.

Use This Coupon For Convenience

(The coupon below can be used for from 1 to 6 subscription orders. Use it today!)



TEAR OUT — MAIL TODAY

RADIO-TELEVISION SERVICE DEALER
67 West 44th Street, New York 36, N. Y.

Please enter 1 year subscription orders for the names given below. Our remittance is enclosed.

NOTE: If you do not wish to tear this order blank out, just print or type the information on a single sheet of paper, following the style given. Each subscriber's occupation must be clearly described.

| | In U.S.A. | Foreign Rates |
|---|-----------|---------------|
| <input type="checkbox"/> One 1-year subscription | \$2.00 | \$3.00 |
| <input type="checkbox"/> Two 1-year subscriptions, each | 1.75 | 2.75 |
| <input type="checkbox"/> Three 1-year subscriptions, " | 1.50 | 2.50 |
| <input type="checkbox"/> Four 1-year subscriptions, " | 1.25 | 2.25 |
| <input type="checkbox"/> Five 1-year subscriptions, " | 1.10 | 2.00 |
| <input type="checkbox"/> Six 1-year subscriptions, " | 1.00 | 1.50 |

Name

Address

Describe Title or Position and Type of Business

State whether a New Subscriber or Renewal Order

Name

Address

Describe Title or Position and Type of Business

State whether a New Subscriber or Renewal Order

Name

Address

Describe Title or Position and Type of Business

State whether a New Subscriber or Renewal Order

Name

Address

Describe Title or Position and Type of Business

State whether a New Subscriber or Renewal Order

Name

Address

Describe Title or Position and Type of Business

State whether a New Subscriber or Renewal Order

Name

Address

Describe Title or Position and Type of Business

State whether a New Subscriber or Renewal Order

[from page 54]

more than

2,000,000

set owners use jfd
panorama indoor tv antennas



MODEL TA135 DELUXE
6.95 list
MODEL TA136 STANDARD
COMPANION 5.95 list
MODEL TA137 ECONOMY
COMPANION 5.50 list
COMPLETE WITH
TWIN LEAD

triple-chrome plated dipoles
absolutely tip-proof



JFD MFG. CO.
BENSINHURST 6-9200 · BROOKLYN 4, N. Y.
RADIO-TELEVISION SERVICE DEALER

ting practice; such as grid emission, discharges in the valves, feeding of the filaments with alternating current, etc. It is hoped that this exceptional book, embodying the results of a vast experience, will benefit the innumerable users of transmitting valves and help students to obtain a deeper insight into this field of radio engineering.

Phillips Technical Press, U. S. representative, Elsevier Press Inc., 402 Lovett Blvd., Houston 6, Texas.

* * *

A new catalog on auto aerials has been released by Ward Products Corp., Division of The Gabriel Company.

The new catalog gives complete description of the Ward line including the "8-Ball", "Phantom" and "Air-King" aerials. It also describes available counter displays and other merchandising material for Ward aerials.

Free copies of the catalog may be obtained from radio parts distributors or from Ward Products Corp., Division of The Gabriel Company, 1523 East 45th Street, Cleveland 3, Ohio.

* * *

A new two-color illustrated folder describing eleven Klipzon test products used by experimental and product development laboratories, radio-TV servicemen, and sold by radio-TV retailers and distributors, is available on request to: United Technical Laboratories, Morristown, New Jersey.

* * *

New Hickok folder illustrating and describing the latest 10 model selection of Dynamic Mutual Conductance tube testers. All interested engineers and technicians write The Hickok Electrical Instrument Co., 10533 Dupont Avenue, Cleveland 8, Ohio. Ask for Form: TT5

* * *

A new tube roll chart for Hickok tube testers dated January 1, 1952 is now available. This chart includes all the new tubes on which data was available at time of printing.

Price \$1.00 to The Hickok Electrical Instrument Company, 10533 Dupont Avenue, Cleveland 8, Ohio.

ASSOCIATIONS

[from page 36]

who will present Mr. Al Saunders, Motorola TV, and the Merit-Ancor meeting for April which will be sponsored by Art Cerf, their representative.

A. George Hardy, (President of the

COYNE BOOKS

SHOP-TESTED TECHNICAL BOOKS
ON RADIO, TV AND ELECTRONICS

Distributed by
HOWARD W. SAMS & CO., INC., Indianapolis 5, Ind.

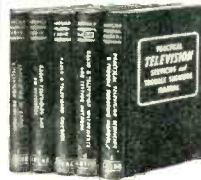

APPLIED PRACTICAL RADIO-TELEVISION

Brand new! Over 1500 pages on the latest in Radio and TV—EVEN COLOR TV and UHF. Over 5,000 subjects, 1,000 illustrations. Shows how to install, align, balance all Radio and TV sets... how to use test instruments for TV service... latest data on adaptors, converters, much more. Get this 5-Volume Library now.

No. CTB-11—Vol. 1... \$3.25
No. CTB-12—Vol. 2... 3.25
No. CTB-13—Vol. 3... 3.25
No. CTB-14—Vol. 4... 3.25
No. CTB-15—Vol. 5... 4.25

5 VOLUME SET
COMPLETE
No. CTB-50 \$15.00



CYCLOPEDIA OF TELEVISION Complete, Up-to-Date Reference Manual

Fact-packed reference book that covers every phase of Television, including COLOR TV and UHF. Gives you complete understanding of how TV receivers work, how to repair and keep them operating properly. Special complete section on picture pattern servicing (dozens of actual photos). 750 pages, over 450 photos, diagrams, charts, drawings, test patterns. In quick reference alphabetical order. \$5.95 Order your copy now. No. CTB-1.....

PRACTICAL TELEVISION SERVICING, TROUBLE-SHOOTING MANUAL

SHOWS YOU HOW TO align, service, install, adjust and tune every part of the audio and video sections. Helps you handle all problems. Covers sweep oscillators, frequency control, FM, amplifiers, tuners, etc. Latest data on COLOR TV and UHF! 18 big chapters, 300 illustrations (many in 4 colors)—1500 TV facts. Complete, practical, up-to-date. \$4.25 No. CTB-4.....



ELECTRONICS

You will find this book a "gold mine" of easy-to-follow "on-the-job" electronic data. Starts right at the beginning—explains in simple language all the basic principles of electronics. Fully illustrated with helpful photographs, diagrams, and tables. Endorsed by leading manufacturers, union officials and educators. 400 pages. \$3.75 No. CTB-2.....

MODERN RADIO INSTRUMENTS AND TESTING METHODS

This up-to-the-minute book tells all about modern radio and electrical testing equipment and how to use it. Packed with money-making shortcuts on trouble-shooting, servicing, construction and other jobs. Over 350 pages, 220 photos and diagrams. Covers Multipliers, Resistors, Ohmmeters, Oscilloscopes and many other subjects. All data has been pre-tested and checked in the Coyne radio shops. \$3.25 No. CTB-3.....



RADIOMAN'S HANDBOOK

Here is a remarkable radio "answer" book. 3,000 facts packed into 350 pages give you complete instructions to speed trouble-shooting. Illustrated with hundreds of charts, diagrams, tables, circuits and shortcuts. Fully indexed. \$2.75 No. CTB-5.....

Order from your Parts Jobber today, or write direct to Howard W. Sams & Co., Inc., 2201 E. 46th St., Indianapolis 5, Ind.

\$..... enclosed (no C.O.D.'S please). Send the following Coyne Books:

CTB-11 CTB-14 CTB-1 CTB-4
 CTB-12 CTB-15 CTB-2 CTB-5
 CTB-13 CTB-50 CTB-3

Name.....

Address.....

City..... Zone..... State.....

Harrisburg group) was appointed Chairman of the Charter Committee to make final arrangements with local attorney to obtain a State Charter for the Federation.

5. Delegates forwarded letters of congratulations and offers of cooperation to the newly appointed Service Manager for the Radio-Television Manufacturers Association, Mr. Albert Coumont, and to Mr. Ray J. Yeranko, the new Chairman of the Radio-Television Manufacturers Association's Service Committee.
6. A ten man committee was authorized and appointed to obtain from all Chapters a list of suggestions for ways and means of eliminating all friction and indifferences that now may exist between servicemen, dealers and their distributors. This committee, after thorough study, will arrange a series of meetings with all distributors in Penna. in order to find ways and means to settle any indifferences and promote harmony and cooperation.
7. A committee of delegates from Harrisburg and York were appointed to investigate State insurance, workmen's compensation, cost and coverage for the Radio and Tele-

vision Service and Installation Industry. Report shows it to be too high and the committee will meet with the Chairman of the Insurance Commission and request a new classification for this Industry.

8. Milan Krupa, Vice Chairman of the Federation was appointed Chairman of a committee to arrange a series of meetings with the broadcasters in Penna. in order to help promote public confidence in local Chapters membership and to promote better reception.

W. J. Lansberry

Southern California Radio Technicians Ass'n., Inc. (RTA)

This association publishes an excellent booklet entitled, "Objectives and By-Laws". This booklet was compiled in order to answer the questions asked most often regarding RTA. It also contains a Code of Ethics, By-Laws, etc., and could serve as an excellent guide for new associations.

Southern Penna. Radio and Television Technicians (York)

On January 17th we held our regular Business meeting. A complete report was made by the delegates and

action taken on many important issues. Arrangements were made to have Service Dealers and Distributors Service Managers to speak to the membership. Joe Hauser spoke on TV Trouble Shooting. A committee will meet with local Broadcasters for cooperation with our Association.

W. T. Lansberry

Mid-State Radio Servicemen's Association (Harrisburg)

Installation of new officers took place in our January 14th meeting. President George Hardy is arranging for a new series of both Technical and Business lectures through the Federation Lecture Bureau. The President is also working with a committee to formulate a complete program of activity for the year of 1952 including social events, membership drive, Public relations and advertising.

W. T. Lansberry

Lackawanna Radio Technicians Association (Scranton)

The Annual Charter Night (Ladies invited) of the Lackawanna Radio Technicians Ass'n is planned for March. The program for this gala affair is under the Chairmanship of August Cianchetti. All members and friends are invited to attend including members of other Federation Chapters are expected. The Capehart-Farnsworth meeting for January was greatly received by the great many who attended it and was one of the finest meetings held in Pa.

W. T. Lansberry

Blair County Radio Service Engineers (Altoona)

At the January meeting, new officers were elected for 1952. President—K. R. Brubaker, Vice Pres.—W. J. Lansberry, Secretary—Wm. Moffitt, Treas.—G. W. Eboch.

Our new officers are men who have made a great deal of progress in our association as members and the membership has great faith in their leadership. The Educational Committee has completed our new TV and Radio Course to be held weekly for our membership. Membership in our organization has increased greatly since the use of Federation sponsored programs and meetings were adopted. We hope to put them to greater usage this year.

W. T. Lansberry

Radio Servicemen's Association of Central Penna. (Williamsport)

Election of new officers were held for 1952 and the following were elected to guide and promote the welfare of the servicing industry in Williamsport. President—Carl W. Smith, Vice-Pres—Frederick Delzert, Treas.—

Insure BETTER Television Service to Your Customers! . . . Exclusively Designed

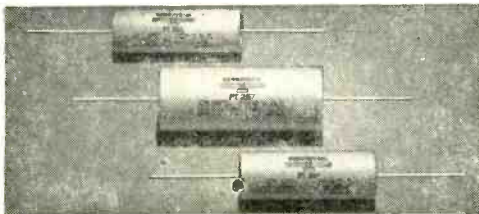

HIGH VOLTAGE AND ELECTROLYTIC TUBULAR TELEVISION CAPACITORS

Especially Engineered for Television Circuits by INDUSTRIAL CONDENSER CORP.

The economical quality line for replacement. Industrial Condenser Corp., manufacturers of Capacitors exclusively bring you highest quality for the particular requirements of Television at exceptionally attractive prices! Special Capacitors are Pyroteen impregnated for low power factor, high insulation resistance, high operating temperatures. Oil, Pyroteen, Wax and Electrolytic Capacitors. Finest materials throughout.

Ask Your Jobber for our Attractive Prices Today!

Or write for Bulletin 1095. Industrial makes quality Capacitors for Television, Radio, every electronic and industrial application—all types.

Send for Complete Catalog

INDUSTRIAL CONDENSER CORP.

3243 N. CALIFORNIA AVENUE CHICAGO 18, ILLINOIS
Sales offices in principal cities.



Modern plant built by Industrial Condenser Corp. for manufacture of capacitors only.

Address Change...

Subscribers to SERVICE DEALER should notify our Circulation Dept. at least 5 weeks in advance regarding any change in address. The Post Office Dept. does not forward magazines sent to a wrong destination unless you pay additional postage. We cannot duplicate copies sent to your old residence.

RADIO-TELEVISION SERVICE DEALER, 67 West 44th St., New York 36, N. Y.

Phillip Marciani, Secretary—William T. Mosteller, Cor. Sec—William S. Guild. Delegates to the Federation will be appointed by the Chairman.

Members of our group are all awaiting the completion of the Community TV System being installed now. The organization is arranging for a complete TV class for all members.

W. J. Lansberry

Radio & Television Technicians Guild of Florida, Dade County Chapter

Here's the latest news on the Florida Association-R&TTG-New Officers Elected-

President Steven Petruff
 Vice-President Shan Desjardines
 Secretary Thomas M. Middleton
 Treasurer A. Ed. Stevens
 Board Members: John Gilbert, Samuel Kessler, C. E. Lawrence, John J. Petruff, Chas. Pierce, Clem Ryan, Orville E. Smith.

The Association voted to join the National Association-NETSDA — I am sincerely hoping that now the Guild will really wake up, do something worth while for the Industry as a whole, and in doing that, realize how much they can succeed in benefiting themselves individually.

Thomas M. Middleton

Philadelphia Radio

Servicemen's Assoc.

At the December meeting of the Federation which was held in Harrisburg in the Hotel Harrisburger the following officers were elected to head the Federation of Radio Servicemen's Association of Pa. for 1952:

Chairman—Dave Krantz of Philadelphia Radio Servicemen's Association.
 Vice-Chairman —Milan Krupa of Luzerne Co. Radio Servicemen's Ass'n (Wilkes-Barre).
 Corres. Sec.—Leon Helk of Lackawanna Co. Radio Servicemen's Ass'n (Scranton).
 Rec. Sec.—Bill Lansberry of Blair Co. Radio Service Engineers (Altoona).
 Treas.—Fred Schmidt of Mid-State Radio Servicemen's Ass'n (Harrisburg).

The Federation will sponsor and publish its own monthly news bulletin in order to keep each individual member of each Chapter fully informed of what progress the Federation and the individual Chapters are making in in their behalf on the various issues that confront us daily. It will also feature stories by the various association heads, and technical information supplied by the various manufacturers who have arranged for lectures and demonstrations through the Federa-



gives you Laboratory Precision at Lowest Cost!



...with a complete line

221K VTVM Kit \$25.95
Wired \$49.95

625K Tube Tester Kit \$34.95
Wired \$49.95

320K Sig. Gen. Kit \$19.95
Wired \$29.95

145K Sig. Tracer Kit \$19.95
Wired \$28.95

425K 5" Scope Kit \$44.95
Wired \$79.95

315K Deluxe Sig. Gen. Kit \$39.95
Wired \$59.95

11V Probe \$6.95

511K VOM Kit \$14.95
Wired \$17.95

306K Sweep Gen. Kit \$34.95
Wired \$49.95
C-5 5mc Crystal \$3.95

RF Probe Kit \$3.75
Wired \$5.95

1040K Battery Elim. Kit \$25.95
Wired \$34.95

Over 50,000 servicemen have bought one or more EICO Kits and Instruments. That's the proof of EICO's leadership in value to the serviceman!

For latest precision engineering, finest components, smart professional appearance, lifetime performance and rock-bottom economy—see and compare the EICO line at your jobber's today before you buy any higher-priced equipment! You'll agree, with over 50,000 others, that only EICO Kits and Instruments—no other—give you the industry's greatest values for the industry's lowest costs!

Read the full story on the complete EICO line. Write today for your free latest Catalog D3.

ELECTRONIC INSTRUMENT CO., Inc.
 84 WITHERS STREET, BROOKLYN 11, N. Y.
 © 1952, Electronic Instrument Co., Inc.

Due to unsettled conditions, prices and specifications are subject to change without notice. Prices 5% higher on West Coast.

NEW GRAYBURNE TUBE & TOOL CARRIER

HOT

EXCLUSIVE TOOL COMPARTMENT
holds tester and tools needed on most calls

BUILT RUGGED
all solid wood and heavy masonite, lock-corner construction, extra top side clasps

HOLDS 175-200 TUBES
in 2 drawers and 1 compartment

HANDSOME
Washable, thick basket-weave black-and-grey leatherette. Resists oil and dirt stains.

REMOVABLE LARGE MIRROR
to observe Pix Tube from back of set

Model CP
LOW COST
\$16.95 net.

PERFECT BALANCE
Hangs straight down.

COMPACT
20½" x 14" x 9"

You made it the Champ!

We interviewed hundreds of Servicemen like yourself to tell us the features you want in a professional carrier. Model CP embodies all your practical suggestions. That's why Servicemen say it's today's truly unbeatable carrier value!

Other Grayburne Tube Carriers available:
 Model CL: for the "long haul". Holds 200-225 tubes. \$13.50 net.
 Model CJ: for the "short haul". Holds 60-70 tubes. \$9.95 net.

SERVICEMEN: For name of your nearest Grayburne distributor, write to us NOW!



GRAYBURNE CORPORATION, 103 Lafayette St., New York 13, N. Y.

tion for its Chapters. It will also keep the individual member informed of who their friends in the industry are and of their efforts on our behalf.

This bulletin will be available only to the members of each Chapter. The editor is Ed. Lukas of Luzerne Co. Radio Servicemen's Ass'n.

Blair Co. delegates will have a full report on the individual company or manufacturer who has been voted by the State Chapter members as the one to receive the annual Federation Plaque at the January meeting.

A course on "Business Management and What Is Your Labor Worth" is now being compiled and will soon be featured at each Chapter meeting for its members. It will be first tried in Reading by the Reading Radio Servicemen's Ass'n.

A. G. C.

[from page 27]

a-g-c taken off between R38 and R39. Condenser C31 (.1 uf) is the filter condenser.

Arvin Model 4162

The Arvin Model 4162 (Fig. 18)

shows an amplified keyed a-g-c system. The current of the keying tube flows through R43, R42, R41 and R38 to ground. In tube V15, the a-g-c amplifier voltages are so set that the tube conducts at all times. Resistor R38, in addition to acting as part of the V16 plate circuit is also part of V15's (6AU6) grid circuit. In this manner, as the current through V15 varies, because of changing carrier levels, the bias on V15's grid will also change. This bias variation will cause V15's plate current to vary. As a result, the voltage at the junction of R37 and the network of R40 and C77 will become more or less negative. The net effect is an amplified d-c voltage. The d-c voltage which has been amplified as a result of the cathode follower action is the a-g-c voltage. An additional feature in this particular model is the local-distance switch. With the switch in the local position, the r-f amplifier grid is returned to the a-g-c line. In the distance position, it operates only on its self-developed bias. The contrast control in this particular circuit is in the screen of the video amplifier. Its operation determines the amount of screen voltage and thereby the tube plate current conductance.

OSC. TROUBLE

[from page 21]

zontal, should not be allowed to remain long on the screen. With full sweep and beam velocity reduced to a narrow band, screen damage may result.

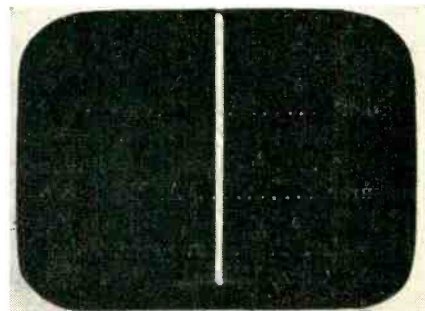

Fig. 9. Loss of hor. sweep.

SELENIUM

[from page 30]

arrow DOES NOT indicate the direction of maximum electron flow.

Visualize selenium rectifiers as di-

THIS IS IT! THE RELAY
WITH *Interchangeable Coil*
FOR A WIDE RANGE OF RADIO APPLICATIONS

GUARDIAN Series 200

Interchangeable

COIL and CONTACT

Switch Assembly

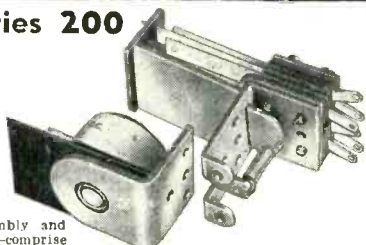

Two basic parts—a coil assembly and a contact switch assembly—comprise this simple, yet versatile relay. The coil assembly consists of the coil and field piece. The contact assembly consists of switch blades, armature, return spring and mounting bracket. The new Guardian Midget Contact Assembly which is interchangeable with the Standard Series 200 coil assembly, is also available in either single pole, double throw, or double pole, double throw.

CONTACT SWITCH ASSEMBLIES

| CAT. NO. | TYPE | COMBINATION | |
|----------|---------------------------------|-------------|--------------|
| | | Single Pole | Double Throw |
| 200-1 | Standard | Double Pole | Double Throw |
| 200-2 | Standard | Double Pole | Double Throw |
| 200-3 | Contact Switch Parts Kit | Double Pole | Double Throw |
| 200-4 | Standard | Double Pole | Double Throw |
| 200-M1 | Midget | Single Pole | Double Throw |
| 200-M2 | Midget | Double Pole | Double Throw |
| 200-M3 | Midget Contact Switch Parts Kit | Double Pole | Double Throw |

13 COIL ASSEMBLIES

| A.C. COILS* | | D.C. COILS | |
|-------------|----------|------------|----------|
| CAT. NO. | VOLTS | CAT. NO. | VOLTS |
| 200-5A | 6 A.C. | 200-6D | 6 D.C. |
| 200-12A | 12 A.C. | 200-12D | 12 D.C. |
| 200-24A | 24 A.C. | 200-24D | 24 D.C. |
| 200-115A | 115 A.C. | 200-32D | 32 D.C. |
| | | 200-110D | 110 D.C. |

*All A.C. coils available in 25 and 60 cycles

GUARDIAN G ELECTRIC

1606-C W. WALNUT STREET

CHICAGO 12, ILLINOIS

A COMPLETE LINE OF RELAYS SERVING RADIO AMATEURS

HICKOK



Model 215

Latest Design VACUUM TUBE VOLTMETER

features:

Accurate Peak-to-Peak measurements
Portable, shock-resistant case
Large 5", easy-to-read meter
Zero-Center scale

INCLUDES:

Exclusive, New Single-Unit AC-DC Probe

DC VOLTMETER

Volts: 0-1200 in 7 ranges
Input Resistance: 10 megohms

OHMMETER

Design Center: 10 ohms
Readability: 0.2 ohm to 1000 meg.

Provides the sensitivity and ranges for quick, accurate measurements of sine or complex waves of electronic devices. Test leads are included. Write for full details today.

AC VOLTMETER

AC, RMS: 0-1200 in 7 ranges
AC, Peak-to-Peak: 0-3200 in 7 ranges

Frequency Characteristics: 40 cps to 3.5 MC, and to 250 MC with crystal probe
Input Impedance: 30 meg. shunted by 150 uuf with dual-probe furnished.

THE HICKOK ELECTRICAL INSTRUMENT COMPANY
10533 Dupont Avenue • Cleveland 8, Ohio

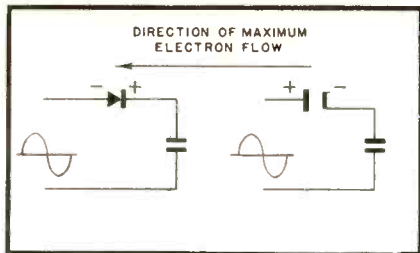

Fig. 3. Analogy between selenium rectifiers and diodes.

odes in circuit analysis. Since electrons are negative quantities, the direction of flow is towards the most positive point, or from the cathode to the plate. If electrons are pulled through the rectifier, the condenser will charge up so that the end from which the electrons are removed will be deficient in electrons or positive in potential. See Fig. 3.

It may be noted that the coding of polarity is opposite to that applied to a diode. Selenium rectifiers are coded according to application, in that the positive end is connected to the positive side of the charged condenser.

Advantages

With selenium rectifiers connected directly to the a-c line the power transformer is usually, although not always, eliminated as are the vacuum diode tubes.

Strong magnetic fields, which exist around power transformers, can cause trouble in the deflection of an electron beam in a picture tube. With this problem removed, the selenium rectifiers can be placed almost anywhere on the television chassis provided adequate ventilation can be obtained.

One manner in which selenium rectifiers are rated is by the voltage which the rectifier can block without conducting excessive reverse current. This is called the maximum a-c inverse voltage rating which allows a safety factor. Rectifiers can withstand increased currents for short periods without being destroyed.

Checking The Rectifiers

When troubleshooting a television set, the best test of the selenium rectifier is the B plus voltage available compared with the proper voltage. After about 5 minutes of operation the set is in the stabilized condition and the B plus voltage is measured.

Taking another measurement of this voltage 15 minutes later should not show a great voltage change. A larger change than 10% indicates very strongly that the selenium rectifiers are not furnishing enough current.

Resistance checks of selenium rectifiers will show nothing of importance, as far as testing them is con-

Mr. Serviceman:

YOUR CERAMIC CONDENSER STOCKING PROBLEMS ARE NOW SOLVED WITH THE INTRODUCTION OF THIS UNIQUE ERIE RESISTOR

"Breakaway" PACKAGE

NOW IS THE TIME TO "Breakaway" FROM LESS EFFICIENT METHODS OF STOCK KEEPING AND MERCHANDISING OF CERAMIC CONDENSERS. THIS EXCLUSIVE NEWLY DESIGNED PACKAGE BY ERIE RESISTOR PROVIDES FOR:

- * Easy stacking on shelves
- * "At a glance" inventory control
- * Quickly dispensing one or several polyethylene bags containing 5 ceramic condensers of the same capacity (note: Trays slide from either end of package)

Complete package consists of a perforated outer sleeve and two trays each containing 25 Ceramicons. The package will "Breakaway" along the perforated edge thus making two "half boxes," each a neat box of 25 which your larger dealers and industrial customers will find ideal for keeping their stock of Ceramicons clean and orderly.



Electronics Division
ERIE RESISTOR CORP., ERIE, PA.
 LONDON, ENGLAND - TORONTO, CANADA

THE JUNIOR SUPER-METER

THE MOST COMPLETE AND COMPACT MULTI-SERVICE INSTRUMENT EVER DESIGNED!

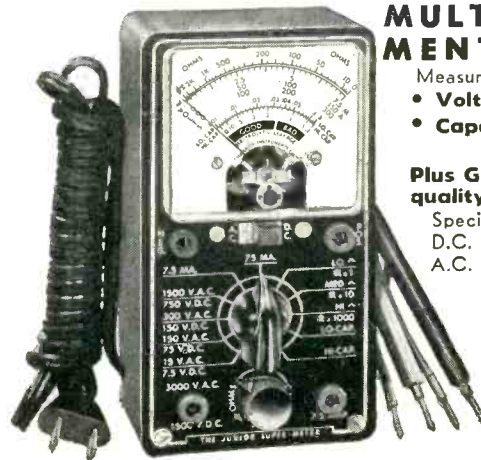

Measures:

- Voltage • Current • Resistance
- Capacity • Reactance • Inductance
- Decibels

Plus Good-Bad scale for checking the quality of electrolytic condensers.

Specifications:

D.C. Volts: 0-7.5/75/150/750/1500 Volts.

A.C. Volts: 0-15/150/300/1500/3000 Volts.

Resistance:

0-10,000/100,000 ohms. 0-10 Mgms.

D.C. Current: 0-7.5/75 Ma. 0-7.5 amps.

Capacity: .001 Mfd.—2 Mfd. .1 Mfd.—20 Mfd.

Electrolytic Leakage: Reads quality of electrolytics at 150 Volt test potential.

Decibels: — 10 Db. to + 18 Db. + 10 Db. to + 38 Db. + 38 Db. to + 58 Db.

Reactance: 15 ohms—25 K ohms 15 K ohms—2.5 Megohms.

Inductance: .5 Henry—50 Henries 30 Henries—10 K Henries.

Handsome round cornered molded bakelite case 3 1/4" x 5 1/2" x 2 3/4" complete with all test leads and instructions.

\$21.40

SOLD ON EASY PAYMENTS AT THE NET CASH PRICE

No interest or carrying charges added, Simply remit \$5.40 with order, pay balance \$4.00 per month for four months.

MOSS ELECTRONIC DIST. CO., INC.

Dept. B-21, 38 Murray St., New York 7, N. Y.

All Channel Reception

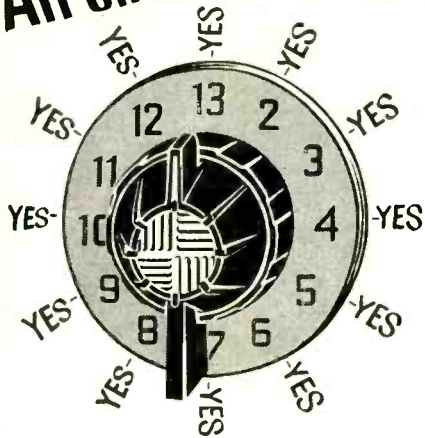

With Extra Performance

WHERE YOU NEED IT

WITH **DUBL·VEE**

BY **WORKSHOP**

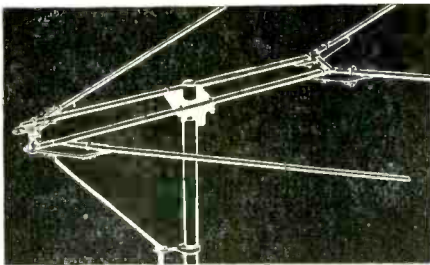

In the high bands . . . it's the original patented Dubl-Vee specially designed by WORKSHOP engineers to "bring-in" extra signal on channels 7 thru 13, while retaining excellent reception on channels 2 thru 6.

Gains up to 8 db for single bays and 10 db for double bays assure maximum signal. Rugged, streamlined construction cuts wind resistance. Only the Dubl-Vee gives these performance extras . . . tops for signal and tops for strength.

On your next installation, install the WORKSHOP Dubl-Vee . . . the original Dubl-Vee designed and patented by WORKSHOP . . . at radio parts distributors everywhere.



**THE
WORKSHOP
ASSOCIATES**
Division of the Gabriel Co.
135 Crescent Road
Needham Heights 94, Mass.

cerned, unless the resistance is very low, particularly in the reverse direction. A minimum voltage between the selenium and the alloy is required before the barrier is formed. Most voltmeters do not furnish nearly enough voltage to give an indication of the units' condition under load.

A partially shorted filter capacitor will usually damage the selenium rectifier as will any heavy drain of current caused by a short circuit in the chassis if the unit is not fused properly.

If the output voltage of the rectifier system is low, it is wise to inspect the chassis thoroughly before installing a new rectifier because the new recti-

fier will also be damaged if the cause of the original trouble is not corrected. The input filter capacitor should be inspected particularly if trouble has developed.

Caution

Cables and leads must not come in contact with the plates of the rectifiers. It is possible that small portions of the protective coating may have chipped or peeled off, exposing the aluminum plate which has both a-c and d-c potentials present. Do not disturb or touch the plates of selenium rectifiers with your hands. Movement of the plates may damage the coatings of alloy, selenium, and the contact surfaces.

USING SCOPE

[from page 25]

across the screen from left to right at a constant rate. The variations of signal voltage are applied to the vertical deflection plates where they move the electron stream up and down the fluorescent screen. A typical use of the oscilloscope in alignment involves the use of the frequency modulated signal generator whose amplitude output is constant but whose frequency output changes over the band width of the circuit to be tested. A visual signal on the oscilloscope is the effect of the circuit under test upon the constant amplitude variable frequency input signal.

Figure 9 illustrates a common use of the cathode ray oscilloscope in testing and aligning a television receiver. If it is assumed that the frequency response curve of a particular portion of the television receiver under test is desired, this curve may be traced by means of the circuit as shown. A frequency modulation sweep generator is applied to the circuit and an input voltage whose amplitude is constant, but whose frequency changes is applied to the amplifier. In its basic function, the frequency modulation sweep generator has an output which may be represented as a series of individual single frequency signals. Actually, of course, the sweep generator puts out a signal whose amplitude is constant and whose frequency varies continuously. It is more convenient for our purpose to assume the output of the frequency modulated generator to be a series of individual signals whose amplitude is constant and whose frequency changes in steps.

As shown in Fig. 9, the signal generator has an output of individual signals of constant amplitude whose frequency varies from $F-1$ to $F-10$ as shown. The cathode ray tube oscillo-

scope has its vertical amplifier connected to the output section of the particular circuit in the television receiver. A sweep voltage used as a time base causes the electron beam to move back and forth from left to right across the fluorescent screen. The output signal from the receiver is applied to the vertical input terminals of the oscilloscope.

Since the receiver amplifier circuit is tuned, the amplifier will have a non-linear response plotted against frequency. This means that the amplifier will enlarge some signals but not all signals. As the sweep generator produces signals in frequencies from 1 through 10, these signals are applied to the vertical amplifier of the oscilloscope after passing through the receiver circuit. This amplifier establishes the vertical motion of the electron beam. Since the sweep circuit provides an up or down motion a response curve will be traced on the fluorescent screen. The amplitude of the response curve at any particular frequency depends on the degree to which the amplifier in the television receiver has affected this particular signal frequency.

As a result the actual response curve of this receiver test circuit is plotted on the cathode ray oscilloscope at once. Any adjustments of the circuit may have their visual effect noticed on the cathode ray tube screen. For example, if a particular adjustment affects the frequency signal number 4, the electron beam trace will either rise or fall at this frequency marked 4 when the circuit is adjusted. By this means, if the desired response of the circuit is known beforehand, the receiver circuit may be so adjusted as to produce this known response.

Kenco Mounts

...are engineered for the JOB!

.....

KENWOOD ENGINEERING CO., Inc.
265 Colfax Avenue
Kenilworth, N. J.



**KENCO
EAVE
MOUNTS**

Easily mounted on hanging rafters or trim boards of eave. Eliminates need for drilling into brick or masonry walls. Ideal for buildings with extended roofs. Hot dip galvanized.

Available in 3 sizes:

- Model #135 22" Eave Mount
- Model #136 28" Eave Mount
- Model #137 48" Eave Mount

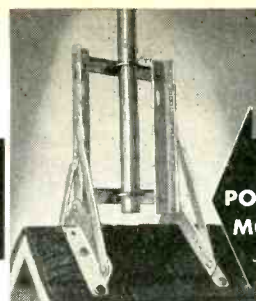

**ALL
POSITION
MOUNTS**

A strong, self supporting mount for peak, slope, side wall, corner or flat mountings. Positive locking braces eliminate need for guy wires in many installations. No blocking or shimming necessary.

- Model #105 . . . For masts up to 1½".
- Model #101 . . . For masts up to 2".

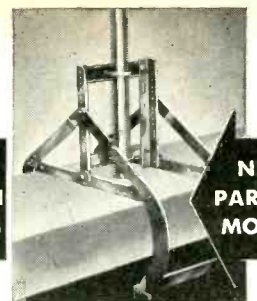

**NEW
PARAPET
MOUNT**

The KENCO Parapet Mount gives positive anchorage to apartment house walls without damage to building. Powerful clamping action insures safe installations. Shipped assembled. Quickly installed. Hot dip galvanized.

- Model #106 . . .
- For walls up to 13½" thick.

**\$1.00 to \$5.00 PAID
"for SHOP NOTES"**

Write up any "kinks" or "tricks-of-the-trade" in radio servicing that you have discovered. We will pay from \$1 to \$5 for such previously unpublished "SHOP NOTES" found acceptable. Send your data to "Shop Notes Editor," RADIO-TELEVISION SERVICE DEALER, 67 West 44 St., New York 18, N. Y. Unused manuscripts cannot be returned unless accompanied by stamped and addressed return envelope.

TV9

HELP CRIPPLED CHILDREN
1952

Crippled Children need YOUR help

Crippled children want to walk, talk and play like other children. They can if you help by giving to Easter Seals. Give generously—your dollars mean new lives for America's crippled children.

**19th ANNUAL
EASTER SEAL APPEAL**
March 13 to April 13

THE NATIONAL SOCIETY FOR CRIPPLED CHILDREN AND ADULTS, INC.
11 S. LASALLE STREET, CHICAGO 3, ILL.
THE EASTER SEAL AGENCY

Under the older method, the same results could only be obtained by arduous point to point plotting. For example, a single frequency signal generator could be applied to the same test circuit of the receiver with voltmeter as the output indicating device. This frequency generator would be adjusted for frequency *F-1* and the output voltage noted and recorded. The single frequency signal generator then has its output adjusted to Frequency *F-2* and the increase in output is read from the meter. The same procedure is followed for all of these individual test points and by means of coordinate graph paper, the frequency response curve may be plotted. This gives the same result as the use of the cathode ray tube oscilloscope but it takes a much longer time and is usually less accurate. It should be pointed out at the same time that any circuit adjustments of the receiver under test would require a replotting of most of the graph in order to ascertain exactly how *all* the response curve was affected by these adjustments.

For ordinary AM equipment, this procedure was not usually necessary since the band width characteristics are not critical. However, the advent of FM and more important the widespread use of television receivers, has brought wide band amplifiers into prominence. These amplifiers *do* have a frequency response and a band width characteristic which is very critical. It is not too much to say that the cathode ray tube used in the oscilloscope, is an indispensable tool to the proper rapid and convenient alignment of wide band circuits, by means of plotting the frequency response in a visual manner. Manufacturers of frequency modulation and television equipment almost invariably include such band width and frequency response data as a part of their operating and service adjustments.

[To Be Continued]

answer the call

1952 RED CROSS FUND

It's...
**KESTER
FLUX-CORE
SOLDER**

IN DEMAND

IN DEMAND and used by the manufacturers of original equipment . . . Best for you, what could be better . . . Kester Rosin-Core, "Resin-Five" and "Specialized" Solders!

KESTER SOLDER COMPANY
4239 Wrightwood Ave., Chicago 39
Newark 5, N. J. • Brantford, Can.

**KESTER
SOLDER**

ATR

For
AC CURRENT ANYWHERE



STANDARD AND HEAVY DUTY INVERTERS

For Inverting D. C. to A. C.
Specially Designed for operating A. C. Radios, Television Sets, Amplifiers, Address Systems, and Radio Test Equipment from D. C. Voltages in Vehicles, Ships, Trains, Planes and in D.C. Districts.

ATR ✓ NEW MODELS
✓ NEW DESIGNS
✓ NEW LITERATURE

"A" BATTERY ELIMINATOR
AC-DC INVERTERS
AUTO RADIO VIBRATORS

See your jobber or write factory

AMERICAN TELEVISION & RADIO CO.
Quality Products Since 1931
SAINT PAUL 1, MINNESOTA-U.S.A.

AD INDEX

| | |
|---|------------|
| Allied Radio Corp. | 64 |
| American Phenolic Corp. | 12 |
| American Television & Radio Co. | 64 |
| Anchor Radio Corp. | 16, 17 |
| Belden Manufacturing Co. | 13 |
| Bussmann Manufacturing Co. | 45 |
| Clarostat Mfg. Co., Inc. | Cover 2 |
| Electro-Voice, Inc. | 48 |
| Electronic Instrument Co., Inc. | 59 |
| Erie Resistor Corp. | 61 |
| General Electric Co. | 4, 5 |
| Grayburne Corporation | 59 |
| Guardian Elec. Mfg. Co. | 60 |
| Hickok Elec. Instrument Co. | 60 |
| Hytron Radio & Electronics Co. (Div. of CBS) | 15 |
| Industrial Condenser Co. | 58 |
| JFD Manufacturing Co., Inc. | 57 |
| Kenwood Engineering Co., Inc. | 63 |
| Kester Solder Copmany | 63 |
| LaPointe-Plascomold Corp. | 14 |
| Mallory, P. R. & Co., Inc. | 7, 18 |
| Merit Transformer Corp. | Cover 3 |
| Mosely Electronics | 64 |
| Moss Electronic Distr. Co., Inc. | 61 |
| Ohmite Manufacturing Co. | 8 |
| Radiart Corporation | 43 |
| RCA Tube Dept. RCA Batteries | 10, 11 |
| RCA Electron Tubes | Cover 4 |
| Rauland Corporation, The Regency Div., I.D.E.A., Inc. | 31 |
| Rider, John F. Publisher, Inc. | 54, 63, 64 |
| Sams, Howard W. & Co., Inc. | 6, 57 |
| Schott, Walter L. Co. | 47 |
| Simpson Electric Co. | 9 |
| Snyder Manufacturing Co. | 2 |
| Standard Transformer Corp. | 53 |
| Sylvania Electric Products, Inc. | 51 |
| Transvision, Inc. | 14 |
| Triplett Elec. Instr. Co. | 49 |
| Turner Company, The | 50 |
| Vaco Products Company | 52 |
| Workshop Associates, The | 62 |



MOSLEY OPEN-WIRE LINE ACCESSORIES

for Better Fringe Area TV

MOSLEY Open-Wire Line Accessories are especially designed to provide Better TV Pictures in areas of weak signal strength. OPEN-wire line, made with MOSLEY Accessories, has less than one-sixth the loss of new standard 300 ohm ribbon line. Its use will often result in good, consistent TV pictures in fringe areas where TV reception had previously been considered impossible. Such line will not increase in loss with age and will withstand adverse atmospheric conditions indefinitely.

CAT. NO. 450-1 SPLICER.

Solderless splicer for joining sections of open-wire line. Maintains line impedance.

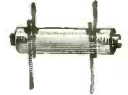

List \$.30

CAT. NO. 450-2 ANCHOR BAR.

Holds open-wire line securely. Use with screw-eye stand-off of type ordinarily used for co-ax line. Maintains 1" spacing for constant impedance.

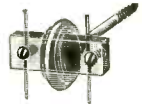

List \$.30

CAT. NO. 450-3 SPACER.

Place 12" apart along line to maintain 1" spacing.



List \$.10

MOSLEY ELECTRONICS

2125 LACKLAND RD. OVERLAND, MO.



Low Cost Powerful P.A.!

COMPLETE • READY TO USE

Tops for powerful indoor-outdoor use; ideal for electioneering. Easy portability. Covers 4,000 persons indoors, up to 25,000 sq. ft. outdoors. Full 30 watts usable output; 2 high-imp. mike inputs, 1 phono input, each with separate volume control; tone control; fidelity ± 2 db from 40-20,000 cps. Complete system includes: 30 watt amplifier and tubes, Electro-Voice "Cardax" unidirectional mike with adjustable floor stand and 20' cable; 2 General Electric 12" PM speakers, each with 30' cable; portable carrying case holds all, 16 1/4 x 12 1/4 x 25". For 110-130 v., 60 cy. A.C. Shpg. wt., 75 lbs. Complete, less only phono top.

93-372. Complete 30 Watt System. Only \$119.75
93-340. 3-Speed Phono Top for above. Only \$16.95

Available on Easy Terms—write for details

FREE See the 212-Page ALLIED Catalog for other Sound Systems, ranging from 8 to 80 watts. Write for Free copy of Radio's leading Buying Guide today.

ALLIED RADIO

833 W. Jackson Blvd., Dept. 26-C-2, Chicago 7, Ill.

MERIT

TV full-line* Components For
Improvement, Replacement, Conversion

SELL IMPROVED RECEPTION

MERIT "TV" Kit No. 1000 consists of matched units for sharp, edge to edge focus — the MDF-70 Cosine Yoke, the HVO-7 Universal Flyback and the MWC-1 Width Linearity Control. Keep a MERIT "TV" Kit handy on service calls — when you spot fuzzy edge focus you'll get plus business and a reputation for real "know-how."

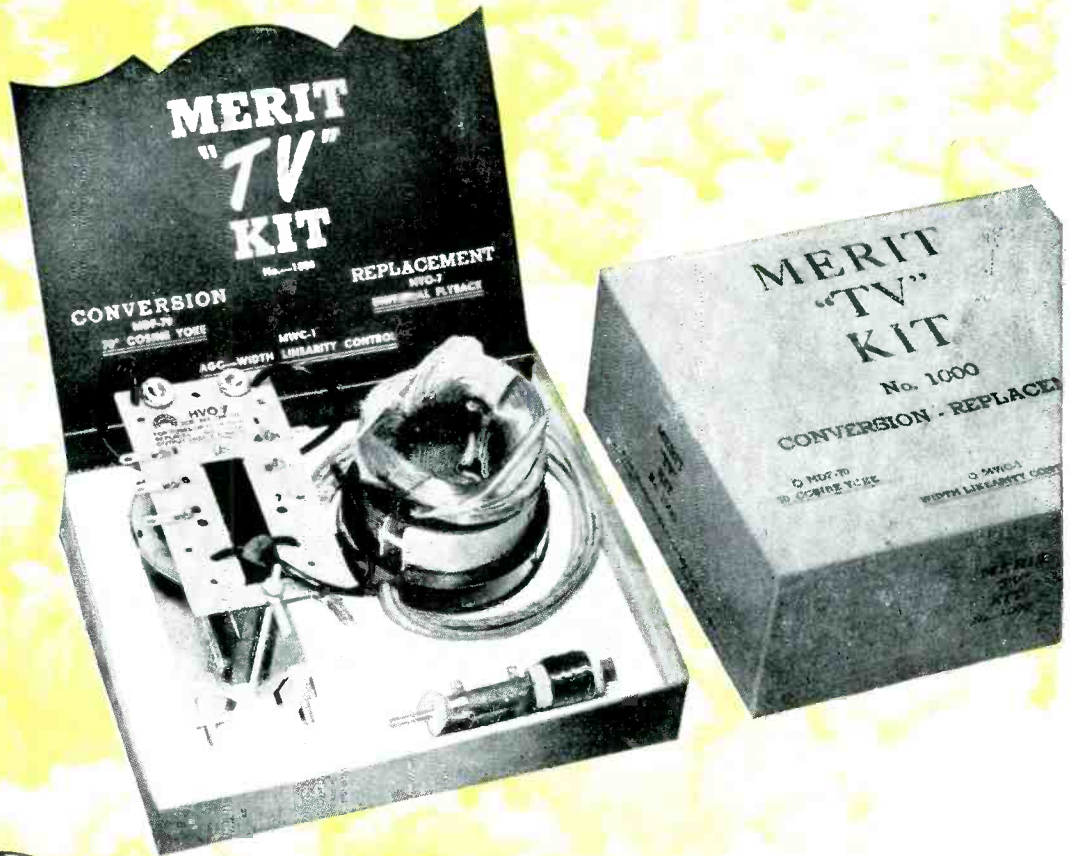

MERIT MDF-70 . . . original of the "cosine" series — low horizontal and high vertical inductance. Now used by such famous sets as Radio Craftsman, the cosine series will improve 10,000,000 sets now on the market!

MERIT . . .

HQ for TV Service Aids

MERIT'S new 1952 Catalog # 5211 is now available . . . introducing MERIT IF-RF Coils and giving complete MERIT Coil and Transformer data and listings. Other MERIT service aids for TV improvement, replacement and conversion problems: TV Replacement Guide #404, September 1951 issue — covers 3000 models and chassis of 82 manufacturers; Cross Reference Data on IF-RF Coils, Form #14.

Write: Merit Coil and Transformer Corporation, 4425 North Clark Street, Chicago 40, Illinois.

These three MERIT extras help you:



..... Exclusive: Tapemarked with specifications and hook-up data

- Full technical data packed with every item
- Listed in Howard Sams Photofacts



*Merit is meeting the TV improvement, replacement and conversion demand with a line as complete as our advance information warrants!

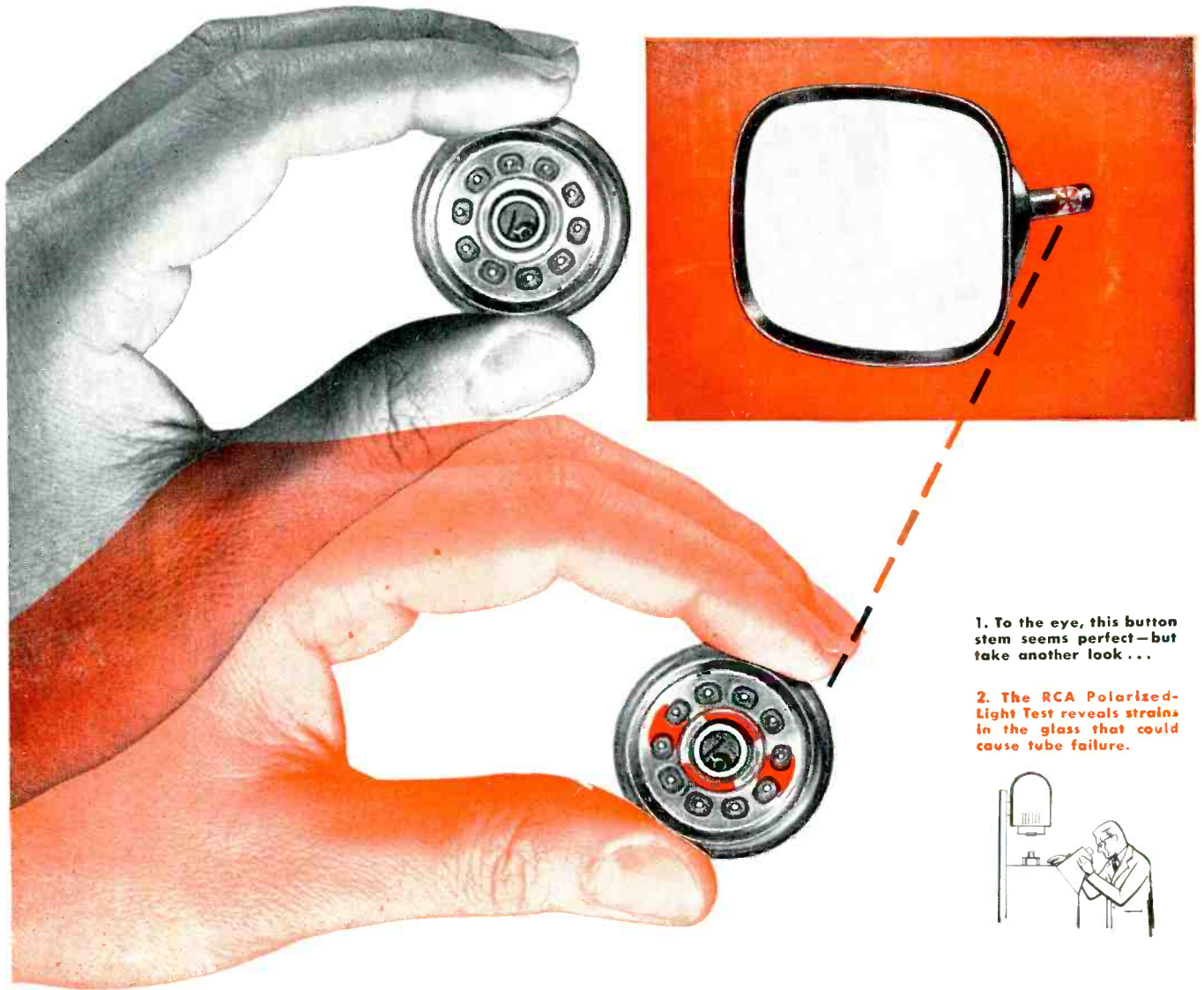

1. To the eye, this button stem seems perfect—but take another look . . .

2. The RCA Polarized-Light Test reveals strains in the glass that could cause tube failure.



A **DOUBLE-TAKE** to safeguard your reputation

AT FREQUENT INTERVALS throughout the day, RCA production inspectors pick finished button stems hot off the griddles of the sealing machines, and subject them to an ingenious "polarized-light test." Reason? Even slight variations in sealing temperature can, and do, set up strains in the areas of glass-to-glass and glass-to-metal seals that could result in fractures. The Polarimeter . . . especially designed for RCA . . . reveals these otherwise invisible strains, and prevents im-

perfect assemblies from reaching the final production line.

By taking a second look, RCA virtually licks a possible fracture before it occurs . . . not only on button stems, but also neck-to-flare seals and the face-plate section adjacent to the rim seal of metal-shell picture tubes.

This constant vigilance and *quality control* at *all* stages of manufacture assure that RCA standards will be met on the final assembly line. In this way, RCA closely guards its own reputation

for quality . . . and yours as well.

In RCA picture tubes, the difference is *top-quality control*. That's why, dollar for dollar, RCA picture tubes have no equal.

With RCA Receiving Tubes, as well as RCA Kinescopes, **TOP-QUALITY CONTROL** makes the difference.



RADIO CORPORATION of AMERICA
ELECTRON TUBES

HARRISON, N. J.