

OCTOBER, 1951

Radio-Television SERVICE DEALER

MR HARRISON CRAIG JR
SHULLSBURG
MO 64501
#1 OCT 28-51 130 14



The Professional Radio-TVman's Magazine

IN THIS ISSUE:

- The Elusive Decibel
- Conversion To Larger Picture Tubes
- Oscilloscope Circuits, Part 3
- Servicing Tape Recorders, Part 5
- Men of Radio, Part 8

AM-FM-TV-SOUND

You wouldn't risk your business on the turn of a card

...but a survey of hundreds of servicemen shows that 57% order capacitors by rating, without specifying a brand. Why risk your reputation on parts that may not deliver top performance?



Make Sure! Make it Mallory!

You'll get top performance every time you make it a Mallory Capacitor... top performance that stems from uniform capacity, long life, and outstanding service at high temperatures and heavy ripple currents.

Mallory produced the first dry electrolytic capacitor and has led the way in setting new standards for smaller sizes, uniform mounting, and resistance to heat in continuous service. Every Mallory FP assures you of trouble-free service, cuts down on comebacks.

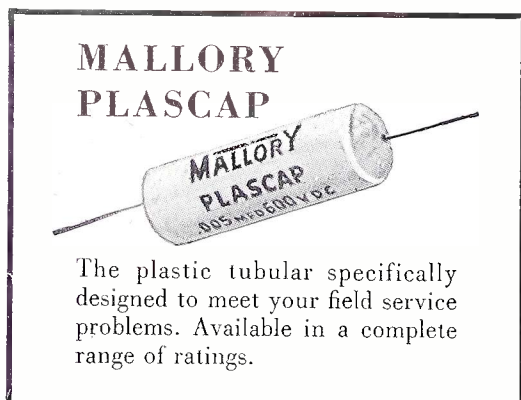

The plastic tubular specifically designed to meet your field service problems. Available in a complete range of ratings.

You will like the Mallory Plascap*, plastic tubular capacitor, too! Ruggedly molded and securely sealed... it has clearly identified, permanently fastened leads, and stands up under high temperatures.

Don't be satisfied with less than the best. It costs no more to get the top performance that only Mallory Capacitors can give you!

**Trade Mark*

Depend on your Mallory Distributor for precision quality at competitive prices



P. R. MALLORY & CO. Inc.
MALLORY

CAPACITORS • CONTROLS • VIBRATORS • SWITCHES • RESISTORS
• RECTIFIERS • VIBRAPACK* POWER SUPPLIES • FILTERS

*Reg. U.S. Pat. Off.

APPROVED PRECISION PRODUCTS

P. R. MALLORY & CO., Inc., INDIANAPOLIS 6, INDIANA

Assured Balanced
Performance On
Both Audio and
Video Signals

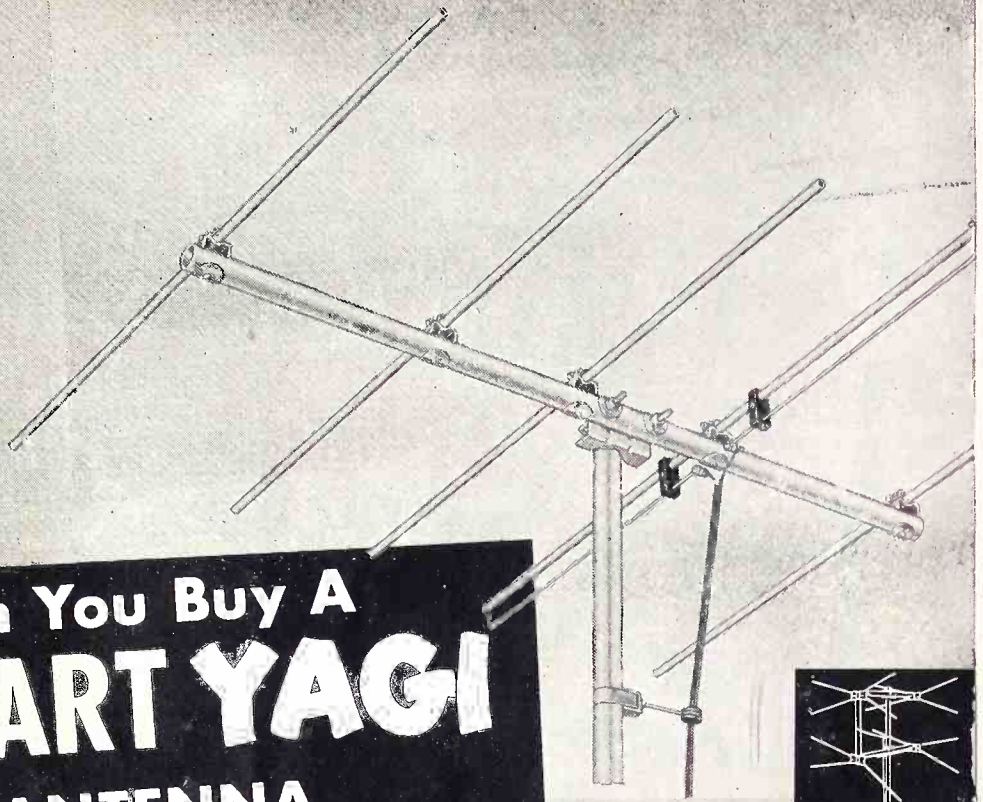

When You Buy A
RADIART YAGI
TV ANTENNA

You **KNOW** it covers the entire
6 Megacycle Band width in the
specific channel for which it
was designed

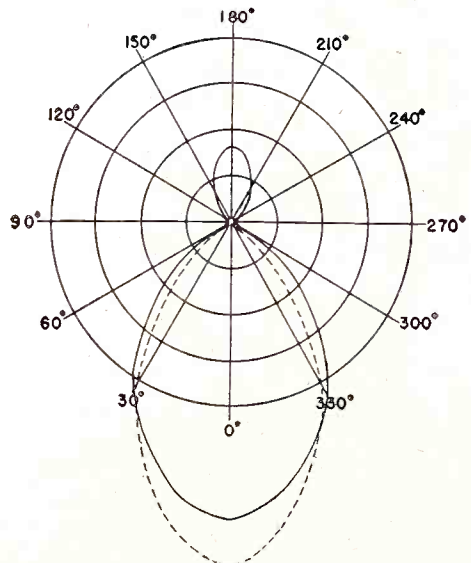
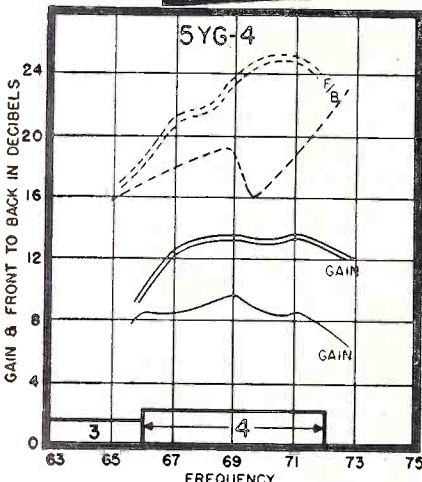

YAGI response curves for all channels available
from your RADIART distributor ... or write direct
to us ... Specify Form F885.

The perfect answer to the need for maximum signal
pickup in "fringe" areas. Each YAGI is cut for a specific
channel and may be used singly or doubly stacked.
Nothing skimpy or shortcut in their manufacture either
— each RADIART YAGI covers the full band width of
its channel.

CHECK THESE FEATURES:

- Pre-assembled Fold-out Design for FAST Installations
- Over 8 lb. Forward Gain
- Excellent Front-to-Back Ratio
- Narrow Beam Width That Develops High Signal-to-Noise Ratio
- Low Standing Wave Ratio
- Sturdy Construction For Lasting and Dependable Performance.

**You Can't Beat A RADIART Antenna
On A TELE-ROTOR ... It's Tops!**



THE RADIART CORPORATION
CLEVELAND 2, OHIO

VIBRATORS • AUTO AERIALS • TV ANTENNAS • ROTATORS • POWER SUPPLIES

Snyder
PHILADELPHIA

Directronic*

MOTORLESS

TV AERIAL SYSTEM

360° ELECTRONICALLY SWITCHED BEAM



**SUPERSTRUCTURE
INSULATOR ASSEMBLY**

- 3 combinations of elements for perfect picture clarity on each channel
- Full 360° electronic orientation

**DIRECTRONIC
BEAM SELECTOR**

- Gives remote control of element combinations
- Mounts on or near set

*T.M. APPLIED FOR

 <p>NO MOTORS OR MOVING PARTS</p>	 <p>NO ROOF ORIENTATION</p>	 <p>NO ELECTRIC POWER</p>	 <p>NO GHOSTS</p>
---	---	--	---

SNYDER MFG. CO.

**ANTENNA ENGINEERS
PHILADELPHIA 40 • U. S. A.**

EXPORT: ROBURN AGENCIES, INC., NEW YORK 7, N. Y.

**P. S. ONLY ONE
LINE TO INSTALL**

EDITORIAL

by S. R. COWAN

Police Licensing Threatens TV Men

TV servicemen in several major cities, (Los Angeles, being typical), are in imminent danger of having forced upon them unjust and uncontrollable municipal police department license laws. Why? Because a few outright gyps or a few incompetent L.A. servicemen got spotlighted by the publicity of a sensation-seeking newspaper. The thousands of honorable, competent and progressive servicemen, compared to the few malingerers, were caught in the web of taint foisted on them . . . and unfortunately they're not organized to combat the hysteria and cry for police license action, which is completely unjustified. Full details about this "mess" are given in this issue's "Sync Pulses" which appears on page 6.

Color TV Converter Sales

Whether or not you favor the CBS incompatible color TV method makes no difference. Such color telecasting is now being done in some major cities and the public seemingly is not adverse to investing in color adapters and converters. So the market for the TV technician's skill in conversion work expands daily.

In the color telecast range of Philadelphia and New York stations, for example, more than 4 million black & white TVsets are in daily use, with more joining them hourly, and everyone theoretically a prospect for a conversion job. Most of the newer TVsets being made have built-in color adapter systems, but only one of the sets, new or old, has the complete converter mechanism. Several prominent manufacturers are about to announce they have such converters available for immediate sale.

Doing a color conversion job is definitely nothing that a layman or novice technician should attempt, despite any advertising claim a manufacturer may advance about his particular product. But to offset the possibility that this will happen, we suggest that service organizations forewarn their customers and at the same time stipulate that they are ready, willing and able to do the jobs. And for the record, let us again stress the fact that *only competent technicians should attempt to do color TV conversion work*. Novices who attempt such jobs will probably "louse up" the set beyond repair.

About The Supply Situation

At the Parts Jobbers' Convention held recently in Cleveland, the high point was the growing shortage of parts, tubes and accessories needed for maintenance and repair work. By all means study and balance out your inventory, don't hoard, and whenever possible be sure to issue an MRO certification when making purchases from your wholesaler.

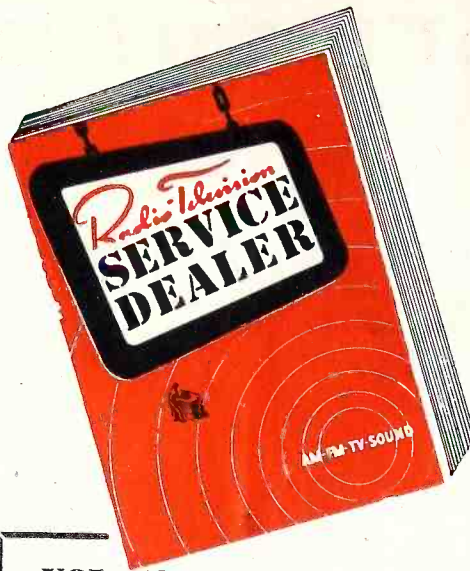

Sanford R. Cowan
EDITOR & PUBLISHER

Samuel L. Marshall
MANAGING EDITOR

COWAN PUBLISHING CORP.
67 WEST 44TH ST.
NEW YORK 18, N. Y.



VOL. 12, NO. 10

OCTOBER, 1951

Editorial	3
Trade Flashes	4
Sync Pulses, by San D'Arcy	12
The Elusive Decibel, by David Gnessin	17
Explaining the meaning of the decibel, together with easy to use charts for the non-mathematician.	
Conversion to Larger Picture Tubes, by Chet Jur	21
Straightforward discussion of large tube conversion principles and procedures. Easy to read, with plenty of "meat".	
Oscilloscope Circuits, Part 3, by Allan Lytel	22
Third and final installment analyzes CRO principles as applied to sync and sweep circuits.	
Servicing Tape Recorders, Part 5, by C. A. Tuthill	25
Discussion of the mechanical and electrical operation of the Brush Soundmirror BK 411 and BK 414 tape recorders, together with adjustment and servicing information.	
Men of Radio, Part 8, by William R. Wellman	27
Armstrong's development of the super-regenerative receiver and Frequency modulation. Television's beginnings with Nipkow, Crookes and Braun.	
Shop Notes	29
Crosley Spiral Inductuner-replacing fiber shaft. Capehart-Farnsworth CX31 Chassis—horizontal displacement. Stromberg-Carlson Model TS125-16 receivers—sync modification to improve picture pulling condition. Air King Model 700-93 Chassis—hum or buzz. Motorola TS-89/TS-94—oscillation.	
New Products	30
Trade Literature	32
Circuits:	
Basic schematic of converted circuit for large picture tubes	21
Sync and sweep circuit schematic of G.E. scope Type ST-2A	23
Simplified schematic of the sweep circuit of G.E. ST-2A/scope	23
Basic sine wave circuit of Philco Model 7008 scope	24
Sweep section schematic of Philco Model 7008 scope	24
Circuit diagram of Brush Soundmirror tape recorder, BK 411 and BK 414	26
Basic circuit diagram of Armstrong's super-regenerative receiver	27
Charts and Illustrations:	
Chart for converting voltage, current and power ratios to db	18
Decibel conversion chart	20
Record-Play head adjustment of Brush Soundmirror tape recorder Models BK 411 and BK 414	25

SANFORD L. CAHN, Advertising Director HARRY N. REIZES, Advertising Manager
DAVID SALTMAN, Production Mgr. CHARLES LO CICERO, Circulation Mgr.
BRANCHES: H. A. METZGER, 230 S. Wells St., Chicago, Ill., WEbster 9-2666
TED E. SCHELL, 112 West 9th St., Los Angeles 15, Calif., VANDike 8921

RADIO-TELEVISION SERVICE DEALER is published Monthly by Cowan Pub. Corp., 67 West 44th St., New York 18, N. Y. Subscription price: \$2 per year in the United States, U.S. Poss. & Canada: elsewhere \$3. Single Copies: 25c. Reentered as second class matter Sept. 25, 1950 at the Post Office at New York, N. Y. under the Act of Mar. 3, 1879. Copyright 1951 Cowan Pub. Corp.

TRADE FLASHES

A "press-time" digest of production, distribution,
and merchandizing activities

Use Sprague TELECAPS®
on TV replacement jobs.
Avoid costly callbacks!

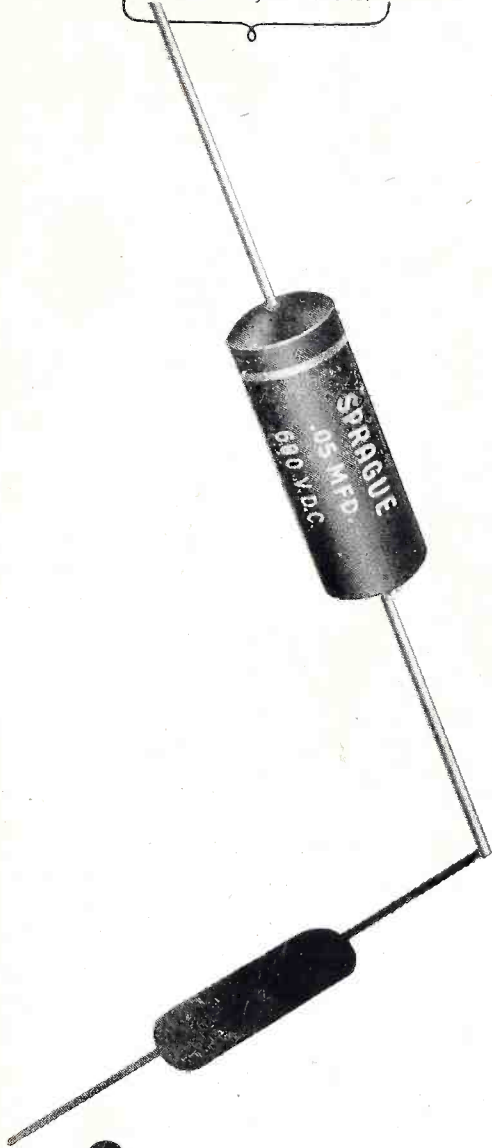

Of course there's a reason why more Sprague Telecap molded tubular capacitors are used in leading television sets and by leading service shops than any other brand! Telecaps are especially designed for TV. They stand the gaff!

Write for Bulletin M-474

SPRAGUE
PRODUCTS COMPANY

DISTRIBUTORS' DIVISION OF THE SPRAGUE ELECTRIC COMPANY
71 MARSHALL ST., NORTH ADAMS, MASS.

Unprecedented Demand Building Up For TV Components

That an unprecedented demand for TV components is building up to a peak this fall and winter, regardless of any momentary dumping, is the opinion of Ed Hinck, Sales Manager, Electronic Parts Department of Allen B. Du Mont Laboratories, Inc., East Paterson, N. J. His organization distributes Du Mont Inputuners, deflection yokes, coil and R-F flyback through the jobbing trade as well as supplying TV set manufacturers.

"Distributors need not draw any hasty conclusions from the few price-cutting examples encountered occasionally in the jobbing trade today," states Ed Hinck. "Such practices are no indication of special price concessions by Du Mont or other leading component manufacturers. Rather, price cuts are usually in connection with components dumped by TV set manufacturers who (a) may have over-bought, (b) who may have changed their circuitry or picture tube, or (c) who may be desperate to convert a parts inventory into ready cash. In some instances the components may be of somewhat ancient vintage and therefore not to be compared with present TV components supplied to and through the jobbing trade. Price cutting, even for the purpose of raising quick cash or making a quick 'buck,' is doing the participating distributor little good because (1) it chops down his profit, and (2) it creates a questionable price structure he may have to live with in the future when business is really good.

"Furthermore, despite the fact that the present market is slow, there are ample indications that the fall and winter trade will be normal. For one thing, television is entering the era of replacements and conversions. Sets now in use for several years need replacements to keep going and even to restore initial performance. Small-sized screens are being replaced by larger tubes. Those jobbers now price-cutting will be sorry!" concludes Ed Hinck.

Tube Industry Faces Sharp Cutback

Unless the receiving tube industry is granted relief from present nickel

allocation policies, manufacturers will be forced to start cutting production and to release employes by mid-October and delays in deliveries to the military services will result, Glen McDaniel, president of the Radio-Television Manufacturers Association, said recently.

Following a special meeting of the RTMA Tube Division, called by Chairman R. E. Carlson, Mr. McDaniel addressed a letter to Edmund T. Morris, Director of the Electronics Division of the National Production Authority, calling attention to the serious situation facing the industry.

Rectangular Tubes Used Almost Exclusively

Ninety-nine per cent of all television picture tubes sold to television receiver manufacturers in July were rectangular in form and 16 inches and larger in size, the Radio-Television Manufacturers Association reported recently.

July sales to manufacturers, however, were considerably less than the preceding month due to plant shutdowns for vacations. July cathode ray tube sales totaled 89,144 units valued at \$1,853,930 compared with June sales of 221,759 tubes valued at \$4,664,744.

Manufacturers' purchases during the first seven months of 1951 totaled 2,641,179 units valued at \$68,387,203. RTMA reported.

Texas State Association Formed

On Sunday, June 3rd, 1951, representatives of the following local associations met in Austin, Texas to complete the formation of a State Organization of Associations. Delegates were present from the Dallas Radio Sales & Service Ass'n, Inc., of Dallas, Texas, Texas Electronic Technicians Ass'n of Houston, Texas, San Antonio Radio & Television Ass'n of San Antonio, Texas, and the Texas Radio Service Ass'n of Austin, Texas. This meeting followed two earlier meetings where the proposed set-up had been thoroughly discussed. Also present at this meeting were representatives from Ft. Worth, Texas, Galveston, Texas, and Lockhart, Texas. At this time the Texas



**Model
3435**

Only \$114.50 and you're "in" —

SPECIALLY DESIGNED EXTERNAL MARKERS

If you have a marker, or any good AM Generator, you can substantially cut your investment in a Sweep Signal Generator by getting a Model 3435. With over 12,000,000 TV receivers in use, here's your chance to get into TV servicing with a minimum investment. Its unusual low price and ten outstanding features make Model 3435 one of the best buys of a lifetime. No complications in use; connection of external marker to the circuit under test is simple and quick through a panel connector. If you don't have a marker, use Triplet Model 1235 or 1236, shown at the right.

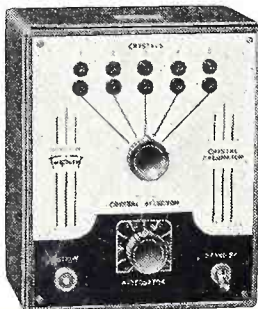
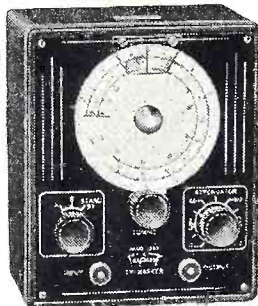

(Designed for use with Model 3435; also can be used with any Sweep Signal Generator)

● **MODEL 1235**—New Absorption TV Marker. First to provide control of Marker Dip Amplitude. Two tuning ranges on this Absorption TV Frequency Marker provide complete coverage of all present TV-IF frequencies, plus ample provisions for future additions. In metal case, 7⁷/₈" x 6⁵/₈" x 4¹/₂" Copper plated feet.

U.S.A. Dealer Net Price \$29.50

● **MODEL 1236**—New TV Crystal Marker. Easy to use—speeds testing. Has frequency coverage on crystal fundamentals up through 19 MC. Harmonics to 240 MC. (Crystals not included). Buy only those crystals needed for a particular TV service area and most-used IF frequencies. For power, plug into special terminals on Model 3435.

U.S.A. Dealer Net Price \$24.50

ONLY \$114.50—at your Distributor

Prices subject to change.



NEW a "must" book
for every
TV Service Technician

**"Servicing TV
in the
Customer's Home"**

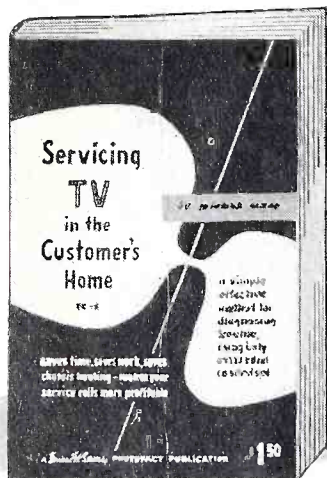

**SAVES TIME
SAVES WORK
Earns More
for You
on Outside
Service Calls**

shows how
to diagnose trouble using
capacitor probe and VTVM

Here's the book you've been asking for—practical, proved help to make your outside TV servicing really effective and profitable. Saves time, work and chassis hauling . . . shows you how to make successful repairs on the spot. You learn the following: 1. A simple, effective method for tracing down trouble, using your VTVM and a simple capacitor probe. 2. Methods for finding your way around a strange circuit—shows you how to "pull tubes" and diagnose trouble by observing audio and picture effects. 3. How to judge TV set performance by analysis of the test pattern. 4. Methods for making adjustments in the field. You'll want this essential, profit-building book. Handy pocket size; sturdy cover. **\$1.50**

ORDER TC-1. Only
Pays for itself on the very first job.

HOWARD W. SAMS & CO., INC.

Order from your Parts
Jobber, or write direct to
HOWARD W. SAMS & CO.,
2201 E. 46th St., Indianapolis 5, Ind.

**ORDER
TODAY**

Send . . . copy(ies) of "SERVICING TV IN THE
CUSTOMER'S HOME," \$1.50 per copy.

(Check) (money order) for \$ enclosed

Name

Address

City State

Electronic Association was organized as a State Ass'n of the local associations. Its purpose is to unify and bring together the programs of the local groups into a cooperative effort, to advance the cause of the radio and television technicians of Texas, and to provide a means for watching for any proposed legislation that would affect the welfare of these technical men. The State Association is supported by the initiation fee paid by each local ass'n upon joining and by regular dues assessments.

The following permanent officers were elected at this time. Mr. Frank J. Humpola, 2502 W. Alabama, Houston, Texas was elected President, Mr. Forrest Baker, 320 North Drive, San Antonio, Texas, Vice-President. Mr. Luther Bradley, 914 N. Peak St., Dallas, Texas, Secretary. Mr. J. D. Huff, 600 Harris Ave., Austin, Texas, Treasurer. Mr. T. P. Robinson, 1905 McMillan Ave., Dallas, Texas, Public Relations Officer. All correspondence should be directed to the Secretary, Mr. Luther Bradley.

The Secretary has been informed by the Ft. Worth, Texas group of their completion of their own local organization and of the fact that it is their intention to make application for membership in the Texas Electronic Association. The next meeting will be held in Austin, Texas in September.

RCA Opens "Treasure Chest"

Promotion

The RCA Tube Department has announced a dramatic "gold rush" promotion campaign, complete with treasure chests and "golden" coins,



Russ Jimieson (center), of the Walker-Jimieson Co., is presented with one of the new tube and tool cases. Max Branigan, RCA, beams approval. designed to spur sales of the company's line of television kinescope tubes.

Heart of the promotion is an offer of "paydirt" in the form of an RCA

**PHOTOFACT Users
Write Our Best ADS!**

Hundreds of unsolicited letters tell what the world's finest Radio & TV Data means to Service Technicians



Norman H. Otto
726 Cherry Ave.
San Bruno, Calif.

"The extent of your PHOTOFACT service amazes me more and more at each publication. Your new P.F. Index is very handy."



E. A. Randall
4710 Annette St.
New Orleans, La.

"I have all PHOTOFACT Folders and use them quite often. Your circuit diagrams help plenty and save a great deal of time. I have been in service work since 1934."



Harry Larrison
1723 Oakwood Ave.
Akron, Ohio

"In my opinion, PHOTOFACT is to radio and TV servicing what the five cent cup of coffee was to the American scene of yesterday—and this isn't idle praise, but cold facts, proved by the needs of everyday servicing."

NOW! GET THE PROOF FOR YOURSELF!

FREE

We'll Send You a FREE Photo-
fact Folder on any postwar re-
ceiver listed in the PF Index.

Learn for yourself—at our expense—how PHOTOFACT pays for itself by earning bigger repair profits for you! Ask for a FREE Folder covering any postwar AM, FM or TV receiver listed in the PHOTOFACT Cumulative Index. Examine it. Put it to work at your bench—then judge for yourself!

WRITE FOR FREE FOLDER TODAY!

HOWARD W. SAMS & CO., INC.
2201 East 46th Street • Indianapolis 5, Indiana

YOU ARE HELPING TO BUILD THIS PLANT!

Your increasing demand for Hytron tubes is helping to build this fine, ultra-modern plant. Located at Danvers, Massachusetts, it will be the most modern receiving-tube plant that engineering know-how can build.

And this is more important to you. Its advanced equipment and skilled staff will — we promise — give you the best tubes your money can buy. Because Hytron sincerely believes only the best is good enough for you.

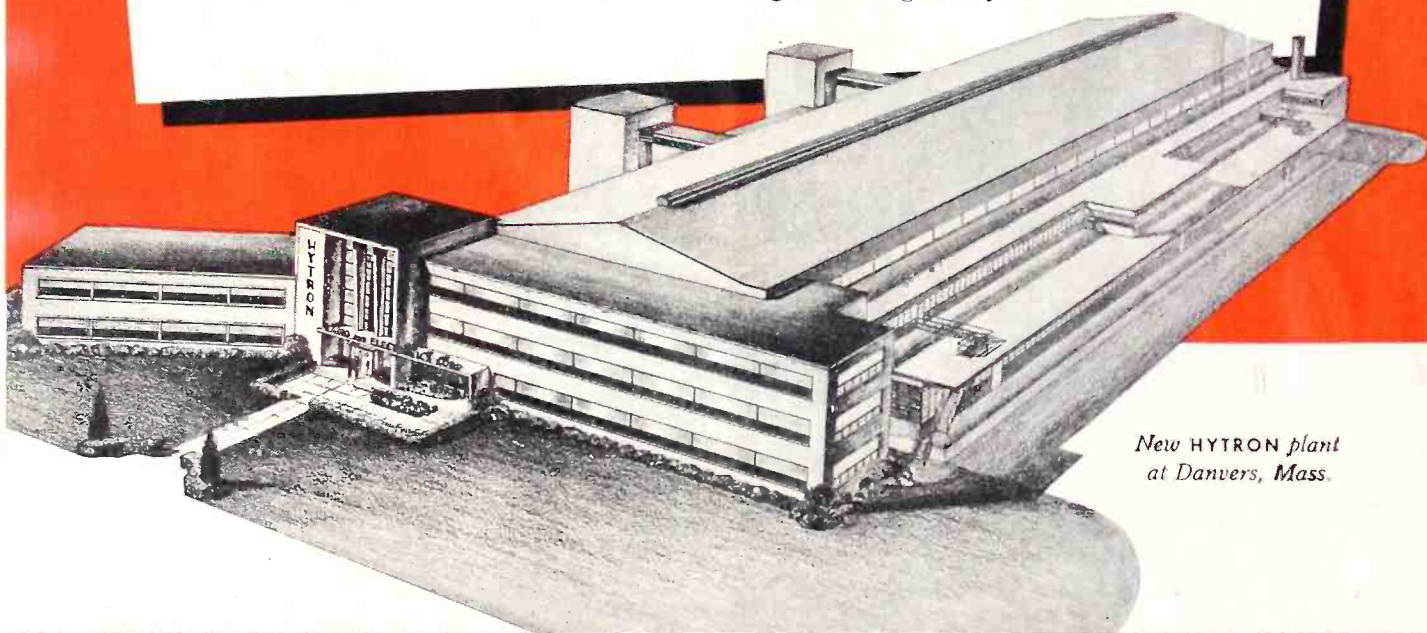

New HYTRON plant at Danvers, Mass.



NEW NAME ADDED

The famous red-white-and-blue Hytron carton has added a famous symbol: CBS. Yes, Hytron is proud to be a division of the Columbia Broadcasting System, Inc. — with greatly expanded opportunities to grow in service to you. Two respected names now guarantee you unsurpassed tube performance. CBS-Hytron is your sign of the very best in electronic tubes. Look for the attractive carton. Be sure to demand the best: CBS-Hytron.



MAIN OFFICE: SALEM, MASSACHUSETTS

NOW!
Get this binder

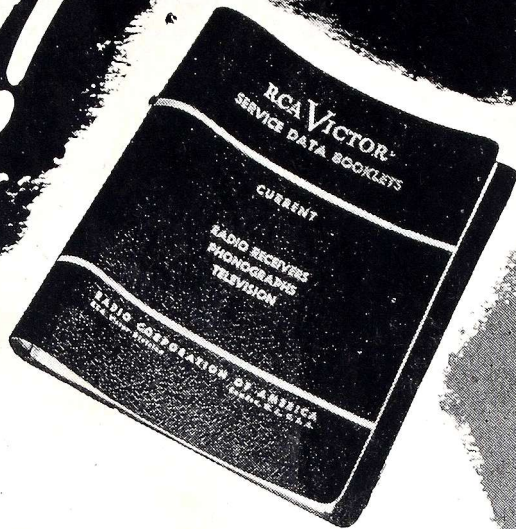

...with a \$10 purchase of
RCA VICTOR Service

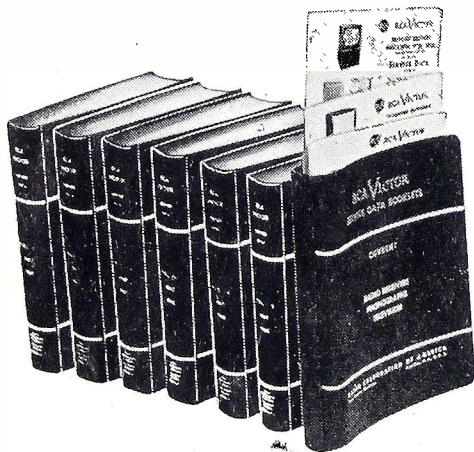

Data

- ✓ Schematics
- ✓ Alignment Procedures
- ✓ Waveforms
- ✓ Trouble-Shooting Suggestions
- ✓ Wiring Diagrams
- ✓ Production Changes

The handsome, serviceable, 3-ring binder illustrated above, was designed especially to hold your loose RCA Victor Service Data Booklets in one convenient file. For a limited time only, your RCA Distributor will give you one at no extra charge with every \$10 purchase of any of the RCA Victor Service Data Volumes or Booklets listed below.

Whether you buy RCA Victor Service Data in bound-volume or booklet

form, you get the detailed, authentic information you need for the rapid servicing of RCA Victor Radios, Phonographs, and Television Receivers... *data you can't get elsewhere.*

You save time and dollars by maintaining a complete file of RCA Victor Service Data for quick reference. It's easy to bring your files up to date. See your RCA Distributor. He has a complete stock and your binder waiting for you.

BOUND VOLUMES — RADIO, PHONOGRAPH, TV

Vol. No.	Years	Pages	Price
I	1923-1937	880	\$3.50
II	1938-1942	816	\$4.00
III	1943-1946	290	\$4.00
IV	1947-1948	566	\$6.00
V	1949	330	\$5.00
VI	1950	472	\$5.50

BOOKLETS

- Early 1951 TV Receivers... 50¢ each
- Early 1951 Radios & Phonos... 25¢ each

Get them from your RCA Distributor. Also see him for genuine RCA Service Parts.



RADIO CORPORATION of AMERICA
ELECTRONIC COMPONENTS HARRISON, N. J.

"Treasure Chest" to each dealer or serviceman who purchases 10 RCA kinescopes during the campaign. The promotion is now in effect and will continue until November 16, 1951.

The "Treasure Chest" is a light-weight, luggage-type tube and tool carrying case containing radio and television service tools and other aids designed to help the serviceman do a better job in less time. Contents include a roll-up tool kit containing a variety of standard and Phillips-type screwdrivers, a liquid-resistant drop cloth, a new book containing basic data on virtually every type of kinescope on the market, a book on television servicing written by well-known RCA service authorities, five TV program holders intended as souvenirs for the serviceman's customers, a yearly tube movement and inventory guide, and a manual on receiving tubes for radio and television.

Under the program, each dealer will receive from his distributor with each RCA kinescope purchased a special gold-colored Treasure Token, each stamped with the distributor's exclusive "goldmine" number. When the dealer has collected ten such coins, his distributor will cash them in for a Treasure Chest.

The roomy, full-view carrying case will accommodate well over a hundred miniature, GT, and larger size receiving tubes. In addition, there are separate compartments for the tools normally required by the serviceman on a house call.

The roll-up tool kit contains five standard and Phillips-type screwdriver blades, selected to match standard screw sizes found in television receivers, and a ratchet-type handle.

To provide maximum protection of the customer's rugs and floors, a "must" for the successful serviceman, RCA has included in the Treasury Chest a liquid-resistant drop cloth which covers approximately 16 square feet of floor space.

The book, "RCA Kinescopes," contains detailed information on characteristics, interchangeability, and conversion requirements for more than 100 different kinescope types now in use.

The leatherette-bound television program holders, designed as souvenirs, will accommodate standard-size television-program magazines, or the weekly program listings carried by most Sunday newspapers. Additional quantities bearing the dealer's imprint can be ordered at a modest cost.

The 16-page RCA Tube Movement and Inventory Guide will enable the serviceman to check at a glance his

TURN FIRST TO BUSS FUSES

—when your problem is Electrical Protection

BUSS offers a complete line of fuses — for television . . . radio . . . radar . . . instruments . . . controls . . . avionics — as well as for all home, industrial and commercial uses. Its easy to select the right BUSS fuse.

Behind the unquestioned high quality of BUSS fuses are 37 years of specializing in nothing but fuses and the world's largest fuse research laboratory and fuse production capacity.

Every BUSS fuse is electronically tested

So that you can depend on every BUSS fuse to operate properly under all service conditions, each fuse is tested in a highly sensitive electronic device that records whether or not; the fuse is correctly calibrated — properly constructed — and right in physical dimensions.

The BUSS Trademark can help you in Sales or Service

People recognize the BUSS Trademark as standing for fuses of unquestioned quality. The millions and millions of BUSS fuses in daily use in Homes, Buildings, Automobiles, Television and Industry have built for BUSS a reputation for quality and an acceptance enjoyed by no other fuse manufacturer.

That is why BUSS Fuses protect your profits and goodwill as surely as they protect the user.

BUSSMANN MANUFACTURING CO., UNIVERSITY AT JEFFERSON, ST. LOUIS 7, MO.
DIVISION MCGRAW ELECTRIC COMPANY

To get the facts —
USE COUPON

Bussmann Mfg. Co., University at Jefferson St. Louis 7, Mo. (Division McGraw Electric Co.) SD 1051
Please send me Bulletin SFB containing complete facts on BUSS Small Dimension Fuses and Fuse Holders.

Name _____
 Title _____
 Company _____
 Address _____
 City _____ State _____

SHURE**2**

NEW PHONO PICKUP CARTRIDGES TO HELP SIMPLIFY CARTRIDGE REPLACEMENT



**Model W22AB-T
TURNOVER CARTRIDGE**

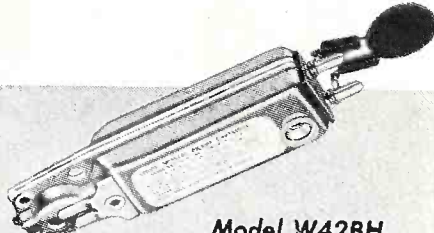

**Model W42BH
"DUAL-VOLTAGE" CARTRIDGE**

WHAT IT IS:	A high quality extended range "Vertical Drive" Cartridge complete with positive turnover mechanism. Has sapphire tipped fine-groove and osmium tipped standard-groove needle.	WHAT IT IS:	A low cost "Lever Type" Cartridge for 78 RPM records. Equipped with unique "slip-on" condenser-harness for dual-voltage output. 1.5 volts or 3.75 volts obtainable in one cartridge.
WHAT IT DOES:	Offers greatly improved performance when used as replacement for single-needle all purpose cartridge. Also recommended for replacement of other types of turnover and dual-needle cartridges. Replaces not only cartridge but turnover mechanism as well.	WHAT IT DOES:	Gives servicemen an ideal replacement for old style 78 RPM cartridges. A "leader" value—it modernizes the equipment at an extremely low price—only \$4.95 list. It guarantees improved reproduction. Minimizes inventory problem: One cartridge with choice of two output voltages covers bulk of requirements.
SPECIAL FEATURES:	<ol style="list-style-type: none"> 1. Extended frequency response to 10,000 c. p. s. 2. Tracks at low needle point pressure—only 8 grams. 3. Sturdy construction guarantees long life of turnover mechanism. 4. Standard 1/2" bracket mount has elongated holes for versatility and quick easy installation. <p>MODEL W22AB-T—CODE: RUVUR LIST PRICE \$10.00</p>	SPECIAL FEATURES:	<ol style="list-style-type: none"> 1. "Lever Type" construction assures improved tracking. 2. Specially designed needle guard which protects crystal from breakage. 3. Equipped with pin jacks and pin terminals. 4. If used for high output, the condenser may be used separately by the serviceman for other purposes. <p>MODEL W42BH—CODE: RUVUS LIST PRICE \$4.95</p>

At Your Shure Distributor

FREE! THE WONDERFUL NEW CARTRIDGE Replacement Manual No. 66



Contains over 1500 Phonographs—Radio-TV Phono Combinations equipped with or which can effectively use Shure crystal or ceramic cartridges. These sets are made by 123 manufacturers and date from 1938 to 1951.

Patented by Shure Brothers and licensed under the Patents of the Brush Development Company.

SHURE

SHURE BROTHERS, Inc. ★

225 W. Huron St., Chicago 10, Illinois

MANUFACTURERS OF MICROPHONES AND ACOUSTIC DEVICES

Cable Address: SHUREMICRO

inventory of each tube type and help him to determine the tube stock adequate for his business.

The manual on "TV Servicing" is a compilation of new and previously published articles by John R. Meagher, together with a new article on TV tuner alignment by Art Liebscher, presenting comprehensive analyses of television servicing.

Final item on the Treasure Chest is a 24-page reference booklet on "Receiving Tubes for AM, FM, and Television Broadcast."

New NEDA Officers

It has just been announced the following were elected NEDA National Officers for the 1952 term:

George Wedemeyer, Wedemeyer Electronic Supply Co., Ann Arbor, Michigan—President.

Harry D. Stark, The Stark Radio Supply Co., Minneapolis, Minnesota—Secretary.

H. E. Rubie, SREPCO, Inc., Dayton, Ohio—Treasurer

W. D. Jenkins, Radio Supply Company, Richmond, Virginia 1st Vice-President

Byron C. Deadman, Northern Radio & Television Co., Green Bay, Wisconsin—2nd Vice-President

TV Statistics

Television set production this year is estimated at 5,300,000 units as against a volume of 7,500,000 units in 1950, according to the annual industry survey released today by Television Shares Management Company, investment advisor of Televison-Electronics Fund, Inc. The ten principal manufacturers will produce a total of 3,780,000 units as against their estimated 1950 output of 5,337,000. RCA will again top the industry with production of 700,000 units as against 950,000 in 1950, followed by Admiral and Philco tied both years for second with production this year for each estimated at 625,000 as against 875,000 last year. Emerson, General Electric and Motorola are tied for third place with 400,000 units against production last year of 550,000, 425,000 and 660,000 respectively.

Present planning indicates that the peak of military production will have been passed late in 1952 and critical materials may then become more readily available for civilian production. The lifting of the freeze, expected to take place by the end of the year, will allow the construction of new television stations, adding untapped markets. The demand from these areas will cause an expansion in the market for teletests. Television

[Continued on page 14]

guaranteed
for

6

months from date of installation

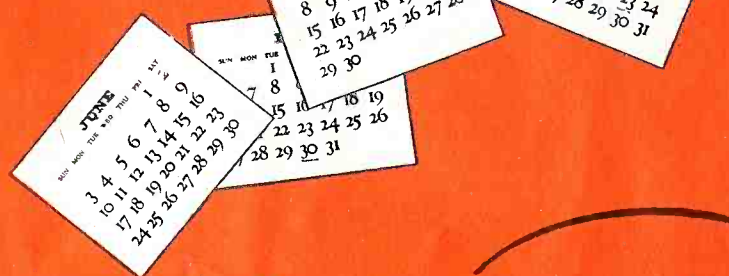

REGISTRATION No. 10861

USER'S REGISTRATION

DUMONT

REPLACEMENT TELETRON WARRANTY

Teletron Serial Number..... Teletron Type Number.....
Purchased From..... (Name of dealer) On..... (Date)

User's Signature..... State.....
Street Address..... City..... Teletron purchased for repair

Make of TV Set..... conversion replacement . Indicate one.

USER—COMPLETE, SIGN AND MAIL THIS SECTION IMMEDIATELY AFTER YOUR PURCHASE. UNLESS YOU DO SO YOUR WARRANTY IS NOT VALID.

Write for complete information on the Du Mont tube line.

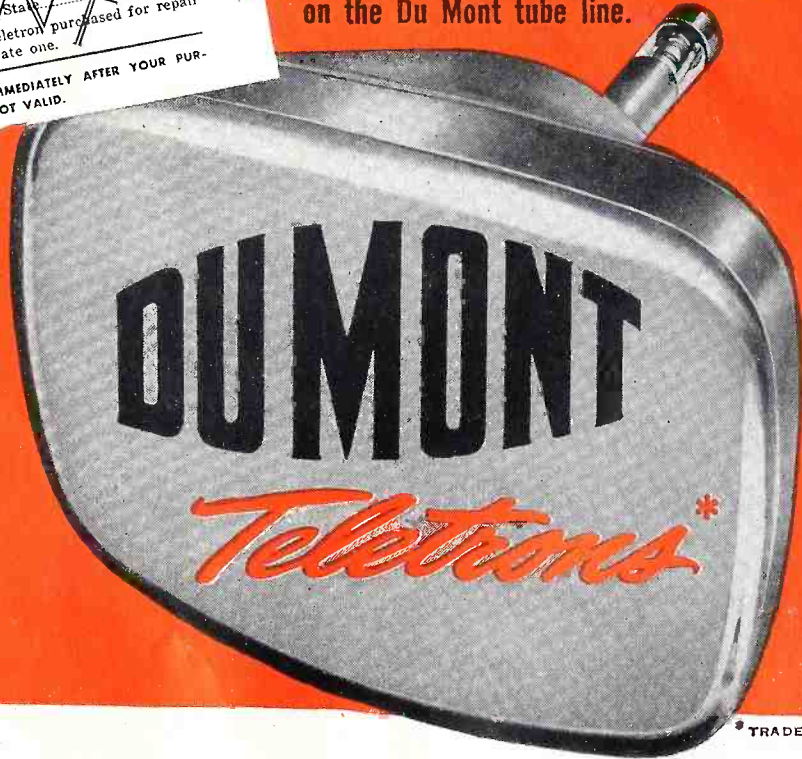

Here is a warranty with sales appeal — with your customer participating in the registration of his Teletron. A series of three cards are supplied with each Teletron. One copy is retained by you, a second is retained by the set owner and the third is sent to Du Mont providing complete protection for the set owner for a period of six months from the date of installation against any defects in the Teletron.

CATHODE-RAY TUBE DIVISION, ALLEN B. DU MONT LABORATORIES, INC., CLIFTON, N. J.

-INLINE*
ANTENNA

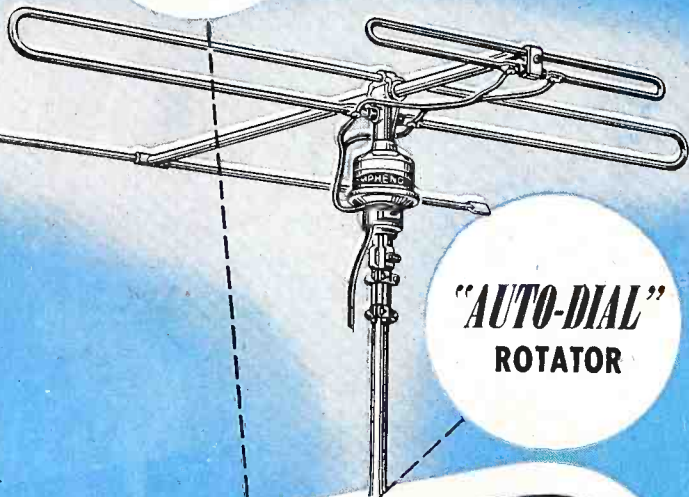

"AUTO-DIAL"
ROTATOR

**Perfect
TV Picture
COMBINATION**

* REISSUE
PAT. NO. 12,273

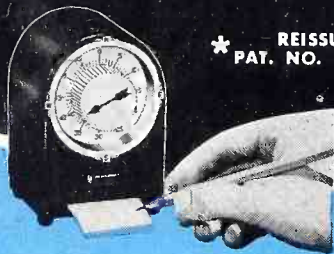

Technical men know that Amphenol's patented "Inline" antenna construction means superior electrical characteristics i.e., a single forward lobe to "pick up" the strongest signal — no minor lobes to receive reflected or spurious radiations. When this single lobe is accurately pointed to the desired signal by Amphenol's "Auto-Dial" antenna rotator, technical men know what any layman can see . . . the picture is the best there is!

For the best TV picture on any channel, from any direction,

Amphenol's "Inline" antenna and Auto-Dial rotator . . .
the unbeatable combination by **AMPHENOL**

AMERICAN PHENOLIC CORPORATION
1830 SOUTH 54th AVENUE CHICAGO 50, ILLINOIS

SYNC PULSES

by San D'Arcy

Winning Public Confidence is the Service Profession's No. 1 job. This is explained by the lead editorial in the current issue, which is prefaced by the statement: "TV servicemen in several major cities are in imminent danger of having forced upon them unjust municipal police department license laws."

Just as the old saying goes: "One rotten apple spoils the barrel," so can one paraphrase it to read, "A few gyp or incompetent technicians give a bad name to all the honest and faithful ones." It's gotten so serious that every man and organization engaged in service work had better seek to join a serviceman's association, or organize one if there is none nearby,—and then the local associations should fraternize and collaborate as state-wide and even nation-wide federations.

Why are we so alarmed? Why do we go so all-out? Listen! Here's what has been happening in several parts of the country. It can "explode" and happen to you, so be prepared by having the complete case history.

Several months ago a Chicago newspaperman decided to create a stir and get some sensational headlines for his paper, using the "scare tactics" long ago popularized by typical yellow journals. TV servicemen were selected to be the "goat." Some TV sets were doctored, servicemen called in to make diagnoses and give price quotations, etc., and the so-called "results were exposed." It goes without saying that a certain number of servicemen who got involved in the "experiment" did their jobs honestly and efficiently and about them nothing was said. However, in every case where a technician either attempted gyp practices, or inadvertently made a faulty diagnosis or if one even quoted a price that seemed higher than par, he was subjected to the big front-page "expose of the so-called TV service racket." Stated simply, the idea was to make the whole industry look like a den of thieves because a few malingerers could be set apart from the thousands of honest ones. Naturally the gullible newspaper-reading public fell for the trap—a spider-web of circumstance that was even more crooked than the "expose" it pretended to unearth.

The same sort of yellow journalism has subsequently been popped for the reading public in other major cities and as a result, in plain English, many TVset owners are getting so that they are simply afraid to have to transact business with anyone who calls himself a radio or TV serviceman or Service Company.

In Los Angeles, California, the recent newspaper "expose" of malpractice amongst servicemen resulted in having some guilty technicians being fined and sentenced to jail terms, which is fitting and proper for those who are genuinely guilty. But, by the same token, the entire service profession, and basically it is exceptionally high in the ratings of integrity and honor, has been prejudged as guilty merely because a few gyps were weeded out. Mind you—the police checkups in L. A. were practically every case merely followups on servicemen who had already been accused of malpractice by several customers. In effect the police were not exposing a racket. Instead they were merely confirming the fact that some servicemen were not doing right by the public. Meanwhile the thousands of honorable servicemen were not getting any favorable publicity and the profession as a whole was being condemned because of the faults of a few.

What's the answer to the problem? The RTA groups situated in and around Los Angeles tried to outline the solution in a straightforward and practical way, but they

[Continued on page 41]

JUST OFF THE PRESS! YOU CAN GET IT FREE!

FROM YOUR SYLVANIA DISTRIBUTOR

when you buy 100 Sylvania Receiving Tubes
or 2 Sylvania Picture Tubes!

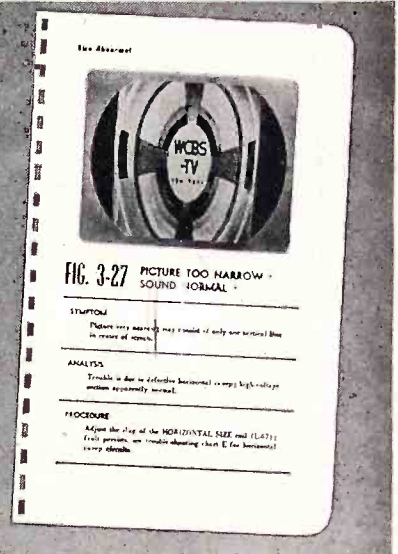
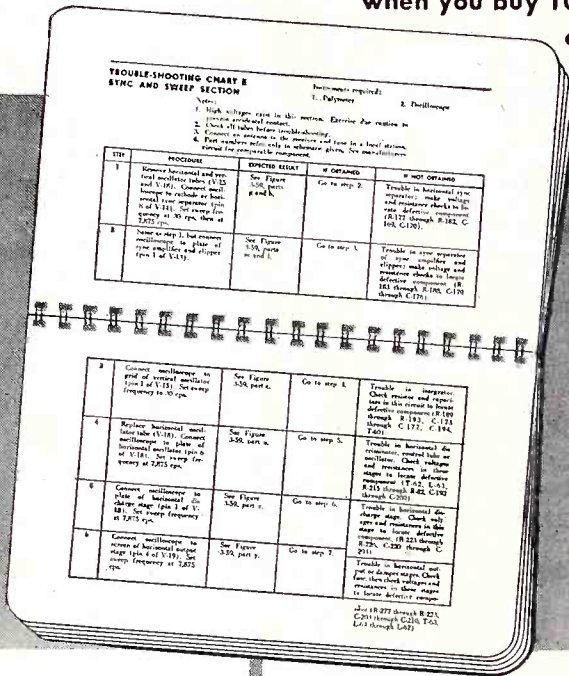
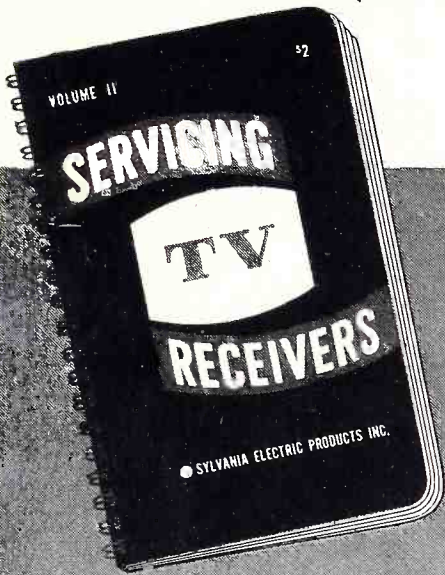

Offer good only Sept. 15, 1951 to Nov. 1, 1951. ACT NOW!

SERVICING TELEVISION RECEIVERS — VOL. II

Not just a revised, brought-up-to-date version of last year's book . . . but a completely new, reworked volume, prepared by an expert TV servicing-writing team!

Sylvania has long recognized your need for a more advanced, more complete, more systematically organized television service manual. Now, after months of careful preparation, this book is ready . . . VOLUME II, SERVICING TELEVISION RECEIVERS. It's yours FREE OF EXTRA CHARGE when you buy 100 Sylvania Receiving Tubes or 2 Sylvania Picture Tubes.

This new book, written around a popular 1951 TV receiver, contains servicing techniques for all the most recent circuits. Its information applies to most all TV sets in use today. In addition, it contains a systematic method of locating, isolating and correcting troubles . . . by far the clearest, easiest, simplest method yet devised for servicing present day receivers.

Get your FREE service book now. Offer expires Nov. 1. See or write your Sylvania distributor today!

Here's what this volume contains, how it helps you!

How to sectionalize trouble by picture analysis. For this, 41 photographs of abnormal TV pictures and their analyses are presented.

How to isolate faulty stage by use of 6 special trouble shooting charts—one for each section of receiver. Charts give step by step procedure, expected results, action required, instruments required. Charts provided for following sections: power supply, video, sound, sync., and sweep, high-voltage.

How to locate defective part—by trouble shooting charts based on voltage and resistance measurements and tube testing. Actual voltage and current readings to be encountered are listed.

Adjustment and alignment of television receivers. Alignment procedures for rf tuner, video if, sound if and discriminator; adjustment of ion trap, focus coil, deflection coils.

150 PAGES! 5 BIG CHAPTERS!
80 PICTURES AND DIAGRAMS!
WIRE-O-BINDING keeps book flat!
HEAVY COVER, TOUGH, COATED PAGES
to stand rough, constant handling!

SEE YOUR SYLVANIA DISTRIBUTOR FOR YOUR FREE COPY TODAY!

SYLVANIA

Sylvania Electric Products Inc.,
Emporium, Pa.



RADIO TUBES; TELEVISION PICTURE TUBES; ELECTRONIC PRODUCTS; ELECTRONIC TEST EQUIPMENT; FLUORESCENT TUBES, FIXTURES, SIGN TUBING, WIRING DEVICES; LIGHT BULBS; PHOTOLAMPS; TELEVISION SETS

RADIO-TELEVISION SERVICE DEALER • OCTOBER, 1951



I SELL ONE OUT OF THREE

BY ASKING:

“When did you last change your Phono-Cartridge?”

This is a typical experience of service-technicians who pop the \$70 (Million) question—because it's the cue to cartridge replacement sales.

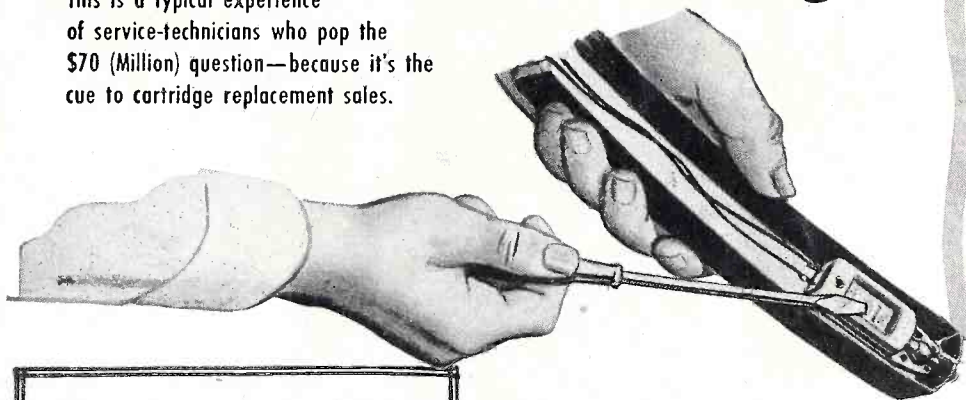

Make the Finger-Tip Compliance Test

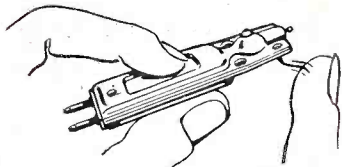

Old style, stiff-acting needle system

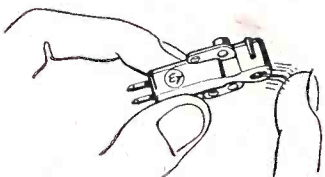

Modern, compliant needle system

It makes record-player owners aware of the importance of the cartridge. It gives you the opportunity to prove that a modern, lightweight, compliant cartridge will greatly improve reproduction and save records and needles.

Right now...10,000,000 old-style, heavy, stiff-acting phono-cartridges in existing players need replacing. Current cartridges that are inefficient should be replaced, too.

Follow the E-V plan — it works. Check the cartridge on every job — you'll make more sales, more profit!

You can make most cartridge replacements with fewer E-V models

Electro-Voice INC.

411 CARROLL STREET • BUCHANAN, MICHIGAN
Export: 13 East 40th St., New York 16, N.Y., U.S.A. Cables: Arlab

Electro-Voice, Inc., Dept. T10-51
412 Carroll St., Buchanan, Michigan

Send FREE Cartridge Replacement Chart

Name (PLEASE PRINT)

Address

City Zone State

Service-Technician Dealer Record Fan

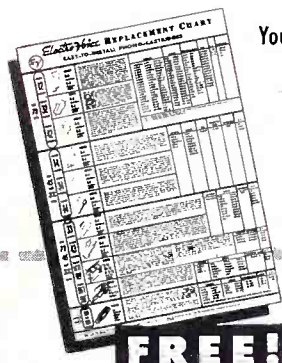

FREE!

REPLACEMENT CHART
Large, Complete Replacement Chart. Gives handy cross-reference and valuable data. Tells when to replace a phono-cartridge. Ask your E-V Distributor or send for it now.

TRADE FLASHES

[from page 10]

Shares Management Company points out that telecasting now consists of only 107 stations operating in 63 markets, of which 52, including the new West Coast markets, have a network connection. Within the foreseeable future, the estimate is for more than 1,000 telecasting stations with gross revenues of \$1,000,000,000. By way of comparison, the Federal Communications Commission stated that the television broadcasting industry in 1950 had gross revenues of slightly under \$106,000,000.

The top ten manufacturers and the estimates for 1950 and 1951 are as follows:

TOP TEN TV PRODUCERS ESTIMATED UNITS

	1951	1950 (Rev.)
RCA	700,000	950,000
Admiral	625,000	875,000
Philco	625,000	875,000
Emerson	400,000	550,000
General Electric	400,000	425,000
Motorola	400,000	660,000
Zenith	300,000	450,000
DuMont	130,000	240,000
Crosley	100,000	140,000
Hallcrafters	100,000	172,000
	3,780,000	5,337,000

Balance of Industry	1,520,000	2,163,000
Total Industry	5,300,000	7,500,000

CBS-Columbia Color Sets Now In Production

Adhering to the time schedule as set up at the time of the first showing of color television receivers by CBS-Columbia Inc., manufacturing subsidiary of the Columbia Broadcasting System, the first “Dual” color and black-and-white television receivers to be produced on production line were completed recently and immediately shipped to CBS-Columbia distributors.

This receiver, known as the model 12CC2 is a console receiver with half door, listing at \$499.95 plus tax. It is the first of a series of color receivers and color companion pieces to be produced by CBS-Columbia.

New Antenna Mfgs. Ass'n Officers

Meeting in Cleveland, during the NEDA Show, the Antenna Manufacturers Association elected Harold Harris as President and Ken Brock as Vice President. Mr. Harris is Sales Manager of Channel Master Corporation and Mr. Brock is in charge of advertising and publicity for the

[Continued on page 34]

They may
look alike - be shaped alike
 but **National Video**
 picture tubes deliver
 better performance



better components
better processing
better assembly

Through every step of manufacturing—perfection—that's why the N.V.C. picture tube delivers the better performance. Designed for conversion and replacement in every standard make television set and engineered to give even a clearer, better and more lasting picture.

Write for the name of our Representative nearest you.

3019 W. 47th St. Chicago

You will quickly see it pays to tie in with N. V. C.



demand the
National **V**ideo **C**orp.
label on every
picture tube

Three plants with over 17 acres of coordinated machinery and personnel, producing the world's finest television picture and receiving tubes.

National Video Corporation

3019 W. 47th St.
 Chicago

Grays Lake
 Illinois

901 W. Huron St.
 Chicago



Tired of old-fashioned
"kit deals" whereby you lose
time and patience trying
to assemble the unit?

And then, when it's all
together, you discover
that it's not the correct
dual-concentric control!

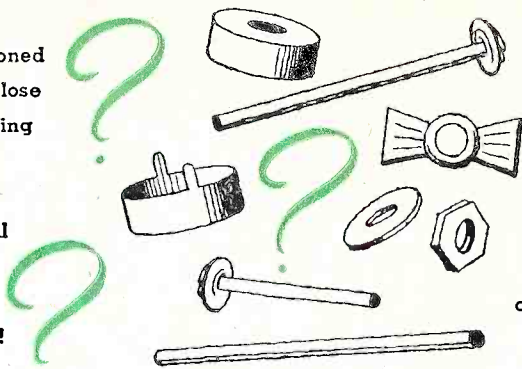

Tired of discovering that
you've got many kit parts
left over that you've
paid for and can't use?

Fed up with running into jobs
that require a combination
of controls that can't be gotten
out of your kit investment?

EVERYONE KNOWS

The exact duplicate replacement is BEST

and best of all--

they are

immediately available!

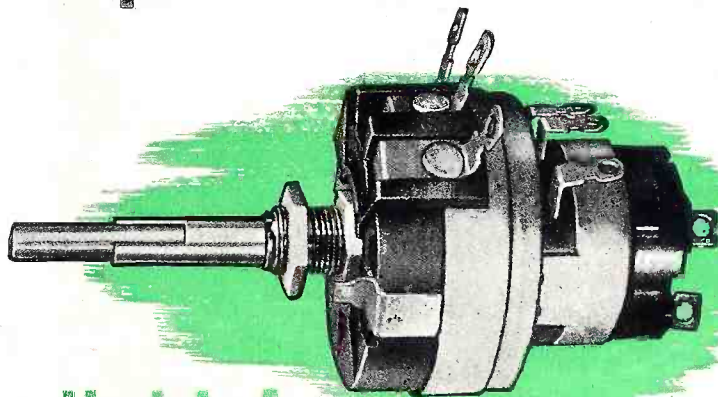

- ▶ Yes sir, Clarostat Dual-Concentrics are immediately available for 99% of controls in 2500 different TV receivers.
- ▶ Clarostat Dual-Concentrics are original equipment with practically all receiver manufacturers. Chances are you're replacing an original control with an exact-duplicate Clarostat!
- ▶ Clarostat Dual-Concentrics are available in both wire and carbon combinations that are not available in kit form.

CLAROSTAT DUAL-CONCENTRICS ARE AVAILABLE FROM YOUR CLAROSTAT JOBBER!

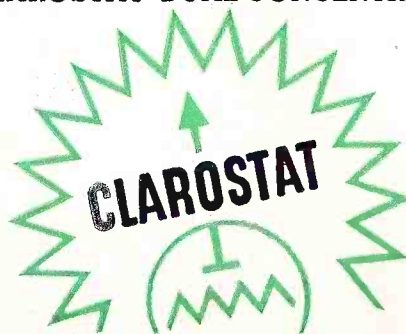

DUAL CONCENTRICS

CLAROSTAT Mfg. Co., Inc., Dover, New Hampshire

IN CANADA: CANADIAN MARCONI CO. LTD., MONTREAL, P. Q., AND BRANCHES

ELUSIVE DECIBEL

by DAVID GNESSIN

A review of the transmission unit with charts for ready solution of problems, plus many examples to practice and acquire dexterity in handling this unit. The reader who might be unfamiliar or a little rusty with logarithmic formulas need only gloss over the derivations and apply himself to the simplified explanations for a better understanding of this subject.

SOME years ago an applicant, taking a radio theory examination (cautioned by the examination instructions to be brief) answered the question: What is a decibel? with: *A decibel is one-tenth of a Bel.* That answer was marked 'wrong'. Apparently the applicant was *too* brief.

On the other hand there is an enormous mountain of literature in print dealing with the subject of the decibel . . . yet it remains an elusive unit. Why should this be so?

The decibel (db) is *truly* one-tenth of a bel. The bel (named after Alexander Graham *You-know-who* is the measure of the ratio of two values, such as voltage, current or power. *So help me, that's all there is to it!* Suppose, for example, a device is capable of 2 watts of power. In comparing this with another device capable of 4 watts, we find a *3 decibel difference*. This value can be measured, calculated or plotted. It is an international convenient measure of difference in level.

Of course, there is the detail involved in solving for exactly how

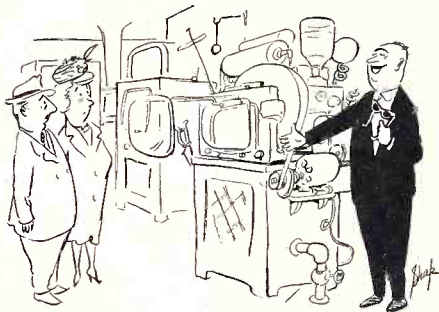

"Now the only thing necessary to this simple color converter are these specs."

many decibels are required. The mathematics concerned are sometimes tedious. Fine, then; use the charts, instead. After a review of the subject herein presented, viewed by a number of authorities referenced, a very simple means of determining and locating the elusive decibel will be presented, using nothing more than a ruler laid across the scale provided. Then, finally, charts will be shown which require less effort even than that. Surely then will the elusive decibel no longer harass the radioman.

Enter The Decibel!

Suppose we have a uniform signaling circuit (telephone or radio) having a length of n miles, and suppose that the power at the input end of this circuit has a value of P_1 . Suppose we next measure the power at a point 1 mile from the source and designate this power value as P_2 . The ratio n of the two power values = P_1/P_2 .*

Continuing the process, let us measure the power values at successive points each 1 mile further from the

source. The successive power ratios will be found to be r^2, r^3, r^4 , etc., the ratio for a point n miles from the first point being r^n .

Thus; $P_1/P_2 = r^n$

This can be re-expressed mathematically as: $n = \log_r P_1/P_2$

Unless you want to set up a special set of logarithm tables with base = r , you may simply declare that $r = 10$, and use the common logarithm tables with that base.

Thus; $n = \log_{10} P_1/P_2$ bels

Since the bel is normally too large, we use the decibel = bel/10, giving us finally:

decibels = $10 \log_{10} P_1/P_2$

(You'll find some authorities will make the power ratio P_2/P_1 instead of P_1/P_2 . It all depends on whether you want the answer *step-up* or *step-down*. In any event, *1 db difference between two powers of audio amplification represents the bare difference between them which can be noted by the human ear.*)

Use Of Decibel To Express Relative Amplification²

The variation of amplification . . . in audio-frequency amplifiers is often expressed in decibels, referred to some arbitrary level taken as zero decibels. The decibel is a unit for expressing a power ratio, and since power output is proportional to the square of the voltage, the equations (may be written) as follows:

$$\begin{aligned} \text{db} &= 10 \log_{10} P_2/P_1 \\ &= 10 \log_{10} (E_2/E_1)^2 \\ &= 20 \log_{10} (E_2/E_1) \end{aligned}$$

The decibel has no other significance.

Decibels And Their Uses³

The standard transmission unit. . .

¹ WHAT IS THIS THING CALLED DECIBEL? McLaughlin & Lamb, QST August 1931

*EDITOR'S NOTE: This ratio does not depend on the initial or final values of power but on the amplification or attenuation (whichever the case may be) of a unit length of line.

² RADIO ENGINEERING, Terman (second edition, 1937)

³ THE AEROVOX RESEARCH WORKER (July, 1941)

⁴ WAVES and ELECTRONICS section I.R.E. PROCEEDINGS, February, 1946 (Miedke)

⁵ Problems 1-3 I.R.E. PROCEEDINGS, February, 1946 (Miedke)

Problems 4-11 CAPITOL RADIO ENGINEERING INSTITUTE Advanced Radio Engineering

⁶ AEROVOX RESEARCH WORKER, 1941

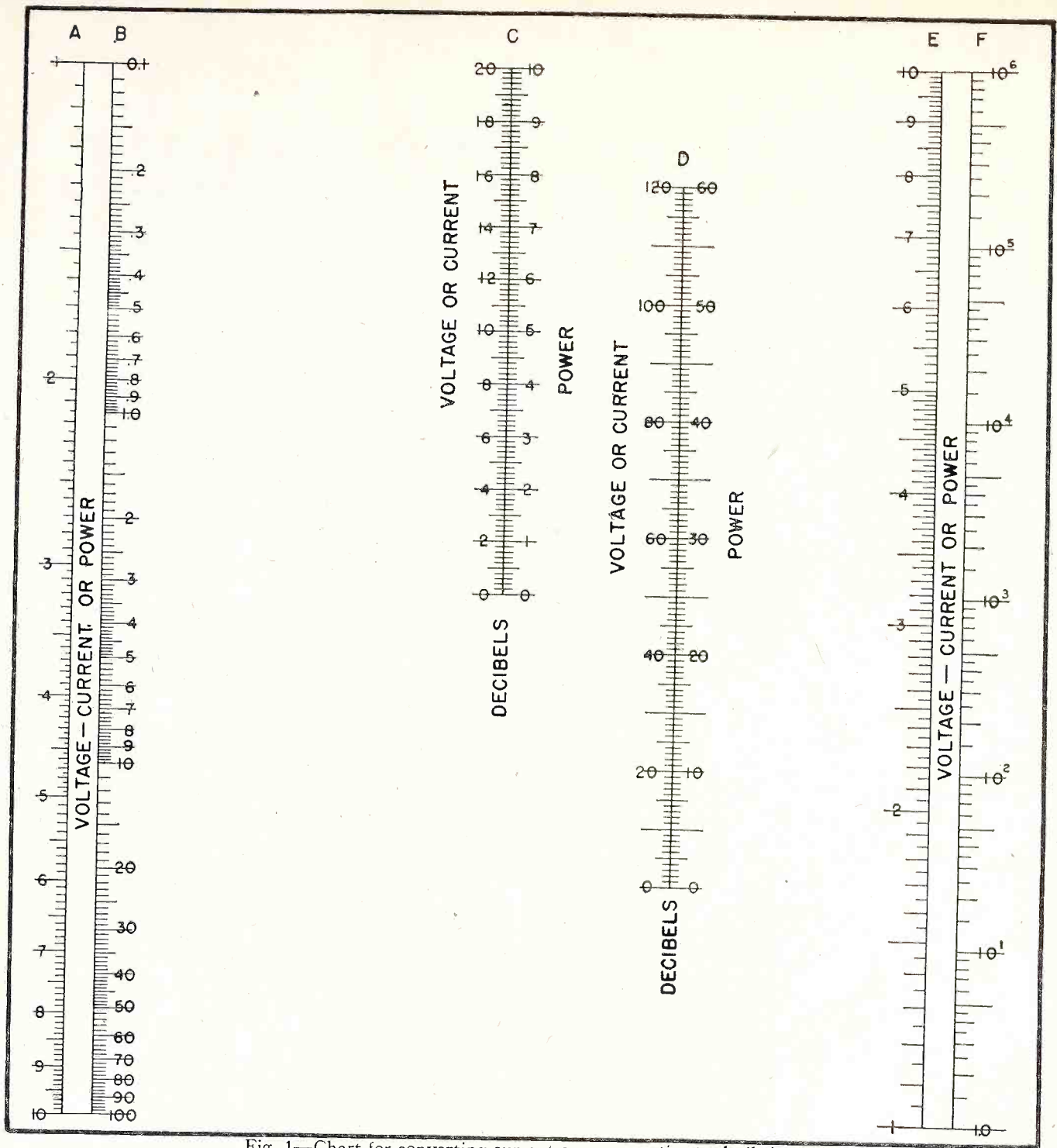

Fig. 1—Chart for converting current or power ratios to decibels.

expresses in *decibels* the gain or loss in amplifiers, antennas, and receivers; the extent of attenuation or transmission in wave filters and volume-level network, etc.

It is a logarithmic expression of a ratio between two quantities. As a unit of measurement, it specifies no definite amount of current, voltage, power or sound, but represents merely a ratio between two magnitudes of either one. It is therefore a relative unit. Since the db is a logarithmic unit, successive gains or losses expressed by it may be added algebraically.

The db may express a ratio between two values of either current, voltage, power, or sound energy. It thus be-

comes possible to determine the db gain for a given amplifier from ratios that express voltage, current or power amplification. Gain is expressed as *plus db*; loss as *minus db*.

It is accepted practice in . . . radio and telephone measurements to designate the power level of 0.006 watt (6 milliwatts) as *zero db* and to express any other values of power as a certain number of "db up" and "db down", now in common parlance.

Decibel Conversion Chart⁴

A decibel conversion chart has been designated for versatility and simplicity of use. This chart gives decibels directly from any two values of voltage, current, or power. (It works *backwards*, too.) It has two ranges;

the lower range (scales A, C, and E of Fig. 1) are for voltage, current, or power ratios up to 10 to 1, and the extended range (scales B, D and F) are for voltage, current, or power ratios up to 10⁶ to 1.

Problems Illustrating Decibel Conversion Chart⁵

(1) Assume a voltage ratio of 2.4 to 1.2. This voltage ratio in decibels is found by drawing a line from 1.2 on scale A to 2.4 on scale E passing through the decibel voltage scale C at 6 decibels. This can also be found on scales B, D, and F; however, the decibel scale D is not expanded so much as the decibel scale C and cannot be read as accurately.

(2) Assume a voltage ratio of 1200

(Courtesy I.R.E.)

to 1.2. This voltage ratio in decibels is found by drawing a line from 1.2 on scale B to 1200 on scale F passing through the decibel scale D at 60 decibels.

(3) Assume a power ratio of 580 to 320. This power ratio in decibels is found by drawing a line from 3.2 on scale A to 5.8 on scale E (the ratio of 580 to 320 is the same as 5.8 to 3.2) passing through the decibel scale C at 2.6 decibels.

From the above examples it will be noted that the smaller value of any ratio will always be located on scale A or B and the larger value will always be located on the respective scale E or F. Also the decibels corresponding to ratios of less than 10 to 1 can be found on either set of scales; however, it is preferable to use scales A, C, and E because the decibel scale C is expanded and can be read with greater accuracy.

Believing that, given a new tool, one cannot be given too many examples of the use of the tool, thus to encourage its use and to familiarize the user with its application, the writer has included several additional examples, worked out by the routine mathematical processes, followed by instructions for checking by use of the chart.

(4) Problem: Find difference between a power level of 20 watts and one of 30 watts.

$$\begin{aligned} \text{db} &= 10 \log_{10} P_2/P_1 \\ &= 10 \log_{10} 30/20 \\ &= 10 \log_{10} 1.5 \\ (\log_{10} 1.5 &= .176 \text{ from tables}) \\ &= 10 \times .176 \\ &= 1.76 \text{ db} \end{aligned}$$

Thus 30 watts is only 1.76 db greater than 20 watts. To the human ear this would represent a hardly distinguishable increase in volume.

Now, use the chart in Fig. 1: Lay the ruler across 20 on "B" and 30 on "F." This will intersect 1.76 on "D" for answer.

Hard to read? Okay, instead divide power values by 10. Now we may use expanded scale. Place ruler across 2 on "A" and 3 on "E." Read answer 1.76 on power side of "C."

(5) Problem: Assume the maximum undistorted power output of an amplifier is 12 watts. What is the output in db?

(Note; output level = level above zero reference level of .006 watts.)

$$\begin{aligned} \text{db} &= 10 \log P_2/P_1 \\ &= 10 \log 12/.006 \\ &= 10 \log 2000 \\ &= 10 \times 3.3 \\ (\log 2000 &= 3.3 \text{ from tables}) \\ &= 33 \text{ db} \end{aligned}$$

Thus 12 watts is 33 db above the reference level of .006 watt; or to put it

as the problem is stated: The output level of the amplifier is 33 db.

Now, use the chart. We can't find .006 on the first column, so we conveniently multiply the power values by 1000 to permit the use of whole numbers. Lay the ruler across 6 on "B" and 12,000 (above 10^4) on "F." Read the answer 33 db on the power side of "D."

(6) Assume the output voltage of an AM diode detector developed across a 120,000 ohm load resistance is 12 volts R.M.S. The power output = E^2/R or $12^2/120,000 = .0012$ watt. What is the power output in db?

(Expressed in reference to zero level $P_2 = .006$ watt)

$$\begin{aligned} \text{db} &= 10 \log .0012/.006 \\ &= 10 \log .2 \\ &= 10 \times -1.3 \end{aligned}$$

(log .2 = -1.3 from tables)

Since the mantissa of logarithm is always positive, the multiplication is performed as follows:

$$\begin{aligned} (-1 + 3) \times 10 &= \\ -10 + 3.0 &= -7 \text{ db} \end{aligned}$$

Therefore .0012 watt represents a power level of -7 db in reference to the arbitrarily selected reference level of .006 watt. In amplifier parlance the detector output is said to be down 7 db from the reference level.

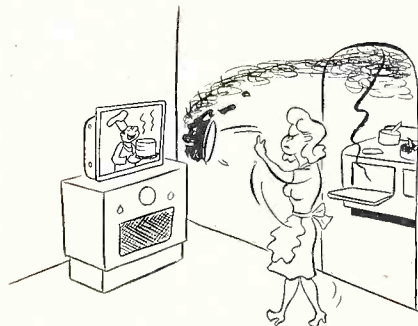

"Now we mustn't lose our tempers if all our cakes don't turn out as lovely as this one of mine."

Now, use the chart. Multiply the power values by 1,000 to get convenient whole numbers. Lay the ruler across 6 on "A" and 1.2 on "E." Note that the db column shows an answer below zero. This indicates the answer will be a negative value. (You could take a caliper and determine just how far the point is below zero, then swing it above zero and find that numerical value. Instead, here is another practical method:) Reverse the figures, using 1.2 on "A" and 6 on "E." Read the answer 7 on the power side of "C." We've already determined it is negative. Thus it reads -7 db.

(7) An interesting problem is to plot problem (5) and (6) against each other. We find the detector output

power applied to the audio amplifier is .0012 watt, while the audio amplifier output is 12 watts. What must be the amplifier gain in db?

$$\begin{aligned} \text{db} &= 10 \log 12/.0012 \\ &= 10 \log 10,000 \\ &= 10 \times 4 \\ (\log 10,000 &= 4 \text{ from tables}) \\ &= 40 \text{ db} \end{aligned}$$

Now, use the chart. Again multiply power values by 1,000 for whole number practicability. Lay the ruler across 1.2 on "B" and 12,000 (above 10^4) on "F." Read the answer 40 db on power side of "D."

(8) The output of sensitive pick-up devices is given in db. Mostly these are minus values. Converting these values requires care. Given a dynamic microphone with a signal output of -30 db. Convert to power level in watts (milliwatts).

(Expressed in reference to zero level = .006 w)

$$\begin{aligned} \text{db} &= 10 \log P_2/.006 \\ -30 &= 10 \log P_2/.006 \\ (\text{dividing by } 10) &-3 = \log P_2/.006 \\ .001 &= P_2/.006 \\ (\text{Antilog } -3 &= .001) \\ P_2 &= .001 \times .006 = .000006 \text{ w} \\ &= .006 \text{ milliwatts} \end{aligned}$$

Now use the chart. The unknown power value sought is the smaller. Again multiply the power values by 1,000. Thus, lay the ruler across 6 on "F" and 30 on power side of "D". Note this goes below the smallest value of "B". Then try multiplying the power values by 1,000,000. Now, lay the ruler across 6,000 on "F" and 30 on power side of "D". Then read answer on "B". Since the original power value was multiplied by 1,000,000, the answer will have to be divided by that value to restore the true ratio. Thus: $6/1,000,000 = .000006 \text{ w} = .006$ milliwatts.

(9) Given an amplifier input signal of -15 db. Convert to watts. This is a very complex problem to write out. Yet the chart indicates a quick conversion to milliwatts. Multiplying the reference power level (.006 w) by 1000 to place it on the scale, we set the ruler at 6 on "F" and 15 on power side of "D". Read answer 0.185 on "B". Divide that by 1,000 to restore proper power unit and get .000185 w = .185 mw as the correct answer.

Note that negative db values are taken in stride with the chart. The minus sign quickly determines the smaller value involved, showing proper column to use.

(10) Convert -19.8 db to milliwatts. (Here, the negative characteristic plus the decimal portion make for complex mathematics.) Use the

• CHART A •

• CHART B •

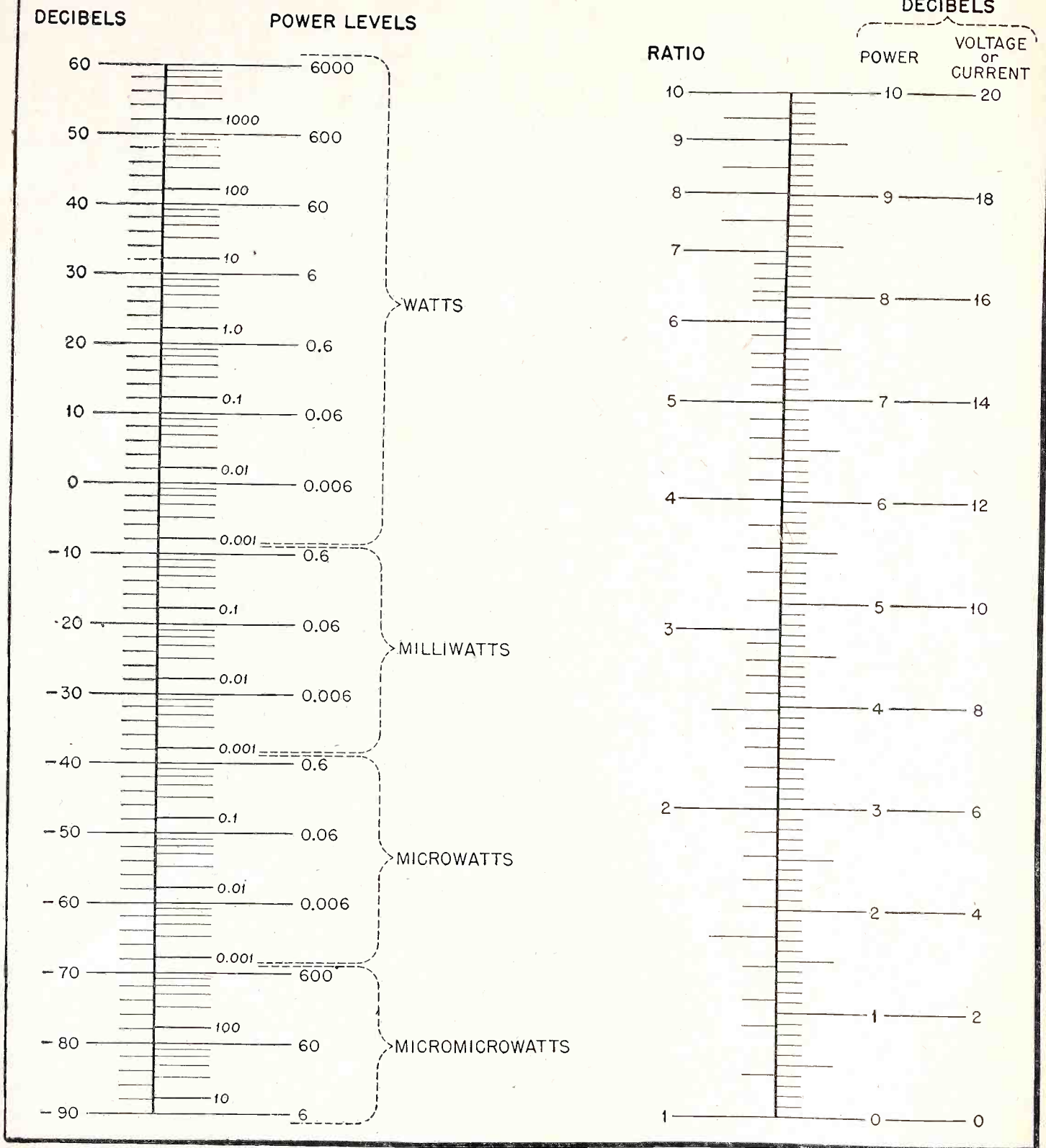

Fig. 2. Decibel conversion chart

(Courtesy Aerovox Corporation)

chart with ease. Multiply power values by 10^6 to place them on the scale. Lay the ruler on 6000 on "F" and 19.8 on power side of "D". Read 62 on "B". Divide by original multiplier; $62/10^6 = .000062 \text{ w} = .062 \text{ mw}$ as the correct answer. This comes within .00000088 watt of the figure reached by worked out logarithmic process—sufficient accuracy.

(11) Voltage and current ratios may also be expressed in decibels. Current or Voltage gain in db = $20 \log I_2/I_1 = 20 \log E_2/E_1$
An amplifier has a voltage gain of 336. Express in db.

$$\begin{aligned} \text{db} &= 20 \log E_2/E_1 \\ &= 20 \log 336/1 \\ &= 20 \times 2.526 \\ &= 50.526 \end{aligned}$$

(log 336 = 2.526 from tables)

$= 50.5 \text{ db}$
To use the chart, lay ruler at 336 on "F" and 1.0 on "B". Read correct answer 50.5 db on *Voltage or Current* side of "D". (You may not be able to read the answer closer than 50 db. That is quite acceptable.)

Aerovox Charts

In an attempt to even further sim-
[Continued on page 47]

CONVERSION TO LARGER PICTURE TUBES

by **CHET JUR**

(Sales Engineer, Merit Transformer Corp.)

BEFORE undertaking the conversion of any TV set to a larger picture tube, many aspects of the change must be considered. The one single factor which will dictate the advisability of change-over is the physical dimensions of the cabinet. In general, Motorola and Admiral are probably the easiest of the big names, Westinghouse and Philco are not too hard and most RCA and GE sets are rather tough due to cabinet size limitations. Any set can be converted electrically. If physical changes do not allow for easy alteration, complete cabinet replacement may be necessary.

A tool which is a must in any shop attempting conversions is the Scinta Saw Model GEB-2. This is the best investment possible in cutting down the time and, consequently, cost of cabinet work.

Preliminary Work

Before starting the job, check the set thoroughly. Make necessary corrections. This may save you hours of work trying to cure such things as insufficient width or poor linearity which may have existed before the conversion. Although many conversions are made without the addition of any parts, we have found in some of these jobs that actual harm was done to the sets. We suggest the following as minimum added material in every job:

A. Merit 70° Deflection Yoke, Part MDF-70 or equivalent

B. Merit Horizontal Sweep Transformer, Part HVO-6 or HVO-7 or equivalent

C. Width Linearity Control, Part MWC-1 or equivalent

Cost of these parts is well warranted considering the saving of time. Remember this is flat fee work and time cost is the greatest single element.

Another in this series on conversions presented by various manufacturers of conversion components. The present contribution is a model of brevity combined with a world of "meaty" information for the technician.

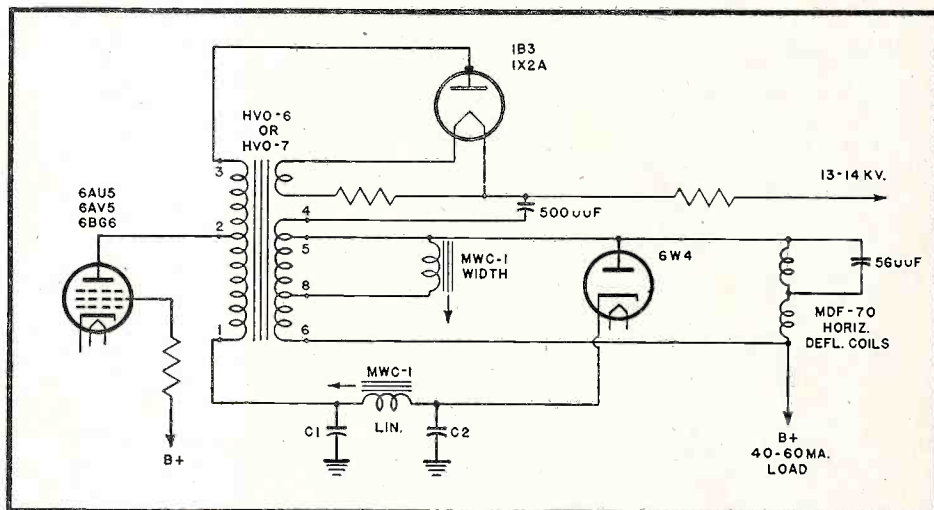

Fig. 1. Basic schematic of converted circuit.

Do not approach the problem on a hit or miss basis. Most sets use the kick-back horizontal sweep circuit, consequently, all are basically the same. For the present, we believe only this type of circuit can be accepted for conversion. Don't dismantle chassis without first making an identified (color coded and terminal designated) drawing of the sections of the set to be altered. We have found that all chassis do not follow the manufacturers data sheets. If you do not have this sketch, you may find yourself wasting hours of time tracing wiring.

Conversion Procedure

Install the Merit HVO-6 or HVO-7 Horizontal Transformer and Merit MDF-70 70° Deflection Coil or equivalents. Connect these parts as shown

in Fig. 1. Check your wiring and, after taking the usual precautions, plug set into outlet and check the set. If the picture size is inadequate, follow the suggestions below:

TO INCREASE HEIGHT

A. Apply greater plate voltage on the vertical output tube by lowering plate load resistor value.

B. Change type of vertical output tube, for instance 6BL7 for 6SN7 or 6V6 for 6K6 tube.

TO INCREASE WIDTH

A. Try connecting width coil, Merit MWC-1, across other secondary taps for better impedance match. It is not mandatory to use any given set of taps.

B. Try width coil of different im-

[Continued on page 45]

voltage output is taken from the plate of V-7B and applied to the grid of V-8A which is the cathode output tube.

The output from this cathode follower tube is taken across R-52A which is the *Horizontal Gain Control*. Sweep voltage output is then applied to the push-pull horizontal amplifier circuit. From this tube, a 12AX7 (V-9) the sweep voltage is applied to the horizontal deflection tubes of the cathode ray tube.

In order to remove the visible retrace, a negative voltage is applied to the grid of the cathode ray tube during the retrace time. The grid of the blanking tube which is V-8B is capacitively coupled to the plate of V-7A, which is cut off and during the retrace and it will have a positive rectangular pulse on its plate. This pulse is applied to the grid of V-8B; the amplifier action of this tube inverts this positive going pulse. This is then coupled to the grid of the cathode ray tube through capacitor C-52. The negative going pulse cuts off the cathode ray tube electron beam during the retrace.

Sine Wave Sweep Philco; Model 7008

The circuit for producing a sinusoidal time base is simplicity itself since the power line frequency of 60 cycles per second is used. As in Fig. 10, a transformer, T-1 has its primary connected to a source of 60 cycle per second a.c. Two potentiometers R-1 and R-2 are connected in series with their common point at ground potential. The high end of R-1 is connected to one horizontal deflection plate and the high end of the other potentiometer R-2, is connected to the other horizontal deflection plate. The ap-

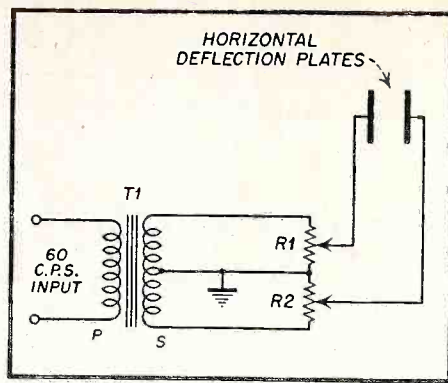

Fig. 10. Basic sine wave circuit, voltage applied directly to the deflection plates.

plied sine wave signal then causes the electron beam to move back and forth at a sinusoidal rate.

An example of commercial equipment using a circuit of this nature is the Philco Precision Visual alignment Generator; Model 7008. In addition to a complete cathode ray oscilloscope, a frequency modulated signal generator is included. The oscilloscope tube is a 3MP1 with a green medium-persistence coating of the tube face. Electrostatic deflection is used; the sweep is a sinusoidal variation at a 60 cycle per second rate. Because the vertical input is at a 60 cycle per second rate, and the horizontal sweep varies at exactly the same rate, there will be no distortion of the response curve. When a response curve pattern is traced on the tube face, it appears exactly as if a linear horizontal sweep were used and the vertical input were varied at a linear rate.

Figure 11 is the actual schematic of the sweep section of the Model 7008. The horizontal deflection voltage is

obtained through a transformer whose primary is connected directly to the 60 cycle input through the power on-off switch. The secondary has a series potentiometer in each leg and a capacitor across the line from one side to the other, as shown. The function of these is to provide a sufficient degree of phase shift variation in order that the sweep and return trace will coincide.

Blanking and Phasing

Two additional potentiometers are used in series with their common point at ground potential. The potentiometer arms go directly through coupling capacitors to the horizontal deflection plates of the cathode ray tube. An interesting feature of the circuit is the addition of the Blanking Tube which is a 6C4. This tube does not function to blank out the return trace. As shown in Fig. 11, the sine wave signal used for horizontal deflection has a reference line AE drawn through it. This represents the reference line or zero voltage for the sine wave. In this Philco circuit, the cathode ray tube sweep is the portion from B to D. The portion of the sine wave other than from B to D is the retrace time which is visible. Any variability between the sweep and retrace is adjusted by means of the phasing controls. The negative-going portion of the sine wave which is from C to its negative maximum at D back to zero at E is the portion which is the blanking voltage.

The phasing controls make the time from B to D, coincide with A to C of the Blanking circuit input. Blanking occurs during time CE on the blanking input sine wave: Phasing makes this the same time as the sine wave retrace from D to F.

By means of this blanking tube circuit, a reference base line is obtained on the cathode ray tube screen to assist in measuring the effectiveness of a response curve. Assume that the blanking tube works during all of the time that the cathode ray tube is in operation. (This is not strictly true since the blanking tube by means of a circuit which is not shown in the drawing is only in operation when the master oscillator generator is also operating.) This does not affect the operation of the circuit with which we are concerned. This base line is produced by removing the swept signal for a time and allowing the electron beam to move directly across the tube during the absence of any vertical deflection. This presents first a pattern on the tube face and then a single horizontal line. It is this horizontal line which is used as a refer-

[Continued on page 45]

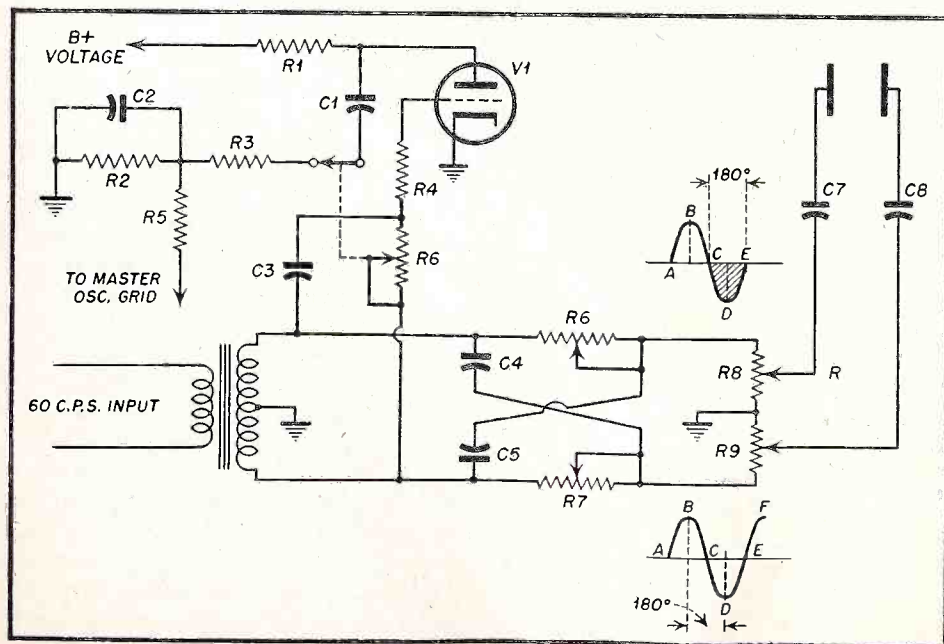

Fig. 11. Sweep section schematic of Philco Model 7008 cathode ray oscilloscope.

SERVICING TAPE RECORDERS

by C. A. TUTHILL

PART 5

THE facts stated herein apply directly to Soundmirrors (Brush) BK 411 and BK 414 but the general or basic facts regarding maintenance also apply to many similar equipments. The magnetic heads and capstan of any tape recording machine will accumulate magnetic particles from the coated tape during normal operation. These components in the subject models may be cleaned when the top dress covers are removed. A stiff bristle brush may be used to clean the capstan which must not become scratched. The magnetic heads and bakelite guide posts on either side of the pole pieces can be cleaned with either acetone or a non-oily nail polish remover. Allow five minutes for the acetone to evaporate before running a tape through the machine. One single induction motor drives both the capstan and reeling mechanism. This motor is mounted on a bracket which allows tension adjustment of the rubber drive belts.

This fifth installment deals with the mechanical and electrical construction and operation of the Brush Soundmirror tape recorders, BK 411 and BK 414

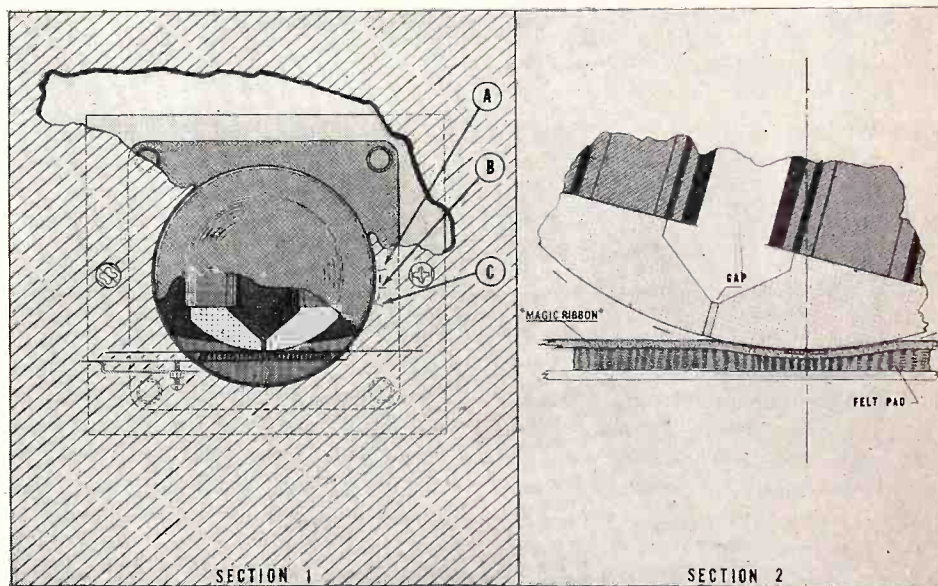

Fig. 1. Record-Play head adjustment.

Record Head Adjustment

Improper head alignment causes faulty operation of any tape recorder. Normal position for the Record-Play head is shown in Fig. 1. The cut-away shot of Section #1 of this figure shows how the pole pieces should contact the tape. It is important to check this position so as to avoid the abnormal position shown in Section #2 of Fig. 1. Such a condition would prevent the gap from contacting the tape with the possible result of no signal recorded or at least a severe loss of highs. To guard against this condition take the following steps:

1. Place a mark on the panel at point B (Fig. 1 Section 1) to identify the position for minimum hum as determined for previous rotation of the head. This mark should be made in line with the end edge of the opening in the record head.

2. Place a recorded portion of the tape through the Record-Play head and the capstan drive spindle and change the control to the Play position.

3. Loosen the head mounting screws enough to rotate the head toward A or toward C while listening to the reproduced signal. When the position is found which better reproduces the higher frequencies, place a second mark on the panel to identify that position. If this position does not coincide with the position for least hum, a compromise position must be selected whereupon the head mounting screws may be tightened to maintain the selected position.

Erase Head Adjustment

The erasing process should disarrange minute particles of magnetic coating upon the tape so that no signal is reproduced during playback. However, if the two magnets in this erase head do not approach the tape at the proper angle, the erasing effect is changed resulting in an arrangement of the magnetic particles so that they produce a noise signal during playback. Corrective steps follow:

1. Thread the machine with a recorded portion of tape which may be erased during this adjustment. Remove the two small trim covers, turn the power switch ON and allow tubes to warm up.

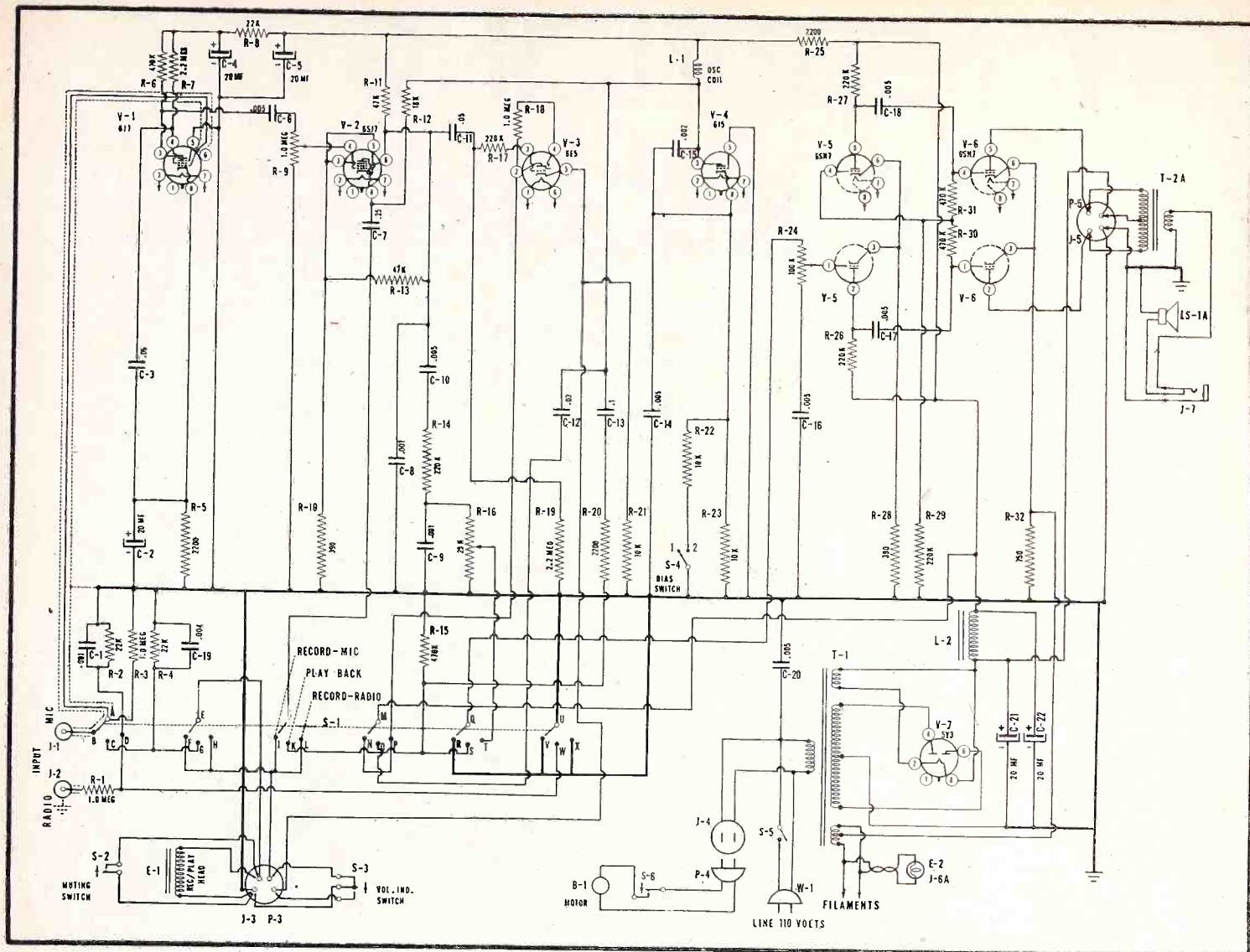

Fig. 2. Circuit diagram of Brush Soundmirrors, BK 411 and BK 414.

2. Set amplifier controls for *Play-back* and top panel control for *Record*. This step puts the erase head in contact with the tape causing erasure before the tape enters the playback head.

3. Set the playback volume control for *Maximum* and the tone control for greatest high-frequency response, (Tone control affects *Play-back* function only).

4. Loosen the screw that holds the erase head to its mounting bracket and rotate the head slightly first in one direction then the other, until a point of minimum noise is found. Do not rotate the head too far in either direction or erasure will be incomplete. Tighten the retainer screw to lock the head in the selected position.

5. Shift the control lever to the *Stop* position to allow the erase head to drop away from contact with the tape. Finally, replace the trim covers.

Adjustment for the multipole heads used in later models is the same as given above.

Adjustment of Clutches

Before proceeding with the adjust-

ment of clutches, the recorder power should be turned *OFF*. Place a loaded reel on the supply turntable and move the control lever from *Neutral* to *Fast Forward* position. As this action is taken, the supply turntable should rise visibly, but not more than 1/32 of an inch. If the turntable fails to rise this amount, the locking nut on the clutch adjusting screw for that table should be loosened with pliers or wrench. Next the Allen screw should be turned *in* with a #8 Allen wrench until the proper amount of lift is obtained. The adjustment should then be relocked, and, with the shift lever in the *Fast Forward* position, the turntable should be lifted by grasping the reel post. This step serves to check that there still is clearance for the turntable when in its fully elevated position.

The takeup turntable is checked by placing a loaded reel upon it whereupon the control lever is set for *Fast Rewind* position while the reel is observed for normal lift. Adjustments correspond to those above. When both reels are observed to lift normally with good clearance, the machine

should operate properly. If not, the clutch pads may require cleaning, the tape guides may be bent causing too much drag on the tape, or the head brake pad may not be retracting properly thus causing drag during the Automatic Rewind function. Failure of the recorder to drive is almost never due to belt slippage.

Tape Tension and Guides

Once the trim covers are removed, pressure of the tape against the record head can be adjusted by turning the screw mounted on the pressure wheel bracket assembly. Loosen the locking hex nut before attempting this adjustment. Proper tension is measured in terms of tension by attaching a scale to the end of a strip of tape which is drawn through the tape guides, record head, pressure pad, and behind the capstan assembly at 7.5 inches per second. A scale reading of 1.5 to 2.5 ounces is normal.

Adjustment of the tape guides, beneath the trim covers, is made by slightly rotating the guides clockwise or counterclockwise around the guide posts so as to increase or decrease the

[Continued on page 42]

MEN OF RADIO

PART 8

by WILLIAM R. WELLMAN

Further contributions of Edward H. Armstrong consist of his regenerative and super-regenerative circuits, and his pioneering in the field of frequency modulation. The beginnings of television are also discussed in this issue.

Super-Regeneration

Just about the same time that Hazeltine was engaged in the Neutrodyne design, Armstrong produced his third great contribution to radio progress, the super-regenerative circuit. The circumstances surrounding the discovery indicate that it may have been partly the result of chance or accident. Deeply engrossed in the regeneration patent suits, Armstrong heard an attorney make a statement regarding regeneration that he disagreed with. Determined to prove that the lawyer was wrong, he went to his Columbia laboratory and set up his feed-back equipment. In the course of this work he arrived at a conclusion that led to the invention of super-regeneration.

As we are all aware, regeneration is tremendously effective up to a point; once the circuit begins to generate oscillations, however, the tube is no longer useful as a detector or an amplifier. But suppose that the oscillation could in some manner be suspended, or that feed-back could be carried beyond the oscillation point with the tube still functioning as a detector. Regeneration could then be increased to limit far beyond those possible in the usual circuit, and the volume and sensitivity would be vastly greater. That is just what Armstrong accomplished in his invention of super-regeneration. It is accomplished in this way: regeneration is advanced beyond the oscillation point, but the tube is triggered on and off periodically at a rate above audibility (usually about 20,000 per second). During the intervals when the tube is functioning signals roar in with tremendous volume. The voltage used to trigger the detector tube may be supplied by an outside source,

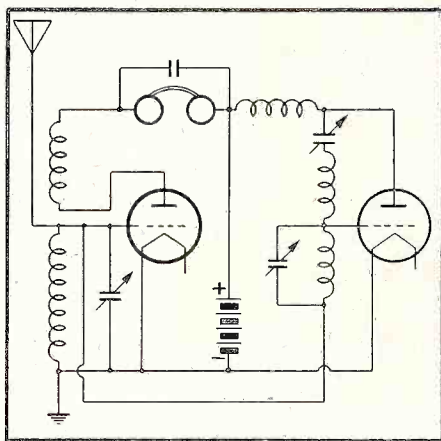

Fig. 1. Basic circuit diagram of Armstrong's super-regenerative receiver.

as shown in Fig. 1, or from within the detector circuit itself.

When Armstrong offered the super-regenerative circuit to RCA, an incident occurred which seems to show that he is as good a business man as he is inventor. After a prolonged study of the situation RCA discovered that there already existed a circuit bearing some resemblance to Armstrong's; the rights were held by a British inventor. They promptly instructed their European office to contact the inventor and buy the patent, with the idea of using it as a bargaining wedge in dealing with Armstrong. Meanwhile, Armstrong also learned of the existence of the English patent, made a quiet search, located the inventor in Africa and bought him out. When the RCA people located the British inventor, they learned what had happened, but were not aware of the reason for the home office's interest. Consequently, they cabled back: "See a fellow named Armstrong."

Armstrong's negotiations with RCA led, indirectly, to his marriage. He had occasion to call upon David Sarnoff frequently, and in the course of business meetings met Sarnoff's secretary, Marian MacInnis. Soon he was taking Miss MacInnis riding in his new Hispano-Suiza car, and within a year the two were married.

At length, RCA bought the super-regenerative patent for \$200,000, plus 60,000 shares of RCA common stock. Later on, when the superheterodyne was ready for introduction into the broadcast entertainment field, Armstrong's assistance in refining and adapting that circuit to mass-production methods brought him another 20,000 shares, making him the largest individual RCA stockholder. Despite its extreme sensitivity super-regeneration never did become popular in broadcast receivers. One reason was the critical tuning; experimenters of that day claimed that it was usually necessary to work the tuning controls with the aid of a fishing pole, to avoid the effects of body capacity. Another drawback was the lack of selectivity. But anyone who ever tinkered with the circuit and made it work will never forget the spectacular results obtained. It was used for a while in police and portable services where great amplification was needed, but where selectivity was not so important, and then was forgotten until World War II when it was revived for use in IFF radar equipment.

Frequency Modulation

A long-standing interest in the problem of static elimination put Armstrong on the track of frequency modulation. He had been interested

in the problem since 1915, and after ten years of intermittent work was able to demonstrate that static possessed all of the characteristics of ordinary radio signals; most important of these, expressed in technical terms, is the fact that static is amplitude modulated. This being the case, there seemed to be no way of eliminating its effects on reception as long as the then standard method of transmission was used. Despite the fact that several firms, including A.T.&T., had experimented with frequency modulation and had dropped the idea, Armstrong went ahead with his experiments and in 1932 applied for patents on a wide-band FM system. Patents were granted the following year.

RCA, as the leader in the industry, seemed to be in the best position to handle the development. When approached, RCA engineers studied the system, made favorable reports and invited him to move his equipment into the test station at the top of the Empire State Building. For more than a year exhaustive tests went on, all turning out favorably. What happened next is subject to speculation; Armstrong momentarily expected an offer, but instead was asked to remove the equipment as the space was needed for RCA's television experiment program. Determined to go ahead with development, Armstrong finally financed the construction of a transmitter and demonstrated FM before the Institute of Radio Engineers in 1935. This was the first public showing of his system. Early the following year, he applied for a construction permit for a permanent station, which was at first denied, but later the FCC did allocate five usable channels to FM. He rushed construction on his station at Alpine, New Jersey and put it into operation by 1938. Shortly afterward, a few manufacturers added FM to their home receiver lines, and within a year three other stations were on the air. No substantial progress was made until RCA decided to enter the field, when Armstrong was offered half a million dollars for his rights. This offer was refused, for by then he had decided to sell only on a royalty-paying basis.

Armstrong's FM system, one of his finest accomplishments, should have provided the listening public with a receiving system better than anything thus far devised. Its slow acceptance is due to several factors, not the least of which is the improper handling it has received. The unexpected shift in frequency alloca-

tions soon after the war did nothing to help its advancement, neither did the restrictions applied by the American Federation of Musicians, when it decided that stations broadcasting both FM and AM would be required to maintain two separate groups of musicians.

Notwithstanding many discouragements, Armstrong has managed to become one of America's most successful inventors, and a few years ago was able to look back upon his career and say: "The continuous good fortune which has followed me, providing second chances at inventions . . . has been all that a man could hope for . . ."

Television

Television, the latest of the electronic age of developments reached a fair degree of commercial perfection just prior to World War II, but actually stemmed from obscure experiments performed more than a half-century ago. In tracing the his-



tory of television, we must remember that many of the early experimenters worked in the period before practical radio communication became a reality; for that reason, much of their work was concerned with the sending of pictures over wire lines. Another fact that must be kept in mind is that the transmission of photographs and facsimiles is rather intimately connected with the history of television.

Paul Nipkow

Paul Nipkow, a German engineer born in 1860, was one of those who visualized the transmission and reception of pictures by electrical means. His conception of such transmission was of course, a far cry from present-day television. Electronic tubes were then far in the future, and he lacked even the neon tubes that formed an essential part of the mechanical television systems of the nineteen twenties.

Nipkow spent a good part of his lifetime in the study of optics and

telephony. In 1883 he invented the rotating scanning disc with a series of apertures arranged in a spiral. Apparently, this was the first conception of the principle that has become so vital to picture transmission—breaking the image up into tiny elements of light and shadow and then re-arranging them into the original image at the receiver. As mentioned before Nipow had no idea of sending pictures without wires; later in life he said: "It was television over telephone wires that appeared before me." Nevertheless, his invention formed the basis of television systems that gave promise of developing into a fair-sized boom a quarter-century ago.

Sir William Crookes

The germ of electronic television was not implanted in inventive minds until many years later, but the heart of the receiver, the cathode ray tube, may be traced back to Sir William Crookes, British scientist. Crookes had devised an early form of the X-ray tube, but just missed the discovery of the rays. This great discovery was made later by Roentgen; Crookes remained totally unaware of the unusual properties of the rays emitted by his tube. He knew that within the tube there existed what he called "a storm of projectiles". He also recognized the fact that they were different from ordinary molecules but did not learn that they were capable of passing through solid objects and of registering their effects upon a photographic plate. Some time later, J. G. Thomson defined the cathode ray as a stream of electrons.

Karl Ferdinand Braun

Karl Ferdinand Braun, born 1850 in Fulda, Germany, invented the counterpart of the modern cathode ray tube and brought it to a peak of perfection approaching that of today, except that he lacked a method of controlling the intensity of the electron beam.

Braun was professor of physics at Karlsruhe and later became director of physical sciences at Strasbourg University. Following in the steps of Crookes and Roentgen, he made a thorough investigation of cathode rays, and learned that they were capable of being concentrated into a narrow, pencil-like beam. Further study showed that with proper concentration and focusing, the beam could be guided toward a fluorescent screen and there could be caused to trace an image of an electrical wave. In fact, he developed all of the important features of the modern tube, except that of modulating the electron

[Continued on page 45]

SHOP NOTES

Write up any "tricks-of-the-trade" in radio servicing that you have discovered. We pay from \$1 to \$5 for such previously unpublished "SHOP NOTES" found acceptable. Send your data to "Shop Notes Editor."

Crosley Spiral Inductuner-Replacing Fiber Shaft

The fiber shaft for the spiral inductuner is available under Part No. A-152460.

In cases where the only damage to the shaft assembly is a broken fiber shaft, the fiber shaft may be replaced as follows:

1. Remove tuner shaft assembly.
2. To drill out the broken fiber in the tuner shaft assembly.
 - (a) Clamp shaft assembly in vise vertically with broken fiber upward. CAUTION—Do not use gear or stop plate as a rest. They are a press

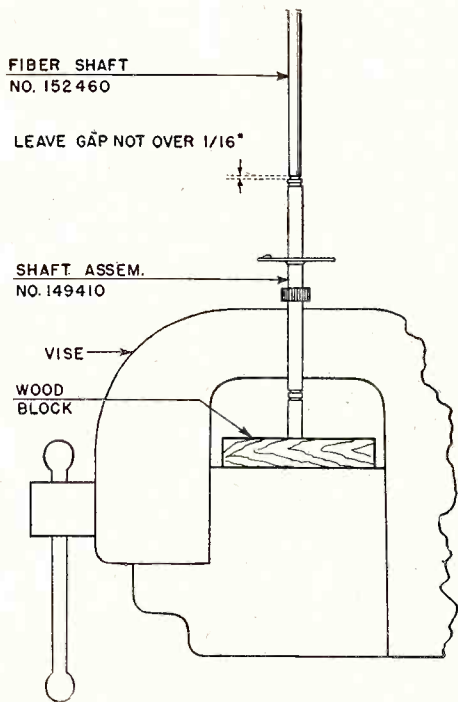

Fig. 1. Mechanical set-up for replacing Inductuner shaft.

fit and may be damaged or misplaced on shaft if subjected to more than moderate pressure. Place a wood block of appropriate thickness beneath the lower end of the shaft in throat of vise to prevent gear from resting on vise jaws (see Fig. 1).

(b) File broken fiber smooth and mark with center punch before drilling out the fiber (about 1/4 inch deep) with a #27 or #28 drill. Pick out

remaining fiber with ice pick or other suitable tool, making sure the hole is clear of chips.

3. To install new fiber shaft:

Hold the new fiber shaft in position over the drilled out hole, as shown in Figure 1, and tap it into place with a small plastic faced mallet or small hammer until shoulder on fiber shaft is 1/16 inch from metal on shaft assembly. Attempting to seat shoulder on metal shaft assembly may result in breakage.

4. Replace tuner shaft assembly.

Capehart-Farnsworth CX31 Chassis

A peculiar trouble which took me quite some time to locate in this chassis as follows:

Any fast motion on the right hand position of the picture, like a person dropping his arms fast, would cause a slight horizontal displacement across the entire screen.

This would lead one to believe that sync trouble was present, however, after testing various tubes and sync circuit components, decided to check the vertical oscillator and output.

Checking the 6R6 vertical output and its associated components, the 90 mfd - 150v cathode bypass condenser was partially shorted.

When replacing this condenser, use a condenser insulated at not less than 250 volts.

*Submitted by
Al Pratesi
White Plains, N. Y.*

Stromberg-Carlson Model TS125-16 Receivers—Sync Modification to Improve Picture Pulling Condition

The TS125 and TS16 Receivers are sometimes subject to picture pulling as the picture control (contrast) is advanced for proper contrast. When this condition is encountered, particularly in strong signal areas, the following suggestions which have been received from the field will improve this condition by reducing the gain of the 1st sync amplifier stage. This gain reduction is accomplished by revising the circuit of this stage as shown by decreasing the plate load, changing the

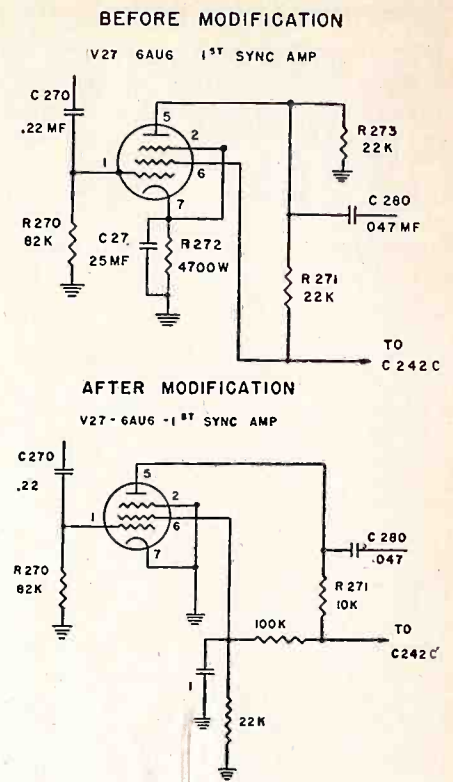

Fig. 2. Circuit modifications to improve sync.

method of supplying screen voltage and removing the cathode resistor and capacitor. (See Fig. 2)

Air King Model 700-93 Chassis—Hum or Buzz

A small number of No. 700-93 chassis have been shipped which were found to have a considerable amount of hum or buzz.

This can be cured by putting a shield over the glass 6SQ7 tube providing the 6SQ7 is of the metal ring base type.

Substitution of a metal 6SQ7 will also have the same effect.

Air King Service Dept.

Motorola TS-89/TS-94 Oscillation

It has been found that the addition of a 100 ohm screen isolation resistor in the vertical output stage will prevent oscillation, which some tubes

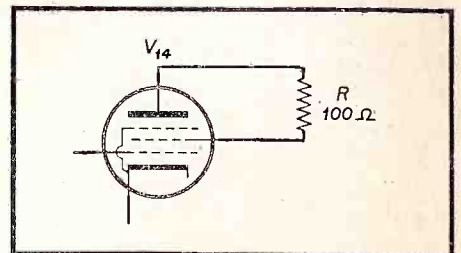

have a tendency to cause. This resistor may also be added if there is trouble with momentary collapsing of the raster. (*R* in diagram).

*Submitted by
George Raymond
Biloxi, Mass.*

NEW PRODUCTS

MULTI-TEST JUNIOR VOLTOHMYST

Latest addition to RCA's Blue Ribbon test equipment line, this new Junior VoltOhmyst meter measures ac volts, dc volts, and resistance in five different ranges. The all-electric meter features a high-impedance diode tube as a



5,000. Output: 2.5, 10, 50, 250, 1,000. Milliamperes DC: 2.5, 10, 50, 250, 1,000. Microamperes, DC: 0 to 50. Amperes, DC: 0 to 10. Decibels: -30 to +55 in 5 ranges. Ohms: 0 to 1,000, 5 ohm center scale; 0 to 10,000, 50 ohm center scale; 0 to 1 meg., 5,000 ohm center scale; 0 to 100 meg., 500,000 ohm center scale.

Portable, heat and acid resistant case with leather handle. 5 3/4" W., 8 3/8" H., 2 1/2" D. 2 3/4 lbs. net weight. Test leads furnished. For complete information write the Hickok Electrical Instrument Company, 10533 Dupont Avenue, Cleveland 8, Ohio.

ANTENNA ROTATOR

Milton S. Roth, Sales Manager of the Radiart Corporation, announces the completion of still further developments and improvements on the company's popular Tele-Rotor "Cub" rotator. Using the same husky motor as Radiart's heavy-duty model, the Tele-Rotor "Cub" can handle a wide range of applications, although primarily designed for average installations.

Set up for swift and convenient installation, it features true in-line thrust between antenna and mast. The durability and performance of the Tele-Rotor "Cub" is assured by the 3/4"

signal rectifier, an electronic bridge circuit similar to the one used in RCA's Senior Volt-Ohmyst meter, a 200-microampere movement, and carbon-film multiplier resistors. The new test-bench unit bears a suggested user price of only \$47.50, and is available through RCA test equipment distributors.

HIGH SENSITIVITY VOLT-OHM-MILLIAMMETER

Accurate, attractive, compact design provides the thinnest instrument of its kind. Large 5" lucite meter case gives increased readability. Guaranteed unbreakable, shock resistant case



protects the high sensitivity of this fine instrument and provides for long, hard day-in, day-out service. Battery operated, handier for the field engineer.

20,000 ohms per volt DC, 5,000 ohms per volt AC. Volts AC and DC: 2.5, 10, 50, 250, 1,000,

steel shaft with in-line, reamed, oilless bearings that rotates on a case-hardened steel ball. Available in Model 502B with a mahogany plastic cabinet containing an indicating meter for "hairline" tuning, it lists for \$44.95 and uses 5-wire cable.

More particulars may be obtained from the Radiart Corporation, Cleveland 2, Ohio, or from your nearby Radiart distributor.

4-WAY ANTENNA SWITCH

The JFD Manufacturing Company, Inc., Brooklyn, New York announces the development of a new TV 4-Way Antenna Switch.

The No. AS4 4-Way Antenna Switch will derive maximum performance of fringe area multiple Yagi installations by permitting instant switching to desired antenna. The new accessory supplies swift, low-loss switching facilities in any TV installation, local or remote, where up to four antennas are used. A constant impedance rotary switch with low-

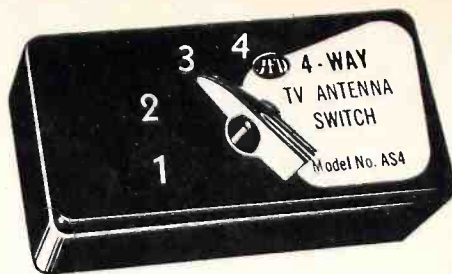

loss resistance silver-to-silver contacts provides maximum energy transfer.

The new JFD accessory is housed in an attractive bakelite case, compactly constructed for simple, unobtrusive installations.

The No. AS4 lists at \$5.95. Catalog sheets describing the 4-Way Antenna Switch are available from the manufacturer.

HYTRON-CBS PICK-UP STICK

Here it is! A sure fire Hytron exclusive—the Hytron-CBS Pick-Up Stick. A Hytron contest winner—asked for by the servicemen. The Hytron-CBS Pick-Up Stick solves two long-ignored irritating problems.

Its special wax tip picks up screws, nuts, etc. dropped into inaccessible spots in radio chassis.



It also holds head of screw in those impossible-to-reach spots while starting nut. Just a slight pressure of the special wax tip does the trick. Pick-Up Stick doubles in brass as a pencil too.

Hytron-CBS Pick-Up Stick is offered to servicemen at cost—only 5c each in handy packages of 25. Servicemen may get their Pick-Up Sticks from their Hytron jobber or distributor.

SMALL SIZE MICROPHONE

The field of inconspicuous microphones, designed to give audiences the clearest, least distracting view of performers, is invaded by The Astatic Corporation, Conneaut, Ohio, with its new crystal model DK-1.

In addition to small size, the simple, curving lines of the Model DK-1 are said to conform to good principles of camouflage and add to the inconspicuousness of the microphone. The finish is brushed chrome, which reduces light reflection and glare and helps further to "hide" the microphone.

The new Astatic mike is a non-directional, high impedance unit offering highest quality performance for studio and public address applications, the manufacturer declares. It is said to have excellent frequency range, with rising characteristics between 2,000 and 5,000 c.p.s.



Output level is approximately —55 db, and the unit is available with or without an off-on switch. The crystal element has a moisture-proof coating.

ROTATABLE GUY ANCHOR

Technical Appliance Corporation, Sherburne, N. Y., manufacturers of TV, AM, and FM antenna systems, are now making available a guy anchor that allows free rotation of the mast after guy wires are attached.

Known as Cat. No. 867 Guy Anchor, it is made of heavy gauge steel and provides the strength necessary for high installations where guy wires are necessary for steadying the an-

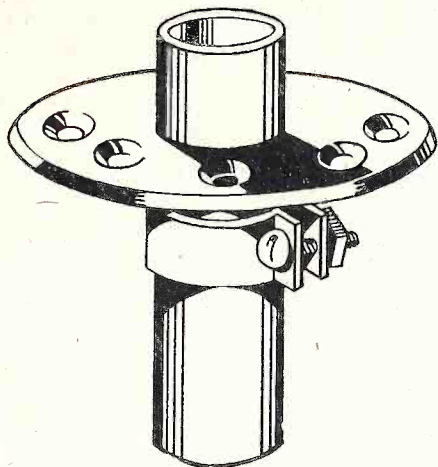

tenna while antenna is oriented. This device also proves worth many times its price in cases where reorientation may have to be done at a later date as is so common. Without removing any of the guys, it is possible to rotate the antenna mast without relocating guy wires on the roof. When guy-wire turnbuckles are tightened the circular plate is pulled down on the mast collar, thus acting as a further assurance of direction stability, in addition to the mast mount.

AUTOMATIC-FOCUSING TV PICTURE TUBE

Representing a complete departure from the usual TV picture tube design, a new Du Mont Teletron boasts 100% built-in automatic focusing. Eliminating all focusing controls, coils, mechanical focusing devices, this new tube maintains a perfect edge-to-edge focus at all times regardless of line-voltage fluctuations, contrast or brightness settings, or installation procedures.

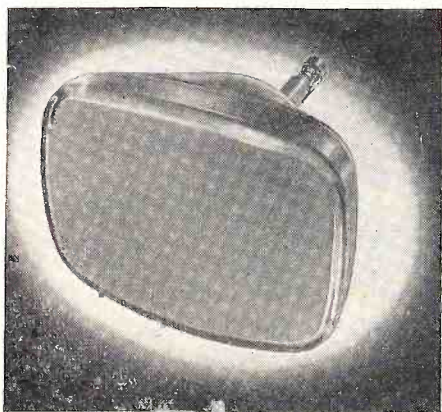

The Cathode-ray Tube Division of the Allen B. Du Mont Laboratories, Inc., Clifton, N. J., are now manufacturing the new automatic focusing tube in the 17" rectangular size, in limited quantities. Other sizes will be announced shortly. The present 17" size is a direct replacement for any 17" all-glass rectangular picture tube whether electromagnetic, or electrostatic focusing. The base is a standard 5-pin duodecal type, requiring no changes in replacement installations.

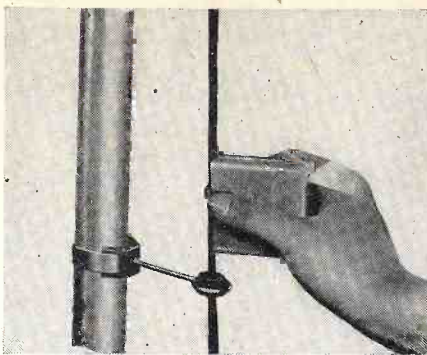

TWIN LINE TESTER

A testing device for quickly locating breaks in 300 Ohm twinline has been introduced by Easy-Up Tower Company, Racine, Wisconsin. Sold under the trade name "TWIN-TEST", it indicates the exact location of the break by means of a light. Twinline can be tested while connected to any type of antenna, whether open-circuit or closed-circuit.

DELUXE TUBE CASE

A heavy-duty carrying case for receiving tubes and small hand tools has just been announced by the National Union Radio Corporation, Orange, New Jersey. This deluxe case, especially designed for use on home radio and television service calls, creates a professional appearance, thereby enhancing the serviceman's prestige.

Fabricated of 1/4" plywood throughout, it is covered with a smart-appearing tweed-textured leatherette material which resists scuffing. There is a steel band reinforcement over the top which in addition, seals the closure. The corners are protected and reinforced by top-grain cowhide leather pieces. Hardware is

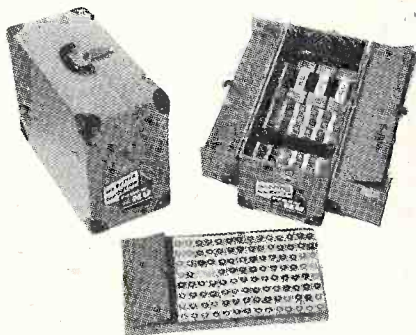

plated and protection against pilferage is assured by the positive draw bolt fitted with a lock.

This rugged case measuring 19 3/8" long x 9 3/4" wide x 14 1/4" high, will safely support 350 pounds. It, therefore, can be used as a stool to extend the reach. The entire inside including all compartments is lined with leatherette.

Between 180 and 225 tubes can be carried in the case, and two compartments in the hinged top are available for tools having a length as great as 19 inches. The removable tray, also of plywood, has a small compartment with a hinged cover that is suitable for such small items as fuses, panel-lamps, etc. The case is available only through National Union distributors.

DUAL COLOR WHEELS FOR COLOR AND MONOCHROME VIEWING

The Celomat Corporation of New York City announces that it is now in production on its new dual color wheel—an ingenious development that permits color and black and white viewing without elaborate change-overs.

"The dual color wheel," Myron J. Greenwald, Vice President of the Corporation, reports, "is a real innovation for set owners who want to receive color and also black and white in the most satisfactory manner possible. The dual color wheel is actually two clear plastic discs with color segments that are balanced and matched in pairs of the same density. These color segments in rotation unite to form a perfect color wheel. For black and white viewing, the wheels are kept stationary; the colored segment sections of the wheels fall below the screen, and the black and white picture is transmitted through the clear plastic upper half of the discs."

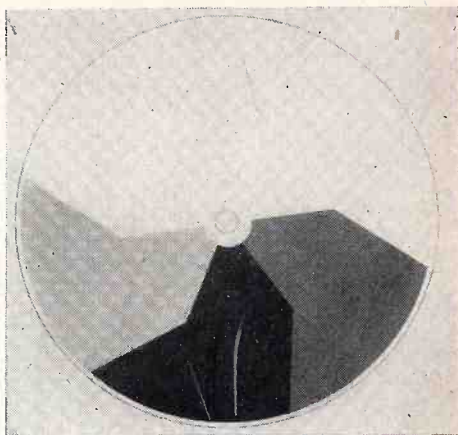

The dual color wheel, Celomat feels, is a cleverly engineered innovation because it simplifies exceedingly the task of the set owner to receive either color or black and white by the flick of a switch.

Manufacturers of TV sets, jobbers, service organizations and retailers are invited to write for additional information to the Celomat Corporation, 521 West 23rd Street, New York City . . . Attention of Mr. Myron J. Greenwald.

RF-AF SIGNAL GENERATOR

Electronic Instrument Co., Inc., 276 Newport Street, Brooklyn 12, N.Y., designers and manufacturers of the famous complete EICO line of instruments and kits, announces production of the new Model 322 RF-AF Signal Generator in both Kit and Factory-wired form.

Especially designed for FM-AM precision alignment, generation of TV marker frequencies and the testing of audio circuits, the Model 322 has a 5-step switching arrangement that permits pure RF, modulated RF or pure AF outputs. Its Hartley oscillator produces fundamentals from 150kc to 34 mc, with powerful

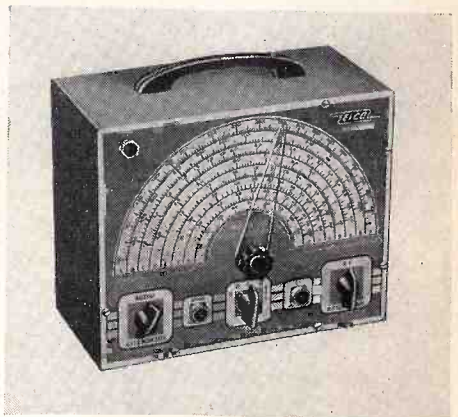

precision harmonics to 102mc. And its colpitts audio oscillator generates 400-cycle pure sine wave voltage. The instrument is housed in a heavy-gauge quality steel case with a handsome 3-color etched rub-proof front panel. Size: 10 x 8 x 4 3/4". Model 322-K, Kit is only \$23.95. Model 322, wired, is only \$34.95.

TRADE LITERATURE

The *Merit Transformer Corporation* has announced a 1951 issue of the *TV Replacement Guide and Catalogue* which lists Merit's complete line of TV transformers and components.

The new edition which is available by direct application to the Chicago factory lists all manufacturers and model numbers, showing the manufacturers part number and the Merit replacements.

* * *

Allied Radio Corporation 833 W. Jackson Boulevard, Chicago 7, Ill., announces the release of its new 1952 catalog—a complete 212-page Buying Guide to “*Everything in Radio, Television and Industrial Electronics.*”

The new *Allied Catalog (No. 127)* contains comprehensive listings of radio, television and electronic parts; test equipment, public address systems, television and radio sets and accessories, TV components, recording equipment and accessories (including the latest tape and disc recorders), new 3-speed record players and changers; high-fidelity amplifiers, speakers, tuners and other components for custom installations—as well as complete high-fidelity phonoradio systems, Amateur gear, radio builders' kits and supplies, tools and hardware, books, manuals, diagrams—plus thousands of other items to meet every requirement in the radio-television-electronics field.

* * *

John F. Rider Publisher, Inc., 480 Canal St., New York 13, N.Y., announces a forthcoming publication *TV And Electronics As A Career*. The book will be available at the organization's distributors in October.

The men who have collaborated to make this book a valuable guide to the individual seeking employment in the electronics industry are J.R. Pople, vice-president, WOR-tv, R.W. Peterson, ass't. mgr., Electronics Div., Admiral Corp., W. H. Bolke, manager, custom service operation section, RCA Service Corp., Ira Kamen, director of TV development, Branch Mfg. Corp., and R.H. Dorf, television consultant.

The book gives all the whys and wherefores of the electronics industry for the newcomer embarking on a career, or the electronics “oldtimer”

desiring to switch to another field of specialization within the industry.

In addition to the eight chapters covering the various phases of activity in the electronics industry, useful appendices include typical salaries for operating personnel in small and large radio stations, curriculum of electrical engineering courses at Illinois Institute of Technology, and public and private schools teaching radio and TV courses.

The authentic, behind-the-scenes stories of such men as Benjamin Abrams, Allen B. Dumont, David Sarnoff, Ross Siragusa, Russell Sprague, Vladimir Zworykin, etc. point out that success in the industry depends on the individual's capabilities and perseverance.

TV And Electronics As A Career is written in an easy-to-read style, and contains 130 pictorial representations of the industry at work. The text has approximately 325 pages in a handsome 5½ x 8½ cloth binding. It is priced at \$4.95.

* * *

Football information of every kind at your fingertips is provided in the fact-packed, 52-page handbook currently being distributed throughout the country by *Westinghouse Electric Corp.*, sponsors of the 19 NCAA College grid games to be televised this fall on the NBC TV outlets.

Official handbook of the American Football Coaches Association, the pocket-size collection of grid data is available free in TV areas wherever Westinghouse major appliances and TV sets are sold.

Complete listing of all of NBC's 52 stations carrying the NCAA games shows the reader, at a glance, what the TV grid fare is in any part of the country.

* * *

The *Telrex “Service News”*, now in its second year of publication, is a technical manual published bi-monthly by Telrex, Inc., Asbury Park, in the interest of Servicemen and Dealers in the Electronic trade.

It is distributed free by direct mail or through the local Telrex distributor.

This informative house magazine carries installation hints, tek-talks, reception problems, and new product news. Also current topics of discus-

sion in TV, such as color, VHF reception, etc.

This booklet, first published in August 1950, is in ever increasing demand by Dealers, Distributors and Servicemen. You can be put on the mailing list by writing to: Telrex, Inc., Dept. T., Asbury Park, N. J.

* * *
* * *

The latest booklet in the RCA electronic training series, titled “*Ultra High Frequency Fundamentals*,” has just been published and is now available, it was disclosed this week by the *Government Service Division* of the *RCA Service Company*.

A revision and expansion of an earlier booklet, “*Practical Analysis of Ultra High Frequencies*,” the new manual has been prepared as a technical aid for UHF training and the installation, operation, and maintenance of UHF electronic equipment. It serves also as a source of introductory information and references for use in the study of radio and radar principles applicable to the service and repair of UHF military equipment. The book is profusely illustrated, and its content is organized for ready reference under such subjects as transmission lines, resonant sections, standing wave measurements, cavity resonators, wave guides, and wave guide application.

The new manual will prove especially useful to military personnel and to manufacturers holding contracts to provide UHF equipment for the military, the company stated. The price is 75 cents per copy. Orders may be placed with the Government Service Division, RCA Service Company, Gloucester, N. J.

* * *

Two new *phonograph cartridge replacement guides* are now being furnished by *The Astatic Corporation*, Conneaut, Ohio, one designed to aid the serviceman and dealer in quickly finding the proper Astatic Cartridge replacements for Columbia Phonographs and Record Changers, the other giving similar guidance on Philco models.

The manner in which the information is presented affords easiest, fastest possible reference. The recommended Astatic Cartridges, and the Astatic Needle types employed in

[Continued on page 38]



Frank J. Moch says —

"there is no other **OSCILLOSCOPE**
like the **NEW Simpson MODEL 476**
MIRROSCOPE"

FRANK J. MOCH,
president of the
National Alliance of Television and
Electronics Service Associations.

Simpson's new and completely advanced type of oscilloscope—Model 476 **MIRROSCOPE**—is designed to eliminate certain inherent disadvantages found in the conventional type of oscilloscope by use of the "Mirroscope principle." In this kind of construction the 5-inch cathode ray tube is mounted in a vertical position, thus reducing bench space requirements to an area of only 9" x 8" thereby permitting better concentration of associated equipment for any type of test procedure. The cathode ray image is reflected from an optical type front surfaced mirror mounted in the adjustable cover at the top of the cabinet bringing the viewing surface of instrument near eye level when instrument is used on benches of normal height. The mirror angle is quickly and easily adjusted to any position of the operator. The cover with integral side wings forms an effective shield against external light sources or may be closed down for protection of the tube and mirror when the instrument is not in use. The upright construction permits location of controls and connections for maximum convenience and allows for internal cathode ray tube connections at the front of the panel instead of the rear.

SENSITIVITY:

Vertical direct.....12 volts rms per in.
Vertical amplifier.20 millivolts rms per in.
Horizontal direct.....14 volts rms per in.
Horizontal amplifier.....38 millivolts rms per in.

INPUT IMPEDANCE:

Vertical direct....10 megohms, 15 mmf.
Horizontal direct...10 megohms, 15 mmf.
Vertical amplifier.300,000 ohms, 30 mmf.
Horizontal amplifier.....500,000 ohms, 15 mmf.

Horizontal trace expansion is over 4 times tube diameter. This makes it possible to examine minute portions of a response pattern for finer detail.

Linear Sweep frequency is continuously adjustable in five overlapping ranges from 15 cycles to 60,000 cycles. Internal, external or line frequency synchronization with variable amplitude is available.

Means for intensity or "Z axis" modulation is provided. Approximately 14 volts peak will blank a trace of normal intensity.

The vertical amplifier frequency response is within 3 DB from 20 cycles to over 300,000 cycles and is usable to well over three megacycles. Square wave slant and over-shoot is held to less than 5 per cent of amplitude. This response will be found adequate for all phases of television receiver service including observation and diagnosis of Sync. signals.



TUBE COMPLEMENT:

- 5UP4 Cathode Ray Tube.
- 4-6J6 Horizontal and Vertical Amplifiers.
- 1-12AU7 Vertical pre-amplifier.
- 1-6J6 Linear Sweep oscillator and Sync. injector.
- 2-6X4 High voltage rectifiers.

LINE VOLTAGE: 105-125 volts, 50-60 cycles.
SIZE: Height 16 1/4"; Width 9 1/8"; Depth 8" over all
WEIGHT: 25 lbs.; Shipping weight 30 lbs.
High Frequency Crystal Probe...\$7.50
DEALERS NET PRICE including operators manual\$179.50



SIMPSON ELECTRIC COMPANY
5200 W. Kinzie St., Chicago 44, Ill.
Phone: Columbus 1-1221
In Canada:
Bach-Simpson Ltd., London, Ontario

BURTON BROWNE ADVERTISING



... Seen the Most in hundreds of thousands of TV homes — Alliance Tenna-Rotor is the universal favorite everywhere!

TAKE A DRIVE AROUND ANY TV TOWN—SEE FOR YOURSELF! AND, THAT'S WHY THE ALLIANCE BOOSTER'S SO POPULAR TOO!



... Seen the Most because they're demonstrated right in the homes of 35 million television viewers! Both the Alliance Booster, Tenna-Scope, and Alliance Tenna-Rotor film Commercials deliver an impact that's terrific — repetitive — continuous! And, they deliver that impulse to buy!

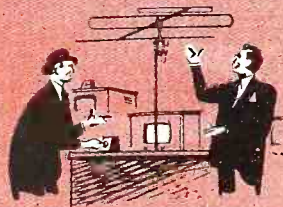

... Seen the Most on the sales counters of smart dealers! IT PAYS TO DISPLAY ALLIANCE PRODUCTS BECAUSE THEY'RE SEEN THE MOST AND SOLD THE MOST!

NOTE: Alliance Tenna-Rotor is a TV Antenna Rotator. Alliance Tenna-Scope is a TV Booster.

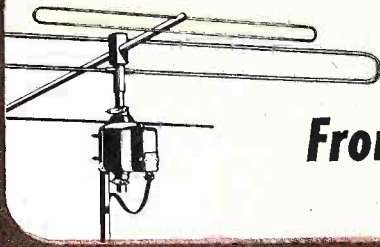

From Coast-to-Coast



alliance
TENNA · ROTOR

alliance
TENNA · SCOPE

Sold the Most

BECAUSE THEY'RE

Seen the Most

*M*illions of free home demonstrations make sales! Thirty-five million viewers see Alliance TV Films in 12 million homes every week! Both Tenna-Scope, the Alliance Booster, and the famous Alliance Tenna-Rotor enjoy unequalled exposure to viewers in the major TV markets where you sell!

ALLIANCE MANUFACTURING COMPANY • Alliance, Ohio

popular 50c, \$1.00, \$1.25 and \$1.50 conventional type needles, as well as the nine special type replacement needles used in the more than 2,500,000 Philco, Admiral and Columbia post war record players.

Deal No. 1 provides that the dealer may order a predetermined grouping totaling five dozen of the fast moving \$1.00, \$1.25 and \$1.50 Fidelitone conventional type needles, and is entitled to his choice of bonus merchandise valued at from \$6.00 to \$60.00. Percentage-wise, the dealer may realize from 116% to 260% profit on the deal, depending on his choice

of free needles.

In Deal No. 2 he orders a predetermined total of eight dozen 50c and \$1.00 Fidelitone Needles, and is entitled to one dozen \$1.00 Deluxe needles free.

Permo, Incorporated has mailed Dealer's Choice Deal announcements to dealers all over the country.

Electronic Devices Inc. Absorbs Precision Rectifier Corp.

Herman Weissberger, President of Electronic Devices, Inc., has announced the purchase, for purposes of expansion, of Precision Rectifier Cor-

poration which will be operated as the Precision Rectifier Division of Electronic Devices. This division will produce high-quality, long-life selenium rectifiers for all civilian and military applications, with a minimum guarantee of 1,000 hours, and in many cases with a guarantee of 2,000 hours.

Earl Steiker, formerly of Federal Telephone and Radio Corporation and Radio Receptor Company has been named Director of Production and Engineering. Sales will be handled by Robert Leonhardt, Secretary-Treasurer of Electronic Devices, Inc.

The Precision Rectifier Division is already in production at the main plant of Electronic Devices, Inc., at 429-12th Street, Brooklyn 15, N.Y. In these large facilities a modern mass production selenium rectifier plant, headed by a skilled engineering and technical staff, is being set up.

Sylvania Ups Wickstrum

The Board of Directors of Sylvania Electric Products Inc., recently elected Barton K. Wickstrum to the post of Vice President and Director of Sales.

Wickstrum, who has been General Sales Manager of Sylvania's Lighting Division since 1946, succeeds Robert H. Bishop, who has resigned to become a vice-president of E. F. Drew & Co., Inc., New York on September 1. Bishop had been sales vice-president of Sylvania since 1946.

DuMont Introduces Color Adapter

Introduction of the Du Matic switch, a color television adapter which will make it possible for viewers to see every type color transmission available today, in black and white, on their present sets, was announced recently by Walter L. Stickel, national sales manager, receiver sales division, Allen B. Du Mont Laboratories, Inc.

Simultaneously Du Mont introduced an Ultra High Frequency converter which will permit owners of any present standard VHF set to receive ultimate commercial UHF telecasting. The converter offers continuous tuning, and covers a range of 475-890 megacycles, those frequencies set aside for future commercial UHF broadcasting. The converter has been designed in advance so that it will be available to the public well ahead of the first UHF programming, Stickel said.

The Du Matic switch, 4½" long, 3" wide and 1½" deep, can be installed on the rear of the set, bolted to the chassis. The switch enables the set owner to change from regular 525 line reception to the 405 lines employed

"CONICAL-V-BEAMS"

REGISTERED TRADE MARK

NOT JUST A WISE CHOICE — BUT THE ONLY CHOICE

for **SUPERIOR PERFORMANCE**

Telrex **"CONICAL-V-BEAMS"**

FOR THE ULTIMATE IN TV RECEPTION

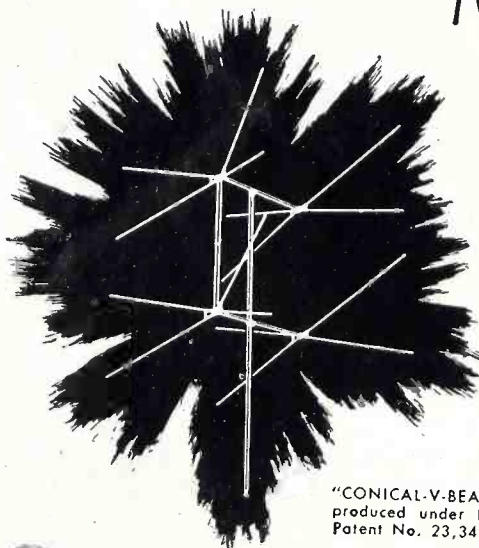

- Full Audio and Video Bandpass
- High Gain and High Signal to Noise Ratio
- Telrex designs and manufactures antennas for all requirements. See your Telrex distributor.

DELUXE SERIES—World's most famous, most powerful, most sturdily constructed antenna. Superior to any for TV-FM and UHF reception. WRITE today for your Telrex catalog.

"CONICAL-V-BEAMS" are produced under Re-issue Patent No. 23,346.

CANADIAN AND FOREIGN PATENTS PENDING



Telrex INC.
CONICAL-V-BEAMS

AMERICA'S STANDARD OF COMPARISON

ASBURY PARK 5, NEW JERSEY

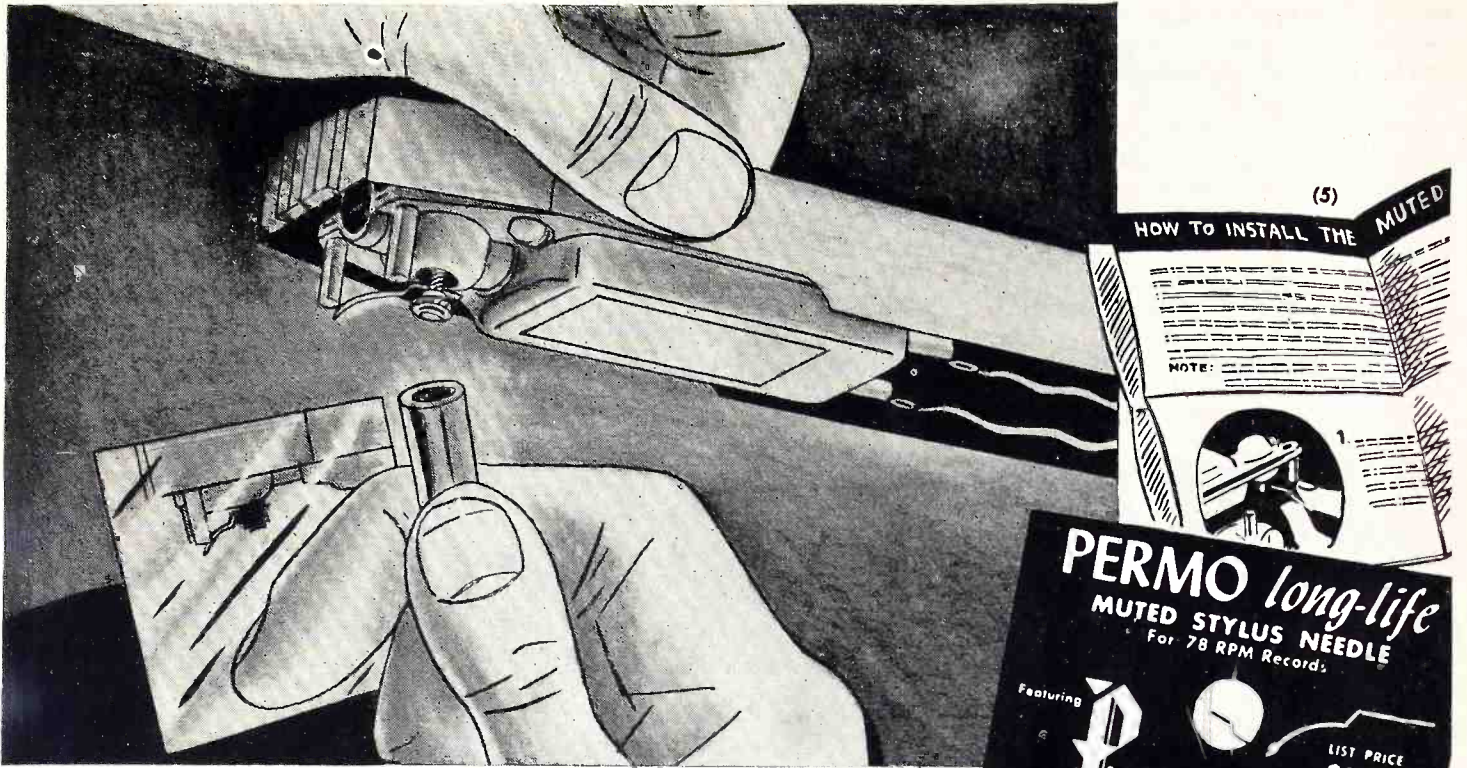

YOU SAVE TIME — MAKE MONEY — WITH
PERMO *long-life*
PHONO NEEDLES

Here's why:

1. COMPLETE "Facts" — Here is a needle replacement guide that's complete, authentic, accurate—one that tells specifically what needle goes where. It's Permo's "Phonograph and Needle Facts", and Permo took the time to do it right. A guide that gives you everything you need to know for fast, easy replacement needle sales.

2. COMPLETE NEEDLE STOCKS — Individually packaged Permo Long-Life Phono Needles come to you on convenient display cards. Each display card carries a full set of replacement needles for one manufacturer's sets.

3. REASONABLE INVESTMENT — Complete initial needle stocks and "Facts" for all post-war Admiral and Philco sets are yours for less than \$12.00 dealer cost. Make high profits selling the easy-replacement needle line—Permo Long-Life!



NO FUMBLING!

YOU GET EVERYTHING YOU NEED IN ONE PACKAGE

Permo Long-Life Phono Needles are individually packaged with installation tools where necessary, spare parts (nuts, screws, etc.) and complete installation instructions. The C-320 Muted Stylus package (above) for example, contains: (1) needle (2) wrench (3) mirror (4) extra nut (5) installation instructions. You get everything you need in one complete package when you buy Permo Long-Life needles.

NOW AVAILABLE

Admiral, Columbia and Philco "Facts" and Replacement Needles. Others coming soon! Write for your free copies of the "FACTS".



PERMO, INC. *Champion of Perfection*

6401-33 N. RAVENSWOOD AVE.

CHICAGO 26, ILLINOIS

by the CBS system, to get color pictures in black and white, whenever the 405-line color system is on the air.

"This means," Stiekel said, "that consumers will be able to see all color programs, in black and white, over their receivers with the Du Matic switch. Their sets are already compatible for reception in black and white of the RCA-type system and the Du Matic will now make it possible for them to see 405-line color programs in black and white, too."

"The Du Matic will sell under \$20," he declared, and, can be installed by a local serviceman in an hour.

"The low price for this quality unit," he said, "is made possible by the superior design of the Du Matic chassis. This has enabled our engineers to do away with a power supply, additional plugs and tubes, normally used in adapters of this type."

Stiekel stated that the Du Matic would be available in kits for installation in Du Mont receivers already in homes and public places.

CBS Presy To Address Conference

A luncheon address by Airtan Murphy, president, Columbia Broadcasting System laboratories division, on

"Color Television" will highlight the seventh annual National Electronics Conference Oct. 22, 23, and 24 at the Edgewater Beach Hotel.

Other luncheon speakers on the program are W. R. G. Baker, vice-president of the General Electric company on "Electronics for Defense", and Phil Hanna, financial editor of the Chicago Daily News, on "Is It True What They Say About Electronics?"

Murphy, who's company has been the center of a heated controversy ever since the FCC chose the CBS color television system, will speak at the 12:15 p.m. luncheon Tuesday, Oct. 23, in the hotel Marine dining room.

More than 2,000 engineers are expected to attend the conference, at which 76 technical papers will be presented during 19 sessions.

Specified in the Best TV Sets for Years...

NOW it's RAM components for REPLACEMENT and CONVERSION!

Bigger, Faster PROFITS for You!

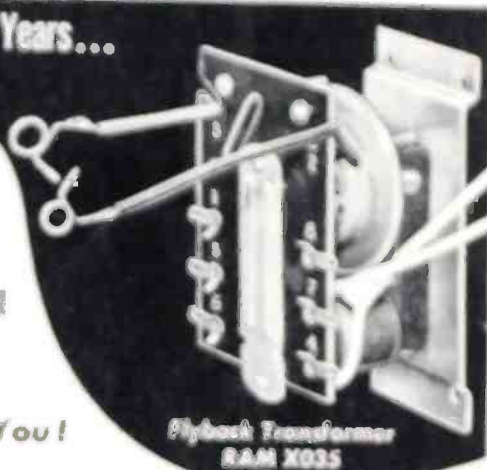

Flyback Transformer
RAM X035

HIGHEST EFFICIENCY! LOWEST COST! IMMEDIATE DELIVERY!

The famous TV set manufacturers who have for years specified RAM components as original equipment are an impressive list of industry leaders—Dumont, CBS-Columbia, Olympic, Tele-Tone, Fada, Silvertone, Starratt, Regal, DeWald, etc. Day after day, RAM Test-Pattern Tested components have far surpassed their every super-critical laboratory, production and field test. This is the proof of RAM superiority!

RAM now makes these identical quality components available to you—at the lowest costs in the industry, with immediate delivery—for your greater replacement and conversion profits!

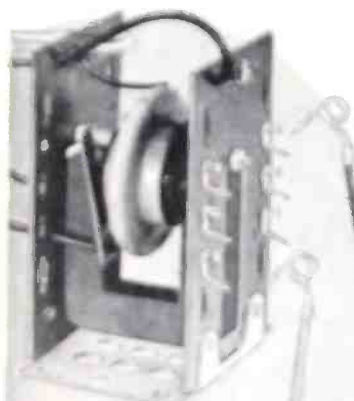

Flyback Transformer
RAM X045



Flyback Transformer
RAM X032

Take a tip from the quality-conscious men who make the best TV sets—specify RAM! There's a RAM Test-Pattern Tested Flyback Transformer, Deflection Yoke, Width Control and Linearity Control for your every need. Ask your parts distributor for them—TODAY!

Write NOW for free latest RAM TV Replacement & Conversion Guide, #D-10.

Ram ELECTRONICS SALES CO.
20070 BUCKHOUT STREET
IRVINGTON-ON-HUDSON, N. Y.
Irvington 9-5700
TEST-PATTERN TESTED COMPONENTS FOR TV



Deflection Yoke
RAM Y-70

TRADE LIT

(From page 32)

each are illustrated, each illustration with a numerical designation. All Columbia and Philips Phonographs and Record Changers for which there are Astatic replacements are listed by model number. Opposite these model numbers are the model designations of the proper Astatic Cartridge replacement and Needle type, together with the illustrative numbers which picture the particular cartridge and needle referred to.

The person using the guides thus finds it not only easy to learn the recommended cartridge and needle replacement in all instances, but can also find what each looks like, to save time and possible mistakes in locating the Astatic products in stock.

In requesting request the guides, ask for Philips Form No. 32 and Columbia Form No. 33.

John F. Rife, Publisher, Inc., 400 Canal St., New York 13, N.Y., reports that *VOL 22* of the *Personal Tractor's Service Series* is now in production and will be available in October.

22 manufacturers contributed their factory authorized servicing data on AM-FM receivers, auto radios, record changers, disc and tape recorders. The volume covers productions for the period November 1950 through August 1951. The latest manual contains 1,520 pages, all filed in place, ready for immediate service bench use. The accompanying cumulative index for Volumes 16 through 22 greatly facilitates the location of any model.

Volume 22 contains schematics.

WV-77A JUNIOR VOLTOHMYST

- ✓ Sturdy 200-microampere meter movement
- ✓ Meter electronically protected against burn-out
- ✓ Metal case shields instrument from rf fields
- ✓ Carbon-film 1% multiplier resistors for lasting accuracy
- ✓ Response flat from 30 cps to 3 Mc on 3-, 12-, and 60-volt ranges
- ✓ DC input resistance, 11 meg-ohms on all dc ranges
- ✓ Pointer can be zero-centered for TV and FM discriminator alignment
- ✓ Equipped with dc-polarity reversing switch
- ✓ Negative-feedback bridge circuit for greater stability
- ✓ More convenient... with new-type slip-on probe
- ✓ Polarity of ohms probe is positive... for checking electrolytics
- ✓ Durable, "full-view" 4½" plastic meter case

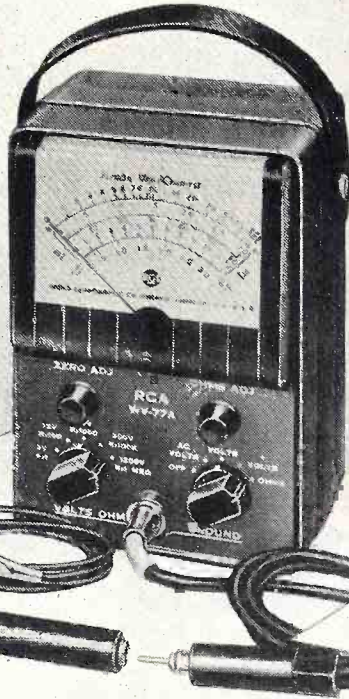

\$47.50
SUGGESTED
USER PRICE

WV-97A SENIOR VOLTOHMYST

Has all the features of the WV-77A and, in addition, the following features...

- ✓ Peak-to-peak direct measurement of complex waves from 0.2 volt to 2000 volts
- ✓ Has 7 non-skip ranges for resistance and voltage measurements
- ✓ All full-scale voltage points increase in a uniform "3-to-1" ratio
- ✓ Response flat from 30 cps to 3 Mc on 1.5-, 5-, 15-, 50-, 150-, and 500-volt ranges
- ✓ Covers wider ac and dc voltage ranges
- ✓ Especially useful as TV signal tracer
- ✓ Has etched aluminum panel
- ✓ Wider overlap of scales—more accurate readings
- ✓ Reads rms and peak-to-peak values of sine waves simultaneously up to 1500 volts rms and 4200 volts peak-to-peak

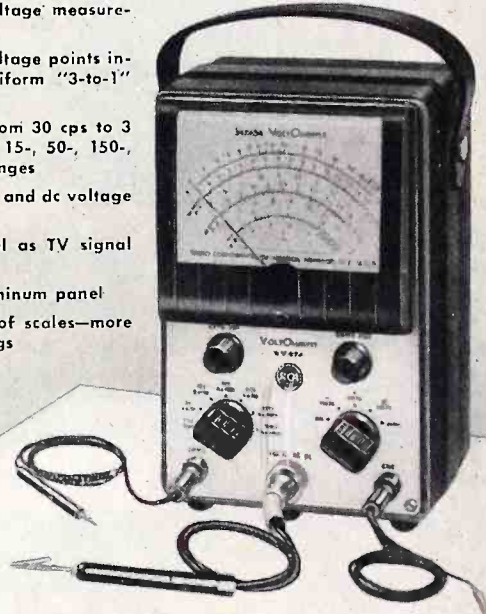

\$67.50
SUGGESTED
USER PRICE

The dc ranges of both the WV-77A and WV-97A can be extended to 50,000 volts with accessory WG-289 High-Voltage Probe and WG-206 Multiplier Resistor. Accessory WG-264 Crystal-Diode Probe extends the frequency range of both instruments to 250 Mc.

YOUR CHOICE of 2 great RCA VoltOhmysts*

WV-77A—Accuracy and Versatility at a Low Price

Unquestionably the greatest value in all-electronic, ac-operated, vacuum-tube volt-ohmmeters... the WV-77A is factory-built and factory-calibrated against the finest laboratory standards. Comes complete with tubes, battery, probes, cables and instruction booklet... ready to use.

Equipped with five ranges each; for dc voltage, ac voltage, and resistance. It measures dc from 0.05 to 1200 volts; ac from 0.1 to 1200 volts rms; and resistance from 0.2 to 1 billion ohms. Superior in every respect to the famous 195-A.

*Reg. U.S. Pat. Off.

Ask your RCA Test Equipment Distributor for complete technical data folders, or write RCA, Commercial Engineering, Section 55JX, Harrison, New Jersey.

WV-97A—Especially useful for Television Servicing

The WV-97A combines in one instrument an unusual array of features of interest to every service technician.

The new Senior VoltOhmyst measures dc voltages from 0.1 volt to 1500 volts in high-impedance circuits, even with ac present. It reads the rms values of sine waves and the peak-to-peak values of complex waves or recurrent pulses, even in the presence of dc. Its electronic ohmmeter has seven ranges to measure resistances from 0.2 to one billion ohms.

An outstanding feature is its usefulness as a television signal tracer... made possible by its high-input resistance, wide frequency range, and direct reading of peak-to-peak voltages.



RADIO CORPORATION of AMERICA
TEST EQUIPMENT
HARRISON, N. J.

SAVE Up to \$1.00 each.

**Form a Group.
Service Dealers**

Subscribe to "RTSD" —

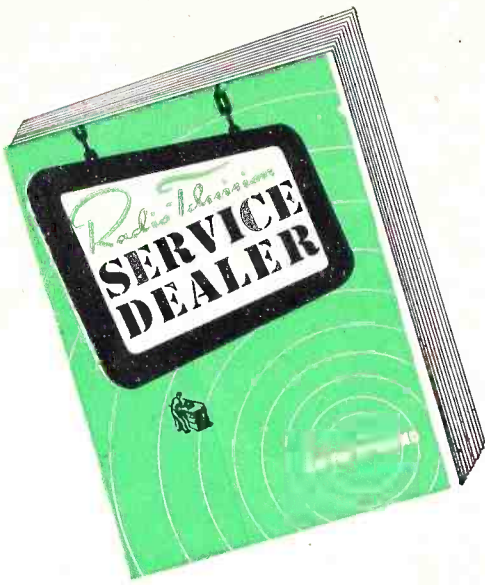

"The Professional Radio-Television man's Magazine"— published monthly. All articles are exclusive and timely. Practically every issue is worth what an entire 1 year subscription costs.

★ The more in a group the bigger the savings. 6 men in a group save \$1.00 each; 4 men groups save \$.75 per man. Present "RTSD" subscribers may participate in or form a group with co-workers, or even competitors. Still active subscriptions are automatically extended 1 year. Start a Group today! The timely and exclusive technical data appearing in future issues of "RTSD" will make this the best investment you ever made. The special Group Rate offer may be withdrawn at any time—so hurry.

Use This Coupon For Convenience

(The coupon below can be used for from 1 to 6 subscription orders. Use it today!)



TEAR OUT — MAIL TODAY

RADIO-TELEVISION SERVICE DEALER
67 West 44th Street, New York 18, N. Y.

Please enter 1 year subscription orders for the names given below. Our remittance is enclosed.

NOTE: If you do not wish to tear this order blank out, just print or type the information on a single sheet of paper, following the style given. Each subscriber's occupation must be clearly described.

	In U.S.A. & Canada	Foreign Rates
<input type="checkbox"/> One 1-year subscription	\$2.00	\$3.00
<input type="checkbox"/> Two 1-year subscriptions, each	1.75	2.75
<input type="checkbox"/> Three 1-year subscriptions, "	1.50	2.50
<input type="checkbox"/> Four 1-year subscriptions, "	1.25	2.25
<input type="checkbox"/> Five 1-year subscriptions, "	1.10	2.00
<input type="checkbox"/> Six 1-year subscriptions, "	1.00	1.50

Name

Address

Describe Title or Position and Type of Business

State whether a New Subscriber or Renewal Order

Name

Address

Describe Title or Position and Type of Business

State whether a New Subscriber or Renewal Order

Name

Address

Describe Title or Position and Type of Business

State whether a New Subscriber or Renewal Order

Name

Address

Describe Title or Position and Type of Business

State whether a New Subscriber or Renewal Order

Name

Address

Describe Title or Position and Type of Business

State whether a New Subscriber or Renewal Order

Name

Address

Describe Title or Position and Type of Business

State whether a New Subscriber or Renewal Order

alignment procedures, chassis views, tube layouts, operating voltages, parts lists and parts values, voltage ratings of condensers, wattage ratings of resistors, coil resistance data, gain data, dial drives, and a "Changes" section for manufacturers' modifications. Ruggedly bound in a blue waterproof loose-leaf binder, it is priced at \$18.00.

SYNC PULSES

[from page 12]

met with solid opposition by the nub of the situation, the newspaper itself, because it was not to the newspaper's best interest to have to "lay-off" the scare-head, front page, "sensational expose" that they were playing to a fare-thee-well at that particular moment.

The various chapters of the Radio Technicians Associations located near Los Angeles suggested that state-wide legislation be promulgated, very much in line with the licensing bill pending action in New York City. The newspaper belittled the idea on the premise that "it takes too long to put through any new legislation in the state of California." Isn't that silly! Instead the newspaper, knowing nothing at all about the complexities and ramifications of radio and TV servicing had the temerity to propose that the local police department should require every person engaged in service work to take out a license which would be subject to revocation if the licensee were found guilty of malpractice . . . and mind you . . . no practical suggestion was made as to who was to qualify to judge whether or not an accused technician actually had been guilty of either unintentional faulty workmanship or even outright and deliberate incompetence. And going a step further, what about the protection that the service profession was entitled to against dishonorable and crooked politicians and policemen who might try the old, well-known graft pay-off rackets? None was even considered. In this regard, naturally a gyp technician would be willing and happy to make a pay-off in order to continue his nefarious endeavors whereas an honest and upright technician who might have the "squeeze" put on him would be put out of business merely because he fought to preserve his integrity. One more point—the L. A. police department heads themselves deplored the suggestion that they be burdened with further work, about which they admit they know nothing, especially now while their budget doesn't provide enough

man-power to handle the legitimate types of crime and law enforcement which they are supposed to handle as a routine matter.

Summed up, our suggestion to the law-makers of California, and particularly to Jack Kennett of the Los Angeles "Daily News" was that patience and proper legal procedure be followed so that state-wide licensing laws would be effected, much along the lines of those proposed for New York, and only after the law-makers had the guidance, advice and collaboration of the several Servicemen's Associations who are qualified to guide the lawmakers in establishing the

basic standards for the several classifications of apprentice, or journeyman technician, etc. Meanwhile, the several California associations had better begin to collaborate with each other at once to protect their equity, and the service organizations located in Los Angeles proper, (now not even having an association of any kind whatever), had better get together and organize. Otherwise they'll all be squeezed right out of the picture by sensation-mongers and the like who aren't even a part of the service industry but who have managed to capitalize on its own basic weakness, the lack of co-ordinated organization.

IF YOU BUY, SELL OR INSTALL TV ANTENNAS YOU KNOW

THE COST OF A DISSATISFIED CUSTOMER. ONE CALL-BACK

TO REPAIR OR REPLACE A FAULTY ANTENNA IMMEDIATELY

REDUCES OR ELIMINATES YOUR PROFIT. MORE THAN 1

MILLION TROUBLE-FREE WALSCO ANTENNAS ARE

INSTALLED THROUGHOUT THE NATION. JOBBERS,

DEALERS, SERVICEMEN. TRUST THE QUALITY OF WALSCO

ANTENNAS TO GIVE CUSTOMERS LASTING SERVICE AND

OUTSTANDING PERFORMANCE AT A FAIR PRICE. USE ANY

ONE OF THE FAMOUS WALSCO MODELS . . . IT'S THE

PRODUCT OF THE LEADER. TO BE SURE, SPECIFY WALSCO.

WALTER L. SCHOTT CO. • 3225 Exposition Place, Los Angeles 18, Calif.

T A P E

[from page 26]

friction of the tape through the guides during a condition of *Fast Forward* or *Fast Reverse*. The tape should wind tightly onto the reel in a short length of time. Guides should be positioned in a vertical plane with respect to the posts to facilitate ease of threading. Some units have small friction brakes attached to the clutch-cup face. These do not require tape guides since proper friction or *drag* upon the turntables is obtained from the brakes.

Pressure of the rubber roller wheel against the tape and capstan spindle is adjusted at the factory. Field adjustments are not recommended. It is better to replace any component found defective in this assembly. If the tape tends to crawl up or down on the capstan spindle, the spring may not be seating properly in the grooves of the wheel shaft. Otherwise the spring may have become bent causing one arm to exert more pressure than the other. Again replacement rather than field adjustment is recommended.

In earlier models, cases of low level or loss of highs were traced to a bend-

ing of the pressure bracket due to its normally violent recoil. Such bending occurred in brackets formed with a sharp bend instead of a radius in the arm of the bracket. When bending occurred the head pad no longer pressed directly against the record head gap. Correction is effected by replacement of the sharply bent brackets with one of the radius type. Also the head locking slide spring should be replaced with a newer lighter type thus eliminating the violent recoil of the bracket.

Motor Vibration

When motor noise is apparent, the clutch and capstan drive belts should be disengaged to ascertain whether the vibration originates from the motor itself. Check the fan for bent or loose blades. Many cases trace to misalignment of shock mounts. The motor must float freely and not touch any other part of the machine. Early models used heavy ground strap material which transmitted vibration to the chassis. Also some of those models had no belt guides which should be installed to prevent the belt from rubbing against itself thus causing rapid wear. The belt guide is simply installed. Replace the present motor mounting screw with a half

inch #vJ self-tapping screw. The new belt guide is slipped under the screw head with a flat washer and lock washer installed between it and the screw head. Space here does not permit coverage for replacement of major components. The reader is referred to Service Manuals for such detail.

Electrical Section

Servicemen are cautioned to be sure the power is turned *OFF* before attempting repairs. This step will avoid cuts and burns from moving fan blades and heated components. Tubes are accessible when the back cabinet cover is removed. When replacement of the 6J7 tube is required, be sure to replace the shield cap over the grid. Otherwise hum will occur. Also dress the shielded grid lead as close to the bottom of the cabinet as possible to avoid hum. The basic amplifier performs four functions now described individually.

Record Amplifier

The first record amplifier stage (*V-1* see *Fig. 2*) is a 6J7 stage having a gain of approximately 120. The grid is connected to contact *A* of selector switch *S-1* and is switched to contact *B* while recording from a microphone or to contact *D* while recording from radio input.

THIS IS IT! THE RELAY

WITH *Interchangeable Coil*
FOR A WIDE RANGE OF RADIO APPLICATIONS

GUARDIAN Series 200

Interchangeable

COIL and CONTACT

Switch Assembly

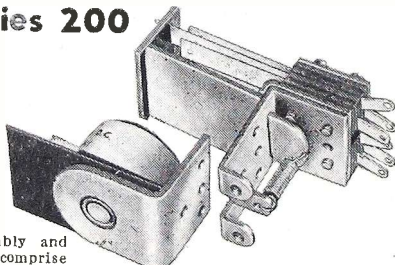

Two basic parts—a coil assembly and a contact switch assembly—comprise this simple, yet versatile relay. The coil assembly consists of the coil and field piece. The contact assembly consists of switch blades, armature, return spring and mounting bracket. The new Guardian Midget Contact Assembly which is interchangeable with the Standard Series 200 coil assembly, is also available in either single pole, double throw; or double pole, double throw.

CONTACT SWITCH ASSEMBLIES

CAT. NO.	TYPE	COMBINATION	
		Single Pole	Double Pole
200-1	Standard	Single Pole	Double Throw
200-2	Standard	Double Pole	Double Throw
200-3	Contact Switch Parts Kit		
200-4	Standard	Double Pole	Double Throw
200-M1	Midget	Single Pole	Double Throw
200-M2	Midget	Double Pole	Double Throw
200-M3	Midget Contact Switch Parts Kit		

13 COIL ASSEMBLIES

A.C. COILS*		D.C. COILS	
CAT. NO.	VOLTS	CAT. NO.	VOLTS
200-6A	6 A.C.	200-6D	6 D.C.
200-12A	12 A.C.	200-12D	12 D.C.
200-24A	24 A.C.	200-24D	24 D.C.
200-115A	115 A.C.	200-32D	32 D.C.
		200-110D	110 D.C.

*All A.C. coils available in 25 and 60 cycles

GUARDIAN ELECTRIC

1606-L W. WALNUT STREET

CHICAGO 12, ILLINOIS

A COMPLETE LINE OF RELAYS SERVING RADIO AMATEURS

HICKOK

High Sensitivity

VOLT-OHM-MILLIAMMETER

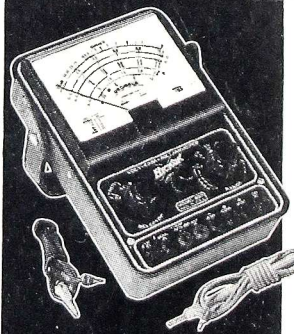

- ✓ THINNEST DESIGN
- ✓ SHOCK RESISTANT
- ✓ LARGE 5" METER
- ✓ BATTERY OPERATED

Ranges:

- 20,000 ohms per volt DC, 5,000 AC
- Volts, AC-DC: 2.5 to 5,000
- Output: 2.5 to 1,000
- Microamperes, DC: 0 to 50
- Amperes, DC: 0 to 10
- Decibels: -30 to +55
- Ohms: 0 to 100 meg., in 4 ranges

This fine quality HICKOK Model 450 is the last word in handier, high sensitivity volt-ohm-milliammeters. Modern lucite meter case for increased readability. Compact design, thinnest instrument of its kind. Highly accurate. Built for long hard service at the bench or in the field. 5 3/4" W. x 8 3/8" H. x 2 1/2" D. Test leads included.

Write today for complete information.

THE HICKOK ELECTRICAL INSTRUMENT CO.

10533 Dupont Avenue

Cleveland 8, Ohio

The screen and cathode are bypassed to ground in the usual manner. The output of this stage provides a flat response to the grid of V-2 through capacitor C-6 and volume control R-9. The filter network in the B plus supply to this stage (C4, C5 and R8) is to prevent the stage from motorboating and eliminate hum from the power supply.

The second stage (V-2) uses a 6SJ7 as a converter tube. Its function is to convert voltage from V-1 into recording head current. This current flows through coupling capacitor C-8, through the contacts I and J or through I and L of selector switch S-1 thence into the record head E-1. Signal current through the head should approximate 0.8 milliamperes.

Together with the audio signal, a 30 kc bias signal is present at the plate of V-2 during a recording. In amplitude the bias signal is about triple that of the audio signal. For this reason the volume indicator V-3 and the monitor amplifier signal inputs are picked off from the screen of this stage. The 30 kc signal is prevented from reaching the volume indicator because of bypass capacitors C8 and C9. Screen degeneration is reduced by connection of R13 between the screen and the cathode. Signal from the screen to the volume indicator is coupled through capacitor C11 and resistor R17. The latter prevents grid current of V-3 from distorting the final recording. Signal from the screen to the monitor amplifier is coupled through the network (C10, R14 and volume control R16).

Bias Oscillator

The bias oscillator V-4 is a 6J5 which supplies the necessary 30 kc bias current mentioned earlier. Certain tapes require more bias current than others. For that reason, choice of a second value of bias has been provided through switch S-4 in the cathode circuit of V-4. When this switch is open, only resistor R23 is in the cathode circuit. A bias current of 2.0 ma results. When this switch is closed, R22 and R23 are in parallel thereby increasing the bias current to 4.5 ma.

Monitor Amplifier

The built-in monitor amplifier uses the same input as the recording amplifier with the exception that the signal is taken from the screen of the second stage (V-2) and transmitted to the phase inverter stage (V-5) employing a 6SN7 twin triode. The phase inverter output is coupled through capacitors C17 and C18 to the final pushpull stage (V-6).

Volume of the monitor amplifier is controlled by R16. Tone is controlled by R24. This amplifier is purposely muted during a recording from a microphone so to prevent acoustic feedback.

Playback Amplifier

The signal for playback is extracted from the tape by the reproduce head (E-1). It is applied to the grid of V-1, amplifier and fed to the next stage (V-2) through capacitor C-6 and volume control R-9. The signal passes from the plate of V-2 through capacitor C-7, selector switch S-1 and tone control R-24 to the grid of phase

inverter V-5. Thence signal transit is the same as given for the monitor amplifier.

During Playback the 30 kc oscillator becomes inoperative. Instead, the oscillator coil (L-1) is shunted by C-12 and, in conjunction with R-20 and C-13, forms a network in the output circuit of V-2. When L-1 and C-12 are paralleled they form a circuit resonating at 5000 cps which boosts the high frequency response. The impedance of this entire network is quite low at 1000 cps hence the middle frequencies are attenuated. At lower frequencies, down to 100 cps, the im-

Especially Designed for Radio & TV!

LYNN Lightning
SOLDERLESS WIRE
TERMINAL
REPAIR KIT

NO. 2195
SERVICE KIT

Now you can get a positive, trouble-free connection on every terminal... as fast as you can close your hand. No messy soldering or waiting for an iron to heat! With a Lynn Lightning service kit you just strip primary wire from 10 to 22 gauge with handy, combination stripping and crimping tool... select the proper terminal... then *crimp* it on. Every job quick, clean, professional-looking! Kit comes complete with crimping tool, 10 different types of terminals in 11-bin, clear plastic box. Only \$8.50

Two New Television Screw Drivers

Reach hard-to-get-at spots with the new Vaco AT 510 non-metallic, fiber shank driver for critical tuning and aligning work... the 10" blade gives you all the length you need. Adjust the new type focalizers with specially designed Vaco Beryllium-copper drivers... non-magnetic, yet nearly as hard as steel for adequate torque without interference with the Ion trap field. Full information on other aligning tools, nut setters and special radio tool kits on request. Write for FREE catalog.



317 E. Ontario St., Chicago 11, Ill.
In Canada: Vaco-Lynn Products Co., Ltd.
1212 Notre Dame St., W., Montreal 3, Que.

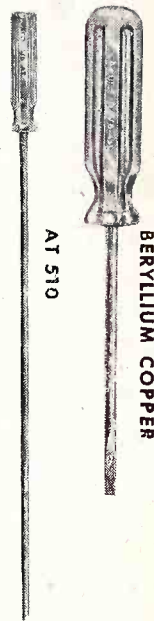



FROM THE SMALLEST

TO THE LARGEST

Eric Ceramicons

STYLE 801
DISC
CERAMICON



STYLE 410
HIGH VOLTAGE
CERAMICON

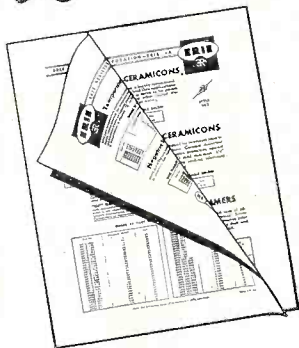

New 1951 Catalog
Ask your Distributor
or write Department B
for a copy

... fill the need for all today's ceramic capacitor requirements in AM-FM Radio and TV ... plus — their ability to better replace paper and molded mica capacitors in a multitude of applications, such as by-passing, coupling, tone compensation, and as AVC filter.

Electronics Division
ERIE RESISTOR CORP., ERIE, PA.
LONDON, ENGLAND · TORONTO, CANADA

A MUST for every radio man

CQ is a monthly publication for Radio Amateurs, Technicians, Engineers, and Communications personnel. As radio-television servicemen you will be interested in knowing that the FCC has recently initiated both Novice and Technician Class licenses for radio amateurs. Since these licenses are easily obtained, many of you will undoubtedly be interested in preparing for them. (These are discussed fully in the March issue.)

For many years CQ has served radio amateurs and communication men throughout the world. Its articles are a constant reading necessity for all men in the radio profession.

Enter your subscription to CQ NOW!

Regular Subscription rates:

1 Year \$3.00 2 Years \$5.00

in U. S., U. S. Possessions, Canada and countries in the Pan American union. All others \$4.00 per year.

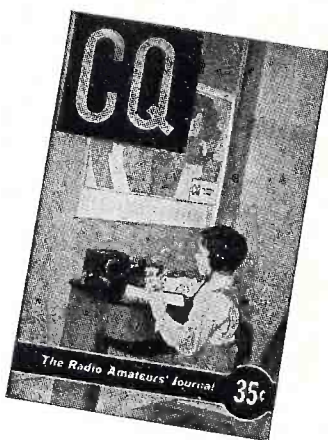

--- TEAR OUT --- MAIL TODAY ---

CQ Magazine

67 W. 44 St., New York 18, N. Y.

RS-1

Sirs: Here is my check (or money order) for \$..... for years subscription to CQ.

Name (print carefully)

Address

City Zone..... State.....

pedance of capacitor C-13 becomes higher causing the network to appear open. This action permits the lower frequencies to be passed on to the next stage (V-5) through capacitor C-7. The playback head is tuned to 5000 cps by capacitor C-19.

Elimination of TV Interference

When operated in the high field strength of TV stations the BK-411 and BK-414 Soundmirrors are sometimes subject to interference. This may appear as a loud hum or whistle when synchronizing signals are induced into the recorder. To eliminate this interference, the steps listed below should be tried in order:

1. Connect a 50 μ f capacitor between the point on the rotary selector switch (S1), to which the grid of V-1 returns, and the center or ground lug on the three terminal strip situated on the front amplifier panel adjacent to the selector switch.

2. Electrolytic Capacitor C-4, by-passing the screen of the first gain stage, should be re-connected. Remove its connector from the cathode pin of the tube socket. Connect this same lead to the ground lug on the combined capacitors C-1, C-3, and C-6.

3. Connect a 0.001 μ f capacitor between the cathode pin of V-1 and the same ground point on the electrolytic capacitor as was used in step 2 above.

4. Connect a 0.001 μ f capacitor between the screen of V-1 and the same point on the electrolytic capacitor as used in steps 2 and 3 above.

Hum Correction

Excessive hum during silent passages of a tape record played may be caused by inductive fields radiated by such sources as the motor, power transformers, filter, choke, or a field set up by an external source. An obnoxious of this sort may often be corrected by re-establishing the balance between the two windings of the Record-Play head. This is simply accomplished by slightly rotating the head counter-clockwise or clockwise according to requirement. Once the equipment has been warmed up and the controls set for Playback operation at full volume, correction is accomplished through the following actions:

1. Remove the small trim covers and loosen the mounting screws on either side of the Record-Play head enough to allow it to be rotated slightly.

2. Thread the tape around the back side of the head and the capstan drive spindle, then shift the control lever to the Play position.

3. Rotate the Record-Play head in one direction and then in the opposite until a central point of minimum

hum is found. Tighten the screws to secure the head in that position.

Other possible sources of hum are:

- (a) Grid lead of the first 6J7 tube not dressed close to the bottom of the cabinet.
- (b) High voltage transformer leads not dressed down to chassis.
- (c) Microphone plug grounded on panel.

MEN OF RADIO

[from page 28]

stream, which was added later by Boris Von Rosing. It is interesting to note here that Braun was also active in wireless research; in 1903 he developed a system that interested the United States Army. He and Sir Oliver Lodge, working independently, contributed a great deal to the development of inductively coupled systems.

[To Be Continued]

OSCILLOSCOPE

[from page 24]

ence base line or a zero reference line.

A 60 cycle sine wave signal is applied to the grid of the 6C4; this signal comes from the secondary of the sweep producing transformer. A phase shifting network of a capacitor and variable resistance is used to allow a change in the phase of this sine wave signal applied to the grid of the blanking tube. The grid resistor which is 10 megohms is sufficiently large to produce almost cut-off bias on this triode. In this manner the negative alternations have no effect on the tube. However, the positive alternation increases the current flow and provides a negative going voltage at the plate of this tube. This negative-going voltage is caused by the drop across the plate load resistor. This gate voltage is capacitively coupled to the master oscillator tube and prevents conduction.

During the retrace portion of the sine wave which is applied to the horizontal deflection plates of the tube *D* to *F* there is no vertical input signal hence a straight line is traced across the tube face by the electron beam. During the input sine wave *B* to *D* there is a vertical signal applied and a response curve is obtained. In this manner we have alternately a response curve and a straight line which is used as a reference base line.

Also, in this manner the amplitude of the response curve may be measured directly in relation to the base line.

CONVERSIONS

[from page 21]

pedance, again trying to achieve better match.

C. Try capacitive loading of the secondary between points 5 and 8 or try different values. Usual value about

1000 uuf. . . A high peak voltage exists here and mica condensers rated at 1000 V must be used. If 1000 V condensers are not available, use two 600 V condensers in series. Be sure they are of equal capacitive value, otherwise one may break down due to overload. If series combination is used, the value of each should be such that when divided by two, it will give the desired value. $(C1 + C2) / 4 =$ Necessary value.

D. Change horizontal sweep output tube. As an example, 6CD6 in place of a 6BG6. The new 6AV5 is a high

NEW! STANCOR



Here are three of the newest additions to the most complete transformer replacement line in the industry.

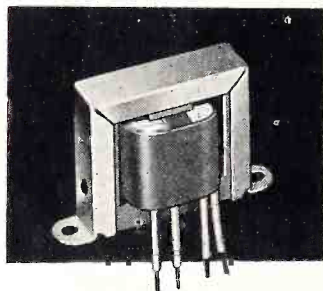

A-8124, VERTICAL BLOCKING-OSCILLATOR TRANSFORMER

A three winding transformer for replacement in Dumont models RA-103, RA-103D, RA-104A, RA-105, RA-105B, RA-108 and RA-110A. See Stancor Bulletin 384.

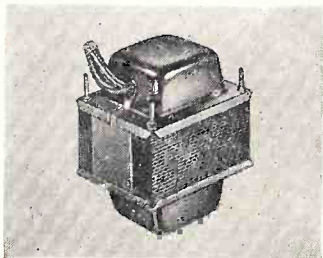

FC-11, FOCUS COIL.

For use with picture tubes up to 24". Equivalent to RCA 202D2. See Stancor Bulletin 383.

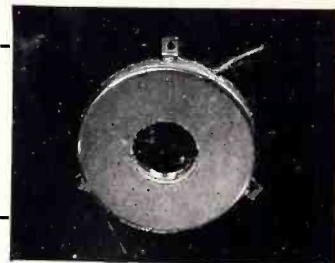

P-8163, TV POWER TRANSFORMER

Equivalent to RCA 75508 (971316-1), used in 28 RCA models. See Stancor Bulletin 388 for a complete list.

Your Stancor distributor has data sheets on these new Stancor TV transformers. Ask him for the latest Stancor Bulletins.

Other new Stancor TV components include **DY-8**, **DY-9**, and **DY-10**, 70° deflection yokes with ferrite cores, nylon coil bobbins and anti-astigmatic focusing (resulting from "cosine" distributed windings) for tubes up to 24". **A-8131**, an air core "flyback" for direct drive circuits, to be used with **DY-10**.

STANCOR TV TRANSFORMER CATALOG AND REPLACEMENT GUIDE lists transformer replacements for over 1500 TV models and chassis. Available FREE from your Stancor Distributor.



STANDARD TRANSFORMER CORPORATION

3580 ELSTON AVENUE, CHICAGO 18, ILLINOIS

Insure BETTER Television Service to Your Customers! . . . Exclusively Designed

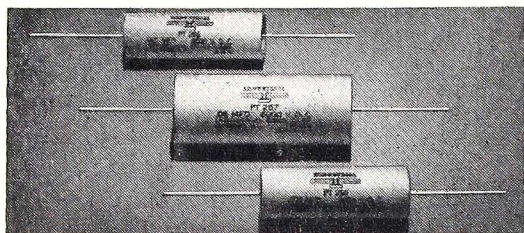

HIGH VOLTAGE AND ELECTROLYTIC TUBULAR TELEVISION CAPACITORS

Especially Engineered for Television Circuits by INDUSTRIAL CONDENSER CORP.

The economical quality line for replacement. Industrial Condenser Corp., manufacturers of Capacitors exclusively brings you highest quality for the particular requirements of Television at exceptionally attractive prices! Special Capacitors are Pyroteen impregnated for low power factor, high insulation resistance, high operating temperatures. Oil, Pyroteen, Wax and Electrolytic Capacitors. Finest materials throughout.

Ask Your Jobber for our Attractive Prices Today!

Or write for Bulletin 1095. Industrial makes quality Capacitors for Television, Radio, every electronic and industrial application—all types.

Send for Complete Catalog

INDUSTRIAL CONDENSER CORP.

3243 N. CALIFORNIA AVENUE CHICAGO 18, ILLINOIS
Sales offices in principal cities.

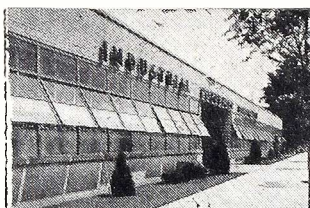

Modern plant built by Industrial Condenser Corp., for manufacture of Capacitors only.

STATEMENT OF THE OWNERSHIP, MANAGEMENT, AND CIRCULATION REQUIRED BY THE ACT OF CONGRESS OF AUGUST 24, 1912, AS AMENDED BY THE ACTS OF MARCH 3, 1933, AND JULY 2, 1946 (Title 39, United States Code, Section 233)

Of RADIO-TELEVISION SERVICE DEALER published monthly at New York, N. Y. for October 1, 1951.

1. The names and addresses of the publisher, editor, managing editor, and business managers are:

Publisher: Sanford R. Cowan, 1620 Ocean Ave., Brooklyn 30, N. Y.; Editor: Sanford R. Cowan, 1620 Ocean Ave., Brooklyn 30, N. Y.; Managing editor: Samuel L. Marshall, 262 Sullivan Place, Brooklyn 25, N. Y.; Business manager: Sanford R. Cowan, 1620 Ocean Ave., Brooklyn 30, N. Y.

2. The owner is: (If owned by a corporation, its name and address must be stated and also immediately thereunder the names and addresses of stockholders owning or holding 1 percent or more of total amount of stock. If not owned by a corporation, the names and addresses of the individual owners must be given. If owned by a partnership or other unincorporated firm; its name and address, as well as that of each individual member, must be given.) COWAN PUBLISHING CORP., 67 West 44th Street, New York 18, N. Y.; SANFORD R. COWAN, 1620 Ocean Ave., Brooklyn 30, N. Y.

3. The known bondholders, mortgagees, and other security holders owning or holding 1 percent or more of total amount of bonds, mortgages, or other securities are: (If there are none, so state.) — None.

4. Paragraphs 2 and 3 include, in cases where the stockholder or security holder appears upon the books of the company as trustee or in any other fiduciary relation, the name of the person or corporation for whom such trustee is acting; also the statements in the two paragraphs show the affiant's full knowledge and belief as to the circumstances and conditions under which stockholders and security holders who do not appear upon the books of the company as trustees, hold stock and securities in a capacity other than that of a bona fide owner.

(Signed) SANFORD R. COWAN, Publisher

Sworn to and subscribed before me this 7th day of September, 1951.

(Seal) HARRY N. REIZES, Notary Public

Address Changes . . .

Subscribers to SERVICE DEALER should notify our Circulation Dept. at least 5 weeks in advance regarding any change in address. The Post Office Dept. does not forward magazines sent to a wrong destination unless you pay additional postage. We cannot duplicate copies sent to your old residence.

RADIO-TELEVISION SERVICE DEALER, 67 W. 44 St., New York 18, N. Y.

efficiency type but will require socket rewiring.

E. CRT anode voltage may be reduced. This can be done in many sets by by-passing the H.V. rectifier to B- instead of ground (C3). This change is on the theory that the higher the anode voltage, the less effect on it by the sweep circuits. Caution must be exercised since change of this type effects the focus control.

F. The least desirable change is increase of screen voltage on the horizontal output tube. Tube life may be adversely effected. CRT anode voltage may be raised.

TO DECREASE WIDTH

This is seldom required but may happen. To achieve this result, the above steps should be reversed.

LINEARITY CORRECTION

After changes are made, in order to get proper picture size, linearity troubles may arise. This is due to the fact that some changes to achieve size requirements cause crowding or spreading effects on the picture. Most of these problems are in the damper circuit. The damper tube function is to eliminate transient oscillations when the current through the deflection coils reverses during retrace. Some troubles and hints on correction follow:

A. Should compression be apparent on the left side of the picture, move the damper tube plate connection to other horizontal output transformer secondary taps.

B. The same applies to underdamping causing fold-over in the picture. When trying for a better match on above circuits, it is recommended that the cathode to heater voltage on the damper tube must not exceed 450 V positive.

C. The linearity I/C circuit consists of the linearity control and condensers C1 and C2. If trouble is experienced with critical control, a linearity control of lower inductance or better yet a lower value of C2 can be used. The value of C2 should not be decreased below .02 uf.

D. Width controls may be changed to one of greater inductance if compression on the right side is apparent.

UNDERWRITER REQUIREMENTS

The plate lead to the horizontal output tube should be arranged so that it cannot ground to chassis.

PHASE SHIFT

A phase shift appears in the picture of some converted Philco sets. This can be cured in many cases by moving the CRT screen grid B+ supply lead from the usual source to the plate of the damper tube.



Easy To Install — Easy To Adjust

Here's an ion trap that fits any picture tube neck and can be installed and adjusted in a jiffy **with just one hand.** It's INDIANA'S E-ZEE-ON Ion Trap—a compact, efficient ion trap made of one piece of permanently magnetized Cunife. E-ZEE-ON does a better job too because it provides an even magnetic field pattern that results in brighter, more uniform picture definition. It's just the beam-bender for conversion jobs, working efficiently on large and small tubes.

Look for the colorful E-ZEE-ON display carton on your jobber's counter. Try an E-ZEE-ON Ion Trap on your next job—you'll save time, please your customer, and be amazed at its efficiency.

Write for illustrated folder describing the E-ZEE-ON Ion Trap.



THE INDIANA STEEL PRODUCTS CO.
VALPARAISO, INDIANA
Specialists in Packaged Energy Since 1908

**\$1.00 to \$5.00 PAID
"for SHOP NOTES"**

Write up any "kinks" or "tricks-of-the-trade" in radio servicing that you have discovered. We will pay from \$1 to \$5 for such previously unpublished "SHOP NOTES" found acceptable. Send your data to "Shop Notes Editor," RADIO-TELEVISION SERVICE DEALER, 67 W. 44th St., New York 18, N. Y. Unused manuscripts cannot be returned unless accompanied by stamped and addressed return envelope.



Give



**The
United
Way**

for ALL Red Feather Services

ELUSIVE DECIBEL

[from page 20]

plify decibel computations, the Engineering Department of the Aerovox Corporation prepared Charts A and B, enabling direct reading of decibel values, without ruler plotting. By referring to Chart A, the number of decibels corresponding to any power level between 6 micromicrowatts and 6 kilowatts may be found quickly . . . From Chart B the number of decibels corresponding to any current, voltage, or power ratio may be quickly located.

Particular notice should be taken of the subdivision in the power column of Chart A. These graduations are uniformly spaced (as regards numerical value) except that the lowermost subdivision in each power group has not the same value as each of the upper five in the group. For this reason . . . the lowermost subdivision in each group is numbered. Thus, the numbered line, 10 micromicrowatts is only 4 micromicrowatts removed from the 6 micromicrowatt major division, while each other subdivision up to 60 micromicrowatts is exactly 10 micromicrowatts higher than the previous one.

Thus, we read 10, 20, 30, 40, and 50 micromicrowatts between 6 and 60 micromicrowatts. Similarly we read 100, 200, 300, 400 and 500 micromicrowatts in the next highest power group, between 60 and 600 micromicrowatts.

At this juncture you might glance back at problem (1) and see the ratio between 2.4 and 1.2 is 2. Examine Chart B. At 2 in the ratio column we follow the line to 6 db under the voltage heading.

Problem (5) requires only that you examine 12 watts in Chart A to read directly opposite 33 db inspection. *Simple enough?*

A current, voltage, or power ratio is located in the ratio column of Chart B and the number of decibels read directly opposite in the power column or current-voltage column, depending upon the nature of the ratio. For example: a power ratio of 4 is seen to correspond to 6 db while a current or voltage ratio of the same value equals 12 db.

The use of Chart B can be extended beyond the current or voltage ratio of 10 by adding 20 db for each place the decimal point has been moved to the right to make the figures in the ratio column correspond to those in the ratio desired. For example: To find the db equivalent to a current

**MOST
POWERFUL
combination for
SINGLE CHANNEL
RECEPTION**



**VEE-DX
"JC" YAGI**

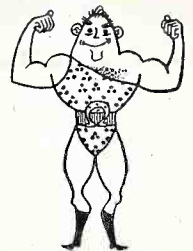

**VEE-DX
Outboard
BOOSTER**

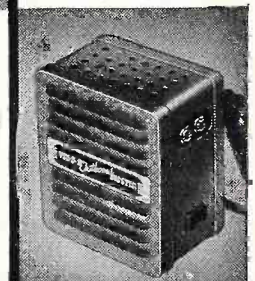

VEE-DX
THE LAPOINTE-PLASCOWLD CORPORATION
Windsor Locks, Conn.

**SHOOT TV TROUBLE
FAST!**

With H. G. CISIN'S
Copyrighted Rapid

"TV TROUBLE SHOOTING METHOD"

EARN more money! Locate television troubles by this *quick, entirely new method.* Rapid checks applied in simple, logical steps enable you to classify, sub-classify, diagnose and locate all faults in record-breaking time regardless of make or model!

H. G. CISIN is well-known to radio and television men as a recognized electronic engineer, inventor, technical author and educator. He has trained thousands of television technicians, many of them now owning their own prosperous TV service organizations or holding important positions in television. The results of his years of experience are embodied in this remarkable **TV TROUBLE SHOOTING METHOD.**

HERE'S PROOF! J. B. Seifer, Chicago, writes: "Rush another copy. Am tickled to death with results. Your book hasn't failed me yet." G. E. Hirsch, Jamaica, N. Y.: "Congratulations! Your book extremely underpriced. Very ingenious in its logical use of cause and effect, should be in every TV tool kit."

INCREASE your earning power with the most valuable aid to TV servicing ever written!

Guaranteed, Money Back in 5 Days If Not Satisfied!

Send Your Name & Address **\$1**
Today. **POSTPAID** - -

RUSH COUPON NOW!

H. G. CISIN—CONSULTING ENGINEER,
Dept. SD-1
200 CLINTON ST., BROOKLYN 2, N. Y.

Enclosed is \$ for which please rush copies (postpaid) of your TV TROUBLE SHOOTING METHOD.

Name.....

Address.....

City..... Zone..... State.....

IT'S AUTO-RADIO TIME

Yes sir, it's auto-radio time. Thousands of auto-radio sets to be repaired. Millions to be kept perking. And fast—for car owners are impatient folks.



Aerovox Vibrator Buffer Capacitors, Type VBC, are especially designed for vibrator buffer applications as well as coupling and many other functions where high-quality tubulars are required. Your local Aerovox jobber carries a complete line of VBC capacitors plus a wide assortment of auto-radio suppressors and filters especially constructed to withstand high temperatures. Your local Aerovox jobber can fill ALL your auto-radio capacitor needs.



**FOR RADIO-ELECTRONIC
INDUSTRIAL APPLICATIONS**
AEROVOX CORPORATION
NEW BEDFORD, MASS., U. S. A.
Export: 41 E. 42nd St., New York, N. Y.
Cable Address: AEROCAP, N. Y.
In Canada: AEROVOX CANADA LTD.
Hamilton, Ont.

or voltage ratio of 44, locate 4.4 in the ratio column of Chart B. Read the equivalent 12.8 db in the current-voltage db column. The decimal point was moved one place in 4.4 to convert it into the ratio, 44. Therefore, add 20 db to the result. Add: $12.8 + 20 = 32.8$ db.

The use of Chart B may similarly be extended beyond the power ratio of 10 by adding 10 db for each place the decimal point is moved to the right. For example: look up the power ratio 160 as 1.6 in the ratio column. This would correspond to 2 db. But the decimal point was shifted two places to change 1.6 to 160 and 10 db must be added for each place. The result, therefore, is 2 plus 20, or 22 db.

Fine: Now go over the problem (1) to (11), using charts A and B as required. If you've followed it this far, you won't forget the elusive decibel in a hurry.

AD INDEX

Aerovox Corporation	48
Alliance Manufacturing Co.	35
American Phenolic Corp.	12
Bussman Manufacturing Co.	9
Cisin, H. G.	47
Clarostat Mfg. Co., Inc.	16
Clear Beam Antennas	48
DuMont, Allen B. Lab., Inc.	11
Electro-Voice, Inc.	14
Erie Resistor Corp.	44
Guardian Elec. Mfg. Co.	42
Hickok Elec. Instrument Co.	42
Hytron Radio & Electronics Co. (Div. of Columbia Broadcasting Sys.)	7
Indiana Steel Products Co.	47
Industrial Condenser Co.	46
JFD Manufacturing Co., Inc.	48
LaPointe-Plascomold Corp.	47
Mallory, P. R. & Co., Inc.	Cover 2
National Video Corp.	15
Permo, Inc.	37
Radiart Corporation	1
Radio City Products, Inc.	34
RCA Tube Department	
RCA Electron Tubes	Cover 4
RCA Test Equipment	39
RCA TV Components	8
Ram Electronics, Inc.	38
Regency Div., I.D.E.A., Inc.	Cover 3
Sams, Howard W. & Co., Inc.	6
Schott, Walter L. Co.	41
Shure Brothers, Inc.	10
Simpson Electric Company	33
Snyder Manufacturing Co.	2
Sprague Products Co.	4
Standard Transformer Corp.	45
Sylvania Electric Products, Inc.	13
Telrex, Inc.	36
Triplett Elec. Instrument Co.	5
Vaco Products Company	43

PERFORMANCE Not Size IS WHAT COUNTS

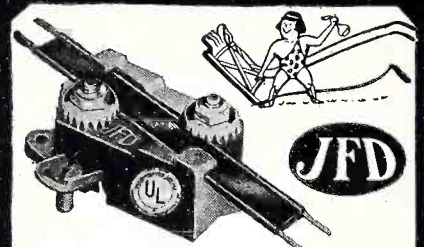

"LITTLE GIANT" LIGHTNING ARRESTER

PROTECTS

Against Lightning Hazards

No. AT 105

For ribbon-type and oval
jumbo twin lead.

\$1.25
LIST

ONLY JFD Lightning Arresters offer you these exclusive patented features . . .

1. Strain-relief Retaining Lip prevents pulling or straining of lead against contact points.
2. You actually see positive contact made with lead-in wire.
3. No wire stripping or cutting.

Write for Form No. 84 showing the damage lightning can do to a Television Installation.



MANUFACTURING CO., Inc.
6125K 16th AVENUE, BROOKLYN 4, N. Y.
FIRST in Television Antennas and Accessories

It's SENSATIONAL!

CLEAR BEAM'S NEW ALL-CHANNEL RHOMBIC

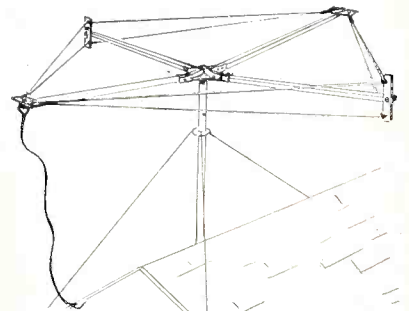

Electronically Engineered for
**LONG DISTANCE
(DX) RECEPTION**
and Unusually

SHARP DIRECTIVITY
Over the Entire TV Spectrum

Clear Beam TV ANTENNAS & ACCESSORIES

100 PROSPECT AVE., BURBANK, CALIF.
ROckwell 9-2141 CHArleston 0-4886

*Largest
Selling Booster*

AT ANY PRICE!



Now! Stake out your claim for the Giant RCA "TREASURE CHEST"

... to help you do a better job in less time and
in the "professional" manner that inspires respect

You get all these valuable servicing aids for
only **10 RCA golden "TREASURE TOKENS"**

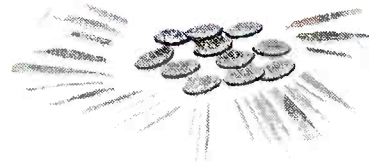

- ✓ Handsome, sturdy Tube and Tool Carrying Case ... holds over 100 tubes to meet every normal service call.
- ✓ Big 48" Red-and-White Drop Cloth ... a magic carpet to "customer confidence."
- ✓ Handy 6-Piece Ratchet-type Screwdriver Kit ... all the sizes you need for everyday service work.
- ✓ New Improved RCA Tube Movement and Inventory Guide ... a yearly record of your business.
- ✓ New "RCA Kinescopes" Booklet ... complete conversion, interchangeability and characteristics data.
- ✓ 5 Leatherette TV Program Holders ... ideal souvenir gifts for your service calls.
- ✓ Plus an extra dividend of the 24-page bulletin "Receiving Tubes for AM, FM, and Television Broadcast"—Form 1275-E—together with latest tube price lists.

Here's all you do

With every purchase of an RCA kinescope, of any type, you will receive a golden RCA "Treasure Token." *Save these coins* on the key chain provided. When you have collected 10 coins, present them to the RCA Tube Distributor from whom you obtained them, and receive, *without cost*, the complete RCA "Treasure Chest" of outstanding service aids.

The RCA "Treasure Chest" is *not for sale*. You can earn it *only* by presenting 10 RCA "Treasure Tokens" to your regular RCA Tube Distributor.

Start prospecting for your golden coins right *now!* This offer expires on November 16, 1951. Your RCA Tube Distributor has a sample RCA "Treasure Chest" for your inspection. See him today!

Extra Bonus!

With every 2 RCA kinescopes you buy, you will receive, along with your "Treasure Tokens," a bonus copy of a new book, "TV Servicing" ... a compilation of the famous "Radio Service News" articles, together with brand-new material by RCA Television Specialists.



RADIO CORPORATION of AMERICA
ELECTRON TUBES

HARRISON, N. J.