

Radio
**SERVICE
DEALER**

FEBRUARY, 1950



IN THIS ISSUE:

Large Screen Projection
High Quality Analysis Series
Repairing Geiger Counters
The Television Waveform and its Components, Part 2
How to Estimate Your 1950 Income Tax

AM-FM-TV-SOUND

The Professional Radioman's Magazine

8224

8223

8222

8205

8209

8204

8216

8225

8235

TRANSMISSION LINE CABLES

Every Type for Every Service

Sold Exclusively Through Recognized Wholesale Distributors

8210

8226

8227

8229

8228

Belden

Radio WIRE

Tube Testers for Today and Tomorrow...

SPECIFY
TRIPLETT

**UP
and
DOWN**

Lever Switching Connects Each Tube Pin to Proper Circuit

1. **ALL ELEMENT CHECK** — Thorough conclusive test of tube elements, shields and taps. The only commercial tester to get at each tube pin and make an open and short check.
2. **NO HUNTING FOR SOCKETS** — No plugging into wrong socket. Circuit flexibility requires only one socket for each type of tube base.
3. **CIRCUIT CLARITY** — Lever switch numbering corresponds to RMA tube pin numbers, connected to bring out each active tube element. A simple up or down motion of the lever instantly makes the connection.
4. **OPERATION SIMPLICITY** — Minimum of control settings plus straightforward arrangement of this outstanding emission circuit. Generally not more than five of the 10 lever switches need be set.
5. **"PICTURE" YOUR CIRCUIT** — Assures confidence in tests and enables special tube checks for balanced circuits, special loads, etc. "Trick" switching circuits make it more difficult for the serviceman to "picture" his test circuit.
6. **SET UP YOUR OWN TEST FOR NEW TUBES** — The "pictured" circuit and straightforward test procedures enable the user to set up data for new tubes. A feature rarely found in commercial type tube testers.
7. **INDIVIDUAL CONTROL FOR EACH TUBE ELEMENT** — Takes care of roaming elements, dual cathode structures, multi-purpose tubes, etc., in addition to standard value tests.

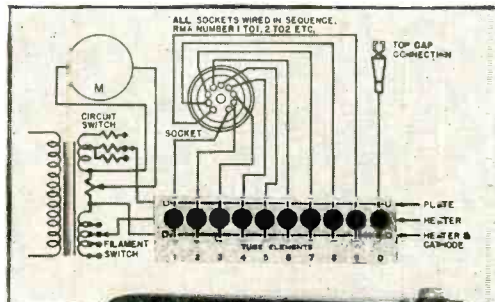

TUBE TESTER MODEL 3413
Triplet lever switching circuit arrangement has 7 distinct advantages contributing to maximum flexibility, simplicity of operation and anti-obsolence.
NET DEALER \$6675 PRICE



**... Combination
Volt-Ohm-Mil-Ammeter Model 3480**

This tester combines the Tube Tester Model 3413 with complete facilities for voltage current and resistance analyses . . . a real economy for those shops requiring a combination tube tester and volt-ohm-mil-ammeter . . . Attractive two tone metal case with detachable hinged cover . . .

TECH DATA

D. C. Volts: 0-3-12-60-300-1200, at 10,000 Ohms/Volt.
A. C. Volts: 0-3-12-60-300-1200, at 2,000 Ohms/Volt.
D. C. Amps: 0-12, at 250 Millivolts.
D. C. Milliamps: 0-1.2-12-120, at 250 Millivolts.
Ohms: 0-1000-10,000 (10-100 at center scale).
Megohms: 0-1-50 (10,000-500,000 Ohms center scale).
Output: Output Jacks, Condenser in series with A. C. Volt ranges.
Scale: 5.6" long on top scale arc. 0-1000 Ohms and 0-50 Megohms on top arc.
0-12-60-300 A. C. and D. C. Volt figures are on four separate arcs. Scale markings are black on white except A. C. are red on white; 0-1K Ohms scale is green on white.



MODEL 3480 **\$9875** . . . U.S.A. Dealer Net

SEE AT YOUR RADIO PARTS DISTRIBUTOR OR FOR MORE INFORMATION . . . WRITE

TRIPPLET ELECTRICAL INSTRUMENT COMPANY • BLUFFTON, OHIO, U.S.A.

In Canada: Triplett Instruments of Canada, Georgetown, Ontario

Precision first... to Last



EDITORIAL

by S. R. COWAN

TV Manpower Shortage

The exact figure is not known but probably less than 50,000 men are engaged in radio-TV servicing in the U.S.A. at this writing. Because of the huge influx of TV, which requires many more man-hours of installation and service time than does AM-FM repairing, the shortage of technically trained men, especially for TV, has become quite apparent.

Replacement Supply Problem

Component parts, receiver and picture tube manufacturers, despite greatly increased production facilities, are hard pressed to meet the demands imposed upon them by TV set manufacturers who are now turning out upwards of 20,000 TV sets daily. Soon TV set production will exceed 30,000 units daily.

Naturally the parts and tube manufacturers have found it possible to assign but a minute portion of their output to the jobbing trade, who in turn is supposed to have same available for the serviceman to use as required in handling replacements. This parts-tubes shortage is beginning to be noticeable and frequently a TV technician is forced to wait weeks, and even months, for needed replacements.

TV set manufacturers could help out in the emergency by making available to parts jobbers any surplus of material they might have on hand, especially parts or tubes that were required for now out-of-production TV models. But they, (the set manufacturers), are not doing this of their own accord. The next best method of getting this dormant stock back into circulation might be accomplished by the original manufacturers themselves who would get it back, issue full credit refunds, and then reship the stuff to jobbers who have back-orders on file.

On the other hand, TV set manufacturers should bear in mind that inoperable TV sets, made unusable because needed replacements can't be had, are their worst advertisement. It is incongruous that TV set makers laud technicians to the hilt, recognizing that such Service Dealers have tremendous recommending power which influences potential TV set buyers, while at the same time they are withholding the very parts that enable the Service Dealers to stay in business and keep their sets in operation.

National "Fix Your Radio" Month

Full details of the success enjoyed by New York and Pennsylvania Service Dealers who put on a joint, two-state "Fix Your Radio Month" in October 1949 are not yet available, but the campaign was so successful that several leading parts and tube manufacturers are already getting ready to support, in line with our advocated policy, such a "Fix Your Radio Month" on a nationwide basis for October, 1950.



Sanford R. Cowan
EDITOR & PUBLISHER

Samuel L. Marshall
MANAGING EDITOR

COWAN PUBLISHING Corp.
342 MADISON AVENUE
NEW YORK 17, N. Y.

Vol. 11. No. 2

FEBRUARY, 1950

Editorial	2
Trade Flashes	6
Large Screen Projection, by Allan Lytel	15
A discussion of the various types of projection systems in use today.	
High Quality Analysis Series, No. 4, by C. A. Tuthill	17
Another high quality tuner analyzed from beginning to end.	
Repairing Geiger Counters Can Be Profitable, by John L. Parker	20
A timely article on the technical details associated with Geiger counter repairs.	
The Television Waveform and its Components, Part 2, by Samuel L. Marshall	22
Basic principles of scanning and the structure of the complete sync signal are discussed in this installment.	
How to Estimate Your 1950 Tax, by Betty Lee Gough	25
Specific references to problems met with by the Radio Service Dealer.	
Circuit Court	26
Hoffman Model CT 800, Belmont Model 22A21, Temple Model TV-1776.	
Shop Notes	27
Motorola Model 5A5-rectifier lights up with switch turned off. Bending tool for band-switch contacts. Philco, intermittent high-voltage supply. Warm air device for testing defective parts. Sentinel 400, 401, 402, 405, 406, 411, tearing and picture break-up. Philco 46-1203, 48-1262, simplified circuit. Damping tube trouble symptom. Westinghouse, C.R.T. damage caused by incorrect adjustment of ion trap magnet. Jensen, new system of rating speakers.	
New Products	29

SANFORD L. CAHN
National Advertising Sales Manager

HARRY N. REIZES
Advertising Manager

JEAN M. WHEELER, Circulation Manager

BRANCH: J. C. GALLOWAY 816 W. 5th St., Los Angeles 13, Calif., Mutual 8335

RADIO SERVICE DEALER is published monthly by Cowan Publishing Corp., 342 Madison Ave., N. Y. 17, N. Y. Subscription price: \$2 per year in the United States, U.S. Possessions & Canada: elsewhere \$3. Single copies: 25c. Entered as second class matter Dec. 13, 1948 at the Post Office at New York, N. Y. under the Act of Mar. 3, 1879. Copyright 1950 by Cowan Pub. Corp.

IF IT'S NEW...

KEN-RAD DEALERS HAVE IT!

YOU'RE in the driver's seat as radio-TV serviceman, if you stock and sell Ken-Rad tubes. Backed by General Electric's vast research and development facilities, Ken-Rad engineers provide you at all times with outstanding new designs. You can service late-model receivers in your neighborhood knowing that the Ken-Rad complete line of tubes, TV-picture, metal, glass, and miniature, includes the advanced types to be found in new circuits . . . like the pace-setting gated-beam 6BN6 shown here (heater 6.3 v, 300 ma), or its 12BN6 companion (heater 12.6 v, 150 ma) . . . Get the service business that goes to the dealer who has the new types—who handles Ken-Rad tubes! It's new and profitable business, and builds prestige for your shop. . . Phone or write your Ken-Rad distributor today!

HOT THIS MONTH!

Here's a clear-all-wires news item! Ken-Rad 1950 advertising help is ready and on its way to you via your distributor. There are sales-getting small ads for newspaper use—postcard mailers that pull—spot announcements for your local radio station. Add these to the fine Ken-Rad displays and other promotions, and you as an alert Ken-Rad dealer have "what it takes" to profit from the active tube market in your area.



6BN6 MINIATURE

Typical Operating Conditions, TV Application

Plate supply voltage	175 v
Plate load resistance	.22 megohms
Accelerator voltage	85 v
Cathode resistance	145 to 400 ohms
Minimum signal voltage for limiting action	1.25 v RMS
Audio output voltage	12.5 v RMS

KEN-RAD *Radio Tubes*

PRODUCT OF GENERAL ELECTRIC COMPANY

Schenectady 5, New York

The gated-beam 6BN6 does three tubes' work. It functions as a limiter, discriminator, and audio-amplifier in new TV and FM receivers. You'll be servicing sets soon with 6BN6's in their circuits, and replacements will be in order. Make sure you have this essential new miniature when you need it . . . and other up-to-the-minute tube types . . . by stocking the Ken-Rad brand!

102-JA2

HERE IT IS...

The First Word In PERFORMANCE
... The Last Word In DESIGN!



THE RADIART TELE-ROTOR

For Clear Sharp Pictures and
Perfect Trouble-Free Performance

MORE POWER TO YOU
(More Than You'll Ever Need)

Streamlined Weather-proof
Housing — Keeps Out Water,
Snow and Ice

Heavy-Duty Motor —
Reverses Instantly

Heavy-Duty Precision Gears

12 Heavy-Duty Ball Bearings in two
6 1/2" diameter Ball Bearing Races

A Triumph In Design!!! There's Nothing Like It — It Is Beyond Comparison

CHECK THESE FEATURES

- Handles Heavier Loads With Ease
... As Much As 150 Pounds
- Streamlined Weather-proof Design
... Durable Sturdy Construction
- 12 Heavy-Duty Ball Bearings in two
6½" diameter Ball Bearing Races
- Heavily Reinforced Die-Cast Housing
- Heavy-Duty Precision Gears
- Positive Stop at End of Rotation
- Will Handle 7/8" to 2" diameter
Upper and Lower Masts
- Heavy-Duty Motor — Reverses
Instantly
- Mast, Tower or Platform
Mounting
- Four Heavy-Duty Guy-Wire Lugs
- Completely Weather-Sealed
... Factory Lubricated For Life

The television industry has been looking for something like this ... and it took RADIART to produce it! THIS is the last word in ROTATORS ... the finest! ... BECAUSE IT HAS EVERYTHING! It wasn't developed overnight but is the result of fourteen solid months of research and development! BUT ... it has been worth it ... BECAUSE IT MEASURES UP TO RADIART STANDARDS ... The quality level that makes RADIART PRODUCTS THE STANDARD OF COMPARISON!

Available in the Following Models:

- TR-1... rotator with control box \$39.95
- TR-2... compass control rotator with "Perfect Pattern" dial \$44.95

A Combination You Can't Beat . . .

It's a Radiart Antenna with a Radiart Tele-Rotor

THE RADIART TELE-ROTOR CONTROL

with the "Perfect Pattern"
Dial . . . Gives Immediate
Indication of Antenna
Position.

Will Handle 7/8" to 2" dia.
Upper and Lower Masts



IT'S RIGHT WHEN IT'S RADIART

THE RADIART CORPORATION
CLEVELAND 2, OHIO



- ROTATORS
- VIBRATORS
- TV ANTENNAS
- AUTO AERIALS
- POWER SUPPLIES



Every

SPRAGUE
TV

dry electrolytic
is processed

FOR
185°F (85°C.)
OPERATION!

Sprague leads again with the largest, most complete line of replacement electrolytic capacitors for television receivers. Each type is engineered especially for tough video applications and will stand up under the high temperatures, high ripple currents and high voltage surges encountered in TV equipment. *Every Sprague TV capacitor rated at 450 d-c working voltage or less has been processed for 185°F. (85°C.) operation.* Send postcard for special TV Bulletin.

SPRAGUE PRODUCTS CO.
71 MARSHALL STREET
NORTH ADAMS • MASS.

TRADE FLASHES

A "press-time" digest of production,
distribution & merchandising activities

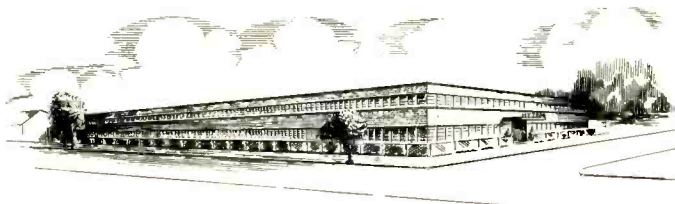

Artist's drawing
of new Hytron
plant.

Hytron Lays Cornerstone For New Plant

Two of the industry's veterans, Bruce A. Coffin, President, and Lloyd H. Coffin, Treasurer, of Hytron Radio & Electronics Corp., recently laid the cornerstone of Hytron's new television picture tube plant at Newburyport, Massachusetts.

Ultra-modern, the new plant is designed especially for mass production of television picture tubes. With it, Hytron will expand its production of these tubes begun nearly a year ago. Three thousand television picture tubes will roll off the new production lines daily. The tubes will range in size up to twenty inches. They will be of round design and of the new rectangular design recently originated by Hytron.

Hytron will thus increase materially its manufacturing facilities. The extra space of this new picture-tube plant, added to Hytron's present facilities, will give Hytron a total of approximately 400,000 square feet. Starting in 1921 with only 6 employees, Hytron now employs approximately 2500 persons. The new TV picture tube plant will add approximately 300 more.

Coast To Coast TV

Coast to coast television is not far off, with high costs of transmission its main deterrent, Dr. Thomas T. Goldsmith, director of research, Allen B. Du Mont Laboratories, Inc., told a television symposium at the American Association for the Advancement of Science convention in New York City. The Du Mont scientists read a paper on the transmission, propagation, networking and reception of television pictures. Included in his discussion was a review of present commercial

VHF channels and the prospective further UHF channels in relation to television service, both national and international.

Radiart Jobber Awards

Awards of the Radiart Service Plaque were made at the recent Minnesota Gopher Conference by Jobber Sales Manager Milton S. "Mike" Roth, pictured here.



Shown left to right are Roth, Ward Jensen of Lew Boun Co., Ray Daly of Power City Radio, Leonard Tesdell of Iowa Radio Corp., each of whom are fifteen-year distributors and Mav Kirkeby, Radiart "rep". Radiart awards these plaques to their jobbers who have a service record of at least five years with Radiart products and adds a gold star for each five year period.

The Radiart Corp. of Cleveland manufactures Vibrators, TV Antennas and Accessories, TV Rotators, Automobile Aerials, "Batrypowers." Vibrator Power Supplies and Converters.

New RCA TV Line

According to a release by RCA-Victor with regard to their new TV line of receivers, news-making highlights of the line are the first sets featuring RCA's new short-necked 16-inch metal-coned picture tube with "Filterglass" face plate, a 10-inch

picture of the Successful T-V Serviceman



© Allen B. Du Mont Laboratories, Inc.
*Trade-mark.



For superlative pictures, he installs Teletrons — in the 12½, 15, 16 and 19 inch sizes — selected from this Teletron Catalog. Write for your copy!

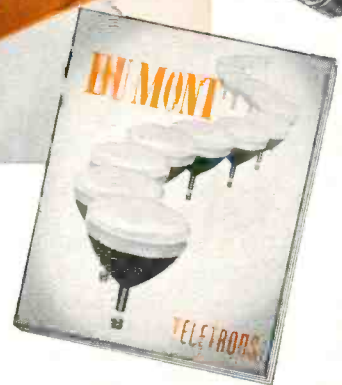

DUMONT

FIRST WITH THE FINEST IN T-V TUBES

Teletrons

ALLEN B. DU MONT LABORATORIES, INC. • TUBE DIVISION, CLIFTON, N. J. • PLANTS AT ALLWOOD AND PASSAIC, N. J.

RADIO SERVICE DEALER • FEBRUARY, 1950

**WHAT LEGAL TEXTS
ARE TO THE ATTORNEY
RIDER BOOKS
ARE TO THE
ELECTRONIC TECHNICIAN**

**The New CATHODE-RAY
TUBE AT WORK** by RIDER et al

The greatest and most complete reference book ever written on the Cathode-ray tube! It is a practical, down-to-earth encyclopedia about five times the size of the old standard text. Starting with basic theory of cathode-ray tube operation, it proceeds through application in scopes and TV receivers...with full and clear explanations for uses in every field and research activity which employs a cathode-ray oscillograph. All scopes produced and sold during the last 10 years, more than 70 different models are described completely — with schematic wiring diagrams. Almost 500,000 words and about 3,000 illustrations are incorporated in more than 900 pages. It is a book which will enjoy years and years of daily use. 22 chapters. Page size 8 1/2 x 11" \$9.00

**THE THEORY AND PRACTICE OF
30-1000 MC RECEIVING ANTENNAS**

by Arnold B. Bailey

This book is a rare combination of theory and practice that:

- 1.—Clearly explains and teaches
- 2.—Can be used as a daily work reference

Reflecting world-wide knowledge of the antenna art, it clearly explains the theory behind the performance of every type of 30-1000Mc receiving antenna on the commercial market, leaving the reader with a full understanding of why each behaves as it does. And since the author has resolved the mathematics of antenna problems into graphs, charts and tables — it can be put to good use by all. Designed to serve all men whose livelihood depends on getting the most out of an antenna system, it is equally important to the antenna design engineer, television technicians, electronics schools, students, radio amateurs . . . More than 500 pages, 6 x 9", cloth bound. . . . \$4.50

OTHER RIDER BOOKS

- Radio Operator's License Q and A Manual.** The radio operator's license manual with the discussion follow-thru — It makes the answers more understandable and also teaches. 608 pages. \$6.00
- TV Picture Projection and Enlargement.** Explains TV receiver optics and removes the mystery from projection and enlargement processes. 192 pages. \$3.30
- FM Transmission and Reception,** 416 pages. \$3.60
- The Oscillator at Work,** 254 pages. \$2.50
- Broadcast Operator's Handbook,** 278 pages. \$3.30
- Inside the Vacuum Tube,** 420 pages. \$4.50
- Servicing by Signal Tracing,** 370 pages. \$4.00
- Understanding Microwaves,** 396 pages. \$6.00
- A-C Calculation Charts,** 168 pages. \$7.50
- Vacuum Tube Voltmeters,** 188 pages. \$2.50
- Business Helper,** 144 pages. \$2.00
- Radio Amateur's Beam Pointer Guide,** 32 pages. \$1.00
- Automatic Frequency Control Systems,** 154 pages. \$1.75
- Installation and Servicing of Low Power Public Address Systems,** 208 pages. \$1.89
- Understanding Vectors and Phase,** 158 pages. Cloth Cover \$1.89
Paper Cover \$1.00
- Radar — What it is,** 80 pages. \$1.00

RIDER BOOKS

JOHN F. RIDER PUBLISHER, INC.
480 Canal Street, New York 13, N.Y.

table model at \$169.95, and the first console instruments, incorporating phonograph facilities for all three record speeds with a separate 45-rpm turntable to preserve all engineering advantages of the RCA-developed 45-rpm system. The new tube length makes possible more compact, well-proportioned cabinets by appreciably reducing depth requirements. The "Filterglass" face plate, based on principles developed before the war by the RCA Laboratories, improves picture contrast by minimizing the effects of unwanted light from sources both within and outside the tube.

Olchak Promoted By Air King

R. D. Payne, Manager of Sales, Air King Products Company, Inc., Brooklyn, New York, manufacturers of radios, wire recorders and television receivers announced the promotion of Samuel Olchak to Advertising and Sales Promotion Manager, effective January 1st.



Mr. Olchak will retain associated duties of his previous position of Commercial Service Manager. Samuel Olchak, well known in the electronic industry for the past twelve years, was formerly Assistant to the Vice-President in Charge of Sales at Tele-Tone Radio.

Alliance Advertising Campaign

The Alliance Manufacturing Company not only continues to advertise the Alliance Tenna-Rotor over most of the major television stations in the nation, but during the past few months has steadily increased the number of stations and the frequency of appearances. The Alliance one-minute TV sound films are strategically placed to capture maximum number of viewers.

In recent months quite a few stations west of the Mississippi were added and the Alliance advertising now includes stations from coast to coast with regularly scheduled spots

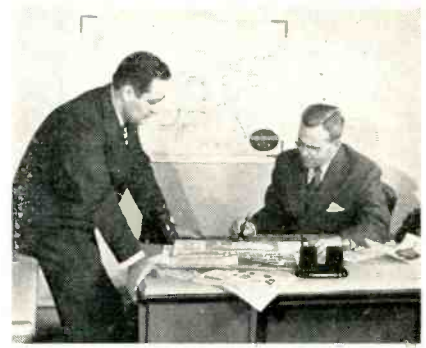

Final plans for the Alliance Tenna-Rotor advertising projected into 1950 are reviewed by John Bentia, Sales Manager of the Alliance Manufacturing Company (standing) and Miles C. McKearney, Account Executive for Foster & Davies, Inc., the advertising agency.

adjacent to practically every top network show. For some time Alliance has added a considerable quantity of entirely new films. To capture the peak audiences between top-rated network shows which do not provide a full minute, they have also added 20-second chain break film which still continues to demonstrate their product.

TV Test Equipment By G. E.

W. L. Parkinson, left, supervisor of technical service for the General Electric Receiver Division at Electronics Park, is shown here explaining the operation of G-E television test equipment to General Electric Supply Corporation personnel who attended a recent week-long television service meeting at Electronics Park. From left to right are A. J. Parsons, GESCO vice-president from Bridgeport;



T. L. Campbell, GESCO-Atlanta; E. A. Anthony, service manager for GESCO-New York; and Samuel Cooper, television service supervisor for GESCO-San Francisco.

Taco Antenna Bulletin

Explanation and detailed drawings of the proper procedure in stacking high-band antennas are given in Engineering Bulletin No. 58 just released by Technical Appliance Cor-

poration, Sherburne, N. Y., manufacturers of TV, FM, and AM antenna systems.

There has been much confusion in the field as to the correct method of stacking antennas for use on Channels 7-13. Taco engineers have provided this information in an easy-to-understand form as a service for the busy TV installation man. Dimensions and proper phasing of antennas are given for both the two-stacked and four-stacked arrays. By following this information, the most efficient array is achieved, providing maximum signal strength.

Telrex Ups Production-Lowers Prices

It is announced by M. D. Ercolino, president of Telrex, Inc., that their newly enlarged plant facilities which trebled output of Conical "V" Beam TV antennas and accessories permitted a substantial price reduction general throughout the entire line. Parts jobbers have been notified that the new prices are in effect and that the "V" beam conicals will continue to feature Dural elements while high quality and design features remain unchanged.

Telrex, Inc., manufacturers of antennas since 1921, are especially identified with the development and introduction of conical type TV antennas.

Air King Produces

16"-Rectangular Tube TV Receivers

D. H. Cogan, president of Air King Products Company, Inc., Brooklyn, New York, manufacturers of radios, wire recorders and television receivers announced the production of 16" rectangular tube television models at full

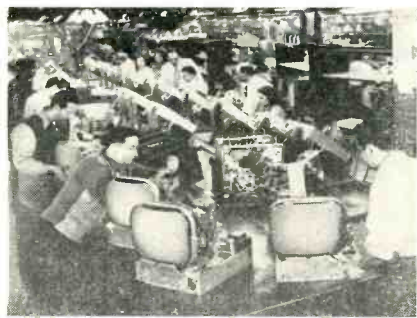

capacity in Air King's modern plant with over 200,000 square feet of space.

Mr. Cogan further stated that with the newly equipped and mechanized facilities, production for the year 1950 would be geared for the largest output of television sets in the company's history.

Anchor Doubles Output

Anchor Boosters of Chicago has finally reached a volume great enough to enable them to double their daily

WHAT A BASIC, LEGAL REFERENCE LIBRARY IS TO THE ATTORNEY... RIDER MANUALS ARE TO THE ELECTRONIC TECHNICIAN



to the ATTORNEY

...the field of legalisms is exacting and highly detailed. There are complex problems to be untangled, narrow paths to travel. The lawyer's BASIC library provides COMPLETE, ACCURATE and AUTHENTIC DATA on laws...with interpretations and decisions, both old and new. His library gives him the information he needs to bring his own case to a successful conclusion.



to the ELECTRONIC TECHNICIAN

...the science of electronics is more exacting, more highly detailed. AM-FM-TV and allied equipment all have their different servicing problems. The Electronic Technician's BASIC Library of RIDER MANUALS gives him the COMPLETE, ACCURATE, FACTORY-AUTHORIZED DATA that he needs to bring each servicing problem to a successful, speedy and profitable conclusion.

--- YOUR JOBBER HAS THEM NOW! ---

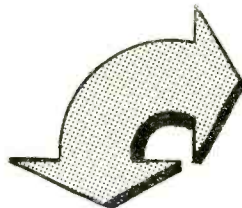

RIDER TV MANUAL VOL. 3

Larger page size, 12" x 15". All pages in place, with diagrams and related text more closely positioned. Giant pages are retained, but now have only one fold for greater convenience and durability. Complete, Accurate, Factory-Authorized Data from 74 manufacturers. 441 models. 243 chassis. An absolute "must" for every Serviceman in every TV area.

Equivalent of 2032 pages (8 1/2" x 11") Plus Cumulative Index Volumes 1, 2 and 3, Plus the famous RIDER "HOW IT WORKS" Book... \$21.00

RIDER MANUAL VOLUME XX

What a Manual this is! Complete, Authentic, Reliable, Factory-Authorized Data from 74 manufacturers. 1776 pages, with every page filed in its proper place...Easier to read and use than ever before. Covers AM, FM, Auto Receivers, Record Changers and Tuners...Covers receivers to November, 1949. RIDER...and RIDER ALONE... gives you the information you need WHEN AND HOW YOU NEED IT! Get Volume XX today!

\$18.00 Including Cumulative Index, Volumes XVI through XX, Plus the Famous RIDER "HOW IT WORKS" Book.

RIDER MANUALS

Television Manual Volume 3 (Plus "How It Works" Book and Index)	\$21.00
Television Manual Volume 2 (Plus "How It Works" Book and Index)	\$18.00
Television Manual Volume 1 (Plus "How It Works" Book and Index)	\$18.00
Volume XX	\$18.00
Volume XIX	\$19.80
Volume XVIII	\$19.80
Volume XVII	\$16.50
Volume XVI	\$ 8.40
Volume XV	\$19.80
Volume XIV to VII (each volume)	\$16.50
Volume VI	\$12.50
Abridged Manuals I to V (one volume)	\$19.80
Master Index, Covering Manuals, Vols. I to XV	\$ 1.50
PA Equipment Manual, Vol. I	\$18.00

NOTE: Are you receiving your copy of "Successful Servicing"? It's Rider's own publication of interest to every Serviceman. Write for it...it's FREE!

JOHN F. RIDER PUBLISHER, Inc., 480 Canal Street, New York 13, N. Y.
Export Agents: Rocke International Corp., 13 E. 40th St., N. Y. C. Cable ARLAB.

RIDER MANUALS mean SUCCESSFUL SERVICING

- NOTE: The Mallory TV Service Encyclopedia, 1st TV Edition, makes reference to only one source of TV receiver schematics - Rider TV Manuals.
- NOTE: The Mallory Radio Service Encyclopedia, 6th Edition, makes reference to only one source of radio receiver schematics - Rider Manuals.
- NOTE: The C-D Capacitor Manual for Radio Servicing, 1948 Edition No. 4, makes reference to only one source of receiver schematics - Rider Manuals.

ALREADY A COAST-TO-COAST HIT!

**The NEW
BURGESS
FLASHLIGHT BATTERY**

**Power Packed In
Steel and Plastic**

**CHROME PROTECTED TO
CHECK POWER WASTE!**



**DESIGNED FROM THE INSIDE OUT
TO GIVE YOU MORE SALES AND NEW PROFITS!**

ONLY BURGESS GIVES ALL THESE FEATURES!

CHROME PROTECTION!

Curbs out-of-use power waste. This EXCLUSIVE feature guarantees longer life and freshness! Only BURGESS

Flashlight Batteries are Chrome Protected to check interior action when battery is not in use.



**SEALED IN STEEL
AND PLASTIC!**

Power loss in the NEW Burgess Flashlight Battery is prevented by machine-sealing the tough plastic outer casing and the steel cap directly into the battery top.

**MODERN, EYE-CATCHING
STYLE!**



Only BURGESS Flashlight Batteries have such a sales-producing design. The distinctive BURGESS stripes are recognized instantly by your customers—they are the mark of engineering skill and know-how that has made BURGESS first choice of scientists and explorers.

ENGINEERED DESIGN!

New, improved construction permits the use of a big full size mix core and big zinc can to give longer life!



GUARANTEED!



The BURGESS reputation for quality and dependability has made it the foremost name in radio batteries. Every BURGESS Flashlight Battery carries the guarantee of this reputable, long-established manufacturer.

STOCK UP NOW!

And Cash in on the Promotion of This Sensational, New Flashlight Battery!

Big, two-color ads in Collier's and an expanded list of other leading magazines feature the NEW Burgess Flashlight Battery to millions of users. Be ready for increased BURGESS sales with a good stock of the new BURGESS Flashlight Batteries in the new display cartons. Order from your BURGESS distributor.

BURGESS BATTERIES

output over the production high established in November of 1949. This, naturally, will help them to cut down the terrific backlog and provide for prompt and efficient deliveries of their successful TV Preamplifier.

They now are asking the industry to disregard the present shipping schedule on all open orders and will advise it of their revised schedule at the earliest date possible.

New Radio Operator's Q&A Manual

John F. Rider Publisher, Inc., 480 Canal Street, New York 13, N. Y., announces its new book (Radio Operator's License Q&A Manual) by Milton Kaufman, is currently at all Rider distributors.

The new book systematically lists the questions and answers to past FCC exams, plus a Follow Through discussion to the answer, so necessary for complete understanding of the technical question. The book is up-to-date in all respects, as of the publication date. It is based upon the latest Government Study Guide and supplementary FCC releases. A valuable "extra" is the useful appendices (Small Vessel Direction Finders and Automatic Alarm), never before available in a book of this type. Abundant illustrations make difficult technical questions picture-clear.

Attractive Service Signs

Celomat Corporation of N.Y.C. announced a new fluorescent plastic sign which is used by the retailer over the different departments in his store.



This sign is available in stock for words such as Tubes, Batteries, Wholesale, Service, Radio, Television, Sound Equipment, etc., and are relatively inexpensive.

Stancor TV Components Replacement Guide

A 20-page booklet, "Stancor Television Components Replacement Guide," has just been released by Standard Transformer Corporation, Elston, Kedzie and Addison, Chicago 18, Illinois. Free copies are available direct or from Stancor distributors.

This guide, Form DD338C, lists Stancor replacement transformers for 215 TV receivers and chassis made by

THE REDSKINS ARE HERE!



SANGAMO'S NEW MOLDED PAPER TUBULARS

Sangamo presents the REDSKIN . . . a new molded paper tubular capacitor that gives *long life* under severe operating conditions. The REDSKIN is an 85° C tubular that is easy to work with, on production line or bench, because the flexible leads resist breakage and can't pull out! It offers greater mechanical strength because of its plastic construction. It is molded under *low* pressure, assuring elements undamaged in fabrication, greater dependability, and the absence of "hot spots."

A trial of these new molded tubulars will convince you! See your jobber—if he can't supply you, write us.

BIG CHIEF SANGAMO SAYS:

PLENTY PROUD OF NEW PAPOOSES!
REDSKINS HEAP TOUGH...STAND TESTS
THAT MAKE OTHER BRAVES FLINCH.
REDSKINS LIVE LONG TIME...WORK
HARD...HELP YOU MAKE WAMPUM TOO!



IMMERSION and HUMIDITY RESISTANCE

Test Result: **EXCELLENT!**

Far surpasses normal specification requirements . . . Insulation resistance practically unchanged under severe conditions of immersion or humidity.



85° C PERFORMANCE

Test Result: **EXCELLENT!**

Long life operation under high temperature conditions make it a "natural" for applications where high temperatures cause trouble.



MECHANICAL STRENGTH

Test Result: **EXCELLENT!**

Especially designed flexible leads resist breaking or pulling out even when handling is extremely rough.



SANGAMO ELECTRIC COMPANY
SPRINGFIELD, ILLINOIS

In Canada: Sangamo Electric Company Limited, Leaside, Ont.



EC1911

Telrex

CONICAL "V" BEAM ANTENNAS

INSTALL THESE SUPER HI-GAIN ANTENNAS FOR BETTER TV AND FM RECEPTION IN ALL AREAS

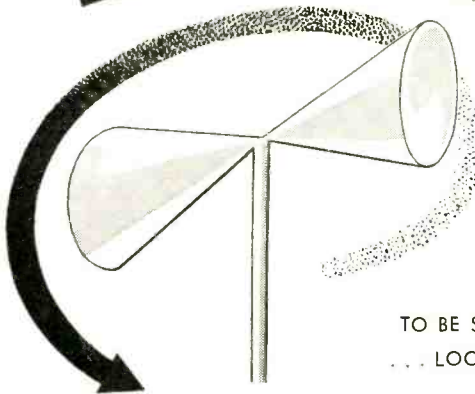

- THE ONE ANTENNA FOR ALL CHANNELS PLUS FM
- NO HIGH FREQUENCY HEAD NEEDED
- BETTER THAN 12 DB FRONT TO BACK RATIO ALL FREQUENCIES
- MODELS FOR EVERY INSTALLATION NEED
- CONICAL WINDOW MOUNTS FOR APARTMENT HOUSES

TO BE SURE IT'S A CONICAL "V" BEAM
... LOOK FOR THE **TELREX** TRADEMARK

... true conical performance without bulky metal cones

Take a tip from Telrex! Look beyond the set for the cause of weak signals, ghosts and reflections. In many cases the antenna installation is the source of trouble. For sharper, brighter pictures follow the lead of thousands of other satisfied Telrex users. Install a Telrex Conical Antenna of proven performance—the antenna with the highest gain and highest signal noise ratio—on *ALL* channels. Telrex delivers the full strength of the signal received to the set with negligible loss, and with practically no reflections or ghosts. For local, congested or fringe reception areas, your one best buy is Telrex!

ALL TELREX ELEMENTS ARE MADE OF HIGH STRENGTH DURAL

PATENTS PENDING
COPYRIGHT 1949



Ask your distributor for complete data or write for illustrated catalog.

Telephone—ASBURY PARK 2-7252

telrex INC.
CONICAL ANTENNAS

AMERICA'S
OUTSTANDING
TELEVISION
BEAM

ASBURY PARK 5, N. J.

forty-three manufacturers. Stancor replacement part numbers are listed together with manufacturers' part numbers for positive identification.

Sylvania Merchandising Idea

A personalized selling aid for television sets has just been developed by Sylvania Television and is being recommended to all Sylvania Television dealers and distributors.

This new merchandising idea consists of a large map, which gives the prospective set owner all the information he wants on television in his area.

This map will show exactly where each prospective television set owner lives in relation to available transmission. Depending on the dealer's locality, two or more maps may be advisable—a street guide for urban areas and a road map or trading area map for suburban and rural coverage.

Colored crayons locate major landmarks, especially high structures that might affect reception in the set owner's home. The map will explain in non-technical terms how expert installation will provide the best possible reception.

Three new television receiver models and new, low prices on current Sylvania Television sets have been announced by E. E. Lewis, President, Colonial Radio Corp., Buffalo, wholly-owned subsidiary of Sylvania.

Burgess Merchandiser

Burgess Battery Company has completed design of two new counter cartons to display its new zebra-striped flashlight battery.



The new merchandisers come in 12 cell and 48 cell sizes. As the cartons are opened for counter use, the zebra pops up and combines with bold type to announce the availability of the new flashlight batteries sealed in steel and plastic.

**YOUR SYLVANIA TUBE
CARTONS ARE WORTH 2¢
IN TRADE!**

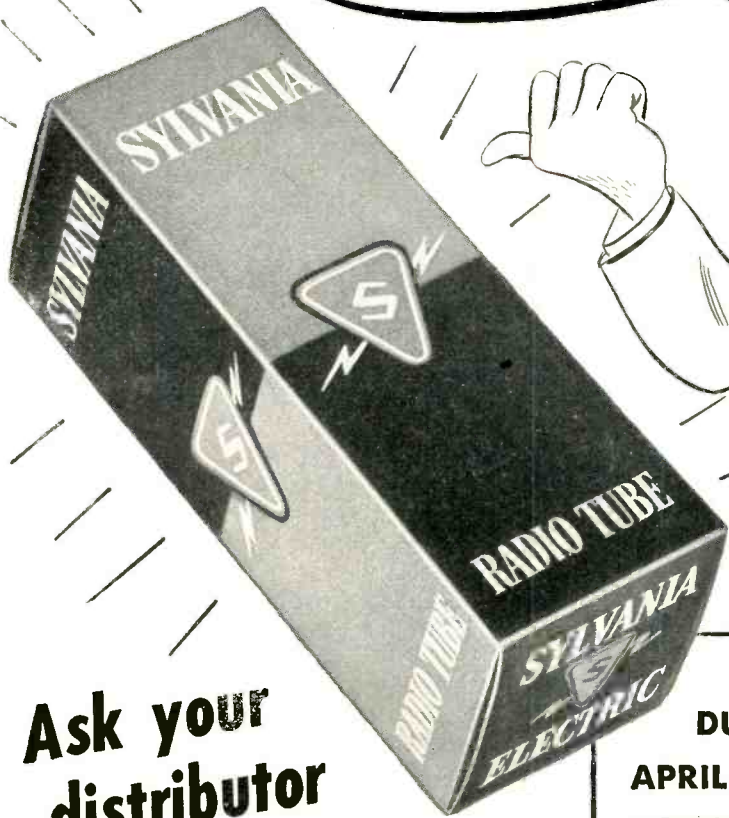

**Ask your
distributor
TODAY—
about Sylvania's
big tube carton
trade-in deal!**

**DURING FEBRUARY, MARCH AND
APRIL YOUR EMPTY SYLVANIA CAR-
TONS ARE WORTH 2¢ EACH AT YOUR
DISTRIBUTOR'S when applied against
the purchase of...**

- SYLVANIA ADVERTISING MATERIAL
- MORE SYLVANIA TUBES
- SYLVANIA TEST EQUIPMENT

SYLVANIA ELECTRIC

RADIO TUBES; CATHODE RAY TUBES; ELECTRONIC DEVICES; FLUORESCENT LAMPS, FIXTURES, WIRING DEVICES, SIGN TUBING; LIGHT BULBS; PHOTOLAMPS

RADIO SERVICE DEALER • FEBRUARY, 1950

**Heat is no
Problem,**
*when you know
your stuff . . .*

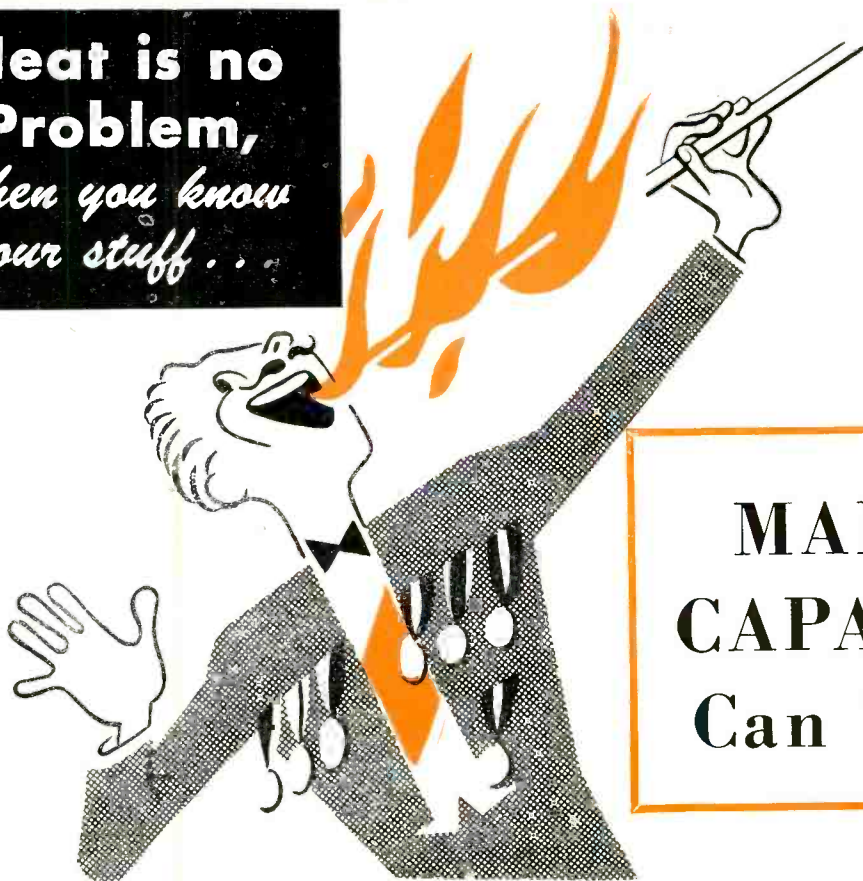

MALLORY CAPACITORS Can Take It!

Mallory FP Capacitors are built to withstand continuous high temperatures. Tests show they perform consistently during 2000 hours of operation at a temperature of 185°F. At lower temperatures, even longer!

Proof of this performance is found in the experience of one television manufacturer, who kept records of field failures for six months. *Of 385,000 Mallory FP Capacitors in service only six failed!* Special design and meticulous production care make such records possible . . . by eliminating the major source of internal corrosion.

Mallory Capacitors have set new long-life standards for the industry, yet cost no more. You will find it pays to rely on the complete Mallory Capacitor line — paper — ceramics — FP Electrolytics.

See Your Distributor for Mallory Precision Quality Parts at Regular Prices



P. R. MALLORY & CO. Inc.
MALLORY

CAPACITORS • CONTROLS • VIBRATORS • SWITCHES • RESISTORS
• RECTIFIERS • VIBRAPACK* POWER SUPPLIES • FILTERS

*Reg. U.S. Pat. Off.

APPROVED PRECISION PRODUCTS

P. R. MALLORY & CO., Inc., INDIANAPOLIS 6, INDIANA

Large Screen PROJECTION

by **ALLAN LYTEL**

(Author of TV Projection and Enlargement)

PROJECTION television receivers for the home have now been on the market for several years under various trade names. There are two fundamental projection systems which have achieved popularity and are presently commercially available. The least used system involves a combination of lenses only which project the image taken from a small direct view tube onto the viewing screen. This is the refractive, or direct lens projection system. *Figure 1* is a simplified drawing showing this type of projection.

Refractive System

The tube face is mounted at a fixed distance behind the lens system. In the figure, the tube face is represented by a single vertical arrow and one single lens is used in place of the complex lens systems, to illustrate the action. Light is gathered by the lens and because of its refractive properties, an enlarged image is projected upon the viewing screen. Usually a transmissive type of screen is used in which the image is viewed on the opposite side of the actual projection, that is, the light forming the image is projected against one face of the screen while the viewing audience is on the opposite face. The transmissive qualities of the screen allow the light to penetrate; a specially designed screen is used to concentrate the available light. The amount of enlargement or magnification depends upon the position of the tube face relative to the lens system. Any lens system has a focal length which is the measure of its convergent properties. Enlargement is only possible when the tube face or the object in optical terms, is located between two points. These are the focus and a point equal to twice the focus. In *Figure 1*, the object is located just beyond the focal length of the lens to the left. Light from the object passes through the lens, through the second focal point and onto the image presentation on the screen.

In this article the writer explains in the most fundamental terms the various types of basic projection systems. Of particular interest is the treatment on optical relations in which is shown how movement of the object towards and away from the focus increases or decreases the viewing size. Refractive and reflective systems are also explained, and commercial applications of these systems are presented.

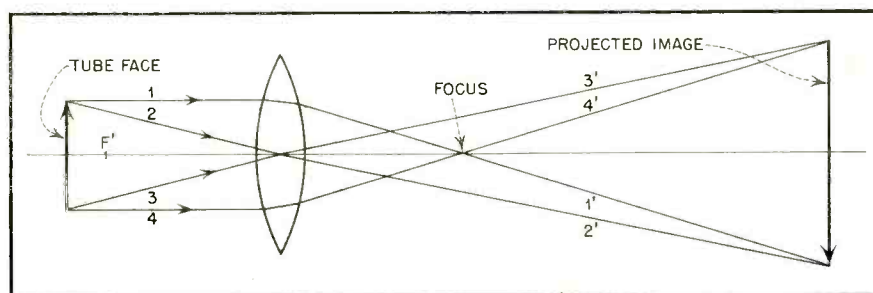

Fig. 1. Refractive or direct lens system used in some projection systems.

Magnification is defined as either the image size divided by the object size or the image distance divided by the object distance. Magnification may therefore be increased by moving the tube face or object to be magnified closer to the lens. As the object is moved nearer to the lens, the image becomes larger and at the same time moves further away from the lens.

In commercial use, this direct and most simple of projection systems has several serious limitations. The lens system is in general, expensive, if all of the inherent and natural defects of convergent lens are properly corrected. Magnification in any case is limited to rather small values. This is because increasing magnification increases the distance between the projected image and the lens and this, of course, causes the projected image to be less bright. The amount of light which forms the image decreases as the square of the distance between the image and the lens.

There are several other systems of projection possible and several of these have been used successfully. There are indeed, several large screen projection systems which do not involve cathode ray tubes but rather use rotating many-faced mirrors. A dark trace tube known as the Skiatron also is in the developmental stage. In this system, the electron beam creates a dark rather than a light image and an external source of visible light projects this dark trace image on the viewing screen.

Schmidt System

The most widely used type of projection is the Schmidt system which has, in its most modern use, been extended to larger and larger screens. This type of projection, technically known as reflective projection, uses a shallow dish-shaped mirror to collect the light rays and throw them upon a screen as an enlarged image. Projection of this type has several popular

sizes. There are the 12 by 16 inch, the 15 by 20 inch, the 18 by 24 inch, and the 20 by 26 inch projected pictures. Modifications of the same system have now been evolved to the point where they can present images as big as 6 by 8 feet and even larger.

The fundamental Schmidt system illustrated in *Fig. 2* uses a concave spherical mirror with the inner surface reflecting. The tube face is mounted facing the inner surface of the spherical mirror which collects the light and by means of its reflective qualities, it enlarges the projected image upon the viewing screen. Since the spherical mirror collects more light than the lens system, it is inherently somewhat more efficient in producing a brilliant well-defined image. There are other components in the complete reflective projection system. However, the simple diagram in *Fig. 2* is illustrative of the optical principles involved. Point *C* is the center of curvature for the mirror whose focus *F* is approximately halfway between the center of the mirror at *B* and its center of curvature at *C*. The tube face, or object, must be located between the center of curvature and the focus. Its distance from the center of the mirror at *B* is known as the object distance. In similar terms, the distance between the projected image and the mirror is the image distance. As shown in the figure, the center portion of the spherical mirror is blacked out so that it will not cause direct reflection from the mirror back into the tube face, thus reducing contrast.

Optical Relations

There are two simple relations involving the several values which determine the optical operation of this modified Schmidt projection system. There is a fixed relationship between focal length, image distance, and object distance which is expressed as:

$$\frac{1}{f} = \frac{1}{D_i} + \frac{1}{D_o}$$

The enlargement or magnification is again expressed in terms of the image and object size. Linear magni-

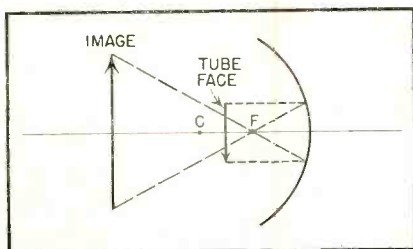

Fig. 3. Object located approximately midway between center of curvature and focus.

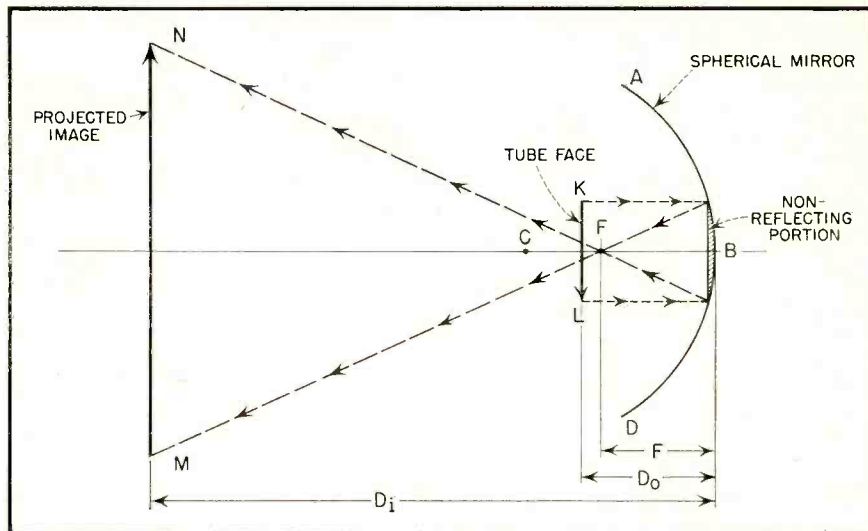

Fig. 2. Fundamental Schmidt system. This uses a concave spherical mirror with an inner reflecting surface. Most projection systems are of this type.

fication, or increase in size is expressed as:

$$M = \frac{\text{Image Size}}{\text{Object Size}} = \frac{S_i}{S_o}$$

$$M = \frac{\text{Image Distance}}{\text{Object Distance}} = \frac{D_i}{D_o}$$

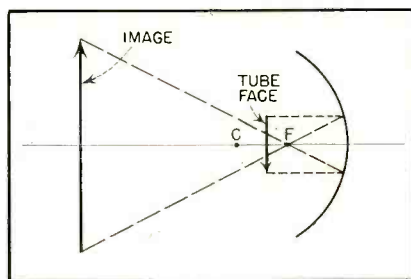

Fig. 4. In this figure the object is moved closer to the focus, increasing the magnification approximately $3\frac{1}{2}$ times.

Since magnification depends upon the relation between image distance and object distance, it would seem that magnification could be increased without limit by decreasing the object distance. This is not strictly true because there are certain optical factors of distortion which prevent excessive magnification. The object must always be located between the center of curvature and the focus to obtain any magnification for the projected image. In *Fig. 3* the object is located approximately midway between the center of curvature and the focus. This produces a magnification of approximately $2\frac{1}{2}$ since the image distance is approximately $2\frac{1}{2}$ times greater than the object distance.

It will be noticed that in *Fig. 2* as with all cases of projection, the object is upside down in relation to the image. This is accomplished by pre-

senting an upside down picture on the tube face which is inverted by the projection system and appears as an upright image on the viewing screen. In order to increase magnification, the object is moved closer to the focus or further away from the center of curvature which is the same thing. In *Fig. 4*, moving the tube face closer to the focus increases the magnification to $3\frac{1}{2}$ times. The object distance is reduced, the image distance is increased, hence the magnification of the system is increased. This is important from the servicing point of view since a larger projected image will be obtained by moving the tube face nearer to the concave mirror.

In *Fig. 5* a magnification of $5\frac{1}{2}$ times is obtained by bringing the object still closer to the focus. As we increase the magnification, the picture will lose some of its brightness since the same amount of radiant energy in the form of light is now spread over a larger area. In this manner it will be seen that the reflective projection system can be and is used to present life size projection television by changing the distance between the tube face and the concave mirror. This is not to say that home type projection television receivers can be modified in this manner. However, it does show that the theatre type and life size type projection television sets now appearing on the market utilize the same optical principles as are found in ordinary projection television receivers.

[Continued on page 38]

High Quality Analyses Series

No. 4

by C. A. Tuthill

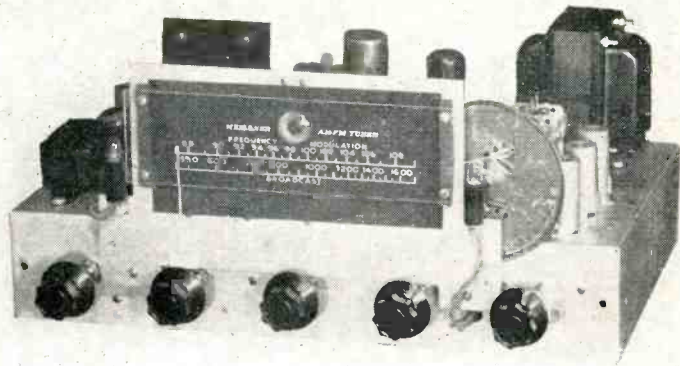

Fig. 1. Meissner 9-1091-C AM-FM Tuner

UNLIKE most combination AM-FM tuners this example truly represents two independent receivers combined within one chassis. A bold contrast is presented against the overplayed tendency to make one set of tubes do everything. Shortcuts are not tolerated in this Meissner model 9-1091C herewith up for analysis. See Fig. 1. Eighteen tubes are employed in this double superhet if we include the tuning indicator and rectifier. Of that total only the tuning indicator, rectifier and the last two cascaded 6J5 audio amplifiers are common to the AM and FM channels. All others are individually assigned modern *miniature* tubes. And the use of more than the usual amount of components is not a mere luxury. Instead, spurious interaction, prevalent in some multi-function tube circuits, is held to a minimum. The direct result is that collective distortion does not grow from stage to stage to mar fidelity. Since the AM circuits are the most familiar we will review that channel first.

Signal Input (AM)

Connections within the chassis are such that no individual antenna for the broadcast band is required. The FM antenna and its transmission line serve as the AM antenna. The schematic (Fig. 2) shows that the FM antenna coil (05768) is designed for balanced input, hence centertapped. The tap is effectively grounded at FM frequencies by the .000047 μ f capacitor which is connected from the tap to ground. This tap feeds the primary of the AM antenna coil (05754) and the .000047 μ f capacitor then serves to tune the primary so

Three products in this High Quality Series have been described in previous issues of RSD. In this article another highly engineered piece of equipment is discussed. We are very happy to make available to those presently engaged in and those contemplating entering the Custom Building field, this information on tuners designed only for quality.

that it is resonant at a point below the broadcast band.

The importance of a good ground is stressed at this point. Any tuner or amplifier leans entirely upon what occurs across its input terminals. Servicemen can profit by pointing this up and by reminding customers that the *best* ground is none too good for high quality tuners which are even more susceptible to extraneous noises riding in with the desired signal than are receivers of lesser quality.

It will be noted that the input and interstage i-f transformers (04216) have three windings. The third coil, which may be looked upon as a continuation of the secondary, is a few turns of wire wound adjacent to the primary. Then, by bringing these secondary connections out to the first two mechanically ganged selector switches, provision is available for *broad* or *sharp* tuning. In the *sharp* position connections are made in a conventional manner to the main secondary at which time the third winding serves no useful purpose. In the *broad* position, due to the third series winding in close proximity to the primary, the transformer becomes overcoupled and thus affords the broad band-pass required for high fidelity reception.

A third section of the same switching system is shown in the lower right

portion of the schematic (above the first 6J5). This section affords phonograph, AM or FM signal input to the audio section. The fourth section of the selector switch, shown to the upper right of the 6U5 indicator tube, pertains directly to that tube. It merely shifts the grid of the indicator tube to the section of the tuner being used so as to indicate proper tuning.

An individual wafer switch, more to the right of the 6U5 indicator, is shown in the schematic to distribute screen grid and plate voltages from the well filtered rectifier.

A crystal-type or high level phono pickup may be plugged directly into the phono-input jack at the rear of the chassis. The 47K resistor and .01 μ f capacitor network, between the phono-input jack and ground, offers compensation for either type pickup since further and thorough equalization of both treble and bass registers is introduced between the two 6J5 audio amplifiers. The variable resistors, shown as components of those latter equalizers, offer a gradual bass boost up to 12 db at 40 cycles, or a treble suppression of 12 db at 8000 cycles. The value of such equalization cannot be over exaggerated. More and more appreciation of such facility, from the discriminating listener, is becoming the accepted rather than the unusual. Others, who just never

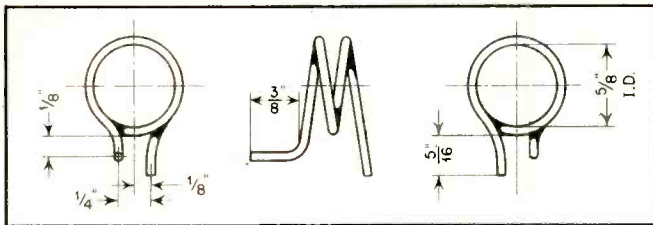

Fig. 3. Antenna coil

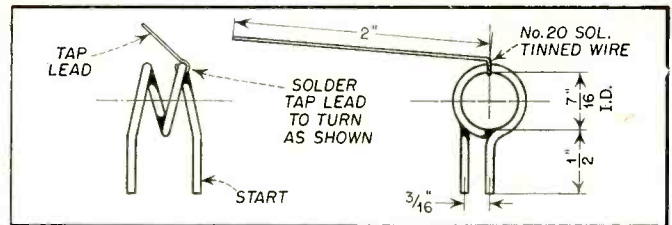

Fig. 4. Oscillator coil

of narrow or broad bandpass again depends upon the inclusion of the third transformer coil as shown.

Careful alignment of the i-f stages at the frequency specified (455 kc) is a positive requirement. For the sharp bandpass (7kc at 1000 kc), top and bottom adjustments of i-f coils 04216, 04216, and 04238 should be made for maximum output. When properly adjusted in the sharp position, response in the broad position (14 kc at 1000 kc) should be double-peaked with the valley between them centered at 455 kc. Peaks of equal amplitude should be equally spaced either side of 455 kc. It will be found there is less gain for the broad position than for the sharp. The remote cutoff characteristics of the tubes used in this section affords a smooth control of gain as grid bias voltage is controlled by delayed a.v.c. in the following diode.

Detector—AVC (AM)

Each diode section of the 6AL5 functions independently from the other which is isolated by an internal shield. In this tuner provision is made to avoid distortion of modulation entering the detector diode from the secondary of coil 04238. For example, no a-c shunting load is permitted across the diode load resistor where-with distortion could be born. A 2.2 megohm resistor is in series with the grid of the 6U5 indicator tube and the volume control has a resistance of 1 megohm so that the shunting effect of these units is small when referred to the actual value of the load resistor.

The second section of the 6AL5 serves to develop delayed a-v-c voltage. Its cathode is connected to the cathode of the last i-f amplifier (6BA6) which has cathode bias and is a few volts positive. The signal which develops the a-v-c voltage is taken from the primary of the output i-f coil (04238) rather than the secondary.

Signal Input Channel 2 (FM)

The FM antenna should be free from local line-of-sight masking or deflection due to nearby buildings, tanks, towers, etc., and the higher above the ground the better. Any good

FM antenna will serve if suitably arranged for 300 ohm line matching. The builders of this tuner enjoy a reputation for coil design hence a few examples are detailed (Figs. 3 and 4).

Even multi-band short-wave and video receivers today find one r-f stage adequate because of well designed antenna-to-grid coupling coils facing modern vacuum tubes such as the 6BA6 employed here. The miniature tubes used throughout this FM channel lend themselves to proper matching for greater signal energy transfer. Voltage ratios of better than 50 to 1 between desired and undesired signals are achieved. Not too troublesome at these higher frequency bands, adequate image suppression is obtained.

Lest the schematic confuse, the coil 05761 is an r-f plate choke. The plate of the 6BA6 is capacity coupled to the tuned coil (05758) input to 6BE6 mixer. The physical dimensions are given in Fig. 3.

Pentagrid Mixer (FM)

The easy application of a converter, acceptable enough for the lower AM channel, is not employed in this v-h-f stage where each control grid of the 6BE6 has its own function. The 6C4 and its tuned coil (05759) provide the beat signal. Mixing occurs in the electron stream between cathode and plate and thereby a cleaner signal is passed on to the i-f amplifiers. Tricky distortive interactions between elements within a converter envelope are averted. Pulling between stages is reduced and greater stability is the payoff.

Plate and screen potentials are supplied to all tubes from busses set up within the tuner. The 5Y3 built-in rectifier provides the source controlled by the wafer switch shown above the rectifier in the schematic. Another bus supplies one side of all heaters while their returns are grounded.

6C4 Triode Oscillator

In the higher frequency bands local oscillator stability becomes imperative. Drift is usually held to a minimum by

such devices as thermal compensation trimmers and separate tubes whose critical circuits are independent of others. In this tuner it has been found more practical to allow for some drift in both the i-f and oscillator circuits, instead of attempting compensation against no temperature drift whatsoever. This has been so handled that the small amounts of drift remaining are in opposite directions and therefore nullify each other. The coil shown beneath the 6C4 in the schematic as 05760 is a close-wound filament choke. The main oscillator coil (05759) Fig. 4 is physically similar to the antenna secondary coil with but the exception of its half-turn feedback tap. Exact-ing simplicity is keynoted here. All coils and capacitances in these circuits are held to exacting specifications.

IF Section (FM)

Three sharp cutoff 6AG5 pentodes having high mutual conductance plus low input and output capacitances are naturally matched with three identical 10.7 mc intermediate stage shielded transformers (04193). A fourth coil or transformer of the same type couples the i-f output to the limiter. Note from the schematic that advantage is taken of the dual cathode leads. Degeneration is minimized when this feature provides isolated cathode returns.

A rather selective alignment trace is recommended for these 6AG5 stages as shown by the FM-IF curve at the bottom of the schematic. Top and bottom adjustment of the four coils (04193) is made for maximum amplitude and symmetry of pattern. Over-coupling with the resultant double peak trace is not used in this case. The reason being to obtain the required bandpass width without creating such undesirable operating characteristics as a change in shape of the bandpass curve when a.v.c. is applied.

With some sacrifice of quality, adequate amplification could have been obtained had one less i-f stage been included. However such would have

[Continued on page 36]

GEIGER C

Can Be R

by JOHN L.



Fig. 1—Walter L. Elliott, service manager for Vinson Carter Electric Co., of Arizona, in this series of illustrations demonstrates the methods he has found successful in repairing over 200 Geiger counters of all types including the rebuilding of some home-made jobs during the past six months. On the bench are two types of units: One with the Muller tube contained in a probe on an extension cable and the other a completely self-contained unit except for earphone. The Muller tube in the small unit is in back of the round grill. The probe type unit is equipped with a meter which is registering heavily from the chunk of high grade uranium bearing carnite alongside the probe.



Fig. 2—With the side cover removed the arrangement of the batteries and the circuit can be readily seen.

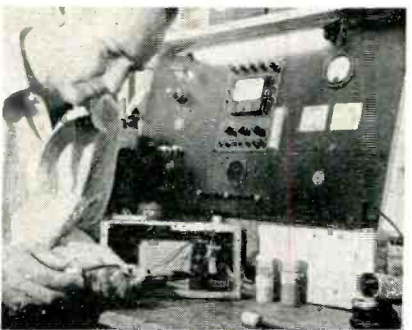

Fig. 3—The Muller tube removed from its probe housing, the open end of which may be seen at right. The tube is wrapped in two sponge rubber cushions held in place by rubber bands. Care should be taken to see that the sponge rubber is not wrapped around the tube near the center lead on the tube or it will cause the tube to short out.

Over the vast stretches of the U. S. and Canada the great Uranium hunt is on in full blast, reports Pathfinder news magazine. The Geiger Counter which is the instrument used in searching for this precious element is also used in hun-

FEW sensitive receivers of a delicate type get rougher usage than the Geiger Counter, that portable click-click spy on uranium and other radioactive minerals. Nearly positive in action, it can follow uranium no matter how minute in quantity. And if you have been thinking of Geigers as something only for bearded minors in the great outdoors, consider them again. They are used in every phase of industry from tracing oil thru pipelines to revealing the progressive action of gases in combustion engines. A trace of radioactive element is mixed with the substance under study and followed from then on to the end of the line by the ubiquitous Geiger. Recently it was done on the human body using radioactive iodine to trace down cancer cells in the spleen.

One of the principal problems troubling most Geiger Counter users is the fact that the delicate units with their basic Muller tubes need careful adjustment and checking often, something Geiger owners find difficult to get done properly—yet it's a natural for any competent radio repairman. The basic principle of operation is similar to radio. The wiring has some aspects of a small television set since high voltage is attained from a low power transformer on most sets. Most standard Geiger circuits follow the conventional audio frequency amplifier pattern with the additions of the

input circuit and neon light indicators and meters used by some manufacturers.

Of the 250,000 or so Geiger Counters now used and the 200 plus being sold every day, most are manufactured by a few leaders in the field. The Muller tube which has a glass envelope and copper shell is the heart of the counters and is made in several different forms, some more delicate than other types. When damaged it must be replaced at costs ranging from around \$15. to \$37.50. However a Canadian company is now said to be producing a counter of somewhat different type which uses a diamond to replace the tungsten wire over which the high voltage is carried in the regular Muller tubes.

Most manufacturers of complete counters use a Muller tube of the self quenching type and these are most easily replaced. However it is always advisable to check this point since the wiring circuit is more complicated in the non-self-quenching tube types which use either a resistor or a vacuum tube to quench the discharge from the Muller tube.

Radioactive detection is made by picking up gamma or beta ray emanations from naturally radioactive materials or those made active for tracing purposes. Most manufacturers produce a counter adapted to gamma ray detection, but any counter can be

iring

COUNTERS

Profitable

PARKER

dreds of other applications. Essentially an electronic instrument, the Geiger Counter needs constant service and is rapidly becoming a new source of income for the Radio Service Dealer. All he has to do is look for this business.

converted to the rarer beta ray use by changing the tube and building up amplifier power to make audible clicks.

In addition to tube variations, Geiger Counters fall into three other general classifications with respect to type of manufacture. The divisions include counters which are equipped with earphones and a neon light for visual check and units with phones and a meter which registers the strength of the rays. Meter type counters are usually small portable units with everything in a single box. However, one of the larger manufacturers does use a meter with earphones on his probe type counter. Manufactured units may be further classified between those in a single unit under one cover and those with the Muller tube mounted in a separate probe unit on the end of a short cable. The rest of the counter is housed in a case carried over the shoulder.

In addition to regular service equipment it is quite essential to have radioactive samples of uranium bearing ores in order to check the operation of the counter. The samples should contain exact percentages of radioactivity preferably not less than 6 per cent. Samples can be had from almost any assay office or from state mineral departments. The Atomic Energy Commission Raw Materials Division, P. O. Box 30 Ansonia Station, New York City will furnish small vials

containing marked samples of radioactive ore upon request.

A common ailment of the counter is battery failure and since battery sales are an important part of the servicing of counters, the battery should be checked first. Batteries must be pretty near peak or the counter will not function. Some manufacturers use three 45-volt batteries and a series of 1½-volt flashlight cells. Others use two 300-volt, a 67½-volt and one 1½-volt cells.

Since the counters are subject to frequent knocks, connections work loose and the switches sometimes develop operational defects. On some models the capacitor tends to short out. The meter or neon button rarely fails. Another minor source of trouble on those units using a regular radio tube or a vacuum tube on the Muller tube circuit is failure of the tube or loosened connection. Some units use either an A5 power pentode or an S4 tube in a standard radio socket in the amplifier circuit. Any loose connections increase resistance and seriously interfere with accurate background count, the most important check to be made on the counter.

This background or basic count is the number of clicks, meter vibrations, or neon flashes per minute which generate from cosmic rays and the existence of a certain small amount of

[Continued on page 35]

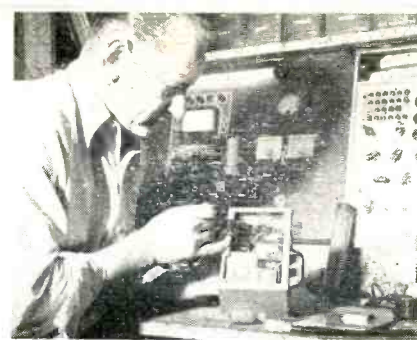

Fig. 4—Elliott is pointing to the location of the Muller tube in the smaller self-contained unit. This unit has a three-way switch, off, start, and on. The "start" position charges the battery up with the capacitor. In the "on" position it gives high voltage without surges in series with the capacitor. The e.m.f. on the units shown is 1000 volts.

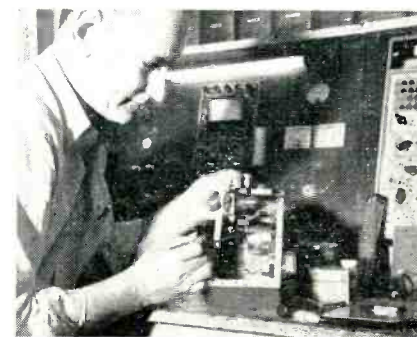

Fig. 5—Batteries and Muller tube removed exposing complete circuit of the unit together with the terminals of the three-way switch. Capacitor at the end of the screwdriver. Note large tube of uranium bearing ore and booklet on uranium prospecting put out by the Atomic Energy Commission which offers a \$10,000 prize for any major Uranium bearing ore discovery.

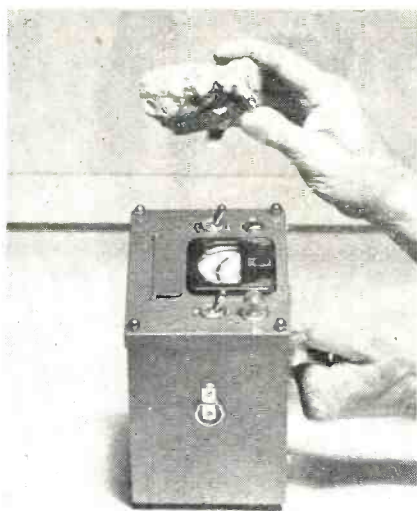

Fig. 6—Final test check of meter and light on another type of counter. Ore contains known percentage of radioactive elements. The sensitive Muller tube is under the hinged metal plate.

The Television WAVEFORM and its COMPONENTS

by SAMUEL L. MARSHALL

(From a forthcoming book, "Television Service Techniques")

Part 2

IN Part I we discussed the simplified block diagram of a TV transmitter. (See *Fig. 1-1*). We then went on to show how a video signal was developed electrically as a result of an image falling on the mosaic being scanned by an electron beam. Just as amplitude is proportional to sound intensities in audio frequencies, at video frequencies it is proportional to relative light intensity. In sound, the signal frequency depends on the actual number of sound vibrations. In video it depends on how many variations in light level are encountered in scanning. No light change over an entire scene results in a d-c signal.

Having determined one component of the TV signal we are ready to discuss a second, the sync signal. This signal which is derived from the Vertical and Horizontal Sync Generator block shown in *Fig. 1-1* is designed primarily to synchronize the start and finish of the electron beam scanning in the receiver with that of the transmitter. See *Fig. 1-7*. Actually two sync signals are involved, a horizontal signal occurring every $1/15,750$ sec., and a vertical signal occurring every $1/60$ sec.

Scanning

The entire reasoning behind the need for a sync signal is wrapped up with the subject of scanning. For this reason let us digress a bit on this subject. To begin with, in the scanning process the electron beam is swept horizontally across and vertically down the screen. The speed of beam horizontally is much greater than it is vertically. In fact during the time it sweeps across the screen it moves down the screen only slightly less than $1/262\frac{1}{2}$ of the entire vertical screen distance, so that the resultant motion is a diagonal path as indicated in *Fig. 1-8*.

Every individual scene is scanned twice in a vertical direction. During

In this installment the sync signal is analyzed. The horizontal, vertical, and blanking pulses are discussed with regard to the types of signals they produce and how they are produced. In addition, the complete scanning sequence taking place on the picture tube is traced from line to line. Sawtooth waves and their relation to linear scanning are also dealt with, thereby laying the proper groundwork for TV.

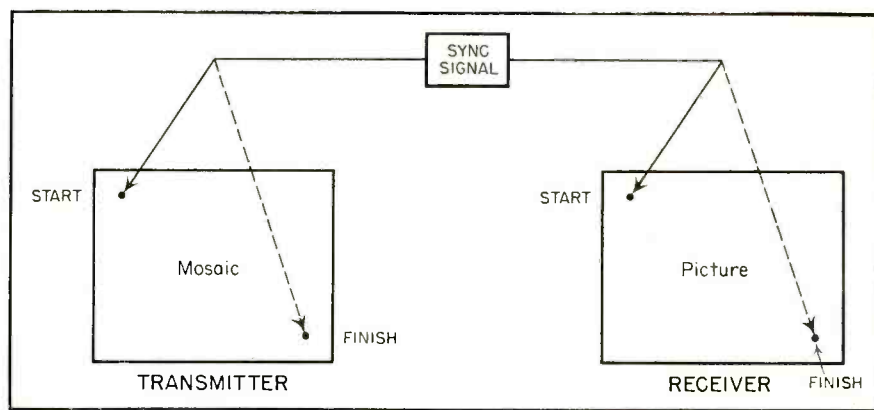

Fig. 1-7: How the receiver signal is synchronized with the transmitter.

the first scanning each horizontal line is traversed in $1/15,750$ sec., and the entire length of the scene is scanned in $1/60$ sec.; however, as shown in *Fig. 1-9*, only the odd-numbered or solid lines are scanned during this period. During the second scanning of the same scene which takes place in the

next sixtieth of a second the even-numbered or dashed lines are scanned. Thus, each scene is scanned at a repetition rate of 60 times per second.

The effect of this high repetition rate is to render smooth and flickerless reproduction. It is common knowledge that the faster a given number of scenes are passed before the eye the smoother and more natural becomes the effect of motion. Compare the early "flickers" and their repetition rate of 16 scenes per second with modern movies having a repetition rate of 48 scenes per second. The reason for a 60 scene repetition rate in TV is tied up with the 60 cycle frequency of the a-c lines.

The process of scanning one set of alternate lines followed by a second set is called "interlaced scanning". The action is so fast that the eye sees only uninterrupted and continuous

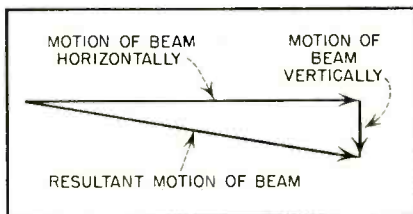

Fig. 1-8: Diagonal motion of the beam due to simultaneous horizontal and vertical forces on the beam.

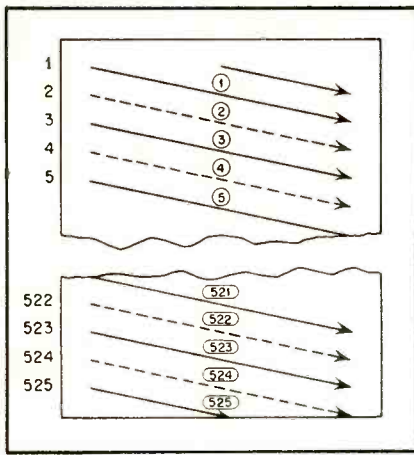

Fig. 1-9: Interlaced scanning. Odd-numbered lines scanned in first field; even-numbered lines in second.

motion. The period corresponding to 1/60 sec. is called a "field". Two fields which are required to scan a complete scene are called a "frame". It is evident that 30 frames are scanned each second and because of interlacing the same effect as a 60 scene repetition rate is obtained.

Sawtooth Waves

For correct picture linearity it is necessary that the scanning beam move at a constant speed both horizontally and vertically. If the speed of the beam varies during scanning then that portion of the time during which the speed changes results in one part of the image being out of proportion with the rest of the image. Thus referring to Fig. 1-10A the scanning beam moving across the mosaic with a constant velocity produces the video signal shown in B. Notice that the pulses in B are in the middle of each line which is in accordance with the location of the light struck elements on the mosaic.

Now let us suppose that for some reason the beam velocity is very high during the first half of the scanning time and slows down during the second half. Under these conditions the first bright element will be scanned

much sooner than the time corresponding to 1/2H, and the corresponding signal waveform will be shown in C. This results in an image displaced somewhat to the left on the picture screen.

But that is not all. If a long line, such as line 10, is scanned, most of the elements will be scanned during the first half of the sweep, that is we are compressing about 3/4 of line length scanned into 1/2 a line on the picture screen. This will make that portion of the image appear shorter than it actually is. On the other hand, during the second half of the sweep, the

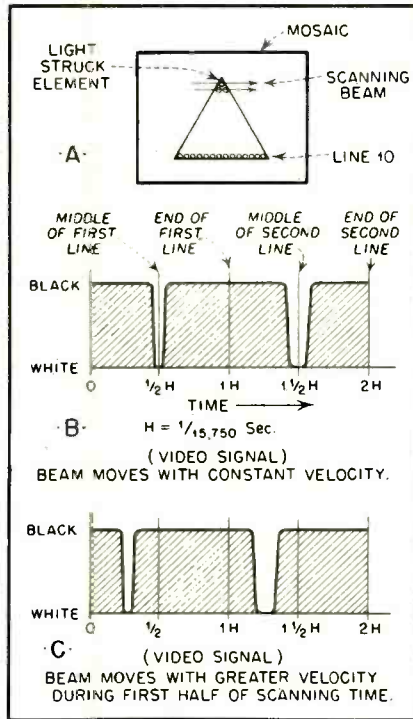

Fig. 1-10: Scanning beam in A produces video signal in middle of first line because light struck element is in middle of picture. This is shown in B. In C, video signal is displaced to left of center of line due to faster speed of electron beam sweeping same element, causing video signal to occur sooner.

remaining elements will give the effect of having been lengthened. Thus, an image shown in Fig. 1-11A will take on the form shown in Fig. 1-11B. Vertical non-linearity results in the image shown in C. This non-linearity may be also produced in directions opposite to those shown.

A beam with a constant velocity is one in which the scanning voltage rise is constant for any time interval. Such a waveform is shown in Fig. 1-12 curve (a). Waveforms which produce non-linear scanning voltages are also shown in (a) and (c). In curve (b) the voltage rise during the first

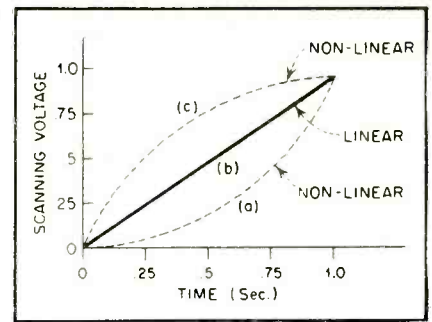

Fig. 1-12: Saw-tooth waveforms are linear.

half-second (.5v) is the same as the voltage rise during the second half-second (.5v). In curve (a) the voltage rise during the first half-second is 1/4 volt, and 1/4 volt during the second half-second. Finally, in curve (c) the voltage rise during the first half-second is 3/4 volt, and 1/4 volt during the second half-second. Only curve (b) is linear, and because of its resemblance to a sawtooth is called a "sawtooth wave".

Sawtooth waves are produced in specially designed oscillators. One of these, called a "blocking oscillator" is shown in Fig. 1-13. Its operation is as follows:

1. Feedback from L₂ to L₁ causes the grid of the tube to become highly negative.
2. In this condition the tube is non-conductive and C₂ charges up slowly being fed through R₂ by the B+ supply. This charging process corresponds to the line O-X in the sawtooth output waveform shown in Fig. 1-14.
3. At the end of the discharge period of C₁R₁ (which controls the free-running frequency of the oscillator) the grid is no longer negative so that the tube conducts and C₂ is discharged through the tube. This corresponds to line X-Y in Fig. 1-14.
4. The tube may also be discharged prematurely by an incoming positive pulse applied to terminals 1 and 2.
5. The complete sawtooth wave consists of a charge period O-X and discharge period X-Y shown in Fig. 1-14.

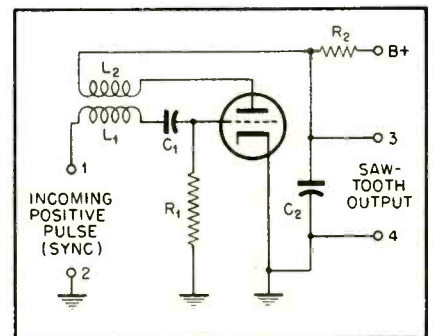

Fig. 1-13: Blocking oscillator.

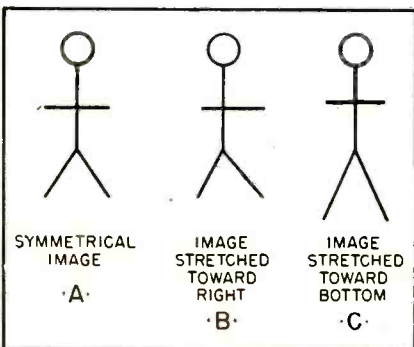

Fig. 1-11: Effects of horizontal and vertical non-linearity.

At the completion of the discharge period the voltage across the condenser is zero and the cycle begins all over again.

Reference to *Fig. 1-1* illustrates the position of the vertical and horizontal scanning generators in the TV transmitter. Notice the sawtooth waveform produced. During the charge period the beam is swept vertically and horizontally. During the discharge period it is brought back to its original position.

Sync Signal

In the previous discussion we pointed out that the frequency of a sawtooth scanning generator may be controlled by applying a positive pulse to the grid of the oscillator tube before it begins to discharge C_2 . This means that the incoming control frequency should be slightly higher than the free running frequency of the oscillator. In the transmitter, specially designed and highly accurate generators produce positive pulses for purposes of

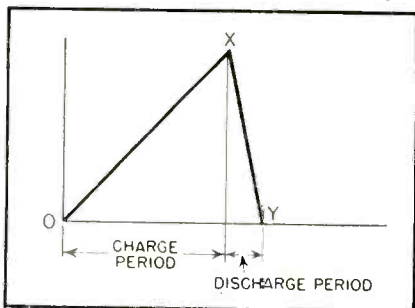

Fig. 1-14: Complete saw-tooth wave.

controlling the frequencies of the horizontal and vertical scanning generators. These pulses are developed in the section marked, **VERTICAL AND HORIZONTAL SYNC GENERATORS**, and trigger the vertical and horizontal scanning generators to the exact pulse frequencies.

It will be also observed that these pulses are fed into the block marked, **MIXER AND AMPLIFIER**, except that an additional **BLANKING** signal is fed into this section together with the sync pulse. Blanking is a condition whereby the signal voltage is brought to a level corresponding to "black" before the actual sync pulse itself is inserted, and keeps the signal at this black level for a short time after the sync pulse has been completed. Actual horizontal and vertical sync signal waveforms with their respective blanking levels and sync pulses are shown in *Figs. 1-15* and *1-16*. In *Fig. 1-15* the relative amplitude relationships between picture, sync, and blanking levels are shown. Also indicated is the duration of the actual sync pulse compared to the actual horizontal blanking signal.

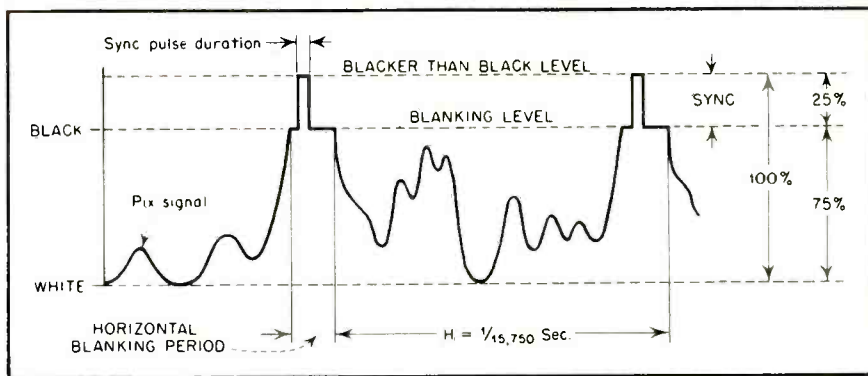

Fig. 1-15: Horizontal pix, sync pulse, and blanking level relationships.

In *Fig. 1-16* the vertical sync signal details are given. In *A* we show this signal as a continuous pulse equal in time to nine horizontal lines. However, in order to maintain continuity of the horizontal sync signal, the vertical sync pulse is sliced or *serrated* into nine sections each one equal to a horizontal line. Each section is then sliced in half again resulting in eighteen short pulses. The first six pulses are of very short duration and are called "equalizing pulses". The second six pulses are of longer duration and are the actual pulses that trigger off the vertical sweep oscillators. The third six pulses are also equalizing pulses and "taper" off the complete vertical pulse. The more exact reasons for the equalizing pulses will be discussed in a later chapter. At this point let it suffice to observe that the frequency of these pulses is twice the horizontal frequency, or 31,500 cps, thereby enabling them to take action in the middle of a horizontal line. The reason for this will shortly become apparent.

(solid line) is scanned, and how the beam starting at point *A* on line 1 is brought down to the bottom of the picture tube to point *C*. During this

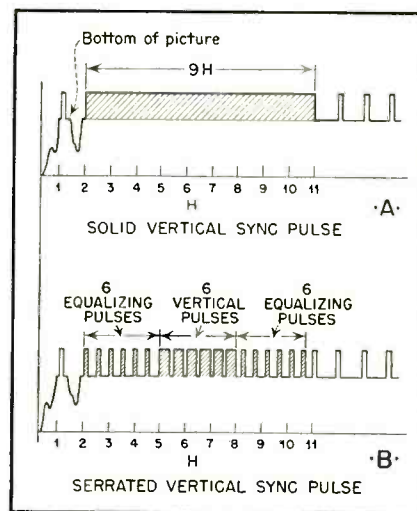

Fig. 1-16: Vertical sync signal details.

process a total of 254½ lines are scanned (this figure varies with different transmitters). At point *C* the line is cut short in the middle. This
 [Continued on page 36]

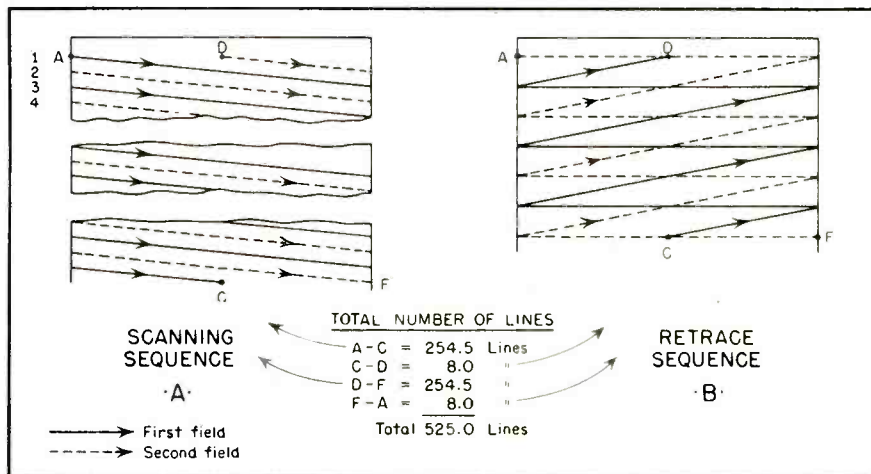

Fig. 1-17: Typical scanning and retrace sequence.

How To Estimate Your 1950 TAX

by **BETTY LEE GOUGH**

COME March 15, 1950, almost every radio service dealer will have to file with Uncle Sam's special henchman, the Collector of Internal Revenue, a statement "estimating" what taxes he will have to pay for the year. The only exceptions to this are the presidents of incorporated radio service shops who draw their money in the form of salary from the corporation; and these men usually have the vastly bigger headache of wrestling with corporation income tax returns.

Most radio service dealers receive the estimation form as a regular early-in-the-year mailing from the Collector of Internal Revenue. But whether he sent one to you or he didn't, you are liable for filling it out and turning it in. Furthermore, you must pay "installments" on your income tax, four times a year—on March 15, June 15, Sept. 15, and January 15.

Who has to file an estimated income tax form? In a pamphlet on the subject of business taxes, the United States Department of Commerce advises that, "you must meet these requirements if you expect to receive more than \$100 from the profits of your business or from other sources besides wages that are subject to withholding; provided that your total income from all sources will be \$600 or more. You would also come under the provisions of the law if you received wages of more than \$4500 plus \$600 for each of your exemptions including your own.

"In meeting these requirements of estimating and paying your tax in advance, you must file a Declaration of Estimated Tax, Form 1040-ES. A copy of this form may be obtained from the Collector of Internal Revenue in your district or from the Bureau of Internal Revenue in Washington, D. C. Copies are not usually sent to you with your regular income tax blank, Form 1040, unless you filed Form 1040-ES in the previous year."

This is the time of the year when the small business man typified by the Radio Service Dealer who owns his own shop begins worrying about his debt to Uncle Sam. Read what this writer advises in this regard.



This very simple form contains clear instructions for preparing and filing your Declaration and paying your tax in advance. In estimating the amount of your tax you may base your calculations on last year's income, but allowance should be made for expected changes in income, exemptions, and deductions, for the current year.

In figuring out net income on which you will estimate your tax, you may take last year's deductions if you expect them to be about the same as the deductions for this year. If you receive part of your income as salary or wages from which a withholding tax is deducted, you are entitled to subtract this withholding tax from your total tax liability in computing your estimated tax to be paid in advance. You may, if you wish, file a joint Declaration of Estimated Tax with your wife, if both of you are citizens or residents of the United States. It

may be quite profitable for you to do this. The income splitting provisions of the tax law may result in a material reduction in your tax liabilities, if you and your wife file a joint declaration.

The Department of Commerce warns that, "you should understand that this Declaration of Estimated Tax does not take the place of your regular income tax return which you must file on Form 1040 by March 15 each year. It represents an advance statement and payment of your year's tax. For 1949, for example, you will still have to file a final income tax return by March 15, 1950, showing your actual income, deductions, and tax for the year 1949. This return, however, will be in reality a year-end settlement of your tax liability. If, on the basis of your Declaration of Estimated Tax, you over-estimated and overpaid your 1949 tax, you will show this in your final return on Form 1040 and will be entitled to a refund. If, on the other hand, you underestimated your tax, you will have a balance to pay in full when you file your final income tax return.

"Your Declaration of Estimated Tax, Form 1040-ES, should be filed by March 15 of the year to which it applies. Even though, on March 15, your income situation is not such as to require you to file a Declaration of Estimated Tax, a change in your income later during the year may bring you under these requirements. In such case, the time for filing is as follows: June 15, if the change occurs after March 1 and before June 2; Septem-

[Continued on page 32]

CIRCUIT COURT

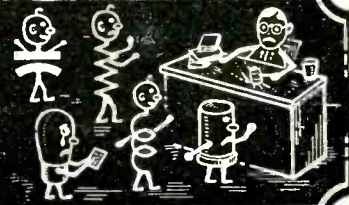

Hoffman Model CT 800

An unusual form of audio feedback circuit appears in this 30 tube TV receiver. A schematic of the audio portion of the instrument is shown.

A 12" PM speaker is driven by a single 6V6 output tube. The impedance of the voice coil is 3.8 ohms. Voltage amplification takes place in a 6AT6 stage, the diodes of which are not used.

The audio volume control, a one megohm unit, is linked to the de-emphasis network following a 6AL5 discriminator. The portion of the signal selected for use feeds the grid of the 6AT6 triode. Bias is developed across the 10 megohm grid leak, the cathode being returned to ground.

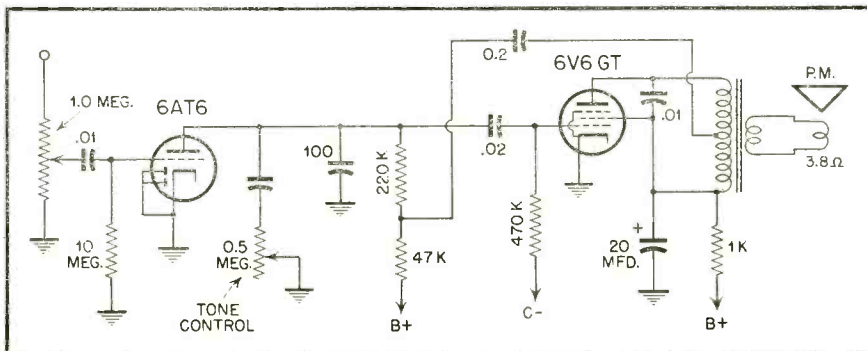

Audio portion of Hoffman Model CT 800

High frequency attenuation is provided in the plate circuit by the .05 μ f and .5 megohm components. Fixed by-pass for high frequencies takes place in a 100 μ mf capacitor. Plate voltage is supplied through 220K and 47K resistors in series.

Fixed bias of 20 volts is provided for the 6V6 output tube via a 470K resistor and across a 1 megohm grid leak. The plate load of the 6V6 is a center-tapped output transformer primary with .01 μ f audio bypass. The tap on the primary is connected back to the junction of the plate resistors of the 6AT6 stage through a .2 μ f capacitor.

The feedback system used results in half the voltage developed across the output transformer primary being applied to one fifth the previous plate impedance. This produces roughly the 10% feedback generally considered optimum for such circuits. The usual advantages of hum reduction and attenuation of distortion can thus be achieved.

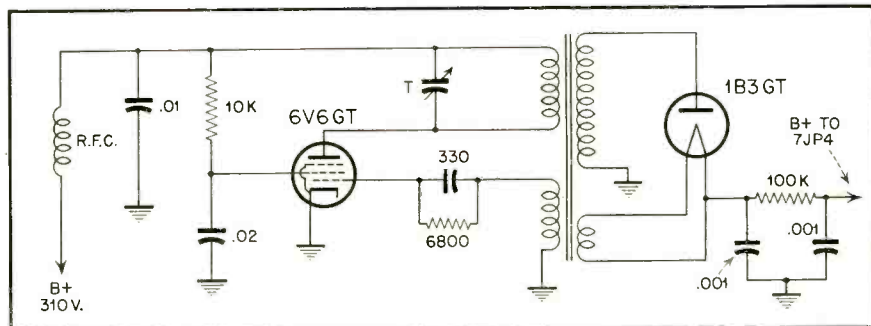

High voltage circuit of Belmont Model 22A21

Belmont Model 22A21

This 22 tube, direct view 7" TV receiver uses a method of high voltage

generation which differs in detail from others to date. The picture tube is the popular 7JP4 type and requires potential of around 4500 volts.

The partial circuit shown discloses that the action takes place in a high-frequency oscillator employing a 6V6GT tube. This differs in tube complement from others in that most use triode tubes or triode-connected beam tubes.

The transformer has four windings; grid and plate coils for the oscillator and filament, and plate coils for the rectifier. The latter is the conventional 1B3GT type. Tuned plate-grid feedback oscillator coupling is used with a grid leak of 6800 ohms. The plate receives 310 volts via an r-f choke from the main power supply. A 10K resistor drops the voltage to 220 for the screen of the oscillator. Bias of about 100 volts is developed on the control grid.

Temple Model TV-1776

A variety of high voltage supply circuits are to be found in present models of TV receivers. This instrument is unusual in that it makes use

(Continued on page 32)

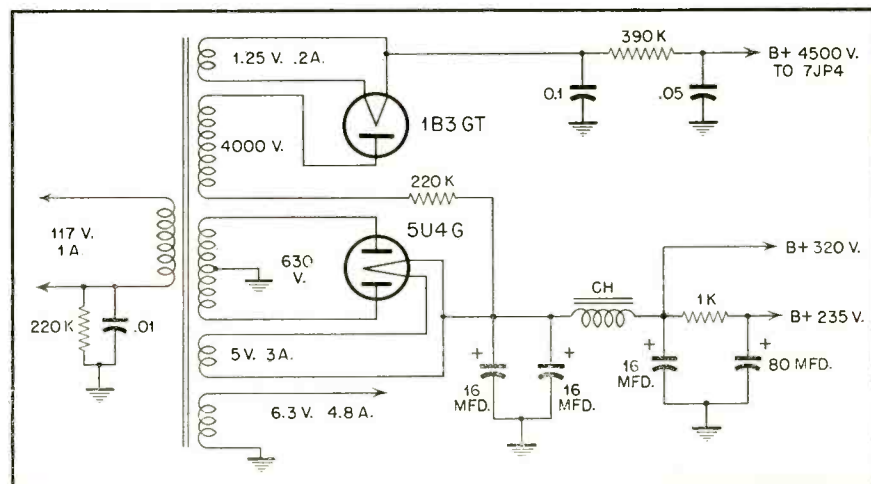

High voltage circuit of Temple Model TV-1776

SHOP NOTES

Write up any "tricks-of-the-trade" in radio servicing that you have discovered. We pay from \$1 to \$5 for such previously unpublished "SHOP NOTES" found acceptable. Send your data to "Shop Notes Editor".

Motorola Model 5A5- Rectifier lights up with switch turned off.

Three way portables with tube rectifiers are subject to an unusual trouble. With the set plugged in but turned off, the rectifier continues to light. A glance at the circuit in *Fig. 1* shows

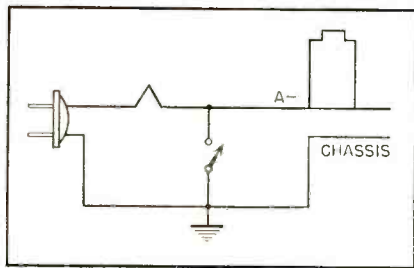

Fig. 1. Ground side of filament connects to A—.

that the ground side of the filament is connected to A— which is normally insulated from chassis ground. However, if the battery is used to the point where it leaks, some of the electrolyte completes the circuit (see *Fig. 2*).

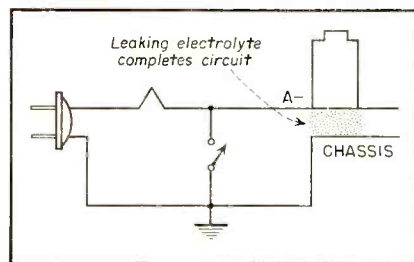

Fig. 2. Short caused by leakage.

2) between A— and chassis ground. Cleaning up the set and replacing the batteries quickly clears up this trouble.

Submitted by:
Fred Weinstein
Bellerose, N. Y.

Bending Tool For Band-Switch Contacts

Take an ordinary sardine, or other vacuum-can type opener, place it in the vise, end up, then saw a quarter-inch slot in the end. Alternately, you might take an opener with a slot already cut through the shaft, and cut off the end, giving the same effect. Either technique will provide you with a bending tool.

Whenever you find a band-switch making less than positive contact, slip

the notch in the tool about the loose contact and twist in the proper direction. The enormous leverage provided by the tool should now make an easy task out of what before was a gigantic task of forcing a needle-nose plier into a space too small for it.

I prefer as long a shaft as possible, bending it if necessary in extreme cases in order to fit the space available in the crowded switch assembly.

Drawn below is *Fig. 3*, showing the cut to be made in the wire to form

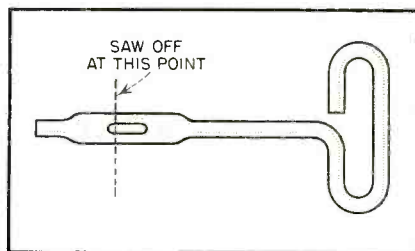

Fig. 3. Where to cut can opener.

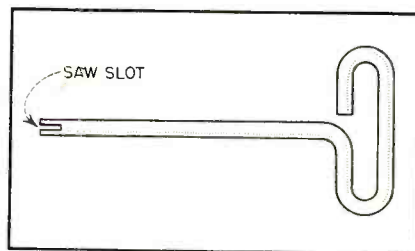

Fig. 4. How to slit can opener.

the tool. *Fig. 4* shows the alteration of a vacuum coffee-can opener. No dimensions are shown. Use what you have.

Submitted by:
David Guessin
Columbus, Ohio

Philco Intermittent High-Voltage Supply

Failure of the high-voltage rectifier will result in a very dim picture or no picture on direct-view receivers using a single half-wave rectifier. On projection and direct-view receivers using voltage-multiplying circuits, an increase in picture size and defocusing will be noted if one of the high-voltage rectifiers fails.

In a number of cases, failure of the 1B3GT high-voltage rectifier has been

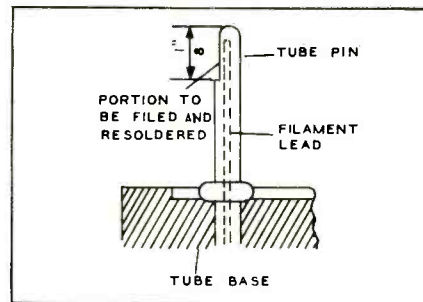

Fig. 5. Repairing 1B3GT tube pin.

traced to poor solder connections between the filament leads and tube pins.

During the present shortage of 1B3GT rectifiers, it is suggested to repair rather than replace 1B3GT tubes having this type of trouble.

To make the repair (see *Fig. 5*) the filament pins No. 2 and No. 7 should be filed and resoldered as shown in figure 4. A small amount of noncorrosive flux should be applied to the filament pin, and the solder should be allowed to flow freely to insure a good connection.

Intermittent 1B3GT tubes are most troublesome in Model 48-2500 where three are used. To reduce the possibility of future trouble, it is strongly recommended that pins No. 2 and No. 7 of all three tubes be filed and resoldered when making a repair.

Philco Service Dept.

Warm Air Device For Testing Defective Parts

One of the most pressing problems in servicing television receivers is a magnification of a frequent difficulty in servicing compact ac-dc "hot-box" table radios—How do you locate a defective capacitor or other part which is defective only when it is heated up during actual operation.

Removing the receiver from its cabinet for test won't work since the extra ventilation does away with the damaging temperature rise. This contributor has come up with a practical, ingenious solution, which should be called to the attention of your readers. He simply uses a home hair-dryer to blow a stream of very warm air on the suspected parts. This simulates the "in cabinet" condition quite quickly.

Submitted by:
Richard Wiseman
Chicago, Ill.

Sentinel 400, 401, 402, 405, 406, 411 — Tearing and Picture Breakup

Tearing and picture breakup (noise streaks) when set is jarred, on early models 400, 401, 402, 405, 406 and 411

television receivers using a 12AT7 oscillator tube is caused by the loose padder trimmer slug screw in C11.

Loose fit between padder trimmer screw and threaded sleeve, preventing a firm grounding contact resulting in a breaking up of the picture, noise streaks and possible detaining of the received picture.

The installation of a locknut bushing, part no. PST 500, on padder trimmer screw which will hold trimmer screw firmly and provide a proper ground.

Slide the locknut bushing on a thin bladed screwdriver with the nut end toward the handle and insert the screwdriver into the trimmer screw slot (see Fig. 6). While holding the padder trimmer screw so that it will not turn, slide the locknut bushing on the padder trimmer and turn it down by hand until it is tight against the front of the r-f tuner unit chassis (see Fig. 7).

Sentinel Service Dep't.

Philco 46-1203, 48-1262 -

Simplified circuit

For your complete files we are presenting the simplified circuit (Fig. 8) of the above receivers in order to complete the service note which appeared in the Jan. 1950 issue of RSD submitted by Wayne Lemons.

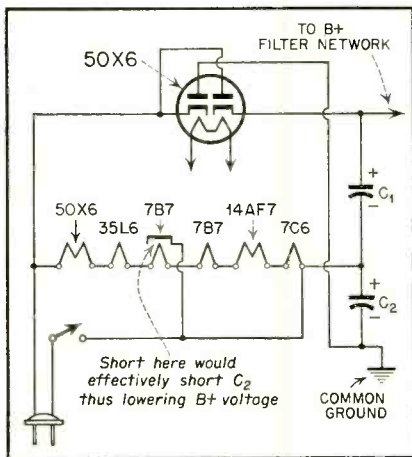

Fig. 8. Simplified circuit of Philco 46-1203, 48-1262.

Damping Tube Trouble Symptom

If a wavy picture appears on the screen of the picture tube, in the vertical direction and more predominant on the right hand side, in many cases the trouble can be traced to a defective damping tube—usually a type 5V4G rectifier tube. Replacing this tube will clear up this trouble.

*Submitted by:
Domenic R. Ripani
217 South Church St.
Rockford, Ill.*

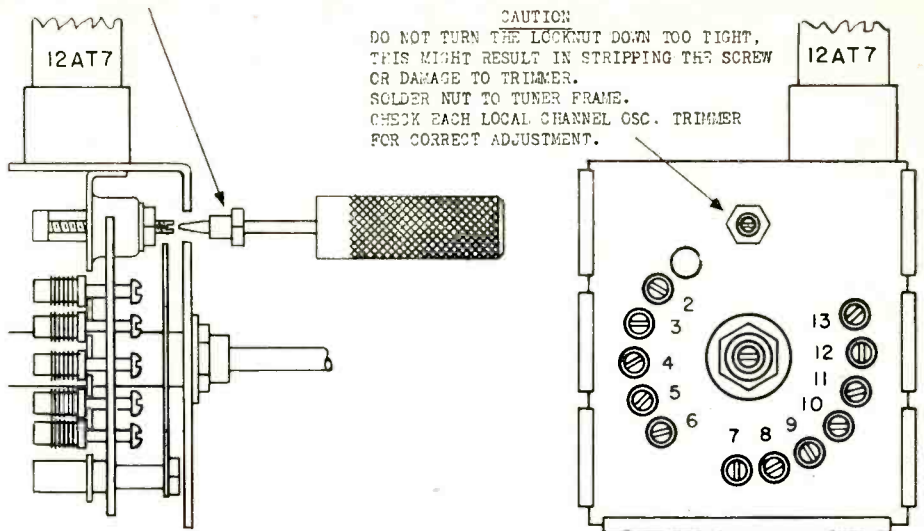

Fig. 6. (Left) Inserting screwdriver into trimmer screw slot.
Fig. 7. (Right) Sliding lock nut bushing on padder trimmer.

Westinghouse — C. R. T.

Damage Caused By Incorrect Adjustment of Ion Trap Magnet

It is extremely important that the ion trap magnet be correctly adjusted immediately after the set is first turned on during the installation. Improper positioning of the magnet may result in the development of circular areas of discoloration on the face of the tube. This is true even though the ions developed in the tube are being properly deflected. When the magnet is not correctly oriented, the electron beam strikes the edge of the aperture in the anode top disc instead of moving cleanly through the hole. The heat produced by the action vaporizes the metal of the disk, thus releasing gas which has a harmful effect on the screen of the tube and be apparent as darkened areas on the screen.

To correctly adjust the ion trap magnet, position it over the neck of the CRT with the arrow on the magnet pointing toward the face of the tube. Then turn on the set, and with the brightness control adjusted for a low intensity, rotate the magnet around the neck of the tube and move it forward and backward until the raster is brightest on the screen. If, in obtaining the brightest raster, it is necessary to move the magnet more than 1/4" from the pole pieces in the tube, or if the magnet is pushed against the focus coil, the magnet may be weak and a new one should be tried. As a final check on the adjustment, the brightness should be turned up slightly above average, the focus control should be adjusted for a clear line structure, and the ion trap magnet should again be adjusted for the brightest raster.

Never move the ion trap magnet to remove a shadow from the raster if the brightness is decreased by so doing. Shadows should be removed by adjusting the focus coil.

It is essential that the brightness control be kept at a low setting until the magnet has been initially adjusted. Furthermore, the magnet must be adjusted immediately after the set is first turned on. Cathode ray tubes have been ruined in 15 seconds by operating the brightness control too high when the ion trap magnet was incorrectly adjusted. However, in some cases it may take much longer for the darkened areas to appear on the screen, and the adjustment procedure should not be omitted merely because the set appears to be operating satisfactorily.

Westinghouse Service Dep't.

NEW JENSEN FREQUENCY RANGE RATING SYSTEM		
JENSEN F.R. RATING	HEARING REFERENCES	TYPICAL USES
20,000 CYCLES		
+8 LIM	AUDIBILITY LIMIT (BEST EARS—TONE TEST) NOISE SOUND EFFECTS PERCUSSION INSTRUMENTS	BROADCAST MONITORING
+7		
+6	BEST EARS } MUSIC MAXIMUM AUDIBLE RANGE (Average Home Conditions)	CUSTOM RADIO-PHONOGRAPH INSTALLATIONS
+5		
+4		
+3		
+2	MINIMUM ACCEPTABLE RANGE FOR MUSIC	INDUSTRIAL SOUND AUTO RADIO
+1 LIM		
3,000 CYCLES		COMPACT RADIOS (LIMITED BY CIRCUITS)

©1949 Jensen Mfg. Co., Chicago, Ill.

Jensen - New system of rating speakers

Instead of the former practice of stating frequency limits of loudspeakers in cycles, the h-f region between the minimum useful limit for music and maximum limit for hearing has been divided into eight steps, each of

[Continued on page 32]

NEW PRODUCTS

THREE-INCH CRT

A new three-inch cathode ray tube, believed to be the shortest three-inch electrostatic cathode ray tube manufactured in the United States, has been announced by the Tube Divisions of the General Electric Company.

The 3MP1 is an electrostatic focus and deflection type with a bulb diameter of three and one-eighth inches and useful screen diameter of two and three-quarter inches. It is equipped with a small-shell, duodecal base which has been set as the standard base on all television tube types.



Maximum ratings for the new tube include an anode no. 1 d-c voltage of 1000 volts and an anode no. 2 d-c voltage of 2500 volts. The maximum negative-bias value is 200 volts d-c and the positive-bias value 2 volts d-c. Maximum circuit values: Grid No. 1 circuit resistance, 1.5 megohms; resistance in any deflecting electrode circuit, 5 megohms.

Further information on the 3MP1 may be obtained from the Tube Divisions, General Electric Company, Schenectady, N. Y.

MILNER ALL-ALUMINUM TV MAST

The Milner Mast, just on the market, combines light weight with durable strength, comes in 10 foot sections—can be installed in any height up to 100 feet. The tubing is joined by special rolled thread. With a variety of bases offered, this mast serves any and all installations. Its universal cap adapts to any



Adjustable after installation; can be manually rotated at base for best reception.

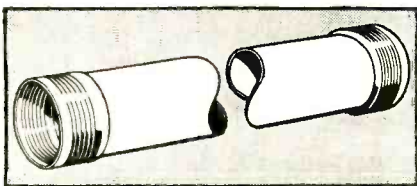

Tubing is joined by a special rolled thread design—(patent applied for). Each 10 ft. section weighs only 7¼ pounds.

size antenna. All fittings as well as the mast are made of rust-proof, non-corrosive aluminum alloy. At 100 feet, complete with fittings, it weighs under 110 pounds.

NAIL POLYETHYLENE STANDOFF

The Odegaard Original Nail Polyethylene Standoff (Patent Pending) is quickly and easily hammered "home" with just a few strokes—no drilling whatsoever is required. It easily drives into wood, mortar, iron and aluminum for a locked permanent installation. In the photo, the top row of Odegaard Standoffs in the wall shows the extremely easy 4-step procedure for use. First the nail is hammered

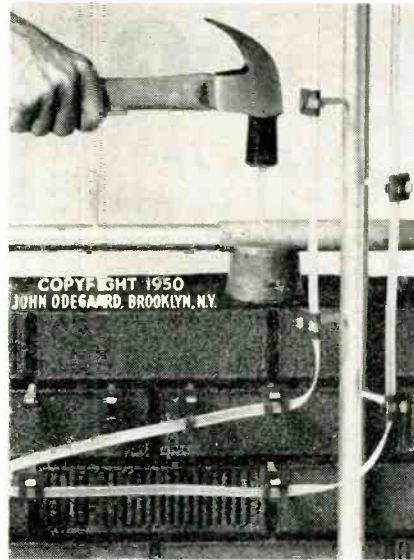

in. Then one of the slots in the polyethylene strip is forced over the nail head. Next the cable is placed beneath the flap, the strip folded over the cable. Finally the slot goes over the head.

For your free sample and full details of this amazing standoff, write directly to Odegaard Manufacturing Company, 5416 Eighth Avenue, Brooklyn 20, N. Y.

RCA-16GP4 COMPONENTS

Tube Department, Radio Corporation of America, Harrison, N. J., announces that five new components have been recently offered to equipment manufacturers particularly for 16-GP4 deflection systems designed to use the horizontal-deflection amplifier tube 6CD6-G and the vertical-deflection amplifier tube 6S4.

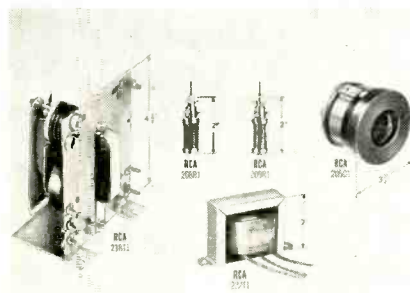

Coordinated in design to operate efficiently with each other and with the 6CD6-G and 6S4, these new components are as follows: Deflecting Yoke, Type 206D1; Width Control, Type 208R1; Horizontal-Linearity Control, Type 209R1; Horizontal-Deflection-Output and High-Voltage Transformer, Type 218T1; and Vertical-Deflection-Output Transformer, Type 222T1.

MINIATURE TUBES

Two new subminiature tubes designed by Sylvania Electric Products Inc., for use as Class A a-f amplifiers or resistance coupled a-f amplifiers have been announced by the Radio Tube Division. Type 6AD4 triode has

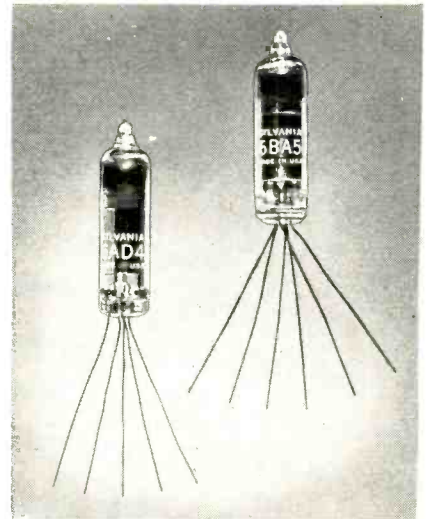

a mutual conductance of 2700 micromhos. The 6BA5 pentode rating is 3800 micromhos. Both tubes are enclosed in T-3 envelopes and are supplied with 6.3 volt, 150 milliamperer heaters.

INDOOR TV ANTENNA

Tricraft Products Company, 1535 North Ashland Avenue, Chicago 22, Illinois has just announced their new "VIDIETTE" indoor TV antenna model "700". There is no pushing and pulling of rods-change stations without

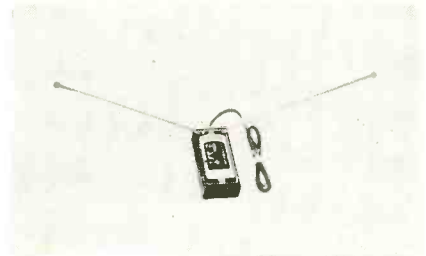

effort. Simply move knob to channel desired . . . the TV set is automatically electrically tuned in and reception comes booming in.

VERSATILE CONCENTRIC CONTROL

A packaged set of specially designed parts trade-named "Concentrikit" has been announced by International Resistance Company.



IRC states that with this set Radio Technicians can assemble a variety of concentrics to meet over 90% of the replacement requirements.

Long searches and waits for exact duplicates are eliminated, and inventory investments are reduced.

In addition to step-by-step instructions which are included with each unit, IRC has published a comprehensive Concentric Dual Control Replacement Manual. This new Manual includes all sets from early radios to current TV's. "Concentrikit" is available from all IRC Distributors. For new Catalog DC1A write: International Resistance Co., 401 N. Broad Street, Philadelphia 8, Pa.

DYNAMIC MICROPHONE

Electro-Voice, Inc., Buchanan, Michigan announces the TV655 high fidelity dynamic microphone. The TV 655 is omnidirectional, becoming slightly directional at extremely high frequencies. Smooth, peak-free response 40-15,000

c.p.s., plus or minus 2.5 db—individually laboratory calibrated and certified. Special hole in lower section of case permits easy control of bass response. Output level: power rating (Odb = 6mw/10 dynes/cm²): -53. Impedance is 250 ohms—can easily be changed to 50 ohms at internal terminal strip. Has Acoustalloy diaphragm. Uses Alnico V in a specially designed magnetic structure. Removable swivel mounting. 1/2" pipe thread on microphone and swivel for stand coupling. 5/8"-27 thread adapter furnished. Case is lathe-turned aluminum with gleaming Alumilite finish. Dark baked enamel finish with chrome trim (illustrated) optional. Cannon XL-3 connector is inserted in cable 6 inches from microphone.

Supplied with 20 ft. of two-conductor shielded synthetic rubber jacketed broadcast type cable. Size of microphone with swivel is 11-

3/8" long; without swivel 8-3/4" long; diameter 1-1/16".



For further information, write for TV Bulletin No. 156 to Electro-Voice, Inc., Buchanan, Michigan.

VTVM KIT

Heath Company, Benton Harbor, Michigan is introducing a new model V-4 Vacuum Tube Voltmeter Kit. Positive automatic meter protection on all functions is given by the electronic a-c voltmeter and push-pull d-c voltmeter circuit. Electronic a-c voltmeter circuit incorporates new balance control which allows complete elimination of contact potential, removes meter shift with various ranges, is re-

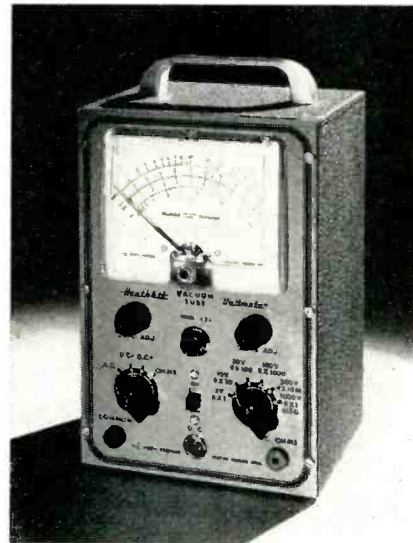

ported to give accurate readings on all ranges, and compensates for variations in tube elements. 200 micro-ampere meter uses Alnico V magnet for fast accurate readings. 1% precision ceramic divider resistors are used. 24 complete ranges are included. Meter pointer can be offset from zero for FM and TV alignment. D-C probe is isolated for dynamic measurements of receiver voltages without disturbing receiver operation.

TV LIGHTNING ARRESTER

Recently announced is a new FM-TV Lightning Arrester of combined bleeder and gap design. Built with a universal base to accommodate all types of lead-in cable—flat or round 300 ohm and twin-x.

Has Underwriters Laboratory listing as safe and approved. Keeps antenna and all surrounding conductors, reflectors, directors and

ANNOUNCING DUOTONE'S

"BIG 50" DEAL

ON BEST SELLING SHOCKPROOF NYLON NEEDLES*



Guaranteed shockproof!

Demonstrate it by actually *bouncing* the whole tone arm on a record! Long lasting . . . up to 5,000 plays!

50% more advertising for the needle with greater acceptance than any other on the market!

50% cooperative advertising offer. Hard selling, carefully prepared to really *move* needles . . . yours, upon authorization, on a 50-50 cooperative basis.

50 dollar deal. You pay only \$50 for 3 cards of Nylons and 2 Stars . . . you get **FREE** ten nylon needles worth \$25! The whole deal complete in one package!

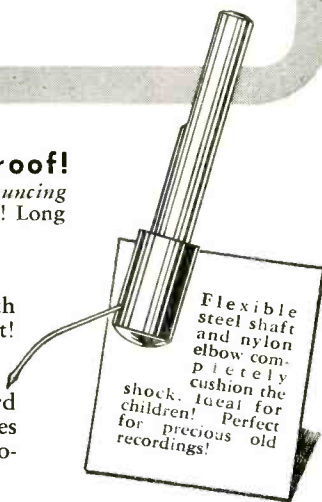

IT'S THE DEAL OF THE YEAR! STOCK UP NOW!

See your jobber or write Duotone direct.

*PAT. PENDING



MILNER TV MAST

At Last! A Sectional ALL-ALUMINUM Mast—Height to 100 feet—Lowest Cost

Before you recommend any television mast look at the MILNER TV MAST. Here's the best mast for TV, perfect for owners in the "fringe areas." The all-aluminum MILNER MAST is light yet strong: 100 foot mast complete with fittings weighs under 110 pounds.

Available in 10 foot lengths with fittings for ground, side-of-building, or any type of roof installation, a MILNER MAST can be installed to

any height up to 100 feet. Lowest-priced mast on the market, it also saves on freight shipments — over 50% less than comparable masts of other material.

Home owners will welcome this rust-proof, non-corrosive and durable MILNER MAST with its streamlined, gleaming beauty. Point for point the MILNER MAST surpasses all others. You can sell and recommend them.

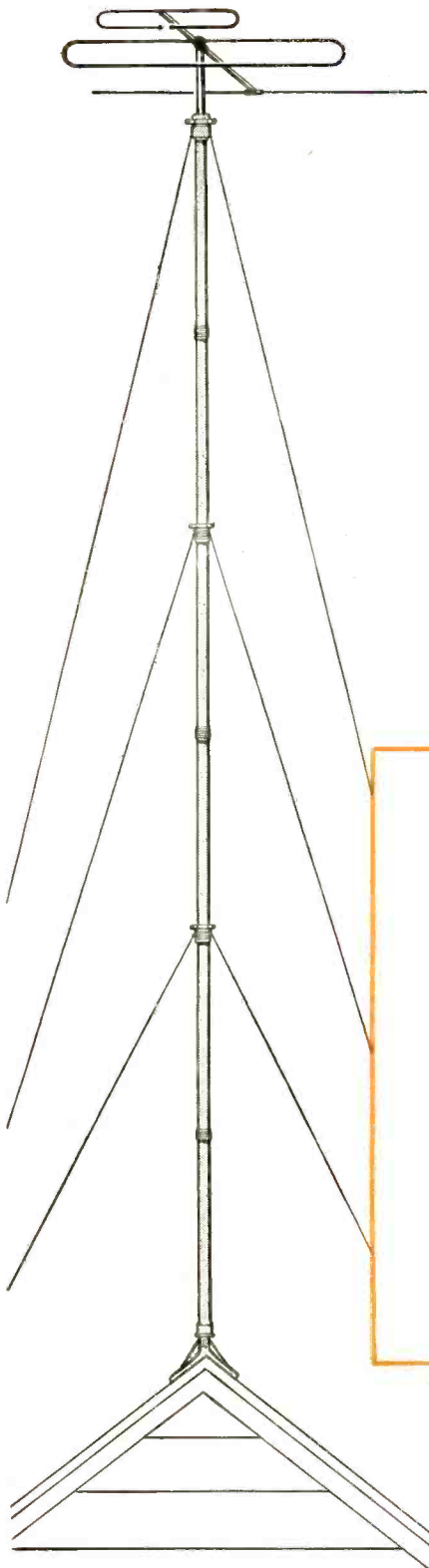

COMPARE THESE FEATURES:

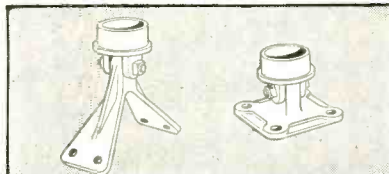

Can be placed anywhere—bases designed for ground or flat installations, for side of building or any type roof.

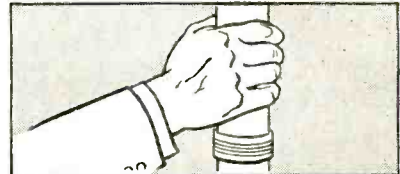

Adjustable after installation; can be manually rotated at base for best reception.

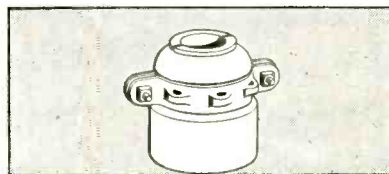

All-aluminum fittings—universal top with adapters to fit any size antenna.

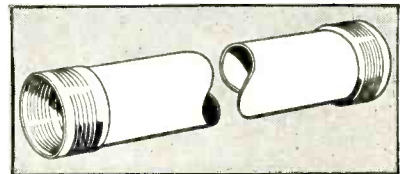

Tubing is joined by a special rolled thread design—(patent applied for). Each 10 ft. section weighs only 7¼ pounds.



For full information, write to:
MILNER MANUFACTURING COMPANY
 Jackson, Mississippi

masts at a constant potential relative to ground. The balanced bleeder resistors prevent any static built up in the antenna. Momentary high voltages break the gap and are by-passed harmlessly to ground.

An illustration of the Cletron lightning arrester is shown at the right hand side of this page. Notice how the twinlead is fed through

the lightning arrester. The ground terminal is in the middle of the arrester, plainly marked, "GND".

In view of the agitation being stirred up by insurance companies and municipal regulations requiring the installation of Underwriter Approved lightning arrestors in TV installations this is a timely item.

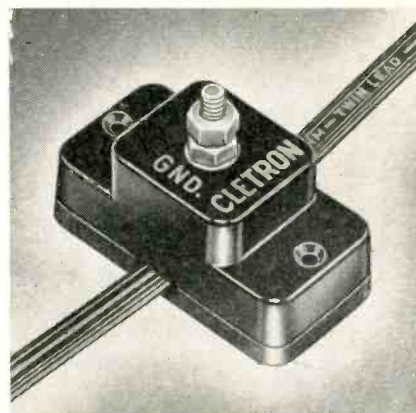

For complete information, write Bill Allen, Cleveland Electronics, Inc., 6624 Euclid Ave., Cleveland, Ohio.

Build YOUR OWN Heathkit TEST EQUIPMENT

Heathkit AUDIO GEN. KIT \$34.50

Heathkit TUBE CHECKER KIT \$29.50

Heathkit TELEVISION GENERATOR KIT \$39.50

Heathkit SIGNAL TRACER KIT \$19.50

Heathkit CONDENSER CHECKER KIT \$19.50

NEW Heathkit IMPEDANCE BRIDGE SET \$69.50

Heathkit 5" OSCILLOSCOPE KIT \$39.50

Heathkit BATTERY ELIMINATOR KIT \$22.50

Heathkit ELECTRONIC SWITCH KIT \$34.50

Heathkit VACUUM TUBE VOLT METER KIT \$24.50

Heathkit R.F. SIGNAL GEN. KIT \$19.50

Heathkits are beautiful factory engineered quality service instruments supplied unassembled. The builder not only saves the assembly labor cost but learns a great deal about the construction and features of the instrument. This knowledge aids materially in the use and maintenance of the equipment. Heathkits are ideal for and used by leading universities and schools throughout the United States. Each kit is complete with cabinet, 110V 60 cycle transformer (except Handi-Tester), all tubes, coils assembled and calibrated, panel already printed, chassis all punched, formed and plated, every part supplied. Each kit is provided with detailed instruction manual for assembly and use. Heathkits provide the perfect solution to the problem of affording complete service equipment on a limited budget. Write for complete catalog.

HEATH COMPANY
BENTON HARBOR, 12 MICHIGAN

EXPORT DEPARTMENT
13 EAST 40th STREET
NEW YORK 16, N.Y.
ABLE - ARLAB - N.Y.

CIRCUIT COURT

[from page 26]

of 60 cycle AC as a source of power rather than the more common high frequencies.

The primary is designed for 117 volts at 1 ampere. A 5 volt winding at 3 amperes supplies the 5U4G low-voltage rectifier. All six volt tubes are fed from a single 6.3 volt winding with 4.8 ampere capacity. Plate voltage for the picture tube is obtained from a 4000 volt secondary. The high-voltage rectifier, type 1B3, requires only 1.25 volts at .2 amperes from its source. The 5U4G plate winding develops 630 volts end-to-end.

SHOP NOTES

[from page 28]

which is just distinguishable from the next as an audible difference for music. The rating of a speaker is determined from the highest interval in which loudness is maintained at a significantly high percentage of normal. The table above relates the ratings to hearing and typical applications.

This new Frequency Range Rating is used to identify all speakers in the Jensen catalog.

Jensen Mfg. Co.

INCOME TAX

[from page 25]

ber 15, if the change occurs after June 1 and before September 2; January 15, if the change occurs after September 1. You may pay your estimated tax in four equal installments if you file on March 15. Fewer equal installments are provided for in case of later filing. Appropriate adjustments

Insure BETTER Television Service to Your Customers! . . . Exclusively Designed

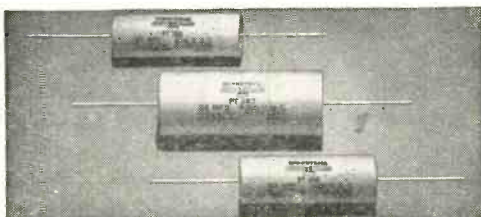

HIGH VOLTAGE AND ELECTROLYTIC TUBULAR TELEVISION CAPACITORS

Especially Engineered for Television Circuits by INDUSTRIAL CONDENSER CORP.

The economical quality line for replacement. Industrial Condenser Corp., manufacturers of Capacitors exclusively brings you highest quality for the particular requirements of Television at exceptionally attractive prices! Special Capacitors are Pyroteen impregnated for low power factor, high insulation resistance, high operating temperatures. Oil, Pyroteen, Wax and Electrolytic Capacitors. Finest materials throughout.

Ask Your Jobber for our Attractive Prices Today!

Or write for Bulletin 1095. Industrial makes quality Capacitors for Television, Radio, every electronic and industrial application—all types.

Send for Complete Catalog

INDUSTRIAL CONDENSER CORP.

3243 N. CALIFORNIA AVENUE CHICAGO 18, ILLINOIS
Sales offices in all principal cities



Modern plant built by Industrial Condenser Corp., for manufacture of Capacitors only.

in these filing and payment dates are permitted for taxpayers who keep their records and file regular income tax returns on a fiscal year basis. However, if, on or before January 15, 1950, you file your 1949 income tax return and pay in full the balance of tax due, you need not file a declaration or amended declaration which would otherwise be due on that date.

"Penalties are provided in case you fail to file when you should, if you underestimate your tax by more than 20 percent, or if you fail to make a payment when due. These penalties are explained in the instructions on Form 1040-ES. You will not be charged with a penalty for underestimation, however, if you base your estimate on the income which you showed in your income tax return (Form 1040) for the previous year. If during the year you discover that you have underestimated your income, you may avoid the penalty for underestimating your tax by filing an amended Declaration containing a revision of your estimated tax. One amendment may be filed in each quarter of the year. The final amendment must be filed by January 15, following the close of the tax year. If you have overestimated your tax, you may reduce your advance payments by filing an amended Declaration."

Let's take a case by way of illustration. Let's call him Johnny Jones, the owner of a midwestern radio service shop which, during 1949, brought him a net profit of \$8000. On that (using a joint return plan with his wife splitting the income), Mr. Jones shelled out \$944.00 to his Uncle Sam up in Washington. This was arrived at on the tax tables. His wife paid \$530.00. Jones took their only child, a daughter, as his exemption on the return and—declaring the identical \$4000 as his wife—paid \$414.00.

Jones figured that his business would be slightly better in 1950 than it was in 1949. He estimated that it would pay him a net profit of \$8500 instead of eight thousand flat. So he turned to the Form 1040-ES which had been sent to him by the Collector of Internal Revenue. On this form, he found the tax tables that also appear on the final tax return forms. Looking down those tables, he found that he and his wife would have to pay \$449.00 and \$565.00 respectively—a total tax of \$1014.00.

So he flipped over to the other side of the form. At the bottom, below the instructions, were two nearly identical tabs. One was for filing with the Collector of Internal Revenue; the other was for Jones' own files. He filled out names of himself and his

wife (using two different estimation forms). On each, he put this information:

Line 1 (estimated income tax)—\$507.00.

Line 2 he left blank, since he received no wages out of which taxes were withheld.

On Line 3, he entered the figure \$507.00 once more.

Since he had no overpayment "credit" for 1949, he ignored Line 4. Line 5 was likewise left blank; this applied to amended declarations. (Amended declarations are filed out in the same manner as original declarations, ex-

cept that this line is included.)

On Line 7 (unpaid balance of estimated tax), he again wrote the dollar sum, \$507.00.

One-quarter was to be paid on each installment. So on Line 7, Johnny Jones wrote the figure, \$126.75.

That's all there was to it.

One thing more: Do you have to file an income tax estimation? The answer is a definite "yes"—provided you come under the classifications explained by the U. S. Department of Commerce. The law provides for prosecution of those who "willfully fail" to do so.

TV SERVICE DEALERS! RIDE THE ALLIANCE TENNA-ROTOR

"CASH IN ON TV ADVERTISING" *Gravy Train!*

NEW!
Direction Indicator Control Model Now Available!

Eye-Compelling TV Demonstrations Sell!... 6,000,000 Viewers Around 50 TV Stations . . .

SEE TENNA-ROTOR IN ACTION!

Here's why it pays to stock Alliance Tenna-Rotor!

- Every week your customers see the Alliance TV film!
- Alliance Tenna-Rotor is the only TV antenna rotator backed by national television advertising!
- Proved in the field by thousands of users!
- Laboratory tested to operate in rain, snow or icy weather!
- Guaranteed for one year! • Underwriters' Laboratories Approved

Special Alliance 4 conductor cable with "ZIP" feature makes for faster, easier installations!

Tenna-Rotor eliminates antenna service complaints and expensive call-backs!

SERVICE DEALERS! . . . Climb on the gravy train now! Write for the Alliance Merchandiser—"Fastest Profit Maker in Television Today".

Alliance Manufacturing Company • Alliance, Ohio

Service Dealers

Form A Group,

Subscribe to "RSD" -

SAVE Up to \$1.00 each.



"The Professional Radioman's Magazine"—published monthly. All articles are exclusive and timely. Practically every issue is worth what an entire 1 year subscription costs.

★ The more in a group the bigger the savings. 6 men in a group save \$1.00 each; 4 men groups save \$.75 per man. Present "RSD" subscribers may participate in or form a group with co-workers, or even competitors. Still active subscriptions are automatically extended 1 year. Start a Group today! The timely and exclusive technical data appearing in future issues of "RSD" will make this the best investment you ever made. The special Group Rate offer may be withdrawn at any time—so hurry.

Use This Coupon For Convenience

(The coupon below can be used for from 1 to 6 subscription orders. Use it today!)



TEAR OUT — MAIL TODAY!

RADIO SERVICE-DEALER MAGAZINE
342 Madison Ave., New York 17, N. Y.

Please enter 1 year subscription orders for the names given below. Our remittance is enclosed.

NOTE: If you do not wish to tear this order blank out, just print or type the information on a single sheet of paper, following the style given. Each subscriber's occupation must be clearly described.

	In U.S.A. & Canada	Foreign Rates
<input type="checkbox"/> One 1-year subscription	\$2.00	\$3.00
<input type="checkbox"/> Two 1-year subscriptions, each	1.75	2.75
<input type="checkbox"/> Three 1-year subscriptions, "	1.50	2.50
<input type="checkbox"/> Four 1-year subscriptions, "	1.25	2.25
<input type="checkbox"/> Five 1-year subscriptions, "	1.10	2.00
<input type="checkbox"/> Six 1-year subscriptions, "	1.00	1.50

Name.....
Address.....

Describe Title or Position and Type of Business.....

State whether a New Subscriber or Renewal Order

Name.....
Address.....

Describe Title or Position and Type of Business.....

State whether a New Subscriber or Renewal Order

Name.....
Address.....

Describe Title or Position and Type of Business.....

State whether a New Subscriber or Renewal Order

Name.....
Address.....

Describe Title or Position and Type of Business.....

State whether a New Subscriber or Renewal Order

Name.....
Address.....

Describe Title or Position and Type of Business.....

State whether a New Subscriber or Renewal Order

Name.....
Address.....

Describe Title or Position and Type of Business.....

State whether a New Subscriber or Renewal Order

announcing

**New OXFORD
Packaged Loud Speakers
Replacement Line**

**A Colorful
Eye-Appealing Box
For Every
Speaker Size!**

- Quality
- Performance
- Acceptance

OXFORD SPEAKERS have always had a wide acceptance for all types of replacements. Manufactured to meet the most exacting speaker requirements has been our business for over 25 years.

These new, attention-compelling boxes will appeal to every member of the radio industry . . . modernly designed to facilitate constant inventory and simplify quick reference.

The Oxford line is complete in every respect from 2" to 15" units, with an OXFORD SPEAKER for every TV, FM, AM, AUTO and PA need.

Write for your copy of our new catalog today!

Leading jobbers carry Oxford Speakers.



OXFORD ELECTRIC CORPORATION

3911 South Michigan Avenue • Chicago 15, Illinois
EXPORT: ROBURN AGENCIES, NEW YORK CITY

Hickok
New Small Size
Dynamic Mutual Conductance
TUBE TESTER

World Famous

MODEL 500

THE HICKOK ELECTRICAL INSTRUMENT CO.
10533 DUPONT AVE. • CLEVELAND 8, OHIO

SEE YOUR JOBBER OR WRITE FOR COMPLETE INFORMATION TODAY

TV WAVEFORM

[from page 24]

is made possible by the equalizing pulse frequency mentioned previously.

In Figure 1-17B the upward motion of the vertical sync pulse begins its action at point C and the beam is retraced along the solid line path to point D. Vertical retrace time is generally 8 lines in duration. This retrace path can be observed on any TV screen by tuning in a station, turning up the brightness control, and turning down the contrast control so that the retrace lines become visible. The total number of horizontal lines traversed from A to D are now 262½, and we are now ready to start scanning the second field.

This is shown by the dotted lines in A. Notice that the beam is brought to point F. Then comes the final vertical retrace to point A for a grand total of 525 lines. It must always be borne in mind that immediately preceding the vertical pulse and just after the time the beam is brought to the top of the screen the blanking signal is active in keeping the retrace well within the black region. This also applies to the horizontal retrace.

At this point we might pause for a moment and recall that we have discussed two components present in the overall video signal. One is the video signal itself which contains the information pertaining to the relative intensities of black and white in each picture area. The other is the pulse signal which controls the beginning and end of each picture in synchronism with the picture scanning at the transmitter, and which cuts off the light on picture screen (blanking) while this control signal is in effect. We are now ready to discuss the remaining signal components present in the composite video signal.

HIGH QUALITY

[from page 19]

necessitated the use of high "Q" with a higher inductance. The resultant lower capacitance therefrom would have netted a less desirable frequency shift characteristic with application of a.v.c.

Coil details follow: The primaries and secondaries of the identical 04193 coils each have 27 turns of #35 P.E. wire close-wound and coupled upon a common bakelite tube having an adjustable alignment core assembly at either end. Two heat-stabilized 43

μ f shunt capacitors are mounted within each shield.

Dual Limiter

Amplified i-f output is coupled through the fourth 04193 coil directly to the control grid of the first 6UA6 sharp cutoff limiter. It is essential that the limiter react to both rapid and slow variations in amplitude and that it smooth out those variations still attending the signal at this point in the channel. Such variations if allowed to reach the following discriminator will cause distortion or noise. Static or other noises of a variable amplitude nature, riding along with the signal, are in this stage deleted. The use of dual limiters assures the removal of such obnoxious provided ample gain preceded this point. Three i-f stages surely saturate this limiter even for weak signal input.

The thoroughness of the cascade limiter as used here is explained basically as follows:

- (a) Time constants set up for the first 6UA6 grid circuit are designed for effective reaction to impulse or noise excitation.
- (b) Optimum reaction at the second 6UA6 grid is designed for a wide range of signal strength excitation.

Additive results mean a far more constant output over a wider range of amplitudes than is possible with a single limiter stage. Resistance coupling used between stages prevents regeneration. A.V.C. is developed within the first limiter stage; a bus is set up from the lower end of the 2.2 megohm resistor whence a.v.c. is fed to the control grids of the r-f, mixer and first i-f stages. The 6U5 tuning eye is fed from that same bus when switched for FM indication. An r-f choke (04588) in series with the heater supply bus appears in the schematic beneath the two limiter tubes.

Discriminator

The 6AL5 duo-diode demodulator affords independent operation of its two diode units. Its function is to discriminate between frequency deviations above and below the FM carrier frequency. The greater the deviation the greater the output. When there is no modulation introduced, there is no output from the 6AL5. Audio frequency modulations at the FM transmitter cause frequency deviations to occur at audio frequencies within this discriminator stage. Hence its rectified audio output can be amplified for linear reproduction of the original modulations. In other words true fidelity is the result.

The relation between frequency deviation at the input of the discrimi-

Get Set for LAND OFFICE BUSINESS on the *Astatic* TELEVISION BOOSTER Soon to be Advertised Nationally on TELEVISION

OWNERS OF TV RECEIVERS, and their friends, the nation over, will soon see the Astatic Television Booster in operation . . . and hear its exclusive advantages explained . . . from their favorite TV stations. It doesn't take a crystal ball to forecast the impact of TV advertising on sales of Astatic Boosters. When set owners in your area actually see weak, washed-out pictures on a TV screen changed to bright, clear action by the Astatic Booster, the skyrocketing of sales will be automatic. They'll be asking — by the thousands — for the "four-tube booster" with "variable gain control," "dual-tuning," "handsome furniture-finish mahogany cabinet," and other exclusive features they've seen and heard about ON TELEVISION. They'll ask by name for the Astatic Booster.

If there is anything you don't know about the Astatic Booster, write for specifications and complete details. Get behind this surefire program to help you sell. Check your stock. Order TODAY for your needs.

Astatic Crystal Devices manufactured under Brush Development Co. patents



Tricraft presents . . .

The new "VIDIETTE" indoor * TV antenna

model
"700"

by the ORIGINATORS of the electrically-tuned antenna

NO PUSHING AND PULLING OF RODS

Change stations without effort . . .

Simply move knob to channel desired . . . you are automatically electrically tuned in and reception comes BOOMING in.

ATTRACTIVE . . . SMALL . . . COMPACT

Priced for volume sales

Individually boxed . . . 24 units to a carton

Shipping weight, 32 lbs.

Write for illustrated literature today

TRICRAFT ANTENNAS are available at all leading jobbers



Tricraft Products Co.

1535 North Ashland Ave., Chicago 22, Ill.

Manufacturers of complete line of Television, FM and AM antennas and accessories

NEW!

OHMITE OHM'S LAW CALCULATOR

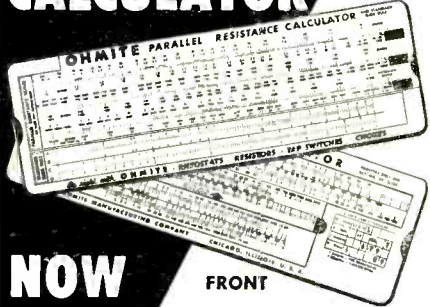

NOW HAS... PARALLEL RESISTANCE AND SLIDE RULE SCALES!

ONLY 25c

Redesigned! This new, improved version of the famous Ohmite Ohm's Law Calculator—popular the world over with servicemen, engineers, and students—now has scales for solving parallel resistance problems, and a standard slide rule. More useful than ever!

ONLY ONE SETTING REQUIRED

Solves Ohm's Law and many parallel resistance problems—simply, quickly, and accurately—with only one setting of the slide. Covers a range of values encountered in electronic and moderate power applications.

HANDY POCKET SIZE

Only 9" by 3"—fits the pocket. Slide rule scales multiply, divide, and find squares and square roots.

Be Right with

OHMITE

Reg. U. S. Pat. Off.

RHEOSTATS • RESISTORS • TAP SWITCHES

SEND FOR YOURS, TODAY

OHMITE MFG. CO.,
4845 Flournoy St.,
Chicago 44, Ill.

Send my new OHMITE Calculator. I enclose 25c in coin.

NAME _____

ADDRESS _____

nator and that of its output voltage amplitude remains linear throughout the i-f bandpass. The shielded coil assembly (04194), conveying the signal from the limiter to the discriminator, introduces both directly inductive and delayed capacitive coupling between the 6UA6 pentode and the 6AL5 double diode. The two cathodes are connected across the network shown and the resultant is passed forward.

Final Output

From the rectified 6AL5 output, the signal is passed on through the final selector of the switching system to the dual 6J5 audio stages whose equalizing attributes were discussed earlier under "Switching". A workable high impedance signal of 11 volts into 30,000 ohms or better, or a balanced 500 ohm 2 volt output, is produced. A maximum distortion of 2½% holds for each output. At higher impedance, care in matching must be exerted and short connectors used, even if low capacity cabling is employed. Checks for losses in frequency response can be compared at the tuner output against that of the input of the following amplifier. The balanced 500 ohm output permits a transmission line link. Don't forget a really good tuner rates a mighty fine following amplifier. This tuner will satisfy discreet custom-made installations.

PROTECTION

[from page 20]

the same optical principles as are found in ordinary projection television receivers.

Figure 6 shows the other optical components which are usually found in the television receiver. The projection tube usually a 5TP4 is mounted facing the concave spherical mirror. However, all spherical mirrors have a certain amount of optical distortion which would present a fuzzy over-all appearance to the projected picture. This is not a defect in manufacture but is rather a built-in defect in all spherical mirrors. Theory and experimentation prove that there are several methods of eliminating or counteracting this spherical aberration or defocusing. One way is to use a non-spherical mirror. However, because of technical production difficulties, this has never been used in any mass produced projection television receiver. Instead, a corrector lens is introduced.

The function of this lens is to introduce an equal and opposite distortion to the spherical aberration. The combined effect of the corrector lens and spherical aberration of the concave mirror is to produce a sharp well-defined picture. This corrector lens is

Nation-wide
ACCEPTANCE
on Proven Superiority



ANCHOR
TV PRE-AMPLIFIER
Here's Proof of Distributor Acceptance

SOUTH BEND, IND.—"We have found Anchor TV Pre-Amplifier to be superior in performance to anything else on the market. It has been a profitable item on which we have built up dealer good will."

COMMERCIAL SOUND & RADIO CO.—A. E. Kester, Pres.

PHILADELPHIA, PA.—"Anchor Booster's consistency, its high gain and its performance in outer fringe areas have built for it a reputation which cannot be beat in our area. The excellency of this product has opened up many television areas and many additional sales in Television Receivers, their component parts and accessories."

RADIO ELECTRIC SERVICE COMPANY OF PENNSYLVANIA
Albert N. Kass, Sales Manager

ANCHOR has established
general acceptance and good will
for all good boosters through its own
top-notch performance!

Unanimous proven verdict of users. Anchor's engineering is not approached—nor will it ever be.

The ANCHOR BOOSTER is built to help you make the best TV installations possible for your customers.

Why then be satisfied with the ordinary? Anchor builds demand for reliable boosters—making more sales—adding good will. Tie Anchor Booster into every television sale.

Here is dependability with instant sales appeal—2½ times average gain (Voltage Ratio), guaranteed coverage of low and high band—precision with beauty—pride in having the best!

Get in touch with your jobber—
or write ANCHOR

"ANCHOR ENGINEERING ALWAYS A YEAR AHEAD"



\$1.00 to \$5.00 PAID
for "SHOP NOTES"

Write up any "kinks" or "tricks-of-the-trade" in radio servicing that you have discovered. We will pay from \$1 to \$5 for such previously unpublished "SHOP NOTES" found acceptable. Send your data to "Shop Notes Editor," RADIO SERVICE DEALER, 342 Madison Ave., New York 17, N. Y. Unused manuscripts cannot be returned unless accompanied by stamped and addressed return envelope.

**JACK-OF-ALL-TRADES
REPLACEMENT...**

AEROVOX

**CLEAT-MOUNTING
ELECTROLYTICS**



● An Aerovox-originated type. Replaces other electrolytics requiring mounting hole in chassis, twist-prong base, spade-lug, and/or tubular types. This jack-of-all-trades cleat-mounting job is installed in a jiffy by center screw and metal cleat.

Available in the aluminum-can (illustrated) Type PRVC for the better trade (single, dual and triple sections). Also in the cardboard tube Type PRV for the price-conscious trade. Definitely, but really definitely, the jack-of-all-trades replacement.

● Keep a supply of these universal replacements on hand. Or depend on your Aerovox jobber to supply you in a hurry. Catalog on request.



**FOR RADIO-ELECTRONIC AND
INDUSTRIAL APPLICATIONS**

AEROVOX CORP., NEW BEDFORD, MASS., U.S.A.
Export: 13 E. 40th St., New York 16, N.Y. • Cable: 'ARLAB'
In Canada: AEROVOX CANADA LTD., Hamilton, Ont.

a very shallow type of lens which does not form the projected image but merely serves to sharpen or bring the image into over-all focus. All present day commercial examples of this modified Schmidt projection system use some type of corrector lens. In Fig. 7 the home type or "small" projection system is shown. In the life size or

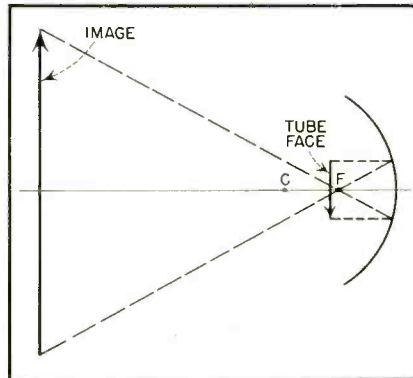

Fig. 5. A magnification of $5\frac{1}{2}$ times is obtained by bringing the object still closer to F.

theatre models, the viewing screen is not a part of the receiver cabinet. The screen is usually of the type found with home motion picture projector systems. In Fig. 7 a plane mirror is used to fold the optical system and al-

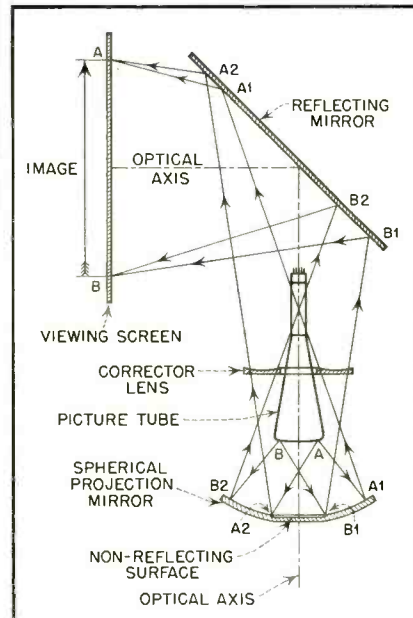
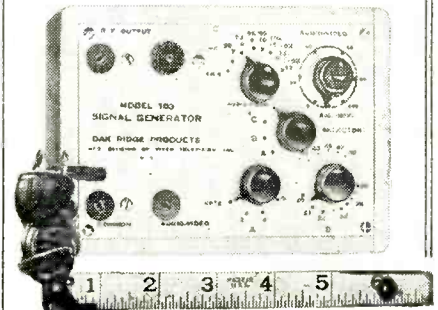

Fig. 6. Components contained in typical reflective TV system.

low it to fit in a more compact unit. Theatre projection uses an optical barrel which is the same as Fig. 7 without the plane mirror.

Life size projection television utilizes the same optical principles as the smaller type of projection which is found on the market under many trade names. The newest trend toward

NEW! FOR FIELD OR BENCH WORK...
OAK RIDGE miniatures
work like **GIANTS** for You!
EASIER, FASTER, MORE PROFITABLE
TV-FM SERVICING... at lowest cost!



**OAK RIDGE 10-in-1 MINIATURE
TV-FM SIGNAL GENERATOR**

Pinpoints any signal failure from antenna to CRT or speaker in 2 minutes flat! Incorporates 3 separate tuning bands and modulation output and attenuator for TV & FM. Generates a signal to perform as complete

- RF, OSC, and Mixer (1st Det.) Tester
- Video IF Tester
- Audio IF Tester
- Video & Audio 2nd Detector Tester
- Video & Audio Amplifier Tester
- Sound Trap Aligner or Tester
- Adjacent Picture Trap Aligner or Tester
- Marker Generator
- Antenna Orientation Tester
- Antenna Sensitivity Tester.

You get ALL TEN IN ONE with this extremely adaptable, precision-made Model 103! Size: $5\frac{1}{4} \times 4 \times 2\frac{1}{4}$ ". Dealer's Net \$29.95.

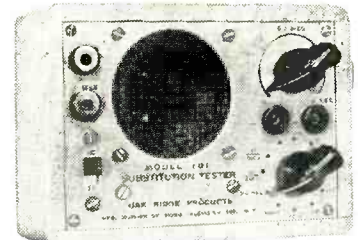

**OAK RIDGE 7-in-1 MINIATURE
TV-FM-AM SUBSTITUTION TESTER**

Which of these Servicing Aids do You Need Most?

- Test Speaker Without Transformer
- Test Speaker With Transformer
- Paper Condenser Substitutor
- Electrolytic Condenser Substitutor
- Fixed Resistor Substitutor
- Variable Potentiometer Substitutor
- Audio Signal Tracer for Video, Audio & Sweep Circuits in TV, FM, AM, Audio Amplifiers, etc.

You get ALL SEVEN IN ONE with the versatile, precision-made Model 101! Size: $5\frac{3}{4} \times 4 \times 2\frac{1}{4}$ ". Dealer's Net \$16.25.



**OAK RIDGE
3-in-1
MINIATURE
TV HIGH
VOLTAGE
TESTER**

Accurately checks all high voltages in any direct-view or projection TV set. Has precision 10,000 ohm/volt movement, three scales: 0-500V, 0-15KV, 0-30KV. Complete with special high voltage test lead. Size: $5\frac{3}{4} \times 4 \times 2\frac{1}{4}$ ". Dealer's Net \$14.95.

Boost your efficiency and earnings! Ask your parts jobber for these amazing new MINIATURES today! Write for free Catalog T-D.

OAK RIDGE PRODUCTS
239 EAST 127th STREET NEW YORK 35, N. Y.
Manufacturing Division of VIDEO TELEVISION, INC.
Makers of the famous OAK RIDGE Patented
SNAP-LOCK TV-FM Antennas and Accessories.

DRAKE

insta-heat SOLDERING GUN

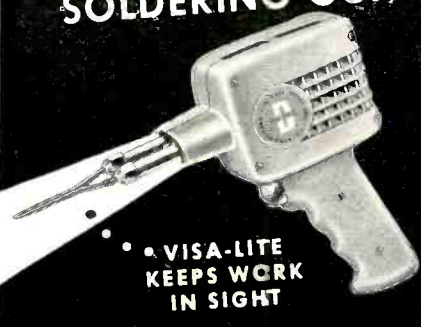

• VISA-LITE
KEEPS WORK
IN SIGHT

Perfectly balanced, functional in design, the DRAKE "insta-heat" Soldering Gun gives you all the features you've wanted: A full 135 watts, this gun has the perfectly located VISA-LITE, that keeps work always in full view—even in dark difficult corners. The soldering tip is easily - instantly - removable, using only a screwdriver. See your distributor.

DRAKE ELECTRIC WORKS, INC.
3656 LINCOLN AVENUE CHICAGO 13

KELLOGG

M-5 SELECT-O-PHONE



ALL THE
ADVANTAGES
OF A *Private* TELEPHONE
SYSTEM AT LOW COST!

Other Models
Available Up to 48 Stations.

SELECT-O-PHONE DIVISION
Kellogg Switchboard and Supply Company
6610 South Cicero Avenue, Chicago 38, Illinois

Please contact us regarding our private telephone requirements. We will need () telephones.

NAME _____

COMPANY _____

ADDRESS _____

CITY _____ ZONE _____ STATE _____

home theatre television has the same optical principles and may be serviced and adjusted with the same techniques as are found useful in other projection receivers. The magnification can be controlled by moving the picture tube

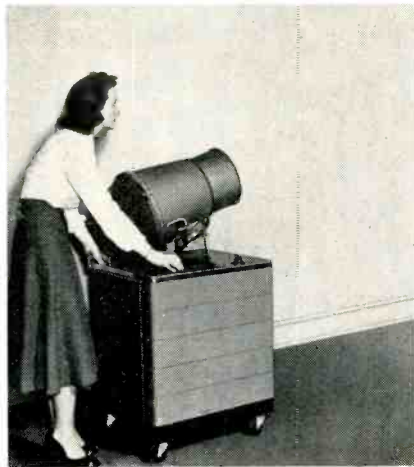

Fig. 7. Home projection system.

in relation to the concave mirror. Increasing the distance between the picture tube and the mirror will decrease magnification and hence decrease the picture size, making the distance between the tube face and the mirror less will increase the magnification while it increases the picture size.

NEW ODEGAARD ORIGINAL NAIL POLYETHYLENE STANDOFF

HIGHEST EFFICIENCY AT LOWEST COST!

for Ribbon or
Coaxial Cable

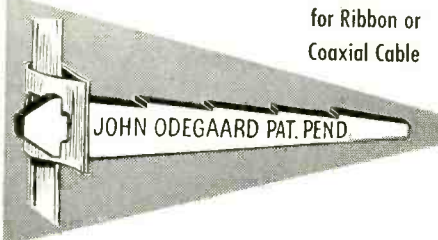

- Saves more labor, time and money than any other standoff!
- No drilling—just quick, easy hammer strokes
- Easily drives into wood, mortar, iron, aluminum, etc.
- Also excellent mast-coupler
- "Step"-locked, durable installation
- Cadmium-plated hardened high-carbon steel nail
- Specially punched lo-loss polyethylene

SERVICEMEN: For free sample and name of nearest distributor, write today to Dept. D.

PARTS DISTRIBUTORS: Choice protected territories still open. For full details write today to Dept. D.

ODEGAARD MFG. CO.

5416 Eighth Ave. Brooklyn 20, N. Y.
Copyright 1950, Odegaard Manufacturing Co.

AD INDEX

Aerovox Corporation	39
Alliance Manufacturing Co.	33
American Television & Radio Co.	35
Anchor Radio Corp.	38
Astatic Corporation, The	37
Belden Manufacturing Co.	Cover 2
Burgess Battery Co.	10
Commercial Trades Institute	35
Drake Electric Works, Inc.	40
DuMont Labs. Inc., Allen B.	7
Duotone Co. Inc.	30
Eastern Technical School	35
Heath Company	32
Hickok Elec'l Instrument Co.	36
Industrial Condenser Corp.	32
Kellogg Switchb'd & Sup. Co.	40
KenRad Tube Div. of G.E. Co.	3
Mallory & Co., Inc., P.R.	14
Milner Manufacturing Co.	31
Oak Ridge Products	39
Odegaard Mfg. Co.	40
Ohmite Mfg. Co.	38
Oxford Electric Corporation	36
Radiart Corporation, The	4, 5
RCA (Electron Tubes)	Cover 4
Rider Publisher Inc., John F.	8, 9
Sangamo Electric Co.	11
Simpson Electric Co.	Cover 3
Sprague Products Co.	6
Strand Hotel	40
Sylvania Elec. Prods. Inc.	13
Telrex, Inc.	12
Tricraft Products Co.	37
Triplett Elec. Instru. Co.	1



HOTEL STRAND

ATLANTIC CITY'S IDEAL CONVENTION HOTEL

Exceptional Convention Facilities adaptable to small, medium or large groups. Ample Meeting, Banquet and Exhibition Rooms. Wonderful location Boardwalk opposite Steel Pier. Write Convention Manager TODAY.

The Strand features Spacious Colorful Lounges—Open and Inclosed Solaria—Salt Water Bath in rooms—Garage on premises. Courteous Personnel.

When in Atlantic City visit

Famous Fiesta Lounge

Food for Epicures

Exclusive Penna. Avenue and Boardwalk.

Simpson
INSTRUMENTS THAT STAY ACCURATE

Presents

the **New!**
MODEL 303

**VACUUM
TUBE
VOLT-OHMMETER**

... A Worthy Companion
of the 260



SPECIFICATIONS

DC Voltage
Ranges—1.2, 12, 60, 300, 1200 (30,000 with Accessory High Voltage Probe)
Input Resistance—10 megohms for all ranges
DC Probe—with one megohm isolating resistor
Polarity reversing switch

Ohms
Ranges—1000 (10 ohms center)
100,000 (1000 ohms center)
1 megohm (10,000 ohms center)
10 megohms (100,000 ohms center)
1000 megohms (10 megohms center)

AC Voltage
Ranges—1.2, 12, 60, 300, 1200
Impedance (with cable) approx. 200 mmf shunted by 275,000 ohms

AF Voltage
Ranges—1.2, 12, 60
Frequency Response—Flat to 100,000 cycles

Decibels
Ranges—-20 to +3, -10 to +23, +4 to +37, +18 to +51, +30 to +63
Zero Power Level—1 M. W., 600 ohms

Galvanometer
Zero center for FM discriminator alignment and other galvanometer applications

R. F. Voltage
(Signal tracing with Accessory High Frequency Crystal Probe)
Range—20 volts maximum
Frequency—Flat 20 KC to 100 M.C.
105-125 V., 60 cycles

Size 5 1/4" x 7" x 3 1/4" (bakelite case). Weight: 4 lbs. Shipping Wt.: 6 1/2 lbs.

Dealer's Net Price Model 303, including DCV Probe, ACV—Ohms probe and Ground Lead—\$58.75; Accessory High Frequency Probe, \$7.50 Accessory High Voltage Probe, \$14.85
Also available with roll top case, Model 303RT—\$64.75

Smaller and Handier for Greater Portability

A worthy companion of the world-famous Model 260 is this brand new addition to the Simpson line—the Model 303!

Skilled Simpson engineers spent months of painstaking research in the laboratory to produce the Model 303, which is one of the most versatile instruments ever made for TV servicing. This ruggedly constructed instrument offers the maximum in portability because it is approximately 60% smaller than other vacuum tube volt-ohmmeters. However, no sacrifice has been made in readability. The 303 has a large 4 1/2" meter, despite its handy compactness.

One of the many features of the 303 is its low current consumption. The AC voltage range is wider than on any other similar instrument—from 1.2 volts minimum to 1,200 maximum. Like all other instruments bearing the Simpson name, the Model 303 is an instrument of highest quality at an amazingly low price.

SIMPSON ELECTRIC COMPANY

5200-5218 West Kinzie Street, Chicago 44, Illinois
In Canada: Bach-Simpson, Ltd., London, Ontario

THE QUALITY OF RCA TUBES IS UNQUESTIONED



ANOTHER MILESTONE IN

Television Progress

...the new RCA-16GP4 short
metal-cone kinescope with
"Filterglass" face plate

UNCEASING RESEARCH in television tubes by RCA engineers is responsible for the development of the new, short 16GP4 metal kinescope.

This 16-inch-diameter tube is actually $\frac{5}{16}$ " shorter than the 10BP4 . . . nearly 5" shorter than the 16AP4. Thus, greater flexibility and compactness is made possible in receiver and cabinet design.

Also, a superior picture is realized from the RCA "Filterglass" face plate. Picture contrast is improved by minimizing the effects of reflected room light, and of light reflections within the face plate itself.

RCA's engineering leadership adds *value beyond price* to the RCA tubes you sell. And you benefit directly from this *continued* research by the new enterprises which it creates.

Always keep in touch with your RCA Tube Distributor



RADIO CORPORATION of AMERICA
ELECTRON TUBES

HARRISON, N. J.