

Radio
**SERVICE
DEALER**

NOVEMBER, 1948



THIS ISSUE:

Field Findings
Sweep Generators
155 Loudspeakers, Voltage-Fed
Making Good TV Installations
TV Picture Tubes
FM-TV Antenna Mast Support

AM-FM-TV-SOUND

The Professional Radioman's Magazine

**ALL
NEW**

P. R. MALLORY & CO. Inc.
MALLORY
Midgetrol

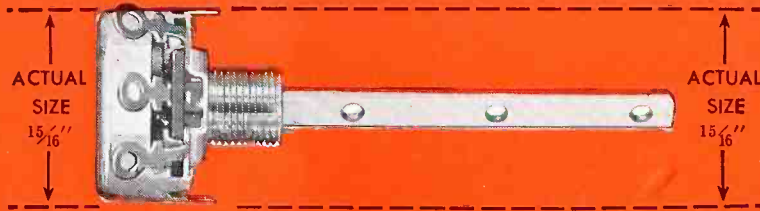

*The Little Volume Control
with BIG Advantages*

**Bigger
Market**

The small size of the Mallory Midgetrol lets you service portables, auto radios and small AC-DC receivers which require $1\frac{5}{16}$ " controls.

**Simpler
Installation**

The unique shaft design of the Mallory Midgetrol saves installation time with *all* types of knobs.

**Simpler
Stocking**

Electrical characteristics let you use the Mallory Midgetrol to replace $1\frac{1}{8}$ " as well as $1\frac{5}{16}$ " controls. Stocks are further reduced because no special shafts are needed.

The Mallory Midgetrol is quietest by actual tests—and tests prove it stays quiet, too. In addition, it has nine big features that are *all new*.

- NEW SIZE
- NEW DESIGN
- NEW SHAFT
- NEW EXTENSION
- NEW SWITCH
- NEW ELEMENT
- NEW CONTACT
- NEW TERMINAL
- NEW TWO-POINT SUSPENSION

It's the NEW Standard in Carbon Controls. See your Mallory Distributor.

P. R. MALLORY & CO. Inc.
MALLORY

CAPACITORS . . . CONTROLS . . . VIBRATORS . . .
SWITCHES . . . RESISTORS . . . RECTIFIERS . . .
VIBRAPACK* POWER SUPPLIES . . . FILTERS

*Reg. U. S. Pat. Off.

APPROVED PRECISION PRODUCTS

P. R. MALLORY & CO., Inc., INDIANAPOLIS 6, INDIANA

CROSLEY *Twice Tested*

★ RADIO PARTS for general replacement



IMMEDIATE DELIVERY!

from your nearest CROSLEY Distributor, listed below



LOOK FOR this emblem on the outside of every package of parts you buy. It's your guarantee of quality parts inside.

HERE'S 100% PROFIT FOR YOU



plus dynamic
Floating Jewel †
Display

You'll want plenty of fast-selling Crosley Floating Jewel † replacement needles for Christmas buying. Here's a special "stock up" offer that means 100% profit for you . . . plus! Order 24 Floating Jewel † needles, retail value \$60.00, your cost, only \$30.00. You make 100% profit! Your profit-plus is the attractive needle display. It's self-dispensing, stores up to 24 needles. Tell-all design shows your customers how the Floating Jewel † floats on sides of grooves, can't dig in and s-c-r-a-t-c-h. Order your needles and display now from your nearest Crosley distributor.

† Patented

CROSLEY
Division—AVCO Manufacturing Corporation
Cincinnati 25, Ohio

Albany, New York Roskin Bros.
Amarillo, Texas

Domestic Appliance Dist.
Atlanta, Georgia . . . Georgia Appliance
Baltimore, Maryland Legum Distributing
Birmingham, Ala. Alabama Service Co.
Boston, Mass. Wahn Distributors
Buffalo, N. Y. Western Mdse. Dists.
Bristol, Tenn.-Va. Interstate Hardware Co.
Carrier Mills, Ill. . . . O'Keefe Distributing
Charlotte, N. C. . . Carolinas Auto Supply
Chicago, Illinois . . . Harry Alter & Bros.
Cincinnati, Ohio . . . Modern Distributing
Clarksburg, W. Va. . . . Utility Co., Inc.
Cleveland, Ohio . . . Frankelite Company
Columbus, Ohio Miami Valley Dist. Co.
Dallas, Texas . . . Lone Star Wholesalers
Davenport, Iowa . . . Sieg Home Supply
Dayton, Ohio Miami Valley Dist.
Denver, Colo. . . Graybar Electric Co., Inc.
Des Moines, Iowa . . . H. E. Sorenson Co.
Detroit, Mich. . . . Peninsular Dist. Co.
El Paso, Texas Vaughan Appliance
 Fargo, N. D. Meyers-Taube Co.
 Ft. Smith, Arkansas Eads Bros. Furniture
 Ft. Wayne, Indiana . . R. M. Kaough Co.
 Ft. Worth, Texas . United Appliance Co.
 Grand Rapids, Mich.

Independent Distributors, Inc.
Great Falls, Mont. . . Gt. Falls Paper Co.
Harlan, Ky. Kentucky Mine Supply
Harrisburg, Pa. . . . Jules Alexandre, Inc.
Hastings, Nebraska . . . Dutton-Lainson
Hazleton, Pa. Lehigh Valley Dist.
Houston, Texas

Reader's Wholesale Distributors
Huntington, W. Va. Huntington Wh'e Furn.
Indianapolis, Ind. . . Capital Paper Co.
Jackson, Miss. . . . Southern Wholesalers
Jacksonville, Fla. . . Graybar Elec. Co., Inc.
Kansas City, Mo. . . Superior Distr. Co.
Little Rock, Ark. . . . Wright Service Co.
Los Angeles, Calif. . . . J. N. Ceazan Co.
Louisville, Ky. Cooper-Louisville
Manitowoc, Wis. . . . J. J. Stangel Hdwe. Co.
Memphis, Tenn. National Rose Co.
Miami, Fla. . . . Graybar Electric Co., Inc.

Milwaukee, Wis. . . . Greusel Distr. Co.
Nashville, Tenn. . . . Nashville Chair Co.
Newark, N. J. Apollo Service, Inc.
New Haven, Conn. . . H. M. Tower Corp.
New Orleans, La.

Woodward, Wight & Co.
New York, N. Y. . . . Crosley Distr. Corp.
Omaha, Nebr. . . Electric Fixture & Supply
Orlando, Fla. . . . Graybar Elec. Co., Inc.
Peoria, Illinois . . . Johnston-Moody Co.
Philadelphia, Pa. . . Judson C. Burns, Inc.
Phoenix, Arizona Appliance Distributors
Pittsburgh, Pa. . . Pittsburgh Products Co.
Portland, Maine Graybar Elec. Co., Inc.
Portland, Ore. . . . Fields Sales Company
Providence, R. I. . . Graybar Elec. Co., Inc.
Quincy, Illinois . . . Tenk Hardware Co.
Reno, Nev. . . . Heat. & Air Cond. Supply
Richmond, Virginia . . Louis O. Bowman
Roanoke, Va. . . . Richardson-Wayland
Rochester, N. Y. . . O'Donnell-Dunigan
Saginaw, Mich. . . J. Geo. Fisher & Sons
Salt Lake City, Utah Western Supply Co.
San Antonio, Texas. . Alamo Distributing
San Francisco, Calif. . California Electric
Savannah, Georgia . . . Frank Corp.
Seattle, Wash. Commercial Appliance Co.
Shreveport, La. Electric Supply Co.
Sioux Falls, S. D. . . . Power City Radio
South Bend, Ind. . . The Ridge Company
Spokane, Wash. Kelly Johns Inc.
Springfield, Ill. . . Central Ill. Wholesalers
Springfield, Mass. . . . Tarbell-Watters
Springfield, Mo. . . . Rogers & Baldwin
Sterling, Illinois . . . Hardware Products
St. Louis, Missouri . . . ARA Distributing
St. Paul, Minn. . . Motor Power Equip. Co.
Syracuse, N. Y. . . O'Donnell Distributors
Tampa, Fla. . . . Graybar Elec. Co., Inc.
Toledo, Ohio

Walding-Kennan & Marvin Co.
Tulsa, Oklahoma Tom P. McDermott, Inc.
Tucson, Arizona Appliance Distributors
Washington, D.C. American Wholesalers
Watertown, S. D. Lyle Meyers
Wichita, Kansas . . . Loyal Distributors
Youngstown, Ohio . . . Dorrance Supply

EDITORIAL

by S. R. COWAN

Service Manpower Shortage

In every locality now receiving telecasts there is a shortage of competent TV technicians and installers. Of the approximately 40,000 technicians now engaged in radio repair work, probably less than 10% are genuinely qualified to handle TV problems. With the rapid strides TV is making, this country will soon require upwards of 100,000 TV technicians. Old-timers in the radio servicing profession may consider the foregoing statement as heresy; but reasoning will prove it's logic.

Time studies indicate that a competent technician requires upwards of 2 hours benchwork to trouble-shoot and repair the average defective TV receiver. So, an average technician can handle 4 TV problem sets a day. There are only 250 (or less) working days a year, so in general terms, a TV technician can be expected to handle 1,000 TV repair jobs a year. Well over 1,000,000 TV sets will soon be in use. By late 1950 it is possible that over 10,000,000 videosests will be in use. BUT, —as the average TV set requires 4 service jobs annually, to handle the volume of repairing and adjusting which will undoubtedly be required, 40,000 technicians must be available. Progressively, when there are 15,000,000 videosests in use in 1951, over 60,000 benchmen will be needed to handle the volume.

So much for actual benchwork. What about installations? The average TV installation takes 2 men four hours. So, two installers working 250 days a year can account for approximately 500 installations. So, projected mathamatically, 12,000 installers can handle 3,000,000 TV installations a year (and there should be over that number in 1949) and the industry will require 20,000 installers to handle 5,000,000 jobs.

Now, assuming that the aggregate of 60,000 benchmen and 20,000 installers are engaged solely in TV work at the end of 1951, certainly the owners of 80,000,000 conventional AM-FM-Phono radios will also require the services of at least 20,000 technicians to handle their repair work. Yes, there is reason to believe that the radio-video industry will require over 100,000 qualified technicians within the next two or three years. You old-timers owe it to yourselves to prepare for the inevitable—either learn all about TV now, or plan to retire to a less hectic line of endeavor in the near future.

Why I Like TV

Over 9,000 radio technicians who heard my talks at one city or another during September and October of this year realized I was sincere every time I stated that TV is the answer to all radio technicians' prayers for a vista that will elevate their earning capacity and standard of living. There will be no \$9.95 TV receivers for some years to come. The TV sets that are sold will require more repairing than conventional AM types as they contain more than 4 times as many components and the potential of breakdown is in the mathematical progression of 10 to 1. So, what were ordinary \$2 and \$5 service jobs on AM sets can be relegated to the obscure past. Now we can look forward to \$25 and \$50 service jobs, and \$25 and \$50 installation jobs. Besides, we can look for-

[Continued on page 48]



Member of the
Audit Bureau of
Circulations

radio service dealer

VOL.
9
NO.
11

SANFORD R. COWAN, Editor & Publisher

SAMUEL L. MARSHALL, Technical Editor

NOVEMBER, 1948

Editorial	2
Trade Flashes	6
Field Findings, by S. R. Cowan..... Industry happenings here and there	9
Sweep Generators, by John F. Rider..... Description and operation of sweep generators	11
155 Loudspeakers, Voltage-Fed, by C. A. Tuthill..... How a difficult p-a problem was solved	16
Making Good TV Installations, by Douglas H. Carpenter..... Principles and practices of good TV installations	17
TV Picture Tubes, by Samuel L. Marshall, Part 2..... Applications of CRT control circuits	19
FM-TV Antenna Mast Support, by Hy D. Kraft..... Principles of safe and workmanlike mast installations	24
Circuit Court	28
Edwards Fidelotuner; General Electric Models 354 and 355; Motorola 77FM Series	
New Products	30

SANFORD L. CAHN
National Advertising Sales Manager

HARRY N. REIZES
Advertising Manager

BRANCH: J. C. GALLOWAY, 816 W. 5th St., Los Angeles 13, Calif., Mutual 8335

Jean M. Wheeler
Circulation Manager

David Saltman
Adv. Production Manager

RADIO SERVICE DEALER (title registered U. S. Pat. Off.) is published monthly at New York, N. Y. by the Cowan Publishing Corp. Executive & Editorial Offices, 342 Madison Avenue, New York City 17, New York. Subscription rates:—United States, U. S. Possessions and Canada, \$2.00 for 1 year, \$3.00 for 2 years; elsewhere \$3.00 per year. Single copies: 25c. Printed in U. S. A. Entered as Second Class Matter at the Post Office at New York, N. Y., under the Act of March 3, 1879. All subscribers should allow at least three weeks for change of address. Copyright 1948, by Cowan Publishing Corp.

SERVES AND PLEASES MILLIONS!



GENERAL  ELECTRIC

176-0A7-0000

FIRST AND GREATEST NAME IN ELECTRONICS

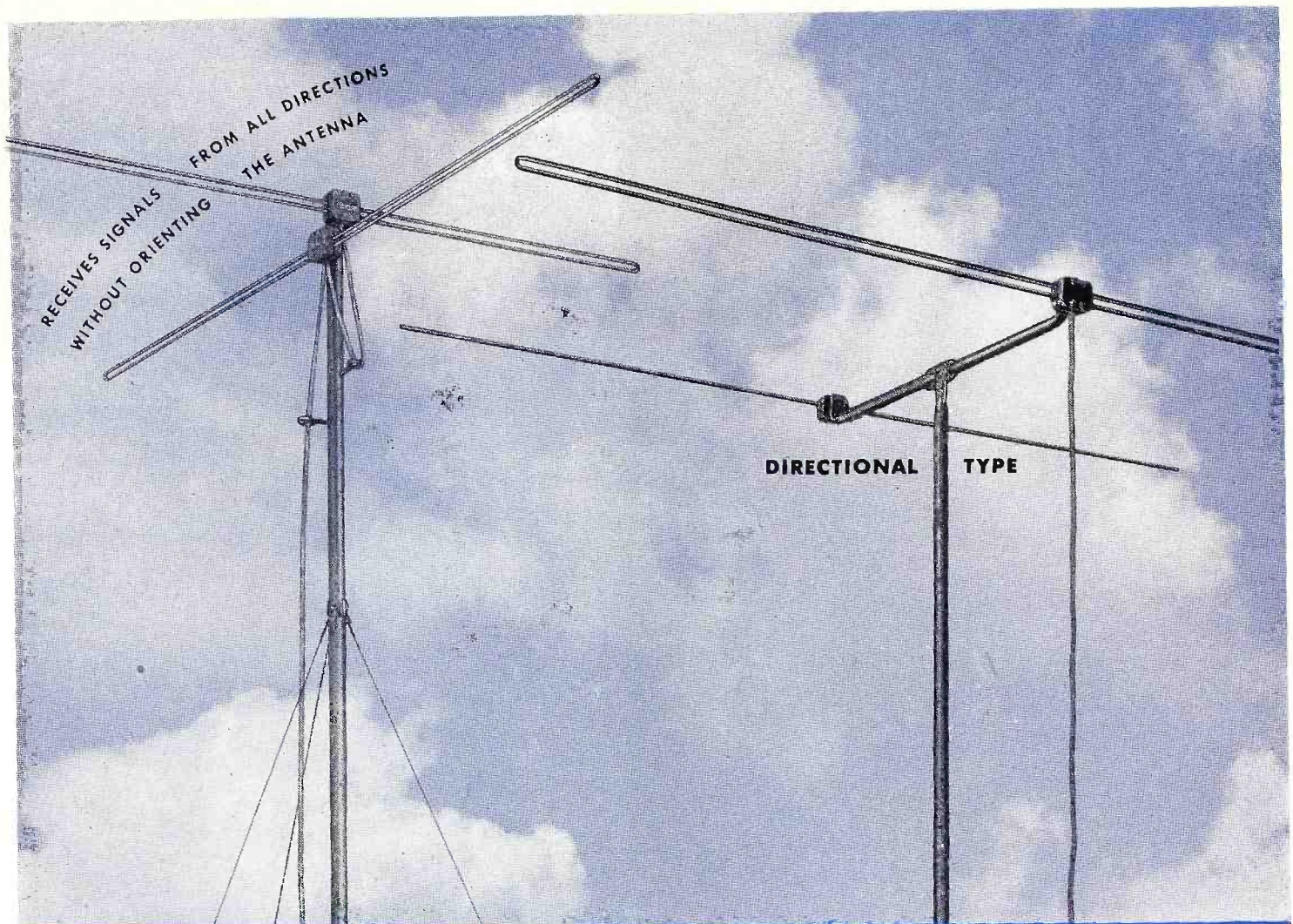

RECEIVES SIGNALS
WITHOUT ORIENTING
THE ANTENNA

DIRECTIONAL TYPE

Insure FM Performance with a GOOD FM ANTENNA

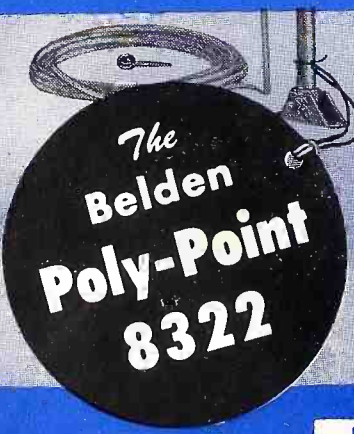

The
Belden
Poly-Point
8322

- Belden FM Antennas are engineered for finest FM reception.
 - Use Belden 8322 Poly-Point Antenna to receive signals from all directions without turning!
 - Use Belden 8320 Dipole Antenna for installations requiring directional characteristics.
 - Sturdy aluminum construction withstands severe ice loading and high wind.
 - COMMON-SENSE PRICES.
- ASK your Belden Jobber

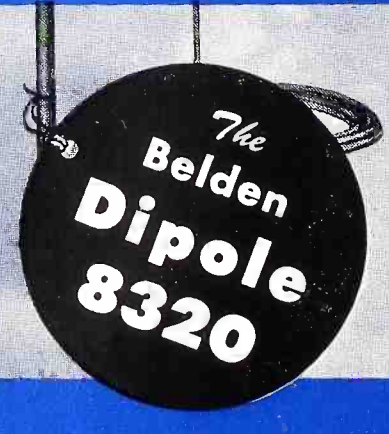

The
Belden
Dipole
8320

Belden Radio WIRE

Form A Group, Servicemen—

Subscribe to "RSD"—

SAVE Up to 50%

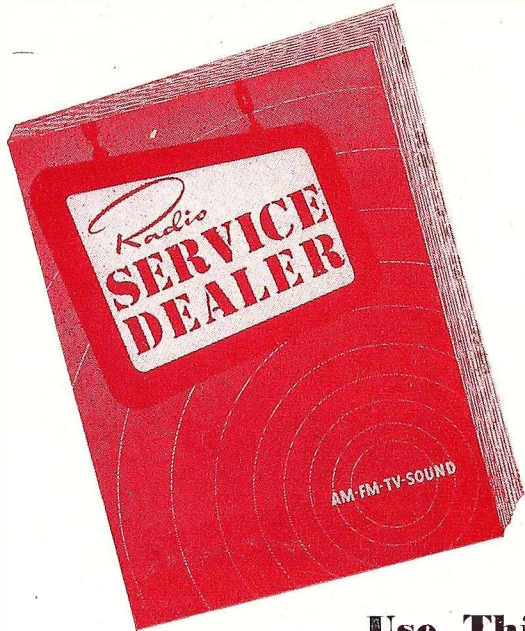

★ The more in a group the bigger the savings. 6 men in a group save \$1.00 each; 4 men groups save \$.75 per man. Present "RSD" subscribers may participate in or form a group with co-workers, or even competitors. Still active subscriptions are automatically extended 1 year. Start a Group today! The timely and exclusive technical data appearing in future issues of "RSD" will make this the best investment you ever made. The special Group Rate offer may be withdrawn at any time—so hurry.

Use This Coupon For Convenience

(The coupon below can be used for from 1 to 6 subscription orders. Use it today!)



TEAR OUT—MAIL TODAY

RADIO SERVICE-DEALER MAGAZINE
342 Madison Ave., New York 17, N. Y.

Please enter 1 year subscription orders for the names given below. Our remittance is enclosed.

NOTE: If you do not wish to tear this order blank out, just print or type the information on a single sheet of paper, following the style given. Each subscriber's occupation must be clearly described.

	In U.S.A. & Canada	Foreign Rates
<input type="checkbox"/> One 1-year subscription	\$2.00	\$3.00
<input type="checkbox"/> Two 1-year subscriptions, each	1.75	2.75
<input type="checkbox"/> Three 1-year subscriptions, "	1.50	2.50
<input type="checkbox"/> Four 1-year subscriptions, "	1.25	2.25
<input type="checkbox"/> Five 1-year subscriptions, "	1.10	2.00
<input type="checkbox"/> Six 1-year subscriptions, "	1.00	1.50

Name.....
Address.....
Describe Title or Position and Type of Business.....
State whether a New Subscriber or Renewal Order

Name.....
Address.....
Describe Title or Position and Type of Business.....
State whether a New Subscriber or Renewal Order

Name.....
Address.....
Describe Title or Position and Type of Business.....
State whether a New Subscriber or Renewal Order

Name.....
Address.....
Describe Title or Position and Type of Business.....
State whether a New Subscriber or Renewal Order

Name.....
Address.....
Describe Title or Position and Type of Business.....
State whether a New Subscriber or Renewal Order

Name.....
Address.....
Describe Title or Position and Type of Business.....
State whether a New Subscriber or Renewal Order

Look for the distributor
who displays this sign!

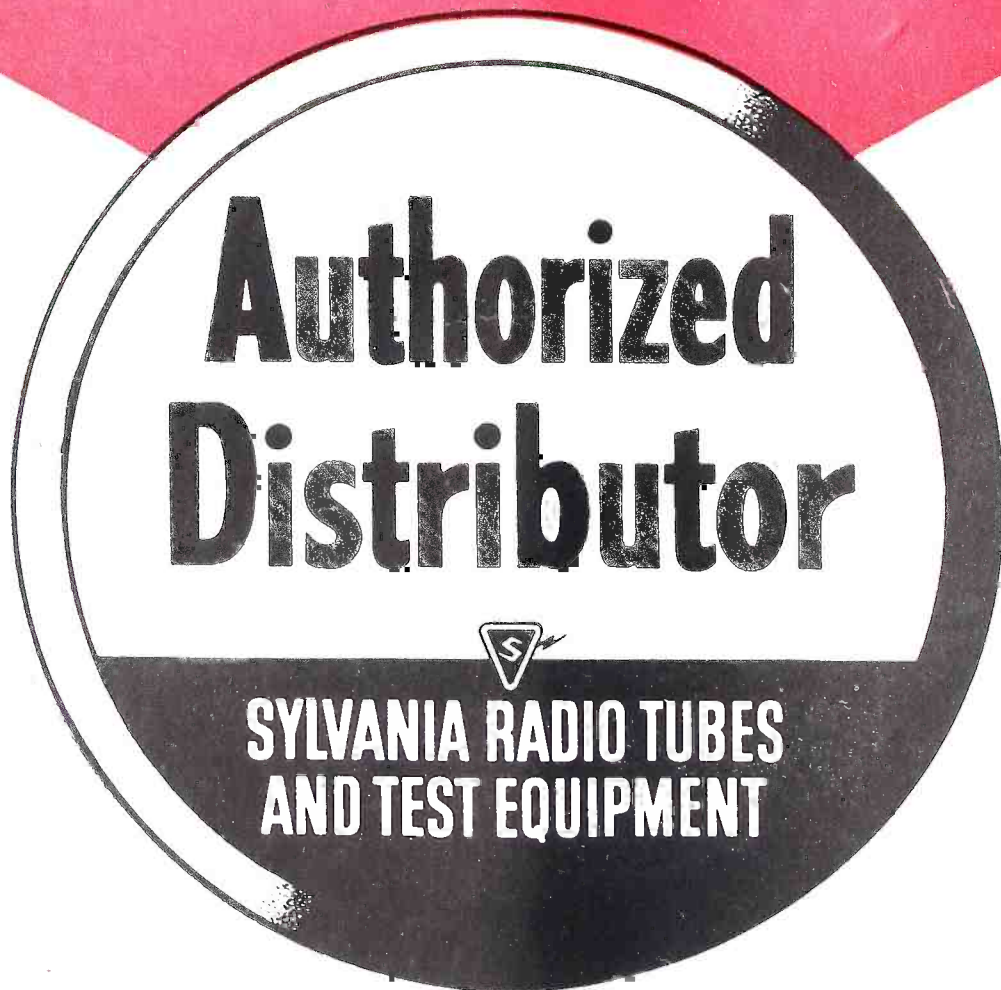

AS a part of its 1948 program, Sylvania Electric will supply each of its authorized distributors with this new decal, printed in red, yellow, black and three shades of green. It's worth your while to look for this sign on

his windows, doors and trucks — it is your assurance that this distributor will supply you with genuine Sylvania radio tubes and top-quality test equipment — and that you can count on prompt, courteous service as well!

Sylvania Electric Products Inc., Radio Tube Division, Emporium, Pa.

SYLVANIA  **ELECTRIC**

MAKERS OF RADIO TUBES; CATHODE RAY TUBES; ELECTRONIC DEVICES; FLUORESCENT LAMPS, FIXTURES, WIRING DEVICES; ELECTRIC LIGHT BULBS

FIELD FINDINGS

A resume of Industry happenings here, there and everywhere

by S. R. COWAN

BETWEEN September 1st and October 12th I traveled 9,830 miles, visited 27 key cities and addressed over 9,000 radio service dealers and technicians in 19 different cities. In all cases the meetings were sponsored by the local parts jobbers and/or servicemen's associations. That I lost 18 pounds and a great deal of sleep is irrelevant.

The great appreciation I hold for the various meeting co-sponsors cannot be expressed adequately. The same is true of my audiences, for each and every one was avidly attentive and wholehearted in their response. Likewise, I am greatly indebted to the dozen or more radio manufacturing firms who went to great expense to provide engineers who participated at every speaking engagement. A partial list of the manufacturers: Shure Bros., Television Assembly Co., Electro-Voice Mfg. Co., Hickok Elec. Instru. Co., Inc., Allen B. DuMont Labs. Inc., Sylvania Elec. Prods. Inc., Transvision, Inc., RCA-Victor Div. of RCA, General Elec. Co., Radiart Corp., Belden Mfg. Co., Newcomb Audio Prods. Co., American Phenolic Corp., etc. The various speakers who participated include: Messrs: Allen S. Nace, Wm. Rickards, Joe Morin, Richard Penners, George Masin, George Kearse, Russell Fenton, A. R. Kahn, etc. Illness or inability to reach certain meetings because of travel difficulties overtook such men as Herb Young, Bert Clintzman and Wm. Maddox, but their intentions were sincere and they helped provide substitutes. To the other participants whose names are not recorded here, my apologies! I must keep this report concise because of space limitations, and despite the brevity, I shall not be able to report all my findings around the country in this issue.

And now, before getting into the text of *Field Findings* itself, let me reiterate that in response to the almost unanimous request of my audiences, we are going to reprint in the December and subsequent issues of **RADIO SERVICE DEALER** the subject matter which I covered, to wit: "Check-

I've given Sandy's Column top billing this month. Read it and you'll see why it rates a "must" in the radio serviceman's readings. —SLM

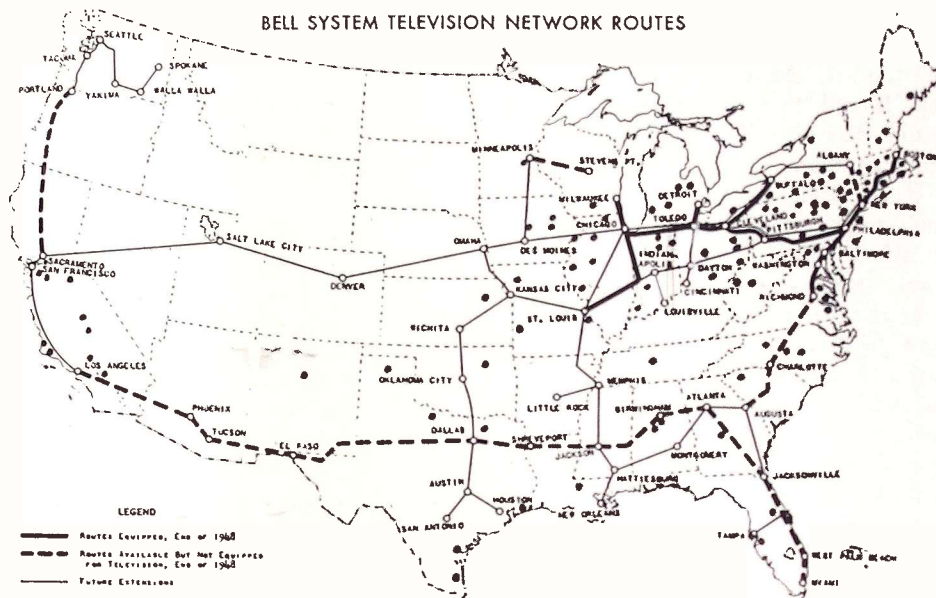

Each dot and circle represents a city with one or more TV stations now on the air or soon to go into operation.

ing Video and Synch Waveforms by CRO" with the accompanying illustrations, so a reference file may be available for more comprehensive study and application. The author of the material, our Technical Editor, Sam Marshall, will also attempt to expand and amplify the text to enhance its value.

One other point, for the benefit of radio jobbers in such cities as Dayton, Columbus, Cincinnati, Louisville, Indianapolis, St. Louis and Kansas City who have made requests for a meeting night . . . yes, I will arrange another speaking tour for February—March, 1949 and plan to include your cities. Just as I did on the tour recently finished, with the cooperation of radio manufacturers, I shall attempt to provide a completely balanced two and a half to three hour program for the service dealers and radio technicians in your territory. (And I might mention, John Rider also has a very comprehensive Coast-to-Coast 1949 tour now under consideration while Al Saunders, representing Howard Sams, is just winding up such a tour).

RCA Revises TV Service Policy

As "RSD" subscribers know, for the past year we have urged RCA and all other TV set manufacturers to abandon mandatory service policies which required a videoset purchaser to engage a factory-owned subsidiary or manufacturer-appointed installation firm to handle and service their videoset for a year on a stipulated fee basis. Happily we can now report that RCA has announced installation policies are optional effective October 15th. All other TV set makers should take heed and follow the new RCA practice whereby the dealer who sells a videoset may negotiate with the buyer to have anyone who is competent handle the original installation and subsequent maintenance work.

While "on tour" we learned that radio dealers in the far West were not plagued by the restrictive installation policies in the same manner as were the Eastern and Midwest dealers. Now the matter is wide open and free enterprise will prevail from Coast to Coast. Hurrah! It's grand to have RCA go this way, and the

sooner other TV makers say "me too" the better it will be for the entire industry.

I still have one big gripe in regards to the present practice of some TV set makers. These firms are buying simple types of dipole antennas in large lots and are shipping the antennas to dealers (through distributors) at a marked-up price, considering the videoset plus antenna as a complete package. Naturally the dealers don't want these antennas. Experience has proven that in the great majority of cases the set installer cannot use the type of antenna that was sold as "part of" the set. As a result the set buyer was forced to purchase another antenna that would meet his particular requirements.

Under strict interpretation of law, such package-deal original antennas constitute "tie-in" sales which are illegal unless the seller, (who in this case can be considered to be the TV manufacturer), is willing to allow a full refund for the unusable dipole. As such happens *not* to be the present policy of TV makers who are including dipoles with their sets, we give them fair warning—desist, or face the likelihood of soon answering to charges in Court. Dealers have told us that they are just biding their time before taking action so this warning to the offending TV set makers may save them plenty of trouble.

TV Licensing Held Up By FCC

Everywhere recently I have been asked for my opinion regarding the FCC's latest order that temporarily stops TV and holds it to status quo. Naturally I cannot account for the actions of the FCC, but I can and will express my opinion as what the stoppage order means. As I see it, for a *very short period of time*, 90 days or less, the present FCC order will remain in effect. Then I expect the Commission will again give most stations holding construction permits the "green light" and at the same time the Commission will resume hearing applications for new CPs.

Without doubt the FCC was justified in holding TV back a bit until the galaxy of engineers who have run into problems of interference could state their case and the merits thereof be taken into consideration. But I am sure this is to be nothing more than a temporary stop-gap measure of short duration. And I further believe that actual rulings on kicking TV "upstairs" will not be issued or actually be put into effect for a period of four years from now.

Meanwhile TV setmakers are striving to their utmost to increase production of present type receivers, for the demand far exceeds the supply.

It is unfortunate that so many communities who were on the verge of being served with video programs have been temporarily stymied by the current FCC order. I am convinced that they will not regret the holdup in the long run, because from a practical viewpoint, the delay is giving FCC ample time in which to select the most suitable applicant for a permit in locales where competition for same is quite severe.

FM Is Failing In Popularity

In many cities where TV is not expected for some time but where FM stations are already beginning to serve the populace, the consensus is that FM programs do not have enough popular appeal and as a result reflect detrimentally to the potential of TV for the future.

For example, in Des Moines and in Denver, dealers told me that the FM stations were "doing such a poor job that the people who recently bought FM sets wanted to return them . . . and that if FM's short-comings were typical of what could be expected when TV arrives, it's a mess that dealers won't be able to live down." For my part, the few FM stations that were on the air when I happened to be in any given Midwestern city were definitely below what we would consider "par" here in the East. And while on this subject, I might mention that the present-day commercials on FM leave much to be desired. Likewise, videostation managers would do well to make a survey of public opinion as it regards television commercials. In the East the public candidly admits that the video commercials used by Texaco's "Theatre of the Air" and Merrill Lynch's presentation of Dr. Gallup are nothing less than "terrific", while the things being said about Emerson Radio's commercials on the Ed Sullivan "Toast of the Town" program are so bad as to be better left unsaid. But that's typical of the radio industry . . . it takes a radio firm to louse things up for people in the radio business.

Getting back to the basic subject, however, the FM stations now on the air should take cognizance of their short-comings and put into immediate effect corrective measures to improve their programs and thus protect their own interests, the welfare of the FM set-buying public, and also the dealers who are in jeopardy of

losing the public Good Will because they did the natural thing, i.e., made a sale of an FM type receiver to what had formerly been a satisfied customer.

Stupid TV Civic Restrictions

I was amazed, (and so were service dealers), when it became known that the Civic Authorities in some cities have promulgated regulations recently which add an untenable burden to TV men, and which at the same time, are quite detrimental to the interests of local citizens, especially those who are about to purchase a TV receiver.

For example, a California city approximately 120 miles south of and on the extreme fringe of the Los Angeles TV range has a population of almost a half-million people. About 1,200 TV sets have been installed there although reception from L. A. is admittedly only fair. The city referred to itself now has no TV station, and the two TV station applicants have no idea as to when FCC will allow them to go on the air. Last month, out of a clear sky, the Building Commission, (I believe it was), of this particular city arbitrarily ruled that: 1) Henceforth only 4 types of TV dipole antenna will be deemed presentable enough *in physical appearance* for installation in that town; and 2) that no TV antenna may be erected to a height exceeding 50 feet off the ground; and 3) that all dipoles erected must be on pipes not exceeding 1½ inches diameter.

In like manner another California city's Civic Fathers (sic) have issued regulations such as these: No dipole can be guyed up by wire heavier than 14 guage; or, no dipole can have on it a guywire rising higher than 4 feet above the mast's base; or, all TV antennas, after erection, must be painted aluminum in color. Did you ever hear of such typically stupid and unwarranted city ordinances? I could tell you of many more, but these that I have cited are sufficient to prove my point that a great deal of educational work has to be done by members of the radio-television fraternity.

I happen to know that many of the present municipal regulations have been instituted against TV because the civic authorities were taken advantage of by people who have had selfish, ulterior motives against either TV or "ham" activities. But the fact remains that little problems like the ones mentioned must be licked through the combined, coordinated efforts of radio service dealers and

[Continued on page 45]

SWEEP GENERATORS

by JOHN F. RIDER

The accelerated pace of TV receiver installations with the accompanying service problems has focused the attention of the maintenance industry on suitable test equipment. One of these items stands out above the rest; this is the TV sweep generator. Not that this is the most frequently used instrument, but rather that it is the newest and most intriguing. It is a device of which there has been no counterpart in the years gone by. It is a device which all TV service installations will eventually own—today it is surrounded by much glamour.

The story of the TV sweep generator can best be told by the answers to four questions which are

1. What is it?
2. What is in it?
3. How does it work?
4. Does every service shop need one

Given the answers to these four questions, it is reasonable to expect that the radio serviceman will come to the correct conclusion concerning the device. However, since we have but forty minutes in which to deliver this paper it becomes necessary to weigh the relative importance of each of the four answers. This we have done, and the theoretical aspects of the subject shall be kept to the minimum; the greatest emphasis shall be placed upon the practical considerations because it seems that no matter how new something may be, most people are concerned with what it can do for them—rather than the theory of its operation.

What Is A TV Sweep Generator

Essentially the TV sweep generator is a signal generator which furnishes frequency-modulated signals over a number of bands—the TV carrier frequency range, the picture i-f band, and the sound i-f band . . . In addition—that is in many cases, the same device also furnishes a series of unmodulated r-f signals of predetermined frequency which are within the acceptance band of the TV receiver r-f, picture i-f, and sound i-f systems. These unmodulated r-f signals are known as marker or calibrating signals. If the TV sweep generator does not furnish these marker signals, then an external r-f signal having the same

As a service to its readers, "RSD" is pleased to present the text of John F. Rider's excellent illustrated lecture on "Sweep Generators", delivered at the Town Meeting for Radio Servicemen, on September 29, 1948. This meeting was one of a group that is currently being sponsored by the RMA Radio Parts Industry Coordinating Committee.

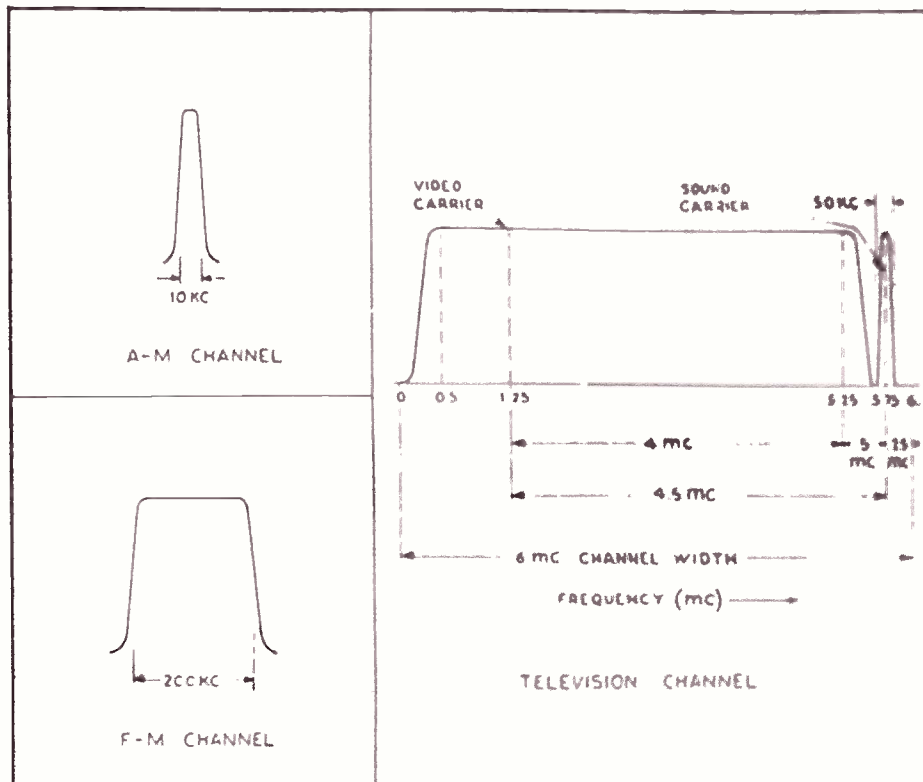

Slide 1—Bandwidths for FM, AM, and TV

frequency range is used. The general run of TV sweep generators offer other facilities too, but since each of these is secondary to the primary functions mentioned, let what has been said suffice for the present.

Being a signal generator the function of the sweep generator and its marker frequency source is immediately assumed to be an alignment device—that is, a device used in conjunction with circuit-alignment operations. By and large that assumption is correct, although it must be stated that few if any of the testing devices employed in the radio servicing industry are single application devices. However, although the TV sweep generator and marker has other service uses, it nevertheless remains essentially a circuit-alignment tool and will be so considered. Accordingly the function of the frequency-

modulated signal source is to furnish a test signal over a band of frequencies whereby it is possible to adjust the appropriate receiver circuits for correct operation—that is, correct band-pass characteristics.

The marker signals complement the operation of the f-m signal source by enabling the identification of the frequencies within the band being generated by the sweep unit after having been fed into the circuit being adjusted. Stated differently, this device makes it possible to identify where within a response curve, certain frequencies are located—thus making it possible to establish definitely the degree of response of the system to the different frequencies fed into it. Without marker frequencies, proper shaping of the response curve—an operation essential to the proper performance of the different tuned cir-

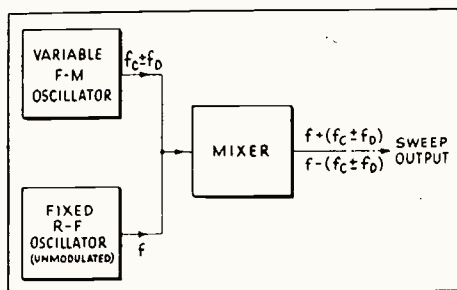

Slide 2—Sweep frequency production

cuits in a TV receiver—would be impossible.

In practice the TV sweep generator is used in conjunction with a cathode-ray scope so as to develop a visual response curve. The marker oscillator furnishes the signals which ride on the response curve at the appropriate point corresponding to the frequency within the band being transmitted. It must also be stated that both the sweep generator and the marker oscillator may be used with devices other than the cathode-ray scope as a visual indicator, in which case the indications will not be response curves.

What Is In It and How It Works

Having defined the TV sweep generator, we now can examine its basis of operation, that is "what is in it?" and "how does it work?" But before doing so we must lay the ground work for what will follow by stating the frequency requirements of a television system. In slide 1 are shown three channel allocations, an a-m channel as used for the conventional a-m broadcasting, which has been in vogue for the past 28 years; an f-m channel as used for conventional f-m broadcasting, and the present TV channel. Each of these is the overall spread allowed the stations which are transmitting such signals. The overall coverage of the a-m station is restricted to 10 kilocycles; the conventional f-m station is allowed 200 kilocycles, although only 150 kilocycles are used—a 25 kilocycle guard band being allowed on each side of the 75 kilocycle deviation above and below the center frequency. The TV station on the other hand is granted a 6-megacycle channel.

If for the moment we consider the individual drawings on slide 1 as the range of frequency response necessary in receivers intended for the reception of signals of each type, we can immediately see the tremendous frequency span of the TV system with respect to the limited span of the a-m system—the former is 600 times as great as the latter.

Checking Wide-Band Circuits

To check the operation of circuits which must respond to a band of frequencies as great as 6 megacycles, or at least show the performance of such circuits, the most convenient method is the use of a frequency-modulated signal. However, because of the general structure of the TV broadcasting system and the design of the receivers, it is insufficient to view the response of the receiver system over just the channel being worked on—it is necessary to view the operation of the circuits on frequencies within the adjacent channels on each side—if for no other reason than to make certain that only the desired channel signals will be received and that adjacent channel signals will be rejected. If this condition does not prevail, interference from adjacent channel signals will be experienced. Therefore, any signal source intended to provide a frequency-modulated signal for such circuit testing, must furnish signals over a frequency band far in excess of the individual station-channel widths. This applies to a-m and f-m channels as well. . . Now we are ready to discuss the TV sweep generator.

It is readily understandable that all such sweep generators must start with an oscillator inasmuch as regardless of the character of the modulation employed, a basic carrier is essential. Since the final output is a frequency-modulated signal, the oscillating system must be arranged to develop a signal possessed of the characteristics of an f-m signal—namely constant amplitude and varying frequency. Up to this point there is nothing unusual.

To attain a change in frequency of from 5 to 10 megacycles above and below a center frequency of from 100 to 200 megacycles is not difficult. Undesired variations in operating potentials are capable of causing such frequency changes. But when it is necessary to secure a frequency swing of from 10 to 15 megacycles around a center frequency of from 25 to 26 megacycles—such as is required for checking picture 1-f channels—or a swing of perhaps 2 megacycles when the center frequency is 4.5 megacycles, which is needed for checking sound i-f channels in inter-carrier systems, convenient operation by direct sweeping or frequency changing in the oscillating circuit is virtually impossible. Recourse to other methods is required. . . This method is the beat frequency or heterodyning method.

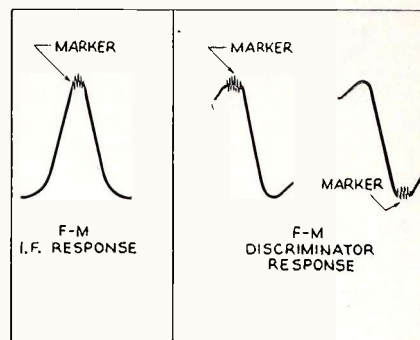

Slide 3—Typical marker pips

Beating one signal against another is not new . . . It has been used since about 1917—since the birth of the first superheterodyne receiver . . . But the methods used in TV sweep generators to generate the necessary f-m signal in conjunction with the heterodyning system is interesting and deserving of comment.

In the system of heterodyning the output of two separate oscillators is mixed in a non-linear vacuum-tube circuit, thereby producing sum and difference frequencies in the output—in fact, similar combinations of the harmonics of the components also are produced. By suitable arrangement in the output circuit of the mixer system, either the sum or difference frequencies may be selected for transfer to subsequent tube systems. . . This is the system used in superheterodynes and it has become quite common-place to select the difference frequency signal, which is the i-f signal for transfer to the i-f amplifier. And as is well known, the i-f signal in every receiver retains the characteristics of the originally received carrier.

This comes about as the result of the condition that if one of the signals fed into a mixer tube is amplitude-modulated and it is heterodyned by an unmodulated signal, the resultant output will be an amplitude-modulated signal which retains the modulation characteristics of the input a-m signal. . . If one of the signals is frequency-modulated and it is heterodyned by an unmodulated signal, the resultant output will be a frequency-modulated signal possessing the frequency-modulated characteristics of the input f-m signal, that is it will possess the rate and amount of frequency deviation present in the input f-m signal. The fact that the resultant output signal retains the characteristics of the signal being heterodyned is what permits the attainment of a great frequency swing around a low center frequency.

As an example of what we have said look at slide 2. The variable f-m

oscillator produces a signal with a center frequency f_c with a plus and minus deviation f_a . For the sake of the discussion assume that f_c is 100 megacycles and the plus and minus deviation is 5 megacycles so that the output of the f-m oscillator is a signal which varies between 95 megacycles and 105 megacycles. How rapidly this variation in frequency takes place is unimportant at the moment.

The fixed r-f oscillator produces an unmodulated signal of frequency f , which we will assume to be 80 megacycles. As can be seen, the output of this oscillator is fed to the mixer—as is the output of the f-m oscillator. In the output circuit of the mixer, many combinations of the mixed signals will be found—for our purposes we are interested in two combinations—namely the sum and the difference signals. If we consider the difference-frequency signal first, it will be a signal which will vary in frequency between 15 megacycles and 25 megacycles—15 megacycles, being the difference between 95 and 80; and 25 megacycles, being the difference between 105 and 80. The center frequency of this new signal will be 20 megacycles or the difference between 100 and 80.

The heterodyne system has transformed an f-m signal of 100 megacycles with a 5-megacycle swing on each side to a 20-megacycle signal with a 5-megacycle swing on each side. So although the center frequency was greatly reduced, the same deviation was retained.

If we examine the sum frequencies present in the output of the mixer, we find a signal which varies in frequency between 175 megacycles and 185 megacycles or a signal with a center frequency of 180 megacycles

with a 5 megacycle deviation on each side. In this the center frequency of the signal was raised from 100 to 180 megacycles, but the 5-megacycle deviation was retained.

By means of the heterodyning process either a reduction or an increase in the center frequency of an f-m signal can be accomplished without disturbing the amount of deviation. It is simply a matter of numerics in the frequencies selected for heterodyning and the deviation present in the original f-m signal.

Actual Oscillator Frequencies

You must understand that the figures we have quoted are purely illustrative. Neither the f-m or the unmodulated oscillator frequencies are necessarily fixed at the frequencies we have stated. Both can be of any center or fixed frequency as dictated by requirements. As a matter of contrast with the figures we have mentioned, the f-m and fixed-frequency oscillators of one TV sweep generator operate at around 10,000 megacycles. The same is true of the deviation; it can be of any amount required to fill a need.

Very frequently frequency-modulated oscillators are referred to as producing a frequency output which varies from zero to some numerical value—say from 0 to 15 megacycles. These come about as the result of mixing an f-m signal with a fixed-frequency signal which has a numerical value equal to either the upper or lower frequency limit of the f-m signal source. For example, if the output of an f-m oscillator varies between 100 and 115 megacycles and this signal is mixed with a 100-megacycle signal, the output of the mixer will

contain a difference frequency signal of from 0 to 15 megacycles. From the examples we have given, you can see that the numerical values of the output signal relative to frequency is a matter of the numerical values of the signals which are mixed.

The use of the heterodyne system is common to all TV sweep generators as a means of developing all or certain output signals, although it is necessary to mention that this “beating down” arrangement is used in most instances for the generation of the wide-swing low center-frequency signal required for i-f and associated circuits alignments. It will bear repetition to say that the heterodyning system is not generally used for the development of the f-m signal at the TV carrier frequencies. As the ratio between the center frequency and the peak-to-peak deviation increases, the problem of direct sweeping becomes simpler, which is the case for the TV carrier frequencies. All of this is of secondary importance except for what information it conveys to the user of a TV sweep generator as he flips the switches to obtain different testing frequencies.

Methods Employed

The means of accomplishing the f-m signal in different TV sweep generators is interesting. Unfortunately we cannot describe these systems in detail because so much more practical information remains to be discussed. Let it suffice to say that two general methods are employed, each of which does have its subdivisions. One of these general systems is mechanical, wherein a vibrating mechanism, somewhat similar to a dynamic loudspeaker assembly, is made to vary either the capacitance or the inductance of the f-m oscillator.

If capacitance variation is employed, the vibrating mechanism, actuated by a variable voltage 60-cycle a-c signal, mounts a specially constructed variable condenser which tunes the f-m oscillator system. This capacitance increases and decreases around a mean value in accordance with the amplitude of the driving voltage. The driving voltage may be called the sweep-amplitude control, since a high value of driving voltage causes large amplitude movement of the vibrating mechanism, thereby, greatly changing the frequency and generating a wide sweep. Conversely, a low-amplitude driving or sweeping voltage causes vibrations of small amplitude; therefore, small changes in capacitance of

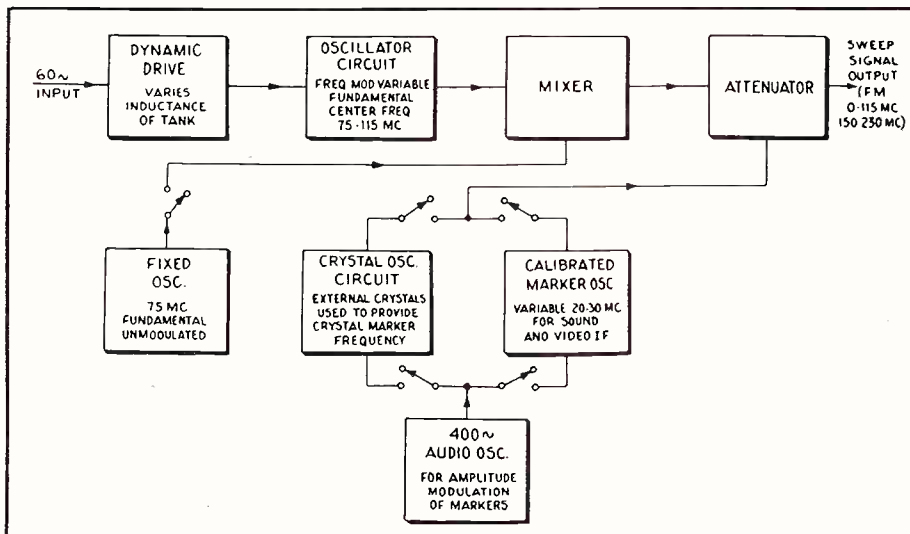

Slide 5—Block diagram of another commercial type of TV sweep generator.

the sweep condenser—consequently a narrow sweep.

The inductance variation is accomplished in like manner except that the vibrating mechanism mounts a metal plate which is located near the f-m oscillator inductor. The to-and-fro motion of this plate around a mean position relative to the oscillator inductor, changes the inductance in the oscillating system, therefore the frequency. A high value of sweep voltage applied to the vibrating system drive causes a wide swing in the sweeping plate, thereby causing a major change in inductance and generating a wide sweep in the output signal. A low value of sweep voltage will cause a small displacement of the sweeping plate, therefore the output signal will be swept through a narrow range.

The other general system is electronic and two methods are used, one of which is very much more commonplace than the other. The most popular method is the use of a reactance

tube across the f-m oscillator. The sweep control voltage is applied to the reactance tube, which in turn varies the apparent capacitance across the f-m oscillator tank circuit, thereby changing the frequency of the output signal. The magnitude of the sweep-control voltage applied to the reactance tube, determines the magnitude of the sweep or change in frequency present in the output signal. This is the system commonly used in direct f-m transmitting systems and in automatic-frequency control circuits.

The other electronic system presently in use is singular in that it is employed in but one TV sweep generator now on the market. This unit makes use of two special tubes developed for use during World War II and known as Reflex Klystrons. They are of special design in many ways, but one is of special interest, namely that the oscillating circuit is a part of the tube assembly; consequently, each tube is capable of operation over

a restricted region around the frequency planned in the design of the tube.

In the TV sweep generator which employs these tubes, one klystron, identified as the signal oscillator, operates at a frequency in the neighborhood of 10,000 megacycles, and can be varied in frequency. The other klystron is the f-m oscillator. This tube also operates at a frequency of approximately 10,000 megacycles, but by applying a changing d-c voltage which is secured from a sawtooth relaxation oscillator, to one of the tube elements, the repeller plate, the frequency of the output signal is automatically made to increase and decrease around the center frequency.

However, these frequencies are entirely too high for normal use and the heterodyning principle is applied to produce output frequencies within the usable region.

So much for the generation of the f-m signal in the TV sweep generators. The next item of interest is the identification of the frequencies being passed through the tuned system being checked, in other words, the marker frequencies. Two methods of such identification are in use at the present time. One of these is the generation of unmodulated signals in one or more crystal oscillator circuits. The frequency of these signals is known and when the signal is injected into the circuit being checked, it appears as a "marker pip" or a few cycles riding on the response curve of the system being viewed on the scope screen. Exaggerated examples are shown in slide 3. In some units this marker-signal source is a part of the TV sweep generator assembly, although in one case it is a separate individual unit.

The second system is the use of an absorption type of wavemeter whereby a dip is created in the response curve at that point which corresponds to the wavemeter frequency in the f-m signal being fed into the unit under test. Whereas the marker-frequency calibrator injects a signal which appears as a few cycles on the response curve, the wavemeter system produces a slight depression—the width of which is narrow because of the high "Q" of the circuit and because the amount of energy absorbed is small. So in one case a marker signal is injected, whereas in the other case, the intensity of the f-m signal fed into the circuit under test at the specific frequency being checked, is reduced.

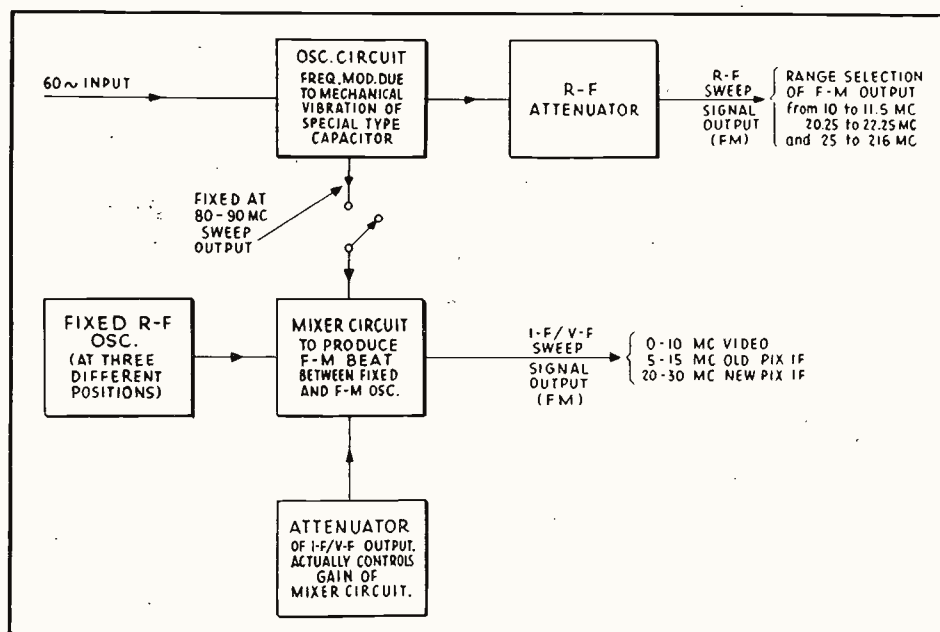

Slide—4 Block diagram of typical commercial TV sweep generator

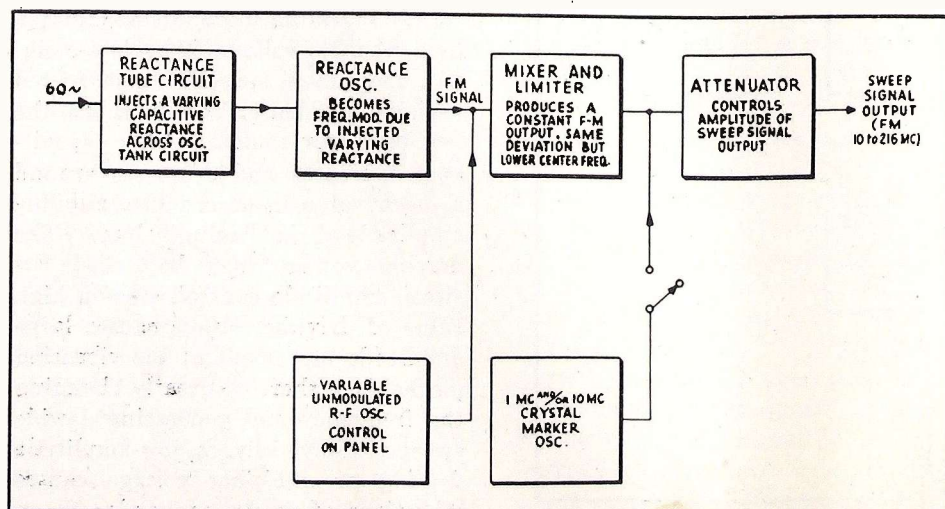

Slide 6—Block diagram of third variety of TV sweep generator

The range of marker frequencies provided in such calibrating systems extend over the TV carrier-frequency band and over the sound and pix i-f ranges including the sound-trap frequencies. Understandably all marker oscillator systems are not alike—except possibly for the use of crystals as the frequency-control devices. Whatever may be the specific circuits employed, these are of no particular significance at the moment, it being more important to appreciate two very pertinent requirements related to such markers. One of these is that they must be available over the TV carrier range and the second is that they must cover all the alignment frequencies of the i-f channels in the TV receiver.

Now it is time to glance at what is inside some of the commercial TV sweep generators. In deference to the wishes of the sponsors of this Town Meeting, we shall not identify the units by name. No doubt some of you will recognize these units, but it will not be harmful to the manufacturers since nothing detrimental is being said about anyone's products.

Admittedly a complete understanding of everything in a TV sweep generator cannot be gained from the slides we shall show—but it is felt that a semblance of familiarity will be created and when added to what has been said and what will be said—the final result will be a general appreciation of what these units are and what they can do.

In slide 4 is shown a block diagram of one commercial version of a TV sweep generator. The arrows on the connecting lines indicate the direction of the TV carriers and what-nals present in the system. The 60-cycle input is the sweep-control voltage which actuates the vibrating plate for inductance variation of the f-m oscillator. The difference f-m outputs are obtained by using different combinations of fundamental and second-harmonic frequencies of the two oscillators. This unit has four f-m ranges; 0-40 megacycles, 35-75 megacycles, 75-115 megacycles, and 150-230 megacycles. The 0-40 megacycle range is accomplished by the difference between the fundamental frequencies of the two oscillators; the 35-75 megacycle range is accomplished by the 2nd harmonic of the fixed oscillator beating against the fundamentals of the f-m oscillator; the 75-115 megacycle band is obtained from the f-m oscillator only and the 150-230 megacycle band is obtained by using the second harmonics of the

f-m oscillator alone.

Two marker oscillator systems are used. One is intended for identification of travel of the actions and sig-ever other frequencies are to be identified. This system utilizes crystals which may be plugged into the system. The other oscillator is variable in frequency between 20 and 30 megacycles for i-f alignment. Four-hundred cycle modulation is provided for the marker oscillators.

Another example of a TV sweep generator is shown on slide 5. In this instance the f-m oscillator is modulated by means of a vibrating condenser, which like the vibrating plate receives its driving voltage from a

60-cycle source. The f-m signal is fed to a mixer, which also receives the signal from a fixed-frequency oscillator, whose actual operating frequency may be changed. The f-m oscillator output over the sound i-f channel frequency range and the TV carrier frequency range is available through its own attenuator. The output for the video or picture channels is taken from the mixer tube and, attenuation of the output signal level is determined by the gain of the mixer. This is the generator which has a companion marker-frequency unit—the marker frequencies are not available from the sweep generator.

[Continued on page 42]

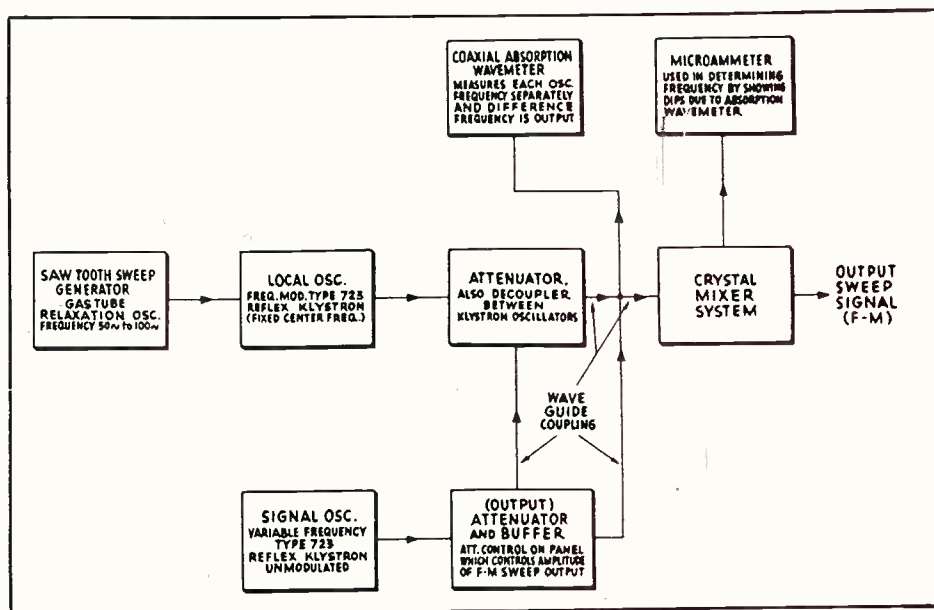

Slide 7—Block diagram of fourth type of TV sweep generator

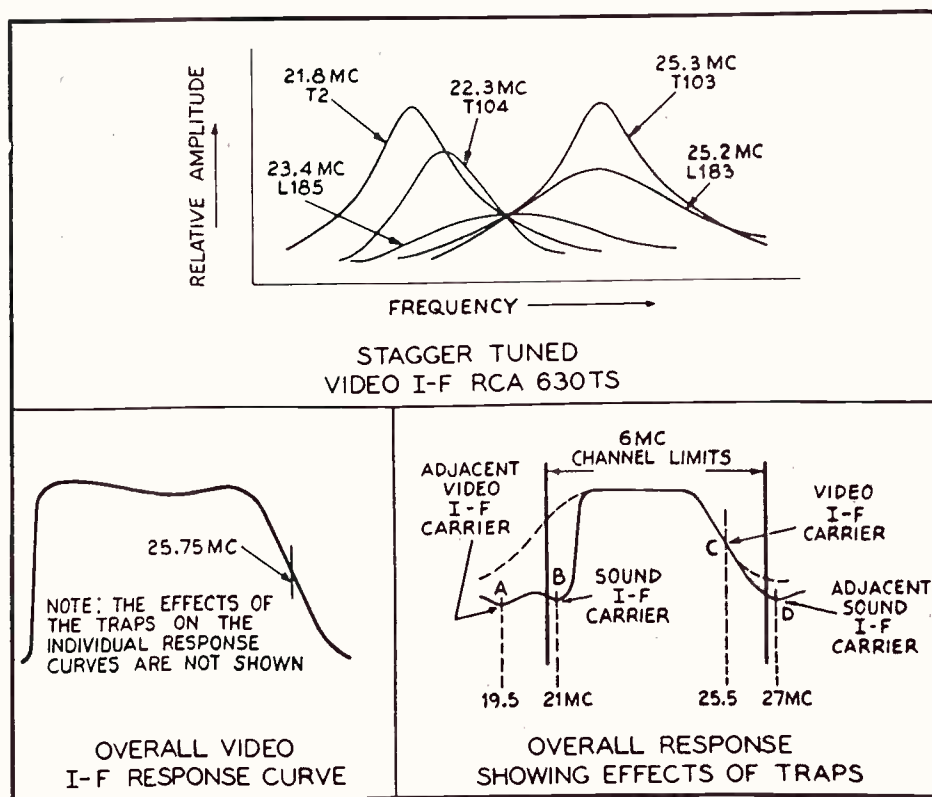

Slide 8—Individual response curves of stagger-tuned pix i-f system in RCA 630 TS

155 LOUDSPEAKERS, VOLTAGE-FED

by C. A. TUTHILL

TWO thousand doctors seated in the grand ballroom of the Waldorf Astoria Hotel in New York during July, attending the first international conference in poliomyelitis, were able to engage in two-way conference discussion with an advisory panel of doctors seated upon the ballroom stage. It was not necessary for any one of them to leave their seats, or even stand, unless they chose to do so. And yet, everyone in the entire ballroom and its double-tiered rows of surrounding boxes, clearly heard every word from both sides of all discussions. This was made possible through the temporary installation of a new unique low-level p-a system comprising 20 portable microphones and 155 loudspeakers evenly distributed throughout the house. This unusual layout is of high interest to all dealers for two salient reasons:

1. An independent operator temporarily installed his rack of amplifying and switching equipment in an elevated forward box at the side of the room (see Fig. 1) commanding a view of the entire conference. Not one piece of hotel equipment was used. This despite the permanent hotel installation within the ballroom. More on that later.

2. The voltage feed distribution greatly simplified speaker wiring and impedance matching complications. One autotransformer handled the entire load of 155 loudspeakers. Economically this meant much in labor-time saved at overtime rates, as well as monetary gain in equipment economy.

Potential Business

Referring to point (1) above, if the Waldorf Astoria can be crashed by an unknown operator who has just entered the sound system field, certainly many hotels, constantly catering to conferences and conventions in metropolitan regions, offer dormant fields of revenue for the small owner of systems. To cut in on this melon it is merely necessary to:

a. Make up a microphone switching panel, including two pre-amplifiers

In this article, which in its essence is a system described in the forthcoming book, "Commercial Sound", published by John F. Rider, the author illustrates how a most difficult p-a problem is met.

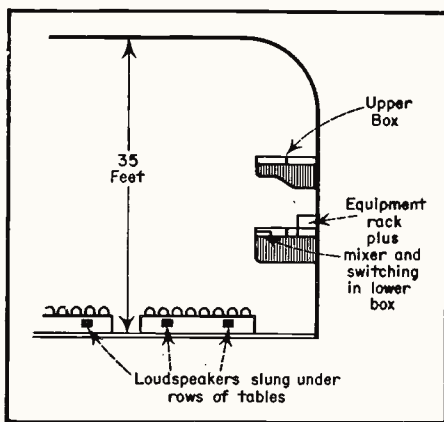

Fig. 1—General layout

fiers so as to serve two microphones simultaneously. This panel will precede your regular mixing facilities. A block diagram appears in Fig. 2.

b. Modify the output of your driving amplifier for a voltage-feed distribution system employing one or several auto-transformers readily available on the market for that purpose. No relays or loudspeaker-shortening switches are required since the entire system is run at an adequate, yet at a low enough level where feedback between microphone and loudspeaker becomes no problem.

With reference to point (a) above,

the number of switches required will depend upon the number of microphones you wish to accommodate. Many assignments will not require 20 microphones but it costs little more to design for expansion and the small additional cost will soon write itself off during usage. Double pole double throw switches (keys) are used with the microphones connected to the center or swinging contacts.

The input to one preamplifier is found on the left-hand side of each of the several switches while the second and companionate preamplifier has its input multiple to the other or right-hand side of each switch. This provides for legitimate use of any two microphones at one time. And, when cross-fire argument sets in, no harm will be noticed if more than one microphone is hung across a given input momentarily.

With regard to point (b) above, we come to the main substance of this article. It is well to review this writer's article titled "70 Volt Loudspeaker Distribution Line" in the January, 1948 issue of *Radio Service Dealer*. Therein will be found a more thorough treatment of voltage feed systems for

[Continued on page 38]

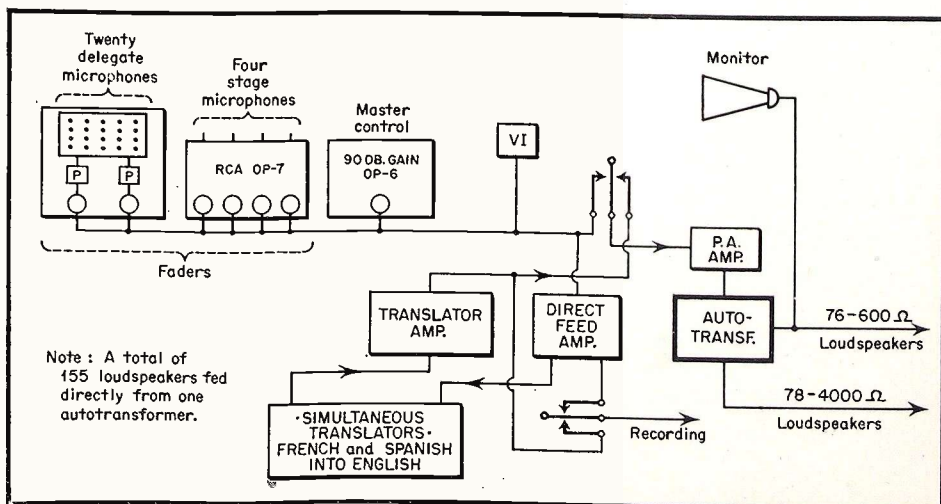

Fig. 2—Block diagram of Waldorf Astoria low-level p-a system, using 151 loudspeakers, voltage-fed. (Temporary)

MAKING GOOD TV INSTALLATIONS

by **DOUGLAS H. CARPENTER**

Practical information regarding fringe area installations

THE relatively new field of television invokes many problems that have no counterparts in more familiar AM practice. Servicing and installation of TV receivers is rapidly becoming the major source of income for progressive service shops throughout the country. It is the purpose of this article to suggest various practice-proven methods that largely contribute to satisfactory reception. Any one of the following practices listed under "Avoid" could invalidate an otherwise perfectly good installation. On the other hand any of those listed under "Observe" might make the difference between contrasty or "snowy" pictures.

The Television Antenna

Probably the most important single item that determines the quality of TV reception is the antenna system itself. Unlike other forms of communication, television utilizes a wide slice of the frequency spectrum for the sound and picture transmission. Noise voltages which are distributed pretty evenly across wide frequencies are amplified along with the TV signal. On weak signals noise is generally referred to as "snow" which tends to mask the picture. Thermal agitation (random movement of electrons in any conductor) becomes a contributing factor when the high frequencies employed for television are involved. Division of electrons between the plate and screen of the first tube in the receiving system is also a source of masking voltage. Receiver manufacturers are rapidly employing grounded grid-cathode coupled input system to minimize this condition. In consideration of the above, it is apparent that the highest possible signal to noise ratio must be established at the antenna itself, if good reception is to be had.

The choice of an antenna will of course depend upon a number of fac-

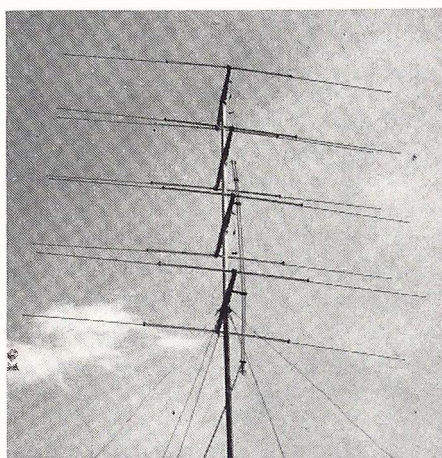

Fig. 1—A high gain broad band array used for fringe area reception.

tors. If the installation is to be made in a large metropolitan area where several high signal strength channels are available the problem is relatively simple. Articles covering elimination of "ghosts" and multi-channel polarization have been covered by several reputable authors in recent trade magazines. If, however, the installation is to be made in or beyond the fringe area, high gain directive arrays are a must.

Several simple arrays have been put on the market which provide varying degrees of gain, and exhibit a more or less flat response over either the high or low television channels. Unless the installation is made in an area of high signal level for all desired channels it is best to steer clear of these cheaper types. Experience has proven that many of these more simple arrays are resonant for one channel only, and their gain drops off rapidly for adjacent stations. The forward gain of a three element beam for instance, can be adjusted to about 5 db over that of a half wave dipole alone. In this condition the antenna is sharply resonant in only one channel. The frequency acceptance would be such as to impair picture quality.

The photograph (Fig. 1) illustrates a typical high gain array that gives extraordinary results, and is adapted for long range television reception. This particular array makes possible reception of TV signals in areas remote from the transmitter. Forward gain in the order of 15 db may be realized. This antenna consists of 32 separate elements (radiators and reflectors for high and low bands) and is flat over all television channels. A pair of "Q" bars are provided with adjustable clips for the transmission line. By this means a weaker channel may be peaked without sacrificing the antenna characteristic over the other channels. This antenna is made of extremely light metal, and may be easily installed by one man.

When using the simpler types of close spaced arrays be sure that the transmission line is properly matched to the antenna. A simple formula for determining the impedance of the matching section required is $Z_m = \sqrt{Z_a Z_1}$. Z_m represents the matching transformer impedance. Z_a is the antenna impedance, and Z_1 that of the transmission line. If we wish to match a 300 ohm line to a close spaced array whose center impedance is 8 ohms the matching stub required would be roughly 49 ohms. The transmission line must in turn be matched to the receiver. Most receivers provide a choice of input impedance. They are commonly 75 and 300 ohms. If a transmission line is employed that does not match the receiver input, a matching transformer should be used to provide optimum transfer of the signal voltage. A slight mismatch does not alter appreciably the strength of the received signal, but gross mismatching can make the difference between a good picture and none at all.

The second consideration when working at high frequencies is the transmission line. There is very

little sense in going to the trouble of getting an antenna high and in the clear only to waste signal voltage in an inefficient coupling system. Some servicemen are under the impression that coaxial line is the answer to all problems when making a TV installation. This type of transmission line has a noise reducing advantage in that the outer shield is one conductor, and may be grounded. It has the disadvantages that its costly, and bulky to install. The losses in the cheaper types may represent the margin between a good or "snowy" picture. The table of Fig. 2 shows a comparison between coaxial, and the popular twin lead types. The X200A is a newly developed type, and should prove extremely advantageous where long runs are required. A method of transposition of twin lead is indicated to secure elimination of noise.

Installation Hints

The following installation hints have been compiled from practical experience. Although many of these may seem obvious and simple, all have been picked up during inspection of commercial installations. Although the following does not represent a complete list, it shows the more common faults that may be observed on many systems. Close adherence to the rules below will save the serviceman a lot of time and trouble, and materially assist in getting good results.

Avoid

1. Using friction tape for transmission line repair.
2. Don't run twin lead against metal surfaces such as gutters, screens, or tin roofs.
3. Don't face antenna into power lines at same height.
4. Don't mount antenna on tin roofs, unless a careful survey is made to determine exact height for satisfactory results.
5. Don't use tacks or nails to secure a transmission line.
6. Don't expect a booster to improve pictures in areas of high noise level.
7. Don't coil transmission line near receiver simply because you have line left over.
8. Don't use regular or moisture absorbent lightning arrestors on twin lead or coaxial cable. Use arrestors designed for TV service.

Observe in Installation

1. Where twin lead is used twist about every two feet if noise is a problem.
2. If objectionable noise is still ob-

Transmission Line Comparison Chart

Type	Attenuation db per 100 ft.		Nominal Impedance
	30mc.	100 mc.	
RG-8/U	1.1	2.0	52 ohms
RG-11/U	1.2	2.1	75
RG-22/U	1.7	3.6	95
RG-59/U	2.0	3.8	73
Twin-lead	1.1	2.0	300
*X200A	0.6	1.1	200

*Supplied by La Pointe Plascamold Corp., Unionville, Conn.

- served, use coaxial line with outer conductor (shield) grounded.
3. In cases of extreme noise use two strands of RG8U coaxial cable as a balanced line. Tie the shielding together about every two feet, and ground.
4. Match the impedance of the transmission line to the antenna (formula), and be sure that the characteristic impedance of the line is matched to the set.
5. Provide a means of lightning protection.
6. Be sure to orient the antenna properly. A good trick is to turn the contrast control on the receiver as low as possible, so that the peak response on the desired stations may be more readily observed.
7. Where multi-channel reception is desired install a good high gain broad band array. Remember that the antenna is your best investment. Don't compromise results with cheap "do all's".
8. Solder all antenna connections.
9. When selecting an antenna system, remember that signal strength is only about 25% as high during the winter. Many servicemen have made installations during the summer only to spend a great deal of time trying to appease dissatisfied customers when the signal level starts to drop off.
10. Keep the transmission line as short as possible. Where lines must be physically long, use low loss line. (See chart)
11. Know the sensitivity of the receivers you handle on all channels. Advantages secured by proper alignment cannot be over-emphasized.

Pre-Amplification

There are several factors that must

be considered when recommending the use of a booster. Receiver manufacturers almost universally are bringing out sets with improved sensitivity. The fringe area market is beginning to represent a sizable hunk of total TV receiver consumption. The front ends of the newer receivers employ the grounded grid input system to secure the most favorable ratio of signal to noise where it is needed most. Pentode r-f amplifiers are becoming a scarcity even though they give more gain than the grounded grid triode system. Petrodies generate much more internal noise voltage than the triode circuits and this will mask or obliterate weak TV signals. There is no doubt that the pentode circuit will give gain and apparent improvement in the overall picture if it is put ahead of a receiver employing a converter input system. To put such a booster ahead of a receiver utilizing a grounded grid r-f amplifier is to add noise and gain in a much less favorable ratio. In the first instance the converter generates much more noise than the same tube used as an r-f amplifier, so a good improvement is realized. In the second instance the original receiver sensitivity is much higher (because the grounded grid circuit is incorporated), and the difference in gain is not as high. The noise voltage will become much more apparent however in contrast to the original condition.

There are several different types of boosters available on the market today; and most of these follow the same pattern. Before describing the general operating characteristics of the boosters now available, it might be well to state that the following does not apply to all types, only to those that are patterned after this circuit construction.

When a booster uses capacitive tun-

[Continued on page 37]

TV PICTURE TUBES

By SAMUEL L. MARSHALL

PART 2

IN the previous installment we pointed out that an electron beam from the cathode reaches the picture screen and is converted into a fine point of light. The manner in which this beam covers each point on the picture screen is somewhat analogous to the manner in which we read a printed page: each line from left to right, and each successive line from top to bottom. In TV, odd alternate lines are "read" in the first picture coverage, followed by a second coverage of the even alternate lines. This is called *interlaced scanning*.

The scanning notion is so fast that before the spot of light at the upper left hand corner of the screen has a chance to die out entirely, the beam reaches the lower right hand corner. The spot illumination drops to less than 1% after a picture period; slow enough for our eye to retain the complete image, but fast enough to be extinguished before the next frame appears $\frac{1}{30}$ sec. later.

Deflection

Control of the electron beam motion, horizontally and vertically, is called *deflection*. Two types of control are currently employed in deflection circuits, electrostatic and electromagnetic. In electrostatic deflection a variable sawtooth voltage is applied to two pairs of plates located at the upper end of the electron gun, causing the electron beam to be deflected vertically (vertical plates) and hori-

The 2nd and concluding installment on TV picture tubes and their associated circuit applications.

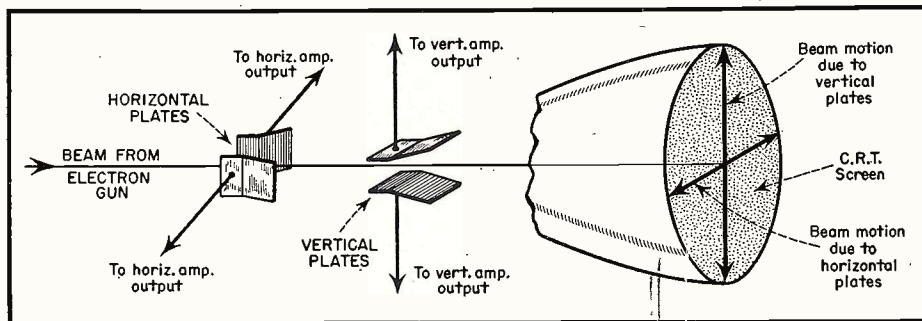

Fig. 1—Beam deflection in electrostatic tube

zontally (horizontal plates). Fig. 1.

In electromagnetic deflection a set of coils is mounted above and below the neck of the tube for horizontal deflection, and another set to the left and right of the tube for vertical deflection. Fig. 2 illustrates the electrical connections, and Fig. 3 a photograph of a typical coil arrangement.

The basic theory of electromagnetic deflection was discussed in the previous installment. However, we might briefly summarize this operation by stating that a moving electron beam is subjected to the following forces:

1. At right angles to the direction of the magnetic flux in the coils.
2. At right angles to the direction of motion of the electron beam. The net force on the electron beam in the vertical direction is, therefore, due to the combined effects of the *horizontal* flux and the forward motion of the electron beam. Similarly, the net force on the electron beam in the horizontal direction is due to the combined effects of the *vertical* flux and the forward motion of the electron beam. This explains why the vertical coils are mounted horizontally and the horizontal coils are mounted vertically.

Effect of Control Grid

The relative white, grey, and black areas on the picture are caused by the incoming grid signal modulating the beam intensity so that the scene appearing on the face of the tube is an exact replica of the scene at the transmitting studio. This is explained as follows. The voltages applied

to the deflection coils from the outputs of the vertical and horizontal synch circuits produce a raster on the CRT screen. During the production of this raster the video signal on the control grid determines the beam intensity and hence the amount of light each spot produces. In addition to supplying the signal information the control grid supplies the blanking information so that the beam is properly extinguished during the horizontal and vertical retrace periods.

Deflection Sensitivity

The amount of vertical or horizontal distance a beam moves on the face of the picture screen for a change in deflection voltage is a measure of the *deflection sensitivity* of the CRT.

For an electrostatic tube, deflection is proportional to:

$$D = E \times L \ d/2 \ V \text{ s where,}$$

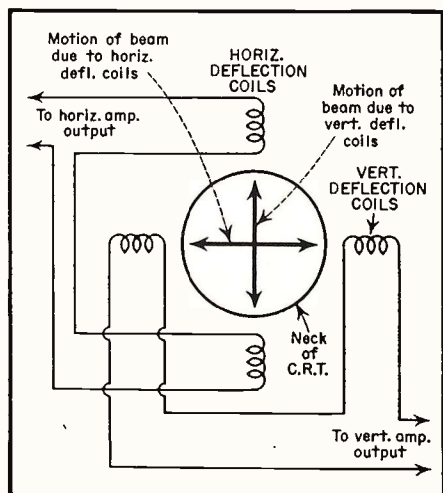
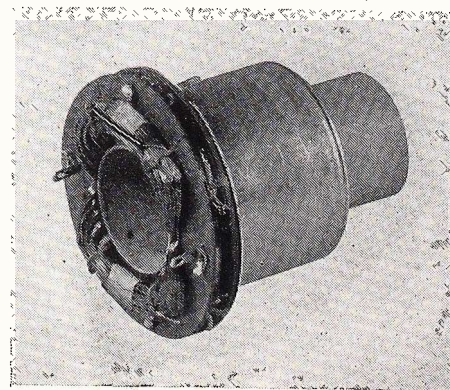

Fig. 2—Beam deflection in electromagnetic tube



(courtesy G.E.)

Fig. 3—Typical electromagnetic deflection coil

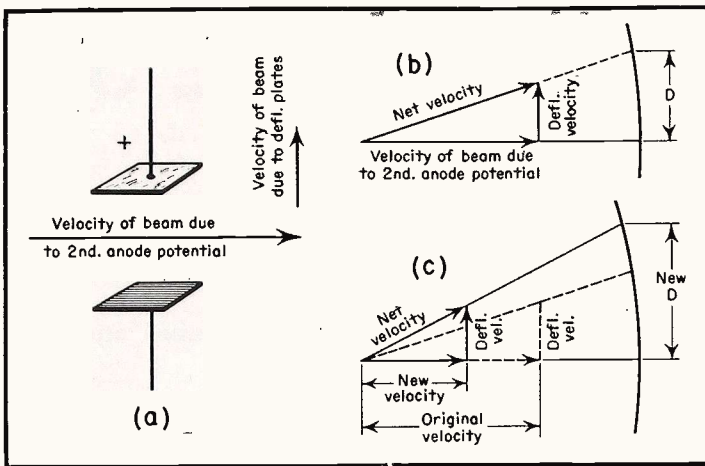

Fig. 4—Effect of accelerating or 2nd anode potential on deflection distance, D , on face of CRT screen.

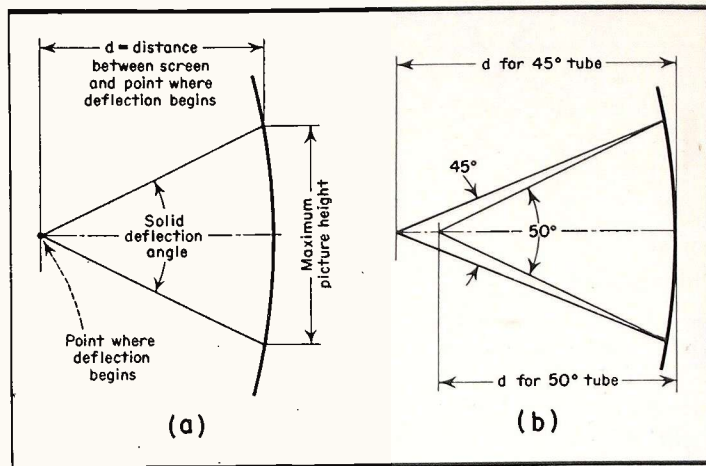

Fig. 5—Effect of solid deflection angle on length of tube d making for shorter or longer tube.

D = deflection, E = deflection voltage, d = distance from screen to the center of the deflecting plates, L = length of the plates, V = accelerating voltage, s = distance between plates.

For an electromagnetic tube, deflection is proportional to:

$$D = .3 d L H / V \text{ where,}$$

D , V , are defined as above, and L = length of deflecting field, H = flux density, d = distance between beginning of deflecting field and the screen.

It is customary in CRT data sheets to express deflection sensitivity in terms of its reciprocal, *deflection factor*. Thus, instead of expressing the quality of a CRT in terms of inches/volts (deflection sensitivity) it is expressed in terms of volts/inch, where the *volts* involved refers to the deflection signal voltage and *inches* refers to the distance the beam is displaced on the screen.

It is interesting to note that the

deflection sensitivity *decreases* as the accelerating anode potential, V , is increased. A study of *Fig. 4* will make the reason for this statement readily apparent. First it must be recalled that an increased accelerating anode potential increases the velocity of the beam. The net velocity of the beam is shown in *Fig. 4b* after being subjected to the influence of the deflecting potential. D represents the distance on the CRT screen the beam moves due to the combined action of the beam velocity and deflecting voltage.

In *Fig. 4c* the accelerating potential has been reduced, the deflecting voltage remaining the same. Notice that the angular displacement of the net force on the beam is now greater than before, resulting in a greater vertical distance, D , in the screen.

In practical applications the size of the picture may be increased ver-

tionally or horizontally by the following:

1. Increasing the horizontal or vertical sweep voltages applied to the plates. In electromagnetic deflection the important consideration is the deflection *current*.
2. Decreasing the accelerating or 2nd anode potential.

In the first case no loss of picture brilliancy will result. In the second, the slowing up of the beam will result in a less brilliant spot.

Solid Deflection Angle

Some tubes list a value called, *solid deflection angle*, which describes, as shown in *Fig. 5*, the maximum picture height that can be obtained with relation to the distance between the screen and the point where deflection begins. *Fig. 5b* reveals why a tube with a 50° solid deflection angle can be made shorter in overall length than a tube with a 45° solid deflection angle. Present day practice is to design the larger tubes with 50° solid deflection angles.

Electrostatic Tube Voltage Network

A typical network designed to supply the various electrode voltages and control circuits for an electrostatic CRT is shown in *Fig. 6*, which is a simplified partial schematic of the Philco Model 48-700 receiver. At the extreme right we observe the manner in which the outputs of the high and low voltage power supplies are related to each other. $B-$ of the low voltage power supply is at ground potential. $B+$ of the high voltage power supply is also grounded. This puts any point on the low voltage power supply voltage divider at a *higher positive potential* than any point on the high voltage power supply. In effect, both power supplies are connected in series so that the total voltage across both is 3,450 plus 395 = 3,845 volts.

The most negative electrode in the

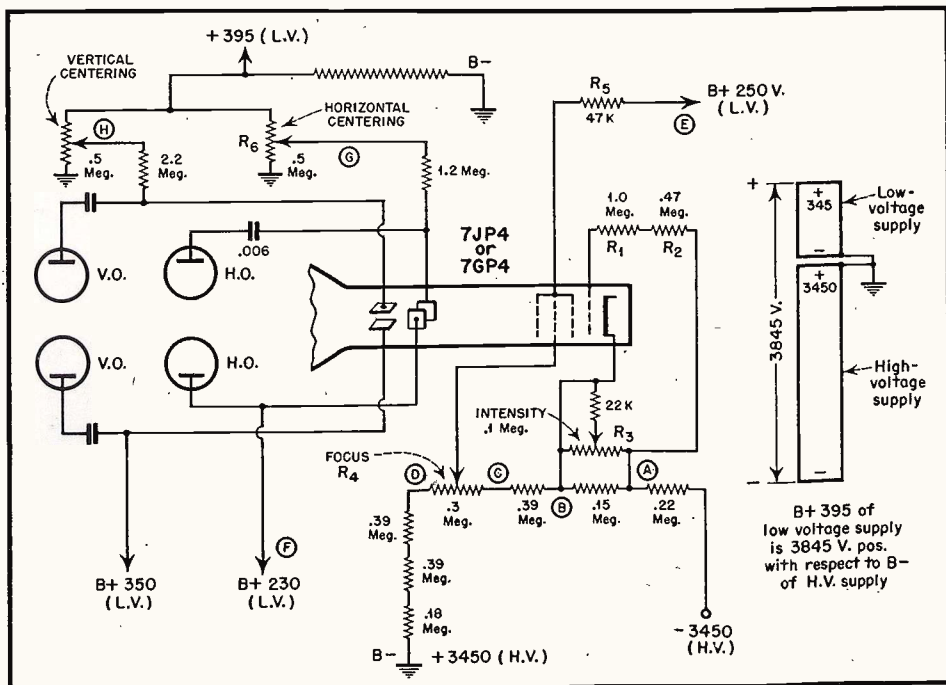

Fig. 6—Philco Model 48-700 simplified schematic of CRT voltage distribution and control circuits.

CRT is the control grid which is connected to point *A* via the load resistors, R_1 and R_2 . At a point *B*, about 150 volts more positive than point *A* is the top end of a variable control, R_3 . The cathode of the CRT is connected to the center arm of this control, enabling the grid bias on the CRT to be varied between 0 and 150 volts, negative. Since this control varies the grid bias and hence the beam intensity, it is called the "intensity control".

Points *D* and *C* determine the positive and negative ends of a second control, R_4 , the center arm of which is connected to the focusing anode of the tube. By varying this arm the voltage on the focusing anode is varied so that, in effect, it becomes the "focus control".

The second anode is connected through a 47K resistor, R_5 , to a point, *E*, which corresponds to a point on the low voltage power supply voltage divider of 250 volts. With respect to the high voltage power supply $B-$ this potential is $250 \text{ plus } 3,450 = 3,700$ volts. The voltage between the 2nd anode and the CRT cathode is $3,450 - \text{grid voltage} + 250$. For a grid voltage of 75, this works out to be $3,450 - 75 + 250 = 3,625$ volts.

We now proceed to a study of the vertical and horizontal deflection control circuits. Referring to the first horizontal plate, we notice that it is connected to a point, *F*, which is 230 volts plus with respect to ground. In order for the electron beam to pass through the center of these plates, the center arm (point *G*) of the "horizontal centering control", R_6 , is adjusted so that the voltage between point *G* and ground is also 230. Notice that one side of the control is connected to 395 plus and that the other side is grounded. Somewhere along the control a 230 volt point will be found which exactly balances the potential effect of the first plate.

The action of the "vertical centering control" is the similar to that of the horizontal centering control. The voltage at the bottom plate is 350. The top plate is connected to the centering control. This arm when varied finds a 350 volt point which exactly balances the potential effect of the bottom vertical plate.

The synch signals which are applied to these deflection plates come from the push-pull outputs of the horizontal and vertical amplifiers. Push-Pull is used so that the a-c signal applied to the plates are exactly balanced with respect to the high volt-

age accelerating potential. In single-ended amplifiers the instantaneous effect of the synch voltage applied to the plates causes the voltage on one of the plates to vary above and below the accelerating potential, thereby changing the velocity of the electron beam, and producing a defocusing effect called, "astigmatism". With push-pull the instantaneous voltage increase at any plate is balanced by a corresponding voltage decrease on the opposite plate, and the average accelerating voltage remains the same.

Electromagnetic Tube Voltage Network

The simplified schematic of the CRT control circuits of the RCA Model 630 TS is shown in Fig. 7. Notice that the low voltage power supply is connected across the voltage divider between points *A* and *J*. The high voltage power supply is connected between points *M* and *P*. Between points *J* and *M* we find a 3rd source of d-c voltage which is due to rectified horizontal synch signal present in the horizontal output transformer secondary. The total voltage of the three power supplies which are effectively connected in series is 9,430 volts. This voltage is distributed as follows: 380 volts from the low voltage power supply, 50 volts from the rectified horizontal synch voltage present in the damper circuit, and 9,000 volts from the high voltage power supply. Ground connection is located 100 volts above the negative terminal of the low voltage power supply.

All voltages are referred to with respect to ground. Thus, the neg-

ative connection of the low voltage power supply is -100 volts, and point *J* is $B+280$ volts.

In the CRT which is a 10BP4, the cathode is grounded and the grid is returned to $B-100$ through two load resistors, R_1 and R_2 , as shown, being connected via the lower end of R_2 to the center arm of the brightness control. The latter is connected between points *A* and *D*, so that the center arm, *E*, provides a variable bias of about 150 volts on the CRT grid.

The focus coil is connected across the voltage divider between points *A* and *B*. The direct current through the focus coil is controlled by the focus control which is connected in parallel with the focus coil through resistor, R_3 . Varying the focus control shunts more or less resistance across the focus coil thereby changing the current in the coil.

The ion trap is connected across a constant source of voltage between points *C* and *B*. In this receiver the adjustment for this circuit is fixed; in some others the current through the ion trap coils is adjustable.

Notice that the accelerating anode (screen grid) is connected to a point, 275 volts above ground. This corresponds to point *F*.

Connected between *F* and *H* is the vertical centering control which is part of the entire voltage divider. The vertical deflection coils are connected at one end to point *G* on the vertical centering control, and at the other through the vertical output transformer secondary to a tap on this control. It is evident that by varying the posi-

[Continued on page 36]

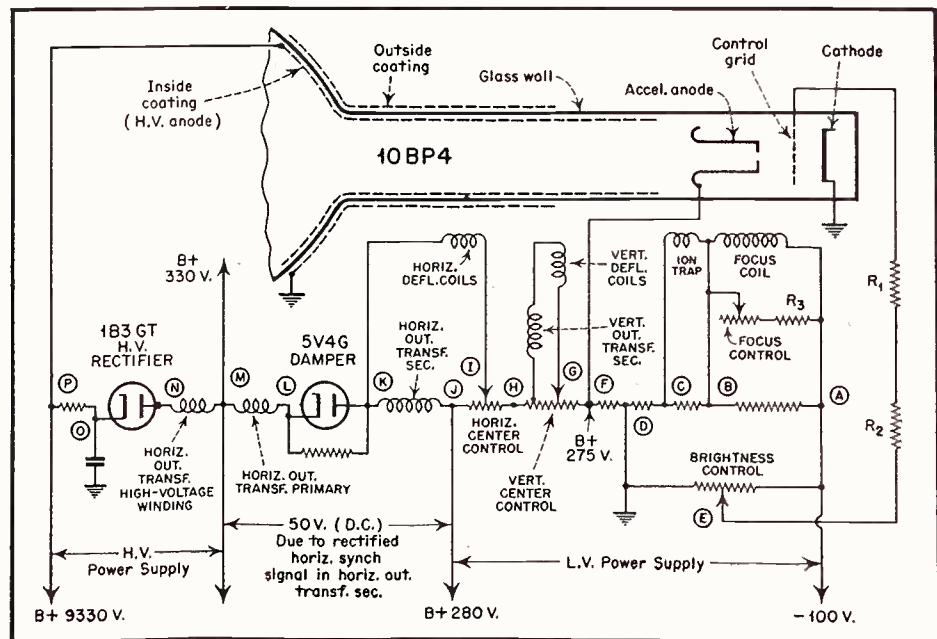
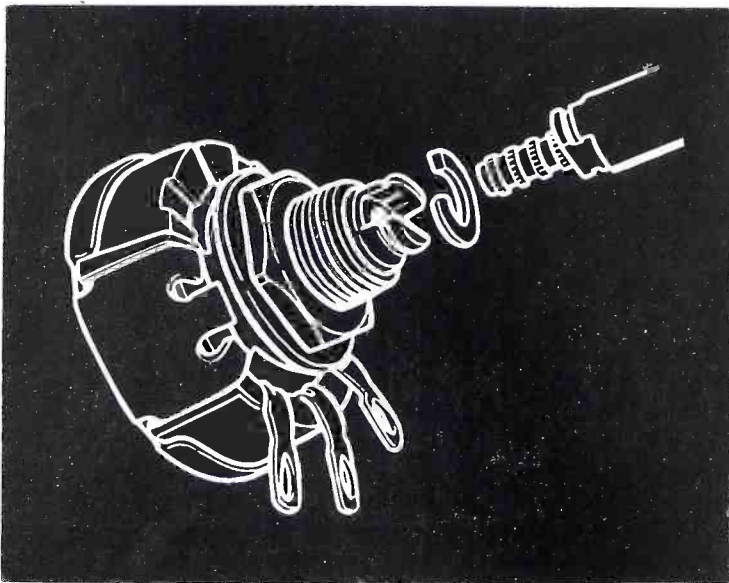
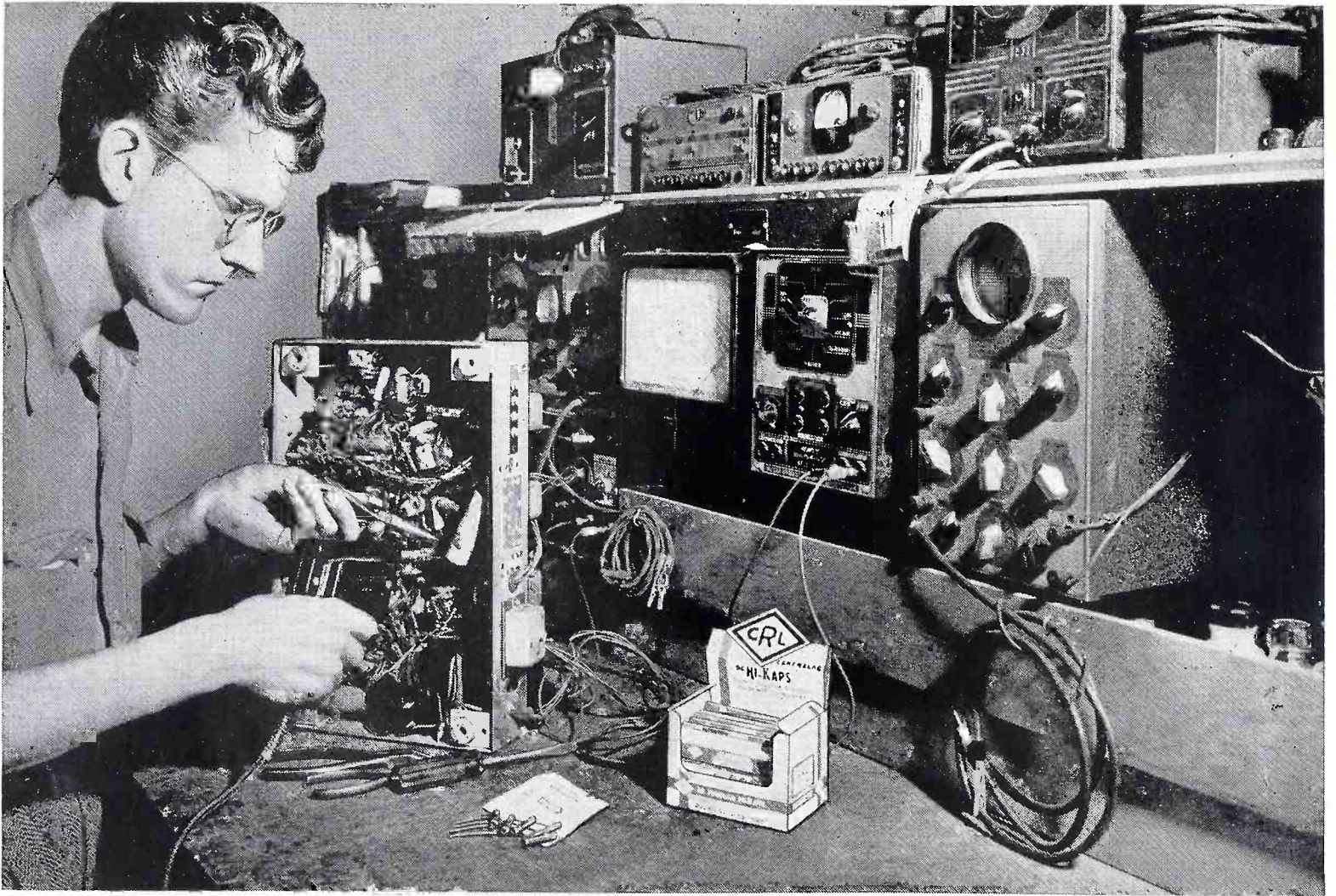
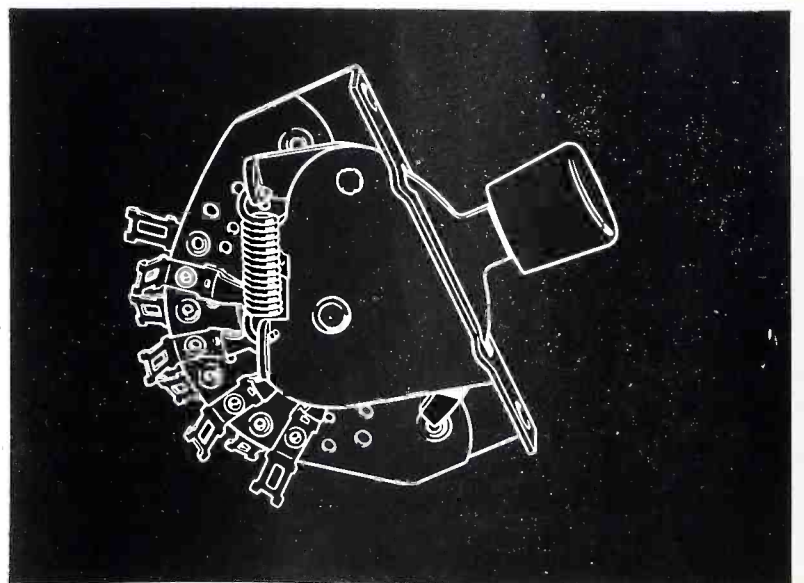

Fig. 7—R.C.A. Model 630 TS simplified schematic of CRT voltage distribution and control circuits,

See how Centralab



Controls: With CRL's improved *Adashaft* Radioshfts you can carry a small stock of controls, yet be ready to handle almost any kind of control replacement problem. No wiggle, no wobble, no slip. Just insert shaft pilot in control stub shaft, and slip "C" washer into place. Available in all sizes for all model "M" volume control applications. Six types of shafts.



Switches: Centralab offers you a complete line of Tone, Rotary Selector, Lever Action and Medium Duty Power Switches, which features a wide variety in both laminated phenolic and steatite insulation. Available with shorting or non-shorting contacts. See your Centralab Distributor for further information, or write direct for new Catalog 26.

boosts your profit

Faster service . . . satisfied customers . . . greater profits go hand in hand when you switch to Centralab replacement parts. CRL components are easy to use — speed repairs. They're easy to stock—cut overhead. They won't let you down — build repeat business. When you compare quality, performance and price, you'll see why radio servicemen everywhere use Centralab parts to increase efficiency in their shops . . . build customer goodwill . . . put extra dollars in their pockets. Find out how the Centralab line can help you build up your service business. For the complete story, get in touch with your Centralab Distributor.

← — "Centralab's line of replacement parts cuts repair time in our shop", says Earl Olson, serviceman for Pohl Radio Service, Wauwatosa, Wisconsin. "This makes it possible to turn out more work every day."

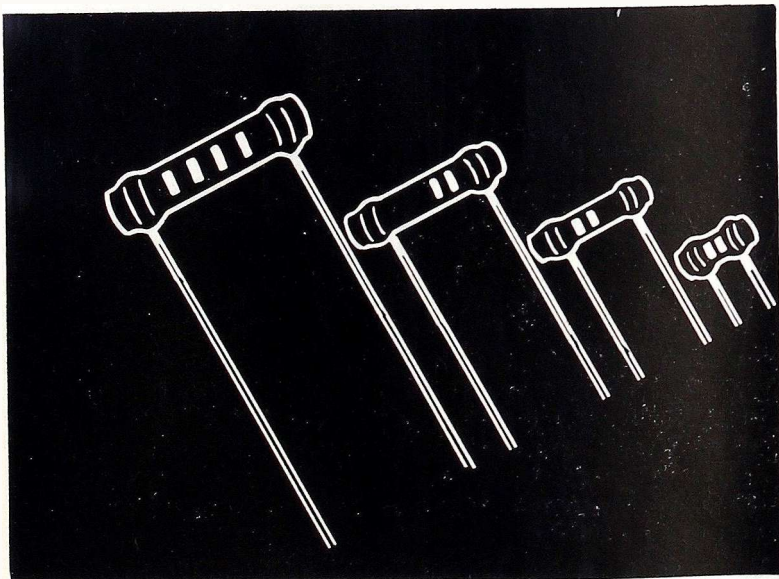

"Hi-Kaps": CRL line of ceramic By-pass and Coupling Capacitors gives you ceramic dependability and permanence at a new low price! Packaged in a convenient envelope of five, *Hi-Kaps* are clean, easy to stock and handle. Wide range from .000050 to .010000 mfd. Rating — 600 WVDC, 1000 V. flash tested. Ask your Centralab Distributor for all the facts.

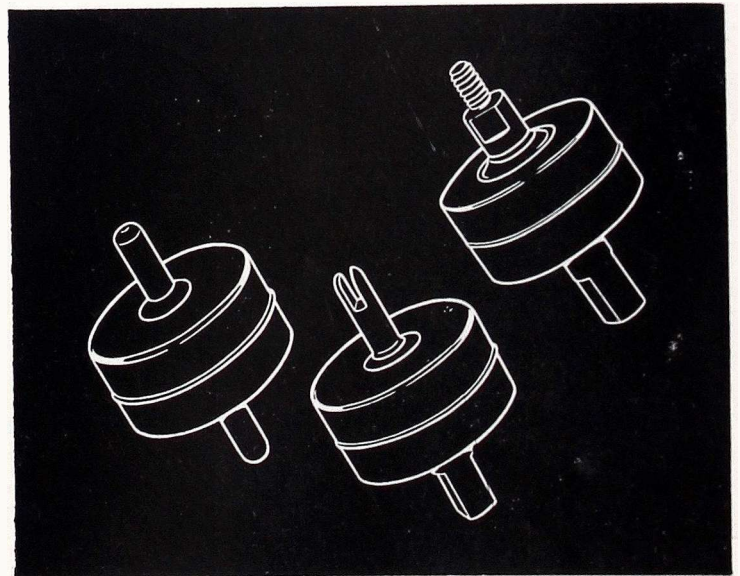

"Hi-Vo-Kaps": Just out! Centralab's new high voltage age capacitors for television and high voltage applications. Made of Ceramic-X, *Hi-Vo-Kaps* combine high voltage and small size to give you convenient, dependable performance, 10,000 WVDC flash, 20,000 VDC. Capacity — 500 mmf. See your CRL Distributor, or write direct.

FM-TV ANTENNA MAST SUPPORT

by Hy D. KRAFT

This article on the theory and practice of securing antenna masts and mounts to roofs and walls of various types was supplied to us by the Engineering staff of the Star Expansion Bolt Co. It represents a basic approach to the problem of installing FM and TV antennas without the danger of collapse when subjected to wind velocities of hurricane strength. Additional information and techniques on this subject which have been contributed by other manufacturers will be presented in subsequent issues of "RSD".

ANY discussion on methods of installing Television Antenna must include a typical example showing the actual loads imposed on the aerial by varying wind velocities. The following example does not include all factors. However, the figures are close enough to use them as a basis for determining the size of expansion shields and bolts needed.

Referring to Fig. 1, and assuming a wind velocity of 100 miles an hour (this is equal to a hurricane) the wind pressure would be 40 lbs. per sq. ft. The following formula will help determine the pressure for varying wind velocity:

$$P = 0.004V^2$$

V = Velocity of wind

Area of crosspiece - $1/12 \times 4' 0" = 1/3$ sq. ft.

Moments around "A" - Pressure x area x distance from point "A" = $40 \text{ lbs.} \times 1/3 \text{ sq. ft.} \times 8' 0" = 106 \text{ + ft. lbs.}$

Vertical shaft moments - $40 \text{ lbs.} \times 2/3 \text{ sq. ft.} \times 4' 0" = 106 \text{ + ft. lbs.}$

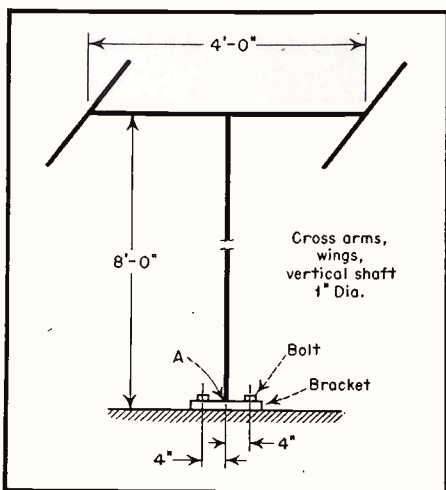

Fig. 1—Support structure used to illustrate design of proper-size bolts.

HOW TO INSTALL STAR DRYVIN

1. The Dryvin and the mounting hole for it should be the same diameter as the hole in the fixture which is to be fastened. Place the fixture in position and drill through hole therein into the wall.
2. Insert Dryvin through the fixture and into mounting hole in wall.
3. Hammer nail in solidly. If fixture requires additional support, repeat drilling and driving operation.

Notes:

Be sure to use a Dryvin sufficiently long so the lead expansion sleeve will be located below the surface of the masonry a distance equal to or greater than the diameter of the Dryvin.

The depth of the hole should be sufficient to accommodate the nail, which is somewhat longer than the Dryvin.

HOW STAR DRYVIN WORKS

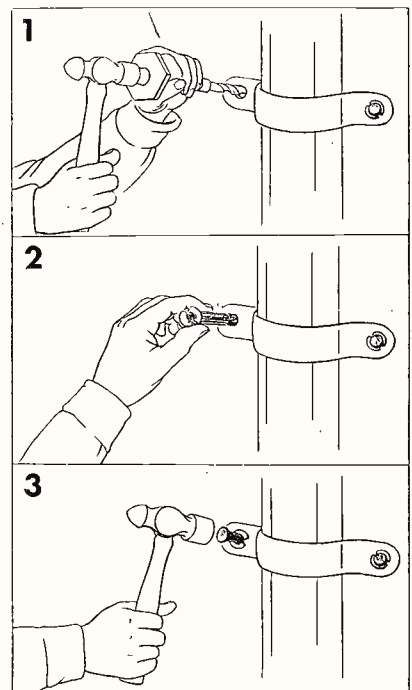
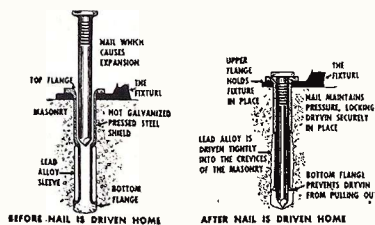

Fig. 2—Instruction sheet illustrating the proper method of installing a Star Dryvin nail. Refer to text for drills to be used in various types of brick, etc.

Total of moments - 212 + ft. lbs.
Using a safety factor of $2/3$ to determine load on each bolt we continue: $2/3 (106 \text{ ft. lbs.}) = 212/3 = 71 \text{ ft. lbs.}$ per bolt. Therefore, $71 \text{ ft. lbs.} / 1/3 \text{ of ft.}$ (this is the distance from center of vertical shaft to center of bracket holes) = 213 lbs. Then - 213 lbs. is the load imposed on the shield and bolt.

You would not use glue to join two pieces of metal, nor would you use thumb tacks. It is true, some things are "just as good as"—but it's equally true that you are the type of mechanic that wants to use the best there is—

especially when it costs less in time, labor and material. All good mechanics always have the right tools for the job at hand. We do not presume to tell the field installation engineer where it is best to set up his aerial, his experience and training is the best judge of that. However, there are some important rules to remember in selecting the best type of fastening device to be used in securing TV antennas to outside masonry and wood walls:

1. Is the shield rust-proof?
2. Is the machine or lag screw that is to be inserted in shield rust-

Stop here!

The NEW General Electric Variable Reluctance Cartridge for Long Playing Records

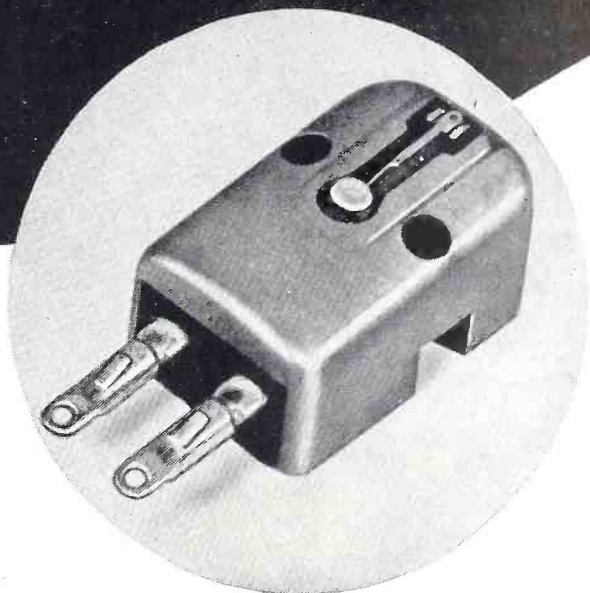

- Specifically designed for the new long playing records...high compliance...low mass stylus assembly
 - Equipped with 1 mil tip radius sapphire stylus
 - Can be used with standard G-E preamplifiers
- Place your order today!

*General Electric Company, Electronics Park,
Syracuse, New York*

You can put your confidence in —

GENERAL  **ELECTRIC**

160-G10

proof?

3. If non-metallic expansion shields are used, be sure they will not rot.
4. Select type of shield that is most resistant to vibrations.
5. Select right size shield for load that antenna must carry in tension and shear.

In some cases the bracket supporting the antenna has two holes, others have four holes.

Reference to a catalog will show us that a 1/4" x 1-1/2" Star Dryvin will take a load of 300 lbs. in tension. See Fig. 2. The nails which are supplied with the shields are large enough to take the load in shear. In the illustration outlined previously we required an expansion shield and bolt to carry a load of 213 lbs. plus, obviously the shield selected is large enough to take care of our needs. Now we have the right size shield and it conforms to the basic rules outlined above.

At this point we are ready to install the brackets on the masonry wall. The field engineer can use any of the following types drills—Star Drill, Hammertwist Drill or Rotor-twist Carbide Drill. See Fig. 3. If he has a hand brace or slow speed electric drill the latter would do a much faster job in drilling holes. The drill size is the same as the shield size, in this instance it is 1/4" dia., other types of shields would require larger size holes and drills. Since the holes in the brackets are 1/4" it is simple to place the drill through the hole and drill direct into the wall eliminating the need for

HOW TO INSTALL

1. Drill hole of correct diameter, slightly deeper than length of Scrutin. Insert Scrutin in hole, bell-shaped end outward and flush with the surface of the masonry.
2. Insert the wood screw through the fixture into the Scrutin and tighten.

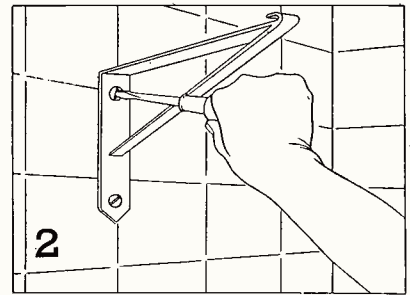
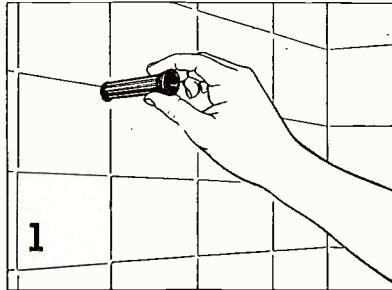

Notes:

To determine proper length of screw, add the thickness of the fixture to the length of the Scrutin plus 1/2-inch. For full expansion and best installation, the screw should protrude through the bottom of the Scrutin approximately 1/4-inch.

Ordinarily, brass screws should not be used as the screw is apt to break when turning into the Scrutin. If necessary to use a brass screw, the correct method is to install a steel screw fully, then remove and replace with the brass screw.

Fig. 5—Instruction sheet illustrating the proper method of installing Scrutins

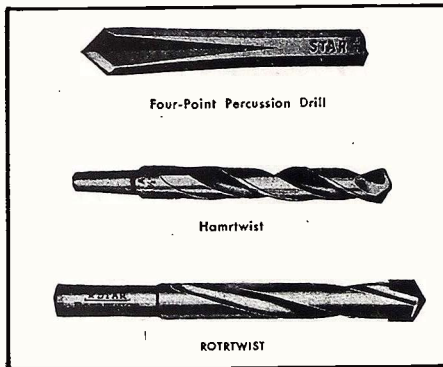

Fig. 3—Various types of drills used in making holes in brick, concrete, tile, and other materials encountered in antenna installations.

HOW TO INSTALL

1. Drill hole in masonry. Consult table above right for minimum depth. Insert Star Tampin in hole, closed end first.
2. Place the pilot of Star Tampin Setting Tool (packed in each box of Tampins) into the exposed end of the Tampin. Strike other end of tool with hammer; a few blows usually are ample. This sets the Tampin nut at the bottom of the hole and drives the lead tightly into every crevice of the hole.
3. Insert standard machine bolt or screw through fixture to be installed, into the anchored Tampin, and tighten.

NOTES:

Star Tampin may be set at minimum depth (length of Tampin) or it may be set at a greater fixed depth as desired—in which case

TO DETERMINE LENGTH OF SCREW—Thickness of work, plus depth of hole, less diameter of screw, equals proper length of screw.

TO USE SCREW OF FIXED LENGTH—Determine Depth of Hole as follows: Length of screw, minus thickness of work, plus diameter of screw, equals depth of hole to be drilled.

Star Tampin may be set as far below the surface of the masonry as the setting tool will permit.

Deeper holes than shown in table should be used for installations in poor masonry, but the same rule for the length of the screw applies.

Because of its large size, the 3/4-inch Star Tampin is assembled with two separate lead sleeves. Each sleeve should be expanded separately. Remove top lead section, insert Tampin in hole and expand bottom section solidly with Tampin Tool, next insert top lead section and expand in same manner. (A third lead section may be added, if desired, when there is sufficient depth of hole.)

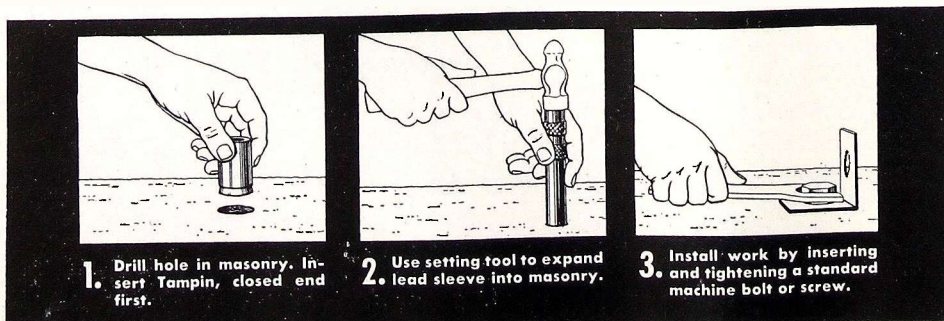

Fig. 4—Instruction sheet illustrating the proper method of installing Tampins

marking hole spacing. Place bracket on wall, drill hole through, place Dryvin shield through hole, then drive nail in. Repeat the operation until all shields and nails are inserted.

It will take about 1200 lbs. pull to dislodge bracket if four shields are used, or 600 lbs. if two shields are used. The swaying of aerial in wind will not pull anchors loose. The aerial will fail before bracket is dislodged. The double headed nails are used to facilitate removal if any adjustment is required on the aerial, also use it for guy wire anchorage. The cost of this type of Expansion Shield is comparatively small as compared to the other type shields.

There are two types of insulated screw eyes—one is a machine screw type, the other a wood screw type. If the machine screw type is used, then the expanded lead shield, (Star Tampin—see Fig. 4) is used, the size to fit the screw eye. If the wood screw type is used then use a Star Scrutin, see Fig. 5. Both these shields conform to the basic rules outlined previously.

Oftimes an aerial must be installed on the ridge of a roof which is made either of slate or asphalt tiles. In that event, the type fastener should be a toggle bolt preferable 1/4" x 3" with round head. This eliminates the need of having a man working under difficult conditions on the under side of the roof to fasten the nut or a machine bolt.

When using toggle bolts the hole size may have to be a little larger. In either case, large or small hole, use a sealer to prevent any roof leakage.

Switch to PHOTOFACT— the Best Service Data Buy You'll Ever Make!

Thousands of Radio Service Technicians are *right!* They've found the way to quicker, easier, more profitable servicing. Join these thousands of successful money-making Servicemen who have switched to PHOTOFACT Service Data. Learn for yourself how this accurate, easy-to-use, practical data saves you time, makes your work easier, helps you earn more. PHOTOFACT gives you 100% useful service data—every photograph, every diagram, every bit of information helps you do a *complete job*. You owe it to yourself to switch to PHOTOFACT. There'll be a big difference in the time you save and the bigger profits you'll earn every single working day.

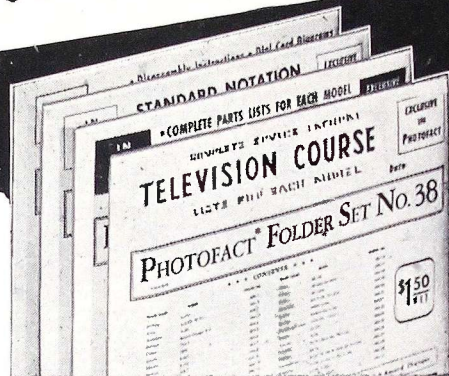

Subscribe Regularly to PHOTOFACT Folder Sets

Here's the most accurate and complete Radio Data ever compiled—issued regularly two sets per month. Keeps you right up-to-the-minute on all current receiver production. Your best buy in Service data—practical, useful information that makes money for you every day by saving you time on service jobs. Shows you everything you need to know about the sets you service—in clear, accurate, uniform style. Packed with extra help—full PHOTOFACT data on Automatic Record Changers—communications receivers—amplifiers—*plus* new PHOTOFACT Television Folders—exclusive, uniform coverage of popular Television Models, data proved best by actual service clinic experience. Subscribe at your Jobber today, for regular monthly issues. **\$1.50 PER SET ONLY**.....

FREE Photofact Cumulative Index

Send for the FREE Cumulative Index to PHOTOFACT Folders covering *all* postwar receivers up to the present. You'll want this valuable reference guide to the Radio Service Data preferred and used by thousands. Helps you find the Folders you want quickly. Get this Index at your Jobber or write for it today.



PHOTOFACT VOLUMES The Preferred Service Data

Bring your file of post-war receiver Service Data right up to July, 1948! Here's the most accurate and complete radio data ever compiled—preferred and used daily by thousands of Radio Service Technicians. Includes: Exclusive Standard Notation Schematics; photo views keyed to parts lists and alignment data; complete parts listings and proper replacements; alignment, stage gain, circuit voltage and resistance analysis; coil resistances; record changer service data, etc. Order Volume 4 today—keep your Photofact library up-to-date—it's the *only* Radio Service Data that meets your *actual* needs!

- Vol. 4.** Covers models from Jan. 1, 1948 to July 1, 1948
- Vol. 3.** Covers models from July 1, 1947 to Jan. 1, 1948
- Vol. 2.** Covers models from Jan. 1, 1947 to July 1, 1947
- Vol. 1.** Covers all post-war models up to Jan. 1, 1947

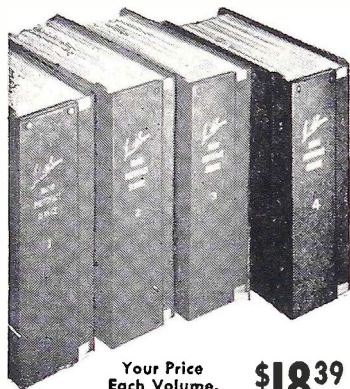

Your Price
Each Volume,
In DeLuxe Binder **\$18³⁹**

1947 Record Changer Manual

Nothing like it! Complete, accurate data on over 40 post-war models. Exclusive exploded views, photos from all angles. Gives full change cycle data, information on adjustments, service hints and kinks, complete parts lists. **PLUS**—for the first time—complete data on leading Wire, Ribbon, Tape and Paper Disc Recorders! 400 pages; hard cover; opens flat. Order now! **\$4.95 ONLY**.....

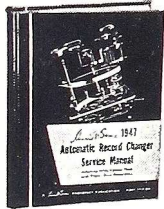

Receiver Tube Placement Guide

Shows you exactly where to replace each tube in 5500 radio models, covering 1938 to 1947 receivers. Each tube layout is illustrated by a clear, accurate diagram. Saves time—eliminates risky hit-and-miss methods. 192 pages, completely indexed. **\$1.25 ONLY**.....



Dial Cord Stringing Guide

The book that shows you the *one right* way to string a dial cord. Here, in one handy pocket-sized book, are all available dial cord diagrams covering over 2300 receivers, 1938 through 1946. Makes dial cord restringing jobs quick and simple. **\$1.00 ONLY**.....

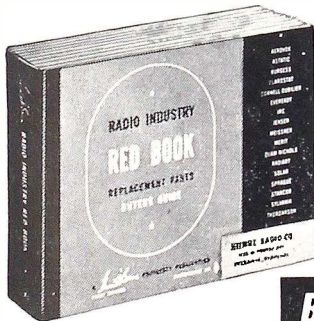
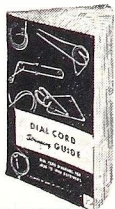

Radio Industry RED BOOK

The RED BOOK tells you *in one volume* all you need to know about replacement parts for approximately 17,000 sets made from 1938 to 1948. Includes complete, accurate listings of all 9 major replacement components—not just one. Lists correct replacement parts made by 17 leading manufacturers—not just one. Covers original parts numbers, proper replacement numbers and valuable installation notes on: Capacitors, Transformers, Controls, IF's, Speakers, Vibrators, Phono-Cartridges. *Plus*—Tube and Dial Light data, and Battery replacement data. 440 pages, 8½ x 11; sewed binding. **\$3.95 ONLY**.....

BOOST YOUR EARNING POWER!

Mail This Order Form

to HOWARD W. SAMS & CO., INC.
2924 E. Washington St., Indianapolis 7, Indiana

My (check) (money order) for \$.....enclosed.

- Send the RED BOOK. \$3.95 per copy.
- Send PHOTOFACT Volumes in DeLuxe Binder:
 - Vol 4. Vol. 3. Vol. 2. Vol. 1 (\$18.39 each).
- Automatic Record Changer Manual, \$4.95.
- Tube Placement Guide, \$1.25.
- Dial Cord Stringing Guide, \$1.00.
- Send FREE Photofact Cumulative Index.

Name.....

Address.....

City.....State.....

HOWARD W. SAMS & CO., INC.
INDIANAPOLIS 7, INDIANA

CIRCUIT COURT

Motorola 77FM series

Numerous novel details are to be found in the Motorola 77FM instruments. The circuit incorporates only six tubes, but 2 of them are the newly developed 12AT7 and 19D8. Both AM and FM bands are covered. Power is provided by a selenium type rectifier. The heaters are series connected, but the inclusion of a phonograph motor precludes operation on d-c line.

Present discussion will center around the unusual system of switching from AM to FM. The FM converter, employing the 12AT7 dual triode feeds a signal to a 4.3 mc i-f transformer. In the FM position the next stage is an i-f amplifier, but the tube is a 12BE6. This tube contains 5 grids and is ordinarily found as a pentagrid converter. For straight amplifier service *B* voltage is applied to the signal grid, and the signal fed into the first or oscillator grid. A 220 ohm resistor provides cathode bias. The plate feeds another 4.3 mc transformer.

When switched to AM an entirely new form of operation is brought into use. The signal grid of the 12BE6 is connected to the loop and a tuning condenser. The oscillator grid sees the FM coil as a small inductance and is coupled to the grid coil by a 50 mmfd. capacitor. Feedback is provided by a cathode coil which also returns the cathode to ground via an r-f choke. The i-f for AM is 455 kc. The plate is switched to a transformer of this frequency. The next stage is a 12BA6 i-f stage.

Edwards Fidelotuner

Of the many FM tuners currently available for attachment to a separate audio system, one interesting one is the Edwards. A conventional i-f and discriminator, using 6SH7 and 6H6 tubes is preceded by a novel converter arrangement. Power for the d-c circuits is supplied by a transformer and selenium rectifier.

A miniature, dual triode tube, type 6J6 performs the functions of mixer and oscillator. While the circuit is not too novel electrically, the method of tuning, coupling and tracking are unusual.

Two sets of parallel rods form the variable portion of the high frequency circuits. Sliders move across

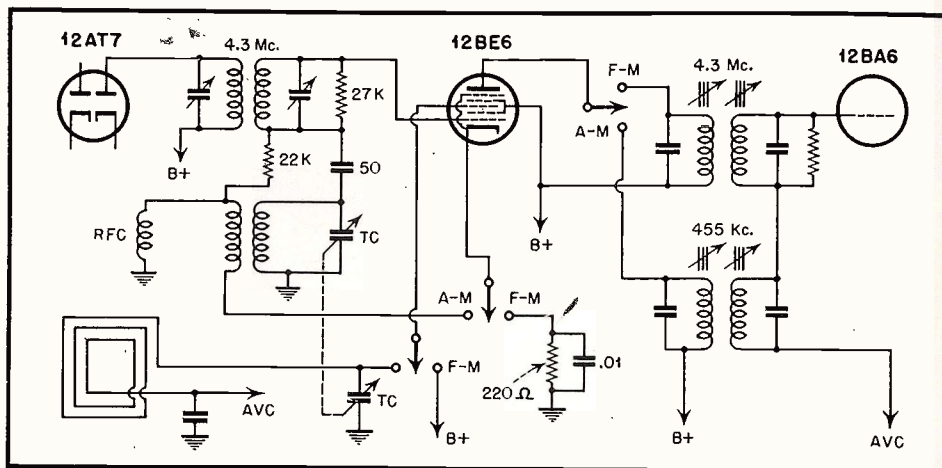

Front Section of Motorola 77FM series

the lines as the tuning control is rotated. As the lines are made electrically shorter they increase in frequency. The lines are mounted in a horizontal position just back of the slide-rule dial and the movement of the sliders is controlled by the action of a string, similar to the action on many indicators.

The mixer circuit has the lines in the high potential portion of the grid circuit. A trimmer capacitor shunts the end of the line adjacent to the grid. The grid circuit is completed to ground through a small coil. Some adjustment of the total inductance in the circuit can be made by bending the turns. The antenna circuit forms the small portion of the coil nearest to ground.

The oscillator circuit is of the ultra-audion type, with the line and series coil across from grid to plate. A 500 μ mf capacitor isolates the grid from the plate potential. As in the grid circuit a trimmer condenser shunts the high end of the line. The

series coil is included in the whole tuned circuit in this case. A 1000 ohm cathode resistor provides starting bias and, being common to both mixer and oscillator, serves to establish coupling between the stages.

General Electric 354 and 355

These nine tube, AM-FM instruments incorporate an interesting variation in second detectors. Previous stages include type 6BA6 tubes as mixer and first IF stages. A 6C4 oscillator is used on both AM and the two FM bands. The second IF stage on FM employs a 6SH7 pentode. AM detection takes place in this stage. A ratio detector, with a 6AL5 tube, demodulates the FM signal. The audio channel incorporates a 6SC7 and a 6V6, with another 6SC7 being utilized as a pre-amplifier during phono operation.

A partial circuit is shown illustrating the details of the two second detector circuits. The plate circuit of

[Continued on page 36]

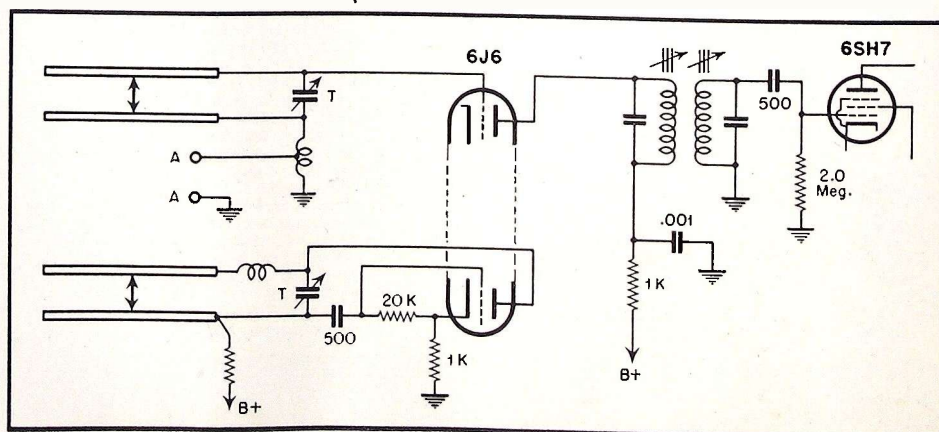

Front End of Edwards Fidelotuner

400,000 Admiral

RADIO-PHONOGRAPHS NEED THIS



Comes smartly packaged in transparent plastic container



\$1,500,000 REPLACEMENT BUSINESS FOR ADMIRAL DEALERS



No matter how sturdy a precision instrument may be, constant abuse is bound to impair its efficiency. The snap-in cartridge housed within ADMIRAL'S Miracle Tone Arm is a sensitive mechanism, and repeated dropping of the tone arm will cause damage.

Today 400,000 ADMIRAL radio-phonographs with Miracle Tone Arm are a year old or older. Each one of these should have a NEW snap-in cartridge if the ultimate in tone fidelity is to be maintained.

Here is a potential market for over 400,000 replacement cartridges. At \$3.95 each, this means a total of \$1,500,000 in sales reserved exclusively for ADMIRAL dealers.

GET YOUR SHARE OF THIS PROFITABLE REPLACEMENT BUSINESS

How many of *your* customers own ADMIRAL radio-phonographs with Miracle Tone Arm that are a year old or older? Every one is a sure-fire prospect for the snap-in cartridge. Here is YOUR OPPORTUNITY for quick, profitable sales.

Attractive display carton (left) placed in your service department or with fast-moving traffic items will mean FAST SALES and SATISFIED CUSTOMERS. Your ADMIRAL distributor has available a supply of hard-selling, compelling penny post cards which you may send to customers. Take advantage of this fast, inexpensive and easy way of letting your customers know the replacement snap-in cartridge is now available. PHONE OR WRITE YOUR ADMIRAL DISTRIBUTOR TODAY.

New VEE-D-X Antenna Line

VEE-D-X antenna systems are mfgd. by LaPointe Plascomold Corp., Unionville, Conn. The manufacturers announced the addition of a new antenna to the line. Known as the Sky Monitor, it is designed for use in prime and near fringe TV areas. This unit, offers broad band characteristics and

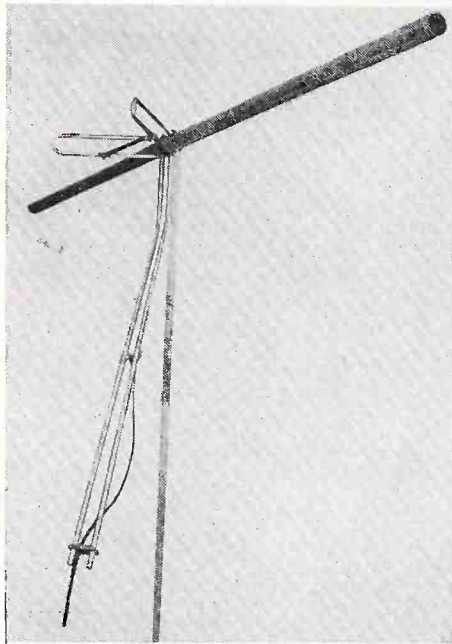

reasonably high gain. Provides a tunable "Q" section for matching line impedance. Allows the user to orient the high channels independently of the low channels. Polyethylene is used for insulation at all points of high frequency. Can be assembled rapidly and weighs less than 5½ pounds including the 6 foot 61ST duraluminum mast supplied.

Stancor High-Fi Audio Transformers

The new STANCOR "HF" and "WF" series of high fidelity audio transformers include a complete range of commonly used ratings for amplifier circuits, speakers, microphones and pickups, including low impedance to grid, push-all input, mixing, output and input.

The "HF" series, except for the HF-65 output transformer, has a wide range frequency response of ± 1 db from 20-20,000 cps. The "WF" series, except for

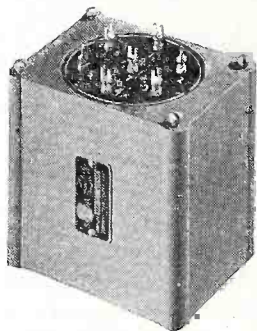

the WF-21, has a frequency response characteristic of ± 2 db from 30-20,000 cps. The WF-21 input transformer has a response of ± 2 db from 50-10,000 cps.

Both series are potted in gray enameled cast cases with four tapped holes on both top and bottom for flush mounting. Stud-type terminals are provided on a phenolic panel. For further information write Standard Transformer Corporation, Dept. S, Elston, Kedzie & Addison Streets, Chicago 18, Illinois.

NEW PRODUCTS

New Hickok Display Tube Tester

The Model 533 DM, a new Hickok Display Tube Tester, is now available for the radio serviceman. It is designed as a tube merchandiser to let customers see for themselves the condition of their tubes. A 9-inch illuminated scale reads "Replace", "Doubtful" and "Good". The 533 DM incorporates the Hickok Dynamic Mutual Conductance Circuits. Instrument uses rectified current to



energize plates and grids using two rectifiers. Meter shows micromho ranges of 0-3000, 0-6000, 0-15,000, for the technician. Roll chart in panel. Gas test provided. Tests diodes separately with low voltage. Power supply: 100-130 Volts, 50-60 Cycles. Size: 26¼" high, 17" wide, 11" deep. Tube Complement: 1 No. 83 and 1 No. 5Y3 GT. Manufactured by the Hickok Electrical Instrument Company, 10533 Dupont Avenue, Cleveland 8, Ohio.

New TV-FM Lead-In Supports

A series of TV-FM lead-in supports are announced by Porcelain Products, Inc., Findlay, Ohio. Available for all

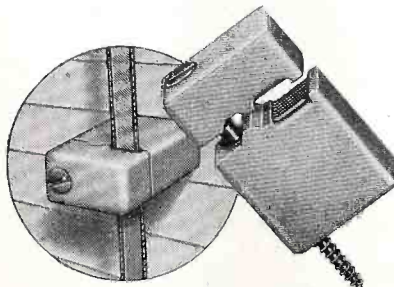

popular types of lead-in cables. Made of the high quality porcelain. Constructed with a positive "Alligator" pressure grip which holds the lead-in wire taut screws are rustproofed.

2 New G-I Motors

Production of two new rim drive, dual speed turntable motors has been announced by The General Industries Company, Elyria, Ohio. Either of these new motors will operate standard ten

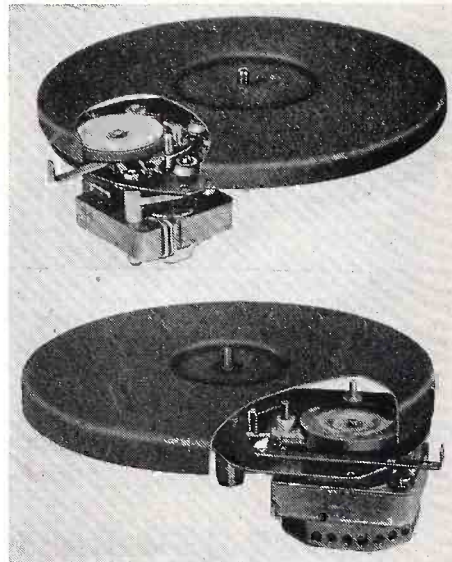

and twelve-inch turntables at both 78 and 33-1/3 r.p.m.

Model DR is a dual speed rim drive 4 pole motor with a positive mechanism for shifting from one speed to the other. Speed change is accomplished by means of an external push-pull lever. Model DM is dual speed phonomotor with external speed change control, and is approximately the same size as present speed turntable motors. By shifting a speed change lever which extends beyond the turntable rim, a neoprene belt-driven step pulley is engaged or disengaged to change speed. Voltages range from 110 to 220, frequency from 50 to 60 cycles. Bulletin available.

G-C New Recording Wire and Spring Maker

The General Cement Manufacturing Company, Rockford, Illinois, announces a complete line of magnetic recording wire. The recording wire is supplied in spools of one hour, one-half hour and fifteen minutes.



The Spring Maker can be used with any size wire and can make springs of

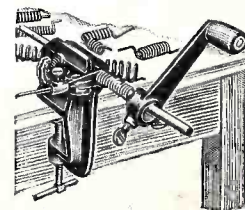

[Continued on page 32]

NEW!

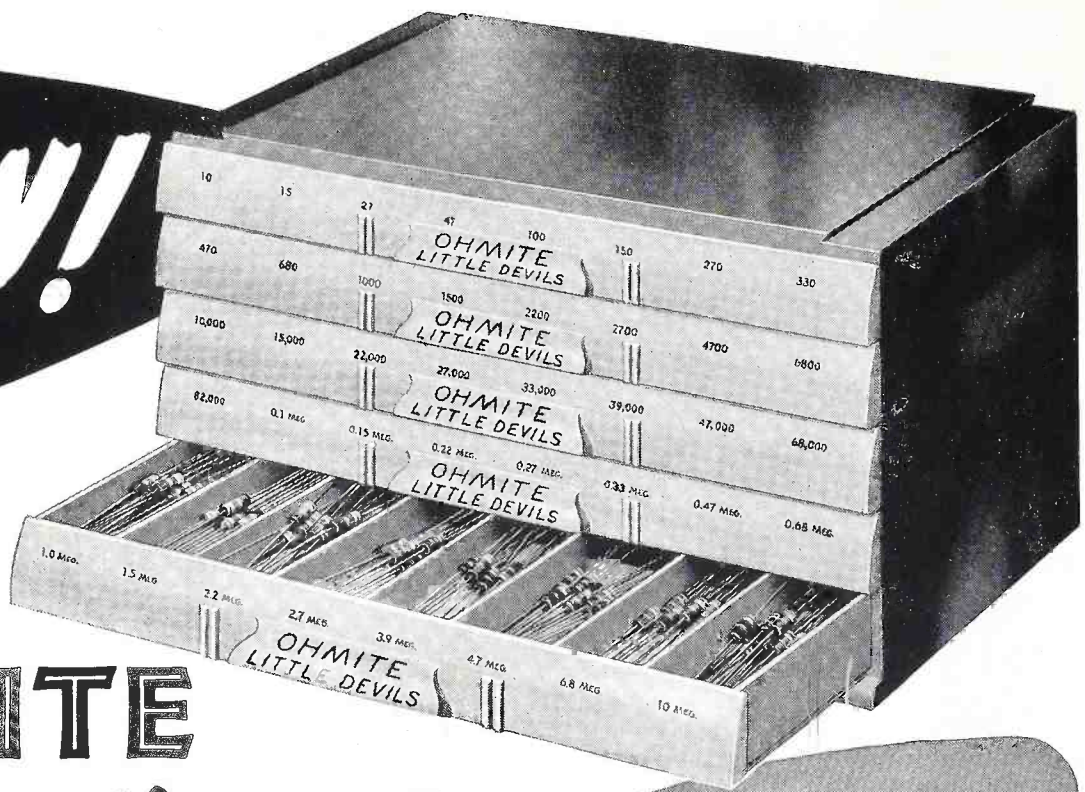

OHMITE
Little Devil

RESISTOR ASSORTMENT

IN RUGGED *All-Plastic* CABINET

REGULAR
PRICE FOR RESISTORS
\$10.00
NO CHARGE FOR
CABINET

Servicemen's Assortment Contains 125 Selected 1/2-Watt Little Devil Composition Resistors in 40 Separate Compartments

Here's a handsome, sturdy, all-plastic resistor cabinet you'll be proud to have in your shop—and one that will save you hours of valuable time. The new cabinet is molded of solid plastic and has five drawers with eight compartments in each drawer. It is extremely compact—only 9" long, 4-3/4" high, and 5-1/4" deep. Factory-packed in the cabinet is a serviceman's assortment of 125 carefully selected Ohmite "Little Devil," 1/2-watt, individually marked, insulated composition resistors, in the 40 values (10 ohms to 10 megohms) most fre-

quently used by servicemen. The assortment is offered at the price of the resistors alone—the cabinet is furnished without extra cost!

You'll need one or several of these handy cabinets in your shop to protect your resistors and to help you find resistance values quickly. What's more, they provide visual stock control so you can avoid duplicate inventories or unnecessary trips to your distributor. Order your assortment and cabinet from your jobber, today!

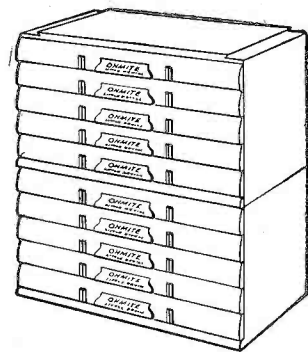

CAN BE STACKED ON EACH OTHER

A dovetail joint is provided on top and bottom of each cabinet so they can be stacked one on top of another.

QUANTITIES AND RESISTANCE VALUES IN THE SERVICEMAN'S ASSORTMENT							
Quantity	OHMS	Quantity	OHMS	Quantity	OHMS	Quantity	OHMS
1	10	3	1000	1	33000	10	0.47 meg.
1	15	1	1500	5	39000	1	0.68 meg.
1	27	1	2200	10	47000	10	1.0 meg.
1	47	3	2700	1	68000	1	1.5 meg.
1	100	5	4700	1	82000	1	2.2 meg.
1	150	1	6800	10	0.1 meg.	1	2.7 meg.
1	270	10	10000	5	0.15 meg.	1	3.9 meg.
1	330	3	15000	1	0.22 meg.	1	4.7 meg.
1	470	5	22000	10	0.27 meg.	1	6.8 meg.
1	680	10	27000	1	0.33 meg.	1	10 meg.

Stocked by Leading Distributors

OHMITE MANUFACTURING CO., 4845 FLOURNOY ST., CHICAGO 44

Be Right with **OHMITE**

RHEOSTATS • RESISTORS • TAP SWITCHES

NEW

TORQUE DRIVE KIT

Makes Sales and Service Easy!

**3 TYPES
REPLACE OVER
150 STANDARD
MODELS**

*Lightest, Most Efficient,
Crystal Pickup Cartridge
Ever Produced!*



SELL MORE CARTRIDGES

It's a colorful display . . . creates interest . . . and action . . . helps you sell *more* replacements to old and new customers.

SATISFY MORE CUSTOMERS

You give *faster* replacement service. Your customers get *more* pleasure and *more* good plays . . . *even from old, worn records!*

SIMPLIFY YOUR SERVICE JOB

It's a complete *service* Kit, too. Contains everything for time-saving, labor-saving replacement. Gives you 3 basic models that replace over 150 standard types.

MAKE MORE MONEY

Saves ordering time and service time. Cuts overhead. You make a good profit on every cartridge sale . . . and every service job. Builds needle sales, too! *Put the Kit on display . . . take one with you on your service calls.* Available in Kit "A" (Osmium) and Kit "B" (Sapphire). Each Kit contains 6 cartridges, 4 extra needles, mounting plates, replacement chart.

Order from your E-V Distributor or write for Bulletin No. 142

ELECTRO-VOICE, INC., BUCHANAN, MICH.

Export: 13 East 40th St., New York 16, N. Y., U. S. A. Cables: Arlab

E-V Pat. Pend. Licensed under Brush Patents.

NEW MODEL L14 MICROGROOVE CRYSTAL CARTRIDGE AND NEW MODELS 20 AND 22 MAGNETIC CARTRIDGE FOR REGULAR AND MICROGROOVE ALSO AVAILABLE

IT PAYS TO REPLACE WITH

Electro-Voice

any desired diameter, pitch, number of coils, etc. A simple screw adjustment varies the pitch instantly. Both compression and extension springs can be made.

New Wire Recorder Combo

The recently announced Harrison Wire Recorder combines a portable wire recorder with a turntable suitable for either 10" or 12" records. The new instrument may be used as a simple electronic phonograph, a complete public



address system or a musical instrument amplifier.

Other features include a tone control, automatic shut-off, roll-out control panel, compactness, and light weight—the instrument measuring 8½" x 10" x 14" and weighing 23 pounds complete with included accessories. Microphone and speaker leads are carried in a compartment in the case lid. Case is leather bound with brass hardware and plush lined interior. Complete details may be had from the manufacturer, Harrison Mfg. Co., 1446 N. St. Louis, Chicago 51, Illinois.

Ohmite Resistor Cabinet

To provide radio servicemen and experimenters with a convenient method of storing composition resistors, Ohmite Manufacturing Co., Chicago, is offering a new servicemen's resistor assortment in a plastic cabinet.

The assortment consists of 125 carefully selected Ohmite "Little Devil" in-

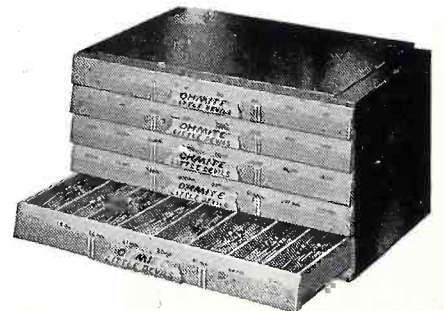

dividually marked insulated composition resistors of the ½-watt size. These resistors are furnished in 40 resistance values from 10 ohms to 10 megohms, and represent the types most frequently used by the radio serviceman in his day-to-day work. The cabinet measures 9" long, 4¾" high, and 5¼" deep.

**"TV.....
and ALL
SEVENTEEN"**
Says R. K. Mosier



"We are fully aware of the importance of Television. It appears as the brightest spot for the future of all radio servicing. But TV, even with its surprisingly rapid growth, does not offer enough servicing volume to support our organization. We realize, as we prepare ourselves for the TV future, that we must continue to service AM radio as today's basic income of our business. That's why we now have a standing order with our wholesaler to keep us up to date with all the latest

RIDER MANUALS"

R. K. Mosier
Mosier Radio Service
Mamaroneck, N. Y.

YES... he has found, like thousands of other successful servicemen, that a complete set of *Rider Manuals* saves time, saves money, builds business. Each *Manual*, kept handy to the bench, is a source of ready reference for all sets from 1930 to 1948. Service data on 80% of the receivers now in American homes can be found only in the first fourteen volumes of *Rider Manuals*.

"Volume 1 **RIDER TELEVISION MANUAL** is up to the usual high standards of all the other *Rider Manuals*" —R. K. Mosier
Over 1400 Pages (equivalent of 2000 pages because of the 440 sq. inch GIANT SIZE schematics). PLUS 2 Separate Books... "HOW IT WORKS" and INDEX.....\$18.00
Includes everything needed on 1946-47 Television Receivers (complete and kit) of 34 leading manufacturers.

"We are equally pleased with the **RIDER PA MANUAL**"
—R. K. Mosier
The first industry-wide service manual covering products of all leading manufacturers of PA amplifying systems, manufactured since 1938 to date. 2024 pages.....\$18.00

... and you, too, should have all *Rider Manuals*

- Volume XVII \$16.50
- Volume XVI \$ 8.40
- Volume XV \$19.80
- Volume XIV to VII
(each volume) \$16.50
- Volume VI \$12.50
- Abridged Manuals I to V
(one volume) \$19.80
- Record Changers and
Recorders \$ 9.00
- Master Index, covering
Manuals, Vols. I to XV. \$ 1.50

JOHN F. RIDER, PUBLISHER, Inc., 480 Canal Street, New York 13, N. Y.
Export Agent: Rocke International Corp., 13 E. 40th St., N.Y.C., Cable, ARLAB.

RIDER MANUALS mean **SUCCESSFUL SERVICING**

On the Way...

VOLUME 18

At Your Jobber's Soon
2000 Pages PLUS Separate "HOW IT WORKS" BOOK

Rider Manual data is RELIABLE, the OFFICIAL AUTHORIZED data right from the Service Departments of the set manufacturers themselves. They know the correct procedures for their sets, and have cooperated fully in getting this authoritative data to you through *Rider Manuals*. Successful servicemen know that they can turn to a *Rider Manual* for all the information they need on any set brought into the shop. They know that the *Rider-Exclusive "Clarified Schematics"* provide time-saving breakdowns of multi-band jobs; that with Volume XVIII even wire re-AM sets are covered, along with FM and recorders and record changers. ONLY RIDER GIVES YOU SUCH COVERAGE!

Both books, complete..... \$19.80

NOTE: The Mallory Radio Service Encyclopedia, 6th edition, makes reference to only one source of radio receiver schematics—*Rider Manuals*.
ANOTHER NOTE: The C-D Capacitor Manual for Radio Servicing, 1948 edition No. 4, makes reference to only one source of receiver schematics—*Rider Manuals*.



WHEN you invest in a Racon Horn or Speaker you get all-around super-efficiency—qualities that can not be duplicated by units of conventional type. Such units may resemble Racon units externally but only a Racon has the internal construction features that bring you top performance.

Racon superiority is the result of Advanced Engineering—improvements developed in the Racon Laboratories by Racon Engineers through tireless research and laboratory testing.

RACON DOUBLE RE-ENTRANT TRUMPET

(Illustrated above)

An excellent example of Racon scientific engineering. Designed to deliver highly concentrated sound over long ranges with maximum efficiency. Seven models, ranging in length from 6-5/8" to 28". All with aluminum casting inside tone arm and bell of heavy gauge aluminum spinning. Large sizes built with center reflecting section of Racon Acoustic material for preventing resonant effects. Smaller sizes have heavy gauge aluminum spinning for center section.

Strong construction, practically abuse proof. Fitted with swivel mounting ratchet wall bracket. For larger sizes U-bracket mounting will be supplied on request, at no extra cost.



PERMANENT MAGNET HORN UNITS

These units, highly popular in all types of service, embody many improvements. Two groups, one with Alnico V Magnets, and one with Alnico Blue Dot Magnets. All steel parts plated to prevent corrosion. Also fitted with corrosion proof metal or plastic diaphragms. Voice coil impedance on all units: 15 ohms. Special ohmages on request.

NOW FURNISHED WITH WATERPROOF CASING

All units, from junior to giant size, may now be had with heavy spun aluminum case, forming a close fitting hermetically sealed watertight housing for outdoor use. Waterproof type at slight extra cost.

Write for Catalog of complete Racon line.

RACON ELECTRIC CO., INC.

52 E. 19th Street, New York 3, N. Y.

RACON

*Speakers
Horn Units
Horns*



TRADE FLASHES

[from page 6]

their Rochester Branch Office, formerly located in the Lincoln Alliance Bank Bldg., has recently moved to 66 South Street, Rochester 7, New York. Ken Savage remains District Manager.

New TV Glare Filter

A new television glare filter, carrying the name, Walco Tele-Vue Filter, is now being distributed by Walco Sales Company, East Orange, N. J. This company also is the producer of the Walco Tele-Vue-Lens liquid-filled magnifier.

La Point-Plascomold Adds To Line

The LaPoint-Plascomold Corp. Unionville, Conn., has announced the addition of new products to their VEE-D-X antenna system line. All items necessary to complete an antenna installation are supplied to jobbers by this company.

Audio Amplifier And Associated Equipment Manual (AA1)

Compiled and published by Howard W. Sams & Co., Inc., Indianapolis 7, Indiana. 8½ x 11 352 Pages. Fully illustrated. Price \$3.95.

This specialized manual of PHOTOFACT Folders includes data on

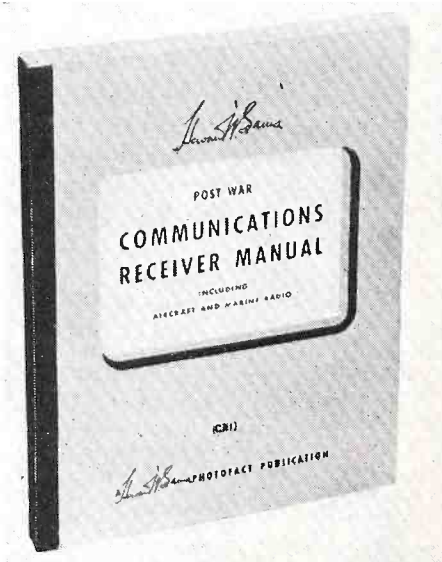

amplifiers, FM tuners and recorders, covered by PHOTOFACTS since the end of the war. The manual is bound in sturdy paper covers and comprises 352 pages fully illustrated, covering post war models produced by 31 manufacturers.

JFD Holds 5th TV-FM Antenna Installation Forum

The JFD Manufacturing Co., Inc., Brooklyn, N.Y., as part of its expand-

Build YOUR OWN TEST EQUIPMENT

Heathkit ELECTRONIC SWITCH KIT DOUBLES THE UTILITY OF ANY SCOPE

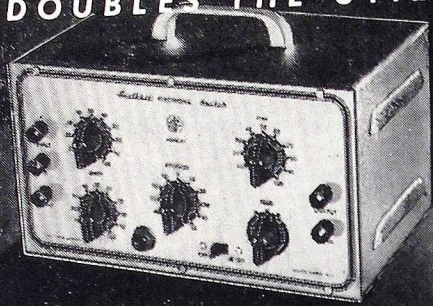

\$34.50

Gives two separately controllable traces with individual inputs on any scope. See both the input and output traces, locate distortion, phase shift, etc., immediately. Individual gain controls and positioning control. Coarse and fine sweeping rate controls. Complete Heathkit matches others, with 5 tubes. All metal parts are punched, formed and cadmium plated. Complete with tubes, all parts, detailed blueprints and instructions. Shipping Wt. 13 lbs.

Nothing ELSE TO BUY

HEATHKIT CONDENSER CHECKER KIT

\$19.50

Nothing ELSE TO BUY

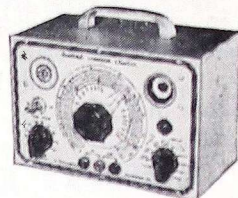

A condenser checker anyone can afford to own. Measures capacity and leakage from .00001 to 1000 MFD on calibrated scales with test voltage up to 500 volts. No need for tables or multipliers. Reads resistance 500 ohms to 2 megohms. 110V 60 cycle transformer operated complete with rectifier and magic eye indicator tubes. Easy quick assembly with clear detailed blueprints and instructions. Small convenient size 9" x 6" x 4 3/4". Wt. 4 lbs.

HEATHKIT SIGNAL GENERATOR KIT

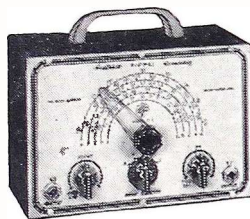

\$19.50

NOTHING ELSE TO BUY

Every shop needs a good signal generator. The Heathkit fulfills every servicing need, fundamentals from 150 Kc. to 30 megacycles with strong harmonics over 100 megacycles covering the new television and FM bands. 110V 60 cycle transformer operated power supply.

400 cycle audio available for 30% modulation or audio testing. Uses 6SN7 as RF oscillator and audio amplifier. Complete kit has every part necessary and detailed blueprints and instructions enable the builder to assemble it in a few hours. Large easy to read calibration. Convenient size 9" x 6" x 4 3/4". Wt. 4 1/2 lbs.

HEATHKIT SIGNAL TRACER KIT

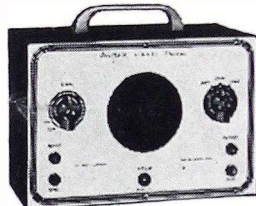

\$19.50

Nothing ELSE TO BUY

Reduces service time and greatly increases profits of any service shop. Uses crystal diode to follow signal from antenna to speaker. Locates faults immediately. Internal amplifier available for speaker testing and internal speaker available for amplifier testing. Connection for VTVM on panel allows visual tracing and gain measurements. Also tests phonograph pickups, microphones, PA systems, etc. Frequency range to 200 Mc. Complete ready to assemble. 110V 60 cycle transformer operated. Supplied with 3 tubes, diode probe, 2 color panel, all other parts. Easy to assemble, detailed blueprints and instructions.

Small portable 9" x 6" x 4 3/4". Wt. 6 pounds. Ideal for taking on service calls. Complete your service shop with this instrument.

HEATHKIT SINE AND SQUARE WAVE AUDIO GENERATOR KIT

The ideal instrument for checking audio amplifiers, television response, distortion, etc. Supplies excellent sine wave 20 cycles to 20,000 cycles and in addition supplies square wave over same range. Extremely low distortion, less than 1%, large calibrated dial, beautiful 2 color panel, 1% precision calibrating resistors, 110 V 60 cycle power transformer, 5 tubes, detailed blueprints and instructions. R.C. type circuit with excellent stability. Shipping weight 15 pounds.

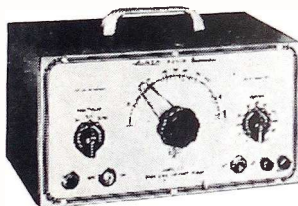

\$34.50

Nothing ELSE TO BUY

THE NEW HEATHKIT VACUUM TUBE VOLTMETER KIT

The most essential tool a radio man can have, now within the reach of his pocketbook. The Heathkit VTVM is equal in quality to instruments selling for \$75.00 or more. Features 500 microamp meter, transformer power supply, 1% glass enclosed divider resistors, ceramic selector switches, 11 megohms input resistance, linear AC and DC scale, electronic AC reading RMS. Circuit uses 6SN7 in balanced bridge circuit, a 6H6 as AC rectifier and 6 x 5 as transformer power supply rectifier. Included is means of calibrating without standards. Average assembly time less than four pleasant hours and you have the most useful test instrument you will ever own. Ranges 0-3, 30, 100, 300, 1000 volts AC and DC. Ohmmeter has ranges of scale times 1, 100, 1000, 10M and 1 megohm, giving range .1 ohm to 1000 megohms. Complete with detailed instructions. Add postage for 8 lbs.

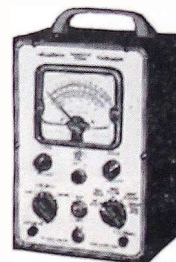

\$24.50

Nothing ELSE TO BUY

HEATHKIT FM AND TELEVISION SWEEP GENERATOR KIT

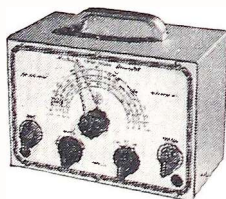

\$24.50

NOTHING ELSE TO BUY

THE BASIC FM AND TELEVISION SERVICE INSTRUMENT

At the lowest cost possible, anyone can now service FM and television receivers. The Heathkit sweep generator kit operates with oscilloscope and covers all necessary frequencies. A few pleasant hours assembling this kit puts any organization in position to share the profits of the FM and TV boom.

Every part supplied — grey crackle cabinet, two color calibrated panel, all metal parts punched, formed and plated. 5 tubes, complete detailed instructions for assembly and use. Shipping weight 6 lbs.

The NEW 1948 HEATHKIT 5 INCH OSCILLOSCOPE KIT

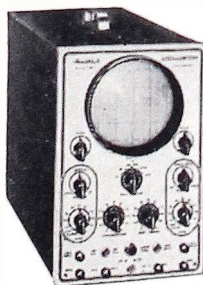

\$39.50

NOTHING ELSE TO BUY

New improved model of the famous Heathkit Oscilloscope. Building an oscilloscope is the finest training for television and newer servicing technique and you save two-thirds the cost. All the features and quality of instruments selling for \$100.00 or more. Supplied complete with cabinet, two color panel, 5B1 tube, 2 5Y3 tubes, 2 6SJ7 tubes and 884 sweep generator tube. Power transformer supplies 1000V negative and 350 volt positive. Sweep generator 15 cycles to 30 M. cycles. Has vertical and horizontal amplifiers. Oil filled filter condensers for long life. Complete blueprints and instructions included.



The **HEATH COMPANY**

... BENTON HARBOR 12, MICHIGAN

the circuit schematic before attempting any measurements of voltage or current; high voltages which are dangerous are always present in these circuits. The distribution of control circuits around a cathode ray tube in any receiver is essentially similar to the two examples discussed.

FM-TV Installations

[from page 18]

ing it is a pretty safe bet that the band pass of the input circuit is not wide enough to pass the total TV picture and sound components. The response of any L/C circuit (when the condenser is of sufficient value to cover the low television channels) resembles a humped or peaked response in the center. This means that unless the input circuit is "loaded" the Q is such as to attenuate certain parts of the TV signal and to boost others in proportion. The input circuits cannot be "loaded" in single tube amplifiers, as the gain would be almost non-existent. The operating effect is probably familiar to some readers. As the booster is tuned through any one channel, the sound may be increased at the expense of picture contrast or vice versa. This is particularly noticeable throughout the lowest channels where maximum capacity is used. On weak signals loss of hold results when the sound portion is favored, as the control pulses are attenuated due to the slope of the input circuit. On practically all channels loss of picture detail occurs because of discrimination across the total bandwidth. This same effect may be noted when using a sharply resonant antenna in comparison to the broad band type.

It is important to have an idea of the gain of a booster across all channels before recommending same to a customer. A few of the popular types actually give an insertion loss throughout channels 7-13. This is usually caused by two things. The components used for switching the antenna circuits exhibit severe losses throughout the high TV channels. Poor positioning of internal antenna lead wiring in respect to the chassis, and disregard of a constant impedance to the grid circuits are contributing factors.

Servicing and alignment

In addition to the installation practices discussed, it might be well to add a few words regarding the importance of proper alignment. No mat-

TRANSVISION

NEW Television Kits, and Equipment
Important Advances in TV Reception and Servicing!

NEW 10" TV KIT
at amazingly LOW PRICE!

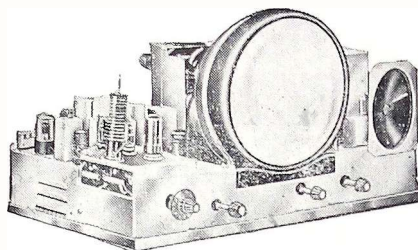

MODEL 10A TV KIT

The new Transvision Model 10A electromagnetic TV Kit gives a bright, stable 52 sq. in. picture. Has 10" picture tube, and CONTINUOUS TUNING on all 12 channels. Its high sensitivity makes for improved long-distance reception; especially good on high channels. Complete with all-channel double-folded dipole antenna and 60 ft. of lead-in wire.

MODEL 10A TV KIT, less cabinet.....Net \$199.00
MODEL 12A TV KIT, same as above,
but has a 12" picture tube.....Net \$263.00

New Streamlined Cabinets

for Transvision Model 10A or 12A TV Kit. Made of select grain walnut with beautifully rubbed finish. Fully drilled, ready for installation of assembled receiver.

Walnut Cabinet for 10A or 12A
(Specify)Net \$44.95
Mahogany and Blonde slightly higher.

Transvision All-Channel Television Booster...

To assure television reception in weak signal areas, or areas which are out of range of certain broadcast stations, Transvision engineers have designed this new booster. It increases signal strength on all television channels. Tunes all television channels continuously. Can be used with any type of television receiver. Unusually high gain in upper television channels.

Model B-1List \$14.95

Transvision Remote Control Unit Kit...

Will operate any TV receiver from a distance. Turns set on, tunes in stations, controls contrast and brightness, turns set off. Ideal for installations where the television receiver is inaccessible. Tuner unit is a high gain, all-channel unit with about 50 micro-volt sensitivity. Easy to assemble in about an hour.

Model TRCU with 25 feet of cable.....Net \$69.00
Without cabinetNet \$65.00

New...Transvision Sweep Signal Generator for Television and FM

OUTSTANDING FEATURES: (1) Frequency range from: 0-227 MC. . . . (2) Dial calibrated in frequency . . . (3) Sweep width from 0-12 MC completely variable. . . . (4) Self-contained markers readable directly on the dial to .5% or better. (No external generator required to provide the marker signals). . . . (5) Crystal controlled output makes possible any crystal controlled frequency from 5-230 MC. . . . (6) Plenty of voltage output—permits stage-by-stage alignment. . . . (7) Output impedance 5-125 ohms. . . . (8) Directly calibrated markers, 20-30 MC for trap, sound and video IF alignment. . . . (9) RF for alignment of traps for IF channels when a DC volt meter is used as the indicating medium. . . . (10) Unmodulated RF signal to provide marker pips simultaneously with the main variable oscillator. . . . (11) Markers can be controlled as to output strength in the pip oscillator. . . . (12) Power supply completely shielded and filtered to prevent leakage. . . . (13) All active tubes are the new modern miniature type. . . . (14) Phasing control incorporated in the generator.

MODEL No. SG..... Net \$99.50



ALL-CHANNEL BOOSTER



REMOTE CONTROL UNIT KIT

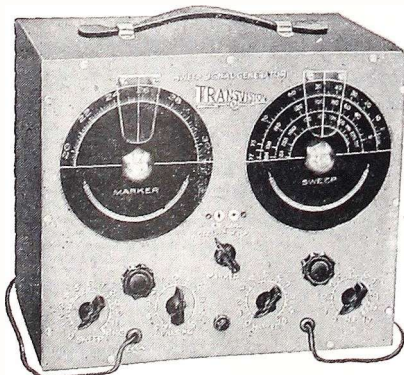

SWEEP SIGNAL GENERATOR

Radiomen . . . You Can Get Into the
TELEVISION BUSINESS
In a BIG WAY with the
TRANSVISION DEALER PLAN
Write for Folder D-1

NEW 8-PAGE CATALOG of Transvision line available at your distributor, or write to:
TRANSVISION, INC. New Rochelle, N. Y.

In Calif: Transvision of California, 8572 Santa Monica Blvd., Hollywood 46
All prices 5% higher west of Mississippi; all prices fair traded. All prices Subject to Change

ONLY

WALCO

OFFERS

these two micro-groove REPLACEMENT NEEDLES

for immediate delivery!

These new Walco needles complete your stocks. Now you can sell a Walco replacement on every phono service call you make! Build a reputation for thoroughness by replacing worn needles with a new dependable Walco jewel or precious metal needle. Customers will appreciate the service and you will profit by the extra sale. Remember, there's a Walco needle for every set and pickup.

WALCO MICRO-GROOVE FLOATING JEWEL SAPPHIRE

Highest quality genuine sapphire tipped needle for the new long playing micro-groove record players. Hand polished, microscopically inspected. List price \$2.50.

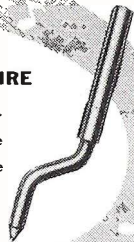

WALCO MICRO-GROOVE PRECIOUS METAL TIP

Bent spring action, special osmium alloy shank helps protect against excessive wear. Available in cartons or mounted display cards. List price \$1.50.



WALCO MUTED STYLUS FOR SHURE PICK-UP CARTRIDGE

The standard replacement needle for SHURE P-30 pickup cartridge. Walco-made under special Shure license. Lasting tip of osmium alloy. List price \$1.50.



PLUS a complete retail line attractively packaged and cleverly displayed. A Walco needle for every purse and purpose. Ask your jobber or write direct for catalog.

ELECTROVOX CO., INC.

66 FRANKLIN STREET, EAST ORANGE, N. J.

ter how good the antenna system or booster used, poor results will be obtained if the TV receiver itself is out of alignment. A good sweep generator and oscilloscope are necessary for rapid and efficient alignment. This is the only safe system to use in view of the necessity of adhering to the receiver manufacturer's response curves. To try to align a receiver on the TV signal itself is comparable to trying to align an AM receiver r. f., without knowing where the local oscillator is operating. Although a fair result may be had by the above method the chances of obtaining the *best* result is remote indeed.

It is hoped that the foregoing information will prove helpful when making TV installations. Don't forget that your reputation as a television specialist depends upon applying the facts presented in conjunction with related information. In the final analysis a satisfied customer is still your best advertisement.

155 LOUDSPEAKERS

[from page 16]

loudspeaker distribution. In this article we therefore include only a basic discussion under *Equipment Layout*.

International Complication

Since this installation serviced an *international* conference attended by doctor delegates from 35 nations an independent IBM system of simultaneous interpretation was also installed. While the doctors spoke one of three basic languages, translations in English were fed to the 155 loudspeakers throughout the house. Hence the block diagram of Fig. 2 is a bit more complicated than would be necessary for the average job. Had not all of the loudspeakers been held to low level projection, the volume would have been too disconcerting in English for the orating doctor to proceed with his foreign delivery, the coverage was that good throughout the house. The shoulder-strap pocket-sized radio receivers and headphones supplied with the translating system offered the delegates a listening choice of French, English or Spanish at all times.

Equipment Layout Microphones

Twelve uni-directional dynamic microphones were distributed and manned by ushers throughout the main floor area where the doctors were seated. During open forum all they had to do was raise their hand, or stand, and a hand microphone was

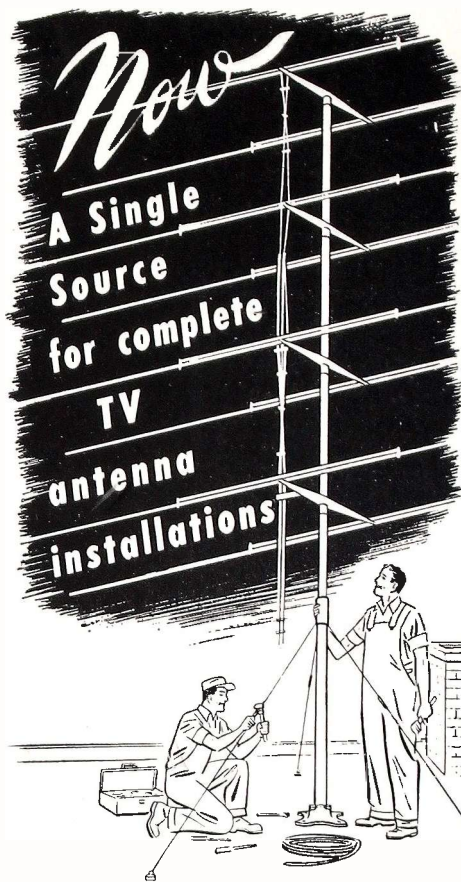

AT long last you can obtain all of the necessary accessories required to make the finest TV antenna installation. VEE-D-X, the name that has put more vision into television, now supplies complete accessories to your jobber.

Saves time . . . shopping around for turnbuckles, guy wire, and masts has been eliminated by this complete and dependable single-source.

See your favorite radio parts jobber for these VEE-D-X products:

- Long range, high gain antennas • Primary FM and TV antenna
- No loss lightning arresters • Two- and three-stage pre-selectors
- Light weight magnesium masts • "All-Angle" aluminum antenna base mounts
- Manual orienting rotators • Guy Wire • Cable clamps • Stand-offs • Turnbuckles • X-200A heavy duty transmission line • 300 ohm transmission line.

LaPOINTE PLASCOMOLD CORP.
UNIONVILLE, CONN.

VEE-D-X

Adds more vision to television

IRC Power Wire Wounds are better built every step of the way

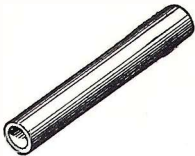

Starting right from the winding form IRC Power Wire Wounds combine the best of materials, workmanship and resistor "know-how".

Highest grade alloy wire uniformly wound on sturdy ceramic tubes. Terminals spot welded for security; heavily tin dipped for easy soldering.

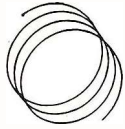

Climate-proof cement coating provides dark, rough surface—best for rapid heat dissipation, moisture protection and ability to withstand reasonable overloads.

Resistors cured at LOW temperature prevents damage to resistance windings, and loss of temper in terminals. Bands for adjustable types feature stainless steel springs and silver contacts. Cannot corrode to cause high resistance.

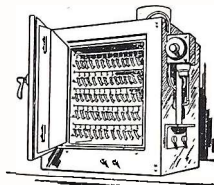

For exacting, heavy-duty requirements you can rely on IRC Power Wire Wounds for balanced performance in every characteristic. Being full-sized, they can operate continuously at full rating. Derating in high ranges is unnecessary.

IRC Power Wire Wounds are available in a full range of ratings, sizes and terminal types. 91 new ranges have just been added. Next time you step up to your distributor's counter—stock up on IRC Power Wire Wounds.

IRC INTERNATIONAL RESISTANCE CO.

401 N. Broad Street, Phila. 8, Pa.

In Canada: International Resistance Co., Ltd., Toronto, Licensee

YES! We're listed in the RED BOOK
Looking for the correct IRC replacement controls for any receiver manufactured from 1938 to 1948? Just refer to the Radio Industry RED BOOK!

supplied by an usher. No local switching was entrusted to the ushers, instead a control engineer cut in and out the various microphones as required. This of course aided decorum since the engineer was guided by recognition and termination by the presiding officer at the podium.

The podium required one microphone while behind it on a floor-stand was another for use with illustrated lectures. Tables on the stage on either side of the podium, where an advisory panel of doctors was seated, required five more microphones. One more was available to the control engineer for cueing of recording facilities situated several blocks from the hotel. A total of 20 dynamic microphones was terminated in the channel as shown in Fig. 2.

Intermediate Equipment

The owner of the gear used in this case happened to possess the well-known RCA combination of OP-6 and OP-7 used extensively as remote pickup equipment in broadcasting. Combined with the dual pre-amplifier and fader arrangement incorporated in the multiple microphone switching panel these two completed a six-position mixer with the main control in the OP-6 serving as the final master. The OP-6 has a gain of 90 db which proved more than enough for severe operating conditions.

A double-throw switch on the rack of main equipment directed the program straight through to the p-a amplifier and loudspeakers while the original delivery was in English. Whenever the source of origin swung to a foreign tongue, this switch was flipped to feed the English translation into the sound reinforcing loudspeakers. Delegates preferring the foreign delivery could hear that through their shoulder-strap radio receivers fed from the low powered 100 megacycle AM transmitter of the translation system.

A second double-throw switch fed the recording room either the original pickup or the interpretation via the translator amplifier as shown in Fig. 2. These two switches could have been ganged mechanically but were left detached in case of a change of requirement.

The power amplifier employed in this case had a 50 watt output directly feeding the input side of one single autotransformer which assumed the distribution responsibility for the entire load of 155 loudspeakers.

Voltage Feed Distribution

In the January 1948 article of this magazine a true 70 volt loudspeaker

JUST PUBLISHED!

2 NEW BOOKS

to help you cash in
on the industry's
GREATEST SERVICING
OPPORTUNITIES

PRACTICAL TELEVISION SERVICING

By J. R. JOHNSON and
J. H. NEWITT
375 pages, 6x9, over 230
illus., \$4.00

NEW! DIFFERENT!
DOWN-TO-EARTH



PRACTICAL HELP ON

- R-f, i-f, detector sections
- video amplifiers
- synchronizing and sweep circuits
- antennas; wave propagation
- installation
- test equipment; alignment
- wiring, repair techniques
- troubleshooting
- service hints; case histories, etc.

At last you can get a book that really gives the lowdown on television servicing — one that tells you just what to do and guides you on precautions to take and mistakes to avoid. PRACTICAL TELEVISION SERVICING isn't a book of theory or mathematics. The authors — one a radio editor, the other a well-known engineer—actually operated a television service shop to get the how-to-do-it data they now pass along to you in easily understood form. Television components, construction and operation and how they differ from radio are clearly explained. Also, they show step by step how to handle every phase of television trouble diagnosing and servicing. You learn fast — and you learn right. Read it 10 days at our risk!

FREQUENCY MODULATION

FUNDAMENTALS
APPARATUS

SERVICING

By NATHAN MARCHAND
448 pages, 6x9, over 300
illustrations, \$5.00

This new book by a well known radio consultant has been prepared first to help you understand FM clearly and, second, to explain fully just how to handle FM service work. Basic theory, circuits, transmitters, receivers and mobile equipment are covered—with special emphasis on modern methods of installing, adjusting and repairing FM receivers. From circuit peculiarities, tuning indicators, antennas, FM test units, receiver alignment to general servicing procedure and dozens of other subjects, this book is a practical guide to one of radio's fastest-growing developments. Use 10-day examination coupon.

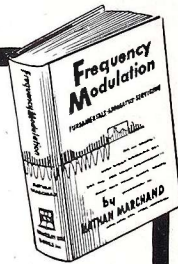

SIMPLIFIES
SERVICE
PROBLEMS!

It takes more than ordinary radio knowledge to handle the complicated special problems of modern FM servicing. This book—replete with illustrations, schematics and on-the-job examples—will quickly help you understand each step of the work.

10
DAYS'
TRIAL

Dept. RSD-118, Murray Hill Books, Inc.,
232 Madison Ave., New York 16, N. Y.

Send me the books checked below for 10-days' examination on approval. In 10 days I will pay for the books plus a few cents postage or return them postpaid. (Postage paid on cash orders; same return privilege. Books sent on approval in U.S. only.)

- Johnson & Newitt — PRACTICAL TELEVISION SERVICING, \$4.00
 Marchand — FREQUENCY MODULATION, \$5.00

Name
Address
City Zone.....
State

AMPERITE

Studio Microphones at P.A. Prices

Ideal for BROADCASTING

- RECORDING
- PUBLIC ADDRESS

"The ultimate in microphone quality," says Evan Rushing, sound engineer of the Hotel New Yorker.

- Shout right into the new Amperite Microphone—or stand 2 feet away—reproduction is always perfect.
- The only type microphone that is not affected by any climatic conditions.
- Guaranteed to withstand more "knocking around" than any other type mike.

Special Offer: Write for Special Introductory Offer, and 4-page illustrated folder.

AMPERITE Company, Inc.

561 BROADWAY • NEW YORK 12, N. Y.

In Canada: Atlas Radio Corp., Ltd., 560 King St. W., Toronto



Models
RBLG—200 ohms
RBHG—Hi-imp.
List \$42.00

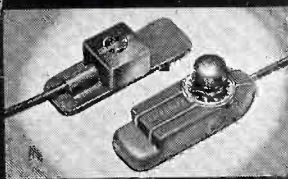

"Kontak" Mikes
Model SKH, list \$12.00
Model KKH, list \$18.00

feed line was described and the values and formulae presented therein should be conformed with. In this case at hand liberties were taken because unusual demands were confronted, as will be seen at the close of this article. Here too it was only necessary to do justice to the speech frequencies at low level, hence, instead of several, merely one heavy duty auto-transformer proved adequate.

To avoid repetition of data in the above mentioned article we will not attempt to explain voltage feed loudspeaker system herein. It is only the purpose of this article to better acquaint the reader with the practical possibilities to be derived from these very fruitful facilities. In this case the 50 watt output of the driving amplifier was loaded by the primary of a heavy duty autotransformer while two feeder lines were set up from its tapped secondary. One 4000 ohm circuit fed 78 low wattage loudspeakers all connected in parallel. A second circuit fed 77 loudspeakers of 600 ohms each, similarly paralleled. Thus the one autotransformer handled the entire load of 155 low level loudspeakers.

Unusual Requirement Easily Met

Concerning the business angle, it is well to describe one particular requirement of this installation which was greatly facilitated by its simplicity of layout. A banquet was scheduled for the same ballroom for one evening in the middle of the week. This meant that the entire stage and main floor had to be cleared of all equipment and wiring after the close of a daily session at 5:30 p.m., in time to permit the installation of banquet facilities ready for use at 8 p.m., two and one-half hours later. Loudspeakers, supported beneath the rows of tables, were quickly unshipped from table hooks and disconnected from terminal blocks attached to the tables used by the doctors. Main twisted-pair feeders and legs branching out to table rows were separately and carefully coiled and tagged, then stored beneath the stage for ready access for rapid re-installation. The entire system had to be re-installed and ready for operation for the next plenary session of the conference at 9 a.m. the following morning. Each table was chalk-marked with rotation numbers so that when replaced, terminal blocks would present themselves within the reach of corresponding loudspeaker lines. Tagged main feeders and their fanned-out branches were systematically rolled out in proper relation.

The re-instatement of all facilities



DESIGNERS of radio, communication, electronic and electrical apparatus protect their products against electrical damage by incorporating the proper type of Littelfuse made for the purpose. **Engineers call this Product Insurance.** Technicians and maintenance men responsible for keeping radio-electrical devices in peak operating condition also rely upon Littelfuse—knowing that when they use our dependable products, they provide their customers and themselves with maximum protection. **We call this Service Insurance.** Ask your Jobber for the Littelfuses you require.

LITTELFUSE

4787 N. RAVENSWOOD AVE.



Incorporated

CHICAGO 40, U. S. A.

NITE-T-LITE • SWITCH-LITE • IGNITION-FRITZ • NEON INDICATORS
SWITCHES • CIRCUIT BREAKERS • FUSES, MOUNTINGS AND ACCESSORIES

"BELIEVE IT OR NOT,
HOPE HAS AN
INTELLIGENT IDEA!"

says CROSBY

CROSBY:

Folks, this is fantastic, but old Hope has a great idea. He thinks *everybody* ought to give U. S. Savings Bonds for Christmas presents!

HOPE:

Thanks for the kind words, son. But no kidding, ladies and gentlemen, those Bonds are sensational. They're appropriate for *anyone* on your list. On Christmas morning, nothing looks better in a stocking—except maybe Dorothy Lamour.

CROSBY:

Old Ski Nose is correct. And don't forget how easy it is to buy bonds—you can get 'em at *any* bank or post office.

HOPE:

How about it, Mr. and Mrs. America? This Christmas let's *all* give U. S. Savings Bonds!



Give the Finest Gift of all...

U.S. SAVINGS BONDS



Contributed by this magazine in co-operation with the Magazine Publishers of America as a public service.

which of these costly 6 HANDICAPS slows up your soldering?

Frequent Retinning and Redressing?
Delayed heating? Clumsy, rigid tip?
Obsolete source of heat?
Blind spots? Awkwardly shaped iron?

NEW WELLER SOLDERING GUNS
Eliminate Them All!

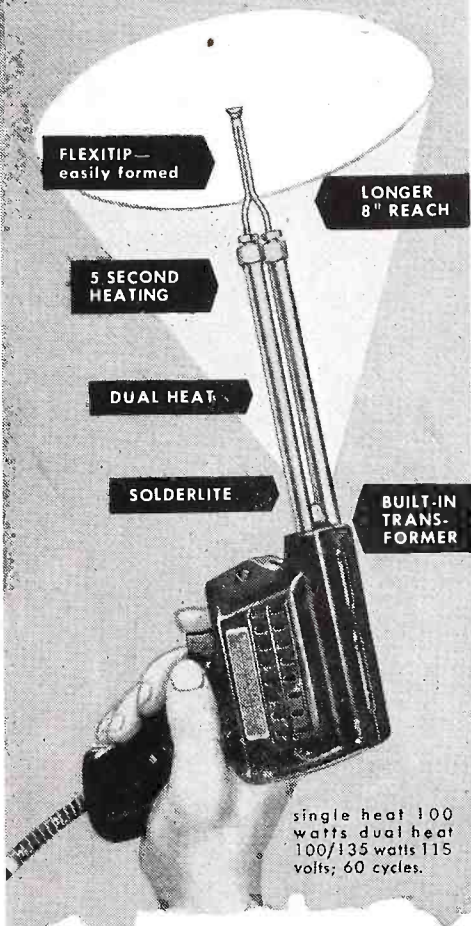

Five-second heating saves time. Quickly formed FLEXITIPS slip easily between wiring. Prefocused Solderlite spotlights your work. And because heat comes "on" only when you pull the trigger, there's no over-heating—no unnecessary retinning or redressing with genuine Weller tips. Your Weller Gun pays for itself in a few months.

For all radio, television and appliance service work, use efficient 8" model DX-8 with dual heat, or 4" types—S-107 single heat or D-207 dual heat. Order from your distributor or write for bulletin direct.



Be sure to get your copy . . . **SOLDERING TIPS**, the new Weller Handy Guide to easier, faster soldering—20 pages fully illustrated. Price 10c at your distributor's, or order direct.

WELLER
MANUFACTURING COMPANY
804 Packer Street • Easton, Pa.

was accomplished by a crew of four men during the night following the banquet. It was 2 a.m. before they could start their work but, thanks to the simplicity of voltage feed systems, everything was in readiness and tested at 6 a.m., three hours prior to program time.

SWEEP GENERATORS

[from page 15]

Maximum convenience is provided by the design. No tuning is required—switching produces all the desired frequencies.

A third variety is shown in *slide 6*. This unit utilizes a reactance tube to frequency modulate an oscillator which signal is fed to the mixer. A variable frequency unmodulated oscillator also feeds into the same mixer. The difference-frequency signal is applied to the output. The marker signal sources are two crystal oscillators—a 1.0- megacycle and a 10 megacycle crystal. Either or both may be used. If both are used markers in steps of 1 megacycle and 10 megacycles are available. If the 10- megacycle unit alone is used, the marker frequencies are in steps of 10 megacycles.

A fourth variety is shown on *slide 7*. A saw-tooth generator, which may be varied in frequency from 50 to 100 cycles, supplies a voltage which frequency modulates a klystron, which is operating around 10,000 megacycles. This signal is fed into the mixer which also receives a signal from the heterodyning oscillator which can be adjusted to operate at several different frequencies. The output of the mixer is an f-m signal. As a means of securing marker indications a special circuit is used; this is the absorption wavemeter. This is connected at the input to the mixer and is tunable over the range of frequency output of either oscillator; consequently it can absorb energy at frequencies within the range of these two units. A microammeter in the mixer system indicates a dip in output when the wavemeter is tuned to resonance with the output of either oscillator. By simple subtraction of the frequency indications corresponding to these dips on the microammeter, the difference frequency corresponding to the output from the mixer can be determined. At the same time a dip is noted on the response curve which appears upon the scope screen. This method of marking is used in place of the conventional marker pips.

These four slides showing the gen-

THE MOST DESIRABLE ANTENNA MOUNT EVER MADE!

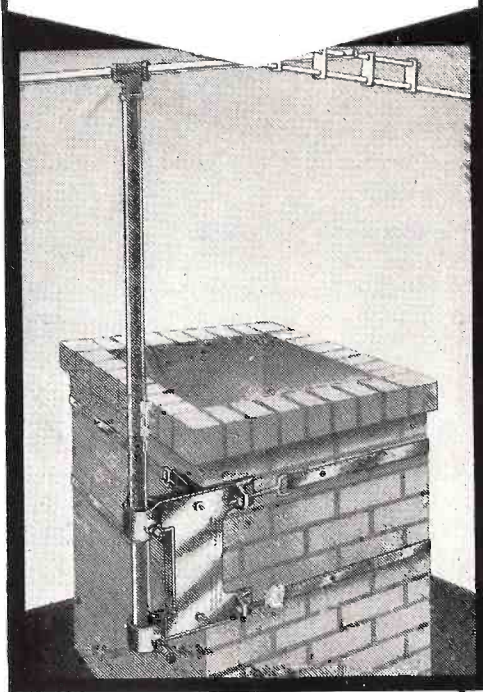

Pat. Pending

Chimney Mount Antenna Base

● for **TELEVISION**
● **FM** ● **AMATEURS**

List Price: **\$7.50**

Cost to Retailer: \$4.50

**Installed in 10 minutes • Permits Use
of Several Mounts on One Chimney**

Chimney Mount is by far the fastest selling product of its type in the radio and television fields. It can be installed in ten minutes without the use of special tools or drilling of holes. Several mounts can be strapped to one chimney—to pole, 2 x 4, side of house or to any rectangular roof extension. Fastens aerial to highest point with galvanized steel bands having a combined tensile strength of more than 3,000 lbs. Made of corrosion-resistant aircraft-type aluminum alloy. Weight: 3 lbs.

Available Through All Leading
Jobbers and Dealers or Write to:

South River Metal Products Co.
South River, New Jersey

eral arrangement of the circuits in commercial TV sweep generators do not encompass every possible arrangement, but as you can readily understand, complete presentation is impossible. At least you have an idea of what is in these units. Now we can advance to the next step in this discussion, which is the answer to the question "Does every service shop need one?" . . .

Does Every Service Shop Need One?

It is possible to answer this question by answering to the affirmative and letting it go at that; however, that is not sufficient. We deem it worthwhile to illustrate why in a simple manner and then let each serviceman draw his own conclusions. Our example is associated with alignment work, although we recognize fully the alignment needs are by far the least in television receiver service work. Nevertheless, the ownership of a TV sweep generator is imperative, even if it is used much less frequently than either a vacuum-tube voltmeter or a cathode-ray scope or an ohmmeter . . . It is just about impossible to do the job properly without a TV sweep generator. Improvising systems for alignment is possible but most certainly not convenient. It is possible to walk from New York to Frisco but it is much more practical to drive, or use the train or fly—especially when time is of the essence. So it is with the TV sweep generator. Naturally the marker oscillator or marker-signal source is considered to be a part of the sweep generator or at least used with it, if it is a separate device.

As a typical case let us consider slide 8. This slide shows the individual response curves of the stagger tuned pix i-f system of the RCA 630 TS receiver. Each of these stages is aligned at a single frequency, which means that the possibility of alignment without a sweep generator exists . . . We repeat—the possibility—Practically it would not be either convenient or profitable to complete the whole job without such a device. Assuming that the individual stages have been aligned at the proper frequencies, the composite response of the amplifier is as shown in the lower left-hand corner of the slide. To view such a curve on a scope requires that an f-m signal source with sufficient sweep width be used.

But this curve is not the final requirement since it is not representative of the desired response of the system. Further adjustments are re-

BACK NUMBERS of "RSD"
Order them now - the supply is low.

- FEBRUARY 1946**
 Applying Neg. Feedback in Audio Amplifiers
 Service Market in Industrial Electronics
 Ballast Tube & Plug-in Resistor Chart
- APRIL 1946**
 Modern Tube Testing, Part 1, Methods
 Servicing Sound Systems
 Short-cuts on Intermittants by use of "Substitution Block"
- JUNE 1946**
 Modern Tube Testing, Part 2, Instruments
 Short-cuts in Trouble-Shooting
 Ohmmeters, Condenser Testers, Capacitance Meters, Part 1
- JULY 1946**
 Distortion—Determining the Cause, Part 1
 Ohmmeters, Cond-Testers, Cap.-Meters, Part 2
- AUGUST 1946**
 Multivibrators
 How Is Your Grid Biased? Part 1
 Distortion—Determining the Cause, Part 2
 Sound Distribution Systems
- SEPTEMBER 1946**
 Transconductance-Reading Tube Tests
 How Is Your Grid Biased, Part 2
 Centralized Radio Servicing
- NOVEMBER 1946**
 The TV Opportunity—Installing & Servicing
 Don't Miss "Hidden" Profits, Part 1
 Service Market in Industrial Electronics
- DECEMBER 1946**
 Modernizing Sets by Using New Rectifiers
 Deflection Generators in TV
 Guide for Miniature Electron Tubes
 Answers to FM Servicing Problems
- JANUARY 1947**
 Accurate Audio Amplifier Measurements
 The "Guillotine" Tuning System
 Dipoles for FM-TV Home Receivers
- FEBRUARY 1947**
 Simple Methods to Determine Impedances
 Servicing Record-Changers
 How To Block Interference
- MARCH 1947**
 Antenna Multicouplers
 Servicing P-A Installations
 Trade Standards for TV Installations
 Industrial Maintenance
- APRIL 1947**
 Using Your 'Scope in Radio Servicing
 Analysis of Coil Checkers
 "Sparx" At Work
 Trouble-Shooting in P-A Installations
- MAY 1947**
 Oscillator & Power Supply Troubles
 Ion-Trap in C-R Tubes
 P-A System Design & Applications, Part 1
- JUNE 1947**
 Simplified Set Checking
 P-A System Design & Applications, Part 2
 TV Installing Is A Specialty Business
 Servicing 3-Way Portables
- JULY 1947**
 Frequency Modulation, Part 1, antenna fundamentals & signal shifting effects
 Automatic Gain Control Circs. in TV Sets
 Using Conventional Sig. Gen. for FM Align.
- AUGUST 1947**
 TV R-F Circuits Described
 FM, Part 2, receiver circuit fundamentals
 TV Antenna Installation Problems
- SEPTEMBER 1947**
 Substitution Boxes Lick Service Problems
 TV Antennas for Multi-Unit Dwellings
 FM, Part 3, Discrim. & Deaccentuation Nets.
- OCTOBER 1947**
 Add Record-players to Modernize Old Sets
 P-A Fundamentals & Complexities
 Modern TV Kits
- NOVEMBER 1947**
 TV Antennas—Their Characteristics & Applications
 Bookkeeping Simplified
 Make A Universal Test Speaker
 Eliminating Cathode Heater Hum from Audio Amplifiers
- DECEMBER 1947**
 A New TV Set Servicing Technique
 Ratio Detection & Its Applications
 External Cross Modulation—Its Cause & Cure
- JANUARY 1948**
 Master vs Indoor TV Antennas
 Audio Extractor for Signal Generators
 TV Kit Alignment Procedures
 70 Volt Speaker Distribution Line
- FEBRUARY 1948**
 High Speed Servicing
 Visual Alignment
 Income Tax Deductions
- MARCH 1948**
 Know Your Tube Tester
 TV Power Supplies
 A-C/D-C Battery Set Circuits
- APRIL 1948**
 Video I-F Circuits & Applications
 Computing What Price To Charge Customers
 Using 'Scopes For Radio Servicing
- MAY 1948**
 FM Set Alignment Procedure
 Video Detectors
 How Vectors Simplify Servicing
 Significance of Power Factor and Q
- JUNE 1948**
 Amplifier Checking by Signal Injection
 Applications of Gas Type Tubes
 Modern TV Kits
- JULY 1948**
 Television's Service Outlook
 Video Amplifiers
 Bad Acoustics Cured Electrically
- AUGUST 1948**
 FM & TV Boosters
 Appliance Repair Hints for Radiomen
 Video Amplifiers D-C Component

RADIO SERVICE DEALER MAGAZINE
 342 MADISON AVE., NEW YORK 17, N. Y.

Please send me the back numbers checked here . . .
 The price is 35c. for each copy unless 10 or more are ordered. If 10 or more are ordered the price is 25c. each copy.

<input type="checkbox"/> Feb. 1946	<input type="checkbox"/> Jan. 1947	<input type="checkbox"/> Sept. 1947	<input type="checkbox"/> May 1948
<input type="checkbox"/> Arr. 1946	<input type="checkbox"/> Feb. 1947	<input type="checkbox"/> Oct. 1947	<input type="checkbox"/> June 1948
<input type="checkbox"/> June 1946	<input type="checkbox"/> Mar. 1947	<input type="checkbox"/> Nov. 1947	<input type="checkbox"/> July 1948
<input type="checkbox"/> July 1946	<input type="checkbox"/> Apr. 1947	<input type="checkbox"/> Dec. 1947	<input type="checkbox"/> Aug. 1948
<input type="checkbox"/> Aug. 1946	<input type="checkbox"/> May 1947	<input type="checkbox"/> Jan. 1948	
<input type="checkbox"/> Sept. 1946	<input type="checkbox"/> June 1947	<input type="checkbox"/> Feb. 1948	
<input type="checkbox"/> Nov. 1946	<input type="checkbox"/> July 1947	<input type="checkbox"/> Mar. 1948	
<input type="checkbox"/> Dec. 1946	<input type="checkbox"/> Aug. 1947	<input type="checkbox"/> Apr. 1948	

I remit herewith \$..... for thecopies ordered atc. each.

NAME

ADDRESS

CITY ZONE STATE

BURGESS

Best bet for more business

This perfect pair for personal portables, the new No. 2R "A", (left) made expressly for personal portables and No. XX45, 67½ volt "B" battery, give more listening pleasure and mean more sales and profits for you. Order your stock today.

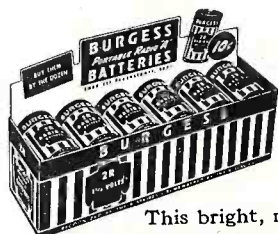

Bright New Package

This bright, new package of 12 2R "A" batteries does its own selling. Carton fits into small space on your counter. Remember, Burgess recognized quality is preferred by 2 out of 3 electronic engineers. Push Burgess—for more sales and profits!



Check Your Supply of Burgess Portable Batteries NOW!

Be ready for the big fall portable battery demand. Football games, hunting trips, and the holiday season create peak usage for this item. Cash in on this seasonal business. Ask your distributor.

BURGESS

IS THE COMPLETE LINE OF BATTERIES

BURGESS BATTERY COMPANY
FREEPORT, ILLINOIS

quired in order that the circuit perform as desired. In other words, the response curve must be shaped to suit. This is shown in the lower right curve, wherein appears the effect of the adjustment of the traps, which in this case involves the action of the circuit at frequencies which are within the selected channel and the two adjacent TV channels: the accom-

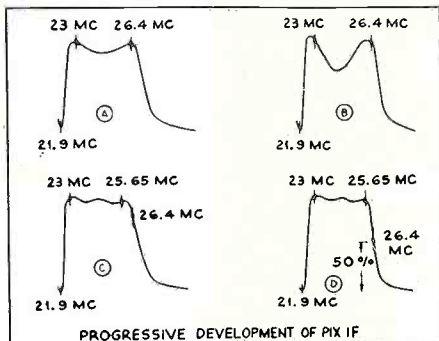

Slide 9—G.E. 802 TV pix i.f. response

panying sound i-f trap and also that of the adjacent picture i-f carrier on one side and the adjacent sound i-f carrier on the other side.

Another example of the progressive development of the response curve in a picture i-f channel is shown in slide 9. This is from the G.E. 802 TV re-

ceiver which utilizes overcoupled video i-f transformers. Reading from left to right, you can see that not only is the curve shaped, but that as a consequence of the shaping, the positioning of the frequencies within the acceptance band is altered as the shaping advances. Note for example the changing location of the 26.4-megacycle point along the response curve.

These are but two examples of many different ones which become evident upon examination of the TV receiver manufacturer's service literature. In other words, it is incorrect to assume that any one curve shape will apply to all receivers—individual manufacturers have their own ideas about the shape of the i-f response curves in their receivers, these being determined by the design of the individual circuits. To attempt to shape such curves without a TV sweep generator and a marker calibrator is just about hopeless. This applies equally well to undercoupled as well as overcoupled i-f systems.

Stated differently, what we are implying is that every serviceman who hopes to do TV receiver service work requires some sort of a TV sweep

Television 'HOW IT WORKS'

Just out. Here is practical theory on the biggest development since the introduction of radio. Deals with transmission and reception of television signals, giving clear overall picture. Goes into frequency standards, antennas, and describes the various portions of a television receiver. Covers alignment and servicing. This book is part of Vol. 1 Rider Television Manual. If you automatically get this book

Even if television is not yet in your area it will be soon. You need to know about it now.

- Manufacturers: Here is the textbook you can use in training your servicemen.

Over 200 pages
Illustrated ... \$2.70

UNDERSTANDING VECTORS AND PHASE

Provides easy understanding of vectorial presentations so you will get more benefit from radio articles and books.

160 Pages Cloth bound ... \$1.89
Paper bound ... 99c

BROADCAST OPERATORS' HANDBOOK

by H. E. Enns, Station Engineer, WIRE

Tells how to operate a radio station and keep it in operation. Covers transmitter operation and maintenance, what to do and how to operate control room, master and remote controls.

288 Pgs.—Profusely Illus.—\$3.30

LEARN RIGHT WITH RIDER!

FM TRANSMISSION & RECEPTION

by John F. Rider and Seymour D. Uslan

Included among the "100 Best Technical Books of 1947 and early 1948" by the "Library Journal" this book has been adopted with equal enthusiasm by schools, colleges, engineers and radio servicemen.

Latest in theory, method of operation, high and low power, antennas, methods of alignment, solutions of servicing problems—everything needed

416 Cloth Cover, \$3.60
Pages

OTHER RIDER BOOKS

Inside Vacuum Tube 424 Pgs. \$4.50

Servicing by Signal Tracing 360 Pgs. 4.00

Cathode Ray Tube at Work 338 Pgs. 4.00

Send for Complete Catalog of titles

BY THE PUBLISHER OF RIDER MANUALS

Order From Your Jobber or write direct to us.

JOHN F. RIDER Publisher, Inc.
404 FOURTH AVENUE, NEW YORK 16, N.Y.
Export: Rocke-International Corp.
13 E. 40th Street, New York 16, N.Y.

generator and marker. We are not stating the possible price of these units because we don't know how high or how low they will go, but one thing is certain: if alignment operations are necessary, the only method of doing it properly is by means of a sweep generator and marker, and of course, the cathode-ray scope. Note that we have said nothing about the adjustment of the sound i-f system and r-f system. We feel that realization of the needs of the picture i-f system is sufficient to form the necessary conclusions—every TV service shop requires a TV sweep generator and marker-frequency source.

FIELD FINDINGS

[from page 10]

technicians, possibly with the assistance of their local broadcast station operators, or even with the aid of TV set manufacturers themselves if such help can be obtained (and in an aside to RMA, it should be). Certainly the Mayor or Building Department Commissioner of a big city will not respond to the plea of a single radio serviceman, or even to the appeals of small groups of such men, but the Civic Authorities will and *must* take cognizance of the appeals made by a committee that represents the *working majority* of a profession such as radio technicians, when appeals are properly advanced on behalf of the whole.

This naturally brings me to the subject of Associations for Radiomen.

Associations Needed More Than Ever

The foregoing paragraphs give tangible proof as to why radiomen in every community in the United States *must now organize and work together* in cooperative association with each other. Wasn't it Ben Franklin who typified the case with his remark: "Gentlemen, we must hang together; or most certainly we will hang alone!"

My various Sept.-Oct. speaking engagements gave me the opportunity to publicly express my fixed opinion that *NOW is the Time for ALL Radio Service Dealers and Technicians to Band Together in Association Membership*. It's so important I can not repeat it too often! But the proper manner of banding together is just as important as the basic idea itself, and on that subject I have a very important bit of news to convey.

In Rochester, N.Y., on October 10, a group of Eastern radio association representatives met and certain men suggested that it was "timely to form

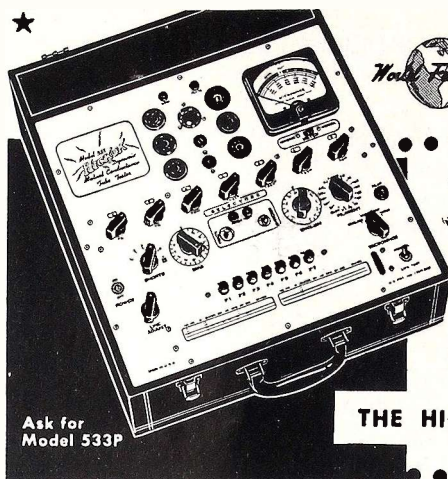

Ask for Model 533P

Dynamic Mutual Conductance TUBE TESTER

by **HICKOK**

Tests all the latest tubes, including television, with the famous HICKOK Dynamic Mutual Conductance circuits. Tests tube-life, an exclusive HICKOK feature. Scale readings are directly in Micromhos—a test originated and developed by HICKOK and used by most expert AM, FM and Television servicemen as the highest standard of accuracy.

See Your Jobber Today or Write For Literature.

THE HICKOK ELECTRICAL INSTRUMENT CO.
10533 Dupont Avenue • Cleveland 8, Ohio

Permoflux SPEAKERS



YOUR JOBBER CAN SUPPLY YOU!

Permoflux quality and dependability—the same as supplied to the major set manufacturers—is your assurance of complete customer satisfaction. You'll find Permoflux Speakers easy to install and readily available in both PM and Electro-dynamic types. You'll find too, that it pays to give your customers "tops in tone" with a Permoflux Replacement Speaker.

TWO COMPLETE FACTORIES TO SERVE YOU **PERMOFLUX** WRITE FOR FREE BULLETIN
PIONEER MANUFACTURERS OF PERMANENT MAGNET DYNAMIC TRANSDUCERS

PERMOFLUX CORPORATION
4900 WEST GRAND AVE., CHICAGO 39, ILLINOIS
236 SOUTH VERDUGO ROAD, GLENDALE 5, CALIFORNIA

A Remarkable NEW LINE

High QUALITY High POWER

Custom-Built **AM-FM Chassis**

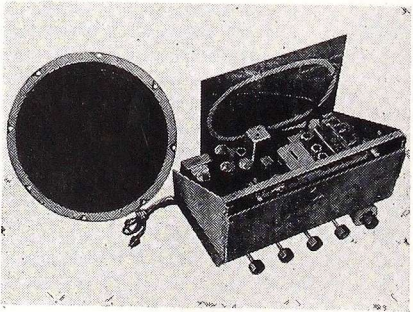

Like every other model in the complete ESPEY line of replacement receivers, and FM Tuners, the Model 511 AM-FM chassis (illustrated) is the last word in modern engineering in the electronics field. Featuring 12 tubes plus Rectifier and Tuning Indicator, it is Drift Compensated, and is supplied complete with all antennas, 25 watt speaker, and all hardware. Its low price assures high profits for you in the growing replacement field. Write today to Dept. M-11 for complete details of this expanding profitable market!

Espey Model 511

ESPEY MANUFACTURING COMPANY, INC.
528 EAST 72nd ST. NEW YORK 21, N. Y. "Established 1928"

INDISPENSIBLE!
AN ESSENTIAL TOOL
FOR YOUR REPAIR KIT!

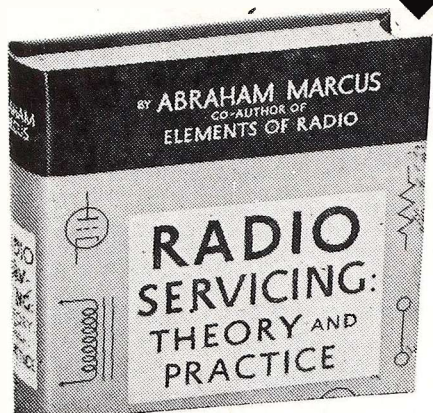

RADIO SERVICING: THEORY AND PRACTICE

By Abraham Marcus
author of Elements of Radio

• This book, the sequel to *Elements of Radio*, is essential equipment for all practical radio men—whether you are a service man, maintenance engineer or a manufacturing superintendent. Specific practices of radio repair and the more advanced problems of radio servicing are explained in clear language and over 575 drawings. It may be used by amateur craftsmen or students.

All Standard Servicing Instruments

For the first time in any book, an extensive section covers all standard servicing instruments—meters,



ABRAHAM MARCUS' first book ELEMENTS OF RADIO sold over half a million copies!

electron-ray-tube indicators, tube checkers, etc.—their parts and their operation, graphically illustrated by 70 drawings in one chapter alone. It discusses electrical and radio theory, components and parts; the many uses of electron tubes, control circuits, power supplies, repair, replacement and readjustment. The sections on the latest

developments in Frequency Modulation—FM—bring this practical book right up to the minute.

CHAPTERS include:

Electrical and Radio Theory • Components and Parts • The Electron Tube, as a Rectifier, as a Detector, as an Amplifier, as an Oscillator • Special Tubes • Circuits • Receivers • Instruments Used for Servicing, Procedures, Techniques • Repair, Readjustment, etc. 832 pages plus 16 pages of photographs, 575 drawings. Completely indexed and tabulated. No other reference materials are needed. Its clarity and completeness make it invaluable for the ham or professional.

Send for your copy now!
Mail check or money order for \$5.95 to
PRENTICE-HALL, Inc., Dept. 309-A
70 Fifth Avenue, New York 11, N. Y.

FIELD FINDINGS

[from page 45]

a National Association of Radio Servicemen." My informant may have erred slightly, but when he told me about this particular meeting, he said that he believed the organizer wanted to call this new national association something approximately equivalent to "National Radio Technicians Guild". (You know, there are several inter-related Eastern associations now functioning under such titles as Radio Technicians Guild of Boston, RTG of Whaling City, RTG of Rochester, etc.).

The sponsors of the proposed new national association, I am told, wanted to bypass several presently well-functioning associations of radio servicemen. The idea, I believe, was to announce the new national body and accept in it as members anyone, as an individual, who wanted to join, regardless of whether that applicant was a member of some existent association, or even if the applicant resided in some remote locale where no association is situated close by. Even part-time technicians would have been eligible for membership in this National Guild. Happily the meeting did not win approval from down-State New York Association representatives, nor were Pennsylvania Association representatives in accord with the idea of launching a "national" body at this time. If the organizers did go ahead with their premature plans, I am sure they will not succeed.

(Flash— I just got word that the RTG groups did launch what is to be called the American Radio Technicians Guild—a national organization.)

After more than 15 years of experience with various types of radiomen's associations I feel qualified to opine that the *only* proper manner in which a national association of radiomen can ever be established and then continue to function successfully is by the following formula, to wit: *First*—establish local associations of radiomen in all communities justified in having an organization, (and that means in any city where 10 or more men are engaged in radio service work), and; *Second*—these separate local associations join in a state-wide Federation. Subsequently the representatives of one State Federation can work out the necessary details so that their Federation can amalgamate with, or at the outset

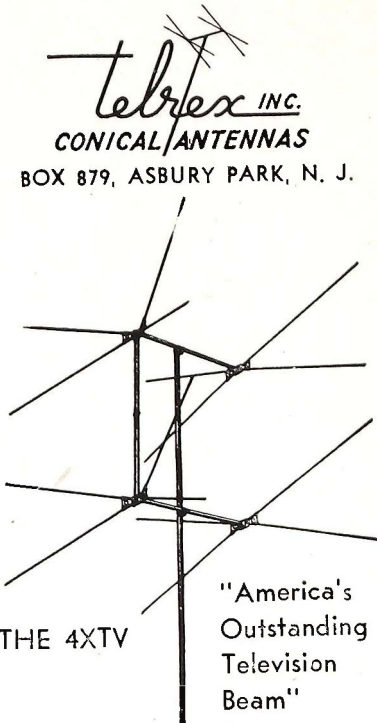

Conical "V" beam. Unidirectional pattern 2-to-13 — 14 DB F to B ratio all channels — Total weight 63/4 lbs.

AT YOUR JOBBER OR WRITE US

SHOOT TROUBLE FASTER!

MAKES MORE MONEY
FOR YOU ON JOB OR
AT SERVICE BENCH!



PRICE
\$9.95 at
Distributor or
postpaid,
direct
Sorry, no
COD's.
Ohioans
add 3%
State
Sales Tax

Signalette

MULTI-FREQUENCY GENERATOR
In radio service work, time means money. Locate trouble faster, handle a much greater volume of work with the SIGNALETTE. As a trouble shooting tool, SIGNALETTE has no equal. Merely plug in any 110 V. AC-DC line, start at speaker end of circuit and trace back, stage by stage, listening in set's speaker. Generates RF, IF and AUDIO Frequencies, 2500 cycles to 29 Megacycles. Also used for checks on Sensitivity, Gain, Peaking, Shielding, Tube testing. Wt. 13 oz. Fits pocket or tool kit. See at your dist. or order direct.

CLIPPARD INSTRUMENT
LABORATORY, INC.

Dept. D 1125 Bank Street
Cincinnati 14, Ohio

Qualified Jobbers write, wire for details.

Mueller

(THE CLIPPER)

ANNOUNCES THE NEW
No. 22 "TWIN-CLIP"

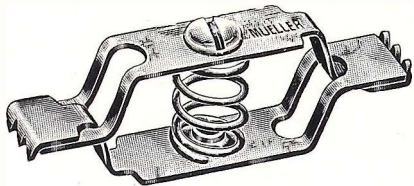

HAS JAWS ON BOTH ENDS
Something New and Different!

Both jaws may be opened at the same time by pressing the center of the clip, or either jaw may be opened separately without disturbing the grip of the other.

Two inches long, made of cadmium plated steel. Has screw connection.

The Twin-Clip is a real time-saver in many electrical and mechanical applications. May be used to make a quick splice, temporary repair hookup, hanging and racking various articles for display or industrial processing, holding identification and record cards, etc.

Send for Free Samples and
Complete Catalog 1905

Mueller Electric Co.

1065 E. 31st St.

Cleveland 14, Ohio

**FREE
ALLIED'S
NEW 1949
RADIO
CATALOG**

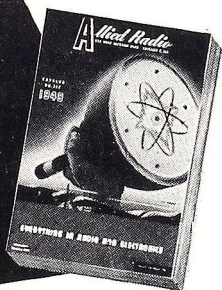

Everything for the
Radio Service
Technician . . .

SEND FOR THIS
180-PAGE BUYING GUIDE NOW

Radiomen! Here's the new 1949 ALLIED Buying Guide that brings you everything you need in radio and electronic equipment. Get everything that's newest and finest from the world's largest stocks—test instruments, sound systems and P.A. equipment, thousands of parts, tubes, tools, books—all at lowest money-saving prices, ready for instant expert shipment. Send for your FREE copy of the new 180-page ALLIED Catalog—today!

ALLIED RADIO

ALLIED RADIO CORP., DEPT. 26-L-8
833 W. Jackson Blvd., Chicago 7, Ill.

Send FREE New ALLIED Catalog.

Name.....

Address.....

simply work in conjunction with, the men who represent the membership of a neighboring State Federation.

And so, in my opinion, there should be a progressive chain of cooperative Federations formed, with the ultimate idea in mind of a National Body eventually coming into being, a voice in which all Federations would have a vote upon an equitable basis. No one State's Federation should have more or less authority or responsibility than any other State's Federation. And underlying the whole plan is the basic knowledge that every participating small unit, such as a single small association in itself, must adhere to and abide by a set of Bylaws, Rules, Regulations and a Constitution with the attendant Code of Ethics to which every other member association in that particular State has subscribed to and agreed upon.

All National Associations founded heretofore failed primarily because of their inherent weakness, insufficient capitalization and the fact that they by-passed the then existant servicemen's associations. Let us not make that mistake again! We can all appreciate why, after hearing of the abortive attempt to launch a National Association or National Guild so improperly, why on October 17th, at a special meeting called for the purpose, delegates of the Federation of Radio Servicemen's Associations of Pennsylvania voted unanimously as follows: "The FRSA of Pa. are opposed to the formation of any national association of radio servicemen without considering inclusion of existing local and state groups; our Federation opposes any national association that accepts individual members not affiliated with a local association or chapter of some standing and recognition; our Federation opposes any national association that is not based upon Democratic and representative principles having recognized parliamentary procedures, etc." For your information, I might mention that the promulgators of the national association, when they met at Rochester, evidenced that they were by-passing the Pennsylvania Federation for reasons not made known, and despite the fact that the Pennsylvania Federation is recognized as being a firmly established, excellently functioning organization that has an enviable record of accomplishment. New York State associations are now in process of organizing a N.Y. Federation. It is to be hoped that many other states will do likewise, and now is the time to do it.

CHECK!

**TOUGHER
POWER RESISTORS
.. GREENOHMS**

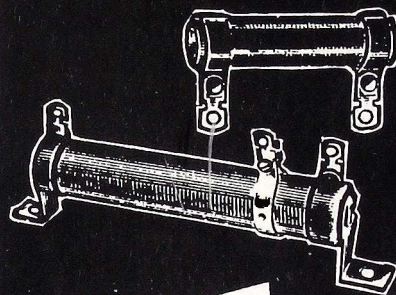

**CEMENT
COATED**

Special cold-setting inorganic cement. Wire winding unimpaired because no intense heat is used in processing. Also no corrosion because no water glass is used! A DIFFERENT cement coating.

**OVERLOAD
INSURANCE**

A Greenohm takes a 500% overload when necessary. Hot enough to light a cigarette! Yet cement coating does not soften, bubble, crack, peel, flake!

**FIXED AND
ADJUSTABLE**

Available in fixed (5 to 200 watt) and adjustable (10 to 200 watt) types. Widest selection of resistance values. And they save you money. Just compare prices!

CLAROSTAT



Ask your
Clarostat
jobber for
latest catalog. Or
write us.

Controls and Resistors

CLAROSTAT MFG. CO., Inc. • DOVER, N. H.

In Canada: CANADIAN MARCONI CO., Ltd
Montreal, P.Q., and branches

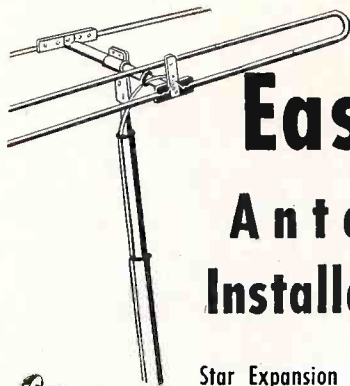

Easier Antenna Installations

Star Expansion Bolts make it easy to fasten TV equipment to brick, stone, concrete or any other type of masonry. Help you to position antenna masts, cables and lines in the best possible manner... assure greater satisfaction; reduce service calls. There's a Star fastening for every masonry job. See your jobber or write for details.

STAR TAMPIN



STAR DRYVIN



STAR STAZIN

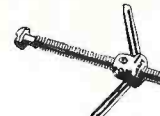

STAR SPRINGIN

Visit Our Display Booth, I. R. E. Show March 7-10 '49

★ STAR EXPANSION BOLT CO. INC.

147 Cedar Street, New York 6, N. Y.

Vital Aids

IN SERVICING
MINIATURE TUBE RADIOS
AND EQUIPMENT



★ Star Miniature Socket Wiring Plugs for accurate alignment of miniature socket contacts during wiring. Precision cast of zinc base alloy—pins of stainless steel. #JE-9 (9 pin); #JE-10 (7 pin).

★ Star Miniature Tube Pin Straighteners (with stainless steel insert) to obtain a perfect fit when the tube is placed in the equipment. #JE-15 (9 pin); #JE-13 (7 pin).



Scientifically designed—Precision made Immediate Delivery in Any Quantities Visit our Display Booth I. R. E. Show, March 7-10, 1949

★ STAR EXPANSION PRODUCTS CO., INC.

147 CEDAR STREET, NEW YORK 6, N. Y.

Admiral Corporation	29
Allied Radio Corp.	47
Amperite Co., Inc.	40
Belden Mfg. Co.	4
Burgess Battery Co.	44
Centralab Div. of Globe-Union 22,	23
Clarostat Mfg. Co.	47
Clippard Instru. Lab., Inc.	46
Crosley Div., Avco Mfg. Corp.	1
Electro-Voice, Inc.	32
Electrovox Co., Inc.	38
Espey Mfg. Co., Inc.	45
General Electric Co.	
(Speaker Div.)	25
General Electric Co.	
(Tube Div.)	3
Heath Co., The	35
Hickok Elec. Instru. Co.	45
Hytron Radio & Electronics Corp.	7
International Resistance Co.	39
La Pointe Plascomold Corp.	38
Littelfuse, Inc.	40
Mallory, & Co., Inc., P.R.	Cover 2
Microcircuits Co.	48
Mueller Electric Co.	47
Murray Hill Books, Inc.	39
Ohmite Mfg. Co.	31
Permoflux Corp.	45
Prentice-Hall, Inc.	46
Racon Electric Co., Inc.	34
R C A (Tube Div.)	Cover 4
Rider Pub., John F.	33, 44
Sams & Co., Inc., Howard W.	27
Service Man's Aid Co.	48
Simpson Elec. Co.	Cover 3
South River Metal Prods. Co.	42
Star Expansion Bolt Co., Inc.	48
Star Expansion Prods. Co., Inc.	48
Sylvania Elec. Prods. Inc.	8
Telrex, Inc.	46
Transvision, Inc.	37
Utah Radio Products	36
Vision Research Laboratories	48
Weller Mfg. Co.	42

EDITORIAL

[from page 2]

ward to the day when the public and press, and more important, the manufacturing phase of the industry itself will look upon radio-video technicians as being members of an honorable profession, as contrasted to their present view of our standing, which may be likened to the tail on the end of a dog.

Dollarwise, not long ago radio repairmen earned less than \$25 a week. Nowadays radio technicians are in the \$65 weekly earnings class and videomen are demanding and getting well over \$100 weekly. Soon, it is logical to assume, all qualified TV men will earn well over \$6000 per annum, and if we handle ourselves properly, that figure can exceed \$10,000.

NEW PRINTED LEARN FUN CIRCUITS PROFIT

RESEARCH - DESIGN - REPAIR -
MANUFACTURE; NOW FASTER AND
EASIER

Be first to learn the new printed-circuit methods. Conducting ink kits, instructions: Standard \$3.00, Super \$5.00 (with silver ink). Cash or M.O. Quantity discounts to dealers. MICROCIRCUITS COMPANY, Dept. 6C, New Buffalo, Michigan.

Stuck?

Send accurate symptoms with name and model number of set. We will promptly assist you in your repair problem. Complaints individually answered; simple and easy to understand. Complete service \$1.00 per set. Schematic free on request (if available). Write

Service Man's Aid Co.

Dept. M 815 Columbus Ave.
New York 25, N.Y.

VISION . . . proudly presents the first SUPER DELUXE BOOSTER

Three stages of high-gain, broad band amplifiers, adjustable gain and smooth continuous tuning . . . that is what makes the VISION TELEBOOSTER MODEL TVZ the finest in its field.

Check these features—

- Continuous tuning over all tv channels, no bandswitching.
- Helps overcome noise and interference conditions.
- Vernier tuning makes the hairline adjustment easy and accurate.
- Gain control permits just the right amount of gain for each station.
- Eliminates need for outdoor antenna in many locations.
- Use three (3) type 6AK5 tubes in stable, high-gain circuit.
- Self contained power supply using long life selenium rectifier.
- Easy to install, just plug into AC outlet and connect to set and antenna.



MODEL TVZ

\$54.50
LIST

Prices slightly higher
on the West Coast.

VISION RESEARCH LABORATORIES INC.

87 - 50 Lefferts Blvd.
Richmond Hill, N. Y.

NEW!...the Roto Ranger

— automatically rotates one of 18 separate scales into position as you select the range.

SIMPSON MODEL 221 ROTO-RANGER
HIGH-SENSITIVITY A.C.-D.C. VOLT-OHM-MILLIAMMETER

Here is the only multiple scale test instrument of its kind in the world. It definitely reduces the possibility of errors by providing a single scale for each range of this finest of volt-ohm-milliammeters. As the selector switch is moved to the range desired, an ingenious gearing mechanism rotates a drum, bringing into place behind the meter window the proper scale for that range. Here is the equivalent of 25 separate instruments combined in one sturdy and compact unit. (18 scales; 7 additional direct reading ranges through use of high voltage and output jacks.) The patented Roto-Ranger principle eliminates the confusion of numerous readings on one scale, and the multiplying factors common to ordinary multi-range testers, by providing a separate scale for each range. There are no cramped calibrations in these full sized Roto-Ranger scales. Each is designed as it would be for a separate instrument.

Simpson
INSTRUMENTS THAT STAY ACCURATE

SIMPSON ELECTRIC COMPANY
5200-5218 W. Kinzie St., Chicago 44, Ill.
In Canada: Bach-Simpson, Ltd.,
London, Ontario

Ranges

20,000 Ohms per Volt D.C., 1,000 Ohms per Volt A.C.
Volts, A.C.: 2.5, 10, 50, 250, 1000, 5000
Volts, D.C.: 2.5, 10, 50, 300, 1000, 5000
Milliamperes, D.C.: 10, 100, 500
Microamperes, D.C.: 100
Amperes, D.C.: 10
Output: 2.5, 10, 50, 250, 1000
Ohms: 0-2000 (12 ohms center), 0-200,000 (1200 ohms center), 0-20 megohms (120,000 ohms center).
Size: 12³/₄" x 10¹/₈" x 5³/₈"
Weight: 8 lbs. 9 oz.
Price, complete with test leads and 28-Page Operator's Manual..... \$69.85

High voltage probe (25,000 volts) for TV, radar, x-ray and other high voltage tests, also available.

Ask your Jobber, or write for complete descriptive literature



A separate scale for every range—automatically!

Large 5 1/2" meter, with 18 separate, full length scales!



*Push RCA Tubes, Batteries, Parts and Test Equipment
—and watch your business grow!*

Radio's greatest line . . . backed by the greatest name in radio

● RCA and *only* RCA, brings you this preferred line of related products for greater sales volume throughout the year.

You benefit by handling RCA Tubes, Batteries, Test Equipment, Parts and Accessories . . . because you can concentrate your requirements with *one* dependable source of supply . . .

because the RCA monogram on *any* product gives it immediate customer acceptance.

What's more, you'll save time and give greater customer satisfaction using the outstanding new line of laboratory-engineered RCA Test Equipment in your service shop.

See your RCA Distributor today for full details.



RENEWAL SALES

RADIO CORPORATION of AMERICA

TUBE DEPARTMENT

HARRISON, N. J.