



radio
service
dealer



JANUARY, 1947



IN THIS ISSUE:

ACCURATE AUDIO AMPLIFIER MEASUREMENTS

"GUILLOTINE" TUNING SYSTEM

SURE CURE FOR COMPLAINTS

DIPOLES FOR FM-TELEVISION RECEIVERS

OPERATING HINTS

Mallory Offers 12 Clutch Type Controls for Use in Auto Receivers



MALLORY offers the widest range of resistance values in clutch type controls to fit every need. Four different values are available in the Universal Midget line (100M ohms, 250M ohms, 500M ohms, 1 megohm), and eight values in popular combinations of overall and tap resistances in our Tapped Midget line.

Add these to the Plug-In Shafts you see at the right, and you can replace original controls in any auto set you name—not merely replace them but *duplicate them mechanically and electrically*. Get the complete story from your Mallory distributor.

You Expect More . . .
and Get More . . .
from Mallory

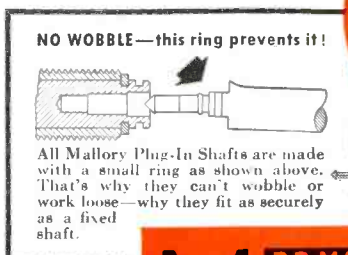

INSIST ON
MALLORY—THE
COMPLETE
CONTROL
LINE

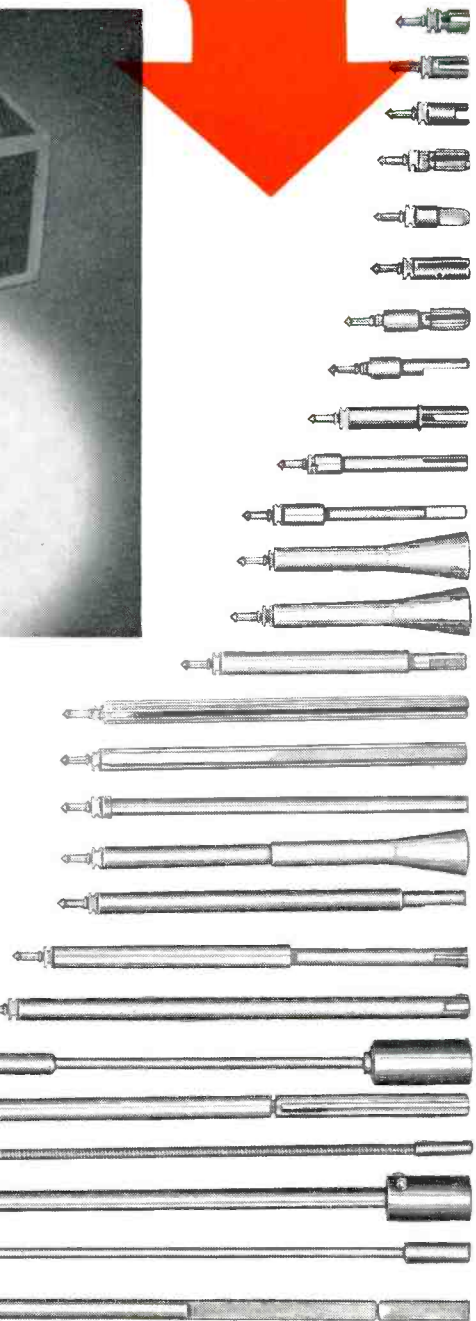

P. R. MALLORY & CO. Inc.
MALLORY

VIBRATORS . . . VIBRAPACKS* . . . CAPACITORS . . . VOLUME CONTROLS . . . SWITCHES . . . RESISTORS . . . FILTERS . . . RECTIFIERS . . . POWER SUPPLIES. ALSO MALLORY DRY BATTERIES, THE ORIGINAL MERCURY BATTERIES.

*Reg. U. S. Pat. Off.

APPROVED PRECISION PRODUCTS

P. R. MALLORY & CO., Inc., INDIANAPOLIS 6, INDIANA



I Will Show You How to Learn RADIO by Practicing in Spare Time

**I Send You
Big Kits
of Radio Parts**

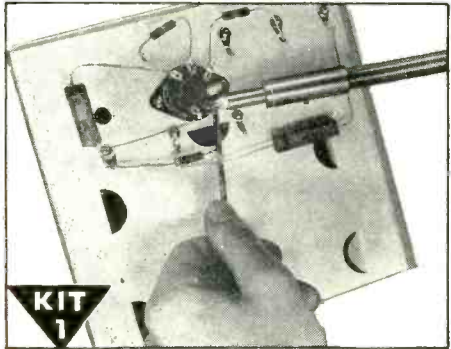

KIT 1
I send you Soldering Equipment and Radio parts; show you how to do Radio soldering; how to mount and connect Radio parts; give you practical experience.

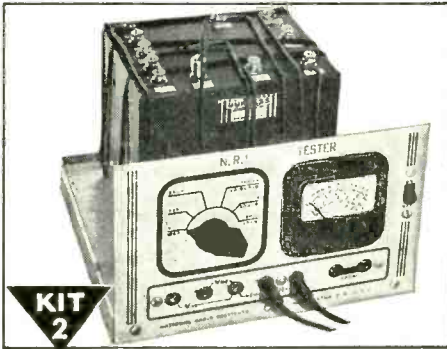

KIT 2
Early in my course I show you how to build this N. R. I. Tester with parts I send. It soon helps you fix neighborhood Radios and earn EXTRA money in spare time.

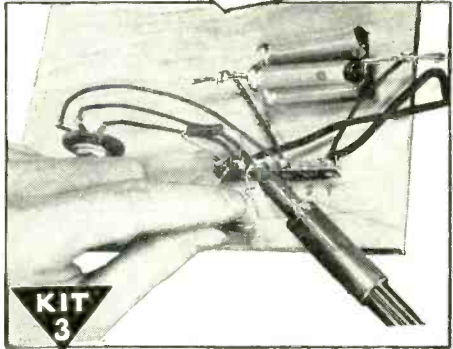

KIT 3
You get parts to build Radio Circuits; then test them; see how they work, learn how to design special circuits; how to locate and repair circuit defects.

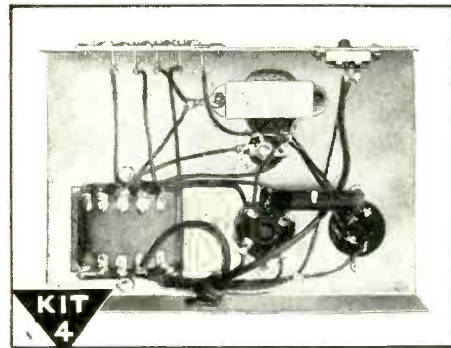

KIT 4
You get parts to build this Vacuum Tube Power Pack; make changes which give you experience with packs of many kinds; learn to correct power pack troubles.

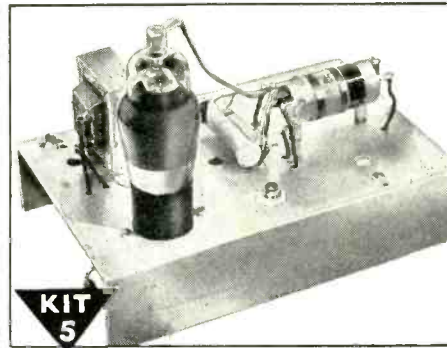

KIT 5
Building this A. M. Signal Generator gives you more valuable experience. It provides amplitude-modulated signals for many tests and experiments.

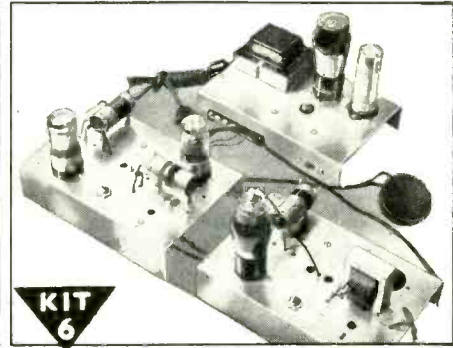

KIT 6
You build this Superheterodyne Receiver which brings in local and distant stations—and gives you more experience to help you win success in Radio.

I Will Train You at Home - SAMPLE LESSON FREE

**APPROVED
for training
under
G.I. BILL**

Do you want a good-pay job in Radio — or your own money-making Radio Shop? Mail Coupon for a FREE Sample Lesson and my FREE 64-page book, "How to Be a Success in RADIO — Television, Electronics." See how N. R. I. gives you practical Radio experience at home — building, testing, repairing Radios with BIG KITS OF PARTS I send!

Many Beginners Soon Make Good Extra Money In Spare Time While Learning

The day you enroll I start sending EXTRA MONEY JOB SHEETS. You LEARN Radio principles from my easy-to-grasp, illustrated lessons — PRACTICE what you learn with parts I send — USE your knowledge to make EXTRA money fixing neighbors' Radios

**My Radio Course Includes
TELEVISION • ELECTRONICS
FREQUENCY MODULATION**

in spare time while still learning! From here it's a short step to your own full-time Radio Shop or a good Radio job!

Future for Trained Men Is Bright In Radio, Television, Electronics

It's probably easier to get started in Radio now than ever before because the Radio Repair business is booming. Trained Radio Technicians also find profitable opportunities in Police, Aviation, Marine Radio, Broadcasting, Radio Manufacturing, Public Address work. Think of even greater

Our 33rd Year of Training Men for Success in Radio

opportunities as Television and Electronics become available to the public! Send for free books now!

Find Out What N. R. I. Can Do For You

Mail Coupon for Sample Lesson and my 64-page book. Read the details about my Course. Read letters from men I trained, telling what they are doing, earning. See how quickly, easily you can get started. No obligation! Just MAIL COUPON NOW in an envelope or paste it on a penny postal. **J. E. SMITH, President, Dept. 7AJ5, National Radio Institute, Pioneer Home Study Radio School, Washington 9, D. C.**

Good for Both - FREE

Mr. J. E. SMITH, President, Dept. 7AJ5
National Radio Institute, Washington 9, D. C.

Mail me FREE, without obligation, Sample Lesson and 64-page book about how to win success in Radio — and Television, Electronics. (No salesman will call. Please write plainly.)

Name Age

Address

City State

(Please include Post Office zone number)



APPROVED FOR TRAINING UNDER GI BILL

New!

Series 200

A RELAY BY GUARDIAN

with Interchangeable Coils

BUILT IN TWO PARTS

A. C. Coil Assemblies available for 6 v., 12 v., 24 v., 115 v.
D. C. Coil Assemblies available for 6 v., 12 v., 24 v., 32 v., 110 v.

★ Two basic parts—a coil assembly and a contact assembly — comprise this simple, yet versatile relay. The coil assembly consists of the coil and field piece. The contact assembly consists of switch blades, armature, return spring, and mounting bracket. The coil and contact assembly are easily aligned by two locator pins on the back end of the contact assembly which fit into two holes on the coil assembly. They are then rigidly held together with the two screws and lock washers. Assembly takes only a few seconds and requires no adjustment on factory built units.

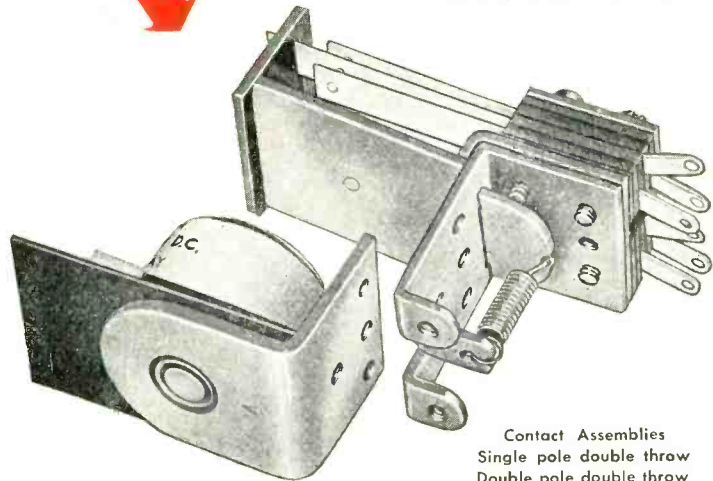

SERIES 200 RELAY

Contact Assemblies
Single pole double throw
Double pole double throw

On Sale at Your nearest jobber NOW!

See it today! . . . this amazing new relay with interchangeable coils. See how you can operate it on any of nine different a-c or d-c voltages — simply by changing the coil. Ideal for experimenters, inventors, engineers.

TWO CONTACT ASSEMBLIES

The Series 200 is available with a single pole double throw, or a double pole double throw contact assembly. In addition, a set of Series 200 Contact Switch Parts, which you can buy separately, enables you to build dozens of other combinations. Instructions in each box.

NINE COIL ASSEMBLIES

Four a-c coils and five d-c coils are available. Interchangeability of coils enables you to operate the Series 200 relay on one voltage or current and change it over to operate on another type simply by changing coils.



Your jobber has this sensational new relay on sale now. Ask him about it. Or write for descriptive bulletin.

GUARDIAN ELECTRIC

1606-A W. WALNUT STREET

CHICAGO 12, ILLINOIS

A COMPLETE LINE OF RELAYS SERVING AMERICAN INDUSTRY

radio service dealer

Member Audit Bureau of Circulations
Covers all phases of radio,
phonograph, sound and elec-
trical appliance mer-
chandising and servicing

VOLUME 8 Number 1

January, 1947

CONTENTS

In and Around the Trade	4
With the Publisher	8
Watch Those "Hidden" Profits!—3	15
Buyers' Market Is No "Bogeyman"	15
Accurate Audio Amplifier Measurements	16
The New "Guillotine" Tuning System	20
Sure Cure for Customer Complaints	22
Operating Hints from "Boss" Service-Dealer	24
Reference Guide for Miniature Tubes—2	25
Merchandise Pre-Views	26
Radio In Every Room	29
Service Data	30
Dipoles for FM-Television Home Receivers	31
Circuit Court	32
Shop Notes	34

RADIO SERVICE DEALER (title registered U. S. Pat. Off.) is published monthly at Boston Post Road, Orange, Connecticut, by the Cowan Publishing Corp. Executive & Editorial Offices, 342 Madison Avenue, New York City 17, New York. Publication Office, Boston Post Road, Orange, Conn. Subscription rates:—United States and Possessions \$2.00 for 1 year, \$3.00 for 2 years; elsewhere \$3.00 per year. Single copies: 25c. Printed in U. S. A. Entered as Second Class Matter at the Post Office at Orange, Connecticut, under the Act of March 3, 1879. All subscribers should allow at least three weeks for change of address. Copyright, 1946

COWAN PUBLISHING CORP.

SANFORD R. COWAN,
Publisher

LEWIS C. STONE
Editor

SANFORD L. CAHN,
National Advertising Sales Manager
H. N. REIZES, Adv. Mgr.

JEAN M. WHEELER, Circ. Mgr.
DAVID SALTMAN, Adv. Prod. Mgr.
Branch Offices

HERBERT S. LAUFMAN
Western Adv. Mgr.

82 W. Washington St., Chicago 2, Ill.,
ANDover 1395

JAMES C. GALLOWAY, Los Angeles Adv. Rep.
816—W. 5th St., Los Angeles 13, Calif.
Mutual 8335



Alfred A. Ghirardi — the man who takes the headaches out of Radio-Electronic Servicing.

**I'LL "LEND" YOU
THESE TWO GREAT
MONEY-SAVERS
For 5 Full Days**

**Save Time—Make Twice as
Much Money... YOU BE THE JUDGE**

Ghirardi's RADIO TROUBLESHOOTER'S HANDBOOK

*Helps you repair 4 out of 5% of all Radio
Receiver troubles in half the usual time*

Ghirardi's big, 4 lb., 744-page RADIO TROUBLE-SHOOTER'S HANDBOOK is the one radio servicing short cut that really works. Eliminates much tedious testing—is worth another man in your shop! The common troubles and their remedies are carefully listed and indexed—for practically every home receiver, auto-radio and record changer in use today. The HANDBOOK tells exactly what the trouble is likely to be—exactly how to repair it. Ghirardi passes on to you its priceless servicing knowledge and experience obtained from thousands of hours of tedious troubleshooting and repair

work on all these receivers. By using it your service work is made EASIER and you can easily cut your own time in half ON FOUR JOBS OUT OF FIVE—and still charge the customer the same price! Think what that will mean in terms of profit! In addition, over 300 pages of this giant, manual-size book contain other invaluable data—tube charts, tube and parts substitution data, 1-f alignment and transformer data, color codes and literally dozens of charts, graphs, diagrams, and compilations that will help you repair any radio ever made EASIER, BETTER and twice as fast! Only \$5 complete—on our 5-Day Money-Back Guarantee Basis.

Ghirardi's MODERN RADIO SERVICING

*All the Science of Professional Radio-Electronic-
Television Servicing in One 1300-Page Book*

744 PAGES!
WEIGHS OVER
4 LBS!

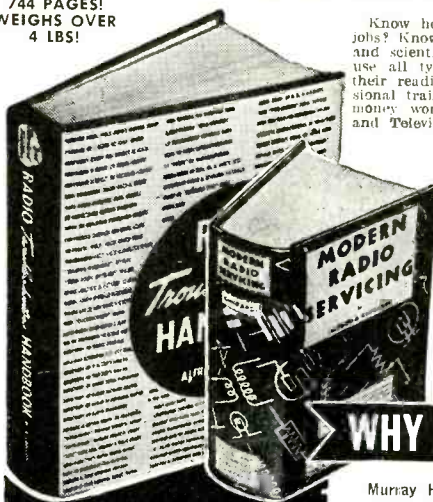

Know how to make preliminary trouble checks on complicated jobs? Know how to analyze any circuit and its components quickly and scientifically? Do you know exactly where, when and how to use all types of test instruments... and how to interpret their readings to track down the trouble? Only by truly professional training of this sort can you hope to qualify for the big-money work—and especially on the more complicated new FM and Television receivers.

INCREASE YOUR EARNINGS!

Nowhere else can you get such training faster, easier and at less cost than in Ghirardi's MODERN RADIO SERVICING. This 1300-page, profusely illustrated book brings you up to date on modern methods, refreshes you on any type of work that may prove puzzling, prepares you for the rich opportunities that only servicemen having the true "Know How" of their profession can grasp. Everything explained simply and thoroughly so you will understand it easily and quickly. Only \$5 complete—on our 5-DAY MONEY-BACK GUARANTEE offer.

1300 PAGES Every cent cheerfully refunded if
706 ILLUS.! you're not more than satisfied!

WHY NOT HAVE A LOOK—Now!

Murray Hill Books, Inc., Dept. RSD-17,
232 Madison Ave., New York 16, N.Y., U.S.A.

- Enclosed find \$..... for books checked; or send C.O.D. (in U.S.A. only) for this amount plus postage. If not fully satisfied, I may return the books within 5 days for refund.
- RADIO TROUBLESHOOTER'S HANDBOOK \$5 (\$5.50 foreign)
- MODERN RADIO SERVICING \$5 (\$5.50 foreign)
- MONEY-SAVING COMBINATION OFFER: Both big books—over 2040 pages—only \$9.50 for the two (\$10.50 foreign).

Name

Address

City & Dist. No. State

MONEY-SAVING OFFER!

Let Ghirardi's RADIO TROUBLE-SHOOTER'S HANDBOOK save you time on common radio jobs. Let MODERN RADIO SERVICING train you in scientific electronic servicing "Know How". Get BOTH big books at special price of only \$9.50. Send coupon today!

In & Around the Trade

Being a condensed digest of production, distribution and merchandising activities in the radio and appliance trade.



Kenny Delmar ("Senator Claghorn") stands in front of new Sparton Combination Radio-Phenograph which was awarded to jackpot winner Sydele Moskowitz at a recent session of "Hollywood Jackpot", CBS radio program sponsored by Anacin and Kolynos. Sparks-Withington product was major jackpot prize.

RADIO PARTS SHOW OVERSUBSCRIBED

Advance registration for the Radio Parts and Electronic Equipment Show to be held at Hotel Stevens in Chicago

from May 11 to 16, 1947, indicates that show attendance will break all records, Kenneth C. Prince, show manager, said today. Drawings for booths at the show were held in New York recently, with 158 manufacturer's booths and ten half-booths for guest exhibitors assigned, a complete sell-out of all available space. Additional space contracts are being placed on a waiting list.

NEDA Day, Monday, May 12, will be

Supervised by Charles Golenpaul (left) Aerovox; Sam Poncher (middle) Newark Electric, Margaret McGowan of New York Show Staff, draws the slips that assigned 158 manufacturers booths and ten half-booths for the Radio Parts and Electronic Equipment Show, to be held at Hotel Stevens, Chicago, May 11 to 16, 1947. This is a complete sellout of all available space. Drawing took place in the Hotel New Yorker ("Radio Service Dealer," December issue).



featured by a breakfast for manufacturer guests of National Electronic Distributors Association members, and a lunch for sponsoring organizations (Radio Manufacturers Association, Sales Managers Club Eastern Division, Association of Electronic Parts and Equipment Manufacturers, and National Electronic Distributors Association). All meetings originally scheduled for Monday will be held earlier in the week or after Friday. The exhibition hall will be open on Tuesday, May 13, for member exhibitors, their booth attendants, members of the press, sales representatives and distributors only, with open house scheduled for Friday. Radio amateurs and the general public will be admitted on that day only.

Manufacturers were requested by the show management to advise their own personnel to visit the exhibition hall only on Open House Day, unless their business requires their daily attendance.

Jack Berman, president of the Show Corporation, announced the following Show committees:

Budget Committee: Sam Poncher, Chairman, Newark Electric Company; W. W. Jablon, Hammarlund Mfg. Co.; J. J. Kahn, Standard Transformer Co.; Charles Golenpaul, Aerovox Corp.

Publicity Committee: R. J. Sherwood, Chairman, Hallicrafters; H. H. Teplitz, Teplitz Advertising Co.; Burton Browne, Burton Browne Adv.

Housing Committee: W. W. Jablon, Chairman, Hammarlund Mfg.; Sam Poncher, Newark Electric Co.; J. J. Kahn, Standard Transformer Co.

Arrangements Committee: C. Golenpaul, Chairman, Aerovox Corporation; R. J. Sherwood, The Hallicrafters Co.; W. O. Schoning, Lukko Sales Corp.; H. W. Clough, Belden Mfg. Co.

Banquet Committee: R. C. Sprague, Chairman, Sprague Electric Company; Les A. Thayer, Belden Mfg. Company; L. B. Calamaras, Executive Secretary of Nat'l. Electronic Dists. Ass'n.

Credentials Committee: J. J. Kahn, Chairman, Standard Transformer Co.; W. O. Schoning, Lukko Sales Corp.; F. R. Ellinger, Ellinger Sales Co.

Credentials Committee Panels: R. J. Sherwood, The Hallicrafters Co.; William Wilson, Hughes-Peters, Inc.; David Sonkin, C. Golenpaul, Aerovox Corp.; Rich. Weatherford, Martin Distributors; Royal Higgins, Royal J. Higgins Co.; Roy Laird, Ohmite Manufacturing Co.; A. D. Davis, Allied Radio Corp.; M. B. Patterson, R. C. Sprague, Sprague Electric Co.; Sam Poncher, Newark Electric Co.; Irving Aaron, E. G. Shaulkhauser, Radio Mfg. Engineers, Inc.; S. W. Berk, Concord

(See page 6)

New! Exclusive!

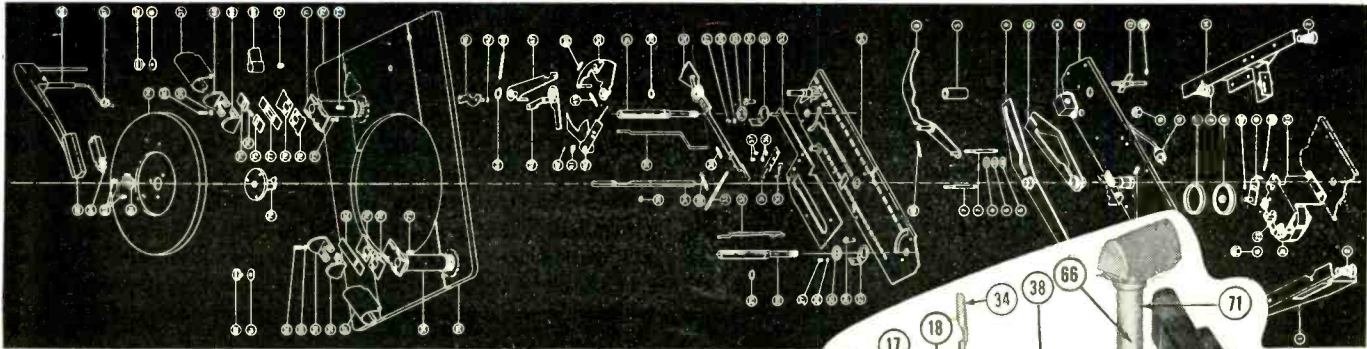

PHOTOFACT FOLDERS^{*} analyze all post-war RECORD CHANGERS!

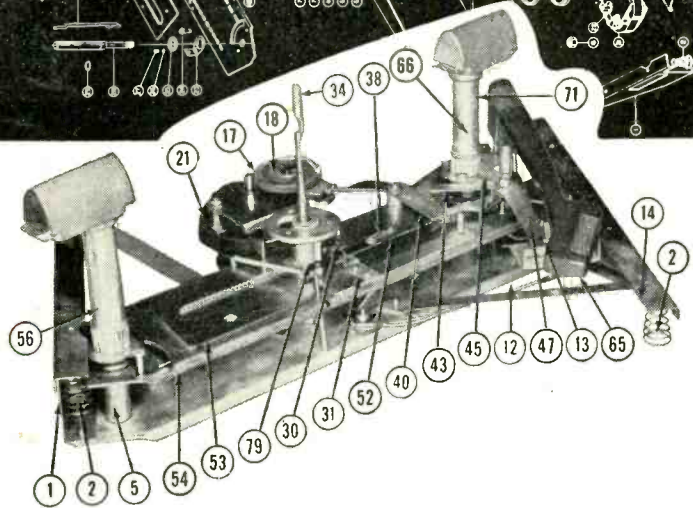

Post-war radio is barely a year old, but already there are 40 different record changers on the market. Do you know who makes them? How they operate? How to service them in case of breakdown? Do you know where you can get up-to-the-minute results of life tests that are now being run?

This vital information now becomes a regular PHOTOFACT FOLDER Service *at no Extra Cost to You!* Clear-cut photographs, exclusive big line drawings, parts lists, operation details, trouble-cause-and-remedy charts, tell you everything you need to know to do a workmanlike job—*help you do twice as many repair jobs a day.*

PHOTOFACT FOLDERS save valuable time in many other ways. They make it easy to

*Trade Mark Reg.

diagnose trouble, hunt defective parts, make adequate replacements in *all* the latest radios, phonographs, record changers, recorders, communication systems and power amplifiers. Data and photographs are made from actual examinations of instruments—not from reprinted or copied information.

The cost? Only \$1.50 for each set of 40 folders. Actually they cost you nothing, for they pay for themselves over and over again in time saved. **Over 25,000 radio service engineers now use and depend upon PHOTOFACT FOLDERS.** Why let service problems stump you? PHOTOFACT FOLDERS help you lick every one of them! See your nearest distributor or use the convenient coupon.

PUBLICATION DATES:

Set No. 11 January 10

Set No. 12 January 25

Cut this out and MAIL IT TO YOUR DISTRIBUTOR. If you do not know his name and address, send it directly to Howard W. Sams & Co., Inc., 2924 East Washington Street, Indianapolis 6, Indiana, and we will see that your nearest distributor gets it. In Canada, write to A. C. SIMMONDS & SONS, 301 King Street East, Toronto, Ontario. Canadian Price, \$1.75.

PLEASE PRINT

Send Vol. 2, Set No. 12 Send Vol. 2, Set No. 11

Send me Volume 1 (including Sets Nos. 1 to 10) with De Luxe Binder. \$18.39. Individual Sets Nos. 1 to 10, \$1.50 each.

Send me a De Luxe Binder (at \$3.39)

My (check) (money order) (cash) for _____ is enclosed.
(If you send cash, be sure to use registered mail.)

Name _____

Address _____

City _____ Zone _____ State _____

Company Name _____

My Distributor's Name _____

City _____

HOWARD W. **Sams** & CO., INC. **RADIO PHOTOFACT SERVICE**

In Canada—write to A. C. SIMMONDS & SONS, 301 King Street East, Toronto, Ontario

Better Instruments

improve your profits

**WITH DYNAMIC MUTUAL CONDUCTANCE
ORIGINATED AND PRODUCED EXCLUSIVELY BY HICKOK**

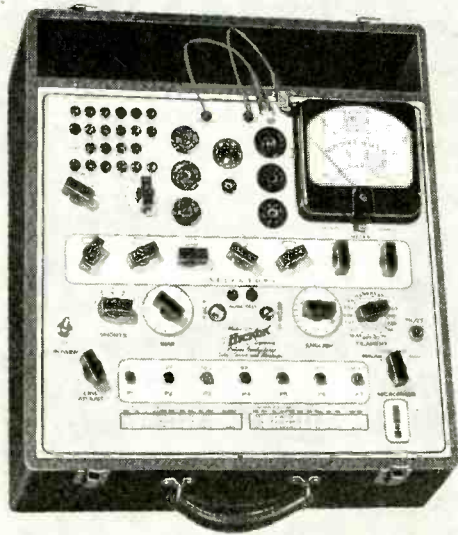

**TRULY, THE HICKOK 534 IS SOMETHING
ANY SERVICE MAN CAN BE PROUD OF...**

- 1.** Faster testing saves time for you.
- 2.** Greater accuracy with HICKOK Tube and Set Testers assures better satisfied customers.
- 3.** These test instruments cut down your customer calls for rechecks.
- 4.** Better quality instruments increase your profits.

Model 534—all purpose Tube and Set Tester illustrated above meets all requirements of the exacting service man. It has everything you will need—even including a complete High Sensitivity Analyzer Unit.

★ ★

Write for catalog today listing all technical characteristics and you will choose—**HICKOK**—the finest in Radio Test Equipment for more than a third of a century.

THE HICKOK ELECTRICAL INSTRUMENT COMPANY
10533 DUPONT AVENUE • CLEVELAND 8, OHIO

OTHER HICKOK INSTRUMENTS OF MATCHLESS ACCURACY

Signal Generators, With or Without Crystal • Traceometers • Channel Testers • Oscillographs • Electronic Volt Ohm Milliammeters • Vacuum Tube Volt Ohm Milliammeters • Volt-Ampere Wattmeters

HICKOK
INSTRUMENTS

IN TRADE

(from page 4)

Radio Corp.; Dan R. Bittan, Bittan-Nevins Co.; W. W. Jablon, Hammerlund Mfg. Co.; Milton Deutschman, Radio Shack Corp.; Russ Diethart.

Credentials Committee Alternates: Leroy Beier; Lew Hatry, Hatry-Young; H. W. Clough, Belden Mfg. Co.

Public Relations: R. J. Sherwood, The Hallicrafters Company, 2611 Indiana Ave., Chicago, Illinois.



Paul Eckstein (above) is assistant general sales manager of Domestic Appliance Division, Pressed Steel Car Co., Inc., 666 North Lakeshore Drive, Chicago 11, Ill.



Carbonneau Industries

Gordon S. Carbonneau, president of Carbonneau Industries, Grand Rapids, Michigan, announces expansion of his newly formed corporation for an early entry into full scale production on all styles and sizes of radio loud speakers in both the jobber and equipment lines. Mr. Carbonneau was formerly production engineer for the Utah Radio Products Company, Chicago, and has been active in the radio industry for the past 25 years.

Production on 5 and 10-inch speakers, which began less than six months ago, has been limited to 2,000 speakers per day by material shortages; however, arrangements are being made for an output of approximately 5,000 units daily

(See page 10)

A Handy Guide TO SPRAGUE EL SELF-MOUNTING MIDGET CAPACITORS (Can Type)

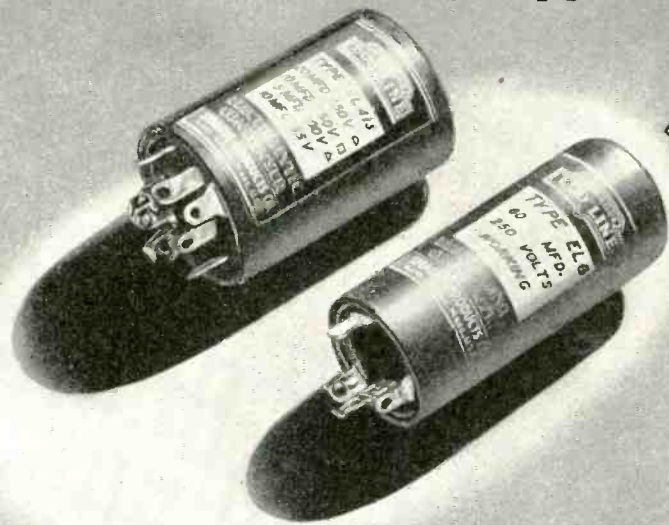

Easier to install... Tops for Dependability

Time is money in radio servicing. Save it—make more of it—by using Sprague Type EL can type dry electrolytic capacitors for every possible replacement use. They're small enough to fit anywhere. They're absolute tops in dependability. And you can mount them in a jiffy, either by direct chassis mounting or by means of their convenient twist prongs. Both bakelite and metal washers are supplied with each unit.

Ask for Sprague Type EL Capacitors by name!

SPRAGUE

PRODUCTS CO., NORTH ADAMS, MASS.

SINGLE SECTION

Catalog No.	Mfd.	Voltage DC working	Dimensions	
			D	L
EL-13	3000	10	1 3/8	3
EL-111	1000	15	1 1/8	3
EL-121	2000	15	1 3/8	3
EL-142	40	25	3/8	2
EL-112	100	25	3/8	2 1/4
EL-152	500	25	1 1/8	2 1/4
EL-122	1000	25	1 3/8	2 1/4
EL-50	150	50	3/8	2 1/4
EL-55	500	50	1 1/8	2 1/4
EL-31	30	150	3/8	2 1/4
EL-51	50	150	3/8	2 1/4
EL-14	40	200	1	2 1/4
EL-12	20	250	3/8	2 1/4
EL-30	30	250	3/8	2 1/4
EL-42	40	250	1	2 1/4
EL-6	60	250	1	2 1/4
EL-203	15	300	3/8	2 1/4
EL-33	30	300	1	2 1/4
EL-53	50	300	1	2 1/4
EL-123	125	300	1 3/8	3
EL-5	50	350	1	3
EL-125	125	350	1 3/8	3
EL-10	10	400	3/8	2
EL-20	20	400	1	2
EL-80	80	400	1 3/8	2 1/4
EL-1	10	450	3/8	2
EL-15	15	450	1	2
EL-2	20	450	1	2 1/4
EL-3	30	450	1	2 1/4
EL-4	40	450	1	3
EL-115	10	525	1	2

DUAL SECTION

EL-242	40-40	25	1	2
EL-250	50-50	50	1	2
EL-221	20-20	150	1	2
EL-231	30-15	150	1	2
EL-230	30-30	150	1	2
EL-24	40-20	150	1	2
EL-35	50-30	150	1	2
EL-25	50-50	150	1	2
EL-26	60-60	150	1	3
EL-101	10-10	250	1	2
EL-120	20-20	250	1	2
EL-245	40-40	250	1	2
EL-21	10-10	300	1	2
EL-253	15-15	300	1	2
EL-22	20-20	300-25	1	2
EL-23	30-30	300-350	1	3
EL-32	30-20	350	1	3
EL-254	15-15	400	1	2 1/4
EL-214	80-10	400	1 3/8	3
EL-210	10-10	450	1	2
EL-451	15-10	450	1	2 1/4
EL-220	20-20	450	1	3
EL-240	40-40	450	1 3/8	3

TRIPLE SECTION

EL-325	20-20-20	25	1	2
EL-335	30-30-30	50	1	2
EL-313	10-30-30	150	1	2
EL-320	20-20-20	150	1	2
EL-224	40-20-20	150	1	2
EL-340	40-40-40	150	1	3
EL-321	30-20-100	150-150-6	1	2
EL-222	20-20-20	150-150-25	1	2
EL-324	30-20-20	150-150-25	1	2
EL-332	30-30-20	150-150-25	1	2
EL-43	30-40-25	150-150-25	1	2
EL-343	40-30-20	150-150-25	1	2
EL-351	50-30-100	150-150-25	1	2 1/4
EL-352	50-50-20	150-150-25	1	2 1/4
EL-355	10-15-15	250	1	2
EL-315	10-15-30	250	1	2
EL-354	40-20-20	250	1	3
EL-331	15-15-20	250-250-25	1	2 1/4
EL-334	30-30-20	250-250-25	1	3
EL-314	10-20-30	250-250-350	1	3
EL-316	10-10-10	300	1	2
EL-333	20-20-20	300-300-25	1	2 1/4
EL-341	40-15-20	300-300-25	1	2 1/4
EL-102	10-10-20	350-350-25	1	2
EL-153	15-10-20	350-350-25	1	2
EL-326	15-15-20	350-350-25	1	2 1/4
EL-212	20-10-20	350-350-25	1	2 1/4
EL-323	30-20-20	350-350-25	1	3
EL-311	10-10-10	400	1	2 1/4
EL-342	15-15-40	400-400-25	1	3
EL-322	20-20-20	400-400-25	1	3
EL-310	10-10-10	450	1	2 1/4
EL-344	15-15-10	450	1	3
EL-362	20-15-10	450-300-300	1	3
EL-363	10-10-20	450-350-25	1 1/8	2
EL-364	15-20-20	450-350-250	1 3/8	2
EL-345	10-10-10	450-450-25	1	2
EL-202	10-10-20	450-450-25	1	3
EL-312	10-20-20	450-450-25	1	3
EL-353	15-15-20	450-450-25	1	3
EL-205	20-15-20	450-450-25	1	3
EL-350	20-20-20	450-450-25	1 3/8	2 1/4
EL-330	30-30-20	450-450-25	1 3/8	2 1/4
EL-360	15-15-10	450-450-300	1	3
EL-215	15-5-15	450-450-350	1	3

QUADRUPLE SECTION

EL-434	30-30-30-40	150-150-150-25	1 3/8	2
EL-443	40-40-30-20	150-150-150-25	1 3/8	2
EL-452	50-50-50-20	150-150-150-25	1 3/8	2
EL-422	40-20-10-20	200-200-200-25	1 3/8	2
EL-412	10-10-10-20	300-300-300-25	1 3/8	2
EL-432	40-40-20-20	350-300-300-25	1 3/8	3
EL-415	20-10-5-10	350-350-350-25	1 3/8	2
EL-442	20-20-20-20	400-400-400-25	1 3/8	2 1/4
EL-410	10-10-10-10	450	1 3/8	2
EL-420	20-20-20-20	450	1 3/8	3
EL-421	20-15-15-20	450-350-350-25	1 3/8	2
EL-423	20-15-20-20	450-450-25-25	1 3/8	2
EL-425	20-20-30-30	450-450-300-300	1 3/8	3
EL-431	10-10-10-20	450-450-450-25	1 3/8	2
EL-424	40-30-10-20	450-450-450-25	1 3/8	3

JOBGING DISTRIBUTING ORGANIZATION FOR PRODUCTS OF THE SPRAGUE ELECTRIC CO.

with the publisher...

Rambling Thoughts for 1947

I DRAFT this just before the New Year Holidays. As yet I've not tilted the cup that cheers. This point is emphasized so you'll know that my subsequent remarks are not the result of a delirium tremens. In mentally reviewing 1946 happenings I find myself a wee bit confused. Perhaps you'll agree there is justification for it after you analyze, as I did, some of the bewildering things that transpired during '46.

We, meaning the radio-appliance servicing and selling industry, have just concluded a year made up of a series of unpredictable, unusual and conflicting events. For example, more dealers and more service organizations made more money in 1946 than ever before, and yet, during the same twelve-month period more dealers and service organizations went broke than in any corresponding earlier period.

The general public avidly demanded more radios and appliances during 1946 than ever before, yet in point of actual number of units delivered to homes the public hardly obtained a fraction of what was really wanted. Likewise, the public got more and better service work during 1946 than ever before and paid much greater fees for same and with much less complaint. But can one explain why it is that many a set or appliance owner who could have bought a new radio or toaster for less than what it cost to have his old one repaired chose to go along with the ancient standby, having it repaired, rather than buy a brand new unit?

We all know that 1946 radios and appliances were, generally speaking, merely prewar types dolled up a bit. Now, although we've heard an awful lot about them, we admit that we're still waiting to see something truly new and outstanding in the way of a postwar radio or appliance to come along. If manufacturers are "holding back" their hot new idea projects, we urge them to take the wraps off. The iron is ready to be struck, so why wait? Pen manufacturers didn't, or haven't you heard that you can now buy ball pens that write under water! Millions were sold to people who had no real need for a new pen. I'll bet that radio and appliance makers would have the same sort of selling field-day if they came up with something really new. And don't mention tubeless and batteryless radios, for I've seen them and they don't work, believe me.

A practical businessman cannot overlook the fact that luxury fields, the fur business, the diamond and jewelry fields, the sporting goods and millinery lines and many others of like nature are now suffering from a bad downward spiral in sales. Those trades are worried about their "re-

cession." Frankly I opine it is nothing more than a natural development. For the general public, I believe, now would rather spend its money on radios, phonographs, appliances and durable goods . . . the things that help make home life more pleasant . . . rather than buy "flash" goods.

It's amazing to me, a guy with over twenty-two years of radio background, to sit here looking at a list of radio manufacturers that totals over 260 names. Can they all survive? Who if any will fail? Ah, for a crystal ball with prognostigation results guaranteed! Yes, I confess, as we head into the months ahead, I do so with a certain amount of trepidation, for, like the June Bride on her wedding night, I know I'm going to get something, but . . . ? Time will tell. 1947, we await you with great anticipation.

Industrial Radio Uses

WITH every passing day one learns of new uses to which either radio or electronic circuits are being put commercially. For example, scientists down in New Mexico are getting a lot of data via radio from the V-2 rockets that are being shot 100 miles or more into the stratosphere. Meanwhile, Cleveland, Ohio taxi drivers are riled because only two radio-equipped cabs are in service as yet and the chaps who drive them, according to carefully maintained records, are "cleaning up" on lush calls that the non-radio-equipped drivers miss out on.

And I like the latest report that Whalers in the Arctic are now killing whales in droves; pump 'em full of air so they will float; fasten to the carcasses a radio transmitter that acts as a direction finder; go away for days killing other whales in the vicinity; and when the fishing slumps, simply track their way back by means of the radio signals to the dead mammals that float around awaiting processing. What I don't know is this: how long will it be before the run-of-the-mill radio service dealer will find himself faced with the problem of keeping in repair such "industrial" radio gadgets?

Meanwhile—A Happy & Prosperous New Year Greeting to you all.

S. R. Lowan
Publisher

where you see the
name **STANCOR**
you can count on
SERVICE

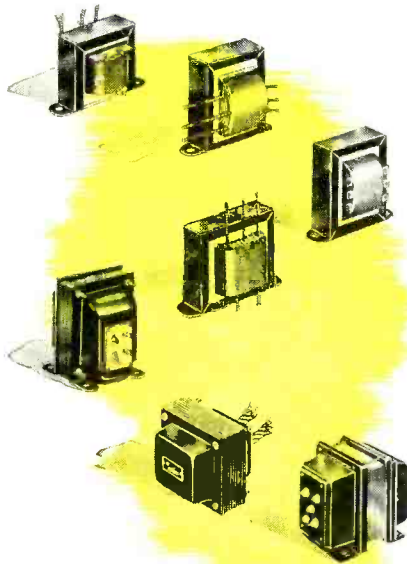

The famous black-and-yellow STANCOR emblem stands for SERVICE . . . in guaranteed transformer performance . . . and in the friendly helpfulness of the Authorized STANCOR Distributor . . . who stands behind the product he sells. . . . Yes, wherever you see the STANCOR emblem you know you will find the most complete selection of Replacement and General Purpose Transformers . . . advanced designs . . . and the universal application that make STANCOR first with radio service men. . . . You bet you can look to STANCOR . . . for the standard of performance that assures you of satisfied customers.

standardize on

STANCOR



TRANSFORMERS

STANDARD TRANSFORMER CORPORATION • 1500 N. HALSTED ST., CHICAGO 22, ILL.

IN TRADE

(from page 6)

by early spring, with but a slight increase in the present personnel. Processing and manufacturing operations are located at 21 Ionia Ave., N. W., Grand Rapids, Mich.; advertising and jobber sales offices will be located in Chicago.

National Union Appoints

The board of directors of National Union Radio Corporation, Newark, New Jersey, announces the election of Mr. C. Russell Feldmann to the chairmanship of its board. Mr. Kenneth C. Meinken, formerly assistant to the president and associated with National Union since 1941, succeeds to the office

of president of the Corporation and continues a member of the board.

Other Corporation officers elected are Mr. Winfield H. Carey, formerly chief accountant, to the office of treasurer and Mr. Jerome V. Deevy, formerly assistant secretary, to the office of secretary. Executive offices of National Union Radio Corporation remain at 57 State Street, Newark, New Jersey.

Admiral Appoints

Ross D. Siragusa, president of Admiral Corporation, Chicago, announced today the appointment of Wallace C. Johnson as General Sales Manager for

the company. Johnson for the past two years has been manager of field activities on all Admiral products.

Johnson will head the sales organization for all of the United States and all foreign countries. The United States territory is broken down into 9 regional sections, each headed by a regional sales manager. Distributors in all major trading areas of the world have been franchised.



Minerva G.M.

Richard Mattison, formerly wholesaler division manager of Tung-Sol Lamp Works Inc., joins the Minerva National Sales Corporation as general manager. In his new post Mr. Mattison will direct the sales of the Minerva line of radios, radio-phonograph combinations, FM and television sets.



Mallory Appoints

Walter E. Harvey has joined P. R. Mallory & Co., Inc., Indianapolis, Ind., as manager of the Wholesale Division, according to an announcement by Ray F. Sparrow, vice president. Mr. Harvey has been placed in charge of distribution and merchandising of Mallory radio and electronic replacement parts. A greatly expanded line of products will be made available for the distributor trade under the company's 1947 program.

(See page 12)



In plastic protective case

NEW LOW PRICE! BRUNO POWER CUTTER KIT

Cuts holes $\frac{5}{8}$ " to $2\frac{1}{2}$ " in metal, wood, plastics

Now Only **\$5.85**
CUTS ANY DIAMETER $\frac{5}{8}$ " - $2\frac{1}{2}$ "

Every radio service man needs this new Bruno Power Cutter Kit - two Bruno Hole Cutters in a convenient, permanent dust- and damp-proof case that keeps tools clean and blades sharp. With these two easily adjustable tools, he can cut holes $\frac{5}{8}$ " to $2\frac{1}{2}$ " in diameter in chassis and plastic panels. Bruno's high speed steel blade makes clean, fast cuts in metal, wood and plastics. Designed by tool engineers to operate efficiently in bench drill, drill press, or portable drill. (Also available for hand drill.)

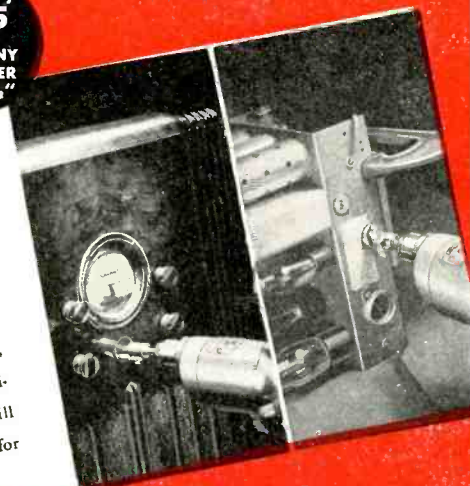

New Bruno Selling Helps

Bruno store displays, catalog sheets, sales literature, packaging and advertising are ready to help you get sales with a minimum of effort and expense.



The 4800 Deal simplifies ordering and stocking. Each No. 4800 Deal contains 6 No. 790 Hole Cutter Kits packed in a convenient carton. Shipping weight 6 lbs.

List Price . . \$36.00
Your Cost . . 24.00
Your Profit \$12.00

Distributors and Jobbers:

Get all details of our attractive jobber plan. Full manufacturer's guarantee. Wire or write Dept. RSD-1

POWER CUTTER KIT (No. 790) CONTAINS:

MODEL	THICKNESS CAP IN METALS	EXPANSION	PRICE
1 No. 100	1/8"*	5/8" - 1 1/2"	\$2.50
1 No. 101	3/8"*	1" - 2 1/2"	\$3.50
790 KIT		5/8" - 2 1/2"	\$6.00**

*Depth in wood and plastics limited only by diameter of hole necessary to clear locking ball.
**Fair Trade Minimum \$5.85



The BIG BUY in TOOLS

BRUNO TOOLS
9330 Santa Monica Blvd.
Beverly Hills, California

the MEISSNER

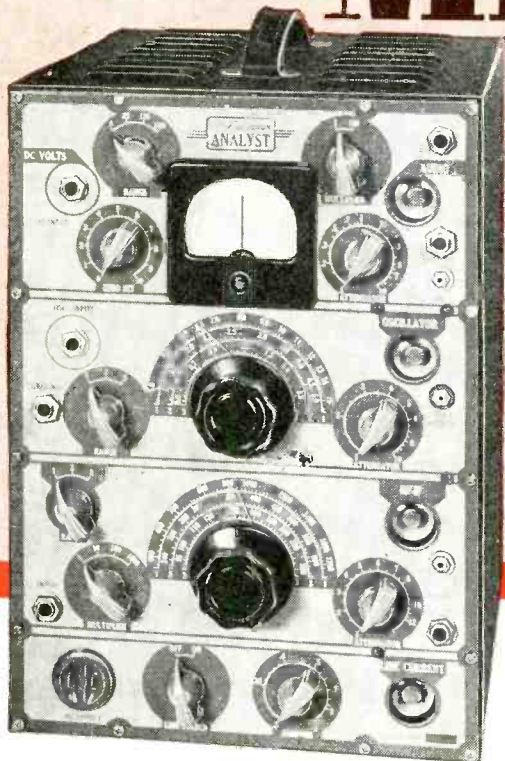

Analyst

THE FINEST MODERN SERVICE INSTRUMENT!

Now available . . . the new postwar Meissner Analyst . . . the most modern and complete service instrument on the present-day market. Tests receivers and locates faults by the signal tracing method . . . the fastest and most reliable method to date. Entirely fundamental in its testing procedure, it can not become obsolete. Not just another signal tracer, the Meissner Analyst is engineered to do your service job in the most efficient manner possible. See it at your jobber's today.

ELECTRONIC DISTRIBUTOR AND INDUSTRIAL SALES DEPARTMENT

MAGUIRE INDUSTRIES, INCORPORATED
936 N. MICHIGAN AVE. • CHICAGO 11, ILLINOIS



The BRILLIANT New Belfone INTERCOM

Here's the smart, sales-exciting Belfone "Maestro" . . . a design masterpiece in rich brown, polished Durez plastic, with durable, marproof finish. Modern to the minute in vivid, curve-and-line styling and superb electronic performance, the "Maestro" responds instantly to fingertip control and transmits voice with natural noise-free clarity. Keep posted on this most advanced intercom ever offered. Ask your nearby BELL distributor about the complete line of BELL Sound Systems. They are all profit-boosters.



BELL SOUND SYSTEMS, INC.
1202 ESSEX AVENUE COLUMBUS 3, OHIO
Export Office: 4900 Euclid Ave., Cleveland 3, Ohio



UNIMETER

This unit fulfills an extremely important need for general utility portable service equipment. It has wide range coverage for both a-c and d-c measurements of voltage, current measurements on d-c and the popular ranges on resistance.

The UM-3 is designed to clearly indicate all the functions which aid in the prevention of application of high voltages when preparing for current or resistance measurements.

Other G-E units for better servicing include: CRO-5A Oscilloscope, PM-17 Electronic Voltmeter, YYW-1 High Voltage Multiplier.

For details write:

General Electric Company,
Electronics Department, SRS-
6411, Syracuse 1, New York.

Electronic Measuring Instruments

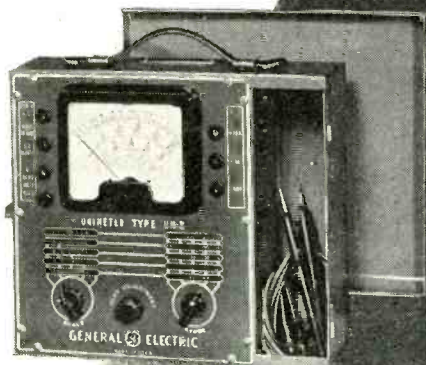

GENERAL ELECTRIC  **UM-3**

IN TRADE

(from page 10)

Meck Merchandising Manager

C. J. Anthony has been appointed merchandising manager of the John Meck Industries, radio manufacturers of Plymouth, Ind., announces John Meck, president. Anthony was formerly sales promotion manager for the company, and, preceding that, personal director. He joined the firm in 1943 as assistant to the sales manager.

Product Manager

Appointment of Milton E. Lauer to the newly created post of product manager of the Radio Tube Division, Sylvania Electric Products Inc., is announced by H. Ward Zimmer, vice president. Mr. Lauer will report directly to Mr. Zimmer and will be responsible for close coordination between manufacturing, engineering, sales and administrative departments with respect to all products of the Radio Tube Division.

New Lake Catalog

Lake Radio Sales Company of 615 West Randolph Street, Chicago 6, Illinois, announces that their new 16-page illustrated catalog NR-116 is now available featuring over 1500 items including condensers, resistors, cabinets, hardware, coils, sockets, tools and accessories, crystal sets and accessories, transformers, plugs, jacks, speakers, baffles, auto aerials and accessories, microphones, amplifiers, pickups and other sound equipment, test equipment, batteries, record changes and phonograph cabinets and countless other items, all manufactured by the leading firms of the country.

Servicemen, dealers, hams and radio men are cordially invited to write in for their free catalog to the above address without any obligation on their part.

Sylvania Data Sheets Available

Data sheets providing electrical specifications, physical dimensions and typical circuit applications of germanium and silicon crystal diodes, hydrogen thyratrons and high intensity flash tubes are available on request to the Electronic Division of Sylvania Electric Products Inc., 500 Fifth Avenue, New York 18, N. Y.

Germanium crystal sheet gives characteristic curves of type 1N34 used as a second detector and d-c restorer in television receivers; and frequency discriminator applications in f-m sets at frequencies up to several hundred megacycles. A separate sheet gives operating characteristics and type numbers of silicon crystal diodes used as converters.

SYLVANIA NEWS

RADIO SERVICE EDITION

JAN. Prepared by SYLVANIA ELECTRIC PRODUCTS INC., Emporium, Pa. 1947

RADIO SERVICEMEN! YOU NEED THIS NEW OSCILLOSCOPE FOR RAPID ALIGNMENT AND TROUBLE-SHOOTING

To make your servicing job easier and faster, Sylvania developed the 3-Inch Cathode Ray Oscilloscope, Type 131.

This accurate measuring device is especially useful in rapid receiver alignment, distortion locating, general trouble-shooting.

Now you can quickly and easily solve problems met in radios and electronic equipment.

Note characteristics and special features below.

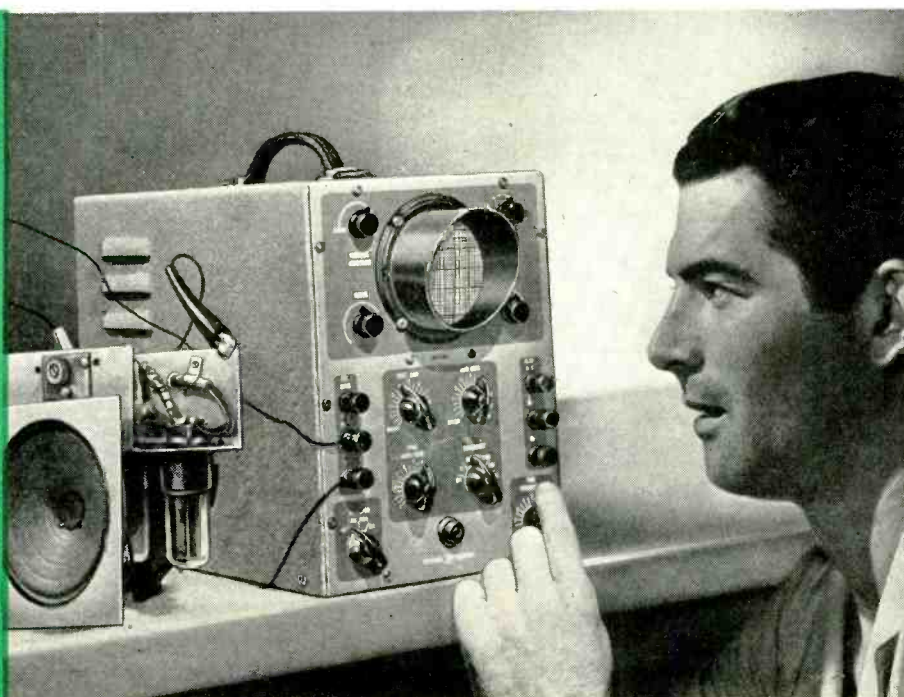

CHARACTERISTICS and SPECIAL FEATURES

- 1. Sylvania 3API Cathode Ray Tube** — Accelerating potential, 650 volts. Electrostatic deflection and focus. Tube is shock-mounted and well protected from stray magnetic and electrostatic fields by efficient shielding. Panel visor shades face of tube permitting oscilloscope use in well-lighted rooms. Removable calibrating screen also included.
- 2. INPUT IMPEDANCES —**
Vertical amplifier — approximately 1 meg., 30 mmf. at full gain.
Horizontal amplifier — approximately 1 meg., 50 mmf. at full gain.
- 3. AMPLIFIER FREQUENCY RESPONSE —**
Sine wave uniform within 3 db. from 10 cycles to 100 kilocycles.
- 4. DEFLECTION FACTOR —**
Through amplifiers — 0.5 volts per inch.
Direct — approximately 17 volts per inch.
- 5. HORIZONTAL SWEEP —**
Direction — left to right.
Frequency range — 15 to 40,000 cycles.
Synchronizing signal sources —
Internal (vertical signal)
External; 60 cycles.
- 6. POWER SUPPLY —**
105-125 volts, 50-60 cycles.
40 watts power consumption.
1 amp. line fuse provided.
- 7. CABINET DIMENSIONS —**
10 $\frac{1}{8}$ " high, 7 $\frac{3}{4}$ " wide, 13 $\frac{3}{8}$ " deep.
See your Sylvania Distributor.

SYLVANIA ELECTRIC

Emporium, Pa.

MAKERS OF RADIO TUBES; CATHODE RAY TUBES; ELECTRONIC DEVICES; FLUORESCENT LAMPS, FIXTURES, WIRING DEVICES; ELECTRIC LIGHT BULBS

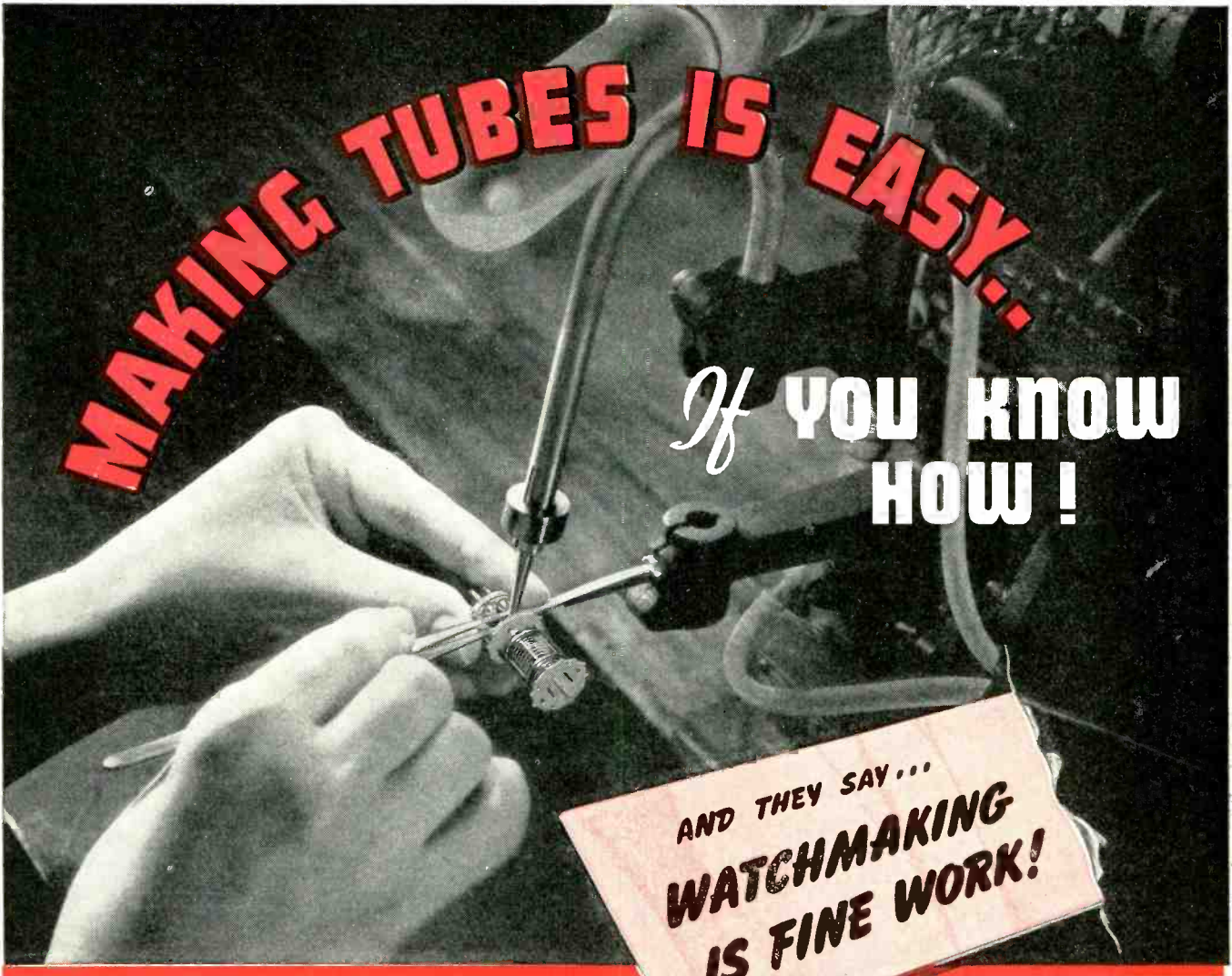

MAKING TUBES IS EASY..

If **YOU KNOW HOW!**

AND THEY SAY...
WATCHMAKING IS FINE WORK!

A fine watch—delicate Italian lace—these are synonymous with superb craftsmanship. But imagine such hand-to-eye co-ordination at mass production speeds. The mount operator who assembles with a small spot welder the tiny internal parts of your Hytron tubes displays just such craftsmanship. Despite painstaking engineering and intricate machinery, it is finally her accuracy, speed, perseverance, and appreciation of fine tolerances which build Hytron quality. Assembly mistakes once sealed within a tube cannot be corrected.

That is why Hytron is so fussy about selecting and training its mount operators. Each applicant must pass exacting tests for eyesight and for finger and tweezer dexterity. Then begins a long training cycle: two months to master a single constructional step; up to two years to

develop the versatility of the expert moulder.

Every possible aid is given to the Hytron mount operator. Work simplification helps her co-ordinate smoothly and efficiently motions of eyes, hands, and feet. Parts design is simplified; supporting micras serve as templates. Welding is automatically timed. Tight spacing tolerances (.003") and frequent engineering changes prohibit widespread use of jigs and fixtures. Magnification is impracticable, because of width and depth of field. Major effort must always be to train the moulder's keen eyes and nimble fingers to assemble delicate parts to fine tolerances, despite varying materials and machine set-ups.

Yet the Hytron moulder works so effortlessly that it all looks easy. It is easy only because she has the know-how. Next time you pick up a Hytron tube, examine her handiwork.



SPECIALISTS IN RADIO RECEIVING TUBES SINCE 1921

HYTRON
 RADIO AND ELECTRONICS CORP.

MAIN OFFICE: SALEM, MASSACHUSETTS



DON'T MISS THOSE "HIDDEN" PROFITS!

Yet, in spite of this obvious profit-making opportunity within their own business, dealers continue to view outside investments — and, sad to relate, speculation — as greener pastures than their own, not infrequently losing their shirt crawling through barbed-wire trying to get out again when they discover they've bit into loco weed. If on the conservative side, they congratulate themselves on 6 percent dividends from this or that stock, an 8 percent return from a real estate holding, or 3 percent from municipal bonds. Meanwhile, they continue to let their accounts with jobbers drag along beyond the discount period. Incidentally, come adverse business conditions, and this kind of a credit rut can wear down to the depth of a business grave.

Profit in Quantity Discounts

In line with cash discounts may also be considered quantity discounts ranging from sometimes as high as 5 to 10 percent, once merchandise again flows freely. Within certain margins of safety, many fast moving items may be purchased in much larger quantities than now generally prevail, provided only funds are available. Here, up to the limits of sound buying practice, with turnover of stock, limited space, risks of obsolescence due to new products and other factors in mind, merchandise may be purchased in larger quantities, carrying with such purchases more attractive prices where surplus funds may earn far more so invested than in any outside venture.

This is not to advocate overstocking, but rather to strike a happy medium involving sound judgment in the light of individual merchandising circumstances. Certainly the most attractive quantity discounts might prove disastrous in the case of new products whose consumer appeal had not yet been tested locally. In fact, the offer of unusual discounts in such instances might well serve as a warning to go slow in buying for stock.

Profit in Modernization

Even larger fields of profitable employment of working capital are to be found in installing new equipment that may pay for itself many times over, either in attracting a greater volume of profitable trade or in labor saving, or both. The marked trend upward of wages, which shows no sign of stopping, makes it imperative to re-assess present equipment and store layouts in the light of what new equipment and

by HAROLD J. ASHE

Part 3. Conclusion

re-arrangement may effect in labor savings.

Since Pearl Harbor, dealers generally have been forced to get along with such equipment as they had at war's outset. This has caused many of them to get in a rut. It is not too soon, even with shortages continuing, to inventory future needs before competition gets the jump. The sight of a large volume business housed in a down-at-heels establishment is always an open invitation for competitors to set up business in the same block.

Both fronts and interiors call insistently for modernization, if not with the thought of increasing business, then as an insurance policy to protect the business now enjoyed against pirating by newcomers who will go to great expense in a bid for the trade.

Even where the dealer leases, it may be profitable to install new store fronts, provided only that the lease has a long time to run and the rental is sufficiently attractive to warrant such an expenditure. Even if rent is high, a new store front may enhance the location sufficiently to make the rent, itself, less burdensome. Initial outlay should be considered in the light of its charge against the remaining life of the lease. Such an approach may reveal the improvement costs very little when prorated against each busi-

ness month. In any case, attention may profitably be directed to signs and lighting, many of which go back almost to the gas-light era.

New Equipment—Less Taxes

In connection with installing new equipment and modernization, dealers should remember that such expenditures have income tax implications. With income taxes graduated sharply upward in successive surtax brackets (1946 surtax rate starts at 17 percent on the first \$2,000 of taxable income plus 3 percent normal tax) tables of depreciation on equipment and store fronts and other long-term improvements may be written off over a period of years, thus reducing the amount of the dealer's income tax. Stated another way, improvements will cost substantially less than what was paid for them, because of savings in taxes.

Tax-wise, new equipment valued at say \$2,000 and written off on a ten-year basis, that is \$200 depreciation a year, will represent a tax saving of \$44 annually to the taxpayer in the second surtax bracket, that is taxable income over \$2,000 and less than \$4,000.

These and many other profit-taking, profit-making considerations cry out for the serious attention of all businessmen who have been scanning the far horizon for money-making investment opportunities, while blinding themselves to those under their own roof.

BUYERS' MARKET IS NO "BOGEYMAN"

Speaking before the Detroit Aircraft Club, Gerald Hulcut (vice president of Electromaster, Inc.), voiced a new note of optimism:

Instead of sitting back and fearing the return of the "buyers market" as something deadly, the sales forces of American business should welcome it as a golden opportunity. Through 175 years American business grew to the giant it is on a succession of buyers or competitive markets.

On a percentage basis statistics show the money in circulation in the U. S. is in the hands of a relative few. Sales performance records of the past prove sales effort has never been concentrated on this small market but that real sales opportunity has always been prevalent in the mass market. *In this great market, it is the practice of buyers to buy—automobiles to zithers, out of current income, not savings.* To attract these buy-

ers in the future will be new merchandise and adequate credit arrangements. Add the well known fact that today every man, woman and child in these United States needs *something*, plus the well known ability of the American salesman and the stage is set for real sales opportunities.

Another reason for American business not to fear a buyers market is the tremendous increases shown in the higher income brackets:

In 1940, 31% of the incomes of the U. S. were under \$1,000.

In 1946, there were only 14% of incomes in this group.

In the \$2,000 to \$3,000 bracket of 19% were placed in this category in 1940, while in 1946 the figure increased to 31%.

More money means more business in all lines!

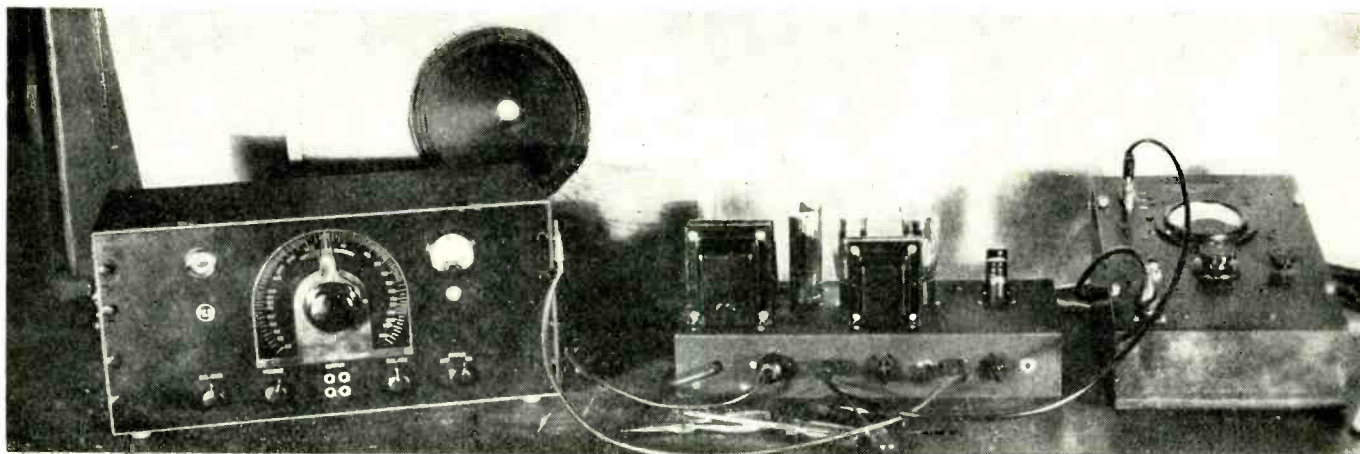

Figure 1. "SET-UP" FOR AUDIO MEASUREMENTS: From left to right are: audio oscillator, amplifier under test, and v.t. voltmeter. Loudspeaker mounted on baffleboard is shown top left background.

ACCURATE AUDIO

by J. PACE

EVERY radio service engineer handling P. A. amplifiers to any extent should adopt the practice of making standard measurements on every amplifier coming into his shop, whether for repair or inspection. And he should file the test data collected. Audio amplifier measurements serve two useful purposes.

(1) They give an accurate picture of the actual performance of the amplifier at the time of the test—data which the serviceman later may refer to when the amplifier again comes in for service; and

(2) They serve to localize faults or to warn of troubles soon to occur. This article will explain how to make standard audio amplifier measurements.

EQUIPMENT NEEDED FOR TESTS

No special laboratory instruments, out of the reach of the average serviceman are required for audio amplifier measurements. The essential equipment is to be found in any modern service shop. For efficient measurements, the only two pieces of apparatus required are a good, low-distortion audio-frequency oscillator covering the range 20 to 15,000 cycles, and a good a. c. vacuum tube voltmeter. Several of the lately developed service-type v. t. voltmeters with external probes, such as

the newest model RCA VoltOhmyst, Silver Vomax and Sylvania Polymeter are admirably suited to wide-range audio measurements. The probe should be used, since it does not discriminate against the high frequencies and it contains a blocking capacitor for isolating d. c. components.

In order to appraise amplifier performance thoroughly, the following important characteristics must be measured: (1) *overall gain*, (2) *gain per stage*, (3) *frequency response*, (4) *power output*, (5) *action of gain controls or attenuators*, (6) *noise level*, and (7) *hum level*.

A description of each of these tests follows.

1. OVERALL GAIN

In order to determine the voltage gain afforded by the entire amplifier—*overall gain*, a low-voltage signal from the oscillator is presented to the amplifier input circuit. This voltage is measured with the v. t. voltmeter. A satisfactory value usually is 1 millivolt. With the amplifier gain control wide open, the amplified signal voltage then is measured between ground (common return) and each of the output tube grids. The output stage usually contributes no appreciable gain (unless the amplifier is a straight voltage amplifier throughout and not a power amplifier)

and so has **not been included** in the measurement loop.

The setup for this test is shown in Fig. 2. A small voltage divider made up of 1-watt resistors is connected between the oscillator output terminals and amplifier input. Using the resistance values shown in the diagram, an audio voltage of 1 millivolt will be delivered to the amplifier when the oscillator output control is adjusted for exactly 1 volt, as measured with the v. t. voltmeter between points 1 and 2.

After the output voltage, that is the audio signal voltage appearing between each output tube grid and ground, is measured, the overall gain may be de-

Figure 2.

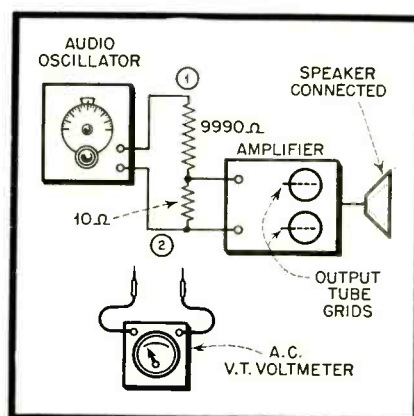

terminated by dividing the output voltage by 0.001. We use the latter figure because 1 millivolt equals 0.001 volt.

The test should be repeated at several frequencies, such as 100, 1000, and 5000 cycles and with the tone control in its various positions. These gain figures then should be recorded. The test should be made separately at both amplifier levels; that is, with the oscillator feeding first into the low-level input and then into the high-level input. If it is desired to determine the voltage gain in *decibels*, the operator need only to look up the logarithm of the voltage gain calculated as just described, and to multiply this log by 20. Any table

ground then automatically will be the gain of that stage. For example; if we feed a 1-volt signal to the grid and measure 10 volts between plate (point 2) and ground, the voltage gain of the stage is 10. To convert this gain into decibels, simply look up the logarithm of the plate-to-ground audio voltage and multiply this log by 20.

In order to obtain a complete performance picture, the gain of each stage should be checked at several frequencies. When testing gain of the stage in which the tone control is located, it is well to make certain that the setting of the tone control is recorded with the gain figure. Most op-

connected for easy transfer of the v. t. voltmeter terminals from input to output of the amplifier. This has been necessary because the input voltage may need frequent readjustment to the 1-millivolt value as the oscillator frequency is changed.

Measurements should be made at 20, 40, 50, 75, 100, 150, 200, 250, 300, 350, 400, 500, 1000, 1500, 2000, 2500, 3000, 4000, 5000, 10,000, and 15,000 cycles. A graph should be plotted to show how the output voltage varies with frequency. If any pronounced "bumps" or "dips" are discovered along the graph curve, additional measurements must be made in the neighbor-

Describing a series of tests which should be made as a matter of routine by every service technician handling P. A. amplifier systems.

Amplifier Measurements

of common logarithms may be employed.

2. GAIN PER STAGE

The voltage gain of any stage in the amplifier may be determined by feeding a known voltage from the oscillator to the control grid of the stage under test and then measuring (with the v. t. voltmeter) the audio voltage from grid to ground and from plate to ground.

The set-up for this test is shown in Fig. 3. For ease in calculating the gain, adjust the oscillator output control until the v. t. voltmeter shows exactly 1 volt between point 1 and ground. (Fig. 3). The meter reading between point 2 and

erators prefer to make separate gain tests at each setting of the tone control.

A single stage with lower than normal gain may be spotted by this test. Such a stage often is responsible for low amplifier output.

3. FREQUENCY RESPONSE

This important characteristic determines the *fidelity* of the amplifier. It refers to the ability of the amplifier to transmit signal voltages at all frequencies with faithfulness throughout the audio range.

For this test (Fig. 4), a constant signal voltage is fed into the amplifier at a number of frequencies throughout the audio range (20 to 15,000 cycles), and the corresponding audio output voltages are measured across the speaker voice coil. In an amplifier having very high fidelity (flat response), the output voltage will not change more than a small amount from end of the a. f. spectrum to the other.

It will be noted from Fig. 4 that the set-up is similar to that shown in Figure 2 for overall gain measurement. A constant 1-millivolt signal is delivered to the amplifier through a simple voltage divider. In the frequency response circuit, however, a double-pole, double-throw switch is

hood of the frequency at which the distortion appears—at a number of closely spaced frequencies. For example; if a bump is discovered in the vicinity of 1000 cycles, go back and check the frequency response at 600, 700, 800, 900, 1000, 1100, 1200, and 1300 cycles.

A complete frequency response run must be made with the tone control in each of its main positions, since this control affects the fidelity of the amplifier by removing certain frequencies.

A frequency response run may be made on a single stage as well as on the entire amplifier. For "per-stage" frequency tests, the audio amplifier is connected to the control grid in the

Figure 3.

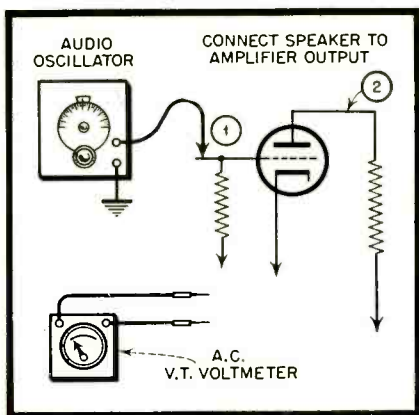
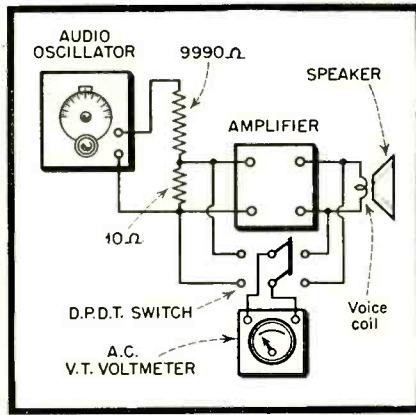

Figure 4.





**MI-6203
VARACOUSTIC**

This high-quality, ruggedly constructed velocity microphone has a slide adjustment, giving choice of directional, bi-directional or non-directional characteristics at will.



**MI-4036
JUNIOR VELOCITY**

Small—lightweight—bi-directional. Low in cost, high in quality. Popular throughout the PA field . . . excellent for studio and stage work, recording and announce use.



**MI-6207
AEROPRESSURE**

Ideal for outdoor use. Reversible paracoustic baffle sharpens or broadens directional characteristics. 60-10,000 cycle response. High sensitivity.



**MI-6228
AERODYNAMIC**

Popular priced, small, streamlined. Excellent performance . . . ideal for close-talking and announce work.



**WIDE CHOICE OF STANDS
DESK AND FLOOR TYPES**

Attractively finished in chrome and black. Low cost. Variety of fittings to match standard microphones.

Popular RCA Microphones for every speech and music range

RCA produces them all . . . pressure-dynamic, velocity and crystal . . . uni-directional, bi-directional, non-directional . . . for indoor or outdoor use on speech and music.

The microphones illustrated here were selected from the new complete line of RCA Package Sound Equipment. In this line you will find every item needed for matching up an efficient sound assembly from RCA Package Units . . . amplifiers, speakers, baffles, turntables, recorders, portable PA systems and reproducers.

This line sells fast. Why not start the ball rolling by getting additional information on RCA Microphones and the rest of the profitable RCA Package Sound Line?

WRITE TODAY to Sound Equipment Section, Dept. 92-A, Engineering Products Dept., RCA, Camden, N. J.



**SOUND EQUIPMENT
RADIO CORPORATION of AMERICA
ENGINEERING PRODUCTS DEPARTMENT, CAMDEN, N. J.**

In Canada: RCA VICTOR Company Limited, Montreal

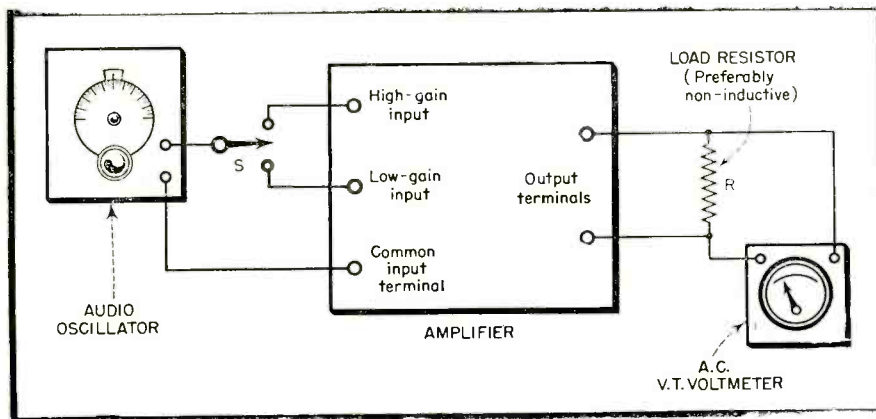

Figure 5.

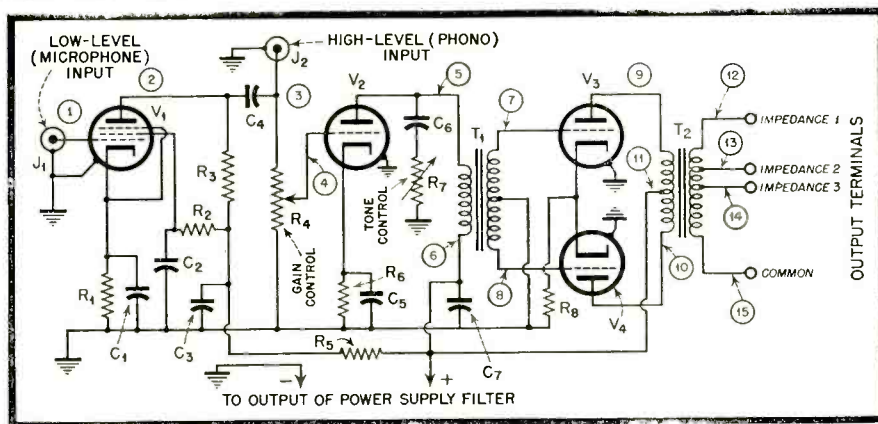

Figure 6.

ABOUT AUDIO SIGNAL TRACING

Signal tracing techniques are as important and useful in audio amplifier servicing as in receiver trouble shooting. The process is somewhat simpler in amplifier testing, however, since the audio signal tracer (the a. f. vacuum-tube voltmeter) does not have to be tuned to the signal.

Fig. 6 shows a typical audio amplifier circuit in which various points have

been numbered for audio voltage measurements. In most tests, these voltages will be measured between the numbered points and ground.

With the audio oscillator delivering a signal to the low-level input jack, J₁, the numbered circuit points may be tested to trace the signal through the amplifier. The following voltmeter readings will have the significance indicated:

Point	Significance of Voltmeter Reading
1 to Ground	Oscillator output voltage (amplifier input voltage).
2 to Ground	Gain and condition of tube V ₁ .
3 to Ground	Gain of 1st stage and condition of capacitor C ₄ .
4 to Ground	Operation and condition of gain control R ₄ .
5 to Ground	Amplification of 2nd stage, condition of tube V ₂ , Operation and condition of tone control C ₆ -R ₇ .
6 to Ground	Condition of primary of transformer T ₁ .
7 to Ground	Amplification in 2nd stage including step-up or step-down ratio of transformer T ₁ (with one half of T ₁ secondary).
8 to Ground	SAME—with other half of T ₁ secondary.
9 to 11	Gain in top half of output stage, condition of upper half of T ₂ primary.
10 to 11	Gain in lower half of output stage, condition of lower half of T ₂ primary.
12-15, 13-15, 14-15.	Output (speaker or line) voltages delivered by corresponding taps. Corresponding step-down ratios of T ₂ . Condition of T ₂ secondary.

stage under test, as shown in Figure 3, and audio output voltage measured between point 2 and ground at a number of frequencies throughout the spectrum, employing a constantly maintained 1-volt audio signal input. A per-stage frequency test often will localize amplifier distortion in the stage where it occurs.

1. POWER OUTPUT

In this test, the amplifier power output is measured in watts. Separate tests are made by feeding the signal from the oscillator first into the low-gain input terminals of the amplifier and then into the high-gain terminals. In this way, the operator may determine how many millivolts input are required in each position to develop rated output watts.

The set-up for the power output test is shown in Fig. 5. Switch "S" allows the audio oscillator signal to be applied at will to either the low- or high-gain input terminals of the amplifier. Resistor R is a load resistor (preferably non-inductive) which replaces the loudspeaker in this test. The ohmic value of R must be known quite accurately. The actual resistance must equal the impedance at the output terminals to which it is connected. The power rating of resistor R should be twice the rated output wattage of the amplifier. For example, use a 100-watt load resistor with an amplifier rated at 50 watts output.

Here is the procedure:

(1) With the loudspeaker temporarily connected to the amplifier, run the amplifier gain control wide open, throw switch S to the right-hand (low-gain) position, and increase the oscillator output until the loudest undistorted signal is heard from the speaker.

(2) Without disturbing the oscillator output or the setting of switch S or the amplifier gain control, remove the speaker and connect in its place load resistor R and the a. c. vacuum-tube voltmeter, as indicated in Fig. 5.

(3) Note reading of the meter.

(4) Calculate the power output (watts) by squaring this voltage and dividing by the resistance of R.

(5) Repeat the entire procedure with switch S thrown to its high-gain position.

(6) Determine the millivolts or volts necessary for full power output by measuring the audio signal voltage delivered to the amplifier by the oscillator. (See page 41)

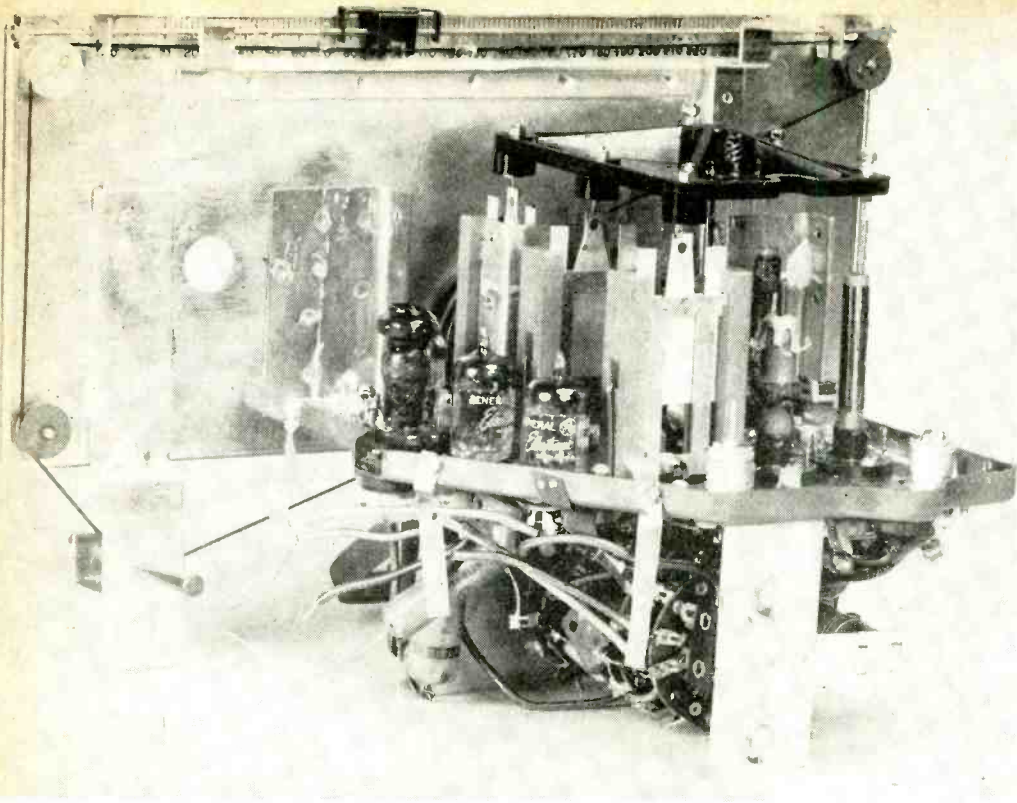

Front end design of radio employing new variable inductance tuners.



by I. J. KAAR*

the new "GUILLOTINE" Tuning System

A NEW method of variable inductance tuning, specifically designed to overcome problems arising from the transfer of FM broadcasting to higher frequencies, has been perfected by engineers of the receiver division, electronics department, General Electric Company. Because of its physical resemblance, this type of slide tuner has acquired the nick-name "guillotine tuner." It is used to tune both FM bands and two or more short wave spread bands in FM receivers now in production. (Example, Model 417. See Schematic.)

This development is more efficient than gang condensers in the reception of FM at its new position from 88 to 108 MC. It is also highly efficient in short-wave tuning.

This type of tuner has the great advantage of being entirely tool made, the human element being absent except for the soldering operation in connecting the two turns together electrically. Very precise production control of tracking is, therefore, possible without high labor content in the cost of manufacture. Both terminals of the tuner

project through the receiver chassis making very short leads possible and providing a rugged tie point for soldered connections.

Other frequency ranges are tuned by adding shunt capacity and by adding fixed series inductance to the guillotine circuit. Electrical design problems in the front end are greatly simplified by the use of the guillotine tuner since it is possible to localize each tank circuit within a small area and to keep rf chassis currents at a minimum. Microphonic troubles are almost completely absent and since the blade of the guillotine is ungrounded, sliding contacts and pigtailed are eliminated. All of these factors contribute to obtain an efficient electrical design which has high performance with little trouble from regeneration or alignment difficulty.

The design of this assembly anticipates that production assembly and testing will be localized in a department set apart from the main chassis production line. This has the advantage that the technique and skill required for high quality workmanship can be con-

centrated on front ends for several models of receivers without duplication of facilities or waste of technical manpower. Tuners will be assembled, tested and then transported to the chassis assembly lines in much the same manner as engines are handled in an automobile assembly plant, he explained. The ever present need for standardization is well served in that only two types of front end assemblies are used to tune eleven different models of General Electric FM receivers.

The tuner assembly is completed
(See page 42)

Component parts of "guillos" are simple.

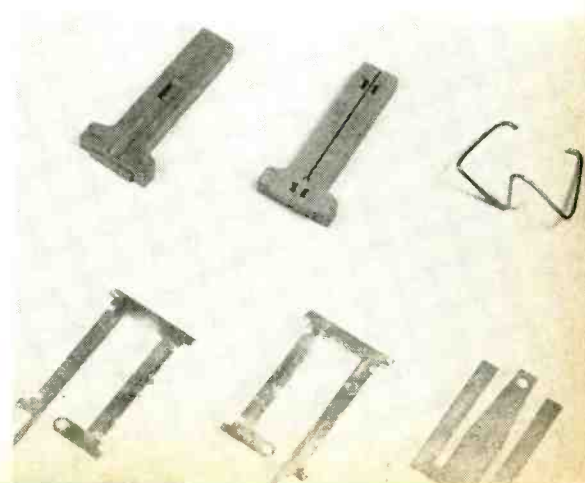

* Manager, Receiver Division, General Electric Co., Bridgeport, Conn.



SURE CURE

SERVICE CONTRACT

OFFICE COPY

No. 15256

BILL LIFSEY'S RADIO SALES & SERVICE CO.

Phones 9-5808 - 9-5809

We Are
You Will Be

PLEASED

To Serve You
With Our Service

1110 Flushing Rd.
AT SIXTH AVE.

Your Order No.

FLINT 4, MICH.,

194

Name _____ PHONE _____

Address _____

CALL TAKEN BY _____ PROMISED _____ BROUGHT SET IN _____ AGE _____ RECORD PLAYER _____ PICK-UP DELIVER _____ PICKED-UP BY _____ SERVICED BY _____

C.O.D.	CHG.	NO CHGE	MAKE	MODEL	ESTIMATE ONLY	CAR RADIO	TAKE OUT CAR	PUT IN CAR
			COMB. RADIO	F. M. TEL.				

ESTIMATES on labor only, parts extra. 90 day guarantee on parts.

RADIO P. A.

DEAD VOL. NOISY TUBES ANT. FADES SHORT SMOKES

RECORD PLAYERS

BEJ. SLOW TUNE XTAL. NEEDLE LANDING

REFRIGERATORS

NOISY MOTOR SWITCH TEMP RUNS TOO LONG

STOVES

ADJ. OVEN PILOT CLOCKS UNIT DAM PORCELAIN

VACUUM CLEANERS

DOESN'T PICK UP NOISY OILY SWITCH BRUSH BELT

WASHERS IRONERS

WRINGER AGITATOR MOTOR CLUTCH NOISY OIL

SWITCH SHOE DRAIN LEAKS

REMARKS OR COMPLAINTS

Received in Good Condition

Rec'd by _____

Payment Rec'd by _____

DEAR CUSTOMER:

We give you an itemized record with each repair because we want you to know what you are paying for. This protects both you and us as only the specified parts replaced and work done are guaranteed. The above policy is necessary because a Radio or anything Electrical is made up of many intricate parts of which one defective part may impair its operation. No prediction can be made as to how long parts will last either new or old. This is to help you understand our service problem.

Sincerely yours,
Bill Lifsey's Radio Sales & Service Co.

MINIMUM CHARGE \$1.50

I hereby authorize the above work be done and agree to pay when completed.

Signature _____

Not responsible for loss or damage in case of fire, theft or any other cause

Merchandise left over thirty days will be sold for charges.

Bill Lifsey's Radio Sales & Service Co.

This form constitutes a contract when signed by customer, and as such is binding on customer with recourse.



Proprietor "Bill" Lifsey

Dealer Lifsey has licked the bugaboo of unfair customer complaints with help of carefully planned form (shown right). Filled in as jobs progress, form is key to vastly improved customer satisfaction. It also provides both office and shop with fool-proof method of accounting, service and operation controls.

FOR CUSTOMER COMPLAINTS

IT'S no secret in the business, and out for that matter, that a radio serviceman has more than his share of headaches. And while that statement may be applied rightfully to any business dealing so directly with the public, the radio service business has certain peculiarities that surround it with a flavor of headaches all its own.

Some of the following remarks from customers must be very familiar to every serviceman who reads this article:

"I can't see why this bill is so high. My set played a little bit and I'm sure it was only a bad tube!"

Or, "I didn't want the whole set repaired. I just wanted it fixed so that it played again."

Or, "The phonograph was all right when I brought the set in. Just the radio was bad. Now the phonograph won't play, so it must have been something you did."

Service department is in rear of the Lifsey establishment. Sales display features radios, plus cleaners, heaters and lamps.



Or, "I can't understand why this set is bad again. You just repaired it a short time ago and it worked only for a few days."

Write It Down

Bill Lifsey, proprietor of the Radio Sales & Service Company, 1110 Flushing Road, Flint, Michigan, had been pondering for some time about the unfortunate aspects of such customer relations. He recognized that most complaints—upon analysis—fell into a small number of definite classifications, with perhaps dozens of easily recognized variations. In studying the basic reasons for these complaints, he concluded that verbal instructions led to misunderstandings between the servicemen and the customers and that the latter, generally, failed to appreciate the intricate and peculiar nature of radio repairing. He began to envision some sort of a system that would pro-

vide a complete understanding between the shop and the customer and at the same time serve also as an accurate record for the office operations such as billing, posting, checking receipts, and furnishing consolidated information on the volume and nature of the business.

Formerly, too, there had never been a definite record in the office whether all service calls had been filled. There was always the possibility that a call might be overlooked, causing the customer to wonder why his set was not being serviced. There was no way of being certain that a charge had been made on a service job completed on the customer's premises or whether the cash was turned in to the cashier if a charge was made for the completed job. Very often radios came in for additional repairs that had been previously serviced, but there was no way for the shopman to determine the nature of the previous repairs. Finally, there have been cases—rare to be sure—when the customer refused to pay his bill after the set was fixed and back in his possession. There was no way, in these instances, of collecting the bill without a costly and lengthy lawsuit which, in most cases, was uneconomical to press.

Mr. Lifsey presented his problem to a firm of specialists in business forms and systems (Uarco Incorporated, Chicago, Ill.). Together, they designed a unique service order form that has virtually eliminated the host of inadequacies formerly experienced when only a simple receipt tag was used. A great deal of time was expended in going over each phase of the shop operations as well as studying forms used by other companies from various parts of the country.

As finally produced, the form consisted of a four-part combination service order and contract, each set consecutively numbered, interleaved with carbons, with each sheet printed in a different color. The first sheet in white, is the office copy. The second sheet, in

(See page 38)

Operating Hints

from a "BOSS" Service Dealer

RECENTLY, I had to let go a young fellow in his first job as radio serviceman at the end of his first day in my employ. In that short space of time, he managed to burn out three tubes, ruin a filter condenser, and put his screw-driver through the loud-speaker. So, at the end of the day, I took him aside.

"You're a nice guy, and I like you," I said, "but I've got to let you go before you put me out of business."

Beginners will find nothing new in this incident. Novices know — or should know — that the damage they can cause is one of the obstacles that stands in the way of their getting jobs. This article is intended to make the going a bit easier for everybody concerned. Its specific purpose is to help the beginner stay put in his chosen calling; and not be fired because of essentially avoidable lapses, such as:

a. Damage he may cause through inexperience.

b. Ignorance of many small, but vital details, that may exhaust the patience of his employer, and cause his dismissal.

c. Ineptness that may cause customers to lose confidence in the apprentice and the store employing him.

The boss will hate you to little pieces if you damage a set. In many cases, damage cannot be repaired. Replacements for many types of dial faces cannot be obtained, and if these fragile units are broken, the appearance of the set is definitely marred. The customer is generally lost in these cases, and the days are over when an employer preferred losing a customer to getting rid of an employee.

To avoid such damage, never turn a chassis upside down for testing, unless

How to get in "solid" with your servicing trade.

you have carefully noted the possibilities of breakage, and have taken necessary precautions, such as propping boxes under parts of the chassis. Some chassis cannot be removed from their cabinets unless the pointer is first taken off the dial face. If this detail is ignored, the dial face will be broken. Examine every set carefully before taking it apart.

Removing tight grid-clips is an operation in which novices do not excel. In most instances, the tube is scalped, and the cap is removed together with the clip. The proper way to do the job is to press down on the cap with one screwdriver while prying up the clip with another screwdriver. Uneconomical repairs will not endear you to the

boss. Some scarce tubes may be restored to duty after failure. (See Figs. 1, 2), and you should know how to revive them when asked to do so.

Solder With Skill

One of the most important assets of a radio service apprentice is the ability to solder well. Keeping your job may very well hinge on this vital skill. Several pointers on correct soldering technique may prove helpful.

The soldering iron being used should have a fairly broad, unpitted surface. Many beginners work with a pitted, scrubby-looking tip that cannot possibly do a satisfactory job. File down the tip, if it needs filing, until a clean,

Figure 1. (left): 35Z5 repair. When filament between prongs 2 and 3 opens, placing a 25-ohm resistor between will permit tube to operate. An open between points 3 and 7 cannot be repaired. Figure 2. (right): Tubes like the 25Z5 and 25Z6 may sometimes be restored to duty when one cathode burns out, in a circuit like the one shown. Connect points A and B. If only 4 tubes are present and remaining cathode has good emission, set will play almost as well as before.

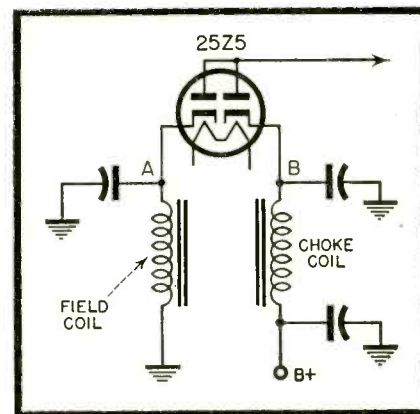
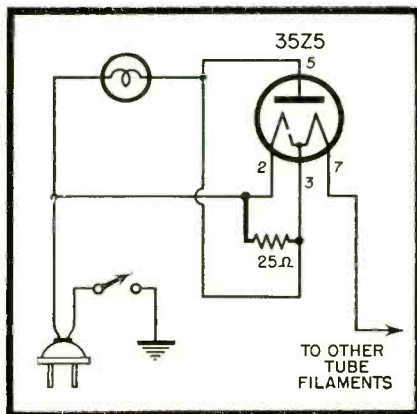

flat, broad surface is present.

A piece of sandpaper will prove sufficient for ordinary cleaning purposes. Don't use a file in this case — it wears away the tip unnecessarily. Let the sandpaper lie flat on the workbench, or tack it down. To clean the iron's tip, rub it along the sandpaper once or twice. Don't clean or use more than one surface at a time—the iron will retain its heat much better if only one side of the tip is used.

Tin the iron before using it for the first time in the day. This will make it hotter, for one thing. It will also enable it to grip the solder better. By tinning, we mean applying solder to one clean surface of the tip, until it is completely covered. A thin film of solder will adhere to the tip if the tinning has been properly performed.

Always clean off connections before soldering them. This will speed up the operation, and also insure a firm, strong joint. If a lead is to be added to a crowded, sloppily-soldered terminal, resolder all the wires present—it pays in the long run. Make a mechanical joint before soldering whenever possible. Many apprentices who have heard this advice let it go in one ear and out the other. Others go to the opposite extreme, and make such an elaborate mechanical connection, that later servicemen have a terrible time unsoldering the joint, if it ever becomes necessary to do so.

Many novices find it very difficult to solder an ordinary piece of wire onto a coil wire. This is necessary in cases where a coil lead has broken off at the terminal, and has to be extended. The first thing to do is to remove the insulation or enameling from the coil wire. Scraping it off with side-cutters is not as efficient as burning it off. Use a match, but blow out the flame almost as quickly as you light it over the wire, otherwise it will burn up the coil wire as well as its insulation to say nothing of setting fire to the coil itself. After this charring process, scrape off the burnt insulation with side-cutters.

Now the coil wire should be tinned, wound around the ordinary wire, and soldered. This should not prove difficult. The other end of the added piece of wire should be soldered to the terminal.

When a "Sick" Set Comes In

The first preliminary in set servicing, that should precede all other preliminaries, is to get a full account of the symptoms from the customer. This step will save time spent in replacing a fuse, if a line short is present. It will tell you the kind, as well as the number (See page 38)

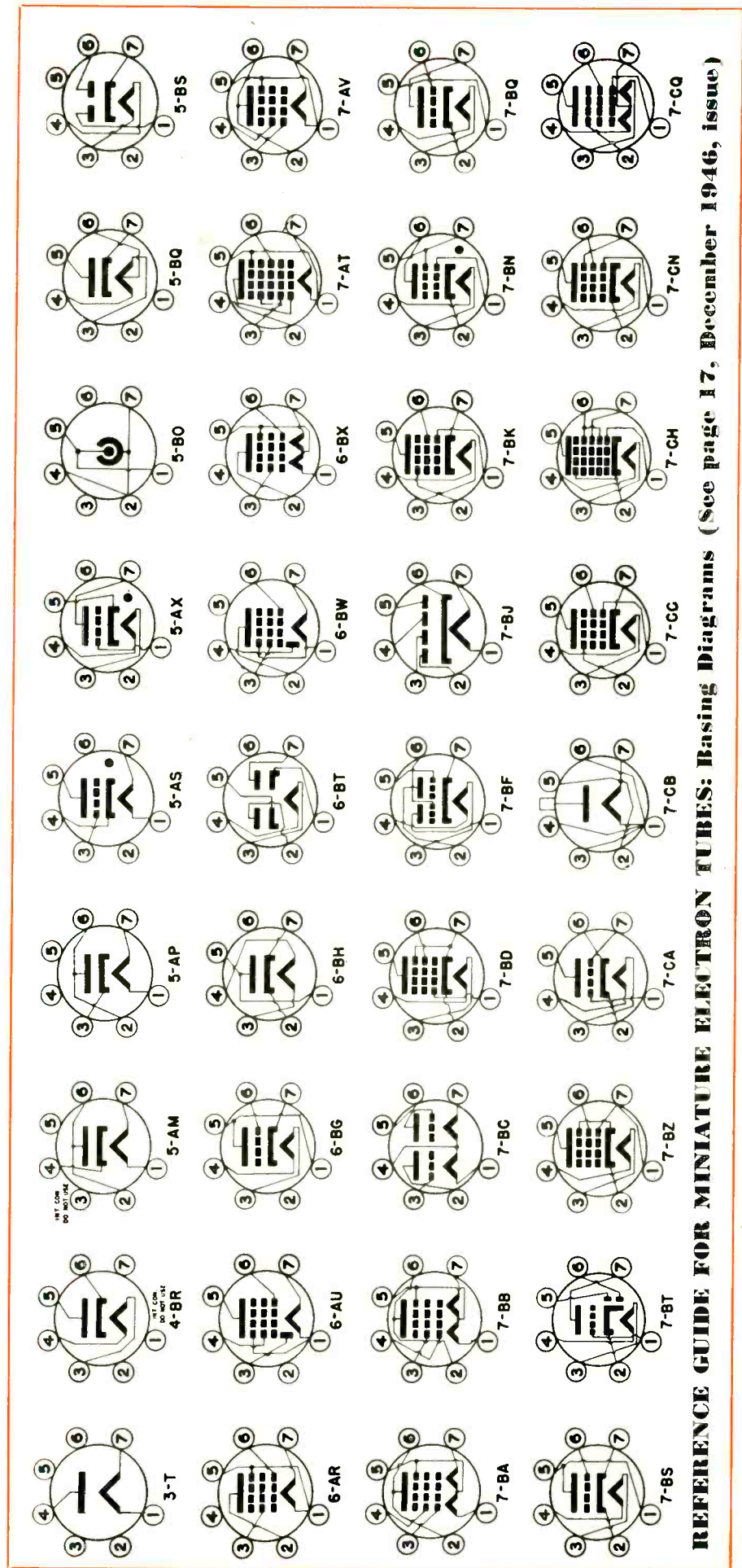

REFERENCE GUIDE FOR MINIATURE ELECTRON TUBES: Basing Diagrams (See page 17, December 1946, issue)

MERCHANDISE

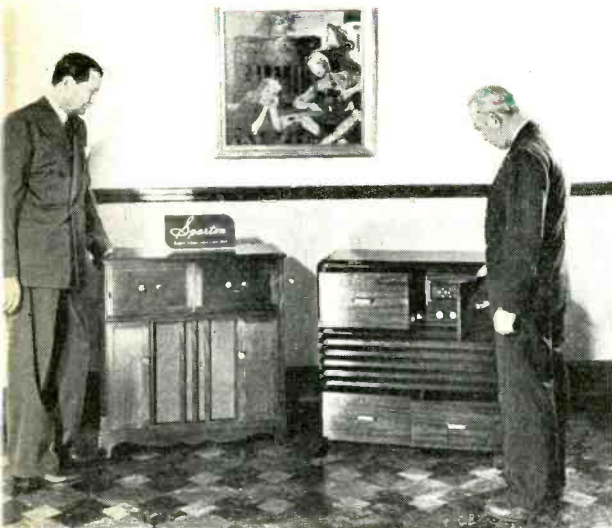

E. C. Bonia, sales manager (left) and N. H. Terwilliger, sales promotion and advertising manager, Sparks-Withington Company, inspect two new Sparton radio phono combinations. Modern cabinet houses 10-tube combo.



Large screen television receiver RCA-Victor Model 648 PTK: image size of newspaper page. Image is received on the face of brilliant 5-inch tube pointing downward; this is reflected by a dish-shaped mirror near base of receiver through a correcting lens to a mirror set at 45-deg. angle at top of set which reflects the picture through the back of special-type translucent screen. Set comes with AM, FM and shortwave radio reception, with pushbutton tuning.

Morgan Co., Savannah. Mr. Ray, who as sales manager of the receiver division in 1940, originated the Musaphonic radio line, will receive the first new instrument to be manufactured by the company since the war. Right is Paul L. Chamberlain, manager of sales for the Receiver Division, with Grady L. Roark, sales manager of the Musaphonic line.

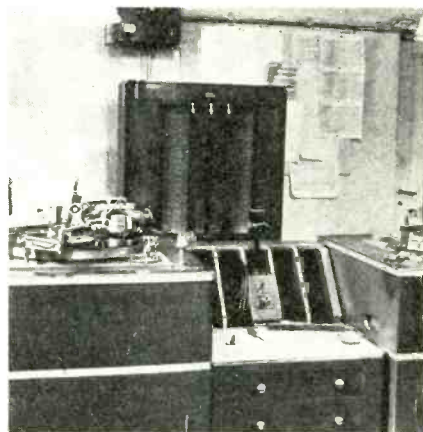

Jensen Bass Reflex Reproducer (against wall) in use in control room of the Cairo, Egypt, branch of British Broadcasting Corp., to monitor program quality.



Viewtone television set, "Adventurer," includes standard radio receiver. Tele unit has 7-inch screen, receives all local programs; radio receiver is 5-tube superhet.



General Electric Model 801 direct view television receiver produces a 10-inch picture; tunes on all 13 tele-cast channels. Equipped to receive AM radio programs. Now in production.

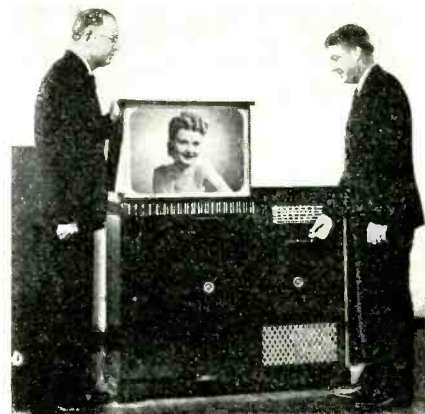

General Electric Model 901 is scheduled for production early in 1947. Tuned by C. G. Fick (right) chief engineer of Receiver Division, while N. F. Shoftstall, division designing engineer, looks on. In addition to AM, high and low band FM and two short-wave radio bands, it has automatic record-player equipped with GE electronic reproducer. Receives on all 13 tele-channels.

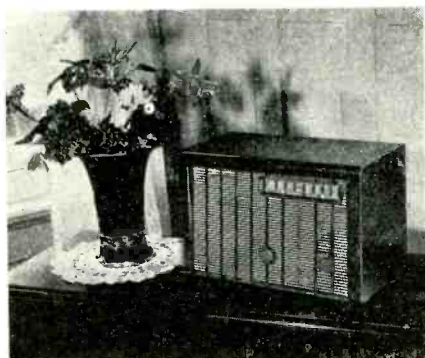

National Union Radio "Companion Model" No. 571, in production.



General Electric Model 41 Musaphonic gets pat from Fred L. Ray (center), vice-president of Lindsay &

Meritone Needles (International Merit Products Corp., New York, are displayed in this counter display for dealers at point-of-sale. Display also facilitates sales: packages of needles at 10 for 10 cents or 25 for 25 cents,

PRE-VIEWS

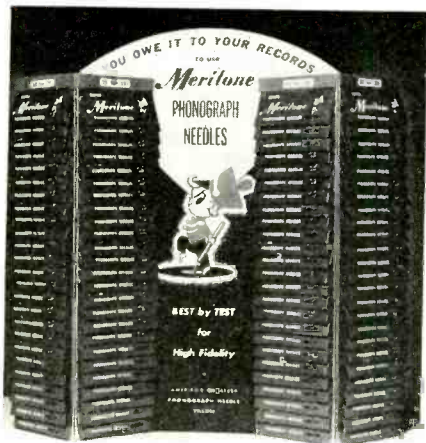

are conveniently stapled to background, easily removable (like packages of nuts at candy bars).

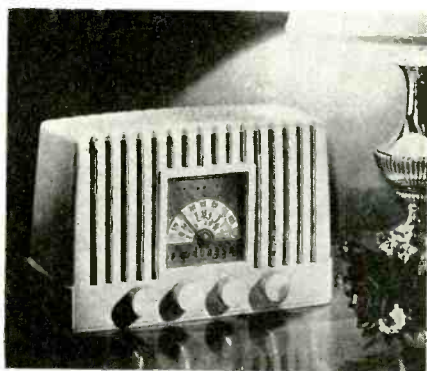

Echophone Model EC-112, 5-tube plus rectifier 3-band superhet table set by Hallcrafters. Rubber mounted chassis installed through bottom so cabinet is completely enclosed, streamlined front, rear and sides. 5-inch Alnico V PM dynamic speaker; automatic volume control, built-in loop antenna. Ivory plastic case.



Fada Model 633 Portable electric amplifying photo in 2-tone luggage type case. Features: Astatic pickup

with L70A crystal cartridge; 5-inch Alnico V PM speaker; needle noise filter; jeweled pilot light; inverse feed-back; four tubes, 12SL7; 35Z5; two 35L6 (push-pull power output).

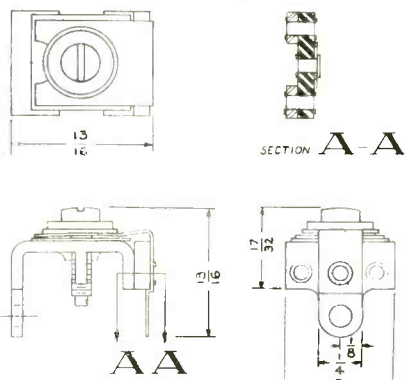

Engineering drawing of the Lear Mica Trimmer Condenser. Read counter-clockwise, it shows dimensions for top, side and end of the unit, with cross-sectional view "AA" indicating the component structure.



General Electric Model 12 record player. 4-tube amplifier; manual operation; 105-125 volts a-c; 25 watts power output undistorted; 3.8 watts maximum. Alnico PM speaker; magnetic phono pickup, 250 ohms; tubes: 6SC7, 6SQ7, 6V6GT, 5Y3GT.



Vibrators by National Union

A new electronic service product for

distribution through dealers and distributors is announced by National Union Radio Corp., Newark, New Jersey. One of these is the new line of N.U. Univibes, "universal" auto radio vibrators, standardized to a minimum of 8 types that will serve the replacement demands of over 2,500 different models of auto radio receivers. Available immediately, individually packaged in the new design National Union carton.



Crystal Controlled Signal Generator

A new signal generator designed for the radio engineer and service man is now in production. It has a wide range in radio-frequencies and audio-frequencies. Its power consumption is 20 watts at 115 volts. Special features:

Complete amplitude modulation coverage from 100 k-c to 110 m-c.

Complete frequency modulation coverage 100 k-c to 160 m-c with three variable bandwidths of sweep: 0-30 k-c, 0-150 k-c, 0-450 k-c.

Frequency modulation at two self-contained modulating frequencies: 60 cycles and 400 cycles.

Provisions for external frequency modulation to 15,000 cycles.

Provisions for external amplitude modulation to 15,000 cycles.

Self-contained amplitude modulation at 400 cycles. 0.01% accurate crystal controlled outputs, both amplitude modulated at 400 cycles and unmodulated. Offered in Models 288X and 277X only.

Continuously variable audio frequency from 0-15,000 cycles.

This new signal generator is manufactured by the Hickok Electrical Instrument Co., 10532 Dupont Avenue, Cleveland 8, Ohio.

MERCHANDISE PRE-VIEWS



Altec Amplifier

Altec Lansing announces the availability of a high quality low price, compact, light weight AC-DC type A-319 amplifier designed primarily for use in commercial wired music systems and in home phonographs and music systems. It also can be used as a terminal amplifier for paging systems, dance studios and in any other place requiring a medium gain low power amplifier. At the present time the amplifier is manufactured in two models which are the A-319A and the A-319B.

The A-319A amplifier which comes in the 10479 metal wall cabinet, has a balanced bridging input transformer with a 5000 ohm input designed for bridging across 250-500-600 ohm lines without requiring isolating transformers.



The A-319B amplifier which is normally supplied without the wall cabinet has a high impedance input for crystal pick-up use. A wall cabinet must be purchased separately if required.

Both the A-319A and A-319B amplifiers have an adjustable low frequency "BASS" boost. The A-319A has an adjustable high frequency "TREBLE" boost to compensate for line losses. The A-319B has an adjustable high frequency droop to eliminate needle scratch. Inverse feedback from push pull output stage to input stage keeps distortion to a minimum. The feedback is taken from a tertiary winding on the output transformer thus leaving the output ungrounded.

SPECIFICATIONS:	A-319A	A-319B
Gain	50 db bridging 600 ohm line	57 db from 250,000 ohm line.
Dimensions	7-3/4" x 11-5/8" x 6 1/4"	6" x 11" x 5 1/2"
Weight	11 lbs.	5 1/2 lbs.
Frequency	Flat \pm 1db from 40 to 15,000 cycles with bass and treble	
Characteristics	boost on 0	
Gain Control	Continuous variable.	
Power Output	4 watts.	
Noise Level	- 28 db (.006 watt ref.)	
Nominal Output		
Load Impedance	8 to 15 ohms	
Vacuum Tubes	6SJ7, 6J5, (2) 25L6, (2) 25Z6.	
Power Supply	105-125 volts AC or DC.	

Condenser-Resistor Bridge

A portable Condenser-Resistor Bridge, Type YCW-1, capable of measuring a wide range of capacity, resistance and other electrical characteristics of condensers, has been announced by the Specialty Division of General Electric Company's Electronics Department. Designed primarily for production testing and radio servicing and featuring push-button switching, the instrument will also measure the turns ratio of transformers, according to R. H. Rudolph, in charge of the sale of test equipment for the division.

The YCW-1 will measure capacity

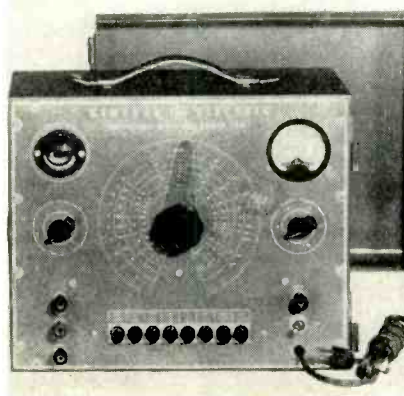

from .000005 to 200 micro-farads in three convenient ranges and resistance from 5 ohms to 20 megohms in two convenient ranges. Using the Wien bridge principal with standards of plus or minus one per cent for capacitance and plus or minus two per cent for resistance, bridge balance is indicated by a sensitive (electronic) visual indicator tube. Measurements are obtained by varying a potentiometer with a knob and a pointer until a maximum shadow angle is obtained on the indicator tube; capacitance and resistance values are also indicated by the pointer.

Insulation resistance, leakage current and power factor are among the other electrical characteristics of condensers that may be measured by the new condenser-resistor bridge. Both insulation resistance and leakage current are indicated directly on a two and one-half inch instrument mounted in the YCW-1's panel. Power factor is measured on the high capacity range by a potentiometer in series with the standard resistance which has a scale of 0 to 50 per cent. The unit is a self-contained steel case unit weighing ten pounds and operates directly from any 115 volt 50 or 60 cycle power source.

Further information or specification sheets may be obtained from the Specialty Division, G-E Electronics Department, Wolf St. Plant, Syracuse, N. Y.



Air King Combo

Case of the new Air King radio phonograph is in satin walnut finish accented by an edge-lighted dial. It fits naturally into any decorative scheme.

Features of the "Crown Princess":

Six tube (including rectifier) super-heterodyne for standard broadcast; two dual-purpose tubes; automatic changer for ten or twelve-inch records; permanent Alnico No. 5 magnet speaker; featherweight, low pressure tone arm; permanent needle; crystal pickup; automatic volume control. Company is at 1523 63rd St., Brooklyn, N. Y.

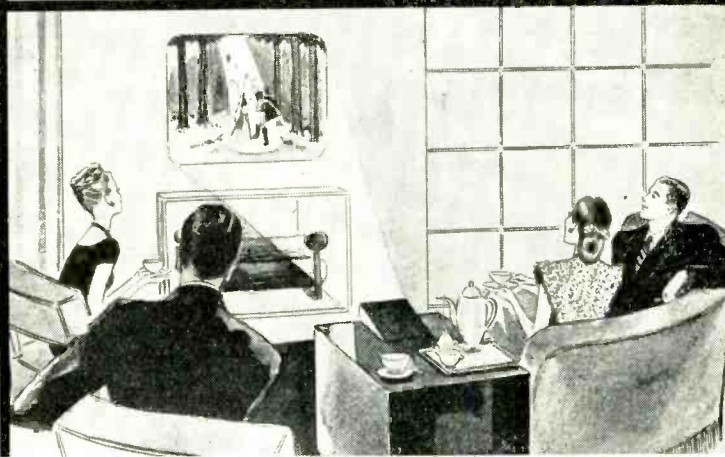
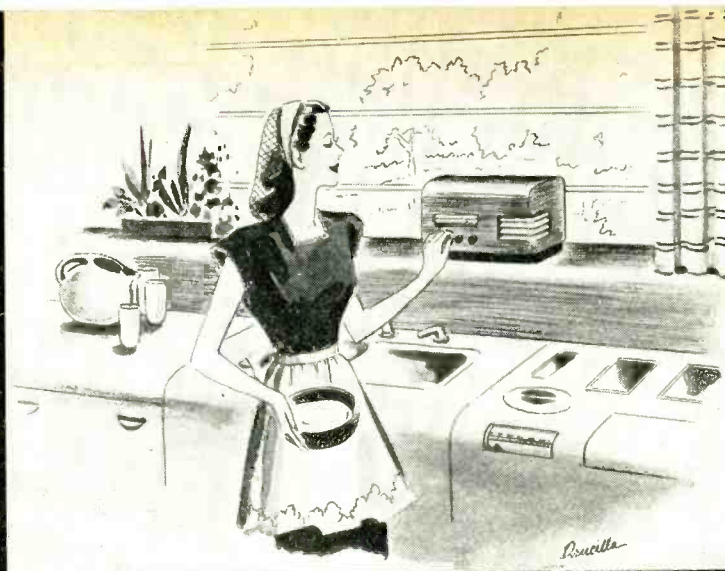
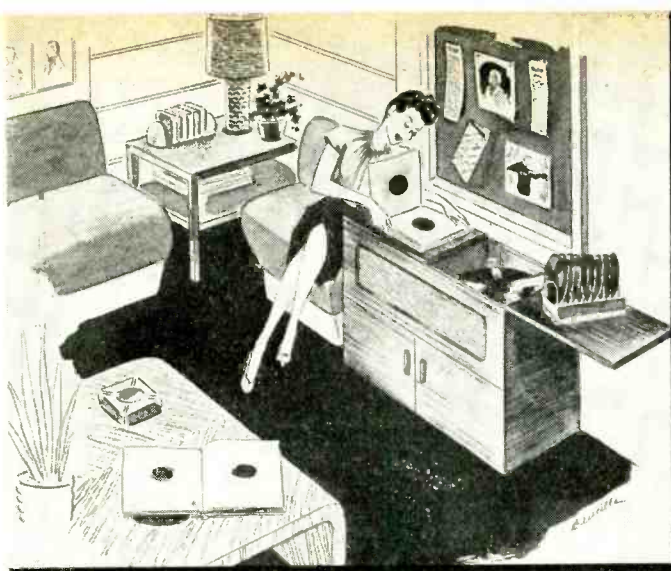

RADIO INDUSTRY COMPETES FOR GREATER SHARE OF CONSUMER DOLLAR: "Radio-in-every-room" is theme of RMA-inspired campaign for 1947. Promotional angles (as devised last year) still apply. *Top, left:* Set in "album room" for record lovers, who are promised machines including FM bands for extra pleasure from high fidelity discs. *Right:* Radio streamlined in colored plastic cases for "tomorrow's" streamlined kitchen, to lighten house chores. *Bottom, left:* School is brought home to Junior in his own private workshop. Television set occupies prominent place on his worktable as tele-lesson proceeds on model airplane construction. *Right:* Projection type receiver is built to serve as a side table; guests sip after dinner coffee as they watch projected tele-show. Basic promotion angle by RMA to usher in era of individual sets for radio listeners.

RADIO IN EVERY ROOM

by LEWIS C. STONE

Editor

AN industry-wide campaign is being inaugurated by the Radio Manufacturers Association to promote the idea of a radio-in-every-room with the American public. The campaign will get the support of manufacturers who will include the multiple-radio theme in their national advertising and in cooperative dealer advertising. Department stores will be asked to include appropriate radio sets in all model room displays. And the lone console radio set shown usually in the living rooms of most model homes will soon have for company additional radios in master bedrooms, children's rooms, guest rooms, hobby rooms, kitchens, maids' rooms, etc.

What this may mean for industry

\$50,000 campaign to promote more radios per home announced by RMA.

radio sales is anybody's guess. At pre-war overall average set prices — around \$35 per set, national average, 1912 estimates—the potential market for radio sets will probably never be met in any one year. For it comes to the astonishing total, for 35 million families, of 140 million sets, at four per family, with a value of \$4,900,000,000. Whereas, in the whole period from 1933 to 1942 inclusive, total production of home radio receivers (according to government-issued figures) was 75 million—for the entire ten years. This includes a peak high

(See page 36)

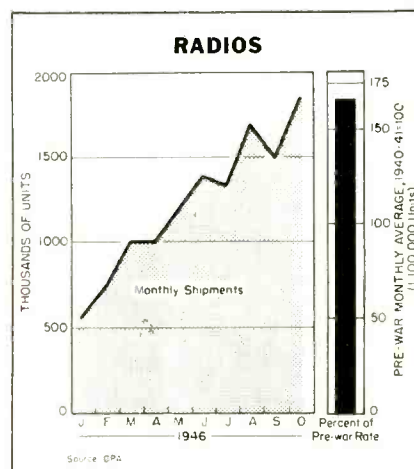

Radios - Shipments of civilian radios in October 1946 increased to 1.8 million units from 50,000 in November 1945 and were 68 percent above the 1940-41 average monthly rate of 1.1 million sets. In spite of substantial cancellations of military orders during the latter part of 1945, remaining contracts absorbed the major portion of the industry's production during that period. Second and third quarter shipments during 1946 consisted mainly of smaller sets as manufacturers were unable to obtain parts for the larger types. A shortage of cabinets, tubes, gang condensers, transformers and fractional horsepower motors prevented an even greater increase in production.

SERVICE DATA

for

DEWALD RADIO

MODELS A-500, A-501, A-502, A-503

This model is a five tube superheterodyne receiver with full automatic volume control. A self-contained loop is incorporated which makes the use of an antenna unnecessary. The range coverage is 525-1720 kilocycles. The receiver has been designed to operate at 105-125 volts, 40-60 cycles A.C.-D.C. unless otherwise specified.

OPERATION:

Insert the receiver line cord plug in electric outlet. Turn left knob in a clockwise direction. Allow approximately one minute for the tubes to heat up and receiver is then ready for operation.

NOTE:

If the receiver is being operated on D.C. and no signals are heard after it has been turned "on" for one minute, reverse the line plug.

ANTENNA:

The receiver operates satisfactorily without an antenna. If additional pick-up is desired, an antenna may be connected to the lead, extending from the rear of the chassis.

VOLUME CONTROL:

The left knob of the receiver is used as the power switch and volume control. Rotation of this knob in a clockwise direction turns the receiver "on". Further rotation in this direction increases the volume.

TUNING SELECTOR:

The right hand knob operates the tuning in of stations and pointer. Ease and accuracy in tuning is provided because of a reduction drive.

IMPORTANT:

Since the loop used has a directional effect, it may be found necessary to change the angle of the receiver.

REPLACEMENT PARTS

1001 ant. loop	3002 vol. cont. and switch
1003 oscillator coil	5000 line cord
1000 1st I.F. coil	6000 dial scale
1002 2nd detector coil	7000 speaker
2000 paper condensers	8001 pilot lamp socket
2001 mica condensers	9000 shaft
2002 comb. electrolytic	9002 bushing
2003 var. condenser	9762 drive spring
3000 1/4 W. resistors	#20 dial cord
3001 2 W. resistors	#47 pilot lamp

	A-500	A-501	A-502	A-503
CABINET	4004	4281B	4000	4016
KNOB	4017	4010	4003	4017
BACK	4018	4013	4019	4020

TUBES

1	35Z5GT
1	50L6GT
1	12SA7
1	12SK7
1	12SQ7

FOR PROFESSIONAL SERVICEMEN

To calibrate receiver connect the output of signal generator to the flexible antenna lead attached to the loop antenna. Connect the low side of signal generator through a 1/10 mfd. condenser to receiver chassis. Adjust signal generator to 855 kilocycles and adjust both I. F. transformers for maximum signal. Open the receiver variable condenser for minimum capacity. Set signal generator at 1720 kilocycles. Push oscillator section of receiver condenser for maximum signal. Next set signal generator at 1500 kilocycles. Tune in this signal. Adjust R. F. section of receiver variable condenser for maximum signal strength. Keep the signal generator output as low as possible when making all of these measurements.

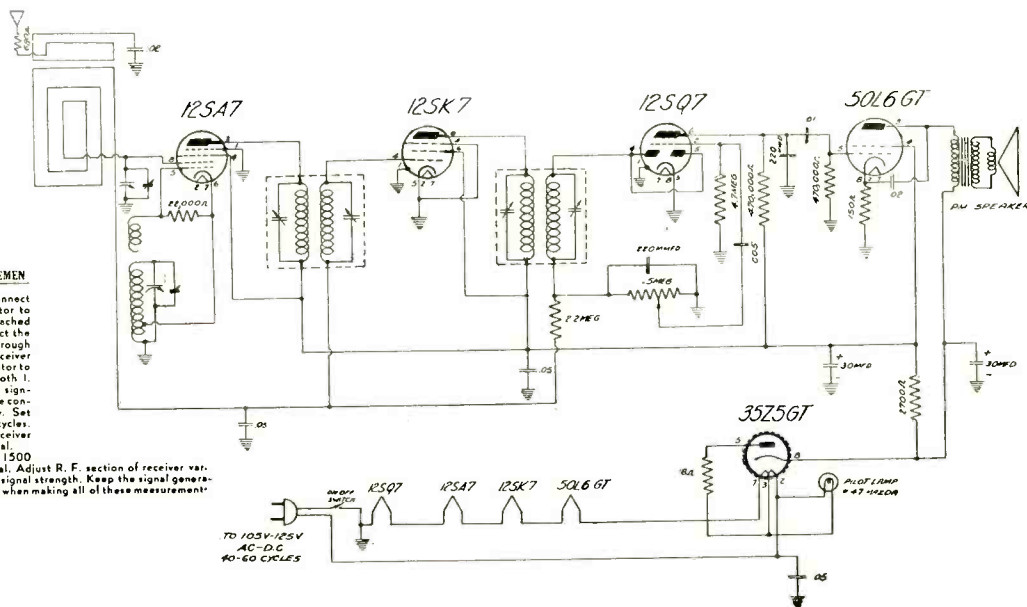

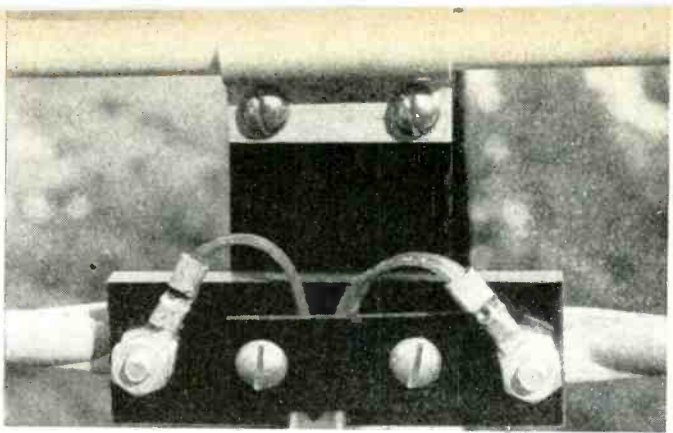
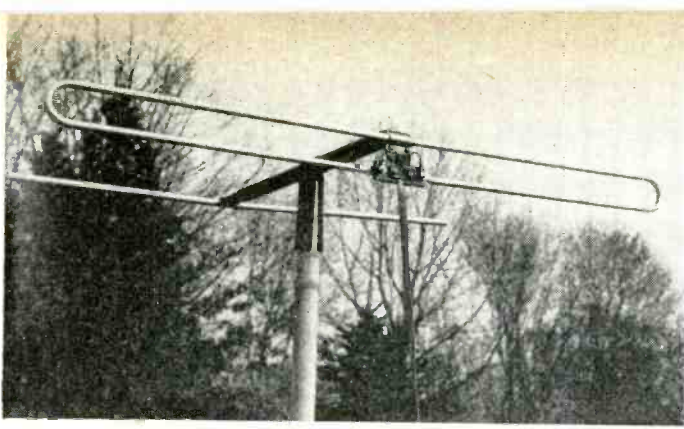

Above, left: Folded dipole antenna for FM and Television. Note connector block and polystyrene ribbon download transmission line; also reflector. Right: Terminal block and center support for folded dipole. The polystyrene ribbon transmission line is split and its lug terminals connected with the binding posts connecting with the ends of folded dipole.

DIPOLLES for FM-Television Home Receivers

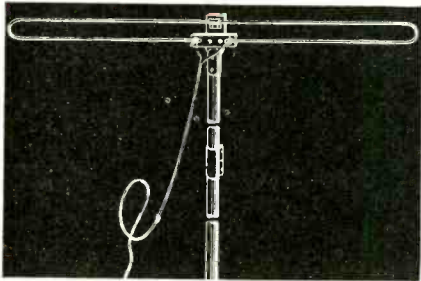

FM Folded-Dipole Antenna: Directional both front and rear, broadside to the transmitter; for areas of low signal strength. FM reception; adapted for AM with special transformer. Standing wave ratio less than 2.5 over entire FM band. (Cat. No. 621)

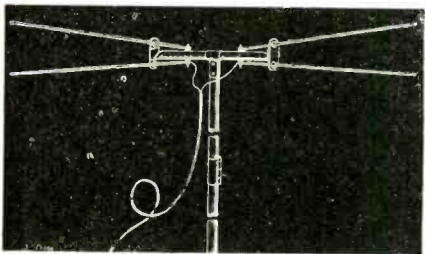

Double-V Antenna: Broad band interceptor; for old and new FM bands; nearly flat frequency response from 40 to 110 MC. In 88-108 MC band, frequency response less than standing ratio of 2. (Cat. No. 655).

Cage Antenna: Response curve is flat with $\frac{1}{2}$ DB over entire television and FM bands; standing wave ratio of 2 or less. Signal collecting portion of copper wire, with soldered connections; insulated at center where transmission line is connected to the two cages. (Cat. No. 433).

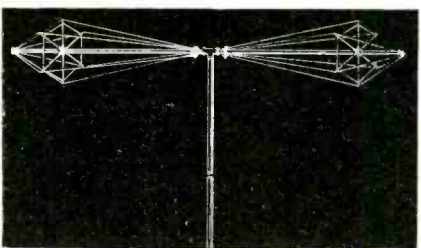

THE erection of a television antenna usually requires considerable care, especially in the crowded city where high buildings and other structures cause troublesome reflection of signals resulting in overlapping images or so-called "ghosts." However, a trained crew of servicemen working with some form of communication means between the man on the roof adjusting the antenna for exact location and direction, and a second man at the television set observing the actual reception, can often overcome the installation problems in a minimum of time, whereas the inexperienced team may soon give up in disgust, blaming the location, the set, or the antenna—and most likely all three.

Fundamentally, a satisfactory television installation simply calls for a lofty, free and unobstructed wave interceptor; the proper aiming of such interceptor to favor the desired signals and to minimize interference; the use of a reflector when necessary; and an efficient transmission line especially for considerable runs between an antenna on a tall building and the television set on a lower floor.

Often a reflector behind the antenna helps overcome troublesome "ghosts." The exact position of the antenna can be very critical, which means that a shift of a few feet one way or another may often cure the "ghost" troubles. Aiming of the antenna is quite important, and this does not necessarily mean direction by compass, since "ghosts" can frequently be minimized by swinging the dipoles one way or the other, and even setting them at an angle from

Note: Catalog numbers in captions refer to listings by Technical Appliance Corp., Flushing, N. Y.

the strict horizontal. In the open country the television installation presents far less problems, although at a con-

(See page 44)

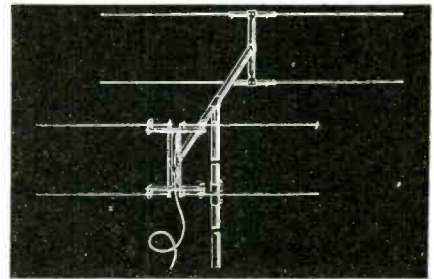

Double-Doublet Antenna-Reflector: H-type antenna combined with reflector; efficient for television, FM and standard broadcast reception; reflector makes antenna unidirectional, desirable in noisy or low signal strength areas (Cat. No. 435).

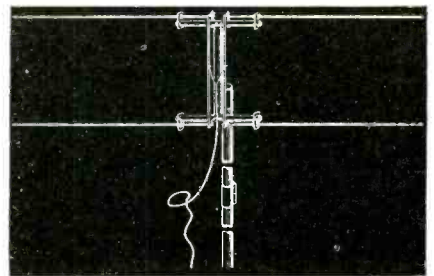

H-Type Antenna: Receives in both directions, broadside to dipole rods; provides additional gain in horizontal plane, effectively eliminates ground reflections, giving cleaner picture. Covers the two television bands, old and new FM bands, with frequency response flat within less than 3 DB. For localities of average signal strength, within 15-20 miles of typical television transmitter. Beyond this range, reflector should be added. (Cat. No. 436).

Listen
... IT'S A
Jensen
SPEAKER!

MODEL VH-91
*Hypex** **PROJECTOR**

This latest addition to the famous JENSEN Hypex line meets a real need for paging and intercommunication applications. Particularly efficient in the voice frequency range, it delivers clear, intelligible speech with maximum "punch" to override high noise levels.

By reason of an extremely clever mounting bracket, this projector can be pointed in any direction and securely locked into position with a single wing nut. Two holes in the bracket are provided for mounting on table, wall, ceiling or a post.

The diaphragm is cloth base, phenolic impregnated. Nominal voice coil impedance, 8 ohms; power handling capacity, 15 watts maximum speech signal input. Two-wire RC cable is provided for connections. Mounting facilities are also provided on the bracket for a $\frac{5}{8}$ " x $\frac{3}{4}$ " core or smaller transformer. Because of the Hypex flare formula, useful output is attained for a 100° total angle.

This new Hypex projector is now in production; deliveries are expected early in 1947 and literature will be available shortly.

JENSEN MANUFACTURING COMPANY

6619 S. LARAMIE AVE., CHICAGO 38, U.S.A.

In Canada: Copper Wire Products Ltd., 11 King St. W., Toronto, Ont.

*Trade Mark Registered



Jensen
SPEAKERS WITH *ALNICO 5*

Designers and Manufacturers of Fine Acoustic Equipment

SHOP - NOTES

FADA MODEL P41

Audio oscillation which cannot be reduced by volume control or by substituting other filter capacitors. Dress grid lead of 1H5 away from 3Q5.

PHONO MOTORS — OPERATING AT LOW SPEED

Synchronous motors which operate at RPMs lower than their rated value, most often do so because of mechanical bearing friction or slippage between the rubber wheel and the rim of the turntable. Sometimes it will be found that the rim is bent due to rough handling. This will cause a whine characteristic of phono amplifiers operating at too low a speed. For perfect speed operation the turntable rim must be perfectly circular, and its contact against the rubber drive positive at all times.

UNIQUE OUTPUT METER ARRANGEMENT

General Electric describes a method of connecting up an output meter which eliminates the necessity of removing the receiver from the cabinet. Make an indicating device by connecting a 4 to 6 inch diameter magnetic speaker or the high-impedance leads from the output transformer of a good p-m dynamic speaker to the terminals of a rectifier-type microammeter with a full scale deflection of 100 microamperes or less. For convenience, meter and speaker may be mounted in a small box in such a way that the meter will be visible when the speaker is placed in front of the speaker on the receiver being aligned.

To use this device, place its speaker in front of and about an inch away from the speaker of the receiver being aligned. The meter will then deflect in proportion to the intensity of sound produced by the speaker, and therefore may be used as an output meter. The meter must not be moved during alignment.

R.C.A. VICTOR MODELS 54B1, 54B1-N, 54B2, 54B3

To insure stable operation of these receivers it is necessary that the following "Critical Dress Lead" data prepared by R.C.A. be adhered to.

1. Dress blue, green and black leads of second I-F transformer as direct as possible. If excess lead exists, dress down side of socket and flat against chassis to transformer opening.

2. Cross the green and the black leads inside the first I-F transformer can, keeping the green lead to the outside. Keep the blue and the green leads separated as far as possible throughout their length.

3. Dress audio coupling capacitor (C14; .002 mfd.) and the lead to the volume control up and underneath the shelf supporting the output transformer.

4. Dress the three capacitors pyramided behind the speaker, parallel to the complete assembly and with enough room behind the battery holder to allow the holder to move when a battery is installed or removed.

5. Dress the "B" battery leads behind the gang frame and over the top of the output transformer.

6. Observe the outside foil connections on all paper capacitors, also the polarity of the electrolytic capacitor (C17).

7. Keep blue and red leads of output transformer above the mounting shelf.

A rubber band should be placed around each tube for cushioning.

R.C.A. VICTOR BP-10 REPLACING LID OR FRONT PANEL

When the molded lid (which contains the loop antenna) or the chrome front panel requires replacement, it is not necessary to replace the complete assembly of lid and front panel, as either may be replaced separately in a few minutes by taking out the hinge pins as described below:

First remove the three self-tapping screws that hold the chassis in the center case, and remove the case. Unsolder the leads from the loop lugs.

(a) With lid closed, cut hinge pins

Figure 1.

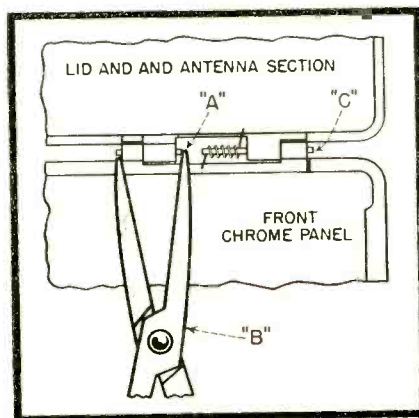

at point "A" (see Fig. 1) with sharp cutters.

(b) Start removal of pin sections as shown, using long-nose pliers.

(c) Grasp end of pin section with long-nose pliers and pull out hinge.

(d) Install new lid, or new front panel, using the replacement hinge pins and springs that are provided with the replacement lids and panels. Arrange springs as shown. Apply a small amount of "Thermoplastic Cement" (G.E. ZV 5057) near outer end of each pin to insure tight and permanent fit.

ZENITH MODELS 6A02-6A04

In these receivers Zenith recommends the following service procedures:

Noisy—right hand pilot light wiring may be pinched by automatic bracket. Check for poor contact on manual push button. Check for loose or poor contacts on pilot lights.

Oscillation on Short Wave Band — Push black lead of automatic away from automatic adjustments. Keep white and green leads of automatic away from 7L7-7H7 socket.

PHILCO LENS ASSEMBLY FOR PICKUP JEWEL

Philco describes the following procedure for examining the pickup jewel contained in its receivers. These jewels, used in the photo-electric pickup, may be the direct cause of faulty reproduction. The double lens assembly used in the photo-electric reproducer makes a perfect magnifying system for this purpose.

The magnification obtained with this lens assembly is sufficient to detect the slightest flaw or damage at the needle's point. Focusing of the lens system is extremely critical and the needle must be held approximately $\frac{1}{4}$ inch from the lens while looking through the opposite end of the cylinder. The power of this lens system is approximately the same as that used by the factory for inspecting these sapphires.

Very often a service man may change a jewel assembly when he merely suspects that the jewel has been damaged. Actual observation of the surface of the jewel will in many cases save considerable unnecessary work in making such changes. Philco can supply the lens assembly as a service replacement part. This is known as Philco Part No. 76-1109.

**THE NEW, COMPACT
SUPER-SENSITIVE**

Analyzer

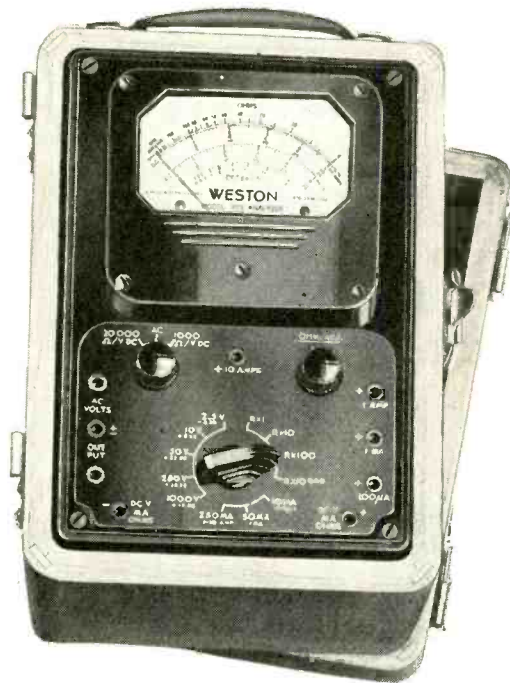

Weston

MODEL 779

Model 779 is designed for use with WESTON Socket Selectors which facilitate checking tube circuit conditions — and with WESTON Televerters for DC voltage measurements up to 10,000 volts.

Extreme compactness and lightweight—dual DC voltage sensitivity of either 1000 or 20,000 ohms per volt — five AC and DC voltage ranges, seven DC current ranges, four DC resistance ranges, and five decibel ranges — all carefully selected to meet the broadest requirements of testing and maintenance —precision WESTON resistors throughout—large 50 microampere WESTON meter — temperature compensated including AC ranges — size only $6\frac{3}{8}$ " x $9\frac{1}{8}$ " x $4\frac{7}{8}$ " — furnished in rugged, solid oak carrying case.

NOW AVAILABLE . . . see Model 779 at the Radio Parts and Electronic Show . . . Stevens Hotel . . . Booth No. 75. Weston Electrical Instrument Corporation, 605 Frelinghuysen Avenue, Newark 5, New Jersey.

Weston *Instruments*

Albany · Atlanta · Boston · Buffalo · Chicago · Cincinnati · Cleveland · Dallas · Denver · Detroit · Jacksonville · Knoxville · Los Angeles · Meriden · Minneapolis · Newark · New Orleans · New York · Philadelphia · Phoenix · Pittsburgh · Rochester · San Francisco · Seattle · St. Louis · Syracuse · In Canada, Northern Electric Co., Ltd., Powerlite Devices, Ltd.

RADIO IN EVERY ROOM

(from page 29)

of 13 million sets produced in the year 1941.

Our industry will have to go stepping some merely to begin to peck at the market represented by the radio-for-every-room program. It should keep us going, and going, and going, for years and years, without end.

Needless to say, the servicing business potential comes to some fantastic figures. Even the simple routine jobs, averaging a cost of around \$3 per set per year multiplies out to a total that comes to a staggering

\$420,000,000 for the country's service dealers as a whole. There aren't enough parts to do the job; there aren't nearly enough servicemen — individual, independent or company controlled; neither are there enough hours in the day, to handle the volume represented by this potential.

There are those who hold, however, that only part of the market can be so exploited; that the best market for multiple radio sales is most probably among those who already own more than one set. With 50 million sets reported among 35 million fami-

lies, the extra 15 million may represent those families who will do the major part of multiple radio purchasing, as laid forth in the RMA program. If so, matching the present 15 million with two or three sets each, some 30 to 45 million extra sets may be sold, over and above "regular" demand production.

But in the meantime, purple futures aside, forecasts announced by R. C. Cosgrove, president of RMA, indicate that about 25 per cent of the total estimated radio set production for 1947 (official totals not issued at this writing) will include FM. Also that between 320 thousand and 360 thousand home television receivers will be produced in 1947. The situation in tubes (original equipment and replacement) is such that they should be in ample supply as early as the first quarter of 1947. So says M. F. Balcom, who estimated that about 195 million receiver tubes would be sold in 1947. He ought to know. He's chairman of the RMA tube division.

Don't!
Miss the Boat!
Right Now is the Time to Make a Resolution
Never to Overlook an Opportunity



Model MAS-808

Model MA-808

MASCO Presents What You Have Wanted THE FAMOUS MASCO HIGH QUALITY 8 WATT AMPLIFIER

MAS-808 portable system consists of a Model MA-808 amplifier less tubes and cover, mounted in an attractive split carrying case, one heavy duty 10" PM speaker, with 25 feet of cable and plug.

MA-808 amplifier less cover and tubes..... **72.50**

Kit of matched tubes for MA-808 amplifier..... **37.00**

Streamlined cover for above amplifier..... **7.50**

..... **4.00**

Contact your local Masco Distributor for immediate delivery on this and all other Masco equipment.

MASCO

MARK SIMPSON MANUFACTURING CO., Inc.
32-28 49th Street, Long Island City 3, N.Y.

SOUND SYSTEMS and Accessories

RAvenswood 8-5810-1-2-3-4

Helping dealers out in the problem of moving lesser known table model radios without having to resort to price cutting, is a campaign in local newspapers sponsored by the Bureau of Radio and Electrical Appliances of San Diego County, California. Theme of the campaign is to encourage families to buy an extra radio set—a theme which is identical with the one declared by the Radio Manufacturers Association.

Dealers with accumulated stocks of small radios, acquired from various new makers in the early postwar days, realize that all of them must be sold before models of better established brands come in full supply. The campaign stresses that radios are available for immediate delivery, points out how an extra small radio can be used in the home to good advantage for various members of the family and in different rooms. The Bureau anticipates that it may not be too easy to sell "standard" brands competitively, let alone push sets with names new to the public.

To resort to price cutting in the "unknowns" would unsettle the local radio market. People would get into the habit of waiting for cut prices on the "knowns" too. And that would be very, very bad for dealers. With the aid of this campaign, dealers hope to avoid such a mishap.

IT'S OUR BUSINESS

TO HELP YOUR BUSINESS

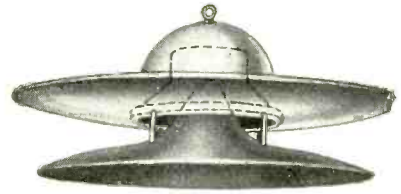

Fast Seller No. 1



Fast Seller No. 2

The Sound Business is a big and profitable business, especially for those who specialize in it. Experience teaches that it pays to use in every Public Address or Paging installation the finest, most dependable and efficient loudspeakers and driving units obtainable. Naturally that means RACONS . . . for more RACONS are in use in more better installations than any other brand.

RACON's new driver units have a rated output for peak and continuous performance far in excess of any other brands—continuous operating capacity 30 watts, peak capacity 60 watts. And as there is a RACON horn, speaker or driving unit for every conceivable type of sound installation, it is simple to get from us, a single source, anything you may require.

RACON Acoustic Material which prevents resonant effects; RACON Stormproof Material which is impervious to any climatic condition; RACON advanced engineering design, dependability and competitive pricing—all account for the reasons why Leading Soundmen Always Specify RACONS.

No. 1.—RADIAL SPEAKERS, projects sound with even intensity over 360° radius. Particularly adapted for use on trucks and in auditoriums where complete coverage is desired. Completely stormproofed, made with RACON ACOUSTIC MATERIAL to prevent resonant effects. Types for 5"-6" and 10"-12" cone speakers.

No. 2.—RE-ENTRANT TRUMPETS compact with long air column to provide highly concentrated sound with great efficiency over long distances. Uses RACON ACOUSTIC MATERIAL to prevent resonant effects. 2½" - 3½" - 4½" and 6" sizes that handle from Baby to Super Giant PM Units.

FAST SELLERS →

Send for our new **FREE CATALOG**

RACON ELECTRIC CO., INC.

52 East 19th St., New York 3, N. Y.

SURE CURE FOR CUSTOMERS COMPLAINTS

(from page 23)

yellow, is the service copy. The third sheet, in pink, is the protecting copy. The fourth sheet, in orange, is the customer copy.

Forms Head Off Complaints

"We realize," Mr. Lifsey stated, "that at first examination these forms may seem unnecessarily complicated but in actual use each item has been justified. Customer reaction to these forms is

good and the understanding which they help to establish has proved very helpful in our business."

When a customer telephones the shop, or even calls in person, the clerk fills out such essential information on the form as name, address, telephone number, make and model of equipment needing repair, when serviceman should call, and—as nearly as possible—what type of trouble is being experienced.

This information, which is entered into suitable spaces provided, is reproduced automatically and accurately on all four copies simultaneously. At this point, the protecting or third sheet is torn out of the set and filed in the office numerically on a post binder where it remains until the office copy of the completed order has been returned. The other three parts of the set are given to the serviceman making the call who fills in the remainder of the necessary information on the job. On the other hand, when the repair service is performed in the shop, the forms are filled out when the work is completed there.

If the service is completed in the home, the fourth copy is given to the customer and first and second copies returned to the office. The third or protecting copy is attached to the first or office copy and filed alphabetically. The second or service copy is filed numerically in the service shop. Similar

(See page 46)

VOLUME XV

**ONE FEATURE ALONE
WILL REPAY THE ENTIRE
COST TO YOU...TIME, AND
TIME, AND TIME AGAIN!**

For years and years on end—far as long as 1946 receivers are in use—Volume XV will continue to pay you annual cash benefits by providing authorized time-saving servicing data complete and bound in a systematic form. The owners of Volume I, purchased 16 years ago, are still deriving benefits from it. A library of Rider Manuals is a lifetime, profit-paying investment.

Volume XV incorporates the latest Rider "first"—"clarified schematics," a plus service on which we have spent tens of thousands of dollars in order to save you hundreds upon hundreds of hours each year. Also, with each copy of Volume XV is the separate book "How It Works," a practical guide to the theories of operation of the new technical features of latest receivers.

Many post-war sets are equipped with record players and changers; these are covered in Volume XV. All the popular brands of "Ham" communication receivers are included. You are brought up to date on all Scott receivers.

Yes, on the 1984 pages of Volume XV, covering the sets of 121 American Manufacturers and the 150 pages of "How It Works" you will find the data and services that will make it pay its profitable way for years to come. Order from your jobber today.

OTHER RIDER MANUALS

Volumes XIV to VII, each volume.....	\$15.00
Volume VI.....	11.00
Abridged Manuals I to V (1 vol.).....	17.50
Record Changers and Recorders.....	9.00

"clarified schematics"

"Clarified schematics" do a job which you have had to do on every multi-band receiver and combination set coming into your shop. They break down composite diagrams of hundreds of complicated multi-band receivers into individual schematics of each circuit as it exists with each turn of the wave band or equipment switch. With a "clarified-schematic" you save the time heretofore spent tracing out an original schematic to find which components are in operation under different positions of the wave band switch. Alone, this one feature will repay the entire purchase price of Volume XV year after year.

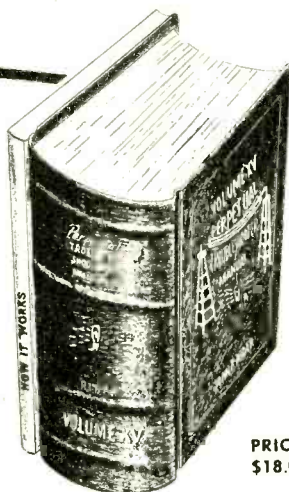

PRICE
\$18.00

**YEAR AFTER YEAR AFTER YEAR
RIDER MANUALS**
Keep pouring profits for Servicemen

JOHN F. RIDER PUBLISHER, INC.

404 FOURTH AVENUE, NEW YORK 16, N.Y.

Export Division: Radio International Corp., New York 16, N.Y. 13 E. 40th Street, Cable ARIAB

OPERATING HINTS

(from page 25)

ber of troubles to look for, thus minimizing the chances of "comebacks." Lastly, it will help you determine whether the trouble lies inside or outside the radio.

Always make sure that the set being tested is really in need of repair. Incorrect setting of a switch, or a combination of switches, may be the only difficulty. Will your face be red if you spend an hour discovering this "obscure" trouble!

When listening to a combination set for symptoms, make sure that the phono-radio switch is correctly placed. If the switch is on the phono position, the radio will not play, and you may come to the incorrect conclusion that the symptom is in operation of the radio.

Phono-radio switches are generally not difficult to locate. In one case, however, some directions are needed. This is the case where the switch is controlled by the tone-arm of the record-player unit. (As in some early models made by General Electric, for example). Moving the tone-arm upward, puts the phonograph on; moving it downward, puts the radio on. Moving the tone-arm inward, starts the motor—moving it outward, turns it off.

When plugging into a dc outlet, remember, the set will play only when the plug is in correctly, so reverse the plug position if the set doesn't work.

(To be continued)

Model 2450

ELECTRONIC TESTER

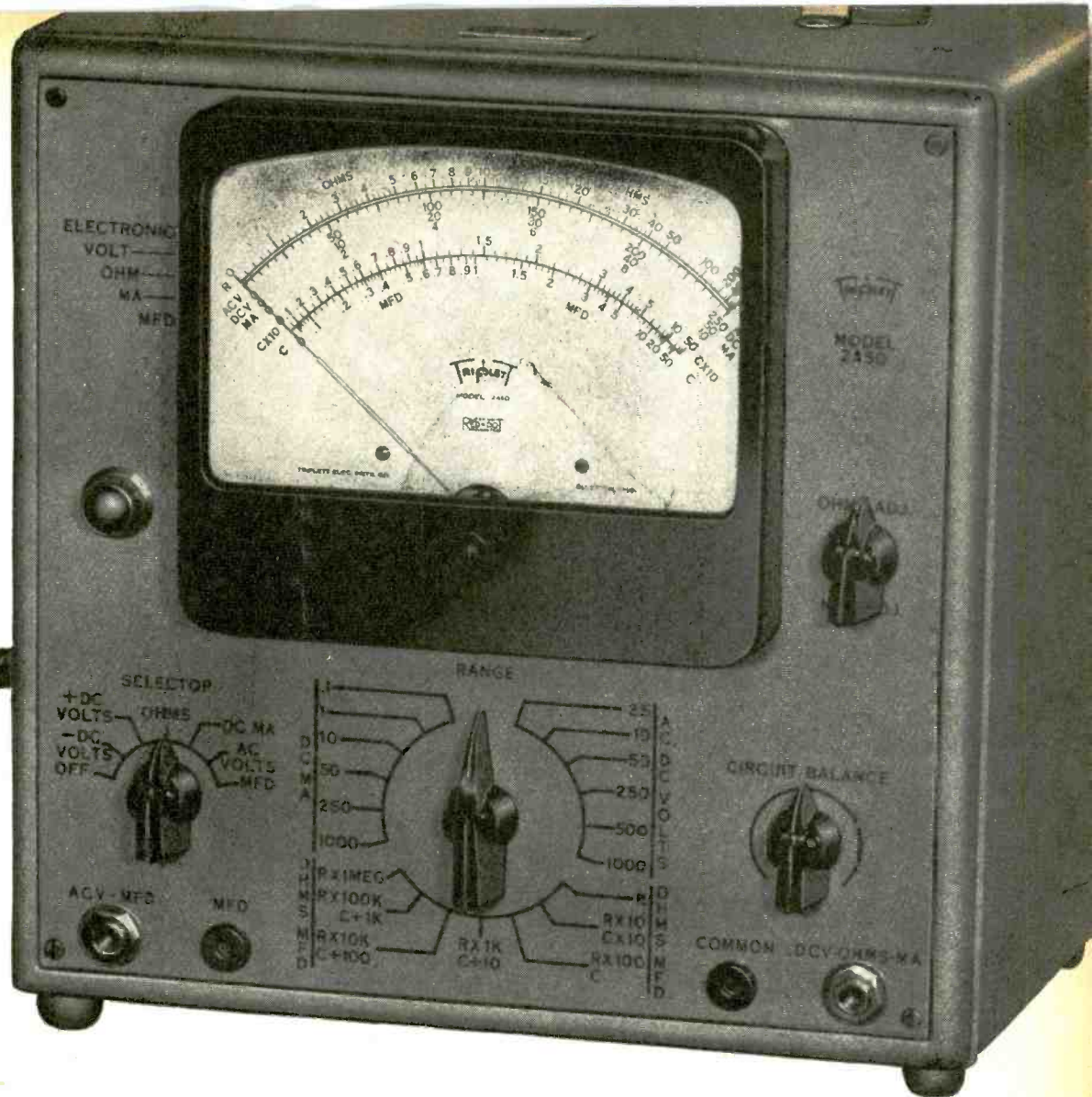

There's never been a tester like this!

Here's a tester with dual voltage regulation of the power supply DC output (positive and negative), with line variation from 90 to 130 volts. That means calibration that stays "on the nose"! That means *broader service* from a tester that looks as good as the vastly improved service it provides. And, together with its many other new features—including our Hi-Precision Resistor which outmodes older types—it means higher performance levels wherever a tester is needed. Detailed catalog sheets on request.

Highlights:

- 42 RANGES: DC and AC. Volts: 0-2.5-10-50-250-500-1000. DC MILLIAMPS: 0-0.1-1.0-10-50-250-1000. OHMS: 0-1000-10,000-100,000. MEGOHMS: 0-1-10-100-1000. CAPACITY IN MFD: 0-.005-.05-.5-5-50.
- LOAD IMPEDANCE: 51 megohms on DC Volts.
- CIRCUIT LOADING: Low frequencies. Circuit loading equal to 8 megohms shunted by 35 mmfd. High frequency circuit loading equal to 8 megohms shunted by 5 mmfd.

*Precision first
...to last*



Triplet



ELECTRICAL INSTRUMENT CO. BLUFFTON, OHIO



How to Avoid Saving Money

by DANNY KAYE



To avoid saving money, the first thing is to cut off all your pockets. (Or throw away your purse and keep your lipstick in your snood.) Thus you will have to carry your money in your hand. Which will insure that you—1. spend it, 2. lose it, 3. get it taken from you—quicker!



Also to be avoided like crazy are piggy banks and sugar bowls. Keep these out of your home! The kiddies in particular are victimized by such devices, often saving quite a bale of moolah. Be stern even if the little ones cry—remember what money could do for them! And be sure to avoid budgets. It is best to draw your pay and walk down Main Street buying anything you don't particularly hate.

Above all, don't buy any U. S. Savings Bonds—or it's impossible not to save money! These gilt-edged documents pay fat interest—4 dollars for 3 after only 10 years! There is even an insidiously easy scheme called the Payroll Savings Plan by which you buy bonds automatically. Before you catch on, you have closets full of bonds. You may even find yourself embarrassed by a regular income! Get-gat-gittle!



IF YOU MUST SAVE

Danny Kaye

SAVE THE EASY WAY...

BUY YOUR BONDS THROUGH PAYROLL SAVINGS

Contributed by this magazine in co-operation with the Magazine Publishers of America as a public service.



Amplifier Measurements

(from page 19)

If the impedance of the loudspeaker voice coil is known, resistor R may be dispensed with entirely and the speaker left permanently in the circuit. Output voltage then is measured across the voice coil. To determine the watts in this case, square the voice coil voltage and divide by the voice coil impedance.

5. ACTION OF GAIN CONTROL OR ATTENUATOR

Action of the amplifier gain control or attenuator may be studied in either one of the tests previously described by repeating the test at various settings of the gain control between minimum and maximum.

6. NOISE LEVEL

Noise in the amplifier, if not caused by some fault, is due to thermal agitation (shot effect) in the tubes. It reveals itself as a rushing or hissing sound in the loudspeaker. For observing noise level, the amplifier gain control should be run wide open and the tone control either cut out of the circuit entirely or placed in its "normal" (neither *high* nor *low*) position.

Noise voltage then is measured with the v. t. voltmeter connected across the speaker voice coil. A very useful figure is the ratio of noise voltage to maximum undistorted signal output voltage. This may be found first by measuring the signal output voltage (as described under *Power Output*), then measuring the noise voltage (as just described) and dividing the signal voltage by the noise voltage. In an amplifier operating properly, this quotient should be very large.

When making a noise test, the operator should listen carefully to the output signal to make certain that noise and not hum voltage is being measured. In some amplifiers, the hum voltage is so large that it masks the noise voltage.

Noise test should be made at several settings of the amplifier gain control.

7. HUM LEVEL

The ratio of hum to maximum undistorted output signal is another important figure in rating amplifier performance. This figure is easily determined. The test is made in the same way as the noise level measurement, except that the tone control is operated at its low position so as to eliminate the relatively high pitched noise components while rather readily passing the lower hum frequencies. The ratio is calculated in the same way as outlined for noise level ratio.

— SET BUILDERS — TWO-TUBE SUPERHET KIT



Upright model

Laydown model where space is essential

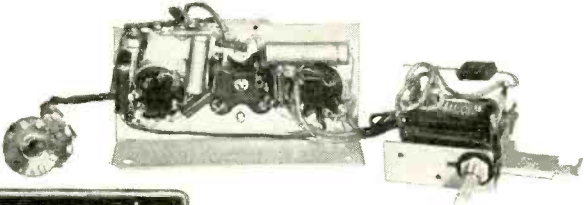

Escutcheon plate with knobs as illustrated goes with each unit—wired or unwired.

Completely wired ready to connect into any AC-DC or 6 volt filament with 125 V or more B supply—plate current drains—2 mls.

High gain and selectivity—plays with 6 ft. of wire—excellent for PA systems, radio tuners and for making combination kits for set builders—tunes police calls.

\$7.95 ea. unwired
\$9.95 ea. wired

CONSISTS OF:

- | | | |
|----------------------------------|---|--------------------|
| 1 312-1 Perm. Tuners. | 1 111-22312 1/3 W. Carb. Resistor, 22K | 1 12SA7 |
| 1 322-2 I.F. Coils | 1 111-33512 1/3 W. Carb. Resistor, 3.3M | 1 12SQ7 |
| 1 263-5034-4 Tub. Cond. .05 mfd. | 1 111-10612 1/3 W. Carb. Resistor, 10M | 1 Vol. Control |
| 2 263-1034-5 Tub. Cond. .01 mfd. | 1 111-27412 1/3 W. Carb. Resistor, 270K | 1 phono switch |
| 1 232-2515-2 Mica Cond. 250 mmf. | 2 558-1 Octal Sockets | 1 on-off switch |
| 1 232-5015-4 Mica Cond. 470 mmf. | 2 727A1 Tube Shields | 2 knobs |
| 1 232-5015-3 Mica Cond. 500 mmf. | 1 571-3 Tube Clips | 1 escutcheon plate |
| | 1 Chassis | |

Quantity unlimited
20% deposit
with orders

UNION Radio Corporation

328 S. Paulina • Chicago 12, Ill.

Immediate
delivery
Dept. B



Raytheon tubes give peak performance. They have been built to this high level of maintained quality through continual testing and research by a company that is recognized everywhere as one of the advanced guard leading the way into the new era of electronics.



Excellence in Electronics
RADIO RECEIVING TUBE DIVISION
NEWTON, MASS. • CHICAGO

-LAKE- Amplifying Systems



Excellent designed, compact amplifiers, ideal for students, professional entertainers, homes, factories, schools, etc. Perfect for voice, musical instruments, pick-ups and contact microphones; clear, rich tone; heavy plywood in luxurious leatherette-covered, streamlined portable cabinets.

As listed below:

No.	Watts	Inputs	List	Your Cost
A16	16	4	\$110.00	\$64.68
A15	15	3	97.50	52.86
A12	12	2	87.50	51.45
A 8	8	2	75.00	44.10
A 6	6	2	60.00	35.28
A 5	5	2	75.00	44.10
ACDC Model	8	3	75.00	44.10

Hawaiian Electric Guitar
Beautiful black plastic, trimmed with chrome. 23" scale. $4\frac{1}{2}$ octaves of playing range. List—\$50. Your Cost—\$29.40

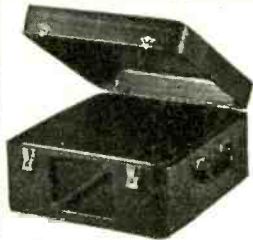

DeLuxe PHONO CABINET

Covered in luxurious, genuine brown leatherette, has deluxe brass hardware throughout, made completely of plywood with brown plastic handle, has padded top and bottom. Motor board 14" x 14 1/2". Overall dimensions 19" L. x 15" W. x 8" H. Your net price..... **\$8.95**

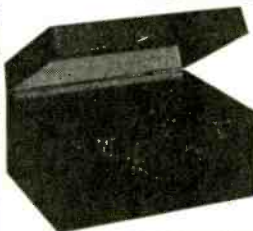

Portable Phono Case of sturdy durable plywood, in handsome brown leatherette finish. Inside dimension 10 1/2" long, 14" wide, 9 1/2" high. Has blank motor board. As illustrated. Specially priced at **\$6.95**

Also blank table cabinets of walnut veneer in the following sizes, with speaker opening on left front side. (*Note: *7 has center speaker grill.)
#1 — 8 1/2" L x 5 1/2" H x 4" D \$1.95
#2 — 10 1/4" L x 6 5/8" H x 5" D \$2.75
#3 — 13 1/2" L x 7 5/8" H x 6 1/4" D \$3.25
#7 — 10 3/4" L x 7" H x 5 1/2" D \$2.50
*Speaker Opening in center of front side.

All types of radio cabinets and parts are available at Lake's Lower prices. A large stock is listed in our catalog.

SERVICEMEN and RETAILERS
Write today for our new, illustrated 16-page catalog NR-116. It's free. Get on our mailing list! Write for our special catalog on microphones, amplifiers and sound equipment.

ORDER FROM LAKE!

YOU'LL MAKE NO MISTAKE!

DEPT. E

Lake Radio Sales Co.
615 W. Randolph Street
Chicago 6, Ill.

"GUILLOTINE" TUNING

(from page 21)

form, is enclosed in a metal box for shielding and for mechanical protection and dust proofing. Operation on the short wave spread bands is comparable to communication receiver performance and ease of tuning. Short wave microphonic howl is completely absent, he said, due to use of the guillotine tuner, making the full audio power output of the receiver usable on all bands. Loop reception is provided on all of the AM bands and power line pick-up is used for local FM reception. Terminal connections are provided, of course, for AM antenna and FM dipole use wherever required.

It is rare indeed that an engineer finds a specific answer to a problem which satisfies him completely, but such is the case with our "guillotine tuner." It appears that this particular technique will be widely employed in the future for applications involving the upper frequencies, especially for FM and television.

SERVICE DATA DESCRIPTION OF "GUILLOTINE" TUNING

The "guillotine" tuners are designed primarily for the 88-108 megacycle FM band where special technique is needed to realize high gain and circuit stability. Ordinary coils, tuned by a variable capacitor are inefficient at these frequencies, first, because of the low inductances required to reach these frequencies when a variable tuning capacitor is employed and, second, because shunt capacity reduces the gain of the amplifier circuit; shunt capacity must be kept very low.

Another disadvantage of standard tuning arrangements at these frequencies is that common coupling is obtained through the shaft of a ganged tuning capacitor unless insulated single sections are used (cumbersome and costly). Common coupling of this type tends to cause oscillation or general instability and precludes high gain per stage. The guillotines makes possible short leads, completely isolated sections, stable tuning, high Q circuits, low shunt capacity, and location of each tuner in the best physical and electrical position in the assembly. Furthermore, since the shunt capacity is small and the inductance is consequently at its highest corresponding value, the additional unavoidable inductance introduced in the wiring, bandswitch, etc., produce a minimum of circuit losses and unbalance.

The guillotine tuner consists of a heavy, silver-plated, two-turn square coil, rigidly supported between two

BEST ON THE ROAD!



**SURE, IT'S A
WARD
AERIAL**



Every Ward model has been tested and approved by car and radio set manufacturers — your proof of quality inside and out.

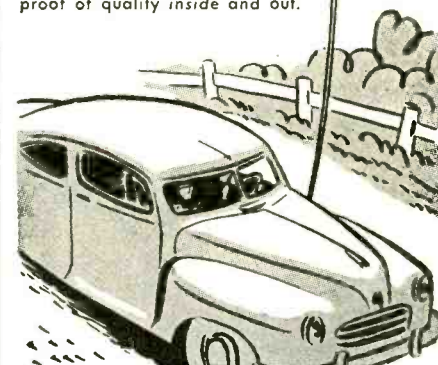

WARD

Aerials

World's largest manufacturers of antennas. We specialize in car, home, amateur and special communications applications, including FM and television. Write for full details.

**THE
WARD PRODUCTS
CORPORATION**

1523 EAST 45TH STREET
CLEVELAND 3, OHIO

In Canada — Atlas Radio Corp.,
560 King St., W., Toronto, Ont., Canada

plastic posts. A flat, solid vane slides up and down between the two turns. It is guided in grooves in the plastic posts so that it passes between the two sections of the coil without touching them. The posts are so moulded and the coil so constructed that the whole assembly is held rigidly at a predetermined spacing.

The tuning vane is raised and lowered by the tuning elevator. When the elevator is all the way up (set tuned to lowest frequency), the vane is completely above the coil which then acts as a simple two-turn coil. As the set is tuned toward the higher frequencies, the vane moves downward into the field of the coil until, finally, it is all the way in. The vane reduces the inductance of the coil through two principles: First, it acts as a shorted turn, and thus reduces inductance directly. Second, it provides a barrier between the two turns of the coil which reduces the mutual coupling and thus also reduces inductance.

The tuners described above are identified as T2, T4 and T5, on the schematic diagram, shown on page 21.



Capacitance-Resistance Bridge

Accuracy, range and flexibility of Model 904 place it in the class of costly laboratory equipment heretofore beyond the reach of all but a few users. It is direct reading in capacitance and resistance upon a 5" diameter "logarithmic" dial of substantially constant percentage accuracy. A total of eight 100:1 ranges, four for resistance and four for capacitance, cover 10 ohms through 1000 megohms and 10 mmfd. through 1000 mfd.

Style, size, weight and convenience are identical with "Vomax" to which Model 904 C-R Bridge is a companion instrument. Quality of parts and construction likewise parallel "Vomax" Bridge draws 35 watts from any 105 125 volt, 50/60 cycle a.c. line. It is furnished complete with 1-6SN7GT bridge amplifier, 1-6E5 electron ray indicator and 1-5Y3GT rectifier tubes. A.C. input cord and plug and one pair of 30" test leads with alligator clips are included.

Made by McMurdo Silver Co., Inc., 1240 Main St., Hartford 3, Conn.

WITH
SILVER "VOMAX"
YOU CAN—

Post-war design and construction at pre-war uninflated price is the secret of overwhelming demand for "VOMAX", the true v.t.v.m. Unequaled at any price, it is bought and used by the Bureau of Standards, Navy, F.C.C., C.A.A., schools, universities, research laboratories—and by thousands of experience-wise service technicians. You, too, will find "VOMAX" your greatest profit meter. Only \$59.85 at your favorite jobber.

OVER 35 YEARS OF RADIO ENGINEERING ACHIEVEMENT
McMurdo Silver Co., Inc.
1240 MAIN ST., HARTFORD 3, CONNECTICUT

Measure every type and kind of voltage in receiver design and servicing. "VOMAX" increases your efficiency and profits by equipping you to measure r.f., i.f., a.f.—actual signal volts—a.v.c., a.f.c., discriminator—a.c. and d.c. volts. Input resistance is so astronomically high you can measure directly even in the highest resistance circuits. "VOMAX" is also your output db. meter; measures direct current up thru 12 Amp. auto set range; resistance up to 2,000 megohms.

Send postcard for new catalog of measuring instruments, communication receivers, transmitters, kits and parts. See them at your favorite jobber.

Quality you can see in **VACO** screw drivers



These transparent Amberyl plastic handles tell their story at a glance... break-proof strength, shock-proof safety... shafts and bits of the finest steel alloy, treated to insure lasting dependability on every type of job.



There are 173 types of Vaco screw drivers. Type shown above is designed to take care of many radio requirements.

VACO PRODUCTS CO. 317 E. ONTARIO ST. CHICAGO 11, ILL.
CANADIAN WAREHOUSE: 560 KING STREET WEST TORONTO 2, ONT.

WRITE FOR CATALOG



**EASY ON THE EAR
WITH**

Smooth Power

• That's what counts with your customers! Give them faithful reproduction, free from wow and rumble, and your selling job will be easier and more profitable.

You'll get that fine performance from our complete *Smooth Power* line of phonomotors, recorders and combination record-changer recorders. They're carefully engineered and faithfully built for quick pick-up, constant speed and freedom from noise and vibration. They're *easy on the ear*.

They'll make fitting companions for your own fine products.



Model LX
Smooth Power
Motor



DEPT. MS • ELYRIA • OHIO

Dipole Antennas

(from page 31)

siderable distance where signal strength is low it may be necessary to resort to a much higher antenna aided by a reflector, and even a multiplicity of dipoles at extreme distances.

Postwar television antennae are designed for the new RMA 300-ohm standard television set input. The transmission line is also of the 300-ohm characteristic surge impedance. A line of such high impedance must be treated carefully or it may pick up interference on the way down to the set. It should therefore be securely anchored in place yet spaced away from walls, roof and floors. In exceptionally noisy locations it may be necessary to use a shielded transmission line of the dual-conductor type. This cable should have a 300-ohm impedance for best results.

As a general rule, only the antenna proper is required for satisfactory reception in high-signal-level areas. The only reason for using a reflector in such areas is to suppress interference and minimize "ghosts." As the signal strength falls off, however, it is advisable to use a reflector to increase the signal-to-noise ratio.

FM Antenna

For the best interception of FM signals, it is desirable to locate the antenna as high above surrounding objects and the ground as possible. It is also desirable to have the antenna adjustable so as to face the transmitter, thereby obtaining maximum signal pick-up with minimum interference or noise.

In the FM and television bands, these two conditions can be fulfilled with reasonable ease, due to the short length of the antenna collector rods required for the higher frequencies now used. far less problems, although at a con-The length of the dipole rods should be approximately $\frac{1}{4}$ wavelength, or about 30", with the low-loss transmission line connecting to terminals in the center where the rods meet. In the higher frequencies where the signals reach out more or less to the "Line of Sight" distances, it is obviously desirable to elevate the antenna as high as possible. Another 10 ft. of elevation often means the difference between acceptable reception and poor reception.

Due to the wide range of frequencies—88 to 108 MC—in which channels the FM stations now operate, it is essential that the antenna be of the broad-band type with a signal response reasonably flat over the entire range. This can be achieved with several de-

**LOOK
AHEAD**



"RSD" publishes more authentic articles on new servicing methods and new test equipment than other magazines. Trouble shooting is made easier—time is saved—more jobs can be done at greater profit.

Merchandising guidance is given to Service Dealers—from the 1-man shop owner to the biggest establishment. It's important to know how other successful Service Dealers conduct their business.

Every issue of "RSD" carries Service Data on the popular new radio receivers now being manufactured. These Data Sheets fit into standard manuals—should be kept until new manuals are available—every technician wants this service!

"RSD" carries more advertising from more manufacturers catering to Service Dealers. Subscribe to "RSD" today.

USE THIS COUPON. RETURN IT WITH YOUR MONEY-ORDER

12 issues \$2—24 issues \$3 in U.S.A. & Canada. Elsewhere \$3 per year.

**RADIO SERVICE DEALER
342 Madison Ave., New York 17, N.Y.**

Gentlemen: Send the next issues of RADIO SERVICE DEALER for which \$..... is enclosed.

Name.....
Address.....
City.....
Zone..... State.....
Firm Employed By:.....
Position or Title.....

signs, depending upon the flatness required, the price range, and the preference of the individual user of one type of antenna over another.

The postwar dipoles are distinguished by exceptional efficiency. Former wooden spreaders or mounting members have been replaced by the best insulating materials such as bakelite and polystyrene. Standard downlead is now ribbon transmission line comprising two stranded conductors insulated by a wide band of polystyrene, resulting in such low losses per 100 feet as only .02 db. at 10mc., 1.25 db. at 50 mc., and 2.1 db. at 100 mc., with 300 ohm surge impedance. In order to avoid the high losses resulting from the use of ordinary friction or rubber tape at such high frequencies, special low-loss splicing tape is available.

To provide the dependability based on extreme ruggedness, steel tubing with an enamel finish, is used for supporting members, combining great strength and light weight. Likewise the dipoles are of aluminum tubing and will not rust nor corrode. Components which come in a flat shipping carton, are assembled and held together by screws, lock washers and nuts.

In addition to the well-known straight-arm dipole and reflector design long in use for FM and Television, several new types are now making their appearance. There is the folded dipole in which a single aluminum tube is folded back on itself, ending at the down-lead terminals. There is the double-v antenna, with the double dipoles on each side spreading farther apart towards their ends to form the V design.

For Television reception, there is the double-doublet or double-decked or H type which has met with widespread popularity and is now available with reflector where necessary. There is also the cage antenna or double-cone type, consisting of two collector cages assembled on a steel tube, the copper wire of the cages being positioned under tension when the antenna is assembled at point of installation.

Efficiencies have been greatly stepped up by these new antenna designs. The cage type, for example, offers a response curve that remains flat within 1/2 db. over the entire FM and Television bands, having a standing wave ratio of two or less. It has also improved pickup in the shortwave and standard broadcast bands.

Hickok Service Depot

A new convenience for Hickok instrument users in the Eastern area is a newly established service station for servicing and repairing of all types of Hickok equipment. The station is under

the management of Mr. Kenneth E. Hughes, District Representative of the Hickok Electrical Instrument Company, and is located at 339 West 44th Street, New York City.

It is fully authorized by the Hickok Electrical Instrument Company and is

equipped to give good, rapid service on the well-known Hickok precision instruments including oscillographs, radio tube and set testers, signal generators, volt-ohm-milliammeters, chargicators, milliammeters, ammeters, voltmeters, wattmeters, industrial analyzers, etc.

"KEEN FOR KIDDIES," AND GROWN UPS TOO!



Little Gem
Kiddy
Phonograph

Complete with Dyna box Speaker and A. C. electric motor, the "Kiddy Phonograph" produces a natural tone. Equipped with an eight or nine-inch turn table, mechanical tone arm, and needle-cup with snap lid, this instrument is electrically safe and foolproof. Any child can operate it. Packed individually in air cushioned cartons.

Here is the "Kiddy Phonograph" designed to liven the play-room on dull days and help children entertain themselves with a grown-up instrument. Brightly decorated with red and blue figures to fit the scheme of any child's play-room, the "Kiddy Phonograph" is a real phonograph to thrill the youngsters and adults as well.

IMMEDIATE DELIVERY \$10.95
RETAIL \$18.50—DEALER tax incl.

MUTUAL INTERNATIONAL CORP.
1354 SALMON TOWER BUILDING, FIFTH AVE. AT 42nd ST., NEW YORK 18, N. Y.

HAVE YOU RECEIVED YOUR SUPREME?



While our production has not yet caught up with the heavy demand for SUPREME Testers, it is steadily increasing.

If you have not received your SUPREME Tube Tester, Set Tester, Oscillator, Oscilloscope, Multi-Meter, check with your Authorized SUPREME Distributor.

Big new catalogue now ready. For complete description of all SUPREME Testers, and Panel Meters, write today.

* * *

EXPORT DEPT. THE AMERICAN STEEL EXPORT CO., INC.
374 MADISON AVE., NEW YORK 17, N. Y.

SUPREME INSTRUMENTS CORP., GREENWOOD, MISS., U.S.A.

New Labels... New Carton!!



A NEW, COMPACT INTRODUCTORY ASSORTMENT OF POPULAR BURGESS "A" & "B" HEARING AID BATTERIES that fit most instruments in use today! This handy counter merchandiser makes it possible for all dealers to put an initial, low-cost stock of these popular batteries in their store's best traffic-spot. Only 5" x 8" in size.

Contains these batteries:

2 No. XX30E	1 No. XX22E
6 No. 1ES	4 No. 2ES
	8 No. TE



It's a sure-fire profit-maker! Bright new labels instantly say "genuine Burgess Batteries" to hearing aid users. Only 4 customers give you 30-day turnover—you get constant, repeat business from this small assortment.

Remember... this new assortment means new profits and steady store traffic... Stock these batteries with confidence... thousands of hearing aid users rely on them.

ASK YOUR BURGESS DISTRIBUTOR FOR No. HA-21 ASSORTMENT. ORDER IT TODAY

BURGESS BATTERIES

RECOGNIZED BY THEIR STRIPES
REMEMBERED BY THEIR SERVICE

Cure for Complaints

(from page 38)

lar handling of the forms also is done when the repair is made in the shop.

Each Job Specified

Many of the common complaints of customers have been circumvented by a number of unique features on the forms. For instance, there are usually people who bring in sets and think they know exactly what is wrong. They usually give instructions to fix one or two specific things only. However, when the set is checked by the serviceman he often discovers something quite different is causing the trouble or that more is needed than the customer specified. If the complete repair was undertaken, this type of customer was very apt to declare he did not ask for such extensive work and therefore refuse to pay the charge.

The solution to this situation was the provision of two check boxes in the lower right hand corner of the form. The customer is required to indicate his choice regarding the extent of repairs desired. If only listed repairs are specified the shop assumes responsibility only for the work done and at the same time permits it to make additional service charges for going into the set a second time should the customer's judgement prove to be wrong. Of course, if the customer authorizes a complete repair job, there is no misunderstanding should the bill run higher than the original estimate.

Under the previous system, there was no way of determining what work had been done on a set that came into the shop for additional repairs at a later date. Current practice now is to inscribe the service number from the form on the chassis of the equipment under repair. Should the set come in again, the serviceman can refer to his numerical file and have before him a complete record of what troubles were experienced by the set previously. The customer is also requested to retain his copy and present it should it be necessary to return the set for further service. This enables both the customer and the shop to appraise the length of service and determine if the second failure was caused in any way by an oversight or failure of new parts. Thus the basis for a second charge, if any, is more easily understood.

Payment Assured

A space is provided for the customer's signature to authorize repair. In addition, a statement at the bottom of the form calls attention to the cus-

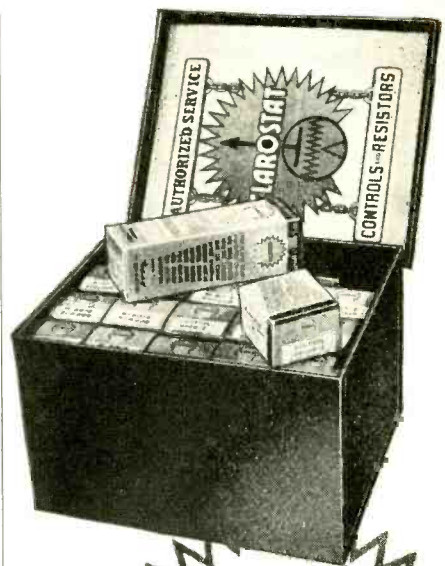

★ Clarostat's Serviceman's Kit No. 4 takes care of upwards of 95% of standard volume control replacements, 17 selected volume and tone controls. 8 Ad-A-Switches. Plus 4 Glasohms or glass-insulated flexible resistors. Packed in a neat steel cabinet, with Volume Control Selector and Authorized Service Plaque. A big \$32.15 value—"special" to you for only \$17.79! ★ Order it from your jobber—today—without delay!



CLAROSTAT MFG. CO., Inc. · 285-7 N. 6th St., Brooklyn, N. Y.

\$1.00 PAID FOR SHOP NOTES

Write up any "kinks" or "tricks-of-the-trade" in radio servicing that you have discovered. We will pay \$1 for such previously unpublished "SHOP NOTES" found acceptable. Send your data to "Shop Notes Editor," RADIO SERVICE DEALER, 342 Madison Ave., New York 17, N. Y. Unused manuscripts cannot be returned unless accompanied by stamped and addressed return envelope.

tomer that the signed form constitutes a contract with recourse and, as such, is binding on the customer. This makes it possible to obtain a replevin order to repossess the equipment and sell it for charges due should the customer refuse to pay.

An unusual feature is the personal statement by Mr. Lifsey introduced by "Dear Customer." It reads: "We give you an itemized record with each repair because we want you to know what you are paying for. This protects both you and us as only the specified parts replaced and work done are guaranteed. The above policy is necessary because a radio or anything electrical is made up of many intricate parts of which one defective part may impair its operation. No prediction can be made as to how long parts will last either new or old. This is to help you understand our service problem. Sincerely yours, Bill Lifsey's Radio Sales & Service Co."

The usual stipulations about minimum charge, responsibility in case of fire, theft, or causes beyond control are included. The form also states that merchandise left over 30 days will be sold for charges.

From the standpoint of internal office control, the new form offers several advantages. No customer calls can be

overlooked or delayed unnecessarily. A daily check of the file of protecting copies will indicate immediately the status of customer service requests. When the work is completed, the protecting copy is removed from the file and permanently attached to the office copy.

There had been no certain method of determining whether a completed service call was billed on a charge basis or whether the cash was turned in provided the work was paid by the customer upon completion in his home. At present, the office copy is returned immediately following repair of the set in the home or if the set is delivered from the shop. A mark on this copy indicates whether the repair was gratis, particularly on new sets still within the guarantee period, or whether the work is to be charged to the customer's account. If the job was cash upon delivery, the money must be turned in with the form.

It is quite evident that a substantial amount of writing is entered on the set of forms at various times in order to accomplish everything for which it was designed. Experience has proved, however, that the extra effort involved in such detail has paid off with tremendously improved customer satisfaction.

CRESCENT Automatic RECORD CHANGER



Model C-100

- Physical Size: 15 3/4" x 12 1/2"
- Plays Twelve 10" or Ten 12" Records
- Noiseless
- Child-proof Mechanism
- Crystal Cartridge
- Reject Button
- Finished in Neutral Beige Crackle

RECORD CHANGER ONLY \$1950
Your Cost Each

LEATHERETTE BASE AS ILLUSTRATED
Above—Model H-100

Brown Finish. Made to Fit Model C-100 Record Changer. 6" High, with Grille for 5" Speaker. **\$4.25 ea.**

Orders are now being accepted for immediate delivery—no waiting. Terms: 2% check with order. Or 25% deposit, balance express C.O.D.

PM SPEAKERS

4" Alnico (5) PM Speaker	\$1.39 ea
5" Alnico (5) PM Speaker	1.49 ea
6" Alnico (5) PM Speaker	1.89 ea

PHONO AMPLIFIERS

1-Tube Phono. Amplifier	\$2.35 ea
3-Tube Phono. Amplifier	4.50 ea

TUBULAR ELECTROLYTICS

100-MFD-25 V....	\$.22 ea.	10-MFD-450 V....	\$.29 ea.
10-MFD-50 V....	.22 ea.	16-MFD-450 V....	.39 ea.
20-MFD-150 V....	.22 ea.	10-10-MFD-450 V....	.59 ea.
30-MFD-150 V....	.29 ea.	20-20-MFD-150 V....	.29 ea.
10-MFD-150 V....	.39 ea.	30-20-MFD-150 V....	.39 ea.
50-MFD-150 V....	.45 ea.	40-30-MFD-150 V....	.45 ea.
8-MFD-450 V....	.25 ea.	50-30-MFD-150 V....	.59 ea.

HOLLANDER RADIO SUPPLY CO.
549 West Randolph Street Chicago 6, Illinois

Just Out!

CONCORD Bargain Catalog of RADIO Equipment FOR Immediate Shipment



THOUSANDS OF ITEMS! OUTSTANDING VALUES!

Just off the press—48 exciting pages of radio parts, equipment, and supplies for dealers, servicemen, amateurs, maintenance, testing, building and experimenting—Thousands of items **NOW IN STOCK** and ready for **IMMEDIATE SHIPMENT!** Big feature sections of Radio Sets, Communications Receivers, Amplifiers, Replacement Parts, Ham Gear, Record Players and Portables, Record Changers and complete Sound Systems. Page after page of bargains in top-quality standard-make radio parts and electronic equipment.

Mail Coupon NOW for FREE COPY

Mail coupon below **TODAY** for your **FREE COPY** of this latest Concord Buying Guide and Bargain Catalog of Radio needs you can order for **SAME DAY SHIPMENT** from complete stocks in Chicago and Atlanta.

CONCORD

RADIO CORPORATION
LAFAYETTE RADIO CORPORATION
CHICAGO 7, ILL. ATLANTA 3, GA.
901 W. Jackson Blvd. 265 Peachtree St.

CONCORD RADIO CORP., Dept. K-17
901 W. Jackson Blvd., Chicago 7, Ill.

Yes, rush **FREE COPY** of the new Concord Bargain Catalog.

Name.....
Address.....
City.....State.....

Radio Books For Radio Servicemen

"INSIDE THE VACUUM TUBE"

A goldmine of information for the student, amateur, serviceman or engineer.

425 PAGES PRICE \$4.50

"UNDERSTANDING MICROWAVES"

Provides a foundation from which the reader can proceed to understanding of various microwave developments of the past five years.

400 PAGES PRICE \$6.00

"RADAR"

For students, hobbyists and laymen . . . \$1.00



and THESE STANDARD WORKS

THE CATHODE RAY TUBE AT WORK . . .	\$4.00
FREQUENCY MODULATION . . .	\$2.00
SERVICING BY SIGNAL TRACING . . .	\$4.00
THE METER AT WORK . . .	\$2.00
THE OSCILLATOR AT WORK . . .	\$2.50
VACUUM TUBE VOLTMETERS . . .	\$2.50
AUTOMATIC FREQUENCY CONTROL . . .	\$1.75
AN-HOUR-A-DAY-WITH-RIDER SERIES— on "Alternating Currents in Radio Receivers," on "Resonance & Alignment," on "Automatic Volume Control," on "D-C Voltage Distri- bution." Hard bindings . . .	\$1.25 each

JOHN F. RIDER PUBLISHER, INC.

404 4th Ave. N.Y. 16, N.Y.

specializing in books for advance-
ment of the radio servicing industry.

RADIO TUBES

Most Critical Types in Stock
50L6, 1A7, 35Z5, etc.
Brand New, in Sealed Cartons
100% Guaranteed
Repairmen and Dealers, Write For
Available List at Trade Discounts

RADIO-EXPERTS

178 E. 33rd St. Dept. D Paterson 4, N. J.

SERVICE MEN!

- RCA Radiotron
 - Tungsol
 - Sylvania
 - Raytheon
- Tubes, Parts & Test Equipment

Write for our latest bulletin, Dept. D1

Distributors of RADIO EQUIPMENT

CHIEF ELECTRONICS

104 MAIN STREET, POUGHKEEPSIE N. Y.

The Square Deal Supply House

Ad Index

B & D Distributing Co.	48
Bell Sound Systems, Inc.	12
Burgess Battery Co.	46
Chief Electronics	48
Christy Supply Co.	48
Clark, Robert H. Co.	10
Clarostat Mfg. Co., Inc.	46
Concord Radio Corp.	47
Constant Electric	48
General Electric Co.	12
General Industries Co., The	44
Guardian Elec. Mfg. Co.	2
Hickok Electrical Instr. Co.	6
Hollander Radio Supply Co.	47
Hytron Radio & Electronics Corp.	14
Jensen Manufacturing Co.	33
Lake Radio Sales Co.	42
Maguire Industries, Inc.	11
Mallory, P. R. & Co., Inc.	Cover 2
McMurdo Silver Co.	43
Meck, John Industries, Inc.	Cover 3
Murray Hill Books, Inc.	3
Mutual International Corp.	45
National Radio Institute	1
Racon Electric Co.	37
Radio Corporation of America	18, Cover 4
Radio-Experts	48
Raytheon Mfg. Company	41
Rider, John F. Publisher, Inc.	39, 48
Sams, Howard W. & Co., Inc.	5
Simpson, Mark Mfg. Co., Inc.	36
Sprague Products Co.	7
Standard Transformer Corp.	9
Supreme Instruments Corp.	45
Sylvania Electric Products Inc.	13
Triplett Electrical Instrument Co.	38
Union Radio Corp.	41
Vaco Products Co.	43
Ward Products Corp.	42
Weston Elec. Instrument Corp.	35

IMMEDIATE DELIVERY!

BAMSCO floor model square heater, nice grille, nicely finished, 12"x14", 2 to carton. **\$7.12 ea.**

Hytron Radio Tubes (50% discount). Cornell-Dubilier Cond. (50 - 10% disc.) Greyhound House and Travel Irons **\$4.40 ea.**

6-tube superhet in beautiful plastic cabinet. Minimum: 2 sets. 20% deposit required. Your cost, complete with tubes. **\$19.74**

Heater Cords, doz. \$5.88

6' cube tap extensions, doz. \$4.44

Broiler cords, doz. \$5.75

6' table top extensions, doz. \$4.68

No catalogs available

B & D DISTRIBUTING CO.

639 Tompkins Ave., Staten Is. 5, N. Y.

Attention Manufacturers!! of Radios and Electrical Appliances

Dealer in Palestine desires to distribute radios and electrical appliances of nationally known manufacturers.

Please address replies to:

MR. RUDOLPH SACHS

42-42 Ithaca Street Elmhurst, L.I., N.Y.

Wireless Phono Oscillator

NO LICENSE REQUIRED

Transmits recordings from phono pickup or voice from mike to radio without use of wires up to 500 ft. Neatly designed.

Complete kit less tubes \$3.49

Above kit assembled and tested \$4.49

Tubes for above kit, 12SA7 & 35Z5 \$2.49

Immediate Delivery

CONSTANT ELECTRIC

112 Cornelia St. Dept. S Brooklyn 21, N. Y.

Electric Heating Element

FLUX

Repair burned out electric elements of coffee urns, electric stoves, flat irons toasters, and other electrical appliances. Simply apply Christy Electric Heating Element Flux to the break, turn on the current and PRESTO the job is done and your appliance is ready again for years of satisfactory service. Generous size package (enough to repair 50 elements) sent postpaid for only \$1.00.

ELECTRICAL APPLIANCE REPAIR PARTS

Renual Iron element. Guar. 1 year Package of 6 . . .	\$3.12
Toaster element forms. Clear Mica. Fits most toasters. 10 for	1.80
Heating element wire. 10 ft coiled 1/4" O.D. #20 . . .	2.55
Heating element wire. 10 ft coiled 3/16" O.D. #22 . . .	1.77
Hot plate bricks, 5 3/4" diameter, 6 for	1.62
Appliance cord. Rubber covered. 20 ft. \$1.00; 100 ft.	4.50
Ribbon element heating wire. Std. size. 100 ft.75
Percolator elements Universal. Flat type. 1 yr. guar. 2 for	1.20
Element cement. Withstand 3000° F. 1 lb. pkg. \$1.00. 5 lb. pkg.	3.50
Lead wire. Asbestos covered heater hook-up wire. 10 ft. 1.00	
Iron Cord Sets with complete plug attachments, 10 for	5.00
Carbon brush set. Assorted. 104 brushes. 15 springs. Complete set.	3.00

HOW TO FIX IT BOOKS

Modern Electric & Gas Refrigeration	\$5.00
Practical Electricity & House Wiring	1.50
Armature & Magnet Winding	1.50

Here is your opportunity to save on repairing your own appliances and to earn extra money repairing appliances for friends and neighbors.

Christy Supply Company

2835 N. Central Ave., Dept. T-354
Chicago 34, Ill.

This *New* Promotion Re-affirms an *Old* Policy

FROM the first announcements of the new Meck plan for producing "Trail-Blazer" radio receivers, one theme has dominated our merchandising:

"Radio specialists have the leadership now—you deserve to keep it continuously through the post-war period. We will do everything possible to maintain the public's acceptance of the dealer—because we know that the best sets will be sold by these 'men who know radio best'."

Check the engineering—you'll find "Trail-Blazer" sets live up to this standard.

Check this new SERVICE promotion aimed to maintain public confidence in YOU. This whole program—national and local advertising, posters, direct mail, and sales helps—built for YOU. Ask your Meck "Trail-Blazer" jobber about it today.

John Meck



Advertising in the Saturday Evening Post



Tie-in Ad Mats for Meck Dealers



Counter Cards



Window Posters



Mailing Cards



Neon Signs



MECK RADIOS

John Meck Industries, Inc., Plymouth, Ind., U. S. A.

You're in the lead with RCA...here's why



Cementing ceramic insulator to miniature tube button stem — one of the many delicate operations in making an RCA tube that calls for unusual skill.



Quality ...skilled hands at RCA
lead more customers your way

If you were to visit the great RCA tube plants at Harrison, N. J., Lancaster, Pa., and Indianapolis, Ind., you would be amazed at the consummate skill and sure touch of the people who make RCA tubes.

RCA has always attached the greatest importance to every individual step in the development and manufacture of the RCA tubes you sell.

Through the years experience has taught

us that the highest standards of quality and dependability can result only from this painstaking attention to detail that is a tradition with our people.

That's why RCA tubes enjoy greater customer confidence and acceptance than any other tubes. That is only one of the many reasons why—*you're in the lead with RCA.*

So, push RCA tubes and watch your business grow!

THE FOUNTAINHEAD OF MODERN TUBE DEVELOPMENT IS RCA



TUBE DEPARTMENT

RADIO CORPORATION of AMERICA

HARRISON, N. J.