

# ET/D

JULY 1981 • \$1.50

ELECTRONIC TECHNICIAN/DEALER  
LEADING THE CONSUMER AND  
INDUSTRIAL SERVICE MARKETS



KDWR 4038013-P2-  
4823AD1P -379-  
RAY KDWECK  
27734 DENMAR  
WARREN  
AB APR82  
-AS  
MI 48093

# CCTV

Microprocessor  
Troubleshooting  
Security Systems Design

# Special

## 2SC1308K Horizontal Output Transistor

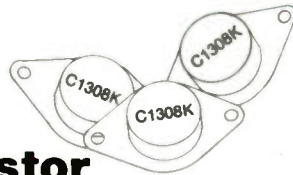

# 2.80

Minimum order of 10

### CATV Parts and Accessories—at low, low MCM Prices.

<p><b>F59 Connector</b></p> <ul style="list-style-type: none"> <li>✓ For use with 59-U Cable</li> <li>✓ Ferrule included</li> </ul>  <p><b>15<sup>c</sup></b> each (100 or more)    <b>18<sup>c</sup></b> each (10-99)</p>	<p><b>TVT-1 Matching Transformer</b></p> <ul style="list-style-type: none"> <li>✓ UHF/VHF/FM 75-300 Ohm matching transformer</li> <li>✓ "F" Type Input, 300 Ohm twinlead output</li> </ul>  <p><b>55<sup>c</sup></b> each (10-up)    <b>65<sup>c</sup></b> each (1-9)</p>	<p><b>TVI Interference Filter</b></p> <ul style="list-style-type: none"> <li>✓ Reduces interference caused by auto ignition, CB's, neon signs, etc.</li> <li>✓ Connects between set &amp; antenna</li> </ul>  <p><b>65<sup>c</sup></b> each (10-up)    <b>80<sup>c</sup></b> each (1-9)</p>	<p><b>JB-300 Coaxial Switch</b></p> <ul style="list-style-type: none"> <li>✓ Quick selection from TV antenna &amp; cable to VCR or other sources</li> <li>✓ 2-Input, slide type A/B switch for CATV, MATV, MDS, STV &amp; VCR applications</li> </ul>  <p><b>\$2<sup>70</sup></b> (10-up)    <b>\$2<sup>95</sup></b> (1-9)</p>
<p><b>SPL-702 UHF/VHF/FM Splitter</b></p> <ul style="list-style-type: none"> <li>✓ 75 Ohm</li> <li>✓ Three way splitter w/F59 connector</li> </ul>  <p><b>\$1<sup>35</sup></b> (10-up)    <b>\$1<sup>55</sup></b> (1-9)</p>	<p><b>JB-2 Deluxe Coaxial Switch</b></p> <ul style="list-style-type: none"> <li>✓ A/B switch for CATV, MATV, MDS, STV &amp; VCR applications</li> <li>✓ 90dB isolation</li> <li>✓ Bandwidth DC-900 MHz</li> </ul>  <p><b>\$7<sup>40</sup></b> (10-up)    <b>\$8<sup>90</sup></b> (1-9)</p>	<p><b>Color Camera Cables</b> <i>Fits Panasonic, RCA, Quasar Equipment</i></p> <ul style="list-style-type: none"> <li>✓ Superflexible, low loss MOGAMI cable</li> <li>✓ For use with Panasonic PK-500, PK-600, PK-700; JVC 66, 77; RCA 003, 004, 006; Quasar 720, 725, 730</li> </ul>  <p>16 ft. No. 2624    33 ft. No. 2626    53 ft. No. 2627 <b>\$3<sup>45</sup></b>    <b>\$4<sup>80</sup></b>    <b>\$7<sup>30</sup></b></p>	

### Join the hundreds who are saving **BIG** with the **ERS** line of replacement semiconductors!

**This special offer expires September 30, 1981.**  
Distributed exclusively by MCM Electronic Parts.

ERS 123A ..... \$ .28	ERS 163A ..... \$3.90	ERS 165 ..... \$2.40
ERS 238 ..... \$3.95	ERS 283 ..... \$4.40	<i>minimum order of 10 no mixed quantities</i>

### Sony Specials! Compare our prices and save!

C867A ..... \$3.60	C1034 ..... \$5.60	C1316 ..... \$3.80
GH3F ..... \$1.20	C1114 ..... \$3.80	C1172B(D348) .. \$3.20
		<i>minimum order of 10 no mixed quantities</i>

### High Voltage Triplers

HVT 500 ... \$11.80 ea.	HVT 523 ... \$13.90 ea.	HVT 526 ... \$17.70 ea.
		<i>minimum order of 10</i>

**Get the whole MCM Parts-Saving Story. Order today and get our 64 page catalog free!**



CALL OUR TOLL-FREE LINES TODAY FOR IMMEDIATE DELIVERY!

**1-800-762-4315**  
Ohio Watts Line



**1-800-543-4330**  
National Watts Line

# INDUSTRY REPORT

## Radio Shack Announces New Compatibility With IBM Equipment

Radio Shack, a division of Tandy Corporation, is introducing a number of new software products for the company's TRS-80 Model II computers which enable them to communicate directly with or to exchange information on diskettes, with IBM equipment. This allows owners of IBM equipment the use of the TRS-80 Model II for data entry, inquiries and communications with their existing equipment. Tandy Corporation President John V. Roach asserts "These new software packages give significant new utility to the TRS-80 Model II computer by entering it into the IBM world. The Model II has rapidly become the leading unit-sales 'very-small-business computer' and each new capability added gives it an even broader market base." The new IBM-compatible features available for the TRS-80 Model II include binary synchronous communications, remote job entry (RJE) for batch processing, and eight-inch disk compatibility. The Bisynchronous Communications package permits the TRS-80 Model II, itself a powerful desktop computer, to communicate with IBM 360/370 and 30-series computers utilizing most IBM 3270 communications techniques. In the remote job entry (RJE) mode, the Model II becomes a terminal with 3780 and related communications protocols. The diskette reformatting program (ReformatTer™) gives the Model II the ability to read, write and modify diskettes utilizing the 3270 formats. "It is our goal," Roach adds, "to continue to make computers and communications more affordable for users. "With our full services—leasing, maintenance and training—coupled with these new software packages, big computer users can now take advantage of the savings offered by microcomputers."

## Some Consumer Electronics Facts and Figures

The Electronic Industries Association, Consumer Electronics Group *Consumer Electronics Annual Review*, 1981 Edition has recently been published. It presents an overview of the consumer electronics industry that should be of interest to everyone involved in it.

It is estimated that there are now about 160 million television sets in use in about 78 million US households. Over 16 million television sets were sold in each of the last three years. Nearly 20 million households are connected to

cable systems and cable growth is rapid. At the beginning of 1981, 625 VHF and 396 UHF TV stations were in operation. The total value at the factory of consumer electronics sold in the United States was \$10.617 billion for 1980 compared with \$9.366 billion for 1979, a growth of nearly 12 percent which is particularly noteworthy when it is understood that consumer electronics is affected by inflation less than nearly any other major industry. The value at retail was about \$16 billion.

Factory sales of consumer electronics products for 1980 break down thus: B&W TV, \$588 million, up from \$561 million in 1979; Color TV \$3.944 billion compared to 3.685 billion in '79; radios \$468 million is an increase of about 10 percent over the previous year; auto-sound, audio and tape players and recorders all did comparably well. In spite of a general agreement that the hi-fi/stereo audio business was in a slump, audio component sales increased in dollars from 1.178 billion in 1979 to 1.424 billion in 1980, a growth of about 17 percent.

The consumer electronics industry still is fairly healthy in spite of a continuing flood of imports, with over 200 US manufacturers employing about 1.4 million workers.

The total number of consumer electronics products in use in 1980 is estimated by the EIA and others to be: 115 million auto radios; 345 million other radios, 79 million B&W and 83.5 million color television receivers, and 1.85 million VCRs. The last estimate made for audio systems was for 1977 when 77.6 million were thought to be in use. Since then over 13 million have been sold many of which have added to the '77 total.

## ISA To Publish Instrument Technician Training Program

Instrument Society of America (ISA) has announced the release of a new videotape-workbook training program for Instrumentation Technicians and Plant Operators. According to Glenn Harvey, Executive Director of ISA, this new program provides training in the basic technical skills directly related to the Instrument Technician's job and helps Equipment Operators to understand the proper function of process control systems. The first 3-tape module is now available and covers 12 hours of training on Electronic Instruments, Sensors, Indicators and Transmitters. When complete the program will have 22 mod-

ules, the equivalent of 240 hours of training. Each module comes with all the materials necessary to conduct in-plant training. ISA has contracted with Industrial Training Corporation (ITC) to produce the program under ISA auspices. ISA is a non-profit, membership organization whose purpose is educational. Its members are people with a direct interest in instrumentation technology. Through a wide variety of publications, meetings, and instructional activity, the Society fosters the advancement of the theory, design, manufacture and use of instrumentation, computers and systems for measurement and control.

## GE To Phase Out US Monochrome TV Production

General Electric has recently confirmed that it plans to phase out domestic production of monochrome TV sets by 1983. Lud Huck, General Manager-Marketing, emphasized that the company will continue to sell monochrome sets under the GE brand name and that manufacturing alternatives are being considered. GE expects that increases in color receiver production as well as possible new product production will maintain current employment levels at its Portsmouth, Virginia manufacturing facility. Huck cited severe cost pressures as the major reason for the planned actions.

## IT PAYS TO COMPARE SPECIAL

IN ORDER TO GET THIS SPECIAL YOU MUST TELL US YOU SAW THIS AD.

REPLACEMENT FOR ECG			MIN. 10/TYPE		
ECG TYPE	ECG PRICE	SALE PRICE	ECG TYPE	ECG PRICE	SALE PRICE
123A	37	0.45	187A	1.50	1.10
128	75	0.70	192	1.80	0.60
129	1.55	0.80	193	1.66	0.60
130	3.50	1.20	196	2.00	0.90
152	2.00	1.00	198	2.55	1.25
153	2.50	0.80	238	1.75	4.00
159	1.83	0.55	280	6.30	3.00
163A	10.75	4.20	291	2.40	1.30
165	13.00	3.15	292	8.20	1.40
186A	25	1.00	310	8.55	5.00

ORIGINAL JAPANESE		MIN. 10/TYPE	
TYPE	SALE	TYPE	SALE
2SA699A	0.60	AN214Q	1.60
2SA771	2.90	BA521	1.80
2SB507	0.95	BA532	1.80
2SB633	1.10	LA4051	1.60
2SC1306	1.10	LA4420	1.70
2SC1308	2.50	LA4430	1.80
2SC1986	1.80	M51513L	2.20
2SD0313	0.70	STK0050	7.00
2SD0613	0.80	TA7203P	1.60
TA7222	2.80	UPC1181	2.20
UPC1182	2.20	UPC1185	3.90

— WRITE FOR COMPLETE CATALOG —  
 ✓ 1500 types original Jap. IC's & TRS  
 ✓ 1000 types exact ECG replacement  
 ✓ Other parts for TV, stereo, etc.

**ELECTRONIC PARTS SUPPLY**  
 P.O. BOX 5356 BERKELEY, CA 94705  
 TOLL FREE: 800 227-0104  
 IN CA, AK, HI. 415 532-2711  
 COO. PREPAID. M/O. VISA. M/C  
 BASIC SHIPPING CHARGES \$2.50

Circle No. 111 on Reader Inquiry Card

ET/D - July 1981 / 3

### Answers to CET quiz:

- |     |      |      |      |      |
|-----|------|------|------|------|
| 1.d | 6.d  | 11.a | 16.d | 21.a |
| 2.c | 7.c  | 12.d | 17.a | 22.c |
| 3.b | 8.b  | 13.b | 18.b | 23.d |
| 4.c | 9.a  | 14.c | 19.a | 24.a |
| 5.a | 10.d | 15.b | 20.b | 25.b |

# ET/D

ELECTRONIC TECHNICIAN/DEALER

LEADING THE ELECTRONIC  
SERVICE MARKETS

July 1981, Vol. 103, No. 7

WALTER H. SCHWARTZ  
Editor

PETER B. CREDIT  
Assistant Editor

RAY ALLEGREZZA  
Contributing Editor

TOM GRENEY  
Publishing Director

DON FRASER  
Graphic Design

MISSY JERSETT  
Production Manager

LILLIE PEARSON  
Circulation Fulfillment

## FEATURES

### Low Cost CCTV

*A consumer product*..... 14

### Residential Security System Design, Part II

*And legal considerations*..... 16

### Microprocessor Troubleshooting

*A different approach*..... 28

### What's New?

*The Electronic Distribution Show*..... 32

### CET Quiz VII

*Puzzled?*..... 35

## DEPARTMENTS

Industry Report..... 3

Service Seminar..... 5

Letters..... 6

From the Editor's Desk..... 9

Newsline..... 10

Security Viewpoint..... 12

TEKFAQ..... 19

Test Instrument Report..... 37

New Products..... 38

Security Products..... 39

Classified Advertisements..... 40

Advertising Index..... 42

Reader Service..... 43



**On the Cover:** Closed Circuit TV has many consumer applications. You can watch the kids play in the back yard, watch the baby sleep upstairs or watch the front door so you do not have to run to answer it.



A HARCOURT BRACE JOVANOVIICH PUBLICATION



ELECTRONIC TECHNICIAN/DEALER (ISSN 0192-7175) is published monthly by Harcourt Brace Jovanovich Publications. Corporate offices: 757 Third Avenue, New York, New York 10017. Advertising offices: 757 Third Avenue, New York, New York 10017 and 111 East Wacker Drive, Chicago, Illinois 60601. Accounting, Advertising Production and Circulation offices: 1 East First Street, Duluth, Minnesota 55802. Subscription rates: one year, \$12; two years, \$20; three years, \$26 in the United States and Canada; all other countries: \$40. Single copies: \$1.50 in the United States and Canada; all other countries: \$4.50. Second class postage paid at Duluth, Minnesota 55806 and additional mailing offices. Copyright © 1981 by Harcourt Brace Jovanovich, Inc. All rights reserved. No part of this publication may be reproduced or transmitted in any form or by any means, electronic or mechanical, including photocopy, recording or any information storage and retrieval system, without permission in writing from the publisher. ELECTRONIC TECHNICIAN/DEALER is a registered trademark of Harcourt Brace Jovanovich, Inc.

POSTMASTER: Send address changes to ELECTRONIC TECHNICIAN/DEALER, P.O. Box 6016, Duluth, Minnesota 55806.

# SERVICE SEMINAR

**Servicing microprocessor controlled products.** Any technician who has worked on a product produced in the last few years certainly knows that the microprocessor has arrived. Manufacturers have jumped on the microprocessor bandwagon and don't plan on getting off for some time. Even their advertising is filled with such phrases as "Computer Control," "Microprocessor Based," etc. "Microprocessor Control" is sure to become the catch word in advertising for the 80's.

Why have manufacturers taken such a liking to the microprocessor? The answer lies in its versatility, for the same chip that's making sounds and blinking lights in your child's new toy can also be used to control your automobile engine as you drive to work. Another reason is parts count and with that cost. Manufacturers have found that designing a product around a microprocessor results in fewer components and smaller size than if conventional hard wired logic was used. This translates down to lower cost. The cost of the computer on a chip is down to about \$2.00 in OEM quantities, so it is no wonder that everyone is using them everywhere.

Finally, the reliability of the microprocessor chip has been well proven. After all they have been used over the years to guide our astronauts to the moon and control our National Defense missiles. And you certainly wouldn't want anything to go wrong there!

So, for these three reasons—versatility, cost and reliability—manufacturers plan many uses for this truly "universal circuit" in the future.

Since these microprocessor-based products aren't about to disappear overnight, and, in fact, they will be getting much more complex very shortly, what do you do about servicing such a product? Well, don't go and quit your job in search of a simpler profession—the microprocessor or MPU is nothing to be afraid of. By using your basic troubleshooting knowledge, you can fix anything from a microprocessor controlled can opener to a home computer.

I know you will have your doubts about my last statement the first time an MPU controlled product is sitting on your bench absolutely refusing to do anything no matter how hard you pound on the buttons. Where do you start, you say? Well, the first tendency is to say, "It must be the chip." After all with the many parts inside (over 10,000 transistors) surely one of them must have gone bad. So you decide to change the chip. My only advice is—don't! It's very unlikely that anything is wrong inside the MPU, and by changing the chip, you are likely to cause yourself new problems by damaging the P.C. Board.

So, if the problem is not in the MPU, where is it and how do I find it, you ask? Well, warm up your scope and turn on your digital voltmeter and you'll find out. Yes, that's right! Those are the only two instruments you need to find the problem. Also, you will need the Service Manual for the product. Don't attempt to fix anything this complex without the proper service literature or you'll just waste hours of your time and get very frustrated.

Now that you have the Service Manual open to the proper section, find the MPU on the schematic. It is usually drawn as a large empty rectangle, not showing any internal logic gates as the smaller IC's do. You will notice that near each pin number there will be code letters such as OSC, VDD, VSS, RST, etc. These tell you what each pin is. Since each manufacturer has his own code, you'll have to check the

manual. There are, however, some standard codes used in the industry. such as: CLK or OSC—Oscillator or Clock Input, can be 2 pins.

VDD	-B +
VSS	-Gnd.
VCC	-B + usually lower than Vdd, if used.
RST	-Reset—used to reset the MPU back to start of program.

The first thing we want to check is if the computer chip is getting the proper voltage and if that voltage is clean. Check the voltage at the (VDD) pin and make sure it is very close to the manufacturer's spec. Tolerances are usually given. Next connect your scope to the same pin and turn up the gain. You are looking for any excess ripple or spikes on the power supply buss. Any noise here can reek havoc with the MPU. If you find excess ripple, check the filter caps and the voltage regulator for problems. If the MPU has a VCC pin, repeat the above procedure for that pin.

Now that we know the MPU has clean dc of the proper voltage getting to it, we can proceed onto the next check. Locate the pin or pins marked (OSC) or (Clock). Every computer contains an oscillator which generates pulses that control the timing of the data flow within the MPU. Without these clock pulses the computer can do nothing. Check the (OSC) pins for proper waveform as shown on the schematic. Note that most single chip computers use either a crystal or a resistor capacitor network across 2 pins which are internally connected to an oscillator circuit. Some use an external oscillator circuit to supply pulses to a clock input. If you don't get the proper waveform at the OSC pins, check the components around these pins. If you still cannot get a clock pulse, then it's possible that the internal OSC is defective (though not likely).

The next pin to check is the (RST) pin. This pin is provided to reset the computer to the first step of the program during power up conditions or any time this pin is pulled low. The usual configuration is low for reset, but check your service literature for there can be exceptions. If this pin is held low, the computer will not advance beyond the first step of the program. If this pin is low, find out why. Some products such as video cassette recorders tie the system protection circuits such as photo transistor sensors, reel motion sensors, dew sensors, servo lockup, etc., to this pin so that if anything goes wrong with the deck, the computer will be reset and the deck shut down. If the reset pin is being held low, disconnect any external circuits one at a time until it goes high. When it does, you have found the problem. Troubleshoot the circuit you disconnected last and your problem will be solved.

If the preceding checks have not solved your problems, it's time to get into a little more complex troubleshooting. But don't despair, since you are working on digital circuitry, you will be looking for only highs and lows at the various points.

We will be troubleshooting the input and output ports of the MPU next. It is through these ports that data enters the computer and commands exit it to the outside world. The data into the computer is usually a high or low pulse from a switch or sensor being activated. When this pulse or combination of pulses enters the computer, the program reads this information and makes logical decisions about what to do next. In some cases, the computer may not do anything, such as if you try to enter a mode that the product is not capable of. On the other hand, if the right information enters the MPU, it may cause another set of instructions to start executing, some of which may cause pulses to appear at the output ports. More about servicing microprocessors next month.

# LETTERS

## State of the Industry:

In the May issue of ET/D there was an article in the Industry Report Section concerning RCA's Projection TV sales outlook for the year 1981. In the article Mr. Jack K. Sauter, Vice-President and general manager of the RCA Consumer Electronics Division made some statements that I simply cannot let go unchallenged. I am co-owner of an independent TV sales & service dealership here in Cayce, South Carolina (suburb of Columbia, S.C.) Our number one line is RCA Home Entertainment Products. We are no "Fly-by night" outfit. We are approaching our 10th year in business. We are the best equipped, most experienced RCA service business in the entire tri-city area (RCA Service Company included). We have been servicing RCA home entertainment equipment since 1955 (eighteen years with RCA distributor). In this article Mr. Sauter said and I quote, "One of the industry's most valuable assets, the independent television dealer has not successfully participated in the VCR business, mostly by choice." He also said and I quote, "while manufacturers can develop new products, much depends on the television dealer making a commitment to be a leader in the video market in the 1980's. A casual participant simply will not share in the growth that lies ahead." Mr. Sauter urged independent TV dealers to be more active in promoting the new video products. "If they do not establish themselves as respected video dealers, then the obvious alternative is to sell the commodity items of the business and settle for the thin profits that go with commodity selling." Before Mr. Sauter makes statements like this he should keep himself a little better informed as to what is really going on out here in the trenches. If he would care to board his private jet and aim it toward Columbia, S.C. I'll not only tell him, I'll be glad to show him why we are out of the VCR business and soon the video disc business. I'll be most happy to take Mr. Sauter to a discount competitor where he can purchase an RCA Video Tape Recorder at retail for less money than I can purchase it at wholesale from my friendly RCA distributor. How do they do this? Transshipping obviously from distributors who are willing to give it away apparently with RCA's blessings because it has been going

on ever since we opened our doors. How do I compete with this? Very simple; I don't. This same discount dealer has already chopped \$50.00 off the video disc player. It's just a matter of time until I'll close out that department also. If all the independent service dealers had an organization like the Teamsters union, we could tell Mr. Sauter that one more case of transshipping and we will push this little red button and no more RCA, TV's, VCR's, etc. will be serviced across this entire nation until it stops. I should live so long. The point I am trying to make in this letter is very simple: If Mr. Jack Sauter would spend more time in trying to rectify this terrible injustice being inflicted on the independent TV Sales & Service dealers by RCA and less time in ridiculing them for not bucking these giant discount centers maybe, just maybe, the independent TV Sales & Service Dealer, who has spent his entire life educating himself in the servicing of this equipment and keeping himself upgraded, while investing everything he has in his business, might start to turn a profit again. The manufacturer can and should decide who is qualified to sell his products. Amana did just that!

Clyde R. Lowery, CET, KL TV Inc.,  
821 State St., Parkland Plaza, Cayce,  
SC 29033

Editor: We've heard that RCA disc players are already being discounted to as low as \$399. Why? No one knows. There certainly can't be any profit at this price. More comments will be welcome.

## Professionalism:

Thank you for telling us all how to run our businesses: some of us certainly need it. I am in total and enthusiastic agreement with your ideas on clothing, and periodically do wear a tie on Service Calls along with double-knit slacks and shined shoes. My parts distributor, however, takes a different view than yours; and virtually every time I walk in with a tie, they rudely gawk at me, and sometimes actually ask, "Why do you wear a tie, John?" in the same tones as one would reserve for asking "Why did you swallow goldfish, Dad?" I should point out, too, that not all customers are happy with a technician who wears a tie. One man, years ago, indicated that he thought I was putting on airs, and that he preferred a "working man" like himself. In fact, it seems to be a common thread running through certain low-income working people that a person wearing a tie is trying to be

a "big shot" and is subject to suspicion. I do not let this deter me, however, as most people are delighted to see professionalism, and respond to it with trust. Here in Florida, with an average temperature of 85, it is not always too practical to wear a blazer, especially when many people are turning off their air conditioners to avoid large electric bills. I love your idea concerning the attache-style tool case. In fact, I actually made one myself with the help of the next-door auto upholsterer in 1974. I am also considering a specially designed rather large cart on wheels which I can roll into the customer's home, place his portable TV upon its flat top, have the front full of instruments, and drawers full of data, tools, parts, extensions, and a good lamp. The "shop on wheels" concept, but your idea is more compact. Now, about your \$54.00 per hour charge suggestion . . . . I have calculated that if I were to pay myself \$20,000/per year in 48 working weeks, and have a good truck and first rate equipment, that I would have to average a gross profit of \$120 per day, five days per week—minimum. That's an average figure which means I'd have to do better on some days to make up for the days when I did worse. With an efficiency of about 30% (actually producing chargeable labor) I could expect to divide my needed \$120 by 2.4 (30%) of 8 hrs = (2.4 hrs) and arrive at a figure of \$50.00 per hour which is pretty close to your own figure.

Now I have two very important questions to ask you, and I hope you'll find the time to answer them.

1) How does one "sell" these rates to an austere public? Is it better to handle it on the phone before the Technician goes out ("our minimum charge is \$30.00, and most repairs, including parts and service, are between \$30 and \$100") . . . ("our Trip Charge is \$18 plus parts and service") or is it better to simply go, act confidently and professionally, and present the bill and let the cards fall where they may?

2) What sort of an offer, short of a price come-on, will draw at least three calls per day? Most people in this business are either selling price, or simply saying, in effect, nothing ("I'm XYZ, I fix TV's. Big expert") Do you know of anyone doing anything imaginative that is working?

John S. Messier  
Home TV Service Co.  
2945 Novus St.  
Sarasota, FL 33577

Editor: Don't let the slobs get you down though I do concede the point on the jacket in Florida or Arizona temperatures. 1) How does one present adequate rates to the public? Being a cautious sort I would be inclined to warn the customer in advance, but I don't know if it is necessary. Customers may take high rates better than you think. I have seen a number of shops raise their rates significantly, expecting a lot of complaints, and very surprised with what resulted. I think you have to present them confidently knowing they are justified and stick by them in the few instances they are questioned. 2) I'm afraid I don't really know what draws business besides satisfied customers and word of mouth. I do know a few shops whose reputations are: "They aren't cheap, but they do it right." I would welcome further comments.

*I just read your editorial concerning professionalism in the repair industry. I paid particular attention because I started working in radio and TV in 1957. I was 12 years of age at the time. I started for Marvin Rahalasis T.V. Repair in Simmesport, LA. I now work as a systems technician (customer engineer) for IBM. I understand your concerns about professionalism. The IBM typewriter technician you refer to is very well trained indeed!! The ability to repair the typewriter is worth about \$20.00 per hour. The rest of the \$50.00 per hour is indeed in the wrapping and marketing of the technician. The field of consumer electronics repair is undergoing dynamic and wide sweeping changes. Parts inventories and equipment are getting more costly; transportation costs are skyrocketing. Now a shop owner had best know accounting or pay some one else for that knowledge. The consumer electronics market is poorly trained. The customer compares his TV repairman with his plumber or auto mechanic. He has to learn that electronics is an exacting science and requires unique training and ability for good technical performance. We technicians sell our skills all too cheaply. I put a lot into learning my fields and I expect to get a lot out of that knowledge. My company pays me to a labor market level. They charge ten times that for my time! That just means that the labor market is way too low. The only way to increase that labor market figure, is to stop working cheap! Most TV technicians I know are barely above the poverty level. They don't have to be in that position. It is only with*



## Easily the best.

In terms of resolution and accuracy, the Model 135 is easily the best handheld DMM available at any price. It's the only handheld offering 4½ digits. That gives it 10 times better resolution than the best 3½-digit DMM and provides 3 to 4 times more useable accuracy. Resolution isn't all you get. You get an easy-to-use instrument that's rugged and reliable enough to live in the read world. You get Keithley packaging. Its large, crisp LCD makes it

easy to read. Rotary switches and a color-coded faceplate make it easy to use. Once-a-year calibration and long battery life make it easy to own. Easy to buy at \$235.

## Best in price, best in performance.

There is a DMM designed specifically for your application in the Keithley line. Your Keithley distributor has instruments in stock for your convenience. Call today for complete information and a demonstration.

## Sound Choice.

New Model 128 Beeper DMM. Audible/visual indication on all 5 functions of this 3½-digit DMM lets you test faster, and the user adjustable threshold and special diode test function make it a sound choice. Unique features, \$139.



## Bench Bargain.

Model 176, Portable Bench DMM. Full 5-function LCD 4½-digit bench DMM offers 0.05% basic DCV accuracy. Keithley ease of use features include range and function annunciators, 1000 hour battery life and optional line operation. A bargain at \$269.



# KEITHLEY

Keithley Instruments, Inc.  
28775 Aurora Road/Cleveland, Ohio 44139/(216) 248-0400

their cooperation that they are kept there. The new modular technology in consumer electronic devices doesn't fail frequently at all. If a customer expected to have to pay \$100.00 for a service call, he wouldn't hesitate to place the call as he would only have to place at the most one call per year. Our biggest problem is that the TV owner of today is still paying, and expecting to pay, yesterday's prices. Most TV/Radio technicians are capable of getting in on the enormous micro computer/industrial electronics market. Large corporations are begging for technicians in smaller cities who will work on their equipment. It costs big dollars to service things like modems and radio terminals from hundreds of miles away. Your magazine should develop and publish a listing of corporations who need remotely located technicians capable of servicing their equipment on a contractual basis. Lack of remotely located service facilities keep many large electronic corporations away from very lucrative markets. Your publication could be the communication's medium for developing markets and service organizations where there currently are none! Professionalism would have to be key

in a technician's reaching and grasping these opportunities. The market for service is there. The technical ability is there. Getting the two together is the challenge of today.

Thomas R. Barnes  
1501 Monte Vista Dr.  
Gadsden, AL 35901

#### HELP NEEDED:

I need a schematic of a Bell and Howell AM-FM radio Model 2399A.  
Andrew Y. Horeczko  
1600 22nd St. W.  
San Pedro, CA 90732

Wanted: A schematic for an AKAI solid state stereo tape recorder Model #M-10.

William Hennen  
324 Forest Ave.  
Aurora, IL 60505

I need a flyback transformer for a Panasonic CT62P. The part number is TLF5007. It is not available from Panasonic anymore, apparently.  
Roberts Appliance Co., Inc.  
8861 Biscayne Blvd.  
Miami, FL 33138

I need a schematic for a Crosley Model 1128 and information on where I can purchase tubes for this radio.  
Frank Manial  
433 Love Rd.  
Sanford, NY 48657

Where can I get information on television sets manufactured in Taiwan? I need information on a color set: United, Mfg. by United Electronics International, Inc. Model No C-140; and a B&W set: Supre-Macy, Model 19TDM.  
Calvin Underwood  
112-28 197th St.  
Jamaica, NY 11412

Please publish the following letter: "I need a HAMMARLUND radio schematic model HQ-180-AZ. I am willing to copy it or buy copy of it or original. Thank you."  
Marios Hatziprokopiou  
151 A Langfield Drive  
Buffalo, N.Y. 14215

I need program pacs for a HP-65, Surveying Pac 1, Stat Pac 2, E.E. Pac 2 and Finance Pac 1.  
E.Z. Ventocilla  
P.O. Box 3285  
Santa Fe Springs, CA 90670



## Why your first choice should be Thordarson

Thordarson flybacks and yokes are re-engineered **exact** replacements. Designs are improved, flaws found in the originals are eliminated, quality workmanship is added, and they are flame retardant.

Thordarson flybacks are silicon encapsulated. All critical parts are completely embedded. Exposed materials cause temperature and coefficient of expansion differences that lead to early failures.

Thordarson deflection yokes have scientifically engineered and precisely wound coils to give distortion free pictures with excellent resolution.

Service is not everything to the O.E.M. . . . but it is to you . . . and it is to us. Make Thordarson your first choice when replacing original failures. Available from your Thordarson distributor at competitive prices.

New cross reference TVPG-14.  
Just off the press!  
Request your copy today.

# THORDARSON

**Thordarson Meissner, Inc.**  
Electronic Center  
Mt. Carmel, Illinois 62863





Walter H. Schwartz, *Editor (Duluth)*

Peter B. Credit,  
*Assistant Editor (Duluth)*

Tom Greney, *Group Vice President  
Publishing Director (Chicago)*

Don Fraser, *Graphic Design*

Missy Jersett, *Production Manager*

Diane Blesener, *Production Supervisor*

Lillie Pearson, *Circulation Supervisor*

Gene Bailey, *Reader Service*

Julie Laitin, *Promotion Director*

Dawn Anderson, *Classified Ad Mgr.*

Please submit editorial  
manuscripts to:  
Editor ET/D, 1 East First Street,  
Duluth, Minn., 55802.

### ADVERTISING SALES

Please send all advertising material to:  
ET/D, Production Mgr.  
120 West Second Street  
Duluth, Minn. 55802  
(218) 727-8511

**East Region**  
Steve Del Duca  
757 Third Avenue  
New York, N.Y. 10017  
(212) 888-4382

**Midwest Region**  
Keith Lewis  
111 East Wacker Drive  
Chicago, Ill. 60601  
(312) 938-2325

**Southern Region**  
Chuck Cummings  
613 N. O'Connor  
Irving, TX 75061  
(214) 253-8678

**Western Region**  
Joyce Amiri  
10741 Moorpark St., Suite #21  
North Hollywood, CA 91602  
(213) 980-7750 or (213) 760-1684



### HARCOURT BRACE JOVANOVIČ PUBLICATIONS

Robert L. Edgell, *Chairman*  
Richard Moeller, *President*  
Lars Fladmark, *Executive Vice President*  
Arland Hirman, *Treasurer*  
Thomas Greney, *Group Vice President*  
Ezra Pincus, *Group Vice President*  
Lawrence Witchel, *Group Vice President*  
Joe Bilderbach, *Vice President*  
James T. Gherna, *Vice President*  
George A. Glenn, *Vice President*  
Harry D. Ramaley, *Vice President*

# FROM THE EDITOR'S DESK

I've received a gratifying amount of thoughtful response to my editorial comments in the May issue of ET/D. And now I wish to comment on three of the letters we received and which appear in the letters column.

The letter writers and I are, I believe, pretty much in basic agreement. I have stated that I believe what the situation should be; they have stated what the situation is.

I do want to respond in turn to some of the comments: Service rates will always be the subject of discussion, short of the formation of a union or other organization with Teamster style clout. However, I do not believe that the low initial cost of much (most?) consumer electronics equipment has anything to do with service rates. To return to the IBM comparison, the technical knowledge and skill, and the investment in service van, parts, service data, the cost of maintaining a shop, etc., are just as great if you are repairing a \$68 black and white television receiver as a \$1500 electric typewriter (some typewriters are less expensive); the value of your time is the same and if you cannot charge for it—go out and get the job fixing typewriters! *Don't subsidize the consumer and the television manufacturer.* Don't feel sorry for the consumers; you can't eat gratitude. I learned that the hard way myself.

I wonder just what the real effect of price competition is. I have, over the last 20 years or so, seen shops advertising \$2 service calls operating right alongside shops charging \$24.95 for service calls. Those with the \$2 calls are the ones that did not survive. I remember back in about 1965 that a shop in the Minneapolis-St. Paul area agonized over raising its rates in one jump, from \$15 to \$25 for a service call. When the decision was made it was expected that there would be a 25-35% fall-off in business. The actual fall-off was not noticeable. Very few customers questioned the new rate. I have seen similar examples since then. I believe it *is* easier to get a proper rate than is generally thought. I have never heard of a shop going out of business because it charged *too much*. The shops mentioned here all were known to do good work and back it up and they still are in business, while those that tried to establish themselves by offering low prices have failed. Also consider this: If you double your rates you can have a fifty percent reduction in the number of repairs and still collect as much cash—and have time to go fishing. Which might not be too bad at that. So don't sell your services cheaply.

Along these lines I also see several dealers sell non-discounted products with some success right along side the discounters, mostly on the basis of good reputation for fair dealing and good service. Sales would be much easier without the discounter, but some can be made nevertheless. At times you can find brands that are not discounted in your area so direct price comparisons cannot be made. This helps. However, I agree, the manufacturers want to sell sets. Who sells them and how is secondary.

Sincerely

TV, VCR SALES REGISTER SHARP INCREASES. Total U.S. market sales to retailers of television receivers and video cassette recorders registered sharp increases in April over the same month last year, according to statistics compiled by the Marketing Services Department, Electronic Industries Association's Consumer Electronics Group. Sales of color television sets in April, 1981 were 703,620 units, an increase of 36.8 percent over 514,251 units sold in the same month a year ago. Color TV sales in the first 17 weeks of 1981 were 3,388,422, up 20.5 percent over 2,811,307 units sold in the comparable period of 1980. Monochrome television receiver sales in April, 1981 amounted to 332,443 units, a rise of 3.6 percent above 321,030 units sold in the same month a year ago. Sales of monochrome TV sets in the first 17 weeks of 1981 amounted to 1,815,479 units, a gain of 13.9 percent over 1,593,733 units sold in the comparable period last year. Video cassette recorder sales to retailers in April, 1981 were 78,571 units, an increase of 150.0 percent over 31,426 units sold in April of 1980. Sales of VCR in the first 17 weeks of 1981 rose to 347,085 units, up 83.1 percent over 189,550 units sold in the same comparable period a year ago.

GRUNDIG TO INTRODUCE VCR IN U.S. Philips-developed video 2000 VCR using 1/2 in. cassette will be introduced to U.S. market by West Germany's Grundig. Video 2000 format uses 1/2 in. cassette about the size of VHS, containing two 1/4 in. helical tracks. Longest playing cassette will record for eight hours, is turned over after 4 hours to play 2nd track, in the same manner as an audio cassette.

RADIO AND RECORDER SALES REACH \$750 MILLION. GE estimates radios and recorders each had retail sales of about \$750 million last year, expects 10% rise for radios, 15-20% increase for recorders this year, according to audio products mktg. mgr. William Smith. Growth in those respective categories will be paced by clock radios and radio recorders, Smith said.

ASIAN EXPORTS. Japan's exports of consumer electronics worldwide rose 35.2% in April to \$1.88 billion, according to Japanese finance ministry while electronics exports from Korea dipped 1.4% in first quarter to \$455.2 million, putting Korea behind in plan for \$2.39 billion in exports this year.

U.S. CONSUMER ELECTRONICS INDUSTRY COULD DOUBLE IN 1980's. U.S. consumer electronics industry will double in size in 1980's which is double growth rate of preceding decade, triple that of 1960-69, predicted Quasar Pres. Alex Stone.

RCA PHASE OUT. RCA Solid State is phasing out production of discrete power rectifiers and RF power transistors and is seeking to sell both lines. RCA has been making both products in Mountaintop, PA and Malaysia. The move follows close on the heels of the addition by the Reagan Administration of discrete transistors, rectifiers and diodes to the list of products that can be imported duty-free from qualified less-developed countries.

# WHAT'S BETTER THAN SPEED READING?

## SPEED LEARNING

(SPEED PLUS COMPREHENSION)

**Speed Learning is replacing speed reading. It's easy to learn...lasts a lifetime...applies to everything you read...and is the only accredited course with the option of college or continuing education credits.**

Do you have too much to read and too little time to read it? Do you mentally pronounce each word as you read? Do you frequently have to go back and re-read words or whole paragraphs you just finished reading? Do you have trouble concentrating? Do you quickly forget most of what you read?

If you answer "yes" to any of these questions — then here at last is the practical help you've been waiting for. Whether you read for business or pleasure, school or college, you will build exceptional skills from this major breakthrough in effective reading, created by Dr. Russell Stauffer at the University of Delaware.

### Not just "speed reading" — but speed reading-thinking-understanding-remembering-and-learning

The new *Speed Learning Program* shows you step-by-proven-step how to increase your reading skill and speed, so you understand more, remember more and use more of everything you read. The typical remark made by the 75,000 slow readers who completed the *Speed Learning Program* was: "Why didn't someone teach me this a long time ago?" They were no longer held back by the lack of skills and poor reading habits. They could read almost as fast as they could think.

### What makes Speed Learning so successful?

The new *Speed Learning Program* does not offer you a rehash of the usual eye-exercises, timing devices, costly gadgets you've probably heard about in connection with speed reading courses or even tried and found ineffective.

In just a few spare minutes a day of easy reading and exciting listening, you discover an entirely new way to read and think — a radical departure from any-

thing you have ever seen or heard about. Research shows that reading is 95% *thinking* and only 5% eye movement. Yet most of today's speed reading programs spend their time teaching you rapid eye movement (5% of the problem) and ignore the most important part (95%) *thinking*. In brief, *Speed Learning* gives you what speed reading *can't*.

Imagine the new freedom you'll have when you learn how to dash through all types of reading material at *least* twice as fast as you do now, and with greater comprehension. Think of being able to get on top of the avalanche of newspapers, magazines and correspondence you have to read... finishing a stimulating book and retaining facts and details more clearly and with greater accuracy than ever before.

### Listen-and-learn at your own pace

This is a practical, easy-to-learn program that will work for you — no matter how slow a reader you think you are now. The *Speed Learning Program* is scientifically planned to get you started quickly... to help you in spare minutes a day. It brings you a "teacher-on-cassettes" who guides you, instructs, encourages you, explaining material as you

read. Interesting items taken from *Time Magazine*, *Business Week*, *Wall Street Journal*, *Family Circle*, *N.Y. Times* and many others, make the program stimulating, easy and fun... and so much more effective.

Executives, students, professional people, men and women in all walks of life from 15 to 70 have benefited from this program. *Speed Learning* is a fully accredited course... costing only 1/5 the price of less effective speed reading classroom courses. Now you can examine the same, easy, practical and proven methods at home... in spare time... without risking a penny.

### Examine Speed Learning FREE for 15 days

You will be thrilled at how quickly this program will begin to develop new thinking and reading skills. After listening to just one cassette and reading the preface you will quickly see how you can achieve increases in both the speed at which you read and in the amount you understand and remember.

You must be delighted with what you see or you pay nothing. Examine this remarkable program for 15 days. If, at the end of that time you are not convinced that you would like to master *Speed Learning*, simply return the program and owe nothing. See the coupon for low price and convenient credit terms.

Note: Many companies and government agencies have tuition assistance plans for employees providing full or partial payment for college credit programs.

In most cases, the entire cost of your *Speed Learning Program* is Tax Deductible.

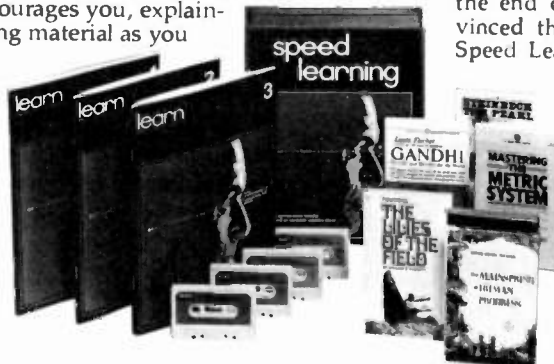

#### COLLEGE CREDITS



You may obtain 2 full semester hour credits for course completion, wherever you reside. Credits offered through Whittier College (California). Details included in your program.

#### CONTINUING EDUCATION UNITS



National Management Association, the world's largest association of professional managers, awards 3.0 CEU's for course completion. CEU's can be applied toward the certificate in Management Studies.

#### PROFESSIONAL SOCIETIES

*Speed Learning* is offered internationally to members of professional associations such as: American Chemical Society, Foundation for Accounting Education, Institute of Electrical and Electronics Engineers and dozens more. Consult your Education Director for information.

#### BUSINESS, INDUSTRY, GOVERNMENT

Many companies and government agencies offer *Speed Learning* as a wholly-paid or tuition reimbursement program. Consult your Training or Personnel Director for details.

**learn**  
INCORPORATED

113 Gaither Drive, Mt. Laurel, NJ 08054

ETD - 781

**YES! Please rush me the materials checked below:**

- Please send the *Speed Learning* program @ \$99.95 plus \$4 postage and handling.
- Please send the *Speed Learning Medical Edition* @ \$109.95 plus \$4 postage and handling.
- Please send the *Junior Speed Learning* program (ages 11 to 16) @ \$89.95 plus \$4 postage and handling.

**Check method of payment below:**

- Check or money order enclosed (payable to learn incorporated)
  - Charge my credit card under the regular payment terms
    - Visa  Master Card  Interbank No.  American Express
- Card No. \_\_\_\_\_ Exp. Date \_\_\_\_\_

I understand that if after 15 days I am not delighted in every way, that I may return the materials in their original condition for a full refund. No questions asked.

Name \_\_\_\_\_  
Address \_\_\_\_\_  
City \_\_\_\_\_ State \_\_\_\_\_ Zip \_\_\_\_\_  
Signature \_\_\_\_\_

If you don't already own a cassette player, you may order this Deluxe Cassette Recorder for only \$49.95. (Includes handling and delivery.)



Check here to order

— Outside USA add \$10 per item—Airmail extra —

## OPTIMA VALUE SALE

TO ORDER CALL TOLL FREE 1-800-327-0224

G.E. SYLVANIA, ZENITH 75% Off LIST NEW-BOXED

<input type="checkbox"/> 3A3	5 for \$11.88	<input type="checkbox"/> 6HV5	5 for \$26.19
<input type="checkbox"/> 6BK4	5 for \$22.06	<input type="checkbox"/> 6JE6	5 for \$24.75
<input type="checkbox"/> 6CJ3	5 for \$11.06	<input type="checkbox"/> 6LB6	5 for \$23.81
<input type="checkbox"/> 6FQ7	5 for \$ 9.19	<input type="checkbox"/> 6LF6	5 for \$24.75
<input type="checkbox"/> 6GF7	5 for \$16.06	<input type="checkbox"/> 17JZ8	5 for \$12.94
<input type="checkbox"/> 6GH8	5 for \$ 9.38	<input type="checkbox"/> 38HE7	5 for \$22.69

All Tubes Not Advertised. Write In at 75% off list. Sleeves Only. Singles 72% off list.

TRANSISTORS & I.C.'s . . . MIN. 5 3 Year Guarantee

<input type="checkbox"/> 2SC1172 Toshiba	\$2.75	<input type="checkbox"/> 1166BA521	\$1.25
<input type="checkbox"/> 2SC667A Sony	\$3.95	<input type="checkbox"/> 2SC1172B	\$1.95
<input type="checkbox"/> SG613 Sony	\$6.95	<input type="checkbox"/> 2SC1308K	\$1.95
<input type="checkbox"/> TA7222 Toshiba	\$1.50	<input type="checkbox"/> 2SC1358A	\$1.95
<input type="checkbox"/> TA7204P Toshiba	\$1.00	<input type="checkbox"/> 165	\$1.95
<input type="checkbox"/> TA7205P Toshiba	\$1.25	<input type="checkbox"/> 238	\$1.95

### REPLACEMENT FOR ECG

<input type="checkbox"/> 130	\$ .75	<input type="checkbox"/> 196	\$ .59	<input type="checkbox"/> 791	\$1.50
<input type="checkbox"/> 152	\$ .49	<input type="checkbox"/> 197	\$ .59	<input type="checkbox"/> 792	\$1.50
<input type="checkbox"/> 153	\$ .49	<input type="checkbox"/> 230	\$2.84	<input type="checkbox"/> 793	\$2.00
<input type="checkbox"/> 171	\$ .59	<input type="checkbox"/> 291	\$ .69	<input type="checkbox"/> 819	\$1.50
<input type="checkbox"/> 182	\$1.50	<input type="checkbox"/> 292	\$ .69	<input type="checkbox"/> 822	\$2.00
<input type="checkbox"/> 183	\$1.50	<input type="checkbox"/> 329	\$1.60	<input type="checkbox"/> 820	\$2.00
<input type="checkbox"/> 186	\$ .55	<input type="checkbox"/> 712	\$1.00	<input type="checkbox"/> 1167	\$1.95
<input type="checkbox"/> 195A	\$ .75	<input type="checkbox"/> 731	\$1.00		

### ZENITH, RCA & SYLVANIA MODULES

<input type="checkbox"/> 9-79	\$ 2.95	<input type="checkbox"/> 145256	\$11.56
<input type="checkbox"/> 9-92	\$ 8.95	<input type="checkbox"/> 145262	\$18.95
<input type="checkbox"/> 9-147	\$10.50	<input type="checkbox"/> Rep. ECG500A	\$ 9.95
<input type="checkbox"/> 150-190	\$12.95	<input type="checkbox"/> Rep. ECG523	\$13.95
<input type="checkbox"/> 138697	\$13.23	<input type="checkbox"/> Rep. ECG526	\$14.95
<input type="checkbox"/> 139546	\$17.36	<input type="checkbox"/> 32-39202-3	\$14.95
<input type="checkbox"/> 141154	\$19.60	<input type="checkbox"/> 32-43068-1	\$14.95
<input type="checkbox"/> 141427	\$19.33	<input type="checkbox"/> 32-41658-3	\$14.95

### GENERAL

<input type="checkbox"/> VEH070 VIDEO HEAD	.....	\$49.50
<input type="checkbox"/> 2 1/2 Amp 1000 PIV	.....	100 for \$ 8.00
<input type="checkbox"/> 15 ft. STEREO HEADPHONE Ext.	.....	10 for \$ 4.90
<input type="checkbox"/> STEREO Y ADAPTER 1/4"	.....	10 for \$ 4.90
<input type="checkbox"/> 9 ft. 59U F-F 99c		<input type="checkbox"/> 10ft 59U F-F \$ 1.09

### Quantity Prices Available

Letters of credit and all checks placed on deposit with Bank of Hallandale, FL. VISA/Bank Americard & Master Charge accepted. Min. order \$75. FOB Dania, FL. Catalog \$3, refundable upon order.

SEND CHECK OR MONEY ORDER TO:

## OPTIMA ELECTRONICS

2022 Tigertail Blvd., Dania, FL 33004

Phone (305) 920-3550

TOLL FREE 1-800-327-0224

Circle No. 106 on Reader Inquiry Card

# SECURITY VIEWPOINT

By Ray Allegrezza

This month I would like to discuss the subject of microwave sensor installations.

Before you can successfully perform 'false alarm free' installations, there are a number of things to keep in mind. Perhaps the biggest obstacle to installing microwave sensors is vibration.

In the event that the mounting surface is allowed to vibrate you can almost be assured that the incidence of false alarms will skyrocket.

When you can, mount your sensors on the outside of load walls. (studies show that load bearing walls are least likely to cause falsing problems).

Another thing to keep in mind is that a direct correlation exists between the microwave sensor's range and vibrations. As the range of the sensor increases, so does its reaction to vibrations.

After you install the sensor, hit the mounting surface and watch the amplifier output. The less the meter reading changes, the less possibility of false alarms.

The best mounting surfaces for microwave sensors have been found to be concrete walls, large wooden beams or brick.

Another problem you should be aware of is motion hazards. For example, a microwave sensor with a range of 50 feet can detect a man walking about 50 feet from the sensor. And while it can detect a man walking at 100 feet, the return signal may be too weak to produce an alarm condition.

Any moving targets (especially those larger than a man) will often times create a signal powerful enough to start the alarm even though the 'target' may be 400 feet away from the detector. Overhead doors, trains, and large trucks can and have done this many times.

Perhaps the most frequent cause of unwanted or false alarms are caused by signs, mobiles and freestanding objects.

As a result, the containment of microwave energy is both important and critical to the installation. The simplest way to do this is to use the building's structure to your advantage. Concrete, bricks and masonry will provide total containment of this energy form.

Microwave can also be contained by using 1/2" plywood or standard half-inch drywall. If you plan to use this type of material, all you have to do is to point the sensor toward the base of the wall and be sure not to overset the range.

Another thing to keep in mind is that sensors utilizing wide angle antennas are many times more susceptible to vibration than narrow patterns.

By taking advantage of this simple list of do's and don't's, you can greatly reduce the risk of making costly and unnecessary call-backs. Your customers will be happier as well since false alarm problems aren't good for either of you.

## Vital protection for PC Boards



Be safe. Desolder PC components with Endeco irons. Get proper HEAT TO MELT and strong VACUUM ACTION TO LIFT solder and cool both PC board and component without damage.

These PC components replaced fast with Endeco desoldering or soldering tools



Endeco professional features include safety light that denotes high, low and off on switch models. SS construction for long life, light weight and balance for easy use.

Contact your distributor for Endeco desoldering and soldering irons, kits and equipment—or write us today

## Enterprise Development Corp.

5127 East 65th Street  
Indianapolis, IN 46220  
Phone: (317) 251-1231

Circle No. 107 on Reader Inquiry Card

# ELECTRONICS

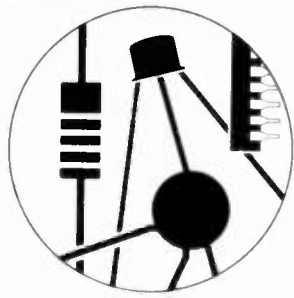

# BOOK CLUB

Take 6  
exceptional  
books for **\$2<sup>95</sup>**  
(values to \$116.70)

Start saving now for discounts up to 75% on hundreds of interesting, info-packed volumes . . . PLUS special Members' Bonus Benefits!

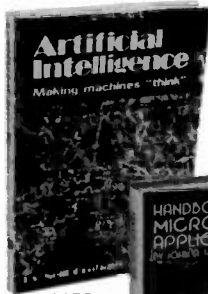

1076  
List \$12.95

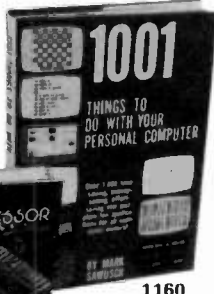

1160  
List \$12.95

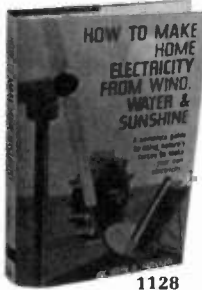

1128  
List \$10.95

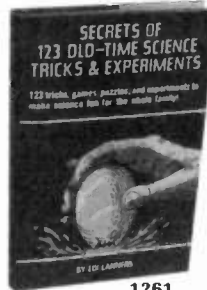

1261  
List \$12.95

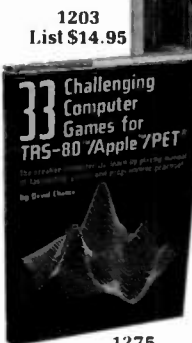

1203  
List \$14.95

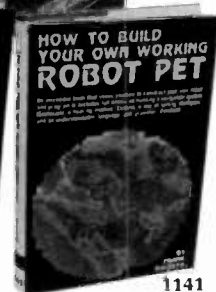

1141  
List \$11.95

More fine books to pick from . . .

- 99 Test Equipment Projects You Can Build. List \$12.95. No. 805
- A to Z Book of Computer Games. List \$12.95. No. 1062
- The Illustrated Dictionary of Electronics. List \$19.95. No. 1066
- Modern RADAR: Theory, Operation & Maintenance—2nd Ed. List \$22.95. No. 1155
- How To Install Your Own Stereo System—2nd Ed. List \$12.95. No. 1186
- The GIANT Handbook of Electronic Circuits. List \$24.95. No. 1300
- Fiberoptics. List \$14.95. No. 1236
- The Master IC Cookbook. List \$16.95. No. 1199

955  
List \$10.95



1071  
List \$12.95



1060  
List \$9.95

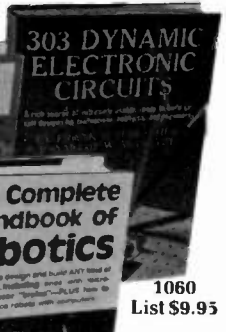

1101  
List \$15.95

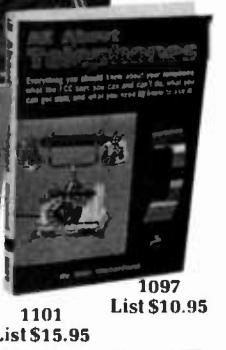

1097  
List \$10.95



1205  
List \$15.95

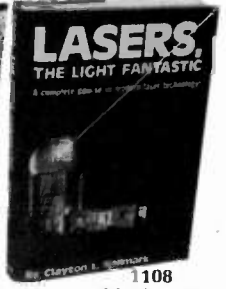

1108  
List \$11.95

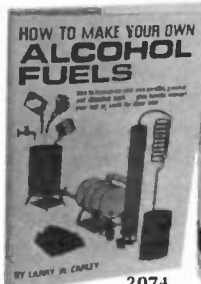

2074  
List \$9.95



1169  
List \$15.95

## 7 very good reasons to try Electronics Book Club . . .

- **Reduced Member Prices.** Save up to 75% on books sure to increase your know-how
- **Satisfaction Guaranteed.** All books returnable within 10 days without obligation
- **Club News Bulletins.** All about current selections—mains, alternates, extras—plus bonus offers. Comes 14 times a year with dozens of up-to-the-minute titles you can pick from
- **"Automatic Order".** Do nothing, and the Main selection will be shipped to you automatically! But . . . if you want an Alternate selection—or no books at all—we'll follow the instructions you give on the reply form provided with every News Bulletin
- **Continuing Benefits.** Get a Dividend Certificate with every book purchased after fulfilling Membership obligation, and qualify for discounts on many other volumes
- **Bonus Specials.** Take advantage of sales, events, and added-value promotions
- **Exceptional Quality.** All books are first-rate publisher's editions, filled with useful, up-to-the-minute info

## ELECTRONICS BOOK CLUB Blue Ridge Summit, PA 17214

Please accept my Membership in Electronics Book Club and send the 6 volumes circled below. I understand the cost of the books selected is \$2.95 (plus shipping/handling). If not satisfied, I may return the books within ten days without obligation and have my Membership cancelled. I agree to purchase 4 or more books at reduced Club prices during the next 12 months, and may resign any time thereafter.

805 955 1060 1062 1066 1071 1076 1097  
1101 1108 1128 1141 1155 1160 1169 1186  
1199 1203 1205 1236 1261 1275 1300 2074

Name \_\_\_\_\_ Phone \_\_\_\_\_

Address \_\_\_\_\_

City \_\_\_\_\_

State \_\_\_\_\_ Zip \_\_\_\_\_

(Valid for new members only. Foreign and Canada add 20%.)

ETD - 781

# A Low Cost CCTV System

A front door monitor—and much more!

Closed circuit TV is becoming a consumer product. It is valuable for security purposes, monitoring the front door, the swimming pool, the nursery, anywhere that needs remote watching. Here is ET/D's impression of one of the more inexpensive systems.

by Walter H. Schwartz

When ET/D first received product announcements on GBC's Look-Out 2000 CCTV system we were mildly surprised to see a system aimed at the residential market. We asked to be allowed to evaluate one and have found the Look-Out 2000 to be very functional and useful.

The Look-Out 2000 consists of a small CCTV camera and a modified black and white 12 inch television receiver and an intercom speaker/signal unit which, in effect, can replace a doorbell. The camera is positioned where it can view anyone who rings the doorbell (weatherproof housings are available) and the speaker unit is mounted where one might position the doorbell button. The monitor is positioned in the kitchen, bedroom, or wherever one wishes to monitor from. The monitor can be used as a conventional receiver; when the intercom button is pushed it switches automatically to monitor, or it can function a monitor continuously.

We used the Look-Out 2000 in a



Fig. 1. The GBC Look-Out 2000 system, camera, monitor, and intercom speaker.

typical sort of installation (your editor's home) and monitored the front door from the workshop and study which are in the back in the basement. It's great! No more running upstairs and through the house to answer the door; just tell the kids that ring the doorbell that there is no one home, from downstairs!

The system works very well. It is stable; it uses a crystal controlled sync generator. It has adequate contrast under almost all lighting conditions; room lights or the front door light are quite sufficient lighting. The camera is straightforward in design and construction (See Figure 2) as the schematic diagram would indicate. IC's are used extensively for

much of the video gain, as the sync generator, as the horizontal and vertical pulse formers, vertical output stage, voltage regulator, and a transistor array IC, IC 101, is used as sync amplifier, blanker, clamper, and two stages of video amplification and an IC is used as a temperature control sensor amplifier (in some models).

Considerable design effort has apparently been made to make the camera as automatic, as adjustment free as possible. There are no external adjustments other than the mechanical focus of the lense. Vidicon adjustments are internal setup adjustments. Adjustment for changes in ambient light are made by automatically adjusting the target

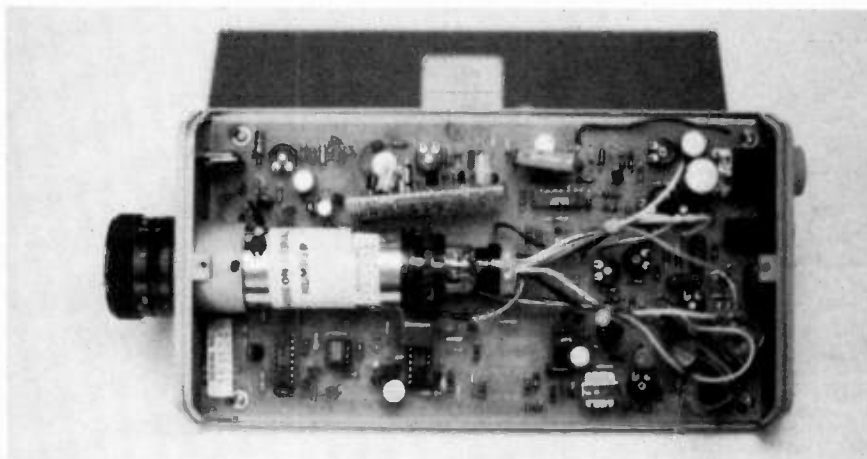

Fig. 4. The GBC Look-Out 2000 camera internal view. This model differs slightly from the schematic.

Fig. 3. A camera weatherproof housing.

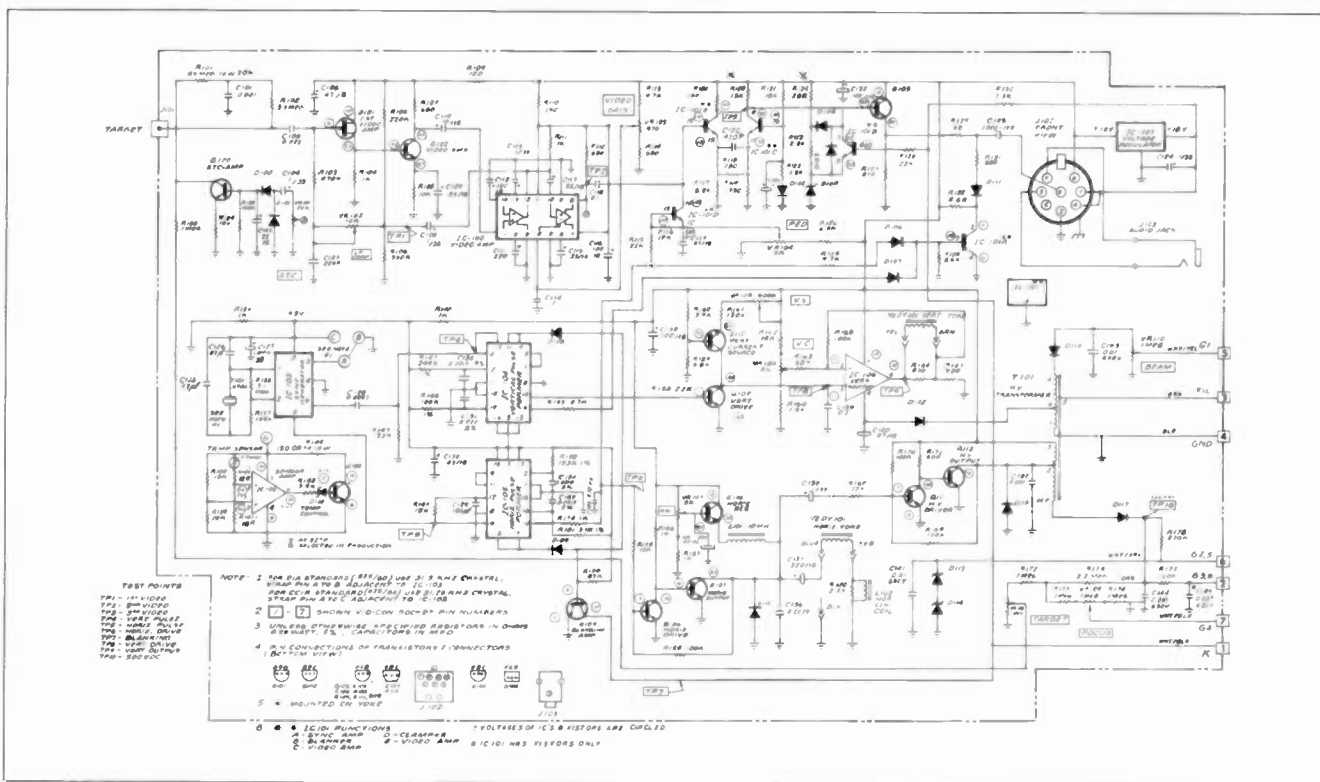

Fig. 2. Schematic of the GBC Look-Out 2000 CCTV camera.

voltage (see Figure 2). Video from pin 8 of IC100 is rectified by D100-D101 and its average level sets the collector voltage of Q100, the ATC (Automatic Target Control) amplifier and thereby the vidicon target voltage.

Most of the camera circuitry is so similar to receiver video and sweep circuitry it needs little explanation. Sync is developed from a 31.5KHz oscillator driving pulse countdown and shaping ICs. The horizontal sweep and the high voltage use separate driver and output transistors, both systems driven by IC105. The various G2, 5, 3, 6 and focus and target voltages are derived from this scan frequency source. There are no great mysteries here.

Video from the target of the vidicon sees a very high impedance load presented by Q101, a source follower. Q102 and IC-100 are simple video amplifiers. IC101 is a transistor array as mentioned earlier, within it, transistors IC101E and IC101C are differential amplifiers which drive Q102 an emitter follower which can drive a considerable length of coaxial cable to a monitor. Sync is added via D111 and sync amplifier IC101A, horizontal via D106, and vertical via D107.

Now for a little editorial comment. These inexpensive CCTV systems have broad application. The front door watch is only one of the most obvious. They can watch a swimming pool,

small children playing in a back yard, your prize tomato plants if you are afraid of vandalism, a farmer's prize sow about to give birth, the aisles in your store (or the cash register if you don't trust your clerk), and the price should make the equipment saleable. This GBC system has a suggested list price of just a little over \$400, with a reasonable dealer profit. With immediately available optional equipment up to three cameras can be switched to one monitor. Wide angle and telephoto lenses are available as are mounting brackets and weatherproof housings. And you should be able to both sell and service it, it should fit your business well. **ET/D**

# Residential Security System Design, Part II

## More Basics

In the first part of this two-part article on residential security system design we began to lay out a system and specify the components of it. Here we complete our design and tie up the loose ends.

by James A. Ross\* and Steven Browne\*\*

There is more to the security business than the technical design of security systems. Both the legal liability and the technical design aspects of residential security are covered in this article.

### Legal Liability

In response to the first article in this series Mr. P. Bernard Fritz of Fritz Radio and TV Service in Reading, Pennsylvania wrote:

"I am very pleased to see the starting of your series on security electronics . . . As with most shops facing a declining service volume, I am looking for ways to diversify my operation. I have considered adding the sale, installation, and service of security equipment to my business. The one thing that has deterred me from going ahead is the possibility of

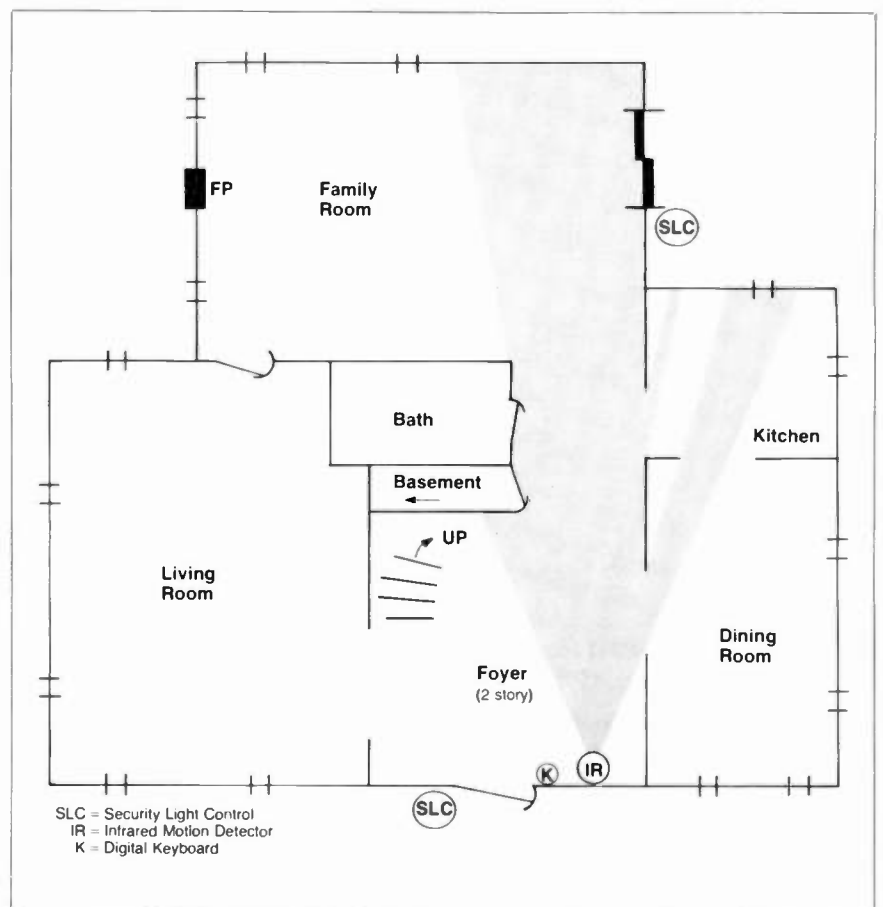

Fig. 1. First floor plan. Shaded area indicates coverage by IR motion detector.

lawsuits where burglars have managed to defeat the system which was installed. I would appreciate if you would address this particular situation and advise how one might avoid litigation, should a successful burglary occur, after a proper installation has been made . . . "

First, let us say "thanks" for writing and for bringing to our attention this

subject of liability—which certainly must be a prime consideration of anyone who is thinking of entering the security business.

There are three things which you should do to limit your liability in the security business:

- 1) Only work when the job is defined by a written contract,
- 2) Carry adequate liability

\* Capital Security and Surveillance Systems, Inc., Washington, D.C.

\*\* Solid State Electronics, Rockville, MD.



insurance, and

3) Establish a reputation for quality.

### Written Contract

Your lawyer will advise you regarding the advisability of incorporating, state and local licenses required, etc.; and you should seek his help in creating a simple, straightforward contract for use in connection with all commercial and residential security systems. This contract will specifically state that your liability is limited, and will describe the limit. This is your principal defense and should be carefully done.

Even with the written contract, you should be careful in what you or your salesman say while trying to make the sale. Your lawyer can advise you on the legal perils involved in oral claims, and how they could be used in litigation; but you should also be wary of what can happen to you outside of court. If a consumer complains to a consumer-action group, you'll find that you'll have to spend an inordinate amount of time defending yourself, instead of working in your business. These administrative procedures can be extremely expensive because of the time that you must spend to defend yourself.

### Liability Insurance

Just as your lawyer should be used in his area of expertise, your insurance man should be consulted to establish the necessary insurance protection. There is at least one firm which advertises liability protection for burglar and fire alarm companies. Bayly, Martin & Fay, Inc. of San Antonio, Texas. Your insurance company may know of others.

Premiums will be set based on several factors, but liability insurance is a must.

### Quality Reputation

Regardless of all other considerations your first and last line of defense is to do a good system design, use quality hardware, install it properly and service it promptly and well. Talk to people in the business; they'll tell you which equipment is good and which equipment is bad. Inform yourself about the shady competition which promises a lot for a very low price. If you understand what they do, you can protect yourself from the temptation of using shortcuts in order to try to bring your price down to their level. You are better off to refuse to bid on any job that you cannot truly take pride in.

Quality work is your first line of

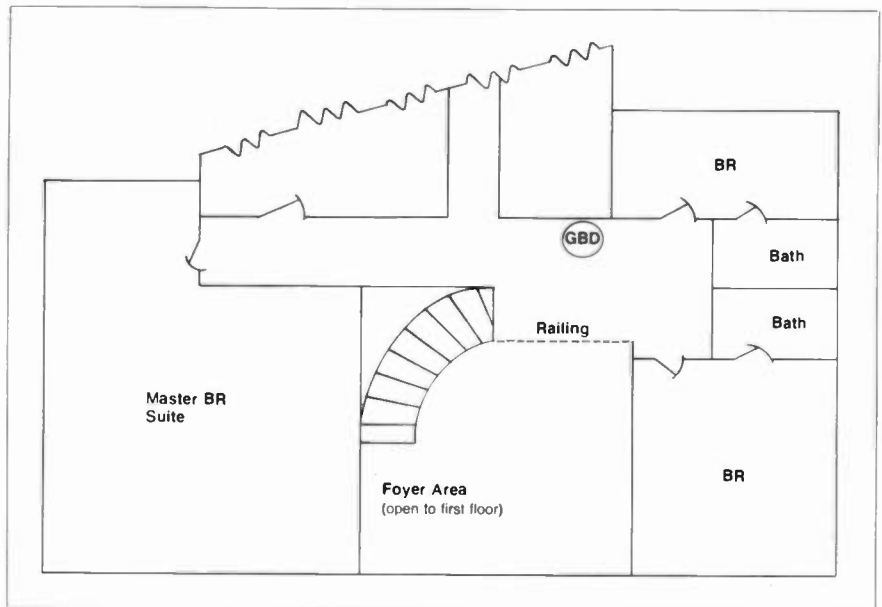

Fig. 2. Partial second floor plan showing location of the glass break detector (GBD) which protects the front door.

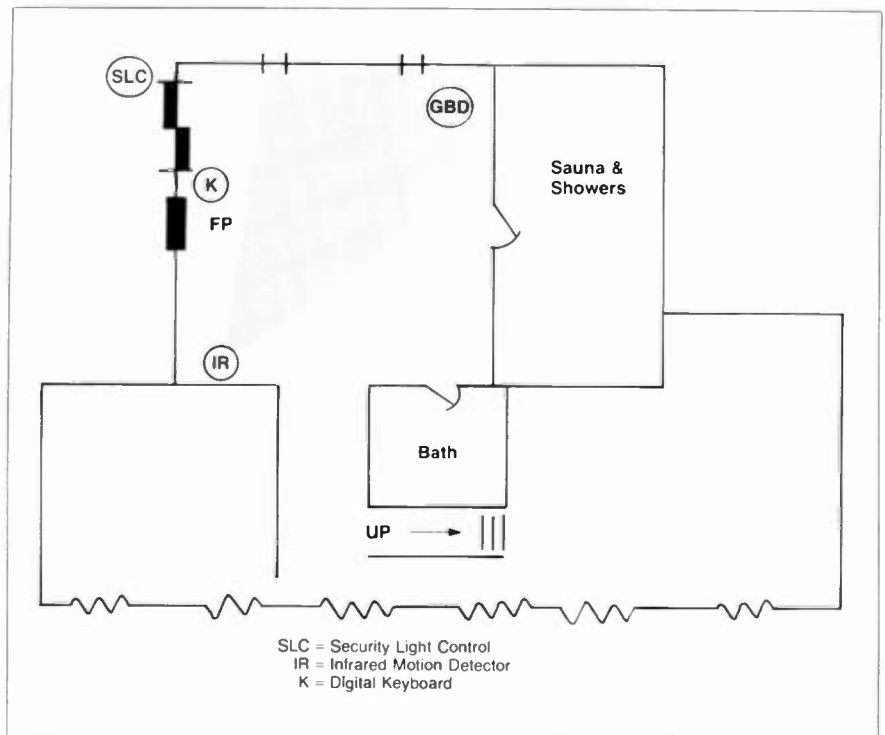

Fig. 3. Partial basement floor plan. Shaded area indicates coverage by IR motion detector. (Basement walls without windows are below ground.)

defense, because the systems you install will perform as intended; and, therefore, will not be defeated by a burglar.

Quality work is your last line of defense because it creates a reputation for quality. If a system should fail and you end up defending yourself in court, your good reputation might be the factor which will cause the decision to be made in your favor.

### Technical Design

In part 1 of this two-part article on the subject of design of a residential

security system we established the goal of the system and special considerations this way, "... most protection with the least inconvenience to family and servants." We also defined portions of the system as follows:

- 1) Nutone S-2252 Panel
- 2) Colorado Electro Optics Security Light controls at three doors. (These are not connected into the control panel.)
- 3) Perimeter circuit with recessed plunger switches on all exterior doors connected to N/C terminals. Floor mat

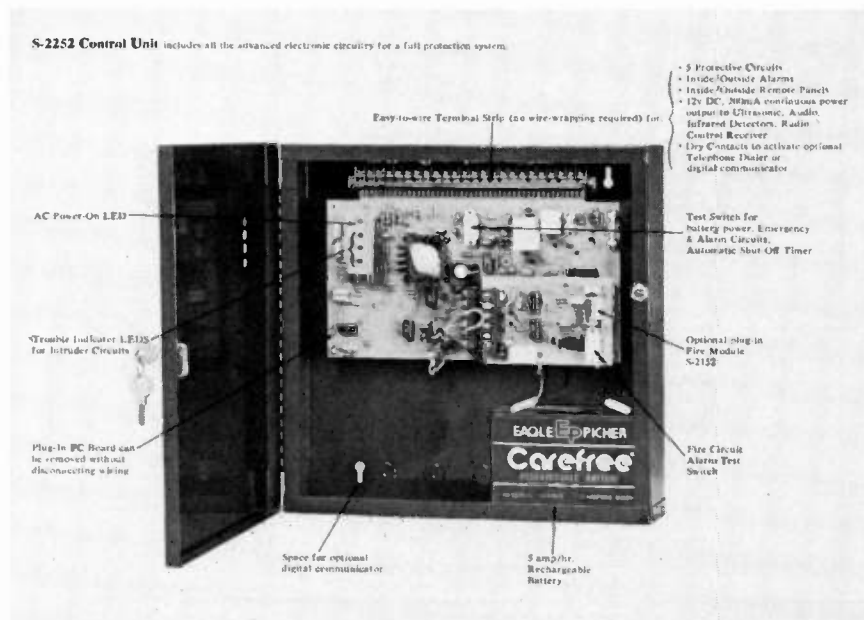

Fig. 4. Nutone S-2252 Control Panel.

at front door connected to N/O terminals. Glass break detectors "look" at all windows not otherwise protected, and are connected to the fast response perimeter terminals. Glass break detectors also protect the sliding glass doors. Alarm screens are used on all windows which can be opened, and are connected into the N/C normal response perimeter circuit.

4) Fire and smoke detectors are connected into the fire/smoke circuit.

5) Passive infrared motion detectors cover the first floor entrances and the basement entrance, and are connected to the interior circuit.

Always remembering "KISS" (see article in June issue) and keeping in mind that your reputation for quality work starts with good system design, we proceed with our theoretical design for maximum security with minimum inconvenience.

### Control Circuits

Figure 1, Figure 2 and Figure 3 show the layout of the house—first floor, second floor, and basement respectively with the location and coverage of the motion detectors and the location of the glass break detectors and digital keyboards. Note that only two of the doors are considered exit-entry doors and that these two have digital keyboards located on the interior wall next to the door. In connection with these exit-entry doors, it is extremely important to be sure that the coverage patterns of the passive infrared motion detectors do not prevent access to the digital keyboards for a person entering the house.



Fig. 5. Nel-Tech Digital Keyboard.

### Digital Keyboards

These are located *inside* the protected premises because there is no real reason for them to be outside, and if they are outside they are subjected to weather and vandals. Also, consider the possibility that the burglar accosts you as you return home. If the keyboard is outside and visible, he knows that you must deactivate the system before entering. If, however, the keyboard is inside, you have options that you would not have with an outside keyboard. First, you can ignore it, and the alarm will sound after the preset entry delay time. Second, you could press several keys

simultaneously, thereby creating an instant alarm. This "panic" feature cannot be used on outside keyboards because any passerby could cause an alarm at any time—an intolerable situation.

The digital keyboards allow you to turn perimeter and/or exterior circuits "off" or "on" without having to go to the control panel. Status lights on the keyboard provide the information on which circuits are "on," and also indicate alarm status. Circuits are activated (or deactivated) by punching in a simple code which can be easily changed if you suspect that it has been compromised. If an error has been made in entering the code, a different, reset, code must be entered before the system will accept any further commands. This feature means that if someone tried to guess your code and made an error, the number of variables is increased—making his guessing job even more difficult.

### Signalling

So far we have designed a system to detect fire or intrusion. The next step is to provide a signalling system which will call for help and perhaps scare the intruder into running away. Local alarms, such as interior or exterior lights, bells, horns, or sirens are used for these purposes. If there is sufficient noise, your neighbors—if they are at home—may telephone the police. Also, light and noise might frighten the intruder enough to cause him to leave. After all, he knows he's breaking the law and he doesn't know who can hear the alarm, nor how the alerted individual(s) will react.

Far more likely to result in decisive action, however, is remote signalling—frequently called "silent alarm". Every good fire/intrusion system should provide this feature because of the uncertainty of response to a local alarm. The most common method of signalling is through a telephone dialer which can be either a tape dialer or a digital dialer. The tape machine will dial a series of telephone numbers—friends, associates, neighbors—and play a recorded message such as "This is John Doe. My house at 1234 First Street has just been broken into."

More modern, and much to be preferred, is a digital dialer which dials a central station and transmits a digitally coded message. Yes, monitoring by a central station does cost the homeowner more. He must

pay a monthly charge for the service, but he *knows* that an alarm will be heard and that the proper authorities will be notified. Central stations are manned 24 hours per day, seven days per week. In any large city you'll have a choice of several local monitoring services. Also, there are several national services which maintain "800" telephone numbers so they can be dialed from anywhere without toll charges.

For this design we are going to use a horn on each level inside the house and an exterior bell fastened as high as possible on the rear of the house. We'll use the 3M monitoring service for our central station and a digital dialer with different coded messages for fire and intrusion.

### Other Sensors

There are many other sensors available which we have chosen not to use for various reasons. First and foremost among these reasons is the fact that the more complex the system, the more false alarms and breakdowns. Also, remember that the family must be able to live with the system and use it. If it is too complicated, there is a temptation to turn it off and not use it. Our perimeter circuit provides very good security without the mess (and expense) of taped glass. We have backed up the door plunger switch at the front door with a N/O mat switch. (Remember, the exit-entry doors and this mat switch must be connected to the exit-entry delay circuit.)

Ultrasonic and microwave motion detectors have not been used for two reasons. First, they are more prone to false alarms than the passive infrared motion detectors. Second, they do not have a sharp sensing pattern, tending instead to be very broad. That means that, if they were used, they would have to be connected into an interior delay circuit so that a person could enter and reach the digital keyboard without causing an alarm. We prefer to use the sharp-patterned infrared sensor aimed in such a way that the keyboard can be approached upon entering, but motion in other areas will cause an instant alarm.

In this regard let's consider a design goal that could be very important: the intruder should be repelled before he enters the house or as soon as possible after he enters. We do not want a weapon-carrying burglar to be well into the house before the horns and bell sound because we do not

want him to feel that he is trapped and has to shoot his way out.

### Operation

If our potential burglar approached any of the doors after dark, the security light control will turn on the outside lights and this alone will probably cause him to change his mind. We have not connected these controls into the alarm system because we would then create an alarm for every approach after dark—friends, delivery men, and even the homeowner himself.

The fire circuit in this design cannot be turned "off," and we recommend that the perimeter circuit be left "on" except during periods of heavy in and out traffic.

The panel, of course, is equipped with a battery and charger, so that it will operate even if normal power is lost. (Figure 4)

When the family leaves the house, the digital keyboard by the door is used to activate the interior circuit. The alarm does not sound because the motion detector is aimed away from the keyboard and exit door. Also, the user must "tell" the system that he is leaving so that it will not alarm

when he opens the door.

When he returns, the homeowner unlocks his door, tells the system that he has returned, and disarms the interior circuit—all through the digital keyboard next to the door. (Figure 5)

Before the advent of remote control through digital keyboards, the location of the control panel was critical because of the need to get to it to prevent an alarm after entering. In this design, with two remote keyboards, the panel location is not as critical. It will be somewhere on the second floor so the family can activate the interior circuit (motion detectors in basement and on first floor) when they retire for the night.

### Summary

The fire/intrusion alarm system which has been described in these two articles is representative of a good security system for a residence. The objective was the simplest possible design which affords a high degree of protection with a minimum of down time and false alarms. We've tried to present the reasoning behind all of our design decisions, and, as always, your questions and comments are welcome. **ETD**

## When you price by "The Book" everyone benefits!

Eliminates undercharging...controls overpricing...treats both customer and shop owner fairly!

### The Parts Pricing Book

Lists over 200 pages of current parts prices for instant reference. Computerized with automatic up-dating service.

### The Labor Pricing Book

The new 4th Edition will expand your business mind as never before! Greatly simplified while being expanded to include all the new products, as well as the traditional...\$29.50.

**CALL TOLL FREE: 800-228-4338**

8/5 C.S.T. MONDAY/FRIDAY

**sperry tech inc.** P.O. Box 5234 Lincoln, Nebraska 68505

tv & radio  
tech's guide  
to pricing

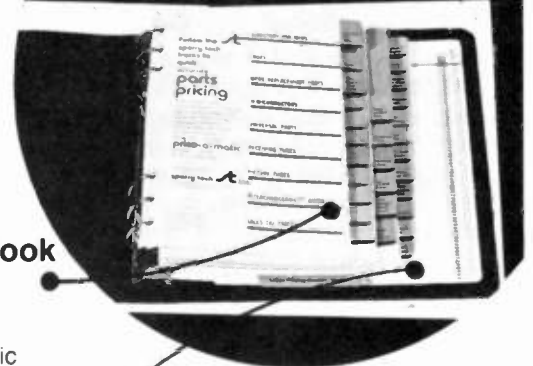

Each book is a great time saver! Pricing parts and labor from **ONE BOOK**...together they're fantastic!

# Microprocessor Service

## A Break with Tradition\*

To most of the microprocessors while not new is a rather mysterious little black box and we still haven't faced its troubleshooting. Here is a new concept of troubleshooting to apply.

by **Steven K. Roberts**

Numerous articles in these pages have presented, over the years, a number of observations about microprocessors which suggest some of the fundamental differences between "smart" and "normal" logic. Not the least of these is the central concept of operation on the basis of a stored program rather than the configuration of the hardware.

This, and the many other aspects of microprocessor-based systems that make them so flexible, results in a real need for a fresh approach to service. Classical debugging and fault isolation techniques are quickly proven inadequate when the attempt to track down a problem with an oscilloscope carries one endlessly in a circle. Assuming some general understanding of microprocessor fundamentals, let's look at the philosophies and tools that are central to their repair.

The job may seem trivial, perhaps, when you consider that most of a system's logic is contained within a relatively small number of complex IC's. Even though this renders invisible the points in the logic which would otherwise be useful as test points, you can always just swap chips, right? The catch here is that the

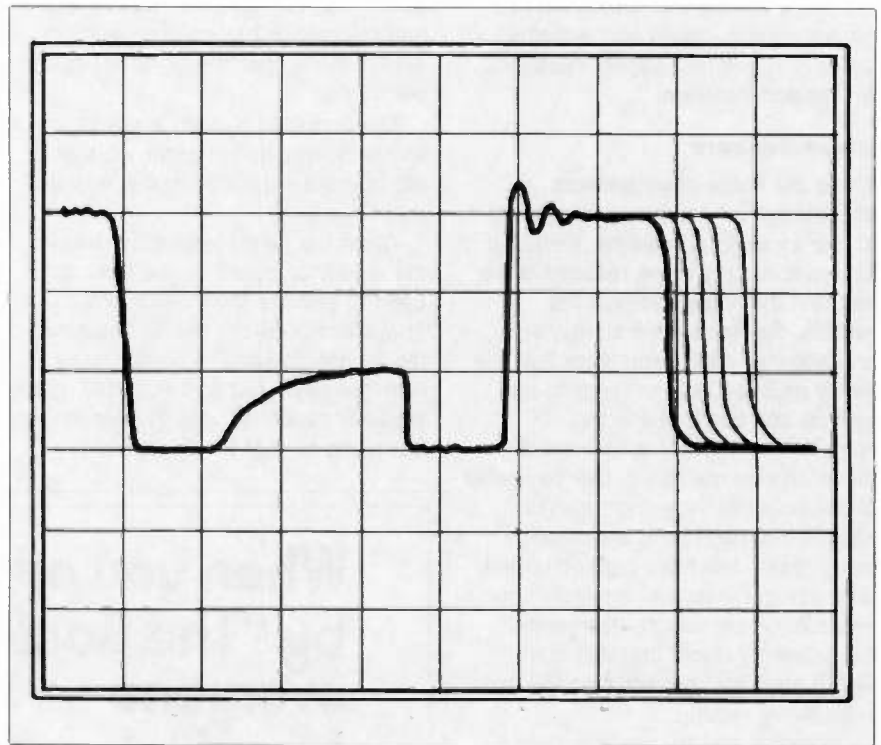

Fig. 1. A scope view of a hypothetical bus line.

majority of system problems do not involve simple device failure.

System problems, instead, tend to be a little more obscure than that. We can split them into two broad, overlapping categories, which we'll call the "inexplicable crash" and the "consistent hardware problem."

The inexplicable crash appears without warning, usually. Perhaps a marginal bus buffer somewhere in the system delivers a "1" instead of a "0" on some bit during an instruction fetch, or perhaps a noise pulse from a nearby air conditioner has the same effect. Maybe an address bit is slow to change and the CPU, for just a few hundred billionths of a second, sees a memory location other than the one which was intended. Suddenly, unpredictable events start to occur with extreme rapidity: instead of, say,

a "Decrement Register B" instruction, the processor may see, for whatever reason, a CALL to some location in high memory. This location may well be a data storage area or even random garbage left over from power-up. At this point, control is long lost, and it is doubtful that it will ever be recovered until the program is reloaded or restarted.

The central point in the inexplicable crash syndrome involves the large, even catastrophic, scope of the effect which can result from a seemingly minor problem. In a "traditional" piece of equipment, one could reasonably expect that the problem, even if intermittent, would have effects limited to a specific part of the circuit—thus providing valuable diagnostic information. A system crash, however, leaves no trace of its cause.

\* Adapted from the book "Micromatics" by Steven K. Roberts, published by Scelbi Publications, Elm, Ct.

It is worth including in this category the less dramatic but equally frustrating phenomenon of spontaneous data changes. Arising from similar circumstances, or from a random fluctuation on a WRITE line, something changes somewhere in memory. It is easy to see that the effects of such a phenomenon are as unpredictable as the phenomenon itself.

Somewhat less baffling, usually, is the consistent hardware problem. This could involve a dead or marginal interface chip, a bad connector, or any of a number of "external" conditions which interfere with healthy operation of a system. Unfortunately, hardware problems are perfectly capable of causing software crashes.

Again, we have a situation wherein a "minor" problem can have far-reaching consequences. A process that is controlled by a micro is likely to come to a halt—or go wild—if a failure develops in the hardware. In the Old Days, when a controller in a similar situation might have contained hundreds of op amps, gates, and discrete components, a hardware failure would have likely caused a repeatable but non-fatal error in the operation. An identical hardware failure in a microprocessor-based controller could bring the process to its knees.

### **A new kind of service**

From the foregoing, we get the idea that microprocessor systems are rather unforgiving machines which go "south" at the slightest provocation. It's not as bad as it sounds—the devices themselves are intrinsically reliable. Problems generally stem from questionable design or environmental stress of some sort.

Let's look a bit at some of the differences between microprocessor service and the more traditional kinds.

First, as noted above, the scope of a "minor" hardware problem is potentially huge. To track down a bad logic gate in a non-micro system, a reasonable measure of intuition and a methodical approach will in most cases pinpoint the ailing part. But in a micro, all you may know is that "it died about an hour ago," and when you push the RESET button, it works fine. Now what? You may sit and watch it for hours and never see another failure. Or, it may fail continuously, refusing to respond in any way to your ministrations. In either case, you have no immediate

clues concerning the source of the problem.

Second, there is the presence of tri-state logic, both on the bus and, often, in other areas. As you may recall from earlier articles on the subject, this suggests the existence of a third possible output condition from a logic device: high impedance. When in this state, the device has electrically "disappeared" as far as the bus—and other driving devices—are concerned. The existence of tri-state logic is a major boon to the computer industry, but it's a real pain to debug. Not only is it next to impossible to determine with an oscilloscope where a signal is coming from, but the high impedance state (floating) is confusing. It may look low, high, or somewhere in between on the scope, and even experienced engineers and technicians sometimes confuse these indications with "asserted" logic states or with failure conditions. Figure 1 shows the appearance of a hypothetical bus line on an oscilloscope.

Third, there is the level of system knowledge required. Since a well-designed microprocessor system has most of its application-oriented functions defined in software, hot pursuit of a problem can quickly become futile if the software is not understood. In a random-logic unit, persistent search with the aid of a logic diagram has a much higher probability of being successful.

Fourth, since 100% testing of a design under all conditions is frequently impossible, subtle engineering errors are quite capable of escaping detection and finding their way into the field. Some of them are insidious indeed, leading to all sorts of "kluged" custom fixes.

This is a good place to point out a key but blurred difference: design debugging versus repair. Although a distinction not unique to microprocessors, it merits mention. In the debugging case, one is constantly suspecting the design, the wiring, and even the power supply connections; in the repair case, one generally assumes that all of that is OK and that the problem is either a device failure or a bad connection. Well . . . there are a lot of subtleties here. A design which allows more than a minimum of noise, heat sensitivity, and other evils, can be at fault even if everything tests OK. The assumption that the design is flawless is usually a dangerous one.

Fifth, the speed of execution can

create some major problems in seeing what is going on in the system. With instructions zipping by in a few microseconds, it is difficult to see cause and effect relationships without software "scope loops" or, preferably, specialized test equipment. A further manifestation of this problem is the relationship between "real time" and "CPU time."

The problem here is that the computer is matched to the process by any of a number of tricks, including "polling loops" and "interrupts." These techniques are necessary because there is seldom, if ever, a 1:1 correspondence between the instruction execution of a microprocessor and the events in the real world to which it is connected. If you were debugging, say, a real-time clock program, and you placed the system in a "single step" mode which allows you to perform only one instruction for every push of a button, you would find that it would appear to have a continuous interrupt condition. With 60 Hz reference pulses arriving every  $16 \frac{2}{3}$  milliseconds, there is no way that you could realistically view program operation without somehow simulating the interrupt conditions. This is not a prohibitive problem, but must be considered at the hardware design level—and usually isn't.

So, there are five major differences (at least!) between microprocessor service and the "traditional" kind (whatever that is). It is worthwhile to keep these deliberately in mind as we consider some of the tools which have evolved to address them.

### **The tools of detection**

One of the most readily apparent requirements of microcomputer-based equipment is in the area of repair tools. The characteristics we have just discussed introduce some problems when one attempts to dive into a system with only a scope, VTVM, and signal tracer.

That old standby, the oscilloscope, has come a long way in the last few decades and shows no indication of slowing down. Bandwidths of a gigahertz have been reached, integration with signal-processing systems has been accomplished, and their general flexibility and performance have totally obsoleted some of the old workhorses of the sixties.

The oscilloscope as a microprocessor analysis tool still has validity. It can display the shape,

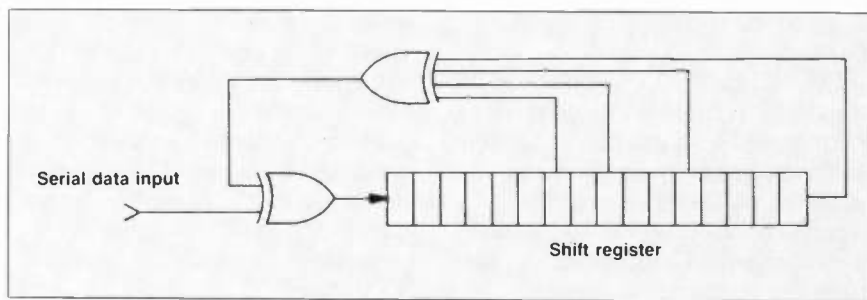

Fig. 2. The basic principle of the signature analyzer.

frequency, level, and polarity of applied signals. It can present multiple traces for view, enabling relationships to be graphically observed. It can spot noise, glitches, and marginal conditions like no other instrument can, and readily handles an infinite variety of analog signals.

But there are some shortcomings inherent in the oscilloscope which limit its usefulness in testing and debugging microprocessor systems. Even with delayed sweep, meaningful analysis of long, complex bit streams is an exercise in eyestrain and patience. Its inability to capture random intermittent events or to display fast pulses with low repetition rates makes it only marginally useful in a large percentage of field service applications. Two channels—or four—aren't enough to unambiguously observe the status of eight or sixteen bit wide data paths. Worse, events can only be observed on a scope AFTER a trigger point—and that trigger can only be "one bit" wide, not a preset combination of addresses or data bits.

These limitations don't by any means spell the obsolescence of oscilloscopes—they are still unsurpassed in the observation of noise, analog signals, and other phenomena. And, despite the negative comments, it IS possible to track down a problem in a microprocessor system with a scope. But some more appropriate instruments are clearly needed and, along with some of the less tangible "tools" like board swapping, we should look at a few of them.

### Tools—old and new

If you have ever had the pleasure of poking about on a board full of IC's, you are probably familiar not only with oscilloscopes but also digital multimeters, logic probes, "DIP clips," and related implements. As we look now at some of the newer tools, you'll note some fundamental differences. First, they're relatively "smart"—

performing a more complex function than simple display of conditions at the probe tips. Second, the information is extensively processed to provide the user with relatively high-level feedback, such as "truth tables" or timing diagrams. Third, they're expensive, and less likely to appear on the surplus market or on hobbyists' benches.

Let's start with the granddaddy of them all.

### Logic analyzers

In 1973, Hewlett-Packard started something of a revolution in circuit design and debugging equipment with their introduction of the Model 1601 logic analyzer. In essence, the analyzer is a recorder of a number of simultaneous data channels, triggered by the occurrence of a preset combination of conditions to produce a stored image of events both before and after the trigger event.

A logic analyzer functions as an expanded oscilloscope, but overcomes many of the scope's intrinsic limitations. It can monitor a large number of channels of data flow or logic states (up to 48 at this writing), such as a 16-bit address bus, 16-bit data bus, and 16 status bits, without the need for constant operator intervention. It can—and this is most useful—operate in a "pretrigger" mode wherein the events leading up to a crash can be studied after the fact. If a failure, for example, can be associated with the processor's excursion out of a limited range of memory addresses, the analyzer can be set to freeze the captured information constantly circulating through memory at the moment the address bus carries a value greater than the limit. The person studying the problem can then look back with leisure and observe the exact manner in which the failure occurred. With an oscilloscope (even a storage scope), this is impossible.

Modern logic analyzers offer considerable operating convenience

as well, normally presenting data on a screen in the user's choice of timing diagrams, binary bit maps, octal or hex data, and sometimes even assembler mnemonics. They also allow glitch detection down to a few nanoseconds.

With all these advantages, logic analyzers generally outperform oscilloscopes on the microprocessor service bench—but they still have a few shortcomings. Like a scope, an analyzer is a passive device, recording and displaying data but unable to manipulate the unit under test. For it to be of any use, some central portion of the ailing system must be functioning or the device is useless and one must revert to conventional techniques.

### Comparison testers

Next to logic analyzers, comparison testers occupy a very minor portion of the microprocessor test equipment market. Yet they can, in certain applications, provide extremely useful information. Occasionally, as in the case of the \$8950 Model DTO-1 from Gould's Biomation Division, the comparison testing function is incorporated with a logic analyzer in one instrument.

This particular unit contains a tape drive which accepts 3M-type mini cartridges. Each can be used to store up to 100 data traces, which are then accessed by the instrument and compared with the data from the unit under test as a prearranged sequence of steps is followed. The operation allows efficient GO/NO-GO testing of a piece of equipment in the field, once the correct reference traces have been stored by the manufacturer.

### Signature analyzers

Hewlett-Packard, again, is responsible for the first of this extremely useful class of instruments. Their essence is depicted in Figure 2.

Signature analyzers use, typically, a 16-bit shift register like that shown in the figure to "compress" a binary stream of data for comparison with a known-good stream—normally established at the factory. The technique requires that the unit under test provide not only the binary data, but also the clock, a start pulse, and a stop pulse (implying that a piece of equipment must be designed for signature analysis from the beginning). Between the start and stop pulses, the binary data is clocked into the shift register, and at the

completion of the interval, the value remaining in the register is displayed on the face of the instrument. Comparison of this 4-digit hexadecimal number with the one printed in the equipment manual for the tested node (or etched onto the PC board near the appropriate test point) then gives an unambiguous indication of the function of that part of the circuit. Concerning accuracy: the 20 MHz, \$990 Hewlett-Packard Model 5004A is said to have a 100% probability of verifying that a correct signal is indeed correct, and a 99.998% probability of catching a faulty one.

There is a fundamental operational difference between logic and signature analyzers. The former presents the operator with substantial amounts of complex information which can be used to determine the operation of a circuit. The user must understand the system intimately and be able to correlate the large quantities of displayed data in order to deduce the nature of a problem. A signature analyzer, on the other hand, while providing a very limited system view which would be useless in the context of the logic analyzer, requires no interpretation: the data represented is either correct or it isn't. By tracing back through the circuit, comparing indicated signatures with those established as correct by the manufacturer, the debugger can generally arrive (with a minimum of system knowledge) at the source of a problem.

Alas, signature analyzers have their problems as well. The unit under test must be self-stimulating because, like the logic analyzer, these instruments are passive and display only as much information as can be extracted from the circuit. The requirement for self-stimulation is actually a bit more stringent, as the device must not only be generating some data, but it must also provide the start, stop, and clock signals. This calls for correct functioning of a significant portion of the system even before debugging can begin.

Further, the design which incorporates signature analysis must provide for initialization to a known state prior to testing, or else misleading failure indications could result. Also, there must be some provision for opening feedback loops to accommodate the test, since recursive logic cannot be traced dependably to the source of a

problem. These requirements, as well as the need for anticipation during the design of all potentially required test signals, make signature analysis a non-trivial technique to successfully implement.

### **In-circuit emulators**

Ah, but all is not lost. A technique called In-Circuit Emulation, pioneered by Intel, can be married to signature analysis or used alone to solve most of the problems outlined above.

An emulator eliminates the need for the unit under test to be self-stimulating; it can be "dead in the water" and still be approached with organized analytical techniques. The trick is the replacement of the system's CPU chip with a cable connected to the instrument, whereupon processor operation can be simulated with either the original application program or, more appropriately, a set of diagnostic routines. Suddenly, much is possible: program execution (and thus system behavior) can be observed one step at a time, complete access to memory and internal registers is possible, and breakpoints—defined places in the flow of a program where the system temporarily halts for close examination—are easily implemented. With this equipment, any problem can be nailed down in the field.

I mentioned the marriage of signature analysis and emulation—this is an attempt to get the best of both worlds that seems to be gaining favor in the microprocessor test equipment marketplace. With the elimination of the requirement that the unit under test be at least centrally functional, it is possible for the GO/NO-GO simplicity of signature analysis to be available at all times—on a system driven entirely by predefined diagnostics running in an emulator. One such hybrid unit is the Millennium Systems Microsystem Analyzer, costing about \$2390 and requiring an \$895 "personality card" for the type of processor under test.

### **Board swapping**

Any discussion of microprocessor system service tools must consider those tools which are not purchased instruments, but rather test techniques. The most prevalent of these is probably the time-honored process of swapping suspect boards with "known-good" ones in order to isolate a failure. It's simple, convenient, and requires no expensive

instruments. For these reasons, it is often the technique of choice when customer uptime requirements call for maximum speed in getting a sick system back "on line."

In essence, the process is as follows: Verify that a problem exists. If a circuit board is suspect, swap it with a good one and test the system. If it works, you're off the hook; otherwise, swap all the boards and test the system again. If it works, the problem is in one of the original boards; otherwise, it must be somewhere else in the box (power supply, backplane, etc.). If it IS one of the boards, swap them back one by one until the faulty one causes failure: then put the good one in, replace the rest of the original boards, and test again. If a problem remains at this point, the appropriate parts of the procedure should be repeated.

Here, however, is an all-too-common occurrence: you reinsert all the original boards and the problem is gone. Hmm. You may have unknowingly cleaned a dirty contact, dislodged a foreign piece of metal, changed the unit's temperature, or caused a reinitialization by cycling the machine's power. Good luck.

There are some other problems with the board swapping approach, beyond the uncertainty implied in the case we just described. A set of spare boards is frequently very expensive, and there is the possibility that a problem which has lain dormant in one of them will be introduced into the system. That's embarrassing. Also, despite careful attempts to prevent it, it seems that one always accumulates a collection of unknown, intermittent, or suspect boards which, of course, can't be installed in a functioning system without considerable uncertainty.

### **Diagnostics**

It is generally in the interest of system manufacturers to take steps to keep the number of field spares to a minimum. Numerous problems are associated with a large spares inventory, not the least of which are the actual equipment costs and the probability of un-updated units existing after engineering changes take place. (Talk about servicing nightmares—installation of a known-good spare causes new problems because the revision levels are different!)

One of the approaches used to improve the efficiency of field testing at this level is the inclusion of built-in

*continued on page 38*

# What's New from the EDS

## Test Equipment and TVRO Systems

This year's Electronic Distribution Show offered a look at the continuing evolution of test equipment and some interesting new developments.

by **Walter H. Schwartz**

The Electronic Distribution Show, this year held in Atlanta, May 5, 6, and 7, is where ET/D went to see the latest test equipment and other products of interest to its editors and readers. This year's show produced no great surprises but instead illustrated the continuing evolution of, for example, the digital multimeter and the general purpose oscilloscope, and did feature the introduction of the first, to our knowledge, neatly packaged for two-step distribution, TVRO, satellite earth station.

So what's new in test equipment? As I just stated, nothing startling. However, there were several interesting introductions. Keithley introduced its new Model 128 (Beeper) DMM, a 0.5% accuracy, 3½ digit unit intended for industrial and consumer service and repair. The beeper indicates levels above



Fig. 1. Keithley's new Model 128 Beeper DMM. Circle Number 172.

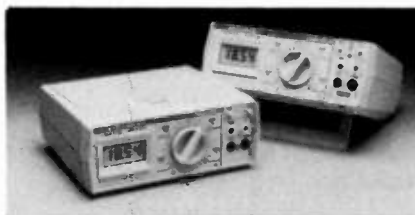

Fig. 2. Beckman's Tech 350 and 360 Bench-top DMM's. Circle Number 173.

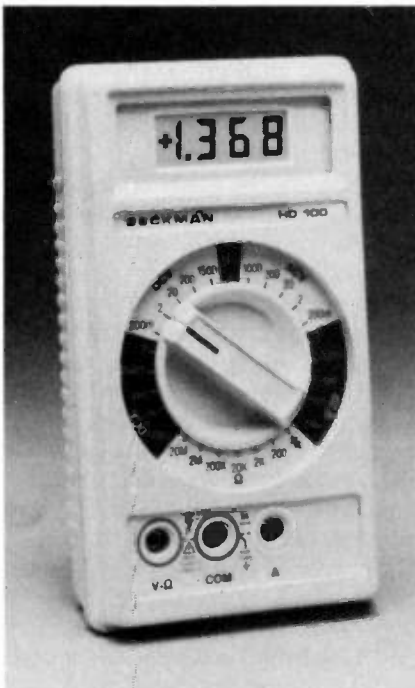

Fig. 3. Beckman's heavy duty Model HD-100 DMM. Circle Number 174.

threshold on volts or amps and below threshold on ohms. It displays a reading, a direction arrow and beeps, simultaneously. The beeper threshold may be set anywhere in the range of 10 to 300 digits, i.e., 1-30 ohms on the 200 ohm range. The 128 also has a diode test range, a shock mounted circuit board and full overload protection. Its cost is \$139.

Beckman introduced a couple of new bench-top DMMs and a

ruggedized handheld model. The bench-top meters, the Tech™ 350 and Tech™ 360 are similar 31 range, 0.1% basic dc accuracy units. The Tech™ 350 is an average reading meter and the Tech™ 360 is a true rms meter capable also of reading only the ac component of a composite voltage. It also has a built in temperature measuring capability. The battery life is expected to be 12,000 hours for each of these instruments., due, according to Beckman, to a specially designed CMOS IC and a special LCD.

Beckman's new HD-100 in its bright yellow O-ring sealed heavy walled ABS case is intended for rough treatment. It is expected to survive drops and input overloads beyond those sustained by previous DMM's according to Beckman. The HD-100 sells for \$164.

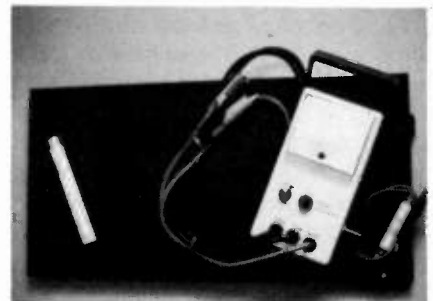

Fig. 4. GC Electronics' Magnameter and MicroMeters intended for microwave oven service. Circle Number 175.

A new specialized test meter was presented by GC Electronics. GC's Magnameter™ is a meter specifically designed for microwave oven service. It features extra heavily insulated test leads and built in switching to permit easy measurement of both magnetron plate voltage, and plate current (voltage across a 10 ohm test resistor). It has a neon flasher which also indicates high voltage and a



discharge "dump," switch for discharging the high voltage filter capacitor. The Magnameter™ sells for \$116.95. GC also recently introduced the Micrometer, a simple and inexpensive microwave oven leakage detector. About the size of a marking pen, the Micrometer is simply moved around the door seals. A green meter reading is safe; a red reading means danger. The Micrometer sells for \$10.95.



Fig. 5. VIZ's Monitor ISO-V-AC, Model WP-29. Circle Number 176.



Fig. 6. VIZ's Model WT-540B AC Leakage Tester. Circle Number 177.

VIZ displayed a couple of items that have been available for a time but were not previously prominently featured, the Model WP-29, a variable isolation transformer/line monitor and Model WT-540B an ac leakage tester. The WP-29 ISO-V-AC Monitor is an isolation transformer and a 0-150 vac variable source rated at 2 amperes. The monitor meter, which may be switched to either line input or variable output, has a nearly 3 1/2 in. long scale and an accuracy of  $\pm 3\%$  of full scale. The WP-29 is protected by a thermal overload in the input and a 2 amp

circuit breaker in the output. Primary to secondary leakage is reportedly less than 0.1ma. The WT-540B ac leakage tester is a simple device. However it, or its equivalent, is necessary equipment in every shop. Connect the ground lead of the W7-540B to a suitable ground and probe all exposed metal of the unit to be tested with red probe. The meter shows leakage level; the 0.5 and 0.75 ma recommended leakage limits are indicated. The cost of the WT540B is under \$35.00 and the WP-29 ISO-V-AC is \$139.95. N.A. (North American) Soar, a newly organized company formed to market the full Soar test instrument line showed six oscilloscope models, various DMMs, and a wide range pulse generator. The scopes range in price from about \$700 for the 6020, a 20MHz dual trace instrument, to nearly \$1700 for the top of the line 6045. At least one model is available with a built in DMM. Soar offers several DMMs. Top of the line is the Model 8010, a 3 1/2 digit LCD meter with a basic dc accuracy of 0.1%. in addition to other, more standard features, it has a high/low limit function. The 8010 is priced at \$199.95. Other meters in the Soar DMM line include the 8025 priced at

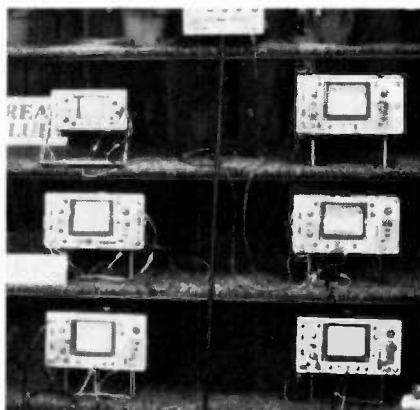

Fig. 7. N.A. Soars oscilloscope line includes at present 6 models, one with a built in DMM. Circle Number 178.

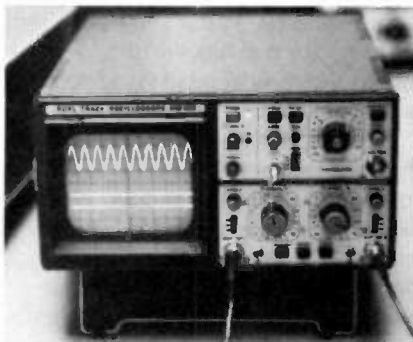

Fig. 8. Hameg offers five different oscilloscopes. Here is the HM203, the latest addition to the line. Circle Number 179.

\$169.95. It offers 0.25% basic dc accuracy and is otherwise similar to the 8010. Lower priced meters are the 0.8% model 8080 at \$99.95 and the thin case 8090 at \$79.95.

Hameg whose name is probably quite new to most of you, displayed its line of oscilloscopes. These have been mentioned in ET/D (Model 312 was featured in December '80) but they have not yet achieved broad distribution. The Hameg scope line includes models from a three inch 10MHz single trace unit to a 50MHz, dual trace, delayed sweep storage scope. New at the show was Model HM 203 a 5 inch, 20MHz, dual trace instrument, complete with probes for \$580.



Fig. 9. B&K-Precision's new SA-1010 Signature Analyzer. Circle Number 180.

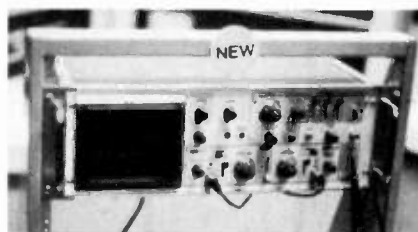

Fig. 10. The B&K-Precision 1479B rackmounting 30MHz dual trace oscilloscope. Circle Number 181.

B&K Precision displayed its full line of test equipment, including the new Model 1479B, a 30MHz dual trace rack mounting scope with a full compliment of features, and its SA-1010 signature analyzer. Signature analyzers, offered by B&K Precision and one or two other manufacturers at present, are at this time, probably the last word in digital troubleshooting tools. Each test point in a circuit that has been previously characterized for signature analysis can be checked quickly against known conditions and the result is read on a four-digit hexadecimal display. The resulting

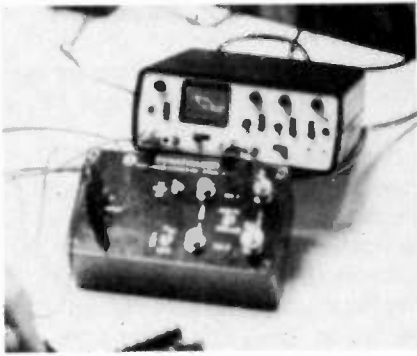

Fig. 11. Non-Linear Systems Dynatracer, an advanced in circuit, curve tracing, component tester. Circle Number 182.

troubleshooting efficiency is excellent.

Non-Linear Systems presented a new in circuit curve tracer called the Dynatracer. The Dynatracer appears to go a significant step beyond the simple component curve tracer testers previously offered. It uses a comparatively high frequency and has switchable impedance levels which make it possible to pick out not only good or bad semiconductor junctions and relative resistances and capacitances, but to effectively judge good bad or capacitors, resistors and inductances in association with each other and with semiconductors. The Dynatracer will be available as a separate unit for \$149.95 and built into various NLS oscilloscopes at slightly less cost.

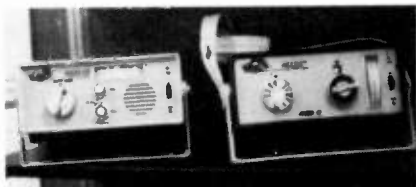

Fig. 12. A new Master Subber and field strength meter from PTS Electronics. Circle Number 183.

Other products worth noting were a new field strength meter and a new master subber from PTS Electronics which also was distributing literature on a soon to be available microwave oven leakage tester, very attractive new tool cases from Chicago Case Co. and Platt and similar cases filled with tools by Vaco and Xcelite, and an improved Model SS20 desoldering system by Sylvania with a new no clog feature.

The last, and to me the most exciting, news from the show was: manufacturers are now packaging TVRO, television satellite receiving systems for distributor to dealer sales. Channel Master and Lindsay both offered such packages. Lindsay will make up systems to suit individual

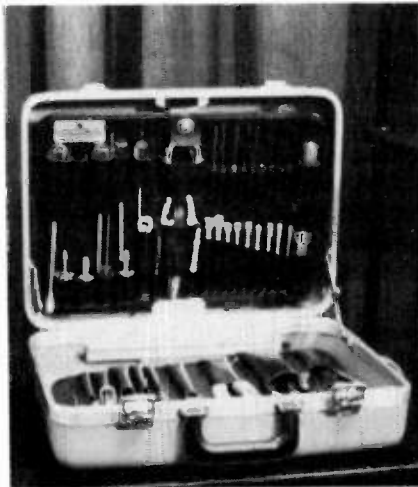

Fig. 13. New tool cases from Platt, Chicago Case Co. and with tools a,b,c from Vaco. Circle Number 184 for Platt, 185 for Chicago Case and 186 for Vaco.

needs; Channel Master offers two standard pre-package systems, one with a 10 ft. and one with a 12 ft. dish. Channel Master has carefully worked out the details of two-step distribution of earth stations, to our knowledge the first to do so, and has its 10 ft. dish system, which is to retail for \$5900, packaged in seven cartons, none of which exceeds 136 lbs. in weight, and which will altogether fit into a van or pickup truck. The dish and mount are easy to assemble and the mount needs a minimum of labor and concrete to install. Expected time of assembly on a pre-poured foundation is said to be four hours.

The Channel Master receiver is weatherproof and mounts at the base of the dish. It is remotely controlled



Fig. 14. Channel Master's TVRO antenna set up. Circle Number 187.



Fig. 15. The control unit for the Channel Master TVRO receiver. Circle Number 188.

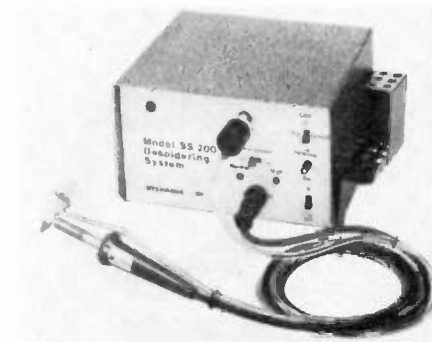

Fig. 16. Sylvania's SS 200 Desoldering System with improved anticlog features. Circle Number 189.

and the output to the television receiver is on TV channels 3 or 4.

Channel Master has pre-programmed printing calculators to supply elevation and azimuth information for anywhere in the U.S., and once set to a given satellite the mount can be indexed to enable return after changing to another satellite.

Channel Master feels that there is the potential for sales of several hundred thousand private earth stations to video enthusiasts and to remote areas of the country. **ETD**

# CET TEST Quiz, Part VII

## Color TV and Ohm's Law

This is the seventh of ET/D's CET Quizzes. If you have done well it is about time to consider taking the CET Examination.

by Frank K. Egner, CET

Here's the next CET test preparation quiz on electronic fundamentals. If you are making passing scores on these quizzes, you should be ready to take the CET Associate exam. The questions you are missing may indicate those areas where reviewing would be helpful. The last six questions of this quiz relate to the NTSC standards for color TV transmission and reception. Each future quiz will include some questions on TV or other home entertainment or industrial devices.

CET exams can only be administered by CET Certification Administrators. A fee is required to cover expenses of administration, grading, and issuance of certificates. However, if both the Associate exam and one Option exam are taken at one time, they count as one exam. Contact the Certification Administrator of The Electronics Technician's Association or The International Society of Certified Electronics Technicians in your area. The national

headquarters addresses for both have been given in previous issues of ET/D.

The passing score for all CET exams, and these quizzes is 75%. Good testing!

1. A transmitter operating on 0.15 GHz radiates a wavelength of:
  - a. 0.5 meter.
  - b. 1.0 meter.
  - c. 1.5 meter.
  - d. 2.0 meters.

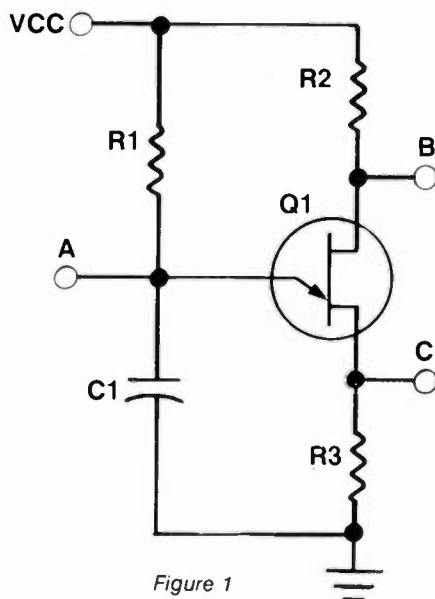

Figure 1

2. In figure 1, Q1 is a:
  - a. JFET.
  - b. MOSFET.
  - c. UJT.
  - d. SCR.
3. The output frequency of the device in figure 1 is primarily controlled by:
  - a. The input signal.
  - b. R1 and C1.
  - c. C1 and R3.
  - d. The VCC voltage.
4. A scope connected to terminal B in figure 1 would display:
  - a. The amplified input at C.
  - b. A ramp voltage.
  - c. A negative pulse train.
  - d. A positive pulse train.
5. In figure 1 the name of the Q1 terminal at C is:
  - a. Base 1.
  - b. Emitter.
  - c. Source.
  - d. Cathode.
6. In figure 1 when terminal A is forward biased with respect to terminal C:
  - a. A positive pulse appears at B.
  - b. A negative pulse appears at C.
  - c. Capacitor C1 charges.
  - d. A to C develops negative resistance.
7. 10 one-half watt resistors, color

coded brown, black, brown, gold, are connected in parallel. An ohmmeter across the combination indicates normal conditions if it measures between:

- 8.5 and 11.5 ohms.
- 9 and 11 ohms.
- 9.5 and 10.5 ohms.
- 95 and 105 ohms.

8. The maximum current that can be passed by the combination in question 7 without overheating any resistance in tolerance is:

- 69 ma.
- 690 ma.
- 72.5 ma.
- 725 ma.

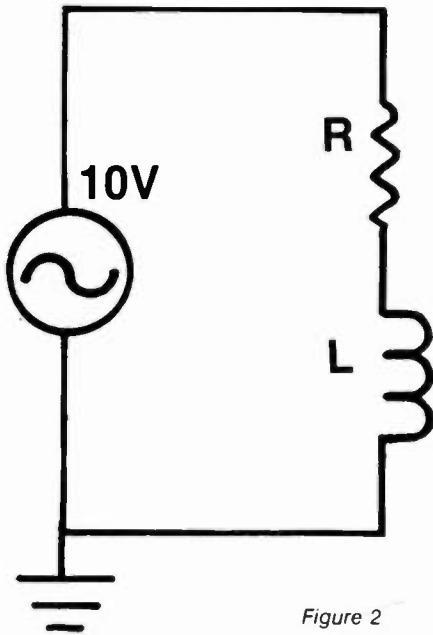

Figure 2

9. Using scope measurements in figure 2,  $X_L$  can be determined by  $E_L/I_L$ . This result is approximate because:

- Coil resistance has been neglected.
- The phase angle has not been considered.
- Voltage and current are out of phase.
- More than one but not all are correct.

10. In the RL circuit of figure 2:

- $E_L$  plus  $E_R$  equals 10v.
- $E_R$  minus  $E_L$  equals 10v.
- 10v minus  $E_L$  equals  $E_R$ .
- $E_R$  plus  $E_L$  is over 10v.

11. In figure 2 decreasing the generator frequency will:

- Increase the resistor voltage.
- Increase the phase angle.
- Increase the inductor voltage.

d. Decrease power dissipation.

12. Connecting a scope across L in figure 2 will display:

- A differentiated sinewave.
- A rectangular waveform.
- A highly distorted sinewave.
- None of these.

13. The cutoff frequency of a circuit occurs when:

- The phase angle approaches 90 degrees.
- The signal out is 0.707 the mid-range signal.
- Output power is 0.707 the mid-range power.
- The signal out is reduced by one half.

14. The product of applied voltage and total current in an ac circuit containing resistance and reactance is:

- Real power.
- Reactive power.
- Apparent power.
- True power.

15. In a high-Q parallel resonant circuit:

- Line current is maximum.
- Tank current is maximum.
- EC equals Q times  $E_{app}$ .
- The phase angle is maximum.

16. A 5-tube ac-dc radio uses one each 50C5, 35W4, 12BE6, 12BA6, and 12AV6. If the 12BA6 filament burns out:

- 0v appears across the 12BA6 filament pins.
- B+ appears at all tube anodes.
- 117v appears across the 35W4 filament pins.
- 0v appears across the 12AV6 filament pins.

17. Six tubes with 600 ma heaters are connected in series across the 120v line. Their filaments total 80v. What value resistor must be connected in series?

- 67 ohms.
- 6.7 ohms.
- 670 ohms.
- 6.7K ohms.

18. In question 17, what is the minimum wattage of the resistor?

- 250 watts.
- 25 watts.
- 40 watts.
- 10 watts.

19. Which of the following devices is

most likely to be damaged by a static charge during handling?

- MOSFET.
- Bipolar transistor.
- UJT.
- SCR.

20. In color TV transmissions, the luminance signal is composed of:

- 0.30G + 0.59R + 0.11B.
- 0.59G + 0.30R + 0.11B.
- 0.11G + 0.30R + 0.59B.
- 0.59G + 0.11R + 0.30B.

21. When the color signal is transmitted as I and Q signals, the I and Q bandwidths are:

- I = 1.5MHz, Q = 0.5MHz.
- Q = 1.5MHz, I = 0.5MHz.
- Both I and Q = 1.5MHz.
- Both I and Q = 0.5 MHz.

22. In the reproduced TV picture, the brightness information is contained in the:

- I and Q signals.
- R-Y and B-Y signals.
- Y signal only.
- More than one but not all above.

23. A maladjusted receiver may display a 920 KHz (herringbone) interference pattern developed from the:

- Video and sound carriers.
- Video and color carriers.
- Color and adjacent channel carriers.
- Sound and color carriers.

24. The frequency and phase of the color oscillator is critical. A shift in oscillator phase can be detected by:

- A change in the hue of the picture.
- A change in color saturation.
- The complete absence of one color.
- A change in overall picture brightness.

25. Some color receivers demodulate I and Q signals and others demodulate R-Y and B-Y signals. The main difference in these demodulators is the:

- Frequency of the 3.58 MHz oscillator.
- Phase of the 3.58 MHz oscillator.
- Both a and b are correct.
- Neither a nor b is correct.

The answers are on page 3.

# TEST INSTRUMENT REPORT

This month we are going to discuss something that is not a physical tool or a test instrument, but instead is a series of carefully formulated troubleshooting procedures.

The system is the result of careful dissection of television receivers, circuit by circuit, and the development of comprehensive troubleshooting procedures

16 covers tube type horizontal oscillator/AFC circuitry typical of many Japanese chassis. Procedures 20 through 39 cover solid state horizontal oscillators/AFC, and outputs; procedures 30 through 42 cover both tube type and solid state vertical problems and troubleshooting. Each of these procedures is four pages in length, and forms a double sheet fold-out for a loose-leaf note book. A generalized schematic covers about half of one side of the double sheet and the troubleshooting procedure text covers the remainder of that side. A good, detailed explanation of typical circuit operation and supplementary troubleshooting tips are included in a background section.

METS also offers in-depth troubleshooting material in book form. The book we reviewed, *Vertical Circuits*, turned out to be more than a re-hash of the various vertical troubleshooting procedures. It presented an overall approach to troubleshooting vertical deflection circuitry, in great detail, symptom by symptom, circuit by circuit.

Later METS procedures follow a little different format. For example, METS Time Lapse Troubleshooter #201 covers the RCA CT 101 type power supply/auto start-up, shut down, circuits. This information is contained on a 17 x 22 inch sheet folded twice for convenient filing. It includes a generalized schematic of the power supply (and horizontal sweep system) and about two dozen small schematics, each with service procedures for the portion of the schematic emphasized. It is a full procedure for walking through the power supply, verifying operation as you go.

METS has done something I do not believe anyone has done before. The concept is not radical, but no one has set down, circuit by circuit, chassis by chassis, the detailed procedures in the way METS has. Some of the manufacturers, notably RCA, in its workshop manuals have come close but, of course only for their specific brands. Many good technicians have developed troubleshooting approaches similar in concept but probably not in comprehensiveness. I think that studying the METS procedures thoroughly and understanding the circuitry involved, as well as the troubleshooting procedures and their implications could result in some very effective technicians. Also included in the book on *Vertical Circuits* is enough information to help someone make the transition from tube type to solid state circuits. METS, by the way, stands for Minimum Effort Troubleshooting. **ETD**

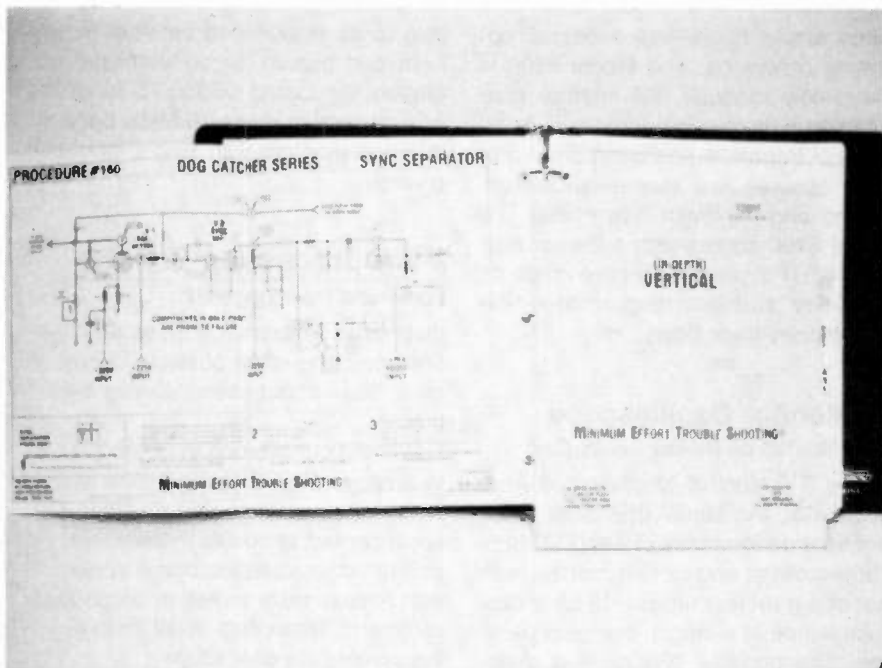

The METS Series of troubleshooting procedures each look like this #160. For more information circle number 150 on the Reader Service Card in this issue.

## The METS System Programmed Troubleshooting

by Walter H. Schwartz

for each of them. METS sent ET/D a selection of procedures for various types of horizontal and vertical sweep, color demodulation, video, AGC, AFPC, bandpass amplifiers, IF audio, sync separators, and power supplies; for all sections of television receivers. Some of these procedures are generalized, when appropriate, and are applicable to a variety of makes and models. Other procedures are very specific. Number 12 for example gives a detailed procedure for troubleshooting Zenith 6U10 horizontal oscillators; it is still generalized to the extent that it apparently covers all Zenith 6U10 oscillator variations. The METS System effectively covers a very broad range of problems and chassis. For example, in the selection we reviewed: procedure 10 covers tube type horizontal oscillator/AFC troubleshooting; procedure 11 tube type horizontal output circuits (no high voltage); 12 as mentioned, Zenith 6U10 horizontal oscillators; procedure 13 is a generalized procedure for Magnavox tube type horizontal output circuitry; 15 is for troubleshooting typical Zenith and other 6LB6, 6JS6, 6LR6, 6LF6, 6LX6 horizontal output circuitry; and procedure

# NEW PRODUCTS

## Temperature Switch

Circle No. 130 on Reader Inquiry Card

Winland, Inc. announces Temp-Alert. Temp-Alert is a Hi-Low Temperature Switch with adjustable hi-low stops. Adjusts from  $-30^{\circ}\text{F}$  to  $+130^{\circ}\text{F}$ . When the temperature indicator touches either limit, the circuit is completed. Temp-Alert may be used in alarm systems for computer rooms, garden beds, greenhouses, animal confinement buildings, and more.

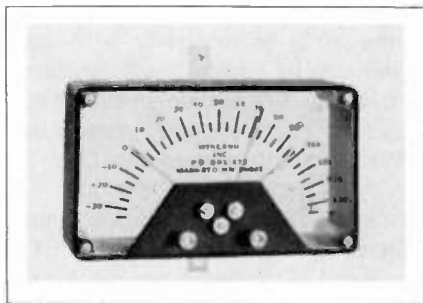

## 100 MHz Oscilloscope

Circle No. 131 on Reader Inquiry Card

A new 100 MHz scope with calibrated delayed sweep has been introduced by Kikusui International Corporation, a subsidiary of Kikusui Electronics Corp., Japan. Called the Model 6100, this new scope will display up to six traces (Ch1, Ch2, Ch3, Trigger View A, Trigger View B plus an Add/Differential trace that represents the sum or difference of Ch1 and Ch2). The Model 6100 also features an auto-dynamic focus circuit for clear, sharp pictures and a metal housing that minimizes RF interference. For versatility of operation, the vertical alternate mode features an alternate trigger (as opposed to a composite trigger) that permits the triggering on a very wide range of non-synchronous signals. For simplicity, a level-lock on the trigger level control for both A and B channels activates a peak-to-peak detector that automatically sets trigger level and triggers on the signal without requiring operator action. This is particularly useful with the B trigger delay that normally requires extensive experience for proper operation. The instrument measures 310 mm  $\times$  150 mm  $\times$  400 mm and weighs approximately 10 kg. The portable configuration allows for both field use and space saving engineering lab use. A 20 kV acceleration voltage as-

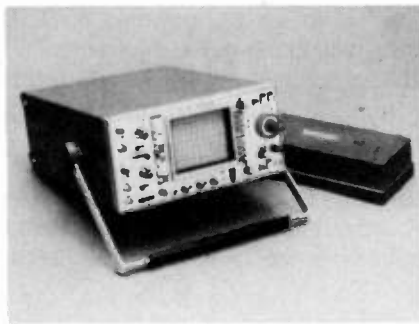

sures ample brightness under all operating conditions. The Model 6100 is completely modular. All internal construction is on plug-in boards and, in the event of trouble, a board swap-out program assures fast maintenance turnaround and minimum down-time. The Model 6100 comes with a 2-year warranty (CRT 1 year). Sales are made on a 30-day satisfaction-guaranteed-or-your-money-back basis.

## TV Monitor Oscilloscope

Circle No. 132 on Reader Inquiry Card

A new TV Monitor Oscilloscope from Gould Co., the Model 0S3350/5, combines the performance of an NTSC 525-line waveform and picture monitor with that of a general purpose 40 MHz dual trace scope in a single, compact package. The portable 0S3350/5 is especially suited for testing and troubleshooting TV, CATV, CCTV, video

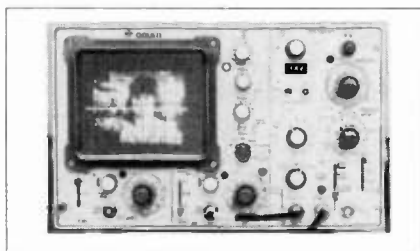

recorder/playback and other video equipment in mobile TV, microwave repeater, broadcast station, institutional, plant, and production line applications. A timebase generator in this new scope allows it to be used for line-by-line examination of 525-line waveforms or to display complete pictures. It accepts standard level composite video signals with or without sound-in-sync signals and provides five different triggering modes: Line 15 through 21 in either field 1 or field 2; Field; Line Repetitive; Field

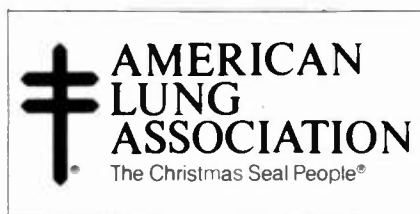

Selector; and Line Selector. In Line Selector the chosen line is indicated on a three-digit LED display. A multiturn vernier control provides triggering delays up to 90  $\mu\text{s}$ , allowing parts of a line to be examined in detail. The displayed video signal can be clamped or not. When the unit is used to display a TV picture, the triggering point selected may be displayed as a bright-up line on the picture, enabling a direct relationship to be established between waveform and picture. In conventional operation the Gould 0S3350/5 functions as a general purpose 40 MHz, 5mV/cm dual trace scope with single timebase control.

## Microprocessor Service

*continued from page 31.*

diagnostic programs. If these are well-designed, it is often possible to zero in on a fault without even opening the box.

Without considering in depth the vast range of self-testing philosophies which exist, we note that they can be implemented at one of three levels: permanent installation in the system with access via a switch or a special command, temporary installation in the system at service time (accomplished by plugging in a "Diagnostics" board) or execution on an in-circuit emulator like that discussed earlier. Any of these approaches call for careful planning and documentation so that the results will not be misleading.

## Testability

Now that we've discussed the major classes of microprocessor service tools, we can close with a mention of the fact that much of their usefulness depends upon designed-in testability. The availability of techniques such as combined emulation and signature analysis allows close communication between the field service force and the engineers behind the design. This makes everyone happier, especially the customers.

But if a system is created with blatant disregard for the possibility of its eventual failure, then even the most sophisticated of the available tools is insufficient. This lesson is being learned across the entire industry, and as time goes on and complexity grows greater, more and more attention will be paid to the requirements of equipment service.

It's a pleasant and long-overdue change. **ETD**

# SECURITY PRODUCTS

## Closed Circuit Video Equipment

Circle No. 151 on Reader Inquiry Card

RCA Closed-Circuit Video Equipment offers a wide range of CCTV products for security surveillance, safety and industrial applications. The company is said to be the largest supplier of CCVE products to these markets in the United States and offers equipment that meets CCIR requirements for international markets. Products include a full line of monochrome television cameras from general-purpose types intended for viewing scenes in starlight to bright sunlight. These cameras include: The TC2000 Family, a new generation of general purpose  $\frac{2}{3}$  in. surveillance cameras using high reliability LSI technology. They have many features and offer a choice of 120v, 240v or 24 vac operation, separate or integral power supplies, and dc operation. Three types of camera tubes are available with the TC2000 family: Vidicon, Newvicon or Ultricon. The TC1005 Family are 1 in. cameras for demanding CCTV applications with a choice of 1 in. camera tubes and ac line or 24 vac operation. The TC1030 Family cameras have silicon intensifier target (SIT) camera tubes for operation in very low light level environments. The TC1040 Family cameras have intensified silicon intensifier target (ISIT) camera tubes for ultra low light level environments. Support equipment includes a full range of monochrome monitors, ranging from 6 to 23-in. displays; local and remote sequential switchers, including types with alarm call-up; date/time generators; motion detectors; screen splitter-inserters; and cassette-type time-lapse video recorders capable of up to 200 hours of unattended recording. A full range of accessories such as pan/tilt units, scanners, housings and enclosures, mountings, consoles, lens and other special video equipment is also available.

## RF Warning System

Circle No. 152 on Reader Inquiry Card

The AP4000 is a Radio Frequency Theft Warning System available from *ATS Marketing International, Inc.* The AP 4000 is a radio frequency transmitter

and receiver with a pre-programmed code tone that provides 24-hour surveillance of a vehicle or other valuables. The AP 4000 is equipped with positive and negative trigger terminals that can be connected to magnetic or mercury switches. The AP 4000 can be installed for home, hospital or store security against burglary. The AP 4000 requires an FCC CB license to operate. (Free application form included).

## CCTV System

Circle No. 153 on Reader Inquiry Card

A closed circuit television system from *Sharp Electronics*, once marketed by the company's Professional Products Department through professional security and A/V dealers, is now available to consumer electronics dealers in many areas of the country. The unit Model IT-25UA, includes a compact camera, a 9-in. monitor and a two-way intercom. The camera weighs 2 lbs. and comes with a standard 16 mm F 1.6 "C" mount lens which adjusts to changing light systems. It is reportedly unaffected by extremes of weather, voltage or humidity and comes with 33 ft. of cable. The two-way intercom offers a talk button that activates the system for about 30 seconds. It can be mounted on the wall, ceiling or door and is designed with a weather sealed speaker (1-15/16-in. round type). The solid state 9-in. (diagonal) television monitor works off 120v with power consumption only 32w when in operation and 8w in standby. It also has a 1-15/16-in. round type speaker and weighs 16 lbs. Optional accessories include extension cable, camera housing, camera selector to permit connection of up to three individual cameras on the monitor, wide angle and telephoto lens, and a motor driven scanner.

## Microwave/Sonic Detection System

Circle No. 154 on Reader Inquiry Card

The new *Microwave Control Device's* Model LHE-23-1-MS consists of two separate motion detection systems, the one sonic, the other microwave. Both systems have to sense man-made motion in the protection area, at the same time, before the LHE-23-1-MS will switch to an alarm state and trigger an electronic siren. The microwave range is said to be approximately 150 ft x 75 ft. in free space, sonic range is said to be 80 ft. x 50 ft. The siren power is 75w rms (producing 126 dcb at 10 ft. from siren driver), operating power is 12vdc and is supplied by 2 gel cells. **ET/D**

Let STEVEN K. ROBERTS

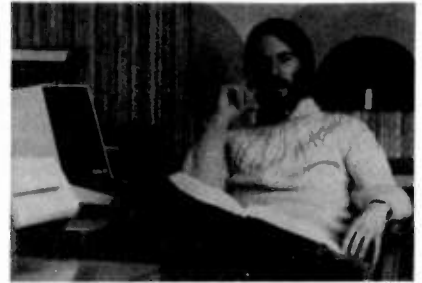

show you.....

- How a good understanding of micro-processors can insure the growth of your business through the 80s and beyond.
- How to outfit your shop to deal with untraditional test instrument requirements.
- How to approach common micro-processor service problems.
- How to expand into industrial and scientific service markets.
- How to stay abreast of this fast-paced technology.



Here is what a prominent reviewer has written about MICROMATICS: "Steven K. Roberts, a hard working, up through the ranks engineer who learned micro-processors from hands-on experience, has a rare talent — the ability to communicate what he has learned clearly and effectively. He has an easygoing style that makes technical information read like a 'who-dunnit' mystery. It is sure to keep you intrigued and eager to read more about this exciting subject. In one complete volume he integrates the aspects of hardware, chips, peripherals... shows how it is coupled with software, programs, machine instructions. It is truly a joy to read this kind of material. Any person who wants to deal effectively with microprocessor systems or simply wants to understand their applications, will find this book of immense value."

Just \$14.95 + \$1.00 s/h charges

**S** SCELBI Publications  
20 Hurlbut St., Elmwood, CT 06110

IMPORTANT ORDERING INFO! Please include \$1 shipping/handling charges for each item. Prices shown are for North American customers. MC/VISA, Postal and Bank Money Orders preferred. Allow 4 weeks for delivery

Name (print) \_\_\_\_\_  
Address \_\_\_\_\_  
City/State \_\_\_\_\_  
Zip Code \_\_\_\_\_  
Card No. \_\_\_\_\_  
Bank No. \_\_\_\_\_ Amt. Enc. \_\_\_\_\_  
Signature \_\_\_\_\_

Circle No. 110 on Reader Inquiry Card

ET/D - July 1981 / 39

# CLASSIFIED

**RATES:** 50 cents per word (minimum charge, \$15). Bold face word or words in all capital letters charged at 65 cents per word. Boxed or display ads charged at \$60 per column inch (one inch minimum). Agency commissions will be given only when camera-ready art is provided by agency. For ads using blind box number, add \$5 to total cost of ad. Send ad copy with payment to Dawn Anderson, **ELECTRONIC TECHNICIAN/DEALER**, 1 East First Street, Duluth, MN 55802.

**BOX NUMBER REPLIES:** Mail box number replies to: **ELECTRONIC TECHNICIAN/DEALER**, Classified Ad Department, 120 W. 2nd St., Duluth, MN 55802. Please include box number in address.

## WANTED

**WANTED: PICTURE TUBE REBUILDING EQUIPMENT** working or not. Write or call Atoll Television, 6425 Irving Park, Chicago, Illinois 60634. Phone 312-545-6667. 9/81

**MIRROR-IN-THE-LID, SPINNING DISK, AND OTHER PRE-1946 TELEVISION SETS**, parts, literature wanted for substantial cash. Also need 12AP4, 9AP4, MW-31-3 picture tubes, and any information on projection sets made by **TELICON CORP.** of N.Y. in 1947. Arnold Chase, 9 Rushleigh Rd., West Hartford, CT 06117. (203) 521-5280. 3/82

Wanted for Cash: 7N7, 7F7, 53, 6L6 metal, 6AF6, 6HU8, 304TL, 4CX1000A, all transmitting, special purpose and Eimac tubes, etc. DCO Inc., 10 Schuyler Avenue, North Arlington, N.J. 07032, Toll Free (800) 526-1270. 8/81

## BUSINESS OPPORTUNITIES

**Florida's Sun Coast.** TV sales & service. New Showroom attached to modern 2 bedroom home in nice area. Plus separate rental house. \$90,000. For details call 1-813-541-2039. Or write Shop Owner: 7744 46 Ave. North, St. Petersburg, Fla. 33709

**ESTABLISHED T.V. SALES, SERVICE & Antenna Business.** Same location for eleven years. Untapped potential. A great opportunity for the right person. Contact Vince Brekel, Box 486, Benkelman, Nebraska 69021 or phone 308-423-2420 or 423-5359. New industry moving into area. 8/81

**RAMPART SECURITY SYSTEMS DEALERS'** sales are booming. The Rampart Dealer Program offers **ENORMOUS PROFIT POTENTIAL PLUS EXCITING RESIDUAL INCOME.** Our success and reputation are a result of a total business format approach for the residential, small commercial market. Product, marketing and management training with complete backup has made success a reality for over 50 dealers. If you qualify, it can do the same for you. Investment only \$12,500, backed by inventory. No experience necessary, just a strong desire to succeed. Call Franchise Director collect (215) 752-2210 or write **RAMPART INDUSTRIES, INC.**, 1 Oxford Valley, Suite 317, Langhorne, PA 19047. 7/81

**SUCCESSFUL T.V. STEREO Specialties,** Sales/Service Store. \$200,000.00/Year Income. Fantastic Opportunity, Will Consider Trade. Call Now! (209) 442-1816, 3134 Palm, Fresno, Calif. 93704. 7/81

**MECHANICALLY INCLINED INDIVIDUALS:** Assemble electronic devices in your home. Knowledge or experience not necessary. Get started in spare time. Above average profits. \$300-\$600/wk. possible. Sales handled by others. No investment. Write for free details. **ELECTRONIC DEVELOPMENT LAB**, Box 1560B, Pinellas Park, FL 33565.

TV Sales Service-Est. 18 yrs. Factory Authorized Service. Owner retiring-Complete shop with equip. parts, etc. \$15,000.00. Call 516-588-4855 or write to Louis Sventora, 321 Portion Rd., Lake Ronkonkoma, L.I., N.Y. 11779. 9/81

Established TV—Stereo repair shop in beautiful Black Hills of South Dakota. Main St. location. Good steady business. Excellent library — equipment and inventory. Priced right — terms available. Call (605)347-4243.

TV Sales and Service Shop - 16 yrs. same location - No. Calif. mountain town. Good Living. 916-628-5513.

Established TV repair. Must sell due to poor health. Just pay for my inventory. Plenty of business. Up to date test equipment. Excellent reputation. PO Box 16268, Jacksonville, FL 32216.

## HELP WANTED

**WANTED TV OR STEREO TECHNICIAN** Send Resume, Excellent Salary, Benefits, Commission (209) 442-1816, 3134 Palm, Fresno, Calif. 93704. 7/81

TV Benchman looking for experienced, hard working partner to open up a "service only" TV shop. No selling. Please reply - P.O. Box 1747, Union, N.J. 7/81

## FOR SALE

**FOR SALE**—Model 1474 B&K dual trace 30MH oscilloscope with probes. Good condition. \$595.00 plus shipping. CB schematics 38 through 141—\$1.50 each. Mike Tucker, 1712 Meadowview Dr., Statesville, NC 28677. (704) 876-1666.

**RF power transistors—tubes—special parts for "ham" linears.** MRF454 \$17.00, MRF455A \$14.00, 8950 \$9.00, 6LF6 \$5.50, catalog and cross-reference help available. COD—Visa/MC. **WESTCOM**, 1320 Grand, San Marcos, CA 92069. (714) 744-0728.

**"QUALITY ELECTRONIC PARTS AT WHOLESALE PRICES."** **ELECTRONIC DEALERS AND HOBBYISTS!** Send your name and address for "free catalog" and be placed on mailing list for monthly specials. **Free** technical assistance available with order! R. L. Miller, Box 391 Bay Station, Dept ETD 1 Brooklyn, NY 11235. TF

**RF spectrum analyzer, ASL model 8622,** 10 to 1,000 MHz, 3-inch CRT, manual and application notes, weight 22 lbs. Excellent condition. \$895. **M.W. ROBERTS**, 3694 East Tompkins, Las Vegas, Nevada 89121. (702) 451-3517.

**LIQUIDATION:** Test equipment, tools, parts, manuals, magazines. Send SASE for inventory of electronics service business to: J. B. Green, 1008B, Prairie Tr., Austin, TX 78758. 7/81

**PICTURE TUBE REBUILDING EQUIPMENT** capable of producing four high quality tubes per day (**WILL TRAIN TO OPERATE**) \$4600.00. Call or Write Atoll Television, 6425 Irving Park, Chicago, Illinois 60634. ph. 312-545-6667. 9/81

Need a 470 mfd at 75 wv (RCA #134179)? Norfolk got a replacement 470 mfd at 80 wv, pc at the right price—\$2.00 each/10 for \$19.00—f.o.b. Garnerville, NY 10923.

**COMPLETE line of microwave television converters** and accessories to suit your needs. Converters have a one year warranty backed by a 3 year reputation. Call or write for complete specifications and pricing, **dealer inquiries invited. TRITON MARKETING**, 1933 Rockaway Parkway, Brooklyn, NY 11236. (212) 531-9004.

Lowcost MATV/CATV equipments, needles, antennas, audio cables, speaker wires, tools, batteries, fuses, tapes, power cords, modular telephone accessories, transistors, connectors, switches, free catalog. 212-897-0509. D & W, 66-19 Booth, Rego Park, NY 11374. 7/81

**HEY TECH'S.** Reconditioned test equipment **\*LIKE NEW!\*** Scopes, audio generators, distortion analyzer's, meters, frequency counter, etc. **LOW PRICES!!** Call for list. **CONSOLIDATED ELECTRONICS, INC.** 1-800-543-3568. 7/81

**TV ANALYST,** B&K Model 1077B, Solid State sweep marker generator B&K Model 415, like new, \$250.00 each, Martin, 4 Audusson Ave., Pensacola, FL., 32507. (904) 456-9091. 7/81

**MINIATURE ELECTROLYTICS.** Assortment No. 56—**10 ALL DIFFERENT 100 VOLT AND UP.** 5 MFD @ 100 AX—20 MFD @ 100 AX—100MFD @ 100 AX—10 MFD @ 150 RAD—25 MFD @ 150 AX—50 MFD @ 150 AX—1 MFD @ 160 PC—2.2 MFD @ 250 PC—10 MFD @ 250 PC—12 MFD @ 250 AX. Norfolk Electronics, P.O. Box 91, Garnerville, NY 10923.

**MINIATURE ELECTROLYTICS.** Assortment No. 57 **10 ALL DIFFERENT 100 VOLT AND UP.** 15 MFD @ 100 AX—20 MFD @ 100 AX—22 MFD @ 100 RAD—100 MFD @ 100 AX—4 MFD @ 150 AX—8 MFD @ 150 AX—22 @ 160 RAD—47 @ 160 AX—3.3 @ 200 PC—20 @ 250 AX—\$7.95 each/2 for \$15. Norfolk Electronics, P.O. Box 91, 55 Railroad Avenue, Garnerville, NY 10923.

For Sale: Sencore SG 165, Stereo Analyzer and LC 53 "Z" Meter, both used 1 year, and in mint condition. (603) 654-2260 Mornings.



## PASS FCC EXAMS

The Original FCC Tests-Answers exam manual that prepares you at home for FCC First and Second Class Radiotelephone licenses. Newly revised multiple choice exams cover all areas tested on the actual FCC exam. Plus "Self-Study Ability Test". Proven! \$12.95 postpaid (Add \$2.00 for first class Air Mail). Moneyback Guarantee.



**COMMAND PRODUCTIONS** P.O. Box 26348 W  
Radio Engineering Division San Francisco, CA 94126

**MICRO WAVE SYSTEM, RECEIVE UNEDITED MOVIES, SUPER SPORTS, LAS VEGAS SHOWS, ETC. COMPLETE INCLUDING CABLE SWITCH \$225.00. SIGNAL ELECTRONICS, 4027 18TH AVE., BROOKLYN, NY 11218. 212-436-0673.**

**THE ONE STOP SOURCE SINCE 1959,** For Coaxial Cable, Connectors, Cable assemblies, CATV Products, Telephone Accessories, Audio Cables & Connectors, Electrolytics, & Multi Conductor Cable. Call or write for our free catalog. CZ Labs, 55 Railroad Ave, Garnerville, NY 10923. (914) 947-1554/5. 7/81

**SEE HOME MOVIES, SEE SPORTS. MICRO-WAVE ANTENNA COMPLETE WITH DOWN CONVERTER AND CABLES. FULL WARRANTY ONLY \$159.00. 2SC1172B 20 LOT ONLY \$1.79., REDCOAT ELECTRONICS, 66-15 THORNTON PL, FOREST HILLS, NY 11374. 212-261-9479.** 7/81

For Sale: Used B&K - 1250 NTSC (used 2 mos.) \$500, B&K - 1801 Counter \$60, Sound Technology FM Generator - 1000A \$1200, Ferrograph RTS-1A Recorder Test Set \$800, HP330B Distortion Analyzer \$100, Sony CVM -194 B&W Video Monitor \$175, or best offer. Call (201) 526-4693. 7/81

## SIMPLE SIMON 7 + 11 PART KITS

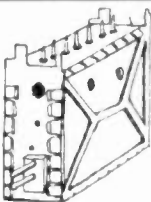

### SPECIAL FOR JULY!! MITSUMI UHF TUNER

OVERSTOCKED  
REG. ~~\$34.95~~

SALE PRICE **\$19.95**

(Offer Expires August 15, 1981)  
Freq. Range UHF 470, 889 mHz  
Channels 14-83 Output Chan 3

- |  |   |          |
|--|---|----------|
| 1 VT1-SW                                       | Varactor UHF Tuner Model UES-A55F   | \$19.95  |
| 2 CB1-SW                                       | Printed Circuit Board Pre-Drilled   | \$18.95  |
| 3 TP7-SW                                       | P.C.B. Potentiometers 1-20K, 1-1K & 5-10K OHMS, 7-pieces  | \$5.95   |
| 4 FR35-SW                                      | Resistor Kit 1/4 W, 5% Carbon Film, 32-pieces   | \$4.95   |
| 5 PT1-SW                                       | Power Transformer PRI-117VAC, SEC-24VAC, 250MA  | \$6.95   |
| 6 PP2-SW                                       | Panel Mount Potentiometers & Knobs 1-IKBT & 1-5KAT W/SW   | \$5.95   |
| 7 SS14-SW                                      | IC's: 7 ea. Diodes 4 ea. Regulators 2 ea. Heat Sink 1 ea.   | \$29.95  |
| 8 CE9-SW                                       | Electrolytic Capacitor Kit 9 ea.  | \$5.95   |
| 9 CC33-SW                                      | Ceramic Disk Capacitor Kit 50 W.V. 33 ea.   | \$7.95   |
| 10 CT-SW                                       | Variable Ceramic Trimmer Capacitors 5-65PFD 6 ea.   | \$5.95   |
| 11 L4-SW                                       | Coil Kit 2 ea., 18 MHS, 1 ea. 22 MHS Inductances-prewound and 1 ea. T37-12 Ferrite Toroid Core with 3 ft. of #26 Wire   | \$5.00   |
| 12 ICS-SW                                      | I.C. Sockets Tin Inlay 5 ea. 8 Pin, 2 ea. 14 Pin  | \$1.95   |
| 13 SR-SW                                       | Speaker Oval 4x6" & Prepunched Wood Enclosure   | \$14.95  |
| 14 MISC-SW                                     | Misc. Parts Kit Includes Hardware, 6/32 & 8/32 Nuts & Bolts, H.U. Wire, Ant. Terms, DPDT ANT. SW., Fuse Fuseholder etc. | \$9.95   |
| *When Ordering All Items 1 Thru 14 Total Price |   | \$139.95 |

### ANTENNA & ACCESSORIES

- |  |  |              |
|--|--|--------------|
| STVA-1-STV   | Yagi Antenna 13.5 DB, 75 OHM, CHN 42 Thru 54 | \$9.95       |
| STVA-2-STV   | Yagi Antenna 13.5 DB, 75 OHM, CHN 20 Thru 28 | \$9.95       |
| CX-75 Coaxial 75 OHMS Low Loss   |  | \$ .12 P/FT. |
| F-59 Coaxial Connectors ea.  |  | \$ .39       |
| MT-1 Special UHF 75-300 OHM Matching Transformer ea.                                   |  | \$1.45       |
| A-1 indoor VHF-UHF Antenna Amplifier with Power Supply 300 OHM In & Out. ABT 13db gain |  | \$19.95      |

Min. Order. Amount is \$19.95, Add 10% Shipping and Handling. Over \$40.00, Add 5% Calif. Residents Add Also 6% for Sales Tax.

### SIMPLE SIMON ELECTRONIC KITS

11850 S. Hawthorne Blvd., Hawthorne, California 90250, Tel: (213) 675-3347  
VISA — MASTERCHARGE ACCEPTABLE

Sams Photofacts. 1 thru 1309 and 1445 thru 1428. All but first 100 in metal filing cabinets. \$900 or best offer plus shipping. Robert Knapp, Box 145, Lyndhurst, VA 22952. 7/81

SCORE VA-48 w/accessories, \$850. Sencore CR-31A, \$500. Both almost new. Degauss coil, \$10. Viz Isotap WP25A \$40. 41 Sams & TAB TV & CB books, \$370 value, \$100. Bill Scott, 111 N. Main, Teton, Idaho 83452. (208) 456-2233. 7/81

**SATELLITE** television...Howard/Coleman boards to build your own receiver. For more information write: **ROBERT COLEMAN**, Rt. 3, Box 58 ETD, Travelers Rest, SC 29690.

**SUPREME** Television - Radio Diagram manuals discounted 60%. Free information. SASE. Supreme, 1760 Balsam, Highland Park, IL 60035. 7/81

**WHOLESALE ELECTRONICS** — Factory Direct Prices — New parts and electronic merchandise. 'Wholesale' catalogs, pricing, and monthly specials for 6 months only \$10.00 or \$16.00 for a full year! **INCREDIBLE ELECTRONICS CO.**, Box 117, Troy, NY 12180 — (518)272-0300.

**SONY-PANASONIC-RCA-ZENITH-EXACT REPLACEMENT PARTS-LARGE INVENTORIES-SEND PART OR MODEL NUMBERS-WILL UPS OR COD-GREEN TELE RADIO DISTRIBUTORS, 172 SUNRISE HIGHWAY, ROCKVILLE CENTRE, N.Y. 11570.** TF

**SCRAMBLED-TV WHAT IT IS-HOW IT WORKS.** New publication explains how the two encoding/decoding systems used today work. Theory, circuits, etc. Send \$9.95 to: Workshop, Box 393ETL, Bethpage NY 11714 TF

Free flyer! Microwave TV Antennas, Cable TV Converters-30 and 40 channel, and Cable Inverters. CB Accessories and books including Bootleggers Bible for PLL modification above channel 40 and below channel 1, CB Repair Manual, and Linear Amplifier Planbook. Catalogue \$1.00 refundable. MC/VISA (401) 846-5627. AP Systems, PO Box 263 ED, Newport, RI 02840. 8/81

**SAVE 90%.** Build your own minicomputer. Free details. **DIGATEK CORPORATION**, 2723 W. Butler Dr., Suite K, Phoenix, AZ 85021.

**NOBODY BEATS OUR PRICES. Y105 YOKES-Y94 YOKES ONLY \$9.99. TRIPPLERS ORIG.-ECG BOXED ONLY ANY TYPE \$16.99. SG613 ORIGINAL SONY ONLY \$6.90. 212-261-9479. REDCOAT ELECTRONICS, 66-15 THORNTON PLACE, FOREST HILLS, NY 11374.** 7/81

**SAVE BIG BUCKS!! MOST POPULAR B&W YOKE (Y105)—\$9.95 each/3 for \$27.** Terms C.O.D.; UPS. **NORFOLK ELECTRONICS**, P.O. Box 91, Garnerville, NY 10923. 914-947-1501/1502.

**TUBES**—Receiving, Industrial and Semiconductor, factory boxed. Free price list. Low, low prices. **TRANSELETRONIC INC.**, 1365-39th Street, Brooklyn, N.Y. 11218E 800-221-5802, 212-633-2800.

Satellite Television: Information on building or buying your own earth station. Six pages of what's needed, where to get it, costs, etc. \$4.00 to Satellite Television, RD #3, Box 140, Oxford, NY 13830. TF

**TV AND RADIO TUBES 49¢ EA!!** Send for free color parts catalog. Your order free if not shipped in 24 hours. **Cornell Electronics** 4215-17 University San Diego California 92105 TF

**Automobile radio and tape replacement parts:** Delco, Chrysler, Philco-Ford, Motorola, Panasonic and many others. Large inventory. **Laran Electronics Inc.** 3768 Boston Road, Bronx, NY 10469 (212) 881-9600 out of New York state (800) 223-8314 TF

**Wholesale Burglar and Fire Alarm Equipment.** Over 70 lines. Free Catalog and Technical Info. **Defensive Security.** 1-800-392-8484 (Texas), 1-800-231-1823 (Nationwide). 7/81

**Go-No-Go Transistor Tester \$16.95** Test Probe Housing with test tip \$6.95. 2 channel wire tracer \$45.95. Send for free catalog quantity discount, dealership. **King Electronics, Inc.** 600 Tremont St., Boston, MA 02118. 7/81

**WHOLESALE TV PARTS-transistors (TM/PTC/ECG) Thordson Yokes & Flies; Resistors; Capacitors; Triplers; Tools; Tubes 72% off; Sams 6.25, Video Tapes.** Video Movies bought, sold, rented. Send for free catalog. **Astro Electronics**, Old Grand Union Shopping Ctr., Rt. 9W, Stony Point, N.Y. 10980. 914-942-2173 8/81

Help Prevent Birth Defects —  
The Nation's Number One  
Child Health Problem.

Support the



**March of Dimes**  
BIRTH DEFECTS FOUNDATION

This space contributed by the publisher

## Tax Problem?

When  
all else  
~~for~~ ~~for~~  
fails...

Call the **IRS Problem Resolution office**. If you've contacted the IRS with a Federal tax problem but had no results, call IRS Taxpayer Assistance and ask for the Problem Resolution Office. The number's in your telephone directory.

A public service message from the Internal Revenue Service.

**ESR METER** checks electrolytics IN-CIRCUIT and is TV shop FIELD-TESTED:

The most fantastic instrument I've ever bought-Billings, Mt. Used it 3 months; it only missed once-Marinette, Wis. (Typical). Squeal & no sync: 3 bad caps in B + & AGC; Many Thanks-Taos, N.M. Please ship another; very satisfied-Glen Rock, Pa. It's fantastic-St. Joseph, Mo. Please rush; heard good reports-Hicksville, N.Y. One tremendous meter-Alexandria, Minn. Send your Super meter; heard about it-N. Olmsted, Ohio. Love that ESR Meter-Acton, Mass. Used it intensively for 30 days; it's been 100% effective-Pittsburgh, Pa. I understand that if I'm not completely flabbergasted, you will refund my money-Sanford, Fla. (Refund not requested)

60-day Satisfaction Guarantee.  
Send check or M.O. or call  
(313)435-8916 for COD

Or write for free brochure to:

*Creative Electronics*

ESR Brochure  
1417 N. Selfridge  
Clawson, Mich. 48017

**\$99.00**  
postpaid  
in USA

Circle No. 112 on Reader Inquiry Card  
42 / ETID - July 1981

## AD INDEX

Circle No.	Page No.
112 Creative Electronics	42
108 Electronic Book Club	13
111 Electronic Parts Supply	3
107 Enterprise Development Corp.	12
104 Keithley Instruments Inc.	7
101 MCM Audio Inc.	Cov. 2
106 Optima Electronics	12
102 PTS Electronics	Cov. 4
110 Scelbi Publications - Micromatics	39
109 Sperry Tech	27
105 Thordarson Meissner, Inc.	8

## NEW PRODUCTS

Circle No.	Page No.
130 Winland Inc.	38
131 Kikusui International Corp.	38
132 Gould Co.	38

## TEST INSTR. RPT.

Circle No.	Page No.
150 METS System	37

## SECURITY PROD.

Circle No.	Page No.
151 RCA Closed Circuit Video Equipment	39
152 ATS Marketing International Inc.	39
153 Sharp Electronics	39
154 Microwave Control Devices	39

This index is furnished for the readers' convenience. However, the publisher can not guarantee its accuracy due to circumstances beyond our control.

## CORRECTION

In the June 1981 issue, there was a printing error in the Optima Electronics ad. Item #238 should be priced at \$1.95.

## JAY WEINBERG: LIVING PROOF YOUR CONTRIBUTIONS COUNT.



These days, Jay Weinberg's most difficult battles take place on the tennis court. Five years ago, he had a different kind of fight on his hands: against one of the toughest forms of cancer. Cancer research and treatment have made Jay's kind of recovery possible for almost 2 million people. Which means that your donations have helped buy Jay Weinberg a very beautiful gift: his life.

**CANCER  
CAN BE BEAT.**

American  
Cancer Society 

THIS SPACE CONTRIBUTED AS A PUBLIC SERVICE



## Are you throwing away tickets to Hawaii?

The Philips ECG sweepstakes can turn tabs into a vacation for two, or one of 2,159 other great awards.

Don't pass up your chances to be a winner in our "Reach for the Rainbow" Sweepstakes. The awards range from a Hawaii vacation to mopeds, workshop tools, calculators, cash, and other valuable items.

Every time you collect 5 receiving tube address tabs or 5 ECG semi-

conductor tabs or bags you're entitled to one chance to win. One color-tube serial label earns you ten entries. The more entries you get, the more chances you have to win. And there's no limit to the number of awards you can receive. We'll have winners from every state.\*

See your local distributor for entry forms and details. All entries must be postmarked by midnight, August 31st, 1981.

Start collecting your stack of address tabs from Sylvania brand products today. They could pay the tab for your next vacation.

**Philips ECG**

*A North American Philips Company*

\*The Philips ECG "Reach for the Rainbow" Sweepstakes is available only to dealers and service technicians. Employees of Philips ECG, Inc., its authorized distributors, or their advertising agencies are not eligible to participate. No purchase required. Reasonable facsimile accepted. Void where prohibited by law.

# Precision Performance

Test Instruments Designed by  
the Nation's Leading Tuner  
and Module Rebuilder

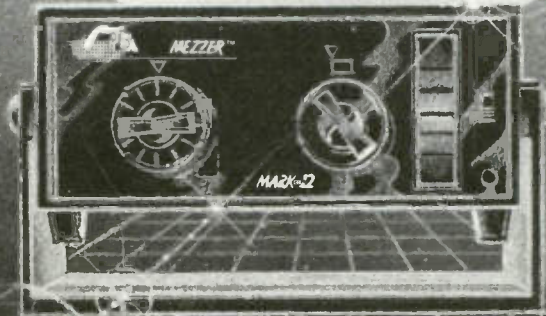
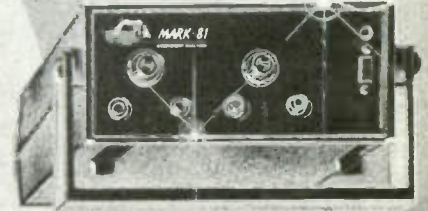

## Mark 5B

With the Mark 5B, professional TV service technicians can quickly analyze which signal stage in the receiver is defective. The Mark 5B performs field strength measurement, and tests antennas, UHF tuners, VHF tuners, video sound IF amplifiers, audio and AGC systems and can serve as a tuner subber™. The Mark 5B may be used with tube, solid state, modular IC or hybrid receivers. This portable, AC/DC unit automatically recharges.

## Mezzer Mark 12

Here's the low priced Field Strength Meter designed to meet the changing needs of the progressive TV service dealer—antenna, cable and MATV systems installer. This compact, ruggedly built unit features 12-position detent VHF tuning, 70-position detent UHF tuning, and AC/DC operation with self-contained rechargeable ni-cad batteries.

## Mark 81

The Mark 81 Component Analyzer saves time and money trouble-shooting electronic components in and out of the circuit. Defective circuits can quickly be identified by comparing wave forms with those on a control. The Mark 81 is calibrated for full-scope display on any range switch position.

For a full demonstration of PTS test instruments, visit your nearest PTS Service Center or Authorized Distributor.



**PTS ELECTRONICS, INC.**

General Headquarters, P.O. Box 272  
Bloomington, IN 47402

Circle No. 102 on Reader Inquiry Card