

JANUARY 1974 • 75 CENTS



ARCOURT BRACE JOVANOVICH PUBLICATION

ELECTRONIC TECHNICIAN/DEALER

WORLD'S LARGEST TV-RADIO SERVICE & SALES CIRCULATION

FRIM5593349-P2
1 WILLIAM
7176 GALE
ATLAS RD
FRISE

-AM

-8753AL
AS

MI 48411

Three Ways to Build Receiver Sales

ABC'S of Optoelectronics

Color-TV "Case History" Faults

PTS ELECTRONICS

Precision Tuner Service



now available near you

OREGON:
PTS ELECTRONICS, INC.
5220 N.E. SANDY BLVD.
PORTLAND, OREGON 97213
TEL. 503. 282-9636

COLORADO:
PTS ELECTRONICS, INC.
4958 ALLISON ST.
ARVADA, COLO. 80001
TEL. 303. 423-7080

CALIFORNIA—NORTH:
PTS ELECTRONICS, INC.
4611 AUBURN BLVD.
SACRAMENTO, CALIF. 95841
TEL. 916. 482-6220

CALIFORNIA—SOUTH:
PTS ELECTRONICS, INC.
5111 UNIVERSITY AVE.
SAN DIEGO, CALIF. 92105
TEL. 714. 280-7070

OKLAHOMA:
PTS ELECTRONICS, INC.
3007 N. MAY
OKLAHOMA CITY, OKLA. 73106
TEL. 405. 947-2013

KANSAS:
PTS ELECTRONICS, INC.
3116 MERRIAM LANE
KANSAS CITY, KANSAS 66100
TEL. 913. 831-1222

MINNESOTA:
PTS ELECTRONICS, INC.
815 W. LAKE ST.
MINNEAPOLIS, MINN. 55408
TEL. 612. 824-2333

TEXAS—NORTH:
PTS ELECTRONICS, INC.
MOPAC LANE
LONGVIEW, TEX. 75601
TEL. 214. 753-4334

TEXAS—EAST:
PTS ELECTRONICS, INC.
4324-26 TELEPHONE RD.
HOUSTON, TEX. 77032
TEL. 713. 644-6793

LOUISIANA:
PTS ELECTRONICS, INC.
2914 WYTCWOOD DRIVE
METAIRIE, LOUISIANA 70033
TEL. 504. 885-2349

INDIANA:
PTS ELECTRONICS, INC.
5233 S. HWY 37
BLOOMINGTON, IND. 47401
TEL. 812. 824-9331

OHIO:
PTS ELECTRONICS, INC.
5682 STATE RD.
LEVELAND, OHIO 44134
TEL. 216. 845-4480

FLORIDA:
PTS ELECTRONICS, INC.
1918 BLANDING BLVD.
JACKSONVILLE, FLA. 32210
TEL. 904. 389-9952

NEW YORK:
PTS ELECTRONICS, INC.
993 SYCAMORE ST.
BUFFALO, N.Y. 14212
TEL. 716. 891-4935

MASSACHUSETTS:
PTS ELECTRONICS, INC.
191 CHESTNUT ST.
SPRINGFIELD, MASS. 01103
TEL. 413. 734-2737

NEW YORK CITY—NEW JERSEY:
PTS ELECTRONICS, INC.
158 MARKET ST.
E. PATERSON, N.J. 07407
TEL. 201. 791-6380

PENNSYLVANIA—EAST:
PTS ELECTRONICS, INC.
1921 S. 70TH ST.
PHILADELPHIA, PA. 19142
TEL. 215. 724-0999

MARYLAND:
PTS ELECTRONICS, INC.
1105 SPRING ST.
SILVER SPRING, MD. 20910
TEL. 301. 565-0025

PENNSYLVANIA—WEST:
PTS ELECTRONICS, INC.
257 RIVERVIEW AVE. W.
PITTSBURGH, PA. 15202
TEL. 412. 761-7648

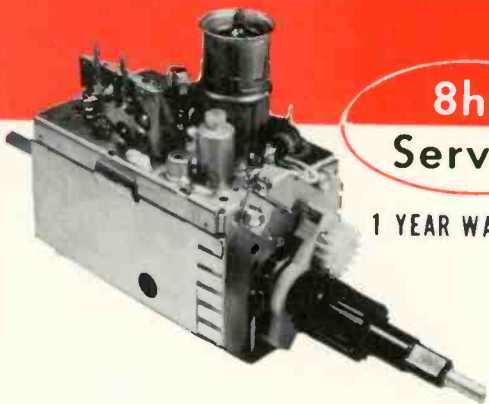

8hr Service
1 YEAR WARRANTY

9⁹⁵VHF-UHF-FM
16⁹⁵UV-COMB.

PTS will repair any tuner—no matter how old or new—black & white or color—transistor or tubes—varactor or detent UHF—8 hour service is a must!



PARTS

PTS is the only tuner service to publish an 80-page Tuner Replacement Guide and Parts catalog—and sell you any or all parts (3rd edition of top information available for one dollar)

8hr Service
1 YEAR WARRANTY

12⁵⁰IF-SUBCHASSIS

PTS was 1st to repair IF modules and make a success of it. We do it right the 1st time. (All prices are dealer net! Major parts, tubes and transistors charged at net cost)

PTS-NUMBER ONE

AND STILL TRYING HARDER!

(NOT A FRANCHISE COMPANY)
... for more details circle 134 on Reader Service Card

You'd probably expect a portable oscilloscope as rugged and reliable as this one to cost a lot.

You'd be wrong.

Introducing the B&K Model 1403 3" Solid-state oscilloscope. It's so compact, reliable, and inexpensive that it's the perfect scope for most on-the-line monitoring applications. Look at its specs: DC to 2MHz bandwidth at 20mV/cm. Recurrent sweep speeds from 10Hz to 100KHz. New wide-angle CRT to reduce case depth to a minimum. Direct-deflection terminals for waveforms up to 150 MHz. Weighs only 8½ pounds. And has a smoked acrylic graticule for trace sharpness and easy reading. All the reliability and accuracy you need in a monitor scope—at a surprisingly low price.

Contact your distributor, or write Dynascan Corporation.

\$179⁹⁵

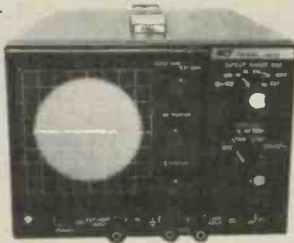

B&K Very good equipment at a very good price.
Dynascan Corporation,
1801 West Belle Plaine Avenue, Chicago, Illinois 60613

... for more details circle 104 on Reader Service Card

Here's everything you'd expect from a high-priced signal generator.

Except a high price.

Our new B&K Model 2050 Solid-state RF Signal Generator has features other companies charge much more for. Look at our specs: 100% Solid-state silicon circuitry with FET's in RF and audio oscillator stages. 6 bands with 1.5% accuracy from 100 kHz to 30 MHz. 3 outputs: RF, modulated RF (400 Hz), and externally modulated RF. Positive anti-backlash dial drive. Zener-regulated power supply. You needn't pay high prices for versatility, accuracy and reliability—now there's the Model 2050. And that's just what you'd expect from B&K.

Contact your distributor, or write Dynascan Corporation.

\$99⁹⁵



B&K Very good equipment at a very good price.
Dynascan Corporation,
1801 West Belle Plaine Avenue, Chicago, Illinois 60613

... for more details circle 147 on Reader Service Card

Introducing the expensive digital multimeter that doesn't cost a lot.

The B&K Precision Model 281.

This 2½-digit unit is so versatile, its range covers 99% of your measurements. And its DC accuracy is 1%. The stable 281 also gives you positive over-range and wrong-polarity indications.

It's easy to use and easy to read across all 32 ranges, 100mV to 1000V.

Naturally, we're enthused about our Model 281. You will be, too, when you see our complete specs.

Call your B&K distributor. Or write Dynascan Corporation.

Very good equipment **B&K** **\$169⁹⁵**
at a very good price.



Product of Dynascan Corporation
1801 West Belle Plaine Avenue, Chicago, Illinois 60613

... for more details circle 146 on Reader Service Card

Here's everything you'd expect from a high-priced Hi-Low FET multimeter.

Except a high price.

Introducing the B&K Model 290 solid-state FET Multimeter. Just by glancing at its specs, you can tell that the 290 is capable of more applications than any other multimeter in its class. 75 ranges. Hi-Lo power ohms ranges (low power only 33 mV). 15 megohms input impedance. A large 7" meter. 50 mV to 1500V full-scale sensitivity on both AC and DC. 50 micro-amp current range. Rx0.1 ohm range with 1 ohm center scale lets you measure low resistance down to .01 ohm. Circuit provides automatic overload protection with fuses and spark gaps. More multimeter for your money—that's

just what you expect from B&K.

Contact your distributor, or write Dynascan Corporation.

Model 290 Hi-Low FET Multimeter including Model PR-21 Probe:

\$139⁹⁵



B&K Very good equipment at a very good price.
Dynascan Corporation,
1801 West Belle Plaine Avenue, Chicago, Illinois 60613

... for more details circle 148 on Reader Service Card

ELECTRONIC TECHNICIAN/DEALER

JANUARY 1974 • VOLUME 21 NUMBER 1

PHILLIP DAHLEN, CET
Editor
1 East First Street
Duluth, Minn. 55802
(218) 727-8511

ALFRED A. MENEGUS
Publisher
757 Third Avenue
New York, N.Y. 10017
(212) 572-4839

TOM GRENEY
Publishing Director

JOSEPH ZAUHAR
Managing Editor

BERNICE GEISERT
Production Manager

JOHN PASZAK
Graphic Design

LILLIE PEARSON
Circulation Fulfillment

GENE BAILEY
Manager, Reader Services

MANAGERS

DAVE HAGELIN
43 East Ohio Street
Chicago, Ill. 60611
(312) 467-0670

CHUCK CUMMINGS
Ad Space South/West
613 North O'Connor
Irving, Texas 75060
(214) 253-8678

KEN JORDAN
DONALD D. HOUSTON
1901 West 8th Street
Los Angeles, Calif. 90057
(213) 483-8530

CHARLES S. HARRISON
CY JOBSON
57 Post Street
San Francisco, Calif. 94104
(415) 392-6794

ROBERT UPTON
Tokyo, Japan
C.P.O., Box 1717

The design shown on this month's cover was made by our artist using a self-illuminating assortment of light-emitting diodes supplied through the courtesy of Motorola Semiconductor Products Inc. A related article concerning light-emitting and light-sensing semiconductors begins on page 31.

-
- 7 EDITORIAL: The Year of Confusion.
 - 11 LETTERS: Pertinent comments concerning past issues.
 - 12 READER'S AID: What you need or have for sale.
 - 14 NEWS: Events of interest to our industry.
 - 20 NEW AND NOTEWORTHY: Merchandise of special interest.
-

FEATURES

23 SYSTEM OFFERS THREE WAYS TO BUILD RECEIVER SALES

Audio by Zimet uses one pair of instruments as a quality FM station, for tuner clinics, and to align and repair receivers.

30 GETTING MORE OUT OF THAT NEW SIGN

Ernest Fair tell how to get the most for your money with this very important form of advertising.

31 ABC'S OF OPTOELECTRONICS

Lambert C. Huneault, CET, describes relatively new families of semiconductors that are becoming increasingly important in the new circuitry that we must service.

37 SENSE AND NONSENSE COLOR-TV "CASE HISTORY" FAULTS

Robert Goodman, CET, offers some "nuts and bolts" service tips based on more than 15 years of servicing experience.

41 TEST INSTRUMENT REPORT

Reviewing specifications for 3M's Model 6500 Recorder Test Set.

42 MANAGING TO LEARN AND LEARNING TO MANAGE

The first article in a new monthly column requiring your immediate written response. Let's hear from you please!

44 COLORFAX: Tips for easier color-TV set repair.

48 TECHNICAL DIGEST: Hints and shortcuts for more effective servicing.

49 NEW PRODUCTS: Instruments and components to make your job easier.

54 DEALER SHOWCASE: These items may increase your sales revenue.

57 TECHNICAL LITERATURE: Informative material that you may need.

58 BOOK REVIEWS: Our appraisal of recent publications.

60 ADVERTISER'S INDEX: Manufacturers concerned about you.

61 READER SERVICE: A source of additional information.

63 TEKFAQ: Up-to-date schematics for easier servicing.



A HARCOURT BRACE JOVANOVIICH PUBLICATION



HARCOURT BRACE JOVANOVIICH PUBLICATIONS: James Milholland, Jr., Chairman; Robert L. Edgell, President; Lars Fladmark, Senior Vice President; Richard Moeller, Treasurer; John G. Reynolds, Vice President; Thomas Greney, Vice President; Ezra Pincus, Vice President; Bruce B. Howat, Vice President; James Gherna, Vice President.

ELECTRONIC TECHNICIAN/DEALER is published monthly by Harcourt Brace Jovanovich Publications. Corporate Offices: 757 Third Avenue, New York, New York 10017. Advertising Offices: 43 East Ohio Street, Chicago, Illinois 60611 and 757 Third Avenue, New York, New York 10017. Editorial, Accounting, Ad Production and Circulation Offices: 1 East First Street, Duluth, Minnesota 55802. Subscription rates: One year \$6, two years \$10, three years \$13, in the United States and Canada. Other countries: one year \$15, two years \$24, three years \$30. Single copies: 75¢ in the U.S. and Canada; all other countries \$2. Second class postage paid at Duluth, Minnesota 55806 and at additional mailing offices. Copyright © 1974 by Harcourt Brace Jovanovich, Inc. All rights reserved. No part of this publication may be reproduced or transmitted in any form or by any means, electronic or mechanical, including photocopy, recording, or any information storage and retrieval system, without permission in writing from the publisher.

POSTMASTER: Send form 3579 to ELECTRONIC TECHNICIAN/DEALER, P.O. Box 6016, Duluth, Minnesota 55806.

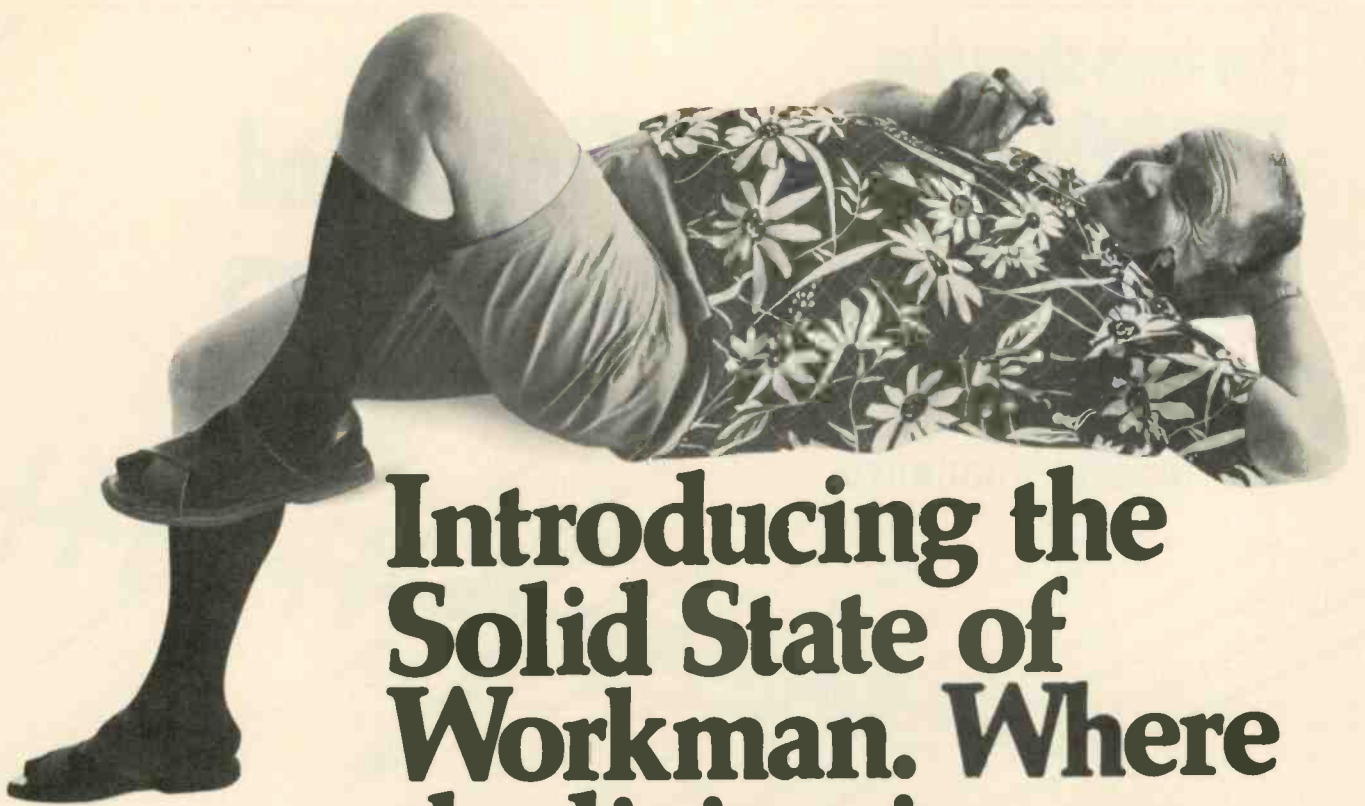

Introducing the Solid State of Workman. Where the living is easy.

Workman's new WEP semiconductor line is, to say the least, uncomplicated.

Our packaging does a lot of work for you: Cross-referenced to all major lines right on the face of the card. Easy-reading model number and description Blister-packed to protect what you're paying for.

The back of the card makes life easier too—basing diagram, full specs with symbol and ratings.

WEP semiconductors are all fully warranted so you can relax about that.

About 200 WEP numbers give you one-for-one replacement against competitive numbers and our complete cross referencing enables them to replace up to 1000 numbers in other lines.

And when the big names fail you, Workman is waiting right there with off-the-shelf delivery.

In fact, that's pretty much the story on all Workman components: Uncomplicated.

In times, like these, who needs complications?

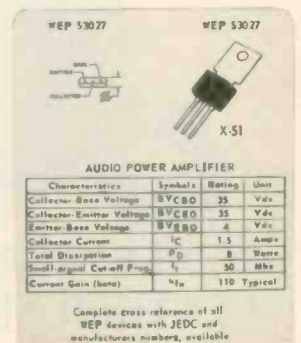

Packaging on Workman's WEP Semiconductors tells you all you need to know—cross referencing, specs, basing diagram, symbol and ratings.

Workman. Your first second resource for replacement components.

Workman Electronic Products, Inc. Box 3828, Sarasota, Florida 33578 A subsidiary of IPM Technology, Inc.

... for more details circle 143 on Reader Service Card

Our tests show that JERROLD Super Vu-Finders And Paralogs Outperform All Others

- MORE GAIN & FLATTER RESPONSE
- RUGGED AND EASY TO INSTALL
- ELECTRICALLY GROUNDED

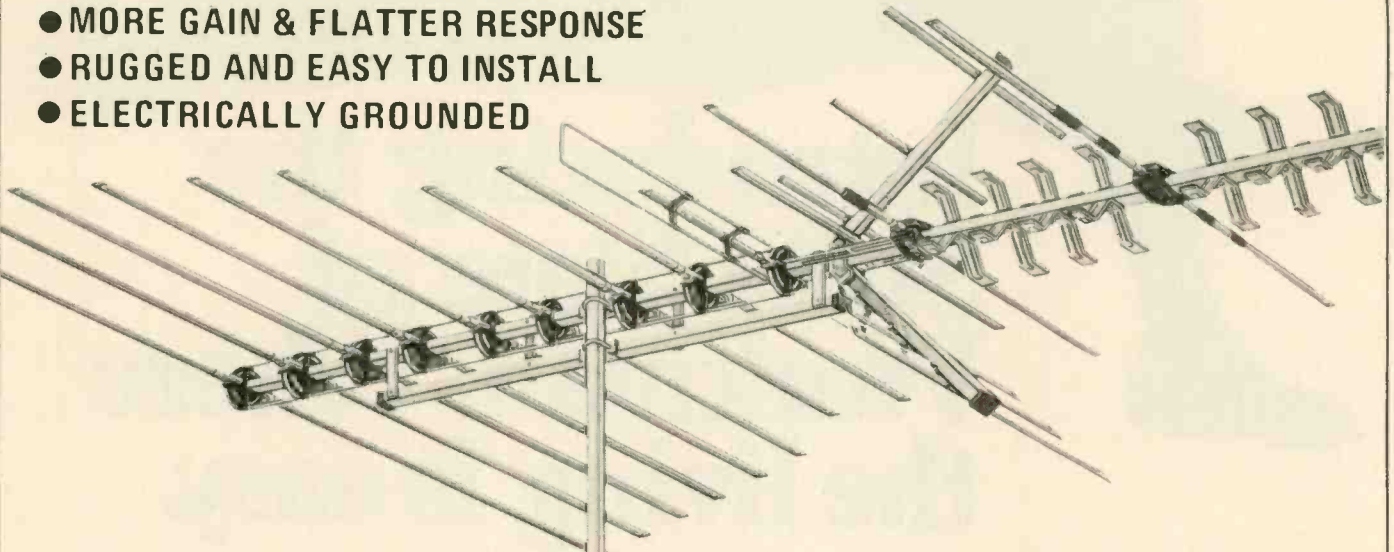

WE WANT YOUR PROFESSIONAL OPINION.



(TOOLS
NOT
INCLUDED)

FREE! HEAVY DUTY LEATHER TOOL POUCH

Last year we offered NFL Coffee Mugs for trying Jerrald antennas. This year it's Tool Pouches. Why do we make these offers? Because we know that once you stack Jerrald antennas up against the antennas you are using now, you'll switch to Jerrald. Hundreds of dealers switched last year.

If you're a professional antenna installer, you owe it to yourself to make this evaluation.

FOR EVALUATING ANY SUPER VU-FINDER OR PARALOG 300 PLUS.

JERROLD ELECTRONICS CORPORATION



P. O. Box 350, Dept. DSD, 200 Witmer Road, Horsham, Pa. 19044

Please send me a free Tool Pouch. Enclosed is an instruction sheet from the following Super VU-Finder antenna.

(model) _____

1 Before trying the Super VU-Finder, I was using the following antenna:
(make) _____ (model) _____

2 In my opinion the Super VU-Finder is: BETTER WORSE
because: _____

3 Comments: _____

NAME _____

COMPANY NAME _____

ADDRESS _____

CITY _____ STATE _____ ZIP _____

COUPON MUST BE POSTMARKED BEFORE FEB. 28, 1974

The Year of Confusion



It is always nice to start the new year in a state of glowing optimism, anticipating even better times ahead. However, things are changing and for the first time that we can recall, we are faced with

reliable predictions of gloom.

Government neglect by both the President and Congress has resulted in unprecedented economic instability. At least during the days of the "great depression" you knew that if you could possibly scrape up the money, what you needed was available on the market; and during World War II one could at least feel confident that there was enough fuel available to heat ones home and keep the lights burning—even if there was rationing of gasoline.

Just as the domestic demand for the food we produce began to approach domestic production, the government proudly announced the export of vast quantities of food—quantities far greater than were ever thought possible—to help offset a dangerous balance of payments problem resulting partly from importing an excess amount of consumer goods, but primarily from our military involvement abroad. (Too many seemed to think that Uncle Sam was everybody's uncle.)

A few years ago I was editor of another publication called INDUSTRIAL GAS. It was a publication for the industrial consumers of natural gas. Our company got rid of the magazine. Why? Because even then there was such a shortage of natural gas that the gas utilities were forced to restrict future sales. Yes, we were faced with the beginning of our current energy crisis several years ago, but the government chose to "stick its head in the sand" rather than do something about the problem before it reached the critical stage that we are now encountering!

In a number of states the governors have had the authority to quickly relieve local strained situations by allocating fuel and reducing highway speed limits.

But they were afraid of possible resulting criticism and so did nothing—leaving the legislature with the responsibility of getting the job done.

This nation has the brain power and the natural resources to remain the richest country in the world. There is enough solar power and wind power potentially available that each alone could be enough to power this country—if the proper investment were made. We also have the talent with which to develop locally available substitutes for any raw material that must now be imported. As much as I appreciate the scientific value of our frequent expeditions into space, that money should have been spent to make those alternative sources of energy and materials practical now—now when we need them!

The great majority of our readers are independent minded individualists who are willing to bear personal responsibility and enjoy working hard to overcome challenging problems. They are also typically conservative, extremely loyal Americans. They believe strongly in our brand of democracy and a free enterprise system too frequently threatened by socialism. The problem is not our form of government, but that far too many of our leaders in government lack the same zeal and personal drive that our readers have. Maybe it is about time that some of our more successful readers take more seriously their dedication to this country and enter politics—driving from office those professional politicians that are expert at putting on the charm, but who fail to keep in touch with reality—or are too concerned with personal gain!

Well, we are in this mess now, what are we going to do about it?

Customers should be advised that solid-state receivers consume only a fraction of the electrical power consumed by tube receivers, and that they can thus help relieve the power problem by purchasing such receivers.

With sections of the country facing potential "brown outs," it might be advisable to purchase an advance supply of constant-voltage power transformers for bringing the line voltage up to normal for those radios and TV sets that

fail to function on low voltage. Some of the new TV sets have power supplies already capable of handling such problems. Customers should be advised of that fact.

Some customers may fear that there will not be even enough power available in their area for operating TV sets and thus will be showing a greater interest in purchasing battery powered radios. For those that are letting their imaginations really run wild, you might even consider selling solar panels that are now on the market as battery substitutes.

The American public is prepared to do a little extra walking if necessary . . . it is prepared to wear warmer clothes and sleep under more blankets . . . but it is not prepared to go without entertainment! In fact, it will turn more and more to entertainment in the home as an escape from its problems. Thus there will be an even greater demand for the sale and servicing of radios and TV sets—particularly those models that consume relatively little power. And they will pay well to see that these products function properly at all voltages available.

With possible factory cutbacks also resulting from the energy crisis, manufacturers will probably tend to concentrate more heavily on merely new products, resulting in even a greater parts availability problem. This will probably mean that the average electronic technician will have to know his theory of electronic circuitry better than many now do, thus permitting him to make slight circuit modifications to permit part substitution.

We certainly can expect more hardships. However, Americans tend to be a hardy lot—descendants of the more adventurous of other nations—and there can be little doubt that although we may grumble a bit, we will take these problems in our stride. In fact, those in our profession will probably make more money this year than ever before!

Phillip Dahlen, C.E.T.

**Now—a middle line
of RCA replacement
color picture tubes...**

COLORAMA



**INTRODUCING
RCA COLORAMA A**

It rounds out RCA's complete range of tube quality, price and warranties.



HI-LITE

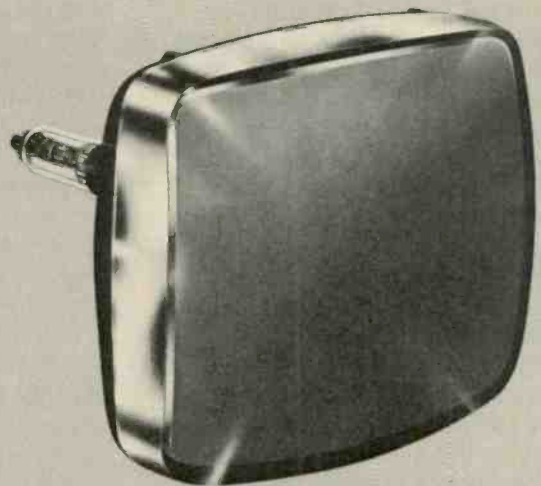

Colorama... Good

This is RCA's commercial standard color picture tube line. Each tube has a new electron gun. The other components and materials are re-used, after careful inspection to meet RCA's high quality standards. 12 month warranty... additional 12 months available.

Colorama A... Better

This is RCA's grade "A" line. Every tube is totally remanufactured using the latest all-new rare earth phosphors, new electron gun, and used X-radiation attenuation glass. 18 month warranty... additional 12 months available.

Hi-Lite... Best

This is RCA's prestige line of all-new color picture tubes. Each incorporates a new electron gun, new X-radiation attenuation glass, latest new rare earth phosphors and Perma-Chrome, for locked-in color purity and uncompromised contrast and brightness. 24 month warranty... additional 12 months available.

And all three lines include RCA BLACK MATRIX Types, the advanced RCA tubes that are as much as 100% brighter than any equivalent non-Matrix picture tube in RCA's history. So get the full choice of color picture tube quality, price and warranties. Make your choice RCA, leader in electronics for the home.



RCA

RCA/Electronic Components/Harrison, N.J. 07029

Channel Master announces changes for the best! An open and shut case for the nation's best selling Antenna Rotator!



We've made a few improvements on our Colorotor...to make it even better!

Our new Golden Colorotor has an easy terminal access that makes installation a snap open and shut case! Now, without having to un-bolt or unscrew, you just snap open the door, hook up your wire, then snap it back shut for a permanently weather protected connection!

And, our new Golden Colorotor stands up even better through industrial pollution and salt air. We've given it a golden armor coating that provides super tough corrosion resistance!

The new Golden Colorotor comes with the same dead center aiming accuracy that's made the Channel Master Automatic the nation's number one. Now, with easier installation, greater durability and eye appeal... the best on the market is even better!

CHANNEL MASTER

DIV. of AVNET, INC., ELLENVILLE, N.Y. 12428



The **NEW**
GOLDEN
COLOROTOR

...a fitting
match to our
golden EPC
coated antennas,
Duratube
masting, and
Gold Vinyl
Rotor Wire.

... for more details circle 109 on Reader Service Card

LETTERS

Reader comments concerning past feature articles, Editor's Memos, previous reader responses or other subjects of interest to the industry.

Wants to Hear More Concerning Seminars

First, I compliment you on your magazine and your editorials. I began in electronics with tubes and transistors. I am now struggling to catch up on IC's, LSI's, MOS's and CMS's. Your magazine is an enormous help.

Second, I write to ask for any information you have on technical seminars in the Philadelphia and Wilmington area. I attend college, as well as work, but can't get courses that will help me as an electronic technician. I think that it might be a useful addition to your magazine to add a monthly feature with information about seminars and other training available around the country. Again, thanks for a useful publication.

WILLIAM FORD, CET

Thank you for your very complimentary letter. Rather than merely forwarding it to but one or two associations that might conduct seminars in your area, we plan to print your letter in hopes that everyone considering such seminars will read it and contact you.

We very much like your idea of printing a listing of seminars as they are conducted by all groups—associations, manufacturers, schools, etc.—across the country. Despite our pleading to all such groups for such information, little if any is received in time to reach our readers prior to the date that such seminars occur. This we consider a significant deficiency on the part of those organizing such seminars. Ed.

Radio and Television Are Best Buy for Consumer

Congratulations on the top editorial in your November 1973 issue. Years ago Khrushchev said we will bury you. He saw what was happening—what has happened to Yankee ingenuity.

Radio and television has been the best buy for the consumer. Progress and improvements have brought lower prices within reach of all. The auto industry is the opposite, having the most inferior product in history and the most expensive, a hazard to all life on Earth.

LEO J. DRAUS, CET

END OF THE REPLACEMENT TRANSISTOR NIGHTMARE

just 47 transistors replace over 22,500 O.E.M. part numbers.

Finding the right replacement transistor has been a real toughie for most service technicians. Over 22,500 existing part numbers have made life difficult. Now, they can be replaced with just 24 small-signal, 18 power, and 5 field effect transistors. You can get any or all of the 'Fantastic 47' on the self-service Semiconductor Q-Mart at your Sprague distributor's. While you're there, pick up a free copy of the 48-page K-500 Semiconductor Replacement Manual. Or . . . write to Sprague Products Co., 65 Marshall St., North Adams, Mass. 02147.

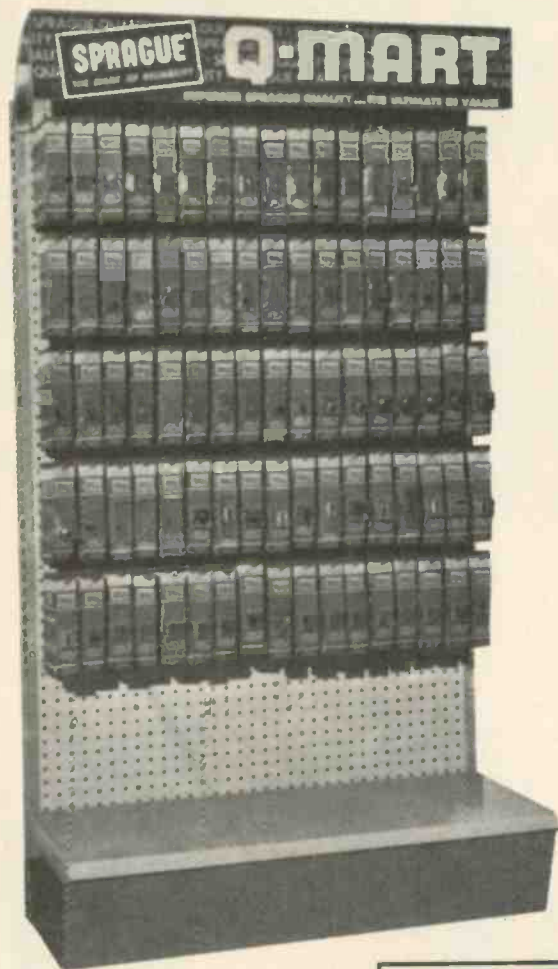

SPRAGUE
THE MARK OF RELIABILITY

THE BROAD-LINE PRODUCER OF ELECTRONIC PARTS

... for more details circle 136 on Reader Service Card

More and more people are learning that a replacement is an improvement with Amperex tubes.



...remember...there's an Amperex replacement tube for any socket in any set you're likely to service. TV, Hi Fi, FM or AM, House Radio, Car Radio, P.A. System or Tape Recorder. Imported or Domestic!

Amperex®

TOMORROW'S THINKING IN TODAY'S PRODUCTS

A NORTH AMERICAN PHILIPS COMPANY



AMPEREX ELECTRONIC CORPORATION, DISTRIBUTOR AND ENTERTAINMENT PRODUCTS DIVISION, HICKSVILLE, N. Y. 11802

... for more details circle 102 on Reader Service Card

READERS' AID

Space contributed to help serve the personal needs of you, our readers.

Schematics

I have Arvin B/W TV schematics for the TE-272 through TE-386 chassis free to anyone who wants them. Just pay the postage. I also have a Super Meter Model 670-A, manufactured by Superior Instruments, VOM booklet at \$.50.

DON AIJALA

50 Fir Circle
Babbitt, Minn. 55706

Business for Sale

Established Radio-TV service business for sale which grossed approximately \$60,000 in 1973. I also have a 12- by 65-ft. mobile home for sale. The business is reasonably priced, with low down payment and easy terms.

BOB BORUM, CET

P.O. Box 894
High Springs, Fla. 32643

For Sale

I have approximately 300 Sams Photofacts No. 147 to 1195 for sale at \$.50 each or best offer.

DONALD LEWIS

Route 1
Central City, Neb. 68826

I have for sale Rider's TV Manuals, Volumes 6 to 25 and a Simpson Model 479 TV/FM Signal Generator, like new with instruction manual.

JOHN DIPINTO

47-19 197 St.
Flushing, N.Y. 11358

I would like to sell a Triplet Model 310 Pocket VOM, RCA Sweep Generator Model 59C and a Simpson Model 488 Field-Strength Meter. All of the instruments have operating instructions.

OWEN REINEY, CET

4733 Lewis Dr.
Port Arthur, Texas, 77640

I have for sale Sams AR Manuals, a B & K Model 1076 Analyst, Sylvania Polymeter, old radio tubes, parts, ballasts and two AK radios. I would like to purchase test equipment.

WILLIAMS RADIO & TV SERVICE
106 South Jefferson St.
Lewisburg, W. Va. 24901

I have an ARP Synthesizer for sale.
DAN KEEN

219 19th Street
Avalon, N.J. 08202

Wanted

I would like to obtain a high-voltage transformer for a Raytheon color-TV set. I can use either Part No. 201-26405 or 12E26639 or Sentinel Part No. 20E1107.

SAMUEL M. PEARLMAN
25 Wolcott Rd.
Lynn, Mass. 01902

I would like to locate the manufacturer of a Triumph Model TC900 Transceiver and the following information and parts: Schematic and alignment instructions, 2-DX-CA antennas, 2-DXPT push-to-talk switches.

RONALD SHOEMAKER
155 Kendall Dr. W.
East Syracuse, N.Y. 13057

I would like to purchase the adapter "Gidget" which enables playing a four-track tape on an eight-track player. If anyone has some to sell or knows where to purchase them, please contact me.

S. S. ELOSH, JR.
231 Gladstone
Campbell, Ohio 44405

I would like to obtain an instruction manual and any other data on a Century Tube Tester, Model No. FC-2.

CARL RODERICK
19866 Seabrook Rd.
Jupiter, Fla. 33458

I would like to obtain a tube chart for a Supreme Model 1-177-B dynamic mutual conductance type tube tester.

D. L. MARSHPUND
Rt. 2, Box 65
Bay Minette, Ala. 36507

I would like to obtain a schematic for an Ansa-Phone Model KH85.

DONNELLE E. GATCH, CET
110 Ester
Orange, Texas 77630

I would like to obtain a complete set of Riders Perpetual Troubleshooters Manuals. Please state condition and price wanted.

LARRY LA DUE
484 Arleta Ave.
San Jose, Calif. 95128

A LITTLE KNOWLEDGE IS A PROFITABLE THING. (LIKE \$50 MORE A WEEK.)



Take our Super Frost Aid, for instance. The more you know about it, the more money it makes for you. You probably know it's the best way to find tricky intermittents. Just let the set cook, and when trouble shows up, spray the suspected circuit or stage component-by-component (it's easy with the free spray extender), until the trouble disappears. That's all there is to it—and there's no liquid residue!

But that's not all there is to Super Frost Aid. Not by a long shot.

When you suspect a cracked PC-board, there's no need to go over it with a magnifying glass. Spray Super Frost Aid on the board, and look for gaps on the conductors. It's easy. Fast. And a great way to make money on "tough dog" problems.

More? More! When you're soldering, Super Frost Aid is the easiest, fastest heat sink around. Spray on semiconductors and other delicate parts before soldering. Spray after soldering to make parts easy to handle. Also helps prevent burnout of transformers and other parts from abnormal conditions, by cooling them off quickly. Minimizes problems caused by shorts and other failures.

Super Frost Aid has many other general uses. Use it to cool and "shrink" the inner of two tight-fitting parts, to join or separate them.

Use it as an emergency fire extinguisher. Or as first-aid on burns. It's also handy for removing chewing gum and other adhesive materials—cold reduces adhesion, makes separation easier.

There are dozens of other ways Super Frost Aid—and our other chemical problem-solvers—can make life easier (and more profitable) for you. See them at your distributor's, or write for our brochure.



CHEMTRONICS
INCORPORATED
1260 RALPH AVE., BROOKLYN, N.Y. 11236
Our business is improving yours.

... for more details circle 110 on Reader Service Card

NEWS OF THE INDUSTRY



Sen. Barry M. Goldwater is shown just before addressing the Radio Club of America at The Plaza in New York City to help celebrate the 64th Anniversary Dinner of this electronic society. In the group (l-r) are Al Menegus, publisher of ELECTRONIC TECHNICIAN/DEALER; Sen. Goldwater; T. C. Tsao, senior research scientist at Columbia University Electronics Laboratory; Joanne Link Sotres, daughter of the Club's president and president of Sotres Link Ltd., a promotional service; and Jack Stroud, a New York broker.



Sen. Goldwater receives the initial Sarnoff Citation for significant contributions in electronic communications from Fred M. Link, club president.

Washington Court Makes Ruling Concerning Liens for Estimates

The November issue of WSEC SERVICE NEWS reports that about a year ago a dispute arose between Bob Lyons, CES/CET, owner of Allied T.V., Seattle, Wash., and a Mr. and Mrs. Cox over Lyons' right to hold a TV set for estimate charges which were agreed upon beforehand.

The Coxes sued and the case was tried before Judge Janice B. Niemi in Justice Court. She held against Lyons

and Allied, who appealed to the Superior Court.

Since this was a case involving the rights of every service shop in the state, both King County TSA and WSEC lent both moral and financial support to Lyons. They retained attorney Kenneth O. Welling who worked with Lyons' attorney, but did not handle the case. The following is the report to the Council's Secretary of his observations in court where the case was tried before Judge Frank Roberts in a two-day trial.

September 28, 1973

Mr. Al Wyman
Washington State Electronics Council
and Oregon State Technical Convention
Sheraton Hotel
1000 N.E. Multnomah Street
Lloyd Center
Portland, Oregon 97208
Dear Al:

This is a report for your convention purposes on the result of the Lyons vs. Cox lawsuit.

You may remember the facts to be as follows: Mrs. Cox brought Mr. Lyons a TV set for repair. Mr. Lyons has a large sign in his store which says \$12.50 minimum charge and no free estimates. Mrs. Cox asked that Mr. Lyons examine the set to find out what was wrong with it and call them before he did any repair work. Mr. Lyons examined the set, called the Coxes, advised them that it needed a new filter and that the cost of repair would be not more than \$50.00. Mr. Cox advised Mr. Lyons to go ahead and repair the set and then in a few minutes Mrs. Cox called back and said don't repair the set, we will have somebody else repair the set for us.

Shortly thereafter, Mrs. Cox came in and wanted to get the TV set and Mr. Lyons told her that she could have the set only if she paid him \$12.50, his minimum charge for inspection of the TV set. Mrs. Cox then prepared to write a check and Mr. Lyons said he could not accept a check under these circumstances, he would have to have cash. Thereupon Mrs. Cox left the store and after two months Mr. Lyons wrote her a letter saying that she would have to pay storage if she didn't come in and pick up the TV set. Whereupon Mr. Cox sued Mr. Lyons for conversion of the set.

The case was tried before Judge Frank Roberts and on the above set of facts Judge Frank Roberts arrived at the following conclusions:

1. That Mr. Lyons' charge of \$12.50 was a reasonable charge for the inspection of the TV set.
2. That the TV set in its non-operating condition was worth \$10.00 at the time Mr. Lyons refused to redeliver to Mrs. Cox.
3. Mr. Lyons did not make any repairs or improvements to the set, all he did was examine it and find out what the trouble was and for this reason Mr. Lyons did not have a common law possessory lien on the TV set, nor did he have a statutory chattel lien on the TV set because he had not made repairs or improved the value of the property.
4. Mr. Lyons did not have the right to withhold the TV set when Mrs. Cox asked for possession. Mr. Lyons was therefore granted a judgment for \$12.50 against the Coxes, and the Coxes were granted a judgment against Mr. Lyons for \$10.00 for converting their TV set. The end result of all this is that Mr. Lyons has \$2.50 coming from the Coxes and the TV set is his, he having converted it and its value having been \$10.00 at the time of the conversion.

Now the important thing for the members of your convention to learn from this is that the Superior Court in King County has ruled that a TV repairman who simply undertakes to inspect the TV set to find out what is wrong with it, cannot withhold possession of the set when the customer comes in and asks to pick up the set without having the repair work done. If the repair work is done, the

repairman obviously has a possessory lien on the goods and can keep the TV set until the bill is paid, but if the repairman only inspects the set, he does not have a lien on the goods and he will have to redeliver and sue the customer for the \$12.50 or whatever his minimum charge is.

Sometime back I have given you a recommendation to the effect that each TV repairman who wants to charge this minimum charge for inspecting the set either have new invoices printed up or that he buy a rubber stamp containing substantially the following language:

I hereby deliver my TV set to you for examination and inspection in order to determine what repairs are necessary. I hereby grant you a possessory lien on the goods and you may retain possession of the goods until the inspection charge has been paid. I further direct that in the event you retain possession of the TV set pursuant to your possessory lien which is herein granted and maintain possession of the same for 60 days, you may sell the TV set at public auction, retaining from the sale of the proceeds your charges for service and remitting the balance, if any, to me.

(customer's signature)

The only other reasonable alternative I can see, having each of the members either print the invoices in the above manner or have a rubber stamp on which this material can be stamped, is to require that the customer make a cash deposit in the amount of the minimum bench charge at the time he brings the TV set in. Mr. Melang seems to indicate to me that this is a very undesirable way to handle this problem and I tend to agree with him. I believe that the giving of a possessory lien by contract rather than by operation of law, as I have outlined above, is the better way for your association members to proceed.

Very truly yours,
KENNETH O. WELLING. . .



A group of 40 dealers, installers, distributors and contractors attended the 15th Winegard MATV seminar held during 1973 at Pzazz! in Burlington, Iowa. An important theme throughout the seminar was how to install TV reception systems that work properly in a wide variety of applications—such as homes, hotels, apartments, schools and hospitals. Instruction centered around MATV system theory and design, sales techniques and bidding procedures. Everyone had a chance to study new Winegard MATV and closed circuit TV products.

NESDA Business Management School Announces Beginning of 1974 Schedule

Les Nesvik, CET, NESDA's Co-ordinator of Education and Training, has announced plans for the first of a nation-
continued on page 18



**DEALER NET
CARD OF 12 TABS \$9.95**

INSTALL 2 TABS AND THE
OTHER 10 ARE YOUR PROFIT
FOR THIS SERVICE

DESIGNED FOR STRIP TYPE
TUNERS—B/W AND COLOR

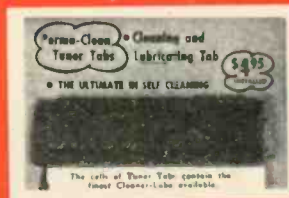
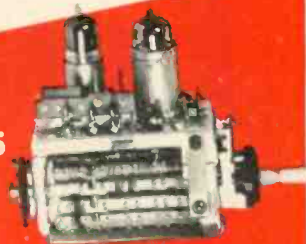

ADHESIVE HOLDS
TUNER TAB TO
SHIELD COVER

"AUTOMATION"
FOR TUNER
MAINTENANCE
IS HERE!

PRETREATED WITH
PERMA-CLEAN

THE NON-EVAPORATING CLEANER
THAT WILL NOT CAKE OR HARDEN

The Service Dealer Now Makes A Profit for Cleaning Tuners

- Continuously Cleans, Polishes and Lubricates Contacts
- Will Not Detune or Cause Frequency Drift
- Harmless to Plastics and Tuner Components
- Fast and Simple to Install

NO SPRAY CLEANER NECESSARY

Available at most electronic part supply companies or send \$9.95 per card to

UNIVERSAL TUNER TABS MFG., INC.

12400 MINNETONKA BLVD., HOPKINS, MINN. 55343

© 1973 by UNIVERSAL TUNER TABS MFG., INC.

. . . for more details circle 145 on Reader Service Card

Take it to the moon
or mountaintop. It's the
new Fluke go anywhere
telecommunications counter.



Model 1980A
with rechargeable battery
pack and carrying case.

- 5 Hz to 515 MHz
- 6 digit LED display
- Units annunciation
- Optional snap-on battery pack for up to 5 hours off-line operation
- 50 millivolt sensitivity over entire range
- Superb Fluke quality and reliability
- TCXO for instant-on full time accuracy
- World-wide network of factory service centers

FLUKE

For data out today,
dial our toll-free hotline,
800-426-0361

John Fluke Mfg. Co., Inc., P.O.
Box 7428, Seattle, WA 98133

. . . for more details circle 118 on Reader Service Card

JANUARY 1974, ELECTRONIC TECHNICIAN/DEALER | 15

A good number of reasons

3,000,000,000

That's a lot of receiving tubes, but when you've been in the business as long as we have you're bound to have produced billions. In fact, our "Receiving Tube Characteristics" brochure (ET-1350), right now, lists over 2000 different tube types. Pick up a copy at your local distributor and see what made us a leader.

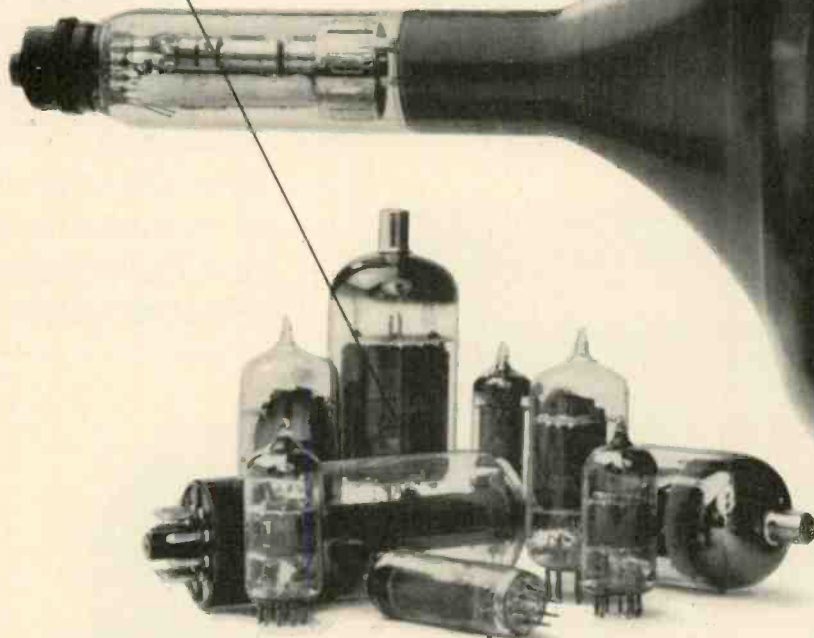

75,000

Who needs that many semiconductor replacement parts? You don't. Actually, what we have is an ECG Semiconductor Replacement Guide (ECG-212E) that will let you replace 75,000 parts with a total number in the low hundreds. That makes it easier for everybody to have a complete stock. And our Replacement Guide makes it easier to select the part you need right when you need it. Just pick up a copy of our Replacement Guide at your local distributor and you'll see why we're the leader.

why we're the leader.



55,000,000

That's how many cathode-ray tubes we've made. Both black-and-white and color. This year alone, we made more TV picture tubes than any other American manufacturer. And our Interchangeability Guide (ET-1496) lets you replace more tubes with fewer types. Get a copy of the Guide at your distributor. You'll see why we're the leader.

We've just given you 3,055,075,000 reasons why we're the leader. What more can you ask for?

Except Sylvania.

Sylvania Electronic Components, 100 First Avenue, Waltham, Mass. 02154

GTE SYLVANIA

MAGIC COLOR ANTENNAS Sales Orbit

THROUGH:

- ★ Higher Profit
- ★ Sales Captivating Packaging
- ★ Excellent Quality
- ★ Full Range Of Models



APOLLO

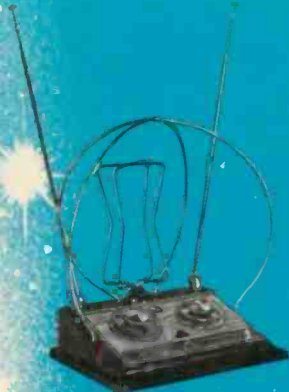

GALAXY



VENUS

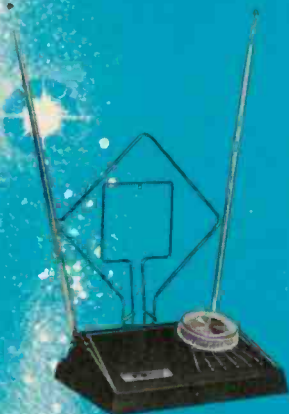

SATURN



GC ELECTRONICS
DIVISION OF HYDROMETALS, INC.
ROCKFORD, ILLINOIS 61101 U.S.A.



... for more details circle 121 on Reader Service Card

NEWS...

continued from page 15

wide series of Business Management Schools to be conducted during this and following years.

The program is designed so that it is valuable to the one- and two-man shop, and yet the larger sales and service organizations will find it an asset also.

Current plans include the following:

January 8 and 9, 1974—7:00 p.m. to 10:30 p.m.

124 Tredeau Lane
Metairie, La.

Sponsored by Pelican Electronics

January 14 and 15, 1974—7:00 p.m. to 10:30 p.m.

Radonics Electronics
4415 Gustino Ave.
St. Louis, Mo.

February 17 through March 1, 1974

10 full-day sessions in Washington and Oregon

For local information contact: Jim Rolison, 6110 N.E.

Union, Portland, Ore., phone (503) 282-7751

or

Enos Rice, CES/CET, 1605 8th Ave., Seattle, Wash.,
phone (206) 622-3240

Those electronic technicians and service dealers wishing additional information so that they might attend, and those distributors interested in possibly sponsoring the school in their own area, may contact Mr. Nesvik directly. His address and phone number are: 1715 Expo Lane, Indianapolis, Ind. 46224, phone (317) 241-8160.



Valerie Miller, CET, new Chairwoman of ISCET, is shown during a recent visit at the Indianapolis association headquarters to look over the CET and ISCET programs. She is shown here talking to one of the staff members, Robin Lyons (right). Valerie replaces Les Nesvik, CET, who has stepped down as this year's Chairman due to his current position as a full time staff member of NESDA. George Sopocko, CET (shown below), was elected by the ISCET delegates in Toledo at the quarterly meeting to succeed Valerie as Vice Chairman.



If you had to name the top electronics service company who would it be?

That's a tough question, because when it comes to service, it's hard to compare apples to apples. Some companies offer you many services—others very few. So before you make up your mind, we'd like to tell you about some of the services Panasonic has developed. Services that can make both our jobs a lot easier.

Like offering complete technical back-up information and assistance. We make available detailed service manuals on every product we've ever sold—over 11,000 since 1959. And if

you need more information, call the regional office in your area. And if you still want assistance, we'll send out one of our traveling field service specialists as your personal problem solver. And there's more. We hold annual training seminars to acquaint you with our products, inside and out. And at industry conventions, you'll find a Panasonic representative to explain our latest service advances.

At the core of it all are our products. All designed with a high level of serviceability—meaning

less time and effort for you. For instance, our Quatecolor TV sets scored 94.6 in the NEA serviceability tests of January 1973. And we're continually looking for new improvements. The fact is that Panasonic pays as much attention to service as it pays to sales. And everybody is profiting—consumers, dealers and service technicians. So before you consider who to name as the top electronics service company, run through the facts. The more you know about Panasonic, the better it is for everybody.



for more details circle 133 on Reader Service Card

Panasonic.
just slightly ahead of our time

NEW AND NOTEWORTHY

For additional information on products described in this section, circle the numbers on Reader Service Card. Requests will be handled promptly.

FOR MORE
NEW PRODUCTS SEE
PAGE 50

FOUR-CHANNEL SYSTEM 700

Facilities for directly decoding or demodulating every four-channel medium

Introduced is a four-channel Receiver, Model SA-8000X, with complete built-in facilities for directly decoding or demodulating every four-channel medium in use today.

The receiver has plug-in adaptability for discrete four-channel broadcasts of the future. Also featured is a built-in demodulator for CD-4 discrete four-channel discs and an Acoustic Field Dimension (AFD) Control System which reportedly permits precise adjustment to any matrix system in use today, as well as any that may be devised in the future. The unit can reportedly accommodate all auxiliary four-channel sources, including discrete four-channel tape equipment, reel-to-reel and cartridge. It has a separate level control for each channel (plus a master gain control), four-channel/two-channel speaker outputs, and expanded tape monitor and dubbing facilities. Panasonic.



TAPE RECORDER 701

Plays tapes faster or slower than normal without changing pitch

A tape recorder is designed which will play back a tape at speeds faster or slower than it was recorded, without altering the proper pitch of the original recorded signal. The Model TSC-8800 tape recorder employs a random access memory that uses digital technology and a delta converter. The frequency converter keeps the frequency during playback the same as during recording. Playback speeds can reportedly be slowed by as much as 50% or increased by as much as 100% without causing any tonal change. It can record and play back at the "normal" speed of 1 7/8 i.p.s. In addition its "talk speed control switch" also allows the user to select from among eight changes in playback speed. Playback speed can be increased 1.2, 1.4, 1.6 or 2.0 over normal or slowed down to 0.8, 0.7, 0.6, 0.5 of normal. The unit features a twin-motor mechanism, automatic stop, cue and review, built-in condenser mike and a three digit tape counter. Hitachi, Ltd.



INTERMODULATION DISTORTION ANALYZER 702

Makes complete check of IM at 10 different levels using a single control

Introduced is an intermodulation distortion analyzer, designed to make SMPTE-type IM measurements of audio equipment. The Model IMA reportedly makes a complete check of IM at 10 different levels over a 45dB range (in 5dB steps) using only a single control. Test frequencies are generated by FET controlled bridge oscillators and are completely independent of line voltage. Typical residual IM is reportedly 0.005% and accurate to within 5% of full scale. Additional input sensitivity of the unit makes it possible to check a power amplifier driving 8Ω down to 900μw. The instrument is built on an aluminum chassis and can be rack-mounted. All controls and connections are front-mounted. Crown.



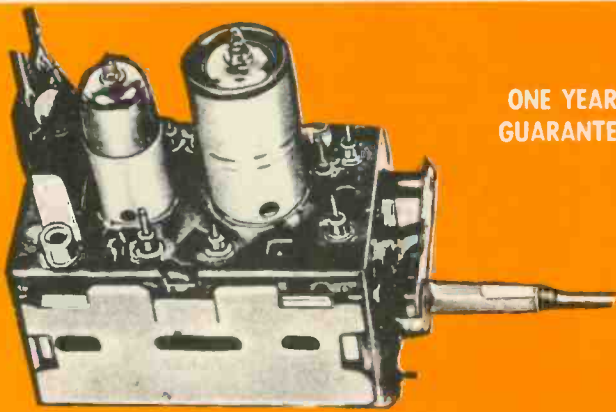

ONE YEAR
GUARANTEE

\$9.95

ALL PARTS
INCLUDED

EXCEPT TUBES & TRANSISTORS

TUNER SERVICE CORPORATION

PROVIDES YOU WITH A
COMPLETE SERVICE FOR
ALL YOUR TELEVISION
TUNER REQUIREMENTS.

REPAIR

VHF OR UHF ANY TYPE \$9.95
UHF/VHF COMBINATION \$15.00

In this price all parts are included.

Tubes, transistors, diodes, and nuvistors are charged extra. This price does not include mutilated tuners.

Fast, efficient service at our conveniently located service centers.

All tuners are ultrasonically cleaned, repaired, realigned, and air tested.

REPLACE

UNIVERSAL REPLACEMENT TUNER \$9.95

This price buys you a complete new tuner built specifically by SARKES TARZIAN INC. for this purpose.

All shafts have a maximum length of 10½" which can be cut to 1½".

Specify heater type parallel and series 450mA or 600mA.

CUSTOMIZE

Customized tuners are available at cost of only \$15.95 - With trade-in \$13.95.

Send in your original tuner for comparison purposes.



WATCH US
GROW

HEADQUARTERS ..	BLOOMINGTON, INDIANA 47401	537 S. Walnut Street	Tel. 812-332-7251
ARIZONA	TUCSON, ARIZONA 85713	P.O. Box 4534, 1528 S. 6th St. ...	Tel. 602-791-9243
CALIFORNIA	NORTH HOLLYWOOD, CALIF. 91601 ..	10654 Magnolia Boulevard	Tel. 213-769-2720
	BURLINGAME, CALIF. 94010	1324 Marsten Road	Tel. 415-347-5728
	MODESTO, CALIF. 95351	123 Phoenix Avenue	Tel. 209-521-8051
FLORIDA	TAMPA, FLORIDA 33606	1505 Cypress Street	Tel. 813-253-0324
GEORGIA	ATLANTA, GEORGIA 30310	938 Gordon Street S.W.	Tel. 404-758-2232
ILLINOIS	CHICAGO, ILLINOIS 60621	741 West 55th Street	Tel. 312-873-5555-6-7
	SKOKIE, ILLINOIS 60076	5110 West Brown Street	Tel. 312-675-0230
INDIANA	HAMMOND, INDIANA 46323	6833 Grand Avenue	Tel. 219-845-2676
	INDIANAPOLIS, INDIANA 46204	817 North Pennsylvania St. ...	Tel. 317-632-3493
KENTUCKY	LOUISVILLE, KENTUCKY 40208	2920 Taylor Boulevard	Tel. 502-634-3334
MARYLAND	BALTIMORE, MARYLAND 21215	5505 Reisterstown Rd., Box 2624	Tel. 301-358-1186
MISSOURI	ST. LOUIS, MISSOURI 63132	10530 Page Avenue	Tel. 314-429-0633
NEVADA	LAS VEGAS, NEVADA 89108	3816 Vegas Drive	Tel. 702-648-1450
NEW JERSEY	TRENTON, NEW JERSEY 08638	901 North Olden Avenue	Tel. 609-393-0999
	JERSEY CITY, NEW JERSEY 07307 ..	547-49 Tonnele Avenue	Tel. 201-792-3730
OHIO	CINCINNATI, OHIO 45216	7450 Vine Street	Tel. 513-821-5080
	CLEVELAND, OHIO 44109	4597 Pearl Road	Tel. 216-741-2314
	TOLEDO, OHIO 43624	119 North Erie Street	Tel. 419-243-6733
OREGON	PORTLAND, OREGON 97210	1732 N.W. 25th Avenue	Tel. 503-222-9059
TENNESSEE	GREENEVILLE, TENNESSEE 37743	1215 Snapps Ferry Road	Tel. 615-639-8451
	MEMPHIS, TENNESSEE 38114	1703 Lamar Avenue	Tel. 901-278-4484
TEXAS	DALLAS, TEXAS 75218	11540 Garland Road	Tel. 214-327-8413
VIRGINIA	NORFOLK, VIRGINIA 23502	4538 East Princess Anne Rd. ...	Tel. 804-855-2518

... for more details circle 141 on Reader Service Card

Winegard challenges the competition

with the new, low cost

DA-825B...



a cost breakthrough in distribution amplifier design!

Winegard's engineers have done themselves proud with this one — an amplifier that does the job at $\frac{2}{3}$ the cost of competition* — and more importantly, without sacrificing all these important features:

HIGH OUTPUT LEVEL: 46 dbmv (200,000 microvolts) on each of 7 VHF channels at 0.5% cross modulation; 45 dbmv (178,000 microvolts) on each of 5 UHF channels at 0.5% cross modulation ... enough to handle up to 48 taps without additional line amps.

HIGH INPUT LEVEL: Allows use in strong signal areas. 20 dbmv (10,000 uv) on each of 8 VHF channels, 22 dbmv (12,000 uv) on each of 5 UHF channels, both at 0.5% cross modulation.

HIGH GAIN: 26 db on VHF, 23 db on UHF for use in most reception areas.

LOW NOISE FIGURE: 3.6 db VHF, 6.0 db UHF for perfect color fidelity.

PASSES MID & SUPER BANDS (108-174 & 216-300 MHZ) — compatible with any CATV system.

LINE AMPLIFIER VOLTAGE to operate model L-213B or L-483B line amplifiers.

PLUS BUILT-IN FM TRAP, REGULATED POWER SUPPLY, LIGHTNING PROTECTION and more!

*Ask your distributor for full specs and prices, or write direct.



WINEGARD
TELEVISION SYSTEMS

Winegard Company
3000 Kirkwood Street
Burlington, Iowa 52601

... for more details circle 142 on Reader Service Card

System Offers Three Ways to Build Receiver Sales

They get straight answers before and after the sale, and as a result Sid Zimet's audio business grows

■ "I offer complete service to my customers—before and after the sale." Sid Zimet, owner of Audio by Zimet in Long Island, continues, "The service I provide is three pronged. Since I have an in-house FM station, customers can hear how a tuner sounds with a controlled program source. Second, my tuner clinics tell a customer exactly what kind of shape his receiver is in. Finally, my shop is fully equipped to repair defective receivers."

"The system that lets me do this is a traffic builder," says Sid. "People around here know that Audio by Zimet is a technically competent dealer that provides complete service. They get straight answers here before and after the sale. As the word spreads, my business grows."

The Receiver Demonstration System

Sid's tuner sales and service capability is keyed to two pieces of equipment. Since Sid mentioned his FM station first, let's begin by analyzing that.

Sound Technology, a Cupertino, Calif. based company, manufactures the Model 1100A/1000A precision FM transmitter that Sid uses. As shown in Fig. 1, the addition of a phonograph or tape recorder to the transmitter is all you need to build your own top-quality FM radio station.

The easiest way to ana-

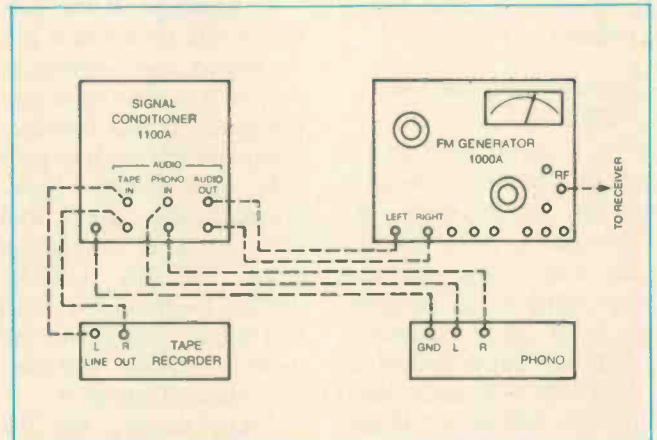

Fig. 1—System connections.

lyze the system in detail is to begin with the audio source. You start with one of the better changers or tape recorders from stock. The same program material you use for demonstration speakers will be suitable for demonstrating receivers.

The audio source is connected to the appropriate inputs on the Model 1100A, which equalizes and amplifies the signal. RIAA equalization is provided on the phono input, and the tape input frequency response is flat according to NAB standards. Pre-emphasis is provided on both inputs as required for FM broadcasting— $75\mu\text{s}$ for the U.S. and Canada, $50\mu\text{s}$ for Europe. Overall frequency response accuracy of the system is $\pm 0.5\text{dB}$.

After the Model 1100A conditions the audio signal, it transmits it to the external audio inputs of the Model 1000A, which generates the FM multiplex stereo signal.

The Model 1000A was originally designed for the stereo receiver service industry and has been on the market for just over three years. It is now used by over 50 receiver manufacturers and hundreds of service shops. It has sweep capability, monophonic FM, continuously variable RF level and is tuneable over 88MHz to 108MHz, as well as providing the FM multiplex stereo signal. The most unusual feature of the 1000A is Dual Sweep, a patented technique that gives you the capability of aligning a receiver for minimum distortion without using a distortion analyzer. The Model 1000A was described in detail in the February 1971 issue of this magazine in an article entitled "FM Stereo Alignment."

The Model 1000A is set to its stereo mode of operation to broadcast FM. The multiplex signal is generated in the conventional manner by switching between the left and right

audio inputs at a 38kHz rate. A 19kHz pilot signal, with carefully controlled phase to maintain high separation, is added in to form the composite stereo signal. This signal is filtered and used to frequency modulate the RF oscillator. Deviation can be monitored on the meter provided in the Model 1000A.

Transmitting the FM Signal

It is tempting to get the signal to the receiver merely by connecting an antenna to the 1000A's RF output and radiating the signal to all receivers in your store. However, there are some difficulties with this approach. Each receiver will see a different signal strength, so direct comparisons can be unfair. Furthermore, radiation of the signal may be in violation of FCC rules.

An alternate method of distributing the FM signal is shown in Fig. 2. The Model 100 Matching Transformer converts the 50Ω impedance level of the 1000A output to 300Ω to match the receivers' antenna impedance. Coaxial switches should be used to maintain the 50Ω impedance level and to prevent crosstalk. This method is a little more costly, but provides the capability of switching the signal from one receiver to another at a central panel.

Proper use of the master antenna system will also provide versatility in using your FM station. The major advantage of the system shown in Fig. 3 is the provision for listening to commercial FM stations as well as your own. Your high-quality signal is tuned in just as local stations are.

The impedance level of the system is 75Ω, thus the

75Ω-to-300Ω transformers at each receiver. The adjustable taps are set to provide the same signal level at each receiver. The directional coupler allows you to listen to local stations as well as your own.

How to Sell with Your FM Station

Application of the precision FM transmitter can be varied and sophisticated, or it can be very simple and straight forward. Some owners use it to provide high-quality background music. Others, who are in poor reception areas, use the 1100A/1000A to provide a clean FM signal. Still others use it to broadcast matrixed four-channel material.

Many owners use the system to demonstrate receiver performance under typical signal conditions. For example, FM stations are permitted by the FCC to occupy a 240kHz bandwidth, and to overmodulate on "occasional peaks." Some stations (often the more popular ones) modulate heavily to improve their coverage. To receive these stations without introducing distortion, a receiver must be able to handle a signal occupying 240kHz bandwidth and with a modulation level occasionally exceeding 100 percent. Many receivers don't. With the 1100A/1000A system you have control over the modulation level, and you can show your customer how various receivers perform with listening tests. He can compare receivers with identical program material, and tests can be repeated.

Sensitivity is another test you can use to show your customer why that more expensive receiver is really worth it. Present Institute of High Fidelity

standards for measuring sensitivity don't really tell you how a receiver is going to sound in stereo on a weak signal. The precision FM transmitter gives you complete control over signal strength, so you can show your customer how strong a signal the receiver requires to sound noise free in stereo.

Poor separation in a re-

ceiver is an obvious defect in itself, of course, but has an even more serious side effect. A receiver lacking in separation will frequently introduce excessive distortion. For example, a signal broadcast on the left channel only should not be heard in the right speaker at all. If the receiver's separation is substandard, the signal will

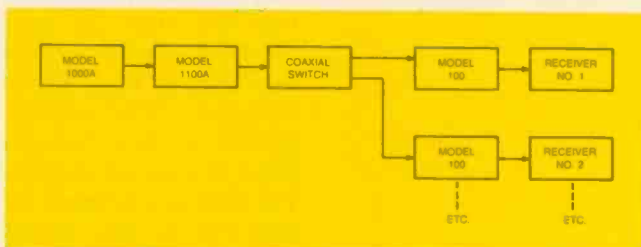

Fig. 2—FM signal distribution system.

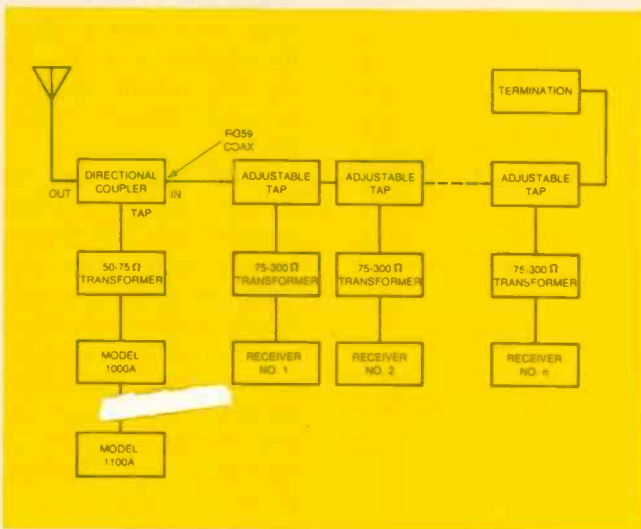

Fig. 3—Master antenna system.



There is no better technique for demonstrating top-of-the-line receivers than to tune them for receiving your own FM station.

not only be heard in the right speaker, but it can be badly distorted. This effect is particularly pronounced when the program material contains high frequencies, since tuners normally lose separation at high audio frequencies. The symptoms are deceptive but highly objectionable. A typical customer's complaint will be "Usually it sounds okay, but on some kinds of music the distortion is terrible." The 1100A/1000A system lets you transmit either channel alone with 50dB of separation so that you can use listening tests for separation as another technique to sell your custom-

er up to a better receiver. Receiver distortion, of course, is an obvious but important performance parameter. It is difficult to evaluate a receiver's distortion by listening to a commercial FM station because of variations in program material, signal strength and signal quality. The 1100A/1000A system overcomes these difficulties because it provides an essentially perfect FM signal. Distortion is less than 0.1 per cent, there are no limiters or compressors, you can have as strong a signal as you want, and you can repeat program passages at will. More expensive receivers

have lower distortion because it is hard to get, and the differences in receivers are clearly audible. The sound from a good receiver when tuned to the precision FM transmitter is as good as the sound you receive when playing a record directly through an amplifier.

The Second Way Sid Sells—Clinics

Last spring Sid ran a three-day tuner clinic using two Model 1000A FM alignment generators. "We were extremely pleased with our clinic," he reports. "We checked 320 receivers and found 280 that needed alignment or repair."

Tuner clinics are fast and effective using the Model 1000A. It lets you completely check a receiver in less than five minutes, including hookup. In fact, many dealers use this feature to make a standing offer:

They will measure the performance of any receiver brought into their stores—free.

If the customer wants his unit serviced, they can tell him what is wrong with it and sell a service job. If it is a possible trade-in, the clerk tells them exactly what kind of shape it is in and helps them sell a new receiver because they know the old unit's deficiencies, and can use them to point out the advantages of a new receiver.

The Third Way to Sell—Provide Service

When the customer wants his receiver fixed, the 1000A demonstrates its virtue as a service instrument. This generator provides all the signals you need for tuner troubleshooting and repair. A manual, "How to Align

Stereo Receivers," published by Sound Technology, fully describes the use of the 1000A as a service tool.

The greatest value of the Model 1000A as a service instrument is in troubleshooting. Features such as variable RF level, tuneability across the FM band, and a complete set of stereo functions including variable pilot level, are keys to time savings in troubleshooting. A survey of 1000A users shows a reduction in troubleshooting and repair time from one hour or more to less than 40 minutes—a 35 percent to forty percent savings.

These labor savings are significant in terms of dollars and cents. Assume your labor rate, including overhead, is \$12.00 per hour. The 35 percent savings in troubleshooting and repair time then amounts to \$4.20 savings per service job. In other words, it only takes 345 service jobs to recover the investment in the 1000A. If you service 10 or more receivers per month, the 1000A pays for itself in less than three years.

Now You Can Increase Sales and Profits

Effective demonstrations, tuner clinics, and complete repair facilities all contribute to business growth and increased profits. They build traffic in your store and increase your sales. They help build your reputation as a knowledgeable dealer who is technically competent. And they give you that word-of-mouth advertising that can't be bought at any price. Sid Zimet says extra profits have paid for his system many times over, and his business continues to grow as his reputation spreads. ■



This Sound Technology 1100A/1000A system simulates a high-quality FM broadcast station. It thus lets a dealer demonstrate overall receiver performance using a turntable or tape recorder and whatever program material he or his customer prefers.



Free tuner clinics are offered for checking out any customer's receiver in less than five minutes—a valuable sales and service tool.

An Extraordinary Offer

to introduce you to the benefits of Membership in

ELECTRONICS BOOK CLUB

for a limited time only you can obtain

ANY 3 OF THESE UNIQUE BOOKS . . . yours for only **99¢** each
... with Trial Club Membership (Combined List Price \$40.85)

May we send you your choice of any three books on the facing page as part of an unusual offer of a Trial Membership in Electronics Book Club?

Here are quality hardbound volumes, each especially designed to help you increase your know-how, earning power, and enjoyment of electronics.

These handsome, hardbound books are indicative of the many other fine offerings made to Members . . . important books to read and keep . . . volumes with your specialized interests in mind.

Whatever your interest in electronics—radio and TV servicing, audio and hi-fi, industrial electronics, communications, engineering—you will find Electronics Book Club will help you.

With the Club providing you with top quality books, you may broaden your knowledge and skills to build your income and increase your understanding of electronics, too.

How You Profit From Club Membership

This special offer is just a sample of the help and generous savings the Club offers you. For here is a Club devoted exclusively to seeking out only those titles of direct interest to you. Membership in the Club offers you several advantages.

1. Charter Bonus: Take any three of the books shown . . . plus the FREE Bonus book worth \$7.95 (combined values to \$40.85) for only 99¢ each with your Trial Membership.

2. Guaranteed Savings: The Club guarantees to save you 15% to 75% on all books offered.

3. Continuing Bonus: If you continue after this trial Membership, you will earn a Dividend Certificate for every book you purchase. Three Certificates, plus payment of the nominal sum of \$1.99, will entitle you to a valuable Book Dividend which you may choose from a special list provided members.

4. Wide Selection: Members are annually offered over 50 authoritative books on all phases of electronics.

5. Bonus Books: If you continue in the Club after fulfilling your Trial Membership, you will receive a Bonus Dividend Certificate with each addi-

SPECIAL FREE BONUS

. . . if you act now!

Yes, if you fill in and mail the Membership Application card today, you'll also get this Bonus Book, FREE!

TV TROUBLESHOOTER'S HANDBOOK

Revised Second Edition

A completely updated quick-reference source for solutions to hundreds of tough-dog troubles.

Regular List Price \$7.95

tional Club Selection you purchase. For the small charge of only \$1.99, plus three (3) Certificates, you may select a book of your choice from a special list of quality books periodically sent to Members.

6. Prevents You From Missing New Books: The Club's FREE monthly *News* gives you advance notice of important new books . . . books vital to your continued advancement.

This extraordinary offer is intended to prove to you, through your own experience, that these very real advantages can be yours . . . that it is possible to keep up with the literature published in your areas of interest . . . and to save substantially while so doing.

How the Club Works

Forthcoming selections are described in the FREE monthly *Club News*. Thus, you are among the first to know about, and to own if you desire, significant new books. You choose only the main or alternate selection you want (or advise if you wish no book at all) by means of a handy form and return envelope enclosed with the *News*. As part of your Trial Membership, you need purchase as few as four books during the coming 12 months. You would probably buy at least this many anyway . . . without the substantial savings offered through Club Membership.

Limited Time Offer!

Here, then, is an interesting opportunity to enroll on a trial basis . . . to prove to yourself, in a short time, the advantages of belonging to Electronics Book Club. We urge you, if this unique offer is appealing, to act

promptly, for we've reserved only a limited number of books for new Members.

To start your Membership on these attractive terms, simply fill out and mail the postage-paid airmail card today. You will receive the three books of your choice for 10-day inspection. **SEND NO MONEY!** If you are not delighted, return them within 10 days and your Trial Membership will be cancelled without cost or obligation. Electronics Book Club, Blue Ridge Summit, Pa. 17214.

Typical Savings Offered Club Members on Recent Selections

Cassette Tape Recorders	List Price \$7.95; Club Price \$4.95
Introduction to Medical Electronics	List Price \$9.95; Club Price \$6.95
MATV Systems Handbook	List Price \$7.95; Club Price \$4.95
Pictorial Guide to Color TV Cir. Troubles	List Price \$7.95; Club Price \$4.95
10-Min. Test Tech. for PC Servicing	List Price \$7.95; Club Price \$4.95
Understanding & Using the Oscilloscope	List Price \$7.95; Club Price \$4.95
How to Repair Small Gasoline Engines	List Price \$8.95; Club Price \$4.95
Miniature Projects for Electr. Hobbyists	List Price \$6.95; Club Price \$3.95
Acoustic Techniques for Home & Studio	List Price \$7.95; Club Price \$4.95
Svcng. New Modular Color TV Recvrs. (2 Vols.)	List Price \$15.90; Club Price \$7.95
Everyman's Guide to Auto Maintenance	List Price \$7.95; Club Price \$4.95
Pictorial Guide to CB Radio Inst./Repair	List Price \$7.95; Club Price \$4.95
Zenith Color TV Service Manual—Vol. 3	List Price \$7.95; Club Price \$4.95
Mobile Radio Handbook	List Price \$7.95; Club Price \$4.95
Understanding & Using the YOM & EYM	List Price \$7.95; Club Price \$4.95
125 Typical Elect. Cir. Anal. & Repaired	List Price \$7.95; Club Price \$4.95
Jap. Radio/Rec./Tape Player Serv. Man.	List Price \$7.95; Club Price \$4.95
Marine Electronics Handbook	List Price \$7.95; Club Price \$4.95
Basic Electronic Test Procedures	List Price \$9.95; Club Price \$6.95
Troubleshooting Solid-State Amplifiers	List Price \$7.95; Club Price \$4.95
How to Repair Musical Inst. Amplifiers	List Price \$8.95; Club Price \$5.95
Kwik-Fix™ TV Service Manual	List Price \$8.95; Club Price \$5.95
How to Build Solid-State Audio Circuits	List Price \$8.95; Club Price \$5.95

SEND NO MONEY! Simply fill in and mail postage-paid Airmail card today!

How to Use Color TV Test Instruments



Here's an opportunity to close whatever gaps there are in your ability to use modern, up-to-date equipment designed specifically to save you time and money. You'll quickly grasp the author's common-sense approach to using the right instruments, thereby getting the most out of your investment in test gear. You'll improve your ability to use an oscilloscope, color bar generator, alignment generators, vectorscope, TV Analyst and sine square-wave generators. The author also has included a description of his "curve tracer." With this simple scope attachment, you can rapidly assess the condition of diodes, transistors—even ICs—in or out of the circuit. 256 pps., over 230 illus. Hardbound. **List Price \$7.95 • Order No. 577**

Installing Hi-Fi Systems



The world of high fidelity doesn't stop with the purchase of equipment. This book explores the many aspects of in-the-home music reproduction, from acoustical considerations to structural requirements. Now in its fourth printing, this timeless and ever-popular guidebook has helped thousands to achieve studio quality sound at home. Includes details on building your own hi-fi furniture, setting up a sound room, eliminating interference and hum, how best to route wires and interconnecting cables, speakers, and speaker enclosures (with information on how to build your own), and much more. Tells all you need to know. 224 pps., 153 illus. Hardbound. **List Price \$8.95 • Order No. 86**

Radio & Television: Principles & Applications



A complete electronics library in a single volume! From raw ac and dc fundamentals to advanced hi-fi, short-wave, and TV theory, the complete spectrum of electronics is covered in depth. Prepared in Great Britain, this book amounts to a full course in electronics—and it's written in extremely readable language. It starts with a description of the manner in which current flows, progresses to wave generation, electron activity in tubes and transistors, and then into the more advanced principles of electronics, its practical applications. Includes comparative descriptions of U.S. and British standards. 400 pps., 286 illus. Hardbound. **List Price \$8.95 • Order No. 296**

Fire & Theft Security Systems



A handy guidebook on the selection, installation, and general maintenance of home and business security devices and systems. Describes many newly introduced systems from simple door and window switches to ultra-sensitive microwave sensing systems. There's also a wealth of information for those who would like to get into sales, installation, and maintenance services—how to design the most effective and economical installation for any situation. And, you'll know where to find the components needed for fire and theft protection, because the equipment section includes data on a myriad of devices, with most of the principal suppliers represented. 176 pps., over 100 illus. Hardbound. **List Price \$7.95 • Order No. 556**

How to Solve Solid-State Circuit Troubles



A troubleshooter's "dreambook"—complete with 161 circuit descriptions and step-by-step troubleshooting procedures—for anyone who occasionally or regularly services solid-state entertainment equipment of any kind—TV receivers, AM-FM radios (including auto radios), tape recorders, record players, etc. Very probably the most complete work of its kind ever published, it will serve as an excellent reference and study guide for those desiring to learn more about solid-state circuits and how they work. Hobbyists and experimenters alike can use it to design and build complex solid-state circuits. 304 pps., 5 1/2 x 8 1/2, 161 illus. Hardbound. **List Price \$8.95 • Order No. 624**

Small Appliance Repair Guide



Learn to repair dozens of small household appliances with the use of this authoritative, low-cost handbook. Profusely illustrated, the text tells how to find the cause of trouble in minutes, and how to go about making the required repairs. You'll also pick up helpful hints on disassembly and assembly, one of the real "tricky" aspects of many appliance repair jobs. General troubleshooting procedures are explained to familiarize you with the techniques of appliance repair. Succeeding chapters deal with thermostats, skillets, sauce pans, irons, toasters, coffee makers, blenders, mixers, knives, deep fryers, hair dryers, electric shavers, and small motors found in countless appliances. 11 Chapters, 224 pps. Over 150 illus. Appendix and Index. **List Price \$7.95 • Order No. 515**

Electronic Circuit Design Handbook



New Fourth Edition—A brand-new, enlarged edition of the ever popular circuit designer's "cookbook," now containing over 600 proven circuits, for all types of functions, selected from thousands on the basis of originality and practical application. Now you can have, at your fingertips, this carefully planned reference source of tried and tested circuits. Selected on the basis of their usefulness, this detailed compilation of practical design data is the answer to the need for an organized gathering of proved circuits—both basic and advanced designs that can easily serve as stepping stones to almost any kind of circuit you might want to build. 416 pps., 19 big sections, over 600 illus. 8 1/2" x 11". **List Price \$17.95 • Order No. T-101**

Dictionary of Electronics



You'll find this huge volume extremely useful in whatever connection you have with electronics. This dictionary of electronic terms you will run across in your everyday reading... from alpha particles through zoom lens terms you need and use most often, including those found in radio, TV, communications, radar, electronic instrumentation, broadcasting, industrial electronics, etc. It provides full, complete and easily-understandable explanations of thousands of specific electronics terms (such as transistors, acoustic feedback, alpha particles, beat oscillator, final audio, electrostatic lens, nonlinear resistance, etc.). 420 pps., 487 illustrations. Hardbound. **List Price \$8.95 • Order No. 300**

The Fascinating World of Radio Communications



Covers the romance of short-wave listening, DXing, specialized bands such as the Coast Guard, radio amateurs, the broadcast band, foreign broadcasts, etc. It also delves into the fascinating developments of radio pioneers—Tesla, Loomis, Voita, Galvani... and shows how their discoveries worked to bring us radio as it is today. Also described are the interesting installations of the National Bureau of Standards, plus WWV services used by industries, citizens and even governments all over the world. Citizens Band? You bet... and how to get your license, what to look for in CB, and how to pick a CB receiver. 176 pps., illus. **List Price \$6.95 • Order No. 586**

Sylvania Monochrome TV Service Manual



Complete service, alignment, parts and schematic data for all Sylvania black-and-white sets introduced during the last 5 years—from the A01 through B14, and 572 through 578 chassis. Contains everything you need including techniques for setup, preliminary adjustments, tuner alignment, and repair and system alignments. Also, included are the latest factory-recommended modifications to help you eliminate "bugs." 19 complete schematic diagrams are printed on big double foldout sheets with waveform illustrations. 196 pps., 8 1/2 x 11", including 36-page schematic foldout section; and complete parts list for all chassis. Leatherette cover. **List Price \$7.95 • Order No. 599**

Practical Color TV Servicing Techniques



This brand-new updated and expanded second edition contains troubleshooting guidelines and case histories on the latest solid-state receivers, including a 4-color section with 32 trouble-symptom photos and a foldout section with 6 complete TV receiver schematics. Now included are service tips and techniques on RCA, Motorola and Zenith solid-state chassis, plus a host of case histories and current data on G.E. chassis. In fact, each of the 12 chapters is filled with information applicable to virtually any brand of color TV receiver, enabling you to solve tough-dog troubles quickly. 404 pps., 250 illus. Hardbound. **List Price \$8.95 • Order No. 436**

Amateur Radio General-Class License Study Guide



A new and unique text—the only one entirely devoted to the subject—for anyone who wants to pass the FCC General-Class exam successfully. Each question is dealt with individually, and the answers are explained in depth at a level that can be easily understood by relatively inexperienced readers. Even if you have no interest in "ham" radio, you'll find the content of this well-written text is an excellent source of information of value to anyone in electronics. Pertinent facts are grouped into palatable, easy-to-assimilate doses, and the conversational style keeps the material fresh and interesting from the first page to the last. 320 pps. Hardbound. **List Price \$8.95 • Order No. 551**

Reliable Electronic Assembly Production



Here is one of those rare books which successfully bridges the gap between design and production technologies, thereby providing guidelines for choosing the best design to achieve the least expensive and most reliable product. The content provides information on material and methods employed in mass production, giving the designer in-depth knowledge of the broad range of processes he should consider in evolving a final product concept. Not only does the content define the best materials for each given application, and detail the best choice for fabricating but it also points out incompatibilities which may evolve between design and production. 208 pages. Hardbound. **List Price \$12.95 • Order No. 287**

Practical Electronic Servicing Techniques



Here is a new and unique handbook that will sharpen your electronics troubleshooting ability. Yes, you can learn to whip those tough dog troubles and prepare yourself for any electronic gear that comes your way with the "inside" information presented in this handbook. You'll be surprised how simple and logical the professional techniques really are. Begins with an analysis of what troubleshooting really is; to condition your thinking (which is part of the secret), the author begins with the analysis of troubleshooting logic; then he tells you how to think like a tough-dog expert. Also logical service approaches to DC circuits, tube circuits, and transistor circuits. 256 pps., 138 illus. Hardbound. **List Price \$7.95 • Order No. 547**

Transistor Projects for Hobbyists & Students

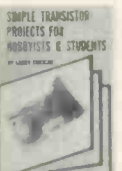

If building useful electronic gadgets and projects turns you on, your imagination will be triggered into conducting the moment you pick up this book. Build all sorts of devices with SCR's, LASCRs, transistors, Triacs, Diacs, Triacs, and integrated circuits. The first section offers suggestions for building or breadboarding these circuits. Sections 2 through 4 describe a wide range of devices for your car, home, office, or wherever electronics can serve you. Section 5 describes Triacs and how to use them in a variety of circuits for switching and control functions. Section 6 is devoted to integrator-circuit projects. 192 pps. Over 100 illus. Hardbound. **List Price \$7.95 • Order No. 542**

Hi-Fi for the Enthusiast



Expert practical guidance for the audiophile who wants to achieve first-class reproduction from radio, tape or records. Content is truly unique—main emphasis is on the efficient selection, assembly and use of modern commercial hi-fi units, modules and construction kits; you will be able to build a system that both suits your individual needs, and gives a high standard of reproduction at an economical price. Room acoustics, amplifiers, pickups and loudspeakers, links with visual sources such as TV, film and slides, are dealt with in detail. Technicians, too, will find this book packed with invaluable advice. A practical book, written by a hi-fi professional. 176 pps., 42 illus. Hardbound. **List Price \$6.95 • Order No. 596**

AN EXTRAORDINARY OFFER.

... for more details circle 106 on Reader Service Card

Getting More Out of that New Sign

by Ernest W. Fair

Experts tell us that the business a firm does can be easily increased by making certain that the sign which identifies it is also a selling sign

■ Here are some suggestions based on practical experience that any electronic technician/dealer can use to make his business sign an effective sales tool:

- Be sure a quick first glance at the sign identifies the nature of the business. No matter how many other features are present, this should never be neglected in that new sign. One cannot depend upon unique building construction, for example, for total identification.

- It pays to avoid the mistake of crowding too many different messages into any sign. One's effort to obtain the utmost from the sizeable dollar investment therein can reduce that total effectiveness of any sign. People will not read any one that is difficult to absorb in a few seconds. It pays to put across one or two big points only.

- Make certain the sign will make everyone feel welcome. Bright and cheerful elements do that. This is of top value for bringing customers into the business. The average person has too much drabness in daily life to show preference toward something which only adds to this negative condition.

- Determine the type and size of the sign by the area in which the business is located. The size of the building and its layout is always important. So is the size of the signs on adjacent business structures. The one you are constructing should dominate even those in other fields of business.

- Plan the sign so that it can be easily read from a distance. One rule is to have the size of letters thereon 1 in. high for each 50 ft. that the sign is to be seen. The sign that

sells a business cannot do so effectively if its message is unnoticed until passersby are immediately in front of the building. It must force attention from everything else in the area and do so well ahead of its location.

- Use color contrast and letter style to maximum effect for positive legibility. As an example, a dark letter against a light background can be seen with maximum clarity. Such color contrast and letter style should also be selected with respect to other business signs in the immediate area. One which offers definite contrast to them is a must.

- Avoid script and other complicated letter styles. They are difficult to read at a distance. The exception is in use for a word or business name which has been firmly entrenched in people's minds so that it is automatically accepted as a block picture rather than read letter for letter.

- Check all local regulations with respect to sign mounting and safety features while the planning is being done. It never pays to take for granted that the sign erector involved has conformed to every last one of these specifications. It is much less expensive to do so before the sign goes up than to have to make costly corrections afterward.

- Take a long hard look at every new material on the market today. New materials are becoming available so fast that there is every chance of something very new, effective and worthwhile being overlooked.

- Try to incorporate at least one feature into the sign which will help people to remember what they have seen. The one such idea that sticks

in an individual's mind brings him back as a customer later on. Available ideas are limitless. The one selected should be that which will have the highest probability of acceptance by the prospective customers of one's business.

- Check all signs on other business establishments near your own to be certain that none have close similarity to your plans. The good sign always stands out from others nearby. It can have maximum effectiveness no other way. Such originality pays off through holding down the possibility of confusion on the part of prospective customers.

- Specify a style of construction and materials which can be easily cleaned and will have minimum maintenance costs. Doing so assures that the sign will be 100 percent effective most of the time, because it is easy to keep that way.

- Don't stint on sign mounting costs. Not only is safety involved but maximum effectiveness of the sign results.

- Make certain the sign is so mounted that any adjacent utility wires, poles, trees, etc., do not reduce its effectiveness through hiding part of its features. Also, too many business owners have, in the past, had expensive sign investments jeopardized by a small tree on an adjacent property which virtually hid the sign after two or three years of growth.

New signs are expensive today, but properly designed they can be of business-building value over a long period of time. It pays to be certain that no possible asset is overlooked in the original planning stage for that new sign. ■

ABC's of Optoelectronics

by Lambert C. Huneault, CET

Although photoelectric devices have been in use for a long time, semiconductor technology has given optical electronics a new "shot in the arm" . . . and a new name: Optoelectronics. This fast-growing field is concerned with light sources (emitters), light sensors (detectors), related circuitry and applications.

■ The early 1970's have witnessed a turning point in the availability of reliable, fast-acting and low-cost light sources and sensors. As a result, electronic technicians may expect to find increasingly numerous applications of these devices in the domestic field as well as in industrial electronics, communications and electronic computers.

The following are some of the many applications where optoelectronic devices are encountered: door openers, burglar alarms, remote-control toys, theater sound systems, electronic calculators, television receivers, pinhole detectors, fire and smoke detectors, pilot lights and illuminated push-buttons, fault indicators, communications, automatic control of street lighting systems, liquid level control, counting and sorting, inspection, controlling flow of materials, reading punched cards and tapes, contactless switching, measurement of weight, time, length or color, measurement of cloud height, etc. . . .

Light Sources

Traditional light sources such as incandescent lamps and gas-filled tubes, such as neon lamps, are now supplemented by newcomers, such as lasers and light-emitting diodes (LED) in many modern electronic applications. By virtue of their many advantages, LED's are rapidly gaining popularity.

Light-Emitting Diode

An LED is a semiconductor diode whose p-n junction emits opti-

cal radiation when forward biased. The light is emitted through a window or lens built into the case of the device. The generally accepted symbol for LED's is shown in Fig. 1.

Also called *solid-state lamps*, LED's are based on the phenomenon of electroluminescence, i.e., the emission of optical radiation (infrared or visible) which occurs in certain types of semiconductors when electrons are injected across a p-n junction and then recombine with holes. When the energy of the recombining carriers generates photons, radiation is emitted at certain wavelengths.

Materials such as indium, gallium, arsenic, phosphorus and aluminum are used in the fabrication of LED's. Depending on the combination of chemicals used, the emitted radiation may be in the infrared or visible portion of the electromagnetic spectrum.

For example, gallium-arsenide-phosphide (GaAsP) solid-

state lamps usually emit their strongest radiation at a wavelength between 600 and 700 nanometers, i.e., they produce light that is orangy-red to deep red in color. GaAsP LED's were first produced in 1964.

For the relationship between color and wavelength, refer to Fig. 2, which also shows the relative response of the human eye to radiation of different wavelengths. Note that the eye is most sensitive to yellowish-green light. Optical wavelengths are usually expressed in nanometers, microns, or Angstrom units. A nanometer (also called millimicron) is a billionth of a meter. A micrometer (also called micron) is a millionth of a meter. An Angstrom unit is a wavelength of 10^{-10} meter.

Gallium-phosphide (GaP) can emit green light that peaks at a wavelength of about 550 nanometers, very close to the maximum sensitivity of the eye. When doped differently, it can emit red light that peaks at about 690 nanometers. Gallium-arsenide (GaAs) emits only infrared radiation at a wavelength of about 900 nanometers. GaAs LED's were introduced in 1961.

LED Ratings

As already mentioned, the p-n junction must be forward biased to emit radiation. Most LED's require a forward bias voltage (V_F) of 1v to

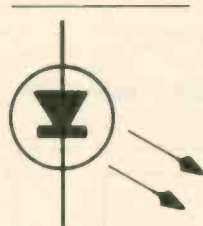

Fig. 1—Generally accepted symbol for LED's.

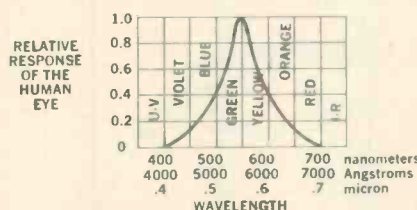

Fig. 2—Human eye's response to the wavelength of various colors.

The author is Supervisor, Electronics Dept., Adult Retraining Division, St. Clair College of Applied Arts and Technology, Windsor, Ontario.

3v. The higher the V_F , the higher the forward current (I_F) and the stronger the emitted radiation, i.e., the brighter the light. For example, at a V_F of 2v, an LED might conduct an I_F of 25ma, and emit a moderate amount of light.

LED's can be damaged by excessive forward current or excessive reverse bias voltage (V_R). Too much I_F causes excessive heat, exceeding the maximum power dissipation rating of the semiconductor chip; too high a V_R causes avalanche breakdown.

Absolute maximum I_F ratings are usually less than 100ma, although some infrared LED's have ratings of several hundred milliamperes. Absolute maximum V_R ratings are usually quite low, 3v being typical. Caution must therefore be exercised when experimenting with LED's. An ordinary silicon rectifier diode with the usual PIV rating of a few hundred volts, connected in series with the solid-state lamp, will provide protection against accidental reversal of the power supply polarity.

Advantages of LED's

It is claimed that LED's might have a light expectancy of 20 to 30 years. This sure compares well with incandescent bulbs whose tungsten filaments last only a few thousand hours, and with neon lamps whose lifetime is of the order of 10,000 hours.

LED's consume low power (e.g., milliwatts), are shock and vibration resistant, and can operate at frequencies of up to several megahertz!

The relationship between light intensity and forward current is quite linear in GaAsP LED's; this makes them ideally suited for analog applications such as in audio circuits or voice communications.

Up to now, digital electronic equipment (e.g., DVM) used mostly cold cathode gaseous display (Nixie) tubes. Now, LED's are available in seven-segment digital readouts (see Fig. 3). They are smaller than Nixie tubes, but just as easily read, and operate at much lower voltage, which makes them compatible with transistors and integrated circuits. These LED numeric readouts are finding widespread application in pocket-size electronic calculators.

Another advantage of solid-state lamps is their narrow-band radiation. The light output of some types of LED's is nearly monochromatic, i.e., of a single color. In certain applications this is a distinct advantage, compared to incandescent tungsten lamps whose radiation covers a very broad range of wavelengths, as seen in Fig. 4. Notice that the ordinary light bulb is quite inefficient, much of its output being wasted infrared (heat) radiation.

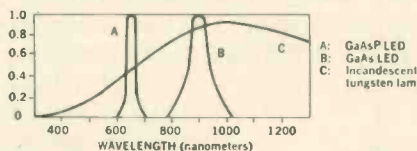
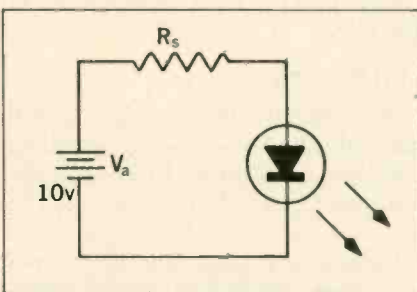
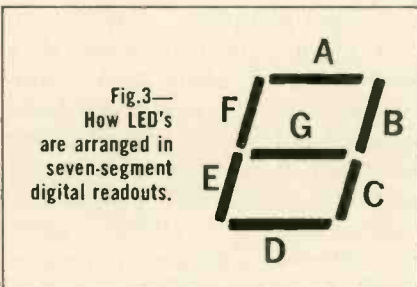

Fig. 4—The radiation emitted from various light sources.

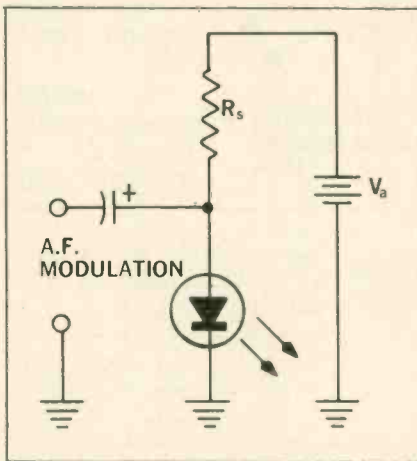

Fig. 6—Linear modulated-light output circuit.

With all of these advantages, the light emitting diode is expected to become the "king" of light sources in many areas of optoelectronics.

Basic LED Circuits

Fig. 5 shows a dc operated LED circuit that can be used in a simple pilot-light application. A limiting resistor R_s is connected in series with the forward biased LED. This is necessary when the applied voltage, V_a , is higher than the normal V_F rating of the diode. For example, if the manufacturer's specifications show that the diode has a normal V_F of 2v and I_F of 50ma when emitting the desired intensity of light, but the available voltage is 10v, R_s must drop the excess 8v. From Ohm's law, $R = \frac{E}{I} = \frac{8v}{50 \times 10^{-3}a} = 160\Omega$.

Fig. 6 shows a linear circuit that produces a modulated light output. The LED is forward biased by a dc source, V_a , and limiting resistor, R_s , so that it emits light under quiescent conditions. When an audio signal is applied across the modulation input terminals, the diode's V_F is varied in accordance with the intelligence, and the emitted light becomes audio modulated. This principle can be used for optical recording, visual communications, optical coupling, etc.

For digital applications, dc source V_a is not required as pulses are used to switch the LED ON and OFF, see Fig. 7. The pulsed light output can be used in optical data links.

If the desired light intensity calls for more LED current than is available directly from the modulating source, a transistor amplifier-LED combination can be used to produce the modulated light, such as in the transformer-coupled amplifier circuit

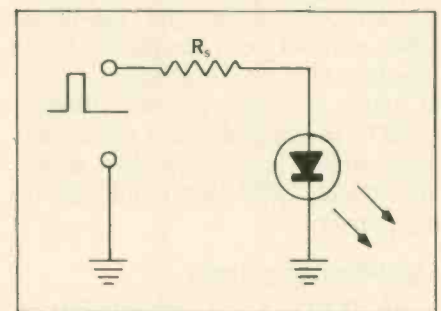

Fig. 7—Digital modulated-light output circuit.

in Fig. 8. Transistor Q1 is forward biased by resistors R1 and R2, and its collector current flows through the LED, causing the latter to emit light with an intensity that varies in accordance with the modulating signal applied across the input terminals.

The circuits in Fig. 5 through 8 illustrate only a few simple arrangements in which LED's can be used. Solid-state lamps are also used in a variety of additional circuits—some of them quite sophisticated—in numerous analog and digital optoelectronic applications.

Light Sensors

In applications other than readout or display, a light sensor must be used to detect the emitted light and produce some form of useful output. The combination of an LED with a compatible photodetector forms an optical link. The name *photocell* is a generic term that applies to the broad family of photodetectors. There are three categories of photocells: photoemissive, photovoltaic and photoconductive.

Photoemissive Cell

A photoemissive sensor is a two-terminal device that emits electrons under the influence of light. In this type of photocell, called phototube, the light shines through the glass envelope onto a photosensitive cathode. The stronger the incident light, the larger the number of photoelectrons emitted. The electrons are

attracted to a positive anode, resulting in a small anode current of a few microamperes. Phototubes are either high-vacuum or gas filled, the latter having higher sensitivities than vacuum phototubes. Symbols are shown in Fig. 9. The principle of secondary emission is applied in certain higher sensitivity photocells called *multiplier phototubes*, which feature a series of "dynodes" operating at progressively higher B+ voltages. They are capable of producing anode currents as high as a few milliamperes.

Phototubes are available with different spectral responses, some responding to all visible radiation, others being most sensitive to violet, green, red or infrared light. For years, phototubes have been giving reliable service in industrial electronics, but their popularity has waned because of their low sensitivity, low output current, high B+ voltage requirements (e.g., 100v to 200v) and because they are bulky and fragile. They are not compatible with today's transistor and IC technology.

Photovoltaic Cell

A photovoltaic sensor is a two-terminal device that generates a potential difference (voltage) under the influence of light, i.e., converts light energy directly into electrical energy. Typical examples are the photocells used in camera light meters and the solar cells used in space satellites. Photovoltaic cells are essentially semiconductor diodes—

when light falls on the p-n junction, a potential difference appears across it. The generally accepted symbol is shown in Fig. 10.

About a ½v is generated in bright sunlight and the power produced by this type of photocell is usually limited to a few tenths of milliwatts per square inch of surface. Large numbers of cells can be combined in series and/or parallel to produce the desired voltage and current.

Photovoltaic cells are usually made of selenium or silicon. Selenium responds mostly to visible radiation, while silicon has a broad spectral response that includes visible and near-infrared radiation, peaking between 800 and 900 nanometers.

Photoemissive and photoconductive detectors require a voltage from an external source, but photovoltaic cells do not, since they generate their own voltage.

Photoconductive Cell

A photoconductive sensor is one whose resistance is affected by light. The brighter the light, the lower the photodetector's resistance, i.e., the higher its conductance. Photoconductive sensors are subdivided into two categories: bulk types and junction types.

Bulk-type photoconductive cells are usually made of cadmium sulfide (CdS) or cadmium selenide (CdSe).

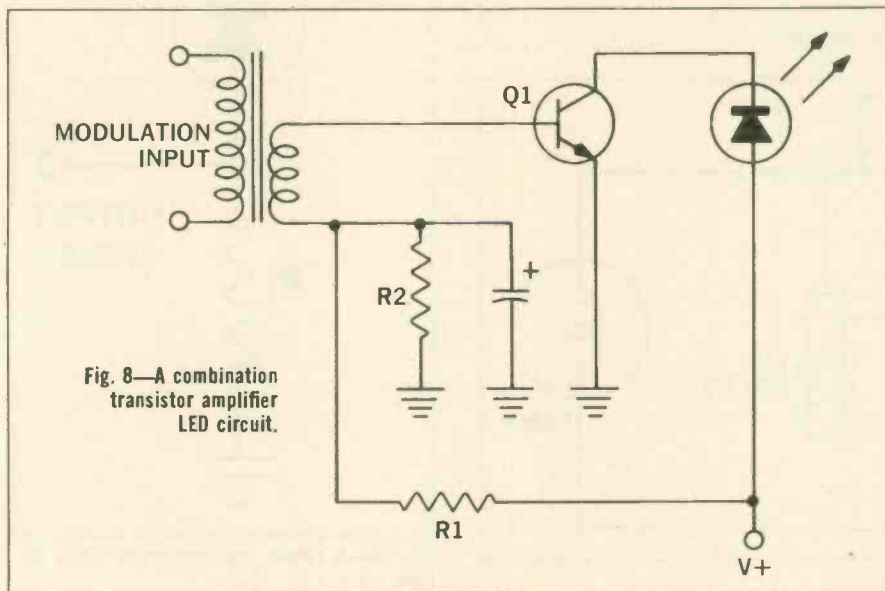

Fig. 8—A combination transistor amplifier LED circuit.

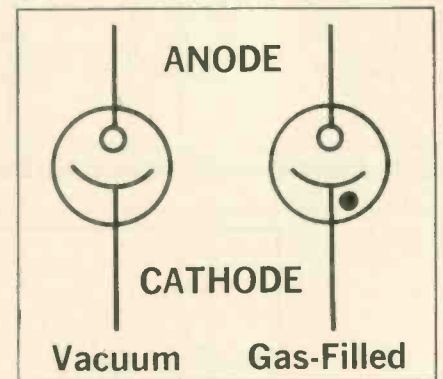

Fig. 9—Generally accepted symbols for photoemissive cells.

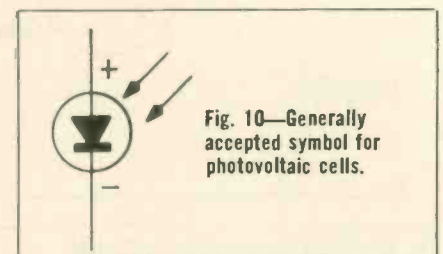

Fig. 10—Generally accepted symbol for photovoltaic cells.

The entire material (bulk) changes resistance when it is illuminated. These devices are often called photo resistors or light-dependent resistors (LDR). Commonly accepted symbols are shown in Fig. 11.

CdS and CdSe photocells exhibit a fairly broad spectral response. CdS detectors are most sensitive to greenish-yellow light (550 nanometers), while CdSe sensors favor red light, being most sensitive to a wavelength of about 720 nanometers. The peak spectral response can be shifted by variations in doping.

Photoconductive detectors are very sensitive devices. The ratio of dark-resistance to light-resistance may be on the order of 10,000-to-1 or more. For example, a CdS photocell may have a dark resistance of a few megohms; in direct sunlight the resistance may drop dramatically to less than 100Ω. This is a sensitivity about one million times greater than that of vacuum phototubes!

However, light dependent resistors are relatively slow devices, being limited to frequencies of about 1kHz. Some are relatively high power devices with maximum current ratings of several hundred milliamperes and capable of dissipating a

few watts of power. They can be used with applied voltages of up to a few hundred volts.

A simple photoresistor application is shown in Fig. 12—the circuit of an automatic lawn lantern that turns ON at night and switches OFF in daylight. Here the CdS photocell is in series with the coil of a normally closed ac relay. Under daytime illumination, the photocell conducts sufficiently to pick up the relay, opening the contacts and switching the lamp OFF. At night, the high resistance of the photocell causes the relay to drop out, turning ON the lamp.

Another simple application of this type of photocell is the *automatic brightness control* (ABC) featured in some TV receivers. Here, a light dependent resistor is part of the CRT grid-to-cathode bias circuit. Changes in ambient light cause variations in the resistance of the LDR, which automatically vary the bias and hence the brightness of the screen.

Junction-type photoconductive cells feature semiconductor junctions and include photodiodes, phototransistors, field-effect phototransistors and light-activated silicon controlled

rectifiers.

Junction Photodiode

A photodiode (for symbol, see Fig. 13) is a two-terminal junction device usually made of silicon. It requires *reverse* bias (usually 5v to 50v) to operate in the photoconductive mode. (Under zero bias conditions, it becomes photovoltaic.) Its dark resistance is very high and is equivalent to leakage resistance in a conventional solid-state diode. When light falls on the junction—through a suitable window or lens—electron-hole pairs are generated and the resistance of the diode decreases; the brighter the light, the lower the resistance. Silicon photodiodes have good frequency capabilities, some responding to light variations up to the megahertz range! They are faster but less sensitive than photoresistors. Under bright illumination, photocurrent is usually limited to 100μa or so, with the actual reverse bias voltage having very little effect on the amount of current flow. The spectral response of photodiodes includes visible and near-infrared wavelengths and usually peaks at about 800 nanometers; hence they are generally more sensitive to red

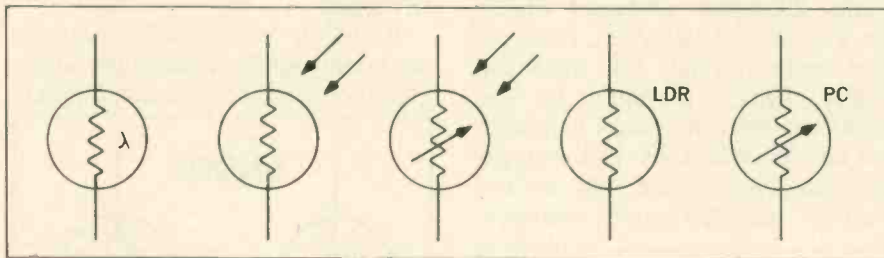

Fig. 11—Commonly accepted symbols for light-dependent resistors.

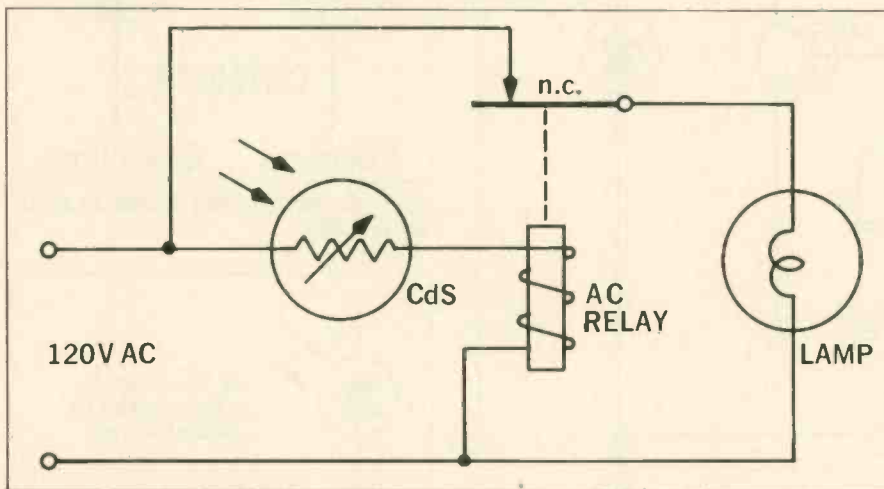

Fig. 12—Simple photoresistor application.

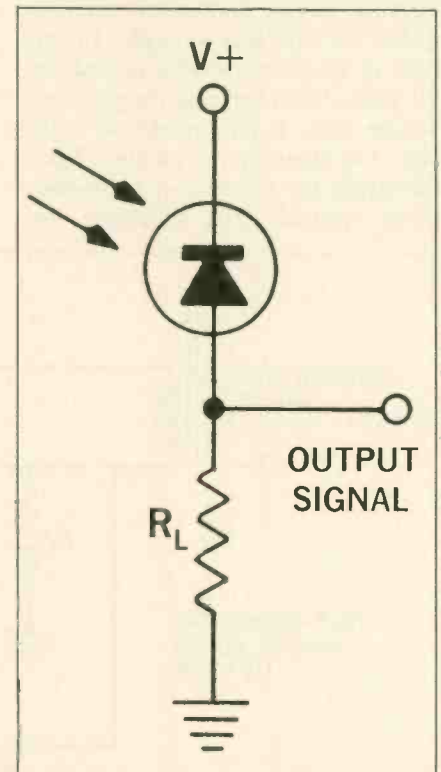

Fig. 13—A simple photoconductive diode circuit.

than blue light.

Fig. 13 shows a photoconductive diode circuit. Variations in illumination cause changes in photocurrent and hence variations in output voltage.

Phototransistor

Phototransistors are quite similar to conventional bipolar transistors, except that the collector-base junction is exposed to light (through a suitable window or lens built into the transistor case). Base current is supplied by light photons illuminating that junction. The stronger the light, the higher the collector current. Phototransistors can be made of germanium (Ge) or silicon (Si) and can be either PNP or NPN. Most modern ones are silicon NPN.

An external connection is sometimes made to the base of the phototransistor and base voltage can be used to vary the operating point and sensitivity of the device. However, many phototransistors feature a floating base (with no base lead), as light energy (photons) replace the forward bias usually necessary to turn ON a bipolar transistor. Hence, phototransistors are either two-terminal or three-terminal devices, as shown by their symbols in Fig. 14.

When the reverse biased C-B junction is illuminated, junction current flows and is equivalent to reverse leakage current I_{CBO} . Because of the inherent gain of the phototransistor, this I_{CBO} is magnified and can produce a substantial amount of collector current (e.g., a few milliamperes) under fairly bright illumination. However, phototransistors exhibit poor sensitivity at low light levels. Dark I_{CBO} current is typically in the nanoampere range, this being somewhat greater than in photodiodes.

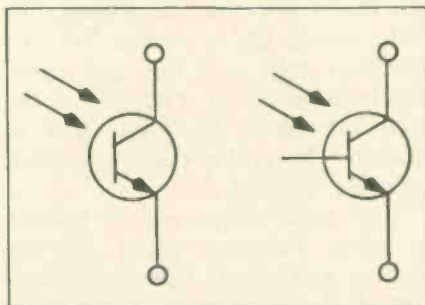

Fig. 14—Phototransistors are either two-terminal or three-terminal devices.

Phototransistors usually have a BV_{CBO} rating of 50v or so, and some can dissipate as much as a few hundred milliwatts of collector power. The spectral response of phototransistors is essentially similar to that of silicon photodiodes (visible and near-infrared wavelengths). Phototransistors have a greater output than photodiodes (milliamperes compared to microamperes) but are rather slow, being limited to maximum operating frequencies of the order of a few hundred kilohertz. Fig. 15 shows average collector characteristics for a typical silicon NPN phototransistor. Note that illumination curves, labelled in foot-candles, correspond to base current curves for conventional transistors.

While the collector current may in some applications be sufficient to activate output loads such as sensitive relays directly, amplification of the phototransistor's output is necessary in many applications. Fig. 16 shows a simple phototransistor-amplifier circuit, featuring direct coupling between the emitter of the phototransistor and the base of transistor Q2.

A phototransistor and a conven-

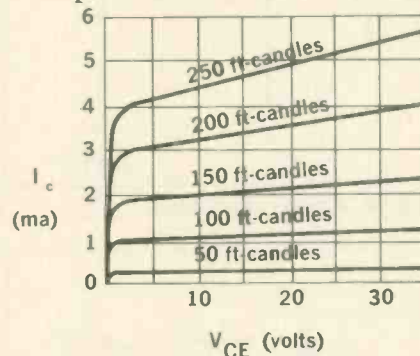

Fig. 15—Average collector characteristics for a typical silicon NPN phototransistor.

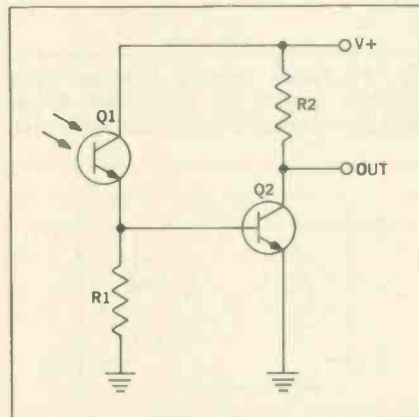

Fig. 16—Simple phototransistor-amplifier circuit.

tional transistor are sometimes enclosed in the same case and connected in a Darlington configuration, as shown in Fig. 17. Photo-darlington amplifiers may or may not have the base lead brought out externally.

PhotoFET

A more recent addition to light-sensitive transistor devices is the field effect phototransistor (photo-FET). Available in both N-channel and P-channel varieties, PhotoFET's are very similar to ordinary junction FET's except that they can respond to light energy.

As shown in Fig. 18, the gate of the N-channel photoFET is reverse biased by dc source V_{GS} . Due to the high impedance of the FET, only a small amount of leakage current (I_{GS}) flows through the gate-to-channel junction. Light photons cause covalent bonds to break down, generating electron-hole pairs in the process, and causing an increase in the I_{GS} current. I_{GS} flows through a high-resistance gate resistor, producing a voltage drop across it, with the polarity shown. This reduces the reverse bias voltage across the FET junction, allowing drain current to increase. I_D variations are much larger than I_{GS} variations, because of the inherent gain (transconductance) of the device.

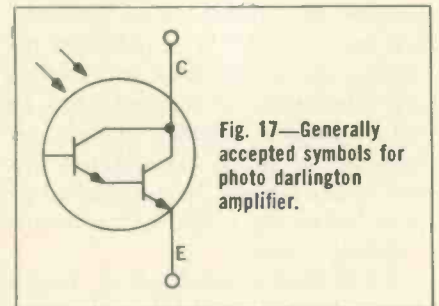

Fig. 17—Generally accepted symbols for photo darlington amplifier.

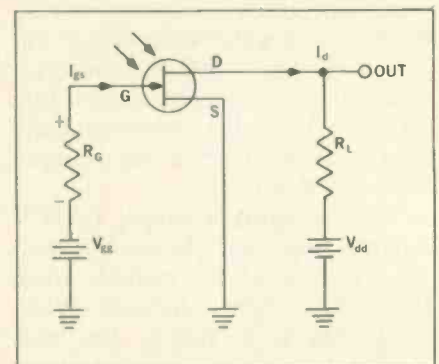

Fig. 18—A simple photoFET circuit.

Phototransistors of this field-effect type are more sensitive than bipolar phototransistors. The higher the resistance of R_0 , the higher the sensitivity of the photoFET. The V_{cc} dc source can be eliminated by connecting a suitable resistor between the source terminal and ground, and returning R_0 to ground—the source resistor then provides the required reverse bias.

LASCR

While conventional silicon controlled rectifiers (SCR) are used in a wide variety of optoelectronic applications, usually in conjunction with phototransistors and other devices such as unijunction transistors, SCR's can be made photo-sensitive and be operated directly by light energy. The light activated SCR (LASCR) is essentially similar to the ordinary SCR except for a window or lens built into the device.

When operated in the photosensitive mode, the device's gate current is supplied by light photons. However, the gate is usually accessible so that a positive voltage can be applied to the gate lead to operate the LASCR in the conventional current-activated mode, should this be desired. Fig. 19 shows the LASCR symbol.

When the anode of the device is positive in relation to its cathode, and incident light is of sufficient intensity, the device fires and latches ON, continuing to conduct even in the subsequent absence of light, as long as the anode remains positive and anode current is not allowed to drop below the LASCR's minimum "holding" current.

LASCR's respond to a broad range of visible and infrared radiation, their spectral response usually peaking at a wavelength of just under 1 micron (1000 nanometers). Maximum anode current and PIV ratings of LASCR's are substantially lower than those of the more rugged ordinary SCR's.

Fig. 20 shows a simple LASCR circuit. Note that the gate is usually returned to the cathode when the SCR is light activated. When used with a dc supply, the SCR latches. It can be reset by interrupting anode current. With an ac supply, the SCR is non-latching, i.e., it

is self-resetting.

Photon Couplers

When a light emitting diode and a compatible photodetector are en-

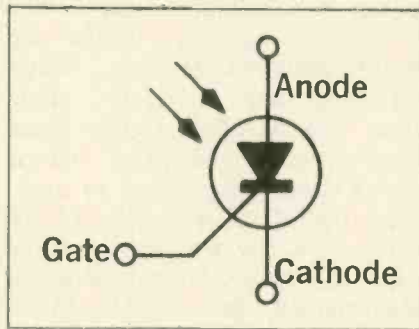

Fig. 19—Generally accepted symbol for a LASCR.

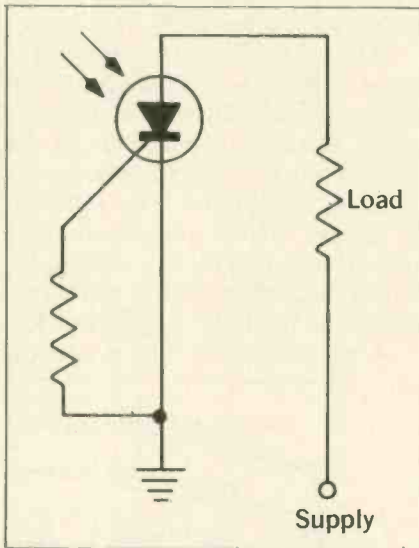

Fig. 20—A simple LASCR circuit.

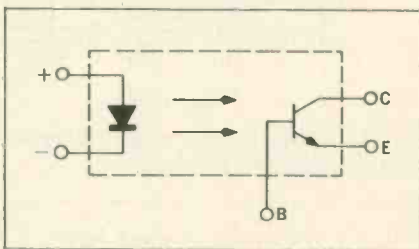

Fig. 21—Photon couplers featuring phototransistor sensors are five-terminal devices when the base lead is brought out of the case.

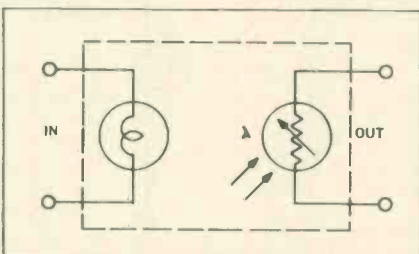

Fig. 22—Generally accepted symbol for optical coupler.

closed in one opaque package, the integrated device is usually referred to as a *photon coupler*, *optical coupler*, or *optoelectronic coupler*. The highest coupling efficiency is achieved when the emission spectrum of the solid-state lamp is matched to the spectral response of the light detector. For example, a GaAs LED has a peak spectral emission at about 900 nanometers, as stated previously. Silicon photodiodes, phototransistors and LASCR's all respond very well to such near-infrared radiation. Therefore, any of these photodetectors can be optically coupled to GaAs LED's.

The LED-photodiode combination forms one of the fastest switching optoelectronic couplers. These devices are ideally suited to electronic computer applications where switching speed is so important. For large output currents, photon couplers feature LED's optically linked with LDR's—phototransistors or photo-darlington sensors are also available, but they are not as fast as those featuring photodiode detectors. As shown in Fig. 21, photon couplers featuring phototransistor sensors are five-terminal devices when the base lead is brought out of the case.

For low-loss coupling, clear epoxy is often used in the package, acting as a light guide or light pipe between the LED and photodetector. When discrete LED and photosensor devices are used instead of integrated photon couplers, fiber-optic light pipes can be used to improve the efficiency of light transmission and minimize the effect of ambient light.

Some photon couplers feature an incandescent lamp instead of an LED for a light source—the sensor is usually of the LDR type. A commonly used symbol is shown in Fig. 22. Being an incandescent lamp, the light source has a shorter life expectancy than on LED, and when the bulb burns out it cannot be replaced because the whole unit is sealed. The entire optical coupler must be replaced.

The main advantage of optical coupling (whether using discrete emitter and sensor devices or integrated photon couplers) is the complete electrical isolation that exists

continued on page 53

Sense and Nonsense Color-TV "Case History" Faults

by Robert Goodman, CET

After more than 15 years of sweating out these "dogs" at the service bench, the "old pro" would like to share some of his "bow-wow" color chassis troubles with other TV technician readers of this magazine

■ Some of these "rare-bird" troubles are, without a doubt very well etched in my memory. Here's hoping some of these "case-book" solutions and service tips will help solve some of your "tough-dog" chassis problems quickly.

If you run into a Zenith 14A9C50 color chassis that pulls in from the top and also wants to roll vertically, here is what was found. This problem may also be of an intermittent nature. And I might add that these same symptoms may also appear in other Zenith Color Chassis that use the same vertical-sweep circuit as that shown in Fig. 1.

After the set was put into operation a few minutes, the vertical oscillator would stop and only a bright horizontal line then appeared across the screen. The scope and VTVM were of very little use on this type problem. In fact, when the probes were touched to any part of the vertical oscillator circuit, the trouble would clear for a few minutes and then start up again. A faulty capacitor in the feedback network was first suspected, but this proved not to be the cause. The defective component was found by subbing in

resistors in the feedback-network circuit. The trouble was caused by the 47K resistor, located between capacitors C237 and C233, that had increased in value to 850K—thus causing the feedback pulse to be so small that it could not sustain vertical oscillation. A very rare and hard to locate problem.

A few years ago I had several General Electric KC Chassis that the complaint always seemed to be weak video or a washed-out picture. In most cases the weak video fault was caused by failure of the 6JC6 third IF tube. These tube failures were due partly to defective tubes, but are also caused by the following systems condition: When a strong TV-station signal is present at the antenna when the set is turned ON, the tuner and IF amplifiers become operative before the sweep system does, because of the slower warmup for the horizontal-sweep output tube. The AGC keyer stage, therefore, does not bias the tuner and first two IF stages for a few seconds. During this time the third IF stage, which has a 180v B+, is overdriven so the grids draw current enough to become over-

heated until the AGC system begins to operate and reduce the drive to the third IF stage. The result is the loss of GM in the tube (and weak video) after several months of receiver operation. One solution would be to install an "instant-on-color circuit" and have the filaments always pre-heated.

Also use the following service tip for this chassis: The third IF tube may short out plate-to-cathode and overheat the R314 plate resistor—plus R160 and R154 located in the power-supply section. The schematic for this third IF circuit is shown in Fig. 2.

We made several service calls to check out a color set for which the customer said, "the picture tube had a wavy black string

hanging down from one corner some of the time." And as stated, we finally saw the dark wavy diagonal line coming from the corner of the screen, as shown in the drawing in Fig. 3. We called this "case-book" trouble the "dancing string caper." This dancing string was caused by an intermittently defective transistor, Q204, in the pincushion correction circuit shown in the schematic in Fig. 4.

Now the "tip-off" to faults in the pincushion correction circuit is that the lines will always be angular. The lines will not run straight vertical or horizontal across the screen. So, when you come across those angular odd line symptoms, always be suspicious of the pincushion

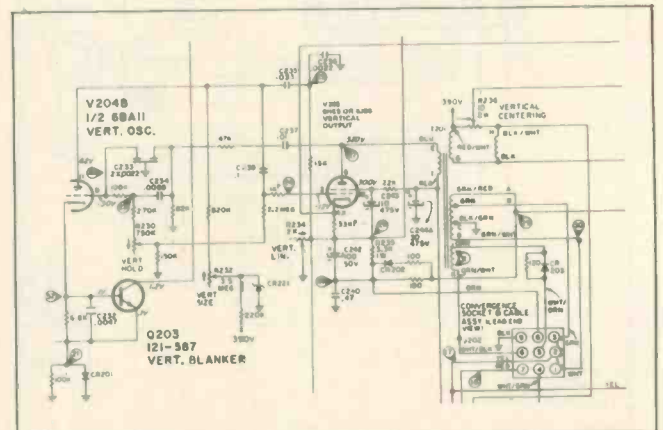

Fig. 1—Vertical-sweep circuit in a Zenith 14A9C50 color chassis. Schematic courtesy of Zenith.

correction circuits. This is the only circuit that naturally has both the vertical and horizontal signals being fed into and then mixed together. This same picture symptom may also be caused by defective capacitors or a fault in T202, the pincushion correction transformer. This same problem has also shown up in other brands of Color-TV chassis. Just

another little electronic glitch that may trip you up.

The picture on a 19KT50 Philco-Ford chassis lacked detail and seemed to be out of focus. If the picture appears out of focus, but the focus voltage is correct, the delay line should be given some attention. The video section schematic for this Philco-Ford set is shown in Fig. 5.

Check and replace delay line DL200 if it is shorted or has leakage to ground. Should the delay line be shorted, the signal will not be delayed and will lead the chroma signal on the CRT.

If the color picture lacks detail (again appears out of focus) and has no monochrome signal, check and replace the delay line if found to be open. The color signal that appears on the screen will lack "Y" and will not have any detail.

Delay lines can have three possible faults: Coils that have shorted to ground; an open coil circuit; and the internal capacitors to ground may have opened.

A common trouble is an open coil and some of the older color-TV set delay lines were found open on the ground side. This would cause standing waves and produce ghosts on the picture. These ghosts could not be eliminated by antenna rotation or by adjusting the FINE TUNING control. It should be noted that misalignment in the IF stages will cause all sorts of ringing and this does change with fine tuning adjustments. If the delay line is suspected, just clip a jumper test lead across the two video signal leads. If the ghosts get lost and the picture clears up, this proved that the delay line is defective. Also, a short from the delay line to ground, or an open delay line, will—in most sets—cause a loss of both raster and picture information.

A very fringed out blue picture, that was not very clear, appeared on one Motorola TS-919 Chassis. In fact, it was noted that this solid-state receiver had lots of blue bleeding

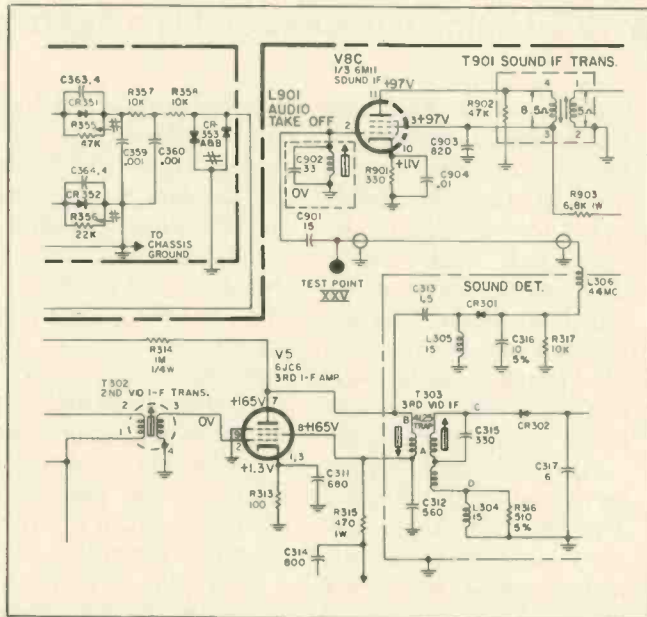

all over the entire screen.

A crosshatch generator pattern was displayed on the screen and we could see the blue lines hanging out all over the screen. A touch-up of the STATIC- and DYNAMIC-CONVERGENCE controls did not help at all. However, all of the controls appeared to be working. Of course, the convergence "H" panel was a prime suspect and a new one was snapped into place, but this did not solve the problem. Note the "H" panel circuit schematic in Fig. 6.

Now was the time to use the scope in order to check the pulses going to the convergence panel and then look at the parabolic current waveform from the panel. This current is then fed into the convergence coils around the neck of the CRT. All of these scope waveforms were found to be correct. This left only the convergence coils, and a finger check of the blue coil proved to be the one at fault as it was very warm to the touch. This coil was replaced and after a convergence touch-up, a good clear picture was in view.

Let's now take a look at how some of these convergence circuits work.

The parabolic current which flows through the convergence coils provide magnetic fields which alter the individual raster produced by each beam to achieve symmetry in order for the three rasters to register completely when superimposed. The shape and amplitude of the parabolic currents are adjustable by the various controls shown for the Motorola TS-915 convergence circuits shown in the Fig. 7 schematic.

The amplitude controls are usually considered as the source (or generator) of these convergence signals. However, the bottom of the vertical output transformer supplies the amplitude controls with a parabola. Secondary windings provide tilt pulses and differential signals.

Diode E-1H is used to prevent a change in static convergence when the parabola goes through maximum amplitude. Vertical centering is accomplished with a bridge circuit. The deflection coils are then connected across

this bridge. When the CENTERING control is varied, the bridge becomes unbalanced to cause centering current to flow through the coils. A bridge is simply a parallel circuit. In this case, the transformer secondary and the CENTERING control are the two branches of a parallel circuit. Horizontal parabolic signals are delivered to the convergence coils from the primary of the sweep transformer.

One of those intermittent picture fade-out problems that would tempt you to

kick the cat developed on an RCA CTC15 color chassis. The set owner reported that this set would play fine for one or two hours, then the screen would go black. Of course, during the three servicing calls that we made, the set performed perfectly. The chassis was pulled out and put on the bench test jig and allowed to cook. After many hours of "air tests" and circuit checks, the raster would fade out, but the high voltage on the CRT was correct. A prime suspect was the chroma circuit board,

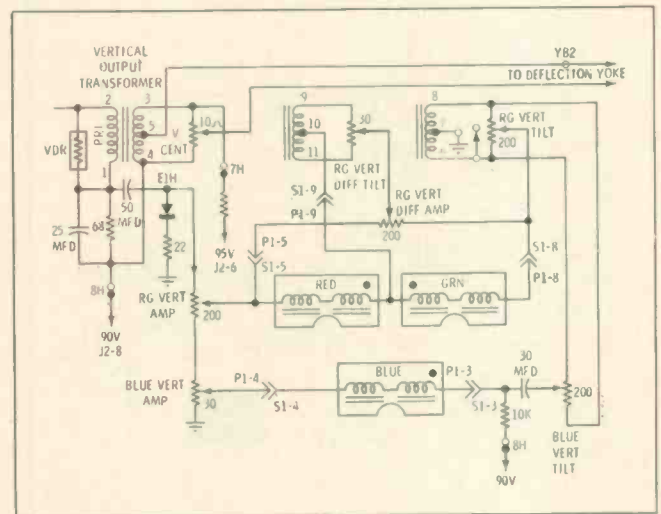

Fig. 7—Vertical convergence circuit in Motorola's TS-915 Chassis. Schematic courtesy of Motorola.

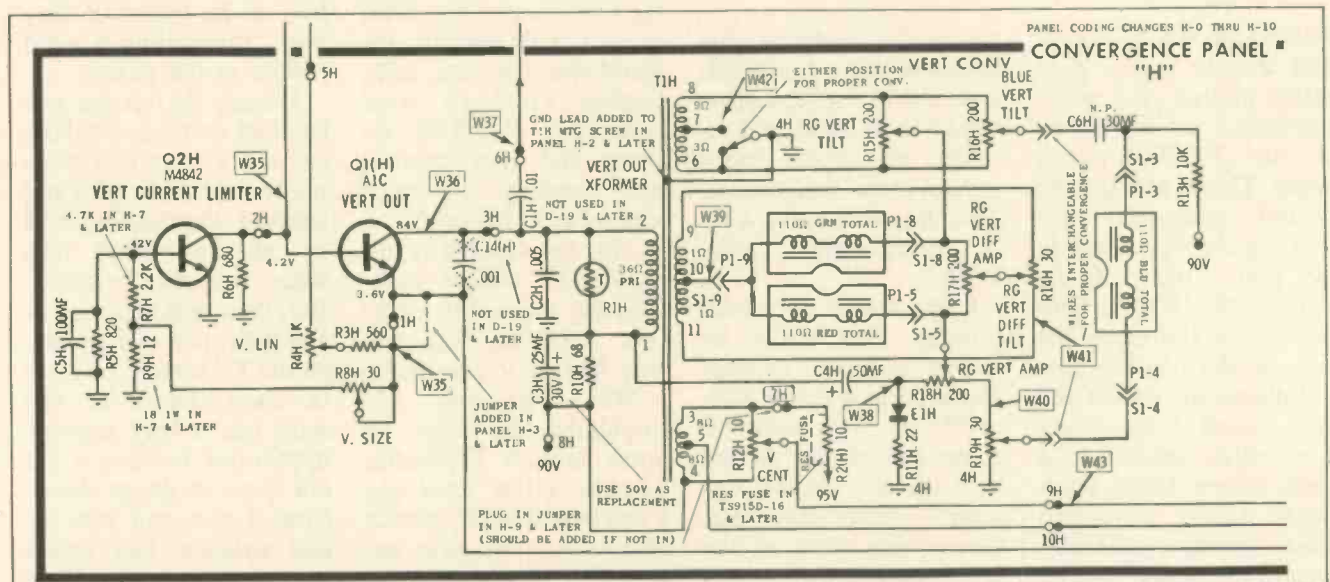
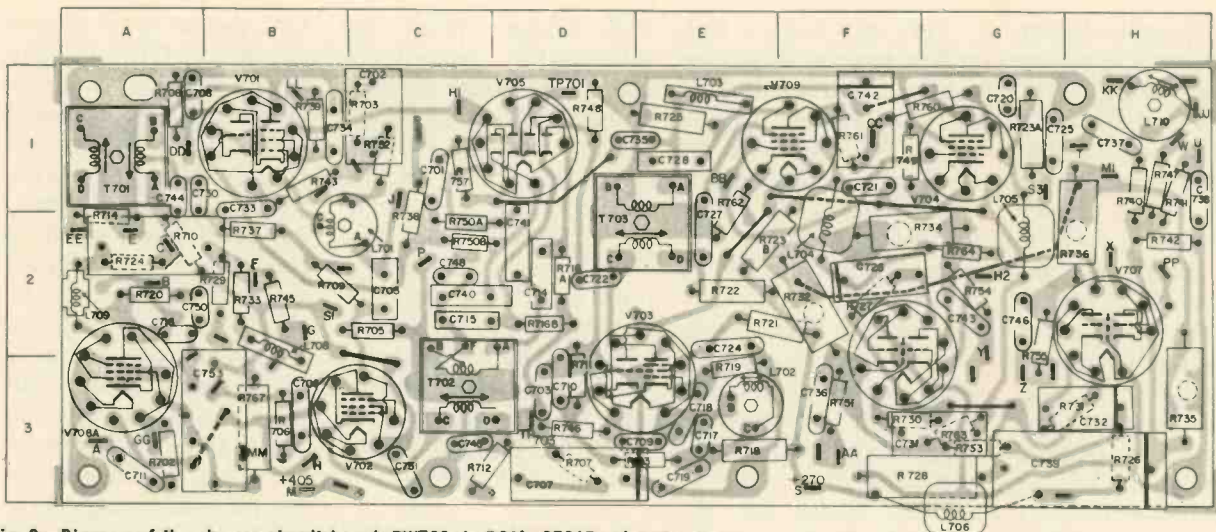

Fig. 6—Portion of the "H" Convergence Panel circuitry in Motorola's TS-915 Chassis. Schematic courtesy of Motorola.



POOR GROUND CONNECTION.
AN INTERMITTENT TROUBLE.

Fig. 8—Diagram of the chroma circuit board, PW700, in RCA's CTC15 color chassis Schematic courtesy of RCA.

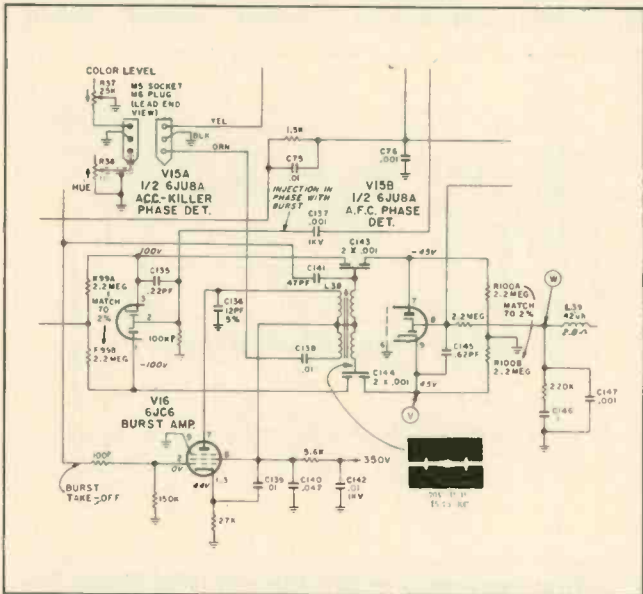

Fig. 9—Color circuitry in Zenith's 23XC38 Chassis. Schematic courtesy of Zenith.

PW700, shown in Fig. 8. The trouble was a poor solder ground post eyelet connection on the corner of the PW700 circuit board. This is actually the ground connection for R742, a 390K resistor in the grid circuit of the blanker tube, V707B. This poor connection upset the bias on the blanker tube and placed the color CRT in a cut-off mode condition, which resulted in a black screen. Other RCA chassis have developed these same cold-solder ground problems. A good service tip—should you

run across a chassis that has odd-ball or intermittent trouble symptoms—would be to check and resolder all circuit board ground eyelet connections. This may well solve a lot of troublesome “bow-wows.”

A very strange short-circuit problem that could be classed as a real “dozee” appeared in a Zenith Color-TV set. This color receiver gave a fine picture until the HUE control was turned counter-clockwise, then sparks flew as the B+ fuse, F1, blew and a small mushroom cloud of

smoke rose up from the chassis center. Thankfully, you just don't run across this type of trouble every day.

The trouble was located and a look at the color circuit schematic in Fig. 9 will illustrate how this can happen. Capacitor C138 (located between the phase detector coil, L38) becomes shorted and the HUE control, R38, (when turned counter-clockwise) puts B+ to ground through the control via the 5.6K screen-grid resistor of the burst amplifier stage, V16, thus causing the smoke and blowing the fuse. This burns the HUE control, the 5.6K resistor and possibly the phase-detector coil, L38. Replace C138 (a .01µf capacitor), the 5.6K resistor and HUE control, and touch-up the color alignment if required.

This last trouble is not a color-TV chassis problem, but was a TV reception condition that you may find very interesting.

While doing some TV troubleshooting—way up north around Fairbanks, Alaska—a few years ago I received this TV service complaint early one extremely cold winter morning. An old-time prospec-

tor came into the shop and as he stomped the snow from his boots, asked me to come over to his cabin and check out a new TV receiver.

Seems as how he couldn't bring in a picture or sound this morning on his TV set. He also reported: “My set has this here funny looking snow on the screen and it sort-ah looks like the TV pitcher sender is maybe outa kilter.” “Oh,” I said, “I'll check with the TV station's chief engineer. Could be the station transmitter was off the air early this morning.” A call to the engineer proved fruitless, as he indicated they were transmitting a good picture at full power.

I made the service call late that evening, checking out the TV set and looking at the lead-in wire and antenna thoroughly. And by all indications they were working properly. But, there was no sound or any indication of a picture on the TV screen. Just lots of snow. However, this snow had a very peculiar appearance because it did not move or dance about. Now if you can just try and visualize that image in your minds eye. Just

continued on page 46

TEST INSTRUMENT REPORT

3M's Model 6500 Recorder Test Set

Designed for use by relatively unskilled operators

by Phillip Dahlen

Note: Those functions for which three separate calibration adjustments are provided are noted as having Type A, B and C Calibration.

OUTPUT SIGNAL (Composite Test Signal)

Level: (A, B and C Calibration).

Microphone: 100 μ v to 1mv rms.

Line: 100mv to 1v rms.

Distortion: <0.1% second-harmonic distortion and
<0.1% third-harmonic distortion

Impedance: Line <600 Ω
Microphone < 1 Ω

Frequencies:

Type	Low Frequency	Reference Frequency	High Frequency
A	200Hz	1kHz	4kHz
B	100Hz	1kHz	8kHz
C	50Hz	1kHz	16kHz

INPUT SIGNAL (Reproduce Input)

Level: 100mv to 1v rms (not to exceed 25v rms, 200v dc or 50v peak)

Impedance: 100K shunted by <100pf for signals of less than 2v rms.

FUNCTION TESTS

Low Frequency: Green Reading—200Hz, 100Hz or 50Hz (A, B, or C) within ± 3 dB relative to 1kHz. Yellow Reading—200Hz, 100Hz or 50Hz (A, B or C) within ± 6 dB relative to 1kHz.

High Frequency: Green Reading—4kHz, 8kHz or 16kHz (A, B or C) within ± 3 dB relative to 1kHz. Yellow Reading—4kHz, 8kHz or 16kHz (A, B or C) within ± 6 dB relative to 1kHz.

Distortion: Measures third-harmonic distortion of 1kHz reference signal. Individual A, B and C Calibration Range: 1% to 3%.

Flutter: Measures flutter of 1kHz reference signal. Individual A, B and C Calibration Range: 0.15% to 3% rms, Bandwidth 0.5Hz to 100Hz unweighted and damped.

Signal-to-Noise: Measures signal-to-noise ratio relative to 1kHz reference signal. Individual A, B and C Calibration Range: -20dB to -50dB.

Self-Test: Self-test feature allows verification of proper operation of each test function.

CONNECTORS: BNC Type.

POWER

AC Power Version (Standard): 115v/230v $\pm 10\%$, 50Hz to 60Hz, less than 1va.

Power Cable: Three-wire, grounded.

Battery Power Version (Optional): 6ANSI "D" Cells (not included).

Life: 90 days at 2 hr. a day.

Current Drain: Fresh Cells—30ma.

End-of-life—18ma to 21ma.

DIMENSIONS

10 $\frac{3}{4}$ in. W (including handle) by 12 in. D by 5 $\frac{1}{2}$ in. H.



3M's Model 6500 Recorder Test Set.
For more details circle 900 on the Reader Service Card.

■ A test instrument has been developed that is designed to show at a glance if tape recorders and other audio systems are operating correctly. This is done with the use of a "quick look" meter that has calibrated color bands to indicate acceptable (green), marginal (yellow) or unacceptable (red) performance of the device being tested.

The manufacturer indicates that the instrument reads a composite signal for testing input and output levels, frequency response, harmonic distortion, signal-to-noise ratio and tape transport flutter for a wide cross section of tape recorders and systems.

The instrument is said to be capable of making all tests while simultaneously recording and reproducing; while for recorders using a common set of magnetic heads and electronics for recording and reproducing, the composite signal is recorded for one or two minutes, rewind and then reproduced into the instrument for performance testing.

For compatibility with the widest cross section of audio recorders, a "Recorder Type" switch is reportedly provided which allows the operator to select any one of three separate, individually calibrated sets of test parameters which cover the range of relatively low performance to professional quality recorders. For operator convenience, a complete step-by-step test procedure is also said to be provided under a transparent cover on top of the instrument. A self-test feature is also provided to verify the proper operation of each of the test functions.

Additional manufacturer specifications indicate the following:

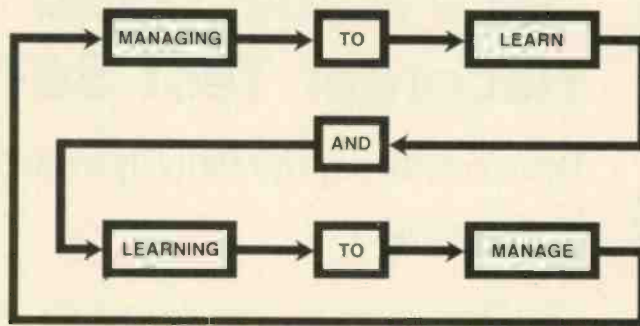

by Ray Sawyer

Managing to learn and learning to manage—a vicious circle? Not so vicious, but indeed a circle. The management process—as much as the technical process—is one that builds progressively upon capabilities and knowledge

■ We build on what we know, capabilities are furthered and knowledge is extended. A good technician in many cases learns more from five repair jobs than the beginner because he has a greater knowledge structure into which he can fit more bits of information. He is tying down more concepts and putting more pieces together. So it goes with management, even though the field is not as well defined as technical areas and there are many more variables because of the human concept.

Although management is not as well defined, how many businesses are failing or have failed recently due to management problems? Quite a few—and yet others in similar circumstances are succeeding. Not only in our field but in all areas today, the press for efficiency is strong and a super manager is as necessary or even more necessary than a

super technician!

The more we know and the more we use our capabilities, the further we extend ourselves. This new series of articles is intended to be just that kind of process—using case histories of service-shop problems. Names, places, dates and parts of descriptions have been changed, but the problems really happened and the actions described as having been taken were real.

Here is the way this new series is laid out: The problem will be given, and then *you* are invited to think about the situation and its resolvement. Then send in your approach to resolving it. About two issues later (magazine lag time), the situation will be restated, the action taken will be printed and selected responses from you, the reader, will be printed. This follow-up will appear elsewhere in this magazine. The block diagram heading (shown

at the beginning of this article) will assist recognition.

Your response is invited to each and every situation. For prompt handling of your response, address your letter as shown on the envelope below. *[A word of warning! The envelope and its contents will be forwarded unopened to the author, so notes concerning other matters should be mailed separately to this magazine. Ed.]*



Situation No. 1

The following describes a situation in a medium-sized television shop that engages in both sales and service. The shop has a

service manager and he has recently initiated a system which allows the technicians to work on sets assigned to them.

A problem arises when Bill, who is one of the outside technicians, grabs a set to work on in the shop because he is caught up on outside calls. The set had been assigned to John, who works exclusively in the shop. Bill works on the set and has it repaired when the service manager arrives on the scene. John is very upset with Bill's action and demands that something be done immediately about it.

The outside men are not assigned any work inside because they are so rarely there. The set chosen to repair was a chassis that Bill had brought in and would like to get back to "his" customer as rapidly as possible.

Bill wants credit and John wants action. What would you do? ■

Best selling vans for 13 straight years...



because of better ideas like these

Swinging or sliding doors—same price. Choose to suit your needs: The hinged side doors pictured at top. Or a sliding door with unique three point track system, shown in the lower illustration. Ford offers both.



Short outside, big inside. Even the SuperVan is substantially shorter than comparable vans. So parking and maneuvering are easy. Yet inside you have over 10 ft. of clear loadspace. And it can carry over two tons.



Walk-thru parcel vans. Newest Econolines, they offer your choice of 10- or 12-ft. body. You can step from the driver's seat into the 6 ft. high cargo area. And huge 66" x 60" rear doors make loading easy.

Twin-I-Beam handling ease.

Only Ford has it. Two big front coil springs for smoothness combine with two forged front axles for ruggedness. You get good stability in crosswinds, too.

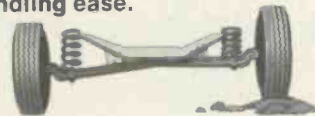

Out-front servicing.

It's a big time-saver. Raise the mini-hood and your routine service points are right at hand—water, oil, battery, voltage regulator, and lots more.



Complete choice of built-ins.

Any Econoline can be ordered with your choice of optional built-ins: racks, bins, cabinets, baskets. They fit into Econolines well because the body-sides are nearly vertical. Like more information on vans? Just ask your Ford Dealer.



FORD ECONOLINE VANS

FORD DIVISION 

A better idea for safety: Buckle up.

... for more details circle 119 on Reader Service Card

NOW A PROFESSIONAL BURGLAR-FIRE ALARM SYSTEM YOU CAN INSTALL YOURSELF.

ONLY 129.95



Save hundreds of dollars in alarm installation and monthly service charges. The EICO SS-500 "install-it-yourself" burglar-fire alarm system offers you the kind of professional protection you have been looking for, at a price you can afford. The SS-500 has been designed on the EICO "Expandability Concept" that enables you to "add-on" protection to meet your own special needs. Before you purchase any security system, we suggest you read the EICO Security Handbook and see how easy EICO makes it to "Do-it-Yourself."

FREE EICO CATALOG/SPECIAL OFFER!

Security handbook (Reg. \$2.95) only \$1.50 with this ad. Includes a catalog on EICO Security Systems, Test Instruments, Stereo, Hobby Kits and name of nearest distributor. For catalog only, check reader service card or send 25¢ for first class mail service.

EICO, 283 Malta Street, Brooklyn, N.Y. 11207



... for more details circle 114 on Reader Service Card

SOLDERING + DESOLDERING + RESOLDERING =

SOLDERABILITY

ELEMENTARY TO ELITE
WORLD'S MOST PRACTICAL SOLDER HANDLING TOOLS

meets industries demands.....

with a COMPLETELY PORTABLE SOLDERING/DESOLDERING/RESOLDERING SYSTEM



Send for our FREE 16 page
SOLDERABILITY
manual

EDSYN
ENGINEERING
DEDICATED TO
SUIT YOUR
NEEDS

15958 ARMINTA STREET
VAN NUYS, CALIFORNIA 91406
PHONE (213) 989-2324
TELEX NO. 65-1469 EDSYNEX VAN

Ads in EEM, OTS, EBG,
AE, TR, and EPAC Catalogs

... for more details circle 113 on Reader Service Card

COLORFAX

The material used in this section is selected from information supplied through the cooperation of the respective manufacturers or their agencies.

GENERAL ELECTRIC

Color-TV Vectors

In attempting to add or subtract two out-of-phase sine waves of equal frequency it becomes immediately apparent that a simpler method of manipulation would ease a difficult situation. For this reason, a method of sine wave addition was derived using vectors.

As shown in Fig. 1, a sine wave can be represented by a vector whose length is equal to the peak amplitude of the sine wave. This vector represents the sine wave by rotating about an axis at the sine wave frequency. When observed at some instant in time, such as at $T = 0$, the vertical amplitude of the vector shows the value of the sine wave at that instant.

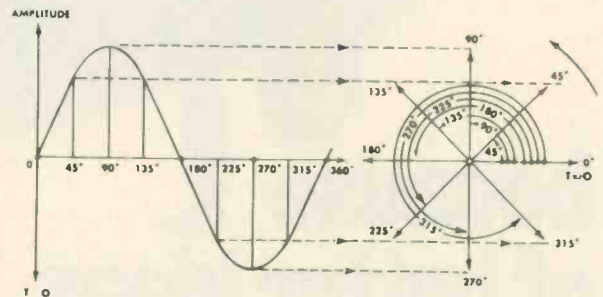

Fig. 1
Sine wave and its vector representation.

Now let us take two sine waves of the same frequency but 90° out of phase, as in Fig. 2. Wave A and vector A represent the wave previously observed in Fig. 1. Notice that sine wave B is maximum when sine wave A is equal to zero. To represent this wave vectorially at $T = 0$ we place vector B in a vertical direction.

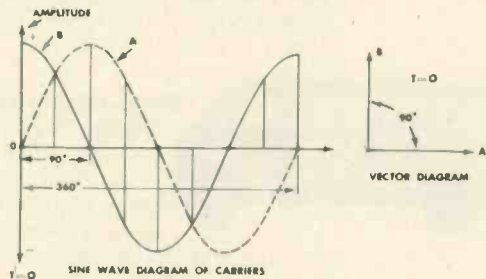

Fig. 2
Two sine waves and their vectors showing 90° phase relationship.

From the vector diagram it can be seen why we refer to wave B as being 90° out of phase with respect to wave A. It should be noted that the waves must have the same frequency to have this 90° relationship remain constant.

Now, what happens if these two waves are added, as shown in Fig. 3: The resultant sine wave C is a point-by-point addition of these two waves.

To add these two waves (A and B) vectorially, let us anticipate the solution and construct a parallelogram. Then, starting from the center point, run a vector diagonally to

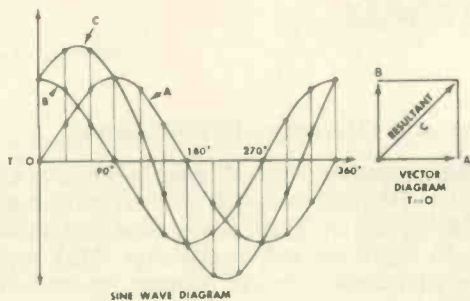

Fig. 3
Vector addition of two out-of-phase sine waves of equal amplitude.

from the resultant vector (C). The length of this vector is determined by the intersection of the two parallel lines.

Fig. 4 shows the addition of two sine waves (A and B) whose amplitudes are unequal. The resultant wave (C) is obtained by the same point-by-point addition of the two

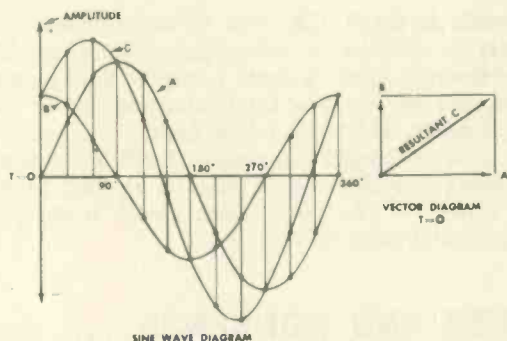

Fig. 4
Vector addition of two out-of-phase sine waves of unequal amplitude.

waves. The vector addition is also accomplished as before. Note that the resultant vector (C) indicates that the change in wave (B) has caused a phase shift towards vector A. It can be seen that this phase shift exists in the waveform diagram also.

We can see from these illustrations that by varying amplitudes and polarities of waves A and B any resultant phase can be obtained.

Color-TV Chassis HE—Striations (Vertical Shaded Lines)

To overcome these symptoms add an R280, 150Ω ½w resistor between terminals 3 and 6 of the yoke as shown in

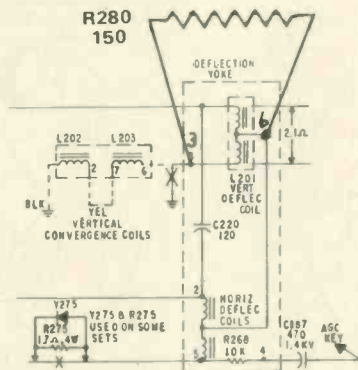

the diagram. Resistor R280 was added in HE chassis production beginning with Serial Number Code 5L1P.

continued on page 46

4 Money-saving reasons to buy EICO's Solid State Test Equipment.



EICO 242 FET-TVOM. Peak-to-peak measurements of AC volts and milliamps. 6½" meter. 7 non-skip ranges. High input impedance. Low 1 volt scale. DC/AC Multi-Probe. AC or battery operated. Kit \$79.95, Wired \$109.95.

EICO 379 Sine/Square Wave Generator. Simultaneous sine and square wave outputs. Covers 20 Hz to MHz in five ranges. Low distortion sultzer feedback circuit. Square wave rise time better than 0.1 microseconds. Kit \$74.95, Wired \$109.95.

EICO 330 RF Signal Generator. 5 bands cover a range from 100 kHz to 54 MHz. Calibrated modulation adjustment control. 400 Hz audio output. Provision for modulating RF with internal or external signal source. Kit \$64.95, Wired \$99.95.

EICO TR-410 Triggered Sweep Scope. 100% solid state. DC to 10MHz bandwidth. Sweep synchronized gate output. Z-Axis Input. Use as vectorscope for color TV servicing. One probe for direct and 10:1 measurements. Wired \$429.95.

FREE 32 PAGE EICO CATALOG

For latest catalog on Eico Solid State Test Equipment, Automotive and Hobby Electronics, Burglar-Fire Alarm Systems, Stereo, and name of nearest EICO Distributor, check reader service card or send 25¢ for fast first class mail service.

EICO, 283 Malta Street, Brooklyn, N.Y. 11207



... for more details circle 114 on Reader Service Card

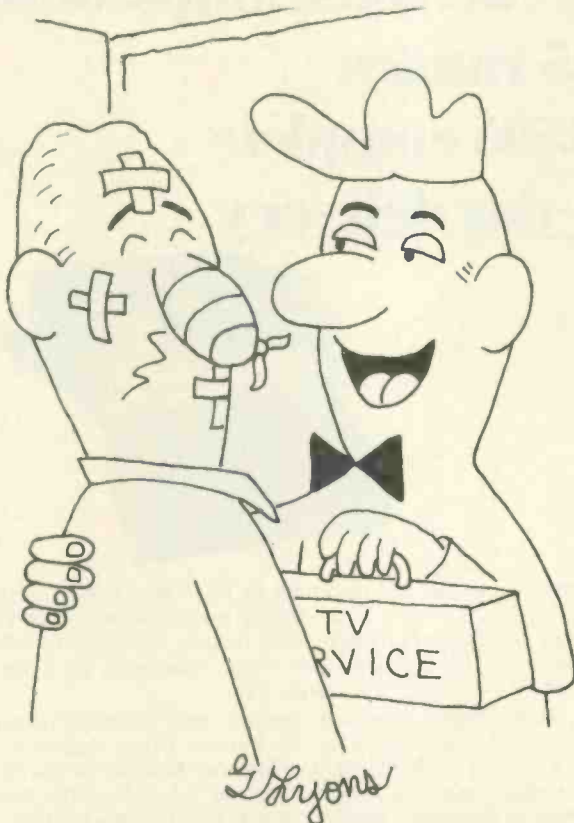

"Next time we'll call a TV man first, won't we?"

NEW!

INSTANT CONTACT CLEANER



**NO RESIDUE • NON-FLAMMABLE
NON-TOXIC • NON-CONDUCTOR**

**A CHEMICALLY PURE CLEANING AGENT
WITH:**

- 1. SELECTIVE CLEANING POWER** — removes greases, oils, dirt and organic soils with no effect on the article being cleaned.
- 2. EXCELLENT PENETRATING AND WETTING ACTION** — Its high density and low surface tension permits maximum penetration of most minute crevices where its superior wetting action then cleans even most difficult materials.
- 3. PURITY** — evaporates completely — leaves **NO** residue.
- 4. SAFETY** — Non-explosive, non-flammable, non-toxic.
- 5. STABILITY** — does not react chemically with other materials.

Available in 7 & 16 oz. aerosols with "Snorkel Tubes"

**SEND FOR
FREE SAMPLE**

LPS RESEARCH LABORATORIES, INC.

2050 COTNER AVENUE, LOS ANGELES, CALIFORNIA 90025
PHONE: (213) 478-0095

... for more details circle 128 on Reader Service Card

ac, dc, volts, amps, ohms
25 ranges
\$595 complete
5-day delivery



- New expanded AC response to 100 KHz
- New carrying case option
- New color-coded pushbuttons
- Optional battery pack with recharger (\$95) mounts internally
- 0.01% dc accuracy
- 1,000 megohm input impedance on 3 lowest ranges
- lab, field, or systems use.

For Model 7004A literature, contact your Scientific Devices office or Systron-Donner at 10 Systron Drive, Concord, CA 94518. Phone (415) 682-6161. Europe: Munich, W-Germany; Leamington Spa, U.K.; Systron-Donner S.A. Paris (Port Marly) France. In Australia: Systron-Donner Pty. Ltd. Melbourne.

SYSTRON  DONNER

... for more details circle 137 on Reader Service Card

COLORFAX...

continued from page 45

MGA

Modification for CATV Systems (T50 Series Chassis)

Modifications on P154 IF Board—Remove C321, .22 μ f capacitor. In its place solder a .01 μ f, 20% capacitor.

Modifications on P156, Sweep Board—Unsolder and lift from the board the end of capacitor C502 which is close to the dual control. Insert between the end of capacitor C502 and the hole from which it was removed a 47K, 1/2w 20% resistor and a .02 μ f 20% 100v minimum capacitor in parallel. Change transistor Q501 to an 86X0048-001 transistor. Cut foil on the PW500 board as shown to eliminate a common-ground path between the heater returns and APC circuits.

ZENITH

Color-TV Chassis 25DC57—Voltage-Sensor Circuit

Should an R339, 12K, 1/2w resistor connected from the emitter to collector of voltage-sensor transistor Q214 become lower in value, it could cause the limit switch circuit to become too sensitive. Complaints may be of occasional loss of raster, which will return again.

It is recommended that resistor R339 be replaced on all sets being serviced with a 12K, 1w resistor (Zenith Part No. 63-6115). The limit switch circuit is for protection and it should never be defeated.

SENSE AND NONSENSE...

continued from page 40

stood still like it was—well, maybe—frozen on the screen. As we stood transfixed watching the set, suddenly the picture and sound came on clear and strong with the evening news report. But wait, something was wrong—it was yesterday's newscast. Boy, now wouldn't this tempt you to quit the TV service business! It sure did me!

Well now, it seems that

the temperature had now warmed up to about 50 degrees below zero, causing the RF signal to thaw out on the TV antenna. It was so cold the RF signal had frozen-up on the antenna. You might say we had megacicles and kilocicles instead of icicles frozen on the old timer's TV antenna. Now, does this "odd ball" TV reception problem make sense or nonsense? ■

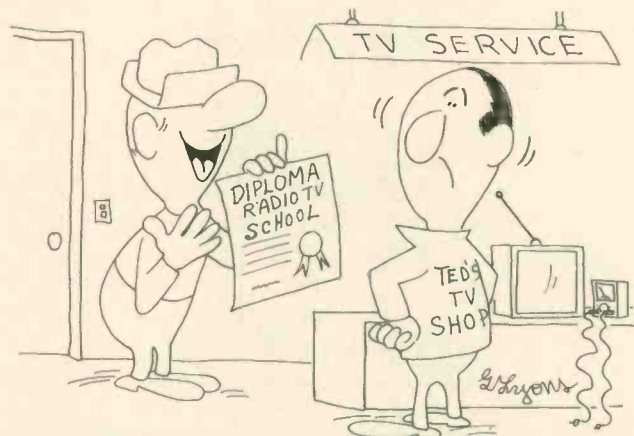

"I saw your ad in the paper for a 'Promising Technician'—just wait 'til' you hear some of my promises!"

GREATEST TV Schematic Bargain EVER Offered

NOW-Complete TV Schematics for less than 5¢ each

COLOR TV
Covers ALL
Color Sets
1960 - 1968

BLACK & WHITE
Coverage for
23 U.S. Brands
1965 - 1968

TV TECH / MATICS - 8 Giant Volumes

Cover 99% of Color TV-4 Years B&W!

Here are FABULOUS savings on nationally-known TV schematic and service data. Here is everything you need to fill your vital service data needs for TV model years 1965 through 1968 . . . plus COLOR TV coverage from 1960 through 1968! What it amounts to is a low, low cost of less than \$9.00 per year for your TV service data . . . with an extra 5 years of Color TV coverage thrown in for good measure! Compare that with the over \$100 a year you may now be paying for comparable information.

SERVICE DATA FOR MORE THAN 20 BRANDS

TV TECH/MATICS is the ideal Service Data package for today's modern technician. It includes complete schematic diagrams and vital servicing data for every TV receiver produced by more than 20 leading American Manufacturers for 1965, 1966, 1967, and 1968. All diagrams and servicing details are completely authentic, based on information provided by the original equipment manufacturers. Each year's coverage is permanently bound into two convenient-to-use volumes which open flat to 11" x 29½", ready to provide you with instant service data at your workbench. Some of the diagrams are as large as 58" x 22".

EASY TO USE

TV TECH/MATICS is easy to use. Brand names are arranged alphabetically by model year. No more hunting through several file drawers to find the schematic you need! And at the special low price, think of the savings you will enjoy on your schematic needs . . . think of the time you'll save by having the schematics you need right at your fingertips in handy, permanently-bound form!

TV TECH/MATICS is the ideal way to cut down your schematic expenses, and to enjoy the convenience of having all your data needs right at your fingertips.

8 BIG Volumes
Regular Price **\$79.60**
...NOW YOURS
for only **\$35.95**

HERE'S WHAT YOU GET

You receive 8 BIG volumes in all, two for each year from 1965 through 1968. Included is a clearly detailed and annotated TV schematic diagram for each specific model. You also get complete replacement parts lists, alignment instructions, tube and component location diagrams, plus key waveforms and voltage readings . . . all the information you need to service over 90% of the TV receivers you'll encounter!

STREAMLINED AND CONVENIENT

All the information for a given model is contained on two facing sheets. The special bound-leaf format allows pages to lie flat when open. Each volume is organized alphabetically by manufacturer, then numerically by model number. In addition, a handy Chassis/Model Finder is bound into each volume. Regular list price for each year's coverage — 2 BIG volumes — is \$19.90. All 8 volumes normally sell for \$79.60. Your price is ONLY \$35.95 . . . a savings of nearly \$45.00!

MONEY-BACK GUARANTEE

You MUST be satisfied that TV TECH/MATICS is the greatest bargain in TV Schematics ever offered. Order at our risk for FREE 10-day examination. Prove to yourself they are worth many times the price. You can return them in 10 days for full refund or cancellation of invoice. No need to send money. But, the supply is limited, so fill-in and mail the NO-RISK coupon today to obtain these time-saving, money-making manuals.

-CONTENTS-

CONTENTS 1965 MODELS

Covers all 1965 models for: Admiral, Airline, Andrea, Coronado, Curtis Mathes, Dumont, Electrohme, Emerson, Firestone, General Electric, Magnavox, Motorola, Muntz, Olympic, Packard-Bell, Philco, RCA Victor, Sears-Silvertone, Setchell-Carlson, Sylvania, Truetone, Westinghouse, and Zenith . . . plus all color sets 1960-1965, at no extra cost!

PUBLISHER'S LIST PRICE . . . \$19.90

CONTENTS 1966 MODELS

Covers all 1966 color and B & W models of: Admiral, Airline, Andrea, Coronado, Curtis Mathes, Dumont, Emerson, General Electric, Hoffman, Magnavox, Motorola, Olympic, Packard-Bell, Philco, RCA Victor, Sears-Silvertone, Setchell-Carlson, Sonora, Sylvania, Truetone, Westinghouse, and Zenith.

PUBLISHER'S LIST PRICE . . . \$19.90

CONTENTS 1967 MODELS

Covers all 1967 color and B & W models of: Admiral, Airline, Andrea, Coronado, Curtis Mathes, Dumont, Emerson, General Electric, Hoffman, Magnavox, Motorola, Olympic, Packard-Bell, Philco-Ford, RCA Victor, Sears-Silvertone, Setchell-Carlson, Truetone, Westinghouse, and Zenith.

PUBLISHER'S LIST PRICE . . . \$19.90

CONTENTS 1968 MODELS

Covers all 1968 color and B & W models for: Admiral, Airline, Andrea, Coronado, Curtis-Mathes, Dumont, Emerson, General Electric, Hoffman, Magnavox, Motorola, Olympic, Packard-Bell, Philco-Ford, RCA Victor, Sears-Silvertone, Setchell-Carlson, Sonora, Sylvania, Truetone, Westinghouse, and Zenith.

PUBLISHER'S LIST PRICE . . . \$19.90



\$3.95 BONUS OFFER
Send remittance with order and we'll add 5 different SINGLPAK Manuals (79¢ list each)! These are 16p. reprints of mfr.'s TV data... yours at no extra charge

LARGE PAGES contain complete circuit schematics, replacement parts lists, alignment instructions critical part locations, important waveforms and voltage readings.

NO RISK COUPON—MAIL TODAY

TAB Books, Blue Ridge Summit, Pa. 17214

- I enclose \$35.95 for which please send me your complete 8-Volume Tech/Matics Schematic offer postage prepaid.
- Please invoice me for \$35.95 plus postage. Same return privileges.

Name

Company

Address

City State Zip

(Paid orders shipped prepaid. Pa. resident add 6% Sales Tax. Outside USA 10% extra.)

ET 14

... for more details circle 107 on Reader Service Card

5 ways to cut your cost of doing more business

Heathkit Transistor — FET Tester...49.95*

Tests transistors, diodes, FETs, SCRs, triacs, uni-junction transistors in or out of circuit. 5 current ranges measure leakage as low as 1 uA and collector currents as high as 1A. Gain (DC Beta), transconductance (GM), and leakage values read directly on large meter face. Special battery testing circuit gives meter indication of self-contained power supply. Kit IT-121, 6 lbs.



Heathkit Solid-State FET VOM...79.95*

This new dual FET portable multimeter has lab-grade accuracy, high (10 megohm) impedance input, and the ranges you really need... at a price you can easily afford. 9 DCV and ACV ranges from 0.1 to 1000 V. at $\pm 2\%$ accuracy. 6 DC and AC current ranges from 10 microamps to 1 amp. 7 resistance ranges, x1 (10 ohm center) to x1 Megohm. 9 dB ranges, -40 to +62. 1% precision metal-film dividers. 4 1/2", 100 uA ruggedized taut-band meter, diode and fuse protected. Battery check switch provided. Kit IM-104, less batteries, 4 lbs.

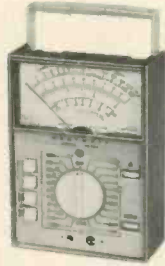

Heathkit 8-Digit 120 MHz Counter...299.95*

Measures 1 Hz to over 120 MHz. Over-range, gate, and two range indicators. Preassembled TCXO time base. 1 megohm FET input. Automatic triggering level. Sensitivity 125 mV or less to 120 MHz. ECL logic. Builds in 15 hours. Kit IB-1102, 12 lbs.



Heathkit 10 MHz Triggered Scope...229.95*

A 5" triggered sweep scope at a low kit price you can't afford to pass up. AC — 10 MHz response, calibrated attenuator, 50 ns sweep rate with magnification. AC-DC coupling, 50 mV sensitivity. One of the outstanding scope values on the market. Order one for your service bench today. Kit IO-103, 36 lbs.



Heathkit Digital Multimeter...229.95*

A digital multimeter that meets lab specs at a low, low kit price! 3 1/2 digits for 100 uV resolution on 200 mV range; 1V on 1000V; 5 DC ranges (100 uV — 1000V), either polarity; 5 AC ranges (100 uV — 500V); 10 current ranges (100 nA — 2A AC or DC); 6 resistance ranges (0.1 ohm — 20 megohms). DC calibrator supplied for 0.2% accuracy without external equipment. Can be lab calibrated to 0.1%. Kit IM-102, 9 lbs.



HEATH
Schlumberger

HEATH COMPANY, Dept. 24-1
Benton Harbor, Michigan 49022

Enclosed is \$ _____, plus shipping.
Please send model (s) _____

Please send FREE Heathkit Catalog.

Name _____

Address _____

City _____ State _____ Zip _____

TE-279

... for more details circle 122 on Reader Service Card

TECHNICAL DIGEST

The material used in this section is selected from information supplied through the cooperation of the respective manufacturers or their agencies.

GENERAL ELECTRIC

TV Chassis SF—Circuit-Board Modification

The SF chassis circuit board has been modified by deleting the audio module and placing the former module components on the printed-circuit board. Operation of the circuitry remains the same and circuit boards made before and after the modification are interchangeable.

In troubleshooting the new circuit board, one important caution should be observed. Disconnect power from the receiver before the audio integrated circuit, IC301, is removed from its socket and leave power disconnected while IC301 is out of its socket. Damage to IC301 and the horizontal oscillator transistor, Q251, is very probable if this caution is not observed.

Both IC301 and transistor Q251 receive their B+ supply voltages from a common +12v source, but IC301 draws much more current than transistor Q251. Therefore, removing IC301 will cause the +12v source to rise to a much higher voltage with probable damage to transistor Q251. The higher voltage would also damage IC301 when reinserted.

The new modification is in receivers beginning with Serial Number 5L2P-----.

MGA

TV Models BT-120/BT-121/BT-122—Vertical Stretch and/or Double Picture

A few cases have been reported whereby the above listed B/W TV models experienced an unusual condition of either vertical stretch causing a test pattern to be egg shaped or a double test pattern superimposed vertically.

This is one of those "oddball" conditions that may not be quickly diagnosed by conventional techniques normally used in vertical circuits.

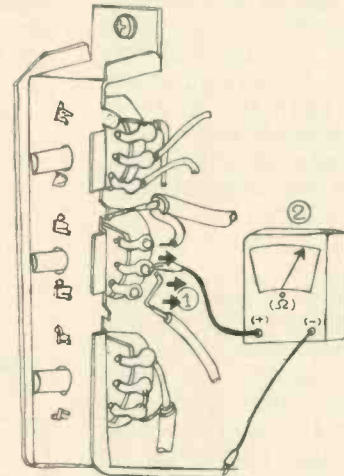

The probable cause may be a defective VERTICAL HOLD control caused by leakage through the case of the control to ground potential. If all leads are disconnected from the control, the resistance from the terminal to ground should be infinity. If the control is defective, it might read a fairly high resistance like 1M.

To correct the trouble, replace the control. For Models BT-120 and BT-121 use Part No. 121C02408. For Model BT-122 use Part No. 120C10703.

NEW PRODUCTS

For additional information on products described in this section, circle the numbers on Reader Service Card. Requests will be handled promptly.

UHF BANDPASS FILTERS 703

Eliminates unwanted TV signals

A line of low-loss, single-channel UHF bandpass filters are introduced employing model numbers UBPF-14 through UBPF-70. Encased in die cast aluminum housings, they are stable enough for use outdoors. Each unit is designed to pass a specific 6MHz band, with reportedly less than 2dB insertion loss and the rejection is 20 to 25dB six channels away and 10 to 15dB three channels away. The units are claimed to be flat within half a decibel through the passband. The filter is ideally suited to eliminate the problem of overload of a UHF

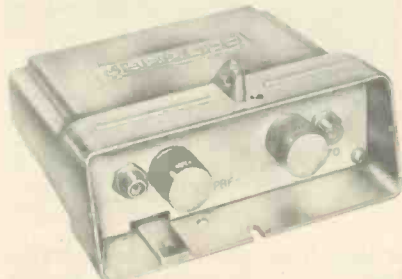

preamplifier. In an area with one or more strong UHF channels, plus a weak UHF channel, the filter can be used between the antenna and the preamplifier. The bandpass filter attenuates the local channel, preventing overload of the preamplifier. Jerrold Electronics Corp.

DESOLDERING TOOL 704

Absorbs the solder by capillary action into braid

A dry wick desoldering tool called "Soder-Wick" is introduced which is said to be simple to use. The wick is laid against the pad or terminal to be desoldered and a hot soldering iron

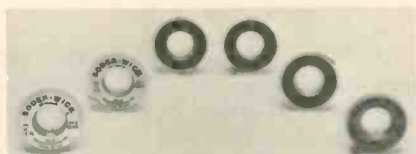

is applied to the top of the wick. As soon as the solder becomes molten, it immediately "wicks" by capillary ac-

tion into the braid. The soldering iron and the wick are simultaneously removed and the pad or terminal is left in a clean and resolderable condition. The heat of the iron is reportedly absorbed by the braid and the solder, preventing heat damage to delicate components. The joint or pad size, amount of solder involved and the speed of operation desired, will vary directly with the size of the wick used. Solder Removal Co.

WIRE UNWRAP TOOL 705

Removes wire-wrapped connections without damaging the terminal

A wire-release-type unwrap tool, Model UW2832-C, is designed to remove both left- and right-handed wire-



wrapped connections from .025 by .025 terminals. It reportedly removes 26, 28, 30 and 32 gauge wire without damaging the terminal. The outer sleeve is insulated to permit work on live equipment. The inner sleeve retains the removed wire which can then be ejected away from the equipment. O.K. Machine and Tool Corp.

SERVICE TABLE 706

Makes moving of heavy chassis and tools easy

A TV service table, Model 10J107, is designed for use by TV service technicians to move heavy equipment.



The table is said to be ruggedly constructed of tubular red enameled aluminum and non-splintering flake-board. To help prevent damage from heavy items or sharp edges, the 24 in. by 24 in. top shelf has been heavily lacquered. For additional storage of tools and equipment, there is a 23 in. by 23 in. shelf built into the table. The

table measures 36 in. tall and has large wheels permitting smooth roll-around. RCA.

ANTENNA 707

10 ft long even though packed in a 4 1/2-ft carton

A giant 10-ft.-long all channel UHF/VHF/FM antenna is designed with a special corner reflector for far fringe area reception of color as well as B/W TV signals. It reportedly employs 17 UHF elements and 13 VHF elements, and simply plugs together and snaps open for fast installation. The antenna comes complete with behind-the-set signal splitter and reportedly has a typical reception range of up to 130 miles for VHF, up to 90 miles for UHF, and FM reception up to 80 miles. The new colorful compact display carton gives TV antenna displays a neater, more appealing appearance, plus getting more product on display and saving vital storage space in stockrooms. The Finney Co.

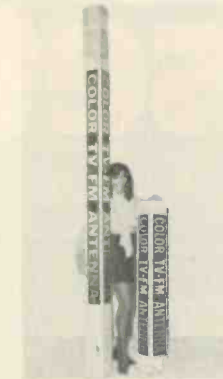

complete with behind-the-set signal splitter and reportedly has a typical reception range of up to 130 miles for VHF, up to 90 miles for UHF, and FM reception up to 80 miles. The new colorful compact display carton gives TV antenna displays a neater, more appealing appearance, plus getting more product on display and saving vital storage space in stockrooms. The Finney Co.

RECORDER ERASE HEAD 708

Designed for Floppy Disk recording systems

An IBM-compatible, long-wear tunnel erase head, FD-TE4, is designed specifically for the latest Floppy Disk recording systems originally introduced by IBM to provide a key to key input system with increased

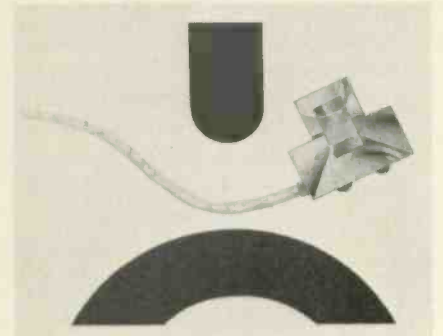

speed and data entry accuracy. In these systems, one small 8-in. flexible disk element reportedly provides considerably greater storage capacity than thousands of standard 80-column punched cards. The erase head is designed for a disk rotational speed of *continued on page 50*

3 ways to power 4 sets

Good

The A-104 U/V signal divider feeds four TV and/or FM sets from one antenna. Low loss, high isolation between sets. Mounts indoors or on mast with optional jiffy mount. 300-ohm connections. One of ten band separator/combiner and signal divider devices.



Better

HOMER 300 U/V—Economy priced, amplified, four-way splitter (four 300-ohm outputs). Excellent choice for moderate signal areas where passive splitter degrades TV pictures. Gain 8.5 dB VHF, 2.5 dB UHF with four sets operating. 4-way lightning and surge protection. One of four Homer models: all channel, 75 ohm, plus a 75 and 300 model featuring patented wide dynamic range ICEF circuit.



Best

DA-4 U/V-300—High performance, all channel amplifier delivers superior picture power to four sets in areas with both strong and weak signals. Features patented ICEF circuit for wide dynamic range. Three transistors, transformer power supply. Typical gain: VHF 7.0 dB, UHF 8.0 dB on four sets. Also available in 75-ohm, all channel version, as well as VHF/FM 300 and 75 ohm models.



In addition to these high quality products, Blonder-Tongue offers TV and FM reception improving products from TV antenna to matching transformers. Available at your local electronics supplier. Blonder-Tongue Laboratories, Inc., One Jake Brown Rd., Old Bridge, N.J. 08857.

BLONDER TONGUE

BL-12

NEW PRODUCTS...

continued from page 49

360 rpm with data transfer rates of 250 bits/second. It operates at 48 tracks-per-inch at a density of 1,600 bpi double frequency. Nortronics Co., Inc.

SCOPE

709

*General purpose unit
at a reasonable cost*

A 5-in. scope, Model 455, is introduced with a 10MHz bandwidth and 10 mv/cm vertical sensitivity. The manufacturer claims that it is a good general-purpose scope at a reasonable cost for TV servicing, industrial applications and for education and institutional use. The scope accepts a camera

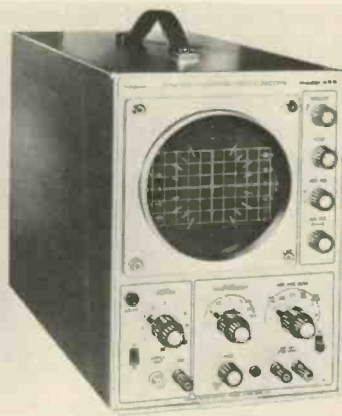

or light hood and has a low-parallax, high-contrast graticule with both an amplitude and vector display index. The sweep frequency is adjustable from 1Hz to 200kHz in five overlapping ranges. For TV work there is a special sweep rate for horizontal sync and R-Y/B-Y inputs for vector alignment. Horizontal sensitivity is rated at 300mv/cm with a bandwidth from dc to 500kHz. Vertical sensitivity is said to be continuously variable through nine calibrated steps from 10 mv/cm to 5 mv/cm \pm 3%; bandwidth: dc to 10MHz. The high linearity sweep has automatic sync and retrace blanking. Simpson Electric Co.

DISTRIBUTION AMPLIFIER 710

*High input and output levels
at a moderate cost*

A low-cost 82 channel distribution amplifier; Model DA-825B, reportedly features an output level of 46dBmv on each of seven VHF channels with 0.5% cross modulation, and 45dBmv on each of five UHF channels with 0.5% cross modulation. The amplifier has a high input level, 20dBmv on

... for more details circle 105 on Reader Service Card

each of seven VHF channels at 0.5% cross modulation, and 22dBmV on each of five UHF channels at 0.5% cross modulation. A reported gain of +26dBmV on VHF and +23dBmV on UHF allows the unit to be used in

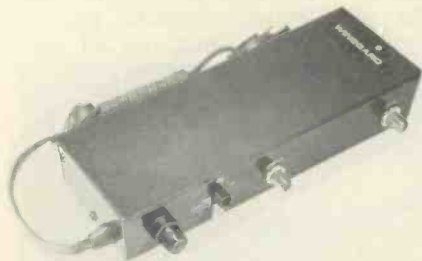

a wide variety of reception situations. A low noise figure of 3.6dB on VHF and 6dB on UHF is said to help provide near perfect color fidelity. An FM trap is built-in to prevent overload from strong local FM stations. The unit also provides voltage to operate line amplifiers. Winegard Co.

FREQUENCY COUNTER 711

Designed for use in the telecommunications field

Introduced is the Model 1980A, VHF/UHF Telecommunications Frequency Counter, which is specifically designed for portable operation. The unit reportedly operates from 5Hz to 515MHz with 50mv sensitivity over



the entire range. A six digit LED display with units annunciation is easy to read even under high ambient light. For totally portable applications, a snap-on battery pack and carrying case provides up to 4.8 hr. of continuous use. On line power, the battery pack is automatically recharged. The weight of the unit is 4.75 lb. John Fluke Mfg. Co., Inc.

TOOL CASE 712

Designed for the servicemen's specific requirements

Attache cases have been designed to hold servicemen's tools in individual pockets mounted on readily accessible pallets. The cases are designed to meet the tool case needs of technicians in the repair field. The design of the case *continued on page 52*

These new IR devices make replacing Zenith Semiconductors a local buy... everywhere!



Now you can buy International Rectifier's "Guaranteed" replacements for the most popular Zenith semiconductors right at your local IR distributor. Besides cutting days from the usual ordering-shipping cycle, they're priced locally too—more than competitive with the Zenith pricing structure.

Like everyone, we recognize Zenith's equipment is top quality, and we're not about to compromise their name, or ours. We analyzed circuits and devices for five months before we guaranteed that IR's devices will match, and meet or exceed Zenith's electrical and physical parameters in all applications.

Right now you can pick up a kit* of 23 IR semiconductors, and save an additional 10%.

Add it all up: Local availability. Local price. Guaranteed IR replacements for Zenith semiconductors. You can't lose.

*13-Transistors; 5-ICs; 3-Rectifiers; 1-Diode; 1-Crystal.

INTERNATIONAL RECTIFIER

Semiconductor Division



233 Kansas Street, El Segundo, California 90245, Phone (213) 678-6281

... for more details circle 124 on Reader Service Card

ARROW AUTOMATIC STAPLE GUNS

CUT WIRE & CABLE INSTALLATION COSTS

... without cutting into insulation!

SAFE! Grooved Guide positions wire for proper staple envelopment! Grooved Driving Blade stops staple at right depth of penetration to prevent cutting into wire or cable insulation!

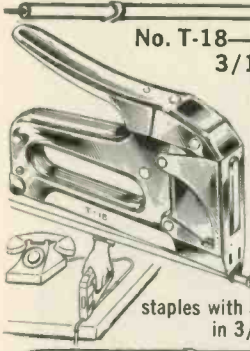

No. T-18—Fits wires up to 3/16" in diameter.

BELL, TELEPHONE, THERMOSTAT, INTERCOM, BURGLAR ALARM and other low voltage wiring.

Uses T-18 staples with 3/16" round crown in 3/8" leg length only.

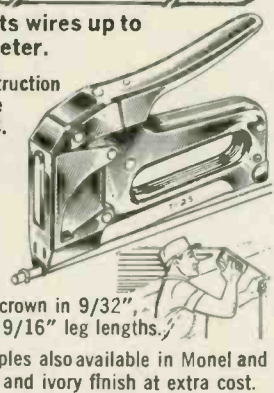

No. T-25—Fits wires up to 1/4" in diameter.

Same basic construction and fastens same wires as No. T-18.

Also used for **RADIANT HEAT WIRE**

Uses T-25 staples with 1/4" round crown in 9/32", 3/8", 7/16" and 9/16" leg lengths.

T-18 and T-25 staples also available in Monel and with beige, brown and ivory finish at extra cost.

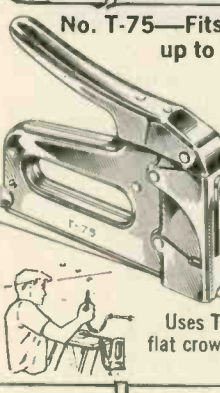

No. T-75—Fits wires and cables up to 1/2" in diameter.

RADIANT HEAT CABLE, UF CABLE, WIRE CONDUIT COPPER TUBING or any non-metallic sheathed cable.

Also used as **DRIVE RINGS** in stringing wires.

Uses T-75 staples with 1/2" flat crown in 9/16", 5/8" and 7/8" leg lengths.

Arrow Automatic Staple Guns save 70% in time and effort on every type of wire or cable fastening job. Arrow staples are specially designed with divergent-pointed legs for easier driving and rosin-coated for greater holding power! All-steel construction and high-carbon hardened steel working parts are your assurance of maximum long-life service and trouble-free performance.

Ask your Electrical Supply Dealer or write for further details.

ARROW FASTENER COMPANY INC.
Saddle Brook, New Jersey 07863
"Pioneers and Pacesetters For Almost A Half Century"

NEW PRODUCTS... continued from page 51

improves the efficiency of the technician as the theory "a place for everything and everything in its place" makes tools easier to find and cuts

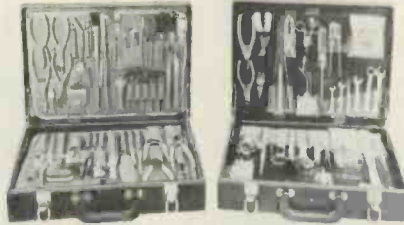

tool loss to a minimum as an empty pocket is a signal that a tool has been left behind. The company's major function is to custom design tool cases to fit individual customer's tools. Howe Industries.

SIGNAL GENERATOR 713

Designed to provide four basic waveforms

The Model 123 VCF generator is frequency controlled by adjusting a Kelvin-Varley divider for an accuracy rated at $\pm 2\%$ of the frequency range (or typically $\pm 2\%$ of the setting), while offering a choice of square, sine,

triangle or sync waveform outputs. The dynamic frequency range is said to be from 0.1Hz to 3MHz with an output greater than 20v p-p open circuit or 10v p-p into 50 Ω for all waveforms. A full 60dB of attenuation is reportedly provided with 20dB steps. The manufacturer indicates that to simplify future maintenance all elec-



tronic components are mounted on one printed-circuit board, calibration adjustments and test points are printed on the top side of the printed-circuit board, and the calibration procedure is printed inside the top cover. Exact Electronics.

ALARM SYSTEM 714

One package contains all equipment needed for installation

A Model 740 Ultrasonic Packaged System is designed for installation by professionals in the electronics field,

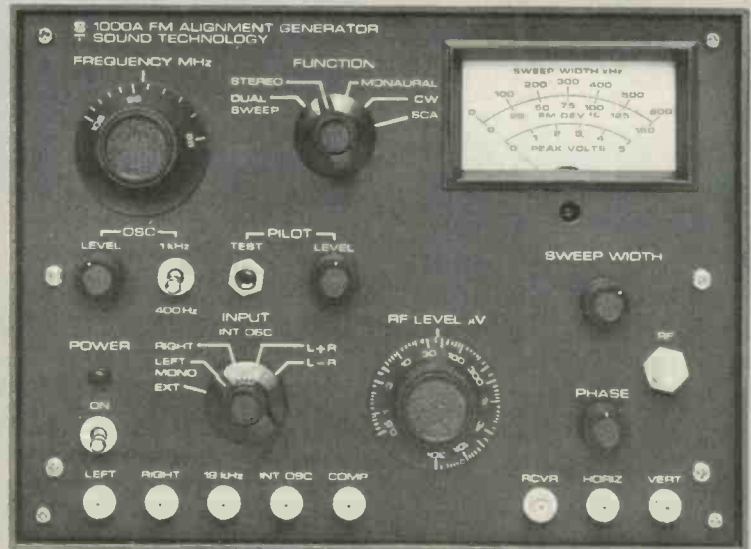

Makes profit for you

Whether you're a big retailer or a one-man shop, this Alignment Generator can increase your profit.

That's because this instrument lets you align receivers better and faster. Pays for itself on one align-

ment a day. Lets shops do aligning and servicing that were hesitant before.

Used by more than 50 receiver factories. So you have their word, too.

S SOUND TECHNOLOGY
10601 SO. SARATOGA-SUNNYVALE ROAD
CUPERTINO, CALIFORNIA 95014
(408) 257-9171

... for more details circle 135 on Reader Service Card



even though they have no previous experience installing alarms. Everything you need is in one package, including illustrated detailed installation instructions. PLC Electronics Inc.

BENCH POWER SUPPLY 715

Pocket-size regulating unit provides $\pm 15v$ dc at 125ma

The Model C621 bench power supply is designed to provide $\pm 15v$ dc of 125ma current with 0.02% regulation.

It can reportedly be driven by 105v ac to 125v ac of 50Hz to 400Hz power over a temperature range of $-25^{\circ}C$ to $+71^{\circ}C$ ($-13^{\circ}F$ to $+160^{\circ}F$) to meet these requirements, while producing only 0.5mv rms of maximum noise and rip-

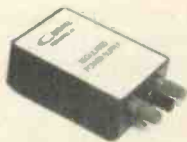

ple. The unit is said to come with a 9-ft. 3-wire line cord, ON/OFF switch and rugged six-way binding posts. Its reported dimensions are 3 in. by $2\frac{1}{2}$ in. by $1\frac{1}{2}$ in. Central Components Co.

OPTOELECTRONICS ...

continued from page 36

between input and output circuits. This can be a definite asset in many electronic circuits, as the optical link does away with interstage transformers, relays, coupling and feedback networks, etc. . . .

Conclusion

As the circuitry of home entertainment equipment becomes increasingly sophisticated and automated, it was just a matter of time until optoelectronic couplers found their way into television receivers. In some of its 1973 line, at least one manufacturer featured an LED-LDR optical coupler and photoconductor cell to control brightness, contrast and chroma level automatically when ambient room lighting

changes. This last application will probably convince readers of ELECTRONIC TECHNICIAN/DEALER that optoelectronics has come of age!

DISCOUNT PRICES

Test Equipment

RECEIVING TUBES

Prices on Request

RAYTHEON

B&K

JEM ELECTRONICS

5401 OXFORD AVENUE
Philadelphia, Pa. (215) 533-7550

... for more details circle 125 on Reader Service Card

TEST RIG FOR TUBE & SOLID STATE

THE COMBO RIG
MODEL CJ-175

\$89⁹⁵
less picture tube



- ELIMINATES HAULING CABINET & TUBE
- SPEEDS TROUBLE SHOOTING
- SERVICES TUBE & SOLID STATE

TELEMATIC TEST RIG CJ-175

CONSISTS OF:



- Compact metal case
- Universal Yoke
- Convergence Yoke
- Blue Lateral Magnet
- Solid State Transverter
- 4' Anode Extension
- 4' 90 degree CRT Extension
- 4' Yoke Extension
- Convergence Load
- 4 Yoke adaptors for Solid State

Telematic

Write us for free subscription of current cross-reference charts.
2245 Pitkin Avenue, Brooklyn, N.Y. 11207

... for more details circle 139 on Reader Service Card

The right
replacement, faster
with



**SERVICE
KITS**

from your Centralab
Distributor



KITS AVAILABLE:

- Fastatch® Controls
- Miniature Wirewound Controls
- Miniature Trimmer Controls
- Axial Lead Electrolytics
- Radial Lead Electrolytics
- General Purpose Capacitors
- High Voltage Disc Capacitors
- Packaged Electronic Circuits

KIT FEATURES:

- Rugged steel frames with high impact plastic drawers.
- Stackable or wall mounted.
- Portable, with convenient handles.
- All contain assortment of the most popular and widely used Centralab components.
- All control kits include latest edition of H. W. Sams Replacement Control Guide.
- All components are functionally arranged in drawers by value, type, etc.
- All drawers are pre-labeled clearly showing contents.
- All kits are completely set up, ready to use.

For complete details,
see your Centralab Distributor
or send for descriptive brochure.

DISTRIBUTOR PRODUCTS



CENTRALAB

Electronics Division
GLOBE-UNION INC.

5757 NORTH GREEN BAY AVENUE
MILWAUKEE, WISCONSIN 53201

DEALER SHOWCASE

For additional information on products described in this section, circle the numbers on Reader Service Card. Requests will be handled promptly.

TELEPHONE SILENCER 716

Converts the jangling bell into a controllable tone

Introduced is the "MiniHush," a new telephone silencer which converts the aggressive, jangling bell into a soothing, controllable tone. Three VOLUME levels, selectable to maximum 77dB @ 1 ft or OFF is offered, plus

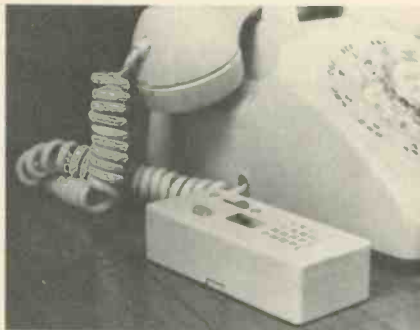

a unique light indicator which flashes in unison with the tone. The unit is said to be packaged in a handsome, rugged plastic case to match the color of your telephone. It can be placed near your phone, desk, table or mounted on the wall or baseboard. The unit is powered by a 9v battery and measures 4 in. by 1 3/4 in. by 1 in. Diversitron Inc.

VIDEO TAPE LOGGER 717

Features audio capability while recording video events

A time lapse audio/video logger has been developed that can continuously record up to 25 hours on a single, standard reel of 1/2 in. video tape. Designated the Model TL350, the new



system records video events in the time lapse mode (2.4 fields per second) while at the same time recording audio continuously. Time lapse recording extends the time the unit

may record without changing the tape, and also conserves tape usage. The primary applications for the logger include television and broadcast logging, security, surveillance and law enforcement. The unit features simplified controls for ease of operation, specially designed two rotary-head scanning system, simplified tape transport mechanism and EIA-J type-one format. The tape speed is 0.3 ips, with fixed 25:1 time lapse ratio offered. GYYR Products, Odetics, Inc.

AM/FM RECEIVER 718

Budget-priced, with bandwidth of 30Hz to 30kHz

A budget-priced FM/AM/FM multiplex receiver is designed with a wide bandwidth from 30Hz to 30kHz and employs FET and IC circuitry. Fly-wheel tuning and an over-sized signal strength meter combine to facilitate station selection. The unit is provided with growth potential by an FM output jack that will accept any four-channel decoder or adapter. This will allow the receiver to reproduce four-channel radio broadcasts when a system for transmitting multiplexed four-channel signals is standardized. Other



features include a LOUDNESS CONTOUR selector for full tonal balance at low listening levels, separate BASS and TREBLE controls, BALANCE and VOLUME controls, front panel stereo headphone jack and FM stereo indicator light. On the rear panel the receiver features push-type terminals for simplified speaker system connection, convenience ac outlet and ac protector fuse. Superscope, Inc.

CAR STEREO 719

So small it can fit in your glove compartment

The Model ACS-217 AM/FM/Multiplex stereo radio cassette has been built small enough to fit most



car glove compartments thanks to the development of a "slot-in" system in which four-track, two-channel tape

cassettes are inserted lengthwise to lock in place behind a built-in dust cover. The unit is said to weigh 4.4 lb and be rated at 14w of music power output. It is designed to cover an AM frequency range of 520 to 1630kHz an FM frequency range of 88 to 108MHz and a tape section frequency response of 80Hz to 10kHz ± 6 dB. Aiko America Corp.

CAR STEREO DISPLAY 720

Lets the customer know how good it really is

The MDS-1305 is a single unit dis-

play designed for demonstrating the manufacturer's Model 12R800 four-



channel car stereo system. The player unit nests in its "Quick Release" mounting bracket, supported by the "wings" that flank it. Full-color artwork and list of

features surround the quadrasonic player. Two speakers are installed in the base unit and two in the header for true, discrete four-channel sound reproduction. RCA Parts and Accessories.

CASSETTE TAPE DECK 721

Servo-controlled tape drive for speed accuracy

Introduced is the Model 4250 cassette tape deck, a high performance unit featuring Dolby noise suppression circuitry and a servo-controlled, tape-drive mechanism for speed accuracy.



The unit features super ferrite heads for longer wear, two large VU meters, a tape counter, seven-button function control and automatic stop. Sanyo Electric Inc.

TELEPHONE ANSWERER 722

Performs many functions of much costlier equipment

A simplified telephone answering machine is designed for the home or office. Named Phone-Mate 300, it will



reportedly perform the various functions of much costlier equipment. This includes answering the phone with the owner's pre-recorded announcement

continued on page 56



DIAL & CODER

Delta's Instant Emergency Telephone Warning System.

Dial & Coder guards you around-the-clock, signaling alarm for any emergency condition where a simple contact closure activates the system. Completely solid state, Dial & Coder utilizes the latest in discrete and integrated circuit technology to provide immediate remote signaling between any two telephones.

CHECK THESE FEATURES!

- Dial any phone number up to eight digits.
- Change numbers in ten seconds.
- Over 100 different code combinations allow multi-phone connections.
- Works with any direct contact switch.
- Unlimited applications. Use with intrusion detectors, fire & smoke detectors or a simple button control. Allows children, clerks, or physically handicapped to call for help.
- Automatic redialer when busy signal received.
- Microphone can be added for audio surveillance.
- Self-contained power supply. Once tripped, unit cannot be stopped.

This one's really priced right!

Made in U.S.A.

Write or Call today for free sales details!



DELTA PRODUCTS, INC.

P.O. Box 1147, Grand Junction, Colo. 81501, Dept. ETD, (303) 242-9000

Superior Products At Sensible Prices

... for more details circle 111 on Reader Service Card

YOU'RE WHISTLING IN THE DARK...

IF YOU THINK HEART ATTACK AND STROKE HIT ONLY THE OTHER FELLOWS FAMILY.

Help your Heart... Help your Heart Fund

Contributed by the Publisher

NEW FINCO

Greenline™

HOME TV/FM MULTIPLE SET ■ SOLID STATE AMPLIFIERS

Amplifies TV-FM signals
for distribution to
every set in the house!

- For COLOR, Black & White, FM Stereo
- Five different models for every reception requirement.

G-922

82 Channel
TV plus FM



300 ohm system
VHF-UHF-FM
300 ohm input and four
300 ohm outputs using twin lead wire.

G-923

82 Channel
TV plus FM

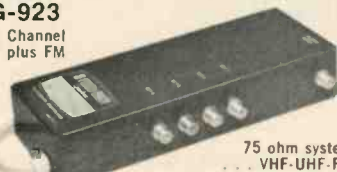

75 ohm system
VHF-UHF-FM
75 ohm input and four
75 ohm outputs using coaxial cable.

G-924

82 Channel
TV plus FM



75 ohm system
VHF-UHF-FM
75 ohm input and a single
75 ohm output using coaxial cable.

G-920

VHF-TV plus FM



300 ohm system
TV Channels 2-13
and FM . . . 300 ohm input
and four 300 ohm outputs using
twin lead wire.

G-921

VHF-TV plus FM



75 ohm system
TV Channels 2-13
and FM . . . both 75 ohm
and 300 ohm inputs and four
75 ohm outputs using coaxial cable.

Write Dept. ETD 1-74 for Catalog No. 20-594

The FINNEY Co.
34 West Interstate Street
Bedford, Ohio 44146

DEALER SHOWCASE . . .

continued from page 55

and taking the messages of up to 20 callers. A speaker permits calls to be screened. The unit may be reportedly hooked up to a remote device which, with a portable electronic key the size of a cigarette package, enables a user to call his phone from anywhere in the world and play back callers' messages. Phone-Mate, Inc.

CASSETTE RECORDER

723

Features an automatic level control for balanced sound

Introduced is a moderately priced cassette recorder, Model 6392, which is said to operate on house current or four C-sized batteries, and feature an automatic LEVEL CONTROL for balanced sound, plus convenient large



piano-key controls. It is designed for all-around home, office and school use, with a hideaway retractable handle. The recorder, with a wood-grain case, is reportedly fully accessorized, including remote control mike with stand. Channel Master.

CB TRANSCEIVER

724

Bantam weight mobile unit provides 23-channel operation

Introduced is a bantam weight Mobile Transceiver, the Rebel 23+, which is said to be ideal for truckers and boaters, while featuring full 23-channel operation with PA provision. The compact 5w rig reportedly uses a 12 crystal synthesized circuit to provide 23 channel operation in both receive and transmit modes, plus containing highly sensitive and selective dual conversion receiver circuitry. In addition to an adjustable SQUELCH, the receiver has a built-in automatic

noise limiter and improved microphone and amplifier circuits. The silver and black control panel includes a PA/CB switch, illuminated S/RF



meter and a large channel selector. The unit is said to come complete with all crystals, built-in microphone and all mounting hardware to be installed in vehicles with positive or negative ground. Fanon/Courier Corp.

STEREO PREAMPLIFIER

725

Plugs directly into the amplifier to increase fidelity and response

A quick, easy method has been developed of adapting a magnetic cartridge to an amplifier not equipped with a stereo preamp. Because of the low output of a magnetic cartridge,



as opposed to ceramic or crystal types, a stereo preamplifier is needed. The Stereo Preamplifier, Cat. No. 30-5015, plugs directly into the amplifier to increase fidelity and response. It is said to feature complete solid-state circuitry, operate on ac current and is RIAA equalized. GC Electronics.

For more information

concerning

DEALER SHOWCASE

Use pages 61 & 62 for

READERS SERVICE

TECHNICAL LITERATURE

Phono-Cartridges

A free pamphlet on selecting and selling magnetic, crystal and ceramic cartridges is available. It provides the dealer and serviceman with many useful suggestions on how to analyze a cartridge replacement problem, how to make a proper selection for replacement and tips on installation. Included is data on replacing Japanese magnetic cartridges on imported sets with American made units, and information on four-channel magnetic cartridges as well as hints on making substitutions when a duplicate of the original is not available. Pfanstiehl, 3300 Washington St., Waukegan, Ill. 60085.

Test Instruments

An eight-page test-instrument catalog lists a manufacturer's general-purpose VOM units from its complete line and a comprehensive complement of accessories. The catalog, three-ring punched for easy reference use, also illustrates each general purpose VOM, provides detailed specifications for each, including ranges, accuracies, construction characteristics, and operating features, plus providing up-to-date pricing information. Triplett Corp., Dept. PR, Bluffton, Ohio 45817.

Broadcast and CCTV Equipment

A second-edition 256-page catalog features new and used broadcast and closed circuit television equipment together with many pages of technical information. Denson Electronic Corp., Longview St., Rockville, Conn. 06066.

Capacitors

A 36-page catalog describes in detail a line of standard capacitors and ceramic substrates. Products listed in the new catalog include: disc, monolithic and special application ceramic capacitors; aluminum electrolytic capacitors; polystyrene film capacitors and a new line of 95% alumina-ceramic substrates. The catalog features over 500 new products. Product information in the catalog includes detailed electrical and test specifications, dimensional drawings and capacitor performance curves. Robert Wright, Merchandising Coordinator, Centralab Distributor Products, 5757 N. Green Bay Ave., Milwaukee, Wisc. 53201.

TV Maintenance Course

A new study training program has been designed to prepare individuals with minimal or no background in electronics for employment as electronic technicians with major concentration in color-TV maintenance. Entitled Electronics Technology and Color Television Maintenance, the program features a 25-in. (diagonal measurement) solid-state color-TV set, a 161-piece electronics laboratory and 111 lessons. In addition, the student receives at no additional cost an op-

tion of 20 advanced math and electronic application lessons and 15 lessons devoted to FCC License preparation. The program gives the student a well-rounded education in electronics technology, extensive hands-on-experience through laboratory experiments and TV assembly, plus the added benefit of finishing the course with a large-screen color-TV set that he and his family can enjoy. Public Relations Department, NR-03, Cleveland Institute of Electronics, 1776 E. 17th St., Cleveland, Ohio 44114.



MINI-HUSH Retail for \$22.50

Dealer Cost:

12 or more \$14.60 each

48 or more 13.50 each

Over 100 12.40 each

Colors: Matching phone in Green, White, Black, Beige

Sample & Starter Sales Kit \$20.00

EXTRA PROFITS on CALLS

On Service Calls Sell MINI-HUSH™

MINI-HUSH, the revolutionary new telephone bell silencer that replaces the nerve shattering bell with a controllable tone and simultaneous light indicator.

- Adds prestige & personality to phones
- Allows undisturbed sleep
- Ends annoying interruptions on private occasions.

Easily installed in less than 90 seconds.

Order today:



Diversitron Inc.
201 Town & Country Village
Palo Alto, CA 94021

Prepaid orders shipped same day postage or Freight Paid.

... for more details circle 112 on Reader Service Card

We help him make it easier for you.

Your GE tube distributor is always there when you need him. With a complete line of GE entertainment receiving tubes, replacement semiconductors and ULTRACOLOR® or all-new Spectra-Brite® picture tubes.

Competitively priced. With fast delivery assured by his balanced inventory and the GE tube warehouse network. Along with all the technical information, business and technical aids you'll ever need. You can depend on him and GE tube products.

Tube Products Department,
General Electric Company,
Owensboro, Kentucky 42301

We're in this business together.

GENERAL  ELECTRIC



The practical cordless original

When the Wahl Iso-Tip® Cordless Soldering Iron was introduced, it became practical to eliminate the cord from soldering.

Weighing only six ounces, compact and fast heating, the Iso-Tip can make up to 125 electronic joints (or more) per charge.

Its recharging stand repowers its batteries overnight. And its worklight lets you see what you're soldering.

Accessories include carrier storage tube, auto charger, and 4 replacement tips. For all the details, see your local electronic component distributor.

Still the greatest advance in soldering since electricity.

General Purpose Tip .156

Heavy Duty Tip .187

Fine Tip .070

Tuner Extension Tip .070

Protective Carrier/Storage Tube

WAHL®

CLIPPER CORPORATION
Department 4 2902 Locust Street
Sterling, Illinois 61081 815-625-6525

Auto Charger Plug Assembly (lighter)
(For use only on irons coded D72 and up)

... for more details circle 144 on Reader Service Card

FREE...

1974 Heath/Schlumberger Electronic Instruments Catalog

One-stop shopping for virtually all your test equipment needs:

80 MHz frequency counters from \$295*
... 200 MHz counters from \$495* ... 600 MHz counter only \$795* ... 600 MHz scaler just \$365* ... programmable timer only \$395* ... dual trace 15 MHz scope, \$595* ... sine, square, triangle wave generator, \$245* ... high and low voltage power supplies from \$34* ... multimeters from \$65* ... DVMs from \$285.*

The new 74 Heath/Schlumberger catalog describes all these and many more... all factory assembled and aligned... all specification-guaranteed for one full year... and all available at low mail-order prices. Use the coupon below and send for your FREE copy now.



FREE...
1974
Heath/
Schlumberger
Electronic
Instruments Catalog.
Send coupon now.

Heath/Schlumberger Instruments
Dept. 199-1
Benton Harbor, Michigan 49022

Please send 1974 Electronic Instruments Catalog.

Name _____

Address _____

City _____

State _____

Zip _____

Prices & specifications subject to change without notice.

*Mail order prices; F.O.B. factory.

EK-409

... for more details circle 123 on Reader Service Card

BOOK REVIEWS

SOUND SYSTEMS INSTALLERS HANDBOOK, third edition, by *Leo G. Sands*, published by *Howard W. Sams*, 192 pages, paperbound \$5.50.

This book is primarily concerned with the proper use of audio component systems to most effectively perform the desired task. Or, as stated by the author in the preface, "The purpose of this book is to assist electronics technicians and electricians in the design, application, and installation of sound systems in a professional manner. The author has found that far too many sound systems have been poorly designed and ineptly installed. In this advanced stage of the electronics art, there is no excuse for the many inadequate sound systems in use today."

As an example of how straight forward the author is in writing the book, one of his first illustrations compares a 70v sound system with house wiring.

Although some attention is given to microphones, the book concentrates most heavily on proper speaker placement and techniques for wiring speaker systems to obtain the desired power output in the desired portion of the sound system.

We consider this book must reading for anyone interested in commercial audio applications.

ACOUSTIC TECHNIQUES FOR HOME & STUDIO by *F. Alton Everest*, published by *Tab Books*, 224 pages, hardbound \$7.95, paperbound \$4.95.

How many service dealers display their expensive component systems in rooms that do nothing to enhance the quality of the music reproduced, or care nothing of the environment in which their customers use such audio equipment? Those that fail to be adequately concerned with the acoustics of such areas are not putting their "best foot forward" in showing how good such equipment is, and they are failing to sell their customers a service that will not only permit better home listening but provide more revenue.

This is probably the first book that we have reviewed for publication that does not contain a single electronic circuit. It is concerned entirely with the travel of sound—on the way to the microphone, or from the speaker to the human ear.

The author covers such subjects as sound pressure levels, good noise, bathroom acoustics, standing waves in nonrectangular rooms, distribution of absorbing materials, comparison of wall structures, midrange absorbers, plus formulas for dead rooms, etc., etc.

This book should be considered must reading for anyone really serious about effective audio applications.

BASIC AUDIO SYSTEMS by Norman H. Crowhurst, published by Tab Books, 240 pages, hardbound \$7.95, paperbound \$4.95.

When writing this book the author appears to have taken great pains to include all possible details so that the material can be understood by both the beginning and the advanced electronic technician. As a result, portions of the book had best be skipped by the advanced technician, who may otherwise quickly lose interest. However, with such a technique, the book should be interesting reading for those of all technical levels.

The author begins the book with some extremely basic coverage of sound, its mechanical production and mechanical storage and transmission. Similar fundamentals are included in the coverage of microphones, earphones, telephones and speaker systems. Something is even said concerning the function of tubes and transistors.

However, once all this background information is covered, much of interest is presented concerning impedance matching, equalization, the use and limitations of negative feedback, and a very interesting power amplifier that the author invented—one that uses switching circuits and modulated pulse amplification to permit power efficiencies many times greater than that currently available with conventional solid-state or tube amplifier systems. Advanced commercial installations are also covered.

Your editor was extremely impressed with one drawing that very clearly illustrated three waveforms produced by a single signal and how they add up to the total voltage or current of the component waveforms.

This book should contain something of interest for everyone.

10-MINUTE TEST TECHNIQUES FOR PC SERVICING by Art Margolis, published by Tab Books, 216 pages, hardbound \$7.95, paperbound \$4.95.

Although Zenith was probably the last to hold out for hand-wired circuitry, we know of no audio or TV receiver circuitry in recently produced consumer electronic products that does not make extensive use of printed circuits. Thus the great importance of developing techniques for effectively servicing circuits built on PC boards.

The author begins the book by showing servicing errors that can easily produce defective circuit boards,

plus techniques for locating these defects. Coverage is also given the problem of what to do when a portion of a PC board is destroyed, offering advice concerning the use of pegboard and etching new circuits. Techniques are also described for removing and inserting components without damage to either the components or the PC boards. Considerable coverage is given both tools and servicing chemicals.

Once the mechanics have been explained, the author goes into some detail concerning the locating of circuitry and components on PC boards for effective servicing. There frequent use appears to be made of manufacturers' illustrations and service literature. This latter section consumes approximately 112 pages of the book.

We feel that the book should prove very useful for the beginning electronic technician that has had little practical experience working on printed-circuit boards. Much of the material would seem rather basic to the more experienced technicians. Although the line drawings were well produced, many of the photographs proved almost ineffective due to their inferior reproduction.

ELIMINATING ENGINE INTERFERENCE, second edition, by John D. Lenk, published by Howard W. Sams, 128 pages, paperbound \$4.50.

Any electronic technician or service dealer concerned with the effective installation of receivers or transceivers in cars, trucks, boats, etc., is usually faced with the task of reducing the electrical interference generated by that vehicle to an acceptable level for the effective use of the installed electronic equipment (including depth finders.) Although the title of this book makes reference to engine noise, there are also many other types of electrical interference generated by the vehicle that must also be controlled.

The author goes into considerable detail concerning the many forms of electrical interference generated within a vehicle, various techniques for locating these sources, and changes in vehicle circuitry to reduce or eliminate the problem. Many practical illustrations are included to assist the reader in this task.

In addition to cleaning up the vehicle's electrical system, the author covers various types of electronic circuitry that may be incorporated in the electronic system to be installed, or in conjunction with it. These include squelch circuits, noise limiters and various forms of shielding.

We feel that the book should prove to be of value to anyone involved in mobile electronics.

T & T VALUE SALE

RAYTHEON NEW JOBBER-BOXED TUBES 80% off LIST

<input type="checkbox"/> 1V2	5 for \$2.50	<input type="checkbox"/> 6FQ7	5 for \$3.25
<input type="checkbox"/> 2AV2	5 for \$3.45	<input type="checkbox"/> 6GJ7	5 for \$3.40
<input type="checkbox"/> 3A3	5 for \$4.40	<input type="checkbox"/> 6DW4	5 for \$4.10
<input type="checkbox"/> 6GH8	5 for \$3.50	<input type="checkbox"/> 3AT2	5 for \$4.25
<input type="checkbox"/> 6JE6	5 for \$9.65	<input type="checkbox"/> 8FQ7	5 for \$3.25
<input type="checkbox"/> 6BK4	5 for \$8.15	<input type="checkbox"/> 6HA5	5 for \$4.20
<input type="checkbox"/> 3GK5	5 for \$4.20	<input type="checkbox"/> 12GN7	5 for \$6.05

TRANSISTORS XACT. REPLACEMENT (BOXED) 80% off LIST

<input type="checkbox"/> SK3006	5 for \$2.35	<input type="checkbox"/> SK3039	5 for \$3.30
<input type="checkbox"/> SK3009	5 for \$3.90	<input type="checkbox"/> SK3040	5 for \$3.75
<input type="checkbox"/> SK3018	5 for \$5.25	<input type="checkbox"/> SK3041	5 for \$4.20
<input type="checkbox"/> SK3020	5 for \$2.20	<input type="checkbox"/> SK3042	5 for \$6.20
<input type="checkbox"/> SK3114	5 for \$2.40	<input type="checkbox"/> SK3052	5 for \$3.90
<input type="checkbox"/> SK3024	5 for \$3.15	<input type="checkbox"/> SK3054	5 for \$4.50
<input type="checkbox"/> SK3025	5 for \$4.50	<input type="checkbox"/> SK3115	5 for \$4.95
<input type="checkbox"/> SK3026	5 for \$3.00	<input type="checkbox"/> SK3122	5 for \$2.20
<input type="checkbox"/> SK3035	5 for \$9.15	<input type="checkbox"/> SK3124	5 for \$2.10
<input type="checkbox"/> BZY 9 Voltage Regulator Diode	75 watt	\$1.50	
<input type="checkbox"/> BZY 93 Voltage Reg. Diode	20 watt	\$.50	
<input type="checkbox"/> BZY 170 Voltage Reg. Diode	25 watt	\$.50	

IC EQUIV. TO: (BOXED)

<input type="checkbox"/> HEP590 IC20	ea.	\$1.00
<input type="checkbox"/> HEP591 IC8	ea.	\$1.00
<input type="checkbox"/> Sylvania VA703 IC7	2 for	\$1.50
<input type="checkbox"/> Zenith 221-36 IC502	ea.	\$2.95
<input type="checkbox"/> Zenith 221-45 IC508	2 for	\$2.45

DIODES & RECTIFIERS

<input type="checkbox"/> Assorted Diodes, incl. IN34	50 for	\$1.00
<input type="checkbox"/> Color Burst Boost Rectifier	7 for	\$2.00
<input type="checkbox"/> Color Focus Rect. ITT 6500 PIV	10 for	\$4.00
<input type="checkbox"/> Color Focus Rectifier RCA 113397	3 for	\$2.00
<input type="checkbox"/> Zenith Voltage Tripler 212-136	ea.	\$3.95
<input type="checkbox"/> 2.5 Amp. 1000 PIV IR 170	40 for	\$5.00
<input type="checkbox"/> 3 Amp. 1000 PIV	40 for	\$5.00
<input type="checkbox"/> 24KV HV Rectifier	2 for	\$1.50
<input type="checkbox"/> IR-DD04	10 for	\$2.95
<input type="checkbox"/> IR-DD05	10 for	\$2.95

YOKES - TUNERS - FLYS

<input type="checkbox"/> Y107-70° Color Yoke	ea.	\$9.95
<input type="checkbox"/> Y109-DY95 AC Mag. RCA, Color Yoke without back cover		\$4.95
<input type="checkbox"/> Y104 DY68AT		\$2.95
<input type="checkbox"/> Jap Color Yoke		\$4.95
<input type="checkbox"/> Standard Coil Tuner, incl. tubes		\$3.95
<input type="checkbox"/> UHF & VHF Combination, incl. tubes		\$5.95
<input type="checkbox"/> UHF Tuner		\$1.50
<input type="checkbox"/> Zenith 175-1109, incl. tubes		\$4.95
<input type="checkbox"/> Zenith 175-1139, incl. tubes		\$4.95
<input type="checkbox"/> Zenith 175-1193, incl. tubes		\$4.95
<input type="checkbox"/> Sylvania Tuner, incl. 6GS7-6HA5		\$4.95
<input type="checkbox"/> Zenith Stand. Tuners, incl. tubes	4 for	\$20.00
<input type="checkbox"/> Zenith Golden Grid, incl. tubes	4 for	\$32.00
<input type="checkbox"/> Philco Color 32-10132-1 H0652C		\$2.95
<input type="checkbox"/> Fly 281 RCA 109221		\$4.95

GENERAL

<input type="checkbox"/> Blue Lateral Magnets, incl. P.R.	2 for	\$2.50
<input type="checkbox"/> 53 Meg. High Vol. Resistor	6 for	\$2.00
<input type="checkbox"/> 66 Meg. High Vol. Resistor	6 for	\$2.00
<input type="checkbox"/> 10 Asst. Cap. Cans		\$4.00
<input type="checkbox"/> 20 Asst. Mylar Caps.		\$2.00
<input type="checkbox"/> 50 Asst. Disc. Caps.		\$1.00
<input type="checkbox"/> Ast. 14B Cartridge	4 for	\$5.00
<input type="checkbox"/> 3.58 Crystal Osc.	5 for	\$3.75
<input type="checkbox"/> 3.58 RCA Crystal Osc.	5 for	\$5.00
<input type="checkbox"/> 100-10.7 mc. IF Cans and others		\$4.00
<input type="checkbox"/> 19" & 25" Color CRT Boosters	3 for	\$11.00
<input type="checkbox"/> 21" Color CRT Boosters	3 for	\$11.00
<input type="checkbox"/> Weller Soldering Gun #B200PK		\$6.95
<input type="checkbox"/> Weller Soldering Iron #SP23K		\$3.50

AUDIO

<input type="checkbox"/> 5 M3D M7D Diamond Needle	ea.	\$5.00
<input type="checkbox"/> 1 Equiv. N44 Shure Diamond Needle		\$2.95
<input type="checkbox"/> 12 BSR Needle 5213		\$3.95
<input type="checkbox"/> 12 Asst. Varco Needle 9208		\$3.95
<input type="checkbox"/> 12 Asst. Needle 5051		\$3.95
<input type="checkbox"/> 1 Equiv. M77 Shure Needle		\$3.95
<input type="checkbox"/> Stereo Headphone, ind. controls	each	\$6.95
<input type="checkbox"/> Lapel Mikes	2 for	\$1.00
<input type="checkbox"/> Telephone Pick-up Coil	3 for	\$1.00
<input type="checkbox"/> 5 90-Min. Irish Cassette Tapes		\$3.50
<input type="checkbox"/> 3 60-Min. Irish Cassette Tapes		\$1.25
<input type="checkbox"/> BSR McDonald 5500X, inc. Base & Cov.		\$29.95

Minimum Order \$35—F.O.B. Brooklyn
Catalogs \$1—Refundable upon your order

T & T SALES CO.

4802 AVENUE K
BROOKLYN, N. Y. 11234
Phone: (212) 241-5940

a 26 year PRICE FREEZE

In spite of rising production costs, labor, materials, freight, etc. Electronic Chemical still maintains the same high quality and low price as in our very first year.

Volume Control and Contact Restorer

For special attention to volume controls, push button assemblies, band switches, relays and other electrical contacts.



For Color and B/W

Tuner Tonic

Cleans and lubricates tuners (incl. wafer type) — economical, a little does a lot.

No-Noise products guaranteed non-flammable, no carbon tet, non-toxic — safe for plastics.



Super Spray Bath

Dissolve and flush away grease, dirt, oil and oxidation. Used for magnetic heads, computers, relays and switches, Tel & Tel equipment, switchboards and switching devices, record changers, timers, automotive and aircraft equipment, printed circuit boards.



Often imitated but never duplicated

Other "No-Noise" Products:

- Super Lube • Frigid Air
- EC-44 • Tape-Recd Head Cleaner

ELECTRONIC CHEMICAL CORP.

813 Communipaw Avenue Jersey City, N. J. 07304

for more details circle 115 on Reader Service Card

BRAND NEW FROM ENDECO
the soldering iron with a light



Exclusive new safety light shows when power is on
MODEL 540S \$10.95 NET

Two heats—20w and 40w—to handle any job
• On-off switch • Cool, unbreakable polycarbonate handle • Ironclad tips for longer life
• Burn-resistant neoprene cord • 8½" long, 2 oz • Converts to a desoldering iron with low cost attachment • Also desoldering irons and soldering/desoldering kits.

See your distributor or write ...



5127 EAST 65TH ST.
INDIANAPOLIS,
INDIANA 46220
PHONE 317/251-1231

enterprise
development
corporation

for more details circle 116 on Reader Service Card

READERS SERVICE INDEX

ADVERTISER'S INDEX

101	Alco Electronic Products, Inc.	60
102	Amperex Electronic Corp.	12
103	Arrow Fastener Co., Inc.	52
104	B & K Division, Dynascan Corp.	3
146	B & K Division, Dynascan Corp.	3
147	B & K Division, Dynascan Corp.	3
148	B & K Division, Dynascan Corp.	3
105	Blonder-Tongue Laboratories, Inc.	50
106	Book Club—Tab Books	26-29
107	Book Club—Techmatics	47
108	Centralab Distributor Products	54
109	Channel Master, Div. of Avnet, Inc.	10
110	Chemtronics, Inc.	13
111	Delta Products, Inc.	55
112	Diversitron, Inc.	57
113	Edsyn, Inc.	44
114	Eico Electronic Instruments Co.	44, 45
115	Electronic Chemical Corp.	60
116	Enterprise Development Corp.	60
117	Finney Company, The	56
118	Fluke Manufacturing, John	15
119	Ford Marketing	43
120	Fordham Radio Supply Co. Inc.	60
121	GC Electronics Company	18
	GTE Sylvania	16, 17
	General Electric Company	57
122	Heath Co.	48
123	Heath Co./Schlumberger	58
124	International Rectifier	51
125	Jem Electronics	53
126	Jensen Tools & Alloys	60
127	Jerrold Electronics Corp.	6
128	LPS Research Labs.	46
129	Leader Instruments	cover 3
131	Mountain West Alarm	60
133	Panasonic	19
134	Precision Tuner Service	cover 2
	RCA Picture Tubes	8, 9
135	Sound Tech	52
136	Sprague Products	11
137	Systron Donner-Concord	46
138	T & T Sales	59
139	Telematic	53
140	Triplett Corp.	cover 4
141	Tuner Service	21
145	Universal Tuner Tabs	15
144	Wahl Clipper Corp.	58
142	Winegard Company	22
143	Workman Electronic Products, Inc.	5

NEW PRODUCTS

700	Four-Channel System	20
701	Tape Recorder	20
702	Intermodulation Distortion Analyzer	20
703	UHF Bandpass Filters	49
704	Desoldering Tool	49
705	Wire Unwrap Tool	49
706	Service Table	49
707	Antenna	49
708	Recorder Erase Head	49
709	Scope	50
710	Distribution Amplifier	50
711	Frequency Counter	51
712	Tool Case	51
713	Signal Generator	52
714	Alarm System	52
715	Bench Power Supply	53
716	Telephone Silencer	54
717	Video Tape Logger	54
718	AM/FM Receiver	54
719	Car Stereo	54
720	Car Stereo Display	55
721	Cassette Tape-Deck	55
722	Telephone Answerer	55
723	Cassette Recorder	56
724	CB Transceiver	56
725	Stereo Preamplifier	56

TEST INSTRUMENT

900	3M's Model 6500 Recorder Test Set	41
-----	-----------------------------------	----

DISCOUNT TEST EQUIPMENT SPECIALISTS



COMPLETE LINE OF ELECTRONIC SUPPLIES
ICC/Mullard & Raytheon Tubes
Telematic Test Rigs

FREE CATALOG

FORDHAM

Radio Supply Co., Inc.
558 Morris Ave., Bronx, N.Y. 10451
Tel: (212) 585-0330

for more details circle 120 on Reader Service Card

"GROUNDED" OUTLET TESTER



New! GT-20 Tester tells if your AC outlets are safely grounded. Just plug in and follow label instructions. Ideal for home, shop, campers, electricians, maintenance men. \$7.95 prepaid. Adapter plug \$.75.

ALCO BOX 1348-ET
Lawrence, Ma. 01840

for more details circle 101 on Reader Service Card

FREE CATALOG

HARD-TO-FIND PRECISION TOOLS

Lists more than 1700 items—pliers, tweezers, wire strippers, vacuum systems, relay tools, optical equipment, tool kits and cases. Also includes four pages of useful "Tool Tips" to aid in tool selection.



JENSEN TOOLS
4117 N. 44th Street, Phoenix, Ariz. 85018

for more details circle 126 on Reader Service Card

FREE ALARM CATALOG

Full line of professional burglar and fire alarm systems and supplies. 80 pages, 400 items. Off-the shelf delivery, quantity prices.



mountain west alarm
4215 n. 16th st., phoenix, az. 85016

for more details circle 131 on Reader Service Card

MOVING?

Be sure to let us know your new address.
Please enclose a complete address label from one of your recent issues.

GROUP
257

SCHMATIC NO.

SCHMATIC NO.

ADMIRAL 1505
Color-TV Chassis M25

PHILCO-FORD 1507
Color-TV Chassis 4CS71

GENERAL ELECTRIC 1506
Color-TV Chassis 10QA

ZENITH 1504
TV Chassis 16EB12/16EB12X

PANASONIC 1508
TV Model AN-182



1 3.5V P-ZERO
60 Hz



2 60V P-PV
60 Hz



3 7V P-PV
60 Hz



4 24V P-PV
15.75 KHz

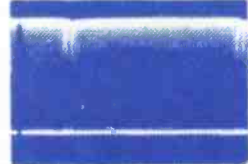

5 24V P-PV
60 Hz

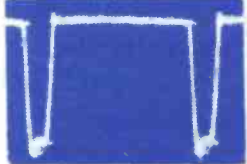

6 32V P-PV
15.75 KHz

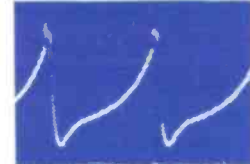

7 9V P-PV
60 Hz

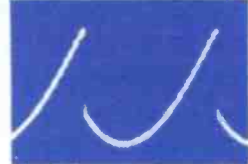

8 3.2V P-PV
60 Hz



9 4.8V P-PV
60 Hz



10 600V P-PV
60 Hz



11 13V P-PV
60 Hz



12 16V P-PV
15.75 KHz

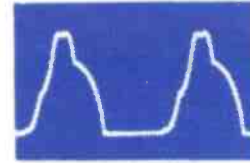

13 16V P-PV
15.75 KHz



14 2.8V P-PV
15.75 KHz

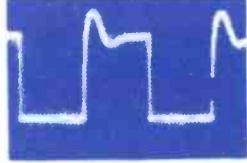

15 170V P-PV
15.75 KHz



16 36V P-PV
15.75 KHz

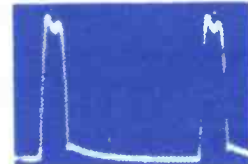

17 960V P-PV
15.75 KHz

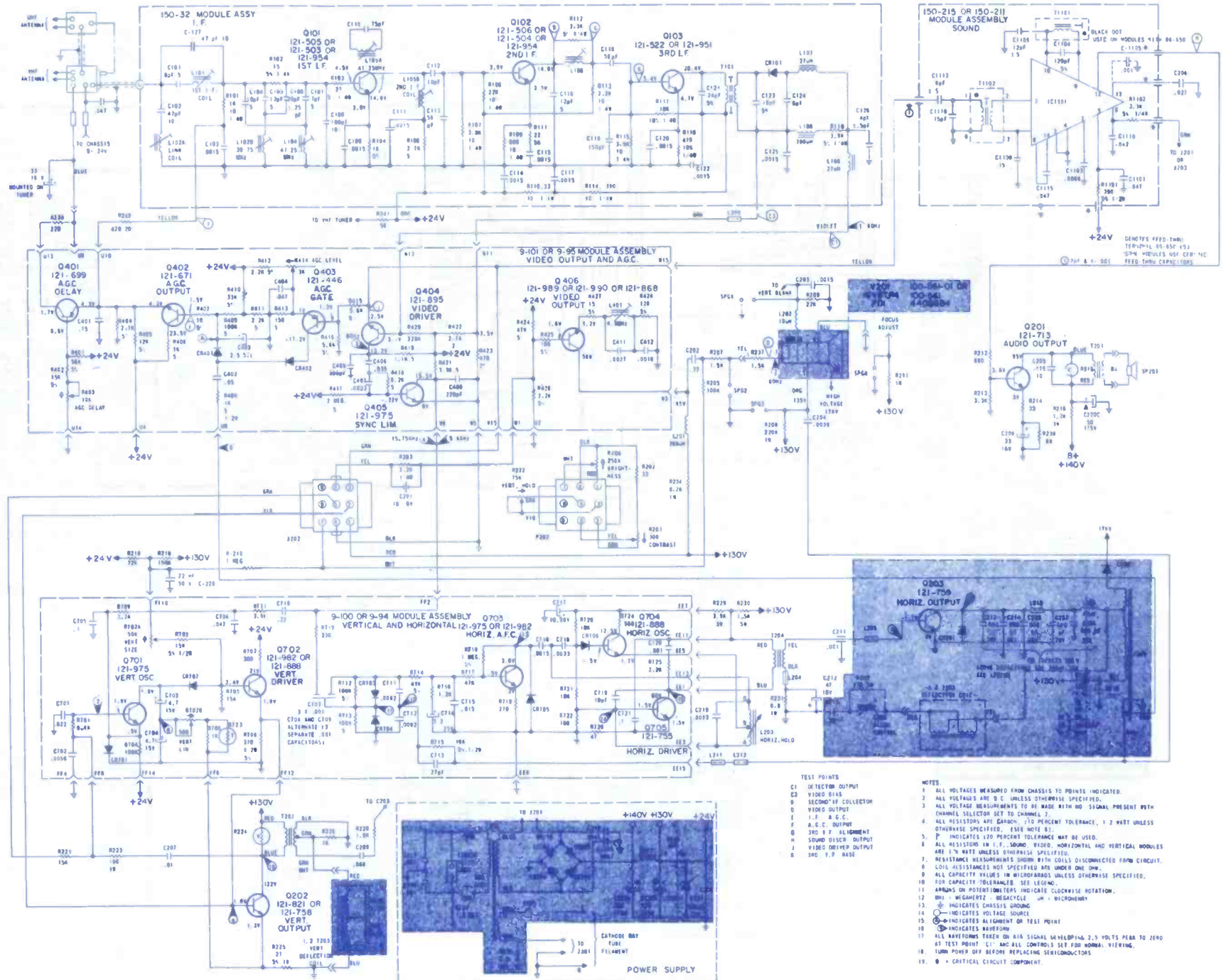

TEST POINTS
C1 DETECTOR OUTPUT
C2 VIDEO BIAS
C3 SECONDARY COLLECTOR
E VIDEO OUTPUT
F I.P. A.C.C.
F A.C.C. OUTPUT
G 3RD I.F. ALIGNMENT
H SOUND OSC. OUTPUT
I VIDEO DRIVER OUTPUT
J 3RD I.F. BIAS

NOTES
1 ALL VOLTAGES MEASURED FROM CHASSIS TO POINTS INDICATED.
2 ALL VOLTAGES ARE D.C. UNLESS OTHERWISE SPECIFIED.
3 ALL VOLTAGE MEASUREMENTS TO BE MADE WITH NO SIGNAL PRESENT WITH CHANNEL SELECTOR SET TO CHANNEL 2.
4 ALL RESISTORS ARE CARBON, 5% PERCENT TOLERANCE, 1/2 WATT UNLESS OTHERWISE SPECIFIED. SEE NOTE #1.
5 P INDICATES 10% PERCENT TOLERANCE MAY BE USED.
6 ALL RESISTORS IN I.F., SOUND, VIDEO, HORIZONTAL AND VERTICAL MODULES ARE 1% RATE UNLESS OTHERWISE SPECIFIED.
7 RESISTANCE MEASUREMENTS SHOWN WITH COILS DISCONNECTED FROM CIRCUIT.
8 COIL RESISTANCES NOT SPECIFIED ARE UNDER ONE OHM.
9 ALL CAPACITY VALUES IN MICROGRAMS UNLESS OTHERWISE SPECIFIED.
10 FOR CAPACITY TOLERANCES, SEE LEGEND.
11 ARROWS ON POTENTIOMETERS INDICATE CLOCKWISE ROTATION.
12 MW - MEGAWATT; MC - MICROHENRY.
13 - INDICATES CHASSIS GROUND.
14 - INDICATES VOLTAGE SOURCE.
15 - INDICATES ALIGNMENT OR TEST POINT.
16 - INDICATES WAVEFORM.
17 ALL WAVEFORMS TAKEN ON A1A SIGNAL DEVELOPING 2.5 VOLTS PEAK TO ZERO AT TEST POINT C1; AND ALL CONTROLS SET FOR NORMAL VIEWING.
18 TURN POWER OFF BEFORE REPLACING SEMICONDUCTORS.
19 - CRITICAL CIRCUIT COMPONENT.

1505

ADMIRAL

Color-TV Chassis
M25

ELECTRONIC TECHNICIAN/DEALER **TEKFA**X

JANUARY • 1974

COMPLETE MANUFACTURERS' CIRCUIT DIAGRAMS
AND TECHNICAL INFORMATION FOR 5 NEW SETS

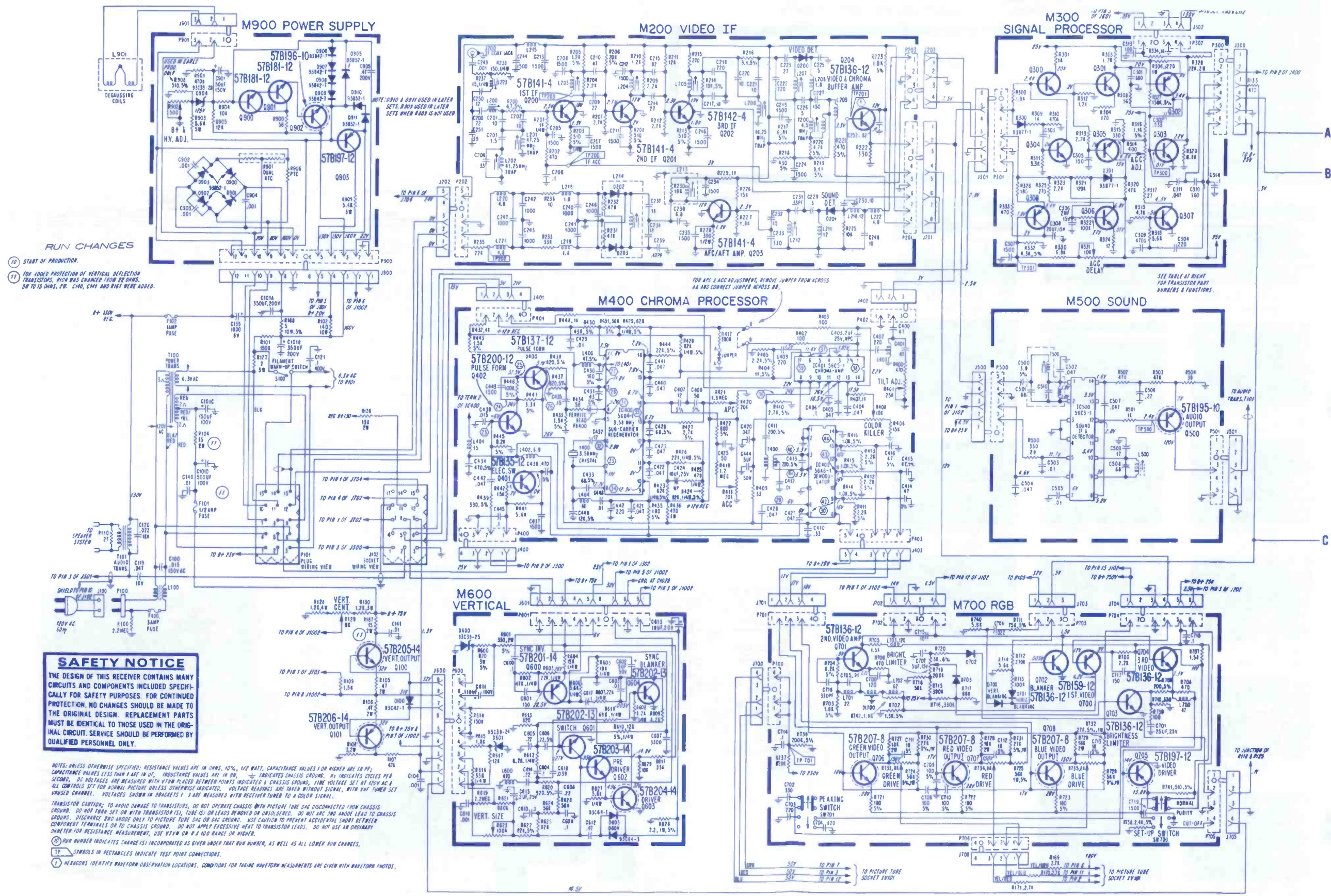

RUN CHANGES

- 10 START OF PRODUCTION.
- 11 FOR ADDED PROTECTION OF VERTICAL DEFLECTION TRANSISTORS, R104 WAS CHANGED FROM 2K OHMS TO 15 OHMS. R105, C104, C105 AND R107 WERE ADDED.

SAFETY NOTICE

THE DESIGN OF THIS RECEIVER CONTAINS MANY CIRCUITS AND COMPONENTS INCLUDED SPECIFICALLY FOR SAFETY PURPOSES. FOR CONTINUED PROTECTION, NO CHANGES SHOULD BE MADE TO THE ORIGINAL DESIGN. REPLACEMENT PARTS MUST BE IDENTICAL TO THOSE USED IN THE ORIGINAL CIRCUIT. SERVICE SHOULD BE PERFORMED BY QUALIFIED PERSONNEL ONLY.

- NOTES: UNLESS OTHERWISE SPECIFIED: RESISTANCE VALUES ARE IN OHMS, 10%, 1/2 WATT. CAPACITANCE VALUES 1 OR HIGHER ARE IN PF; CAPACITANCE VALUES LESS THAN 1 ARE IN P.P. INDUCTIVE VALUES ARE IN MH. INDICATES CHASSIS GROUND. IN INDICATES CYCLES PER SECOND. DC VOLTAGES ARE MEASURED WITH VTM PLACED BETWEEN POINTS INDICATED & CHASSIS GROUND. LINE VOLTAGE SET AT 120V AC. ALL CONTROLS SET FOR NORMAL PICTURE UNLESS OTHERWISE INDICATED. VOLTAGE READINGS ARE TAKEN WITHOUT SIGNAL, WITH VHT TUNER SET UNUSED CHANNEL. VOLTAGES SHOWN IN BRACKETS () ARE MEASURED WITH RECEIVER TUNED TO A COLOR SIGNAL.
- TRANSISTOR CAUTION: TO AVOID DAMAGE TO TRANSISTORS, DO NOT OPERATE CHASSIS WITH PICTURE TUBE DISCONNECTED FROM CHASSIS GROUND. DO NOT TURN SET ON WITH TRANSISTOR(S), TUBE(S) OR LEADS REMOVED OR UNSOLDERED. DO NOT ARC AND ANODE LEAD TO CHASSIS GROUND. DISCHARGE AND ANODE ONLY TO PICTURE TUBE DAC OR DAC GROUND. USE CAUTION TO PREVENT ACCIDENTAL SHORT BETWEEN COMPONENT TERMINALS OR TO CHASSIS GROUND. DO NOT APPLY EXCESSIVE HEAT TO TRANSISTOR LEADS. DO NOT USE AN ORDINARY SHORTER FOR RESISTANCE MEASUREMENT, USE VTM ON R A 100 RANGE OF HIGH.
- 10 RUN NUMBER INDICATES CHANGE(S) INCORPORATED AS GIVEN UNDER THAT RUN NUMBER, AS WELL AS ALL LOWER RUN CHANGES.
 - TP SYMBOLS IN RECTANGLES INDICATE TEST POINT CONNECTIONS.
 - W HEADERS IDENTIFY WAVEFORM OBSERVATION LOCATIONS. CONDITIONS FOR TAKING WAVEFORM MEASUREMENTS ARE GIVEN WITH WAVEFORM PHOTOS.

1506

GENERAL ELECTRIC

Color-TV Chassis 10QA

ELECTRONIC TECHNICIAN/DEALER **TEKFAK**

JANUARY • 1974

COMPLETE MANUFACTURERS' CIRCUIT DIAGRAMS AND TECHNICAL INFORMATION FOR 5 NEW SETS

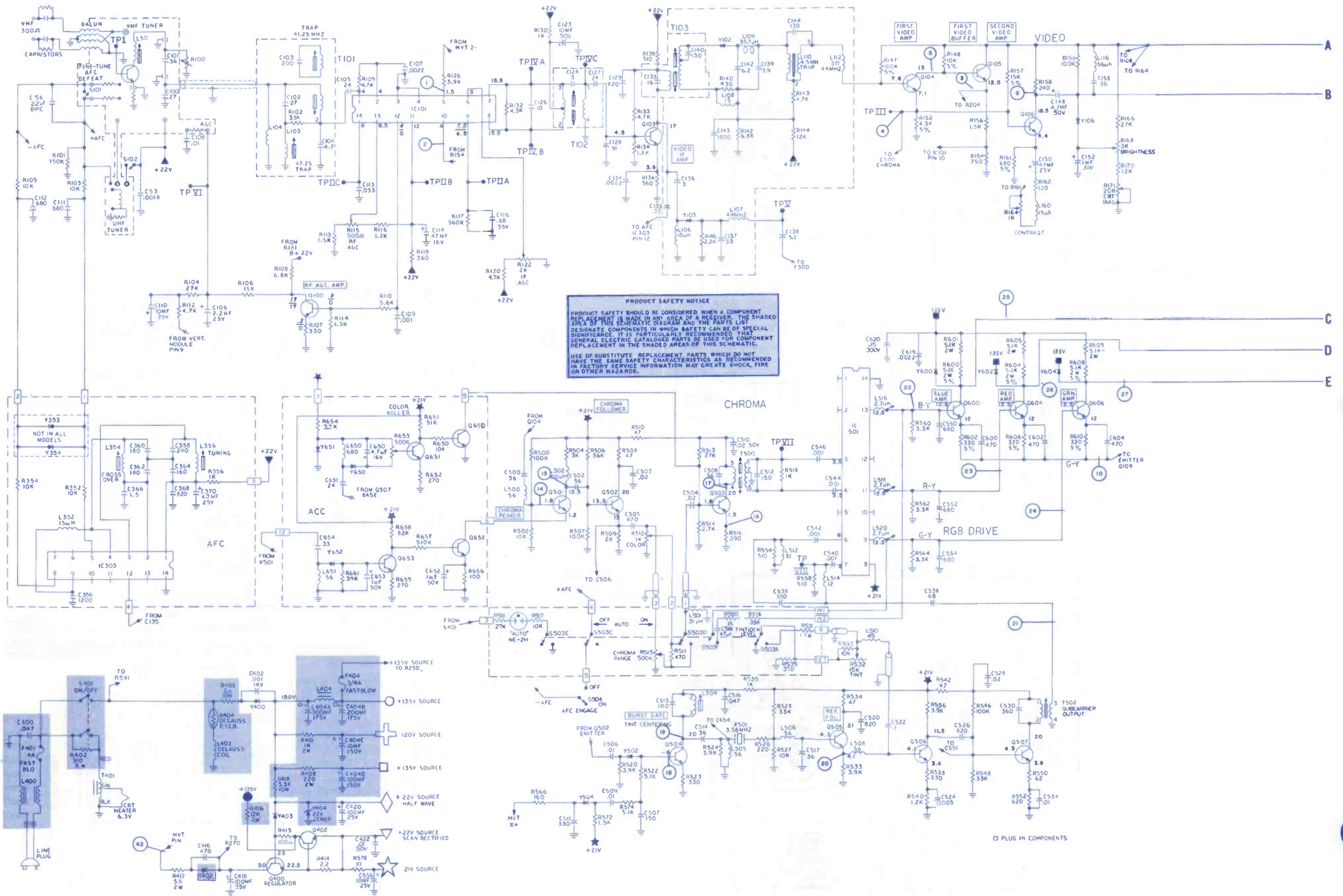

PRODUCT SAFETY NOTICE

PRODUCT SAFETY SHOULD BE CONSIDERED WHEN A COMPONENT REPLACEMENT IS MADE IN ANY AREA OF A RECEIVER. THE SHADED AREA OF THIS SCHEMATIC DIAGRAM AND THE PARTS LIST DESIGNATE COMPONENTS IN WHICH SAFETY CAN BE OF SPECIAL SIGNIFICANCE. IT IS PARTICULARLY RECOMMENDED THAT GENERAL ELECTRIC CATALOGED PARTS BE USED FOR COMPONENT REPLACEMENT IN THE SHADED AREAS OF THIS SCHEMATIC.

USE OF SUBSTITUTE REPLACEMENT PARTS WHICH DO NOT HAVE THE SAME SAFETY CHARACTERISTICS AS RECOMMENDED IN FACTORY SERVICE INFORMATION MAY CREATE SHOCK, FIRE OR OTHER HAZARDS.

SYMBOL	DESCRIPTION	GENERAL ELECTRIC PART NO.
R115	-RF AGC 500Ω, 20%	EP49X92
	dual control	EP49X94
R122	-1F AGC, 2K	
R196	-blue drive, 40K	EP49X95
	dual control	
R263	-vert hold, 500K	
R270	-vert height, 500K	EP49X90
R277	-vert center, 2K	EP49X159
R515	-chroma range 500Ω	EP49X159
R653	-color killer, 500K	ES49X535

C404A	-300μf, 175v	EP31X28
C404B	-200μf, 175v	
C404C	-10μf, 150v	
C404D	-100μf, 150v	
L112	-coil, 44MHz trap	EP36X4
	conv yoke assembly	EP62X32
L202	-coil horiz osc w/core	EP36X55
L301	-coil quad w/core	EP36X83
IC101	-integ ckt IF, AGC	EP84X1
IC301	-integ ckt audio	EP84X2

IC303	-integ ckt AFC mod	EP84X4
IC501	-integ ckt demod	EP84X3
	fuse 4a fast blo F401	EP10X52
	fuse 5a fast blo F404	EP10X3
T202	-xformer horiz buffer	EP64X19
T204	-HV xformer, w/air gap	EP77X11
T301	-xformer audio output	ET64X105
T401	-xformer filament	EP64X21
T500	-xformer chroma bandpass	EP61X14
T502	-coil 3.58 output xformer w/core	EP36X84

GENERAL ELECTRIC Color-TV Chassis 10QA

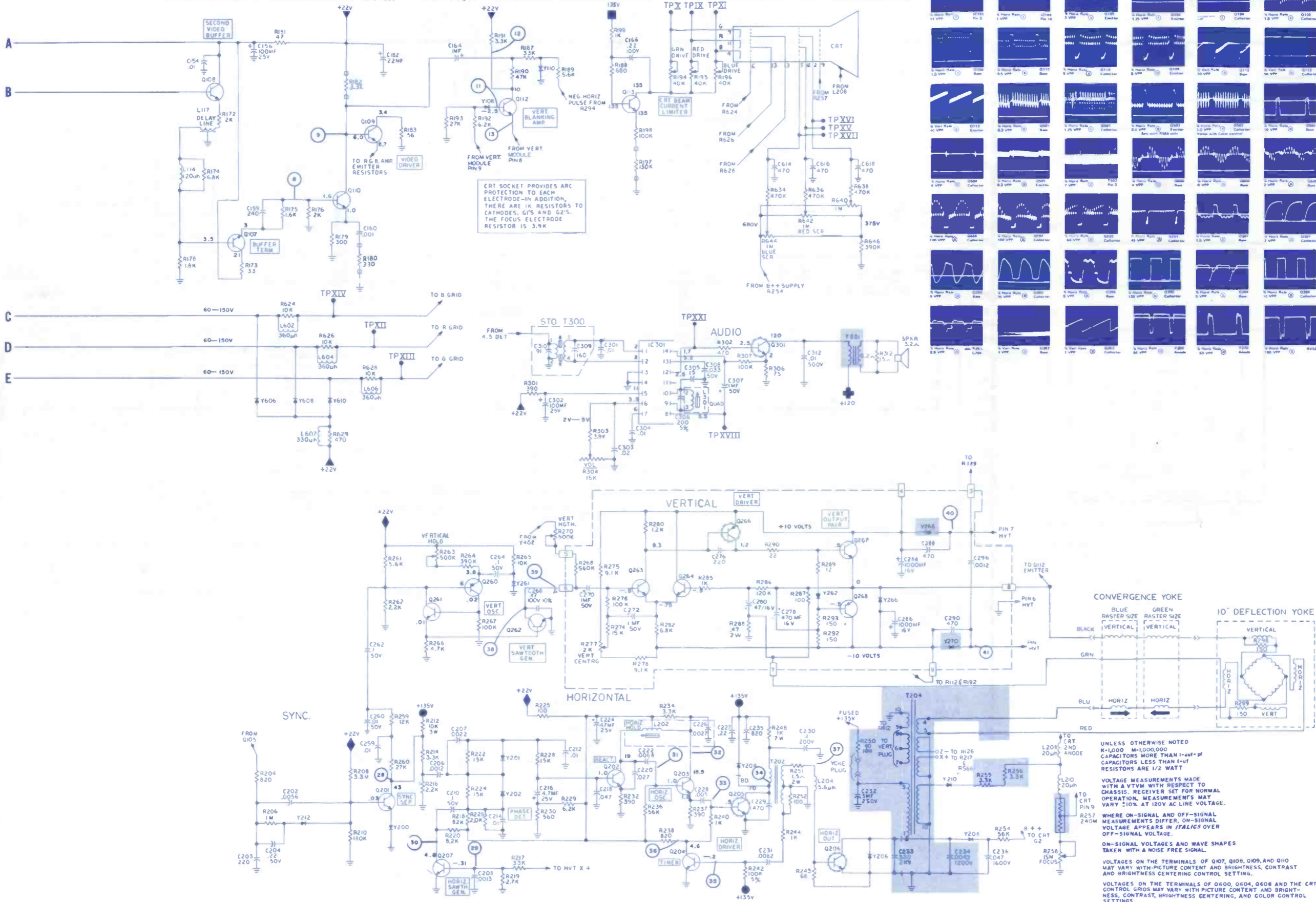

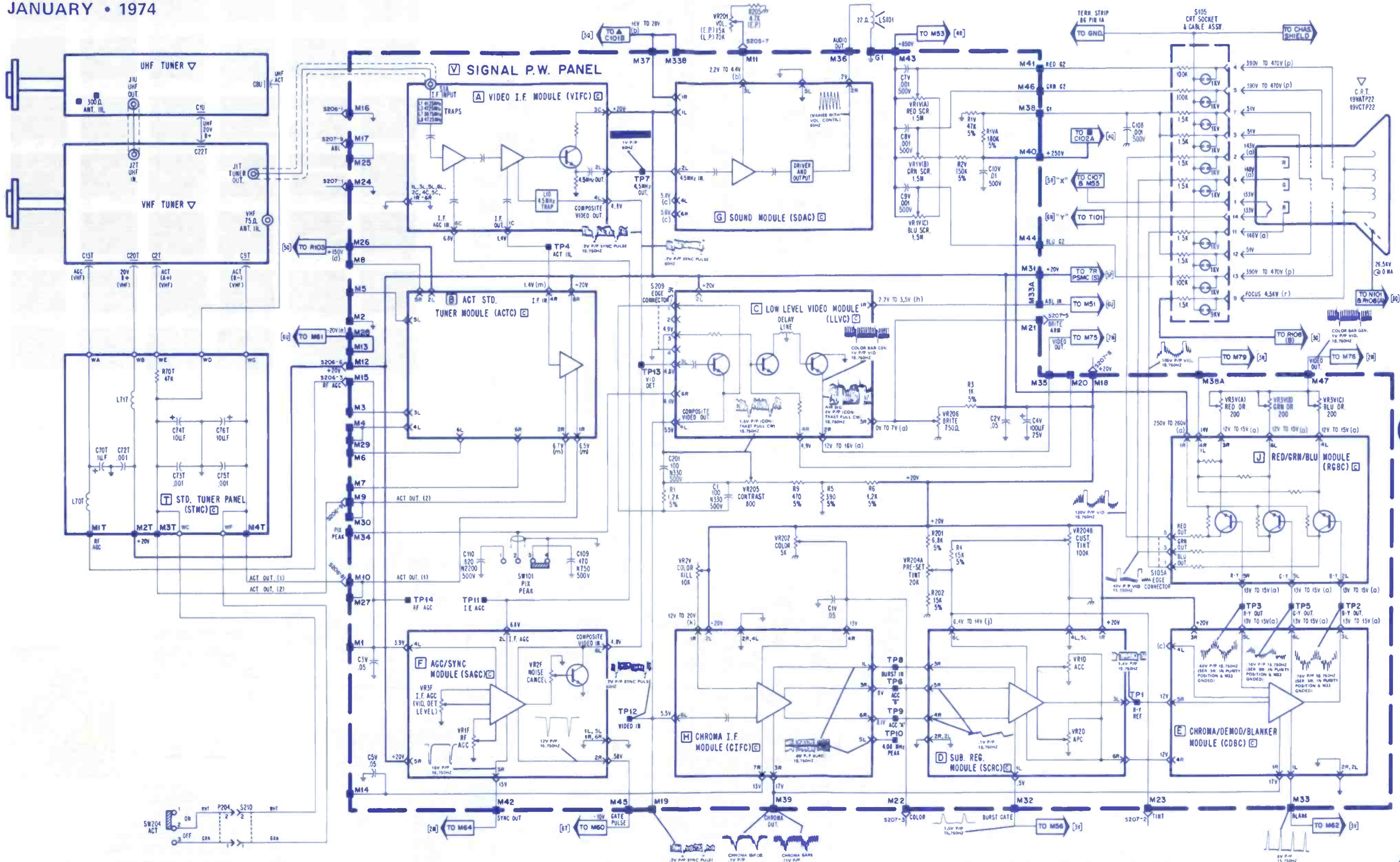

- NOTES:
- USE HIGH IMPEDANCE V.T.V.M. FOR VOLTAGE MEASUREMENTS.
 - RESISTANCES ARE MEASURED WITH YOKE AND CONVERGENCE PANEL DISCONNECTED.
 - VOLTAGES ARE NOMINAL AND CAN VARY ±10%.
 - VOLTAGES AND WAVEFORMS ARE WITH SIGNAL (5000 MICRO-VOLTS). ACT SWITCH SET FOR "OFF/DEFEAT OPERATION, EXCEPT WHERE INDICATED OTHERWISE. CUSTOMER COLOR AND TINT CONTROLS SET FOR NORMAL.
 - FOR NO SIGNAL VOLTAGES AND VOLTAGES WITH MODULES REMOVED, REFER TO VOLTAGE CHART IN THIS SECTION.

- [] INDICATES GRAPH LOCATION ON SCHEMATIC WHERE LUG CONNECTIONS ARE LOCATED.
- [] CRITICAL SAFETY (REPLACE WITH EXACT SPECIFIED PART AS INDICATED IN PARTS LIST).
- [] FEDERAL REGULATION (REPLACE WITH EXACT SPECIFIED PART AS INDICATED IN PARTS LIST).

- (a) VARIES WITH BRIGHTNESS CONTROL.
- (b) VARIES WITH VOLUME CONTROL.
- (c) NO CONNECTION—FACTORY USE ONLY.
- (d) +38V WHEN VCTC (B) MODULE USED. +150V WHEN ACTC (B) MODULE USED.
- (e) -20V NOMINAL (NORMALLY -15V ±20%).
- (f) VARIES WITH BRIGHTNESS, CONTRAST AND COLOR CONTROLS FROM ALL CCW TO ALL CW.
- (j) VARIES WITH TINT CONTROL.
- (k) VARIES WITH COLOR KILLER CONTROL.
- (l) ACT SWITCH SET FOR "ON" OPERATION.
- (p) VARIES WITH SCREEN CONTROL.
- (r) VARIES WITH FOCUS CONTROL.

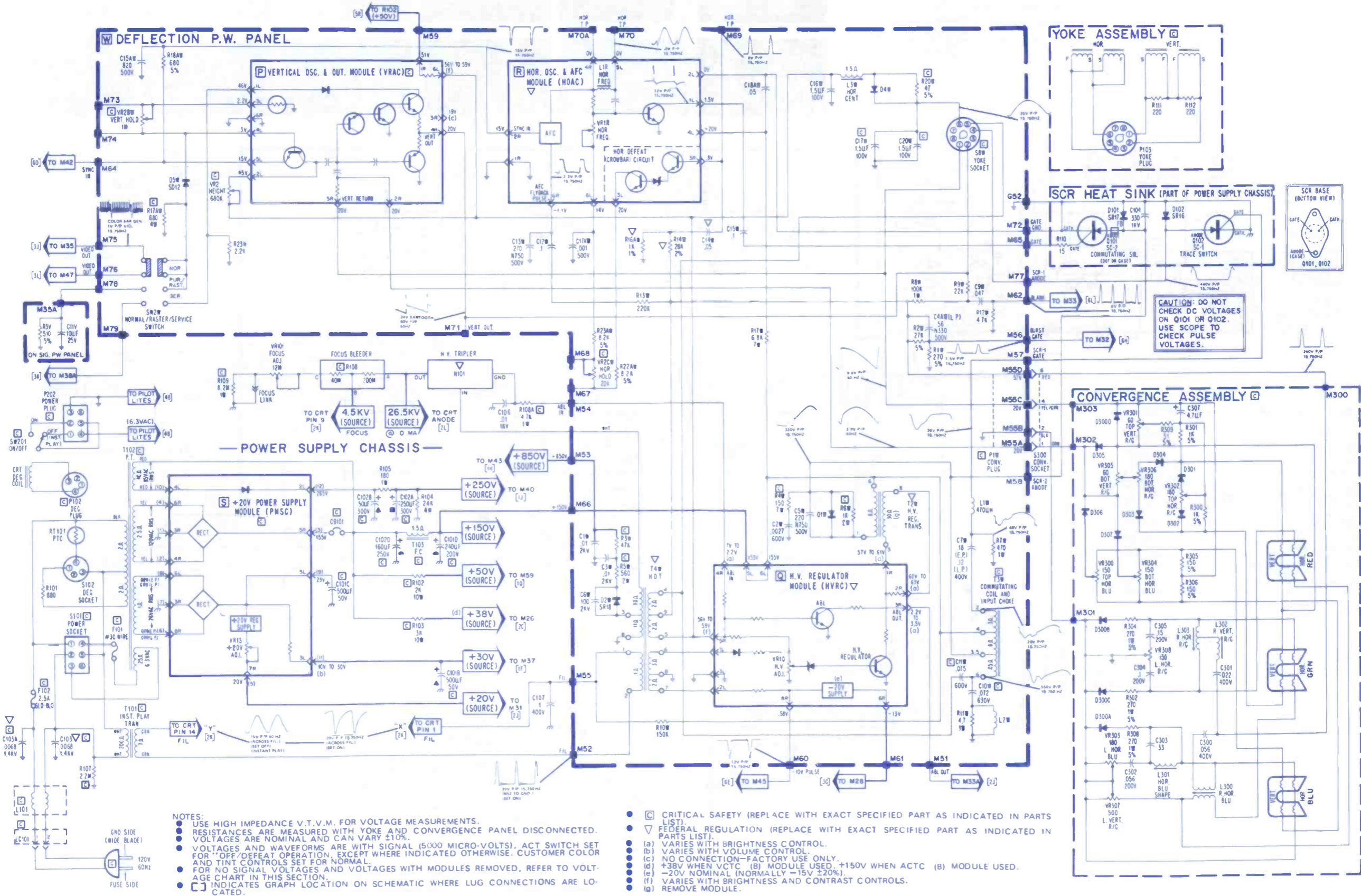

NOTES:

- USE HIGH IMPEDANCE V.T.V.M. FOR VOLTAGE MEASUREMENTS.
- RESISTANCES ARE MEASURED WITH YOKE AND CONVERGENCE PANEL DISCONNECTED.
- VOLTAGES ARE NOMINAL AND CAN VARY ±10%.
- VOLTAGES AND WAVEFORMS ARE WITH SIGNAL (5000 MICRO-VOLTS), ACT SWITCH SET FOR "OFF/DEFEAT OPERATION, EXCEPT WHERE INDICATED OTHERWISE. CUSTOMER COLOR AND TINT CONTROLS SET FOR NORMAL.
- FOR NO SIGNAL VOLTAGES AND VOLTAGES WITH MODULES REMOVED, REFER TO VOLTAGE CHART IN THIS SECTION.
- [] INDICATES GRAPH LOCATION WHERE LUG CONNECTIONS ARE LOCATED.

- [] CRITICAL SAFETY (REPLACE WITH EXACT SPECIFIED PART AS INDICATED IN PARTS LIST).
- [] FEDERAL REGULATION (REPLACE WITH EXACT SPECIFIED PART AS INDICATED IN PARTS LIST).
- (a) VARIES WITH BRIGHTNESS CONTROL.
- (b) VARIES WITH VOLUME CONTROL.
- (c) NO CONNECTION—FACTORY USE ONLY.
- (d) +38V WHEN VCTC (B) MODULE USED, +150V WHEN ACTC (B) MODULE USED.
- (e) -20V NOMINAL (NORMALLY -15V ±20%).
- (f) VARIES WITH BRIGHTNESS AND CONTRAST CONTROLS.
- (g) REMOVE MODULE.

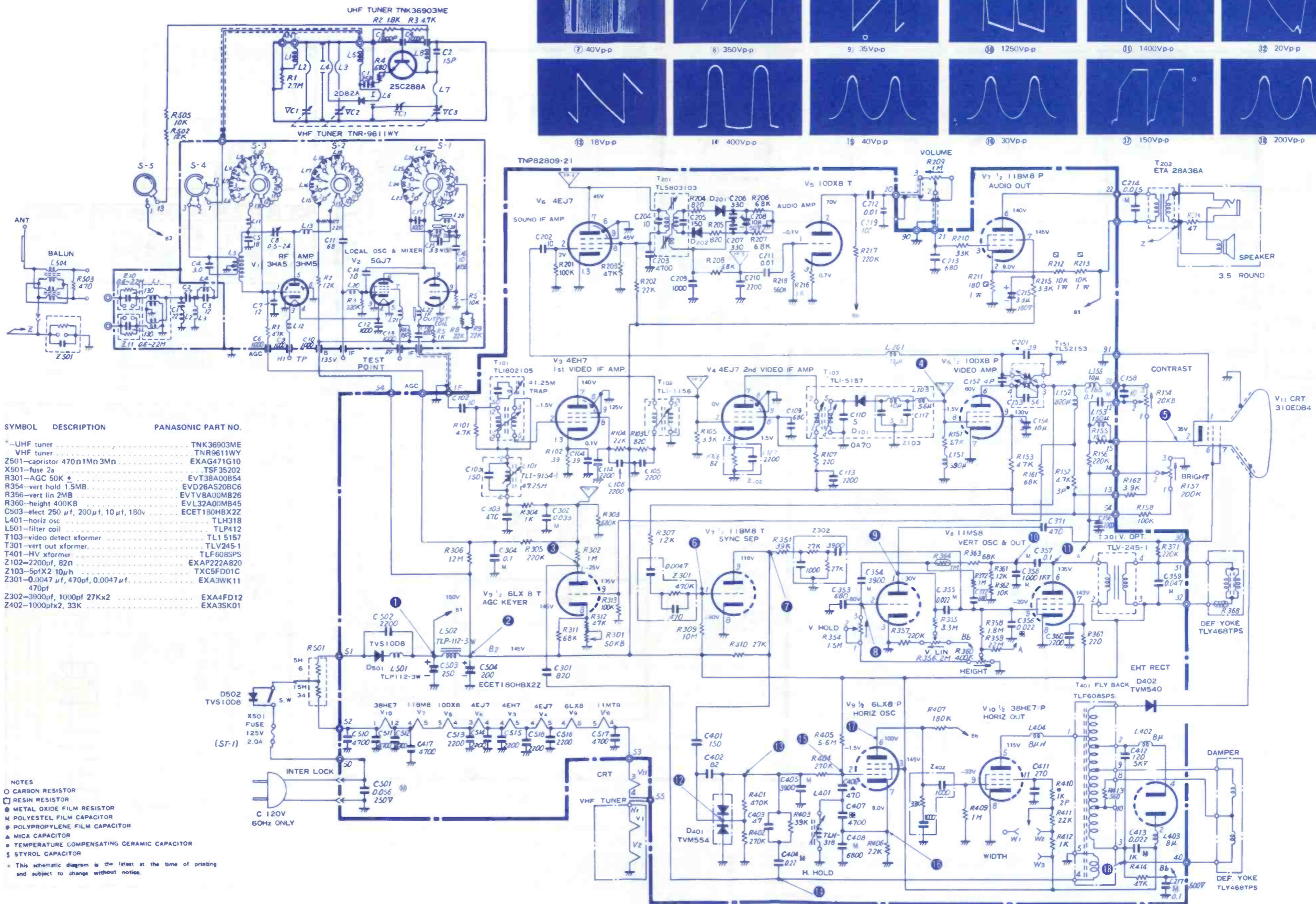
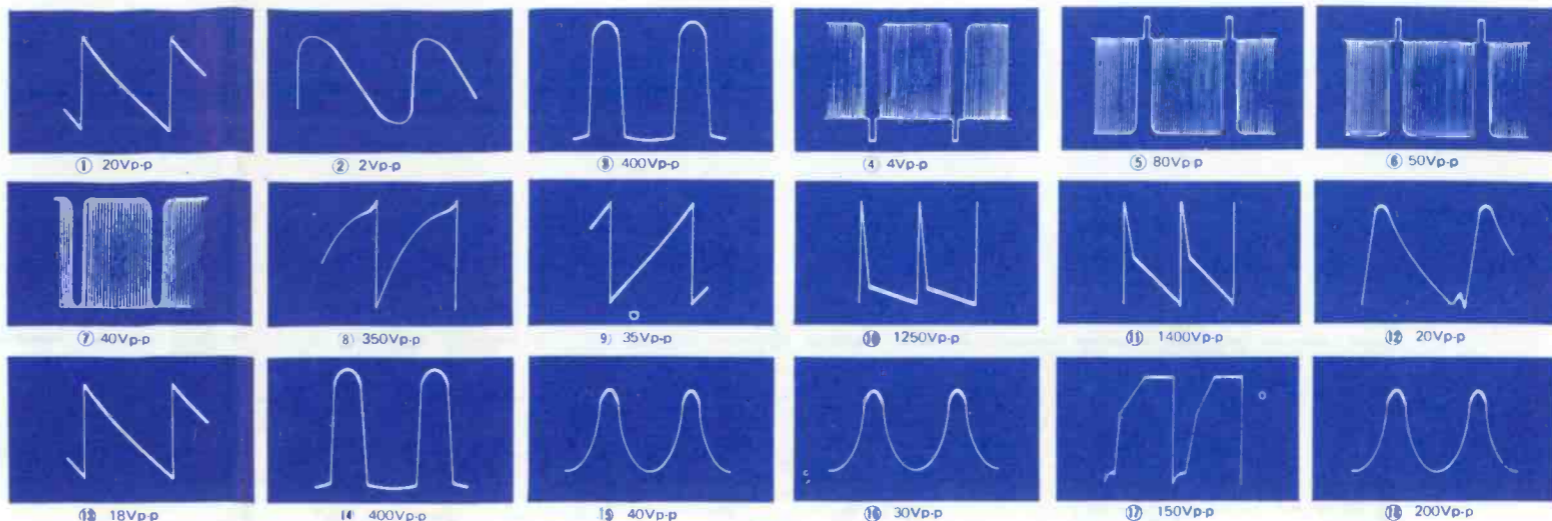

SYMBOL	DESCRIPTION	PANASONIC PART NO.
*	UHF tuner	TNK36903ME
	VHF tuner	TNR9611WY
Z501	capristor 470n1Mn3Mn	EXAG471G10
X501	fuse 2a	TSF35202
R301	AGC 50K	EVT38A00B54
R354	vert hold 1.5MB	EVD28AS20BC6
R356	vert lin 2MB	EVTV8A00MB26
R360	height 400KB	EVL32A00MB45
C503	elect 250 μ f, 200 μ f, 10 μ f, 180v	ECET180HBX2Z
L401	horiz osc	TLH318
L501	horiz osc	TLH412
T103	filter coil	TL15157
T301	video detect xformer	TL15157
T401	vert out xformer	TLV245-1
T401	HV xformer	TLF608SPS
Z102	2200pf, 82n	EXAP222AB20
Z103	5pfX2 10 μ h	TXCF5D01C
Z301	0.0047 μ f, 470pf, 0.0047 μ f, 470pf	EXA3WK11
Z302	3900pf, 1000pf 27Kx2	EXA4FD12
Z402	1000pfX2, 33K	EXA3SK01

- NOTES
- CARBON RESISTOR
 - RESIN RESISTOR
 - METAL OXIDE FILM RESISTOR
 - M POLYESTER FILM CAPACITOR
 - POLYPROPYLENE FILM CAPACITOR
 - ▲ MICA CAPACITOR
 - ▲ TEMPERATURE COMPENSATING CERAMIC CAPACITOR
 - § STYROL CAPACITOR

* This schematic diagram is the latest at the time of printing and subject to change without notice.



LBO-502 \$529.95

THE NEW LEADER LBO-502 5" SOLID STATE TRIGGERED SCOPE MAKES VOLTAGE READINGS AS EASY AS...

The 3 segment "A", "B", "C" scale on the lighted graticule is another example of Leader know-how to help you save time, labor and money. For this solid state, 15MHz bandwidth performer delivers push button convenience, too — triggering source, slope, mode and other functions. Add to this a rectangular bezel, front panel adjustable illumination, scale tilt adjustment and a separate on-off triggering light. Now, consider the lab grade performance and the broad range of uses in most every electronic area . . . the LBO-502 is also a vectorscope. Basic specifications include: Automatic and Triggered sweep ranges from $1\mu\text{sec}/\text{cm}$ to $0.5\text{sec}/\text{cm}$, 17 steps calibration; magnification is 5X, max sweep $0.2\mu\text{sec}/\text{cm}$ and vertical sensitivity is from $10\text{mVp-p}/\text{cm}$ to $20\text{Vp-p}/\text{cm}$; bandwidth is DC to 15MHz and the rise time is 35 nanoseconds. Compact, lightweight and complete with probe, adapter and leads.

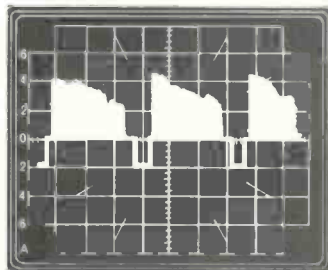

• "A" Scale

For readings in multiples of 2, from 0 to 6 (+ and -) peak to peak.

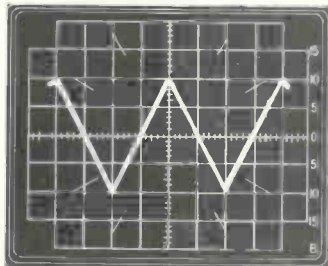

• "B" Scale

For readings in multiples of 5, from 0 to 15 (+ and -) peak to peak.

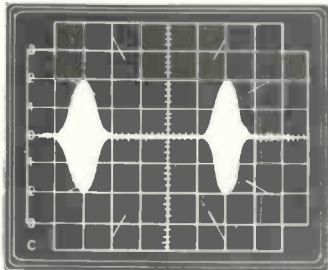

• "C" Scale

For readings in multiples of 1, from 0 to 3 (+ and -) peak to peak.

"Put us to the test"

Leader

INSTRUMENTS CORP.

151 Dupont Street
Plainview, New York 11803
516-822-9300

. . . for more details circle 129 on Reader Service Card

"TRIPLETT MICRO · POWER™" TURN IT ON AND LEAVE IT ON

FET V · O · M

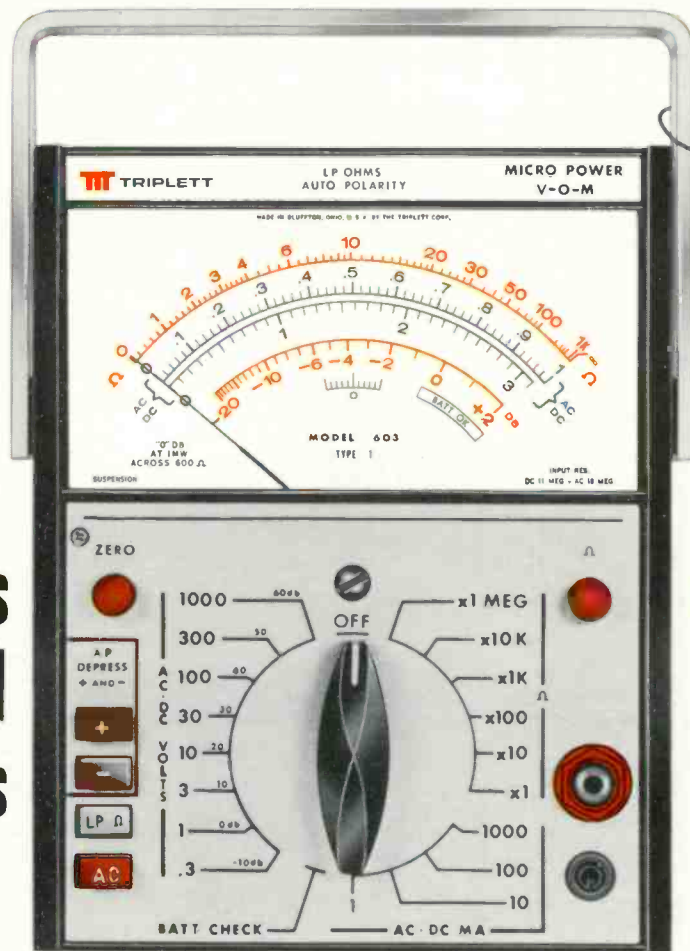

TURN IT ON
&
LEAVE IT ON

Combines
4 V-O-M
firsts

Model 603 \$165

1. Exclusive TRIPLETT MICRO-POWER — TMP™ provides battery life in excess of a year for carbon batteries.
2. LOW-POWER OHMS—LP Ω™—6 ranges with 70 mV power source for in-circuit measurements without component damage.
3. FET V-O-M WITH AUTO-POLARITY — convenient and time-saving, always reads up-scale.

FET Input Circuit—which Triplett pioneered in the Model 600.

LP Ω™ Low Power Ohms—which Triplett pioneered in the Model 601.

Auto-Polarity—which Triplett pioneered in the Model 602.

TMP™ Triplett Micro-Power—which Triplett is pioneering in the Model 603.

In fact, the Model 603 FET V-O-M combines all 4 of those pioneering features to make it the most feature-packed V-O-M that Triplett or anyone else has ever offered.

The new innovation—Triplett Micro-Power—is a revolutionary V-O-M circuit with such a tiny power con-

sumption that the service life of its ordinary carbon batteries is equal to, or longer than, their normal shelf-life. Imagine a V-O-M which needs batteries only once a year.

And the Model 603 has a simple, uncluttered dial with just four scales to cover 44 ranges, a null-type zero adjustment for quick setting with no parallax error, a suspension movement that soaks up the shocks of everyday bench and field use, and a built-in overload protection that shrugs off overload.

This great, new, feature-packed tester... Triplett's **Model 603 FET V-O-M**... is available for immediate delivery

through your local Triplett Sales/Service/Modification Center or distributor for **\$165**. For more information, or for a free, no-obligation demonstration, see him or your Triplett sales representative. Triplett Corporation, Bluffton, Ohio 45817.

For full details, dial toll-free
800-645-9200 for nearest Triplett
Representative... New York State...
Call Collect 516-294-0990

TRIPLETT
BLUFFTON, OHIO 45817

The World's most complete line of V-O-M's...
choose the one that's right for you.