

APRIL 1973 • 75 CENTS  A HARCOURT BRACE JOVANCVICH PUBLICATION

ELECTRONIC TECHNICIAN/DEALER

WORLD'S LARGEST TV-RADIO SERVICE & SALES CIRCULATION



FRIM5593349-P2-
1 WILLIAM
7176 GALE RD
ATLAS

-AW -8753AL
AS
#

MI 48411

NEW/COM SHOW ISSUE



***Super performance.
Super sales. Get both in
the all-new Zenith
Super Chromatenna
antenna line.***

Zenith's new Super Chromatenna line gives you 13 super selling features, for area peak reception in color TV, black-and-white, and FM.

Five all-new Zenith features are:

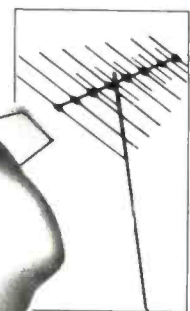

- FM Block**—reduces FM gain if desired.
- VHF Colinear Directors**—provide extra signal boost.
- Dual Isolator Bars**—no loss UHF to VHF signal transfer.
- Double Butterfly UHF Elements**—provide high UHF gain.
- Transmission Line Termination**—improves front-to-back ratio.

Eight more performance-proven features are incorporated from the standard Chromatenna line.

You can also choose from an expanded line of Zenith quality accessories. Installation hardware. Antenna rotors. Wire and cable.

Ask your Zenith Distributor about the full range of Zenith outdoor antennas—both new Super Chromatenna and the expanded standard Chromatenna line. Ask also for the powerful sales aids he has to add muscle to your market.

At Zenith, the quality goes in before the name goes on.®



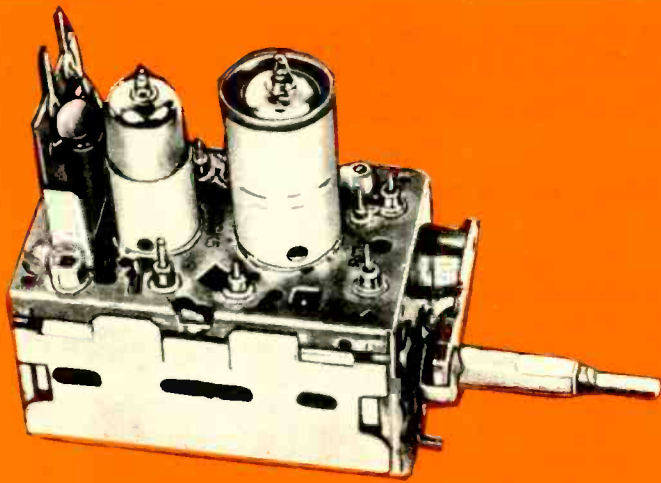

\$9.75

ALL PARTS
INCLUDED

ONE YEAR GUARANTEE

TUNER SERVICE CORPORATION

PROVIDES YOU WITH A
COMPLETE SERVICE FOR
ALL YOUR TELEVISION
TUNER REQUIREMENTS.

REPAIR

VHF Or UHF any Type \$9.75.
UHF/VHF Combo \$15.00.

In this price all parts are included. Tubes, transistors, diodes, and nuvistors are charged at cost.

Fast efficient service at any of our conveniently located service centers.

All tuners are cleaned inside and out, repaired, realigned and air tested.

REPLACE

Replacement Tuner \$9.75.

This price buys you a complete new tuner built specifically by SARKES TARZIAN INC. for this purpose.

All shafts have a maximum length of 12" which can be cut to 1½".

Specify heater type parallel and series 450mA or 600mA.

CUSTOMIZE

Customized tuners are available at a cost of only \$15.95.

Send in your original tuner for comparison purposes to:

TUNER SERVICE CORPORATION FACTORY - SUPERVISED TUNER SERVICE

Backed by the largest tuner manufacturer in the U.S.—Sarkes Tarzian, Inc.

HEADQUARTERS	537 SOUTH WALNUT ST., Bloomington, Indiana 47401	TEL: 812-332-7251
INDIANA	817 N. PENNSYLVANIA ST., Indianapolis, Indiana 46204	TEL: 317-632-3493
ARIZONA	2629 NORTH 1st AVENUE, Tucson, Ariz. 85717	TEL: 602-791-9243
CALIFORNIA	SARKES TARZIAN, Inc. TUNER SERVICE DIVISION 10654 MAGNOLIA BLVD., North Hollywood, California	TEL: 213-769-2720
FLORIDA	1505 CYPRESS ST., Tampa, Fla. 33606	TEL: 813-253-0324
GEORGIA	938 GORDON ST., S. W., Atlanta, Georgia 30310	TEL: 404-758-2232
INDIANA	6833 GRAND AVENUE, Hammond, Ind. 46323	TEL: 219-845-2676
KENTUCKY	2920 TAYLOR BLVD., Louisville, Kentucky 40208	TEL: 502-634-3334
NEW JERSEY	547-49 TONNELE AVE., Jersey City, New Jersey 07307 <small>(On U.S. Highway 1 & 9)</small>	TEL: 201-792-3730
TENNESSEE	1703 LAMAR AVENUE, Memphis, Tenn. 38114	TEL: 901-278-4484
	1215 SNAPPS FERRY RD., Greeneville, Tenn. 37743	TEL: 615-639-8451
TEXAS	11540 GARLAND ROAD, Dallas, Texas 75228	TEL: 214-327-8413
VIRGINIA	4538 PRINCESS ANNE ROAD, Norfolk, Virginia 23502	TEL: 703-855-2518

... for more details circle 134 on Reader Service Card



ELECTRONIC TECHNICIAN/DEALER

APRIL 1973 • VOLUME 95 NUMBER 4

PHILLIP DAHLEN, CET
Editor

1 East First Street
Duluth, Minn. 55802
(218) 727-8511

ALFRED A. MENEGUS
Publisher

757 Third Avenue
New York, N.Y. 10017
(212) 572-4839

TOM GRENEY

Publishing Director

JOSEPH ZAUHAR

Managing Editor

NANCY HOYUM

Production Manager

JOHN PASZAK

Graphic Design

LILLIE PEARSON

Circulation Fulfillment

GENE BAILEY

Manager, Reader Services

MANAGERS

BERNARD H. PYGON

43 East Ohio Street
Chicago, Ill. 60611
(312) 467-0670

CHUCK CUMMINGS

Ad Space South/West
613 North O'Connor
Irving, Texas 75060
(214) 253-8678

KEN JORDAN

DONALD D. HOUSTON

1901 West 8th Street
Los Angeles, Calif. 90057
(213) 483-8530

CHARLES S. HARRISON

CY JOBSON

57 Post Street
San Francisco, Calif. 94104
(415) 392-6794

ROBERT UPTON

Tokyo, Japan
C.P.O., Box 1717

This month's cover photo is supplied through the courtesy of GTE Sylvania; and a related article concerning semiconductors begins on page 38.

- 7 EDITORIAL: The NEW/COM Show.
- 8 LETTERS: Pertinent comments concerning past issues.
- 16 READER'S AID: What you need or have for sale.
- 18 NEWS: Events of interest to our industry.
- 24 TECHNICAL LITERATURE: Informative material that you may need.
- 26 NEW AND NOTEWORTHY: Merchandise of special interest.

FEATURES

29 INTRODUCING PHILCO-FORD'S SOLID-STATE MODULAR CHASSIS

Our first-hand evaluation of a new color-TV set that is approximately eighty-five per cent modular in design.

32 ADVANCED EDUCATION FOR ELECTRONIC TECHNICIANS

Dennis Hegler of the Cleveland Institute of Electronics offers some practical suggestions on how to keep ahead of our rapidly changing servicing problems.

38 SOLID-STATE REPLACEMENT CONSIDERATIONS

Gerald Quint of GTE Sylvania offers some insight concerning the problems faced when servicing modular solid-state electronic products.

39 ONE PLUS ONE EQUALS FOUR

Our first-hand evaluation of synthesizing four-channel sound with Motorola's Model FH410HW Quadraline Receiver.

43 NOT-SO-SIMPLE MATV PROBLEMS WITH NOT-SO-OBVIOUS SOLUTIONS

Ray St. Louis of Blonder-Tongue Laboratories offers some excellent tips on how to improve MATV signals with the use of components generally considered only for other applications.

47 TEST INSTRUMENT REPORT

Reviewing specifications for B & K/Precision's Model 501A Semiconductor Curve Tracer.

- 48 COLORFAX: Tips for easier color-TV set repair.
- 52 TECHNICAL DIGEST: Hints and shortcuts for more effective servicing.
- 53 NEW PRODUCTS: Instruments and components to make your job easier.
- 56 DEALER SHOWCASE: These items may increase your sales revenue.
- 60 ADVERTISER'S INDEX: Manufacturers concerned about you.
- 61 READER SERVICE: A source of additional information.
- 63 TEKFAQ: Up-to-date schematics for easier servicing.



A HARCOURT BRACE JOVANOVIICH PUBLICATION



HARCOURT BRACE JOVANOVIICH PUBLICATIONS: James Milholland, Jr., Chairman; Robert L. Edgell, President; Lars Fladmark, Senior Vice President; Richard Moeller, Treasurer; John G. Reynolds, Vice President; Thomas Greney, Vice President; Ezra Pincus, Vice President; Bruce B. Howat, Vice President; James Gherna, Vice President.

ELECTRONIC TECHNICIAN/DEALER is published monthly by Harcourt Brace Jovanovich Publications. Corporate Offices: 757 Third Avenue, New York, New York 10017. Advertising Offices: 43 East Ohio Street, Chicago, Illinois 60611 and 757 Third Avenue, New York, New York 10017. Editorial, Accounting, Ad Production and Circulation Offices: 1 East First Street, Duluth, Minnesota 55802. Subscription rates: One year \$6, two years \$10, three years \$13, in the United States and Canada. Other countries: one year \$15, two years \$24, three years \$30. Single copies: 75¢ in the U.S. and Canada; all other countries \$2. Second class postage paid at Duluth, Minnesota 55806 and at additional mailing offices. Copyright © 1973 by Harcourt Brace Jovanovich, Inc. All rights reserved. No part of this publication may be reproduced or transmitted in any form or by any means, electronic or mechanical, including photocopy, recording, or any information storage and retrieval system, without permission in writing from the editor or publisher.

POSTMASTER: Send form 3579 to ELECTRONIC TECHNICIAN/DEALER, P.O. Box 6016, Duluth, Minnesota 55806.

TRY THIS PHILIPS MULTIMETER FOR 15 DAYS

then - return it without obligation
if it doesn't meet
your every requirement.

World famous Philips who makes the PM2403 is anxious to get this versatile FET-input multimeter into your hands because they're confident that once you use it, you'll find it such a unique experience in general purpose portable, electronic multimeters, that you'll never want to let go of it!

The PM2403 has input impedance of 20 M Ω in parallel with 30 pF on the 100 mV AC and DC scales ... 10 M Ω in parallel with 50 pF on other ranges. No more need to worry about circuit loading effects and loss of accuracy.

The PM2403 offers guaranteed accuracy of 2% on DC voltage ranges and 3% (guaranteed) on all other voltage and current ranges, even at 100 mV or 1 μ A full scale, and flat out to 25 KHz. Resistance measurement accuracy is 5% at mid-scale readings from 10 Ω to 1M Ω .

The PM2403 separates combined AC/DC signals automatically; and the reading is always up-scale, even when you've connected the leads backwards. A separate indicator shows you the polarity of every measurement and even lets you turn PM2403 into a sensitive DC null detector for voltage (100 μ V) or current (1 nA).

It all adds up, we say, to a unique experience in general purpose portable electronic multimeters for the modest investment of \$130... an experience you can't afford to miss.

And that's why... if you act now... Philips is offering a 15-day free trial of the PM2403 with no obligation to buy.

For data and for details of the free trial offer, fill out and mail coupon to Test & Measuring Instruments Inc., 224 Duffy Avenue, Hicksville, New York 11802.

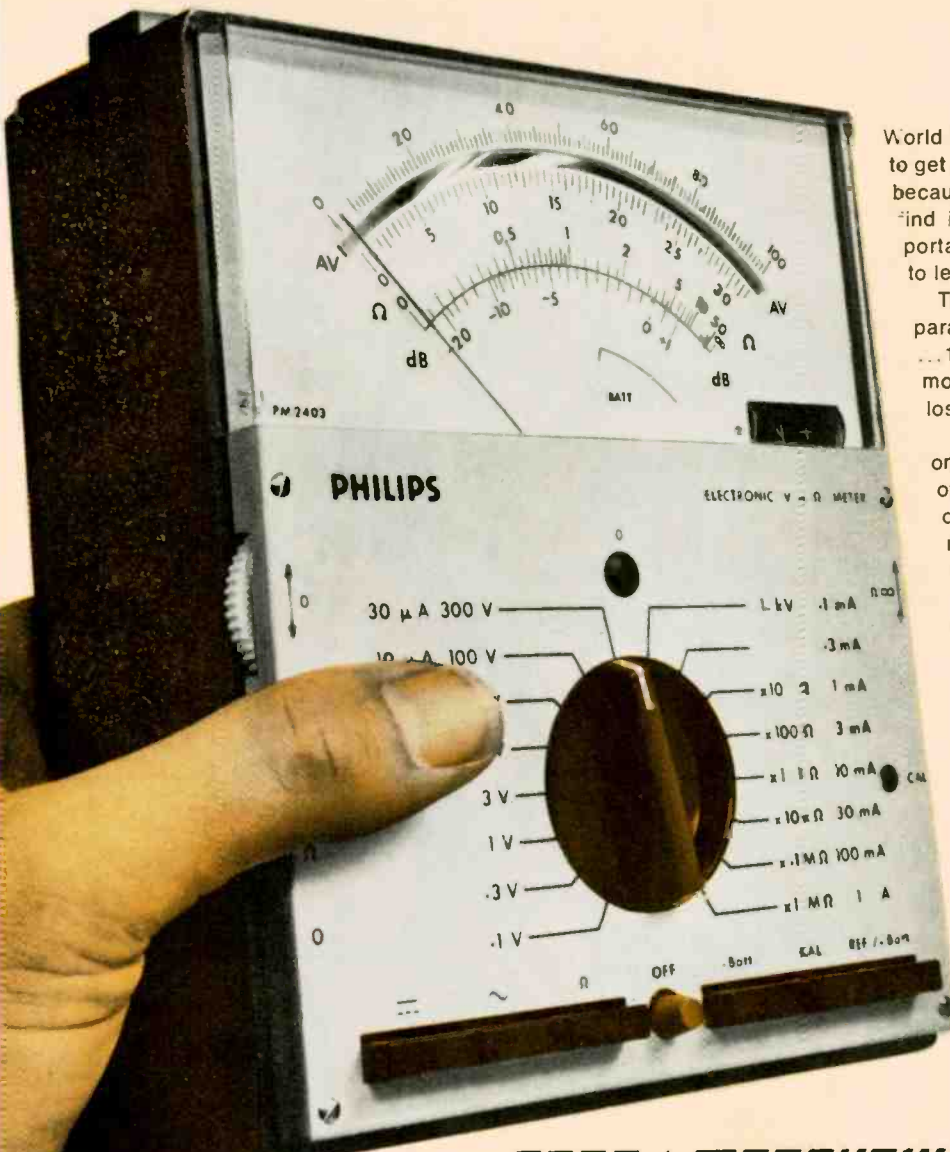

TEST & MEASURING INSTRUMENTS INC.

A NORTH AMERICAN PHILIPS COMPANY

- 48 ranges on only 4 scales; no-parallax mirror-scale readout.
- Pushbutton self-calibration, battery check.
- Overload protection to 3 KV.
- 6 ampere fusing on current ranges; inherent protection on resistance ranges.
- 2% guaranteed accuracy on DC voltage ranges.
- Completely shielded case and Philips ring-core meter movement for EMI isolation.
- Specifications and calibration procedure on back of case for ready reference.
- Test leads and leather case supplied.
- Full range of matching probes and shunts available.
- 1 year unconditional warranty.

TEST & MEASURING INSTRUMENTS INC.

A North American Philips Company
224 DUFFY AVENUE, HICKSVILLE, NEW YORK 11802

- Rush details of your 15-day free trial offer on the PM2403
- Send complete data on the PM2403

NAME _____

COMPANY NAME _____

COMPANY STREET ADDRESS _____

CITY _____ STATE & ZIP _____

TELEPHONE _____

Don't give in to temptation!

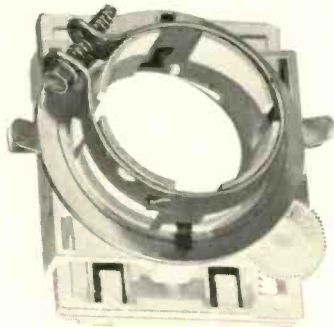

At Channel Master we realize how tempting it is to reuse the old blue lateral and purity ring assembly when you're replacing CRT's. The old part may look OK, or a new one may not be handy---so why not?

Because it's a sinful waste of time! The magnets that are vital to purity and convergence are often too weakened to even do the job.

So Channel Master has put temptation out of reach, and put a new blue lateral and purity ring assembly right at your fingertips---on the neck of every 90° Color CRT! The new part comes free to help you do the job faster and easier, and maintain the tube's peak operating performance longer!



The blue lateral and purity ring assembly is only one part in our big plan to make your work easier.

Others are:

- Channel Master Speed-Fit CRT's ---with preassembled hardware that cuts installation time as much as 40 minutes!
- Channel Master Foam Pak Cartons---that make CRT's easier to handle, store and transport!

At Channel Master we want to make life a Garden of Eden for the Independent Service Dealer. And if we have to remove all temptation to do it---we will!

CHANNEL MASTER
PICTURE TUBE HEADQUARTERS
ELLENVILLE, NEW YORK 12428

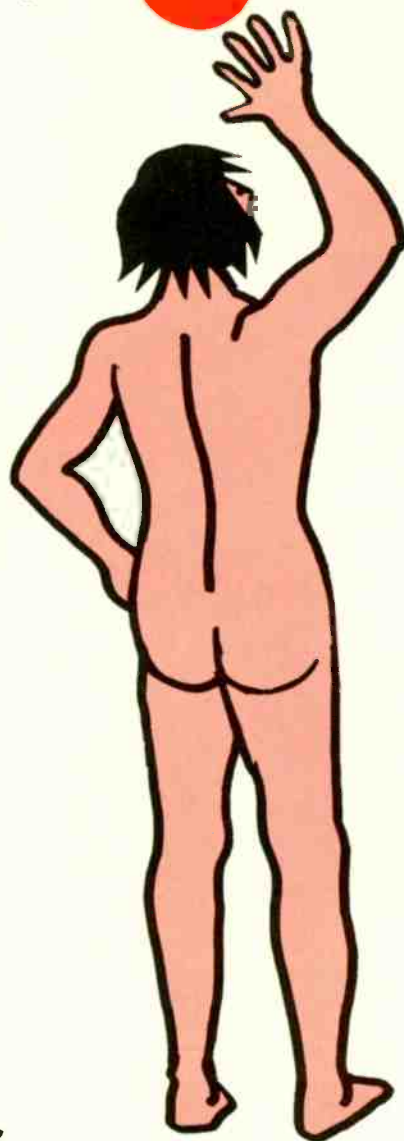

The NEW/COM Show

This publication has given considerable attention to our own professional associations (NATESA, NEA and IS CET) and their national functions, as well as the meetings conducted by their state and local affiliates.



However, this certainly does not represent the entire spectrum of association activity that affects us and our work.

The IEEE INTERCON held each March is sponsored by The Institute of Electrical and Electronics Engineers, Inc. It provides a "taste" of what engineers have developed that soon may find its way into the design of the consumer products and test instruments that you will be working with.

There is also the winter (held in January) and summer (held in June) Consumer Electronic Show sponsored by the Electronic Industries Association's Consumer Electronics Group. It introduces new product lines to the distributor that you will be selling or servicing—the show concentrating most strongly on audio systems and TV sets, plus calculators.

Still another show—the one that probably has the greatest affect on the highest percentage of our readers—is NEW/COM. More commonly referred to by some as the "parts show," it is arranged by the Electronic Industry Show Corp., which is supported mainly by participating manufacturers. This show offers manufacturers an opportunity to exhibit their wares to your distributors, while also providing these distributors with helpful seminars. In addition to all the products made available to you through your local parts distributors,

there is exhibit space for the companies that supply your distributors with support services, plus those publications that are devoted exclusively for your distributor.

NEW/COM is being held May 2, 3 and 4 entirely within the huge new Las Vegas Convention Center. This modern facility, located next to the Las Vegas Hilton, is so new that we were only able to examine its beautiful exterior as it was under construction during NEW/COM '72 at the Las Vegas Hilton last year. So successful was last year's show that we understand that this time it is the biggest ever.

Like you, our readers, NEW/COM is of considerable interest to all of us on the editorial and sales staff of ELECTRONIC TECHNICIAN/DEALER, since it deals directly with the equipment and supplies that you will be purchasing in the future, as well as your future working relationship with your distributor. Thus we are attending in full force.

"Doing the Two-Step," is the title of the three-day seminar program that is of particular interest to those of our readers involved in retail sales. For instance, during the Thursday session three distributors and sales representatives are describing their actual experiences in opening and retaining outlets for consumer products—among mass merchandisers and chains, as well as the "mama-poppa" stores. (Registrants who enroll for these seminars in advance are being pre-assigned to tables to provide a good cross-section of geography, parallel interests and non-competitive territories.)

Being held in Las Vegas, we are certain that those attending the show will again not find it all work and no play. As an example, the Young Tigers Growl—a lavish party for the industry's

younger set including the young at heart—is being held at the Hotel Sahara the night before the Show opens. And the first night of the Show the Electronic VIP's (a successor group to Radio's Old Timers) is holding a dinner party at the Las Vegas Hilton featuring the Johnny Cash Show.

A special reservation service is being provided at the Convention Center to assist attendees in securing reservations for dinner or midnight shows. Some of the headliners expected to be in town during NEW/COM include Buddy Hackett, Shecky Greene and Robert Goulet.

The Lady's Program begins each day with complimentary coffee on the pool deck of the Las Vegas Hilton.

In addition to charter flights from New York and Chicago to Las Vegas for NEW/COM, the Electronic Industry Show Corp. has made arrangements for special package deals—including lodging at either the Sahara or the Flamingo Hotel—that are available from any point of departure where a group of 15 can be organized for travel to Las Vegas together. To obtain this charter discount, return must be via the same carrier, but may be on an individual basis.

AEM-Eastern's charter flight leaves Kennedy Airport on Sunday, April 29th, and returns to New York on Saturday, May 5th. AEM-Central's flight leaves Chicago's O'Hare field on Monday, April 30th, and also features a Saturday return.

We expect to see the greatest NEW/COM ever. Be sure to look us up if you are going to be there, too.

Philip Dahlen, C.E.T.

LETTERS

Reader comments concerning past feature articles, Editor's Memos, previous reader responses or other subjects of interest to the industry.

Clarifies February Editorial

Your excellent editorial no doubt will be pulled apart by some; will also be considered felling it as it is; but most of all, will be misinterpreted by quite a few. Personally, I would like to congratulate you upon your great efforts.

I do not believe you have a copy of the NATESA By-Laws. If you did, you would readily see that Leo Shumavon, President of NATESA, had no choice but to say as you have quoted: "NATESA has not given nor does it intend to give the Merger Committee undue power. Their job is to progress to as far as possible, then report to the Executive Council. After the Council acts on its progress and they feel it is warranted, they will ask the NATESA membership for a vote." *The above procedure is called for by the By-Laws.* That is the reason Leo Shumavon took himself off the By-Laws committee and that is also the reason that the NATESA Merger Committee has no member on it that is a member of the Executive Council.

Please let me enlighten you on another item—that is Moch and Glass battling. *There is no such thing.* Frank Moch and Dick Glass have not been battling, quite the contrary. It is impulsive individuals that are doing the talking and battling. Both of these men are far above that stage.

The other item I would like to clarify is in your fifth paragraph on your article, about the Electronician's license NATESA gives to its members. The person that wrote you and the affiliate that he belongs to has not put into effect the requirements of being a NATESA member. It is true that we have failed to require a written examination from each and every member, but we do require a complete investigation of the applicant for his ability to perform and run his business in a professional manner, and abide by our code of ethics. There is no question that this license would be better appreciated if we charged \$10.00 or \$15.00 for an examination. As far as someone sending in \$35.00 and becoming a member—this is not so. We take his application and money—then investigate him. If he is within an affiliate's boundaries, that affiliate gets the application for approval or disapproval. Mr. Moch can show you many

applications that NATESA has turned down.

Phil, I trust you will take this letter as a point of information only. It is not meant in any other way. Keep up your excellent editorials and thank you.

LEO P. SHUMAVON
PRESIDENT OF NATESA

You Degraded Yourself

I believe you degraded yourself by becoming a CET. I had a great image of you, because in order to be able to write such a good book as "Semiconductors from A to Z" you showed a great knowledge of electronics, and I thought you had a college degree in electronics. In the eyes of your readers you have degraded yourself instead of upgraded. We all think of you electronic magazine editors as well versed in electronics, otherwise you would not hold that position.

Concerning electronic associations, I think all electronic magazines should be neutral. An electronic technician or dealer should be allowed to make his own decision to join or not to join an association. I do not believe it is right for an electronic magazine editor to become an official of such associations, because he becomes partial to it, and many of his readers will not like it, and may not subscribe to his magazine or quit the magazine if he is already a subscriber.

In your February issue, you write about the disagreements among the members and officials of NATESA and NEA—for which I am not surprised. There are too many jealousies among them. I believe it is best to keep them separate for the good of the electronic industry, because in this way they will be competing against one another to do better work for their own members—just like one business competing against another.

Contrary to your opinion, I think these associations will dictate to their members what to do and how and when to do it. In other words, the members will not be free to run their shops as they see fit. And then, there is the nuisance of having to pay dues and attend meetings. If they get too powerful, they will be just like unions.

As for certification of electronic technicians—I think it is all right for those who learned electronics in a practical way and do not have an electronic education from accredited electronic institutions. But it should be on a voluntary basis. I do not think compulsory licensing is right, because every American citizen has the right to earn a living. And when a person has to have a license to work, he is given

a *privilege* to work to make a living, not a right, which in a democracy is wrong. We have become too greedy for our own good.

I like your magazine, but it does not have as many educational articles as it used to. It has become too small.

LOUIS MONTOYA

Your compliments concerning my abilities in electronics are certainly appreciated although my college background did not include solid-state circuitry. Solid-state was acquired later the hard way—by reading books and manufacturers' literature, and by experimenting on my own with new circuitry.

Unfortunately a degree in physics (I have a B.S. degree) or electronics does not necessarily give one the proper background for being a good electronic technician and passing the CET Exam. Many a person with a college degree may argue that his training is superior to that of a person repairing a TV set, but can such an individual then go out and fix a TV set? One of our readers recently supplied us with employment application papers for a young man with a master's degree in solid-state physics. He failed the CET Exam badly and didn't get the job. (With the cancellation of many major government military contracts, you will find many engineers and physicists in some parts of the country that are attempting to call themselves electronic technicians.)

I took the CET Exam merely because I believe that all good electronic technicians should take and pass the exam. And only a hypocrite would encourage others to take an examination that he is not prepared to take himself.

You are certainly correct in believing that our readers should make their own decision concerning whether or not they will join an association. But if we do not present facts concerning associations, how are they then to make an intelligent decision? And if your editor fails to become personally involved in associations (as I did by becoming chairman of ISCET), having no active contact with them, how can he make any accurate statements concerning them?

Although it is true that associations cannot effectively represent you—at least if you fail to attend meetings and make your thoughts known—neither can they effectively serve your needs in matters of training, better warranty programs, or consumer protection (protecting you from the consumer), unless they have strength in numbers. And such strength is not possible if they are divided up into competing groups.

There was once a time in American
continued on page 10



This tube has a 1-Year Warranty. This tube has a 2-Year Warranty. This tube has a 3-Year Warranty.

The choice is up to you.

Now, you're the one to decide the best type of customer warranty for Sylvania Color Bright 85® replacement tubes.

The one-year warranty is basic. GTE Sylvania gives you that.

But, through your distributor, you can offer a 2- or 3-year warranty for just a little extra cost.

No matter which warranty you offer, it's backed up all the way.

The whole idea of this program is to give you

and your customers an added incentive for using Color Bright 85 replacement tubes.

Now, you can offer your customer the warranty that suits both of you best.

Or better yet, you can offer him all three.

Talk to your GTE Sylvania distributor to get full details.

Sylvania Electronic Components, 100 First Ave., Waltham, Mass. 02154

GTE SYLVANIA

LETTERS...

continued from page 8

history when there was a far greater degree of personal freedom. Why there was once a time when one needn't even fear the law, and could openly make money robbing others. Public pressures became such that to remain free theft later had to be disguised—there then merely being the "buyer beware" philosophy. Now consumers are demanding that they be protected to the point that they are able to know that the technician coming into their home to fix the TV set knows at least the difference between a transistor and tube circuit. We once had a "technician" come into our lab asking about color-TV circuitry. He was fixing one of his first color-TV sets. I told him not to tinker with someone else's TV set when he didn't understand the circuitry. His response was: "Why not, the TV set doesn't work anyway?" How many of us have repaired TV sets that have been **BUTCHERED** by a supposedly qualified electronic technician who had worked the set over before the customer called us. There are far too many such TV sets lying around. But if the public is to be protected to some

degree by licensing, then our associations must get involved to protect the honest technicians from unreasonable legislation.

We cannot say that it's just because of our support of the professional associations, but recent reports indicate that our circulation count is now even more easily maintained than it had been in the past.

We certainly want to do all that we can to protect our readers from the dilemma described below in "What Would You Do?" Ed.

What Would You Do?

We received a phone call from one of our readers in Pennsylvania who seemed just about to climb the walls. In fact, a recent encounter with a dissatisfied customer had made him temporarily "gun shy" and he was hesitant about even making house calls that day for fear of the chance of a similar encounter.

This gentleman, who has a one-man shop, had repaired an older name-brand TV set (he sells two other brands). He found it necessary to replace the picture tube, in this case using a high-quality tube of another brand (one well known to electronic technicians, although not necessarily

a popular brand to the general public in that area). It was also necessary to replace seven other tubes in the TV set. An itemized bill was prepared, the customer paid cash for the job, the total cost including sales tax coming to \$260.85.

Unfortunately when making the repair the electronic technician failed to note a slight tear in the shadow mask of the new picture tube. This would normally pose no problem since there is a good warranty for this tube, including the cost of labor. However, the customer complained that he had never heard of this brand of picture tube before and some less reputable service dealers in town were so cut throat that they advised the customer that the TV set would work properly only with the TV-set manufacturer's picture tube, quoting a slightly lower price for the job just performed. The customer also checked the seven bad tubes at the drug store, the "instrument" there indicating that many of these tubes were "good."

The electronic technician is prepared to make the TV set work properly at no extra charge to the customer, but now the customer is accusing him of being dishonest. He even brought a local magistrate into the

continued on page 12

Fastest gun tester of them all... for only \$169*

It's the new RCA WT-333A Television Picture Tube Tester that:

- Tests red, blue and green color guns simultaneously with RCA's unique CR III "SIMUL-TEST" 3-meter system.
- Provides new, more effective 3-step rejuvenation function and newly-designed "no-delay" G1 shorts removal function.
- Reveals H-K leakage other testers may miss, with special high-voltage surge circuit.
- Performs "brightness," "life" and other evaluation-type tests.
- Tests over 1800 TV picture tubes — including RCA's new "Precision In-Line," Sony's "Trinitron" and other in-line types.
- Includes built-in socket plus four socket adapters at no extra charge to cover most of today's picture tubes.

See your RCA Distributor now for more information on the WT-333A. Or write RCA Electronic Instruments Headquarters, Harrison, N.J. 07029.

*Optional Distributor Resale Price



RCA Electronic Instruments

... for more details circle 129 on Reader Service Card

Announcing the Panasonic Parts Hot Line.

In 48 hours we can ship you anything we've got.

The New Panasonic Parts Hot Line is a performance promise: 24-hour-a-day 7-day-a-week service. Now, if you have a problem getting the part you need, just call one central number.

Then things start happening fast: we'll ask our computer to locate your part (or parts) by searching all five regional Panasonic parts depots. In just seconds. Electronically. Then we'll telex an order to the depot which has the part you need and within

48 hours, your order is on its way.*

And we can make this promise with confidence, because our warehouses are now fully automated. We've got the 2,000 fastest moving parts on electronic order pickers. At the touch of a button any of these high traffic parts is at our fingertips.

To become a member of the Panasonic Parts Hot Line, call the toll-free number below. We'll send you a bright red emblem imprinted with the hot line num-

ber for your particular region. We'll also send you an easy-reference booklet that gives you the names of authorized Panasonic parts distributors in your area, and information on other Parts Division services.

We know that your business depends upon having the right parts at the right time — when your customer needs them. Our business is standing right behind your business, with quality parts for over 1,000 products.



**Panasonic
Parts
Hot Line
3-4712**

Panasonic
just slightly ahead of our time

Call toll-free anywhere in the U.S. 800-523-5336 (in Pa. 800-562-5395)

*Of course we cannot ship on weekends or holidays. . . . for more details circle 124 on Reader Service Card

Wading through reams of manufacturers' references is the hard way to find transistor replacements. We know, because we checked over 45,000 types to find just 66 universal transistors that cover 99% of your functional needs.

Now we've put them on our new Transistor Application Slide-Rule so that you can locate a replacement every time — in seconds. All you have to know is the transistor's function and polarity.

You'll spend more time on profitable servicing, less time tracking down replacement numbers, special sources

and waiting for deliveries.

You'll save money, too. You stock fewer types to do more jobs. And when you buy ten IR premium quality transistors, you get 20% off net, not the usual 10% other brands allow.

GET OUR LATEST SLIDE-RULE FREE, plus our current "Semiconductor Cross Reference and Transistor Data Book", by redeeming the coupon below at your nearest IR distributor. And, with the addition of 14 new types, IR's "universal transistor line" now offers broader coverage of your application requirements than ever before.

Can't find the right transistor in your references?

Try IR's New Application Slide-Rule, Free!

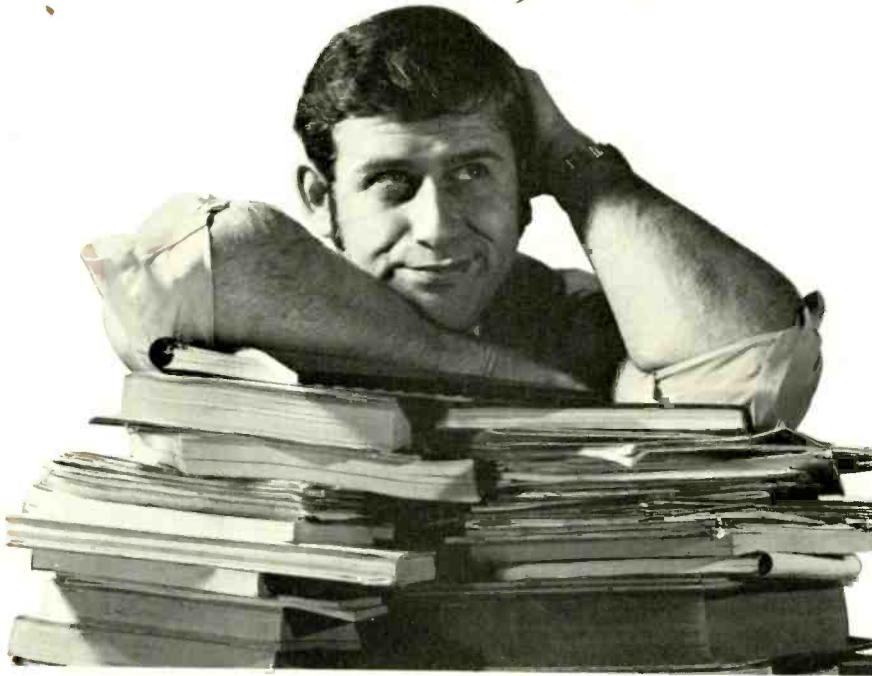

GOOD FOR NEW

FREE SLIDE RULE

REDEEMABLE FOR ONE IR TRANSISTOR APPLICATION SLIDE-RULE (Value \$1.00)

AND FREE IR SEMICONDUCTOR CROSS REFERENCE AND TRANSISTOR DATA BOOK (Value \$1.00)

INTERNATIONAL RECTIFIER

Semiconductor Div.: 233 Kansas St., El Segundo, California 90245 • (213) 678-6281

... for more details circle 118 on Reader Service Card

LETTERS...

continued from page 10

shop to help press the matter. This reader is worried about the bad publicity that may result.

When phoning your editor, our reader asked if there was any release form that he might have had the customer originally sign that would have protected him from such a situation. It was your editor's opinion that no such form could be considered binding under these circumstances. Your editor felt that if he could get the customer to agree to arbitration in a larger community nearby, then this might settle the matter. Your editor then gave him the phone number of another service dealer in his area that might at least help calm him down.

What would you have suggested he do? Please, let us hear of similar experiences that you have had and how you have handled them.

Industry's Reading Habits

You may be interested in a few figures I have recently collected. As you know, the Winegard Co. conducts 14 seminars a year in various parts of the country, plus a large number of clinics. These seminars are intended primarily to raise the level of competence and ability of technicians who design and install master antenna TV systems. They make a fine starting place for the technician who is just getting into this line of work, and as such they are well attended. They are also open to dealers, distributors and others who need a basic understanding of what their technicians are doing and the difficulties they may encounter.

My duties with Winegard Co. include attendance at these seminars whenever possible. I've taken advantage of these occasions to pass around a questionnaire about what trade and technical publications these technicians read. While your magazine is the most widely and intensively read, I was appalled to find that slightly more than 37 percent of those questioned read no trade or technical publications at all!

Mind you, these people are so interested in improving their knowledge and ability that they willingly pay a fee for the course, spend three days of intensive study and foot their own expenses to attend these seminars. Many travel long distances, sometimes hundreds of miles. So you can readily see that they are concerned about their profession. Yet roughly one third of them don't keep up with the state of the art by reading a publication in the field!

continued on page 14

Introducing the expensive digital multimeter that doesn't cost a lot.

The B&K Precision Model 281. A solid-state, lab-quality portable instrument that measures AC/DC voltage, current and resistance.

The state-of-the-art Model 281 shows readings on a large, clear, 2½-digit numeric display. It also has positive over-range and reverse-polarity indication. There's no need to switch leads. You can reverse polarity at the flick of a switch.

Model 281 readings are faster and more accurate than analog-type meters. Unlike hard-to-see needle indicators, you can read the large, illuminated numerals—including the decimal point—from a distance.

Featured are 26 ranges: five DC voltage, 100mV to 1000V, with 1% accuracy and 10 megohms input impedance; five AC voltage, 100mV to 1000V RMS, five DC current, 100 μ A to 1A; five AC current, 100 μ A to 1A; and six resistance, 10 ohms to 10 megohms.

With built-in protection, the 281 can't be harmed by overload. And for safety's sake, it has a three-line AC grounded cord.

Everything about the 281 says expensive—except the price.

Call your B&K distributor.

Or write Dynascan Corporation.

Very good equipment
at a very good price. **B&K**

\$169⁹⁵



Product of Dynascan Corporation. 1801 West Belle Plaine Avenue, Chicago, Illinois 60613

... for more details circle 101 on Reader Service Card

Keep inventories small with SK 3004.

It's the only solid-state device you need to make over 4,000 different replacements. And it's just one part of RCA's compact SK line of 156 devices that can replace over 51,000 foreign and domestic types. SK is the way to go to cut inventory to the bone and still have the replacement you need when you need it.

Ask your RCA Distributor about SK, The Solid State System. And get your copy of the new RCA SK Replacement Guide SPG-202N.

RCA Electronic Components
Harrison, N.J. 07029

RCA Electronic Components



LETTERS...

continued from page 12

I'm convinced that most of those who do not read trade and technical publications are simply unaware of what is available, or how valuable such publications can be to them. How can these people discover this rich source of information? I'd like to propose an informal program to your readers:

1. *Pass-along:* List every technician in your shop on a card and staple the card to the outside front cover of every publication you receive. List your own name last to make sure the magazine gets back to you. When you have gone through it one time, pass the magazine along to the next name on the list. Have each person cross out his name as he finished with the publication. Get this routine started, and you'll soon find that it's regarded as something "we've always done."
2. *Library:* Almost any vacant shelf or table corner will do for a stack of current magazines. Urge those who do subscribe to publications to contribute back issues. But don't keep them in an enclosed place like a file cabinet; they need to be out where they are readily accessible.
3. *Gifts:* Birthdays, Christmas and other gift-giving occasions provide opportunities for an inexpensive, yet thoughtful gift of a subscription that will contribute to a technician's professional growth.

These are only three suggestions, and I'm sure many more will occur to your readers. The only way that the problem of "non-literacy" among technical people can be solved is through the efforts of those who already know how valuable such publications have been to them. It seems to me that every older, long-time technician has a moral responsibility to help the young, inexperienced ones if he is to be a true professional.

DONALD K. COLLINS
TECHNICAL EDITOR
WINEGARD COMPANY

Thanks for Telling It like It is

I admire the quality and the excellence of your reports about NEA, NATESA, CET and IS CET. The information you have provided is essential to the industry and the problems you have stated—the difficulties—the differences in the various associations—point out that much has to be done to bring all to their proper places and functions.

There has to be a give and take for any combination. Personalities are of necessity going to have to be sub-

merged and, though there will be possibly something in the by-laws, the constitution that develops from merger should be concerned uppermost with the need, the aims and the betterment for all that it can provide.

Recognition must be given for past efforts. Men who saw the need and did something about it should be able to keep their place in the sun. There must also be recognition given to men who have done outstanding work and are not eligible as dealers—a status they might like to have but do not.

The aim is for betterment of the industry and its personnel. No worker should be excluded because of status. We are all in this together and dealers and/or their technicians have to work together. Manufacturers and distributors would have no place without them, and consideration should be first given to so many who have given so much of their time, money and work to establish these associations. No one can be 100 percent satisfied as to detail, but it seems far better to have the overall program given top support, while rejecting all negative thinking.

Certainly if the program now can support these top men, then a new one taking on a combination of these efforts can do likewise.

I want to compliment you again for your efforts, your clear thinking and analysis and for telling it like it is. More power to you.

MAYNARD R. YOUNG, SR.,
CET/SECRETARY
THE MAINE ELECTRONIC
TECHNICIANS' ASSN., INC.

Questions Warranty Payment Schedule

A recently announced payment schedule has prompted this letter as a contribution to the dialogue between TV-set manufacturers and the service industry regarding warranty labor payments.

Electronic technicians, in general, applaud the fact that manufacturers are beginning to accept responsibility for their products. It is a wise decision to employ the independent service industry to help in this effort. We recognize that the final cost of this effort is legitimately passed on to the consumer.

Dealer views regarding warranty repair vary widely. A sales oriented dealer might expect to have to subsidize his service department. Any type of payment schedule is an improvement for this dealer who previously received nothing. Others do warranty work in the expectation of building future out-of-warranty business. Because of special considerations, others find warranty repairs

profitable. Our view is that repairs must be profitable whether in warranty or out.

I don't know the method other dealers use to calculate service charges. My method is hardly scientific. It is this: We operate efficiently with competent people. We are reasonably provident. When we have difficulty meeting our financial obligations—we increase our rates.

This simple method of necessity has imposed the following schedule:

1. A basic hourly charge of \$15.00, with a minimum shop charge of:

B/W-TV portable	\$15.00
B/W-TV console	20.00
Color-TV set	25.00
2. We have no maximum shop rate. However, with the exception of combination models with multiple problems, we have not charged over \$45.00 shop labor. Our philosophy is that the minimum charge should be high enough to compensate for the occasional tough dog. Insurance companies operate on this same principle. This ingredient is not included in your payment schedule [the manufacturer's schedule].
3. On home service calls we make a trip charge of \$10.00 plus \$15.00 per hour. As an example, half an hour spent in the home would be:

Trip charge	\$10.00
Home labor	7.50

Total\$17.50

We charge by quarter-hour increments and the customer benefits from the odd time.

4. For the repair that cannot be completed in the home and requires shop facilities, the charges are itemized thus:

Color-TV sets

Trip charge	\$10.00
Home labor, pick up, install	20.00
Shop time	25.00 to 45.00

Total\$55.00 to 75.00

B/W-TV sets

Trip charge	\$10.00
Home labor, pick up, install	15.00
Shop time	20.00 to 35.00

Total\$45.00 to 60.00

We recognize that a warranty repair can be accomplished more quickly than a repair of the same TV set three years later. The newer chassis and cabinet do not require cleaning. Generally, the alignment is okay. Tuner maintenance probably is not required. However, additional time is required for warranty paper work and parts handling, and the element of profit from parts sales is missing.

For all of the above reasons, our estimate is that we can accomplish an in-warranty shop repair in about 70 percent of the time required for the older TV sets. I do not know the exact percentage. Nevertheless, it is an important figure for the industry to know exactly, because it is the only one we have in common. It applies to all servicers regardless of ability. If applied to each dealer's current rates, it would have the benefit of national uniformity and would consider local economics and service areas.

Each servicer has arrived at his own present customary rate schedule after years of trial. The process is individualistic. It is *not* the result of collusion with other servicers. It *does* take into consideration that income is also derived from parts sales. It is *not* the result of average-time studies made by people with stop watches. However interesting these studies may be, averages do not apply to the individual.

It is not the manufacturer's role to attempt to change this process. He should cooperate in it to our mutual benefit, or find the "average" shop to act as his service agency. A job-rated schedule, that is offered on a take it or leave it basis, is a source of annoyance in a relationship that should be harmonious.

We are mutually concerned with providing the consumer the best possible service at a fair cost. I hope these ideas contribute to that goal.

DICK HOLMES, CET

Editorial Makes Him Mad

I have been mad ever since I read your editorial on CATV. Why indeed do we *not* have a satellite of our own *already* in place? The CATV syndicate is like the iceberg—only a small percent shows. If we only knew how many miles and miles of cable are already in place in prime reception areas like Los Angeles.

Only one thing is driving the syndicates to gobble up every available cable company after it is established, and that is GREED, spelled out with capital dollar signs. I have already begun writing Congress and am spreading the word among my customers. I will try to force this issue in any way that I can.

If every technician who reads this publication would do the same, we might make a dent. Sure, I hate antenna work. I'd much sooner leave it for a cable company. But before the principle of TV, on or off the air, is reduced to just another utility like the gas and electric companies, I'll work on antennas until I drop.

Keep the truth.

BOB GLOMB

You'll be happy, too, with SK3020.

It replaces nearly 2,800 types and does the job as well or better. That means less service time, less inventory, more business for you. And with RCA's full SK line of only 156 devices, you'll have everything you need to replace over 51,000 foreign and domestic types.

Contact your RCA Distributor today for the full SK story and get the new RCA SK Replacement Guide, SPG-202N, too.

RCA Electronic Components
Harrison, N.J. 07029

RCA Electronic Components



READERS' AID

Space contributed to help serve the personal needs of you, our readers.

Schematic Wanted

I need a schematic and service manual for a Tube Tester, Model 648, manufactured by Jackson Electric Instrument Co., Dayton, Ohio.

WILLIAM SULLAR

Box 553
East Moriches, N.Y. 11940

I need a schematic for a Grundig Tape Recorder, Model TK341b.

THOMAS G. ASHCROFT

29624-18th Ave. S.
Auburn, Wash. 98002

I would like to obtain a schematic for a Majestic Model 20 radio.

EDWARD FREY

8 Sloan St.
Albany, N.Y. 12202

I would like to obtain a schematic for a Multi-Band Transistor Radio,

Model TRS25C, manufactured by E. J. Cooley.

ROGER R. GARDNER

1522 So. 6th St.
Aberdeen, So. Dak. 57401

I need service information and a schematic for a Franklin, Model 400A, Digital Multimeter.

SERVTRONICS

9808 Montauk Ave.
Bethesda, Md. 20034

I need a schematic for a Topp Clock Radio, Model KK-1005, made in Japan. Also, the name of a U.S. dealer with parts for the Topp products.

HAROLD PRIEST

Rt. 4, Box 647
Belair Road
Augusta, Ga. 30907

I am interested in obtaining an operator's manual, tube chart, schematic and any other information on a Supreme, Model 500, Tube Tester.

D. A. BACKEBERG

Rt. 3, Box 2836
Sumner, Wa. 98390

I need the schematic and part list for a Longine Symphonette Radio, Model LCR511, Serial No. 5510822-990. Also, on the back cover it is marked Japan 713.

ALEX NEMETH

310 Henry Ave.
Steubenville, Ohio 43952

Service Information Wanted

I would like to obtain service information or schematic for an antique Bestone Radio, Type 70, Serial No. 3079, manufactured by Henry Hyman & Co., Inc. This radio was manufactured on Nov. 20, 1923, and sold by Kelly How Thompson Co.

WILLIAM H. HANSEN

5207 E. Superior St.
Duluth, Minn. 55804

For Sale

I have back issues of ELECTRONIC TECHNICIAN/DEALER magazines to 1965 and circuit digest (only) to 1954, some missing copies. One RCA Model M1-36113 Vidicon Camera, less lens; and one utility Monitor Model M1-26113, less base unit; and other used test equipment for sale.

RAY MATAYA

R & M Hardware, Inc.
Iron River, Wisc. 54847

Leader

AUDIO TEST INSTRUMENTS

Now You Can Say Service... and Smile!



**LV-77
FET MULTIMETER**
Solid state dependability and stability plus high impedance—make this a fine general purpose meter. Has dual power supply—batteries and AC line. It's truly portable! $\pm 3\%$ full scale accuracy with easy to read, clearly marked face panel. \$129.95

**LFM-30
TAPE SPEED/CHECKER**
Checks any tape recorder for speed and drift accuracy at 3KHz as well as 1, 2, 4, 5, 6, 7, 8 & 9KHz frequencies. 100MV to 10Vrms Input level. $\pm 5\%$ end scale accuracy with -3% to $+3\%$ test range. Complete with carrying case. \$159.95

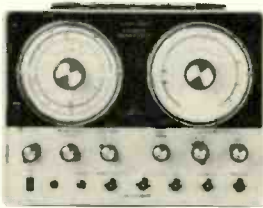

**LSW-250
FM-TV SWEEP/MARKER
GENERATOR**
Use with any scope to test and service FM, TV and more. Has 2-260MHz freq. range, cont. adjustable, with calibrated markings for most often used bands. Marking method is post injection with external signal input provision. Highly stable and accurate. With accessories. \$349.95



**LMV-89
2 CHAN. AC
MILLIVOLT METER**
Test stereo circuitry and 4-channel too—especially where differences exist in voltage at two separate points. $\pm 3\%$ full scale accuracy (1KHz); dB scale readings at $0dB=0.775V$ and $1V$ each. 2 chans. 100MV to 300V range in 12 steps. With separate pointers, individual switches, and amplifier systems. Both channels operate separately or together. \$279.95



Write for details. See your distributor.

The more you see... the more you believe... the more you save

Leader Instruments Corp. 37-27 Twenty-Seventh St. L.I.C., N.Y. 11101 (212) 729-7410

... for more details circle 121 on Reader Service Card



As you can see, your Sylvania distributor has 200 picture tubes in stock.

And they're all in just five Sylvania cartons.

Because our line of five color bright 85XR® OEM-quality tubes gives maximum coverage of 19V, 21V, and 25V diagonal sets with a minimum of stock.*

It also means faster service because these Sylvania picture tubes are direct replacements. You replace a kimcode with a kimcode, a bonded with a bonded.

And then, there is the biggest advantage of all: You can count all your large-screen color tube needs on the fingers of one hand.

See your local GTE Sylvania distributor for a complete replacement list. With needs that you

can count on one hand, you can bet he has the tube you want in his hands.

Sylvania Electronic Components, 100 First Ave., Waltham, Mass. 02154.

*XR23VANP22/

SRE25BGP22 Replaces 53 types

XR23VAQP22/

SRE25BHP22 Replaces 27 types

XR19VABP22 Replaces 22 types

XR18VAHP22 Replaces 82 types

XR18VADP22 Replaces 16 types

GTE SYLVANIA

NEWS OF THE INDUSTRY

NATESA/NEA Merger Sub-Committee Highly Critical of Moch and Shumavon

The following report of the NATESA/NEA Merger Sub-Committee was sent us by wire for last-minute insertion in this month's issue. All editorial comments concerning the subject matter in this report are restricted to those shown in italics.

NATESA/NEA Merger
(Press and Public Information Release)
Monday, March 12, 1973

The NATESA/NEA Sub-Committee meeting was held on March 10-11, 1973, at the Air Host Inn in Atlanta, Ga. The following were in attendance: Mr. M. L. Finneburgh, Sr., E.H.F. Chairman of the NATESA/NEA Joint Committees; Mr. Charles Couch, Jr., President of NEA; Mr. Norris Browne, Chairman of the NEA Merger Committee; Mr. LeRoy Ragsdale, Chairman of the NATESA Merger Committee; and Mr. Dick Glass, Executive Vice-President of NEA. Invited guest Mr. Frank Moch, Executive Director of NATESA, and Mr. Leo Shumavon, President of NATESA, were not present at this meeting. Their reasons for non-attendance at this meeting were not valid, in the opinion of this sub-committee. *[Page 15 of the February 1973 issue and page 16 of the March 1973 issue reported previous attempts to hold meetings with these two men in an effort to learn some details of what they expected of the merger committees. Ed.]*

Mr. Shumavon stated in a telephone conversation with Mr. Finneburgh: "If Mr. Moch attends and asks me to attend, I will do so." It is the opinion of this Sub-Committee that as President of NATESA, Mr. Shumavon had the responsibility of deciding if he or Mr. Moch, or both, should or should not attend. This Sub-Committee does not concur with Mr. Moch's opinion that Mr. Finneburgh did not have the authority to call the Atlanta meeting. As Chairman of the Joint Merger Committees, unanimously confirmed by both Associations at New Orleans, Mr. Finneburgh has the right to call such meetings as he deems necessary.

After lengthy review of the problems that beset the merger committees, it is the opinion of this Sub-Committee that the stalemate of the merger is due primarily to the arbitrary attitude and the procrastination of Mr. Moch and certain other members of the NATESA Executive Council, to wit:

- (A) The unauthorized press release of an internal communication of Mr. Moch's response to the questionnaire submitted by the Chairman of the Committee.
- (B) Mr. Moch's statement that the NATESA Executive Council stated that no further merger meetings can be held until NATESA and NEA arrive at acceptable by-laws.
- (C) Character defamation as illustrated in the NATESA Secretary General's letter of March 2, 1973, that uses such terms as "shotgun wedding," "refugees from MAD Magazine," "the Mafia," and "side money rackets." *[We also received a letter—not intended for publication—from Mr. Moch, dated February 27, 1973, in response to our February Editorial, which twice accused Mr. Glass of being a "dictator." Ed.]*
- (D) Procrastination regarding the Kansas City convention site, arrangements, programming and operation.
- (E) The shocking and distressing announcement by Mr. Moch that NATESA will produce a separate convention yearbook, indicating continued NATESA vs. NEA internal conflict and unnecessary duplication of

advertisers' dollar expenditures. A similar action was attempted last year, which created unwarranted confusion.

For these reasons, and coupled with the continuing refusals of the chief officials of NATESA to meet with the chief officials of NEA to resolve merger problems, it is apparent to this Sub-Committee that the general membership of NATESA must act to enforce their mandate of merger.

Respectfully submitted and released by
The NATESA/NEA Merger Sub-Committee
LeRoy Ragsdale, Chairman NATESA Merger Committee
Norris Browne, Chairman NEA Merger Committee
Charles Couch, Jr., President NEA

Signed: Morris L. Finneburgh, Sr., E.H.F.,
Chairman Joint Merger Committees

Richard Glass, Executive Vice-President NEA—
invited and attending

Leo Shumavon, President NATESA—
invited and not attending

Frank Moch, Executive Director NATESA—
invited and not attending

NATESA Council Meets In Kansas City, Mo.

The NATESA Executive Council held its second quarterly meeting of the 1972-73 fiscal year on February 3-4, 1973, at the Muehlebach Hotel in Kansas City, Mo. The meeting was hosted by TESA-Kansas City and was combined with a tour of the Crown Convention Center, which is in the final stages of construction and scheduled to be fully operational in May of this year.

NATESA President Leo P. Shumavon opened the meeting on Friday evening and received a reading of the previous meeting's minutes by Secretary General Earl Grove and a completely itemized financial report by Treasurer Phillip E. Holt. Vice-President Charlie Varble reported extensively on warranties procedures and internal association communications, and informed the Council that TESA-St. Louis intends to join the proposed new merged-association. Executive Director Frank J. Moch outlined the many association services provided by the 25 years of NATESA Headquarters operation.



NATESA Convention Chairman Nolan B. Boone reported on the status of the second annual joint-associations convention, and it was resolved that the NATESA-NEA 1973 Convention would be produced August 24-26, 1973, at the Crown Center Hotel in Kansas City. A discussion as to whether to participate in a joint Yearbook or to produce a separate association convention publication was deferred, pending disposition of a final proposal presentation to NEA.

Reporting on the lack of progress by the combined merger committees, NATESA Merger Committee Chairman LeRoy Ragsdale stressed a need to steer away from any

continued on page 20



PTS ELECTRONICS, INC. is proud to announce the GRAND OPENING of our new Service Center in

PHILADELPHIA, PA.

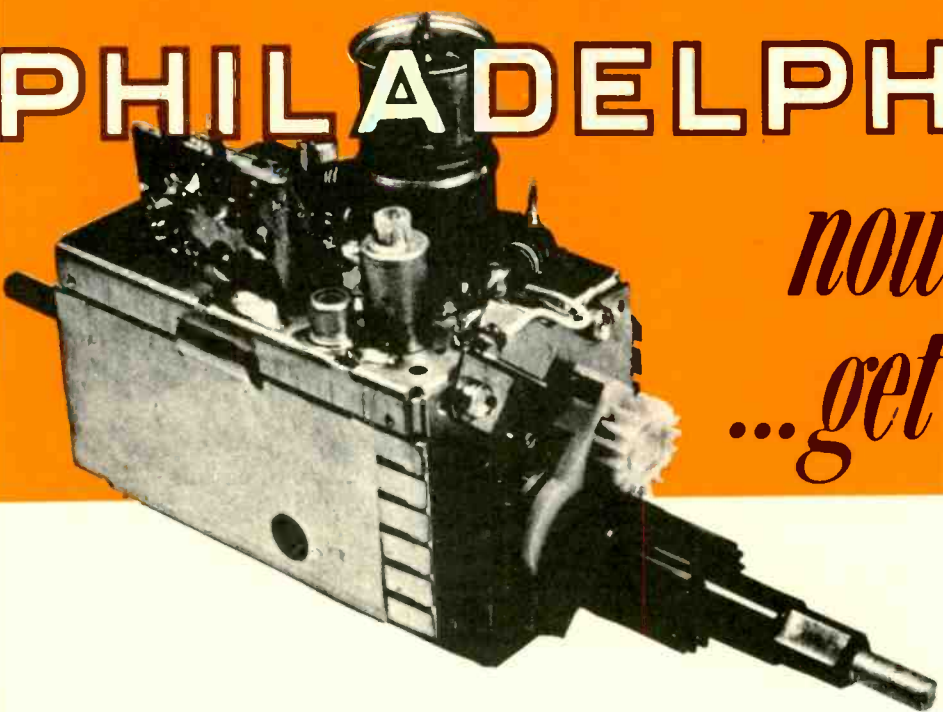

now you too...
...get Fast 8 hr. Service!

\$9.95

1 YEAR GUARANTEE

Come and see us. PTS Branches are all company owned—No Franchises—we care for our customers. For a TUNER PART or COMPLETE TUNER REBUILT, come to us, we will take care of your tuner problems like no one else can. WE'RE PROFESSIONALS—18 years experience made us what we are!

You owe it to yourself

to try P.T.S. We are the fastest growing, oldest and now the largest tuner service company in the world. Here is what you get:

1. **Fastest Service**—8 hour—in and out the same day. Overnight transit to one of our plants.
2. **Fine Quality!** Your customers are satisfied and you are not bothered with returning tuners for rework!
3. **Lower Cost!** Up to \$5.50 less than other tuners for rework!
4. **Friendly, helpful service!** We help you do more business—that way we will do more, too. We want your business and we try to deserve it!

Color—Black & White—Transistor—Tubes
 —Varactor—Detent UHF

VHF or UHF.....\$9.95
 UV-Comb.....\$16.95

Major parts, tubes, transistors, Shipping
 charged at net cost
 (Dealer net!)

for finer, faster, ... Precision Tuner Service



FREE JOB CARDS . FREE SHIPPING LABELS

... send faulty unit with tubes, shields and all broken parts to:

PTS ELECTRONICS, INC.
 P. O. BOX 16855
 1921 S. 70TH ST.
 PHILADELPHIA, PA. 19142

..... Or to any of these strategically located Service Centers:

HOME OFFICE—MIDWEST:
 PTS ELECTRONICS, INC.
 P. O. BOX 272
 BLOOMINGTON, IND. 47401
 TEL. 812, 824-9331

EAST
 PTS ELECTRONICS, INC.
 P. O. BOX 16855
 PHILADELPHIA, PA. 19142
 TEL. 215, 724-0999

NORTHEAST
 PTS ELECTRONICS, INC.
 P. O. BOX 3189
 SPRINGFIELD, MASS. 01103
 TEL. 413, 734-2737

SOUTHEAST:
 PTS ELECTRONICS, INC.
 P. O. BOX 6881
 JACKSONVILLE, FLA. 32205
 TEL. 904, 389-9952

WEST COAST:
 PTS ELECTRONICS, INC.
 P. O. BOX 41354
 SACRAMENTO, CALIF. 95841
 TEL. 916, 482-6220

SOUTHWEST:
 PTS ELECTRONICS, INC.
 P. O. BOX 7332
 LONGVIEW, TEX. 75601
 TEL. 214, 753-4334

MOUNTAIN:
 PTS ELECTRONICS, INC.
 P. O. BOX 4245
 DENVER, COLO. 80204
 TEL. 303, 244-2818

... for more details circle 126 on Reader Service Card

NEWS...

continued from page 18

tendencies toward personality conflicts and continued dwelling on negative aspects. The Council unanimously concurred that positive action toward the goals of merger was the only sensible course of action to take at this time. Mr. Moch reemphasized that he would not hesitate to work for the new association if a realistic and equitable merger can be effected.

Bob Harrison, NATESA By-Laws Committee Chairman, was unanimously instructed by the Council to receive studied suggestions of procedural rules for the new association and to compile the information into a completely drafted By-Laws proposal. The completed proposal is to be submitted as a composite suggestion to the combined Merger Committee for study and possible additional corrections prior to presentation to the NATESA Convention Delegates in August. The Council and all meeting participants engaged in constructive discussions to aid in defining prospective membership categories, officers, ruling authorities, voting procedures, etc., for the anticipated new association.

Growth of ISCET Continues At Ever Increasing Rate

Three people that have had much to do with the success of the CET Program and ISCET are Sam and Sharon Wilson (left) and Dick Glass. Sam and Dick are authors of the book *STUDY GUIDE FOR CET EXAMINATIONS* published by Howard W. Sams, which was reviewed on page 69 of our July 1972 issue. They have had an active role in the preparation of updated examinations.

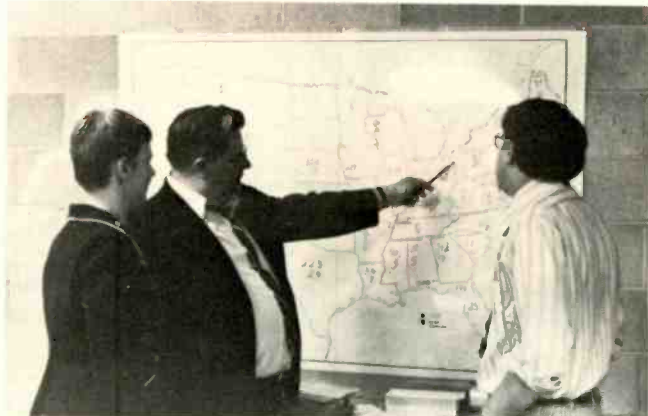

In the photo they are shown at association headquarters studying the latest count of CETs and ISCET members across the country.

The questions listed below are representative of the subject matter included in Section XI of the CET Exam.

Section XI

Color Television

1. Explain the function of the color AFPC circuits.
2. The TINT control can vary only the phase of the 3.58-MHz oscillator. (True/False)
3. What is the bandwidth of the color IF in a normal color-TV set?
4. What will be the effect if direct current is allowed to flow in the automatic degaussing circuit?
5. Dynamic convergence adjustment is performed by adjusting only the amplitude of current in the convergence coils. (True/False)

continued on page 22

Yours for only \$95 with any RCA Electronic Instrument

That's right... you can own a quality, all-steel, 10' x 7' Utility Storage Building by Arrow Group Industries for only \$95 when you buy any RCA Electronic Instrument. It's a money-saving combination you can't afford to miss, and here's how to make sure you don't:

Just send a warranty card from any RCA Electronic Instrument and your check or money order, payable to RCA Corporation, to RCA Electronic Instruments Headquarters, Harrison, N.J. 07029. We'll see that the Utility Building is sent to the address on your card, *shipping charges prepaid*.

That's all there is to it... but send in your order now because this offer ends on June 15, 1973. For more information on the building shown here plus the other three storage sheds now being offered, see your RCA Distributor or write RCA Electronic Instruments Headquarters, Harrison, N.J. 07029.

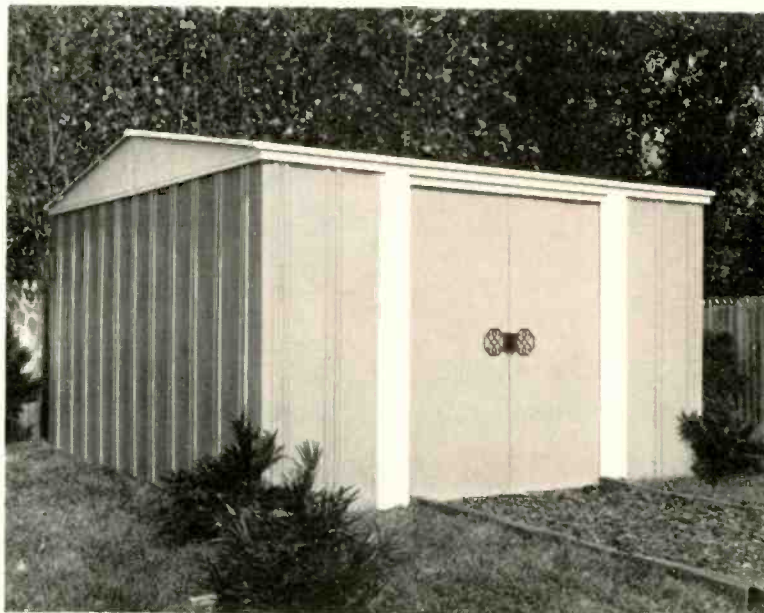

RCA Electronic Instruments

... for more details circle 130 on Reader Service Card

Every time you sell an antenna for one set, you're losing money

by Bert Wolf
 Manager, Jerrold DSD Division

EVERY CUSTOMER WHO BUYS AN ANTENNA FOR A NEW COLOR SET ALREADY OWNS ONE OR TWO BLACK AND WHITE TV SETS.

Chances are, he's been getting along with an indoor antenna for his old black and white set. He decided to invest in an outdoor antenna because he realized he needed more signal power and more directivity for top-notch color reception.

What your customer probably doesn't know is that he can connect two or more TV sets to a single antenna, using a 2-set antenna amplifier.

Essentially, color reception is not very different from black and white reception. Ghosts, snow and other types of interference look a lot worse in color, but they are easily discernible on a black and white set, too.

Therefore, you are doing your customer a real favor when you recommend that he hook a second set up to his new antenna. Only in this way can he get maximum value from his investment. For you, of course, the sale of a 2-set antenna amplifier represents extra profit.

COLORCASTER II IS A BREAKTHRU IN QUALITY AND PRICE

Figure 1 shows how easy it is to add a second set to an antenna system. The Jerrold Colorcaster II is an important breakthrough in quality and price. Never before has it been so inexpensive to connect two or more sets to a single antenna — even in poor signal areas — without deteriorating picture quality.

The Colorcaster II lists for only \$21.50. Yet, it amplifies all UHF and VHF TV channels, plus all FM stations. It provides more signal voltage to each TV set than the antenna would provide if connected directly to one set. Thus, it more than overcomes the splitting losses caused by ordinary passive multi-set couplers.

TWO TV SETS PLUS FM RADIO

What if the home includes not only two TV sets, but an FM stereo receiver, as well? FM stereo is a lot like color TV. FM stereo receivers require stronger signals than monophonic radios. What's more, they are subject to multi-path distortion, which is the equivalent of a "ghost" in TV reception.

Therefore, a good outdoor antenna can do wonders for FM stereo reception. However, your customer doesn't have to invest in a separate outdoor FM antenna. Many TV antennas, such as the Jerrold



Super VU-Finder series, provide excellent pick-up of FM signals.

The system in Figure 2 shows how easy it is to connect an FM stereo receiver to the color TV antenna. Using the Colorcaster II and a Jerrold FS-1314-FM frequency splitter as shown, you can provide superb pictures to two TV sets, plus outstanding stereo signals to the FM receiver. What's more, there is absolutely no interference between receivers.

FOUR TV SETS PLUS FM RADIO

No, the home with three or four TV sets is no longer unusual. Black and white portables are now so inexpensive that they are frequently given to teenagers as gifts.

You can easily use a Colorcaster II to serve three or four TV sets, plus an FM stereo receiver. All you have to do is split the outputs of the Colorcaster II with Jerrold MF-82 couplers. The high gain of the Colorcaster II is sufficient to overcome the coupler.

... for more details circle 119 on Reader Service Card

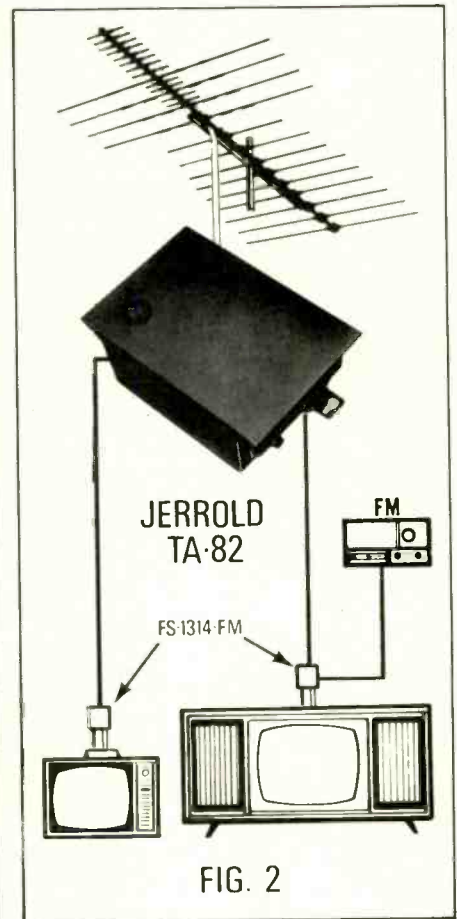

An easier way of installing a 4-set home system would be to use a 4-output Colorcaster Plus, such as the Jerrold TA-84.

This brings us to another point. Jerrold has a complete line of Colorcaster Plus models, including 75 ohm models and VHF/FM only models. Thus, you can offer your customers a very wide choice for any reception area.

Jerrold also makes a full range of outdoor Powermate Plus preamplifiers for fringe and deep fringe areas. These preamps are ideal for bringing in distant channels and eliminating snow.

Finally, Jerrold offers the industry's most complete line of reception aids, including filters and traps to eliminate all kinds of interference.

When you need to improve TV or FM reception, Jerrold has the products to do it. And you should be suggesting the appropriate Jerrold reception aids with every antenna you sell. Your customers will love you for it and you'll make a lot more money.

THE NEW 360° VALVE...

IT SPRAYS UP

MAGIC VISTA

IT SPRAYS DOWN



**GOLDEN
FOAM
CORRECTS
TUNER
PROBLEMS
LIKE
MAGIC!**



GC ELECTRONICS

DIVISION OF HYDROMETALS, INC.
ROCKFORD, ILLINOIS 61101 U.S.A.

... for more details circle 116 on Reader Service Card



NEWS...

continued from page 20

Explanations

1. The AFPC in the color section locks the local color reference signal frequency to the transmitted burst signal frequency.
2. This statement is false. The TINT control varies the phase between the local reference signal and the incoming chroma information. This can be done either by changing the local oscillator's phase or by changing the phase of the color information.
3. Modern color-TV sets normally employ a 1MHz bandwidth color IF or bandpass section.
4. Purity will be impossible to maintain if dc is allowed to flow in the degaussing coil.
5. False. The amplitude and waveshape of the convergence-coil current are both adjusted during dynamic convergence.

Vocational Technical Institute Learns There Is a Santa Claus

Santa Claus came to the Vocational Technical Institute at Kansas State College this past winter in the form of Miss Pat Alexander, general manager of Pittsburgh Radio Supply. On behalf of Pittsburgh Radio Supply, she presented a donation of approximately \$5000 worth of merchandise to the electronics department of the KSC Institute.

Among the items donated were a color pattern generator, a vector scope and two sweep-alignment generators. Other gift equipment included an all-band radio, a tape-recording preamplifier, two electronic message centers, and two turntables that can be used as training equipment. All this in addition to numerous tools and electronic parts including tubes, transistors, potentiometers, capacitors, coils, transformers and speakers. Accepting the donation on behalf of the Vocational Technical Institute was L. D. Boone, chairman.



Shown examining the gift are from left: Thomas F. Compton, electronics instructor; Dr. L. D. Boone, Institute chairman; and Pat Alexander, general manager of Pittsburgh Radio Supply.

In commenting about the gift, Miss Alexander said: "It was really too bad we couldn't work the truck in the picture some way. There was an entire truckload of merchandise and equipment.

"We really did this with the idea of clearing our own corners and at the same time assisting the Vocation School, which in this case really does not have much to work with. We have received many 'thank you's' from the Advisory Committee and others connected with the college. We highly recommend something of this type for any distributor who needs to clean house and at the same time help someone else." [Editor's Note: It's tax deductible, too.]

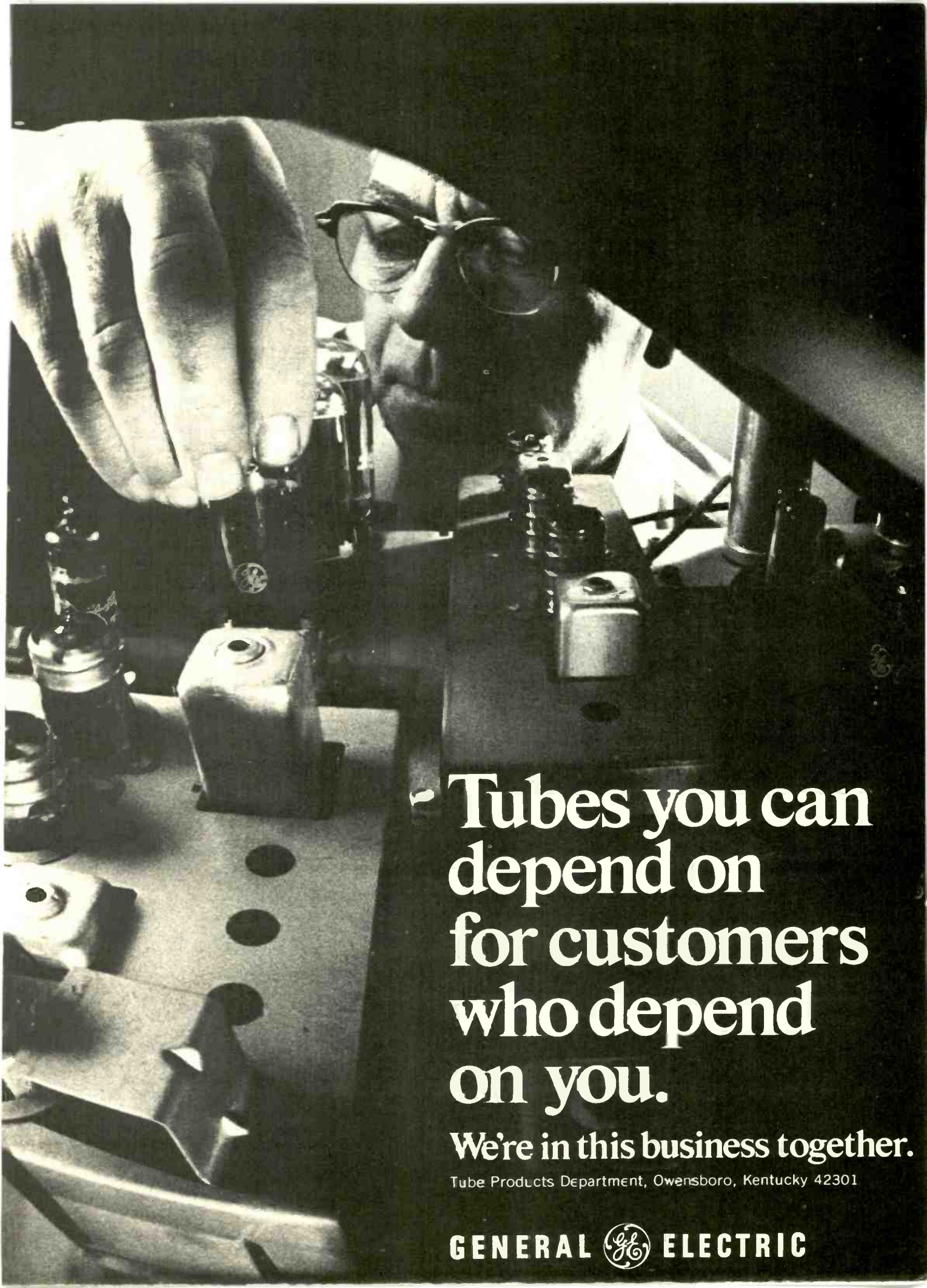

Tubes you can
depend on
for customers
who depend
on you.

We're in this business together.

Tube Products Department, Owensboro, Kentucky 42301

GENERAL  ELECTRIC

**SELL IT.
INSTALL IT.
FORGET IT.**

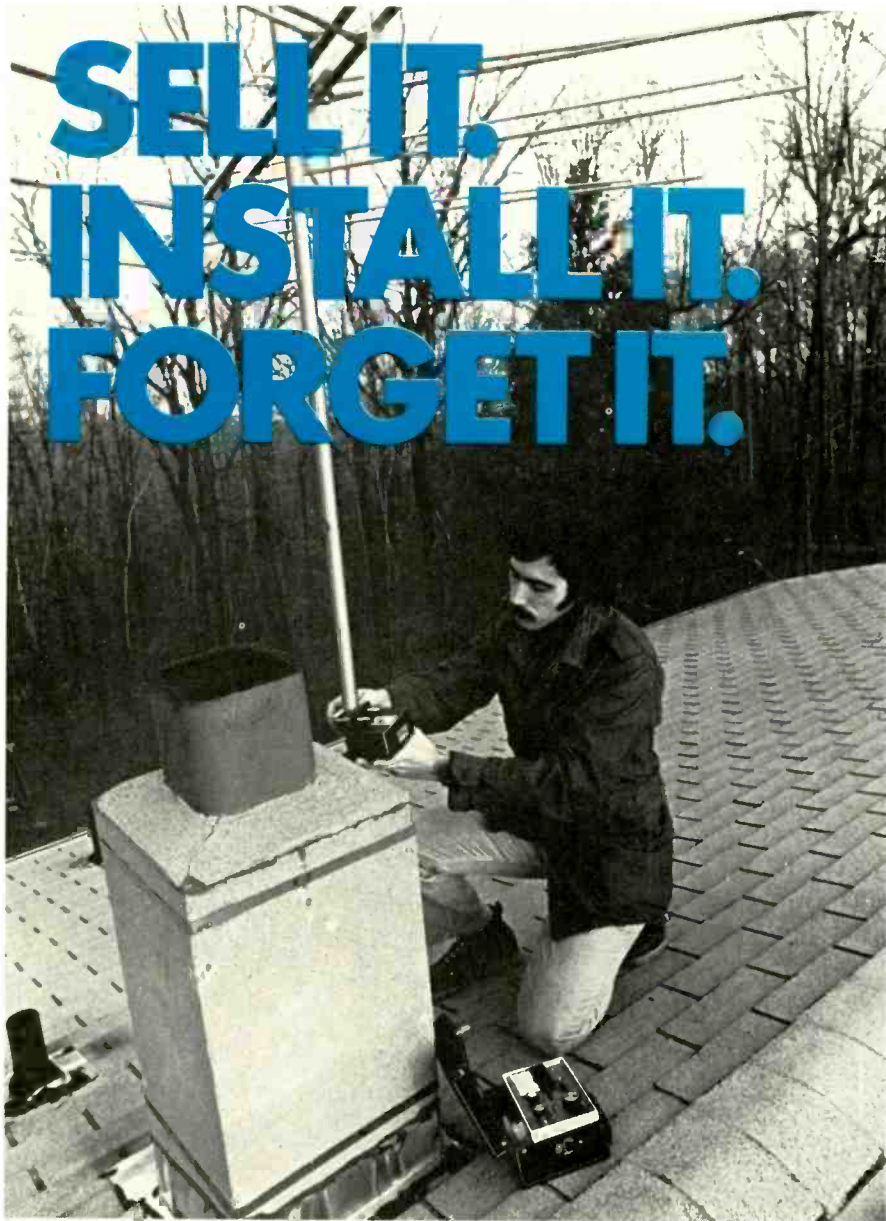

Call-backs are just what you and your customers' don't want. Once you install the B-T Horizon VHF two-set amplifier, you can forget it, because it's quality built to be reliable. It's the mast-mounted amplifier that thousands and thousands of TV installers have found "stays on the roof."

What makes Horizon so reliable? Solid-state, trouble-free circuitry. Four-way lightning and surge protection. Temperature compensation for all-weather reliability, and two individual amplifier circuits—one for Ch. 2-6 and the other for Ch. 7-13.

But the Horizon would not stay on the roof long if it didn't perform. And perform it does. It's back-matched for clearer color pictures. The patented ICEF circuit delivers wide dynamic range so that strong signals won't overload weak ones. It delivers more than ample gain for weak to medium signal areas for up to two TV sets.

And these are the reasons that made the Horizon one of the fastest and best sellers ever, and once it's sold, forget it. B-T has the industry's broadest line of home and MATV TV signal amplifiers—indoors and outdoors. Available from Blonder-Tongue distributors.

For solutions to your reception problems write: Blonder-Tongue Systems Engineering Dept. One Jake Brown Rd., Old Bridge, N.J. 08857.



BLONDER TONGUE

... for more details circle 102 on Reader Service Card

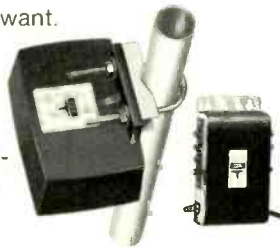

TECHNICAL LITERATURE

MATV Systems

A 44-page manual is offered to help electronics technicians with a limited knowledge of master-antenna TV systems (MATV) obtain a fuller understanding of this rapidly growing field. The "MATV System Planning Manual," one of the most comprehensive books of this type, explains the principles of such a system and will be of value to technicians and dealers who would like to design or install MATV systems. The manual is divided into 10 sections covering theory, definitions of MATV terms, and the fundamentals of planning and installing systems of different sizes. Required equipment is illustrated and explained. Charts and drawings showing typical systems are included. MATV Planning Div., Channel Master, Ellenville, N.Y. 12428.

Digital Multimeter

An eight-page brochure gives the performance characteristics, design features and complete specifications of the Model 245 4½ digit, portable digital multimeter. Other product lines are also described in the brochure. Data Precision Corp.

Instrumentation Products

A 16-page catalog, No. 369, features a complete line of instruments including Digital Electronic Counter/Timers, Digital VOMs, Solid-State Electronic Multimeters, a variety of miniature Strip Chart Recorders, Multi-Range Chart Recorders, an RLC Bridge, low-cost Secondary Standards, Multi-Range Precision Milliohmmeters, and Multi-Range DC Standards. Simpson Electric Co.

Test Instruments

A new Mini-Brochure to be published every other month illustrates more than 250 new and reconditioned test instruments. The recurrent theme "How to Save 20-50% on Your Test Instrument Requirements" is demonstrated by drawing on the company's experience and inventory of over 15,000 instruments. More than 200 reconditioned and slightly used demonstrator instruments are also listed for sale. Tucker Electronics Co.

Delta Answers Four Big Questions About Security Systems With Their Problem Solver, The All New Centrally Controlled System.



Will it detect intrusion, fire, gas, sound alarms; determine power failure, trigger dialers and sound internal and external alarms?

Yes, the system protects anything you want protected.

Can it be installed easily with minimum wiring?
Yes, the system uses existing AC wiring in the building?

Is it flexible to use with existing systems?
Yes, the system is completely flexible and can be used with other existing systems.

Is it affordable? Can you add on to meet new demands?
Yes, the system is priced to sell. Completely expandable, it can be used with any other components to fit customer needs.

8 NO-PROBLEM COMPONENTS THAT WORK FOR YOU!

(1) **Fire Detector:** Detects dangerous gases and fire. Activation puts computer system in immediate alarm condition by overriding any other signal. (2) **Phase Lock Loop Alarm Transmitter:** Used to connect existing N/O or N/C circuits

to computer with minimum wiring. (3) **Phase Lock Loop Emergency Transmitter:** Panic/emergency signal device puts system into instant alarm. (4) **Computer:** Central control unit receives signals from Delta's alarm transmitter via existing AC power lines, thus activating self-contained horn, Delta's telephone dialer (when attached) or other alarm devices. Equipped with time exit and entrance delay. The system will sound an alarm condition should AC power fail for more than 45 seconds. (5) **Disable Transmitter:** Allows the complete system to be turned on and off from some remote area. (6) **Phase Lock Loop Receiver:** Accessory to activate 110V light, bells or other alarm device. (7) **DeltAlert Ultrasonic Detector:** Senses movement of intruder in protected area causing activation of alarm system. (8) **Projector:** All-weather type speaker creating loud 100db noise.

The complete system uses existing AC wiring as a signal carrier. This advantage is made possible by Delta's breakthrough in fool-proof electronic circuitry. Modern technology and Delta Products now present you with the **No Problem Security System.**

If you want a security system that solves problems instead of creating them, write or call today, for complete information on Delta's Problem Solver, the Total Security System with Central Control.

See the No Problem Delta Centrally Controlled Security System in operation.

Booth A45, at the NewCom '73 Show in Las Vegas, May 2, 3, 4.

Booth C12, at the Security Show in Chicago, May 21, 22, 23.

*100% American Made
Superior Security at Sensible Prices*



DELTA PRODUCTS, INC.

P.O. Box 1147, Grand Junction, Colo. 81501,
(303) 242-9000

NEW AND NOTEWORTHY

For additional information on products described in this section, circle the numbers on Reader Service Card. Requests will be handled promptly.

FOR MORE
NEW PRODUCTS
SEE PAGE 61



VOM

Designed to meet field-service abuse

The Model WV-529A Service Special Volt-Ohm-Milliammeter has been designed to meet both the electrical measurement needs of modern servicing and the rigorous abuse to which a portable instrument is subjected in the field. The unit reportedly includes voltage, current and resistance measuring ranges most suited to modern electronic needs, providing a 5000v dc range for servicing TV receivers, a front-panel polarity-reversal switch for testing semiconductor devices, a panel-mounted overload fuse, and full-scale ac and dc ranges based on 0.5 and 1.5 scale factors. Other features are said to include a taut-band meter movement, recessed panel controls, a high-impact case and diode protection against burnout of the meter movement. The 20,000 ohms per volt instrument is said to be supplied complete with test leads, batteries, spare fuse and instruction booklet. RCA/Electronic Components.

AM/SSB TWO-WAY RADIO 701

Produces 15w peak envelope power

A two-way mobile radio, the Cobra 132 AM/SSB mobile, has been developed to produce 15w of peak envelope power. Features of the radio reportedly include 69 channels (23 AM, 46 SSB); 100% modulation with exclusive "Dyna-Boost" compression circuit; better than 60dB cross-modulation interference rejection to eliminate bleedover, howls and squeal; RF gated noise blanker that drops noise levels significantly both on AM and SSB; three filters, including one ceramic, to prevent adjacent-channel interference; and a drift-free, ultra-stable "Voice Lock" circuit. Transmitter specifications indicate better than -40dB SSB carrier suppression and unwanted sideband suppression; a 350 to 2500 Hz frequency response (AM and SSB); 50Ω output impedance, unbalanced; an adjustable automatic load control which holds P.E.P. to 1db increase with 20dB increase of output signal; crystal lattice-type filter; a full-function illuminated meter that shows relative RF output and SWR; plus a lamp that provides a proportional RF output indication. Receiver sensitivity on SSB is said to be less than 0.25μv for 10dB (S + N)/N at greater than 1w of audio; and on AM, sensitivity is said to be less than 0.5μv for 10dB. The unit measures 2¾ by 7½ by 10 5/16 in. deep. Dynascan Corp.



FREQUENCY EQUALIZER 702

Provides tone adjustment in five frequency ranges

The Model FEW-1 multiband frequency equalizer is designed as a complex TONE control for connection to any stereo system. The equalizer is said to incorporate five slide controls to operate tone adjustment circuits in five frequency ranges—altering the sound to suit personal taste, room acoustics, or audio component deficiencies. It can reportedly compensate for unusually "live" or "dead" listening rooms, make up for poor speaker placement, change the apparent frequency characteristics of phono cartridges, microphones and speakers, or act as a complex loudness compensator for individual hearing characteristics. BSR (USA) Ltd.



Everytime we introduce a new product, you become more important.

New products mean more business. Not only for us, but for you. Independent service technicians. Once a product leaves our hands, it's in yours. Along with our reputation for making quality electronics. And for standing behind them. That's why you're so important to us. You help us maintain our good name. Product after product. Year after year.

Our products are designed not to break down. But the present state of the art, and the continuous flow of new and unique products, con-

tinue to provide opportunities for the service technician.

We think about you even before we introduce a product. We build our equipment for easy serviceability. Service literature and replacement parts are programmed to be available when a product goes to market. Not months later, when a customer may need help. There's no delay for you. No inconvenience for your customer.

As a special feature, we subscribe to a country-wide, toll free tele-

phone referral system. It operates 24 hours a day, 365 days of the year. When a customer calls 800-243-6000 asking for Panasonic service, he is referred to the nearest authorized independent service center. Yes, our nationwide network of authorized service centers is made up of men like you, independent service technicians. Panasonic depends on you. For in-warranty and out-of-warranty work. It adds up to more business for you. And, it's no wonder that you become more important to us.



... for more details circle 125 on Reader Service Card

Panasonic
Just slightly ahead of our time

Panasonic Service Division, 10-16 44th Drive, Long Island City, N.Y. 11101

**Tough.
Big in capacity.
Quick in traffic.**



Ford Vans ...born and bred for city work.

City service demands a lot from a truck. And Ford Econolines... America's No. 1 vans... really deliver.

A choice of swinging or sliding doors, for example... whichever might fit your needs. Only Ford offers you both. The latest sliding type rides on three tracks with true-center support... to give you smooth one-hand operation.

Short overall length... shorter than other comparable vans... gets you through city traffic easier... into skimpy parking spots faster.



Twin-I-Beam independent front suspension uses



two forged I-beam axles to give Econolines special toughness. And uses big coil springs to smooth the ride for driver and load alike.

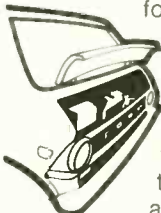

Ford's out-front servicing saves you time in the shop, too. Just flip up the hood to reach water, oil, battery, voltage regulator and more.

Payload ratings up to 4,250 lbs. give Econolines the capacity for your biggest jobs. And now Ford offers the

... for more details circle 113 on Reader Service Card

E-300 Parcel Van with 6-foot-high walk-in bodies, 10 or 12 feet long. A wide choice of regular Van and Super Van models, too. Get the full story at your Ford Dealer's now.

Availability may be subject to Environmental Protection Agency certification.

FORD ECONOLINE VANS

FORD DIVISION



TEKLAB REPORT

Introducing Philco-Ford's Solid-State Modular Chassis

by Joseph Zauhar

Approximately 85 percent of the components employed in this solid-state chassis are mounted on plug-in modules

■ Each year we have seen a growing number of solid-state chassis employing plug-in modules. If any of these modules required servicing, the manufacturers have supplied new or rebuilt replacement modules or the technician has repaired the module.

Philco-Ford's all-new solid-state modular color-TV chassis 3CS91, called the "Boss," employs a fully modularized approach, which they call "functional modularization" to solid-state. This chassis includes 14 modules which operate independently of each other, but in concert. Each module has its own specific function to perform and if one module malfunctions, the others reportedly continue to operate, which should simplify servicing problems.

According to the manufacturer, the quality and reliability designed into these modules reduce failures, enabling them to go into a modular "throw away" program. By throw away, they mean that any module that fails, will not be factory serviced. The module is thought of as an individual component and should be replaced as any other component. To insure that the customer receives a new replacement module, components which are part of the module will not be carried as a replacement item. Also, as part of the quality and reliability expected from the modules, there should reportedly never be the need for sweep align-

ment of the RF, IF, sound or chroma circuits of the TV set.

Some of the other important features include: A pushbutton channel selector featuring voltage-variable capacitance diodes (VVC) instead of the usual rotary detent channel selector type. The 12 pushbuttons can be set by the owner in different combinations of VHF or UHF channels. A new Philcomatic Super Black Matrix picture is used, which reportedly uses an improved light transmission glass to allow 85 percent of the available light from the electron beam gun to filter through—producing a brighter, sharper pic-

ture. It also features a new gun design using a metal cathode which reportedly lasts from two to three times as long as earlier models of picture tubes.

We received in our lab a Philco-Ford Model C4890BRW color-TV set which included a rollabout stand. The contemporary cabinet was finished to match Rosewood and included a detachable reflection shield to reduce reflections from room lighting or bright daylight, which can be easily snapped on or off for cleaning.

The CONTRAST, BRIGHTNESS, COLOR and TINT controls are hidden on

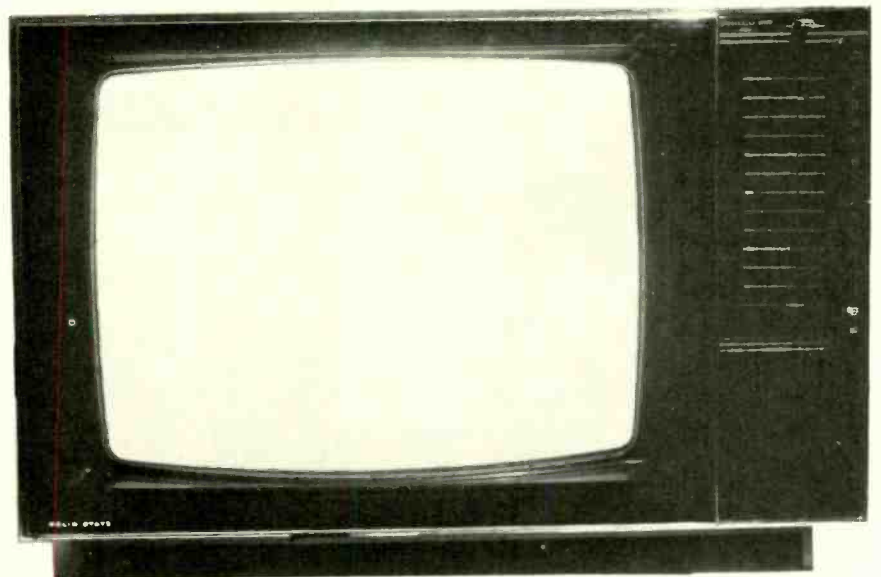

Philco-Ford's all solid-state, modular, portable color-TV set, Model C4890BRW, employing a pushbutton channel selector.

the rear upper right edge of the cabinet, giving the front control panel a clean uncluttered appearance.

Even at first glance it was obvious that the chassis was designed for ease of servicing with a number of features to save time when removing the chassis or components. No leads or components are placed on the bottom of the mother boards. The tuners and control assembly, speaker, degaussing coil, convergence assembly and yoke, all plug-in for quick disconnect if required. Most components that were previously mounted on the top of the VHF tuner are now mounted on a panel adjacent to the VHF tuner. In the event a tuner requires replacement, the components can remain with the set. The anode lead, which is part of the high-voltage-tripler block, and the lead from the focus block are fastened by a screw and clamp within the anode dust cover, allowing the replacement of leads within the dust cover without soldering. When the back cover is removed, the chassis bottom is exposed, allowing servicing without the need for chassis removal. Large components such as the power transformer, filter choke, high-voltage tripler and focus bleeder can be easily replaced, even in the home, without removing the chassis.

This modular chassis has 14 plug-in modules containing approximately 85 percent of the components employed in the chassis. Each of the modules are letter coded and the first three letters of the letter

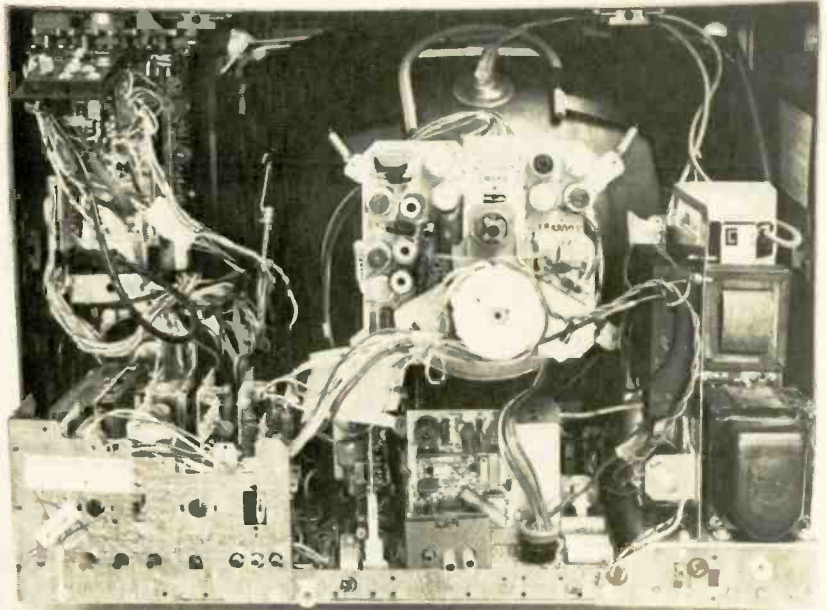

Rear view of the 3CS91 solid-state modular chassis. The convergence board is placed around the neck of the picture tube to conserve cabinet space and shorten harness lengths.

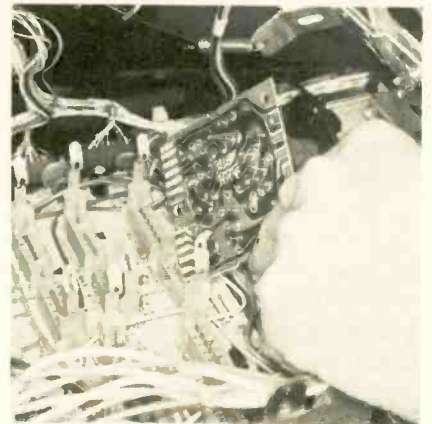
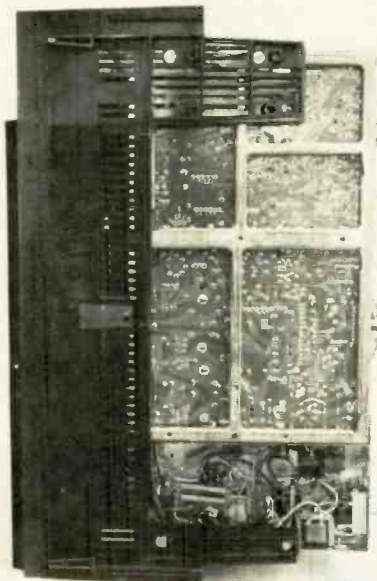

The vertically mounted modules are pressed into edge connector sockets on the mother board and are retained by spring clips.

After removing the back cover and tipping the TV set, the complete chassis bottom is exposed—allowing access for servicing without the need for chassis removal.

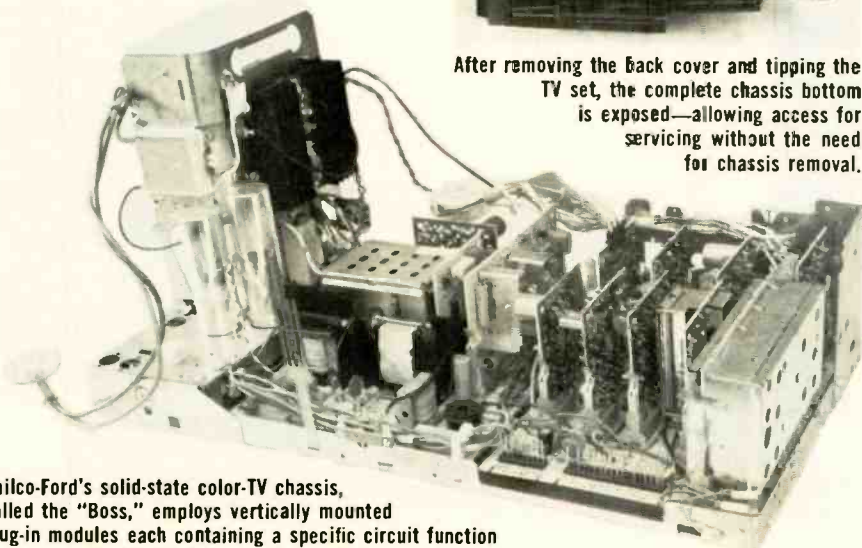

Philco-Ford's solid-state color-TV chassis, called the "Boss," employs vertically mounted plug-in modules each containing a specific circuit function to help shorten troubleshooting time.

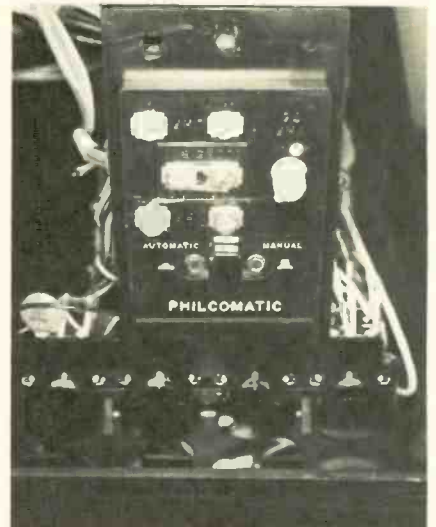

A 75Ω coaxial antenna input, along with the Philcomatic switch, is located on the antenna terminal block.

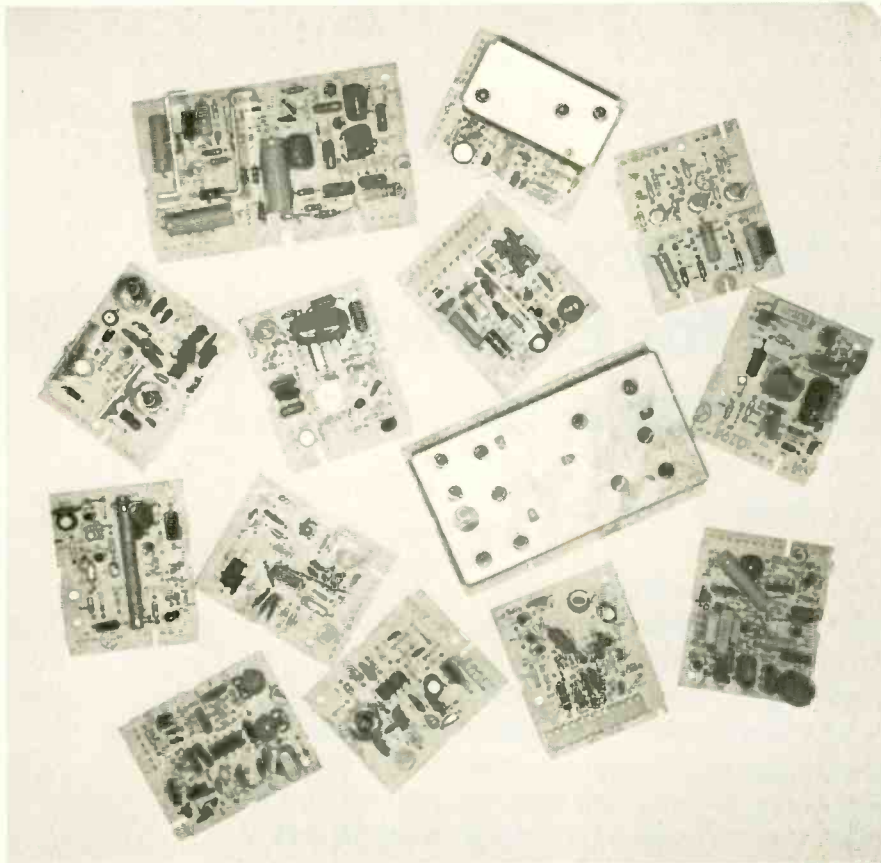

These 14 plug-in modules contain approximately 85 percent of the components employed in the chassis.

code are used to designate the module function. As an example, H.O.A.C. (Horz. osc. AFC). The last letter C is used to distinguish a color module from a monochrome module, which may eventually be employed in a B/W-TV set. The modules are inserted vertically into edge-connector-type sockets on a mother board and retained by spring clips. Caution must be taken not to attempt to operate the TV set with the modules removed.

This modular chassis has three main sections—signal PW panel with nine plug-in modules mounted on it, deflection PW panel with three modules and the power-supply chassis with one module for the 20v supply. Also, one module is mounted on the tuner instrumentation assembly, thus bringing the count to 14 modules. The signal PW panel and the deflection PW panel are referred to as the mother boards, which contain most of the modules. There are other PW panels which are not the plug-in type, but which are easily replaced. These include the Philomatic switch PW panel assembly, which is located on the secondary control bracket; and the VVC tuner PW panel, mounted on the tuner bracket.

The schematic for this chassis can be found in the March Tekfax Schematic No. 1463.

VHF/UHF Variable Voltage Capacitance (VVC) Tuner

Viewing the new VVC tuner selector controls from the front of the TV set, they appeared quite different from most of the other TV sets that we have examined in our lab. The channel selector control panel contains 12 knobs and 12 windows to the left of the knobs. Each of the knobs can be pulled out and rotated to three different positions. In the first position the window indicator reads 2-6, the second position 7-13, and the third position 14-83. With this tuning system, each knob has the capability to tune in any VHF or UHF channel. By pushing-in and rotating the knob, the desired channel can be selected within the window indicator range.

When adjusting a knob or changing a channel with the front door open, the ACT is automatically de-

continued on page 54

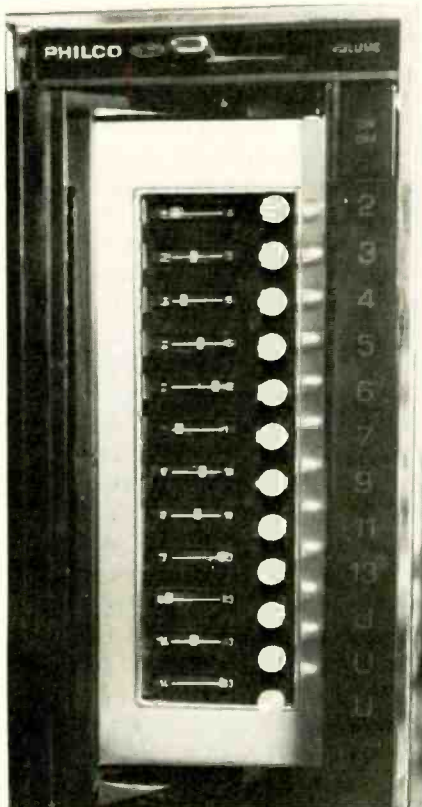

The 12-position, pushbutton VVC tuner has the capability of delivering any VHF or UHF channel in the public TV broadcast spectrum. When the front door is open, the ACT circuit is defeated.

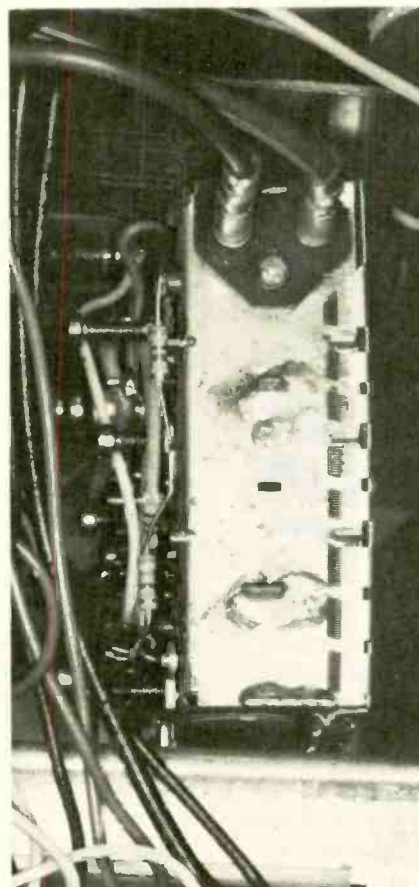

End view of the new thin VVC tuner, which includes the UHF/VHF tuner as one unit.

Advanced Education for Electronic Technicians

by Dennis J. Hegler

An article telling electronic technicians why they need advanced training could have been written 25 years ago to warn the now extinct radio technicians of the advent of television. This type of article could have been written 15 years ago to tell about color television; a decade ago on transistorized circuitry; or five years back on modular construction. Advanced training is required today, and the reasons behind it are more important than ever before: the increasing popularity of linear and digital integrated circuits in all consumer products, and the CET Examination.

■ The best electronic technicians have and maintain two skills that keep them on top in this business—direct application skills and theory skills. Direct application skills are the ones you consciously use every day, such as where to look to eliminate blooming, correcting poor color sync., and spotting AGC problems. You acquire them through a combination of on-the-job experience, servicing literature, and manufacture-sponsored seminars. Every technician has these skills. Without them, he wouldn't last long.

But direct-application skills are not enough to move you to the top. The best technicians have the skill in theory, the knowledge it takes to tackle the tough jobs. It is easy to identify the man with a background in theory—he's got the answers when you are in a pinch. Most of the time you don't fully realize how much he depends on theory. His answers are attributed to a "gut sense," a deeper feeling for what is happening. Consequently, many technicians look upon theory as being unnecessary. Nevertheless, the value of theory skills is shown by the fact that in general, the best technicians are those who have gone through the best electronic schools, where the emphasis is always on theory, and applications based on the theory learned. Face it: If theory isn't needed, what happened to the old time hammer-and-chisel technicians and tube jockeys?

Advanced training can put you on the top and keep

you there. The better you know your theory, the more short-cut methods you can discover to better and faster servicing. You'll be able to expand your shop into more money-making areas like cable and closed-circuit television. A solid knowledge of the basic electronic theory will prepare you for an FCC license, which is required for all two-way communication work such as Marine and Citizens Band Radio. Think of it: "*FCC Licensed Technicians*" in your servicing ads and promotional material—even on your shop door—impress the public. I have never seen a busier small shop than the one in a nearby suburban village where I live. All their promotional materials, both ads and direct mailings, prominently display the line: "All repair work by government licensed technicians." Earn your FCC license and then promote it right, and watch the increased business roll in! It will be easy for you to get an FCC license because of your wealth of hands-on experience. Just season that experience with the proper easy-to-learn theory and the license is yours. Not only the license and the associated prestige is yours, but also the theory is ours to make you more proficient on the job, and to help you catch on fast when new circuitry comes your way. And speaking of new circuitry, it's coming fast. The latest TV sets are jam-packed with

The author is a member of the Technical Staff at the Cleveland Institute of Electronics.

integrated circuits. Tuning, video detector and amplifiers, AGC circuits, sound stages, chroma circuits, remote control—these are just some of the jobs the “bugs” are now or will be handling. Integrated circuits are appearing more and more in Hi-Fi equipment: digital tuning, integrated phase-locked-loop circuits, even power amplifiers. You’ll be seeing digital IC’s in electronic organs and kitchen appliances. New circuits are appearing every day, and the man with a solid knowledge of theory won’t be turning cash customers down.

Finally, an advanced education will help you in what is now a most controversial issue, and what will probably become the most important issue in the electronic technician’s career—the CET Examination. Whether or not there should be certification of electronic technicians is not going to be discussed, simply because the question has been rendered academic: The CET Exam exists today, and will continue to exist tomorrow and every day after. Complaints have surfaced concerning the amount of theory required to pass the exam. It is to your advantage that the theory questions remain. Otherwise the certification of your ability as a service technician will be the equivalent of “earning” a drivers’ license.

The business advantage of the certified technician is readily apparent when compared to other professions. Doctors are certified through the A.M.A.; lawyers through state bar exams. First Class FCC licenses are required of those who maintain and operate broadcasting equipment. Plumbers, electricians, and others in the building trades are licensed; even automobile repairmen are being subjected to certification exams. Once the public is made aware that they can have their TV sets serviced by “CERTIFIED ELECTRONIC TECHNICIANS” (and you can be sure they will announce it boldly in their advertisements), the only business the non-certified ones will get will be the leftovers!

Whether you want advanced training for prestige and self-satisfaction, or for reasons easily translated into dollars and cents, you can nevertheless get it through resident training or home study. If you are so fortunate as to have a good, conveniently located residence school offering the training you want at an hour you can attend, your problem is solved. You will have the advantage of competent instructors to answer your questions on the spot. Good resident schools have well-equipped laboratories where you can take the theory learned in the classroom and see it in action. Tuition varies greatly, but is often surprisingly low.

Unfortunately, most experienced technical men wanting to upgrade their skill level won’t be lucky enough to have such a convenient set up. The only courses offered may be planned for beginners and offer nothing beyond a repeat of training they have already had. Unless you are particularly lucky, you won’t find the advanced type of training you need in a nearby resident school unless you live in a large population area.

A very obvious advantage of home study for advanced training is that you have a wide choice of

schools, since you can “attend” no matter where the school is located. While all don’t offer the advanced type of training you need, you can easily find what you want because of the many different courses offered. Home-study training lets you zero in on exactly what you need to learn. Home study also has other advantages. You pick your time and place of study to suit your own personal schedule. Home-study schools have teams of instructors who can answer all of your questions. For those seeking advanced training, there is another important advantage that is often overlooked. Almost all advanced home-study courses include an excellent review of beginning theory. Nearly all electronic technicians who have been out of school for any length of time need this review before undertaking more advanced training.

You will also find many home-study schools that include laboratories as an integral part of some of their courses. Although these kits of parts and instruments are invariably touted as included “without extra cost,” common sense tells you that you are paying for the lab through the higher price of the course. In fact, it is often a considerable part of the entire cost. If you are an experienced electronic technician, you will probably not need this lab training unless it is of an advanced nature. You can save money and often get higher-level training by avoiding courses that include kits. Short courses in specialized subjects could be an exception. For example, a course in digital logic may include simple but instructional equipment with which you can experiment by building a variety of logic circuits.

It is an unfortunate fact that some home-study schools do exist that are more interested in your money than in providing good training. The same is true of resident schools, but it should be fairly easy to investigate a local school. Visit the school to see how it is run. Check with the Better Business Bureau before signing up for an expensive course. Find out what local high-school counselors think of the school.

One simple check for a home-study school is to see if their literature clearly states that they are an accredited member of the National Home Study Council (NHSC). Accredited home-study schools must meet rigorous standards which assure you of excellent training. There are some good home-study schools, particularly small ones, that are not NHSC accredited although they offer top-notch training. Ask for the names of students or graduates in your area, and find out from them the quality of the training materials and services, as they can be considerably different from what was promised.

Remember, however, that signing up for a course is only the first step. If it is a resident school, you have got to attend every class and do your homework to make the most of your training. If you enroll in a home-study course, plan on spending 5 to 10 hours a week on your studies. If you haven’t got what it takes—determination and stick-to-it-iveness—don’t waste your time and money. There is always room at the bottom. But if you are the kind of person who wants to make his mark and won’t settle for second best, advanced training is for you—NOW. ■

An Extraordinary Offer

to introduce you to the benefits of Membership in

ELECTRONICS BOOK CLUB

for a limited time only you can obtain

ANY 3 OF THESE UNIQUE BOOKS . . . yours for only **99¢** each
(Combined List Price \$45.85) Club Membership . . . with Trial

May we send you your choice of any three books on the facing page as part of an unusual offer of a Trial Membership in Electronics Book Club?

Here are quality hardbound volumes, each especially designed to help you increase your know-how, earning power, and enjoyment of electronics.

These handsome, hardbound books are indicative of the many other fine offerings made to Members . . . important books to read and keep . . . volumes with *your* specialized interests in mind.

Whatever your interest in electronics—radio and TV servicing, audio and hi-fi, industrial electronics, communications, engineering—you will find that Electronics Book Club will help you.

With the Club providing you with top quality books, you may broaden your knowledge and skills to build your income and increase your understanding of electronics, too.

How You Profit From Club Membership

This special offer is just a sample of the help and generous savings the Club offers you. For here is a Club devoted exclusively to seeking out only those titles of direct interest to you. Membership in the Club offers you several advantages.

1. Charter Bonus: Take any three of the books shown (combined values up to \$45.85) for only 99¢ each with your Trial Membership.

2. Guaranteed Savings: The Club guarantees to save you 15% to 75% on all books offered.

3. Continuing Bonus: If you continue after this trial Membership, you will earn a Dividend Certificate for every book you purchase. Three Certificates, plus payment of the nominal sum of \$1.99, will entitle you to a valuable Book Dividend which you may choose from a special list provided members.

4. Wide Selection: Members are annually offered over 50 authoritative books on all phases of electronics.

5. Bonus Books: If you continue in the Club after fulfilling your Trial Membership, you will receive a Bonus Dividend Certificate with each addi-

SPECIAL FREE BONUS

. . . if you act now!

Yes, if you fill in and mail the membership application card today, you'll also get this Bonus Book, FREE!

BASIC ELECTRONICS PROBLEMS SOLVED

Easy step-by-step solutions to the most common basic electronics problems in a convenient one-source manual.

Regular List Price \$7.95

tional Club Selection you purchase. For the small charge of only \$1.99, plus three (3) Certificates, you may select a book of your choice from a special list of quality books periodically sent to Members.

6. Prevents You From Missing New Books: The Club's FREE monthly *News* gives you advance notice of important new books . . . books vital to your continued advancement.

This extraordinary offer is intended to prove to you, through your own experience, that these very real advantages can be yours . . . that it is possible to keep up with the literature published in your areas of interest . . . and to save substantially while so doing.

How the Club Works

Forthcoming selections are described in the FREE monthly *Club News*. Thus, you are among the first to know about, and to own if you desire, significant new books. You choose only the main or alternate selection you want (or advise if you wish no book at all) by means of a handy form and return envelope enclosed with the *News*. As part of your Trial Membership, you need purchase as few as four books during the coming 12 months. You would probably buy at least this many anyway . . . without the substantial savings offered through Club Membership.

Limited Time Offer!

Here, then, is an interesting opportunity to enroll on a trial basis . . . to prove to yourself, in a short time, the advantages of belonging to Electronics Book Club. We urge you, if this unique offer is appealing, to act

promptly, for we've reserved only a limited number of books for new Members.

To start your Membership on these attractive terms, simply fill out and mail the postage-paid airmail card today. You will receive the three books of your choice for 10-day inspection. **SEND NO MONEY!** If you are not delighted, return them within 10 days and your Trial Membership will be cancelled without cost or obligation. Electronics Book Club, Blue Ridge Summit, Pa. 17214.

Typical Savings Offered Club Members on Recent Selections

Pictorial Guide to Tape Recorder Repairs	List Price \$7.95; Club Price \$4.95
All-in-One TV Alignment Handbook	List Price \$8.95; Club Price \$5.95
How to Repair Musical Instrument Amplifiers	List Price \$8.95; Club Price \$5.95
Kwik-Fix TMTV Service Manual	List Price \$8.95; Club Price \$5.95
Troubleshooting Solid-State Amplifiers	List Price \$7.95; Club Price \$4.95
Basic Electronic Test Procedures	List Price \$9.95; Club Price \$6.95
Selecting & Improving Your Hi-Fi System	List Price \$7.95; Club Price \$4.95
Marine Electronics Handbook	List Price \$8.95; Club Price \$5.95
The 2-Meter FM Handbook—Using the FM Amateur Bands	List Price \$8.95; Club Price \$5.95
Handbook of IC Circuit Projects	List Price \$7.95; Club Price \$4.95
Basic Electronic Circuits Simplified	List Price \$8.95; Club Price \$5.95
How to Build Solid-State Audio Circuits	List Price \$8.95; Club Price \$5.95
How to Repair Small Gasoline Engines	List Price \$8.95; Club Price \$4.95
How to Solve Solid-State Ckt. Troubles	List Price \$8.95; Club Price \$5.95
Troubleshooting Solid-State Electronic Power Supplies	List Price \$7.95; Club Price \$4.95
Designing & Maintaining the CATV & Small TV Studio	List Price \$12.95; Club Price \$7.95
Refrigeration	List Price \$7.95; Club Price \$3.95
Using Electronic Testers for Automotive Tune-Up	List Price \$7.95; Club Price \$4.95
Basic Color Television Course	List Price \$9.95; Club Price \$6.95
Basic Electronics Course	List Price \$8.95; Club Price \$5.95

SEND NO MONEY! Simply fill in and mail postage-paid Airmail card today!

Servicing the Solid-State Chassis

SERVICING THE SOLID-STATE CHASSIS



Here is the most practical, comprehensive, up-to-date manual ever published on the repair and maintenance of consumer-type solid-state equipment—from auto tape players to TV. Contains the vital information necessary for the profitable repair of transistor TV sets, pocket-size and AC DC radios, AM-FM and multiband receivers, auto radio and tape players, portable phonos, stereo phonographs and amplifiers, and home-type tape recorders. Not an involved theory textbook, but a "how-to-fix-it" handbook, containing authentic know-how nourished by dozens of case histories, trouble charts and servicing procedures. 256 pps., over 200 illus. Hardbound.

List Price \$8.95 • Order No. 495

Dictionary of Electronics

DICTIONARY OF ELECTRONICS



You'll find this huge volume extremely useful in whatever connection you have with electronics. This dictionary of electronics defines most all of the electronic terms you will run across in your everyday reading... from alpha particles through zoom lens terms you need and use most often, including those found in radio, TV, communications, radar, electronic instrumentation, broadcasting, industrial electronics, etc. It provides full, complete and easily-understandable explanations of thousands of specific electronics terms (such as transistors, acoustic feedback, alpha particles, heat oscillator, final anode, electrostatic lens, nonlinear resistance, etc.). 420 pps., 487 illustrations. Hardbound.

List Price \$8.95 • Order No. 300

Electronic Circuit Design Handbook



New Fourth Edition —A brand-new, enlarged edition of the ever popular circuit designer's "cook-book" now containing over 600 proven circuits, for all types of functions, selected from thousands on the basis of originality and practical application. Now you can have, at your fingertips, this carefully planned reference source of tried and tested circuits, selected on the basis of their usefulness. This detailed compilation of practical design data is the answer to the need for an organized gathering of proved circuits... both basic and advanced designs that can easily serve as stepping stones to almost any kind of circuit you might want to build. 416 pps., 19 big sections, over 600 illus. 8 1/2" x 11". List Price \$17.95 Order No. T-101

Installing & Servicing Electronic Protective Systems



Here's everything you need to know to break into this challenging field! Covers the installation and servicing of virtually every electronic fire and theft security system, tells how to estimate costs, and contains data on how to build your business. Over 160 photos and illustrations, including complete schematic diagrams of many protective devices. Discusses sensing and detecting methods, then covers specific types—electromechanical, photoelectric, ultrasonic, microwave, proximity audio and visual, seismic, vibration and stress intrusion systems, night viewing devices, vehicular, etc. Federal Crime Insurance regulations, glossary, and list of manufacturers and suppliers. 256 pps. Hardbound. List Price \$7.95 • Order No. 605

FET Applications Handbook



This revised 2nd edition contains a wealth of data on the FET and its various applications in practical circuit designs, material prepared by some of the most capable engineers in the field. Early Chapters delve into current-voltage relationships, application areas, DC and AC amplifiers, voltage controlled attenuators, and limiter and chopper circuits. Additional Chapters deal with linear applications, chopper and switching circuits, integrated circuits and photo-FETs. Also FET oscillators, describing various types and the necessary biasing arrangements. Essential design data includes starting conditions, power output, frequency stability, and efficiency. 324 pps., 250 illus., 26 Chapters. Hardbound.

List Price \$14.95 • Order No. 240

TV, Radio, Hi-Fi Hints & Kinks



If you want to get the best performance out of consumer electronics equipment, you'll find this to be the most informative and useful handbook ever published. Over 150 ideas suggest ways to customize and add accessories to any equipment setup—how to connect single and multiple accessory speakers, how to add remote controls to TV's, radios, hi-fi systems, how to connect microphones, etc. Also includes many tips on hi-fi equipment, CB and 2-way radio equipment, antenna systems, remote monitoring techniques, intercoms, a wireless baby sitter, telephone amplifier, moisture, fire and other alarm accessories for any existing amplifier. 256 pps., over 150 illustrations. Hardbound.

List Price \$7.95 • Order No. 561

Electric Motor Test & Repair



A guide to maintenance practices for all types of small horsepower motors. While many of the larger motor repair shops find it more expedient to replace low horsepower units, rewinding of small electric motors is still a wide-spread and profitable practice. This practical guide contains a wealth of information on testing and rewinding small motors of every type, including fan, starter, polyphase, capacitor, induction, synchronous, etc. Early chapters tell you how to set up a motor test panel, make general tests and measurements, and advise you about the tools and equipment necessary (such as an armature winder, wedge driver, cutting and gauging board, coil taper, pulser plate, etc.). 160 pps., 102 illus. Comb-bound with soft cover. List Price \$6.95 • Order No. T-97

Electronics Data Handbook: New 2nd Edition



This brand-new, completely updated and greatly enlarged edition of an industry classic now saves you even more time in quickly finding the electronics data you need! Now 50% larger than the earlier edition, it includes just about any formula you want—plus numerous worked out tables and charts which give you direct answers so you don't even have to use a formula. Here is an all-in-one reference to the data for DC and AC circuits, vacuum tubes, transistors, antennas and transmission lines, measurements, and all the conversion factors, abbreviations, equivalents and mathematical data for electronics. 256 pps., 256 tables, charts, illustrations and formulas. Hardbound. List Price \$7.95 • Order No. 118

64 Hobby Projects For Home & Car



Here's a variety of gadgets bound to please almost everybody—from the hobbyist and experimenter to the engineer who likes to make things in his own home workshop. From an auto ice alarm to a vibrator recharger, from an amazing electric candle that lights with a match to a splash alarm for the swimming pool, there's a host of fun-to-build devices, many of which are quite unique. For the home there are 28 individual projects, for the car a total of 36, each accompanied by a schematic and/or pictorial diagram and parts list. If you like to build, here's a fine collection of practical projects with everything worked out for you except the fun! 192 pps. Hardbound. List Price \$6.95 • Order No. 487

Small Appliance Repair Guide



Learn to repair dozens of small household appliances with the use of this authoritative, low-cost handbook. Profusely illustrated, the text tells how to find the cause of trouble in minutes, and how to go about making the required repairs. You'll also pick up helpful hints on disassembly, one of the aspects of many appliance repair jobs. General troubleshooting procedures are explained to familiarize you with the techniques of appliance repair. Succeeding chapters deal with thermostats, skillets, sauce pans, irons, toasters, coffee makers, blenders, mixers, knives, deep fryers, hair dryers, electric shavers, and small motors found in countless appliances. 11 Chapters, 224 pps. Over 150 illus. Appendix and Index. List Price \$7.95 • Order No. 515

Practical Electronic Servicing Techniques



Here is a new and unique handbook that will sharpen your electronics troubleshooting ability. Yes, you can learn to whip those tough dogs and prepare yourself for any electronic gear that comes your way with the "inside" information presented in this handbook. You'll be surprised how simple and logical the professional techniques really are. Begins with an analysis of what troubleshooting really is; to condition your thinking (which is part of the secret), the author begins with the analysis of troubleshooting logic; then he tells you how to think like a tough-dog expert. Also logical service approaches to DC circuits, tube circuits, and transistor circuits. 256 pps., 138 illus. Hardbound. List Price \$7.95 • Order No. 547

CATV System Engineering - Third Edition



Third Edition, Revised. This 3rd edition of the accepted technical standard of the CATV industry is an expanded and revised version of the first and only authoritative book on planning, designing, and operating a CATV plant. Covers systems composed of uncorrelated components as well as fully integrated solid-state plants. Subjects covered include disadvantageous amplifier design concepts, high level distribution, principles of cable powering, amplifier and system dynamic range, cascaded figure of merit, system operating levels, jumper cables, equalization and alignment, and a host of other vital subjects, including how to modernize older systems with the newest equipment available. 256 pps. List Price \$12.95 • Order No. 298

Reliable Electronic Assembly Production



Here is one of those rare books which successfully bridges the gap between design and production technologies, thereby providing guidelines for choosing the best design to achieve the least expensive and most reliable product. The content provides information on material and methods employed in mass production, giving the designer in-depth knowledge of the broad range of processes he should consider in evolving a final product concept. Not only does the content define the best materials for each given application, and detail the best choice for fabricating but it also points out incompatibilities which may evolve between design and production. 208 pages. Hardbound. List Price \$12.95 • Order No. 287

Radio Control Handbook: Third Edition



A completely revised and updated version of the model radio controller's bible—covering the entire range of control systems. Contains the latest information on proportional control and pulse rate-length systems. Describes the basics of control using simple escapements and mechanical control linkage, versatile pulse-proportional control and the methods of attaining it, methods for using magnetic actuators and servos to control engine speed, R-C receivers and transmitters, transmitter keying techniques, batteries and power supplies, relay operation and maintenance, test equipment applicable to R-C activity, and installation of systems in model planes, cars and boats. 320 pps., over 240 illus. Hardbound. List Price \$8.95 • Order No. 93

General Electric Color TV Service Manual - Vol. 2



This second volume picks up where Vol. 1 left off. Covers the new solid-state JA chassis plus H-2, H-3, H-4, N-1, N-2, K-E, C-2, J-2. Provides complete setup, alignment, troubleshooting, and adjustment procedures for all these receivers, plus Parts Lists for uncommon components. The foldout section provides complete, large-size schematics for the 10 chassis mentioned above. 212 pps., including 36-page schematic foldout section. Leatherette cover. List Price \$7.95 • Order No. 609

Beginner's Guide to Computer Programming



Computer programming is really quite simple—once you understand the fundamental principles. This new book will help you develop that understanding because, simply, it begins at the beginning! Instead of working backward from a language, this book begins by developing a simple programming language of its own. Each concept is developed by determining a need, then an instruction to fulfill that need. After you learn the basics, the author shows you how to prepare flowchart diagrams of actual programs. Then you begin transforming program requirements into "computerese." Finally, various language levels are explained. 384 pps., 400 illustrations. Hardbound. List Price \$9.95 • Order No. 574

AN EXTRAORDINARY OFFER...

... for more details circle 103 on Reader Service Card

Solid-State Replacement Considerations

by Gerald L. Quint

TV service dealers and electronic technicians operate in a constantly changing environment of new designs and components. Although receiving tubes and other familiar components remain an important part of most home entertainment equipment now in use, the newer designs are utilizing more and more solid-state circuitry. In 1972, almost one-fourth of the color-TV sets produced domestically were of all solid-state construction. Replacement of these parts is a major consideration for the electronic service technician.



Gerald L. Quint is Product Sales Manager, ECG® Semiconductors, GTE Sylvania Inc.

■ The abundance of type numbers generated by the many different designs offered and the large variety of manufacturer's parts numbers in use have created the need for a simplified reference source and comprehensive replacement product line.

Solid-state devices began to penetrate consumer electronic equipment with the introduction of the selenium rectifier, which has now yielded to the silicon rectifier. The silicon UHF mixer diode, and the germanium point-contact diode for AM/FM detection are also examples of early solid-state devices used in home entertainment equipment.

TV deflection systems, still a stronghold for tubes, are beginning to be converted to all solid-state circuitry. Early domestic and even some present imported TV sets employ PNP Germanium devices. However, NPN-Silicon is becoming the major technology for these applications. While silicon controlled rectifiers (SCR) are being used in some systems, this approach is not common in the industry.

High-voltage rectifiers have seen the introduction of first the selenium focus rectifiers and now the selenium and silicon stick rectifiers used for applications up to 45kv. Triplers are also becoming more prevalent as they offer some improvements in economics and reliability for the fly-back transformer system. Quadriplers have been used on a limited

basis, but it appears that the tripler device will dominate this application.

There is really no part of a contemporary TV receiver that cannot be produced with "solid-state" components. However, economics and reliability are important factors that will determine when the complete transition from electronic tube designs will be achieved. For the AM/FM, FM-Stereo, and audio markets the transition has already been accomplished. Industry prophets predict the complete conversion of color-TV to all solid-state construction in the 1974-1975 period. Black-and-white TV is predicted to follow a year or two thereafter.

The nature of the solid-state incursion has been changing rapidly and dramatically. Thus, even as the discrete transistor displaced the electron tube, now discrete transistor systems are being displaced by silicon monolithic integrated circuitry. Look at the circuits that are now or will soon be using this technology: FM-IF, TV-Sound IF, A.F.T., Chroma demodulation, color subcarrier regenerator, chroma IF, video processor (also known as the video jungle) which produces the AGC voltage for RF/IF, sync signal information and noise-cancelled video outputs, vertical and horizontal oscillators, FM detector, stereo multiplex decoder, stereo preamplifiers and even some AM radio

circuitry has been replaced by the "chip," dual audio power amplifiers up to 5w, and the list goes on.

The TV sound system seems destined for major change as integrated circuits now under development will take the 4.5MHz signal and deliver some 2w of audio power directly to the speaker, eliminating the discrete audio power amplifier stage.

The FM-multiplex "integrated circuit" stereo decoder has seen the introduction of the phase-locked loop techniques, bringing the technology and sophistication of "space-age" developments into home entertainment products. Further, the advent of "quad-stereo" has spawned a new family of "integrated circuits," from the four-channel decoders to the logic systems that go with them to complete the system. As a matter of fact, without integrated-circuit technology, the phase-locked loop decoders and the four-channel stereo systems could be impractical from a business standpoint.

Color processing circuitry will also undergo major revision as the industry strives to put more of this circuitry onto one integrated-circuit chip.

To add to the above array of spectacular solid-state achievements, don't forget that some consumer equipment uses Silicon Controlled Rectifiers (SCRs), TRIACS, and Programmable Unijunction Tran-

continued on page 59

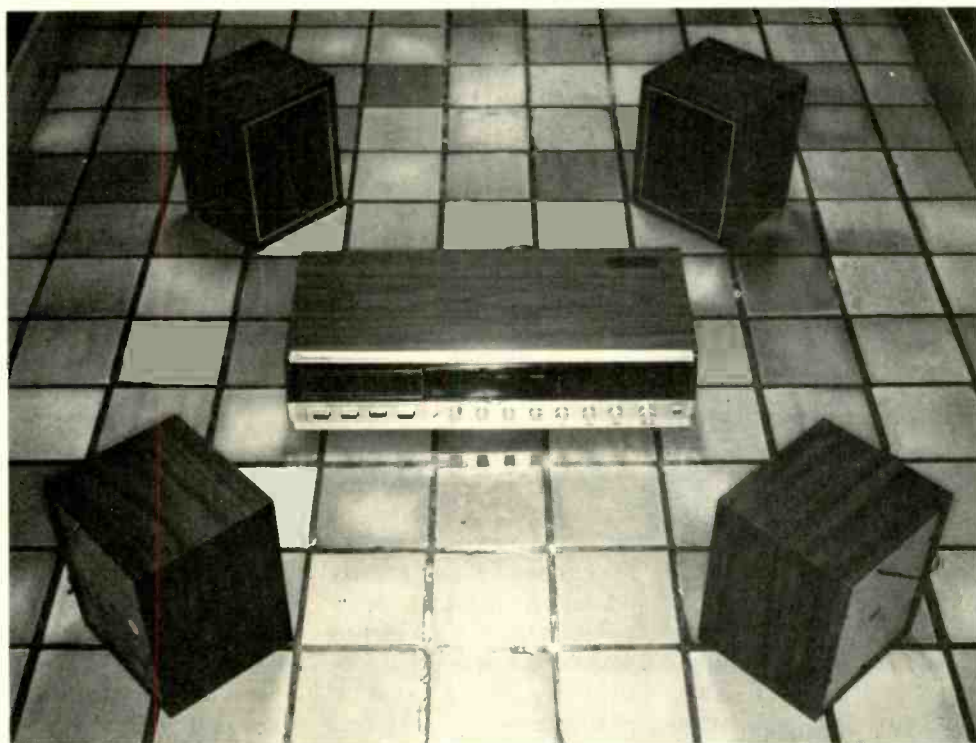

Motorola's Model FH410HW Quadraline Receiver with the speakers that are included in the system.

One Plus One Equals Four

by Phillip Dahlen

Motorola's Model FH410HW Quadraline Receiver synthesizes four audio channels from two audio signals

■ In an earlier audio article (Quadraline Four-Channel Sound, page 50, February 1972) we described Motorola's Model 275 Quadraline four-channel cartridge tape player, which was designed to play back four discrete audio channels through a set of four speakers. At the rear of the unit there was also a set of four phono-type jacks for discrete four-channel auxiliary input.

That unit proved to be one rather satisfactory answer to the problem of obtaining quality four-channel program material. However, unfortunately there are no eight-track

cartridge tapes on the market that run as quietly or have a frequency response comparable to reel tapes, good phonographs, or even a good FM receiver. And, the assortment of eight-track, four-channel cartridge tape is still somewhat limited—if by nothing more than one's own budget. As an answer to this problem, Motorola's Quadraline receiver electronically synthesizes four-channel sound from the phase relationship of stereo signals received through its own FM receiver (an adapter jack being provided for discrete four-channel FM once such a system is

available for public use) or the stereo signals obtained from phonograph records. Additional jacks are provided at the rear of this unit for discrete four-channel records (requiring conversion to four-channel sound prior to being applied to the unit) or an accessory eight-track, four-channel cartridge tape player (such as a Model GA48HW accessory styled to match the Quadraline receiver).

The April 1972 issue of the JOURNAL OF THE AUDIO ENGINEERING SOCIETY contains an in-depth mathematical study of four-channel matrixing on page 167 which utilizes

the phase angles of signals present in two-channel sound. After having attempted to see how such mathematics could be applied to a realistic situation, your editor was most anxious to give a system of this type a first-hand evaluation.

Extensive listening tests were made — primarily with Columbia SQ records played on Motorola's Model CA12HWA "Mini-Changer." Other brands of records, as well as the FM receiver, were also used to assist us in our evaluation.

Everyone listening to the system, including your editor, felt that the synthesized four-channel music was more enjoyable than mere stereo music. Unlike stereo, the music seemed to envelop the room without coming from merely in

front of the listener. People would gather in our electronics lab just to hear Columbia's "An Introduction to the World of SQ Quadraphonic Sound," test record — QX31403. However, unlike the tape system described in the earlier article, there did not seem to be any discrete sources of sound, although the general direction did seem to vary.

An earphone jack was provided on the Quadraline receiver and when in its stereo mode of operation channel separation was most apparent. With some Columbia SQ record selections it was even possible to turn the BALANCE control in such a way that certain musical instruments recorded on but one channel could be removed entirely, our hearing only

those instruments that remained.

The Quadraline receiver is designed so that when in the synthesized four-channel mode (STEREO²), the earphones are connected to but the front-left and front-right channels. When switching between the STEREO and STEREO² modes, there was no apparent loss of program material as observed when switching between left and right stereo channels. The front left or right speaker did not seem to contain any program material intended only for the rear speakers—at least none that your editor could detect.

Not wanting to restrict these tests to merely our sense of hearing, we connected the receiver to Leader's Model LSG-231 FM Stereo Signal Genera-

tor. Various resulting pairs of audio output signals were fed to Leader's Model LS-5 Electronic Switch, which permitted us to use Leader's Model LBO-301 Scope as a dual-trace scope for direct signal comparison.

In Fig. 1 we can observe the left and right channels (audio output channels to the speakers) from the receiver when in its STEREO mode while receiving 1kHz test signals (in phase) from the stereo generator. Fig. 2 shows the same outputs, but with the applied 1kHz test signals being 180° out of phase with each other. And in Fig. 3 we see the resulting scope traces when the 1kHz test signal is applied to only the right channel. A similar pair of stereo waveforms would have been observed (only



The receiver turned ON to display its FM-tuning scale.



Motorola's Model CA12HWA "Mini-Changer" used with the system to evaluate synthesized stereo records.



Time exposure taken as the receiver is switched between various modes of audio output—MONO, STEREO, STEREO² and FOUR CHANNEL SOUND.



Rear view of Quadraline receiver showing its four-channel speaker output terminals, four-channel tape output terminals, four-channel tape input terminals, four-channel phonograph input terminals, four-channel FM decoder terminal, 300Ω FM antenna terminal, rear-channel BALANCE control and accessory power outlet.

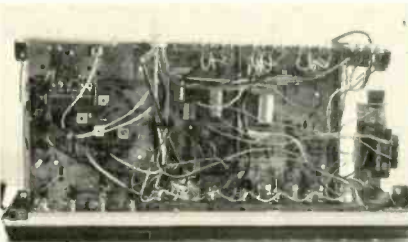

Top view of Quadraline receiver chassis.

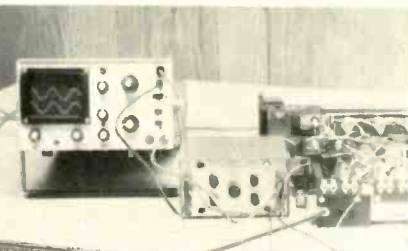

Leader's Model LBO-301 Scope and Model LS-5 Electronic Switch are used together for observing two audio channels at a time as they appear at the receiver's speaker terminals.

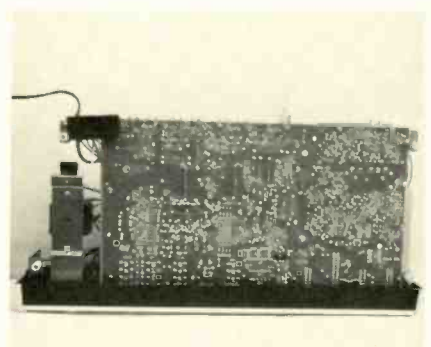

Bottom view of Quadraline receiver chassis.



Close-up view of Leader's Model LSG-231 FM Stereo Signal Generator. Note the FUNCTION switch which can be rotated for EXT. MOD, L - R, L + R, L, R, and 67kHz.

interchanged) had we applied the 1kHz test signal to only the left channel.

We next switched the Quadraphonic receiver to its STEREO² mode (synthesized four-channel sound) and observed the signals present at the four speaker terminals of the receiver.

Fig. 4 shows a composite photograph of the waveforms observed on all four synthesized channels as 1kHz stereo signals are fed in-phase to the receiver. We note maximum output in the left-front and right-front channels, but minimum output in the left-rear and right-rear channels.

When reversing the signal polarity of one 1kHz test signal so that it was 180° out of phase with the other, we obtained the waveforms observed in

Fig. 5. Although the settings of the BALANCE controls have remained the same (remaining balanced for equal gain on all four channels), there appears a slight reduction in the amount of signal present in the left-front and right-front channels, and a marked increase in signals present in the right-rear and left-rear channels.

Fig. 6 shows the output signals present when only a right-channel signal is transmitted, while Fig. 7 shows the output signals present when only a left-channel signal is transmitted. With this stereo² system it would appear as if a greater signal results in neighboring channels than was the case while in the stereo mode.

Thus far, the waveforms observed are representative only of signal

conditions when the two applied signals are either in phase (0° phase angle), 180° out of phase, or when one of the pair of signals is missing. Vector patterns, however, can be used to show the four output channels under all phase conditions.

Fig. 8 is a vector display appearing on the Leader LBO-301 scope as the receiver functions in its stereo mode. To produce this scope pattern, two independently operated audio generators are both tuned to about 1kHz and their signals are fed to the external signal inputs of the stereo signal generator. The resulting right-channel output is fed to the scope's vertical input, while the left-channel output is fed to the scope's horizontal input (thus bypassing the scope's hori-

zontal-sweep circuitry). Since the two audio generators are not synchronized, the phase relationship of the two 1kHz signals varies, but the photo shown in Fig. 8 was taken at the moment that these two signals were approximately 90° out of phase.

Unfortunately, the waveform shown in Fig. 8 still illustrates only the vector relationship of two signals while they are 90° out of phase. This limitation can be overcome by applying signals of two different frequencies to the system. Fig. 9 shows the vector pattern that results when a signal of approximately 1kHz is fed to the left channel of the stereo generator and a signal of approximately 1.2kHz is fed to the right channel of the generator. Thus, when the receiver is in its

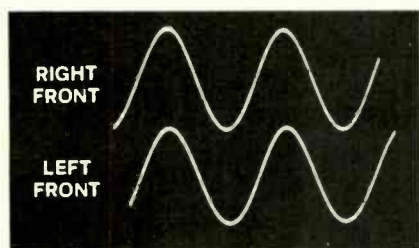

Fig. 1—The L + R signals observed at the receiver's front speaker terminals when in its STEREO mode.

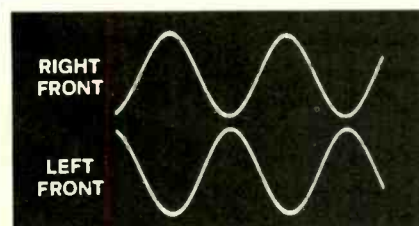

Fig. 2—The L - R signals observed at the receiver's front speaker terminals when in its STEREO mode.

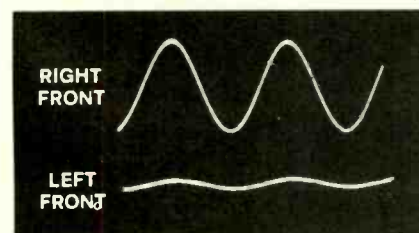

Fig. 3—The R-only signals observed at the receiver's front speaker terminals when in its STEREO mode.

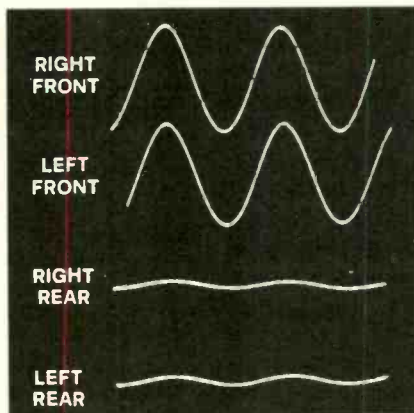

Fig. 4—The L + R signals observed at the receiver's speaker terminals when in its STEREO² mode.

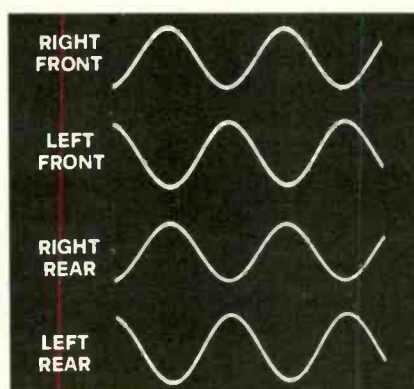

Fig. 5—The L - R signals observed at the receiver's speaker terminals when in its STEREO² mode.

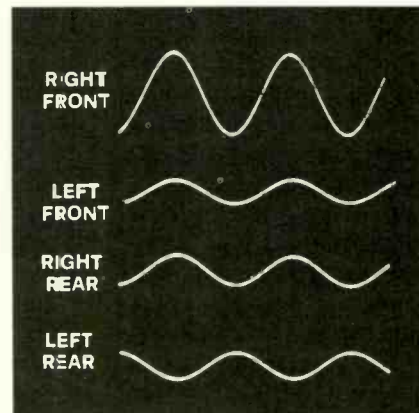

Fig. 6—The R-only signals observed at the receiver's speaker terminals when in its STEREO² mode.

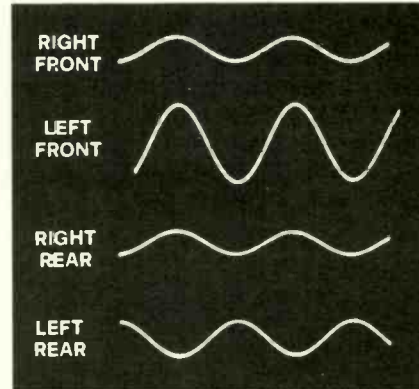

Fig. 7—The L-only signals observed at the receiver's speaker terminals when in its STEREO² mode.

STEREO mode, the vector pattern is formed as the scope's horizontal frequency is about 1kHz and its vertical frequency is about 1.2kHz. This is a ratio of $\frac{1000\text{Hz}}{1200\text{Hz}} = \frac{5}{6}$. (These vector photos were taken without the use of a frequency counter to calibrate the audio generators. An analysis of the vector pattern shown in Fig. 9 indicates an actual frequency ratio of $\frac{6}{7}$. The nearest

pair of frequencies that would form this ratio would be a left-channel frequency of $1015\frac{5}{13}\text{Hz}$ and a right-channel frequency of $1184\frac{8}{13}\text{Hz}$ —but this minor discrepancy is of no significance in our analysis of the manner in which the receiver synthe-

sizes four-channel sound.) The outer edge of the vector pattern in Fig. 9 roughly resembles that of a square, and thus we know that when in the STEREO mode the left- and right-channel output remains equal and unaffected by the phase angle of the two signals—every possible phase angle appearing in this vector display.

When switched to its STEREO² mode, the output of the Quadraline receiver no longer appears to be quite as independent of phase angles. Fig. 10 shows this apparent change in signal conditions (the vertical deflection being the right-front channel and the horizontal deflection being the left-front channel).

In Fig. 11 we note an even greater limitation of

the audio output with respect to phase angle—the vertical deflection representing the right-front channel and the horizontal deflection representing the right-rear channel. And similar limitations are noted in Fig. 12, where the vertical deflection represents the left-front channel and the horizontal deflection represents the left-rear channel.

As limited as these audio responses may seem, this is nothing as compared to the limitations imposed on the rear channels and seen in Fig. 13. With the gain increased (Fig. 14), we note that basically only one phase angle between the right-rear (vertical) and left-rear (horizontal) channels is possible—despite the phase angles of the applied signals. Fig. 14 shows the

same frequency ratio ($\frac{6}{7}$) present in the previous vector patterns, only as modified for the rear channels by the stereo² circuitry.

As a matter of interest, we readjusted both audio generators so that they both produced signals of approximately 1kHz, but with a varying phase relationship. However, instead of producing a vector pattern that fluctuated between an oval and the circle shown in Fig. 8, the amplitude of the pattern varied markedly with its phase angle—it being relatively large along one diagonal and relatively small along the other diagonal. A time exposure of this changing rear-speaker vector pattern produced the picture

continued on page 50

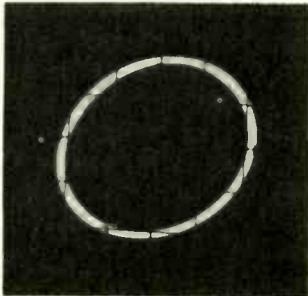

Fig. 8—Vector display produced when two 90° out of phase 1kHz signals are obtained from the receiver's front speaker terminals when in its STEREO mode.

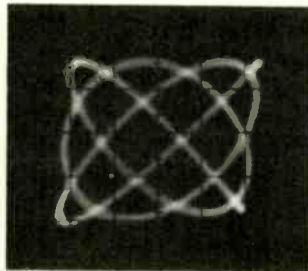

Fig. 9—Vector display produced when two signals of a $\frac{6}{7}$ frequency ratio are obtained from the receiver's front speaker terminals when in its STEREO mode.

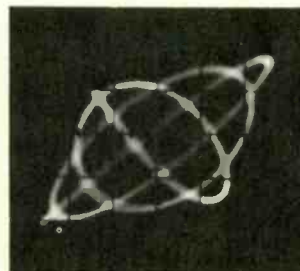

Fig. 10—Vector display produced when two signals of a $\frac{6}{7}$ frequency ratio are obtained from the receiver's front speaker terminals when in its STEREO² mode.

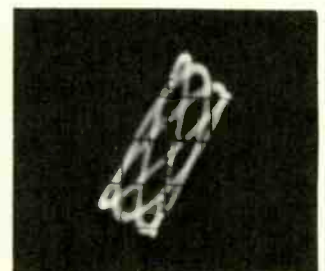

Fig. 11—Vector display produced when two signals of a $\frac{6}{7}$ frequency ratio are obtained from the receiver's right speaker terminals when in its STEREO² mode.

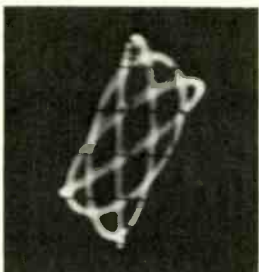

Fig. 12—Vector display produced when two signals of a $\frac{6}{7}$ frequency ratio are obtained from the receiver's left speaker terminals when in its STEREO² mode.

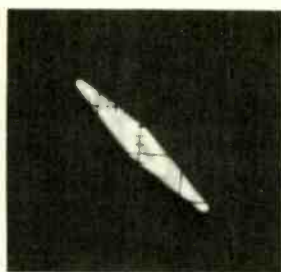

Fig. 13—Vector display produced when two signals of a $\frac{6}{7}$ frequency ratio are obtained from the receiver's rear speaker terminals when in its STEREO² mode.

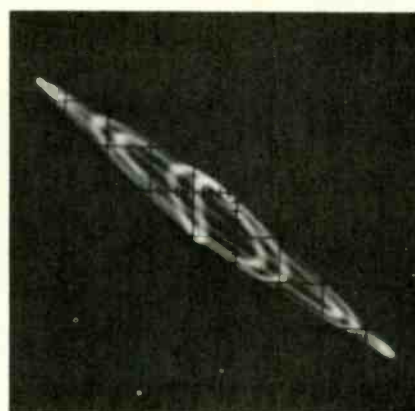

Fig. 14—Enlarged vector display produced when two stronger signals of a $\frac{6}{7}$ ratio are obtained from the receiver's rear speaker terminals when in its STEREO² mode.

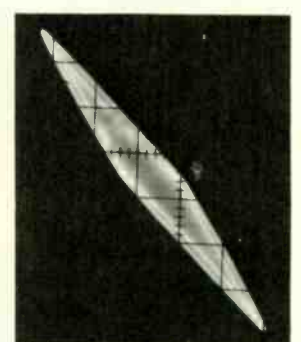

Fig. 15—Time exposure of changing vector pattern produced as two signals of approximately 1kHz—obtained from the receiver's rear speaker terminals when in its STEREO² mode—change through a complete range of phase angles.

Not-So-Simple MATV Problems with Not-So-Obvious Solutions

by Ray St. Louis

With the ever-increasing use of MATV systems in multi-set installations such as hospitals, hotels, motels, schools and high-rise apartment complexes, a great many interference problems often arise which require the use of additional filtering equipment which would not ordinarily represent a standard signal-distribution system. Often, part of inexpensive multiplexers or band splitters can do the job of more costly elaborate filters if the installer knows how to insert them properly into the signal-distribution system.

■ The few examples of system problems which are described in this article fall into two main categories. First, there are those types of interference problems which arise from causes not related to the installation—such as the presence of strong nearby signals which can overload the signal amplification devices in the MATV system and cause cross-modulation products of an unpredictable nature. Second, are those system-created problems which arise because of the need to introduce locally generated program channels which bear a frequency relation-

ship to existing, undesired transmission in the vicinity of the installation.

CB, Land Mobile and Ham Interference

Ordinarily, a broadband amplifier, such as Blonder-Tongue's CVB-45A shown in Fig. 1, would be used to provide the necessary gain for a medium sized MATV system. It has two separate amplifying sections—one for channels 2 to 6 plus FM, and the other for channels 7 to 13, each with its own GAIN control and TILT control to balance low-band and high-band signal levels and to compensate for the effects

of frequency-dependent cable losses. While this broadband amplifier has a band-pass characteristic from 54MHz to 108MHz and from 174MHz to 216MHz; attenuation outside these bands, although high, may not be sufficient to prevent strong-signal interference from local ham, landmobile or CB transmissions—all of which operate between 0 and 48MHz. Thus, the simple array shown in Fig. 2 can often be severely overloaded by the presence of such signals.

One solution would be to use a VHF/sub-channel multiplexer, such as

Blonder-Tongue's Model MSVM shown pictorially in Fig. 3. Normally, this high-performance filter is used in educational TV head-end systems, where it enables sub-channel TV signals (14-50MHz) from one or more closed-circuit TV cameras to be sent by means of existing TV distribution cables back to the "head-end" where they can be converted to unused VHF TV channels for distribution in the usual manner. To solve our interference problem, however, the VHF input is connected to the antenna line, while the sub-channel input (dc to

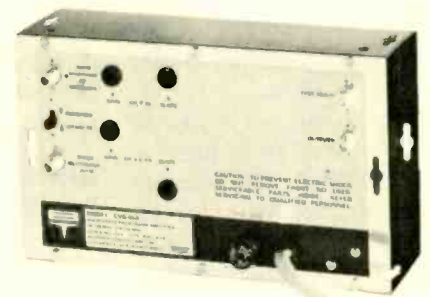

Fig. 1—Blonder-Tongue Model CVB-45A Broadband VHF Amplifier.

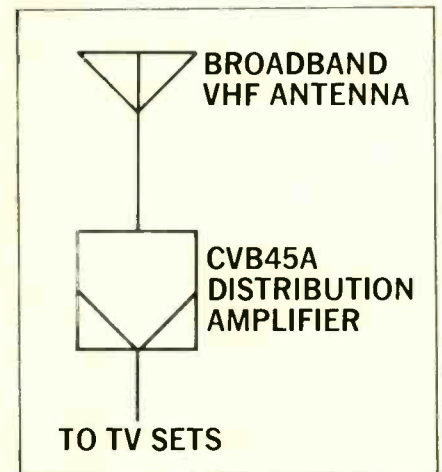

Fig. 2—A simple amplification system for MATV system signal distribution.



Fig. 3—Blonder-Tongue's Model MSVM VHF/Sub-Channel Multiplexer can be used as either a mixer or a splitter

48MHz) is simply terminated in its proper impedance, as shown in Fig. 4. While the insertion loss of the MSVM as a filter is only 0.25dB, the attenuation characteristic for all frequencies below Channel 2 will be greater than 40dB, as shown in the plot accompanying Fig. 4.

If 40dB of attenuation is not sufficient to remedy the interference caused by local, low-frequency transmissions, it is possible to cascade more than one MSVM unit, as shown in Fig. 5. This time, *both* sub-channel (low-frequency) inputs must be resistively terminated and, although the insertion loss now doubles to 0.5dB, attenuation of all frequencies below Channel 2 will now be 80dB or more, as shown, usually more than enough to get rid of the annoying interference.

Cross-Modulation from Nearby UHF Channel

Often, in weak signal areas, VHF band preamplifiers such as Blonder-Tongue's Skyliner VHF unit, will be mast-mounted to improve VHF reception, as shown in Fig. 6. A local UHF channel—say Channel 23—may be so strong in the area, however, that its incoming signal causes cross-modulation in the preamplifier. In this case, instead of using all manner of complex filters to try to attenuate incoming Channel 23 frequencies, a simple VHF/UHF mixer, such as Blonder-Tongue's Model A-107, can be inserted ahead of the preamplifier, as shown in Fig. 7. Normally, this mixer would be used to combine UHF and VHF signals together from their respective antennas, but in this case the UHF input is terminated with a 300Ω resistor. Resulting attenuation of the undesired Channel 23 signal is

roughly -30dB, as shown. A photograph of the A-107UHF/VHF mixer is reproduced in Fig. 8.

UHF-to-VHF Channel Conversion and "Beats"

In many MATV installations it is often desirable to translate a UHF signal down to an unused VHF channel for subsequent distribution in an all VHF system. In the example shown in Fig. 9, a Model UX-3 UHF-to-VHF amplified converter is shown converting a Channel 17 signal down to Channel 5. Nearby, a powerful transmitter is operating at a frequency of 164MHz. Because this signal is extremely strong, third-harmonic components generated in the converter will land squarely on top of Channel 17's frequency, causing visible beats to the output Channel 5 signal from the converter.

One possible solution might be the introduction of a Model MUVF Blonder-Tongue multiplexer, shown in Fig. 10. Normally, this device is intended for mixing together UHF and VHF signals from separate antenna down-leads (it is an indoor unit). In this case, however, the VHF unit is terminated resistively, as shown in Fig. 11, and the UHF output connector is fed to the UHF/VHF channel converter shown earlier. In this configuration, the multiplexer acts as a high-pass filter, affording greater than 40dB of attenuation to the undesired 164 MHz signal *before* it is supplied to the converter.

Two-Way ETV Systems

In school signal distribution systems it is often desirable to have a locally originated sub-channel signal sent "up the line" after re-amplification in a direction opposite that of the incoming VHF channels

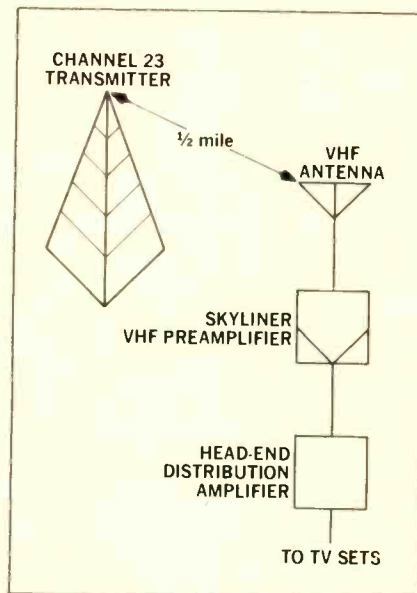
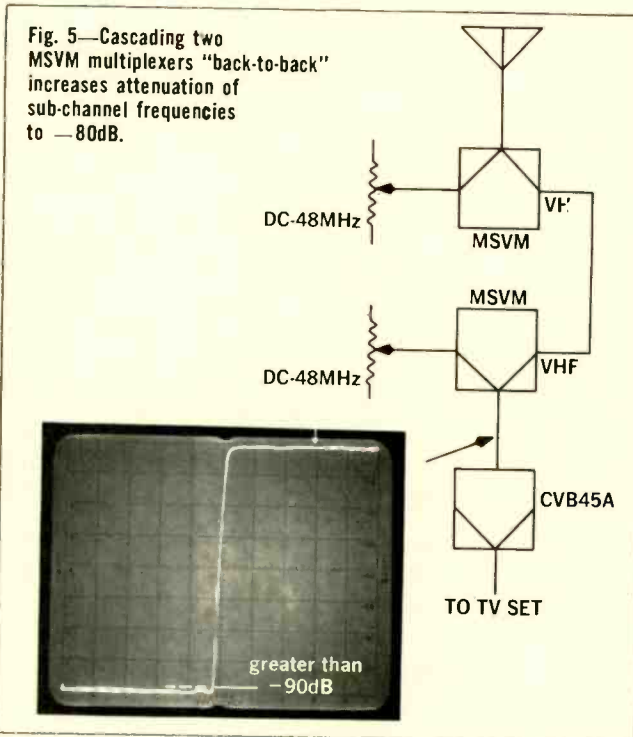
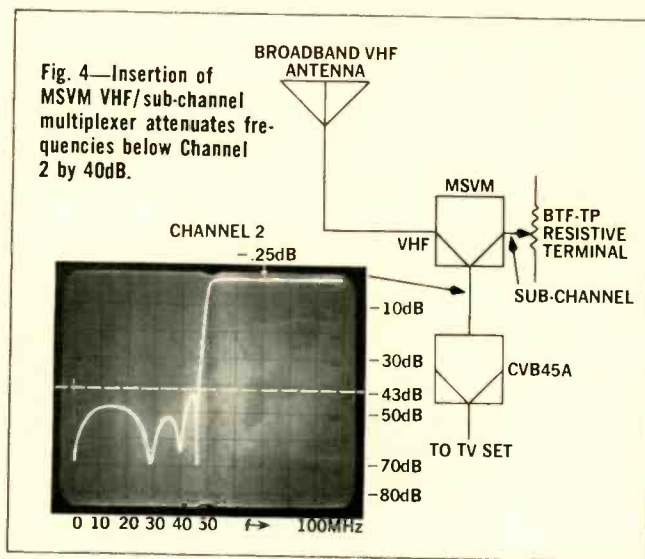

Fig. 6—Nearby UHF transmitter can cause cross-modulation interference in simple VHF MATV installations.

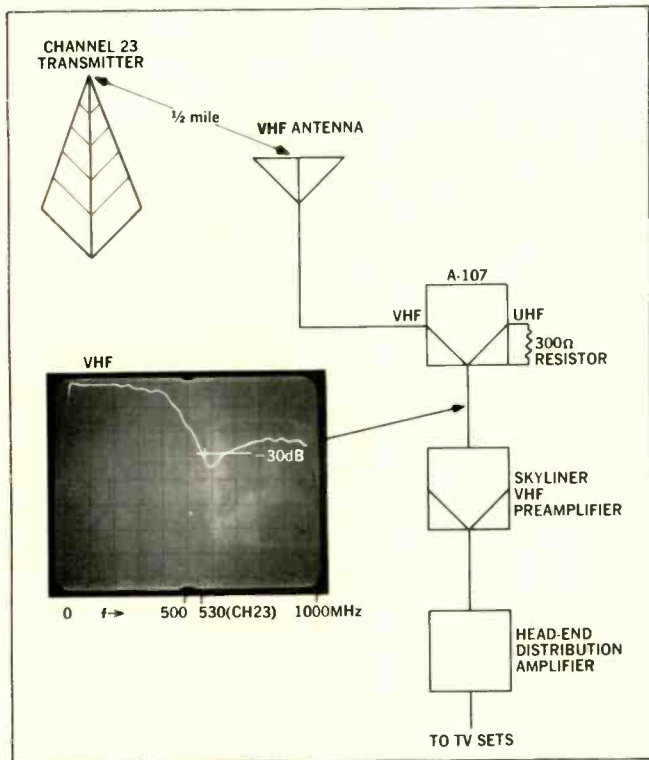

Fig. 7—VHF/UHF mixer is used to attenuate strong UHF signal prior to any amplification in this VHF MATV system.

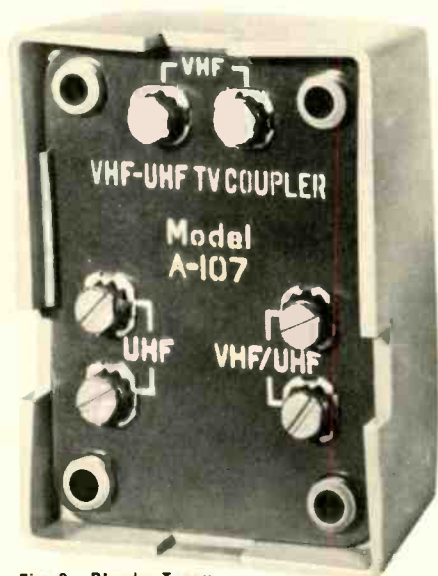

Fig. 8—Blonder-Tongue Model A-107 VHF/UHF Mixer.

Fig. 10—Blonder-Tongue Model MUVF UHF/VHF Multiplexer.



picked up from antenna distribution—so as to afford two-way communication. Fig. 12 illustrates how this may be accomplished using readily available multiplexers, plus a variable trap and a UHF/VHF broadband distribution amplifier.

Channel Removal and Substitution

A recent installation required the combination of a CATV multiple-channel feed as well as the introduction and down-conversion of two educational UHF channels to VHF frequencies. Since Channels

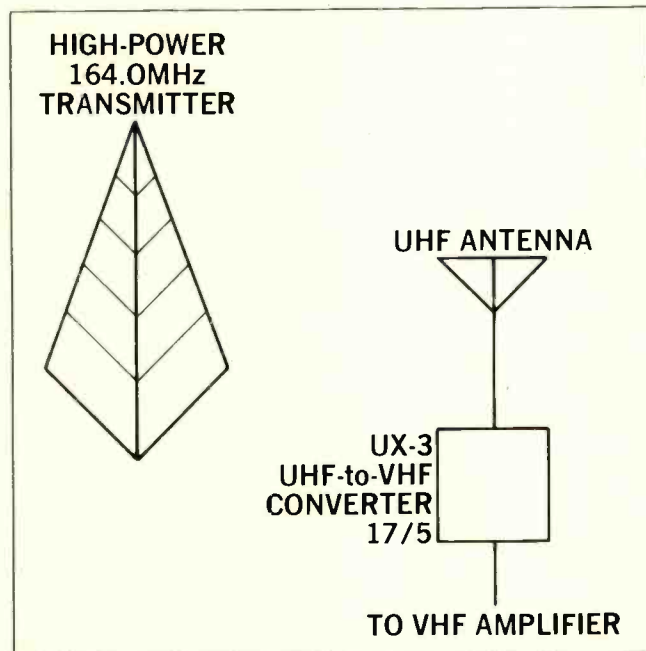

Fig. 9—Third harmonic of nearby VHF transmitter can cause "beats" to appear in converted Channel 5 signal.

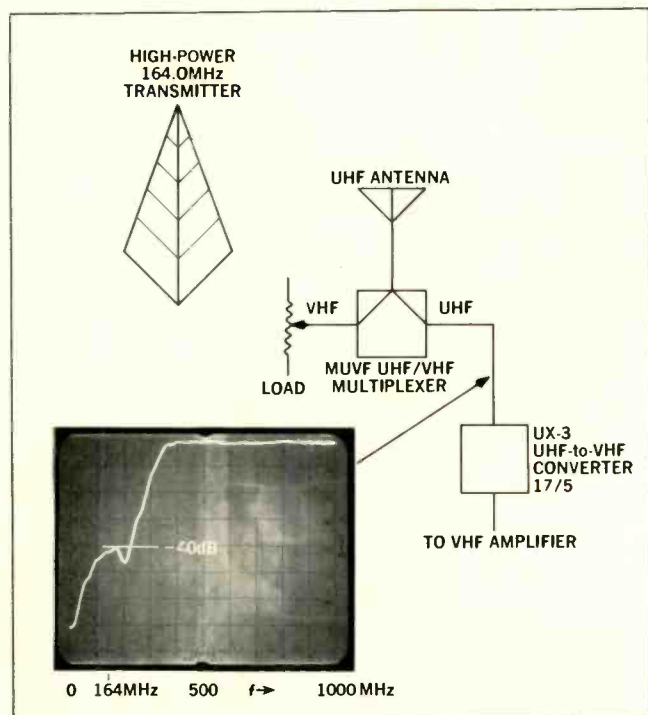

Fig. 11—Using MUVF multiplexer as VHF attenuator results in 40dB of attenuation of undesired strong VHF signal before application to UHF/VHF converter.

2, 3, 4, 5, 6, 7, 8, 9, 10, 11, 12 and 13 were all provided by the CATV feed, it was decided to eliminate Channels 6 and 8 from the feed by proper filtering and attenuation and to substitute Channels 31 and 50 by conversion to Channels 6 and 8 in the final system. To properly make such a substitution, however, it was found necessary to provide at least 58dB of attenuation of the CATV fed Channels 6 and 8 below the locally added channels if interference was to be invisible. Furthermore, the locally added channels had to be added to the system at a level approximately equal to that of Channels 5, 7 and 9 supplied by the CATV feed. Finally, the CATV feed itself had to be AGC controlled to keep adjacent-channel set-up constant, since virtually all the VHF channels are in use.

The final system design is shown in Fig. 13. Note

the double use of both the MLHF low-high VHF multiplexers and the various band-pass filters. At the left of the diagram, the first multiplexer is being used in a reverse manner—that is, the input includes all the CATV fed channels, while the two outputs provide a separate low- and high-band group of channels. The band-pass filters for Channels 6 and 8, shown terminated, actually act as sharp-notch filters attenuating the undesired CATV-fed Channel 6 and 8 signals; while the complementary pair of band-pass filters in line with the down-converted newly derived Channels 6 and 8 (actually Channel 31 and 50 programming) are utilized as an additional function in their more conventional application — passing Channel 6 and 8 frequencies while rejecting all others. The MLHF low-high VHF multiplexer shown at the right of the

diagram is used to remix low and high channels—the original purpose of this product—feeding the new combination of signals on to the distribution system.

Summary

Proper understanding of the way in which simple filters and band-pass networks operate can of-

ten enable the MATV system designer and installer to solve problems in novel and often inexpensive ways. We have shown just a few typical examples of how these products can multiply their usefulness, but the reader actively engaged in MATV work will surely be able to come up with many more equally effective applications. ■

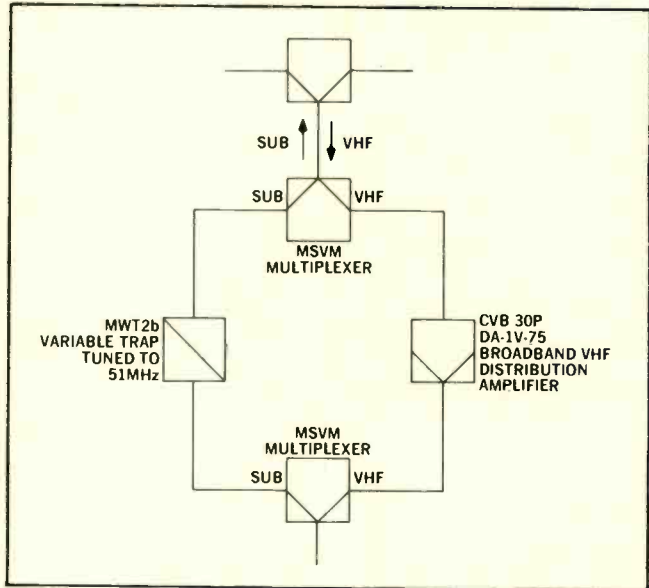

Fig. 12—Reamplifying signal in a sub-channel two-way system.

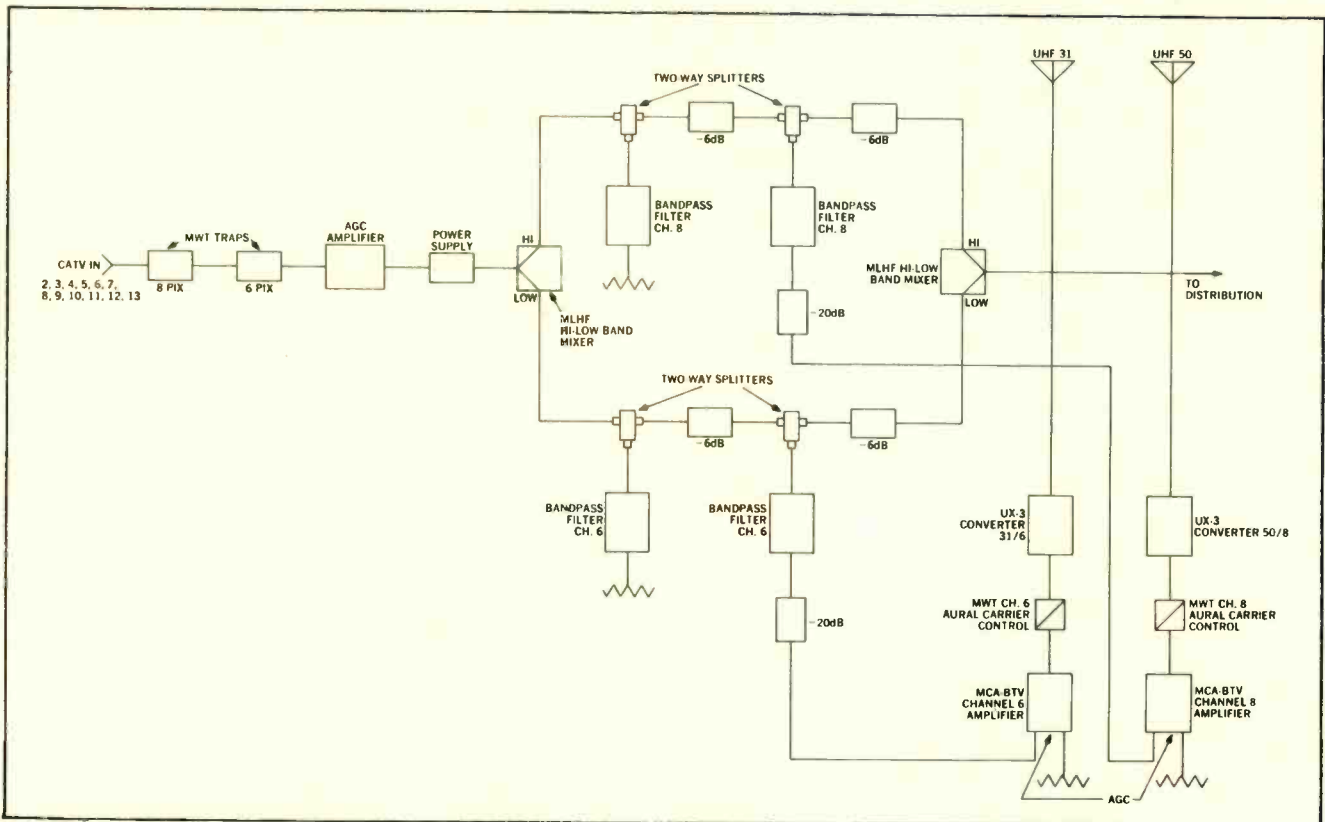

Fig. 13—MATV/CATV system in which CATV Channels 6 and 8 are replaced by ETV Channels 31 and 50, which have been converted to VHF channels. Blocks noted as -6dB and -20dB are fixed attenuators used for matching purposes.

TEST INSTRUMENT REPORT

B & K/Precision Model 501A Semiconductor Curve Tracer

by Phillip Dahlen

Permits comparison of semiconductor characteristic curves both in and out of circuit



B & K/Precision's Model 501A Semiconductor Curve Tracer. For more details circle 900 on the Reader Service Card.



The FP-3 test probe for making in-circuit measurements with the curve tracer.

■ The B & K Precision division of Dynascan Corp. is producing a semiconductor curve tracer that can reportedly be purchased with a special test probe for making in-circuit measurements, plus a special scope graticule for easier use of the characteristic curves produced on a scope. The instrument is designed for use with any scope having moderate horizontal and vertical input sensitivity.

Since the instrument comes with two transistor sockets, plus inputs permitting the simultaneous connection of up to two in-circuit test probes, this feature makes it ideal for either comparing semiconductors (including FETs) out of circuit, or even comparing the solid-state characteristics of two solid-state circuits. [We used the instrument to effectively compare the solid-state red and green output circuits in a circuit board that had been removed from a color-TV set.]

In addition to the components just mentioned, the manufacturer includes a useful 40-page instruction manual with the instrument, explaining in detail its specifications and the various applications possible with the instrument. Some of the specifications included in that manual are listed at the right:

Collector Sweep

Range:
Polarity:
Current Limiting:

0 to 100v dc peak at 100ma maximum.
NPN (N-Channel) or PNP (P-Channel).
Automatic at approximately 130% of full scale for each vertical attenuator range.

Sweep Generator

Current Ranges:
(11 total)

1 μ a, 2 μ a, 5 μ a, 10 μ a, 20 μ a, 50 μ a, .1ma, .2ma, .5ma, 1ma, 2ma per step; $\pm 3\%$ constant-current steps.

Voltage Ranges:
(5 total)

.05v, .1v, .2v, .5v, 1v per step, $\pm 4\%$; 1K source resistance.

Number of Steps:
Steps per Second:
Step Polarity:

Six, continuous display.

120.

Same as collector sweep (NPN or PNP); inverted in volts/step positions.

Calibration

Source:
Attenuator Range:

$\pm .05v$ to 5v p-p, $\pm 3\%$ accuracy.

1ma, 2ma, 5ma, 10ma per division vertically, $\pm 3\%$.

Additional

Sockets:

Two TO-5 type transistor sockets (right and left) with each pin (three per socket) paralleled by a banana jack for external cables. Slide switch selects right or left socket.

Output Terminals:

Banana jacks for vertical, horizontal and ground outputs to scope.

Accessories:

Cables to scope.

Mylar 10 x 10 division graticule.

FP-3 probe.

Instruction Manual.

Power Requirements:

105v to 125v ac, 50/60 Hz, supplied with three-wire line cord.

Dimensions:

40 in. H by 10 in. W by 9½ in. D.

Weight:

6 lb.

COLORFAX

The material used in this section is selected from information supplied through the cooperation of the respective manufacturers or their agencies.

EMERSON

Color-TV Chassis K20—Failure of Sound IC

If failure of the sound IC in the K20 chassis is encountered, check the wiring of capacitor C134, .022 μ f. This capacitor should be connected to the shield braid of the leads going to the VOLUME control. If C134 is found to be grounded to the control bracket, it should be disconnected from the bracket and connected to the shield braid ground.

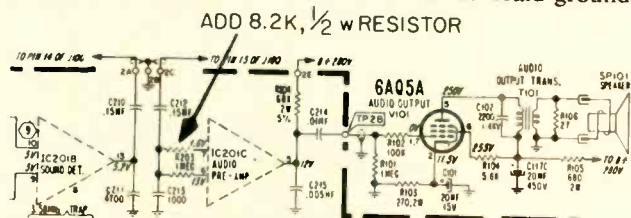

The production change now being incorporated in the K20 chassis protects the sound IC by connecting an 8.2K, 1/2w resistor between Pin 7 of the IC and the junction of capacitors C212 and C213 and resistor R203, as shown in the partial schematic. If the 8.2K resistor is installed in the field, it is necessary to cut the foil pattern and to keep the leads short.

Color-TV Chassis K17/K18 Run 16 and Under—"Snaking" in the Picture

To reduce "snaking" in the picture (video bend) with changes in contrast level, redress the orange lead, which

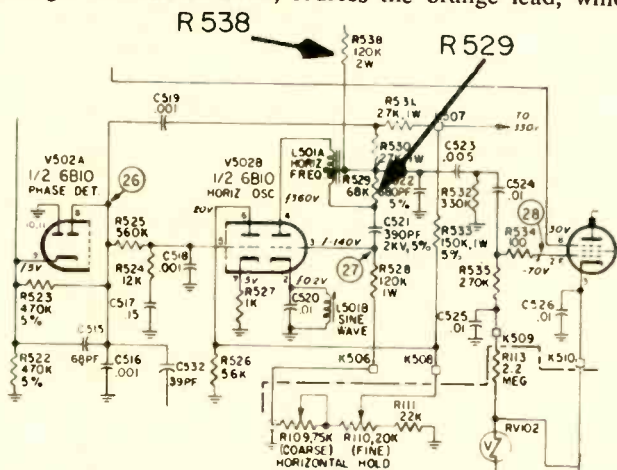

is connected between resistor R538 (120K, 3w) and resistor R529 (68K, 1/2w), away from the delay line.

GENERAL ELECTRIC

Color-TV Chassis MA—Dark Horizontal Line Rolling from Bottom to Top of Screen

In moderately weak signal locations, a dark horizontal line approximately 1/16-in. in width may be seen rolling from the bottom to the top of the screen when properly tuned and adjusted.

Capacitor C112 is a BPE (Bipolar Electrolytic) 2.2 μ f capacitor located between the tuner and the exterior wafer on the rear of the tuner. Leave this capacitor in place and

add a 1 μ f, 50v polarized capacitor from either side of the BPE capacitor to ground, with the negative side connected to ground. Since a lead from the BPE capacitor connects to a terminal on the UHF tuner, this is a convenient mounting location. This capacitor is stocked as Part No. EP31X16.

MAGNAVOX

Correction for Horizontal Convergence "Blue Droop"

Inability to converge horizontal blue lines at the edges is described as "blue droop." This condition can be corrected by optimizing the value of resistor R816, which is connected in series with the HORIZONTAL BLUE TILT control. In most chassis, resistor R816 will be a 10 Ω , 1w resistor. In some cases, however, the tolerances in the circuitry will be such that the optimum value of resistor R816 for proper correction may be 22 Ω or 33 Ω . If this condition is noticed on a particular chassis, you may find that the best value for resistor R816 may be anywhere between 10 Ω and 33 Ω .

Color-TV Chassis T952—Elimination of 3.58MHz Beat Pattern

Later versions of the T952 chassis incorporate a 33pf capacitor across L19 in the delay line circuit. This capacitor, which is identified as C75 (Part No. 250508-3305)

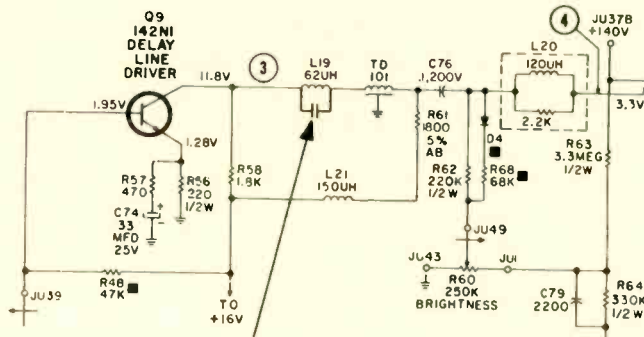

can be added to earlier version chassis to improve performance in cases where this beat pattern is noticed.

Color-TV Chassis T952—Removal of Capacitor C220 for Reduction in Heat Dissipation

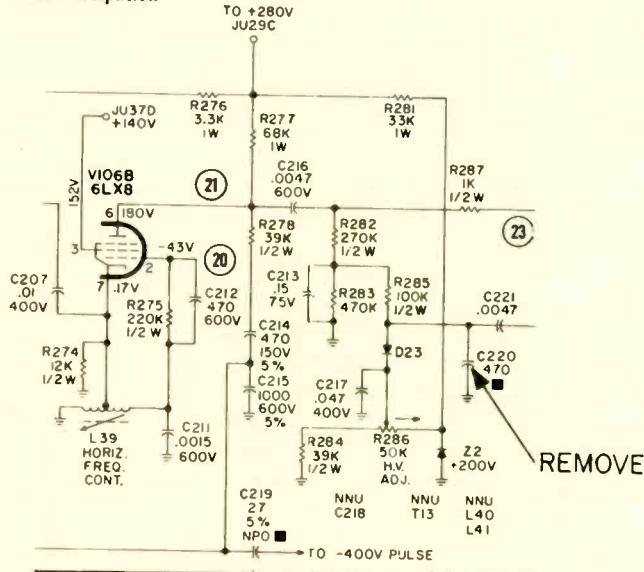

Capacitor C220 (470pf) was used in some T952 chassis—connected between the junction of C221, resistor R285 and diode D23 to ground. This capacitor was removed in later production and results in a reduction in heat dissipation in the horizontal output circuit. You are requested to remove this capacitor, if found in any T952 chassis that you are servicing.

PHILCO-FORD

Color-TV Chassis 3CS90/91 and 3CY90/91—Picture Tube Test Jig Yoke Adapter

Because of the differences between the yoke employed in a picture tube test jig and yoke used in the Philco modular chassis, a yoke conversion adaptor must be used when troubleshooting any of the subject chassis.

Under no circumstances should a standard yoke be plugged into a modular chassis. Therefore, the manufacturer has available a conversion adaptor which can be used on the Philco modular chassis as well as many other modular brands. The adaptor may be ordered under part number 328-0334-2.

Color-TV "A" Line Chassis 23-in. and Smaller Screen—Three Vertical Lines in Left Side of Raster

In the event three black vertical bars appear on the left side of the raster—with or without video information—field reports indicate resistors R77 and R78 may be the cause. It is recommended that resistor R77 be changed to 330K, 1/2w. It is also suggested that resistor R78 be changed to

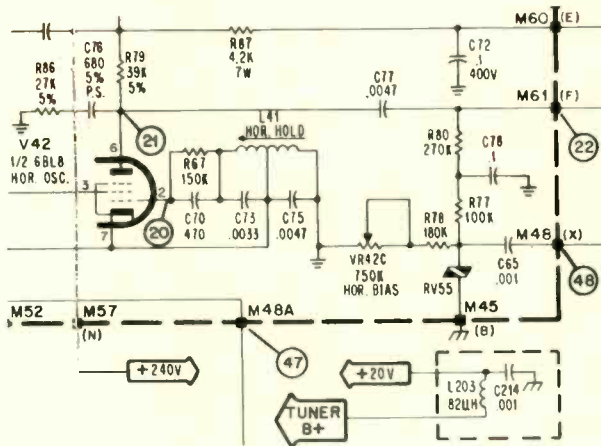

100K, 1w and be mounted vertically on the panel. Check the HORIZONTAL BIAS ADJUST control which should be set at its maximum high-voltage setting.

For an improvement in performance, resistors R77 and R78 may be changed to these values indicated on all incoming chassis repairs, thereby, possibly eliminating the occurrence of the symptoms described.

All Hybrid Color-TV Chassis—Vertical Rolling

Field reports have indicated that a potential problem of vertical rolling may exist because of the failure of capacitor C59, 8200pf, located at the grid of the vertical-oscillator tube. Should this capacitor develop leakage, complete loss of vertical sync develops and the VERTICAL HOLD control has no effect.

Failure of capacitor C59 may be caused by heat generated by resistor R64 (750Ω or 1.5K, 7w), which is in close

continued on next page

Business Partners



Two new Heathkit Calculators.

At left is the totally new Heathkit IC-2009. It's first a self-contained portable, weighing in at 11 oz. and small enough to fit in your coat pocket. But it's a desk-top calculator, too. The internal Nickel-Cadmium battery gives five to eight hours use between charges. Or, the IC-2009 can be left connected to its charger for indefinite operation. And unlike other pocket calculators, the Heathkit IC-2009 is designed to be maintained by you. Plug-in keyboard and display boards, plus a complete troubleshooting section in the manual, make it easy — and economical. Add up the features for yourself: 8-digit capacity. Four arithmetic functions. Full floating decimal. Constant key. Chain calculation capability. Clear entry key. Entry and total overflow indicators. Negative answer indicator. Battery-saver circuitry. Low battery indicator. Tactile-feedback keyboard for positive entry indication. Order your IC-2009 now. You'll have it built in two or three evenings. Mailing weight, 3 lbs.

The Heathkit IC-2108 on the right features a sleek, low-profile case with bright 1/2" readout tubes in an 8-digit display — one of the largest, most legible in the industry. The color-coded keyboard is human engineered to slope down to the desk so you can rest your arm while using. And the IC-2108 is loaded with features: Four arithmetic functions. Floating and fixed decimal. Constant key. Chain calculation capability. Clear display key. Entry and result overflow indicators. Negative number indicator. 120/240 VAC operation. In addition, the IC-2108 is amazingly simple to build. Two spare evenings will do it. Kit IC-2108, 4 lbs.



HEATH
Schlumberger

HEATH COMPANY, Dept. 24-4
Benton Harbor, Michigan 49022

Please send my FREE Heathkit Catalog.

Enclosed is \$_____, plus shipping.

Please send model(s)_____

Name_____

Address_____

City_____ State_____ Zip_____

*Mail order prices F.O.B. factory GX-274

... for more details circle 117 on Reader Service Card

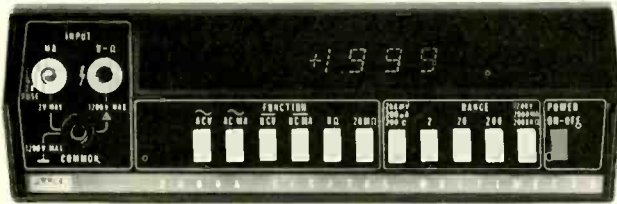

Think of it as the best tester in your bag. Only \$299

Now you can get a high performance Model 8000A Digital V.O.M. from Fluke, America's foremost maker of quality digital multimeters, especially designed for TV, radio, stereo and audio service. No other digital V.O.M. gives you the resistance range to check breakers and switches, the high resolution voltage to look at emitter base and other transistor voltages, excellent ac accuracy and full accuracy with a 30 second warm-up.

Measures in 26 ranges 100 μ V to 1200 V, 0.1 μ A to 2A, and 100 mill Ω to 20 meg Ω with a basic dc accuracy of 0.1%. Full year guarantee. Low cost options include rechargeable battery pack, printer output, deluxe test leads, HV, RF & 600-amp ac current probes, carrying case, and rack mount. Unique self zero eliminates offset uncertainty. Electronics securely mounted in high-impact case. Service centers throughout U.S., Canada, Europe and Far East for 48-hour turnaround repair.



P. O. Box 7428,
Seattle, Washington 98133.

Get all the details from your nearest Fluke sales office. Dial toll-free 800-426-0361 for address of office nearest you.

... for more details circle 112 on Reader Service Card

New Cordless SOLDERING IRON greatest advance in soldering since electricity

The new Wahl "Iso-Tip" lets you solder in difficult-to-work places without a cord hindering your action; lets you move from place to place without plug or extension cord! (Patents Applied For) Just press the button and you have soldering heat in 5 seconds. Nickel cadmium batteries power up to 100 joints or more. Recharges in stand (included) to full charge overnight. Replaceable, isolated-tip design eliminates electrical leakage and need for grounding. Tip performance equivalent up to 50 Watts. Fine tip standard. Work light and pilot light built-in. Weighs less than 6 ounces! See how fast and easy soldering can be. Only Wahl makes it — \$19.95.

WAHL®
CLIPPER CORPORATION
Department 4
2902 Locust Street
Sterling, Illinois 61081
815-625-6525

Model
7500

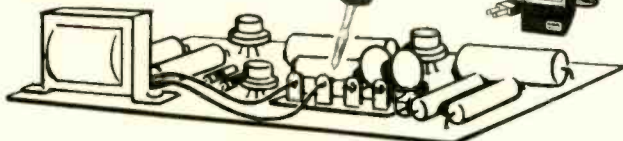

Contact your local distributor or write direct.

... for more details circle 135 on Reader Service Card

COLORFAX...

continued from page 49

proximity to capacitor C59. It is therefore, strongly recommended that should this capacitor be found to be defective, be sure that resistor R64 is kept as far away from the capacitor as possible after replacement. Also, when performing any type of service on a hybrid chassis, reposition resistor R64 away from the capacitor to prevent any future failure of the capacitor.

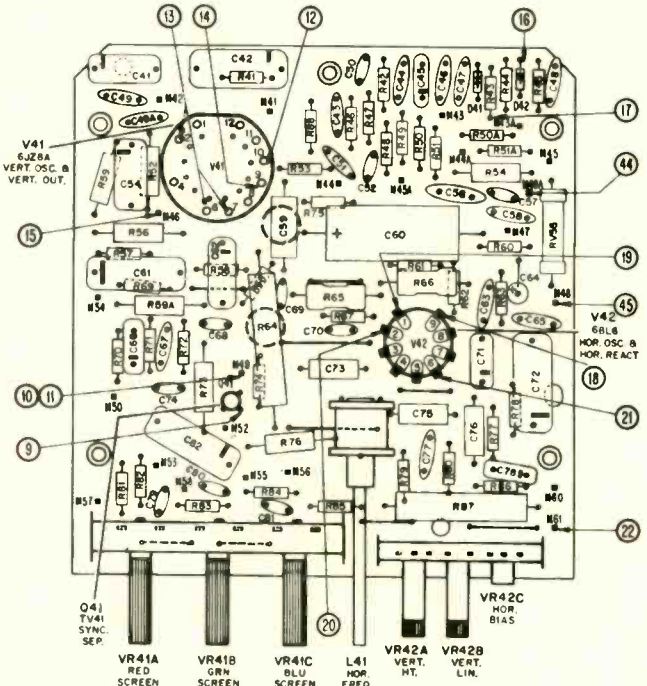

ONE PLUS ONE

continued from page 42

shown in Fig. 15.

Your editor is of the opinion that the Quadraphonic receiver examined for this article does an excellent job in performing the task assigned it. Its music does sound good, and one does tend to feel enveloped in an enjoyable room of sound. As indicated previously in the article, the receiver is designed to handle discrete four-channel sound (as far as our current commercial technology will take us) and is built to adapt readily to future discrete four-channel systems once they are on the market. To fill in the current gaps, we do have the four-channel synthesizer (stereo²). Although it may use a slightly different phase angle to synthesize the additional

channels, we understand that it does operate on the same basic principle as all other phase-control systems now on the market—and is subject to the same basic limitations. Although more enjoyable than mere stereo, one should recognize these limitations. For instance, two musical instruments producing a note of similar frequency will not remain in constant phase with one another. Any shift in their relative phase angles will likewise shift their apparent location in the room—as determined by the fluctuating volume at the rear speakers.

However, as we recognize these limitations, we must also realize that this system does offer us the pleasure of listening to good music in a manner not possible in the past with stereo. ■

How to tell which is the largest compact van built in America.

(No matter how you look at it.)

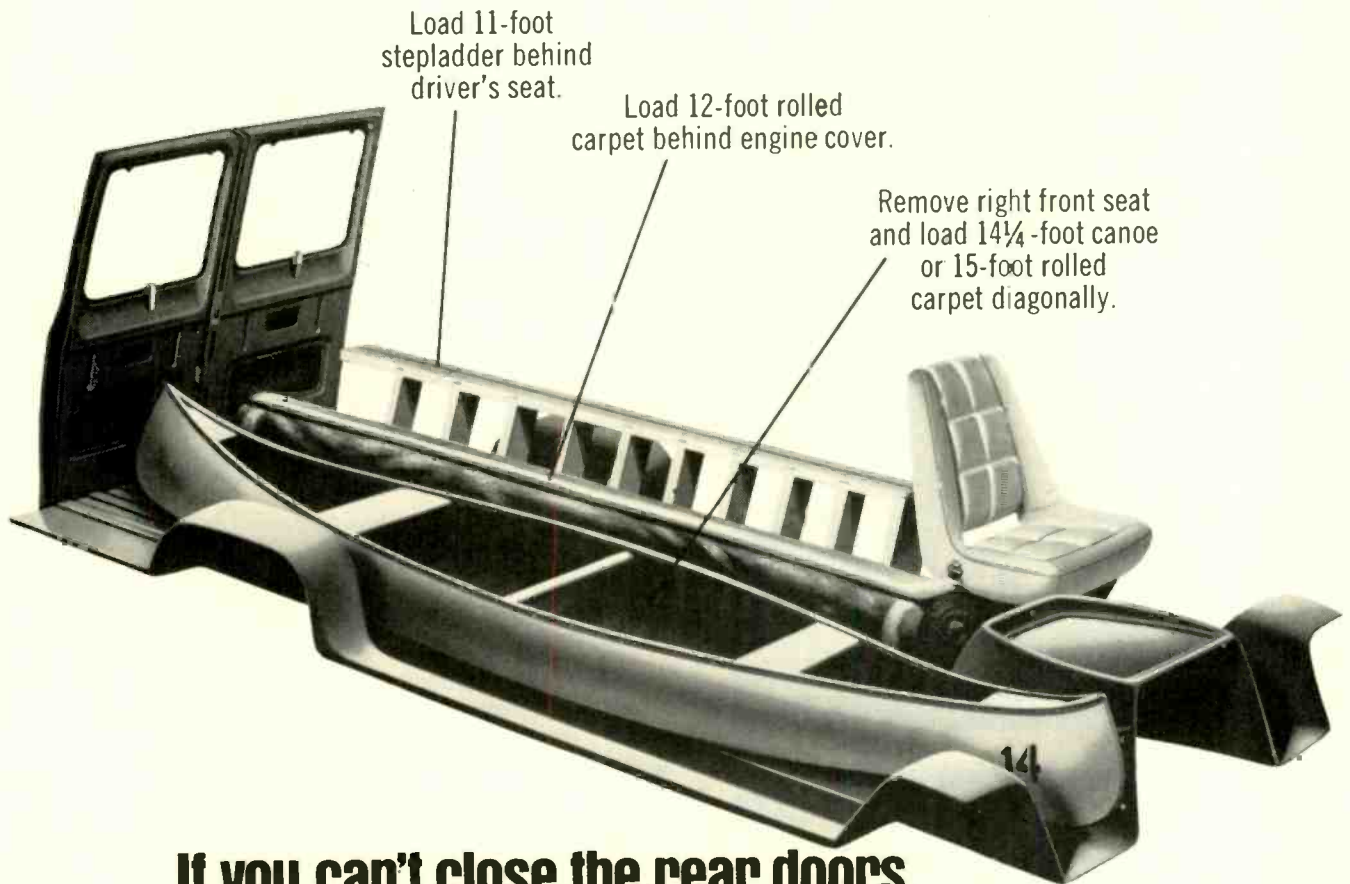

**If you can't close the rear doors,
you haven't loaded a Dodge Maxivan Strong Box.**

And you'd better get one.

Dodge Maxivans give you a lot more than just more room:

Independent front suspension and longer 127-inch wheelbase mean better handling and ride. □ Shorter turning circle. Even with a big 127-inch wheelbase, you get greater maneuverability. □ Only Dodge has vans with the Electronic Ignition System as standard equipment. It helps to keep your van running like new longer than conventional ignition systems do. It decreases the frequency and cost of tune-ups. And it sends up to 35 percent more starting voltage to each sparkplug in difficult starting conditions. □ Power brakes with discs up front. □ Three-speed TorqueFlite automatic transmission.* □ Biggest V8 offered. 360 cubic inches.* □ Power steering.* □ Air conditioning.* □ Wind-tunnel body and curved windows reduce wind-sway effect.

□ Front wheels can be inexpensively realigned on passenger-car equipment. □ Large hood opening makes the battery, dipstick, and radiator easy to reach. □ Engine can be removed quickly and easily through the front. □ Smaller engine cover is easy to remove for servicing. It also makes it easier to reach the cargo area. □

Extra rust protection on the undersides, doors, and panels. □ Big 23 gallon gas tank. □ Full-foam padded front bucket seat for more driver comfort. □ Front passenger's seat* does not block side cargo door entrance. □ Wider front doors and steps. □ Concealed side safety-step offers firm footing since it doesn't collect rain, snow, or ice. □ Two-stage door checks conveniently hold doors in two positions. □ And the list continues at your Dodge Dealer's.

Dodge Maxivan takes the "packed" out of compact vans!



*Optional at extra cost.

**Extra care in engineering makes
a difference in Dodge... depend on it.**



... for more details circle 106 on Reader Service Card

NEW EICO TR-410

Solid-State Triggered Sweep 10MHz Oscilloscope

\$379.95

Never before has so much been built into a low cost solid state triggered sweep scope!



INCLUDES EXCLUSIVE DUAL PROBE

EICO introduces the first laboratory quality, high performance, wideband Triggered Sweep Oscilloscope, at a price you can afford!

Use as Vectorscope for Color TV Servicing ■ 3 calibration voltages (2, 5 and 10) ■ Quick connect BNC connector at Vertical Input ■ Front panel adjustable Horizontal and Vertical DC Balance Controls ■ Vertical and Horizontal selection of AC or DC modes of amplification ■ Sweep synchronized Gate Output ■ Flat-faced CRT ■ Z Axis input ■ Rear panel astigmatism control ■ Edge lit calibrated screen ■ Operates on a standard 120 volt, a low 100 volt or a 220-230 volt line.

FREE 1973 EICO CATALOG

For name of nearest dealer and free catalog check re-order service card or send 25¢ for prompt first class mail service. EICO—283 Malta St., B'klyn, N.Y. 11207



... for more details circle 110 on Reader Service Card

Now!! Selling Direct To Public

Big Powerful 7 H.P. Briggs & Stratton
Mustang RIDING MOWER

DIRECT
FROM FACTORY
TO YOU.

1973 Model

constructed of steel and built for constant rugged use, this powerful 7 H.P. Mower will easily cut grass and weeds 3 feet deep, pull fertilizer distributor, seeder, roller or any other lawn attachment for your lawn needs.

now **\$229.95**
Full Price

TAX & FREIGHT PAID
TO YOUR DOOR



Compare at **\$349.95**

ACTUAL PHOTO
OF MOWER YOU
WILL RECEIVE

- ONE FULL YEAR NATIONWIDE FACTORY WARRANTY
- COMES COMPLETE WITH ILLUSTRATED PARTS LIST AND FULL OPERATING INSTRUCTIONS.
- TWO DAY SERVICE ON PARTS MOST STATES
- COMES COMPLETELY ASSEMBLED IN CRATE.
- BEAUTIFUL BAKED ON RUST PROOF ENAMEL FINISH
- MADE IN U.S.A.

WE REPEAT **\$229.95**
FULL PRICE

Tax & Freight Paid TO YOUR DOOR

TO OWN ONE RUSH CHECK OR MONEY ORDER

TO: **FRANKLIN MANUFACTURING SALES**
2783 MAIN STREET
EAST POINT, GEORGIA 30344
PHONE (404) 768-4585

FEATURES

- 7 H.P. BRIGGS & STRATTON (EASY SPIN START) ENGINE
- HEAVY GAGE ALL STEEL CONSTRUCTION
- BIG 25" CUTTER AND MOWING DECK
- RUGGED!! THREE-POSITION TRANSMISSION
- EASY HEIGHT ADJUSTMENT, VARIABLE FROM 1 1/2" to 3 1/2"
- AUTO TYPE STEERING

- BALL JOINT ADJUSTABLE TIE-RODS
- TROUBLE FREE POSI-TRAC CHAIN DRIVE
- LARGE 3 x 10 TRACTOR CLEAT SURE GRIP REAR TIRES
- ALL TIRES SEMI-NEUMATIC
- SAFETY CLUTCH
- WIND TUNNEL DESIGN VACUUM-SUCTION AUSTEMPERED STEEL DECK.

ALSO AVAILABLE:

- STURDY, LARGE GRASSCATCHER ONLY \$20.00
- SNOW PLOW ATTACHMENT LOW PRICE OF \$34.50 THIS PRICE ONLY APPLIES WHEN PURCHASED WITH LAWN MOWER.

A TRULY GREAT OFFER. UNBELIEVABLE, AT TODAY'S INFLATED PRICES

... for more details circle 115 on Reader Service Card

TECHNICAL DIGEST

The material used in this section is selected from information supplied through the cooperation of the respective manufacturers or their agencies.

ADMIRAL

Polyester-Film Capacitor Identification

Many current Admiral electronic products use a green rectangular plastic capacitor with both leads at the bottom. Polyester film is used as their dielectric.

Some of these capacitor types have the value printed on the case (.01, 0.02, etc.), while others have the value printed in a code which consists of the first two digits of the value in picofarads, plus a digit which indicates the number of zeros that follow. For instance: 223 represents 22000pf or .022 μ f, 103 represents 10000pf or .01 μ f, etc.

The letters M, K or J indicate tolerance: M represents 20%, K represents 10% and J represents 5%. The working voltage and vendor code also appear on many. Most capacitors of this type have this information neatly arranged on four separate lines.

PHILCO-FORD

Hi-Fi Tuner Chassis Models C8180UWA/C8182UPC—Removing Tuner Chassis

Before the Hi-Fi tuner can be removed for servicing, the bezel overlay and tuner bezel must first be removed. To remove these, use the following procedure while referring to the exploded view drawing: Remove all knobs and the two cross-head screws at the rear of the bezel overlay. Lift the rear of the bezel overlay gently and slide it towards the rear of the cabinet so that the bezel overlay tabs clear the

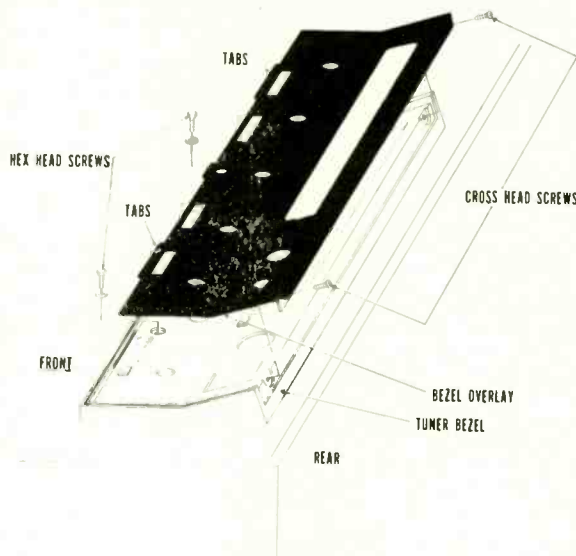

tab holes in the tuner bezel. Remove the two hexhead screws which captivate the tuner bezel to the tuner bracket and remove one hex head screw (located on the bottom of the wood panel) and clip which hold the tuner bezel, then remove the bezel.

The chassis can now be removed as follows: Remove the two hex-head screws holding the front of the tuner bracket (screws located on the top side of the wood panel). Remove the two nuts holding the rear of the tuner bracket (nuts located at the bottom of tuner bracket), then remove the tuner from the cabinet.

NEW PRODUCTS

For additional information on products described in this section, circle the numbers on Reader Service Card. Requests will be handled promptly.

ACOUSTIC RESPONSE ANALYZER 703

Analyzes full audio spectrum

A new instrument for analysis of the full audio spectrum, the Model ARA-411 Acoustic Response Analyzer, is available in a portable case or

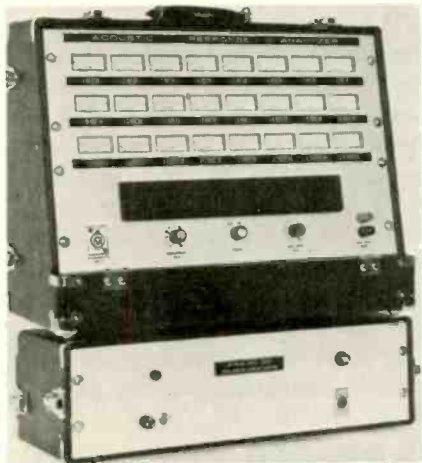

for rack mounting. The unit utilizes 24 meters to provide simultaneous measurement of the audio frequency spectrum at 1/3 octave center frequencies from 62.5Hz to 12.5 kHz. There are 24 adjustable band pass filters for measurement purposes. The instrument has a built-in amplifier with 70v, 18w output for checking system gain. High level and microphone inputs are provided with GAIN controls. The enclosure dimensions are 16-in. high by 20-in. wide by 10-in. deep, and total weight is 36 lb. Communications Co.

VHF BROADBAND AMPLIFIER

Protected from lightning and power-line voltage surges 704

A solid-state VHF/FM amplifier, Model CVB-30A, designed for medium sized MATV systems, features separate GAIN controls for high- and low-band channels, thus permitting individual balancing of both bands to compensate for higher cable losses in high-band service. This additional flexibility also helps to reduce cross-modulation interference. An inductively-coupled emitter feed-back circuit is said to provide a wide dynamic range and enables the use of the unit even where both strong and weak signals co-exist. The input circuit is re-

portedly protected from lightning, and a fused power supply affords positive protection against power-line voltage surges. With both GAIN controls fully



open, rated full gain is typically 35dB for the low TV channels and FM, and 33dB for channels 7 through 13. Input and output impedance is 75Ω and noise figure for the amplifier is said to be typically 8dB. Output capability is rated at +52dBmV per channel for seven channel operation. Blonder-Tongue Laboratories.

POCKET CALCULATOR KIT 705

Offers eight-digit display with full floating decimal

A portable pocket calculator, Model IC-200, is said to be a battery-powered, self-contained calculator offering an eight-digit LED display with full floating decimal. In addition to the four arithmetic calculations, a CONSTANT key is said to permit chain

calculations. A CLEAR ENTRY key allows removal of an entry from the display window without disturbing prior calculations. Specifications indicate that negative answers, entry and total overflow indicators are automatically displayed. The internal nickel-cadmium battery is said to give 5 to 8 hrs. of use between charges from the battery charger supplied with



the kit. A battery indicator warns of low battery charge. A built-in battery-saver circuitry blanks each display after 15 sec. to preserve the charge. The display is instantly reactivated by pressing the DISPLAY key, or entering another number or operation. Heath Co.

The "Country Boys" Have it!

Isn't an absolutely safe
BEL Chemical FUSE
worth a nickel more?

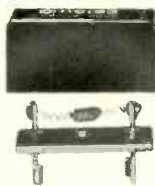

Bel Chemical Fuse

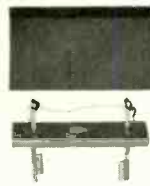

Wire Type Competitive Fuse

If there's any doubt about which replacement fuse to install in your customer's TV set... install the only fuses used in original television sets... BEL-FUSES. It's what's inside that makes BEL-FUSES safe for expensive sets... a chemical. Never substitute a wire type fuse. Here's why. Break open an Oneida BEL-FUSE. Now do the same with the one that looks like ours. Light a match to each. Result? The chemical in the BEL-FUSE blows instantly. And you'll burn your fingers before the other one blows. This same safety protects the circuitry in TV sets. So specify Oneida BEL-FUSES.

We even have handy Oneida Caddy Kits with a complete range of BEL-FUSES... for all major TV sets. See your Oneida Distributor or Dealer TODAY.



The "Country Boys" Appreciate Your Business

ONEIDA ELECTRONIC MFG. INC.
MEADVILLE, PA. 16335



George Dalton

ELECTRONIC
MFG. CO.

Oneida

SEE US IN BOOTH F-39-41 NEW COM '73 LAS VEGAS

... for more details circle 123 on Reader Service Card

TEKLAB ...

continued from page 31

feated; and when closed, the circuit is activated again by means of a switch in the door panel.

The UHF/VHF pushbutton channel selector changes the preselected channel by varying the "tuning" voltage to the tuner. Five switching diodes are made non-conducting on channels two to six. This effectively increases the tuning inductances required for tuning low-frequency signals. There are three

modes, or three bands, of operation. Any one of the 12 selector positions is capable of tuning to any channel —2 through 83. Bandswitching is accomplished by shipping different sets of voltages to the UHF/VHF tuner.

There are several voltages needed for bandswitching, the ACT voltage has a different range on UHF and VHF, the AGC is switched on VHF or UHF, etc.

When the channel select button is depressed, a bar is activated to a preset position determined by the band selected. This bar engages five

switches, selecting the proper tuner voltages and connecting the variable tuning potentiometer into the circuit. Because of the complexity of all these switches in the tuning unit, it will not be considered serviceable by the manufacturer. The assembly, complete with pushbuttons, switches and bulb sockets, will be carried as a replacement unit. The tuner panel, wiring harness, bulbs, door ACT switch, AC POWER switch, VOLUME control, door and bracket are not part of the pushbutton tuning unit.

Power-Supply Module

The power-supply module contains most of the smaller components (such as resistors, diodes, transistors, controls, etc.) used in conjunction with the low-voltage supplies and the 20v regulated supply. The dc supply voltages include: +250, +40, +150, +31, VVC B+ and regulated +20v.

The power supply module along with the transformer, chokes and electrolytic filter capacitors are conveniently mounted on the power-supply chassis.

R-G-B Output Module

In previous color-TV sets the matrixing of the R-Y, G-Y and B-Y was accomplished in the picture tube. In this chassis the matrixing of the signals is done in the R-G-B output module. The resulting signals produced by the additions of -"Y" to R-Y, -"Y" to B-Y and -"Y" to G-Y are "R," "B" and "G," which represent the individual instantane-

RCA Antenna System Accessories For A Brighter Profit Picture.

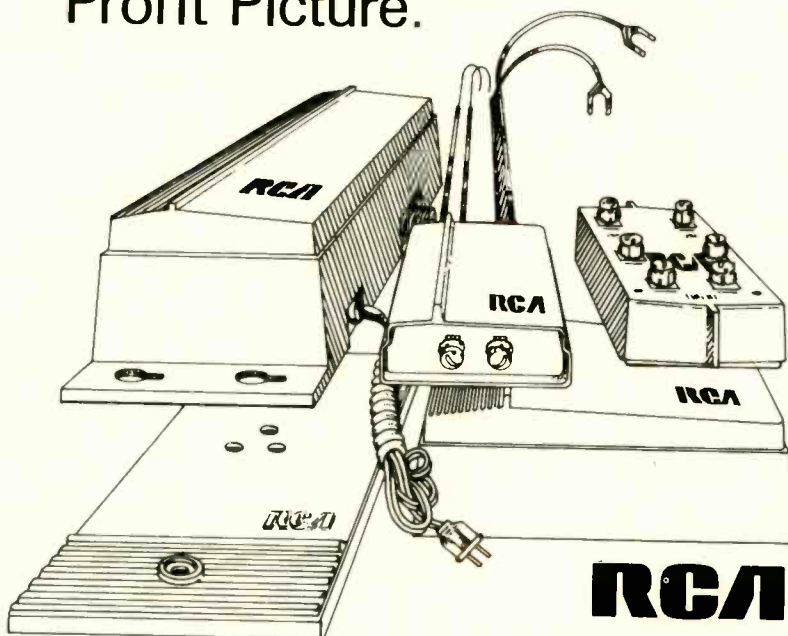

RCA

Better reception for your customers, more sales for you. From band separators to distribution amplifiers, RCA makes them all. An entire line of easily installed, beautifully compact units, designed to meet rigid performance standards.

For trouble free performance, every device contains RCA solid state circuitry, housed in a contemporary-designed sturdy IMPAC® plastic casing. All amplifiers contain protection against lightning-in-

duced voltage surges. All passive devices are engineered for low insertion loss.

Individually packaged for product protection and consumer appeal, these RCA reception aids are a must for every professional dealer and technician.

For full information on RCA's fast moving profitable line of reception aids, contact your RCA Antenna System Distributor, or mail the coupon below. We'll send you information about our complete line of antenna system accessories.

RCA Parts and Accessories P.O. Box 100 Deptford, N.J. 08096

Please send me your RCA Antenna Systems Accessories Catalog.

Name _____

Firm _____ Phone _____

Address _____

City _____ State _____ Zip _____

... for more details circle 138 on Reader Service Card

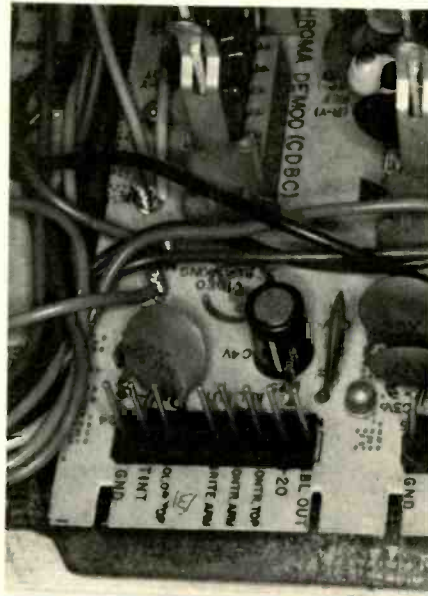

The mother chassis board terminals, components and test points are clearly marked for identification

ous voltage outputs of the cameras.

A precaution must be taken not to operate the TV set with this module removed. Since the positive dc component originates on this module and the picture-tube grids are at a positive potential, a positive bias would be applied to the picture-tube guns.

Vertical Module

The vertical system employs only one control to adjust the height and does not have the familiar LINEARITY control. This is made possible because the operation of the vertical oscillator/output produces a very linear sweep. A slide-type switch is used on this chassis for vertical centering. The vertical sweep circuit

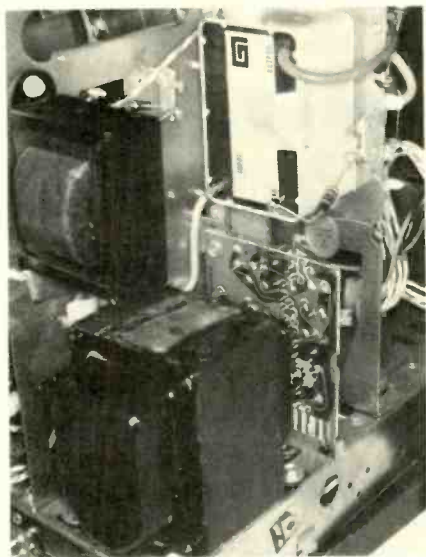

Large components such as the power transformer, filter choke, high-voltage tripler and focus bleeder can easily be replaced without removing the chassis from the cabinet.

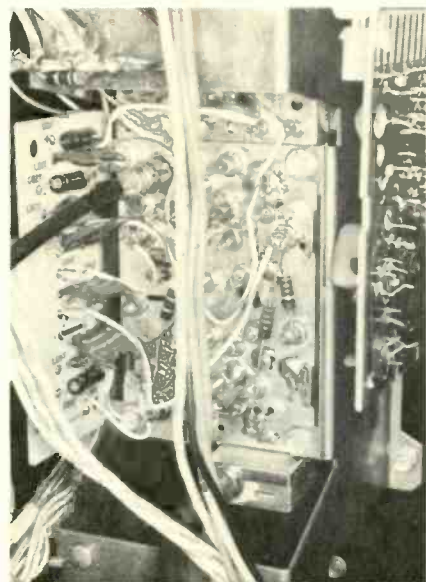

Most components previously mounted on the top of the tuner are now mounted on a panel adjacent to it.

utilizes a Miller circuit and the output transistors are in a complementary symmetry configuration — a matched pair of NPN and PNP transistors contained within the vertical module.

High-Voltage-Regulator Module

The ground return for the high-voltage tripler is through the high-voltage regulator module, and this current is applied to an automatic beam limiter circuit. This circuit limits the picture-tube beam current so that any cause of high brightness will not drive the picture tube into saturation, reducing blooming be-

cause of high brightness scenes. The automatic brightness limiter control voltage from Pin 3 of the module is fed to the emitter circuit of the delay line driver on the Low Level Video module on Pin 1R. This point is dc coupled to the picture-tube cathodes, providing a means of brightness control. When the picture-tube beam current approaches its maximum, the output voltage at Pin 3R of this module increases, causing an increase in voltage on the picture-tube cathode, thus reducing picture brightness.

This module also contains the
continued on page 57

RCA's XL-100 Components Kit...

The portable repair shop expander

that improves your in-home service capabilities.

It's especially designed with 27 necessary components to be a perfect companion to RCA's Color TV Module Caddy. In fact, it fits right into a special compartment provided in the caddy.

The components kit contains resistors, transistors, diodes, fuses, a circuit-breaker and a tube of heat sink compound. And when you carry them with the RCA Module Caddy's 11 modules, it's like bringing

your shop right to your customer's set. It also helps minimize reschedules and call-backs. No matter how you look at it, the components kit is a must for every professional TV technician. For more information, see your local RCA Distributor or fill out the coupon and mail it today. RCA Parts and Accessories will send you complete details on these essential kits, with no obligation.

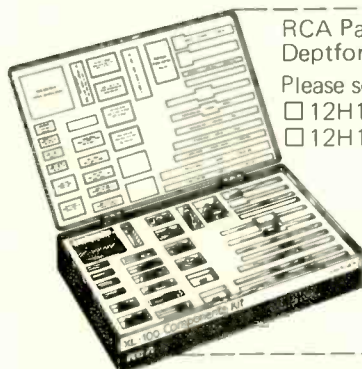

RCA Parts and Accessories, P.O. Box 100
Deptford, N.J. 08096

Please send information on: (check one or both)

- 12H190 Module Caddy
 12H195 Components Kit

Name _____

Address _____

City _____ State _____

Zip _____

RCA

... for more details circle 139 on Reader Service Card

DEALER SHOWCASE

For additional information on products described in this section, circle the numbers on Reader Service Card. Requests will be handled promptly.

TV/RADIO COMPONENTS BOARD

Contains 62 of the most used replacement parts **706**

A Model BP basic parts board is said to contain 62 pieces of the most frequently needed replacement parts used by the TV/radio service industry. The board can reportedly supply a large percentage of your replacement part requirements on an eye appealing 17- by 24-in. white pegboard display. The parts consist of fuses, fused resistors, focus rectifiers, circuit breakers, CRT anode connectors, current limiting resistors, and the all-new universal TV Channel Selector, Fine Tuning and Control Knobs. Each board is said to come individually packaged complete with hooks and merchandise. Workman Electronic Products Inc.

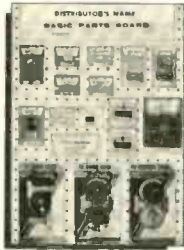

SOUND COLUMN

Excellent directional sound dispersion

A new sound column, Model 10/150, is said to be ideal for sound reinforcement applications in auditoriums, schools, churches, etc. Specifications indicate that the directional sound dispersion pattern (120° horizontal and 40° vertical with a frequency response of 80-15,000Hz, program material 40w, peak 80w) allows true high-fidelity sound for music reproduction and high intelligibility in the speech range. The cabinet is reportedly hand crafted in oil walnut veneer finish to complement any room decor. The sound column is supplied with wall and mounting brackets and has provisions for plug-in line transformer modules. The unit measures 47 in. H by 10½ W by 5¼ in. D and weighs 34 lb. American Geloso Electronics, Inc.



707

POWER AMPLIFIER

708

Eliminates dc fuses and the protection MODE switch

The Model DC-300A power amplifier will reportedly drive any impedance load, including a totally reactive load, with no adverse effects. The new output protection design is said to eliminate the flyback pulse, currently used widely in the high-powered solid-state amplifier field. The output circuitry has reportedly also allowed the elimination of the dc fuses and the protection MODE switch, with a consequent simplifying of the amplifier operation. The input amplifier of the unit is designed around a dual integrated circuit, simplifying the circuit design. For those who require a large monaural amplifier, it reportedly becomes a 600w continuous power (8Ω) mono amplifier with the simple insertion of two plug-in parts to the main



circuit board. The balanced 70v mono output will reportedly drive any load from 4Ω to 16Ω with no difficulty. Other manufacturer specifications include the following: Power Output: not less than 150w rms per channel into 8Ω (both channels operating), dc to 20 kHz at rated distortion. Distortion: I.M. less than 0.05%, 0.01w to 150w into 8Ω; less than 0.01% at 150w. Frequency response: ±0.1dB dc to 20kHz at 1w into 8Ω; ±1.0dB dc to 100kHz. Crown International.

TAPE STORAGE CABINETS 709

Cushioned interior to protect tapes

An eight-track bookshelf storage cabinet, Model BS-T, is designed with wood-grained side and top panels, and a red cushioned interior to protect the



tapes. The front panels have the look of expensive rare book bindings and are gold stamped on soft leather-like material. The units are available in brown, black, maroon or green. Duotone Co.

Pix-Mate™

the crt tester

you can afford to take along

only ... \$34.95



A quality CRT tester with individual test for each gun.

- Compare guns for emission.
- Test for leakage and shorts.
- Legible 3 color scale.
- Compact, portable, rugged.
- Avoid recalls, check the CRT on every call.

WRITE US!

TeleMatic



take along the time savers

- PIX-MATE • CRYST-MATE • GEN-MATE
- SOUND-MATE • TRACE-MATE

The Caddy-Mate Line.

2245 PITKIN AVE., BROOKLYN, N. Y. 11207

... for more details circle 131 on Reader Service Card

TEKLAB...

continued from page 55

HIGH-VOLTAGE ADJUST control. Regulation of the high voltage is achieved by varying the current through the high-voltage regulation transformer, which is a saturable reactor. The secondary winding is part of a resonant circuit in the horizontal ACR stages. Changing the saturation point of the transformer changes the inductance, which in turn changes the frequency of one of the resonant circuits in the horizontal-output system. This in turn determines the amount of high voltage developed.

Horizontal-Oscillator Module

The horizontal-oscillator module has two circuits—the sweep hold-down circuit to limit the amount of horizontal output and high voltage; and a blocking oscillator circuit, providing the sawtooth voltage to the phasing diodes.

A special defeat (crowbar) circuit employed in this module uses two transistors. The second of these transistors is used to short one end of the HOLD control to ground whenever the horizontal output exceeds a predetermined value. This prevents the high voltage from exceeding an excessively high level. The input to the circuit is applied through a 28K resistor, R14W, and a .05 μ f coupling capacitor, C14W (found on the mother board), to pin 3R of the module. The input is a 225v p-p fly-back pulse.

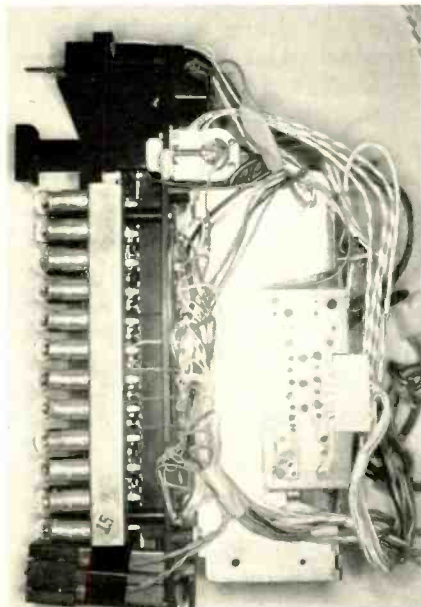

Side view of the VVC tuner and primary controls.

The first in the pair of transistors is an amplifier with a zener clamped emitter circuit. When the pulse exceeds a predetermined amplitude, the zener breaks down and causes the second transistor to conduct. The low impedance emitter-to-collector path of this second transistor effectively throws the oscillator off frequency. This circuit protects the customer from possible X-radiation.

Horizontal-Deflection System

This chassis employs a silicon controlled rectifier (SCR) horizon-

tal deflection system incorporating components that are different from those used in conventional tube or solid-state deflection circuits. However, the method of deflecting the picture-tube beam is very similar to the conventional system.

An SCR and diode combination is used in both the trace and retrace circuits for a number of reasons. It enables a component to complete a circuit because current must flow in each direction in both the trace and retrace circuits. It also provides a

continued on next page



**It's this easy to install
Electro-Voice phono cartridges.**

Almost 100% original or exact replacements. But half of our competitors' cartridges are substitutes. And you know what problems that means. Like having to adjust the tracking weight and set down position of the tone arm. And changing the terminal clips on the tone arm wires. And installing a new bracket to adjust the cartridge to the arm. And, maybe, when you're finished, an output voltage difference exists.

Of course, when you specify Electro-Voice quality-assured cartridges, you avoid all this time-consuming, costly work. What's more, you don't make unprofitable double repairs. Your customer is happy the first time. And when he needs other services, he'll call you.

You'll find just about every cartridge you'll need in our comprehensive catalog. Use it for fast cross referencing, assistance in identification and detailed specifications. A free copy is available from your E-V/Game distributor. Get yours today, or write E-V/Game, Inc., Box 711, Freeport, N.Y. 11520.

 **EV·GAME inc.**

DIVISION OF ELECTRO-VOICE INC. • A **Gulton** COMPANY

In Canada: E-V of Canada, Ltd., Gananoque, Ontario

**CARTRIDGES • NEEDLES • WHEELS • BELTS • PULLEYS • STEREO HEADPHONES
MICROPHONES • HI-FI ACCESSORIES**

... for more details circle 109 on Reader Service Card

APRIL 1973, ELECTRONIC TECHNICIAN/DEALER | 57

HOW DOES GEORGE DO IT?

#1 IN A SERIES



IN EVERY GROUP OF TECHNICIANS, THERE'S A "GEORGE" WHO ALWAYS SEEMS TO EARN A LITTLE MORE THAN THE REST OF US - SOMETIMES EVEN WITH SHORTER HOURS TO HELP EVERY TECHNICIAN MAKE THE MOST OF HIS TIME, HERE'S "HOW GEORGE DOES IT":



THAT TUNER'S SO DIRTY, IT LOOKS MORE LIKE A GUNKED-UP ENGINE. GUESS I'LL HAVE TO SEND IT TO A TUNER REPAIR SERVICE FOR ULTRASONIC CLEANING. NOT ONLY WILL MY CUSTOMERS WAIT, I'LL MAKE LESS PROFIT!



WHY SEND IT OUT? YOU CAN DO A TOTAL CLEANING JOB WITH CHEMTRONICS TUN-O-WASH, RIGHT HERE IN YOUR SHOP.

C'MON-- A CHEMICAL ULTRASONIC BATH?



JUST ABOUT! IT'S GOT THE ADVANTAGES WITHOUT THE DRAWBACKS! DISSOLVES GUNK AND CORROSION. BLASTS IT AWAY. WON'T DO A THING TO PLASTICS AND THERE'S NO CHANCE OF OPENING WEAK SOLDER JOINTS! TRY IT--JUST BOUGHT SOME AT THE DISTRIBUTOR'S.

HEY, IT REALLY WORKS! I CAN PUT THE TUNER BACK IN TOMORROW-- AND I GET ALL THE PROFITS!



NOW THAT YOU'VE CLEANED THE TUNER WITH TUN-O-WASH, SPRAY IT WITH THIS CAN OF TUN-O-FOAM. ITS SPECIAL SILICONE WON'T GUNK UP. HOW'S THAT FOR CALLBACK INSURANCE?

O.K. JUST SO I DON'T HAVE TO PAY YOU COMMISSION ON THE INSURANCE POLICY!

WHY LET GEORGE DO IT? MAKE MORE PROFITS IN LESS TIME YOURSELF WITH THE WORLD'S BEST-SELLING PROFESSIONAL CHEMICALS. TUN-O-WASH AND TUN-O-FOAM TWO OF CHEMTRONICS MANY WORK-SAVING PROBLEM SOLVERS.

FOR YOUR FREE PROBLEM SOLVING BROCHURE AND CATALOG WRITE TO:

CHEMTRONICS

INCORPORATED
1260 RALPH AVENUE BROOKLYN, N.Y. 11236
OUR BUSINESS IS IMPROVING YOURS

TEKLAB ...

continued from page 57

method of keeping the trace and retrace circuit non-conducting even when the SCR is forward biased, because a gate pulse is also required for conduction of an SCR. Flexibility is obtained by allowing only the retrace or both trace and retrace circuits to conduct at any one time.

A high-voltage tripler is used in this chassis with an output high enough to provide 26.5kv of high voltage with no beam current; and a focus bleeder, like that used in the previous chassis, is placed across the high-voltage supply to divide it down to the approximately 5kv required for proper focus. A 12M FOCUS control is mounted on the rear of the chassis to vary this voltage.

Summary

We felt the vertically mounted modules permit a smaller compact chassis, and yet they are quite accessible. All of the heavier chassis components—such as the power transformer, filter capacitors, and choke—are rigidly mounted on the main part of the chassis and are accessible from under the set without removing the chassis.

The extensive use of sockets permits more component replacement in the home, and in most cases without using a soldering iron.

The VVC tuners proved to be of great interest, especially the simplified method of pre-setting the 12 channels and the positive action of the pushbuttons when selecting the channel. This tuner should eliminate some of the service required on tuners of the past.

This TV set produced a very good color picture and the detachable reflection proved to be very effective in providing darker blacks without reducing the apparent brightness of the resulting picture under the bright fluorescent lights of our laboratory. ■

Comments from our readers are always welcome.

Address your letters to:

Phillip Dahlen, Editor
Electronic Technician/Dealer
1 East First Street
Duluth, Minnesota 55802

... for more details circle 105 on Reader Service Card

SOLID-STATE...

continued from page 38

sistors in some functions. And popping up when you least expect it are a few digital integrated circuits, light emitting diodes, a frequency synthesizer system for FM tuners, voltage regulators, operational amplifiers, MOS field-effect transistors, Varactors, Darlington Amplifiers, complementary vertical deflection systems, and many more still germinating in the minds of the circuit designers and the solid-state component manufacturers. And let's not forget "imported" equipment with its own dazzling array of solid-state goodies.

Then too, there is the increasingly popular buzz-word "MODULES." One gets the impression from the talk and advertising about modules that they should be held in the same awe and reverence usually reserved for the "Deities" or motherhood. Remember the old Setchel Carlson TV sets with "MODULES?" How many were thrown away because a tube, resistor or capacitor went bad? Well then, why throw away a solid-state module if a transistor, integrated circuit or other component fails? Why not fix the "module" instead of throwing away all those good parts? A few modules are made so as not to be repairable, but so far they are in the minority.

The military has resorted to throw-away modules because the urgency of repair generally overrides consideration of economy and availability of on-the-spot competent service technicians.

It is hard to understand why the electronic technicians' way of life should change because one big cir-

cuit board with all the associated circuitry has been subdivided into several little boards with their circuitry and connectors. The circuits are essentially what you have seen in the past and really offer nothing mysterious. Sure, they are convenient to change in the home—so why not keep a test chassis on hand at the shop to service the module you replaced? It should be a fairly simple job. After all, you already know exactly where the trouble is.

Let's not misunderstand the modular concept. Repair those that can be repaired and get replacements for the ones that are not practical to repair. In its most absurd form, we could consider the TV set itself to be a "module" and when it needs repair, throw it out and replace it with a new one. TV set sales would then boom and there would be no need for the electronic technician—think about it.

The technological era in which we live has sponsored such a diverse array of products and components that it could become truly "mind-boggling." Transistors and integrated circuits come in such a variety of physical configurations, electrical characteristics, and complexity of functions, that the electronic technician never really knows what he may encounter in his next service call. ■

MOVING?

Be sure to let us know your new address. Please enclose a complete address label from one of your recent issues.

The Complete Line

FINCO[®] MATV EQUIPMENT

Get all your MATV needs from one reliable source. Use genuine FINCO MATV equipment and FINCO Color Spectrum Antennas. Free layout service. Write:

THE FINNEY COMPANY

34 W. Interstate Street, Dept. 0
Bedford, Ohio 44146

... for more details circle 111 on Reader Service Card

REBUILD YOUR OWN PICTURE TUBES?

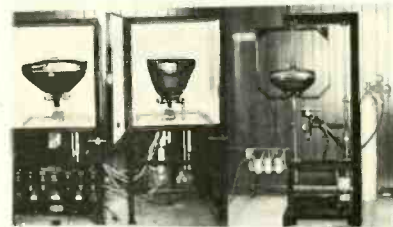

With the Lakeside Industries, Inc. picture tube rebuilding unit, you can rebuild any picture tube, be it black and white or color or 20mm or etc. We offer you the most revolutionized equipment of our modern times. This unit is easy to operate and requires only 4 x 8 ft. of space. You can rebuild the finest tube available. The picture will be clear and sharp. Your cost to rebuild a color tube is approx. \$6.60. Your cost to rebuild a black and white tube is approx. \$1.85.

Profit? Imagine building four color tubes per day and if you sold these tubes for \$60.00 each. Total income \$240.00. Total cost \$26.40. Net profit \$213.60. Multiply this figure by five days per week. Your profit \$1,068.00 per week. Cut this figure in half! Build and sell only two color tubes per day. Your profit \$534.00 per week. Facts are facts, figures do not lie.

For further information, please send your name and address to Lakeside Industries, Inc., 3520 West Fullerton, Chicago, Ill. 60647. Phone: (312) 342-3399.

P.S. No salesman will call.

... for more details circle 120 on Reader Service Card



CORNELL ELECTRONICS COMPANY

4213 N. UNIVERSITY AVE. SAN DIEGO CALIF. 92105

THE ORIGINAL HOME OF

36¢

PER TUBE

UNLESS OTHERWISE PRICED

100 TUBES OR MORE 33¢ PER TUBE

Same Low Price East or West Coast!

★ Bargain Tools
★ Transistor Tester
★ Technician's Library

SEND FOR FREE NEW 48 PAGE COLOR CATALOG

★ Dumont Picture Tubes
★ Diodes—Transistors—Kits
★ Tube Cartons

SPECIAL OFFER

ON ALL ORDERS OVER \$10.00

25¢

PER TUBE (NO LIMIT)

FROM THIS LIST

6AG5	6CB6
6AU6	6J6
6AX4	6SN7

ONE YEAR GUARANTEE

INDIVIDUALLY BOXED

5 DAY MONEY BACK OFFER

LAB TESTED USED

Your Order FREE if Not Shipped in 24 Hours

... for more details circle 107 on Reader Service Card

WORKMAN *Electronic*
Subsidiary of IPH TECHNOLOGY INC.
BOX 3828 SARASOTA, FLA. 33578
PRODUCTS, INC.

SOCKETS

for TV and RADIOS

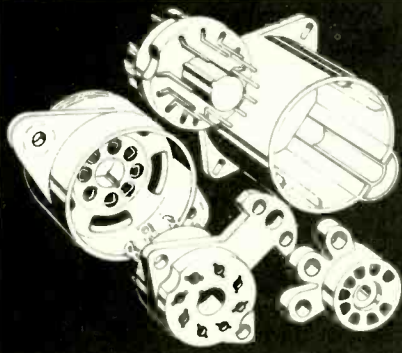

OCTAL • NOVAR • PRINTED
CIRCUIT • TUBE and MINIATURE
SOCKETS. SEVEN, NINE, TWELVE
PIN PLUG SOCKETS with NUVIS-
TOR, TRANSISTOR, SILICON
RECTIFIER, CRYSTAL AND
GENERAL PURPOSE SOCKETS.
Individually packaged for pegboard display

Ask For CROSS REFERENCE X68.

... for more details circle 136 on Reader Service Card

A LITTLE SQUIRT

stops
all the
noise.

A squirt of Quietrole from the handy Spray Pack silences any moving T.V. part. Cleans as it lubricates, too. Guarantees quiet, trouble-free operation. Absolutely safe for any black and white or color set. Try it and see why it's preferred by top servicemen everywhere.

Also available in bottles, and the new silicone—"Silitron."



Product of
QUIETROLE
COMPANY

Spartanburg, South Carolina

... for more details circle 127 on Reader Service Card

READERS SERVICE INDEX

ADVERTISER'S INDEX

101	B & K Div., Dynascan Corporation	13
102	Blonder-Tongue Laboratories, Inc.	24
103	Book Club—Tab Books	34-36
104	Channel Master, Div. of Avnet, Inc.	6
105	Chemtronics, Inc.	58
106	Chrysler Corporation	51
107	Cornell Electronics Co.	59
108	Delta Products, Inc.	25
109	E/V Game, Inc.	57
110	EICO Electronic Instruments Co., Inc.	52
111	Finney Company, The	59
112	Fluke Manufacturing, John	50
113	Ford Marketing Corp.	28
114	Fordham Radio Supply Co., Inc.	60
115	Franklin Manufacturing Sales	52
116	GC Electronics Company	22
	GTE Sylvania, Electronic Components	9, 17
	General Electric Company	23
117	Heath Company, The	49
118	International Rectifier Corp.	12
119	Jerrold Electronics Corp.	21
120	Lakeside Industries	59
121	Leader Instruments Corporation	16
122	Mountain West Alarm Supply Co.	60
123	Oneida Electronic Mfg. Inc.	53
124	Panasonic	11
125	Panasonic—Service Div.	27
126	Precision Tuner Service	19
127	Quietrole Company	60
128	RCA Parts & Accessories	3rd Cover
138	RCA Parts & Accessories	54
139	RCA Parts & Accessories	55
	RCA Semiconductor Dist. Prod.	14, 15
129	RCA Test Equipment	20
130	RCA Test Equipment	10
131	Telematic Div., UXL Corp.	56
132	Test & Measuring Instruments, Inc.	5
133	Triplett Corporation	4th Cover
134	Tuner Service Corporation	3
135	Wahl Clipper Corporation	50
136	Workman Electronic Products, Inc.	60
137	Yeats Appliance Dolly Sales Co.	60
	Zenith Radio Corporation	2nd Cover

NEW PRODUCTS

700	VOM 700	26
701	AM/SSB Two-Way Radio	26
702	Frequency Equalizer	26
703	Acoustic Response Analyzer	53
704	VHF Broadband Amplifier	53
705	Pocket Calculator Kit	53
706	TV/Radio Components Board	56
707	Sound Column	56
708	Power Amplifier	56
709	Tape Storage Cabinets	56

TEST INSTRUMENT

900	B & K Precision Model 501A Semiconductor Curve Tracer	47
-----	--	----

DISCOUNT PRICES TEST EQUIPMENT



I.E.C./Mullard Tubes Specials
Catalog & Prices on Request

FORDHAM Radio Supply
Company, Inc.



558 Morris Avenue, Bronx, N.Y.
Tel: (212) 585-0330



DISTRIBUTORS OF ELECTRONIC SUPPLIES

... for more details circle 114 on Reader Service Card

YEATS dollies

FURNITURE PADS \$4.00 EACH

YEATS PLATFORM DOLLY \$24.95

TRUCK DEVELOPED!

ROLLS UP & DOWN STAIRS

FREE illustrated brochure

YEATS dollies
1307 W. FOND DU LAC AVE.
MILWAUKEE, WIS. 53205

YEATS Model No. 5 \$76.50

... for more details circle 137 on Reader Service Card

FREE ALARM CATALOG

Full line of professional burglar and fire alarm systems and supplies. 80 pages, 400 items. Off-the shelf delivery, quantity prices.



mountain west alarm
4215 n. 16th st., phoenix, az. 85016

... for more details circle 122 on Reader Service Card



"Hey Jack! In case old sour-puss checks back about her TV, I have the pile of junk fixed!"

SYMBOL	DESCRIPTION	RCA PART NO.	
R4201	control, volume	137475	R201C-control red screen
R4202	control, brightness	137477	R202A-control contrast
R4203	control, color	137476	R202B-control sharp
R4204	control, tint	137478	R202C-control vert hold
C103	-3 section elect	132588	R203A-control vert height
C104	-3 section elect	132380	R203B-control noise
C105	-3 section elect	132644	R203C-control kine bias
CB101	-circuit breaker	138123	RT301-thermistor
T101	-xformer	132594	T401-xformer
R201A	-control blue screen	132163	RV1101-varistor
R201B	-control green screen	132163	R7-control killer
			R9-control ACM adj yoke, deflection

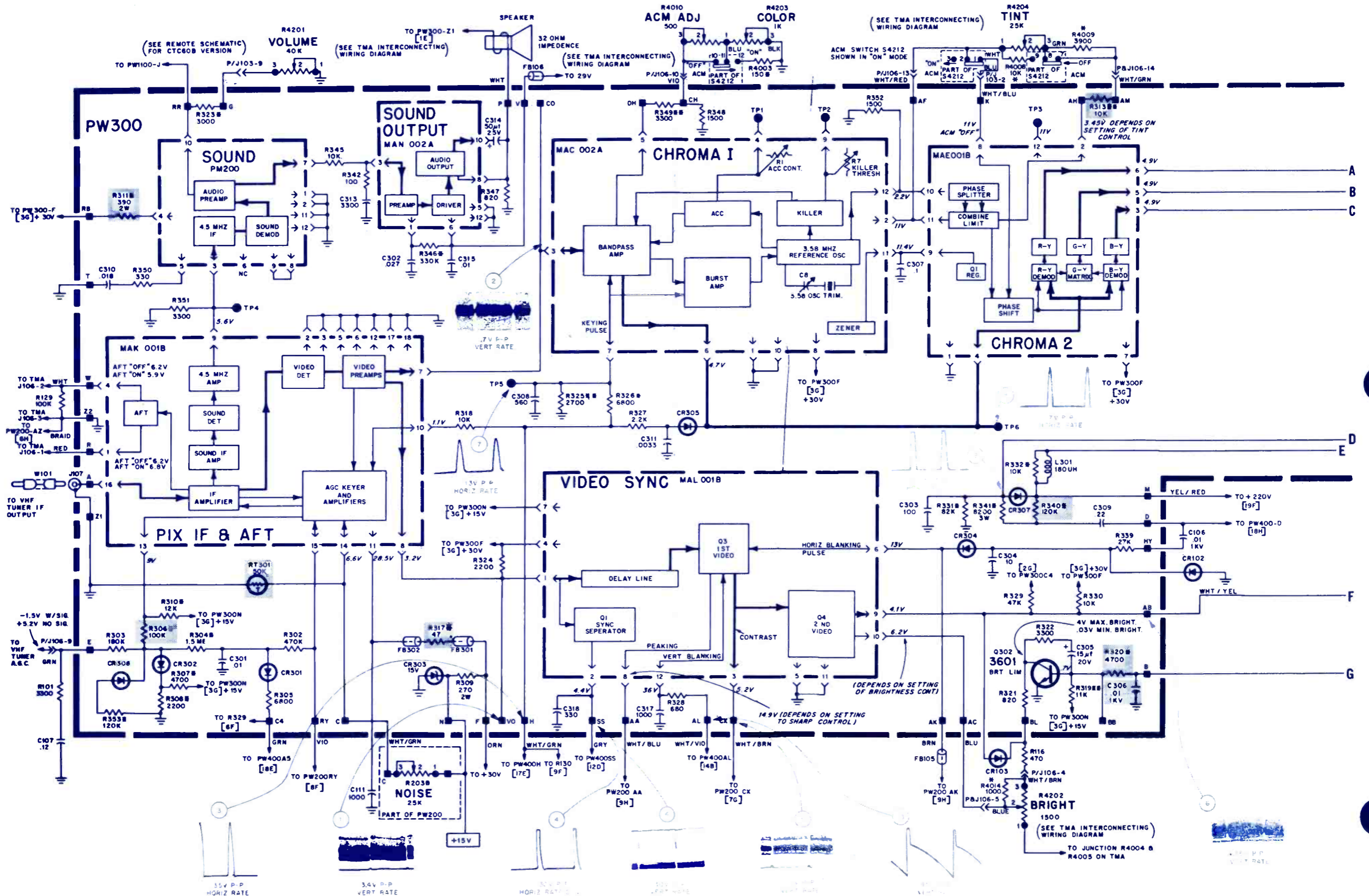

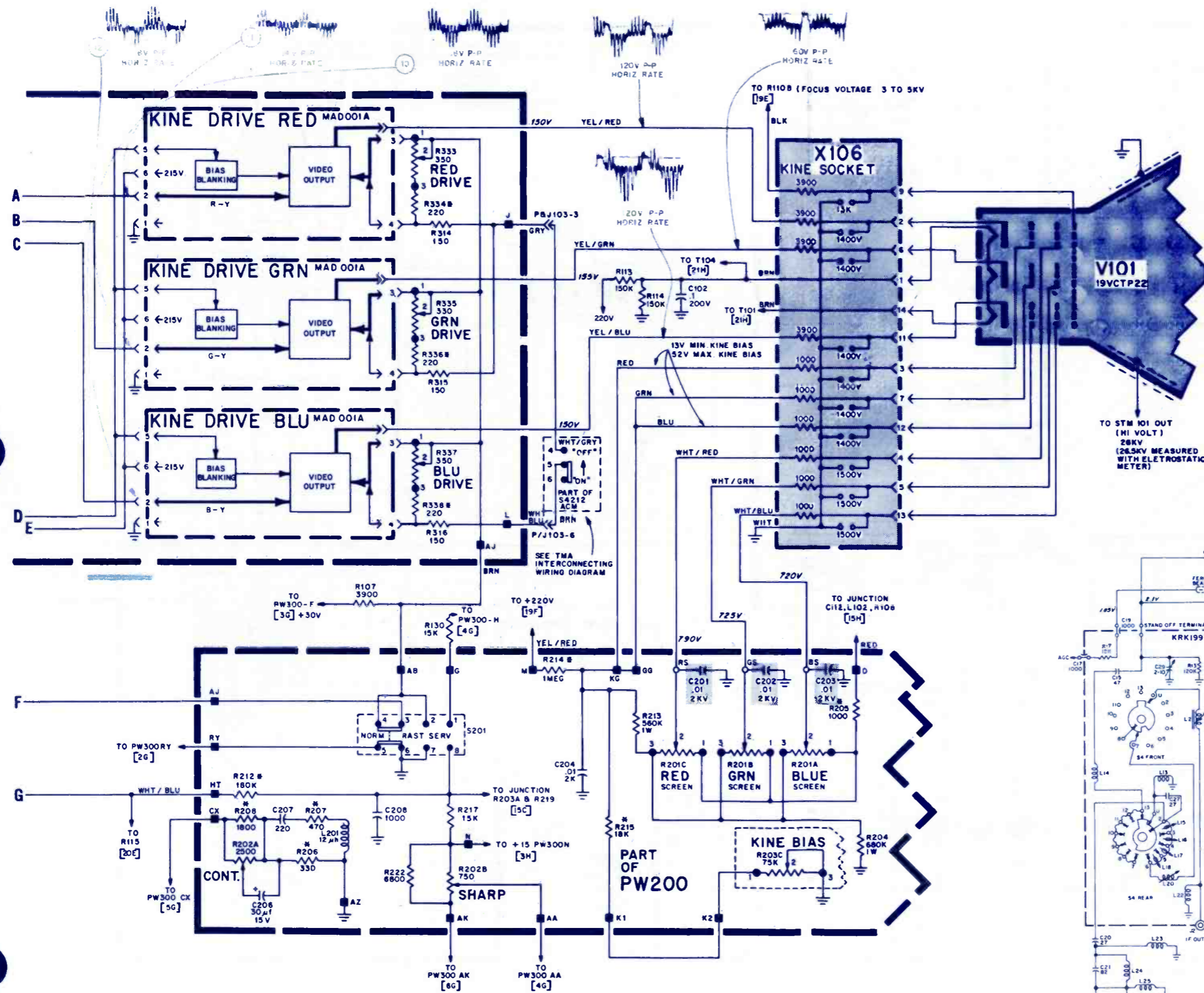

ADDITIONAL
INFORMATION
NEXT PAGE

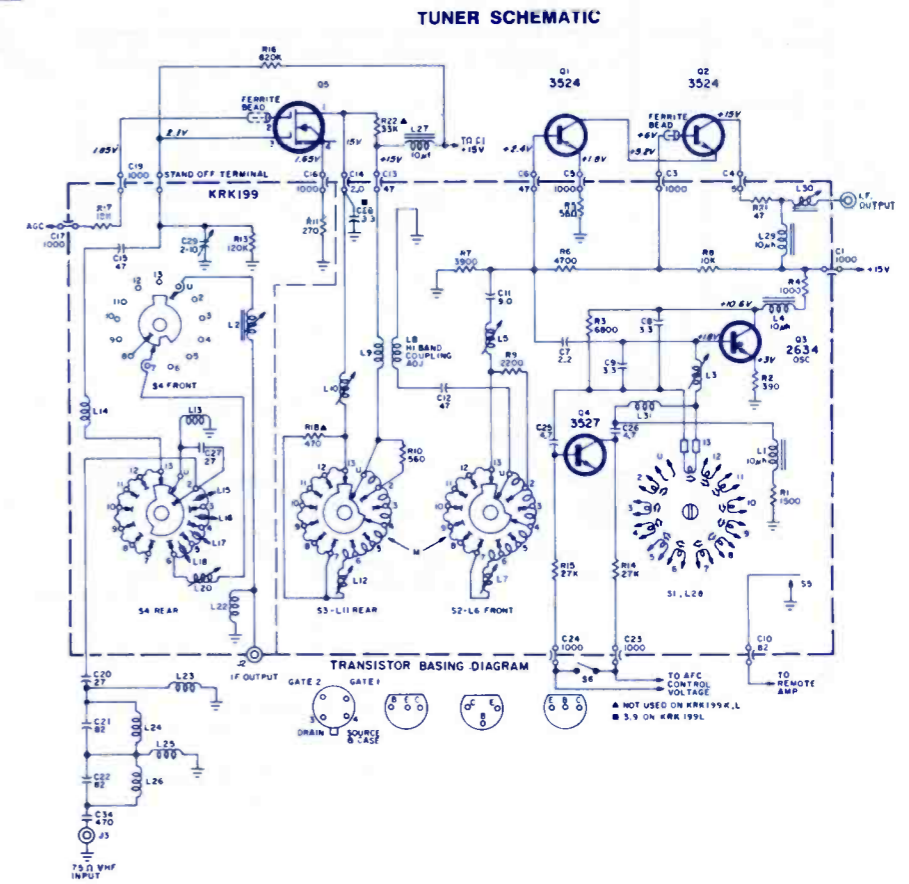

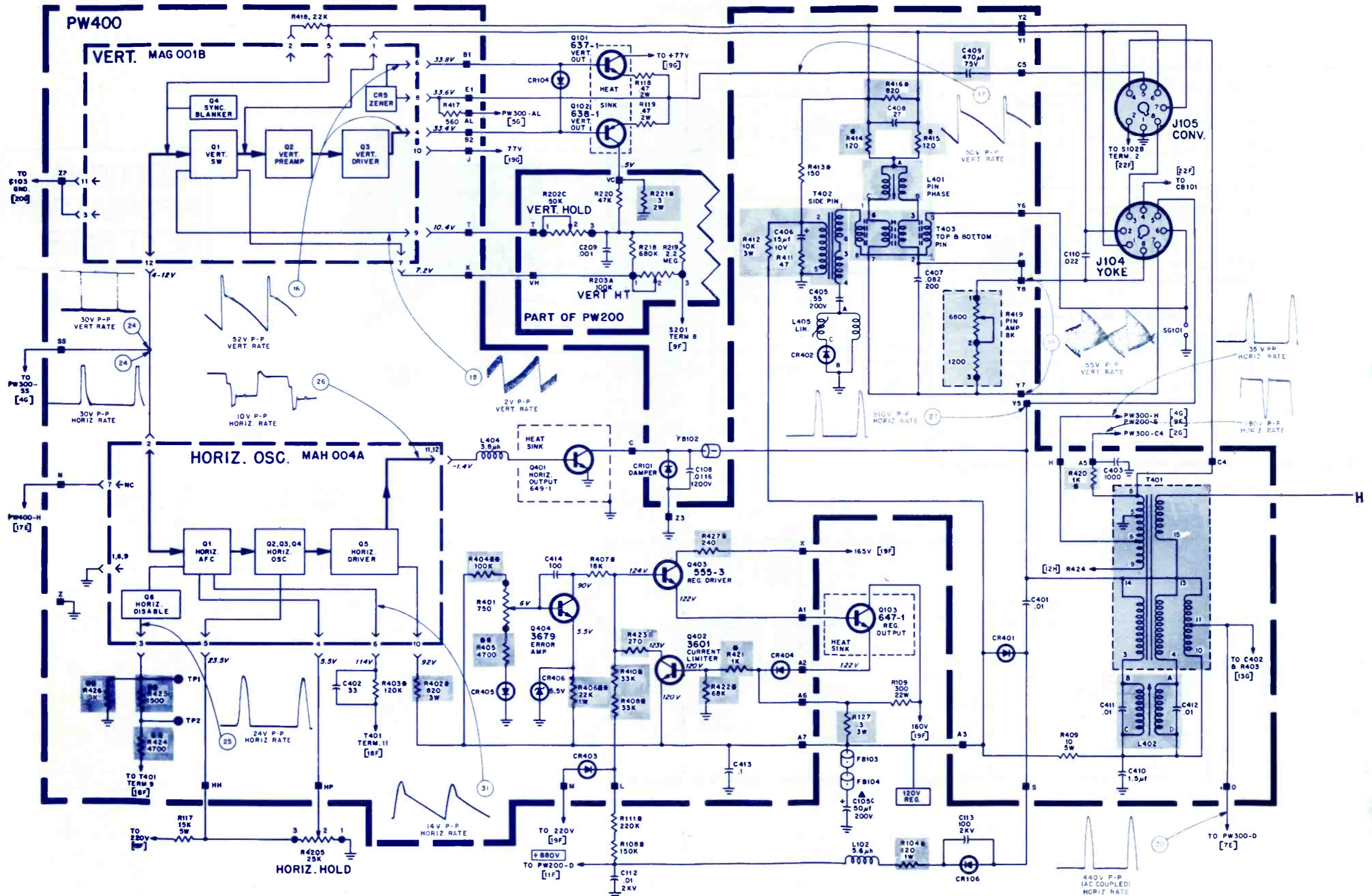

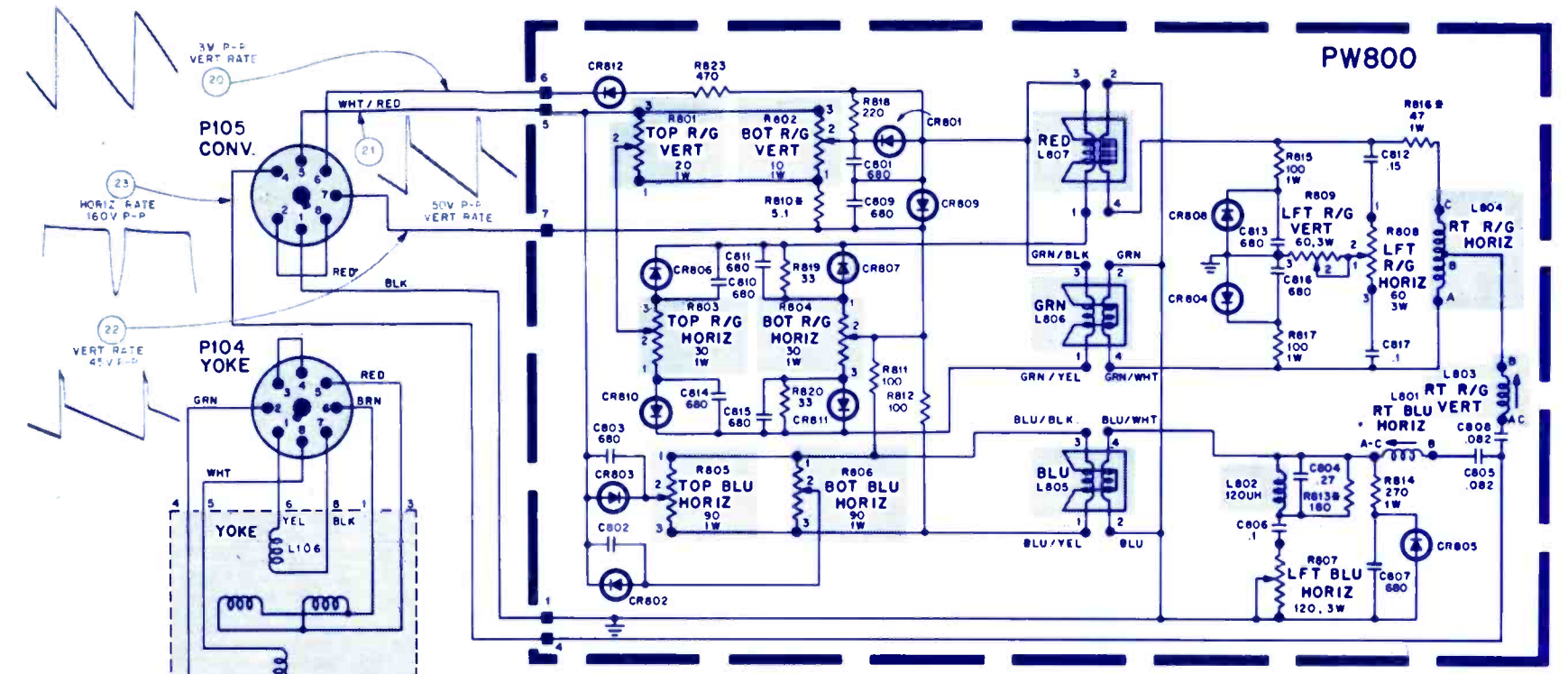

TO PICTURE TUBE ULTRON ANODE
26KV (28.5KV MEASURED WITH
ELECTROSTATIC METER)

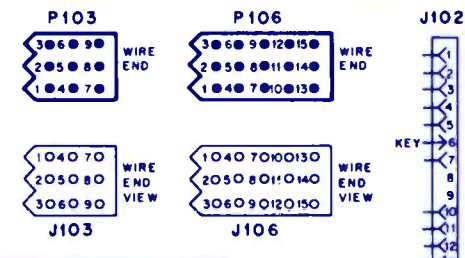
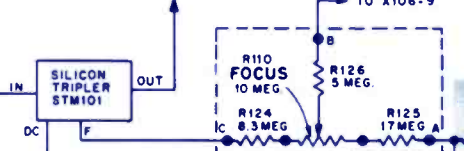

- NOTES**
1. RESISTANCE VALUES ARE IN OHMS K=1000.
 2. CAPACITANCE VALUES 1.0 AND ABOVE ARE IN μ F, LESS THAN 1.0 ARE IN μ F, UNLESS OTHERWISE SPECIFIED.
 3. \pm INDICATES 5% TOLERANCE.
 4. \pm INDICATES 2% TOLERANCE.
 5. VOLTAGES ARE MEASURED TO CHASSIS GROUND WITH A "VOLTOHMYST" (NO SIGNAL APPLIED) AND SHOULD HOLD WITHIN $\pm 20\%$ AT RATED SUPPLY VOLTAGE. VOLTAGES SHOULD HAVE A POSITIVE POTENTIAL UNLESS OTHERWISE SPECIFIED.
 6. WAVEFORMS TAKEN WITH COLOR BAR (DOT-BAR) GENERATOR SIGNAL APPLIED AT 100% MODULATION.

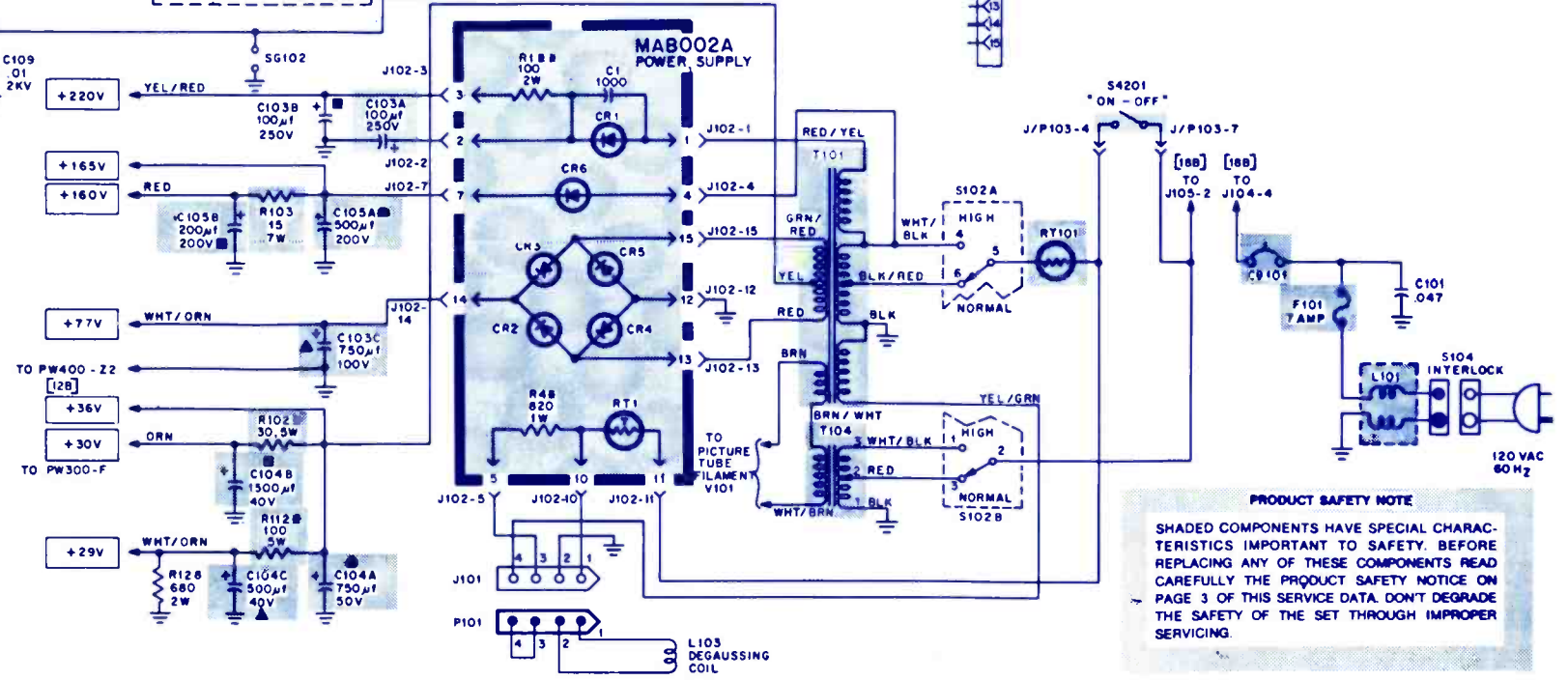

PRODUCT SAFETY NOTE

SHADED COMPONENTS HAVE SPECIAL CHARACTERISTICS IMPORTANT TO SAFETY. BEFORE REPLACING ANY OF THESE COMPONENTS READ CAREFULLY THE PRODUCT SAFETY NOTICE ON PAGE 3 OF THIS SERVICE DATA. DON'T DEGRADE THE SAFETY OF THE SET THROUGH IMPROPER SERVICING.

VHF TUNER

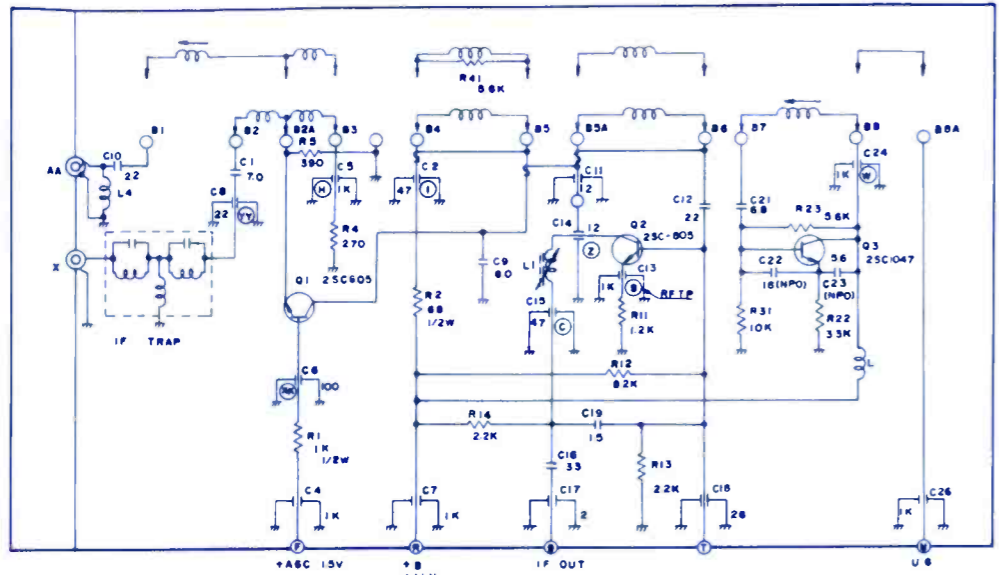
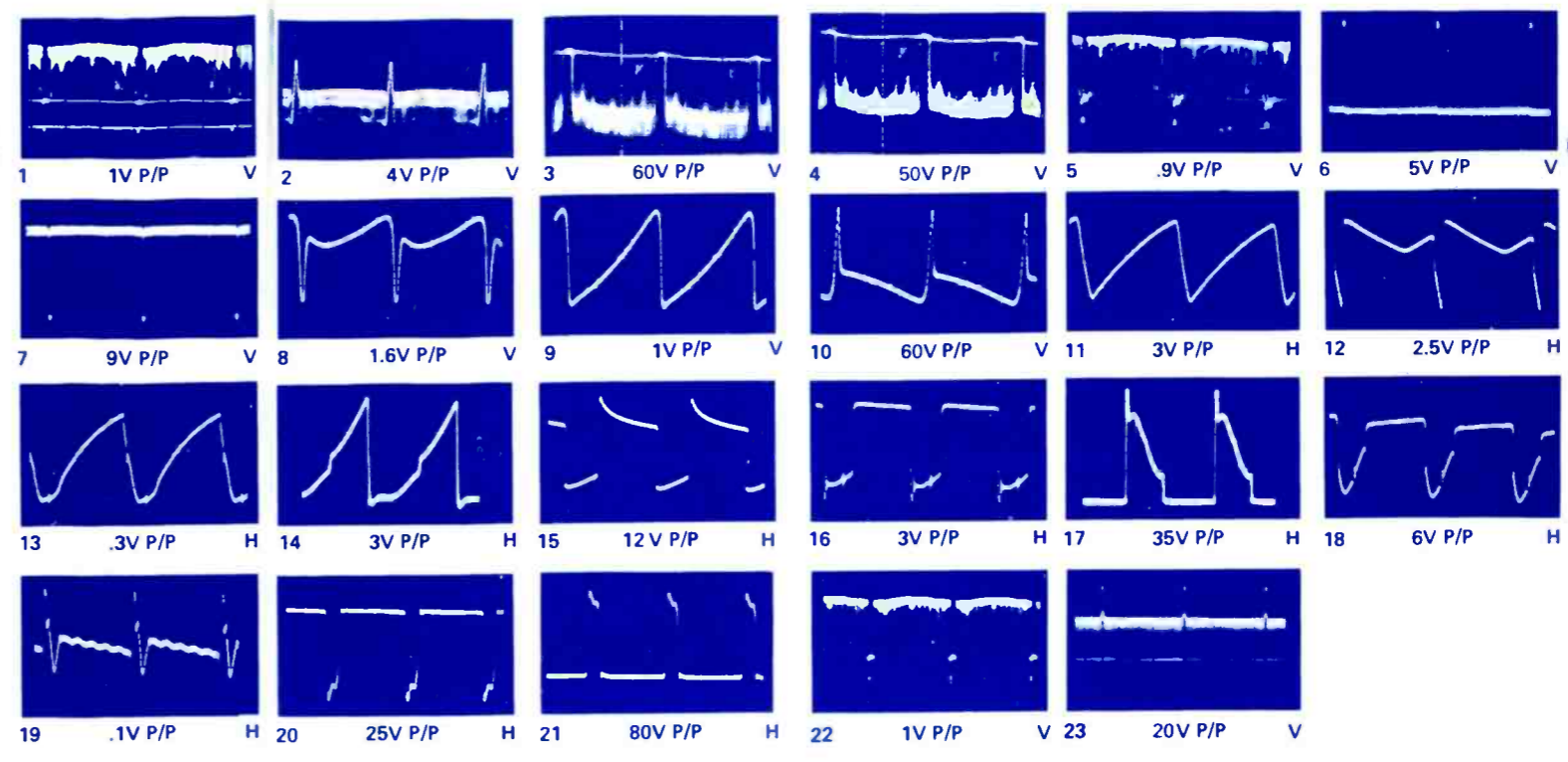

- NOTES:
1. ALL CAPACITANCE VALUES 10R OR GREATER ARE IN PICOFARADS.
 2. ALL CAPACITANCE VALUES LESS THAN 1 ARE IN MICROFARADS.
 3. CAPACITORS ARE 10%, 50V.
 4. RESISTORS ARE 10%, 1/4W.
 5. ▲-LOCATED OFF BOARD.
 6. ■-LOCATED ON BOTTOM OF BOARD.
 7. □-WAVEFORM IDENTIFICATION.
 8. ALL VOLTAGES ARE MEASURED UNDER NO SIGNAL CONDITIONS.

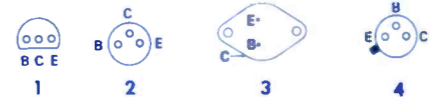

TRANSISTOR BASING

TR6	2	TR20	1
TR7	2	TR21	1
TR8	1	TR22	1
TR9	1	TR23	3
TR10	4	TR24	2
TR11	1	TR25	4
TR12	1	TR26	3
TR13	1	TR27	3
TR14	1	TR28	1
TR15	1	TR29	1

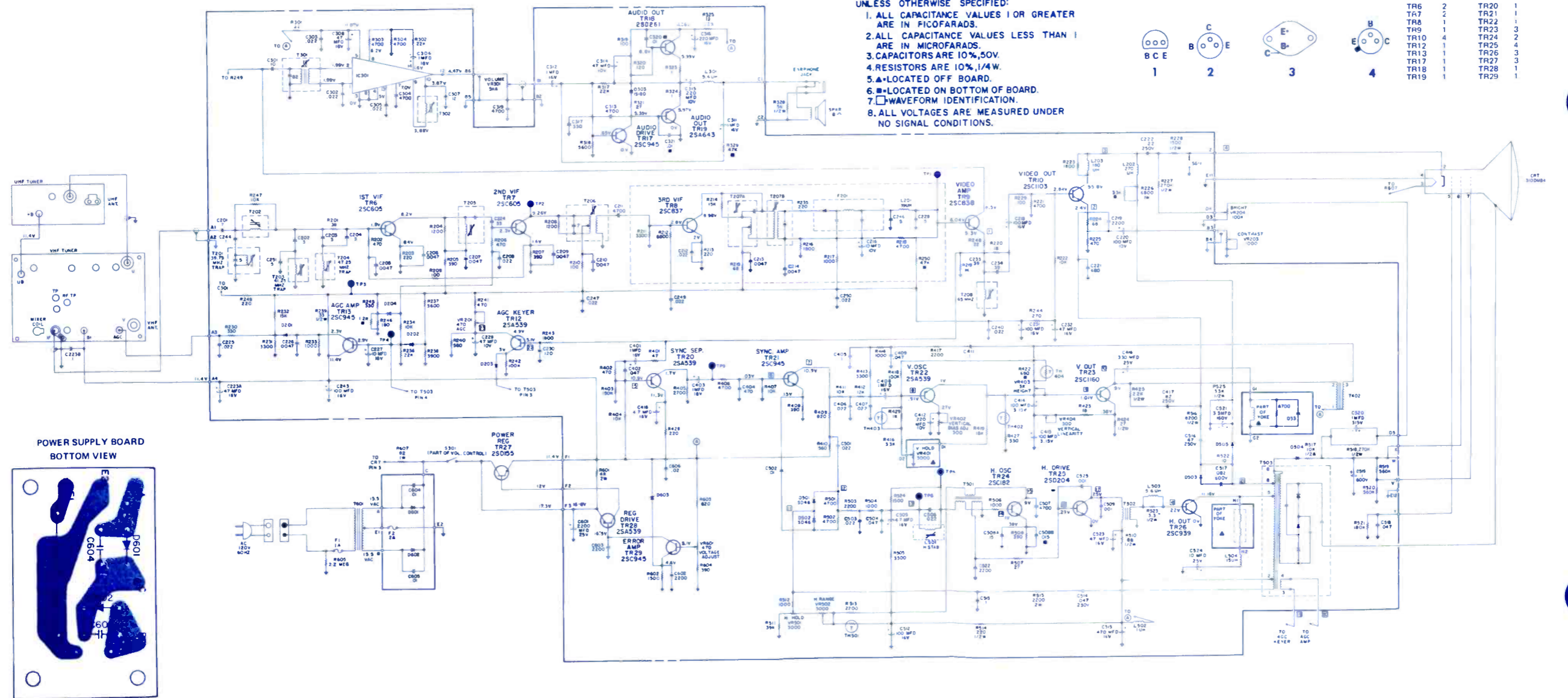

POWER SUPPLY BOARD
BOTTOM VIEW

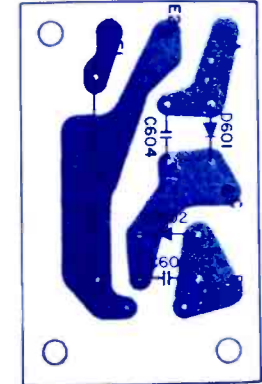

Announcing the RCA MINI-STATE Antenna System



**The profitable new
achievement in antenna technology.**

The Mini-State is brand new from RCA. It's the first true miniaturized rotating antenna system on the market. *It works . . . and works well!*

This system is specifically made for your metropolitan and suburban customers who want the quality reception of an outdoor-type antenna, in a beautifully compact unit suitable for homes and apartments.

Measuring just 21" across and 7" high, the Mini-State is completely enclosed in an attractive sturdy plastic case that's weatherproof and resistant to dust and dirt. It weighs just 6 pounds and can be mounted almost anywhere: rooftop, chimney, window, attic and closet.

The RCA Mini-State's uni-directional pattern, VHF slotted ring and multi-element UHF design, combined with its completely integrated solid state circuitry, provides excellent reception on all channels, and helps avoid interference and ghosts.

Mini-State model 5MS440, with built-in rotator, allows your customers to zero-in for best reception on any chan-

nel. Exclusive direction indicator light on the hand held control unit tells them where the antenna is aimed.

The RCA Mini-State rotating antenna system includes: The antenna with built-in amplifier. Built-in rotator and hand held remote control unit. A 120 volt AC power supply. A VHF-UHF antenna matching transformer. An outdoor mast clamp. Legs which can be snapped into place for indoor use.

Although regular coaxial and rotator cable may be used, a unique combined coaxial and rotator cable is available in prefabricated lengths for quick, easy installation. (A fixed non-rotating model 5MS330 is also available.)

Yes, this new RCA Mini-State antenna system can mean maxi-profits for you. See your RCA Parts and Accessories distributor today, or contact RCA Parts and Accessories, P.O. Box 100, Deptford, N.J. 08096. Make sure you're in on the ground floor of this profitable new era in TV antenna systems.

RCA

