

DECEMBER 1972  A HARCOFT BRACE JOVANOVIH PUBLICATION

ELECTRONIC TECHNICIAN/DEALER

WORLD'S LARGEST TV-RADIO SERVICE & SALES CIRCULATION



FRIM5593349P2AW
WILLIAM W FRISE
7476 GALE RD
ATLAS
XX

8756723AL1

MI 48411

AS

NATESA Plan to Create Confidence
Introducing Heathkit's Dual-Trace Scope
Better Merchants Make Better Profits

There must be an easier way...



There is: Sylvania's Chek-A-Color test jig.

TV servicemen were never meant to be movingmen.

But, that was before antique, modern and French Provincial units that included hi-fi, tape decks and record players were built around a large-screen color TV set.

Getting those units to the shop can be a big job.

That's why we developed our two Chek-A-Color test jig units. One, our full-house model, gives everything you need to test a chassis. The other is a basic unit that practically lets you design your own test jig.

All you have to take back to the shop is the electronic guts of the TV monsters.

Regardless of the size of the original picture, Chek-A-Color lets you see it on a benchtop 14-inch



(diagonal) screen. It adapts to both high and low focus voltage sets and a full line of adapters lets you test over 5,000 different models.

A front-panel switch controls a yoke programming system that gives you a range of impedances and/or deflection voltages to closely match both tube and solid-state systems.

For actual testing, a convenient meter lets you measure anode voltage and a speaker lets you check sound performance.

Since Chek-A-Color handles tube, hybrid and solid-state chassis, there won't be many complete cabinets to lug.

With a Chek-A-Color test jig all you have to take is the chassis. Get the picture? Sylvania Electronic Components,

100 First Avenue, Waltham, Mass. 02154

GTE SYLVANIA

ELECTRONIC TECHNICIAN/DEALER is published monthly by HARCOURT BRACE JOVANOVICH PUBLICATIONS, INC., 1 East First St., Duluth, Minn. 55802. Subscription rates: One year \$6, two years \$10, three years \$13, in the United States and Canada. Other countries: One year \$15, two years \$24, three years \$30. Single copies 75¢ in the United States, and \$2 in other countries. Second class postage paid at Duluth, Minnesota 55806 and at additional mailing offices. Copyright 1972 by HARCOURT BRACE JOVANOVICH PUBLICATIONS, INC. POSTMASTER: Send Form 3579 to ELECTRONIC TECHNICIAN/DEALER, HARCOURT BRACE JOVANOVICH PUBLICATIONS, INC., 1 East First St., Duluth, Minn. 55802.

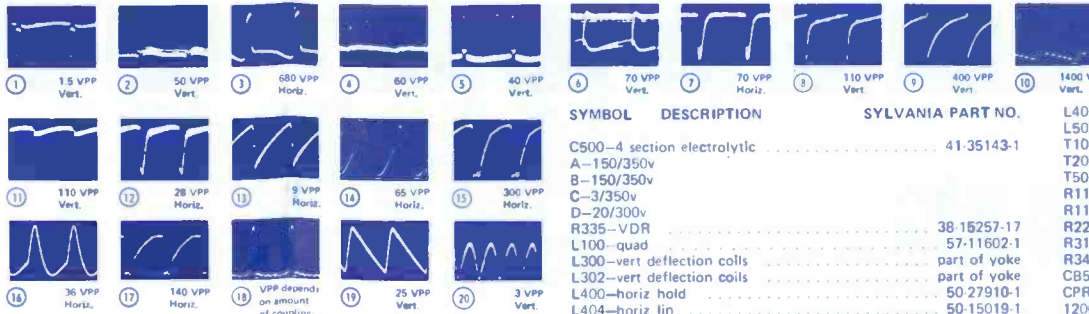
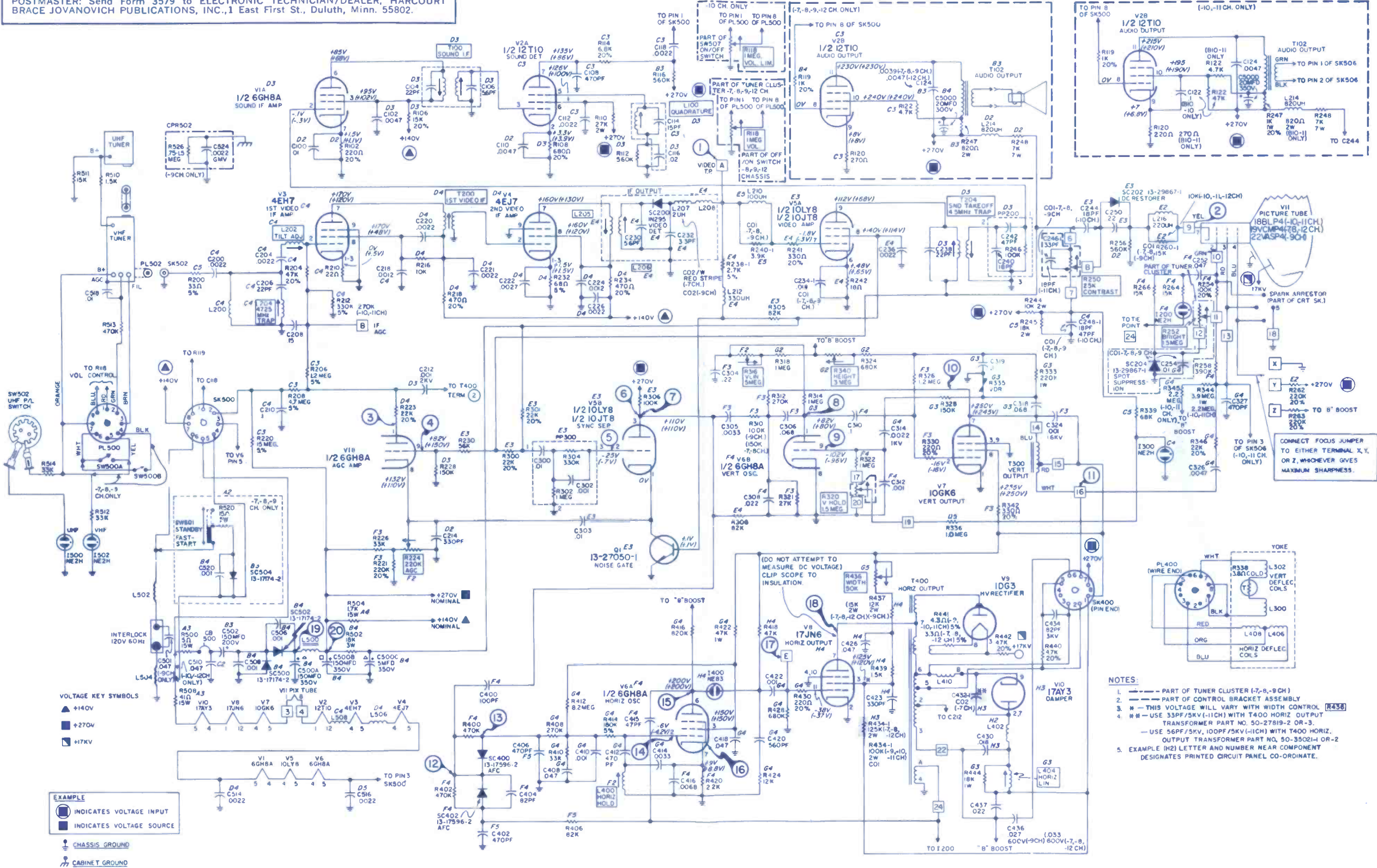
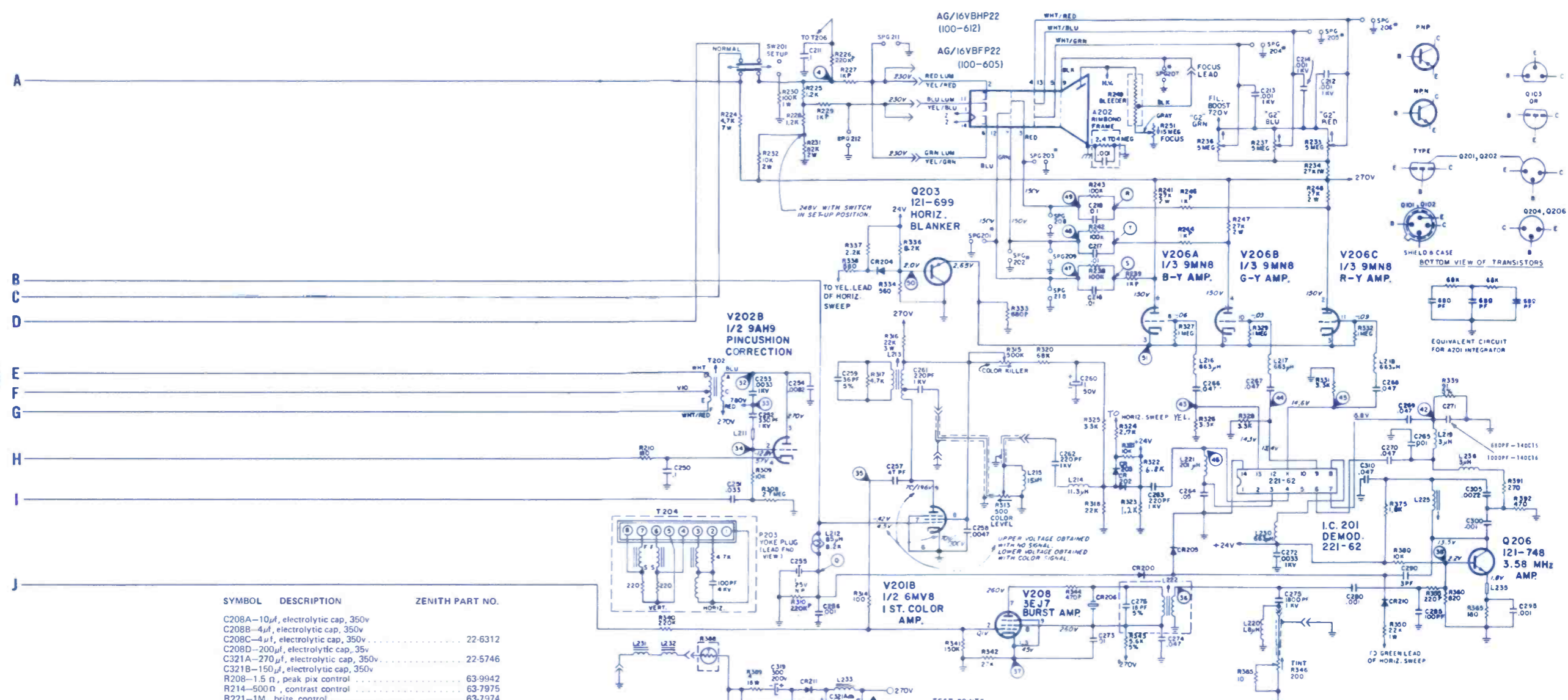
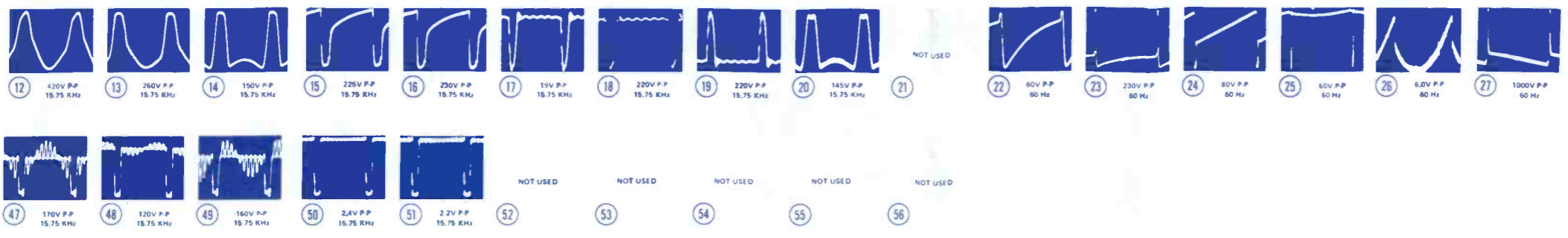

Table with 3 columns: SYMBOL, DESCRIPTION, SYLVANIA PART NO. It lists various electronic components and their part numbers, such as L408-horiz deflection coils (part of yoke), L502-choke, power line (50-29833-2), T102-audio output (56-3693-1), T204-sound take off/4.5MHz trap (57-11604-1), T502-low voltage power (-10, .11CH) (55-11121-1), R118-1M volume (-7 CH) (37-23044-6), R118-1M volume/on/off/ (-8, -9 CH) (37-35102-3), R224-220K, AGC (37-11632-1), R316 -5M, vert lin (part of R224), R340-3M, vert ht (part of R224), CB500-circuit breaker (29-88908-5), CPR502-capristor cabinet ground (-9, -10, -11 CH) (32-11488-3), 1200, 1300-lamp neon NE2H (30-33062-3), and 1400-lamp neon NE83 (30-97684-11).



ZENITH
Color-TV Chassis
14DC15, 16



SYMBOL	DESCRIPTION	ZENITH PART NO.
C208A	10µf, electrolytic cap, 350v	
C208B	4µf, electrolytic cap, 350v	
C208C	4µf, electrolytic cap, 350v	22-6312
C208D	200µf, electrolytic cap, 35v	
C321A	270µf, electrolytic cap, 350v	22-5746
C321B	150µf, electrolytic cap, 350v	
R208	1.5Ω, peak pix control	63-9942
R214	500Ω, contrast control	63-7975
R221	1M, brite control	63-7974
R251	15M, focus control	63-9013
R254	500Ω, AGC delay control	63-8543
R283	5K, AGC level control	63-7976
R284	750K, vert hold control	63-7973
R299	thermistor	63-6824
R307	2K, vert lin control	63-7983
R315	500K, color killer control	63-9942
R351	750Ω, buzz control	63-6487
R378	voltage dependent resistor	63-7658
R388	thermistor	63-8687
R396	voltage dependent resistor	63-7658
L202	4.5MHz trap coil	S-77669
L209	sound take-off coil	S-77414
L222	3.58MHz burst a output coil	S-80791
L224	quad coil	S-80480
L226	horiz osc coil	S-56877
L233	ac choke	95-2917
T201	vert output xfomer	95-2924
T204	deflect yoke	S-92263
T206	filament xfomer	95-2944
T207	horiz sweep xfomer	S-89112
A201	integ unit	87-7
F201	heater fuse 1lnk 2½ in. min. loop of No. 24 AWG copper	91-2061
F202	500ma, bel-fuse	136-84
F203	2.7a, bel-fuse	136-76
F204	100ma, bel-fuse	136-104

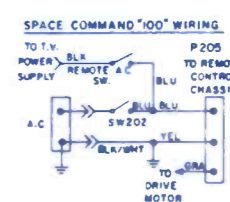
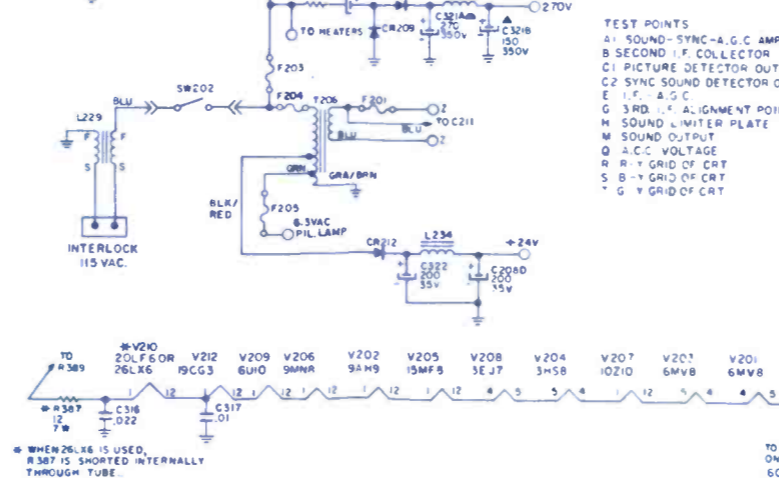

- TEST POINTS
- A1 SOUND-SYNC-A.G.C. AMP OUTPUT
 - B SECOND I.F. COLLECTOR
 - C1 PICTURE DETECTOR OUTPUT
 - C2 SYNC SOUND DETECTOR OUTPUT
 - E I.F. A.G.C.
 - G 3RD. I.F. ALIGNMENT POINT
 - M SOUND LIMITER PLATE
 - O A.C. VOLTAGE
 - R R-Y GRID OF CRT
 - S B-Y GRID OF CRT
 - G Y GRID OF CRT

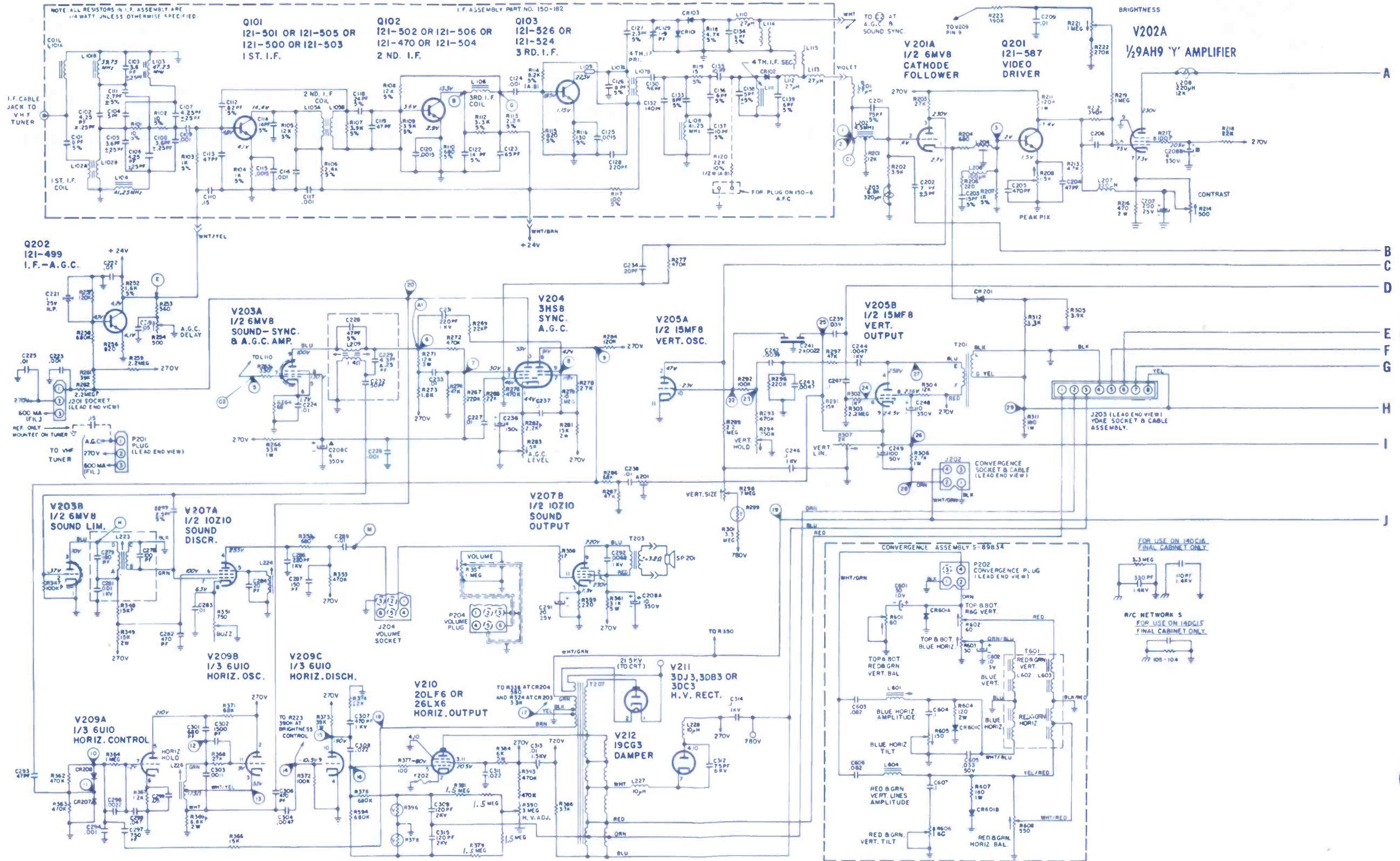
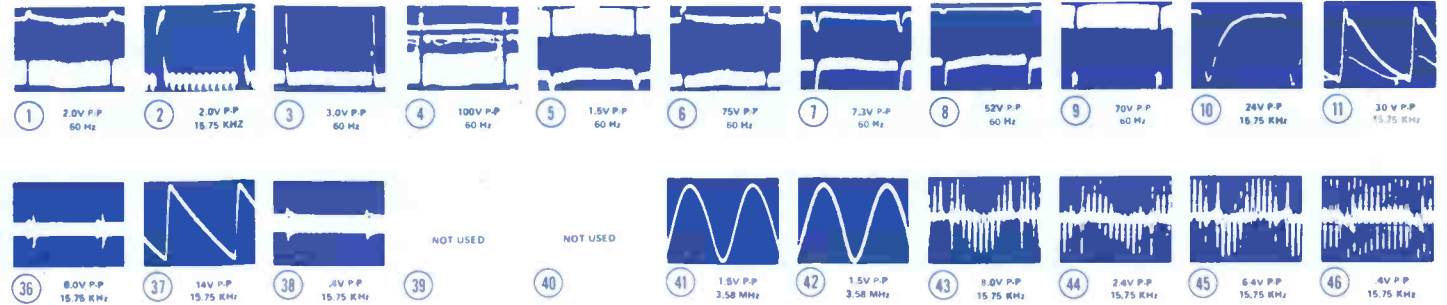

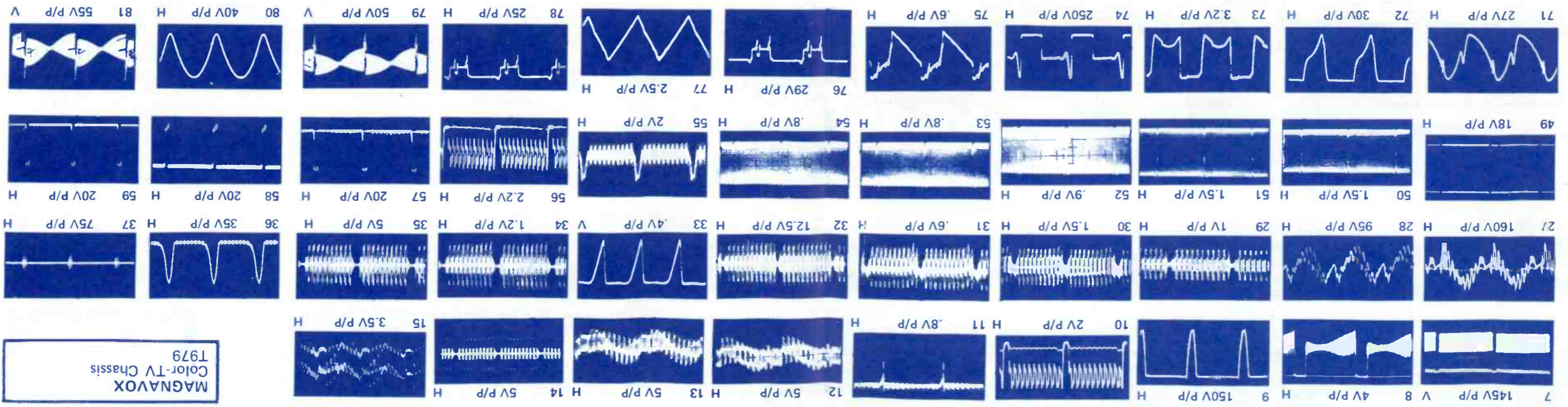
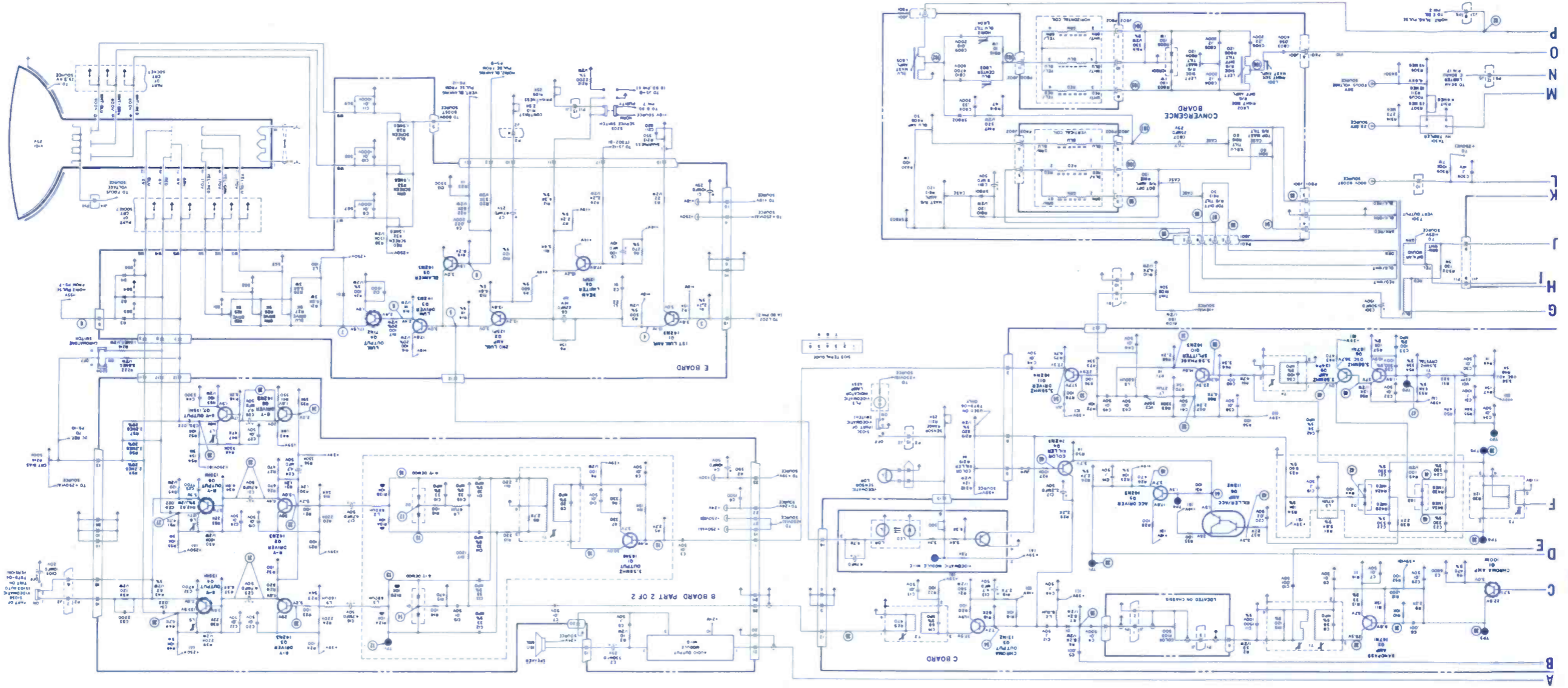

MAGNAVOX
Color-TV Chassis
T979

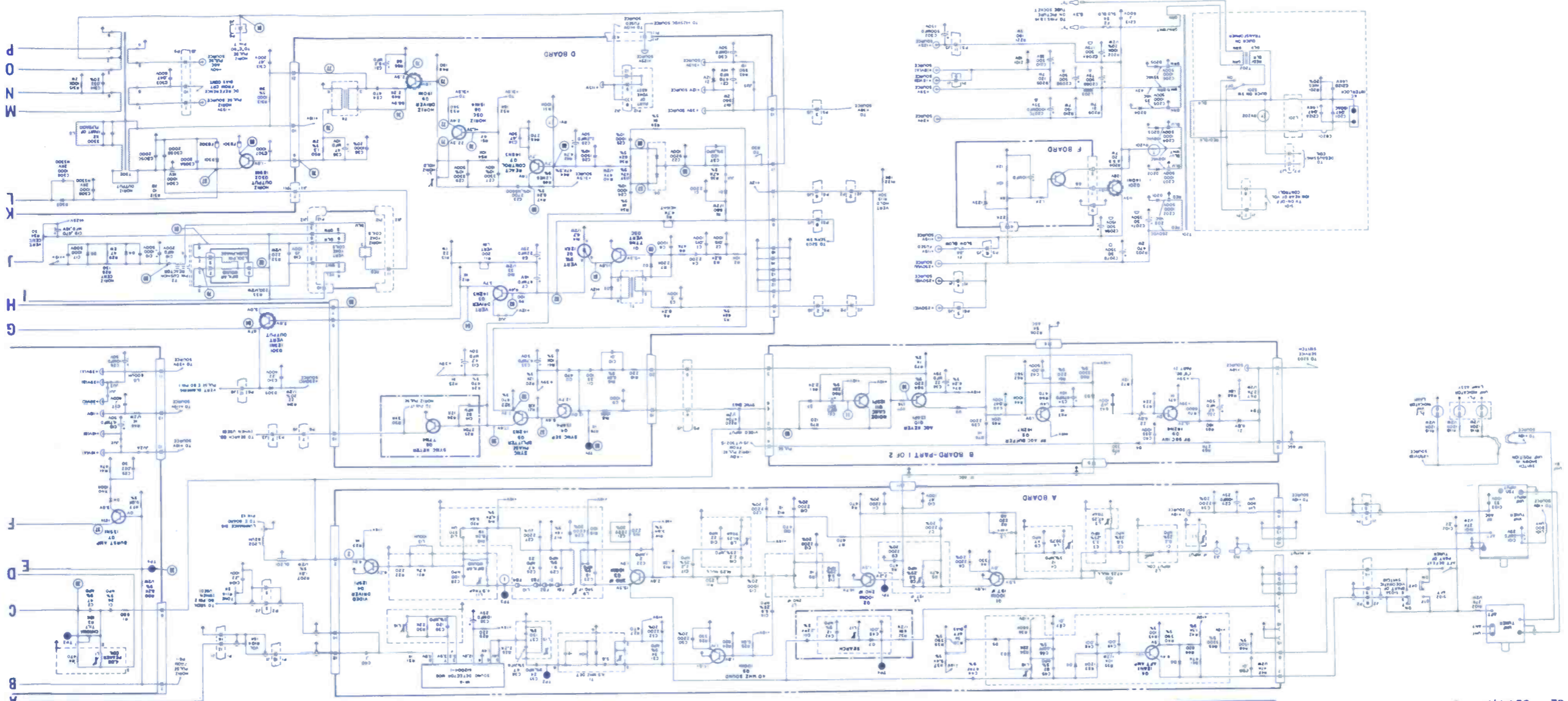
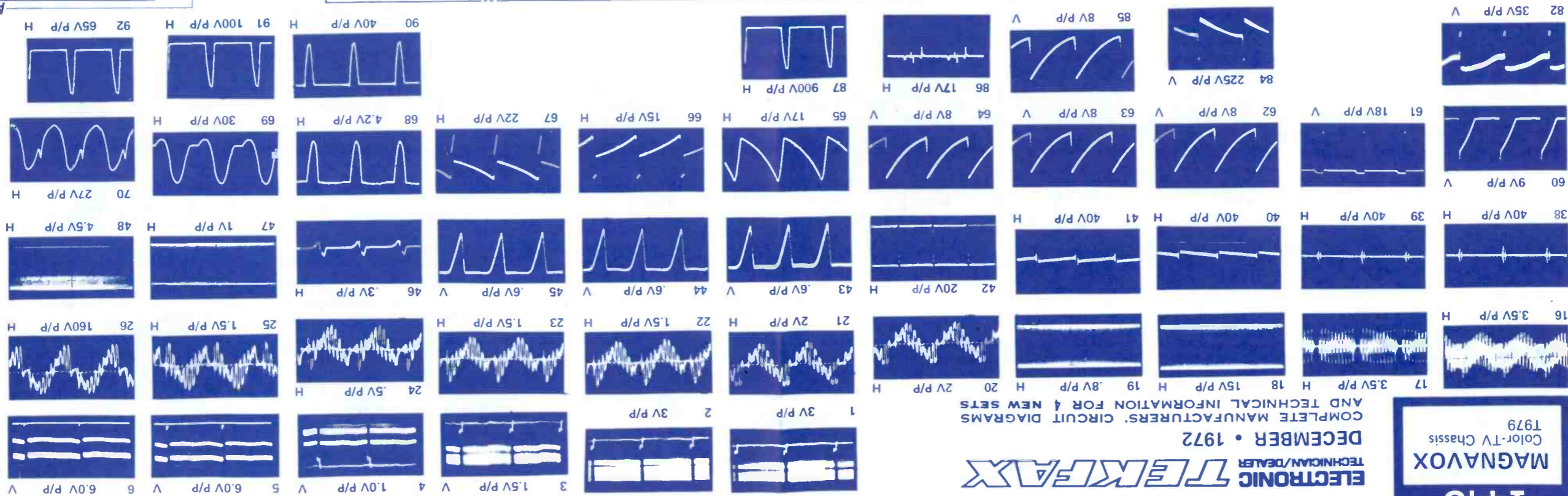

SYMBOL DESCRIPTION GENERAL ELECTRIC PART NO.

R801-on/off vol, 10K	ES49X74
R802-brfte, 500K	ES49X75
R803-contrast, 1K	ES49X77
R804-AGC, 1K	ES49X45
R805-vert hold, 30K	ES49X79
R806-vert ht, 20K	ES49X78
R807-vert lin, 20K	ES49X78
R808-focus, 2M	ES49X42
L112-deflect yoke	ES57X9
L113-coil, horiz osc	ES35X6

T109-xformer, horiz output	ES77X15
T110-xformer, power	ES88X4
IC01-sound IF pre-amp	ES84X3
IC02-audio output	ES84X1
IC03-horiz phase det	ES84X2
TH01-thermistar	ES14X39
CP01	ES57X15
CP02	ES57X16
CP03	ES57X17
CP304	ES57X16
fuse 1a, slo blo F701	ES10X7

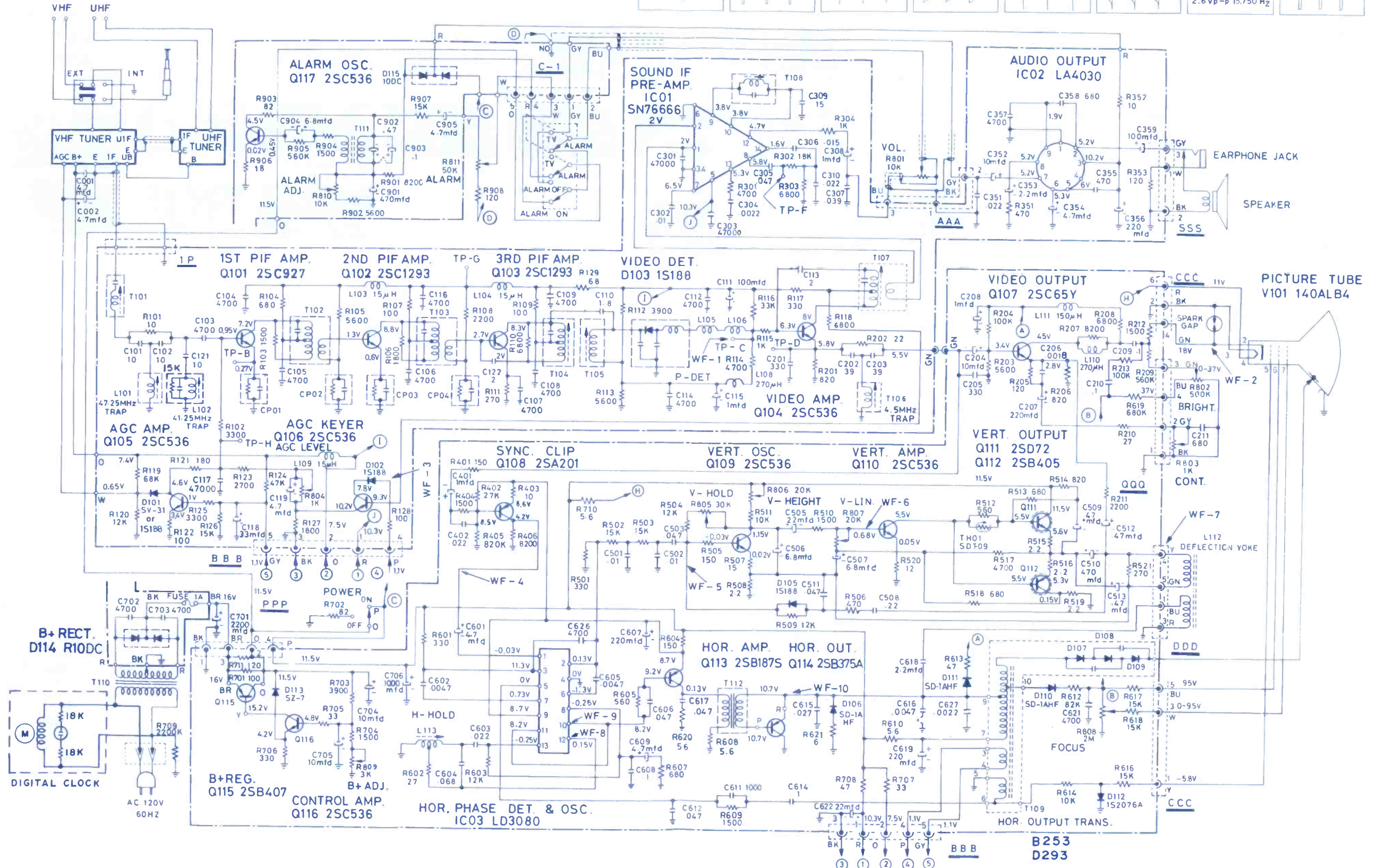
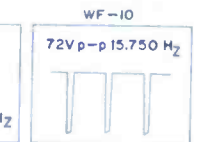
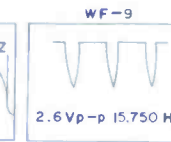
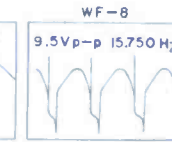
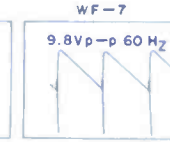
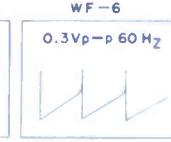
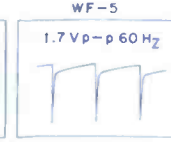
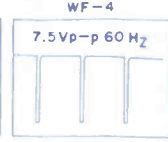
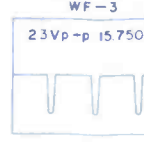
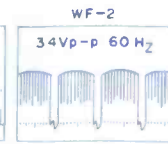
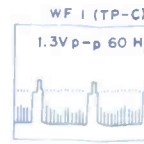

SCHEMATIC NO.		SCHEMATIC NO.		SCHEMATIC NO.		SCHEMATIC NO.		SCHEMATIC NO.		SCHEMATIC NO.		SCHEMATIC NO.		SCHEMATIC NO.	
120904, 911	1239	M618	1030	TS-440	700	G-500 & RC-200 Remote Control	797	RK-295 Stereo Adapter	721	7156	1098	D16-2	1338	H-M1900, 01, 03 Phono	734
120914A, B	1221	M638	1171	TS-454	931			RP-215-C1 Record Player	848	7157	1098	D17-1-2	1413	Chassis:	
120921, 923	1290	M649	1101	TS-458	1107	PHILCO-FORD		Chassis:		7158	1098	D18-1, -2, -3	1423	V-2407-4 Radio	789
120962, 964	1303	M685	1123	TS-460 Series	1089	Model:		81401, 411, 421	1167	81401, 411, 421	1167	D19-1, -2, -3	1388	V-2409-4, -5, -6, -7, -8	688
120969, 970	1288	M687	1112	TS-461	1047	L-1532 Stereo Phono	761	Chassis:		456.61580	955	E01-1, -2, -11, -12	1322	V-2417-1, -2, -3, -4, -5, -6	711
120974B	1352	N-1	1307	TS-465	1258	L1650 Stereo	764	CTC11	706	456.61581	955	406-3 Stereo	859	V-2436	758
120976, 977, 980, 981, 982, 983, 984	1313	HEATH		TS-467	1424	M1618 Stereo Phono	822	CTC12, A, B, P, R	736	456.70120	967	V-2444-1, -2, -3, -5, -6, -9, -10	795	V-2444-1, -2, -3, -4, -5, -6	837
Model:		AA-21 Stereo Amp	829	TS-499	752	M-1660 Stereo Phono	822	CTC16, X	885	456.70121	967	V-2446-1, -2, -3, -4	825	V-2451-2CB Transceiver	774
9P50	1005	GR-22	773	TS-576	681	NT-600 Radio	867	CTC17X	952	528.61580	955	V-2451-2 CB Transceiver	817	V-2474-1, -2, -3, -6, -7	875
11P50/12P50	1375	GR-53	839	TS-578	763	Q1054	1113	CTC19	984	528.70120	967	V-2475-1, -4	887	V-2476-1, -4	900
12HP02	1390	HOFFMAN		TS-584-05, -H	913	RC-65 Remote Control Receiver	737	CTC20	1032	528.70121	967	V-2478-1, -2	907	V-2483-1	1053
12P50	975	Chassis:		TS-586	904	T-63 Trans Radio	708	CTC22 Series	1109	528.70122	967	V-2495-11	961	V-2486 Series	996
12P60/12P61/W	1280	BP318 Trans Radio	703	TS-587	919	T-909 Trans Radio	824	CTC25	1040	528.70270, 71	1133	V-2487 Series	1002	V-2490 Series	1014
29P10	1248	Model:		TS-588	964	Chassis:		CTC27X Series	1261	528.71120	1120	V-2496 Series	1023	V-2498 Series	1029
35P01/35P02	1177	P-1913 Stereo/Radio	790	TS-589	899	N1052	935	CTC28 Series	1136	528.71150	1138	V-2515-2 Phono	734	V-2515-6 AM/FM/Tuner	771
T2R2-1A	1374	913-000366, 386	1166	TS-592	1149	N1200	932	CTC31 Series	1144	528.72280	1114	V-2528-3 Radio	846	V-2652-2	1092
T8K3-1B	1442	BP318 Trans Radio	703	TS-594	1031	N1204	932	CTC35 Series	1132	528.72281	1114	V-2652-3 4-7-8-13	1058	V-2656-1-2	1121
T10K10-1D, C	1336	Model:		TS-596	957	13N51	754	CTC38 Series	1237	528.72282	1114	V-2659 Series	1143	V-2660	1143
T25H4-1A	1446	P708 Trans Radio	703	TS-597	1021	13N52	754	CTC39XAA	1319	528.72500	1160	V-2664 Series	1157	V-8001	1213
1800/2000 Series	742	KORTING		TS-598	1298	13N53	754	CTC40	1219	529.61580	1249	ZENITH			
FIRESTONE		Model:		TS-611	1196	14G20	855	CTC41	1314	529.61581	955	40 Radio	857		
Chassis:		MT 2233, 2243 Tape Recorder	865	TS-612A	1203	14N30	871	CTC43	1308	529.70120	967	40 Radio	857		
12-129-94U	918	MT3643/3633 Stereo Tape Recorder Constellation	853	TS-613	1232	14N50	862	CTC44 Series	1368	529.70121	967	Royal 50L Trans Radio	781		
FISHER		MAGNAVOX		TS-908C-02 to D-02	924	15G20	905	CTC46 Series	1373	564.10000	972	Royal 490 Trans Radio	811		
Model:		Model:		TS-912A	819	15J25	1007	CTC47 Series	1278	564.10003	972	Chassis:			
800 AM/FM Amp	693	77-D1 AM/FM Tuner	794	TS-914A 00 to A-07	819	15J27	951	CTC48 Series	1444	564.10001	988	10PG	712		
GENERAL ELECTRIC		Chassis:		TS-921 Series	1142	15M91	898	CTC49	1342	564.10002	988	TRAVELER			
Chassis:		34 Series	722	TS-924B, C	1225	15N30	914	CTC50 Series	972	564.10003	988	Model:			
AA	889	36-08, 09 Series	762	TS-929	1363	15N50	921	CTC51, 52	1436	564.10004	988	GTC-3014A, B	821		
AB	963	40 Series	849	TS-930 Series	1260	16J27	980	CTC54	1440	564.10005	988	GTC-3114A	821		
AC	1164	43 Series	835	TS-934 (Late prod.)	1366	16J27, 27A	1063	CTC55 Series	1378	SONAR		GTC-4014A	821		
AD	1148	44 Series	812	TS-938 (Additional Information)	1419	17C21, A, V, AV	1099	CTC59 Series	1408	Model:		GTC-4044A	821		
AE	832	45 Series	882	TTS-587	919	17J25	1084	KCS130YAB, YAC	687	"G" CB Transceiver	770	GTC-4054A	821		
AF	1191	47 Series	1062	WTS-436	731	17J27	1063	KCS136M	1008	SONORA		GTC-4114A	821		
AG	1370	48 Series	912	Model:		17K128	1096	KCS136X	879	Model:		GTC-4144	821		
AH	1447	49 Series	901	202 Auto Radio	727	17K150	1017	KCS136Y Series	744	563P197	852	GTC-4154A	821		
AI	1353	203 Auto Radio	727	204 Auto Radio	727	17N35	1049	KCS140A, B	730	563P197	852	Chassis:			
AJ	1370	2TMR Auto Radio	691	12MAM Auto Radio	661	17N45	1078	KCS142	834	564K236M	989	1156-89	696		
AK	1447	70-01 FM Multiplex Adapter	702	19P7-1, -2, -3	700	18C24	1305	KCS142XA	982	565P198	1080	TRUETONE			
AL	1353	T907 Series	981	19T5, 7, 11, 12, 13 and A19T8 Series	731	18J32	1151	KCS144E	998	Chassis:		Model:			
AM	1376	T908 Series	993	C2AA-18806-M-N Auto Radio	741	18L33	1130	KCS147A, B	786	1194-194	869	2DC1300B	767		
AN	953	T909 Series	993	C2YA-18806-E Auto Radio	741	18LT43	1137	KCS148	927	2DC1300C	767	12CB12X	1414		
AO	861	T910 Series	985	RV2F C20Z-18875-C Auto Radio Reverb	723	18NT45	1125	KCS149AA, AB, AD	942	2DC1300D	767	1M30T20	977		
AP	930	T911 Series	1088	MUNTZ		18QT85/18MT70	1118	KCS151A	917	2DC1301C	780	13A12	1325		
AQ	990	T912 Series	954	Chassis:		19FT608	1277	KCS152A	915	2DC1302B	767	13M15	923		
AR	1075	T913 Series	1181	T68A14	940	19HT15	1250	KCS153	959	2DC1302C	780	13X15	1034		
AS	1214	T914 Series	1181	T68A15	940	19KT40B	1242	KCS154A, B	948	2DC1303B	767	13X18	1086		
AT	1345	T915 Series	1140	T68H2B	947	19KT50/50B	1207	KCS155	966	2DC1303C	780	13Y12	1176		
AV	1046	T916 Series	1186	OLYMPIC		19L21	1233	KCS156	1019	2DC1501A, B	894	13Z12, 13Z12S	1228		
AW	866	T917 Series	1103	Model:		19P22	1226	KCS157 Series	1116	2DC1605	983	13Z13	1187		
AX	1156	T918 Series	1059	3P70	1430	19Q22	1226	KCS158 Series	1119	2DC1606	1079	14A9C29	1187		
AY	1173	T919 Series	1079	6P28, 6P29, 6P30	992	19Q78R	1197	KCS161	1022	2DC1803	1110	14A9C50	1324		
AZ	1236	T920 Series	1076	9P44	1275	19S32	1235	KCS162	1028	2DC2555	1079	14A10C29	1309		
B1	1318	T921 Series	1135	9P45	1275	20HT70	1332	KCS163 Series	1065	2DC3651	949	14B36	1334		
B2	1406	T922 Series	1111	9P46	1275	20HT71	1332	KCS164	1050	2DC3712	1073	14B36Z, 30Z	1355		
B3	1011	T923 Series	1158	9P54	1293	20L23	1264	KCS165 Series	1104	2DC3715	1041	14CC14Z	1418		
B4	1432	T924 Series	1311	9P94 Series	1379	20P22	1299	KCS166 Series	1175	2DC3815	1127	14DC15,16	1449		
B5	1037	T925 Series	1200	CT-910	1064	20P24	1267	KCS168 Series	1192	2DC3818	1168	14L20	842		
B6	1141	T926 Series	1283	9P56, 57, 58	1095	20Q74	1358	KCS169 Series	1306	2DC3819	1168	14L25	836		
B7	1184	T927 Series	1285	9P59, 60	1095	20Q75	1372	KCS171 Series	1198	2DC3918	1222	14M20	893		
B8	1417	T928 Series	1341	9P99/99P1	1246	20R27	1276	KCS172 Series	1385	2DC3918, 19	1210	14M21	1054		
B9	899	T929 Series	1311	Chassis:		20S230AV	1422	KCS173 Series	1180	2DC3920	1193	14M23	878		
BA	785	T930 Series	1271	CTC-19/21 Series	1077	20V35	1287	KCS174 Series	1182	2DC4815	1178	14M27	916		
BB	1412	T931 Series	1254	CTC 31	1231	21HT15	1434	KCS175 Series	1204	3912	1227	14M32	934		
BC	1357	T932 Series	1344	CTC 1940	1218	21KT41	1367	KCS176 Series	1269	Chassis:		14N22	1001		
BD	1195	T933 Series	1349	CTC 400	1255	21L23A	1439	KCS177 Series	1251	1096-243	788	14N26	958		
BE	772	T934 Series	1259	JU-JUCU	710	21ST31V	1438	KCS178 Series	1270	1095-232	729	14N27	1080		
BF	828	T935 Series	1364	NB	820	21T90, 91	1347	KCS179 Series	1340	UNITED SCIENTIFIC LABS		14N28	1010		
BG	1435	T936 Series	1349	NBU	820	22LT45/R	1401	KCS180	1410	Model:		14N29	969		
BH	911	T937 Series	1377	NDP	1013	22OT79	1396	KCS181	1410	Contact 23 CB Transceiver	986	14N31	986		
BI	939	T938 Series	1407	NEC	1365	PHILHARMONIC		KCS182	1410	UTICA		14X21	1039		
BJ	1018	T939 Series	1384	RAYTHEON CO.		Chassis:		KCS183	1410	Model:		14Y33	1169		
BL	1155	T940 Series	1297	Model:		TSL-001	689	KCS184	1410	T&C11 CB Transceiver	805	14Z21, 14Z21Z	1252		
BM	1393	T941 Series	1384	Raytheon Two-Way Encoder/Decoder	895	RAYCHELL-CARLSON		KCS185	1410	UTICA		14Z37	1216		
BN	881	T942 Series	1377	RCA VICTOR		Chassis:		KCS186	1410	Model:		14Z38, 14Z43	1240		
BO	1004	T943 Series	1407	Model:		401	1066	KCS187	1410	14Z37	1216	725 Tape Recorder	850		
BP	1048	T944 Series	1377	23DC16	748	U809/U810	1201	KCS188	1410	14Z38	1240	WEBCOR			
BQ	1257	T945 Series	1407	MPX-1-1 Stereo Adapter	716	SILVERTONE									

ELECTRONIC TECHNICIAN/DEALER

TEKFAK

COMPLETE MANUFACTURER'S CIRCUIT DIAGRAMS
AND TECHNICAL INFORMATION FOR 4 NEW SETS

GROUP
244

	SCHEMATIC NO.		SCHEMATIC NO.
GENERAL ELECTRIC TV Chassis BA	1447	SYLVANIA TV Chassis B10-7/-12	1450
MAGNAVOX Color-TV Chassis T979	1448	ZENITH Color-TV Chassis 14DC15, 16	1449

COMPLETE MODEL CHASSIS INDEX FOR ALL CIRCUIT DIGESTS AND TEKFAK FROM JANUARY 1962 THROUGH DECEMBER 1972

MONTH IN WHICH SCHEMATIC APPEARS

681-686	Jan. 1962	951-953	Sept. 1965	1223-1228	May 1969
687-692	Feb. 1962	954-961	Oct. 1965	1229-1234	June 1969
693-698	Mar. 1962	962-969	Nov. 1965	1235-1240	July 1969
699-705	Apr. 1962	970-975	Dec. 1965	1241-1246	Aug. 1969
706-709	May 1962	976-982	Jan. 1966	1247-1252	Sept. 1969
710-716	June 1962	983-988	Feb. 1966	1253-1258	Oct. 1969
717-723	July 1962	989-995	Mar. 1966	1259-1264	Nov. 1969
724-729	Aug. 1962	996-1001	Apr. 1966	1265-1269	Dec. 1969
730-735	Sept. 1962	1002-1009	May 1966	1270-1275	Jan. 1970
736-743	Oct. 1962	1010-1015	June 1966	1276-1281	Feb. 1970
744-749	Nov. 1962	1016-1022	July 1966	1282-1287	Mar. 1970
750-755	Dec. 1962	1023-1028	Aug. 1966	1288-1293	Apr. 1970
756-761	Jan. 1963	1029-1035	Sept. 1966	1294-1299	May 1970
762-766	Feb. 1963	1036-1041	Oct. 1966	1300-1305	June 1970
767-772	Mar. 1963	1042-1047	Nov. 1966	1306-1310	July 1970
773-779	Apr. 1963	1048-1054	Dec. 1966	1311-1315	Aug. 1970
780-784	May 1963	1055-1060	Jan. 1967	1316-1320	Sept. 1970
785-790	June 1963	1061-1067	Feb. 1967	1321-1325	Oct. 1970
791-797	July 1963	1068-1073	Mar. 1967	1326-1330	Nov. 1970
798-805	Aug. 1963	1074-1080	Apr. 1967	1331-1334	Dec. 1970
806-811	Sept. 1963	1081-1086	May 1967	1335-1339	Jan. 1971
812-817	Oct. 1963	1087-1092	June 1967	1340-1344	Feb. 1971
818-822	Nov. 1963	1093-1098	July 1967	1345-1349	Mar. 1971
823-828	Dec. 1963	1099-1104	Aug. 1967	1350-1354	Apr. 1971
829-833	Jan. 1964	1105-1110	Sept. 1967	1355-1359	May 1971
834-838	Feb. 1964	1111-1116	Oct. 1967	1360-1364	June 1971
839-843	Mar. 1964	1117-1122	Nov. 1967	1365-1369	July 1971
844-850	Apr. 1964	1123-1127	Dec. 1967	1370-1374	Aug. 1971
851-853	May 1964	1128-1133	Jan. 1968	1375-1379	Sept. 1971
854-858	June 1964	1134-1139	Feb. 1968	1380-1384	Oct. 1971
859-863	July 1964	1140-1145	Mar. 1968	1385-1389	Nov. 1971
864-870	Aug. 1964	1146-1151	Apr. 1968	1390-1393	Dec. 1971
871-875	Sept. 1964	1152-1157	May 1968	1394-1398	Jan. 1972
876-881	Oct. 1964	1158-1163	June 1968	1399-1404	Feb. 1972
882-887	Nov. 1964	1164-1169	July 1968	1405-1409	Mar. 1972
888-893	Dec. 1964	1170-1175	Aug. 1968	1410-1414	Apr. 1972
894-900	Jan. 1965	1176-1181	Sept. 1968	1415-1419	May 1972
901-908	Feb. 1965	1182-1187	Oct. 1968	1420-1424	June 1972
909-916	Mar. 1965	1188-1193	Nov. 1968	1425-1429	July 1972
917-923	Apr. 1965	1194-1198	Dec. 1968	1430-1434	Aug. 1972
924-926	May 1965	1199-1204	Jan. 1969	1435-1438	Sept. 1972
927-934	June 1965	1205-1210	Feb. 1969	1439-1442	Oct. 1972
935-942	July 1965	1211-1216	Mar. 1969	1443-1446	Nov. 1972
943-950	Aug. 1965	1217-1222	Apr. 1969	1447-1450	Dec. 1972

SCHEMATIC NO.

ADMIRAL	
Chassis:	
C21B12-1, 1AG, 1AS, 1HR,	
1N, 1R, 1C	910
C21B13-1	910
C21B15-1, 1AG, 1AS	910
C21C12-1AG, 1AS, 1C	910
C21C15-1, 1AG, 1AS	910
D4	883
D11	890
D42-1	883
D44-1, 2, 4	883
D61-1, 2, 4	844
D412-1	883
D414-1, 2, 4	883
D415-1	883
D416-1, 2, 4	883
D610-1, 2, 4	844
D761-1	928
D1160-2, 6	890
D1161-2, 6	890
D4117-1	883
G2	991
G3	956
G4	944
G5, 2G5, 3G5, 5G5, 7G5, 9G5	1074
G6	936
G7 Series	976
G11	920
G13 Series	997
G61-2	936
G310-1, 4	956
G336-1	956
G416-1, 5	944
G417-1	944
G422-1	944
G610-2, 3	936
G612-1	936
G613-1	936
G617-2	936
G618-4	936
G620-1, 2, 3, 4, 6	936
G1161-2, 3	918
H1-1A, H2-1A	1016
H1-1A, 1H1 1A, 1AH1, H2 1A	1300
H3-1A, H4-1A, 1H4 2A	1093
H10	1069
H12, 1H12	1044
K10	1346
K15	1147
K20	1351
NA1-1A	1273
NA10-1A	1429
T2H4-1AX	1326
T3K3-1A, T3K3-1B	1294
T3K4-1A, T3K4-1B	1205
T7H2-1A, T9H1-1A	1281
TG2-1	1170
TG2-2	1291
TH3-1A, TH4-1A, T2H4-1A,	
T3H4-1A, T8H4-1A	1199
T10H1-1AX	1217
T11K10-1A	1431
TK2-1A	1241
TL2	1316
TR2	1380
TR3	1399
1D4	883
1D11	890
1D13-2	883
1D42-2	883
1D61-1	903
1D412-2	883
1D611-1, 2, 3, 4	903
1D760-1	928
1D761-1	928
1D1160-5	890
1D1161-5	890
1G310-1	956
1G311-1	956
1G31-1	956
1G611-1	936
1G1155-1	918
1K18-1A, 2A	1391
2D4	883
2D11	890
2D42-1	883
2D412-1	883
2D413-1, 3, 4	883
2D414-1	883
2D415-3	883
2D1163-1	890
2G4	944
2G421-1	944
2K16	1361
7D413-1	873
8D4	883
8D418-1	883
8G4	944
BG423-1	944
930 Series	1386
9D410-1	883
9D412-1	883
9G4	944
9G410-1	944
9G413-1	944
9G416-1	944
16A4D, C	823
16B4C	823

SCHEMATIC NO.

16UA4D, C	823
16UB4C	823
18D8B	686
19B8B	686
19H10	1317
19K3U	816
19M3U	816
19R3U	816
19T3U	816
19UB8B	686
19UD8B	686
24A2	808
24B2	808
24C2	808
24D2	808
24UA2	808
24UB2	808
24UC2	808
24UD2	808
24UE2	808
AIRLINE	
Chassis:	
1078-233, 243, 1078U233, 243	766
10-116-254U	847
1174-184, 117U-184, 1188-184	831
12-124-24U, 12-124-34U	909
Model:	
GCI-11102A, 102B, 132A, 132B	1403
GCI-12102A	1411
GCI-12420A, B	1295
GCI-12460A	1337
GCI-13668B	1282
GCI-14821A, 41A, 51A	1389
GCI-17821A, 41A, 51A	1371
GEN-12440C	1312
GEN-13460A	1304
GEN-173A Radio	787
GEN-1225A Trans. Radio	753
GEN-1266A	945
GEN-1866A	1003
GEN-1867A	1036
GEN-1967A	1081
GEN-2485A	902
GEN-8077A, GEN-8447A	1106
GEN-11160A	1274
GEN-11269A	1208
GEN-11460A	1256
GEN-11461A, GEN-11481A	1330
GEN-11469A	1202
GEN-11760A	1279
GEN-11768B	1220
GEN-11960A	1292
GEN-11961	1354
GEN-12069A	1183
GEN-12078A	1165
GEN-12349A	1183
GEN-12442A	1426
GEN-12448A	1185
GEN-13160A	1244
GEN-13168A	1146
GEN-13489A	1165
GEN-13768B	1238
GEN-17148A	1165
GEN-17158A	1165
GHJ-1466A	978
GHJ-1566A	978
GHJ-1786A	978
GHJ-4516A	978
GHJ-4546A	978
GHJ-4556A	978
GHJ-3067A	1042
GHJ-3367A	1042
GHJ-8247A	1100
GHJ-8257A	1100
GHJ-14098A	1128
GHJ-14148A	1128
GHJ-14158A	1128
GHJ-14549A	1223
GHJ-14829A, GHJ-14849B,	
GHJ-14859B	1229
GHJ-17949A, 59A	1189
GMW-1447A	1068
GMW-1457A	1068
GMW-14447A	1087
GMW-14457A	1087
GTC-1684A	831
GTC-1694A	831
GTC-2684A	831
GTC-3914A	847
GTC-3944A	847
GTC-3954A	847
GTC-4015A	909
GTC-4415A	909
GTC-4445A	909
GTC-4455A	909
GTC-4914A	847
GTC-4944A	847
GTC-4954A	847
GTM-1583A	784
GTM-1827A Clock Radio	814
GTM-2583A	784
GVC-8019A Reverb	800
WG-1683A	746
WG-2313A AM/FM Console	778
WG-2343A	778
WG-2373A, BB	778

SCHEMATIC NO.

WG-2343B	778
WG-2373B	778
WG-2683A	746
WG-2785A	888
WG-4234A	694
WG-4334A	694
WG-5220A	655
WG-5226A	655
WG-5230A	655
WG-5320A	655
WG-5326A	655
WG-5330	655
WG-6050B	713
WG-6051B	713
WG-6052B	713
WG-6150B	713
WG-6152B	713
ANDREA	
Chassis:	
VTT323-5	818
CHANNEL MASTER	
Chassis:	
T5001 Series	1416
CORONADO	
Chassis:	
1197-153	860
Model:	
TV2-7110A	1124
TV2-7112A	1129
TV2-7310A	1117
TV2-9368A	1015
TV2-9398A	943
TV2-9442A	783
TV2-9453A	1105
TV2-9454A	1070
TV2-9552A	1061
TV2-9553A	1061
TV2-9590A	643
TV2-9591A	643
TV2-9592A	643
TV17-9386A	860
TV17-9444A	743
TV21-9367A	1102
TV21-9643A	1094
CURTIS MATHES	
Chassis:	
TV-17, 17-1	1057
TV-19-1	937
DELCO	
Model:	
7276605 Auto Radio	684
7284742 Reverb Unit	804
7284893 Reverb Unit	804
7286315 Cadillac Auto Radio	815
980464 Radio	777
980655 Auto Radio	826
980886 Auto Radio	864
9821137 Radio	793
983687 Auto Radio	707
985332 Auto Radio	701
985431 Radio	769
985694 Auto Radio	833
R59 and T-59-12V Garage Door Opener	
Transmitter/Receiver	724
DUMONT	
Chassis:	
4K16	1356
120509-B Stereo Amp	733
120591A	709
120592B	709
120593A	709
120622A	802
120623B	802
120633 Series 900	756
120644A	802
120677A	813
120678B	813
120679A	813
120684A	813
120688A	802
120689A	813
120699	891
120708	876
120712	876
120722	891
120725	876
120780	962
120783	962
120804A, B	1071
120805A, B	1071
120806B	1071
120807A, B	1071
120810	962
120827-A	1025
120846-B	1025
120847-B	1025
120856A, B	1056
120857A, B	1056

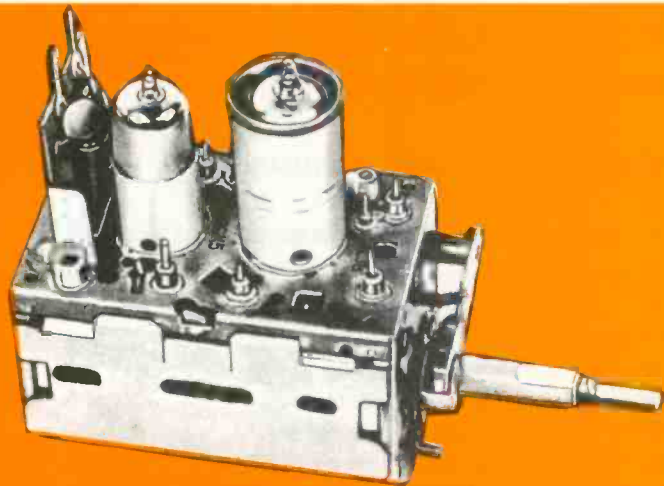

\$9.75

ALL PARTS INCLUDED

ONE YEAR GUARANTEE

TUNER SERVICE CORPORATION

PROVIDES YOU WITH A COMPLETE SERVICE FOR ALL YOUR TELEVISION TUNER REQUIREMENTS.

REPAIR

VHF Or UHF any Type \$9.75.
UHF/VHF Combo \$15.00.

In this price all parts are included. Tubes, transistors, diodes, and nuvistors are charged at cost.

Fast efficient service at any of our conveniently located service centers.

All tuners are cleaned inside and out, repaired, realigned and air tested.

REPLACE

Replacement Tuner \$9.75.

This price buys you a complete new tuner built specifically by SARKES TARZIAN INC. for this purpose.

All shafts have a maximum length of 12" which can be cut to 1½".

Specify heater type parallel and series 450mA or 600mA.

CUSTOMIZE

Customized tuners are available at a cost of only \$15.95.

Send in your original tuner for comparison purposes to:

TUNER SERVICE CORPORATION FACTORY - SUPERVISED TUNER SERVICE

Backed by the largest tuner manufacturer in the U.S.—Sarkes Tarzian, Inc.

HEADQUARTERS	537 SOUTH WALNUT ST., Bloomington, Indiana 47401	TEL: 812-332-7251
INDIANA	817 N. PENNSYLVANIA ST., Indianapolis, Indiana 46204	TEL: 317-632-3493
ARIZONA	2629 NORTH 1st AVENUE, Tucson, Ariz. 85717	TEL: 602-791-9243
CALIFORNIA	SARKES TARZIAN, Inc. TUNER SERVICE DIVISION 10654 MAGNOLIA BLVD., North Hollywood, California	TEL: 213-769-2720
FLORIDA	1505 CYPRESS ST., Tampa, Fla. 33606	TEL: 813-253-0324
GEORGIA	938 GORDON ST., S. W., Atlanta, Georgia 30310	TEL: 404-758-2232
KENTUCKY	2920 TAYLOR BLVD., Louisville, Kentucky 40208	TEL: 502-634-3334
NEW JERSEY	547-49 TONNELE AVE., Jersey City, New Jersey 07307	TEL: 201-792-3730
	(On U.S. Highway 1 & 9)	
TENNESSEE	1703 LAMAR AVENUE, Memphis, Tenn. 38114	TEL: 901-278-4484
	1215 SNAPPS FERRY RD., Greeneville, Tenn. 37743	TEL: 615-639-8451
VIRGINIA	4538 PRINCESS ANNE ROAD, Norfolk, Virginia 23502	TEL: 703-855-2518

WATCH US GROW

... for more details circle 128 on Reader Service Card



ELECTRONIC TECHNICIAN/DEALER

DECEMBER 1972 • VOLUME 94 NUMBER 12

PHILLIP DAHLEN, CET
Editor

1 East First Street
Duluth, Minn. 55802
(218) 727-8511

ALFRED A. MENEGUS
Publisher

757 Third Avenue
New York, N.Y. 10017
(212) 572-4839

TOM GRENEY

Publishing Director

JOSEPH ZAUHAR

Managing Editor

GAYNELLE DAVIDSON

Production Manager

JOHN PASZAK

Graphic Design

LILLIE PEARSON

Circulation Fulfillment

JOHN KESSLER

Manager, Reader Services

MANAGERS

JIM SMITH, CET

43 East Ohio Street
Chicago, Ill. 60611
(312) 467-0670

CHUCK CUMMINGS

Ad Space South/West
613 North O'Connor
Irving, Texas 75060
(214) 253-8678

KEN JORDAN

DONALD D. HOUSTON
1901 West 8th Street
Los Angeles, Calif. 90057
(213) 483-8530

CHARLES S. HARRISON

CY JOBSON
57 Post Street
San Francisco, Calif. 94104
(415) 392-6794

ROBERT UPTON

Tokyo, Japan
C.P.O., Box 1717

This month's cover photo is supplied through the courtesy of the Ford Motor Co.

-
- 3 **TEKFAX:** Up-to-date schematics for easier servicing.
 - 23 **EDITORIAL:** Merger? We're for it!
 - 24 **LETTERS:** Pertinent comments concerning past issues.
 - 27 **NEWS:** Events of interest to our industry.
 - 30 **READER'S AID:** What you need or have for sale.
 - 31 **BOOK REVIEWS:** Our appraisal of recent publications.
 - 32 **NEW AND NOTEWORTHY:** Merchandise of special interest.
-

FEATURES

39 TEKLAB REPORT

Some interesting features of a professional dual-trace, triggered-sweep scope that was assembled by our own staff.

42 ELECTRONIC SECURITY

Part II—A description of basic automatic telephone dialer circuitry by Terry Tuttle and Tom Turnbull.

45 BASIC DIGITAL CIRCUITRY

The second in a series of articles explains how flip-flop circuits can be used for counting to ten.

50 NATESA PLAN TO CREATE CONFIDENCE

Another approach for certifying the work performed by qualified electronic technicians.

52 BETTER MERCHANTS MAKE BETTER PROFITS

William Joseph tells how an effective direct-mail program can help eliminate those seasonal business slumps.

66 1972 ARTICLE INDEX

The page and issue of the articles and reference material that you may wish to review for help in servicing or developing better business principles.

-
- 54 **COLORFAX:** Tips for easier color-TV set repair.
 - 56 **TECHNICAL DIGEST:** Hints and shortcuts for more effective servicing.
 - 58 **NEW PRODUCTS:** Instruments and components to make your job easier.
 - 61 **DEALER SHOWCASE:** These items may increase your sales revenue.
 - 62 **TECHNICAL LITERATURE:** Informative material that you may need.
 - 68 **ADVERTISER'S INDEX:** Manufacturers concerned about you.
 - 69 **READER'S SERVICE:** A source of additional information.



A HARCOURT BRACE JOVANOVIICH PUBLICATION



HARCOURT BRACE JOVANOVIICH PUBLICATIONS: James Milholland, Jr., Chairman; Robert L. Edgell, President; Lars Fladmark, Senior Vice President; Richard Moeller, Treasurer; John G. Reynolds, Vice President; Thomas Greney, Vice President; Ezra Pincus, Vice President; Bruce B. Howat, Vice President; James Gherna, Vice President.

ELECTRONIC TECHNICIAN/DEALER is published monthly by Harcourt Brace Jovanovich Publications. Corporate Offices: 757 Third Avenue, New York, New York 10017. Advertising Offices: 43 East Ohio Street, Chicago, Illinois 60611 and 757 Third Avenue, New York, New York 10017. Editorial, Accounting, Ad Production and Circulation Offices: 1 East First Street, Duluth, Minnesota 55802. Subscription rates: One year \$6, two years \$10, three years \$13, in the United States and Canada. Other countries: one year \$15, two years \$24, three years \$30. Single copies: 75¢ in the U.S. and Canada; all other countries \$2. Second class postage paid at Duluth, Minnesota 55806 and at additional mailing offices.

POSTMASTER: Send form 3579 to ELECTRONIC TECHNICIAN/DEALER, P.O. Box 6016, Duluth, Minnesota 55806.

Copyright © 1972 by Harcourt Brace Jovanovich, Inc. All rights reserved. No part of this publication may be reproduced or transmitted in any form or by any means, electronic or mechanical, including photocopy, recording, or any information storage and retrieval system, without permission in writing from the editor or publisher.

Everytime we introduce a new product, you become more important.

New products mean more business. Not only for us, but for you. Independent service technicians. Once a product leaves our hands, it's in yours. Along with our reputation for making quality electronics. And for standing behind them. That's why you're so important to us. You help us maintain our good name. Product after product. Year after year.

Our products are designed not to break down. But the present state of the art, and the continuous flow of new and unique products, con-

tinue to provide opportunities for the service technician.

We think about you even before we introduce a product. We build our equipment for easy serviceability. Service literature and replacement parts are programmed to be available when a product goes to market. Not months later, when a customer may need help. There's no delay for you. No inconvenience for your customer.

As a special feature, we subscribe to a country-wide, toll free tele-

phone referral system. It operates 24 hours a day, 365 days of the year. When a customer calls 800-243-6000 asking for Panasonic service, he is referred to the nearest authorized independent service center. Yes, our nationwide network of authorized service centers is made up of men like you, independent service technicians. Panasonic depends on you. For in-warranty and out-of-warranty work. It adds up to more business for you. And, it's no wonder that you become more important to us.



... for more details circle 120 on Reader Service Card

Panasonic.
just slightly ahead of our time

Panasonic Service Division, 10-16 44th Drive, Long Island City, N.Y. 11101

Introducing the expensive digital multimeter that doesn't cost a lot.

The B&K Precision Model 281. A solid-state, lab-quality portable instrument that measures AC/DC voltage, current and resistance.

The state-of-the-art Model 281 shows readings on a large, clear, 2½-digit numeric display. It also has positive over-range and reverse-polarity indication. There's no need to switch leads. You can reverse polarity at the flick of a switch.

Model 281 readings are faster and more accurate than analog-type meters. Unlike hard-to-see needle indicators, you can read the large, illuminated numerals—including the decimal point—from a distance.

Featured are 26 ranges: five DC voltage, 100mV to 1000V, with 1% accuracy and 10 megohms input impedance; five AC voltage, 100mV to 1000V RMS, five DC current, 100μ A to 1A; five AC current, 100μ A to 1A; and six resistance, 10 ohms to 10 megohms.

With built-in protection, the 281 can't be harmed by overload. And for safety's sake, it has a three-line AC grounded cord.

Everything about the 281 says expensive—except the price.

Call your B&K distributor.

Or write Dynascan Corporation.

\$169⁹⁵

Very good equipment
at a very good price. **B&K**



Product of Dynascan Corporation, 1801 West Belle Plaine Avenue, Chicago, Illinois 60613

... for more details circle 102 on Reader Service Card

Merger? We're for it!



Those publications really concerned about you and your professional future have printed much recent information concerning the activities of the National Alliance of Television Electronic Service

Association (NATESA) and National Electronic Associations (NEA) as they prepare to develop a workable agreement for merger. As you probably know, NATESA is a national association of electronic service dealers (only), and NEA is a national association of electronic service dealers, plus (in many states) electronic technicians—the International Society of Certified Electronic Technicians (ISCET) also being an arm of NEA.

These groups represent the only national associations that we know of that are concerned exclusively with our phase of the electronic industry. They are to be commended for the work that has been done to improve the public image of the electronic technician and service dealer, to provide government with a more enlightened understanding of our profession, and to help those in our industry increase their revenue through more effective sales, servicing and business procedures!

Previous issues of **ELECTRONIC TECHNICIAN/DEALER** have given quite a bit of coverage to the First Joint Convention, held last August in New Orleans. Those of you who missed it, missed a sight that many of us will never forget—for as we ate together as one group, we filled the huge dining area—even at breakfast!!! And we were not the only ones impressed by our size. So were the manufacturers that came to see us!

As much as you and I cherish our

personal independence, it frequently becomes apparent that individually we cannot even hope to accomplish tasks that can collectively be performed with relative ease. We simply do not have the financial, technical, business and political resources to do it alone. But just because we work together does not mean that we cannot continue to make our own personal decisions.

Show me someone active in national association activities, and I will show you a person who has developed enough personal success to become financially comfortable, or maybe even financially independent. Show me someone who is unable to maintain his business, and I will show you a person unwilling to give wholehearted support to one of these professional associations. It is just that simple! (There are, of course, others that do not fall into either category—those who have had some degree of success, but could come closer to their true potential if they really cared.)

I know quite a number of service dealers who want to take optimum advantage of association membership and thus belong to both NATESA and NEA. As an example, Jim Boyd, CET, of Rockledge, Fla., is not only Vice Chairman of ISCET but an active member of both NATESA and NEA. And he, like so many others, is very anxious to see a merger of these two great national associations—thus eliminating considerable duplication of efforts.

But we are not the only ones faced with such a duplication of efforts. Manufacturers wishing to demonstrate their support of electronic sales and servicing must (except for our joint conventions) be faced with the choice of putting up exhibit booths at either one convention or the other—or not wanting to appear partial, at both conventions or neither convention. And in the same manner, they are faced with the question of what association activities to support,

and what efforts to duplicate or ignore.

It was about 10 years ago that there were disagreements among certain members of NATESA, and some left that association to form NEA. Since then, a number of those people have left their respective associations, and the two associations have become increasingly cooperative—NEA becoming the larger of the two groups.

Both of these associations are sincerely dedicated to the task of upgrading our profession. Both associations have dedicated leaders that have earned the respect of the industry. Neither association can hope to accomplish a merger without respecting the rights of the other.

Last month's issue of **ELECTRONIC TECHNICIAN/DEALER** included a detailed report of the first meeting of the Joint Merger Committee. Both associations have since had executive council or board meetings endorsing the results of this first Joint Merger Committee Meeting. The second (and possibly final) Joint Merger Committee Meeting was scheduled for December second and third in Denver, Colo.—having been held much too recently to be reported in this issue.

It is quite possible that there may not be a Joint Convention in Kansas City this coming August. By that time the members of both associations may have already approved the merger, and it may instead be a convention of the new association.

We are 100 percent behind this merger and are very pleased to see how well these efforts have proceeded. The new association will be even better able to help improve the lot of the electronic technician and service dealer.

Phillip Dahlen, CET

LETTERS

Reader comments concerning past feature articles, Editor's Memos, previous reader responses or other subjects of interest to the industry.

Still Considerable Confusion

I have read the various comments of the readers regarding CB Radio, and there still seems to be a great deal of confusion regarding what can be done and what cannot be done. I will put my two cents in for what it is worth.

I am a holder of an FCC License with a Radar Endorsement, and have held this license for 18 years. According to the letter of the law, I can maintain all types of two-way radios, including CB units. Also, I am a member of the American Association of Engineers.

I have taken care of approximately 125 60-to-100w mobile units and 5 100-to-300w base stations. This in addition to the engineering that goes with it.

I am not bragging, but setting my qualifications down on paper so that you can see that I am speaking facts as they exist.

1. What could I [if without an FCC License] fix on a CB unit? (This is a question that many TV/Radio technicians ask, both themselves and others.)

A. You can fix (maintain) anything that does not affect the frequency nor the power. You can replace tubes in the receiver and so on. But, **DO NOT REPLACE ANYTHING THAT WILL AFFECT THE FREQUENCY OR POWER.**

B. Should I make frequency checks? Yes—just as on the larger two-way radios that are around in cars and offices.

2. Do I need a copy of the rules and regulations?

In Part 95.105, it states quite clearly that "Each licensee in this service shall maintain as a part of his station records a current copy of Part 95, Citizens Radio Service, of this chapter." This says "shall maintain." This does not mean, "could," "maybe," "when I get around to it," "next week." It means "right now." Many people who are taking care of Citizens Band radios do not have the current Part 95. This will spell out exactly what you

can do and what you cannot do.

Too many TV/Radio technicians are getting all upset about what they can do and what they cannot do. From the letters that you have received, it is evident that they do not have a current copy of Part 95. As I said, this spells out what you, as a TV/Radio technician, can do and what you cannot do.

You may, by rule of thumb, replace tubes, transistors, vibrators, tighten loose bolts, and then inform the owner that "this must be fixed by a holder of a First or Second Class Radio License."

Just remember, neither you nor I make the rules, we only live by them. All the "sour grape" people will have to do is take the examination for a license and they too can fix Citizens Band radios—legally.

Your magazine is very good, but I would like to see more two-way radio articles in it.

Each of us (radio and television technicians) has his own special interest, so I realize that you cannot satisfy everyone, but in time. . . .

Thank you for listening to me spout off, but I just got tired of listening to all the people complain about the men that have FCC licenses and can fix CB radios, and they cannot (legally). It is off my chest now.

JOHN E. BUMBALCK

Pix-Mate™ the crt tester you can afford to take along

only ... \$34.95

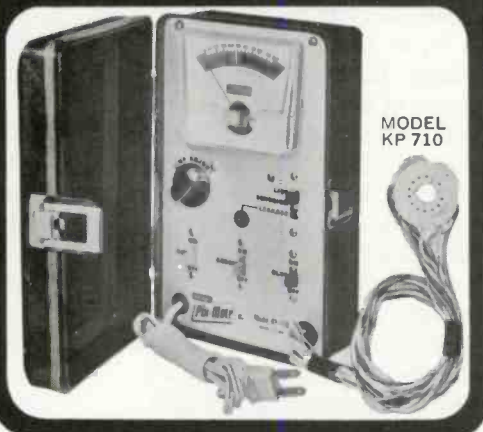
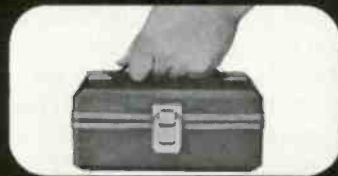

- A quality CRT tester with individual test for each gun.
- Compare guns for emission.
 - Test for leakage and shorts.
 - Legible 3 color scale.
 - Compact, portable, rugged.
 - Avoid recalls, check the CRT on every call.

WRITE US!

TeleMatic

take along the time savers

- PIX-MATE • CRY-S-MATE • GEN-MATE
- SOUND-MATE • TRACE-MATE

The Caddy-Mate Line.

2245 PITKIN AVE., BROOKLYN, N. Y. 11207

... for more details circle 127 on Reader Service Card

Holds Same View As in Editorial

Your editorial titled, "What's Wrong," that appeared in your September issue seemed very appropriate and I thought you might enjoy a few comments on your philosophical approach to ELECTRONIC TECHNICIAN/DEALER.

Your "Capitalism" came through very strong and indicated to me a type of character of which our country is becoming less familiar, namely, "The hard core middle-class America, with enough sense and understanding to criticize justly what is wrong with our society, and strong enough to hold their own individual values and pit them against an awesome tide of shallow, decaying minds, whose cures for the ills of our society are suicidal."

Our nation is becoming a "nation of sheep." The "follow-the-leader" attitude prevails throughout much of our society. Self respect, once an inbred quality in individuals, necessary for survival, is now a lost concept of belief. During much of our American History, a man knew his own worth because he had to work hard to eat and provide for his family. Now, it is not even necessary for a man to work to survive. Our welfare system, which

is responsible for this undertaking, in its final analysis, is the one most single factor in our history that deteriorates human self respect, the most important ingredient in the make-up of a man and a great nation.

I'm an individualist too, and a hypocrite on top of that, if that is what you call a person who has taken a good hard look at his country and dislikes what he sees. It is not our youth that is responsible for our apparent decaying condition, nor is it our government—it is simply ourselves. We as Americans must realize that as a nation we must nourish the individual in terms of self respect, creative ability, and a genuine depth of character. This philosophy is what it takes to be an independent service dealer and survive, and this philosophy is what America needs to survive. My hat is off to all independent business men throughout our country, for indeed they are the very backbone of this country, and I for one, am extremely proud to be part of that tradition.

JAMES E. OSBORNE

Afraid of Losing Business?

Is Robert O. Parsons afraid of losing some C.B. Business? If his complaint is "unqualified butchering," let him charge for these repairs. I do. When I get a "botched job," the repair price automatically increases \$10.

Keep up the good work or stop all "fix-it" articles.

LES A. GOODMAN

Receives Excellent Response

I am writing to thank you for placing my free "Ad" in the Readers' Aid Section of the September issue of ELECTRONIC TECHNICIAN/DEALER.

I have received to date approximately 25 letters and cards—also a few 12A8 tubes were sent.

I would like to thank all of the kind people that responded.

The radio, which belongs to a friend of mine, is now working fine.

MR. G. I. ROBERTS

Possessions Never Found

I want to thank you—first, for featuring my letter in the September issue and, second, for sending me extra copies of that issue.

We have moved back to Mt. Prospect, after our disastrous trip to Kansas City, and are getting reestablished again.

As a direct result of printing my letter, a retired TV man in Norwich, Conn. has voluntarily sent me some of his equipment and tools—an act of

generosity that I deeply appreciate.

In relation to your Crime Issue—was the ease in which this large U-Hall truck was stolen. It was parked over night at a motel near St. Louis, securely locked and in a brightly lit area 30 ft. directly in front of our motel door. The thief must have had a duplicate key.

I might add that in the past six months we have heard nothing about our stolen possessions or the 30 ft. truck that they were in. The police have never contacted us and I doubt if a search was ever made.

Thank you.

WILLIAM R. BURGESS

Field Work Hints

The new Vector voltage and current test adapters are very good, particularly for measuring cathode and screen current in the horizontal output tube. This is especially useful on house calls, because I'd rather not carry the horizontal output tube current meter around in the car.

I have to take a VOM anyway, and it takes a beating from the vehicle vibration.

Do you know that a meter should be transported face down? The reason is to put the wear and tear on the front

pivot. We want to protect the rear pivot because, for best accuracy, the meter lies on its back and the movement balances on the rear pivot.

Getting back to the Vector adapter, I have one that fell apart from bouncing around in the tool box. So, I drilled a hole through the center of the base, cemented a nut in the barrel of the upper portion of the adapter and installed a nylon screw to hold it together. (The screw held the nut in place while the cement hardened.)

Now, I can disassemble the adapter for cleaning or just adjust contact tension with a turn of the screw.

EDWARD H. SAMPLE

A Smack of Arrogance

After reading many of your editorials, I am sure you do agree with me and many other CET's that licensing or certification of technicians is becoming more and more necessary. Not only from the consumer's standpoint but also from the shop owner's.

When commenting on a prospective technician from another shop owner, what can be said? "He'll be okay for your shop?" I consider this comment rather arrogant because how does this shop owner know what standard of

continued on next page

SAVE TIME WITH OUR CHEMICAL SIGNAL TRACER

Time is money. And nothing eats up time like troublesome intermittents.

There is a way to fight back, though. With a faster kind of test equipment that comes in a can: SUPER FROST AID. After the set 'cooks' and the problem appears, hunt it down in minutes with SUPER FROST AID's unbeatable (-55°F) cooling power. Even on the most crowded printed circuit, SUPER FROST AID's lack of liquid residue lets you check component-by-component with pinpoint applications. And it's long-lasting—saves you more by using less!

Next intermittent you run across, cure the problem faster with a chemical signal tracer. SUPER FROST AID (catalog #1500)—one of the best-selling chemical tools from

CHEMTRONICS INC.
1260 RALPH AVE., BROOKLYN, N.Y. 11236
TEL. (212) 629-1300

Our business is improving yours.

... for more details circle 106 on Reader Service Card

LETTERS...

continued from page 25

competence the other shop owner is looking for in a technician? On the other hand, certification makes the competence of a CET more uniform. Perhaps the system is not perfect, but it is far better than none or the former.

There have been many comments concerning the CET Test in your magazine. I give more support to the theory side of the test. Theoretical applications of troubleshooting are much

more practical. The shotgun method (replacing part after part until either the bad one is found or he's run out of parts or butchered up the printed-circuit board) should be done away with.

I cannot be sure of someone who comes to me with no certificates, or who is not willing to take a practical theory test. Some technicians have said, "I can fix any set in your shop, but I won't take your test." This again smacks of a little arrogance. I can't understand how an uneducated technician can possibly locate open or leaky capacitors, open transformers,

open or shorted transistors without the proper knowledge of the circuitry, because they certainly can't be found by just looking at them.

It is high time that a technician be capable of more than merely replacing burned resistors, picture tubes, cleaning tuners or anything that requires only the five senses. Through certification/licensing, we hope technicians will be more qualified and the standards of competence more uniform.

With proper knowledge of Ohm's law, Kirchoff's law and the fundamentals of vacuum tube and transistor theory, along with the proper use of test equipment, I am sure a technician should be well prepared to troubleshoot.

Experience will help him a lot, but with an understanding of the fundamentals he is less apt to tell his boss, "Gee, I never ran into this before," which is typical of the five-senses memory-bank-of- troubles type of technician.

The educated technician will most likely develop his own servicing techniques. He should be familiar with varactor diodes, FETs and new developments. Solid-state devices are here to stay and the more knowledge about them, the more proficient a technician will be.

ROLAND (RON) MEYER, CET



Perma-Power Color Brite

When the picture looks good, you look good.

When a color TV picture fades, or when the black-and-white is erased by a cathode-to-filament short, you can save the day, and the tube, by installing a Perma-Power Britener.

Boost models bring out lost sharpness and detail by providing increased filament voltage to increase electron emission. Full contrast and color quality return immediately.

Isolation models restore the black-and-white information that gives a color picture its quality, by isolating the short, thus restoring black-and-white video drive.

Short now . . . fade later? Handle

both jobs with a Color-Brite *Combination Isolation and Boost Britener*.

There are Perma-Power Color Brite models for both round tubes and rectangular tubes. In fact, Perma-Power has a Britener for just about every picture tube ever made! You'll look very good to your customer when you prolong the life of the expensive picture tube. Pick up a supply of Color-Brites from your Perma-Power distributor!



PERMA-POWER DIVISION
CHAMBERLAIN MANUFACTURING CORPORATION
5740 North Tripp, Chicago, Illinois 60646

... for more details circle 121 on Reader Service Card

Editorial Hit Too Closely

If all the specialized fields of electronics were equated to 100 percent, the home entertainment field would be 2 to 3 percent. That's not meant to be derogatory, it's a fact. In nine years as an electronics technician, I've hit nearly 75 percent, and that's not bragging—rather, a rough way to spend nine years. It's just a shame that one of the most interesting of all the fields of work is so plagued by questionable techs and employers.

I am no longer working full time in home entertainment electronics, having gone into industrial electronics in order to make a decent living. My gross wages as a bench tech for a wholesaler near here were less than my net wages when I was discharged from the Navy, and they're both far, far less than I get in industry—along with all the benefits of a union but no union. Consumer electronics is extremely satisfying, but 'ya gotta eat!

The wholesaler that I worked for supposedly supports the local association but is not active. Even after becoming a CET, I was considered an apprentice. Words and actions never seemed to coincide. I'm afraid your June editorial fit all too closely.

I plan to continue work in consumer electronics
continued on page 64

NEWS OF THE INDUSTRY

TV Picture Displayed On Thin Matrix Panel

Research scientists from Zenith Radio demonstrated a newly developed thin-panel TV display employing the gas-discharge principle at the IEEE Conference on Display Devices in New York City on Wednesday, October 11, 1972. The experimental unit demonstrated at the Conference employed a Burroughs "Self-Scan" panel and showed only a portion of the TV picture.

This thin panel was operated next to a 25-in. diagonal color-TV set masked to show the same portion—12 percent



Front and side views of the thin-panel gas-discharge display. Without the associated electronics, the panel is $\frac{5}{8}$ -in. thick.

of the picture width and 43 percent of its height—with the brightness and contrast turned down to match the output of the thin-panel display.

The report indicates that other attempts to produce panel displays have been made in the past—employing incandescent lights, electroluminescence, liquid crystals and other techniques. However, the Zenith thin-panel display is said to be the first matrix device to produce a TV picture of sufficient quality to warrant comparison with a CRT.

More Virginians Take CET Exam

VEA State President John McPherson journeyed from Yorktown to Lynchburg, Va. to administer the CET Tests to interested parties in the western part of the state. The facilities of the Virginia Community College were made available to the seven persons who assembled for the test on Sunday, October 22, 1972.

The testing session followed a Saturday evening meeting of members from VEA-Lynchburg and VEA-Danville to discuss the pros and cons of state licensing.

The questions provided below are representative of those included in Section VII of the CET Exam.

Section VII

Tests and Measurements

1. What should be determined to safely use an ohmmeter on its lowest ohms range in measuring a transistor junction?
2. Use of an attenuator probe on a scope instead of a direct probe (increases/decreases) loading of a circuit under test by (increasing/decreasing) resistance and (increasing/decreasing) capacitance.

continued on next page

GC ELECTRONICS CALECTRO test meters

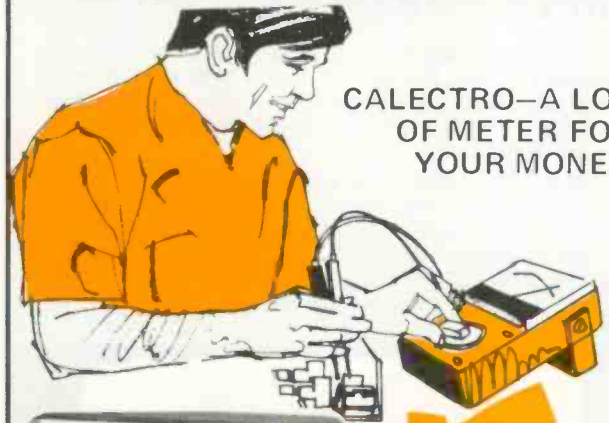

CALECTRO—A LOT
OF METER FOR
YOUR MONEY



**20 RANGE TEST
METER**
One of the most
popular test meters
at any price.



**19 RANGE TEST
METER**
A precision instrument
in a small convenient
size.



**16 RANGE TEST
METER**
Outstanding all-
around test meter
for technician or
do-it-yourselfer.

**INSTANT
REPLACEMENT
WARRANTY**



GC ELECTRONICS

DIVISION OF HYDROMETALS, INC.
ROCKFORD, ILLINOIS 61101 U.S.A.



... for more details circle 113 on Reader Service Card

Here's a Special offer to show you how you can cut back on TV haul backs.

FREE

Our solid state replacement/renewal parts for color TV receivers work so that you don't have to do a lot of extra work. EDI SOLID-TUBES, multipliers, stick and cartridge rectifiers all help avoid haul backs. You cut back on annoying call backs.

5 EDI SOLID-TUBES serve as plug-in replacements for 25 vacuum tubes. That means you don't have to contend with tube filaments that fail. And you eliminate the need for the filament winding on the fly-back transformer. EDI solid state SOLID-TUBES are instant starting, run cool without x-radiation and provide greater reliability as well as longer life.



BUY \$25.00

WORTH OF SOLID STATE SOLID-TUBES AND

GET THIS FREE



5 1/4 x 9 x 5 1/2

We're so convinced that our SOLID-TUBES and other solid state replacement/renewal parts mean solid business for you and EDI that we make this FREE offer. Buy \$25.00 worth of solid state SOLID-TUBES or other replacement/renewal parts from your local distributor and you'll get a handy 9 drawer small parts cabinet FREE.

To get your FREE cabinet, please send a copy of your invoice showing purchase, together with the attached coupon. Write for a FREE EDI solid state replacement/renewal parts guide.

MR. JOEL WASSERMAN, DISTRIBUTOR PRODUCT SALES MANAGER
Electronic Devices, Inc., 21 Gray Oaks Avenue, Yonkers, N. Y. 10710

- Please send FREE cabinet. I enclose Invoice showing purchase of \$25.00 worth of EDI solid state replacement/renewal parts.
- I would like a copy of your solid state replacement/renewal parts guide.

NAME _____
 COMPANY _____
 ADDRESS _____
 CITY, STATE, ZIP _____



ELECTRONIC DEVICES, INC.
 21 GRAY OAKS AVENUE, YONKERS, N. Y. 10710
 PHONE: 914-965-4400 TELETYPE: 710-560-0021
 IN CANADA: LEN FINKLER, LTD.
 designers and manufacturers of
 solid state devices since 1952

... for more details circle 109 on Reader Service Card

NEWS ...

continued from page 27

3. What is the voltage that would be measured with a dc voltmeter from a generator producing the waveform shown below? On an ac voltmeter? ($t_1 = t_2$.)
4. What should the front-to-back resistance ratio of a good silicon diode be?
5. The trouble in a set will clear up if a very leaky capacitor is bridged with a known good capacitor, if the leaky capacitor was the cause of the problem. (True/False.)

Explanation

1. Before using the lowest ohms range of a meter to measure a transistor junction, the maximum safe forward current for that junction should be known, plus the short-circuit output current of the ohmmeter. If the ohmmeter delivers 300ma for example, and the maximum current that can be safely handled by the junction is 100ma, the junction could be damaged during testing.
2. Decreases, increasing, decreasing. The ac and dc loading effects are decreased because the probe has a resistor and capacitor between the circuit under test and the input impedance of the scope. The resistor increases the resistance, and the capacitor—because it is in series with the input capacitance—decreases the capacitance.
3. The average value of the waveform is 5v, since half the time it is at 10v and half the time it is at 0v. The dc voltmeter would measure 5v. An ac voltmeter should not be used, since it is accurate only on sinusoidal ac.
4. 100-to-1. Germanium diodes could be less, with selenium even less.
5. False. A leaky capacitor has an appreciable drop in resistance, the resulting current remaining in the circuit to cause a problem. Hum may be reduced, but the problem cannot completely disappear.



Participants in the CET Tests given recently in Lynchburg, Va. were (rear, l to r) Richard Sandige and Dan Bowling, instructors at the Community College in Richlands, Va.; and Julius Morris and Edwin Fowlkes from Morris Electronics in Burkeville, Va.; (front, l to r) Joe Henderson and Jerry Hartley from the Western Virginia Community College in Lynchburg; Ted Jennings of Jennings Electronics, President of VEA-Lynchburg; and John McPherson, CET, VEA State President (displaying the October issue of ELECTRONIC TECHNICIAN/DEALER).

Anyone wishing more information concerning the CET Exam may circle Reader Service No. 717.

Anyone wishing more information concerning the International Society of Certified Electronic Technicians may circle Reader Service No. 718.

Alarm System Scares Burglar So Badly that He Leaves Car

At about the time our September issue was coming off the press, Couch's Inc. (described in that issue as the victim of many a burglary) was again being put to the test.

On September 7th, the front window at Couch's was smashed with such a powerful blow that glass flew over 15



Another smashed window, plus this time a "hot" car left behind at Couch's Inc.

ft into the store. In fact, it even chipped the picture tube face of a portable color-TV set ruined by the break.

A fine, nearly invisible wire secured to the window was, of course, also broken, triggering the amplifier-tape player shown on page 44 of our September issue. The ensuing noise (siren and voice described in that article) must have literally frightened the would-be robber away.

Arriving just moments later, the police discovered more evidence of a hasty departure. An automobile, stopped with the motor running, was still parked at Couch's back door. The car was later found to be "hot."

Before Charles Couch, Jr., CET, arrived to deactivate the alarm, many Gainesville residents phoned police to complain or inquire about the noise—some even suspecting an air raid. This certainly attested to the audibility of the system.

Thus, the cost of planning and installing an alarm system was certainly justified. The thief or thieves would almost surely have escaped with merchandise worth hundreds of dollars had the alarm not frightened them away.

continued on page 65

Lowest priced digital multimeter



**NEW HEATHKIT
2½-Digit DMM
Kit IM-1202
\$79.95***

The Heathkit IM-1202 2½-Digit Multimeter sets the new low price for a high performance DMM. It's an easy to assemble kit that pays you for your time — with accuracy, flexibility and features found on multimeters costing twice as much. 1% accuracy on DCV, 1½% on ACV and AC-DC current, 2% on ohms. 29 selectable ranges measure voltage from 10 mV to 1000 V on DC in either polarity, 10 mV to 700 rms on AC; currents from 10 µA to 2 A, AC or DC; resistance from 1 ohm to 2 megohms. And the bright cold-cathode display puts parallax and meter-tapping misreadings out of the picture. Lighted indicators for overrange, positive and negative DC — plus a neat front-panel polarity switch make operation even easier. Internally, the IM-1202 is solid-state perfection — with a pseudo memory for clear, non-blinking display; a dependable ramp analog-to-digital converter with readout updated every 16 msec., and overload protection on all ranges. Everything's housed in a rugged aluminum case with handle, 3-wire line cord (no batteries needed) and universal banana jacks for the test leads supplied.

Kit IM-1202, 6 lbs. 79.95*

Lowest priced frequency counter

**NEW HEATHKIT 5-Digit 30 MHz
Counter
Kit
IB-1100**



\$169.95*

We've broken the price barrier for frequency counters, too! The new Heathkit IB-1100 has 5-digit readout with 8 digit capability. Switch selection of kHz and MHz and a lighted overrange indicator. The all-solid-state circuitry features cold-cathode readout tubes; custom-designed time-base for accuracy better than ±3 ppm from 22° to 37° C.; diode-protected J-FET for improved triggering over inputs from 100 mV to 150 V rms. Input impedance is 1 megohm, shunted by 20 pF. Professional features include the compact aluminum case with diecast front panel, tinted viewing window, BNC input connector and bail feet. Most components mount on one large PC board — build it in two evenings.

Kit IB-1100, 6 lbs. 169.95*

HEATHKIT	
Schlumberger	
 <p>The FREE Heathkit Catalog has over 350 fun to build kits. Order yours today</p>	<p>HEATH COMPANY Dept 24-12 Benton Harbor, Michigan 49022</p> <p><input type="checkbox"/> Please send FREE Heathkit Catalog. <input type="checkbox"/> Enclosed is \$_____, plus shipping. Please send model(s) _____</p> <p>Name _____ Address _____ City _____ State _____ Zip _____</p> <p>Prices & specifications subject to change without notice. *Mail order prices; F.O.B. factory. TE-276</p>

... for more details circle 114 on Reader Service Card



DIAL & CODER

Delta's Instant Emergency Telephone Warning System.

Dial & Coder guards you around-the-clock, signaling alarm for any emergency condition where a simple contact closure activates the system. Completely solid state, Dial & Coder utilizes the latest in discrete and integrated circuit technology to provide immediate remote signaling between any two telephones.

CHECK THESE FEATURES!

- Dial any phone number up to eight digits.
- Change numbers in ten seconds.
- Over 100 different code combinations allow multi-phone connections.
- Works with any direct contact switch.
- Unlimited applications. Use with intrusion detectors, fire & smoke detectors or a simple button control. Allows children, clerks, or physically handicapped to call for help.
- Automatic redialer when busy signal received.
- Microphone can be added for audio surveillance.
- Self-contained power supply. Once tripped, unit cannot be stopped.

This one's really priced right!

Made In U.S.A.

Write or Call today for free sales details!



DELTA PRODUCTS, INC.

P.O. Box 1147, Grand Junction, Colo. 81501,
Dept. ETD, (303) 242-9000

Superior Products At Sensible Prices

... for more details circle 107 on Reader Service Card

READERS' AID

Space contributed to help serve the personal needs of you, our readers.

Equipment For Sale

I have several pieces of service equipment for sale. Please write for listing and price.

VAL OBAL

3201 S. 73 St.
Omaha, Neb.

I have a Hewlett Packard Signal Generator Model 608D for sale. Please write for price.

JOHN V. CAVASEND

87-10 Lefferts Blvd.
Richmond Hill 18, N.Y.

One 1972 picture tube rebuilding unit manufactured by Lakeside Industries with additional supplies for sale.

CARL H. MEYER

P.O. Box 973
Vista, Calif. 92083

Used TV Analyst, oscilloscope and electronic Switch for sale. Selling due to illness. Please write for information.

JACOB PETTNER

1624 2nd Ave.
Conway, Pa. 15027

Because of employment outside of the U.S., I will sell unused CRT rebuilding equipment for any reasonable offer. Will deliver.

BERNARD STERNO

3011 Redwood St.
Brunswick, Ga. 31520

Going out of audio service and I have the following pieces of equipment for sale: Hewlett-Packard Model 205AG Audio Signal Generator and Model 330B Distortion Analyzer in good condition.

H. F. BILTERMAN, CET

110 So. Conrey
Knoxville, Iowa 50138

Back Issues for Sale

I have back issues of ELECTRONIC TECHNICIAN/DEALER, including Tek-fax schematics, from Sept. 1952 to current issue for sale.

J. E. COHEN

13457 Magnolia Blvd.
Van Nuys, Calif. 91403

Business for Sale

TV business for sale in central Wisconsin, which includes a three bedroom apartment above store, also apartment and store rental.

WILLIAM RALLOFF

2016 Wisconsin Ave.
New Holstein, Wisc. 53061

I am selling a well-credited TV shop in Florida with a very good location and low rent for a reasonable price. Please write for details

M. C. DI PIERRI

213 Palm Ave.
Hialeah, Fla. 33010

Service Information

I have retired from the TV repair business and am trying to dispose of some Rider's radio manuals—No. 1 to 15 with indexes. I would like to give them away to anybody able to use them, either a school or library, etc. I also have a Rider's TV manual No. 1.

HERMAN MARCUS

4335 44th St.
Long Island City, N.Y. 11104

Equipment Wanted

We have a new radio and TV service school that opened in August for juniors and seniors in high school. We would like to purchase used test equipment and a complete set of Sams Photofacts from No. 500 to date.

RALPH DOROUGH, INSTRUCTOR

3101 Clinkenbeard Dr.
Killeen, Texas 76541

Information Wanted

I am in need of a schematic diagram, operational instructions and maintenance manual for a General Electric Oscilloscope Type SC2A. I am willing to borrow or buy the information.

ROGER FLETCHER

Cumberland/Perry Area
Vocational-Technical School
R.D. #4 Willow Mill Rd.
Mechanicsburg, Pa. 17055

Schematic Needed

I am in need of a schematic and parts list for a Citreon tape recorder Model 660. I would be glad to reproduce or pay for reproduction if anyone can provide me with the information.

ROBERT L. HELMS

1514 Auburn Dr.
Colorado Springs, Colo. 80909

BOOK REVIEWS

ELECTRONICS SELF-TAUGHT WITH EXPERIMENTS & PROJECTS by Jim Ashe, published by Tab Books, 288 pages, hardbound \$7.95, paperbound \$4.95.

Although we have stressed the importance of understanding the theory of how electronic circuitry functions, there is a lot that can also be said concerning the value of practical experience—the first-hand observation of circuit functions—for more effective servicing. This book describes such basic circuit functions and then helps you demonstrate them by experimenting with simple projects.

After a review of the history of electronics and some ideas on developing one's skills in the first chapter, the second chapter goes into some practical considerations concerning the design of an effective bench and work area, plus the selection and maintenance of appropriate tools and instruments.

In the chapters that follow the author progresses from such fundamentals as a charged comb attracting balls to the design of phase-shift oscillators. Each chapter concludes with complete circuit schematics and construction tips for proving to yourself that components do function as described in the book.

We feel that this book is excellent for improving your understanding of fundamental solid-state circuitry.

MODERN DICTIONARY OF ELECTRONICS by Rudolf F. Graf, published by Howard W. Sams, 688 pages, hardbound, \$12.95.

Dictionaries certainly do not make the most exciting reading for a review, but on the other hand, this fourth edition does contain a lot of interesting, useful information. The publisher indicates that it includes more than 18,000 terms.

Upon looking through the dictionary we find that a good portion of the terms included in this book are those that should be known by the electronic technician. We feel that those encountering an unfamiliar term when servicing an electronic product will find the description of that term very clear and easy to understand. Illustrations are also included in many cases to help explain the term.

We feel that this dictionary is a must for all electronic technicians and service dealers that realize the importance of a resource library.

NEW AUTORANGING DIGITAL MULTIMETER... IN-PROBE DISPLAY, HIGH-SPEED READOUT, BATTERY OPERATION...

\$325.



For AC or DC voltage, resistance and even current, our Model 167 with unique in-probe readout lets you make time-saving measurements directly at the point of measurement. With up to 3-month battery life. The Model 167's combination probe/readout, with 3½ digit LED display, automatically indicates decimal point, polarity, range and function. Front panel terminals and probe receptacle allow alternative use as a bench instrument. The neat, sweet-to-hold 167 Auto-Probe DMM is only \$325 (less in quantity). Check it out and get our latest "How Sweet" button.

Measures easily ... 1 mV to 1000 VDC
• 1 mV to 500 VAC RMS • 1 ohm to 20 megohms
with the convenience of ... 55 megohms input resistance • 2-sec. reading time to rated accuracy • 1200 volts overload protection • Complete choice of accessories.



KEITHLEY INSTRUMENTS
U.S.A.: 28775 AURORA ROAD, CLEVELAND, OHIO 44139
EUROPE: 14, AVENUE VILLARDIN, 1009 PULLY, SUISSE



The Model 167... another how-sweet-it-is Keithley Multimeter

... for more details circle 117 on Reader Service Card

NEW AND NOTEWORTHY

For additional information on products described in this section, circle the numbers on Reader Service Card. Requests will be handled promptly.



FOR MORE NEW
PRODUCTS SEE PAGE 58

EDUCATIONAL FM/SCA RECEIVER 700

Employs crystal controlled oscillator for frequency accuracy

A completely self-contained professional educational receiver, Model TR-E2, is designed for continuous use. Operation is as easy as using a standard FM receiver, with controls consisting of only a combination ON/OFF switch and VOLUME control. This unit is housed in an attractively styled metal cabinet with a beige textured finish, and a front-mounted speaker with fabric grill. The main channel sensitivity and high-Q input circuits minimize crosstalk and give wide dynamic range. The oscillator is reportedly crystal controlled to guarantee on-frequency operation, without user adjustments. Optional features include a rear mounted main/subchannel switch and headphone jack. McMartin Industries Inc.



TAPE PLAYER 702

Special brackets simplify insertion and removal

For motorists who love a great tape sound but who still want to keep in tune with their local FM Stereo sounds too, a combination FM Stereo and Stereo 8 tape player is offered. The Model 12R600, with five integrated circuits plus 8 transistors, has a rated output of over 16w peak power. The tape player's alignment reportedly eliminates the need for any fine tuning controls. The unit can be installed with the company's special "Quick Release" mounting brackets, featuring smooth sliding tracks for easy insertion and removal of players, while locking a player into position with the turn of a key. RCA Parts and Accessories.

FM MULTIPLEX STEREO GENERATOR 701

Compact with dual power supply

The Model LSG-231 Multiplex Stereo Generator is said to have unusual precision and stability. The generator has a pilot signal frequency of 19kHz with a rated accuracy of ± 2 Hz. The 1kHz audio signal is said to be accurate to $\pm 1\%$. Signal separation is rated at 50dB with an output voltage of 0 to 3v rms, continuously variable. Specifically designed for the field or workbench, this unit reportedly offers such high reliability that many technicians may not find it necessary to use a scope. It is said to be easy to operate, compact and complete with a handy tilt stand. The generator has a dual power supply and measures 8 in. W by 12 in. D by 3½ in. H. Weight 5.5 lb. Leader Instrument Corp.

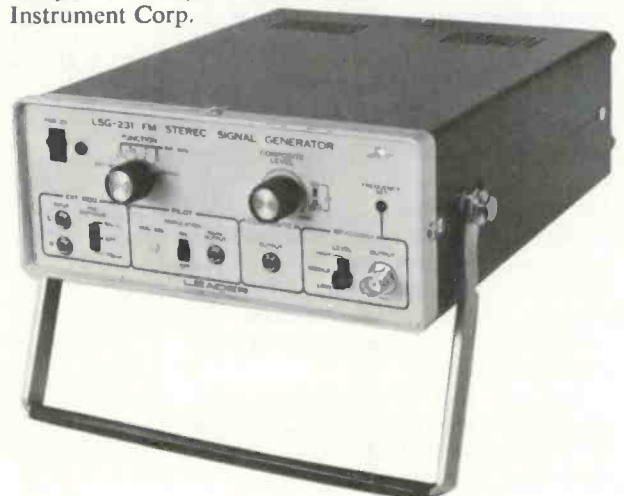

Give yourself a break!

Save up to 40 minutes per installation

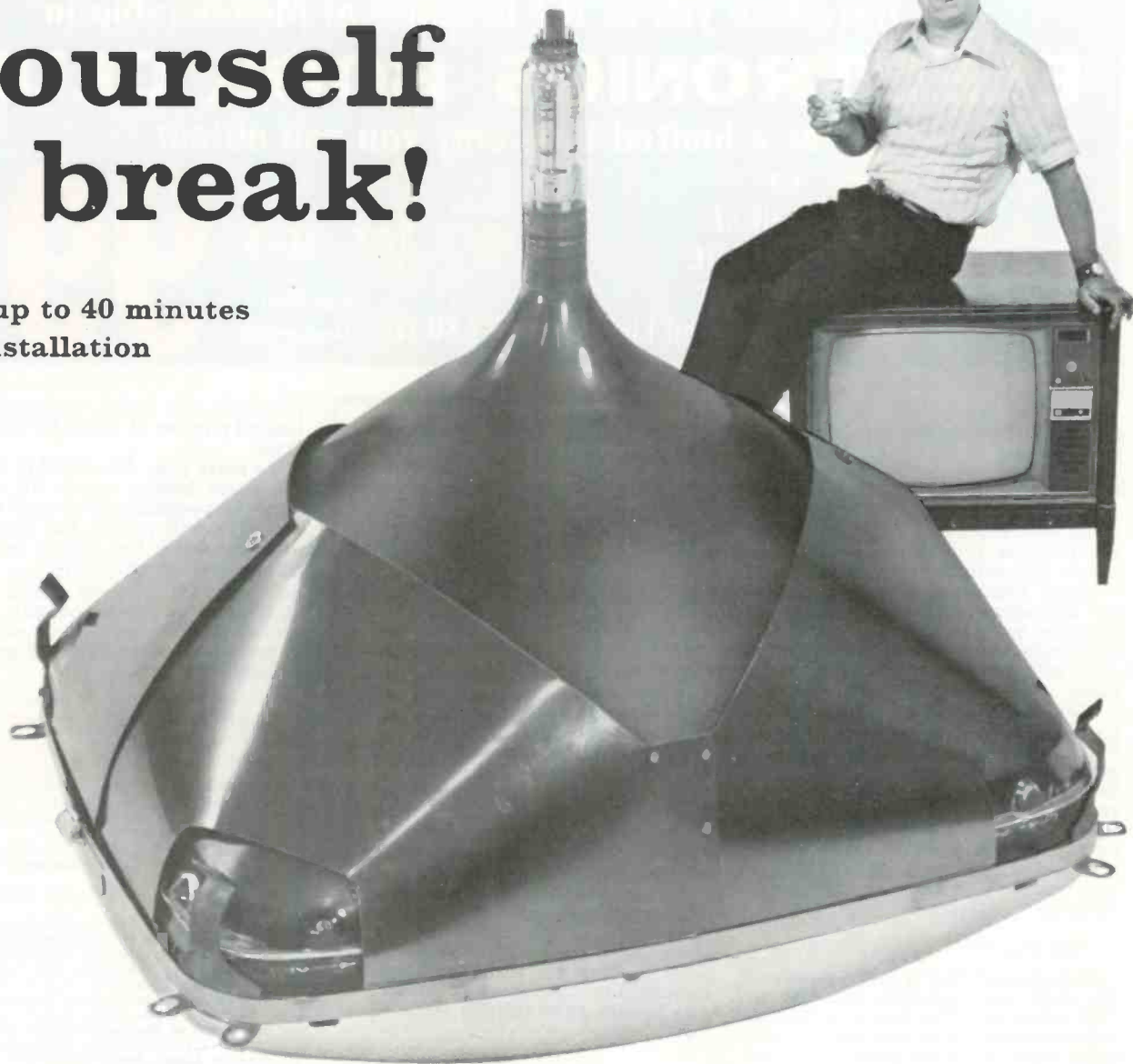

Coffee, lunch or whatever kind of break with the extra time you'll have using our new Speed-Fit replacement CRT's with premounted hardware.

Speed-Fit CRT's eliminate the need for transferring hardware from the dud to the new tube and can save you up to 40 minutes per installation. They'll do it in all RCA 25", Motorola 908, 914 and 914A and Zenith 20XIC36, 20XIC38, 23XC36, 23XC38, 23XC38Z, 25MC35, 25MC36, 25MC46, 25NC38 chassis. Our Zenith Speed-Fit models even come with a one-piece shield that slips on easily!

We're working on other Speed-Fit models so that soon you'll be able to install bright, sharp Speed-Fit color in just about every major name set on the market. Since the guys who engineer TV sets never seem to think about the guy who has to repair them we think it's about time somebody gave the serviceman a break.

And we want you to have it on us---with the new Speed-Fit CRT line!

*PATENT APPLIED FOR

CHANNEL MASTER
Speed-Fit
PICTURE TUBES

FROM CHANNEL MASTER PICTURE TUBE HEADQUARTERS

... for more details circle 105 on Reader Service Card

DECEMBER 1972, ELECTRONIC TECHNICIAN/DEALER | 33

An Extraordinary Offer

to introduce you to the benefits of Membership in ELECTRONICS BOOK CLUB

for a limited time only you can obtain

ANY 3 OF THESE UNIQUE BOOKS . . . yours for only **99¢** each
... with Trial Club Membership
(Combined List Price \$43.80)

May we send you your choice of many three books on the facing page as part of an unusual offer of a Trial Membership in Electronics Book Club?

Here are quality hardbound volumes, each especially designed to help you increase your know-how, earning power, and enjoyment of electronics.

These handsome, hardbound books are indicative of the many other fine offerings made to Members . . . important books to read and keep . . . volumes with your specialized interests in mind.

Whatever your interest in electronics—radio and TV servicing, audio and hi-fi, industrial electronics, communications, engineering—you will find that Electronics Book Club will help you.

With the Club providing you with top quality books, you may broaden your knowledge and skills to build your income and increase your understanding of electronics, too.

How You Profit From Club Membership

This special offer is just a sample of the help and generous savings the Club offers you. For here is a Club devoted exclusively to seeking out only those titles of direct interest to you. Membership in the Club offers you several advantages.

- 1. Charter Bonus:** Take any three of the books shown (combined values up to \$43.80) for only 99¢ each with your Trial Membership.
- 2. Guaranteed Savings:** The Club guarantees to save you 15% to 75% on all books offered.
- 3. Continuing Bonus:** If you continue after this trial Membership, you will earn a Dividend Certificate for every book you purchase. Three Certificates, plus payment of the nominal sum of \$1.99, will entitle you to a valuable Book Dividend which you may choose from a special list provided members.
- 4. Wide Selection:** Members are annually offered over 50 authoritative books on all phases of electronics.
- 5. Bonus Books:** If you continue in the Club after fulfilling your Trial Membership, you will receive a Bonus Dividend Certificate with each addi-

SPECIAL FREE BONUS

. . . if you act now!

Yes, if you fill in and mail the membership application card today, you'll also get this Bonus Book, FREE!

TV TROUBLESHOOTER'S HANDBOOK Revised Second Edition

A completely updated quick-reference source for solutions to hundreds of tough-dog troubles.
Regular List Price \$7.95

tional Club Selection you purchase. For the small charge of only \$1.99, plus three (3) Certificates, you may select a book of your choice from a special list of quality books periodical-ly sent to Members.

6. Prevents You From Missing New Books: The Club's FREE monthly *News* gives you advance notice of important new books . . . books vital to your continued advancement.

This extraordinary offer is intended to prove to you, through your own experience, that these very real advantages can be yours . . . that it is possible to keep up with the literature published in your areas of interest . . . and to save substantially while so doing.

How the Club Works

Forthcoming selections are described in the FREE monthly *Club News*. Thus, you are among the first to know about, and to own if you desire, significant new books. You choose only the main or alternate selection you want (or advise if you wish no book at all) by means of a handy form and return envelope enclosed with the *News*. As part of your Trial Membership, you need purchase as few as four books during the coming 12 months. You would probably buy at least this many anyway . . . without the substantial savings offered through Club Membership.

Limited Time Offer!

Here, then, is an interesting opportunity to enroll on a trial basis . . . to prove to yourself, in a short time, the advantages of belonging to Electronics Book Club. We urge you, if this unique offer is appealing, to act

promptly, for we've reserved only a limited number of books for new Members.

To start your Membership on these attractive terms, simply fill out and mail the postage-paid airmail card today. You will receive the three books of your choice for 10-day inspection. **SEND NO MONEY!** If you are not delighted, return them within 10 days and your Trial Membership will be cancelled without cost or obligation. Electronics Book Club, Blue Ridge Summit, Pa. 17214.

Typical Savings Offered Club Members on Recent Selections

Kwik-Fix TV Service Manual	List Price \$8.95; Club Price \$5.95
Color TV Repair	List Price \$7.95; Club Price \$2.95
How to Repair Musical Instrument Amplifiers	List Price \$8.95; Club Price \$5.95
Refrigeration	List Price \$7.95; Club Price \$4.95
Beginner's Guide to Computer Program'g	List Price \$9.95; Club Price \$6.95
How to Solve Solid-State Ckt. Troubles	List Price \$8.95; Club Price \$5.95
Elements of Tape Recorder Repairs	List Price \$7.95; Club Price \$4.95
Handbook of Electronic Tables; 2nd Ed.	List Price \$7.95; Club Price \$4.95
How to Repair Small Gasoline Engines	List Price \$8.95; Club Price \$4.95
Fire & Theft Security Systems	List Price \$7.95; Club Price \$3.95
Servicing Electronic Organs	List Price \$7.95; Club Price \$4.95
Basic Electronic Circuits Simplified	List Price \$8.95; Club Price \$5.95
Electronics Data Handbook; New 2nd Ed.	List Price \$7.95; Club Price \$4.95
How to Interpret TV Waveforms	List Price \$7.95; Club Price \$4.95
Inst. & Svc'ng. Electronic Protective Sys.	List Price \$7.95; Club Price \$4.95
Electronic Testers for Auto Tune-Up	List Price \$7.95; Club Price \$4.95
199 Color TV Troubles & Solutions	List Price \$7.95; Club Price \$4.95
Commercial FCC License Handbook	List Price \$8.95; Club Price \$5.95
RCA Color TV Service Manual—Vol. 2	List Price \$7.95; Club Price \$4.95
Citizens Band Radio Service Manual	List Price \$7.95; Club Price \$4.95
Electronic Musical Instruments	List Price \$7.95; Club Price \$4.95
Computer Technician's Handbook	List Price \$10.95; Club Price \$7.95
How to Build Solid-State Audio Circuits	List Price \$8.95; Club Price \$5.95

SEND NO MONEY! Simply fill in and mail postage-paid Airmail card today!

104 Simple One-Tube Projects



A collection of useful, easy-to-build construction projects for technicians, experimenters, hams, and hobbyists. Now you can put those idle tubes and components to work with this vast, one-of-its-kind assortment of unique electronic circuits. Included in this convenient selection are test instruments, ham gadgets, receivers, power supplies, PX aids, wireless mikes, tube rejuvenators, electronic games, aversponders, stereo and hi-fi devices, and literally dozens more. None use more than one tube! Few will cost more than \$5. Astute technicians and hobbyists will find many gadgets adaptable to specific needs. 192 pps. Hardbound.

List Price \$6.95 • Order No. 486

Understanding Solid-State Circuits

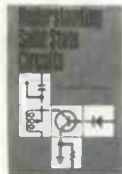

This brand-new book truly eliminates the mystery of solid-state circuits and devices. Written to serve the interests of anyone at the sub-engineering level (service technicians, hobbyists, students, etc.), the content thoroughly explains semiconductor circuit operation without delving into electrochemical physics and high-level mathematics. Encompasses amplification, feedback, sinusoidal and non-sinusoidal oscillators, gain control, logic circuits, and integrated circuits. Semiconductors covered include SCRs, FETs, ICs, light-sensitive and voltage-sensitive devices. The perfect text and reference on solid-state devices and basic circuit operation. 192 pps., over 150 illus.

List Price \$7.95 • Order No. 513

DICTIONARY OF ELECTRONICS

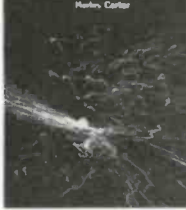

DICTIONARY OF ELECTRONICS

You'll find this huge volume extremely useful in whatever connection you have with electronics. This dictionary of electronics defines most all of the electronic terms you will run across in your everyday reading... from alpha particles through zoom lens... defines the terms you need and use most often, including those found in radio, TV, communications, radar, electronic instrumentation, broadcasting, industrial electronics, etc. It provides full, complete and easily-understandable explanations of thousands of specific electronics terms (such as transistors, acoustic feedback, alpha particles, beat oscillator, final anode, electrostatic lens, nonlinear resistance, pool cathode, etc.). A unique feature of this selection is the cross-indexing, whereby key words contained in the definitions (words that are defined more fully elsewhere in the book) are printed in small capitals so you are not left in the dark by any definition. An example of this is the definition for "Susceptance," which includes the words "Conductance," "Admittance," "Resistance," and "Reactance," indicating other applications. Appendix material includes a list of units and abbreviations, graphic symbols used in schematics, component color codes, db conversion tables, data on the electromagnetic spectrum, tube base diagrams, etc. 420 pps., 487 illustrations. Hardbound.

List Price \$8.95 • Order No. 300

Practical Color TV Servicing Techniques



This brand-new updated and expanded second edition contains troubleshooting guidelines and case histories on the latest solid-state receivers, including a 4-color section with 32 trouble-symptom photos and a foldout section with 8 complete TV receiver schematics. Now included are service tips and techniques on RCA, Motorola and Zenith solid-state chassis, plus a host of case histories and current data on 12 E chassis. In fact, each of the 12 chapters is filled with information applicable to virtually any brand of color TV receiver, enabling you to solve tough-dog troubles quickly. 404 pps., 250 illus. Hardbound.

List Price \$8.95 • Order No. 436

Motorola Color TV Service Manual - Vol. 2



This new second volume covers the new Quasars CTV7 (TS-931) and CTV8 (TS-938), the Quasar II Models CTV5 (TS-929) and CTV6 (TS-934), plus additional alignment and troubleshooting information on the original Quasars (TS-915-919). Typical of all volumes in the popular schematic-servicing manual series, this second volume on Motorola includes full-size schematics, waveforms, chassis and plug-in panel layout drawings and photos, and parts lists. Numerous troubleshooting case histories on Quasar and Quasar II chassis will enable you to quickly identify defective panels, and to repair panel defects. 196 pps., 8 1/2" x 11", 36-page foldout section with 9 full-size schematic diagrams.

List Price \$7.95 • Order No. 584

Handbook of Semiconductor Circuits



Contains 124 examples of standard transistor circuits, complete with operational data for amplifiers, oscillators, logic and switching circuits, power supplies, and various nonlinear circuits. The broad range of circuits included were selected on the basis of application and practicality. A design philosophy section is included with each group of circuits, thereby providing a basis for understanding circuits other than those selected as examples. This is a collection of practical circuits which have wide application. Each circuit description includes data concerning any unique design or operational data. Hundreds of illustrations and diagrams. 448 pps., 6" x 9", Hardbound.

List Price \$8.95 • Order No. G-30

Servicing Modern Hi-Fi Stereo Systems



A practical, up-to-date guide on repairing hi-fi systems—turners, amplifiers, phonos, tape recorders, etc. Thoroughly describes modern system design and how to use performance tests in troubleshooting—SMITE and CCIF methods for analyzing performance, square-wave testing, distortion and harmonic measurement, equalization and feedback. The final chapter, tied in with a schematic foldout section, offers typical service data: complete schematics, PC board illustrations, component location diagrams, troubleshooting charts, and adjustment and alignment instructions. 256 pps., including 32-page foldout schematic section. Over 125 illus. Hardbound.

List Price \$7.95 • Order No. 534

Electronic Circuit Design Handbook



New Fourth Edition—A brand-new, enlarged edition of the ever popular circuit designer's "cookbook," now containing over 900 proven circuits, for all types of functions, selected from thousands on the basis of originality and practical application. Now you can have, at your fingertips, this carefully planned reference source of tried and tested circuits. Selected on the basis of their usefulness, this detailed compilation of practical design data is the answer to the need for an organized gathering of proved circuits... both basic and advanced designs that can easily serve as a starting point for almost any kind of circuit you might want to build. 384 pps., 19 big sections, over 600 illus., 8 1/2" x 11".

List Price \$17.95 Order No. T-101

TV Trouble Diagnosis Made Easy



A brand-new picture-service guide for solving every TV trouble, both color and black-and-white. You simply compare the symptoms you see and hear with those pictured or described and you'll be able to pinpoint any trouble to a specific circuit and component in short order. In the first chapter, each trouble symptom is pictured and described to help you identify the probable cause. From there you are referred to one of the remaining 19 chapters dealing with specific troubles in each section of the receiver, explaining how to further analyze existing symptoms and pinpoint troubles. Individual component tests are suggested, too, everything from flybacks to transistors. 256 pps., 225 illus. Hardbound.

List Price \$7.95 • Order No. 544

How to Use Color TV Test Instruments



Here's an opportunity to close whatever gaps there are in your ability to use modern, up-to-date equipment designed specifically to save you time and money. You'll quickly grasp the author's common-sense approach to using the right instruments, thereby getting the most out of your investment in test gear. You'll improve your ability to use an oscilloscope, color bar generator, alignment generators, vectorscope, TV Analyst and sine, square-wave generators. The author also has included a description of his "curve tracer." With this simple scope attachment, you can rapidly assess the condition of diodes, transistors—even ICs—in or out of the circuit. 256 pps., over 230 illus. Hardbound.

List Price \$7.95 • Order No. 577

Japanese Monochrome TV Service Manual



This brand-new, all-in-one schematic-servicing manual contains all the data you need to repair virtually every Hitachi, Panasonic, and Sharp black-and-white model sold in the U.S. and Canada during the past three years (1969-71). In this one compact volume, you have all the basic information needed to service 75 specific models. Included are full-size schematic diagrams, PC board layout drawings and photos, adjustment and alignment instructions, and parts lists. The foldout section has 24 full-size schematic diagrams. The text provides service information on 47 additional chassis similar to those shown in the foldout section. 188 pps., 8 1/2" x 11".

List Price \$7.95 • Order No. 602

Basic Electronics Problems Solved



Here are easy step-by-step solutions to many basic electronics problems in a convenient one-stop source dealing with both solid-state and tube-type circuits. The content not only presents a detailed explanation of each point, but also provides many actual examples on how to work out problems. Then, to firmly fix the information in your mind, there are numerous example problems for you to solve; answers to these are included in one Appendix, and worked out solutions in another. Covers DC circuits, AC circuits, powers of ten, semiconductors, power supplies, and receiver circuits. A final chapter shows how to use a slide rule to speed calculations. 192 pps., over 100 illus. Hardbound.

List Price \$7.95 • Order No. 530

Jack Darr's Service Clinic No. 2

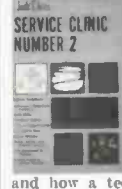

Here's more of the Jack Darr wisdom (and wit!) in book form—a valuable collection of timely service hints and trouble solutions covering color and monochrome TV, radio, stereo, phonos, recorders, CB gear, etc. Discusses the "engineering" servicing approach, efficiency and how a technician may condition his thinking to produce more in a given time period. Like the first volume, the content was selected on the basis of usefulness to the average technician, covering a wide range of electronics devices. Each of the 10 chapters covers a general category of interest, and in each the subject matter is arranged in logical order, enabling you to find what you need quickly. Provides a wealth of information. 176 pps., numerous illus. Hardbound.

List Price \$7.95 • Order No. 566

Modern Radio Repair Techniques



Up-to-date service data on all types of modern radio receivers, including AM, FM, stereo, auto and multiband—plus complete 36-page foldout schematics for 12 popular brand-name sets. Reveals many simple shortcuts to making radio repair a profitable side or main line of business. Material is presented so that seasoned technicians can gain from the numerous troubleshooting tips, and beginners, with a few hours study, can begin to turn out profitable work in a short time. Includes shortcut methods of troubleshooting, plus general test techniques. Covers receiver circuits and fundamentals of circuit operation. 260 pps., 170 illus. Hardbound.

List Price \$7.95 • Order No. 580

199 Electronic Test & Alignment Techniques



Here's a brand-new quick-reference guide of 199 tests that will help you troubleshoot virtually any electronic device found in the average home—AM and FM radios, TV receivers, antenna systems, intercoms, electronic organs, garage door openers, auto ignition systems, and many others. You'll also learn how to check out home intercom systems and electronically-controlled garage door openers. With this book, it'll be a breeze for you to tackle almost any electronic repair job. You'll learn how to analyze the results of each step you take and how to come to the right conclusion. A concise, easy-to-use source of troubleshooting information. 224 pps., 130 illus. Hardbound.

List Price \$7.95 • Order No. 593

AN EXTRAORDINARY OFFER...

... for more details circle 103 on Reader Service Card

GTE Sylvania has the lines that lay it on the line.

Only GTE Sylvania gives you a choice of three different price lines in color picture tubes.

And GTE Sylvania tells you and your customer exactly what you are getting in each line.

That makes Sylvania tubes easier to sell.

You can tell your customers the advantages of the top-line *color bright 85[®] XR*. You can show them where the savings come from in the economy *color screen 85* line. And you can tell them exactly what they're getting for their money in the middle-line *color bright 85[®] RE*.

The way we see it, if we lay it on the line with you, you can lay it on the line with your customers.

Instead of just handing them a line.



GTE SYLVANIA

	color bright 85 [®] XR	color bright 85 [®] RE	color screen 85
Sylvania rare earth red phosphors	yes	yes	yes
Other manufactured rare earth phosphors	no	no	yes
All sulfide phosphors	no	no	no
X-ray inhibiting glass	yes	no	no
New glass	yes	some	some
Reused glass	no	some	some
Regunned	no	no	some
Screen blemish specs	OEM	OEM	slightly wider than OEM
White field uniformity	OEM	slightly wider than OEM	slightly wider than "RE"
Cut off; purity currents; beam shield leakage	OEM	OEM	slightly wider than OEM

TEKLAB REPORT**Introducing Heathkit's
Dual-Trace Oscilloscope**

by Joseph Zauhar

By assembling this kit one can step-up to a professional-type dual-trace scope for but a moderate cost

■ Each year we find more trigger-sweep, dual-trace scopes introduced, but Heath's Model IO-105 is the first one that we have encountered in kit form. This scope was sent to us by the manufacturer for assembly and review. This instrument has many features found in more expensive scopes, making it a versatile tool for the service bench at but a moderate price.

The oscilloscope has calibrated vertical and horizontal circuits permitting precise voltage and frequency measurements of complex waveforms. The Channel 1 and Channel 2 circuits are identical with dc-to-15MHz wide-band amplifiers. The VOLTS/CM ATTENUATOR switches provide nine sensitivities from .05 to 20v/cm, with variable sensitivities at each switch position. Any one of 18 calibrated horizontal time bases can be selected by the TIME/CM switch, providing frequency measurements of applied signals. The triggering controls allow the time base to be

triggered at any point along the positive or negative slope of the input signal.

The Channel 1 and Channel 2 input signals can be individually displayed as a function of time in either the CHANNEL 1 or CHANNEL 2 mode, while

the CHOP MODE samples the input signals at a 50kHz rate so that both signals appear as a function of the same time base. The ALTERNATE MODE displays the input signals alternately on successive sweeps. Trapezoidal and Lissajous patterns—which are useful

in studying modulation characteristics and frequency, plus phase comparisons—can be checked by placing the VERTICAL MODE switch in the X-Y position. The inputs used are Channels 1 and 2 on the front panel of the scope.

Assembly

Some electronic technicians feel that they do not have the time to assemble an instrument in kit form, but there are a number of advantages for those that do: Not only do you have the pride of assembling the instrument yourself, you also become familiar enough with it to correct any difficulties which you may eventually encounter in the scope, saving repair time and costs. Another important feature is the calibration of the scope, which may drift after a period of time. In many cases factory instruction manuals included with an assembled instrument only cover the calibration of the vertical amplifier and attenuator. The manual supplied with this kit clearly

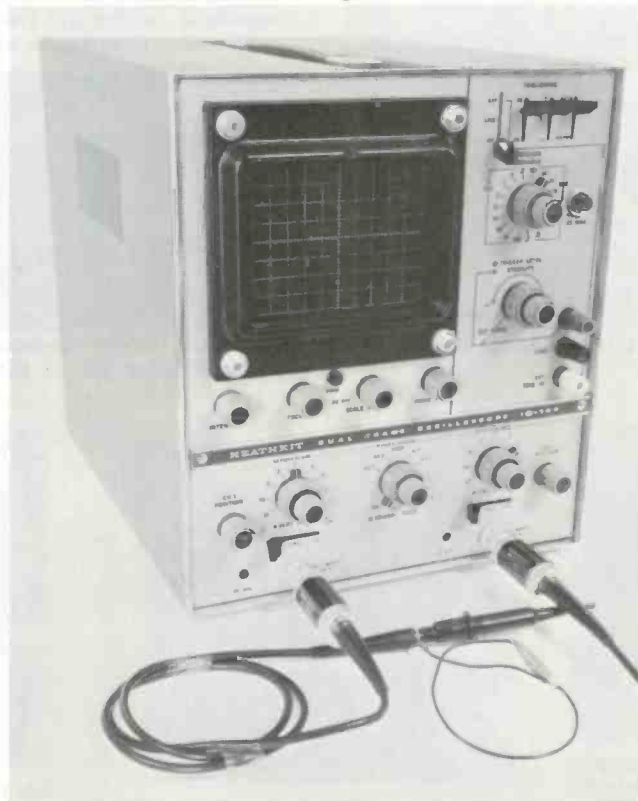

Heathkit's Model IO-105 Dual-Trace Oscilloscope.

instructs you on how to calibrate any circuit in the instrument.

We assembled the oscilloscope in a relatively short time, following the clearly illustrated step-by-step assembly manual provided with the instrument. We first assembled the six modular circuit boards in the following order: vertical switching, two vertical preamplifiers, horizontal amplifier, power supply and the deflection circuit board.

The vertical subchassis was the first unit completed. It contained the vertical switching circuitry and two vertical preamplifier boards. This subchassis is a drawer type unit that slides out of the main chassis and employs socket connectors on the wire harness to simplify removal if required. The assembly of this as well as other chassis units was simplified by factory assembled wire harnesses.

After the chassis was

assembled, but before the scope was turned ON, we measured the resistance of various voltage taps to prevent component damage in case of error in assembling the unit.

When the unit was turned ON, the first check made was to measure the voltages at the given test points on a chart. When any of them did not agree with the voltages given, we went to the "In case of Difficulty" section of the manual and corrected the

problem before the unit was again turned ON.

Assembling Hints

We cannot claim we did not make any errors in assembling the unit, but they were quickly corrected by going back to the step-by-step instructions of the particular circuit in question.

In one instance, we found the rotary VOLTS/3CM switch shield sheet-metal screws to be just a little long, shorting out the vertical preamplifier board

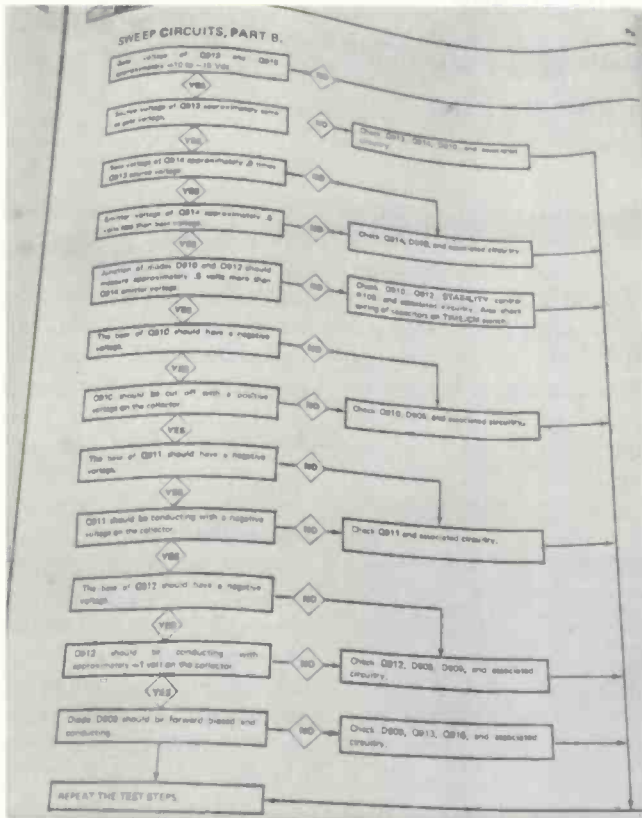

A computer-type troubleshooting chart is included in the assembly manual if service is required.

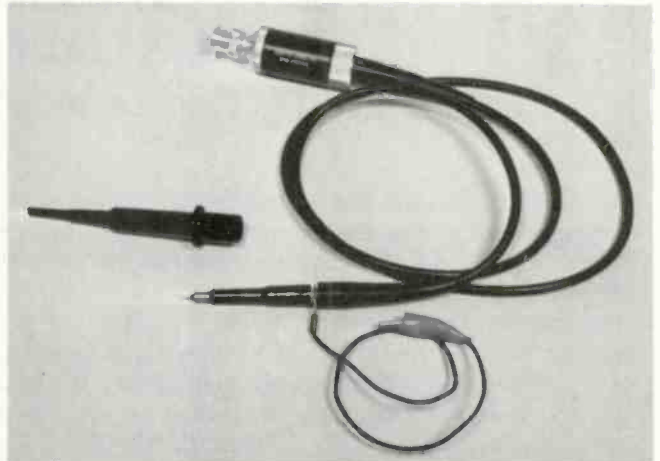

The Heath Model PKW-101 oscilloscope probe is a high-impedance, low-capacitance isolating type probe used to examine high-frequency waveforms without distorting the waveform or loading the circuit.

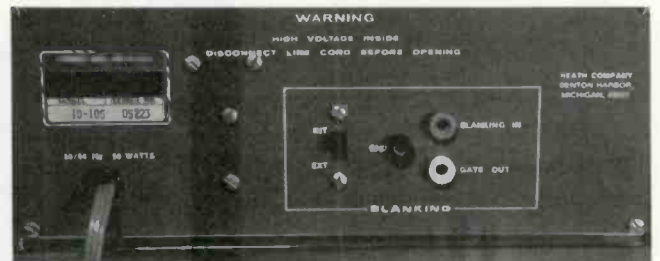

Rear panel of the oscilloscope showing the INTERNAL/EXTERNAL BLANKING switch, plus the blanking in and the gate output connectors.

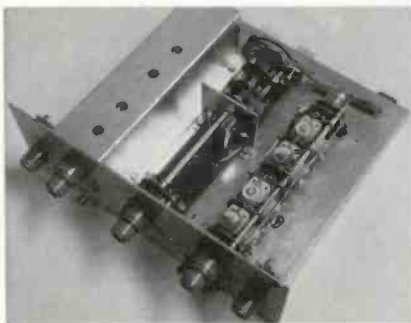

The assembled vertical subchassis with the right switch shield removed.

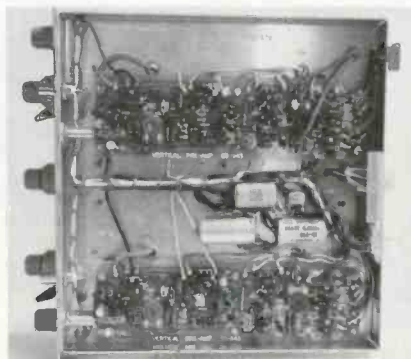

The bottom of the vertical subchassis showing the Channel 1 and 2 vertical preamplifier circuit boards.

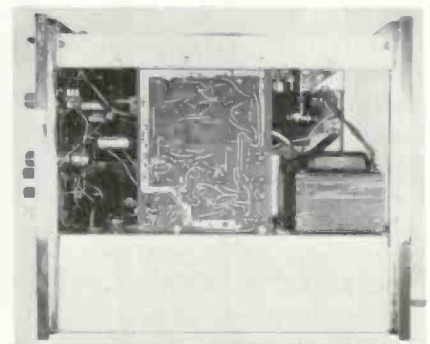

Side view of the assembled oscilloscope with panels removed, exposing the horizontal circuit board.

Oscilloscope Specifications

VERTICAL

Accuracy	±3%
Input Impedance	1M shunted by 35pf
Maximum Input Voltage	600v dc
Sensitivity	ac or dc: .05v/cm
Frequency Response	dc to 15MHz: 3dB with 4cm deflection
Vertical Windows	2 minimum
Rise Time	24ns
Overshoot	Less than 10%
Attenuator	9 positions in a 1, 2, 5 sequence. .05v/cm to 20v/cm. Variable gain (uncalibrated) through entire range
Vertical Display in Sweep Mode	Channel 1, Channel 2, Channel 1 and Channel 2 alternately, or Channel 1 and 2 chopped (50kHz)

HORIZONTAL

Time Base	Triggered with 18 calibrated rates: .2μs/cm to 100ms/cm in a 1, 2, 5 sequence, ±3%. Continuously variable (uncalibrated) within the same range.
Sweep Magnifier	X5 (time base accuracy is ±5% when the magnifier is being used)
External Horizontal Input	750mv/cm (uncalibrated and not adjustable). 100K minimum input impedance, dc to 100kHz

X-Y MODE

Sensitivity	.05v/cm to 20v/cm, ±3%
Frequency Response	—3dB at 100kHz (Channel 2)
Phase Shift between Channels	±5° or less from dc to 50kHz within graticule limits

TRIGGERING

Delay	Approximately 600ns
Automatic	Zero crossing to ±½cm of zero crossing
Normal	Within viewing area
Source	Channel 1, Channel 2, or Channels 1 and 2
Polarity	+ or — slope
Coupling	ac or dc
Sensitivity	Internal: ½cm. External: 100mv minimum, 7v maximum

GENERAL

Blanking In	TTL compatible (logic 0 blank)
Gate Out	3.5v minimum
Input Connections	Vertical: Coaxial, BNC. Horizontal: Binding post. External Trigger: Binding post on ¾-in. center with ground
CRT Accelerating Potential	2200v dc regulated
CRT Type	8 × 10cm rectangular, flat face, D14-1076A
Warm-up Time	CRT heating time, approximately 30 sec. For full calibration, approx. 15 min.
Graticule	8cm × 10cm grid, edge lighted
Overall Dimensions	10% in. wide by 12% in. high by 15 in. deep
Net Weight	28 lb

Probe Specifications

Input Resistance	10M
Input Capacitance Range	Up to 40pf
Connector	BNC
Maximum Voltage	600v dc or 600v ac p-p
Attenuation	10:1 (with oscilloscope having 1M input resistance)
Attenuation Accuracy	±3%
Frequency Range	dc to 30MHz

under the vertical subchassis. Also, a manufacturer suggested change was made to protect the input FET transistors (Q402 and Q403) from transient spikes on early production models. This was done by connecting 0.1μf/100v capacitors in parallel with resistors R407 and R408 on each vertical preamplifier board.

Calibration

The instruments needed for calibration are very minimal. In fact, about the only instrument required is a high-input-impedance voltmeter. This method of calibration is advisable unless a precision signal generator is available, because the final oscilloscope accuracy depends almost entirely upon the accuracy of the signal generator.

This simplified calibration method is made possible with an internal 100kHz crystal-controlled oscillator built into the scope just for calibration purposes. We were curious about the accuracy of the oscillator frequency, so we checked the frequency with a frequency counter and found it to be within 17Hz of the 100kHz specified, and "rock solid" without drift.

The calibration of the scope was quite easy following the step-by-step instructions given in the assembly manual. The first part of the calibration consisted of adjusting the +15 and -15v supply voltages

and the dc level voltages, then the following adjustments: trace, triggering, vertical calibration, sweep calibration and input attenuator compensation adjustments. The voltage for the vertical calibration is also obtained from the regulated 15v power supply terminal found in this instrument.

The triggering adjustments were the most time consuming and critical, but after reading the instructions over a few times we got the traces to lock in very solidly.

High Frequency Probe

The probe used with the scope to examine the various waveforms was the Heath Model PKW-101, a high impedance (low capacitance) isolating type probe.

This probe can be used to examine high-frequency waveforms without distorting the waveform or loading the circuit, and can also be used in any other application where a high-impedance probe is desired.

A trimmer capacitor adjustment compensates for the internal capacitance in the probe and probe cable, and at the same time it matches the probe to the particular input capacitance of the scope. We made the trimmer adjustment in the usual way by connecting the probe to the output of a sine/square-wave generator set

continued on page 65

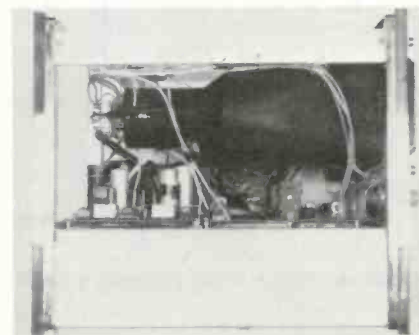

After the side panels are removed, most of the circuits are exposed, simplifying adjustments. Note the all shielded 8 × 10cm rectangular flat-face CRT.

Electronic Security Part II—Automatic Telephone Dialer

by Terry Tuttle and Tom Turnbull

Once an intrusion has been electronically detected, the alarm must be transmitted to some location where it can do some good.

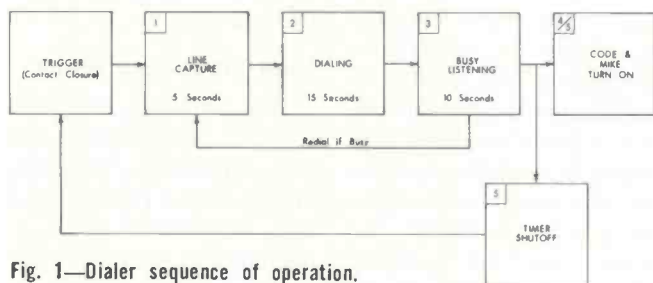

Fig. 1—Dialer sequence of operation.

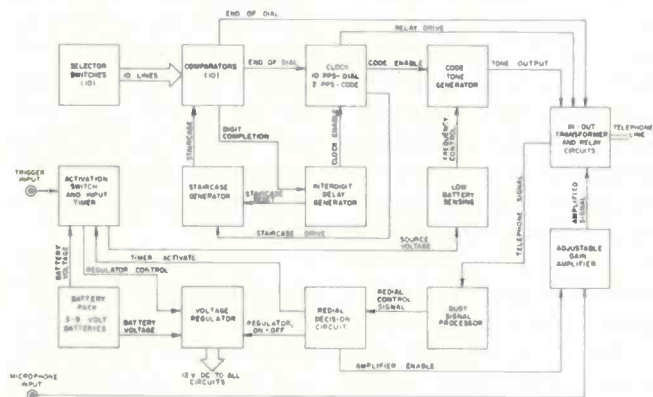

Fig. 2—Block diagram of the Dialer.

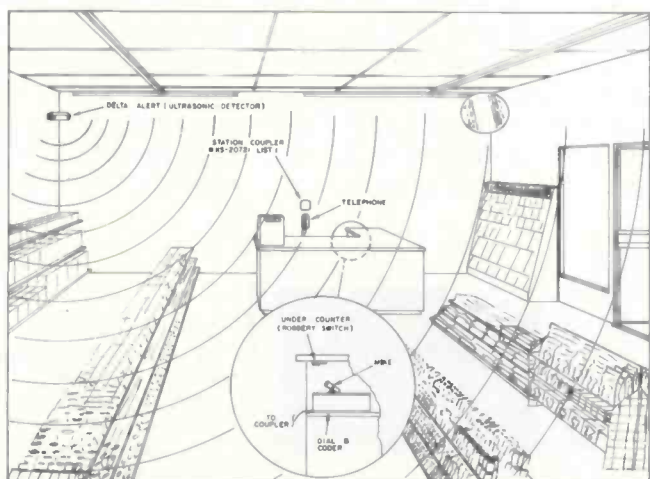

Fig. 3—Sketch showing the final installation of the electronic security system.

■ The Automatic Telephone Dialer can be programmed for dialing the police, a neighbor, friend or relative to indicate an alarm condition. Those with shops located elsewhere, may even use the system for signaling the alarm at their home. This system has the advantage of not requiring any special leased wires, dialing the desired party on existing telephone lines.

The unit described in this article is completely electronic—solid state—with no moving parts other than a reed relay. Upon receiving a contact closure for activation, the unit proceeds through the following sequence (Fig. 1):

1. Line Capture—connection is made to the telephone line and sufficient delay is provided to obtain a dial tone.
2. Digital dialing—unit proceeds to dial preset number at the rate of 10 pulses per second, with 2 sec. spacing between digits. (Break/Make ratio is 60/40.)
3. Line Busy Detection—system listens for a 10 sec. period to determine if the called number is busy. If the line is busy, the unit “hangs up,” waits 15 sec., and then redials the number. This redialing continues until the line is no longer busy.
4. Listening Mode—sensitive microphone is switched ON, enabling called party to listen in on the room covered by the detection equipment.
5. Identifying Code—tone code is superimposed on the line every 12 sec., identifying calling location.
6. Automatic Reset—the Dialer “hangs up” and turns itself OFF after 1½ min. of operation.

The block diagram of the Dialer is shown in Fig. 2 with arrows indicating the direction of signal flow. Although appearing rather complex from the block diagram and circuitry involved, the Dialer and Coder operate in a straightforward manner.

The phone number and code are set in the Dialer by cross connecting the voltage taken off a voltage divider to the appropriate comparator. The cross connection is through a 10 × 10 matrixing switch (Fig. 4).

The circuit (shown in Fig. 5 on the third page of this article) is activated by shortening the trigger input jack, which latches an SCR in series with the battery pack. The battery voltage is then fed to the voltage regulator, and the voltage regulator in turn activates all circuits, providing the operating voltage.

Upon receiving an operating voltage, the output relay closes, presenting an “off hook” signal to the telephone line. The first comparator is reset by the operating voltage turn-ON. After a 5 sec. delay, dialing starts. The dial pulse generator that drives the telephone line relay also supplies the input to a staircase generator, with each pulse stepping up the output of the generator by ½ v. When the comparator senses that the staircase generator output is equal to the voltage switched from the divider, it changes state, stopping the dialing of that digit and activating the interdigital delay. The staircase generator resets to zero during the interdigital delay. The “switching” of a comparator resets the next comparator in line. This process continues until the last of the dialing digit

Mr. Tuttle is Chief Engineer and Mr. Turnbull is Development Engineer for Delta Products, Inc.

comparators activates. There are eight dialing comparators, but any comparator can be switched OFF, giving the desired number of digits.

The change of state of the eighth comparator generates the end-of-dial signal, which turns ON the busy signal processing circuitry. If a busy signal is present, the unit "hangs up" by turning OFF the power supply. The dialer redials after a short time and will continue the wait-and-redial process until it does not receive a busy signal.

The end-of-dial signal also turns ON the code tone generator and slows the frequency of the pulser to two pulses per sec. If no busy signal is present, this puts a series of beeps on the telephone line as well as connecting a microphone to the line through a high-gain amplifier. The beeps are counted by the code comparators as were the digits by the dialing comparators.

The two-digit code is produced by a recycling circuit that causes the dialer to repeat the code digits on a 12 sec. interval. This enables a person to identify the origin of the call and to hear what's going on as well.

The unit will turn OFF after about 1½ min. of "listening" generating the code.

A low-battery sensing circuit has been incorporated into the Dialer and Coder for recognition of weak batteries. At approximately 16v, this circuit switches and causes a radical lowering of the code frequency. The batteries may also be checked externally, using a voltmeter connected between the trigger and microphone connections.

In most cases, the Dialer will be installed in an "out of the way" spot with the microphone located for best pickup. If the KS-20721 Station Coupler (Telephone Company installation) is used, it will probably be mounted near the telephone. To minimize the necessary interconnection wiring, locate the Dialer near the Coupler. The only wiring left is the connection between the ultrasonic detector and the trigger input of the Dialer, which requires only one pair of conductors.

To complete the system installation (using both the Automatic Telephone Dialer described in this article and the Ultrasonic unit described on page 42 of the October 1972 issue), check the ultrasonic detector for the correct setting of SENSITIVITY, PERSISTENCE and TIME controls.

A sketch showing an installed system is shown in Fig. 3. Note that the ultrasonic unit is mounted to provide adequate coverage of the counter and cash register, but not where it might be critical of door and window conditions. The Dialer is mounted under the counter where it is out of the way, and the microphone placed for adequate sound reception. The coupler has been shown installed on the wall near the telephone, but could have easily been more inconspicuously placed if desired.

It is sometimes quite reassuring to provide a daily check on the system. This can be done by using a 24 hr timer which triggers the system at a preset time (6:30 a.m. would double as an alarm clock). You would then receive a telephone call every day at that time, assuring you of proper system operation. ■

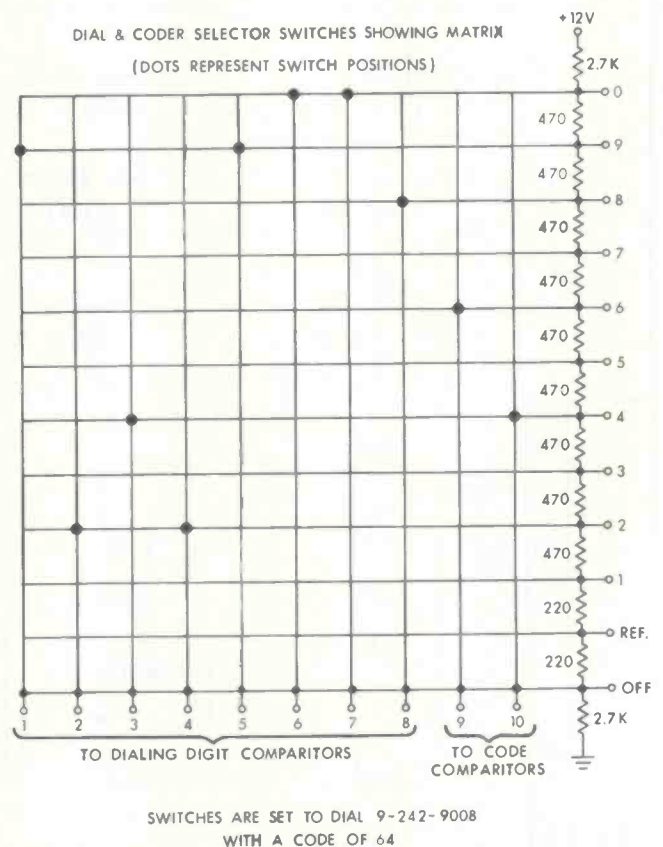
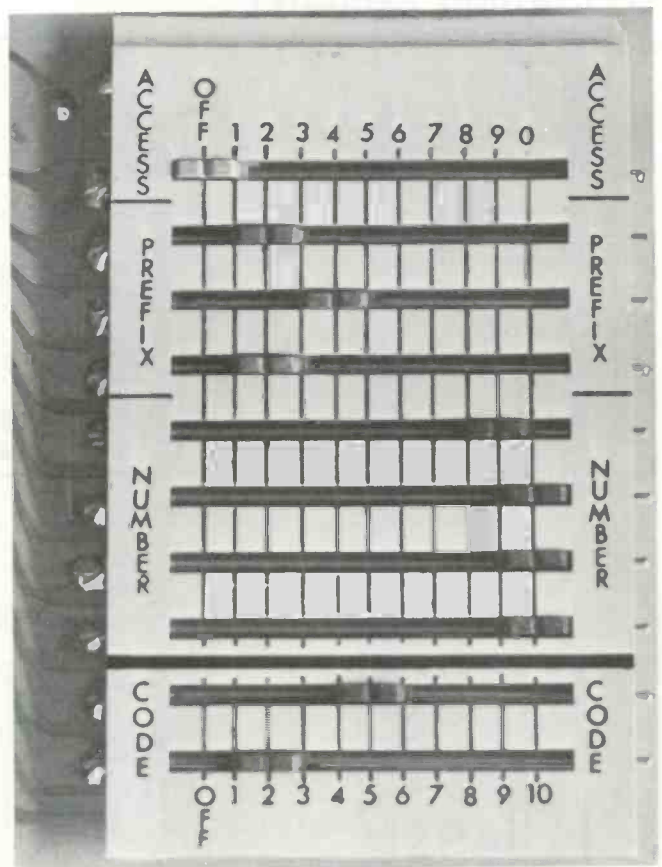

Fig. 4—The unit contains a series of 10 switches (photo above), each having 11 positions for 10 × 10 matrixing (schematic above), plus OFF.

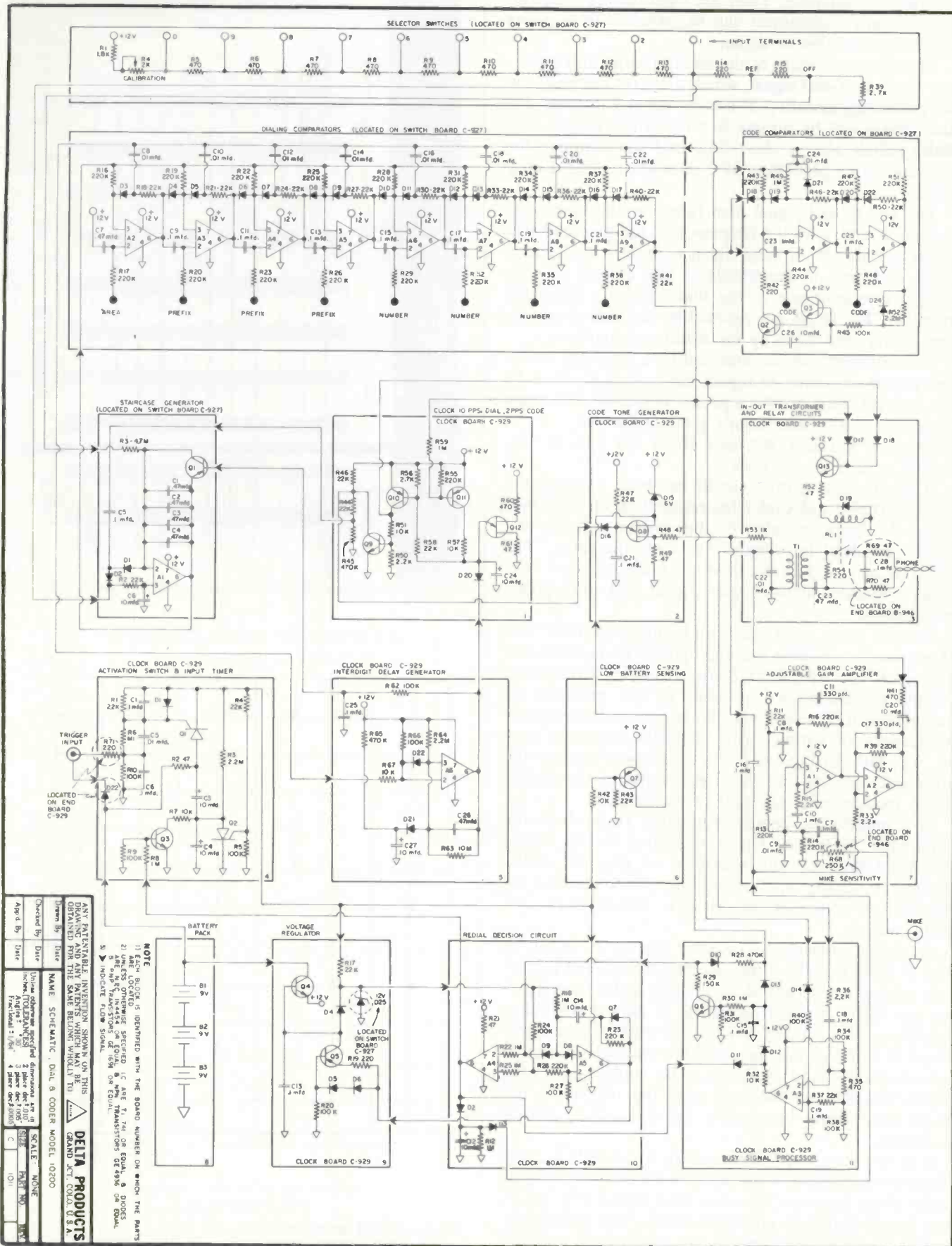

Fig. 5—Schematic diagram of the Automatic Telephone Dialer.

Basic Digital Circuitry

by Phillip Dahlen

Part II—The function of IC decade-counter circuitry

■ Last month's article introduced this series by referring to the technological changes that have resulted in a greater use of digital circuitry in consumer electronic products. Then, using the Heathkit Model IB-101 as an example of new digital circuitry, the article explained (with the aid of scope traces) how the input signal is modified into a signal that can be handled by the circuitry in this instrument's first decade counter.

Probably the most prevalent function in a frequency counter, and the one most difficult to understand, is decade counting with the use of Base-Two mathematics. The mathematics that we are most familiar with is to Base Ten. In other words, we are accustomed to counting from 0 to 9 in the first column (the right, units column), 0 to 9 in the second column (the 10's column), 0 to 9 in the third column (the 100's column), and so on. However, when working with Base Two, we count from 0 to 1 in the first binary column (the right, 1's column), 0 to 1 in the second binary column (the 2's column), 0 to 1 in the third binary column (the 4's column), 0 to 1 in the fourth binary column (the 8's column), and so on. Table I compares these two systems in counting from 0 to 15—although in this instrument, no Base-Two counting is done to any number greater than 10.

When referring to the Base-Two 1's column, we note that with the first applied count a "1" is registered, while with the second count a "0" is registered, a second "1" being registered with the third count, and so on with every other count resulting in a "1." A flip-flop circuit can be made to count in the same manner, alternately turning from one state ("1") to another ("0") with each applied pulse. (Notice

that in this flip-flop the occurrence of a "1" state is at half the applied frequency, because every other cycle—or count—registers a "0." At this point, many authors introduce negative logic, a subject that we will ignore for greater simplicity of circuit descriptions.)

In the Base-Two 2's column a similar action is obtained. Just as the 1's column flip-flop is switched to register "1" (or "0") at half the frequency of the applied count, the 2's column flip-flop is switched to register "1" (or "0") at half the frequency it obtains a count from the previous 1's stage—it alternately flipping between the "1" and "0" state each time the preceding flip-flop switches to the "0" state.

We can also see that the flip-flop for the 4's column functions in the same manner—it alternately flipping between the "1" and "0" states each time the 2's column flips to the "0"

state. And the same action applies to the 8's column, which alternately flips between the two states each time the 4's column flips to the "0" state. (Since we are not counting beyond 10, the 8's column is as high as we need go.)

Although it may be great to have a circuit that can count, the resulting numbers will probably have little practical value to us unless they are compared to something else. (We are not interested in total numbers, like the ticket agent at a fair, but rather in rates.) For this reason, a gate circuit (ON/OFF control circuit) is provided to permit the flip-flops to function only during a predetermined period of time. After this period of time has ended, the gate circuit prevents the flip-flops from counting further. And after the count has been registered, a reset signal returns the decade circuitry to its initial "0" condition.

First Decade

Even without a frequency scaler, which may be covered in another article, this particular frequency counter is designed to directly count signals up to 15MHz. However, only the flip-flop in IC21 (shown in the schematic used in Fig. 7, Page 58 of last month's issue) need operate at so high an input frequency—since the other IC flip-flops are driven by this or later flip-flops and thus operate at no more than 7.5MHz. It is due to such high-frequency requirements that the first decade counter contains three integrated circuits (IC23 merely appears as if it were two IC's). Since the other decade counters operate at no more than a tenth of the maximum applied signal frequency (1.5MHz or less), merely a single IC has the required frequency response, at a reasonable price, to perform as a complete decade counter.

A more detailed study of the 3½ IC's incorporated in the first decade counter (Fig. 1) is required for effective servicing. This is due to the fact that the function of these IC's must differ slightly from the previous description of Base-Two numbers, since upon reaching 10 each digital counter must be capable of carrying a pulse to the next digital counter and then repeating the

Table I
Comparing Two Systems for Counting
from 0 to 15

Base 10	Base 2
0	0000
1	0001
2	0010
3	0011
4	0100
5	0101
6	0110
7	0111
8	1000
9	1001
10	1010
11	1011
12	1100
13	1101
14	1110
15	1111

0-to-9 sequence, rather than continuing on to higher numbers (no single decade counter can go beyond 9). Fig. 2 shows the signals used in this decade circuit for counting to 10.

The first flip-flop (IC21) remains in a "0" condition and does not function until the inhibit signal, generated in the master oscillator circuit, allows the input signal to be counted for a predetermined length of time (1ms in the kHz range and 1s in the Hz range). When not inhibited (B—shortly after time T_0), the first flip-flop is switched to the "1" condition (C—at time T_1) by the negative excursion of a square wave (A—at the time T_1) generated by the signal being measured (as described in last month's article). We now have the number 0001.

The second negative excursion (A—at time T_2) causes the first flip-flop to return to its original "0" condition (C—at time T_2), producing a negative excursion at C that switches the second flip-flop to the "1" condition (E—at time T_2). (This second flip-flop remains uninhibited until after the fourth flip-flop circuit has become activated.) With a "1" conditioning existing in only the 2's column, the resulting number is 0010.

With the third negative excursion from the square-wave input (A—at time T_3), the first flip-flop is

again switched to the "1" condition (C—at time T_3). Since in changing from the "0" to "1" condition the IC does not apply a negative pulse to the second flip-flop, that second circuit remains in a "1" condition (E—at time T_3). We now have the number 0011.

With the fourth negative excursion of the square-wave input (A—at time T_4), the first flip-flop again switches to the "0" condition (C—at time T_4), which produces another negative excursion at C. This negative excursion in turn switches the second flip-flop to the "0" condition (E—at time T_4)—it also producing a negative excursion at E. The third flip-flop responds to this negative excursion at E and is switched to the "1" condition (G—at time T_4). We now have the number 0100.

This sequence continues with the input signal causing the first flip-flop to again switch to the "1" state (C—at time T_5) when a negative excursion is received from the square-wave input (A—at time T_5). Under these conditions, the second and third flip-flop circuits do not receive a negative going pulse from the preceding circuits and remain in their current states. We now have the number 0101.

The next negative excursion (A—at time T_6) causes the first flip-flop to return to its "0" state (C—

at time T_6), producing a negative excursion at C that causes the second flip-flop to switch to its "1" state (E—at time T_6). This second IC does not produce a negative excursion at E to affect the third flip-flop, which remains in the "1" state. We now have the number 0110.

The seventh negative excursion from the square-wave input (A—at time T_7) switches the first flip-flop to its "1" state (C—at time T_7). Since the second and third flip-flops do not then receive a negative excursion from the preceding ones, they remain in their current states. We now have the number 0111.

From the information contained in Table I, it would seem as though a fourth flip-flop might be used like the others (connected directly to the third flip-flop) for switching to the "1" state with the application of another input pulse (A—at time T_8). Although this would produce the desired number (1000), such circuitry would not return to the zero condition upon receipt of the tenth negative input pulse (A—at time T_{10}). Slightly different circuitry is required for such a function.

Each of the three flip-flop circuits described thus far actually has two outputs—one that goes positive during the "1" condition (C, E and G) and one that goes negative during the "1" condition (D, F and H). Some of these outputs are used in

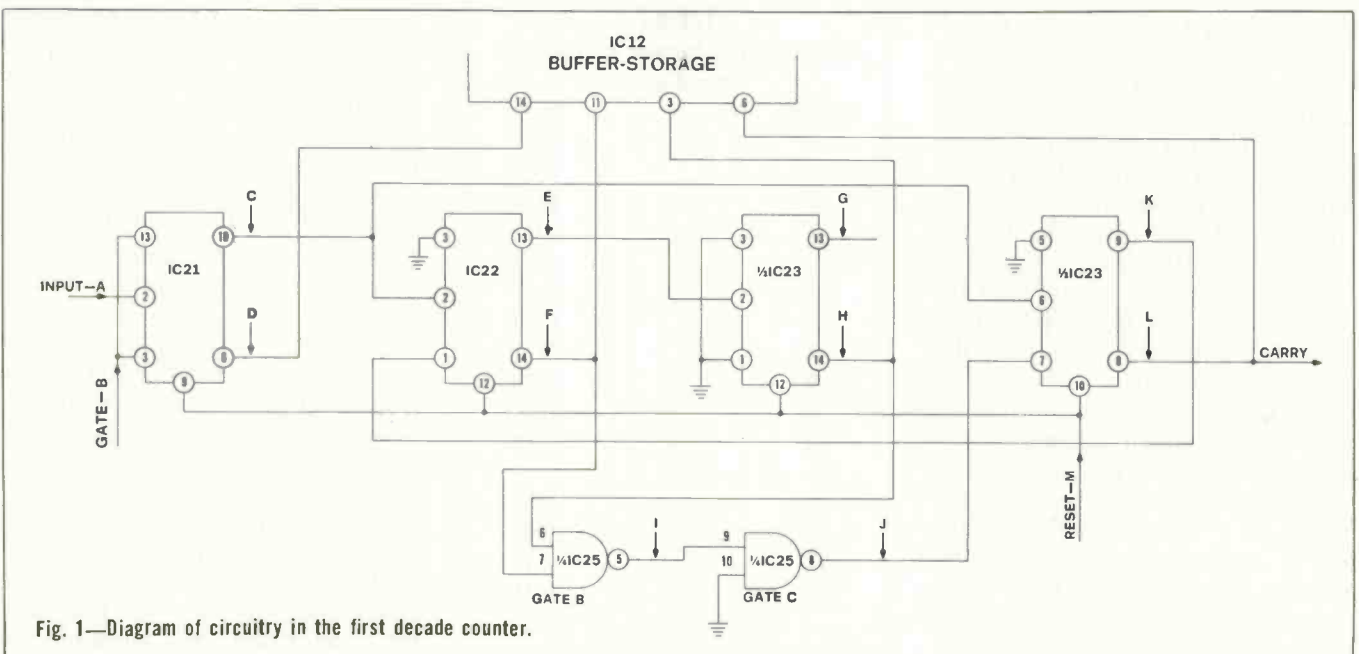

Fig. 1—Diagram of circuitry in the first decade counter.

regulating the fourth, and last, flip-flop circuit in this decade counter.

From Table I we see that the fourth flip-flop must be switched to the "1" condition when both the second and third flip-flops are in the "1" condition and the first flip-flop is switching to the "0" condition—the second and third flip-flops then also following to the "0" condition. As has been somewhat exaggerated in Fig. 2, the flip-flops do not switch simultaneously—internal circuit capacitance causing each flip-flop circuit to switch slightly after the preceding one. (The fourth flip-flop would appear to be an exception, but only if you fail to note the source of the negative excursion causing it to change state.) Thus, the second and third flip-flops are still in the "1" condition (E and G—at time T_8) as the first flip-flop is switched to the "0" condition (C—at time T_8).

Gate B (a portion of IC25) has a positive output (I—from just after time T_6 to just after time T_8) only when the applied outputs from both the second (F) and third (H) flip-flops represent the "1" condition. The output of Gate B (I) is inverted by Gate C, the resulting negative output (J) beginning shortly after time T_6 and ending shortly after time T_8 .

Just as the first IC flip-flop is regulated by an inhibit signal applied to it (B—ceasing to inhibit shortly after time T_0), the fourth flip-flop is also regulated by an inhibit signal (J—allowing it to function from just after time T_6 to just after time T_8)—that produced by Gate C. Only during this time interval is it permitted to switch to the "1" condition upon receipt of a negative switching pulse.

The fourth flip-flop, like the second one, is switched between states by the negative-pulse output of the first flip-flop (C). But not until after time T_6 is the fourth flip-flop allowed to function—the first acceptable negative switching pulse being C—at time T_8 .

With the eighth negative excursion from the square-wave input (A—at time T_8), the first flip-flop switches to the "0" condition (C—at time T_8), producing a negative excursion at C that is now permitted

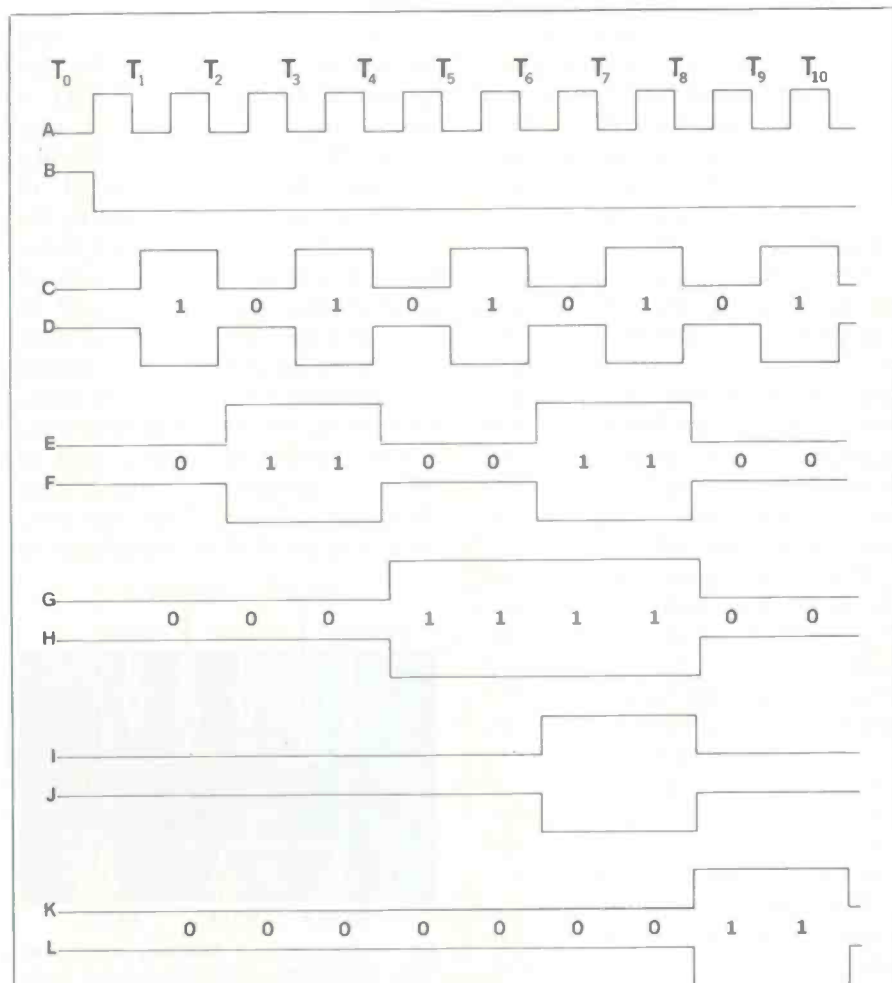

Signals Present in Initial Decade Circuitry

- A = Square-wave signal to be counted—applied to input of first flip-flop (IC21, Pin 2).
- B = Inhibit signal—applied to first flip-flop (IC21, Pins 3 and 13).
- C = Output from first flip-flop (IC21, Pin 10)—applied to input of second flip-flop (IC22, Pin 2) and fourth flip-flop (IC23, Pin 6). Output is half frequency of input.
- D = Inverted output of first flip-flop (IC21, Pin 6)—applied to buffer-storage (IC12, Pin 14). This is the binary 1's column output.
- E = Output from second flip-flop (IC22, Pin 13)—applied to input of third flip-flop (IC23, Pin 2). Output is half frequency of input.
- F = Inverted output from second flip-flop (IC22, Pin 14)—applied to Gate B (IC25, Pin 7) and buffer-storage (IC12, Pin 11). This is the binary 2's column output.
- G = Output from third flip-flop (IC23, Pin 13)—not used.
- H = Inverted output from third flip-flop (IC23, Pin 14)—applied to Gate B (IC25, Pin 6) and buffer-storage (IC12, Pin 3). Output is inverted, but half frequency of input. This is the binary 4's column output.
- I = Output from Gate B (IC25, Pin 5)—applied to Gate C (IC25, Pin 9). Gate B output signal "0" appears only when "1" condition occurs at the same time at both inputs.
- J = Output from Gate C (IC25, Pin 8)—applied to inhibit input of fourth flip-flop (IC23, Pin 7). This gate inverts the applied signal.
- K = Output from fourth flip-flop (IC23, Pin 9)—applied to inhibit input of second flip-flop (IC22, Pin 1).
- L = Inverted output from fourth flip-flop (IC23, Pin 8)—applied to next decade counter (IC17, Pin 9) and buffer-storage (IC12, Pin 6). This is the binary 8's column output.
- M = Reset signal—applied to return all decade flip-flops (IC21, Pin 9; IC22, Pin 12; IC23, Pins 10 and 12) to initial state after count is completed. (Signal shown only in composite photographs.)

Fig. 2—Signals used in the first decade circuitry for counting to 10.

to cause the fourth flip-flop to switch to the "1" condition—in addition to causing the second flip-flop to switch to the "0" condition. The second flip-flop, in turn, causes the third flip-flop to switch to the "0" condition. We now have the number 1000.

The ninth negative excursion of the square-wave input (A—at time T_9) switches the first flip-flop to the "1" condition (C—at time T_9). Since switching from the "0" condition to the "1" condition does not generate a negative pulse at C to activate the other flip-flops, they remain in their present state. We now have the number 1001.

The 10th negative excursion of the square-wave input (A—at time T_{10} , or T_0 if we are repeating the cycle during the 1ms or 1s counting time for a number larger than 10) switches the first flip-flop from the "1" to the "0" condition. This produces a negative excursion (C—at time T_{10} or T_0), which switches the fourth flip-flop to the "0" condition (K—at time T_{10} or T_0).

Since some time (although extremely little) is required for the fourth flip-flop to change conditions, it is still in the "1" condition at the instant that the negative excursion (C—at time T_{10}) is applied to both it and the second flip-flop. And the positive potential that does remain at output K is applied to inhibit the control gate of the second flip-flop—thus preventing it from switching to the "1" condition. In this manner, the decade circuitry is returned to 0000. However, in returning to a zero state, the inverted output of the fourth flip-flop (a positive excursion from L) is carried to the next decade—the second decade counter receiving one positive pulse each time the initial decade circuit receives 10 negative pulses from its square-wave input. (Note that in this instrument the flip-flops for the first decade require negative square-wave-type pulses, while the remaining decade counters require positive square-wave-type pulses.)

Scope Traces

Fig. 4 is a composite picture made up of 12 photographs taken of dual-trace scope waveforms obtained with

a Telequipment D54 scope from various IC terminals when the frequency of the input signal (A) is about three times that of the gate signal (B), or nearly 3kHz. The first original photograph consisted of dual-trace waveforms A and B, the second consisted of dual-trace waveforms C and B, the third consisted of dual-trace waveforms D and B, . . . , and the 12th consisted of dual-trace waveforms M and B. Although the duplicate photographs of waveform B are not shown in this composite picture, they were used to align the second waveform in each dual-trace picture. Thus, we were able to align all of the waveforms in

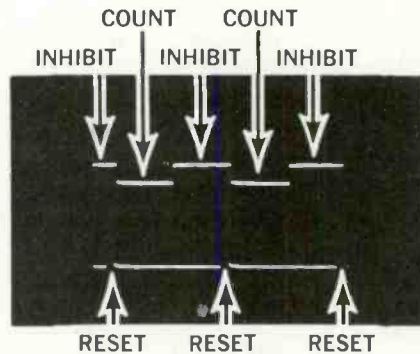

Fig. 3—Photograph of dual-trace scope waveforms showing the relationship between the inhibit gate signal (upper trace) and the reset signal (lower trace).

relation to waveform B and show the approximate relationship of each waveform to the other. [This relationship between waveforms could have been shown with a slightly greater degree of accuracy had the input signal (A) been synchronized with the gate signal (B), for it is the combination of both signals (A and B) that determines the exact phase position of the other waveforms. However, without the aid of a ruler, the resulting error is too small to be observed in this picture.]

Fig. 4 contains one more waveform (M) than shown in Fig. 2. This additional signal (M) is used to reset all the flip-flops to their "0" condition before the start of each counting interval determined by inhibit gate signal B. The relationship between these two signals is shown more clearly in Fig. 3 (the gate signal being the upper trace and the reset signal being the lower trace).

Referring to Fig. 4, we note that

since the input signal frequency (nearly 3kHz) is about three times that of the gate signal (1kHz), the decade counter circuitry is allowed to count to three. Just prior to counting (the time interval just before the first vertical line drawn through the illustration), all flip-flops are in their "0" condition. Once the counting interval has ended (the time interval just after the second vertical line drawn through the illustration), the flip-flops are in a state corresponding to the number "3" (0011). By referring to scope traces L, H, F and D, we note that the voltages for L and H have remained unchanged (they

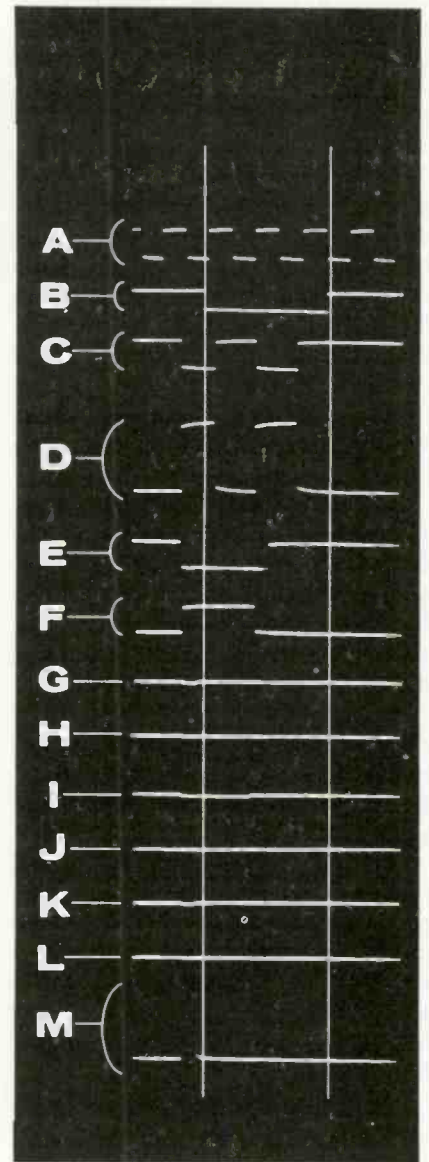

Fig. 4—Composite picture showing actual scope traces as first decade circuitry counts to three.

still represent a "0" condition). However, the voltages for F and D have been switched from that representing the "0" condition to that representing the "1" condition. Thus we do have the number "0011" or "3."

The composite picture in Fig. 5 was made from 12 photographs using the same techniques used for making the picture shown in Fig. 4. However, this time an input signal of nearly 6kHz is shown applied to the decade counter circuitry, its frequency being about six times that of the 1kHz gate signal (B). Thus, at the end of the counting interval, the flip-flops have been switched to

conditions corresponding to the number "6" (0110). Scope trace L has remained in the "0" condition, trace H has switched to the "1" condition, trace F has switched to the "1" condition and trace D has switched to the "0" condition at the end of the time interval.

The composite picture in Fig. 6 was made in the same manner as the two other composite pictures, but this time an input signal of about 12kHz is used. During this time interval, scope trace L switched from the "0" condition to the "1" condition and then back to the "0" condition. As it switches from the "1" condition to the "0" condition, a pulse is

transferred to the next decade counter (IC17, Fig. 7 in last month's article) to indicate the number "10." At the end of the time interval, the first decade counter circuitry (Fig. 1), merely records the number "2" (0010), since the second decade counter (IC17) must handle the 10's portion of the number. And from the composite picture (Fig. 6), we see that we do have a "0010" condition (scope trace L has returned to a "0" condition, trace H has returned to a "0" condition, trace F has been switched to a "1" condition and trace D has returned to a "0" condition).

Counting Entire Number

Had the digital counter been switched from its "kHz" scale to its "Hz" scale, then the first decade counter would have been permitted to function for 1 sec. intervals rather than .001 sec. intervals. If under these conditions we applied a 35167Hz signal, the first decade counter circuit (Fig. 1) would record the "7" and feed 3516 pulses to the second decade counter (IC17, Fig. 7 in last month's article), which would record the "6" and feed 351 pulses to the third decade counter (IC18), which would record the "1" and feed 35 pulses to the fourth decade counter (IC19), which would record the "5" and feed three pulses to the fifth decade counter (IC20), which would record the "3." In this manner, a "0111" (7) is fed to IC12 for storage, a "0110" (6) is fed to IC13 for storage, a "0001" (1) is fed to IC14 for storage, a "0101" (5) is fed to IC15 for storage and a "0011" (3) is fed to IC16 for storage. Each buffer-storage IC then contains a condition corresponding to the frequency of the applied signal.

Conclusion

Although this is an extremely lengthy description, it concerns the basic function of *all* digital meters. The next article in this series, a relatively short one, will show how the 1kHz and 1Hz timing signals are produced from a 1MHz oscillator signal. ■

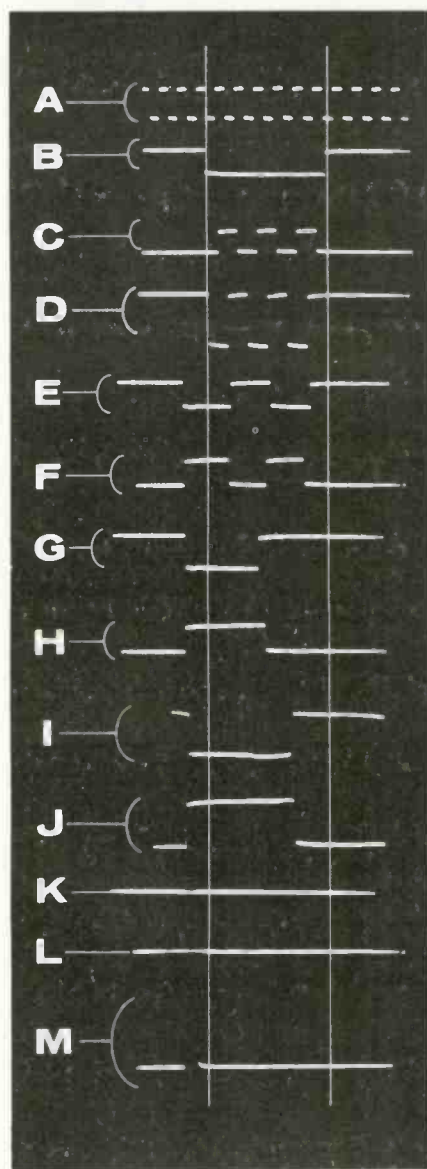

Fig. 5—Composite picture showing actual scope traces as first decade circuitry counts to six.

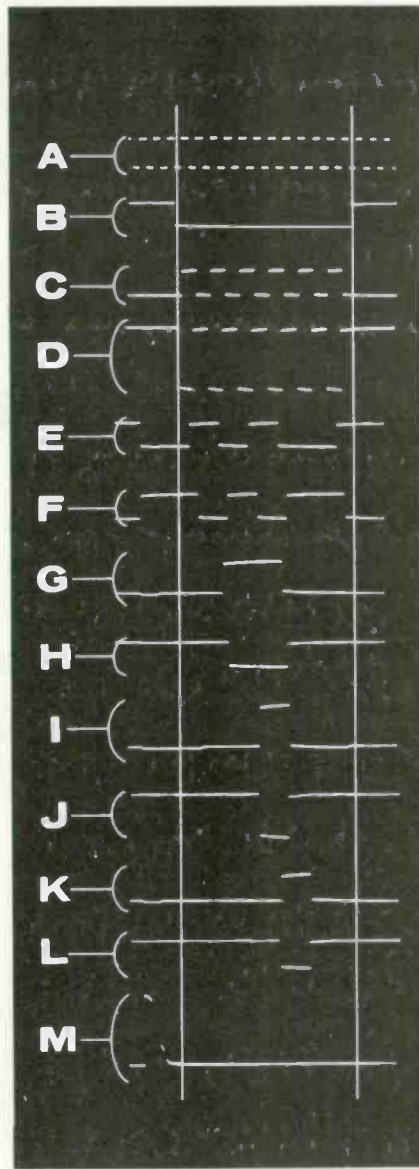

Fig. 6—Composite picture showing actual scope traces as first decade circuitry is used for counting to 12.

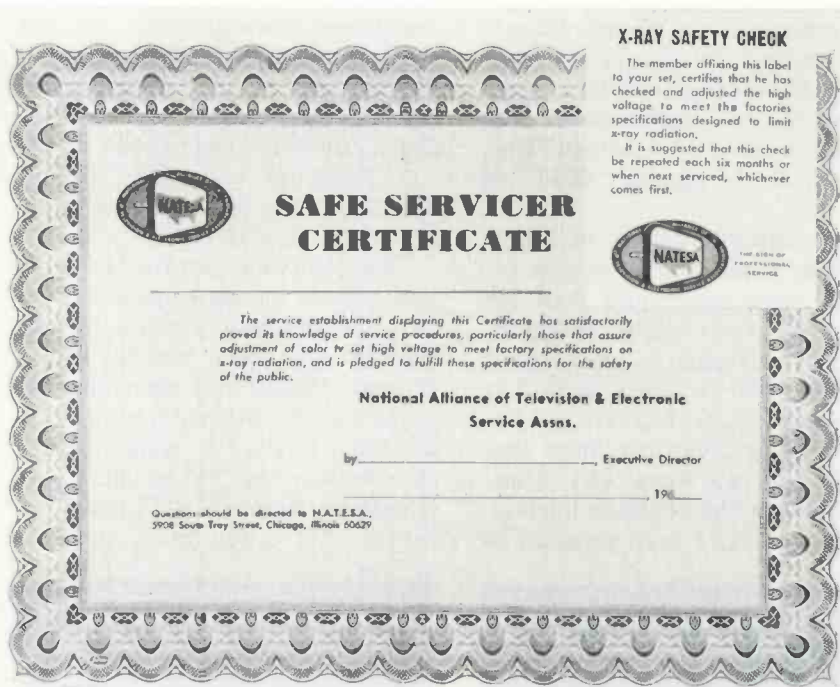

Fig. 1—Upon receiving the Safe Servicer Certificate, employees of the certified service establishment may secure the label shown at the upper right to any TV set that has been given the X-Ray Safety Check.

NATESA Plan to Create Confidence

by Phillip Dahlen

National association works to upgrade quality of work performed by employees of member shops

■ So much publicity has been given another association's certification program that we decided that publicity should also be given to the program sponsored by the National Alliance of Television & Electronic Service Associations. When contacting Frank J. Moch, Executive Director of NATESA, concerning their program, he was very helpful and sent us a large packet of material. Included was a letter from him that is quoted, in part, below:

"TV and radio being highly sophisticated devices, cause most set owners to keep hands off except for most obvious problems. They as-

sume that he who offers his services, knows his business. They couldn't care less whether he knows all the theory in the world if the servicer doesn't approach the set problem from an effect and cause basis, and in a reasonable time.

"NATESA's Confidence Plan and Certification thus is predicated on the fact that the technician does in fact have the basic theory augmented by practical experience. It recognizes that new comers coming out of technical schools with diplomas, know theory but only after several years of experience and upgrading seminars, can they truthfully call

themselves experts. When they achieve that point, they are accorded the registered title of Electronician (Fig. 2), a term understandable by the public, which long has called an expert on house wiring an electrician.

"Since the NATESA by-laws grant membership only to professional home electronics business, and recognizes that all affiliates screen their membership applicants, NATESA accepts as de-facto that employees of all members are professionals. At the same time it does police all members and customer complaints and so is in a position



CERTIFICATE OF MEMBERSHIP

1972-73

Specimen

HAVING PLEDGED TO OBSERVE THE CODE OF ETHICS BELOW, HAS BEEN ISSUED

ELECTRONICIAN

LICENSE # _____

CODE OF ETHICS

- | | |
|---|---|
| <ol style="list-style-type: none"> 1. Employ qualified personnel to assure proper service. No student shall be passed off as a technician. 2. Make proper arrangements for the protection of reserve funds on contracts. 3. Carry adequate insurance coverage. 4. Avoid trick advertising which offers to service or deliver materials under conditions which are questionable or unfair to the set owner or your fellow members. 5. Employ professional methods of doing installations and maintenance. 6. Issue a standard guarantee. 7. Have available sufficient and proper test equipment to assure a good job. | <ol style="list-style-type: none"> 8. Maintain an adequate service data library. 9. Render service without undue delay. 10. Install only parts as are really necessary. Use only new parts of a quality at least equal to original. 11. Leave with, or return to customer, all parts replaced, when requested, (except where impractical). 12. Issue an itemized bill. 13. Furnish estimates upon request. 14. Service sets in home whenever possible. 15. Be honest, courteous and treat each client in a professional manner. 16. Observe the Golden Rule. |
|---|---|

This Certificate is issued conditional upon adherence to the above Code of Ethics. Display after expiration date or after termination of membership for any cause is strictly prohibited and is subject to a license fee of \$10.00 per day for each day of such unauthorized use. All communications regarding the above member should be directed to the address below:

National Alliance of Television & Electronic Service Associations

5906-08 S. TROY ST. — CHICAGO, ILLINOIS 60629

Fig. 2—After several years of experience and upgrading seminars, technical-school graduates have achieved the point at which they can be accorded the registered title of Electronician.

to recall Certification. It has done this on several occasions. In this we operate as does the AMA and BAR.

"Most current NATESA affiliates have qualified their membership in the past for the Plan to Create Confidence. All are urged to carry on (and do) a continuing program of seminars to keep up to date.

"All individual membership applicants are cleared through the nearest member, distributor, BBB or Chamber of Commerce.

"We have used special seminars and tests as at the time of the x-radiation scare when we tested knowledge of proper set-up of high volt-

age. See enclosure." [The corresponding material consisted of a one-page reprint of Photofax Volume 2, No. 3, dated March 1968 and entitled Color TV High-Voltage Regulation. Printed on the back side of the reprint were five multiple-choice questions that made up the NATESA High Voltage Regulation Test. At the bottom of that page was a NATESA Safe Servicer Pledge. Also included were the certificates shown in Fig. 1.]

Mr. Moch's letter continued by saying: "We urge the Qualifications Of Technicians Plan on all new Affiliates." [This plan is not just some

recent brainstorm, having been outlined nearly 20 years ago in the February 1953 issue of SYLVANIA NEWS.]

Concerning that program, his current letter said: "We have updated the program to call for seminars on solid-state, FM stereo, color, modules, etc. We are readying video tape material."

Mr. Moch added, "We have adopted EIA's 'Television Symptom Diagnosis' by Richard W. Tinnell as a proper training method and will use tests in that text to supplement the NATESA current 125 multiple-choice-question test, to qualify capability of Techs."

In the 1953 reprint covering the Qualifications Of Technicians Plan, Mr. Moch explains the following:

"Refresher courses will be conducted for: 1) Association member employees and 2) outsiders who are actively engaged in the service business.

"The course consists of one lecture of approximately three hours per week (with a break of 10 minutes at the half-way point). Qualified distributors and factory service personnel will be asked to cooperate in the conduct of sessions. Courses are to consist of 10 sessions as follows: 1) Front ends, 2) Video I.F., 3) Audio I.F., 4) Vertical sweep and sync, 5) Horizontal sweep, 6) Hi-voltage systems, 7) Low-voltage systems, 8) Alignment, 9) Record changers, and 10) Antennae. The black and white course should be supplemented by a three-session color TV course.

"Upon completion of the course, a clinic will be held. All set distributors in the area will be asked to have booths fully equipped and manned to answer all technical questions on their products. The 12th week, a written examination will be given on practical theory and practice. Questions asked in the test will be determined on the basis of practical value by a committee from independent associations, distributor service managers, factory service managers and RTMA. Those that pass will be issued a certificate attesting to the fact that the applicant has taken the course and passed the requirements." ■

Better Merchants Make Better Profits

by William Joseph

The telephone can be a cruel master for electronic service dealers. When it rings, everything is fine; but when it stops, many dealers only know how to sit on their hands waiting for business to pick up again. That kind of dependency is one of the worst profit robbers in the service business.

■ Healthy profits in a service organization are the result of a high degree of efficiency, and one of the deadliest enemies of efficiency is a constantly fluctuating workload. During busy seasons, you must have the necessary manpower available to give your customers prompt service. But what happens when the workload falls off?

Some dealers know the answer to that question all too well: Either you put up with the crippling expense of a lower output per man, or you lay off help. It is hardly much of a choice, since either alternative must inevitably result in a loss of profits. Furthermore, if the scarcity of work persists long enough, it can spell financial disaster.

Fortunately, there is another choice. It is fast and easy, requires only a small investment, and will add strength and profits to your business. The answer? Teach yourself to be a better merchant.

As a basic premise, the service dealer should bring himself to understand that the product that he offers is a saleable commodity. There is absolutely no need to stand by helplessly when busy periods cause overtime expenses and long delays for the customers, or when a falling-off of calls sharply reduces income. This "feast or famine" tendency in the service business is both a profit killer and . . . unnecessary.

The first thing that a retail merchant learns is that there are times when customers are going to be plentiful, and times when business can be expected to fall off sharply.

If he is to be successful, he must analyze these natural "seasons," staff his store so that he can adequately take care of his customers when business is good, and then take steps to bring in customers during the naturally slow periods. The idea, of course, is to attempt to level off the sharp peaks and valleys in business volume that will result if nature is left to take its course. This is precisely the same set of circumstances facing the electronic service dealer.

As is so often the case, the first step in facing up to this problem is the preparation of adequate records. A simple analysis of the number of incoming calls for service during each month of the year will give you a graphic picture of your busy and slow periods. For most dealers, this graph of business volume will be surprisingly consistent. If March and November were relatively slow months for you last year, the chances are that the same condition will repeat itself again this year—*unless you decide to do something about it!* A prime requirement in bolstering your slow periods is the knowledge, in advance, of when they are coming. Once you know when to expect a drop-off in incoming calls, you can begin your plans to combat it.

Obviously, the small service dealer cannot afford the elaborate advertising campaigns that his retailing counterparts have come to depend upon to build business when customers are scarce. Fortunately, though, he doesn't have to. Direct mail—easy and inexpensive—is a

powerful sales promotion tool for the service dealer. It also has the advantage of extreme flexibility. The number of mailings can be quickly adjusted once the response has been measured, and the campaign can be turned off almost like a spigot as soon as the slow period comes to its natural end.

Frequently, the method of direct mail to small businessmen causes them to think of post cards. Forget it! Direct-mail professionals learned long ago that the simple post card has a very limited and specialized value as an advertising medium. It simply isn't adequate to tell enough of a story. If you attempt to use it, you will surely be disappointed in the results. Selling a potential customer on the reasons for choosing your service firm requires, at the very least, the dignity of a standardized letter.

Many service dealers make the costly mistake of dismissing direct mail because of the feeling that, "unless the letter arrives at just the time of a breakdown, it is a waste." Actually, that is a mistake for two reasons: First, a recent national survey confirms the suspicion that most TV sets give considerable advance warning to the viewer that all is not well. In this survey, 73 percent of all TV owners who recently had service indicated that their sets had been acting improperly for up to several weeks before they finally had to call for an electronic technician. In other words, they were prime prospects for a well-written advertisement suggesting service.

Second, a good number of TV-set owners are always anxious to locate an established local service dealer upon whom they can depend for all their service needs. A skillful direct-mail promotion can develop new customers from both of these categories.

The chances are that your local printer will be happy to work with you in setting up a format and letterhead. He is experienced in developing printing layouts and you should take advantage of his help.

As far as the actual text of your sales letter is concerned, you would probably be wise to seek professional help. The experts stress that skillful wording is of paramount impor-

tance in direct-mail efforts. A properly written letter has been known to bring in 10 times, or even 100 times, the response of a poorly written one. Unless you have a particular and obvious talent for that sort of thing, you would do well not to attempt to compose your own advertising.

Considering the fact that getting professional help in composing your letter is a one-time investment, and that it can be used indefinitely (with but slight modifications), spending a few dollars to get it done properly is good business.

Some dealers have had good results by calling on small local advertising agencies for help with their letters. The small dealer may not get the attention that can be given to a regular account, and he may have to wait until the agency can

find time to work on his project, but the effort will usually be well worthwhile.

In many cities, freelance copywriters can be located in the Yellow Pages. If there is a lettershop in your community, you may want to check with them. Many of these shops are equipped to handle your entire project from composition to mailing.

For those who will insist on composing their own letters, here are a few tips that may prove helpful: Write your letter in the first-person (on a you and I basis), and sign your own name. The informality of a first-person letter will often improve the results for businesses located in the same general community as the addressee. While you will want your letters to reflect your own personality and that of your business, the example shown in this ar-

ticle may provide you with some basic ideas.

On a separate sheet, or on the reverse side of your letter, you may want to outline the various services you offer and/or the terms of your guarantee. Direct mail promotions also present a good chance to test the "two dollars off on your first service call," type of coupon. Experience shows that many people will respond to such a savings and, if the service provided is satisfactory, most will remain on as regular customers. The face amount of the coupon can be as little as a dollar, or it can be several dollars, depending on your own ideas.

Your direct-mail program can be as simple or as extensive as your needs dictate, but it should always be ready for action whenever you

continued on page 68

A. B. C. SERVICE CO.

2205 First Avenue South
Home Town, Hawaii
Phone 943-0200

Dear TV Viewer:

Satisfied with your TV-set reception lately? Is the picture as clear as it used to be? Are some channels snowy or fuzzy? In other words, are you missing out on the full enjoyment that can be provided only by a TV set in top-operating condition?

For most people, the purchase of a modern TV set represents a considerable investment. My years of experience in the electronics field has taught me that the best way to protect that investment and to get the full enjoyment built into every TV set, is to see that it gets the best possible care.

That's the kind of care that we provide here at A.B.C. Service Co. The success of our business depends on satisfied customers who come back to us time after time, and we know it. Now, we'd like to have the pleasure of adding you to our long list of satisfied customers.

If you're not happy with the way your set is working, why not call us right now at 943-0200. We'll have you back on the road to happy TV viewing in a jiffy . . . and we'll do it at the lowest possible cost to you.

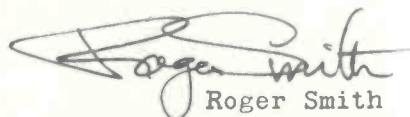

Roger Smith
A.B.C. Service Co.

P.S. I hope your set is working fine at the moment. If so, please tuck the enclosed coupon away so that you'll have our number if you should need it in the future. You'll be glad you did.

COLORFAX

The material used in this section is selected from information supplied through the cooperation of the respective manufacturers or their agencies.

ADMIRAL

Color-TV Chassis K16 Series—No Control Of Brightness

This problem can be caused by defective diode CR402 (93A69-1). Check for the presence of a negative voltage at the anode of this diode, it should be approximately -130v to -160v.

This diode and associated components provide the nega-

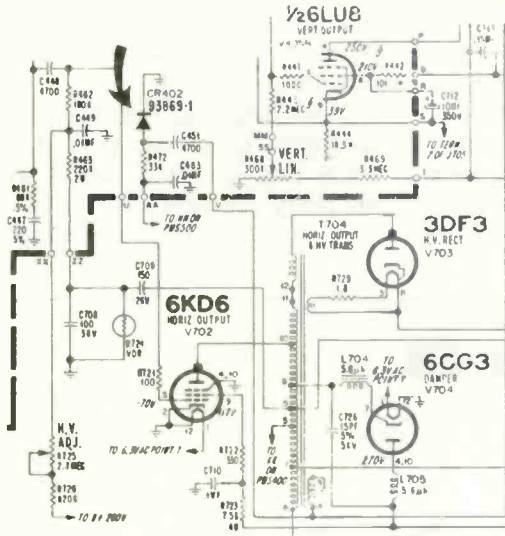

tive voltage for the BRIGHTNESS control through the MASTER BRIGHTNESS control and for the BACKGROUND controls. The circuit is not used for high voltage regulation in this chassis, as it was in some previous chassis.

This diode can also be replaced by Part No. 93A60-3.

Color-TV Chassis G11/G13/H10/H12/K15/K16 Series—Weak Or No Color

A weak or no color complaint can be caused by defective capacitor C521.

Failure of this capacitor permits a negative voltage to be produced at the plate (Pin 1) of the color killer tube, which will bias off the second bandpass amplifier. Check

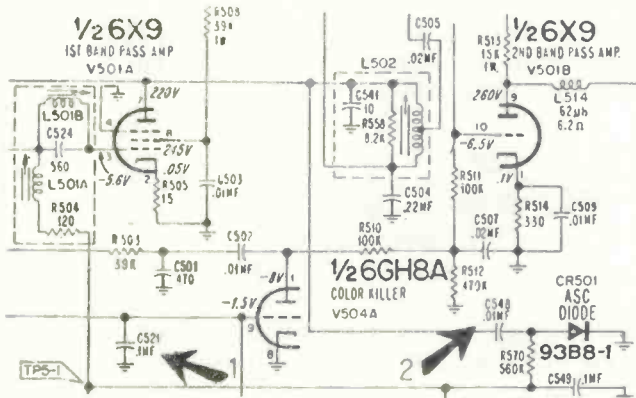

this capacitor by substitution since measuring it with an ohmmeter may not reveal a defective capacitor. Replace it with a 0.1μf of higher working voltage capacitor such as a

Part No. 64A53-98 capacitor which was used in later production models.

Another possible cause of a weak or no color complaint is leaky capacitor C540 in the H10 and K16 chassis, and capacitor C548 in the H12 and K15 chassis. Low plate voltage on the first bandpass amplifier probably identifies the leaky capacitor as the cause.

Color-TV Chassis G11—Installing Replacement High-Voltage Transformer

When you install a 98A131-5 replacement HV transformer kit (79A148-1 transformer) in the G11 chassis, you may find some sets which require horizontal centering.

Horizontal centering can be accomplished by adding a diode, with parallel resistor, in series with the blue lead to the deflection yoke at Terminal 3 of the transformer.

The polarity of the diode determines the direction that the picture shifts. Diode polarity shown in the illustration

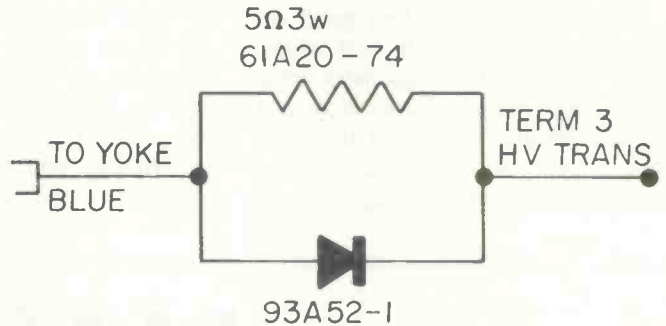

will shift the picture to the left. A special diode is not required, a 500ma with 600PIV being satisfactory.

The amount of picture shift is determined by the value of the resistor. A 5Ω resistor will shift the picture approximately 1 in. (do not exceed 10Ω).

Color-TV Chassis K20—No sound

When you check out a dead audio complaint on these chassis and find that the 57C29-2 audio IC has failed; before replacing the IC, check the ground point of the TONE control capacitor (.022μf). This capacitor must be grounded to the shield braid at the VOLUME control. If, instead, it is grounded on the tuner cluster bracket, change it before you put in the new IC.

Color-TV Chassis M20—Service Hint

There have been reports of an unusual condition in the M20 chassis that can result from the failure of a fuse in the low-voltage power supply. You would not expect to find an open fuse causing excessive brightness, washed out video and no control of the brightness condition. However, an open fuse—F904, 1/2a pigtail, Part No. 84A7-16—on the power supply module is a probable cause. This fuse is found in the power transformer secondary ac supply to the 400v B+ circuit. Because of the power supply configuration, 285v remains on the 400v line when this fuse is open—the reduced voltage to the picture tube cathodes resulting in excessive brightness.

Check the circuits supplied by the 400v B+ source and the components in the supply. When repairs have been made, replace the open fuse.

GENERAL ELECTRIC

Color-TV Chassis C-1—Troubleshooting Guide

When encountering a dim raster symptom, capacitor

TECHNICAL DIGEST

The material used in this section is selected from information supplied through the cooperation of the respective manufacturers or their agencies.

RCA SALES CORP. Amplifier Crossover Diodes

Class-B complementary symmetry amplifier circuits are widely used in consumer electronics products. Although these circuits have been previously discussed, the function of the crossover diode connected between the bases of the two complementary output transistors has never been fully explained.

Basic theory reveals the output transistors of Class-B amplifiers conduct on alternate half cycles. In the example illustrated, the active devices (tubes or transistors) are assumed to be perfectly matched and linear in response to the input signal. Under these ideal conditions, a smooth, distortion-free transition is made from the conduction of one output device to the other as the instantaneous signal voltage crosses the 0v condition. In practice, however, tran-

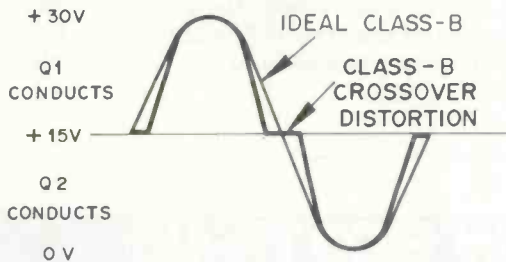

sistors are non-linear at low currents, since it is necessary that the base signal voltage exceed 0.7v—resulting from the diode voltage drop of the base emitter junction. It can be seen that the transistor that is being driven ON remains non-conductive until the base-to-emitter voltage exceeds the 0.7v barrier potential. If a smooth transition is not made from one output transistor to the other, the signal will be distorted.

Crossover Distortion

To overcome this distortion (known as crossover distortion), Class-B amplifiers are designed so that the transistors are not driven completely into cutoff. Instead, they operate with a small value of base bias current under no signal conditions. This bias current assures that the base-to-emitter junction is always conducting so it can accept signal drive. The bias current is carefully chosen to provide minimum crossover distortion and minimum no-signal collector current. In practice, the no-signal or idle current of a Class-B output stage is quite low, being approximately 2 to 10ma. The required base bias is obtained by a resistor bias network.

Complementary Class-B Circuit

In the complementary symmetry circuit shown, complementary output transistors Q1 and Q2 are biased, in a manner to be described, to provide equal conduction under no-signal conditions. With a supply voltage of 30v, the voltage at the mid-point of the circuit (emitters of both transistors) assumes a voltage equal to half the supply voltage, or in this case 15v.

To meet the requirements for base bias, let us consider what is necessary to allow conduction of NPN transistor Q1, and PNP transistor Q2. Assuming that the mid-point

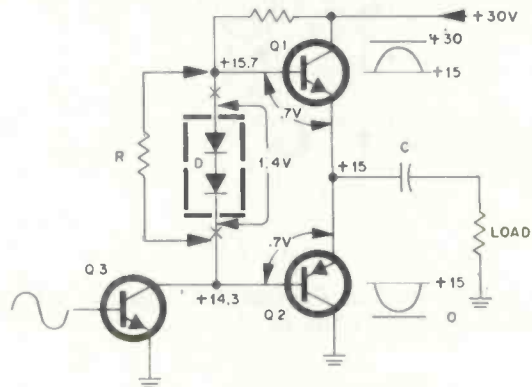

voltage of the circuit must equal 15v (½ supply voltage), it is necessary for the base of transistor Q1 to be approximately 0.7v more positive than the emitter. (The exact voltage will depend upon the transconductance characteristics of the specific transistor used.)

Thus, with 15v at the emitter, the base voltage must be 15.7v. For PNP transistor Q2 to conduct, the base must be more negative than the emitter by approximately 0.7v. This means the base voltage of transistor Q2 must be approximately 14.3 or .7v less than the supply voltage. When the voltage difference between the base of Q1 and the base of Q2 is determined, it is found to be 1.4v. It is then only necessary to calculate a resistance value which provides this voltage drop for the collector current of driver transistor Q3.

Although in theory a resistor can be used for bias, in practice a diode package is nearly always used for this application because it provides a measure of bias stability under conditions of changing dc supply voltage and temperature. It is also interesting to note that in an actual amplifier, even though the schematic symbol may show only one diode, in reality the circuit requires the junction drops of two series connected diodes, even though both are in a single package. Also, it is necessary to carefully choose the characteristics of the diodes used so that the exact voltage drop required to set the no-signal operating point of the output transistors is obtained.

If a resistor were used instead of a diode to establish the

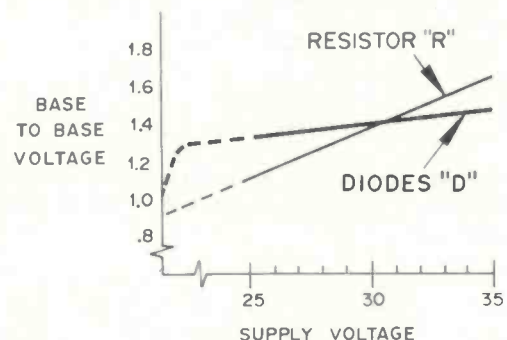

base bias of transistors Q1 and Q2, the voltage drop across the resistor is a direct function of its current. In the event that the power supply voltage increases, increased bias is applied to the base of driver transistor Q3, causing increased collector current and a larger voltage drop across resistor R. This produces a higher base voltage and base current that results in increased collector idle current and more power dissipation in the output transistors. Consider now the use of diodes.

The diodes, like the base-emitter junction of the output transistors, have an intrinsic voltage drop of approximately 0.7v that is for all practical purposes independent of current. Thus under conditions of changing collector current of driver transistor Q3, far less change in base-to-base voltage results when diodes are used. For this reason, the output stage collector current and power dissipation remain more constant under conditions of varying input voltage.

Consider the effects of elevated temperature on bias stability. As the temperature increases, the base-to-emitter voltages (V_{be}) of the output transistors decrease. In the case of the circuit using bias resistor R, the decreased V_{be} permits increased base current and correspondingly more collector current. This in turn causes more heating and finally a condition which could degenerate until thermal runaway and transistor failure occurs. In a circuit using diode D, the decrease in V_{be} is accompanied by a similar decrease in diode junction voltage. Because of the diode compensation, the effect of elevated temperature on output stage idle current and power dissipation is minimized. The preceding discussion should make clear the important function played by the crossover diode as used in Class-B complementary symmetry amplifier circuits. It's obvious that characteristics of these diodes are specified to provide the required degree of circuit stability. Thus, when servicing, it is extremely important that crossover diodes are replaced with the correct type as specified by stock number.

Tape Player Model YZD589, 593, 595—No Program Change

The symptom "Does not change channels manually or automatically, plays one program continuously" may be encountered in the instruments listed above. If this symptom

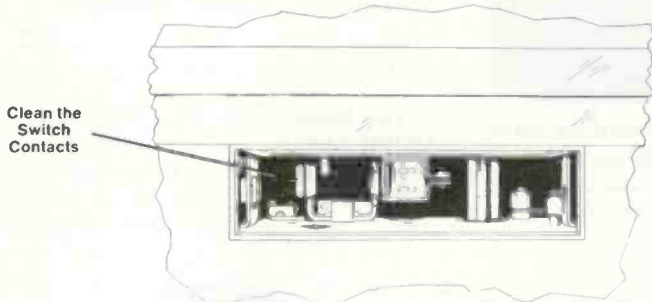

is evident, check the AUTO TRACK SELECTOR switch. Normal buildup of oxide from the tape can short the two switch contacts together. Clean the contacts in the same manner as that used to clean the head and capstan.

Tape Player Model YZD589—Tape Speed Too Fast

There is the possibility of the tape speed being too fast

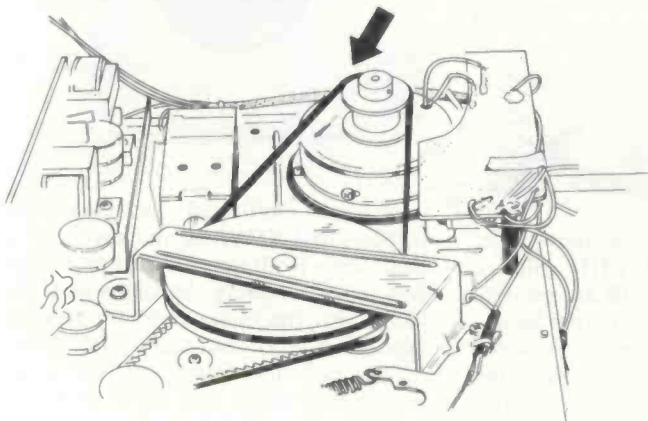

in some Model YZD589 tape players. This can be caused by the rubber mounting inside the motor assembly, allowing the motor to tilt. As a result, the belt may ride up on the side of the pulley as shown, thereby increasing the tape speed. Change the motor, Stock No. 165814 (includes pulley), to correct this symptom. It may be necessary to adjust the pulley height after installing the motor so that the belt tracks on the flywheel.

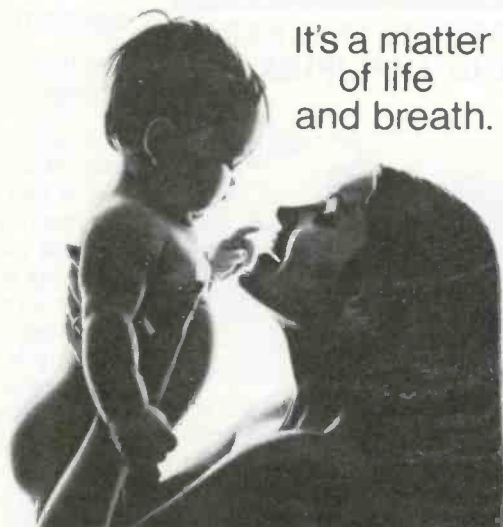

It's a matter
of life
and breath.

Give more to
Christmas Seals.

Fight emphysema, tuberculosis, air pollution.



Space contributed by the publisher as a public service.

Clamp down on service time with RCA Clamp Tester WV-526A

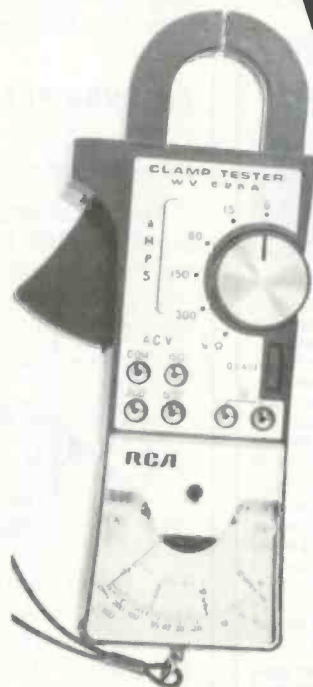

\$54 (Optional Distributor Resale Price)

— including tester, test leads, battery, line splitter, shorting plug, splitter extension leads, carrying case, and spare fuse.

It brings new efficiency to electrical servicing. Here's how:

- Measures AC current to 300 amperes, AC voltage to 600 volts and resistance from 1 ohm to 1,000 ohms on three easy-to-read color-coded scales.
- "Stop-lock" switch freezes meter pointer — simplifies handling in dark or hard-to-get-at areas.
- High-impact plastic case for rugged usability.

See your RCA Distributor for more information. Or write: RCA Test Equipment Headquarters, Harrison, N.J. 07029.

RCA Electronic Components

... for more details circle 123 on Reader Service Card

DECEMBER 1972, ELECTRONIC TECHNICIAN/DEALER | 57

SPEAKER GUARD

PROTECTS SPEAKER
AND AMPLIFIER

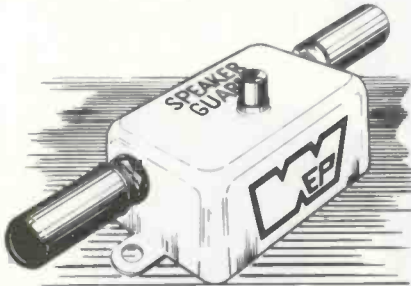

An overload in wattage of amplifier output activates circuit breaker and prevents damage. Reset circuit breaker and make sure you use correct values of Speaker Guard.

18 DIFFERENT VALUES

ASK FOR CAT. # 145C

WORKMAN
PRODUCTS, INC.

Electronic
PRODUCTS, INC.

Subsidiary of THE TRAVELER, INC.
BOX 3828 SARASOTA, FLA. 33578

... for more details circle 129 on Reader Service Card

REBUILD YOUR OWN PICTURE TUBES?

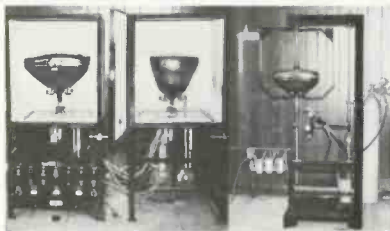

With the Lakeside Industries precision picture tube rebuilding unit, you can rebuild any picture tube, be it black and white or color or 20mm or etc. We offer you the most revolutionized precision equipment of our modern times. This unit is easy to operate and requires only 4 x 8 ft. of space. You can rebuild the finest tube available. The picture will be clear and sharp. Your cost to rebuild a color tube is \$6.60. Your cost to rebuild a black and white tube is \$1.85.

Profit? Imagine building four color tubes per day and if you sold these tubes for \$60.00 each. Total income \$240.00. Total cost \$26.40. Net profit \$213.60. Multiply this figure by five days per week. Your profit \$1,068.00 per week. Cut this figure in half! Build and sell only two color tubes per day. Your profit \$534.00 per week. Facts are facts, figures do not lie.

For further information, please send your name and address to Lakeside Industries, 3520 West Fullerton, Chicago, Ill. 60647. Phone: (312) 342-3399.

P.S. No salesman will call.

... for more details circle 118 on Reader Service Card

NEW PRODUCTS

For additional information on products described in this section, circle the numbers on Reader Service Card. Requests will be handled promptly.

SOLDERING IRON 703

*Has light to indicate
wattage selected for use*

A 20w to 40w new pencil soldering iron, Model 540, has been developed that is said to have an exclusive built-in operating light inside the handle—the light indicating whether the iron is operating at 20w or 40w. A three-way handle switch selects either wattage, plus turning the unit OFF, so that unplugging is unnecessary. A special attachment is available that converts the soldering iron into a desoldering iron. Other features reportedly include an unbreakable polycarbonate handle,

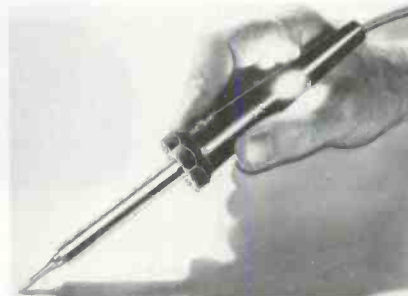

burn-resistant neoprene cord set, stainless steel element, solid-state control and ironclad tips. The iron is 8½ in. long and weighs only 4¼ oz. Enterprise Development Corp.

ANTENNA PREAMPLIFIER 704

*Extremely linear
frequency response*

The Model SP2300-CD preamplifier provides VHF/FM amplification of signals from any VHF/FM antenna.

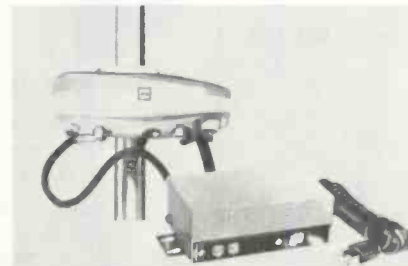

The silicon overlay transistor design reportedly gives 14dB VHF gain at one 300Ω output or 8.5dB at two outputs. Specifications indicate that its extremely linear frequency response makes it ideal for color reception. Included is the PS-6501 power supply that operates on 117v ac. The unit

comes packed in a colorful showcase display carton. JFD.

SCREWDRIVER 705

*Handle pivots 90° to form
"T-handle" for maximum torque*

A screwdriver, called the "Tork-It" is offered as part of a set with five interchangeable blades. It features a handle that pivots 90° to form a "T-Handle" position when maximum turning power is desired, and then pivots back to the "in-line" position for fast spinning of screws in the normal fashion of regular screwdrivers. The T-Handle position allows the user to apply heavy downward pressure to keep the blade in the screw slot and at the same time increases the turning torque that can be applied. The set contains pivoting handle, three Phillips blades (No. 1, No. 2, No. 3), two regular slotted screw blades (3/16-in., ¼-in.), and a handy roll-up pouch. Hunter Tools.



WATTMETER-VSWR MONITOR 706

*Displays the three prime
RF transmission measurements*

The Model 4342 Dual Wattmeter-VSWR Monitor has been designed to display three prime RF transmission measurements at once on a single meter face—forward and reflected



power are indicated by individual pointers and VSWR is monitored on a third scale from the intersection of the two power pointers. Specifications indicate that the meter does not require adjustments to full-scale deflection, or any switching before VSWR readings can be taken. The power and frequency range of the monitor depends

on two plug-in elements selected from more than eighty choices available. Full-scale power levels reportedly have $\pm 5\%$ accuracy from 10w to 5000w for forward indication and 1w to 500w for reflected in discrete frequency bands from 2MHz to 2.3GHz. A choice of QC Quick-Change connectors permits mating with N, BNC, TNC, UHF, C, SC, LC, HN, LT, GR type 874 and $\frac{7}{8}$ -in. EIA lines. The monitor is a portable instrument measuring about 7 in. by 4 in. by 6½ in. high and weighing only 5½ lb. Bird Electronic Corp.

TOOL SET

707

Solves all driving needs

The set, Stock No. 70191, consists of a five-piece all magnetic screwdriver with four interchangeable tips, including 3/16 and 9/32 in. regular slot and No. 1 and No. 2 Phillips cross slot. The magnetism is transmitted from the shank to the tip of the screw, providing a screw holding driver. The other part of the combination consists of a 7-piece hex drive-socket set including



¼, 5/16, ¾, 7/16, and ½-in. sockets for turning all hex head nuts and bolts. A ¼-in. hex key wrench is included free for driving sockets in recessed or hard-to-reach places. The wrench is also useful for driving ¼-in. recessed hex head screws and bolts. Extra components are stored in the handle of each tool, offering the user extreme versatility in a minimum amount of carrying space. Vaco Products Co.

FOUR-SET COUPLER

708

Provides 90% Signal Transfer with corresponding low loss

A 300Ω high-efficiency, 82-channel TV/FM coupler is reportedly unusually efficient, providing 90% signal transfer with corresponding low loss. Designated Model MF-84, the coupler is ideal for splitting signals so that four TV sets can be attached to a single outdoor antenna with low loss and high-isolation between sets. Specifications indicate that the unit passes all frequencies between 54MHz (Channel 2) to 890MHz (Channel 83) with an insertion loss of only 7dB and the isolation between sets of at least 15dB.

Encased in an attractive, compact high-impact plastic housing, the coupler can easily be mounted along a baseboard, to the back of a TV set or

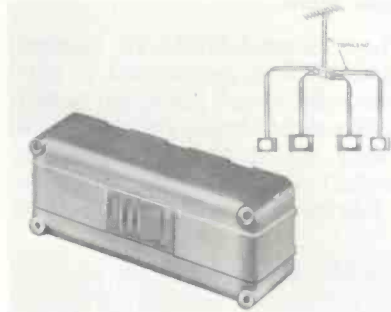

in the basement or the attic. Being weather resistant, it can even be mounted outdoors on the mast or outside of a window. Jerrold.

BROADBAND POWER AMPLIFIER KIT

709

Covers a range from 0.5MHz to 100MHz

Kit MP-100 is an all solid-state broadband power amplifier covering a frequency range of 0.5MHz to 100 MHz. Rated at 2.5w CW, it accepts inputs of AM, SSB, pulse, and other complex modulation. It delivers full power output when driven by any

signal or sweep source of 0.15v over the entire frequency range—without tuning adjustments. The unit reportedly will not oscillate for any

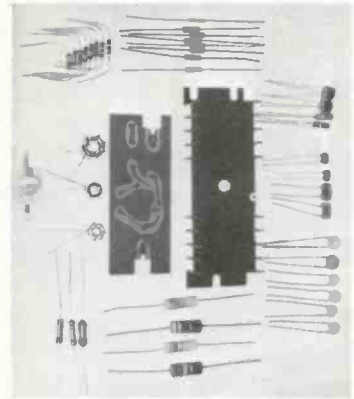

condition of load of source impedance, withstanding 15dB overdrive, including short and open circuit loads. The kit can be assembled in approximately 3 hours. A data and specification sheet is available from the manufacturer. Larkton Scientific.

DIGITAL MULTIMETER

710

Low cost autoranging 3½ digit instrument

An automatic Digital Multimeter, continued on next page

START THE NEW YEAR WITH A GREAT BARGAIN!

GET THESE TWO TV TECH AID BOOKS AT REDUCED PRICES:

1971 B&W BOOK — NOW \$4.95

1970-BOOK FORM — NOW \$4.95

TV TECH AID BOOKS ARE FILLED WITH THE LATEST QUICK-SERVICING INFO ON COLOR TV, B&W TV, AND STEREO . . .

TV Tech Aid Takes you right to the source of the trouble without guess work and wasted time. In each monthly issue you receive over 40 actual causes and cures of color and B&W TV trouble symptoms. You also receive timely and complete information about circuit modifications and other valuable service data.

USE THE COUPON BELOW TO PLACE YOUR 1973 SUBSCRIPTION (12 ISSUES \$7.95) OR VALUABLE BACK ISSUES

SEND YOUR CHECK OR MONEY ORDER

- 1969 12 issues \$4.95 1970-Book Form \$4.95
 1971 B&W Book \$4.95 1971 12 issues \$5.95
 1972 12 issues \$7.95 1973 All New 12 issues \$7.95

TO:

TV TECH AID

P. O. Box 603
Kings Park
N.Y. 11754

Name
Address
City
State Zip

... for more details circle 126 on Reader Service Card

DECEMBER 1972, ELECTRONIC TECHNICIAN/DEALER | 59

NEW PRODUCTS ...

continued from page 59

Model 8310, reportedly features 3½ digits with 100% overrange, auto zero, auto polarity, and dual slope integration for maximum accuracy and noise



rejection. Specifications include 0.1% tolerance on the dc volts scale and 0.5% tolerance on the ac volts scale at frequencies up to 20kHz. The unit features resistance measurements to 200M, plus dc and ac current measurements to 2a. Other options include ac and dc high-voltage probes. The instrument measures less than 8¾ in. wide by 3 in. high by 8½ in. deep and weighs less than 5 lb. California Instruments Co.

SPEAKER GRILLE REPLACEMENTS

711

Kit contains easy-to-cut acoustic fabric

The Change-A-Grille kit consists of acoustic fabric premounted on perforated baffle board. Easily cut to size with household shears, the new grille is simply affixed with self-stick tape (included). Especially-designed acoustic fabrics in bright, decorative



weaves assure unobstructed, distortion-free passage of sound. Mellotone, div. of Wendell Fabrics Corp.

INDICATOR LIGHTS AND SWITCHES

712

Overall length less than 1¾-in.

A new line of Series 81 Indicator Lights is available in various mounting styles, which include front panel bezel mount, sub-panel mount, and bushing mount. All styles are available with either round or square button caps. Lamps are replaceable from the front of the panel. The button caps can be legended to your order. Overall length is less than 1¾-in. The indicator lights complement a line of lighted and unlighted pushbutton switches. The same color choices that are available in the

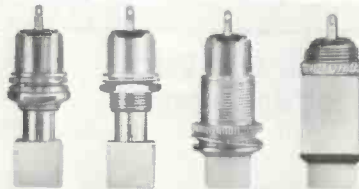

line switches are also available in this indicator light line. Lamps are not supplied, however, units accept standard T-1¾-in. midget flange lamps. Grayhill, Inc.

DIGITAL VOLTMETER

713

Accurate measurements in presence of superimposed noise amplitudes

A new low-cost digital voltmeter, designated Model PM2422, is a "3+1" instrument with three-digit resolution and an over-range digit for any of five ranges of ac or dc current and voltage, and six ranges of resistance. The



instrument is said to be an integrating DVM reportedly capable of accurate measurements in the presence of large superimposed noise amplitudes. The integrating period of 20msec is reportedly accomplished through a patented "delta pulse modulation circuit" that is designed to give fast response with series mode rejection down to 1% of the original signal value. Measurements may be made either grounded or floating and common mode rejection is rated at 100dB for dc and 90dB at line frequency. Philips.

It's a TALL order!



**birth defects
are forever
unless you help.
March of Dimes**

THIS SPACE CONTRIBUTED BY THE PUBLISHER

FINCO

Handy-Helper DOLLY

For MOVING and LIFTING

• TV • APPLIANCES • FURNITURE • LARGE CARTONS

FLUSH WITH FLOOR

Model TC-1 DEALER NET \$89⁵⁰
WRITE FOR CATALOG 20-621

The FINNEY Co.
34 West Interstate Street
Bedford, Ohio 44146

... for more details circle 110 on Reader Service Card

DEALER SHOWCASE

For additional information on products described in this section, circle the numbers on Reader Service Card. Requests will be handled promptly.

SCANNING MONITOR 714

Covers both VHF and UHF channels

A new scanning monitor can be set up on any combination of eight VHF and/or UHF channels with but simple jumper plug changes, requiring no soldering. In addition to auto-scan, the

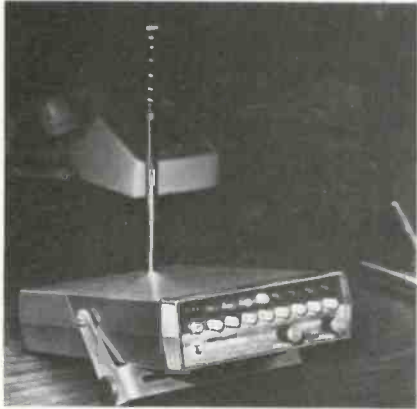

radio provides lock out switches to bypass channels, as well as manual operation for continuous monitoring of a single channel. A special circuit employing two ceramic selectivity filters reportedly prevents the problem of strong, nearby FM transmissions covering up the desired broadcast. Specifications indicate that the sensitivity of the receiver eliminates the need for preamplifiers, even on UHF, even though the "front-end" circuitry is highly immune to overloading. The receiver comes complete with a built-in dual power supply for 117v ac base operation and 12v dc mobile operation. E. F. Johnson.

INDUSTRIAL SPEAKER 715

Simplified impedance selection and mechanical mounting

Ease of impedance selection and mechanical mounting are two of the attractive characteristics offered in the all-weather Model WR-5T reflex speaker. Through the use of a built-in line transformer having a screwdriver-adjustable WATTS/IMPEDANCE switch, proper line connection and sound level adjustments are achieved very quickly. The 70v impedance levels are 8000/4000/2000/1000/666Ω. The power levels that may be selected are 7.5/5/2.5/1.25/0.65w at 70v and 1/0.62/0.31w at 25v. The all-metal

unit is reportedly constructed of alodine treated heavy gauge aluminum



spinning and structural aluminum die-casting, assuring weather-resistance. The speaker can also be used as a sensitive microphone for intercom talk-back applications. Manufacturers specifications include: Program power, 7.5w; frequency range, 375Hz to 10kHz; sound level, 105dB; dispersion, 120°; dimensions, 6-in. bell by 4-in. depth. Atlas Sound.

TAPE PLAYER 716

Designed for custom in-dash installation

A new "in-dash" eight-track AM/FM/FM MPX player, Model C976, is designed to meet the need for a quality theft-proof tape player that can be easily and professionally installed into the dash by most Ameri-



can car owners. The features reportedly include: five pushbutton AM/FM tuning, 8w output per channel on FM and tape, LOCAL/DISTANT switch, VOLUME and TONE controls, front to rear and left to right BALANCE control, and automatic and manual track switching. The player is said to employ a solid-state chassis with 18 transistors, 12 diodes and 4 integrated circuits—operating from 12v dc with an output impedance of 8Ω. Dimensions of the unit are 7 $\frac{5}{8}$ in. w by 3 $\frac{3}{8}$ in. H by 7 in. D. Audiovox Corp.

MOVING ?

Be sure to let us know your new address. Please enclose a complete address label from one of your recent issues.

Your
Centralab
distributor has
just the right one,

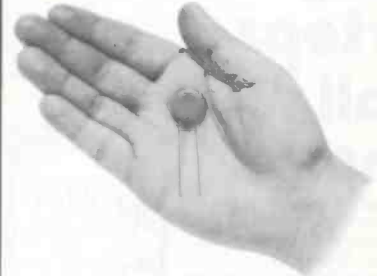

or all of them



Your Centralab distributor has the most complete line of ceramic capacitors available. He's your best supplier of just the right capacitor for fast, reliable replacement service.

Choose from low voltage, transistor circuit, general purpose, high voltage and Gap-Kap™ Ceramic disc capacitors. Available with voltage ratings from 3 V to 6000 V, in values from .75 pF to 2.2 mF.

Your Centralab distributor stocks other highly reliable, special purpose ceramic capacitors including feed-thru, variable trimmer and transmitting types. He's also your source for a wide range of polystyrene capacitors and miniature electrolytics in both axial and PC lead styles. Check your parts stock, then call your Centralab distributor. He has just the capacitors you need.

DISTRIBUTOR PRODUCTS



CENTRALAB
Electronics Division
GLOBE-UNION INC.

... for more details circle 104 on Reader Service Card

A LITTLE SQUIRT

stops all the noise.

A squirt of Quietrole from the handy Spray Pack silences any moving T.V. part. Cleans as it lubricates, too. Guarantees quiet, trouble-free operation. Absolutely safe for any black and white or color set. Try it and see why it's preferred by top servicemen everywhere.

Also available in bottles, and the new silicone—"Silitron."



Product of
QUIETROLE
COMPANY

Spartanburg, South Carolina

... for more details circle 122 on Reader Service Card

take a quick look...



...at readable 23 channel CB.

Bold, illuminated numbers on the Messenger 122 make channel changing fast and sure. Its unique rotary drum dial makes these larger numbers possible. But that's only part of the picture... Inside is advanced solid-state circuitry with a ceramic filter, speech compression, and much more. U.S.-Made — backed by our full 1-year parts and labor warranty. For just \$139.95 suggested list price.

Messenger 122.



JOHNSON
Waseca, Minnesota 56093

... for more details circle 116 on Reader Service Card

TECHNICAL LITERATURE

Metal Cutting Snips

Catalog information is available on a new line of metal and wire cutting snips. Drop forged of highest quality tool steel, the tools are said to be specially designed to yield maximum cutting power with minimum effort. The handles on all styles are reportedly equipped with dipped heavy vinyl, hand-ease cushion grips. Channellock, Inc., Meadville, Pa. 16335.

Circuit Boards and Chemicals

A 12-page catalog features new sensitized printed-circuit boards in a line of breadboard and printed circuit supplies. The catalog also provides information on chemicals used in electronic servicing and maintenance. Injectorall Electronics Corp., 98-100 Glen St., Glen Cove, N.Y. 11542.

Closed Circuit Television

Bulletin GEZ-4996 describes the Model TE-26 solid-state security and surveillance closed circuit television camera. The camera features complete "hands-off" operation, high resolution, excellent stability and picture fidelity where lighting conditions may vary. General Electric Communication Systems Div., Section P, P.O. Box 4197, Lynchburg, Va., 24502.

Tool Kits

A 16-side brochure describes a line of tool kits and cases for use in the field. The brochure describes six professional tool kits, each engineer-designed to do a particular job. Included in the publication are the JTK-17 Field Engineer Kit, which contains over 100 tools in an executive attaché case; the JTK-2 Electronic Technician Kit for industrial personnel; the JTL-16 Compact "Detective" Kit, which contains 30 multipurpose tools in a zipper case; the JTK-27/37 Electronic Lab Kit, a complete portable electronics tool kit with test instruments in two attaché cases; the JTK-90 Instrument Repair, emphasizing watchmakers' tools; and the JTK-80 Electronic Technician Roll-Pouch Kit, a lower priced kit for technicians, students and kit builders. Jensen Tools and Alloys, 4117 N 44th St., Phoenix, Ariz 85018.

Selector Chart

A new selector chart makes it easy to choose and use line switches and

accessories for Fastatch II replacement controls. The detailed chart covers rotary and push-pull action line switches. Convenient wiring diagrams are illustrated for each switch. In addition, photographs provide a quick reference guide to replacement push-pull line switches and to accessories for total replacement control service. Centralab Distributor Products, 5757 N. Green Bay Ave., Milwaukee, Wisc. 53201.

Camera Tube Interchangeability Guide

A new four-page interchangeability guide, No. CAM-702A, lists over 200 vidicon TV camera tube types and their direct or similar replacement. The guide reflects the latest changes in the RCA vidicon line. RCA Commercial Engineering, 415 So. 5th St., Harrison, N.J. 07029.

Electrical Clips and Insulators

A 8-page catalog, G172, completely covers all the manufacturer's clips and insulators with illustrations and full descriptions—a complete line, from miniaturized clips to large ground clamps. The catalog includes materials, sizes, characteristics, current-carrying capacities, and shipping information. Mueller Electric Co., 1575Y E. 31st St., Cleveland, Ohio 44114.

Audio Accessories

A new catalog, A-404A, of audio accessories is released listing the company's line of phone jacks and plugs, switches, connectors, adapters and molded cable assemblies. Hundreds of items can be found quickly with the catalog's numerical-alphabetical index system. Each part is listed by number and the page on which it is found. Accessories listed include phone jacks and plugs, pushbutton and slide switches, audio and phono connectors, audio accessory kits, microphone mixers and amplifiers, Hi-Fi switches and controls, audio adapters, special purpose cable assemblies and molded cable assemblies. Switchcraft, Inc., 5555 N Elston Ave., Chicago, Ill. 60630.

Fuses and Circuit Breakers

A 4-page catalog features an extensive line of exact replacement fuse and circuit breaker caddy assortments designed for domestic and foreign electronic equipment service requirements in the field or shop. Punched for easy reference use, the new two-color cata-

log, "FCA," describes the new "One Stop Service Caddy" which provides the user with a convenient two-in-one assortment of eight popular circuit breakers and 30 of the most widely used fuses. Littelfuse, Inc., Dept. PR., 800E. Northwest Hgw., Des Plaines, Ill. 60016.

Microphone and Speaker Stands

A 4-page color brochure, Form 7201, is available which is exclusively devoted to microphone and speaker stands, stand accessories, adaptors and fittings. The publication outlines the functional and mechanical details of 14 commercial and professional floor stand models, 12 microphone desk stands, 4 boom stands and more than 50 models of stand accessories. Sales Department, Atlas Sound, 10 Pome-roiy Rd., Parsippany, N.J. 07054.

Transistors

A catalog listing operating parameters of more than 100 types of epoxy-encapsulated field-effect and bipolar transistors is available. The catalog contains a detailed FET cross-index, in addition to data on general-purpose, switching and RF FET's; and NPN/PNP bipolar devices. Siliconix Inc., 2201 Laurelwood Rd., Santa Clara, Calif. 95054.

Outlet Strips

A 16-page, two-color catalog describes a complete line of pre-wired outlet strips and instrument carriers. The line of power outlet strips includes multiple outlets, providing convenient and safe receptacles at low cost. A complete line of high quality carriers are shown, some models are available for audio-visual applications, and outlet strips are included on most models. Also shown in the catalog are motor speed controllers. Waber Electronics, Inc., 300 Harvard Ave., Westville, N.J. 08093.

Tools

A 64-page catalog of professional tools and other products lists hundreds of useful products rarely sold by industrial distributors or stores. This collection includes hard-to-find hand tools and small power tools used by technicians and service personnel. Brookstone Co., 3720R Brookstone Bld., Peterborough, N.H. 03458.

Paging Systems

A 4-page catalog, PG 192, describes paging systems for immediate, selec-

tive and private paging of personnel by means of radio signals transmitted to lightweight pocket receivers. It covers such features as ease of installation and operation, negligible operating cost, and easy add-on capability for the systems. Included are detailed specifications of systems with 20-call or 110-call capacities supplied complete with paging encoder, radio transmitter, paging receivers, antenna, coaxial and interconnect cables, batteries and accessories. Picker Briggs Corp., 4135 West 150th St., Cleveland, Ohio 44135.

Electronic Parts

A 420-page catalog is the comprehensive buying guide for everything in electronic parts and supplies. The catalog lists over 50,000 separate stock items from more than 400 manufacturers. Merchandise is grouped by sections and numerical cover margin tabs guide you quickly to the products you need. Allied Electronics, 2400 W. Washington Blvd., Chicago, Ill. 60612.

Electronic Servicing Aerosols

A complete line of aerosol products for color and B/W TV servicing is described in this new catalog. Also included is a new volume-control and contact restorer that reportedly will not harm metals or change capacities, and prevents gumming when used on automatic record changers. All the aerosol products are said to be non-toxic, contain no carbon tet, remain non-flammable and not affect plastics. W. Gottlieb, Electronic Chemical Corp., 813 Communipaw Ave., Jersey City, N.J. 07304.

Silicon Rectifiers

A 6-page catalog illustrates an extensive line of standard and fast recovery silicon rectifiers. It devotes individual pages to ratings and electrical characteristics, as well as dimensional drawings of case styles for EDI bridges, high-voltage axial-lead rectifier cartridges, high-voltage rectifier assemblies and miniature axial rectifiers. Dennis Dean, Industrial Products Sales Manager, Electronic Devices, Inc., 21 Gray Oaks Ave., Yonkers, N.Y. 10710.

MOVING?

Be sure to let us know your new address. Please enclose a complete address label from one of your recent issues.

Alyeska Pipeline Service Company
American Standard, Inc.
Arcata National Corporation
Ashland Oil & Refining Company
Circle K Corporation
Combined Insurance Company of America
Equitable Life Assurance Society
Fluor Corporation Ltd.
Garrard & Company
General Foods Corporation
General Motors Corporation
Harding Associates
Hariford National Corporation
Hyde Park Bank & Trust
ITT
Metropolitan Life Insurance Company
North American Development Corporation
Olin Corporation
Phillips Petroleum Company
Pioneer Properties Company
Pioneer Systems, Inc.
Prudential Insurance Company of America
S. C. Johnson & Son, Inc.
Standard Oil Company (Indiana)
University Computing Company
Varian Associates

FIRST NAMES IN FREER ENTERPRISE.

Fewer than 3 per cent of American businesses are owned by the black, Spanish-speaking and Indian-Americans who make up 17 per cent of our population.

These companies have done something about it.

Each is among the first sponsors of a Minority Enterprise Small Business Investment Company. (Or MESBIC, for short.)

The seed capital they provided is being channeled directly to promising businesses in the form of long-term loans (5 to 20 years), equity investments or a combination of both.

The leveraging potential is impressive. Through Small Business Administration loans and guarantees, as much as \$15 of investment monies can be generated for each \$1 of private capital.

Headline stuff? Hardly. MESBIC sponsorship simply means financially backing minority people who want to go into business, then helping them make a go of it.

Not all will make it, even with help. The first MESBIC sponsors knew that.

But most will. And that makes MESBIC a concrete way to make the American free enterprise system a little freer.

Maybe a little stronger, too.

If you agree that's good business, ask for complete information on MESBIC sponsorship.

You'll be in good company.

Write: Director, Office of Minority Business Enterprise, United States Department of Commerce, Washington, D.C. 20230.



Advertising contributed for the public good.

LETTERS...

continued from page 26

er electronics, but only on a part time basis. Among other things, I am a qualified instructor and hope to get a chance to teach a vocation course in the area I'm moving to.

The percentages are against the majority of the field being as bad as I've seen, but I would feel it only fair to prepare potential technicians to such conditions, and the knowledge that it's hard for one man to fight employer or technical incompetence.

Unions are an extreme measure in my estimation. The company you pointed out in your editorial needed no union, nor does the company I am now with. But servicemen aren't getting what they deserve. Perhaps a temporary union with provision for continuance or abolishment after a given period would be the answer.

THOMAS E. GALKO, CET

Thanks to Those Who Made CET

Some 31 years in electronics is a long time to wait for a certificate of recognition. Back in the early 1950's in Long Island, N.Y., a group of us formed an association. We were for licensing and an upgrading of TV technicians. Time and time again we were turned down by the state legislature. Many of us, of which I was one, crawled into our shells. I lost contact with everyone and everything, worked

long hours and tried to conceal the fact that I was a TV serviceman.

This year I moved to Florida and heard about CET. I purchased the necessary study material and inquired when the test would be given. Three hours a day of study and three months later, I was ready. The passing of the test was no longer important now. I had accomplished what CET and myself had set out to do. I had upgraded myself through study and knew that from now on a study program to "keep up with things" would become part of my life.

I want to thank those who carried on and made CET a reality. You have brought me back out of my shell—now I confess to being a TV Technician.

Having been an Electronics Instructor for many years, I see a way that I can help with the program. Anyone in my area can feel free to call on me and perhaps I can help them pass the test.

The test is rather difficult, but I think the computer has a heart. I believe that I passed on old age!

WARREN J. QUIBELL, CET

Viking Television
St. Petersburg, Fla.

One of the Old Timers

Being one of the "old" timers in the electronic business, I am writing you this letter. I notice that from time to time many of your readers speak of

old-time radios . . . this make and that . . . and so forth.

I have in my possession, probably in as good working order as the day it was made, one of the old timers, one that many probably never hear of. This radio is a Tuska Model, Type 225, made in 1922, serial number 15146.

I have been in this business since 1921 and still going in the retail and service business . . . and probably will remain in it until it is impossible.

Thought I would let you know about this old set as it is now 50 years old and workable. "Tuska" was made by C. D. Tuska Co., Hartford, Conn. and was on the market only a few years, so they are rare.

D. A. WHITAKER

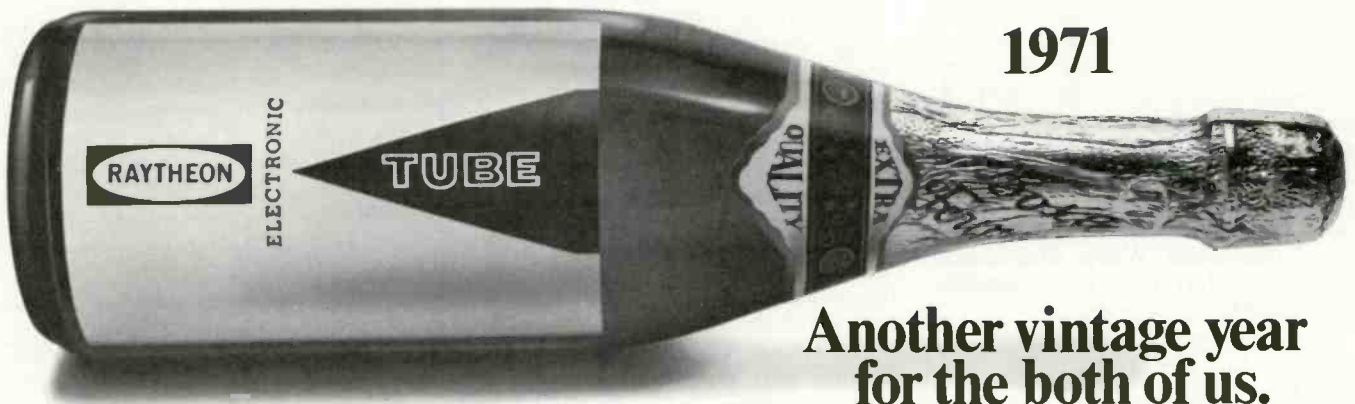
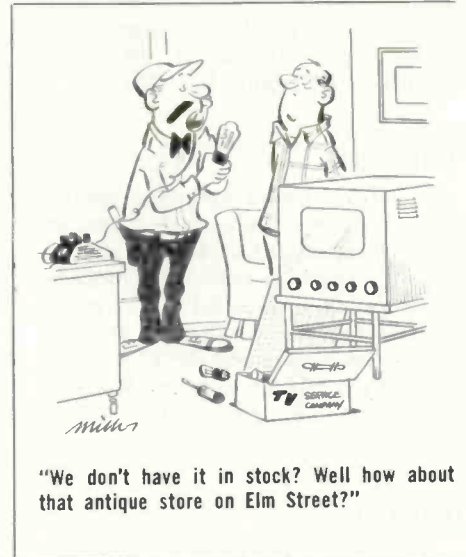

1971

Another vintage year for the both of us.

1971 was a very good year. And 1972 already tastes even better. The truth is every year's a vintage year for you, the independent serviceman, and Raytheon, the largest independent tube supplier in the business. Last year, while a lot of other suppliers were running behind, even dropping out of the race, the two of us had another great year. We've come a long way together.

And like a good wine, we keep getting better.

That's because Raytheon works so well with you.

And never works without you. That's the kind of thing that makes for a very good year for both of us. Year after year.

. . . for more details circle 125 on Reader Service Card

continued from page 41

for a 1kHz square-wave output. Then, observing the square-wave trace on the oscilloscope screen, we adjusted the trimmer on the probe for an ideal square-wave pattern.

We felt that the probe is well designed for ease of operation and small enough for working in close areas. The hook on the outer probe tip is exposed by pulling back on the spring-loaded portion of the tip. This feature allows hooking on to a test point, leaving both hands free to make adjustments while observing waveforms. This spring-loaded hook can also be removed, exposing a metal pin that can also be used for making electrical contact.

Operational Waveforms

We put the oscilloscope to work checking waveforms on a new color-TV set, comparing them against manufacturer's waveforms at given test points. The optional probe used was the Heath Model PKW-101 high-impedance (low-capacitance) isolating type just described.

The first complex waveform displayed with the scope (Fig. 1) is very familiar to most TV service

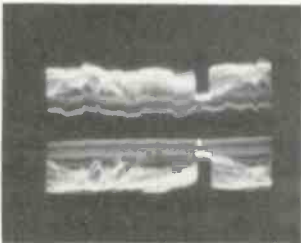

Fig. 1—The video signal trace displayed with the oscilloscope. Top trace: The video signal obtained at the first video amplifier tube grid at the TV vertical-sweep frequency, applied to scope Channel 1. Lower trace: The same video signal at the plate of the tube applied to the input of scope Channel 2.

technicians, the video signal at the vertical sweep

frequency, 60Hz. The top waveform was obtained at the first video amplifier tube grid, using the Channel 1 input; and the lower waveform was obtained at the plate of the same tube using the Channel 2 input of the oscilloscope.

The waveforms shown in Fig. 2 were obtained using the same TV set test

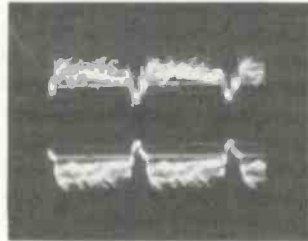

Fig. 2—The video signal obtained at the TV horizontal-sweep frequency. Top trace: The video signal obtained at the first video amplifier tube grid employing the scope's Channel 1 input. Lower Trace: The video signal obtained at the first video amplifier plate using the scope's Channel 2 input.

points, but this time the scope was set at the horizontal-sweep frequency.

We also applied a 200-kHz square-wave signal (the highest that we had available) from a sine/square-wave generator to the input of Channels 1 and 2, producing the waveforms shown in Fig. 3.

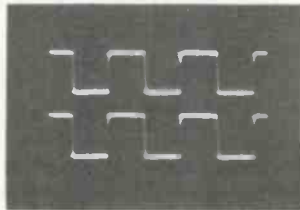

Fig. 3—Ideal square-wave traces produced by applying a 200kHz signal from a sine/square-wave generator to Channels 1 and 2.

We were very pleased with the operation of the scope and the waveforms displayed. In a future article in the series "Basic Digital Circuits" we will be seeing more waveforms produced by this impressive scope. ■

continued from page 28



John Jacobson (l), Zenith Field Engineer, and Warren Foran (r), Service Manager from Elliott & Bottom Corp., presented a service seminar in Norfolk, Va. on October 10, 1972. Approximately 140 dealers from southeastern Virginia and northeastern North Carolina attended a well presented discussion on the new solid-state Titan Chassis. A similar meeting, also well attended, was held in Richmond, Va. on October 19th.

Gift Certificate Program Ends

We have been advised that effective December 1, 1972 the Finco \$35.00 NATESA NEA Gift Certificate Program has been terminated. In order to clear their books for the new year, the Finney Co. has advised its distributors that they should not accept for redemption any gift certificates after that date, and that there will be no exceptions to this rule.

1972 ARTICLE INDEX

COLORFAX

	<i>Month/Year/Page</i>
Admiral	
Color-TV Chassis K16—Color-Monitor Circuit	7/72/58
Color-TV Chassis K18—Automatic Degaussing Circuit	8/72/59
edi Electronic Devices Inc.	
Color-TV Service Tip	3/72/68
Color-TV Chassis K16 Series—No Control of Brightness	12/72/54
Color-TV Chassis G11/G13/H10/H12/K15/K16 Series—Weak or No Color	12/72/54
Color-TV Chassis G11—Installing Replacement High Voltage Transformer	12/72/54
Color-TV Chassis M20—Service Hint	12/72/54
Emerson	
Color-TV Models 35P03, 35P04—Repairing Convergence Yoke	3/72/68
General Electric	
Color-TV Chassis N-2—One Color Missing	3/72/68
Color-TV Chassis N-2—Blooming Picture	3/72/68
Color-TV Chassis C1/L1—Blooming—Excessive High Voltage and Poor Color Sync	4/72/66
Color-TV Chassis C1/L1—Troubleshooting Guide	5/72/66
Color-TV Chassis U-1—Dark Vertical Wedge on Left Side of Picture	6/72/58
Color-TV Chassis U-1—Picture Tube Circuit Changes	6/72/58
Color-TV Chassis JA—One Predominate Color with Retrace Lines	10/72/54
Color-TV Chassis JA—Low Brightness and Overload with Strong Signals	10/72/54
Color-TV Chassis C1/L1 and C2/L2—Chroma Gain	10/72/54
Color-TV Chassis KE—Low-Resistance Contrast Control	1/72/58
Color-TV Chassis C-1—Troubleshooting Guide	12/72/54
Magnavox	
Color-TV Chassis T938—Installing Replacement High-Voltage Transformer 361328-1	1/72/57
Color-TV Chassis T918—Installing Replacement High-Voltage Transformer 361328-1	1/72/57
Remote-Control Receiver Model 704069—Addition of Current Limiter Resistor	1/72/57
Color-TV Chassis T946—AGC Control Added	1/72/57
Color-TV Chassis T924/T939/T950—Reduced High Voltage Caused by Leaky Regulator Diode	1/72/58
Color-TV Models 7322,24,26—Elimination of Static Electricity Build-Up on Controls	4/72/67
Convergence and Screen Purity Problems	7/72/58
Color-TV Chassis T962-10—New Tuner and AFT Correction Circuit	12/72/55
RCA Sales Corp.	
Color-TV Chassis CTC55—Brightness Limiter/HV Adjustment	2/72/68
Focus and Picture Tube Cable Modification	3/72/68
Color-TV Chassis CTC51—"Hum-Bar" Interference	3/72/68
Color-TV Chassis CTC50—Chassis-to-Test Fixture Adaption	4/72/66
Color-TV Chassis CTC51—Diode CR101	

Protection	4/72/67
Color-TV Chassis CTC40,44,47—Servicing SCR Sweep Systems	5/72/67
Color-TV Chassis CTC22/41,42,43—Damper Diodes	7/72/58
Color-TV Chassis CTC46—Troubleshooting Focus Symptoms	7/72/58
Color-TV Chassis CTC44/46/47/49/54—High-Voltage Quadrupler Interchangeability	7/72/59
Color-TV Chassis CTC36—Unstable Vertical Sweep	7/72/59
Color-TV Chassis CTC54—Horizontal Interference	8/72/59
Color-TV Chassis CTC54—Vertical Sweep/Video Symptoms	8/72/59
Slow Remote Control Operation	11/72/62
Color-TV Chassis CTC46—Hum Modulation	11/72/62
Color-TV Chassis CTC52—Remote Noise Immunity	11/72/62
Color-TV Chassis CTC59—Use of Color Bar Generator	11/72/62
Color-TV Chassis CTC63—High-Voltage Protection Circuit/Isolating "No Video" Symptoms	11/72/62

TECHNICAL DIGEST

Admiral	
Tape Cassette—Service Hint	1/72/56
Three Function Remote Control	10/72/55
Tape Recorder Model CTR571—Service Hint	10/72/55
Repairing Power Tune Radios	11/72/64
Emerson	
Radio Model 31T73W—Excessive Hum at Low Volume Level	2/72/70
Ceramic Capacitor	8/72/60
General Electric	
New 3DS3 High-Voltage Rectifier Tube	3/72/71
Magnavox	
Record Changers—Slow Turntable Speed	2/72/70
Tape Recorder Model 1K8879—Replacing 60Hz Capstan Sleeves	2/72/70
Amplifier Models A595/A596—Resistor Identification	3/72/70
Remote Control Receiver Models 704064/704065—Erratic Stopping Driving Search Operation	3/72/70
Remote Control Receiver Model 704064	3/72/70
Remote Control Receiver Model 704065	3/72/70
Radio Chassis R231—Noise on AM Band Only	3/72/70
Tuner/Amplifier Chassis R243/244/245—Distorted or No Audio on One Channel Only (Early Version)	6/72/60
Fuse Failure for No Apparent Reason	9/72/63
Tape Recorders Models 1K8870, 1K8871, and 1K8877—Wiring to Headphone Jack Reversed	9/72/63
Olympic	
Radio Chassis 330-1,330R—Noisy Loudness Control Symptoms	3/72/70
Radio Chassis 329-1,1-329-1—Interchangeable Transistors	3/72/70
TV Chassis NEC—Vertical Sweep Failure	3/72/71
Tape Deck TD20—Displaced Drive Belts	3/72/71

RCA Sales Corp.	
TV Chassis KCS171—Circuit	
Modifications	1/72/56
Varactor Diodes	5/72/68
Cleaning Module Edge Connectors	8/72/60
FM/AM Tuner Chassis RC1238D—Stereo	
Indicator Threshold Adjustment	8/72/60
TV Chassis KCS172, 179, 183—High-Voltage	
Tube Socket Removal	8/72/60
Amplifier Crossover Diodes	12/72/56
Tape Player Model YZD589, 593, 595—No	
Program Change	12/72/57
Tape Player Model YZD589—Tape Speed	
Too Fast	12/72/57

Sylvania	
Amplifier Chassis R62/R63/R64—Power	
Hum	9/72/63

Westinghouse	
Quadrix Four-Channel Sound	7/72/60
Matrixed Four-Channel Sound	7/72/60
Discrete Four-Channel Sound	7/72/60
Quadrix Four-Dimensional Sound	7/72/60
Radio Models RPA5035A, RPA5040A—	
Weak and Fuzzy Sound	7/72/60
Radio Models RS21P08A, RS11P28A—	
Hum and Distortion	7/72/60
Radio Model RG13S68C—No AM	
Reception	7/72/60

ANTENNA AND ACCESSORIES

Wideband Distribution Equipment	4/72/51
Satellite TV—Coming Down to Earth	4/72/64
Professional Antenna Installation Methods	5/72/44
The Best Antenna	8/72/43

AUDIO EQUIPMENT

Working with Commercial-Audio Equipment	1/72/43
Quadraline Four-Channel Sound	2/72/50
Working with Commercial-Audio Equipment,	
Part II	3/72/48
Panasonic's Model SP-10 Turntable	4/72/48
Working with Commercial-Audio Equipment,	
Part III	5/72/50
Which Tape System?	6/72/44
Magnavox's Model 1500 DT1 Receiver	7/72/40
Working with Commercial-Audio Equipment,	
Part IV	8/72/57

BUSINESS

Selecting That Partner	5/72/57
Service Contracts are Big Business	6/72/51
Protecting Business Records	6/72/54
Successful Advertising	7/72/51
The Business Side of Things	10/72/49
Reducing Check Voucher Costs	10/72/50
Better Merchants Make Better Profits	12/72/52

CLOSED-CIRCUIT TV

On Camera at Central	3/72/52
Cleveland's May Co. Boasts Top Security	
CCTV, Mod Squads and All	3/72/54
Skitch's Restaurant Goes CCTV	7/72/39

COLOR TV

Motorola's Model TU945HS Color-TV Set	1/72/39
Motorola's Model TU945HS Color-TV	
Set, Part II	2/72/41
Panasonic's Model CT-771 Portable	
Color-TV Set	3/72/43
Panasonic's Model CT-771 Portable	
Color-TV Set, Part II	4/72/41

Channel Master's Model 6124A Modular	
Color-TV Set	5/72/39
Philco-Ford's Model C4870AWA Color-	
TV Set	6/72/39
Sylvania's D18 Color-TV Chassis	8/72/37
Introducing General Electric's 19JA Solid-	
State Color-TV Chassis	9/72/35
Introducing General Electric's 19JA Solid-	
State Color-TV Chassis, Part II	10/72/39
RCA's Argosy Model ER475 Portable	
Color-TV Set	11/72/39

COMMUNICATIONS

Servicing CB Transceivers	2/72/45
Satellite TV—Coming Down to Earth	4/72/64

GUEST AUTHOR

Receiving Tubes Take a Look at	
Solid-State	1/72/51
Cashing in at the MATV Super Market	2/72/58

MISCELLANEOUS

Servicing with a Color-TV Test Jig	1/72/46
Diagnosing Power Supply Circuits	1/72/48
Search Continues for Loch Ness Monster	1/72/61
The Champions of Independent TV Service	3/72/46
Semi-Tips Part V	3/72/60
Glad to Meet You, "Slim Jim"	4/72/60
Which Tape System?	6/72/44
Electronics and Crime	9/72/40
Smash and Snatch	9/72/43
TESA Wisconsin Feature Crime Seminar	9/72/45
And Now What?	9/72/55
Electronic Security Part I—Ultrasonic	
Detection Circuitry	10/72/42
What's New in TV Receivers for	
1973—Part I	10/72/45
What's New in TV Receivers for	
1973—Part II	11/72/43
Kenwood's KC-6060A Solid State Audio	
Lab-Scope	11/72/49
Basic Digital Circuitry	11/72/49
Introducing Heathkit's Dual-Trace	
Oscilloscope	12/72/39
Electronic Security, Part II	12/72/42
Basic Digital Circuitry, Part II	12/72/45
NATESA Plan	12/72/50

TEST INSTRUMENT REPORT

California Instrument's Digital	
Multimeter/Counter	1/72/52
Leader's LS-5 Electronic Switch	2/72/60
Heath's Model IB-1101 Frequency Counter	3/72/65
RCA'S WR-515A Color Bar Generator	4/72/62
B & K's Model 1465 Triggered-Sweep	
Scope with Cali-Brain	5/72/60
Triplet's Model 603 FET-VOM	6/72/51
Another Step Forward	7/72/47
Simpson's Model 460 Digital Volt-	
Ohm-Milliameter	7/72/56
Logi Metric's Model 750 RF Signal	
Generator	8/72/58
Leader's Model LBO-505 Triggered-Sweep	
Scope	9/72/60
Dana's Model 3300 Digital Multimeter	10/72/52
Fluke's Model 8000A 3½-Digit Multimeter	11/72/60

TV-RADIO SERVICING

Servicing With a Color-TV Test Jig	1/72/46
Diagnosing Power Supply Circuits	1/72/48
Temporary Fixes for Etched Circuit Modules	6/72/46

ANTENNA POWER

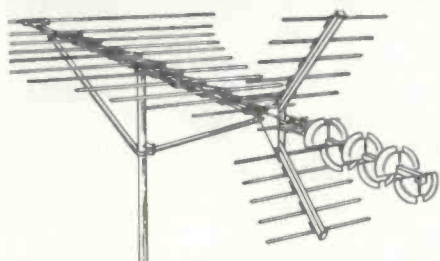

RMS 'STAR-TRACK'™ #SK-1117 VHF/UHF/FM COLOR ANTENNA...

Performance proven for Suburban and Semi-Fringe Areas. Similar design to Space Tracking Antennas- 6 UHF Disc Directors, 11 VHF Cut-to-Channel Elements, 1 Driven Element, and 10 Corner Reflector Elements, 28 Elements for maximum reception- Up to 125 miles on VHF, and up to 75 miles on UHF. With VHF/UHF Splitter for single down-lead. Suggested Retail... \$55.95

Breaking All Sales Records...

since their introduction- 6 performance proven models for all areas- See Your Distributor.

RMS ELECTRONICS, INC.

50 Antin Place, Bronx, N.Y. 10462
Tel. (212) 892-6700

... for more details circle 124 on Reader Service Card

FREE CATALOG

HARD-TO-FIND PRECISION TOOLS

Lists more than 1700 items—pliers, tweezers, wire strippers, vacuum systems, relay tools, optical equipment, tool kits and cases. Also includes four pages of useful "Tool Tips" to aid in tool selection.



JENSEN TOOLS
4117 N. 44th Street, Phoenix, Ariz. 85018

... for more details circle 115 on Reader Service Card

YEATS dollies

FURNITURE PADS
\$5.50 EACH

MOST VERSATILE Color Television TRUCK DEVELOPED!

YEATS Model No. 5 \$66.50

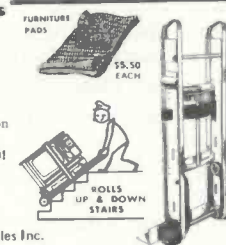

ROLLS UP & DOWN STAIRS

FREE illustrated brochure

Yeats Appliance Dolly Sales Inc.
1307 W. Fond du Lac Ave.
Milwaukee, Wisconsin 53205

... for more details circle 130 on Reader Service Card

FREE ALARM CATALOG

64 PAGES FILLED WITH 350 BURGLAR AND FIRE ALARM PRODUCTS FOR INSTALLERS AND ELECTRONIC TECHNICIANS. INCLUDES RADAR, INFRARED, CONTROLS, HARD-TO-FIND PARTS, AND 6 PAGES OF APPLICATION NOTES.



mountain west alarm
4215 n. 16th st., phoenix, az. 85016

... for more details circle 119 on Reader Service Card

READERS SERVICE INDEX

ADVERTISER'S INDEX

102	B&K Div., Dynascan Corp.	22
103	Book Club-Tab Books	34-37
104	Centralab Distributor Products Globe-Union Inc.	61
105	Channel Master Div. of Avnet, Inc.	33
106	Chemtronics, Inc.	25
107	Delta Products, Inc.	30
108	EICO Electronic Instruments Co., Inc.	55
109	Electronic Devices, Inc.	28
110	Finney Company, The	60
112	Fordham Radio Supply Co., Inc.	68
113	GC Electronics Co.	27
	GTE Sylvania, Electronic Components	38, 2nd Cover
	General Electric Company Television Business Div.	3rd Cover
114	Heath Company, The	29
115	Jensen Tools & Alloys	68
116	E.F. Johnson Company	62
117	Keithley Instruments, Inc.	31
118	Lakeside Industries	58
119	Mountain West Alarm Supply Co.	68
120	Panasonic-Service Div.	21
121	Perma-Power Company Div. Chamberlain Mfg. Co.	26
122	Quietrole Company	62
123	RCA Test Equipment	57
	RCA Semiconductors	4th Cover
124	RMS Electronics, Inc.	68
125	Raytheon Company	64
126	TV Tech Aid	59
127	Telematic Div., UXL Corp.	24
128	Tuner Service Corporation	19
129	Workman Electronic Products	58
130	Yeats Appliance Dolly Sales Co.	68

NEW PRODUCTS

700	Educational FM/SCA Receiver	32
701	FM Multiplex Stereo Generator	32
702	Tape Player	32
703	Soldering Iron	58
704	Antenna Preamplifier	58
705	Screwdriver	58
706	Wattmeter-VSWR Monitor	58
707	Tool Set	59
708	Four-Set Coupler	59
709	Broadband Power Amplifier Kit	59
710	Digital Multimeter	59
711	Speaker Grille Replacements	60
712	Indicator Lights and Switches	60
713	Digital Voltmeter	60
714	Scanning Monitor	61
715	Industrial Speaker	61
716	Tape Player	61

DISCOUNT PRICES

TEST EQUIPMENT



I.E.C./Mullard Tubes Specials
Catalog & Prices on Request

FORDHAM Radio Supply
Company, Inc.



265 E. 149 Street, Bronx, N.Y.
Tel: (212) 585-0330

RCA

DISTRIBUTORS OF ELECTRONIC SUPPLIES

... for more details circle 112 on Reader Service Card

BETTER MERCHANTS...

continued from page 53

need additional business. Not only can a good mail campaign help to fill in the slow spots, it will also bring new customers into your business who will look to you for their future service needs. And don't forget, every customer who responds to your direct mail program will be a good prospect for a repeat in six months or a year. The names of all such customers should be carefully filed, because they will be your hottest prospects for future promotions.

The next time your telephone leaves you in the lurch, try direct mail. You will find that it is both exciting and profitable to run your business, instead of letting it run you. ■

MOVING?

Be sure to let us know your new address. Please enclose a complete address label from one of your recent issues.

Circle the Reader Service numbers of those items of interest to you.

For those countries outside the U.S., please apply appropriate postage before mailing.

READER SERVICE INFORMATION CARD

For more information on products or services mentioned in this issue, simply circle the appropriate numbers below, type or print your name and address and drop in the mail.

ADVERTISED PRODUCTS

101	110	119	128	137	146
102	111	120	129	138	147
103	112	121	130	139	148
104	113	122	131	140	149
105	114	123	132	141	150
106	115	124	133	142	151
107	116	125	134	143	152
108	117	126	135	144	153
109	118	127	136	145	154

TEST INSTRUMENTS

900	909
901	910
902	911
903	912
904	913
905	914
906	915
907	916
908	917

NEW PRODUCTS

700	709	718	727	736	745
701	710	719	728	737	746
702	711	720	729	738	747
703	712	721	730	739	748
704	713	722	731	740	749
705	714	723	732	741	750
706	715	724	733	742	751
707	716	725	734	743	752
708	717	726	735	744	753

This card is usable until March 5, 1973.

12/72

NAME _____ POSITION _____

COMPANY _____ STREET _____

CITY _____ STATE _____ ZIP CODE _____

Please describe your type of business or industry _____

Your signature _____

GET MORE FACTS
NO POSTAGE NECESSARY

BUSINESS REPLY MAIL

NO POSTAGE STAMP NECESSARY IF MAILED IN THE UNITED STATES

FIRST CLASS

PERMIT NO. 665

DULUTH, MINNESOTA

POSTAGE WILL BE PAID BY

Reader Service Department

ELECTRONIC TECHNICIAN/DEALER

POST OFFICE BOX 6016, DULUTH, MINNESOTA 55806

For those countries outside the U.S., please apply appropriate postage before mailing.



PERSONAL SUBSCRIPTION CARD

GET A FREE BONUS WITH YOUR PERSONAL SUBSCRIPTION TO ELECTRONIC TECHNICIAN/DEALER!

- 3 Years \$13 2 Years \$10 1 Year \$6*
- Payment Enclosed Bill Me

*BONUS: With a 2 or 3 year subscription, you receive both TEKFAX 110 and the COLOR TV GUIDEBOOK free! If you are subscribing for 1 year, please indicate your choice of either: TEKFAX 110 COLOR TV GUIDEBOOK

IMPORTANT! Please check your business classification.

Type of Business Check One

- A. Independent or Self-Employed Service Technician
 B. Independent Electronic Service Organiz.
 C. Retailer with Electronic Service Dept.
 D. Electronics, Radio, TV Manuf
 E. Industrial Electronic Service
 F. Wholesale, Jobber, Distributor
 G. Other (Specify) _____

Position Check One

- H. Technician
 I. Owner, Manager, Buyer
 J. Service Manager
 K. Other

Be sure you have checked appropriate boxes above.



NAME _____ STREET _____

FIRM _____ TITLE _____

CITY _____ STATE _____ ZIP _____

Your own personal copy for only pennies per issue

BUSINESS REPLY MAIL

NO POSTAGE STAMP NECESSARY IF MAILED IN THE UNITED STATES

FIRST CLASS

PERMIT NO. 665

DULUTH, MINNESOTA

POSTAGE WILL BE PAID BY

Reader Service Department

ELECTRONIC TECHNICIAN/DEALER

POST OFFICE BOX 6016, DULUTH, MINNESOTA 55806

GET MORE FACTS

NO POSTAGE
NECESSARY

For those countries outside the U.S., please apply appropriate postage before mailing.

READER SERVICE INFORMATION CARD

For more information on products or services mentioned in this issue, simply circle the appropriate numbers below, type or print your name and address and drop in the mail.

ADVERTISED PRODUCTS

101	110	119	128	137	146
102	111	120	129	138	147
103	112	121	130	139	148
104	113	122	131	140	149
105	114	123	132	141	150
106	115	124	133	142	151
107	116	125	134	143	152
108	117	126	135	144	153
109	118	127	136	145	154

TEST INSTRUMENTS

900	909
901	910
902	911
903	912
904	913
905	914
906	915
907	916
908	917

NEW PRODUCTS

700	709	718	727	736	745
701	710	719	728	737	746
702	711	720	729	738	747
703	712	721	730	739	748
704	713	722	731	740	749
705	714	723	732	741	750
706	715	724	733	742	751
707	716	725	734	743	752
708	717	726	735	744	753

This card is usable until March 5, 1973.

12/72

NAME _____ POSITION _____

COMPANY _____ STREET _____

CITY _____ STATE _____ ZIP CODE _____

Please describe your type of business or industry _____

Your signature _____

Circle
the
Reader
Service
numbers
of those
items of
interest
to you

BUSINESS REPLY MAIL

NO POSTAGE STAMP NECESSARY IF MAILED IN THE UNITED STATES

FIRST CLASS

PERMIT NO. 665

DULUTH, MINNESOTA

POSTAGE WILL BE PAID BY

Circulation Department

ELECTRONIC TECHNICIAN/DEALER

POST OFFICE BOX 6016, DULUTH, MINNESOTA 55806

Your own
personal
copy
for
only
pennies
per issue

These solid state color systems are the most serviceable we've ever built. Because independent servicers helped us design them.

Independent servicers awarded us these serviceability ratings. Proof that foresight pays. The foresight of the television service industry in developing specific serviceability guidelines and urging TV manufacturers to use them. The foresight of General Electric in working side by side with independent servicers to create 100% solid state sets that are easy to service.

GE's new solid state sets are designed for maximum accessibility. With extensive use of visual aids. And plug-in modules and components. Example: 95% of the total components in GE's new solid state modular color console models can be removed for servicing without using a soldering iron. Solid state Porta Color® II models open like a book for ease of service.

Impressed? That's only half the story. To improve local parts availability we are expanding parts distribution through independent parts distributors.

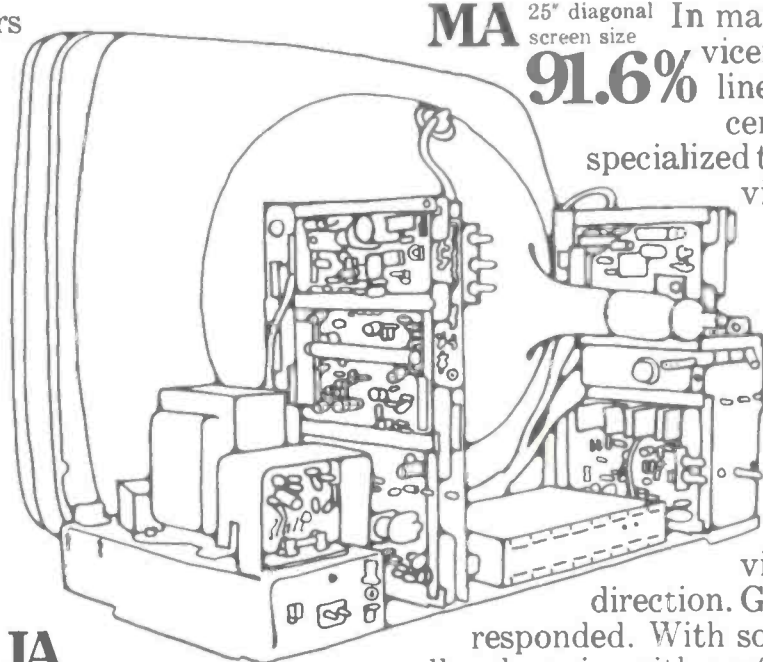

MA 25" diagonal screen size

91.6%

In many states, TV servicers use direct phone lines to regional parts centers. We provide specialized training. Our Television Service News provides advance information servicers need to more easily service GE monochrome and color models.

The service industry has provided foresight and direction. General Electric has responded. With solid state products to sell and service with confidence. To achieve our mutual goal of customer satisfaction.

JA

19" diagonal screen size

93.9%

If you want to know more about GE service, call collect or write "Dutch" Meyer, Television Receiver Products Department, Portsmouth, Virginia 23705. Phone (703) 484-3521.

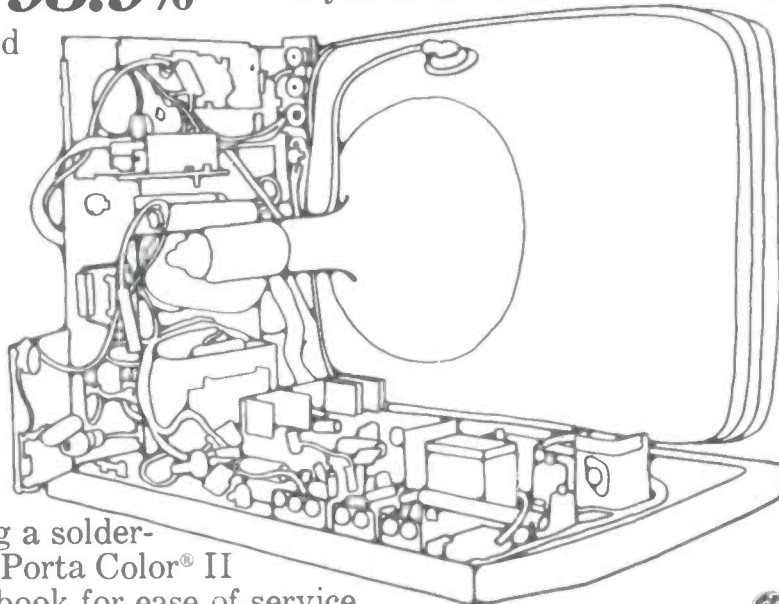

OUR NO. 1 GOAL:
TO MAKE
GENERAL ELECTRIC
YOUR BEST BUY

We build every television as if we were going to use it ourselves.

GENERAL  ELECTRIC

sk

The Solid-State System ... for better servicing

It all works together to help you meet today's tough demands of solid-state servicing. See your RCA Distributor now and put SK, The RCA Solid-State Replacement System, to work in your business. You'll see why you can't beat it for better servicing and profits. It's the system built from your point of view.

RCA/Electronic Components
Harrison, N.J. 07029

RCA
Electronic
Components

RCA

Quality Product

- Top-of-the-line premium devices
- Meet or exceed specs for professional servicing
- 146 RCA SK's replace over 50,000 devices

RCA

Solid-State Hardware

- 10 sockets for transistors and ICs
- 15 heat sinks from TO-18 to TO-3 package styles



RCA

Information Support

- Replacement Guide (SPG-202M) cross-references over 50,000 domestic and foreign devices and supplies specific application information to assure correct replacement
- SK Quick Selection Wall Chart (1L1367A) ... saves you time making the right choice
- Three slide-film/cassette tape presentations on Transistor Servicing cover Basic Techniques for Transistor Checking (1L1337), Identifying The Defective Stage (1L1377), Identifying & Replacing The Defective Component (1L1378), plus the Transistor Servicing Booklet (1L1379). Available through your RCA Distributor