

SEPTEMBER 1972  A HARCOURT BRACE JOVANOVIĆ PUBLICATION

# ELECTRONIC TECHNICIAN/DEALER

WORLD'S LARGEST TV-RADIO SERVICE & SALES CIRCULATION

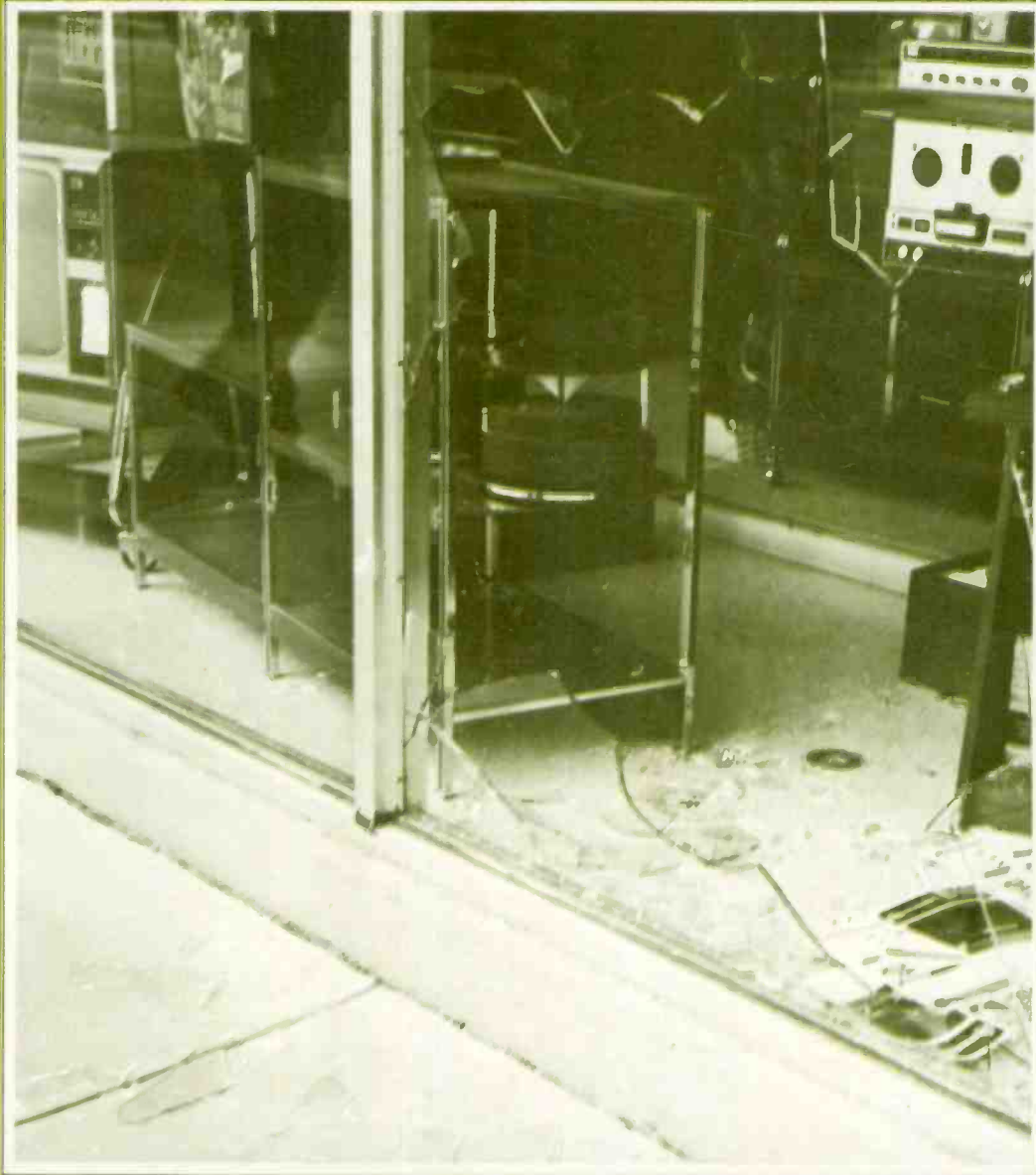

FRIM 593349P2AZ 8756723AL1

WILLIAM W FRISE AS

7176 GALE RD

MI 48411

XX

## CRIME ISSUE

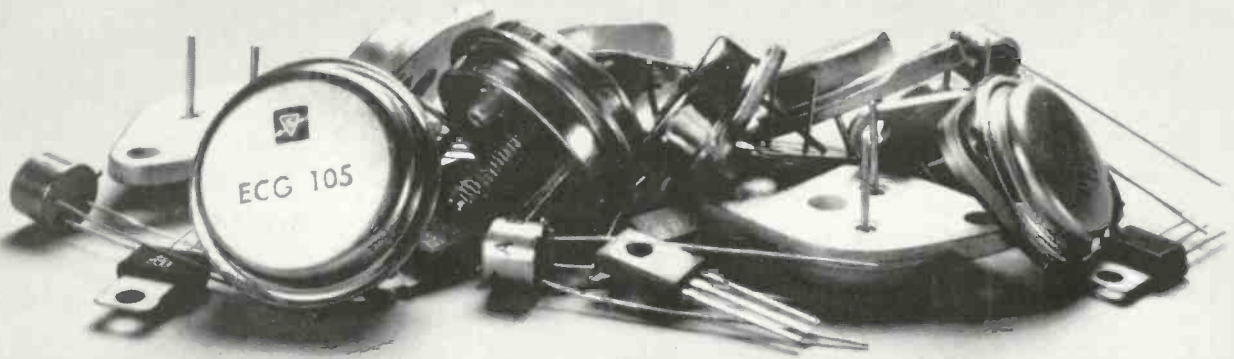

**Our 39 audio power transistors replace...**

To Be Replaced	ECG Replacement	To Be Replaced	ECG Replacement
AD138	121	QP-1A	179
AD138/50	121	QP-2	179
AD139	104	QP-3	179
AD140	121	QP-4	179
AD142	179	QP-5	179
AD143	179	QP-6	179
AD143B	179	QP-7	179
AD148	131	QP-8	130
AD149	104	QP-8-1	130
AD149-01	121	QP-8-P	130
AD149-02	121	QP-10	179
AD149B	121	QP-11	130
AD150	121	QP-12	130
AD152	131	QP-13	185
AD155	131	QP-14	184
AD156	131	QP8-6623N	105
AD157	131	QP-13	153
AD159	121	QP-14	152
AD16C	175	QQC61209	158
AD161	155	QQC61210	102A

**and thousands more.**

There are a lot of identical transistors around hiding under different manufacturers' part numbers.

But we've boiled power transistors down to just 39 types that will handle almost all of your replacement problems.

And we've also put together a cross-reference guide that tells you which one replaces which.

Our cross-reference guide also tells you about the rest of our ECG replacement semiconductor line. Altogether they can substitute for 53,000 others.

Practically everything from diodes to integrated circuits.

And we don't stop there.

The ECG semiconductor line includes a variety of heat sinks, heat-sink compounds, transistor mounting kits, and sockets.

In short, carrying Sylvania's ECG replacement semiconductor line can take a big load off your back.

And you can still give power to the people.

*Sylvania Electronic Components, Waltham, Mass. 02154.*

**GTE SYLVANIA**

GROUP  
**241**

SCHEMATIC NO.

SCHEMATIC NO.

GENERAL ELECTRIC .....1435  
TV Chassis R-2

RCA SALES CORPORATION .....1436  
Color-TV Chassis CTC51, 52

PHILCO-FORD .....1438  
TV Chassis 21ST31V

ZENITH .....1437  
Color-TV Chassis 12BC15, 12B9C16

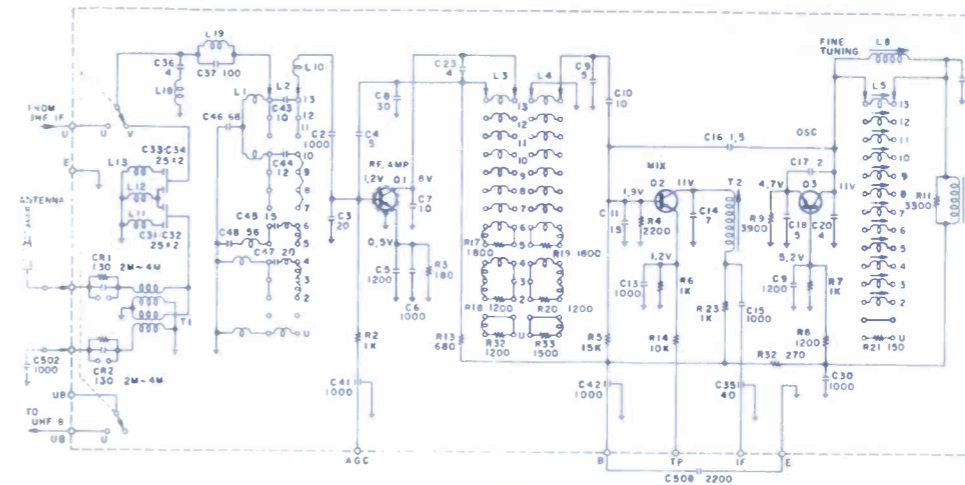

VHF TUNER

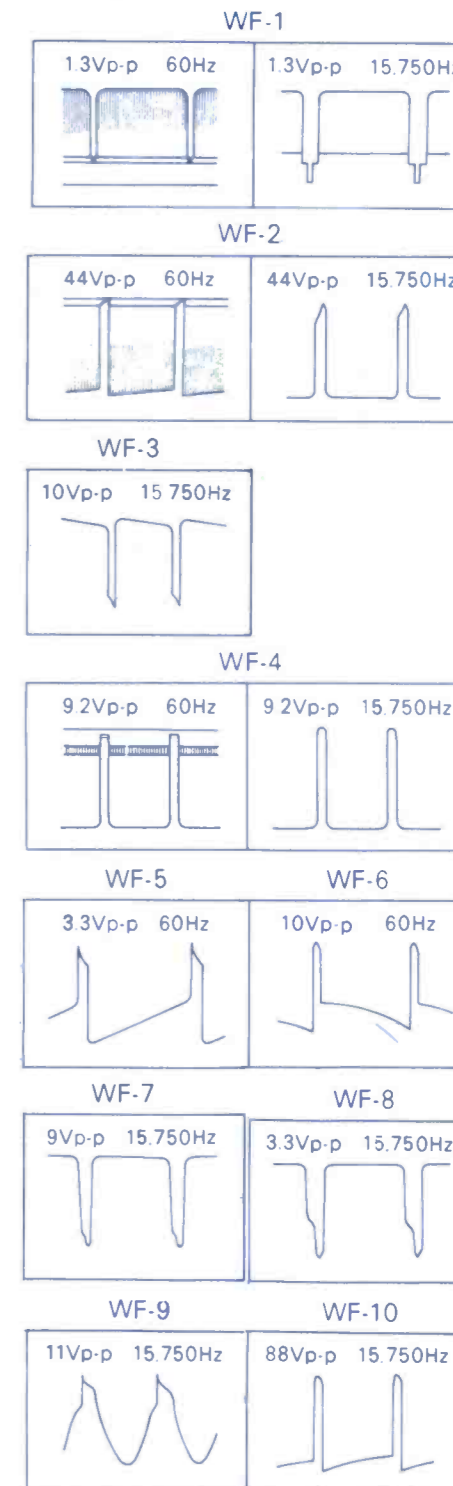
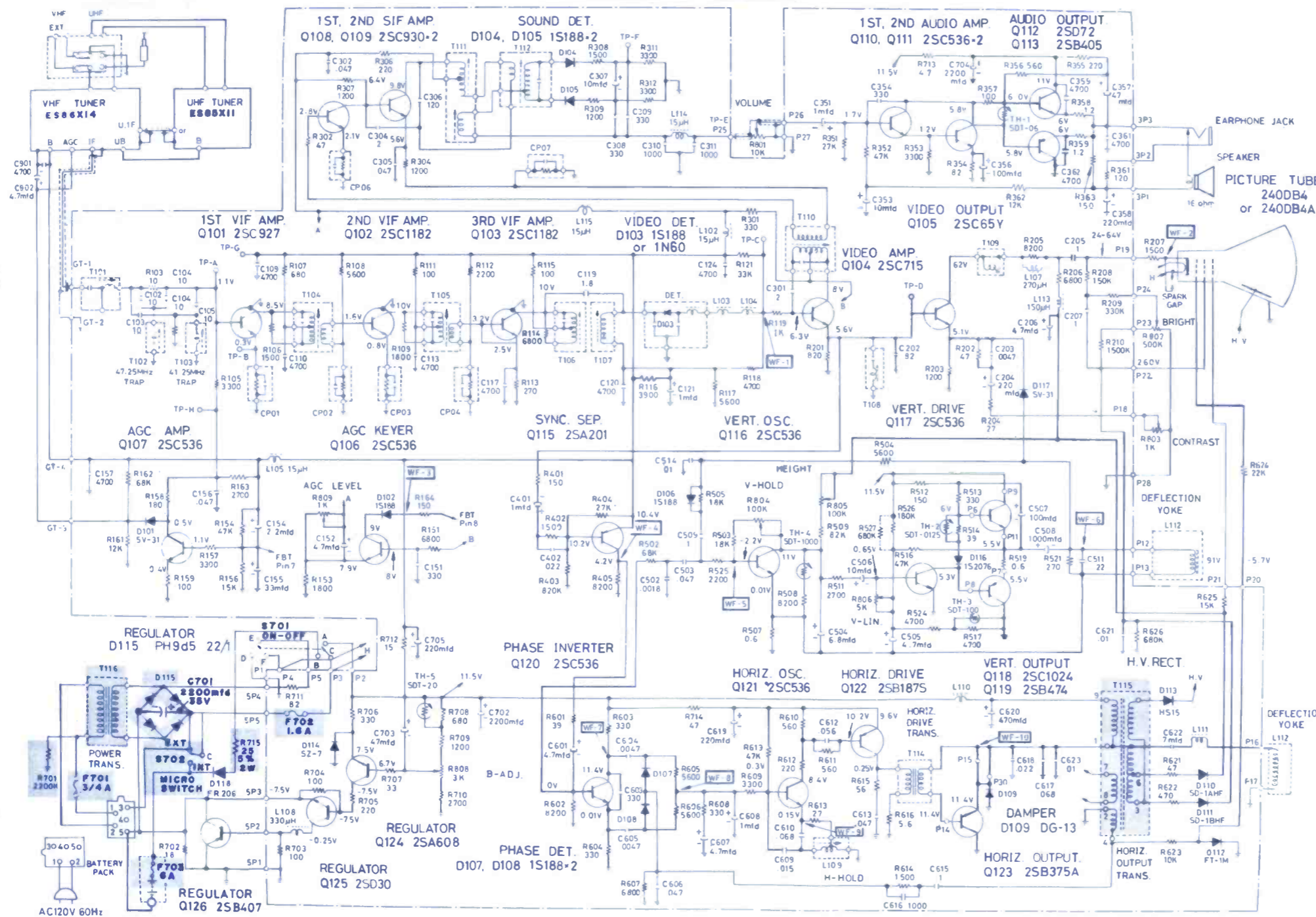

SYMBOL	DESCRIPTION	RCA PART NO.
C105A	special capacitor	132993
C105B	special capacitor	132993
C105C	special capacitor	132993
C106A	special capacitor	126340
C106B	special capacitor	126340
CB101	circuit breaker	135700
F101	fuse-5a	118969
R4202	var comp, tint CTC 51E	130621
R4202	var comp, tint CTC 51XU	133742
R4203	var comp, brite CTC 51E	130621
R4203	var comp, brite CTC 51XU	133742
R4204	var comp, color CTC 51E	130621
R4204	var comp, color CTC 51XU	133742
RT102	thermistor	127227
RT103	thermistor	136226

T102	x-former, CTC 52 series	133747
T102	x-former, CTC 51 series	133739
T104	x-former	130092
T105	x-former	135773
1C299	circuit, Integrated	130751
L299	coil, discriminator	130121
T299	x-former, input	130120
1C201	circuit, integ aft	130130
R211	var comp	130137
RT201	thermistor, 4300n, cold	124813
T201	x-former	127244
T202	x-former	124708
R4207	var comp	133180
RV401	varistor	133181
RV402	varistor	133137
TF401	fuse	135930

L501	coil	109947
R604	var comp	130995
T601	x-former	130559
DL701	delay line	133952
R701	var comp	130107
R701A	var comp killer	130107
R701B	var comp helght	130107
R701C	var comp lin	130107
RV701	varistor	126424
T701	x-former	130104
T702	x-former	130100
T703	x-former	121559
T704	x-former	130101
	yoke, deflect assembly, CTC 52	135852
	yoke, deflect assembly CTC 51	136425
RT101	thermistor	114742

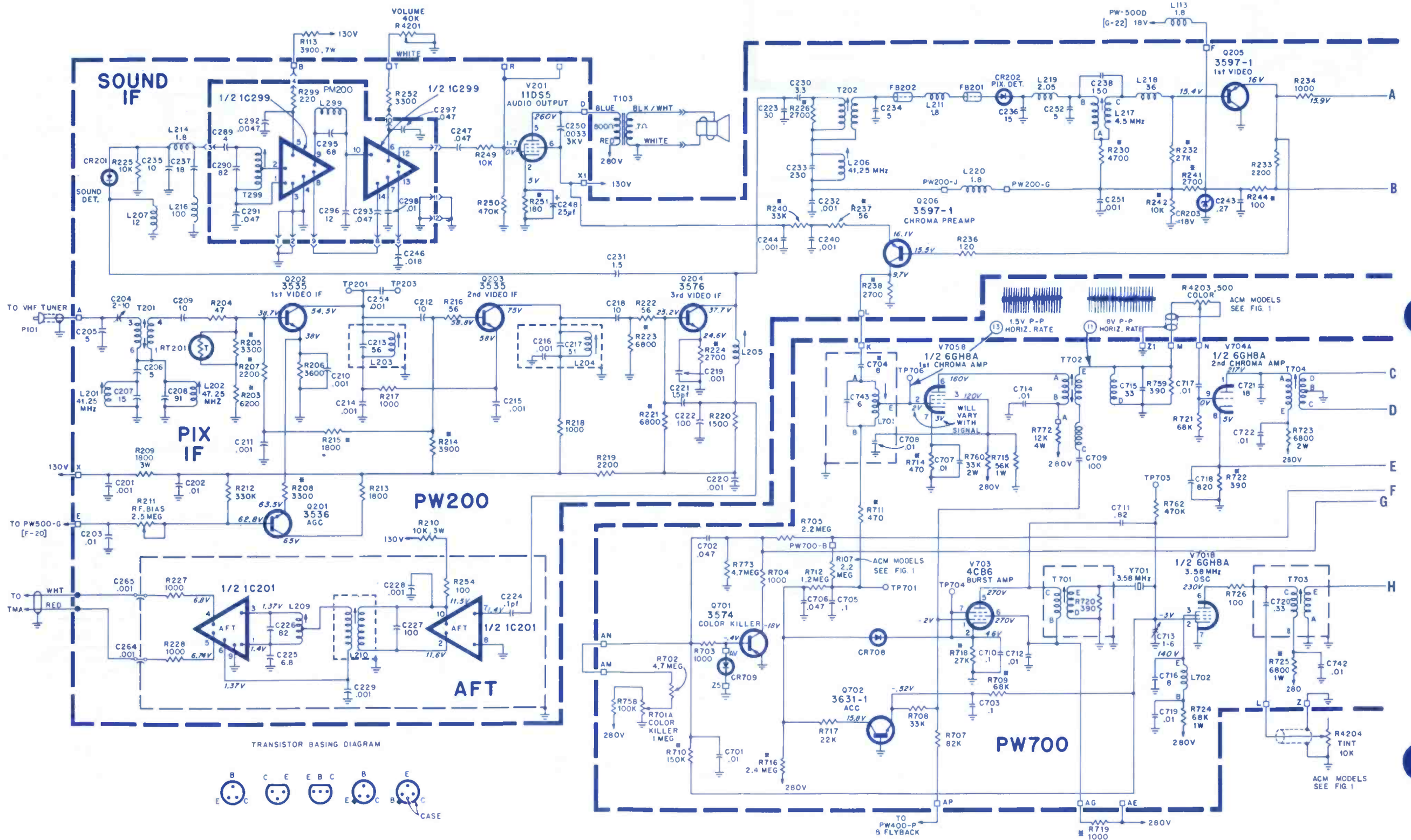

RCA CONTINUED NEXT PAGE

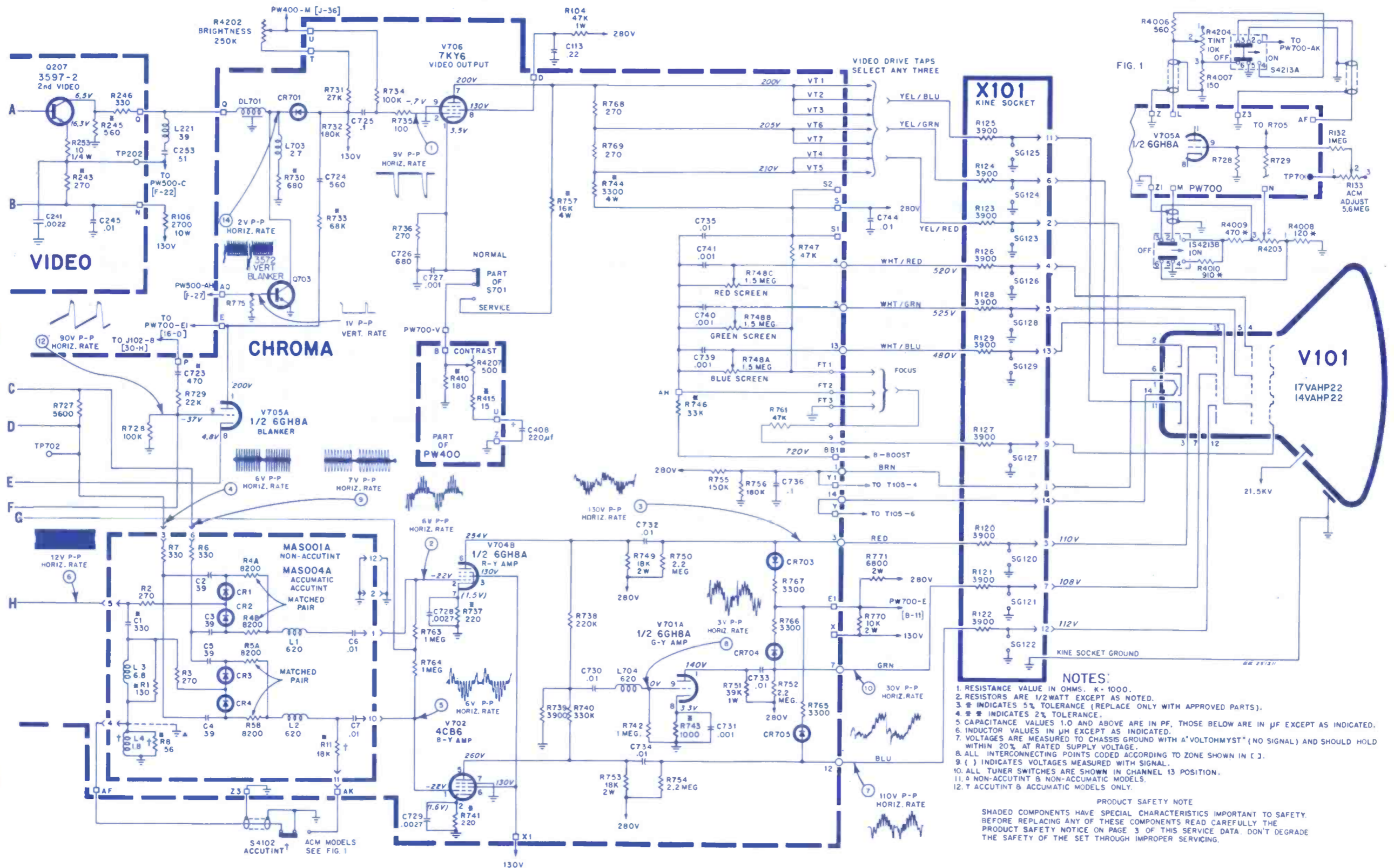

- NOTES:**
1. RESISTANCE VALUE IN OHMS. K=1000.
  2. RESISTORS ARE 1/2 WATT EXCEPT AS NOTED.
  3. \* INDICATES 5% TOLERANCE (REPLACE ONLY WITH APPROVED PARTS).
  4. \*\* INDICATES 2% TOLERANCE.
  5. CAPACITANCE VALUES 1.0 AND ABOVE ARE IN PF, THOSE BELOW ARE IN  $\mu$ F EXCEPT AS INDICATED.
  6. INDUCTOR VALUES IN  $\mu$ H EXCEPT AS INDICATED.
  7. VOLTAGES ARE MEASURED TO CHASSIS GROUND WITH A "VOLTHOMYST" (NO SIGNAL) AND SHOULD HOLD WITHIN 20% AT RATED SUPPLY VOLTAGE.
  8. ALL INTERCONNECTING POINTS CODED ACCORDING TO ZONE SHOWN IN [ ] .
  9. ( ) INDICATES VOLTAGES MEASURED WITH SIGNAL.
  10. ALL TUNER SWITCHES ARE SHOWN IN CHANNEL 13 POSITION.
  11.  $\Delta$  NON-ACCUTINT & NON-ACCUMATIC MODELS.
  12. T ACCUTINT & ACCUMATIC MODELS ONLY.

**PRODUCT SAFETY NOTE**  
SHADED COMPONENTS HAVE SPECIAL CHARACTERISTICS IMPORTANT TO SAFETY. BEFORE REPLACING ANY OF THESE COMPONENTS READ CAREFULLY THE PRODUCT SAFETY NOTICE ON PAGE 3 OF THIS SERVICE DATA. DON'T DEGRADE THE SAFETY OF THE SET THROUGH IMPROPER SERVICING.

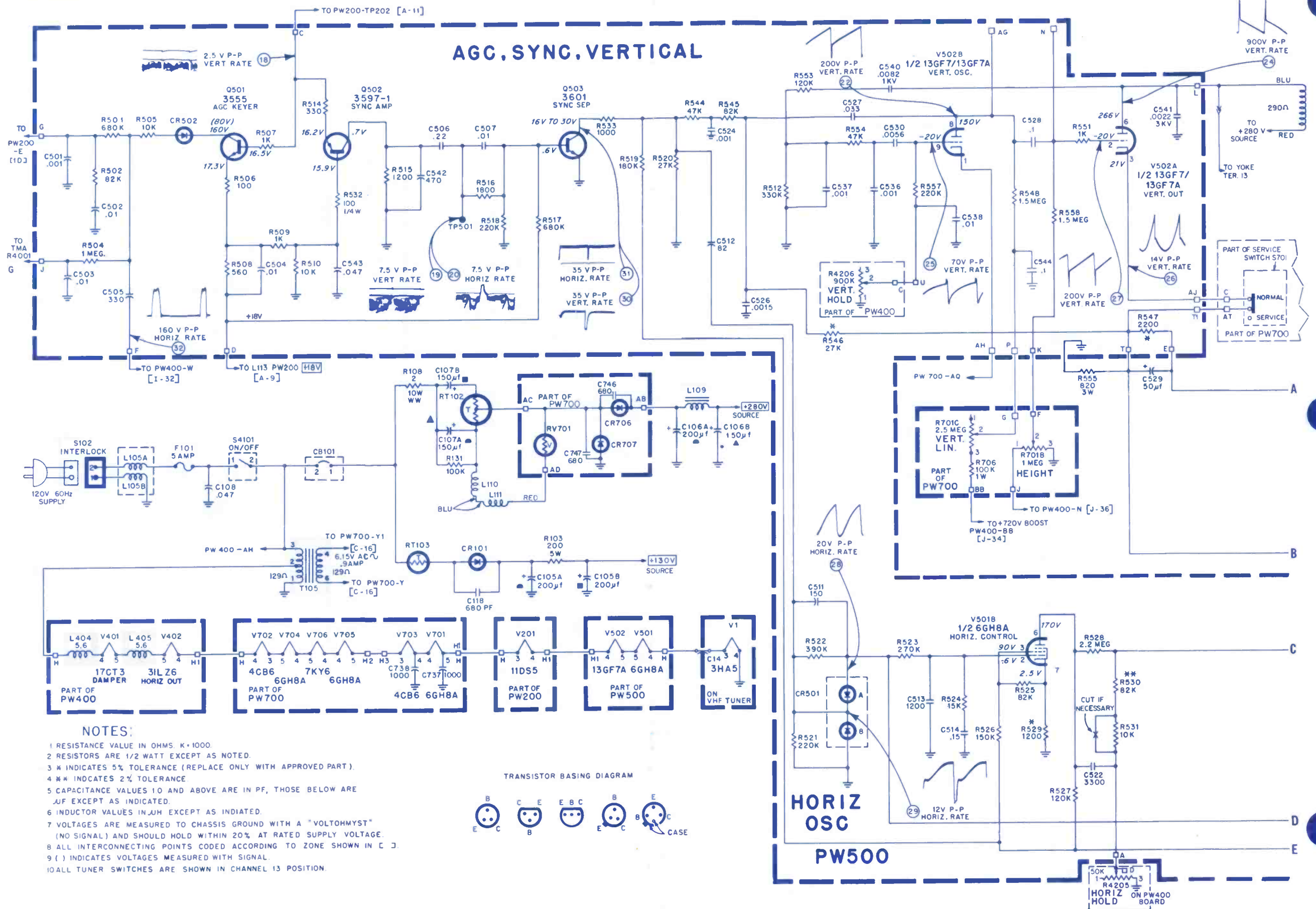

- NOTES:**
- 1 RESISTANCE VALUE IN OHMS. K=1000.
  - 2 RESISTORS ARE 1/2 WATT EXCEPT AS NOTED.
  - 3 \* INDICATES 5% TOLERANCE (REPLACE ONLY WITH APPROVED PART).
  - 4 \*\* INDICATES 2% TOLERANCE.
  - 5 CAPACITANCE VALUES 10 AND ABOVE ARE IN PF, THOSE BELOW ARE  $\mu$ F EXCEPT AS INDICATED.
  - 6 INDUCTOR VALUES IN  $\mu$ H EXCEPT AS INDICATED.
  - 7 VOLTAGES ARE MEASURED TO CHASSIS GROUND WITH A "VOLTHMYST" (NO SIGNAL) AND SHOULD HOLD WITHIN 20% AT RATED SUPPLY VOLTAGE.
  - 8 ALL INTERCONNECTING POINTS CODED ACCORDING TO ZONE SHOWN IN C J.
  - 9 ( ) INDICATES VOLTAGES MEASURED WITH SIGNAL.
  - 10 ALL TUNER SWITCHES ARE SHOWN IN CHANNEL 13 POSITION.

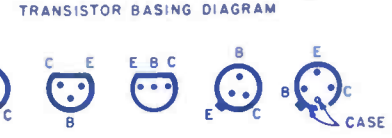

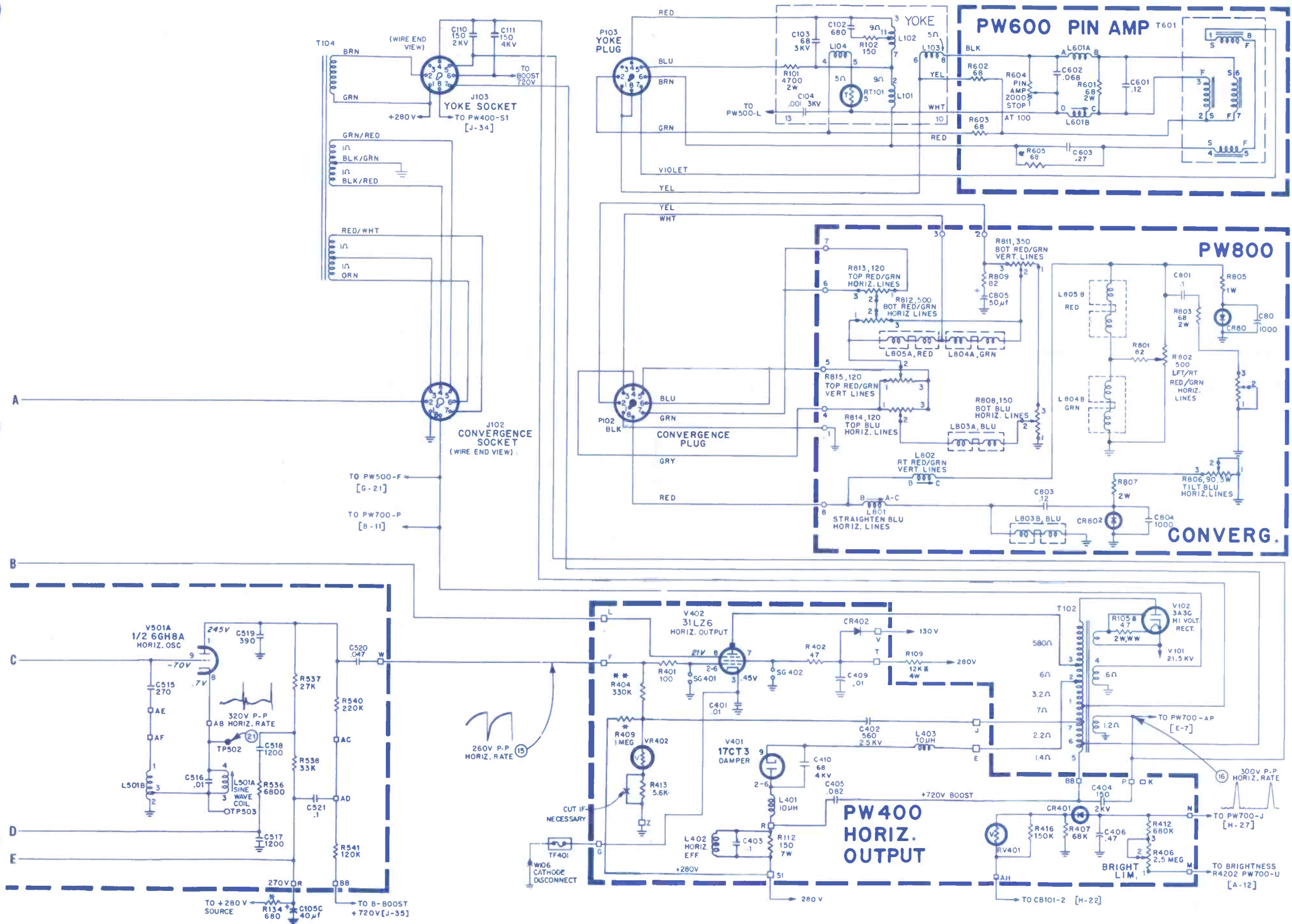

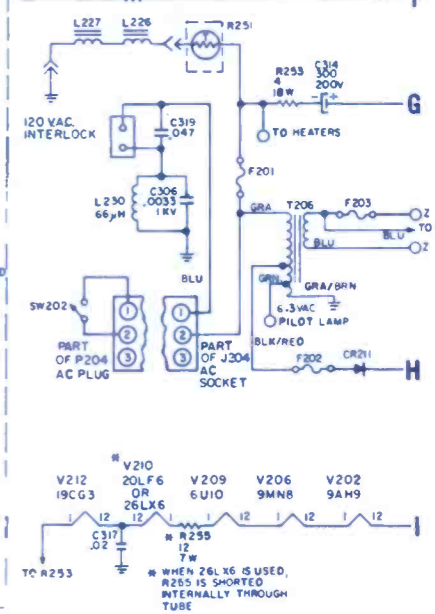
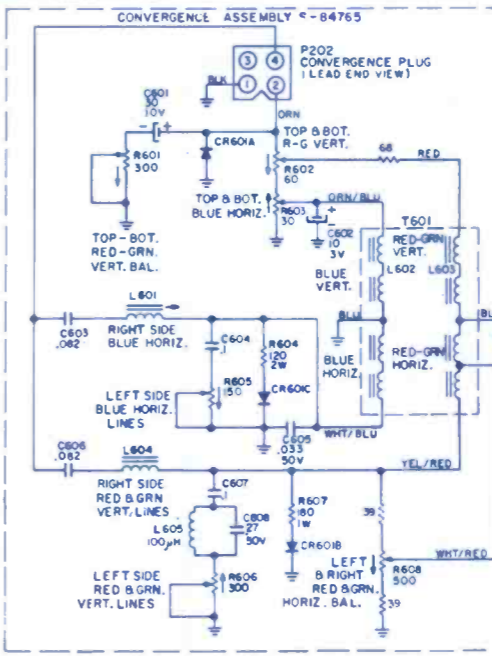
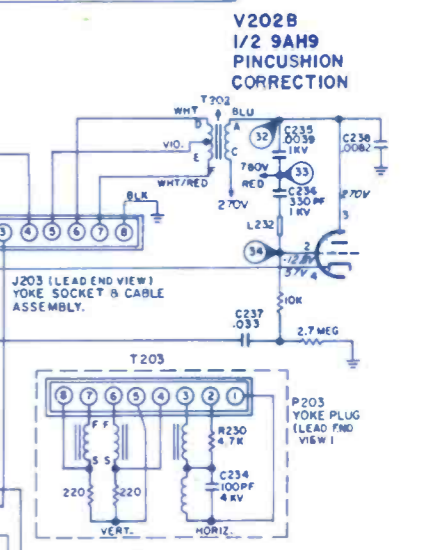
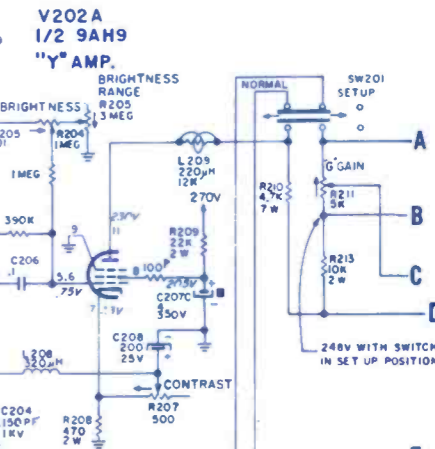
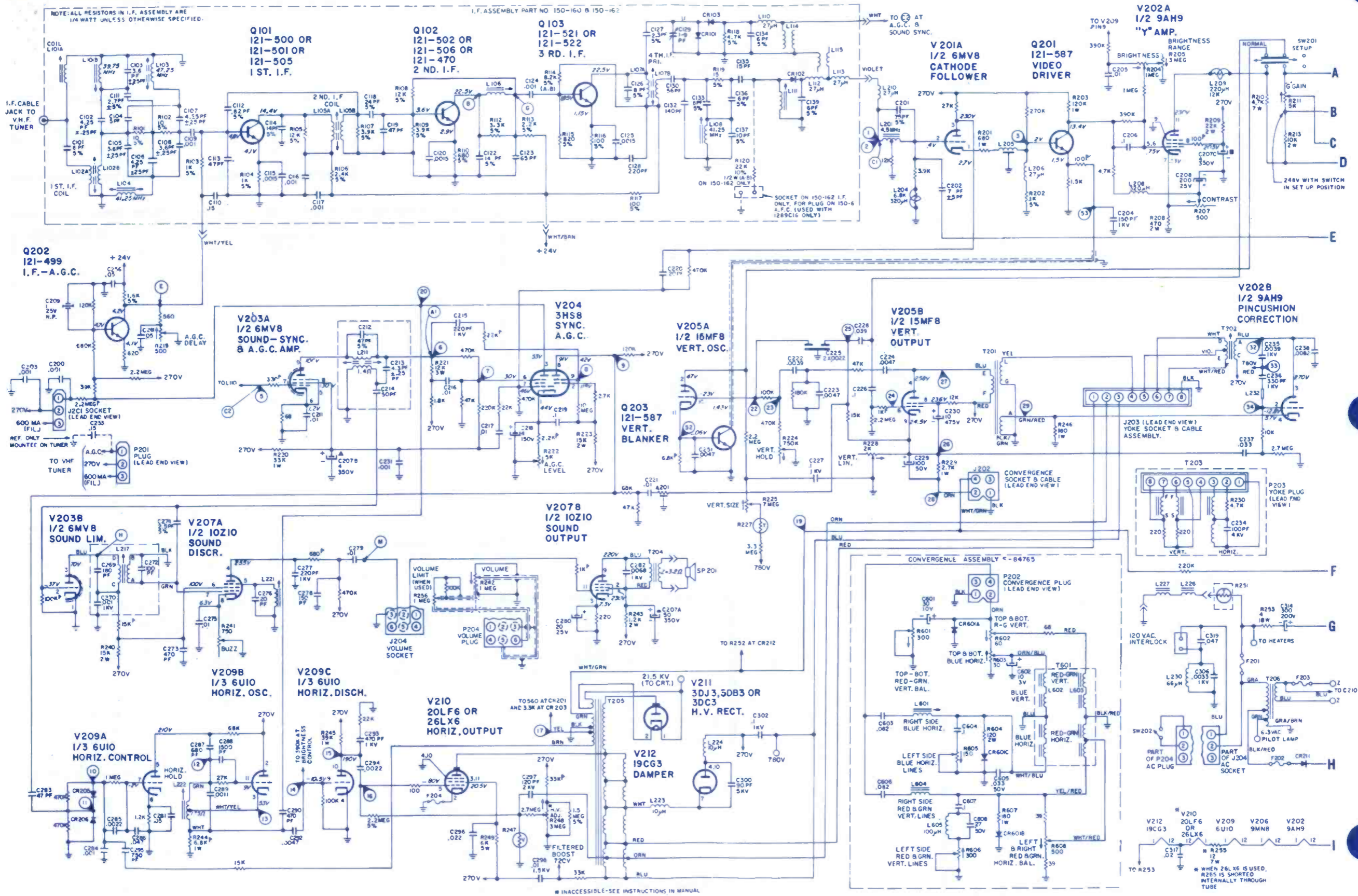



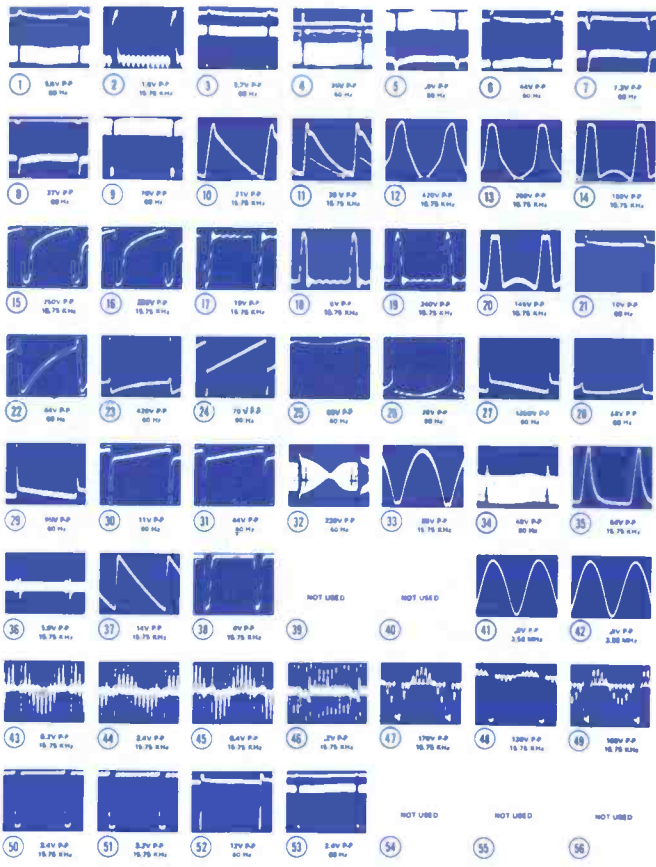
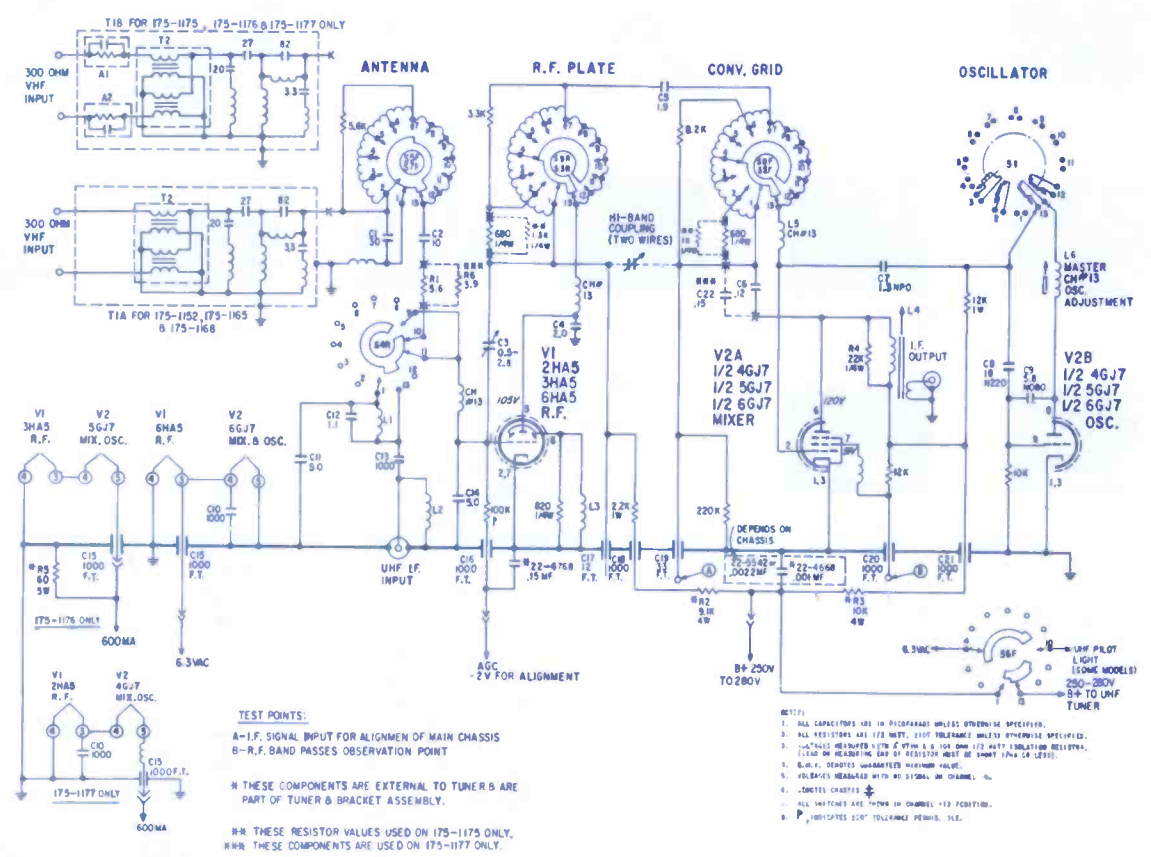
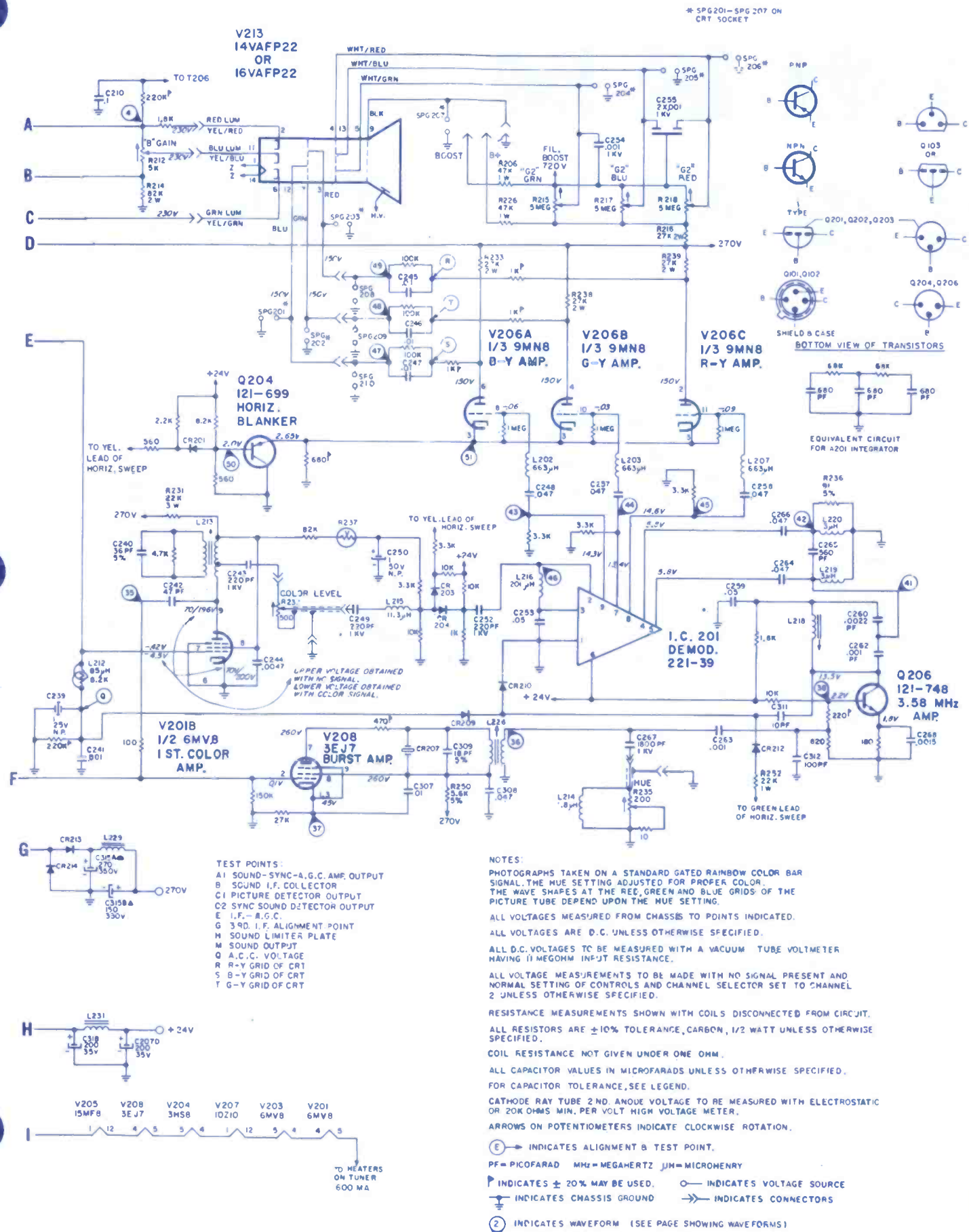

SYMBOL	DESCRIPTION	ZENITH PART NO.
C207A	50 μf, electrolytic cap, 350v	
C207B	4 μf, electrolytic cap, 350v	
C207C	4 μf, electrolytic cap, 350v	22-5910
C207D	200 μf, electrolytic cap, 35v	
C315A	270 μf, electrolytic cap, 200v	22-5746
C315B	150 μf, electrolytic cap, 350v	63-7974
R204	1M, brite control	63-7977
R205	3M, brite range control	63-7975
R207	600 Ω, contrast control	63-8543
R219	500 Ω, AGC delay control	63-7973
R224	750K, vert hold control	63-6433
R225	7M, vert size control	63-6824
R227	thermistor	63-6823
R228	2K, vert lin control	63-7983
R232	color level control (14-in. only)	63-8461
R232	color level control (16-in. only)	63-7991
R235	hue control (14-in.)	63-7980
R235	hue control (16-in.)	63-7990
R237	voltage dependent resistor	63-7143
R241	750 Ω, buzz control	63-6487
R242	volume control & ac switch (14-in. only)	63-7979
R242	volume control (16-in. only)	63-7993
R247	voltage dependent resistor	63-7658
R248	3M, high voltage control	63-8460
L103	47.25MHz trap coil	20-1859
L211	sound take-off coil	S-77414
L221	quadrature coil	S-86212
L222	horiz osc coil	S-58877
T201	vert output xformer	95-2764
T203	deflection yoke	95-2781
T204	sound output xformer	95-2688
T205	horiz sweep xformer	S-85571
T206	filament xformer	95-2763
A201	integ unit	87-7
F201	2.7a, bel-fuse	136-76
F202	35a, bel-fuse	136-75
F204	50a, fuse	136-83



1 2V P/P, 15,750Hz



2 1.9V P/P, 15,750Hz

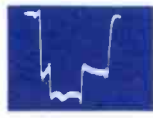

3 1.9V P/P, 15,750Hz  
Expanded View of  
Hor. Sync. Pulse



4 1.8V P/P, 15,750Hz  
Hor. Sync. Pulse  
Showing 4.5MHz  
Trap out of Adj.



5 96V P/P, 15,750Hz

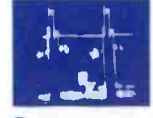

6 14V P/P (min. contrast)  
90V P/P (max. contrast)  
15,750Hz



7 75V P/P, 15,750Hz



8 50V P/P, 15,750Hz



9 12.5V P/P, 15,750Hz

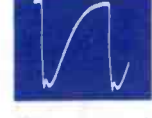

10 17V P/P, 15,750Hz

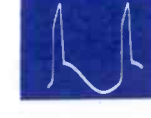

11 36V P/P, 15,750Hz



12 9V P/P, 15,750Hz



13 17V P/P, 15,750Hz

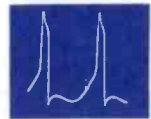

14 30V P/P, 15,750Hz



15 130V P/P, 15,750Hz

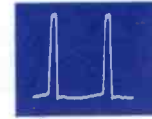

16 15,750Hz, Loose  
coupled to plate  
lead of 22JR6



17 50V P/P, 60Hz



18 16V P/P, 60Hz



19 30V P/P, 60Hz



20 55V Sawtooth,  
80V P/P, 60Hz

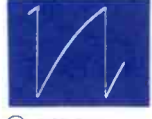

21 30V P/P, 60Hz



22 1150V P/P, 60Hz



23 34V P/P, 15,750Hz



24 11V P/P, 15,750Hz

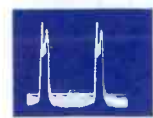

25 34V P/P, 15,750Hz



26 7.5V P/P, 15,750Hz

PANEL INTERCONNECTING LEADS

WA TO WA WC TO WC  
WB TO WB WD (WIDTH ADJ. LINK)

SYMBOL DESCRIPTION PHILCO-FORD PART NO.

C101-240/240/5/1600 f. @200v, filter	30-2601-33
L3-sound take off, 4.5MHz trap coil	32-4955-2
L13-horiz stabilizer coil	32-4754-3
L18-47.25MHz trap	32-4652-78
L19-42.5MHz trap	32-4652-80
L101-filter choke	32-10162-1
N1-CRT network	30-6058-2
Q1-TV17, audio driver	34-6001-63
Q2-TV32, 2nd S1F	34-6015-12
Q3-TV32, 3rd S1F	34-6015-12
Q4-TV54, 3rd V1F	34-6015-37
Q5-TV50, 2nd V1F	34-6015-29
Q6-TV44, RF AGC	34-6016-15
Q7-TV50, 1st V1F	34-6015-29
Q8-TV17, gate	34-6001-63
Q9-TV32, 1st S1F	34-6015-12
R73-1K, width adj	
R74-1.5K, width adj	
R78-4.7K, contrast control	
R93-varistor, 560v @10ma., vert bias	33-1373-6
R103-3n, fusistor	33-1381-5
AOT-audio output xfomer	32-10161-2
HOT-horiz output xfomer	32-10152-1
VOT-vert output xfomer	32-10160-3
VR1A-B-2.5M, vert lin, 500K, vert size	33-5645-2
VR3A-B-60K, horiz hold aux 25K contrast	33-5637-4
VR101A-B-25K, on-off volume, 250K, brite	33-5644-5
VR102A-B-40K, horiz hold, 150K, vert hold	33-5644-2
TT216 tuner, VHF TT216	76-14248-1
Yoke assembly	76-14309-1

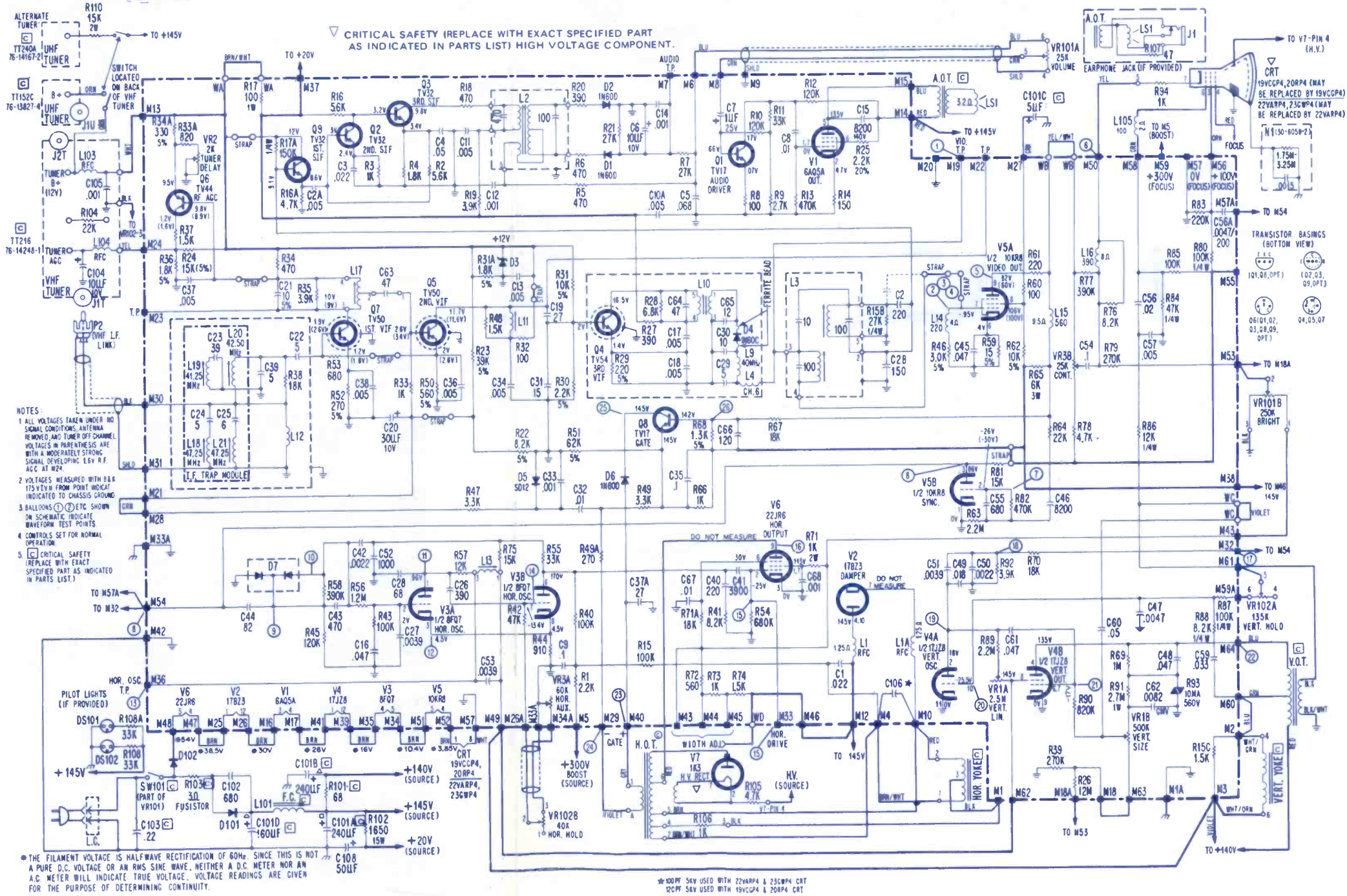

ELECTRONIC TECHNICIAN/DEALER is published monthly by HARCOURT BRACE JOVANOVICH PUBLICATIONS, INC., 1 East First St., Duluth, Minn. 55802. Subscription rates: One year \$6, two years \$10, three years \$13, in the United States and Canada. Other countries: One year \$15, two years \$24, three years \$30. Single copies 75¢ in the United States, and \$2 in other countries. Second class postage paid at Dansville, New York and at additional mailing offices. Copyright 1972 by HARCOURT BRACE JOVANOVICH PUBLICATIONS, INC. POSTMASTER: Send Form 3579 to ELECTRONIC TECHNICIAN/DEALER, HARCOURT BRACE JOVANOVICH PUBLICATIONS, INC., 1 East First St., Duluth, Minn. 55802.

# TV TUNER SERVICE

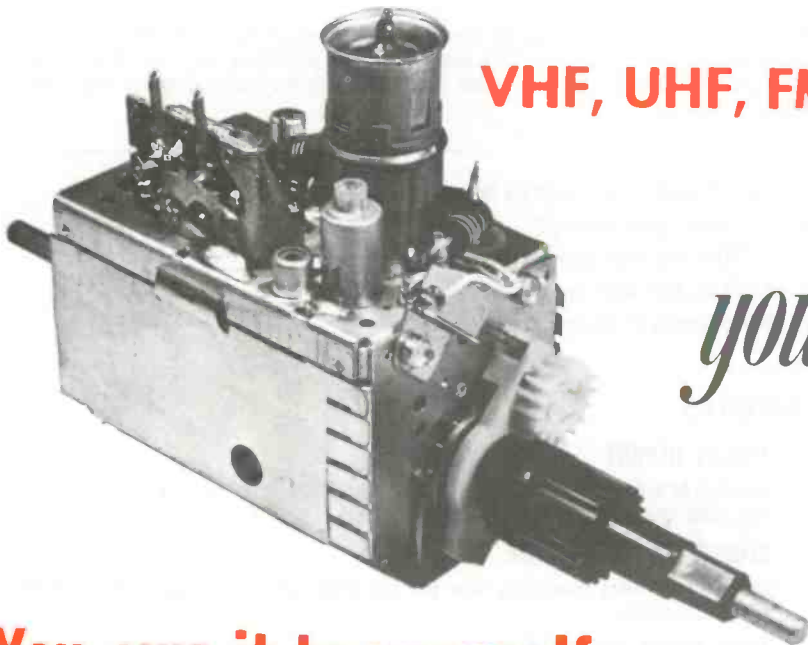

VHF, UHF, FM or IF-Subchassis. . .  
 . . . All Makes

*you get...*

**Fast 8 hr. Service!**

## You owe it to yourself

to try P.T.S. We are the fastest growing, oldest and now the largest tuner service company in the world. Here is what you get:

1. Fastest Service — 8 hr. — in and out the same day. Overnight transit to one of our six plants, for parts, tuners or IF-modules.
2. All tuners cleaned inside and out, repaired, realigned and air tested.
3. On IF-modules all stages checked, all traps set with high calibre test equipment.
4. Fine Quality! Your customers are satisfied and you are not bothered with returning your units for rework!
5. Lower Cost! Up to \$5.50 less than other tuner companies!
6. Friendly, helpful personalized service!



**1 YEAR GUARANTEE**

**We offer you finer, faster...**

**Precision  
 Tuner Service**



FIRST TO OFFER 365-DAY GUARANTEE!  
 COLOR—BLACK & WHITE—TRANSISTOR TUNERS—ALL MAKES  
 GUARANTEED COLOR ALIGNMENT—NO ADDITIONAL CHARGE

VHF-UHF-FM	\$ 9.95
UV-COMBO	\$16.95
IF-MODULE	\$12.50

Major Parts charged at Net Price

CUSTOMIZED REPLACEMENTS AVAILABLE  
 FOR \$12.95 UP (NEW OR REBUILT)

### LIKE TO DO IT YOURSELF?

PTS makes all tuner parts available to you.

Send one dollar (redeemable) for our  
**TUNER REPLACEMENT GUIDE AND PARTS CATALOG**

- 60 pages of top information
- Blow-up of all tuners
- Largest exact tuner replacement guide
- Antenna Coil Replacement Guide
- Multi-fit Replacement Tuner Shaft Guide

For fastest service, send faulty unit with tubes, shields and all broken parts to:

## PTS ELECTRONICS, INC.

HOME OFFICE—P. O. Box 272—Bloomington, Ind. 47401 Tel. 812/824-9331  
 EAST— P. O. Box 3189—Springfield, Mass. 01103 Tel. 413/734-2737  
 WEST COAST— P. O. Box 41354—Sacramento, Calif. 95841 Tel. 916/482-6220  
 MOUNTAIN— P. O. Box 4145—Denver, Colo. 80204 Tel. 303/244-2818  
 SOUTHWEST— P. O. Box 7332—Longview, Tex. 75601 Tel. 214/753-4334  
 SOUTHEAST— P. O. Box 6771—Jacksonville, Fla. 32205 Tel. 904/389-9952

... for more details circle 126 on Reader Service Card

# ELECTRONIC TECHNICIAN/DEALER

SEPTEMBER 1972 • VOLUME 94 NUMBER 9

## PHILLIP DAHLEN, C.E.T.

Editor  
1 East First Street  
Duluth, Minn. 55802  
(218) 727-8511

## ALFRED A. MENEGUS

Publisher  
757 Third Avenue  
New York, N.Y. 10017  
(212) 572-4839

## TOM GRENEY

Publishing Director

## JOSEPH ZAUHAR

Managing Editor

## GAYNELLE DAVIDSON

Production Manager

## JOHN PASZAK

Graphic Design

## LILLIE PEARSON

Circulation Fulfillment

## JOHN KESSLER

Manager, Reader Services

## MANAGERS

### JIM SMITH, C.E.T.

43 East Ohio Street  
Chicago, Ill. 60611  
(312) 467-0670

### CHUCK CUMMINGS

Ad Space South/West  
613 North O'Connor  
Irving, Texas 75060  
(214) 253-8678

### KEN JORDAN

DONALD D. HOUSTON  
1901 West 8th Street  
Los Angeles, Calif. 90057  
(213) 483-8530

### CHARLES S. HARRISON

CY JOBSON  
57 Post Street  
San Francisco, Calif. 94104  
(415) 392-6794

### ROBERT UPTON

Tokyo, Japan  
C.P.O., Box 1717

This month's cover photo is supplied through the courtesy of the Gainesville, Fla. Police Department. More details concerning how the police accidentally shot out this service dealer's front window before killing one of the suspects are included in the article beginning on page 43.

- 
- 3 TEKFAQ: Up-to-date schematics for easier servicing.
  - 23 EDITORIAL: What's Wrong?
  - 25 LETTERS: Pertinent comments concerning past issues.
  - 28 READER'S AID: What you need or have for sale.
  - 30 NEWS: Events of interest to our industry.
- 

## FEATURES

### 35 TEKLAB REPORT

The first in a two-part series concerned with what we observed when examining the NEA rated General Electric 19JA Color-TV Chassis.

### 40 ELECTRONICS AND CRIME

Some helpful hints concerning how you too might take advantage of the nation's rising crime rate.

### 42 THIEF WIPES OUT TV SHOP

A plea for help from one of our readers who lost all his possessions when moving to a new location.

### 43 SMASH AND SNATCH

It took four years for Couch's Inc. to develop adequate burglar protection. [The Charles Couch, Jr., mentioned in this article and author of this month's first Letter to the Editor is the same gentleman that was last month elected president of NEA.]

### 45 TESA WISCONSIN FEATURES CRIME SEMINAR

A bad check writer, a safe cracker and a hold-up man go straight and give sound advice for more effective self-protection.

### 55 AND NOW WHAT?

Some helpful hints on how you as a concerned electronic technician or service dealer can have a part in drastically reducing our nation's crime rate.

### 60 TEST INSTRUMENT REPORT

Reviewing specifications for Leader's Model LBO-505 Triggered-Sweep Scope.

---

63 TECHNICAL DIGEST: Hints and shortcuts for more effective servicing.

76 ADVERTISER'S INDEX: Manufacturers concerned about you.

77 READER'S SERVICE: A source of additional information.

---



A HARCOURT BRACE JOVANOVIICH PUBLICATION

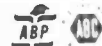

HARCOURT BRACE JOVANOVIICH PUBLICATIONS: James Milholland, Jr., Chairman; Robert L. Edgell, President; Lars Fladmark, Senior Vice President; Richard Moeller, Treasurer; John G. Reynolds, Vice President; Thomas Greney, Vice President; Ezra Pincus, Vice President; Bruce B. Howat, Vice President; James Gherna, Vice President.

ELECTRONIC TECHNICIAN/DEALER is published monthly by Harcourt Brace Jovanovich Publications. Corporate Offices: 757 Third Avenue, New York, New York 10017. Advertising Offices: 43 East Ohio Street, Chicago, Illinois 60611 and 757 Third Avenue, New York, New York 10017. Editorial, Accounting, Ad Production and Circulation Offices: 1 East First Street, Duluth, Minnesota 55802. Subscription rates: One year \$6, two years \$10, three years \$13, in the United States and Canada. Other countries: one year \$15, two years \$24, three years \$30. Single copies: 75¢ in the U.S. and Canada; all other countries \$2. Second class postage paid at Duluth, Minnesota 55806 and at additional mailing offices.

POSTMASTER: Send form 3579 to ELECTRONIC TECHNICIAN/DEALER, P.O. Box 6016, Duluth, Minnesota 55806.

Copyright © 1972 by Harcourt Brace Jovanovich, Inc. All rights reserved. No part of this publication may be reproduced or transmitted in any form or by any means, electronic or mechanical, including photocopy, recording, or any information storage and retrieval system, without permission in writing from the editor or publisher.

# Look for the PTC *Please The Customer* Semiconductor Mart at your Mallory Distributor's.

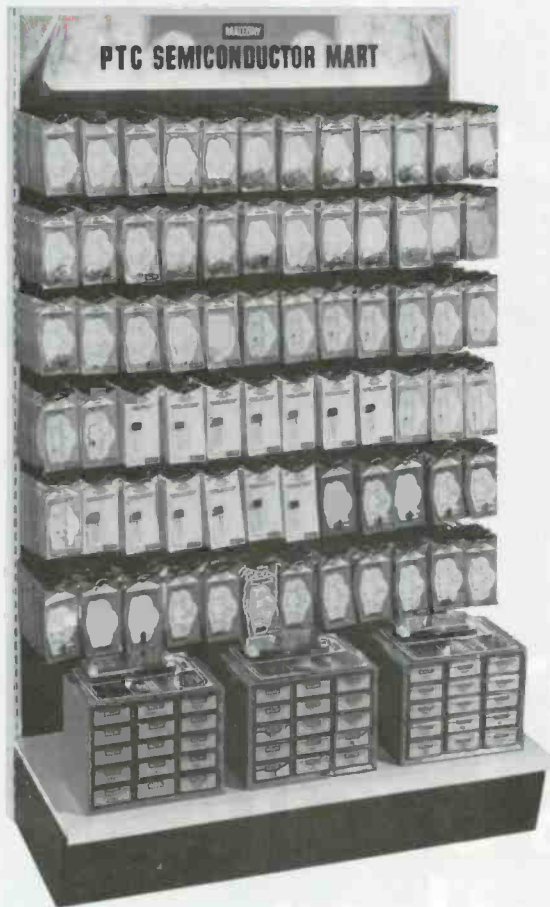

**THE SEMICONDUCTOR MART.** Here's the quick, easy way to get the replacements you need. It's the best assortment of the hottest semiconductors around. Transistors, diodes, multiple diode packages, zener diodes and integrated circuits included.



**THE FAMOUS MALLOBIN WAREHOUSE.**  
With the semiconductors most needed by service technicians.

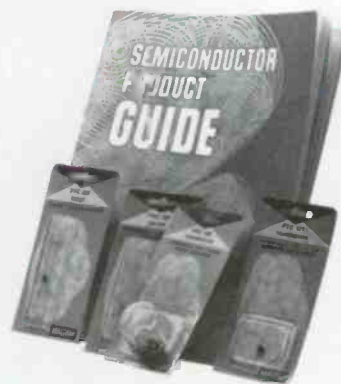

**FREE** copies of the very latest cross-referenced Semiconductor Product Guide.

Clear, concise product data on the packages makes your choice easy. And Mallory quality, versatility, and dependability make every choice a good one.

## You know what you need. Now you know where to find it.

**MALLORY**

**MALLORY DISTRIBUTOR PRODUCTS COMPANY**

a division of P. R. MALLORY & CO. INC.

Box 1284, Indianapolis, Indiana 46206; Telephone: 317-636-5353

... for more details circle 121 on Reader Service Card

SEPTEMBER 1972, ELECTRONIC TECHNICIAN/DEALER | 21

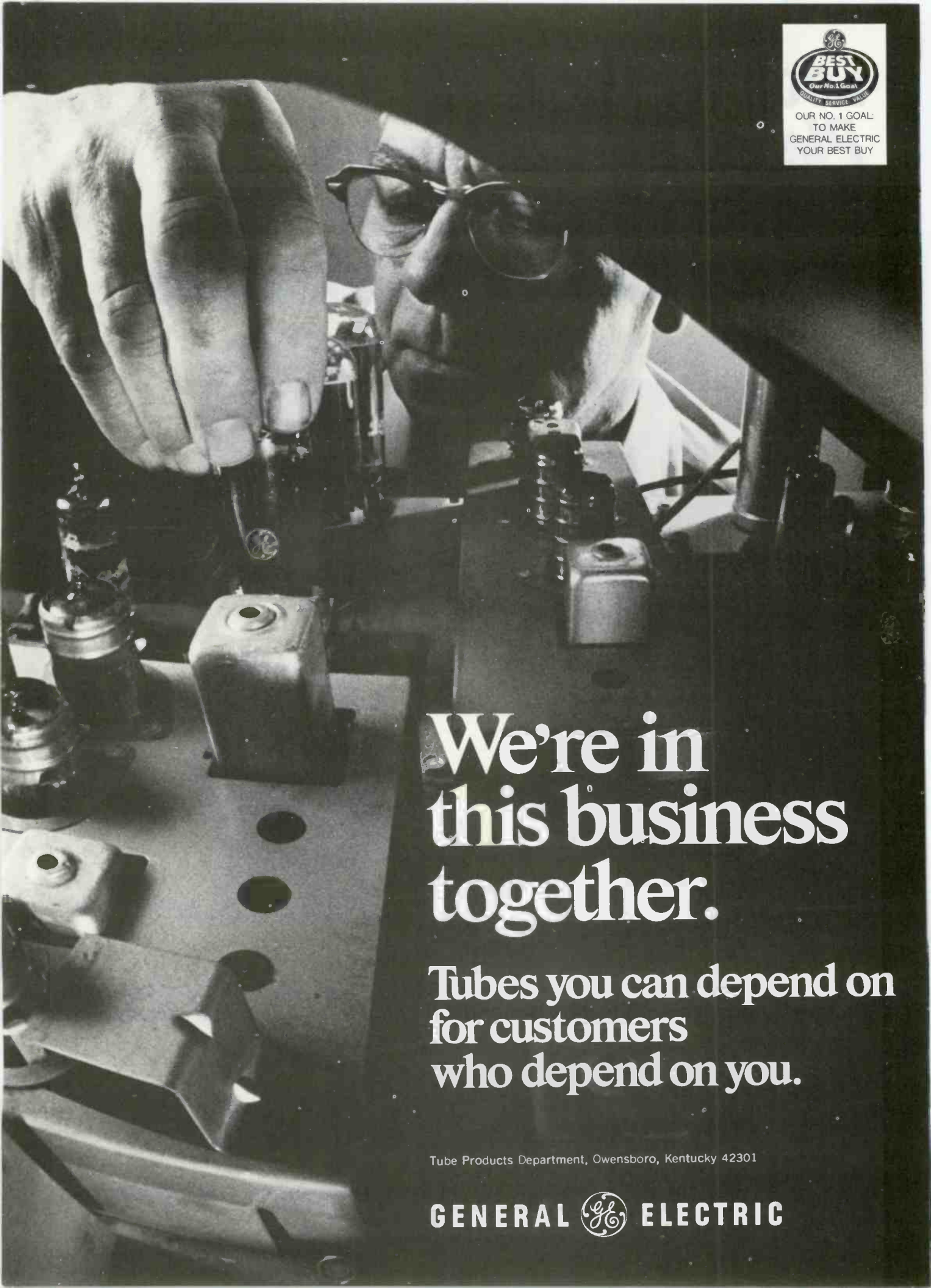

We're in  
this business  
together.

Tubes you can depend on  
for customers  
who depend on you.

Tube Products Department, Owensboro, Kentucky 42301

GENERAL  ELECTRIC

**What's Wrong?**

As in all other "free" countries—and even some that aren't—our society is experiencing a period of rapid change. On the plus side, there are the comforts gained through the technological



advances and effective marketing techniques generated by our society; and it is good to see our youth showing a greater concern for the welfare of their fellow man, rather than merely wanting to exploit the masses for corporate gain. However, on the negative side, too many in our society have lost the ability to dare and adapt. They now lack the necessary self confidence for fighting for self improvement, let alone even caring about themselves. Many instead attempt to escape through the use of alcohol, other narcotics or even crime.

I don't particularly care whether these dropouts prefer to call themselves communists, fascists, anarchists or just lovers. Whatever the name of their apparent orientation, they still represent a threat to our society.

The basic problem, as I see it, is that too many people are trying to be "progressive." They feel that just because our technology is undergoing change that our social structure must also change. They somehow seem to think that a person driving a modern, beautifully styled automobile must have a different set of social standards than the driver of a once modern horse-drawn coach.

As an ex-school teacher who has children that will begin school in another few years, one of the reasons that I recently moved outside of Duluth was to get away from a progressive school district which ignores a child's basic need for security by throwing the poor kid into a pod system where no one actually has the time to really notice

whether the child is making it or not—and where small children do not have one adult at school that they can relate to. Schools exist where the doctrine of individuality and "its a free world" propaganda stresses individual activity to the point that many young adults upon graduation don't even have enough self discipline to know how to hold down a job. (In contrast to what is now considered normal behavior, at this year's public-school graduation exercise in Esko, Minn. three out of the four student speakers spoke of their need for God.)

It is about time we recognize the fact that we do not live in a free world. Yes, we are fortunate enough to live in a country where we can peacefully determine the future direction of our government. But the right to free speech doesn't include the right to slander—nor even necessarily the right to be offensive. The right to free travel doesn't include the right to trespass. The right to equal opportunity doesn't include the right to empty someone else's cash register. Next some progressive fool will even attempt to pass a bill repealing Newton's Law of Gravity or Ohm's Law. And are these laws constitutional?

Yes, I am for individuality. Those that really get to know me realize that in my own way I am as extreme an individualist as anyone they know. But to be an individualist doesn't mean that you have to be dressed hippy style like everyone else in your social set. It doesn't mean that you have to reject as irrelevant all of the basic social standards developed during the past several thousand years. True, our environment has experienced drastic change, but our bodies, although maybe a little larger, have remained basically the same since pre-recorded history. This includes our basic level of intelligence, our basic curiosity, our drives for security, acceptance and love, and our limited mortality.

Since my father was a minister, you might say that I was raised in the church. However, I am in complete agreement

concerning Donald Schwannecke's criticism of the church in this month's article, "And Now What?". I do not say that one's theology need be fundamentalist, but I do say that if one's religion is a lot of talk and no action, it's merely a lot of hot air. I recently left one church—where I was serving as chairman of its official board, and became active in another—simply because I felt that not enough people there really cared about young people. And after all, they are our tomorrow!

Sociologists worry about what our society is to do with all the free time our technology is beginning to permit. I don't know who has all this free time, but its best investment is in one's family—working closely with one's children to see that they are well loved, well disciplined and creatively inspired.

Although you are at times definitely subject to economic pressures, you as electronic technicians and service dealers are the type of people that represent the backbone of our society. You too are extremely independent in your outlook, but you creatively channel this spirit into your business. You aren't tied up in the red tape of some oversized conglomerate or saddled with over-secure civil servants. You make your own way in life as truly free citizens, a glowing example to other segments of our society. I only hope that as examples you also speak out forcefully against mollycoddling social outcasts, being rough as . . . in helping to catch those that chose to live outside the law.

As you go out there to install electronic security systems to protect others from the fruit of their labors, let a little of your capitalism show—its refreshing and healthy. In your outside business activity, demonstrate that there is at least some honesty left in this old world. The world is crying for more people like you.

*Philip Walker*



# MEET YOUR NEW RIGHT HAND MAN

## the Sprague Model TO-6 TEL-OHMIKE® Capacitor Analyzer

### MEASURES ALL FOUR!

1 CAPACITANCE	2 POWER FACTOR	3 LEAKAGE CURRENT	4 INSULATION RESISTANCE
<p>Measures up to 2000 <math>\mu</math>F in five overlapping ranges . . . including a special 1 to 100 pF range, exclusive with Sprague. Low ac voltage . . . Capacitors rated at 3V can now be tested without damage.</p>	<p>Power factor of electrolytic capacitors is measured by the highly accurate Wien Bridge method. Reads up to 50% in three ranges for convenience in power factor measurement.</p>	<p>Leakage current of electrolytics is measured directly on easy-to-read meter, with exact rated voltage up to 600V applied from continuously adjustable power supply. 4 ranges: .06, .6, 6, 60 mA.</p>	<p>Insulation resistance of paper, ceramic, and mica capacitors is read directly on meter. Dual range—to 10K<math>\Omega</math> @ 30V for low voltage capacitors, to 50K<math>\Omega</math> @ 150V for higher voltage units.</p>

**A must for checking all capacitors, the TO-6 is moderately priced, yet offers laboratory quality and accuracy.**

See the TO-6 TEL-OHMIKE in action at your Sprague Distributor Today . . . or, for more information, write to Sprague Products Company, 65 Marshall Street, North Adams, Mass. 01247.



**THE BROAD-LINE PRODUCER OF ELECTRONIC PARTS**

. . . for more details circle 131 on Reader Service Card



## LETTERS

Reader comments concerning past feature articles, Editor's Memos, previous reader responses or other subjects of interest to the industry.

### FCC Covers CB Radio Question

*As a result of a couple of letters to the editor in the June 1972 issue of ELECTRONIC TECHNICIAN/DEALER, Charles Couch, Jr., C.E.T., wrote the following letter to the F.C.C.:*

The National Electronic Assn. (known as N.E.A.) would like to ask the F.C.C. for some clarifications or interpretations in regards to reports of Citizens Band and Marine Communications equipment. The N.E.A. membership consists of the most outstanding and technically knowledgeable electronic service dealers throughout the United States, and are anxious to legally serve their customers and to abide by the F.C.C. regulations.

As Chairman of the National Consumer Relations Committee of the N.E.A., I can assure you the Committee is anxious to inform the N.E.A. members what they can and cannot do in regards to repairs of Citizens Band and Marine Communications equipment. Would you please give us the answers to the following questions?

1. How much repair work may a non-licensed technician, not under the supervision of an F.C.C. licensed technician do? Please go into detail if necessary for a precise understanding.
2. May he change crystals in the transmitter circuitry?
3. Tune the antenna matching network to the antenna array?
4. Do work in the receiver audio circuitry when it is connected in the modulation circuitry of the transmitter?
5. May he check voltage standing wave ratios (VSWR)?
6. Measure power output?
7. Check frequency calibration?
8. What basic equipment is required by the F.C.C. for a repair shop that has an F.C.C. licensed technician to:
  - a. Do Citizens-Band repairs only?
  - b. Do Marine Communications only?
  - c. Do both a and b?

These questions pertain to AM equipment only.

9. What additional restrictions and equipment apply when servicing FM, SSB and other special transmissions other than pure AM transmissions?

10. What can you tell us about all the linear amplifiers, from 50w to

500w or more, that are being sold and used on the Citizens Band. When are they legal and not legal?

11. What about CB dealers, vendors, manufacturers and importers who sell linear amplifiers from 50 to 500 or more watts that will operate on the CB channels?

12. Do we violate the F.C.C. regulations when we repair linear amplifiers of more than 5w for CB licensed owners?

13. Again we ask, do we violate the F.C.C. regulations if we sell them to our CB licensed customers?

14. How do we legally sell linear amplifiers and to whom?

No doubt many are innocently violating the law because of a lack of knowledge of the F.C.C. regulations. N.E.A. wants to help disseminate the F.C.C. regulations to its members. Any other pertinent information that you can supply us in regards to the aforementioned main topics, Citizens Band and Marine Communications equipment will be appreciated.

CHARLES R. COUCH, JR., C.E.T.

#### Reply

This is in response to your letter asking a number of questions about the repair of Citizens and Marine Communications equipment.

If the manufacturer of the Citizens transmitter certifies that the changes or adjustments specified in your numbered question 2, 3 or 4 may be made without off-frequency operation, excessive input power, overmodulation, or excessive harmonics or other spurious emissions, a non-licensed technician may do the repair work. The measurements listed in 5, 6 and 7 may be taken by a non-licensed technician provided the instruments do not affect the proper operation of the transmitter [See the Citizens Rules, Part 95, Sections 95.97 (c) (4) and (5).] The crystals of a Class D Citizens transmitter may be replaced by a non-licensed technician provided either the transmitter manufacturer or the crystal manufacturer certifies that a specific crystal may be used in a specific transmitter without exceeding the frequency tolerance specified in Section 95.45. The crystals of a Class A transmitter may be replaced only by a first or second class commercial radio operator.

Question 8: The Commission does not specify the equipment that a Commission licensed technician must have in order to repair Citizens or Marine Radio Service equipment. The equipment must be capable of providing certain determination that the equipment is adjusted within rule requirements.

Question 9: See answer to Question 8.

Question 10: No use of a linear am-

plifier in the Citizens Radio Service or any other service would be legal where such use results in excessive input or output power.

Questions 11, 12, 13 and 14: The Commission now has under study the question of regulating the sale, offer for sale, installation, etc., of linear amplifiers in the Citizens Radio Service in light of the new Section 302 and other provisions of the Communications Act. When this study is completed, we will notify you of its results. In any event, a licensed radio operator risks possible loss of his license if he engages in installation or repair of illegal equipment.

With regard to Marine Services, Section 83.162 of the Commission's Rules provides that all adjustments of radio transmitting apparatus in any station in the Marine Service or coincident with the installation, servicing or maintenance of such apparatus which may affect the proper operation of such station, must be performed by or under the supervision and responsibility of a person holding a first- or second-class operator license, either radiotelegraph or radiotelephone. Only a person holding a radiotelegraph first- or second-class operator license may perform such functions at radiotelegraph stations. Persons holding either a radiotelegraph or radiotelephone third-class permit or restricted radiotelephone operator permit are prohibited from making any equipment adjustments that may result in improper transmitter operation.

In accordance with Section 83.162, none of the adjustments in your questions 2, 3 and 4 may be made by a person holding lower than a second-class radiotelegraph or radiotelephone operator license. The measurements mentioned in your questions 5, 6 and 7 need not be made by the holder of an operator license. However, any corrective action must be taken in compliance with the Rules.

JAMES E. BARR  
CHIEF, SAFETY AND SPECIAL RADIO  
SERVICES BUREAU

### Congratulations on July Editorial

Again, you have rendered a great service with your editorial in the July issue, with the highlights of M.L.'s speech at the NEW/COM show in Vegas.

I can just picture the standing, cheering ovation that was so vivid and well deserved (from your report). The talent and ability to hold an audience spellbound that M.L. has is quite a moving experience to behold. It's just impossible to hear M.L. without being inspired. . . .

*continued on next page*

## LETTERS . . .

*continued from page 25*

It was most gratifying to learn that the Independent Manufacturer has at last also become aware that "M.L. is also the Champion of the Independent Manufacturers." We, in Service, have long been aware of this truly Great Man and the unselfish efforts that he has exerted for his Industry.

Phil, after reading your fine editorial, which again pays tribute to the Industry's Champion, I just had to express my "thanks."

LEROY RAGSDALE

## Would Like Second Article

I hold an FCC Second Class License and do a limited amount of service work on Class D CB radios. I would like to read Mr. Tuthill's second article. In fact, I would like to see a review, similar to the Teklab articles, on CB sets each month in ET/D.

Would Mr. Parsons have Howard W. Sams and others stop supplying service information because this information might reach unqualified persons?

Let's be realistic, good technicians need good service information. It saves time and is vital in doing the job properly. Have you ever tried to align a

transistorized mobile CB rig without the proper data? The alignment probably could be accomplished but the time required certainly wouldn't be covered by a reasonable charge!

I agree with Mr. Parsons that Class D CB is badly abused, both by the users and by some dealers and service technicians. However, as penalties do exist for unauthorized adjustments of two-way radios, I feel the job of enforcement should be left to the FCC. In my opinion, restricting publication of good CB service information can only lead to poor service even by qualified technicians using the proper equipment.

As Mr. C. Robert Parsons cites the need for FCC approved test equipment for servicing CB radios, perhaps he can inform me where I might obtain a copy of the listing of the approved equipment. It is my understanding that only equipment used to monitor commercial broadcast stations need be FCC approved.

I asked the FCC engineer who administered the examination for my Second Class License and was told a "rule of thumb" was applied with respect to test equipment for CB radios. The accuracy of frequency measuring equipment should be 5 to 10 times greater than the allowable tolerance of the radio being tested. Modulation checks can be done with a good scope, as the regulations (Sec. 95.51a FCC Rules and Regulations) only specify that the modulation not exceed 100 percent positive or negative. The requirements for power measuring devices are spelled out in Sec. 95.43 Note 2.

L. K. DINGELSTEDT

# RCA CONSUMER ELECTRONICS SERVICE DATA SUBSCRIPTIONS



A SUBSCRIPTION INCLUDES A COMPLETE "FILE" YEAR OF:

- COLOR TELEVISION DATA
- B & W TELEVISION DATA
- RADIO DATA
- PHONOGRAPH DATA
- TAPE RECORDER DATA
- "GOLDENROD" BULLETINS
- PARTS TIPS
- SERVICE TIPS
- "PLAIN TALK" PERIODICALS
- COMPLETE INDEX

- "File-1972" Service Data including 2 binders \$19.95
- "File-1972" Service Data subscription \$14.95 (Binders available separately—\$2.95 each)
- Previous years Data (\$12.50 per set) File: 71 , 70 , 69 , 68

Amount enclosed: \$ \_\_\_\_\_

NAME \_\_\_\_\_  
(Please Print)

STREET ADDRESS \_\_\_\_\_

CITY \_\_\_\_\_ STATE \_\_\_\_\_ ZIP CODE \_\_\_\_\_

- Your order will be processed promptly upon receipt of your check or money order in the amount indicated above

SEND TO: RCA CONSUMER ELECTRONICS  
600 N. Sherman Drive, Indianapolis, Ind. 46201

ATTN: Technical Publications, 8-106 (Or Contact Your Distributor)

Note: Prices Subject To Change Without Notice

Postpaid U.S.A. only

... for more details circle 127 on Reader Service Card

## Here's Requested Comments

You asked for comment on C.B. repair/adjustment articles, ethics, etc., so here is one man's opinion.

Your reader who screams "ethics" should inquire into some of the situations which have come to the attention of this writer: One—a licensed party who refuses to certify the log on a party fishing boat . . . because the owner had purchased a Pearce Simpson fiberglass antenna, which was necessary so that the boat in question could clear a low bridge in emergency storm situations. That party said the radio and antenna must by Federal Law be of the same make.

Three in a row who could not load a radio to the antenna. Five bands . . . only one would load . . . the band-switch had a burned out section and someone had strapped it out . . . the next three could not find the trouble.

The "licensed" technician . . . who

*continued on page 70*

NEW

“TRIPLETT MICRO·POWER™”

TURN IT ON AND LEAVE IT ON

FET V·O·M

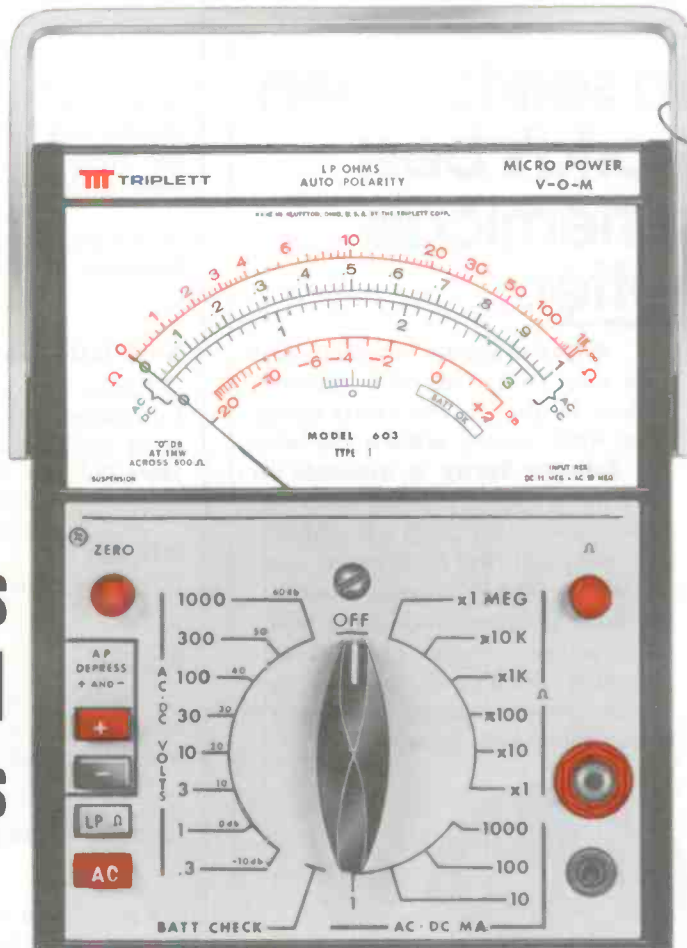

TURN IT ON & LEAVE IT ON

Combines 4 V-O-M firsts

Model 603 \$150

1. Exclusive TRIPLETT MICRO-POWER — TMP™ provides battery life in excess of a year for carbon batteries.
2. LOW-POWER OHMS—LPΩ™—6 ranges with 70 mV power source for in-circuit measurements without component damage.
3. FET V-O-M WITH AUTO-POLARITY — convenient and time-saving, always reads up-scale.

FET Input Circuit—which Triplett pioneered in the Model 600.

LPΩ™ Low Power Ohms—which Triplett pioneered in the Model 601.

Auto-Polarity—which Triplett pioneered in the Model 602.

TMP™ Triplett Micro-Power—which Triplett is pioneering in the Model 603.

In fact, the Model 603 FET V-O-M combines all 4 of those pioneering features to make it the most feature-packed V-O-M that Triplett or anyone else has ever offered.

The new innovation—Triplett Micro-Power—is a revolutionary V-O-M circuit with such a tiny power con-

sumption that the service life of its ordinary carbon batteries is equal to, or longer than, their normal shelf-life. Imagine a V-O-M which needs batteries only once a year.

And the Model 603 has a simple, uncluttered dial with just four scales to cover 44 ranges, a null-type zero adjustment for quick setting with no parallax error, a suspension movement that soaks up the shocks of everyday bench and field use, and a built-in overload protection that shrugs off overload.

This great, new, feature-packed tester... Triplett's Model 603 FET V-O-M... is available for immediate delivery

through your local Triplett Sales/Service/Modification Center or distributor for \$150. For more information, or for a free, no-obligation demonstration, see him or your Triplett sales representative. Triplett Corporation, Bluffton, Ohio 45817.

**TRIPLETT**  
BLUFFTON, OHIO 45817

The World's most complete line of V-O-M's... choose the one that's right for you.

... for more details circle 135 on Reader Service Card

## READERS' AID

Space contributed to help serve the personal needs of you, our readers.

### Seeks Information

I am interested in contacting any and all owners of Lakeside Industries' Picture Tube Rebuilding Equipment.

C. H. MEYER

P.O. Box 973  
Vista, Calif. 92083

### For Sale

One complete picture tube rebuilding unit manufactured by Lakeside Industries with color and B/W guns and additional reneck glass, reasonable.

JOSEPH REKOWSKI

6217 W. Fairview Ave.  
Milwaukee, Wis. 53213

I have the following test instruments for sale: Sencore Model PS163 Dual Trace Triggered Oscilloscope, Hickok

Tube Tester Model 6000A and a B & K Television Analyst Model 1077B. All probes and manuals are supplied with the instruments.

W. D. SHEVCHUK

1 Lois Ave.  
Clifton, N.J. 07014

I have two new scopes for sale, one has single-trace triggered-sweep and the other has dual-trace triggered-sweep.

JIM NICKS

10209 N. 23rd St.  
Tampa, Fla. 33512

I have the following for sale: tape deck, scope, sweep analyzer, flyback checker and sine-square pulse generator. Would also consider a trade on some equipment.

EDWARD TANRATH

3035 LaSalle Ave.  
Rockford, Ill. 61111

### Back Issues for Sale

I have a quantity of back issues of ELECTRONIC TECHNICIAN/DEALER and other publications for sale. I am 69 years old and retired from TV-radio servicing in 1969.

HORACE D. WESTBROOKS

P.O. Box 85  
Sunny Side, Ga. 30284

### Wanted

I would like to purchase a good used Bird Watt Meter and a Frequency Counter.

JERRY GRAY

908 Fleet St.  
Chillicothe, Ohio 45601

I am in need of a 12A8GT tube for an antique radio.

GEORGE I. ROBERTS

12375 Military Trail  
Delray Beach, Fla. 33444  
Lot 117

I would like to purchase a used picture rebuilding machine. Send details of equipment and price wanted.

C. RANDOLPH

5496 River Rd.  
Cincinnati, Ohio 45233

I would like to purchase Tekfax Schematics No. 1055 through 1110 and 1117. Please write fee desired.

ARNOLD G. SCHMIDT

Route 3  
Jamestown, N.D. 58401

# How listening to servicemen made the world's best electronic chemicals even better.

While we're proud of all the R&D we do, some of our best ideas come from the many servicemen who use our products.

Take our newest "first"—**Adjusta-Spray**. Its continuously-variable valve system lets you dial any spray intensity you want. We developed it because different jobs (and different servicemen) require different spray intensities: light for pinpoint cleaning and lubrication without overspray; medium for average jobs; and heavy, to blast away stubborn dirt.

**Adjusta-Spray** has it all. And it's fully compatible with extender tubes, to give you the **exact spray** you want, exactly **where** you want it. **Adjusta-Spray** is available on the world's most popular electronic chemicals: our **TUN - O - BRITE** cleaner/polisher/lubricant and **TUN-O-FOAM** cleaner/lubricant—both at your distributor's now. They're even more of a value, because there's no increase in price. How's that for making a good thing even better?



**CHEMTRONICS**  
INCORPORATED  
1260 RALPH AVE., BROOKLYN, N.Y. 11236  
Our business is improving yours.

... for more details circle 105 on Reader Service Card

# Now every product in this catalog is available on a special money saving offer from your RCA distributor.

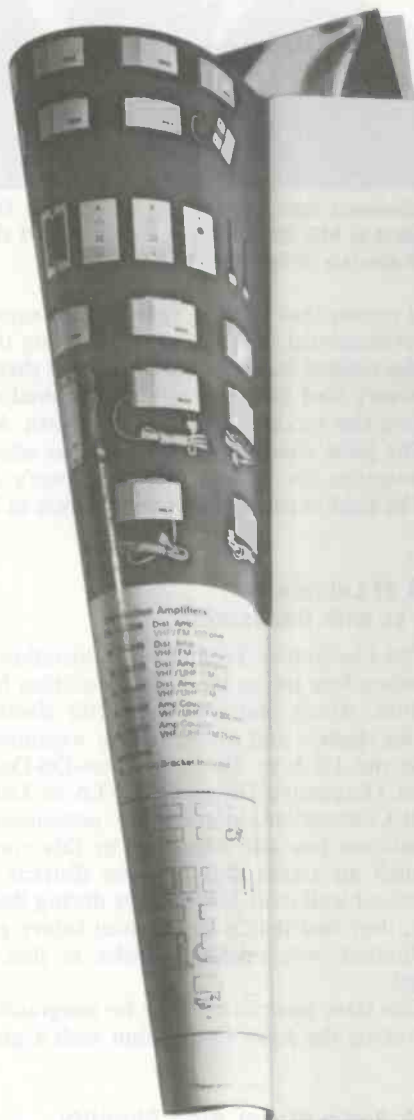

## A complete new look from RCA in Antenna System Accessories

RCA's all new line of Antenna System Accessories has been planned and designed to fulfill specific requirements of any antenna system in every detail. Covering every requirement from a simple passive two-set coupler up to a complete amplified, 82-channel coaxial multi-outlet distribution system for houses, offices, stores and small apartment buildings, this new line is complete in every respect and represents a new standard of performance, convenience and styling.

The entire line is advanced-engineered by RCA to meet rigid performance standards. RCA's all-solid-state circuitry provides dependable trouble-free performance. Protection against lightning induced voltage surges is provided in all amplifiers. All passive devices designed for low insertion loss.

All housings have RCA's "new-look styling" in molded high IMPAC® plastic cabinets. Similar styling design for all models presents a uniform appearance for a complete line.

Installation convenience . . . mounting is simplified with the use of the new RCA "slip-on" clamps. No solder connections are required to connect any model into a system. Serrated washers simplify connecting 300-ohm line to the devices. All hardware, complete installation instructions and system wiring connectors are included with every model.

### INDEX

Multi-Set Couplers	3
Band Separators (Back of Set)	5
(Well Mount)	7
Matching Transformers	8
Antenna Couplers	9
Interference Filters and Traps	11
Wall Outlets and Plugs	13
Preamplifiers	16
Distribution Amplifiers	24
Typical Distribution Systems	31

## This is how to get it.

The RCA Antenna Systems Accessories Catalog is the TV service dealer's complete guide to better reception for his customers and more sales. So tune in and get your free copy today with absolutely no obligation. Ask your local RCA Parts and Accessories distributor how to get your free copy, and find out about

the special money saving offer available from participating RCA distributors. For the name and address of your nearest RCA distributor, write: RCA Parts and Accessories, Distribution Services, 2000 Clements Bridge Road, Deptford, New Jersey 08096. **RCA**

... for more details circle 128 on Reader Service Card

# NEWS OF THE INDUSTRY

## Joint Association Convention Makes Commitment for Merger

The National Alliance of Television and Electronic Service Associations (NATESA), and the National Electronic Associations (NEA) have voted overwhelmingly at their conventions to proceed with their plans for merger. At an extremely impressive ceremony led by Morris L. Finneburgh, Sr., E. H. F.—who was unanimously elected chairman of the joint merger committee—the newly elected presidents of both associations (Leo Shumavon, President of NATESA and Charles Couch, Jr., President of NEA), the executive officers of both conventions (Frank Moch of NATESA and Dick Glass of NEA), and the other officers of both associations, dedicated themselves to this purpose.

Mr. Finneburgh has already begun coordinating joint meetings of the merger committees and will continue to do so with such dedication during the coming year that he is even seriously considering taking a year's leave of absence from The Finney Co. for that purpose.

Upon completion of the new constitution and detailed merger plans, all that will remain to complete the merger will be a two-thirds majority vote by both conventions at the Joint Convention next year.

The response to this ceremony was extremely enthusiastic! And all rose to cheer when Mr. Finneburgh announced that he had been advised by representatives of the Canadian and Mexican associations (in attendance at this Joint Convention) that they were also dedicating themselves to merger with the one giant association once the initial merger is completed at next year's convention!



Leo Shumavon (left), President of NATESA, and Charles Couch, C.E.T., President of NEA, stand together in their support of association merger. Photo courtesy of Enos Rice, C.E.T.

This means that by next year we can expect to have a single professional association representing the service dealers of the United States of America, and that in two years we may very well have a single professional association representing the service dealers of all North America!

The joint committee authorized to select the next Joint Convention site agreed that next year's Joint Convention will be held at the Crown Center Hotel in Kansas City, Mo.

## ETA of Louisiana Grc vs with Convention

The Electronics Technician Association of Louisiana did a tremendous job as the host association for the Joint Convention, which had well over 700 electronic technicians, service dealers and manufacturer executives in attendance.

At the ETA of Louisiana Fais-Do-Do Banquet, Roger Drost (Executive Director of ETA of Louisiana and 1972 Joint Convention Coordinator) announced that their state association has also benefited by this convention. In fact, to such an extent that in some districts membership has increased well over 100 percent during the past year. However, they find that in one district future growth is going to be limited—every service dealer in that district now belongs!

This state association is to be congratulated for its work at making the Joint Convention such a great success!

## RCA Audio-Visual Aids Simplify Teaching Transistor Servicing

A three-part audio-visual service aid composed of slide-film/cassette-tape presentations that will enable distributors to hold impressive, ready-made seminars for technician customers is now available from RCA Electronic Components.

The "Transistor Servicing" series of audio-visual aids includes: Part I—Basic Techniques for Transistor Servicing; Part II—Identifying the Defective Stage; and Part III—Identifying and Replacing the Defective Component. Each of these lessons is contained in a "Carousel-type" slide tray with color 35mm slides, a cassette tape with a prerecorded dialog keyed to the slides, and a printed lesson booklet for use by the instructor and students.

Each of the parts is about 25 minutes in duration and  
*continued on page 32*

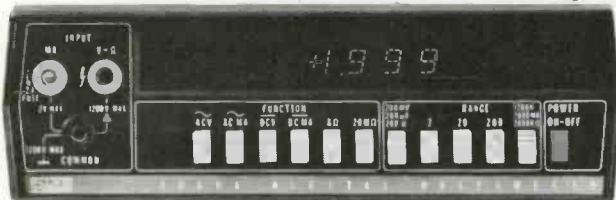

## New digital V.O.M. \$299

- 26 ranges to measure ac/dc voltages from 100 microvolts to 1200 V, ac/dc currents from 100 nanoamperes to 2 amperes and resistance from 100 milliohms to 20 megohms.
- Guaranteed to stay within specifications for one full year. Fluke gives you the best specs and strongest warranty on the market today for the lowest cost of ownership ever.
- Wide choice of options including rechargeable battery pack, digital printer output, deluxe test leads, high-voltage probe, RF probe, 200-amp ac current probe, carrying case, dust cover and rack mounts.
- Unique self-zero feature eliminates offset errors.
- Rugged high-impact case with securely mounted internal electronics.
- Service centers throughout U.S., Canada, Europe and Far East for 48-hour turnaround repairs.



P. O. Box 7428,  
Seattle, Washington 98133.

Get all the details from your nearest Fluke sales office. Dial toll-free 800-426-0361 for address of office nearest you.  
... for more details circle 141 on Reader Service Card

# Performers

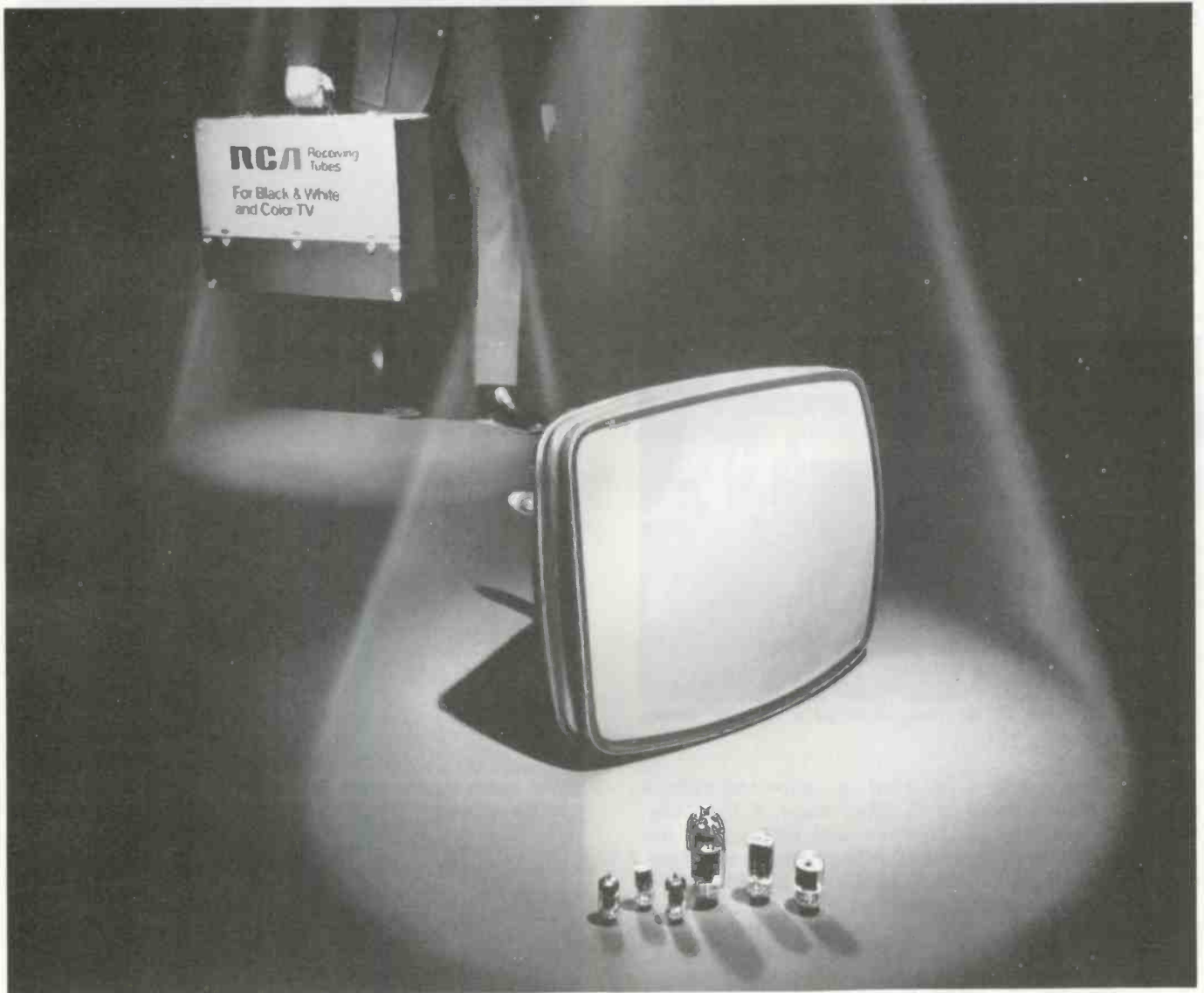

## RCA tubes and the service technician

A color TV set is probably the most intricate piece of equipment in the average home. And you're the expert who services it. But even an expert needs performance-proven components to back up his technical skills, components like RCA receiving and picture tubes. After all, RCA is a pioneer in TV tube design and has been in the forefront of new tube development since the start of the industry.

Just consider the fact that 6 of the TOP 10 types\* of receiving tubes used in color TV were designed by RCA: 6DW4B, 6GF7A, 6FQ7/6CG7,

6GH8A, 6JC6A and 6L06/6JE6C. And as part of its constant efforts to improve tube performance, RCA introduced the Pre-coated Cathode to reduce arcing and the Dark Heater to prolong tube life.

RCA picture tubes are also designed with performance in mind. RCA PERMA-CHROME offers locked-in color purity and RCA MATRIX provides the sharpest, brightest color pictures in RCA history. With RCA picture tubes you can offer your customers a choice of the finest tubes in the industry... all-new HI-LITE produced to rigid OEM specifications, popular-priced COLORAMA produced to RCA's high re-manufacturing standards... and SILVERAMA for black/white replacements.

RCA tube performance is solid. Our record to date is more than three billion receiving tubes and twenty million color picture tubes. See your RCA tube distributor for the broadest possible tube type coverage and offer your customers your own expert service and performance-proven RCA tubes.

Two top performers, you and RCA tubes.

RCA | Electronic Components | Harrison, N.J. 07029

\*Based upon available EIA statistics

# RCA

continued from page 30

has an optional distributor resale price of \$39.95 each. They are available now from RCA distributors or from RCA Commercial Engineering, Harrison, N.J. 07029.

**TSA Iowa Conducts Successful Mini Convention**

The Television Service Association of Iowa conducted a Mini Convention at Backbone State Park on Sunday, July 9th, inviting all members, electronic students and your editor.

Many arrived the previous evening with tents and campers, gathering for a campfire and a delicious special camp soup. And despite heavy rains that night—which forced at least one national executive secretary to move his tent during the night—all were enthusiastic about the convention the next morning.

Sunday activities began with a "sunrise" service conducted by Ken Brown, president of the Iowa association.



Ken Brown, President of TSA Iowa, conducted a "sunrise" service attended by the early risers.

This was followed by a breakfast of coffee and rolls; a technical session conducted by Don Anker, C.E.T., concerning the checking of transistors and FETs; open discussion about effective servicing techniques; and a business management school conducted by Harrie Buswell, C.E.T.

At the business management school, they distributed some excellent forms entitled, "Management Evaluation for Consumer Electronic Sales and/or Service Business." Working in teams, those in attendance evaluated one an-



Preparing steaks for noon dinner.



Ron Crow, Executive Secretary of IS CET, helps Cherry Hicks prepare for the CET exam.

other's shops. Based on their results, the forms will be slightly modified and then used by association teams on invited visitations for the financial improvement of member shops.



By noon it was dry enough for some to eat outside the park pavilion.

By noon convention attendance was so good that there was some concern that there would not be enough steaks for the steak fry conducted by electronic students and their wives.



Service dealers checking over used test equipment prior to the auction.



The auction was conducted by Les Buchan, Executive Secretary of TSA Iowa (seen holding the tube cavity, and Harrie Buswell, C.E.T. (standing beside him).

During the afternoon there was an auction of members' used test equipment and new technical books—the association receiving a 25 percent commission on the equipment and 100 percent commission on the books. The association made at least \$200 profit from these sales.

Following the auction there was a state association meeting and then an informal IS CET meeting.

continued on page 62



## Why RCA XL-100's can be a quick fix:

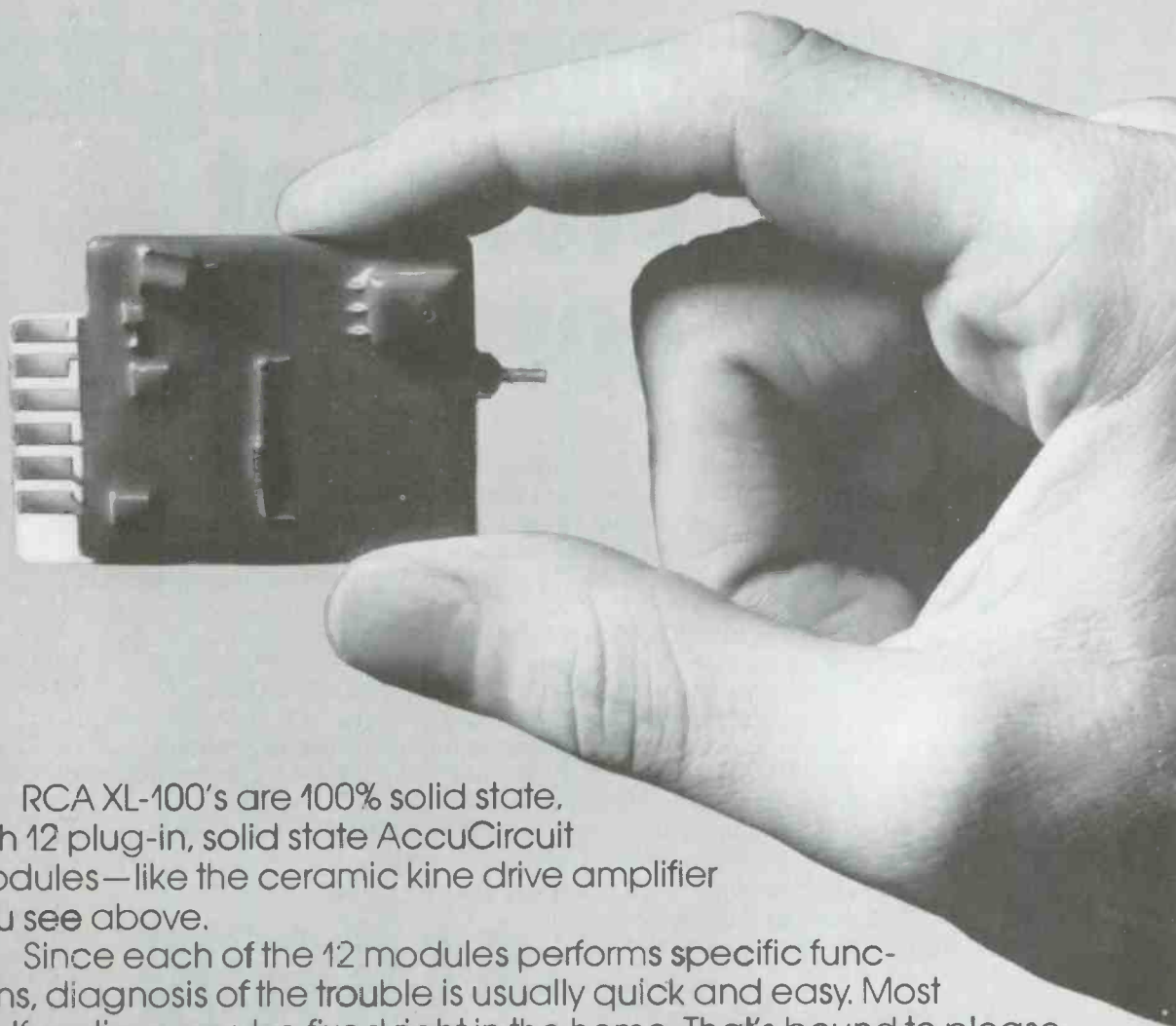

RCA XL-100's are 100% solid state, with 12 plug-in, solid state AccuCircuit modules—like the ceramic kine drive amplifier you see above.

Since each of the 12 modules performs specific functions, diagnosis of the trouble is usually quick and easy. Most malfunctions can be fixed right in the home. That's bound to please your customer.

So when it comes to servicing RCA solid state color, XL-100's let you make more house calls—in a lot less time!

And you won't waste so much time hauling sets back and forth to the shop.

Something else: Whether you're servicing an XL-100 console, table model or portable, most modules are interchangeable, function for function. That will make your life easier, and you won't have to worry about stocking a large parts inventory.

RCA XL-100. It's already got a great reputation. It could even add to yours.

**RCA** **XL-100**   
100% Solid State AccuColor

# Introducing the expensive digital multimeter that doesn't cost a lot.

The B&K Precision Model 281. A solid-state, lab-quality portable instrument that measures AC/DC voltage, current and resistance.

The state-of-the-art Model 281 shows readings on a large, clear, 2½-digit numeric display. It also has positive over-range and reverse-polarity indication. There's no need to switch leads. You can reverse polarity at the flick of a switch.

Model 281 readings are faster and more accurate than analog-type meters. Unlike hard-to-see needle indicators, you can read the large, illuminated numerals—including the decimal point—from a distance.

Featured are 32 ranges: five DC voltage (+ and -), 100mV to 1000V, with 1% accuracy and 10 megohms input impedance; five AC voltage, 100mV to 1000V RMS; five DC current, 100μA to 1A; five AC current, 100μA to 1A; and seven resistance, 10 ohms to 10 megohms.

With built-in protection, the 281 can't be harmed by overload. And for safety's sake, it has a three-line AC grounded cord.

Everything about the 281 says expensive—except the price.

Call your B&K distributor.  
Or write Dynascan Corporation.

# \$169<sup>95</sup>

Very good equipment  
at a very good price. **B&K**



Product of Dynascan Corporation, 1801 West Belle Plaine Avenue, Chicago, Illinois 60613

... for more details circle 102 on Reader Service Card

## TEKLAB REPORT

# Introducing General Electric's 19JA Solid-State Color-TV Chassis

by Joseph Zauhar

One common solid-state signal board drives  
various color-TV set screen size models

■ Many of the new color-TV sets are employing plug-in modules, but General Electric is using a different standardization approach in their small-screen-size TV sets. The unique approach uses a signal board that is standard between all different sizes, and then uses plug-on modules for all circuits and features that are not common.

This new chassis was designed with the help of field service technicians, and the TV set was given a high rating for accessibility and serviceability by an independent service review panel using the NEA (National Electronic Associations, Inc.) rating form for an all solid-state color-TV set. The serviceability features are quite similar to General Electric's "U" line B/W chassis, which is also designed to cut service time without a large inventory of parts and special equipment. Most of the chassis problems can be diagnosed by using many of the servicing techniques used in tube-type chassis.

We received for lab purposes, a Model JA7458WD employing the 19JA solid-state color-TV chassis. The 19-in. (measured diagonally) table model color-TV set incorporates a 19VCRP22 picture tube. Located on the front control panel of the TV set are the BRIGHTNESS, CONTRAST, COLOR, and a three position TINT LOCK control hidden by a swing-open panel. This tint lock

feature is a part of the one touch color circuitry which modifies the receiver's color reproduction so that objects which normally appear greenish-yellow or reddish-magenta will be reproduced as reddish-orange. This control has the three positions to compensate for transmission variations which cause skin tones to be tinted green or magenta. The VOLUME control is the slide-throttle type. Also, included on the control panel is the AUTOMATIC COLOR button which puts the advanced ONE TOUCH COLOR SYSTEM into action—including the AFC

color and tint range lock circuitry. These circuits enable the customer to get a good color picture by merely pressing this AUTO button, but still allows him to make minor COLOR and TINT adjustments.

As we adjusted the TV set for a normal picture, we noted that the operation of the BRIGHTNESS and CONTRAST controls is slightly different from other TV receivers; and when the CONTRAST control is at maximum contrast, the BRIGHTNESS control has a limited range of adjustment. We found the difference in the adjustments to be normal be-

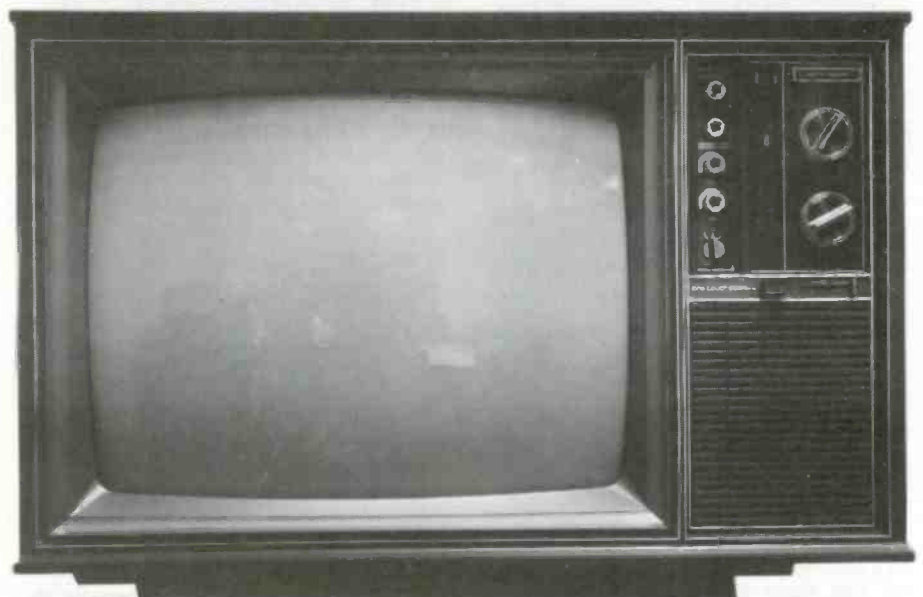

General Electric's Model JA7458WD TV set with the One Touch Color system and employing the JA color-TV chassis.

cause of the dc restoration circuit configuration.

The VERTICAL and HORIZONTAL HOLD controls are located on the back of the chassis. By pushing in on the HORIZONTAL HOLD control shaft, a sync shorting switch is activated, killing the sync and causing the picture to float, allowing a more accurate HORIZONTAL HOLD setting.

The JA chassis series employed



Most of the controls are hidden by a panel door. The One Touch Color system is activated by pushing in on the "auto" button, which is then illuminated. Also featured is a slide-throttle-type VOLUME control.

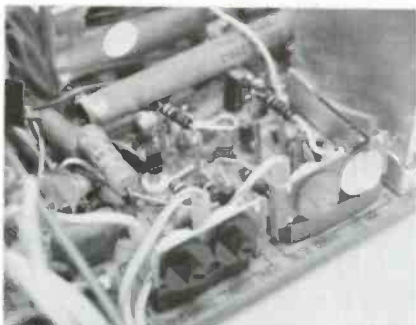

Plug-in resistors are used to change the color drive signal for the different screen sizes.

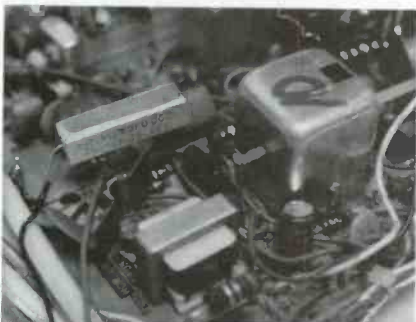

When the HORIZONTAL HOLD shaft is pushed in, a shorting switch (center) is activated, killing the sync signal and causing the picture to float, for a more accurate HORIZONTAL HOLD adjustment.

in this TV set is completely solid-state, with the exception of the picture tube. This chassis employs 38 transistors, 30 diodes and 3 integrated circuits, plus the additional solid-state devices used in the tuners and optional circuits such as AFC, one touch color system and AUTOMATIC CHROMA control.

This chassis uses the full disconnect potential using plug-in connectors and a step-toward standardization by employing the same main signal processing circuit board in the 10- and 16-in. screen-size TV sets.

One of the differences between screen sizes is that less color drive signal is needed by the smaller picture tube. The RGB output must provide 100v p-p black to white, 100 percent restored for the 10-in. and 130v p-p for the conventional delta gun 19-in. used in this chassis. This is accomplished by one resistor change controlling the gain of the driver to the RGB output. Except for this small change, the color output stages of the main board remains identical. The higher output for the larger screen requires a

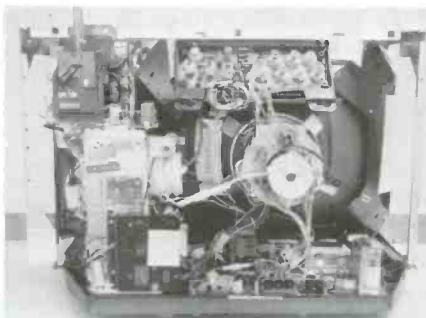

Rear view of the TV set showing the main signal processing board (bottom) which contains a major portion of the circuitry also common to the 10-in. and 16-in. screen size Color-TV sets. Plug-in modules and components are used for those circuits and features which are not common.

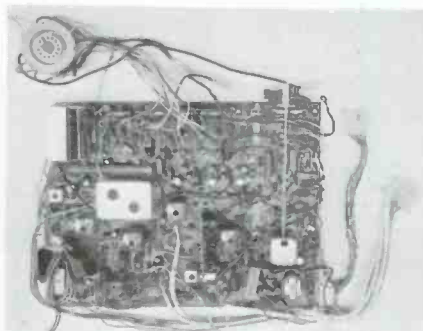

The complete solid-state signal processing circuit board uses plug-in connectors for easy removal without using a soldering iron.

higher collector supply for the RGB output amplifiers than the 135v dc rectified from the line voltage. Scan-rectification generates the additional 65v dc and is stacked on the 135v to obtain the 200v dc to supply the collectors of the RGB amplifiers. Heat sinks are also added to handle the extra power dissipation.

Two different vertical output modules are needed for the different screen sizes. The desired module is simply plugged on to the common signal board. A different high-voltage sweep transformer is required for the different screens. Two leads in a plug come off the signal board and connect to the base of the horizontal output transistor on the correct high-voltage transformer assembly, which also contains the low-voltage supplies.

### Serviceability Features

There are a number of advantages to this standardized approach. Once the service technician in the field is familiar with the "JA" chassis he will be able to service all screen size chassis. Part inventory will be reduced because there will be a greater number of common interchangeable parts.

Many plugs and sockets are employed in the TV receiver to facilitate troubleshooting by allowing quick substitution of components and providing a means of quickly isolating a fault to a particular section of the TV set. As an example, the vertical sweep amplifier module and the AFC module (when used) are assemblies which are mounted in sockets so they can be replaced or substituted very quickly. The main circuit board, picture tube socket and the deflection yoke can also be disconnected or replaced without the use of a soldering iron.

In the main chassis integrated circuits are employed in the Video IF, audio and chroma circuits. These integrated circuits, 10 discrete transistors, and the high-voltage rectifier, plug into sockets, simplifying removal when replacement is necessary or when using the substitute method of troubleshooting to reduce repair time.

You may have had difficulty removing tuner covers for cleaning or repair in many TV sets, and often needed special tools for removal of

the tuner assembly. The tuner cover on this chassis may be removed without dismounting or disconnecting any other components and is mounted for easy accessibility.

The circuit boards are clearly roadmapped on both sides with component numbers, functions and test points.

Servicing labels are placed inside of the cabinet as a quick service aid. These labels are not a substitution for the service manual, but they do provide the most essential service information when the service manual is not readily available, and in many cases they eliminate a trip back to the shop for service information. The labels include the schematic diagram, chassis layout, adjustment guide and a disassembly label. Also included are the transistor functions, locations, basing diagram and catalog numbers.

The transistor functions are printed in red to improve readability. The layout label shows the picture tube socket lead identification and the location and function of the main service controls. Adjustment procedures for high voltage, purity, convergence, gray scale, and brightness centering are given on the adjustment label.

For fast diagnosis, a computer-type troubleshooting chart is included for the JA solid-state color chassis.

As we review some of the important circuits found in this solid-state color-TV chassis, they can be followed in Tekfax schematic 1432.

### VHF Tuner

The VHF tuner employed in this TV set is a wafer-switch type using three transistors. A MOSFET is used as the RF amplifier, and NPN bipolar transistors are used in the oscillator and mixer stages. The VHF input terminal impedance is  $75\Omega$  and is connected by a shielded cable to a  $75\Omega$ -to- $300\Omega$  balun mounted near the VHF terminals on the rear of the receiver. Co-channel or harmonic interference on cable systems is minimized by using shielded cable between the antenna terminals and the VHF input.

### Video IF, AGC Circuits

The first two stages of amplification, plus several sections of the

keyed AGC system are contained in an integrated circuit, IC101. The third stage employs a discrete transistor, Q103, for amplification, which is a transistorized version of the stage used in previous General Electric tube-type receivers.

The video detector circuit is basically the same circuit employed in General Electric's C-1 and C-2 color-TV chassis.

### Video Amplifier

The video amplifier circuitry used in this chassis is divided into two sections—one consisting of transistors Q104 and Q106, and the other transistors Q108, Q109 and

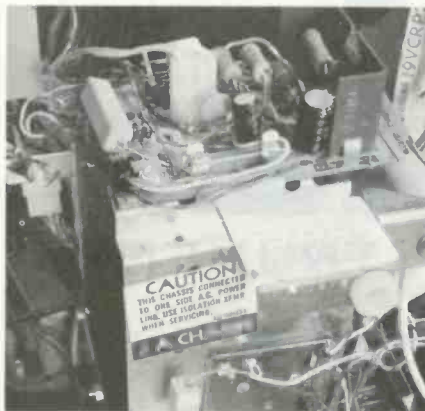

The power supply panel is located on the top of the high-voltage cage.



After the cabinet back cover is removed, component removal can be further simplified by removing one screw and sliding the bottom panel out.

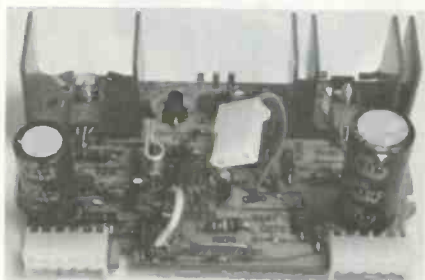

One of the vertical modules which is plugged into the common signal board to compensate for the different screen sizes.

Q110. The amplifier stages in each section are dc coupled, and the sections are separated by ac coupling.

A dc restoration circuit is used at the input of the second section. This circuit clamps the most positive portion of the video signal to a voltage level determined by the setting of the BRIGHTNESS control. Because at this point, the sync pulses are the most positive part of the signal, they

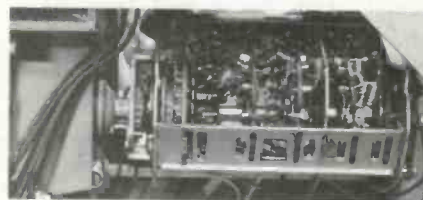

When the tuner cover is removed, most of the tuner components are exposed for cleaning or servicing.

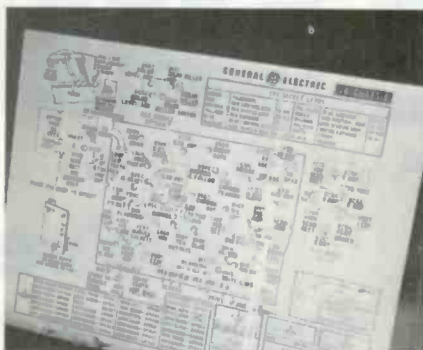

Servicing labels are placed on the inside of the cabinet or on the chassis—providing essential service information, such as chassis adjustments, schematic diagrams, chassis layout and catalog numbers.

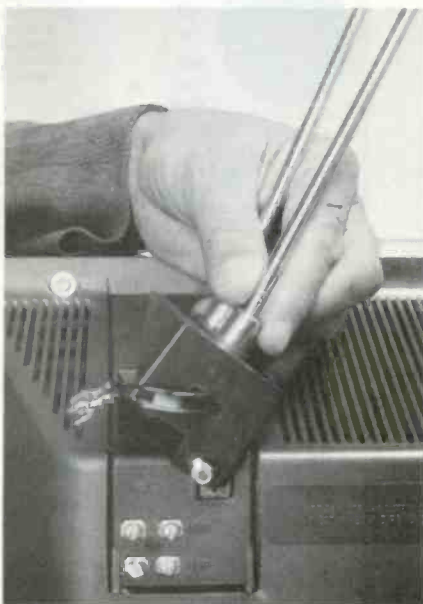

The antenna assembly can be replaced by removing one screw and the antenna terminals, eliminating the need to remove the back cover of the TV set.

are the part of the signal upon which the restorer circuit operates. And with this dc-restoration circuit configuration, the operation of the BRIGHTNESS and CONTRAST controls differs slightly from other receivers and should be adjusted in the following manner:

Adjust the BRIGHTNESS control so that the very dark objects or areas in the picture appear black. (If too bright, dark areas will look gray and washed out.) Then increase the CONTRAST so that the picture is bright enough for room lighting con-

ditions and there is a proper balance between the light and dark areas of the picture. To compensate for changes in room lighting adjust the CONTRAST control—no further adjustments of the BRIGHTNESS control being required.

#### Power Supply

A standard half-wave rectifier is combined with a scan rectified, 22v regulated B+ supply in the JA chassis.

Scan rectification is a method of converting horizontal sweep energy

into a dc voltage. The conversion is accomplished by a winding on the horizontal-output transformer, which inductively transfers the horizontal sweep voltage to the scan rectifier, Y402. It then rectifies this sweep voltage during the relatively long scanning period. The scan rectifier is reverse biased and does not conduct during the relatively short duration of the retrace pulse. The rectifier's output is then filtered by capacitor C418 and regulated by transistor Q400 and its associated components.

Transistor Q400 is a series regulator operating without feedback, and a 22.5v reference voltage is developed at its base by the zener diode, Y404, and the path provided by rectifier Y403, and resistor R416.

The circuit—consisting of zener diode Y404, resistor R18 and capacitor C420—also provides a separate 22v supply for the sweep circuits of the receiver. Transistor Q400 regulates by acting as a variable resistance. As the circuit current increases, the emitter voltage begins to decrease because of the increased voltage drop across Q400. This condition increases the forward bias on the base-emitter junction of Q400, causing it to conduct more heavily. More conduction by Q400 is comparable to a decrease in its resistance, restoring the supply voltage to normal. A protection against momentary short circuit conditions in the 22v line is provided by resistor R414 and diode Y405, limiting the amount of current through Q400 during overload conditions.

Next month we will continue with review of the new advanced "One Touch Color" system, which enables the customer to get a good color picture by merely pressing a button. This new system still allows minor COLOR and TINT adjustments to suit his own taste. Also included will be the high voltage, chroma and other important new circuits. ■

# Leader

AUDIO TEST INSTRUMENTS

**We've got a lot of good things going for you.**



**LSG-231 FM MULTIPLEX, STEREO GENERATOR.**  
Checks balance, separation and alignment. Unequalled stability, accuracy. ±1% @1KHz signal accuracy; 0-3Vrms output, cont. variable. Access. Included. \$229.95

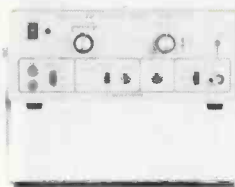

**LBO-501 5" TRIGGERED SCOPE.**  
Lab grade, solid state performance. Has DC to 10MHz bandwidth; built in calibrator; 35nsec. rise time; 5X sweep magnifier; 20MV/cm vert. sensitivity. With probes. \$389.95



**LFM-36A WOW & FLUTTER METER.**  
Measure wow, flutter, drift—simultaneously! Drift Test Range, -5% to +5%; 3KHz signal frequency. Separate meters for each function. Solid state, direct reading. \$579.95

Write for details. See your distributor.



**LTC-905 CURVE TRACER**  
Test transistors, triacs, SCR's, diodes, FET's, & MOSFET's, in or out of circuit, 8 precise volt or amp. steps. Has horiz. length adj. to 100V sweep. With special probe. \$119.95

**The more you see... the more you believe... the more you save**

Leader Instruments Corp. 37-27 Twenty-Seventh St. L.I.C., N.Y. 11101 (212) 729-7401

... for more details circle 119 on Reader Service Card

## MOVING?

Be sure to let us know your new address. Please enclose a complete address label from one of your recent issues.



# WIN THIS FORD ECONOLINE VAN WORTH OVER \$3100.00

*and over \$1900.00 worth of tools, parts, test equipment, tubes and chemicals.*

Sometime this Fall, TECH SPRAY will ship the 1,000,000th can of BLUE STUFF. And just to say thank you for the way the Service Industry has made BLUE STUFF the Number One tuner care product, the lucky technician who purchases the 1,000,000th can will receive the FREE FORD ECONOLINE VAN loaded up with

ALPHA WIRE PRODUCTS - TV Flatline, Coax & Rotor Wire . . . . .	150.00	QUAM-NICHOLS - Case of 4" Replacement Speakers . . . . .	75.00
CHICAGO MINIATURE LAMPS - Replacement Lamp Assortment . . . . .	75.00	RAYTHEON - Assortment of popular Replacement Tubes with Tube Caddy . . . . .	270.00
CENTRALAB - 8 Dealer Service Kits of Fastach® II Controls, Wirewound Controls, Trimmers, Electrolytics, GP Capacitors, H.V. Capacitors & Packaged Electronic Circuits . . . . .	283.00	HOWARD W. SAMS - 1 Year's Subscription to Sams' Photofacts and all Specialized Service Data for that year . . . . .	250.00
O. W. DONALD - 500 No. 110 Service Forms and Formholder . . . . .	60.00	SWITCHCRAFT - Stereo Mixer . . . . .	75.00
LITTLEFUSE - Assortment of TV and Radio Replacement Fuses . . . . .	40.00	TECH SPRAY - Complete Assortment of Chemical Products . . . . .	330.00
OHMITE - 1/2 Watt Carbon Resistor Assortment . . . . .	20.00	TRIPLETT - Model 603 FET Volt-Ohm-Milliammeter . . . . .	150.00
POLARIS INDUSTRIES - High Voltage Probe . . . . .	25.00	WALDOM - Several Assorted Hardware Service Kits . . . . .	75.00
		XCELITE - 99SM Servicemaster Tool Kit . . . . .	29.00
		<b>TOTAL</b>	<b>1907.00</b>

*Just be the lucky technician that purchases  
the 1,000,000th can of BLUE STUFF.*

No, there is nothing special you have to do to participate . . . just keep on buying BLUE STUFF like you have been. Or, if you want to increase your chances of winning by stocking up, you can buy a case of 12 cans of BLUE STUFF for the price of ten at any participating jobber. Offer good in the United States and Canada only.

**TECH SPRAY . . . makers of chemical tools for Technicians.**

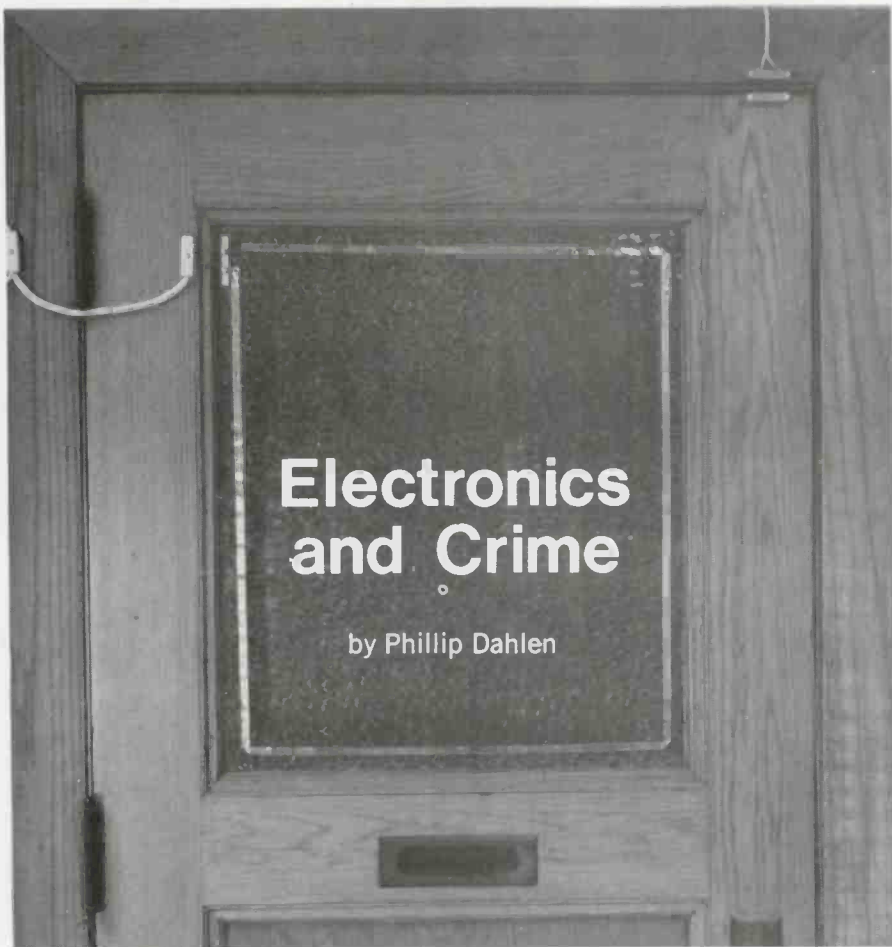

# Electronics and Crime

by Phillip Dahlen

One of the doors to the ELECTRONIC TECHNICIAN/DEALER Lab was secured by installing EICO conductive foil around the inner perimeter of the window, and wiring in a magnetic door switch.

## Crime certainly does pay for those entering this rapidly growing field

■ When out on a house call to fix that defective TV set, one has a perfect opportunity to case the joint as a future burglary site. Look for those doors that can be easily forced open, windows that can be readily broken and entered, plus, of course, the valuables—such as Hi-Fi sets, TV sets, etc.—that are sitting out for a quick take. Think of how easily you could pull the job and what it's worth.

Yes, such service calls do represent a "golden opportunity" for you—not as a potential criminal, of course, but as an imaginative businessman.

Tell your customers what you have noted, point out the rising crime rate and suggest that they protect themselves electronically.

But wait a minute. We've already gotten ahead of ourselves. Yes, this

does represent an excellent source of additional revenue—electronic crime fighting, that is. However, just as it is rather stupid to go in and attempt to fix a customer's color-TV set without any knowledge of color circuitry, it is equally important that you have some knowledge of the types of security systems now on the market, how they function, and the most effective way to install them to be certain that they perform as intended by the manufacturer.

Just as a criminal runs a risk when he breaks into a home, you run a risk when designing and installing a system for your customer's protection. Just imagine the predicament you would be in if some woman about to be attacked in her home just managed to press the alarm button that you installed . . . and *nothing happened!*

At least one security-system manufacturer requires that its products be installed only by those certified by Underwriters' Laboratories, Inc. In order to qualify for such certification, one must use only the devices and equipment of a type listed or recommended by UL for that application. A minimum of four electronic security systems incorporating this listed equipment and installed in compliance with their approved specifications must be inspected by UL for evaluating your competence in this field. You must also be able to demonstrate to their satisfaction that you have an effective maintenance program for these systems.

For the initial Underwriters' Laboratories visit, a cost limit of \$320 is currently specified, not including travel and expenses. The annual fee is currently \$240, plus \$2.00 for each outstanding certificate issued for an installation.

This certification does, of course, provide you with standards upon which you can base the quality of your installations . . . a level of achievement that can be promoted to customers for increasing your business. However, such certification *does not* serve as a substitute for good liability insurance. As stated in one of their booklets, "Underwriters' Laboratories, Inc. assumes no liability for any loss which may result from failure of equipment, incorrect certification, or non-conformity with requirements." (More information about UL's program concerning local burglar alarm systems can be obtained by writing to: R. D. McCleary, Associate Managing Engineer, Burglary Protection and Signaling Department, Underwriters' Laboratories, Inc., 333 Pfingsten Rd., Northbrook, Ill. 60062.)

In many states liability insurance programs represent still another reason why it pays to belong to a professional service association. Many state associations now offer group insurance programs designed to offer you liability insurance in conjunction with your installation of intrusion alarm systems.



It is also important that you check any state or local building codes and/or laws that might regulate the sale and installation of burglar alarm systems.

One of the first questions prospective security system customers are probably going to ask you is where you have installed other security systems. If your own shop isn't at the top of the list, you might as well forget their business. And let's face it, a burglar would probably be even more interested in robbing your shop than in robbing your customer's home. Look at all the expensive test instruments that you have that could be sold for a good price through a fence. (The article beginning on page 43 of this issue tells of one service dealer's efforts to attain such self protection.)

Before even installing your own security system, become familiar with all the electronic security products that are available and investigate various security system designs. We have attempted to assist you in this effort by including in this article a listing of most sources available—including, for your convenience, reader service numbers for virtually all but the book and booklet that you may wish to purchase. It should also prove worth your time and money to seek the advice of those that have considerable first-hand experience with electronic security systems—including the Crime Prevention Consultants described in the article beginning on page 55 of this issue.

Experiment, as we did, with a number of security systems before making your first installation.

Probably the simplest security system would be an apartment in which various rooms contained alarm switches resembling door-bell buttons. With the first sign of an intruder, one of the buttons would be pressed by the occupant, sounding the alarm. More elaborate systems use buttons connected to small transmitters that activate the alarm system with an RF signal—generally conducted through the power line.

Another basic system might

merely consist of conductive foil secured around the inside perimeter of a window—as shown in the photo containing the title of this article. When breaking the glass, the conductive foil also breaks (if cemented securely and located properly), breaking an electrical circuit, which trips a relay and sounds a bell or horn.

Magnetic-reed switches may be used in conjunction with one or more magnets on window frames or doors (as also shown in the same title photo). Opening the door or window moves the magnet, which causes the switch to open, tripping a relay and sounding the alarm.

Many of the alarm systems contain batteries that maintain the system during power failures. Some of



*Terry Tuttle, Chief Engineer (left), and Tom Turnbull, Development Engineer for Delta Products, are authors of a series of articles beginning next month concerning the design and function of ultrasonic intrusion detection systems and automatic telephone dialers.*

these batteries are kept charged by the system.

In addition to an assortment of foils and switches—many of which are included in the listing at the end of this article—there are also sound detectors and mechanical motion detectors, besides ultrasonic, microwave, infrared and video intrusion detection systems.

The ultrasonic system—which will be described in detail in a series of articles by Terry Tuttle and Tom Turnbull of Delta Products, Inc., that we plan to begin next month—emits sound at a frequency above the audio range. Any significant motion in the area reflecting that

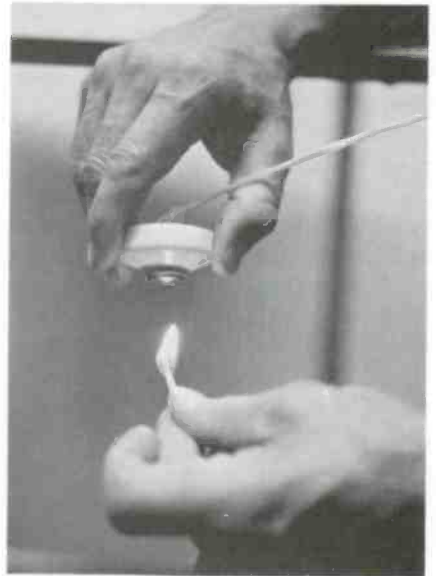

A lighted match was used to test an EICO 135°F heat detector that could be attached to the alarm system to add fire protection.



Investigating EICO's Security Control Center.

sound back to the alarm system—such as the motion of a person not belonging there—will change the pitch of the reflected sound (the Doppler effect), activating the alarm system. Some systems of this design sound false alarms due to the motion of air, i.e., from ventilation systems, while other ultrasonic alarm systems are designed to reduce or eliminate such problems.

Microwave systems also use the Doppler effect, although they use a low-power UHF signal instead of sound. Such systems are not effected by air motion, although some are effected by fluorescent lights—which produce an interference corresponding to the signal generated as an object in the reflected microwave field moves about 5 miles per hour.

Infrared detection systems sense

the body heat of the intruder—this heat activating the alarm system.

None of these alarm systems will function unless the intruder enters the alarm system's area of sensitivity—which they may be experienced at avoiding. In some areas the flashing light, horn or alarm bell will immediately attract neighbors, who will come to the rescue. Unfortunately, in other areas this emergency alarm signal will remain ignored . . . as in some reported instances when even an act of murder is not interfered with on a busy street!

Automatic telephone dialing systems (we have an article describing such a system which will follow the subject of ultrasonic alarm systems in a future issue) can be used to automatically dial any predetermined telephone number and give the alarm message. There is even an alarm that can be activated if the telephone line is cut. Maybe then one might automatically send the alarm message via a battery powered transmitter on the Citizens' Band Emergency Channel 9, or some police frequency.

The video system is probably the most sophisticated system for intrusion detection. Any sudden changes in the image observed by the CCTV camera can activate the alarm system. But the police will hesitate to break-in to investigate a false alarm, and will proceed differently if they observe someone armed inside. Narrow-band CCTV systems permit a continual, economical transmission of such information via conventional telephone lines.

There is virtually no limit to the number of possibilities in the design of an effective intrusion detection and alarm system. Unfortunately, the more sophisticated the system you use, the more sophisticated the burglar becomes. However, at least you can feel certain of eliminating the amateur burglar; and the better your system, the more likely the burglar will either be caught or go elsewhere with his business. ■

#### 700 ON READER SERVICE CARD

The Model 6200 Infrared intruder detector from Advanced Devices Laboratory, Inc. is a self contained, all

## THIEF WIPES OUT TV SHOP . . .

Gentlemen:

While moving from Mt. Prospect, Ill. to Kansas City, Mo. on May 2, 1972, our rented truck, containing all our possessions and my complete TV show, was stolen. To date, nothing has been found.

I hope that this letter may alert shops to some of the stolen items.

My shop included 2000 tubes, four special aluminum tube caddies (like skate cases), two 60 drawer cabinets, four bench lights, fluorescent lights, hundreds of tools all marked with a "B" or "W.R.B." on the handle, a Wen 250 and two Weller Model 8200 solder guns, three soldering irons, Sams schematics (that I had edited to remove obsolete schematics—to save weight), TAB schematics, ELECTRONIC TECHNICIAN/DEALER schematics in a Sams Binder from 1960 to 1972—plus the following instruments:

B & K Model 700 Tube Tester—with a special 10-pin miniature tube socket mounted at lower left corner on top  
 Heathkit 10-12 Wide Band Scope—with a special flyback test tap at lower right hand corner in front  
 Electro D612 Power Supply for Auto Radios  
 B & K Model 177 VTVM  
 B & K Model 162 Transistor Tester  
 B & K Model 445 CRT Tester  
 Sencore Color Generator with mirrored lid  
 Heathkit Capacitor Tester and VTVM  
 Heathkit Audio Signal Tracer  
 Sencore Transistor Power Supply  
 Sencore Mighty Mite Tube Tester  
 EICO Sweep Generator  
 EICO Signal Generator  
 Precision Signal Generator  
 RCA Geiger Counter  
 Also six other instruments

I could not get theft insurance and it turned out that theft is not covered under the insurance of the truck rental company.

This loss has wiped out my chance of starting my own TV shop—at least for the present.

I hope someone may run across some of these items. Maybe it would lead to the recovery of more of them.

Yours very truly,

*Wm. R. Burgess*

Wm. R. Burgess  
 8915 McGee  
 Kansas City, Missouri 64114

solid-state system that utilizes infrared energy as its means of detecting the presence of an intruder.

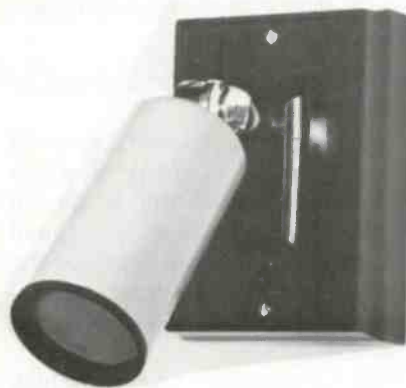

#### 701 ON READER SERVICE CARD

Alarm Products International has a 22-page catalog, Catalog-G, which describes their complete line of security systems, including control panels, bells, sirens, magnetic contact switches,

vibration contact switches, door cords and tamper switches, plus related components.

#### 702 ON READER SERVICE CARD

TVID is a new system from Ampex that remembers and instantly displays a picture of who's who in your personnel file; permitting the company guard to compare an employee's face with his stored picture in 2 seconds on a video monitor. The basic system is said to be capable of storing a minimum of 1000 pictures, while being expandable to an unlimited number.

#### 703 ON READER SERVICE CARD

The Model HB-2 Anes Positive Action Car Alarm is designed to sound the regular car horn continuously when activated by an intruder. Specifications indicate that an optional "flasher" accessory may be added to pulsate the signal so that the horn will

*continued on page 64*



A police bullet missed the suspect and smashed through Couch's front window, damaging two Hi-Fi sets and breaking a color picture tube.

## Smash and Snatch

by Nick Adams

During the past four years, Couch's has been burglarized eight times

■ The smashing sound of breaking glass and the clanking clunk of a discarded iron bar broke the silence of a quiet night. Broken glass crunched underfoot as burglars hastened to load as much loot as possible from a once attractive window display.

The sleepy proprietor had to go downtown, take inventory to check the losses, supply the police with a list of models and serial numbers, determine the value of the stolen goods, and then make arrangements to secure the broken window before returning home.

According to Charles R. Couch,

Jr. of Couch's Inc., it was one of those, "Well, I've heard that before, but it will never happen to me," tales. Those were exactly his thoughts in October 1968. But since then several more burglaries have occurred, with much the same methods used each time.

Couch's Inc. is a small (about 15 employees) retail electronic dealership located in North-central Florida. The main items sold include TV sets, radios, audio components, tape recorders and accessories. The store has a large service department with a fleet of five trucks to support the sales force, including antenna installations.

The establishment is located on the main north-south artery in a university town [Gainesville] of about 65,000 people. The street is well lighted with mercury lamps and heavily traveled. Those factors, combined with the atmosphere of a friendly town, created a false sense of security that probably prevails

elsewhere throughout the country. Couch's was indeed ill prepared for the rash of break-ins about to occur.

Prior to this 1968 robbery, the store was simply locked up, with a time clock set to turn off the window lights at 11:00 p.m. After the robbery, the lights in the office area were left burning.

Just one month later, at around 4:00 a.m., a large rock went through Couch's window. Only two small B/W-TV sets were taken, so it is assumed that street traffic may have deterred this attempt. On the same night, five other businesses were robbed with the same "grab and run" technique.

Now all the lights in the front of the store were left burning in hopes of keeping would-be thieves away. The interior of the store was now quite visible from the street—even to those passing by in automobiles.

All was to little avail, however, for shortly before Christmas another window was smashed and out went three more TV sets. That night, eight other stores were also robbed, and the local glass installer had to advertise for more help.

The police, suspecting a grand gathering of merchandise for Christmas fencing, provided a stake-out for Couch's and other similar businesses.

Just three days before Christmas, on a very un-Florida-like night of 23°F, two policemen observed a pair of men drive up and park in Couch's parking lot. They proceeded to walk up to the well-lighted, front door and knock the glass out—as had been done before—picking up a fairly heavy 14-in. color-TV set and a 12-in. B/W-TV set.

The police shouted three times for the men to halt during the few moments that it took them to get out of their car and reach the middle of the street. Ignoring all warnings, the police then fired in the air, but this also failed to stop the would-be crooks. Then one of the police officers shot at them. This second shot smashed a showroom window, breaking the picture tube of a customer's TV set scheduled for December 24th delivery, plus damaging two stereo systems. The suspects were still running.

The next shots were fired at the



Despite frequent attempts to break through Couch's back door, it has remained firm.

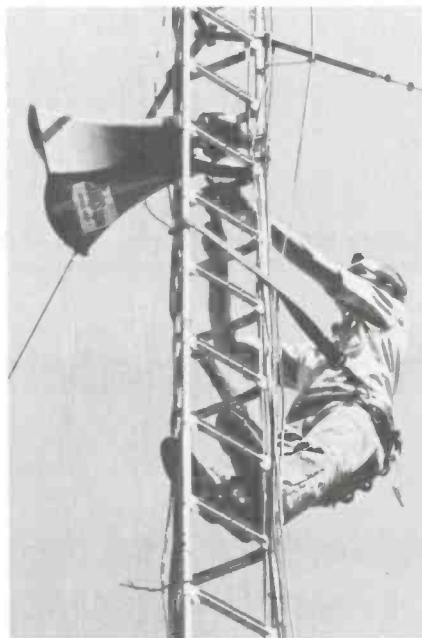

The speaker used with the alarm system is mounted 40 ft up the antenna tower.

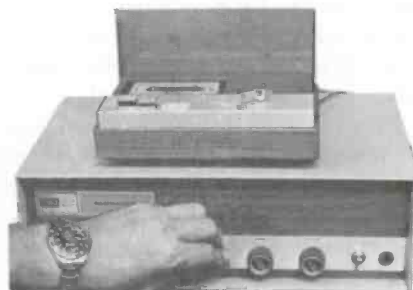

The tape recorder and amplifier for sounding the alarm through the tower speaker.

suspects as they ran into the side lot. One suspect was slightly wounded, while the other was seriously hurt and died on the way to the hospital.

The local GAINESVILLE DAILY SUN, owned by the NEW YORK TIMES, gave the incident front-page coverage. In subsequent issues their editorials condemned the police for the killing, each time mentioning Couch's, Inc. Although this gave the company much free publicity, this was the type of advertising everyone could do without.

Further diligent efforts by the police revealed that the surviving suspect had given his girl friend a color-TV set. This TV set proved to be one of those stolen from Couch's at an earlier date.

Freed on \$1000 bond before his trial, the suspect disappeared, and neither he or the other stolen merchandise has been seen since.

Except for an occasional attempt to pry open the back door, after that incident Couch's was not troubled by a burglary for two years.

To obtain better protection, Mr. Couch decided to install an alarm system of his own design. Magnetic switches were placed on all doors, the windows were wired with fine wire along the edges, and the system was connected via a telephone line to a central control board at the police station. If the circuit was broken, an indicator would light at a constantly monitored station.

Couch's was wired, protected and again complacent.

In February 1971, a group of real professionals paid a night visit. They found the telephone company terminal box and with a piece of bare copper wire shorted out all outgoing lines, defeating the alarm circuit to the police station. They then proceeded to knock out the front door and made off with five new B/W-TV sets. For some still unknown reason, they also removed a defective 14-in. color-TV set from the service department, while ignoring other new TV sets that were readily at hand.

About 30 days later the snatch and run gang neatly cut a large circular hole in the glass window about 6-in. from one of the window alarm wires—thus not activating the alarm system. This occurred around 5:00

*continued on page 75*

# TESA Wisconsin Features Crime Seminar

by Phillip Dahlen

Ex-offenders use personal experience to help electronic service dealers combat crime

■ David Egan, executive secretary of the Television and Electronic Service Association of Wisconsin, arranged a Crime Seminar as the feature topic of the association's spring convention. This seminar was conducted by representatives of Felons And Community Together (FACT), which is located at 3420 West Center St., Milwaukee, Wis. 53210.

The information presented at this seminar should be of extreme value to all electronic technicians and service dealers—potential victims of crime. Due to the unusual nature of the subject matter, the balance of this article represents quotes transcribed from the seminar.

Introduction by David Egan: Ansel Briggs is the coordinator of FACT—Felons And Community Together. With Mr. Briggs' help, we sat

down to plan with him a program of crime prevention that would bring to the members of the Grocer's Assn. ideas and people who are former felons, that could show them how they could tighten their individual store security to keep from getting "ripped off" as often as you seem to be getting "ripped off." The program was a tremendous success.

Mr. Briggs, then learning of your convention coming up through your TESA Wisconsin office, sat down and talked with us, and we surveyed his storehouse of people to find people that would be of specific interest to the television and electronic service industry—people who have knowledge of your industry from a peculiar vent. And without further adieu, and for your edification and knowledge, I present Mr. Ansel Briggs, a Crime Prevention Consultant.

Ansel Briggs: Thank you. That applause is almost like what it feels like when you "rip somebody off." You get a good feeling!

We got together about a year ago and formed an organization called FACT—Felons And Community Together. This is a group of ex-cons trying to help rehabilitate people coming out of institutions . . . trying to help you people . . . trying to keep you from getting "ripped off" . . . trying to get these people back on the main stream of life. And one of the things we're trying to do is use the expertise, the knowledge, the years of experience of armed robbers, forgers, boosters, safe crackers, to maybe give you a little bit of insight into what's happening in your own stores, as well as putting the ex-con back on the paths of





putting some creative input back into the community.

With me today, I have Don Schwannecke, a bad armed robber—he got caught; and Larry Barnekow, forger. Granada Miller (the fourth to have been present), one of the best boosters in the city of Milwaukee—who ripped off \$50,000 in six months—is in the hospital. The pace that we've been keeping, working with our organization and making conventions, proved too great a physical strain.

And then there is myself—a safe cracker and a burglar.

We'll tell you a little bit about the statistics that go behind the crimes, how many people get ripped off in burglary, forgery, boosting and safe cracking . . . the fact that most of you are easy marks . . . the fact that your stores are very insecure . . . you get the feeling that you're on the top of the pile.

Nobody could rip you off? You're very easy to rip off. You leave yourself open.

The profits from this organization, "Crime Prevention Consultants" go back into community projects . . . go back into FACT—Felons And Community Together—to help other people coming out of the institutions, either in a training program, consulting program or drug-abuse program. And we also feel that being here today is a service for us as well as for you. Ten years ago, I wouldn't talk to any one of you, because I felt that you were the people that put me in jail. Well,

I realize today that's different. Okay? I took control of my life.

But we will get into some of the things . . . some of them, not all of them . . . that we can do. And if you'd like us to, we'll come into your stores, do seminars, consultant work . . . sit down with your employees . . . to show you where you could make it just a little bit tougher and prevent kids or criminals from trying to rip you off.

At this time, I'll turn it over to Don Schwannecke, who'll go into the armed robbery. This is almost an impossible thing to stop, but there are different ways that you can make yourself a little more secure . . . that you can make a little more of a deterrent to people. Maybe you'll also understand why some of these people got into this also. Maybe it'll be a little bit of political consciousness arising . . . you know, to understand why the majority of people that rip people off are poor white, poor black, or poor Mexicans; and that because of social-economic reasons and because of their community, the reason they're involved in this. And maybe some input can go into a great change in this country.

**Donald Schwannecke:** Beyond a doubt, one of the hardest things to do is to prevent an armed robbery. There are a number of reasons for this particular statement.

Basically, the armed robber carries the gun to rip off his victim because he himself is afraid. He doesn't basically want to hurt anyone; but because of his fear and paranoia, he may just do that.

You've probably all heard of the cases of individuals who have . . .



with the aid of a gun . . . gone in to rob a bank or a food store or whatever . . . and at the same time the gun was empty. This is not an isolated instance . . . it happens very frequently. It's kind of stupid, but it happens. People who commit crime do so basically because of economic pressure.

There may be a lot of personal hassles that go on in a man's life that will lead up to that economic pressure . . . emotional hassles that they are unable to deal with in a community, or that the community is unable to deal with and respond to. But these emotional hassles often lead to an economic hassle, and you, the community, have to provide for the offender some way that they can answer their needs . . . and that way is often illegitimate through robbery, check cashing, armed robbery, etc.

Because of these financial pressures, which we of course want to relieve through some economic way, money is the only answer to this particular problem. In your specific industry, right now, probably one of the most sought after things for fences . . . in areas like Chicago, Philadelphia and New York . . . are electronic equipment. There's a great market for it. It can be sold at a very high rate of profit when you get it for nothing. And it's very easy to sell. There is always somebody on the block that wants to buy another TV set, or a stereo, or a tape deck for his car; and it's probably one of the most sought after items right now in the offensible market . . . other than drugs.

If I were to go into your store, I would probably not go in with a gun. Your particular industry, especially neighborhood TV centers that are doing repair work, are not generally ideally suited for an armed robber. There's generally very little cash on hand to make it worth your while to go in and risk getting yourself hurt, or hurting someone else.

But there have been incidents, and we're all aware of those. And there are ways that you can prevent it in your present set up . . . perhaps with the location of your cashiering. That's probably the most important area because that's where the money is.

I was talking about economic pressures. Because of these economic pressures . . . because of the sociological pressures that are coincidental with them . . . the armed robber is very often very mindless of the probability of getting caught. The gun he usually hopes will be enough of a deterrent . . . when he sticks it in his victim's face . . . that they'll be sufficiently scared . . . if not to recognize them, sufficiently scared that there might not be a recourse after the crime is committed.

This is one of the reasons why armed robbery is so hard to deter. In addition to that, parole is easy to make in the state of Wisconsin, and in most states today. The armed robber knows that if he gets a good count in his heist, it'll be well worth the two, three or five years he gets. The unfortunate thing is that it really isn't . . . that they really really don't know what's happening inside prisons today. But, again, we don't give that a thought when we go in and stick somebody up . . . all we want is the money . . . because we got bill collectors on our backs.

Most armed robbers are small-time people like myself. They're not syndicated hoods . . . they're not in crime for a livelihood . . . they're into it for a one or two shot deal to satisfy economic pressures of the time with the hope that they can alleviate these pressures, and then go back on the straight and narrow. It generally doesn't work. Most armed robbers are caught after a very short period of time in the business.

Probably the safest thing that an individual who is the victim of an armed robber can do is not hassle the person who's committing the crime . . . don't do anything to get him alarmed and upset . . . don't try to be a hero . . . keep cool and calm and collective. The minute you try to play the hero, you—the victim—could end up dead . . . or me, much worse than that, could end up dead—as the armed robber—and I'm not happy with that song. Nobody wants to kill anybody, and consequently the chances of anybody here trying to be a hero, I would assume, would be remote, but we have those cases.

Just recently I read in a newspaper in Florida where the proprie-

tor of a business wanted to shape up his personnel, so he masked himself, went in with a gun, and scared the h### out of his employees. And in the process of doing so, an off-duty officer walked by, saw him with the gun in his hand, and shot and killed him. This is where CPC (Crime Prevention Consultants) can come in . . . we can save your life in that respect. We have the knowledge, and we have the experience. We can help you, as individuals, set up the security methods that you need. We can do it, not only in the areas of my specialty of armed robbery . . . or my ex-specialty . . . but we can also do so in boosting and thieving and robbing. You're generally the "rip off" of a burglar. I've had some experience at that . . . I don't particularly want to talk about it, because it's something I haven't been busted for yet. But most of us have had some experience in that area . . . we can show you what's going on . . . we can show you how your little corner store is an easy let-in . . . either through the roof or through the window or through the back door.

We can show you how, in many cases, where you have TV setups [surveillance cameras] that you've been a rip off to the TV people that have come in and set up the cameras . . . because they didn't set them up accurately; and it's easy to hide underneath them without being in the range of the scope of the TV camera. And that's an industry you should know about anyway.

We can show you how burglar alarms can be messed with so that they don't go off. I'm sure that I saw some people shaking their heads . . . that you have been victims of that kind of thing. If you're interested in us, you can contact us through Dave.

And now I'd like to turn it over to Larry Barnekow.

**Laurence Barnekow:** I think one of the important things to keep in mind . . . to keep it down to reality . . . is the fact that you can't stop all crime . . . it's going to happen . . . but you can make places more secure.

I noticed a few people taking pictures, but I hope that they post those pictures on the wall. I know

you won't see any of our people in your stores trying to "rip you off."

I want to thank at least two of the individuals that I see in the audience, because they made about four years of my life very enjoyable.

I am a little different than Don—he carried a gun . . . and Ansel—who carried a crowbar. This is my weapon [his business suit], and I probably burned the people here worse than either one of these two ever did.

One kind fellow, sitting right in this room, was so excited over a \$600 TV sale that when I gave him an \$800 check, he took a 20 minute coffee break and ran to the bank to cash it for me. I'll bet he was kicking himself in the tail about three days later though . . . I had \$200 cash from him, and a \$600 set that I sold for \$500. Very likely . . . it's easy to do . . . and you people sitting



right here are the biggest gophers. You're the ones that the clerks take the checks to, you know, where you put your initials on it, sure . . . how many of you check those checks through. Not a d### one of you.

Believe me, I've had a lot of fun with you. I traveled to Europe, I've had more broods than I could handle, the best booze, money in my pocket . . . so I thank you for it.

I'm not here to brag about my accomplishments. I'm here to try and enlighten you so that you can save some of this money . . . you know, your waste of gas going to the bank to cash that check for me . . . just little things. You are the most susceptible for checks, for credit cards . . . because of the

# An Extraordinary Offer

## to introduce you to the benefits of Membership in ELECTRONICS BOOK CLUB

for a limited time only you can obtain

**ANY 3** OF THESE UNIQUE BOOKS ... yours for only **99¢** each ... with Trial Club Membership (Combined List Price \$35.85)

May we send you your choice of any three books on the facing page as part of an unusual offer of a Trial Membership in Electronics Book Club?

Here are quality hardbound volumes, each especially designed to help you increase your know-how, earning power, and enjoyment of electronics.

These handsome, hardbound books are indicative of the many other fine offerings made to Members... important books to read and keep... volumes with your specialized interests in mind.

Whatever your interest in electronics—radio and TV servicing, audio and hi-fi, industrial electronics, communications, engineering—you will find that Electronics Book Club will help you.

With the Club providing you with top quality books, you may broaden your knowledge and skills to build your income and increase your understanding of electronics, too.

### How You Profit From Club Membership

This special offer is just a sample of the help and generous savings the Club offers you. For here is a Club devoted exclusively to seeking out only those titles of direct interest to you. Membership in the Club offers you several advantages.

- 1. Charter Bonus:** Take any three of the books shown (combined values up to \$35.85) for only 99¢ each with your Trial Membership.
- 2. Guaranteed Savings:** The Club guarantees to save you 15% to 75% on all books offered.
- 3. Continuing Bonus:** If you continue after this trial Membership, you will earn a Dividend Certificate for every book you purchase. Three Certificates, plus payment of the nominal sum of \$1.99, will entitle you to a valuable Book Dividend which you may choose from a special list provided members.
- 4. Wide Selection:** Members are annually offered over 50 authoritative books on all phases of electronics.
- 5. Bonus Books:** If you continue in the Club after fulfilling your Trial Membership, you will receive a Bonus Dividend Certificate with each addi-

### SPECIAL FREE BONUS

... if you act now!

Yes, if you fill in and mail the membership application card today, you'll also get this Bonus Book, FREE!

#### 1972 POPULAR TUBE/TRANSISTOR SUBSTITUTION GUIDE

An all-in-one substitution guide for both tubes and transistors. 8 sections, 256 pages.

Regular List Price \$4.95

tional Club Selection you purchase. For the small charge of only \$1.99, plus three (3) Certificates, you may select a book of your choice from a special list of quality books periodically sent to Members.

**6. Prevents You From Missing New Books:** The Club's FREE monthly *News* gives you advance notice of important new books... books vital to your continued advancement.

This extraordinary offer is intended to prove to you, through your own experience, that these very real advantages can be yours... that it is possible to keep up with the literature published in your areas of interest... and to save substantially while so doing.

### How the Club Works

Forthcoming selections are described in the FREE monthly *Club News*. Thus, you are among the first to know about, and to own if you desire, significant new books. You choose only the main or alternate selection you want (or advise if you wish no book at all) by means of a handy form and return envelope enclosed with the *News*. As part of your Trial Membership, you need purchase as few as four books during the coming 12 months. You would probably buy at least this many anyway... without the substantial savings offered through Club Membership.

### Limited Time Offer!

Here, then, is an interesting opportunity to enroll on a trial basis... to prove to yourself, in a short time, the advantages of belonging to Electronics Book Club. We urge you, if this unique offer is appealing, to act

promptly, for we've reserved only a limited number of books for new Members.

To start your Membership on these attractive terms, simply fill out and mail the postage-paid airmail card today. You will receive the three books of your choice for 10-day inspection. **SEND NO MONEY!** If you are not delighted, return them within 10 days and your Trial Membership will be cancelled without cost or obligation. Electronics Book Club, Blue Ridge Summit, Pa. 17214.

### Typical Savings Offered Club Members on Recent Selections

Electronics Data Handbook: New 2nd Ed.	List Price \$7.95; Club Price \$4.95
How to Interpret TV Waveforms	List Price \$7.95; Club Price \$4.95
Solid-State Circuit Troubleshooting Guide	List Price \$7.95; Club Price \$4.95
Installing & Servicing Electronic Protective Systems	List Price \$7.95; Club Price \$4.95
Using Electronic Testers for Auto Tune-Up	List Price \$7.95; Club Price \$4.95
Basic Color Television Course	List Price \$9.95; Club Price \$6.95
199 Color TV Troubles & Solutions	List Price \$7.95; Club Price \$4.95
Digital Electronics: Principles & Practice	List Price \$8.95; Club Price \$5.95
Commercial FCC License Handbook	List Price \$8.95; Club Price \$5.95
RCA Color TV Service Manual—Vol. 2	List Price \$7.95; Club Price \$4.95
Citizens Band Radio Service Manual	List Price \$7.95; Club Price \$4.95
FET Applications Handbook	List Price \$14.95; Club Price \$9.95
199 Electronic Test & Alignment Techniques	List Price \$7.95; Club Price \$4.95
Electronic Musical Instruments	List Price \$7.95; Club Price \$4.95
Electronic Designer's Handbook	List Price \$9.95; Club Price \$5.95
Dictionary of Electronics	List Price \$6.95; Club Price \$5.50
Japanese Color TV Service Manual	List Price \$7.95; Club Price \$4.95
Solid-State Circuit Design & Operation	List Price \$9.95; Club Price \$7.95
Electronic Test & Measurement Handbook	List Price \$7.95; Club Price \$4.95
Computer Technician's Handbook	List Price \$10.95; Club Price \$7.95
Servicing Modern Hi-Fi Stereo Systems	List Price \$7.95; Club Price \$4.95

**SEND NO MONEY!** Simply fill in and mail postage-paid Airmail card today!





New Fourth Edition—A brand-new, enlarged edition of the ever popular circuit designer's "cookbook," now containing over 600 proven circuits, for all types of functions, selected from thousands on the basis of originality and practical application. Now you can have, at your fingertips, this carefully planned reference source of tried and

tested circuits. Selected from thousands submitted by distinguished engineers, these "thought-starters" are a collection of original circuits selected on the basis of their usefulness. This detailed compilation of practical design data is the answer to the need for an organized gathering of proved circuits . . . both basic and advanced designs that can easily serve as stepping stones to almost any kind of circuit you might want to build. 384 pps., 19 big sections, over 600 illus., 8 1/2" x 11".

List Price \$17.95 ● Order No. T-101



Everything you need to know to fix any major electrical appliance is contained in this comprehensive, up-to-date volume. The authors explain every step in great detail, and illustrate typical situations with detailed photos and drawings. Numerous troubleshooting charts help you pinpoint the cause of virtually any problem

in a matter of minutes. Repair procedures are included for dishwashers, clothes washers, dryers, water heaters, garbage disposers, and ranges, using typical models and case-history data drawn from actual experience. In every case, the material is based on practical, down-to-earth reasoning and techniques. 288 pps., over 260 illus. Hardbound.

List Price \$8.95 ● Order No. 555



Here's an opportunity to close whatever gaps there are in your ability to use modern, up-to-date equipment designed specifically to save you time and money. You'll quickly grasp the author's common-sense approach to using the right instruments, thereby getting the most out of your investment in test gear. You'll improve

your ability to use an oscilloscope, color bar generator, alignment generators, vectorscope, TV Analyst and sine, square-wave generators. The author also has included a description of his "curve tracer." With this simple scope attachment, you can rapidly assess the condition of diodes, transistors—even ICs—in or out of the circuit. 256 pps., over 230 illus. Hardbound.

List Price \$7.95 ● Order No. 577

Sylvania Monochrome TV Service Manual

Jack Darr's Service Clinic No. 2

Modern Radio Repair Techniques

SYLVANIA MONOCHROME TV SERVICE MANUAL

Complete service, alignment, parts and schematic data for all Sylvania black-and-white sets introduced during the last 5 years—from the A01 through B14, and 572 through 578 chassis. Contains everything you need including techniques for set-up, preliminary adjustments, tuner alignment, and repair and system alignments. The

content provides in-depth treatment of individual chassis with emphasis on specific troubleshooting procedures. Also, included are the latest factory-recommended modifications to help you eliminate "bugs." 19 complete schematic diagrams are printed on big double foldout sheets with waveform illustrations. 196 pps., 8 1/2" x 11", including 36-page schematic foldout section; and complete parts list for all chassis. Long life leatherette cover.

List Price \$7.95 ● Order No. 599

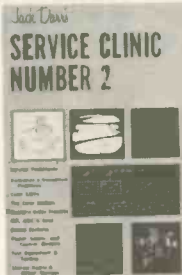

Here's more of the Jack Darr wisdom (and wit!) in book form—a valuable collection of timely service hints and trouble solutions covering color and monochrome TV, radio, stereo phonos, recorders, CB gear, etc. Discusses the "engineering" servicing approach, efficiency, and how a technician may condition his

thinking to produce more in a given time period. Like the first volume, the content was selected on the basis of usefulness to the average technician, covering a wide range of electronics devices. Each of the 10 chapters covers a general category of interest, and in each the subject matter is arranged in logical order to enable you to find what you need quickly. Not only provides a wealth of information, but also hours of enjoyable reading. 176 pps., numerous illus. Hardbound.

List Price \$7.95 ● Order No. 566



Up-to-date service data on all types of modern radio receivers, including AM, FM, stereo, auto and multiband . . . plus complete 36-page foldout schematics for 12 popular brand-name sets. Reveals many simple shortcuts to making radio repair a profitable side or main line of business. Material is presented so that seasoned technicians can gain from the numerous troubleshooting tips, and beginners, with a few hours study, can begin to turn out profitable work in a short time. Includes shortcut methods of troubleshooting, plus general test techniques, and how to set up a radio repair bench. Covers typical receiver circuits, and the fundamentals of circuit operation. 260 pps., 36-page schematic foldout. 170 illus. Hardbound.

List Price \$7.95 ● Order No. 580

TV, Radio, Hi-Fi Hints & Kinks

Handbook of Semiconductor Circuits

Practical Solid-State Principles and Projects

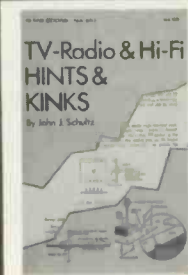

If you want to get the best performance out of consumer electronics equipment, you'll find this to be the most informative and useful handbook ever published. Over 150 ideas suggest ways to customize and add accessories to any equipment setup—how to connect single and multiple accessory speakers, how to add remote controls to

TV's, radios, hi-fi systems, how to connect microphones, etc. Also includes many tips on hi-fi equipment, CB and 2-way radio equipment, antenna systems, remote monitoring techniques, intercoms, a wireless baby sitter, telephone amplifier, moisture, fire and other alarm accessories for any existing amplifier. 256 pps., over 150 illustrations. Hardbound.

List Price \$7.95 ● Order No. 561



Contains 124 examples of standard transistor circuits, complete with operational data for amplifiers, oscillators, logic and switching circuits, power supplies, and various nonlinear circuits. The broad range of circuits included were selected on the basis of application and practicality. A design philosophy section is included with each group of circuits, thereby providing a basis for understanding circuits other than those selected as examples. This is not a handbook of "preferred" circuits, but rather a collection of practical circuits which have wide application and exemplifying good engineering design. Each circuit description includes data concerning any unique design or operational data, along with schematic diagrams. Hundreds of illustrations and diagrams. 448 pps., 6" x 9". Hardbound.

List Price \$8.95 ● Order No. G-30



Now build an electronic burglar alarm, solid-state timer, metronome, automatic night light, doorbell with a different tone for each door, CB receiver, stereo amplifier, battery charger, precision tachometer—52 unique projects in all, the required components to which are all readily available. These are just a few of the practical projects you can build, some of which use IC's and light-source diodes with microcopic circuitry. When not busy at the workbench, you can explore the realms of elementary electronics, conventional communications electronics, LEDs, light-activated SCRs, JFETs, MOSFETs, and TRAPATTs at your leisure. 176 pps., 127 illus. Hardbound.

List Price \$6.95 ● Order No. 590

AN EXTRAORDINARY OFFER...

... for more details circle 104 on Reader Service Card

There's  
an **Amperex**  
replacement tube  
for any socket in any set  
you're likely to service...

TV, HiFi, FM or AM,  
House Radio, Car Radio,  
P.A. System or Tape Recorder.  
Imported or Domestic!



**Amperex®**  
A  
NORTH AMERICAN PHILIPS  
COMPANY

**ELECTRON  
TUBE**

**Amperex**  
ELECTRON  
TUBE



AMPEREX SUPPORTS THE INDEPENDENT SERVICE DEALER

**Amperex®**

TOMORROW'S THINKING IN TODAY'S PRODUCTS

A NORTH AMERICAN PHILIPS COMPANY

■ It is most certainly our responsibility to use electronic intrusion detection equipment to help reduce the current crime rate. And as business men, we must work to protect ourselves from potential crimes. However, we have still another responsibility. To not merely see that the criminal is found guilty, but to see that once he has served his time that we do our part in keeping him from robbing us again.

The balance of this article consists of an exclusive interview with Donald Schwannecke, who offers some very useful suggestions concerning how this can be done. Mr. Schwannecke may not have all the answers, but statistics show that what we are now doing certainly is not the answer . . . most crimes now being committed by repeat offenders. Just as Alcoholics Anonymous has proven to be the most effective organization for helping alcoholics, an ex-con knows how to handle other ex-cons better than anyone else. What Mr. Schwannecke says doesn't apply to just some parole officer, it applies to those of us in the electronic industry . . . to you and me.

We have laws against discrimination, but right now the laws of discrimination protect the employer more than it does the ex-offender. Blacks and minority groups are included in the laws of discrimination, but ex-offenders are not. It's so blatant that even the state has laws that prohibit ex-offenders from getting jobs. The state leads the way in that kind of thing. Quite frankly, the ex-con is on the bottom of the s### pile, we are the last to be considered for employment in almost every case.

The first priority an ex-offender needs is a job. He's not only told by the division of correction . . . his parole officer . . . he *must* get a job . . . his own economic sustenance depends upon getting a job. And if he is barred from employment, what other relief does he have to provide food, clothing and shelter for his family. If he's turned off by all segments of society in terms of earning a living, he has to resort

## And Now What ?

by Phillip Dahlen



So you installed an alarm system and succeeded in catching the criminal . . . even helped get him convicted. Good work! Job well done! You have helped get a criminal off our streets. Now do you suggest that we kill him . . . use our tax money to train him to become a more efficient criminal . . . or provide some other alternative?

to illegal methods to sustain himself.

He knows that eventually he is going to make that trip back to the joint . . . because he knows that eventually he's going to have to get busted . . . the laws of averages are just against him.

We program people in the institutions for failure. When we come out of the institution, the community reinforces that failure, and what can you do but go back to jail?

Statistically . . . nationally . . . 75 percent of all crime committed in the United States is committed by someone with a previous felony conviction. That tells you what a dismal failure the community is . . . the dismal failure the prison setting is . . . what a dismal failure the court system is . . . what a dismal failure parole is . . . Where do you stop it? And who stops it?

For 20 years or so the prisons have been teaching barbering. Only recently has the union said . . . we will now give some credit toward an apprenticeship for the instruction learned in the prison. And that's only some credit. There are guys that may be barbering for five and six years inside the prison system, and when they come out they are probably better barbers than many barbers that are licensed in the state of Wisconsin . . . and they can't even get an apprenticeship.

Look at license plates. That's one of the biggest industries of the prisons of the whole state. But where on the outside can you get a job in a field like this? They're only made by prisons. So this is how they are teaching them a trade . . . teaching them something that is worthwhile, that they can constructively make a living at when they are out? Yet they have got to be in prison to be able to do this.

It's really a mixed-up kind of a situation.

I guess as an ex-offender and as an advocate for rehabilitation, generally speaking I say that I give a blanket indictment for all institutions. But on the other hand, if you look at individual programs within the various institutions, there are some good ones at the Green Bay Reformatory in the state of Wisconsin.

sin. The prison print shop instructor is a very fine instructor. I have gotten to know him very well. He's hampered because he has poor equipment to instruct on . . . outmoded equipment . . . equipment that the industry has ceased to use for a long, long time. In addition to that, the union bucks licensing or giving apprenticeships to any individual who has a prison record. Yet they carry this on as a training process in the institutions.

We have a fairly good basic electronics program in two of the state institutions. The problem with that is that in these two particular institutions—the reformatory and the Wisconsin correctional institution in Fox Lake—most individuals are not in those two institutions long enough that they can take advantage of the whole program. They'll get into it . . . maybe they'll get four or five weeks of it, or even six or seven months of it . . . and get transferred out to another institution where there is a greater need for that physical body. So his rehabilitative program ceases, because he is taken away from the program that he wanted to get into.

They also have some pretty good educational programs as far as academic programs go. You have got a start in it . . . and if they need you to cut trees in another institution or another camp, they will transfer you out regardless of what you may be doing or how close you might be to the completion of your program.

They have got a very fine masonry program at Fox Lake, but the instructor has not been in the community. He doesn't know what's going on and the changes that are being made in masonry. My g###, we're using designs in masonry today that are the next thing to . . . a beautiful structure . . . real art work. He doesn't instruct in that kind of thing. Here's a brick. Slap it down. It has to be so high, so square and so forth . . . that's it. And these guys . . . even if they were in the program to completion . . . when they come out, they are not equipped through the training that they have had to keep up with the way the techniques are being utilized in the community today. And you

can say that almost across the board.

This is the kind of thing that the prison setting continually perpetuates . . . meaningless jobs that they are training on . . . and then on top of that, whatever meaningful programs that there are . . . there is no reinforcement in the community once the individual is paroled.

If a training program is a good program, and he gets a smattering of an education inside the institution . . . that program should be an on-going program . . . so that when he is paroled and while he is still under the jurisdiction of the state department division of corrections . . . he should still be able to continue that training within a community so that when he finished that training he can get himself a decent job. That seems to make sense to me. It is not happening right now.

One of the reasons why we are going into an economic program in our agency . . . I'm tired of having people coming to me and look for work . . . and I can't give them a job because the community isn't responding. And the only segments of society in Milwaukee that have been responding are like car washes, foundry work, tannery jobs and stuff like that.



Not everybody can work in a tannery . . . and not everyone can work in a foundry . . . not everybody can work in a car wash at \$1.60 an hour . . . especially if they have a family.

So what can we do to respond to individuals who can't get a job? Well, the answer seems to be . . . to us . . . to develop our own business . . . train our own people so that they can get into a meaningful kind of work and be guaranteed a job after the training. And that's what we want to do.

The thing that we're looking into now . . . that you might be interested in . . . we're looking into an electronics/small-appliance repair center. A number of individuals going through the prison setting do get

into and involved in electronics. They get a smattering of basic electronics. Those individuals that have not only the aptitude but the desire to get into that program . . . we would like to have a company where we could put them through very intensified training, and when they finish their training they would be guaranteed a job within that company. Maybe we'll only train 25 guys . . . maybe the company would only lend itself to 25 employees, but these would be 25 employees that will be trained in meaningful kinds of work. Electronics is a big field, and it's going to get bigger.

What we hope to do in Milwaukee is get into television and stereo repair plus into hospital diagnostic equipment and automotive diagnostic equipment. If we can do that, we will have a good business going . . . we will work with retailers as far as television and stereo are concerned . . . work with hospitals . . . work with service stations. We have a reason to believe that there is a good market for it—just based on very preliminary market studies.

The only reason why a guy would be forced to leave our company, or asked to leave our company, or leave our company would be: If he wanted to get into his own business . . . hopefully then we would try to help him through a small business association loan or whatever. If he would go on to a better job, because there are probably a lot of companies that could pay him more money than we could pay him. Then the third reason would be if he was just a bad employee, you know, we would intend to be a profit making company, and as a profit making company we do not intend to perpetuate bad attitudes and work habits . . . and if we can't work with that individual . . . then after giving it every effort that we can through our social services at FACT we find that we can't reorientate that individual to good work habits . . . well then we will have to cut him loose and make a vacancy for another person.

These would be the only three reasons why we would see anybody leaving our company, and we would do what we can to promote people

leaving the company to go into their own business, or into better jobs. And we not only fully intend to train as far as technicians are concerned . . . we want to train on the level of management and mid-management positions . . . and sales and things of that nature. These are industries that are pretty much closed out to the ex-offender.

If a guy goes into jail and through this process of rehabilitation becomes somewhat pseudo-sophisticated and feels that he has more to offer than what his academic credentials say he has to offer . . . and he wants to get a job . . . say as a sales manager or as an office manager, or maybe learned accounting and would like to get into accounting, or maybe he feels that he could run his own business but he doesn't have the training for it . . . he will be able to get that training within our company.

From the janitor to the president—they will all be ex-offenders. On the other hand, we do hope to use community help. We will need people to do the initial training of our people; and thereby we may draw upon the people of the community, the people who are now in electronics . . . draw them in.

There is a lot of unemployment in the field of electronics in Milwaukee. We can draw these people in and give them a job as trainers, and teachers, and educators, and train our people. It should be a worthwhile project. We can't get it off the ground because we don't have any money around. And that is unfortunate because I don't know when the money will come forth. I've been working on it for almost a year, and I'm not too much further ahead on it now than I was a year ago.

One of the big things that society itself does not realize is what it's like for somebody coming out from behind bars . . . whatever type of institution it is or what degree you were sent up on . . . you come out and try to make a go of it . . . the straight and narrow as society calls it . . . the emotional things you go through. I know that in the last four years I've gone through a h### of a lot. Different jobs that you apply for that you really, really feel

that you were capable of doing . . . and really wanted to do . . . and were heartened so into it . . . and it was a question . . . do you lie on the application, saying you were never convicted of anything and never arrested in hopes that you'll get the job . . . and if you do get it, the fear that your employer is going to find out that you lied . . . and if he does find out, it's like an automatic firing. If you tell the truth in the beginning, you are completely disqualified from even getting a chance at that job.

If you want to plan on getting married and having a family, whatever . . . you can't get life insurance . . . you can't plan on a decent job . . . any kind of a decent providing for that family. It's like you once do something wrong and for the rest of your life you pay for it. There is no way in h### that you can make up for it and prove that you don't really intend to carry on the rest of your life this way.

If you have never committed a crime and for some reason you get into it, you never live it down, you never escape from it . . . because even after you have served your time, even after you've gotten off parole . . . that prison record, the conviction, the sentence, what you have done are all a matter of public document and can be looked up by any employer or any credit agency or whatever. All they have to do is just call the police department to find out if Mr. X has got a record. And if he has, he can be discriminated against in all kinds of ways.

I am not a very religious person . . . and one of the reasons for my lack of involvement in religion . . . when I say religion I don't say that I don't believe in God and in Christ and the tenets of Christianity . . . I mean that I just can't get into a structural religion. Because I just can't stand to hear a minister talk about forgiving the flock and the wayward and all that kind of thing . . . and yet their lack of involvement with people . . . I mean their

real lack of involvement! They're not doing anything meaningful.

I have approached many a minister . . . at least a dozen and a half in the last four years . . . and asked them how they would feel if I would go with their daughter. And you can see the hairs go up on the back of their neck . . . you can see the appalling thoughts going through their minds. But they asped the rhetoric . . . well, if she loved you I wouldn't mind. But you know d### well that he's not speaking the truth. You can feel it! There are various ways that people show their animosity . . . you can just see that it's an appalling thought to that guy.

You know how many times I've tried to get church people involved in what we are doing at our agency? And they don't come forth, they just don't come over.

I challenged a church group here just a while ago. It was a small group . . . 12 people one Sunday morning. And one of the ladies asked what she could do to get involved. She said she didn't know too much. She has an interest, but she doesn't know what to do with it.

I said: If you want to get involved . . . I mean seriously get involved . . . and then I directed the dissertation to the rest of the group . . . if you want to all get involved . . . this is the challenge I set forth to you. Four Sundays from now I will be willing to bring our group back and give the same pitch to you, the same program that we gave to you today. The only thing that I want you to do . . . is each of you bring two or three friends with you. And then what we will do is . . . we will give our program again and we will ask that group . . . all those in attendance . . . to bring two or three more people. One month later then, we will give a similar program. And then we will divide the group up into work shops, and we will give specialized individual education in areas that each of these people might be concerned with. And we will form action committees and go out in the community and see what we can do. We never got invited back.

They asked how they could get in-



volved. I told them how they could get involved. They never picked up the challenge. But they're going to go running around for the rest of their lives telling people how good a Christian they are. And this turns my stomach.

I see more Christians that are drug addicts and alcoholics . . . that are doing and trying to do some good in the community, and never go to church . . . than I do see in church. And that is the unfortunate truth.

I am very much bummed out at trying to get the community to help us because the community has not responded. And the things that we are preaching today about crime, rehabilitation, community involvement . . . are not new things. These are things that we have been talking now for eons of time. When I was in a prison . . . in a reformatory . . . the library that they had there was a very inadequate library. But there were some books about criminal reform, and prison settings, and things of this nature. These books were printed in 1929, 1931 and 1940. Then they said principally what we're saying today.

People are more concerned about going to work at 8:00 in the morning . . . coming home at 4:30 . . . reading the evening newspaper, eating chow . . . watching the television set . . . going to bed with their wife . . . and getting up and going to work in the morning. That's their whole life. They read the newspaper and what they read effects them for a day or two at the most . . . unless

they are really touched by it in a very personal way . . . then it might stay with them a little bit longer. But basically we don't care. Basically people don't really care. We don't get involved.

One beautiful thing about our agency. While we have some very definite kinds of structure going on . . . there is kind of a hierarchy . . . each of us is free to do what we feel is best to do . . . and without too much condemnation for doing it. I say pretty much what I feel and think I feel. And sometimes it doesn't always coincide with what Ansel thinks and feels, and vice versa. But basically speaking, everyone at our agency—those that are directly affiliated or indirectly affiliated—have the same ideas and goals. And that is to keep everyone that we can—legitimately—on the streets. And we do it fairly effectively. Some 30 people out of . . . Ansel said 600 . . . but it's over 700 clients . . . that we've had is a h### of a batting average. We are very pleased with it, very pleased. And on the other hand, we haven't been a total success either.

Some 30 of them have gone back to jail . . . so 640 of them or better are not in jail . . . they're making it . . . but with a lot of difficulty. A lot of them are unemployed. A lot of them are on welfare and having hassles in that way, because welfare is not an ideal way of life. A lot of them are supporting themselves in ways I'm not sure about . . . maybe they are getting it illegally and we're not aware of it yet.

And those that are working on jobs . . . Many of them are working on jobs for \$1.80 an hour, \$2.00 an hour. And that's a pretty difficult routine. It really is. And if you're married and have to go that way, it is even doubly difficult, you know. At \$2.00 an hour, that's less than \$80.00 a week . . . \$80.00 a week gross. Your take-home pay is about \$65.00 or \$66.00, whatever. A single man, who has to rent a room, pay for his own food and buy his own clothing and clean his own clothing and keep up his personal hygiene, doesn't have much money for many other things. We're living in pretty expensive times.

So, we've got a lot of failures in our program right now . . . as much as the public may hate to hear it. The only answer to it is more money and more staff . . . so that we can keep on top of the situation . . . so that we can better the programs that we have . . . and so that we can expand the facilities that we have.

This year we are going for a new budget. Last year we went for a budget of about \$50,000 or so. Next year we're going for well over \$150,000. If we get funded, we can look for some very meaningful things next year, and we are all just waiting and hoping it will happen that way.

We need an estimated \$7000 to complete this year in the black . . . so we just break even. The philanthropists that we have asked for help are more interested in building monuments for themselves than helping people like us. ■

## CRIME SEMINAR...

*continued from page 49*

left one of your prominent establishments and was a little bit stupid . . . really. I should have gotten my time for stupidity rather than armed robbery. But I was seen by a neighbor . . . I was out of the vicinity . . . evidently it was a news flash . . . she got the description of my car and turned in my license number. If I had been a little bit more careful . . . and if I wouldn't have been so hesitant . . . and if I wouldn't have had other things planned for that evening . . . that I was in a hurry to get to . . . I would have not gotten

caught. It was just lucky for the particular establishment I robbed that a neighbor saw me.

**David Egan:** Where would you recommend that a small store in the



electronics industry locate its money-changing activities, cash registers and such? Within full view of the front window, back of the store, or where?

**Donald Schwannecke:** The problem with that is that where it's less convenient for the armed robber, it's more convenient for the check cashier. But, if you're more concerned about getting killed than you are about getting ripped off with a bad check . . . in full view of the public . . . where somebody passing by could see a crime in the process.

**David Egan:** May I address a question to Mr. Barnekow. How can an

*continued on page 73*



## How to stay in shape without getting your wallet out of shape.

We've shaped up a plan that lets you mix business with pleasure.

The program is simple: You buy Sylvania receiving tubes, you get merchandise award points. When you have enough points, you just pick out what you want from the catalog that Sylvania's distributors will be glad to give you. (Ask him for the "Take Stock with GTE Sylvania" book.)

To keep you in shape, there are things like golf or fishing equipment and shop tools. And if whittling is your sport, there's even a knife for that.

If you'd rather keep your wife in good shape, there are pages of kitchen and household equipment that will make her workload a lot lighter.

Or if you are interested in really living the good life, there is everything from clothing to cameras.

And then there are the Sylvania color television sets. They take a lot of points, but they deliver a lot of picture.

Buying Sylvania receiving tubes can keep your business in good shape.

And if you buy enough Sylvania tubes, you can keep the whole family in shape.

But, we have to warn you, your wallet will get a lot fatter.

Sylvania Electronic Components, 100 First Avenue, Waltham, Mass. 02154.

**GTE SYLVANIA**



# TEST INSTRUMENT REPORT

## Leader's Model LBO-505 Triggered-Sweep Scope

by Phillip Dahlen

Provides both dual-trace  
and vector displays



Leader's Model LBO-505 Triggered-Sweep Scope. For more details, circle 900 on the Reader Service Card.

■ More and more electronic technicians are upgrading their bench by not only purchasing triggered-sweep scopes, but by insisting that these scopes also include dual-trace and vector functions.

One scope containing these functions—Leader's Model LBO-505 solid-state scope—is said to be designed to permit checking for the simultaneous arrival of the fly-back pulse and color-burst signals, checking delay lines, and stereo separation.

Some of the more interesting manufacturer specifications for this instrument are included below:

### Vertical Amplifier

(each channel)

Sensitivity	10mv p-p/cm to 5v p-p/cm ±3%, calibrated in nine steps, 1-2-5 sequence and continuous (uncalibrated) adjustment
Bandwidth	dc to 15MHz, 3dB (with 4cm deflection)
Rise Time	35ns
Input Impedance	1M shunted by 40pf; or with 10:1 probe, 10M shunted by 15pf or less

### Display

(in sweep mode)

Channel 1	
Channel 2	
Channel 1 and 2—alternately chopped	
Channel 1 and 2—added algebraically	
Vector (X-Y)	

### Calibration

Square-Wave Voltage 0.5v p-p ±3%, 1kHz

### Horizontal Amplifier

Sensitivity 200mv p-p/cm  
Bandwidth 2Hz to 200kHz  
Input Impedance 1M shunted by 40pf

### Time Base

Sweep Speeds 1μs/cm to 0.5 sec/cm, calibrated in 17 steps, 1-2-5 sequence and continuous (uncalibrated) adjustment

TVV Preset (33.3ms/cm; 30Hz)

TV H Preset (127μs/cm; 15,750Hz/2kHz)

### Magnification

× 10 (maximum speed 100ns/cm)

### Sweep Mode

Triggered and automatic (slope + and -)

Triggered selection: alternate, chopped or selection of Channel 1 or 2 when added. Polarity inversion for Channel 2 only

### Synchronization

Triggered and automatic—internal or external at + or - slope

### Intensity Modulation

External input over 15v p-p, negative polarity

### Power Supply

115/230v; 50/60Hz; 50va

### Size and Weight

7<sup>3</sup>/<sub>8</sub> in. high by 9<sup>7</sup>/<sub>8</sub> in. wide by 15 in. deep. Approximately 17 lb



# superstick

Use Eastman 910® adhesive on:  
Wafer Switches,  
Tuners, Drive Belts,  
Cabinets, Ferrite  
Cores, Ferrite  
Antennas, Knobs,  
Panels, Trim.

Use it to bond:  
Metals, Rubber,  
Plastics, Ceramics,  
Glass.

No refrigeration  
necessary. One pack-  
age system. Easy to  
use. No mixing. No  
heat. No clamps. No  
waiting. Virtually no  
shrinkage on setting.



Economical.  
About 1½ cents  
per one-drop  
application,  
which covers one  
square inch.

High Strength.

Reliable.  
Manufactured by  
Eastman—the  
originators and sole  
producers of  
cyanoacrylates in the  
United States.

Available through  
Tech Spray,  
P.O. Box 949,  
Amarillo, Texas  
79105

... for more details circle 111 on Reader Service Card

Eastman Chemical Products, Inc. Industrial Chemicals Division



**THIS UHF  
CORNER-  
REFLECTOR  
YAGI,  
DELIVERS  
UP TO  
15dB GAIN!**

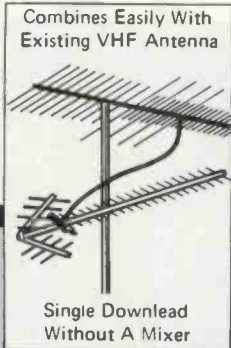

GENERAL INSTRUMENT COMPANY  
P.O. Box A, 401 Walnut St.  
Phila., Pa. 19105  
(215) 925-9870

- \* FLAT RESPONSE FOR SUPERB COLOR PICTURES**
- \* LARGE VERTICAL CAPTURE AREA**
- \* FOUR MODELS**

MODEL	CHANNELS	GAIN
CYD-1430	14 thru 30	14-15 dB
CYD-1446	14 thru 46	12-13.5 dB
CYD-1470	14 thru 70	9-11.5 dB
CYD-7083	70 thru 83	14-15 dB

... for more details circle 118 on Reader Service Card

## Why pay an answering service when you can own your own?



Dictaphone has a machine to make sure you never lose an other cent through a missed phone call or a garbled message. In fact, we have a whole line of them.

They're called Ansafones. You can buy one outright or possibly lease it for about what you're paying your answering service now. And it works for you 24 hours a day, 7 days a week.

For a free brochure describing how much an Ansafone can help you, mail this coupon now.

### ▶ Dictaphone

Box L-9-24, 120 Old Post Road, Rye, New York 10580  
Please send me full details of the Ansafone line.

Name \_\_\_\_\_  
Company \_\_\_\_\_ Phone \_\_\_\_\_  
Address \_\_\_\_\_  
City \_\_\_\_\_ State \_\_\_\_\_ Zip Code \_\_\_\_\_

Ansafone and Dictaphone are registered trademarks of Dictaphone Corp.

... for more details circle 109 on Reader Service Card

## NEWS...

*continued from page 32*

### Virginia Electronics Assn. Holds Eighth Annual Convention

The eighth annual Virginia Electronics Assn. State Convention was held at the Marriott-Twin Bridges Motel in Arlington, Va. on July 22-23, 1972. The Saturday evening banquet was attended by over 225 enthusiastic people who were treated to the vocal renditions of the Virginia Jubilaires and, later, to a versatile soft and swinging dance band. Sandwiched between the musical entertainment were several well-received festivities.

NEA President, Norris Browne from Houston, Texas, installed the newly elected officers and delivered the featured address. Cliff Sheffield, from host VEA-Northern Virginia, served ably as the master of ceremonies and accepted a performance plaque on behalf of the convention committee. Outgoing president, Walter Cooke, presented special awards to members John McPherson and Bob Harrison, and received the president's plaque for his own meritorious service. Cliff Shaw and M. L. Finneburgh, Sr., E.H.F. were honored as the very first Honorary Lifetime Members of VEA, and received standing ovations for their numerous contributions to VEA and to the service profession.

Considerable business was conducted at the association business meeting, including the adoption of a completely new set of bylaws and code of ethics. The National Affairs Committee promoted attendance to the joint NATESA-NEA convention and supported the concept of association unity and joint membership. A resolution urging merger between NEA and NATESA was unanimously adopted, and nearly \$600.00 was raised for the S.I.S. Fund.

### Canadian TV Satellite Scheduled for November

ANIK I, Telesat, Canada's new domestic synchronous communications satellite, is shown being examined by a Hughes Aircraft Co. technician following recent tests in El Segundo, Calif. There the 1200-lb satellite is being made ready for scheduled launch from Cape Kennedy in November.



The new satellite, first of three spacecraft being built by Hughes for Telesat, will link the entire nation, bringing color TV and telephone service to remote areas in Canada for the first time. It will be the world's first domestic satellite, operating at synchronous altitude 22,300 miles above the equator.

The Hughes-designed transparent antenna, covered with a fine mesh to minimize solar pressure, has been tailored to provide a signal pattern covering the nation from coast-to-coast and far north into the Canadian arctic islands.

As had been indicated in an earlier article published in ELECTRONIC TECHNICIAN/DEALER, some of the satellite's signal pattern will also cover the northern portions of the United States. This publication will attempt to investigate direct satellite reception once the appropriate equipment can be obtained.

## TECHNICAL DIGEST

The material used in this section is selected from information supplied through the cooperation of the respective manufacturers or their agencies.

### MAGNAVOX

#### Fuse Failure for No Apparent Reason

Repeated fuse failure for no apparent reason can be the result of a bad fuse holder clip. Anything that happens to a clip to cause its resistance to increase, will result in increased heat in the clip as current flows through it. This heat is transferred from the clip to the fuse, lowering the current value necessary to cause the fuse to open.

Bending a clip by pressing the sides toward each other to provide a tighter fit between fuse and clip, results in increased resistance of the metal and increased heat to be transferred to the fuse.

Clips constructed of two pieces of metal—the individual clip itself being one piece and the associated connection tab being the second piece—can develop a resistance between the two pieces of metal. This too can result in lowering the current value at which an associated fuse will open.

In cases of nuisance opening of fuses in clip-type holders, replace the fuse holder block, using as a replacement only those of one-piece-clip construction.

### MAGNAVOX

#### Tape Recorders Models 1K8870, 1K8871, and 1K8877—Wiring to Headphone Jack Reversed

In early production units of the models 1K8870, 1K8871 and 1K8877 tape recorders, the right channel output was connected to the ring of the headphone jack and the left channel output was connected to the tip of the headphone jack. These connections are opposite to standard polarization of stereophonic headphones. A complaint of reversal of channel information when headphones are used can be corrected by reversing the wiring to the headphone jack. Magnavox stereophonic headphones are internally wired to conform to current standards of polarization and their wiring should not be changed to correct for reversal of audio channel information.

### SYLVANIA

#### Amplifier Chassis R62/R63/R64—Power Hum

Power hum on the R62, R63 and R64 chassis, most noticeable when the amplifier is operated through the auxiliary inputs, will be reduced by opening the ground

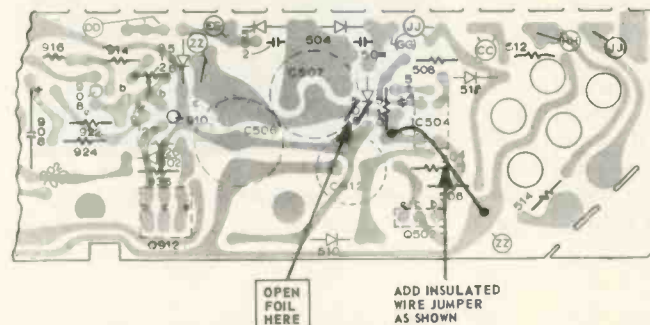

foil near capacitor C507 and then running an insulated wire jumper on the bottom of the printed circuit panel as shown.

## 5 ways to cut your cost of doing more business

### NEW Heathkit Transistor — FET Tester...49.95\*

Tests transistors, diodes, FETs, SCRs, triacs, uni-junction transistors in or out of circuit. 5 current ranges measure leakage as low as 1 uA and collector currents as high as 1A. Gain (DC Beta), transconductance (GM), and leakage values read directly on large meter face. Special battery testing circuit gives meter indication of self-contained power supply. Kit IT-121, 6 lbs.



### NEW Heathkit Solid-State FET VOM...79.95\*

This new dual FET portable multimeter has lab-grade accuracy, high (10 megohm) impedance input, and the ranges you really need... at a price you can easily afford. 9 DCV and ACV ranges from 0.1 to 1000 V. at  $\pm 2\%$  accuracy. 6 DC and AC current ranges from 10 microamps to 1 amp. 7 resistance ranges, x1 (10 ohm center) to x1 Megohm. 9 dB ranges, -40 to +62. 1% precision metal-film dividers. 4 1/2", 100 uA ruggedized taut-band meter, diode and fuse protected. Battery check switch provided. Kit IM-104, less batteries, 4 lbs.



### NEW Heathkit 8-Digit 120 MHz Counter...349.95\*

Measures 1 Hz to over 120 MHz. Over-range, gate, and two range indicators. Preassembled TCXO time base. 1 megohm FET input. Automatic triggering level. Sensitivity 125 mV or less to 120 MHz. ECL logic. Builds in 15 hours. Kit IB-1102, 12 lbs.



### Heathkit 10 MHz Triggered Scope...229.95\*

A 5" triggered sweep scope at a low kit price you can't afford to pass up. AC — 10 MHz response, calibrated attenuator, 50 ns sweep rate with magnification. AC-DC coupling, 50 mV sensitivity. One of the outstanding scope values on the market. Order one for your service bench today. Kit IO-103, 37 lbs.



### Heathkit Digital Multimeter...229.95\*

A digital multimeter that meets lab specs at a low, low kit price! 3 1/2 digits for 100 uV resolution on 200 mV range; 1V on 1000V; 5 DC ranges (100 uV — 1000V), either polarity; 5 AC ranges (100 uV — 500V); 10 current ranges (100 nA — 2A AC or DC); 6 resistance ranges (0.1 ohm — 20 megohms). DC calibrator supplied for 0.2% accuracy without external equipment. Can be lab calibrated to 0.1%. Kit IM-102, 9 lbs.



HEATH COMPANY, Dept. 24-9  
Benton Harbor, Michigan 49022

Enclosed is \$ \_\_\_\_\_, plus shipping.

Please send model (s) \_\_\_\_\_

Please send FREE Heathkit Catalog.

Name \_\_\_\_\_

Address \_\_\_\_\_

City \_\_\_\_\_

State \_\_\_\_\_

Zip \_\_\_\_\_

Prices & specifications subject to change without notice.  
\*Mail order prices; F.O.B. factory.

TE-271

... for more details circle 116 on Reader Service Card



# ONE FOR THE MONEY

- Discounted to provide you with a higher profit margin.
- Proven quality for better customer satisfaction.
- A complete range of service types for radio, TV, hi-fi, foreign and industrial electronics.

In every important way, International Servicemaster is number one. For complete details, contact your International representative today, or International Components 10 Daniel Street, Farmingdale, New York 11735, (516) 293-1500.

**International**  
International Components Corp.  
Div. of IESC

... for more details circle 117 on Reader Service Card

## AND CRIME...

*continued from page 42*  
sound intermittently 90 times per minute. This system reportedly cannot be shut off without the use of a special key switch.

### 704 ON READER SERVICE CARD

Only forced entry is said to activate the Autolarm. This kit reportedly includes a 6-in. high-decibel



alarm, three door-jam switches, key lock switch, 20 ft of wire and complete instructions.

Automated Alarms Corp., of 116 South Ave., Garwood, N.J. 07027, has published a handbook (HSS-1) entitled AAC HOME SECURITY & SAFETY INSTALLATION HANDBOOK. Available for \$1.00, it gives helpful suggestions for planning an installation and the selection of components including thermostats, window foil and connectors, flood light controls, sirens, emergency button, etc. Many helpful diagrams are included.

### 705 ON READER SERVICE CARD

A bulletin is available from C & S Security Devices, Inc. describing the Royal Sentry 7, a complete solid-state electronic door lock and supervisory system designed to eliminate key control problems, accidental lock-outs and lock-picking burglaries. It is activated by pressing the proper sequency of buttons at the door, these buttons resembling those found on a touch-tone telephone.

### 706 ON READER SERVICE CARD

The Carter Craft Model 34-126 Burglar Alarm is battery operated to insure protection even when electricity

is shut off by storms, burglaries, etc. Specifications indicate that a shattering noise erupts upon any entry



where attached, whether a forced entry or one where the burglar may open your lock. Normal battery life is said to range from 6 months to 2 years.

### 707 ON READER SERVICE CARD

Colorado Video, Inc. has developed a system for offering video intrusion protection. For this system, a conventional CCTV camera is focused on the

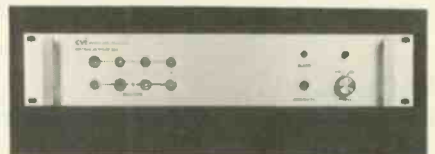

area to be kept under surveillance. Should a rapid brightness variation occur in any of four pre-selected points in the TV picture, Motion De-

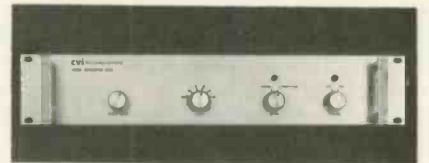

detector 304 will activate an alarm system. Video Converter 201B can convert the conventional CCTV picture for narrow-band transmission on a standard telephone line, while Video Converter 220B can process the signal received on the telephone line into

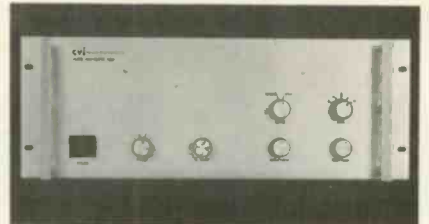

that required for a TV set or other monitor—thus permitting the remote observation of any activity activating the alarm system.

### 708 ON READER SERVICE CARD

The Model 510 "Controller Systems" by "Controller Systems" Corp. *continued on page 66*

# GREATEST TV Schematic Bargain EVER Offered

## NOW-Complete TV Schematics for less than 5¢ each

**COLOR TV**  
Covers ALL  
Color Sets  
1960 - 1968

**BLACK & WHITE**  
Coverage for  
23 U.S. Brands  
1965 - 1968

### TV TECH / MATICS - 8 Giant Volumes

Cover 99% of Color TV-4 Years B&W!

Here are FABULOUS savings on nationally-known TV schematic and service data. Here is everything you need to fill your vital service data needs for TV model years 1965 through 1968 . . . plus COLOR TV coverage from 1960 through 1968! What it amounts to is a low, low cost of less than \$9.00 per year for your TV service data . . . with an extra 5 years of Color TV coverage thrown in for good measure! Compare that with the over \$100 a year you may now be paying for comparable information.

### SERVICE DATA FOR MORE THAN 20 BRANDS

TV TECH/MATICS is the ideal Service Data package for today's modern technician. It includes complete schematic diagrams and vital servicing data for every TV receiver produced by more than 20 leading American Manufacturers for 1965, 1966, 1967, and 1968. All diagrams and servicing details are completely authentic, based on information provided by the original equipment manufacturers. Each year's coverage is permanently bound into two convenient-to-use volumes which open flat to 11" x 29½", ready to provide you with instant service data at your workbench. Some of the diagrams are as large as 58" x 22".

### EASY TO USE

TV TECH/MATICS is easy to use. Brand names are arranged alphabetically by model year. No more hunting through several file drawers to find the schematic you need! And at the special low price, think of the savings you will enjoy on your schematic needs . . . think of the time you'll save by having the schematics you need right at your fingertips in handy, permanently-bound form!

TV TECH/MATICS is the ideal way to cut down your schematic expenses, and to enjoy the convenience of having all your data needs right at your fingertips.

**8 BIG Volumes**  
Regular Price **\$79.60**  
...NOW YOURS  
for only **\$34.95**

### HERE'S WHAT YOU GET

You receive 8 BIG volumes in all, two for each year from 1965 through 1968. Included is a clearly detailed and annotated TV schematic diagram for each specific model. You also get complete replacement parts lists, alignment instructions, tube and component location diagrams, plus key waveforms and voltage readings . . . all the information you need to service over 90% of the TV receivers you'll encounter!

### STREAMLINED AND CONVENIENT

All the information for a given model is contained on two facing sheets. The special bound-leaf format allows pages to lie flat when open. Each volume is organized alphabetically by manufacturer, then numerically by model number. In addition, a handy Chassis/Model Finder is bound into each volume. Regular list price for each year's coverage — 2 BIG volumes — is \$19.90. All 8 volumes normally sell for \$79.60. Your price is ONLY \$34.95 . . . a savings of nearly \$45.00!

### MONEY-BACK GUARANTEE

You MUST be satisfied that TV TECH/MATICS is the greatest bargain in TV Schematics ever offered. Order at our risk for FREE 10-day examination. Prove to yourself they are worth many times the price. You can return them in 10 days for full refund or cancellation of invoice. No need to send money. But, the supply is limited, so fill-in and mail the NO-RISK coupon today to obtain these time-saving, money-making manuals.

### -CONTENTS-

#### CONTENTS 1965 MODELS

Covers all 1965 models for: Admiral, Airline, Andrea, Coronado, Curtis Mathes, Dumont, Electrohme, Emerson, Firestone, General Electric, Magnavox, Motorola, Muntz, Olympic, Packard-Bell, Philco, RCA Victor, Sears-Silvertone, Setchell-Carlson, Sylvania, Truetone, Westinghouse, and Zenith . . . plus all color sets 1960-1965, at no extra cost!

PUBLISHER'S LIST PRICE . . . \$19.90

#### CONTENTS 1966 MODELS

Covers all 1966 color and B & W models of: Admiral, Airline, Andrea, Coronado, Curtis Mathes, Dumont, Emerson, General Electric, Hoffman, Magnavox, Motorola, Olympic, Packard-Bell, Philco, RCA Victor, Sears-Silvertone, Setchell-Carlson, Sonora, Sylvania, Truetone, Westinghouse, and Zenith.

PUBLISHER'S LIST PRICE . . . \$19.90

#### CONTENTS 1967 MODELS

Covers all 1967 color and B & W models of: Admiral, Airline, Andrea, Coronado, Curtis Mathes, Dumont, Emerson, General Electric, Hoffman, Magnavox, Motorola, Olympic, Packard-Bell, Philco-Ford, RCA Victor, Sears-Silvertone, Setchell-Carlson, Truetone, Westinghouse, and Zenith.

PUBLISHER'S LIST PRICE . . . \$19.90

#### CONTENTS 1968 MODELS

Covers all 1968 color and B & W models for: Admiral, Airline, Andrea, Coronado, Curtis Mathes, Dumont, Emerson, General Electric, Hoffman, Magnavox, Motorola, Olympic, Packard-Bell, Philco-Ford, RCA Victor, Sears-Silvertone, Setchell-Carlson, Sonora, Sylvania, Truetone, Westinghouse, and Zenith.

PUBLISHER'S LIST PRICE . . . \$19.90



LARGE PAGES contain complete circuit schematics, replacement parts lists, alignment instructions, critical part locations, important waveforms and voltage readings.

### NO RISK COUPON—MAIL TODAY

TAB Books, Blue Ridge Summit, Pa. 17214

- I enclose \$34.95 for which please send me your complete 8-Volume Tech/Matics Schematic offer postage prepaid.
- Please invoice me for \$34.95 plus postage. Same return privileges.

Name .....

Company .....

Address .....

City ..... State ..... Zip .....

(Paid orders shipped prepaid. Pa. resident add 6% Sales Tax. Outside USA 10% extra.)

ET92

... for more details circle 103 on Reader Service Card

## SOLVE YOUR DRIVE BELT PROBLEMS IN MINUTES

### with ONEIDA'S all new DRIVE BELT KITS

- Eliminates "Down Time" on special and foreign belts.
- No need to stock replacement belts; makes any size in minutes.
- No molds or complicated vulcanizing processes to follow.
- No special skill required, cutting guide, cutting tools and adhesive all included.
- Special Insta-Weld® adhesive makes replacement belts as strong as or stronger than originals for lasting repairs.



**ORK-1 Round Rubber Drive Belt Kit** ..... \$19.95

**ORK-2 Flat and Square Rubber Drive Belt Kit** ..... \$19.95

**ORK-3 "O" Ring Kit** ..... \$19.95

Get up to five times your investment back in belt sales. Each of these kits will make from 80-100 dollars or more in rubber drive belts. Included with the kit is the special cutting guide, razor blade, Special Insta-Weld® adhesive, a large quantity of rubber stock and easy-to-follow directions. Nothing has been left out. Packed in an attractive, handy, plastic box that fits into the tube caddy or on the bench. Now, you can replace over 90% of the belts found on tape recorders, phonographs and cassette recorders, both foreign and domestic, right on the spot. Check with your distributor now. If he doesn't stock them, ask him to order them for you today.

## PERMABOND ADHESIVE POWER WITH ONEIDA'S Insta-Weld®



*Makes Space Age Bonds*

**Great for: Rubber • Plastic • Metal • Ceramics • Glass • Etc.**

Insta-Weld® is new, not epoxy, nothing you have heard of before. There is no mixing, just apply and hold parts together. Just seconds are all that is required for a bond stronger than anything you could ever get before. One drop supports 2,000 pounds per square inch.

Now make economical repairs that were never before possible. Extremely economical, up to 132 bonds per tube.

**NEW INSTA-WELD®**

**only \$2.00 per 2-gram tube**

**oneida ELECTRONIC MFG., INC.**  
MEADVILLE, PENNA. 16335

For more details circle 125 on Reader Service Card

ELECTRONIC TECHNICIAN/DEALER, SEPTEMBER 1972

## AND CRIME...

*continued from page 64*

can be used in conjunction with door and window sensors, an emergency signal button, mat sensor, door sensor or fire sensor to activate an alarm. The resulting electronic siren can be

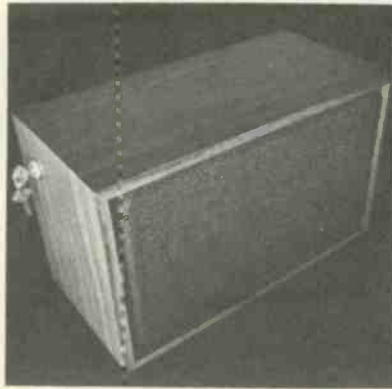

used to drive remote speakers, or the unit can be used to activate a two-channel telephone dialer.

### 709 ON READER SERVICE CARD

A bulletin available from DARCO describes their MONITOR. The unit is said to contain a time delayed loop that is used with magnetic door and window switches, photo or ultrasonic sensors and pressure mats for the detection of burglars and other intruders; while the instant loop can be used with panic buttons, plus heat, fire or smoke detectors.

### 710 ON READER SERVICE CARD

Literature from Delta Products, Inc. describes the operation of their Ultrasonic Burglar Detection and Alarm System, plus their telephone dialer, remote controls and "Screamer."

### 711 ON READER SERVICE CARD

A new Detex Exit Alarm, No. 504R, features an integral transformer



and is powered by ac current rather than batteries. It is said to use a sensor

switch which monitors the door, two loud horns sounding a warning should anyone attempt to pass through without authorization.

### 712 ON READER SERVICE CARD

EICO's SS-500 Burglar/Hold-Up/Fire-Alarm System is said to contain the FC-100 Security Control Center with the A-75 6v dc Power Supply, SD-10 Door/Window Magnetic Contact Reed Switches (four pairs), SD-20 Heat/Fire Sensors (three), SD-40 12-in. Door Cords (two), SD-50 Tamper Switches (two), SA-25 Indoor/Outdoor 8-in. Bell, A-65 Remote Station Control with Indicator Lights, A-35 Emergency Buttons (two), A-45 Momentary Entrance Key Switch with signal light, A-95 Installers Handbook and A-105 Warning Decals (six). Optional accessories include the SA-15 Indoor Twin Horn Alarm, SD-24 Furnace/Attic Heat Sensors (three), SD-32 Window Protective Foil and SD-30 Window Foil Adhesive Blocks (six).

### 713 ON READER SERVICE CARD

The Model No. 570 Electronic Security System produced by Electronic Security Systems, Inc. is said to include 10 indicator lights on its remote control panel designating exact points protected. An additional line-out light warns of broken or cut internal or external wiring of the supervised circuit. An alarm switch sounds an external bell and controls a reversible relay for telephone lines to the police or a central headquarters.

### 714 ON READER SERVICE CARD

Emberling's Alarm Co. announces an electronic security guard that is said to use the principles of doppler radar to sense human motion with the use of UHF radio waves. It is said to have a range that can be adjusted anywhere from a 3-ft to a 25-ft radius. In one mode of operation it will reportedly



activate the siren with two movements, in a second mode activate a lamp upon sensing human movement

and sound an alarm 20 seconds later, and in a third mode it will perform both functions immediately upon detecting human movement.

**715** ON READER SERVICE CARD

Javelin has announced the introduction of a packaged system—the AVS-102 Video System—that has been completely integrated to perform a professional surveillance job. It reportedly



comes with all components necessary to provide a high-quality monitor image as great as 1000 ft from the camera point—although only 50 ft of cable is provided.

**716** ON READER SERVICE CARD

A small sonic transducer has been developed by King Research Labs, Inc. It is said to be sensitive to only local sounds, while remaining relatively insensitive to loud more distant sounds; and can reportedly be used on the outside of the building to sound the alarm before someone has time to break in.

**717** ON READER SERVICE CARD

Linear's Bulletin SPL describes its line of FSK (Frequency Shift Keyed) transmitters and receivers, designed to provide the security industry with a complete line of remote, wireless signaling devices. The transmitters may be used in conjunction with magnetic switches on doors and windows, or electrically taped windows; special models being provided for heat sensing and panic buttons.

**718** ON READER SERVICE CARD

Mallory Distributor Products Co. has a bulletin describing its line of security systems including ultrasonic intrusion alarms, timers, lockswitch, bells and horns, rotating lights, and 24 hour timer. Many of these components function together by means of signals transmitted through the power line, thus eliminating the need for special wiring throughout the building.

**719** ON READER SERVICE CARD

3M Co. offers a pair of books with simulated leather covers for intrusion detection. However, these are not ordinary books. The Model B451 ENGLISH LANGUAGE DICTIONARY actually contains an ultrasonic intrusion alarm system; while the second book, a Model B80 HERALDRY COATS OF ARMS, contains a remote indoor alarm horn.

**720** ON READER SERVICE CARD

A custom designed, 60 piece tool kit for use by professional alarm installers has been announced by Mountain West Alarm Supply Co. Designated

the MW-700, this kit is said to contain a set of tools selected for the installation and repair of burglar and



fire alarms, new motion detectors, CCTV, and all other systems and devices currently in use in the alarm industry.

*continued on next page*

## As fast as you get 'em we help you fix 'em

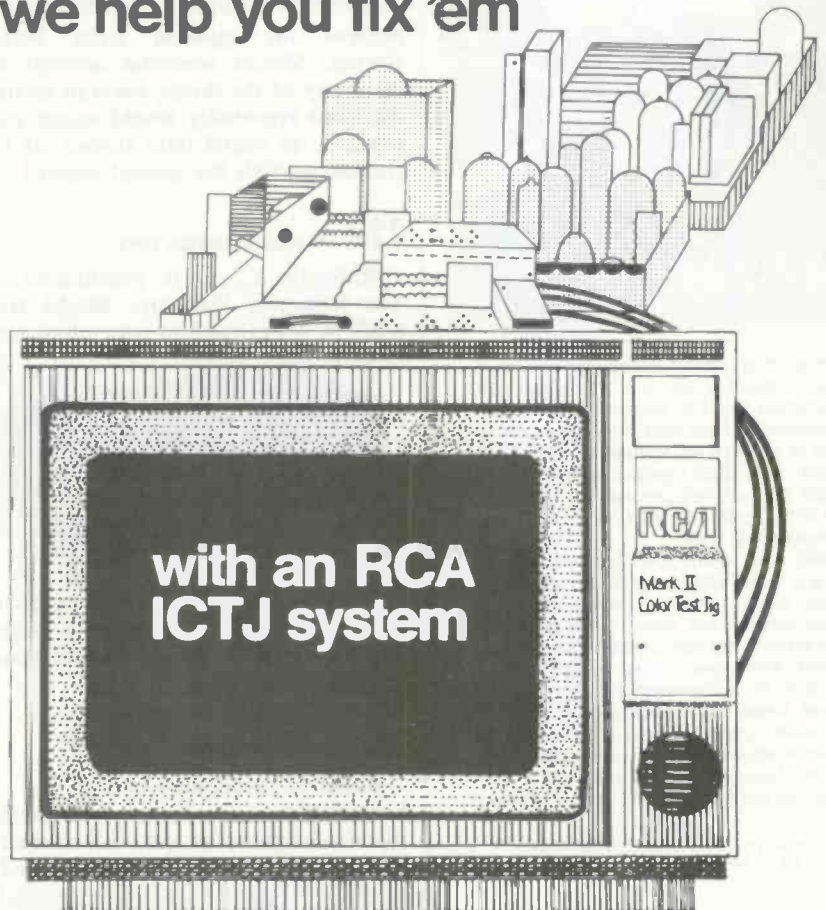

Sound like the TV serviceman's dream? It is. RCA's Industry Compatible Test Jig is a complete testing system that lets you service more than 90% of all color TV console chassis on the market—and updates you as new ones come along.

Here's how: The RCA ICTJ system includes the test jig itself (in bench or portable models), your choice of 102 adaptors and cables, plus a handy cross-reference manual that specifies the right adaptors for each set. But most important, as the new models need service, you'll be kept up to date with new inserts for the manual and any necessary new adaptors will be made available. So whatever's coming, you'll be ready.

See your RCA Parts and Accessories distributor today for full information.

Parts and Accessories, Deptford, New Jersey 08096



... for more details circle 129 on Reader Service Card

# Prevent Shop Lifting!

## Tie 'em up with CLERK ALERT.



Shoplifting is big business. No merchant, large or small, is immune. The results are disastrous to a P&L statement. That's why we developed Clerk Alert, a unique advancement in crime fighting devices. This completely solid state system installs with a simple plug-in, and secures any merchandise through which a light phono cable can be looped or threaded.

Clerk Alert is fail-safe. Turn the key and the unit is activated. Any tampering, puncturing, cutting, breaking or removal of the cables actuates the alarm. There is no way to deactivate the unit without the key!

Clerk Alert runs on AC and/or DC. It operates on a harmless 12 volt U.L. approved power source, plugs into any 115 volt outlet, and automatically switches to battery when the power is interrupted.

Clerk Alert weighs in at 3 pounds and measures only 3" x 3" x 7". And it's priced to sell.

Tie up your profits with Clerk Alert. Send for free literature today!

## AND CRIME...

*continued from page 67*

### 721 ON READER SERVICE CARD

On Guard Corporation of America announces the introduction of its Model DU-272 Deluxe Siren Vehicle Alarm, which features an ignition cut-off switch lock. When in the armed position, the dual-purpose lock is said to



prevent the ignition from being started. Should someone attempt to open any of the doors, hood or trunk, the siren reportedly would sound and continue to sound until turned off by the owner with the special alarm key.

### 722 ON READER SERVICE CARD

Radatron Corp. is manufacturing The Radatron Protector, Model No. 8502. It is designed to emit ultrasonic

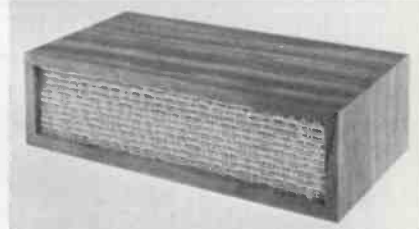

sound waves over an area of approximately 300 sq ft, activating an alarm when an intruder interrupts the wave pattern.

### 723 ON READER SERVICE CARD

Reflector Hardware Corp. has a Spacemaster security alarm system that is designed for use with all rear-loading showcases. The alarm sounds



when the door is opened (unless a sales person is standing on either of the two floor mats) when wiring is cut or disconnected, when the power is disconnected or interrupted, or when

any un-authorized attempt is made to open the showcase doors.

### 724 ON READER SERVICE CARD

The No. 100 packaged alarm system produced by Remote Control Devices Corp. is said to contain a local alarm control and weatherproof speaker, plus three magnetic door switches, 100 ft of two-conductor wire, a key switch for the entry-exit, door cord, appropriate hardware and instructions.

### 725 ON READER SERVICE CARD

Russell Industries, Inc. has developed an alarm that uses a single 1.5v cell that is easily replaced. A simple ON/OFF switch acts as a con-



trol for usage. The alarm is primarily intended for occupants who have but one or two doors or windows, and it can be installed in seconds.

### 726 ON READER SERVICE CARD

Se-Kure Controls' Protector is designed for basic alarm protection while a person is either in or out of



an apartment. On the "out" setting specifications indicate that the door can be opened and closed once as a person leaves the apartment, but the

Dept. ETD  
**DELTA PRODUCTS, INC.**  
 P.O. Box 1147 / Grand Junction, Colo. 81501  
 (303) 242-9000  
 Please rush me free information on Clerk Alert.

Name \_\_\_\_\_

Address \_\_\_\_\_

City \_\_\_\_\_ State \_\_\_\_\_ Zip \_\_\_\_\_

More details circle 107 on Reader Service Card



next time the door is opened the alarm will sound after a 10 second delay, unless first deactivated by key. While on the "in" setting specifications indicate that the door may be opened or closed without sounding the alarm—so long as the "hold" button is pressed. Releasing this button while the door is open will reportedly also sound the alarm.

### 727 ON READER SERVICE CARD

Sensor Systems has a group of specification sheets that describe a line of concealed security switches—including door contacts and pressure mats—for hidden installations.

### 728 ON READER SERVICE CARD

Sentrol, Inc. has designed its No. 1055 Magnetic Contact so that the electrical switch can be easily enclosed inside a door or window casing, thus eliminating any exposed terminals or wire. This design is said to even permit easy installation in all makes of aluminum windows and sliding doors.

### 729 ON READER SERVICE CARD

The Model 715 Telephone Line Monitor has been developed by Silent Knight Security Systems to sound the local alarm 10 sec. after the telephone line is cut by a would-be intruder. It reportedly monitors the telephone line without interfering, in any way, with normal telephone operation. The alarm contacts return to their normal position as soon as telephone service is restored.

### 730 ON READER SERVICE CARD

Sontrix, Inc. has reportedly developed an electronic signal processing technique which analyzes the ultrasonic doppler shift signal and electronically distinguishes between signals caused by air motion and those caused by intruder motion. The second type of signal will trigger the relay. SP-500 units are designed for use in areas with heating and/or air-conditioning units, ventilating systems, or situations where weather conditions (high winds, convection from abrupt temperature changes, etc.) may cause false triggering.

### 731 ON READER SERVICE CARD

In addition to a rather extensive line of other security products, Speedex has a pull trap designed to protect walkways, garage doors, etc. It is said to come with a thin, almost invisible nylon string. A slight pull on the string by an intruder will reported-

ly open an electrical contact to activate an alarm system.

**INSTALLING & SERVICING ELECTRONIC PROTECTIVE SYSTEMS** by Harvey Swearer is a very useful 256-page book on intrusion detection systems published by Tab Books, Blue Ridge Summit, Pa. 17214. The hardbound edition sells for \$7.95, while the paperback edition sells for \$4.95. Various chapters in this book cover basic alarm systems, business operations, sensors and detectors, electro-mechanical alarm systems, photo-electric alarms, ultrasonic-detection systems, microwave systems, proximity alarm systems, audio and visual alarms, plus seismic, vibration and stress intrusion systems.

### 732 ON READER SERVICE CARD

The Telealarm No. 301 is a solid-state burglar control unit manufactured by Telealarm Corp. Specifications indicate that one No. 6 1½v circuit battery will operate this system efficiently for five to seven years. In operation of this system, the key is rotated through four positions as follows: Position No. 1, bell and protection systems, microwave systems, proximity alarm systems, audio and visual alarms, plus seismic, vibration and stress intrusion systems.

*continued on next page*

## If we don't have the needle, there's no point in looking for it.

We're a prime manufacturer of phonograph needles and cartridges. So we're always ahead in needle knowledge. That's why your E-V/Game distributor always has just the right replacement needle you want. Factory sealed. Attractively packaged. And priced right.

And, it's easy to specify Electro-Voice needles. They're listed in the most up-to-date, comprehensive catalog in the industry. Simplified cross-referencing and precise illustrations enable you to pinpoint: what you want in seconds.

Tell your local distributor haystacks are for making love. Ask him for a free E-V/Game needle and accessories catalog today. Or contact us. E-V/Game, Inc., Box 711, Freeport, N.Y. 11520.

## E-V/GAME, INC.

Division of Electro-Voice, Inc. • A GULTON Company  
In Canada: E-V of Canada, Ltd., Gananoque, Ontario



... for more details circle 110 on Reader Service Card



## Signal Emergencies Between Any Two Telephones With Delta's Revolutionary Dial & Coder.

Dial & Coder guards you around-the-clock, signaling alarm for any emergency condition where a simple contact closure activates the system. Completely solid state, with a self-contained power supply, Dial & Coder utilizes the latest in discrete and integrated circuit technology to provide immediate remote signalling between any two telephones.

### Check these features!

- Dial any phone number up to eight digits.
- Change numbers in ten seconds.
- Over 100 different code combinations allow multi-phone connections.
- Works with any direct contact switch.
- Unlimited applications. Use with intrusion detectors, fire & smoke detectors or a simple button control. Allows children, clerks or physically handicapped to call for help.
- Automatic redialer when busy signal received.
- Additional built-in electronics allow you to merely add a microphone for audio surveillance.
- Self-contained power supply. Once tripped, unit cannot be stopped.

If you're looking for a versatile, reliable telephone dialer, Delta's Dial & Coder is for you. Competitively priced to retail under \$150.

Superior Products At Sensible Prices  
Made in U.S.A.

Send coupon today for free sales details!

Dept. ETD



**DELTA PRODUCTS, INC.**  
P.O. Box 1147 / Grand Junction, Colo. 81501  
(303) 242-9000

Please RUSH free sales details on the Dial & Coder.

Name \_\_\_\_\_

Address \_\_\_\_\_

City \_\_\_\_\_ State \_\_\_\_\_ Zip \_\_\_\_\_

For more details circle 108 on Reader Service Card

## AND CRIME...

*continued from page 69*

tive house circuits are disconnected. Position No. 2 tests the bell, bell batteries and internal circuit. Position No. 3 tests premises circuit and circuit battery conditions with meter. Position No. 4 turns the alarm ON and automatically disconnects the meter from the circuit.

### 733 ON READER SERVICE CARD

Unisec has published a well illustrated, detailed booklet describing the theory of operation, system balancing and trouble-shooting of their USD-21 ultrasonic intrusion alarm system and its accessories.

### 734 ON READER SERVICE CARD

An electronic crime prevention center display can be obtained from Universal Security Instruments, Inc. for retail sale to the do-it-yourself customer. Some of the items in this dis-

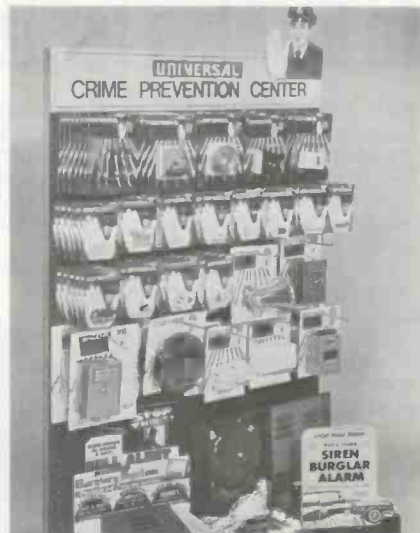

play include a vehicle bell alarm system, door alarm system with entrance timer, door alarm with chain, electronic whooper alarm, electronic hood or trunk lock, vehicle shaker switch, mercury tilt switch, door cords, window and floor trap, magnetic contact switches, energy pack, push button switches, lock switches, window foil and alarm wire.

### 735 ON READER SERVICE CARD

The Dage Television RGS-50 Camera is available from Visual Educom Inc. with a complete line of optional accessories which are said to make it exceptionally flexible for indoor, outdoor, low light level and adverse environment conditions—making it ideal for security and surveillance applications. It is reportedly able to automatically compensate for light variations from 4000 to 1 foot lamberts.

## LETTERS...

*continued from page 26*

regularly for a price . . . hides a 500w linear amplifier designed for 10 meter amateur work on any C.B. where the cash is forth coming.

But, while we are on the subject of "legality" . . . the F.C.C. regulations specifically state that a license is required for any repair which affects "the power output or frequency of a transmitter" or "transmitter on the air of any radio energy or signals" . . . and it does not . . . nor cannot regulate the testing, repair or operation of a transmitter into a dummy load so that the signals do not emanate from the confines of the shop or laboratory premises.

The regulations do specify limits of interference with interstate communications. And the blundering idiots who yell "one, two, three, four, testing" for hours on end with a mis-matched antenna . . . may have an F.C.C. approval . . . but they either did not read the rules or did not comprehend them.

And on the subject of the . . . ordained holder of an F.C.C. permit, which allows him to fiddle with C.B. and belittle other people . . . most, not all but most of the holders of F.C.C. second class paper have just that, a piece of paper, nothing else that this writer could discover. And we are only talking of the ones we have met. But with a multiple answer test, and a "question and answer" book, the licensee has just the same understanding of the subject at hand as a tape-recorder . . . which plays back brainless what is fed into it.

Knowledge, and the sharing of knowledge is one of the most desirable things in this world . . . and any secretive, selfish individual who would attempt to limit that knowledge—especially in what amounts to a limited circulation trade publication—fails to understand that at least ninety nine and ninety nine hundredths of everything he knows came from others, and his simple secretive approach says that the other one hundredth percent is not too original in research or thought.

We do not service C.B. and in another 30 days or so we will not service anything, so we have no personal ax to grind. We also do not wish to be involved in controversy and recriminations. Please do not, if you use this letter, publish our name.

NAME WITHHELD

### What About CB Radio?

In your June issue, you asked for other readers' comments on C. A. Tut-hill's article "Servicing CB Transceiv-

ers," which appeared in your February issue. Let me start by saying that although I have been a Radio-TV Technician for the past eight years, I confess to know almost nothing about CB Radios.

My reluctance to get into what some Electronic Schools describe as a "lucrative field" is based on the following points: I have heard "vague" warnings about the FCC's strict regulations that must be adhered to in servicing CB Radios. I don't think any technician relishes the idea of servicing a CB Radio with a law book in one hand and a soldering gun in the other. Another thing that bothers me, and I assume many other technicians, is the extremely high cost of equipment necessary to service CB Radios.

I have no objections to devoting the time, effort and money needed to acquire an FCC license. A technician can never learn too much. But he does like to be able to put his knowledge to a good and profitable use. Licenses, diplomas, degrees and whatnot may be impressive, but they don't pay bills—as many of our college students are finding out these days.

Everybody talks about the high cost of service equipment for CB Radios. I think it would be beneficial if you explained in detail just what equipment is needed and how much it costs. Don't list the bare essentials, but include all the equipment necessary to do a thoroughly professional job.

It would also help if you would elaborate on the FCC Regulations. Just what is required to obtain an FCC license? Do you think the FCC Regulations are unnecessarily strict for CB Radios, or do they justify their strict enforcement?

When I first read Mr. Tuthill's article, I thought it might be a good way to supplement my Radio-TV income. But after reading a couple of letters in your June issue, I'm not sure. Both letters indicate a jungle of red tape and an excessive investment in equipment was required. Neither of these points were really brought out in Mr. Tuthill's article.

It would seem to me that an article explaining the legal and technical requirements for servicing CB Radio would be in order. It should also include the equipment needed and the cost of such equipment. After reading an article containing such information, it would then be possible to make an intelligent decision concerning the servicing of CB Radios. I am sure that most readers who were stimulated by Mr. Tuthill's article would consider such an article an invaluable service.

E. L. SCALLY

*continued on next page*

## 'No-Noise' Products Work Like Magic!

For Color and B/W

### SUPER - LUBE

Concentrated formula for heavy duty jobs. Foams away corrosion, dirt, oxidation and polishes all tuners without drift or detuning. Avoid call-backs.

"No-Noise" products are guaranteed non-flammable, no carbon tet, non-toxic, safe for plastics.

### Volume Control & Contact Restorer

Cleans, lubricates, restores volume controls, push button assemblies, band switches, relays and other electrical contacts.

Manufacturers of These Other Famous "NO-NOISE" Products:  
Tuner-Tonic • EC-44 • Super Spray Bath  
Frigid-Air • Tape-Reco Head Cleaner

Often imitated but never duplicated  
**ELECTRONIC CHEMICAL CORP.**  
813 Communipaw Avenue Jersey City, N. J. 07304

... for more details circle 113 on Reader Service Card

## Unsolder it with the Endeco 300

Pencil Desoldering Iron

MODEL 300

Removes miniature soldered components in seconds—without damage

Hollow tip fits over connection; vacuums all solder for easy removal of component. Leaves terminals and mounting holes clean. Then, with 360° contact, it resolders faster, better than regular irons. Handles miniature and standard components in PC boards and conventional wiring. Self-cleaning. All parts replaceable. 40 watts, 120-v. Standard tip supplied, 5 other tip sizes available. Pays for itself. \$11.95 net East of the Rockies. 

Larger model available. See your distributor or write:

**ENTERPRISE DEVELOPMENT CORPORATION**  
5127 E. 65th St. • Indianapolis, Ind. 46220

... for more details circle 114 on Reader Service Card

# Pix-Mate™

## the CRT tester

### you can afford to take along

only ... \$34.95

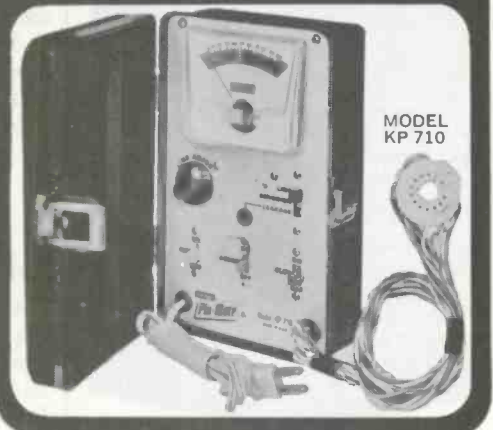

- A quality CRT tester with individual test for each gun.
- Compare guns for emission.
  - Test for leakage and shorts.
  - Legible 3 color scale.
  - Compact, portable, rugged.
  - Avoid recalls, check the CRT on every call.

WRITE US!

# TeleMatic

take along the time savers

• PIX-MATE • CRYST-MATE • GEN-MATE  
• SOUND-MATE • TRACE-MATE

**The Caddy-Mate Line.**

2245 PITKIN AVE., BROOKLYN, N. Y. 11207

... for more details circle 133 on Reader Service Card

how often  
could you  
have used...

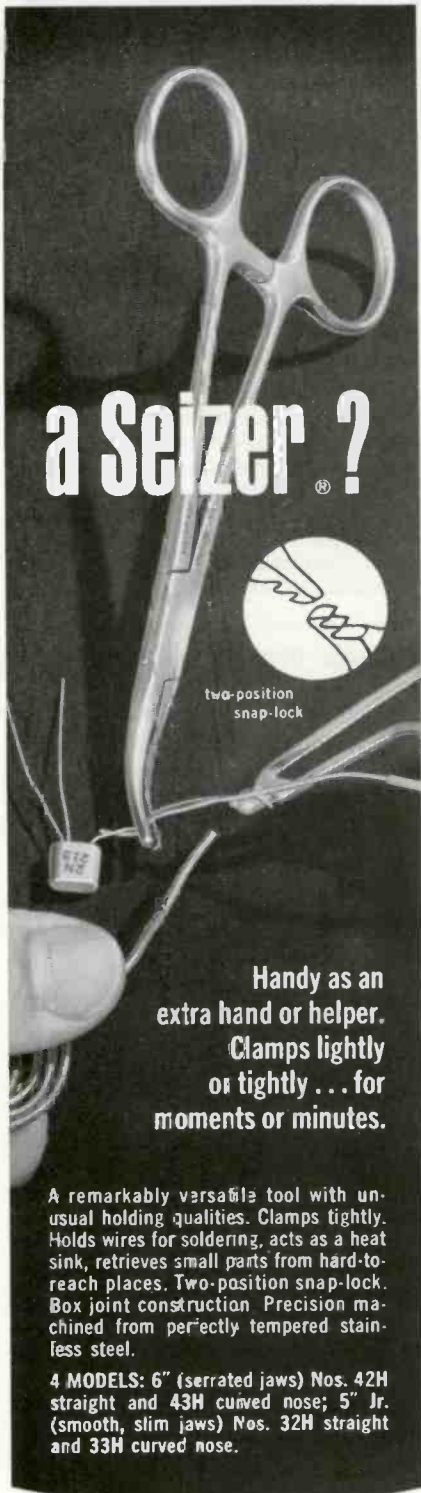

a Seizer?®

two-position  
snap-lock

Handy as an  
extra hand or helper.  
Clamps lightly  
or tightly... for  
moments or minutes.

A remarkably versatile tool with unusual holding qualities. Clamps tightly. Holds wires for soldering, acts as a heat sink, retrieves small parts from hard-to-reach places. Two-position snap-lock. Box joint construction. Precision machined from perfectly tempered stainless steel.

4 MODELS: 6" (serrated jaws) Nos. 42H straight and 43H curved nose; 5" Jr. (smooth, slim jaws) Nos. 32H straight and 33H curved nose.

**XCELITE**®

XCELITE, INC., 14 Bank St., Orchard Park, N.Y. 14127  
In Canada contact Charles W. Pointon, Ltd.

For more details circle 139 on Reader Service Card

## LETTERS...

*continued from page 71*

### Error in May Antenna Article

The article on "Professional Antenna Installation Methods" by Bert Wolf (May, 1972) was as plain and simple as anyone would desire. However, the author did not take into consideration all government rules pertaining to antenna installations. Here in Wisconsin, and possibly various other states, the state building code forbids chimney mounts or any other type of attachment [to chimneys]. I enclose a photostat of the code law.

The author also somewhat discredits the tripods. This I feel is a bit of bias on his part. The tripod is easier, quicker and much more stable than any other roof mount. They come in various sizes—from 18 in. to 10 ft—for all types and sizes of antennas. The leg spread is for 16-in. centers, which most roof rafters are. The mast will not then have to be guyed under normal installations—therefore more customer satisfaction, a cleaner look and the peace of mind that in 5 to 10 years it will not fall down due to rusting guy wires. The tripod can also be a one-man installation, regardless of antenna size or installation type. Using lag screws with a speed wrench makes for quick roof anchoring.

The author's list of tools should have included a 7/16-in. nut driver in place of the 3/8-in. nut driver. Also a great aid is electricians' plastic tape. This tape has many uses. It is used for splicing wires, taping coaxial cable and rotator control wire to the mast, for taping the wire to a fish wire or cord, and on and on. A 1/2-in. drill with a long shank (15 in.) comes in quite handy for drilling through basement window casements.

These items, I think, are quite noteworthy and of importance to anyone starting in the antenna installation field. I know, I was at the starting gate six years ago.

JOHN L. KOEHLER

### Let Them Continue

In answer to your request concerning Mr. C. A. Tuthill's series of articles, I would like to suggest that you let them continue. I hold a First Class F.C.C. license and would like to see commercial transmit/receive equipment articles become a permanent feature in your publication. I have been properly licensed and qualified and have in fact properly serviced C.B. and Marine Radio for years. But there are just too many models and makes

on the market and new ones coming up all the time. I doubt if anyone knows them all.

Unfortunately, I have witnessed properly licensed men using proper instrumentation butcher two-way radio equipment. They were new in the business. Although they could obtain a license, they lacked knowledge and experience. This was their only weakness. Your articles could help overcome this.

HARRY C. KELLER

### Wants CB Series Continued

Please print the second article in the series by Mr. C. A. Tuthill. Your editorial exposure of other facets of electronics is appreciated by this cover-to-cover reader.

Since you publish a restricted circulation magazine, you have an obligation to be technically accurate and comprehensive in your articles. Your magazine would decline in value and appeal if you printed articles relative to only one type or make of equipment. Such editorial format is more the function of manufacturers' publications.

While it may be argued that a little knowledge is a dangerous thing, I believe more danger lurks in lack of knowledge. May I suggest references be included with your articles for those who desire more information on the subject?

ROBERT B. FRANKE

### Please Complete Series

Please complete your planned series on C.B. Service.

No matter how much you give or don't give, there will be those that are going to foul up C.B.'s or anything else, all the laws going are not going to stop them.

I do have a Second Class F.C.C. license, am studying for an associate degree and plan to take the C.E.T. Exam in the near future. I have a minimum and maximum charge for labor to work on any piece of gear, plus an additional charge which I add on if the unit has been tampered with. These are all posted so that all can see.

I feel that those other people that wrote chewing you out were very short sighted. You can get all kinds of information on any subject from libraries, the government printing office and Sams. It seems they want to put this magazine out of existence.

I say publish this article and many more like it. Keep up the good work.

WILLIAM E. GARLAND

## CRIME SEMINAR...

*continued from page 58*

owner, or what can a store owner do—my question is two-fold—to cut down on the possibility of his taking a worthless check . . . not necessarily from someone he knows because there's darn small opportunity to guard against that . . . but to take steps to prevent him from receiving a stolen or forged welfare check. You know . . . you used to go into a gas station, and the checkbook was lying open there, and you'd steal the last three pages out of the checkbook . . . things like this. What can the store owner do to keep from taking one of those checks?

**Laurence Barnekow:** Generally speaking, a check of any amount of money is a payroll check. These are the easiest checks to bounce. And any legitimate payroll check always has the phone number of the company on it. It costs you a dime to call that company and see if that man works for them. But it's going to cost you \$600 if you don't spend that dime.

That man may work for them, but that's not the guy behind the counter. If you call the company and you say: Is Joe Blow working for you? That you have a check for X number of dollars. If there are checks stolen, they're going to say . . . checks number so and so are outstanding. And chances are . . . when I go in to rip a place off . . . or if I pay somebody to go in and rip a place off . . . to steal me some checks . . . I don't know the first d### employee that works there. So I'm going to use whatever identification I can get my hands on. By spending a dime, you can really safeguard yourself.

**David Egan:** What I'm trying to bring out here is this: Most often it is not a personal check, it is a payroll check of some kind that you got or somebody like you got by stealing it. A lot of the breaking and entry people will come in and while they're ripping off the place and taking merchandise out or money or the safe, will also take the last three pages of a checkbook. And then when the owner comes in and finds out he's been burglarized, he never thinks to look in the checkbook, and therefore doesn't report the loss to

the bank or the police department.

**Laurence Barnekow:** Very true. My main gate was filling stations. Now you can walk into any d### filling station . . . and I bet you that we can all walk into five filling stations here . . . and probably out of four of them I'm going to walk out with some checks.

They have these three-page checkbooks laying around on the counters. You know, they pay for auto parts, for this and for that with checkbooks. If I was up against the wall and I had to have money, I'd go to one filling station and I'd bet you that I'd come out of there with some checks. And you can tell . . . you know your locality . . . you know what your wages are and everything . . . and the check seems a little too high or something. For C##### sakes, spend a dime . . . it's going to save you a h### of a lot in the long run.

You know, I could spend two hours telling you how to safeguard yourself. But each store, I'm sure has different methods of operation. Each one has particular, different

*continued on next page*

# AKTRON

When quality makes the difference

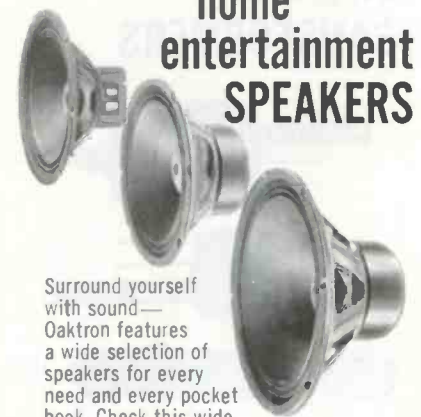

## home entertainment SPEAKERS

Surround yourself with sound—Aktron features a wide selection of speakers for every need and every pocket book. Check this wide selection—speaker size from 4½" to 15"—magnets from 6 oz. to 20 oz.—voice coils from 1" to 2"—power from 10 to 75 watts. All have free edge cone suspension and aluminum voice coils. Aktron speakers speak for themselves. Write for complete information.

# AKTRON

INDUSTRIES, INC.  
1000-30th St., Monroe, Wisconsin

... for more details circle 124 on Reader Service Card

# all test jigs GO SOLID STATE with a TELEMATIC TRANSVERTER

service:

Motorola

Zenith

Sylvania

RCA... etc. etc...

- Converts any test jig to service any solid state TV.
- Simple plug-in operation
- Economical — Saves buying a solid state jig.
- Versatile — Dual impedance.

Available from your distributor.

## TeleMatic

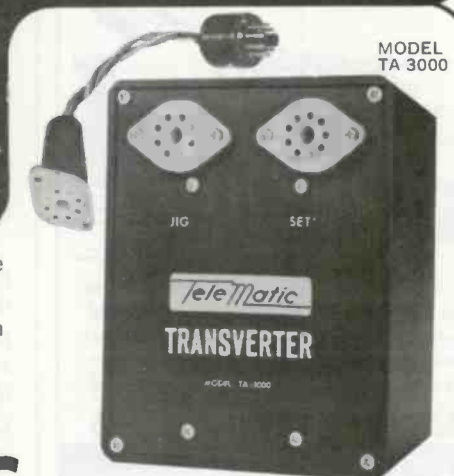

MODEL  
TA 3000

2245 PITKIN AVE., BROOKLYN, N. Y. 11207

Write Us! Free subscription for current cross-reference charts

... for more details circle 134 on Reader Service Card

## THE BEST PERFORMING SPLITTERS AND MATCHING TRANSFORMERS

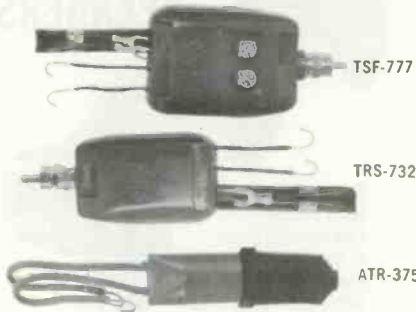

RMS has the most complete line of Splitters and Matching Transformers required for multiple-set home installations, master antenna systems, and closed circuit TV systems. All have unbeatable, dependable ratings. #SPF-555 3-Way UHF/VHF/FM Splitter. #SP-332 UHF/VHF Splitter. #TSF-777 UHF/VHF/FM Splitter and Matching Transformer. #TRS-732 Universal Matching Transformer and UHF/VHF Splitter. #TR-730 Matching Transformer. #ATR-375 Weather-Proof Antenna Side Matching Transformer. For complete specs and Profit picture—Write:

### RMS ELECTRONICS, INC.

50 Antin Place, Bronx, N.Y. 10462  
Tel. (212) 892-6700

... for more details circle 130 on Reader Service Card

## SPEAKER GUARD

PROTECTS SPEAKER  
AND AMPLIFIER

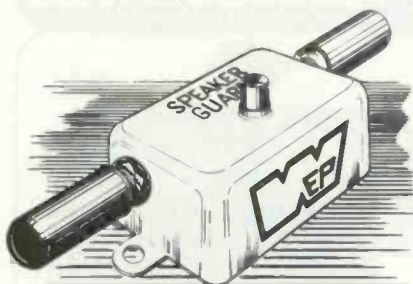

An overload in wattage of amplifier output activates circuit breaker and prevents damage. Reset circuit breaker and make sure you use correct values of Speaker Guard.

18 DIFFERENT VALUES

ASK FOR CAT. # 145C

**WORKMAN**  
Subsidiary of IPM TECHNOLOGY, INC.  
BOX 3828 SARASOTA FLA 33518

*Electronic*  
PRODUCTS, INC.

... for more details circle 137 on Reader Service Card

## CRIME SEMINAR...

continued from page 73

problems... depending on your locality. This is one of the reasons why Ansel mentioned earlier that he contacted Dave Egan... and the group of us will come out and we'll evaluate your store.

David Egan: Larry, I have one question. I'm wondering... how did you get caught? I heard it all from the other two. How did you get caught and how did you get prosecuted for paperhanging?

Laurence Barnekow: Paperhanging is one of the hardest possible crimes to prove. Like I say, I had been in the business for about seven years, and I had them strung all over the country, and they really didn't prove anything. I admitted to guilt in Wisconsin and about seven other states just decided to drop their charges. I knew I was going to get caught anyway. If they can prove one check, they're going to get me on all of them.

One of the stores had one of those phonies, you know, where you take your picture when you're cashing a check. But it wasn't phoney. On nine out of 10 of them, I will stick gum on the lens so that they don't get my picture. But I had bounced two or three of them and never got caught, so I went back there brave as h###... and I walked in... and it just so happened that that day they had a film in the camera.

So they had my mug... they go down to the police station... and about four months later I got stopped down in Miami... and I screwed up and I told them I was from Wisconsin. They called back here and they said, yeah, he's wanted back here. So then they checked a little deeper... and I was wanted all the way up... I just made a trail, you know.

Some of the discussion that followed the seminar:

Ansel Briggs: If I'm coming in to get a carryable safe, I don't give a d### if the alarm goes off. It's going to take 15 or 20 minutes for someone to get there. I don't care if it goes off or not. That doesn't scare me. I'll be gone before anyone can get there.

A good 500 pound safe? What does it take to get it out of a store with a dolly? One man with a dolly!

Laurence Barnekow: For homes they have these burglar alarms... they've got a red light on your roof. Well if you're gone on vacation or something and somebody busts in, this light goes on so all your neighbors around the neighborhood see your light... now they know that somebody is in the house that doesn't belong there.

How many of you have been ripped off when on a service call... had your truck burglarized. H###, there's electric shocks, there's a million different types of truck burglar alarms that you can install. There are devices where nothing happens to the truck, but maybe in the tool box there is a buzzer or something. So someone's monkeying with his truck. He's in the house. His box is always with him... right there by the TV. Now that buzzer is going to go off. Now he's going to know it... so he's going to get the h### out there to see who's monkeying with his truck.

A security check by our Crime Prevention Consultants will probably cost you between \$200 and \$300, depending upon the size of your shop and necessary travel.

I'll tell you what we did in Philadelphia. We rented an apartment, got a phone number and had checks printed up with that phone number on it. Now that girl sat there... she knew we were all working... there was four of us hitting the town. Call the bank... naturally you look at the check... the phone number's right there... so you dial that number. Now you're calling the apartment... you're not calling that bank. But she answers the phone... First Wisconsin National Bank... whatever it is... just a minute... I'll check for you. She comes back in a couple of seconds... yes, there's sufficient funds in that account. So you cash the check.

So you deliver the d### thing. That check might lay there for three days before it ever goes to the bank. Well, in three days I've got 20 TV's delivered to that address... they're hauled into Chicago on a semi... the money's in my pocket... and I'm out of town.

Should you wish to have these Crime Prevention Consultants check you out, either write them at the address provided at the beginning of the article or phone 414-447-1100.

## SMASH-SNATCH . . .

continued from page 44

a.m. in full view of a newspaper circulation office that was open next door. Police arrived quickly, but not before another load of TV sets disappeared.

Only two weeks later, the window was cut out again, and several Hi-Fi sets and tape recorders were removed.

Everyone at Couch's was in a state of despair. Trained dogs were considered. Mr. Couch's suggestion that all employees take turns at sentry duty was not met with bounding enthusiasm.

Instead, the wiring pattern was altered to include the center of the windows. A 50w solid-state power amplifier was installed in the circuit, along with a large University CLH horn speaker mounted about 40 ft up on the antenna tower. A cassette-tape player was connected to the amplifier, with a siren recorded on one track and a voice yelling, "HELP, HELP, CALL THE POLICE!" recorded on the other track. This circuit also remained connected to police headquarters. All but the speaker were installed inside in a remote location not visible to the shopping public.

To help prevent disarming the circuit, a latch relay is used. Once set into operation, the power must be discontinued before the siren will stop. With this circuitry, the alarm has on occasion gone off by mistake—a very effective traffic stopper.

The place has not been burglarized since these refinements were made to the alarm system.

Couch's is now finalizing plans for a new building which will be designed to offer even greater burglar protection. Further refinements provide for a dual switchbox to discourage the removal of ac power—a second source of ac power being obtained from a neighboring building.

Closed circuit television will be used in conjunction with a video recorder for better identification of those choosing to take delivery without paying.

Still another consideration is an infrared detection system, which it is hoped will thwart even the most

sophisticated robbery attempt.

The back doors will be of metal construction. Front glass areas will be minimized. Although the initial cost is somewhat higher, a material other than plate glass (such as Lexan plastic) may be used.

Couch's lesson has been hard learned. More sophisticated crooks mean that better detection systems must be developed and installed. Don't be caught short. Protect your business before you get a 2:00 a.m. phone call. ■



Could you put my set on the blink? I'd like my husband to take me out a couple of evenings.

## CORNELL ELECTRONICS COMPANY

4213 N. UNIVERSITY AVE. SAN DIEGO CALIF. 92105

THE ORIGINAL HOME OF

# 36¢

PER TUBE  
UNLESS OTHERWISE PRICED  
100 TUBES OR MORE  
**33¢ PER TUBE**

Same Low Price East or West Coast!

- ★ Bargain Tools
- ★ Transistor Tester
- ★ Technician's Library

**SPECIAL OFFER**  
ON ALL ORDERS OVER \$10.00

# 25¢

PER TUBE (NO LIMIT)  
FROM THIS LIST

6AG5	6CB6
6AU6	6J6
6AX4	6SN7

**SEND FOR FREE NEW 48 PAGE COLOR CATALOG**

- ★ Dumont Picture Tubes
- ★ Diodes—Transistors—Kits
- ★ Tube Cartons

ONE YEAR GUARANTEE  
INDIVIDUALLY BOXED  
5 DAY MONEY BACK OFFER  
LAB TESTED USED

Your Order FREE if Not Shipped in 24 Hours

. . . for more details circle 106 on Reader Service Card

## SALES SLIP on NCR Paper\* with PORTABLE REGISTER

. . . provides instant copies of every transaction on-the-spot, without carbons.

Compact, lightweight, easy-to-operate . . . just write up sale . . . release Sales Slip, pull out and detach . . . next form is in place, ready-to-use.

NCR paper adds efficiency to your business. Saves time and money by eliminating the need to adjust, replace or throw away messy, dirty carbon paper. This modern system is business-like yet not expensive. Sales Slips priced as low as \$9.95 . . . in quantities of 250 printed with your heading.

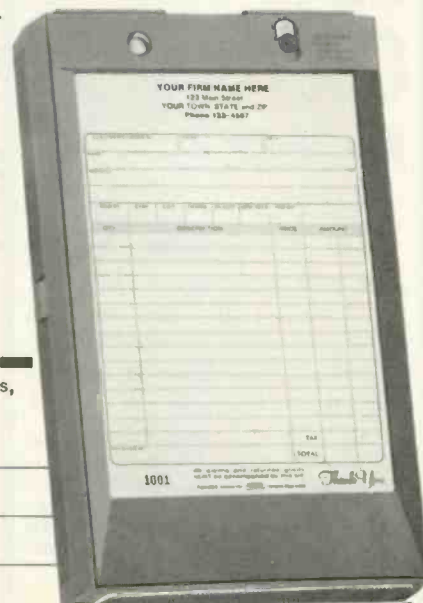

Please rush more information on Sales Slips, and catalog of other time-saving forms.

Name \_\_\_\_\_

Street \_\_\_\_\_

City, State & Zip \_\_\_\_\_

Your line of business \_\_\_\_\_



Mail to: New England Business Service, Inc.  
P.O. Box 500, Dept. 236, Townsend, Mass. 01469

\*NCR PAPER—A REGISTERED TRADEMARK of NATIONAL CASH REGISTER COMPANY

. . . for more details circle 123 on Reader Service Card

# DESIGNS OF THE NEW SHAPE OF SOUND TOMORROW



TAPE PLAYERS



PARTS & ACCESSORIES DC MOTORS & BELTS

COMPLETE CATALOG AVAILABLE.  
CALL YOUR WELTRON DISTRIBUTOR TODAY!  
or write or call direct:

**Weltron**  
COMPANY  
514 East Peabody Street, Durham, N.C. 27702  
919-682-0333

... for more details circle 136 on Reader Service Card

## READERS SERVICE INDEX

### ADVERTISER'S INDEX

Amperex Electronic Corp.	54
101 Apeco Corporation	76
102 B&K Div., Dynascan Corp.	34
103 Book Club—Schematics	65
104 Book Club—Tab Books	50-53
105 Chemtronics, Inc.	28
106 Cornell Electronics Co.	75
107 Delta Products, Inc.	68
108 Delta Products, Inc.	70
109 Dictaphone	62
110 E-V/Game, Inc.	69
111 Eastman Chemical Products Inc.	61
112 Eico Electronic Instruments Co., Inc.	4th Cover
113 Electronic Chemical Corp.	71
114 Enterprise Development Corp.	71
141 John Fluke Mfg. Co.	30
115 Fordham Radio Supply Co., Inc.	76
General Electric Company Tube Product Dept.	22
GTE Sylvania, Electronic Components	59, 2nd Cover
116 Heath Company, The	63
117 International Components Corp.	64
118 Jerrold Electronics Corp.	62
119 Leader Instruments Corp.	38
120 Leader Instruments Corp.	3rd Cover
121 Mallory Distributor Products Co.	21
122 Mountain West Alarm Supply Co.	76
123 NCR Paper-Appleton Papers, Inc.	75
123 New England Business Service, Inc.	75
124 Oaktron Industries, Inc.	73
125 Oneida Electronic Mfg. Inc.	66
126 Precision Tuner Service	19
RCA Electronic Components	33
127 RCA Electronic Components Technical Publications	26
128 RCA Parts & Accessories	29
129 RCA Parts & Accessories	67
RCA Picture Tubes	31
130 RMS Electronics, Inc.	74
131 Sprague Products Co.	24
132 Tech Spray	39
111 Tech Spray	61
133 Telematic Div., UXL Corp.	71
134 Telematic Div., UXL Corp.	73
135 Triplet Corporation	27
136 Weltron Co., Inc.	76
137 Workman Electronic Products, Inc.	74
138 Workman Electronic Products, Inc.	76
139 Xcelite, Inc.	72
140 Yeats Appliance Dolly Sales Co.	76

### TEST INSTRUMENT

900 Leader's Model LBO-505 Triggered Sweep Scope	60
--	----

## MOVING?

Be sure to let us know your new address. Please enclose a complete address label from one of your recent issues.

# DISCOUNT PRICES TEST EQUIPMENT



## SENCORE

Test Equipment of Other Manufacturers also Available

Catalog & Prices on Request

## FORDHAM Radio Supply Company, Inc.



265 E. 149 Street, Bronx, N.Y.  
Tel: (212) 585-0330



DISTRIBUTORS OF ELECTRONIC SUPPLIES

... for more details circle 115 on Reader Service Card

**MOST VERSATILE Stereo Theatre TRUCK DEVELOPED!**

**FURNITURE PADS** 5.50

**CONSOLE TV COVER** 21.50

**YEATS PLATFORM DOLLY** 122.95

FREE illustrated brochure

**YEATS APPLIANCE DOLLY SALES CO.**  
1307 W. FOND DU LAC AVE.  
MILWAUKEE, WIS. 53205

... for more details circle 140 on Reader Service Card

## C. C. TV EQUIPMENT FOR SALE

Cameras, VTR, monitors and accessories new and used. Available for immediate inspection and quotation.

Write to or call:

### RICHARD A. DAVIS

410 North Michigan Avenue, Suite 660  
(312) 869-9000, Chicago, Illinois 60611

... for more details circle 101 on Reader Service Card

## FREE ALARM CATALOG

64 PAGES FILLED WITH 350 BURGLAR AND FIRE ALARM PRODUCTS FOR INSTALLERS AND ELECTRONIC TECHNICIANS. INCLUDES RADAR, INFRARED, CONTROLS, HARD-TO-FIND PARTS, AND 6 PAGES OF APPLICATION NOTES.



mountain west alarm  
4215 n. 16th st., phoenix, az. 85016

... for more details circle 122 on Reader Service Card

## A NEW LINE OF TROUBLE FREE MATV CATV PRODUCTS



MATCHING TRANSFORMER, SPLITTER AND DIRECTIONAL TAPS IN BOTH MINIATURE AND STANDARD SIZES, HYBRID AND DIRECTIONAL WALLPLATES, LIGHTNING GROUNDING ARRESTERS

Cases are epoxy covered cadmium plated steel • Circuits embedded in polyurethane foam, encased in epoxy resin • High degree directivity prevents unwanted reflected signals. • Shockproof • Waterproof

ASK FOR CAT.# 144C

**WORKMAN** Electronic PRODUCTS, INC.  
Subsidiary of IPM TECHNOLOGY INC.  
BOX 3829 SARASOTA, FLA. 33578

... for more details circle 138 on Reader Service Card



For those countries outside the U.S., please apply appropriate postage before mailing

# READER SERVICE INFORMATION CARD

For more information on products or services mentioned in this issue, simply circle the appropriate numbers below, type or print your name and address and drop in the mail.

### ADVERTISED PRODUCTS

101	110	119	128	137	146
102	111	120	129	138	147
103	112	121	130	139	148
104	113	122	131	140	149
105	114	123	132	141	150
106	115	124	133	142	151
107	116	125	134	143	152
108	117	126	135	144	153
109	118	127	136	145	154

### TEST INSTRUMENTS

900	909
901	910
902	911
903	912
904	913
905	914
906	915
907	916
908	917

### NEW PRODUCTS

700	709	718	727	736	745
701	710	719	728	737	746
702	711	720	729	738	747
703	712	721	730	739	748
704	713	722	731	740	749
705	714	723	732	741	750
706	715	724	733	742	751
707	716	725	734	743	752
708	717	726	735	744	753

This card is usable until December 5, 1972.

9/72

NAME \_\_\_\_\_ POSITION \_\_\_\_\_  
 COMPANY \_\_\_\_\_ STREET \_\_\_\_\_  
 CITY \_\_\_\_\_ STATE \_\_\_\_\_ ZIP CODE \_\_\_\_\_

Circle the Reader Service numbers of those items of interest to you.

**GET MORE FACTS**  
 NO POSTAGE NECESSARY

Your own personal copy for only pennies per issue

## BUSINESS REPLY MAIL

NO POSTAGE STAMP NECESSARY IF MAILED IN THE UNITED STATES

### FIRST CLASS

PERMIT NO. 665  
 DULUTH, MINNESOTA

POSTAGE WILL BE PAID BY

Reader Service Department

## ELECTRONIC TECHNICIAN/DEALER

POST OFFICE BOX 6016, DULUTH, MINNESOTA 55806

For those countries outside the U.S., please apply appropriate postage before mailing



## PERSONAL SUBSCRIPTION CARD

GET A FREE BONUS WITH YOUR PERSONAL SUBSCRIPTION TO ELECTRONIC TECHNICIAN/DEALER!

- 3 Years \$13     2 Years \$10     1 Year \$6\*  
 Payment Enclosed     Bill Me

\*BONUS: With a 2 or 3 year subscription, you receive both TEKFAX 110 and the COLOR TV GUIDEBOOK free! If you are subscribing for 1 year, please indicate your choice of either:  TEKFAX 110     COLOR TV GUIDEBOOK



### PLEASE CHECK BELOW:

1. In the TV, Radio and other consumer products fields, is your firm PRIMARILY a: (please check most descriptive item)  
 Retailer with service department     Industrial electronics service firm  
 Service/repair firm with some retail     Manufacturer  
 Service/repair firm with no retail     Other (please describe)
2. Title (please check one)  
 Owner, manager, buyer, other executive  
 Service manager  
 Service repairman or other employee

NAME \_\_\_\_\_ STREET \_\_\_\_\_  
 FIRM \_\_\_\_\_ TITLE \_\_\_\_\_  
 CITY \_\_\_\_\_ STATE \_\_\_\_\_ ZIP \_\_\_\_\_

If you are renewing your subscription, check here and attach your address label. If you renew your subscription for 2 to 3 years, you are still eligible to receive your free bonus.

# BUSINESS REPLY MAIL

NO POSTAGE STAMP NECESSARY IF MAILED IN THE UNITED STATES

POSTAGE WILL BE PAID BY

Reader Service Department

## ELECTRONIC TECHNICIAN/DEALER

POST OFFICE BOX 6016, DULUTH, MINNESOTA 55806

FIRST CLASS

PERMIT NO. 665

DULUTH, MINNESOTA



# GET MORE FACTS

NO POSTAGE  
NECESSARY

For those countries outside the U.S., please apply appropriate postage before mailing.

## READER SERVICE INFORMATION CARD

For more information on products or services mentioned in this issue, simply circle the appropriate numbers below, type or print your name and address and drop in the mail.

### ADVERTISED PRODUCTS

101	110	119	128	137	146
102	111	120	129	138	147
103	112	121	130	139	148
104	113	122	131	140	149
105	114	123	132	141	150
106	115	124	133	142	151
107	116	125	134	143	152
108	117	126	135	144	153
109	118	127	136	145	154

### TEST INSTRUMENTS

900	909
901	910
902	911
903	912
904	913
905	914
906	915
907	916
908	917

### NEW PRODUCTS

700	709	718	727	736	745
701	710	719	728	737	746
702	711	720	729	738	747
703	712	721	730	739	748
704	713	722	731	740	749
705	714	723	732	741	750
706	715	724	733	742	751
707	716	725	734	743	752
708	717	726	735	744	753

This card is usable until December 5, 1972.

9/72

NAME \_\_\_\_\_ POSITION \_\_\_\_\_

COMPANY \_\_\_\_\_ STREET \_\_\_\_\_

CITY \_\_\_\_\_ STATE \_\_\_\_\_ ZIP CODE \_\_\_\_\_

# BUSINESS REPLY MAIL

NO POSTAGE STAMP NECESSARY IF MAILED IN THE UNITED STATES

POSTAGE WILL BE PAID BY

Circulation Department

## ELECTRONIC TECHNICIAN/DEALER

POST OFFICE BOX 6016, DULUTH, MINNESOTA 55806

FIRST CLASS

PERMIT NO. 665

DULUTH, MINNESOTA



Circle the Reader Service numbers of those items of interest to you.

Your own personal copy for only pennies per issue

# What you see is what you get



Solid State  
DIGITAL  
MULTIMETER  
\$299.95

# LEADER

The LDM 850. No compromise. No ifs, no buts. Here is precision and accuracy, never before possible in a DVM... with non-blinking digital readout that eliminates any possibility for error or parallax. Scale accuracy is  $\pm 1.0\%$  or greater with  $3\frac{1}{2}$  digit identification up to 1,999. You can measure AC or DC voltage, current and ohms in 25 ranges and the 115/230V power supply gives you in-shop or in-the-field flexibility. We've even developed an exclusive dual slope operating mode with an instant response, manual range switch. Max. input is 1,000VDC and 350VAC; 10 M $\Omega$  input impd. Sensitivity ranges from 100 $\mu$ V to 1V; current from 0.2mA to 1,000mA; resistance from 0.2K $\Omega$  to 2,000K $\Omega$ ; plus automatic polarity reversal. Size? Just  $3\frac{1}{4}$ "hx $7\frac{3}{4}$ "d. *What you see is what you get from Leader - outstanding quality.*

**The more you see... the more you believe... the more you save**

LEADER INSTRUMENTS CORP. 37-27 TWENTY-SEVENTH ST. LONG ISLAND CITY, N.Y. 11101 (212) 729-7411

# WHEN YOU BUY A BURGLAR OR FIRE ALARM, YOU MAY BE BUYING A FALSE SENSE OF SECURITY.

There's a world of difference between the professional system and corner-cutting imitators. Only the professional system has all these benefits and features:

## PROFESSIONAL BENEFITS

1. 4-way protection: against intruder, burglar, fire, emergency.
2. Expandable System: additional sensors (smoke, flood, freeze, etc.), remote control stations, entrance key switches may be added *any time* to meet future needs.
3. System safe to install and operate.
4. Power failure does not disable system.
5. Long battery life.
6. Battery monitoring.
7. Positive monitoring of alarm circuits.
8. Remote setting of security system.
9. No false alarms.
10. Visible intruder/burglar deterrence.
11. System concept provides tamper-proof protection.
12. GUARANTEED professional reliability.
13. Exclusive EICO Security Handbook.

## PROFESSIONAL FEATURES

- 4 major protection circuits: intruder/burglar "closed circuit," intruder/burglar "open circuit," 24 hour fire protection circuit and intruder "open circuits," emergency/panic circuit.
- Compact Centralized Security Control Center (EICO FC-100) with independent circuit loops for monitoring, and accommodating detectors, alarms, accessories. Ideal for apartment, home and factory installations.
- Powered by low voltage supplies—6 volts.
- Fail-safe Power Circuit: If AC power fails or is cut, internal lantern battery automatically takes over; automatically switches back to AC when power is restored.
- Battery gets trickle charge when AC power is on.
- Built-in Meter to check condition of battery.
- Signal lights at entrance key switches, remote control stations and Control Center; white "Circuit Test" light; red "Alarm On" light.
- Alarm can be activated or turned off from any desired entrance or inside location.
- Highly reliable circuit design and circuit components.
- Warning decals, red "Alarm On" light at key switch, visible alarm bell.
- Security Control Center is designed to be easily "hidden from view"—in closet, basement, etc. Tampering with outside bell sets off alarm.
- EICO guarantee on all parts—incontrovertible proof of EICO's superior circuit and component reliability.
- Enables anyone without any technical knowledge to install a complete home security system by himself.

## BEWARE THE IMITATORS OF EICO

They *look* like EICO but what they leave out gives you a false sense of security.

## ONLY PROFESSIONAL TYPE SECURITY SYSTEMS TRULY PROTECT

Anything less is worse than *no* protection at all. Anything less gives you a false sense of security, permits false alarms, easily becomes inoperative. The DO-IT-YOURSELF Security System that totally meets PROFESSIONAL PROTECTION STANDARDS is *ONLY* available from EICO.



**EICO FC-100 SECURITY CONTROL CENTER**

Completely assembled, ready-to-install, only **\$69.<sup>95</sup>**

## ACCLAIMED BY EDITORS AND CONSUMERS!

"The EICO SS-500 Home Protection system works as well as, if not better, than many so-called "professional" or industrial systems — at a lot less cost. Fact is, the SS-500 has more features than much "professional" equipment. And it certainly works a lot better than many do-it-yourself systems presently on the market that are supposedly intended for the average home owner."

*(Test Report Summary E/E Magazine Aug. 1972)*

- Performance-proven in thousands of homes
- Conceived and designed by EICO, the leader in electronic kits for over 26 years
- Available for immediate "off-the-shelf" delivery at your local EICO Security Electronics Center

## SEND FOR FREE EICO CATALOG

Describing security products, test instruments, automotive electronics, Eicocraft project kits and name of nearest dealer. Check reader service card or send 25¢ for prompt first class mail service.

**EICO-The Company that started the 'Do-it-Yourself' Trend In Home Security**



283 Malta Street, Brooklyn, N.Y. 11207 (212) 272-1100