

ELECTRONIC TECHNICIAN/DEALER

WORLD'S LARGEST TV-RADIO SERVICE & SALES CIRCULATION



FRIM0347468M2AZ
7176 GALE RD
ATLAS
MI 48411
AS
8722693AJ1

MATV Made Simple

How to Exorcise City and Suburban Ghosts

Service Training Schools

It's strange, but while tubes are on the way out—tube-testers are needed more than ever. That's because the home electronic sets today use sophisticated tubes in sophisticated circuits—and simple Shorts and Emission tests don't take into account the actual operation of the tube. Now B & K offers the Model 747 Dyna-Jet Solid State 100% *Dynamic Mutual Conductance* Tester—the last tube-tester you'll ever have to buy.

Triodes, nuvistors, tetrodes, pentodes and all other multi-element tubes can now be tested under AC operating conditions for 100% *dynamic mutual conductance*. Intermittents, low gain and other tube problems that would be obscured in an emission test, show up in this tester's dynamic mutual conductance tests.

A special Dynamic test has been designed into the B & K Model 747 to test high-voltage regulators. This test puts one signal on the regulator grid and another on the plate—actually operating the tube with the correct plate current. Too much or too little current can either destroy the tube or produce an unreliable reading.

Diodes, low- and high-voltage rectifiers are tested with proper voltages and loads to determine their emission capability.

And, of course, you'll still want to test for shorts, leakage and gassy tubes. The B & K Model 747 makes this easy with a one-button "Shorts" test and a one-button grid-leakage and gas test. And it "quick tests" 82% of the tubes you'll test. And gives you functional pin-straighteners to fit any tubes you'll ever run into. And to help you predict a tube's reserve, the 747 has a built-in "Life" test. Filament voltage is reduced 10% when the "Life" test switch is set on.

The last tube-tester you'll ever have to buy!

All-in-all, the B & K Model 747 Dyna-Jet Tube-Tester has all the features you've wanted—all the features you'll ever need in a tube-tester. And it's small, lightweight and very good-looking.

See it at your B & K distributor, and you'll see why it's the last tube-tester you'll ever have to buy!

Model 747
100% Dynamic Mutual Conductance
Dyna-Jet Tube-Tester Price \$249.95



Product of
DYNASCAN
CORPORATION
 1801 W. Belle Plaine
 Chicago, Illinois 60613

*There is a
 difference in test
 equipment —
 ours works!*

... for more details circle 101 on Reader Service Card

SYMBOL	DESCRIPTION	AIRLINE PART NO.
C117A	—80 µf/450v elect	67A15-398
C117B	—30 µf/450v elect	67A15-398
C117C	—20 µf/450v elect	67A15-398
C118A	—80 µf/450v elect	67A15-399
C118B	—80 µf/450v elect	67A15-399
C118C	—10 µf/450v elect	67A15-399
R131	—200M/40M (focus module) resistor	750A871-4
R133	—VDR resistor	61B46-8
R134	—thermistor	61C49-3

R108	—2K, AGC control	75A110-11
R110	—3.4M, vert size control	75A96-20
R123	—10Ω, vert centering control	75A64-37
R124	—10Ω, hold centering control	75A64-30
R132	—15M, focus control	75A108-2
R139	—250K, bright control	055-071300
R140	—500K, color control	055-067300
R141	—1.1K, tint control	055-071800
R142	—100K, vert hold control	055-072800
R143	—350Ω, contrast control	055-071200
R144	—50K, loudness control	055-071600

R145	—100K, tone control	055-072900
R149	—2K, preference control	055-072100
R330	—10Ω, bright limiter control	75A95-15
R341	—6K, blue drive	75A95-15
R342	—5K, green drive	75A95-15
R520	—100 n, AGC delay	75A101-33
R549	—8K, hi voltage adjust	75A64-41
R652	—300K, vert lin	75A101-10
DL101	—delay line	72A217-3
L101	—coil, line choke	72A31-16
L102	—coil, filter choke	74A27-4

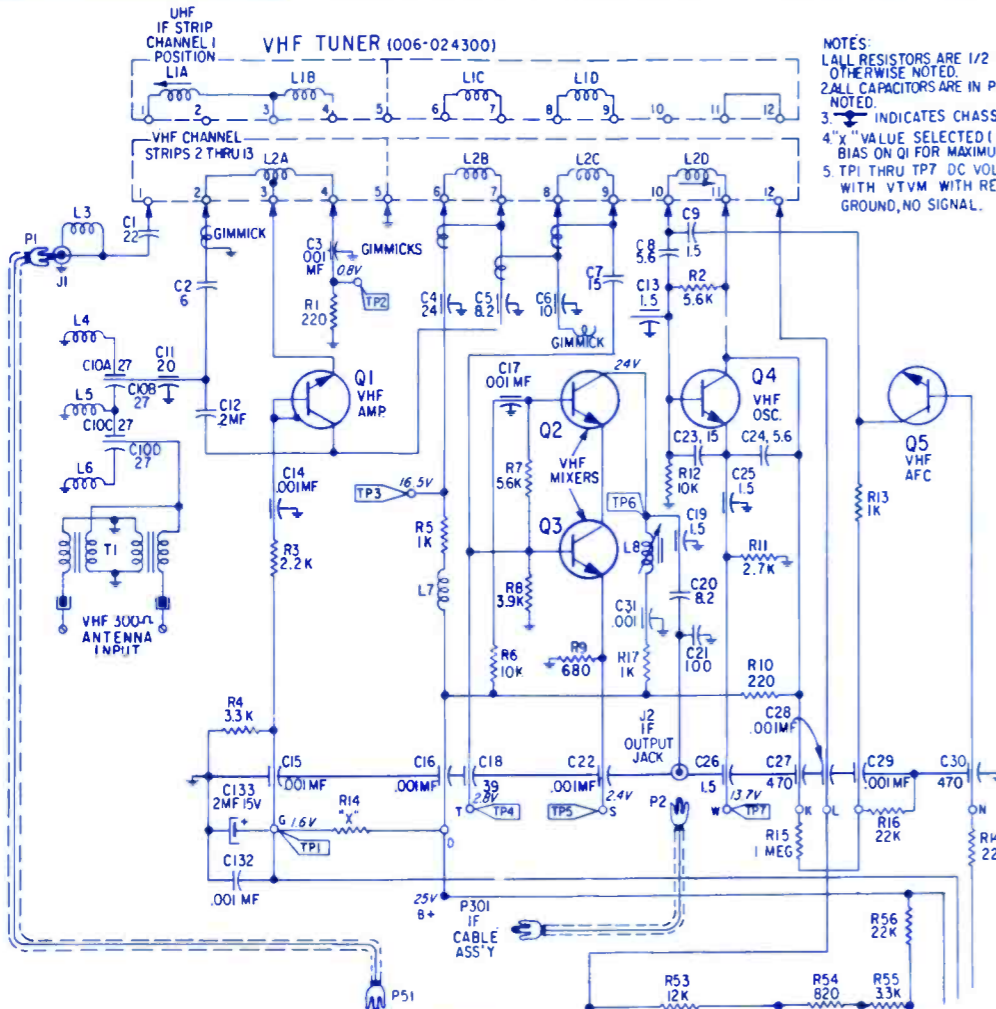

NOTES:
 1. ALL RESISTORS ARE 1/2 W, 10% UNLESS OTHERWISE NOTED.
 2. ALL CAPACITORS ARE IN PF, UNLESS OTHERWISE NOTED.
 3. ⚡ INDICATES CHASSIS GROUND.
 4. X VALUE SELECTED (33K TO 68K) TO ADJUST BIAS ON Q1 FOR MAXIMUM GAIN.
 5. TPI THRU TP7 DC VOLTAGES ARE MEASURED WITH VTVM WITH RESPECT TO CHASSIS GROUND, NO SIGNAL.

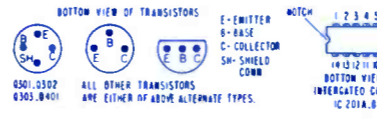
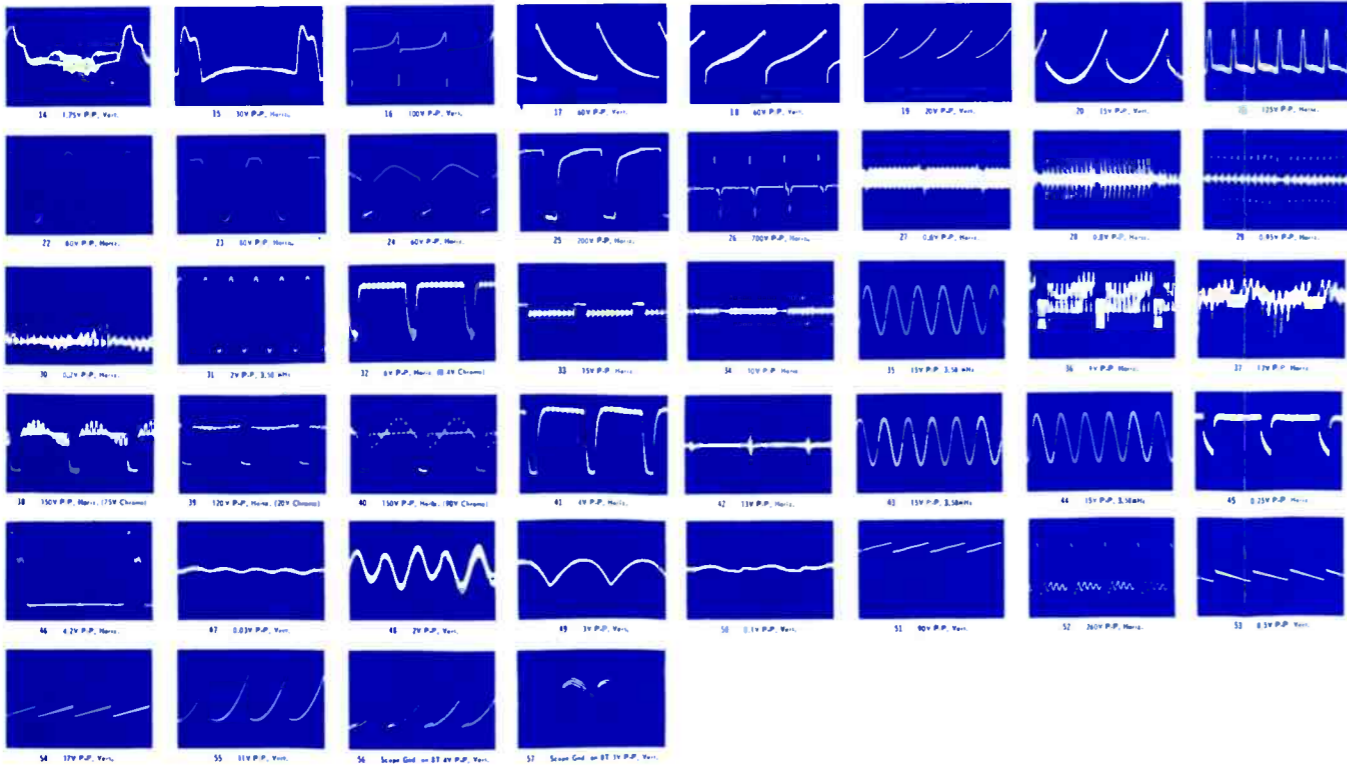
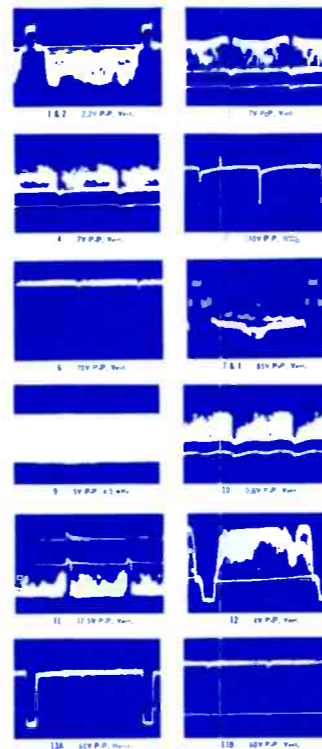

SCHEMATIC NOTES: ⚡ CHASSIS GROUND
 UNLESS OTHERWISE NOTED: ALL RESISTORS ARE 1/2 WATT, 10%. ALL CAPACITORS ARE IN PF. DC VOLTAGES MEASURED WITH VTVM PLACED BETWEEN POINTS INDICATED & CHASSIS GROUND. LINE VOLTAGE SET AT 120V AC. ALL CONTROLS SET FOR NORMAL PICTURE.
 VOLTAGE READINGS SHOWN IN BRACKETS () TAKEN WITH COLOR SIGNAL. VOLTAGE READINGS WITHOUT BRACKETS, INDICATES READINGS TAKEN WITHOUT SIGNAL, TUNER SET AT UNUSED CHANNEL.
 # INDICATES VOLTAGE READINGS TAKEN WITH BRIGHTNESS CONTROL AT MAXIMUM ROTATION (FULLY CW) BELOW DISK SIGNAL.
 & INDICATES VOLTAGE READINGS TAKEN WITH BRIGHTNESS CONTROL AT MINIMUM ROTATION (FULLY CCW).
 VOLTAGES IN VIDEO CIRCUITRY WILL VARY WITH VIDEO CONTENT OF PICTURE BEING RECEIVED. VOLTAGES SHOWN ARE TYPICAL READINGS. VOLTAGES AT 0001 THRU 0005 TAKEN WITH COLOR MONITOR IN FULL-ON POSITION.
 # INDICATES THESE VOLTAGES WILL VARY WITH SCREEN CONTROL SETTINGS.
 # NUMBERS IN HETEROGONS INDENTIFY WAVEFORM OBSERVATION LOCATIONS. CONDITIONS FOR TAKING WAVEFORM MEASUREMENTS ARE GIVEN WITH WAVEFORM PHOTOGRAPHS.

TRANSISTOR CAUTION: TO AVOID DAMAGE TO TRANSISTORS, DO NOT OPERATE WITH PICTURE TUBE DISCONNECTED FROM CHASSIS GROUND. DO NOT TURN SET ON WITH TRANSISTOR (S) TUBE (S) OR LEADS REMOVED OR UNDISCONNECTED. DO NOT ARC PIP AND ANODE LEAD TO CHASSIS GROUND. USE CAUTION TO PREVENT ACCIDENTAL SHORT BETWEEN COMPONENT TERMINALS OR TO CHASSIS GROUND. DO NOT APPLY EXCESSIVE HEAT TO TRANSISTOR LEADS.

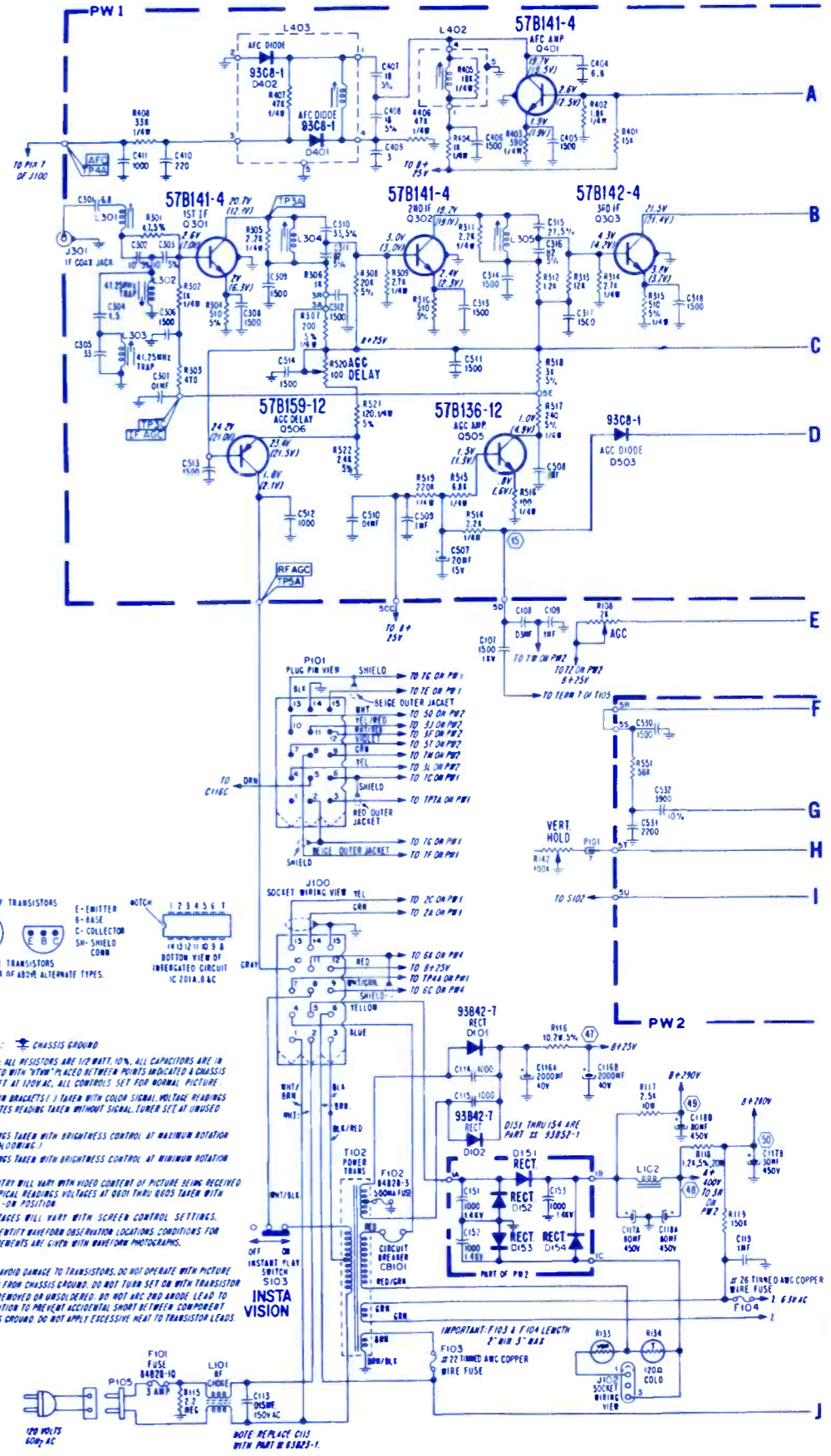

NOTE: REPLACE C115 WITH PART # 53823-1.

L105—coil width 94A279-3
 L108—deflection yoke 94A377-14
 L501—coil, horiz hold 94A351-1
 T101—audio output xformer 79A142-1
 T102—power xformer 80A106-1
 T103—pin cushion xformer 79A143-2
 T104—vert output xformer 79A134-2
 T105—horiz output xformer 79A145-2
 T201—4.5MHz xformer 72A317-4
 T202—4.5MHz discriminator xformer 72A356-1
 T701—bandpass xformer 72A333-2

T702—burst xformer 72A325-2
 CB101—circuit breaker 84A17-14
 S104—ON/OFF switch 146-013500
 VHF tuner 006-024300
 F101—3a (chemical) fuse 84A28-10
 F102—0.5a (chemical) fuse 84A28-3

AIRLINE
 Color TV Models
 GCI-17821A, 41A, 51A

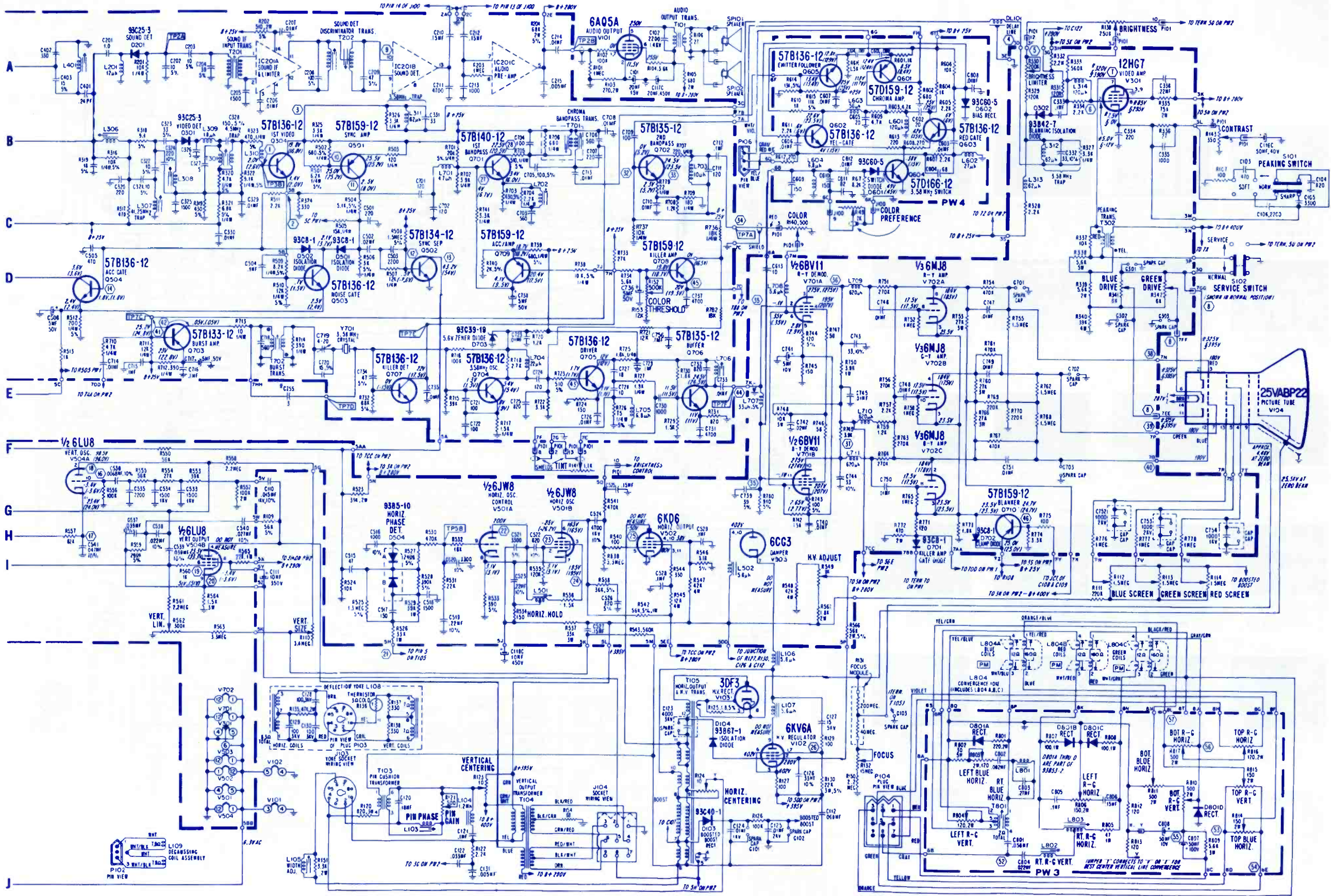

SYMBOL	DESCRIPTION	PHILCO-FORD PART NO.
IC1	act	46-5002-6
L2	47.25MHz trap	32-4959-2
L3	39.75MHz trap	32-4959-8
L17	4.5MHz trap	32-4893-3
L41	horiz hold	32-4891-2
L91	sound interstage	32-4936-2
L93	sound ratio det	32-4928-1
L94	tint control	32-4942-1
L96	chroma T.O.	32-4878-3

L99	chroma bandpass	32-4929-1
DL91	delay line	32-4839-3
RT200	degaussing thermistor	33-1376-6
RT201	vert damping thermistor	32-0292
RV55	horiz bias	33-1379-2
RV200	degaussing coil	33-1379-1
RV201	pin-cushion damping	33-1379-1
SW202	ON/OFF switch	42-2167-1
T1	audio output xformer	32-10119-3
T2	filter choke xformer	32-10093-0
T3	vert output xformer	32-10080-4

T4	horiz output xformer	32-10130-2
T5	power xformer	32-10131-1
VR41	A-red screen, B green screen, C blue screen	33-5595-20
VR42	A-vert. height, B-lin, C-bias	33-5627-3
VR91	video drive	33-5632-1
VR92	color killer	33-5628-6
VR93	CRT bias	33-5628-12
VR202	12M, focus adjust control	33-5631-24
VR202	25K, vol control	33-5634-17
VR203	1.2K, tint control	33-5623-0
VR204A & B	500Ω, color, 750K vert hold control	33-5644-4

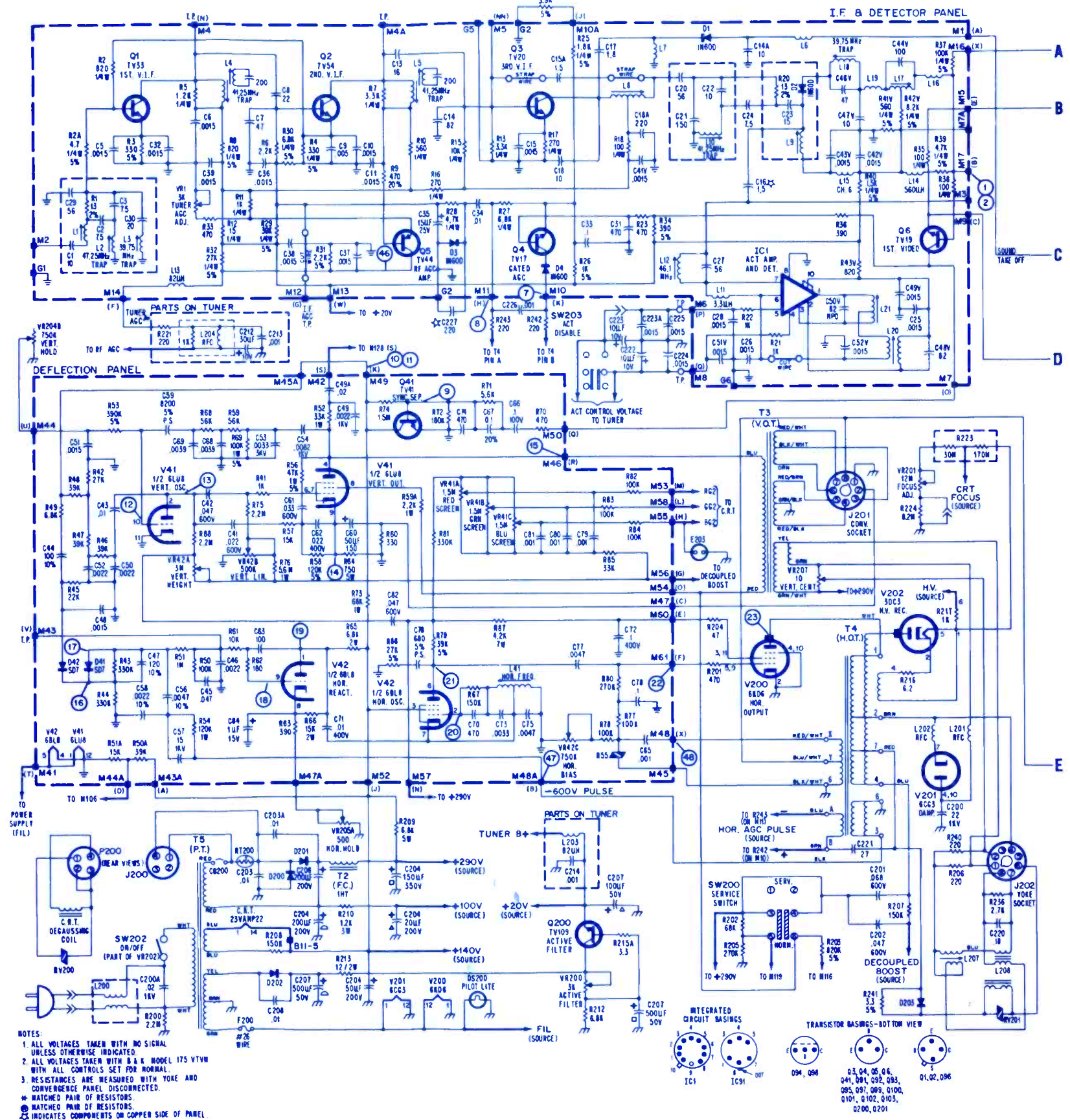
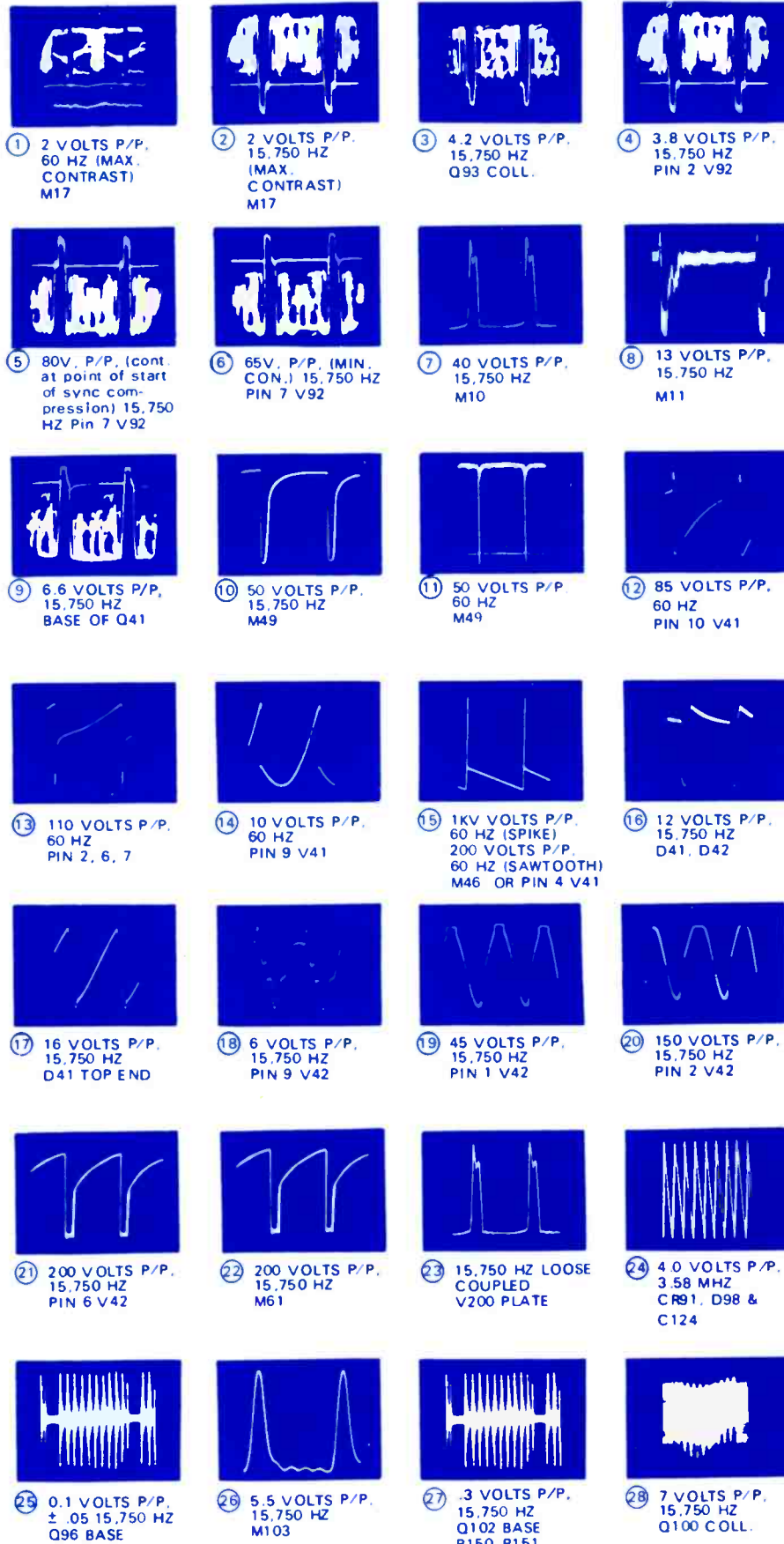

VR205A & B 500Ω, horiz hold, 100Ω contrast control .33-5636-16
 VR206A & B 300Ω, pix quality, 500Ω bright control .33-5636-20
 VR207—vert centering control .33-5609-1
 VHF tuner 76-14099-5V
 UHF tuner 76-14099-5U
 yoke assembly 76-14236-1

PHILCO-FORD
 Color TV Chassis
 20QT75

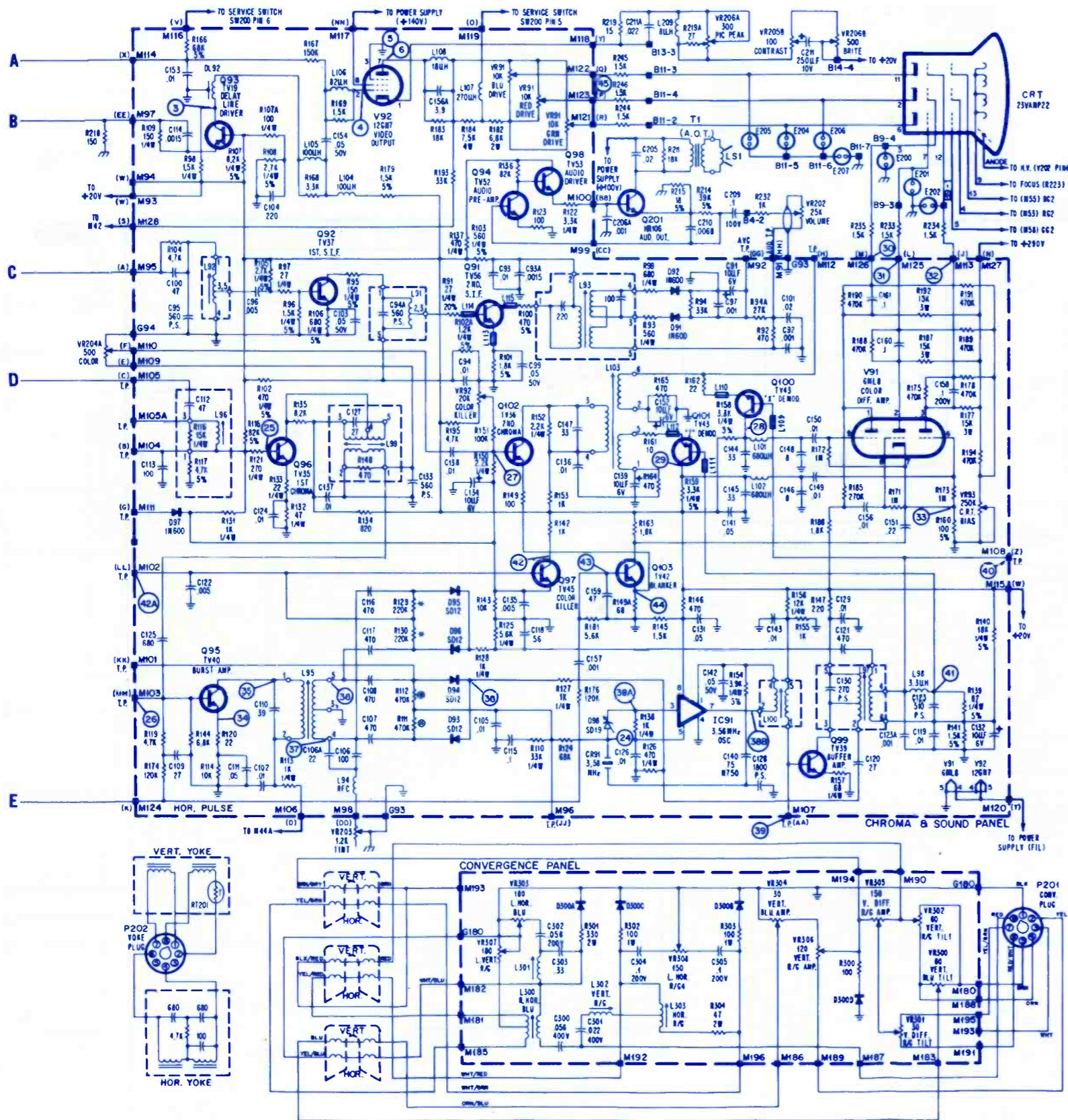

- 29 8.5 VOLTS P/P, 15.750 HZ Q101 COLL.
- 30 45 VOLTS P/P, (CHROMA) 70 V P/P, (SYNC) 15.750 HZ M126
- 31 17 VOLTS P/P, (CHROMA) 70 V P/P, (SYNC) M125
- 32 50 VOLTS P/P, (CHROMA) 70 V P/P, (SYNC) M113
- 33 2 VOLTS P/P, (CHROMA) 25 V P/P, (SYNC) R160, R173 PIN 7 V91
- 34 0.7 VOLTS P/P, 15.750 HZ Q95 EMIT
- 34A EXPLODED VIEW OF BURST OF VIEW 34
- 35 70 VOLTS P/P, 15.750 HZ Q95 COLL.
- 36 12 VOLTS P/P, 15.750 HZ PIN 5 L95
- 37 12 VOLTS P/P, 15.750 HZ PIN 4 L95
- 38 6 VOLTS P/P, 3.58 MHz D93, D94
- 38A 0.8 VOLTS P/P, 3.58 MHz PIN 3 IC91
- 38B 16 VOLTS P/P, 3.58 MHz PIN 7 IC91
- 39 1.6 VOLTS P/P, 3.58 MHz M107
- 40 1.0 VOLTS P/P, 3.58 MHz PIN 4 L97 OR M108
- 41 1.0 VOLTS P/P, 3.58 MHz L98-R139
- 42 .55 VOLTS P/P, 60 HZ Q97 COLL.
- 42A 0.85 VOLTS P/P, 60 HZ M102
- 43 12 VOLTS P/P, 15.750 HZ Q103 BASE
- 44 3.5 VOLTS P/P, 17.500 HZ Q103 EMIT.
- 45 90 VOLTS P/P, 15.750 HZ. CONT SET JUST BELOW POINT OF SYNC COMPRESSION M123
- 46 30 VOLTS P/P, 15.750 HZ Q5 COLL.
- 47 660 VOLTS P/P, 15.750 HZ M45
- 48 420 VOLTS P/P, 15.750 HZ M48

LINE VOLTAGE - 120 VAC
 AIR SIGNAL - FOR MONOCHROME SIGNALS
 COLOR BAR GEN. - B & K 1245 - FOR COLOR SIGNALS
 ACTIVE FILTER AT 20 VDC

Table with 3 columns: SYMBOL, DESCRIPTION, and RCA PART NO. listing various electronic components like capacitors, resistors, and diodes.

Table with 3 columns: SYMBOL, DESCRIPTION, and RCA PART NO. listing various electronic components like resistors, capacitors, and transformers.

Table with 3 columns: SYMBOL, DESCRIPTION, and RCA PART NO. listing various electronic components like traps, transformers, and coils.

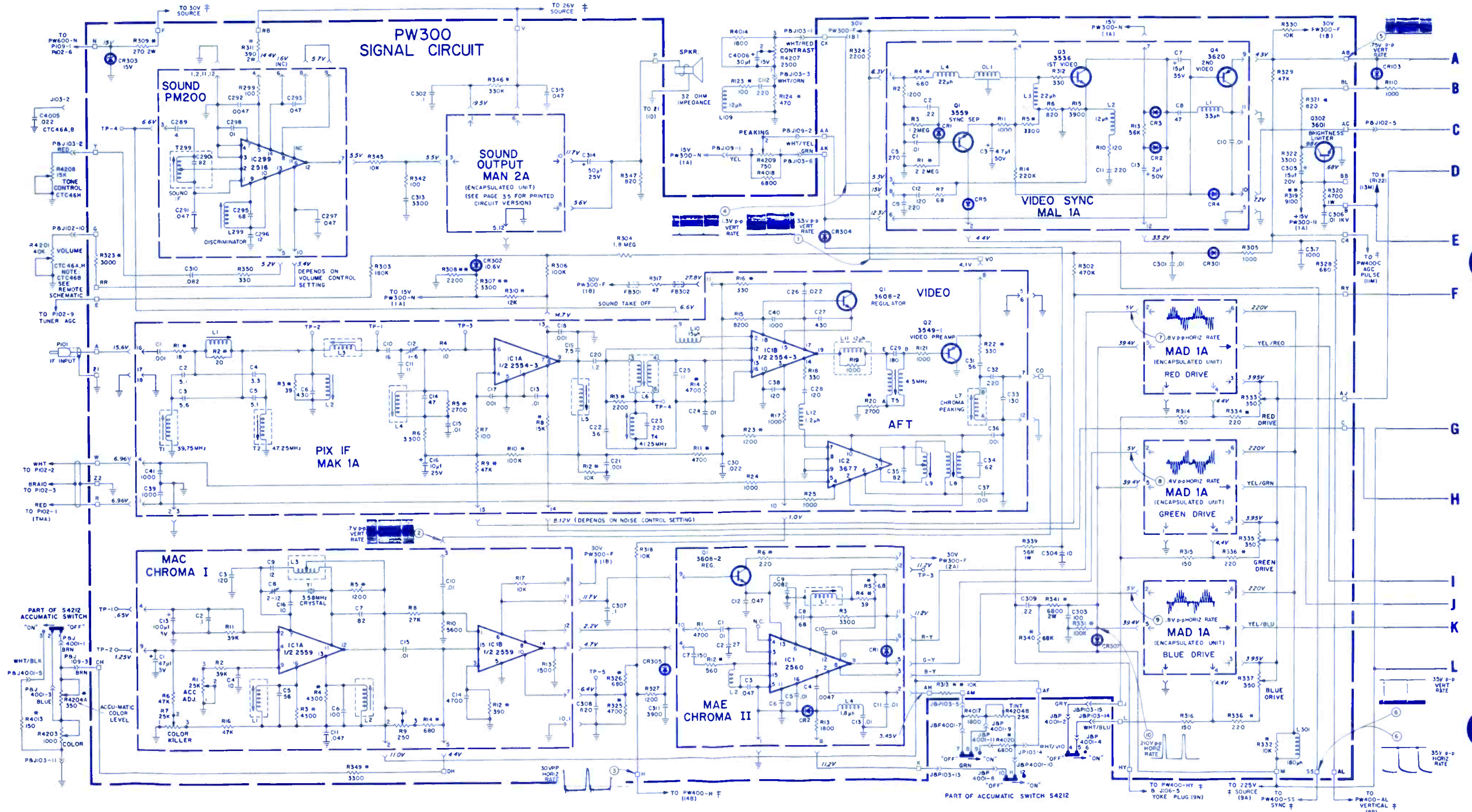

- NOTES:
1. RESISTANCE VALUES ARE IN OHMS, K=1000.
 2. CAPACITANCE VALUES 10 AND ABOVE ARE IN μ F, LESS THAN 10 ARE IN μ F, UNLESS OTHERWISE SPECIFIED.
 3. * INDICATES 5% TOLERANCE.
 4. ** INDICATES 2% TOLERANCE.
 5. VOLTAGES ARE MEASURED TO CHASSIS GROUND WITH A "VOLTMYST" (NO SIGNAL APPLIED) AND SHOULD HOLD WITHIN ± 20 AT RATED SUPPLY VOLTAGE. VOLTAGES SHOWN HAVE A POSITIVE POTENTIAL UNLESS OTHERWISE SPECIFIED.
 6. WAVEFORMS TAKEN WITH COLOR BAR (DOT-BAR GENERATOR). SIGNAL APPLIED AT 100% MODULATION.
 7. ∇ SEE DEFLECTION CIRCUIT AND POWER SUPPLY SCHEMATIC DIAGRAM.

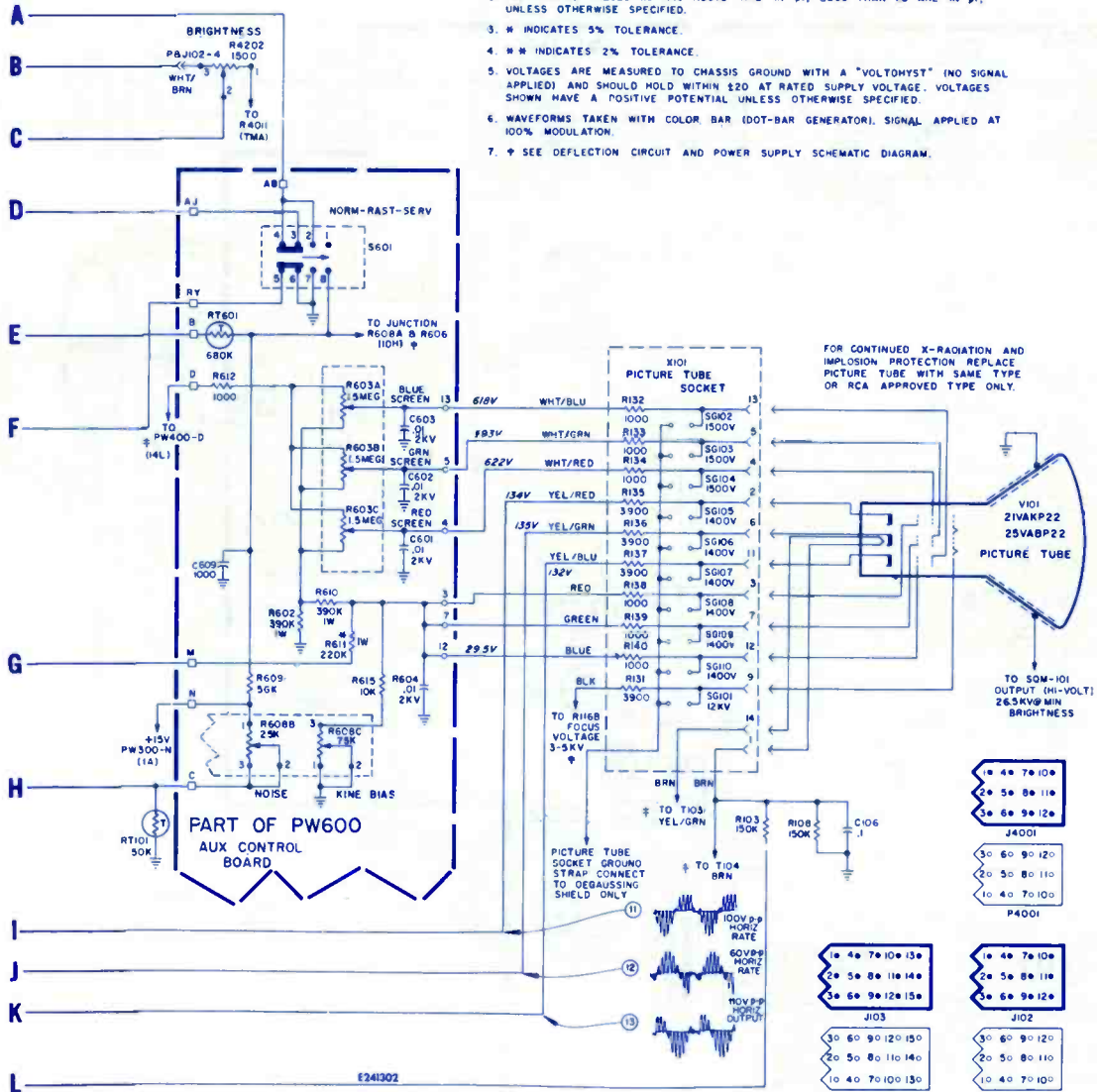

E241302

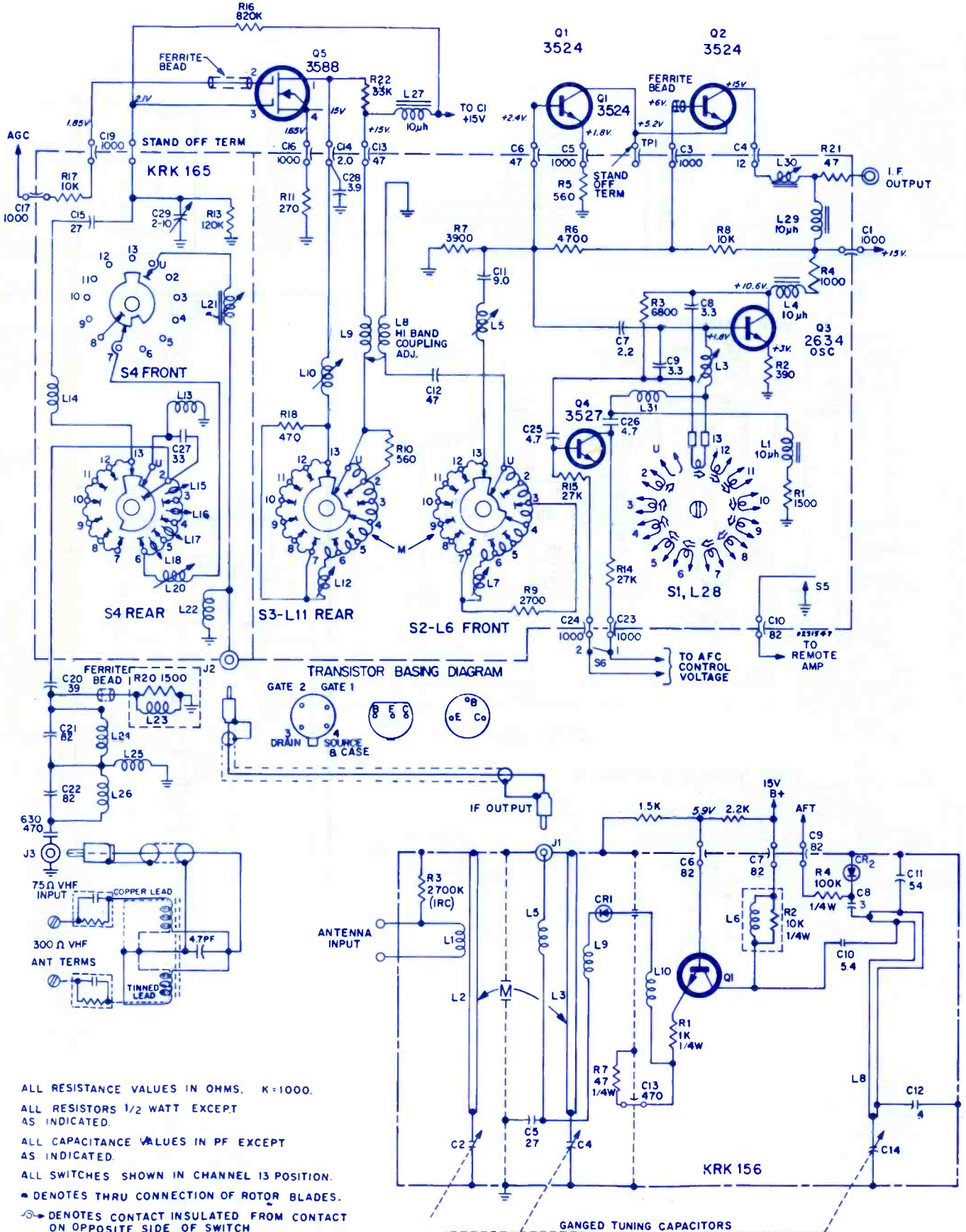

- ALL RESISTANCE VALUES IN OHMS, K=1000.
ALL RESISTORS 1/2 WATT EXCEPT AS INDICATED.
ALL CAPACITANCE VALUES IN PF EXCEPT AS INDICATED.
ALL SWITCHES SHOWN IN CHANNEL 13 POSITION.
• DENOTES THRU CONNECTION OF ROTOR BLADES.
○ DENOTES CONTACT INSULATED FROM CONTACT ON OPPOSITE SIDE OF SWITCH

ELECTRONIC TECHNICIAN/DEALER is published monthly by HARCOURT BRACE JOVANOVICH PUBLICATIONS, INC., 1 East First St., Duluth, Minn. 55802. Subscription rates: One year \$6, two years \$10, three years \$13, in the United States and Canada. Other countries: One year \$15, two years \$24, three years \$30. Single copies 75¢ in the United States, and \$2 in other countries. Second class postage paid at Dansville, New York and at additional mailing offices. Copyright 1971 by HARCOURT BRACE JOVANOVICH PUBLICATIONS, INC. POSTMASTER: Send Form 3579 to ELECTRONIC TECHNICIAN/DEALER, HARCOURT BRACE JOVANOVICH PUBLICATIONS, INC., 1 East First St., Duluth, Minn. 55802.

SYMBOL	DESCRIPTION	EMERSON PART NO.
R208	—500K volume control (includes R320 and S501)	970989
R320	—25K video control	970989
R418	—5M vert height control	970001
R422	—1.2M vert hold control	75A100-B
R502	—5.5Ω, fusible resistor	61A48-1
R503	—750Ω, 5W, 10% resistor	970990
R504	—100Ω, 5W, 10% resistor	61A20-76
C432	—100μf, 4kV, 10%, N1500, cer disc	970994
C504A	—150μf, 165V elect	970996
C504B	—150μf, 150V elect	970996
C504C	—200μf, 150V elect	970996
L201A	—sound IF coil	72A301-2
L201B	—sound IF coil	72A301-2
L202	—quad coil (includes C207)	970383
L309	—video peaking coil	73A5-20
L401	—horiz hold coil	94A17-19
T201	—audio output xformer	79A124-5
T303	—sound take off and 4.5MHz trap	72A185-5
T401	—vert output xformer	79A139-4
T402	—deflection yoke	94A372-1
T403	—horiz output xformer	970998

MODEL/CHASSIS CROSS-REFERENCE CHART

MODEL NO.	MODEL TYPE	CHASSIS NO.	PICTURE TUBE	VHF TUNER	UHF TUNER
9FP02	(Plastic) Beige-White	T2R2-1A	10ASP4	971034	94A296-4
9FP03	(Plastic) Green-White	T2R2-1A	10ASP4	971034	94A296-4
9FP04W	(Plastic) Walnut-Black	T2R2-1A	10ASP4	971034	94A296-4

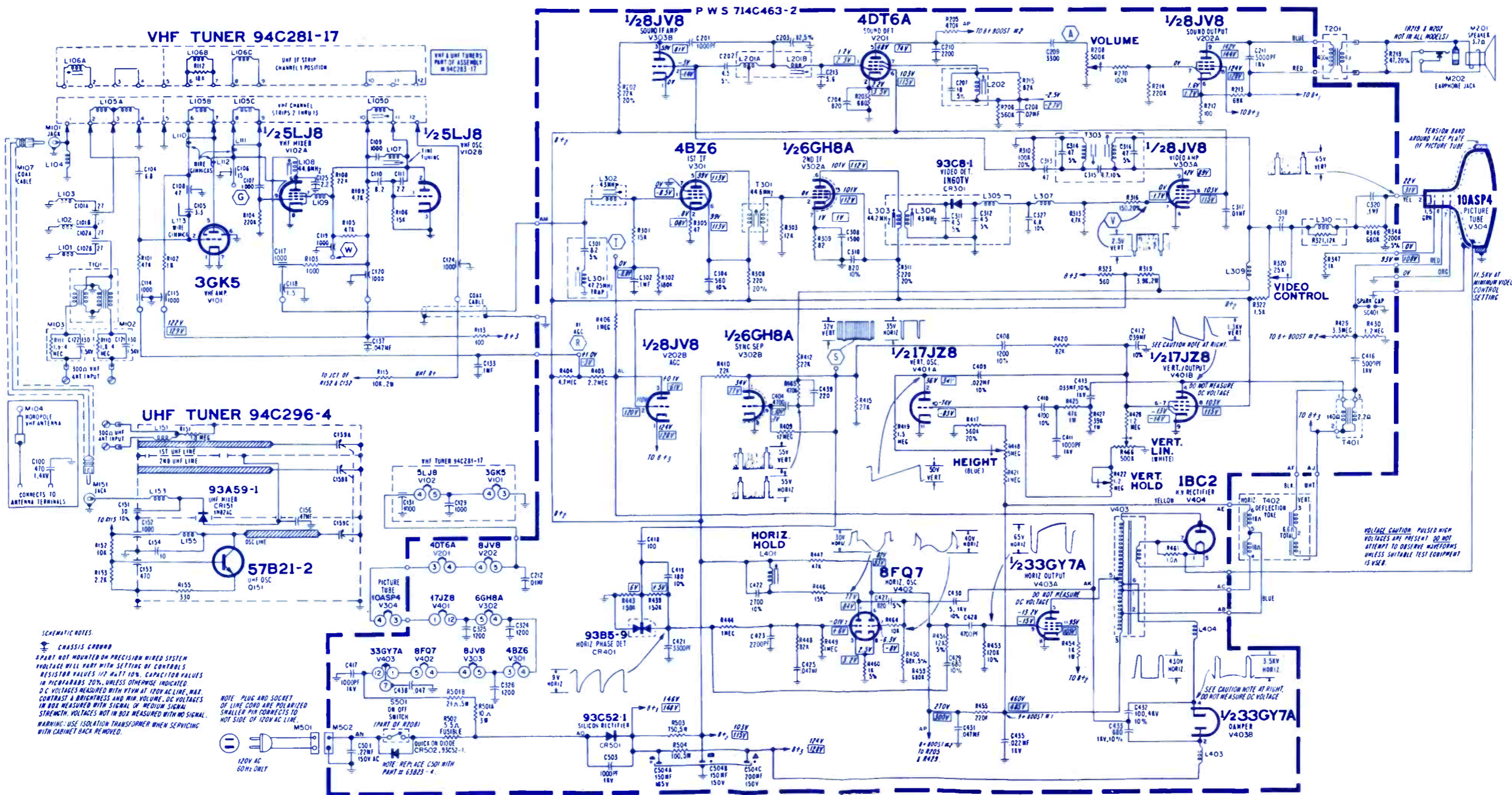

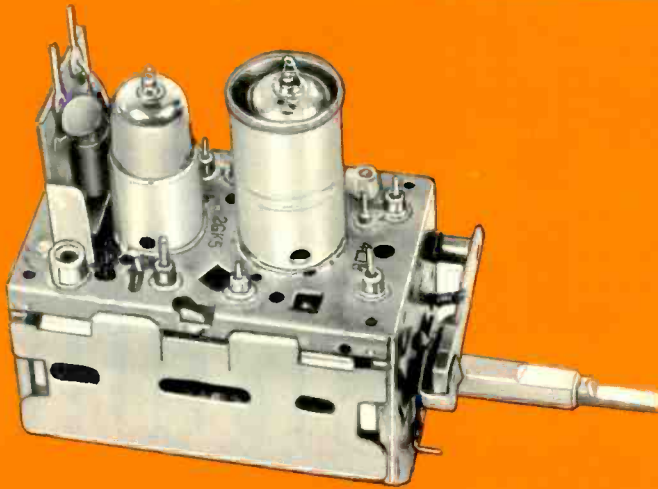

\$975

TUNER SERVICE CORPORATION

PROVIDES YOU WITH A COMPLETE SERVICE FOR ALL YOUR TELEVISION TUNER REQUIREMENTS AT ONE PRICE.

TUNER REPAIR

VHF Or UHF Any Type \$9.75.
UHF/VHF Combo \$15.00.

In this price all parts are included. Tubes, transistors, diodes, and nuvistors are charged at cost.

Fast efficient service at our four conveniently located service centers.

1 year guarantee backed up by the largest tuner manufacturer in the U.S.—SARKES TARZIAN, INC.

All tuners are cleaned inside and out, repaired, realigned and air tested.

TUNER REPLACEMENT

Replacement Tuner \$9.75.

This price buys you a complete new tuner built specifically by SARKES TARZIAN INC. for this purpose.

The price is the same for every type of universal replacement tuner.

Specify heater type

Parallel 6.3V
Series 450 mA
Series 600 mA

All shafts have the same length of 12".

Characteristics are:

Memory Fine Tuning
UHF Plug In
Universal Mounting
Hi-Gain Lo-Noise

If you prefer we'll customize this tuner for you. The price will be \$18.25. Send in original tuner for comparison purposes to our office in INDIANAPOLIS, INDIANA.



TUNER SERVICE CORPORATION

FACTORY-SUPERVISED TUNER SERVICE

MIDWEST 817 N. PENNSYLVANIA ST., Indianapolis, Indiana TEL: 317-632-3493
(Home Office)
EAST 547-49 TONNELE AVE., Jersey City, New Jersey TEL: 201-792-3730
SOUTH-EAST 938 GORDON ST., S. W., Atlanta, Georgia TEL: 404-758-2232
WEST SARKES TARZIAN, Inc. TUNER SERVICE DIVISION
10654 MAGNOLIA BLVD., North Hollywood, California . . . TEL: 213-769-2720

. . . for more details circle 128 on Reader Service Card

Cut arc-back in TV damper circuits with RCA tubes...

6AF3

6AY3B

6BS3A

6CG3/6BW3

6CJ3/6CH3

6CL3

6DW4B

17AY3A

17BE3/17BZ3

17BS3A/17DW4A

All have the pre-coated cathode!

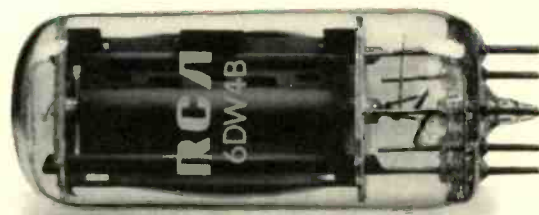

These are the 10 most popular industry types for TV damper circuits. The cathodes in these RCA tubes are pre-coated to reduce arcing.

A special manufacturing process pre-coats the cathode and pressure-welds the coating. This produces a smooth, uniform surface that virtually eliminates arcing.

In every way, the quality that goes into these tubes backs up your reputation for quality work. Systematic

parts inspection, tough environmental testing, sample life testing . . . these are some of the ways we build quality in and then check it out.

See your RCA tube distributor for the complete line of RCA tubes for damper circuits, high-voltage circuits and all your other tube needs.

RCA | Electronic Components | Harrison, N.J. 07029.

RCA

PHILLIP DAHLEN

Editor
1 East First Street
Duluth, Minn. 55802
(218) 727-8511

ALFRED A. MENEGUS

Publisher
757 Third Avenue
New York, N.Y. 10017
(212) 572-4829

TOM GRENEY

Publishing Director

JOSEPH ZAUHAR

Managing Editor

CAROLYN SAND

Associate Editor

BERNICE GEISERT

Production Manager

BOB ANDRESEN

Graphic Design

LILLIE PEARSON

Circulation Fulfillment

JOHN KESSLER

Manager, Reader Services

MANAGERS

DEAN GREENER

43 East Ohio Street
Chicago, Ill. 60611
(312) 467-0670

CHUCK CUMMINGS

Ad Space South/West
613 North O'Connor
Irving, Texas 75060
(214) 253-8678

DONALD D. HOUSTON

KEN JORDAN

1901 West 8th Street
Los Angeles, Calif. 90057
(213) 483-8530

CHARLES S. HARRISON

CY JOBSON

57 Post Street
San Francisco, Calif. 94104
(415) 392-6794

ROBERT UPTON

Tokyo, Japan
C.P.O., Box 1717

AUGUST 1971 • VOLUME 93 NUMBER 8

Four audio-response channels in hues of red, blue, green and yellow are shown in this month's cover photo of EICO's Sound N' Color Model 3450 Audio Two-Color Organ. Cover courtesy of EICO.

-
- 3 **TEKFAX:** Up-to-date schematics for easier servicing.
 - 24 **EDITORIAL:** Facing the Heat.
 - 26 **LETTERS:** Pertinent comments concerning past issues.
 - 28 **READERS' AID:** What you need or have for sale.
 - 30 **NEWS:** Events of interest to our industry.
 - 33 **NEW AND NOTEWORTHY:** Merchandise of special interest.
-

FEATURES

- 39 **MATV MADE SIMPLE**
Basic principles to consider when designing a practical master antenna system—by Keith T. Peterson.
 - 42 **HOW TO EXORCISE CITY AND SUBURBAN GHOSTS**
Antenna installations become more effective when you know the cause of those annoying "ghosts" and techniques for eliminating them—by Lon Cantor.
 - 44 **SEMI-TIPS—PART II**
Basic principles that must be understood for the effective servicing of circuits containing zener diodes—by Jack Jaques.
 - 45 **UNDERSTANDING TODAY'S CAPACITORS—PART II**
Capacitor replacement can be more effective with a better understanding of electrostatic capacitors—by Richard Marsh.
 - 46 **SERVICE TRAINING SCHOOLS**
The efforts of one manufacturer to update the technical skills of electronic technicians.
 - 47 **SERVICING THE AUTO STEREO TAPE DECK—PART II**
Case histories related to specific problems in servicing auto tape decks—by Homer L. Davidson.
 - 50 **COLOR TV RECEPTION—PART IV**
Effective servicing also requires a thorough understanding of how the color CRT functions—by William Spero.
 - 52 **GUEST AUTHOR: SOLID STATE REPLACEMENT—PROBLEM OR PROFIT**
Jack Devinsky, manager of Replacement Solid State Merchandising, RCA Electronic Components, tells how your revenue can increase with the proper selection of replacement semiconductors.
 - 53 **TEST INSTRUMENT REPORT**
Reviewing specifications for Leader's Model LSW-330 Post-Injection Sweep/Marker Generator.
-
- 55 **NEW PRODUCTS:** Instruments and components to make your job easier.
 - 56 **TECHNICAL DIGEST:** Hints and shortcuts for more effective servicing.
 - 62 **DEALER SHOWCASE:** These items may increase your sales revenue.
 - 66 **BOOK REVIEWS:** Our appraisal of recent publications.
 - 68 **ADVERTISERS' INDEX:** Manufacturers concerned about you.
 - 69 **READER SERVICE:** A source of additional information.
-



A HARCOURT BRACE JOVANOVIICH PUBLICATION



ELECTRONIC TECHNICIAN/DEALER is published monthly by Harcourt Brace Jovanovich Publications. Corporate Offices: 757 Third Avenue, New York, New York 10017. Advertising Offices: 43 East Ohio Street, Chicago, Illinois 60611 and 757 Third Avenue, New York, New York 10017. Editorial, Accounting, Ad Production and Circulation Offices: 1 East First Street, Duluth, Minnesota 55802. Subscription rates: One year \$6, two years \$10, three years \$13, in the United States and Canada. Other countries: one year \$15, two years \$24, three years \$30. Single copies: 75¢ in the U.S. and Canada; all other countries \$2. Second class postage paid at Dansville, New York 14437 and at additional mailing offices. Copyright © 1971 by Harcourt Brace Jovanovich, Inc.

POSTMASTER: Send form 3579 to ELECTRONIC TECHNICIAN/DEALER, P. O. Box 6016, Duluth, Minnesota 55802.

There's a special way you can meet customers without lifting a finger. The Yellow Pages! The Yellow Pages is every town's complete shoppers' service.

How can you best take advantage of the Yellow Pages? Ask your Yellow Pages representative to help you prepare ads for any or all Yellow Pages telephone directories coast to coast.

Remember, 3 out of 4 potential customers let their fingers do the walking. Advertise in the Yellow Pages.

We'll put you at your customers' fingertips.

3 out of 4 prospects let their fingers do the walking.

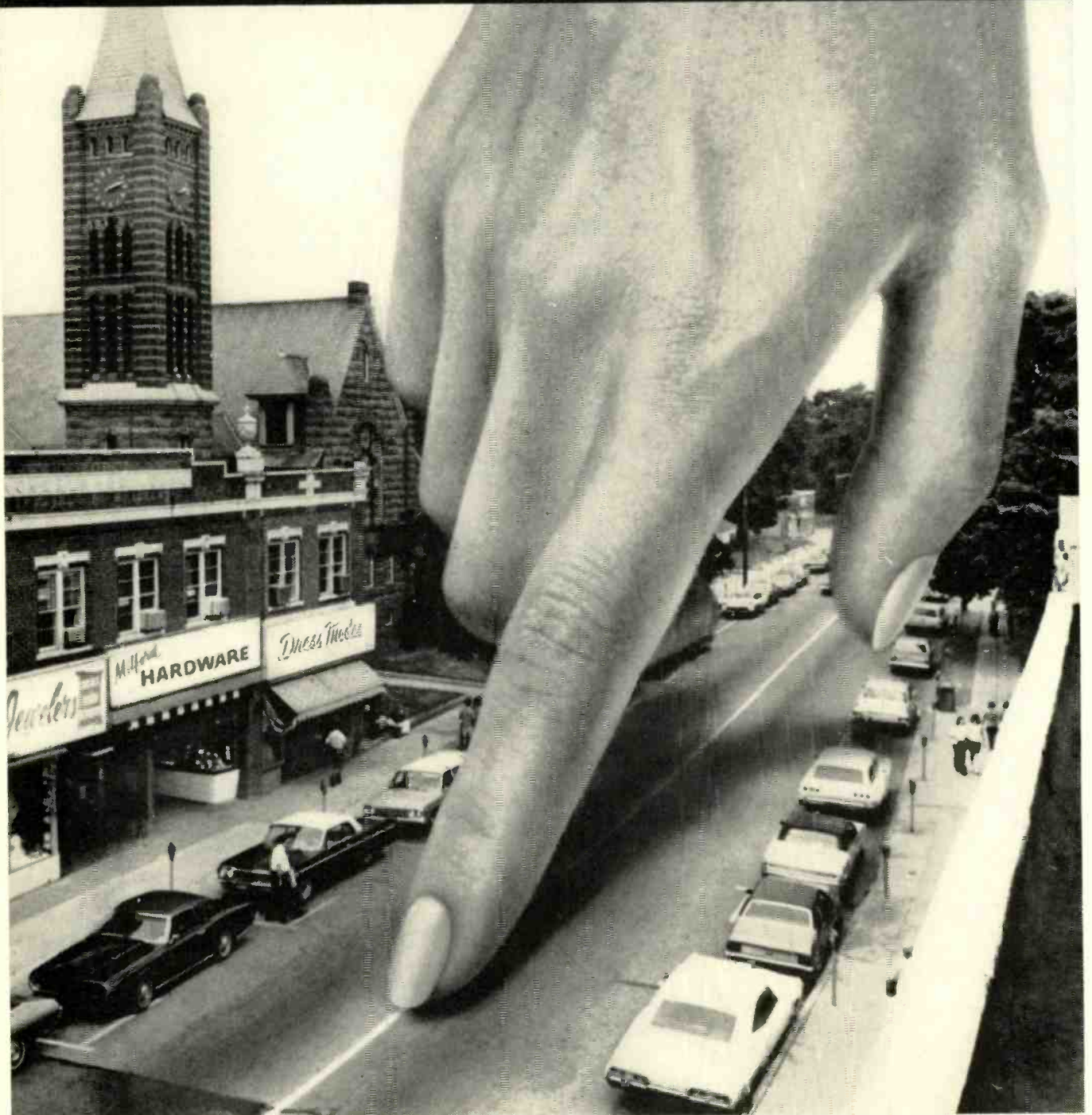

The replacement picture tube no other color tube can replace!



Simulated TV picture

ZENITH
CHROMACOLOR

Now you can install the revolutionary Chromacolor picture tube in almost any brand of 23" (diag.) color TV. And let your customer see the difference: a new, sharper Chromacolor picture with greater brilliance, contrast and color definition.

Zenith pioneered, developed and patented (U.S. Patent No. 3146368) the Chromacolor picture tube. And only Zenith has Chromacolor.

Chromacolor is an easy sale because people already know of Chromacolor's superiority. (Last year, after the revolutionary new Chromacolor system was

introduced, Zenith giant-screen color TV sets became the No. 1 best-seller!)

Full two-year warranty.

Here's your sales clincher: Chromacolor replacement color tubes are warranted for two full years. Exactly double the warranty period for most other replacement color picture tubes.

Give your customers the best — Chromacolor replacement color tubes. Only your Zenith Distributor has them.

TWO-YEAR WARRANTY

Zenith Radio Corporation warrants the replacement CHROMACOLOR picture tube to be free from defects in material arising from normal usage for two years from date of original consumer purchase. Warranty covers replacement or repair of picture tube, through any authorized Zenith dealer; transportation, labor and service charges are the obligation of the owner.



Zenith Chromacolor picture tube pinpoints the color dots on a jet black background and for the first time fully illuminates every dot.

ZENITH
The quality goes in
before the name goes on

EDITORIAL



Facing the Heat

This year's Consumer Electronics Show has certainly been one that Joe and I will **never** forget! Although in Duluth the day's high was not much more than the low 60's, upon landing in Chicago we encountered 100 plus temperatures. Then, the second night in our hotel, a Catholic priest one floor below us was strangled in his bed. For some reason, Al Menegus, our publisher from New York City, requested that Dean Greener, our Chicago district manager, share a room with him the third night.

Even if this tragedy and the weather could have been ignored, at the convention we observed some of the "heat" that you will be facing in the coming year—the threat of technical obsolescence for those technicians unable to keep up with the rapid pace as manufacturers compete for a greater share of the market.

The forecast for 1972 sales are bright. The American public insists on being entertained whether their job situation is good or not. And many electronic manufacturers, feeling the pinch from reduced military and industrial electronic sales, are going all out to get their share of this healthy consumer electronic market. But in doing so, competitive pressures are forcing them to apply aerospace technology in the development of new consumer products. We noted an increased emphasis on miniaturization and the use of semiconductors.

At a special luncheon for the press, we were introduced to a new magnetic-tape system that is to be introduced by several manufacturers. It is smaller than the two present cartridge-tape standards and will permit the installation of tape systems in the dash of cars, rather than under the dash as is now customary. Some rather pleasant music was played during the demonstration.

A major U.S. manufacturer has drastically modified the design of its TV-set power supplies. The earlier power supply was self regulated; and with the transformer and large capacitors, it must have weighed about 25 lb. However, by converting the power line frequency from 50 or 60Hz to that of the horizontal-sweep circuit, the transformer and related circuitry were reduced to the point that they could fit comfortably in your hand—probably weighing less than 2 lb. This power supply is used to provide the power for the solid-state circuits in the balance of the receiver.

We visited the hotel room of one new west coast company that was just recently formed by executives formerly employed by an industrial instrument company. The gentleman that I spoke with said that they did not manufacture any products that have ever been on the market before. And upon looking at his line of consumer electronic products, this seemed to be true. Some of these new products will be seen in the New Products Section in future issues of ELECTRONIC TECHNICIAN/DEALER.

As we toured the booths we were able to observe that TV sets are following the lead of audio components. There are several manufacturers now producing color-TV sets for which the only tube is the CRT—and that in a few years will also become obsolete. At one booth we observed an FM radio that contained a clock and what appeared to be two clear sheets of glass. However, embedded in the surface of the clock were liquid crystals which could be observed only when agitated with electricity applied through transparent conductors. When looking through one glass we saw numbers telling the frequency of the FM station received, while the numbers in the other glass could indicate the current time on any portion of this planet.

Some of the electronic technicians attending the Consumer Electronics Show were not sweating from the heat outside, but from the fear of becoming technically obsolete.

Phillip Dahlen

Now—Just 3 RCA Hi-Lite “V” Type Color Picture Tubes Replace **185** Types



Replaces **92** types

18VABP22	19HCP22/	490ASB22
18VACP22	19HKP22	490BAB22
18VADP22	19HFP22	490BCB22
18VAHP22	19HJP22	490BDB22
18VAJP22	19HKP22	490BGB22
18VAQP22	19HQP22	490BHB22
18VARP22	19HRP22	490BRB22
18VASP22	19XHP22	490CB22
18VATP22	19JBP22	490CHB22
18VBAP22	19JDP22	490CUB22
18VBCP22	19JHP22	490DB22
19EXP22	19JKP22	490EB22
19EXP22/	19JNP22	490EB22A
19GVP22	19JQP22	490FB22
19EYP22	19JYP22	490GB22
19EYP22/	19JZP22	490HB22
19GWP22	19KEP22	490JB22
19FMP22	19KFP22	490JB22A
19FXP22	490AB22	490KB22
19GLP22	490ACB22	490KB22A
19GSP22	490ADB22	490LB22
19GVP22	490AEB22	490MB22
19GVP22/	490AFB22	490NB22
19EXP22	490AGB22	490RB22
19GWP22	490AHB22	490SB22
19GWP22/	490AHB22A	490TB22
19EYP22	490AJB22	490UB22
19GXP22	490AJB22A	490VB22
19GYP22	490AKB22	490WB22
19GZP22	490ALB22	490XB22
19HBP22	490AMB22	490YB22
19HCP22	490ANB22	490ZB22
	490ARB22	

Replaces **22** types

19VABP22	21FJP22A/
19VACP22	21GVP22
21AXP22	21FKP22
21AXP22A	21GUP22
21AXP22A/	21GUP22/
21AXP22	21FBP22A
21CYP22	21GVP22
21CYP22A	21GVP22/
21FBP22	21FJP22A
21FBP22A	21GXP22
21FBP22A/	21GYP22
21GUP22	21GZP22
21FJP22	21HAP22
21FJP22A	

Replaces **71** types

23VACP22	25AEP22	25BRP22
23VADP22	25AFP22	25BSP22
23VAHP22	26AGP22	25BVP22
23VALP22	25AJP22	25BWP22
23VAMP22	25ANP22	25BXP22
23VANP22	25AP22	25BZP22
23VAQP22	25AP22A	25CBP22
23VARP22	25AP22A/	25CP22
23VASP22	25XP22	25CP22A
23VATP22	25AQP22	25FP22
23VAUP22	25ASP22	25FP22A
23VAWP22	25AWP22	25GP22
23VAXP22	25AXP22	25GP22A
23VAYP22	25AZP22	25RP22
23VAZP22	25BAP22	25SP22
23VBAP22	25BCP22	25VP22
23VBBCP22	25BDP22	25WP22
23VBDP22	25BFP22	25XP22
23VBEP22	25BGP22	25XP22/
23VBGP22	25BHP22	25AP22A
23VBHP22	25BJP22	25YP22
23VBJP22	25BMP22	25YP22/
23VBRP22	25BP22	25BP22A
25ABP22	25BP22A	25ZP22
25ADP22	25BP22A/	
	25YP22	

Here's the way to save yourself time, give your customers faster service and improve your profit. Stock these three RCA Hi-Lite color picture tubes and have immediate replacements for the fastest moving industry types — 185 of them.

RCA Hi-Lite types are all new, made to OEM specifications and contain the newest RCA manufacturing technology, including Perma-Chrome and the latest X-ray attenuating glass.

It adds up to a big plus for you. Order these three RCA Hi-Lite tubes, and other types you may need, from your RCA Distributor. He also has the complete RCA Interchangeability Guide, available free of charge.

RCA | Electronic Components | Harrison, N.J. 07029

RCA Electronic Components

INTERNATIONAL frequency meter

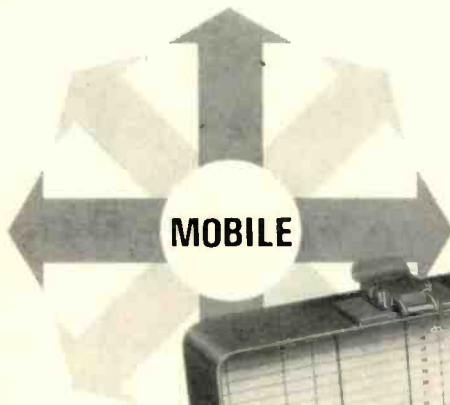

- Tests Predetermined Frequencies 25 to 1000 MHz
- Extended Range Covers 950 MHz Band
- Pin Diode Attenuator for Full Range Coverage as Signal Generator
- Measures FM Deviation

FM-2400CH

MOBILE



WRITE FOR CATALOG!

The FM-2400CH provides an accurate frequency standard for testing and adjustment of mobile transmitters and receivers at predetermined frequencies.

The FM-2400CH with its extended range covers 25 to 1000 MHz. The frequencies can be those of the radio frequency channels of operation and/or the intermediate frequencies of the receiver between 5 MHz and 40 MHz.

Frequency Stability: $\pm .0005\%$ from $+50^\circ$ to $+104^\circ\text{F}$.

Frequency stability with built-in thermometer and temperature corrected charts: $\pm .00025\%$ from $+25^\circ$ to $+125^\circ$ (.000125% special 450 MHz crystals available).

Self-contained in small portable case. Complete solid state circuitry. Rechargeable batteries.

FM-2400CH
(meter only).....\$595.00
RF crystals (with temperature correction) 24.00 ea.
RF crystals (less temperature correction) 18.00 ea.
IF crystals.....catalog price



... for more details circle 115 on Reader Service Card

LETTERS

Reader comments concerning past feature articles, Editor's Memos, previous reader responses or other subjects of interest to the industry.

Article Promotes Safety

Thank you very much for the copies of **ELECTRONIC TECHNICIAN/DEALER**. I was very pleased with the outstanding editing on the microwave oven article, which gave it an excellent presentation.

Through a mutual acquaintance, this May issue was given to a member of the Safety Board of Kaiser Steel Corp. in Fontana, Calif. It turns out that Kaiser Steel has many microwave ovens of this type located throughout their plant for the use of their employees to cook or warm their food during lunch breaks.

I have been told that their ovens do not have any specific safety instructions for the employees to abide by. However, I understand that the article will be presented to the Kaiser Safety Board for possible adoption of rules on the use of their ovens. The safety officer who obtained the copy conceded that he was ignorant of the fact that their ovens contained such potential hazards!

This also proves that **ELECTRONIC TECHNICIAN/DEALER** contributes to humanitarian benefits as well as offering technical advice.

LEW CHRISTY

Agrees With June Editorial

Your editorial in the June 1971 issue of **ELECTRONIC TECHNICIAN/DEALER** is as excellent an article as I have ever read on the subject.

For several years I have been promoting, through various organizational efforts, upgrading our industry in the Kansas City area through knowledge.

I started servicing radios in 1928, and have been at it almost continually. Since that time I have seen literally hundreds of shops come and go. All of them failed for the same reason—lack of knowledge! Some business, some technical.

It is my contention that education would have prevented the majority of these failures.

For the past several years I have been setting up classes through local boards of education, going into a local territory through the parts distributor in that area. I set up training programs for 20 to 30 men, and through

continued on page 66

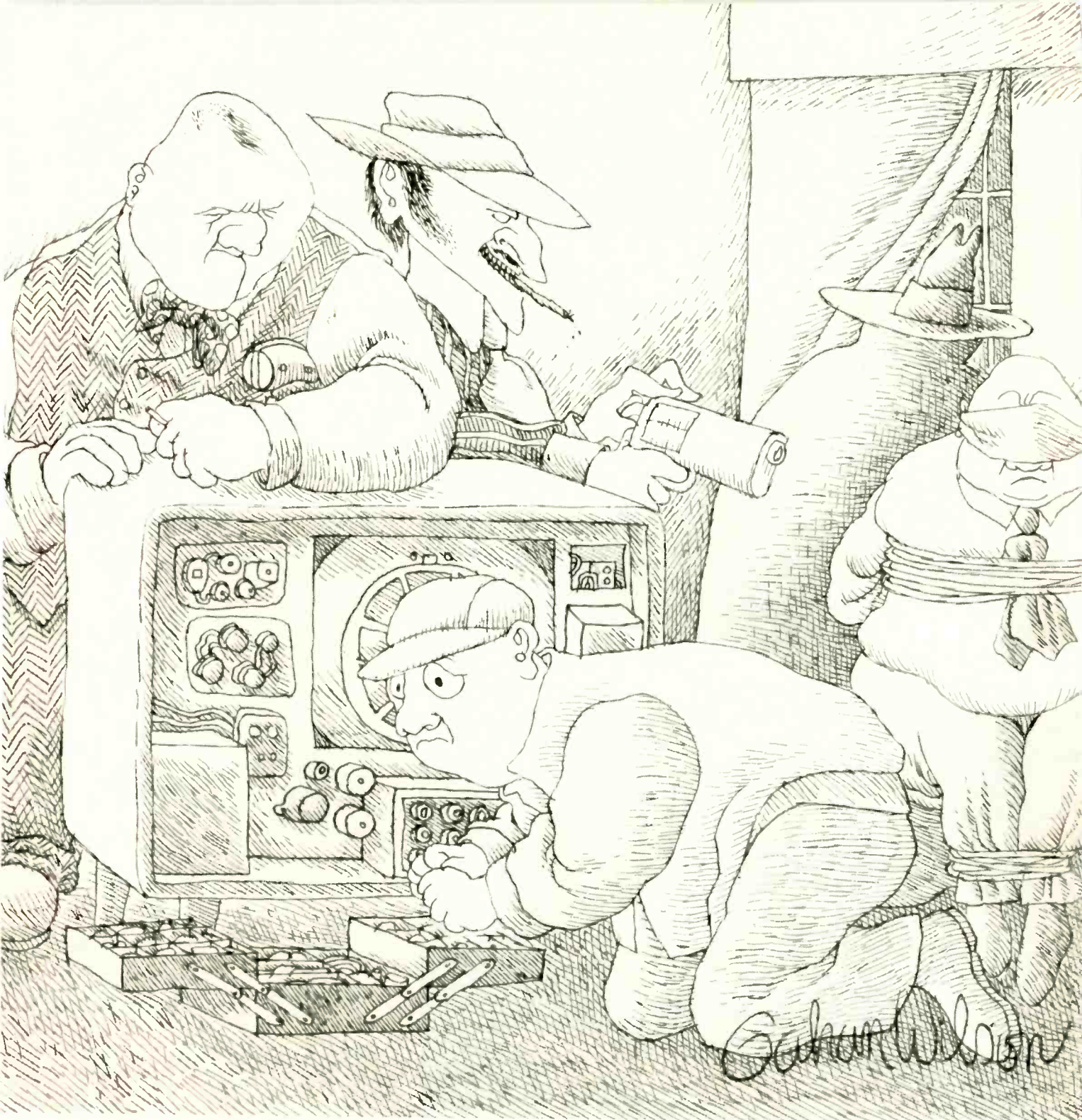

When you're in a hurry, it's nice to know Sylvania has the parts.

Only 34 tubes and ECG solid-state components will solve practically all of your high-voltage rectifier replacement problems.

And they're all available from your Sylvania distributor.

Because tubes are tubes, we can't promise to reduce the number you'll have to carry. But, with the Sylvania line, your distributor will have the tube you need when you need it.

In semiconductors, the story is different. Just 124 ECG solid-state devices including transistors, diodes and integrated circuits will replace over 41,000 differ-

ent types. In the high-voltage section alone, only 8 ECG rectifiers and triplers will take care of almost every job.

And they save a lot of space in your tube caddy.

When your distributor is stocked with Sylvania receiving tubes and ECG semiconductors you'll have the parts you need. And you'll get them fast.

It's like having a complete warehouse built into your telephone.

And that should help you make a fast getaway.

GTE SYLVANIA

3 GREAT NEW VALUES IN CHEMICALS with TOOL KITS!

from **WORKMAN** *Electronic* PRODUCTS, INC.
 Subsidiary of IPM TECHNOLOGY INC.
 BOX 3828 SARASOTA, FLA. 33578

Model SC6A-8

8
 6 oz. AEROSOL CANS OF
ULTRA WISSH
 COLOR and B/W TV CONTACT CLEANER
 With
 BOX OF FIVE MINIATURE PRECISION SCREWDRIVERS AND TORQUE HANDLES
 Only **\$888**

ACTUAL SIZE New ULTRA WISSH COLOR TV CONTACT CLEANER WITH TOOL KIT OF 5 PRECISION MINIATURE SCREWDRIVERS

Model HL6-8

8
 6 oz. AEROSOL CANS OF
LUBRITE
 FOAMY WHITE CONTACT LUBE
 With
 BOX OF FIVE MINIATURE PRECISION NUT DRIVERS AND TORQUE HANDLES
 Only **\$888**

ACTUAL SIZE LUBRITE FOAMY WHITE CONTACT LUBE WITH TOOL KIT OF 5 PRECISION MINIATURE NUT DRIVERS

Model HG6A-8

8
 6 oz. AEROSOL CANS OF
MIRACLE BATH
 TUNER CLEANER AND DEGREASER
 With
 BOX OF FIVE MINIATURE PRECISION WRENCHES
 Only **\$888**

ACTUAL SIZE MIRACLE BATH TUNER CLEANER AND DEGREASER WITH TOOL KIT OF 5 PRECISION MINIATURE WRENCHES

READERS' AID

Space contributed to help serve the personal needs of you, our readers.

Needs Schematic

I need a schematic for Model 906 signal generator made by the McMurdo Silver Co. Also, a tube replacement sketch would be of help.

DUKE HOLY

5443 51st Terrace No.
 St. Petersburg, Fla. 33709

Needs Information

I would like to find service information or a schematic diagram for a "Graetz" canzonetta, Model 816E, AM/FM/SW radio.

JAMES R. LEONARD

13 Seabrook Rd.
 Hyannis, Mass. 02601

Shop For Sale

We wish to retire as soon as we can find the right man or couple to take over our appliance and TV business of 21 years. With over \$200,000 of yearly sales and services, the business is located in a town of about 6000. The business should pay for itself in about four years. We are willing to inventory out and rent or sell the buildings.

LEUTYS RADIO TV

110 S. Broadway
 Salem, Ill. 62881

For Sale

I have previous issues of ELECTRONIC TECHNICIAN/DEALER for sale.

JACK STUART

Box 991
 El Paso, Texas 79946



"Everytime I change channels my neighbor's garage door goes up!"

... for more details circle 132 on Reader Service Card

... new ideas for moving electrical energy

134 new stock answers

to keep your wiring
jobs on schedule.

BELDEN
**Electronic
Wire**
and cable

They're exceptional items to find in stock. But your Belden Distributor offers them. Over 134 new electronic cable and cord offerings have been added to the continually growing line of Belden standards. We like to keep new standard products coming. To make your critical wiring applications easier to cope with. To keep your projects on schedule. Get a copy of the latest Belden catalog. It identifies and describes all the new items, plus the longest, strongest line of electronic wire/cable around. See your Belden Distributor or write: Electronic Sales Service Dept., Belden Corporation, Richmond, Indiana 47374.

134 new stock cables and cords for: communications • broadcast audio • sound • data—coax, twinax • controls • instrumentation • strain gages • CCTV cameras • MATV • retractile cords for telephones, microphones and power.

Electronic Sales Service Dept.
Belden Corporation
Richmond, Indiana 47374



* Please send me
the latest Belden Electronics Catalog

Name _____

Title _____

Company _____

Address _____

City _____ State _____ Zip _____

Type of Business _____

8-1-1

... for more details circle 102 on Reader Service Card

**Sharper, brilliant
Jitter-Free intensity or
pulse markers!**



SMG-39 LECTROTECH sweeper marker generator

A precision sweeper with quality and features found only in high priced laboratory instruments. The SMG-39 utilizes post injection markers for fast, accurate alignment of any television receiver when used with any standard oscilloscope. The SMG-39 provides all needed bias' and linear sweeping signals for accurate alignment. Unique marker display enables accurate marker positioning for superior receiver alignment. VFO facility provides any additional marker from 39 MHz to 49 MHz for protection from future obsolescence, may also be used for spot alignment.

Exclusives

- Jitter-Free Intensity or Pulse Markers • VFO Variable Marker
- 4 Bias Supplies including — 67 Volts

Marker Options

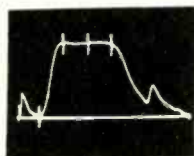

Pulse Vertical
(Overall Chroma).

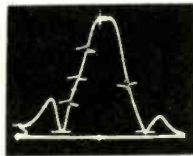

Pulse Horizontal
(Typical I.F.
response).

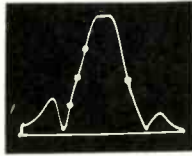

Intensity
(Typical I.F.
response).

Benefits

- Clean, bright Jitter-Free pulse markers
- All markers of equal amplitude regardless of position on response curve.
- Adjustable marker amplitude
- Marker location accurately determined with brilliant pulse or intensity markers (a must in AFT alignment)
- All signals have blanking included for zero base line
- All markers of equal amplitude regardless of position on response curve.

FULL TWO YEAR PARTS WARRANTY

SMG-39 Solid state, glass epoxy circuit boards.
Complete with all cables. NET **33950**



See your distributor or write Dept. E-9
LECTROTECH, INC.

4529 North Kedzie Avenue • Chicago, Illinois 60625

... for more details circle 121 on Reader Service Card

NEWS OF THE INDUSTRY

Jerrold Holds Advanced MATV Technical School

More than 60 MATV technicians and contractors attended the advanced MATV Technical School held by Jerrold Electronics at the Howard Johnson Motor Inn in Waltham, Mass. The two-day course covered the interface between MATV and CATV systems, system design and layout considerations, advanced MATV techniques, aerial and underground construction, trailer park systems, handling more than 12 channels, proposal and specification writing, and two-way systems.



Instructors for the school were Allen Pawlowski, Jerrold systems engineer, and Lenny Elkings, Jerrold Eastern regional sales manager. In addition to advanced technical information, they covered the business and marketing aspects of MATV.

Jerrold has been holding MATV training schools for almost two decades. This year, 17 two-day sessions are planned, covering the entire country and including Instructional Television Fixed Service training.

X-Ray Radiation Found to be Minimal for TV Technicians

The conclusion of a report by the U.S. Department of Health, Education & Welfare's Bureau of Radiological Health on findings of an x-ray exposure survey of 70 Baltimore, Md. TV repair shops showed that TV technicians in some instances are exposed to a small amount of x-ray while working on color-TV receivers, but the public health significance of their exposure is minimal.

John C. Villforth, the bureau director, pointed out that technicians, unlike color-TV set viewers, often must be close to operating x-ray sources—such as picture and high voltage tubes—without the protection of the receiver cabinet and internal shielding. He also noted that x-radiation rates inside the sets usually were found to be below 0.5mr (milliroentgen) per hour, the Federal limit for x-ray emissions outside TV receiver cabinets. This means, he said, that in many cases the amount of radiation penetrating the cabinets was virtually zero.

"On the basis of information obtained in this study, we feel safe in saying that the health significance of x-radiation exposure to TV technicians is minimal and that further efforts to evaluate occupational exposure to this group are unnecessary," Mr. Villforth stated.

the new
Finco[®]

Greenline

**HOME TV/FM
MULTIPLE SET AMPLIFIERS**

Amplifies TV/FM signals for distribution to every set in the house!

Solid state design meets the most demanding reception conditions
Five different models for every reception requirement.

SAFE! DEPENDABLE! INEXPENSIVE!
FOR COLOR TV . . . BLACK & WHITE TV . . .
FM/FM STEREO



G-922

300 ohm system, VHF-UHF-FM, 300 ohm input and four 300 ohm outputs using twin lead wire.

List \$43.95

 <p>G-923</p>	<p>75 ohm system VHF-UHF-FM, 75 ohm input and four 75 ohm outputs using coaxial cable.</p> <p>List \$46.95</p>	 <p>G-924</p>	<p>75 ohm system, VHF-UHF-FM, 75 ohm input and single 75 ohm output using coaxial cable.</p> <p>List \$45.95</p>
 <p>G-920</p>	<p>300 ohm system, VHF-FM only, 300 ohm input and four 300 ohm outputs using twin lead wire.</p> <p>List \$33.95</p>	 <p>G-921</p>	<p>75 ohm system, VHF-FM only, both 75 ohm and 300 ohm inputs and four 75 ohm outputs using coaxial cable.</p> <p>List \$39.95</p>

WRITE DEPT. 110-8 FOR CATALOG NO. 20-594.



THE FINNEY COMPANY
34 W. Interstate Street
Bedford, Ohio 44146

... for more details circle 110 on Reader Service Card



It takes time to replace a color picture tube...

GE ULTRACOLOR[®]

works to cut back
the need of
replacing the
replacement

sustained brightness and color purity are assured through use of advanced getter material. Gases generated by the tube's operation are removed, providing longer life and sustained color purity.

reliability and quality assurance are built in. Only the highest quality replacement components are used... and they're still expected to prove themselves. First during the manufacturing process, through continuing in-line inspections, and extensive life testing of the finished product, afterwards.

GE ULTRACOLOR[™] picture tubes provide the service and dependability that guarantee customer satisfaction. *(Made by professionals, for professionals.)*

TUBE PRODUCTS DEPARTMENT • GENERAL ELECTRIC COMPANY
OWENSBORO, KENTUCKY 42301

GENERAL  ELECTRIC

NEW AND NOTEWORTHY

For additional information on products described in this section, circle the numbers on Reader Service Card. Requests will be handled promptly.



FIELD STRENGTH METER 701

Provides audio signal from channel measured

A solid-state portable field strength meter, Model 747, reportedly is capable of measuring the signal levels of all UHF, VHF and FM channels plus mid-band and super band CATV channels. The unit is said to be tunable from 50 to 260 MHz and 470 to 890MHz. The unit features a single input for the entire spectrum and single knob tuning. A dial light operates from a separate C cell battery, reportedly not affecting the accuracy of the meter. The meter itself is said to operate from four 9v batteries. To extend battery life, the meter automatically turns OFF when the cover is closed. Specifications indicate the accuracy of the meter is $\pm 1.75\text{dB}$, 50 to 260 MHz and $\pm 3\text{dB}$, 470 to 890MHz over a temperature range from 20° F to 100° F. They also indicate that the meter provides simultaneous readings in microvolts and dBmV, with a range from 10 μV (-30dBmV) to 1.0v (+60dBmV). By plugging the earphone supplied into the high level audio output jack, the technician can reportedly hear the sound of each channel as it is tuned in. Price \$450. Jerrold.



AUDIO SWEEP GENERATOR 700

Shows response characteristics of passive or active circuits

The audio sweep/signal generator, Model ASG-1, is designed for use in the frequency range of 0 to 100kHz. With this instrument, the response characteristics of either passive or active circuits can reportedly be displayed on a standard scope. Specifications indicate both swept and CW operating modes are provided and sweep width is variable from a few Hz to 100KHz in a single sweep. Output is said to be adjustable from 0 to 5v p-p. A synchronized ramp output, with adjustable amplitude, is supplied for driving the horizontal input to the scope. If triggered operation is desired, the generator blanking pulses are reportedly available. Sweep time reportedly is variable from 20msec to 20 sec for one sweep. Price \$195. Rameco Corp.

FOR MORE NEW PRODUCTS SEE PAGE 55



CADDY BAR JR. 702

Features pushbutton operation and automatic 15 min shut-off

The Caddy Bar Jr., Model CG22, utilizing "Perma-Lock" circuits, is small enough to fit in a coat pocket or tube caddy. The unit features pushbutton operation and automatic shut-off, which shuts the unit OFF after 15 min of operation. Also featured is a new built-in preheater for fast warm-up, powered by two mercury cells. The retractable signal leads can be stored inside the unit. The unit measures 4 $\frac{1}{8}$ in. by 6 in. by 2 in. and weighs 2 lb. Price \$89. Sencore.

An Extraordinary Offer

to introduce you to the benefits of Membership in

ELECTRONICS BOOK CLUB

for a limited time only you can obtain

ANY 3 OF THESE UNIQUE BOOKS ... yours for only **99¢** each
(Combined List Price \$50.80) Club Membership ... with Trial

May we send you your choice of many three books on the facing page as part of an unusual offer of a Trial Membership in Electronics Book Club?

Here are quality hardbound volumes, each especially designed to help you increase your know-how, earning power, and enjoyment of electronics.

These handsome, hardbound books are indicative of the many other fine offerings made to Members... important books to read and keep... volumes with your specialized interests in mind.

Whatever your interest in electronics—radio and TV servicing, audio and hi-fi, industrial electronics, communications, engineering—you will find that Electronics Book Club will help you.

With the Club providing you with top quality books, you may broaden your knowledge and skills to build your income and increase your understanding of electronics, too.

How You Profit From Club Membership

This special offer is just a sample of the help and generous savings the Club offers you. For here is a Club devoted exclusively to seeking out only those titles of direct interest to you. Membership in the Club offers you several advantages.

- 1. Charter Bonus:** Take any three of the books shown (combined values up to \$50.80) for only 99¢ each with your Trial Membership.
- 2. Guaranteed Savings:** The Club guarantees to save you 15% to 75% on all books offered.
- 3. Continuing Bonus:** If you continue after this trial Membership, you will earn a Dividend Certificate for every book you purchase. Three Certificates, plus payment of the nominal sum of \$1.99, will entitle you to a valuable Book Dividend which you may choose from a special list provided members.
- 4. Wide Selection:** Members are annually offered over 50 authoritative books on all phases of electronics.
- 5. Bonus Books:** If you continue in the Club after fulfilling your Trial Membership, you will receive a Bonus Dividend Certificate with each addi-

SPECIAL FREE BONUS

... if you act now!

Yes, if you fill in and mail the membership application card today, you'll also get this Bonus Book, FREE!

TUBE/TRANSISTOR SUBSTITUTION GUIDE

A completely updated, quick-reference source for popular tube & transistor substitutions.

Regular List Price \$4.95

tional Club Selection you purchase. For the small charge of only \$1.99, plus three (3) Certificates, you may select a book of your choice from a special list of quality books periodically sent to Members.

6. Prevents You From Missing New Books: The Club's FREE monthly News gives you advance notice of important new books... books vital to your continued advancement.

This extraordinary offer is intended to prove to you, through your own experience, that these very real advantages can be yours... that it is possible to keep up with the literature published in your areas of interest... and to save substantially while so doing.

How the Club Works

Forthcoming selections are described in the FREE monthly Club News. Thus, you are among the first to know about, and to own if you desire, significant new books. You choose only the main or alternate selection you want (or advise if you wish no book at all) by means of a handy form and return envelope enclosed with the News. As part of your Trial Membership, you need purchase as few as four books during the coming 12 months. You would probably buy at least this many anyway... without the substantial savings offered through Club Membership.

Limited Time Offer!

Here, then, is an interesting opportunity to enroll on a trial basis... to prove to yourself, in a short time, the advantages of belonging to Electronics Book Club. We urge you, if this unique offer is appealing, to act

promptly, for we've reserved only a limited number of books for new Members.

To start your Membership on these attractive terms, simply fill out and mail the postage-paid airmail card today. You will receive the three books of your choice for 10-day inspection. **SEND NO MONEY!** If you are not delighted, return them within 10 days and your Trial Membership will be cancelled without cost or obligation. Electronics Book Club, Blue Ridge Summit, Pa. 17214.

Typical Savings Offered Club Members on Recent Selections

199 TV Tough-Dog Problems Solved	List Price \$7.95; Club Price \$4.95
Jack Darr's Service Clinic No. 2	List Price \$7.95; Club Price \$4.95
Zenith Color TV Service Manual—Vol. 2	List Price \$7.95; Club Price \$4.95
Transistor Projects for Hobbyists & Students	List Price \$7.95; Club Price \$4.95
Philco Monochrome TV Service Manual	List Price \$7.95; Club Price \$4.95
Electronic Musical Instruments	List Price \$7.95; Club Price \$4.95
Electronic Designer's Handbook	List Price \$9.95; Club Price \$5.95
Dictionary of Electronics	List Price \$6.95; Club Price \$5.50
Computer Circuits & How They Work	List Price \$7.95; Club Price \$4.95
Commercial Radio Operator's License Study Guide	List Price \$7.50; Club Price \$5.95
Japanese Color TV Service Manual	List Price \$7.95; Club Price \$4.95
Solid-State Circuit Design & Operation	List Price \$9.95; Club Price \$7.95
How to Read Electronic Circuit Diagrams	List Price \$7.95; Club Price \$3.95
Electronic Test & Measurement Handbook	List Price \$7.95; Club Price \$4.95
Pulse & Switching Circuits	List Price \$7.95; Club Price \$4.95
Circuit Consultant's Casebook	List Price \$9.95; Club Price \$5.95
How to Use Vectorscope-Oscilloscopes & Sweep-Marker Generators	List Price \$7.95; Club Price \$4.95
Computer Technician's Handbook	List Price \$10.95; Club Price \$7.95
Handbook of Magnetic Recording	List Price \$7.95; Club Price \$4.95
125 One-Transistor Projects	List Price \$7.95; Club Price \$4.95
Computer Architecture	List Price \$12.50; Club Price \$8.95
Servicing Modern Hi-Fi Stereo Systems	List Price \$7.95; Club Price \$4.95

AN EXTRAORDINARY OFFER...

Electronic Circuit Design Handbook

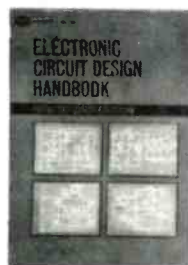

New Third Edition—A brand-new, enlarged edition of the ever popular circuit designer's "cookbook," now containing over 600 proven circuits, for all types of functions, selected from thousands on the basis of originality and practical application. Now you can have, at your fingertips, this carefully-planned reference source of tried and

tested circuits. Selected from thousands submitted by distinguished engineers, these "thought-starters" are a collection of original circuits selected on the basis of their usefulness. This detailed compilation of practical design data is the answer to the need for an organized gathering of proved circuits... both basic and advanced designs that can easily serve as stepping stones to almost any kind of circuit you might want to build. 384 pps., 19 big sections, over 600 illus., 8½" x 11".

List Price \$17.95 ● Order No. T-101

How to Use Your VOM-VTVM & Oscilloscope

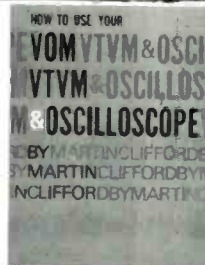

Whether you want to know more about how these instruments work, or how to use them in everyday applications, this "3-in-1" guide contains the answers. Moreover, it will be of tremendous value in helping you select the instruments best suited to your individual needs. Part I deals with the VOM—how it works, general guide-

lines for using a VOM, and how to use the VOM in troubleshooting all types of circuits, with step-by-step procedure charts you can refer to. Part II discusses the VTVM—describing functions, applications in troubleshooting, and servicing with the VTVM, pointing out applications where it is unique as a measuring device. Step-by-step servicing procedure charts are included. Part III discusses the oscilloscope and its applications in troubleshooting radio and television circuits. 192 pps; 120 illus.

List Price \$6.95 ● Order No. 438

CATV System Engineering—

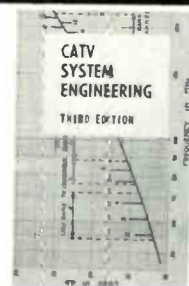

Third Edition. Revised Third Edition of the accepted technical standard of the CATV industry... an expanded and revised version of the first and only authoritative book on planning, designing, and operating a CATV plant. Covers systems composed of uncorrelated components as well as fully integrated solid-state plants. Subjects covered include disadvantageous amplifier design concepts, high level distribution, principles of cable powering, amplifier and system dynamic range, cascaded figure of merit, system operating levels, jumper cables, equalization and alignment, and a host of other vital subjects, including how to modernize older systems using the newest equipment available. 256 pps.

List Price \$12.95 ● Order No. 298

Home-Call TV Repair Guide



With this handy, quick-reference home-call trouble guide, you'll increase your ability to complete more service calls per day. It's arranged in logical reference sections—covering raster, video, chrominance, and other circuit troubles—to guide you right to the cause. By simply comparing the symptoms in each case with the handy

charts, you'll be guided, step by step, through quick checks for the most logical causes of any malfunction. In minutes you'll know whether the set can be repaired on the spot or if it's a bench job because you'll have your own portable "memory jogger" right at your fingertips! Specifically planned to serve as an on-the-spot TV repair guide, with numerous quick-reference charts for use by the home-call service technician. 144 pps., 14 quick-reference charts. Hardbound.

List Price \$6.95 ● Order No. 517

Electric Motor Test & Repair



A guide to maintenance practices for all types of small horsepower motors. While many of the larger motor repair shops find it more expedient to replace low horsepower units, re-winding of small electric motors is still a wide-spread and profitable practice. This practical guide contains a wealth of information on testing and re-

winding small motors of every type, including fan, starter, polyphase, capacitor, induction, synchronous, etc. Early chapters tell you how to set up a motor test panel, make general tests and measurements, and advise you about the tools and equipment necessary (such as an armature winder, wedge driver, cutting and gauging board, coil taper, puller plate, etc.). 160 pps., 102 illus. Comb-bound with soft cover.

List Price \$6.95 ● Order No. T-97

Semiconductors From A to Z

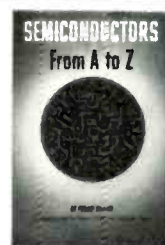

Here it is—everything you need to know about semiconductors — from basic diodes and transistors to FETs, MOS FETs, tunnel diodes, integrated circuits, varicaps, photoFETs, light-sensitive and light-emissive devices, incandescent and luminescent optoelectronic circuits, unijunction transistors, field-effect

diodes, SCR and zener diodes, etc. Explains how these various devices work and how they are used, with descriptions of all the common and unique circuits used in modern semiconductor technology. Attention is given to integrated circuit applications — variable-current and constant-current sources, unbalanced differential amplifiers, IC applications in FM and TV receivers, TV sound circuits, discriminator circuits, and cascade amplifier networks. 272 pps., over 300 illus., 26 Chapters.

List Price \$7.95 ● Order No. 493

FET Applications Handbook



This revised 2nd edition contains a wealth of data on the FET and its various applications in practical circuit designs, material prepared by some of the most capable engineers in the field. Early Chapters delve into current-voltage relationships, application areas, DC and AC amplifiers, voltage controlled attenuators, and limiter and

chopper circuits. Additional Chapters deal with linear applications, chopper and switching circuits, integrated circuits and photo-FETs. Also FET oscillators, describing various types and the necessary biasing arrangements. Essential design data includes starting conditions, power output, frequency stability, and efficiency. Information of immediate value to anyone looking for FET circuit applications, including numerous practical circuits. 320 pps., 250 illus., 26 Chapters. Hardbound.

List Price \$14.95 ● Order No. 240

How To Fix Transistor Radios & Printed Circuits

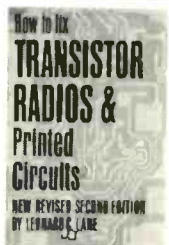

Here it is! Just off the press—a completely updated, revised edition of Leonard Lane's best-selling classic on transistor radio repair. In addition to extensive enrichment of the first edition, the author brings FETs, zener diodes, FM radios—in fact, everything related to the current state of the art—into the picture. Here's the perfect

reference and guide for electronic technicians who need to understand and repair semiconductor circuits efficiently. For those interested in transistor physics, fundamentals are emphasized in the first two chapters. The real "meat" begins in Chapter 3 which will thoroughly familiarize you with amplifier fundamentals, basic circuit configurations, biasing, FETs, JFETs, and IGFETs. The next two chapters will acquaint you with RF and IF amplifiers. 256 pps., over 150 illus., 12 Chapters.

List Price \$7.95 ● Order No. 504

RCA Monochrome TV Service Manual



Covers 33 RCA black-and-white models from 1964 to current chassis —KCS136 to KCS178—packed with vital service data regarding adjustments, alignment, and troubleshooting tips. Initial chapters cover tuners, IF repair and alignment, video circuits, AGC and sync circuits, sound circuits, and vertical and horizontal sweep systems,

with emphasis on newer solid-state circuits used in hybrid and all-transistor receivers. The remainder of the manual, chapters 9 through 23, deals with specific chassis. In each case, there are chassis layout drawings, circuit board component location diagrams, specific information relating to construction and adjustment, plus a wealth of case-history troubleshooting data. Includes especially helpful data on small portable and compact models. 176 pps., 8½ x 11. Over 150 illustrations.

List Price \$7.95 ● Order No. 549

SEND NO MONEY!

Simply fill in and mail postage-paid Airmail card today!

... for more details circle 103 on Reader Service Card

From Antennas to Wall Outlets KAY-TOWNES Makes Everything!

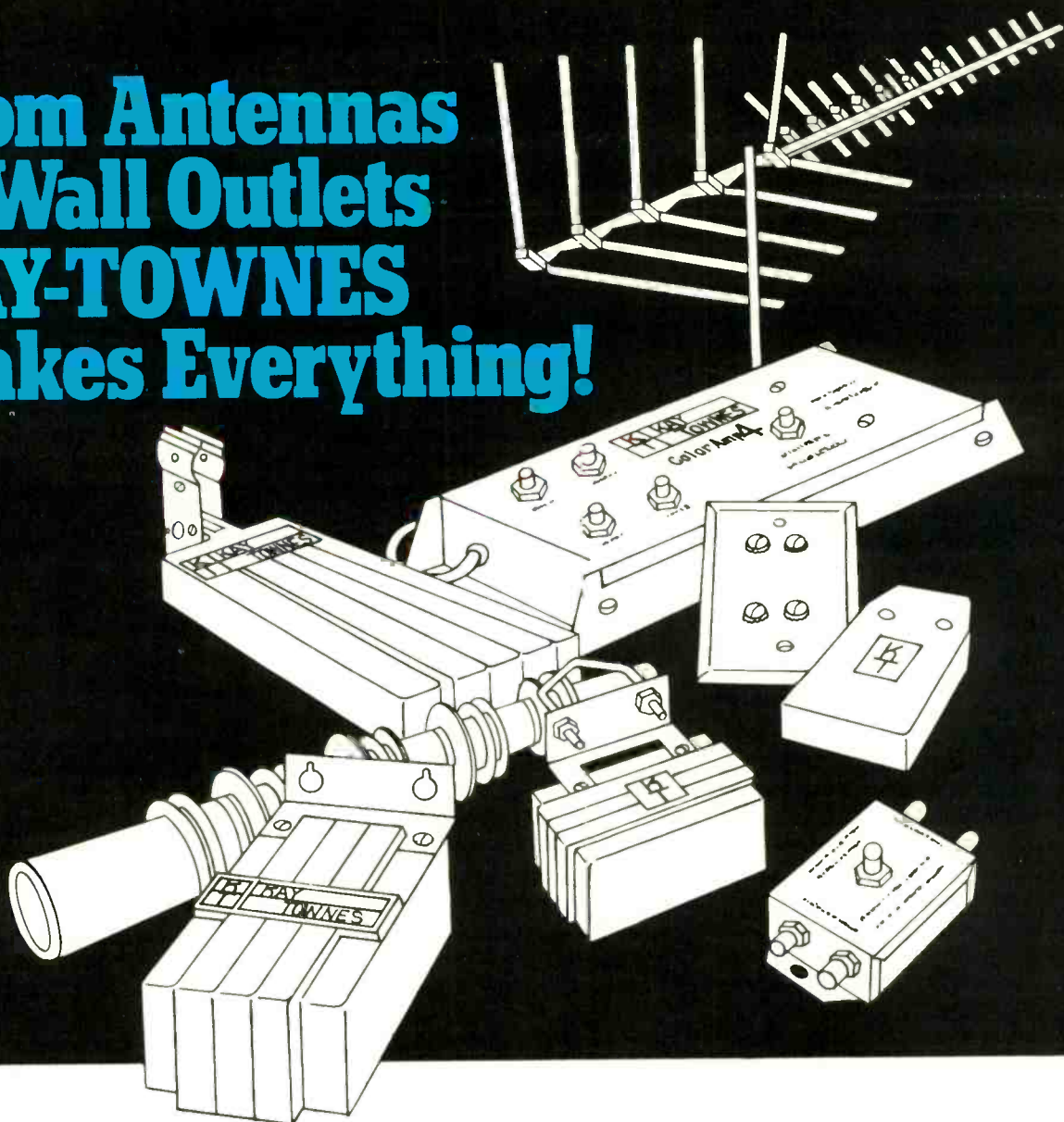

One supplier, one distributor can give you a complete line of high quality systems and components for better TV pictures and brighter sales pictures!

FROM DESIGN TO DELIVERY, IT'S KAY-TOWNES ALL THE WAY ...

Every Kay-Townes product is researched and developed by our own staff in our own laboratories. We even design the machinery needed to make our products. Every item we make is manufactured under rigid quality controls entirely within our own plant. Many of our customers receive their shipments in our own Kay-Townes trucks! When you buy a Kay-Townes product, you can sell it with the confidence that you are handling a precision engineered item manufactured by craftsmen!

SEE OUR COMPLETE LINE, INCLUDING: ANTENNAS

- All-Channel TV and FM Antennas
- Area Special Antennas for your Location
- Antenna Switch-Splitters
- Hi-Carbon Golden Masts... telescoping or straight lengths

MATV

- Distribution Amplifiers and Systems
- Antenna Mounted Amplifiers and Couplers
- All related equipment including Splitters, Couplers, Mixers, Traps, Wall Tap-offs, Wallplate Outlets

WRITE TODAY FOR OUR
COMPLETE MATV AND
ANTENNA CATALOGS



KAY-TOWNES

P.O. Box 593 • Rome, Georgia • (404) 235-0141

... for more details circle 118 on Reader Service Card

MATV Made Simple

by Keith T. Peterson

An MATV (Master Antenna Television) system could consist of a single antenna connected to two TV sets through coaxial cable, or an elaborate array of stacked Yagi antennas fed through a head end and line amplifier system into several hundred TV sets. The demand for these MATV systems has increased greatly in recent years due to the broad and varying programs of many TV stations. The popularity for these systems in homes, motels, hotels and apartment houses has made it necessary for simplicity when designing these various MATV products. By following some simple instructions and using the diagrams provided in this article, an electronic technician can make such installations with little or no past experience.

■ The simplest system (Fig. 1) would consist of an all-channel antenna (Channel 2 through 83, plus FM) mounted with a rotor on a push-up mast or tripod. An 82-channel matching transformer, mounted on the antenna terminals, enables the installer to use RG-59/U or RC-11/U coaxial cable down to a two-way hybrid splitter. At the back of the TV sets, 75Ω UHF/VHF bandsplitters may be used to match the impedance of the coaxial cable into a 300Ω splitter network to the terminals on the back of the set. Following the instructions supplied with the various equipment, makes the installation so simple that even a do-it-yourselfer could install this system.

In weak signal areas, a tandem amplifier (Fig. 2) should be used. This amplifier consists of two units, a pre-amplifier and a power supply amplifier. Several TV sets may be operated with this system, but in this case only a band splitter with an FM tap is used. This splitter is connected to the UHF and VHF terminals on the back of the TV set and then through an FM filter tap so that an FM stereo system might also be operated.

Another simple system for the home is shown in Fig. 3. This system is usually operated in moderately high signal areas where weak distant signals are also desired. It consists of an all-channel antenna, plus an 82-channel pre-amplifier with power supply, and two UHF/VHF 75Ω bandsplitters.

A slightly more complex system for operating four TV or FM sets is shown in Fig. 4. An antenna mixer is used to couple a UHF antenna with a VHF antenna, which are pointed

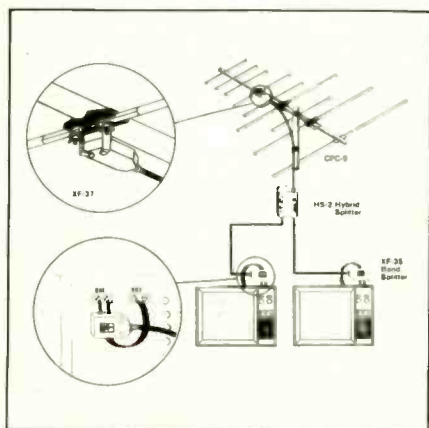

Fig. 1—82-channel, 2-set system

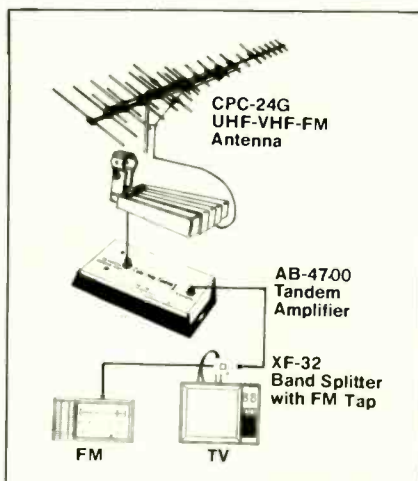

Fig. 2—82-channel, 1-set system, plus FM.

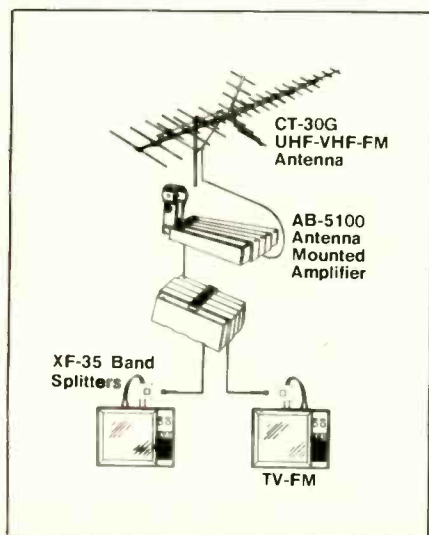

Fig. 3—82-channel, 2-set system.

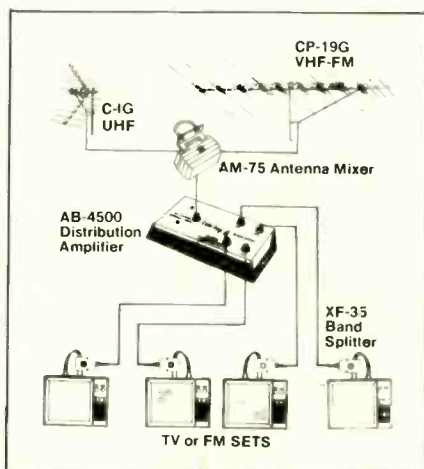

Fig. 4—82-channel, 4-set system.

The author is chief engineer for Kay-Townes, Inc.

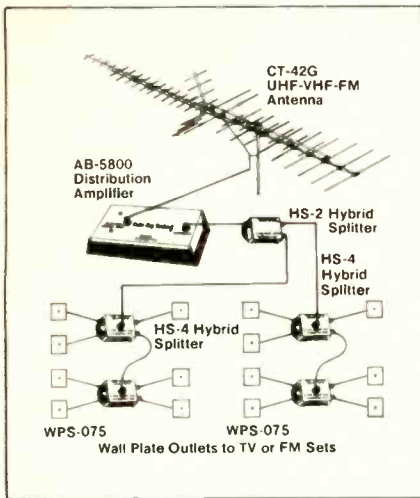

Fig. 5—82-channel, 14-set system.

in the same or different directions. And a 75Ω RG-59/U coaxial cable is fed down to a distribution amplifier mounted in the attic or basement. Feeder lines are connected to each of the four outputs on the distribution amplifier through coaxial cable to the 75Ω bandsplitters on each of the TV sets, located in different rooms.

The best system to use in dealer display rooms, small motels or apartment houses is shown in Fig. 5. The antenna array could consist of several antennas pointed in different directions connected together with a coupler system, or it could be as shown in this diagram.

A distribution amplifier is used to increase the gain from the antenna array to boost the signal through the cable into the various hybrid splitters and out of each wallplate to the TV/FM sets. These amplifiers are designed to increase the sig-

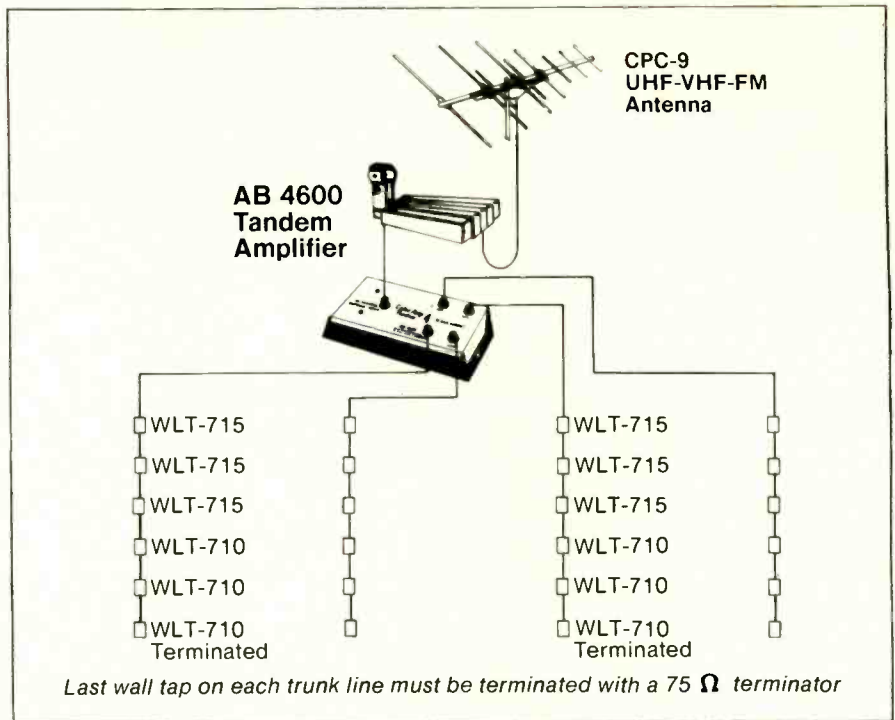

Fig. 6—82-channel, 24-set system.

nal to overcome the losses in the cable and splitting networks with enough gain to produce excellent color and picture.

An 82-channel, 24-set system using individual line tap offs built into the wallplates is shown in Fig. 6. Line tap offs are used in these systems because of the low insertion loss on the trunk line and to increase isolation between TV sets. These two features are very important in a large system. Low insertion loss minimizes the amount of signal loss in the trunk line per tap off. High isolation between outlets prohibits one TV set from interfering

with the other sets on the system.

The distribution amplifier shown in Fig. 6 has a built-in four-way hybrid splitter so that four trunk lines may be fed in different directions, thereby eliminating long lines. The longer the trunk line, the greater the signal loss at high frequencies due to the RF tilt characteristics of coaxial cable.

Larger systems can be designed using the various MATV building blocks shown in Fig. 7. In this case, a high-gain amplifier is used in conjunction with four two-way splitters, giving the system eight trunk lines with various isolation line tap offs.

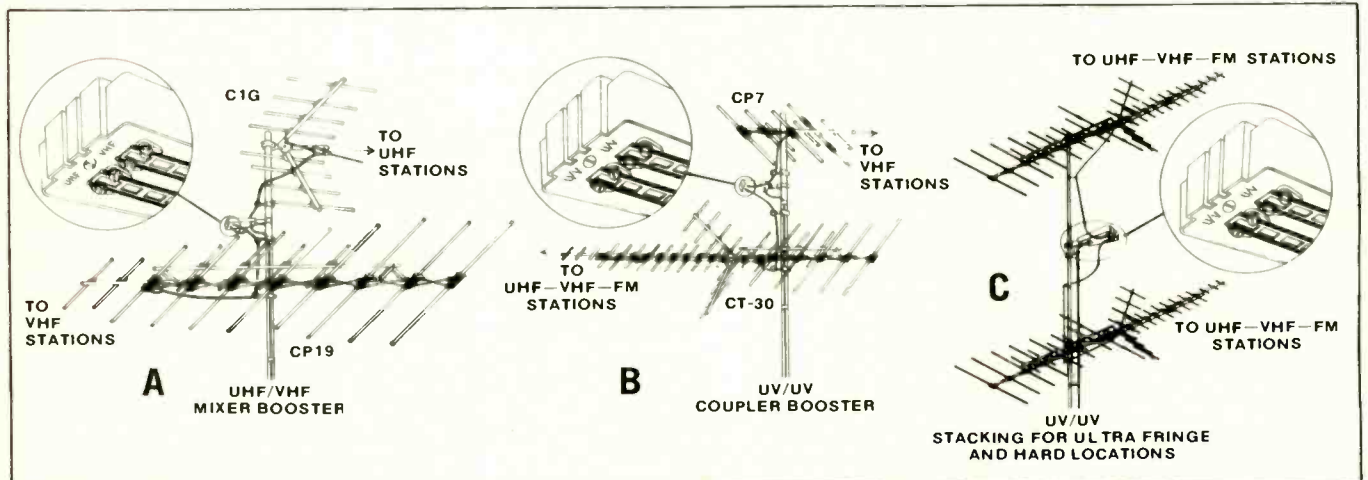

Fig. 8—Mixer/coupler/signal-doubler systems.

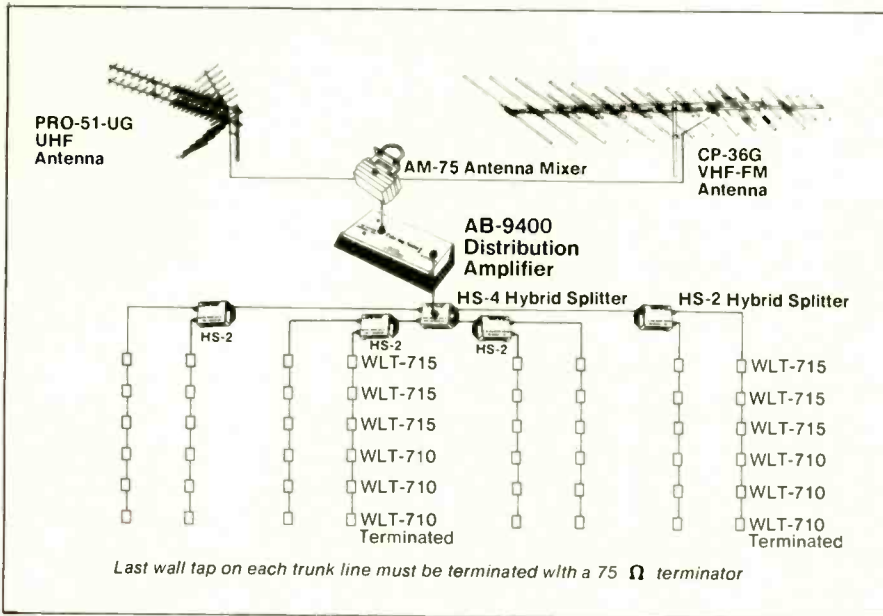

Fig. 7—82-channel, 48-set system.

Different isolation tap offs are used to compensate for cable loss and insertion loss as the signals reach the end of the trunk lines. In this case, higher isolation tap offs are used towards the front of the system where there is more signal, and lower isolation taps at the end where there is less signal.

Two important points to keep in mind when laying out and installing MATV systems are the input level (how much total signal is going into the amplifier), and the amount of signal you have at the highest channel at the end of the trunk line. Read the specifications on the amplifier you wish to use and do not exceed the maximum input signal for that amplifier. Make sure there is enough amplification at the highest channel you are receiving to compensate for the losses through the system.

To simplify MATV systems even further, some special products have been designed (Fig. 8). Twin-input boosters can be used to stack antennas and amplify the signals at the mast. Fig. 8A shows a UHF antenna coupled to a VHF/FM antenna through an 82-channel mixer booster. Two antennas pointed in different directions are coupled through an all-channel booster (Fig. 8B). In deep fringe areas, two UHF/VHF/FM antennas are stacked and coupled into an 82-channel amplifier (Fig. 8C). Other special compo-

nents—such as antenna mounted 30dB FM traps, antenna mounted 300Ω to 75Ω matching transformers, special single-channel traps and multiple attenuation H pads—are shown in Fig. 9.

There are many types of coaxial cable on the market that are not suited for 82-channel MATV sys-

tems. After many tests and evaluations, it has been found that the foam-filled, large-diameter, center-conductor coaxial cable with braided shield and outer aluminum foil shield is excellent for these types of systems. Usually RG-59/U coaxial cable is used in smaller systems while RG-11/U cable is used in larger systems where there are long runs to be considered. Caution must be taken when selecting the cable.

MATV is not really complicated if you consider each component as a building block. The individual products have their function and are designed to fit the next component in the line.

Most manufacturers have engineering services for the larger systems. If you think a system may be too complicated, send the specifications to the manufacturer and he will lay out the system in block form for you—usually free of charge.

In most cases, the simple diagrams shown in this article will cover your needs. Follow the block diagram and read the instruction sheets supplied with the equipment. Simplicity in design will help you be an expert in MATV systems. ■

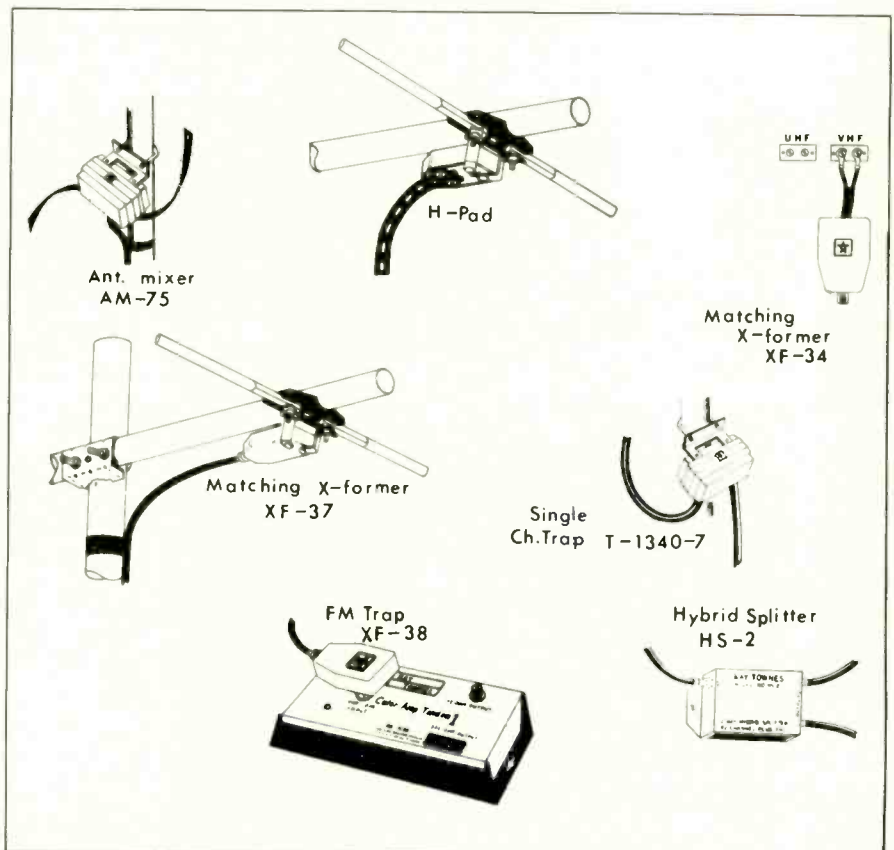

Fig. 9—Other special MATV system components.

How to Exorcise City and Suburban Ghosts

by Lon Cantor

In medieval days, a common practice was to exorcise ghosts by means of rituals and incantations. In this electronic age, we are still plagued by ghosts—on our TV screens. The problem is especially acute in city and suburban areas, where tall buildings, water towers and hills make excellent TV-signal reflectors.

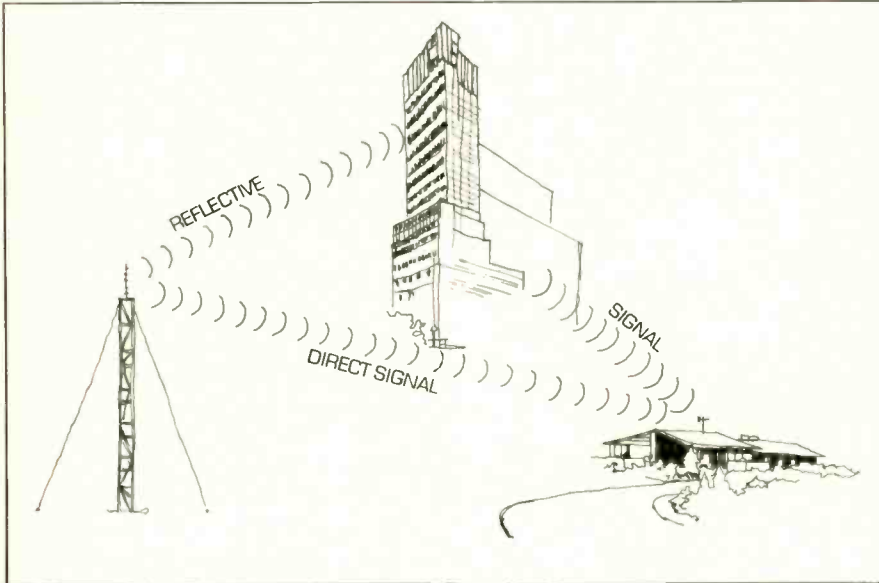

Fig. 1—Because signal reflection from tall building arrives at home antenna later than direct signal, it causes "ghost" image displaced to the right of direct image.

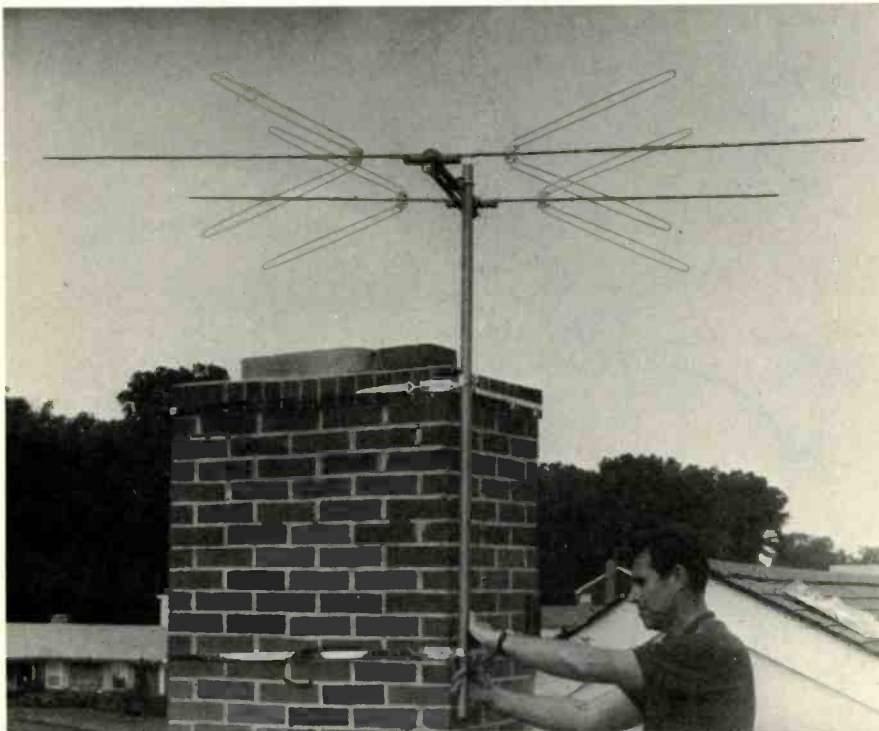

Fig. 2—Metropolitan "ghost killer" antennas, such as the Channel Master Coloray shown, reject signals which approach the antenna from the side.

■ As Fig. 1 indicates, ghosts are most commonly caused by signals arriving at the receiving antennas from two different directions. The problem is that the direct signal reaches the TV set a split second before the reflected signal. In the short time it takes a TV signal to travel an extra half mile, the horizontal oscillator has caused the sweep to move about $\frac{1}{2}$ in. across a 21-in. TV screen. Thus, if the reflected path is half a mile longer than the direct path, you get a ghost displaced about $\frac{1}{2}$ in. to the right of the direct image.

Ghosts are annoying enough in black-and-white, but in color they are intolerable. Even more annoying than horizontal displacement is the introduction of extraneous colors. Because the reflected signal arrives late, it generally arrives out of phase. Since color signals are detected in phase, the ghost signal is colored differently than the direct image.

Directional Antennas Reject Reflected Signals

The key to eliminating ghosts is to reject reflected signals. This can be done with a good, highly directional antenna. Generally speaking, the more elements an antenna has, the more directional it is. You can eliminate city and suburban ghosts pretty effectively with a large, fringe area yagi or log periodic antenna.

Unfortunately, few customers are willing to pay for a large, high-gain antenna when they live relatively close to the transmitter. A better answer is to use a metropolitan antenna specifically made to reject signals from the side and rear.

One of the many good metropolitan ghost-killing antennas now on the market is the Channel Master Coloray, shown in Fig. 2. It is physically a very small antenna, with very low gain. However, according to the polar plot in Fig. 3, this antenna is very effective in rejecting signals from the back and sides.

It is interesting how this is accomplished. Fig. 4 shows that the Coloray is basically a two-element phased array, with transposed feed. A signal coming in from the front of the antenna is intercepted by Dipole 1 and then Dipole 2, in that order. The signal intercepted by Dipole 2 has travelled distance S further in space. Therefore, it is out of phase with the signal intercepted by Dipole 1.

However, the signal from Dipole 2 is transmitted back to Dipole 1 through a transposed phasing harness, which shifts it 180° plus S . The two signals are then combined at Dipole 1 (added vectorially) and fed down the transmission line to the TV set. Since the signals are not 180° out of phase, they do not cancel each other out.

Now, let us look at a signal approaching the antenna from the rear. This signal is intercepted first by Dipole 2 and then by Dipole 1. The Dipole 2 signal is fed to Dipole 1 through the phasing harness, which shifts it 180° plus S . However, since the Dipole 2 signal started at S distance behind Dipole 1, it arrives at Dipole 1 exactly 180° out of phase. (Notice that this relationship holds true regardless of frequency and regardless of the value of distance S .)

If the signals from Dipole 1 and Dipole 2 are equal and 180° out of phase, they cancel out. The phasing array just described insures that the signals will be 180° out of phase when the signals approach from the rear, but their amplitudes are seldom equal. Therefore, complete cancellation, resulting in a very high front-to-back ratio, is unlikely.

However, this antenna utilizes a voltage and impedance balancing circuit built around a duplex ferrite toroidal core (Fig. 5). This circuit insures that the signal amplitudes of the two dipoles are equal under virtually all conditions.

Installing the Antenna

Because of its size, this antenna is relatively easy to install. The author and a friend recently cleared up a severe color ghost problem by putting up this antenna on a typical suburban New Jersey home. The

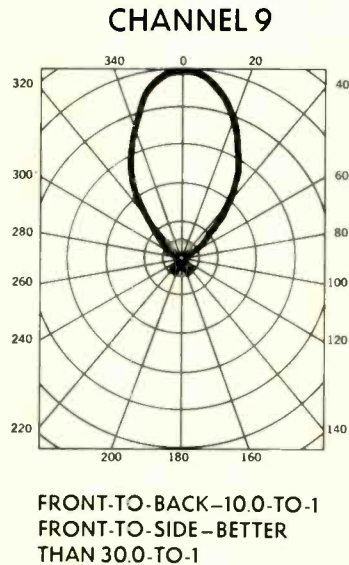

Fig. 3—Polar pattern of Coloray indicates that at Channel 9 it provides a front-to-side ratio in excess of 30-to-1.

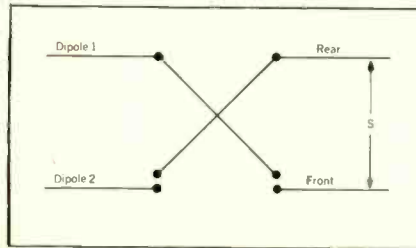

Fig. 4—Ghost killing capability is achieved through combination of phased dipoles and signal power balancing circuitry.

antenna is used to feed Channels 2, 4, 5, 7, 9, 11 and 13 to a color-TV console.

In making this installation, we used a chimney mount with a 5-ft mast. There was no point in going up any higher since signals from all channels are strong. Our problem was signals from several directions, rather than not enough signal. (In fact, we would have installed the antenna in the attic—a good place to keep it out of the elements—if we could have oriented it properly in that confined space.)

Because the antenna was quite low and well supported, no guy wires were necessary. We chose coaxial cable rather than twin lead, to avoid direct signal pick up as well as standing waves.

In a strong signal area, unshielded twin lead itself picks up a fair amount of signal. Thus, you can take pains to eliminate a ghost signal at the antenna, only to pick it up on the download.

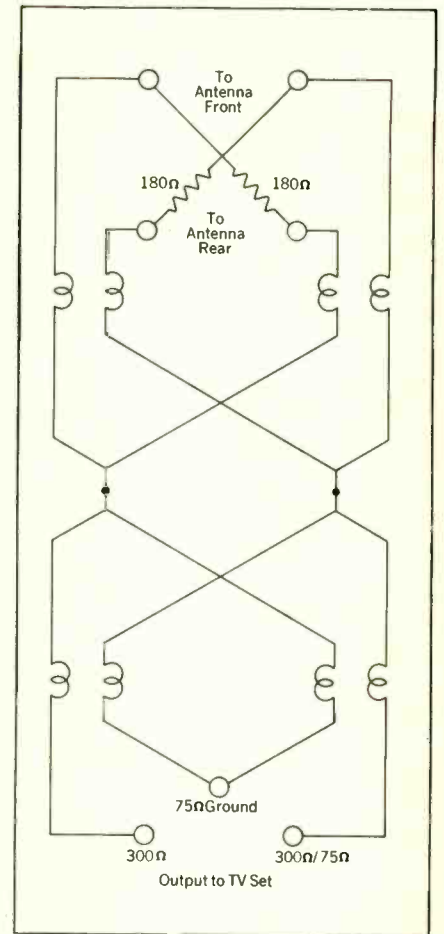

Fig. 5—Schematic of Coloray power balancing circuit.

Standing waves on the twin lead are another common cause of color ghosts or smears. In spite of the careful use of standoff insulators, it is very difficult to avoid running downlead across an aluminum gutter or near metal of some kind. At every point where twin lead is close to metal (including metal standoffs and the staples commonly used to run twin lead indoors), the signal "sees" a "lump," or impedance mismatch in the line. Some of the energy bounces back off the lump and heads back to the antenna, setting up reflections or standing waves. These reflections bounce around within the downlead, eventually reaching the TV tuner late enough to cause closely spaced ghosts, which are seen as indistinct color smears.

Coaxial cable minimizes the possibility of standing waves, as well as direct pickup. We connected the coax to the antenna through a snap-in matching transformer, using sili-

continued on page 67

Semi - Tips

by Jack Jaques

The second in a series that is intended to clarify and simplify the usage of specific semiconductors. This month's article refers specifically to the silicon zener diode, some of its unique capabilities and how to use these devices properly.

■ Basically, the silicon zener diode is a simple P-N junction device (refer to the first article appearing on page 50 of the June 1971 issue of *ELECTRONIC TECHNICIAN/DEALER*) that is connected into a circuit in such a manner that it is reverse biased. All P-N junction diodes exhibit a very low forward-bias resistance and a very high reverse-bias resistance. However, all reverse-biased P-N junctions have a critical voltage point or avalanche phenomena at which the resistance becomes quite low and reverse current through the diode increases very rapidly. This voltage phenomena is referred to as the Zener Point or Zener Kneec. A typical zener diode characteristic curve is shown in Fig. 1.

In practical applications, the optimum operating point of the zener diode *must* be considered as the I_{ZT} condition. At this operating point, the V_Z will be the rated zener voltage (plus or minus the actual device tolerance), and as can be seen from the characteristic curve, if the circuit draws less or draws more current, there is an adequate safety factor so that the zener voltage applied to the circuit should be maintained at all times.

Since the usage of zener diodes in original equipment is on a constant increase, it therefore stands to reason that their replacement is also going to increase. Because of this factor, the electronic technician should certainly educate himself in a

manner that will permit him to make an adequate replacement that will permit the equipment to operate in the intended manner.

Probably one of the least known, or least utilized, features of these devices is that when two or more zener diodes are connected in series the zener voltage is additive. For example, if a 15v, 1w zener diode is required, it is possible to connect a 6.8v, 1w and an 8.2v, 1w zener diode in series; and the results would be a 15v device rated at 1w.

Another replacement technique, that can be used as a matter of expediency, is to place a resistor in series with a zener diode that has a voltage rating lower than the required zener voltage. While the exact resistance value could be calculated by using Ohm's Law, the author feels that the empirical method is

more practical. In which case, a resistance substitution box and a milliammeter are connected in series with the zener diode and a voltmeter connected across the circuit. Switch the various resistance values into the circuit until the closest voltage and zener I_{ZT} are attained—then replace the resistance substitution box and milliammeter with a fixed resistor of equal value. This resistor should have the same wattage rating as the zener diode. Although this method does exhibit a slight sacrifice in regulation, it will be quite satisfactory in all but the extremely critical circuits.

It is hoped that the information presented in this article will help to promote a better understanding of these popular devices, and permit the user to interpret and apply the published specifications and data. ■

Terms Used with the Characteristic Curve

Z_{ZK} = Zener impedance, in ohms, as measured at a point just after the avalanche phenomena has started to cause voltage breakdown of the reverse-biased junction.

V_Z = Nominal zener voltage. This is the rating that is commonly referred to as the zener voltage.

Z_{ZT} = Zener impedance, in ohms, as measured at the quarter-power test current point, I_{ZT} . (The "quarter-power" point is the ideal operating point of a zener diode.)

I_{ZK} = The current measured at the same point as Z_{ZK} .

I_{ZT} = The current measured at the same point as V_Z and Z_{ZT} .

I_{ZM} = The maximum current rating of the specific device.

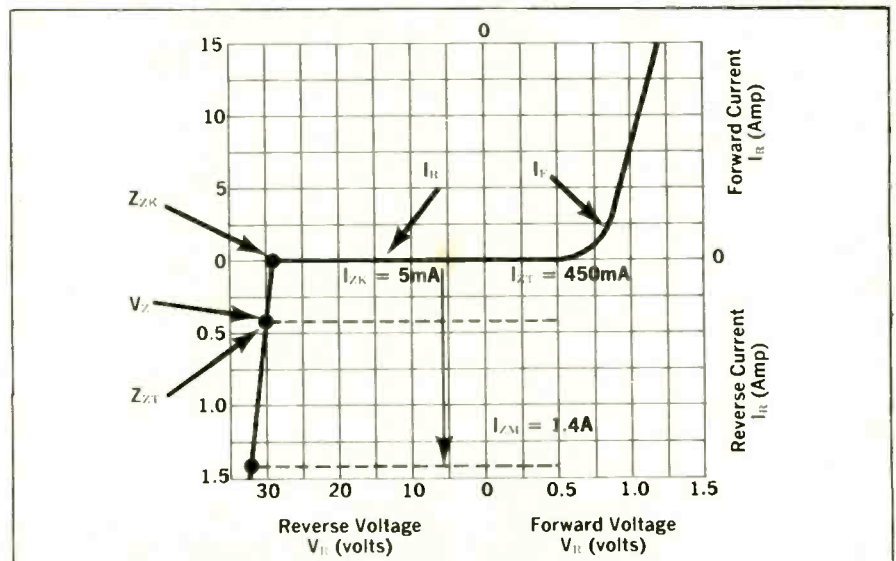

Fig. 1—Characteristic curve of a typical zener diode.

The author is HEP technical manager of Motorola Semiconductor Products, Inc., Phoenix, Ariz.

Understanding Today's Capacitors

by Richard Marsh

Part II—The electrostatic capacitor is quite different from the electrolytic, both in the way it is manufactured and in its application

■ Unlike the electrolytic capacitor, the electrostatic types (impregnated paper, film, mica, ceramic and air) can be built to very close tolerances. The dielectric material is generally of uniform thickness, and once a machine is set-up or materials cut to specific sizes, thousands of capacitors can be made at a time and all will be close to their designed capacity. Electrostatic dielectrics are generally quite stable and exhibit extremely high electrical resistance.

The tolerance of electrostatic capacitors are generally assumed to be ± 10 percent, unless otherwise noted or specified. This is quite unlike its electrolytic counterpart, which can be as much as 150 percent over its printed label. Many electrostatic capacitors, such as micas, are built to extremely close tolerances and then selected, bridged and labeled as close as ± 0.25 percent. Consumer electronic equipment rarely demands better than ± 5 percent.

Ceramic capacitors offer unique characteristics—such as changing in capacity as the temperature varies. This can be either in a positive or a negative manner, depending on the mixture of materials used in their fabrication. Temperature compensating ceramic capacitors find popular application in tuned circuits—adjusting them as the environmental temperature changes. Ceramic capacitors with zero temperature coefficient exhibit little or no change when exposed to varying temperatures.

Mica and ceramic capacitors offer extremely low inductance, making them quite effective in high-frequency circuits. Mica was one of the



Richard Marsh is distributor market manager of Cornell Dubilier Electronics. There he is responsible for the design of the CDE Replacement program, including the new type of wide-range electrolytic capacitor. He joined CDE five years ago after completing, for them, a consulting assignment on distributor-dealer marketing. Included was an extensive survey of hundreds of electronic technicians in person throughout the country. Mr. Marsh has owned and operated electronic distributor and dealer organizations, was with P. R. Mallory Co. for eight years and has instructed in military and civilian electronic schools.

first dielectrics used in capacitors. It offers extreme stability and precision ratings. The dipped mica capacitor is the most popular in use today, obsoleting the early molded types. The radial leads of the dipped mica capacitor adjust to almost any type of circuit board or chassis configuration.

Many ceramic capacitors can be directly replaced with dipped mica types—assuring better performance and dependability. However, this *does not* apply to temperature-compensating applications!

Impregnated paper is one of the earliest dielectrics used. But unfortunately paper has very little moisture resistance, and even with oil and wax impregnation and filling, a danger of leakage always exists. By employing expensive construction—using metal and glass—the paper capacitor can be a very effective component.

The introduction of films, such as Mylar* and polycarbonate, has been an important contribution to the construction and dependability of electrostatic capacitors. They offer a moisture impervious dielectric at low cost, making possible relatively high capacitance and simple construction. Film capacitors do not always require an outer container or special seals, but often must be de-rated for ac applications. In OEM design, where the parameters are known, an engineer can specify the use of pure film capacitors and achieve quite a savings in the cost of manufacturing a product.

Paper-film type capacitors have become very popular. Combining both impregnated paper and a film, a combination dielectric is formed that offers most of the advantages of each. The paper-film capacitor has become very popular in the replacement field, as it is a perfect substitute for both paper and film components. Many industrial and OEM applications use these capacitors where intermittent alternating currents are likely to be encountered.

Where a paper dielectric is used, even in combination with film, it is essential that moisture be eliminated and prevented from returning. Moisture is extracted from the fabricated unit and impregnated with oils and wax to prevent its return. Encapsulation is mandatory. Usually a dipped epoxy cover or a molded plastic cover is provided, but for more demanding applications metal or ceramic containers are required.

In an effort to achieve extremely small sizes at very high capacity ratings, a process called metalizing is

continued on page 51

Service Training Schools

TV-set manufacturer helps train nation's electronic technicians

■ Can a woman do a better job at TV servicing than a man? Maybe—maybe not. But recently a 17-year-old electronic technician, a girl, proved that women have what it takes to do the job. The young Job Corps graduate in electronics averaged 90 in final exams she took at Magnavox's Service Training Center in East Rutherford, N.J. She admits that she made the most of her on-the-job training as a TV technician at Regal Magnavox Home Entertainment Center and that she did a lot of homework if only because she wanted to prove that a woman could

pass the tests with flying colors.

Female students are a rarity at Magnavox's seven regional service training centers. For the past three years, the unique regional training program has been giving, at no charge, technical training that cannot be presented in field training sessions. The centers are located in East Rutherford, N.J.; Atlanta, Ga.; Westlake, Ohio; Skokie, Ill.; Dallas, Texas; and San Francisco and Torrance, Calif. Courses are open to all qualified TV and stereo service technicians.

The program—facilities, instruc-

tors and equipment—are arranged in such a way that the technician is able to gain the highest degree of theoretical and practical training in the minimum number of hours. Five training programs, consisting of two or more complete courses, are scheduled Monday through Thursday. A class day begins at 8:00 a.m. and ends at 5:30 p.m.—with a complimentary lunch provided.

The study programs, with some overlay in courses, are set up so that the student can select the one most beneficial to him. Progress is gauged by workbooks and quizzes. The programs, and their included courses, are: Color TV I, courses 120, 202, and 203; Color TV II, courses 202, 203 and 502; Color TV III, courses 203 and 204; Solid State courses 130 and 302; Fundamental Color and Solid State courses, 110, 120 and 130.

Course 110—Technical Indoctrination—provides background on Magnavox, its facilities, services and products. It covers product identification, service manuals, replacement parts, etc. This course is suggested for new dealers and new service personnel.

Course 120—Basic Colorimetry and Color-TV Set-up—is for service technicians without prior color experience. This course covers degaussing, purity, color temperature, convergence and all other field adjustments.

continued on page 60

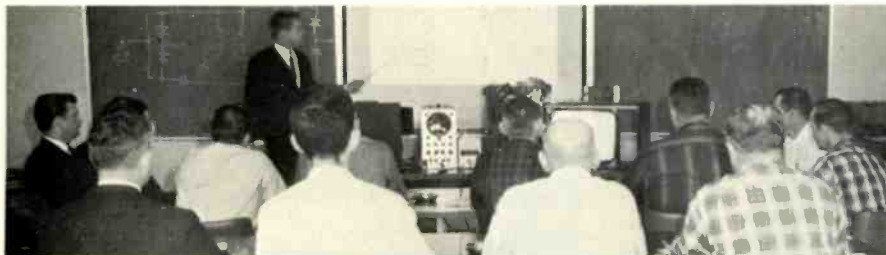

Magnavox Service Training programs are arranged to provide the highest degree of theoretical and practical training in a minimum number of hours.



Working with actual equipment during class is an essential part of the courses offered at Magnavox's Service Training Schools.



A service training specialist at Magnavox's East Rutherford, N.J. Service Training School, gives some personal instruction to the student. Classes are limited in size so that instructors can take time out to help individuals on specialized programs.

Servicing the Auto Stereo Tape Deck

by Homer L. Davidson

Useful techniques for improving your competence
in maintaining these increasingly popular car audio systems

■ Last month's article includes some helpful hints for curing auto stereo tape deck speed problems and problems in changing cartridge tape channels. Suggestions were also provided for effectively cleaning and lubricating these units. This month's article continues the subject by suggesting what to check when encountering problems in obtaining adequate volume, noise and distortion, and defective tape cartridges. The case histories that are included in this article relate to the problems described in both this and the previous issue.

NO SOUND/WEAK SOUND

The audio circuitry in a tape play may contain from four to nine stages of amplification. Many of these solid-state stages are directly coupled, while the output stages may be directly or transformer coupled. A noise or audio signal generator should be used first to isolate the channel and stage that the trouble is in. Then use a VTVM and transistor tester to locate the defective component. When making in-circuit transistor tests, remove the collector terminal from the circuit of a directly coupled transistor. Remove the motor belt or disconnect the motor when checking out difficult sound problems.

Intermittent sound problems may be caused by capacitors, transistors or printed-circuit boards. Do not overlook a possible intermittent connection leading to the tape head. VOLUME and BALANCE controls also produce their share of intermittent sound problems. Check the RADIO/PLAYER switch for poor switching connections in radio/tape-player models.

No sound or weak sound may result from defective capacitors, resistors or transistors. Locate the weak

stage with an audio- or noise-signal generator, comparing each stage with the other good channel (Fig. 1). Dried-up electrolytic coupling capacitors produce weak stages. A leaky transistor may produce weak and distorted music. Burned or open bias resistors can also cause weak conditions. When both stages are weak, check for packed oxide dust on the tape head. It is also possible to have a weak channel when the tape head height adjustment is off to one side.

NOISE AND DISTORTION

Noisy and distorted conditions may be caused by a dirty or magnetized tape head, improper adjustments, resistors and transistors. Periodically cleaning with a tape head cleaning cartridge will eliminate most tape head problems. If noise still exists, isolate the stages by turning down the VOLUME control. Check the pre-amplifier and driver transistors for noisy conditions. The tape head should be demagnetized after making bench repairs.

Extreme distortion is generally the result of malfunctions in the power output stages. Remove and check each power output transistor for leakage. In directly coupled

stages, check each audio-frequency amplifier and driver transistor for leakage or open conditions. Check each base- and emitter-bias resistor to make certain that it is not burned and has the correct resistance. Look the printed-circuit board over carefully, it is possible to find a burned section where leaky or shorted output transistors are located.

Improper adjustment of the tape head may produce weak or distorted music. Also, crosstalk is caused by improper height and azimuth adjustments of the tape head. Make sure that the tape head is changing channels properly before making these adjustments. A loose capstan drive and tape head assembly can produce crosstalk and wow conditions. In models having outside height adjustments, you may find the adjustment turned way to one side.

Use a test cartridge to make proper height and azimuth adjustments. Start with the tape head in the foremost top position, and then adjust the tape-head height screw for proper response. The sound will be "clean" and loud on both channels at adjustment point. Connect an ac VTVM across the speaker output terminals of one channel and adjust

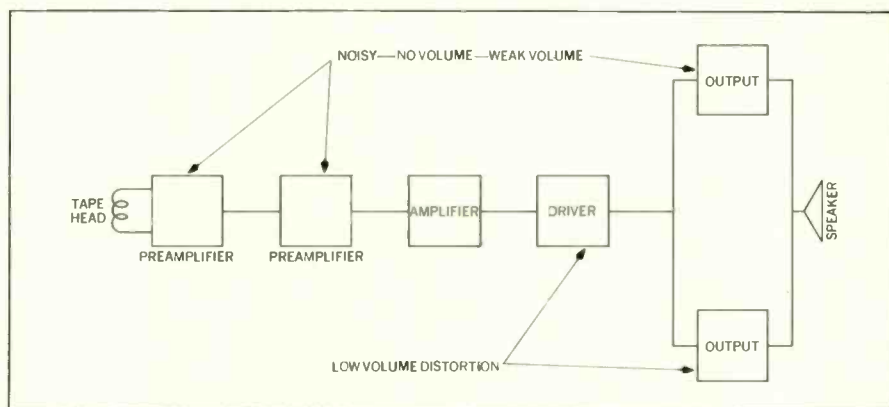

Fig. 1—Block diagram of one channel in typical auto stereo amplifier.

the azimuth screw for maximum meter readings. Double check each channel for good clean reproduction of music.

TAPE CARTRIDGE PROBLEMS

Many tape problems are caused by a defective cartridge. Insert a new cartridge and see if the player acts in the same manner. If not, the tape cartridge is defective. A squeaking noise can be caused by a dry rubber roller inside the cartridge. The rubber roller is rotating against a plastic bearing and needs oiling. Place a drop of oil on each side of the rubber roller—just a drop. A scraping noise may be heard when the cartridge is not seated properly.

When the tape is pulled from the cartridge and winds around the capstan drive, suspect a rough or dirty capstan drive assembly. Clean off the capstan drive and check for parts of tape still around the drive assembly. This condition will even make a new cartridge pull tape. A defective cartridge may pull out tape or have a sticky substance on the tape and roller. Be sure that the "A" lead is connected to the positive terminal, or the tape motor will run backwards—unwinding tape from the cartridge.

When installing a stereo tape system, make certain that you observe the proper polarity. Some autos use a negative ground while others use a positive ground. If polarities are not correctly observed, transistors and tapes may be damaged. In some tape players, a diode is found to correct this situation.

SOME PROBLEMS ENCOUNTERED IN THE SHOP

Runs Too Fast

The owner of a Lear-Jet Model AS-831 tape player reported that the tapes were running too fast. Sure thing, when we placed the tape player on the bench, it was running real fast. (In most cases the complaint is that the player is running too slow.)

We checked the motor speed circuit and hoped that the trouble was there, as some tape motors are difficult to obtain. The motor control transistor (GC4045) was checked in the circuit and appeared open

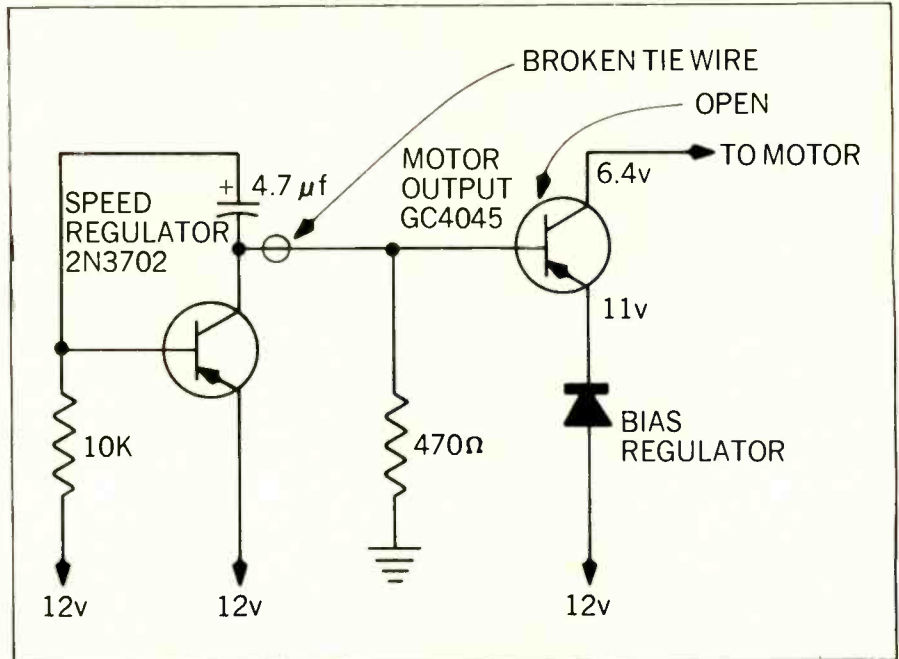

Fig. 2—Schematic showing problems encountered in a Lear-Jet Model AS-831 tape player.

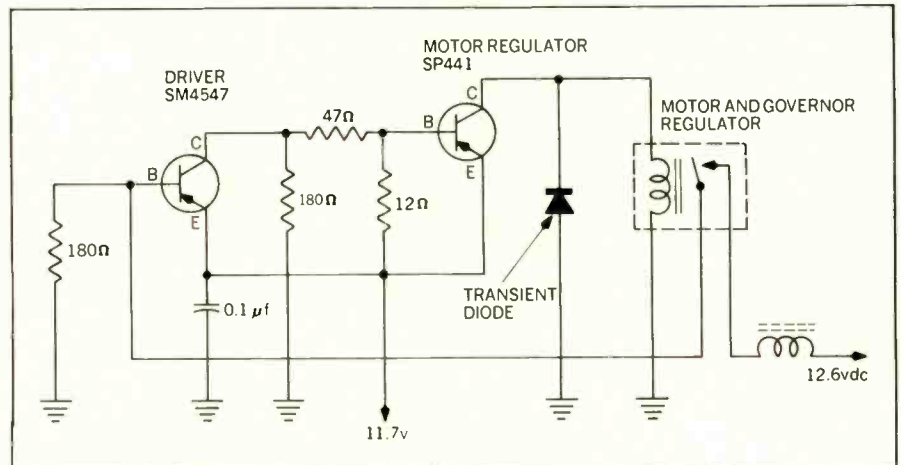

Fig. 3—Schematic of a Ford Model T65MF tape player that ran too fast.

(Fig. 2). Replacing the transistor with an RCA SK3009 transistor solved the too-fast-speed problem.

Intermittent Speed

A Ford Model T65MF tape player came into the shop having an intermittent-speed problem. Sometimes the player would run very slow and then too fast. At first we suspected a frozen or binding capstan drive or stretched rubber drive belt. Cleaning and lubricating the complete player, however, did not solve the problem.

We checked voltages in the motor regulator circuit and the only incorrect voltage—11.5v—was found at the collector terminal of the motor

regulator transistor (Fig. 3). We removed the power transistor and it checked good. The motor transient diode was checked while the transistor was out of the circuit and it was also good. With an in-circuit transistor test, the driver transistor was found open. If possible, replace these regulator transistors with the original part number, although an RCA SK3025 universal transistor solved this intermittent speed problem.

Wow Conditions

The complaint given for an Automatic Model GES-6394PAK tape player concerned "slow and wow conditions." This sounded like a

TROUBLE	CAUSES OR SERVICING PROCEDURE
Fails to play	Check fuse Poor ground Defective cartridge switch Frozen capstan bearing Broken drive belt Motor defective Broken power connection on printed-circuit board
Does not change channels	Check manual channel selector switch Check automatic channel selector switch Indicator arm binding Pawls out of line Head index cam frozen Solenoid defective Power not getting to solenoid Plunger not fully engaged Blows fuses when changing channels (check diode across solenoid winding)
Tape Plays Slow or erratic	Belt slipping Misaligned capstan drive assembly Oil on belt and capstan drive Dry capstan drive bearing
Unbalanced audio output	Check tape head Check balance control Check for poor speaker ground Check for incorrect height adjustment Check for weak stage
Noisy	Check to see if noise is on both channels Check to see if transistors in last two stages (audio and output) are noisy Check for ignition noise, installing capacitor on ignition coil or suppressor in distributor lead Check playback head and demagnetize
Wow conditions	Defective capstan bearing Defective motor Dry pinch roller Check electronic speed circuitry Defective cartridge
No sound or weak sound	Dirty head Head out of alignment Defective cartridge Check terminals on tape head with audio-signal generator to see if heads are defective Use audio-signal generator to locate dead stages
Distorted sound	Dirty head Check bias adjustments Check power output transistors Check for burned bias resistors Locate with square-wave generator and scope

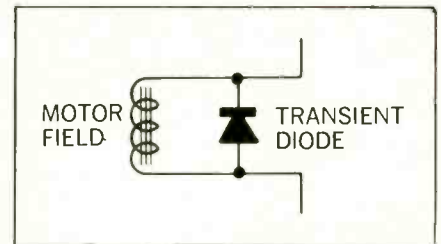

Fig. 4—Leaky or shorted diode across motor winding makes motor run backwards.

good clean-up and lubrication project. A new cartridge was inserted and it started off very slowly. While beginning to clean the capstan drive assembly, we found a loose bearing. A top nylon bearing had worked up, letting the capstan drive assembly become loose—causing wow conditions. The nylon bearing was pressed down, even with the drive spindle, and the speed was restored to normal.

Dead Motor

A Lear-Jet Model AS-831 tape player came in with a “dead motor.” The motor windings checked out, but it still would not rotate. The collector terminal of the speed regulator transistor was removed and the transistor tested in the circuit. The transistor tested good; and when the collector terminal was restored, we found a broken tie wire between transistors (Fig. 2).

Erratic Sound

The owner of this Automatic tape player, Model GE6-6394, complained that when the car hit a bump or went over rough roads, the sound would cut louder and softer in the left speaker. We placed the tape player on the bench and removed its covers. When pressing around near the VOLUME control, the sound would act up. We located a hair-line crack near the dual ground connections for the VOLUME control on the printed-circuit board.

Pulling Tapes

A Borg-Warner Model 3800 tape player came into the shop which pulled tapes. Sure enough, when connected to the bench power supply, the tape ran backwards. We rechecked the power supply connections, and it was hooked-up with correct polarity.

continued on page 60

Color Television Reception—Part IV

The Color Picture Tube

by William Spero

Shadow-masked, three-gun, color-picture tubes are at present most widely used for the color presentation of a televised scene

■ Previous articles in this series have described the nature of a color-TV signal and resulting antenna requirements, compared circuits used in both color- and B/W-TV sets, and covered the special circuits required for color-TV reception. This article concludes the series with a description of CRTs capable of reproducing either full-color or monochrome pictures (Fig. 1).

The three guns in this CRT are positioned so that their electron beams converge as they pass through a perforated shadow mask. This

mask is about 1/2 in. from the phosphor-dot screen. The output from the red, green and blue guns excite their respective phosphor dots—producing a picture as the screen is scanned. The shadow mask is composed of approximately 375,000 dot holes or apertures; while the phosphor dots are arranged on the back of the tube face plate in triad groups approximately 0.029 in. apart. There are approximately a million phosphor dots in a color-TV CRT (Fig. 2).

As the electron beams emerge

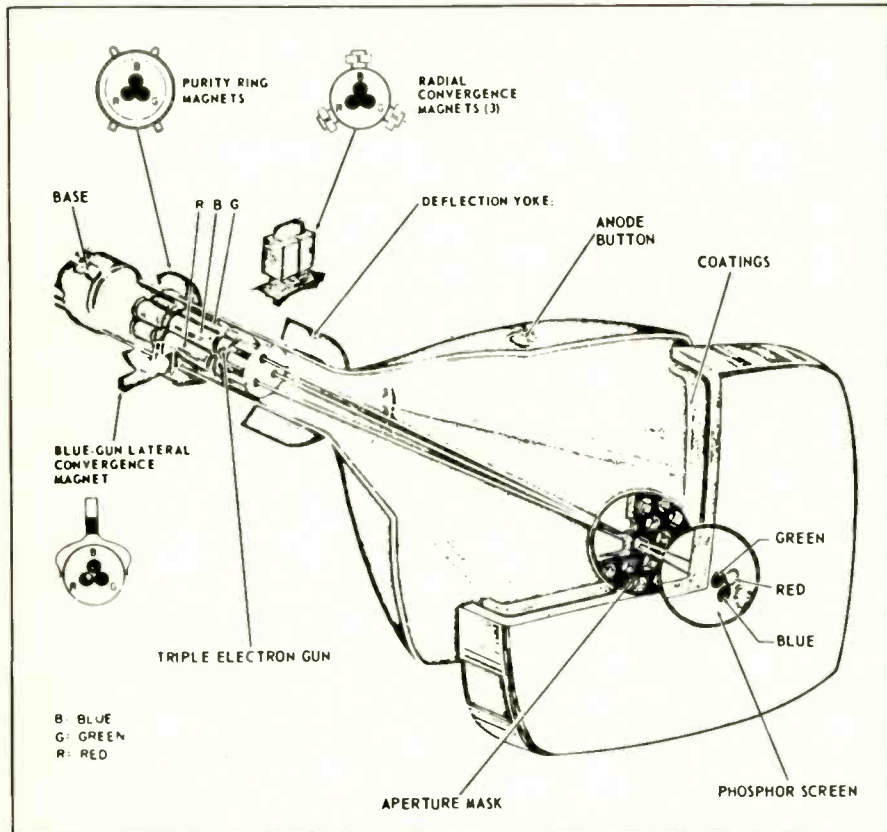

Fig. 1—Features at the color picture tube face plate and externally mounted neck assembly.

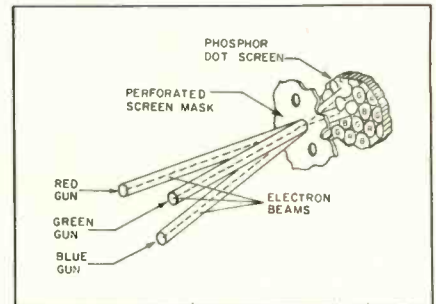

Fig. 2—Phosphor-dot, electron-beam and shadow-mask placement in a color-picture tube.

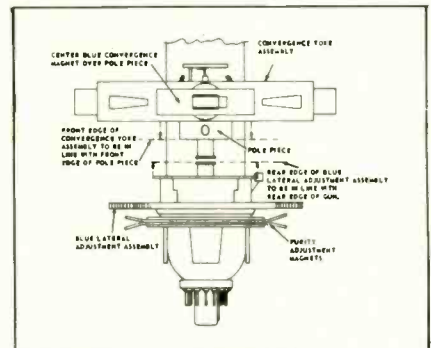

Fig. 3—Positions of assemblies on the color-picture tube (90° deflection).

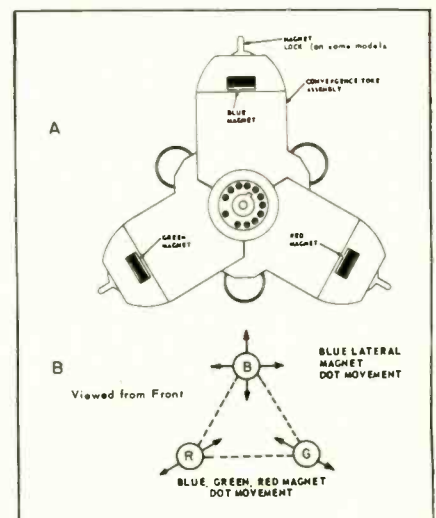

Fig. 4—Convergence yoke.

from the back side of the shadow mask, they will hopefully strike individual dots of phosphor. The ability of the red beam to strike only red dots, and the blue and green beams to strike only their respective dots, is dependent on the purity and convergence adjustments made during the initial setup in the customer's home.

The relative placement of the convergence assemblies can be seen in Fig. 3. The convergence magnets are directly behind the deflection yoke. Next is the blue-gun lateral-convergence magnet, and finally the purity ring magnet. Adjustments are generally made in the following sequence:

- Purity—usually for a red field.
- The radial convergence magnets and the blue lateral magnet.
- Adjusting dynamic convergence.

These assemblies are placed in discrete positions over the CRT guns. Incorrectly placed assemblies can make it difficult if not impossible to obtain proper purity and convergence. The movement of the beams, with the convergence yoke, is limited to the following directions (Fig. 4):

Red—Lower left to upper right in a back-and-forth movement.

Green—Lower right to upper left in a back-and-forth movement.

Blue—Up and down.

The blue lateral assembly moves the blue beam in a horizontal direction. By moving the proper magnets, one can hopefully adjust all beams so that they converge in the center of the screen—superimposed to make a white dot. A "dot and bar generator" is the instrument used when making these adjustments.

Dynamic convergence is performed after static convergence is completed. This adjustment compensates for misalignment of the beams at the ends of the picture tube as the face of the CRT is scanned.

If two parallel light beams are made to swing back and forth at a point of rotation and are made to scan a screen horizontally, the problem of dynamic misconvergence can be illustrated as shown in Fig. 5. Note that the red and green beams coincide at the center of the screen

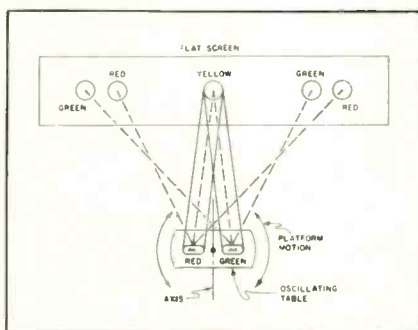

Fig. 5—Dynamic misconvergence.

to produce a circle of yellow light. However, when the beams swing an equal amount to the left or right, they no longer coincide and separate red- and green-light circles are formed. The further the beams move away from the central position, the worse this condition becomes.

In order to correct this condition and maintain a yellow spot of light as the platform moves in all posi-

tions, one of the following conditions must be met: The swing of the beam most remote from the point being scanned must be reduced; the swing of the beam nearest the point being scanned must be increased; or a combination of both of these corrective measures must be performed. The adjustment for making this correction is called dynamic convergence. All of these adjustments are fully described in manufacturers' service literature.

These manuals are printed for you, the electronic technician, to enable you to do professional and thorough servicing on the TV sets in your shop. By making use of these manuals, you add another effective "tool" to your service bench.

I would like to thank Gene Nanni, manager of Publications at Sylvania, and his staff, for their continuing efforts in making this material available to the industry. ■

CAPACITORS . . .

continued from page 45

employed. This capacitor is manufactured by applying molten aluminum directly on the dielectric material. This dielectric material is often paper or film. Due to the extreme thinness of the aluminum, it is possible to produce capacities otherwise unobtainable. The metalized capacitors are derated, as far as current is concerned, because of the extreme thinness of the conducting material. Applications are generally found in resonant-frequency circuits and certain by-pass and coupling functions where maximum currents fall within the capability of the component. As an example, you certainly could not replace a $2\mu\text{f}$ or $4\mu\text{f}$ motor running capacitor with a metalized type, since it would almost immediately burn up.

Many electronic technicians replace capacitors with those having a higher voltage rating to insure longer component life. Although this is usually acceptable where frequency-sensitive circuits are not involved, often the added thickness of the dielectric may require additional layers—increasing capacitor inductance and insertion losses.

It must be remembered that most

capacitors are rated at dc working voltages, which means that they must be derated when used in ac applications. As an example, a 300v secondary of a power transformer would have to be bypassed with a capacitor rated at 300v ac. Multiplying 300v dc by 1.4 gives you an ac equivalent of 420v. A 600v dcw capacitor would be a suitable replacement.

There are some rules applicable to the replacement of electrostatic-type capacitors that will help you in making the proper selection:

- DC rated capacitors should be derated for ac applications.
- Film, paper and combination paper-film capacitors can generally be replaced by dipped paper Mylar*.
- Capacitors of wrapped, molded or potted construction can be replaced by dipped epoxy types.
- Mica capacitors can be substituted for ceramic capacitors where temperature compensation is not critical.
- With the exception of frequency-sensitive circuits, it is generally acceptable to replace capacitors with those having higher voltage ratings.
- Zero temperature coefficient disc ceramic capacitors are generally

continued on page 66

Solid State Replacement - - Problem or Profit?

by Jack Devinsky

The rapidly increasing number of solid-state devices being incorporated in home entertainment equipment can present serious problems for service dealers—or an abundance of profits. On the one hand, a hit-and-miss approach to solid-state service can lead to frustrating losses in bench time, exasperating call backs, customer dissatisfaction and shrunken profits. On the other hand, a systematized approach using top-of-the-line quality devices specifically engineered for replacement use, ample technical information and accurate replacement data, provides the service dealer with a straight shot at customer satisfaction and profits.

■ The replacement market is moving in two directions—growth in dollars and growth in technical sophistication. End-use purchases of solid-state devices for replacement is rapidly approaching a \$25-million level. Technically, the growth pattern is marked with the increasing use of second-generation solid-state devices, such as integrated circuits (IC's) in color-TV sets. The IC's are replacing discrete devices and are being used in all types of circuits, including RF, IF and chroma.

With such increase in market usage and technical development, the service dealer must move in the right direction to optimize his time and his profit.

In solid-state servicing's infancy, some device manufacturers offered for replacement use their rejects, culls and other such products, originally intended for hobbyists. They were not called out as such, but that is what they were. The service dealers using them, however, soon realized the questionable parenthood of such devices and acceptance of them dwindled.

To continue trading in the professional service marketplace, therefore, some of these manufacturers began to provide a higher quality product. Actually, where a recommended replacement device may have to replace hundreds of industry types, *the device must be of premi-*

um quality with narrowly designed parameters to effect broadest replacement.

Here is how this is achieved.

A family of devices may include 20 different types, depending upon voltage and current capability, frequency response and beta. True top-of-the-line replacement from that family is selected or "creamed" from the top 10 percent of that production. This, and only this, is premium product, with premium characteristics, to serve the broadest replacement requirements. The service dealer, in his everyday business, cannot afford to use any but such



Jack Devinsky is manager of Replacement Solid State Merchandising, RCA Electronic Components, Harrison, N.J. He is responsible for product planning, and development and implementation of merchandising programs for replacement solid state.

premium products. The unwise luxury of using a questionable product is just that, a luxury which he cannot afford, since it generates duplication of effort and losses in time and money. As a business man, intent upon maximizing profits, the service dealer must minimize or eliminate the use of non-professional devices, just as he must minimize the use of non-professional equipment in his everyday servicing. He must insist upon premium quality devices for dependability and reliability.

The challenge to realize the best profit position encompasses other aspects as well. How does one insure that the proper replacement selection is made? This can be achieved best by a *manufacturer's offering of accurate replacement data*—not in terms of numbers of replacements carried in a book—but by the accuracy of the book's recommendations. Futile indeed is the service technician's effort when a manufacturer's recommendation does not do the job. Wasted time, wasted effort.

The dilemma can be solved by a systematized approach: Top-of-the-line premium product, ample technical information, accurate replacement data, and ample breadth of product line. This is the chain, and any weak link in the structure rips the system apart and sets the service dealer sailing on a sea of potential problems.

Solid-state servicing is a dynamic, growing business. It is changing rapidly—especially in the technical area—and the professional service dealer intent upon fruitful merchandising of his skills will make the right choice. He will elect to use a modern systems approach *which incorporates premium devices specifically designed for replacement*, rather than risk the inevitable frustrations. ■

TEST INSTRUMENT REPORT

Leader Model LSW-330 Post-Injection Sweep/Marker Generator

by Phillip Dahlen

Incorporates solid-state circuitry for easier handling

■ A number of articles in recent issues of *ELECTRONIC TECHNICIAN/DEALER* have described the frequency response of the various tuned circuits incorporated in B/W- and color-TV sets. They have indicated that as a result of component aging or replacement, circuit resonant frequencies shift and are no longer properly aligned for optimum reception.

For this reason, every qualified electronic technician involved in TV set or closed-circuit TV maintenance must own some sweep/marker generator. Such alignment cannot be effectively done merely by adjusting tuned circuits for best sound

or picture quality on the TV set.

One new sweep/marker generator now on the market (Leader's Model LSW-330 Post-Injection Sweep/Marker Generator) is designed for aligning both TV sets and FM receivers. Specifications indicate that it can provide six sweep-frequency outputs having a central frequency of 10.7MHz (FM receiver intermediate frequency), 195.5MHz (Channel 10 frequency), 69.5MHz (Channel 4 frequency), 43.5MHz (TV set video intermediate frequency), 4.5MHz (TV-set sound intermediate frequency), and 3.58MHz (TV-set chroma intermediate frequency). These signals are reportedly able to

sweep up to ± 0.7 MHz, ± 10 MHz, ± 10 MHz, ± 5 MHz, ± 0.5 MHz and ± 1.5 MHz, respectively. An automatic limit control is said to be included to provide constant output-signal amplitude, while triangular waveform voltages reportedly facilitate sweep linearity.

In addition to switches for providing ± 1 kHz modulation and/or 100kHz side markers to the FM and TV-sound IF sweep outputs; specifications indicate that it has switches for applying 39.75 MHz, 41.25MHz, 41.67MHz, 42.17MHz, 42.67MHz, 42.75MHz, 44.0MHz, 45.0MHz, 45.75MHz and 47.25-MHz markers to the video IF sweep output; and switches for applying 3.08MHz, 3.58MHz and 4.08MHz markers to the chroma sweep output.

The manufacturer indicates that the instrument has a 100mv rms output, when applied across a 75 Ω load, which can be attenuated 0 to 60dB by using both stepped and variable output controls.

The instrument's internal dc bias supply is said to provide two independent voltage sources, one providing 0 to ± 50 v and the other providing 0 to ± 20 v.

One unusual feature is said to include variable horizontal and vertical outputs for the crystal-controlled markers—not only permitting control of marker size, but permitting the markers to be rotated between horizontal and vertical.

Manufacturer specifications indicate that the instrument can be powered by 115/230v, 50/60Hz; measures 5 $\frac{7}{8}$ in. H by 12 in. W by 8 in. D and weighs 20 lb. ■

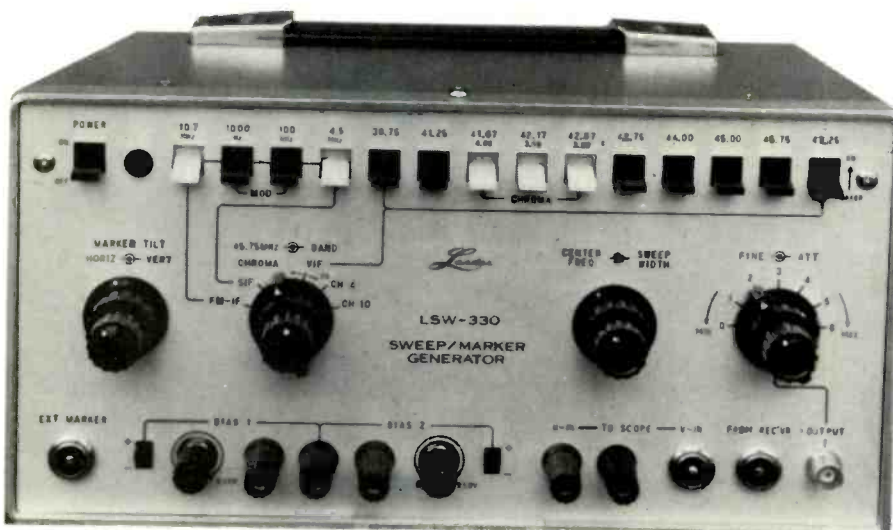

Leader's Model LSW-330 Post-Injection Sweep/Marker Generator. For more details circle 900 on Reader's Service Card.

The right replacement, faster

with

8 new service kits

from your Centralab distributor



DISTRIBUTOR PRODUCTS



CENTRALAB

Electronics Division
GLOBE-UNION INC.

5757 NORTH GREEN BAY AVENUE
MILWAUKEE, WISCONSIN 53201

KITS AVAILABLE:

- Fastatch II® Controls
- Miniature Wirewound Controls
- Miniature Trimmer Controls
- Axial Lead Electrolytics
- PC Lead Electrolytics
- General Purpose Capacitors
- High Voltage Capacitors
- Packaged Electronic Circuits

KIT FEATURES:

- Rugged steel frames with high impact plastic drawers.
- Stackable or wall mounted.
- Portable, with convenient handles.
- All contain assortment of the most popular and widely used Centralab components.
- All control units (KIT-10F, -20W, -30T) include latest edition of H. W. Sams Replacement Control Guide.
- All components are functionally arranged in drawers by value, type, etc.
- All drawers are pre-labeled clearly showing contents.
- All kits are completely set up, ready to use.

By Centralab, your Parts-Time Helper

DS-7114

... for more details circle 105 on Reader Service Card

NEW PRODUCTS

For additional information on products described in this section, circle the numbers on Reader Service Card. Requests will be handled promptly.

VOM

703

Designed for semiconductor troubleshooting

The VOM, Model 666, is designed for semiconductor troubleshooting. The unit reportedly offers an input impedance of 10M and special resistance ranges—with low voltage drops required for semiconductor testing. The VOM is said to be warranted to withstand a 5 ft drop and still continue

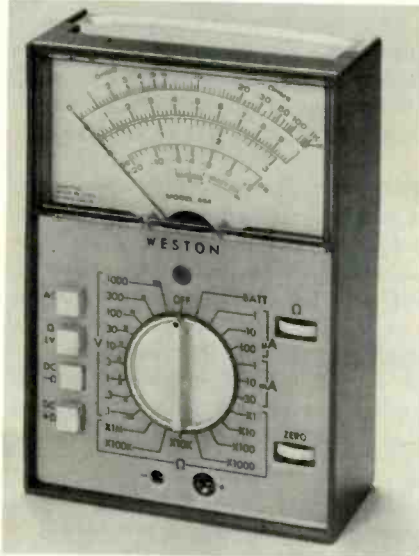

to operate. Specifications indicate that the unit will withstand 200v ac or dc on any range without permanent damage. Other features are said to include diode protection on the meter movement, temperature compensation, external fuse replacement and a self-storing handle. Other specifications indicate sensitivity of 10M dc, 10M (47pf) ac, and a current circuit 100-mv drop. The unit weighs under 2 lb. Price \$132.50. Weston Instruments.

TOOL CASE

704

Contains removable flat tray

An attache case, No. TC-100, is designed with three panels and a hinged tool holder, which is attached inside the lid. The lid may reportedly be unfastened and placed to stand by itself outside the case. Specifications indicate that both the tool holder and a removable flat tray, which is stored in the case, have straps and pockets for up to 59 individual tools. The bottom of the case is said to be divided into two compartments to accommodate kits, test meters, parts boxes and



additional tools. A full width pocket in the lid provides room for service manuals, schematics, job sheets and invoice pads. Xcelite.

INTRUSION DETECTOR

705

Operates in an area of up to 40 ft

The Model 307 radar intrusion detector is designed to sense the presence of an intruder entering into its operating field. The unit will reportedly cover a circular area ranging from

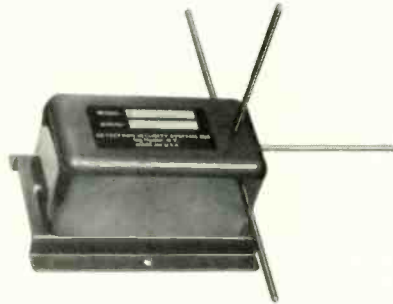

a few feet to 40 ft in diameter, depending on room conditions and setting of the sensitivity control. The detector is said to operate on 12v dc at 30ma. Specifications indicate that when its radar field is disturbed a relay closure is generated within the unit, triggering any alarm device hooked up to the detector. This unit can reportedly be wired directly into any perimeter system and can be used in conjunction with a wide variety of security controls. Dimensions are 4½ in. by 3½ in. by 3 in. Price \$90. Detectron Security Systems.

TUNER SPRAY

706

Cleans and polishes tuner contacts

A chemical compound, called Super-Lube, has been developed which

is said to foam away corrosion, dirt and oxidation. Specifications indicate that it cleans, lubricates and restores

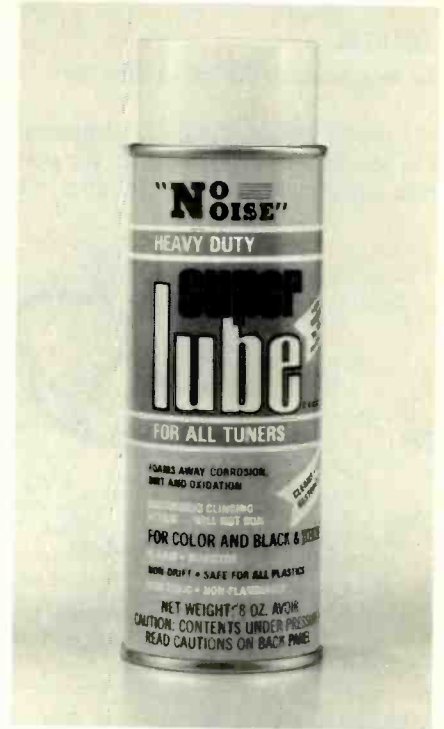

tuners while continually polishing their contacts. The manufacturer indicates that it will not cause drift or detuning, and is non-flammable, non-toxic and harmless to plastic and rubber. Electronic Chemical Corp.

DESOLDERING TOOL

707

Removes solder without damage to components

A desoldering tool, Model DS-40, reportedly removes soldered components without damage to either components or circuit boards by utilizing

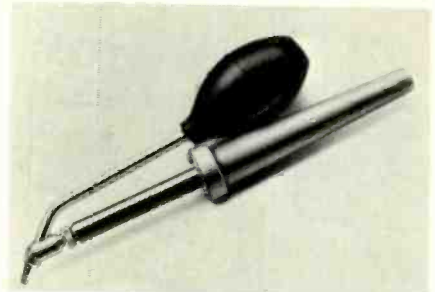

a vacuum and a hollow tip. Specifications indicate that the unit is complete with a 40w power handle, vacuum bulb, a 0.063 in. tip and cord. Replacement tips are available in a variety of sizes. Price \$14.50. Weller.

continued on page 60

TECHNICAL DIGEST

The material used in this section is selected from information supplied through the cooperation of the respective manufacturers or their agencies.

ADMIRAL

Tape Recorder Model CTR 591—Service Hint

If the UP button should be depressed while the recorder is in the leather carrying case, the door will be prevented from completely opening. If other buttons are depressed

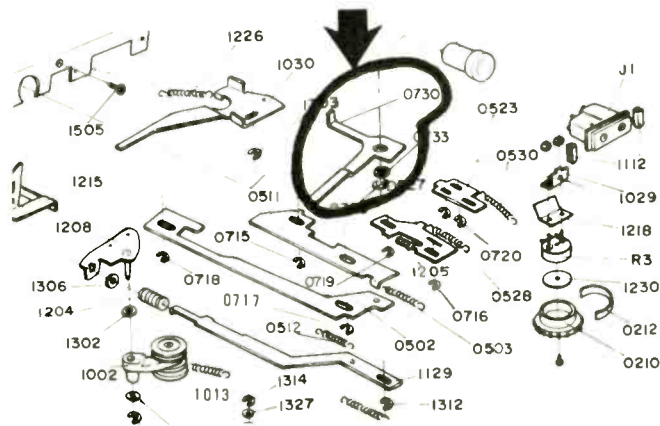

while the door is in a partially open position, it is possible for Lever 0730 (under the flywheel) to be bent. The bending of this lever will prevent the recorder from pulling the tape through the cassette. To repair, straighten or replace the lever, 2015A1-183.

Elimination of Objectionable Sound Originating in the Horizontal Output Stage

B/W- and color-TV sets generate sound at fundamental and subharmonic horizontal sweep frequencies. When this sound level becomes objectionably loud, the following steps should be attempted to reduce it to an acceptable level.

Substitute several tubes for the horizontal output, damper, regulator (if used) and high-voltage rectifier, one at a time, to see if the sound level is reduced. An alternate method is to hold an insulated rod against the glass envelope of each tube to see if it will dampen the sound. Replace the tube or tubes which produce objectionable sound.

If the set has a pincushion correction circuit, slightly reduce the PINCUSHION AMPLITUDE control setting and note if objectionable sound is reduced. If it is, tighten the transformer mounting nuts and place tapered toothpicks between coils and core.

With an insulated rod, exert pressure on all mounting screws, rivets, brackets and hinge pins on the high-voltage cage and door. Any part causing sound can be dampened by applying a dab of Silastic RTV silicon rubber, Admiral part 17199-3, or by adding a tab of adhesive tape. If the cage door is found to be the source of sound, add a cork pad or tape to the contact edges of the door assembly.

To eliminate sound caused by the horizontal output transformer, carefully move the transformer away from its

FIND A REPLACEMENT, EVERYTIME

...with IR's new universal
TRANSISTOR APPLICATION
SLIDE RULE!

... for more details circle 134 on Reader Service Card

mounting, just far enough to insert a rubber spacer and grommets over the transformer mounting screws. Carefully reinsert transformer mounting screws into the side of the cage. Mounting nuts should be tightened sufficiently to insure a secure fit, taking care not to over-tighten them. Turn the receiver ON and check for corona. (The grommets and spacer are packaged with instructions as 98A147-1.)

To insure good operation and customer safety, it is recommended that the high-voltage adjustment and safety checks be made as instructed in the service manual.

If these steps do not reduce the sound to an acceptable level, replace the horizontal output transformer.

MAGNAVOX

TV Model 1S117/2S117—12DEP4 Picture Tube Replacement

Those models using the T917-02 TV chassis employ a type 12DEP4 picture tube. When a replacement picture tube is needed, it is said to be important that you use only a Magnavox replacement 12DEP4. Physical dimensions for the 12DEP4 will vary between the different picture tube manufacturers to the extent that the cabinet back cannot be fitted into place if some general replacement types are used.

RCA SALES CORPORATION

C/COS Tuner/Amplifiers—Troubleshooting Methods

The following simple noise isolation procedure can save valuable service time when troubleshooting the C/COS Tuner/Amplifier audio circuits. Turn the LOUDNESS control to minimum, and if the noise is not present, the trouble is probably before the zener Z605 substrate (towards the tuner). If the noise is still present, then disconnect the preamplifier-to-amplifier audio cable. If it still appears, the trouble is probably in the power amplifier chassis; while if it is eliminated, the trouble is probably the zener Z605.

Semiconductor substrates can be damaged during normal troubleshooting if the technician is not careful. As an example, the terminal guide shown is of zener Z605, used in preamplifier chassis RS247 and tuner chassis RC1238. Note the proximity of pins 2 (ground) and 3, and pins 6 (ground) and 7. If either pin 3 or 7 is momentarily grounded (very easily done with a test probe) the zener circuitry can be damaged, resulting in a dead channel.

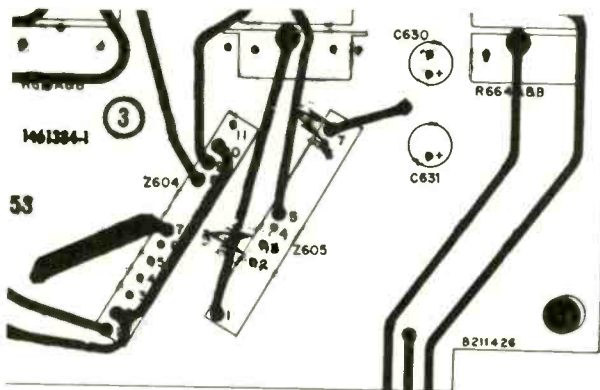

When replacement is necessary, damage to the substrate and/or the printed circuit can be minimized by using a good desoldering tool (a type having high plunger pressure is required). Solder can be removed from each connection with the desoldering tool and then the component can be lifted out intact.

NEW! INSTANT CONTACT CLEANER



SEND FOR FREE SAMPLE

NO RESIDUE • NON-FLAMMABLE
NON-TOXIC • NON-CONDUCTOR

A CHEMICALLY PURE CLEANING AGENT
WITH:

1. **SELECTIVE CLEANING POWER** — removes greases, oils, dirt and organic soils with no effect on the article being cleaned.
2. **EXCELLENT PENETRATING AND WETTING ACTION** — Its high density and low surface tension permits maximum penetration of most minute crevices where its superior wetting action then cleans even most difficult materials.
3. **PURITY** — evaporates completely — leaves NO residue.
4. **SAFETY** — Non-explosive, non-flammable, non-toxic.
5. **STABILITY** — does not react chemically with other materials.

Available in 7 & 16 oz. aerosols with "Snorkel Tubes"

LPS RESEARCH LABORATORIES, INC.

2050 COTNER AVENUE, LOS ANGELES, CALIFORNIA 90025
PHONE: (213) 478-0095

... for more details circle 119 on Reader Service Card

Put it to Work!

NEW AND ONLY FROM EICO—THE INDUSTRY'S LOWEST-PRICED PROFESSIONAL FET-TVM.

Model 239
KIT \$39.95



Use the battery powered Solid State EICO 239 on your bench or in the field. Check semiconductor and vacuum tube circuits. 11 Megohm DC input impedance. Read AC rms and DC voltages in seven steps from 1 to 1000 volts on large 4½" meter. Measure and read peak-to-peak AC to 2800 volts. Check resistance from 0.2Ω to 1000MΩ on seven ranges. Provides a total of 28 useful ranges on 12 accurate scales. Automatic battery check. Includes exclusive DC/AC ohms Uniprobe™. Factory Assembled, \$59.95.

FREE 32 PAGE EICO CATALOG

For latest catalog on EICO Test Instruments, Stereo, EICOCRAFT Projects, Environmental Lighting, Burglar/Fire Alarm Systems, and name of nearest EICO Distributor, check Reader Service Card.

EICO, 283 Malta Street, Brooklyn, N.Y. 11207



... for more details circle 109 on Reader Service Card

GREATEST TV Schematic Bargain EVER Offered

NOW-Complete TV Schematics for less than 5¢ each

COLOR TV
Covers ALL
Color Sets
1960 - 1968

BLACK & WHITE
Coverage for
23 U.S. Brands
1965 - 1968

TV TECH/MATICS- 8 Giant Volumes

Cover 99% of Color TV-4 Years B&W!

Here are FABULOUS savings on nationally-known TV schematic and service data. Here is everything you need to fill your vital service data needs for TV model years 1965 through 1968 . . . plus COLOR TV coverage from 1960 through 1968! What it amounts to is a low, low cost of less than \$9.00 per year for your TV service data . . . with an extra 5 years of Color TV coverage thrown in for good measure! Compare that with the over \$100 a year you may now be paying for comparable information.

SERVICE DATA FOR MORE THAN 20 BRANDS

TV TECH/MATICS is the ideal Service Data package for today's modern technician. It includes complete schematic diagrams and vital servicing data for every TV receiver produced by more than 20 leading American Manufacturers for 1965, 1966, 1967, and 1968. All diagrams and servicing details are completely authentic, based on information provided by the original equipment manufacturers. Each year's coverage is permanently bound into two convenient-to-use volumes which open flat to 11" x 29½", ready to provide you with instant service data at your workbench. Some of the diagrams are as large as 58" x 22".

EASY TO USE

TV TECH/MATICS is easy to use. Brand names are arranged alphabetically by model year. No more hunting through several file drawers to find the schematic you need! And at the special low price, think of the savings you will enjoy on your schematic needs . . . think of the time you'll save by having the schematics you need right at your fingertips in handy, permanently-bound form!

TV TECH/MATICS is the ideal way to cut down your schematic expenses, and to enjoy the convenience of having all your data needs right at your fingertips.

8 BIG Volumes
Regular Price \$79.60
...NOW YOURS
for only \$34.95

HERE'S WHAT YOU GET

You receive 8 BIG volumes in all, two for each year from 1965 through 1968. Included is a clearly detailed and annotated TV schematic diagram for each specific model. You also get complete replacement parts lists, alignment instructions, tube and component location diagrams, plus key waveforms and voltage readings . . . all the information you need to service over 90% of the TV receivers you'll encounter!

STREAMLINED AND CONVENIENT

All the information for a given model is contained on two facing sheets. The special bound-leaf format allows pages to lie flat when open. Each volume is organized alphabetically by manufacturer, then numerically by model number. In addition, a handy Chassis/Model Finder is bound into each volume. Regular list price for each year's coverage — 2 BIG volumes — is \$19.90. All 8 volumes normally sell for \$79.60. Your price is ONLY \$34.95 . . . a savings of nearly \$45.00!

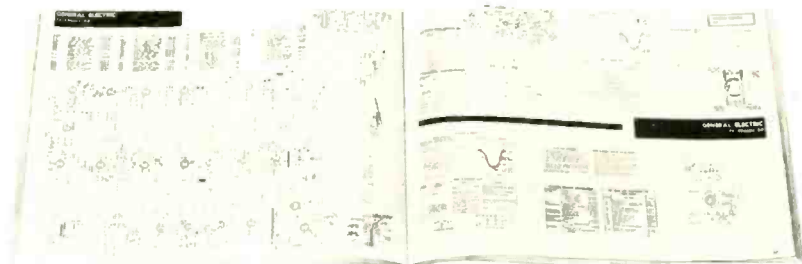

LARGE PAGES contain complete circuit schematics, replacement parts lists, alignment instructions critical part locations, important waveforms and voltage readings.

MONEY-BACK GUARANTEE

You MUST be satisfied that TV TECH/MATICS is the greatest bargain in TV Schematics ever offered. Order at our risk for FREE 10-day examination. Prove to yourself they are worth many times the price. You can return them in 10 days for full refund or cancellation of invoice. No need to send money. But, the supply is limited, so fill-in and mail the NO-RISK coupon today to obtain these time-saving, money-making manuals.

-CONTENTS-

CONTENTS 1965 MODELS

Covers all 1965 models for: Admiral, Airline, Andrea, Coronado, Curtis Mathes, Dumont, Electrohome, Emerson, Firestone, General Electric, Magnavox, Motorola, Muntz, Olympic, Packard-Bell, Philco, RCA Victor, Sears-Silvertone, Setchell-Carlson, Sylvania, Truetone, Westinghouse, and Zenith . . . plus all color sets 1960-1965, at no extra cost!

PUBLISHER'S LIST PRICE \$19.90

CONTENTS 1966 MODELS

Covers all 1966 color and B & W models of: Admiral, Airline, Andrea, Coronado, Curtis Mathes, Dumont, Emerson, General Electric, Hoffman, Magnavox, Motorola, Olympic, Packard-Bell, Philco, RCA Victor, Sears-Silvertone, Setchell-Carlson, Sonora, Sylvania, Truetone, Westinghouse, and Zenith.

PUBLISHER'S LIST PRICE \$19.90

CONTENTS 1967 MODELS

Covers all 1967 color and B & W models of: Admiral, Airline, Andrea, Coronado, Curtis Mathes, Dumont, Emerson, General Electric, Hoffman, Magnavox, Motorola, Olympic, Packard-Bell, Philco-Ford, RCA Victor, Sears-Silvertone, Setchell-Carlson, Truetone, Westinghouse, and Zenith.

PUBLISHER'S LIST PRICE \$19.90

CONTENTS 1968 MODELS

Covers all 1968 color and B & W models for: Admiral, Airline, Andrea, Coronado, Curtis-Mathes, Dumont, Emerson, General Electric, Hoffman, Magnavox, Motorola, Olympic, Packard-Bell, Philco-Ford, RCA Victor, Sears-Silvertone, Setchell-Carlson, Sonora, Sylvania, Truetone, Westinghouse, and Zenith.

PUBLISHER'S LIST PRICE \$19.90

NO RISK COUPON—MAIL TODAY

TAB Books, Blue Ridge Summit, Pa. 17214

- I enclose \$34.95 for which please send me your complete 8-Volume Tech/Matics Schematic offer postage prepaid.
- Please invoice me for \$34.95 plus postage. Same return privileges.

Name

Company

Address

City

State

Zip

(Paid orders shipped prepaid. Pa. resident add 6% Sales Tax. Outside USA 10% extra.)

ET-81

for more details circle 104 on Reader Service Card

TV TUNER SERVICE

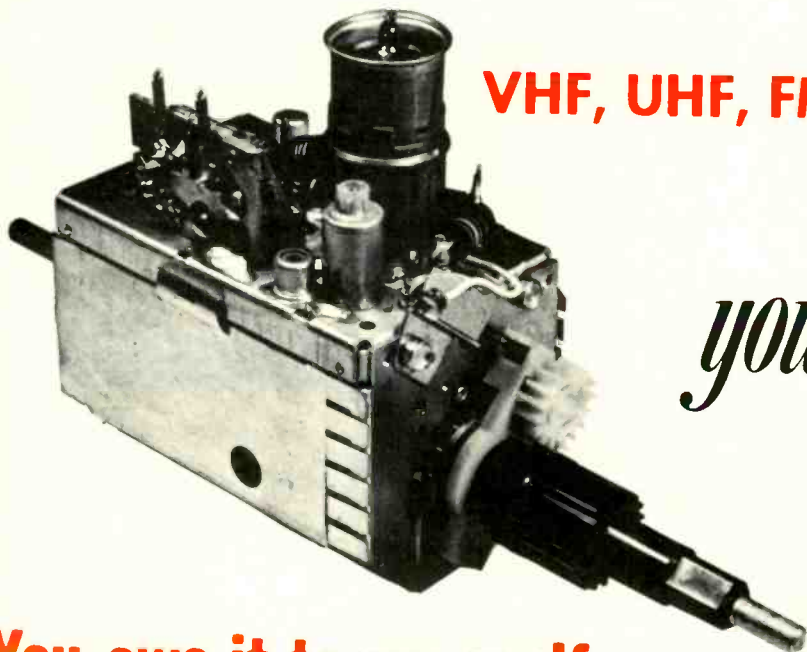

VHF, UHF, FM or IF-Subchassis. . .
 . . . All Makes

you get...

Fast 8 hr. Service!

You owe it to yourself

to try P.T.S. We are the fastest growing, oldest and now the largest tuner service company in the world. Here is what you get:

1. Fastest Service — 8 hr. — in and out the same day. Overnight transit to one of our six plants, for parts, tuners or IF-modules.
2. All tuners cleaned inside and out, repaired, realigned and air tested.
3. On IF-modules all stages checked, all traps set with high calibre test equipment.
4. Fine Quality! Your customers are satisfied and you are not bothered with returning your units for rework!
5. Lower Cost! Up to \$5.50 less than other tuner companies!
6. Friendly, helpful personalized service!

1 YEAR GUARANTEE



FIRST TO OFFER 365-DAY GUARANTEE!
 COLOR—BLACK & WHITE—TRANSISTOR TUNERS—ALL MAKES
 GUARANTEED COLOR ALIGNMENT—NO ADDITIONAL CHARGE

We offer you finer, faster...

VHF-UHF-FM	\$ 9.95
UV-COMBO	\$16.95
IF-MODULE	\$12.50

Major Parts charged at Net Price

CUSTOMIZED REPLACEMENTS AVAILABLE
 FOR \$12.95 UP (NEW OR REBUILT)

**Precision
 Tuner Service**



LIKE TO DO IT YOURSELF?

PTS makes all tuner parts available to you.

Send one dollar (redeemable) for our

TUNER REPLACEMENT GUIDE AND PARTS CATALOG

- 60 pages of top information
- Blow-up of all tuners
- Largest exact tuner replacement guide
- Antenna Coil Replacement Guide
- Multi-fit Replacement Tuner Shaft Guide

For fastest service, send faulty unit with tubes, shields and all broken parts to:

PTS ELECTRONICS, INC.

HOME OFFICE—P. O. Box 272—Bloomington, Ind. 47401	Tel. 812/824-9331
EAST—P. O. Box 3189—Springfield, Mass. 01103	Tel. 413/734-2737
WEST COAST—P. O. Box 41354—Sacramento, Calif. 95841	Tel. 916/482-6220
MOUNTAIN—P. O. Box 4145—Denver, Colo. 80204	Tel. 303/244-2819
SOUTHWEST—P. O. Box 7332—Longview, Tex. 75601	Tel. 214/753-4334
SOUTHEAST—P. O. Box 6771—Jacksonville, Fla. 32205	Tel. 904/389-9952

... for more details circle 133 on Reader Service Card

SCHOOLS . . .

continued from page 46

Course 203—Color-TV Circuit Analysis and Troubleshooting—is for the electronic technician who is now doing or preparing to do bench work. It provides detailed coverage of circuit operations and a logical approach to troubleshooting band-pass amplifiers and all other color circuits. Workshops are provided on adjustments required in color circuits and troubleshooting actual receiver problems.

Course 204—Solid-State Color-TV Circuits—is an extension of course 203, covering the solid-state circuits in the Magnavox T936 and T950 chassis. It includes work periods and solid-state troubleshooting techniques.

Course 202—Color-TV Alignment—teaches how to analyze problems resulting from misalignment and the use of sweep alignment instruments as a troubleshooting aid.

Course 130—Solid-State Components, Their Operation and Application in Solid-State Radios—introduces the theory and operation of semiconductor components and cir-

cuitry in radio and TV sets. Circuit applications and component checking are taught by using student workboards. The correlation of circuit analysis and symptom analysis is taught in workshop sessions.

Course 302—Solid-State TV Circuitry and Service Techniques—provides a study of solid-state components in specialized TV circuits, with emphasis on age, sync, vertical and horizontal deflection, video and high-voltage circuits.

Course 502—Magnavox TV Remote Control Systems—provides a complete study of Magnavox's eight-function remote control. ■

AUTO STEREOS . . .

continued from page 49

The continuity of the motor winding was normal and seemed to be in order. One lead of the transient motor diode was removed and an ohmmeter test showed a leaky condition. Upon replacing the leaky diode, the motor ran forwards (Fig. 4). Since then, we have encountered several Japanese tape players that acted in the same manner.

No Right Channel

In this Lear-Jet Model AS-831 tape player we were unable to obtain any sound from the right channel. A quick signal injection with a noise-signal generator indicated that the right channel was good at the tape-head terminals—both channels had about the same amount of gain. We discovered that in error the height adjustment had been screwed tight so that the right channel was off the tape area. Undoubtedly, someone had tried to adjust the height control for channel crosstalk interference and went a little too far. ■

NEW PRODUCTS

continued from page 55

COLD GALVANIZE 708

Protects all metals from rust, corrosion and rust creepage

LPS Instant Cold Galvanize is said to be a hard coating of 95% pure zinc that protects all metals from rust,



corrosion and rust creepage for many years. Specifications indicate that it is not a paint, and unlike skin-type coatings it will not peel—actually fusing to iron or steel for protection through sacrificial galvanic action. It will reportedly withstand over 3000 hr in a salt spray cabinet. The coating is available in 16-oz aerosol cans and in bulk. LPS Research Laboratories, Inc.

continued on page 64

Telematic

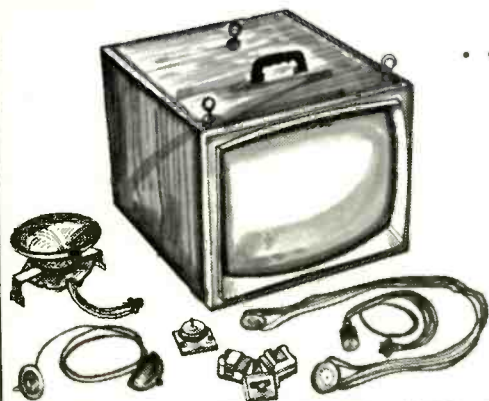

COLOR TEST JIG KIT

. . . From "Telematic"

NOW . . .

ECONO TEST JIG KIT

to Service
Solid State
Color Television

Model:
EJ-390

59⁹⁵

NET

Solid State
ECONO JIG KIT
Less Picture Tube

Model:
EJ-190

49⁹⁵

NET

For Standard Tube Type
ECONO JIG KIT
Less Picture Tube

Also available a complete line of solid state yoke adaptors and cables.
ASK YOUR DISTRIBUTOR FOR INFORMATION

TELEMATIC DIV., U.X.L. CORP., 2245 PITKIN AVE., BKLYN., N.Y. 11207

. . . for more details circle 125 on Reader Service Card

Only one van gives you all these better ideas.

Ford Econoline



Sales leader for 10 straight years.

Engine clear forward

The engine is moved forward in Ford's clear-deck van—all the way out of the cargo area. Clear floor space behind driver's seat measures over 8½ ft. in Econoline Van . . . over 10 ft. in the Supervan.

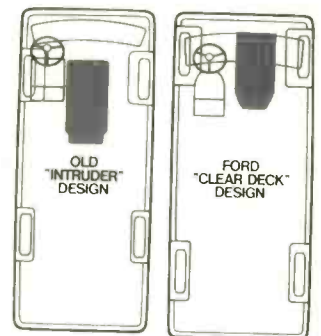

Strong, smooth-riding Twin-I-Beam

The independent front suspension that has revolutionized truck riding qualities. Two forged steel I-beam axles give it strength . . . big coil springs give it a smoother ride.

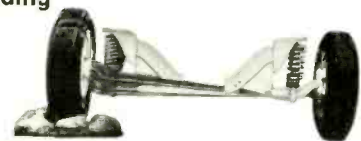

Easy, out-front servicing.

Simply raise the convenient outside hood and your routine service points are right at hand: radiator, oil level, battery, windshield washer reservoir, voltage regulator, wiper motor, brake master cylinder. Better ideas make servicing fast, easy.



Shorter outside, easier to park.

Overall length of Econoline Vans is significantly shorter than other makes. This means easier parking and better maneuverability in city delivery operations—time saved on every trip.



Wider at top for built-ins

Body sides are more vertical, wider apart at top than other vans. So built-in units fit better and leave more aisle. Modular units, designed to fit and work together allow you to custom design almost any interior you need. Job packages, such as insulated florist's van, are also available.



Biggest payload of all

Husky construction and high capacity axles allow you to carry a heavier load than any other van. Maximum payload of 4320 lbs. is largest in industry.

Model	Max. Payload	Max. GVW
E-300	4320 lbs.	8300 lbs.
E-200	1800 lbs.	5400 lbs.
E-100	1120 lbs.	4500 lbs.

Driver's "walk-thru" to rear

Econoline's forward engine position clears the deck for the driver, too. He can easily step from his seat into the rear load area and exit through side or rear doors.

See your Ford Dealer and see all the better ideas in America's best-selling van—Ford Econoline.



FORD 

... for more details circle 111 on Reader Service Card

The look, feel, and sound of tomorrow's CB radio...



Here today in the all new Messenger 121!

From the engineering that brought you the famous Messenger 100... a new generation of citizens radio equipment with even greater performance! New punch-button controls for instant channel selection. Voice tailored audio and acoustically isolated speaker for really clear sound. Plus exclusive Johnson speech compression circuitry, new ceramic filter, and more!

You're going to hear more from...



JOHNSON

1211 Waseca, Minnesota 56093
for more details circle 117 on Reader Service Card

TV TECH SPECIALS

90 Degree Color Yoke	
Repl. Y 109-DY95 AC	\$8.95
Magnavox Yoke #361290	
equiv. to DY92AC	\$8.95
20 Assorted Controls	\$3.95
10 1N34A Diodes	\$1.00
20-1 Amp. 1000 PIV (Epoxy)	\$3.95
20-2 Amp. 1000 PIV (Epoxy)	\$4.95
6500 PIV Focus Rect.	3 for \$2.00

RCA COND. AXIAL LEADS

50 Mfd. 50 V	4 for \$1.00
500 Mfd. 50 V	4 for \$1.89
1000 Mfd. 50 V	4 for \$2.50
40 Mfd. 150 V	4 for \$1.29
80 Mfd. 150 V	4 for \$1.89
100 Mfd. 250 Volts	4 for \$1.98
2 Mfd. 450 V	6 for \$1.49
4 Mfd. 450 V	6 for \$1.69
10 Mfd. 450 V	6 for \$1.98
16 Mfd. 450 V	6 for \$2.29
30 Mfd. 450 V	6 for \$2.98
10 Mfd. 600 V	4 for \$2.29
20 Mfd. 600 V	4 for \$2.69

RCA COND. CANS

50-30 Mfd. 150 V	3 for \$1.29
300 Mfd. 150 V	2 for \$1.59
125 Mfd. 350 V	3 for \$1.98
80 Mfd. 450 V	4 for \$2.39

SEND FOR FREE CATALOG

Tubes Up To 80% Off
Minimum Order \$15.00
Send Check or M.O.

TV TECH SPECIALS

P.O. Box 603
Kings Park, L.I., New York 11754

for more details circle 129 on Reader Service Card

DEALER SHOWCASE

For additional information on products described in this section, circle the numbers on Reader Service Card. Requests will be handled promptly.

CASSETTE TAPE RECORDER 713

Features a system to guard against accidental erasing

A cassette recorder, Model 1420, is said to feature a semi-automatic cassette insert and a pushbutton cassette eject. The portable recorder/player is reportedly powered by five 1½v "C" cells or by ac through an adapter supplied with the unit. Specifications indicate that the microphone is omnidirectional with a remote Start-Stop switch. A safety system is designed to guard against accidental erasing of pre-recorded cassettes. The recorder is



said to include PLAY, STOP, FAST FORWARD, REWIND, VOLUME and TONE controls. A VU meter and battery level meter are reportedly also included. Price \$54.95. Norelco.

STEREO TAPE PLAYER 714

Includes AM/FM multiplex receiver

A solid-state modular, portable 8-track stereo tape player, Model 2001, is designed with all controls, selectors



and dials positioned on one concave side of the unit. Specifications indicate that it includes an AM/FM multiplex indicator lamp, stereo headphone jack and a music power rating of 3w per channel. The unit measures 12 in. in diameter and has a black face for night-time selection, plus chrome slide-bar VOLUME, TONE and BALANCE controls. The tape player operates on battery, ac/dc or 12v auto power. Price \$160. Weltron.

SOLID STATE ELECTRONIC 715 SWITCH

Extends operation of any single-trace scope

A compact transistorized electronic switch is reportedly designed to enable the user to extend the operation of any single trace scope to dual trace use. The Model LS-5 instrument is said to have switching frequencies of 1.5, 5, 30 and 50kHz and offer a triggered output to facilitate fast and highly stable synchronization of the observed phenomena. A specially integrated mounting bracket reportedly facilitates direct placement of the unit on any scope to be used. The rated



frequency response is dc to 300kHz and 2Hz to 300kHz on ac. The unit has two channel inputs, ac or dc switchable for each channel. The vertical sensitivity is said to be 0.05v/cm with an input impedance of 1M at 40pf. Gain and positioning controls are individual and wide range for each channel. The unit has a 115v/50-60Hz power supply and measures 3½ in. H by 5¼ in. W by 4 in. D. Weight 3 lb. Price \$69.96. Leader.

TAPE ERASER 716

For hand-held or table-top use

A double-duty bulk tape eraser, Model 30-140, is designed to be used on either a table top or as a hand-held

unit. It will reportedly magnetically wipe clean audio tape reels, cassettes, cartridges and video tapes. The eraser is powered by standard house current and is said to draw 4a in operation.



The unit is turned ON with an integral pushbutton switch. A single pass over the unit by a magnetic tape reportedly will erase all program material and background noise. Price \$18.31. GC Electronics.

STEREO HEADPHONES 717

Selector switch permits use with either a stereo or mono system

A set of stereo headphones, Model CIS-300, is said to feature a frequency response of 20 to 19,000Hz. Specifications indicate that a 10-ft coiled extension cord, fitted with a three-socket plug to mate with the three-pin socket of the headphone, has a remote control with adjustable left and right VOLUME controls. A selector switch built into the control reportedly per-



mits use of the headphones with any stereo or mono audio system. Other features are said to include an adjustable foam filled vinyl headband and soft vinyl covered earphone cushions, which provide an air-tight seal to the ear. Price \$29.95. RMS Electronics.

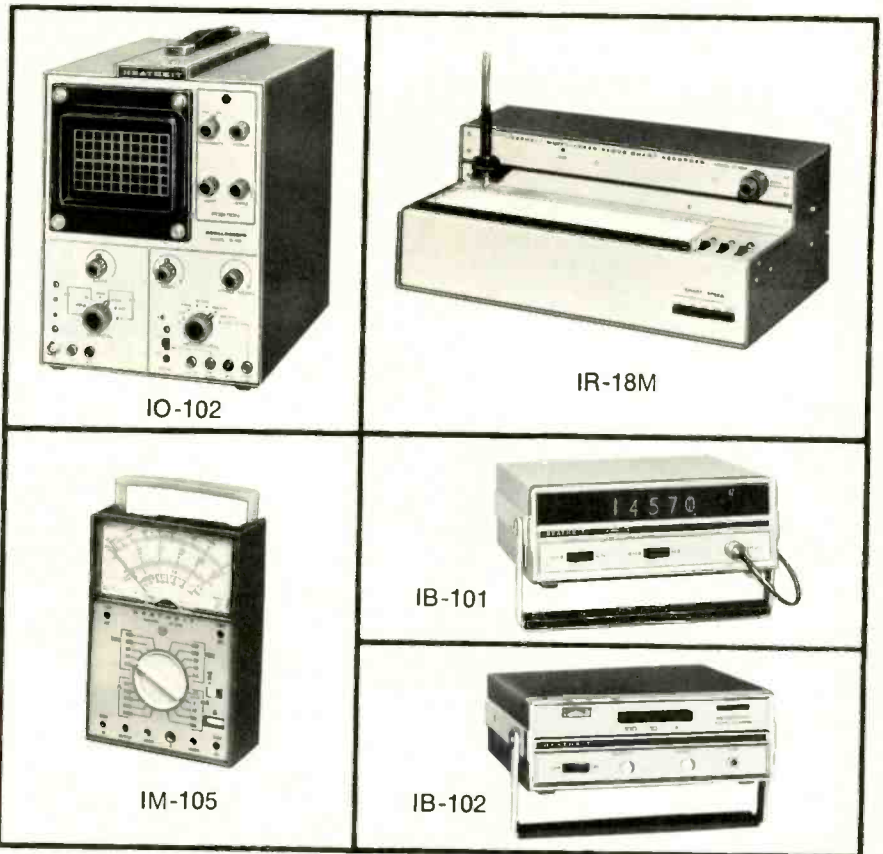

New Heathkit® Cost-Cutters

Here's happy news for budget-watchers... a complete new line of Heathkit solid-state test instruments designed to deliver professional performance at traditional Heathkit savings.

NEW Heathkit IO-102 5" solid-state scope delivers DC-5 MHz response... AC or DC coupling... Hi-Z FET input... 30 mV/cm sensitivity... continuous sweep rates from 10 Hz to 500 kHz... external horizontal & sync inputs... 1 V P-P output... large flat face CRT with 6x10 cm ruled graticule... choice of kit or assembled. **Kit IO-102, 29 lbs., 119.95*. Assembled IOW-102, 29 lbs., 179.95***

NEW Heathkit IM-105 VOM... 8 DC ranges to 5 kV; 7 AC ranges to 5 kV; 6 DC current ranges to 10 A; 5 ohms ranges to x10 k with center scale of 20; 5 dB ranges to +50. High impact Lexan® case & ruggedized taut-band protected meter. Exceptional accuracy. Easy assembly. **Kit IM-105, 4 lbs., 47.95***

NEW Heathkit IR-18M solid-state chart recorder... 12 pushbutton selected speeds... 1 mV or 10 mV full scale... full 10" chart width... 1 second full scale pen response... 3-terminal floating input... 240 Hz photo-chopper reduces 60 Hz noise. Fast, easy assembly, rapid paper loading. **Kit IR-18M, 14 lbs., 149.95***

NEW Heathkit IB-101 solid-state frequency counter... 1 Hz to over 15 MHz range... 5 digit cold-cathode tube readout... overrange indicator & Hz/kHz switch for 8-digit capability... wide range input without adjustment... low triggering level... 1 megohm input... rock-stable time base. **Kit IB-101, 7 lbs., 199.95***

NEW Heathkit IB-102 solid-state frequency scaler... turns virtually any counter into a 175 MHz counter. Scales 100:1, 10:1 or 1:1. Very low triggering level. Easy assembly & operation. Compatible with practically all 1 megohm input counters. **Kit IB-102, 7 lbs., 99.95***



FREE '71 CATALOG

Describes these and over 300 other Heathkits. Save up to 50% by building them yourself. Use coupon and send for your FREE copy!

HEATH COMPANY, Dept. 24-8
Benton Harbor, Michigan 49022 a Schlumberger company

Please send FREE Heathkit catalog
 Enclosed is \$ _____, plus shipping.
Please send model(s) _____

Name _____
Address _____
City _____ State _____ Zip _____

Prices & specifications subject to change without notice.
*Mail order prices; FOB factory. TE-244

... for more details circle 114 on Reader Service Card

THE CRIMESTOPPER THAT SELLS!

New DeltAlert "double-warning" increases protection for home and industry at lower cost.

How? Because the DeltAlert ultrasonic system offers a choice of options for burglar detection and alarm, lights and/or a shrieking alarm. Because it comes in a choice of systems, portable or permanent installation. Because it sells at approximately 1/3 the price of many more cumbersome units giving similar protection. No wonder our distributors say "3 out of 5 prospects buy!"

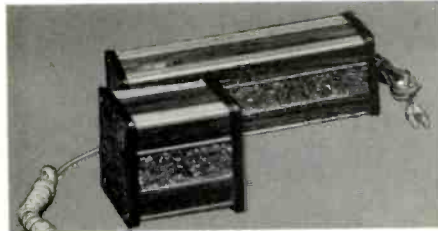

Portable DeltAlert

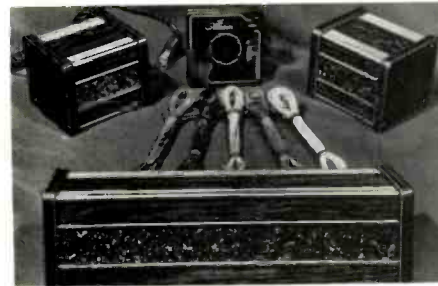

Super DeltAlert Package

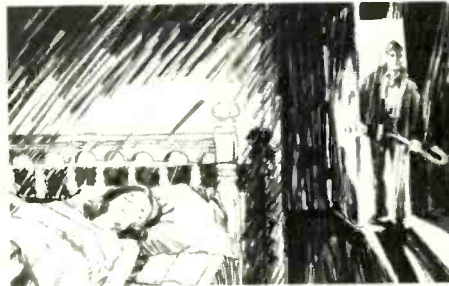

ONE HOME OUT OF EVERY 6 WILL BE VICTIMIZED THIS YEAR

No one knows where crime will strike. No one knows whose life, family and property will be menaced. With the crime rate so high, and with one family out of six potential victims of burglary, vandalism or personal attack, everyone needs the peace-of-mind protection of DeltAlert. The portable DeltAlert plugs into any 110-volt outlet. When traveling, take it along, use anywhere. If concerned about power shortages, install the permanent Super DeltAlert package with 12-volt standby power supply. Either system reacts the instant an intruder breaks its broad-range field of ultrasonic sound waves.

Send the coupon today for free sales details on this high-profit system.



DELTA PRODUCTS, INC. Dept. ETD

P.O. Box 1147, Grand Junction, Colo. 81501

I want to help control the soaring crime rate, and make big profits, too, demonstrating the new DeltAlert Protection. Please RUSH free sales details.

Name _____

Address _____

City _____ State _____ Zip _____

... for more details circle 107 on Reader Service Card

NEW PRODUCTS

continued from page 60

TRANSISTOR ADAPTER 709

Converts a VOM to a transistor/diode tester

This adapter, Model TRA-1, is designed to convert a VOM into a transistor and diode tester. Specifications indicate that PNP and NPN transistors, high- and low-power transistors, shorts, leakage, open and current gain can be tested. It is also said to test diodes, open and shorts, forward and reverse currents. The switching system eliminates the transfer of leads.



Other features include a built-in socket, plus flexible alligator clip leads for transistors that do not fit the socket. Price \$15.95. Coletronics Service Inc.

CASSETTE TAPE SPLICER 710

Designed for 1/8 in. cassette tapes

A cassette tape splicer, No. 30-650, designed for 1/8-in. cassette tapes, has two blade positions—one for cutting while the other provides a tapered

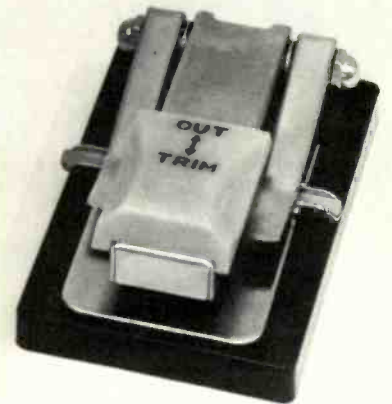

trimmed splice. The splicer is said to have felt-tipped tape hold-down fingers. Price \$4.95. GC Electronics.

AEROSOL VALVE 711

Designed for dispensing electronic chemicals

A valve has been developed which is said to have three important features: a large button for finger con-

Now Weller® helps you de-solder faster and easier.



De-solder and re-solder cleanly with one hand and with less chance of heat damage. Stainless steel tube prevents clogging, and there's a choice of six metal tip sizes.

For straight soldering, you can't beat Weller's 25 watt and 40 watt professional soldering irons. They have stainless steel barrels, popular pencil shape and double-coated, industrial-grade interchangeable tips. Ideal for service work, kits, hobbies. The Weller de-soldering tool is available nationwide through local electronic parts distributors.

The Cooper Group

CRESCENT · KEN-TOOL · LUFKIN · WELLER

... for more details circle 130 on Reader Service Card

trol and position direction, heavier spray for fuller application and easier insertion of the extension tube, which is needed for pinpoint application. This valve is reportedly incorporated in special promotional packages for three chemicals: Ultra Wissh for color



tuners; Miracle Bath for cleaning and degreasing tuners; and Lubrite, a self-polishing lubricant for all tuners. A set of miniature tools are said to be also included in each promotional package. Workman.

METAL CASSETTE

712

Designed to eliminate problems resulting from static charges

The metal cassette reportedly eliminates static charge problems developed in plastic cassettes. The cassette acts as a ground, draining off these charges. The manufacturer indicates that the metal housing insures precise dimensional stability and contains two machined bearing tape guides for exact tape location and extremely low internal friction. Temperatures and humidity reportedly do not affect the



stability of the metal cassette. The cassette is said to provide more exact tolerances and decreases flutter and wow. It is available in 60, 90 or 120 min lengths. Auricord Div., Scovill.

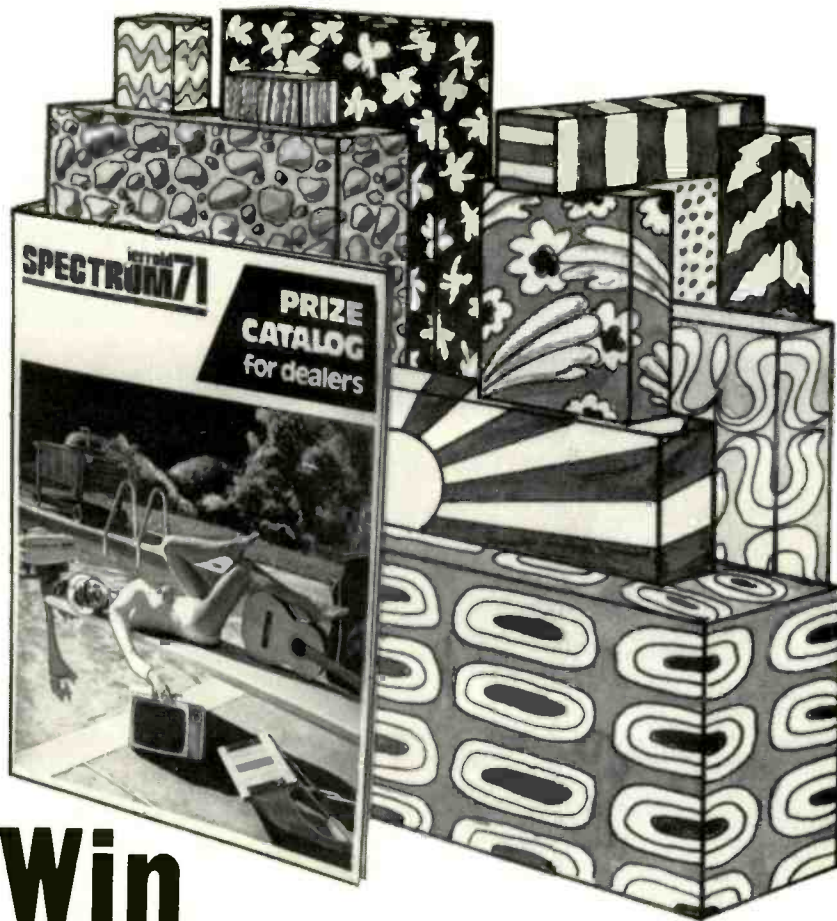

Win Fabulous Free Gifts

selling up to JERROLD antennas & systems

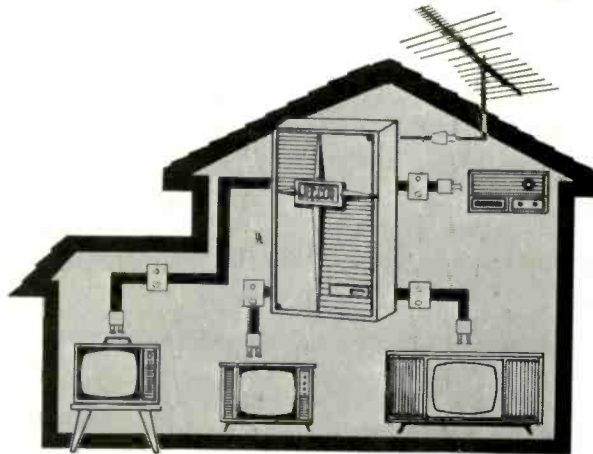

Spectrum '71 is designed to focus your attention on the broad spectrum of JERROLD high profit "better reception" products. When you sell up to the best in antennas and Master Antenna TV systems, you earn more profit... plus fabulous free gifts.

Ask your distributor for details on Spectrum '71 or write Jerrold Electronics Corporation, Distributor Sales Division, 401 Walnut Street, Philadelphia, Pa. 19105.



Focusing on one thing... better reception

a GENERAL INSTRUMENT company

... for more details circle 116 on Reader Service Card

BOOK REVIEWS

EDLYN'S JAPANESE DIRECTORY
published by Edlyn Directories, paperbound \$2.00

This 13-page directory provides over 300 addresses for many of the more popular Japanese imports, indicating where you may write for schematics and technical information. The listing is arranged according to the American trade mark on the product, providing the U.S. address of the American distributors.

AUDIO SYSTEMS HANDBOOK by Norman H. Crowhurst, published by Tab Books, hardbound \$7.95, paperbound \$4.95.

Electronic technicians involved in audio work must understand a great deal more than amplifier servicing if they are to be successful. This book deals with these many other aspects.

Written in an easy-to-read style, the author covers the basic principles related to impedance matching speakers and microphones to a given amplifier, decibel gain, level limitations, equalizers, mixers, filters, loudness compensation, acoustic radiation and speaker efficiency, constant-voltage line systems, low-level distribution, microphone frequency responses and directivity, remote controls, multivibrator tone generators, noise suppression, the compression and limiting of audio signals, re-emphasis, gain-shifting, power ratings (*a subject about which we have received frequent reader inquiry*), commercial applications, studio applications, and many types of speaker systems.

We feel that this book is a must for those electronic technicians and dealers entering the audio field. A better understanding of this material should help improve both sales and servicing—even if the book doesn't include amplifier troubleshooting.

HOW TO USE VECTORSCOPES, OSCILLOSCOPES & SWEEP-SIGNAL GENERATORS by Stan Prentiss, published by Tab Books, hardbound \$7.95, paperbound \$4.95.

As might be expected, the author makes fairly frequent use of photographs showing scope traces to supplement the text. A Telequipment D54 dual-trace scope is used for producing most of the conventional-type traces, while a Mercury 3000 scope is

used for producing vector patterns.

Beginning with a block diagram representing virtually all scopes, the author progresses to a description of available scope specifications, performance parameters and probes. Equations and graphs are used to explain Lissajous patterns, vectorscope phase measurements and patterns produced by a chroma signal generator. Dual-trace scope patterns are compared with vectorscope color demodulator patterns.

Other chapters cover various waveforms observed with conventional horizontal sweep traces. (One chapter covers sampling, storage and spectrum analyzer scopes, which are too sophisticated to be of practical value for most electronic technicians in our field.) Sweep generators are described as they relate to aligning FM-receiver and TV-set tuned circuits.

The last three chapters deal with troubleshooting scopes, semiconductor circuitry and FM stereo multiplex circuitry.

This book should be of assistance to those requiring a greater fundamental knowledge concerning scopes.

199 TV TOUGH-DOG PROBLEMS SOLVED by Art Margolis, published by Tab Books, hardbound \$7.95, paperbound \$4.95.

According to the author, "A TV repair becomes a tough dog when the job does not yield quickly to routine quick check repair measures. As most repair jobs appear on the bench the experienced technician doesn't pull a schematic; instead he makes a fast appraisal of the symptoms and, with a few voltage and resistance checks, pinpoints the defect."

After showing the waveforms that should be observed on a scope at the various stages of a TV set, the author (for the balance of the book) deals with specific service problems that an electronic technician might encounter in various TV-set brands and models.

From the contents page we see that the book is arranged according to the type of trouble encountered. This listing includes the trouble, make and chassis or model in which it is encountered, and the corresponding page number. At the back of the book a cross reference is arranged according to brand of TV set, the chassis or model, and finally the trouble, giving the corresponding page number in the book.

This book may be of help to those that fail to regularly read **ELECTRONIC TECHNICIAN/DEALER** and do not file feature articles, **TECHNICAL DIGEST OF COLORFAX**.

CAPACITORS . . .

continued from page 51

suited as replacements for the general purpose types.

- Power capacitors are generally rated at ac voltages and usually cannot be replaced with dc capacitors.
- Many capacitors in coupling and bypass circuits can be replaced with much higher capacity ratings.
- The operating temperature of a capacitor must be observed or its value derated if this temperature is exceeded.
- AC line bypass capacitors must be replaced with those designed for that application.

Major capacitor manufacturers produce thousands of different types of electrostatic capacitors—most of which are required for military, industrial and commercial application. Only a few of these are necessary for the consumer electronics market; and of the smaller number, only a few are necessary for replacement purposes. The wise electronic technician will find that with a few types and values he can satisfy almost any replacement need. It is only occasionally necessary to have an "exact" replacement.

A modest and carefully selected stock of electrostatic capacitors will meet most requirements for the electronic technician; and in my next and concluding article, I will make some recommendations. ■

Letters . . .

continued from page 26

a 30-week class program (for a nominal fee) give them training that will make them better electronic technicians.

These men have been very complimentary, stating that they are making more money, and making it easier, because of our program.

You have stated in your editorial so eloquently what I have tried to say many times. I would like the privilege of xeroxing this page for distribution at service meetings. Due credit of course will be given.

HENRY V. GOLDEN, DIRECTOR
HEART OF AMERICA TELEVISION
TRAINING CENTER

MOVING ?

Be sure to let us know your new address. Please enclose a complete address label from one of your recent issues.

GHOSTS . . .

continued from page 43

con grease and a weatherboot to make a durable, weatherproof connection. Then, the cable was taped securely to the mast, lead across the roof and through a small space between the house and aluminum gutter, as seen in Fig. 6.



Fig. 6—Shielded coaxial cable can be run directly adjacent to aluminum gutter without fear of mismatch.

Running twin lead this close to the metal gutter would have resulted in poor color-TV reception, but it had no effect on the coax.

To keep the installation unobtrusive, we used staples to run the coax under the bottom shingles across the house to the playroom, which housed the TV set. Then, we pried away one shingle, drilled a hole in the wall and snaked the cable into the house (Fig. 7). No drip loop was necessary because we led the cable up into the hole. When we nailed the shingle back into place to hide the hole, we were careful not



Fig. 7—Coax download is fed into house under shingle, making neat, unobtrusive installation.

to crush the coax. You can run coax through metal pipes, under water—almost anywhere, but if you crush it, you ruin the impedance match, setting up standing waves.

At the TV set, we used a 75Ω-to-300Ω matching transformer. The results were so good that several of the customer's neighbors have ordered new antenna installations. All ghosting was eliminated and colors were sharp and true.

Ghost killing metropolitan antennas cost more than ordinary conicals and small yagies or log periodicals. However, they produce excellent results up to about 25 miles from the transmitter. If ghosting is a problem in an area where signals are strong, a metropolitan ghost killer, carefully installed, is usually the least expensive way to insure excellent picture quality. ■

Then use Quietrol . . . the choice of better servicemen everywhere for cleaning and lubricating all T.V. moving parts.

Spray Pack guarantees silent, smooth operation, with absolutely no harmful aftereffects for both color, and black and white sets.

Also available in bottles if you prefer.

Product of
QUIETROLE
 COMPANY
 Spartanburg, South Carolina

. . . for more details circle 122 on Reader Service Card

REPLACEMENT PARTS & ACCESSORIES

WELTRON'S GOT 'EM! DO YOU?

plugs & jacks * stereo switches * universal replacement antennas & bases * volt meters * cables * microphones * power supplies * auto stereo accessories * high precision motors * synchronous motors * shaded 4-pole motors *

COMPLETE CATALOG AVAILABLE. CALL YOUR DISTRIBUTOR NOW!

514 EAST PEABODY STREET, DURHAM, N.C. 27702
 919-682-0333

. . . for more details circle 131 on Reader Service Card

CORNELL ELECTRONICS COMPANY

2413 N. UNIVERSITY AVE. SAN DIEGO CALIF. 92105

THE ORIGINAL HOME OF

36¢

PER TUBE
UNLESS OTHERWISE PRICED
 100 TUBES OR MORE
33¢ PER TUBE

Same Low Price East or West Coast!

- ★ Bargain Tools
- ★ Transistor Tester
- ★ Technician's Library

SPECIAL OFFER

ON ALL ORDERS OVER \$10.00

25¢

PER TUBE (NO LIMIT)
FROM THIS LIST

6AG5 6CB6
 6AU6 6J6
 6AX4 6SN7

SEND FOR FREE NEW 48 PAGE COLOR CATALOG

- ★ Dumont Picture Tubes
- ★ Diodes—Transistors—Kits
- ★ Tube Cartons

ONE YEAR GUARANTEE

INDIVIDUALLY BOXED

5 DAY MONEY BACK OFFER

Your Order FREE if Not Shipped in 24 Hours

. . . for more details circle 106 on Reader Service Card

"STAR-TRACK" SPACE-AGE VHF/UHF/FM COLOR ANTENNAS FOR ALL AREAS!



**the most
Advanced Antennas
ever introduced!**

Similar design to Space Tracking Antennas! Combines the "Corner Reflector Disc Director Array" for total UHF coverage, with "Multiple Tuned, Cut-to-Channel, VHF Elements for unsurpassed Color and Black and White TV! Includes VHF/UHF Splitter for economical single down-lead installation. Licensed under U.S. Pat. No. 3,440,658 of Richard D. Bogner, the designer of many Antennas used in the Space Program! 6 Antenna models for all areas—write for FREE illustrated specification brochure.

RMS ELECTRONICS, INC.

50 Antin Place, Bronx, N.Y. 10462
Tel. (212) 892-6700

... for more details circle 124 on Reader Service Card

REBUILD YOUR OWN PICTURE TUBES?

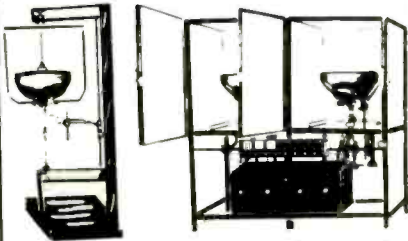

With Lakeside Industries precision equipment, you can rebuild any picture tube!

EASY TO OPERATE!

Requires only 4 x 8 ft. of space.

Rebuilds either black and white or color, regardless of tube size.

Amazingly low operational costs.

Offers excellent additional income to your present business.

For complete details on how you can become part of this increasing industry, write direct or mail this coupon.

LAKESIDE INDUSTRIES

5234 N. Clark St.
Chicago, Ill. 60640
Phone: 312-271-3399

- Free demonstration appointment
 Send me more information

Name

Address

City

State

... for more details circle 120 on Reader Service Card

READERS SERVICE INDEX

ADVERTISER'S INDEX

101	American Telephone & Telegraph Co. 22
101	B & K Division, Dynascan Corp. Cover 2
102	Belden Corporation 29
103	Book Club—Tab Books 34-37
104	Book Club—Schematics 58
105	Centralab
	Globe-Union Inc. 54
106	Cornell Electronics Co. 67
107	Delta Products, Inc. 64
108	Edlyn Directory 68
109	EICO Electronic Instruments Co., Inc. 57
110	Finney Company 31
111	Ford Marketing Corp. 61
112	Fordham Radio Supply Co., Inc. 68
	GTE Sylvania Electronic Components (Consumer Renewal) 27
	General Electric Company 32
113	Grantham School of Engineering 68
114	Heath Company 63
115	International Crystal Mfg. Co. 26
134	International Rectifier 56
116	Jerrold Electronics Corp. 65
117	Johnson Company, E. F. 62
118	Kay-Townes Antenna Company 38
119	LPS Research Labs 57
120	Lakeside Industries 68
121	Lectrotech, Inc. 30
133	Precision Tuner Service 59
122	Quietrole Company 67
	RCA Entertainment Tubes 20
	RCA Parts and Accessories Cover 4
	RCA Picture Tubes 25
124	RMS Electronics, Inc. 68
125	Telematic Division, UXL Corp. 60
126	Terado Corporation 68
127	Triplett Corporation Cover 3
128	Tuner Service Corporation 19
129	TV Tech Aid 62
130	Weller Electric Corporation 64
131	Weltron Co., Inc. 67
132	Workman Electronic Products, Inc. 28
	Zenith Radio Corporation 23

NEW PRODUCTS

700	Audio Sweep Generator 33
701	Field Strength Meter 33
702	Caddy Bar Jr. 33
703	VOM 55
704	Tool Case 55
705	Intrusion Detector 55
706	Tuner Spray 55
707	Desoldering Tool 55
708	Cold Galvanize 60
709	Transistor Adapter 64
710	Cassette Tape Splicer 64
711	Aerosol Valve 64
712	Metal Cassette 65
713	Cassette Tape Recorder 62
714	Stereo Tape Player 62
715	Solid State Electronic Switch 62
716	Tape Eraser 62
717	Stereo Headphones 63

TEST INSTRUMENT

900	Leader Model LSW-330 Post-Injection Sweep/Marker Generator 53
-----	--

INCREASE PROFIT — SATISFY CUSTOMER

NOW PERFECT COLOR T.V. with
TERADO VOLTAGE ADJUSTERS

CORRECTS HIGH OR LOW
VOLTAGE TO NORMAL CAP. 300 to 500 watts

SATURN (shown) Model 50-172 Dealer Net \$18.77
POLARIS (w/o meter) Model 50-204 Dealer Net \$12.24
SEE YOUR ELECTRONIC PARTS JOBBER. OR WRITE

terado CORPORATION
1058 RAYMOND AVE. ST. PAUL, MINN. 55108

... for more details circle 126 on Reader Service Card

Technicians, Earn Your Associate DEGREE

mostly by correspondence

Accredited by the Accred. Comm. of National Home
Study Council. G.I. Bill Approved. Free catalog.
Write Dept. T

Grantham School of Engineering
1505 N. Western, Hollywood, Calif. 90027

... for more details circle 113 on Reader Service Card

JAPANESE DIRECTORY

\$2.00

Where to write for schematics and technical
information. Over 290 listings.

EDLYN DIRECTORY

P.O. Box 49345, Los Angeles, Calif. 90049

... for more details circle 108 on Reader Service Card

TEST EQUIPMENT at Discount Prices



SENCORE

Equipment by Other
Manufacturers also Available

Write for free Catalog



FORDHAM

Radio Supply Co., Inc.

265 E 149 St., Bronx, N.Y. 10451

Tele: 212 585-0330

RCA Distributors of
Electronic Supplies

... for more details circle 112 on Reader Service Card

MOVING ?

Be sure to let us know your new address.
Please enclose a complete address label
from one of your recent issues.



Model 310-FET

\$78

*If you need
a high-sensitivity,
hand-size V-O-M...
Buy Triplet's 310-FET*

1. Hand-size FET V-O-M with 10 megohm DC input resistance.
2. Low voltage range of 300 mV DC; X1 megohm range.
3. Single range switch; DC polarity-reversing switch.

With a 10 megohm input resistance and a 300 mV DC sensitivity, Triplet's handy little Model 310-FET can handle practically any electrical measurement you may need.

Seventeen ranges (plus 6 AC current ranges to 300 A with its optional clamp-on ammeter attachment), 3% DC and 4% AC

accuracy, a polarity-reversing switch and a rugged suspension-type meter to soak up the hard knocks make the 310-FET the most convenient and most capable hand-size V-O-M you can buy.

It's a real value at \$78, so see it right now at your local Triplet distributor. For more infor-

mation, or for a free demonstration, see him or your Triplet sales representative. Triplet Corporation, Bluffton, Ohio 45817.

TRIPLETT

The World's most complete line of V-O-M's...
choose the one that's just right for you

... for more details circle 127 on Reader Service Card

Untie your money

With "QT" The Quick Turnover Inventory System from RCA:

How much money do you have tied up in old, unsold replacement parts? If you have more than your share of them, then it could be plenty.

RCA can change all that with a new Quick Turnover Inventory System—"QT" for short. It represents years of studying inventory control.

Now you can have an inventory of the fastest moving RCA parts, selected by RCA's computers. You'll have the parts you need when you need them. You'll know when the supply is running low. And, if any parts are dropped from the "top-mover" list, simply return them through your "QT" distributor.

Talk to your RCA Parts Distributor about putting in a "QT" Inventory System. The sooner you untie your money the sooner you'll be counting it.

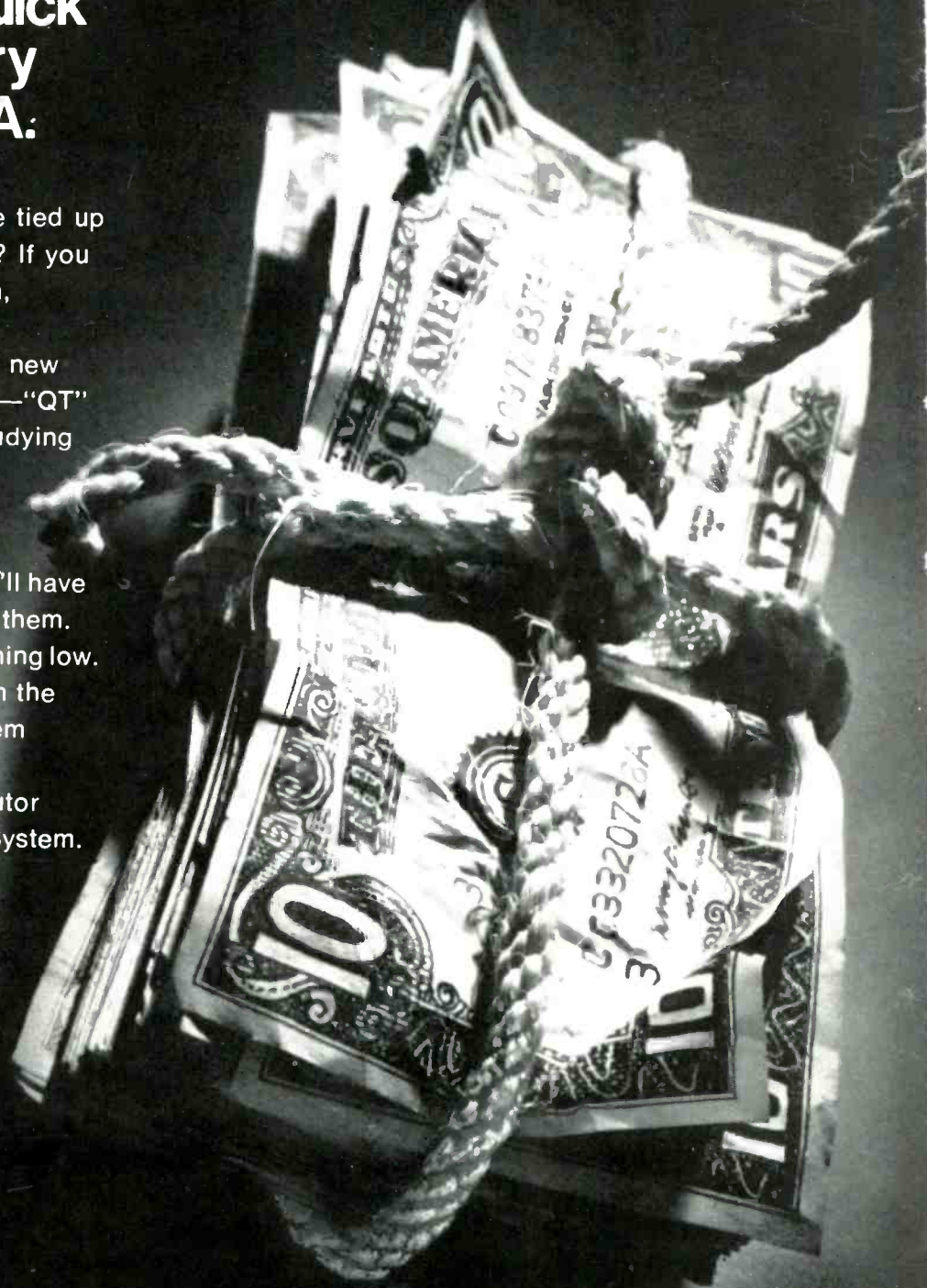

RCA Parts and Accessories