

# ELECTRONIC TECHNICIAN/DEALER

WORLD'S LARGEST TV-RADIO SERVICE & SALES CIRCULATION

FRIM9347465M2AZ 8722693AJ1  
WILLIAM W FRISB A6  
7176 GALE RD  
ATLAS MI 48411  
XX



FROM THE COMPANY WHO GIVES YOU  
THE STRONGEST GUARANTEE IN THE BUSINESS

# BUY AN INSTRUMENT. GET AN INSTRUMENT FREE.\*

## SIGNAL TRACER PROBE



Gain 3000 at 2 KHz. Bandwidth 50 Hz to 200 MHz. Z 3500 $\Omega$  to 350 K $\Omega$ . Output 0.3 p-p volts. Noise -45db. Supplied with anti-overload probe tips: Eico PST-2, Kit \$19.95, Wired \$29.95.

## NEW TRANSISTOR ANALYZER



Tests trans-conductance and Beta in and out of circuit. Measures FETs, bipolars, diodes, rectifiers, SCRs, UJTs. Built-in voltmeter, ohmmeter. 50 $\mu$ a taut band meter movement. Eico 685, Kit \$99.95, Wired \$149.95.

## NEW CURVE TRACER

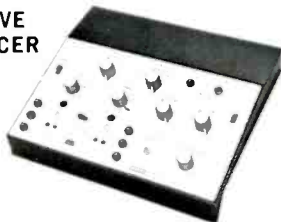

New professional transistor/diode curve tracer enables any general-purpose oscilloscope to display direct readouts of the most meaningful data. Eico 443, Kit \$99.95, Wired \$149.95.

## SOLID STATE COLOR GENERATOR



Standard offset carrier type stable 10-bar display plus precision dots, crosshatch, individual series of V & H lines; gun killers. Feeds to ant. terminals. Portable, battery/AC. Eico 385, Kit \$69.95, Wired \$99.95.

## \*FREE EICO TRUVOHM™ MULTIMETERS (with purchases as described)



Model 1A1  
1 K  $\Omega$ /V



Model 4A3  
4 K  $\Omega$ /V

## NEW OSCILLOSCOPE/ VECTORSCOPE

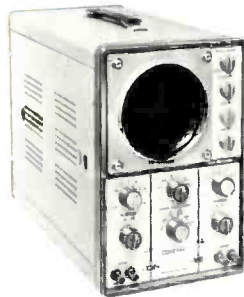

DC-8MHz (usable to 10 MHz). 5" flat-face CRT. Sensitivity 12 MV RMS/CM. Negligible relative H & V phase shift. Excellent curve tracer with Eico 443 (below). Eico 465, Kit \$179.95, Wired \$249.95.

## CRT TESTER AND REJUVENATOR



For all B-W & Color Picture Tubes. Each gun of Color Tube measured individually and numerically, provides required gray scale tracking information. Eico 633, Kit \$79.95, Wired \$109.95.

## NEW SOLID STATE SINE/SQUARE WAVE GENERATOR



Provides simultaneous sine and square wave outputs. Covers 20 Hz-2MHz, 5 bands. Max. distortion 0.25%. Rise time at 20 KHz <0.1  $\mu$ sec. Eico 379, Kit \$69.95, Wired \$99.95.

## NEW SOLID STATE FET-TVM'S



AC RMS/DCV: 0-1, 3, 10, 30, 100, 300, 1000V. P-P ACV: 0-2.8, 8.5, 28, 85, 280, 850, 2800V. DC Input Z 11 M $\Omega$ . Ohmmeter 0.2 $\Omega$  to 1000 M $\Omega$ . 4 1/2" 200  $\mu$ A meter. Eico 240 Kit \$59.95, Wired \$79.95. With 6 1/2" meter & AC/DC Current readings.

Eico 242 FET-TVOM, Kit \$69.95, Wired \$94.50.

## TUBE TESTER



Tests all standard tubes plus decals, magnovals, 7-pin nuvistors, popular TV picture tubes. Professional, compact, lightweight, and modest price. Eico 635, Kit \$44.95, Wired \$69.95.

## NEW SOLID STATE SIGNAL TRACER



Output 400mw. Inputs: 1mv RF; 63 mv AF; Hum >60 db below 400 mv. 200  $\mu$ a meter. Provides substitution output Xfmr & spkr. Eico 150, Kit \$59.95, Wired \$79.95.

## THE TECHNICIAN'S CAUSE EICO helps it. With . . .

1. The first and only instruments with the MOST capability-per-dollar. They do more, faster — save you more time, effort, money.
2. The first and only solid state instruments guaranteed for 5 years.
3. Now, in the teeth of inflation, EICO makes your dollars buy even more TOTAL VALUE than ever before.

OUR 25th YEAR. LABORATORY PRECISION AT LOWEST COST.

After purchasing any instrument on this page from your local EICO Distributor, mail EICO the sales slip, Registration Card and coupon at right. We'll ship you prepaid an EICO Truvohm Multimeter as follows: For each purchase up to \$100, the Model 1A1; for each purchase over \$100, the Model 4A3. Offer expires Jan. 31, 1971. Void where prohibited or taxed.

For latest catalog on EICO Test Instruments, Stereo, EICOCRAFT Projects, Environmental Lighting, and name of nearest EICO Distributor, check Reader Service Card or use coupon.

ETD-12 Offer expires March 31, 1971.  
Name \_\_\_\_\_  
Address \_\_\_\_\_  
City \_\_\_\_\_ State \_\_\_\_\_ Zip \_\_\_\_\_



EICO • 283 Malta Street • Brooklyn, N.Y. 11207

. . . for more details circle 108 on Reader Service Card

GROUP  
**222**

	SCHEMATIC NO.	SCHEMATIC NO.
MAGNAVOX	.....1341	RCA SALES CORPORATION
Color TV Chassis T936		Color TV Chassis CTC49 Series
MAGNAVOX	.....1344	SYLVANIA
TV Chassis T941 Series		Color TV Chassis D12-20, 21
RCA SALES CORPORATION	.....1340	
TV Chassis 179 Series		

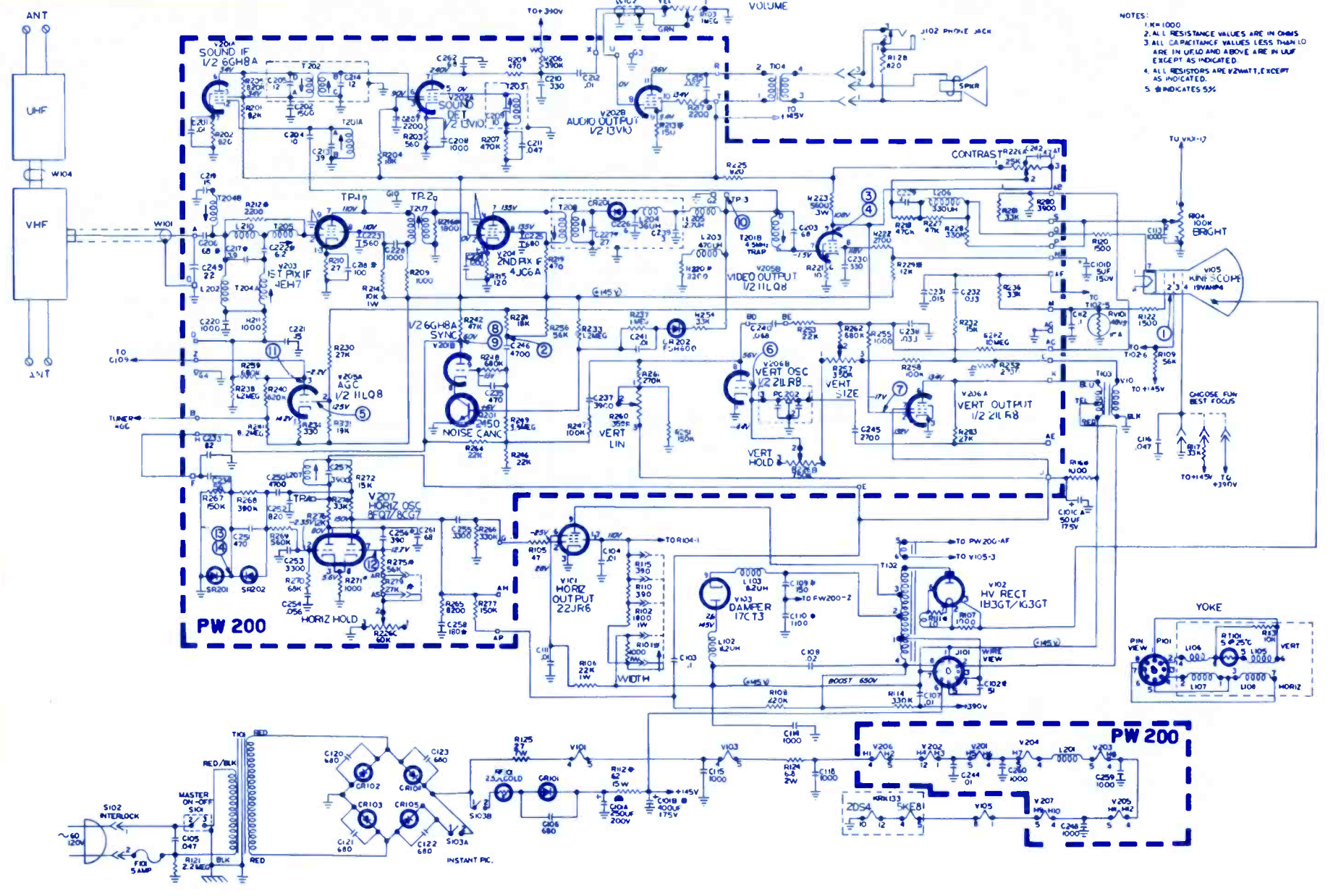
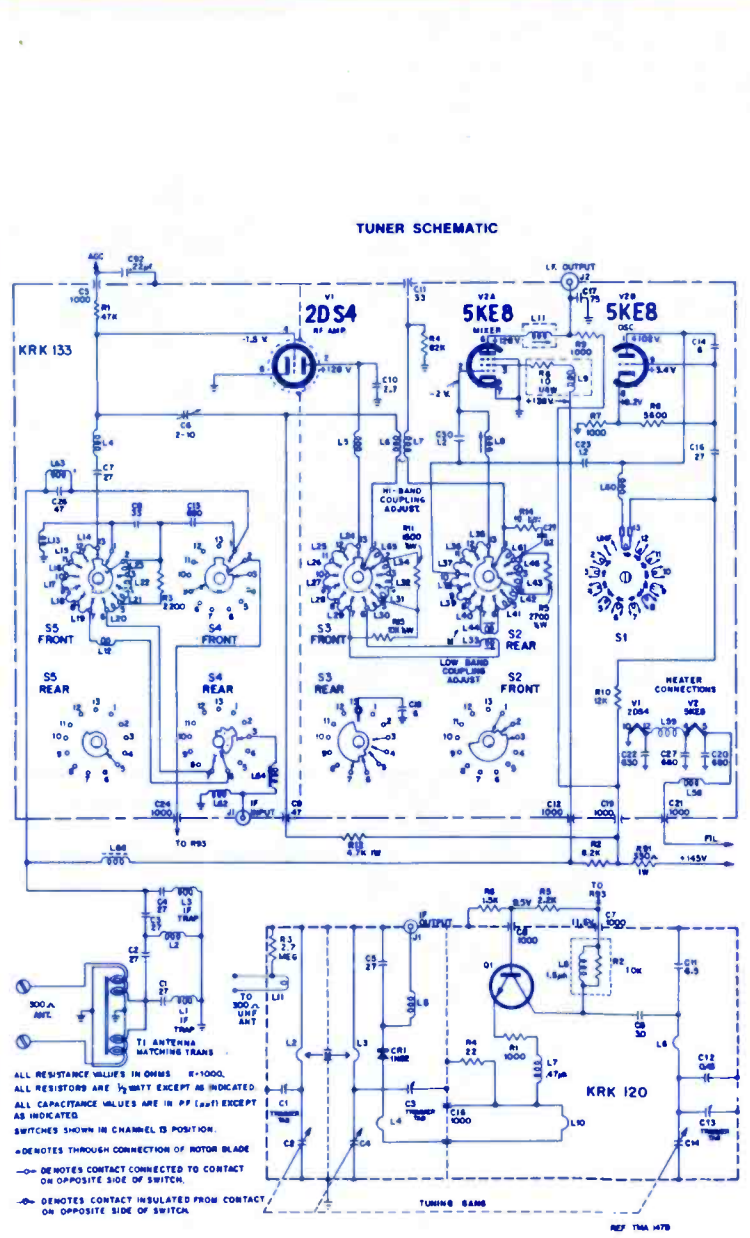
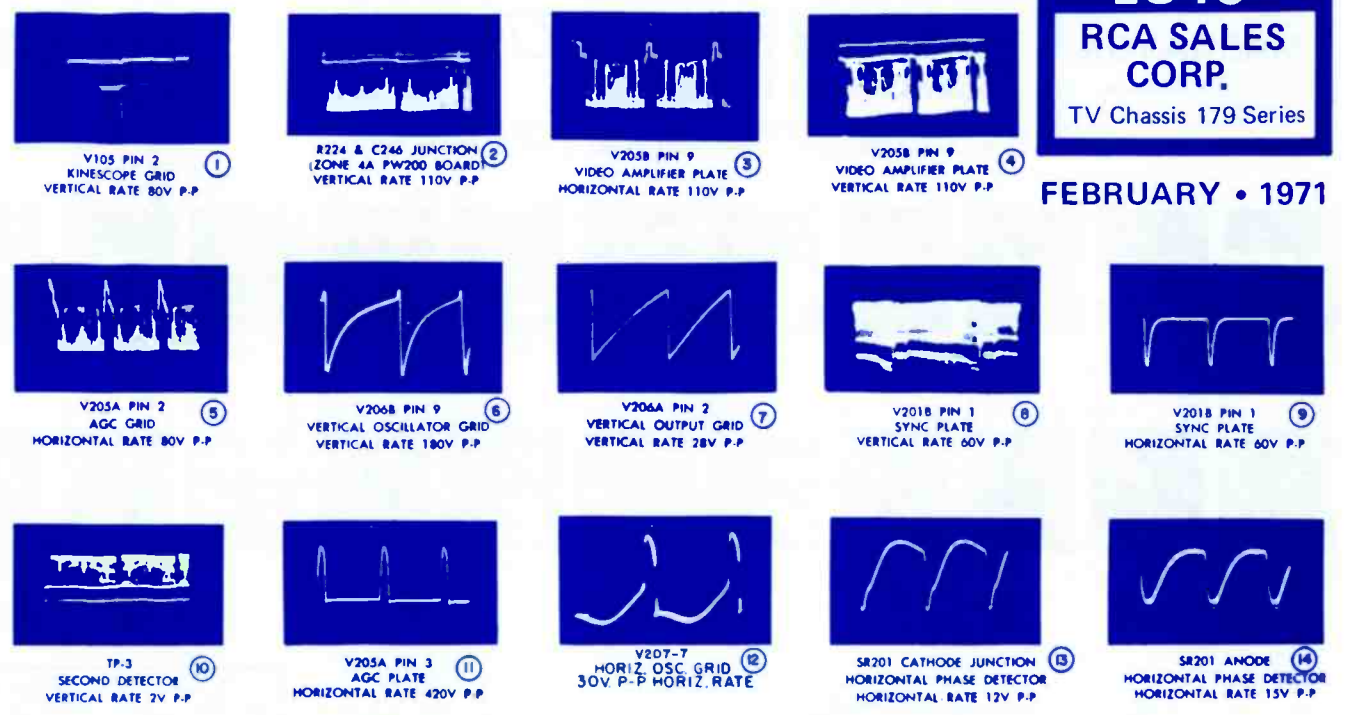

NOTES:  
1. R=1000  
2. ALL RESISTANCE VALUES ARE IN OHMS  
3. ALL CAPACITANCE VALUES LESS THAN 10 ARE IN UF AND ABOVE ARE IN UF EXCEPT AS INDICATED  
4. ALL RESISTORS ARE 1/2WATT, EXCEPT AS INDICATED  
5. @ INDICATES 5%

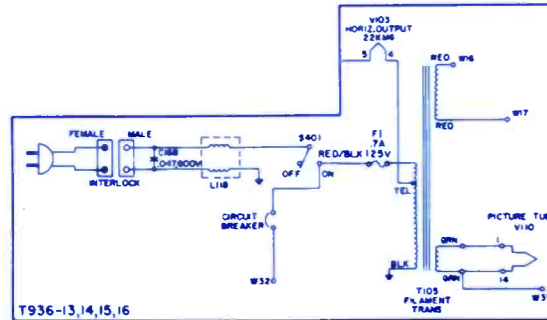
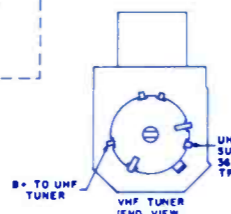
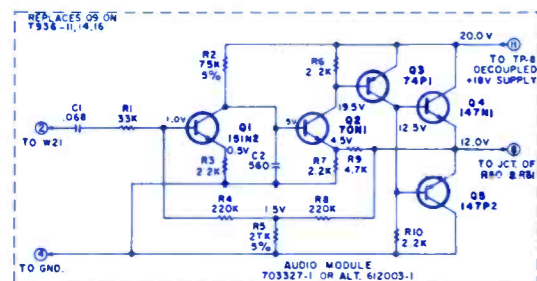
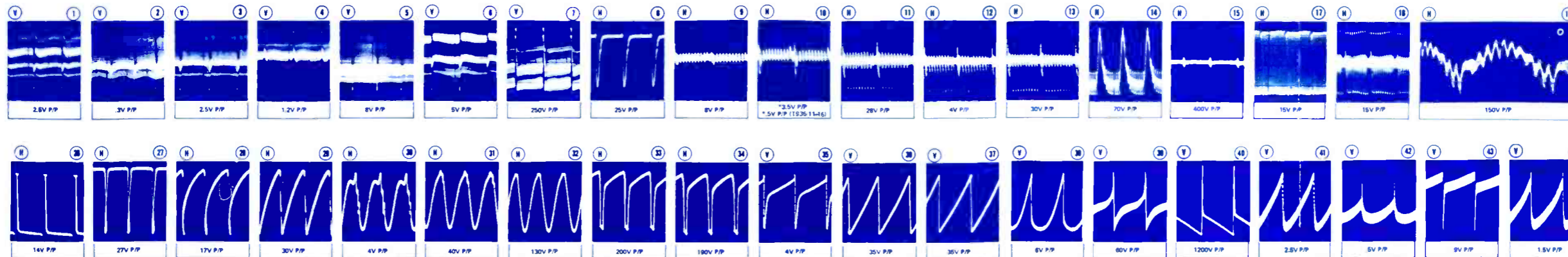

- NOTES UNLESS OTHERWISE SPECIFIED:
- 1. COMPONENT LOCATED OFF BOARD.
  - 2. CAPACITANCE VALUES OF 1 OR MORE ARE IN PICOFARADS.
  - 3. CAPACITANCE VALUES LESS THAN 1 ARE IN MICROFARADS.
  - 4. SOURCE VOLTAGES MEASURED WITH SIGNAL. ALL OTHERS MEASURED WITH NO SIGNAL EXCEPT THOSE IDENTIFIED WITH A DOT (•).
  - 5. CIRCLED NUMBERS REFER TO WAVEFORMS.
  - 6. WAVEFORMS OBTAINED USING 10 BAR COLOR GENERATOR, CONTRAST MAXIMUM COUNTERCLOCKWISE AND BRIGHTNESS SET TO PRODUCE 150V AT PLATE OF V107PIN 7. COLOR CONTROL SET TO PRODUCE 4V P/P AT BASE OF Q14 AND TINT CONTROL ADJUSTED TO PRODUCE A NORMAL COLOR BAR DISPLAY (14TH BAR W/WHITE).
  - 7. PARTS MAY BE CONNECTED IN EITHER DIRECTION OR SHORTED AS REQUIRED FOR HORIZ. CENTERING.
  - 8. C5 USED WITH AUDIO MODULE 703327-1 OR 612003-1 ONLY.
  - 9. △ UNDERSIDE OF P.C. BOARD (COPPER SIDE).
  - ▷ T936-11,12

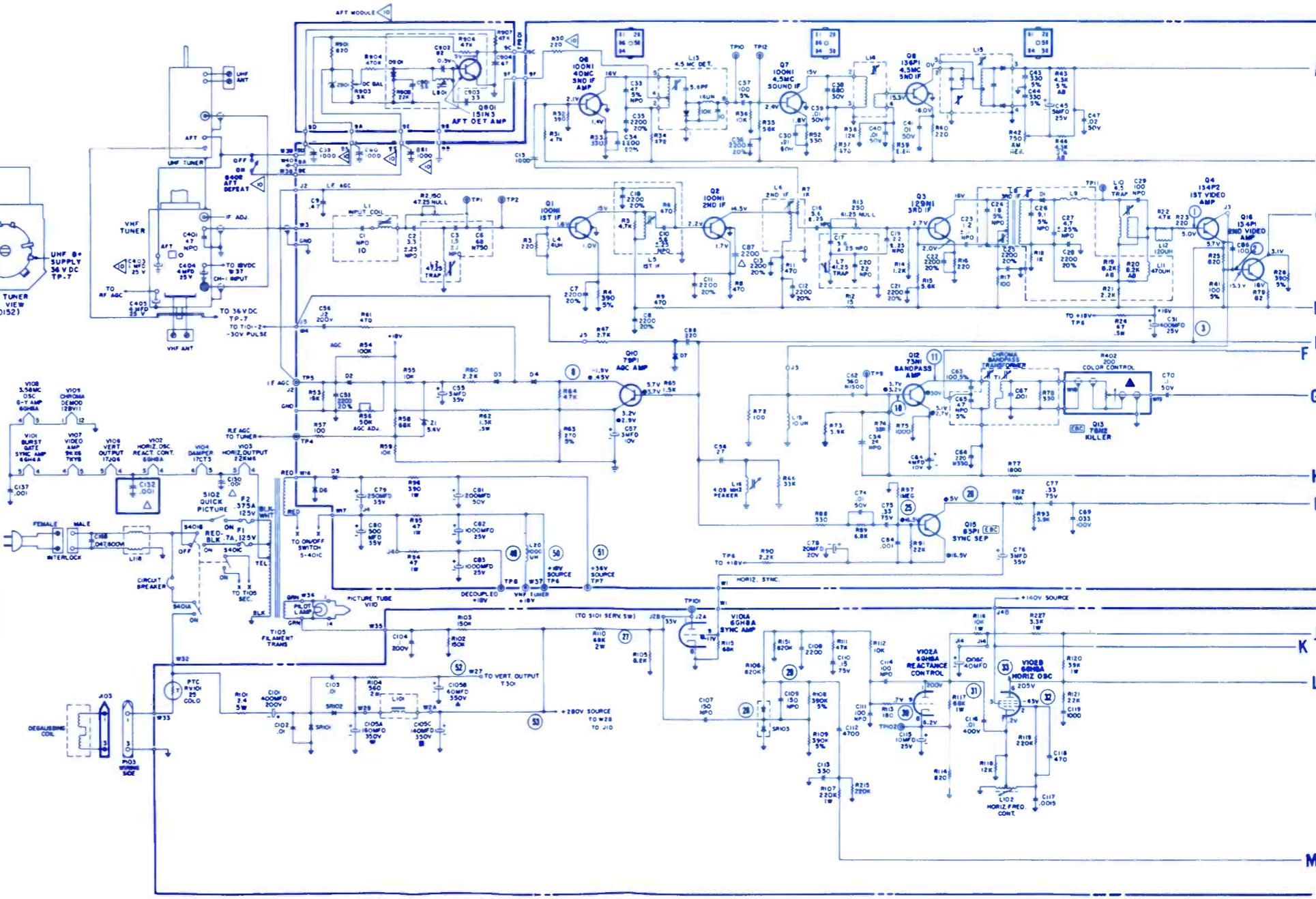

**MAGNAVOX**  
Color TV Chassis  
T936

VHF TUNER SCHEMATIC

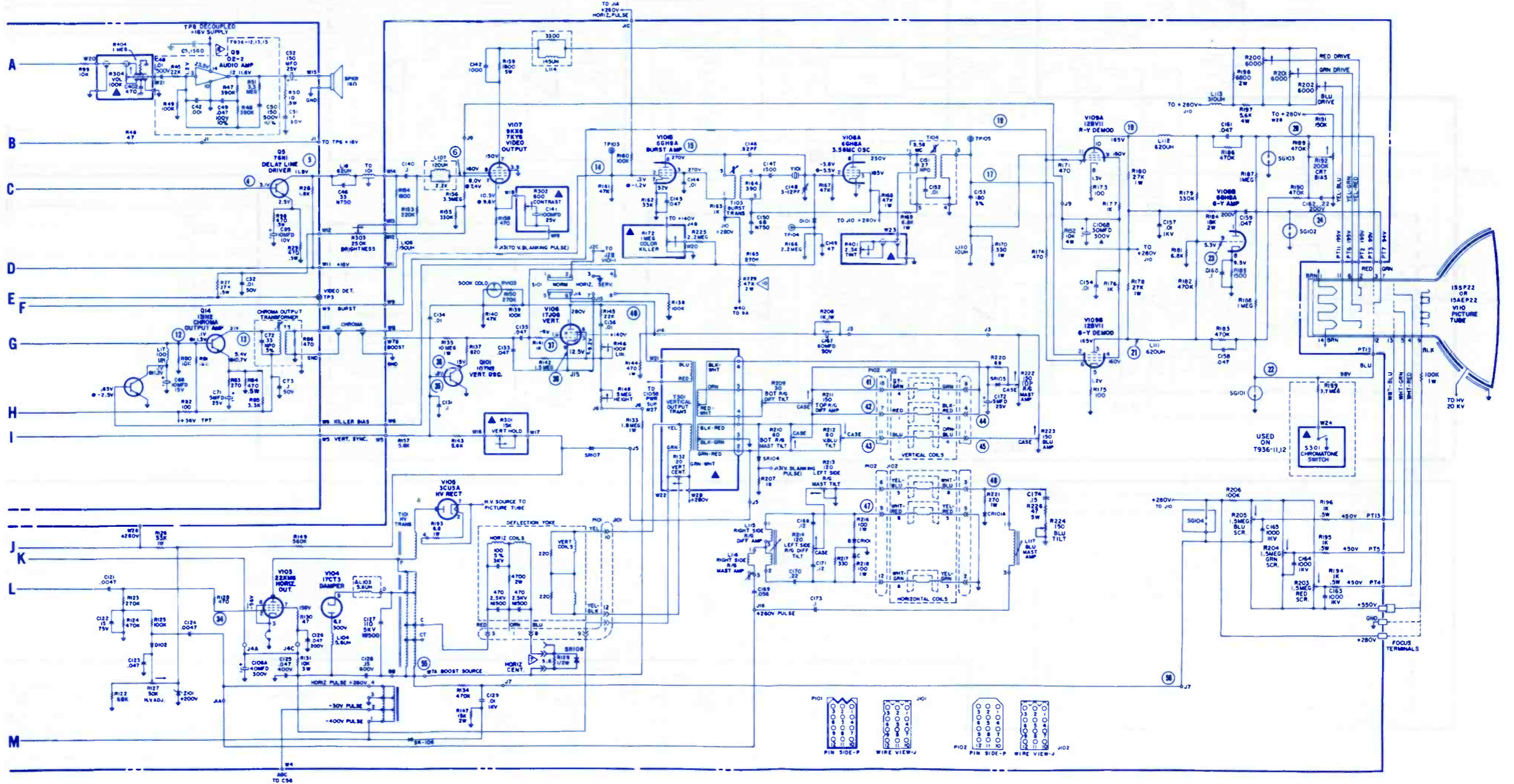
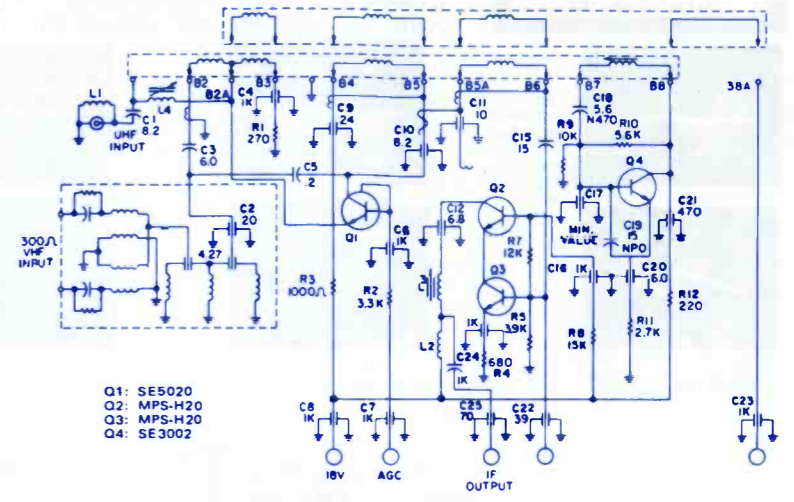
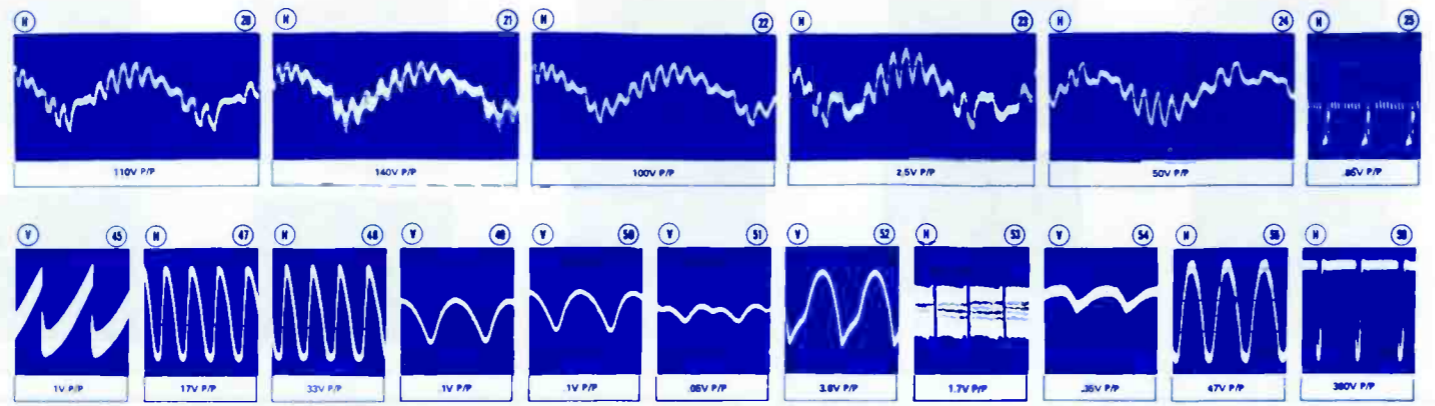

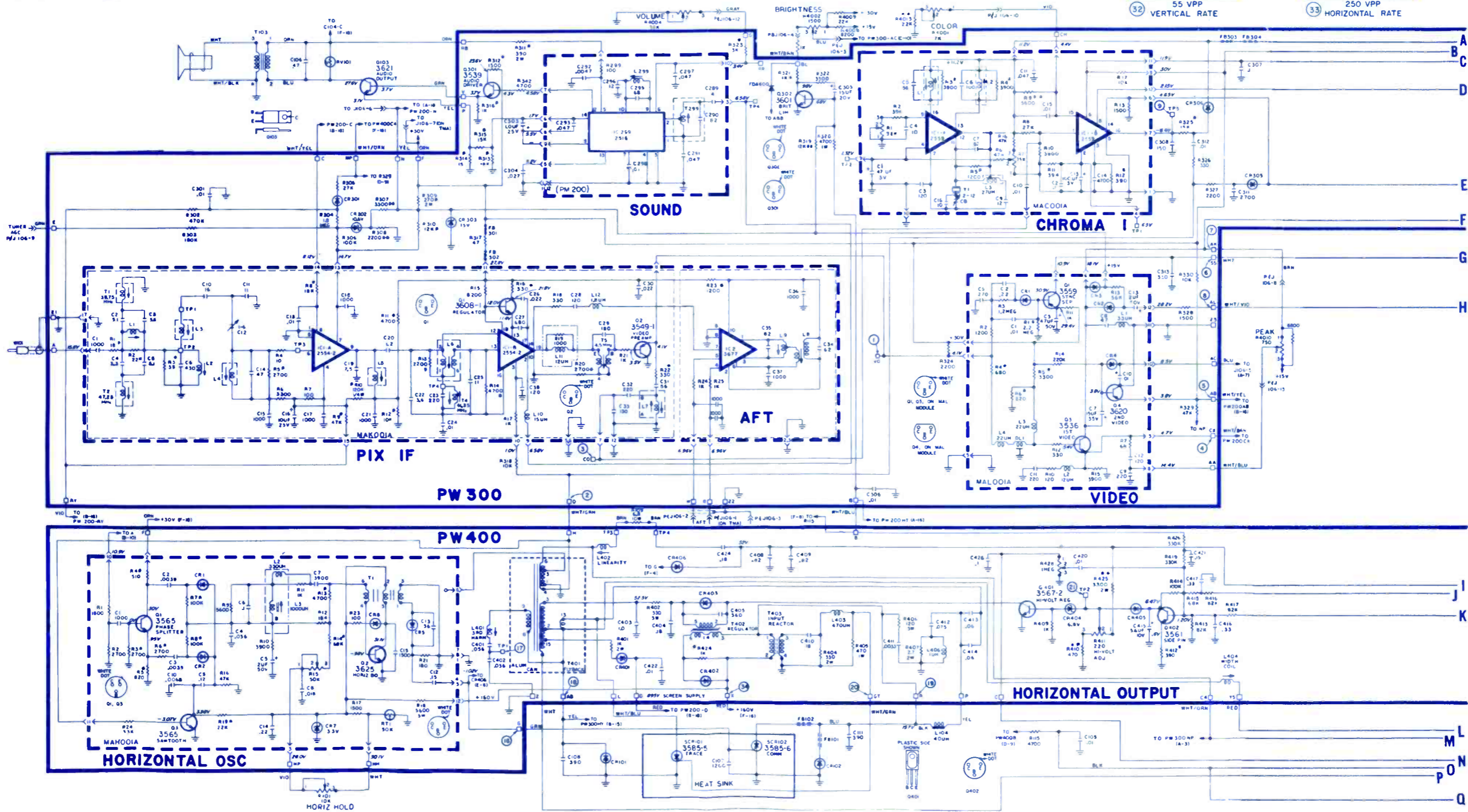
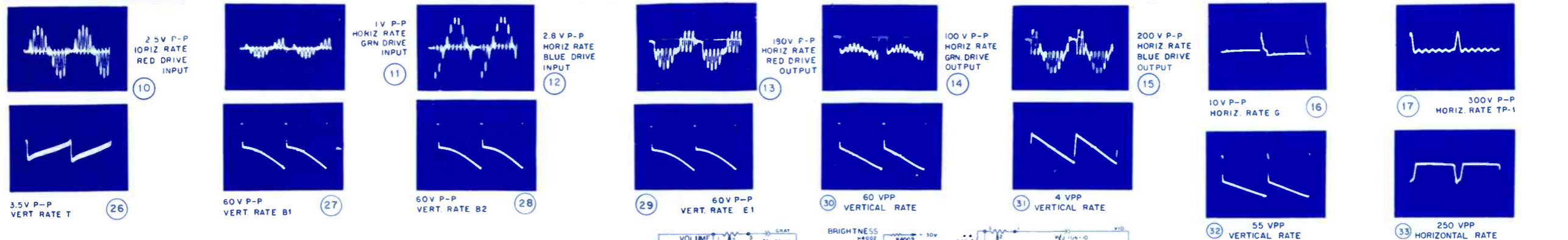

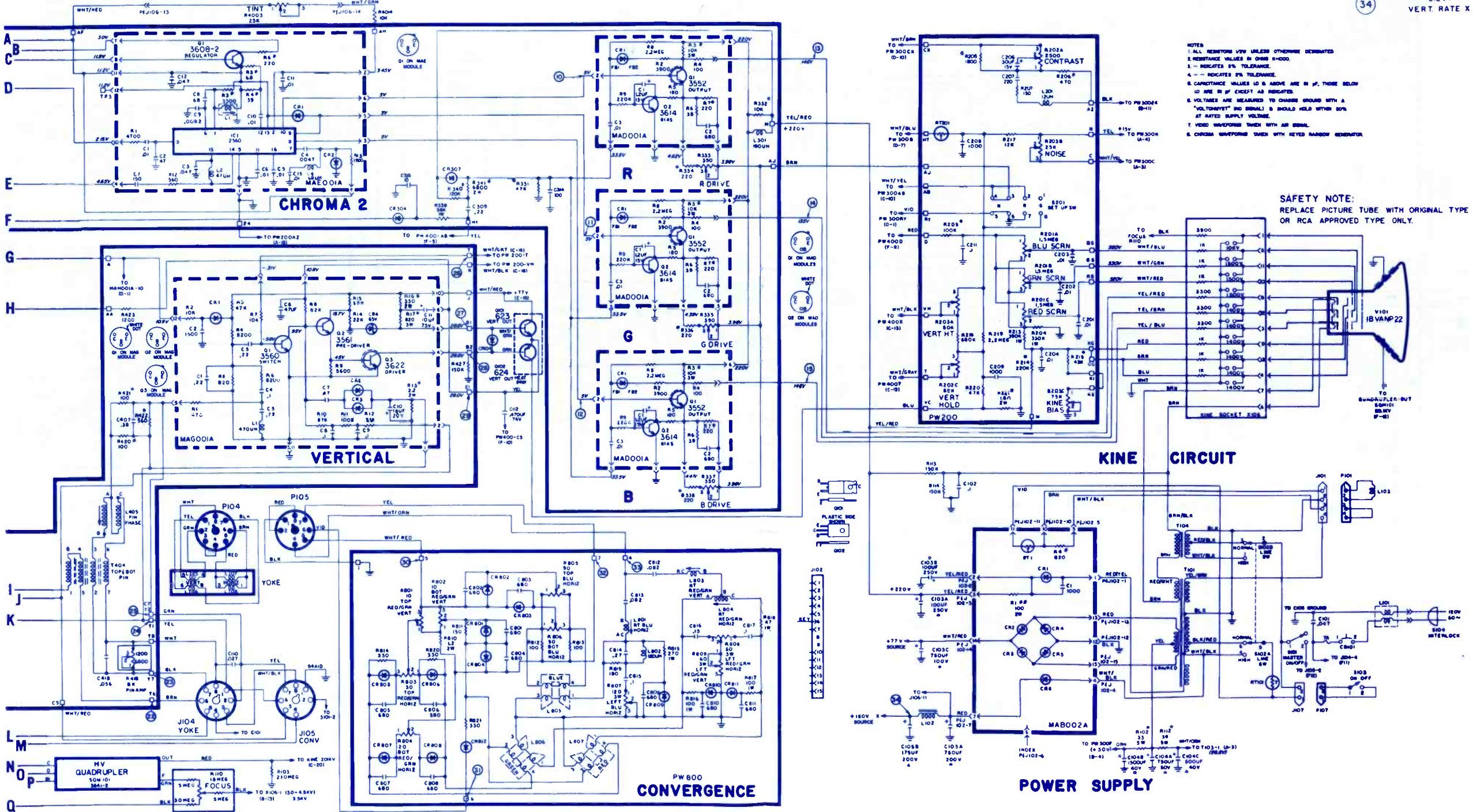
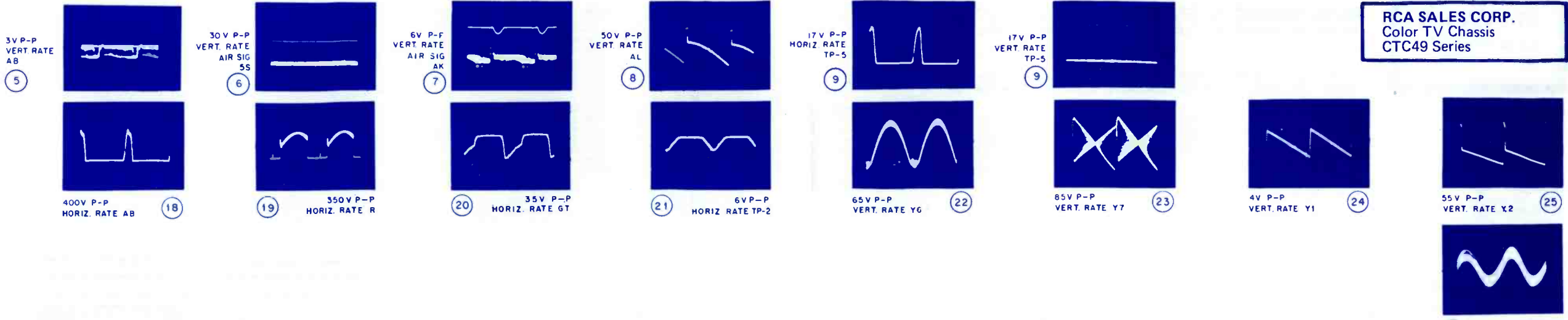

- NOTES:  
1. ALL RESISTORS VIEW UNLESS OTHERWISE DENOTED.  
2. RESISTANCE VALUES IN OHMS K=1000.  
3. — INDICATES 5% TOLERANCE.  
4. — INDICATES 2% TOLERANCE.  
5. CAPACITANCE VALUES 10 & ABOVE ARE IN  $\mu$ F, THOSE BELOW 10 ARE IN P.F. EXCEPT AS INDICATED.  
6. VOLTAGES ARE MEASURED TO CHASSIS GROUND WITH A "VOLTOHMETER" NO SIGNAL & SHOULD HOLD WITHIN 50% AT RATED SUPPLY VOLTAGE.  
7. VIDEO WAVEFORMS TAKEN WITH AIR SIGNAL.  
8. CHROMA WAVEFORMS TAKEN WITH REYES RAINBOW GENERATOR.

SAFETY NOTE:  
REPLACE PICTURE TUBE WITH ORIGINAL TYPE OR RCA APPROVED TYPE ONLY.

COMPLETE MANUFACTURERS' CIRCUIT DIAGRAMS  
AND TECHNICAL INFORMATION FOR 5 NEW SETS

FEBRUARY • 1971

SYMBOL	DESCRIPTION	SYLVANIA PART NO.
C336A	10/400v elect	41-27344-1
C336B	50/150v elect	41-27344-1
C518A	100/400v elect	41-27418-1
C518B	100/400v elect	41-27418-1
C518C	20/400v elect	41-27418-1
C518D	20/400v elect	41-27418-1

C522A	1000/40v elect	41-27421-1
C522B	100/40v elect	41-27421-1
C522C	50/400v elect	41-27421-1
R124	4.5K 15w	36-92898-51
R126	VDR, 1ma, 76v	38-15257-18
R274	5.6K 4w	35-92495-71
R444	13K 7w	35-92495-54
R514	VDR, 67ma, 20vdc	38-17072-1
R516	thermistor - 125Ω, cold	38-17071-1
L102	sound input	57-23832-2

L202	44.5MHz IF input	57-23827-1
L204	47.25MHz trap	57-23827-2
L218	4.5MHz trap	50-16238-5
L400	horiz frequency	50-23508-1
L404	focus coil	50-27845-1
L408	horiz efficiency	50-23507-1
L600	5.6 μh	50-15904-4
L610	reactance coil	50-16185-3
T102	ratio detector	57-23547-1
T104	audio output	56-16018-9
T200	44.5MHz output	57-23831-1
T300	vert output	56-17559-6
T400	horiz output	50-27415-1
T500	power xformer	55-27416-3
T600	chroma output	50-29658-1
T602	band pass	50-27405-1
T604	burst	50-27406-1
SC100	IF sound detector IN295	13-85962-1
SC400, SC402	horiz AFC IN4092	13-15465-1
SC406	focus rectifier	13-29656-1
R110	25K tone	37-27242-8

R254	1K contrast	37-27242-12
R260	250K bright (-20)	37-29782-7
R260	250K bright (-21)	37-23479-47
R280	6K blue drive	37-11632-18
R335	750K vert hold	37-27242-6
R352	1.5K AGC	37-11632-18
R362	10Ω vert center	37-16021-17
R370	3.4M vert linearity	37-29755-6
R422	1K horiz hold	37-27242-12
R442	10Ω horiz center	37-17539-3
R456	500K HV	37-16020-27
R606	250 CRT bias	37-16020-30
R609	600 tint (-21)	37-29440-102
R616	500n color killer	37-29755-6
R629	500n color (-20)	37-29783-5
R629	500n color (-21)	37-29440-101
CB500	circuit breaker	29-23918-1
tuner UHF		54-29184-4
tuner VHF (-20)		54-23858-13
tuner VHF (-21)		54-23858-12
yoke - deflection		51-29986-2

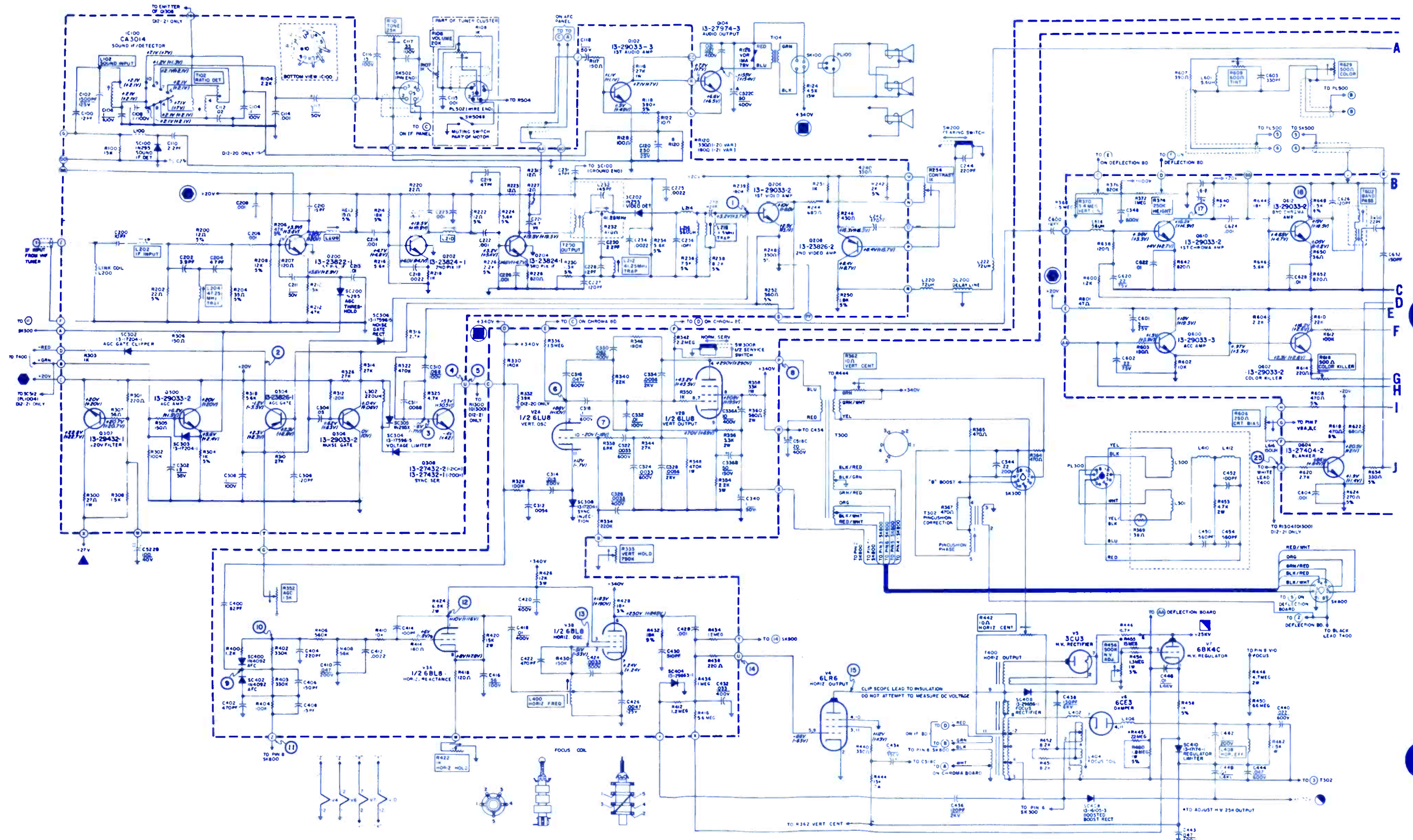





SYMBOL	DESCRIPTION	MAGNAVOX PART NO.
L109	-deflection yoke	36B047-2
L110	-horiz stability coil	36B056-14
L112	-horiz filter coil	36B056-15
T101	-vert oscillator xformer	32B021-1
T102	-vert output coil	32B010-2
T103	-horiz oscillator xformer	32B021-2
T104	-horiz driver xformer	32B021-3
T105	-horiz output xformer	36B056-17
T106	-power xformer	36B006-1
R801	-10K, vol On-Off	22B016-25
R802	-500Ω contrast	22B016-24
R803	-500K, bright	22B016-23
R804	-3K, horiz hold	22B016-22
R805	-5K, vert hold	22B016-21
R807	-5K, sub-linearity	22B016-29
R808	-1K, vert linearity	22B016-27
R809	-50K, vert frequency	22B016-13
R810	-10K, horiz frequency	22B016-8
R811	-1K, AGC level	22B016-27
R812	-1K, AGC	22B016-28
R814	-1M, sub-bright	22B016-26
D10	-damper diode	53B017-1
D12	-focus rectifier	53B010-10
TH1	-thermistor	23B008-1
TH4	-thermistor	23B008-1
TVL1	-VDR	23B011-1
	0.5 amp fuse (ac)	18B031-2
	1.5 amp fuse (dc)	18B031-1
	UHF tuner	34B006-1
	VHF tuner	34B005-1

- NOTES: UNLESS OTHERWISE SPECIFIED,  
 1. ALL RESISTORS ARE 1/4 WATT, 10%.  
 2. CAPACITANCE VALUES GREATER THAN 1 ARE IN PICOFARADS AND VALUES LESS THAN 1 ARE IN MICROFARADS.  
 3. ALL CAPACITORS ARE 10% TOLERANCE AND 50V MINIMUM RATING. EXCEPTIONS ARE NOTED IN REPLACEMENT PARTS LIST.  
 4. VOLTAGES MEASURED WITH VTVM FROM POINT INDICATED TO GROUND WHILE USING A 120 VAC POWER SOURCE.  
 5. VOLTAGE & CURRENT MEASUREMENTS MADE UNDER NO SIGNAL CONDITIONS WITH VOLUME CONTROL SET TO MINIMUM. CONTRAST AND BRIGHTNESS CONTROLS ARE SET TO PRODUCE A NORMAL PICTURE.  
 6. F1, F2, ETC. INDICATE NUMBERED TERMINALS ON H.O.T. (FLYBACK TRANSFORMER) I/O5.

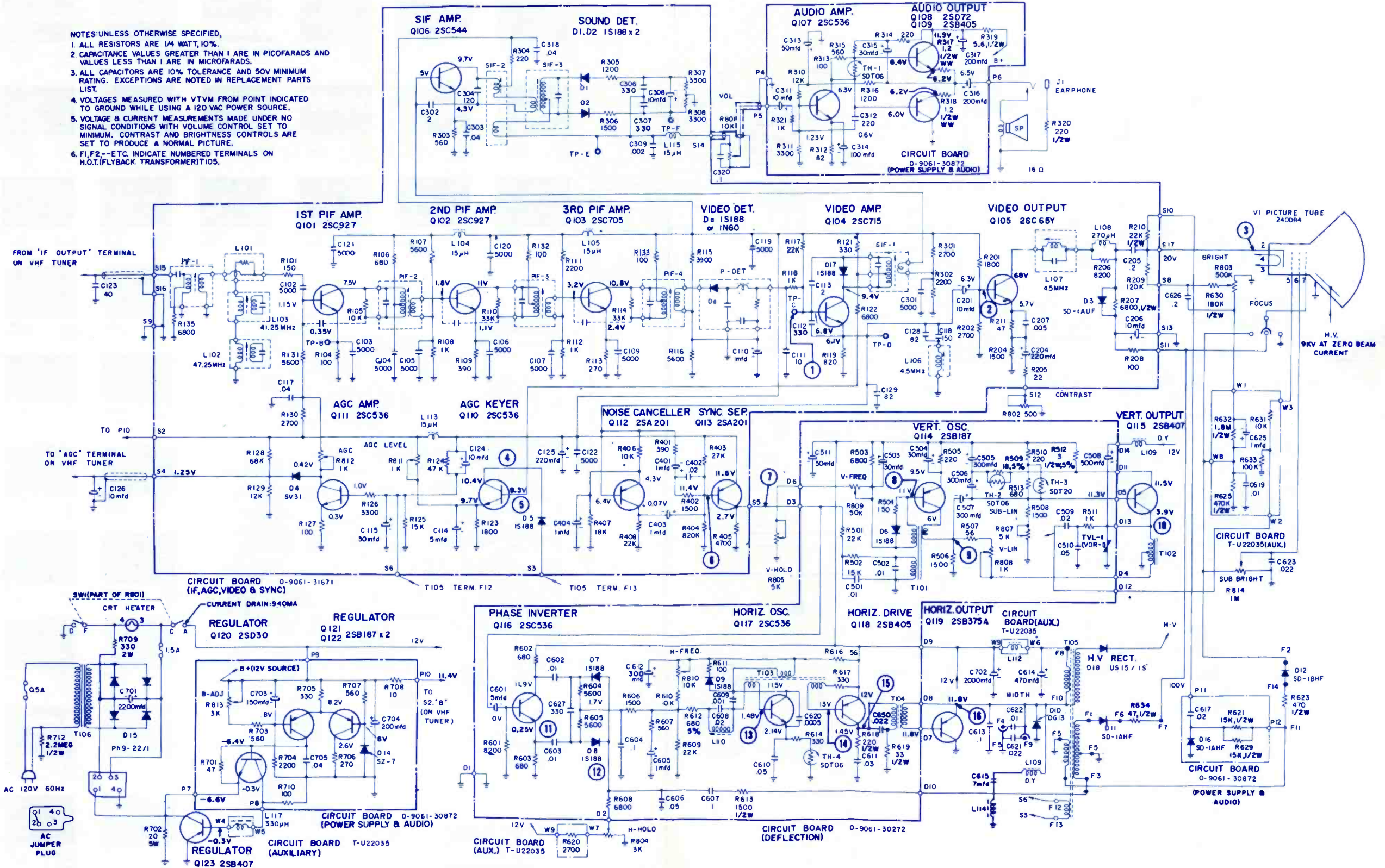

ELECTRONIC TECHNICIAN/DEALER is published monthly by HARCOURT BRACE JOVANOVIĆ PUBLICATIONS, INC., 1 East First St., Duluth, Minn. 55802. Subscription rates: One year \$6, two years \$10, three years \$13, in the United States and Canada. Other countries: One year \$15, two years \$24, three years \$30. Single copies 75¢ in the United States, and \$2 in other countries. Second class postage paid at Duluth, Minn. POSTMASTER: Send Form 3579 to ELECTRONIC TECHNICIAN/DEALER, HARCOURT BRACE JOVANOVIĆ PUBLICATIONS, INC., 1 East First St., Duluth, Minn. 55802.

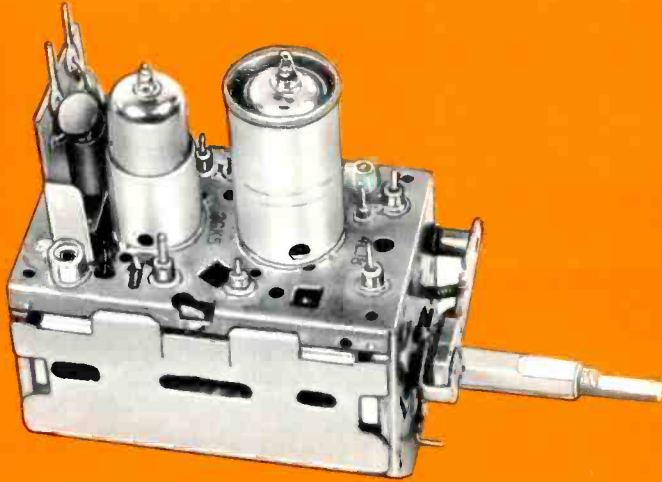

# \$975

## TUNER SERVICE CORPORATION

**PROVIDES YOU WITH A COMPLETE SERVICE FOR ALL YOUR TELEVISION TUNER REQUIREMENTS AT ONE PRICE.**

### TUNER REPAIR

VHF Or UHF Any Type \$9.75.  
UHF/VHF Combo \$15.00.

In this price all parts are included. Tubes, transistors, diodes, and nuvistors are charged at cost.

Fast efficient service at our four conveniently located service centers.

1 year guarantee backed up by the largest tuner manufacturer in the U.S.—SARKES TARZIAN, INC.

All tuners are cleaned inside and out, repaired, realigned and air tested.

### TUNER REPLACEMENT

Replacement Tuner \$9.75.

This price buys you a complete new tuner built specifically by SARKES TARZIAN INC. for this purpose.

The price is the same for every type of universal replacement tuner.

#### Specify heater type

Parallel 6.3V  
Series 450 mA  
Series 600 mA

All shafts have the same length of 12".

#### Characteristics are:

Memory Fine Tuning  
UHF Plug In  
Universal Mounting  
Hi-Gain Lo-Noise

If you prefer we'll customize this tuner for you. The price will be \$18.25. Send in original tuner for comparison purposes to our office in INDIANAPOLIS, INDIANA.



## TUNER SERVICE CORPORATION

**FACTORY-SUPERVISED TUNER SERVICE**

**MIDWEST** . . . . . 817 N. PENNSYLVANIA ST., Indianapolis, Indiana . . . . . TEL: 317-632-3493  
(Home Office)  
**EAST** . . . . . 547-49 TONNELE AVE., Jersey City, New Jersey . . . . . TEL: 201-792-3730  
**SOUTH-EAST** . . . . . 938 GORDON ST., S. W., Atlanta, Georgia . . . . . TEL: 404-758-2232  
**WEST** . . . . . SARKES TARZIAN, Inc. TUNER SERVICE DIVISION  
10654 MAGNOLIA BLVD., North Hollywood, California . . . . . TEL: 213-769-2720  
. . . for more details circle 129 on Reader Service Card

# ELECTRONIC TECHNICIAN/DEALER

## HUGH "SCOTTY" WALLACE

Publisher  
43 East Ohio Street  
Chicago, Ill. 60611  
(312) 467-0670

## PHILLIP DAHLEN

Editor  
1 East First Street  
Duluth, Minn. 55802  
(218) 727-8511

## JOSEPH ZAUHAR

Managing Editor

## CAROLYN SAND

Associate Editor

## DEBBIE GOLDBERG

Production Editor

## BOB ANDRESEN

Graphic Design

## LILLIE PEARSON

Circulation Fulfillment

## JOHN KESSLER

Manager, Reader Services

## BERNICE GEISERT

Advertising Production

## TOM GRENEY

Publishing Director

## MANAGERS

### ALFRED A. MENEGUS

757 Third Avenue  
New York, N.Y. 10017  
(212) 572-4829

### DEAN GREENER

43 East Ohio Street  
Chicago, Ill. 60611  
(312) 476-0670

### DONALD D. HOUSTON

1901 West 8th Street  
Los Angeles, Calif. 90057  
(213) 483-8530

### CHARLES S. HARRISON

**CY JOBSON**  
57 Post Street  
San Francisco, Calif. 94104  
(415) 392-6794

### ROBERT UPTON

Tokyo, Japan  
I.P.O., Box 5056

FEBRUARY 1971 • VOLUME 93 NUMBER 2

This month's cover, supplied through the courtesy of P. R. Mallory Co., depicts a burglary in the process of being attempted. It may be thwarted if the house is equipped with an ultrasonic intrusion alarm.

- 
- 3 TEKFAQ: Up-to-date schematics for easier servicing.
  - 23 EDITORIAL: Industry Involvement
  - 24 LETTERS: Pertinent comments concerning past issues.
  - 26 READERS' AID: What you need or have for sale.
  - 30 NEW AND NOTEWORTHY: Merchandise of special interest.
- 

## FEATURES

### 33 TEKLAB REPORT

Part II—More information concerning the unique features that have been incorporated in RCA's Argosy Portable Color TV set.

### 38 ALIGNING FM STEREO RECEIVERS

Techniques for improving FM receiver sensitivity and channel separations with the aid of a scope and alignment equipment.

### 41 SWEEP ALIGNMENT POINTERS

Jim Smith describes color-TV set IF signal curves that should be obtained in order to obtain the best color picture.

### 44 GUEST AUTHOR: THE INDEPENDENT DEALER-DISTRIBUTOR RELATIONSHIP

A. M. Efron, this month's guest author, describes the value of promotional incentives—gifts that are offered to improve sales.

### 45 TEST INSTRUMENT REPORT

Reviewing specifications for the Heathkit Model IB-101 frequency counter.

- 
- 48 TECHNICAL DIGEST: Hints and shortcuts for more effective servicing.
  - 54 COLORFAQ: Tips for easier color-TV set repair.
  - 56 NEW PRODUCTS: Instruments and components to make your job easier.
  - 62 DEALER SHOWCASE: These items may increase your sales revenue.
  - 67 TECHNICAL LITERATURE: Informative material that you may need.
  - 68 ADVERTISERS' INDEX: Manufacturers concerned about you.
  - 69 READER SERVICE: A source of additional information.
- 



A HARCOURT BRACE JOVANOVICH PUBLICATION



ELECTRONIC TECHNICIAN/DEALER is published monthly by Harcourt Brace Jovanovich Publications. Corporate Offices: 757 Third Avenue, New York, New York 10017. Advertising Offices: 43 East Ohio Street, Chicago, Illinois 60611 and 757 Third Avenue, New York, New York 10017. Editorial, Accounting and Circulation Offices: 1 East First Street, Duluth, Minnesota 55802. Subscription rates: one year \$6, two years \$10, three years \$13, in the United States and Canada. Other countries: one year \$15, two years \$24, three years \$30. Single copies: 75¢ in the U.S. and Canada; all other countries \$2. Second class postage paid at Dansville, New York 14437 and at additional mailing offices. Copyright 1971 by Harcourt Brace Jovanovich Publications.

POSTMASTER: Send form 3579 to ELECTRONIC TECHNICIAN/DEALER, P. O. Box 6016, Duluth, Minnesota 55802.

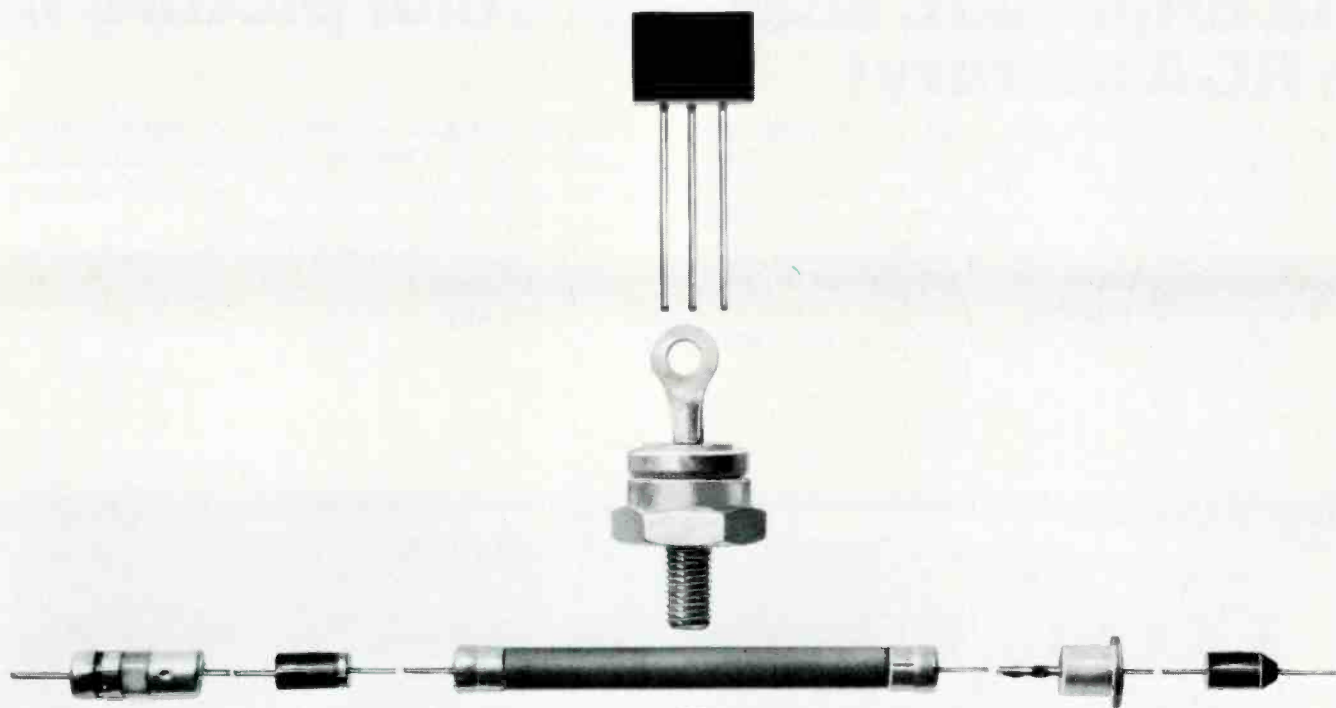

**There's  
a big  
plus...**

When you specify Mallory semiconductors. It's always been the most dependable line . . . for more of what you want, when you want it. And now there are more extras than ever before.

For one thing, we've added items to make the selection better than ever . . . from pre-tested multiple-cell rectifiers—such as the popular VB, CTN, FW, and FWL types—to hard-to-find items like our 2.5 amp rectifiers.

Then there's performance — it's even higher than before. Our rectifiers have higher forward-current capacity and lower reverse leakage. And our Zener line has higher wattage ratings and sharper knee characteristics.

And don't forget Mallory semiconductor prices: they're just about unbeatable . . . take our focus rectifiers and epoxy case rectifiers, for example.

So specify Mallory for silicon rectifiers, prepackaged rectifiers (voltage doublers, center-tapped full waves, full-wave bridges), color TV selenium rectifiers, Zener and dual-trigger diodes. Your Mallory distributor has them now.



**MALLORY DISTRIBUTOR PRODUCTS COMPANY**

a division of P. R. MALLORY & CO. INC.  
Box 1558, Indianapolis, Indiana 46206; Telephone: 317-636-5353

Batteries · Capacitors · Controls · CRIME ALERT® · DURATAPE® · Recorders · Resistors · Semiconductors · SONALERT® · Switches · Timers

. . . for more details circle 133 on Reader Service Card

# 10 million reasons why it pays to promote matrix, the brightest, sharpest color picture tube in RCA history!

Reasons 1 to 10,000,000. Large-screen MATRIX can upgrade the performance of at least 10 million color TV sets now in use. The RCA MATRIX 23VALP22 is a direct replacement for the 23VANP22, 23VARP22, 25AP22A, 25BAP22 (Chromacolor), 25BCP22, 25BGP22, 25XP22, and 45 other industry types! Giant-screen sales potential for the RCA MATRIX — practically unlimited!

More RCA Color Picture Tubes are stocked and sold by

distributors than any other color picture tubes in the industry. So, MATRIX is more readily available to you no matter where you are, to give your customers faster service and ring up more profitable sales.

MATRIX is the brightest and sharpest color picture tube in RCA history!

Here's why:

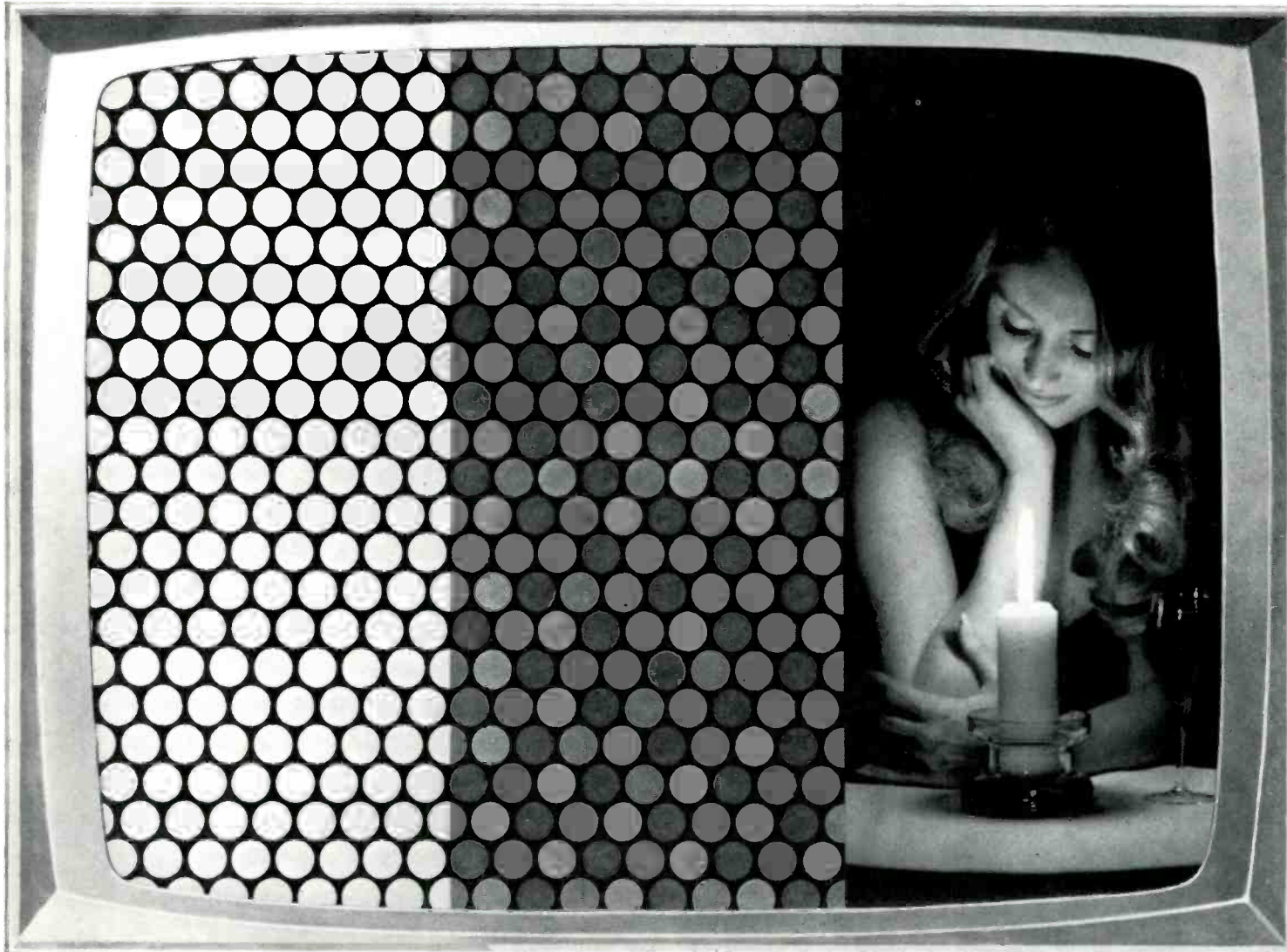

#### The RCA jet-black matrix®

It soaks up room-light normally reflected back at the viewer from the face of the tube. Result: brighter pictures because now there's no need to "filter out" brightness to maintain contrast under strong room-light conditions.

#### The RCA MATRIX phosphor-dot process\*

First, we developed brilliant new phosphors and a unique screening process incorporating a jet-black matrix. Then we deposited the 1,200,000 red, green, and blue high-intensity phosphor dots precisely within the black matrix. Result: brightness doubled with dramatic improvement in contrast and clarity.

#### The RCA MATRIX picture®

Spectacular! In operation, a new, unique high-resolution gun "shoots" the phosphors with more energy than any other gun previously available. Result: black matrix + phosphors + high-resolution gun = maximum sharpness over the entire brightness range, truer colors under all viewing conditions.



New 4-color consumer flyer on MATRIX is available from your RCA Distributor.  
RCA | Electronic Components | Harrison, N. J. 07029

\*Magnified drawing \*\*Simulated

# RCA

## Industry Involvement



ELECTRONIC TECHNICIAN/DEALER exists to serve you as a member of the electronics industry. Although Joe Zauhar's and my personal electronics backgrounds, plus our continual personal contact with others in the electronics industry, helps us maintain an awareness of your interests and needs, **that is not enough!**

You, our readers, have fortunately been a very vocal group, frequent to express your needs, interests and opinions by **either** letter or telephone. When comparing notes with other editors working in the same building, it becomes apparent that our industry is unique in that respect. Although as dealers and technicians we find ourselves placed in competitive positions, it is not the kind of competition encountered elsewhere. In other industries, the extreme jealousy over trade secrets often results in communication barriers. We, however, can be proud of the fact that those in our industry are typically congenial, having the "gift to gab," the desire to get together to "cry in each other's coffee," and warm hearted enough to care about the other fellow. In what other industry would a Readers' Aid Column—such as the one published in ELECTRONIC TECHNICIAN/DEALER—result in such good responses, promptly providing those asking for help with assistance from their fellow readers? Many a reader has sent us a note expressing surprise at the amount of help received from other readers as a result of our publishing his letter.

We appreciate your active interest in ELECTRONIC TECHNICIAN/DEALER and look forward to continuing such communication. We intend to continue to respond to your comments so that this publication will fulfill your professional needs.

It is our belief that with the increasingly complex technology that must be mastered for effective sales and servicing, ELECTRONIC TECHNICIAN/DEALER must continue to emphasize that aspect of our industry—devoting its primary attention to that subject. However, it is not enough to merely possess adequate technical skills for mastering today's and tomorrow's electronic circuitry. We are in a field which requires continual contact with the public and a good business "sense." As you have probably noticed, we recently began including articles related to that subject.

Despite the outgoing nature of most technicians and dealers in our industry, we are inclined to be quite independent in our thinking and actions. Only when faced with some common threat do we tend to ban together. Although we do care about each other, as proven by our Readers' Aid Column, the professional associations across the country represent only a small portion of our readership. We feel that this is unfortunate since these local, state and national associations are excellent for supplementing the technical and business information included in our publication, they keep us abreast of service charges prevalent in the region, help us to compare wholesale prices, make us aware of outside threats to our business and help us in petitioning for local ordinances which may offer us better protection. Some associations even offer credit plans to help improve retail sales and group insurance protection.

As a publication, we are also very interested in these associations. Unfortunately we are generally advised of meetings too late to publish that information or attend, but we are attempting to rectify this situation. We would appreciate it if you would advise us three months in advance concerning the date, location and activity planned for your association meetings. This will permit us to publish that information, thus hopefully improving industry interest and attendance. And if these meetings can be fitted into our schedule, we hope that it will be possible for us to be there with you.

*Phillip Dahlen*

## LETTERS

I suppose it is the crust left over from Christmas celebration that gives me the nerve to comment on your excellent article, "Tuned Circuit Signals."

Fig. 7 causes me some wonder that there is no crossover point, which one would expect with a two-to-one frequency input [for a single curved line (complex or not) if in the correct phase—edge on]. I also tend to think that the pictures over Fig. 19 and 20 should be exchanged.

To me, it would seem that some element of the fundamental square wave was present in the scope pictures with the exception of Fig. 19 (corrected). Since "continuous sweep" produces an even sinewave and all the inputs using triggered sweep or even the other Lissajoux patterns all show something akin to Decay—the response to a step function, I speculate that there is some unwanted pick-up.

Fourier would lead us to believe that each of the harmonics of the wave should be of constant amplitude, whatever their phase relationship to the fundamental. However, in all cases

but one there is a pattern that decays over the period of a half wave, or between the positive and negative excursion (step) of the fundamental. In my humble opinion, if the fundamental was truly filtered out, there would be some sort of pattern that would have continuity over the full period of the fundamental and not such definite "separate halves."

You state that the horizontal input in most of the illustrations was the fundamental sinewave from the generator and that there is a noticeable decay factor in each figure. But then for Fig. 21 you state that you are using the scope's sinewave sweep and I see that there is *no* noticeable decay—instead it is the pattern that would be expected when beating two sinewave frequencies in the scope (Lissajoux). It must therefore be concluded that the sinewave output of your signal generator includes higher partials and is not a sinewave at all.

Believe me, I am all for this sort of article and would not want my comments to discourage you from suggesting that such investigations are not just textbook fillers, but have actual practical value and can be reproduced on any workbench. I think it was unfortunate that you did not mention that Fig. 22 represents a 90° phase difference between the horizontal and vertical inputs and that the rotating, slanting ovals represent other phases in addition to not exactly matched inputs (frequency). These are all things that help to get the most out of a scope. Many technicians are all too prone to throw everything aside that smacks of theory, saying: "We don't have to know about that sort of thing."

JOSEPH G. BRADLEY, JR.

*We appreciate receiving your detailed letter. It is good to know that after going to the effort of digging out information for an original article there are subscribers, such as you, who are interested enough to read the material closely.*

*You are correct in stating that the photographs for Fig. 19 and 20 were transposed on page 51 of our December 1970 issue.*

*In the more conventional scope trace (Fig. 18) we see that the harmonic frequencies are subject to decay. This is not what would be expected from the Fourier mathematic model of square waves. However, this theory ignores one important reality—it assumes that all components are without internal resistance and function at 100 percent efficiency. The rate of decay observed is dependent on the tuned circuit's efficiency or  $Q$  factor. The higher the  $Q$  factor, the lower the rate of de-*

*cay. By using two resonant circuits tuned to the same resonant frequency, we can increase the total effective  $Q$  factor and reduce the rate of decay to that shown in Fig. 20 (corrected) of the article.*

*One simple analogy can help further demonstrate the limitations of the Fourier concept of square waves. A square wave can be compared to a voltage that is switched ON and OFF at a constant rate. But assume that this rate is but once every 2 sec. We can not expect the surge in current, which occurs as the circuit is switched, to be sufficient to maintain a continuous harmonic sinewave during the entire 2 sec. interval.*

*You are correct in assuming that Fig. 7 should appear looped like "a figure eight" or a diagonal line if sinewave signals are applied to both the scope's horizontal and vertical inputs and one signal is twice the frequency of the other. However, since we are instead comparing a decaying sinewave with a sinewave, the waveform shown in Fig. 7 results.*

*Although not very noticeable, some decay is apparent in Fig. 21, just as it is in Fig. 20 (corrected). The difficulty in observing the decay results from the increased  $Q$  factor of the dual-tuned circuit and not a distortion of the signal generator's sinewave output. Although not shown in the article, the EICO signal generator has a well formed sinewave output.*

*Signals of the same frequency were applied to the scope's horizontal and vertical inputs for producing the pattern shown in Fig. 22, 23, and 24. You are correct in indicating that Fig. 22 shows a 90° phase relationship while the slanting ovals represent other phase angles. These phase angles are also covered in this month's article, "FM Stereo Alignment," which begins on page 38 and will be covered in future issues.*

Ed.

## Who Needs a Tuner Wash?

Use

# QUIETROLE

## Mark II Spray Pack

The product that cleans and lubricates better than any product you can buy and has been used for more years than any product of its kind.

The Choice of "Better Servicemen" Everywhere



manufactured by

# QUIETROLE

COMPANY

Spartanburg, South Carolina

... for more details circle 119 on Reader Service Card



The extra charge is for listening to your husband tell me how to do the job.



When you need  
a Sprague component "yesterday"  
and our distributor  
doesn't have it in stock...

PRINTED BY THE STANDARD REPRINTS COMPANY, U.S.A. 2/1967 8

REMOVE COPIES 1 AND 2 FROM BOOK AND FORWARD TO SPRAGUE PRODUCTS

**SPRAGUE**  
THE MARK OF RELIABILITY

Distributor's Supply Subsidiary of the Sprague Electric Company  
**SPRAGUE PRODUCTS COMPANY**  
NORTH ADAMS, MASSACHUSETTS 01247

BILL TO \_\_\_\_\_

SHIP TO \_\_\_\_\_

CUSTOMER ORDER NO. \_\_\_\_\_

SP. PRODUCTS ORDER NO. \_\_\_\_\_

PRICE \_\_\_\_\_

QUANTITY \_\_\_\_\_ ITEM \_\_\_\_\_

**RUSH ORDER SERVICE**

ORIGINAL ORDER

*...ask him to use this form!*

Upon arriving at our factory, the order will bypass normal order entry procedures, assuring same-day shipment by air, UPS, or first-class mail, as distance dictates.

Now there's no need to waste time "shopping" for an exact replacement. Any Sprague distributor can get any factory stock item on its way in 24 hours!

**THE BROAD-LINE PRODUCER OF ELECTRONIC PARTS**



'Sprague' and '®' are registered trademarks of the Sprague Electric Co.

... for more details circle 125 on Reader Service Card

## READERS' AID

I will sell my service and lab equipment which consists of scopes, signal generators, meters, UHF generator and converters, tube tester, over 300 tubes and many other items at very

reasonable prices. All in A-1 condition.

Also I have a collector's item for sale—RCA's first all electric radio with matching speaker in a wood, table model cabinet. It uses a neutrodyne circuit with UV226, 227 and 41 tubes.

SAMUEL H. MILLER

1104 Hellerman Street  
Philadelphia, Pa. 19111

I am looking for the schematic of an organ manufactured by the Minshall Estey Organ, Inc., Brattleboro, Vt., Organ Model H. I was informed that the company had moved by the returned letter that I had mailed them. Does anyone have any information concerning where I may purchase the schematic?

GEORGE OLSEN

George Olsen TV  
13519 Westwind Drive  
Silver Spring, Md. 20904

I have for sale a set of John F. Riders Radio Perpetual Trouble Shooter's Manuals, Vol. I through Vol. XV in good condition. I will sell these by the set or by each volume at \$3.50.

RUSSELL G. SPLAR

1425 Lincoln Way  
San Francisco, Calif. 94122

I am in need of two Westinghouse IC's. Westinghouse will sell them only in lots of a thousand. Does anyone have two WC183T's they would part with at a reasonable price?

R. IWASYK

12601 Regina Lane  
Palos Park, Ill. 60464

I am in need of the schematic and instruction book for the TV field strength meter, Model A-460, made by Approved Electronics Instrument Corp., New York, N.Y. I understand this company is not in business anymore.

CHARLES C. ASMUS, JR.

2016 Rockingham Road, Apt. 1  
Davenport, Iowa 52802

I have for sale the following instruments: transistor checker, tube tester, genometer and high-voltage probes. Operating instructions and schematics supplied with each instrument. All instruments are in good condition.

LAWRENCE GARRISON

P.O. Box 59  
Wallburg, N.C. 27373

I need help. I have a 27-in. Muntz TV set, Model 2763-A, for which I need a horizontal output transformer. The part number of this unit is TO-0036. I cannot locate one in my area and there seems to be no substitute. Any assistance in this will be greatly appreciated.

RICHARD F. PENZOTTI

1901 Embarcadero  
Palo Alto, Calif. 94303



B&K  
Precision  
Model 1460  
Triggered  
Sweep Scope  
\$389.95

## B & K Precision's new 1460 Triggered Sweep Scope... the one that's been worth waiting for.

You won't believe how easy it is to sync TV-V and TV-H signals until you've actually tried it.

Trouble shooting complex TV circuits takes enough time without having to fiddle with dials and controls to adjust to the proper wave form.

That's why the new B&K Triggered Sweep Scope features the TV-H and TV-V positions. These are the two new positions you've always needed for quick one-knob selection of horizontal or vertical TV signals. Exclusive sync separator circuit. No complicated and time-consuming adjustments . . . just flick a single knob.

Fully automatic triggered sweep lets you view the entire complex TV signal or any part of it. Including the VITS (vertical interval test signal).

And the "back porch" of the horizontal sync pulse, with color burst information. All locked in rock steady.

All solid state with 6 FETS. Runs coolest. Vertical sensitivity (10mV/cm) and writing speed of 0.1 microsecond/cm (using 5X multiplier). Features usually found in expensive lab scopes. Complete with direct/10 to 1 probe. 19 sweep speeds and 11 voltage calibrated ranges, DC to 10 MHz.

Pinpoint your problems quickly and accurately with the new 1460 Triggered Sweep Scope. The only thing you'll have to adjust to is having more time on your hands. Ask your distributor or write for our free catalog.

There is a difference in test equipment—ours works!



Product of DYNASCAN CORPORATION  
1801 W. Belle Plaine / Chicago, Illinois 60613

. . . for more details circle 102 on Reader Service Card

# How Can You Make A Good Product Better - - - Without Changing It?

Simple - - - Just take a winner like **BLUE SHOWER** that comes in a bench size can for bench jobs and put it in a caddy size can for house calls.

Many of our technician friends that use **BLUE SHOWER** in the shop have wanted a smaller package to carry in a caddy for use on house calls - - - not only to clean contaminated tuners but also to clean dust from high voltage cages and other components that need to be spotless in order to function best.

**So now BLUE SHOWER comes in two sizes -  
No. 1657-12S, 12 ozs. for \$1.99  
No. 1657-24S, 24 ozs. for \$3.25**



**Either way its the best way to flush out tuners  
and restore them to like new condition.**

**TECH  
SPRAY**

makers of better chemical tools for technicians

P. O. Box 949 Amarillo, Texas • Canada: Wm. Cohen, Montreal • Export: Empire Exporters, N.Y.C.  
... for more details circle 126 on Reader Service Card

# the most practical service tool ever devised!

## SENCORE POWER MONITOR

Here is an instrument that will pay for itself in time saved the first month you use it.



PM157 \$69.50

**A** IT IS A ZERO TO 1150 WATT WATTMETER

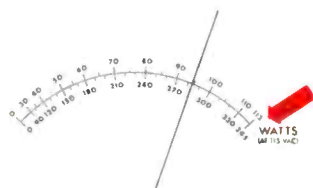

You will know whether or not you are dissipating too much power before you start changing expensive parts.

**B** IT IS AN AC LINE VOLTAGE MONITOR

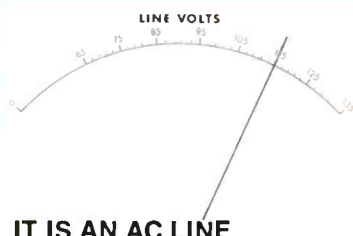

Calibrated right on the nose at 115 volts. How many times has your trouble simply been line voltage and you could have saved so much time?

**C** IT IS AN AC AMMETER TO DETERMINE HOW MUCH LINE CURRENT IS BEING DRAWN

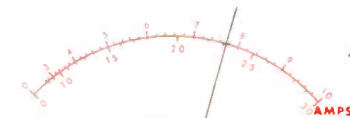

Up to 10 amps. A good check on fuses and other line protectors. How do you know that a circuit breaker is really bad?

**D** IT IS A FUSE RESISTOR CHECKER WITH SPECIAL SCALES FOR EACH FUSE RESISTOR



You will know whether or not you are sending back a TV or radio set with an overloaded fuse resistor that will go out within hours.

**E** IT IS PROTECTED BY A 10 AMPERE CIRCUIT BREAKER

Fully protected against shock hazard to appliance being tested, and is also safe for the operator. 8" x 6" x 5" 5 lbs.

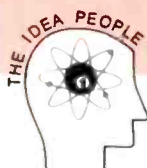

# SENCORE

3200 SENCORE DRIVE, SIOUX FALLS, SOUTH DAKOTA 57107

... for more details circle 123 on Reader Service Card

# The replacement picture tube no other color tube can replace!



Simulated TV picture

**ZENITH**  
**CHROMACOLOR**<sup>®</sup>

Now you can install the revolutionary Chromacolor picture tube in almost any brand of 23" (diag.) color TV. And let your customer see the difference: a new, sharper Chromacolor picture with greater brilliance, contrast and color definition.

Zenith pioneered, developed and patented (U.S. Patent No. 3146368) the Chromacolor picture tube. And only Zenith has Chromacolor.

Chromacolor is an easy sale because people already know of Chromacolor's superiority. (Last year, after the revolutionary new Chromacolor system was

introduced, Zenith giant-screen color TV sets became the No. 1 best-seller!)

### Full two-year warranty.

Here's your sales clincher: Chromacolor replacement color tubes are warranted for two full years. Exactly double the warranty period for most other replacement color picture tubes.

Give your customers the best — Chromacolor replacement color tubes. Only your Zenith Distributor has them.

## TWO-YEAR WARRANTY

Zenith Radio Corporation warrants the replacement CHROMACOLOR picture tube to be free from defects in material arising from normal usage for two years from date of original consumer purchase. Warranty covers replacement or repair of picture tube, through any authorized Zenith dealer; transportation, labor and service charges are the obligation of the owner.



Zenith Chromacolor picture tube pinpoints the color dots on a jet black background and for the first time fully illuminates every dot.

**ZENITH**  
The quality goes in  
before the name goes on

## NEW AND NOTEWORTHY

For additional information on products described in this section, circle the numbers on Reader Service Card. Requests will be handled promptly.



### OSCILLOSCOPE 700

*Controls are grouped on panel by function*

A Model 556A Oscilloscope is designed so that the controls are grouped on the front panel by function for more convenient use. The vertical amplifier is reportedly ac/dc coupled and fully compensated for optimum response with a sensitivity of 20mv/cm over a dc to 1.5MHz bandwidth. Specifications indicate that the instrument has a sweep frequency of from 10Hz to 100kHz in four ranges and is continuously variable in the respective ranges. The scope features solid-state circuitry and a compact chassis measuring 6¼ in. W by 10½ in. H by 17¾ in. D and weighing 18¾ lb. Price \$239. Kikusui Electronics.



### TAPE DECK 701

*Features three motors and three heads for quality recordings*

The three-motor, three-head stereo tape deck, Model 640, is said to incorporate many of the features found in the more expensive models. These reportedly include a record equalization selector switch, which optimizes performance with both standard tape and low-noise high-output tape; a die-cast tape guide and head black mounting frame for permanent alignment of critical transport components; plus front panel sound-on-sound, echo controls, and microphone and line mixing. The tape deck is said to also feature mechanical memory capability, which permits timer-activated recording, playback and shut-off, and positive-acting lever-type transport controls. Price \$369.95. Superscope.



### AM/FM TUNER 702

*Slips into all automotive 4- and 8-track cartridge players*

A new cartridge AM/FM and FM-multiplex tuner, Model 30-3075 has been designed for automotive stereo tape players. The unit will reportedly slip into the cartridge loading slot of all automotive 4- and 8-track tape cartridge players. It is powered by an internal 9v battery and slides into the cartridge slot, after being connected to the car's external radio antenna. A special antenna adapter connector is said to be included, which can be permanently left in the car's antenna line. A slide switch on top of the unit selects AM or FM modes. Price \$45. GC Electronics.

FOR MORE NEW PRODUCTS SEE PAGE 56

# FINCO 70 SERIES

COLOR TV ANTENNAS  
SPECTRUM®

NO VHF    VHF STRONG    VHF MODERATE    VHF WEAK    VHF VERY WEAK

NO UHF	All Prices Subject to Change			
70-V11	70-V17	70-V14	70-V20	70-V28
\$26.95	\$39.95	\$34.95	\$49.95	\$74.95

UHF STRONG	70-12A	70-18A	70-23A	70-23A
\$12.05	\$39.95	\$56.95	\$73.95	\$73.95

UHF WEAK	70-12B	70-18B	70-23B	70-29B
\$18.35	\$44.95	\$62.95	\$80.95	\$100.00

UHF VERY WEAK	CS-U3	70-18B	70-23B	70-29B
\$26.40	\$62.95	\$62.95	\$80.95	\$100.00

NOTE: Each model above is also available with 75 ohm coaxial cable download and compact behind-the-set balun-splitter to match antenna system to proper set terminals.

Select the antenna for your area from this chart  
**The set choice is yours...  
 the antenna choice is FINCO**

Send for free Catalog 20-556

NAME \_\_\_\_\_

ADDRESS \_\_\_\_\_

CITY \_\_\_\_\_ STATE \_\_\_\_\_ ZIP \_\_\_\_\_



**THE FINNEY COMPANY**  
 34 West Interstate St., Dept. 110-2  
 Bedford, Ohio 44146

... for more details circle 109 on Reader Service Card

# Parts - time help

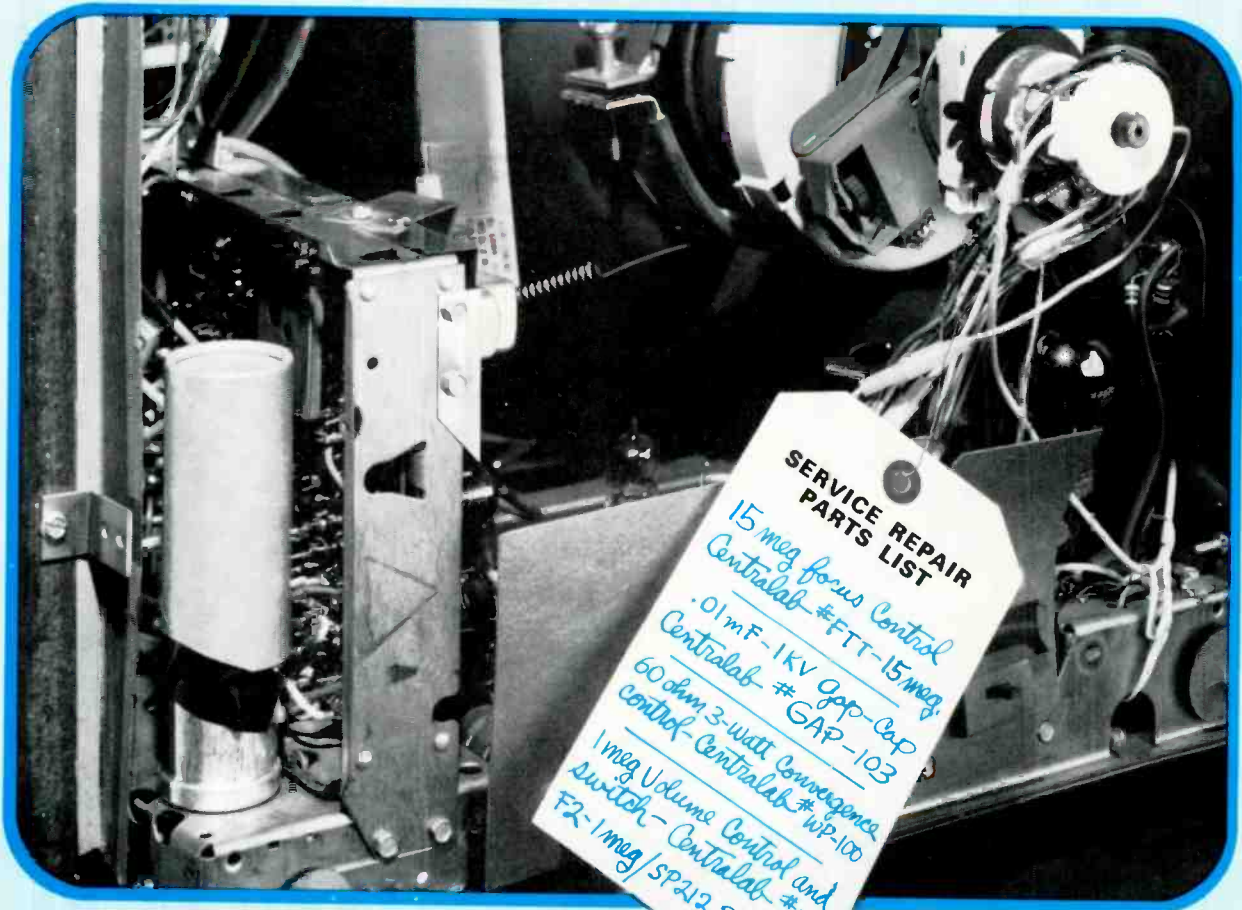

## a full-time service from your Centralab distributor

Time. It's the only way you can make your repair skills available to customers. So, the better use you make of it, the better your profit potential. That's where we can help. At parts time.

More than 1,000 Centralab distributors nationwide specialize in stocking the exact replacement components you need. And putting them in your hands fast.

Whether it's for color or black and white TV, hi-fi, stereo or radio . . . all Centralab replacement parts feature the reliability you can depend on. Our broad line includes ½ watt carbon, Fastatch® II, 3 watt wirewound controls, and miniature trimmer resistors. Plus capacitors: discs, electrolytics, polystyrenes, and Gap-Caps®. Also, a wide variety of PEC® packaged electronic circuits, and fire retardant push-pull line switches. To name just a few.

A complete listing of the replacement parts available from your nearby Centralab distributor can be found in Photofact®, Counterfact® and the Replacement Control Guide. Or, ask us to send you a Centralab replacement parts catalog.

DISTRIBUTOR PRODUCTS



**CENTRALAB**

Electronics Division  
GLOBE-UNION INC.

5757 NORTH GREEN BAY AVENUE  
MILWAUKEE, WISCONSIN 53201

. . . for more details circle 105 on Reader Service Card

DS-7105



## TEKLAB REPORT

The receiver's vertical feedback circuit, known as a Miller run-down circuit, was seldom employed before the advent of transistors, due to its high gain requirements

# Introducing RCA's Argosy Portable Color-TV Set - Part II

■ Most of the repairs that might eventually be required for this chassis can be accomplished by module replacement rather than by replacing single defective components. However, it is still important to know how each circuit functions for more effective servicing or possible module repair.

Last month's Teklab Report reviewed the RF, IF, AGC, Noise Control, Video and Kine Driver circuits, while this month we cover the power supply, and horizontal and vertical deflection circuits, which in many ways are different from comparable circuits in earlier RCA receivers. The complete schematic for this RCA CTC49 chassis can be found in the February Tekfax, Schematic No. 1342.

### Power Supply

Although the power supply utilizes a transformer, one side of the ac line is connected to the chassis. Its dc outputs and their principal uses are as follows:

- The 220v source powers the kine drivers, Modules MAD. A half-wave rectifier and an RC-pi circuit are used in supplying this filtered voltage.
- Four diodes in a bridge configuration provide two additional power sources. One of these, us-

ing capacitive filtering, supplies about 77v to the vertical-output transistors. The second is divided into separate supplies—one for the low-level transistors used throughout the receiver, the other for the audio system. Both are nominally 30v sources and both use RC-pi filters.

- A half-wave rectifier, with an LC-pi filter, is used to supply 160v to the horizontal deflection system.

As illustrated in the schematic diagram, Fig. 1, the receiver contains a rather unusual degaussing circuit. In this schematic, T101 is the power transformer (for simplicity several windings were deleted from the illustration) and S102 is the NORMAL/HIGH line switch. At "turn-on" the resistance of temperature compensating thermistor RT1 is low and the degaussing current is high. As thermistor RT1 warms, its resist-

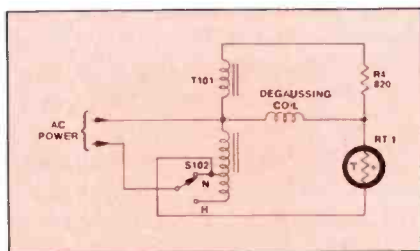
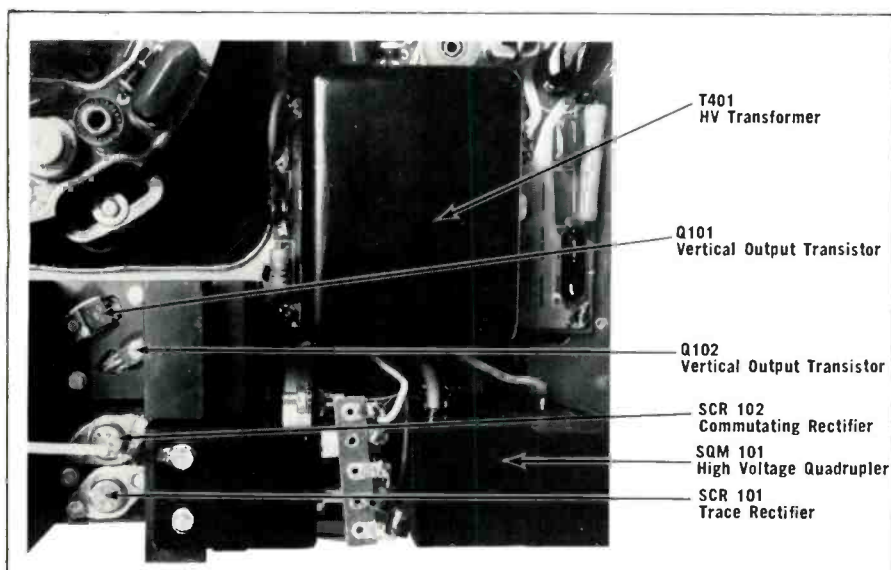

Fig. 1—Simplified schematic of the automatic degaussing circuit.

ance increases until the degaussing current approaches zero. After warm-up, the voltage drops across resistor R4 and thermistor RT1 are equal to the voltage drops across the upper and lower transformer windings, respectively; making the voltage across the degaussing coil equal 0v. The current, which still flows through resistor R4 and thermistor RT1, keeps the latter warm to maintain its high resistance.

### Horizontal Deflection Circuits

The CTC49 chassis employs a horizontal deflection and high voltage system similar to the one employed in the CTC47 chassis, which was derived from the circuits in the CTC40 chassis. However, because of the wider CRT deflection angle used in the CTC49 chassis, a more sophisticated means of correction is necessary to overcome side pin-cushion, the horizontal scan must be increased when vertical scan is near the center of the raster. In earlier RCA color-TV sets, this correction was accomplished by passive components. Since the high-voltage regulator of this chassis also controls the scan width, side pin-cushioning may be corrected by providing a second input to the regulator. This input is derived from the vertical deflection circuits and proc-



Rear view of chassis showing components employed in the horizontal and vertical sweep circuits of the RCA CTC49 color chassis.

essed by the circuit shown in Fig. 2.

To correct side pincushioning, it is only necessary to increase the forward bias of transistor Q402 when vertical scan is near the center of the raster and decrease it when the vertical scan is near the top and bottom. One output from the vertical deflection system is fed to the base of transistor Q402 by way of resistors R416 and R415 while another arrives through resistor R417. These samples of vertical deflection signal are shaped into a parabolic waveform which reaches its maximum positive potential at vertical mid-scan.

Two additional inputs from the horizontal deflection system are used to optimize this high-voltage regulation and pincushion correction. The first of these is obtained from terminal D (Fig. 3) of the high-voltage quadrupler through resistor R115, and reaches the base of transistor Q402 by way of resistors R426 and R419. It allows the regulator system to "measure" the beam current and more accurately regulate the high voltage.

The second input is obtained from terminal C of the quadrupler and reaches the base of transistor Q402 by way of potentiometer R428. This input samples the high voltage by means of the capacitive voltage divider, made up of capacitor C426 and the capacitors in the quadrupler. It compensates for phase shift of the side pincushion correction voltage,

which is the result of the capacitance of the kinescope ultor (second anode) connection.

The amount of effect which this sample from the quadrupler will have on the pincushion amplifier may be adjusted with potentiometer R428. The amplifier has been designed so that when brightness is set for a barely visible raster and potentiometer R428 is set to minimum (CCW) there will be no pincushion. Potentiometer R428 is then adjusted to correct the pincushioning, which will appear when the brightness is increased to maximum.

Unlike conventional high-voltage power supplies, which rectify a positive pulse from the flyback transformer with a half-wave rectifier, the CTC49 chassis uses a solid-state quadrupler to produce high voltage. This reduces the required pulse amplitude from about 23kv to normally 6kv. The quadrupler itself is hermetically sealed and is not repairable.

### Vertical Deflection Circuits

The vertical feedback circuit employed in the CTC49 chassis is known as a "Miller run-down circuit." This circuit was seldom used until the advent of transistors because of its high gain requirements. The Miller run-down circuit multiplies the changing capacitance by a factor equal to the gain of the amplifiers without feedback, resulting in a very linear output. Many of the

variations in supply voltage, amplifier gain, etc., which would drastically change the output of a conventional vertical-deflection circuit, would have very little effect in the Miller circuit because of the large degenerative feedback.

A schematic of the RCA CTC49 chassis vertical-output stage is shown in Fig. 4 with a simplified yoke circuit. The circuit configuration is similar to a high-quality audio amplifier. The yoke itself is analogous to a speaker voice coil, capacitor C419 to the coupling capacitor, and  $R_y$  equivalent to the total resistance of the yoke and convergence circuits. The value of capacitor C419 has been chosen to provide maximum energy transfer at the vertical scanning frequency. Feedback to the Miller capacitor is developed across resistor R13, and capacitor C10 is a filter.

During retrace, transistor Q3 is cut off, allowing its collector voltage to increase towards B+. The 65v zener diode, CR4, limits the maximum base bias of transistor Q101, serving to limit yoke retrace current. During scanning time, the bases of transistors Q101 and Q102 are driven progressively less positive at a linear rate. Conduction is through transistor Q101 during most of the retrace time and as the scan passes from the top to the center of the raster. The voltage across capacitor C419 reaches its maximum at the center of vertical scan (90° out of phase with the current), and during the lower half of the scan capacitor C419 discharges back through the yoke and transistor Q102. This current increases at a linear rate, since the forward bias on the base of transistor Q102 is also increasing at a linear rate.

The diode connected between the bases of transistors Q101 and Q102 improves the switching characteristics of the transistors at mid-scan. Transistor Q102 has no bias as long as transistor Q101 is conducting. Therefore, only slight voltage swings are necessary to cut off transistor Q101 and turn on transistor Q102 at the center of the raster. If the diode were shorted or bypassed, reverse bias would exist between the base and emitter of transistor Q102 while transistor Q101 was conduct-

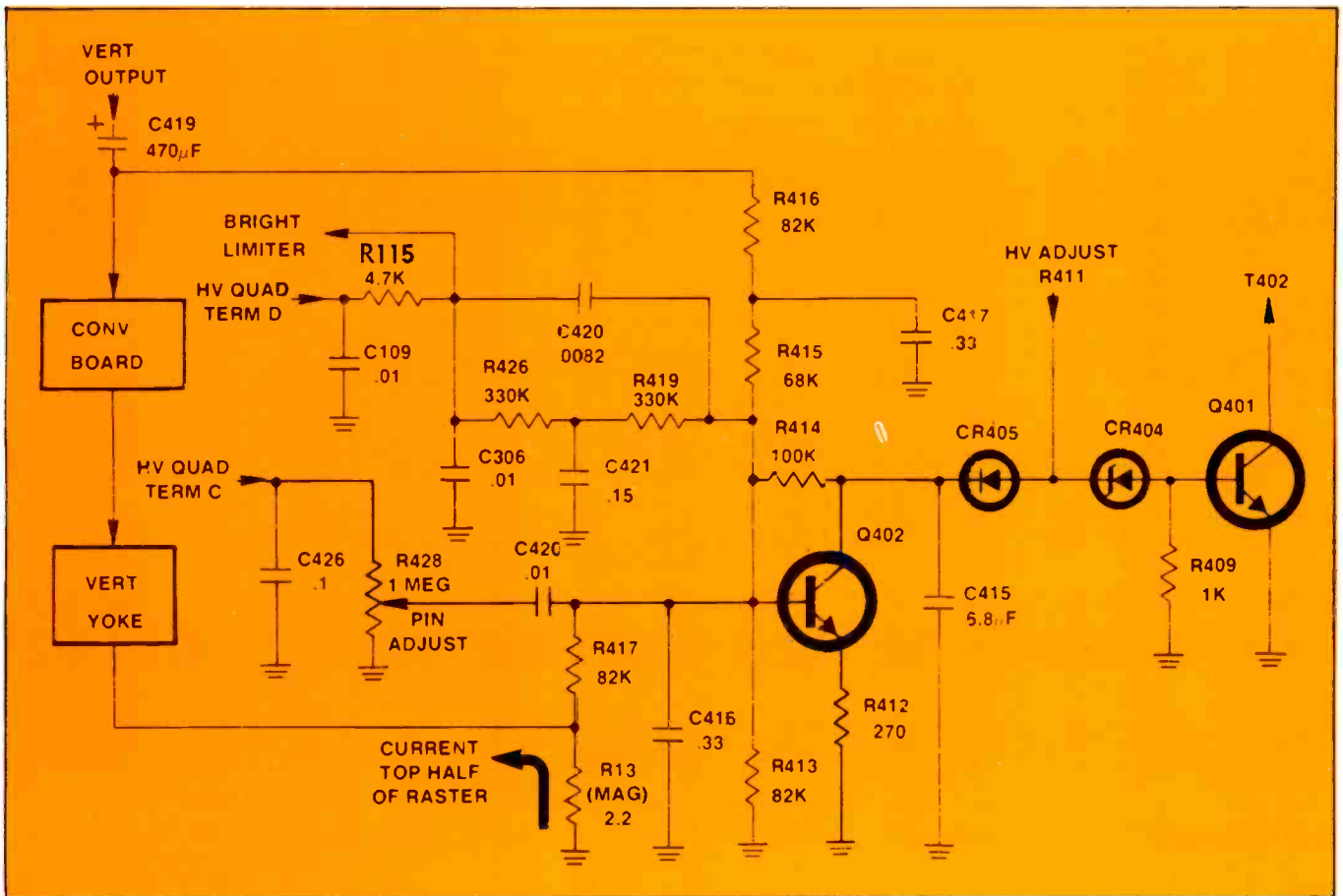

Fig. 2—Diagram of the side pincushion amplifier circuit. The high voltage regulator also controls the scan width. The side pincushioning is corrected conveniently by providing a second input to the regulator.

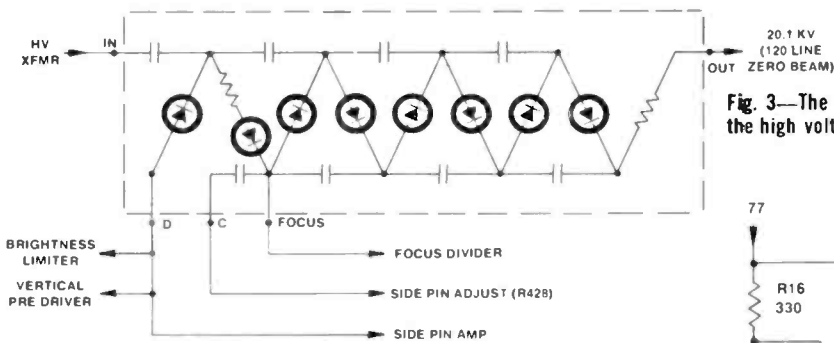

Fig. 3—The solid-state High-Voltage Quadrupler (at left) produces the high voltage. It is hermetically sealed and not repairable.

ing, and consequently there would be appreciably more disturbance in the circuit during the transition time. This probably would be sufficient to produce a white horizontal line at the center of the raster.

Connected between the two vertical yoke windings is the top and bottom pincushion circuit (Fig. 5), which is similar to the ones used in many other RCA color receivers. Horizontal yoke current passing through the primary of the Top/Bottom pincushion transformer, T404, excites a tuned circuit which

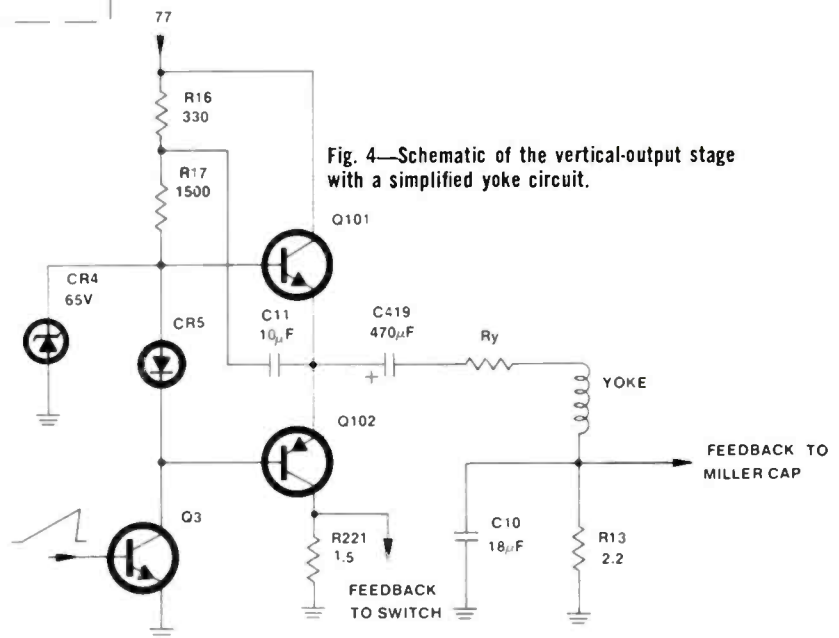

Fig. 4—Schematic of the vertical-output stage with a simplified yoke circuit.

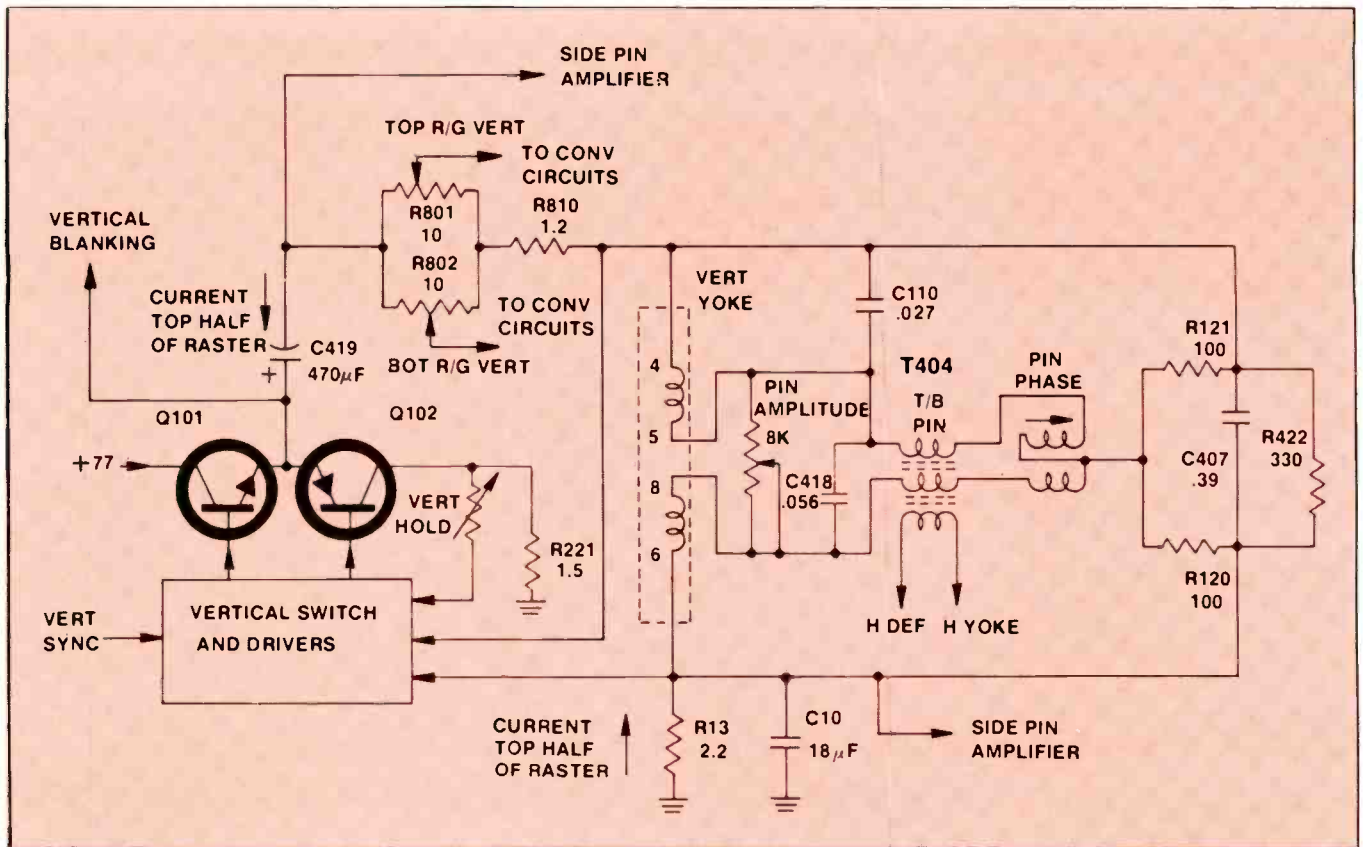

Fig. 5—Yoke circuit of the RCA CTC49 color chassis.

consists of the pincushion phase coil and capacitor C418, which is in series with the vertical yoke.

Depending on its phase, this 15.73kHz voltage may either buck or boost the vertical deflection. The core in the pincushion coil is adjusted so that vertical-yoke current is decreased at the edges of the raster and increased at the vertical centerline. The 8K potentiometer controls the amount of yoke current buck and boost, so that the inherent pincushioning is cancelled.

Passing through the second yoke winding, terminals 8 to 6, the yoke current reaches ground through resistor R13. The voltage at the junction of resistor R13 and the yoke is positive during the top half of scan and negative during the bottom half. This voltage is fed to the vertical amplifier through the Miller feedback loop and also to the side pincushion amplifier, where it is used for wave shaping.

The components of the predriver stage are physically located in a number of places in the instrument; locations may be determined by the symbol numbers. Component symbols of one or two digits (C9 and

R11, for instance) are in Module MAG. The 200-, 300-, and 400-series symbols indicate locations on boards PW 200, PW 300, and PW 400, respectively.

When comparing the vertical predriver circuit in Fig. 6 to the simplified circuit in Fig. 7, we see that transistors Q1 and Q2 have the same functions in each diagram, and capacitor C1 of Fig. 7 is analogous to capacitor C7 of Fig. 6. Resistor R2 of Fig. 7 is replaced by resistor R8, plus a number of other components also included between the base of transistor Q2 and B+.

In understanding the functions of these additional components, remember that anything which increases the positive voltage at the junction of resistors R8 and R203A will increase the raster height. Consider first the major voltage source to resistor R8, consisting of resistors R203A and R217. As the value of resistor R203A is decreased, height will increase. If the setup switch, S201, is closed to the service position, the voltage applied to resistor R8 is diminished to practically 0v, collapsing the raster.

Because transistor Q102 is cut off

while the top half of the raster is scanned, the voltage at its collector is 0v until the vertical scan reaches its center. During the bottom half of scan, the collector current of transistor Q102 increases linearly, so that the voltage fed back to resistor R8 tends to "stretch" the lower part of the raster, to overcome a tendency towards bottom compression. Feedback to the vertical-switch transistor also is derived from resistor R221.

The remaining input to resistor R8 comes from the horizontal system. As the high-voltage return current from the quadrupler to the brightness limiter increases or decreases, the voltage at the junction of resistors R426 and R320 also varies. An increase in kine current reduces the voltage to the height control, causing a slight decrease in vertical deflection. This causes scanning height to track scanning width.

The most important feedback signal in the system is fed to capacitor C7 from the junction of resistor R13 and the yoke. Ignoring the effect of capacitor C10, the voltage at this point reaches its maximum positive value at the beginning of scan, pass-

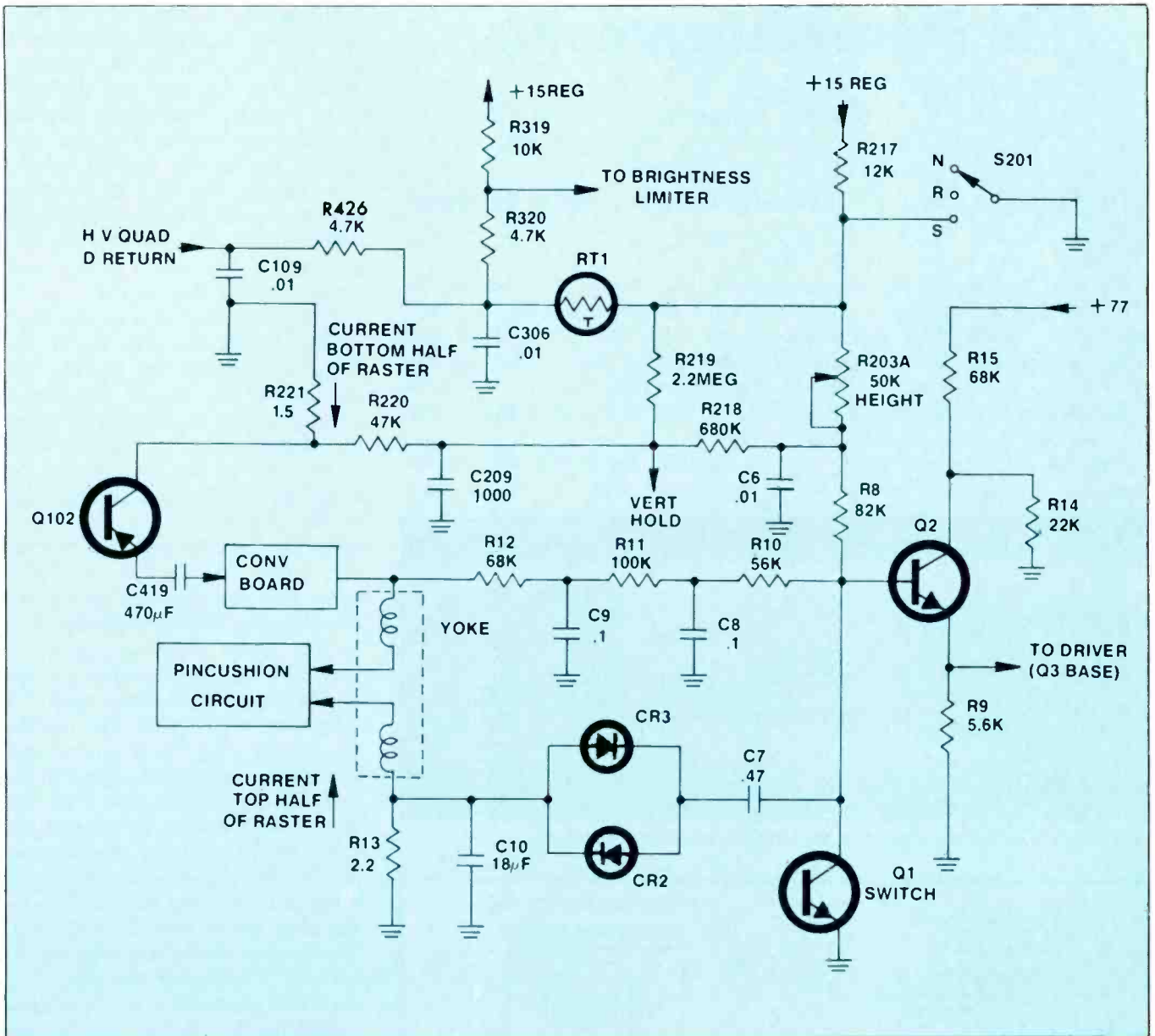

Fig. 6—The Vertical Predriver Circuit with its inputs.

es through 0v, and reaches its maximum negative value just before vertical retrace. Therefore, the feedback to transistor Q2 is degenerative, since the voltage at the base of transistor Q2 tends to rise throughout the scanning interval. Capacitor C10 is used to filter out any horizontal-deflection voltage present.

The switch transistor Q1, and its circuit (Fig. 7), perform three functions—it controls the free-running frequency of the vertical deflection system, allows synchronization with the received signal and determines the duration of vertical retrace.

Information used in this article is based on material supplied through the courtesy of RCA Sales Corp. ■

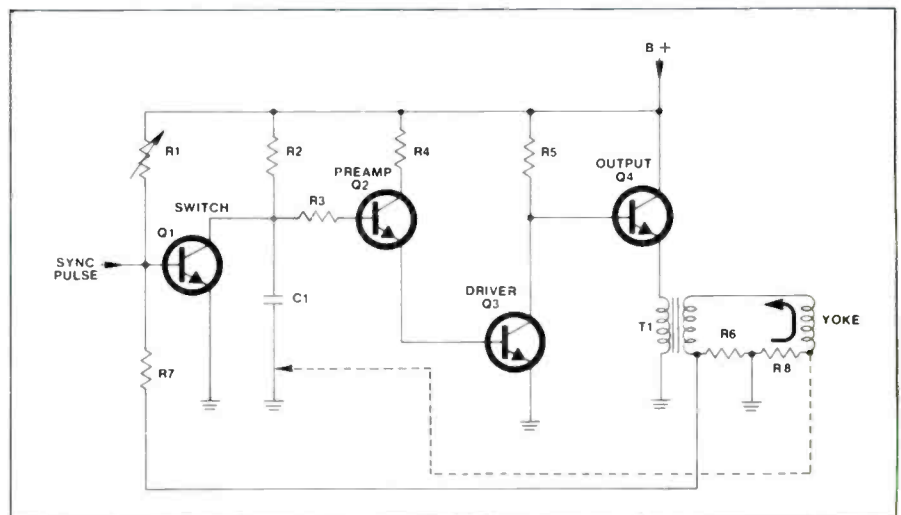

Fig. 7—A simplified Vertical Deflection Circuit.

# FM Stereo Alignment

by Phillip Dahlen

## Simple techniques for peaking a high-quality receiver

Recently a Minnesota representative of Sound Technology brought their Model 1000A FM alignment generator to Duluth to be evaluated by both the ELECTRONIC TECHNICIAN/DEALER lab and Mel's TV, a major dealer in town. Working in conjunction with Dennis Ford, an electronic technician at Mel's, we

used this instrument to supply the desired frequency-modulated (FM) signal to the antenna terminals of a Fisher 500 receiver, observing the resulting waveforms on a Telequipment Type D54 dual-trace scope (Fig. 1).

Five test leads were required for the hookup (Fig. 2). These were

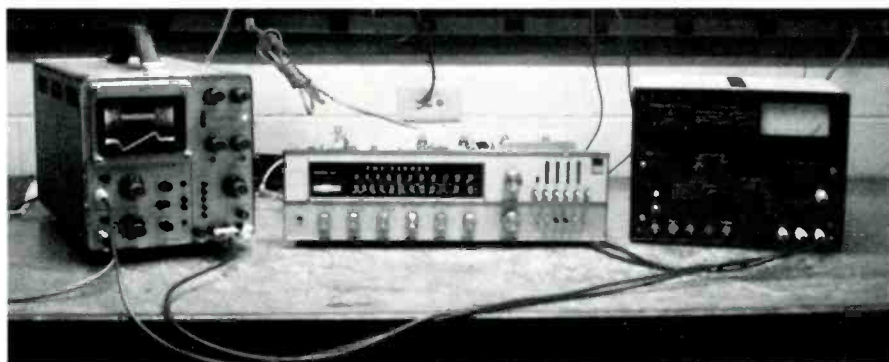

Fig. 1—Receiver and instruments used for observing FM characteristic waveforms.

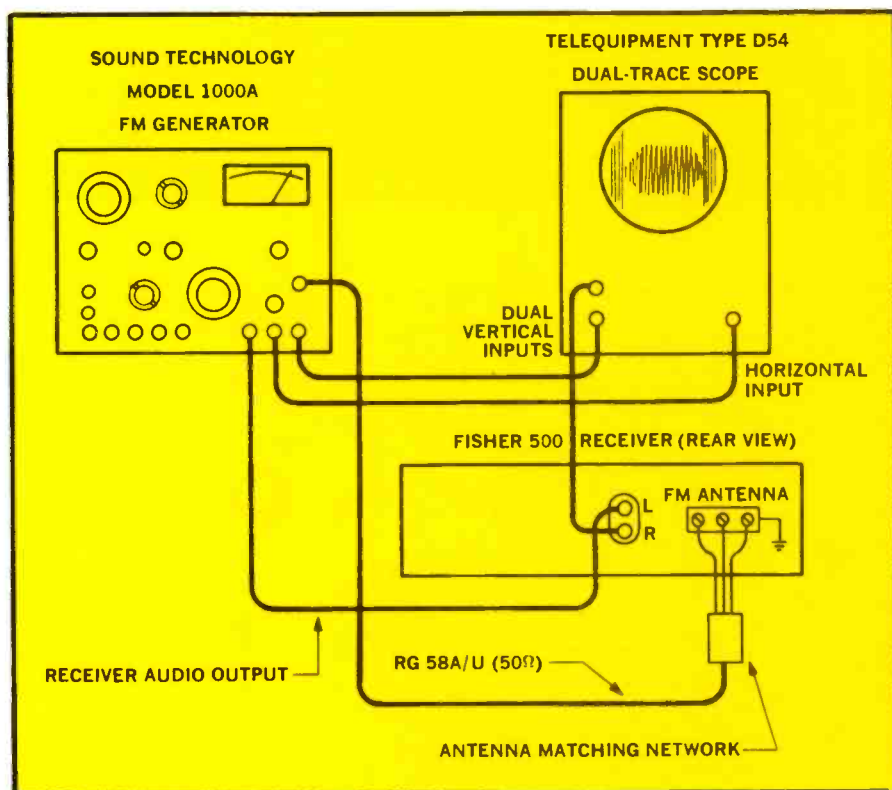

Fig. 2—Arrangement of test leads for connecting receiver and test instruments.

run between the generator's RF output and the receiver's antenna terminal, between one of the receiver's audio output channels and the generator's receiver terminal, between the generator's vertical output and one of the scope's vertical inputs, between the receiver's other audio output channel and the scope's second vertical input, and between the generator's horizontal output and the scope's horizontal input.

Unlike amplitude-modulated (AM) signals, where the audio signal is transmitted by varying the strength of the carrier frequency, FM signals are transmitted by varying the frequency of the carrier wave in response to the amplitude of the audio signal—the rate at which the carrier frequency changes corresponding to the frequency of the audio signal. The stronger the audio signal being transmitted, the greater the change in carrier frequency.

The signal generator produces both 60Hz and 10kHz signals, which are frequency modulated upon the instrument's RF signal. The oscillator control (Fig. 3) determines the amplitude of the 10kHz signal in relation to the 60Hz signal, while the sweep width control determines the amplitude of the more predominant 60Hz signal, and as a result the range of frequencies that the RF signal must cover as it is modulated. The level of the 19kHz pilot signal, used as a reference for separating the stereo channels, can also be controlled on the instrument—the test button on the instrument permitting the meter to measure the strength of this pilot signal rather than measuring the sweep width. The remaining level control determines the amount of RF signal voltage applied to the receiver, permitting a measurement



Fig. 3—Sound Technology's 1000A FM Alignment Generator.

of the receiver's effective sensitivity.

In addition to these level controls, the instrument has controls for determining the carrier frequency (some receivers are more sensitive at one end of the tuning dial than at the other), how this frequency is modulated (whether it is merely a carrier signal or contains a monaural signal, a stereo signal or an SCA 67kHz subcarrier signal, and the resulting RF waveform), and what audio signals are used (whether an external left and right channel signal is substituted for the 10kHz signal, whether only the left or right channel audio signal is transmitted, or whether a left minus right channel or right minus left channel stereo signal is transmitted).

Besides the four test-lead terminals shown connected in Fig. 2, the two left terminals on the instrument are for applying an alternate audio signal to be transmitted in place of the 10kHz signal, the third terminal can provide a 19kHz signal, the fourth terminal can provide a 10kHz signal, and the last terminal can provide a composite audio signal.

### So much for virtually all of the controls and connections, but what can they be used to show?

When the generator applies a  $1.7\mu\text{v}$  RF signal to the receiver (Fisher's rating for the receiver's sensitivity), the lower scope trace (obtained directly from the receiver) forms a straight diagonal line (Fig. 4)—its output voltage going

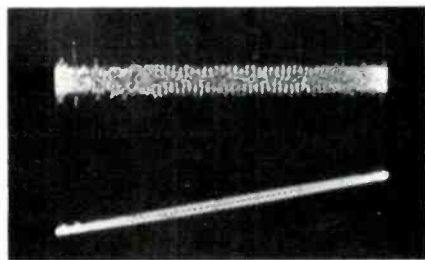

Fig. 4—Scope traces that resulted when a  $1.7\mu\text{v}$  RF signal, sweeping 150kHz, was applied to the receiver. (Upper trace is 10kHz signal obtained through generator while lower trace is 60Hz signal obtained directly from receiver.)

up as the sweep frequency rises. A small ripple may be seen on this lower scope trace. It represents the superimposed 10kHz audio signal.

In the two previous articles describing RF signals ("Tuned Circuit Signals," Parts I and II), we stressed the fact that there are occasions when it is necessary to apply a sine wave to a scope for its horizontal trace rather than using the scope's internal horizontal sweep signal (a saw-toothed wave). The scope traces shown in Fig. 4 (plus many of the other scope traces shown in this article) resulted from using a 60Hz sine wave, obtained from the generator, as the horizontal sweep signal. The phase control on the generator is adjusted so that the 60Hz vertical signal obtained from the receiver and the 60Hz scope sweep signal obtained from the generator are at such a phase angle that a diagonal line is formed. (In Fig. 22, 23 and 24 on pages 52 and 53 of the October 1970 issue we saw that when sine waves of the same frequency are applied to the horizontal and vertical inputs of a scope, a pattern forms that can look like either an oval or a circle—depending on the phase relationship between the two applied signals. The phase angles can be further shifted so that a diagonal oval, such as that shown in Fig. 24, will flatten out more and form a diagonal line—as seen in the lower trace in Fig. 4 of this article.)

As had been previously indicated, the more positive portion of the 60Hz sine wave (the higher voltage portion) is seen at the right side of the screen, while the less positive portion of this sine wave (the lower voltage portion) is seen at the left side of the screen. As the 60Hz sine-wave voltage becomes greater, the modulated radio frequency becomes greater; while as the voltage forming the 60Hz signal becomes less, the modulated radio frequency becomes less.

The 60Hz signal obtained from the receiver's other audio channel is filtered out in the generator cabinet, leaving only the 10kHz signal to appear as the upper trace on the scope (Fig. 4). This 10kHz signal, which in the receiver had been riding on the more predominant 60Hz signal, is also produced by FM variations of the RF signal. Since the 10kHz signal is not nearly as strong as the 60Hz signal, its corresponding ac voltage does not produce significant

frequency shifts of the RF signal (it is the amplitude of the ac signal voltage that determines the range of frequencies that the RF signal sweeps and not the frequency of the audio signal). Therefore, the left portion of the upper scope trace shows the 10kHz signal as it is produced by variations of lower-frequency radio signals, while the right portion of this trace shows the 10kHz signal as it is produced by variations of higher-frequency radio signals.

In other words, the 10kHz signal, shown as the top scope trace, is produced by FM variations of an RF signal which is changing in frequency—sweeping a larger frequency range than that required to produce this signal. The 10kHz signal shown in the left portion of the screen is produced by a lower radio frequency than the 10kHz signal shown in the right portion of the scope screen.

In this instance the amplitude of the predominant 60Hz modulating signal present in the generator resulted in a 150kHz sweep of the RF signal. This is about as wide a radio frequency range as the receiver could handle with the current RF input voltage and the present adjustment of its IF and discriminator tuned circuits. Note how a very slight trace of noise is apparent at either end of the two scope traces.

### These same general principles apply to most of the remaining scope traces.

When increasing the amplitude of the generator's internal 60Hz modulating signal so that the RF signal sweeps a 300kHz frequency range, the receiver is unable to handle so large an RF fluctuation and a distorted 60Hz waveform is produced at its audio output—noise appearing at

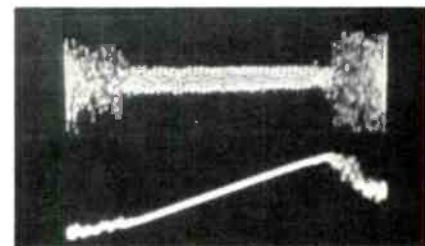

Fig. 5—Scope traces that resulted when a  $3.0\mu\text{v}$  RF signal, sweeping 300kHz, was applied to the receiver.

the left and right ends of the lower scope trace (Fig. 5) rather than an extended horizontal line representing peak maximum and minimum 60Hz voltages.

Under these same conditions, the receiver is also unable to receive the 10kHz signal carried by the higher and lower radio frequencies, and noise is therefore also apparent at either end of the upper scope trace.

In addition to increasing the RF signal sweep to cover 300kHz, we elected to increase the RF signal strength from  $1.7\mu\text{v}$  to  $3.0\mu\text{v}$ . Although so small an increase was not adequate to help the receiver cover the entire RF sweep, it did help improve the receiver's coverage. By increasing this RF voltage to  $30,000\mu\text{v}$  we were able to cover the entire

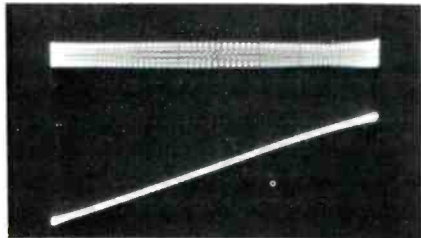

Fig. 6—Scope traces that resulted when a  $30,000\mu\text{v}$  RF signal, sweeping 300kHz, was applied to the receiver.

300kHz RF sweep (Fig. 6) with the receiver.

By adjusting the generator for a  $100\mu\text{v}$  RF signal sweeping 600kHz, the receiver distortion (Fig. 7) approximated that previously received with the lower RF signal strength and narrower sweep width. How-

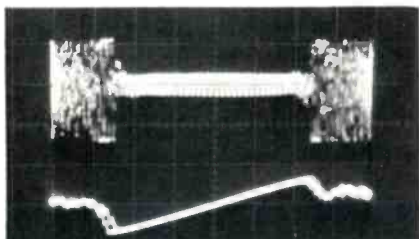

Fig. 7—Scope traces that resulted when a  $100\mu\text{v}$  RF signal, sweeping 600kHz, was applied to the receiver.

ever, in this instance increasing the applied RF signal strength to  $30,000\mu\text{v}$  did not result in the receiver adequately covering the applied FM signal (Fig. 8). (The left portion of the upper scope trace indicates that noise is present at lower

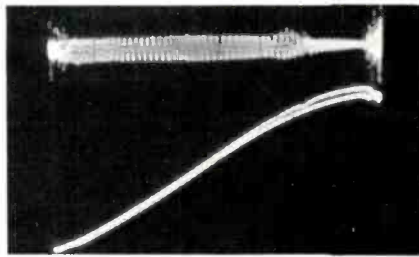

Fig. 8—Scope traces that resulted when a  $30,000\mu\text{v}$  RF signal, sweeping 600kHz, was applied to the receiver.

radio frequencies. The right portion of the lower trace indicates that the receiver is unable to receive the more positive portion of the 60Hz sine wave and there is a corresponding loss of 10kHz signal on the right portion of the upper trace. Noise is apparent near the right end of the upper trace.)

Adjustments such as these can be used to determine a receiver's sensitivity, effective RF bandwidth and the efficiency of its automatic gain control (AGC).

### This instrument can also be used to improve the receiver's IF and discriminator circuit alignment.

In Fig. 6 we saw the scope traces that resulted when the discriminator was properly adjusted and a  $30,000\mu\text{v}$  signal was applied having a 300kHz sweep width. With the discriminator still properly adjusted, a similar set of scope traces appeared when  $300\mu\text{v}$  of RF signal was applied having a 150kHz sweep width. By misadjusting the bottom tuning slug in the receiver's discriminator circuit, we obtained the distortion shown in Fig. 9. (For this and the following illustrations the scope's vertical sensitivity to the

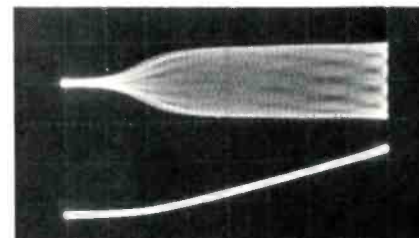

Fig. 9—Distorted scope traces that resulted when a  $300\mu\text{v}$  RF signal, sweeping 150kHz, was applied to the receiver and the lower portion of the discriminator circuit was tuned out of alignment.

10kHz signal voltage was increased so that we could more readily see how the strength of this signal was made to vary by misadjusting the discriminator circuit.) As misadjusted, the receiver became insensitive to the lower-frequency radio signals—no 10kHz signal appearing at the left end of the upper trace and the 60Hz signal's peak minimum voltage being clipped off.

With the bottom discriminator tuning slug readjusted and the top one tuned out of alignment, we ob-

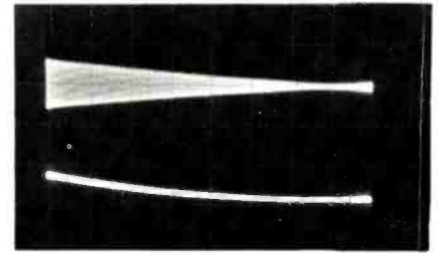

Fig. 10—Distorted scope traces that resulted when a  $300\mu\text{v}$  RF signal, sweeping 150kHz, was applied to the receiver and the upper portion of the discriminator circuit was tuned out of alignment.

tained the scope patterns shown in Fig. 10. In this instance the receiver was more sensitive to lower radio frequencies than higher ones and there was a stronger 10kHz signal appearing at the left end of the upper scope trace than in the central portion or at the right end.

Had the RF sweep width been even greater than 300kHz and the discriminator circuit further detuned, we would have seen a greater increase in the 10kHz signal at the right end of the upper scope trace, the minimum 10kHz signal amplitude appearing near the center of this upper scope trace. Even in Fig. 10 we can see a slight increase in 10kHz signal amplitude at the right end of the upper scope trace, as compared to one division to the left on the scope's gradient.

We did not elect to further misadjust this receiver's discriminator circuit, but had we done so we would have seen scope traces similar to those shown in Fig. 11. Such a pattern (had it occurred with the previous scope settings) would have indicated that the receiver was more sensitive to the higher and lower frequencies swept by the RF signal

*continued on page 60*



# Sweep Alignment Pointers

by Jim Smith

Although many articles have been written in the past on how to use a specific sweep generator or how to align a certain TV chassis, the reasons for the shape of the IF amplifier response curve and important related information have generally been lacking. It is important to know why the response curve is shaped the way it is and what effects will occur when it is not shaped properly. Understanding a few basic points about sweep alignment will make the alignment of any TV set both faster and easier

■ The IF amplifier response curve is the most important response curve in a TV set. The shaping of the signal in the IF strip will determine

whether the receiver will pass color, sync in properly, have ghosts or ringing in the picture. It is also in these circuits where the greatest change will occur as the set ages.

An ideal IF amplifier response curve is shown in Fig. 1. Although it is not a "text-book curve" (as in Fig. 2), it does come very close. Some of the newer receivers, such as Zenith have a

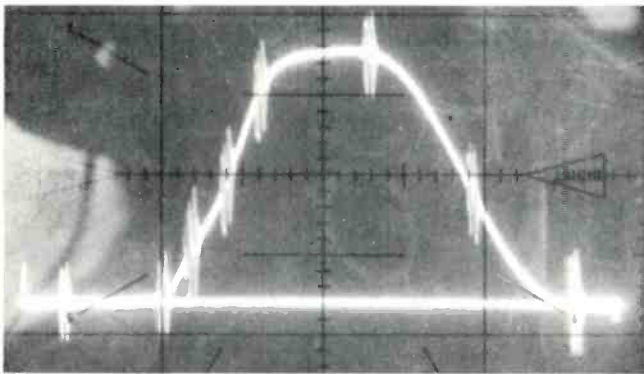

Fig. 1—Ideal IF amplifier response curve obtained from a TV set.

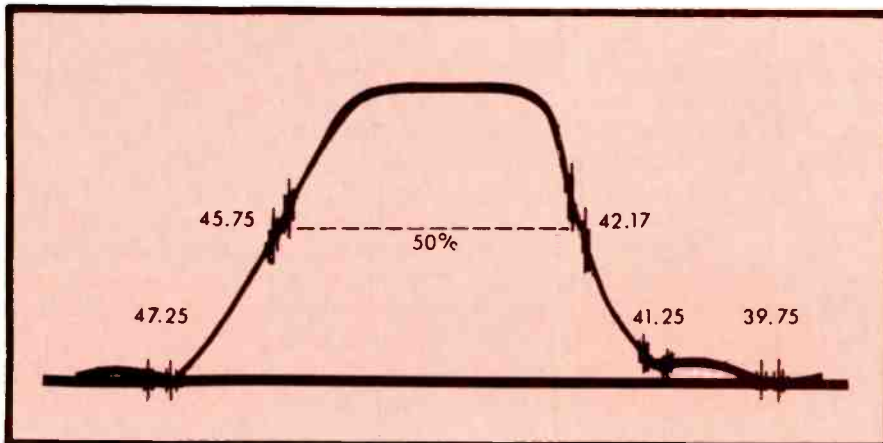

Fig. 2—"Text-book" type illustration of what an ideal IF amplifier response curve should look like.

rounded or "hay stacked" curve.

For most receivers it is best to have the alignment instructions so that the actual shape of the curve is known as well as the location of the adjustments in the receiver. However, when doing alignment work it is best to strive to get as close to the ideal curve as possible without spending too much time on the alignment. In most cases, coming "close" can result in a fairly good job of alignment, but the more alignment experience gained, the easier it is to approach the ideal curve.

## Marker Positions

The 45.75MHz video carrier signal should be seen halfway up the leading edge of the response curve. However, this marker position for that frequency may vary between 40 and 50 percent of maximum amplitude without affecting the picture. If the marker falls below the 40 percent level, some difficulty may be encountered with the sync; while if it rises above 50 percent, ringing in the picture, tunable ghosts and a poor picture will result.

If the marker appears as in Fig. 3, the slope of the video portion of the response curve will not be straight between the 47.25MHz and 45MHz points. The TV set will then experience the same difficulties as those previously mentioned.

The position of the 45MHz point on the response curve is not critical and can vary slightly just as long as the video portion of the curve remains horizontal. This point can be easily found since it will fall on the curve exactly halfway between the 45.75MHz video carrier and the 44.25MHz marker. With some of the haystacked curves in the newer receivers, it is normal for the 44.25 MHz marker to appear near the top of the curve on the video carrier slope.

There are some cases when the 47.25MHz adjacent-sound trap may be misaligned without causing any trouble in the TV set. However, Fig. 4 shows a condition in which the trap can cause poor sync conditions by reducing the straightness of the video slope on the response curve, as well as reducing the low-frequency signals applied to the video detector. The alignment of this trap is

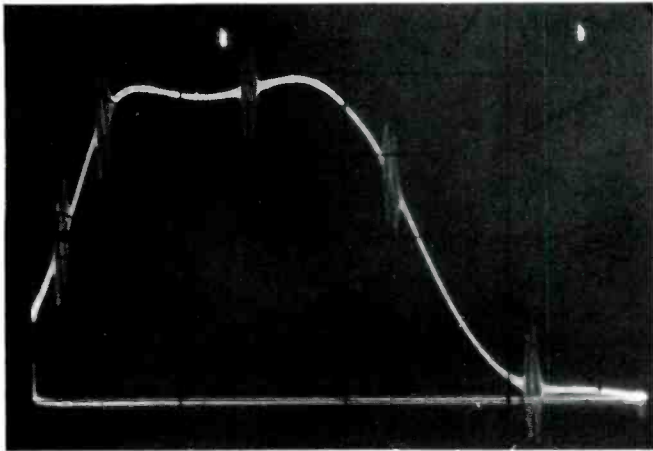

Fig. 3—A dip at the top of the IF amplifier response curve may result in ringing in the picture, tunable ghosts and a poor picture.

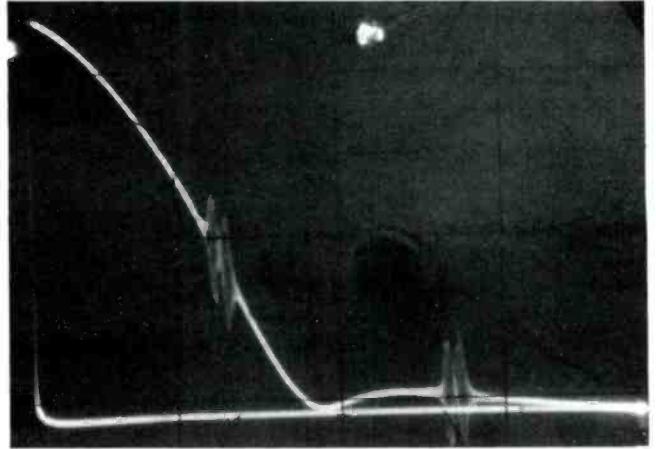

Fig. 4—The sound trap can cause poor sync conditions by reducing the straightness of the video slope on the response curve.

very critical in TV sets connected to cable systems since they are subject to interference not normally encountered during the reception of "free-air" signals.

The color slope of the IF amplifier response curve is very important and demands as much attention in a color-TV set as does the video slope. Fig. 5 shows the positions of the color markers as they should normally appear on the response curve. If the 42.67MHz marker is allowed to fall below the 20 percent relative amplitude limit or is filtered through the 41.25MHz sound trap as a result of misadjustment, not all of the color information will reach the chroma bandpass amplifier, resulting in weak colors on the screen. However, if the 41.67MHz marker rides on the flat portion of the IF amplifier response curve, or above the 80 percent point as shown in Fig. 6, the same trouble may result but with the additional possibility of ringing or a ghost effect in the picture. Slight variations in the color slope portion of the response curve can be compensated for with the chroma bandpass amplifier if the markers are close to their proper location.

The chroma bandpass amplifier has an unequal response that is opposite that of the color slope of the IF amplifier. As a result, the response curve of signals at the output of the chroma bandpass amplifier is flat, and information of uniform amplitude is fed to the color demodulators.

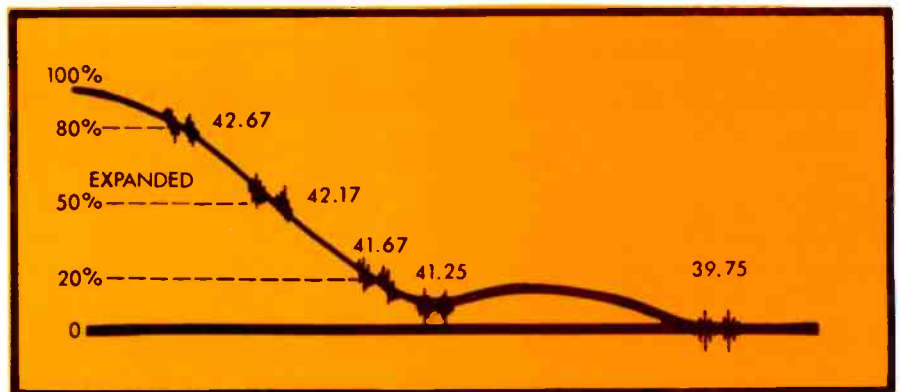

Fig. 5—Relative positions of the color markers as they should normally appear on the response curve.

### Alignment Procedures

The traps in a TV set are very important and should be adjusted before any other alignment is performed. Generally, the 41.25MHz sound trap is the one that will be found to need a slight touch up. Misalignment of this trap will cause sound bars to appear when the picture is properly tuned in, or a smeary picture if the sound is tuned out of the picture. The adjacent-sound trap will upset the slope of the video curve and, as explained previously, also cause smear in the picture.

Alignment of the 41.25MHz sound trap can be made easier by tuning to center the 41.25 marker and setting the scope's sweep width to about 1.5MHz. In this manner the IF amplifier response curve is enlarged and its dip becomes more apparent for trap adjustment. From

the resulting scope trace, shown in Fig. 7, we see the 41.25MHz marker above the dip caused by the trap. This indicates that the trap is out of alignment and that in this case the sound signal is not being filtered out as it should.

Fig. 8 shows a chroma bandpass amplifier response curve with the 3.08MHz and 4.08MHz markers at equal amplitude. This is the response curve seen when the sweep-marker signal is injected into the IF test point in the tuner and the signal is passed through both the IF and chroma bandpass amplifiers. If instead the marker-sweep signal is injected into the chroma bandpass amplifiers, as recommended by several manufacturers in their older alignment procedures, the unequal response curve shown in Fig. 9 will result. This unequal response of the

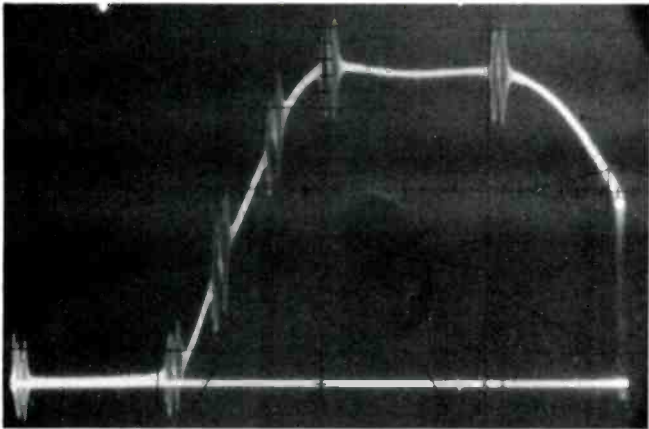

Fig. 6—If the 41.67MHz marker rides above the 80 percent point not all of the color information will reach the bandpass amplifier and there may also be ringing or a ghost effect in the picture.

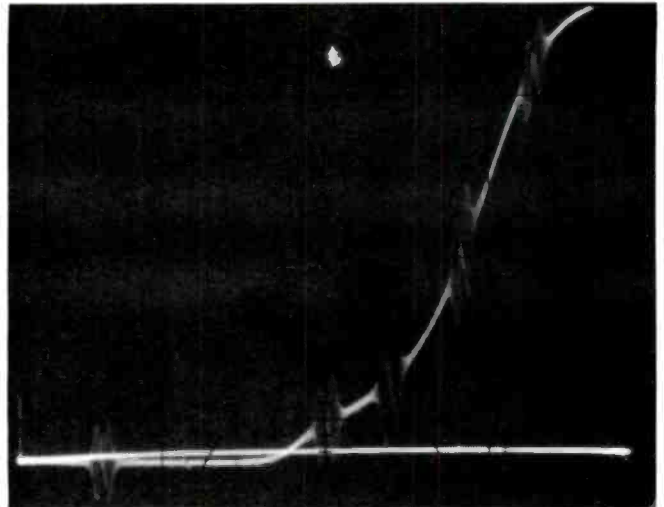

Fig. 7—The 41.25MHz marker appears above the dip caused by the trap, which indicates that the trap is out of alignment and that in this case the sound signal is not being filtered out as it should.

chroma bandpass amplifier matches the unequal response of the color slope on the IF amplifier response curve, as explained earlier. The best procedure, which is also recommended by most manufacturers today, is to align the chroma bandpass amplifiers for a flat output curve when passing the sweep-marker signal through both the IF amplifier and the chroma bandpass amplifier—just as the normal color signal would have to pass through both. This results in greater accuracy when aligning the chroma bandpass amplifier.

There has been some question concerning the 4.5MHz sound trap since many procedures are given for aligning this trap which fail to include any explanation as to what is happening. The 4.5MHz trap is located after the video detector and cannot be aligned with the normal IF sweep-marker curve. However, this trap can be aligned by watching the chroma bandpass amplifier curve and the 4.5MHz marker; and then adjusting for a minimum gain from the base line of the marker or by watching the dip as was done when aligning the traps in the IF response curve. This makes it a simple trap to align after learning where it is and when to align it.

### Conclusion

Sweep alignment is a very important tool as it can correct the picture in many TV sets that have troubles which seem "sort of way out." But sweep alignment, like anything else,

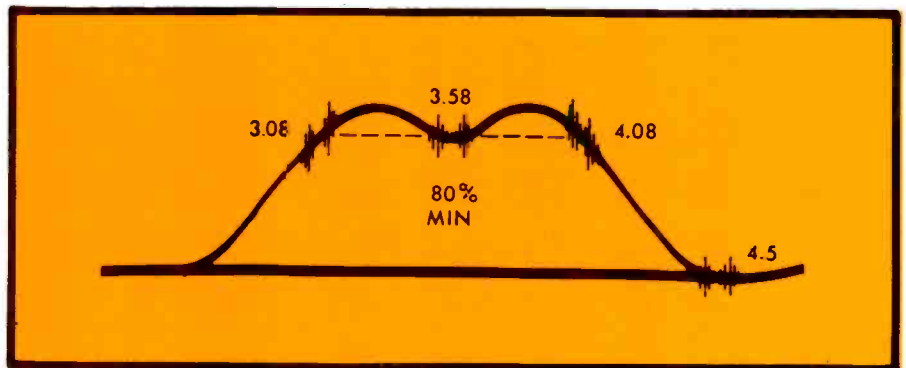

Fig. 8—By feeding the sweep-marker signal through both the IF and chroma bandpass amplifiers, the 3.08MHz, 3.58MHz and 4.08MHz markers appear to all be of equal amplitude.

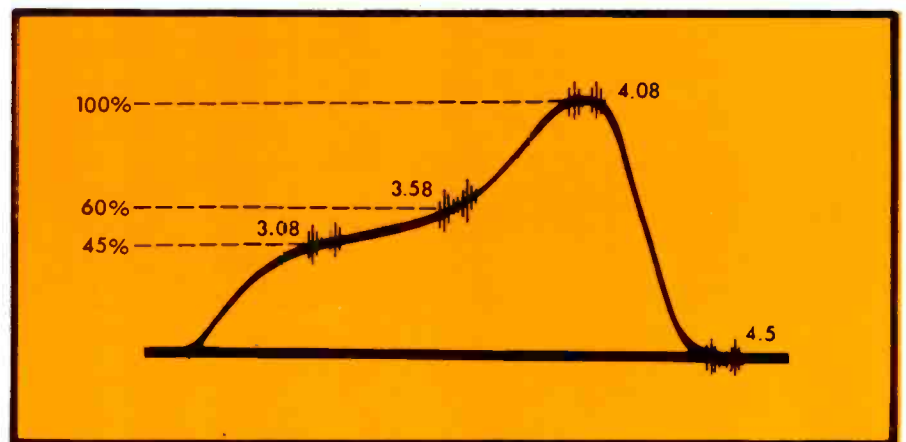

Fig. 9—By feeding the sweep-marker signal through only the chroma bandpass amplifier, an unequal response curve results. This curve matches the unequal response of the color slope on the IF amplifier response curve.

must be practiced if it is to be done proficiently. With more practice, it can be done faster, and the customer will be pleased with a better job. Providing customers with cleaner and sharper pictures will more than pay for itself in days to come. ■

## **GUEST AUTHOR**

# The Independent Dealer-Distributor Relationship

by Arthur M. Effron

Keeping this relationship satisfying and viable is not only a challenge to the manufacturer's marketing effort but also a daily test of every supplier's professional concern for future market growth.

■ Although our approach to market promotion emphasizes a close relationship between the independent service dealers and the distributor, compatibility here is not entirely contingent on product line, pricing and service. There is another element that is certainly worthy of

attention—incentives.

Sales incentives are used for many reasons. Among these is the need to help remind dealers and distributors that they are receiving advertising and service support, plus high-quality, reliable products that are supplied for their customers.

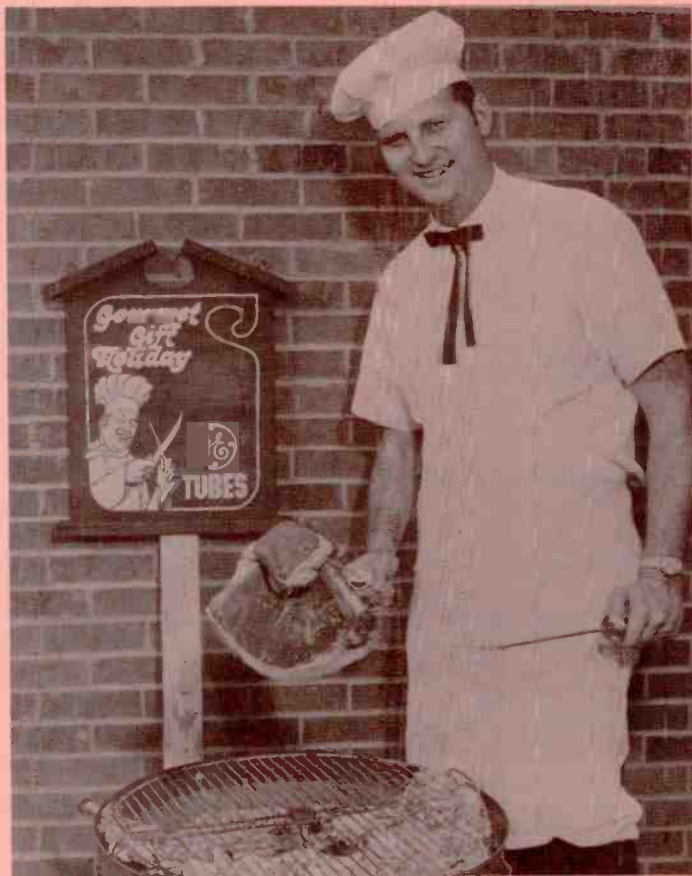

Art Effron makes ready a prime steak from one of the gift offerings in General Electric's promotional program. The author is a district sales manager in Los Angeles for General Electric's Distributor Sales Operation, Electronic Components Sales Dept. Prior to this appointment, he was manager of advertising and sales promotion for General Electric's Tube Products Dept. in Owensboro, Ky. He is a graduate of the University of Cincinnati and has spent more than nine years in the electronics industry.

The best incentives are not found in novelty shops, but instead they should feature the same built-in quality as the product line sold. Incentive programs are usually keyed to major holidays, vacation periods and sports for greatest appeal. Such programs work particularly well during prime selling seasons.

The key to the success of many promotions today is coming up with *quality, name-brand* "bonus items" or incentives with *immediate* attraction. Above all, do not offer junk.

Items that we have recently used successfully include luggage; name-brand cameras, pocket radios and hams; and coupons redeemable for gas at national-brand stations. Each had instant appeal and was convenient and easy to use.

Now I suppose it would be easy to stop here and ignore such "minor" points as what the distributor really wants or needs in terms of his local market, or whether or not he will consider one line of products over the competitors. After all, the market effort is one thing, while your product image is another.

As we well know, distributors often follow the path of least resistance and "push" a product simply because it is overstocked, there is a promotion program going on, they have just been briefed on how to sell it, or it is "new." Or, they will sell the dealer the brand he specifies, without even thinking to recommend a better value.

We think this viewpoint can be changed by combining quality services and products with quality incentives—often something of value, something worth working for, something worth taking home to the family. Better yet, offer more than one item.

There is no doubt in my mind that dealers and distributors often are quite selective in over-the-counter marketing. But once the dealer and distributor taste the fruits of a sound, well-planned marketing program offering the best in incentive products and sales opportunities, they will certainly consider the corresponding manufacturer's products again when placing future orders. And that is what it is all about. ■

## TEST INSTRUMENT REPORT

# Heathkit Model IB-101 Frequency Counter

by Phillip Dahlen

Operational simplicity  
was apparently one  
of the goals of the  
instrument's designers

■ Obtaining precise frequencies is a must for today's electronic technicians. FM multiplex receivers must produce 38kHz signals that are in phase with the pilot signal, color TV sets must generate a 3.58MHz continuous wave signal in phase with the color burst signal. And last month's article, "Commercial Two-Way Radio," told of all the frequencies available for business use, which must be precisely tuned. These and many other similar applications require the availability of a precise frequency counter for calibration purposes.

The IB-101 counter uses digital



Fig. 1—Heathkit's Model IB-101 frequency counter. For more details circle 900 on Reader's Service Card.

integrated circuitry to provide counting from 1Hz to reportedly over 15MHz with the elimination of divider chain adjustments. Specifications indicate that an overrange indicator and Hz/kHz switch gives the instrument's five cold-cathode display tubes the same capability as a more expensive eight-digit counter. This means that with the use of that range switch you should be able to make such frequency readings as 14,857,236Hz (a number taken at random to indicate the possible capability).

The input circuit uses a dual-gate, diode-protected MOSFET that is designed to provide proper triggering levels from less than 100mv to greater than 200v without any input level adjustment. The input impedance is said to be 1M shunted by less than 20pf to minimize circuit loading and error.

The \$199.95 kit includes a double-sided circuit board, dual primary power transformer, 26 integrated circuits, 7 transistors and 5 cold-cathode display tubes, plus many related components. ■

Fig. 2—Although the instrument contains complex circuitry, components are well arranged to simplify construction.

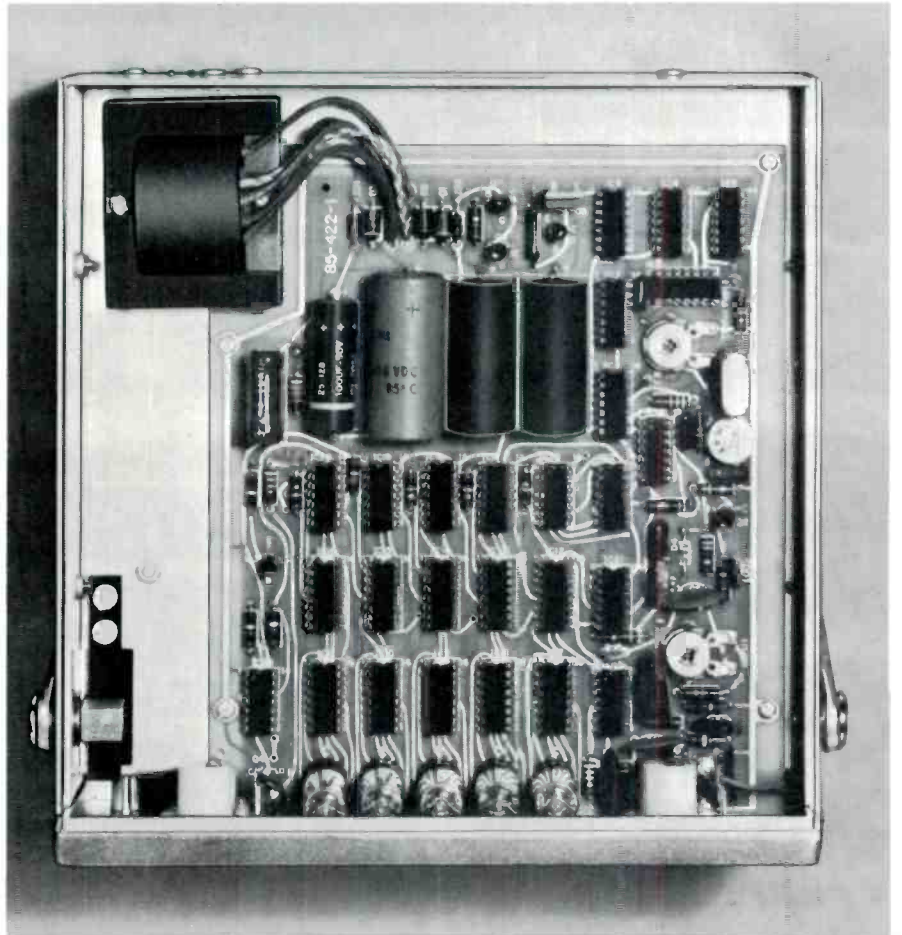

**“We need three Yellow Pages ads to cover our business.”**

“We advertise under washer-dryers, television, and vacuum cleaners. That way, whatever a potential customer needs, he’s bound to run across us” explains Albert Carlson, of Barn Appliances, Fenton, Michigan. “In a small area like this you have to build up a good reputation, and you have to stay in contact with people. One of the best ways to do that is in the Yellow Pages. We stress service after a sale. It’s one of our key points in our Yellow Pages ad. That way customers know we stand behind what we

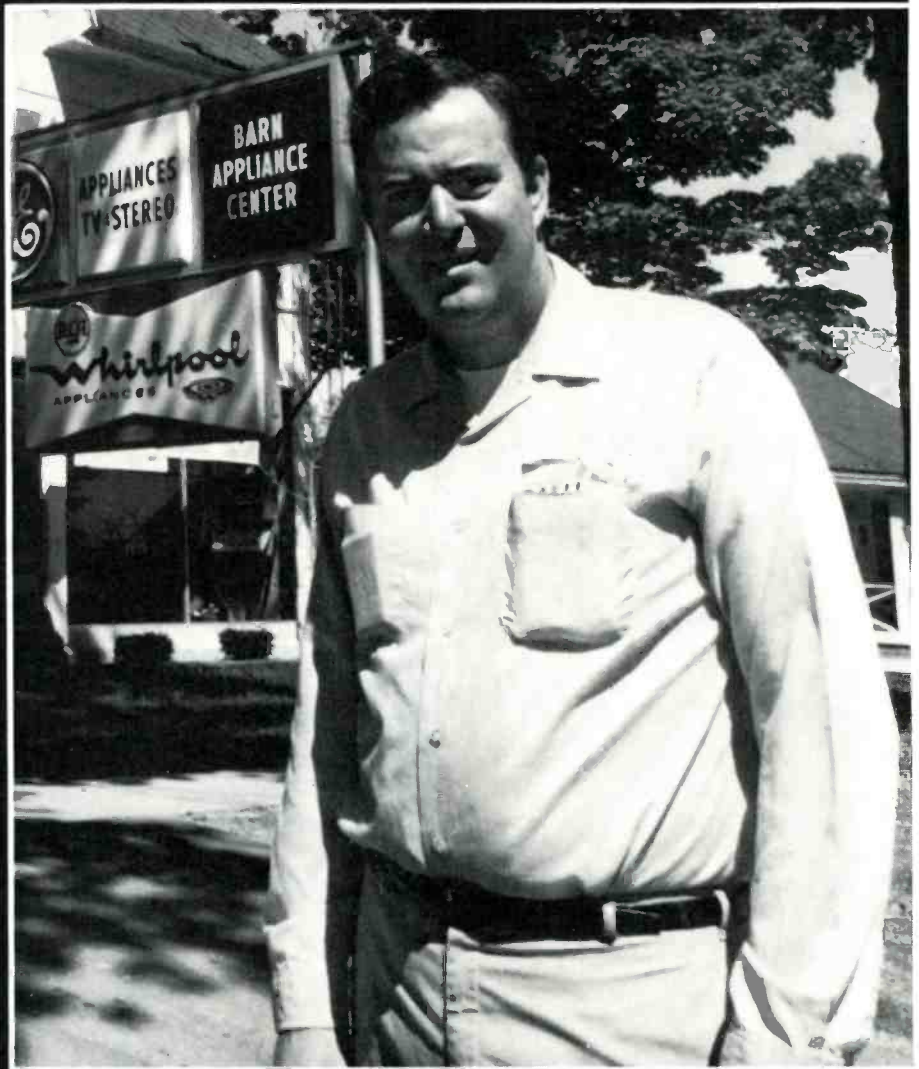

sell. We’ve been advertising in the Yellow Pages for 13 years now, and its brought us nothing but good customers.”

Let the Yellow Pages do your talking. People will listen.



*An effective way to build business.*

# Only the best-selling van gives you all these better ideas



### Easy, out-front servicing.

Simply raise the convenient outside hood and your routine service points are

right at hand: radiator, oil level, battery, windshield

washer reservoir, voltage regulator, wiper motor, brake master cylinder. Better ideas make servicing fast, easy.

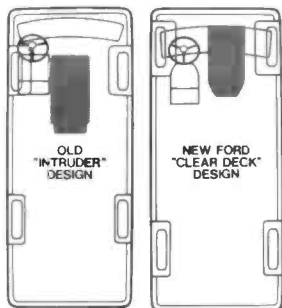

### Engine clear forward.

The engine is moved forward in Ford's clear-deck van—all the way out of the cargo area. Clear floor space behind driver's seat measures over 8½ ft. in Econoline Van . . . over 10 ft. in the Supervan.

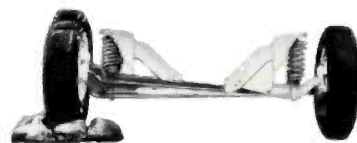

### Strong, smooth-riding

**Twin-I-Beam.** The independent front suspension that has revolutionized truck riding qualities. Two forged steel I-beam axles give it strength . . . big coil springs give it a smoother ride.



### Biggest payload of all.

Husky construction and high capacity axles allow you to carry a heavier load than any other van. Maximum payload of 4320 lbs. is largest in industry.

Sales leader for 10 straight years.

Model	Max. Payload	Max. GVW
E-300	4320 lbs.	8300 lbs.
E-200	1800 lbs.	5400 lbs.
E-100	1120 lbs.	4500 lbs.

### Shorter outside, easier to park.

Overall length of Econoline Vans is significantly shorter than other makes. This means easier parking and better maneuverability in city

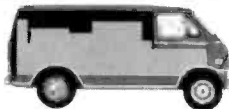

delivery operations —time saved on every trip.

### Wider at top for built-ins.

Body sides are more vertical, wider apart at top than other vans. So built-in units fit better and leave more aisle. Modular units, designed to fit and work together allow you to custom design almost any interior you need. Job packages, such as insulated florist's van, are also available.



### Driver's "walk-thru" to rear.

Econoline's forward engine position clears the deck for the driver, too. He can easily step from his seat into the rear load area and exit

through side or rear doors. See your Ford Dealer and see all the better ideas in America's best-selling van—Ford Econoline.



A better idea for safety: Buckle up.

## FORD ECONOLINE VANS



. . . for more details circle 110 on Reader Service Card

# TECHNICAL DIGEST

The material used in this section is selected from information supplied through the cooperation of the respective manufacturers or their agencies.

## OLYMPIC

### Table Radio Models 32/33/34/35—Service Hints

- Symptom:** Weak sound output, no distortion discernible.
- Correction:** Check the following electrolytics by substitution: C47, C55 and C56.
- Symptom:** FM inoperative.
- Correction:** Check transistor Tr-1 and the following electrolytics by substitution: C3 and C10.
- Symptom:** AM reception weak, FM inoperative.
- Correction:** Check the following electrolytics by substitution: C27, C33 and C19. Also consider a transistor defect whenever the forward bias exceeds 0.4v.

### Solid-State TV Model 9P59—Service Hints

- Symptom:** Loss of raster within first 30 min. of operation.
- Correction:** Replace resistor R514, a 1.5Ω, ½w base bias resistor in the horizontal output stage.
- Symptom:** Critical vertical sync lock and/or complete loss of vertical and horizontal sync.
- Correction:** Check sync transistors Tr-18 and 19. Also check by substitution capacitor C405, 10μf at 25v.
- Symptom:** Picture flagging at top of raster.
- Correction:** Replace capacitor C503, 3μf at 6v located in

Anti-Hunt network of the Horizontal AFC circuit.

- Symptom:** Picture bending and distorted.
- Correction:** Replace capacitor C805, a dual section electrolytic in the power supply.
- Symptom:** Weak sound output.
- Correction:** Check the following electrolytics capacitors by substitution: C323 and C320 located in the audio-amplifier circuitry.
- Symptom:** Fine grain appearance in video (4.5MHz beat).
- Correction:** Realign the L201-trap coil. Refer to service manual for alignment instructions.

### Model 327 Stereo Chassis—Service Hint

**Symptom:** Whenever this chassis is separated from cabinet wiring harness, as during shop service, it will be necessary to install a jumper wire between pins 2 and 4 of the remote speaker socket to secure stereo speaker operation.

## RCA SALES CORP.

### TV Chassis KCS179/KCS183—Sync and Noise Cancellation Circuit

This receiver's sync section consists of the sync-separator stage and the noise-cancellation stage. Under normal signal conditions, the sync-separator tube, V201B, and the noise-cancellation transistor, Q201, are conducting.

A positive-going signal from the video output stage is coupled through resistor R224 and capacitor C246 to the RC network made up of resistor R248 and capacitor C235.

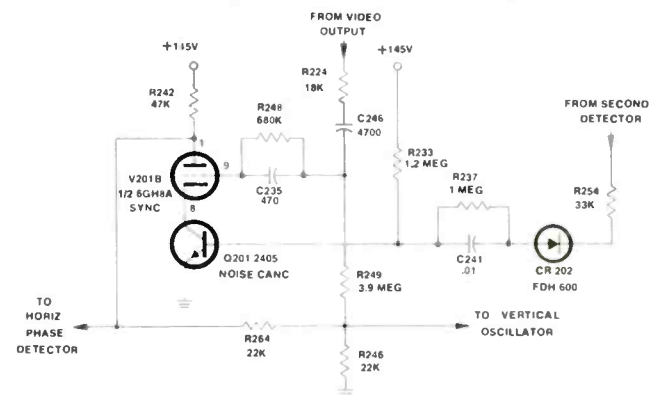

The signal bias developed by this RC network sets the operating point of the tube, allowing the tube to conduct during sync-pulse time only.

A negative-going video signal from the second detector is coupled through resistor R254 and diode CR202 to the RC network, consisting of resistor 237 and capacitor C241. This RC network sets the cutoff point of the transistor at the sync-tip level.

Under normal signal conditions, both stages are conducting, providing sync pulses to the vertical and horizontal oscillators. Since transistor Q201 is operating just short of cutoff at the sync top level, any pulse, such as a noise spike, which drives the base of the transistor more negative than the sync tip will cut off the transistor. With transistor Q201 cut off during a noise spike, the conduction path of the sync amplifier tube V201B is open, deleting any output from the sync separator during the noise-pulse time; thus maintaining stable vertical and horizontal synchronization.

## TRUE TRIGGERED SWEEP OSCILLOSCOPE/VECTORSCOPE

### MODEL TO-50

- DC to 10 mhz frequency response
- .02 volt sensitivity
- Calibrated vertical attenuator
- Calibrated time base
- Supplied with combination direct/locap probe
- 5 X magnifier
- Automatic triggering mode
- 5" flat face tube edge-lit graticule



One Year Warranty \$339<sup>50</sup>  
All American Made NET



See your distributor or write Dept. ET- 2.  
**LECTROTECH, INC.**  
4529 N. Kedzie Ave., Chicago, Illinois 60625

... for more details circle 118 on Reader Service Card



With Sylvania's 3 lines of color tubes, you can meet it.

Customers' wallets come in different sizes.

Thick, thin and in-between.

With Sylvania's 3 complete families of replacement color picture tubes, you can be sure of having the right-priced tube for each one.

At the top end of the line, you've got the *color bright 85<sup>®</sup>XR*, the tube with our brightest phosphors and X-ray inhibiting glass.

And in the middle, you have the *color bright 85<sup>®</sup>RE*. This is the tube that brought color TV out of the dark ages. Its bright rare-earth phosphors still

make it *the* tube to watch.

For economy, there is the *color screen 85* family of replacement tubes. But, economy doesn't mean cheap construction. You can still give your customer features like Sylvania's Sharp-Spot electron gun and a rare-earth phosphor screen without breaking his budget.

When you sell Sylvania, you're selling from the broadest line in the industry. You'll have the tube to match the set.

And a price to match the wallet.

**SYLVANIA**  
GENERAL TELEPHONE & ELECTRONICS

**Every man has his price.**

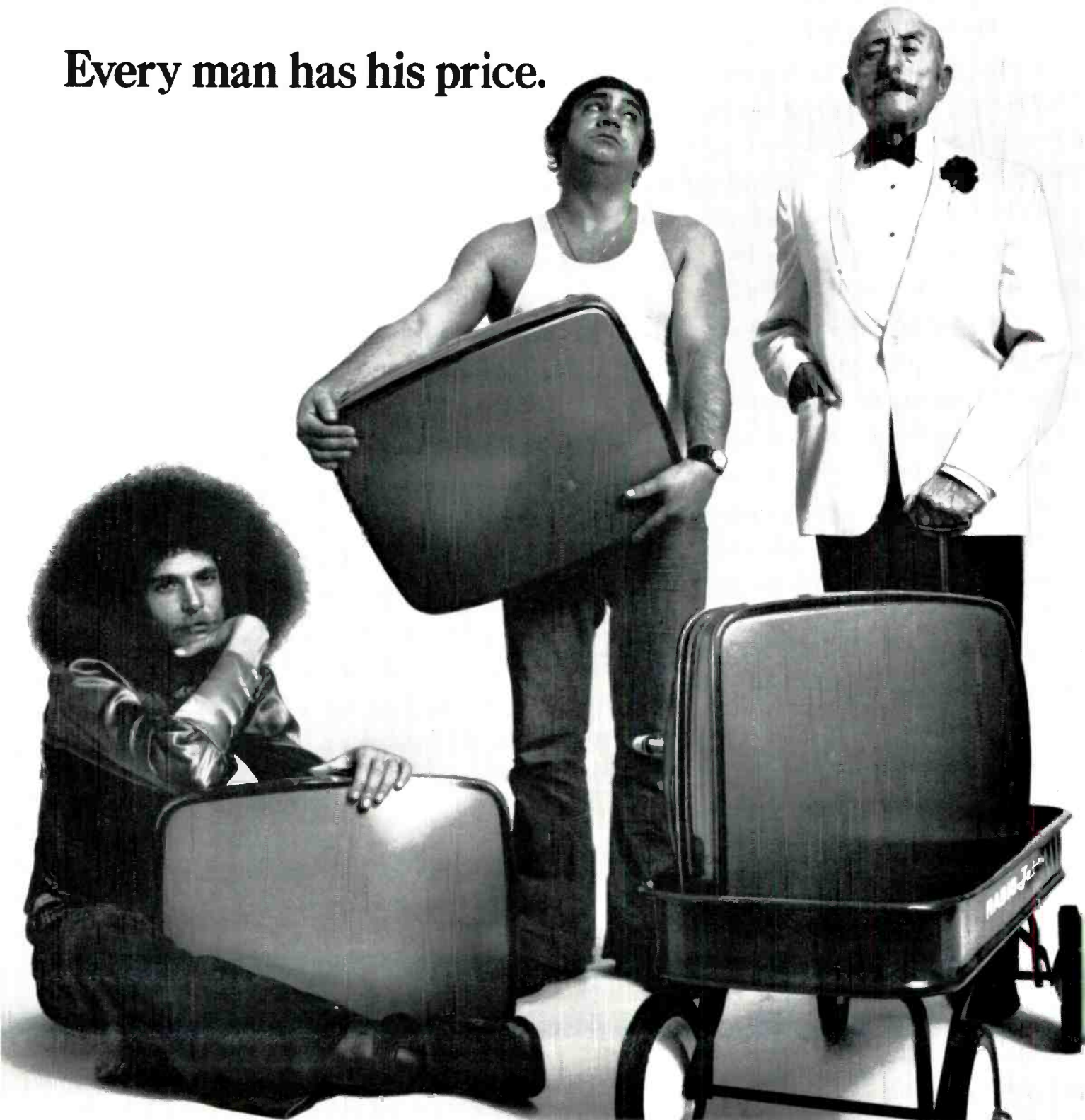

# An Extraordinary Offer

## to introduce you to the benefits of Membership in ELECTRONICS BOOK CLUB

for a limited time only you can obtain

**ANY 3** OF THESE UNIQUE BOOKS . . . yours for only **99¢** each  
(Combined List Price \$34.85) . . . with Trial Club Membership

May we send you your choice of any three books on the facing page as part of an unusual offer of a Trial Membership in Electronics Book Club?

Here are quality hardbound volumes, each especially designed to help you increase your know-how, earning power, and enjoyment of electronics.

These handsome, hardbound books are indicative of the many other fine offerings made to Members . . . important books to read and keep . . . volumes with your specialized interests in mind.

Whatever your interest in electronics—radio and TV servicing, audio and hi-fi, industrial electronics, communications, engineering—you will find that Electronics Book Club will help you.

With the Club providing you with top quality books, you may broaden your knowledge and skills to build your income and increase your understanding of electronics, too.

### How You Profit From Club Membership

This special offer is just a sample of the help and generous savings the Club offers you. For here is a Club devoted exclusively to seeking out only those titles of direct interest to you. Membership in the Club offers you several advantages.

**1. Charter Bonus:** Take any three of the books shown (combined values up to \$34.85) for only 99¢ each with your Trial Membership.

**2. Guaranteed Savings:** The Club guarantees to save you 15% to 75% on all books offered.

**3. Continuing Bonus:** If you continue after this trial Membership, you will earn a Dividend Certificate for every book you purchase. Three Certificates, plus payment of the nominal sum of \$1.99, will entitle you to a valuable Book Dividend which you may choose from a special list provided members.

**4. Wide Selection:** Members are annually offered over 50 authoritative books on all phases of electronics.

**5. Bonus Books:** If you continue in the Club after fulfilling your Trial

Membership, you will receive a Bonus Dividend Certificate with each additional Club Selection you purchase. For the small charge of only \$1.99, plus three (3) Certificates, you may select a book of your choice from a special list of quality books periodically sent to Members.

**6. Prevents You From Missing New Books:** The Club's FREE monthly *News* gives you advance notice of important new books . . . books vital to your continued advancement.

This extraordinary offer is intended to prove to you, through your own experience, that these very real advantages can be yours . . . that it is possible to keep up with the literature published in your areas of interest . . . and to save substantially while so doing.

### How the Club Works

Forthcoming selections are described in the FREE monthly *Club News*. Thus, you are among the first to know about, and to own if you desire, significant new books. You choose only the main or alternate selection you want (or advise if you wish no book at all) by means of a handy form and return envelope enclosed with the *News*. As part of your Trial Membership, you need purchase as few as four books during the coming 12 months. You would probably buy at least this many anyway . . . without the substantial savings offered through Club Membership.

### Limited Time Offer!

Here, then, is an interesting opportunity to enroll on a trial basis . . . to prove to yourself, in a short time, the advantages of belonging to Electronics Book Club. We urge you, if this unique offer is appealing, to act promptly, for we've reserved only a limited number of books for new Members.

To start your Membership on these attractive terms, simply fill out and mail the postage-paid airmail card today. You will receive the three books of your choice for 10-day inspection.

SEND NO MONEY! If you are not delighted, return them within 10 days and your Trial Membership will be cancelled without cost or obligation. Electronics Book Club, Blue Ridge Summit, Pa. 17214.

### Typical Savings Offered Club Members on Recent Selections

Zenith Color TV Service Manual	List Price \$7.95; Club Price \$4.95
Understanding Solid-State Circuits	List Price \$7.95; Club Price \$4.95
RCA Monochrome TV Service Manual	List Price \$7.95; Club Price \$4.95
TV Trouble Diagnosis Made Easy	List Price \$7.95; Club Price \$4.95
Practical Electronic Servicing Techniques	List Price \$7.95; Club Price \$3.95
Dictionary of Electronics	List Price \$6.95; Club Price \$5.50
Admiral Color TV Service Manual	List Price \$7.95; Club Price \$3.95
Computer Circuits & How They Work	List Price \$7.95; Club Price \$4.95
Commercial Radio Operator's License Study Guide	List Price \$7.50; Club Price \$5.95
Home-Call TV Repair Guide	List Price \$6.95; Club Price \$2.95
FET Applications Handbook-2nd Edition	List Price \$14.95; Club Price \$9.95
Electronic Musical Instruments	List Price \$7.95; Club Price \$4.95
Computer Architecture	List Price \$12.50; Club Price \$8.95
Simple Transistor Projects for Hobbyists	List Price \$7.95; Club Price \$3.95
Electronic Test & Measurement Handbook	List Price \$7.95; Club Price \$4.95
Pulse & Switching Circuits	List Price \$7.95; Club Price \$4.95
Circuit Consultant's Casebook	List Price \$9.95; Club Price \$5.95
Amateur Radio Extra Class License Study Guide	List Price \$7.95; Club Price \$4.95
Small Appliance Repair Guide	List Price \$7.95; Club Price \$4.95
Basic Electronics Problems Solved	List Price \$7.95; Club Price \$4.95
Handbook of Magnetic Recording	List Price \$7.95; Club Price \$4.95
125 One-Transistor Projects	List Price \$7.95; Club Price \$4.95
Integrated Circuits & Systems	List Price \$12.95; Club Price \$8.95
Servicing Modern Hi-Fi Stereo Systems	List Price \$7.95; Club Price \$4.95
104 Easy Projects for the Electronics Gadgeteer	List Price \$6.95; Club Price \$3.95

# AN EXTRAORDINARY OFFER...

## Semiconductors From A to Z

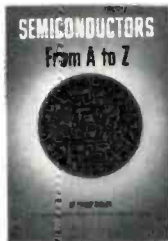

Here it is—everything you need to know about semiconductors — from basic diodes and transistors to FETs, MOS FETs, tunnel diodes, integrated circuits, varicaps, photoFETs, light-sensitive and light-emissive devices, incandescent and luminescent optoelectronic circuits, unijunction transistors, field-effect

diodes, SCR and zener diodes, etc. Explains how these various devices work and how they are used, with descriptions of all the common and unique circuits used in modern semiconductor technology. Attention is given to integrated circuit applications — variable-current and constant-current sources, unbalanced differential amplifiers, IC applications in FM and TV receivers, TV sound circuits, discriminator circuits, and cascade amplifier networks. 272 pps., over 300 illus., 26 Chapters.

List Price \$7.95

Order No. 493

## Electronic Circuit Design Handbook

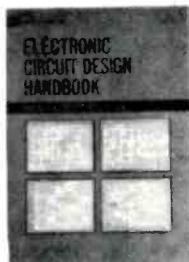

New Third Edition—A brand-new, enlarged edition of the ever popular circuit designer's "cookbook," now containing over 600 proven circuits, for all types of functions, selected from thousands on the basis of originality and practical application. Now you can have, at your fingertips, this carefully-planned reference source of tried and

tested circuits. Selected from thousands submitted by distinguished engineers, these "thought-starters" are a collection of original circuits selected on the basis of their usefulness. This detailed compilation of practical design data is the answer to the need for an organized gathering of proved circuits . . . both basic and advanced designs that can easily serve as stepping stones to almost any kind of circuit you might want to build. 384 pps., 19 big sections, over 600 illus., 8 1/2" x 11".

List Price \$17.95

Order No. T-101

## How to Repair Solid-State Imports

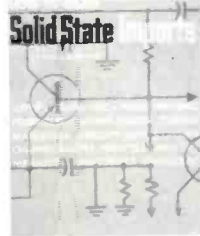

Among this vast collection of nearly 100 hard-to-find schematics you'll find such names as Allied, Automatic Radio, Peerless Teledrad, Mercury, Lloyd's, Panasonic, Crown, Midland, Pennerest, Toshiba, and Matsushita, representing the major foreign-made chassis distributed in the U.S. And to help you find replacement parts, there

is a list of importers and distributors of Japanese consumer products. There's also a chapter to help you when a schematic isn't available—numerous tips to help you get by without the exact diagram. Truly unique among manuals of this type. Chapter 5 contains a host of schematics and service data representing virtually every import you'll come across, along with a 24-page foldout section. 160 pps., 8 1/2 x 11", plus 24-page foldout section.

List Price \$7.95

Order No. 532

## How To Fix Transistor Radios & Printed Circuits

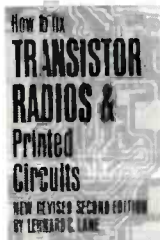

Here it is! Just off the press—a completely updated, revised edition of Leonard Lane's best-selling classic on transistor radio repair. In addition to extensive enrichment of the first edition, the author brings FETs, zener diodes, FM radios—in fact, everything related to the current state of the art—into the picture. Here's the perfect

reference and guide for electronic technicians who need to understand and repair semiconductor circuits efficiently. For those interested in transistor physics, fundamentals are emphasized in the first two chapters. The real "meat" begins in Chapter 3 which will thoroughly familiarize you with amplifier fundamentals, basic circuit configurations, biasing, FETs, JFETs, and IGFETs. The next two chapters will acquaint you with RF and IF amplifiers. 256 pps., over 150 illus., 12 Chapters.

List Price \$7.95

Order No. 504

## Electronic Hobbyist's IC Project Handbook



Here's your chance to become familiar with those fascinating components—integrated circuits—and have fun building some useful devices at the same time. In all, this new book describes 50 different projects, all based on using popular IC's which are inexpensive and available at all parts stores. Some of the devices—such as

the 1-watt phono amp and IC power supply—can be built in an evening. More sophisticated projects—like the electronic organ or the RD1AA equalization preamp—offer a greater challenge. You can build practical devices like the tachometer with bulb alert, or the 50-watt amplifier, or some "just for fun" gadgets like the simple memory tester or the miniature adding machine. 160 pages, 50 projects, 100 illus.

List Price \$6.95

Order No. 464

## Philco Color TV Service Manual



An all-in-one service guide for Philco color sets, with 12 complete schematic diagrams for chassis 15M90/91 to 20QT88. Here in one manual is complete service data for all the color models produced by Philco and Philco Ford (thru 1970), from the all-tube to the latest hybrid solid-state chassis, including the small-screen portable

Model T5062WA. The unique 36-page foldout section contains 12 complete schematic diagrams, representing all the chassis covered. The profusely illustrated text delves into each section (video, chroma, vertical, horizontal, etc.), and points out specific problems based on the author's extensive experience. Included are complete alignment and setup instructions, detailed in step-by-step form. 160 pps., plus 36-page schematic foldout section. Long-life vinyl cover.

List Price \$7.95

Order No. 522

## Handbook of Semiconductor Circuits



Contains 124 examples of standard transistor circuits, complete with operational data for amplifiers, oscillators, logic and switching circuits, power supplies, and various nonlinear circuits. The broad range of circuits included were selected on the basis of application and practicality. A design philosophy section is

included with each group of circuits, thereby providing a basis for understanding circuits other than those selected as examples. This is not a handbook of "preferred" circuits, but rather a collection of practical circuits which have wide application and exemplifying good engineering design. Each circuit description includes data concerning any unique design or operational data, along with schematic diagrams. Hundreds of illustrations and diagrams. 448 pps., 6" x 9". Hardbound.

List Price \$8.95

Order No. G-30

## Electronics Reference Databook

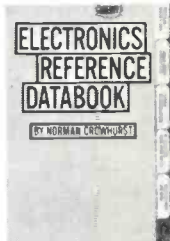

This new book is much more than a simple collection of tables, formulas, graphs, equations, etc. In addition to the abundance of helpful information given, it provides specific guidance in the use of data. Numerous problems associated with every level of interest—from electronics theory (formulas, laws) to measurements, tests, and circuit

design work—are covered. In so doing, the author explains how to use the data (from this or other volumes) for purposes other than those listed. Covers Electronics Theory, Use of J Operator, Exponential and Other Tables, Attenuators and Equalizers, Filter Design, Practical Component Design and Application, Tube and Semiconductor Circuit Design and Operation, and Transmission Lines. 224 pps., over 100 illus., plus 45 tables. Hardbound.

List Price \$7.95

Order No. 488

## How to Use Test Instruments in Electronics Servicing



A long-needed, practical handbook on test equipment applications — ranging from the use of audio gear to tube and transistor checkers. Just what you need to put your test equipment to work. Not a "how-it-works" treatment, but a "how-to" manual describing specific tests and troubleshooting techniques for the electronic technician. You'll discover new ways to use your scope and several new "tricks" you can perform with multimeters. You'll learn signal-injection troubleshooting, how to measure inductance and capacitance with the help of your signal generator, pointers and pitfalls for using signal markers, sweeps and pattern generators, shortcuts and special techniques for color TV troubleshooting, how to test audio circuits and FM stereo equipment, and much more. 256 pps., over 200 illus. Hardbound.

List Price \$7.95

Order No. 485

# SEND NO MONEY!

Simply fill in and mail postage-paid Airmail card today!

... for more details circle 104 on Reader Service Card

# COLORFAX

The material used in this section is selected from information supplied through the cooperation of the respective manufacturers or their agencies.

## ADMIRAL

### Color TV Chassis K20—Troubleshooting For No Color

As shown in the block diagram, the chroma section of the K20 series color-TV chassis has 10 transistor stages. Of these, six circuits function as ac amplifiers and four circuits function as dc control switches. The following procedure

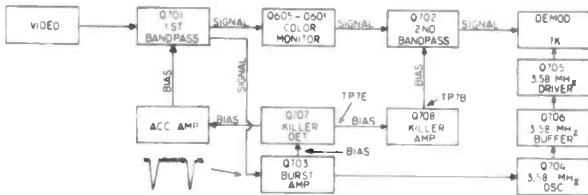

will help you to quickly isolate a defective stage for "no color" after which normal troubleshooting will isolate the defective part.

1. Apply color bar signal to VHF tuner terminals (a color program can be used).
2. Set Color control to mid-range.
3. Set Color Threshold control fully clockwise.

#### Test Procedure

1. Connect scope to point 7K (Pin 2 of 6BV11 tube) and check for a 3.58MHz signal. (Test point 7K is the pin to the left of the word "7K" printed on the board—do not use the pin directly above the printed 7K.)

- a. If a 3.58MHz signal is not present, the problem is in the buffer, driver or color oscillator circuit. Proceed to step 2.
- b. If a 3.58MHz signal is present, proceed to step 3.

2. Using an AM generator, inject approximately a 3.58MHz signal at the base element of transistor Q706. Leave the scope at point 7K and watch for the 3.58MHz signal. Use the same procedure in checking transistors Q704 and Q705. After you have isolated the stage that does not produce a signal at point 7K, use a VTVM to locate the faulty component. Do not overlook the crystal circuit.

3. Connect the jumper from the 25v supply (red wire) to TP7B (Collector of transistor Q708, the killer amplifier) on the circuit board.

- a. If the color does not appear on the CRT, the problem is in the Color Monitor (if used) or in the first or second bandpass amplifier. Continue to step 4.

- b. If color does appear, the problem is in the Killer amplifier, Killer Detector or Burst amplifier. Proceed to step 5.
4. To check the Color Monitor, disconnect the wire from point 6F on the monitor board and connect it to point 6H.
- a. If color is now present, the problem is in the Color Monitor. Check the stages containing transistors Q601 and Q605.
  - b. If color does not appear, the problem is in the first or second bandpass amplifier. Use the VTVM to check.
5. Disconnect the jumper to point TP7B that was added in step 3.
6. To check the Killer amplifier, connect a 68K resistor from TP7E to ground (collector of transistor Q707). If color now appears, the Killer amplifier is okay. Remove the resistor.
7. To check the Killer detector, short the base element to ground. The collector voltage should rise to approximately 22v. Remove the base short and the collector voltage should decrease to approximately 17.5v. If the stage voltages are okay, proceed to step 8.
8. If the Burst amplifier is at fault, there should be color on the CRT during step 3 but it is probably out of sync.

## WESTINGHOUSE

### Color TV Chassis V2655, V2656—Service Hints

In early production of the IF printed circuit boards, the value of resistor R213, a 47Ω resistor, was incorrectly marked 47K on the top of the PC board.

Resistor R213 is a stone-type fusible resistor which may

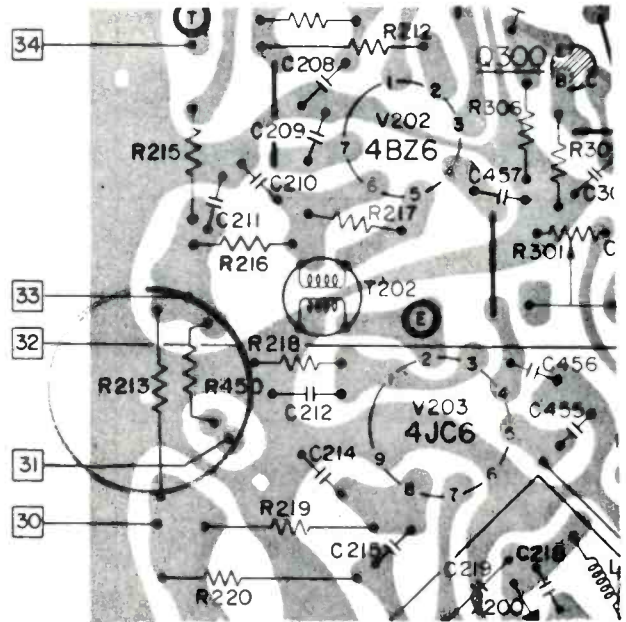

break apart under overload conditions. When this happens, the technician may see the 47K marking and replace the burned out one with a 47K value (which is wrong), the correct value should be 47Ω. Please note the location of resistor R213 on the partial diagram of the IF PC board and replace it only with a 47Ω, 4w, fusible, stone-type resistor, Westinghouse part number 250V020H79.

## TOOL CASES

**FIELD ENGINEER ATTACHE CASE HOLDS 60 TOOLS**

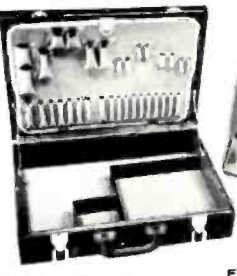

Thousands of these cases are in use today by field engineers stationed throughout the world. The Jensen case features solid wood frame with scuff-proof Marvlon cover. All brass hardware. Compartments in base for spare parts and a test meter. Dimensions 18 x 13 x 4-3/4". Three styles. Write for catalog. 54D704... \$49.50 (postpaid)



*Free Catalog* →

**ELECTRONIC ASSEMBLY TOOLS**



**JENSEN TOOLS and ALLOYS**  
4117 N. 44th Street,  
Phoenix, Arizona 85018

... for more details circle 113 on Reader Service Card



## Thirteen cures for 78 headaches.

Integrated circuits are replacing transistor circuits in many stereos, radios, B & W and color TVs.

That means more parts to stock and more money tied up in inventory.

Now, Sylvania ECG can take some of the pain out of these stocking headaches.

Our 13 ICs will replace 78 part numbers, including RF, IF and audio amplifiers, sound detectors, oscillator/mixers, chroma demodulators, and automatic fine-tuning systems.

That's 65 fewer items to stock. And our 13 ICs are just part

of our ECG replacement line. That's the line that lets you replace 35,000 semiconductor types with just 87 Sylvania ECG types.

It's the line that lets you put a complete stock room on one shelf.

Maybe the same shelf where you used to keep the aspirin.

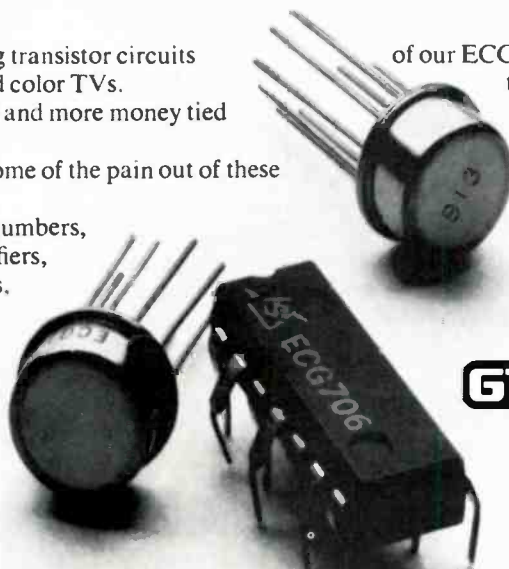

**GTE SYLVANIA**

**WORKMAN** *Electronic*  
P.O. BOX 3828 SARASOTA, FLORIDA 33578 PRODUCTS, INC.

OEM and REPLACEMENT  
MANUFACTURERS OF

# FAIL SAFE CIRCUIT BREAKERS

IN MOLDED BLACK PHENOLIC CASE

14 Models  
FA1 to  
FA7



**FREE** BUTTON EXTENSION  
IN PACKAGE

**FREE** VEST POCKET  
CROSS REFERENCE

ASK FOR BOOKLET # X53

RECOGNIZED UNDER THE  
COMPONENT PROGRAM OF  
**UNDERWRITERS' LABORATORIES, INC.**

for more details circle 132 on Reader Service Card

## REBUILD YOUR OWN PICTURE TUBES?

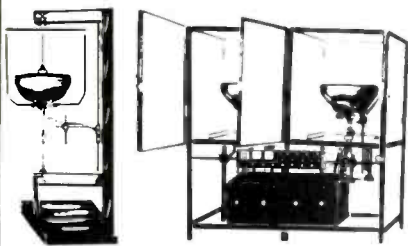

With Lakeside Industries precision equipment, you can rebuild any picture tube!

EASY TO OPERATE!

Requires only 4 x 8 ft. of space.

Your cost to rebuild black and white—\$1.50.

Your cost to rebuild Color—\$5.80.

For complete details, mail coupon.

**LAKESIDE INDUSTRIES**

5234 N. Clark St.  
Chicago, Ill. 60640  
Phone: 312-271-3399

- Free demonstration appointment
- Send me more information

Name \_\_\_\_\_  
Address \_\_\_\_\_  
City \_\_\_\_\_ State \_\_\_\_\_

for more details circle 116 on Reader Service Card

## NEW PRODUCTS

For additional information on products described in this section, circle the numbers on Reader Service Card. Requests will be handled promptly.

### ATTENUATOR 703

*Replaces standard carbon composition components*

Distortion free ac signals, 0 to 300 MHz, for CATV or audio distribution systems are reportedly now provided by a 75Ω plug-in "T" pad, measuring 0.375 in. in diameter and 0.473 in. high, and incorporating a thick film cermet resistive element. The design reportedly provides minimum inductance with improved stability. They are said to be available in 11 values ranging from 0 to 15dB. Signal levels are determined at each CATV/CCTV or audio installation by simply plugging in the proper "T" pad. Rated tolerances are ±0.05 to ±1.0dB, depending on the component. The plas-



tic-cased plug-in attenuator reportedly mounts in a standard TO-5 base having a 200 in. pin circle. The manufacturer indicates that it has gold-plated half-hard corrosion-resistant brass pins with rounded tips for easier insertion. The "T" pad is said to be installed in PC boards to replace standard carbon composition components, especially in automatic control circuits where attenuation is needed over a 0 to 300MHz frequency range. Examples of its use at audio frequencies are said to include line amplifiers, telephone terminals, communications receivers, and similar 75Ω impedance/power matched installations. Other impedances are said to be available on special order. Aerovox.

### TV STRIP AMPLIFIER 704

*Occupies minimum of rack space*

A series of solid-state, high-voltage strip amplifiers is developed for the

distribution of TV and FM signals in very large MATV and CATV systems. Manufacturers specifications indicate the unit features a full 4v output and occupies only 1¾ in. of rack space.



Designated the THPM, each single-channel unit has a rated bandwidth of 6MHz for semi-adjacent TV channel operation. Models are said to be available for low band operation (Channels 2 to 6), high-band operation (Channels 7 to 13) and FM band operation with a 20MHz bandwidth. Each amplifier reportedly has separate 75Ω input terminals for various source pick-ups, while outputs are loop-mixed with 75Ω cable. Specifications indicate that the total gain of the AGC controlled TV amplifier is greater than 55dB, while the gain of the FM amplifier is above 45dB. The wall or rack mounted units have a rated output capability of 4v (+72dBmv), with a level control to adjust between 1v and 4v. For good skirt selectivity, greater than 30dB at the next non-adjacent channel edge, the amplifiers reportedly have triple-tuned input and double-tuned output band-pass filters. Jerrold.

### CONTACT CLEANER 705

*Force removes solids and leaves no residue*

A contact cleaner is said to contain trichloro-trifluoroethane with a fluorinated propellant in an aerosol container. It reportedly forces residual contamination from the surface and dissolved oils are said to be volatilized and removed in seconds with solvent evaporation. Manufacturer specifications indicate that the cleaner has no flash or fine point and is nonexplosive, nonstaining and noncorrosive for all metals. The solvent is formulated to permit clean-



for more details circle 103 on Reader Service Card

# Grab the **HOT LINE**

in color TV lead-in sales!

**BELDEN** 

They're "market-engineered" to dominate color reception lead-in sales. Metro-Color™ for congested viewing areas. Maxi-Color™ for the suburban viewing market. Real sales grabbers. Created to bring home a better color picture . . . more profit for you. Colorful eye-stopping packages. Long warranties. Flexible, small size for easy installation. Competitive pricing. And a "Hot Line" display, too! That's the program. Grab it while it's hot. See your Belden DISTRIBUTOR today.

8-3-C

Belden Corporation,  
P. O. Box 5070-A,  
Chicago, Illinois  
60680.



Metro-Color and Maxi-Color also available in bulk



... new ideas for moving electrical energy

REPEATED BY POPULAR DEMAND

# FREE! A CAN OF YOUR FAVORITE TUNER-SPRAY!

Of course, there's a catch. You have to buy a can of TUN-O-BRITE to get your free can. The whole idea is to get you to try TUN-O-BRITE. Because TUN-O-BRITE is so much better than ordinary tuner sprays that once you try it, you'll never settle for anything less.

## HOW TO GET YOUR FREE CAN

- 1 Buy a can of TUN-O-BRITE from your favorite distributor.
- 2 Send the empty can to Chemtronics and tell us what kind of tuner spray you want free.
- 3 We'll send you any 8 oz. can you request, FREE!

That's right, you can get a free can of TUN-O-BRITE or any competitive brand. So far, nobody has asked us for anything but TUN-O-BRITE, but we'll send you anything you want.

**CHEMTRONICS** INC.  
 1260 RALPH AVE.  
 BKLYN., N.Y. 11236



ONLY ONE  
FREE CAN TO A  
TECHNICIAN

THIS OFFER  
EXPIRES  
APRIL 15, 1971

... for more details circle 106 on Reader Service Card

## NEW PRODUCTS

ing of components without having an effect on plastics, elastomers, painted or varnished base material. Low surface tension reportedly permits penetration of the contact cleaner into cracks and crevices and also allows for good wetting properties. CRC Chemicals.

### CRT ADAPTER

706

*Converts tube tester into CRT tester*

The Model MH-3A CRT Adapter reportedly tests all B/W picture tubes ranging from 8 in. to 30 in., 50° to 115°, 12 pin bases, 8 pin bases or the

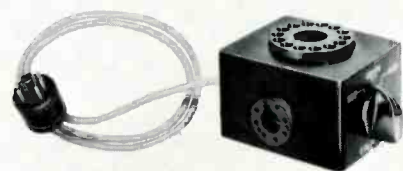

very latest 7 pin bases. Specifications indicate that two 14-pin sockets and a special color switch are designed to check each of the red, green and blue color guns of the color CRT separately. Coletronics Service.

### VOM

707

*Large three-color meter panel with mirror-scale*

The WV-520A VOM features a rated sensitivity of 100,000Ω/v for dc measurements and 10,000Ω/v for ac measurements. Also featured is a





rotating function and range switch, a convenient polarity reversing switch, and a large meter panel with a mirror-scale. Manufacturer specifications indicate that this instrument is designed to

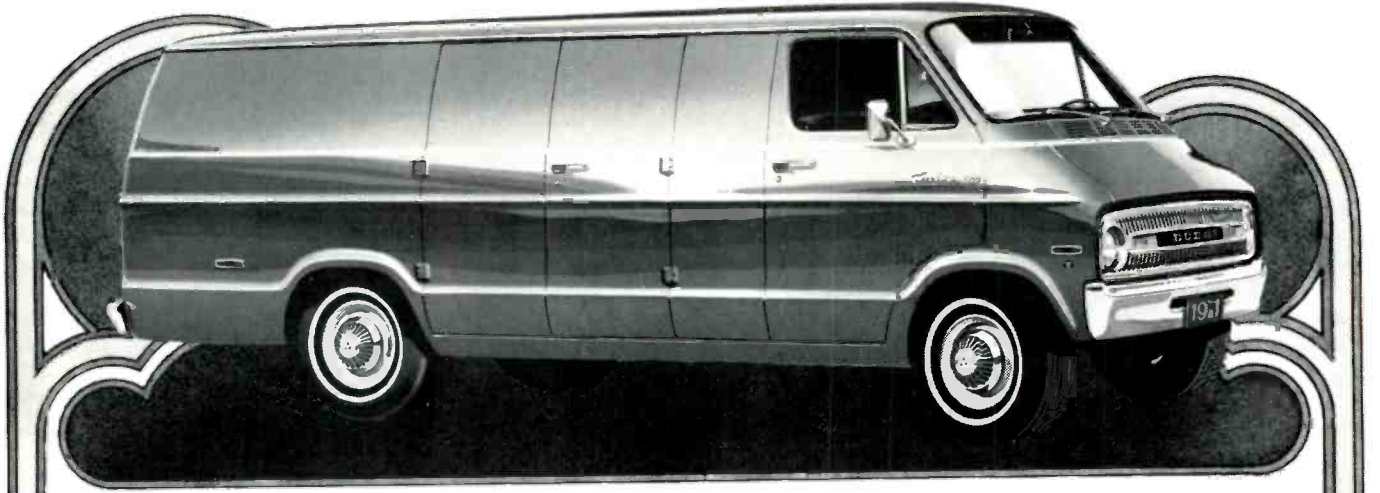





## THE NEW DODGE MAXIVAN TRADESMAN

will carry a 12-foot sailboat  , plus its mast  , a living room-size roll of carpeting  ,

a snooker table  , or a full-size alligator  , under cover, and still give you all 31

features the other **Dodge Strong Box** models do.

There's only one way to get power steering  and Fresh Air air conditioning  in a compact

van, and that is to buy a Dodge. Go ahead, call it the **world's**  **biggest compact van.**

Because that's what the Dodge Maxivan is.

Open its doors and say, "ah!"

At your Dodge Dealer's.

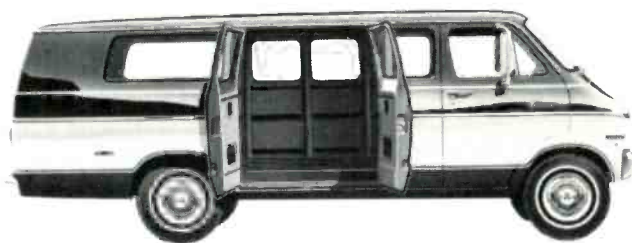

## NEW DODGE MAXIVAN STRONG BOX

*Dodge Trucks*



## NEW PRODUCTS

measure dc voltages from 10mv to 1,500v, ac voltage (RMS) from 100mv to 1500v, direct current from 0.5ma to 5amp, resistance from 0.05Ω to 20M and decibels from -20dB to +55.5dB. The instrument is said to be in a case that measures 7½ in. by 5¼ in. by 2¾ in., weigh 3 lb and is reportedly supplied complete with test leads and two 1.5v C-cell batteries. Price \$48. RCA.

### SIGNAL-TONE ENCODERS 708

Five switch-selected output tones

Automatically activated signal-tone

encoders are designed for use with two-way radio equipment. Keyed by closing the transmitter microphone switch, the encoder generates a short duration tone burst which modulates the transmitter and automatically ac-



tivates tone-access repeaters, tone operated receiver squelch circuits, or other signaling devices. The Model TE-5 is said to have five switch-selected output tones. The frequency range is reportedly field adjustable from 1600 to 2800Hz with a frequency stability of  $\pm 2$  percent from  $-10^{\circ}$  to  $+60^{\circ}$ C. Specifications indicate that the 0.5 sec output tone burst is a 6v P-P open circuit sine wave, with output impedance adjustable in three steps. The encoders and their 9v batteries are reportedly housed in a 2¼-by 1½-by 3¼-in. high-impact plastic case and connected to the transmitter microphone audio circuit by a 15in. shielded cable. An aluminum bracket is provided for mounting the encoder to the transmitter. Price \$39.95. Ross and White Co.

## FM STEREO...

continued from page 40

than it was to those RF frequencies that fell between. Under these conditions, a receiver would be able to tune in the same station at two adjacent points on the dial.

As had been previously indicated, the description just given for the scope traces shown in Fig. 11 would have been true had the scope been functioning as before. Actually something entirely different was seen

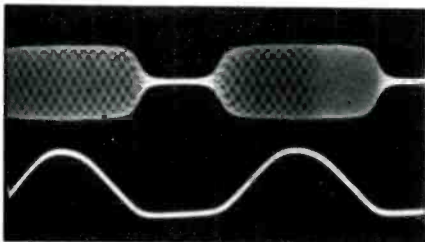

Fig. 11—Same vertical signals applied as in Fig. 9, but with the scope's 30Hz internal horizontal sweep rather than the 60Hz sine-wave horizontal sweep provided by the generator.

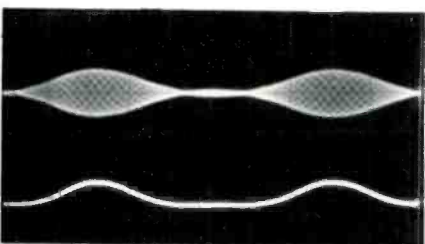

Fig. 12—Same vertical signals applied as in Fig. 10, but with the scope's 30Hz internal horizontal sweep rather than the 60Hz sine-wave horizontal sweep provided by the generator.

on the scope. The scope traces in Fig. 11 and 12 are of the same signal conditions illustrated in Fig. 9 and 10, respectively, except that the

scope was using an internal 30Hz saw-tooth horizontal-sweep signal rather than the 60Hz sine-wave horizontal-sweep signal that had been used. In the previous illustrations we saw a distorted 60Hz sine wave folded back upon itself, and with the non-linear horizontal sweep trace it appeared as a distorted diagonal line. (This was not due to some fault of the scope. Sine waves are non-linear in nature.) These last two illustrations instead show a pair of waves representing the distorted 60Hz signal obtained from the detuned discriminator circuit. A similar comparison could be made of the 10kHz patterns—the top scope traces in each of these illustrations.

When aligning an FM receiver, the IF and discriminator circuits should be adjusted so that the diagonal wave shown in the bottom scope trace (Fig. 4) remains straight, while there is little noise apparent in the upper scope trace. With each improvement in alignment, it is possible to reduce the generator's RF output while maintaining the desired scope pattern—thus increasing receiver sensitivity.

### Many multiplex waveforms are also possible.

Space does not permit us to cover each of the many special features incorporated in this generator. Because of such limitations, the remaining photographs show but two of the many stereo waveforms that

this generator can produce. Fig. 13 shows the right channel receiving a 60Hz signal (note the 10kHz signal riding upon it), while Fig. 14 shows

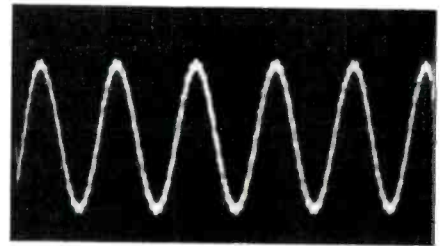

Fig. 13—Waveform observed when a 60Hz stereo signal was transmitted to the receiver's right channel, the channel to which the scope was connected.

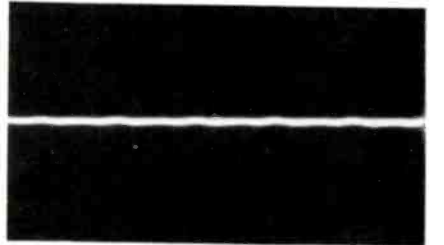

Fig. 14—Virtually no waveform was observed when the same 60Hz stereo signal was transmitted to the receiver's left channel, while the scope remained connected to the right channel.

the same audio channel after the stereo signal has been switched to the left channel. In this instance the channel separation resulted from a 10 percent pilot signal level, but channel separation was also observed with a 2.5 percent pilot signal level.

As with the previously described alignment procedures, stereo separation can be improved by peaking the tuned circuits to maintain the desired waveform while at the same time reducing the generator's signal output. ■



Model 310-FET

\$78

## If you need a high-sensitivity, hand-size V-O-M... Buy Triplet's 310-FET

1. Hand-size FET V-O-M with 10 megohm DC input resistance.
2. Low voltage range of 300 mV DC; X1 megohm range.
3. Single range switch; DC polarity-reversing switch.

With a 10 megohm input resistance and a 300 mV DC sensitivity, Triplet's handy little Model 310-FET can handle practically any electrical measurement you may need.

Seventeen ranges (plus 6 AC current ranges to 300 A with its optional clamp-on ammeter attachment), 3% DC and 4% AC

accuracy, a polarity-reversing switch and a rugged suspension-type meter to soak up the hard knocks make the 310-FET the most convenient and most capable hand-size V-O-M you can buy.

It's a real value at \$78, so see it right now at your local Triplet distributor. For more infor-

mation, or for a free demonstration, see him or your Triplet sales representative. Triplet Corporation, Bluffton, Ohio 45817.

**TRIPLETT**

The World's most complete line of V-O-M's...  
choose the one that's just right for you

... for more details circle 128 on Reader Service Card

# ARROW AUTOMATIC STAPLE GUNS

## CUT WIRE & CABLE INSTALLATION COSTS

... without cutting into insulation!

**SAFE!** Grooved Guide positions wire for proper staple envelopment! Grooved Driving Blade stops staple at right depth of penetration to prevent cutting into wire or cable insulation!

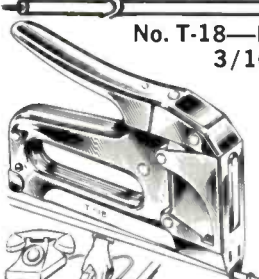

**No. T-18—Fits wires up to 3/16" in diameter.**

**BELL, TELEPHONE, THERMOSTAT, INTERCOM, BURGLAR ALARM and other low voltage wiring.**

Uses T-18 staples with 3/16" round crown in 3/8" leg length only.

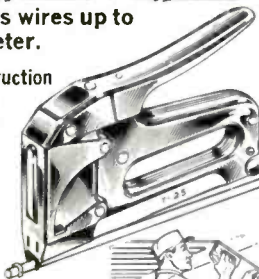

**No. T-25—Fits wires up to 1/4" in diameter.**

Same basic construction and fastens same wires as No. T-18.

Also used for **RADIANT HEAT WIRE**

Uses T-25 staples with 1/4" round crown in 9/32", 3/8", 7/16" and 9/16" leg lengths.

T-18 and T-25 staples also available in Monel and with beige, brown and ivory finish at extra cost.



**No. T-75—Fits wires and cables up to 1/2" in diameter.**

**RADIANT HEAT CABLE, UF CABLE, WIRE CONDUIT COPPER TUBING or any non-metallic sheathed cable.**

Also used as **DRIVE RINGS** in stringing wires.

Uses T-75 staples with 1/2" flat crown in 9/16", 5/8" and 7/8" leg lengths.

Arrow Automatic Staple Guns save 70% in time and effort on every type of wire or cable fastening job. Arrow staples are specially designed with divergent-pointed legs for easier driving and rosin-coated for greater holding power! All-steel construction and high-carbon hardened steel working parts are your assurance of maximum long-life service and trouble-free performance.

Ask your Electrical Supply Dealer or write for further details.

**ARROW FASTENER COMPANY INC**  
Saddle Brook, New Jersey 07863  
"Pioneers and Pacesetters  
For Almost A Half Century"

## DEALER SHOWCASE

For additional information on products described in this section, circle the numbers on Reader Service Card. Requests will be handled promptly.

### TOOLS

709

Display board with walnut finish and colorful header

A compact, specialized tool department, No. 70071, is designed for high performance. Reportedly included on the display are reversible screw drivers, screw launchers, spring tools, self-adjusting nut drivers, 6/12v testers, crimping tools, flexible shaft tune-up tools, hex key wrench sets, pow'riveter, wire strippers, and a selection of solderless terminals and pow'rivets. The display panel features are said to include: on-sight inventory control through printed illustrations and stock numbers of each item, attractive wal-

nut finish with colorful header and durable chrome-plated hanging hooks. The display is said to measure 24 in. by 36 in. and sell for \$100. Vaco.



nut finish with colorful header and durable chrome-plated hanging hooks. The display is said to measure 24 in. by 36 in. and sell for \$100. Vaco.

### CAR STEREO TAPE PLAYER

710

Total rated peak power of 18w

The Model 12R300 eight-track tape stereo player features solid-state circuitry and operates on 12vdc negative



gnd. It is rated for a total peak power of 18w and has a front loading arrangement with dust door. Controls

### DIRECTION FINDER RADIO 711

Covers 30 short-wave services plus marine and aviation

The CR-44A "Ranger" is designed to tune over the 200 to 400kHz range where directional finding (DF) beacon stations transmit. The finder is reportedly equipped with an AGC circuit and special 20dB transistor amplifier used in the meter circuit to provide null indication. The portable's high efficiency circuitry reportedly provides for extended battery life (400 hr), precise signal-locking reliability and over 500mw of audio output power. The radio is also said to provide AM reception of standard broadcast stations on 540 to 1600kHz; FM in the 88 to 108MHz band; FAA and Canadian weather-navigation stations, plus

## NEW MONITOR RECEIVER goes anywhere!



- **MOBILE** with built-in DC supply
- **BASE** with AC supply in convenient desk-top stand
- **PORTABLE** with rechargeable power pack complete with handle and antenna

VHF FM models cover 148-174 MHz with 5 channels. Professional features include crystal filter and true noise-operated squelch.



You're going to hear more from...



**JOHNSON**

Waseca, Minnesota 56093  
... for more details circle 114 on Reader Service Card

# Stack These Up Against The Others

your best buys in meters  
come from Heath

For over 20 years, Heath has been the first choice in meters for tens of thousands of service technicians, schools and home labs. There's a reason for this continued popularity — Heath meters are designed to have that balance of versatility, needed features and low cost that make them your best buy. For the price of just a couple of meters from others, you can buy every meter Heath makes. We believe that you should still be able to get a stack of meters without spending a pile of money. When you need a meter, look to Heath. For performance, versatility and top dollar value, the others just don't stack up.

**(A) \$21.95\* Buys A Portable Solid-State Volt-Ohm-Meter.** Four ranges on AC & DC volts measure 1-1000 volts full scale. Four resistance ranges measure 0.1 ohm to 1000 megohms. Features convenient battery operation... zero & ohms adj. controls... DC polarity reversing switch... spare jack for HV & RF probes... rugged polypropylene carrying case. IM-17, 5 lbs.

**(B) \$34.95\* Buys A Portable Volt-Ohm Milliammeter.** Measures AC & DC volts 1.5-5000 full scale. DC current from 150 uA to 15A. Resistance midscale from 15-150,000 ohms. Large 4½" 50 uA movement meter for extra accuracy. MM-1, 5 lbs.

**(C) \$29.95\* Buys An Accurate VTVM.** 7 AC & DC ranges measure RMS volts from 1.5-15,000 full scale... AC P-P from 4.0-4000... 7 resistance ranges from 0.1 ohms to 1000 megohms. 25 Hz — 1 MHz response. Single probe makes all measurements. IM-18, 5 lbs. Assembled IMW-18, 6 lbs. ... \$54.95\*

**(D) \$41.95\* Buys A Laboratory AC VTVM.** Especially useful for low-level AC & audio work. Ten RMS ranges from 0.01-300 V full scale... measures dB from -52 to +58. ±1 dB response from 10 Hz-500 kHz. 10 megs. input impedance. IM-38, 5 lbs. Assembled IMW-38, 6 lbs. ... \$57.95\*

**(E) \$39.95\* Buys A Big Service Bench VTVM.** Has the same high performance as the IM-18 above, plus added features to make it more useful for service work... separate 1.5 & 5 VAC scales... calibration controls that are adjustable from the front panel... versatile gimbal mounting... large 7" meter. IM-28, 7 lbs.

**(F) \$49.95\* Buys A Big Solid-State Volt-Ohm Meter.** Battery-powered portability plus built-in AC supply. 8 AC & DC ranges 0.5-1500 full scale... 7 resistance ranges (10 ohm center scale) x1-x1 meg. High input impedance & 6" meter for greater accuracy. IM-16, 10 lbs. Assembled IMW-16, 11 lbs. ... \$79.95\*

**(G) \$85.00\* Buys A Deluxe Solid-State Volt-Ohm Milliammeter.** 9 AC & DC ranges from 150 mV-1500 V full scale... 7 resistance ranges measure from 1 ohm to 1000 megohms... 11 current ranges from 15 uA-1.5 A full scale. 100 kHz response... high input impedance... large 6" meter with zero center. IM-25, 11 lbs. Assembled IMW-25, 11 lbs. ... \$120.00\*

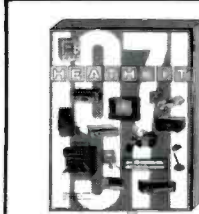
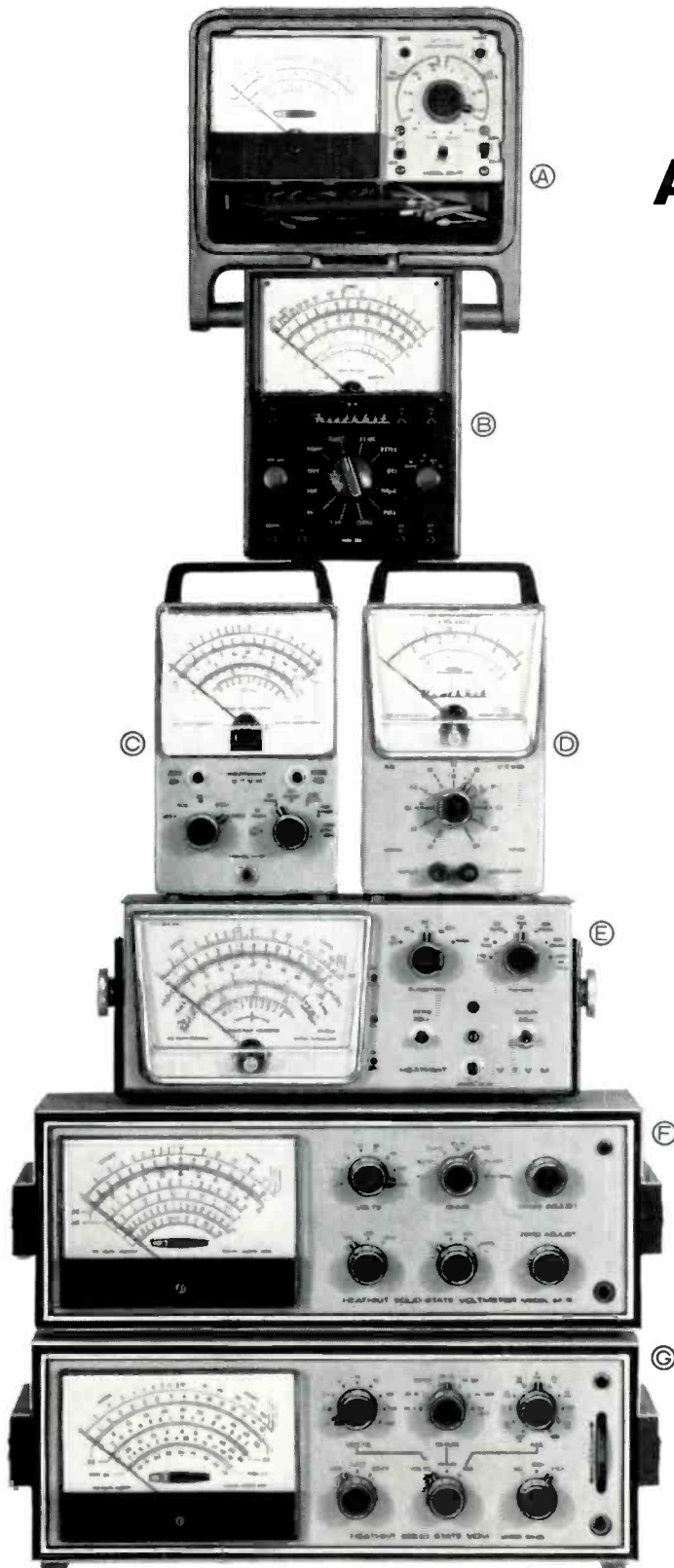

**NEW  
FREE 1971 CATALOG!**  
Now, with more kits, more color. Fully describes these along with over 300 kits for stereo/hi-fi, color TV, electronic organs, guitar amplifiers, amateur radio, marine, educational, CB, home & hobby. Mail coupon or write Heath Company, Benton Harbor, Michigan 49022.

HEATH COMPANY, Dept. 24-2  
Benton Harbor, Michigan 49022

Enclosed is \$ \_\_\_\_\_, plus shipping.

Please send model (s) \_\_\_\_\_  
 Please send FREE Heathkit Catalog.     Please send Credit Application.

Name \_\_\_\_\_  
 Address \_\_\_\_\_  
 City \_\_\_\_\_ State \_\_\_\_\_ Zip \_\_\_\_\_

\*Mail order prices; F.O.B. factory. Prices & specifications subject to change without notice. TE-238

... for more details circle 112 on Reader Service Card

# THE WORKHORSE

The industry's top replacement tube, 6GH8A, is used in so many makes of TV and in so many different applications that it will be a high volume replacement type for years to come.

RCA's versatile 6GH8A is designed to satisfy the demands of all these applications:

Multi-vibrator type horizontal-deflection-oscillator circuits, sound if-amplifier, agc-amplifier, burst-amplifier, chroma-amplifier, 3.58 MHz-oscillator demodulator circuits, video-amplifier, sync-separator, noise inverter, color killer control, matrix-amplifier and blanker applications.

Three good reasons to replace with the RCA-6GH8A:

1. Stringent performance tests eliminate shorts. Special processes and tests minimize inter-element leakage.
2. Low heater-cathode leakage.
3. Optimum gm for efficient operation in all applications.

Stock up on the industry's workhorse 6GH8A and specify RCA! See your RCA tube distributor for all your tube requirements.

RCA | Electronic Components, | Harrison, N.J.



# RCA

## DEALER SHOWCASE

marine and aviation radio beacons on the 185 to 400kHz long-wave range.



The radio reportedly also provides the user with marine calling and distress, marine weather stations, amateur and other services in the 2.0 to 5.2MHz range. Services in the 152 to 174MHz range are also said to be received. The manufacturer indicates that this is a 7½-lb, "D"-battery-operated radio which is equipped with a navigational direction finder that operates on three bands: longwave, standard broadcast (AM) and marine 2.0 to 5.2MHz. Retail price \$149.95. Hallicrafter.

## ANTENNA MOUNTING HARDWARE 712

*Blister packed for merchandising convenience*

A line of TV-antenna mounting accessories including masting, ground rods and UHF/VHF transmission lines is blister packed for merchandising convenience. The line is said to include chimney mounts, roof mounts, wall mounts, standard lead-in wire insulators, turnbuckles, guy hooks, eye bolts, guy rings and clamps, lightning



arrestors, ground rods, various lengths of poly clad transmission line, signal splitters, multiset couplers, and lengths of mast. Channel Master.

## BURGLAR ALARM 713

*Monitoring capability expands for broader coverage*

A solid-state ultrasonic burglar alarm system contains a separate receiver and transmitter for greater flexibility and broader coverage. Using the same detection principles found in military and industrial alarm systems,



the patented "double check" electronic circuitry reportedly offers built-in protection against false alarms. The unit is designed for usage in small commercial businesses as well as homes and apartments. Northern Electric.

## IF YOU ARE A TV REPAIR MAN YOU NEED TV TECH AID

TV TECH AID is the best trouble shooting guide available today. It takes all the guesswork out of TV repair and is designed to help you solve your problems quickly and economically.

Each month you receive updated information on up to 40 different trouble-shooting cases. This important information is supplied to us by technicians, field reps and all the leading TV manufacturers. You will find every symptom pictured with a clearly marked schematic of the particular faulty stage. The faulty components and corrections will also be listed to aid in repair.

You go right to the source of the trouble without guesswork. In addition you get valuable information on current models as well as older models along with circuit changes and modifications as they occur.

TV TECH AID  
P.O. BOX 603  
KINGS PARK, N.Y. 11754

ENCLOSED IS A CHECK OR MONEY ORDER FOR \$.....

PLEASE SEND:

- 1971-12 ISSUES-\$7.95
- 1970-BOOK FORM-\$5.95
- 1969-12 ISSUES-\$4.95

TO:

NAME .....

ADDRESS .....

CITY .....

STATE ..... ZIP .....

... for more details circle 130 on Reader Service Card

# Little GIANT



## SENCORE CG19 CADDY BAR COLOR GENERATOR

Small enough, light enough to carry right in your tube caddy—so you have it handy on every color TV service call.

*Little giant in performance.* All crystal controlled standard RCA licensed color bars, crosshatch, white dots, vertical lines, horizontal lines. Rock solid or your money back.

*New circuitry.* Less current drain permits full voltage regulation on all circuits, and increases battery life.

*Timer range doubled over previous models.*

**Lowest priced unit available, \$84.50** All Domestic Made

IN STOCK AT YOUR LOCAL PARTS DISTRIBUTOR.



**SENCORE**

NO. 1 MANUFACTURER OF ELECTRONIC MAINTENANCE EQUIPMENT

3200 Sencore Drive, Sioux Falls, South Dakota 57100

... for more details circle 124 on Reader Service Card



When people  
turn to you  
to make things  
right again...



use **GE ULTRACOLOR** picture tubes  
(made by professionals for professionals)

TUBE PRODUCTS DEPARTMENT • GENERAL ELECTRIC COMPANY  
OWENSBORO, KENTUCKY 42301

GENERAL  ELECTRIC



## TECHNICAL LITERATURE

For additional information on products described in this section, circle the numbers on Reader Service Card. Requests will be handled promptly.

### Electronic Parts and Supplies 400

A 616-page 1971 catalog, No. 710, of electronics parts and supplies lists over 70,000 separate stock items from more than 700 manufacturers. Detailed specifications, descriptions and illustrations, as well as pricing cover a vast array of parts and components including—semiconductors, integrated circuit devices, tubes, relays, timers, transformers, resistors, capacitors, connectors, coils, chokes, sockets, plugs, jacks, switches, fuses, batteries, clips, lamps, wire and cable, and much more. Other major sections of the catalog feature test instruments, recording equipment, sound equipment, intercoms and other business communications gear, power supplies, electronic counters, industrial silicones, epoxy material and other chemicals, hardware, technical books, tools and solder equipment. Allied Electronics.

### Wire Cable and Tubing 401

A 72-page catalog of wire, cable and tubing products, No. W-7, describes more than 7000 products manufactured and marketed by the company. It includes descriptions and specifications for products ranging from hook-up wire and multiconductor cable to coaxial cable and zipper tubing. Among the new products listed in the catalog are heat shrinkable soldering sleeves, solid and miniature Teflon wire and machine tool wire. A two-page construction index provides the reader with a quick reference for locating the various gauges and combinations of cables. Alpha.

### Sound Systems 402

Techniques and equipment for sound systems in the sports and entertainment fields is covered in a 12-page brochure. The publication illustrates the equipment used in sports arenas, stadiums, automobile speedways, hotels, restaurants and other public entertainment buildings. Altec Lansing Div.

### Switch Catalog 403

Information on enclosed push-button and rotary switches and termination hardware is contained in the G-306-A catalog. Among the products included are: decorative push-button

switches (momentary and alternate action), environmentally sealed push-button switches, key-operated rotary switches, a build-your-own rotary switch kit, spring return rotary switches, and isolated position (pull-to-turn or push-to-turn) rotary switches. The engineering data section of this catalog provides information on switch parameters. A push-button switch selector chart and a rotary switch selector chart allow you to determine readily the switch for your application. Another feature of the catalog is a shortform listing of the manufacturer's switches. This catalog allows you to pick a qualified switch from a variety of sizes and current ratings for rotary switches. Grayhill.

### Capacitor Replacement Guide 404

A 24-page replacement guide for electrolytic capacitors is being offered by the manufacturer. It lists original part numbers for color and B/W TV sets, and includes cross reference guides for other manufacturers' products. Loral Distributor Products.

### 1971 Electronics Catalog 405

The 1971 edition of the Industrial Electronic Components catalog, No. FR-71-1, containing nearly 1700 items, has been released. The 84-page catalog has been revised and expanded. It lists such diverse hardware items as connectors, adapters, alignment tools, clips, plugs and jacks, binding posts, cable clamps, and cable ties. A broad selection of Nylon and metal mounting hardware, printed circuit materials, printed circuit connectors, spacers, switches, test prods, production-type wire strippers, grommets and lacing cords are included. A special appendix in the catalog provides part-number cross-references to identify parts made by other suppliers. GC Electronics.

### Tools 406

A 100-page tool supply catalog, No. 1170, features more than 375 quality items such as cutting tools, hard-to-get taps and dies, thread plugs and ring gauges, drills, gauges, micrometers and many more. Rutland Tool & Supply.

### Instrument Rental 407

The 42-page catalog, GEC-155D, 1971 edition, lists more than 100 new items giving the monthly rates and ordering information for a wide variety of analytical instruments, electro-mechanical measuring devices, and electrical and electronic instrumentation available to industry through rentals. Technicians are available to operate the rental instruments or to conduct electro-mechanical measurements on site. General Electric.

## NOW . . . A NEW BOOK FROM TV TECH AID BLACK & WHITE TV TIPS

Our new book will contain over 400 actual causes and cures for BLACK & WHITE TV and STEREO trouble symptoms of all the leading manufacturers. Each "tip" will be presented in a concise, brief format including a clearly marked schematic diagram of the associated circuitry.

We are dealing with "FACTS" . . . not theory! This book has been compiled to help you save time, and time is MONEY. **ONLY \$5.95** Send for it now. **MONEY BACK GUARANTEE.**

TV TECH AID  
P.O. BOX 603  
KINGS PARK, L. I.  
NEW YORK 11754

ENCLOSED IS A CHECK OR M.O. FOR \$5.95. PLEASE SEND COPY OF BLACK & WHITE TV TIPS.

NAME .....  
ADDRESS .....  
CITY .....  
STATE ..... ZIP .....

... for more details circle 131 on Reader Service Card

## Telematic

### for Fast High Voltage Repairs



CUPS

Replace  
only cap  
or spring

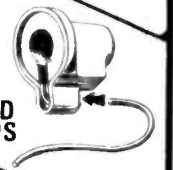

GRID  
CAPS

### Get Telematic's Anode Repair Kit Model KV-370

— contains —  
anode cups, springs  
grid cups, anode wire  
30 KV spaghetti

FOR SAFE SURE HIGH VOLTAGE  
REPAIRS SPECIFY TELEMATIC'S 30 KV  
REPLACEMENT PARTS.

TELEMATIC, BKLYN, N.Y. 11207

... for more details circle 127 on Reader Service Card

# READERS SERVICE INDEX

## ADVERTISER'S INDEX

American Telephone and Telegraph	46
101 Arrow Fastener Co., Inc.	62
102 B & K Division Dynascan Corporation	26
103 Belden Corporation	57
104 Book Club—Tab Books	50-53
105 Centralab, Division of Globe-Union Inc.	32
106 Chemtronics, Inc.	58
107 Chrysler Corp.—Dodge Division	59
108 EICO Electronic Instruments Co., Inc.	2nd Cover
109 Finney Co.	31
110 Ford Marketing Corp.	47
General Electric Company	66
111 Grantham School of Engineering	68
112 Heath Company	63
113 Jensen Tools & Alloys	54
114 Johnson Company, E. F.	62
115 Kikusui Electronics Corp.	68
116 Lakeside Industries	56
117 Leader Instruments Corp.	3rd Cover
118 Lectrotech, Inc.	48

133 Mallory Distributor Products Co.	21
119 Quietrolle Company	24
RCA Entertainment Tubes	64
RCA Parts & Accessories	4th Cover
RCA Picture Tubes	22
122 RMS Electronics, Inc.	68
123 Sencore, Inc.	28
124 Sencore, Inc.	65
125 Sprague Products Company	25
Sylvania Electric Products	49, 55
126 Tech Spray	27
127 Telematic Division UXL Corp.	67
128 Triplett Corporation	61
129 Tuner Service Corporation	19
130 TV Tech Aid	65
131 TV Tech Aid	67
132 Workman Electronic Products, Inc.	56
Zenith Radio Corporation	29

707 VOM	58
708 Signal-Tone Encoders	60
709 Tools	62
710 Car Stereo Tape Player	62
711 Direction Finder Radio	62
712 Antenna Mounting Hardware	65
713 Burglar Alarm	65

## TECHNICAL LITERATURE

400 Electronic Parts and Supplies	67
401 Wire Cable and Tubing	67
402 Sound Systems	67
403 Switch Catalog	67
404 Capacitor Replacement Guide	67
405 1971 Electronics Catalog	67
406 Tools	67
407 Instrument Rental	67

## TEST INSTRUMENT

900 Heathkit's Model IB-101 frequency counter	45
---	----

## NEW PRODUCTS

700 Oscilloscope	30
701 Tape Deck	30
702 AM/FM Tuner	30
703 Attenuator	56
704 TV Strip Amplifier	56
705 Contact Cleaner	56
706 CRT Adapter	58

Technicians, Earn Your Associate **DEGREE**  
*mostly by correspondence*  
 Accredited by the Accred. Comm. of National Home Study Council. G.I. Bill Approved. Free catalog.  
 Write: **Dept. T**  
**Grantham School of Engineering**  
 1505 N. Western, Hollywood, Calif. 90027  
 ... for more details circle 111 on Reader Service Card

# Low Cost, Compact Oscilloscope

If shelf space is critical, and budgets are small—you have 2 reasons for choosing a **KIKUSUI** oscilloscope!

1-7½" high, 5½" wide, 14" deep

2-ONLY \$167<sup>00</sup> complete

### Compare these features:

- Solid state circuitry
- High sensitivity of 20 mv/cm
- Bandwidth of 1.5 MHz
- Controls grouped by function for easy operation
- AC/DC coupled
- Flat 3 inch CRT face for sharper traces
- 3 step attenuator with variable control
- Excellent for lab or field use

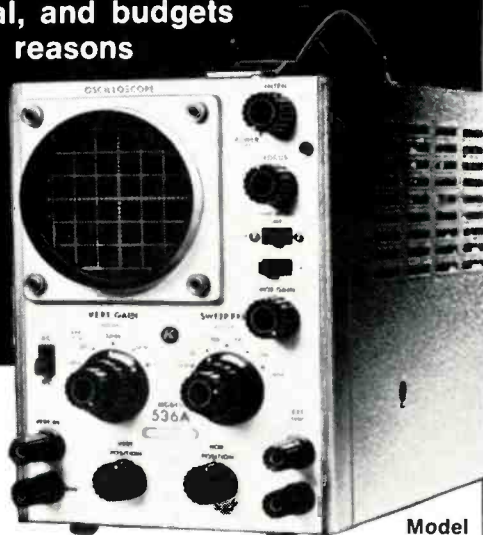

Model 536A

Full line of electronic test instruments include: trigger, dual trace trigger, alignment and standard oscilloscopes.

Call or write for **FREE** specification catalog



**kikusui**  
ELECTRONICS CORP.

Address all inquiries to:  
**Marubeni-Iida (America) Inc.**  
 200 Park Avenue, New York, N. Y. 10017  
 Telephone 212-973-7152

# THE BEST PERFORMING UHF/VHF/FM HIGH GAIN 4-SET COUPLER...

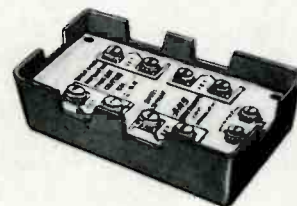

#C-4UV

Couples 4 TV and/or FM Sets to a single antenna with low loss of signal... minimum interference between sets. Two antennas, any combination of VHF, UHF, or FM, can be coupled to a single down-lead. Penetrating washers eliminate the need to strip wire. Assures simple hook-up of set and antenna leads. Wood screws are provided for mount to back of set or base board of a wall.

Model C-4UV Specifications...	
Bandwidth	20-890 MHz
Splitting Loss	20-220 MHz—7.5 db
	450-890 MHz—11 db
Isolation	20-220 MHz—10 db
	450-890 MHz—14 db
VSWR	20-220 MHz—2.5 Max.
Input	450-890 MHz—3.5 Max.

Also available—model C-2UV 2-Set UHF/VHF Coupler. Write for Profit Details—

## RMS ELECTRONICS, INC.

50 Antin Place, Bronx, N.Y. 10462  
 • Tel. (212) 892-6700

... for more details circle 122 on Reader Service Card

# LOTS

# NEW

A broad new line of exciting, laboratory grade test instruments from Leader, for servicing all electronic equipment — priced to give you the best dollar-for-dollar value — and built to the highest standards in the industry!

Leader's got it in New, Portable Triggered Scopes; Battery Operated Color Bar Generators; Post Injection Sweep Marker Generators; and lots more. Accessories too. Seeing is believing. Send for your new catalog. See your distributor.

FROM

# LEADER

## LOTS OF SCOPE ...



LBO-301

Here's the only 3" Portable Triggered Scope with vertical and horizontal calibration! All solid state, it features highest sensitivity, wide bandwidth and an easy-to-use, horizontal panel design for testing under all conditions. Great for servicing color TV and computer circuitry. It's compact, it's portable, it's remarkably low-priced. \$334.50

## LOTS OF STABILITY ...



LCG-384

Our fabulous, new, Mini-Portable Color Bar Generator that's battery operated, yet offers test patterns of the highest stability. Features Leader's digital clock and binary system that acts as a miniature computer. Has two switch selectable frequencies, four basic patterns including gated rainbow for testing NTSC color sets. With carry case, extra battery compartment and all accessories. \$109.50

## LOTS OF SENSITIVITY ...



LBO-54B

This 5" Wideband Scope features calibrated vertical input, 10MVp-p/cm sensitivity and unstinting operational stability. Bandwidth is DC to 10MHz and the high linearity sweep range has automatic synch. DC coupling and push-pull amplifiers help deliver distortion-free displays. \$249.50

## AND LOTS MORE ...

From left to right here's our

LBO-501—5" Triggered Scope/ Vectorscope .....	\$339.50
LSW-330—Solid State Post Injection Swemar Generator .....	\$399.50
LBO-32B—3" Wideband Oscilloscope .....	\$189.50
LDM-810—Grid Dip Meter .....	\$44.50

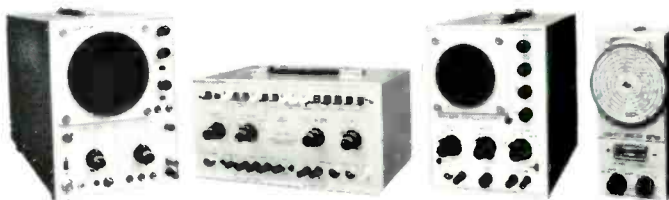

**Seeing is believing.**

**Leader**  
TEST INSTRUMENTS  
37-27 27th Street, Long Island City  
New York 11101.  
Telephone: (212) 729-7410

# Cut your time

## With "QT." The Quick Turnover Parts Inventory System from RCA.

How much time do you spend in the shop searching for parts? And if you don't have them how long does it take you to get them?

If you're doing more than your share of looking for parts or ordering them on the phone, you're wasting time.

Time that's cutting down your efficiency and preventing you from doing the really important things.

That's where our Quick Turnover Parts Inventory System ("QT" for short) can help.

- It's a system that puts 250 of the fastest moving RCA parts for TV sets, radios and phonographs at your fingertips. Parts selected by RCA's computers.

You'll also know when the supply is running low. And should any of the parts be dropped from the "top-mover" list, simply return them through your "QT" distributor.

Talk to your RCA Parts & Accessories Distributor about putting in a "QT" Inventory System.

The sooner you do the faster you'll start saving time.

**RCA** Parts and  
Accessories

