

ELECTRONIC TECHNICIAN / DEALER

WORLD'S LARGEST TV-RADIO SERVICE & SALES CIRCULATION

Teklab Report on Silvertone / Signal Strength Meters / Servicing Color High Voltage Systems

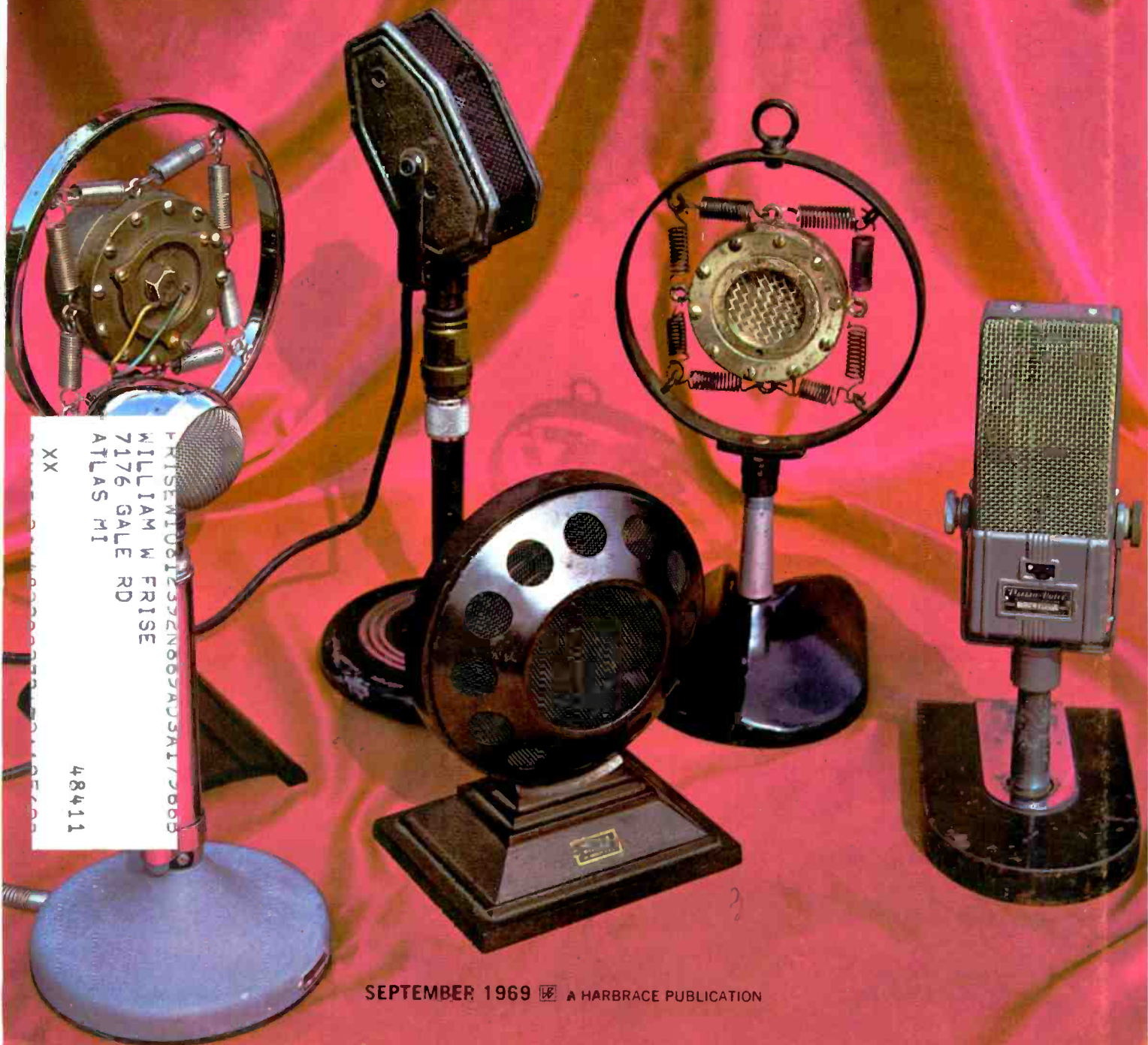

XX
FRISBEN
WILLIAM W FRISE
7176 GALE RD
ATLAS MI
48411

ANALYSE THYSELF

So you can analyse fast and simple with the *B&K Model 162 FET/Transistor Tester* with features nobody else has.

TESTS EVERYTHING: Diodes. Bipolars. FETs. Unijunctions. SCR'S and Triacs.

HIGHER CURRENT CAPABILITIES: Up to 1 ampere. You need this for power transistors and FETs.

THREE TRANSISTOR LEAKAGE TEST: I_{cbo} - I_{ceo} - I_{ces} . Finds failures missed by other transistor testers. Especially "avalanche mode breakdown" failures, common in horizontal output or other power stages.

CORRECT BETA READING: From 1-5000.

SPECIAL BALANCING CIRCUIT: Permits balancing-out as low as 6 ohm circuit impedance for in-circuit test.

FRONT PANEL SOCKETS: For bipolar and FET transistors. Especially useful for FET test. Minimizes damage due to static charges.

SEPARATE CHECKS: Checks Gate 1 and Gate 2 of dual gate FETs separately.

PROGRAMMED INSTRUCTION GUIDE: Provides instruction on Go-no-Go conditions for Beta and Leakage.

But, the new *B&K 162* doesn't just have the features nobody else has. It has *all* the features they have, too. And has them better.

Which means all the other transistor and field effect transistor testers are obsolete.

So, if you didn't just get stuck with somebody else's outdated unit, go see a good analyst. Ours. At your nearest B&K distributor.

See B&K . . . you'll be better in your field.



Price: \$99.95

B&K puts an end to test equipment. We've developed Silent Partners.



Product of DYNASCAN CORPORATION
1801 W. Belle Plaine Chicago, Illinois 60613



. . . for more details circle 107 on postcard

COMPLETE MANUFACTURER'S CIRCUIT DIAGRAMS
AND TECHNICAL INFORMATION FOR 6 NEW SETS

GROUP
205

	SCHEMATIC NO.	SCHEMATIC NO.
EMERSON	1248	SEARS SILVERTONE 1249
Color TV Model 29P10		Color TV Chassis 528.72940
PHILCO-FORD	1250	SYLVANIA 1247
TV Chassis 19HT15		TV Chassis B12-1, -2
RCAVICTOR	1251	ZENITH 1252
TV Chassis KCS177 Series		TV Chassis 14Z21, 14Z21Z

SYMBOL DESCRIPTION

SYMBOL DESCRIPTION	SYLVANIA PART NO.
C500---3 sec elect	41-29367-1
C500A---3 sec elec, 50/400v	41-29367-1
C500B---3 sec elec, 120/400v	41-29367-1
C500C---3 sec elec, 5/350v	41-29367-1
R248---7k, 7w	35-92495-16
R335---VDR	38-15257-17
R504---1.7k, 15w	36-92898-18
L100---quad	57-11602-1
L202---tilt adj	57-11611-1
L204---47.25MHz trap	57-11631-2
L205---video det	57-11616-2
L206---video det	57-11652-1
L400---horiz hold	50-27910-1
L404---horiz lin	50-15019-1
L500---choke filter	56-11651-6
T100---sound IF	56-11606-1
T102---audio output	56-27824-1
T200---1st video IF	57-11612-2
T204---sound take off/4.5MHz trap	57-11604-1

T300---vert output	56-27823-1
T400---horiz output	50-27819-1
T500---power	55-29368-1
R117---1.5M tone (-2 CH)	37-15230-2
R118---1.0M volume on/off (-2 CH)	Part of R117
R118---1.0M volume/on/off (-1 CH)	37-11959-8
R224---220K AGC	37-11632-1
R250---25K contrast	37-29373-1
R252---1.5M bright	37-29373-2
R316---5M, vert lin	Part of R224
R320---1.5M, vert hold	37-29373-2
R340---1.5M, vert height	Part of R224
R436---50K, width	37-11632-1
CB500---circuit breaker	29-29000-1
1200, 1300---lamp neon NE2H	30-97684-3
PP200---printed circuit plate sound take off	32-11631-1
PP300---printed circuit plate sync take off	32-88098-2
Q1---transistor, noise gate 2N388	13-27050-1
SC200---diode video det	1N295
SC202---diode DC restorer	0B462
yokey, def.	51-29369-1

TRANSISTOR LAYOUT

—WARNING—
TO INDICATE HIGH VOLTAGE, ARC ANODE TO CHASSIS NEAR HV. TRANSFORMER ONLY. DO NOT ARC TO ANY OTHER METAL PARTS.

USE ONLY GENUINE SYLVANIA TUBES IF REPLACEMENT IS NECESSARY. PICTURE TUBE 23FHP4 CABINET MOUNTED NOTE: REPLACE ALL TUBES WITH ORIGINAL TYPE ONLY.



—WARNING—
FRAGILE GLASS PICTURE TUBE IS DANGEROUS TO HANDLE.

REFER SERVICING TO QUALIFIED SERVICE PERSONNEL. THE PICTURE TUBE IN THIS RECEIVER EMPLOYS INTEGRAL IMPLOSION PROTECTION. REPLACE WITH A TUBE OF THE SAME TYPE NUMBER FOR CONTINUED SAFETY.

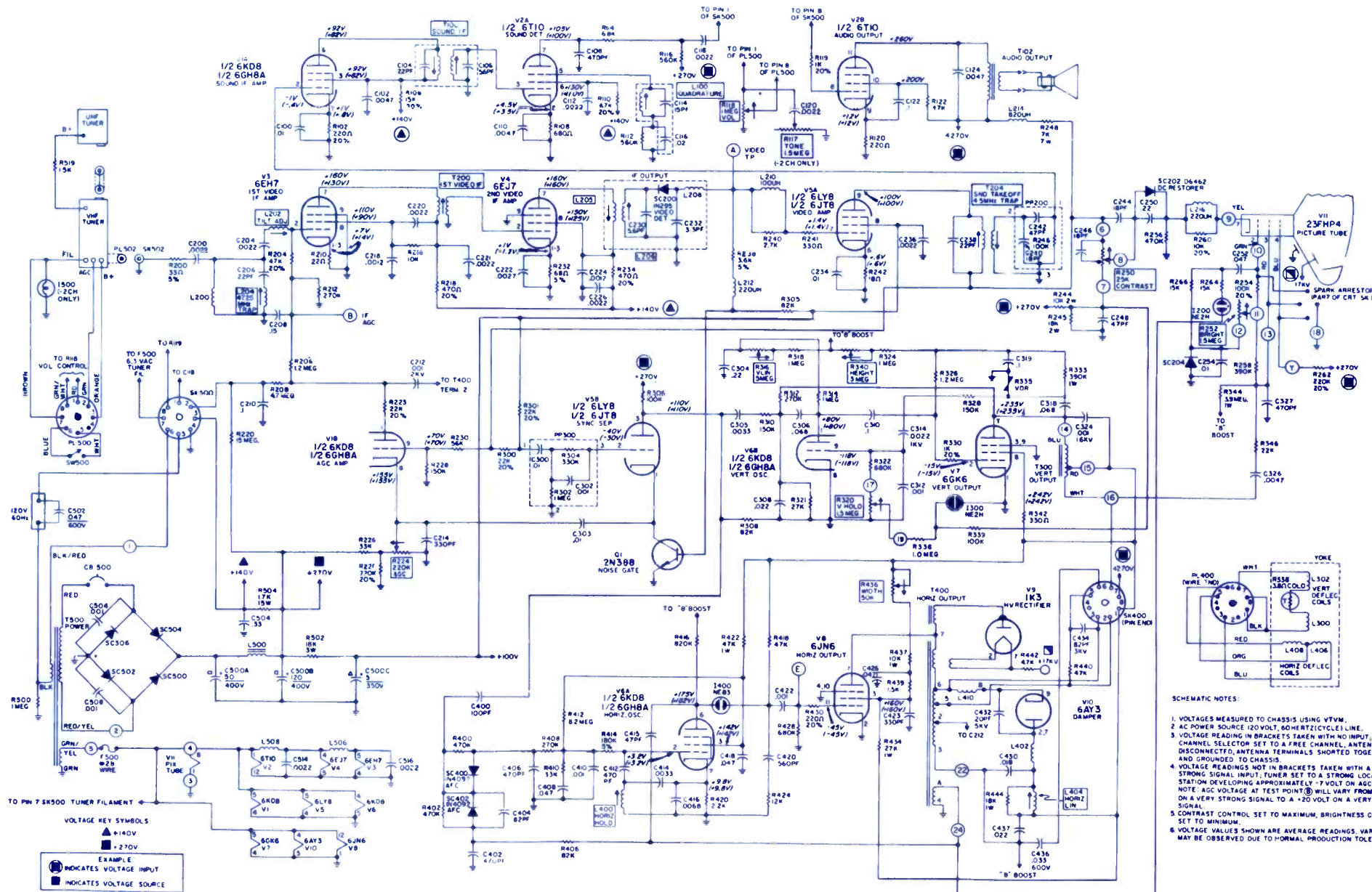
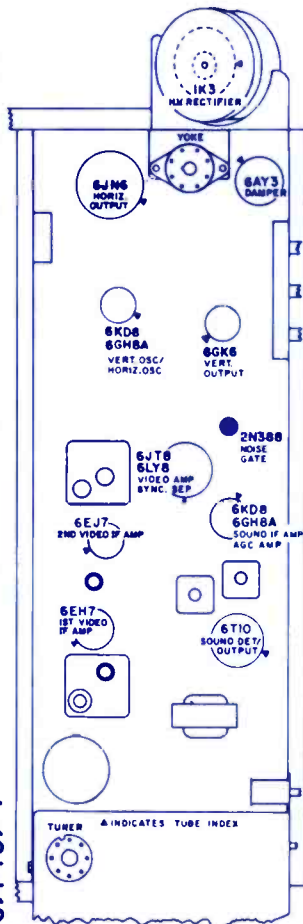

SCHEMATIC NOTES:

- VOLTAGES MEASURED TO CHASSIS USING VTVM.
- AC POWER SOURCE 120 VOLT, 60 HERTZ (CYCLE) LINE.
- VOLTAGE READINGS IN BRACKETS TAKEN WITH NO INPUT. CHANNEL SELECTOR SET TO A FREE CHANNEL. ANTENNA DISCONNECTED. ANTENNA TERMINALS SHORTED TOGETHER AND GROUNDED TO CHASSIS.
- VOLTAGE READINGS NOT IN BRACKETS TAKEN WITH A STRONG SIGNAL INPUT. TUNER SET TO A STRONG LOCAL STATION DEVELOPING APPROXIMATELY 7 VOLT ON AGC BUS. NOTE: AGC VOLTAGE AT TEST POINT (D) WILL VARY FROM 7 VOLT ON A VERY STRONG SIGNAL TO A +20 VOLT ON A VERY WEAK SIGNAL.
- CONTRAST CONTROL SET TO MAXIMUM, BRIGHTNESS CONTROL SET TO MINIMUM.
- VOLTAGE VALUES SHOWN ARE AVERAGE READINGS. VARIATIONS MAY BE OBSERVED DUE TO NORMAL PRODUCTION TOLERANCES.

COMPLETE MANUFACTURERS' CIRCUIT DIAGRAMS AND TECHNICAL INFORMATION FOR 6 NEW SETS

SEPTEMBER • 1969

SYMBOL	DESCRIPTION	EMERSON PART NO.
C908, C940	elec. 30 + 50 + 80µf, + 50%	
-10%	450WV	981974
C931	elec. 22 + 33 + 100µf, + 100%	981974
-10%	350WV	98177

R119	15K, 7w	
R704	10K, 7w	984020
R931	4Ω ± 5%, 35w	981980
R933	1800Ω ± 5%, 15w	984027
VR102	500Ω, sound reject	981999
VR301	3K, R-Y blnce	984006
VR505	100Ω, top R/G horiz lines	982040
VR506	150Ω, top blu horiz lines	982041

VR701	10K sub bright	982368
VR702	5K, blu drive	982047
VR705	1M, grn screen	982048
VR707	1M, AGC	982048
VR708	1M, vert height	982048
VR709	1M, vert lin	982048
VR711	500K, killer threshold	982369
VR713	500K high volt adi	982369
VR712	100K, horiz drive	982370
VR714	50K DPC balance	982372
VR901	1M volume with on/off switch	984002
VR902	1M bright	981964
VR903	500Ω, contract	981963
VR904	500K vert hold	982329
VR905	3K tint	982001

VR906	500Ω, color	984004
VR907	100K, horiz hold	981965
VR908	100K high volt sub regulator	984005
TH1	thermistor, SDT-200	982033
VDR1	voltage dependent resistor, VDR-1B13151MB	982032
T105	xformer, 4.5MHz trap	983976
T106	xformer, sound IF	983977
T302	xformer, 2nd bandpass	983987
T303	xformer, burst drive	983988
T501	xformer, right horiz blu lines	982037
T901	xformer, audio output	981938
T902	xformer, vert output	981939
T905	xformer focus	981919
T906	xformer, heater	983961

L117	coil, sound take-off	983963
L118	coil, quad	983984
L301	coil, horiz osc/stab	982014
L302	coil, chroma take-off	983990
L316	coil, horiz eff	982015
L901	coil, delay line	983962
L905	coil, filter	983161
L911	deflection yoke	983955
SW2	switch, CRT bias	982049
F901	cir brkr	981948
	video and sound cir brd ass'y (except tubes)	983963
	chroma & def cir brd ass'y (except tubes)	983964
	purity & blu lat magnet ass'y	981923

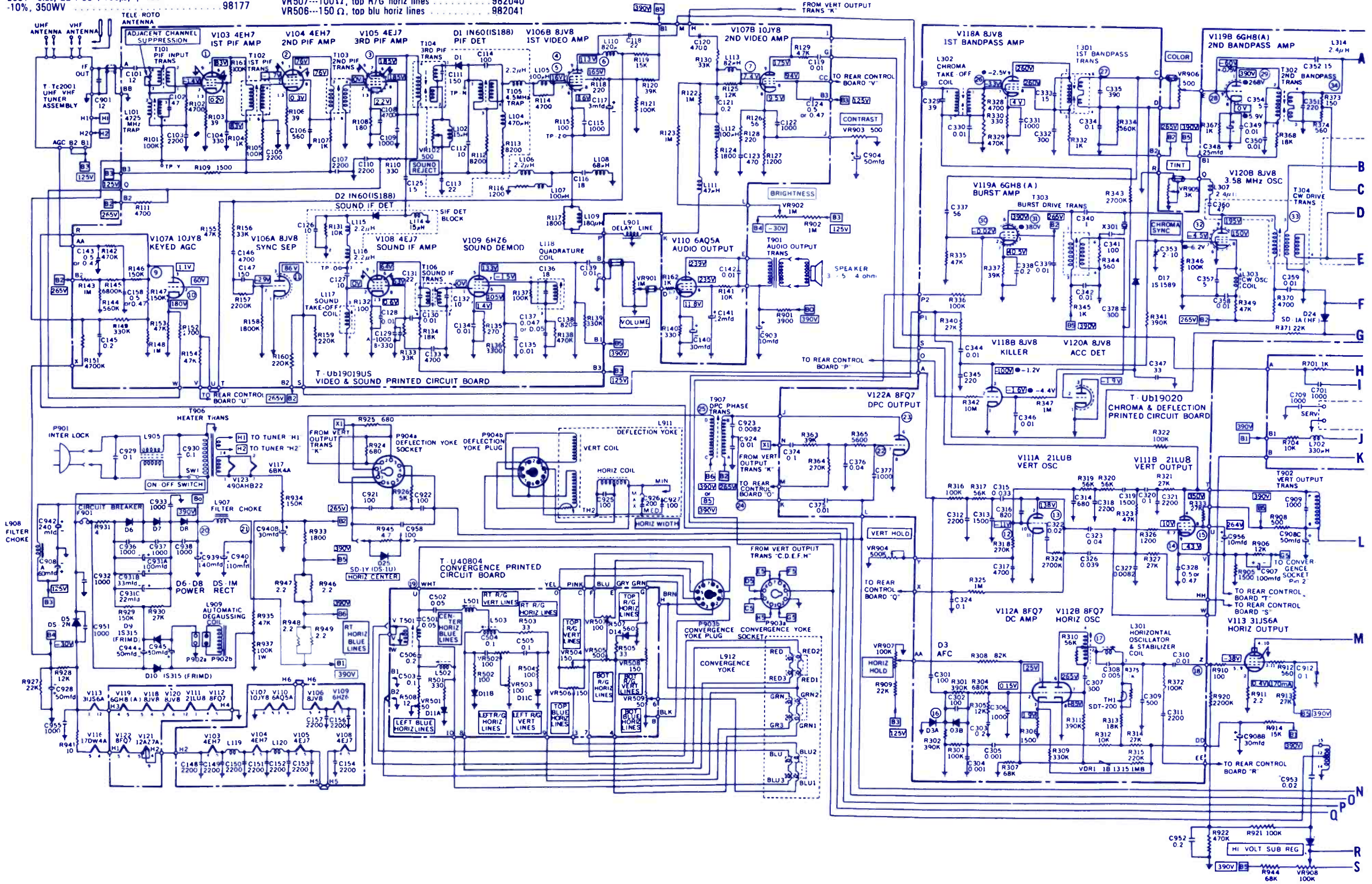

SYMBOL DESCRIPTION	SILVERTONE PART NO.
C102A,B,C,D---elec(A) 25/350v, (B) 400/350v, (C) 80/350v, (D) 20/350v	18-138-3
C103A,B,C,D---elec (A) 200/200v, (B) 250/350v, (C) 100/350v, (D) 40/350v	18-121-3
R14---control, 750K (chromix)	24-1162
R21---control, 1.5M (vert hold)	24-1033
R37---control, vol., 250K (SW101 pull on-push off)	24-1155
R45---control, 1.2K (tint)	24-1163
R47---control, 500Ω (color)	24-1164
R48---control, 150Ω (contrast)	24-583
R49---control, 2M (bright)	24-1C52
R112---control, 100K (hv adj)	24-951
R122---control, 10Ω (horiz center-part of T103)	24-721
R131---control, 15M (focus)	24-1C40
R160,R162---control, 2M (screen grid)	24-957
R161---control, 3M (screen grid)	24-956
R216---control, 2.5M (vert height)	24-832
R218---control, 1 M (vert drive)	24-1C94
R225---control, 100K (vert lin)	24-897

R326---control, 20K (41.25MHz trap)	24-1050
R397---control, 50K (AGC)	24-833
R403---2.5M (bright limit adj)	24-1035
R417---control, 1M (color killer)	24-981
R429,R435---control, 2.5M (grid drive adj)	24-976
R504,R508---control, 120Ω, 1w, WW	24-577
R505,R509---control, 150Ω, 1w, WW	24-579
R510---control, 60Ω, 3w, WW	24-880
R602---control, 5K (AFC bias adj)	24-989
R100---300Ω, 10w, WW	61-299-0
R101---2.2Ω, 15w, WW	61-428-0
R108---thermistor, 120Ω cold	61-78-1
R111---varistor	61-87-1
R119---13K, 7w	68-13371
T101---xformer, audio output	80-246-1
T102---xformer, vert output	80-45-2
T103---xformer, horiz output (inc R122)	80-82-3
T104---xformer, filament	80-21-5
L14---yoke, defl (inc C1,C2,C3,R1,R2,R3,R4)	80-77-4
L24---coil, horiz hold	10-120-4

L101---choke line radiation	10-362-1
CB101---cir brkr	43-33-2
TD331---delay line	23-22-2
Yoke def (L14)	80-77-4
R200---varistor	61-91-1
R228---varistor	61-95-1
T331---coil, chroma take-off	10-109-3
T352---coil, sound ratio det	10-328-1
L321---coil, video det	10-100-3
L331---coil, peaking (60μh)	10-341-1
L355---coil, peaking (330μh)	10-253-1
Q31---noise gate	86-291-2
R480---3.9K, 7w, dep oxide	68-39271
T410---xformer, chroma band pass	10-288-1
T440---coil, burst phase	10-250-1
T490---coil, 3.8MHz osc	10-258-1
T101---coil, blu horiz	10-101-5
L501---coil, horiz conv	10-126-5
L502---coil, right horiz	10-102-5
Q62---transistor, AFC amp	86-308-2

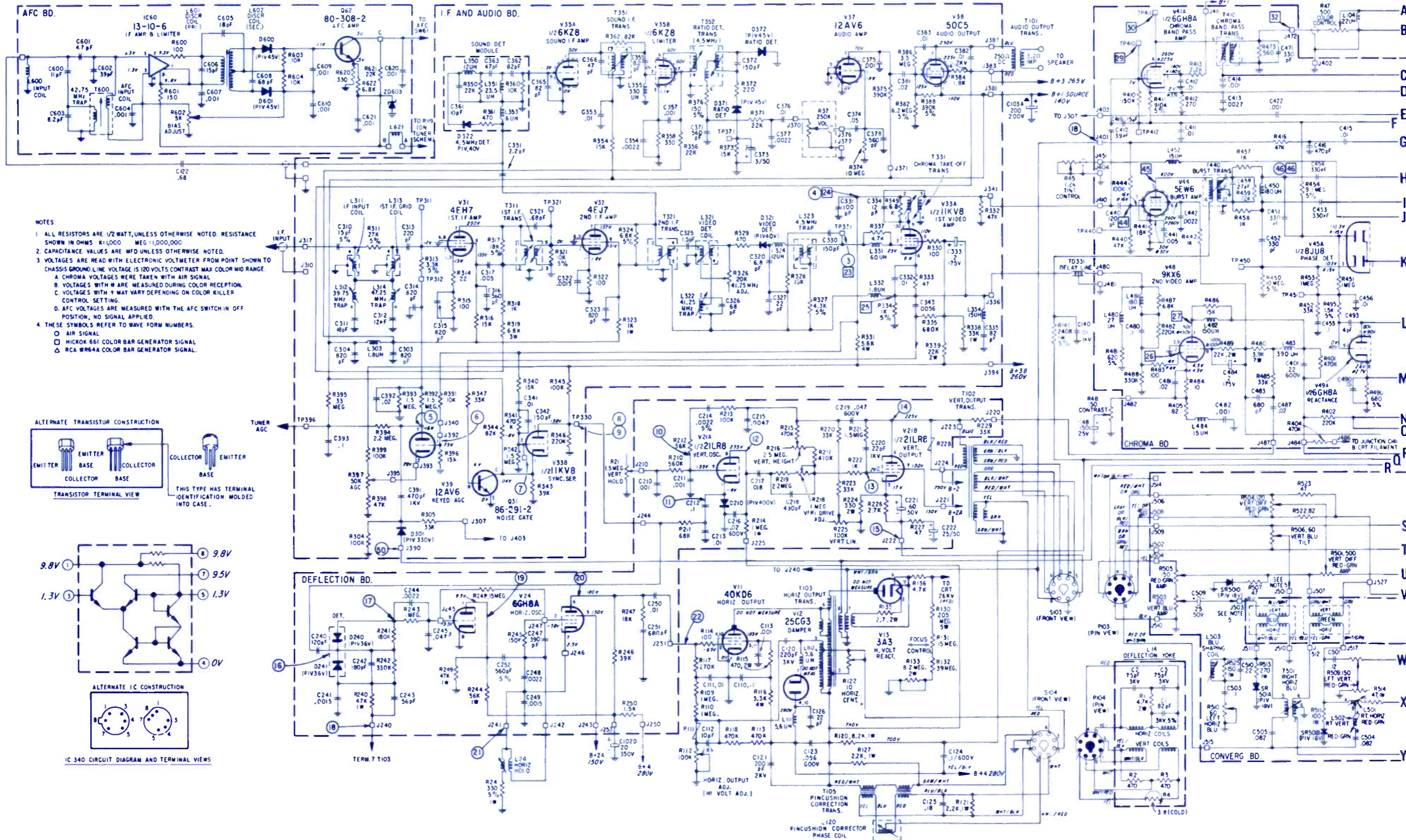

- NOTES:
- ALL RESISTORS ARE 1/2 WATT, UNLESS OTHERWISE NOTED. RESISTANCE SHOWN IN OHMS K=1,000 MEG=1,000,000
 - CAPACITANCE VALUES ARE MFD UNLESS OTHERWISE NOTED.
 - VOLTAGES ARE READ WITH ELECTRONIC VOLTMETER FROM POINT SHOWN TO CHASSIS GROUND. LINE VOLTAGE IS 120 VOLTS CONTRAST MAX. COLOR MID RANGE.
 - CHROMA VOLTAGES WERE TAKEN WITH AIR SIGNAL.
 - VOLTAGES WITH * ARE MEASURED DURING COLOR RECEPTION.
 - VOLTAGES WITH † MAY VARY DEPENDING ON COLOR KILLER CONTROL SETTING.
 - AFC VOLTAGES ARE MEASURED WITH THE AFC SWITCH IN OFF POSITION, NO SIGNAL APPLIED.
 - THESE SYMBOLS REFER TO WAVE FORM NUMBERS.
 - AIR SIGNAL
 - MICROK 661 COLOR BAR GENERATOR SIGNAL
 - RCA WR644 COLOR BAR GENERATOR SIGNAL

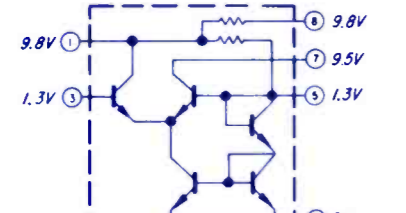
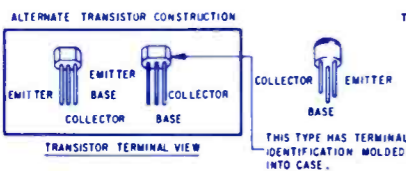

SEARS SILVERTONE
Color TV Chassis 528.72940

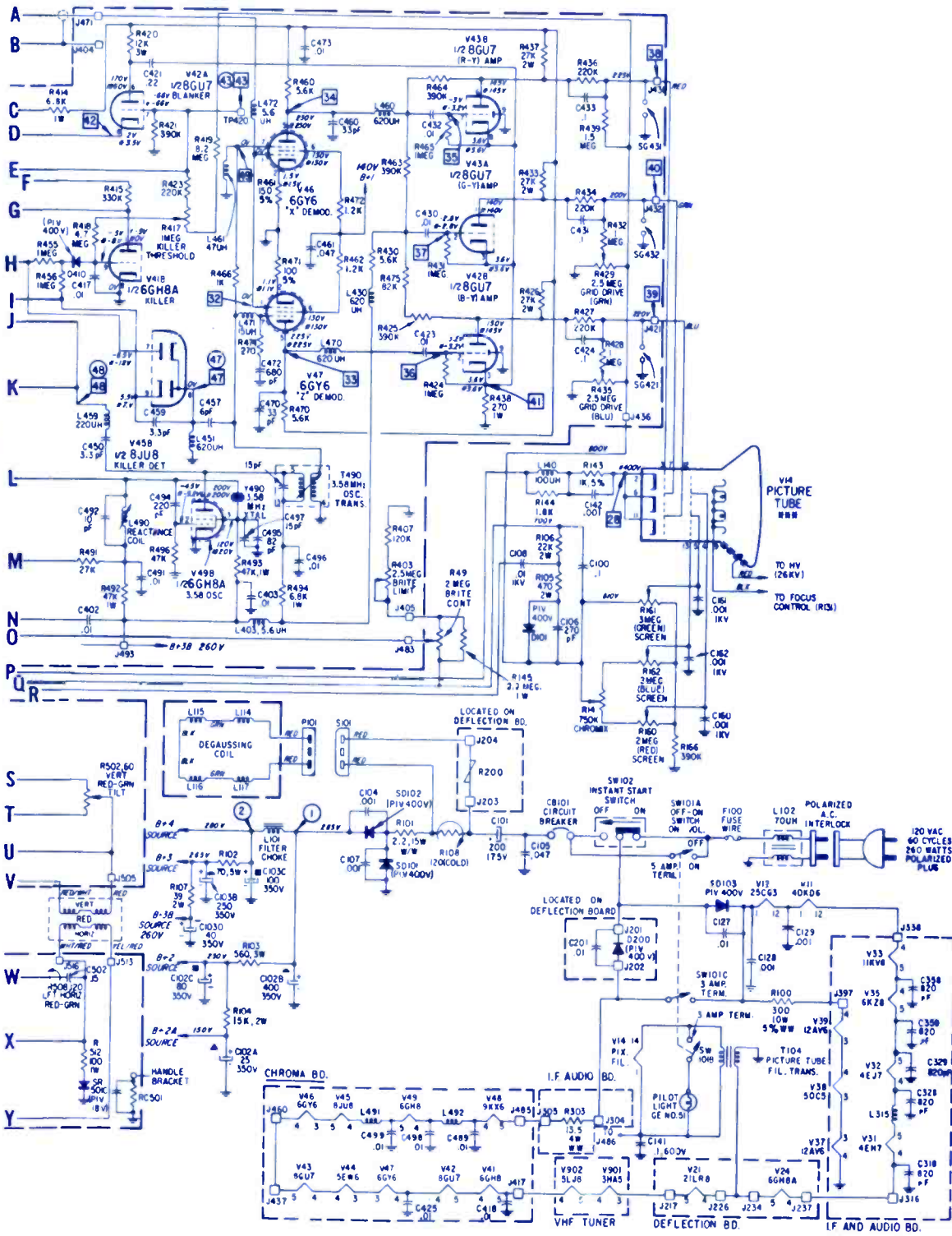
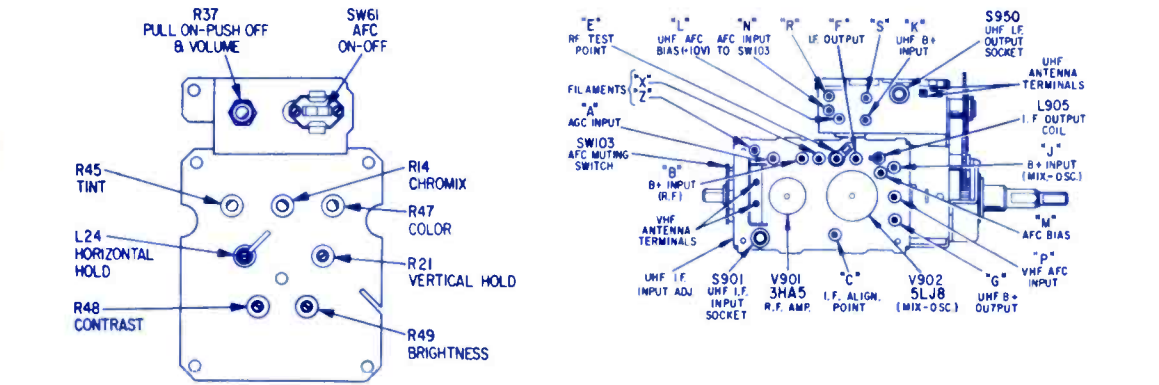

LEGEND:
 ○ DENOTES "AIR" SIGNAL.
 □ DENOTES HICKOK 661 COLOR BAR GENERATOR SIGNAL.
 △ DENOTES RCA WR64A COLOR BAR GENERATOR SIGNAL.

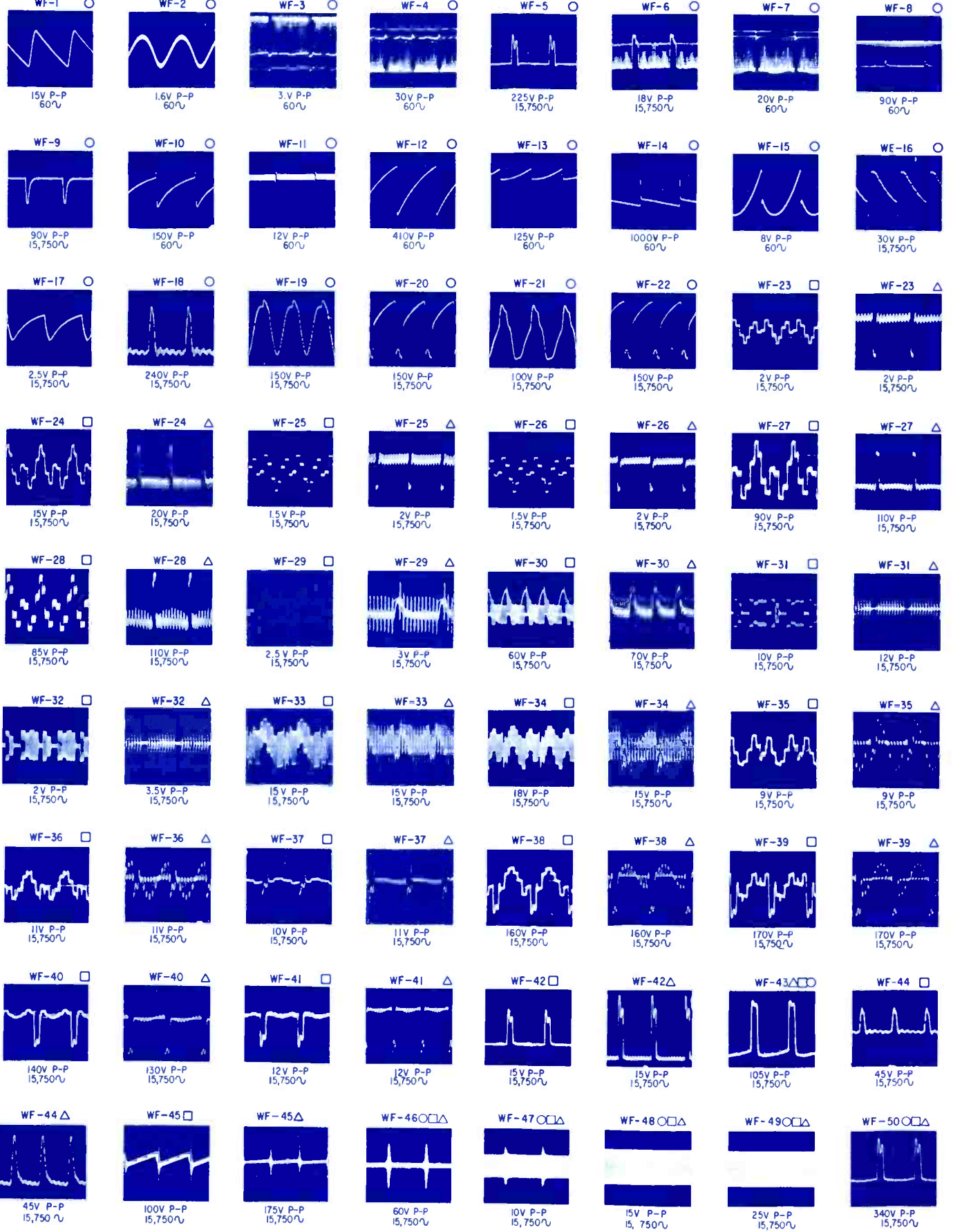

OSCILLOSCOPE WAVEFORMS

These waveforms were taken with the receiver adjusted for a snow free picture. Voltage readings taken with line voltage of 120 VAC and all controls set for normal picture viewing except for photo 1, 2 and 3 where contrast was at maximum. The voltages given are approximate peak-to-peak values. The frequencies shown are those of the waveforms ... not the sweep rate of the oscilloscope. All readings taken with the model 1450 B & K oscilloscope.



1 4.5 Volts p/p
15,750 Hz

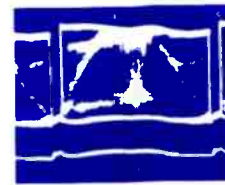

2 4.5 Volts p/p
60 Hz

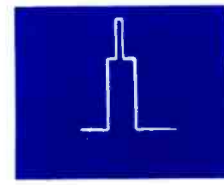

3 70 Volts p/p
60 Hz

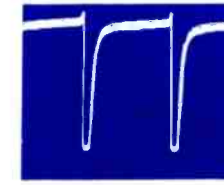

4 9.5 Volts p/p
15,750 Hz

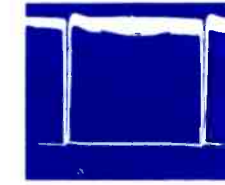

5 9.5 Volts p/p
60 Hz

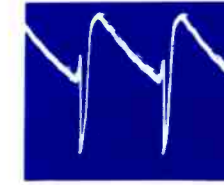

6 5.8 Volts p/p
15,750 Hz

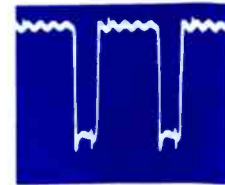

7 0.9 Volts p/p
15,750 Hz

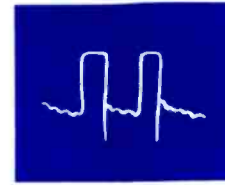

8 21 Volts p/p
15,750 Hz

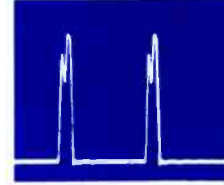

9 105 Volts p/p
15,750 Hz

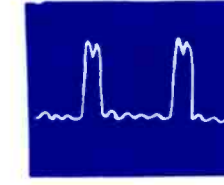

10 32 Volts p/p
15,750 Hz

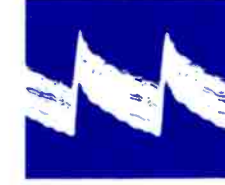

11 0.6 Volts p/p
15,750 Hz

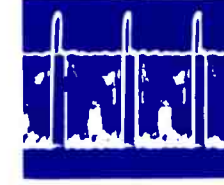

12 4.5 Volts p/p
15,750 Hz

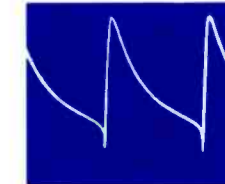

13 4.4 Volts p/p
60 Hz



14 3.8 Volts p/p
60 Hz

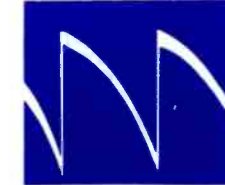

15 3.6 Volts p/p
60 Hz

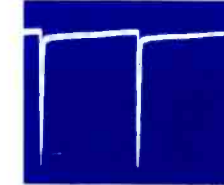

16 112 Volts p/p
60 Hz

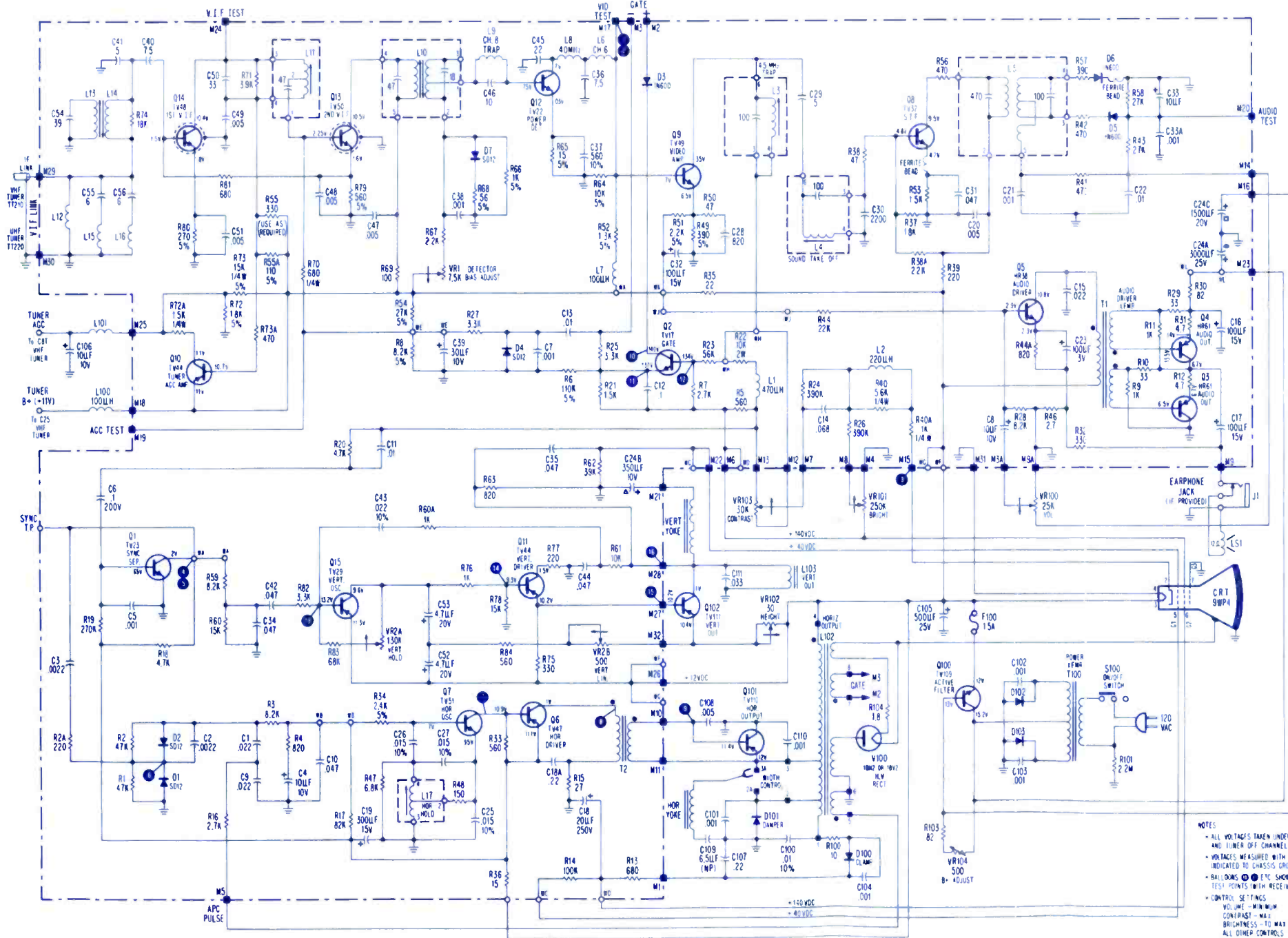

SYMBOL	DESCRIPTION	PHILCO-FORD PART NO.
C24A, B, C	3000 μ d/25v, 1500 μ d/20v, 350 μ d/10v active filter	30-2585-34
D1	SD12, horiz AFC	34-8057-13
D4	SD12, video det bias	34-8057-13
D101	SD22, video B + damper	34-8057-22
D102	B + rec	34-8054-7
D103	B + rec	34-8054-7
L3	4.5MHz trap	32-4901-1
L4	sound take off	32-4901-1
L5	ratio det	32-4906-1
L11	interstage	32-4893-4
L102	HOT	32-10106-2
Q1	TV23, sync sep	34-8001-80
Q2	TV17, AGC gate	34-8001-63
Q3	HR61, audio output	34-8016-11
Q4	HR61, audio output	34-8016-11
Q5	HR38, audio driver	34-8001-71
Q6	TV47, horiz driver	34-8015-26
Q7	TV51, horiz osc	34-8015-30
Q8	TV32, sound IF	34-8015-12
Q9	TV49, video amp	34-8015-28
Q10	TV44, tuner AGC amp	34-8016-15
Q11	TV44, tuner driver	34-8016-15
Q12	TV22, video det	34-8001-79
Q13	TV50, 2nd VIF	34-8015-27
Q14	TV48, 1st VIF	34-8015-27
Q100	TV109, active filter	34-8002-28
Q101	TV110, horiz output	34-8002-30
Q102	TV111, vert output	34-8002-31
R5	560 Ω contr limit	42-2161-11
S100	ac, on-off (slide)	32-10108-1
T1	audio driver	32-10104-1
T2	horiz drive	32-10104-1
T100	power	32-10107-1
VR1	7.5K det bias	33-5628-10
VR2A, B	130K, vert hold 500 Ω vert lin	33-5627-4
VR100	25K volume	33-5624-16
VR101	250K bright	33-5624-15
VR102	30 Ω height	33-5620-9
VR103	30K contrast	33-5624-14
VR104	500 Ω , B + adi	33-5624-17
	tuner, VHF (TT220)	76-14125-1
	tuner, VHF (TT210)	76-14124-1
	yoke	32-9748-2

SYMBOL DESCRIPTION

UHF tuner ass'y	KRK 150A
VHF tuner ass'y	KRK 157A
C240A---200µ, 175v	128498
C240B---400µ, 175v	128498
C240C---50µ, 175v	128498
C240D---10µ, 175v	128498
IC301---cir - int	126871
L203---horiz hold	125129
Q401---transistor	125144

RCA VICTOR PART NO.

Q402---transistor	125144
Q403---transistor	125144
Q404---video driver	129699
Q405---AGC amp	125140
Q406---IF AGC	129697
Q407---transistor	129698
Q501---AGC	125142
Q502---sync	125141
Q503---sync driver	125139
Q504---video output	116081

R101---control, bright	129696
R105---control, volume	129695
R210---control, vert size/hold/lin	128297
R215---control, contrast	128298
R224---control, video bias	128499
RT201---thermistor-16 cold	129698
S101---switch - on/off	128484
T202---vert output	128494
T203---horiz output	129778
yoke def	128486

ELECTRONIC TECHNICIAN / DEALER **TEKFAK**

COMPLETE MANUFACTURERS' CIRCUIT DIAGRAMS AND TECHNICAL INFORMATION FOR 6 NEW SETS



PW400-12
VIDEO DRIVER EMITTER
1.3V P-P VERT. RATE

1



PW500-12
KINESCOPE CATHODE
70V P-P VERT. RATE

2

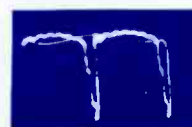

PW500-4
AGC KEYING PULSE
23V P-P HORIZ. RATE

3



PW500-10
HORIZ SYNC PULSE
30V P-P HORIZ. RATE

4



PW500-8
VERT. SYNC PULSE
18V P-P VERT. RATE

5

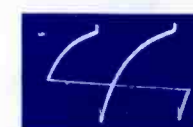

V202-10
VERT. OSC. GRID
180V P-P VERT. RATE

6



V202-6,7
VERT. OUTPUT GRID
30V P-P VERT. RATE

7

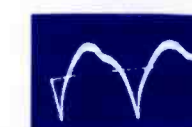

PW500-11
+130V RIPPLE
1V P-P VERT. RATE

8



SR201-SR202
CATHODE JUNCTION
8V P-P HORIZ. RATE

9



SR202
ANODE
11V P-P HORIZ. RATE

10



V204-1
HORIZ. CONTROL PLATE
35V P-P HORIZ. RATE

11



V204-7
HORIZ. OSC. GRID
30V P-P HORIZ. RATE

12



V203-9,10
HORIZ. OUTPUT GRID
100V P-P HORIZ. RATE

13



KINESCOPE PIN 1
VERT. BLANKING PULSE
50V P-P VERT. RATE

14

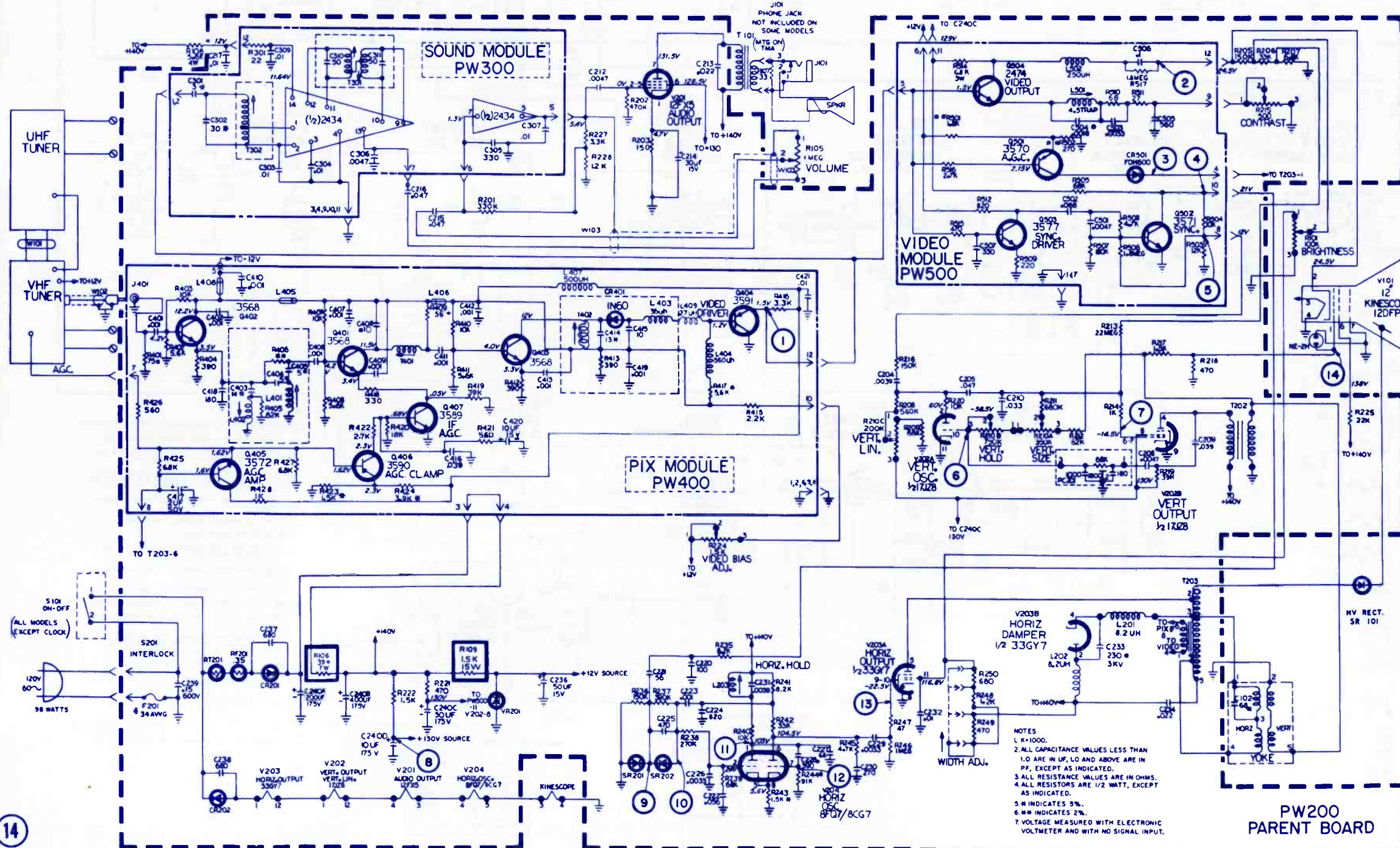

NOTES
1. K=1000.
2. ALL CAPACITANCE VALUES LESS THAN 1.0 ARE IN UF, LO AND ABOVE ARE IN PF, EXCEPT AS INDICATED.
3. ALL RESISTANCE VALUES ARE IN OHMS.
4. ALL RESISTORS ARE 1/2 WATT, EXCEPT AS INDICATED.
5. W INDICATES 5%.
6. MW INDICATES 5%.
7. VOLTAGE MEASURED WITH ELECTRONIC VOLTMETER AND WITH NO SIGNAL INPUT.

PW200
PARENT BOARD

SYMBOL DESCRIPTION	ZENITH PART NO.
C36A---10 μ elec, 350v	22-4503
C36B---60 μ elec, 50v	22-4503
C36C---150 μ elec, 350v	22-4503
C36D---100 μ elec, 350v	22-4503
R7---15K contr cont	63-6356
R8---250K bright cont	63-5033
R12---1M vol cont	63-6961

R15---1M AGC cont	63-6888
R19---750K vert hold cont	63-5032
R20---5M vert size cont	63-5030
R22---1.5K vert lin cont	63-7465
R23---6 Ω 10%	63-4450
L10---quad coil wind ass'y	PT of 17
L12---horiz osc coil wind ass'y	20-2005
T5---sound take-off coil ass'y	S-78217

T7---quad coil ass'y wiring	S-78218
T8---sound output xformers	95-2144
T9---vert output xformer	95-2564
T10---yoke	95-2157
T11---horiz sweep xformer	S-75306
A1---integrator	87-4
A2---integrator	87-5
A3---R/C network	105-79

SEPTEMBER • 1969

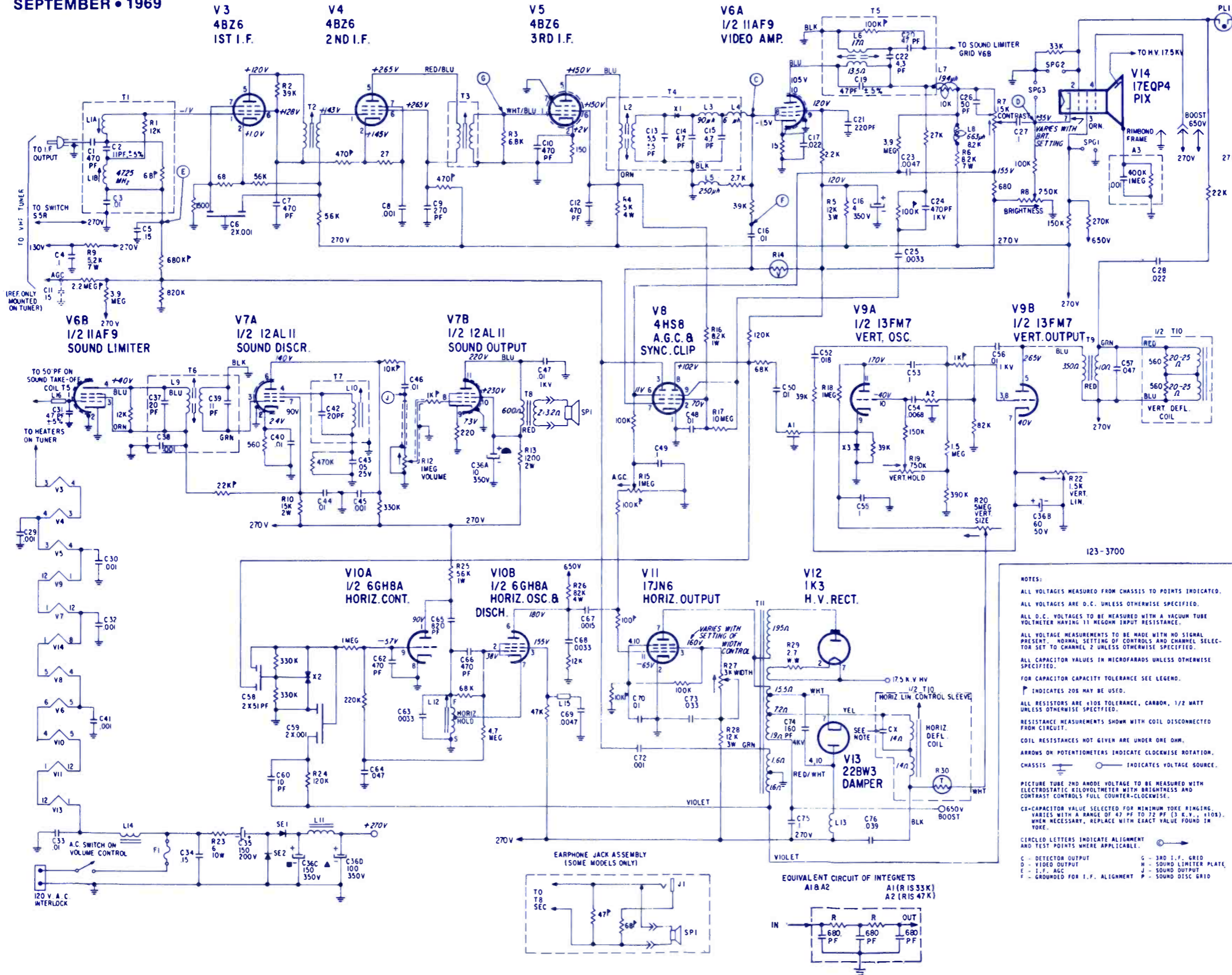

NOTES:

ALL VOLTAGES MEASURED FROM CHASSIS TO POINTS INDICATED.
ALL VOLTAGES ARE D.C. UNLESS OTHERWISE SPECIFIED.
ALL D.C. VOLTAGES TO BE MEASURED WITH A VACUUM TUBE VOLTMETER HAVING 11 MEGOHM INPUT RESISTANCE.
ALL VOLTAGE MEASUREMENTS TO BE MADE WITH NO SIGNAL PRESENT. NORMAL SETTING OF CONTROLS AND CHANNEL SELECTOR SET TO CHANNEL 2 UNLESS OTHERWISE SPECIFIED.
ALL CAPACITOR VALUES IN MICROFARADS UNLESS OTHERWISE SPECIFIED.
FOR CAPACITOR CAPACITY TOLERANCE SEE LEGEND.
P INDICATES 20% MAY BE USED.
ALL RESISTORS ARE $\pm 10\%$ TOLERANCE, CARBON, 1/2 WATT UNLESS OTHERWISE SPECIFIED.
RESISTANCE MEASUREMENTS SHOWN WITH COIL DISCONNECTED FROM CIRCUIT.
COIL RESISTANCES NOT GIVEN ARE UNDER ONE OHM.
ARROWS ON POTENTIOMETERS INDICATE CLOCKWISE ROTATION.
CHASSIS \perp INDICATES VOLTAGE SOURCE.
PICTURE TUBE 2ND ANODE VOLTAGE TO BE MEASURED WITH ELECTROSTATIC RELOVDMETER WITH BRIGHTNESS AND CONTRAST CONTROLS FULL COUNTER-CLOCKWISE.
CX-CAPACITOR VALUE SELECTED FOR MINIMUM TUBE RINGING. VARIES WITH A RANGE OF 47 PF TO 72 PF (3 K.V., $\pm 10\%$). WHEN NECESSARY, REPLACE WITH EXACT VALUE FOUND IN YOKE.
CIRCLED LETTERS INDICATE ALIGNMENT AND TEST POINTS WHERE APPLICABLE.

C - DETECTOR OUTPUT G - 3RD I.F. GRID
D - VIDEO OUTPUT H - SOUND LIMITER PLATE
E - I.F. AGC J - SOUND OUTPUT
F - GROUNDED FOR I.F. ALIGNMENT P - SOUND DISC GRID



OVERHAUL

\$9.75

GUARANTEED for 1 Year

OVERHAUL \$9.75 • REPLACEMENT TUNERS...\$10.45

Nine-seventy-five buys you a complete tuner overhaul—including parts (except tubes or transistors)—and *absolutely no hidden charges*. All makes, color or black and white. UV combos only \$15.

Guaranteed means a full 12-month warranty against defective workmanship and parts failure due to normal usage. That's 9 months to a year better than others. And it's backed up by the only tuner repair service authorized and supervised by the world's largest tuner manufacturer—Sarkes Tarzian, Inc.

Four conveniently located service centers assure speedy in-and-out service. All tuners thoroughly cleaned, inside and out... needed repairs made... all channels aligned to factory specs, then rushed back to you. They look—and perform—like new.

SEND ORDERS FOR UNIVERSAL AND CUSTOMIZED REPLACEMENT TUNERS TO OUR OFFICE IN INDIANAPOLIS.

Prefer a universal replacement? Sarkes Tarzian will give you a universal replacement for only \$10.45. This price is the same for all models. The tuner is a new tuner designed and built specifically by Sarkes Tarzian for this purpose. It has memory fine tuning—UHF plug-in for 82 channel sets—universal mounting—hi-gain—lo-noise.

ORDER TUNERS BY PART NUMBER, AS FOLLOWS:

Part #	Intermediate Frequency	AF Amp Tube	Osc. Mixer Tube	Heater
MFT-1	41.25 mc Sound 45.75 mc Video	6GK5	6LJ8	Parallel 6.3V
MFT-2	41.25 mc Sound 45.75 mc Video	3GK5	5LJ8	Series 450 MA
MFT-3	41.25 mc Sound 45.75 mc Video	2GK5	5CG8	Series 600 MA

Prefer a customized replacement tuner? The price will be \$18.25. Send us the original tuner for comparison purposes, also TV make, chassis and model numbers.



TUNER SERVICE CORPORATION FACTORY-SUPERVISED TUNER SERVICE

MIDWEST	817 N. PENNSYLVANIA ST., Indianapolis, Indiana	TEL: 317-632-3493
EAST	547-49 TONNELE AVE., Jersey City, New Jersey <small>(Home Office)</small>	TEL: 201-792-3730
SOUTH-EAST	938 GORDON ST., S. W., Atlanta, Georgia	TEL: 404-758-2232
WEST	SARKES TARZIAN, Inc. TUNER SERVICE DIVISION 10654 MAGNOLIA BLVD., North Hollywood, California	TEL: 213-769-2720

WATCH FOR NEW CENTERS UNDER DEVELOPMENT



The Benchtop Organizer.

Mallobin®. The smartest way to buy components . . . in this sturdy, stackable plastic case with partitioned drawers that keep parts where they belong. Indexed for instant access. Instant inventory.

The Mallobin you see here contains a popular assortment of our quality MTA capacitors. But that's just the beginning. We have others. There's one containing an assortment of 2-watt MOL resistors with ranges from 33 ohms to 56K ohms. Another contains MTV molded aluminum electrolytic capacitors with values from 750 mfd at 6

WVDC to 100 mfd at 50 WVDC. And there are many other cases which contain either GP, PVC, TT or TC capacitors. There are Mallobins for carbon and wirewound controls, too. Each with a wide range of popular values. The choice is yours.

But whichever you choose, you will find your Mallobin has a popular assortment of values that should satisfy all your component needs.

Remember the name Mallobin next time you're thinking of buying components. They're available from your local Mallory dealer.

MALLORY

MALLORY DISTRIBUTOR PRODUCTS COMPANY

a division of P. R. MALLORY & CO. INC.
Box 1558, Indianapolis, Indiana 46208; Telephone: 317-636-5353

Batteries • Capacitors • Controls • Resistors • Semiconductors • Switches • Sonalert® • Timers • Vibrators • ICs • Cassette Tapes

HUGH "SCOTTY" WALLACE
Publisher

PAUL DORWEILER
Editor

JOSEPH ZAUHAR
Technical Editor

MORTON WARNOW
Field Editor

DONNA BUTLER
Production Editor

BOB ANDRESEN
Graphic Design

LILLIE PEARSON
Circulation Fulfillment

JOHN KESSLER
Manager, Reader Services

BERNICE GEISERT
Advertising Production

OFFICES

71 Vanderbilt Ave.
New York, N.Y. 10017
Phone: (212) 686-2200
Telex: 01-26286

43 East Ohio St.
Chicago, Ill. 60611
Phone: (312) 467-0670
Telex: 02-53549

1901 West 8th Street
Los Angeles, Calif. 90057
(213) 483-8530

Harbrace Building
Duluth, Minn. 55802
Phone: (218) 727-8511
Telex: 02-94417

MARKETING REPRESENTATIVES

HUGH "SCOTTY" WALLACE
Chicago: (312) 467-0670

DEAN GREENER
Chicago: (312) 467-0670

ALFRED A. MENEGUS
New York: (212) 686-2200

DONALD D. HOUSTON
Los Angeles: (213) 483-8530

ROBERT UPTON
Tokyo, Japan
I.P.O., Box 5056

HARBACE PUBLICATIONS, INC.

JAMES MILHOLLAND, JR.
Chairman of the Board

JOHN B. GELLATLY
President

RICHARD MOELLER
Treasurer

LARS FLADMARK
Senior Vice President

HARRY RAMALEY
Vice President

BEN MARSH
Vice President

JAMES GHERNA
Art Director

WILLIAM SWAIN
Director of Marketing Services

DOUG HEDIN
Ad Production Manager

ELECTRONIC TECHNICIAN / DEALER

WORLDS LARGEST ELECTRONIC TRADE CIRCULATION

SEPTEMBER 1969 • VOL. 90 NO. 3

41 TEKLAB REPORT

Our report this month continues with Part Two of the Silvertone Model 9168 18in. portable color set as it explains the circuits used in the low voltage power supply, horizontal output, color oscillator, chroma bandpass and color sync sections.

44 SIGNAL STRENGTH METERS

This article concludes the two part series on these versatile instruments and discusses their use in testing receiver sensitivity, frequency response, amplifier noise figure and other circuit parameters with practical application guidelines.

50 SERVICING COLOR HIGH VOLTAGE SYSTEMS

This timely article will be of special interest to technicians as it outlines many of the common and not-so-common circuit problems caused by defects in the high voltage section.

54 REPAIRING SOLID STATE AM-FM

A service feature we recommend as must reading, explains many troubleshooting techniques which can be put to practical use in transistorized circuits of stereo and hi fi equipment.

60 TESTLAB REPORT

This month our lab technicians roll up their sleeves to build and evaluate two popular test instruments. They are the versatile Knight KG-686 signal generator and the unique Heath IG-28 color bar-dot generator.

22 EDITOR'S MEMO

24 NEW AND NOTEWORTHY

28 LETTERS TO THE EDITOR

33 TECHNICAL DIGEST

64 DEALER SHOWCASE

70 COLORFAX

74 NEW PRODUCTS

80 NEWS OF THE INDUSTRY

84 CATALOGS AND BULLETINS

94 AD INDEX

Cover Copy

The microphones shown on this month's cover were used during the golden age of radio. Old timers will doubtless remember these classic masterpieces of the early days.

TEKFAX • 16 PAGES OF THE LATEST SCHEMATICS • Group 205

EMERSON: Color TV Model 29P10

PHILCO - FORD: TV Chassis 19HT15

RCA VICTOR: TV Chassis KCS177 Series

SEARS SILVERTONE: Color TV Chassis 528.72940

SYLVANIA: TV Chassis B12-1, -2

ZENITH: TV Chassis 14Z21, 14Z21Z



HARBACE PUBLICATIONS, INC.

A subsidiary of Harcourt, Brace & World, Inc.

ELECTRONIC TECHNICIAN/DEALER is published monthly by Electronic Technician, Inc., Harbrace Building, Duluth, Minnesota 55802, a subsidiary of Harcourt, Brace & World, Inc. Subscription rates: One year \$5, two years \$8, three years \$10, in the United States and Canada. Other countries: One year \$9, two years \$14, three years \$18. Single copies 75¢ in the United States and Canada; all other countries: \$2.00. Second class postage paid at Dansville, New York, and at additional mailing offices. Copyright 1969 by Harbrace Publications, Inc.

POSTMASTER: Send Form 3579 to ELECTRONIC TECHNICIAN/DEALER, Harbrace Building, Duluth, Minnesota 55802.

The FM-2400C provides an accurate standard frequency signal for testing and adjustment of mobile transmitters and receivers at predetermined frequencies between 25 and 500 MHz. Up to 24 crystals may be inserted into the meter. The frequencies can be those of the radio frequency channels of operation, and/or of the intermediate frequencies of the receivers between 5 MHz and 40 MHz. Frequency stability (standard) $\pm .001\%$ from 32° to 122°F. Frequency stability with built-in thermometer, calibrated crystals and temperature corrected charts, .00025% from

+25°F to +125°F. (.000125% special 450 MHz crystals available)

FM 2400C
(Meter Only).....\$445.00

RF Crystals
Hi Band.....\$24.00 ea.
Lo Band.....15.00 ea.

IF Crystals.....8.00 ea.

Write for free catalog.



CRYSTAL MFG. CO., INC.
10 NO. LEE • OKLA. CITY, OKLA. 73102

ET/D

EDITOR'S MEMO

Silent Death

Practically every time you pick up a newspaper there are articles about auto accidents, cancer from smoking or the misuse of drugs. The point is that people tend to kill each other off in one way or another regardless of wars and disease.

Very few of us work under what we consider "hazardous" conditions. Yet, we could be injured in an auto accident on the way to work or fall in the bathtub at home. Just living in our pace-setting environment can be hazardous. When we jump in the family car for a sightseeing trip, how many of us stop to think of all the little things that could go wrong mechanically to turn our magic carpet into a sudden death trap? If we did, we'd all become nervous wrecks. We trust these man-made machines.

So what about our home appliances? They too, can become lethal if mis-handled or mis-adjusted. But we seldom read about it.

Color television sets are something else. They are great mysterious works of an inventive mind but can, we are told, spew out a silent death to anyone near them. Cynical? Maybe. Naturally, we all want to stay as healthy as possible. That goes for television viewers the same as it does for the technicians who have to work on them.

When properly handled and adjusted, it is no more lethal than the radium dial on your wrist watch.

It's easy to scare the consumer with an article telling him his TV set is radiating dangerous X-rays. Most people are wary of what they don't understand. It's up to us to clue them in on the facts. Consider the recent history-making moonshot. A man who was asked his opinion of this country's space effort remarked that we were fooling with dynamite and if we weren't careful, one of our space buggies would get stuck between us and the sun and shut off all the light. Of such inanities is made much of the current shocktalk about television X-rays.



Paul A. Horvick

ELECTRONIC TECHNICIAN/DEALER

Now With Solid State Circuitry & Rechargeable Batteries



ICM FM-2400C
**frequency
meter...**

- Completely Portable
- Tests Predetermined Frequencies 25 MHz - 500 MHz

... for more details circle 121 on postcard

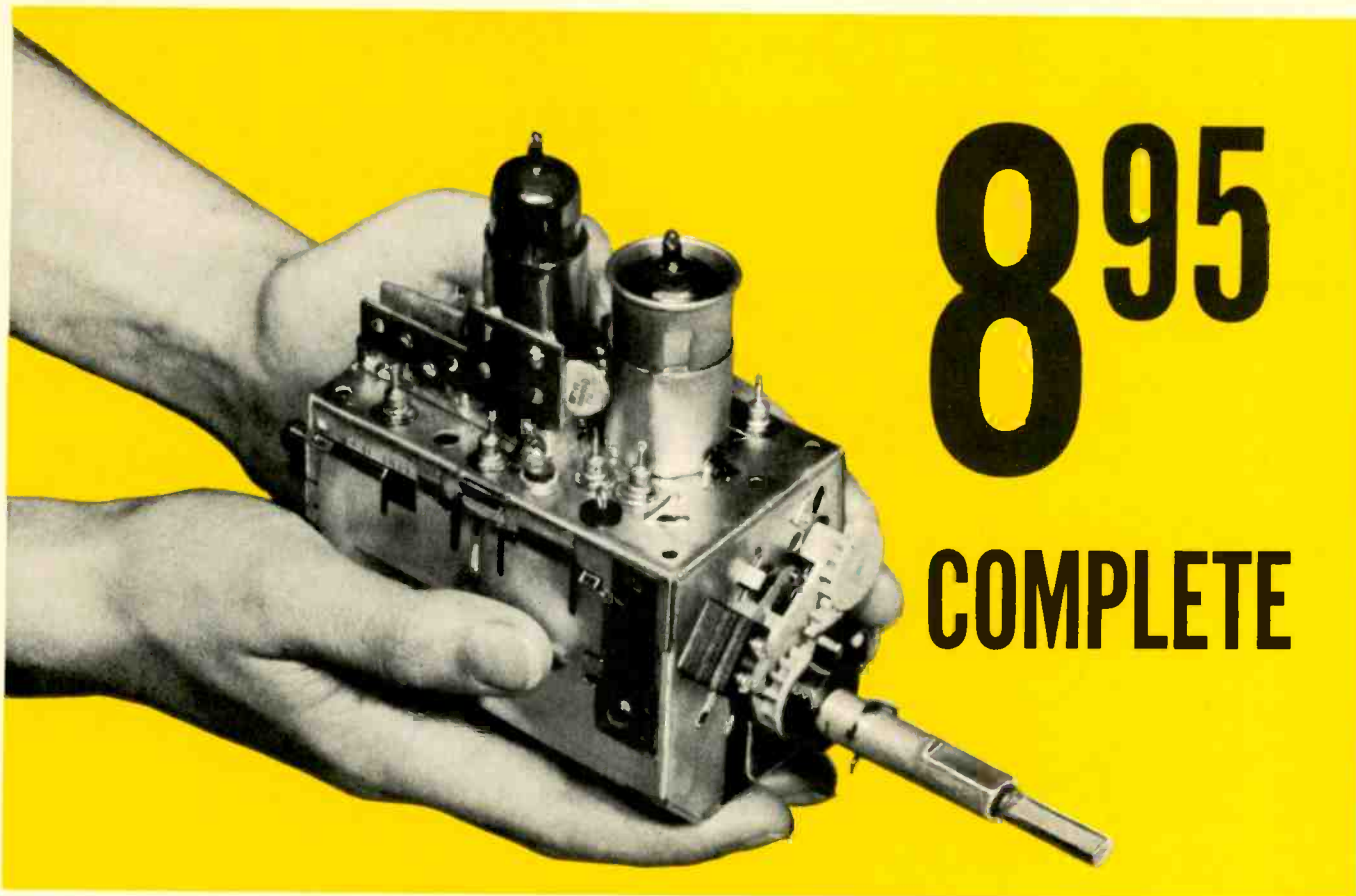

895 COMPLETE

Castle, the pioneer of television tuner overhauling, offers the following services to solve ALL your television tuner problems.

● **OVERHAUL SERVICE** — All makes and models.

VHF or UHF tuner	\$9.95
UHF-VHF combination (one piece chassis)	\$9.95
TRANSISTOR tuner	\$9.95
COLOR tuner (Guaranteed color alignment . . . no additional charge)	\$9.95

Overhaul includes parts, except tubes and transistors.

Simply send us the defective tuner complete; include tubes, shield cover and any damaged parts with model number and complaint. Your tuner will be expertly overhauled and returned promptly, performance restored, aligned to original standards and warranted for 90 days.

UV combination tuner must be single chassis type; dismantle tandem UHF and VHF tuners and send in the defective unit only.

And remember—for over a decade Castle has been the leader in this specialized field . . . your assurance of the best in TV tuner overhauling.

● **CUSTOM REPLACEMENTS**

Exact replacements are available for tuners that our inspection reveals are unfit for overhaul. As low as \$12.95 exchange. (Replacements are new or rebuilt.)

● **UNIVERSAL REPLACEMENTS**

Prefer to do it yourself?

Castle universal replacement tuners are available with the following specifications.

STOCK No.	HEATERS	SHAFT		I.F. OUTPUT		PRICE
		Min.*	Max.*	Snd.	Pic.	
CR6P	Parallel 6.3v	1¾"	3"	41.25	45.75	8.95
CR7S	Series 600mA	1¾"	3"	41.25	45.75	9.50
CR9S	Series 450mA	1¾"	3"	41.25	45.75	9.50
CR6XL	Parallel 6.3v	2½"	12"	41.25	45.75	10.45
CR7XL	Series 600mA	2½"	12"	41.25	45.75	11.00
CR9XL	Series 450mA	2½"	12"	41.25	45.75	11.00

*Selector shaft length measured from tuner front apron to extreme tip of shaft.

These Castle replacement tuners are all equipped with memory fine tuning, UHF position with plug input for UHF tuner, rear shaft extension and switch for remote control motor drive . . . they come complete with hardware and component kit to adapt for use in thousands of popular TV receivers.

Order universal replacements out of Main Plant (Chicago) only.



CASTLE TV TUNER SERVICE, INC.

MAIN PLANT: 5713 N. Western Ave., Chicago, Illinois 60645
EAST: 41-92 Vernon Blvd., Long Island City, N.Y. 11101

**Two-Way Radio****700**

Transmitter and receiver have 12 IC modules

Introduced is a hand-held FM two-way radio in personal size units. The new line is called the MASTR Progress Line Personal Series. UHF models are in the 406-420MHz and 450-470MHz range and deliver 2w. High band units operate in the 132-174MHz range with 4.5w of RF power. Crystal discriminator and crystal filters aid interference-free reception. Approximately 70 percent of the receiver and about 40 percent of the transmitter use IC circuits. The transmitter and receiver have 12 separate, easily removed integrated circuit modules replacing more than 200 components. One rechargeable 7½ v nickel-cadmium battery is used for all power requirements. The radio system includes a charging system that reportedly prevents over-heating and over-charge. It is designed to accept either a fast or slow charge. The unit reportedly can be brought to 70 percent of its capacity in 15 min. Accessory options include remote speaker-microphones, lapel microphones, high noise headsets, miniature headsets, earpieces and lapel speakers. G.E.

**CB Radio** **701**

Percent of modulation monitored on a large 2½ in. meter

Announced is the Messenger 124, the newest addition to its line of two-way radios. The radio is all solid-state with 26 transistors, 18 diodes, 1 FET and 3 thermistors and has both a built-in 117vac and 12vdc power supply for base or mobile use. Its dual conversion receiver has a 4.3MHz crystal filter for selectivity to eliminate adjacent channel interference. Delta tune allows ±3MHz receiver fine tuning to pull in those other stations that are slightly off frequency. The CBER can adjust audio response to his own taste with the built-in tone control. The adjustable microphone gain control allows the operator to place the microphone at a comfortable speaking distance and adjust modulation for 100 percent. Modulation can actually be monitored on the large illuminated, 2 1/2in. meter built into the unit. In addition to percent of modulation, the meter also checks standing wave ratio (SWR), relative power output, and received signal in "S" units. The radio employs a high level Class B modulator with speech compression. Receiver sensitivity is 0.5mv for 10db signal-to-noise ratio. Receiver audio power output is 3w and it has a 3 1/2in. speaker. Controls on the units include: channel selector; noise limiter on/off; multimeter control; squelch control with PA position; volume with power off switch; microphone gain; delta tune; tone; percent modulation meter adjust; and power output meter adjust. The dimensions are 5 9/16in. high x 11in. x 9 1/16in. deep; weight is 14lb. Price \$289.95. E. F. Johnson.

**Oscilloscope****702**

Maximum performance with minimum space requirements

Introduced is the Model LBO-31M oscilloscope designed for the field as well as multichannel monitoring applications. A band-width of 1MHz makes it suitable for applications in the video region. Its small size will appeal to servicemen, students and plant technicians who desire maximum performance with minimum space requirements. Specifications: Vertical axis--Sensitivity: 80mv, p-p/cm at 1kHz. Response--3db; 3Hz to 400kHz. Sweep frequency--10Hz to 100kHz. Power Supply--105 to 125v 50/60Hz; 40va. Size and Weight--7in. H x 4in. W x 12in. D; 11 lb. Price is \$99. Leader.

FOR MORE NEW PRODUCTS SEE PAGES 64 AND 74

At last! A practical way to provide servicing training right in your own shop.

ICS offers the lowest priced course in TV Repair and Servicing on the market today—less than \$100. Yet you'll say that the texts on color repair alone are worth double the price.

No other training course available today can touch the new ICS TV Servicing/Repair Course for practicality and simplicity.

It solves your training problems. Saves valuable shop time...expands employee capacity and professionalism. Fact is, with the very first text, a complete novice can learn to repair 20 percent of all TV troubles. In just a few short months, he can be doing advanced bench test and repair work, on color sets as well as black-and-white. Practice work on trade-ins or sets you're repairing.

6 texts, 936 pages in all. 329 illustrations. Photos show how to recognize and diagnose the effect of various TV troubles on the screen. Concise, easy-to-follow texts tell how to remedy the trouble and why that remedy is best. Self-examinations along the way measure what is learned.

Fully approved by the National Electronic Associations for use in their apprenticeship program; the first course to receive this recognition. Completion of final exam an important step toward NEA certification.

Plus, at no extra charge—complete, easy-to-understand glossary of TV terms (schematics of top models of leading TV manufacturers also available—a bargain in itself). For full information, fill out coupon and mail today.

ICS

ICS, Dept. K8746J, Scranton, Penna. 18515

Yes, I'm interested in your new TV Servicing/Repair Course for training in my shop. Please send me complete information without obligation.

Name _____

Street _____

City _____

State _____ Zip _____



... for more details circle 122 on postcard

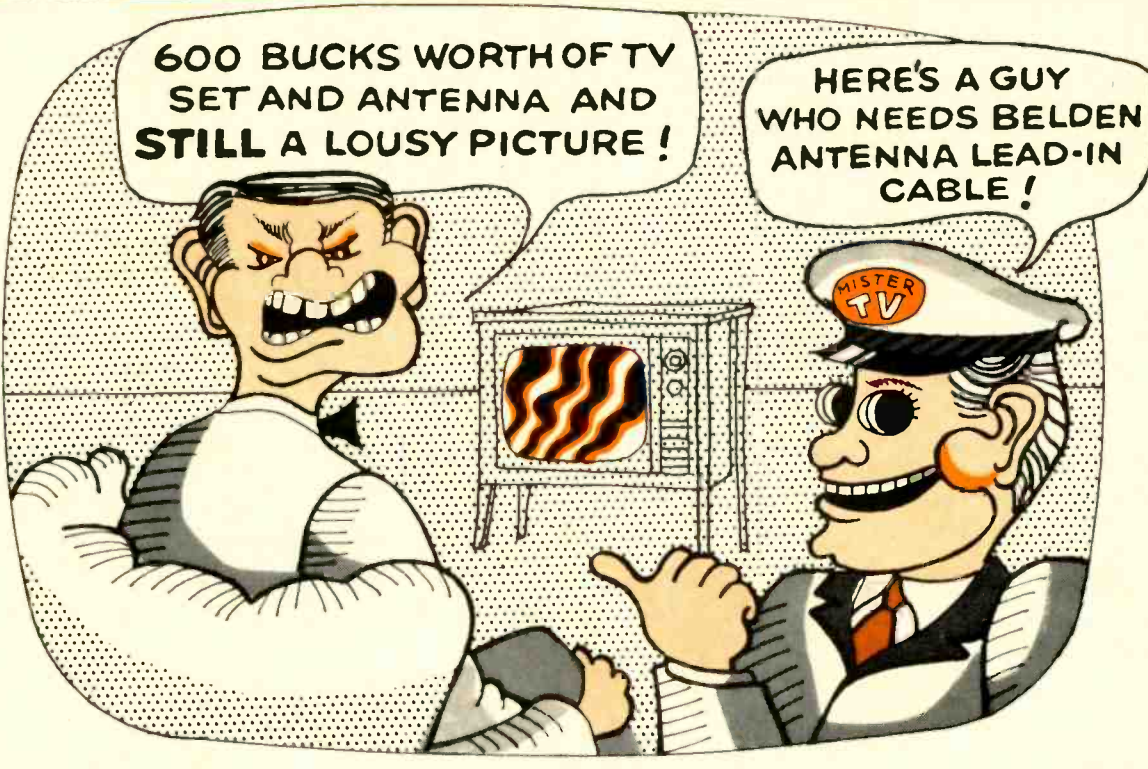

Color or UHF set perfect? Antenna perfect? Then obviously there's a missing link. Check that antenna lead-in cable. Old, worn-out, weather-beaten cable, or the ordinary flat ribbon kind designed for black and white VHF, causes more fuzzy, distorted pictures than you can count. It's your opportunity to upgrade these customers to a cable matched to their particular signal reception situations. One of Belden's Big Four—the link to perfect reception.

FOR CONGESTED AREAS...
8290 SHIELDED PERMOHM®



In congested, in-city areas, stray electrical interference and noise are at their worst. For perfect, all-82 channel reception—color or B/W—replace old cable with Belden's 8290 Shielded PermoHM. Its aluminum Beldfoil® shielding prevents pickup of ghost signals and electrical noise by the lead-in. Weather-proof and water-proof. You can tape it right to the mast. Or install it underground, in conduits—even in rain gutters.



AWG & (Stranding)	Color	Nom. O. D. (inch)	Nom. Velocity of Propagation	Nom. Capacitance (mmf/ft.)	Nom. Attenuation per 100'		Standard Package Lengths in ft.
					mc	db	
22 (7 x 30)	Brown	.305 x .515	69.8%	7.8	57	1.7	50', 75', 100' coils have terminals attached. Available in counter dispenser. 250', 500' spool.
					85	2.1	
					177	3.2	
					213	3.5	
					473	5.4	
					671	6.6	
					887	7.7	

Copperweld, 2 conductors, orange polyethylene insulation and web between conductors, cellular polyethylene oval insulation, Beldfoil shield, stranded tinned drain wire, polyethylene jacket.

BELDEN 8285 - PERMOHM

FOR FRINGE AREAS...

8285 PERMOHM®

Antenna cable in uncongested or fringe areas picks up little electrical interference. But does get a lot of weathering, which degrades an already weak signal. These customers need encapsulated cable. Belden 8285 Permohm. Its special polyethylene jacket protects the energy field, regardless of weather conditions. It delivers the strongest signal of any unshielded twin lead under adverse conditions. Requires no matching transformers and connectors. For all 82 channels, color or B/W.



AWG & (Stranding)	Color	Nom. O. D. (inch)	Nom. Velocity of Propagation	Nom. Capacitance (mmf/ft.)	Nom. Attenuation per 100'		Standard Package Lengths in ft.
					mc	db	
22 (7 x 30)	Brown	.255 x .468	73.3%	5.3	100	1.4	50', 75', 100' coils have terminals attached. Available in counter dispenser. 250', 500' coils and 1000' spool.
					300	2.8	
					500	3.8	
					700	4.8	
					900	5.6	

Copperweld, 2 conductors parallel, orange polyethylene insulation and web between conductors, cellular polyethylene oval jacket.

FOR LOCAL BLACK AND WHITE...

8275 CELLULINE®



Cracked, corroded, weathered cable, full of dirt and moisture, loses signal strength; prevents any TV set from delivering a quality picture. Upgrade B/W VHF and local UHF customers to Belden 8275 Celluline. Performance is improved because all possible moisture between conductors has been eliminated. Abrasion-resistant and weather-resistant for a long, long service life. And, it requires no end sealing.

AWG & (Stranding)	Color	Nom. O. D. (inch)	Nom. Velocity of Propagation	Nom. Capacitance (mmf/ft.)	Nom. Attenuation per 100'		Standard Package Lengths in ft.
					mc	db	
20 (7 x 28)	Brown	.300 x .400	80%	4.6	100	1.05	50', 75', 100' coils in counter dispenser. 250', 500', 1000' spools.
					200	1.64	
					300	2.12	
					400	2.5	
					500	2.98	
					700	3.62	
900	4.3						

Bare copperweld; 2 conductors parallel, polyethylene jacket with inert gas filled unicellular polyethylene core.

EN DUOFOIL

FOR MATV AND CATV...

8228 DUOFOIL® COAX

Got an apartment or townhouse complex in your area? Motels or hotels? Or is CATV coming? Use Belden's new 75 ohm coaxial cable—8228 Duofoil. Shielding is 100%—sweep tested 100%. Spiral wrapped drain wires provide long flex life. Small diameter saves space in conduit installations. Use Duofoil for all coaxial color and B/W VHF, UHF and CATV applications.



AWG & (Stranding)	Color	Nom. O. D. (inch)	Nom. Velocity of Propagation	Nom. Capacitance (mmf/ft.)	Nom. Attenuation per 100'		Standard Package Lengths in ft.
					mc	db	
18 Solid, Bare	Black	.242	78%	17.3	50	1.5	100', 500', 1000' spools.
					100	2.1	
					200	3.1	
					300	3.8	
					400	4.5	
					500	5.0	
					600	5.5	
					700	6.0	
					800	6.5	
					900	6.9	

Don't forget to ask them what else needs fixing.

See your local Belden distributor for full details or to order. For a free copy of the recent reprint article, "Electronic Cable," write: Belden Corporation, P.O. Box 5070-A, Chicago, Illinois 60680.

BELDEN

8-G-81

FAST

COMPLETE SERVICE ON ALL MAKES OF TV TUNERS

Maximum Time In Shop 24 Hrs.

(90 Day Warranty)

(WE SHIP C.O.D.)
YOU PAY SHIPPING

\$9.95



Black &
White
or Color

VHF or
UHF

UV Combo's \$16.50

Price includes all labor and parts except Tubes, Diodes & Transistors. If combo tuner needs only one unit repaired, disassemble and ship only defective unit. Otherwise there will be a charge for a combo tuner. When sending tuners for repair, remove mounting brackets, knobs, indicator dials, remote fine tuning arrangements and remote control drive units.

EFFECTIVE AUGUST 1, 1969

All tuners must have remote control units and/or mounting brackets removed before tuner can be cleaned and repaired. If these accessories are left on tuner, there will be a \$2.00 charge for disassembly and reassembly.



All tuners are serviced by **FACTORY TRAINED TECHNICIANS** with years of experience in this specialized field. All tuners are **ALIGNED TO MANUFACTURER'S SPECIFICATION** on crystal controlled equipment and air checked on monitor before shipping to assure that tuner is operating properly.

GEM CITY TUNER REPAIR SERVICE

Box 6D Dabel Station
2631 Mardon Drive
Dayton, Ohio 45420

ET/D

LETTERS TO THE EDITOR

Reader Offers Free Consultation

Your magazine has a high reputation and many interested readers as proven by the number of replies I received to a recent request which you published. I would like to reciprocate by offering **ELECTRONIC TECHNICIAN/DEALER** readers a personalized service. I am a sound engineer specializing in audio design and installation. Many audiophiles are faced with the problem of putting in the best possible audio system for the money. I am willing to answer letters from your readers who want help in this area. To save time, they should send me the approximate size of their budget, dimensions of the room or rooms including the number of doors, windows and carpeting, and they must indicate they are **ELECTRONIC TECHNICIAN/DEALER** subscribers. I offer this service free of charge. I am not a miracle man, but I am sure I can help some of your readers save money and time.

VLADIMIR D. BET-EIVAZI

c/o American Embassy-USIS
Tehran, Iran

Thanks for Curve Tracer

Thank you for the curve tracer article in the May issue of **ELECTRONIC TECHNICIAN/DEALER**. I made one up with a few modifications of my own and it is a very useful addition to my test equipment. It has cut my transistor and diode testing time in half. I built the curve tracer into an old model GCT-8 Seco Grid Circuit Tester. This way I have the advantage of range sweep voltage from 2 to 12 volts. Incidentally, this little sweeper is fine for checking noisy pots, trimmers and even capacitors. Thanks again for a fine magazine.

CHARLEY HOSACK

Phoenix, Ariz.

Notes on B & K Model 415

Your excellent article on "Post Marker Color TV Service Alignment" in the June 1969 issue brought out some very valid precautions which we carefully considered in the development of our B&K model 415 Sweep Marker Generator (illustrated in your article).

1) To automatically eliminate the "hash" or "grass" caused by the hori-

zontal output sweep, we incorporated a special filter in our circuit. This eliminates the need to remove the output tube or use a dummy power load resistor, as suggested in your article. This filter is especially valuable when aligning transistor sets, since disabling the horizontal output circuits might be troublesome.

2) As was indicated, "Ground loops" and other feedback problems do cause varying patterns depending upon the way the connecting cables are "draped" around the equipment. Your article did not point out that the B&K model 415 eliminates this problem through the use of a low impedance matched system. Alignment patterns are completely independent of the cables. This makes them very stable and the alignment results repeatable.

3) As your article pointed out, a scope with poor low frequency response will cause a "tilt" in waveforms. We believe it is very difficult for the technician to "memorize" the amount of this tilt and "take into consideration" when aligning the TV receiver, especially when he doesn't have to. The 415 enables the user to match the output to the scope providing a normal or flat pattern. This compensation is thus easily made when using scopes with low frequency response.

4) To make it easy to supply the bias required, as suggested in the article, the 415 includes 3 bias supplies.

These improvements, when added to the marker tilt feature and others in the Model 415, give the technician, who has always "feared" alignment, complete confidence in his equipment.

CARL KORN, President
Dynascan Corp.
Chicago, Ill. 60613

Readers' Aid

I need the latest chart for a Superior Instrument Co. Rapid Tube Tester, Model 22-A. I will gladly defray the cost if one of your readers can supply me with a copy. I also need the information on using this unit to test picture tubes.

C. J. NOWAK

238 Amherst St.
Buffalo, N. Y. 14207

I recently took in a Saba/Meersburg Automatic 125-Stereo for repair. I would appreciate any information your readers can give me on this unit.

GILL'S SALES SERVICE
1505 E. Genesee St.
Syracuse, N.Y. 13210

ELECTRONIC TECHNICIAN/DEALER

WHO

stands to benefit most from Color TV? Everyone, including the service technician, has a lot to gain. That's why Sprague wants to help you get your fair share of this increasing business.

NEEDS

of the service technician are of great importance to Sprague. That's why we supply capacitors with the exact ratings required to meet the exacting requirements of Color TV.

COLOR

has been both boon and bane of the service trade. While it has added to service volume, it has also caused some headaches. That's why Sprague is constantly striving to simplify Color TV capacitor selection.

TV?

Yes, TV repair represents a big portion of your business. And color is boosting it even higher. You do faster, surer work with Sprague replacement capacitors for Color TV.

THE BROAD-LINE PRODUCER OF ELECTRONIC PARTS



SKINNY, YES.

undernourished?

HARDLY!

This QUAM speaker is thinner and lighter than most, but there's nothing scrawny about its sound or emaciated about its performance.

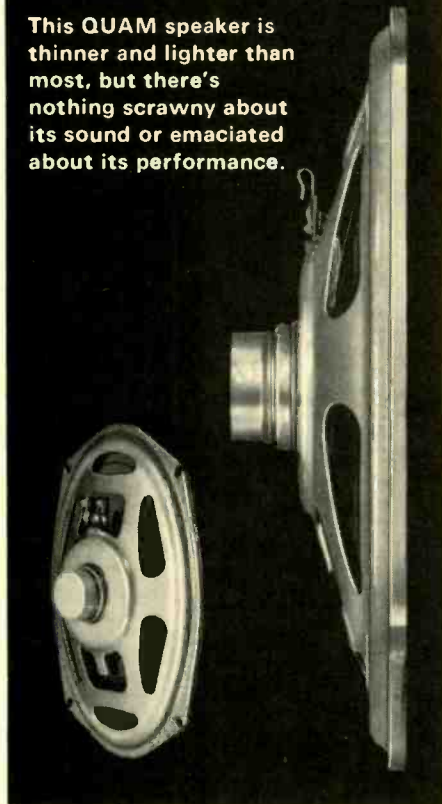

It's one of 25 models in the Quam line that's being fed a special diet... an exclusive new high energy magnet material we call Q/8.

Q/8 provides more gap energy for less weight, so a .65 ounce magnet gives you the same performance as a full ounce of Alnico V. Ideally suited to Quam's high density cup-pot structure, Q/8 slims the speaker down in contour as well as weight—while delivering full, robust sound.

Q/8 magnets are exclusively available today on Quam speakers—part of our ongoing program of nourishing our customers first with the finest.

QUAM

—always the
Quality Line,
for every
speaker need.

QUAM-NICHOLS COMPANY
234 East Marquette Road
Chicago, Illinois 60637

... for more details circle 131 on postcard

ET/D LETTERS TO THE EDITOR

We need a schematic and instruction book for a Triplet Model 3434 TV-FM marker generator. Any help you or your readers can provide will be appreciated.

NEIL KRISCH

181 Morningside Ave.
Union Beach, N.J. 07735

I had written before in search of a schematic for a Japanese made Philco. Now I need schematics for two other units—a Crosley Model P60-GY, chassis 5060P and a Sony Model M-1851. I have been unable to obtain either one here. Any help will be appreciated.

GERALD L. HILD

1356 Lake Rd., Rt. 1
New Carlisle, Ohio 45344

Would you please list in your "Letters" column my request for service information (frequency and voltage charts) for a Jerrold transistorized field strength meter, Model TMT, serial no. 6759.

AL HAWKES

Hawkes Television Service
Route 302
Highland Lake Corner
Westbrook, Maine 04092

I have seen many requests from your readers for schematics and would like to add mine. I need a schematic for a Fender instrument amplifier, Model 6G13. I wrote to the Fender Co. in Fullerton, Calif., but received no answer. Any help will be appreciated.

CHARLES LESSNER

Mercury Maintenance Service
2014 W. Division St.
Chicago, Ill.

I was overwhelmed by your fast research and reply to my inquiry. I wrote to Teletest but received no reply. As you recall, I purchased a used tube tester which uses a perforated card system. I need these cards to bring the unit up to date. I have number one to 58 and need cards from 58 to the present. Perhaps one of your readers can help me. The instrument is

a Dynamic Automatic Tube Tester, Model DM-456 made by the Teletest Instrument Corp.

RICHARD V. GIANGROSSI
18 Highview Circle
Middletown, N.J. 07748

I would appreciate it if one of your readers could supply me with manuals for a couple of "oldies." I need instructions for a Radio City Flybacker, Model 123 and a Superior Instruments, Model 1280, which is a combination tube tester, VOM and capacitance checker.

A. L. SHOEMAKER

1410 E. Miles St.
Tucson, Ariz. 85719

Tuner Servicing

Enjoyed your article in June ELECTRONIC TECHNICIAN/DEALER about tuner servicing. Many service technicians need to give more thought to whether their trouble is in the tuner before they send it in for repair. In addition, we would suggest that they check sound alignment on a set when the sound and picture do not come in together at the correct point on the fine tuning. Often a slight touch-up of the discriminator will correct this problem.

THOMAS SMITH

National Tuner Service
Worthington, Ind.

Holidays
are what you
make them.

Make them
safer with
safety belts.

What's your excuse?

Advertising contributed
for the public good.



THE PROFIT-MAKER!

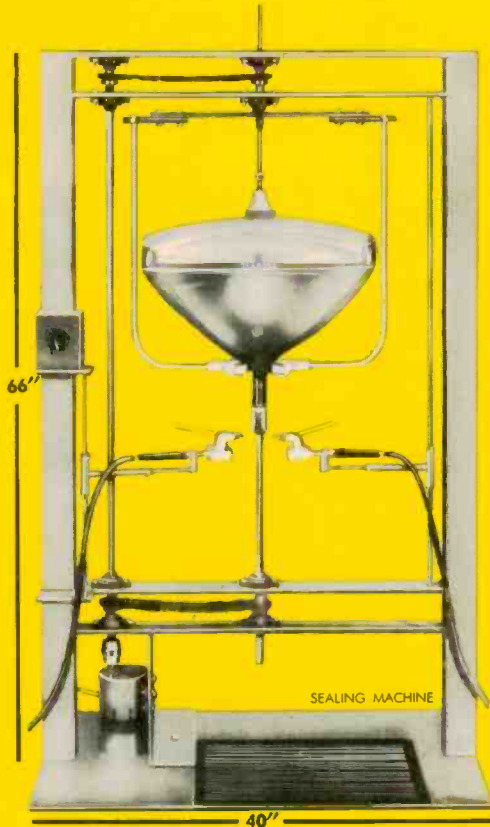

- REBUILDS ANY SIZE ROUND OR RECTANGULAR COLOR PICTURE TUBES . . . AVERAGE COST PER TUBE \$7.80
- REBUILDS ANY SIZE BLACK AND WHITE PICTURE TUBE . . . AVERAGE COST PER TUBE \$1.80
- FREE INSTALLATION AND TRAINING ANYWHERE IN THE CONTINENTAL U.S.A.
- FREE SUPPLIES FOR REBUILDING YOUR FIRST 50 PICTURE TUBES

- EXTREMELY EASY TO OPERATE
- INCLUDES LAMINATING AND DELAMINATING EQUIPMENT FOR REBUILDING BLACK AND WHITE AND COLOR BONDED-FACE PICTURE TUBES.
- INCLUDES ALL TOOLS FOR REBUILDING ROUND AND RECTANGULAR COLOR PICTURE TUBES
- INCLUDES ALL TOOLS FOR REBUILDING BLACK AND WHITE PICTURE TUBES

CRT COLOR CHAMPION

CRT COLOR CHAMPION . . . \$2,875.00

Mail Coupon Today for FREE CATALOG

C.R.T. Equipment Company, Inc.
2740 Old Lebanon Road
Nashville, Tennessee 37214

Telephone (615) 883-0215

(Please Print)

Name _____

Firm Name _____

Address _____

City _____

State _____ Zip _____

What can the works in a drawer mean to you?

The chance to do the job right on the first call

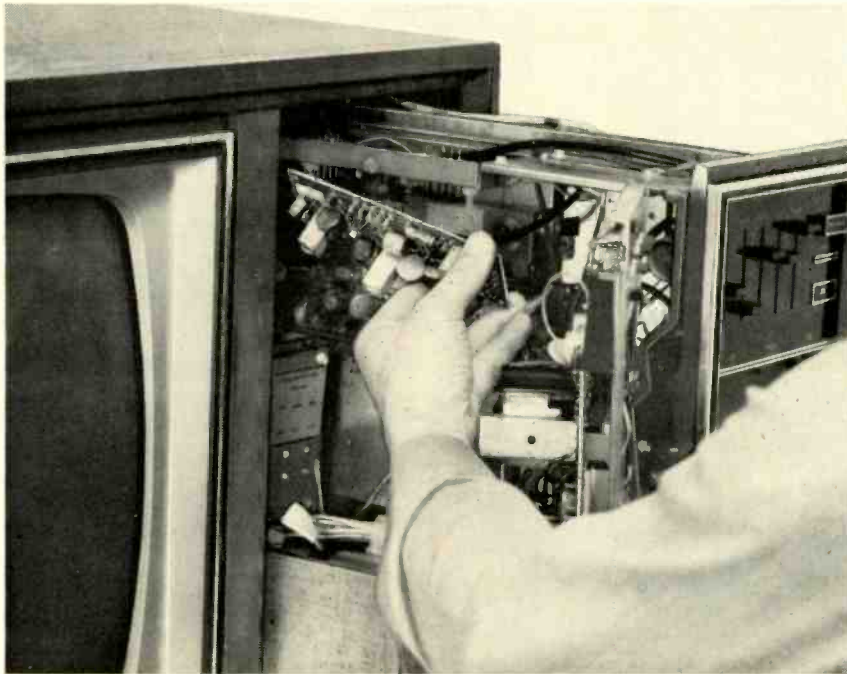

instead of
making call-back after call-back

We don't have to tell you how frustrating it is to replace a component in a color set and then be called back the next day or next week, because something else went wrong. You know how new components show up other weak spots hours or even days later. But all that your customer understands is that the set doesn't work right, and you get the blame. Quasar Color TV helps eliminate this problem. When a plug-in module is changed an entire circuit is replaced. What can the works in a drawer mean to you? A new respect for your professionalism by your customers.

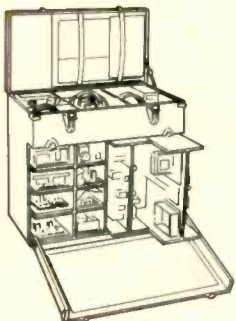

All the reference materials you need to service Quasar Color TV are found in this panel caddy. If you feel you need additional information, call your distributor and he will set up training sessions.

QuasarTM Color TV
with the works in a drawer
by MOTOROLA[®] 

designed to help the professional be more professional

... for more details circle 128 on postcard

ELECTRONIC TECHNICIAN/DEALER

The material used in this section is selected from information supplied through the cooperation of the respective manufacturers' or their agencies

ADMIRAL TV Trap Alignment

Admiral has included a more accurate method of TV IF trap alignment in its recent television alignment procedures. It amounts to using the alignment generator set at

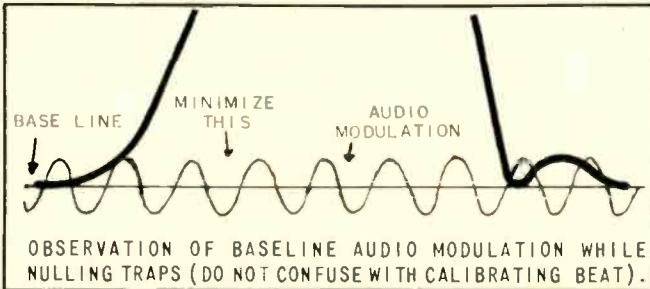

the trap frequency in the usual way and then adding a small amount of audio modulation, usually available from the generator. In theory, we are using the generator set at the trap frequency for carrier, while the modulation forms sidebands

which appear on the baseline as sine waves.

To adjust the trap, observe the trace on the scope and vary the trap adjustments to minimize (null) the audio on the base line, giving more usable indication.

Be sure to keep the audio modulation at a low level as shown in the drawing.

EMERSON

Color TV Chassis-Channel Four Interference

It is possible for a harmonic of the 3.58MHz oscillator to radiate and be picked up by the tuner, resulting in picture interference on channel four. In the majority of cases of this type, the antenna system from which the set is operated from a properly balanced 300 Ω antenna system, the interference disappears. An antenna pad will improve the balanced input to the receiver's antenna systems. It again should be realized that there will be approximately a 6db loss of signal and as a result the pad cannot be used effec-

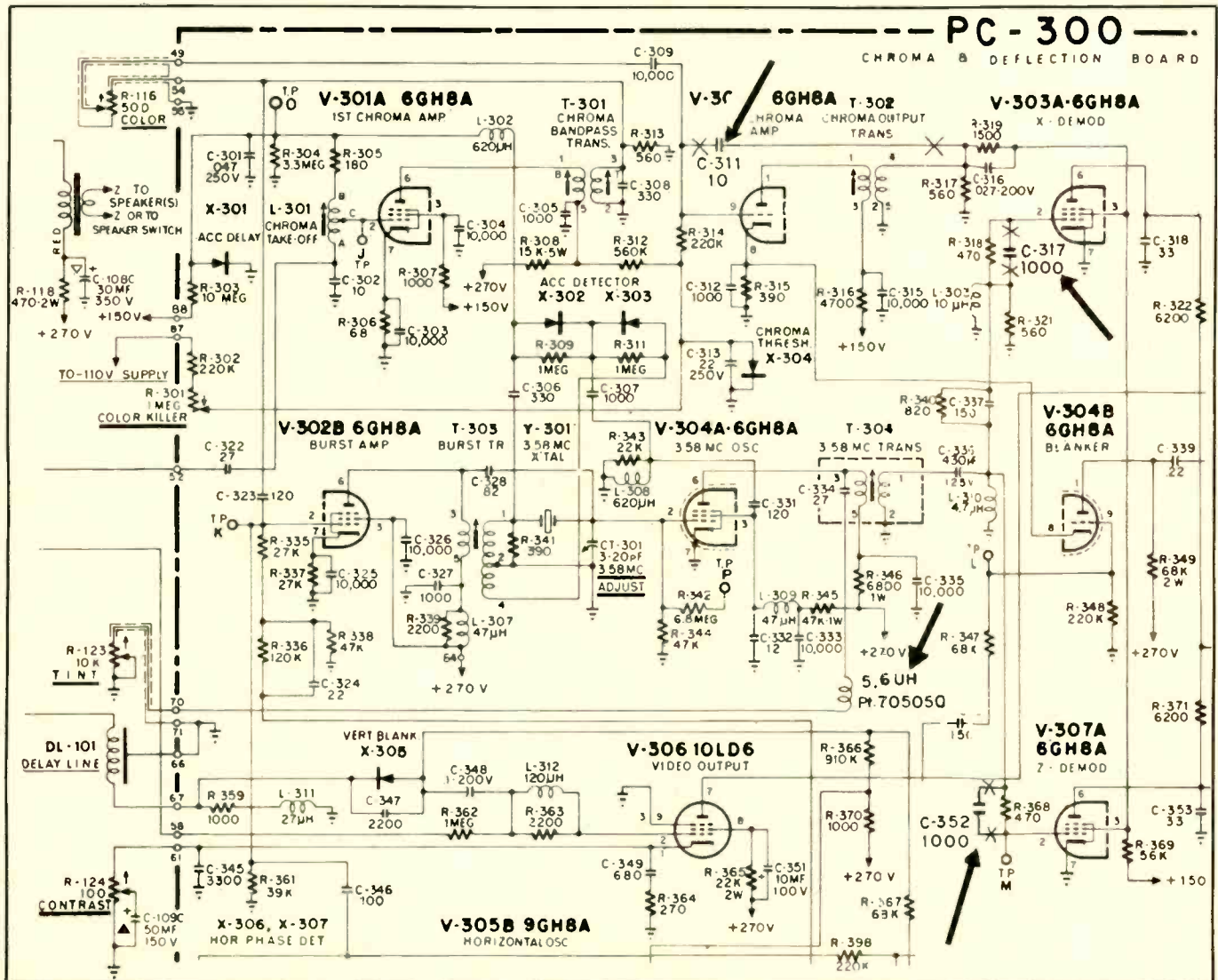

When you think Meters... Think Best Value! Choose Heath!



NEW
Heathkit IM-28
Bench Type VTVM

**Heathkit IM-17
Solid-State
Volt-Ohm-Meter**

Kit
\$21.95 • 4 AC & DC volts ranges from one volt full scale to 1000 volts • 4 Resistance ranges measure from 0.1 ohm to 1000 megohms • 11 megohm DC input impedance, 1 megohm AC • Response 10 Hz to 1 MHz • Battery powered • Includes all probes and portable case



Kit
\$39.95
Wired
\$59.95

• New Heathkit styling • 7 DC & AC volts ranges — 1.5 volts full scale to 1500 volts • 7 Resistance ranges measure from one ohm to 1000 megohms • Response 25 Hz to 1 MHz • 11 megohm DC input impedance, 1 megohm on AC • AC powered • 6" meter

**NEW Heathkit IM-18
Standard VTVM**

• A restyled version of the IM-11 • 7 DC & AC volts ranges from 1.5 volts full scale to 1500 volts • 7 Resistance ranges measure from one ohm to 1000 megohms • Response 25 Hz to 1 MHz • 11 megohm DC input impedance, 1 megohm on AC • AC powered

Kit
\$29.95
Wired
\$49.95



**NEW Heathkit IM-38
Lab AC VTVM**

• Features the Heath "New-Look" • 10 AC volt ranges measure from 0.01 to 300 volts RMS full scale • Decibel range —52 to +52 total in ten ranges • Response 10 Hz to 1 MHz • 10 megohm input impedance • AC powered

Kit
\$41.95
Wired
\$57.95



**Heathkit IM-25
Solid-State Volt-
Ohm-Milliammeter**

• 9 DC & AC volts ranges — 150 millivolts full scale to 1500 volts • 7 Resistance ranges measure from one ohm to 1000 megohms • 11 Current ranges — 15 uA full scale to 1.5 A • Response to 100 kHz • 11 megohm DC input impedance, 10 megohm on AC • Battery or AC power



Kit
\$85.00
Wired
\$120.00

**Heathkit IM-16
Solid-State
Volt-Ohm-Meter**

• 8 DC & AC volts ranges — 500 millivolts full scale to 1500 volts • 7 Resistance ranges measure from one ohm to 1000 megohms • 11 megohm DC input impedance, 1 megohm on AC • Battery or AC power



Kit
\$46.95
Wired
\$69.95

ET/D TECHNICAL DIGEST

tively in weak signal areas. In a few cases involving the color chassis with series filaments, the removal of the components C317, C352 and C311 shown in the partial schematic will effectively reduce picture interference on channel four which stems from a harmonic radiation of the 3.58MHz oscillator circuit. In some cases, disconnecting the ground lead between the shielded 300 Ω input antenna lead and the tuner is effective.

If interference is still present, disconnect the center conductor of the shielded lead from the tint control at the bottom of the chroma board. Connect choke coil (5.6μh), part number 705050 in series with this lead connecting the tint control at the chroma board end.

SYLVANIA Min-Nom-Max Parameters

In a direct coupled silicon quasi complimentary power amplifier the idling current level is set by the bias networks voltage drop (see illustration). This voltage is equal to the

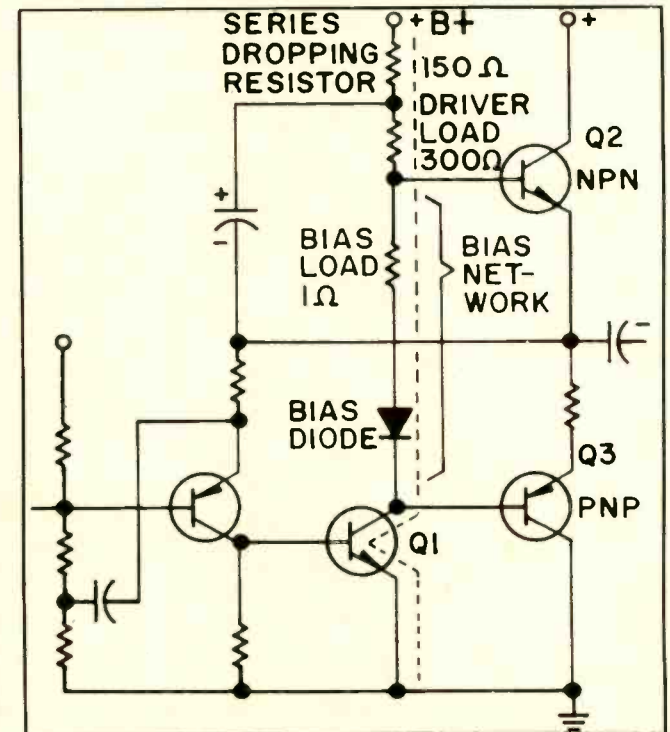

voltage drop across the diode and bias load resistors. Since this network is connected from the base of transistor Q3 to the base of transistor Q2, its voltage forward biases both transistors into conduction and sets an idling current val-

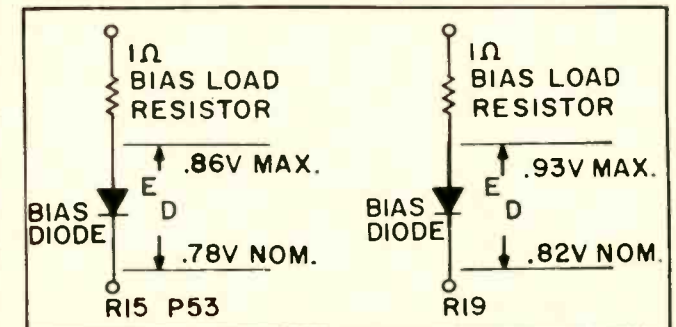

HEATH COMPANY, Dept. 24-19
Benton Harbor, Michigan 49022



- Please send my FREE 1970 Heathkit Catalog
 Enclosed is \$ _____, plus postage

Please send model (s) _____

Name _____

Address _____

City _____ State _____ Zip _____

Prices & specifications subject to change without notice. TE-206

... for more details circle 118 on postcard

continued on page 87
ELECTRONIC TECHNICIAN/DEALER

**no other
rotator
can make
this statement.**



Reliable performance . . .

Brand-name acceptance

RCA rotators offer an exclusive combination of features that give the top-notch performance that people identify with the RCA name. *Engineered and designed by RCA*, these rotators feature a rugged, lightweight drive unit that handles many times the weight of the largest TV antenna easily, effortlessly. RCA rotators—the ones that sell—that don't come back.

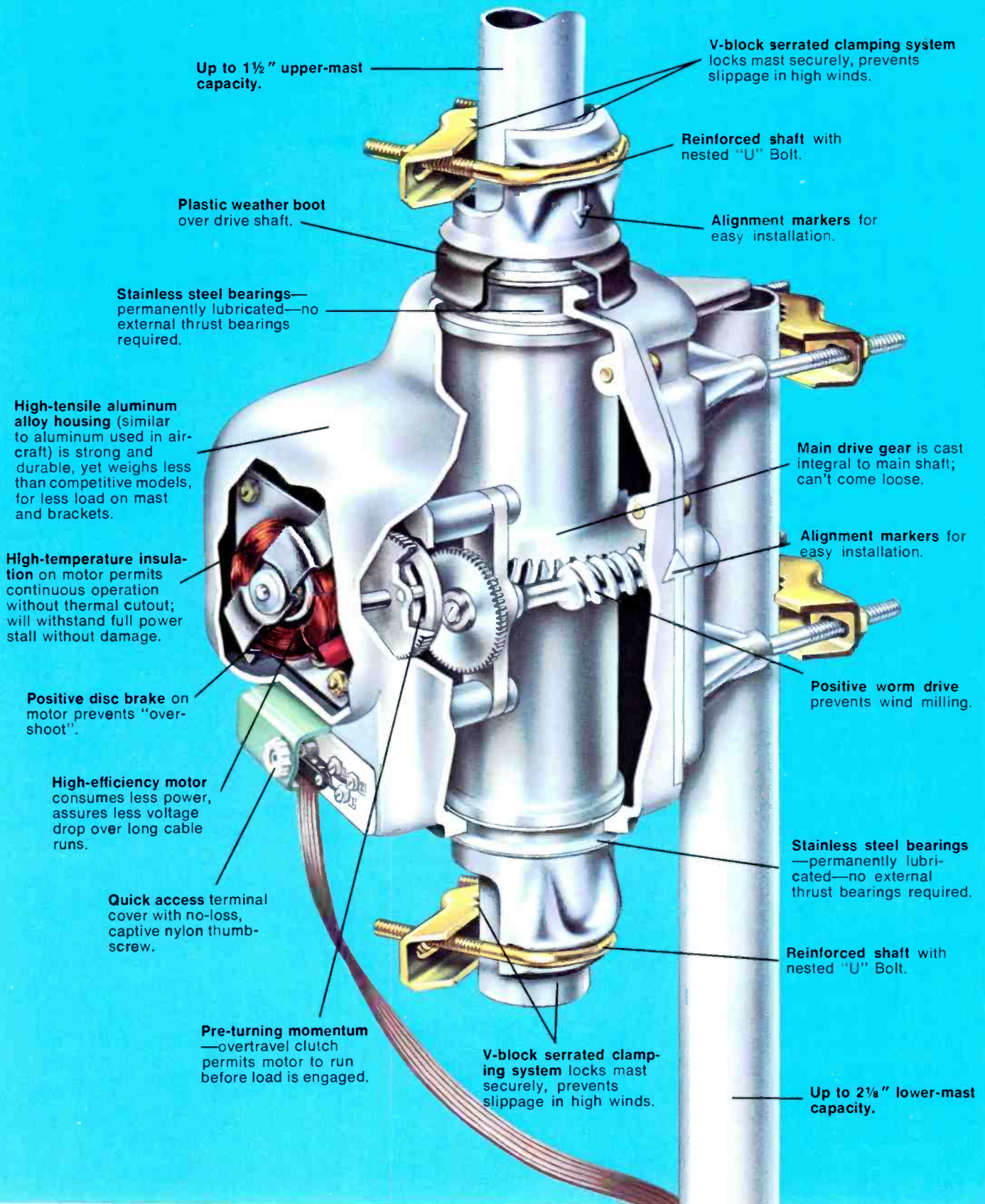



The RCA fully Automatic Rotator (model 10W707) has "Space Age" Solid State Circuitry for absolute synchronization plus the *RCA silent operation*. The "707" uses a fully balanced DC bridge circuit to synchronize control unit and antenna with a positioning accuracy of two degrees, unaffected by line voltage variations, cable length, weather conditions or age. No mechanical detents to limit antenna positioning. Full 360° operation—no dead spots. It's "childproof" too—can't be put out of synchronization or damaged by any amount of knob-twisting. Positive directional indicator lights instantly show the *exact* direction of operation, and are positive indication that drive motor is drawing power.

Sheer elegance in appearance Plus the name you can depend on . . . RCA

The new RCA low silhouette beige control cabinets will complement any decor . . . to please the man and woman of any household. And, they perform as beautifully as they look. No competitive antenna rotator does all the things, has all the features, that are built into RCA Rotators!



The RCA sleek positive push-button fingertip control Rotator (model 10W505) has a 360° indicator dial that shows the antenna position at all times . . . to change this position just touch a button. Unique mechanical design achieves precise control with few moving parts. Proven in life tests . . . over 30,000 operations without a failure! A great value in a push-button rotator—RCA quality at a budget price!

RCA

“Space Age” Engineering... Tested Performance

RCA Tests and Tests—RCA subjects rotators to continuous-operation life tests. Far more severe than any normal use, these tests surpass the use a rotator would receive over a period of more than 20 years. In one of these tests (top photo), the RCA Rotator was operated *continuously* with 64 lb concrete weight loading for over 30,000 full 360° rotations without failure. Results of this testing prove the RCA rotators you sell will perform year in and year out at their peak. Tell your customers about RCA testing, reinforcement for RCA brand-name power.

RCA Engineered—RCA engineers took a long, hard look at every factor involved in creating a rotator to turn an antenna. Circuitry, mechanics, materials were among the problems carefully studied. Solutions to each problem drew extensively from RCA's 50-year engineering experience, and were directly related to RCA accomplishments in space and radar systems. The result: the best rotator the RCA name can sell for you.

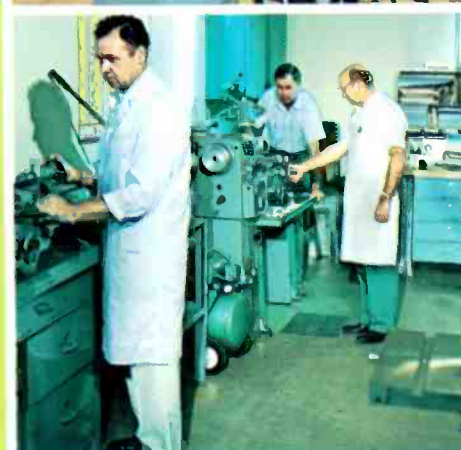

RCA

Parts and Accessories | Rotators | Antennas | Reception Aids & Installation Hardware

TELEQUIPMENT

TYPE S54

Rectangular CRT, 4KV, 6 x 10 cm viewing area illuminated Graticule; P31 phosphor.

X10 Gain increases deflection factor to 10 mV/cm (DC to 4 MHz).

Step Selectors with variables, standard 1-2-5 sequence. Attenuators accurate within 5%.

Convenient line voltage range selector on rear panel.

Portable; 17 lb. space-saving size: 9 in x 7 in x 16 in.

Full Triggering with AUTO or LEVEL selective operation.

TV Frame or line selection for easy TV waveform triggering.

Slope and source selection.

Convenience Jacks include Amplitude Calibrator, Probe Test, EXT input and Sweep output.

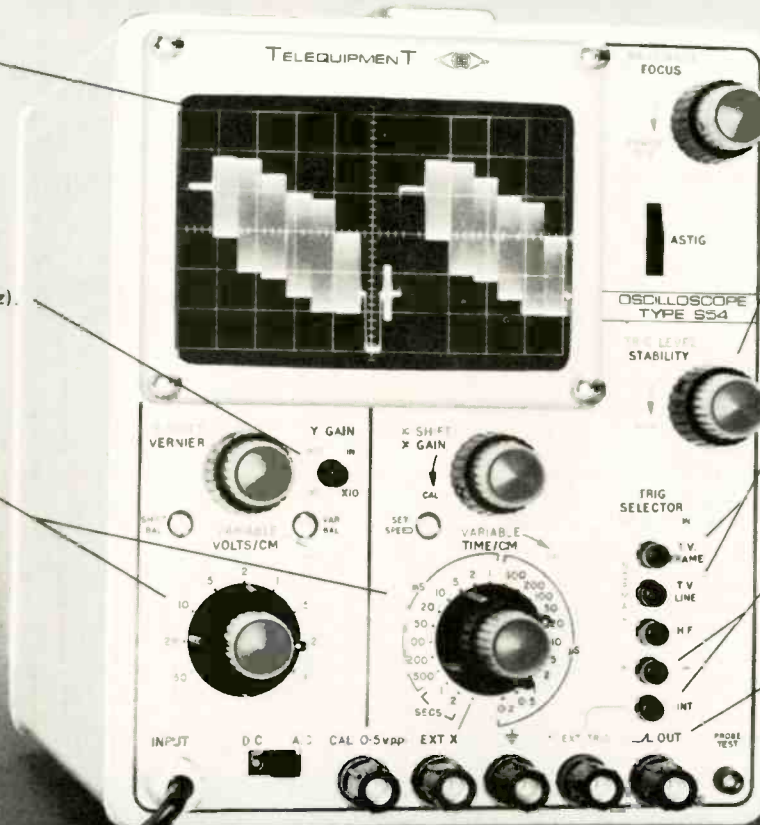

SOLID-STATE OSCILLOSCOPE

DC to 10 MHz

35 ns RISE TIME

TRIGGERED OPERATION

PRICE: \$ 395

Designed for the service industry; backed by a one year warranty, parts support and 22 service centers; marketed through 48 Tektronix Field Offices.

For more information call your local Tektronix field engineer or write Tektronix, Inc., P.O. Box 500, Beaverton, Oregon 97005.

U.S. Sales Price FOB Beaverton, Oregon

TELEQUIPMENT



a subsidiary of **Tektronix, Inc.**

Don't sell a color picture tube unless its been on a test ride.

Down at the bottom of the page, you have a major advance in space-age homeliness.

And a major advance in color tube testing as well.

That machine squatting down there is our beloved Iron Horse, the fully-automated, revolving carousel we use to test our color bright 85° tubes for emission, gas leakage, shorts, arcing and screen uniformity prior to shipment.

Now we don't intend to go into a song and dance on how total automation reduces testing error.

But we will tell you one thing.

Our Iron Horse test ride, combined with our life testing and 100% set testing, makes it almost impossible for you to get a defective color tube from us.

Which in turn makes it almost impossible for you to get chewed out by a customer.

Next time you need a color replacement tube, remember the great thing about the color bright 85. We don't send it to you till it's been around.

SYLVANIA
GENERAL TELEPHONE & ELECTRONICS

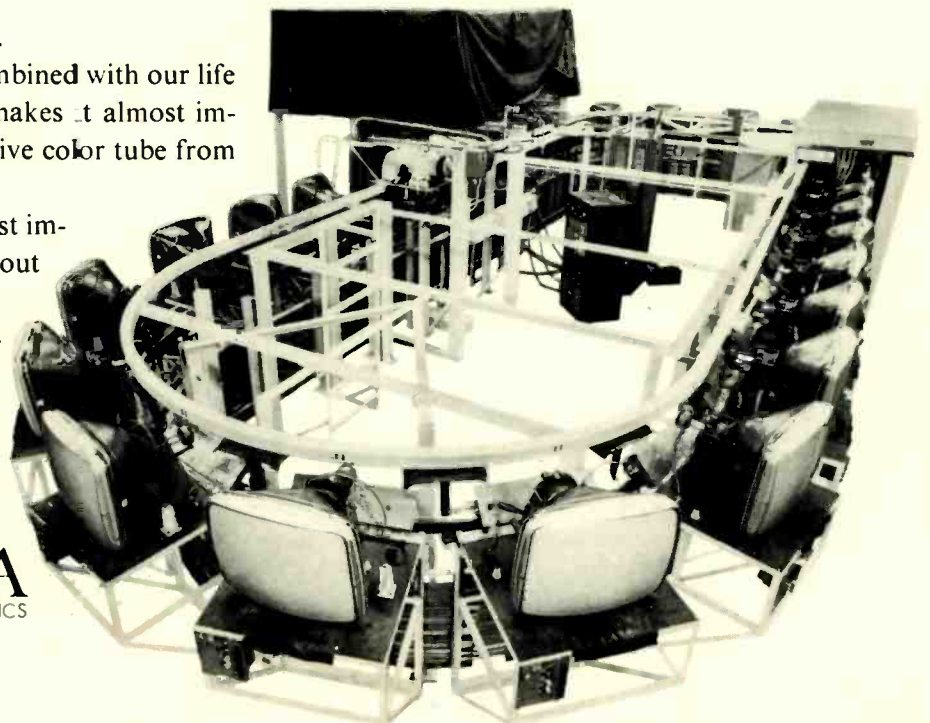

... for more details circle 138 on postcard

ELECTRONIC TECHNICIAN/DEALER

ET/D TEKLAB REPORT

Study the AFC circuit; It is not found on most portable color sets

Sears Silvertone Model 4168 Portable TV

■ Last month we reviewed the circuits employed in the low voltage power supply, horizontal output, color oscillator, chroma bandpass amplifier and the color sync section of this portable color TV.

We now review the color difference amplifiers and the demodulator circuits with outputs ac coupled to the difference amplifier inputs.

The color killer and detector combine to furnish a voltage

which biases the bandpass amplifier beyond cutoff.

COLOR KILLER AND DETECTOR

The AFC circuit monitors the video IF and when the frequency is not correct, it provides a correct voltage for the VHF or UHF tuner.

The color killer and detector shown in Fig. 1, combine to furnish a voltage which biases the bandpass amplifier beyond cut-

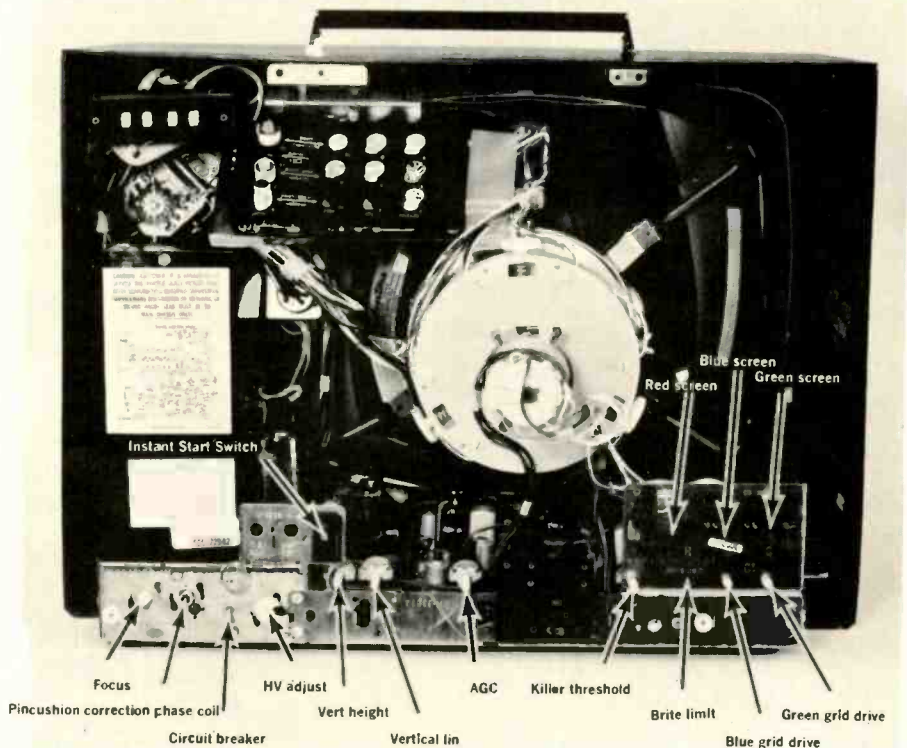

Rear view of the set showing adjustments and controls.

off whenever color burst is not received. Whenever burst is present, the killer is inoperative and permits normal chroma amplification in the bandpass amplifier.

During monochrome reception, the only signal to the killer detector is from the 3.58MHz oscillator plate transformer secondary. Both diodes conduct equally on alternate half cycles with zero voltages resulting at the junction of resistors R455 and R456. Under these conditions the killer threshold can be adjusted to provide bias necessary to cause killer tube conduction. The tube conducts only during retrace time when a positive pulse from the high voltage transformer is coupled to the plate. During tube conduction C415 is charged. During trace time C415 discharges through R415 and R411, producing a negative voltage potential. Filtering is accomplished by C411. The threshold control is normally adjusted until sufficient negative voltage is created to provide cutoff bias for the bandpass amplifier. This is determined by the absence of color snow on a B/W picture or a snowy raster, with the chroma control at normal setting.

Whenever color is received, 3.58MHz burst signals 180deg out of phase are coupled to the separate killer diodes. At one diode the 3.58MHz oscillator and burst signals are in phase, at the other they are 180deg out of phase. Conduction is unequal with maximum diode current through R456. This creates a negative voltage potential on the killer control grid, cutting off tube conduction and eliminating the negative

voltage at the bandpass amplifier grid. Normal chroma amplification can now be accomplished.

COLOR DIFFERENCE AMPLIFIERS

The two demodulated chroma signals are amplified to provide the red and blue difference color signals for the CRT. The green difference color signal is obtained by mixing the R-Y and B-Y amplifier tube signals across their

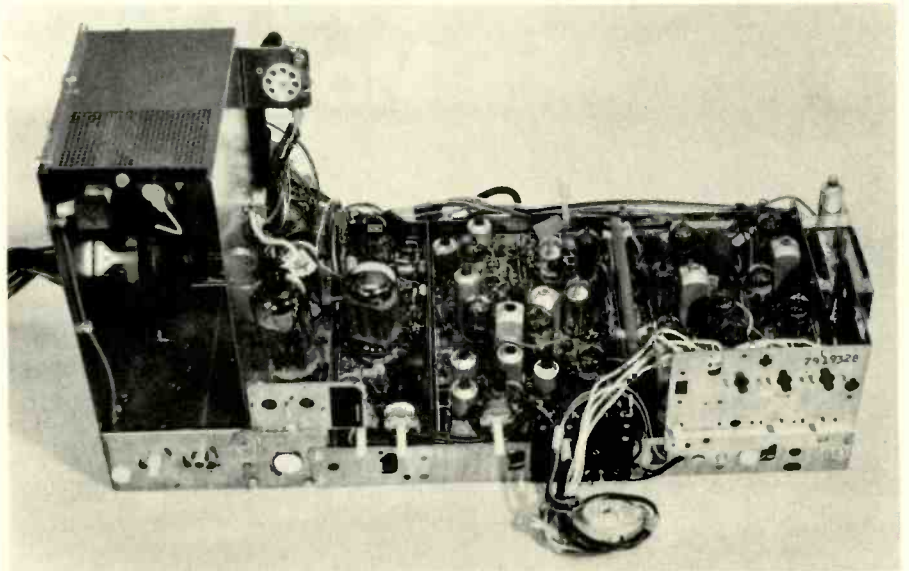

Top view of the 528.72940 low B chassis with all components arranged for easy access.

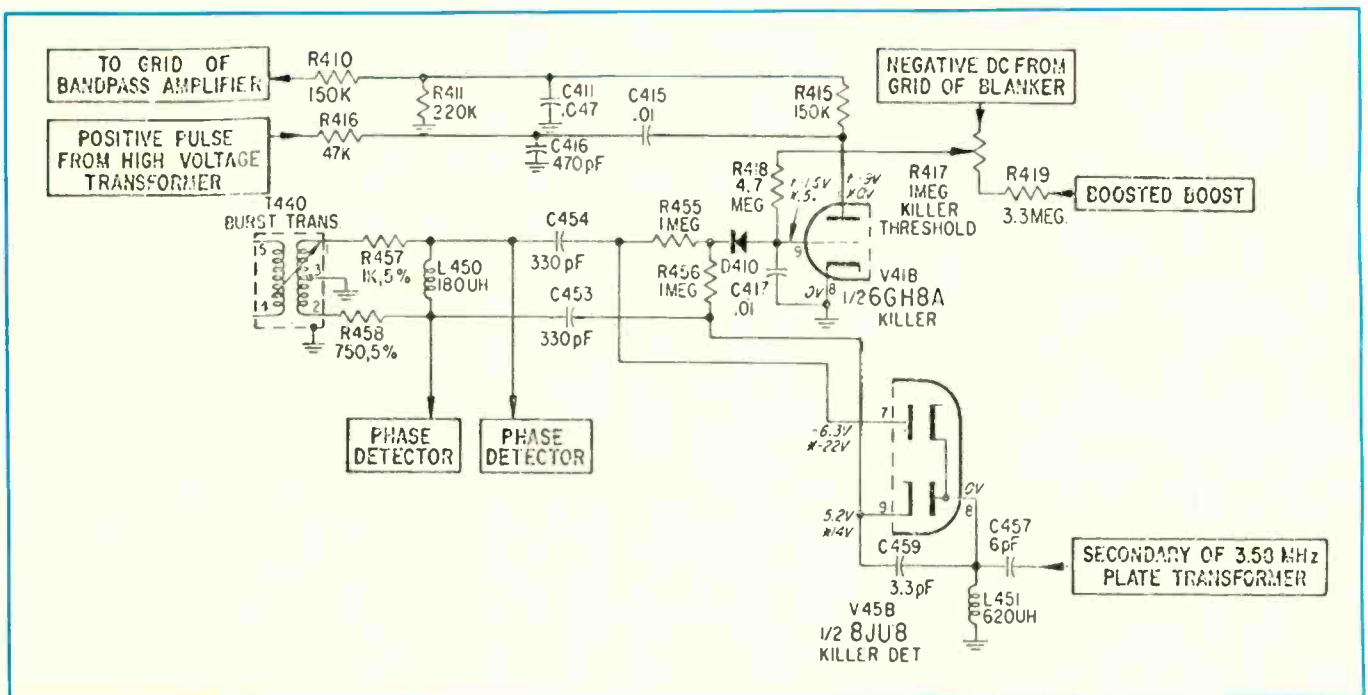

Fig. 1—Diagram of the color killer and detector which combine to furnish a voltage which biases the bandpass amplifier beyond cutoff whenever color burst is not received.

common cathode resistor, also shared by the G-Y amplifier. The output of the G-Y amplifier furnishes the green difference color signals for the CRT.

The demodulator outputs, shown in Fig. 2, are ac coupled to the difference amplifier inputs--the "X" demodulator output going to the (R-Y) amplifier and the "Z" demodulator output going to the (B-Y) amplifier. The red and blue difference color signals are amplified, inverted and dc coupled to the respective CRT control grids.

Cathode resistor R438 is common to all the difference amplifiers. Any signal voltage across this resistor will be the result of (R-Y) and/or (B-Y) signal at the control grids of these amplifiers. The vectoral sum of these two signal voltages when they produce a positive going voltage across R438 results in a new signal voltage. The new developed signal is equivalent to the (G-Y) signal seen at the station.

The (G-Y) amplifier control grid is at ac ground potential through C430, R430 and L706 and functions as a grounded grid amplifier. Signal voltages across the cathode resistor are amplified by the (G-Y) amplifier and appear in the plate circuit unchanged in polarity. The green difference color signals are dc coupled to the green CRT control grid.

The dc potential at the green and blue CRT control grids are adjustable. Controls located in the corresponding difference amplifier plate circuits provide the adjustable dc potentials needed for tracking adjustment. Spark gaps at each CRT control grid protect these controls and associated circuitry from damage if internal CRT arcing should occur.

AFC CIRCUIT

The AFC circuit shown in Fig. 3 monitors the video IF and, when the frequency is not correct, provides a correction voltage to a control device in the VHF and UHF tuner. The control device changes the tuner oscillator back to the correct frequency.

In the VHF tuner oscillator

circuit, the control device is a transistor (Q901) connected as a diode. In the UHF tuner, the oscillator control device is a varactor diode (D952). Both control devices are reverse biased. It is the difference in the amount of reverse bias which determines the effect that the control device has on the oscillator.

When the AFC circuit is OFF, the correct oscillator frequency is determined with a station tuned

in and fine tuning adjusted. Fixed voltages are applied to the tuner oscillator control device. When the AFC is operating, the proper correction voltages are applied to the control device. The AFC circuit operating voltages and the fixed voltages applied to the oscillator control devices are provided by a zener diode regulated 10v source.

In the VHF tuner oscillator
continued on page 89

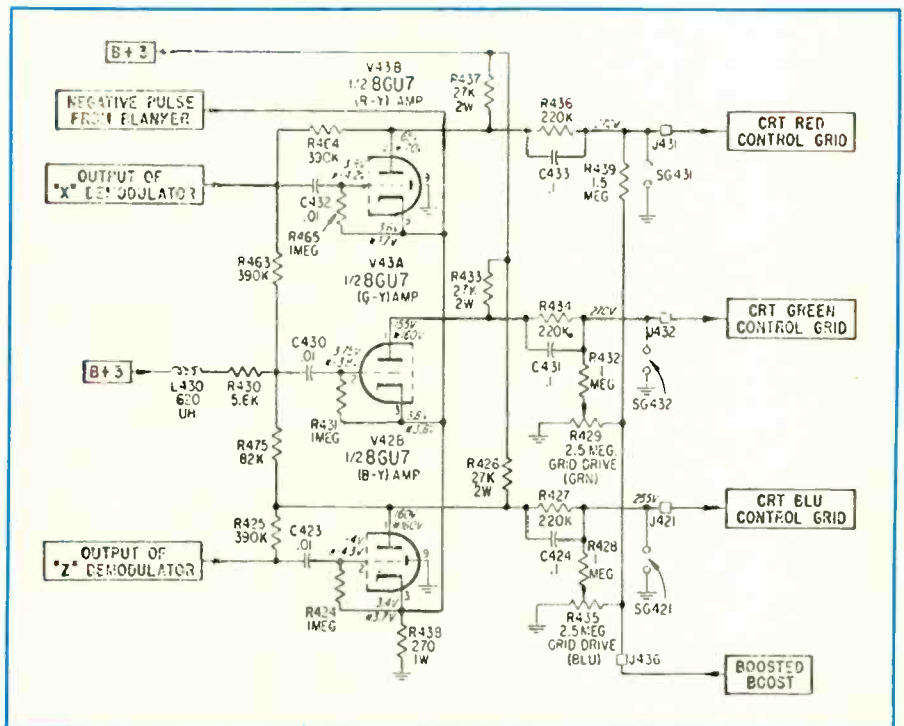

Fig. 2--Schematic of the color difference amplifier. The demodulator outputs are ac coupled to the difference amplifier inputs.

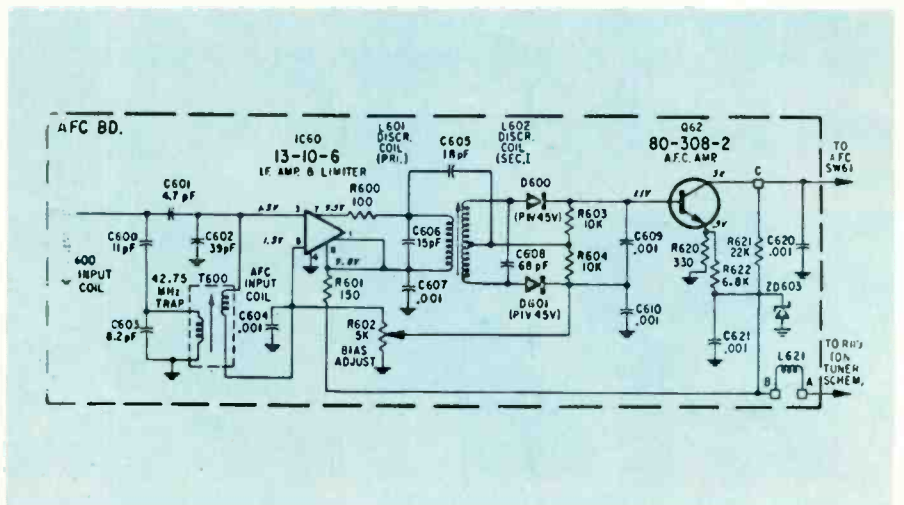
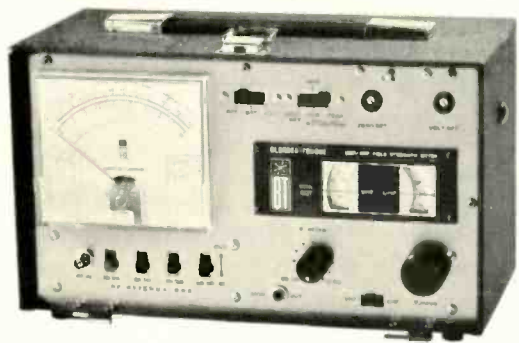

Fig. 3--This AFC circuit monitors the video IF and when the frequency is not correct, it provides a correction voltage for VHF or UHF tuner.

Blonder-Tongue
Laboratories, Inc., field
strength meter,
Model FSM-2.



Signal Strength Meters

Part Two

The application of signal strength meters for testing receiver sensitivity, response and other circuit parameters further proves the versatility of this instrument with practical guidelines for efficient shop use



Jerrold antenna installers meter, Model AIM 718.

■ Part one of this series (ELECTRONIC TECHNICIAN/DEALER, May 1969) explained the basics of SSM (signal strength meters) and their applications. This article will show you how to apply the SSM to practical circuit tests of VHF, UHF, TV and FM equipment including many of the VHF-UHF components used in MATV systems.

TV RECEIVER SENSITIVITY

Testing receiver sensitivity is essentially a check for over-all receiver gain through the video detector. We will be using the SSM as a tunable microvoltmeter. To do this, connect your wide-band oscilloscope to the video detector output. There is usually a test point between the 4.5MHz trap and lowpass input circuit of the video amplifier grid that serves well for this purpose. Set your scope for ac coupling with a 60 cycle sweep rate and calibrate it for 5v P-P deflection. Next, set the TV tuner and sweep generator for a given channel. Connect the sweep generator to the SSM through a 75 to 300 Ω matching transformer and set its output to give a reading of 100 μ v on the meter. Disconnect the SSM and attach the 300 Ω leads of the matching transformer to the TV set input terminals. Oscilloscope deflection should be in the order of 3v. This value may differ in various receiver models but after using the technique you'll be able to determine what to expect. The sensitivity check will quickly tell whether the IF strip or tuner needs some "touching-up" after tube replacement. It is also a good test of over-all receiver RF performance prior to releasing a completed repair job.

FREQUENCY RESPONSE AND PERFORMANCE EVALUATION --UHF, FM, VHF, AMPS AND PREAMPS

Many preamplifiers and amplifiers feature individual high and low band amplification transistors which subsequently feed into a combining circuit. Since these units generally have 75

or 300Ω outputs, the SSM will provide a means of quick, reliable performance evaluations. To check the unit in the field, disconnect the antenna downlead from the amp or preamp. Connect this downlead to your SSM and ascertain whether the antenna is feeding an adequate signal on one of the high band channels (minimum input for a given output will depend on the amplifier specs). Make a note of this signal reading. Do the same for a low-band channel and an FM station. Reconnect the antenna downlead to the amplifier input. Now check the amplified signal levels by taking the readings on the same channels and FM station used to obtain the previous unamplified readings. (If you don't have built-in attenuators on your SSM, it's a good idea to use a resistive pad of known attenuation to cut down the signal.) Compare the unamplified and amplified signal readings with the manufacturer's specifications. If the system you are checking was designed with very close tolerances, a 5 or 10dbmV deficiency in amplifier output could cause significant picture quality degradation at some or all of the TV tap-offs.

A similar, more precise test can be made in your shop by using a sweep generator as the signal source. The constant output level available from the sweep generator can be used to make a graphic plot of the amplifier or preamplifier response if desired. In this way, a problem such as a dip in the amplifier response curve at a desired channel may be easily discovered and the appropriate corrective measures taken. This same technique will enable you to check amplifiers before you install them in a MATV system and you can be more certain that they will perform the way you intend them to.

DETERMINING NOISE FIGURE OF AMPLIFIERS AND PRE-AMPLIFIERS

The noise figure (increase in noise output due to the generation of internal noise) of an am-

plifier or preamplifier is determined by obtaining the ratio of the total noise power at an amplifier's output to the noise power due to the input termination at a noise temperature of 290°K (approximately room temperature). The noise introduced by the 75Ω input of a TV distribution amplifier is determined as follows:

$$e_n = \sqrt{4RBc}$$

where e_n is the RMS noise voltage,

R is the resistance of the termination resistor in ohms

B is the approximate TV channel bandwidth in MHz
c is derived from Boltzmann's constant and equal to approximately 40×10^{16} at room temperature (68°F)

Solving for e_n generated by a 75Ω termination resistor will yield 2.2μv. Since the 75Ω resistor may be considered as a noise generator matched to its load (also 75Ω), only half of e_n , or 1.1μv (-59dbmv) will be introduced at the amplifier input. The other half will be dropped across the 75Ω termination resistor itself. See Fig. 1.

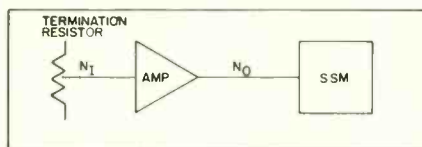

Fig. 1--Test setup for determining noise figure.

Given this -59dbmv (1.1μv rms) noise input and the gain of the amplifier under test, the noise figure may be easily computed.

$$F = N_I - (N_O) + \text{Rated Amplifier Gain}$$

Where F is the Noise Figure of the amplifier

N_I is the input noise

(-59dbmv in this case)

N_O is the noise measured at the output with input terminated + 3db.

(This value is an average correction factor added to compensate for the .5MHz SSM bandpass and detector efficiency. Some manufacturers



Hickok field strength meter, Model 235A.



Sencore field strength meter, Model FS134.

provide a correction curve giving precise values for the particular SSM.)

N_O is fairly constant across the band for most distribution amplifiers. Consequently, an SSM reading taken at any frequency setting within the amplifier's bandwidth should provide a reliable value for N_O .

In a typical case, we first determined the gain of a VHF amplifier under test (with the SSM and sweep generator method). This came to an even 36db across the band. The termination resistor was then connected to the amplifier input. After tuning the SSM to approximately mid-band (ch. 7), it was connected to the amplifier output for the N_O reading. The SSM indicated -18.5dbmv. Applying the noise figure formula:

$$\begin{aligned} F &= N - (N_O) + \text{Amplifier output for a 0dbmv input} \\ &= -59\text{dbmv} - (-18.5\text{dbmv} + 3\text{dbmv}^{**}) + 36\text{dbmv} \\ &= 7.5 \text{ noise figure.} \end{aligned}$$

continued

SIGNAL-TO-NOISE RATIO OF AMPLIFIERS AND PREAMPLIFIERS

The signal to noise ratio is a useful means of describing the relative noise component of a desired signal. The maximum possible signal-to-noise ratio for a 75Ω TV distribution amplifier is defined as:

$$S/N_{\max} = \frac{E_s^2}{e_n^2}$$

Where S/N_{\max} is the ideal signal-to-noise ratio

E_s is the signal voltage, μv
 E_n is the noise voltage, μv

This formula does not take into account the internally generated noise of the amplifier. To do this, and at the same time change your variables into the dbmv form compatible with MATV system calculations, the actual signal-to-noise ratio may be expressed as:

$$S/N = S_0 - (N_0)$$

Where

S/N is the actual signal-to-noise ratio expressed in db

S_0 is the signal output, dbmv

N_0 is the combined noise output and correction factor in dbmv.

Using the same amplifier as that utilized in the determination of noise figure, we obtained the following results with an off-the-air TV signal:

$S_0 = 35\text{dbmv}$ (video carrier signal strength measured at the amplifier output with SSM)

$N_0 = -15.5\text{dbmv}$ (obtained as described in noise figure section)

Therefore, by the formula

$$\begin{aligned} S/N &= S_0 - (N_0) \\ &= 35\text{dbmv} - (-15.5\text{dbmv}) \\ &= 50.5\text{db} \end{aligned}$$

(S_0 will, of course, vary from channel to channel.)

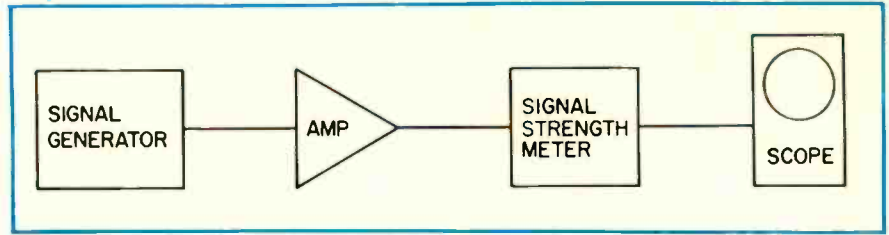

Fig. 2--Equipment setup for measuring percent of hum modulation.

Since signal and noise will be equally attenuated in the distribution system following an MATV head-end amplifier, the initial S/N ratio will remain relatively constant provided no additional amplifiers or other high noise sources are inserted.

The following values will serve as approximate guidelines in relating S/N ratios to picture quality.

Typical Picture Rating S/N Ratio

1. Excellent (no snow)	49db
2. Good (very little snow)	39db
3. Acceptable (snow present but not objectionable)	33db
4. Borderline (snow very apparent)	29db

MEASUREMENT OF HUM MODULATION

Leaky power supply filter capacitors in TV preamplifiers and amplifiers can cause 60 or 120Hz hum modulation of the RF signal being amplified. If the percentage of modulation of the RF by the half or full-wave power supply ripple exceeds approximately 5 percent, undesirable effects on the TV picture become noticeable. The percentage of modulation may be determined by connecting the SSM, your ac-dc coupled oscilloscope and a signal generator as shown in Fig. 2.

The procedure consists of measuring the peak amplitude of the detected modulated RF signal (mid-VHF or UHF, whichever appropriate) and the peak amplitude of the "hum" signal modulating it and then solving by the formula:

$$\% \text{ Mod} = \frac{\text{Peak Ripple}}{\text{Peak Modulated RF} - \text{Peak Ripple}} \times 100$$

The scope gain may have to be increased by a known factor (X 10 is usually sufficient) to make the ripple amplitude easier to measurement against the CRT reticule increments. This will usually involve recentering and division of the measured peak ripple value by the increase in gain used. Fig. 3 illustrates typical scope traces obtained with the method described.

In this example, Fig. 3A shows the modulated RF peak value to be 10 increments in amplitude (the oscilloscope is switched to dc coupling). The hum modulation is slight, so in order to measure it the scope must be switched to ac coupling and the gain increased by a factor of 10 (depending on your scope) by turning the calibrated vertical attenuator switch to the next most sensitive position. After recentering for the peak ripple measurement, the indicated amplitude as shown in Fig. 3B is 1 increment. Dividing by the gain factor, 10, the peak ripple is converted to the same scale as was used in determining peak modulated RF. In this case, relative peak ripple is equal to 1/10 or .1 increment in amplitude. Solving according to formula:

$$\begin{aligned} \% \text{ Mod} &= \frac{\text{Peak Ripple}}{\text{Peak Modulated RF} - \text{Peak Ripple}} \times 100 \\ \text{or,} \\ &= \frac{0.1}{10 - 0.1} \times 100 \\ &= \frac{0.1}{9.9} \times 100 \\ &= .0101 \times 100 \\ &= 1.01 \text{ percent hum modulation} \\ &\text{Excessive values of hum modu-} \end{aligned}$$

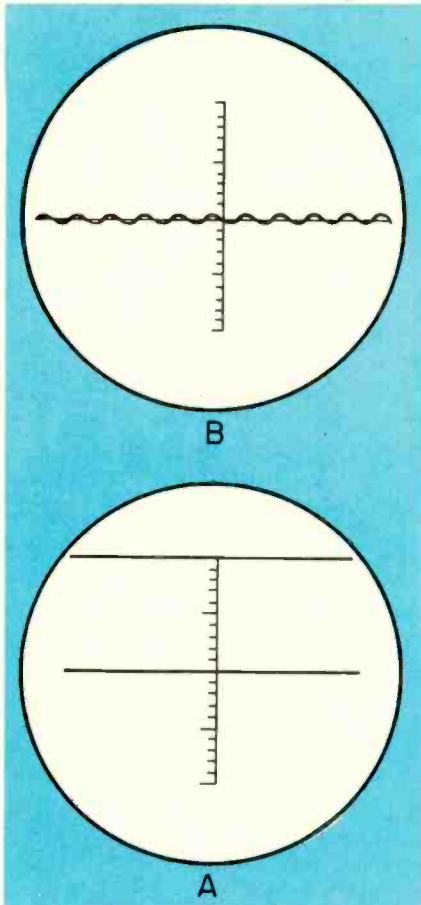

Fig. 3--Scope traces showing percent of modulation.

lation in a given amplifier may be an indication of increasing power supply filter capacitor leakage. A knowledge of the percentage of hum modulation normal for the amplifiers used in a particular system can be helpful in judging the results obtained with individual models. By using this technique as part of your final quality control check on repaired preamplifiers and distribution amplifiers, you can detect problems before returning equipment to the system.

ANTENNA INSTALLATIONS (INCLUDING MATV)

The competitive bidding aspects of MATV system installations require that you have a detailed knowledge of precise VHF, FM and UHF signal levels. These readings should be taken with the proposed antenna models in, or as close as possible to, the anticipated actual mounting location. The basic signal

SIGNAL SURVEY CARD						Location _____		
					By _____			
CHANNEL	3	7	9	17	28			
BEARING	220	225	225	190	230			
HEIGHT (Ft.)	dBmV	dBmV	dBmV	dBmV	dBmV	dBmV	dBmV	dBmV
20	+5	+3	+2	-5	+2			
25	+5	+3	+3	-3	+3			
30	+5	+4	+3	-2	+3			
35	+5	+4	+3	+2	+3			

Bearings: relative to magnetic North
Height: relative to ground level

Fig. 4--Typical signal strength readings plotting station channel, direction and antenna height (Courtesy Jerrold Electronics).

survey should be made more than once and at different times of the day and evening. This is particularly true if over-the-horizon of fringe area transmissions are to be received.

The best setup for surveys is provided by equipping a standard service-truck with a crank-up tower arrangement. You should design the "survey-rig" to give you full control over antenna direction and height from your position at the base.

The hoped-for ideal is that a single broadband antenna will bring in each desired TV and FM station with sufficient strength to drive your proposed distribution system. (Information on bid specifications and distribution systems for MATV may be obtained from most system component manufacturers, distributors and dealers. Detailed engineering manuals are also available at nominal cost.) Most systems designers aim for a minimum TV channel signal strength of $1000\mu\text{v}$ or 0dBmV --measured by the SSM at the end of whatever length of 75Ω coaxial cable will be necessary to cover the distance from the antenna to the amplifier input.

It is best to take complete signal strength readings in 5ft increments starting at about 5ft

above the roof level of the building where the system is to be installed. Relative station direction or bearing for maximum signal strength should be taken for each desired channel. Each channel should be checked at whatever height seems necessary. Typical readings are indicated in Fig. 4.

In this case, channel 17 comes in acceptably only at a height of 35ft. The other signal levels indicate that a bearing compromise might work between channel 17 at 190° and the others at around 225° . Since the 225° station signals are comparatively strong, the compromise should favor the weaker channel 17. Turning the antenna to 205° at 35ft will give you a better idea of what the compromise means in terms of signal and this educated juggling may put you in business with one antenna.

If the signal strengths are too low for the size of the distribution system you are bidding on, you will have to revise the tactics a bit. Mast-mounted preamplification, cut-to-channel yagis, stacking or separate VHF and UHF antennas may be in order. Whatever the trial combination, an SSM will help to keep you informed of signal progress and you should be able to quickly

arrive at a reasonable solution.

As a general cautionary note, it is advisable to consult both a portable TV receiver *and* the SSM when making surveys or installing antennas in *metropolitan* and *suburban* areas. If you consult a TV receiver only, the antenna might be aimed in the direction of a strong reflected signal and still present a good picture. In addition, the receiver picture will not provide the quantified signal strength information necessary for an MA-TV distribution system design. On the other hand, if the SSM alone is consulted, it will indicate the correct antenna orientation for maximum signal strength—but the antenna may be receiving both reflected and direct TV signals. This could result in multiple TV picture images on any set later connected to the antenna.

The logical solution to this dilemma is to consult both the SSM *and* the portable TV receiver before deciding on the final antenna height and direction. These units can be used simultaneously by connecting

them to the 75Ω TV downlead via a 2-way splitter. Splitting and insertion losses (usually in the order of 3.5db) must be taken into account when making SSM readings. But aside from this slight inconvenience, the "double-check" technique insures fast error-proof signal surveys and antenna installation in areas plagued by multipath reception problems.

The procedures outlined in this article are equally useful in home antenna installations. Where purely local reception in a private home is involved, a quick height check for adequate signal strength is usually sufficient and a rotor can be used to take care of the rest.

CURING INTERFERENCE PROBLEMS WITH AN SSM

The second harmonics of a strong channel 6 (82-88MHz) signal would fall within a range of from 164 to 176MHz. Since the video carrier of channel 7 falls at 175.25MHz, (Fig. 5), the possibility of interference from channel 6 harmonics exists. Like-

wise, the RF spectrum from 88 to 174MHz (the region between channels 6 and 7) is occupied by potential sources of harmonic interference capable of affecting channels 7 through 13.

If your SSM is of the continuous-tuning type covering the range *between* channels 6 and 7, then interference affecting high-band channel reception can frequently be isolated and "trapped." When the well-known symptoms of video interference occur (horizontal bar comprised of wavy lines, crosshatch pattern, etc.), the procedure is:

- (a) Determine channel frequency range (see Fig. 5)
- (b) Divide this range by 2 and search the resultant spectrum by tuning the SSM

A strong signal in the "search area" should be held suspect. A quarter-wave or half-wave trap can then be made to confirm or refute this assumption.

To prepare a quarter-wave open-end stub trap, cut a length of 300Ω polyethylene dielectric twin-lead according to the formula:

$$\text{Length (in feet)} = \frac{208}{\text{Interfering frequency (MHz)}}$$

Interfering frequency (MHz)

Thus, if the interfering frequency is 120MHz, the length of the quarter wave stub will be $\frac{208}{120}$ or approximately 1.75ft. Connect one end of this trap across the 300Ω input to the TV set (leaving the antenna lead-in attached, as illustrated in Fig. 6).

If the interference pattern is noticeably reduced, the stub/lead-in combination can be connected to the SSM for optimal "tuning." To accomplish this, merely cut off small sections from the free end of the stub until the SSM indicates maximum attenuation (lowest reading) of the interfering frequency.

Half-wave shorted stub traps can be similarly fashioned and are somewhat more efficient due to decreased radiation loss from the free end. The length of a half-wave stub trap made

CH	FREQ. RANGE IN MHz	CARRIERS IN MHz		
		VIDEO	COLOR	SOUND
LO-VHF	54-88	—	—	—
2	54-60	55.25	58.83	59.75
3	60-66	61.25	64.83	65.75
4	66-72	67.25	70.83	71.75
5	76-82	77.25	80.83	81.75
6	82-88	83.25	86.83	87.75
FM	88-108	—	—	—
HI-VHF	174-216	—	—	—
7	174-180	175.25	178.83	179.75
8	180-186	181.25	184.83	185.75
9	186-192	187.25	190.83	191.75
10	192-198	193.25	196.83	197.75
11	198-204	199.25	202.83	203.75
12	204-210	205.25	208.83	209.75
13	210-216	211.25	214.83	215.75
UHF	470-890	—	—	—
14	470-476	471.25	474.83	475.75
20	506-512	507.25	510.83	511.75
27	548-554	549.25	552.83	553.75
35	596-602	597.25	600.83	601.75
42	638-644	639.25	642.83	643.75
50	686-692	687.25	690.83	691.75
60	746-752	747.25	750.83	751.75
70	806-812	807.25	810.83	811.75
76	842-848	843.25	846.83	847.75
83	884-890	885.25	888.83	889.75

Fig. 5--Chart showing VHF-UHF TV channels and their respective carrier frequencies.

from 300 Ω twin-lead is calculated as follows:

$$\text{Length (in feet)} = \frac{416}{\text{Interfering frequency (MHz)}}$$

The half-wave stub is attached to the TV receiver (and tuned) in the same manner as the quarter-wave trap. Its free end, however, must be shorted.

Information on multi-stub and quarter-wave tapped stub traps possessing somewhat greater selectivity is available in many TV-

servicing text. Where *maximum selectivity* is sought (minimal attenuation of desired signals) it is recommended that commercially available FM band reduction filters and interference traps be used.

IMAGE BOOSTER AND SILENT SALESMAN

The SSM is particularly useful in the home when returning a repaired TV set and on routine service calls. In the customer's presence you can check each channel for adequate signal level. If inadequate reception occurs on a given channel, an SSM will help convince the set-owner that his antenna or distribution system is to blame in instances where the poor-reception problem is not the fault of the receiver. In addition, the extra care shown in taking actual instrument readings of signal strength will help support any recommendations you make concerning the need for a new (or better) antenna. If all expected channels are received satisfactorily, a history card attached to the rear of the

customer's set (Fig. 7) will remind him of his source for *professional* TV repair and reception advice.

Of course, an SSM is also invaluable in quickly determining whether a distribution amplifier, mast-mounted preamplifier, or signal distribution system is causing loss of reception (rather than the TV receiver itself).

WHAT TO LOOK FOR IN AN SSM

An accurate SSM that provides good readability together with minimal necessary control manipulation and easy setup is mandatory. Readability is a function of both meter face design and circuitry. Color coding of separate dbmv and μ v scales is also helpful. Changed scale values with the various attenuator combinations should be clearly indicated in discrete sets that correspond to all possible fixed attenuation values. This eliminates the need for mental calculation on each reading. A logarithmic (compressed at the upper end) scale provides for direct reading of dbmv values

continued on page 90

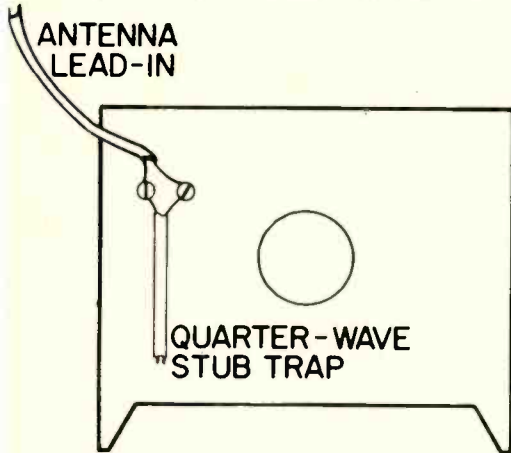

Fig. 6--Diagram showing quarter wave stub trap connected to TV set.

SIGNAL STRENGTH HISTORY CARD		Your TV Service center is: Tom's TV Tel. LO3-7411							
DATE	CHANNEL NUMBER								
7/21	S	2	3	8	11	17	29		
	I	2000	3200	4000	2500	1000	800		
	G								
	N								
	A								
	L								
	S								
	T								
	R								
	E								
	N								
	G								
	T								
	H								

NOTE: Keep this card attached to the rear of your TV set. All readings are in Microvolts. Minimum recommended signal strength on any channel is 1000 microvolts.

Copyright, 1968 The Jerrold Electronics Corp.

Fig. 7--History card on customer's TV set indicates various signal levels for several channels is reminder of professional service. (Courtesy Jerrold Electronics).

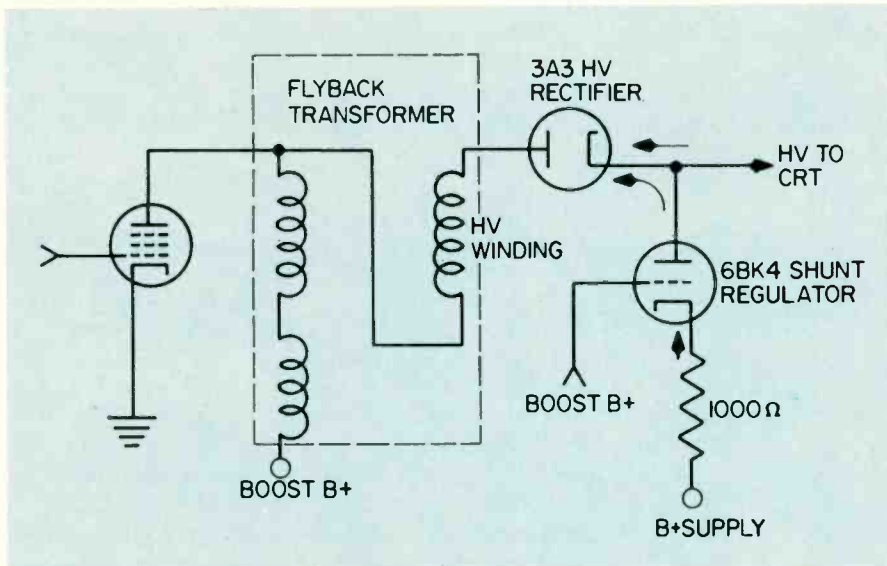

Fig. 1--Simplified diagram of the shunt regulator circuit.

Servicing Color High Voltage Systems

Develop an organized approach to color high voltage circuit troubleshooting

■ More service calls are made on color TV receivers for troubles traceable to the high voltage section than any other part of the receiver. In this section we have the greatest power dissipation; parts are under greatest stresses and the failure of one part can cause numerous secondary failures.

Symptoms of trouble in this section most commonly include: loss of raster, narrow raster, blooming, loss of focus, no brightness, misconvergence, recurrent high voltage rectifier, horizontal output and regulator tube failure.

The voltage required places great strain on the components of this section, and it is the basic reason for the failures. A high voltage near 25kv is common

in most sets as well as its regulation to \pm Kv. Extra Power is also needed to drive convergence circuits; provide up to 6kv focus voltage and triggering pulses for AGC, sync separation, blanking and burst detection.

When no HV exists in a receiver, the technician should check the high voltage rectifier, regulator, horizontal oscillator and horizontal output tube. All fuses or circuit breakers should be checked. If these protective circuits are all found satisfactory, then open the HV cage and inspect the flyback transformer for burns, signs of arcing, cracked insulation or overheated related parts. Melted insulation, rubber coating, or in some cases dripping wax indicates the transformer has been carrying excessive current. One

important check point is the drive bias developed at the grid of the horizontal output tube which is usually from -25 to -45 vdc. If this voltage is low or out, nothing will function and the horizontal oscillator circuit should be serviced before going any further.

By measuring the drive voltage, you will detect if the horizontal oscillator is performing correctly. If the drive voltage is very low, you know the trouble is in the horizontal oscillator circuit. Of course this drive voltage may be low because of heavy currents in the horizontal output tube caused from a short or high leakage in the flyback circuits. Remove the plate cap from the horizontal output tube and observe if the drive voltage returns to near normal. If this is the case, the trouble exists with the tube or its output circuit. If the drive voltage still remains low, then troubleshoot the horizontal oscillator circuit.

SERVICE PRECAUTIONS

Do not have the horizontal output tube plate cap "off" for a long period of time as this generally causes excessive screen current which may cause the screen dropping resistor to overload and change value.

The 25kv voltage is dangerous; when working on this HV circuit, exercise extreme caution. Turn off the set and discharge CRT high voltage anode before making adjustments or connections.

A HV probe must be used for measuring the 25kv at the CRT anode. Accurate measurement requires the probe be calibrated against a known standard periodically. Connections should be made with TV set OFF. After all leads are dressed away from chassis and connections made, turn on set and note the reading. Any signs of erratic readings should be noted, and if arcing takes place, de-energize the set and improve the connections.

Some HV measuring probes now on the market have a hand held probe, built-in meter and

ground connections. These may be used with the set "on" with proper precautions. If there is no raster on the color CRT screen and the fuse and circuit breaker checks good, check and substitute all tubes. If you still don't have HV, go directly to the high voltage, checking it with the HV probe. Be certain that the meter is set to the proper scale for the probe used. Most color chassis high voltages will be between 22 and 27kv. This value is often given on a sticker on the chassis. If the reading is low, the drive voltage on the horizontal output tube should be checked.

HINTS ON SERVICING THE HORIZONTAL HV CIRCUITS

The component parts of the HV and horizontal scanning circuits of a color set are under high stresses. Abnormal operation can cause excessive stress, permanently damaging parts including the CRT. Here are precautions to observe and servicing notes:

- (1) Shut off set when no brightness is obtained under normal conditions.
- (2) Avoid operating set with a blooming raster.
- (3) Verify drive to the horizontal output tube at all times; monitor cathode current with a 500ma meter.
- (4) When replacing the horizontal output tube, readjust the horizontal efficiency coil to a minimum (210 to 240ma. See manufacturers data) cathode current. If a dip in plate current cannot be obtained, there is a fault in the flyback circuit. A quick way to adjust the horizontal efficiency coil in the field is to place a 1/4a pilot lamp in series with the horizontal output tube plate cap. Use two alligator clips with short leads and solder them to the lamp. Adjust the coil for minimum lamp brightness.
- (5) Do not draw an arc from the HV supply with a screw driver to check presence of high voltage. (Listen for static and corona to verify its presence when turned on.)
- (6) Any changes in parts or tubes can cause detuning of the horizontal

efficiency and the setting should be rechecked. (7) Allow the horizontal oscillator tube to warm up to normal before checking the drive voltage on the horizontal output tube. (8) Obtain and use a HV probe to measure up to 30kv.

HV REGULATOR CIRCUIT

The HV regulator tube in many receivers is a 6BK4, high voltage triode. This voltage regulator tube and its corresponding circuits are connected between the HV source and boost B+. The purpose of the voltage regulator tube is to keep the voltage within limits at all times. The HV adjustment should be set so that the manufacturers specified HV is applied to the CRT. A simplified diagram of the shunt regulator is shown in Fig. 1.

Nominal current through the 3A3 rectifier is 1.2ma. This should remain substantially constant with electrons supplied from either or both picture tube HV lead or from the shunt regulator.

SERVICING THE HV REGULATOR SECTION (SHUNT TYPE)

When the high voltage regulation circuit appears defective, the picture will bloom, misconverge and usually vary in height and width. The procedure for servicing would be as follows:

- (1) Determine and measure the HV. Adjust to the manufacturers specified value if possible.
- (2) Operate the brightness control up and down while monitoring the HV. The HV should stay within ± 1 kv. Note the effect on picture and HV regulator current. It should not exceed $1200\mu\text{a}$ at zero (0) brightness, or less than $100\mu\text{a}$ at full brightness.
- (3) Check efficiency coil setting and measure cathode current flows in the horizontal output tube.
- (4) If trouble persists, check horizontal output tube drive, damper tube, HV rectifier and shunt regulator.
- (5) If shunt regulator tube is replaced, be sure all checks and adjustments above are made over again.

WIDTH AND HORIZONTAL EFFICIENCY

The width requirement of a color TV set is more critical than the B/W set because the amount of tolerable "over" or "under" scan is less. The width control on some sets will provide some variation for small adjustments. Where a large amount of adjustment is needed, the circuit should be analyzed for possible defects.

Common causes of not enough or incorrect width may be low horizontal drive from the horizontal oscillator, low line voltage, low-high voltage, weak tubes, poor horizontal efficiency and defective HV regulator circuit. The reduced width is often accompanied by low brightness and blooming conditions. A burned resistor (possibly from leaving the plate cap off while servicing) in the horizontal output stage screen grid circuit can cause insufficient width. Check the bypass capacitor off this screen grid resistor for a short or high leakage and make sure the resistor has not changed value.

Also check for high leakage in horizontal efficiency coil circuit capacitors. If the horizontal efficiency coil adjustment cannot change the width of the raster, check the capacitors across it, also checking the internal resistance of this coil. Insufficient width can also be caused by a leaky shunt regulator capacitor.

Using the scope you can check the drive in horizontal circuits. Place the scope probe on the grid of horizontal output tube and compare the waveforms on the horizontal tube with those on the manufacturers' schematic. Check the output waveforms at the plate of the oscillator tube and also the input waveforms. Waveforms at the output of the horizontal phase dual-diode detector should closely match those shown on the schematic.

Pulse type waveforms and complex horizontal waveforms are best measured with a scope. A good horizontal sinewave adjustment is almost impossible to make without observing the waveform. A low-capacitance

probe should be used in this check. A quick scope check of the horizontal output circuit can be made by clipping the scope lead to the insulation of the horizontal output plate lead. A large pulse should be seen on the scope screen if the horizontal output circuit is working properly.

Arcing, hissing and corona discharge in the color set commonly originates in the CRT, flyback transformer, CRT socket or outer aquadag coating and high voltage corona cup. Corona discharge may be most noticeable on a new set before complete burn-in, during periods of high humidity and in an old set. The high voltage anode rubber cap and cable may develop corona burns that cannot be seen but will hiss and arc over to adjacent objects. Replace the cap and cable and clean the HV socket with methanol-chloride.

Arc-over in the flyback transformer causes burning as well as voltage transients and may damage the entire flyback transformer. High voltage protection dope has been successfully used at the critical spots to protect the transformer. Observe the flyback operation in a darkened room to find the extent and points of arcing and corona.

CRT arcing may occur between the screen grids and focus electrodes or inner aquadag coating. If this does occur, a strong pulse of current through the screen control involved may stop the arcing. When arcing of a serious nature does occur, these controls should be checked. At times arcing may occur in the CRT socket between the focus pin and screen pin or other electrodes and result in a burned or open CRT socket contacts.

If the CRT outer aquadag coating is not properly grounded, it will build up static charges that will arc over to adjacent assemblies. Sometimes it will arc to the tuner, back through into the chassis causing considerable damage especially in transistorized sets. Make sure the CRT aquadag coating and adjacent assemblies are grounded.

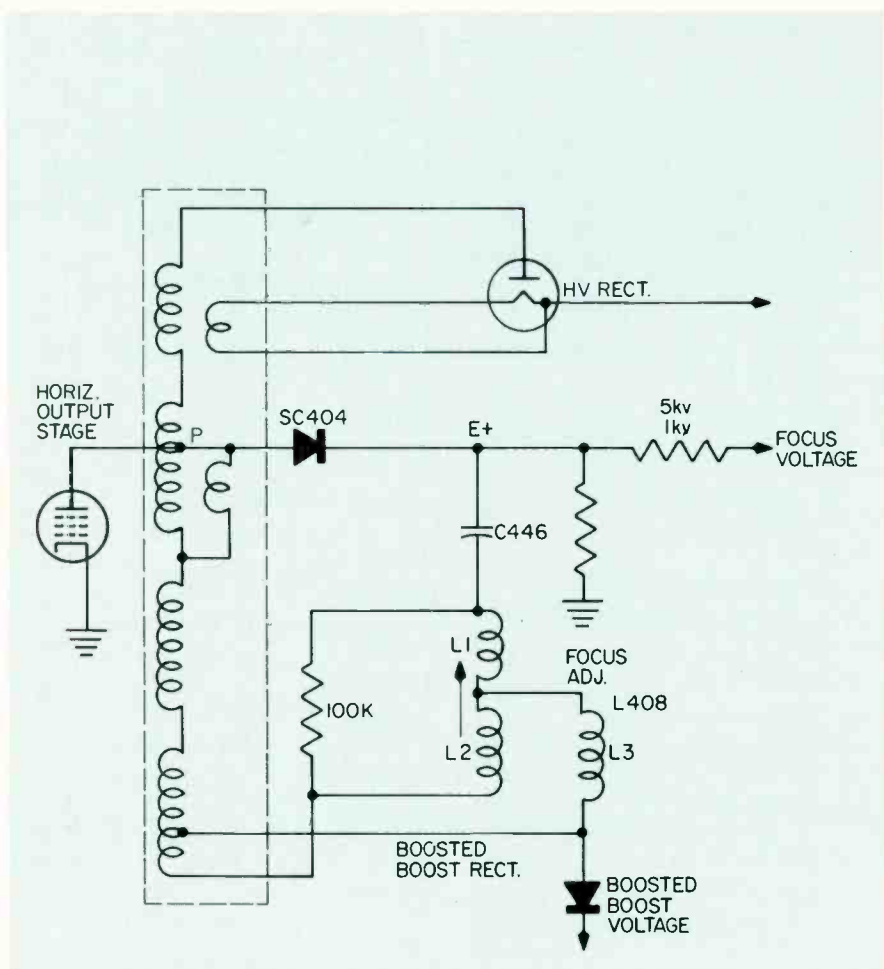

Fig. 2--Simplified focus voltage supply circuit.

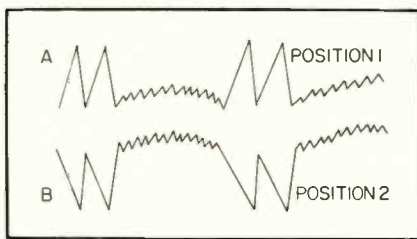

Fig. 3--Waveforms obtained at the cathode of diode SC404.

COLOR RECEIVER FOCUS VOLTAGE SUPPLY

An adjustable intermediate HV of about 5kv is required for the CRT focusing electrode. This voltage is developed using flyback pulses at a suitable tap on the flyback transformer; applying it in series with a rectifier diode to the focus electrode. A capacitor and coil network, shown in Fig. 2, is connected between the diode output and the B-boost terminal.

The complete focus coil net-

work, L408, incorporates three windings, an input winding L1, and a common winding L2. These coils are mounted on a common form with a damping resistor (100K) placed across the L2 and L1 windings. The focus coil output is coupled by C446 to the focus rectifier cathode. This capacitor, in addition to supplying a reference pulse, also serves as the focus supply filter capacitor.

In the coil form there is a powdered iron core slug (FOCUS control) which varies the effective pulse voltage division at the junction of L1 and L2 by differently varying the coupling of L1 to the other two coils.

Coils L2 and L3, operate in mutual opposition so that additional pulse input of adjustable amplitude and polarity may be applied to the rectifier cathode. This control affects the amount

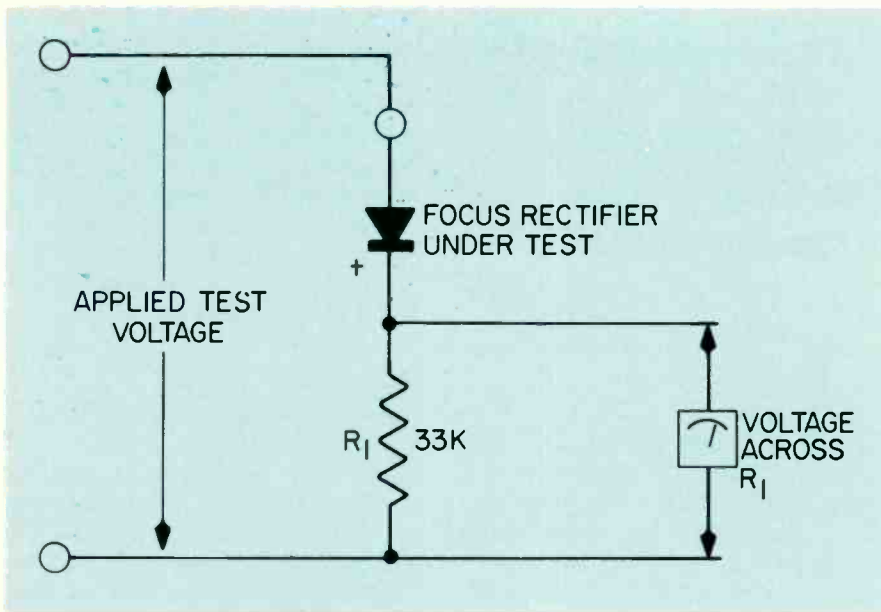

Fig. 4--Focus rectifier (selenium type) test circuit.

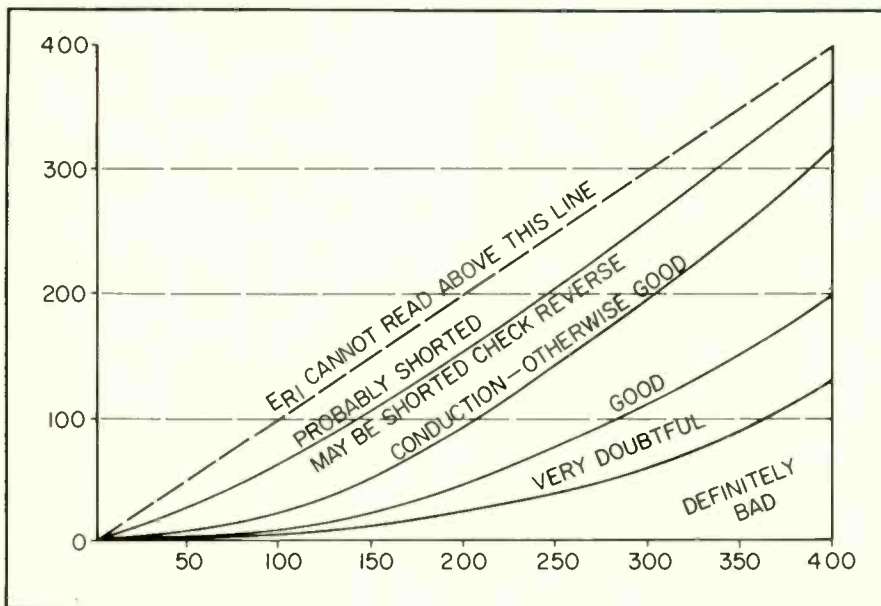

Fig. 5--Chart showing the focus rectifier test curves.

of "turn on" bias of the rectifier; therefore, the focus voltage is developed. The coils are wound and connected so that by adjusting the slug, a waveform similar to Fig. 3A and B may be obtained at the cathode of diode SC404.

If the focus rectifier shorts, the pungent odor of selenium will be noted along with loss of picture focus with possible damage to the 100K damping resistor and focus voltage will drop to a low value. The most common failing mode is too short and when overloading occurs, the unit will

open. If the equipment is operated in this condition, the coil network insulation will break down along with the 100K resistor.

A method of checking a focus rectifier is shown in Fig. 4. The test voltage may be one used in the set power supply.

SOME CAUSES OF VERTICAL RASTER BARS ON COLOR TV

Occasionally a receiver will exhibit vertical raster bars. These are generally caused by (1) slight non-linearity of scan between damper current and horizontal output tube current; (2) horizontal

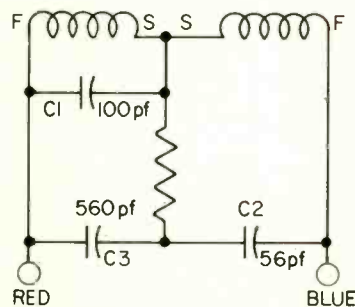
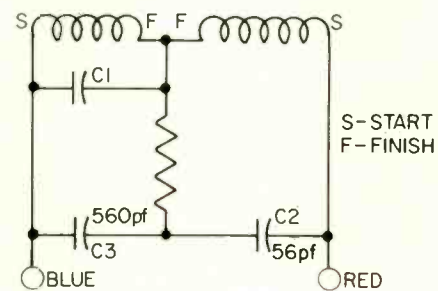

Fig. 6--Diagrams showing the original connections, then changing the wire routings on the yoke coils correcting the mismatch between the flyback and yoke.

sweep system pulses modulating the received video; (3) flyback-yoke mismatch or (4) unusual horizontal output drive characteristics. Of course before going too deeply into a solution of these problems, the tubes involved and lead dress of video and low signal level wires should be properly shielded and routed.

(1) Non-Linearity of Scan: Vertical lines produced by this defect often occur as the scanning current drive transfers from the damper tube to the horizontal output tube. When the damper tube stops conducting, it may oscillate in and out of conduction. This too, may produce vertical lines across the screen.

A possible solution to this problem may be made by slightly detuning from the normal "dip" position--the horizontal efficiency coil. Be sure to keep the horizontal output tube current in a safe range. The purpose of this detuning is to keep the damper tube from changing its conduction state.

(2) Horizontal Sweep System
continued on page 91

Repairing Solid-State AM-FM

Basic troubleshooting techniques used on tube type circuits will not always hold true for transistorized circuits as you will learn by following us through a stereo receiver with some typical problems

■ Solid-state AM-FM receivers are found in table models, stereo-phonographs and stereo-TV combinations. Shown in Fig. 1 is a block diagram of a typical solid-state AM-FM receiver. The most common is the AM-FM stereo combination which employs up to 15 transistors and several diodes. Deluxe AM-FM stereo models sometimes employ up to 40 transistors and 24 diodes.

A typical AM-FM tuner covers the AM broadcast band (540 kHz - 1600kHz) and the FM-band

(88MHz - 108MHz). These circuits are basically the same as most vacuum tube models except that you will find a few chassis contain IC circuits. Most common stereo combinations will employ from four to six speakers while the deluxe models will have eight or more speakers, including horns and additional accessory speaker jacks at the rear of the cabinet.

Special devices such as the field-effect transistor are being used in many of the 1968-

1969 FM receivers as well as integrated IC FM limiter circuits (Fig. 2). Even some phono circuits use an IC chip within the pickup cartridge. Additional features are delayed AM-FM AGC and FM automatic frequency control. In the power supply, a zener diode is used to stabilize the supply voltage to the AM-FM tuner section.

ISOLATION

Before attempting to signal trace an AM-FM chassis, try to isolate the defective section. If the AM band is performing and the FM section is dead, the trouble lies in the FM front end. Conversely, if the FM section is working and there is no reception on the AM band, check the AM convertor or RF stage. Most AM-FM receivers share the IF and audio circuits.

Suspect a defective oscillator stage when only background noise is heard as stations are tuned. Also, replace the trans-

Fig. 1--A block diagram of a typical modern stereo AM-FM Receiver and amplifier system.

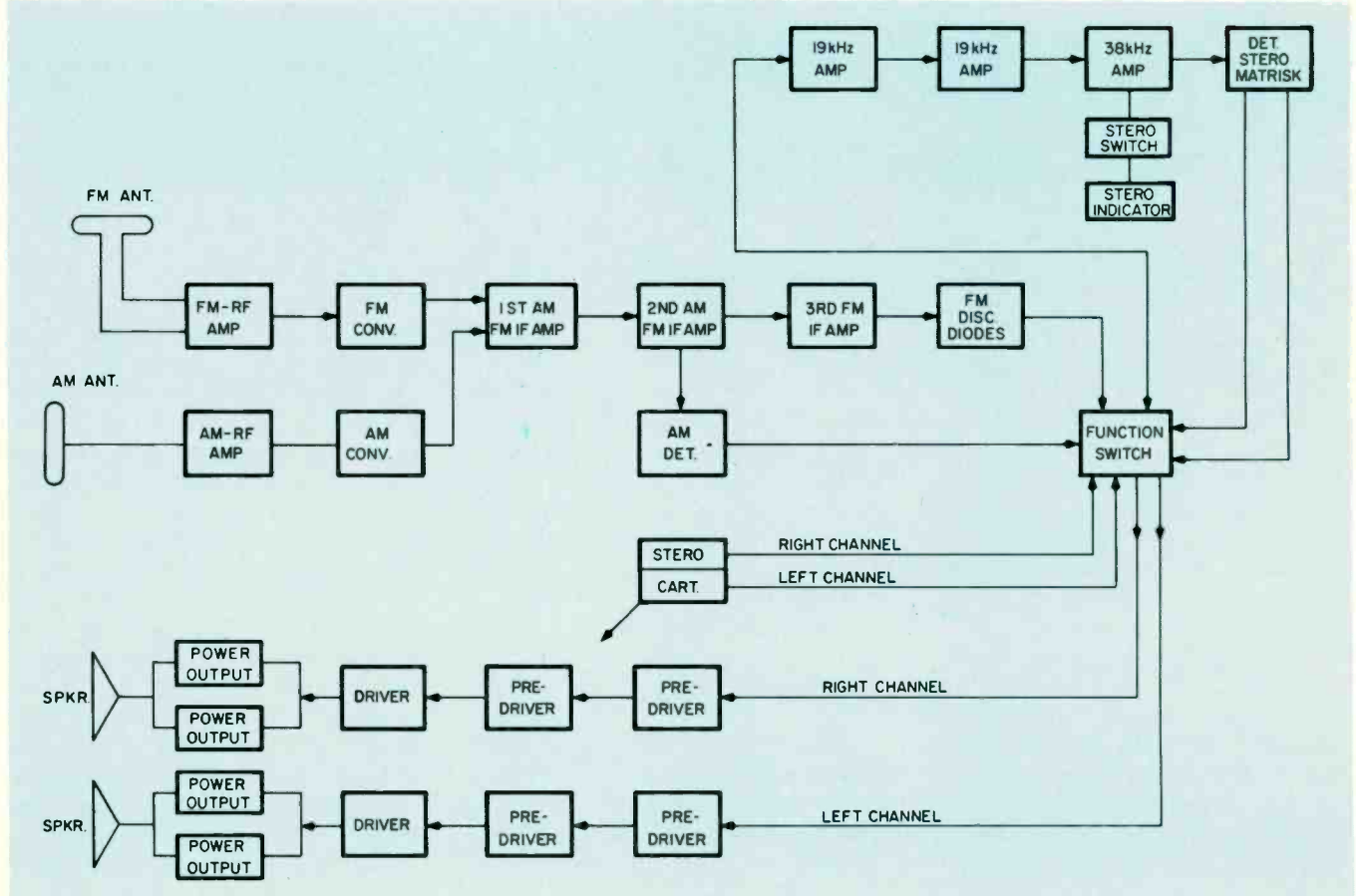

istor oscillator when only stations on either the high or low end of the band are received. Generally, an oscillator transistor becomes open or leaky. When only local AM-FM stations can be heard, suspect a defective RF transistor. Also, check the IF stages when the problem is weak reception on both AM and FM bands. Microphonic conditions in the FM band are usually isolated to the RF, mixer and transistors. They should be replaced if microphonics are occurring.

In cases where the left audio channel is working and the right channel is dead, check the right channel audio circuit. Check whether the audio stereo channels are working on both FM stereo and stereo phonograph. If the FM stereo section is normal, the trouble is probably a defective crystal cartridge. If the phono stereo section is normal and the FM stereo music is only coming out of one channel, suspect a defective multiplex section.

SIGNAL TRACING

One quick method to locate a defective stage is to inject a signal into the AM-FM circuits. A pencil type noise signal generator is useful to quickly locate the defective stage (Fig. 3). Start at the volume control and see if the audio section is alive. When a high gain amplifier section is performing as it should, just touching the metal cover of an audio transistor with the noise generator tip will indicate whether audio is present. As you proceed toward the volume control from the output stages, you should achieve gain in each stage. If not, start at the output stage and work forward. To locate a weak or distorted audio stage use an audio signal generator and scope.

The noise signal generator can be used in the IF and AF section to locate a dead circuit by simply moving the signal from the collector and then to the base terminal of each stage. Be careful not to short the tip

to both the transistor base and collector terminals as you can quickly ruin a good transistor. To locate a weak front end stage, use an RF signal generator instead of the noise generator. The RF signal generator is more

accurate and its output can be regulated.

VOLTAGE AND RESISTANCE READINGS

Once the defective stage has been located, take voltage mea-

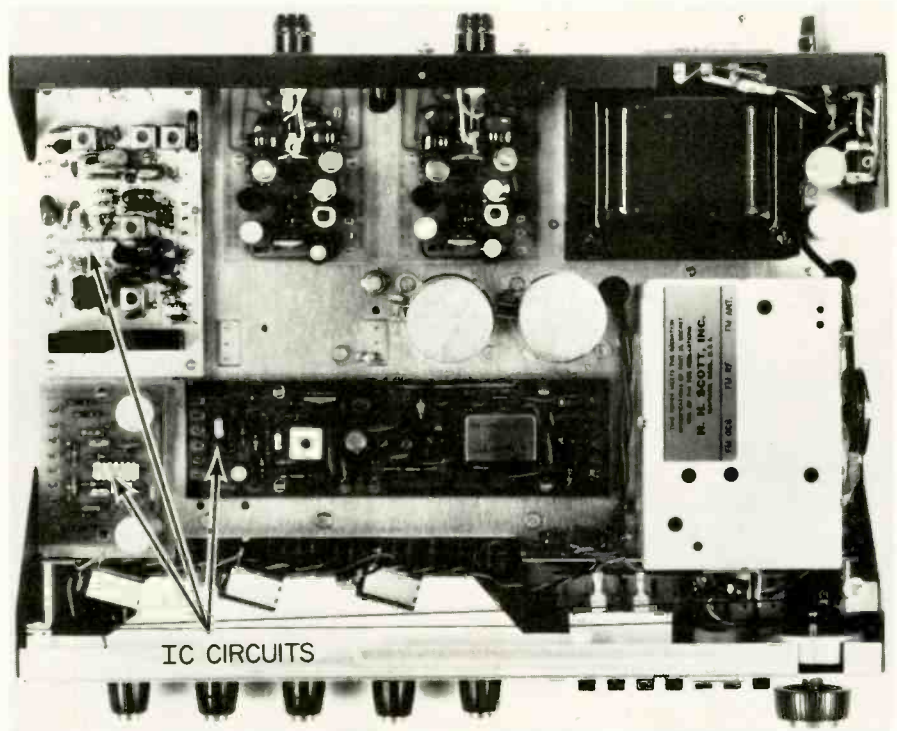
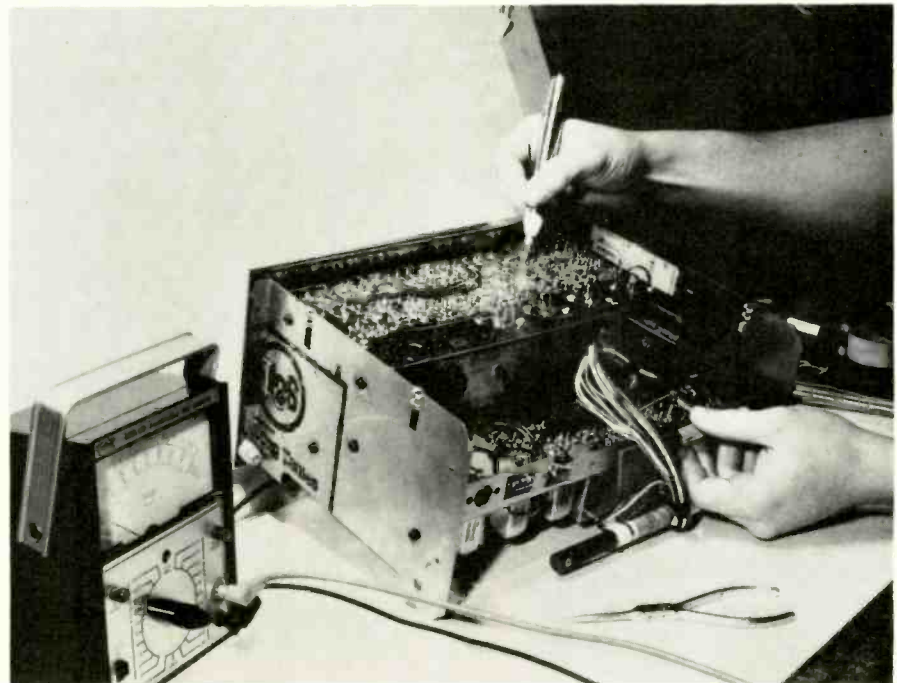

Fig. 2--Integrated circuits (IC) are used extensively in new Scott Model 342C stereo FM-tuner/amplifier.

Fig. 3--Use a pencil type noise signal generator to quickly locate a defective stage in an AM-FM chassis. Check the signal from the collector and base of each transistor starting at the output and moving to the volume control.



measurements of the suspected transistor. Use an FET-VOM or VTVM to measure the low voltages on the transistor elements (Fig. 4). Transistor emitter and base voltages vary from .1 to 8v. Forward bias voltage readings be-

tween emitter and base terminals may read from .01 to 1v. The average values of forward bias in the RF-IF stages are .4 and .6v.

Besides low emitter and base voltages, transistor circuits may

also have low values of resistance. The emitter resistance in an audio output stage may be as low as $.47\Omega$. Always remove one end of a suspected resistor or diode to be sure of a correct reading. Continuity checks on coils and IF transformers can be made on the PC board and will be quite accurate, but resistance measurements on other components may produce erroneous readings. If in doubt, reverse the ohmmeter terminals and use the lowest reading.

TRANSISTOR TESTS

Another method used to quickly check a defective AM-FM chassis is to take in-circuit transistor tests on each transistor. Seventy-five percent of solid-state failures are transistors. By quickly checking the transistors within the circuit, a number of troubles are solved. The in-circuit beta transistor tester will indicate if the transistor is open or shorted, but a transistor with low leakage may not show up. For an accurate leakage test, the suspected transistor should be removed from the circuit board. Many times a diode or directly driven transistor tied in the collector circuit will show up as leaky. Also, RF and IF transistors with coils or transformers tied to the collector and base terminal will show up with a high leakage. An in-circuit transistor test on these can be made with collector terminal removed from the PC board.

When an AM-FM solid-state receiver has an intermittent condition, it can often be found by using a squeeze spray on the suspected transistor after isolating the intermittent stage. Always have the receiver operating when spraying the suspected transistor so you will know when the receiver begins to act up. Spray the transistor at least three times before leaving it.

Sometimes, when an intermittent transistor is checked within the circuit, the in-beta transistor tester may shock the transistor into operation. This

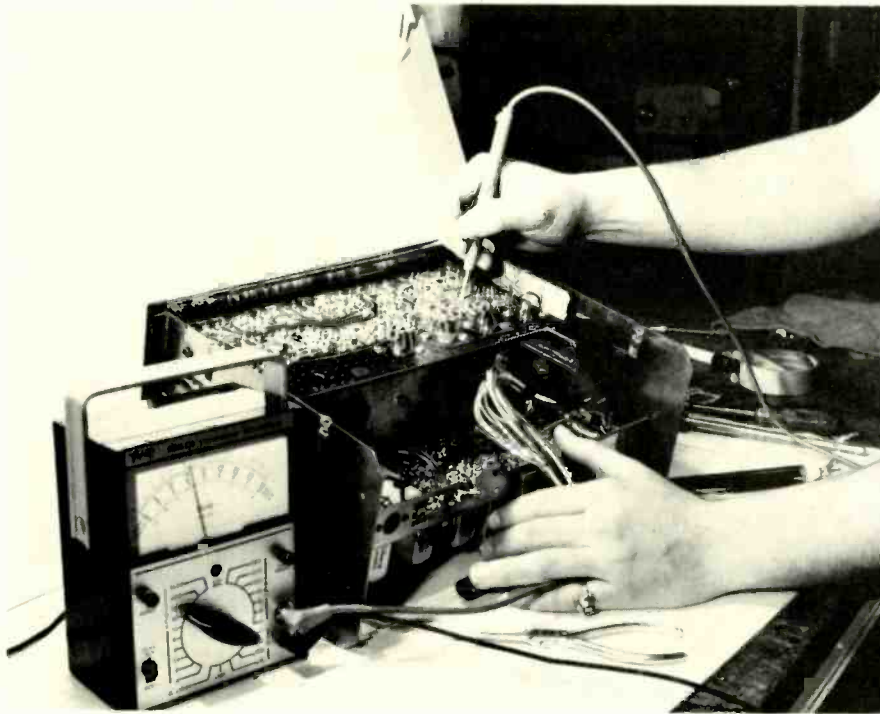
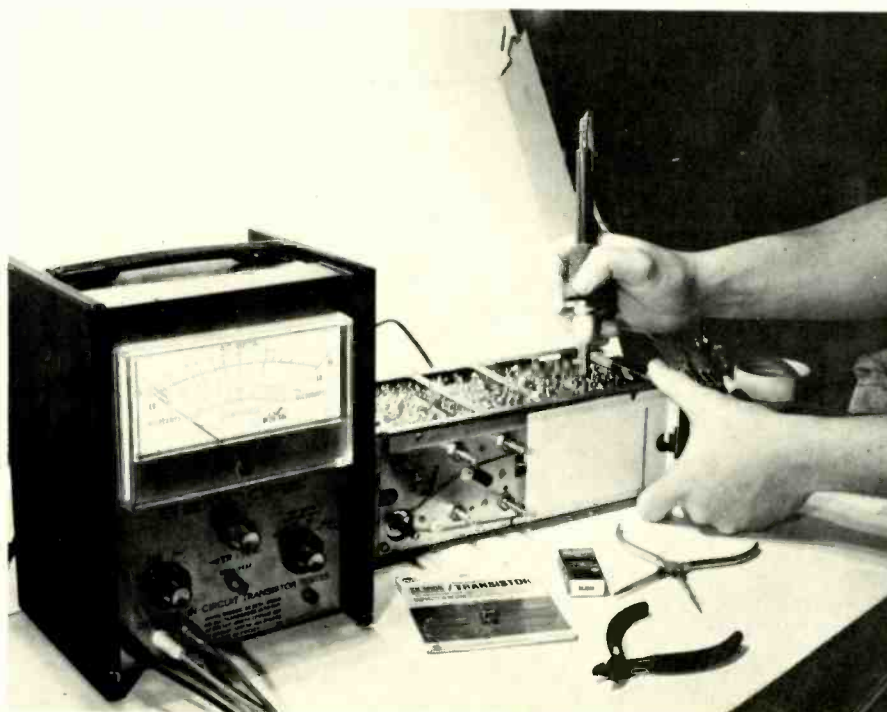

Fig. 4--Use an FET-VOM or VTVM to make low voltage checks. These voltages are sometimes less than .01v.

Fig. 5--Use a small soldering iron when removing and replacing transistors and other components on printed circuit boards.



also applies to injection signal tracing. When the signal injection probe is touched to the base terminal, the suspected transistor returns to normal operation. If this happens, let the receiver become intermittent again, remove the transistor from the circuit board and test it in a good beta transistor tester. With the transistor connected to the tester, spray it with the coolant and see whether the meter hand goes to the open position. Warm the suspected transistor between your fingers and make the test again. Many times an intermittent transistor will act up only once and test good for several days. If in doubt, replace it.

TRANSISTOR INSTALLATION

Always test the replacement transistor before soldering it to the circuit board. In many solid-state receivers, the circuitry is so compact that some transistors are difficult to get at. Be careful when unsoldering and installing the small transistors (Fig. 5). Always use a heat sink such as a long nose pliers when soldering terminal elements to the circuit board. Be careful not to damage small surrounding components with the soldering iron and don't accidentally push them against other components.

All FM transistor terminals should be cut to exact length and installed in the same position as the original. Check and recheck for correct mounting holes before soldering into place. When possible, leave the transistor terminal leads intact during soldering and cut the leads off only after the receiver is functioning properly.

Apply silicon grease on both sides of a plastic insulation or on the power transistor before mounting to the heat sink. Be careful to seat the power transistor properly to insure that both emitter-base terminals are intact (Fig. 6). By removing a couple of screws, power transistors can easily be taken out and tested. Remember, beta readings of power transistors are quite low. Check against a new one for comparison

readings. When replacing transistor in RF, IF and multiplex circuits, Multi Cir alignment may be necessary.

CHECKING THE AUDIO SECTION

As mentioned earlier, a noise

signal generator can be used to find a defective audio stage. Start at the base terminal of the audio output transistor and work toward the volume control. A complete loss or weak signal will indicate a defective stage. Now check the suspected

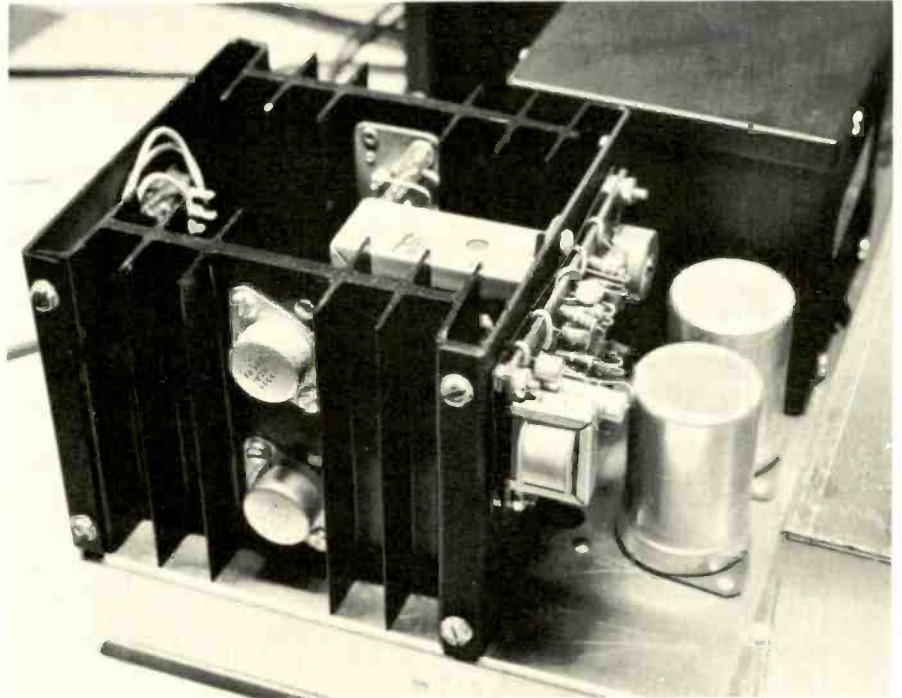
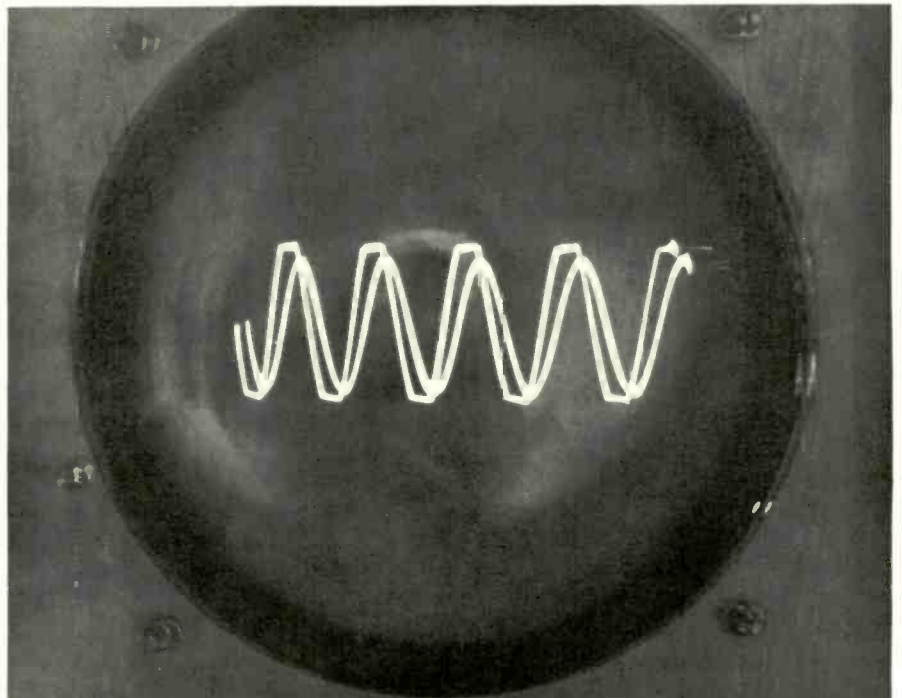

Fig. 6--When replacing power transistors on heat sinks, be sure the transistors are properly seated and apply silicone grease to insure even heat dissipation.

Fig. 7--The scope waveforms shown indicate a normal audio sine wave from one channel with the flat-topped distorted waveform from the opposite channel of a stereo tuner-amplifier.



transistor in the circuit by taking voltage measurements with an FET-VOM or VTVM.

In cases of extreme distortion or a small signal loss, use an audio signal generator and scope. Use either the sine or square wave signal for distortion problems. Fig. 7 shows a normal sine

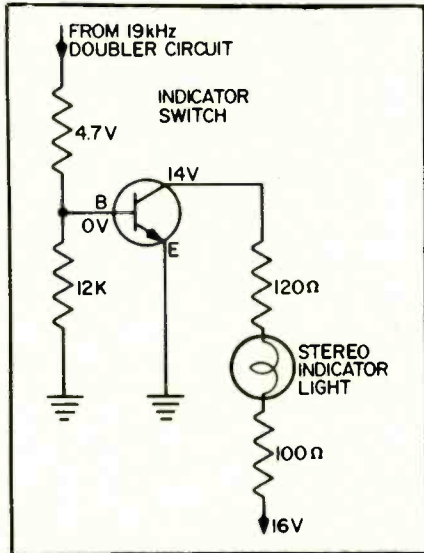

Fig. 8—Typical stereo multiplex indicator circuit.

wave and the same sine wave with 10 percent distortion. Generally, excessive distortion is found in the final audio output stages. If distortion is still present after replacing the power output transistors, check the emitter and base bias resistors.

When the volume of one channel is extremely low and will not balance properly, the audio signal generator will help to locate the trouble. Check each audio stage with an audio signal generator and scope. Then, check the same signal response in the good channel. By comparing readings in both channels, a weak or distorted stage can be quickly located.

MULTIPLEX CIRCUITS

The ratio detector circuit employed in most AM-FM circuits uses two crystal diodes. Only one diode is used for AM detection. In an AM-FM circuit during stereo reception, the signal is fed to a multiplex amp and doubler stages. The multiplex detector circuit employs four diodes. The

stereo indicator lamp is located in the matrix indicator control amp.

The stereo FM indicator lamp will light if only a stereo multiplex signal is being received. Nearly all solid-state FM receivers use a pilot light in the collector circuit of the indicator amplifier or stereo switch (Fig. 8). If the stereo lamp is not working when a stereo FM station is tuned in, check for a defective lamp. Also, check the pilot lamp assembly and wired circuits. In some cases, a touch-up of the multiplex alignment may be needed.

Multiplex tuned circuits seldom change alignment by themselves. Always be sure the multiplex circuitry is functioning before attempting alignment. An FM stereo multiplex signal generator is a "must" test unit for multiplex alignment and the manufacturer's alignment procedure should always be followed.

CHECKING THE POWER SUPPLY

When no sound is heard from the AM-FM chassis, suspect a defective power supply. Go to the silicon rectifiers and take voltage measurements. If no voltage is found on the cathode side, check the negative side for low ac voltage. The stepdown ac voltage will measure between 15 and 30v. In most solid-state power supplies, fullwave or bridge type rectification circuits are found.

To check the condition of the silicon diode, take resistance measurements across it—it is best to remove one end from the circuit board. A good silicon diode will measure a low value such as 10 Ω, and with reversed leads, the resistance measurement will be very high. If the diode shows a low reading in both directions, replace it. A silicon diode will either short or open. When it shorts, the diode will run red hot, blow the power supply line fuse and possibly destroy other diodes or dropping resistors in the

power supply circuit.

Excessive hum in the speakers is often caused by a defective filter capacitor as used in tube units. If hum still exists with the volume control turned down, a filter capacitor is at fault. If hum develops only when the volume is increased, poor ground or base resistors are the cause. Check whether the hum exists on AM, FM or phono position. Pickup hum can sometimes be isolated to one audio channel.

Let's take a look at some actual AM-FM receiver problems and how they are located.

NO FM

A Zenith AM-FM chassis 20YT20 was found to have normal AM reception but no FM. In fact, with full volume only a small rushing noise could be heard. Since the AM convertor signal is fed into the first FM-AM IF amplifier, we suspected a defective FM transistor.

The FM circuit was signal traced with a noise generator and appeared normal on the collector terminal. In this particular circuit, the FM signal from the RF amplifier feeds to the emitter terminal. Signal was still heard with the signal probe applied to the emitter terminal. The in-circuit transistor tester indicated that the FM convertor transistor was open and it was subsequently replaced. To make leakage tests in FM circuits, remove the transistor from the circuit board. This transistor can usually be replaced with a general replacement type. Always cut the transistor leads to exact length and replace in the original position.

MICROPHONIC FM RECEPTION

Another problem brought to our attention was noisy and microphonic reception on a Tru-ton model WEG5955A unit. The AM and phono sections worked perfectly, but experience on other sets made us suspect a microphonic convertor or RF stage.

Most microphonic conditions can be located by simply tapping the suspected transistor with a pencil or small screwdriver. In this case, when either transistor was tapped, the FM band became noisy. The FM mixer transistor was replaced with another transistor but the microphonic condition persisted until the RF-FM A376 transistor was replaced. Microphonic transistors, like tubes, will not show up in a transistor tester and must be replaced to correct the condition.

WEAK AM RECEPTION

An Olympic AM-FM table model AFM33 appeared to be weak on AM reception. The FM band operated normally. A look at the schematic diagram eliminated the AM converter transistor as a suspect because this same transistor is also used as the first FM-IF amplifier.

The weak AM reception was isolated to a broken AM antenna coil. In some cases, the ferrite rod can be replaced by sliding the antenna coil onto a new one. However, the antenna coil alignment should be touched up by tuning in a station at the middle of the tuning range and moving the coil over the ferrite rod with an insulated tool to obtain maximum volume.

DEAD LEFT CHANNEL

A single dead channel in a stereo unit was the problem in a Coronado Model RA1-6214A. Only a low level of hum could be heard in the left channel. A noise signal generator tip was placed on the base terminal of either output transistor but no sound could be heard. Checking closer, we noticed a couple of bias resistors were burned. Both output transistors were removed and tested. One showed a short and the other a high leakage reading.

The two audio transistors were removed from the circuit board and all low value resistors were checked for correct resistance. Both of the 1 Ω emitter resistors and a 470 Ω base bias resistor were replaced (Fig. 9). The output transistors were

continued on page 91

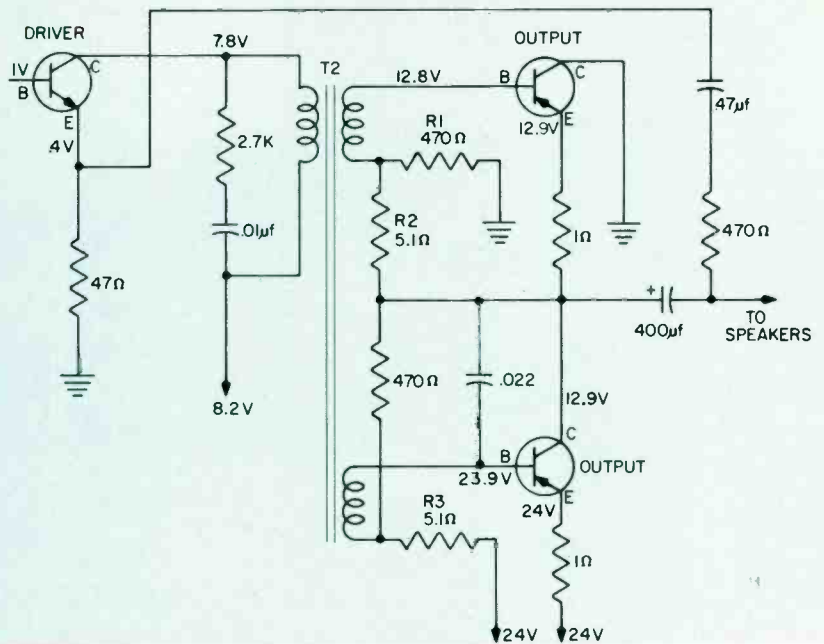

Fig. 9--A dead left channel in this unit was traced to defective output transistors and burned bias resistors R1, R2 and R3.

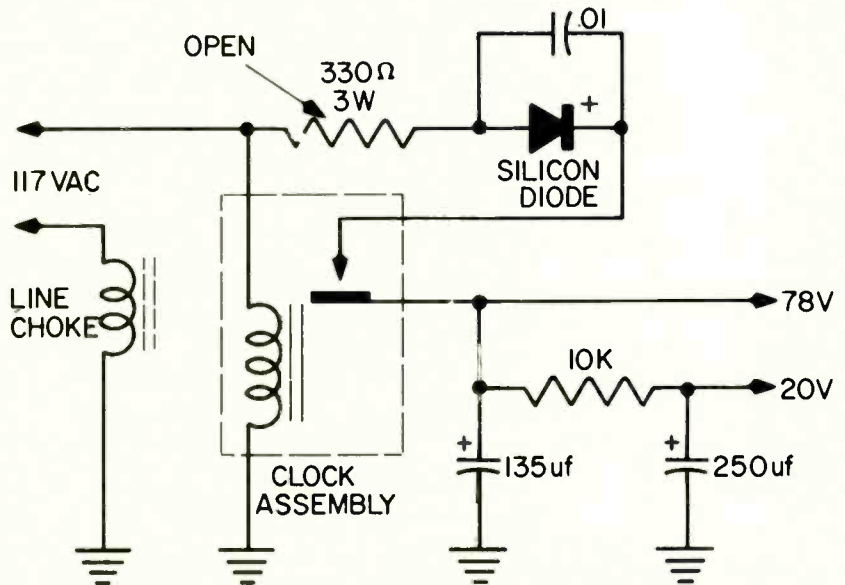
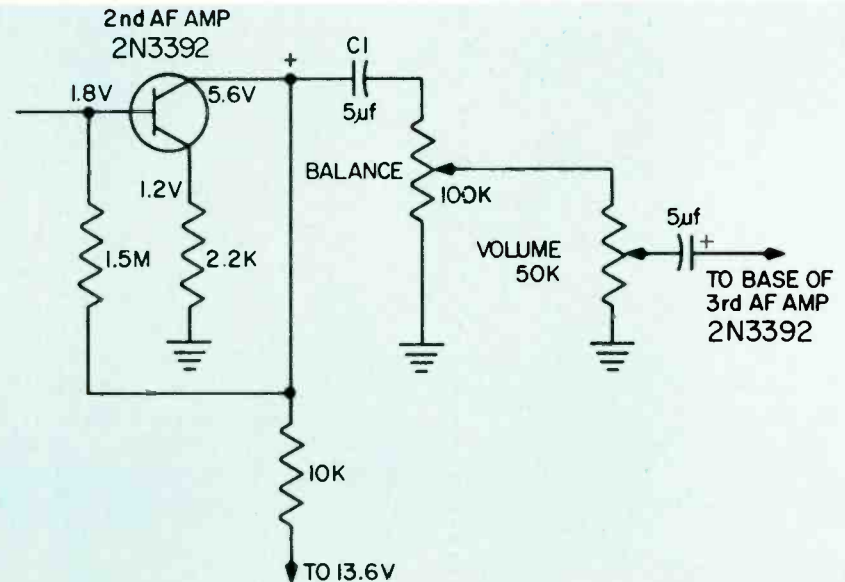

Fig. 10--A dead AM-FM receiver was caused by an open dropping resistor and a shorted diode in this power supply.

Fig. 11--Poor balance and weak output in this circuit was caused by a leaky coupling capacitor C1.



ET/D

TEST LAB REPORT

Knight KG-686 RF Generator

■ The first thing we look for in any kit is the packing of the components, then we check the components against the parts list. There's nothing worse than sitting down to assemble a unit and half way through discovering a part is missing or broken. Fortunately, the manufacturers have virtually eliminated this problem through careful quality control. The KG-686 comes packed with two chassis: the main chassis and

The KG-686 RF generator provides cw or modulated signals from 100kHz to 54MHz and can be built in an afternoon to add to your test equipment line-up

... for more details circle 900 on postcard

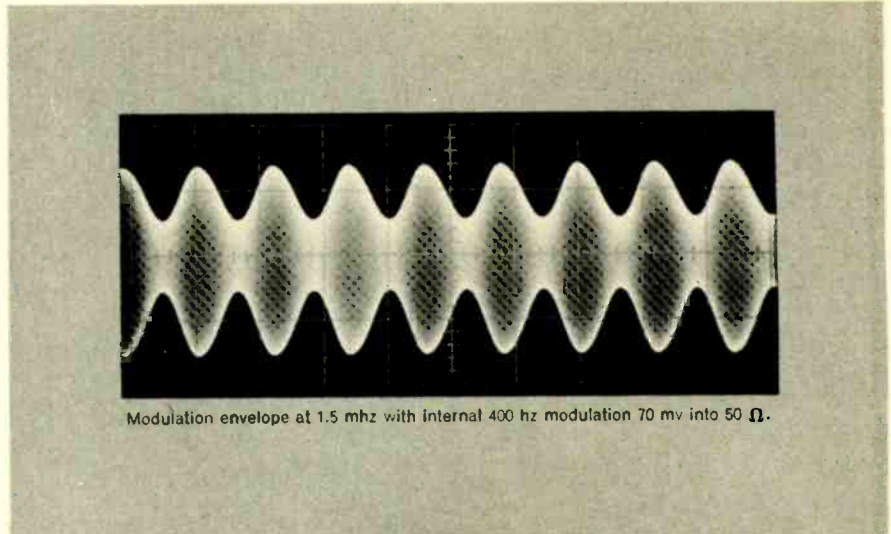

Modulation envelope at 1.5MHz with 400Hz modulation 70mv into 50Ω board.

a copper shielded RF sub chassis.

The entire unit is transistorized but uses no printed circuit boards. All components are mounted on the chassis or terminal strips. Parts layout makes assembly relatively easy to follow and it is done in a manner that keeps chassis wiring to a minimum. The generator uses three wafer switches for MOD SELECTOR, RANGE and XTAL CALIBRATOR. None of these is difficult to wire. The RANGE switch does have the various band coils mounted on it and some care must be used when assembling these. But again, the assembly manual diagrams show this clearly enough to make the job easy if you watch what you're doing. A small copper plate which holds the trimmer capacitors for the various bands also mounts on the RANGE switch. The front of the switch is fastened to the generator panel while the rear of the assembly is bolted to the chassis through a ceramic standoff. Be careful when tightening the screw in this ceramic stand-off as it can be easily stripped.

The generator also has a resistive switching attenuator assembly which is made up of five slide switches with small copper shields between each switch for RF shielding. There are two things to watch here. First, the manual notes that the shields and chassis should be sanded to remove a protective coat of lacquer before as-

sembly. This is to insure electrical conductivity and reduce RF leakage. Pay attention to this note. Sand all of the shields where any contact is to be made. Sandpaper is supplied with the kit. Also, use care when installing the coax to the attenuator to be sure the coax inner conductor and shield do not touch each other or other parts of the switch when the cover is installed. Make an ohmmeter check of the assembly as indicated in the manual.

The second note we want to mention on this attenuator network is that the manual and schematic do not agree with the resistor values for R30 and R33. The manual is correct. R30 and R32 are both 100Ω; R33 and R35 are both 150Ω.

The rest of the assembly is as shown in the manual except for a couple of changes which are indicated on supplementary sheets supplied with the unit. The calibration adjustments are not hard to do, but you should have a VTVM, wideband scope and an accurate receiver or two which cover the various generator frequencies. The band coils are preset at the factory and will be close to the correct frequency. Preset the trimmers according to the manual and then adjust them during calibration.

SPECIFICATIONS: Frequency coverage--100kHz to 54 MHz in 5 fundamental bands. Fre-

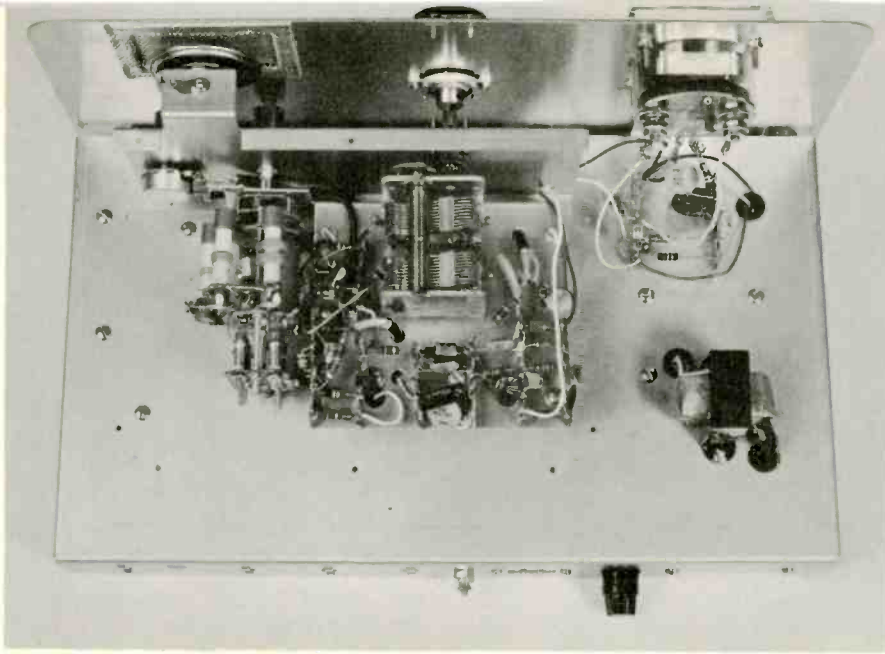

Top view of KG-686 with shields removed to show RF section.

Knight KG-686 RF signal generator.

quency accuracy-- $\pm 1.5\%$ of highest frequency on any given band, usable to $\pm 0.1\%$ with crystal calibrator. Output--calibrated into 50Ω load - $120,000\mu\text{v}$ Open Circuited (Uncalibrated): Band A - 100-370kHz, 3v RMS min.; Band B - 370-1400kHz, 2v RMS min.; Band C - 1.4-5.1MHz, .6v RMS min.; Band D&E - 5.1-54MHz, .3v RMS min.. Calibrated accu-

racy-- $\pm 2\text{db}$ ($\pm 20\%$) of nominal to 30MHz. Attenuator system--fine control with meter covers -10 to +2db calibrated on meter (0db = $100,000\mu\text{v}$ into 50Ω). Six step attenuators for total of -96db. Output as low as -106db ($0.5\mu\text{v}$) can be obtained. Modulation--internal frequency 400Hz $\pm 20\%$. Bridged "T" two-stage oscillator metered depth to 50%

± 5 to 30MHz. External Modulation Sensitivity; approximately 1v RMS 50% at 400Hz. Crystal calibration system--frequencies 1MHz and 100kHz (derived). Accuracy $\pm 0.5\%$. Unit incorporates a built-in detector, amplifier and speaker system. Power requirements size--100-130vac, 50/60Hz at 6w. 14 3/4 x 7 3/4 x 10 1/4 in. (WHD). ■

Knight KG-686 schematic diagram.

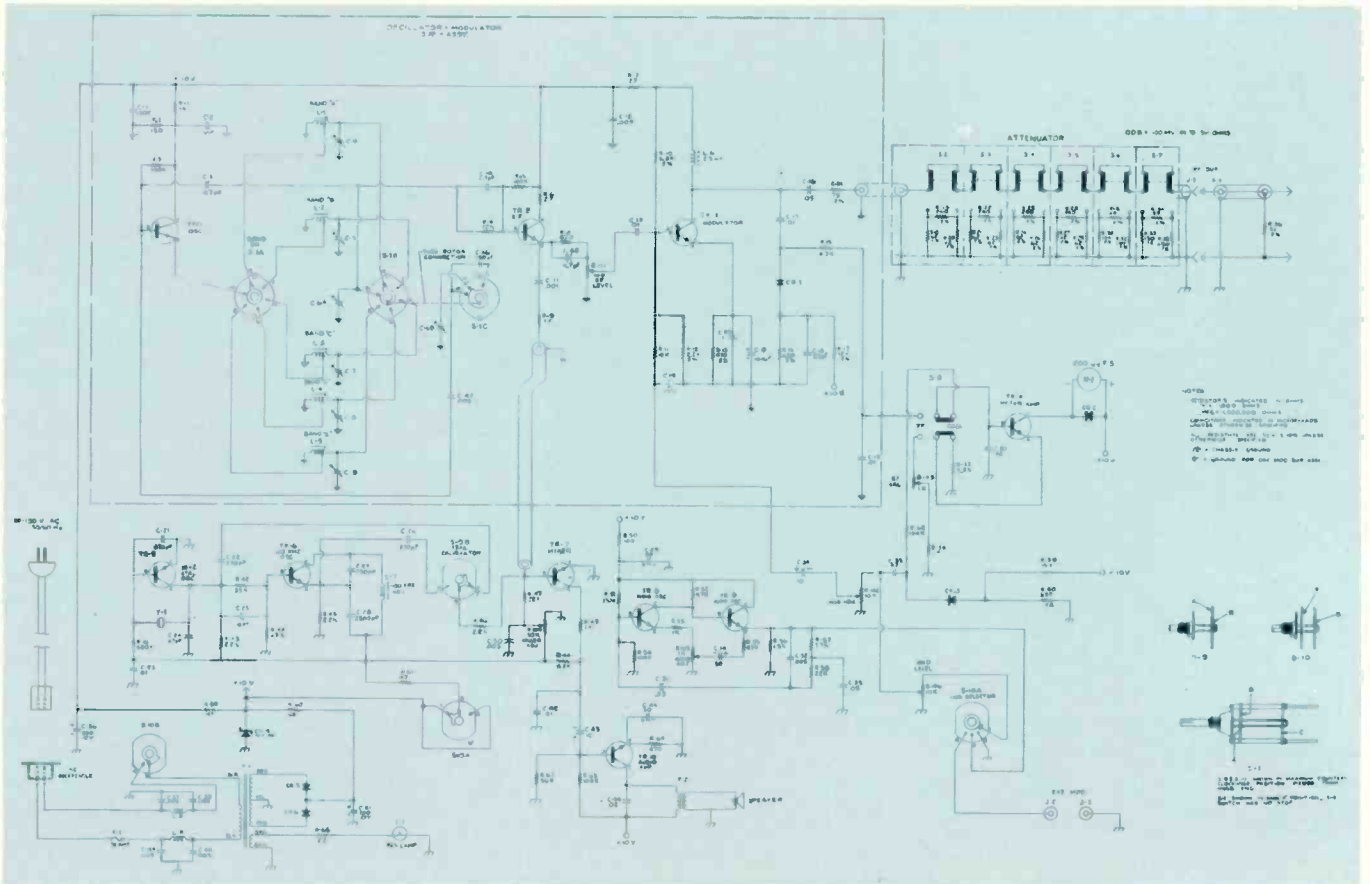

Heath Model IG-28 Color Bar and Dot Generator

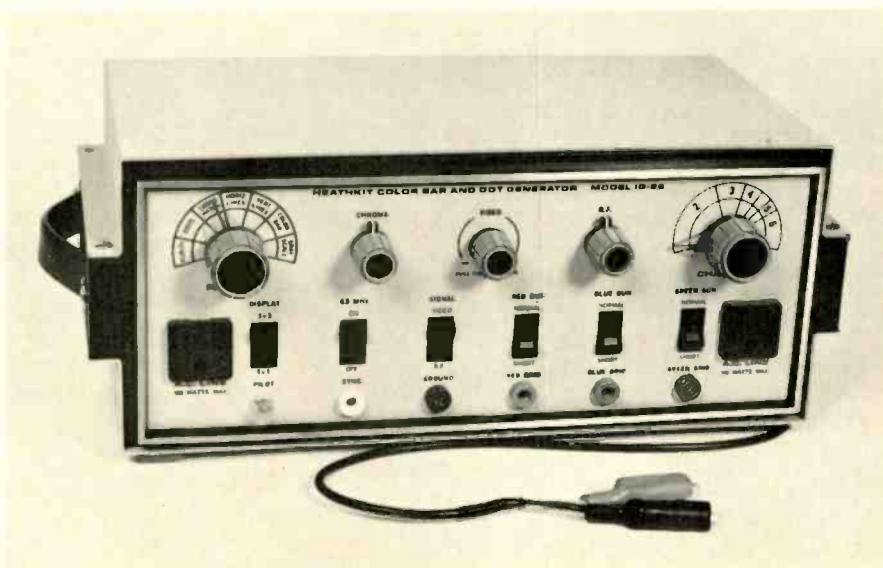

Heath Model IG-28 color bar and dot generator.

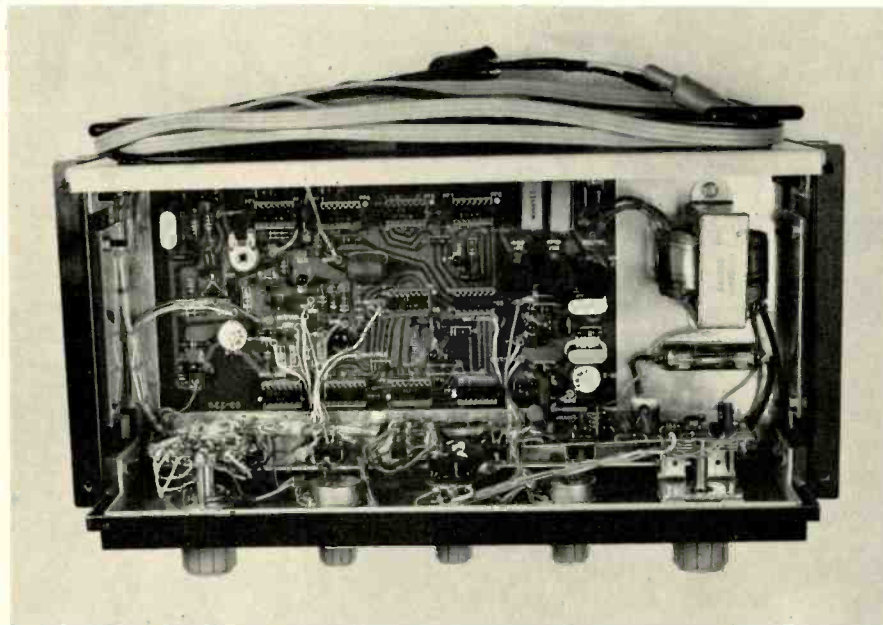

Top view of the generator showing the ten integrated circuits and other components in a compact arrangement.

■ We recently assembled the Heath Model IG-28 color bar and dot generator in our ET/D lab for this report.

The generator was assembled in a short time because of a number of time-saving features: The wire leads are formed into a harness, with most of the wires cut to the proper length. Nine integrated circuits are employed reducing the number of components. Circuit boards are used with all component values clearly marked. The number of first adjustments is reduced by employing fixed crystals and integrated circuits. The step-by-step assembly guide is easy to follow and covers various adjustments of the color TV.

When assembling the generator, a very small soldering iron should be used especially when mounting the IC socket. The pins on the IC socket are very close and it is quite easy to have unwanted solder bridges between the foils.

Do not try to remove the IC with your fingers; use the tool supplied, otherwise the IC pins will be bent.

We did make a small production change, the value of resistor R31, 4700 was changed to 10K1/2w. Otherwise some pattern drift was noticed.

The generator is all solid-state and can be used for servicing color or B/W TV receivers. The instrument is compact enough to be carried in the field and offers all the professional features for the shop. It generates stable, crystal-controlled test signals to produce all the color and convergence patterns needed to adjust color circuitry and tri-gun

... for more details circle 901 on postcard

Assemble this generator employing advanced integrated circuitry and get a professional instrument at a nominal cost

convergence systems accurately. Twelve patterns plus purity (a clear raster for purity adjustments) can be produced. Dots, crosshatch, horizontal lines, vertical lines, color bars and gray scale patterns are available in either a 3X3 or 9X9 display.

The patterns produced lock firmly on the screen without jitter or crawl, because of the crystal-controlled horizontal and vertical sync pulses incorporated in this instrument. Also the sync signals are available at the front panel jack.

The RF output available from the generator covers channels two through six, another important feature of this generator. The RF level control varies the RF output to check sensitivity and prevent overloading the RF and IF circuits of the receiver. A crystal-controlled 4.5MHz sound carrier with an ON/OFF switch aids in fine tuning the generator to the receiver frequency.

A video signal is available for troubleshooting video circuits and may be adjusted with the video level control. The chroma signal has also been made adjustable to allow a check of color hue and sync with different signal levels. Front panel switches are provided to turn the individual red, blue and green beam currents on or off.

This generator employs combinations of logic circuits to provide the several output patterns, a stable sinewave signal is generated by a master clock oscillator. The signal is shaped by succeeding stages and proceeds to a divider chain that consists of a series of flip-flop multivibra-

tor circuits. The flip-flops are connected in such a way as to perform frequency division of the master clock signal. At various points in the divider chain, signals of desired frequency are picked off and applied to other logic circuits consisting of OR, NOR, AND or NAND gates. These circuits, in turn, combine the proper signals to produce the desired output patterns.

Silicon diode rectifiers are used in the zener regulated power supply. The 115/230vac 50/60Hz special copper-banded, low flux-leakage power transformer prevents stray magnetic fields from disrupting the receiver under test.

The generator is enclosed in an attractive cabinet to match other instruments in its line. The price of the IG-28 kit is \$79.95. ■

SPECIFICATIONS

PATTERNS: Purity--Produces a snow-free raster for purity adjustments. Dots--9x9 produces a display of 110 small dots. 3x3 produces a display of nine dots, for convergence adjustments. Crosshatch--9x9 produces a display of 11 vertical and 10 horizontal lines. 3x3 produces a display of three vertical and three horizontal lines, for convergence and linearity adjustments. Horizontal Lines--9x9 produces a display of 10 horizontal lines. 3x3 produces a display of three horizontal lines, for vertical linearity and pin-cushion adjustments. Vertical Lines--9x9 produces 11 vertical lines. 3x3 produces a display of three vertical lines, for horizontal linearity and con-

vergence adjustments. Color Bars--9x9 produces a display of ten standard color bars. 3x3 produces a display of three standard color bars, for demodulator phase adjustment and color circuit servicing. Gray Scale--Provides a wide bar crosshatch pattern with six shades of brightness, for color gun level adjustments.

OUTPUT SIGNALS: Video--Variable $\pm 2v$ -P-P composite signal for composite signal injection beyond the video detector. RF--Variable to $50,000\mu v$ output, channels 2 through 6, for composite signal injection into the receiver antenna input terminals. Sync--2v signal for servicing sync circuits without video, or sets having separate video and sync demodulators. Control Grids (3)--Individual red, blue and green control grid signals for viewing chroma signal and demodulator phase adjustments.

POWER SUPPLY: Type--Transformer operated, full-wave, voltage doubler circuit, using two silicon diodes. Input--120 or 240vac, 50/60Hz. Output--3.6vdc, 500ma, zener diode regulated.

GENERAL: Integrated Circuits--7 - MC790P dual J-K flip-flop. 1 - MC723P single J-K flip-flop. 2 - MC724P 4-dual input gate. Diodes and Transistors--10 - 2N3692 NPN transistor. 2 - 2N3638 PNP TRANSISTOR. 6 - 1N295 crystal diode. 1 - Zener diode. 2 - Silicon diode. Crystals--1 - 190.08kHz. 1 - 3563.795 kHz. 1 - 4.5 MHz. Cabinet Dimensions--8 1/2 in. wide x 4 1/4 in. high x 7 1/8 in. deep (including handle). Weight--7 lb.

For additional information on products described in this section, circle the numbers on Reader Service Card. Requests will be handled promptly.

TAPE CASSETTE MERCHANDISERS

703

Designed to hold four types of tape cassettes

Two blank tape cassette counter merchandisers are available. The 1T1135 is a revolving display designed to hold four types of blank tape cassettes



(30-, 60-, 90- and 120-min. lengths). The unit is a compact, spring-action display that can be placed either on a counter or a shelf. Both are available free with purchase of cassettes. RCA.

RADAR ALARM

704

Forms invisible three-dimensional radar shield

A compact electronic protection system is available for use in homes or commercial buildings. The basic

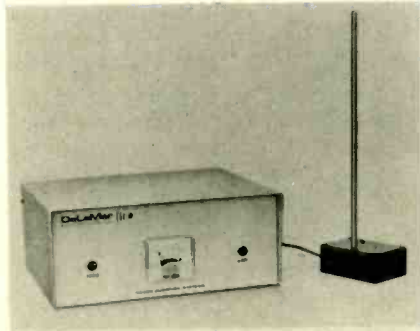

components include a monitor (which plugs into regular house current) and one or more detectors which are mounted in the area to be protected. Alarm devices available include an indoor/outdoor police type siren, a battery-operated bell and a buzzer and light for remote alarm indications in police stations, answering services or guard booths. The system forms an invisible three-dimensional radar shield

which saturates the area. Any human movement reportedly can be detected immediately, and warning is also automatic when wiring is cut or short-circuited. DeLaMar Electronics.

CASSETTE RECORDER

705

Built-in FM/AM radio

Introduced is an ac or battery-operated cassette recorder with a built-in FM/AM radio. A convenient pop-



up feature provides quick and easy cassette changing. A single lever controls the operation for recording, playback, rewinding and fast forward. An "SP" switch enables monitoring of the material when recording. The FM/AM radio features slide-rule tuning, AFC on FM, and slide-touch controls for adjustments of the volume and tone. Suggested retail price of the Model RQ-232S is \$99.95. Panasonic.

ALARM SYSTEM

706

Completely installed by plugging into light socket

A burglar and fire alarm system that can be completely installed by plugging into an ordinary light socket



is introduced. Called Preventor II, the solid-state electronic system operates much as radar or sonar in guarding a given area with sound waves. It emits silent, ultrasonic frequencies that saturate various areas. The ultrasonic saturation reportedly makes it impossible for an intruder to get

under, over or around the surveillance pattern. The ultrasonic pattern will also detect fire or excessive smoke with a built-in thermostat which reacts to dangerous heat levels. When its ultrasonic pattern is interrupted or when it detects fire, the unit will sound a 100db police warning horn. The alarm contains an ac outlet into which floodlights, sirens or other devices can be plugged. It also provides a control panel which can link the system to an automatic dialer for phoning emergency messages. In case of power failure or deliberately severed power lines, the alarm continues to operate by automatically transferring its power requirements to a built-in battery system which will function for a ten-hour period. When power is restored, the batteries are automatically recharged to full capacity. The unit resembles a stereo component housed in a wood and metal cabinet. Measuring 13.5in. long, 7.5in. wide, and 5in. high, it retails for under \$400. Defensive Instruments.

PROJECT KITS

707

Kits feature ease of assembly and low cost

Announced are six kits, including the "super snoop" private listening device, three converters covering police, fire and aircraft bands, a two-station intercom and a do-it-yourself



printed circuit etching kit. The EC-2600 "super snoop" kit consists of a sensitive crystal microphone feeding a special low-noise input stage of a three-

In the Age of Solid State, Ungar outguns the heavyweights.

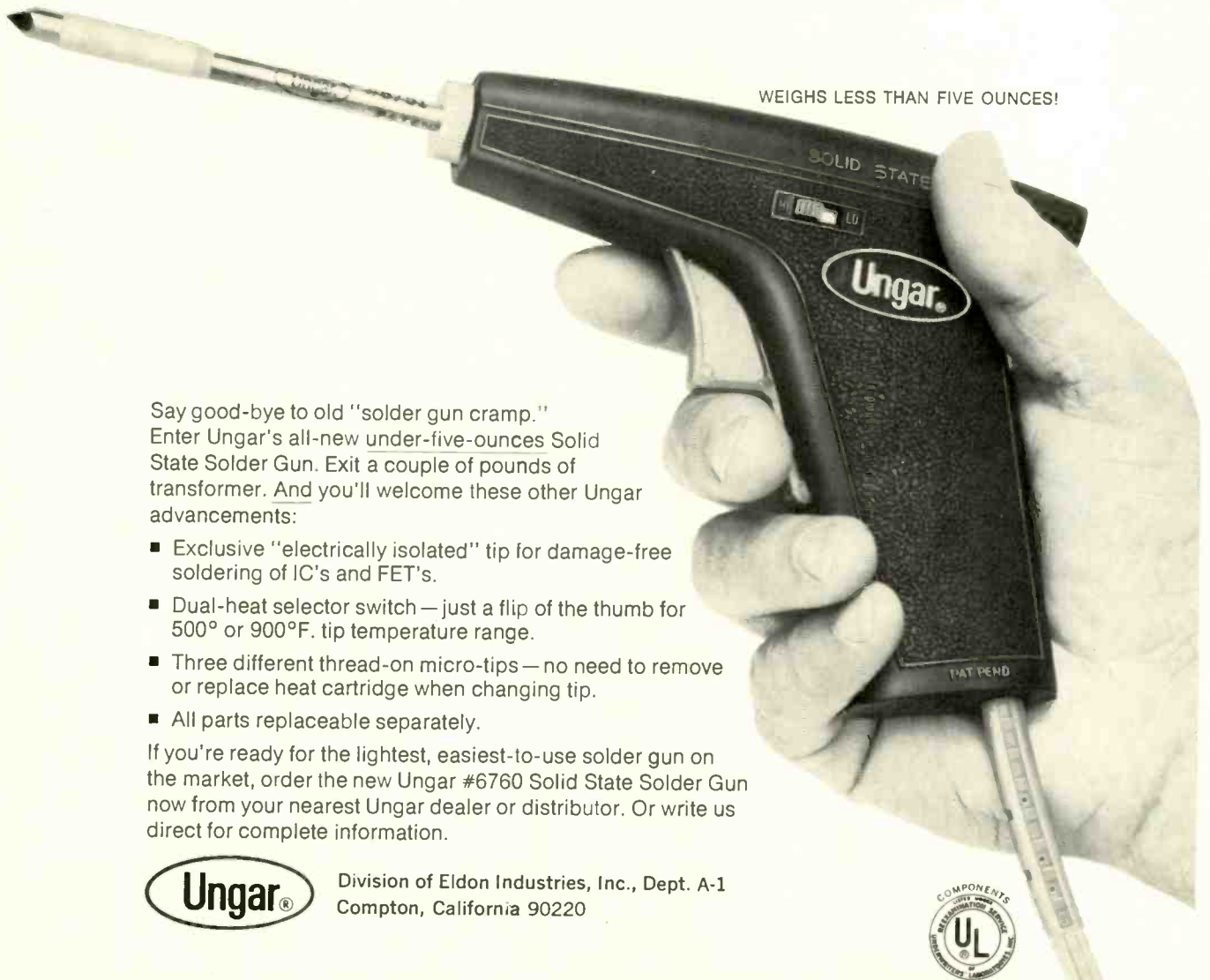

WEIGHS LESS THAN FIVE OUNCES!

Say good-bye to old "solder gun cramp." Enter Ungar's all-new under-five-ounces Solid State Solder Gun. Exit a couple of pounds of transformer. And you'll welcome these other Ungar advancements:

- Exclusive "electrically isolated" tip for damage-free soldering of IC's and FET's.
- Dual-heat selector switch — just a flip of the thumb for 500° or 900°F. tip temperature range.
- Three different thread-on micro-tips — no need to remove or replace heat cartridge when changing tip.
- All parts replaceable separately.

If you're ready for the lightest, easiest-to-use solder gun on the market, order the new Ungar #6760 Solid State Solder Gun now from your nearest Ungar dealer or distributor. Or write us direct for complete information.



Division of Eldon Industries, Inc., Dept. A-1
Compton, California 90220



ET/D DEALER SHOWCASE

transistor audio amplifier, and then to an earphone. Some popular uses include hearing aids, private listening devices and audio stethoscopes. The three new converter kits provide for monitoring police, fire and aircraft bands with a standard AM radio. No connections need be made to the AM radio. The converter is simply placed next to it. The EC-2900 kit covers the high (152-174MHz) police and fire bands. The EC-2700 tunes the low (30-50MHz) police and fire bands. The aircraft converter, EC-2800, will pick up all local aircraft and airport control towers in the 108-136MHz aircraft band. EC-3100 intercom kit is a complete two-station inter-communications system for home or office. The stations come complete with cases. The EC-3200 do-it-yourself printed-circuit etch kit reportedly includes everything needed to make printed circuit boards. Prices on the new kits are as follows: EC-2600 "super snoop" \$8.95; EC-2700, EC-2800, EC-2900 police fire and aircraft converters \$7.95 each; EC-3100 2-station intercom \$10.95; and EC-3200 printed circuit kit \$5.95. EICO.

KNOBS 708

A variety of sizes, shapes and styles are available

The introduction of a standard and custom line of injection molded plastic knobs designed for the home en-



tertainment electronics industry is announced. A variety of different sizes, shapes and styles of knobs are available for use on radios, television sets, tape recorders, high fidelity receivers, tuners, amplifiers and other electronic equipment. Electronic Hardware.

PANEL LAMPS 709

Offered in 15 different sizes and voltages

A self-service pegboard panel lamp display rack is offered, with purchase of a 200 card assortment. The lamps are of special interest to technicians



and engineers. They come in 15 different sizes and voltages, and are guaranteed long life. The counter display, 30in. high by 20in. across, is designed to develop self-service sales in the electronic center. Suggested net is 49 cents per card. Mura.

SPEAKERS 710

Self-aligning voice coil and diaphragm

Complete with a strapping bracket feature and reportedly ideal for mounting on I-beams and concrete pillars is the revised series of multipurpose public address speakers. Seven speakers make up the "AP" Series, all with

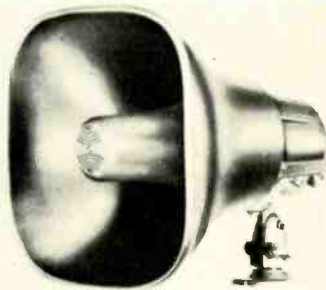

screw terminals for solderless line connection, water-sealed construction, protective terminal cover and strapping bracket. The AP-30 shown is a high efficiency speaker for either high or low power applications. The unit has a self-aligning voice coil/diaphragm assembly with solderless connectors for ease for replacement. Atlas.

CONVERTER 711

No electrical connection; plug-in coax cable

Introduced is a converter that provides reception of police, fire, marine and industrial bands on a standard AM broadcast radio. The new Tunavert S has its own built-in squelch providing noise-free monitoring between calls. Another feature of the unit is that it can be either tunable or crystal-controlled by flipping a switch

and plugging in a crystal. The American-made converter also features zener voltage regulation. Sensitivity is reportedly .5µv minimum usable signal

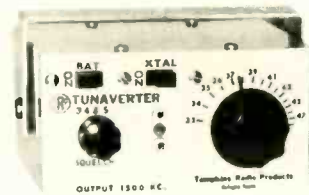

for the low band Model 348S which covers from 33 to 48MHz; .9µv minimum usable signal for the high band Model 1564S covering 150 to 164-MHz. No connections to the auto radio are needed other than plugging in the coax connecting cable. It is 2 1/4 x 3 1/3 x 4 1/4in., light grey and powered by 12vdc from the auto battery. The unit comes complete with a swinging mount, mounting screws, 24in. connecting coax cable and instructions. Price is \$44.95. Tompkins.

DISTRIBUTOR DISPLAY 712

Header identifies store

A distributor display promotion is announced. When a distributor selects one of five product packages consisting of speaker systems, baffles, sound columns or a combination, he will receive the BBD-69 display stand free, an extra 10 percent cash dis-

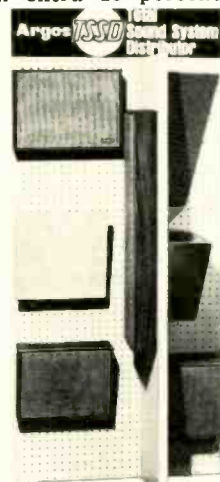

count and prepaid freight. The new Musi-Cube high fidelity speakers are only 7 3/8 in. in each dimension. The display is distributor oriented and header sign identifies the store as a total sound system distributor. The display requires less than 21/2 sq. ft. display requires less than 2 1/2 sq. ft. of floor space. The two Musi-Cubes list for \$39.95. Argos.

Use Zip Code

*It took more than skill
to design the world's
smallest complete mobile
5-watt CB
transceiver*



Johnson Messenger 125 ***\$99⁹⁵***

Only the famous Johnson "talk-power" is big as ever on Johnson's radically new Messenger 125! Virtually every vehicle on the road, including the 1969 and 1970 models, can easily accommodate this versatile new radio. Its far-ahead features make operation extremely simple and enjoyable. Best of all, we sliced the most out of the price!

Features

- 5 push button channels—no knobs ■ slide-lever vol. and squelch
- World's smallest panel configuration—1 $\frac{1}{16}$ " by 4 $\frac{1}{32}$ ", just 7" deep
- 4 watts output at 13.8 VDC ■ Accessories for portable use



E. F. JOHNSON CO.

WASECA, MINNESOTA 56093

POWERFUL

One \$100 Winegard Color-Wedge equals the performance of twelve ten-element yagis!

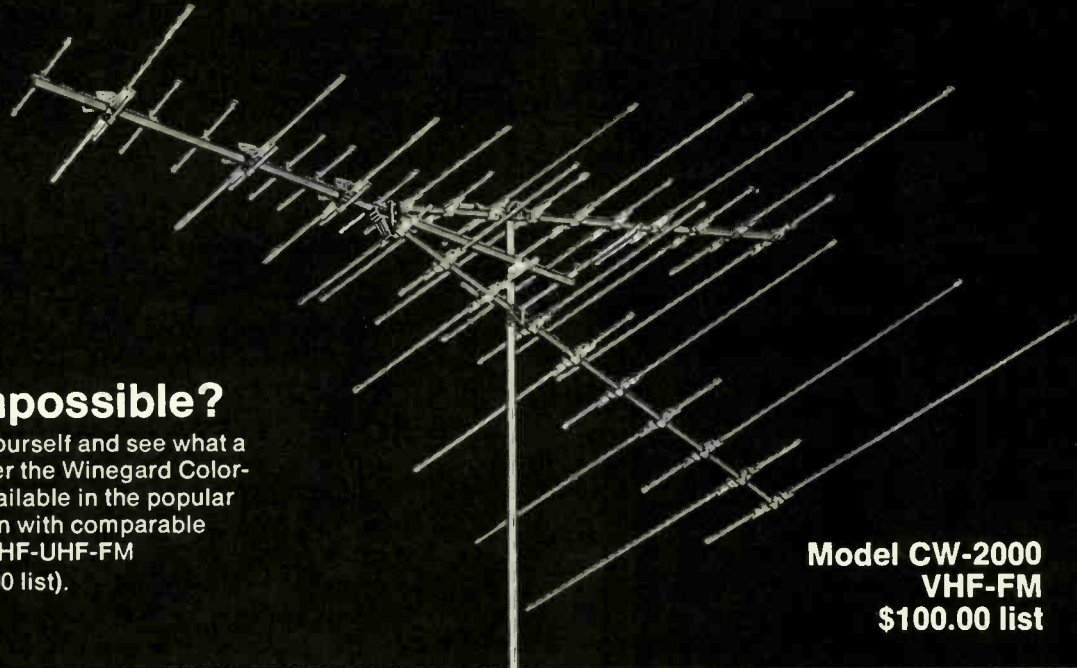

Sound impossible?

Then try one for yourself and see what a powerful performer the Winegard Color-Wedge is. Also available in the popular 82-channel version with comparable performance on VHF-UHF-FM (CW-1000, \$100.00 list).

Model CW-2000
VHF-FM
\$100.00 list

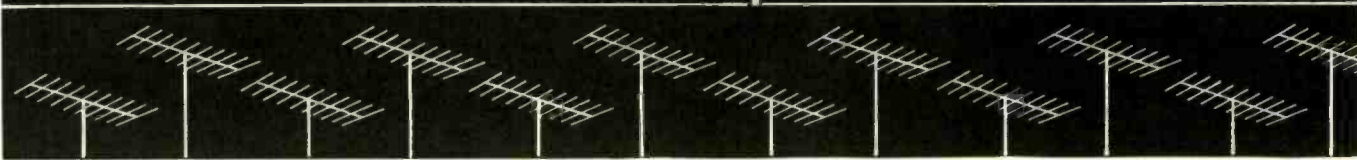

example A:

CHECK DB GAIN

Channel	CW-2000	10-Elem. Yagi
2	7.2	7.8
4	7.2	7.6
6	7.4	8.0
7	12.2	10.8
10	11.4	11.0
13	12.0	11.5

example B:

CHECK DIRECTIVITY

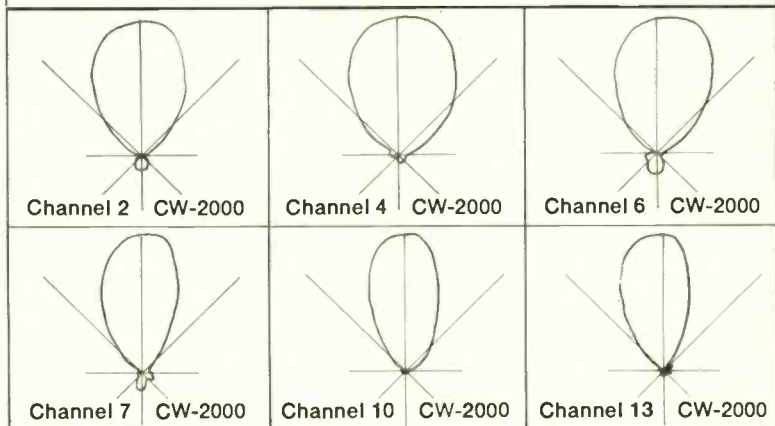

example C:

CHECK FRONT-TO-BACK RATIO

CW-2000	CH. 2	CH. 4	CH. 6	CH. 7	CH. 10	CH. 13
DB	22	26	17	20	35	30



WINEGARD COMPANY • 3019-6 KIRKWOOD STREET
BURLINGTON, IOWA 52601

SEE YOUR WINEGARD DISTRIBUTOR AND WRITE FOR FACT-FINDER #284

... for more details circle 143 on postcard
ELECTRONIC TECHNICIAN/DEALER

The New 1969 Improved Model 257 **A REVOLUTIONARY NEW TUBE TESTING OUTFIT**

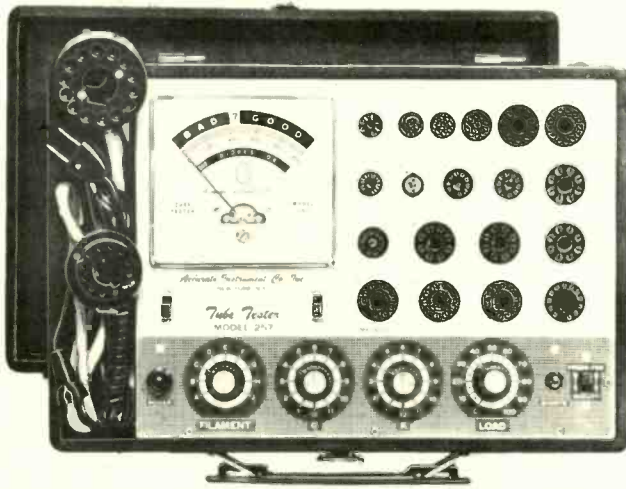

- Tests all modern tubes including Novars, Nuvistors, Compactrons and Decals.
- All Picture Tubes, Black and White and Color

COMPLETE WITH ALL ADAPTERS AND ACCESSORIES, NO "EXTRAS"

STANDARD TUBES:

- ✓ Tests the new Novars, Nuvistors, 10 Pins, Magnovals, Compactrons and Decals.
- ✓ More than 2,500 tube listings.
- ✓ Tests each section of multi-section tubes individually for shorts, leakage and Cathode emission.
- ✓ Ultra sensitive circuit will indicate leakage up to 5 Megohms.
- ✓ Employs new improved 4½" dual scale meter with a unique sealed damping chamber to assure accurate, vibration-less readings.
- ✓ Complete set of tube straighteners mounted on front panel.

BLACK AND WHITE PICTURE TUBES:

- ✓ Single cable used for testing all Black and White Picture Tubes with deflection angles 50 to 114 degrees.
- ✓ The Model 257 tests all Black and White Picture Tubes for emission, inter-element shorts and leakage.

COLOR PICTURE TUBES:

- ✓ The Red, Green and Blue Color guns are tested individually for cathode emission quality, and each gun is tested separately for shorts or leakage between control grid, cathode and heater. Employment of a newly perfected dual socket cable enables accomplishments of all tests in the shortest possible time.

The Model 257 is housed in a handsome, sturdy, portable case. Comes complete with all adapters and accessories, ready to plug in and use. No "extras" to buy. Only

\$47⁵⁰

NOTICE We have been producing radio, TV and electronic test equipment since 1935, which means we were making Tube Testers at a time when there were relatively few tubes on the market, way before the advent of TV. The model 257 employs every design improvement and every technique we have learned over an uninterrupted production period of 32 years. *Accurate Instrument Co., Inc.*

SEND NO MONEY WITH ORDER PAY POSTMAN NOTHING ON DELIVERY

Try it for 10 days before you buy. If completely satisfied you may remit \$47.50 plus postage and handling charge. (If you prefer you may use our **EASY PAYMENT PLAN.**) If not completely satisfied, return to us, no explanation necessary.

ACCURATE INSTRUMENT CO., INC.
 Dept. 696, 2435 White Plains Road, Bronx, N.Y. 10467
 Please rush me one Model 257. If satisfactory I agree to remit \$47.50 plus postage and handling charge. (If you prefer you may use our **EASY PAYMENT PLAN.**)
 If not satisfactory, I may return for cancellation of account.

Name

Address

City Zone State

Save Money! Check here and enclose \$47.50 with this coupon and we will pay all shipping and charges. You still retain the privilege of returning after 10 day trial for full refund.



COLORFAX

The material used in this section is selected from information supplied through the cooperation of the respective manufacturers' or their agencies.

GENERAL ELECTRIC

Color Chassis KE--Field Alignment of the AFC Module

A number of AFC modules have been received from the field in which coil L350 was misaligned, possibly because of mistaking this coil for the T351 cross-over adjustment.

We would like to re-emphasize that the T351 cross-over

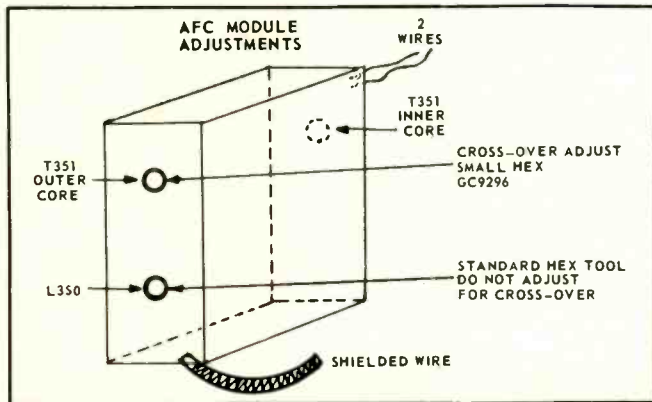

tuning core requires the use of a special small hex alignment tool (General Cement Co. GC9296 or equivalent). In contrast, L350 requires the standard hex alignment tool which is carried by all technicians.

Since the standard hex tool fits only L350, it is our feeling that this may account for the misalignment.

Color TV Chassis KE--HV Arcing to CRT Shield or Neck

When encountering a complaint of HV arcing from the CRT aquadag coating to the tube shield or through the neck to the guns, the CRT should not be replaced, unless it is defective for other reasons.

Correction of problem: (1) Inspect the grounding springs at points where they contact the aquadag coating. Aquadag will probably be burned enough to destroy contact. (2) Bend or reform ground springs to contact a fresh spot on the aquadag coating and be sure a good contact is made. (3) Replace the 6LJ6 regulator tube since arcing in this tube is usually responsible for the burned spots on the aquadag.

Failures of B + power supply rectifiers may also cause the arcing problems, since heavy transients always result from HV arcing.

RCA VICTOR

Automatic Gain Control

Automatic gain control of a television receiver differs fundamentally from the AGC of an AM broadcast receiver because of the difference between video modulation and audio modulation. In an AM broadcast signal, tones lower than about 30Hz are not transmitted; consequently, any .3-second sample of RF carrier amplitude will be the same as any other .3-second sample. The AGC detector needs a time constant no greater than about 0.3 second to average the received signal and adjust the gain accordingly. The video which modulates a TV transmitter has much lower frequency components. For example, if an all-white pic-

ture is transmitted for 5 seconds, the frequency of the video is 0.1Hz. Simply increasing the time constant of the AGC (to perhaps 30 seconds) is not a solution, because unwanted variations in signal level may have shorter periods than the modulation video.

There is one part of the video signal which always produces the same level of transmitter output, namely the horizontal sync pulse. For this reason, the AGC system is made to be sensitive only to sync pulses, and completely insensitive to video information. If the amplitude of sync pulses from the second detector is made to be always the same, all the shades of gray which comprise a scene can be displayed correctly. This type of AGC system is called "keyed AGC," and is used almost universally in modern TV receivers.

Fig. 1 shows the basic keyed-AGC system. Under no-signal conditions, the control grid voltage is zero and the cath-

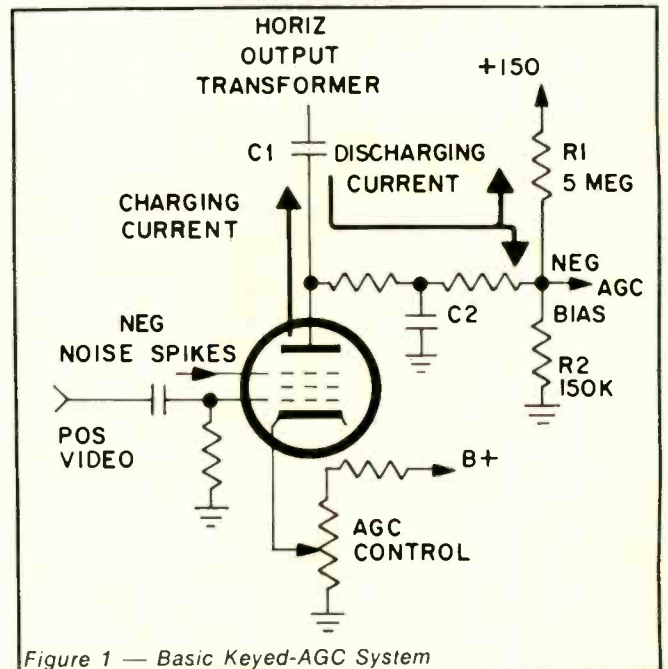

Figure 1 — Basic Keyed-AGC System

ode is biased positive enough to hold the tube near cutoff. The signal at the plate consists of a series of positive pulses from the horizontal-output transformer, but these have no particular effect, since the tube cannot conduct. The bias voltage under these conditions is determined by the voltage division between R1 and R2, and is about + 4.3v. This positive bias to the grids of the RF and IF amplifiers causes them to have maximum gain when no signal is present.

When the receiver is switched to an active channel, video from the receiving section appears at the AGC keyer. As the horizontal oscillator syncs to the incoming signal, each positive retrace pulse from the horizontal-output transformer appears at the plate of the AGC keyer at the same instant a horizontal- sync pulse appears at the control grid.

With both control grid and plate driven positive, the keyer tube conducts, charging capacitor C1. Between pulses, the charge on C1 leaks off through resistors R1 and R2, causing their junction to become negative with respect to ground. This voltage is filtered by capacitor C2 and fed to

More than 5 million two-way transmitters have skyrocketed the demand for service men and field, system, and R & D engineers. Topnotch licensed experts can earn \$12,000 a year or more. You can be your own boss, build your own company. And you don't need a college education to break in.

HOW WOULD YOU LIKE to earn \$5 to \$7 an hour... \$200 to \$300 a week... \$10,000 to \$15,000 a year? One of your best chances today, especially if you don't have a college education, is in the field of two-way radio.

Two-way radio is booming. Today there are more than five million two-way transmitters for police cars, fire trucks, taxis, planes, etc. and Citizen's Band uses—and the number is growing at the rate of 80,000 per month.

This wildfire boom presents a solid gold opportunity for trained two-way radio service experts. Most of them are earning between \$5,000 and \$10,000 a year more than the average radio-TV repair man.

Why You'll Earn Top Pay

The reason is that the U.S. doesn't permit anyone to service two-way radio systems unless he is licensed by the FCC (Federal Communications Commission). And there aren't enough licensed experts to go around.

This means that the available licensed expert can "write his own ticket" when it comes to earnings. Some work by the hour and usually charge at least \$5.00 per hour, \$7.50 on evenings and Sundays, plus travel expenses. Others charge each customer a monthly retainer fee, such as \$20 a month for a base station and \$7.50 for each mobile station. A survey showed that one man can easily

maintain at least 15 base stations and 85 mobiles. This would add up to at least \$12,000 a year.

How to Get Started

How do you break into the ranks of the big-money earners in two-way radio? This is probably the best way:

1. Without quitting your present job, learn enough about electronics fundamentals to pass the Government FCC License. Then get a job in a two-way radio service shop and "learn the ropes" of the business.

2. As soon as you've earned a reputation as an expert, there are several ways you can go. You can move out, and start signing up your own customers. You might become a franchised service representative of a big manufacturer and then start getting into two-way radio sales, where one sales contract might net you \$5,000. Or you may be invited to move up into a high-prestige salaried job with one of the same manufacturers.

The first step—mastering the fundamentals of Electronics in your spare time and getting your FCC License—can be easier than you think.

Cleveland Institute of Electronics has been successfully teaching Electronics by mail for over thirty years. Right at home, in your spare time, you learn Electronics step by step. Our AUTO-PROGRAMMED® lessons and coaching by expert instructors make everything clear and easy, even for men who thought they were "poor learners."

Your FCC License... or Your Money Back!

By the time you've finished your CIE course, you'll be able to pass the FCC License Exam with ease. Better than nine out of ten CIE graduates are able to pass the FCC Exam, even though two out of three non-CIE men fail. This startling record of achievement makes possible our famous FCC License Warranty: you'll pass the FCC Exam upon completion of your course or your tuition will be refunded in full.

Find out more. Mail the bound-in post-paid card for two FREE books, "How To Succeed In Electronics" and "How To Get A Commercial FCC License." If card has been detached, use coupon below.

ENROLL UNDER NEW G.I. BILL

All CIE courses are available under the new G.I. Bill. If you served on active duty since January 31, 1955, or are in service now, check box on card for G.I. Bill information.

CIE Cleveland Institute of Electronics

1776 East 17th Street, Cleveland, Ohio 44114

Please send me without cost or obligation:

1. Your 44-page book "How To Succeed In Electronics" describing the job opportunities in Electronics today, and how your courses can prepare me for them.
2. Your book on "How To Get A Commercial FCC License."

Name _____ Age _____
(PLEASE PRINT)

Address _____

City _____ State _____ Zip _____

Accredited Member National Home Study Council ET-53

How to get into one of today's hottest money-making fields—servicing 2-way radios!



He's flying high. Before he got his CIE training and FCC License, Ed Dulaney's only professional skill was as a commercial pilot engaged in crop dusting. Today he has his own two-way radio company, with seven full-time employees. "I am much better off financially, and really enjoy my work," he says. "I found my electronics lessons thorough and easy to understand. The CIE course was the best investment I ever made."



Business is booming. August Gibbemeyer was in radio-TV repair work before studying with CIE. Now, he says, "we are in the marine and two-way radio business. Our trade has grown by leaps and bounds."

AT LAST solid state triggered sweep, wide-band at a price you can afford!

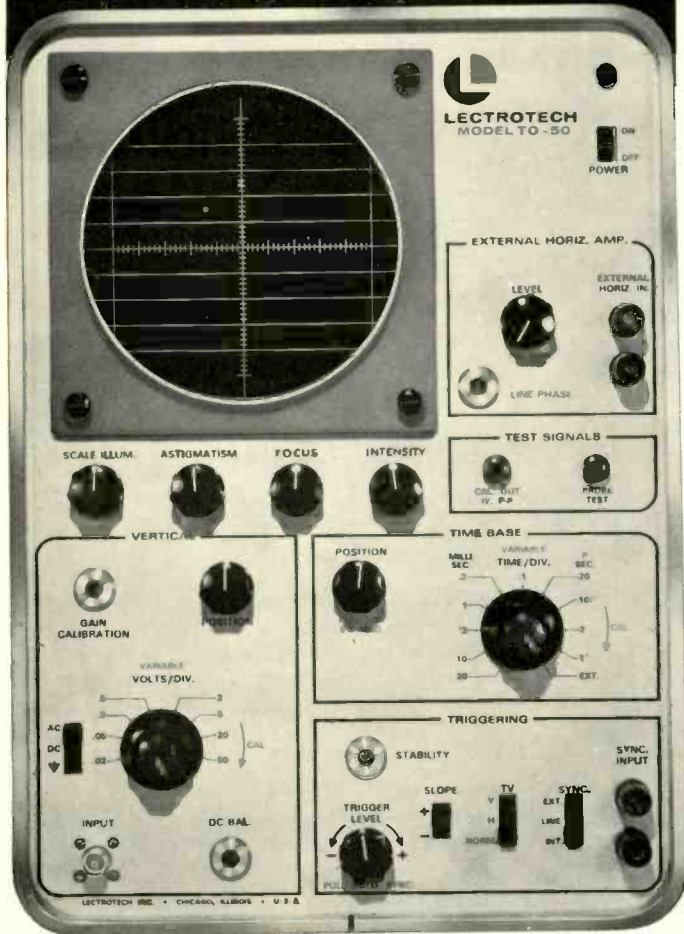

Made in U.S.A.

5" oscilloscope / vectorscope

Triggered Sweep: Easy to use. Positive sync results in absolute stability of patterns.

Solid State: For reliability and performance.

Wide Band: 10 MHz—for increased use in all servicing, industrial and educational applications.

D.C. Amplifiers: Eliminates pattern bounce. Permits viewing A.C. signals and D.C. level simultaneously. Use as a sensitive D.C. voltmeter.

plus . . . Calibrated vertical attenuator. • Calibrated horizontal time base. • Automatic sync mode. • TV sync selector. • Vectorscope input for color TV servicing. • External horizontal amplifier. • 60 cycle horizontal sweep (sine wave) with phasing control. Compatible with all sweep generators. • Edge lit calibrated scale. • All solid state (tube protected input).

ONE YEAR WARRANTY

TO-50—oscilloscope / vectorscope Net 329⁵⁰

See your distributor or write Dept. ET-9

LECTROTECH, INC.

4529 North Kedzie Avenue • Chicago, Illinois 60625

... for more details circle 124 on postcard

ET/D COLORFAX

the grids of the RF and IF amplifiers.

The amount of charge on C1 is determined by the amplitude of the horizontal-sync pulses. If this amplitude increases, the charge increases, the currents through R1 and R2 increase and the AGC voltage becomes more negative. This reduces the receiver gain and, consequently, the amplitude of horizontal-sync pulses from the receiver is maintained at a constant value.

If there were no noise-immunity provisions, a positive noise transient (spike) occurring simultaneously with a sync pulse would effectively increase the amplitude of pulse

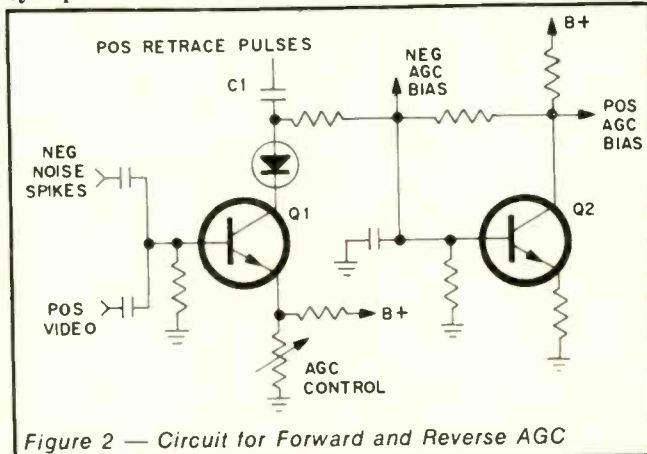

Figure 2 — Circuit for Forward and Reverse AGC

at the grid of the keyer and cause the AGC voltage to swing too far negative. To prevent this, the video signal is inverted and passed through a differentiator, a short-time-constant circuit which removes the sync pulses but passes noise spikes. These negative pulses are fed to the suppressor grid of the keyer tube, thereby reducing conduction. In

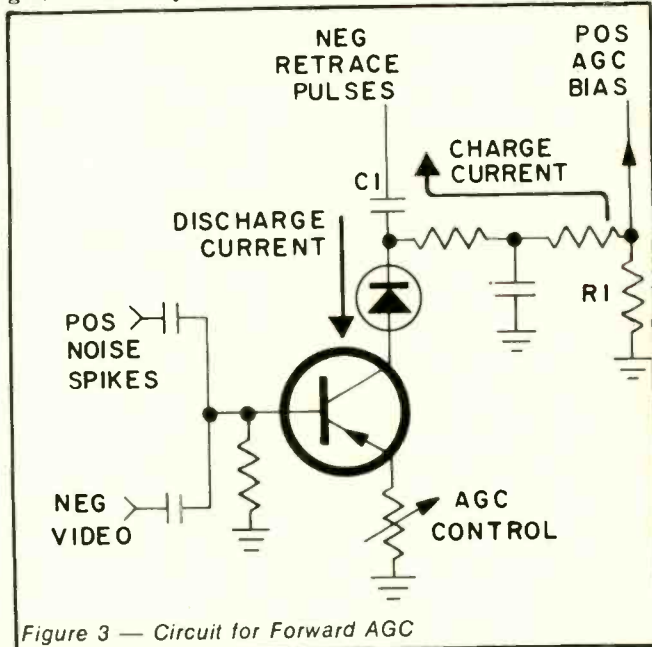

Figure 3 — Circuit for Forward AGC

effect, any unwanted noise pulse is fed to both the control grid and suppressor grid, but the polarities are opposite and they are canceled.

Another method of separating noise spikes from sync pulses is to apply the composite video to a circuit which is biased so that it requires a signal more positive than the sync pulse to bring it out of cutoff. Its action is similar to a sync separator, except that noise spikes, instead of sync

continued on page 88

Engineered for outstanding reception— Zenith outdoor antennas for Color TV!

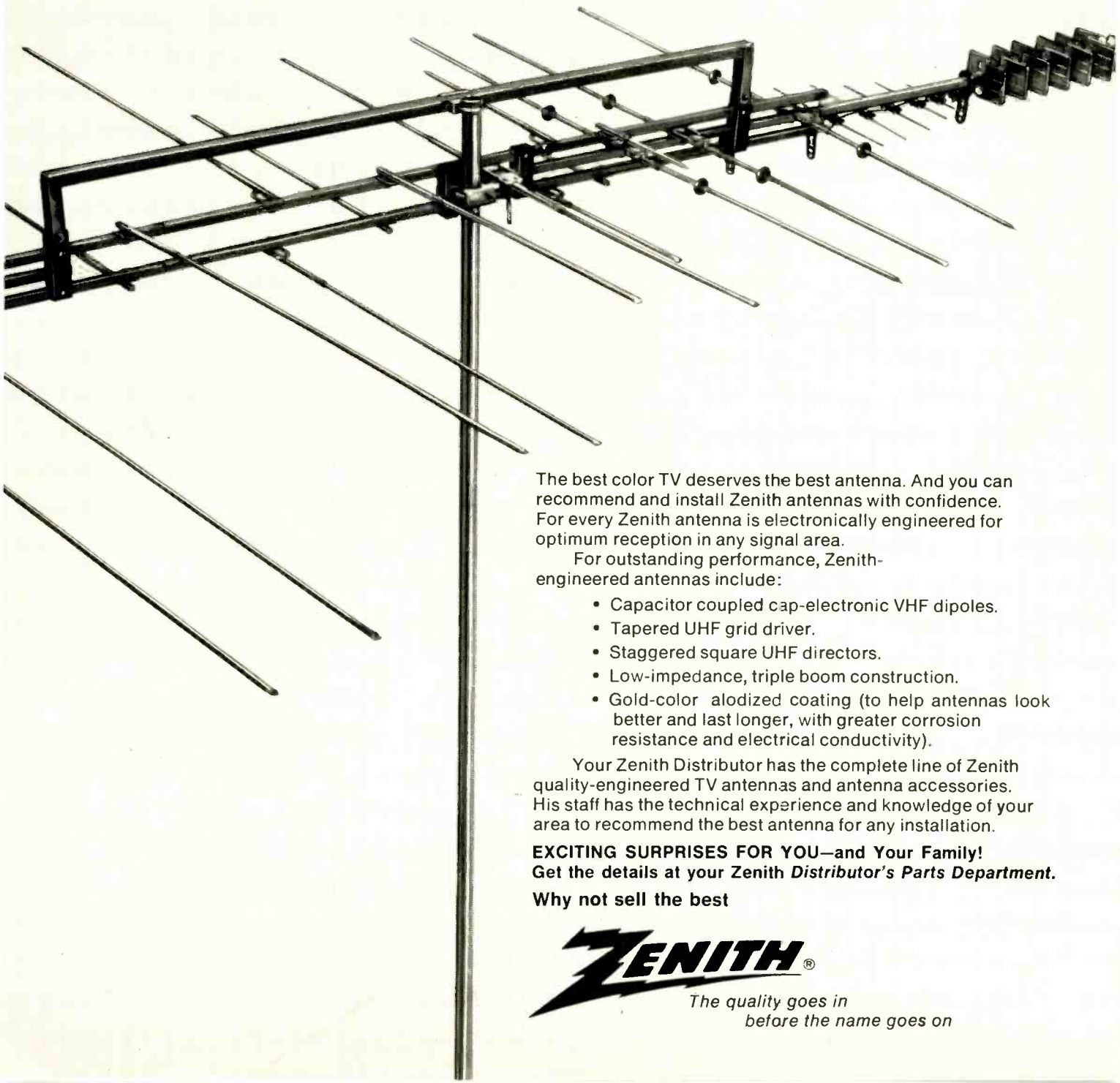

The best color TV deserves the best antenna. And you can recommend and install Zenith antennas with confidence. For every Zenith antenna is electronically engineered for optimum reception in any signal area.

For outstanding performance, Zenith-engineered antennas include:

- Capacitor coupled cap-electronic VHF dipoles.
- Tapered UHF grid driver.
- Staggered square UHF directors.
- Low-impedance, triple boom construction.
- Gold-color alodized coating (to help antennas look better and last longer, with greater corrosion resistance and electrical conductivity).

Your Zenith Distributor has the complete line of Zenith quality-engineered TV antennas and antenna accessories. His staff has the technical experience and knowledge of your area to recommend the best antenna for any installation.

EXCITING SURPRISES FOR YOU—and Your Family!
Get the details at your Zenith *Distributor's Parts Department*.

Why not sell the best

ZENITH®

*The quality goes in
before the name goes on*

For additional information on products described in this section, circle the numbers on Reader Service Card. Requests will be handled promptly.

CAPACITORS

713

Temperature range of -80C to +110C

Introduced is an aluminum electrolytic capacitor with a temperature range of -80C to +110C. This line

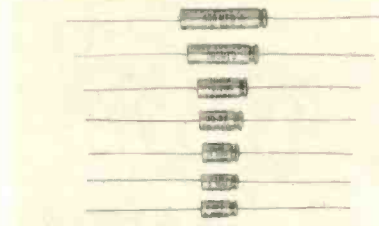

of capacitors is now added to other high temperature lines recently developed. The type HNLH capacitor reportedly offers temperature stability over its broad temperature range of 190C. These all-welded, polarized, etched foil constructed capacitors are stocked in voltage ratings from 3 to 150vdcw and reportedly operate between -80C and 110C without derating of the rated voltage. The all-aluminum construction provides minimum capacitor weight for airborne applications. It is recommended where requirements include compactness, light weight, moderate cost, a high order of electrical-mechanical dependability and high capacitance per unit volume. The seven-case sizes available provide higher voltages and more microfarads per cubic inch, according to the maker. Cornell-Dubilier.

REMOTE CONTROL

714

Transistorized system consisting of transmitter and receiver

A wireless control switching system is introduced. Called "REMO," the transistorized system consists of

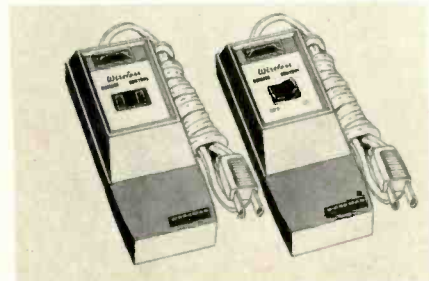

a transmitter and a receiver. It will operate the ON-OFF control of a television, stereo, tape recorder or any

other electrical appliance with a demand of up to 300w. Operation of the equipment is dependent on the transmission of an inaudible high frequency signal which, when sensed by the receiver unit, closes the circuit of the ac receptacle and provides current to the device being used. No installation is required. The TV or other appliance is plugged into the receiver and receiver is plugged into the ac outlet. The transmitter is then plugged into a convenient ac outlet as long as it is on the same transmission line. By just switching the transmitter control, the appliance can be operated on or off. Net price is \$14.95. Workman.

SERVICE AIDS

715

Available for inspecting and determining cause of picture tube failure

Two new service aids are available for TV service technicians. A free, handy CRT identification card offers



a method of visually inspecting and identifying the type of screen on color picture tubes ("rare earth" or "sulfide" screen for 23in. 90deg and 21in. 70deg color picture tubes). Colors shown on the card ETR0-5199 approximate the appearance of the "unexcited" color screen. Visual inspection should be made in a well-lighted area. Slight variations in observed color may be noted because of different lighting conditions and different degrees of tinting employed in the faceplate and/or cover panels. The Vacuum Spark Tester ETRS-5198 provides the most effective method of determining cause of picture tube's failure. A high frequency arc gener-

ator, the tester generates about 50kv at a frequency of 3MHz to 4MHz and the voltage is adjustable. The tester is available to dealers at \$10.95 and to distributors at a special rate. GE.

HAND TOOLS

716

Rust and corrosion resistant

A variety of hand tools with tough, nonmagnetic, nonsparking, rust- and corrosion-resistant beryllium-copper blades and shafts is introduced. These

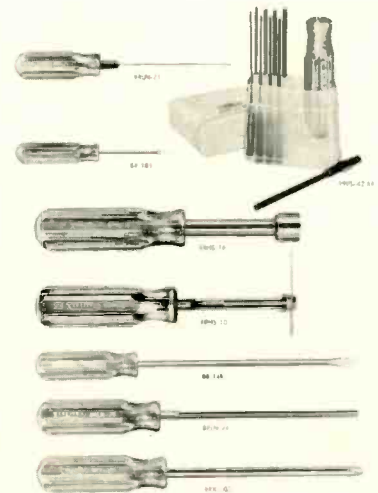

tools have many applications in electronic assembly and servicing and are particularly desirable where magnetism is a deterrent to adjustment. Their rust and corrosion resistance makes them ideal for work in which they may be exposed to moisture, salt air, weather, chemicals or chemical fumes and are regarded as safety tools. Fixed-handle screwdrivers for slotted, Phillips and Allen hex type screws are offered in a large number of popular sizes. Hollow shaft, fixed-handle nutdrivers with hex openings from 3/16 through 1/2in. are also available with brass shanks and beryllium-copper sockets. Set 99-PS-42-BR--consisting of 9 interchangeable, beryllium-copper, Allen hex type blades (hex sizes .050in. through 3/16in.) with stainless steel check adaptors and a Xcelite Series 99 handle with brass spring chuck-is included in the line. This set is furnished in a pocket-size plastic case for easy carrying or use as a bench stand. Xcelite.

FANTASTIC INTRODUCTORY SPECIALS!

3 New Motorola HEP
Transistor Replacement Kits

Revolutionary! These new kits are the first of a *computer-planned* series designed to provide you with replacement semiconductors to *do the job right*... with replacements to satisfy the most used and most often needed device types.

"Universal" replacements just don't fill the bill any more in many circuits. With more and more consumer products using semiconductors... with many of these products becoming increasingly complex... closer tolerances are needed in more and more replacement devices. Our computers have selected the *right* devices for the *right* jobs!

And we're bringing these kits to you at the *right* prices!



HDK-6... RF-IF Transistor Replacement Kit
12 HEP types (26 units) programmed to replace 3,794 original equipment types plus several "universal" device numbers. Doesn't cover everything, just the major portion of your IF and RF replacement needs!

REGULARLY \$32.68
SPECIAL INTRODUCTORY PRICE \$23.95



HDK-7... FOREIGN Transistor Replacement Kit
Replacements for foreign semiconductors are hard to find... but not with this kit! 12 types (22 units). Covers over 5,700 types, including most of nearly 2,000 Japanese type numbers. In fact, they'll replace 83% of the foreign types listed in our Cross Reference Guide. Quantities of each type are programmed to give you more of what you need most.

REGULARLY \$27.35
SPECIAL INTRODUCTORY PRICE \$19.95



HDK-8... RF-IF/AUDIO/FOREIGN Transistor Replacement Kit
Computer-programmed to give you the best replacements for today's complex RF-IF and foreign applications plus an excellent selection of the most popular audio devices. 47 units—23 HEP types—covering the specific numbers you need most. No odd-balls to gather dust. Replaces over 10,000 specific type numbers.

REGULARLY \$60.09
SPECIAL INTRODUCTORY PRICE \$39.95

Get in touch with your HEP distributor now!
These special introductory prices are in effect only while his on-hand inventory lasts!

GET HAPPY! GET HEP! FROM MOTOROLA!

MOTOROLA HEP SEMICONDUCTORS

P. O. Box 20924 / Phoenix, Arizona 85034

... for more details circle 127 on postcard



VOLTAGE REGULATOR 717

Corrects high or low line voltage

A voltage regulator for color television and other appliances rated at 400w or under is announced. The unit is designed to reduce television problems caused by high line voltage transmission in the 130v range. The Model D-111 voltage regulator reportedly corrects this problem when it is set



to the DOWN 10 position. Here it will continuously drop line voltage by 10v, correcting over-voltage faults. It can also be set in an UP 10 position or an OFF position. The unit can then be used to correct low line voltage in color TV and also in many industrial

applications. The Model D-111 carries a manufacturer's suggested list price of \$12.40. It is a companion model to Perma-Power's other voltage regulators, the Model D-101 (similar, but rated at 300 watts only), the Model D-210 and D-200(400 and 300 watt automatic voltage regulators).

TRANSFORMER-BALUN 718

Receiver broadcast bands below 4MHz on shortwave antennas

Introduced is the TRS-57 transformer-balun to adapt the SWL-7 and RD-5 short wave listening antennas (and



TRS-57

any short wave listening doublet) to receive standard broadcast bands below 4MHz. On these bands the transformer-balun automatically transforms the doublet into the long wire antenna necessary for broadcast band reception; it reportedly eliminates the need for an additional antenna to receive local stations and distant cities. On regular short wave bands, the unit acts as a balun to provide balanced receiver input. It is said to be easily installed on the back of the SWL receiver with the screwdriver. Mosley.

TUNER CLEANER 719

All-purpose cleaner leaves no film

Introduced is an all-purpose spray cleaner and tuner degreaser called "Clean." The fast-drying solvent re-



portedly leaves no film, is non-flammable and quickly dissolves all types of dirt, grease and oil. The cleaner has a very low toxicity of 500 parts

Customer Relations Specialist.



B&K 465 CRT Rejuvenator/Checker

A good part of successful servicing is successful selling. That's why we developed the 465 CRT Rejuvenator/Checker. It's the "Silent Partner" that leaves a good impression. One that guarantees repeat and referral business.

The B&K 465 shows the customer the true condition of his picture tube and forecasts its life expectancy. It is capable of checking both color and black & white, foreign or domestic picture tubes. And through the use of continuously variable voltages for all CRT elements, you never have to worry about obsolescence. And the best thing of all is that it does it all right in the customer's home without removing the tube from the set.

As a result, he gains confidence in your abilities and judgment and becomes

more susceptible to the idea of purchasing a new tube. But if your customer temporarily can't take on the expense of a new picture tube, you can rejuvenate the old one as part of your service or for an additional fee which you can offer to apply to a new tube at a later date. Either way, you've satisfied your customer and increased your profits.

So if you would like to know more about how our customer relations specialist can stimulate your business, contact your B&K distributor or drop us a line direct. We have a lot of new ideas we'd like to share that can mean *money* for you.

CRT Rejuvenator/Checker
Model 465. Net: \$94.95

B&K Division of Dynascan Corp.
1801 W. Belle Plaine
Chicago, Illinois 60613

B&K puts an end to test equipment. We've developed Silent Partners.



... for more details circle 108 on postcard

LATEST BEST SELLER (for you)

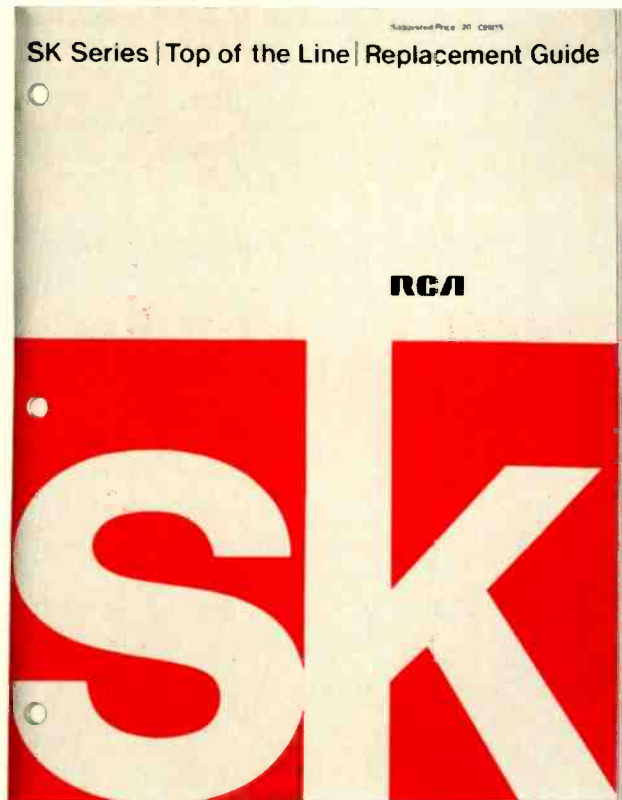

Here it is, strictly non-fiction — in fact, all fact — the indispensable RCA solid-state replacement guide. It works for you by charting the replacements of some 12,200 semiconductors — domestic and foreign. The 39 SK "Top-of-the-Line" transistors, integrated circuits, and rectifiers are designed and manufactured specifically for your kind of servicing problems. All top quality, too — no cast-offs, no factory seconds, no unbranded culls. All with electrical characteristics comparable or superior to originally designed-in devices.

As for range — from small-signal operations to the newest 100-watt audio outputs!

The comprehensive RCA SK Series — and the thousands of types they can replace — are *clearly* cross-referenced in the RCA SK Series Top-of-the-Line Replacement Guide.

Pick up your copy from your local RCA Distributor today.

RCA/Electronic Components/Harrison, N. J. 07029.

RCA

ET/D NEW PRODUCTS

per million and is safer to use than carbon tetrachloride which has a toxicity of 25 parts per million. Thus, carbon tetrachloride has 20 times the toxicity of "clean." It is also a solvent for contaminants such as mineral oils, greases, waxes and soils. The cleaner reportedly can be used safely on glass, ceramics, metals and plastics. It is available in a 24oz. spray can. Price \$3. Injectorall.

MOBILE ANTENNAS 720

Loading coil finned to aid heat dissipation

Three tunable antennas featuring base loaded and rugged construction are announced for vehicular applications. Model SS-27, 27 to 33MHz; SS-34, 34-40MHz; SS-45, 40 to 50MHz. All three have taper ground stainless steel whips and reportedly can be tuned to exact frequency. The loading coil is finned to aid heat dissipation and is potted in epoxy for waterproofing and to prevent detuning in damp weather. The antennas come with their own integral mounts, 20 ft of RG58U cable and PL259 connec-



tors and are guaranteed for 1 year. The mounting components are heavy chromeplated brass with high impact ABS shell and are compatible with the "no-hole trunk lip" base. Specifications: VSWR--1.3:1; Nominal Impedance--50 Ω ; Power Handling--100 +. Price \$21.25. Avanti.

SOLDERING PENCIL 721

Instant heat without transformer

A slim, 3oz. instant heat pencil iron that will do the work of much heavier pistol-type guns is introduced. The iron employs a dual heat element



controlled by a thermal time delay relay, without a transformer. When a switch on the handle is depressed, a high wattage element brings the tip temperature up to operating heat in seconds. The relay then cuts in a lower wattage element that maintains the proper soldering heat, without overheating. It continues at the lower wattage until a higher heat is required, then the relay cuts in again for as long as needed. Initial input is 180w and it operates at 40w. The handle is molded of a polycarbonate, Lightweight unbreakable plastic. Iron plated or regular 1/8in. plugin tips are inserted by loosening one set screw. Since any tip shape may be used and changed easily, the tip can be matched to the job. Wall. *continued on page 92*

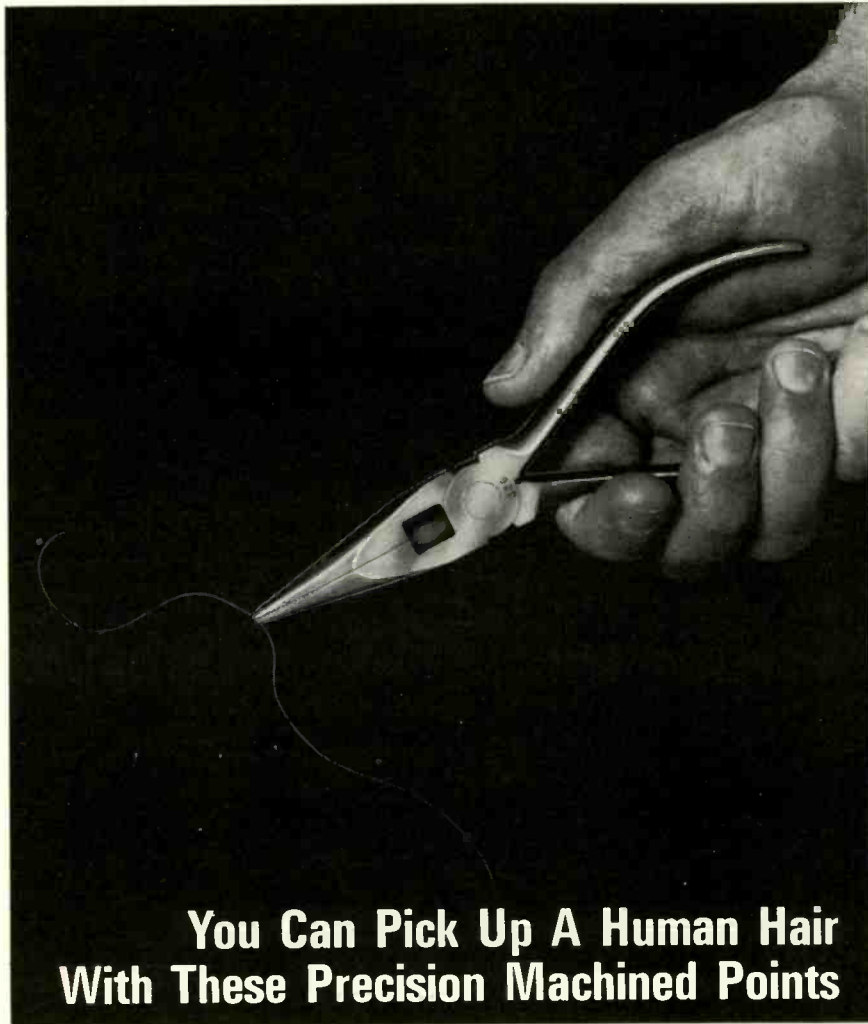

You Can Pick Up A Human Hair With These Precision Machined Points

Dentists would call the exact matching of the fine teeth and jaws of this plier "perfect occlusion." You'll call it the niftiest long nose plier you've ever used. It's precision made of full-polished highest quality drop-forged steel with smooth working moving parts and hand honed cutting edges — in short, designed and

made to do a better job, time after time, year after year. And the expert craftsmanship you see here is typical of the entire line of Channel-Lock hand tools . . . good reason why Channel-Lock is the first choice of discriminating tool users the world over. — Let us send you our catalog, no charge.

TOOLS BY
CHAN NEL LOCK
MEADVILLE, PA.

... for more details circle 111 on postcard

Zenith's new **CHROMACOLOR** outcolors...outbrightens...outdetails... and outperforms...every giant-screen color TV before Chromacolor

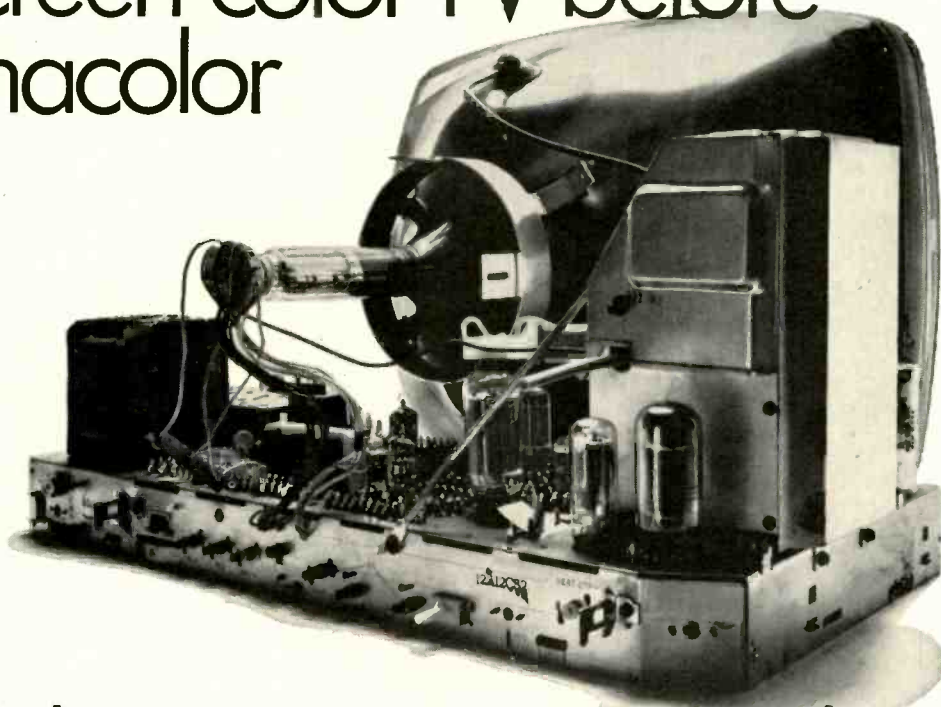

...and it's the easiest to service!

Zenith Chromacolor is a revolutionary new color television system... featuring a revolutionary new patented color picture tube... pioneered and developed by Zenith.

Five important engineering advances make Zenith Chromacolor the most dependable color TV ever made. And by far the easiest to service.

New Chromacolor Picture Tube uses Zenith's patented black-surround screen and fully illuminates every color dot—for a color picture that's more than 100% brighter, with truer colors, sharper detail, and greater contrast than any giant-screen color TV before Chromacolor.

New Titan Color Chassis combines Handcrafted dependability with solid-state performance. All transistors are either plug-in or part of a plug-in assembly. All test points are flagged or coded for easy identification.

New RGB Color Circuitry is more sophisticated and highly refined—for higher color fidelity. And alignment is simplified for setup and servicing.

New Color Commander Control. Now! One control simultaneously adjusts contrast, color level and brightness in proper balance to provide the most pleasing picture for any light conditions in the room! This easy viewer adjustment means fewer false service calls to remedy maladjustments.

Exclusive Chromatic Brain introduces TV's first integrated circuit in a color demodulator... for the purest reds, greens, and blues. 100% of the color demodulator circuitry is in the easily accessible plug-in Dura-Module.

Take a good look at new Zenith Chromacolor. Designed with both you and your customer in mind. The best giant-screen color picture! The easiest to service!

ZENITH
The quality goes in
before the name goes on

ALL NEW!

NRI learn-by-doing training in

ADVANCED COLOR TV



- **Build your own custom color set in 5 training stages**
- **50 designed-for-learning color circuit experiments**
- **Programmed with 18 "bite-size" lesson texts**

A comprehensive training plan for the man who already has a knowledge of monochrome circuits and wants to quickly add Color TV servicing to his skills. DEFINITELY NOT FOR BEGINNERS. It picks up where most other courses leave off—giving you "hands on" experience as you build the only custom Color TV set engineered for training. You gain a professional understanding of all color circuits through logical demonstrations never before presented. The end product is your own quality receiver.

TRAIN WITH THE LEADER

This NRI course — like all NRI training — is an outgrowth of more than 50 years experience training men for Electronics. NRI has simplified, organized and dramatized home-study training to make it easy, practical, entertaining. You train with your hands as well as your head, acquiring the equivalent of months of on-the-job experience. Demand for Color TV Service Technicians is great and growing. Cash in on the color boom. Train with NRI—oldest and largest school of its kind. Mail coupon. No obligation. No salesman will call. NATIONAL RADIO INSTITUTE, Color TV Div., Washington, D.C. 20016.

MAIL FOR FREE CATALOG



NATIONAL RADIO INSTITUTE
Color TV Division
Washington, D.C. 20016 42-099

Send me complete information on NRI new Advanced Color TV Training. (No salesman will call)

Name _____ Age _____

Address _____

City _____ State _____ Zip _____

ACCREDITED MEMBER NATIONAL HOME STUDY COUNCIL



NEWS OF THE INDUSTRY

RCA Introduces Solid-State Power Supply

RCA Electronic Components has announced the availability of two new solid-state power supplies.

"The new units, WP-703 and 704, are versatile, bench type, regulated dc power supplied ideal for today's electrical needs," said J. A. Haimes, division vice president and general manager, RCA Distributor Products. "All silicon transistors and diodes are used in the new units. A key feature in the circuit design is a negative feedback circuit to maintain constant output voltage with low ripple regardless of varying line voltage or lead resistance. No damage will occur even if connected to an external short circuit," he said.

Output voltage of the WP-703 is continuously adjustable from 0 to 20v at current levels up to 500ma. The output voltage of the WP-704 is adjustable up to 40v at current levels up to 250ma.

Compact, lightweight units have three convenient five-way output terminals (plus dc, minus dc and gnd). Attractively designed functional panels with easy-to-read meters, convenient panel switches and overload indicator lamps add to serviceability of the new power supply units.

Both models have an optional user price of \$58.50 in quantities of one to four.

EIA Projects Over-All 1969 Electronics Sales Rise at 3.1 Percent

With 1969 half over, U. S. factory sales of electronic products appear headed for a 3.1 percent rise over sales during 1968. The increase would bring total industry sales to \$24.9 billion, as compared to the \$24.2 billion posted in 1968.

This is the prediction made by Mark Shepherd, Jr., president of the Electronic Industries Assn.

Based on figures compiled by the EIA Marketing Services Dept., Shepherd said he expects federal government purchases of electronics and related services to stay at about the 1968 level of slightly more than \$12 billion; industrial electronic sales to rise about 6.8 percent to reach nearly \$7.2 billion; consumer electronics sales to increase 4.4 percent to more than \$4.8 billion; replacement component sales to increase 2.2 percent to about \$690 million; and total sales of electronic components to advance about 2 percent to about \$5.3 billion.

The anticipated "conservative sales gains," Shepherd said, "reflects a somewhat slower growth for the over-all U.S. economy."

Looking at the various categories, the electronics executive said spending for military electronic systems will level out during the year but that government spending can be expected to rise in such areas as education, health, transportation, safety and antipollution.

"The ghettos and other problems of our cities demand priority attention," Shepherd said, "and the electronics industry will plan an increasingly important role in the efforts to solve these problems not only by working with federal agencies but also with state and local governments."

In the industrial area, indications are that computing and data processing equipment sales will continue strong in 1969. Shepherd noted that electronic instrument makers are developing improved techniques, reliability and precision in a wide range of sensing, measuring and ana-

General Electric tubes get to you in original factory condition, because inspectors like Ken Omer are real *tough customers* when it comes to giving packaging the once-over. For example, machines with a lighter-than-a-feather touch fill each unit tube carton. Corrugated containers are built to rigid government specifications. Tubes, cartons and containers must pass the "rough handling" test—a dead drop to a solid surface on all eight corners! Unpacked, then tested, only 100% tube operation is good enough. After all, only 100% operation will satisfy you and *your* customers. That's why GE builds extra security into tube packaging. You can stake your reputation on dependable, high-performance GE tubes — the "service designed" line for all of your replacement needs. Stock up at your GE distributor today. 288-21

**GE tube protection
must satisfy
these tough customers
before they'll ship to you!**

GENERAL  ELECTRIC



Reach for this when you ask,
"What else needs fixing?"

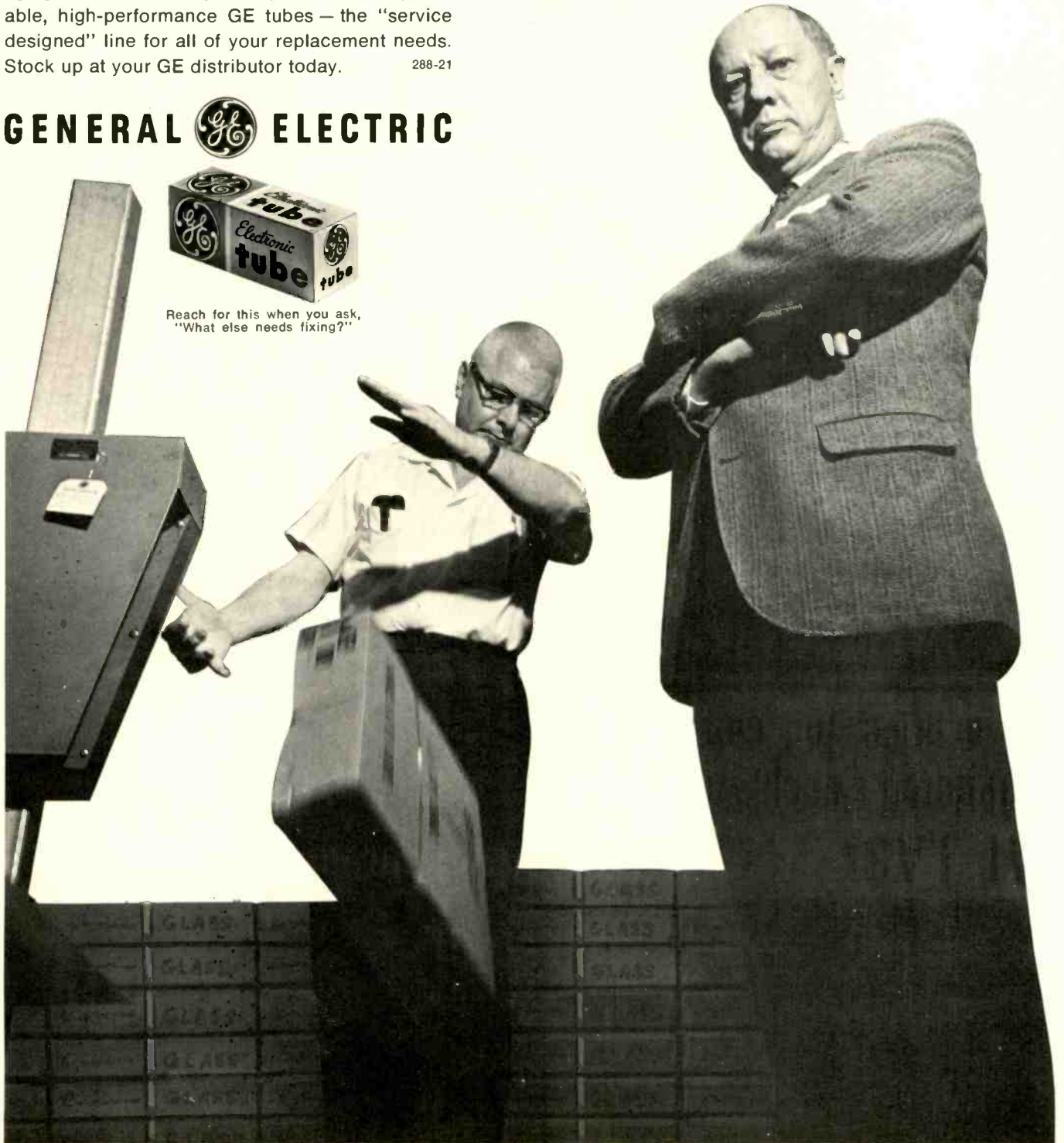



**Bugged about never having
the right replacement lamp?**

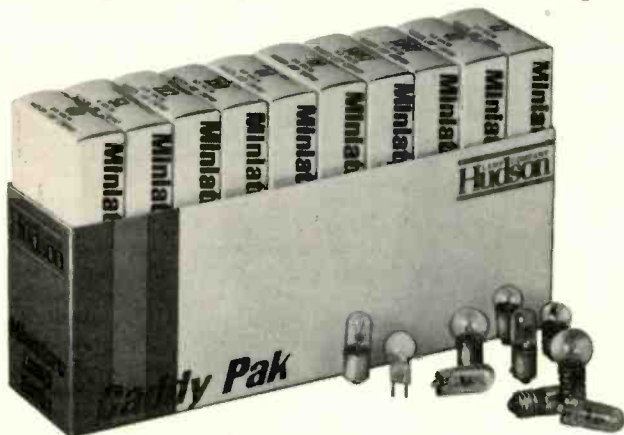

**Hudson's New "Caddy-Pak"
puts them right at your fingertips.**

Now there's a replacement kit of miniature lamps packed just like replacement tubes. Hudson's "Caddy-Pak" — available in four assorted packages of eight to ten types — a total of 100 miniature lamps of those types proven in day-to-day experience to be the most needed in servicing all makes of television and radio sets.

The "Caddy-Pak" is convenient and handy for in-shop repairs — and is especially useful for house calls. Makes it easy for your jobber to keep you well supplied, too.

So take in a supply of first-quality, made in U.S.A., miniature lamps in a Hudson "Caddy-Pak". Save yourself time, frustration — and money. Ask your jobber about the "Caddy-Pak" today.

**LAMP COMPANY
Hudson**

Hudson Lamp Company, 528 Elm Street,
Kearny, New Jersey 07032. Telephone: (201) 997-1850

... for more details circle 119 on postcard

lyzing activities. "Increased use of integrated circuits in many industrial products has enhanced their portability and permitted wider applications to the benefit of users," Shepherd said.

The total market for consumer electronics is expected to expand by more than 5 percent during 1969 when foreign-labeled imports sold in this country are added to U.S. factory sales, he pointed out. The most significant growth in this area, he indicated, will be in color television receivers and tape equipment.

While gains in component sales are expected to be relatively slight, Shepherd said some products in this category will show good growth. He included TV picture, power and special purpose tubes, integrated circuits, field effect silicon transistors, thyristors, rectifiers, zener and microwave diodes, diode assemblies and semiconductor chips.

On the subject of U.S. balance of trade, Shepherd noted that electronics still maintains a favorable balance with U.S. 1969 electronic exports expected to be about \$2.3 billion—a 10 percent increase over 1968—while imports of electronic products will be about \$1.7 billion—a 25 percent increase over 1968.

He projected the 1969 electronics trade balance at \$660 million—approximately 16 percent below the 1968 favorable balance of \$790 million.

NAB Urges FCC Adoption Of New AM Monitoring Rules

The National Assn. of Broadcasters has urged the Federal Communications Commission to adopt rules which would relax present requirements governing the inspection of directional antenna facilities.

In a recent filing, Douglas A. Anello, NAB general counsel, supported a commission proposal to amend its rules to provide for utilization of remote phase monitors and a relaxation of the two-hour directional antenna inspection rule.

Anello stated that: "The utilization of remotely read phase monitors will undoubtedly enhance the licensee's ability to monitor the operation of the directional antenna system and also provide a more comprehensive record of its performance than has previously been available."

Marquette Agrees To Sell Setchell Carlson TV Div.

Marquette Corp. reported it had agreed to the cash sale of its Setchell Carlson television manufacturing operation to Audiotronics Corp. of North Hollywood, Calif.

The announcement, made jointly by Richard I. Lange, president of Marquette, and Don E. Warner, president of Audiotronics, said the transaction has been approved by the directors of both firms.

The purchase price was not disclosed.

Audiotronics, a leading manufacturer of audio-teaching equipment for schools, had sales of about \$5.1 million in the year ended June 30, 1969. Setchell Carlson, manufacturer of closed-circuit television sets and systems and home TV sets, reported sales of \$5,363,000 in 1968 of which approximately \$2 million were of educational and closed-circuit TV equipment.

Henry B. Christian, Jr., present general manager of Setchell Carlson, will continue in the same position under the new ownership, Warner said.

Laboratory or General Purpose

Triplett meets
the need
precisely

Whatever your testing needs, wherever you're working, there's a Triplett portable tester to meet the requirements — as perfectly as the skills of dedicated craftsmen can guarantee. For example, here are four winners from Triplett's great 630 Series:



**MODEL 630-A
LABORATORY V-O-M**

- 1 $\pm 1\frac{1}{2}\%$ DC, $\pm 3\%$ AC accuracy.
- 2 One selector switch minimizes chance of incorrect settings and burnouts.
- 3 Rugged $5\frac{1}{2}$ " suspension meter movement with $4\frac{1}{2}$ " mirrored scale.

\$71⁰⁰



**MODEL 630-APL
LABORATORY V-O-M**

- 1 $\pm 1\frac{1}{2}\%$ DC, $\pm 3\%$ AC accuracy.
- 2 One selector switch minimizes chance of incorrect settings and burnouts. Polarity reversing for DC.
- 3 Suspension meter movement diodes protected against instantaneous overloads.

\$71⁰⁰



**MULTI-PURPOSE V-O-M
MODEL 630-PL**

- 1 One selector switch minimizes chance of incorrect settings and burnouts. Polarity reversing for DC.
- 2 4.4 Ohms center scale, 0.1 ohm to 100 megohms resistance.
- 3 Meter movement diode protected against instantaneous overloads.

\$61⁰⁰



**MULTI-PURPOSE V-O-M
MODEL 630**

- 1 One selector switch minimizes chance of incorrect settings and burnouts.
- 2 4.4 Ohm center scale, reads from 0.1 ohm up to 100 megohms resistance in 4 ranges.
- 3 20,000 ohms per volt DC sensitivity; 5,000 AC.

\$61⁰⁰

See your Triplett representative or distributor for free demonstration.

TRIPLETT ELECTRICAL INSTRUMENT CO.

TRIPLETT

BLUFFTON, OHIO 45817



FREE Electronics Data Guide

Want help in working out those tricky electronics calculations? Send for our FREE Electronics Data Guide. This heavy-duty plastic guide fits right in your shirt pocket—gives you instant reference to over 40 indispensable electronics formulas...plus conversion factors, color codes and decibel table as well. Saves you time and the trouble of memorizing or "looking it up." A "must" for every man interested in electronics—provided as a service by CIE. Why not get your FREE Data Guide today? Just fill in your name and address below, then cut out this ad and mail it to:

Cleveland Institute of Electronics
1776 E. 17th St., Cleveland, Ohio 44114

Name _____
(Please Print)

Address _____

City _____

State _____ Zip _____

Accredited Member National Home Study Council. 919

... for more details circle 114 on postcard

ET/D CATALOGS & BULLETINS

Test Equipment 400

A catalog contains the complete test equipment line of vectorscopes, color-bar generators, oscilloscopes, picture tube analyzer, in-circuit transistor analyzer, transistor TV sweep circuit analyzer, CB analyzer and frequency meter, power supplies, lectrocell, metergard. Lectrotech.

Hand Tools 401

A four-page, catalog supplement containing descriptions and specifications on professional hand tools and sets added to the line since publication of the latest general catalog. A large number of nonmagnetic, non-sparking, rust- and corrosion-resistant, beryllium-copper tools are shown. Charts help determine the proper drivers to use with popular sizes of metric fasteners. Seven, fixed-handle nutdriver and screw-driver assortments are listed. They are packaged in plastic cases for pegboard hanging or storage in tool cabinet or service kit. Xcelite.

Semiconductors 402

A 67-page guide cross references 60 ECG solid-state devices to some 28,000 semiconductor devices currently used in entertainment equipment. The guide, ECG212B, has been updated to include devices added to the line, such as zener diodes, a high voltage video output transistor, plastic power transistors, and an NPN germanium power transistor in a T0-66 package. The semiconductors reduce the number of devices required for stock. Price 75 cents. Sylvania.

Recording Booklet 403

A 24-page booklet, designed to help improve sound quality of home tape recordings, is available. The illustrated booklet offers tips on properly selecting magnetic tapes, recording techniques and recording procedures in non-technical terms. It also defines various types of tape recorders and illustrates the proper techniques for editing and splicing magnetic tapes as well as maintenance tips for recorders. 3M.

Integrated Circuits 404

A brochure provides data on three transistor-transistor logic IC series—the standard Series 54/74, the high-speed Series 54H/74H and the low-power Series 54L/74L. Compreh-

Zenith "Royal Crest" Tubes... with unrivaled dependability

Zenith "Royal Crest" replacement circuit tubes are engineered to the same exacting standards as original Zenith circuit tubes in new sets. With the same unrivaled dependability and "new set" performance.

Zenith "Royal Crest" circuit tubes are life-tested under actual operating conditions for more than 1,500,000 hours every month!

The "Royal Crest" line is broad and comprehensive. Over 900 different types, all built to Zenith rigid quality standards.

Insist on Zenith quality. Choose Zenith's "Royal Crest" circuit tubes and assure customer satisfaction.

EXCITING SURPRISES FOR YOU—and your family!
Get the details at your Zenith Distributor's Parts Department.

Why not sell the best



The quality goes in
before the name goes on



“I’d advise new businesses to have their opening coincide with the coming out of the newest Yellow Pages book.”

“My Yellow Pages ad was there working for me the minute I opened my new store,” says John W. Beyer, owner, Maytag Evanston Co., Wilmette, Illinois. “There was no waiting around. The phone started ringing immediately. My new store is in an area with no other stores around it. The Yellow Pages worked for our old store, too. We had more business than we could handle. And that was pretty much due to the Yellow Pages, where I ran as big an ad as I could get. And because I’m an authorized dealer for Maytag and Hoover, I emphasize those products in my ad. When someone wants to buy a nationally advertised



washer, he goes to the Yellow Pages to find a local dealer. I put about 50% of my advertising budget into the Yellow Pages. If I had to advertise

just one way, I would stay with the Yellow Pages.”



An effective way to build business.



sive catalog listings are furnished for more than 90 distinct functions in the line, including 35 medium-scale integration circuits. The MSI functions listed are data selectors/multiplexers, decoders, memories/latches, shift registers, counters, parity generator/checker and arithmetic elements. This 80-page bulletin (CB 102) also features typical applications, truth tables, design loading

rules and pin configurations. An introductory section illustrates the complete TTL logic family and provides the designer with typical characteristics, common to the three logic groups.

Descriptions of speed and gate performance are also given. Texas Instrument.

Tools 405

A 24-page catalog of hand tools is available for industry, production and assembly line, maintenance, service or home workshop use. The catalog is reproduced in two colors with all product illustrations shown in "wood-cut-line" technique. Contents includes

sizes and styles of screwdrivers, nut-drivers, ratchet tools, pliers, wrenches, electrical testers, steel tapes, as well as snap rings, snap ring pliers and Pow'Rivets—the blind rivet that reportedly clamps up tight, even in over-size holes. Vaco.

Knobs 406

An eight-page catalog listing a line of machine aluminum anodized knobs is available. Types of knobs cataloged are: standard series, concentric, spinner, skirted and knurled models. Sizes available are 1/2, 3/4, 1 and 1 1/4in. These aluminum knobs are anodized in either natural, black or gold. Alco.

Consumer Electronics Annual 407

The Consumer Electronics Annual is available. It contains a year-by-year statistical review of products through 1968, including television, radios, phonographs and tape equipment. It also contains a profile and history of the industry, a chronology of events and a glossary of terms. Copies are available in quantity: 25 or more copies at 25 cents each, postpaid; 24 copies or less at 50 cents each, postpaid. EIA.

Switches 408

A 20-page Bulletin S-305 illustrates and describes the latest switch innovations. Included are: miniature rotary switches featuring printed circuit applications, tamperproof key lock versions, isolated positions and spring return styles; miniature push-button switches for printed circuit mounting, lighted push-button switches and bi-pin lamp sockets. Complete technical data and specifications are given on each item. Grayhill.

Wire and Cable 409

A 36-page catalog lists nine major wire product groups and related products. The company features aluminum-backed mylar tape wrap on a number of its products. The special shielding is needed by many high-gain electronic systems including data processing systems, telemetering equipment, TV cameras and receivers, microphones and other communications equipment. Garrett.

Switches 410

A 12-page catalog features complete data on all four popular switch families—rotary, push-button, lever and slide. Included are photographs, line drawings electrical characteristics, mechanical specifications and prices. A cross-referenced guide provides information for finding the right low-power switch for any equipment or circuit application. Oak.

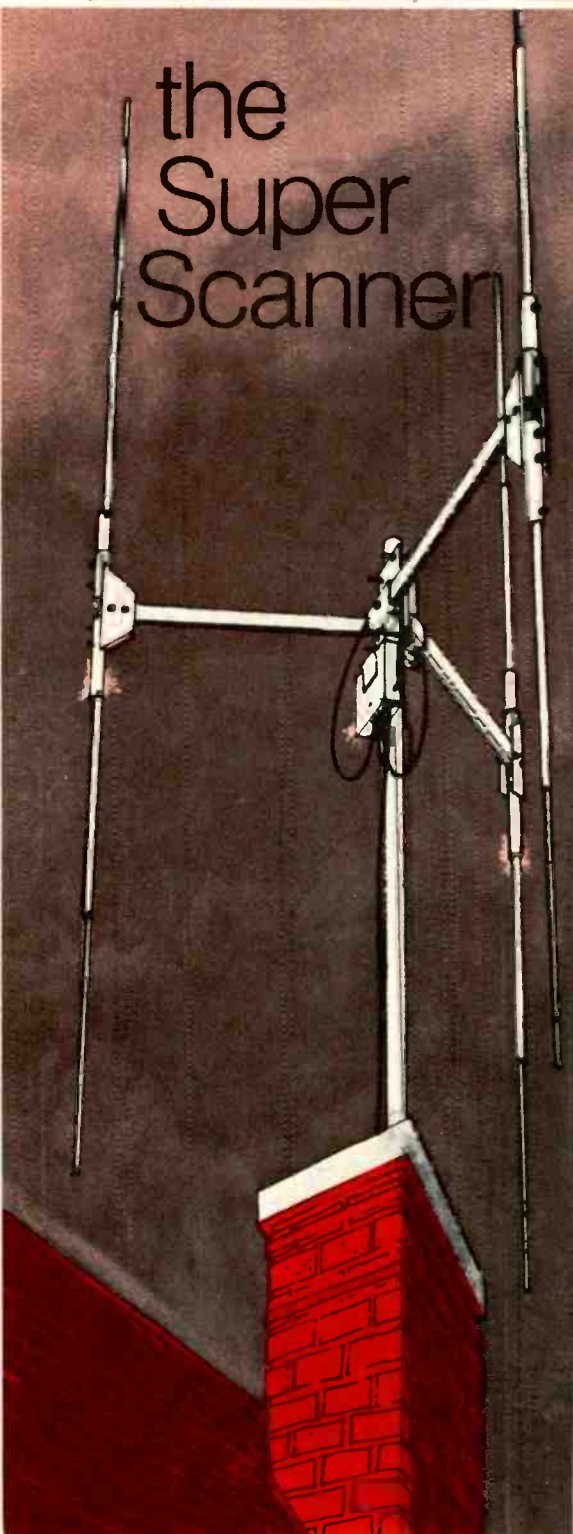

the
**Super
Scanner**



It took us two years
to make the
CB Scanner scan 360°
automatically

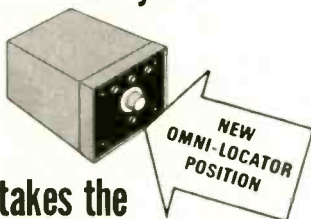

It takes the
Super Scanner
1/3 of a second to do it!

- Beam Mode: positive electronic beaming in choice of sectors — no mechanical rotator needed!
- Omni Mode: Special position for omnidirectional "searching"—just switch to use!
- Tremendous 7.75 dB forward gain in beam mode; 2.5 dB gain in omni mode!
- Front-to-back 23 dB—cuts backside noise drastically, increases effective forward range.
- Compact design—beats all beams for size and weight (just 17 lbs.) yet ruggedly constructed to take 100 MPH winds!

the antenna specialists co.

Division of Allen Electric and Equipment Co.
12435 Euclid Ave., Cleveland, Ohio 44106
Export offices: 2200 Shames Dr.,
Westbury, N.Y. 11590



® "Stripes of Quality"

ue. See the idling current chart for chassis numbers and their permissible values.

When idling current is too high, it is directly related to the bias network's diode voltage. A high voltage drop across the bias diode causes a high idling current. The diagram shows acceptable diode voltage drops for the R15, P53 and R19 chassis.

To monitor the idling current of the power output stages requires a current meter (Simpson 260 or equivalent) and a monitoring point that will not upset circuit parameters. The best place to check the idle current is in the Q2 collector to collector voltage supply circuit.

Carefully open the foil track from the collector to B+ and connect the current meter leads across the open foil. Switch on the power and monitor the current. Should the chassis current be greater than those listed on the idling current chart, correction in the bias network is needed.

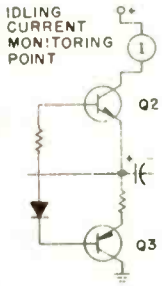

To correct for high idle current in the silicon quasi chassis, replace the original bias diode with a regular silicon power diode. Check the idle current again, should the current remain higher than normal, shunt the bias load resistor with a 47Ω resistor to bring the idle current into the min-nom-max parameter.

Reviewing the monitoring procedure by the numbers: (1) Open the foil track of Q2 from the collector to B+ . (2)

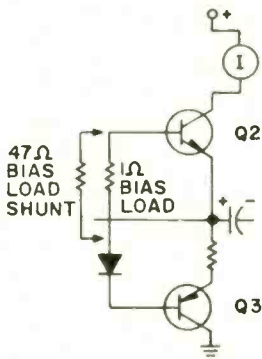

Place the Simpson 260 Current Meter across the open track. (3) Compare meter reading to idling current chart values. If high, replace bias diode with regular silicon power diode. (4) Recheck idle current. If further correction is needed, shunt the bias load resistor with 47Ω. The bias load resis-

3 GUN SALUTE

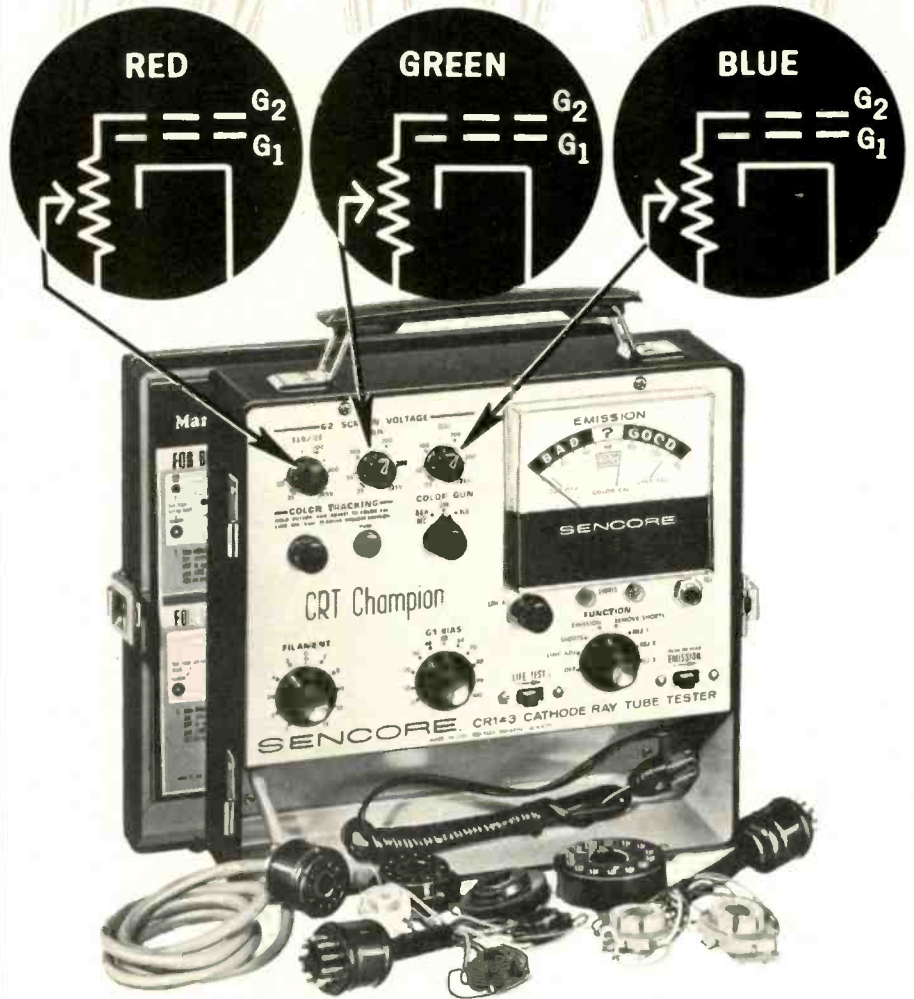

Only the Sencore CRT Champion has three gun control . . . Just like the color TV set.

Only Sencore has automatic color tracking to make your job easier.

Only Sencore has the simplified instructions in the cover so that you can analyze any color CRT tube in seconds. Just flip the "Color Gun" switch from red to green to blue (after setting the three G2 controls) and the CR143 Champion will tell you if the tube has adequate emission and if it will track in the TV set.

Why don't you salute the Sencore Champion today by marching in and asking your distributor to try one. You won't bring it back because it is 100 percent.



SENCORE

NO. 1 MANUFACTURER OF ELECTRONIC MAINTENANCE EQUIPMENT
426 SOUTH WESTGATE DRIVE, ADDISON, ILLINOIS 60101

. . . for more details circle 134 on postcard



Mark this

FOR IMMEDIATE ACTION!
6 MARKING PENS FREE
when you buy 3
specially priced

Perma-Power Color-Brite Briteners

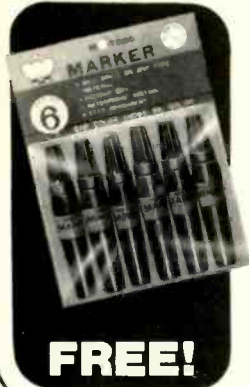

FREE!



Set of 6 broad-line
felt-tipped markers
1 Blue 1 Red
1 Green 3 Black

C-501 + C-511 + C-511
for for for
round rectangular rectangular
tubes tubes tubes

\$5.85 + \$5.85 + \$5.85 = ~~\$17.55~~
Now specially priced at \$15.75

Thousands of uses
in

SHOP AND HOME

Sets like this sell for
\$2.95 at office
supply counters

You save \$1.80, get the free pen set, and make 3 customers
VERY HAPPY by prolonging the life of their expensive color
picture tube.

**HURRY—HURRY—HURRY—SUPPLIES LIMITED
SEE YOUR DISTRIBUTOR NOW**

Perma-Power

Division of Chamberlain Manufacturing Corporation
5740 North Tripp Avenue • Chicago, Illinois 60646
Phone: (312) 539-7171

... for more details circle 130 on postcard

Tech. Digest . . .

tance change will normally bring the idling current into the min-nom-max parameter.

NOTE: Use number 1 and 2 of the monitoring procedure when checking out the idling current of germanium quasi amplifiers.

Germanium quasi amplifiers use a bias resistor and no diode in their bias network. Should idling current run in excess of the values in the idling current chart, a 47Ω shunt across the bias resistor will bring the idle current within the min-nom-max parameters as it did on the silicon quasi amplifier.

Germanium Quasi Chassis	MA Min	Idling Nom	Current Max.
R11	2	4	15
R16	2	4	15
R17	2	4	15
S36	2	4	15
U06	2	4	15
U07	2	4	15
P53	4	6	10
R15	4	6	10
R19	4	6	10

Silicon Quasi Chassis

P53	5	10	15
R15	5	10	15
R19	5	10	15

All measurements made at 120vac line.

Colorfax . . .

continued from page 72

pulses, are the output. These spikes are fed to the AGC keyer.

In solid-state receivers, it is normal for the AGC bias to be made more positive as the signal tends to increase (forward bias). Fig. 2 and 3 show two methods of modifying the AGC keyer to accomplish this. In Fig. 2, an NPN transistor (Q1) is used as a keyer. The circuit works much like the tube circuit, except that noise pulses are canceled at the base of the transistor instead of being fed to separate elements of the amplifying device. Transistor Q2 is simply an inverter which changes a negative-going input into a positive-going output; gain is very low and may be less than unity. This circuit is useful if both forward and reverse AGC are used in the same receiver.

In Fig. 3, positive-going AGC is obtained by using a PNP transistor and reversing the polarities of all the inputs. In this circuit, capacitor C1 is discharged through the transistor during retrace time, and then it must charge through R1 during trace time. As in Fig. 2, the function of the diode is to prevent the AGC voltage from "leaking off" through the transistor.

The brand for all reasons



BSR McDONALD 800

Every BSR McDonald automatic turntable is precision made in Great Britain to the most exacting specifications. Upon their arrival in the U.S., every model is unpacked and re-tested under actual playing conditions. That's why BSR service calls are the lowest in the industry—and perhaps that also explains why BSR sells more turntables than anyone else in the world.



McDONALD

"S"
BSR (USA) LTD.
BLAUVELT, N.Y. 10913
Please send FREE detailed literature
on all BSR McDonald automatic turntables.

Name _____

Address _____

City _____

State _____

Zip _____

... for more details circle 110 on postcard

continued from page 43

circuit, approximately 6v is applied to the collector of the control transistor. This 6v is provided by the zener regulated 10v source through a 36K resistor and a 56K voltage divider. In the UHF tuner oscillator circuit, approximately 6v is applied to the cathode of the varactor diode. This 6v is provided by the zener regulated 10v source through a 27K and a 68K voltage divider.

With the AFC switch in the OFF position, a fixed voltage of approximately 5v is applied to the base of the control transistor in the VHF tuner and to the anode of the varactor diode in the UHF tuner. This 5v is provided by the zener regulated 10v source through two 10K resistors in a voltage divider network.

With the AFC switch in the ON position, the AFC circuit should provide an equivalent 5v to the control devices as was provided with the AFC switch OFF. To provide this equivalent 5v, the AFC bias adjustment is set to develop 5v at the collector of the AFC amplifier transistor. This 5v is determined by the conduction of the AFC amplifier transistor. Conduction of the transistor is in turn determined by the voltage applied to its base. The voltage (1.3v) at the AFC bias adjustment is provided by the voltage divider between pins 8 and 5 of the IF amplifier and limiter integrated circuit.

The output of IC60 is coupled to a discriminator circuit. Any change in tuner oscillator frequency, causing a change in IF frequency, is detected as a dc voltage on the base of Q62, the AFC amplifier transistor. These base voltage variations affect the conduction of Q62, causing a change in the collector voltage. The collector voltage change is then applied to the control devices (Q901 or D952) in the tuner oscillator circuit to bring the circuit back on frequency.

Next month's Teklab report will cover the circuits employed in Admiral's Model 2017P portable color television. ■

NOW - CHECK ALL TRANSISTORS IN OR OUT OF CIRCUIT . . .

Flick function switch to left to check all regular transistors.

Flick function switch to right to check any FET.



all regular transistors plus the new field effect transistors.

You won't be stopped when you run into the new FETs that are wired into the latest hi-fi, newest TV receivers and nearly every other new device coming on the market. For the very first time, you can check them all, in or out of circuit. The TF151 works every time using tried and proven signal injection techniques. New, improved tests on special RF transistors and the latest high power transistors, mean that the TF151 is the only up-to-date transistor tester on the market. A new, exclusive setup book in rear compartment guides you to every test for over 12,000 transistors and FETs. The book is not needed for general service troubleshooting. Regular transistors are checked for beta gain and I_{cbo} leakage. FETs are checked for transconductance and I_{gss} leakage. **only \$129⁵⁰**

Your distributor just got this new tester in stock.
See him, it obsoletes all others.



SENCORE

NO. 1 MANUFACTURER OF ELECTRONIC MAINTENANCE EQUIPMENT
426 SOUTH WESTGATE DRIVE, ADDISON, ILLINOIS 60101

. . . for more details circle 135 on postcard

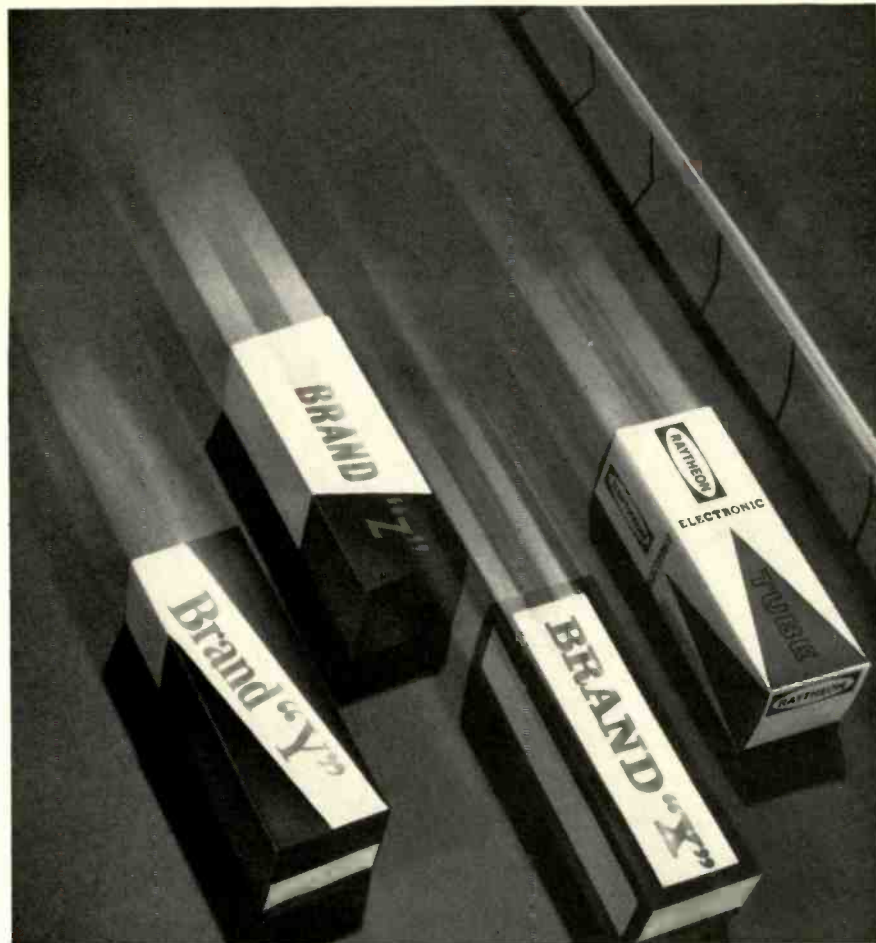
continued from page 49

Who'll be first?

It could be us. We're getting there...working our way up...because we put quality first. We're already the leading independent tube manufacturer serving independent servicemen.

You see, ever since Raytheon produced the first receiving tube, we've made tubes to just one specification: our own highest quality standards. Every tube must pass rigorous electrical and mechanical checks before we sell it to you.

That's why you rarely—if ever—get a call-back because of Raytheon receiving tubes. It's also why we've sold more than 500 million tubes. And why Raytheon is universally regarded as the No. 1 supplier of reliable receiving tubes.

Who knows? If we keep on put-

ting quality first, we could become the largest supplier! Especially if you keep on backing us by asking for "Raytheon quality" receiving tubes.

Why not? You earn greater customer satisfaction...make more profit per tube. Ask your distributor about the current Raytheon promotion.

Raytheon Company, Receiving Tube Operation, Fourth Avenue, Burlington, Massachusetts 01803.



Remember to ask
"WHAT ELSE NEEDS FIXING?"

...for more details circle 132 on postcard

without the need for conversion. In addition, the log scale gives an expanded range capability much greater than that achievable with a linear scale of comparable arc. A useful convenience item (available on some SSM models) is an automatic shutoff switch actuated by closing the meter cover.

In the circuitry area, adequate shielding of the IF and separate tuner sections is a must. Lack of shielding will tend to make the unit susceptible to internal signal interaction and pickup of external RF; either of these problems could result in a false set of signal readings.

VHF tuning should be accurate with sound and video carriers falling within their respective marks. The UHF tuning control should have indicated channel designations together with the accuracy required in this crowded 70 channel segment of the spectrum. A separate 360° UHF tuning control is helpful in this respect. Some units possess separate VHF and UHF 300 Ω inputs with shorter jacks provided in the critical UHF section to reduce the effects of stray capacitance. Properly compensated attenuators are also a must. Since different compensation is necessary to ensure the accuracy of VHF and UHF attenuators, most manufacturers of SSM units provide independent attenuation switches for each of the respective tuners.

Taking maximum advantage of your SSM requires that it be portable, light weight and include a shoulder strap to make life easier—particularly if you intend to do any ladder climbing for rooftop signal surveys. Many of the mentioned "desirables" can be checked at the time of purchase. A length of 300Ω twin-lead wire enables you to make some on-the-spot determinations of such things as channel accuracy, ease of reading and control simplicity. With cautious selection, and a familiarity with capabilities of your SSM, it can become one of your most useful, profitable and versatile TV test instruments. ■

Servicing . . .

continued from page 53

Pulse Modulating the Received Video: This type interference is often caused by spurious high frequencies generated by the flyback system entering the RF and IF stages of the receiver. Since the horizontal circuit does the generating interference, it will easily lock in a vertical black, white or wavy line on the TV raster. If the interference enters in the video circuit, no station is needed to see the lines. If entry is made in the IF or RF sections, a carrier of some sort is needed to carry the signal through to the video detector. ■

Repairing . . .

continued from page 59

also replaced and operation restored to normal.

DEAD RECEIVER POOR BALANCING

A dead receiver was checked for output voltage which proved to be zero. A resistance measurement of the silicon diode revealed a shorted condition and the diode was replaced—still no reception.

Checking the circuit a step further we found an open 330Ω 5W dropping resistor (Fig. 10). After replacing the dropping resistor the supply voltage returned to normal at 78v.

In another AM-FM chassis, the radio and phono section appeared dead. The same check showed no dc output voltage. A resistance reading was taken on each of the silicon diodes. One diode was open and the other a dead short (Fig. 11). Replacing both diodes restored operation.

The right channel in a Silver-tone chassis appeared weak.

The audio signal generator was used to check each AF stage for a loss of signal by feeding a low level output from the audio signal generator to the base and collector of each stage. This particular problem was traced to a defective $5\mu\text{f}$ electrolytic coupling capacitor (Fig. 12). ■



Imagine
a doctor
without a
stethoscope



Imagine
an engineer
without a
slide rule



Imagine
a professional
service technician
without a Sencore
Mighty Mite V.



STANDARD OF A PROFESSION!

The Mighty Mite has become the standard of the industry with over 50,000 used daily by competent professional servicemen from coast to coast. The Mighty Mite checks them all; tubes large and small . . . and it checks them critically too. 100 megohm grid leakage sensitivity, individual tube element shorts test and cathode emission test at full rated current make the Mighty Mite really tough. It's tough on tube tests, tough in appearance with vinyl case and cover, and mighty tough on competition. But, it's not tough on your pocketbook at only

See your Sencore distributor today.

He has the TC142 Mighty Mite in stock.

\$84.50



SENCORE

NO. 1 MANUFACTURER OF ELECTRONIC MAINTENANCE EQUIPMENT

426 SOUTH WESTGATE DRIVE, ADDISON, ILLINOIS 60101

. . . for more details circle 136 on postcard

NEW FROM INJECTORALL



HERE'S PROOF!

PROOF that "SUPER 100" tuner cleaner is BETTER!

Tested by a leading independent laboratory against competitive products!

	SUPER 100	A	B	C
CLEANING	Excellent	Good	Fair	Fair
LUBRICATION	Good	Fair	Fair	Poor
PLASTIC ATTACK	None	None	None	None
FLAMMABILITY	None	None	None	None
CONDUCTIVITY	None	None	Slight	Slight
ANTI-STATIC PROTECTION	Excellent	Fair	Poor	Poor
DRIFT	None	Slight	Yes	Yes

SUPER 100 TUNER CLEANER . . . for COLOR and Black and White TV tuners 6 oz. spray can with INJECTORALL steel needle CAT. NO. 100-6 net \$2.10 Buy it at your Electronic Dealer. For free catalog on the complete line, write to: ET-9

INJECTORALL ELECTRONICS CORP.
Great Neck, New York 11024

. . . for more details circle 120 on postcard

ATR PRODUCTS FOR MODERN LIVING



ATR UNIVERSAL INVERTERS

A. C. Household Electricity Anywhere . . . in your car, boat or plane!
To Operate • Tape Recorders • TV Sets • Dictating Machines • Radios • Public Address Systems • Electric Shavers • Record Players • Food Mixers • and Emergency Lighting.
NET 12U-RHG (12 V.) 175-200 W. Sh. Wt. 27 lbs. 79.66
28U-RHG (28 V.) 150-175 W. Sh. Wt. 27 lbs. 96.66



ATR "A" Battery ELIMINATOR

For Demonstrating and Testing Auto Radios—TRANSISTOR or VIBRATOR OPERATED!
Designed for testing D.C. Electrical Apparatus on Regular A.C. Lines.

MAY ALSO BE USED AS A BATTERY CHARGER
MODEL 610C-ELIF . . . 6 volts at 10 amps. or 12 volts at 6 amps. Shipping weight 22 lbs.
USER NET PRICE \$59.82

ATR AUTO RADIO and COMMUNICATION

LONGER-LIFE VIBRATORS

"The Best by Test!"



ATR ELECTRONICS, INC.

Quality Products Since 1931
St. Paul, Minnesota 55101—U.S.A.

. . . for more details circle 106 on postcard

ET/D NEW PRODUCTS

continued from page 78

DIGITAL MULTIMETER 722

Reads ac, dc voltage;
ac, dc current and resistance

Introduced is the Type 340 Digital Multimeter. The configuration stations the instrument in a horizontal position at workable angle. All controls are by key command, reportedly increasing the ease of operation. The portable unit weighs 3 lb and is self-contained with no plug-ins or other extras to buy. Only one probe (included with instrument) is necessary for all measurement functions. It measures 6in. wide, 9in. long and 5 1/2in. high, including integral handle. Readout



display consists of 3 type plug-in tubes, with memory capacity to permit non-blinking display, plus a neon "1" indicator. Decimal points are automatically programmed by the range key. "Minus" sign lights to indicate negative signal. The Automatic Zero Adjustment is said to eliminate drift and assure instant stability. The unit operates directly from the ac line, with self-contained power supply. Ranges Available: From 1v F-S to 100v F-S, both ac and dc, 1K to 10M, 100µa to 1a, both ac and dc. 100 percent over-range on all ranges; over voltage protection of 100 times range (1000v and 1a maximum). Maximum Sensitivity: 1mv, 100na, 1 Ω. Accuracy: dc volts ±0.1% F-S ±1 digit; ac volts ±0.2%

F-S ±1 digit; K ohms ±0.2 percent
F-S ± 1 digit; M ohms ± 1.0 percent
F-S ± 1 digit. Measurement Cycle: Approximately 5 times per second. Stability: Single external vernier calibration adjustment. 60-day re-calibration recommended. Response Time: 20µs. Price: \$345. Digilin.

BATTERY CHARGER 723

Solid-state construction
and precision cutoff

A constant current battery charger, Model 520, is introduced. Designed for alkaline rechargeable nickel-cad-

AMAZING BERN'S PERFECT PIN CRIMPER

Picture-Tube Repair Tool
Also for—5U4, 6SN7, 6BQ6, etc.

Eliminates that hard soldering job
only \$1.69 each

A MUST for round color pic tubes
PT-1 3/32" PIN

Fix loose pin connections in seconds. Pays for itself in time saved on first job. Less than 3" long. Carry it in your pocket.

Patented

Intermittent operation of picture tubes and other tubes due to defective solder connections easily corrected. Provides solid electrical connections, can also be used as channel-selector wrench and screwdriver. Pin keeps its original form. A 3-in-1 tool.

3 MODELS ELIMINATE SOLDERING

Makes Solid Electrical Connections

Phono Pin-Plug Crimper

Strip wire in "pin plug," insert in tool, and squeeze . . . job is done.

AU-2 1/8" PIN

C-Rings 3 for 5¢
Use end of tool to push on C-ring for ground connection.

Ant. plugs, hi-fi, multiple plugs, public address, radio and TV tubes, radar, speakers, and loop connections. Many, many more uses.

Model LC-3 for 5/32" pin diameter
At your parts distributor, or write us

BERN'S MANUFACTURING CO.
P.O. BOX 237
WASHINGTON, MICH. 48094

. . . for more details circle 103 on postcard

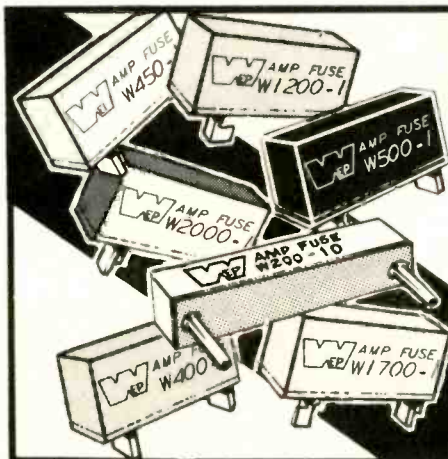

AMP FUSES

Reliable protective fusing device. COLOR CODED for easy replacement of original manufacturer's parts.

Listed in Howard Sams' Photo-facts and Counterfacts.

FREE vest pocket cross reference booklet indicating correct Workman part numbers to manufacturer's part numbers.

Ask for #X58

WORKMAN Electronic PRODUCTS, INC.
BOX 3828 SARASOTA, FLA. 33578
TELEPHONE: Area Code 813 955-4242

. . . for more details circle 144 on postcard

ARROW AUTOMATIC STAPLE GUNS

CUT WIRE & CABLE INSTALLATION COSTS

... without cutting into insulation!

SAFE! Grooved Guide positions wire for proper staple envelopment! Grooved Driving Blade stops staple at right depth of penetration to prevent cutting into wire or cable insulation!

No. T-18—Fits wires up to 3/16" in diameter.

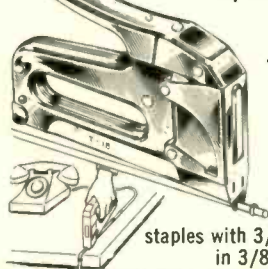

**BELL,
TELEPHONE,
THERMOSTAT,
INTERCOM,
BURGLAR
ALARM
and other low
voltage wiring.**

Uses T-18 staples with 3/16" round crown in 3/8" leg length only.

No. T-25—Fits wires up to 1/4" in diameter.

Same basic construction and fastens same wires as No. T-18.

Also used for
**RADIANT
HEAT WIRE**

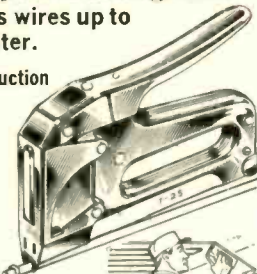

Uses T-25 staples with 1/4" round crown in 9/32", 3/8", 7/16" and 9/16" leg lengths.

T-18 and T-25 staples also available in Monel and with beige, brown and ivory finish at extra cost.

No. T-75—Fits wires and cables up to 1/2" in diameter.

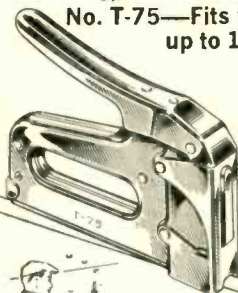

**RADIANT HEAT
CABLE,
UF CABLE,
WIRE CONDUIT
COPPER TUBING
or any non-metallic
sheathed cable.**

Also used as
**DRIVE RINGS
in stringing wires.**

Uses T-75 staples with 1/2" flat crown in 9/16", 5/8" and 7/8" leg lengths.

Arrow Automatic Staple Guns save 70% in time and effort on every type of wire or cable fastening job. Arrow staples are specially designed with divergent-pointed legs for easier driving and rosin-coated for greater holding power! All-steel construction and high-carbon hardened steel working parts are your assurance of maximum long-life service and trouble-free performance.

Ask your Electrical Supply Dealer or write for further details.

ARROW FASTENER COMPANY INC.

Saddle Brook, New Jersey 07663

**"Pioneers and Pacesetters
For Almost A Half Century"**

... for more details circle 105 on postcard



mium, silver-cadmium, silver-zinc or similar cells with an end-of-charge voltage of up to 50v, the charger limits output current to a preset value. With solid-state construction, the device is protected against short circuits by its own current limiting capability. Price \$175. A&R Controls.

AUDIO GENERATOR 724 SOLID-STATE POCKET SIZE

A mini-size solid-state audio generator is introduced. The #4110 measures 2 7/8 x 4 x 1 5/8in. and weighs

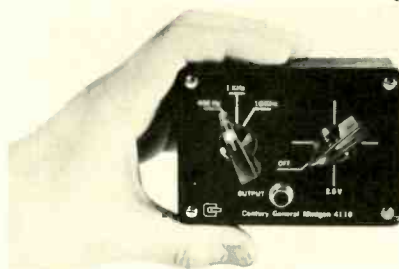

7 1/2oz. It produces tones at 400Hz, 1kHz and 10kHz. The 10kHz tone is convertible to 5kHz by slight internal modification. The output is continuously variable 0 to 2.5v. Price with probe and standard 9v transistor battery is \$14.95. Century.



**Free copy
on request**

NEW!



- World's largest selection
- Factory OEM prices
- Reliable service

ALLIED 600-PAGE 1970 INDUSTRIAL ELECTRONICS CATALOG

600 pages, over 60,000 items—by far the largest, most comprehensive electronics catalog in the world. Circle reader service card for your free copy, or send postcard to:

ALLIED ELECTRONICS Dept. 702
100 N. Western Ave., Chicago, Ill. 60680

FEATURING **DEARBORN** WIRE & CABLE CORP. 

Allied's in-depth stocks of Dearborn wire and cable are available to service the needs of the industrial, military, and electronics market. Allied can supply any Dearborn wire and cable to satisfy your requirements.

... for more details circle 102 on postcard

**MILLIONS ARE
SPENT TO FIX
2-WAY RADIOS.
WHAT'S YOUR
CUT?**

If you'd like to get into a top-paying job, maybe FM 2-way radio is for you. Each year, more and more businesses are buying 2-way. That means service. And service means money. We can train you to get in on the action. Our special home study course is the place to start. We teach you FM 2-way radio servicing, and prepare you for an FCC license.

- Send me FREE Evaluation Examination.
- Send details on Home Study Course on FM 2-way radio servicing.
- Send details on how you can prepare me for an FCC license.

Name _____ Occupation _____

Address _____

City _____ State _____ Zip _____

**MOTOROLA
TRAINING INSTITUTE**



1301 Algonquin Road, Schaumburg, Ill. 60172

... for more details circle 126 on postcard

WIRE OUT AT THE RF. AMP



Order No. 2400
GIANT 24 oz. CAN
only \$325
DEALER NET



CHEMTRONICS

1260 RALPH AVE.
BKLYN., N. Y. 11236

FOR EXPORT:
ROBURN AGENCIES INC., NEW YORK, N.Y.
IN CANADA: PERFECT MANUFACTURING LTD.,
MONTREAL 9, CANADA

... for more details circle 112 on postcard

ET/D AD INDEX

Accurate Instrument Co.	69
Allied Radio Corp.	93
American Telephone & Telegraph Co.	85
Antenna Specialists Co.	86
Arrow Fastener Co.	93
ATR Electronics	92
B & K Division	2nd Cover, 76
Belden Corporation	26-27
Berns Manufacturing Co.	92
BSR (USA) Ltd.	88
Castle TV Tuner Service	23
Channelock, Inc.	78
Chemtronics, Inc.	94
Cleveland Institute of Electronics	71, 84
Cornell-Dubilier	3rd Cover
C.R.T. Equipment Co.	31
Enterprise Development Corp.	94
Gem City Tuner	28
General Electric Co., Receiving Tubes	81
Heath Company	34
Hudson Lamp Co.	82
Injectorall Electronics Corp.	92
International Crystal Mfg. Co.	22
International Textbook Co.	25
Johnson Co., E.F.	67
Lectrotech, Inc.	72
Mallory Distributor Products Co.	20
Motorola Communications & Electronics	32, 75, 93
Multicore Sales Corp.	94
National Radio Institute	80
Perma-Power Co.	88
Quam-Nichols Co.	30
Raytheon Company	90
RCA Electronic Components, Entertainment Tubes	4th Cover
RCA Parts & Accessories	35-38
RCA Electronic Components, Semiconductor	77
Sencore, Inc.	87, 89, 91
Sprague Products Co.	29
Sylvania Electric Products	40
Tektronix, Inc.	39
Triplet Electrical Instrument Company	83
Tuner Service Corp.	19
Ungar Div., Eldon Industries	65
Winegard Company	68
Workman Electronic Products, Inc.	92
Zenith Radio Corp.	73, 79, 84



**WORLD'S
FINEST
5-CORE
SOLDER**

**ERSIN
MULTICORE**

**NEW EASY
DISPENSER
PAK ONLY 69¢**

BUY IT AT RADIO-TV PARTS STORES

MULTICORE SALES CORP., WESTBURY, N.Y. 11591

... for more details circle 129 on postcard

NEW!

A BETTER WAY
TO REPLACE
SOLDERED
COMPONENTS

LENGTH 8"
WEIGHT 3½ OZ



ENDECO

**Pencil
Soldering
Iron**
MODEL 300

Now—remove miniature soldered components in seconds—without damage

Hollow tip fits over connection; vacuums all solder for easy removal of component. Leaves terminals and mounting holes clean. Then, with 360° contact, it resolders faster, better than regular irons. Handles miniature and standard components in PC boards and conventional wiring. Self-cleaning. All parts replaceable. 40 watts, 120-v. Standard tip supplied, 6 other tip sizes. Pays for itself. \$10.95 net East of the Rockies.

Larger model available. See your distributor or write:

ENTERPRISE DEVELOPMENT CORPORATION

5149 E. 65th • Indianapolis, Ind. 46220

... for more details circle 117 on postcard

ELECTRONIC TECHNICIAN/DEALER

... for more details on Cornell Dubilier Circle Number 115.



Put your parts in order.

All it takes is genius to arrive at simplicity. This new display stand is deceiving. It's more than a display stand. It's set up to operate like a store within your store for instant servicing.

Here, within this unit, is a complete stock of all the wide range twist prongs you'll need plus micas, miniature electrolytics, ceramics, wide range tubulars and dipped paper Mylar.* The selection was based on an extensive study of all capacitors used in the replacement market. Now, with the Re-Place, you're in the capacitor

replacement business. The Re-Place only takes 2' x 5' in space and you have all your parts in order.

Interested? Write for our new catalog on The Re-Place™ capacitor line. "The Replacers" — the most complete line of replacement capacitors in the smallest possible package.

CDE CORNELL-DUBILIER

COMING YOUR WAY FOR CHRISTMAS '69 RCA'S

TOY CARNIVAL

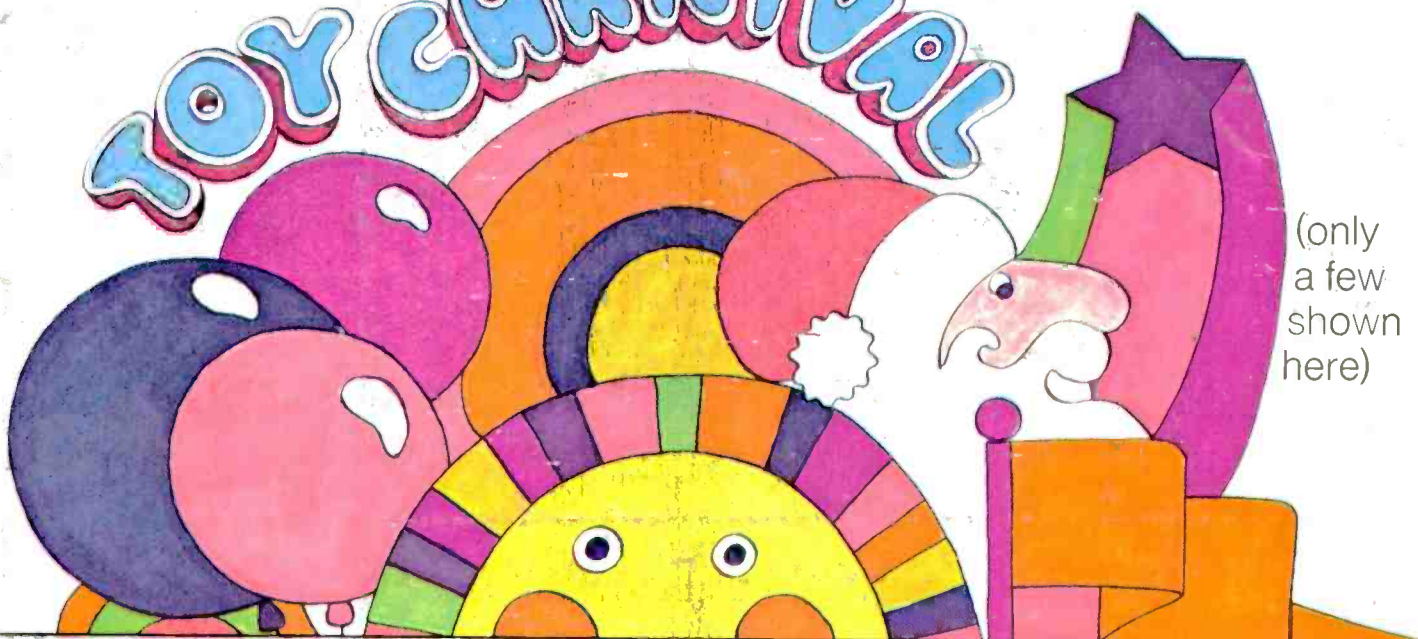

(only a few shown here)

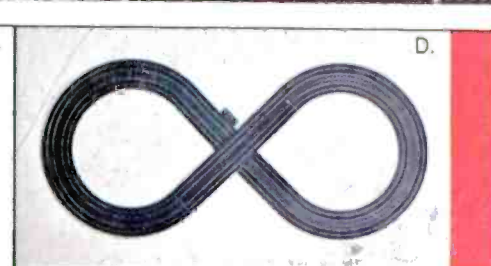

* 17 wondrous toys (only a few shown here) to light up the eyes of children of all ages!
 * available with purchases of RCA Entertainment Receiving Tubes and Picture Tubes from your local participating RCA Tube Distributor.



- A. HUFFY BOY'S BICYCLE "DRAGSTER III"—TC-2044—3 speeds
- B. ATLAS N-GAUGE READY-TO-RUN TRAIN SET—TC-69364—complete
- C. PLUSH DOG—TC-2262—cute-as-a-button beagle type
- D. ATLAS ROAD RACING-SET—TC-1202—complete with power supply
- E. PARKER "QUBIC" GAME—TC-400—3-dimensional Tic-Tac-Toe
- F. COLLECTOR'S SET AMERICAN SPACE PROGRAM BY REVELL—TC-1839—3 ready-to-assemble models
- G. HORSMAN "BABY BUTTERCUP" DOLL—TC-5301—drinks and wets
- H. MIGHTY-TONKA DUMP TRUCK—TC-3900—a kid can ride it
- I. HORSMAN "BABY TWEAKS"—TC-2570—18" tall, she "coos"

See your participating RCA Tube Distributor for details

RCA Electronic Components, Harrison, N.J. 07029

