

# ELECTRONIC TECHNICIAN

WORLD'S LARGEST ELECTRONIC TRADE CIRCULATION

AUGUST 1967



The State of Solid-State  
Servicing Solid-State TVs  
Using Audio Test Instruments

FRISEW108123922N869AA3A17966B  
WILLIAM W FRISE  
7176 GALE RD  
ATLAS MI

48411

## Help stamp out blue people

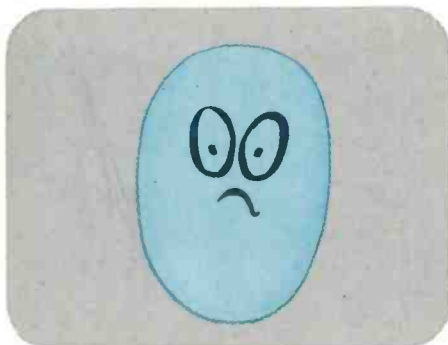

## Focus on Jerrold Paralog Plus™ Coloraxial Antennas for true color



Jerrold Paralog Plus Antennas show a definite improvement in the sharpness, fidelity and color stability of the image on any TV set. Sharp directivity, uniform response and perfect matching see to that! And the rugged construction insures that the quality stays

high—not for months—but for years. It's the high-gain Coloraxial antenna for people who insist on VHF and FM reception—without compromise. And there are seven models to choose from.

The Paralog Plus is one of a complete spectrum of problem-

solving Jerrold TV reception aids—Pathfinder, VUfinder and Colorpeak antennas...Powermate pre-amplifiers, amplified-couplers and splitters... Coloraxial cable, wall outlets and wall plates. See your Jerrold distributor today. Catalog available on request.

**JERROLD**®

Focusing on one thing—  
better reception

... for more details circle 102 on postcard

# ELECTRONIC TECHNICIAN TEKFAK

COMPLETE MANUFACTURER'S CIRCUIT DIAGRAMS  
AND TECHNICAL INFORMATION FOR 6 NEW SETS

## 1099

PHILCO  
TV Chassis  
17C21,A,V,AV

AUGUST • 1967

GROUP  
**180**

SCHEMATIC NO.

SCHEMATIC NO.

AIRLINE ..... 1100  
Color TV Model GHJ-8247A,57A

MAGNAVOX ..... 1103  
Color TV Chassis T920 Series

CANADIAN GENERAL ELECTRIC ... 1101  
TV Chassis M649

PHILCO ..... 1099  
TV Chassis 17C21,A,V,AV

CORONADO ..... 1102  
TV Model TV 21-9367A

RCA VICTOR ..... 1104  
TV Chassis KCS165 Series

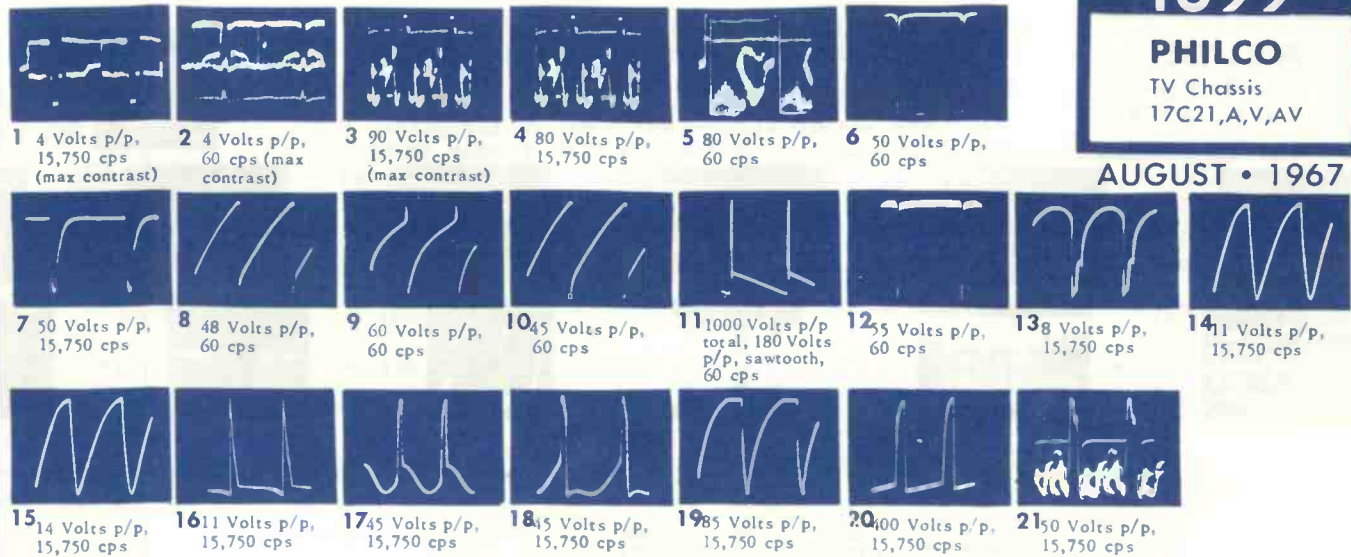

### OSCILLOSCOPE WAVEFORMS

These waveforms were taken with the receiver adjusted and 3 where contrast was at maximum. The voltages given are for an approximate output of 4 V p/p at the video detector. approximate peak-to-peak values. The frequencies shown are Voltage readings taken with raster just filling screen and all those of the waveforms...not the sweep rate of the oscilloscope. controls set for normal picture viewing except for photos 1, 2, All readings taken with Model PS127 Sencore Oscilloscope.

SYMBOL	TUBE	FUNCTION	PIN NUMBERS											
			1	2	3	4	5	6	7	8	9	10	11	12
V1	6X4	Sound Oscillator	9	8	800V	FIL	FIL	200V	18A	2	3	3	3	
V2	12X5	Video Amp & Cathode AGC	4	8	25K	1	8	FIL	FIL	0.2L	13A	18A	10H	
V3	12X5	Audio Output	8	8	0.1L	FIL	FIL	0.2L	13A	18A	18A	10H		
V4	6GH8A	Sec. IF & Sync. Sep.	18A	0.2L	18A	FIL	FIL	0.2L	13A	18A	18A	10H		
V5	17J28	Vari. Osc.	FIL	3	8	18A	FIL	18A	18A	18A	18A	10H		
V6	6FQ7	Horiz. Dev.	23A	2	18	0.2L	FIL	FIL	0.2L	13A	18A	10H		
V7	4EH7	1st Video IF	20L	6	600V	2	3	FIL	FIL	0.2L	13A	18A		
V8	4EJ7	2nd Video IF	100L	0.2L	100	FIL	FIL	0.2L	13A	18A	18A	10H		
V9	38897	Horiz. Out & Damper	FIL	13A	8C	8	8	8C	8C	0.2L	13A	18A		

SYMBOL	DESCRIPTION	PHILCO PART NO.
C41	240/240/160/5µf/200v B+ filter (17C21 & 21A)	30-2601-33
D1	dual phase comp	34-8037-1
D2	1N60C 2nd det	34-8022-6
L1	180mh CRT cathode (17C21 & 21A)	32-4762-7
L2	180mh CRT cathode (17C21V & 21AV)	32-4902-10
L3	390mh video plate (17C21 & 21A)	32-4762-11
L4	390mh video plate (17C21V & 21AV)	32-4902-14
L5	quad snd det	32-4876-1
L6	snd IF (17C21 & 21A)	32-4745-13
L7	snd IF (17C21V & 21AV)	32-4745-12
L8	4.5MHz trap and snd take-off	32-4688-14
L9	tuner cplg	32-4652-101
L10	1st IF plate	32-4686-34
L11	ch 6 beat video det	32-4754-3
L12	horiz stabilizer	32-4754-3
L13	RFC 60MHz damper plate	32-4112-63
L14	47.25MHz trap	32-4652-78
L15	41.25MHz trap	32-4652-80
L16	1st grid pole	32-4652-79
L17	47.25MHz trap	32-4652-78
L18	40MHz choke video det	32-4652-79
L19	video det coil	32-4652-78
L20	2nd IF plate	32-4112-63
L21	RFC 60MHz damper cathode	30-6024-9
N1	retroce suppress	30-6030-12
N2	vert integrator	30-6035-2
N3	horiz osc	33-1363-39
N4	phase comp	33-1373-6
N5	5.6k 3w video plate	33-1366-21
N6	varistor 560v @ 10ma vert out	32-10013-5
N7	5.6k fusistor	32-10010-10
N8	filter choke .6 hy (17C21 & 21A)	32-10075-1
N9	filter choke .6 hy (17C21V & 21AV)	32-10075-1
N10	horiz output	32-10008-8
N11	vert output	32-10012-9
N12	500k v size 2M v lin 60K H hold	33-5596-16
N13	500k vol & on-off sw	33-5619-22
N14	250k brightness	33-5619-21
N15	15k contrast	33-5619-20
N16	135k vert hold	33-5619-23
N17	VIF trap assy w/comp (module "A")	38-10213
N18	VIF trap panel less/comp	27-10561-9
N19	VIF det assy w/comp (module "B")	38-10214
N20	yoke & cable assy	76-12942-9
N21	tuner UHF TT152B (all chassis)	76-13827-2
N22	tuner VHF TT170 (17C21)	76-13978-1
N23	tuner VHF TT164B (17C21A & 21AV)	76-13945-3
N24	tuner VHF TT164C (17C21V)	76-13579-8

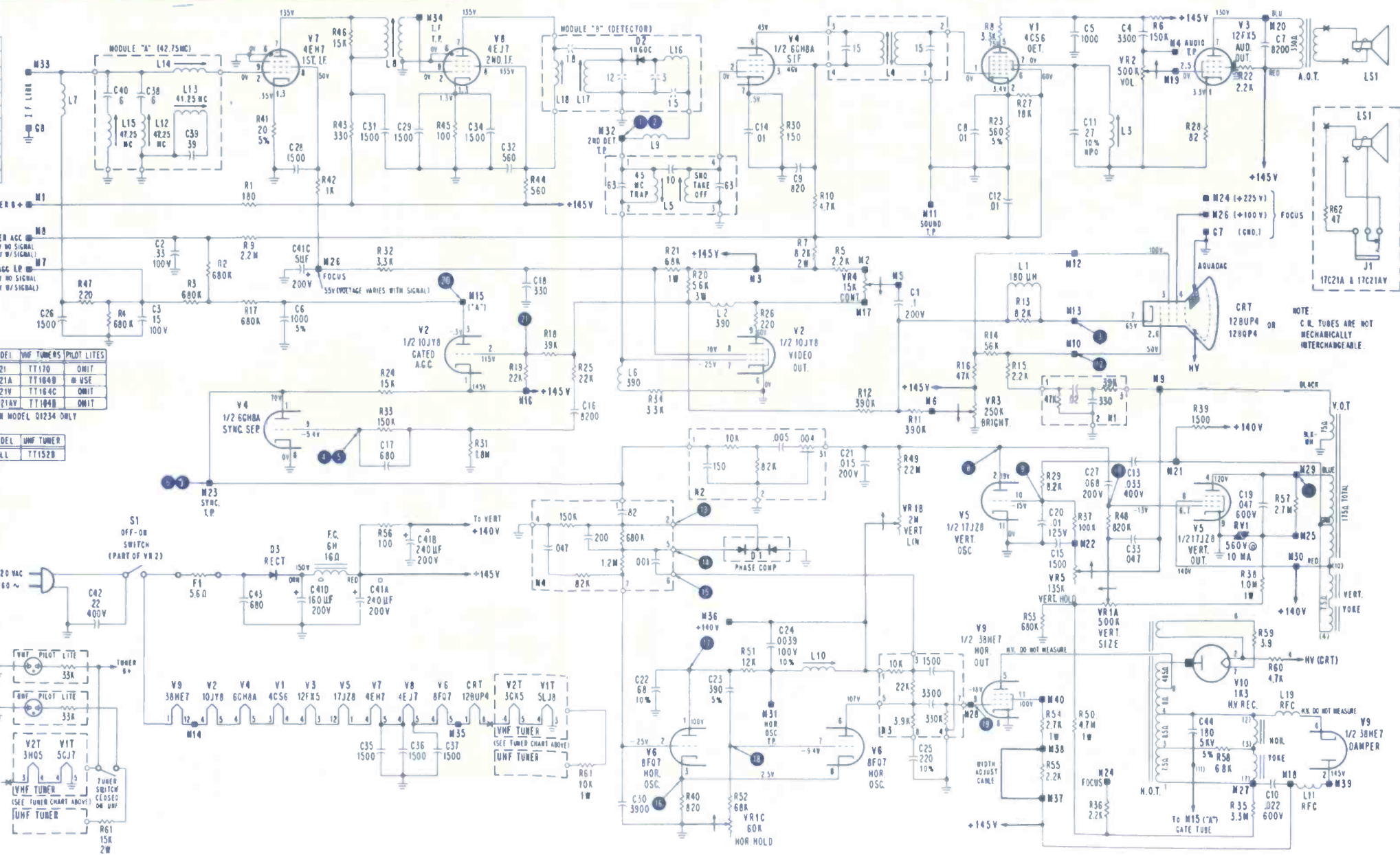

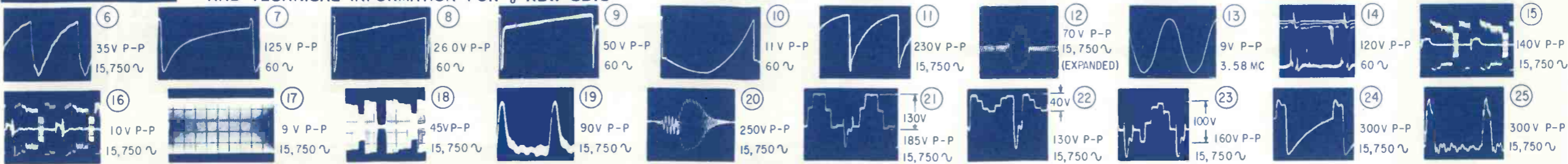

TELEVISION WAVEFORMS

NOTE: USE LOW-CAPACITY PROBE WHEN OBSERVING WAVEFORMS

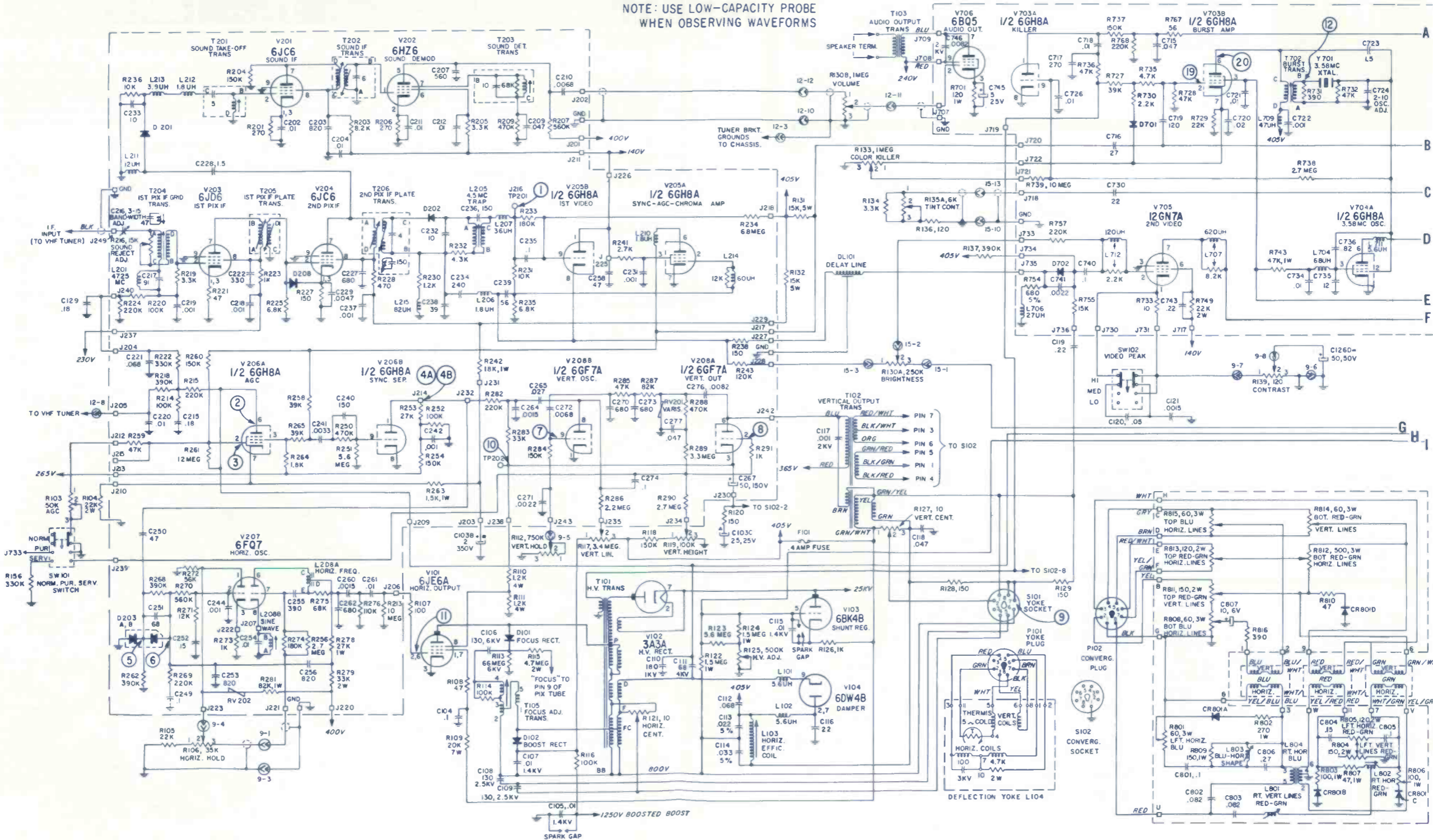

SYMBOL	DESCRIPTION	AIRLINE PART NO.
C103A	80µf 450v	
C103B	2µf 350v elect	034-025800
C103C	25µf 25v	
C107,115	0.1µf 1.4kv ±80-20% ceramic	837-103896
C106	130pf 6kv 20% N2200 ceramic	035-033300
C108,109	130pf 2.5kv 10% N2200 ceramic	035-043200
C111	68pf 4kv 10% N1500 ceramic	886-680017
C116	22pf 1kv 20% N750 ceramic	101CU-022
C117	100pf 2kv 20% paper	046-015500
C125A	80µf 450v	
C125B	30µf 450v elect	034-027000
C125C	20µf 450v	
C125D	20µf 450v	
C126A	80µf 450v	
C126B	50µf 450v elect	034-026000
C126C	20µf 250v	
C126D	50µf 50v	
C216	3-15pf ceramic trimmer	050-003500
C232,233	10pf 500v ±5% NPO ceramic	10TC-Q10
C255	390pf 2kv 5% N1500 ceramic	886-391957
C262	680pf 500v 5% mica	045-007300
C707	330pf 500v 5% mica	047-007200

C733	560pf 500v 5% mica	045-008600
R109	13k 7w 10% film	054-133710
R110,111	1200Ω 4w 10% film	054-122410
R113	66M 6kv 20% film	057-000400
R131,132	15k 5w 10% film	054-153510
R141	27k 7w 10% film	054-273710
R151	25k 10w 10% WW	053-252110
R154	14k 20w 10% WW	053-142310
R176	15k trimmer pot	055-055400
RT01	thermistor	057-001200
RV201	voltage dependent resistor	057-000200
RV202	voltage dependent resistor	057-001600
RV203	voltage dependent resistor	057-001300
R706	6800Ω 4w 10% film	054-682410
L101,102	5.6µh RF choke coil	111-021200
L103	horiz efficiency coil	111-036200
L104	deflection yoke assembly w/cable and plug	027-032900
L105	filter choke	032-002600
L201	47.25MHz trap coil	109-036000
L203,204	filament choke	111-035100
L205	4.5MHz trap coil	109-034700
L206,210,212	1.8µh choke coil	111-021000
L207	36µh peaking coil	111-036900
L208	horiz osc coil	110-003800
L211	12µh choke coil	111-036800
L213	3.9µh choke coil	111-036400

L214	60µh peaking coil	111-035000
L215	82µh choke coil	111-034900
L701,702	620µh coil	111-036700
L703,711	5.7µh coil	111-036500
L704	68µh coil	111-035400
L705	3.9µh coil	111-036400
L706	27µh coil	111-035200
L707	620µh coil	111-037000
L708	390µh coil	111-036600
L709	47µh coil	111-035300
L710	chroma take-off coil	109-033800
L712	120µh coil	111-021400
L801	R/G vert lines coil	111-031800
L802	R/G horiz lines coil	111-031700
L803	blue horiz shape coil	111-031900
L804	blue horiz lines coil	111-031600
L101	horiz output xformer	033-012800
L140	green drive 6k	033-013300
L142	blue drive 6k	033-013300
L143	pix tube bias 250k	031-009400
L144	blue screen adjust 1.5M	033-012900
L145	green screen adjust 1.5M	033-012900
L146	red screen adjust 1.5M	031-009400
L153	color killer 1M	033-012900
R801,808,814,815	60Ω 3w WW	111-032200
R804,811	150Ω 2w WW	109-034200
R802	2nd pix IF xformer	109-034300
T206	2nd pix IF xformer	109-034400

T206	2nd pix IF xformer	109-034600
T701	chroma bond-pass xformer	109-035700
T702	burst amplifier xformer	109-033700
T703	3.58MHz osc xformer	109-035600
R103	AGC 50k	055-058200
R106	horiz hold 35k	055-057100
R112	vert hold 750k	055-057000
R117	vert lin 3.4M	055-058100
R119	vert height 100k	055-057500
R121	horiz centering 10Ω	056-039100
R125	high voltage 500k	055-036500
R127	vert centering 10Ω	056-037700
R130A	volume 1M	
R130B	brightness 250k	055-058400
R135A	fini 6k	
R135B	color 500k	055-055600
R139	contrast 120Ω	055-055500
R140	green drive 6k	055-057600
R142	blue drive 6k	055-057700
R143	pix tube bias 250k	055-057300
R144	blue screen adjust 1.5M	055-058000
R145	green screen adjust 1.5M	055-057900
R146	red screen adjust 1.5M	055-057800
R153	color killer 1M	055-057400
R801,808,814,815	60Ω 3w WW	056-046800
R804,811	150Ω 2w WW	056-047300

R805,813	120Ω 2w WW	056-047200
R812	500Ω 3w WW	056-046700
D101	diode focus rectifier	004-003200
D102	diode boost rectifier	004-003100
	chroma board	073-036000
CB101	circuit breaker 3amp	009-002500
CPR101,102	couplate 2.2M/100pf/S.G.	134-039400
DL101	delay line	111-036100
F101	fuse 4amp slo-blo	099-002800
SG101,102,103	spark gap	140-000300
SW102	switch video peaking	146-007800
SW103	switch ON/OFF power tuner VHF	146-010500
	tuner UHF see tuner parts list	006-018901

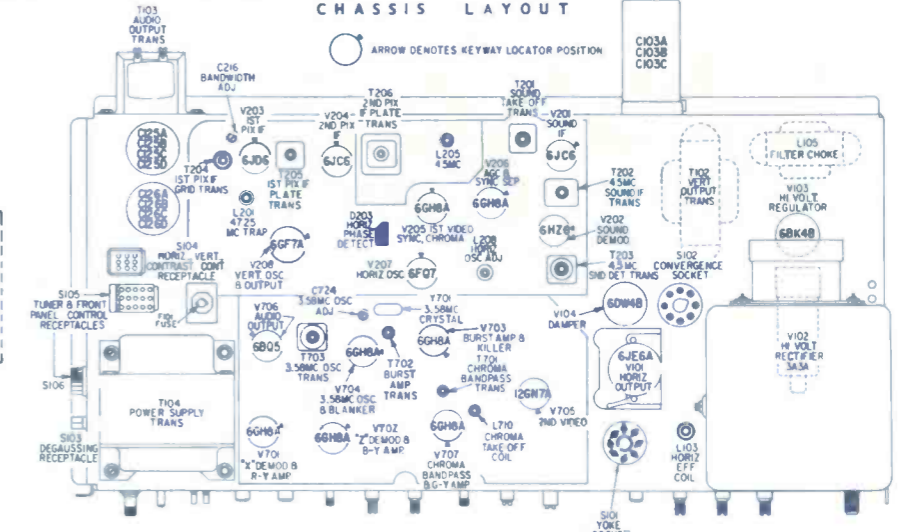
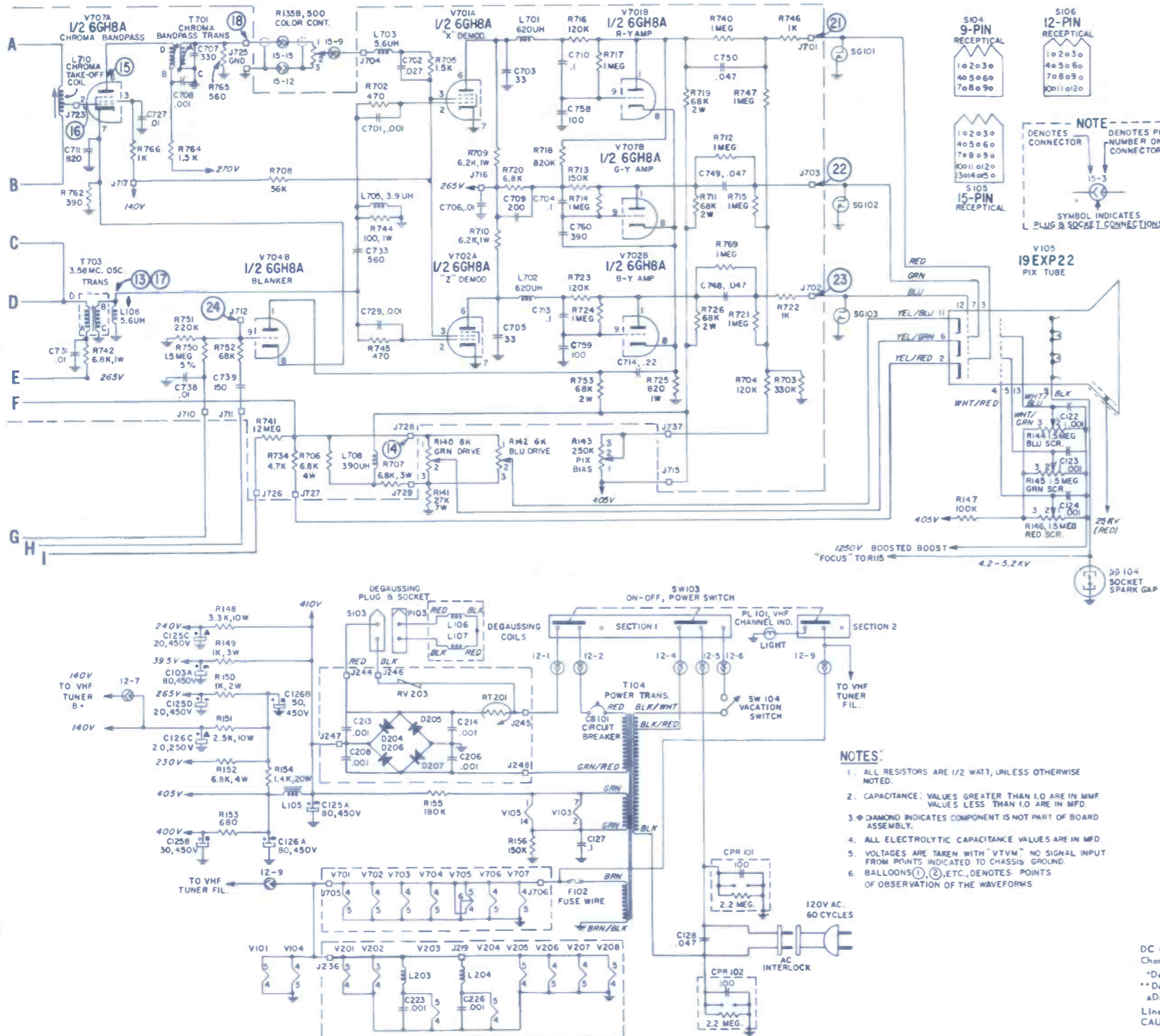

**VOLTAGE CHART**

TUBE	FUNCTION	PIN								
		1	2	3	4	5	6	7	8	9
V1 6J4	R-F Amplifier	0	0	0	6.3AC	120	0	0		
V2 6J8	VHF Osc. Mixer	0	-2.4	0	0	6.3AC	130	130	135	0
V101 6J6A	Horizontal Output	130	-55	0	0	6.3AC	-55	130	35	0
V102 3A3A	High Voltage Rectifier				25KV				25KV	
V103 6B4B	Shunt Regulator	400					390			
V104 6D4B	Damper		400		6.3AC	0		400		DO NOT MEASURE
V201 6J6	Sound IF Amplifier	1.5	0	1.5	0	6.3AC	N.C.	95	95	0
V202 6H26	Sound Demodulator	0	1.2	0	6.3AC	0	135	115	0.5	
V203 6J6	1st Pix IF Amplifier	0.6	0	0.6	0	6.3AC	N.C.	95	95	0
V204 6J6	2nd Pix IF Amplifier	1.5	0	1.5	0	6.3AC	N.C.	165	165	0
V205 6CH8A	1st Vid. Sync. AGC, Chroma	140	-2.0	140	0	6.3AC	260	0	8.5	6.0
V206 6CH8A	AGC & Sync Separator	85	70	250	0	6.3AC	0	-10	90	-20
V207 6F07	Horizontal Oscillator	25	0.3	1.0	0	6.3AC	0	260	-115	0
V208 6GF7A	Vert. Osc. & Output	0	60	70	0	6.3AC	260	0	8.5	6.0
V701 6CH8A	"X" Demod. & R-Y Amp.	125	-2.8	2.8	0	6.3AC	0	250	0	12
V702 6CH8A	"Z" Demod. & B-Y Amp.	125	-2.8	2.8	0	6.3AC	0	250	0	12
V703 6CH8A	Burst Amp. & Color Killer	±5.5	-12	4	255	6.3AC	0	400	55	0
V704 6CH8A	3.58 Mc Osc. & Blanking	120	6.0	150	0	6.3AC	0	215	0	3.0
V705 12GN7A	2nd Video Amplifier	0	*1.0	0	6.3AC	6.3AC	0	*290	*85	0
V706 6BQ5	Audio Output	N.C.	0	6.5	6.3AC	0	N.C.	230	N.C.	240
V707 6CH8A	Chroma Band-pass & G-Y Amplifier	125	±3.0	-11	160	6.3AC	0	255	43.0	12

**MEASURING CONDITIONS**

N. C. No Connection

DC voltages measured with VTVM placed between point measured and chassis ground. Channel selector set to active channel. Unless otherwise noted, brightness and contrast controls set for normal picture on screen.

\*Denotes readings taken with brightness control at maximum rotation (fully CW).

\*\*Denotes readings taken with brightness control at minimum rotation (fully CCW).

±Denotes readings taken with color signal.

Line voltage input set at 120 Volts AC.

CAUTION: Exercise extreme care to avoid shock hazard. Dangerous pulsed high voltages are present at V101, V102, V103 and V104. Exercise extreme care when measuring near these tubes.

COMPLETE MANUFACTURERS' CIRCUIT DIAGRAMS AND TECHNICAL INFORMATION FOR 6 NEW SETS

AUGUST • 1967

TUNER CROSS REFERENCE LIST

MODEL	CAT. #	TUNER DRAWING #	VENDOR CODE	MODEL	CAT. #	TUNER DRAWING #	VENDOR CODE
23-22Z	R7653	177A9139	"ET"	33765	R7653	177A9139	"ET"
23-24	R7653	177A9139	"ET"	35763	R7655	861D680	"ET"
23-25	R7653	177A9139	"ET"	35764	R7655	861D680	"ET"
31765	R7655	861D680	"ET"	35764U	R7657	861D681	"ET"
31767	R7655	861D680	"ET"	36763	R7655	861D680	"ET"
31767U	R7657	861D681	"ET"	36764	R7655	861D680	"ET"
	R7656	4VH4471-2	(VHP)	36764U	R7657	861D681	"ET"
32761	R7655	861D680	"ET"		R7656	4VH4471-2	(VHP)
32761U	R7657	861D681	"ET"	36766	R7655	861D680	"ET"
	R7656	4VH4471-2	(VHP)	36767	R7655	861D680	"ET"
32764	R7655	861D680	"ET"	39762	R7655	861D680	"ET"
32765	R7655	861D680	"ET"	39762U	R7657	861D681	"ET"
32766	R7655	861D680	"ET"		R7656	4VH4471-2	(VHP)

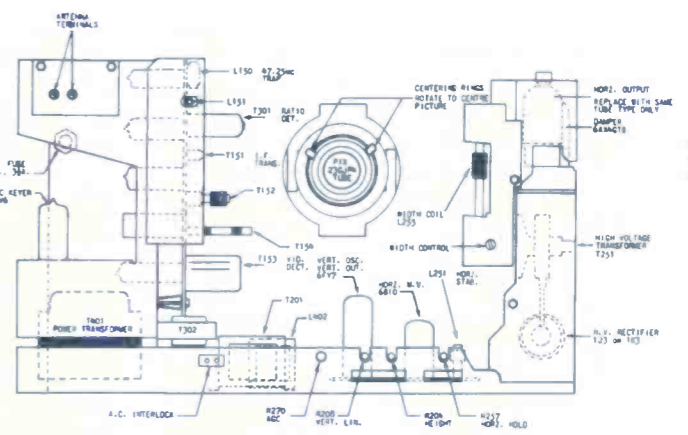
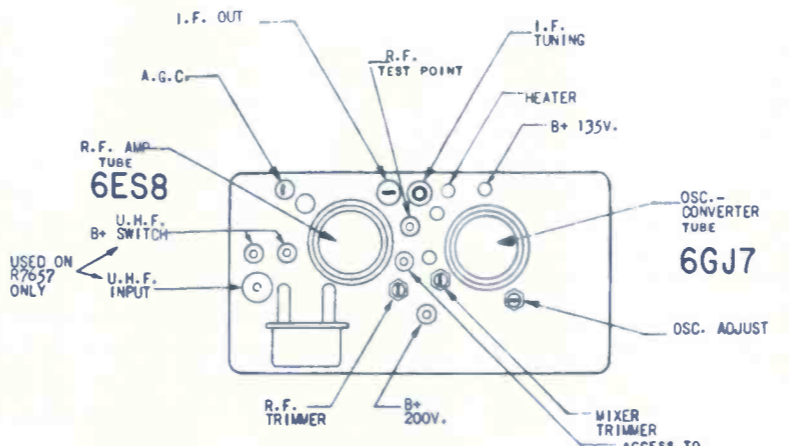

TUBE & ADJUSTMENT LOCATIONS M649

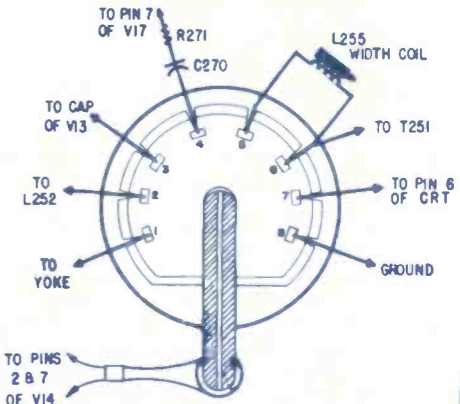
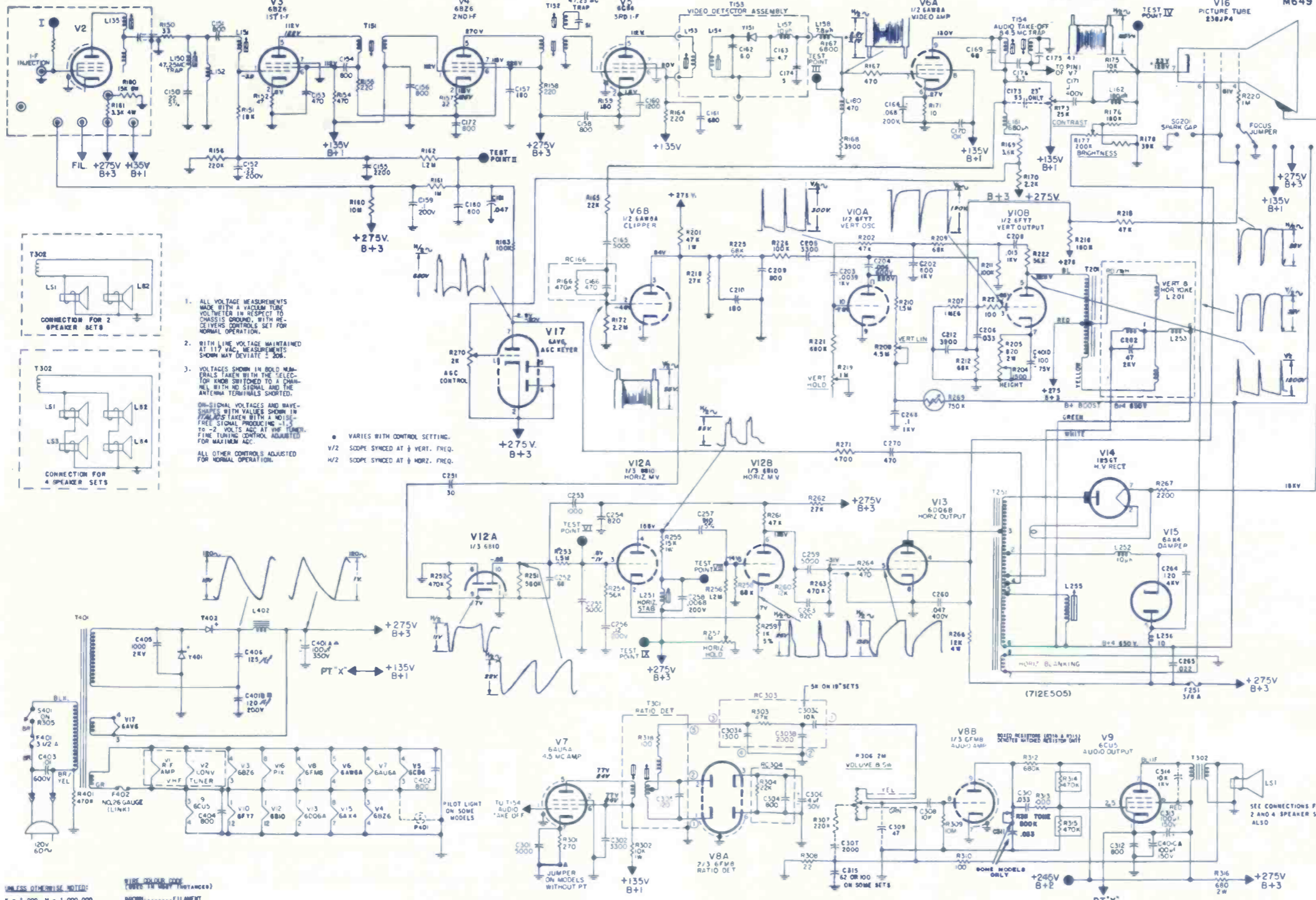

T251 WIRING

- ALL VOLTAGE MEASUREMENTS MADE WITH A VACUUM TUBE VOLTMETER IN RESPECT TO CHASSIS GROUND, WITH REGULATORS CONTROLS SET FOR NORMAL OPERATION.
  - WITH LINE VOLTAGE MAINTAINED AT 117 VAC, MEASUREMENTS SHOWN MAY DEVIATE ± 5%.
  - VOLTAGES SHOWN IN BOLD NUMERALS TAKEN WITH THE SELECTOR KNOB SWITCHED TO A CHANNEL WITH NO SIGNAL AND THE ANTENNA TERMINALS SHORTED.
- ON-SIGNAL VOLTAGES AND BAY-SHAPES WITH VALUES SHOWN IN ITALICS TAKEN WITH A NOISE-FREE SIGNAL PRODUCING -1.5 TO -2 VOLTS AGC AT THE FINE-TUNING CONTROL ADJUSTED FOR MAXIMUM AGC.
- ALL OTHER CONTROLS ADJUSTED FOR NORMAL OPERATION.
- VARIES WITH CONTROL SETTING.  
 V/2 SCOPE SYNCH AT VERT. FREQ.  
 H/2 SCOPE SYNCH AT HORIZ. FREQ.

SYMBOL	DESCRIPTION	CANADIAN G-E PART NO.
L152	coil IF	R5565
L151	coil 1st IF grid	R4655
L157	coil choke 10µH 20%	R6402
L158	coil choke 7.8µH 10%	R4650
L60	coil choke 470µH 7%	R6733
L161	coil choke 240µH 7%	R5328
L251	coil horiz stabilizing	R6618
L255	coil width	R6672
T302	x-former audio output	R6044
T251	x-former horiz output	R7652
T401	x-former power	R7570
T151	x-former 1st IF plate	R5329
T152	x-former 2nd IF plate	R6272
T153	video det assy	R6151
T154	x-former audio take-off and trap	R5809
T201	x-former vert output	R6612
T301	x-former ratio det	R4955
L201	yoke deflection	R6620
Y151	diode	R1889
Y401, Y402	diode silicon rect	R6048
R269	thermistor 750K	R6897
RC166	RC unit 470K/470µF	R4917
RC304	RC unit 22K/800µF	R4648
C303A, B, C		R5318
R303	RC circuit de-emphasis network	
F251	fuse 0.375 amp slo-blo	R4962
F401	fuse 3.5 amp bayonet type	R5340
L402	reactor filter	R6611
R204	control vert size 1.5K	R6674
R208	control vert lin 4.5M	R6886
R257	control horiz hold 1M	R4256
R270	control AGC 2K	R7544
C150	ceramic 22µF 5% 500V NPO	R4625
C264	ceramic 120pF 10% 4kV T.C.	R6614
C202	ceramic 800pF 20% 1500V	R4631
C405, C502	ceramic 1000pF GMV 2000V	R4935
C203	paper 0.039µF 10% 1000V	R4618
C314	ceramic 0.1µF GMV 1000V	R3034
C152	mylar 22µF 20% 200V	R6386
C313	mylar 100µF 150V	R4637
C406	elect 125µF 200V	R6047
C401A, B	100µF 120V 120µF 200V	R6047
C401C, D	100µF 150V 100µF 125V	R6616
R177	control bright 200K (Model 31T65)	R7176
R173	control contrast 25K (Model 31T65)	R7180
R219	control vert hold 1M (Model 31T65)	R7178
R311	control tone 300K (Model 31T65)	R7658
R306	control vol 2M (Model 31T65)	R7174

UNLESS OTHERWISE NOTED:  
 K = 1,000 M = 1,000,000  
 CAPACITORS MORE THAN 1 = µF  
 CAPACITORS LESS THAN 1 = pF  
 RESISTORS ARE Ω WATT

WIRE COLOR CODE (UNLESS OTHERWISE NOTED)  
 BROWN.....FILAMENT  
 RED.....HIGH B+  
 ORANGE.....LOW B+  
 GREEN.....BY BOOST  
 WHITE.....AGC

NOTE - C307, C308 & R307 & C314 ARE USED ON '25' SETS ONLY.

COMPLETE MANUFACTURERS' CIRCUIT DIAGRAMS AND TECHNICAL INFORMATION FOR 6 NEW SETS

CAUTION ONE SIDE OF AC LINE CONNECTED TO CHASSIS

TUBES	VHF - Twelve, UHF - One Transistor	
POWER SUPPLY	110-120 Volts AC, 60 Cycles	RATING 101 Watts @ 117 Volts AC
TUNING RANGE	Channels 2 thru 13 VHF, 14 thru 83 UHF, Video IF 45.75 MC, Sound IF 41.25 MC (Intercarrier)	

# UHF TUNER

SYMBOL DESCRIPTION

- D1 - video det
- D2 - silicon rectifier (1S558)
- T201 - AF output
- T202 - vert output
- T203 - horiz output (flyback)
- T204 - deflection yoke
- L102 - heater choke
- L103 - 47.25MHz trap
- L104 - video IF input
- L105 - video trap
- L106 - first video
- L107 - video det
- L108 - filter coil
- L109 - filter coil
- L110 - snd take-off and trap
- L111 - peaking coil (270µh)
- L112 - peaking coil (480µh)
- L113 - peaking coil (220µh 5k)
- L114 - 4.5MHz snd IF
- L115 - quad
- L116 - horiz stabilizer

- CORONADO PART NO.
- L117 - RF choke
- L118 - combination coil
- L202 - line filter
- L203 - filter choke
- VR101 - AGC 100K
- VR102 - height 1M
- VR103 - vert lin 300K
- VR104 - Horiz hold 45K
- VR105 - horiz range 100K
- VR204 - vert hold 1M
- VR211 - contrast 30K
- VR212 - brightness 100K
- VR221 - vol on-off 500K
- R114 - 4.7K 3w
- R200 - 12K 2w
- R221 - 680Ω 2w
- R241 - 31Ω 5w
- T-S2009
- T-L2005
- T-L2006
- T-L2004
- T-S2010
- T-S2011
- T-A25

- T-107
- T-L7069
- T-108
- T-828A
- T-G0031T
- T-G0032T
- T-G0033T
- T-G0034
- T-G0039
- T-G2024
- T-G2023
- T-G2025
- T-G2017
- RC-607
- RC-720
- RW-27
- 5FJ3
- TCC-010
- CE-174-2
- 300CT3
- 690-147
- T-T8659 USP20
- T-11025US

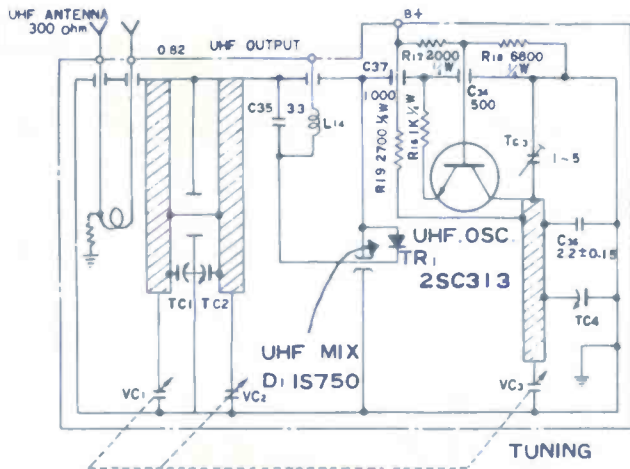

## TUBE PLACEMENT CHART

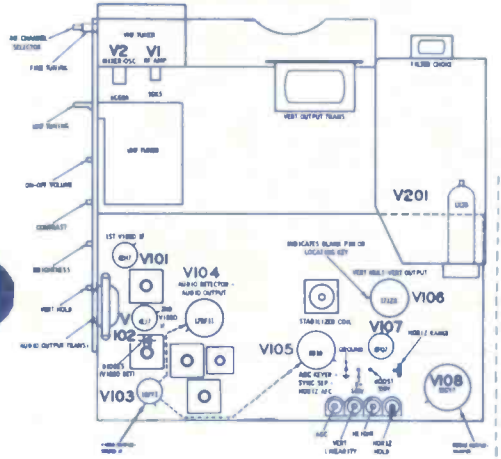

## SERVICING IN THE FIELD

- SAFETY GLASS**  
For picture tube and safety glass cleaning, it is necessary to remove the chassis. (See Disassembly Instructions.)
- FUSE**  
A 2 Amp. fuse is used for L.V. power supply and filament protection. (See "Tube Placement Chart" for location.)
- VHF OSCILLATOR ADJUSTMENT**  
Set Fine Tuning control at center of its range and adjust oscillator slug (one for each channel) for best sound and picture.
- AGC**  
AGC may be varied by means of an AGC control. (See "Tube Placement Chart" for location.)
- FOCUS**  
The focus may be varied by connecting the lead from resistor R-166 from pin 4 of picture tube to various voltage points. (For location see "Tube Placement Chart".)
- CENTERING**  
Centering is accomplished by two magnetic rings located on rear cover of yoke.
- HORIZONTAL LINEARITY**  
Horizontal linearity can be adjusted by turning the disc magnets located on each side of the yoke.
- HORIZONTAL OSCILLATOR FIELD ADJUSTMENT**  
Coarse adjustment of the horizontal hold is accomplished by the proper setting of the Horizontal Stabilizer coil and Horizontal Range control. (See "Tube Placement Chart" for location.)

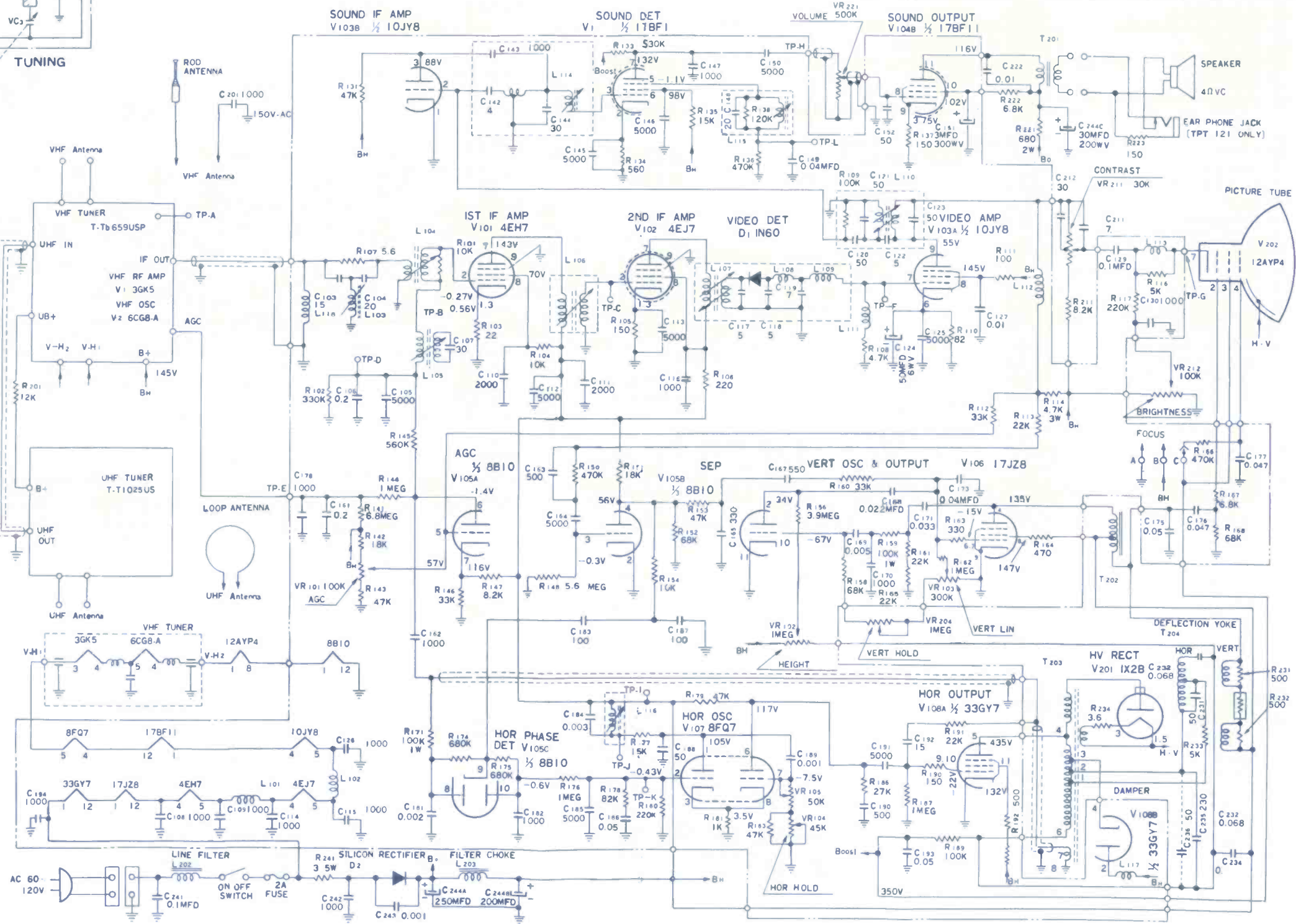

COLOR TELEVISION CHASSIS  
SPECIFICATIONS

Power Source Rating

Frequency  
Voltage  
Wattage

60 cycles  
117 volts  
330 watts

Tuning Range

Channels 2-83

Antenna Input Impedance

Balanced 300 ohms

IF Frequencies

Video IF

45.75MC

Sound IF

41.25MC

Intercarrier IF

4.5MC

Color Sub-Carrier (Nominal)

42.17MC

Audio System (TV only)

Output Impedance

3.2 ohms

Power Output (Maximum)

2.5 watts

SYMBOL	DESCRIPTION	MAGNAVOX PART NO.
T101	power xformer	300238-1
T102	H.V. xformer	361197-1
T103	focus xformer	361240-3
T104	vert output xformer	320317-2
T105	audio output xformer	320130-3
T106	pin cushion xformer	361134-3
T201	video IF input xformer	360951-1
T202	1st video IF xformer	360951-6
T203	2nd video IF xformer	360951-5
T204	3rd video IF xformer & 41.25MHz trap	360952-2
T701	bandpass xformer	361192-1
T702	burst xformer	361094-2
T703	3.58MHz osc xformer	361198-1
L101	reactance choke	320124-4
L103	5.6µh choke	360676-5
L104	horiz efficiency coil	361022-3
L109	reactance choke (int audio version)	320232-3
L110	5.6µh choke	360676-7
L111	pin cushioning phasing coil	361135-1
L112	line filter	361250-1
L203	177MHz tweeter coil	360852-5
L206	4.5MHz trap	360953-2
L208	8.2µh coil	360677-11
L210	620µh peaking coil	361043-3
L501	horiz osc & sine wave coil	360960-3
L701	snd take off coil	360845-2
L702	snd IF coil	360846-3
L703	quad coil	360847-2
L707	150µh peaking coil	360853-5
L713	620µh peaking coil	360853-11
L717	chroma take-off coil	360959-4
L802	R/G differential amplitude coil	361092-3
L804	horiz blue tilt coil	361188-1
L805	blue master amplitude coil	361092-5
	deflection yoke	361290-102
C105	elect 160µf 250v 80µf 450v	270071-6
C106	elect 160µf 250v	270071-3
C107	elect 80/30/50µf 450v	270071-7
C113	ceramic 60pf 10% 4000v (N1500)	250475-24
C118	ceramic 130pf 6000v (M2200)	250475-11
C119	ceramic .01µf 1400v (w/spark gap)	250562-1
C130	elect 20µf 450v 20/20µf 350v	270023-42
C130	elect 20µf 450v 20µf 350v	270023-43
C219	ceramic 10pf 5% (NPO)	250508-1005
C527	ceramic 390pf 5% 1500v (N1500)	250236-63
C528	paper .01µf 10% 400v (special)	250484-1
C564	elect 5µf 25v	270082-603
C735	silver mica 270pf 5%	
C760	mica 200pf 5%	
C771	ceramic .01µf 1000v	
R102	1.1K 18w (WW)	240088-4
R106	4.3K 5w (glass)	230150-533
R112	15K 7w (glass)	230150-746
R113	1.8K 2w (glass)	230160-65
R114	220Ω 3w (glass)	230150-326
R117	66M 20% (6kv breakdown)	230161-1
R128	3.3K 3w (glass)	230150-330
R129	1.8K 3w (glass)	230150-324
R145	2.2K 3w (glass)	230150-330
R160	820Ω 10w (WW)	240082-71
R161	910Ω 5w (glass)	230150-517
R162	18K 4w (glass)	230150-448
R206A,B	150K (matched within 2%)	
R617	5.6K 4w	230150-436
R759A,B	1M (matched within 2%)	
R780	27K 2w (glass)	230160-79
R792	270Ω 3w (glass)	230150-304
R794	27K 2w (glass)	230160-79
R108	45K horiz hold (see note)	220146-69
R109	750K vert hold	220146-50
R120	500K H.V. Adjust	220189-4
R126	10Ω 2w vert centering	220181-1
R131	1M color killer	220208-34
R133	600Ω contrast	220146-29
R134	3M tone	220146-26
R136	50K AGC	220208-33
R138	100Ω sharpness	220146-62
R164	2.5K CRT bias	220181-11
R201	10K adj snd rej	220182-1
R215	750Ω snd rejection	220166-4
R401	1M off on vol	see chart
R402	500Ω color	see chart
R404	250K bright	see chart
C406	5.2 to 67pf hue	see chart
R604	6K green drive	220166-15
R608	3.4M vert lin	220166-19
R611	1.5M blue screen	220166-17
R804	120Ω R/G Master tilt (horiz)	220167-6
R813	30Ω R/G differential tilt (vert)	220167-4
R814	60Ω R/G master tilt (vert)	220167-5
RY101	degaussing relay	160326-6
TD101	delay	360949-5
VDR501	varistor	230167-5
VDR701	varistor	230175-2
RV701	thermistor	230170-2
	circuit breaker	180723-2
	VHF tuner	see chart
	UHF tuner	see chart

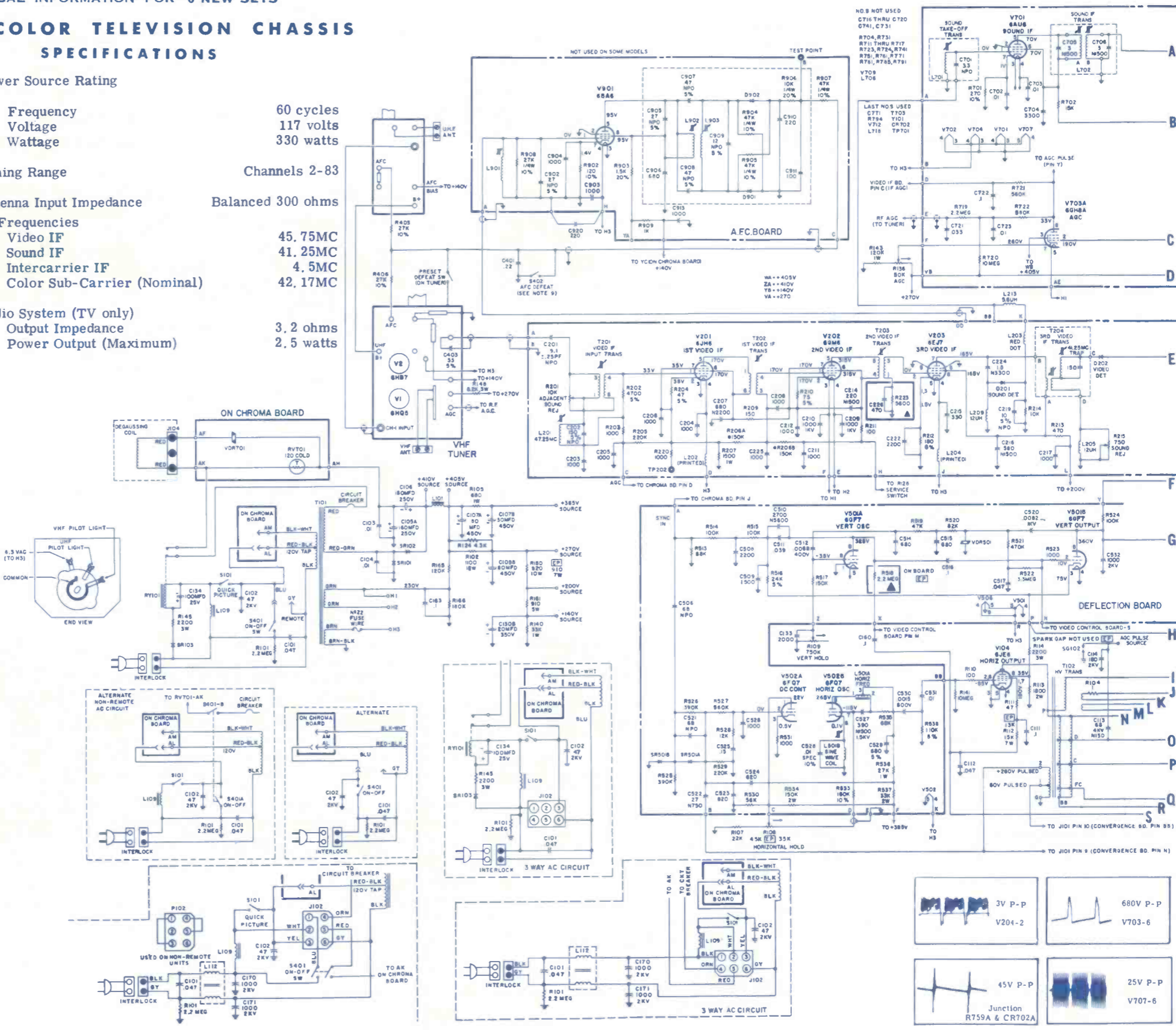



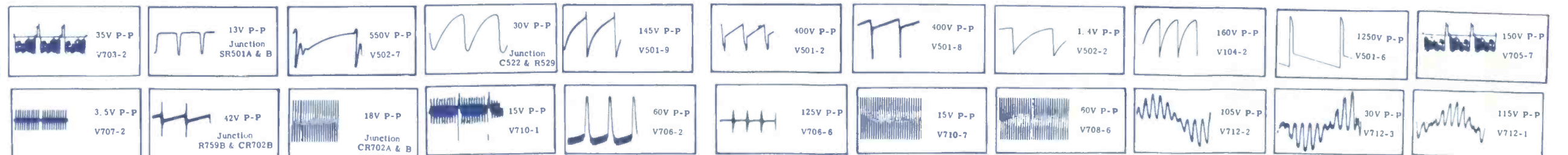
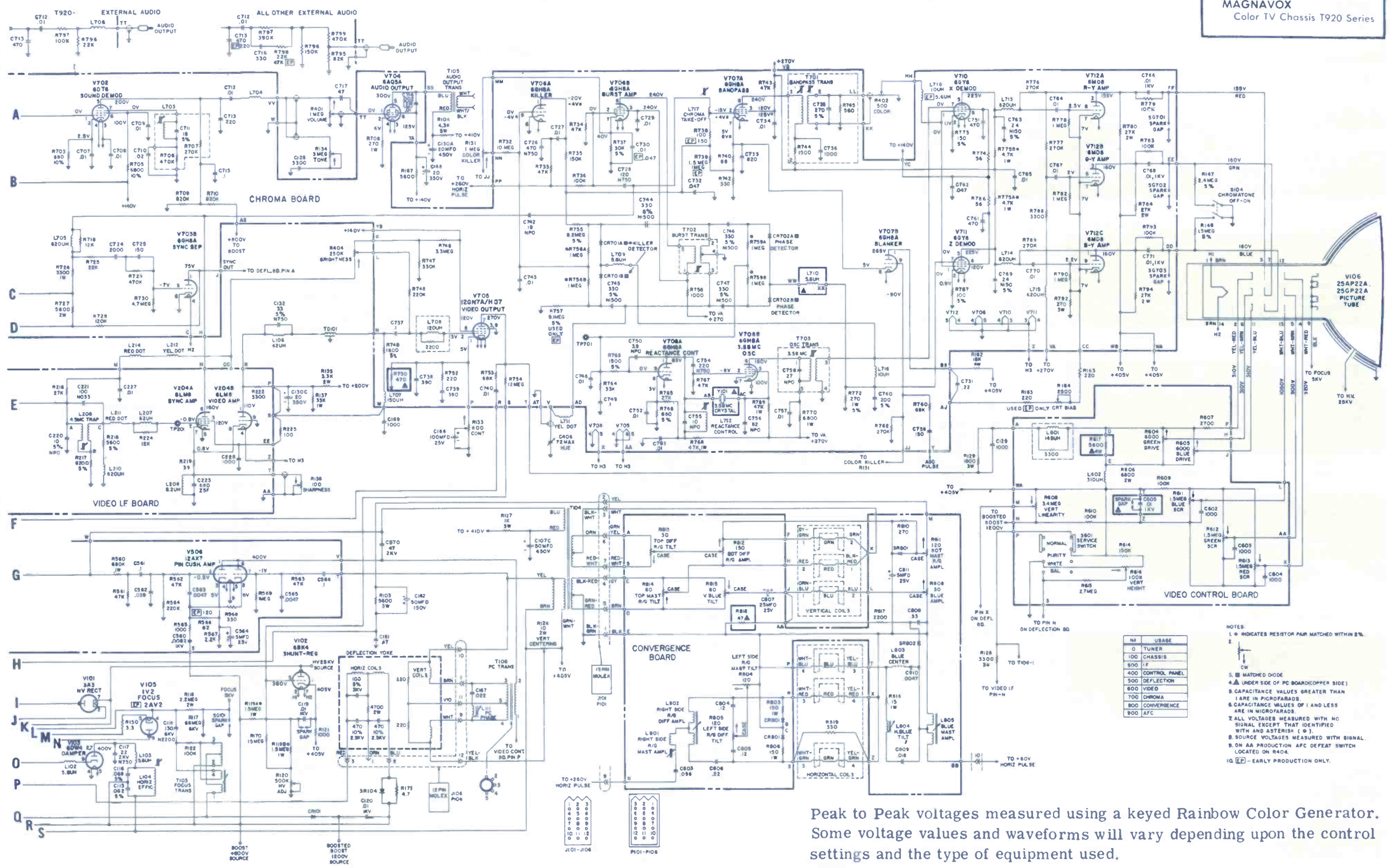



1 TP-3  
SECOND DETECTOR  
VERTICAL RATE 2V P-P



2 V205 PIN 9  
VIDEO OUTPUT PLATE  
VERTICAL RATE 100V P-P

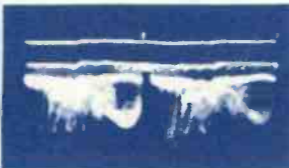

3 C246 & C235 JUNCTION  
ZONE 2B, PW-200  
VERTICAL RATE 10V P-P



4 V201 PIN 1  
SYNC PLATE  
HORIZONTAL RATE 55V P-P

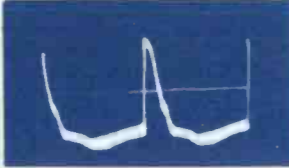

5 V205 PIN 2  
AGC GRID  
HORIZONTAL RATE 35V P-P

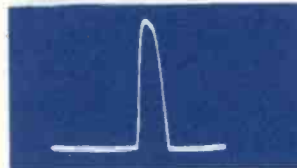

6 V205 PIN 3  
AGC PLATE  
HORIZONTAL RATE 400V P-P

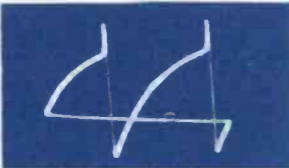

7 V206 PIN 9  
VERTICAL OSCILLATOR GRID  
VERTICAL RATE 160V P-P

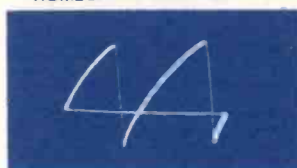

8 V206 PIN 2  
VERTICAL OUTPUT GRID  
VERTICAL RATE 25V P-P



9 PW-200, TERMINAL "L"  
VERTICAL OUTPUT TRANSFORMER  
VERTICAL RATE 150V P-P

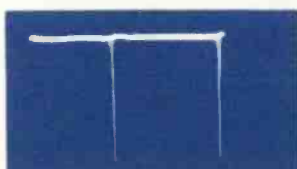

10 V105 PIN 1  
PICTURE TUBE GRID  
VERTICAL RATE 110V P-P



11 SR201 CATHODE JUNCTION  
HORIZONTAL PHASE DETECTOR  
HORIZONTAL RATE 13V P-P

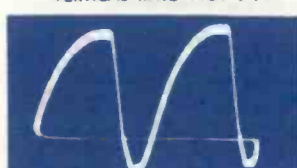

12 SR201 ANODE  
HORIZONTAL PHASE DETECTOR  
HORIZONTAL RATE 14V P-P

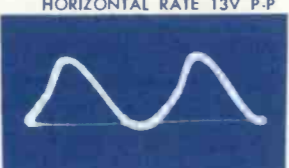

13 TP-4  
HORIZONTAL SINE WAVE  
HORIZONTAL RATE 18V P-P

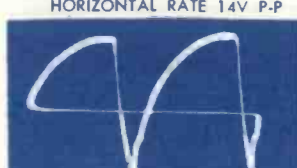

14 V101 PIN 9  
HORIZONTAL OUTPUT GRID  
HORIZONTAL RATE 100V P-P

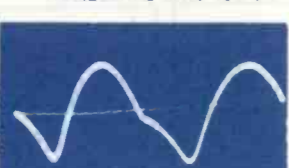

15 PW-200 TERMINAL "T"  
145V B+ RIPPLE  
VERTICAL RATE 1.5V P-P

SYMBOL	DESCRIPTION	RCA PART NO.
R112	control val with S101	120395
R113	control brightness	121220
R226A,B,C	control contrast vert & horiz hold	121222
R257	control vert size	121223
R260	control vert lin	121221
S101	switch part of R112 tuner KKK137A	121254
	tuner UHF complete	121088

C101	4 section elect	121798
A	250µf 200v	
B	400µf 175v	
C	50µf 175v	
D	5µf 150v	
C102	43pf ±5% 2Kv ceramic N1500 part of yoke	121236
C103	22µf ±20% 100v mica	
C109	270pf ±5% 3v ceramic N1500	121224
C257	.0039µf ±10% 100v mica	
CR101	diode silicon rectifier 1N3194	113998
CR201	diode det	112524
F101	fuse 2 1/2in 34AWG	
RF101	fuse resistor 2Ω 9A	121086
L102	RF choke 8.2µh	107385
L202	RF choke	114315
L203	560µh	114488
L204	36µh	116056
L205	2.7µh	107463
L206	270µh	115427
L207	stabilizer	114486
L210	RF choke	118697
PW200	circuit printed complete less tubes	121488
R103	47Ω ±5% 7w WW	121229
R104	16Ω ±5% 7w WW	121228
R114	12K 1w	512312
R210	39Ω ±5% metal oxide	121230
R212	3.3K ±5% metal oxide	228714
R216	3.3K ±5% film	228714
R220	3K ±5% metal oxide	227097
R223	5.6K 3w	104180
R271	1.3K ±5% metal oxide	228710
R275	39K ±5% metal oxide	227104
SR201	diode selenium	109474
T102	horiz output	121213
T103	vert output	121212
T104	audio output	121803
T201A,B	4.5MHz	114489
T202	snd IF	118411
T203	quod	118410
T204	47.25 trap	113097
T205	IF input	113097
T207	pix IF	109158
T208	pix IF output yoke deflection	114317

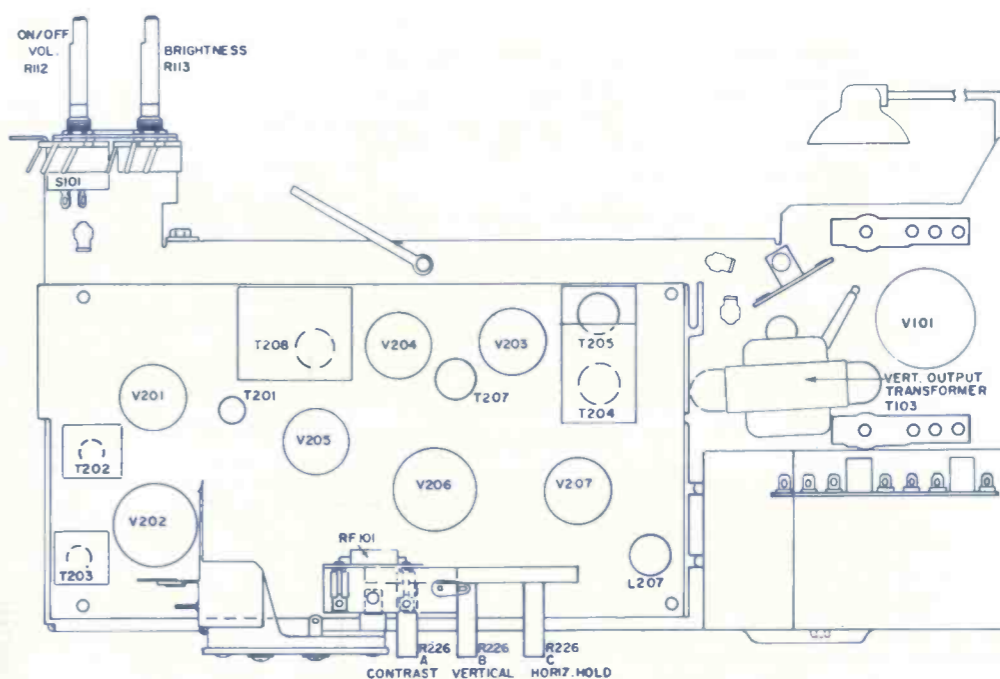

KCS165 Chassis Layout Drawing

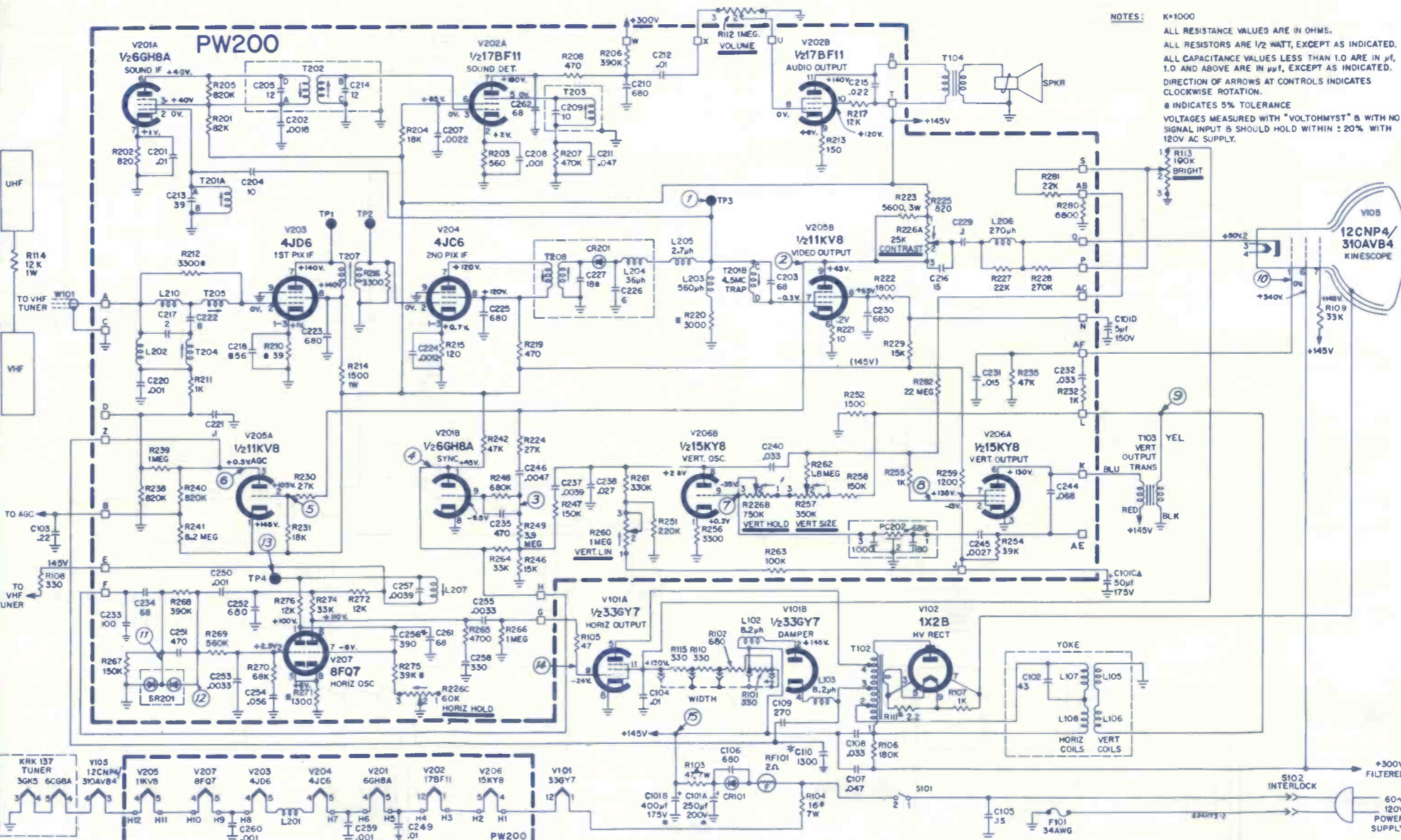

NOTES:  
K=1000  
ALL RESISTANCE VALUES ARE IN OHMS.  
ALL RESISTORS ARE 1/2 WATT, EXCEPT AS INDICATED.  
ALL CAPACITANCE VALUES LESS THAN 1.0 ARE IN µf, 1.0 AND ABOVE ARE IN µf, EXCEPT AS INDICATED.  
DIRECTION OF ARROWS AT CONTROLS INDICATES CLOCKWISE ROTATION.  
# INDICATES 5% TOLERANCE  
VOLTAGES MEASURED WITH "VOLTOHMST" & WITH NO SIGNAL INPUT & SHOULD HOLD WITHIN ±20% WITH 120V AC SUPPLY.

# Precision Apparatus

introduces 5 new models; now a complete line of quality test equipment for service technicians

For over 30 years, professionals in industry, service, laboratory and educational fields have relied on Precision Apparatus Test Equipment. Today, through the experience and marketing know-how of Dynascan Corporation, Precision Apparatus offers even greater reliability and performance—maximum versatility—in all applications. By every standard, they are the hallmark of quality in test equipment.

## NEW! A MUST FOR COLOR TV ALIGNMENT

### MODEL E-410C—SWEEP GENERATOR AND MARKER ADDER



Wide range, frequency modulated signal source combined with Marker Adder circuitry designed for the alignment of color TV, FM and other high frequency wide-band receivers and circuits. Solves marker visibility and overloading problems. Furnished with a 4.5 mc crystal and 5 output cables. \$169.95

## NEW! MODEL B-12—REGULATED POWER SUPPLY



A reliable source of variable, regulated DC plate voltages, and bias plus AC filament voltages . . . with exclusive 6.3 VAC and 12.6 VAC supply. Perfect for service bench and circuit development, it offers regulated DC voltages from 0 to 400 volts, and a bias supply from 0 to -150 volts. Each output is variable throughout its range. Rugged, double-jewelled, D'Arsonval meters mounted on the front panel. \$99.95

## NEW! MODEL B-10—BATTERY ELIMINATOR & CHARGER



Twice the filtering provides .15% ripple! Designed to meet rigid, low-ripple output requirements of modern transistorized automobile radios and other electronic equipment of 6 and 12 volt ratings. Does not require additional investment for external filter adapters. Functions as an efficient, reliable battery charger with special high-current output at separately labeled terminals. \$59.95



## NEW!

### MODEL V-95 PROFESSIONAL VTVM

More accurate readings on huge 7" mirrored scale. Special 0.5 VDC scale for precise transistor circuit analysis. Zener controlled internal power supply obsoletes ohmmeter batteries. Two-way protection: transit switch position and anti-burnout shunts prevent meter damage on the job or on the road. Single test probe eliminates cable tangles and lead shuffling. Rugged walnut-grain metal case; name-personalized handle stops "borrowing." \$79.95  
MODEL V-75 with 4½" meter. \$59.95



## NEW!

### MODEL S-55 PUSH-PULL OSCILLOSCOPE

Wide band amplification, DC coupled, zero to 5 MC. High vertical sensitivity and large CRT screen give more than 6" undistorted deflection. Automatic horizontal synchronization includes 60 Hz sinusoidal sweep for TV and FM alignment. Special 500 KHz sweep makes it easy to see complete 3.58 MKz burst signals; ideal for color TV. Exceptionally low distortion. \$169.95



**ES-550B WIDE-BAND OSCILLOSCOPE**  
Deluxe scope; extra brightness; extra high sensitivity. Unique calibration voltage makes measurement easy. \$279.95



### E-200C MULTI-BAND SIGNAL GENERATOR

Unique AVC substitution system for total accuracy. 88 KHz to 400 MHz, hand-calibrated. \$119.95



### 120M VOM

1½% DC accuracy. Exclusive extra-low R x 1/10 scale reads to 0.1 ohm. Transit and burnout protection. Mirrored scale. \$65.00  
ALSO: MODEL 120 with 2% DC. \$56.00  
E-310 SINE & SQUARE WAVE GENERATOR  
Only moderate-cost, low-distortion, 5 Hz to 600 KHz wide band generator. \$199.95



The Complete Line That Sets Industry Standards



**PRECISION APPARATUS**

hallmark of quality in test equipment

Tube supplement information now available for all Precision and Paco Tube Testers.

Division of Dynascan Corporation  
1801 W. Belle Plaine Avenue  
Chicago, Illinois 60613

Where Electronic Innovation Is A Way Of Life

... for more details circle 122 on postcard

# The hottest thing in electronics hardly gets hot at all

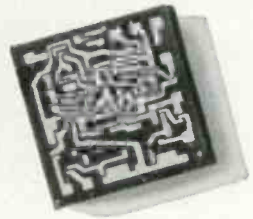

(RCA's solid integrated circuit, that is)

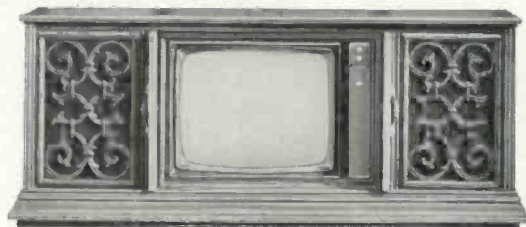

With the tiny chip there are few heat problems and low power consumption. And because integrated circuits run cooler, parts can be placed closer together to enhance design convenience. One day you may see stereo cabinets with more real storage space, and color TV sets the size of a transistor radio. At RCA Victor we've taken a

step into tomorrow by using integrated circuits now in new color and black and white TV and in stereo phonographs. They're not only the most advanced products of their kind, they are more reliable than ever before.



The Most Trusted Name in Electronics

™(s)®

# ELECTRONIC TECHNICIAN

WORLDS LARGEST ELECTRONIC TRADE CIRCULATION

AUGUST 1967 • VOL. 86, NO. 2

Publisher  
RON KIPP

Managing Editor  
JACK HOBBS

Technical Editor  
JOSEPH ZAUHAR

Associate Editor  
PHILLIP DAHLEN

Field Editor  
RICHARD CLAYTON

Production Editor  
BARBARA BURNSON

Art Editor  
KEN McSHANE

Circulation Manager  
RUTH GELINEAU

Manager, Reader Services  
JOHN KESSLER

Advertising Production  
MAGGIE KANE

**GENERAL OFFICES**  
OJIBWAY PRESS, INC.  
Ojibway Building  
Duluth, Minn. 55802  
Phone: (218) 727-8511  
Telex: 029-4417

President  
MARSHALL REINIG

Treasurer  
GREG BLODGETT

Executive Vice President  
DEAN MYHRAN

Vice President, Marketing  
JOE WOLKING

Vice President, Editorial  
BEN MARSH

Vice President, Production  
HARRY RAMALEY

Circulation Director  
LARS FLADMARK

Art Director  
JAMES GHERNA

Ad Production Supervisor  
WARREN BODIN

**NEW YORK OFFICES**  
71 Vanderbilt Ave.  
New York, N.Y. 10017  
Phone: (212) 686-2200

President, Publications Division  
ROBERT EDGELL

Vice President, Publications Division  
RICHARD C. REINHARDT

Manager, New York Office  
DON GENOAR

**CHICAGO OFFICES**  
43 East Ohio Street  
Chicago, Illinois 60611  
Phone: (312) 467-0670  
Telex: 02-53549

Manager, Chicago Office  
DOROTHY BOLAN

## MARKETING REPRESENTATIVES

New York: (212) 686-2200  
RON KIPP

Chicago: (312) 467-0670  
ED KELLY

## 39 THE STATE OF SOLID-STATE

An ET TEKLAB report covers developments in solid-state equipment and test instruments. It brings you up to date in this area, including latest information on integrated circuitry

## 43 UNDERSTANDING MODERN AGC CIRCUITS

The fifth article of this in-depth series digs into the common-sense principles of troubleshooting today's AGC circuits

## 46 SOLID-STATE TV SERVICING THE EASY WAY

The "old pro" tells you how to do the job easily and save time

## 49 USING AUDIO TEST AND ALIGNMENT INSTRUMENTS

Part three of another in-depth article series continues with the "how-to" approach in using test instruments for audio equipment maintenance and troubleshooting

## 54 SEMICONDUCTORS FROM A TO Z

The thirteenth article in this important in-depth series covers the RCA IC201 circuits and how they function

## 59 THE APPRENTICE AND THE PRO

The second article of this series—in the midst of a critical technician shortage—continues with the day-to-day experiences of an apprentice and the "pros" with whom he worked

22 LETTERS TO THE EDITOR

28 EDITOR'S MEMO

32 TECHNICAL DIGEST

66 COLORFAX

68 NEW PRODUCTS

74 NEWS OF THE INDUSTRY

78 CATALOGS & BULLETINS

80 ADVERTISERS' INDEX

81 READER SERVICE CARD

## COVER

The more than 80,000 service-dealers and technicians who read ELECTRONIC TECHNICIAN are participating heavily in the upsurging sales of transistorized portable AM/FM radios.

## TEKFAX • 16 PAGES OF THE LATEST SCHEMATICS • Group 180

AIRLINE: Color TV Model GHJ-8247A,57A

CANADIAN GENERAL ELECTRIC: TV Chassis M649

CORONADO: TV Model TV 21-9367A

MAGNAVOX: Color TV Chassis T920 Series

PHILCO: TV Chassis 17C21,A,V,AV

RCA VICTOR: TV Chassis KCS165 Series

OJIBWAY PRESS, INC.



ELECTRONIC TECHNICIAN is published monthly by Ojibway Press, Inc. Subscription Rates: One year \$5.00, Two years \$8.00, three years \$10.00 in United States and Canada. Other Countries: One Year \$9.00, two years \$14.00, three years \$18.00. Single Copies, 60¢. Second Class postage paid at Waseca, Minnesota and at additional mailing offices. Copyright 1967 by Ojibway Press, Inc. POSTMASTER: Send form 3579 to ELECTRONIC TECHNICIAN, Ojibway Building, Duluth, Minnesota 55802.



has  
everything  
in

# chemicals

From service cements to aerosol cleaners, from solvents to lubricants, only GC satisfies the critical chemical needs of the electronics field.

All GC chemicals are formulated to meet rigid requirements; packaged for convenience; and "proven in use" to make electronic jobs easier, faster, more profitable.

Remember too, with GC aerosols you get double value . . . highest product quality plus valuable GC "BONUS COUPONS".

Get more for your money . . . always insist on GC!

Write for your Giant FREE GC Catalog today . . .

over 12,000 items including TV Hardware, Phono Drives, Chemicals, Alignment Tools, Audio, Hi-Fi, Stereo & Tape Recorder Accessories, Nuts & Bolts, Plugs & Jacks, Service Aids, and Resistive Devices.

*only GC gives you  
everything in electronics.  
..... for almost 40 years!*



## GC ELECTRONICS COMPANY

400 South Wyman Street  
Rockford, Illinois 61101

A DIVISION OF HYDROMETALS, INC.



Radio-Television  
Service Cement  
Cat. No. 30-2



SPRA-KLEEN  
Contact-Control Cleaner  
Cat. No. 8666



SPRA-LUBE  
Cleaner-Lubricant  
Cat. No. 8888



GC "JIF"  
Contact and Control  
Cleaner  
Cat. No. 8670



"Super Grip"  
Epoxy Glue  
Cat. No. 347



Super Freeze Mist  
Cat. No. 8668



## LETTERS TO THE EDITOR

### 'Aerosound' 20/20 Stereo

Can anyone advise me where I can locate a schematic for an "Aerosound" 20/20 Stereo Hi Fi amplifier?

JAMES CARTER

10417 Montrose Ave.  
Bethesda, Md. 20014

• *Not knowing the manufacturer's name, we were unable to locate a schematic.—Ed.*

### Needs Help

I am unable to obtain information on using my Precision model 650 tube tester for checking CRTs. The chart I have is dated August 1962. Can any reader help me with a more modern chart? Answer via ET.

DONALD W. LAUGHLIN  
Belle Chasse, La.

. . . I need schematics and instruction manuals for 1) CES Electronic Products micro miker, model 402D, and 2) same for a Hazeltine Model OAP1 frequency meter oscillator. Answer via ET.

DAVID M. AMIDON  
Sierra Madre, Calif.

### Has Trades Institute Schematic

I can furnish a schematic and alignment date for a Commercial Trades Institute model TV321. Contact me direct.

WILLIS WALTERS  
295 Glenn Ave.  
Carey, Ohio 43316

### Finds 'A to Z' Article Valuable

You are indeed putting out a great magazine and doing a great service for service-dealers and technicians. May you long continue this service. I have come to realize the value of the series "Semiconductors from A to Z" and I am saving the articles. The new series, "The Apprentice and the Pro," also looks very promising.

VINSON BLUE  
Richmond, Calif.

### FYI

The 19BR5 tube will replace the UM80. If the tubes are not available in certain areas I can furnish a 19BR5 upon receipt of certified check for \$4.

PETER KNIP  
71 Tunis Bay  
Winnipeg 19, Man. Canada

. . . for more details circle 114 on postcard

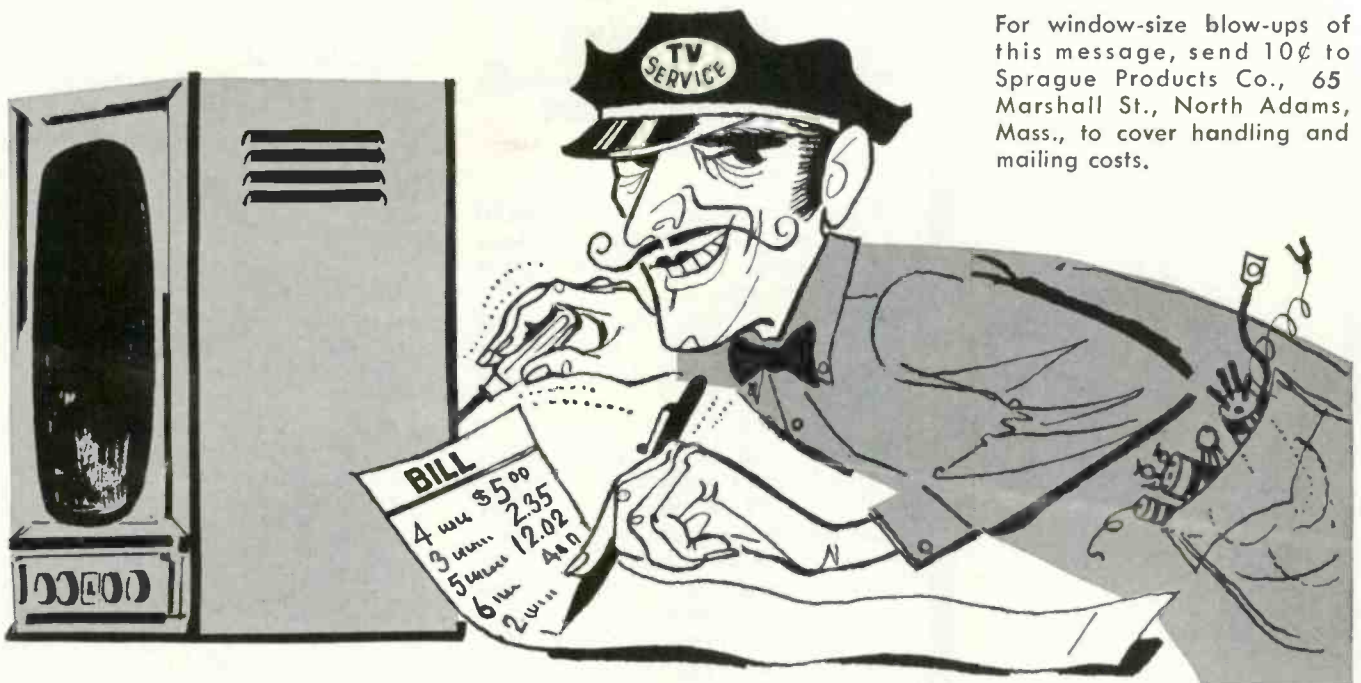

For window-size blow-ups of this message, send 10¢ to Sprague Products Co., 65 Marshall St., North Adams, Mass., to cover handling and mailing costs.

## ARE TV SERVICE DEALERS GYPS?

Every so often, some magazine or newspaper sounds off about TV-radio service shops.

"Service technicians are a bunch of gyps," is the general theme. "They'll clip you if you don't watch out."

They might just as well write the same thing about doctors, lawyers, storekeepers, auto mechanics—or anyone else. There are gyps in every line of business. Actually the percentage in TV-radio is lower than in most.

The average service technician is a hard-working, straight-shooting individual. Rather than gyp customers, he is far more likely to spend more time on a job than he knows he will be paid for—simply as a matter of personal pride in doing things right.

We recently heard about someone's TV set going bad. A service technician called for it with his truck and returned it in good working condition within 48 hours. His bill came to \$10 for service plus \$2.68 for replacement parts.

The set owner argued that this was too much—yet he would never dream of complaining to the medical specialist who charged him \$10 for a 15-minute office visit; the lawyer whose bill for writing a simple will was \$75; or the garage man who laughingly admits that he charges \$5 for "just raising the hood" of a car.

In one of our very large cities, the Better Business Bureau received fewer than 500 complaints about serv-

ice in a year. Most of the complaints came from folks who expected first-class reception in doubtful fringe areas; who tried to operate their sets without suitable antennas; or who had bought sets "wholesale" at ridiculously low prices from cut-rate dealers who could offer little or no service.

Actually, it takes almost as long to become a good service technician as it does to train for any other profession. Beyond this, it calls for regular study to keep up with the constant stream of new developments. Also, it requires a surprisingly big investment in test instruments, manuals, and other shop equipment. The modern TV or radio receiver is by far the most intricate piece of equipment the average person ever owns or uses.

Service technicians are not fly-by-night businessmen—99 out of 100 run their businesses properly. The other one per cent—the gyps—can usually be spotted a mile away. Nine times out of ten, they are the shops that feature "bargain" prices and ridiculously liberal service contracts. And their victims are generally set owners who expect to beat the game by "getting something for nothing."

Good television sets or good TV service are not things to be bought on a "bargain counter" basis. Set owners who recognize this aren't likely to get gyped.

Instead, they'll find that they get more real value for their television entertainment dollars than for any other dollars they spend!

**THIS MESSAGE WAS PREPARED BY SPRAGUE PRODUCTS COMPANY,**  
DISTRIBUTORS' SUPPLY SUBSIDIARY OF SPRAGUE ELECTRIC COMPANY, NORTH ADAMS, MASSACHUSETTS, FOR . . .

**YOUR INDEPENDENT TV-RADIO SERVICE DEALER**

65-123-63 . . . for more details circle 128 on postcard

# Listen!



## Help stamp out back seat drivers!

Millions of Americans are replacing the back seat driver with a back seat speaker. It's all part of the booming Rear Seat/Rear Deck loudspeaker market within the automotive field. Ten million cars worth!

Jensen's Rear Seat/Rear Deck speaker kits help you get your share . . . and *more!* The attractive "see-thru" packaging of these Show Pack models, instant solderless connectors and an assortment of Jensen bonus features (whizzer cones, heavy duty magnets, solid domes, dust drain holes, etc.) all team up to make your cash register ring. (Also available individually boxed.)

Insist on Jensen Rear Seat/Rear Deck speaker kits.

# jensen

Jensen Manufacturing Division, The Muter Company,  
6601 South Laramie Avenue, Chicago, Illinois 60638.

. . . for more details circle 116 on postcard

## LETTERS TO THE EDITOR

### Needs Weston Tube Tester Booklet

Can any ET reader help me locate an instruction booklet for a Weston model 798 tube tester?

COL. LEONINO JUNIOR  
Rua Raimundo Correa 19—Ap. 502  
Copacabana—Rio de Janeiro, Brazil

### The Pro and Con of It

I have been a subscriber and avid reader of ET for many years. I find that of all the trade publications I read, as far as a technician's viewpoint is concerned, that you have the most comprehensive magazine in the industry. Therefore, I was a little surprised to read your "Formula Kick" editorial in the April issue. This pro and con licensing argument is of course getting quite old and badly maligned but the facts involved in the case, and the need, do not change. All those who oppose licensing continually and repeatedly fall back on the argument of self-governing, self-certifying, self-policing and self-cleaning as the great cure. Unfortunately, the people at whom licensing is directed never joined an association and never self-license, self-govern, self-certify, self-police or self-clean themselves and you will find that the BBB in almost all communities, even though they have publicly opposed licensing many times, admit themselves that the same people do the same cheating year after year.

Unfortunately, self-control and conscience do not motivate these individuals whatsoever. On the other hand, if they stood to lose a license to operate this dishonest business, it would motivate them into either going out of business or becoming honest.

Again, I don't disagree with your editorial except for the fact that in opposing licensing, the only solution you or anyone else who opposes it has to offer is self-policing. During the 20 years I have spent in this industry, self-policing has *not* worked and I see no reason in the next 20 years why it would be any different. Furthermore, I don't think that anyone in the industry, no matter how violently he is opposed to licensing, could produce any evidence that would alter these facts.

Again, those who support licensing intelligently do not offer it as a panacea, nor do we even hint that it is, but it is far better than nothing and has proven to be so in all areas where it has been put into force.

I think the record of its actions speaks for itself.

GREGORY BARKOUKIS  
NEA/OJT Coordinator  
National Electronics Assoc.  
859 Coburn St.  
Akron, Ohio 44311

. . . Your April Editor's Memo, "Formula Kick," was sent to me by one of my associates: I could not agree with you heartily!

It is indeed heartening to find at least one writing man in our service publishing field who is ready, willing and able to speak out forthrightly about this licensing regulation phobia.

I and my associates have for years fought licensing in Illinois, and it has always been our belief that it is wrong, unworkable, and where it has been put in—against the apathy of those most affected and by legislators with one eye on the ballot box—that over the long pull it became nothing but another nail in the coffin designed for the "free enterprise" system, under which this country grew straight and strong.

And also where its proponents would have you believe that it did work miracles of self-enforcing honesty and morality, over the long pull, all that it did accomplish was to sweep the "hot shots" under the rug, who could and will work the licensing gambit for all it is worth, as a merit badge to really steal legitimately.

If all the fellows who have worked so enthusiastically to push for this through the years had put their energies into the channels of raising the sights of their fellow technicians, and spent their money in this activity, we all would have been much further along in the public esteem.

HOWARD WOLFSON, Secretary  
ARTS of Illinois  
25 E. Congress Parkway  
Chicago, Ill.

• *The fact is, although it has independently commented on the subject from time to time, ET has never taken a hard-nosed position for or against licensing per se—and does not intend to—since it is devoted entirely to upgrading the technical and business know-how of service-dealers and technicians.—Ed.*

### Needs AMC Schematic

I think your "Letters to the Editor" columns are a wonderful source of information. I need a schematic for an AMC radio, model 7TAF. Apparently the manufacturer is out of business and I can't get one. Can any reader help me? Answer via ET.

ANDRES A. VINENT  
Fayetteville, N.C.



**New low cost.  
 New ease of operation.  
 No waiting. No warm-up.  
 No adjustments.  
 Brightest patterns in the industry.**



## The **B&K** 1242 Color Generator is all business\$!

There's nothing else like it. The all-new B&K 1242 represents the highest state of the art today. Go ahead and compare it; it's unique.

Ultrastable solid-state circuits make antiquated heating elements unnecessary. The 1242 works instantly in all service

environments — no waiting, no warm-up, no adjustments. Other units have up to 3 times as many front panel controls. For ease of operation, the 1242 has just two: color level and selector switch. It provides dots, crosshatch, horizontal or vertical lines, and color bars. And these are the sharpest, brightest patterns in the industry.

The 1242 handles easily, too. It's the smallest, lightest-weight color generator! Rugged, too; it's all steel, with storage

space for leads. It's transformer powered and complete with leads. Calls take less time and you make more money, because you can go from a cold or hot truck into a home and get right to work.

On every count, the new B&K 1242 is amazing. In time saved, it will pay for itself in just a few weeks — especially at this low price: **\$99.95**

B&K Division of Dynascan Corporation  
 1801 W. Belle Plaine • Chicago, Illinois 60613

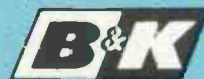

Where Electronic Innovation Is A Way Of Life  
 . . . for more details circle 106 on postcard

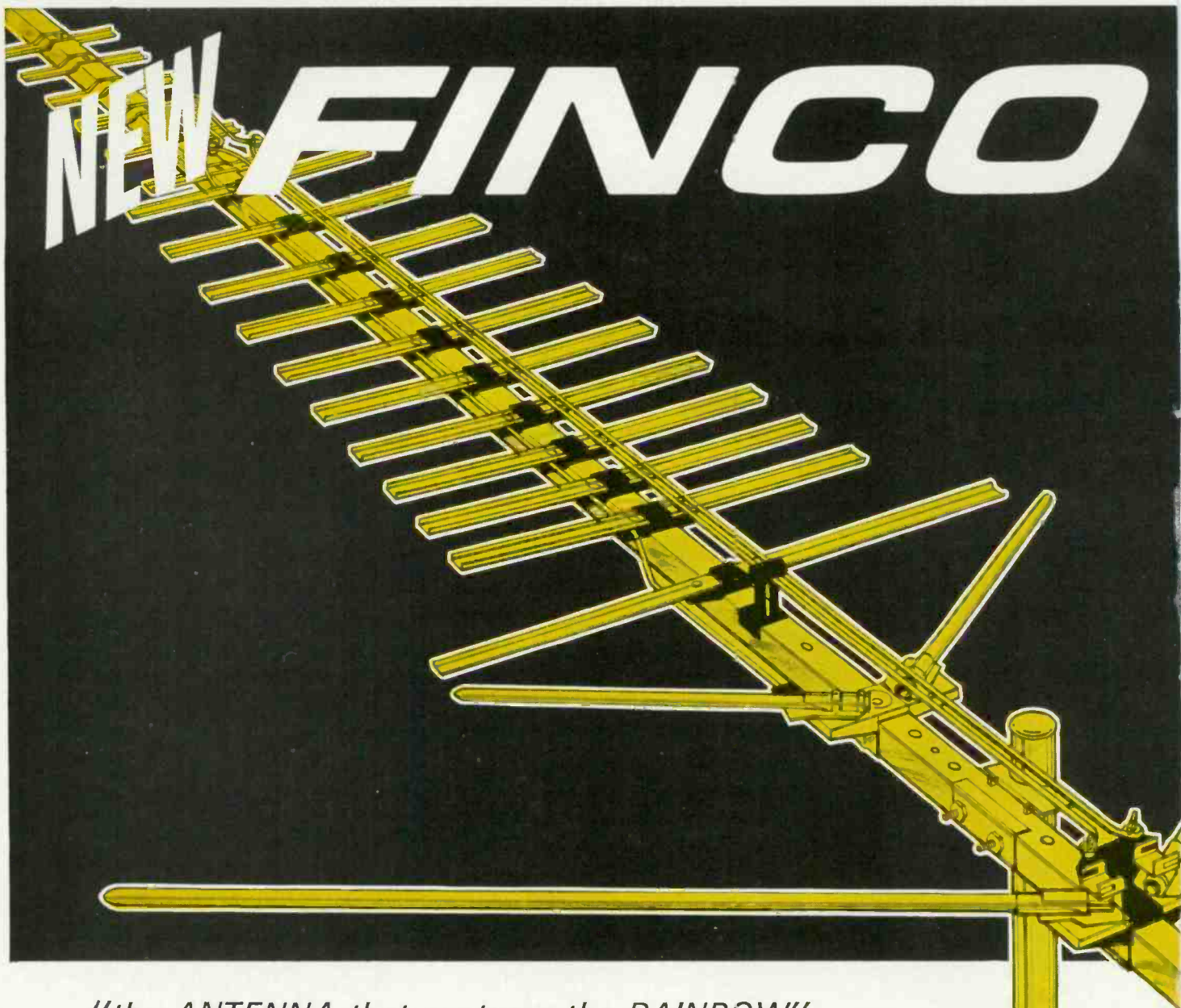

*"the ANTENNA that captures the RAINBOW"*

No two reception areas are alike in the number of stations, UHF and VHF, station channel frequencies, and signal strengths.

FINCO has developed the Color Spectrum Series of antennas — "Signal Customized" — to exactly fit the requirements of any given area. There is a model scientifically designed and engineered for every area, even the most troublesome, and for all combinations of signal conditions.

Engineering studies show that a receiving antenna should have more gain as channel frequency is increased — that is, channel 6 more than channel 2, channel 13 more than channel 7, and UHF from channel 14 on up...

- 1 — to compensate for signal strength loss
- 2 — to compensate for down-lead loss
- 3 — to meet receiver requirements for more signal to operate properly

FINCO Color Spectrum Antennas obtain this frequency dependent characteristic through a newly developed principle of spacing between elements. Gain increases as frequency increases. This new FINCO engineering break-through, combined with superior flat response patterns and unusually high front-to-back ratios, assure the finest COLOR and B & W reception possible... everywhere.



Write for full information on "Signal Customized" Antennas:

**THE FINNEY COMPANY**















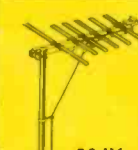

34 West Interstate Street • Dept. 110 • Bedford, Ohio 44146

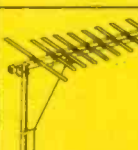
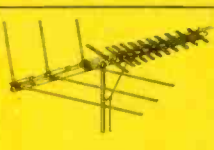
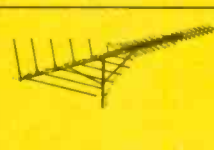
# COLOR SPECTRUM

# ANTENNAS

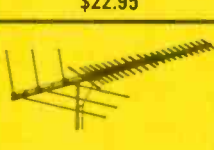
*are "signal customized"  
for better reception.*

Check this chart for the FINCO "SIGNAL CUSTOMIZED" Antenna best suited for your area

STRENGTH OF UHF SIGNAL AT RECEIVING ANTENNA LOCATION	Strength of VHF Signal at Receiving Antenna Location				
	NO VHF	VHF SIGNAL STRONG	VHF SIGNAL MODERATE	VHF SIGNAL WEAK	VHF SIGNAL VERY WEAK
NO UHF →→		 CS-V3 \$10.95	 CS-V5 \$17.50   CS-V7 \$24.95	 CS-V-0 \$35.95	 CS-V15 \$48.50   CS-V18 \$56.50
UHF SIGNAL STRONG →→→	 CS-U1 \$9.95	 CS-A1 \$18.95	 CS-B1 \$29.95	 CS-C1 \$43.95	 CS-C1 \$43.95
UHF SIGNAL WEAK →→→→	 CS-U2 \$14.95	 CS-A2 \$22.95	 CS-B3 \$49.95	 CS-C3 \$59.95	 CS-D3 \$69.95
UHF SIGNAL VERY WEAK →→→→→	 CS-U3 \$21.95	 CS-A3 \$30.95	 CS-B3 \$49.95	 CS-C3 \$59.95	 CS-D3 \$69.95

NOTE: In addition to the regular 300 ohm models (above), each model is available in a 75 ohm coaxial cable download where this type of installation is preferable. These models, designated "XCS", each come complete with a compact behind-the-set 75 ohm to 300 ohm balun-splitter to match the antenna system to the proper set terminals.

# 2

## ALIGNMENT OSCILLATORS DESIGNED TO MAKE SERVICING EASIER BOTH NEW FROM INTERNATIONAL



### MODEL 812 (70 KHz — 20 MHz)

The Model 812 is a crystal controlled oscillator for generating standard signals in the alignment of IF and RF circuits. The portable design is ideal for servicing two-way radios, TV color sets, etc. This model can be zeroed and certified for frequency comparison on special order. Individual trimmers are provided for each crystal. Tolerance .001%. Output attenuators provided. Battery operated. Bench mount available.

Complete (less crystals) \$125.00

### MODEL 814 (70 KHz — 20 MHz)

The Model 814 is identical in size to the 812. It does not have individual trimmers for crystals. Tolerance is .01%. Battery operated. Bench mount available.

Complete (less crystals) \$95.00

*Both the Model 812 and Model 814 have positions for 12 crystals and the entire frequency range is covered in four steps.*

Write for catalog



**CRYSTAL MFG. CO., INC.**  
10 NO. LEE • OKLA. CITY, OKLA. 73102.

... for more details circle 115 on postcard

## EDITOR'S MEMO

### They Must Standardize

Technological changes take place in the electronics industry at a fantastic rate. These changes require new service techniques and may produce unnecessary headaches.

One recent change has come with Motorola's introduction of a transistorized color-TV set. If a component goes bad in the set's audio circuit board, for example, the technician merely unplugs the board and returns it to his supplier who will replace it for about \$6, if the warranty has expired. Other plug-in circuits—forming the major portion of the receiver—are replaced in a similar manner at a slightly greater cost. The cost of replacing these boards may frequently be less than the value of the technician's time if he replaced the defective components on the board.

Some technicians have speculated that the development of modular components would endanger their future livelihood, since a few TV set owners might attempt to service their receivers by replacing modules. This is highly unlikely since the owner would not know which module is defective. A technician's skill is needed to determine which module is causing the trouble-symptom.

The real danger, however, may result from the industry's failure to standardize future modular microcircuits. It is already becoming increasingly difficult to catalog the wide assortment of integrated circuits currently being developed. Microcircuits and simple integrated circuits will be mass produced for modular use in future receivers. The nature of these "beasts" prohibits their repair, and once they have developed a flaw, they must be replaced. But will technicians be able to maintain an adequate inventory if new modular circuits are designed for every new receiver model introduced?

In the case of Motorola's new set, as an example of things to come, a spokesman acknowledges that the average service-dealer will probably not be able to maintain a supply of their color-TV set's plug-in circuit boards.

Unless the electronics industry begins an immediate program of standardization, servicing procedures may become a time-consuming necessity. The number of house calls may double. TV sets may sit for days unrepaired. And technicians may find themselves working more hours as "delivery boys" than as technicians.

# Getting a hernia and not getting paid for it?

Switch to Elmenco dipped Mylar®-paper capacitors and you won't have to worry about call-backs, lost profits, broken reputations or broken anything else.

The only ordinary thing about them is their price. You get capacitors that meet the requirements of high-reliability computer and missile systems. You get capacitors that hold their rating at 125°C continuous operation. Yet you get them at TV set prices.

Elmenco dipped Mylar-paper capacitors come in just about any value you need from .001 mfd to 1.0 mfd. And just about any TV rated voltage you need, too, from 100V through 1600V.

Ask your Authorized Arco Distributor to put them on your next order. Without fail.

Tell him you're counting on his support.

(While you're at it, ask about other Elmenco types: padders and trimmers; high voltage dipped micas.)

## Arco Electronics

A Division of Loral Corporation ■  
Community Drive, Great Neck, N. Y. /  
Arlington, Texas / Elk Grove Village,  
Illinois / Pasadena, Menlo Park, California.

© DU PONT TRADEMARK.

... for more details circle 104 on postcard



# Channel Master smashes the 82 Channel size barrier!

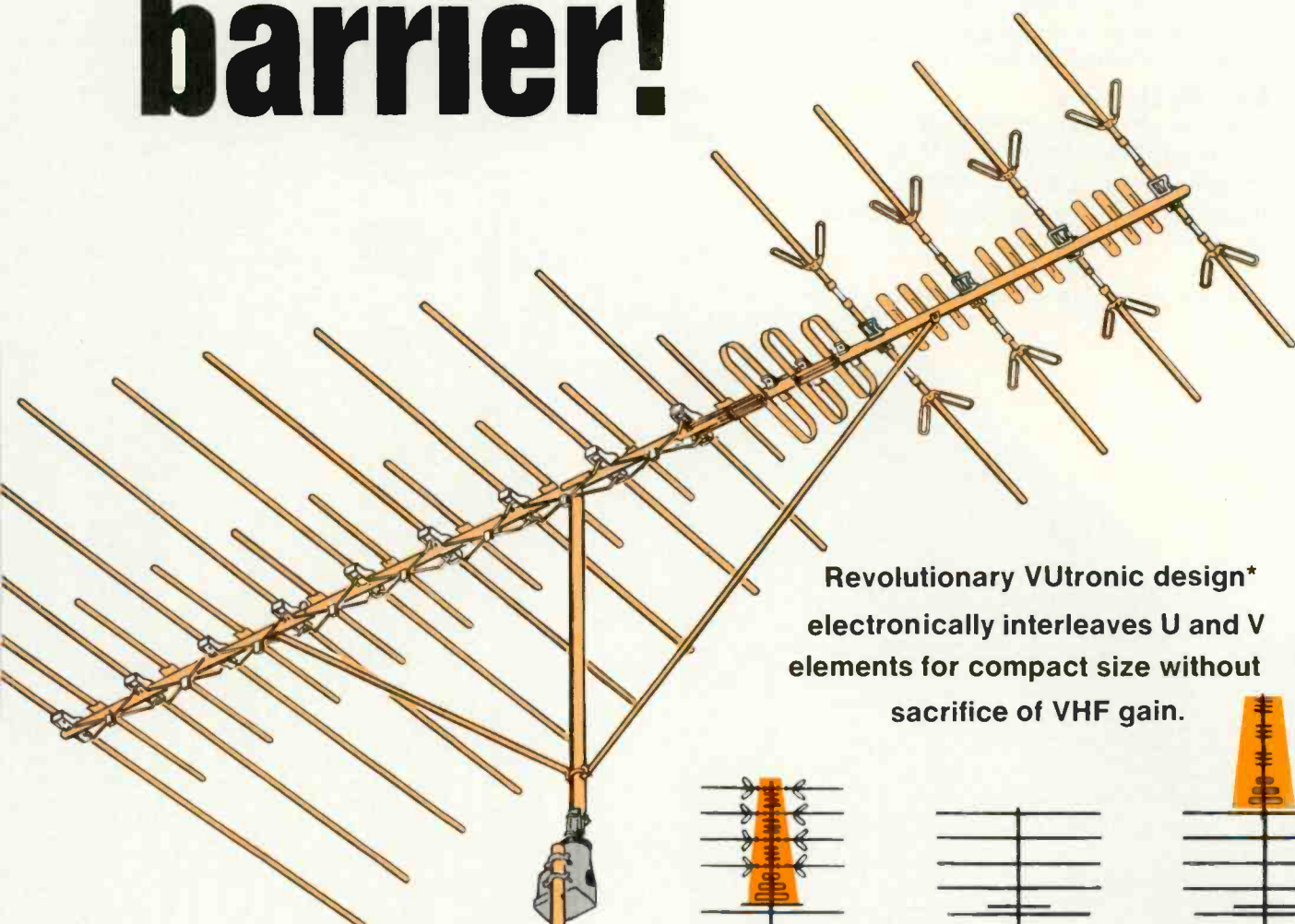

Deep Fringe  
**Model 3661-G**  
Same VHF gain as  
Color Crossfire  
Model 3610-G

Revolutionary VUtronic design\*  
electronically interleaves U and V  
elements for compact size without  
sacrifice of VHF gain.

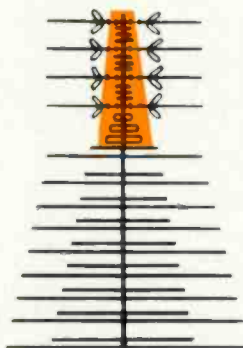

Fringe area Model 3661G has all UHF elements contained within the over-all length of the VHF section

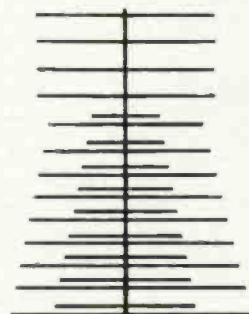

A VHF only antenna with exactly the same VHF gain as the 82-channel Model 3661G is also practically the same size.

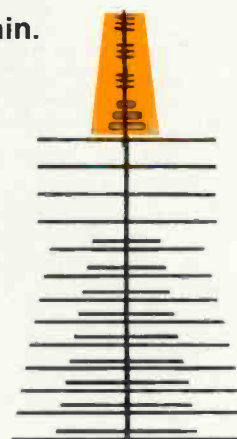

Usual design 82-channel antenna would have to be 34% longer to provide the same UHF and VHF gain as Model 3661G Color Crossfire 82.

\*Patent Applied For

# New Color Crossfire 82

## UHF/VHF Antennas plus FM/FM Stereo

Totally new concepts in UHF/VHF design are joined with Channel Master's proven Crossfire principle to produce the first 82-channel antennas that meet UHF reception needs yet also provide unsurpassed VHF gain...and with no appreciable increase in over-all size.

Here is another example of a major development from Channel Master Laboratories where, as always, leadership begins with research.

Until now, antenna manufacturers have created combination UHF/VHF antennas by coupling a UHF section to the front of a VHF antenna. To avoid costly, unwieldy, and unsightly construction, this has always meant sacrificing VHF gain. Now Channel Master fills the 82-channel gain gap with Color Crossfire 82 antennas designed for metropolitan to fringe areas where maximum VHF gain is as important as UHF reception power.

In addition to the famous Channel Master Crossfire VHF Proportional Energy Absorption Principle, these new antennas employ unique series-fed folded UHF dipoles with carefully engineered dimensions so that they literally "disappear" and operate as a perfect 300 ohm line at VHF frequencies...no "lossy" couplers required as is the case with the usual parallel-fed UHF elements.

And, of course, every Color Crossfire 82 antenna features Channel Master's famous E.P.C. golden coating and rugged preassembled construction.

**HERE'S THE SECRET**

UHF Director Low end UHF    UHF Director High end UHF    2 UHF Wave-Lengths overall

VHF Director    UHF Phase Controller    Center Insulator    VHF Director

Ultronic design employs unique dual-function co-linear directors (on all but three metropolitan models) serving both UHF and VHF sections. This permits space-saving inclusion of the UHF elements **into** the physical structure of the full-power VHF array. The exclusive UHF phase controller "whiskers" boost UHF gain by making each full-wave director the equivalent of two full wave lengths.

Now the first and only complete line of full VHF Power 82-channel antennas.

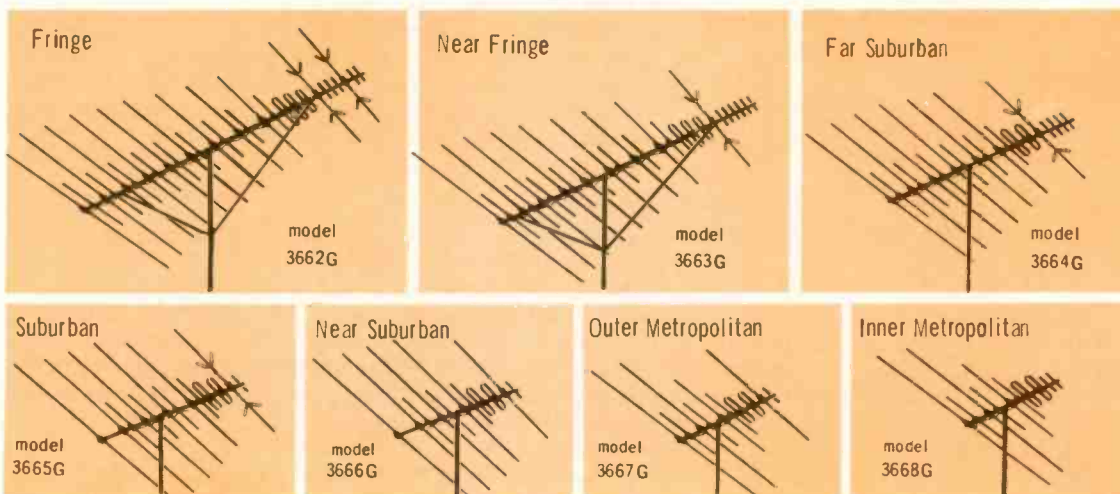

More Channel Master Crossfire Series Antennas have been sold and are being sold...than any other antenna in the history of television.

**CHANNEL MASTER**  
Ellenville, N.Y.

... for more details circle 108 on postcard

# TECHNICAL DIGEST

## Making TV and FM Absorption Traps

Television and FM receivers are specially designed to reject unwanted signals. Occasionally, however, in areas where undesirable signals are extremely strong, a problem may appear. For example, adjacent channel interference may occur in areas where a customer wishes to watch a distant station and there is a local station on an adjacent channel. Although correct antenna orientation and selective tuning will usually help, the unwanted signal may still cause interference. In such cases, a tuned trap will usually solve the problem.

RF interference is another problem that sometimes presents itself. This type interference usually occurs in areas where the set is located "next door" to a TV or FM transmitter. These particular circumstances can cause interference on several or all TV channels. On an FM receiver, spurious signals may be received at several spots on the dial, or in extreme cases, block out several or all FM stations.

In solving problems of an interference nature, it is often desirable to attenuate (or reject) a specific frequency or band of frequencies. In most cases, this can be done by simply installing an absorption trap on the antenna lead-in. Such traps may be quickly constructed by using a section of 300-ohm flat ribbon transmission line, terminated on one end by a small trimmer capacitor. The other end of the trap is short-circuited for trapping VHF signals;

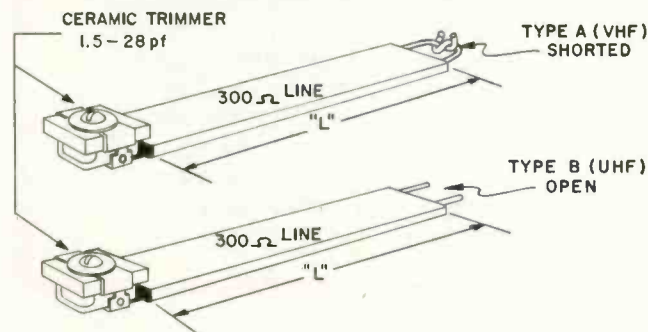

whereas for UHF, the other end is open-circuited as shown in the illustrations.

Lengths of 300-ohm line for typical traps follow: (Tuning trimmer capacitance range in all cases is 1.5 to 28 pF.)

Channels	Length "L"
Ch. 2-6 and FM	8in. VHF Type A
Ch. 7-13	3in. VHF Type A
Ch. 14-50	5in. UHF Type B
Ch. 51-83	3in. UHF Type B

These traps are installed by taping them to the 300-ohm antenna lead-in. The effectiveness of the trap is controlled by several factors:

1. Position of the trap along the lead-in: The trap sets up a standing wave at the trapped frequency in the lead-in wire to the receiver. The trap should be moved along the lead-in until the optimum trap placement is found, remembering to retune the variable trimmer.
2. Physical length of the trap: The length (dimension "L") may be varied and the trimmer adjusted accordingly. A longer trap tends to be "broad band."
3. Coupling of the trap to the line: For effective oper-

ation it is necessary that the trap be installed against flat 300-ohm lead-in. After final adjustment the trap can be held in place by paper or vinyl tape. A convenient initial adjustment technique is to hold the trap on the

## ADJUSTABLE CERAMIC CAPACITOR

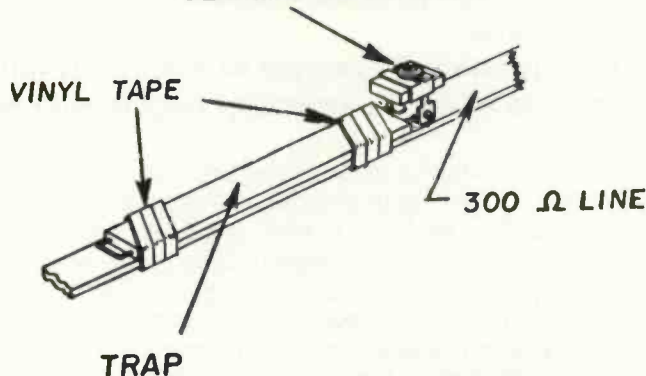

300-ohm line with spring-loaded plastic clothespins. The clothespins serve as convenient handles during the initial trimmer adjustment and allow positioning along the lead in for optimum attenuation.

Practical use of the traps may fall into three categories:

1. A trap for narrow band interfering signals.
2. Trapping a broad band signal like a TV channel.
3. A method for identifying the frequency of an interfering signal in the field.

To reject a narrow band signal, the trap is coupled to the transmission line and adjusted to the interfering signal. The trap lengths given in the table will cover the range of frequencies from 50 to 890 MHz. Remember to position the trap along the lead-in for optimum rejection.

Trap circuits can attenuate a broad band signal (a strong TV channel) that is interfering with a weaker channel. Because the trap will have a pronounced effect on the channel to which it is tuned it is very important to check the performance of the receiver on the "trapped" channel, with and without the trap in place. In particular, a color TV should be checked with a color program. If undue effect is noticed, it may be necessary to "broad band" the trap circuit. This may be done in one of two ways: by increasing the length "L" of the trap and readjusting the trimmer or alternatively, by loading the trap with a resistor, typically 10K. *Courtesy RCA Victor*

## ADMIRAL

Radio Phono Chassis 5V6, -6A and 5W6—Output Transistor Replacement

A stud-mounted type output transistor, 57C6-14, was used in early production, and is no longer available. A replacement kit consists of a 57C6-10 transistor, an insulating wafer and two plastic screws stocked under the original part number 57C6-14. The aluminum heat sink in which the original transistor was mounted also contains holes for the 57C6-10, but they are not tapped. This can be done easily with a 6-32 thread-cutting screw (1A51-4-24). The transistor must be mounted only with the furnished plastic screws. Do not use metal screws for this purpose.



## CANADIAN GENERAL ELECTRIC

### Color TV Model M663—Audio Trouble

There have been reports of audio problems that can be caused by bad lead dress in the audio circuit.

The leads of C313 and C306 have been found to be in contact with the envelope of the 12BF11 audio output tube. The transfer of heat will cause distortion.

The solution, of course, is to bend the capacitors away from the envelope so they are no longer in contact.

### Color TV—New Picture Tube Type

At present there are two types of 25in. color tubes used in Canadian G-E sets. The only differences are as follows:

Characteristics	25AP22A	25SP22
Heater current	0.8a	1.3a
G1 cutoff at 440v G2	-95 to -190	-75 to -167v
Over-all length	20.924 ±0.375	21.123 ±0.375

It can be seen that both tubes are interchangeable. There is one small modification — R124, the 0.8Ω.

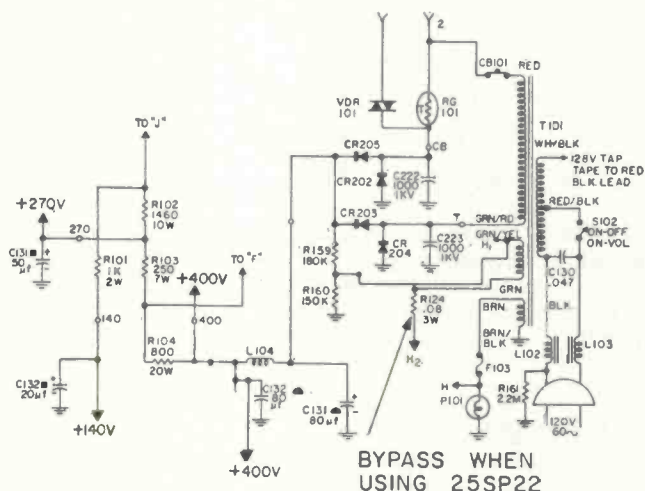

3W resistor should be bypassed by a piece of buss wire when you use the 25SP22, the buss wire is removed if you replace a 25SP22 with a 25AP22A. The resistor is located under the chassis near the power transformer.

## GENERAL ELECTRIC

### Color TV Chassis KC—Changing HV Regulator Tube Type

Regardless of the type of service being done on the KC chassis color TV, the high voltage regulator tube V17, with white printed code (white branding) is to be changed to a new type, as shown. Tubes having a yellow code and branding are not to be changed. Chassis stamped EN378 or higher do not require this change.

This tube type change should be performed regardless of whether the TV is in or out of warranty. The old tube removed from the chassis is to be tagged with customer's name and address, along with the model and serial number of the TV set. Return the tagged tube to the nearest G-E TV distributor for credit or exchange.

For 6EA4 .....use 6EH6  
For 6EF4 .....use 6EJ4  
For 6LC6 .....use 6LH6

After installing the tube, attach one of the new tube type labels (packed with the tube) to the rear wall of the HV compartment and the other label to the outside of the cabinet back near the top. The information on the label will then indicate to anyone subsequently servicing receiver that the new type tube has been installed.

Swingin'  
Combo  
for  
Top  
Performance!



## NEW SENCORE SM112B SERVICE MASTER VTVM/VOM

Here it is — the third generation of Sencore's famous Service Master — the two-in-one professional instrument that saves your time, speeds your service work, puts extra profits in your pocket.

- Just one function switch, one range switch and one probe provide all functions of VTVM and VOM.
- Voltage, current and resistance in 33 ranges — for accurate measurements anywhere, anytime.
- VTVM operates from 115v AC for precise bench or lab work; battery powered VOM gives you a 5000 ohms per volt meter.
- Lighted arrows automatically indicate VTVM scales.
- Large, easy-to-read 6-inch two percent meter covers all measurements.
- Handsome new styling in tough, vinyl-clad steel case.
- Optional high voltage probe attaches for measuring up to 30,000 volts DC.

So why use two when one will do — the new Sencore SM112B. Truly professional quality, and still only **\$79.95**  
High Voltage Probe HP118 ..... \$7.95

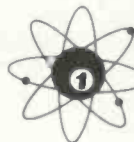

**SENCORE**

NO. 1 MANUFACTURER OF ELECTRONIC MAINTENANCE EQUIPMENT

426 SOUTH WESTGATE DRIVE, ADDISON, ILLINOIS 60101

... for more details circle 125 on postcard

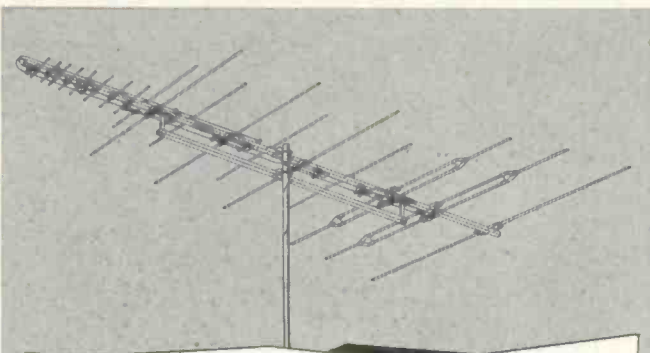

**3-Way Combination  
FREE SPACE STANDING WAVE  
MAGNETIC ANTENNA**

**ZEROS IN  
YOUR SIGNAL—**

**Discriminates Between  
Desired Signal and  
Unwanted Noise!**

Here is an antenna with the unique ability to discriminate between the desired signal and unwanted noise! A complete absence of minor lobes and an extremely high front to back ratio are characteristics of these antennas. This is made possible by the development of the Free Space Standing Wave Magnetic Drive Antenna system (F.S.M.). The outstanding electrical qualities, combined with the simplified mechanical construction of this system yields a total performance package unparalleled in today's market. 4 models, 60-inch to 180-inch boom, all modestly priced.

**UNEXCELLED!**

**UHF — VHF — FM — COLOR**

**INVESTIGATE NOW!**

**S&A Electronics Inc.**

Manufacturers of the TARGET ANTENNA

**204 West Florence Street  
Toledo, Ohio 43605**

... for more details circle 124 on postcard

**TECHNICAL DIGEST**

Operate receiver and adjust the HV as instructed in the KC manual. The marking (or lack of marking) on the HV shield determines if the HV requires adjustment.

**Amplifier Models T20/30 and T60/112—On/Off 'Pop' Noise**  
If there is a "pop" in the speaker when the amplifier is switched on or off, the noise can be eliminated as follows:  
Place a 0.047 $\mu$ f 600v capacitor (Cat. No. EA26X10 or

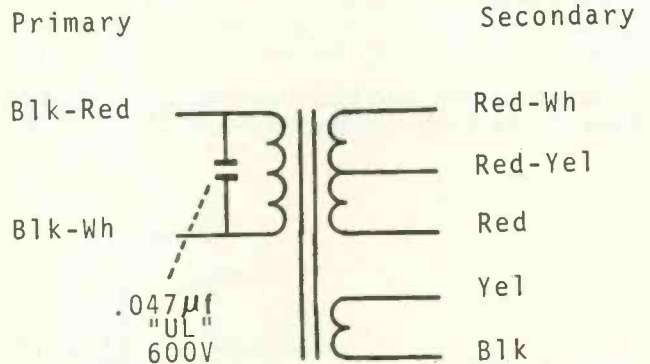

equivalent) across the primary winding of the amplifier power transformer.

The addition of this 0.047 capacitor will greatly reduce the amplitude of the "pop." Late production amplifiers had this capacitor installed at the factory.

**MAGNAVOX**

**Record Player Motor Pulley Adapters for 50Hz Operation**

From time to time we have requests on how a Magnavox record player can be modified to operate in areas where only a 50Hz power source is available. Most recent record players can be adapted to provide proper turntable speed on a 50Hz supply by installation of a motor pulley adapter which fits over the existing pulley on the motor. These motor pulley adapters are available from your "Magna-Par" parts depot. Here's a list of the adapters and the record players on which they can be used.

<i>Record player model numbers</i>	<i>Use 50Hz pulley</i>
W603-01 through W603-05, W603-07 & W603-08 (using non-synchronous 4 coil, 4 pole type motor)	170573-1
W603 (all versions except those listed above) and W607 all versions (using non-synchronous 2 coil, 4 pole motor)	170574-1
W604, W620, W621, W622 all versions (using synchronous 4 coil, 4 pole motor)	170572-1
W615 all versions except W615-06, W615-07, W615-08 & W615-15	523711-5
W617-03 only	52640 (VM Part No.)

\*W615-06, 07, 08 & 15 versions use a motor with an ac overwind for power to the amplifier and cannot be adapted to 50Hz operation.

# FREE

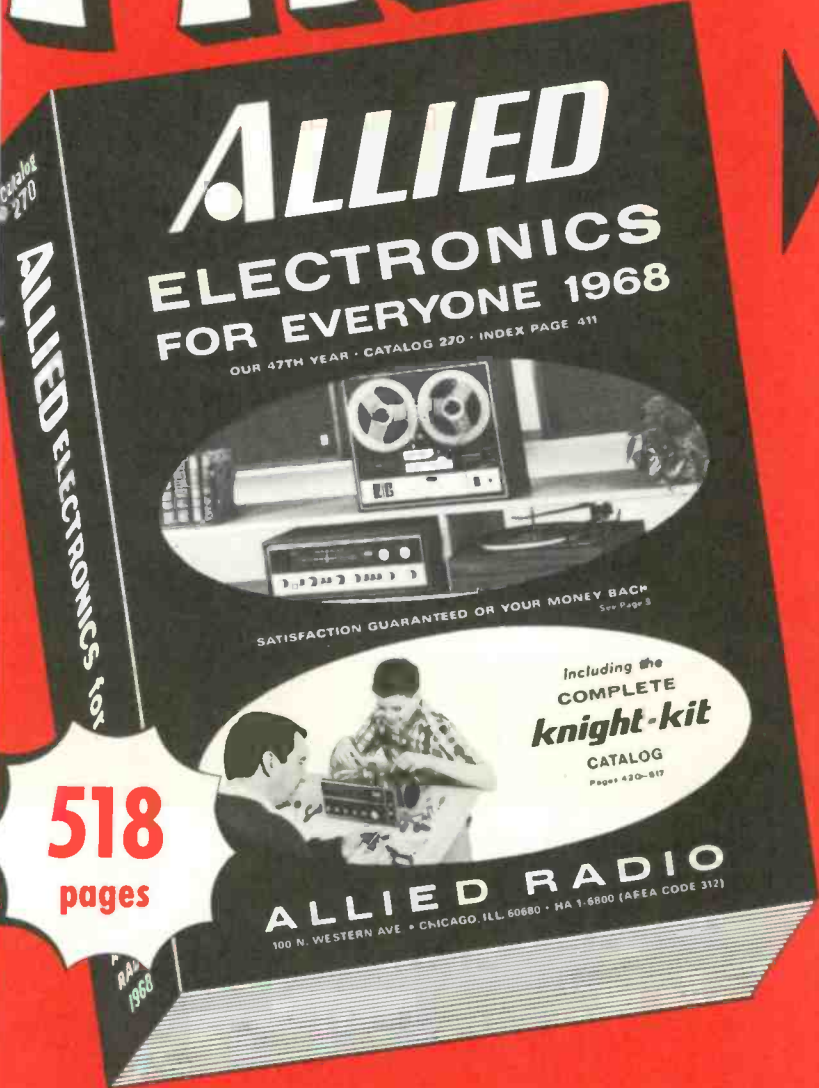

## New 1968 Allied Catalog

Here it is! The brand-new 1968 edition of the world's most famous catalog of electronic equipment.

518 pages, including the complete Knight-Kit Catalog—picturing, describing and pricing thousands of items—the most complete inventory ever assembled of hi-fi, radios, tape recorders, CB, electronic equipment, parts and tools—all at money-saving low prices.

You'll want your own personal copy of the Allied Catalog. It's free. So fear off, fill out, and mail a card. Do it now!

**NO MONEY DOWN—24 MONTHS TO PAY!**  
**Low Monthly Payments to fit your budget.**

**DO A FRIEND A FAVOR—give him this card to send for his FREE ALLIED CATALOG**

NAME—PLEASE PRINT \_\_\_\_\_

ADDRESS \_\_\_\_\_

CITY \_\_\_\_\_

STATE \_\_\_\_\_ 28H \_\_\_\_\_ ZIP \_\_\_\_\_

**FILL THIS CARD OUT—MAIL IT NOW!**

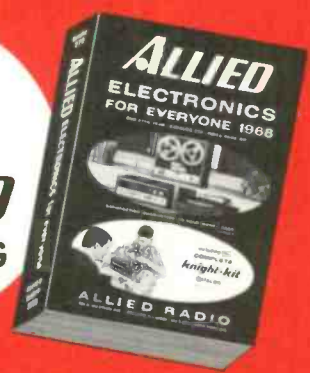

**WORLD'S LARGEST SELECTIONS. SATISFACTION GUARANTEED OR YOUR MONEY BACK**

NAME—PLEASE PRINT \_\_\_\_\_

ADDRESS \_\_\_\_\_

CITY \_\_\_\_\_

STATE \_\_\_\_\_ 28H \_\_\_\_\_ ZIP \_\_\_\_\_

**FILL THIS CARD OUT—MAIL IT NOW!**

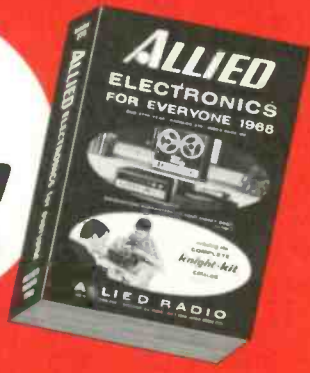

**WORLD'S LARGEST SELECTIONS. SATISFACTION GUARANTEED OR YOUR MONEY BACK**

**RUSH THIS CARD TODAY!**

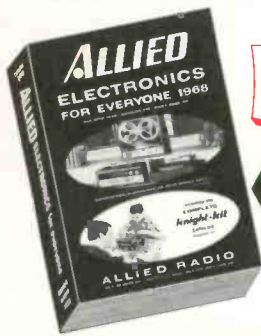

for your  
**FREE**

1968  
**ALLIED  
CATALOG**

TO:  
**ALLIED RADIO**  
P.O. BOX 4398  
CHICAGO, ILLINOIS 60680

PLACE  
STAMP  
HERE



## Why Buy by Mail from **ALLIED?**

Each year Allied fills more than a million orders by mail. Only the complete facilities of the world's largest electronics supply house can satisfy all the needs of hi-fi enthusiasts, CB users, engineers, "Hams" and experimenters.

### WORLD'S LARGEST SELECTIONS

Imagine shopping for hi-fi where you can select from every model of 15 major manufacturers of receivers, tuners and amplifiers, 14 brands of tape recorders, 7 makes of turntables, nearly 100 speakers from a dozen manufacturers. Plus similar choices in every area of electronics—CB and Ham, test equipment, kits (including Knight-Kits), parts, supplies . . . almost anything you want.

### MANY PRODUCTS NOT AVAILABLE ANYWHERE ELSE

As the world's largest supplier of electronics, Allied can afford to stock thousands of items not available elsewhere. In addition, many products are specially-designed and built to our specifications.

### FIRST WITH THE LATEST FOR 47 YEARS

We have always been the first to offer the latest developments in electronics, as you will see when you receive your new 1968 catalog from Allied.



**RUSH THIS CARD TODAY!**

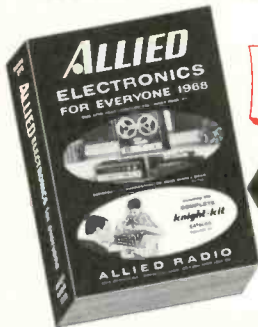

for your  
**FREE**

1968  
**ALLIED  
CATALOG**

TO:  
**ALLIED RADIO**  
P.O. BOX 4398  
CHICAGO, ILLINOIS 60680

PLACE  
STAMP  
HERE

### WE QUALITY-TEST WHAT WE SELL

Among all electronics supply houses, only Allied has a continuous program of quality-testing to assure you that everything you buy meets the highest standards.

### COUNT YOUR SAVINGS AT ALLIED

You always get the lowest prices at Allied. Check Allied prices and compare. Look for the special values—available only when you shop in the Allied catalog.

### IMMEDIATE SHIPMENT

There's no delay when you deal with the world's largest electronics supply house. Orders are filled promptly—usually the day they're received.

### NO MONEY DOWN — UP TO TWO YEARS TO PAY

You don't need cash at Allied. Make "add-on" purchases—even though you are already paying for something else. It's easy to be a credit customer at Allied.

### SATISFACTION GUARANTEED OR YOUR MONEY BACK

You can buy with confidence from Allied. We guarantee satisfaction or your money back.

### ENJOY "EASY-CHAIR" SHOPPING

Shopping's easy at Allied. More accurate, too! You always know *exactly* what you get. And *what a choice!* A selection of merchandise so vast that no store could ever assemble and stock it all.



# The State of Solid-State

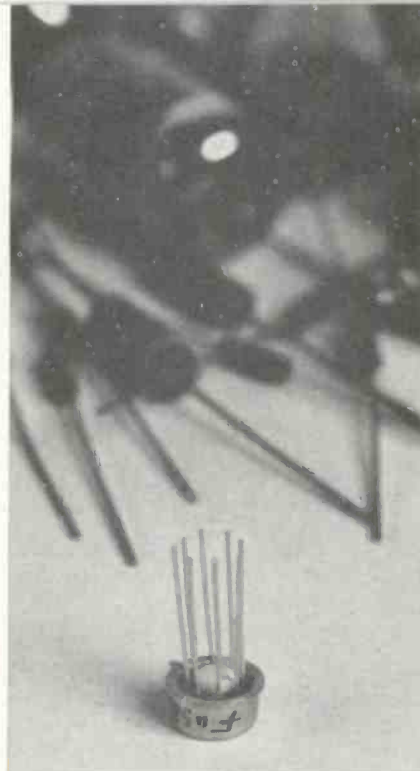

The Fairchild  $\mu$ A702A IC (in the foreground) replaces the components shown out of focus in the background.

Solid-state technology surges upward to ultimate levels with microintegrated 'chips'

## **TEKLAB REPORT**

■ For many years electron tubes have provided the only practical detectors and amplifiers. Until transistors were developed, electronic equipment manufacturers depended entirely on electron tubes. But it has been obvious for some time that the trend has turned toward solid-state electronic circuitry and very few "crystal-ballers" would even hazard a guess regarding the "end of developments" in this area.

Transistors and solid-state diodes have largely replaced tubes in radios, TVs, hearing aids, digital computers, test instruments and a wide variety of industrial electronic products.

Semiconductors—and especially microintegrated packages—are reducing the size and weight of most electronic equipment used in the home, in industry and in space exploration.

During the first quarter of 1967, for example, sales of receiving tubes to original electronic manufacturers (OEMs) reached 59 million units—a decline of 17.5 percent from

sales of 72 million units during the same period in 1966.

Total receiving tube sales were also off 14.5 percent—at 95 million units—during the first three months of this year.

Declines were shown in other receiving tube market areas. Sales for renewal purposes decreased 9.8 percent to reach 27 million units and direct sales to the government were down 9.3 percent.

Some reasons why transistors have many advantages over tubes are as follows:

1. "Small-signal" transistors are about the size of an eraser on the end of a pencil and take up less space than tubes. Power transistors are about the size of a quarter.

2. Power consumption is small. Transistors and solid-state diodes do not require filaments. Their voltage needs are only a fraction of tube requirements. When used in portable equipment the units are smaller and lighter in weight. Operating costs are lower. Less heat is generated in most applications.

## Solid-State . . .

3. No warm-up time is required. Solid-state equipment operates instantly when switched on.

4. Solid-state construction in a single compact unit eliminates moving or floating parts making them rugged when used in portable equipment.

5. Transistors have a longer life expectancy and can be easily waterproofed with a plastic shell which allows them to be operated in damp environments and even under water.

6. Transistors can provide more flexibility in circuit designs and circuits are frequently more simple than tube circuits—requiring fewer components.

Although the basic troubleshooting approach to solid-state circuits is the same as with electron tube circuits, the specific procedures require entirely different techniques. Solid-state circuits must not be compared with electron tube circuits—we must think solid-state!

More care must be exercised when servicing solid-state circuits to prevent additional problems because of careless application of test instruments—especially when using metal probes. A momentary short or overload can destroy a transistor or other component in the circuit.

As in tube circuits, the over-all troubleshooting approach is “logical deduction through knowledge of circuit operation.” And technicians must apply their knowledge of solid-state circuit operation to master these circuits successfully.

### Solid-State Test Instruments

Solid-state VTVMs, with self-contained power supplies and having a 1.5v full scale, are now being manufactured. Small potentials as

low as 0.025v can be measured with these instruments. This feature is extremely useful when measuring the base-to-emitter bias—ranging from 0.1 to 0.6v with germanium and silicon transistors—when troubleshooting transistorized circuits. These meters are protected against damage from accidental overload. The high input impedance of these VTVMs prevent circuit loading which may cause damage to a transistor or other circuit component.

Solid-state signal-injection and -tracer instruments have also been designed to check transistor radios.

Servicing solid-state equipment by signal-tracing and signal-injection is the most effective way to isolate defective stages in solid-state equipment. With this type of test instrument, either the signal-tracing or signal-injection method can be used. When signal-tracing, the instrument is set up as a receiver. Signals in the RF, IF and audio stages are picked up with the probe, amplified, then converted into an audible signal which is monitored by the test instrument's speaker.

When signal-injection methods are used, the tester is set up as an



Hickok FM/stereo multiplex generator model 727.



Sencore's MX11 solid-state stereo generator.

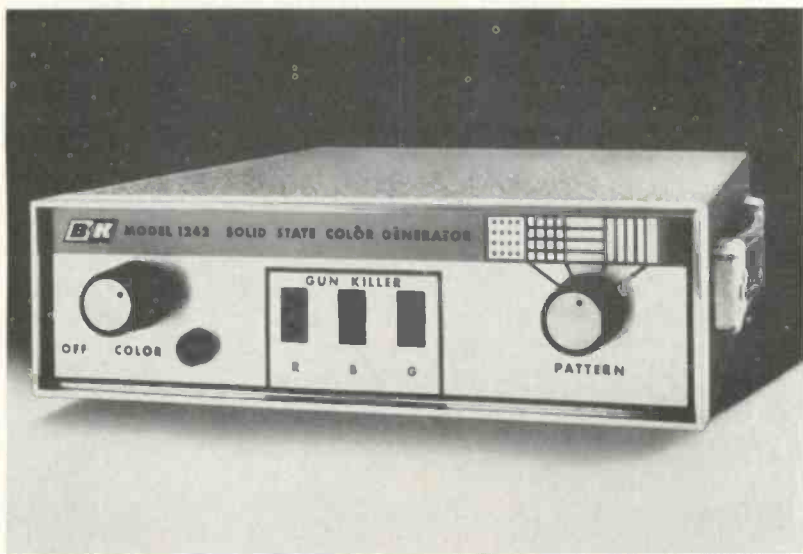

B&K's solid-state color generator model 1242.

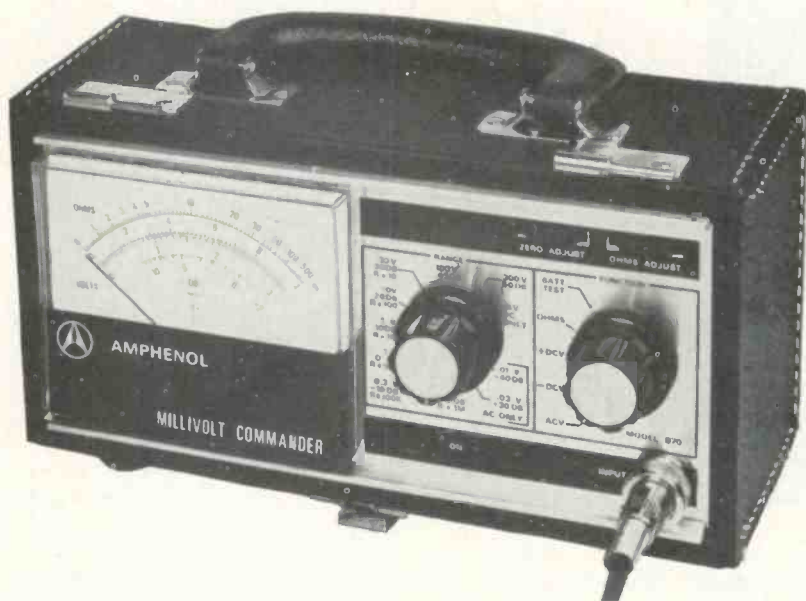

Amphenol's solid-state millivolt "Commander," model 870.

RF or audio generator. Signals are injected and the radio's speaker is used as an indicator. When signal-tracing, the usual method is to begin with the defective set's RF stage and work toward the speaker. With signal-injection, the reverse procedure is used—starting at the speaker and working backward toward the RF stage.

FM/stereo broadcasting and receiving is rapidly gaining public interest. Standard FM broadcasting will no longer satisfy the millions of people who have been educated to fine music and voice reproduction.

The best receivers and associated equipment cannot give proper response if the components are not properly balanced and aligned.

Rules and regulations set forth by the FCC require complex receiver circuitry which is difficult to service without special test instruments. But special solid-state test instruments have also been designed to cope with these problems.

A light-weight, portable, self-contained power supply FM/multiplex generator can be carried into the home and it generates a complete composite FM/multiplex signal in

accordance with FCC specifications. For more information on these generators refer to the article series, "Using Audio Test and Alignment Instruments," which began in the March 1967 issue of *ELECTRONIC TECHNICIAN*.

Solid-state test instruments fulfill the need for lightweight portable test instruments.

#### IC and FET Circuits

Many transistor tuners and receivers on the market today are subject to cross modulation—powerful stations can appear at several points on the dial—interfering with other signals which listeners want to receive. Resistance to cross-modulation is an inherent failing of ordinary transistor circuits. One solution to this problem is to use regular tubes or muvistors in the front end of an otherwise all-solid-state tuner. This hybrid design works well initially, but is said to defeat its own purpose eventually, since tubes generate drift-producing heat and fail more quickly than transistors. One manufacturer claims to have solved this problem by using field-effect transistors (FETs). For detailed information on FET circuitry, refer to the article, "Semiconductors from A to Z," which has been running in *ET* since August 1966.

The first FETs made are reported to have sold for about \$30 each and were considered a curiosity by design engineers. After a short time, however, useful applications were developed for special military equipment. FETs had a very high input impedance but circuit designers who had experience only with transistors found themselves attempting to apply unfamiliar electron tube techniques.

Today, the price of FETs has dropped to only a few dollars. Various types of field-effect transistors are now available, including insulated-gate, metal oxide and even thin-film types. A number of FET FM receiver front ends have been developed and the circuit of one of these is shown in Fig. 1.

Integrated circuits are now being used more widely. They can be applied to regenerate the 3.58MHz subcarrier in color TV sets. At

Fig. 1—Diagram of the Scott FM tuner front-end which employs three FET and one conventional transistor.

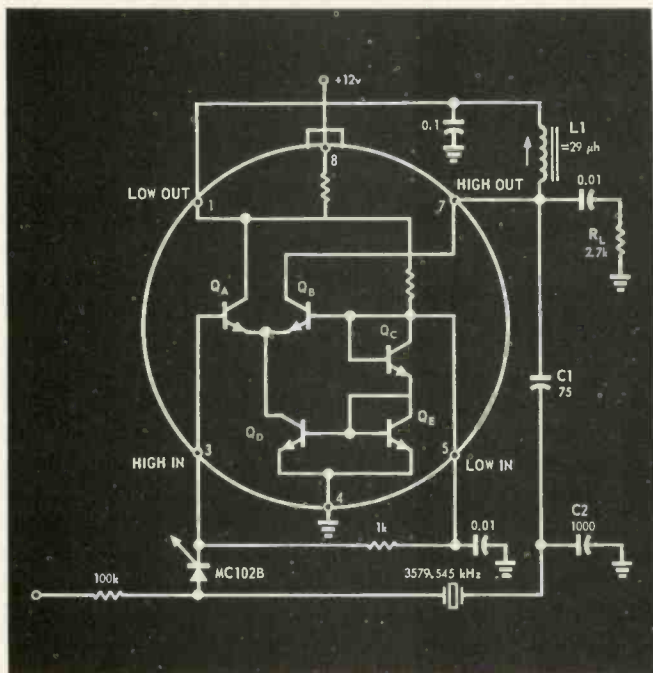
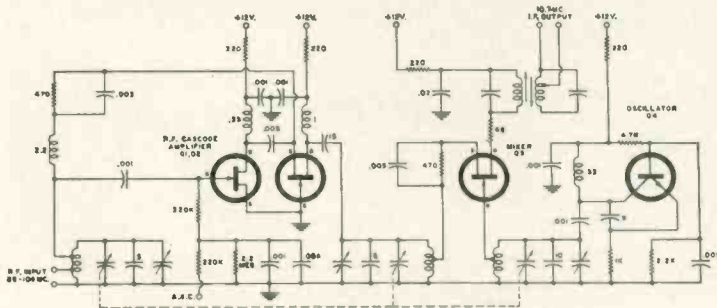

Fig. 2—Schematic of voltage-controlled crystal oscillator using the Fairchild  $\mu A703C$  IC.

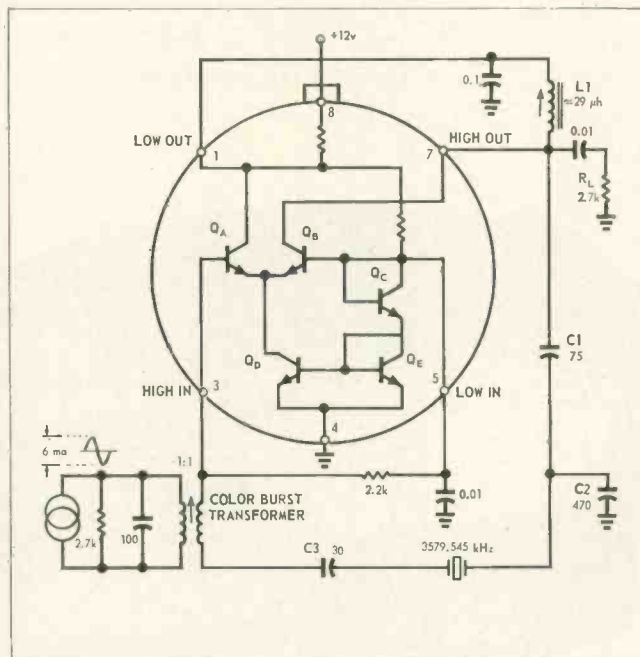

Fig. 3—Schematic of injection-locked crystal oscillator using the Fairchild  $\mu A703C$  IC.

present, three methods are used: (1) The voltage controlled crystal oscillator in an automatic phase control (APC) loop, (2) The injection-locked crystal oscillator, (3) The narrow bandpass crystal ringing circuit.

Two of the aforementioned methods are shown in Fig. 2 and Fig. 3. The IC and associated circuitry for a voltage controlled crystal oscillator is shown in Fig. 2. The IC and associated circuitry for an injection-locked crystal oscillator that is basically similar to the voltage-controlled oscillator is shown in Fig. 3. Except for the smaller ratio of C1 and C2—allowing for additional voltage drop of the burst transformer impedance in the feedback loop—the output tuned circuit is the same.

### Solid-State Home Entertainment Equipment

Most manufacturers today are extending their lines of equipment containing transistors, microelectronic and integrated circuits. This includes color and B/W TV, console stereo, portable phonographs, tape recorders and tape players.

One company has a color TV and a color TV/radio/phono combination with an IC in the picture amplifier circuits.

A console stereophonic Hi Fi phono has an IC in its FM limiter stage.

A new remote-control transmitter has an integrated circuit.

The same company claims to have 85 percent of its radio line fully solid-state.

Another company has already introduced a line of solid-state color TV receivers—believed to be the first sets of their kind to be marketed in this country. These receivers also employ ICs.

As previously made clear, solid-state transistor products operate cooler than electron tube versions—an advantage which extends the life potential of components and promises greater reliability over tube sets.

ET's TEKLAB is extending its investigation into solid-state troubleshooting and repair techniques. It is recommended that all service-dealers and technicians review previous articles on this subject and follow closely forthcoming articles which deal with solid-state developments and servicing methods. ■



# UNDERSTANDING MODERN AGC CIRCUITS

Learn some of the 'service-secrets' that separate the 'men' from the 'boys'

■ The fourth article of this series (ELECTRONIC TECHNICIAN, July 1967) explored some general and particular considerations concerning troubleshooting modern keyed AGC circuits—tube and solid-state.

It was also pointed out that a special "viewpoint" was necessary before these circuits could be repaired rapidly enough to satisfy present-day TV owner demands and meet competitive standards now being established by an increasing number of alert and progressive service-dealers.

Perhaps it would be helpful to repeat: use your intelligence (it's also called common sense) when approaching any service problem—and this includes modern AGC service problems.

## The Modus Operandi

In the previous article it was made clear that an AGC system is but one circuit in a closed-loop "chain" composed of individual, interdependent, interactive links. It was also indicated that the entire loop must be "seen" and considered in-total when diagnosing trouble-symptoms as revealed by the CRT screen or the speaker. But we did not suggest that the total loop be considered as one solid, elaborate, complicated and formidable maze which, according to the views of some, was designed especially by the engineers to frustrate hard-working technicians.

The modus operandi of troubleshooting AGC circuits—the manner in which you work—is the same for all types of electronic circuitry: in

most cases it involves common-sense techniques and proper test instruments. To state it another way, it requires knowledge of the equipment and logical thinking. It's as simple as finding a needle in a hay-stack—by using a hundred-thousand-gauss electromagnet!

As every skilled technician knows, three of the five inherent human senses—sight, touch and smell—can reveal clues that lead directly to a rapid solution to most electronic circuit problems.

Observe the "old pro" in action at the service bench for a moment. He has just placed a chassis on its side, with the "guts" showing and the set is switched on. In a cool, relaxed and confident manner, he pokes his nose close to the chassis innards and literally "sniffs around"—like a bird-dog circling through quail cover. He looks closely for tell-tale charred or broken or heat-discolored resistors. He cautiously feels a few resistors or power transistors with a forefinger.

When he locates one or more resistors that are obviously burned open, discolored or overheating, he looks for the cause: a shorting tube or defective transistor, a leaking capacitor or possibly some other cause and he may briefly refer to a schematic of the equipment. At any rate, the fault is quickly confirmed by a VOM, VTVM, a scope, an in-circuit transistor or capacitor tester. He may replace one or more defective components and the job is done. Skilled bench technicians frequently troubleshoot and repair a very large percentage of ailing TV

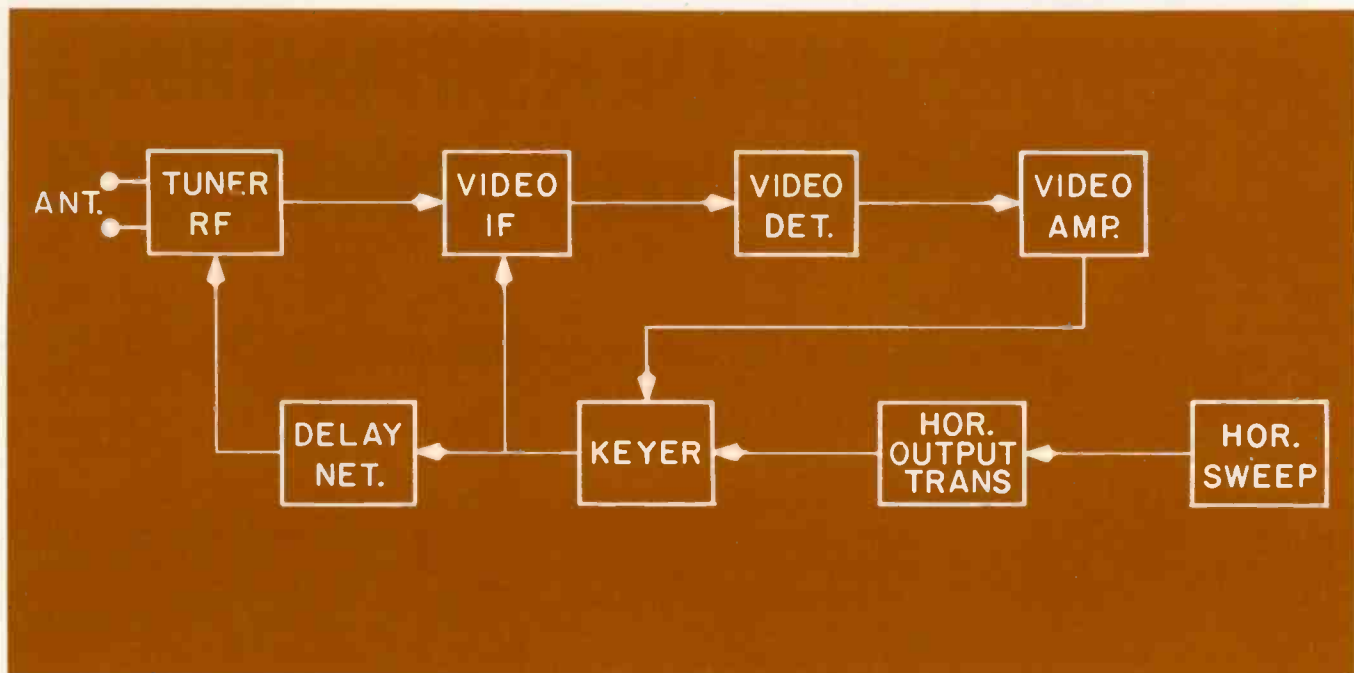

Fig. 1—The loop in which the AGC keyer unit is but one link in an interdependent chain.

sets by using these simple methods.

But a substantial number of problems do not yield to these troubleshooting techniques. These problems usually arise because of subtle shifts in circuit-component tolerances—sudden changes in resistance and capacitor values, small leakages in capacitors, intermittently defective tubes, transistors, capacitors, resistors, coils and solder connections. These are the problems that often become time consuming for unskilled and inexperienced technicians—these are the “hair-pulling” problems that separate the “men” from the “boys” in the troubleshooting area of electronics.

As repeatedly stated in previous articles, the first step in servicing any equipment is to localize the problem to one specific area of the equipment—one particular circuit. Since the AGC system is one “link” in a closed-loop “chain” our first step here is to determine if the problem is in the AGC link or some other link in this loop (see Fig. 1).

In tube circuits particularly, we stated that the best way to determine whether or not the fault is in the AGC circuit or elsewhere, is to substitute a variable bias supply. And

this also holds true in most cases with solid-state circuits. But remember that “forward-AGC” is frequently employed in solid-state AGC circuitry and, depending on the transistors and circuitry used, the polarity of the AGC voltage may be either *positive* or *negative* with respect to ground. If you are not up-to-date on your transistor theory, study the comprehensive article, “Semiconductors from A to Z,” which has been running in *ELECTRONIC TECHNICIAN* for more than a year.

Now let's stop the philosophizing and generalizing, get our dogs before the guns, and see what specific game we can flush up.

#### To the Point

The schematic in Fig. 2 shows a forward-AGC transistor circuit which provides a positive voltage on the AGC buss. This circuit is used in Motorola's TS458 chassis.

The following checks on the AGC system are recommended to determine if the fault is in the system or elsewhere:

1. Set the tuner between channels (no signal). Measure the voltage at test-point (TP) “A.” It should be 2.5v. With the tuner set on a

medium-strength station, the potential should be close to 4.5v.

2. Measure the voltage at TP “B.” It should be about 33v with no signal and approximately 15v with a medium-strength station tuned in.

3. Measure the voltage at TP “C.” It should be near 3.2v with no signal and about 5v with a strong signal. It should be noted, however, that the voltage at TP “C” will vary with the setting of the AGC delay control, R405.

If the voltages are not within the aforementioned tolerances under the stated conditions, the next move is to determine if the AGC gate transistor (Q11) can function properly—can be “keyed” on and off:

To turn Q11 off, short its emitter and base. The voltages at TP “A,” “B” and “C” should then be the same as they were when the tuner was set between channels (no signal) as previously stated in steps 1, 2 and 3—2.5, 33 and 3.2v respectively.

To turn Q11 on, short the emitter and base of the 1st video amplifier, Q4. The voltages at TP “A,” “B” and “C” should now read 6, 2 and 13v respectively—about the same as when a very strong signal is being received.

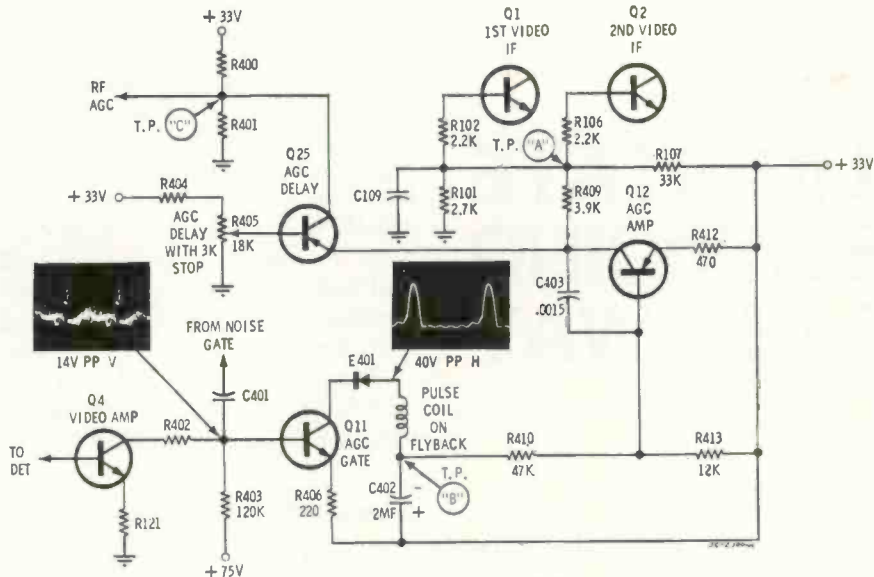

Fig. 2—Keyed AGC system in Motorola's transistorized TS458 chassis.

If these steps check out OK as indicated, you will then know that the entire AGC network is functioning properly and your problem—horizontal bending and overloading, for example—is probably being caused by a fault in the IF section, the video detector or the video output circuit.

We should remind ourselves at this point of a few important functional details regarding this particular keyed AGC circuit. A thorough understanding of how it functions will make troubleshooting much easier.

When the tuner is set between channels (no signal), the AGC gate (Q11) is reverse biased by the low collector voltage of the 1st video amplifier (Q4). This transistor (Q4) produces a large voltage drop across R403 which causes the base of Q11 to be negative with respect to its emitter—thus reverse biasing its emitter/base junction and preventing conduction.

When a TV signal is tuned in, the diode video detector (not shown in the schematic) feeds a negative-going video signal, plus a certain amount of dc, to the base of Q4 which drives it toward cutoff. This decreases Q4's collector current and

the voltage drop across R403 also decreases. This will cause the voltage on the base of Q11 to become more positive with respect to its emitter. This action will forward-bias Q11 and allow collector current to flow—if we apply a positive voltage to its collector of sufficient amplitude to override the 33v on its emitter. This override voltage is obtained from a small winding on the flyback transformer.

Note that the 40v P-P positive-going flyback pulse is fed to the anode of the diode, E401, forward-biasing it and turning it on. This voltage will cause Q11 to conduct, in turn charging C402 as follows:

Electron-current will flow from the plus side of C402 through limiting resistor R406 to the emitter of Q11, then through E401, the horizontal pulse coil and to the negative side of C402. This capacitor charges to a negative value which is proportional to the amplitude of the horizontal sync pulses of the received signal.

When the horizontal pulse is not present, C402 starts to discharge but the negative voltage on it reverse-biases E401. This prevents C402 from discharging through the collector-to-base junction of Q11

forcing it to discharge partially in a negative-to-positive direction through R410 and R413.

Note the time cycle of C402 and associated components. The capacitor charges rapidly through a relatively small resistance but discharges only partly through a relatively large resistance. The net result of this action creates a negative charge on C402 which makes TP "B" negative with respect to the 33v supply. The swing of this negative voltage is directly proportional to the amplitude of the horizontal sync pulses which appear at the base of the AGC gate, Q11, at a given instant.

But wait! We observe that the design of the IF section requires a *plus* bias voltage on its 1st and 2nd video stages so the forward-bias between base-and-emitter can be varied to increase and decrease the current flow in their collector circuits (decrease and increase the collector voltage) to control the signal strength through forward-AGC-action.

The AGC amplifier (Q11), a PNP transistor connected as a common-emitter, inverts the voltage 180deg and makes it *positive*. This additional positive voltage, together with the 2.25v which already appears at TP "A," is the AGC voltage which is coupled to the bases of Q1 and Q2 through current-limiting resistors R102 and R106.

The AGC delay transistor circuit, Q25, is designed to turn on and apply RF AGC just before signal overload occurs in the tuner.

The proper way to adjust the RF AGC control (R405) is as follows:

1. Set the control fully clockwise—giving maximum RF AGC delay.
2. Tune in a medium strength signal.
3. Turn the AGC delay control slowly counterclockwise (CCW) until noise is just visible in the picture. Then turn the control clockwise (CW) until the noise on the screen just disappears.

Forthcoming articles will deal with additional troubleshooting problems in various types of AGC circuits—both electron tube and solid-state. ■

# SOLID-STATE TV SERVICING THE EASY WAY

Don't let the 'little monsters' scare you

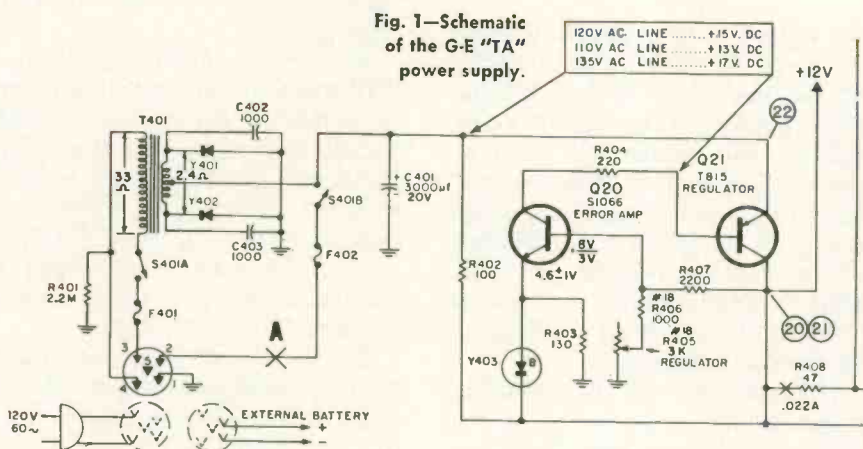

■ It has been made repeatedly clear that you cannot survive in this business unless you have a thorough knowledge of basic solid-state circuit theory. Many articles — covering various aspects of this subject — have already appeared in these pages. Practical servicing techniques have been detailed. But forthcoming articles will explore these areas even more thoroughly. This article will deal entirely with practical troubleshooting procedures and, although concentrating on the G-E "TA" chassis, the fundamental servicing techniques can be applied to all comparable solid-state circuitry.

## Practical Troubleshooting

The "TA" chassis first came to our bench "dead" — no raster, no audio. You may or may not know that the "TA" chassis has a line-operated 12v, regulated dc power supply (see Fig. 1). You would normally check this supply first when confronted with the previously mentioned symptoms. And you'll

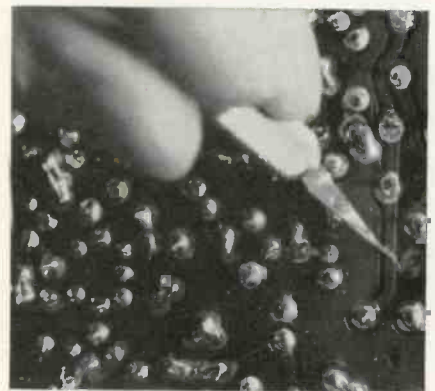

Fig. 3—Penknife is used to cut circuit foil and isolate overloaded section of set.



Fig. 2—The "old pro" uses a variable ac power supply to bring up the line voltage slowly when checking for shorts and overloads.

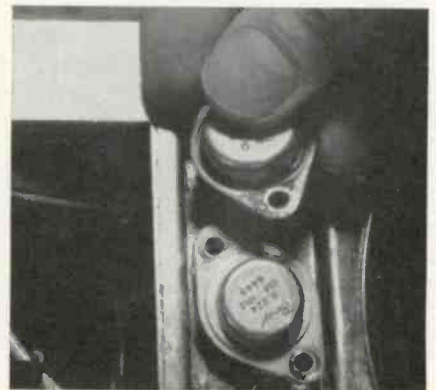

Fig. 4—Q24 transistor and Y254 diode are lifted from heat sink when checking for shorts in the B+ line.

find it helpful to use a variable 117vac supply.

Plug the set into the variable ac supply output. Check the ac line fuse, F401 (Fig. 1) and the output fuse, F402. If the ac input fuse is blown, replace it. And if the dc output fuse is blown, replace it also.

Now adjust the variable-voltage transformer to bring the ac line potential slowly up to 120v while using the old "see, feel and smell" bench technician's technique. At the same time, monitor the 12v B+ line to ground with a VOM. If you have little or no voltage, switch the set off.

Disconnect the B+ loads from the power supply (one at a time) — switching the set on after each load has been disconnected. Each load can be disconnected easily by cutting the circuit foil (see Fig. 3) with a sharp penknife, razor blade, etc. Observe if the B+ rises to 12v. If the B+ is still not correct when all loads have been disconnected, then the trouble is either in the voltage regulator or the power supply.

Now try to obtain correct B+ voltage by adjusting R405 (see Fig. 1). If this does no good, check Q20, the error amplifier and Q21, the regulator transistor on an in-circuit transistor tester. If they check OK, all you have left is the zener diode, Y403. If you don't have a zener diode tester, substitute the suspected zener with a known-good one.

These regulator circuits can have a very fast control response — fast enough, in fact, to remove 60 or 120Hz ripple. This regulator acts like a large filter capacitor and helps smooth the B+ voltage.

Of course, you can vary this approach in a number of ways. Suppose, for example, the dc voltage at the regulator output is lower than normal but not out altogether. You suspect that heavier-than-normal current is being drawn by one of the loads. In this case, remove the fast-blow 1.5a fuse (F402 shown in Fig. 1) and replace it temporarily with a 0.5a similar-type fast-blow fuse. Open the line at "A." Insert a 1a full-scale meter in the line. Switch the set on. If the meter reads much more than 430ma, you will have some idea of what your prob-

lem is. Of course, you could open lines at various points in the supply, including individual output load points, measuring the current drawn at each point and probably come up with all the information you need to pinpoint the trouble. But be careful you do not burn out the milliammeter — make initial checks on the highest scale.

Because Q24, the horizontal output transistor, Y254, the damper diode and Q19, the vertical output transistor, have been known to short, it would be wise to lift and isolate these from their heat-sink mounts when checking for a loss or for extremely low B+ voltage (see Fig. 4).

### Precautions

We believe it would be advisable at this point to mention some precautions that should be taken before attempting to troubleshoot this or similar-type equipment.

To avoid excessive transient voltages while servicing any part of the set, use a zener diode connected from the emitter to the collector of Q24, the horizontal output transistor. A zener can be used on any solid-state circuit where expensive transistors are involved.

Always use a low-wattage desoldering iron and heat-sink clips when removing or installing transistors (see Fig. 5). And the equipment should be switched off before probes or leads from test instruments are connected into any circuit. Also make sure that all test leads are at ground potential and momentarily short each test probe to chassis ground before making contact with the test point. Excessive transient voltage will quickly destroy solid-state components. An ohmmeter can be used for checking the forward and reverse resistance of semiconductors. But make sure that no more than 1.5v appears across your meter probes.

### Horizontal Section

If the screen of this set does not light or the raster size is inadequate, check the 12v B+ first. If the B+ checks OK, then check the voltage

at test-point A. It should be 90v. If so, this usually means the output transistor is operating properly. Use your scope to check for proper operation of the horizontal sweep section and if this checks out but the 90v source is not correct, disconnect various loads from this supply until correct voltage appears — isolating the defective area. Also check diode Y259.

Now check the amplitude, frequency and shape of the waveform of the horizontal output drive signal. The emitter and base leads are disconnected for this check and a 10Ω resistor is connected between these leads. The scope is then connected across this resistor and a 4 to 6v P-P drive voltage, at the horizontal sweep rate, should appear at this point. If the drive signal is correct, check the components in the horizontal output circuit. An incorrect drive signal would point to trouble in the buffer or oscillator stage. A slight decrease in horizontal sweep and striations (see Fig. 6) indicate that damper diode (Y254) has



Fig. 5—A desoldering iron and heat-sink clips are used to remove and replace transistors.

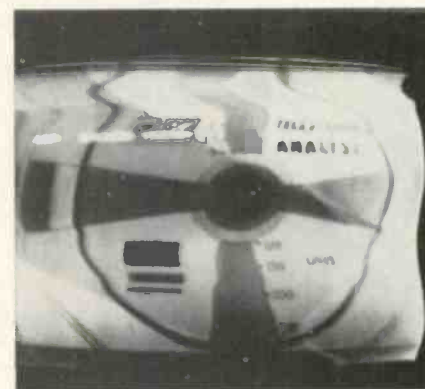
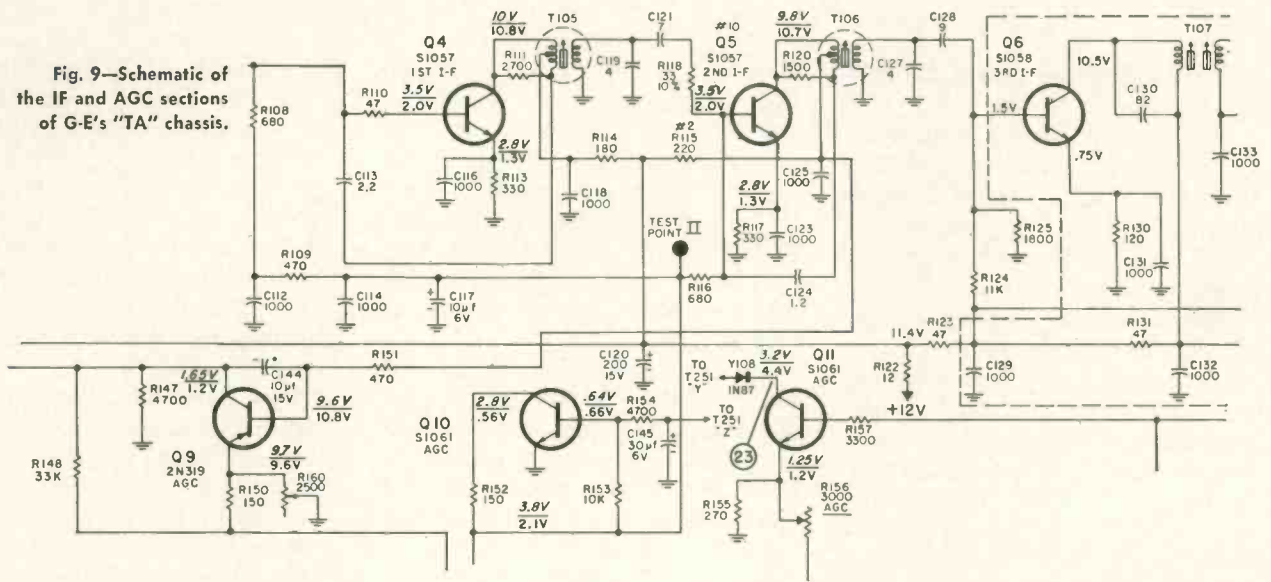

Fig. 6—This symptom was caused by an open damper diode.

Fig. 9—Schematic of the IF and AGC sections of G-E's "TA" chassis.



opened. Unlike tube sets, this TV chassis will operate under these conditions but the B+ current will increase about 100ma if Y254 opens.

A scope is a must for checking vertical and horizontal sweep circuits in solid-state TV equipment. All transistors in these circuits are driven by shaped pulses.

#### Raster Good, Video and Audio Absent

A systematic signal injection approach is recommended to pinpoint troubles in solid-state TV equipment. To determine if the aforementioned symptoms are caused by a defective tuner or IF component, check B+ and AGC to the tuner. Inject a modulated IF signal at the IF link. If the IF test signal passes through the video IF amplifier, then the defect is probably in the tuner. And the RF stage in the tuner may become inoperative because of too much or too little AGC voltage.

Measure the voltages of Q1, Q2 and Q3 in the tuner. Check the transistors on an in-circuit transistor tester. But you'll need eagle eyes, the steady hands of a brain surgeon and the patience of Job to repair these tuners (see Fig. 7).

The ability of the tuner to pass RF is determined by injecting an RF sweep signal into the input of the RF stage. If the RF signal does not pass through the tuner, check the oscillator circuit. One easy way to check the oscillator is to measure the transistor's emitter and base voltages while rotating the fine tuning control. If the voltage varies, the oscillator is operating.

If you find the VHF tuner is operating properly, check out the video IF section. Inject a 45MHz signal (see Fig. 8). The first two stages of this IF strip are controlled by forward-AGC. Check the AGC voltage at this point. If it is not correct, use a bias box to apply 3v positive to test point II of the AGC

line (see Fig. 9). If the test signal now appears on the screen, then the fault is in the AGC circuit.

The symptoms that appear on the CRT screen of a defective set can sometimes be misleading. The picture shown in Fig. 10, for example, would lead most technicians to suspect AGC or sync troubles. This symptom, however, was caused by an open 1st IF transistor, Q4.

Continue injecting a test signal into the IF strip until the test pattern appears on the screen — right on up to the video detector. Then switch the "analyst" to a video signal and trace right up to the control grid of the CRT.

#### AGC and Sync Sections

The AGC circuits of this set are composed of a keyer stage, followed by a dc amplifier that controls the gain of the 1st and 2nd IF stages. A second dc amplifier controls the

*continued on page 80*

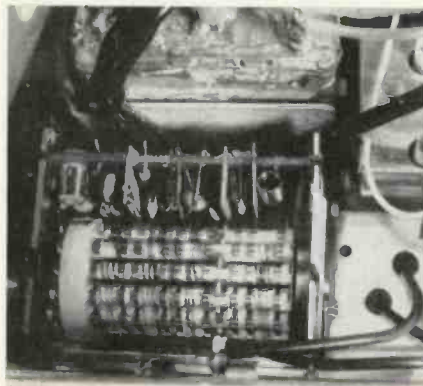

Fig. 7—Close-up view of miniaturized VHF tuner frequently used in compact solid-state TVs.



Fig. 8—Using the "analyst" to isolate trouble by signal injection.

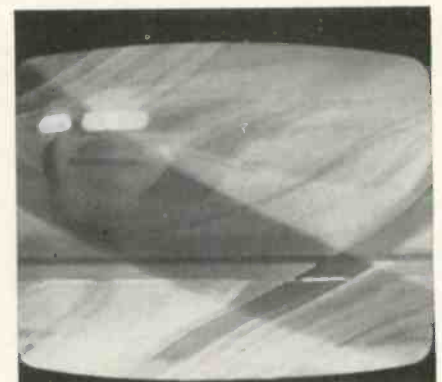

Fig. 10—This symptom looked like AGC or sync trouble but was caused by an open 1st IF transistor, Q4.

Part three of a

# TEKLAB REPORT

test instrument series

Fig. 1—The basic make-up of a squarewave with all elements in phase.

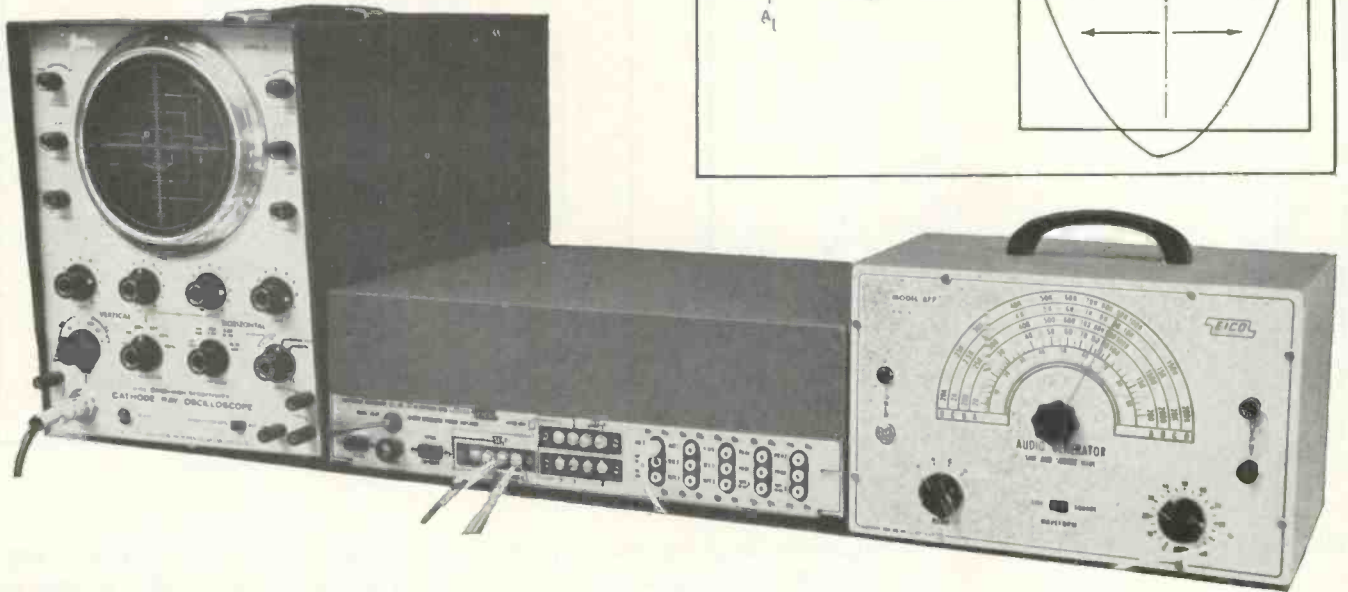
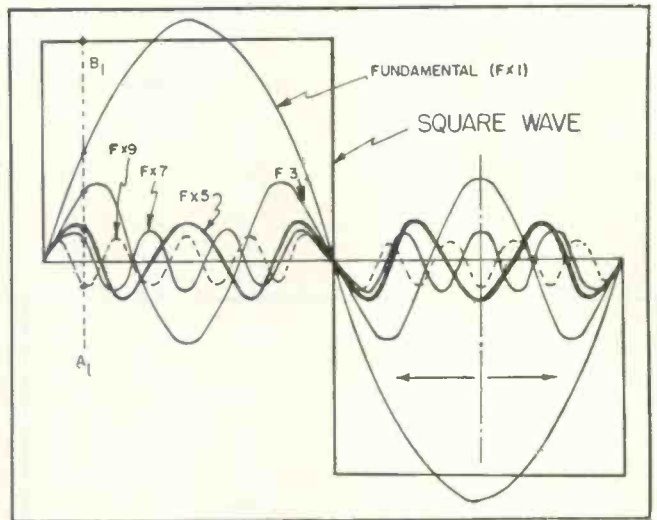

## Using Audio Test and Alignment Instruments

Combine a sine/squarewave generator with a good scope for faster and more efficient servicing

■ Two previous articles in this series covered multiplex signal generator applications.

Sine/squarewave generators can also be used effectively to locate defective circuits in medium and wideband amplifiers. The square-wave generator, in conjunction with your scope, can be a valuable instrument combination for troubleshooting audio amplifiers.

It should be pointed out here that the price you would pay for a sine/squarewave generator depends on the amount of audio service you do and how much you can afford to spend. A rule-of-thumb here indicates that you should spend as much as you can afford.

The only requirements that must be met by the sine/squarewave generator is good rise time (about

0.5 $\mu$ sec or better) and a frequency variable between 60Hz and 25kHz. Generators in this category are also available in kit form. Most generators cover the entire frequency range (both sine and squarewave) from 20Hz to 100 or 200kHz in four or five bands.

As most of us know, a theoretically perfect squarewave is made up of an infinite series of odd harmonic sinewaves (1st, 3rd, 5th, etc.).

The basic makeup of a squarewave is shown in Fig. 1. All odd-numbered harmonics are shown in the in-phase relationship—each sinewave cycle. To develop the squarewave as shown it is necessary to draw a number of vertical lines through the squarewave and to add, algebraically (observing polarity), the magnitudes of the sinewaves

along this vertical line. For simplicity, we will only consider harmonic content to the 9th harmonic.

At "A1" for example, we have algebraically added the fundamental, 3rd, 5th, 7th and 9th harmonics with the resultant summation of wave magnitudes along a large number of vertical "check" lines to obtain the squarewave.

When a squarewave is sent through an amplifier it is equal to using a number of test frequencies simultaneously. If the resultant squarewave trace on the scope is not misformed in any respect at various frequencies, then we can say the amplifier response is flat over a wide range of frequencies. If the squarewave frequency is 100Hz, the amplifier response is good up to about 900Hz to 1.1kHz.

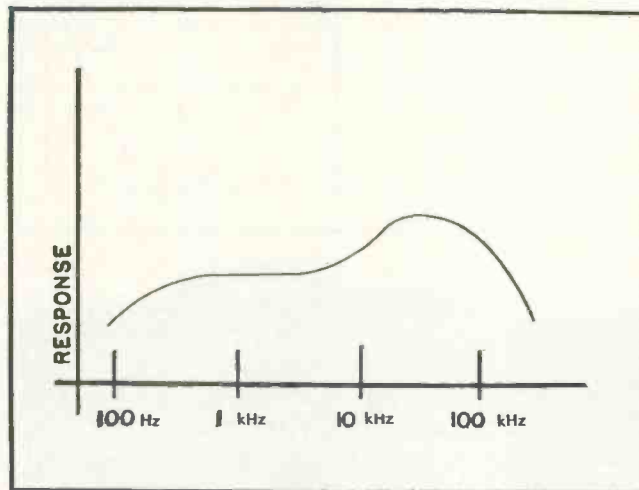

Fig. 2—Chart showing frequency response of amplifier.

### Test Setup

Although the test setup shown on the previous page does not picture it, the Precision model E310 sine/squarewave generator was used in these tests. It should also be noted that the output impedances of the generator and amplifier must be matched. Keep leads short. Allow the amplifier and test instruments to warm for about 15 min.

1. Set the generator controls and switches as follows:

WAVEFORM switch to SINE

RANGE switch to 50-600

OUTPUT LEVEL control to approximately 50

OUTPUT to XI

2. Connect the ground binding post of the generator to the amplifier ground—the other output post to the amplifier input.

3. The output of the amplifier may be measured with any high impedance ac measuring instrument with flat response over the anticipated range. A VTVM equipped with ac measuring facilities may be used; however, a scope equipped with a low capacity probe is one of the most useful high impedance in-

struments available to technicians. We will then assume that a scope is connected directly across the amplifier output (the speaker voice coil or to the plate circuit of the last amplifier).

4. Set the generator tuning dial to 60 Hz, for example, and adjust the gain of the scope and the output of the generator to obtain a good sized sine pattern on the scope screen. Keep in mind that the generator output should be maintained at minimum—consistent with operating conditions—to minimize the possibility of overloading the amplifier and introducing false indications of distortion.

Use the OUTPUT LEVEL control to set the maximum output desired from the generator and then use the OUTPUT switch to reduce the generator output.

5. Note the total height of the sine pattern on the scope screen by counting the number of vertical squares it occupies on the scope's calibrated crosshatch mask (P-P measurement).

6. Without touching any other controls or switches, merely rotate the tuning dial of the generator to

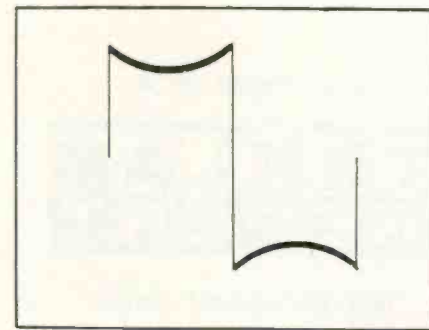

Fig. 4—Curve obtained by depressing the low frequency components in the squarewave.

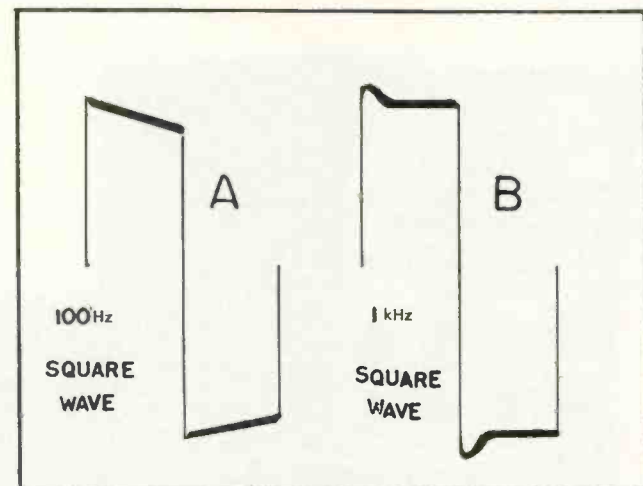

Fig. 3—Squarewave patterns at various frequencies.

200 and note the difference, if any, in the height of the sine pattern on the scope.

7. Repeat the procedure for as many frequency points as required to display the curvature of the amplifier response, using the P-P sinewave amplitude readings as indicated on the scope's cross hatch mask.

### Squarewave Generator Amplifier Checks

Amplifier distortion can be classified into the following three categories:

**Frequency Distortion.** This refers to the change from normal amplitude of a component of a complex waveform. Resonant networks or selective filters created by a combination of reactive components (resonant networks and selective filters in amplifier circuits) will create peaks or dips in an otherwise flat frequency response curve.

**Non-linear Distortion.** This refers to a change in waveshape produced by application of the waveshape to non-linear components or elements such as electron tubes, an iron core transformer and in an extreme case,



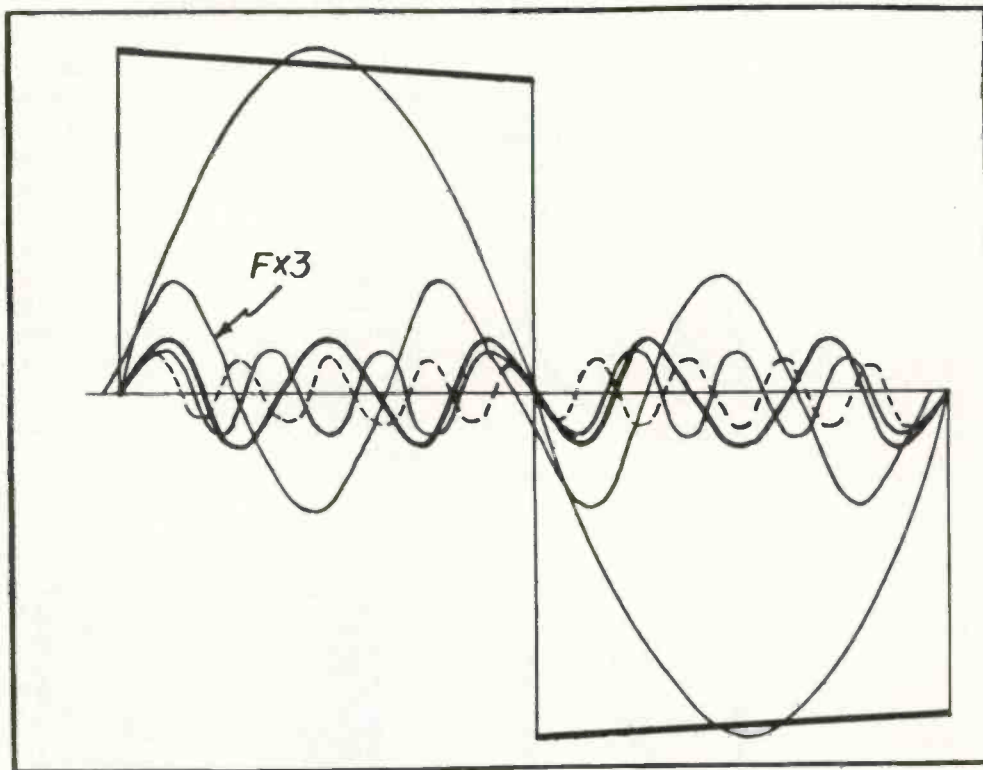

Fig. 5—Graphical development of a similarly tilted squarewave Fx3 out of phase (lead).

a deliberate non-linear circuit such as a clipper network.

**Delay or Phase Distortion.** This is distortion produced by a phase shift between one or more components of a complex waveform.

In actual practice, a reduction in amplitude of a squarewave component (sinusoidal harmonic) is usually caused by a frequency selective network which includes capacity, inductance or both. The presence of C or L introduces a difference in phase angle between components—creating phase distortion, or delay distortion.

In squarewave testing of practical circuitry, we will usually find that the distorted squarewave includes a combination of amplitude and phase distortion clues.

If we apply squarewaves to a typical wideband amplifier, we find the check accurately reveals many distortion characteristics of the circuit.

As indicated in Fig. 2, the amplifier response was poor at low frequencies along with overcompensated high frequency boost.

A 100Hz squarewave applied to the input of this amplifier will ap-

pear as in Fig. 3A. This illustration indicates satisfactory medium frequency response (approx. 1kHz to 2kHz) but shows poor low frequency response. In Fig. 3B, a 1kHz squarewave was applied to the input of the same amplifier. This figure displays good frequency response in the region of 1kHz to 4kHz but clearly reveals the overcompensation at the higher 10kHz region by the sharp rise at the top of the leading edge of the squarewave.

As a rule of thumb, it can be safely said that a squarewave can be used to reveal response and phase relationships up to the 15th or 20th odd harmonic or up to approximately 40 times the squarewave fundamental. Wide band circuitry will require at least a two-frequency check to analyze the complete spectrum properly. In the case illustrated in Fig. 2, a 100Hz squarewave will encompass components up to about 4kHz. To analyze above 4kHz and beyond 10kHz a 1kHz squarewave would be satisfactory.

The region between 100Hz and 4kHz (Fig. 2) shows a rise from

poor low frequency response to a flattening out from between 1kHz and 4kHz. Therefore we can expect the higher frequency components in the 100Hz squarewave will be relatively normal in amplitude and phase but the lower frequency components in this same squarewave will be strongly modified by the poor low frequency response of this amplifier (see Fig. 3A).

If the combination of elements in this amplifier were such as to only depress the low frequency components in the squarewave, a curve similar to that shown in Fig. 4 would be obtained. Reduction in amplitude of a component as already noted, however, is usually caused by a reactive element which results, in turn, to a phase shift of the component, producing the strong tilt shown in Fig. 3A. The graphical development of a similarly tilted squarewave is shown in Fig. 5. The tilt is seen to be caused by the strong influence of the phase-shifted 3rd harmonic. It also becomes evident that very slight shifts in phase are revealed by tilt in the squarewave. An up-coming article will explore this subject further.

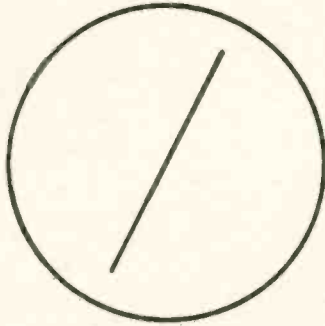

Fig. 6—In-phase (or 180deg out of phase) no overload distortion.

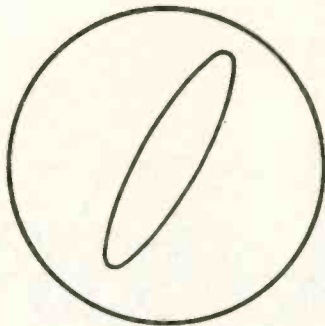

Fig. 7—Phase shift; no overload distortion.

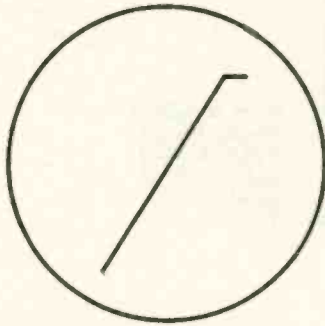

Fig. 8—In phase and overload distortion.

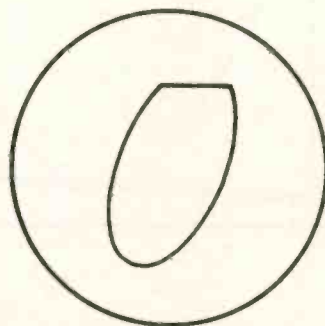

Fig. 9—Phase shift and overload distortion.

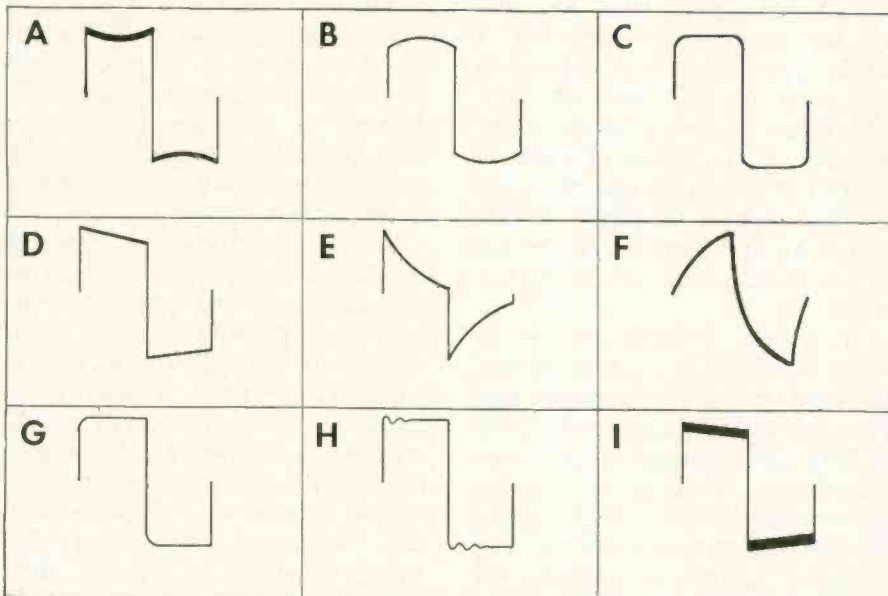

Fig. 10 (A)—Frequency distortion (amplitude reduction of low frequency component) no phase shift. (B)—Low frequency boost (accentuated fundamental). (C)—High frequency loss—No phase shift. (D)—Low frequency phase shift. (E)—Low frequency loss and phase shift. (F)—High frequency loss and low frequency phase shift. (G)—High frequency loss and phase shift. (H)—Damped oscillation. (I)—Low frequency phase shift (trace thickened by hum-voltage).

## Detecting Phase Shift

1. Set the sine output of the generator to the desired frequency.

2. Set the LEVEL control to maximum position and apply the output directly to the vertical plates of a scope.

3. Construct a simple resistive voltage divider by connecting a 2K pot across the generator output. Feed the voltage developed across the arm of the pot and ground to the input of the amplifier being checked. (Set the pot for minimum voltage consistent with a size-



Jackson Model 605D audio sine/squarewave oscillator.

### JACKSON MODEL 605D

**FREQUENCY RANGE:**

20Hz-200kHz in 4 ranges

**CALIBRATION ACCURACY:**

3% or 1Hz whichever comes first

**OUTPUT VOLTAGE:**

Cathode follower, continuously variable

Sinewave 0 to 5.0 RMS volts, squarewave 20mv

to 7.0 P-P

**OUTPUT LEVEL CHARACTERISTICS:**

1db over full range

**HUM LEVEL:**

Down more than 50db at all output levels

**SINEWAVE:**

Less than 1% distortion

**SQUARE WAVE RISE TIME:**

Less than 0.2μs

**SQUAREWAVE TILT:**

5% at 60Hz, less than 1% above 200Hz

**SIZE:**

7<sup>5</sup>/<sub>8</sub> x 13<sup>1</sup>/<sub>8</sub> x 10<sup>3</sup>/<sub>8</sub> in.

**WEIGHT:**

14 lb

**PRICE:**

\$144.95

able scope pattern.) The amplifier output is fed directly to the horizontal plates of the scope. The resulting scope waveform will display an elliptical form if phase distortion exists in the amplifier at the test frequency. The degree of phase shift is of course indicated by the shape of the elliptical pattern. (Top or bottom flattening of the elliptical shape indicates overloading produced by excessive input to the amplifier.) If overloading does occur, set the pot to a lower level (see Fig. 6 to 9).

### Speaker Checks

The sinewave generator becomes useful when applied to correct the usual mis-match between speaker and the speaker enclosure itself.

The "boomy" bass response of commercial speaker enclosure combinations can be transformed into a smooth natural response.

A bass reflex speaker system may be checked as follows:

1. Connect the variable sine output of the generator in series with a 100Ω resistor to the speaker voice coil.

2. Connect an ac voltmeter or scope across the speaker voice coil.

3. Determine the low frequency resonant peaks in the system by noting peak voltmeter readings. The frequency of these peaks will vary with the size of the speaker and cabinet but should occur in the region between 40 and 150Hz. In a properly tuned system the two peaks should be rather broad and of approximately the same amplitude. If one of the peaks is greater than the other, try damping the port with additional layers of grill cloth. ■



Hewlett-Packard Model 200CD wide range oscillator.

#### MODEL 200CD HEWLETT-PACKARD

##### FREQUENCY RANGE:

5Hz-600kHz in 5 ranges

##### ACCURACY:

±2% including calibration error, warmup, changes caused by aging of components, tubes, etc.

##### DIAL:

6in dia calibrated over 300 deg of arc. 85 divisions. Total scale length, 78 in.

##### FREQUENCY RESPONSE:

±1db entire frequency range (reference 1kHz)

##### OUTPUT:

160mw (10v) into 600 Ω rated load, 20v open circuit

##### OUTPUT BALANCE:

Better than 0.1% at lower frequencies and 1% at higher frequencies

##### INTERNAL IMPEDANCE:

600 Ω Output is balanced to ground for zero attenuation. (May be operated with one side grounded if desired.)

##### DISTORTION:

0.2% from 20Hz to 200kHz; 0.5% from 5Hz to 20Hz and from 200kHz to 600kHz

##### HUM VOLTAGE:

Less than 0.1% of rated output, decreases as output is attenuated

##### POWER:

115/230v ±10%, 50Hz-1kHz 90w

##### SIZE:

7½ x 11½ x 14¾

##### PRICE:

\$225



Eico Model 377 sine/squarewave generator.

#### EICO MODEL 377

##### FREQUENCY RANGE:

Sinewave 20-200kHz in 4 bands

Squarewave 60-50kHz (5% tilt at 60Hz, 5% rounding at 50kHz)

##### CALIBRATION ACCURACY:

±3% or 1Hz whichever is greater

##### FREQUENCY RESPONSE:

±1.5db, 60-150kHz

##### OUTPUT VOLTAGE:

10v across 1K rated load (100mw), drops to 8v across 500 Ω, rises to 14v across 10K or higher

##### DISTORTION:

Less than 1%

##### HUM:

Less than 0.4% of rated output

##### SIZE:

(HWO) 7½ x 11½ x 7½ in.

##### WEIGHT:

13 lb

##### PRICE:

Kit \$39.95 Wired \$54.95

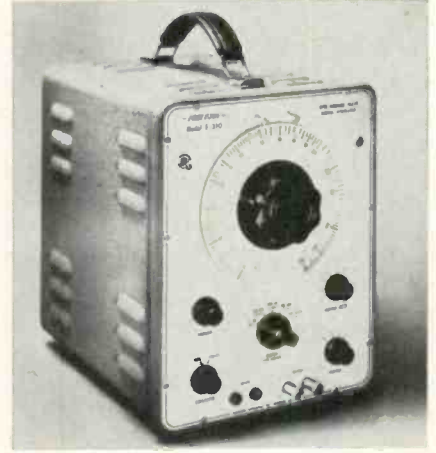

Precision Model E-310 sine/squarewave signal generator.

#### PRECISION MODEL E-310

##### FREQUENCY RANGE:

Sine and squarewaves 5Hz-600kHz in 5 bands

##### OUTPUT LEVEL

Within ± 1db band to band

##### DISTORTION:

Less than 1% from 5kHz to 600kHz

##### CALIBRATION ACCURACY:

±2% from 50Hz to 600kHz ±1Hz from 5Hz to 50Hz

##### DIAL:

6in. with 12-1 gear drive ratio provides a scale length of 7ft over the 5 bands

##### OUTPUT LEVEL:

Sinewave 10v RMS into 600 Ω

Squarewave 10v P-P, 4 position step attenuator and continuous amplitude control

##### SQUAREWAVE RISE TIME:

0.2μsec

##### SIZE:

11½ x 9 x 11¼.

##### WEIGHT:

24 lb

##### PRICE:

\$199.95

##### SUPPLY VOLTAGE:

117vac 50/60Hz standard 220vac 50-60vac 50-60Hz available

Understand integrated circuits and most solid-state electronic circuits will be easier to service

# Semiconductors

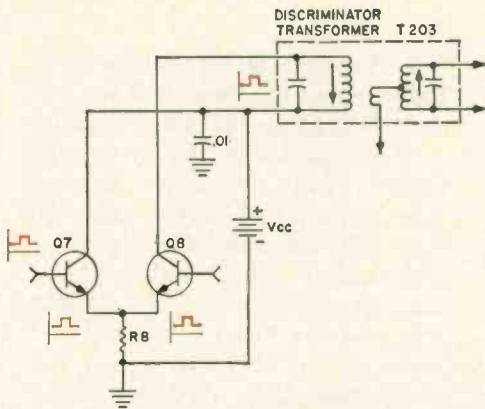

Fig. 2—The last pair of transistors in the IF section of the integrated circuit function in the same manner as the first pair of transistors.

■ The previous article in this series explained how a temperature-compensated, voltage-regulating transistor (Q9) is used in integrated circuit, IC201, to provide a nearly constant supply voltage to the first five amplifier stages. These stages contain still another circuit to improve their stability further.

### A Negative Feedback Circuit

A resistor (R15) couples the base of transistor Q2 to the emitter of transistor Q6 (Fig. 1). Since the portion of the integrated circuit shown in this figure is used to amplify FM IF signals, the circuit handles frequencies of around 4.5MHz. The 0.1μf capacitor connected to the base of transistor Q2 is, therefore, able to short these ac signals to ground. The ac portion of the transistor (Q6) emitter current develops an ac voltage across resistors R7 and R15, while virtually none of this ac voltage appears at the base of transistor Q2. If the value of resistor R15 is sufficiently large, it does not significantly reduce the ac voltage across resistor R7.

If a temperature change or slight production variance results in an increased dc current, a larger dc voltage drop will result across resistor R7. This increases the forward bias of transistor Q2, increasing its collector current and the current flow through resistor R2. With a greater voltage drop across that resistor, the base of transistor Q3 becomes less positive and a reduction occurs in its dc collector

current. This, in turn, results in reduced current through transistor Q4, increased current through transistor Q5 and a reduced dc current through transistor Q6. The dc voltage drop across resistor R7 is, therefore, reduced and negative feedback has taken place.

Transistors Q7 and Q8 function (Fig. 2) in the same manner as transistors Q1 and Q2 (described with Fig. 5 in the July 1967 article). A positive pulse applied to the base of transistor Q7 causes that transistor to conduct more current and transistor Q8 to conduct less current. This results in a reduced voltage drop across the primary winding of transformer T203, and

the winding becomes more positive.

This differential amplifier circuit (Fig. 2) need not be balanced and the increased current through transistor Q7 may not necessarily equal the decreased current through transistor Q8. A 0.01μf capacitor shunts any of the resulting 4.5MHz signal, which may otherwise be developed across the voltage source (Vcc), to ground.

Transistor Q10 (Fig. 3) functions in the same manner as transistor Q9 (described with Fig. 13 of the July 1967 article). Just as the equivalent to the circuit containing transistor Q9 (Fig. 4 of the previous article) is shown as Fig. 14 in that article, the equivalent to the

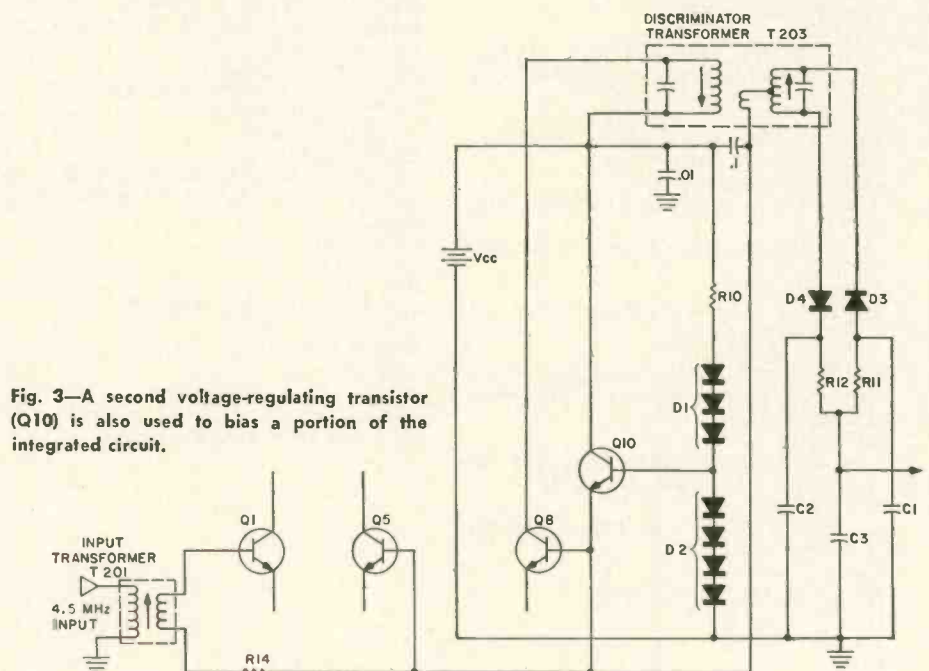
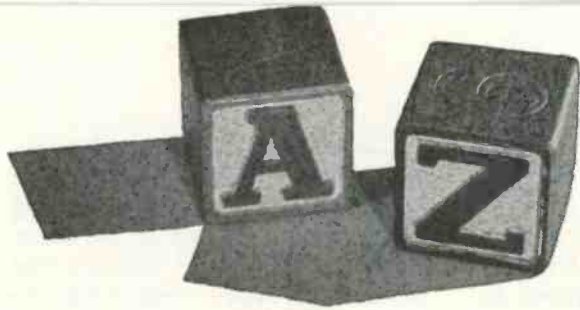

Fig. 3—A second voltage-regulating transistor (Q10) is also used to bias a portion of the integrated circuit.



# from A to Z

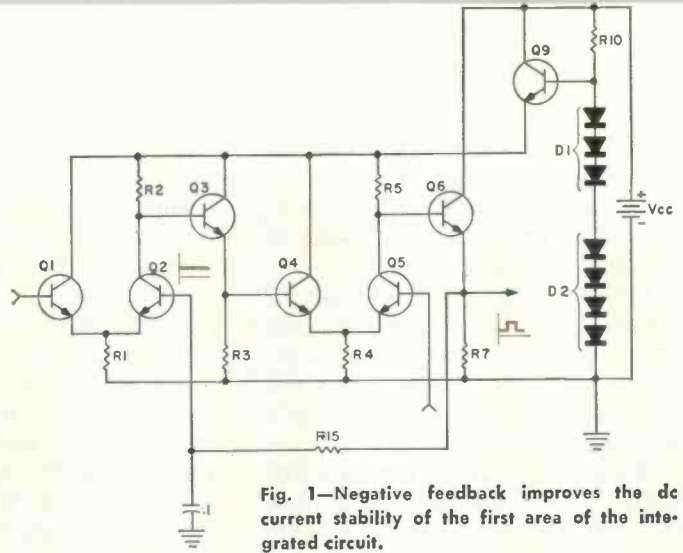

Fig. 1—Negative feedback improves the dc current stability of the first area of the integrated circuit.

circuit containing transistor Q10 (Fig. 3) is shown in Fig. 4. Transistor Q10 supplies a temperature-compensated, virtually constant voltage source to the base of transistor Q5, the base of transistor Q8, a secondary winding of transformer T203 and resistor R14, which is connected to a secondary winding of transformer T201.

When no signal is induced into the secondary winding of transformer T201, the base of transistor Q1 has a 2.1v bias — there having been an insignificant dc voltage drop across the transformer's secondary winding and resistor R14. The 4.5MHz signal induced in the transformer's secondary winding

increases and decreases the transistor's base bias at that frequency.

Specifications indicate that the 4.5MHz signal applied to terminal 1 of the integrated circuit (Fig. 4 of the July 1967 article) experiences a gain of about 60db with a bandwidth of 70 to 80kHz before it leaves the circuit at terminal 5.

The frequency of the FM IF signal, amplified in the first portion of the integrated circuit, varies with the audio signal it contains. This varying IF signal is applied to the primary winding of discriminator transformer T203 (Fig. 3).

### The Discriminator Transformer

When a transformer has a single

secondary winding, the voltages in the two leads at the ends of the winding (Fig. 5) are 180deg out of phase — when one lead is positive, the other is negative. If another secondary winding is connected to the first secondary winding (Fig. 6), the voltages in the two leads connected to the first secondary winding are still 180deg out of phase. The voltage induced in the third lead, however, need not have a fixed phase relationship with the other voltages. The phase of the voltage at the third lead depends on how the second coil is wound and the frequency of the signal induced.

Some less experienced technicians may not be familiar with the

Fig. 4—The equivalent of a voltage-regulating transistor is substituted for transistor Q10.

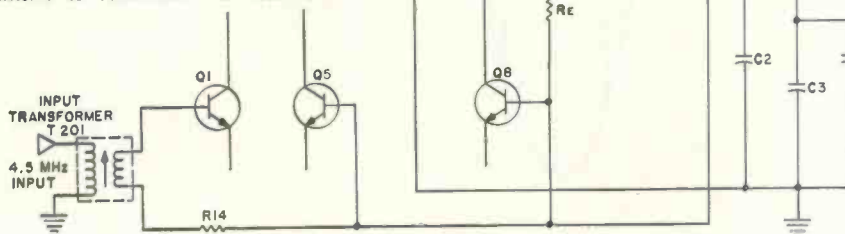

Fig. 5—The voltages present at the transformer's two secondary leads are 180deg out of phase.

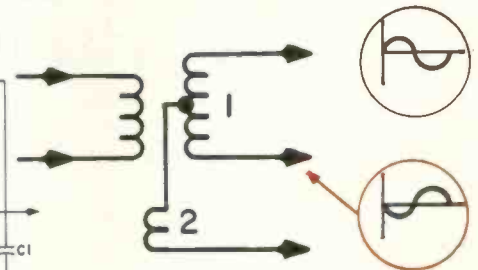

Fig. 6—The voltages present at two of the transformer's secondary leads remain 180deg out of phase, while the phase relationship of the voltages present at the third lead varies with the signal's frequency.

# Semiconductors . . .

term "phase angle." This term is used either to indicate portions of a sinewave or to indicate the degree of time lag between two sinewaves of the same frequency.

Positive and negative changes of voltage generally appear on the screen of an oscilloscope as a sinewave — whether the signal observed is from an ac power line or some unmodulated RF source.

When a line is horizontal (zero deg), it has no height (Fig. 7), and the corresponding portion of the sinewave (Fig. 8) is at zero voltage. After rotating 45deg, the line has risen slightly more than 70 percent of its full height, and the corresponding portion of the sinewave is slightly more than 70 percent of its maximum positive voltage. After rotating 90deg, the line is at its full height, and the corresponding portion of the sinewave is at its peak positive voltage. At 135deg, the line is again only slightly more than 70 percent of its full height, and the corresponding portion of the sinewave is slightly more than 70 percent

cent of its maximum positive voltage. At 180deg, the line is again horizontal, and the corresponding portion of the sinewave is at a zero voltage. By the time the line has rotated 225deg, it has dropped to slightly more than 70 percent of its length below the horizontal, and the corresponding portion of the sinewave is slightly more than 70 percent of its maximum negative voltage. By the time the line has rotated 270deg, it has dropped its full length below the horizontal, and the corresponding portion of the sinewave is at its peak negative voltage. After rotating 315deg, the line is again slightly more than 70 percent of its full length below the horizontal, and the voltage at the corresponding portion of the sinewave has been reduced to about 70 percent of the maximum negative voltage. When the line has rotated 360deg and has returned to its initial horizontal position (zero deg), it again has no height, and the corresponding portion of the sinewave has returned to zero volts.

The number of times the line rotates each second corresponds to the frequency of the sinewave. If two lines are rotating at the same frequency, the angle between the two rotating lines corresponds to the angle between their two corresponding sinewaves.

## The Discriminator Circuit

The ac signal in the third lead in the secondary of the discriminator transformer (Fig. 9) is shorted to ground by a 0.1 $\mu$ f and a 0.01 $\mu$ f capacitor. The discriminator transformer is designed in such a manner that at 4.5MHz the voltages induced across the grounded extra secondary lead are 90deg out of phase with the voltages induced across the other two secondary leads.

For convenience, the first secondary of discriminator transformer T203 is shown in Fig. 13 of this article as coils 1 and 2 while the second secondary is shown as coil 3. Curve A (Fig. 10) represents the voltages induced across coil 2 at 4.5MHz while curve B represents

Fig. 7—The height of a rotating line corresponds to the voltages that form a sinewave.

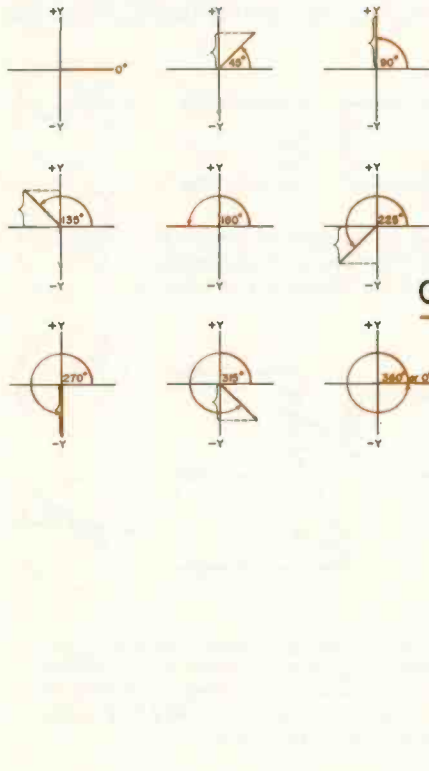

Fig. 8—A sinewave can be divided into various phase angles.

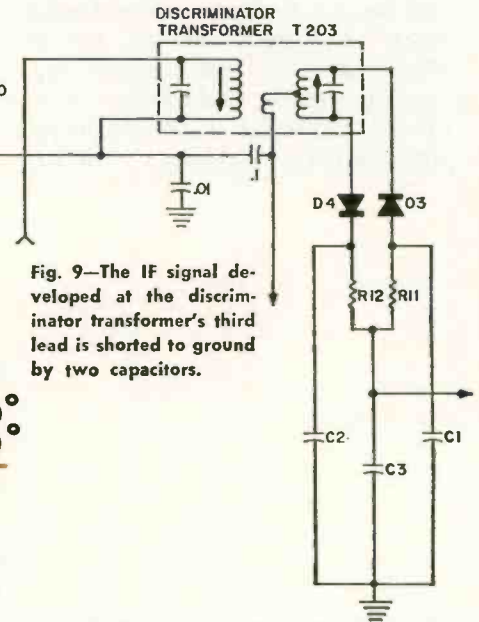
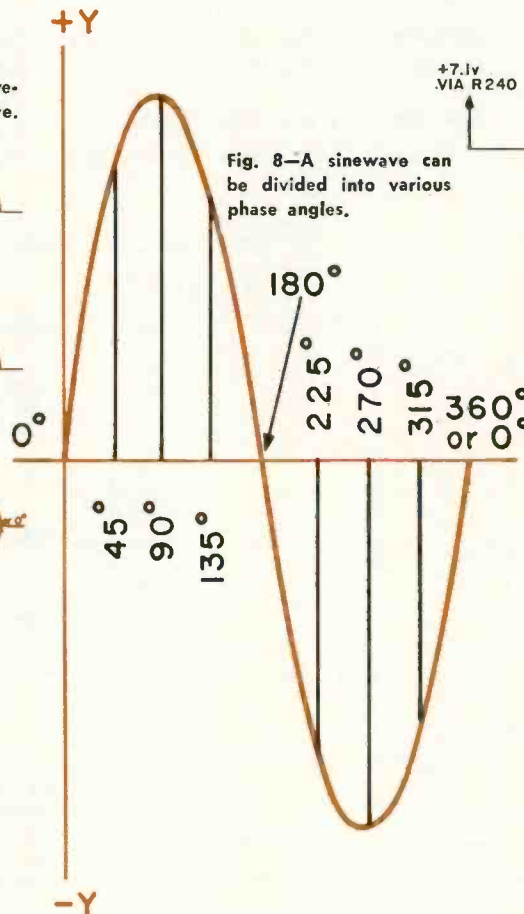

Fig. 9—The IF signal developed at the discriminator transformer's third lead is shorted to ground by two capacitors.

the voltages induced across coil 3 at the same frequency. Note that the two curves are shown 90deg out of phase. For convenience, we will assume that the amplitude of the two curves is the same. The voltage applied to the anode of diode D4 is equal to the sum of the voltages developed across coils 2 and 3. Curve C represents the sum of the two curves (curve C = curve A + curve B).

Curve D represents the voltages developed across coil 1, while curve E, like curve B (curve E ≡ curve B), represents the voltages developed across coil 3. The voltages applied to the cathode of diode D3 is shown as curve F and is the sum of the voltages developed across coils 1 and 3 (curve F = curve D + curve E).

Curves C and F are of equal amplitude, and the same amount of voltage is applied to both diodes.

From curves A and D (Fig. 10) we see that the voltages developed across coils 1 and 2 of the first secondary are 180deg out of phase

with each other, as in Fig. 6. The voltages applied to diodes D4 and D3, however, as can be seen from curves C and F, are not 180deg out of phase. They are instead 90deg out of phase ( $\theta = 90\text{deg}$ ). The voltages developed across coil 3 have resulted in a phase shift in the voltages applied to the two diodes.

The curves in Fig. 11 show the voltages developed across the same coils (1, 2 and 3) at a frequency below 4.5MHz. At this lower frequency, the voltages developed across coil 3 (curves B and E) are not 90deg out of phase with the voltages developed across coils 1 and 2. They are instead 18deg out of phase with the voltages developed across coil 2 (curve A) and 162deg out of phase with the voltages developed across coil 1 (curve D). The voltage applied to diode D4 at this lower frequency is shown by curve C in Fig. 11 (curve C = curve A + curve B). Curve C, as you may know, was formed by adding the amplitudes of curves A and B at each point along their horizontal

axis and plotting the total amplitude along corresponding points on another horizontal axis. The amplitude of curve C is greater at the lower frequency (Fig. 11) than it was at 4.5MHz (Fig. 10) — although the amplitude of curves A and B have been the same at both frequencies. The change in amplitude of curve C has resulted merely from a change in the phase angle between curves A and B.

The voltages applied to diode D3 at this lower frequency are shown by curve F in Fig. 11. The change in the phase angle of the voltages induced in coil 3 has reduced the voltages represented by this curve (F).

The voltages applied to diode D4 (represented by curve C) are 90deg out of phase ( $\theta = 90\text{deg}$ ) with the voltages applied to diode D3 (represented by curve F).

When the frequency of the IF signal is greater than 4.5MHz, the voltages induced across coil 3 have still another phase relationship with the voltages induced across coils 1

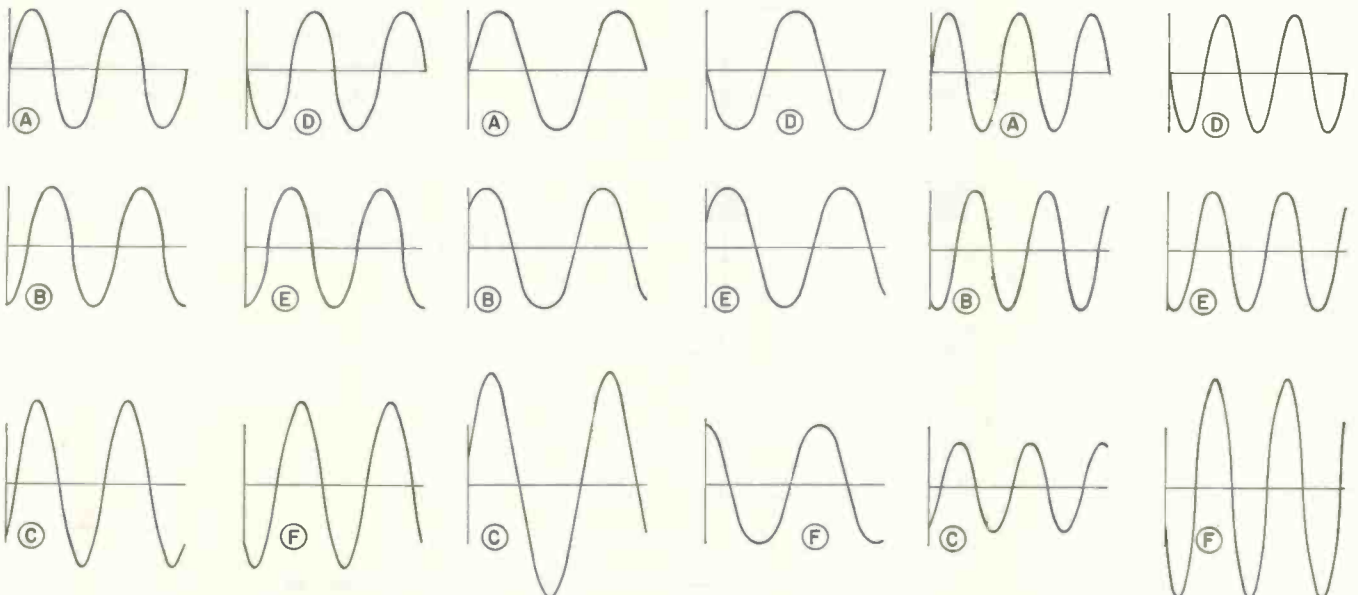

Fig. 10—Voltages induced in various portions of the discriminator transformer at 4.5MHz.

Fig. 11—Voltages induced in various portions of the discriminator transformer at a frequency below 4.5MHz.

Fig. 12—Voltages induced in various portions of the discriminator transformer at a frequency above 4.5MHz.

# Semiconductors...

and 2 (Fig. 12). In this third example, the voltages induced across coil 3 (curve B) are 45deg out of phase with the voltages induced across coil 2 (curve A) and 135deg out of phase with the voltages induced across coil 1 (curve D). As a result of this phase shift, larger voltages are applied to diode D3 than to diode D4 (amplitude of curve E > amplitude of curve C).

Again, the voltages applied to diode D4 are 90deg out of phase ( $\theta = 90$  deg) with the voltages applied to diode D3. This phase relationship is the same as those that occurred at 4.5MHz and the other lower frequency. The phase relationship of the voltages applied to the two diodes ( $\theta$ ) will not change with the frequency of the IF signal — unless the frequency is one at which the phase of the voltages induced across coil 3 is the same as the phase of those induced across coil 1 or 2. The frequency shift normally experienced, however, is not great

enough to produce such a phase shift in the discriminator coils used in this circuit. The phase angle ( $\theta$ ) between the voltages applied to the two diodes is instead dependent on the relationship of the voltages induced across coil 3 to the voltages induced across coils 1 and 2. Curves C and F are 90deg out of phase ( $\theta = 90$ deg) only when the amplitudes of curves B and E are the same height as curves A and D. (Curve B  $\equiv$  curve E, and the amplitude of curve A = amplitude of curve D.  $\theta = 90$ deg when amplitude of curve B = amplitude of curve A = amplitude of curve D.) In the next article of this series we will see that, with the capacitors in the detector circuit (Fig. 13), we need not be concerned with the phase angles of the voltages applied to the diodes (D4 and D3).

Curves C and F, shown in Fig. 13, represent the voltages applied to the two diodes (D4 and D5) at 4.5MHz (these curves are respec-

tively the same as curves C and F in Fig. 10). On page 61 in the August 1966 article of this series, we observed that electrical currents flow from negative to positive. These currents can pass only from the anode to the cathode of a diode. Diode D4 in Fig. 13 will conduct current only when positive voltages are applied to its anode (as shown in Fig. 3A on page 61 of the August 1966 article), and diode D3 will conduct current only when negative voltages are applied to its cathode (as shown in Fig. 3B of the same article).

Diode D4 (Fig. 13) is connected in series with resistor R12, and diode D3 is connected in series with resistor R11. When capacitors C1 and C2 are not connected in the circuit, the current flowing through the diodes will also flow through the series resistors. Under these conditions, the resulting voltage drops across resistors R12 and R11 resemble curves G and I. Only positive half-cycles appear across resistor R12, while only negative half-cycles appear across resistor R11. The resulting waveforms are the same as those shown in Fig. 3 of the August 1966 article.

The next article in this series will describe capacitor time constants and their effect on the waveforms in the discriminator circuit. The cascade amplifier, representing the un-discussed portion of the integrated circuit, IC201, will also be described in detail. ■

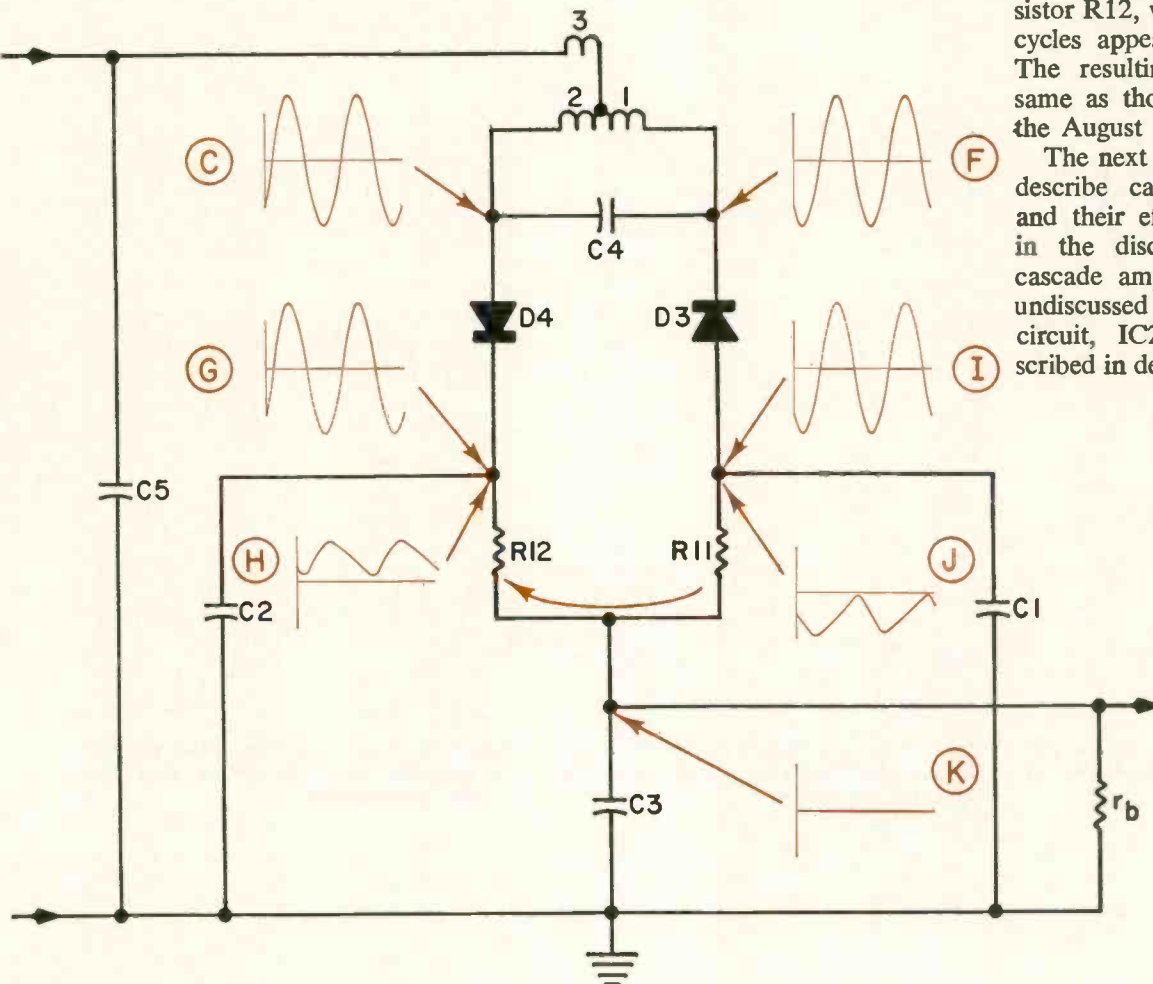

Fig. 13—Voltages present in an unbiased discriminator circuit at 4.5MHZ.



# THE APPRENTICE AND THE PRO

**A technician makes his first house call and learns how the pros operate**

Part two of a continuing series

■ On a Monday morning, in the early spring of 1962, Don Jackson, the TV-radio apprentice, was on the way to his first home-call, and his teacher, Bob Morkin, a certified technician and "pro," wasted no time initiating Don to some of the simple customer-relations principles involved in making house calls. For one thing, he was told to take off his rubber overshoes at the front door, leave them on the front porch and wipe his shoes on the doormat.

"And remember one very important thing, I'll do all the talking while we're in the house," Bob smiled. "Also, since we have a few minutes before we arrive at our first call, now's a good time to begin learning some of the important polices of our operation.

## Learning the Ropes

"For example," Bob continued, "there have been arguments in the industry for years about 'home repairs' versus 'shop repairs.' And our company does not make *major* repairs in the home. We don't replace resistors, capacitors or other components, except tubes, unless the set is in warranty. In this case we do install a few flybacks, yokes and certain resistors and capacitors—when the defective parts can be isolated easily and installed quickly. But on older sets, when more than a tube is necessary, we take the chassis to the shop. No technician can do a good job repairing sets in the home. You can't wait around in the house while the set 'cooks' for hours." Don was thoughtful as he

## EIA Launches Training Program

Washington, May 16, 1967—The service committee of the Electronic Industries Assoc. (EIA) launches a long-term program in the areas of recruiting, training and upgrading electronics technicians needed in ever increasing numbers by electronics service-dealers.

This program is the latest phase in the association's long-standing effort to provide adequate service support for the complex electronic products used today and planned for the future.

Operating under instructions from EIA's consumer products division executive committee, the service committee outlined a series of actions to be taken in the following areas:

1. Career guidance through brochures, films, exhibits, lectures and every other form of communications to make potential service personnel, and the people who counsel them in the schools, aware of the career opportunities awaiting them in the consumer-products service area of the electronics field.

2. Vocational education upgrading to bring electronics vocational education in this country up to the sophisticated level demanded by the revolutionary technology now transforming consumer electronics—via teacher institutes, correspondence courses, bulletins, scholarships, etc.

3. Coordination with the service activities of manufacturers, distributors, dealers and other interested industry groups.

The service technician development program's basic team will soon be expanded by the addition of an EIA staff specialist in technical vocational education.



## THE APPRENTICE AND THE PRO

began to realize how much there was to learn about this business.

"Another thing," Bob said, as he pushed on with the briefing, "the boss is a stickler for methodical procedures. You'll soon begin to learn how to work without wasted motions. And you'll learn that certain movements are made before others. But, after a while, you'll do it fast and automatically without thinking about it.

"For instance, when we arrive at the front door on this call, and after you've removed your overshoes and wiped your shoes, take the small drop-cloth from the caddy and carry it inside—rolled up. When you arrive in the room where the set is located, place the drop-cloth on the floor—whether there's a rug on the floor or not—and place it to

the right or left rear side of the set about a foot from the wall. I'll put the caddy on that drop-cloth a second later. If you were alone, you'd carry the caddy in one hand and the small drop-cloth in the other and you'd spread the cloth on the floor with one hand and then set the caddy on it.

"Then," Bob continued, "while I switch the set on and take a look, open the caddy and take out the large drop-cloth and place it on top of the open caddy. Depending on the particular situation, you'll probably help me move the set away from the wall—and we'll turn it at an angle to the right or left—depending again on where the set is located and its relationship to the caddy.

"After this, spread the big drop-cloth on the floor back of the set,

get a ¼ in. hex-head wrench, a Phillips screwdriver and a cheater cord from the caddy and place them side by side on the top-right corner of the drop-cloth. Then you stand near me on my left or right, depending on which way the set is turned. You'll see what I mean after we get the set away from the wall. Whatever else I ask for after that, remove it from the caddy and hand it to me. Thereafter, watch every move I make—and keep your eyes and ears open."

Don was going over every step of the routine in his mind as Bob had outlined it.

"Can you remember all that?" Bob's voice interrupted Don's thoughts.

"I've memorized every step of it, I think," Don said, grinning with confidence.

"OK. Here we are now," Bob said, as he pulled the service truck alongside the curb and parked in front of the house.

### Audio but No Picture

Everything went smoothly, according to plan, and Bob had already switched the TV set on. The screen of the 21 in. B/W console lit up with a bright raster but no picture showed. Bob switched the tuner to all local channels and the screen was the same. The audio seemed strong on all channels as Bob turned up the volume briefly and then backed it off again. Then he switched the set off and glanced at the service order card. Following TROUBLE SYMPTOMS printed on the card, he read: "good audio but no picture."

He stepped to one side of the set, removed the power cord from the wall outlet and then the two men, facing slightly forward, lifted the set, moved it forward slightly and turned it about 45deg to the left. The right rear leg (viewed from the back) was about 18 in. from the wall.

Don picked up the large drop-cloth from the caddy, spread it on

the floor back of the set and placed the tools and cheater cord on the right top corner of the drop-cloth. He then stepped to the left.

Now Bob moved quickly behind the set, picked up the hex-head wrench and Don noted that the first screw he removed from the set's back cover was just below the ac interlock. Bob then picked up the Phillips-head screwdriver and removed one of the eight screws having captive washers that held the back to the cabinet—the screw in the top left corner. Don also noted that Bob continued to remove the screws in a counter-clockwise direction until the seventh screw, top right, was removed. Then Bob's left hand suddenly grasped the "bump" on the back which covered the CRT socket. He then removed the eighth and last screw, the one at the top center of the set's back. Suddenly again, Bob's right hand relieved his left hand which went quickly to the interlock, pulled on it lightly and the back came off. Bob then placed the back against the wall out of the way to the right. Don had noticed by his wristwatch that Bob had removed the TV's back in less than one minute.

Bob then turned to Don and whispered, "did you notice how the back was removed?"

"Sure did," Don said.

"Remember the procedure and do it the same way every time. The screw at the top is removed last to prevent the back from turning to one side or dropping down and cracking up something on the CRT neck. Of course, you don't have to worry too much about this on most modern wide-angle, short-necked CRTs—but you have to watch it on some old sets," Bob said. "Besides, if you remove the screws in a regular way each time, you'll do it faster after awhile."

"Now we'll see if we can fix this set. We think the video output tube is defective. This set uses 1/2 of a 12AU7 as video output. Give me a 12AU7, please," Bob said.

When the defective tube was replaced, the picture came in good.

"The mirror," Bob said.

Bob removed a pencil from his shirt pocket and began to tap lightly on one tube after another, watching the screen in the mirror. The screen flashed two or three times and Bob said, "6AX4 please." Don removed one from the caddy and handed it to him.

Bob then showed Don how to remove the front safety glass. He then cleaned the CRT face and the glass. Bob adjusted the vertical height and linearity controls slightly.

Finally, Bob said, "I think that's it. Now I want you to replace the back on the set," and he removed the cheater cord, rolled it up neatly, picked up the mirror and placed both in the caddy.

Don experienced some slight difficulty with the interlock for a moment but quickly replaced the interlock screw, the middle-top screw, then continued replacing the other screws. When he had finished he picked up the tools, rolled up the large drop-cloth and placed everything in the caddy. The two men then moved the set back to its normal position near the wall.

Bob Morkin explained to the lady-of-the-house what had been done to the set. Since this was a new, first-time customer, he went into details, explaining about the replaced tubes, cleaning the screen and the adjustments. He explained about the service charge.

"The \$5.95 charge for service," he said, "is our cost of providing you with honest and efficient service. It includes a portion of the rent and electricity at the store. It includes a portion of my salary, cost of operating the service truck, cost of tools and many other necessary operating expenses. Our company makes little or no profit on service calls at the price we charge . . ."

The lady interrupted Bob and asked, "What if one of the tubes you replaced burns out?"

"If that happens within a 90-day

period you get another tube free," Bob answered. "But don't misunderstand me," he added quickly. "The tube is free because the manufacturer gives us another if it fails within the 90-day period. But the manufacturer won't pay us for putting the tube in your set. The cost of service remains the same. The charge will be the same as it was today."

The lady's brow puckered slightly, but she smiled and said, "That seems logical and fair, but why do you need two technicians on a service call?"

"Here it comes," Don thought, "now Bob is stuck!" But Don underrated Bob's human-relations and business know-how.

"We *don't* need two men," Bob said quickly. "Don here," he said, turning to me, "has studied TV servicing for more than a year in technical school but he is an apprentice—a technician in training. He's like an intern—a doctor in training at a hospital. It will be three or four years before he'll be allowed to make a service call alone and be entrusted with the responsibility of repairing your TV or Hi Fi. Our company pays him a salary for doing other work around the shop—but none of his salary comes from service-call charges."

Bob gave the set owner the two old tubes explaining that one of them, the 6AX4, would probably test OK on a "drug-store" tube tester but it had a defect and was replaced *before* it broke down and caused another service charge. He also explained that a TV set—any TV set—could break down without warning at any time.

The two men left the house and entered the service truck. Bob Morkin called the shop on the two-way radio and recorded two calls for the afternoon. Then the truck took off eastward across town to the next service call on the list. Bob and Don had been in the house a full half hour. Alone, the call would have taken Bob only about 20 minutes. ■

# An Extraordinary Offer

to introduce you to the benefits of Membership in  
**ELECTRONIC TECHNICIAN'S BOOK CLUB**

for a limited time only you can obtain

**ALL THREE** of these unique books (Combined List Price \$20.85)

yours for only **\$1.99** ... with Trial Club Membership

**M**ay we send you these three unique timesavers as part of an unusual offer of a Trial Membership in Electronic Technician's Book Club?

## Ten-Minute Test Techniques

Now you can have at your fingertips, this brand-new book, especially written for service technicians, outlining simple troubleshooting procedures that can be applied to any type of electronic circuit.

Without delving into involved theoretical discussions, this practical new handbook describes how trouble in any piece of electronic equipment may be pinpointed quickly and easily. Especially written for practicing technicians by an accomplished and well known author, the book approaches circuit troubleshooting from a new and unique slant—that every circuit is basically either an amplifier or a rectifier which can be easily tested and analyzed using simple servicing procedures.

Step-by-step techniques are outlined for pinpointing troubles to a specific improper stage, and then to the defective component itself, using a minimum amount of test equipment. Profusely illustrated, the content describes several specific troubleshooting methods which can be used to analyze the performance of various types of circuits—tube or transistor—in any kind of equipment. Contains just the kind of practical, down-to-earth information you can *immediately* put to use in your everyday service work! Many invaluable "Time and Temper Savers" are included, offering shortcuts and practical hints which will increase your servicing efficiency and cut down on troubleshooting time.

**TEN-MINUTE TEST TECHNIQUES** for Electronic Servicing contains 8 BIG CHAPTERS — 38 separate subject headings. Includes the type of *practical* servicing data every electronic technician should have. Truly an authoritative servicing guide which will help you solve "tough-dog" troubles fast and eliminate costly call-backs.

Chapter titles are: Fundamentals of Troubleshooting; Power Supplies; Filters,

Bleeders, and Regulators; Special Purpose Power Supplies; Basic Amplifier Tests; Amplifier Tests with Scope; Basic Oscillator Tests; Special Amplifiers and Transmitters

## Servicing TV Receiver Circuits

Contains the TV service data *most needed* for troubleshooting both monochrome and color receivers. Selected by the Editorial Staff of "Electronic Technician," this brand-new volume contains just the kind of practical down-to-earth information you can use in your everyday service work. The material—written by nearly a dozen of the leading experts in the field—is based on articles which originally appeared in "Electronic Technician." Edited and arranged to provide a quick and easy reference, emphasis has been placed on the *practical* information you can use in home or at the service bench.

## Detailed, Practical Help

This detailed compilation of practical help is the answer to the need for an organized gathering of proven troubles and cures that will help you locate and correct the most elusive TV circuit faults. This practical information will help you solve your daily servicing problems . . . will save you hours of time and effort. These accurate and clear servicing descriptions are supplemented by scores of easy-to-follow schematic diagrams and illustrations.

While no one book is a cure-all for TV troubles, *Servicing TV Receiver Circuits* comes about as close as you can get. Every chapter follows the time-proven methods of experienced troubleshooters—analyzing circuit performance and applying logical and efficient test procedures. Numerous example troubles are cited to help you solve "tough-dog" problems.

## Special Color Section

More than half the content is devoted to color, and includes the practical background theory needed to troubleshoot and repair today's complex color TV receivers. A full 10 Chapters are devoted to step-by-step color TV servicing tech-

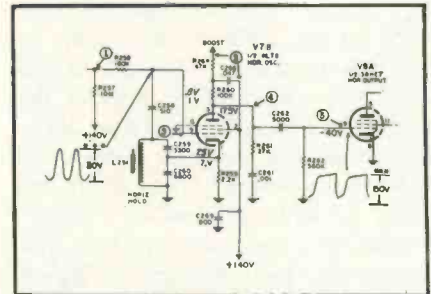

Literally scores of easy-to-use schematic diagrams are contained in all these new books. (Example shown greatly reduced in size)

niques, complete with test procedures, waveform photos, and trouble-correction techniques. While experience is the best teacher, an occasional re-reading of a Chapter or two when you're faced with a "tough-dog" set will make this book invaluable to you in servicing TV receivers.

## TV Troubleshooter's Handbook

Here are helpful techniques which are a complete digest of late-model TV receiver troubles and cures, compiled strictly on the basis of their usefulness to you!

This practical compilation of servicing help contains data on new and unusual circuits and descriptions of how they work, field and factory changes, recurring defects, etc.

These accurate and clear servicing descriptions are supplemented by over 175 easy-to-follow schematic diagrams and illustrations. For ease of use, all troubles have been logically organized by manufacturer and model number.

A Special Section on color TV describes recurring defects and cures, and includes service hints for troubleshooting chroma circuits, short cuts for making convergence adjustments, descriptions of new circuits, etc.

*Ten-Minute Test Techniques*, *Servicing TV Receiver Circuits* and *TV Troubleshooter's Handbook* are handsome, hardbound books, indicative of the many other fine offerings made to Members . . . important books to read



- 176 pages • 125 illus.
- BRAND-NEW & Original
- 38 Subject Headings
- Permanent, Hardbound Volume

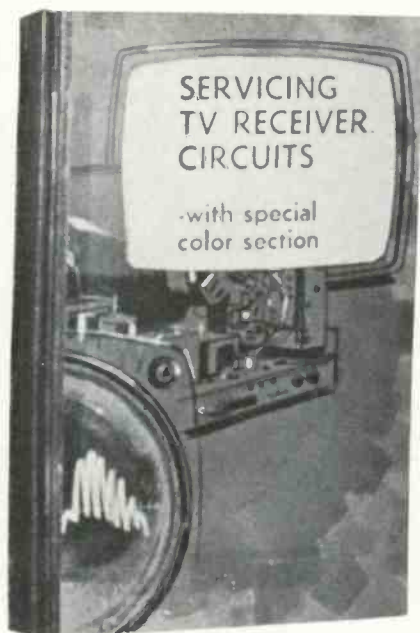

- 224 pages
- Special Color Section
- 34 FACT-FILLED Chapters
- Permanent, Hardbound Volume

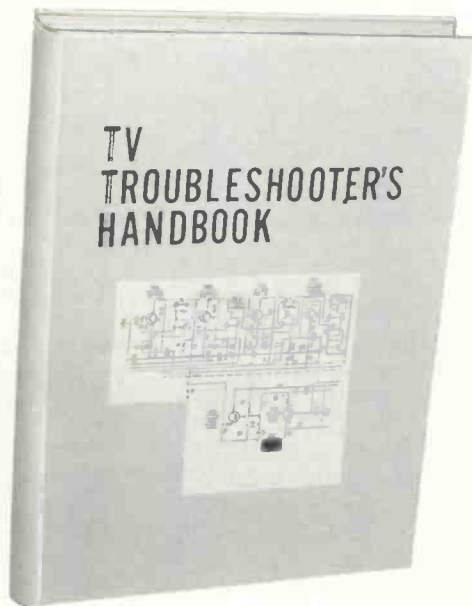

- 192 pages
- Special Color Sections
- Permanent, Hardboard Volume
- Over 350 solutions to "tough dog" problems
- Over 125 schematic diagrams & illustrations

and keep . . . volumes with your specialized interests in mind.

#### How You Profit From Club Membership

This is just a sample of the help and generous savings the Club offers you. For here is a Club devoted exclusively to seeking out only those titles of interest to you as an electronic technician (no hobby or "fringe" books are offered). Membership in the Club offers you several advantages:

**1. Charter Bonus:** *Ten-Minute Test Techniques*, *Servicing TV Receiver Circuits* and *TV Troubleshooter's Handbook* carry publisher's retail price of \$20.85. But they can be yours for only \$1.99 with your Trial Membership.

**2. Continuous Savings:** The Club guarantees to save you 15% to 75% on the books you need.

**3. Editorial Advisory Services:** The Club's Editorial Advisory Board selects only the important books of direct interest to you.

**4. Wide Selection:** Members are annually offered over 50 of the authoritative books on all phases of electronic servicing. The Club makes it a point to offer new books, along with standard classics . . . lists books from all publishers — not just one or two.

**5. Prevents You From Missing New Books:** The Club's FREE monthly *News* gives you advance notice of important new books . . . books vital to your continued professional advancement.

This extraordinary offer is intended to prove to you, through your own experience, that these very real advantages can be yours . . . that it is possible to keep up with the professional literature

published in your specific area of interest . . . and to save substantially while so doing.

#### How the Club Works

Forthcoming selections are described in the FREE monthly *Club News*. Thus, you are among the first to know about, and to own if you desire, significant books. You choose only the main or alternate selection you want (or advise if you wish no book at all) by means of a handy form and return envelope enclosed with the *News*. As part of your Trial Membership, you need purchase as few as four books during the coming 12 months. You would probably buy at least this many anyway . . . without the substantial savings offered through Club Membership.

#### Limited Time Offer!

Here, then, is an interesting opportunity to enroll on a trial basis . . . to prove to yourself, in a short time, the advantages of belonging to the only Book Club devoted exclusively to electronic servicing. We urge you, if this unique offer is appealing, to act promptly, for we've reserved only a limited number of Handbooks for new Members.

To start your Membership on these attractive terms, simply fill out and mail the postage-paid Airmail card today. You will receive *Ten-Minute Test Techniques*, *Servicing TV Receiver Circuits* and *TV Troubleshooter's Handbook* for 10-day inspection. SEND NO MONEY! If you are not delighted with these quality hardbound books, return them within 10 days and your Trial Membership will be cancelled without cost or obligation. Electronic Technician's Book Club, Drawer D, Thurmont, Md. 21788.



#### Typical Savings Offered Club Members on Recent Selections

Elementary Industrial Electronics,	Pub. pr. \$9.00; Club pr. \$6.95
Radio Operating Q & A,	Pub. pr. \$8.25; Club pr. \$6.95
Logical Electronic Troubleshooting,	Pub. pr. \$5.95; Club pr. \$3.95
Repairing Transistor Radios,	Pub. pr. \$6.50; Club pr. \$3.50
Pinpoint TV Troubles in 10 Minutes,	Pub. pr. \$6.95; Club pr. \$4.95
Transistors: Principles & Applications,	Pub. pr. \$6.95; Club pr. \$3.95
Practical Oscilloscope Handbook,	Pub. pr. \$6.95; Club pr. \$4.95
CATV System Engineering,	Pub. pr. \$12.95; Club pr. \$7.95
TV Troubleshooting & Repair,	Pub. pr. \$6.95; Club pr. \$3.95
Advanced Servicing Techniques, Vol. 1,	Pub. pr. \$8.25; Club pr. \$5.95
Repairing Home Audio Systems,	Pub. pr. \$7.25; Club pr. \$5.95
Reference Data for Radio Engineers,	Pub. pr. \$6.00; Club pr. \$5.00
Fundamentals of Transistors,	Pub. pr. \$12.00; Club pr. \$9.95
Basic Mathematics for Electronics,	Pub. pr. \$10.75; Club pr. \$8.50
Technical Television,	Pub. pr. \$14.65; Club pr. \$5.95
Profitable Television Troubleshooting,	Pub. pr. \$7.95; Club pr. \$5.95
Electronic Troubleshooting,	Pub. pr. \$12.50; Club pr. \$9.95
Color Television Fundamentals,	Pub. pr. \$10.95; Club pr. \$7.95
Advanced Servicing Techniques, Vol. 2,	Pub. pr. \$9.95; Club pr. \$4.75
TV Technatics '65, '66, '67 (each 2 vols.),	Pub. pr. \$19.90; Club pr. \$13.50 each
Basic Radio Repair,	Pub. pr. \$5.95; Club pr. \$4.75

**SEND NO MONEY!** Simply fill in and mail postage-paid Airmail card today!

. . . for more details circle 133 on postcard



A NEW  
TUNER CLEANER

*Specially*

FORMULATED  
FOR TV-TUNERS

USING NUVISTORS &  
TRANSISTORS

NO TUNER DRIFT

Nuvistors and Transistors are highly sensitive to drift from ingredients in most ordinary TV tuner cleaners. Drift has been found to cause call backs and expensive tuner repairs. For over 18 months CHEMTRONICS has been formulating and testing this new cleaner in both the lab and field. Under the most critical test, there has been NO DRIFT on scope patterns. We invite you to try this test yourself.

CAT. NO.  
**800**  
\$198  
DEALER  
NET

*Another First*

**SUPER  
FROST AID**

Cools Faster • Leaves  
No Liquid Residue

SUPER FROST AID is a faster  
circuit freezer designed to  
locate intermittent components  
... without leaving a  
liquid residue.





BROOKLYN

N. Y. 11236

... for more details circle 109 on postcard

80

## ... The Easy Way

*continued from page 48*

amount of *positive* delayed AGC voltage fed to the tuner and this is controlled by the 2nd IF collector current. Bending of vertical lines usually indicates an overload condition. Check the AGC control for proper adjustment and then check AGC circuit voltages — following manufacturers' service notes. Pay special attention to sync and keying pulses from the flyback. Scope checks here will speed your work in locating faults.

The vertical output stages on some solid-state TVs have a bias

control that must be set in conjunction with the height and linearity controls. Check manufacturers' service manuals when adjusting these controls. In this set, the vertical oscillator will lock at 30Hz instead of 60Hz if Y201 fails. This will place the vertical blanking bar in the center of the screen and also cause the vertical hold to be very soft.

Procedures for troubleshooting the audio section of this set are the same as for an FM transistor radio. Signal injection works wonders. Many TV manufacturers supply a circuit template for rapid location of components and test points (see Fig. 11). This, along with "roadmap-

## ADVERTISERS' INDEX

Allied Radio Corp. ....	35-36
Amperex Electronic Corp. ....	3rd Cover
Arco Electronics .....	29
Armco Steel Corp. ....	69
B&K Div., Dynascan Corp. ....	25
Castle TV Tuner Service .....	76
Channel Master Corp. ....	30-31
Chemtronics, Inc. ....	80
Cleveland Institute of Electronics .....	73, 79
Electro-Voice, Inc. ....	77
ELECTRONIC TECHNICIAN Book Club .....	62-65
Finney Co. ....	26-27
GC Electronics Co. ....	22
International Crystal Mfg. Co. ....	28
Jensen Mfg. Div., The Muter Co. ....	24
Jerrold Electronics Corp. ....	2nd Cover
JFD Electronics Co. ....	67
Matsushita Electric .....	71
Microflame, Inc. ....	71
Miller Co., J. W. ....	77
Mosley Electronics .....	72
Precision Apparatus Div., Dynascan Corp. ...	19
Quietrol Co. ....	78
Radio Corp. of America	
RCA Electronic Components	
& Devices .....	4th Cover
RCA Sales Corp. ....	27
S & A Electronics, Inc. ....	34
Sencore, Inc. ....	33, 74, 79
Sprague Products Co. ....	23
Triplett Electrical Instrument Co. ....	70
Weller Electric Corp. ....	78
Yeats Appliance Dolly Sales Co. ....	71
Zenith Sales Corp. ....	76

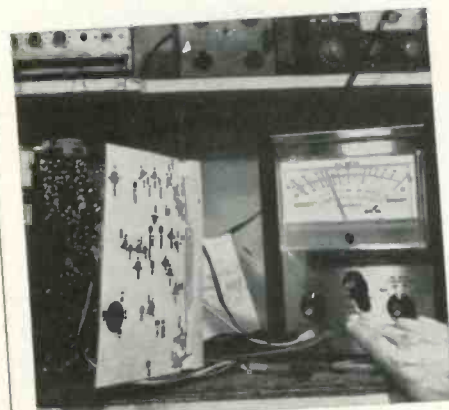

Fig. 11—Circuit template is used to locate components and test points quickly.

ping" which appears on the circuit board, can speed your checking processes.

When the problem is narrowed down to a specific section of a set, use an in-circuit transistor tester. You can locate defective transistors very quickly in this way. Although we have been told to suspect transistors last, our experience shows that they should be checked first. We find many shorted transistors — for whatever cause. And when a transistor shorts, it almost always burns up the emitter resistor.

One other thing to remember: if this set is operated on a 12v auto power supply, high spike pulses from the car alternator will frequently destroy the horizontal output transistor.

Don't fear these "little monsters." Know your solid-state circuits thoroughly, know the precautions you must take when troubleshooting and repairing them. You can then do boldly into their "innards" and soon become known as the solid-state specialist in your area. ■

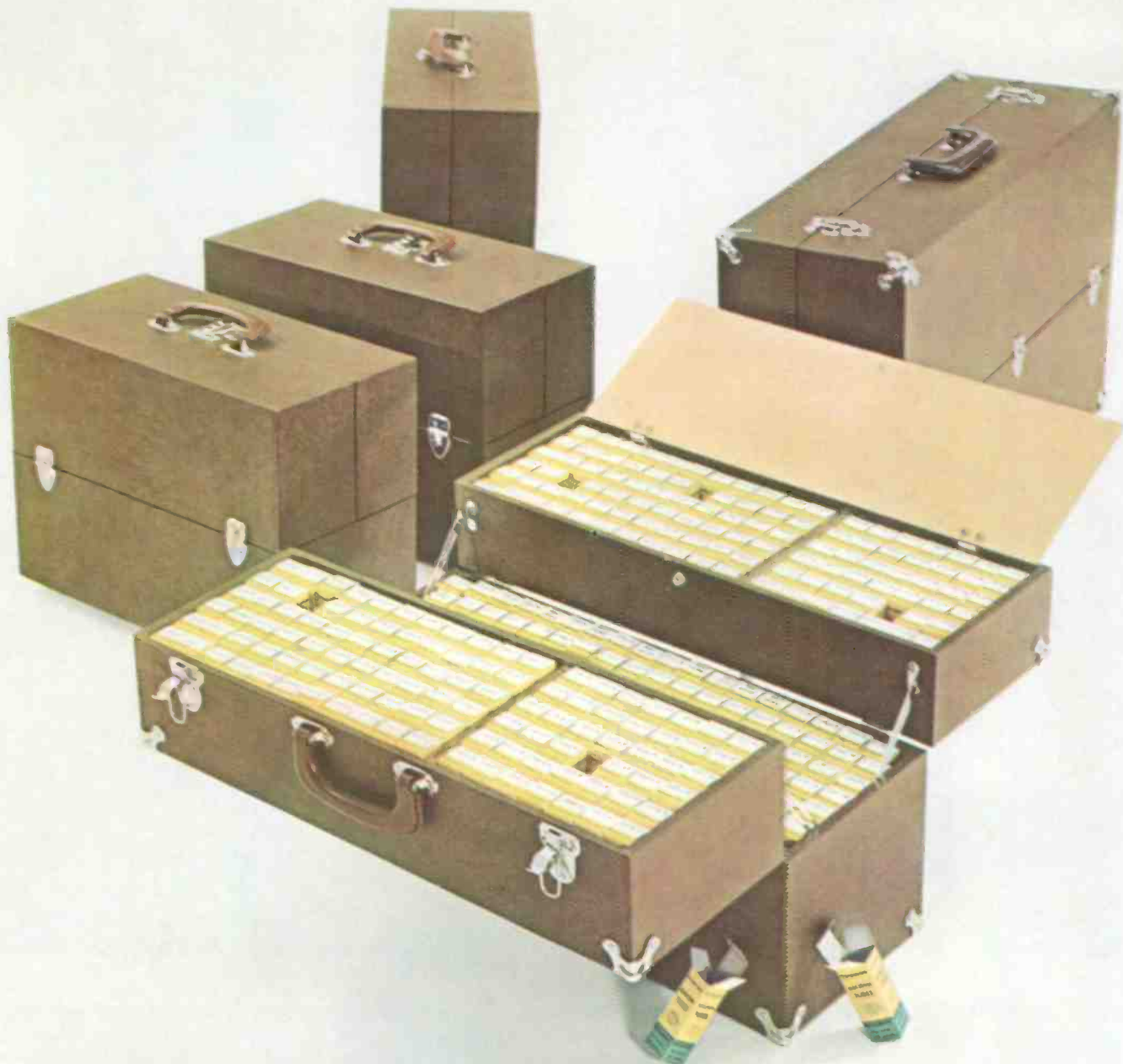

One out of every five  
professional servicemen  
has switched to Amperex  
TV replacement tubes

It takes a lot of quality to change the buying habits of 20% of the most knowledgeable technicians in the business. These servicemen are following the pattern set by the leading TV manufacturers, who are designing more and more of their quality lines around tubes originated by Amperex. The Amperex line of popular types is expanding all the time. Look for the green and yellow cartons at your distributor's or write; Amperex Electronic Corp., Hicksville, L. I., N.Y. 11802.



**Amperex**

TOMORROW'S THINKING IN TODAY'S PRODUCTS

... for more details circle 101 on postcard

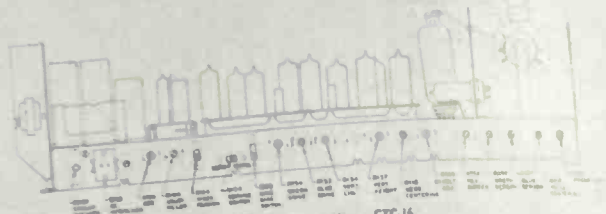

Fig. 1 - Rear Chassis View - CTC-16.

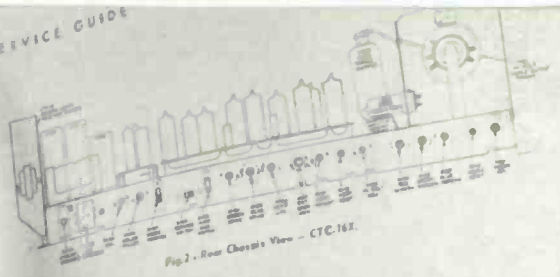
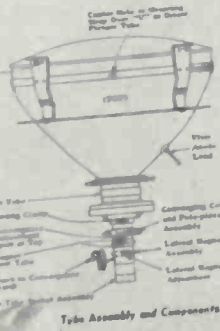

Fig. 2 - Rear Chassis View - CTC-16E.



Tube Assembly and Components.

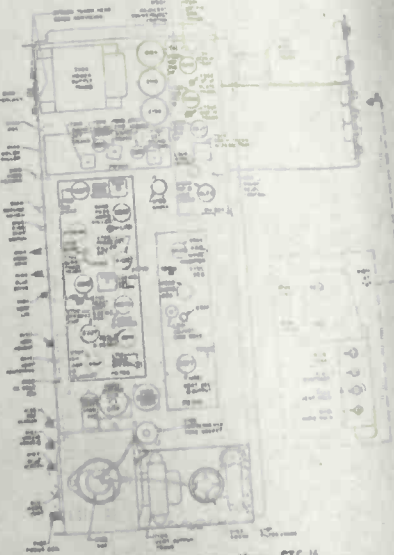

Fig. 4 - Top Chassis View - CTC-16.

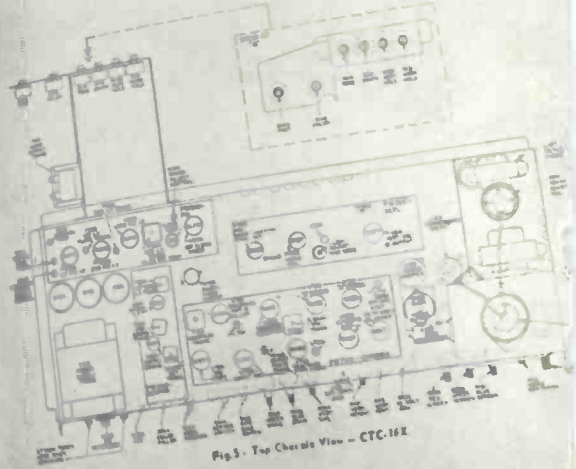

Fig. 3 - Top Chassis View - CTC-16E.

# You need this guide for RCA Color Home Service Calls!

RCA'S NEW FIELD SERVICE GUIDE, ERT-200 helps you make all adjustments on all RCA color sets from 1955 to 1966 that can be performed in the home... including step-by-step procedure for replacing a color picture tube.

Three part index lets you look up the set you are working on by model number, name or chassis number. You'll find the ERT-200 Field Service Guide indispensable. There's nothing like it on house calls for RCA color sets.

**WHAT THIS GUIDE CONTAINS:**

- Schematics on all RCA color sets from 1955 to 1966
- Field service adjustments (AGC, linearity, centering, etc.)
- Convergence, purity and black and white setup adjustments
- Parts lists
- Wave forms keyed to test points for majority of chassis
- Top and rear chassis views
- Photos of typical receivers
- Index of models from CTC2 through CTC20
- Separate section on tuner schematics
- Separate section on remote tuner schematics



**FIELD-SERVICE GUIDE**

**RCA COLOR-TV RECEIVERS**  
1955-1966

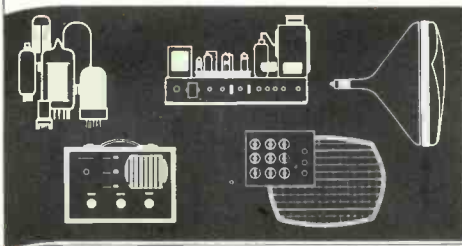

- FEATURES:**
- Field Service Adjustments - CTC-20 through CTC-20A
  - Top and Rear Chassis Views
  - Schematic Diagrams
  - Voltage Waveforms Keyed To Test Points
  - Separate Section on Tuner Schematics
  - Parts Lists
  - Comprehensive Index of Model Number, Model Name and Chassis Number

See your RCA Tube Distributor today and arrange to get your copy.

RCA Electronic Components and Devices, Harrison, N.J. 07029



The Most Trusted Name in Electronics