

# ELECTRONIC TECHNICIAN

WORLD'S LARGEST ELECTRONIC TRADE CIRCULATION

JULY 1967



FRISEW1081R392N869AA3A179668  
WILLIAM W FRISE  
7176 GALE RD  
ATLAS MI  
XX  
48411

Repairing Solid-State Auto Radios  
Servicing Integrated Circuits  
Troubleshooting Color Video Amplifiers

# we looked into your future, then created the "little corporal," a most remarkable CRT tester.

B & K has done it again . . . put you a "jump ahead" by looking into your future . . . your problems, *your* needs. This is the "Little Corporal," the CRT Rejuvenator and Checker, designed to provide maximum obsolescence protection by providing continuously variable voltages for all CRT elements. You can make the most accurate possible tests, even on future CRT types, because the heater

voltage is metered and is continuously variable from 0 to 13 volts with any tube heater current. And, using the required adaptors, you can test and correct all tube, transistor or integrated circuit black and white and color picture TV tube troubles (including GE 11" color and imported color tubes) in a few minutes . . . in the home or on the bench . . . without removing tubes from the TV set.

You can give new life to weak or inoperative picture tubes—prove to your customers their need for new tubes.

The "Little Corporal," another product of B & K electronic innovation, carries the B & K Professional Servicing Equipment emblem, your assurance . . . your customers' assurance . . . that you use the finest equipment made.

Model #465, Net: \$89.95.



A Division of  
Dynascan Corporation  
1801 W. Belle Plaine  
Chicago, Illinois 60613

Export: Empire Exporters, Inc.  
123 Grand Street  
New York, N.Y., 10013



A Division of Dynascan  
Where Electronic Innovation  
Is A Way of Life

. . . for more details circle 104 on postcard



# ELECTRONIC TECHNICIAN TEKFAX

COMPLETE MANUFACTURER'S CIRCUIT DIAGRAMS  
AND TECHNICAL INFORMATION FOR 6 NEW SETS

## 1093

ADMIRAL  
TV Chassis H3-1A, H4-1A, 1H4-2A

JULY • 1967

GROUP  
**179**

SCHEMATIC NO.

SCHEMATIC NO.

ADMIRAL.....1093  
TV Chassis H3-1A, H4-1A, 1H4-2A

PHILCO-FORD.....1096  
TV Chassis 17J28

CORONADO.....1094  
Color TV Model TV21-9643A

SILVERTONE.....1098  
TV Model 7151, 7152, 7154, 7155,  
7156, 7157, 7158

OLYMPIC.....1095  
TV Chassis 9P56, 57, 58

TRUETONE.....1097  
Color TV Model 2DC3555

**SCHEMATIC NOTES:**

- ⚡ CHASSIS GROUND
- ⊕ PART NOT MOUNTED ON PRECISION WIRING SYSTEM. VOLTAGE WILL VARY WITH SETTING OF CONTROLS. RESISTOR VALUES 1/2 WATT 10%. CAPACITOR VALUES IN MICROFARADS, UNLESS OTHERWISE INDICATED. DC VOLTAGES MEASURED AT 100V AC LINE, NO SIGNAL. MAX. CONTRAST & BRIGHTNESS, & HIGH VOLUME WITH 90PH.

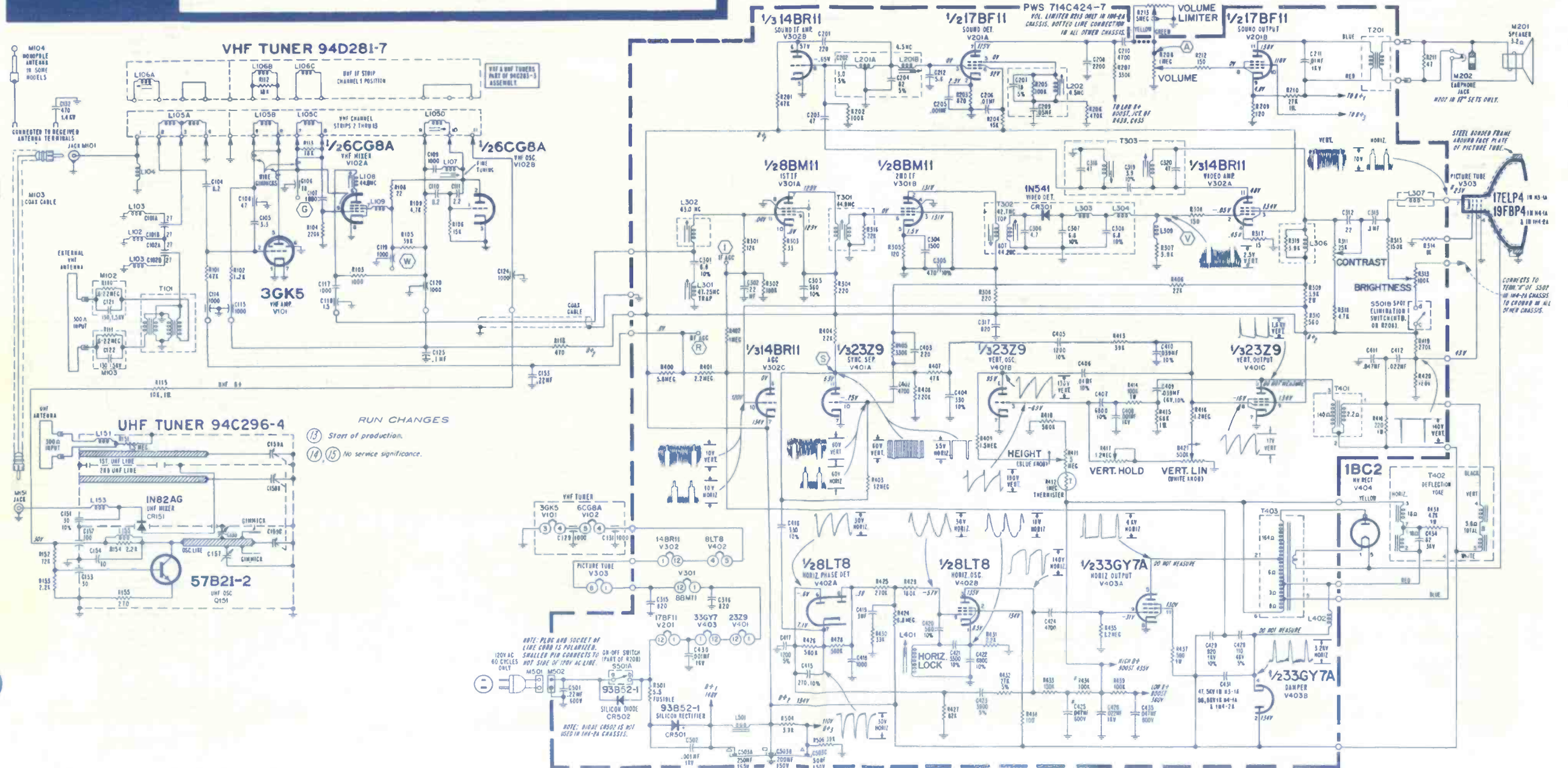
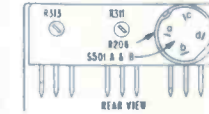
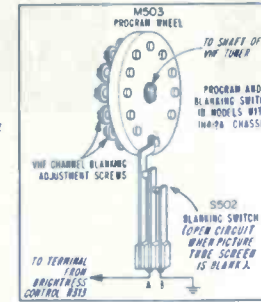

**RUN CHANGES**  
 13 Start of production.  
 14 15 No service significance.



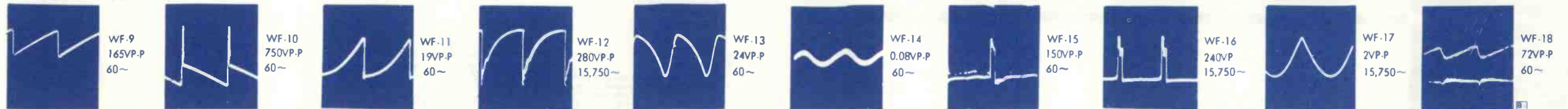
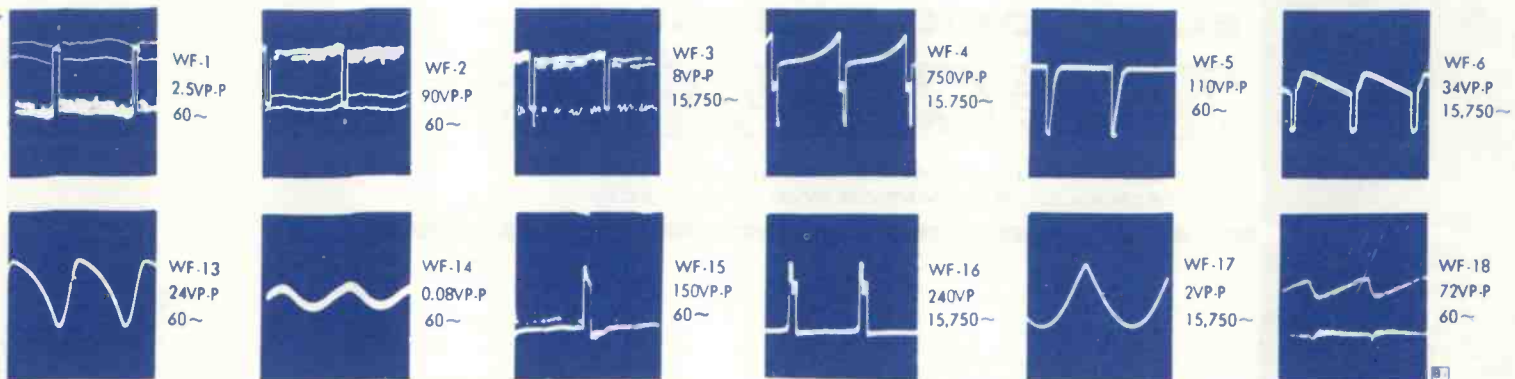

SYMBOL	DESCRIPTION	CORONADO PART NO.
T101	1st video IF	T-S1810
T102	47.25MHz trap	T-S1519
T103	2nd video IF	T-S1038
T104	3rd video IF	T-S1040
T105	video det	T-S1039
T106	4.5MHz trap	T-S2706
T107	2nd snd IF	T-S2016
T108	audio output	T-V108
T109	bond pass	T-S3002
T110	burst phase	T-S3001
T111	3.58MHz osc	T-S3004
T112	vert output	T-W32
T113	H.V. flyback	T-F86A
T114	power	T-P42AA
T115	Rt. horiz blue line	T-A38
T116	top bottom pin	T-A39
L101	heater choke	T-L106
L102	heater choke	T-L106
L103	12µh peaking	T-L500
L104	100µh peaking	T-L2501
L105	12µh peaking	T-L50
L107	200µh peaking	L-2505
L109	quad	T-S2014
L110	480µh peaking	T-L2006
L113	150µh peaking	T-L2516
L114	180µh peaking	T-L65
L115	chroma take off	T-S3003
L116	reactance	T-S3005
L117	4.7µh peaking	T-L1002
L119	1500µh filter	T-L7010
L120	horiz osc	T-A41
L123	12µh peaking	T-L67
L125	efficiency	T-A90
L126	Rt. R/G vert lines	T-A36
L127	RT. R/G horiz lines	T-A37
L128	filter choke	T-B25
L130	delay line	T-S308
L135	bottom pin	T-A20
L136	convergence correcting blue	T-A40
L137	70µh peaking	T-L2514
L138	degaussing	T-L7068
L139	lin	T-A95
L140	deflection yoke	T-D70
L141	convergence yoke	T-D68
D1	video det	T-E1014
D3	H.F. burst amp	T-E1029
D4ab	AFC	T-E1061A
D5	power rectifier silicon	T-E1050
SE1	convergence diode selenium	T-E1011
	degaussing coil voltage regulator diodes (4 used)	T-E1078
VR101	snd reject 500K	T-G0046
VR102	vol cont and off/on switch 500K	T-G6425
VR104	brightness 250K	T-G1848
VR105	contrast 500K	T-G1808
VR106	blue drive 5K	T-G1012
VR108	AGC 5K	T-G1012
VR109	vert hold 1M	T-G1820
VR110	vert lin 1M	T-G1002
VR111	vert height 100K	T-G1010
VR112	vert center 15Ω	T-G1832
VR113	focus 500K	T-G1802
VR114	H.V. adjust 500K	T-G0025
VR115	horiz center 15Ω	T-G1832
VR116	color killer 1M	T-G1002
VR117	hue 1K	T-G1853
VR118	color 500K	T-G1855
VR119	line bias 500K	T-G1802
VR121	green screen 1M	T-G1002
VR124	left R/G horiz lines	T-G2006B
VR126	top R/G vert lines	T-G2030
VR131	bottom blue horiz lines	T-G2031
VR132	horiz hold 1M	T-G1820
VR133	vert peaking 5K	T-G0006
VR134	DPC balance 50K	T-G0501
VR135	sub brite 1M	T-G0012
R3	5K 3w	RW-54
R46	800Ω 20w	
R72	12K 3w	
R901	thermistor (part of L140)	T-E1059
C24	500pf 5kv ceramic	500S15K
C27	500pf plastic film	CC-152
C30	50µf elect (part of C33-C34)	T-C8164V
C33	30µf elect (part of C30-C34)	T-C8164V
C34	60µf elect (part of C30-C33)	T-C8164V
C51	500pf 1kv ceramic	CC-6305
C59	50pf 5kv ceramic	CC-130
C64	60.50-30µf elect	T-C8164SNR
C317	100µf 100v elect	CC-102
C327	400pf plastic film	CC-115
C336	.001 1kv ceramic	
C404	.5µf met paper	CC-17
C428	1µf met paper	40AM1
	circuit breaker 1.75A	T-E2709

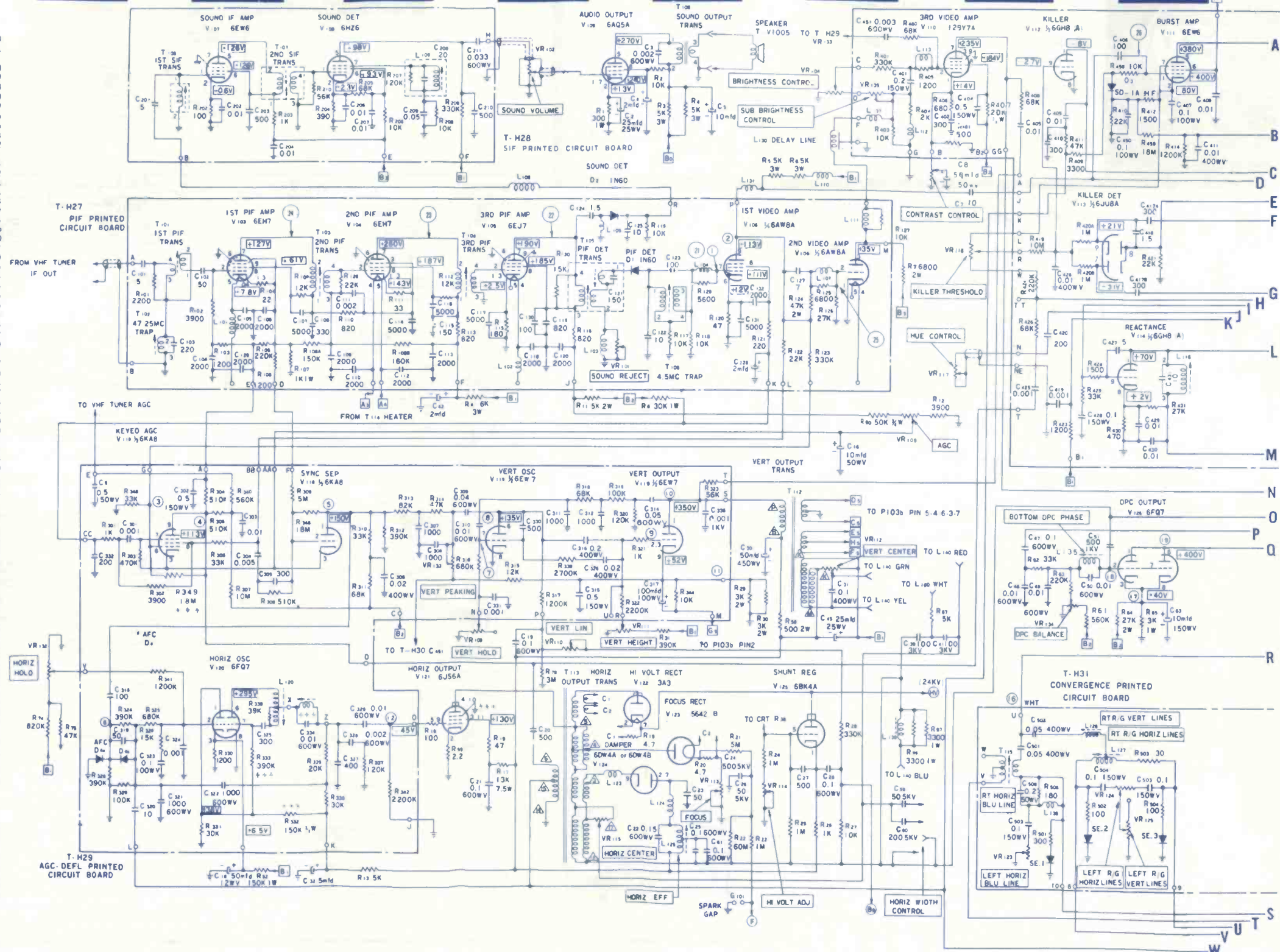



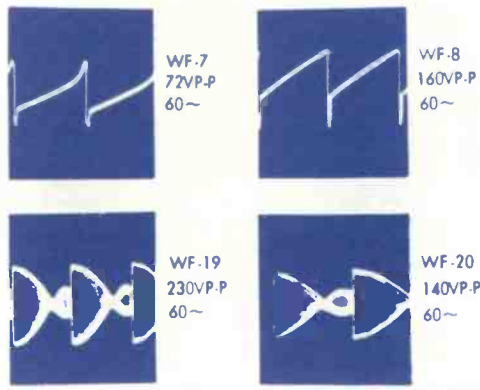

ANTENNA INPUT IMPEDANCE ..... 300 ohms balanced  
 CONVERGENCE ..... Magnetic  
 FOCUS ..... Electrostatic  
 INTERMEDIATE FREQUENCIES  
 Picture I-F Carrier Frequency ..... 45.75 mc.  
 Sound I-F Carrier Frequency ..... 41.25 mc.  
 Color Sub Carrier Frequency ..... 42.17 mc. (Nominal)  
 PICTURE SIZE ..... Approx. 170 sq. in. on a 490EB22 Kinescope  
 POWER INPUT RATING ..... 350 watts total, 120 volts, AC, 60 cycle  
 SWEEP DEFLECTION ..... Magnetic  
 TELEVISION R-F FREQUENCY RANGE  
 Any of 70 UHF channels ..... 470 mc. to 890 mc.  
 Any of 12 VHF channels ..... 54 mc. to 88 mc., 174 mc. to 216 mc.

**CHECK OF VHF R-F OSCILLATOR ADJUSTMENTS (FIELD)**  
 Tune in all available stations to see that receiver R-F oscillator is adjusted to the proper frequency on all channels.  
 Remove the channel selector knob by loosening the set screw.  
 There are thirteen gears around the disc on the tuner face, one for each channel from 2 through 13. The one in the "U" position is not used. Center line tuning for each channel as shown in Figure 5.  
 Rotate the channel selector to a channel received in your area.  
 Then adjust the channel oscillator slug for the best picture and sound.  
 Repeat the steps for all other channels.  
 NOTE: This is a critical adjustment and should be performed by a qualified service technician.  
 After the oscillator slugs are properly set, the "One-Set" fine tuning gears may be readjusted at any time to maintain identical tuning for all channels as the channel selector is rotated.

SET FINE TUNING TO CENTER OF ITS RANGE. TURN FINE TUNING SHAFT CLOCKWISE WHILE DEPRESSING IT UNTIL A CLICK IS HEARD. THEN TURN IT COUNTER CLOCK WISE 1 1/2 TURNS.

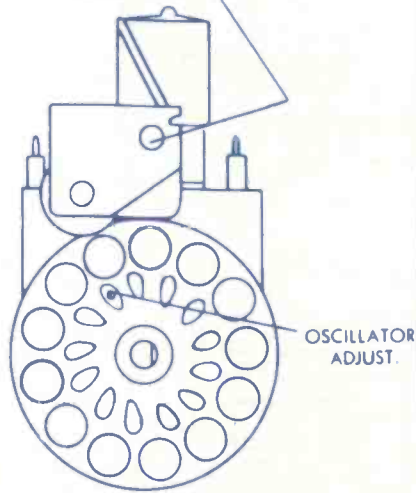

VHF R-F OSCILLATOR ADJUSTMENT

CORONADO  
 Color TV Model TV21-9643A

VHF TUNER T-Tc852US

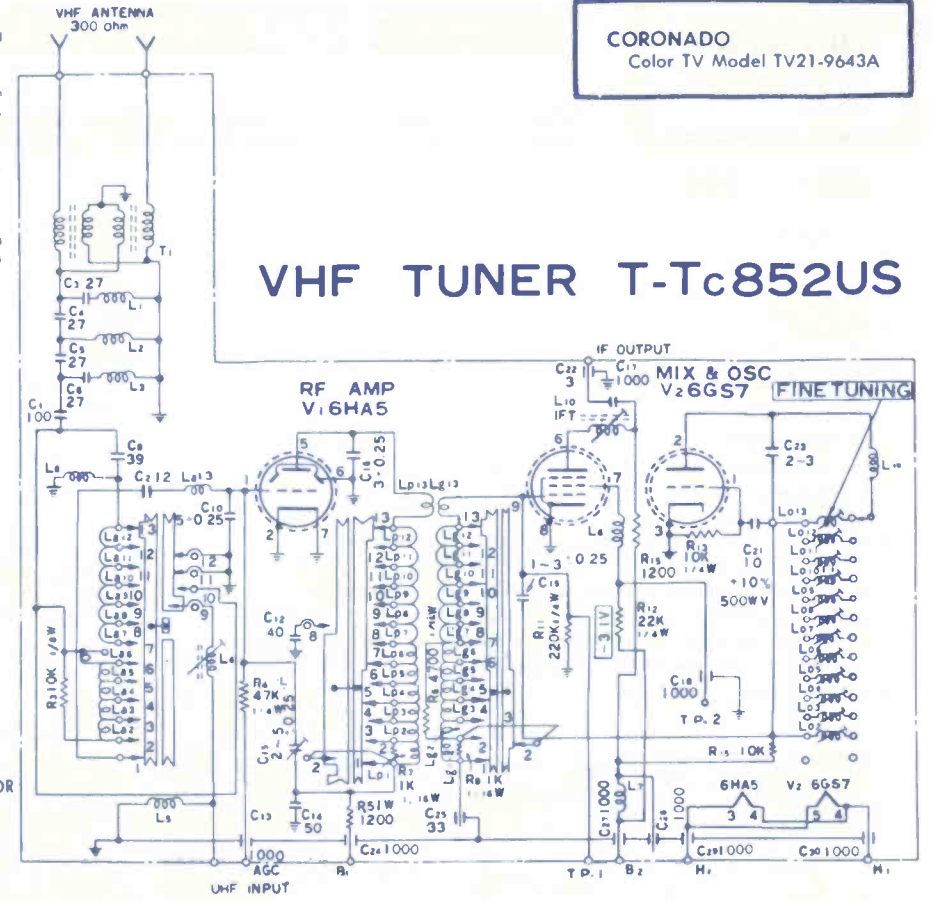

UHF TUNER T-T1026US

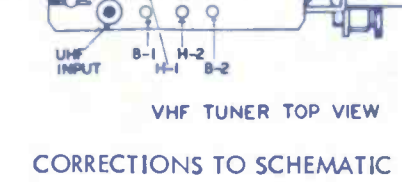
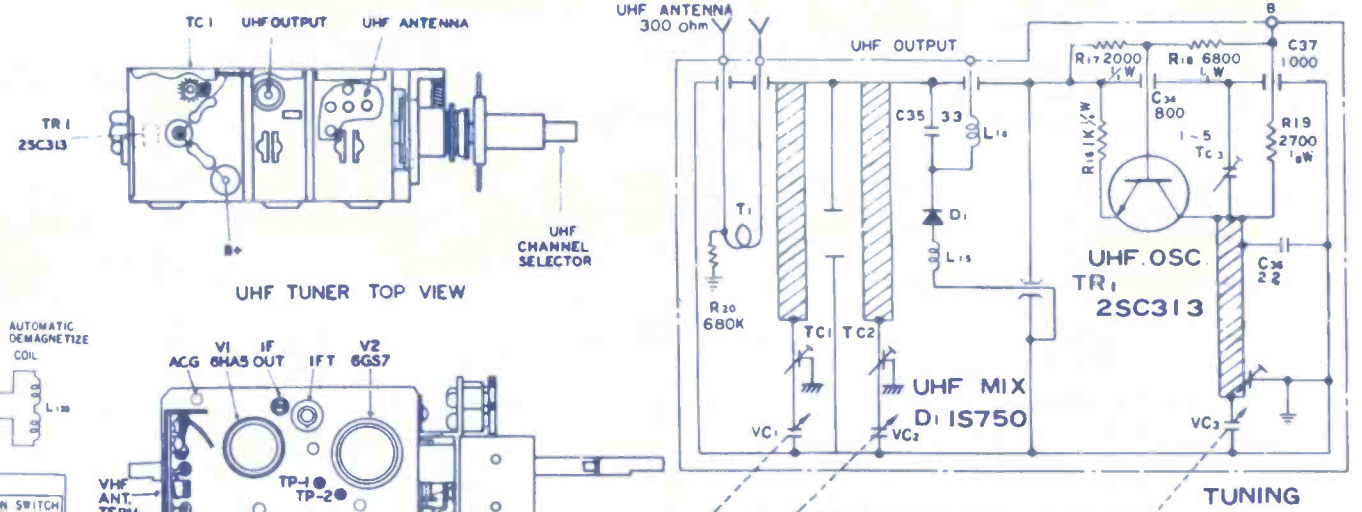

CORRECTIONS TO SCHEMATIC

R119	1200
R204	270
R205	68K omit
R206	3900
R207	68K
R208	390K
C3	0.005

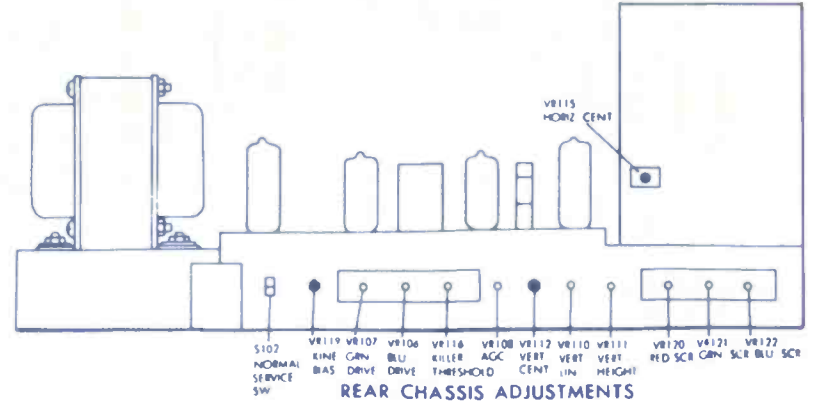
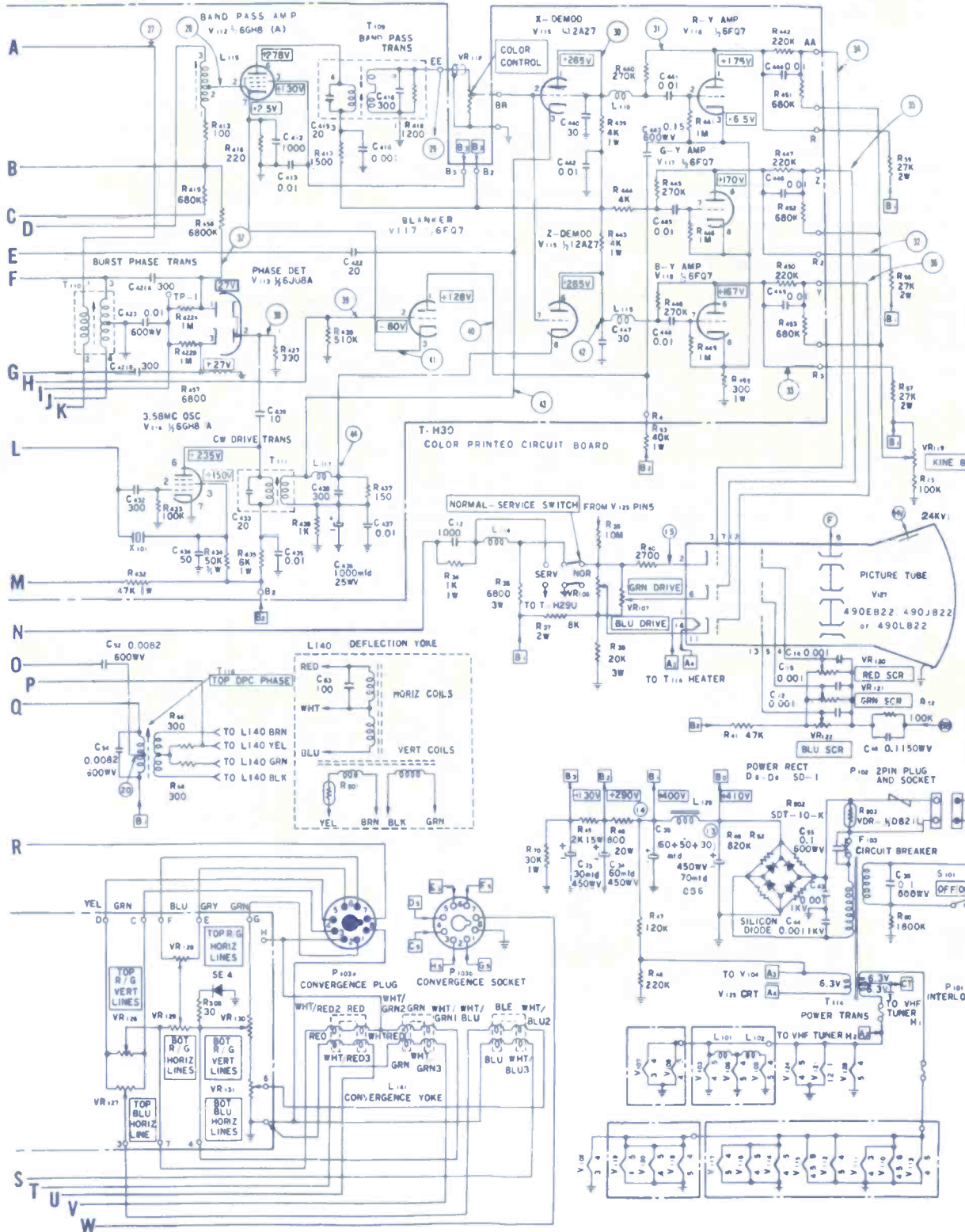







SYMBOL	DESCRIPTION	PHILCO PART NO.
C48	160/240/5@200v elec	30-2601-33
D1	phose comp	34-8037-1
D2	2nd det	34-8022-6
D3	rect silicon	34-8054-7
L1	180 plate series	32-4762-7
L2	330 plate shunt	32-4762-20
L3	choke 60MHz RF choke damper	32-4112-62
L4	interstage snd IF	32-4745-13
L5	choke 60MHz damper cath	32-4112-62
L6	220mh noise inv cath	32-4876-1
L7	quid snd det	32-4876-14
L8	transformer 4.5MHz trap & snd take off	32-4645-7
L9	ch 6 beat video det	32-4652-96
L10	tuner coupling	32-4686-34
L11	1st IF plate	32-4753-3
L12	horiz stabilizer	32-4652-78
L13	47.25MHz trap	32-4652-80
L14	41.25MHz trap	32-4652-79
L15	1st grid pole	32-4652-78
L16	47.25MHz trap	32-4837-1
L17	40MHz trap 2nd det	32-4652-79
L18	video det	32-4652-78
L19	2nd IF plate	32-4652-78

N1	retroce supp	30-6024-9
N2	SIF cathode	30-6031-16
N3	vert int	30-6030-12
N4	horiz osc	30-6057-1
N5	phase comp	30-6035-2
N6	isolation CRT	30-6058-2
N7	isolation vol contrl	30-6058-2
R63	1.5Ω 7w fil & B+	33-1363-134
A.O.T.	audio output	32-10013-4
H.O.T.	horiz output	32-10008-7
V.O.T.	vert output	32-10012-6
F.C.	B+ filter choke	32-10010-5
VR1	2M V fin-500K V size 60K horiz hold	33-5595-8
VR2	1M noise adjust	33-5613-1
VR3	3K width	33-5620-1
VR4	100K bright 1M vol on-off sw	33-5618-24
VR5	15K contrast	33-5619-29
VR6	150K vert hold	33-5619-3
	tuner UHF TT152	76-13827-1
	tuner VHF TT162C	76-13945-4
	yoke & cable assy	76-12942-4

OSCILLOSCOPE WAVEFORMS

These waveforms were taken with the receiver adjusted for an approximate output of 2.5V p/p at the video detector. Voltage readings taken with raster just filling screen and all controls set for normal picture viewing except for photos 1, 2 and 3 where contrast was at maximum. The voltages given are approximate peak-to-peak values. The frequencies shown are those of the waveforms...not the sweep rate of the oscilloscope. All readings taken with Model PS127 Sencore Oscilloscope.

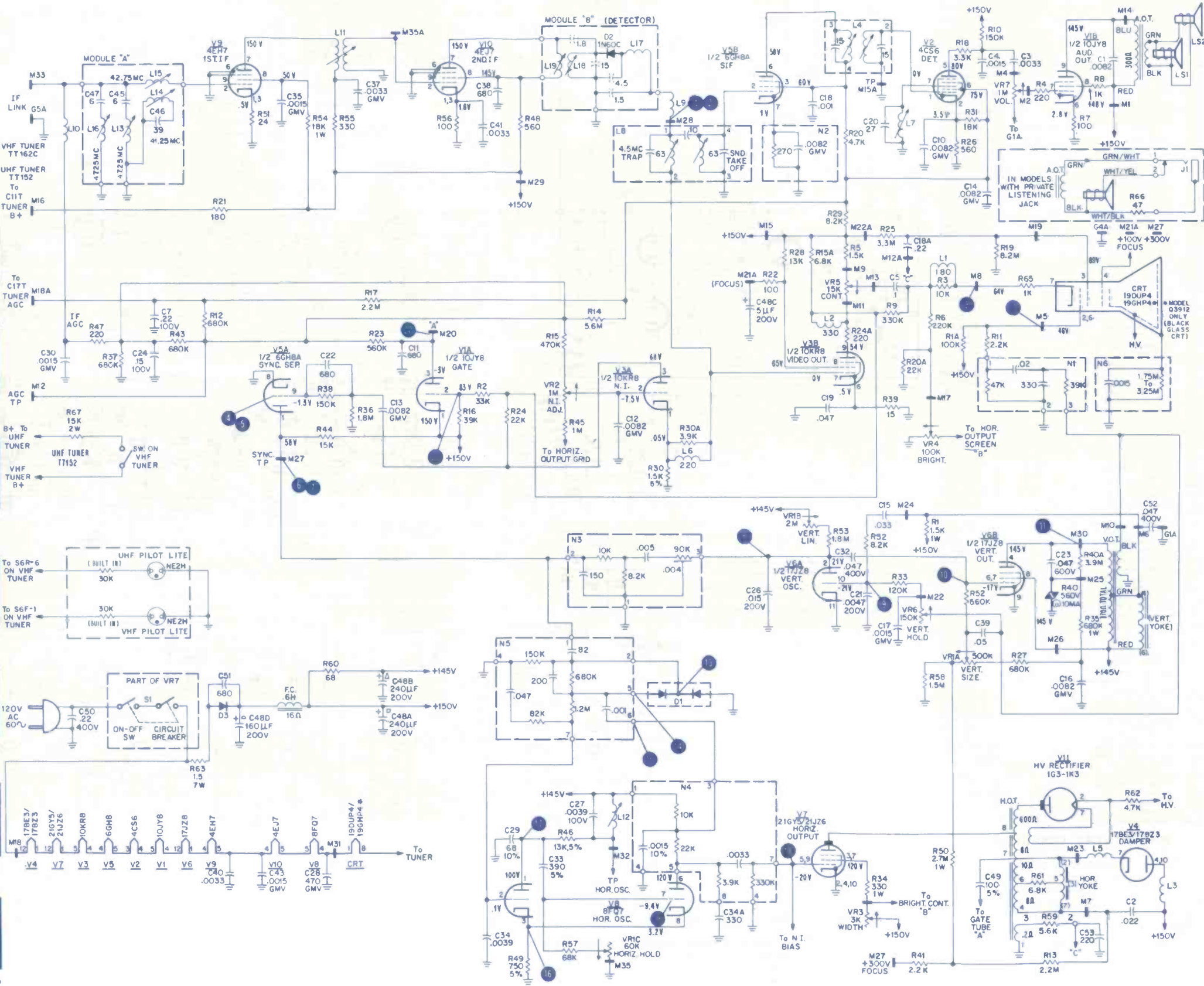
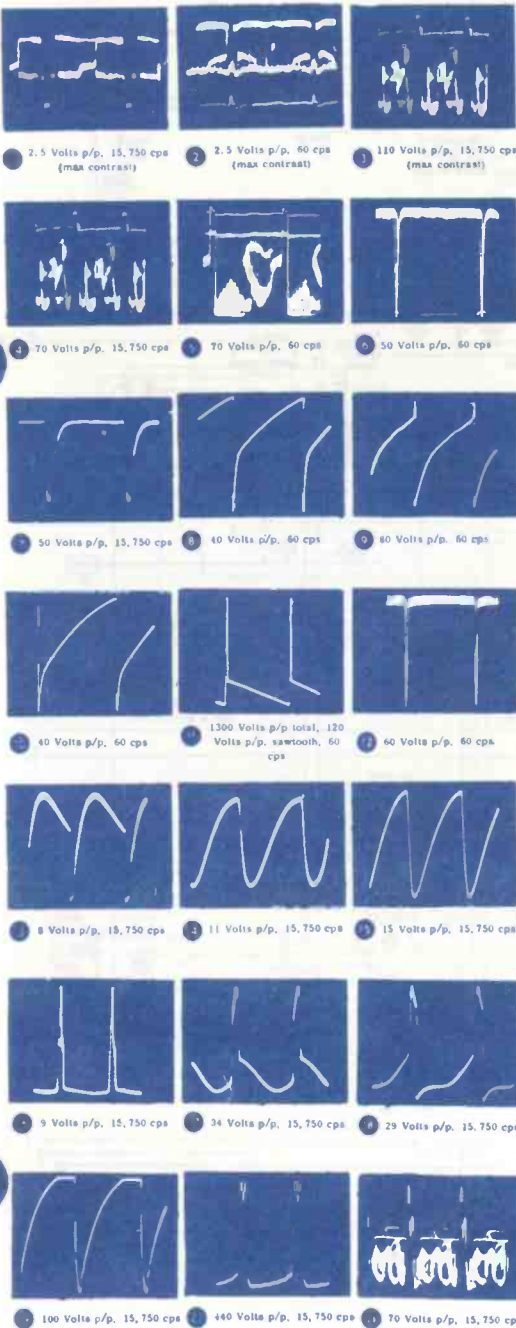







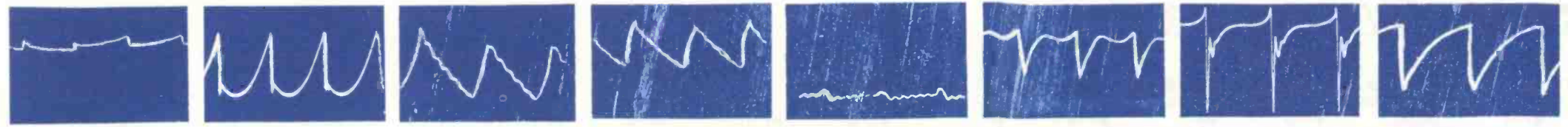

7 140Vp/p, 60cps    8 6Vp/p, 60cps    9 17Vp/p, 15,750cps    10 21Vp/p, 15,750cps    11 17Vp/p, 15,750cps    12 140Vp/p, 15,750cps    13 490Vp/p, 15,750cps    14 140Vp/p, 15,750cps

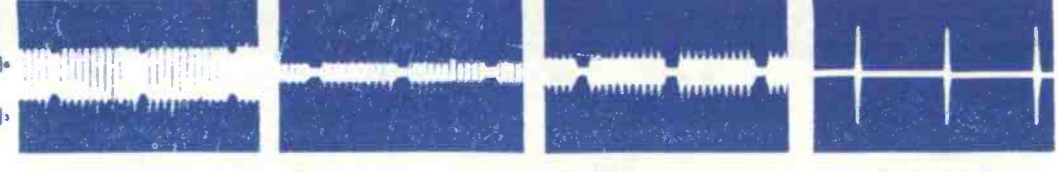
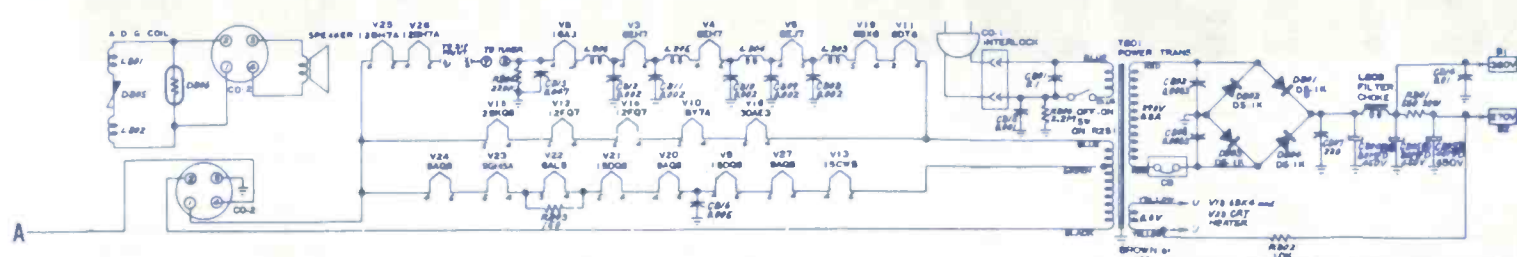

15 9Vp/p, 15,750cps    16 2Vp/p, 15,750cps    17 4Vp/p, 15,750cps    18 330Vp/p, 15,750cps

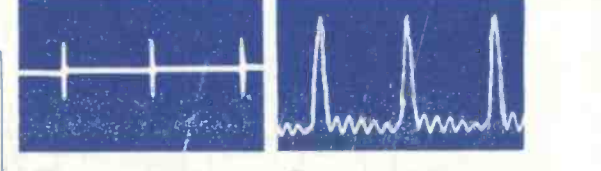
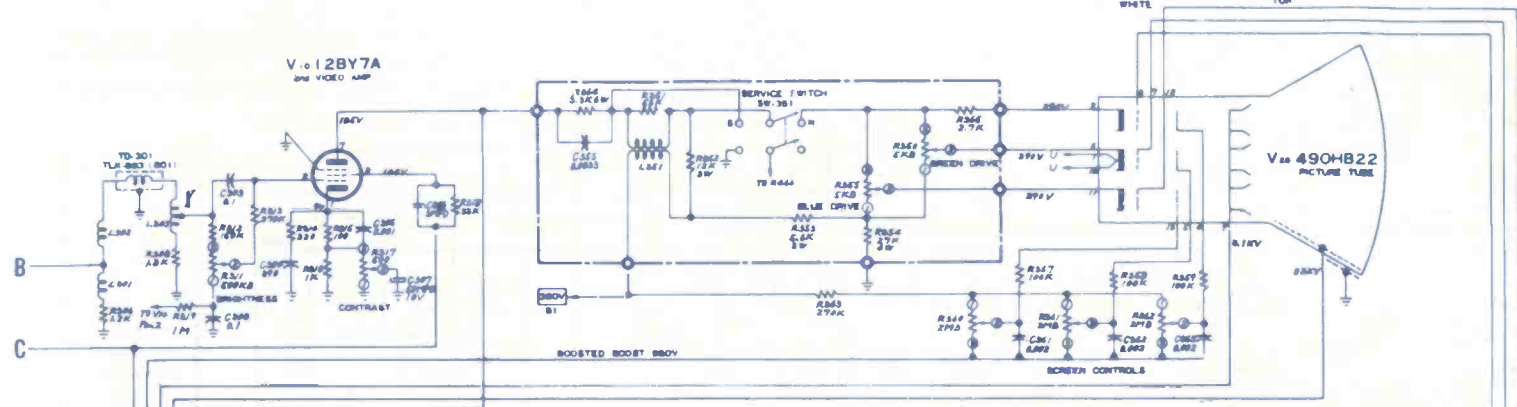

19 100Vp/p, 15,750cps    20 200Vp/p, 15,750cps

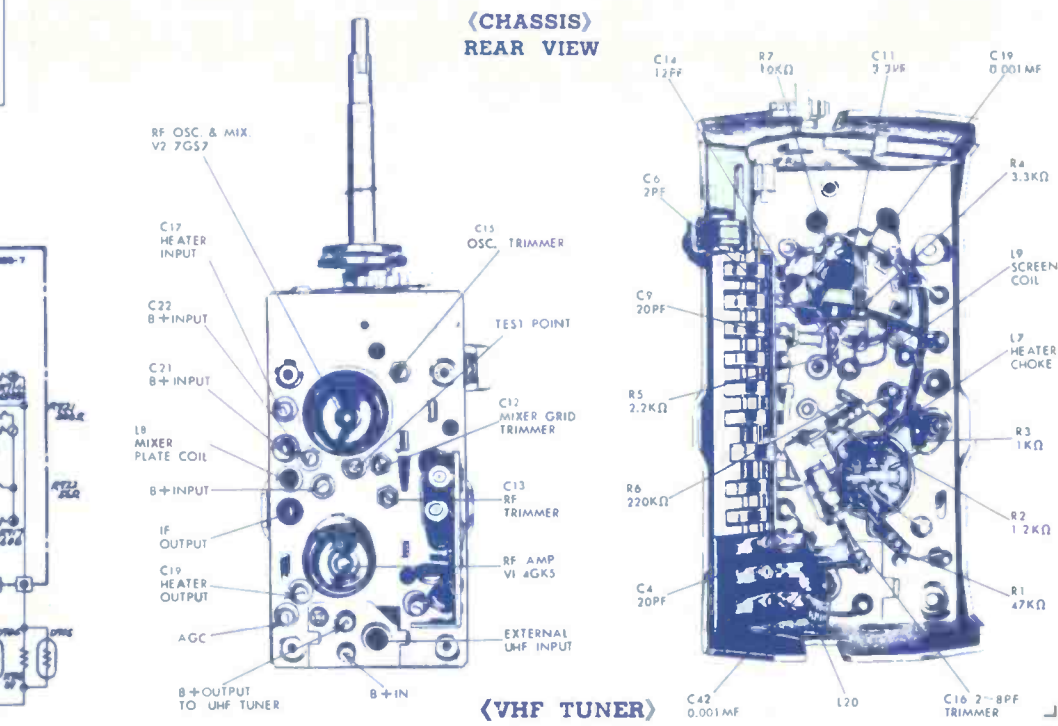
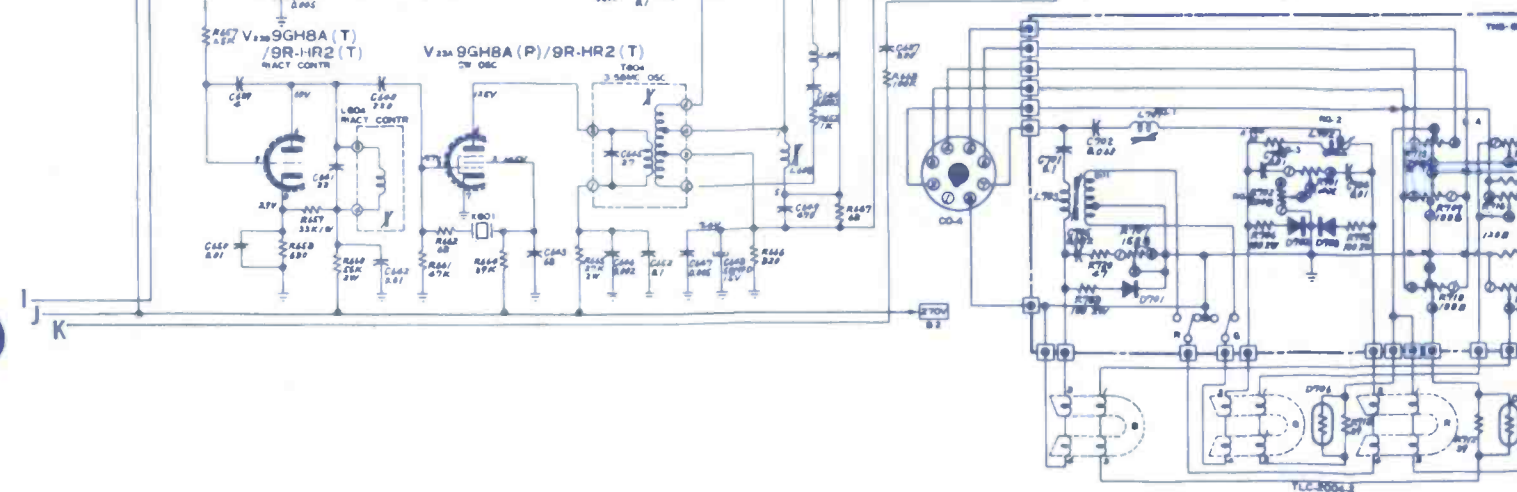
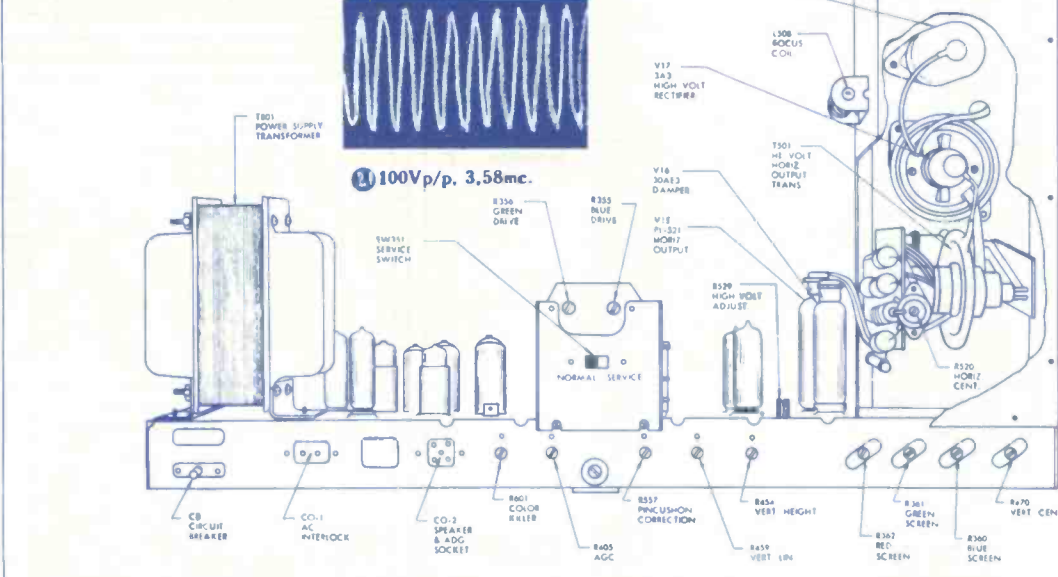
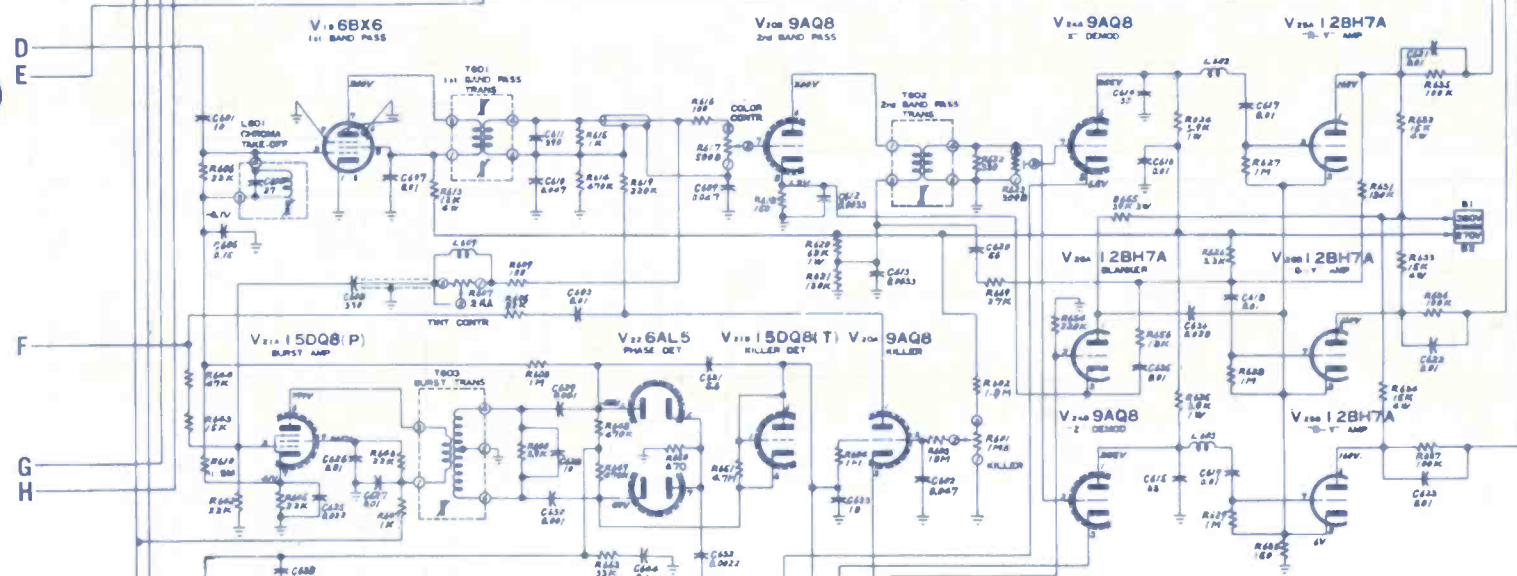







# Complete TUNER REPAIR for only

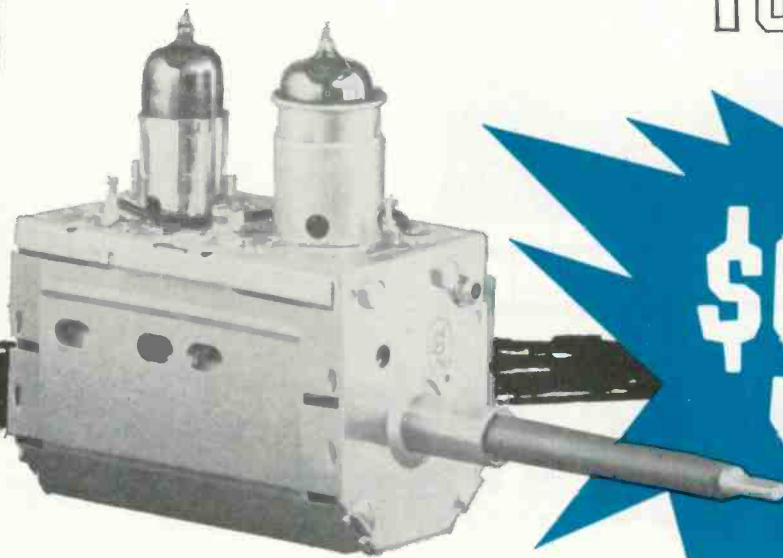

**\$9.50**

Sarkes Tarzian, Inc., largest manufacturer of TV and FM tuners, offers unexcelled tuner overhaul and factory-supervised repair service. Completely-equipped and conveniently-located Service Centers offer fast, dependable and factory-supervised repair service on all makes and models. Centers are staffed by well-trained technicians, assisted by engineering personnel.

Most Tarzian-made tuners received one day will be repaired and shipped out the next. More time may be required on other makes. Every channel—not just the channels existing in any given area—is checked and re-aligned per orig-

inal specifications. Exclusive cleaning method makes the tuner look—as well as operate—like new.

Cost, including ALL labor and parts (except tubes) is only \$9.50 and \$15 for UV combinations. No additional charge. No hidden costs. Too, you get a full, 12-month warranty against defective workmanship and parts failure due to normal usage.

Always send TV make, chassis and Model number with faulty tuner. Check with your local distributor for Sarkes Tarzian replacement tuners, parts or repair service. Or, use the address nearest you for fast, factory-supervised repair service.



## TUNER SERVICE CORPORATION

*(Factory-supervised tuner service authorized by Sarkes Tarzian)*

MIDWEST — 817 N. Pennsylvania St.  
Indianapolis, Ind., Box 1642  
Tel: 317-632-3493

EAST — 547-49 Tonnele Ave., Jersey City, N. J.  
Tel: 201-792-3730

SOUTH-EAST — 938 Gordon St., S. W.  
Atlanta, Georgia  
Tel: 404-758-2232

WEST—

**SARKES TARZIAN, Inc.**  
Tuner Service Division

10654 Magnolia Blvd.,  
N. Hollywood, Calif.  
Tel: 213-769-2720





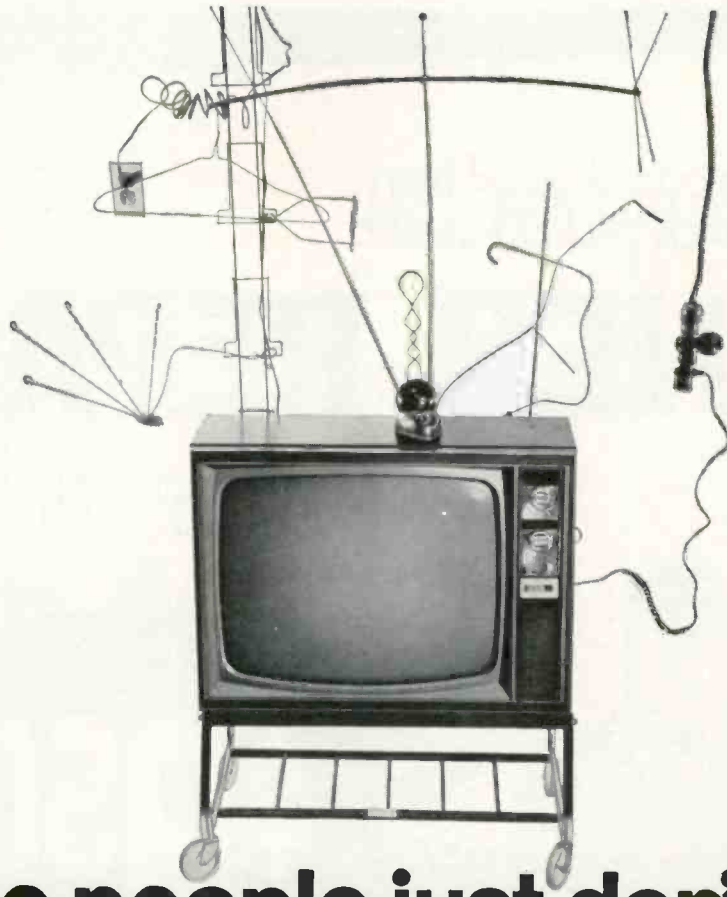

# Some people just don't like to admit they need a service man.

They know they're going to have to pay bills for something they don't really understand. They feel a little uneasy, a little helpless.



That's why millions of Philco owners automatically choose their local Philco Qualified Service Center when they need something fixed. They feel safer with the specialist.

There's a lot of new business waiting for you when you hang out the Philco sign.

Your service technicians can get all the training they need right there in your area. And when they're through, our Tech Data Service keeps them in the picture with all the new developments and service short cuts.

When your shop appears in our Yellow Pages listings you become the headquarters for Philco Service in your area. You can get new business you'd probably never have uncovered. And you get the fastest parts delivery in the industry.

That's briefly how it works — how it'll mean more business for you. Your local Philco-Ford Distributor will give you all the details.

Call his Service Manager.



FAMOUS FOR QUALITY THE WORLD OVER

Philco-Ford Corporation  
Philadelphia, Pa. 19134

... for more details circle 121 on postcard  
ELECTRONIC TECHNICIAN



# ELECTRONIC TECHNICIAN

WORLDS LARGEST ELECTRONIC TRADE CIRCULATION

JULY 1967 • VOL. 86, NO. 1

Publisher  
RON KIPP

Managing Editor  
JACK HOBBS

Technical Editor  
JOSEPH ZAUHAR

Associate Editor  
PHILLIP DAHLEN

Field Editor  
RICHARD CLAYTON

Production Editor  
JUDITH BERINI

Art Editor  
KEN McSHANE

Circulation Manager  
RUTH GELINEAU

Manager, Reader Services  
JOHN KESSLER

Advertising Production  
MAGGIE KANE

GENERAL OFFICES  
OJIBWAY PRESS, INC.  
OJIBWAY BUILDING

DULUTH, MINN. 55802  
Phone: (218) 727-8511  
Telex: 029-4417

President  
MARSHALL REINIG

Treasurer  
GREG BLODGETT

Executive Vice President  
DEAN MYHRAN

Vice President, Marketing  
JOE WOLKING

Vice President, Editorial  
BEN MARSH

Vice President, Production  
HARRY RAMALEY

Circulation Director  
LARS FLADMARK

Art Director  
JAMES GHERNA

Ad Production Supervisor  
WARREN BODIN

NEW YORK OFFICES  
71 VANDERBILT AVE.

NEW YORK, N. Y. 10017  
Phone: (212) 686-2200

President, Publications Division  
ROBERT EDGELL

Vice President, Publications Division  
RICHARD C. REINHARDT

Manager, New York Office  
DON GENOAR

CHICAGO OFFICES  
43 EAST OHIO STREET

CHICAGO, ILLINOIS 60611  
Phone: (312) 467-0670  
Telex: 02-53549

Manager, Chicago Office  
DOROTHY BOLAN

## MARKETING REPRESENTATIVES

NEW YORK: (212) 686-2200  
RON KIPP

CHICAGO: (312) 467-0670  
ED KELLY

## 39 TROUBLESHOOTING COLOR VIDEO AMPLIFIERS WITH A DUAL-TRACE SCOPE

Here's an article for those technicians who would like to get into the "pro" class

## 43 REPAIRING SOLID-STATE AUTO RADIOS

Read how you can make money servicing transistorized auto radios

## 47 UNDERSTANDING MODERN AGC CIRCUITS

Part four of an in-depth series tells you how to solve AGC problems faster

## 50 WORKING WITH INTEGRATED CIRCUITS

Since microelectronic circuits are now being used in TVs, radios and phonos, it's time for you to learn how to handle them

## 54 SEMICONDUCTORS FROM A TO Z

The twelfth article of this series explores some integrated circuits in detail

22 LETTERS TO THE EDITOR

26 EDITOR'S MEMO

28 TECHNICAL DIGEST

60 COLORFAX

62 NEW PRODUCTS

70 BOOK REVIEWS

72 NEWS OF THE INDUSTRY

75 CATALOGS & BULLETINS

76 ADVERTISERS' INDEX

77 READER SERVICE CARD

## COVER

Solid-State electronic circuits are being made smaller and smaller. See page 61 for details about this month's cover.

## TEKFAX • 16 PAGES OF THE LATEST SCHEMATICS • Group 179

ADMIRAL: TV Chassis H3-1A, H4-1A, 1H4-2A

CORONADO: Color TV Model TV21-9643A

OLYMPIC: TV Chassis 9P56, 57, 58

PHILCO-FORD: TV Chassis 17J28

SILVERTONE: TV Model 7151, 7152, 7154, 7155, 7156, 7157, 7158

TRUETONE: Color TV Model 2DC3555

OJIBWAY PRESS, INC.



ELECTRONIC TECHNICIAN is published monthly by Ojibway Press, Inc. Subscription Rates: One year \$5.00, Two years \$8.00, three years \$10.00 in United States and Canada. Other Countries: One Year \$9.00, two years \$14.00, three years \$18.00. Single Copies, 60¢. Second Class postage paid at Waseca, Minnesota and at additional mailing offices. Copyright 1967 by Ojibway Press, Inc. POSTMASTER: Send form 3579 to ELECTRONIC TECHNICIAN, Ojibway Building, Duluth, Minnesota 55802.





has  
everything  
in

# alignment tools

Whether it be channel selectors or tuning wands, aligning wrenches or screw drivers, all-purpose or specialty tools, GC meets those needs perfectly.

All GC tools and kits, designed and manufactured to strict quality standards from the finest materials available, reflect the GC dedication to quality and performance that makes jobs easier, faster, more profitable. Small wonder GC tools are preferred . . . everywhere.

*Insist on GC . . . and you'll get the best!*

Write for your Giant FREE GC Catalog today . . . over 12,000 items including TV Hardware, Phono Drives, Chemicals, Alignment Tools, Audio, Hi-Fi, Stereo & Tape Recorder Accessories, Nuts & Bolts, Plugs & Jacks, Service Aids, and Resistive Devices.

*only GC gives you  
everything in electronics.  
..... for almost 40 years!*

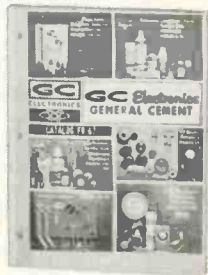

## GC ELECTRONICS COMPANY

400 South Wyman Street  
Rockford, Illinois 61101  
A DIVISION OF HYDROMETALS, INC.



Universal Color TV  
Alignment Tool Kit  
Cat. No. 8454



TV Plastic  
Long Slim" Screw  
Driver . . . Cat. No. 8987



All-Purpose 12 Tool  
Alignment Kit  
Cat. No. 5040



Zenith-Admiral Delrin  
Hex Wrenches  
Cat. No. 8606-5"  
Cat. No. 8606-L-11"



TEL-A-TURN TOOLS  
I.F. Aligner . . .  
Cat. No. 8867  
Alignment Screw-  
driver . . . Cat. No. 8868  
Hex Aligner . . .  
Cat. No. 8869



. . . for more details circle 114 on postcard

## LETTERS TO THE EDITOR

### He Thinks It's About Time, Too

Your editorial, "It's About Time," in the October 1966 issue of **ELECTRONIC TECHNICIAN**, was excellent. The industry needs someone to go to bat for the home-entertainment service technician.

If you could get service-dealers and manufacturers to agree with your thinking, we might get somewhere. In the same issue there's an article "Marching in the 'Peacock' Parade," which tells about a service-dealer operation that does not make a profit on its service department, primarily because of warranty work. The cost is billed to the sales department.

Manufacturers could be a big help if they spent more money educating the public and dealers to the facts of life — including the lack of trained electronics technicians. A good share of the shortage is the fault of both. Locally, two good independent service technicians quit the business recently.

Hooray for you. I hope you have started something. More surveys and pricing examples by locality would be helpful.

I have enjoyed your magazine for years. I think it is the best in the business. It has helped me keep up with the technology of this ever-changing business.

RALPH B. OLSON

Elmira, N.Y.

### CRT Tester/Rejuvenator

I need a schematic for an Anchor CRT tester/rejuvenator Model #T400. Answer via ET editor.

N. R. ROBINSON

Little Rock, Ark.

### More on Technician Shortage

The reason there are few good TV-radio technicians available is because the pay generally offered in this area of the electronics industry is too low. For example, in Los Angeles technicians are being offered \$140 for a 6-day week. In Portland, Ore., technicians are being offered \$3.31 an hour. In Detroit they are offering a little more. I'm making \$4 an hour here (15 years' bench experience). I think the shop-owners who can't manage their business so they can pay technicians at least \$4 an hour are putting themselves slowly out of business.

JACK DENTON

Chicago, Ill.



# WHY risk your reputation with "just-as-good" capacitors?

When you pay little or no attention to quality in tubular replacement capacitors, you leave yourself wide open for criticism of your work . . . you risk your reputation . . . you stand to lose customers. It just doesn't pay to take a chance on capacitors with unknown or debatable performance records when it's so easy to get guaranteed dependable tubulars from your Sprague distributor!

## There's no "maybe" with these 2 great SPRAGUE DIFILM<sup>®</sup> TUBULARS!

The ultimate in tubular capacitor construction. Dual dielectric . . . polyester film and special capacitor tissue . . . combines the best features of both. Impregnated with HCX<sup>®</sup>, an exclusive Sprague synthetic hydrocarbon material which fills every void in the paper, every pinhole in the plastic film *before it solidifies*, resulting in a rock-hard capacitor section . . . there's no oil to leak, no wax to drip. Designed for 105°C (220°F) operation without voltage derating.



**DIFILM<sup>®</sup> BLACK BEAUTY<sup>®</sup>**  
Molded Tubular Capacitors

The world's most humidity-resistant molded capacitors. Tough, protective outer case of non-flammable molded phenolic . . . cannot be damaged in handling or installation. Black Beauty Capacitors will withstand the hottest temperatures to be found in any TV or radio set, even in the most humid climates.



**DIFILM<sup>®</sup> ORANGE DROP<sup>®</sup>**  
Dipped Tubular Capacitors

A "must" for applications where only radial-lead capacitors will fit . . . the perfect replacement for dipped capacitors now used in many leading TV sets. Double-dipped in rugged epoxy resin for positive protection against extreme heat and humidity. No other dipped tubular capacitor can match Sprague Orange Drops!

For complete listings, get your copy of Catalog C-617 from your Sprague distributor, or write to Sprague Products Company, 65 Marshall Street, North Adams, Massachusetts 01247



WORLD'S LARGEST MANUFACTURER OF CAPACITORS



# SERVICE MASTER HANDIEST HANDFUL of service tools

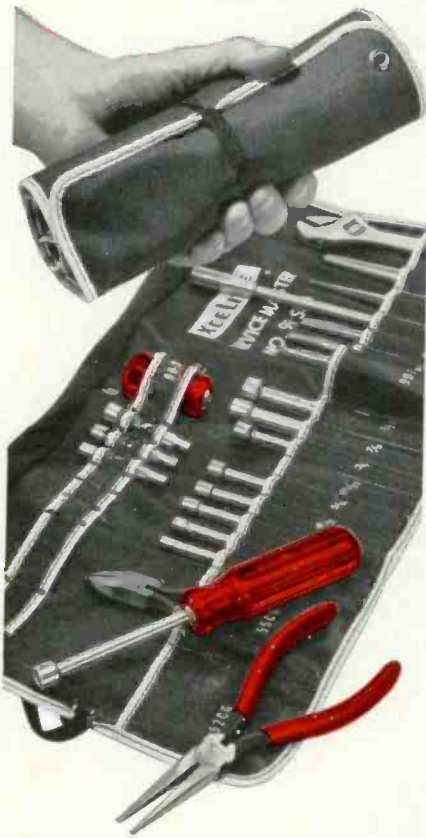

23 essential tools at your fingertips in this lightweight (only 2¾ lbs.), compact, easy-to-carry, roll-up kit. Contains long nose plier, diagonal plier, adjustable wrench, regular and stubby plastic handles with these interchangeable blades: 9 regular and 3 stubby nutdriver, 2 slotted and 1 Phillips screwdriver, 2 reamer, 1 extension. Eyelets in plastic-coated canvas case permit wall hanging. New elastic loop secures roll, eliminates need for tying.

## many optional accessories:

Junior and Tee handles... Additional nutdriver, Phillips & slotted screwdriver, and extension blade sizes... Allen hex type, Bristol multiple spline, Frearson, Scrufox, and clutch head blades... Awl/Scriber... Chuck adaptors to use blades in spiral ratchet drivers.

WRITE FOR CATALOG 166

# XCELITE

XCELITE, INC., 14 Bank St., Orchard Park, N.Y. 14127  
In Canada contact Charles W. Pointon, Ltd.

... for more details circle 130 on postcard

## LETTERS TO THE EDITOR

### Ferris Microvoltmeter

Can any reader help me locate an instruction manual for a Ferris model 18D, #367, microvoltmeter. I have been a subscriber to ET since 1954 and like it very much. Answer via ET editor.

AUBREY DOUCETTE

Holt, Mich.

### German Radio

Can any reader tell me where I can obtain service information on a Loewe Opta Mallorca Stereo type 4822w German radio? Answer via ET editor.

W. R. CULLEN

Little Rock, Ark.

### Needs Precision Roll Chart

I wonder if any reader can help me with an old roll chart for a Precision Model 660 if they have an extra to spare? I have none. Data for this tester comes in book form to supplement with the roll chart. Answer via ET.

M. JEFFREY

New York, N.Y.

### Supreme Tube Tester

I need a tube listing later than the one I have (1948/4965-248) for a Supreme tube tester. The chart was used on models 504A, 504B, 589, 589A, 599 and 599A.

LEO SMITH  
RD1 Box 375b

Sandy, Utah 84070

### Dobro Guitar Amplifier

Need information on Model B, 20w guitar amplifier made by National Dobro Corp. I have been reading ET for over 10 years and find it the best TV-radio magazine of its kind. Answer via ET editor.

KENNETH SASAKI

Honolulu, Hawaii

### A Stale Orchid

In reading and utilizing ELECTRONIC TECHNICIAN since even before its present title, I feel as rewarded as someone who recently purchased a very lucrative stock which did exceptionally well.

On pages 42 and 43 of the June 1966 issue is a seemingly familiar article concerning Homer Davidson

and the quite successful organization he operates. Needless to say, I refer specifically to the last paragraph of the article.

Recently in Chicago, it was found that several service-dealers were "gyps," etc. People like Mr. Davidson have a distinct advantage over the Chicago folk, according to your article. I feel confident that he would classify as one of the more sensible, qualified and above all, most ethical type businessmen. What we need now is more of this type to upgrade our industry.

We here at Central TV & Radio and I'm certain the state of Ohio (TSA-OHIO) voice our opinion in favor of your article about Mr. Davidson. It is greatly appreciated by all our members and we thank you kindly.

BILL FRANK, Owner  
Central TV & Radio

Columbiana, Ohio

### Wants To Relocate

I have enjoyed ELECTRONIC TECHNICIAN for several years and the articles are great. Keep up the good work.

After reading the letter from Mr. Delzio in the April issue it occurred to me that you might assist me. I plan to relocate in Burlington, Mass. this summer.

I would like to offer my services to one of the better service organizations in the Boston area. I have been servicing home entertainment equipment for the past eight years—mostly color TV.

I attended National Electronics Inst. in Denver. I also have certificates from Delco Radio, Philco Quality Service and RCA. I am thirty years old and will furnish work and character references.

I will be available after June 1st.

LEON ELDRIDGE  
3040 NW 65th

Oklahoma City, Okla. 73116

### More on the 19A3 Tube

In certain Japanese made AM/FM table radios the 19A3 tube is frequently used as a rectifier.

No American made equivalent is available in many areas. Experience has shown, however, that a 35W4 will, in nearly all instances, operate satisfactorily in the circuit.

Please pass this information on to service technicians.

ROBERT E. GERSON  
Electronics Div.  
Japan Light Machinery  
Information Center

437 5th Ave.  
New York, N. Y. 10016



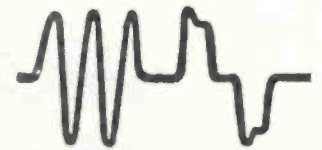

## Tips on replacing circuit breakers

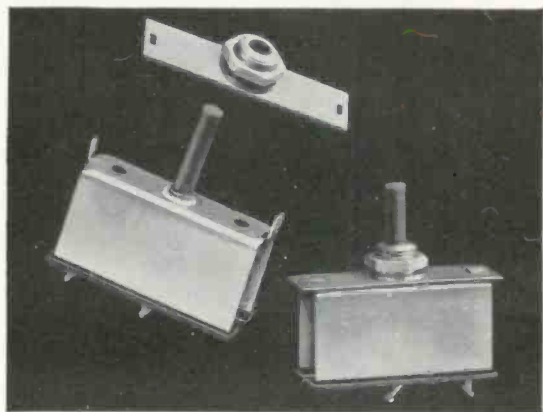
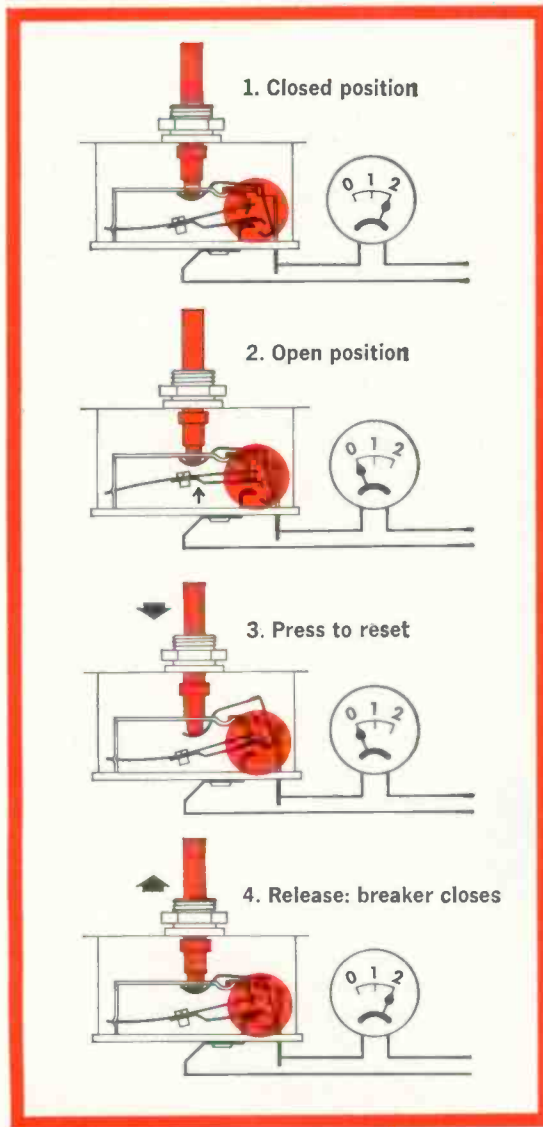

That little red "breaker reset" button that sticks out of the back of nearly every television chassis can be a time-saver or a trouble-maker, depending on what's wrong inside the set, and who's pushing the button. As you well know, when a transient fault has popped the breaker, you can get the set back in business just by pressing the reset. But if there has been a short-circuit failure and some uninformed tinkerer presses the button and *keeps* it pressed, there's a good chance that more power keeps flowing into the fault. Result: a minor trouble becomes a calamity.

This is why Underwriters' Laboratories require that breakers should be "cheat-proof"—that is, they should not allow current to pass when the reset button is held depressed. Some of the replacement breakers you'll find on the market *aren't* cheat-proof. We have one that *is*. It has features that you'll find valuable any time you need to install a new breaker, or when you're working on a breadboard circuit that needs over-current protection.

Take a look at how this breaker works, and you'll see what we mean.

At top (Picture 1) is the way the breaker mechanism looks when it's in the "on" position.

Along comes an overload (Picture 2). The bi-metal strip heats, snaps into the "break" position, opening the current carrying contacts.

Now you press the button to reset (Picture 3). As long as you hold the button down, the contacts at the right remain open. Release the button and the contacts go back to closed (Picture 4). If the overload is still there, the breaker will open again. You can't keep it closed on a short circuit!

No wonder this particular breaker is used as original equipment on the majority of all television sets. They're made for Mallory by Mel-Rain Corp. to the same specifications as for original equipment, and they're available from a Mallory distributor near you. Off-the-shelf ratings go all the way from 0.5 to 7 amperes break current, and include all the values you'll need for service replacement or for industrial equipment maintenance. And as an extra convenience, you can get them with either a twist-tab or bushing mount. For your copy of our new 24-page cross-reference guide to circuit breaker replacement in all popular TV sets, see your Mallory distributor, or write to Mallory Distributor Products Company, a division of P. R. Mallory & Co. Inc., P. O. Box 1558, Indianapolis, Indiana 46206.

... for more details circle 116 on postcard



# WILL THE REAL NO. 1 In Replacement Phono Cartridges Please Stand Up!!

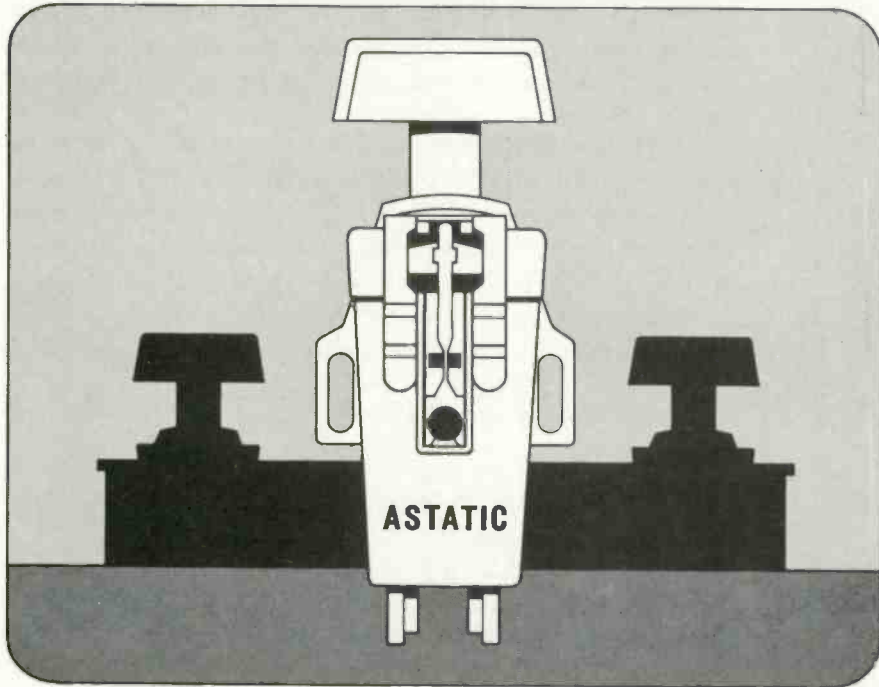
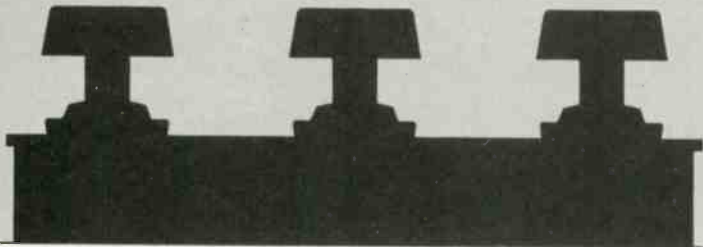

So many pretenders have been laying claim to No. 1 position that they've turned the situation into a game.

Having held the No. 1 position for more than 30 years, Astatic is naturally reluctant to play around about it. But, in case you're interested in how to spot the leader, ask questions like these: Is your line really the most COMPLETE, or will I run into complications of needing several sources of supply? Do you follow RESPONSIBLE practices such as visual Date Coding and Shelf Life Control? Are you really the largest OEM supplier creating a replacement demand for your cartridges? There are many similar questions, but this is enough. ONLY ASTATIC CAN SAY YES. There can be only one No. 1—and its STILL ASTATIC.



## THE ASTATIC CORPORATION

Conneaut, Ohio 44030 U.S.A.

In Canada: Canadian Astatic Ltd., Toronto, Ontario

Export Sales: Roburn Agencies, Inc.

431 Greenwich Street, New York, New York 10013, U.S.A.

THE PIONEERS AND THE PACESETTERS OF QUALITY SOUND REPRODUCTION

## EDITOR'S MEMO

Today Well Lived

There's a very old Chinese saw which says: "Today well lived makes every yesterday a dream of happiness and every tomorrow a vision of hope—look well, therefore, to this day."

Viewed from another angle, it means that you will never regret what you did yesterday nor worry about what tomorrow will bring if you keep up with today's events and grasp today's opportunities.

We are reminded that many service-dealers and technicians are not taking advantage of the business and educational opportunities that present themselves today.

Take FM radio, for example. In the past five or six years the number of FM broadcast stations in the United States have increased about 70 percent—from 889 stations in 1961 to 1521 at the end of 1966. And the number of stations that broadcast programs on FM/stereo have increased 900 percent—from 50 to nearly 450. Sales of FM radios have increased 500 percent. Approximately 10 million sets capable of receiving FM were sold in 1966. But this is only the beginning.

FM radio is a natural. You don't need to sell it. It sells itself when properly demonstrated. Audio output is almost completely free of static—even during a local thunder storm.

Solid-state technology has made the equipment more compact. Programing has increased in both quantity and quality.

The FCC's ruling which prevents stations in larger cities from duplicating more than 50 percent of their programing on commonly owned AM/FM facilities has brought about a greater diversity of programs available to listeners. The big price tags that once hung on FM/stereo equipment have become smaller. There is now a wider selection of FM/stereo equipment available to the listener today at prices which were unheard of only a few years ago.

And there's some talk about using space satellites to beam FM/stereo signals throughout the country. If and when this takes place—and it will eventually—the public interest in FM/stereo will surge upward to higher levels.

Yes, indeed: how you function *now* will determine the character of your "yesterdays" and your "tomorrows." Look well, therefore to this day.

... for more details circle 103 on postcard



# The hottest thing in electronics hardly gets hot at all

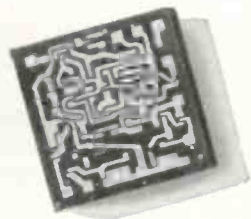

(RCA's solid integrated circuit, that is)

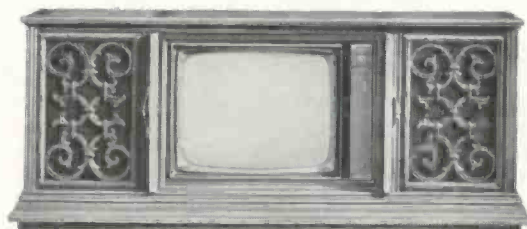

With the tiny chip there are few heat problems and low power consumption. And because integrated circuits run cooler, parts can be placed closer together to enhance design convenience. One day you may see stereo cabinets with more real storage space, and color TV sets the size of a transistor radio. At RCA Victor we've taken a

step into tomorrow by using integrated circuits now in new color and black and white TV and in stereo phonographs. They're not only the most advanced products of their kind, they are more reliable than ever before.



The Most Trusted Name in Electronics

Tmk(s)®



# TECHNICAL DIGEST

## MOTOROLA

### TV Chassis TS460 — Vertical Sweep Circuit Description

The purpose of the vertical sweep section is to supply the proper voltage and current to the vertical deflection coils, causing the CRT beam to trace from top to bottom in synchronization with the TV studio camera.

A simplified diagram of the vertical sweep section is shown here. The oscillator is a multivibrator, similar to that used in tube-type receivers, which provides feedback from the output to the discharge stage, maintaining oscillation. Capacitors C602 and C603 make up the sawtooth-forming network. (These capacitors are directly across the

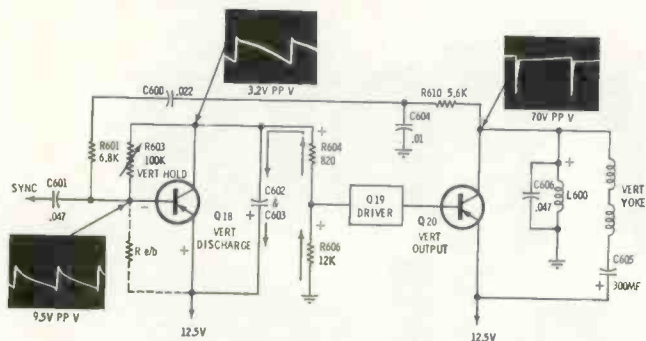

discharge transistor, Q18.) At the beginning of trace, these capacitors are completely discharged. The collector and base of Q18 are at the same potential as its emitter, therefore, Q18 will not conduct. As the capacitors charge, the forward bias on the driver and output stages increases causing the beam to be deflected from top to bottom.

During this time, the voltage across the vertical discharge transistor, Q18, is also increasing. This voltage is divided by the vertical hold control, R603, and the emitter-to-base resistance of Q18, and it is used to forward bias this stage.

When Q18 begins to conduct, its collector voltage becomes more positive, reducing the forward bias on the driver and output stage. (The driver is an emitter-follower and can be considered a direct connection as far as the oscillator action is concerned.) The magnetic field that has been built around the vertical deflection coils, L600, now begins to collapse, causing retrace, inducing a voltage across the deflection coils and L600 which causes the collector of the output stage to go negative. This negative pulse is coupled by R610, C600 and R601 back to the base of the discharge transistor, Q18, driving it into

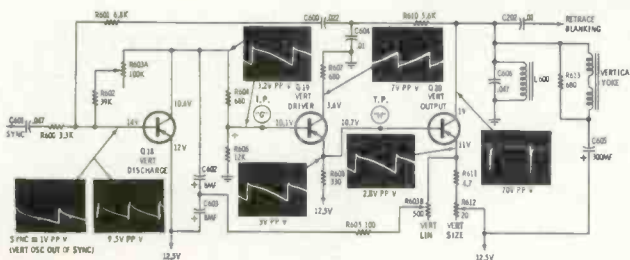

saturation, discharging the sawtooth forming capacitors quickly. When the magnetic field around the yoke has collapsed, no more negative voltage is induced across the deflection yoke and the collector voltage of Q20 now goes back toward zero. This positive-going voltage now cuts off Q18 and the sawtooth capacitors begin to charge, repeating the sequence of events.

Negative going sync pulses are applied through C601 to the base of Q18 which turns Q18 on to begin trace. This synchronizes the receiver with the transmitted signal.

A complete schematic of the vertical sweep section is shown.

The vertical discharge transistor, Q18, receives forward bias from its collector and R604. Q19 provides an impedance match between the high impedance of Q18 collector circuit and the low impedance base circuit of the output transistor, Q20. The vertical size control, R612, determines the amount of bias and degeneration in the emitter circuit of the output stage. A sawtooth is taken from the emitter circuit of Q20, shaped into a parabolic waveform by C603 and fed back into the base of the driver, Q19. The amplitude and shape of the parabola is controlled by the vertical linearity control, R603B. As in the horizontal output stage, a germanium device is used for the vertical output circuit. C604, in the feedback circuit, filters out the horizontal pulses picked up by the vertical yoke, to prevent vertical jitter.

C605, in series with the vertical deflection coils, blocks dc current through the coils to prevent decentering of the raster.

R613 and C606 prevent the negative pulse, induced during retrace, from exceeding the breakdown voltage of Q20. C606 presents a relatively low reactance to this short-time duration pulse. R613 lowers the "Q" of the yoke to help limit this pulse.

## GENERAL ELECTRIC

### Tape Recorder TP1150/TD20-1 Tape Deck—Intermittent 'Mechanical Buzz'

"Mechanical Buzz" caused by vibration of the motor hum shield against the motor mounting plate can be

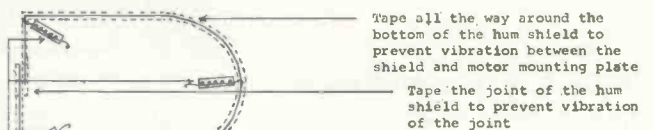

Be sure the tubing over the mounting springs is positioned to prevent the mounting springs from vibrating against the hum shield.

eliminated by installing electrical tape as shown in the illustration.



Zenith is honored  
to be the only TV manufacturer  
to win NATESA's  
"Friends of Service" award  
five times!



Zenith supports the aims and objectives of the National Alliance of Television and Electronics Service Association. So we are especially proud to receive the NATESA "Friends of Service" award for the *fifth straight year*.

Zenith is the only TV set manufacturer to be so honored five times by NATESA.

NATESA members for many years have played a vital role in providing expert electronics service and in training new men for dedicated service to the public.

We at Zenith pledge our continued support and cooperation in NATESA's great program.

**ZENITH**® *The quality goes in before the name goes on*

... for more details circle 131 on postcard



# Channel Master smashes the 82 Channel size barrier!

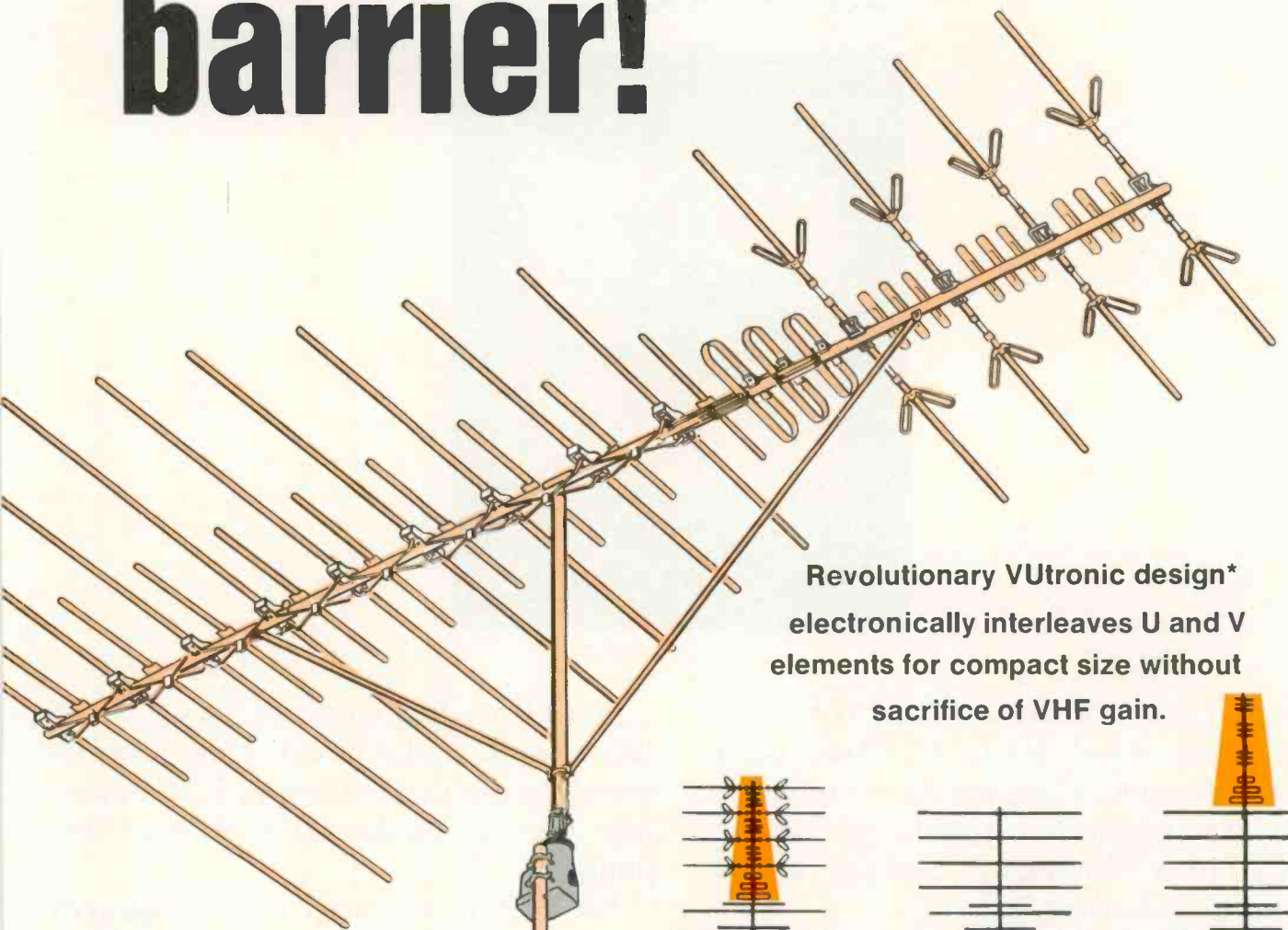

Revolutionary VUtronic design\*  
electronically interleaves U and V  
elements for compact size without  
sacrifice of VHF gain.

Deep Fringe  
**Model 3661-G**  
Same VHF gain as  
Color Crossfire  
Model 3610-G

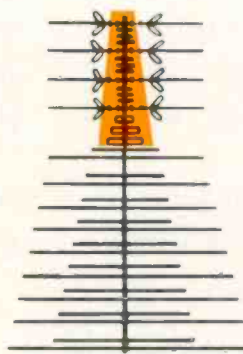

Fringe area Model 3661G has all UHF elements contained within the over-all length of the VHF section

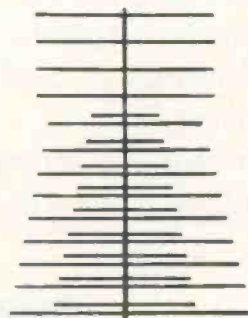

A VHF only antenna with exactly the same VHF gain as the 82-channel Model 3661G is also practically the same size.

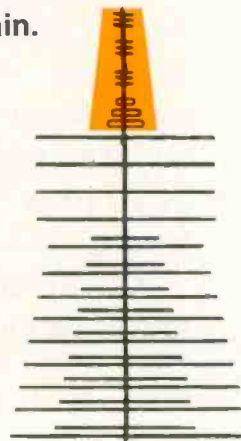

Usual design 82-channel antenna would have to be 34% longer to provide the same UHF and VHF gain as Model 3661G Color Crossfire 82.

# New Color Crossfire 82

## UHF/VHF Antennas plus FM/FM Stereo

Totally new concepts in UHF/VHF design are joined with Channel Master's proven Crossfire principle to produce the first 82-channel antennas that meet UHF reception needs yet also provide unsurpassed VHF gain...and with no appreciable increase in over-all size.

Here is another example of a major development from Channel Master Laboratories where, as always, leadership begins with research.

Until now, antenna manufacturers have created combination UHF/VHF antennas by coupling a UHF section to the front of a VHF antenna. To avoid costly, unwieldy, and unsightly construction, this has always meant sacrificing VHF gain. Now Channel Master fills the 82-channel gain gap with Color Crossfire 82 antennas designed for metropolitan to fringe areas where maximum VHF gain is as important as UHF reception power.

In addition to the famous Channel Master Crossfire VHF Proportional Energy Absorption Principle, these new antennas employ unique series-fed folded UHF dipoles with carefully engineered dimensions so that they literally "disappear" and operate as a perfect 300 ohm line at VHF frequencies...no "lossy" couplers required as is the case with the usual parallel-fed UHF elements.

And, of course, every Color Crossfire 82 antenna features Channel Master's famous E.P.C. golden coating and rugged preassembled construction.

**HERE'S THE SECRET**

UHF Director Low end UHF      UHF Director High end UHF      2 UHF Wave-Lengths overall

VHF Director      UHF Phase Controller      Center Insulator      VHF Director

VUtronic design employs unique dual-function co-linear directors (on all but three metropolitan models) serving both UHF and VHF sections. This permits space-saving inclusion of the UHF elements **into** the physical structure of the full-power VHF array. The exclusive UHF phase controller "whiskers" boost UHF gain by making each full-wave director the equivalent of two full wave lengths.

**Now the first and only complete line of full VHF Power 82-channel antennas.**

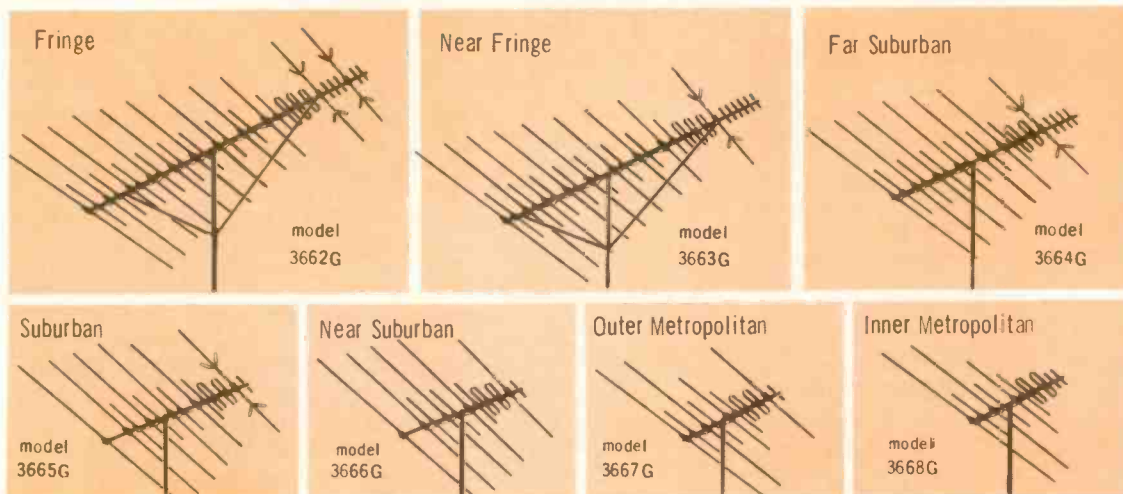

**More Channel Master Crossfire Series Antennas have been sold and are being sold...than any other antenna in the history of television.**

**CHANNEL MASTER**  
Ellenville, N.Y.

... for more details circle 108 on postcard





# TEST TRANSISTORS IN SECONDS in circuit

TR139  
8950



Also check all  
transistors, diodes,  
and rectifiers out  
of circuit for true AC beta  
and  $I_{cbo}$  leakage.

Your best answer for solid state servicing, production line testing, quality control and design.

Sencore has developed a new, dynamic in-circuit transistor tester that really works—the TR139—that lets you check any transistor or diode in-circuit without disconnecting a single lead. Nothing could be simpler, quicker or more accurate. Also checks all transistors, diodes and rectifiers out of circuit.

**BETA MEASUREMENTS**—Beta is the all-important gain factor of a transistor; compares to the gm of a tube. The Sencore TR139 actually measures the ratio of signal on the base to that on the collector. This ratio of signal in to signal out is true AC beta.

**ICBO MEASUREMENTS**—The TR139 also gives you the leakage current ( $I_{cbo}$ ) of any transistor in microamps directly on the meter.

**DIODE TESTS**—Checks both rectifiers and diodes either in or out of the circuit. Measures the actual front to back conduction in micro-amps.

**COMPLETE PROTECTION**—A special circuit protects even the most delicate transistors and diodes, even if the leads are accidentally hooked up to the wrong terminals.

**NO SET-UP BOOK**—Just hook up any unknown transistor to the TR139 and it will read true AC beta and  $I_{cbo}$  leakage. Determines PNP or NPN types at the flick of a switch.

Compare to laboratory testers costing much more. . . . \$89.50

See America's Most Complete Line of Professional Test Instruments — At Your Distributor Now.

NO. 1 MANUFACTURER OF ELECTRONIC MAINTENANCE EQUIPMENT  
**SENCORE**  
426 SOUTH WESTGATE DRIVE, ADDISON, ILLINOIS 60101

... for more details circle 124 on postcard

## TECHNICAL DIGEST

### ADMIRAL

Stereo Chassis 17A4—Low FM Sensitivity

Incorrect adjustment of the RF BIAS control, R28, (shown in schematic) may cause low FM sensitivity. The control can be adjusted with a pocket screwdriver without removing the chassis from the cabinet. If this does not correct the condition, you may have a bad FM IF trans-

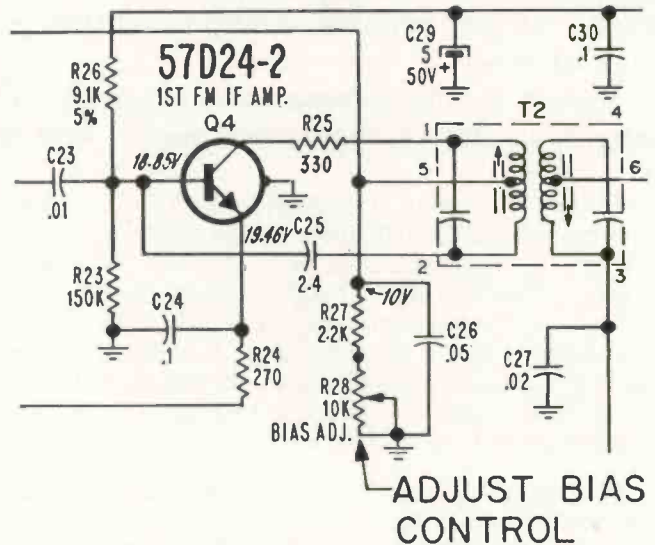

sistor. Tune in a local FM station and adjust the RF BIAS control to kill the FM RF amplifier. If the output is cut off completely instead of just being reduced or if the tuning meter acts peculiarly as you tune near cutoff, replace transistor Q4.

### RCA VICTOR

Color Chassis CTC10, -11 — Yoke Substitution

When RCA yoke stock #109457 is used on the CTC10 and 11 chassis, the following changes should be made as shown in the schematic. Also, a check should be made against the schematic.

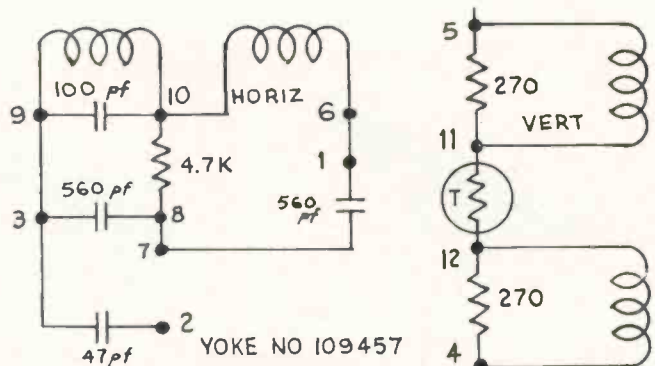

Add two soldering lugs to the holes marked 7 and 8. Move components from lug 2 to lug 8. Add jumper wire from lug 7 to lug 8. Add a 47pf  $\pm 5\%$  3kv (106306) from lug 2 to 3. Change the two resistors on lugs 5 and 11, 4 and 12 to 270 $\Omega$  (502127).

Order RCA's 9-volt summer special

# "A bucket of batteries"

with



TRANSISTOR



catch  
all the  
this  
year!

**ACTION**

## BATTERIES

9 VOLT VS 323

REPLACES 216



Catch all the battery action during the peak summer months

72 of the popular RCA VS323 9-volt transistor batteries are prepacked in this attractive, reusable ice-bucket merchandiser. It's a sure-fire summer seller. Offer the bucket as a gift to the customer who buys the last battery... or use it at home for picnics or parties. All batteries have a plastic terminal protector to prevent shorting.

See your RCA battery distributor and ask about his summer special "Bucket of Batteries" promotion offer!

RCA Electronic Components and Devices, Harrison, N. J.



The Most Trusted Name in Electronics



# TECHNICAL DIGEST

## RCA VICTOR

Radio/Victrola Model VGT66 — Loud 'Pop' in Speakers

If a loud pop is heard in the speakers when the pickup touches the record and adjusting the muting switch will not correct the trouble, it may be caused by the following:

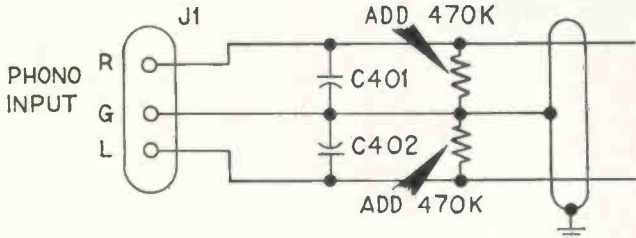

The charge and discharge cycles of C401 and C402 may not follow the muting switch, causing a pop in the speakers. To correct this condition, add a 470K ½w resistor across each channel of the phono input as illustrated.

The phono input jack is located on the rear apron of the RC1218 tuner chassis.

## AM Tracking Alignment Tool

When checking alignment tracking of broadcast receivers a simple and inexpensive tool can be made from a piece of ferrite rod and a shorted loop of copper wire.

The device consists of a 6in. length of ½ or ¾in. ferrite rod (old discarded ferrite antenna) and a 2in. diameter coil of #6 copper wire with the ends soldered. The coil is attached to the end of the ferrite rod to form a wand. The wire loop can be attached to the ferrite rod with adhesive or plastic electrical tape.

In practice the device is quite simple to use in checking tracking. The ferrite rod with the shorted loop of the tuning wand is held near the ferrite or loop antenna of the receiver, while tuning the receiver to 600kHz, 1MHz, 1.4MHz and while listening to the noise level.

If there is any noticeable increase in the noise level, it is an indication that tracking is off and could be improved by realignment of the RF section of the receiver. Tests indicate that the average discernible noise level change heard by the human ear is approximately 3db, under quiet surroundings.

When the coil end of the wand is placed against the receiver ferrite antenna and a noise increase is noted, it would indicate the circuit inductance is too high. The circuit would require adjustment.

When the rod-end of the wand is placed against the receiver antenna and the noise increases, the circuit has insufficient inductance and requires readjustment.

When required, alignment of the RF section, including antenna, RF and oscillator tracking, can best be done by rocking the tuning capacitor above and below 600kHz with an excursion of 40kHz for maximum output. The best tracking at 1MHz requires trimming of the split plates of the tuning gang rotor. The high side 1.4MHz adjustment can be easily attained by trimming paddlers for maximum output. This method requires an audio modulated RF signal generator and speaker or meter indicator. *Diagram courtesy of RCA Victor.*

# GAS WELDING TORCH

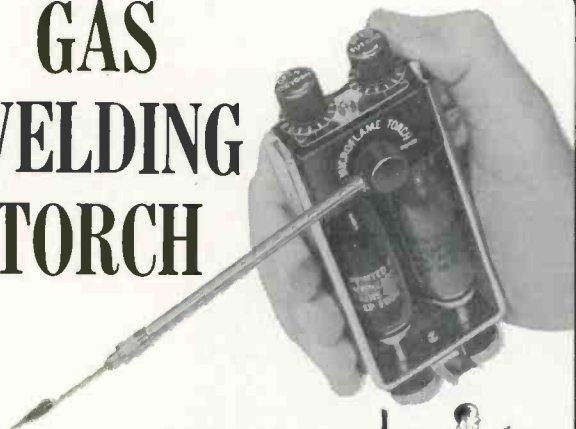

Uses **OXYGEN** and **LP GAS**

- Completely self-contained.
- Produces 5000° pin-point flame.
- Welds, brazes, solders.
- Hundreds of lightweight uses.
- Suggested list — \$19.95.

GET COMPLETE DETAILS AT MOST INDUSTRIAL DISTRIBUTORS, OR WRITE TO MICROFLAME, INC.

**MICROFLAME, INC.**

7800 COMPUTER AVENUE  
MINNEAPOLIS, MINNESOTA 55424



# INSTANT CHOICE

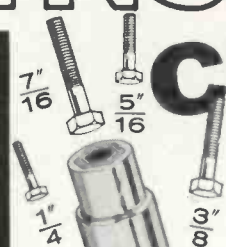

**NEW VACO NUT DRIVER**  
AUTOMATICALLY FITS  
ALL HEX NUT SIZES 1/4"  
TO 7/16"

Just press down and start turning. Ideal for servicemen, repairmen, assembly workers, or just around the home or car. Spring loaded sockets retract for instant fit on the seven most popular hex head sizes. New compact size fits into close quarters. Look for Vaco demonstration display and try it today for time-saving pleasure in nut driving!

No. SA-711 VACO

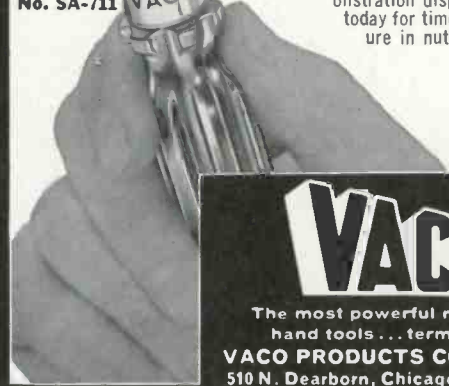

**VACO**®

The most powerful name in hand tools... terminals  
**VACO PRODUCTS COMPANY**  
510 N. Dearborn, Chicago, Ill. 60611

... for more details circle 117 on postcard

... for more details circle 129 on postcard  
ELECTRONIC TECHNICIAN

## OLYMPIC

TV Models 5T100, 6C125, 6C126 — Parasitic Oscillation

To prevent the possibility of parasitic oscillations (inability to lock picture horizontally), particularly on channels 2, 3, 4, the front bottom control panel should only be grounded to the CRT grounding strap. If the control panel is grounded to the speaker and tuner mounting bracket, remove the ground between the control panel and speaker.

On units with monopole antennas, using the NCP or NDP chassis, lift the ground lead running from antenna to top of the HV cage, insert a 560Ω ½ w resistor between terminal of cage and ground lead.

## GENERAL ELECTRIC

Phono Models V631, V632, V633—Securing Cartridge Mount

If the cartridge mount is loose when playing a record, the output from the speaker may have an intermittent "Raspy or Garbled" sound.

In some units it has been found that the screws securing the cartridge mount are too long and it is possible to "bottom" the screws without securing the mount.

The problem can be solved by installing shorter screws or by filing the screw ends off until they secure the cartridge mount properly.

## GENERAL ELECTRIC

Identification of EA1451/EA15X59 Transistors

Two different vendors are currently supplying

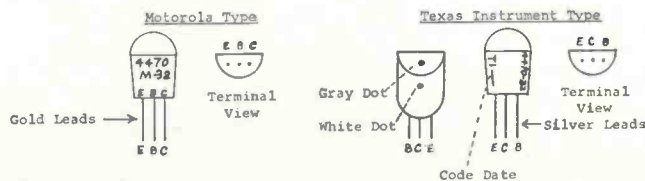

EA1451/EA15X59 transistors used both in the manufacture of amplifiers and in New Concord and Utica replacement parts stock. These transistors are electrically identical but differ in terminal arrangement and therefore must be connected into the terminal board differently. The necessary information to identify both units completely and the terminal diagram of each is illustrated here.

Since the Texas Instrument type unit was not in use at the time of printing the amplifier service manuals, its base diagram does not appear on the schematic page of the appropriate manuals.

### IF YOU

### CHANGE YOUR ADDRESS

NOTIFY: ELECTRONIC TECHNICIAN

Ojibway Building

Duluth, Minnesota 55802

Please include the address label from a recent issue and allow six weeks for the change.

# Why not sell the best

## ZENITH TUBES built to the quality standards of Zenith original parts

### "Royal Crest" Circuit Tubes

More than 875 tubes—a full line with the same quality as original Zenith equipment. Get Zenith tubes for greater dependability and finer performance.

Order all genuine Zenith replacement parts and accessories from your Zenith distributor.



### TV Picture Tubes

For color TV, B&W TV or special purposes. A complete Zenith line of more than 200 tubes built for greater reliability, longer life.

Zenith B&W replacement picture tubes are made only from new parts and materials except for the glass envelope in some tubes which, prior to reuse, is inspected and tested to the same high standard as a new envelope. Some color picture tubes contain used material which, prior to reuse, is carefully inspected to meet Zenith's high quality standards.

# ZENITH®

The quality goes in before the name goes on

... for more details circle 132 on postcard



1. Amphenol CRT Commander tests, rejuvenates both color and black and white tubes. Captivated socket assembly reduces lost sockets. 11 filament steps to 20 v give wide range for future CRT development. Built-in high impedance voltmeter 0 to 1000 v, 0 to 5000 v, 0 to 50 KV.

2. Amphenol Signal Commander is battery operated, easily held in one hand. Plug-in frequency modules—840-13 VHF and FM, 840-83 UHF, to cover entire TV Spectrum. Meter accurately reads direct db or mv.



3. Amphenol Color Commander cuts alignment time 40%. Nine test patterns—five are exclusive Amphenol timesavers. Three-color-bar test pattern adjusts demodulators without scope—in the home. Single dot pattern simplifies static convergence—returns to the same dot. Squares for horizontal/vertical linearity.

4. The new Millivolt Commander measures down to one-tenth of a volt d-c full scale and one/one hundredth a-c. Transistorized, weighs less than 4 lbs. Costs less than \$100. Accuracy within  $\pm 2\%$  and  $\pm 3\%$  a-c full scale. As ohm-meter: measures from .1 ohm to 1K megohms in 7 steps.

# new for transistor servicing

For more information see your Local Amphenol Distributor or write Amphenol Corporation, 2875 South 25th Avenue, Broadview, Illinois 60153



**AMPHENOL**

TM

**JULY 1967**

# **TROUBLESHOOTING COLOR VIDEO AMPLIFIERS WITH A DUAL-TRACE SCOPE**

**The 'old pro' tells how to use a high performance lab-type scope and squarewave generator to check, troubleshoot and peak video amplifiers for top picture quality**

■ As every experienced technician knows, a video signal is composed of a combination of transient voltages, and a good TV picture depends on the transient response of the video amplifier. Squarewaves can prove highly successful in making frequency-response and over-all performance checks of color video amplifiers. Clues to circuit defects that cause poor picture reproduction can be uncovered.

Sometimes marginal defects are caused by cumulative drift of component values. Capacitance, inductance and resistance can be very critical in obtaining peak-picture quality from video-amplifier circuits. Peaking coils develop shorts or leakage between layers, thus changing their inductance. Resistors tend to increase in value as the TV set ages and capacitors (common trouble-makers) develop various degrees of leakage. Tolerances are cumulative and as picture quality deteriorates, it is very difficult to determine which components are defective.

Considering the competitive factors involved in today's service atmosphere, it has become necessary to employ the best test instruments available for solving various types of troubleshooting problems. And the ability to use these techniques comes only with experience and study.

All checks described here are performed with a dual-trace, triggered, wide-band type scope and a squarewave generator.



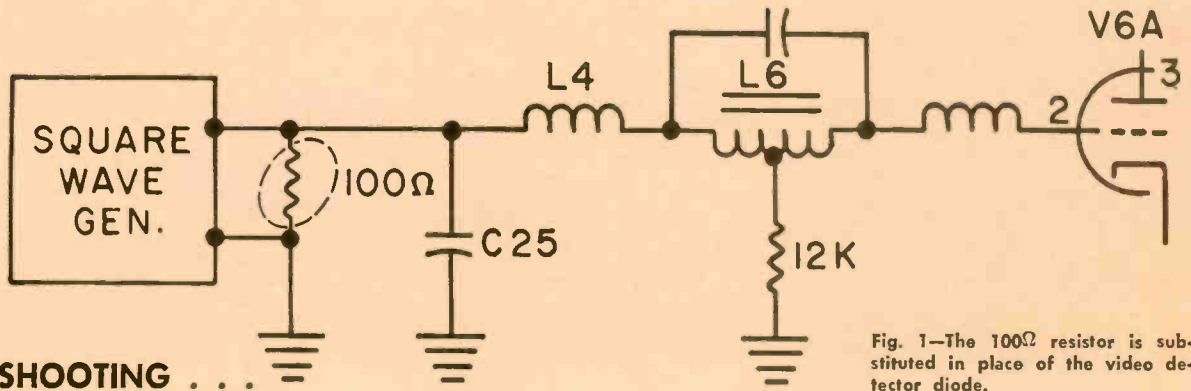

Fig. 1—The 100 $\Omega$  resistor is substituted in place of the video detector diode.

Triggered-sweep scopes have direct-reading vertical gain controls in terms of P-P voltages—permitting you to make quick voltage and gain measurements. Until you have used one of these scopes, you cannot realize what an asset it can be for fast, accurate and more profitable troubleshooting. The scope used by the “old pro” was purchased second-hand at a reasonable price.

#### General Considerations

The video-amplifier circuits in color TV receivers are more elaborate than those in B/W sets. A delay line, for example, slows the color video signal for approximately 1 $\mu$ s without distortion.

To obtain an undistorted squarewave display, interference from blanking pulses and stray fields must be eliminated. This is done by removing both the horizontal and vertical output tubes from the set. Signal overload from all sources should also be eliminated.

To check the video amplifier, a signal from the squarewave generator is injected at the input. The video detector is removed from the circuit and a 100 $\Omega$  resistor is substituted, as shown in Fig. 1. A low-capacity probe is then employed to trace the squarewave to the CRT cathode.

Tune the squarewave generator to 100kHz. This frequency will provide the most information while viewing the scope screen for proper video signal response. The normal 100kHz squarewave response of a color video section is illustrated in Fig. 2. Note that “preshoot” and “overshoot” are indicated. This is essentially a symmetrical waveform because the video section has a linear phase response. A five-times (5X) expanded squarewave trace showing details is illustrated in Fig. 3.

If the squarewave response is unsymmetrical, a defective peaking-coil or choke is indicated. A waveform with the squarewave generator set at 50kHz is shown in Fig. 4. These same checks can be used for B/W sets but the squarewave response will have overshoot and ringing present—but no preshoot and the waveform will be unsymmetrical.

Squarewave checks can also be made to determine the response and gain of the R-Y, B-Y and G-Y color amplifiers. It is very easy to measure the gain with a dual-trace scope. The amplitudes can be compared, for example, by connecting the scope’s “A” amplifier to

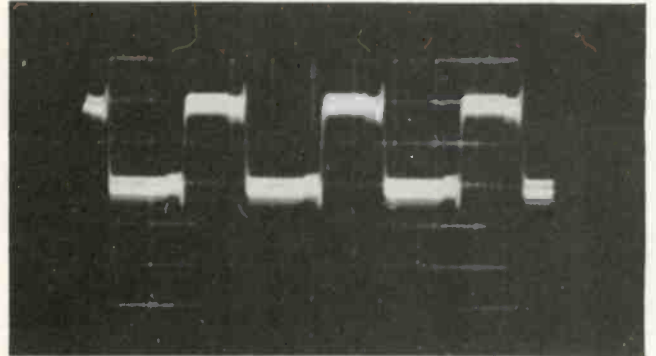

Fig. 2—Normal 100kHz squarewave taken from the output of a color TV video amplifier. Note both preshoot and overshoot.

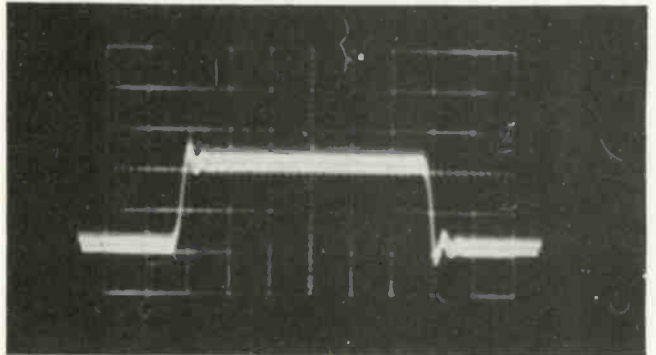

Fig. 3—Same squarewave as shown in Fig. 2 but expanded five times.

the “Y” amplifier control grid and the “B” amplifier to the plate of this same tube. Then we can determine stage gain, if any.

#### Actual Troubleshooting Cases

A Zenith color chassis, 23XC38, had a half-black and half-white picture with retrace lines as shown in Fig. 5. A very faint picture appeared in the background. The squarewave signal was injected and each of the three video stages were checked. It was quickly determined that L10, a 250 $\mu$ h choke was open (see Fig. 6.). This choke feeds the blanking pulses to the control grid, element 2, of the 12HL7 “Y” amplifier (V7). A new L10 choke was installed and a sharp picture appeared.

#### Phantom Color ‘Spoofer’

An intermittent video picture problem came up in

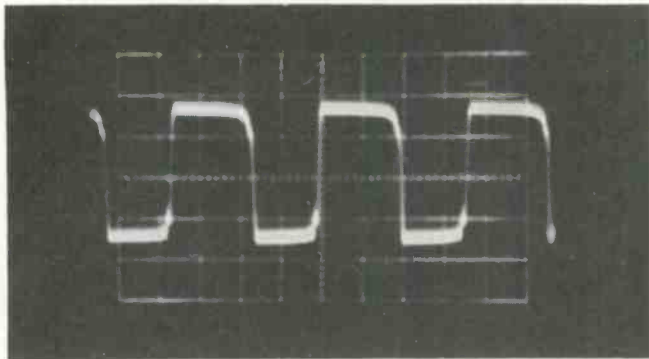

Fig. 4—A normal 50kHz squarewave that has passed through a properly operating color TV.

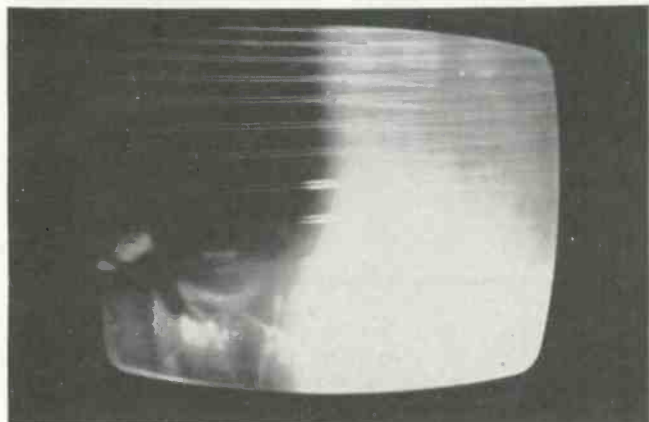

Fig. 5—Defective picture caused by open choke.

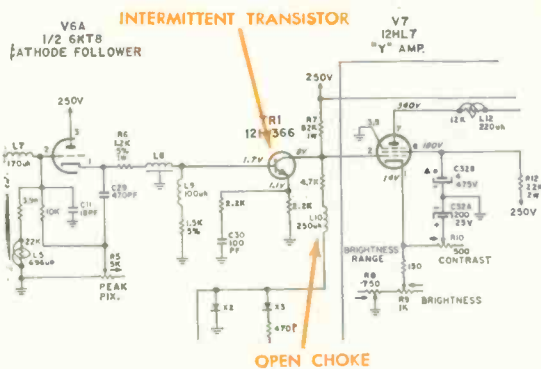

Fig. 6—Schematic of a portion of the video section of a Zenith 23XC36 chassis.

the same type of chassis. B/W information on a color telecast would disappear and the color information only would appear. This condition would exist for about five minutes and then disappear. The set would then work fine for about an hour and even sometimes for a full day.

In this case we used the station video signal and the dual-trace scope was connected to various test points in the video section. The set was then switched on to "cook" and the bench technician, while working on another set, glanced over at the scope occasionally. After swapping the scope probes around several times, the trouble was narrowed down to transistor TR1 (see Fig. 6). The transistor would open for a few seconds and the waveforms appeared as shown in Fig. 7. Note the bottom trace shows only the blanking pulse present (no video) at terminal 2 of V7. The top trace was taken at the base of transistor TR1. This problem could

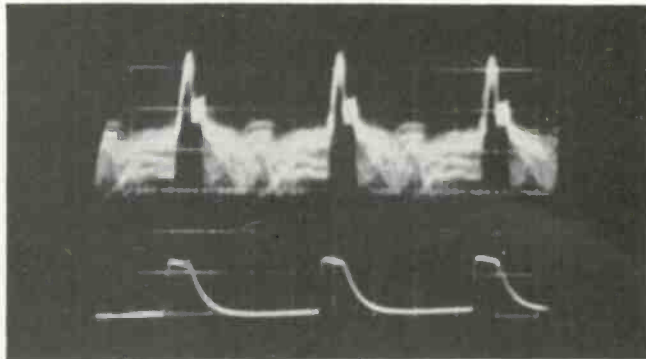

Fig. 7—(Top) Normal video signal at the base of transistor TR1. (Bottom)—Blanking pulse only is shown with video missing at tube terminal 2 of V7. This problem was caused by an intermittent transistor.

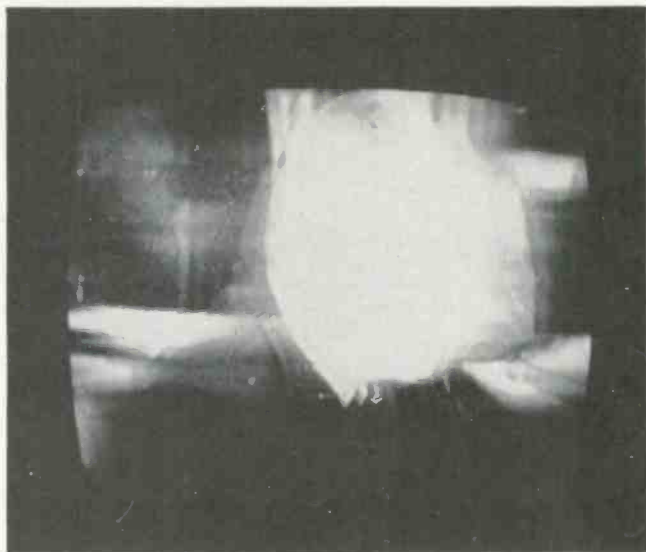

Fig. 8—The shorted diode, CR103, in an RCA CTC19A caused this double reflected image on the screen.

have been a tough nut, but the dual-trace scope cracked it quickly. This same technique can be used to spot intermittently open coupling capacitors.

### Reflected Images

An RCA CTC-19A color TV chassis had what appeared to be double reflected images (Fig. 8). The tuner and IF stages checked out OK so the scope and squarewave generator were warmed for a look at the video amplifier stages. The trouble was quickly narrowed to a shorted diode, CR103, shown in Fig. 9 at the delay line, DL101, output. Apparently a reflected signal was set up within the delay line as the current flowed in both directions because of the shorted diode. The blanking pulses are fed into this diode via R167 and these pulses caused the condition. We have noted the same problem on some older model color sets caused by component aging. If a diode is inserted at the output and in series with the delay line, this will sometimes solve the problem.

Someone slipped a Zenith 20X1C36 color chassis on the service bench when our back was turned. The picture that greeted us when the set was switched on, is shown in Fig. 10. Without thinking, we ran outside to check our antenna but found that it was "ghost-free."



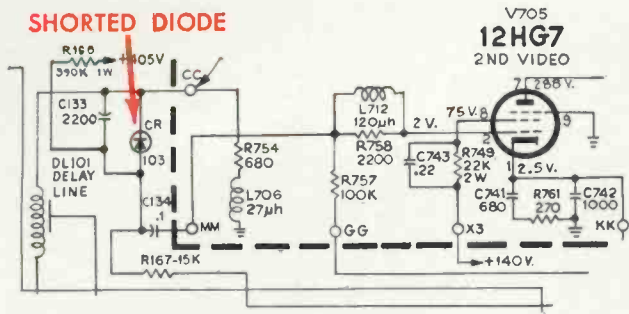

Fig. 9—Section of the CTC19A where shorted diode is located.



Fig. 10—Triple image caused by an open choke, L9, in a Zenith 23xC36 chassis.

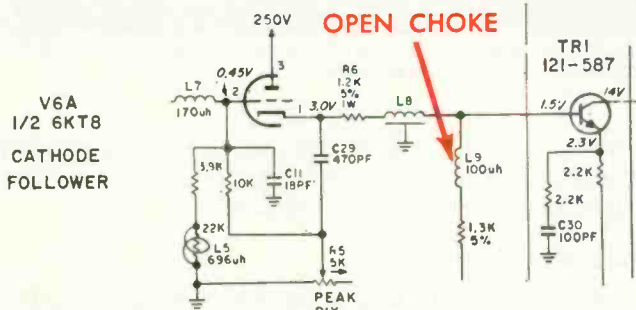

Fig. 11—Schematic of a portion of the video section showing where open choke, L9, is located in a Zenith 23XC36 chassis.

A few preliminary checks were made and all symptoms pointed toward the video section. The scope was still warm so the probes were jumped quickly across all three stages. Ringing of the squarewave appeared at the base of transistor TR1 and a few ohmmeter checks quickly located an open L9 choke. (See the schematic in Fig. 11.) Here the return of the delay line is through a 180Ω resistor to ground. With this coil open, the delay line was actually having a ringing or reflected effect on the video signal—thus causing a triple ghost in the picture. A defective delay-line has been known to cause this same type of picture ghost.

#### Damped Vertical Stripes

A new 20X1C38 Zenith was unpacked and fired up for checking before making delivery. What appeared

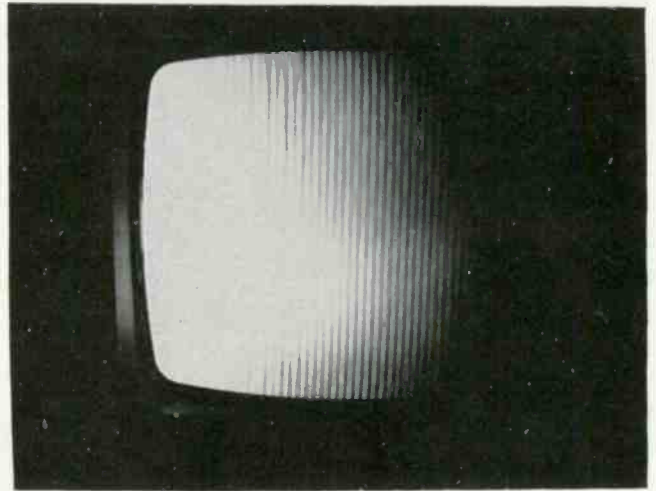

Fig. 12—'Rare-bird' photo made from screen of Zenith 20X1C38 which was caused by a poor solder joint in the horizontal sweep section.

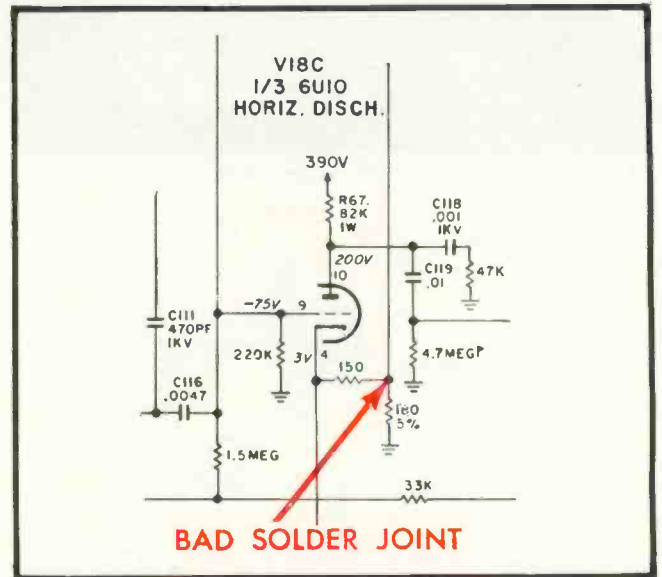

Fig. 13—Simplified schematic of the horizontal discharge section of a Zenith 20X1C38 chassis where a poor solder joint was located.

on the screen is shown in Fig. 12. We were afraid to even guess at the cause. The dual-trace scope was used to track down this "video trouble" which turned up as a cold solder joint in the horizontal oscillator stage. The ground end of the 150Ω resistor connected to terminal 4, cathode, of the horizontal discharge tube, V18C, had the poor joint (see Fig. 13).

We've told you what caused this odd condition, but you'll have to decide how the picture was completely eliminated — because we obtained a good picture after the ground-end of this resistor was well soldered.

The beauty of using a dual-trace scope is that the two waveforms, from the input and output of a video stage, for example, can be superimposed for an exact analysis and comparison. ■

# Repairing Solid-State Auto Radios

**You can make money in this business today if you go at it properly**

■ Many service-dealers still think of solid-state auto radio repair as a "dirty job" and not worth the effort. But it is a profitable business today if you have or obtain, the necessary tools and specialized know-how.

Most auto owners have "acclimated" themselves to the higher costs now prevailing for solid-state auto radio repairs and, although it may be a little more difficult to locate and replace defective transistors, not every Tom, Dick and Harry can locate defective transistors like they can bad tubes. Hence, if you know your business, you can increase your profits by doing solid-state auto radio repairs.

You'll need the following equipment, test instruments and material to do this type of repair work:

1. Universal bench power supply
2. Signal tracer
3. Noise or regular signal generator
4. Transistor tester
5. Auto radio schematics and service data.

You will also need a few convenient tools, most of which are

found in the average TV-radio shop.

## Checking Speaker and Antenna

Depending on the complaint, always check the antenna and speaker before pulling the radio out of the auto. Check both for continuity with a VOM set on a low resistance range.

The impedances of transistorized auto radio speakers run from about 8 to 40 $\Omega$ . Although the speaker cannot be checked for reproduction quality while mounted in the auto, a continuity check can be made to determine if the voice coil is open. Many situations arise with inexperienced technicians where the car radio is pulled and when connected on the bench it operates perfectly—the trouble being in the car.

The antenna can be checked for an open lead-in or high resistance leakage from center wire to the outside shielded cable. An open auto lead-in will pick up only strong local radio stations. If water or heavy moisture accumulates inside the antenna or lead-in, the results will be similar. Sometimes the ohmmeter will not show leakage caused by

moisture or water but the antenna, if suspected, should be removed and checked.

If the antenna checks open, the lead-in will usually be broken at the plug that goes into the radio or at the bottom of the antenna mounting assembly. If the lead-in is open, it is better to install a completely new antenna.

Speaker troubles will show up usually as open voice coils, cone vibration or "mushy" distortion. Under various kinds of weather conditions the speaker cone may warp and drag on the center pole piece. Sometimes only the cone will vibrate loose and can be re-glued again. Low- or high-note vibrations can be caused by split or torn speaker cones. Check intermittent speakers by pressing gently on the cone while the speaker is operating.

## Troubleshooting

Several methods can be used to locate solid-state auto radio troubles quickly. Defects can be located by signal tracing, through sight or smell and by rapid transistor checking methods. Generally, most skilled



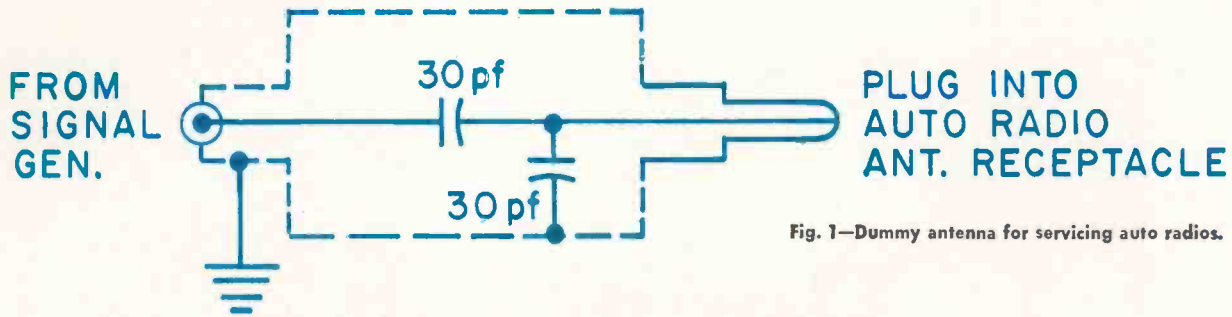
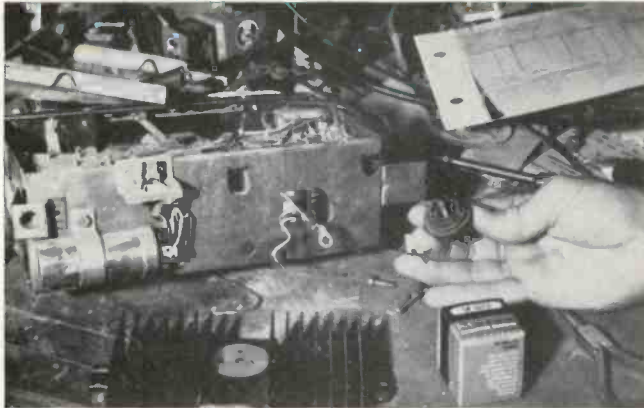
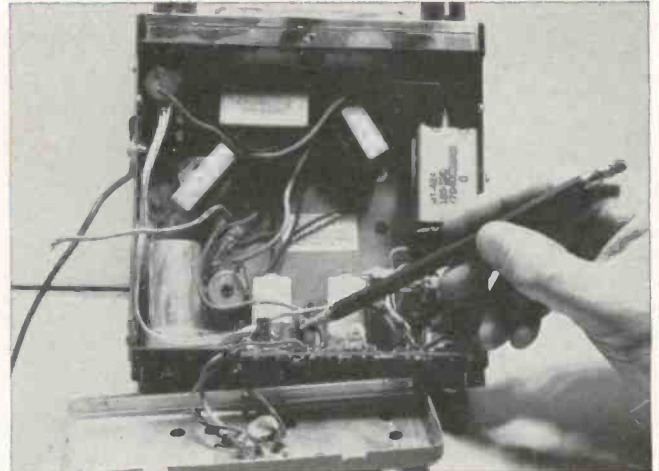

Fig. 1—Dummy antenna for servicing auto radios.



When replacing a power transistor make sure it is mounted exactly as the original component. Watch for small mica insulators on some transistors and do not forget to put silicone grease on the metal collector terminals for heat dissipation.



Pencil points to a defective auto radio transistor.

technicians use a combination of these methods.

When checking transistorized radios, whether in the auto or on the service bench, trouble-symptoms indicated by the speaker are very important. If a clicking or humming sound appears in the speaker, for example, it can be assumed that the output stage is operating. Weak audio from the speaker may be caused by a shorted or weak power output transistor. No audio usually indicates a shorted output transistor having an open bias resistor.

To begin troubleshooting, go directly to the volume control. Inject a signal here with a noise generator or 400Hz modulated signal from a regular signal generator and check out the audio stages. With the volume control wide open, a loud signal should be heard. If so, all the audio stages are functioning. Now proceed toward the detector, IF and converter stages.

If you do not get a loud signal from the speaker with a signal injected at the volume control, then proceed toward the speaker, from base to collector of each audio tran-

sistor, until the signal is heard. At this point you have located the defective stage. It can be found one stage back toward the front end of the receiver.

The IF stages can be checked by injecting a generator signal to the base of the converter transistor. The signal generator frequency must be set at the proper IF. To check the RF stages, connect the signal generator through a dummy antenna load as shown in Fig. 1.

Do not forget your sense of sight, touch and smell. Expert technicians locate many troubles by detecting charred or overheating resistors through one or more of these three senses. If a transistor becomes hot after the set has been on for a few minutes, it is probably shorted. But this is a relative matter which becomes significant only through experience. Most power output transistors, for example, will get rather warm after operating for several hours. Always check the variable bias resistor and adjust it for correct current in the output stage as specified on the manufacturers' schematic.

### Checking Transistors

Suspected transistors should always be checked with an in-circuit transistor tester. This tester will check both NPN and PNP types for beta quality and element leakage while the transistors are soldered to the circuit board. Not only can the quality of the transistor be checked, but a short or high leakage can be quickly detected.

When checking for beta or leakage, it is important to remember one thing: Many AF stages in solid-state auto radios are directly driven. In this case, remove the transistor from the PC board before checking. It is possible, under these circumstances, to get an erroneous reading when a diode or a directly coupled transistor is used in a circuit.

Several sources for transistor replacements are available. Major source include: 1) G-E, 2) Motorola (HEP line), 3) RCA (SK top of line series), 4) Semitronics and 5) Workman (miracle five).

### Intermittent Trouble

Dead solid-state auto radios are

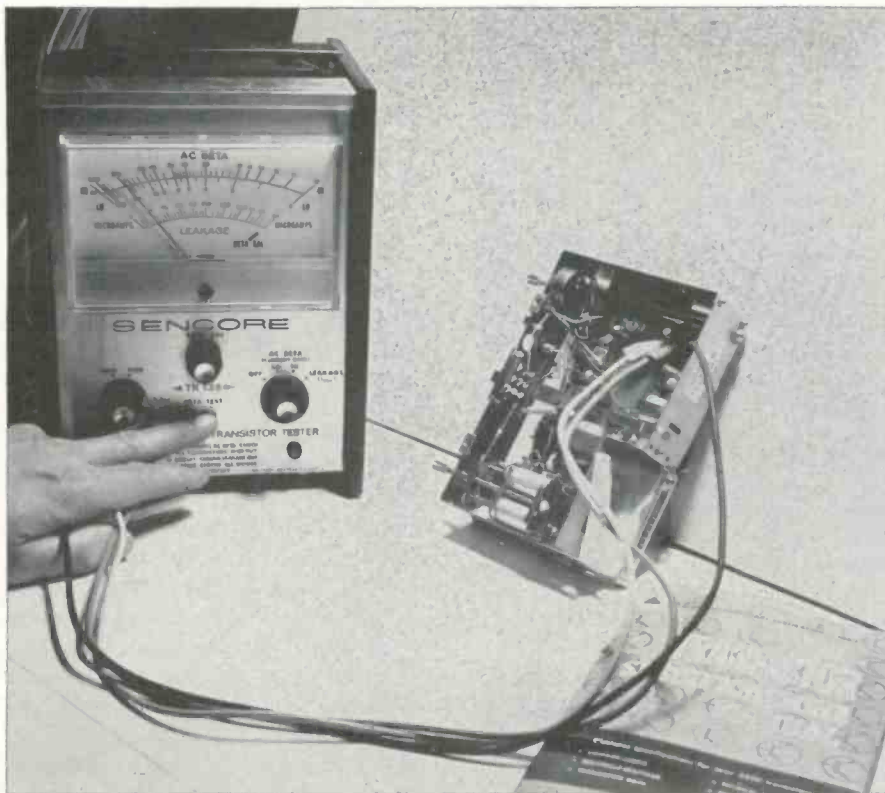

An in-circuit beta transistor tester is used to check auto radio transistors.

very easy to repair. Weak or intermittent radios are difficult at times. All intermittent equipment should be handled with care. Intermittent troubles are frequently caused by broken or poor etched board connections, IF transformers and high-ohm voice coil speakers generally come next.

It is also possible to have an intermittent transistor. Isolate the intermittent stage first and unsolder the transistor from the PC board, connect the tester to the transistor and tap it lightly while observing if the beta reading changes on the tester's meter scale.

**Noisy Volkswagen.** A Bendix model 6BVT Volkswagen, solid-state radio came into the shop with noisy reception. The noise was traced to the first RF assembly. C14A (Fig. 2) proved to be leaking. When it was checked with an ohmmeter, however, no leakage resistance could be measured. The top end of the capacitor was unsoldered and a VTVM reading showed 0.45v leakage. After replacing C14A and B trimmer assembly, the radio was quiet.

**'Cold' Chevrolet Radio.** After operating for the first half hour, this Delco radio had very weak audio output. The volume would then slowly increase but it still never reached peak output. The radio was left to cool overnight and the next morning a few voltage checks were made. An incorrect bias voltage appeared on the output transistor.

Very little voltage existed on one side of the bias fuse resistor. The input potential was 12.6v. The value of the bias resistor was 10K and should have been 0.47 $\Omega$ . This same bias resistor was placed back in the circuit and after warming up it measured 10 $\Omega$ ! Both the bias resistor and the DS501 output transistor were replaced. Although the radio operated perfectly with the old transistor, we saw no good reason to take a chance on a possible intermittently shorting component.

**Weak 'Olds.'** A Delco 7279515 model had very weak audio output. All stations tuned in up and down the dial but they were difficult to hear. We reasoned that the RF and IF stages were good, so we went directly to volume control.

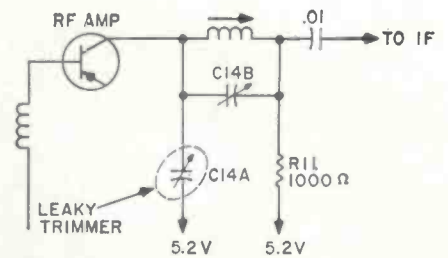

Fig. 2—Dashed circle encloses leaky trimmer section in a Volkswagen auto radio which caused noisy reception.

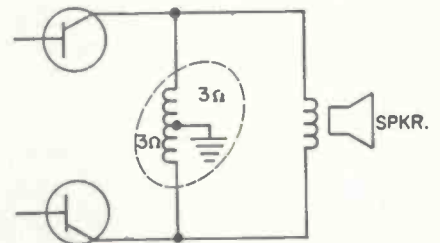

Fig. 3—Burned transformer in CTA62 Motorola auto radio.

The noise generator was connected to the volume control and the signal at the output was very weak. Tracing the signal to the output revealed a defective power transistor. It's collector-to-emitter resistance was 0.5 $\Omega$ . A transistor tester showed that the component had a definite leakage of 3ma.

**'Mid-day' Ford.** The owner of a 5TMF Ford solid-state auto radio turned in a very unusual complaint. "The radio," he said, "could be switched on when I took the car to work and would begin operating about mid-morning or around lunch time. On cool summer days the radio would not begin operating until much later."

Sure thing, when we placed his radio on the bench, it was "dead." Our records show that dead auto radios are the easiest to repair, but what component in it would warm up and be OK after three or more hours under summer weather conditions?

A few important voltage checks were made but no clues showed up. Then each transistor was checked in-circuit and the 1st IF transistor



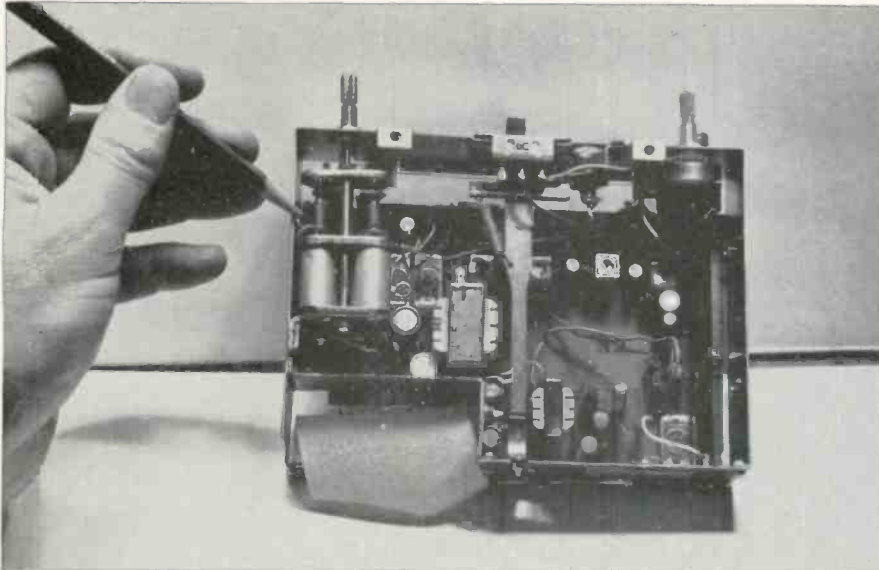

Poor selectivity and poor sensitivity can result from a cracked or broken RF tuning rod. Defects can often be seen.

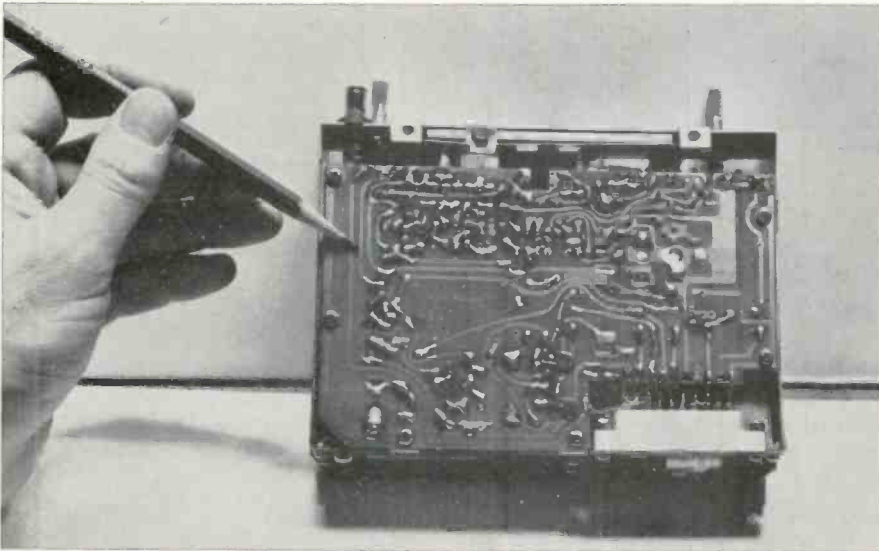

Many intermittents are caused by defective etched boards. Boards warp and sag. Cracks are caused by heavy components — filter capacitors and transformers.

#### Chart I

1. Be sure the power on solid-state auto radios is switched off before doing in-circuit checking or repairs. The voltage may be low enough to eliminate shock hazards, but you may generate sparks and transients that cause damage to transistors.
2. When using an ohmmeter in transistor circuits be sure the voltage in series with the meter isn't too great to damage transistors.
3. When servicing solid-state auto radios, set the volume control to mid-range — otherwise the audio input transistors, when checked in-circuit, may appear to be shorted.
4. In FM auto radios it is possible to find transistors that will not oscillate at their designed frequencies. The beta of the new transistor should match that of the original transistor. Check this in a transistor specification manual.
5. When replacing power output transistors be sure and use silicone grease on the new one.

checked very weak. Most RF and IF transistors will show a high beta reading and should be checked on the high-beta meter scale of the tester. A new 2SA72 IF transistor was placed in the circuit. After four days of alternately "cooking" and "cooling," the set operated perfectly and was re-installed in the car.

**Burned Output Transformer.** A dead Motorola model CTA62 came into the shop. It had a "smelly" output transformer. You could see that the small transformer was practically burned to a crisp.

After checking with the local parts distributor and then with the Motorola distributor, it was determined that a replacement could not be obtained for about three weeks.

This kind of job always seems to come up when a customer plans to go on a trip the very next day. This customer planned to leave for a West-Coast vacation within 12 hours. Now we really had a problem.

We checked the radio's schematic and service date and learned that the output transformer was a simple center-tapped affair, wound with number 26 enameled wire. The total resistance was  $6\Omega$  (see Fig. 3).

What won't technicians do sometimes to keep a customer happy! The old winding was removed from the shell and steel laminations. We scramble-wound number 26 enameled wire over the coil form until it measured  $3\Omega$  on the VTVM. The coil form was twisted into a loop and another  $3\Omega$  of wire was wound on the coil form. Although the scramble-wound coil was slightly larger than the original, the assembly did go back together again. A flexible piece of wire was soldered to the center and taped up. Spaghetti insulation was slipped over each end of the coil leads and they were soldered directly to the output transistors.

Since the old transformer was badly burned, both output transistors were replaced. The radio operated like a charm. The customer, to this day, doesn't know that the old output transformer was "rebuilt," but he was happy to have a radio on his journey westward.

Some hints on repairing transistor auto radios are listed in Chart I. ■



AGC circuits are not as difficult as some "experts" have led us to believe.

■ The third article of this series ended with a brief introduction to AGC trouble symptoms and troubleshooting techniques.

It was made clear that troubleshooting AGC circuits was not as difficult as some "experts" have led us to believe. It was admitted, however, that *apparent* AGC trouble symptoms could be caused by a defect in any one of a number of other circuits, but it was also made clear that an external bias supply could, in most cases, be used to determine if the fault was in the AGC system or elsewhere. This technique may have to be varied somewhat in certain types of AGC systems, especially solid-state circuits, but it will not be necessary to alter the procedure radically.

#### The Over-all Viewpoint

Before we can begin to troubleshoot modern, keyed AGC circuits quickly and effectively, we must first establish and constantly maintain a special mental viewpoint based on the general nature of these circuits.

What is the "nature" of a keyed AGC circuit? The AGC circuit is part of a closed loop system that covers a considerable area and its efficiency depends on the proper operation of a number of other circuits—RF, IF, video detector, video amplifier and certain areas of the horizontal sweep circuit. Thus, the nature of keyed AGC circuits is characterized by interdependence.

# UNDERSTANDING MODERN AGC CIRCUITS

Use your 'noodle' — diagnose — isolate — repair

#### Part Four of a Continuing Series

The efficient operation of a keyed AGC circuit depends on the proper operation of the video detector and video amplifier circuits. And these two circuits cannot operate properly unless the IF section is up to par. But an efficient IF section depends on a properly operating AGC system! This may appear to be an enigma or a paradox or worse. But it is neither.

A keyed AGC circuit, for example, is somewhat comparable to a horizontal oscillator/discharge circuit that takes its B+ from a "boost" voltage source. The oscillator/discharge and boost circuits are *interdependent*. A component failure in either circuit can disable both circuits. And it is difficult to determine which is the *cause* and which is the *effect*.

The nature of these circuits, then, requires that we "see" the total area clearly and recognize that a symptom revealed by the CRT screen can be caused by a defective component in other circuits apart from the AGC circuit. We must be careful to avoid jumping to conclusions and "suspecting" any particular circuit. We must proceed in a logical, orderly manner to isolate the problem to a particular circuit. And once we have arrived at this stage, we then pin-point the defective component in that circuit by using the most effective test instruments available on the bench. If we do not proceed in this manner, however, we are almost certain to end up

with a self inflicted, time-consuming "tough dog" on our hands. And, of course, as every skilled technician knows through experience, "tough dogs" belong only to the unskilled and the so-called experts who become too "cocky" at times.

With this over-all view firmly established in our minds, let's explore some common and not-too-common symptoms that point to possible trouble in keyed AGC circuits.

#### Symptoms and Troubleshooting Logic

In a generalized sense, most AGC trouble symptoms are caused by either too much or too little AGC voltage. And the records will probably indicate that most troubles are caused by *too little* or *no* AGC voltage. Additionally, both conditions have clearly defined symptoms which can be categorized.

Too much AGC voltage, for example, can cause a weak picture, a "snowy" picture or no picture and the sound can also be poor or completely absent. Too little or no AGC voltage can cause overloading (very dark picture elements), horizontal tearing, a negative picture, excessive audio buzz or even a complete picture loss. In this case a very strong signal can cut the tubes off and leave a "snow free" raster. Both the vertical and horizontal sync can also be adversely affected through compression.

The records will probably also



A magnifying glass with circular fluorescent bulb helps when checking or replacing an IC.

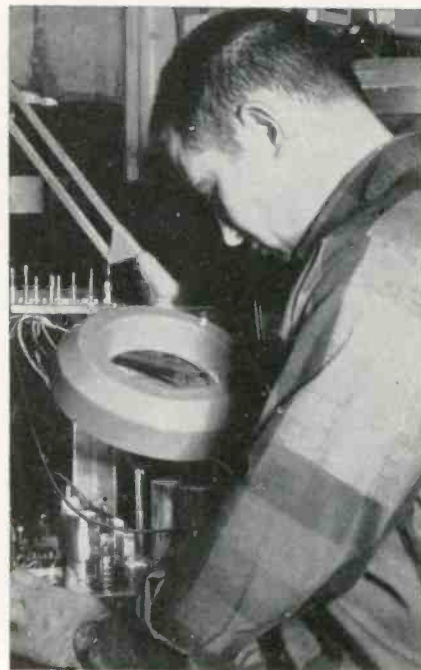

# Working with ICs

Don't let these microminiature marvels scare you

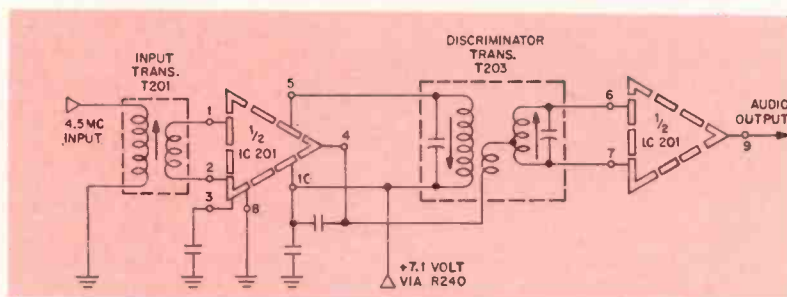

Fig. 1—IC used in CTC25 and KCS157 RCA TV sets.

■ Every alert service-dealer and technician knows by now that we live in the space-age. And the space-age is synonymous with integrated circuitry (IC).

A number of home-entertainment equipment manufacturers have already produced B/W and color TV receivers, radios and portable phonographs having ICs.

Two types of ICs are currently being manufactured — linear and digital. We are primarily concerned only with linear types. Linear-type ICs are designed to be used in audio, mixer, RF, video, phase detector and limiter circuits. More specifically, linear IC-types will be used in radio, Hi Fi stereo, other audio amplifiers and the audio sections of TV receivers.

One group of ICs consists of

several layers of silicon material on a chip about the size of the end of a pencil. Transistors, capacitors and resistors form the internal IC. Most of the transistors in ICs are directly coupled—and transistors are frequently used in place of coupling capacitors. It is said that ICs were designed primarily for reliability and longer life.

## TV Applications

The RCA IC201 is used in the CTC25 color chassis and in the 38-sq-in. B/W portable receivers—the transistorized KCS157 portables which use the 9WP4 CRT.

This small microelectronic package contains about a dozen resistors and two dozen transistors and diodes. It performs IF amplifica-

tion, audio detection and low-level audio amplification. Conventional transistors are used for the external audio driver and push pull audio output. A schematic of the IC201 circuitry is shown in Fig. 1.

A 4.5MHz IF signal is taken from the emitter of the 1st video amplifier and applied to a selective tuned circuit, T201 — the IF input transformer. This signal is then processed by a series of transistor amplifier/limiters contained in the IC. At this point the discriminator transformer is inserted — the output of this transformer being fed back into the IC where detection takes place and the signal is amplified by a series of low-level audio amplifiers which deliver approximately 100 to 200mv of audio at the IC output.

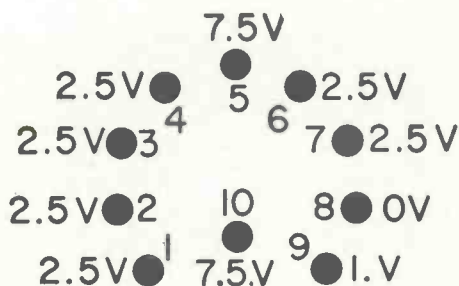

Fig. 2—Bottom view of IC201 showing terminal numbers and voltage measured under no-signal conditions.

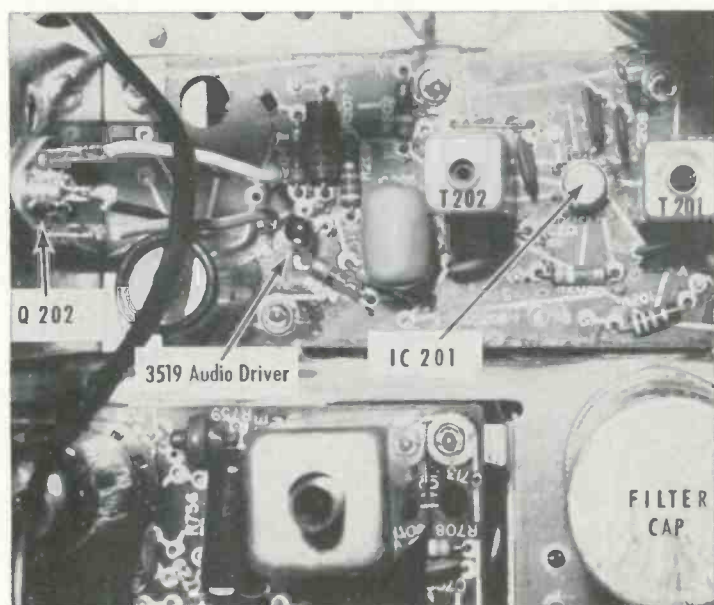

Fig. 3—Top view of the RCA IC201. The small IC package is placed between the two sound IF transformers.

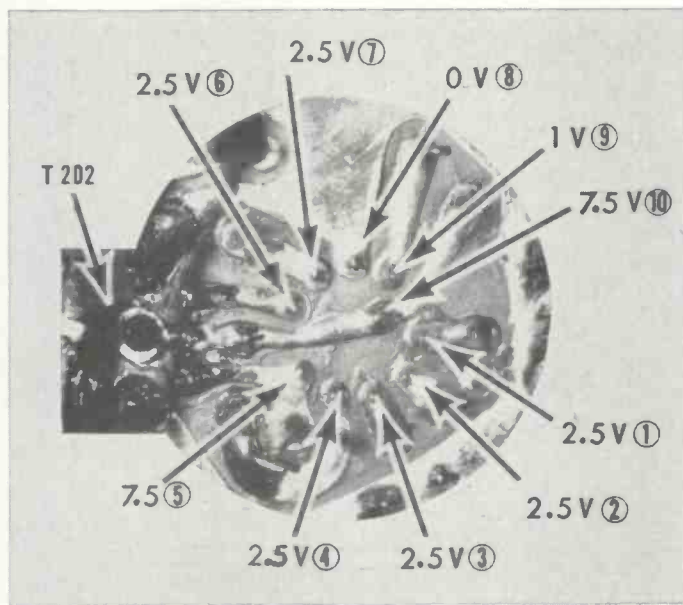

Fig. 4—Soldered-in bottom view of the IC201 showing voltage measurements under no-signal conditions.

## Troubleshooting

Our approach to troubleshooting ICs is, of course, in no way different from that used in conventional circuitry. All we have to remember is to think of the entire IC as one component. If it breaks down—the entire IC will be replaced. The important point is, however, to know the circuit and what jobs it performs. This means knowing IC trouble-symptoms, too.

First, make certain the trouble is in the IC and not in external connecting components. In the RCA CTC25 chassis, for example, check the audio signal from the IC201 output (terminal 9) through the two following audio stages up to the speaker. If the audio section is working properly, a loud rushing

sound will be heard when the volume control is fully clockwise. If there's only a hum, instead of a loud rushing noise, the trouble is probably in the IC or forward of it.

Inject a signal from a noise generator or a modulated 1kHz signal from a regular signal generator at terminal 9 of the IC. Turn the volume control all the way up. If the audio section is functioning properly, a loud 1kHz tone will come from the speaker.

If the audio stages are OK, then check the IC. Now remove the 3rd video IF tube (6JS6). When the tube is removed and the volume is turned full up, a fairly loud hum can be heard in the speaker.

Apply the signal or noise gen-

erator probe tip to terminals 1 and 7. A loud hissing tone will be heard if the IC is functioning properly. If you get a weak signal or no signal through the IC, it is probably defective. Another sure method is to apply a modulated 4.5MHz signal to terminal 1 and chassis ground. Leave the volume control full on and turn up the signal generator output so that the signal is heard in the speaker. If no signal is heard, proceed to terminal 5 and check for signal amplification at this point. In this case, if a modulated tone is heard in the speaker, we know the discriminator coil is working.

## Voltage and Current Checks

To determine definitely if an IC is defective, a quick voltage



## WORKING WITH ICs . . .

measurement can be made. Look at Fig. 2 for approximate voltages on various terminals of the IC201. The potential at terminals 5 and 10 is 7.5v. In the event one of these voltages is very low, we have a leaky IC or insufficient supply voltage. All measurements are made with a VTVM under no-signal conditions. When making resistance checks on an IC, it is best to use a VTVM or a 20,000 ohm/v VOM to prevent possible damage to the IC.

Voltage checks can be made from the top of the chassis directly at the IC leads. This IC is soldered directly to the PC board. You will find that all ICs are generally "wedged" between components, and voltage measurements are sometimes difficult from the top of the PC board. The IC201 is mounted on the PW200 board as shown in Fig. 3. The bottom view of the PC connections to the IC201 in the color chassis is shown in Fig. 4. Note that terminal 10 is off center. It is easy to mistake this terminal for the common ground connection, as the etched wiring is tied to the mounting legs of T202. Actually, the etched wiring goes on through the transformer terminals to the driver emitter transistor components.

To determine if the IC has a short or is drawing too much current, insert a milliammeter in series with terminal 10. Since voltage is supplied by the etched wiring, take the point of a sharp knife blade and cut out a section of the etched wiring. This is a simple job and can be done by digging the blade under the etched wiring. Attach your VOM probes (with the VOM set on the 50ma scale) and then switch the receiver on. The correct current reading should be 10 to 12ma. If considerably higher, replace the IC component. Resolder a piece of bare tinned wire over the cut-out section before installing a new IC.

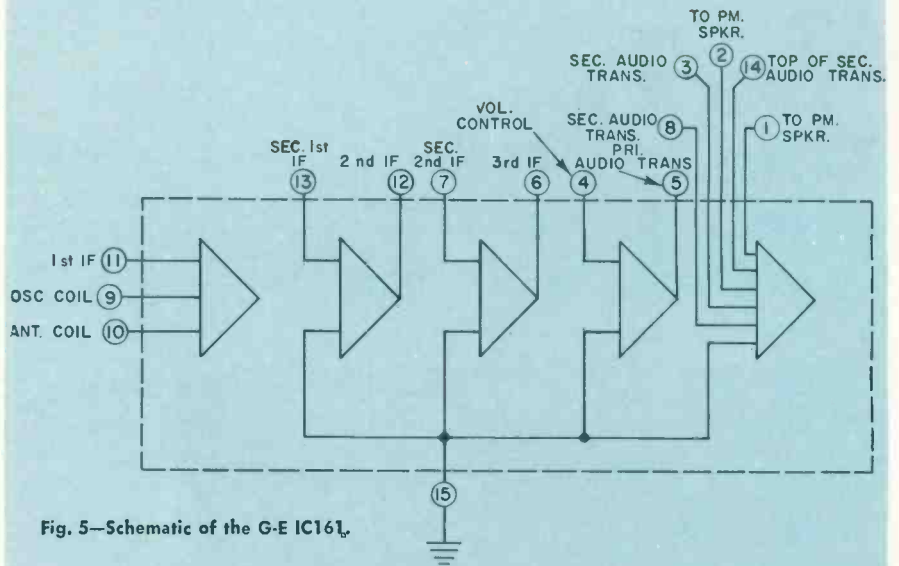

Fig. 5—Schematic of the G-E IC161.

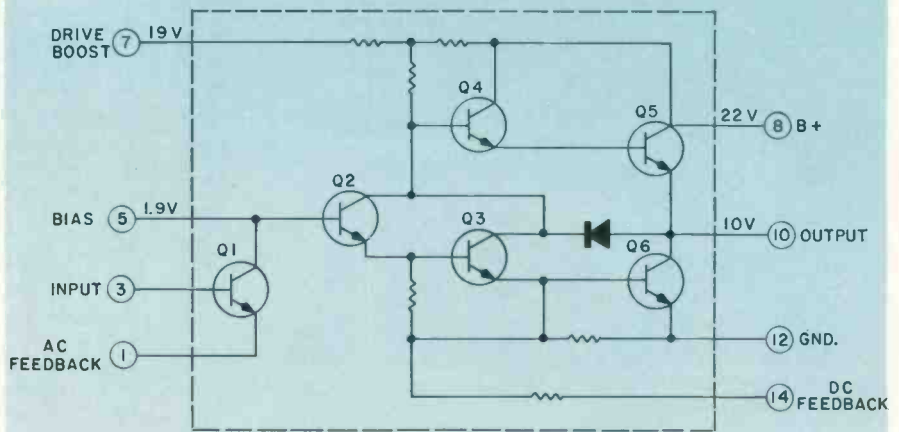

Fig. 6—Schematic of IC used in G-E portable phono.

Resistance measurements are not too valuable when checking out an IC. Voltage, current and signal checks are more positive and much faster. You should always check for poor solder joints and especially grounding points from the etched board to TV chassis. An in-circuit transistor tester can't be used to check out an IC circuit.

### Various IC Types

G-E has produced an IC radio which operates from a 3.75v nickel-cadmium battery. No external transistors are used in this small radio. The only external components are coils, transformers, speaker, capacitors and some resistors. A schematic of the flat, 14-lead IC (IC161) is shown in Fig. 5.

By injecting a noise or tone-modulated signal at the various

terminal connections, the signal can be traced to the speaker. Again, voltage and current measurements are important in locating the defective components. Minimum current drain is 8ma.

This same manufacturer is also using an IC amplifier in a portable phonograph. The small audio chip produces an audio power of 1w and is said to have a maximum distortion of 5 percent. A schematic of this IC is shown in Fig. 6.

When troubleshooting this amplifier, connect a 1kHz tone from an audio signal generator to the ungrounded side of the phono crystal cartridge. Proceed toward terminal 3 until the defective component is uncovered. A low signal can be heard in the speaker when the audio generator signal is connected to terminal 10. The B+ supply

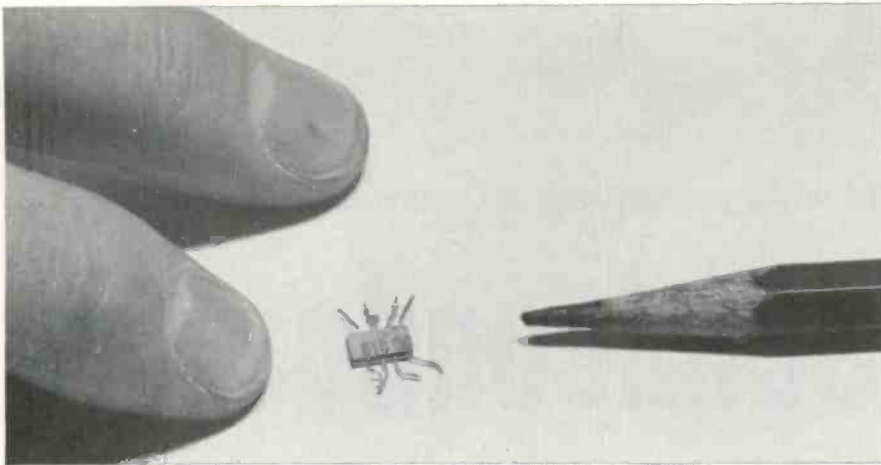

Fig. 7—The Westinghouse WC183 compared to a pencil point.

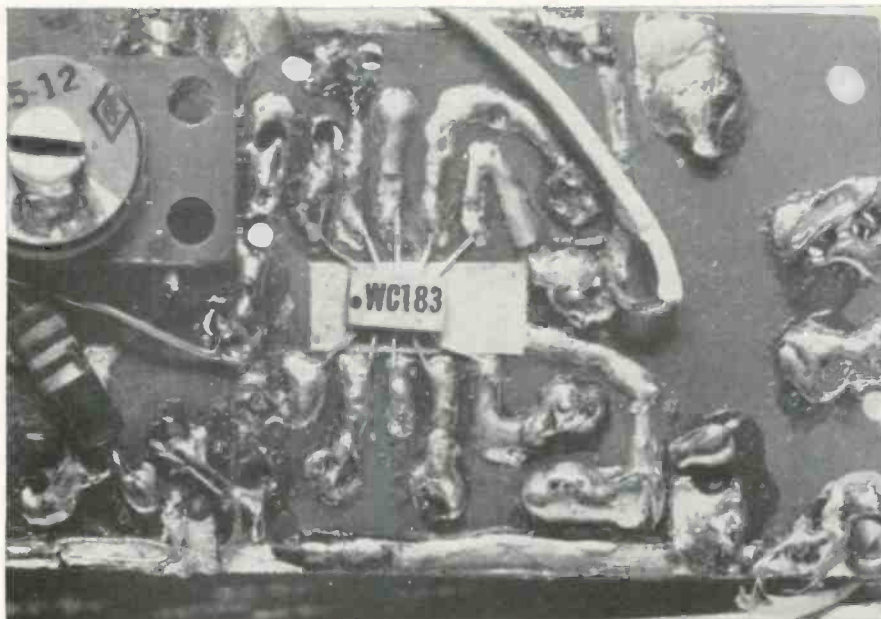

Fig. 8—The WC183 shown wired into an etched board.

#### Chart I IC Dos and Don'ts

1. Do be careful not to apply too much heat with the soldering iron and use long-nose pliers as a heat sink.
2. Do be careful when making voltage checks on the terminal connections of an IC to avoid shorting two terminals.
3. Do use a small pencil soldering iron and magnifying light when working on an IC.
4. Don't unsolder or change any lead of an IC while the equipment ac switch is in the ON position.
5. Don't remove an IC until all other external components have been checked.
6. Don't forget to check all soldered terminals of an IC to determine if they are good or bad.
7. Don't forget to check all IC terminal voltages after soldering in a new unit.

of this unit is taken from a secondary winding on the phono motor field. Fullwave bridge rectification is used with a 25v filter network.

Voltage measurements on terminals 5, 7, 8 and 10 will quickly determine if the IC is defective. A milliammeter from the bridge rectifier to terminal 8 should read from 8 to 40ma.

An audio circuit by Westinghouse, WC183, is shown in Fig. 7. This unit is shown wired into a circuit in Fig. 8.

The flat 10-terminal unit is said to produce 100mw and have a reasonably flat frequency range from 50Hz to 20kHz.

#### A Case History

An RCA CTC25A chassis had no audio. Only a hum came from the speaker when the volume control was rotated up and down. From past experience we felt certain that the final output stages were working properly. But a signal from a noise generator was applied to the base of the driver transistor, 3519, to make sure. We got a loud signal from the speaker with the volume control wide open. The two final audio stages were good.

A voltage check was now made on terminal 10 of the IC. Instead of 7.5v, the VTVM measured only 0.5v. A milliammeter inserted in series with terminal 10 and the supply voltage read 52ma. We suspected the IC had a high internal leakage.

The IC unit was removed and a new one soldered in and voltage checks were made. All voltages were normal and the audio section worked normal also.

Replacing an IC201 requires skill and patience. When removing one, use a soldering iron with a solder suction bulb to take up the solder from the 10 connections. A good magnifying light comes in handy when working with IC circuits.

Although ICs are relatively new, skilled technicians can troubleshoot and repair these circuits with proper test instruments and tools.

A few "dos" and "don'ts" for servicing IC circuits appear in Chart I. ■



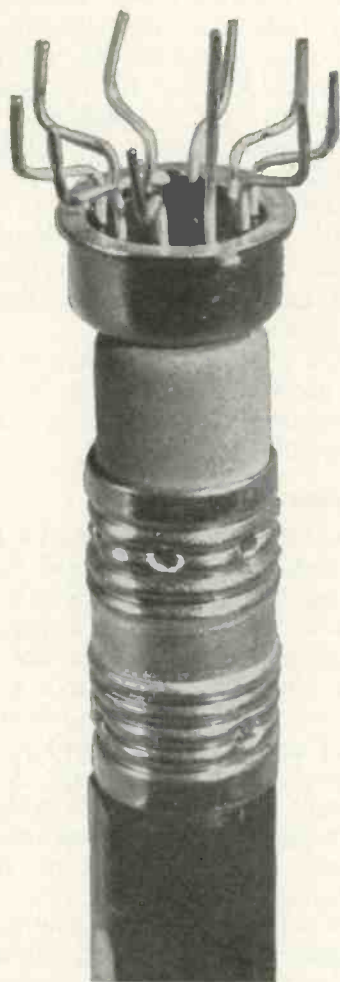

Fig. 1—The integrated circuit currently used in many TV sets is so small it can be placed on the end of a pencil.

TV service is easier when you understand integrated circuits

# Semiconductors

■ A line of TV sets currently on the market uses an integrated circuit, IC201, in the sound IF and audio circuits. The silicon chip upon which this circuit is grown measures less than 0.05in. and, when in its case, the IC201 is not much larger than the end of a pencil (Fig. 1).

The manufacturer's schematic of the integrated circuit is shown in Fig. 2, while a schematic of how the integrated circuit is incorporated in a TV set is shown in Fig. 3.

These two schematics are combined and converted to a more conventional form in Fig. 4. The general layout of the integrated circuit's sub components in this diagram is nearly the same as that shown in Fig. 2. The only modifica-

tion, for the sake of simplicity, is in the change in layout of the sub components connected to terminals 6 and 7.

The dc voltages indicated at the terminals of the integrated circuit (Fig. 4) are within  $\pm 15$  percent of the VTVM voltages that can be read when the TV set is functioning properly. If the voltage at terminal 10 is not within the indicated range, the fault probably lies in the B+ supply. An improper bias voltage at terminal 1 might be caused by an open secondary winding of the input transformer (T201), while an abnormal reading at terminal 5, 6 or 7 may be caused by a defective discriminator transformer (T203).

When checking a TV set that

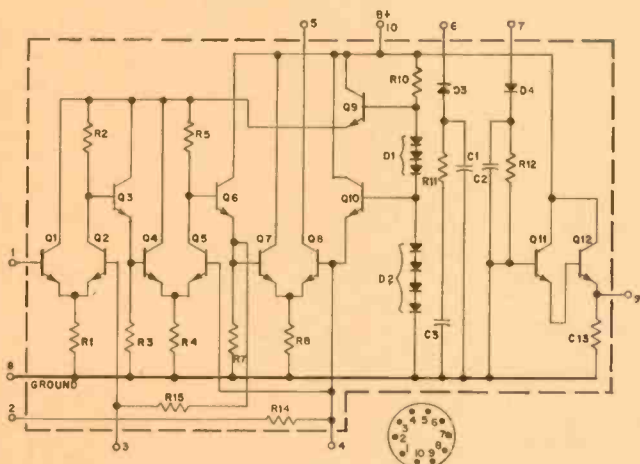

Fig. 2—The manufacturer's schematic of IC201.  
Courtesy of RCA.

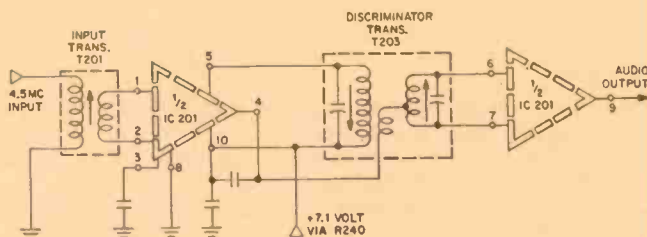
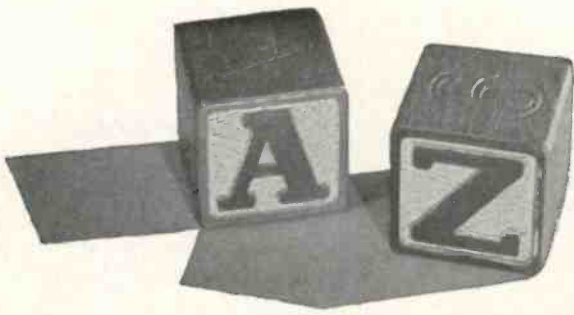

Fig. 3—The manufacturer's schematic of how IC201 is incorporated in a TV receiver's sound IF and audio circuits. Courtesy of RCA.



# from A to Z

has no audio, the integrated circuit is the component that should be least suspected. To service a TV set containing an integrated circuit, however, technicians should understand how the circuit functions.

## Differential Amplifiers

The bases of the two transistors (Q1 and Q2), in the first two stages (Fig. 5) of the integrated circuit, have been forward biased to produce emitter currents in both transistors. This bias circuitry is not shown since it will be described later. (A similar unbalanced differential amplifier circuit was described and shown in Fig. 9 of the April 1967 article.)

A positive signal applied to the base of transistor Q1 (Fig. 5) will

cause it to conduct more collector-to-emitter current. This will result in a greater voltage drop across the common emitter resistor (R1). The emitters of both transistors will, therefore, become more positive with respect to ground.

The base of transistor Q2 is biased at a relatively constant potential above ground. As the transistor's emitter becomes more positive with respect to ground, its base becomes less positive with respect to the emitter. The effective reduction in the second transistor's base bias reduces its collector-to-emitter current. This, in turn, reduces the voltage drop across resistor R2, and the collector of transistor Q2 becomes more positive.

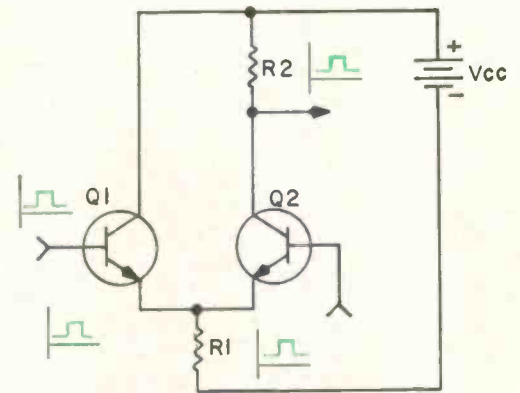
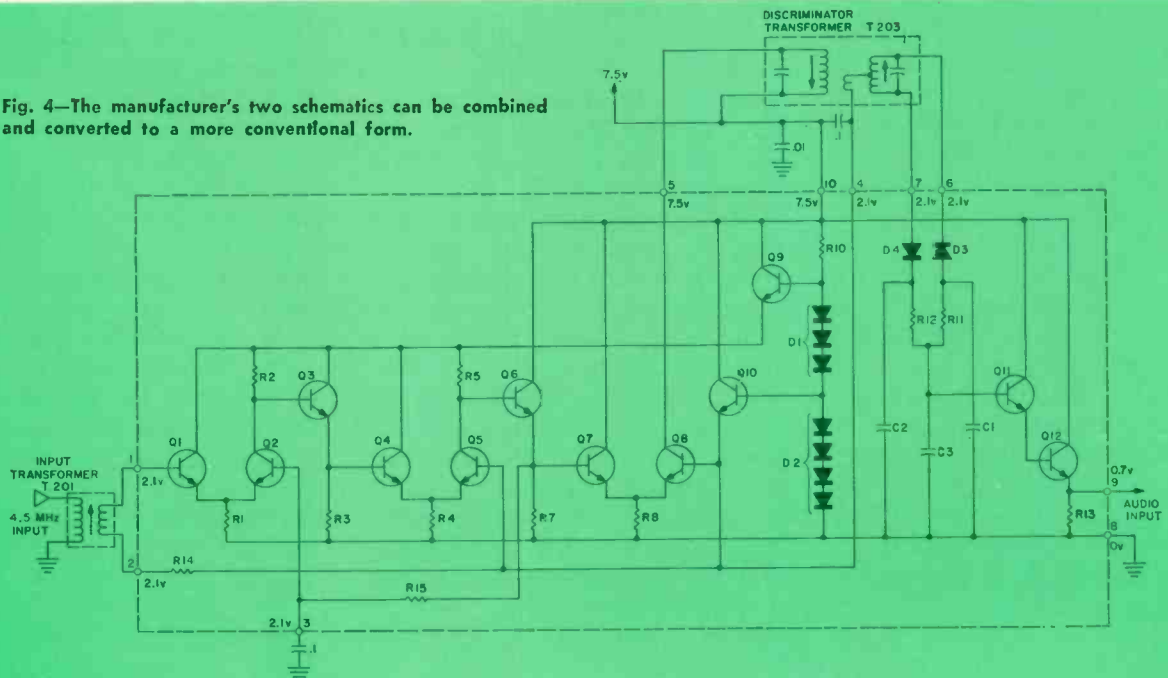

Fig. 5—The first two transistors are shown apart from the total integrated circuit to simplify functional descriptions.

The April 1967 article also explained that in a differential amplifier circuit, such as this, the collector-to-emitter signal current in the second transistor (Q2) must be smaller than the collector-to-emitter signal current in the first transistor (Q1). The circuit still experiences a gain, however, since the entire collector-to-emitter signal current in the first transistor (Q1) alters the voltage drop only across resistor R1 while the collector-to-emitter signal current in transistor Q2 alters the voltage drop across both resistor R1 and resistor R2. A voltage gain, rather than a current gain, is experienced in the circuit.

The first two amplifier stages (Fig. 5) are shown as a part of the

Fig. 4—The manufacturer's two schematics can be combined and converted to a more conventional form.





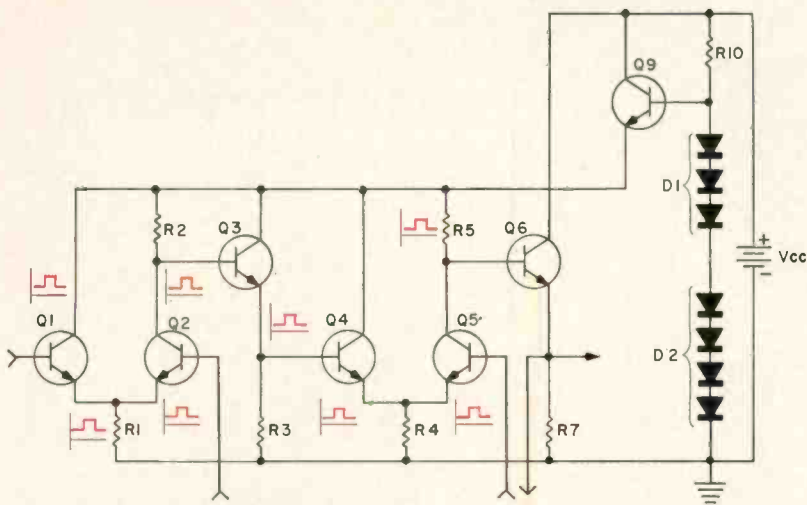

Fig. 6—The first six amplifier stages in the integrated circuit.

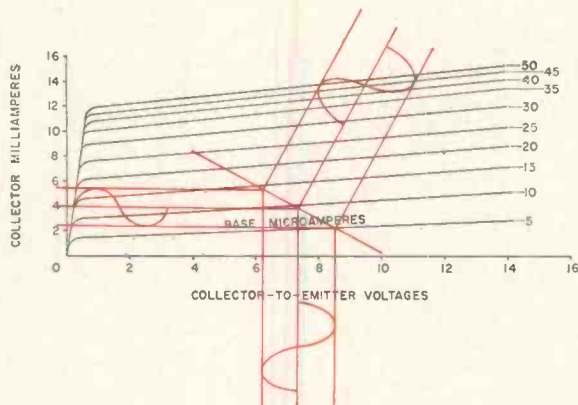

Fig. 7—Load line of a typical transistor circuit.

circuit in Fig. 6. A positive signal applied to the base of transistor Q1 results in a voltage-amplified, positive signal across resistor R2, increasing the base forward bias of transistor Q3.

As the emitter current of transistor Q3 increases, a greater voltage drop is developed across resistor R3, and the signal is amplified further.

The positive signal across resistor R3 is applied to the base of transistor Q4. Transistors Q4 and Q5 then function in the same manner as the transistors shown in Fig. 5. A positive signal applied to the base of transistor Q1, therefore, results in an amplified positive signal across resistor R5.

When the collector-to-emitter current in transistors Q2 and Q5 decreases, a corresponding increase occurs in the collector-to-emitter current through transistors Q1, Q3 and Q4. Conversely, this current through transistors Q2 and Q5 in-

creases when it decreases through the other transistors.

As previously indicated, the collector-to-emitter signal current through transistor Q1 is greater than that through transistor Q2. This situation is also true for transistors Q4 and Q5.

When a positive signal is applied to the base of transistor Q1, its increase in collector-to-emitter current is greater than the corresponding decrease in current through transistor Q2. At the same time, there is an increased current flow through transistor Q3. The increase in current flow through transistor Q4 is also greater than the decrease in current through transistor Q5. The transistors that experience the greatest collector current when the base of transistor Q1 is positive, experience the least current when this signal is negative.

As a positive or negative signal is applied to the base of transistor Q1, the total amount of collector

current conducted by transistors Q1 through Q5 increases or decreases as though these transistors were but a single component.

As indicated in the April 1967 article, IC resistors cost more to produce than transistors since they require a larger area on the chip. The cost of producing resistors R1 through R4 can be reduced if their values can be kept to a minimum.

### Voltage-Regulating Transistor

Transistor load line characteristics were discussed in the October 1966 article in this series. It was indicated that the voltage supplied to a transistor circuit is equal to the voltage drop across the load resistor plus the transistor's collector-to-emitter voltage. The load line of a typical transistor is shown here in Fig. 7. By reducing the load resistance from 750Ω to 500Ω, the cost of manufacturing it in an integrated circuit is also reduced. This change (Fig. 8), however, has increased the transistor's collector-to-emitter voltage drop across the load resistor. The transistor is now consuming more power ( $P = I_C V_{CE}$ ), and producing more destructive heat, to provide nearly the same amount of amplification as before.

A reduction in the amount of voltage supplied to the transistor circuit (Fig. 9) reduces only slightly the voltage across the load resistor and appears almost entirely as a reduction in collector-to-emitter voltage. The signal voltage remains virtually the same while the transistor's power consumption has been reduced.

The economy resulting from a lower supply voltage and load resistance can be applied to the amplifier stages shown in Fig. 6. A lower supply voltage is not applicable to later amplifier stages since the signal voltage is then greater.

A resistor (R6) connected in series (Fig. 10) with the collectors of transistors Q1 through Q5 cannot reduce the voltage applied to that portion of the circuit. The value of that resistor is now a portion of the total load resistance, with the voltage supplied remaining the same. As indicated pre-

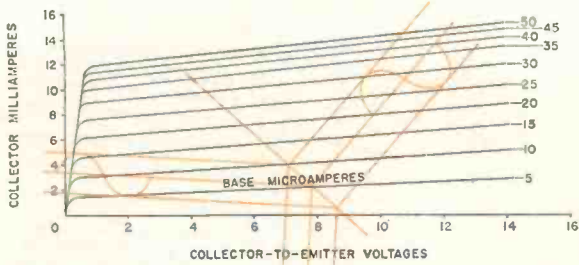

Fig. 8—The transistor's collector-to-emitter voltage increases as the load resistance decreases.

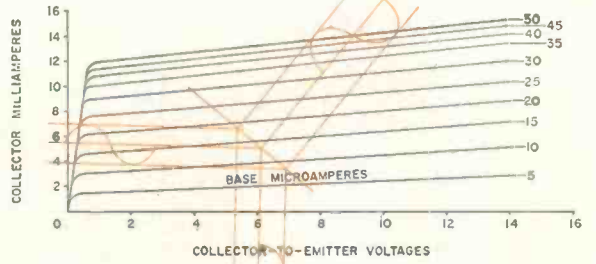

Fig. 9—A reduction in the amount of voltage supplied to a transistor circuit appears almost entirely as a reduction in its collector-to-emitter voltage.

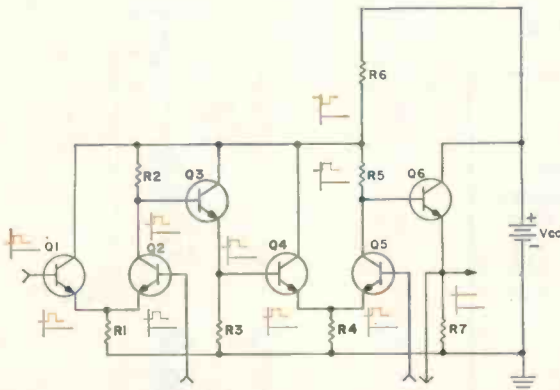

Fig. 10—A resistor connected in series with the first five amplifier stages will increase their total load resistance rather than reduce the supply voltage.

viously, when a signal is applied to the base of transistor Q1, the total amount of collector current conducted by transistors Q1 through Q5 increases or decreases as though these transistors were but a single transistor.

A positive pulse applied to the base of transistor Q1 would result in an increased voltage drop across resistor R6. As previously indicated too, the positive pulse applied to transistor Q1 also results in a reduced voltage drop across resistor R5. Depending on the values of resistors R5 and R6, the increase in voltage across one resistor may equal the decrease across the other, and the signal to be applied to the base of transistor Q6 could be neutralized.

Transistor Q9 can be used (Fig. 4) to reduce the voltage applied to transistors Q1 through Q5. Since resistor R10 and diodes D1 and D2 are also required for biasing the base of transistor Q10, the cost

of using transistor Q9 to provide a lower supply voltage is less than the cost of providing transistors Q1 through Q5 with larger load resistors. Transistor Q9 not only reduces the cost of the integrated circuit but, as we will see, increases the stability of the circuit.

The base of the voltage-regulating transistor (Q9) is biased in the same manner as the current limiting transistor (Q3) in the CA3005 balanced differential amplifier circuit. This circuit is shown in Fig. 6 in the May 1967 article. The two groups of diodes (D1 and D2) in the IC201 circuit are used to regulate the base current of transistor Q9 in the same manner as the two diodes (D1 and D2) in the CA3004 circuit. These diodes cost less to "grow" than resistors and compensate for the changes in the characteristics of transistor Q9 with changes in temperature.

The varying relationship between the base bias current and the

Fig. 11—The diodes are used as part of a voltage divider and compensate for temperature changes in the integrated circuit. Transistor Q9 and resistor R10 represent the effective equivalent of transistors Q1 through Q5 and their related load resistors.

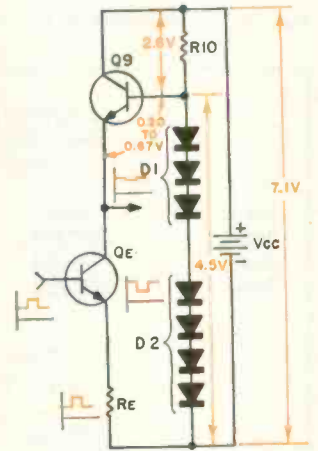

base-to-emitter voltage of a typical transistor was shown in Fig. 8 on page 104 of the October 1966 article.

As indicated in the present article, however, the diodes shown in Fig. 11 compensate for this varying relationship and we can assume that the 25°C curve will apply for all temperatures. From this curve we can see as the base-to-emitter voltage increases from 0.2 to 0.67v, the base current increases from 0 to 50μa.

A drop of about 4.5v is developed across diodes D1 and D2. Since 7.1v is supplied the circuit, a 2.6v drop in potential must occur across resistor R10 [ $V_{CC} - V_{(D1 + D2)} = V_{R10}$ ].

The collector-to-emitter voltage ( $V_{CE}$ ) of transistor Q9 is the sum of its collector-to-base voltage ( $V_{CB}$ ) and its emitter-to-base voltage ( $V_{EB}$ ). ( $V_{CE} = V_{CB} + V_{EB}$ .) The voltage drop across resistor R10 determines the col-



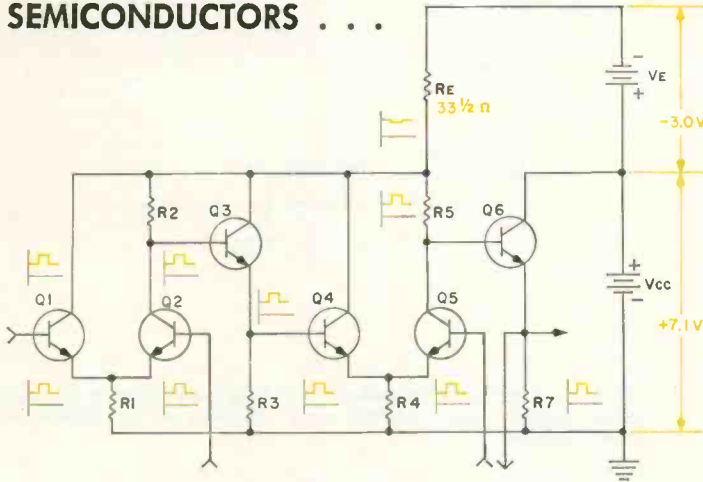

Fig. 14—The equivalent to a voltage-regulating transistor is substituted for transistor Q9.

**Factory Sales of Integrated Circuits  
During First Two Months of 1966 and 1967**

Circuit Type	First Two Months 1966			First Two Months 1967		
	Units	Dollars	Average Value	Units	Dollars	Average Value
Digital	2,847,000	14,914,000	5.24	6,297,000	22,059,000	3.50
Analog	179,000	3,615,000	20.20	857,000	7,782,000	9.08
<b>Total</b>	<b>3,025,000</b>	<b>18,529,000</b>	<b>6.13</b>	<b>7,154,000</b>	<b>29,841,000</b>	<b>4.17</b>

**Percent of Increase or Decrease  
First Two Months 1966 and 1967**

Circuit Type	Average Value		
	Units	Dollars	Average Value
Digital	121.2	47.9	33.2
Analog	378.8	115.3	55.0
<b>Total</b>	<b>136.5</b>	<b>61.1</b>	<b>32.0</b>

lector-to-base voltage of transistor Q9 ( $V_{CE} = 2.6v$ ). This collector-to-base voltage is shown on the characteristic curve (Fig. 12) of a typical transistor as a dot-dashed line representing part of the total collector-to-emitter voltage.

As previously indicated, when the emitter-to-base voltage of a typical transistor increases from 0.2 to 0.67v, the base current increases from 0 to  $50\mu a$ . (The description of Fig. 6 in the September 1966 article of this series explained the composition of the base current. In good transistors this current is virtually the current from the emitter to the base.) This data, obtained from Fig. 8 of the October 1966 article, can be applied to the typical transistor characteristic curve (Fig. 12). There the collector-to-base voltage ( $V_{CB}$ ) is shown as a dot-dashed line. (This

line is used merely as a reference and does not indicate any corresponding base or collector current.) By adding the emitter-to-base voltage ( $V_{EB}$ ), to the collector-to-base voltage ( $V_{CB}$ ), we can show the total collector-to-emitter voltage ( $V_{CE}$ ). This total voltage is plotted against corresponding base currents.

Transistor  $Q_E$  and resistor  $R_E$  represent (Fig. 11) the effective equivalent of transistors Q1 through Q5 and their related resistors. Just as the total current conducted by these amplifier stages increases as a positive pulse is applied to the base of transistor Q1, the current conducted by transistor  $Q_E$  increases as a positive signal is applied to its base. We have substituted a single transistor and resistor for these stages of amplification merely to simplify the explanation of the function of transistor Q9 in the circuit.

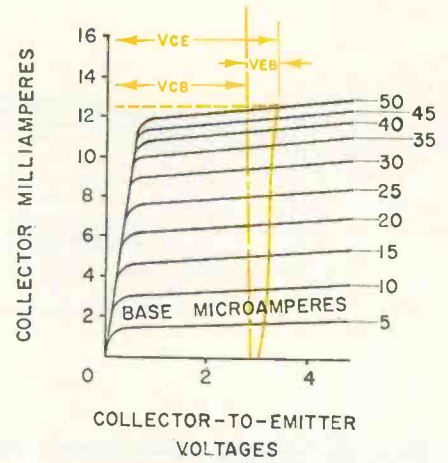

Fig. 12—Collector-to-base and emitter-to-base voltages are shown on a transistor's characteristic curve.

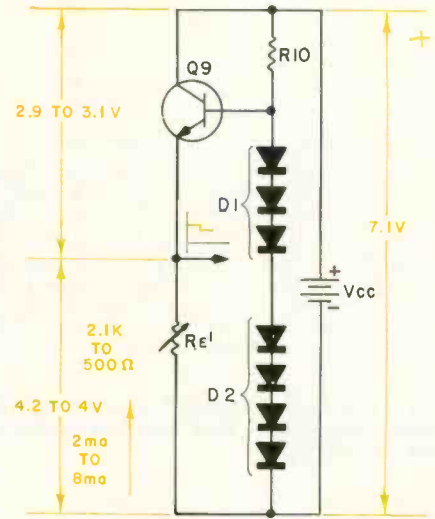

Fig. 13—A variable resistor demonstrates the function of a voltage-regulating transistor.

As a positive signal is applied to the base of transistor  $Q_E$ , there is a reduction in its collector-to-emitter voltage, and the transistor ( $Q_E$ ) conducts more current. This results in a greater voltage drop across the emitter resistor ( $R_E$ ) and a greater voltage drop between the emitter and base of transistor Q9.

Since transistors  $Q_E$  and Q9 are connected in series, the collector current of transistor  $Q_E$  is virtually the collector current of transistor Q9.

If we knew that resistor  $R_E$  had a value of  $375\Omega$ , the collector current of transistor  $Q_E$  varied from 2 to 8ma, and Fig. 12 represented the characteristic curves of transistor Q9, we could calculate the range of voltage in this portion of the circuit.

From Fig. 12 we see that the collector-to-emitter voltage of tran-

*continued on page 69*

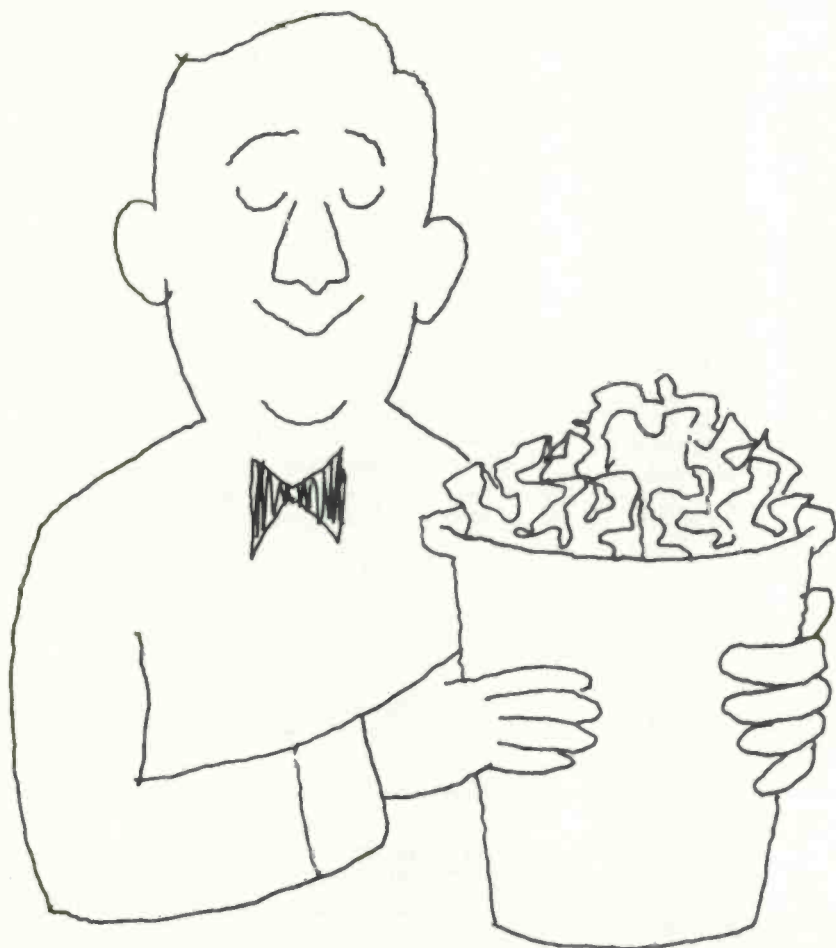

## Our janitors are specialists.

Like every other good businesspaper publisher, we have one or more specialists in each industry we serve. But virtually every one of our 412 people is a specialist of some kind. Take our janitor in the circulation department on the first floor. Be-

cause of the highly confidential nature of the list print-outs from our computers, we shred every throw-away with special electric shredder wastebaskets. So our janitor on that floor is a specialist. He has to operate electric wastebaskets.

### OJIBWAY PRESS, inc.

Ojibway Building, Duluth, Minn. 55802

*Satisfying the need to know . . . with 27 publications in 13 industries.*



ELECTRONIC TECHNICIAN • DRIVE-IN MANAGEMENT • DRIVE-IN MANAGEMENT GUIDEBOOK • HOSPITAL & NURSING HOME FOOD MANAGEMENT • SCHOOL & COLLEGE FOOD MANAGEMENT • PLANT & BUSINESS FOOD MANAGEMENT • KITCHEN PLANNING • GAS AGE • GAS APPLIANCE MERCHANDISING • LP-GAS • INDUSTRIAL GAS • BROWN'S DIRECTORY • PAPER SALES • THE PAPER YEAR BOOK • CONVENTION NEWS • MODERN CONVERTER • HEARING DEALER • HOSIERY & UNDERWEAR • OFFICE PRODUCTS DEALER • OP CONVENTION DAILY • AMERICAN FUR BREEDER • MEAT • SPONSOR • FLOORING • RSI (ROOFING, SIDING & INSULATION) • BAKERS WEEKLY • BISCUIT & CRACKER BAKER





07, T918-09, T919-10, T920-08 and later versions) use a universal power cable. In non-remote models a jumper plug assembly (part #170796-1) is used to terminate this cable. In remote control models this cable plugs into the remote chassis, but if the TV chassis is removed to the shop for service without the remote chassis the jumper plug will be required to operate the TV chassis. Also if the remote receiver should be removed

to the shop for repair, this jumper plug can be used to permit normal operation of the TV receiver by the customer. A 170796-1 plug assembly is now included.

On stereo theatre models this same jumper plug can be used to operate the TV chassis on the service bench. When the TV chassis is removed for service you can keep the radio and phono portions of the unit operating for the customer by using the special ac line cord (part #170786-1) to connect between the remote and outlet.

On non-remote stereo theatre models a relay and cable assembly (part

#704038-1) is used between the TV chassis power cable and the radio chassis. If the TV chassis is removed for service on these models the special ac line cord (170786-1) should be plugged into the relay assembly to allow the radio and phono to be operated in the normal manner.

The 704038-1 relay assembly can be a handy service accessory if a remote chassis is removed from a stereo theatre model for service in the shop. By temporarily installing this assembly the customer can have full use of TV, radio and phono while the remote chassis is being repaired.

### Our Cover

The semiconductors appearing on our cover this month are shown here in outline and with numbers

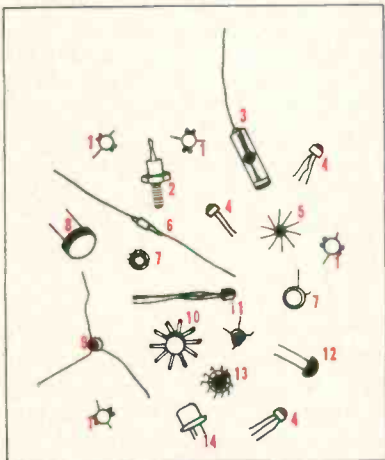

to identify each component. Included are the following:

1. Four Bendix B500 plastic encapsulated 25w silicon power transistors.
2. IR 1N1341 silicon diode.
3. RCA 7412 photo resistor.
4. Three Siliconix epoxy-encapsulated field-effect transistors.
5. Texas Instrument's 2N929 0.6w low level, silicon transistor.
6. Sylvania 1N38B germanium diode.
7. Two Fairchild  $\mu$ A702 linear-amplifier integrated circuits.
8. Polaris Electric LRD-C1 photo resistor.
9. Olson TR32 photo transistor.
10. RCA 2N3553 7w silicon RF transistor.
11. Two Crystaionics FF102 Photofet transistors.
12. Fairchild  $\mu$ A703 integrated circuit described last month in the article "Semiconductors from A to Z."
13. RCA R3502 (IC201) integrated circuit described this month in two different articles.
14. G-E 2N167 germanium transistor.

## NO MORE GUESSWORK!



### AMERICA'S MOST RELIABLE TUBE ANALYZER

You don't need three guesses to tell if a tube is bad — or why. With the new Sencore MU140 Continental, you know. Right now. And you simply can't go wrong. Because it's a complete tube analyzer for 4-way testing — true mutual conductance (using exclusive 5000 hertz square wave), full cathode emission, 100 megohm grid leakage, and internal shorts. Tests all tubes, including foreign — over 3000 in all. Obsolescent-proof, too — with "new socket" panel, and controls so standard the switch numbers correspond to the pin numbers in any tube manual.

If it's reliability you want — for years to come — you need the Continental. It's the best way to be sure —

for only  
**\$179<sup>50</sup>**

See America's most complete line of professional test instruments — at your Distributor now.

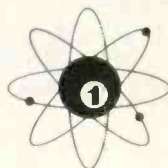

# SENCORE

NO. 1 MANUFACTURER OF ELECTRONIC MAINTENANCE EQUIPMENT

426 SOUTH WESTGATE DRIVE, ADDISON, ILLINOIS 60101

... for more details circle 125 on postcard



# NEW PRODUCTS

For additional information on any products in this section, circle the number on Reader Service Card. Requests will be handled promptly

## Marker Generator 700

Announced is a marker generator designed to superimpose well-defined, crystal-controlled ac or dc marks on an oscilloscope display of response curves. This instrument can reportedly



be programed to provide any desired fundamental frequency between 2 and 100MHz. The manufacturer indicates that proper choice and proper mixing will provide harmonic and sideband markings across a wide band width. Jerrold.

## Transistor Tester 701

Announced is an instrument designed to be used as a transistor and diode tester, wattmeter, ammeter and signal generator. It will reportedly also



function as an in-circuit tester and an ac and dc beta tester. The manufacturer indicates that the instrument can be used to determine whether a transistor is a PNP or NPN type. Price \$34.95. Semitronics.

## VTVM 702

A VTVM is announced that reportedly incorporates a 117v 50 to

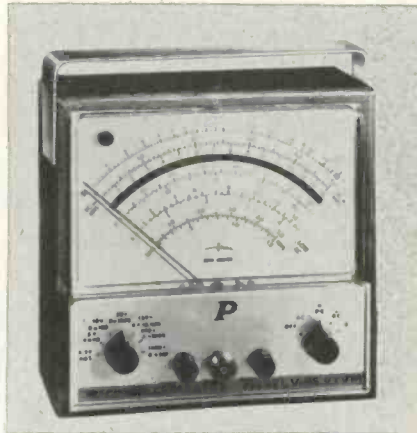

60Hz solid-state power supply to replace the batteries normally required in a VTVM's ohmmeter section. The manufacturer indicates that the instrument also includes a 7in. meter with mirrored scales to eliminate parallax, a single probe and a transit switch position for meter movement protection. The instrument is also designed to provide electronic protection against burnout. Specifications indicate that the dc scales are  $\pm 0$  to 0.5v, 1.5v, 5v, 15v, 50v, 500v and 1.5kv while the ac RMS scales are 0 to 1.5v, 5v, 15v, 50v, 150v, 500v and 1.5kv and ac p-p scales are 0 to 4v, 14v, 40v, 140v, 1.4kv and 4.0kv. The instrument reportedly has a frequency response of  $\pm 1$ db from 40Hz to 3MHz across a 600 $\Omega$  source on the 5v range. The VTVM has a rated accuracy of  $\pm 5\%$  full ac scale and  $\pm 3\%$  full dc scale. The instrument weighs 4½ lb and is housed in a walnut-grained vinyl-covered steel case. Size 7½ by 7¼ by 3½in. Price \$79.95. Precision.

## RF Signal Generator 703

Announced is an RF signal generator designed to cover 100 to 370kHz on Band A, 370 to 1400kHz on Band B, 1.4 to 5.1MHz on Band C 5.1 to 16MHz on Band D and 16 to 54MHz



on Band E. Specifications indicate that over these frequencies the instrument has an accuracy of  $\pm 0.5\%$  and is usable to  $\pm 0.1\%$  with a built-in 100kHz/1MHz crystal calibrator. A switchable meter reportedly shows RF carrier or modulation levels, while an individually shielded six-switch attenuator is designed for 21 levels to -96db. The manufacturer indicates that the instrument has a floating-type chassis-isolated oscillator and has tunable LC on every band for increased tracking capability. The instrument will reportedly operate on 110 to 130v, 50 to 60Hz. Kit price \$95. Allied.

## FET Volt/Ohm Meter 704

A field-effect transistor volt/ohm meter is announced that reportedly measures dc voltages from 0.1v full scale to kv full scale in nine increments and ac voltages from 0.01v full scale to 300v full scale in 10 steps.



When used as an ohmmeter, its resistance ranges are reportedly from 10  $\Omega$  center scale to 10M center scale. According to the manufacturer, the input resistance of the instrument as a voltmeter is 11M on all dc ranges; and when used as an ac voltmeter its input impedance from 10mv to 1v is 10M shunted by a 31pf capacitor, and from 3v to 300v its impedance is 10M shunted by a 30pf capacitor. Specifications indicate that the instrument has an accuracy within  $\pm 2\%$  full scale when measuring dc voltages and within  $\pm 3\%$  full scale when measuring ac voltages and resistances. Power reportedly is supplied by two 1.4v mercury cells and eight 1.5v AA zinc/carbon cells capable of lasting their shelf life when used under normal eight-hour-per-day working conditions. Specifications indicate that the instrument uses a single probe for both ac

and dc measurements. Size 9¼ by 6¾ by 5¾ in. Price \$99.95. Amphe-nol.

### CRT Tester 705

A CRT rejuvenator and tester is announced which reportedly incorporates continuously variable voltages for all CRT elements to safeguard against obsolescence of the test instrument. Specifications indicate that



this includes continuously variable metered heater voltage from 0 to 13v, G1 voltage from 0 to 100v and G2 voltage from 25 to 300v. CRT checks reportedly include leakage, shorts, open circuits, emission and useful-life checks of cathode emissive coatings. The manufacturer indicates that the instrument can be used to repair correctable conditions including removal of interelement shorts and leakage, and restoration of emission and brightness. The Tester is completely self-contained. Size 10½ by 11½ by 4½ in. Weight 4 lb. Operates on 117v 60Hz. Price \$89.95. B&K.

### Digital Voltmeter 706

Announced is a digital voltmeter that features automatic range selection and a display storage system. Specifications indicate that the in-



strument contains integrated circuits and an overload indicator is used to prevent erroneous readings. It measures 3¼ x 8¾ x 10 in. Price \$495. Electrolab.

### Test Lead Holder 707

A test lead rack designed to store patch cords and cable assemblies used in electronic testing is announced. The rack is designed to accept cables up to 0.450 in. which includes RG213/U, RG214/U and other coaxial cables. Mounting holes are provided for in-

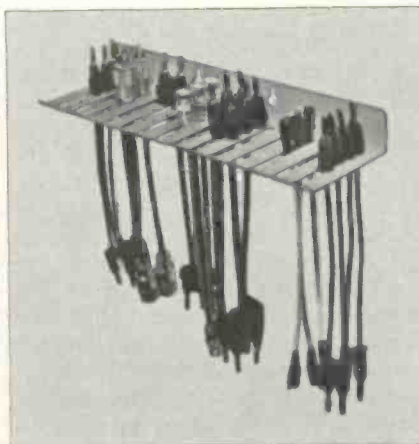

stallation on a vertical surface. The manufacturer indicates that the holder is fabricated from cold rolled steel and has a baked enamel finish. Net Price \$2.95. Pomona.

### Tube Tester 708

A tube tester is announced that is designed to make full emission, grid-leakage and short tests. Each tube is reportedly checked under full rated



load to find borderline types. The instrument features a horizontal in-line switch arrangement and reportedly has a 0.5µa grid-current sensitivity. Price \$74.50. Sencore.

### Power Supply 709

A solid-state power supply containing constant voltage and constant current modes is announced. It features a three decade digital potentiometer that reportedly has a 25mv resolution at 50v maximum output. Specifications indicate 0.01% line and load regulation, 100µv P-P ripple and a time stability of 0.002% during a full day. In the constant current mode, the power supply reportedly has an out-



put current of 1 to 500ma with 25µa ripple and 0.05% regulation at a compliance voltage of 0 to 50v. It is designed for 10G dc isolation and 0.5pf ac isolation from ac input to dc output. The manufacturer indicates that the zener reference and error sensing differential amplifier are housed in an oven that is designed to achieve a high degree of stability for as long as 30 days. Price \$275. Moxon.

### Tantalum Capacitors 710

A line of solid tantalum capacitors has reportedly been enlarged to include three different case sizes with a total of 41 ratings ranging from 0.0047µf @ 35wvdc to 68µf @ 2-

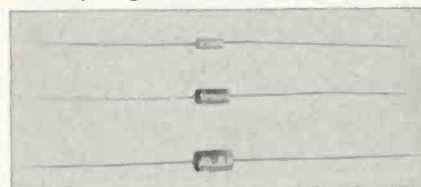

wvdc. The manufacturer indicates that the capacitors are of entirely dry construction and, therefore, can not leak electrolyte. According to specifications, the capacitors have an indefinite shelf life and will function properly when operated over a temperature range from -67 to +185°F. Components.

### Metal Shears 711

Miniature metal shears are announced for light electronic assembly work and repairs. Specifications indicate that these shears have a long



nose for working in tight spots, plus hot-forged, heat-treated, hollow ground blades for wire snipping and cutting .025-in. thick material. P & C Tool.



## NEW PRODUCTS

### CB Transmitter/Converter 712

A solid-state CB radio designed to provide motorists with two-way communications is announced. Specifications indicate that the set is a 12-chan-



nel, 5w transmitter/converter which receives in conjunction with a conventional AM car radio and antenna. With this combination unit installed in an automobile, a motorist can reportedly transmit emergency calls up to 10 miles and receive messages over his car radio receiver — tuned to 1505kHz. The manufacturer indicates that the transmitter/converter is no larger than the tuning head of the average push-button car radio, and draws no more current (on standby) than an electric auto clock. Specifications indicate that the Transmitter/converter is designed to operate on any 12v negative ground electrical system. Price \$69.95. Pace.

### AM/FM Radio/Tape Player 713

Announced is an AM/FM portable radio with a built-in tape player. It has a removable front panel for insertion of snap-in tape cartridges, each reportedly able to provide up to 90-min playing time. Specifications indicate that the radio/player is powered by five D size cells and weighs 6 lb. According to the manufacturer, it has AFC for FM tuning, a 4in. speaker, ferrous antenna for AM and telescopic antenna for FM. It also

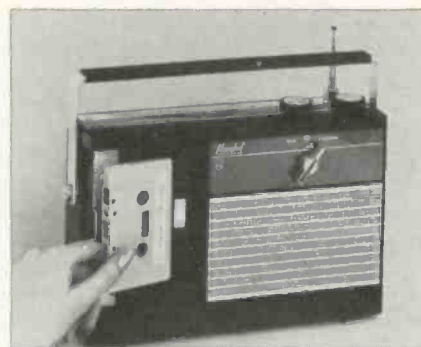

has outlets for earphone listening and for use with a car antenna. The radio/player measures 6 $\frac{5}{8}$  by 10  $\frac{3}{5}$  by 3in. and comes in a black case with chrome trim. List price \$119.95. Norelco.

### Stereo Amplifier 714

Announced is a silicon solid-state stereo amplifier with a rated IHF music power output of 70w and 50w with 4 or 8 $\Omega$  speakers, respectively. The manufacturer indicates that, by

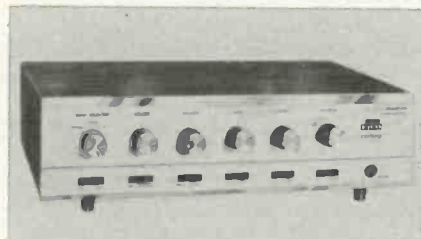

having eliminated output or interstage transformers, the amplifier has a frequency response of 5Hz to 100kHz  $\pm 1.5$ db with less than 0.8 percent harmonic distortion. The power bandwidth is reportedly from 10Hz to 40kHz. Kit price \$89.95. Wired price \$119.95. EICO.

### Dual Power Supply 715

Introduced is a dual power supply designed to provide two independent adjustable sources of 0 to 16v at



500ma. The manufacturer indicates that these sources can be operated in series for 0 to 32v, or opposing for positive and negative voltages. Specifications indicate that the power supply has 25mv maximum regulation, 250 $\mu$ v RMS maximum ripple and 0.3 $\Omega$  output impedance. Price \$59.95. Spar-Electrostatics.

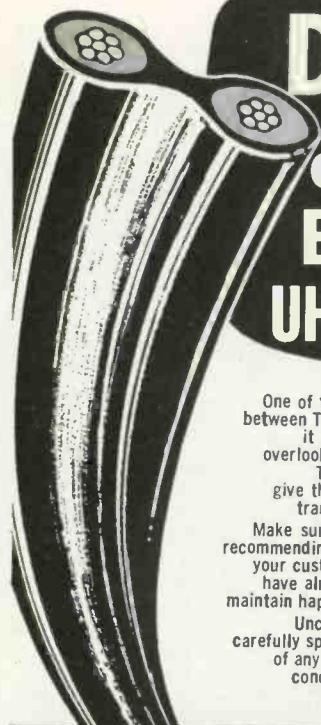

## DURAFOAM<sup>®</sup> Helps Your Customers Enjoy the BEST-LOOKING UHF/VHF & COLOR TV

One of the most critical links in the chain of electronic components between TV broadcast and reception is the antenna lead-in cable. Since it isn't a glamour component, the transmission cable is often overlooked in checking out the customer's set for better reception. This is a serious matter. Even the finest TV receivers won't give their full potential if they are dependent upon old or inferior transmission cable.

Make sure your customer is getting the full potential of his set by recommending and installing Durafoam cable on every sale. Both you and your customer will be glad you did. Over 18 million feet of Durafoam have already been used to help electronic technicians establish and maintain happier customer relations. Under U.S. patent number 3219752.

Unconditionally warranted for 15 years, Durafoam features two, carefully spaced tubes of yellow foam polyethylene for lowest signal loss of any UHF/VHF channel. The outer protective jacket separating the conductors is specially compounded, with high molecular weight, black, polyethylene insulation.

Impedance of the cable is 290 ohms and nominal capacitance is 4.9. Attenuation per 100 feet is 1.04 DB at 100 MC., 3.5 DB at 500 MC and 4.5 DB at 900 MC. Cable size is .410 wide, .150 over foam polyethylene tubes. Available in 500 and 1,000 ft. spools and 50, 75 and 100 foot coils with terminals at one end. Order from your distributor! Write for complete information today!

*Columbia*

WIRE PRODUCTS CO.

2850 IRVING PARK RD. CHICAGO, ILLINOIS, 60618

... for more details circle 110 on postcard

# EXTRA POWER

with

# FINCO

## AMPLIFIERS

*For perfect color TV and  
FM Stereo Reception*

**FINCO MODEL #65-4**  
Antenna Amplifier  
\$47.95 list VHF-TV  
Two-transistor Antenna  
Amplifier for 75 OHM  
Downlead, and power  
supply with built-in  
single or dual 300 ohm  
outputs. Provides 12  
dB gain in the low band  
and 14 dB gain in the  
high band.



**FINCO MODEL #65-1**  
Distribution Amplifier  
\$29.95 list 2-tube 4-  
output VHF-TV or FM  
Distribution Amplifier  
for 300 OHM Opera-  
tion, providing 8 dB  
gain at each 300 ohm  
output to feed home or  
commercial systems.

**FINCO MODEL #65-5**  
Distribution Amplifier  
\$44.95 list VHF-TV 75  
OHM Single Outlet Dis-  
tribution Amplified for  
deluxe home or com-  
mercial use to feed  
multiple sets through  
line tap offs or split-  
ters. Delivers 17 dB  
Low Band and 14 dB  
High Band.

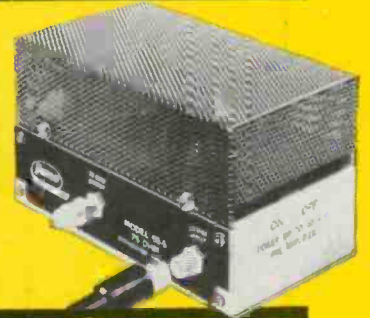

**FINCO MODEL #65-2**  
Distribution Amplifier  
\$39.95 list 2-tube 4-  
output VHF-TV or FM  
Distribution Amplifier  
for 75 OHM CO-AX  
Operation, providing 6  
dB gain at each 75 ohm  
output to feed deluxe  
home or commercial  
systems.

**FINCO MODEL #65-6**  
Amplifiers \$79.95 list.  
VHF-TV Antenna Mount-  
ed two-transistor pre-  
amplifier with 75 OHM  
two-tube Single Output  
Distribution Post-am-  
plifier up to 30 dB gain  
for improved reception.  
Used in home or com-  
mercial installations to  
feed multiple sets.



**FINCO MODEL #65-3**  
Antenna Amplifier  
\$44.95 list New VHF-  
TV Antenna Amplifier  
and Power Supply with  
built in single or dual  
outputs to improve re-  
ception of weak signals  
in fringe areas. Pro-  
vides 12 dB gain in the  
low band and 14 dB  
gain in the high band.

**FINCO MODEL #65-7**  
FM Signal Amplifier  
\$24.95 list. One-tran-  
sistor Indoor Behind-  
the-set FM amplifier  
with a passive filter in-  
put circuit to reject sig-  
nals outside the FM  
band which cause in-  
terference. Delivers 20  
dB Gain.



### Sets "COME ALIVE" with Brilliant Sound and Color

A Finco high-gain, low-noise amplifier  
will bring in the sharpest **COLOR** or  
B & W TV picture and the finest sound!

**All FINCO Products are Engineered  
For Color!**



Write for Color Brochure #20-411.

**THE FINNEY COMPANY**

34 W. Interstate Street • Dept. 110 • Bedford, Ohio 44146



# NEW PRODUCTS



**Tape Recorder 716**  
A four-track, solid-state tape recorder is announced that reportedly produces 3w of peak power on a matched pair of six-in. wing speakers. The swing-out speakers can be removed from their hinges for greater separation. Specifications indicate that the 3¼ and 7½ ips tape-speeds are

controlled by capstan drive, and that the frequency response at 7½ ips is 50Hz to 15kHz with a s/n ratio of 145db. The manufacturer indicates that the cabinet is a walnut grain finish on polystyrene. Price \$129.95. G-E.

**Bolt Buster 717**  
A tool is designed to remove rusted nuts without damaging bolts or studs. The manufacturer indicates that it exerts 25,000 lb of pressure on a chisel

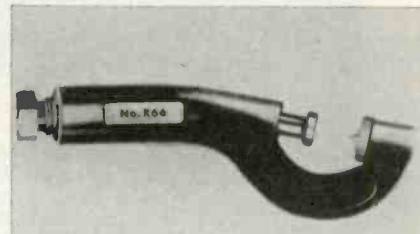

point, splitting the flat of a rusted or frozen nut without need of a hammer. The tool is reportedly made of forged steel with ball thrust bearings for minimum effort in removing bolts. Price \$9.95. Roycraft.

**Cartridge Tape Player 718**  
Announced is a new eight-track stereo, solid-state cartridge player with inputs for phonograph, AM/FM tuner, or another tape recorder. The manufacturer indicates that the cartridge

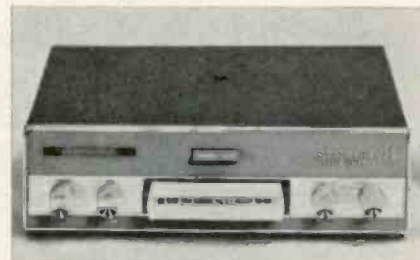

player automatically switches to the next track at the end of the program or it can be changed manually with a simple push button switch. Housed in a walnut cabinet with matching speakers, the player is reportedly fully transistorized. Price \$139.95. Tele-Tone.

**Tape Recorder 719**  
A cartridge tape recorder is announced which is designed to operate not only as a cordless portable tape



recorder but as a foot controlled dictating machine. An optional adapter is available for ac recorder operation or for recharging the batteries. 3M.

**Who put a new "twist" on speaker design?**

the **Troubador** Model TSW-8S

## Argos of course!

- Distinctive contemporary "art frame" styling.
- Mounts square or in modern diamond position.
- Argos' famous "Speedy Mounting Clips" cut labor—hangs like a picture.
- New dual-cone, full-range 15-watt speaker for superb music or voice. 8 ohms impedance.
- Hand-rubbed Antique Birch or Dusk Walnut finish. Argos quality construction throughout.
- Neutral-color Belgian linen grille cloth.

If it's crafted by ARGOS . . . it'll stay sold.

**Argos**  
PRODUCTS COMPANY

600 So. Sycamore, Genoa, Illinois 60135

. . . for more details circle 102 on postcard

# Pull in more profits with Jerrold VUfinder® Antennas

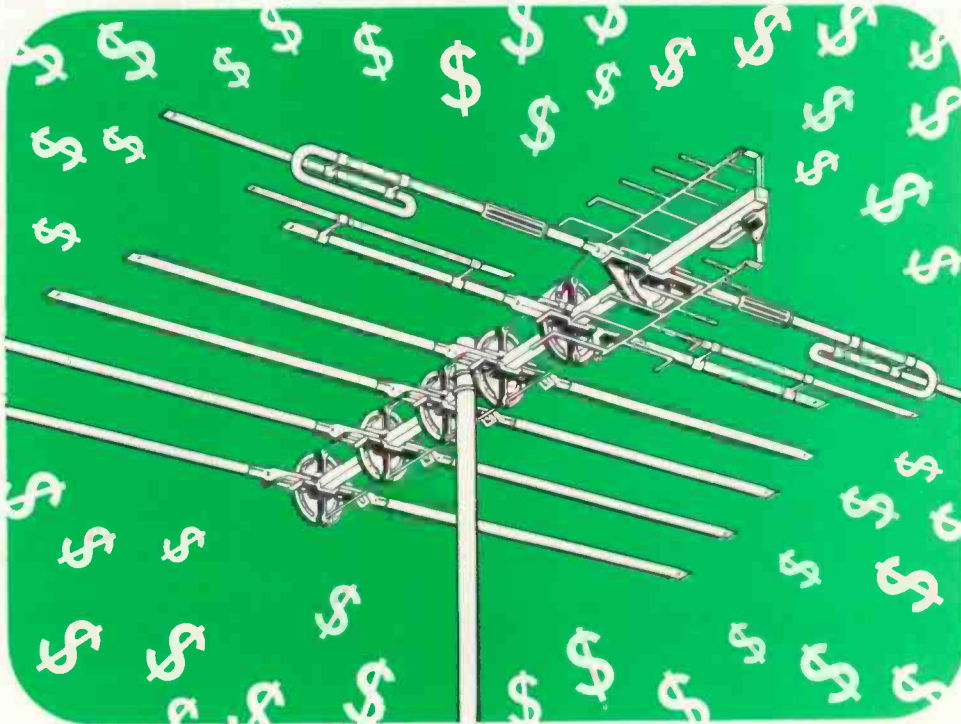

Now—a line of antennas designed to deliver quality performance without eroding your profit margin. The Jerrold VUfinder 82-channel Antenna line. Perfect for bringing you the best in VHF, UHF color and black and white, plus FM reception:

- Excellent front-to-back ratio eliminates interference
- Unusual flatness assures greater color fidelity
- Sharp directivity eliminates ghosts, picks up strong, clear

signals—even in difficult reception areas

- Tough, all-weather construction of vibration-proof, point-contact element locks, rugged Cyclocac insulators and twist-resistant boom
- All parts snap into place—anywhere—on the ground or on the roof

In short, all the benefits of the Jerrold Colorpeak line—plus UHF—are available with Jerrold VUfinders.

Compact, rugged, easy to install, Jerrold VUfinders come in five models ranging between \$17.95 and \$79.95 List.

The VUfinder line is one of a complete spectrum of problem-solving Jerrold reception aids—Pathfinder, Paralog Plus, and Colorpeak antennas... Powermate pre-amplifiers, amplified-couplers, and splitters... coaxial cable, wall outlets, and wall plates. Get more details. See your Jerrold distributor, or write for our new catalog.

Swing  
with

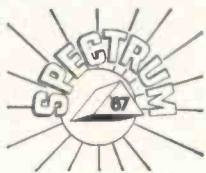

*Focusing on one thing...  
better reception*

... for more details circle 115 on postcard



# BELL *Carillon*

an economical  
standard amplifier  
with a full complement  
of deluxe features . . .

- Continuous audio taper gain control on each input channel.
- Master gain and separate bass and treble controls.
- 70 volt (500 ohm) line output.
- 4-8-16 ohm speaker outputs.



Carillon Amplifiers in  
10-20-23-35-75 Watt Models.

plus plug-in accessories  
for converting to  
the most sophisticated  
applications . . .

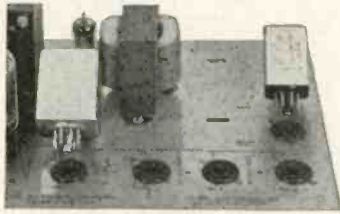

- Plug-in transformer converts microphone channels to low impedance.
- Plug-in transformer converts program channel to 600 ohm line.
- Plug-in relay provides for paging from remote microphone.

Write for complete Spec-Data sheets on the Carillon line and new Bell Commercial Sound Equipment Catalog.



**BELL P/A PRODUCTS CORP.**  
1209 N. Fifth St. Columbus, Ohio 43201

. . . for more details circle 105 on postcard

## NEW PRODUCTS

### Portable PA System 720

Announced is a 4w, transistorized, public address system which measures 9 x 8 x 3½ in. and operates on eight

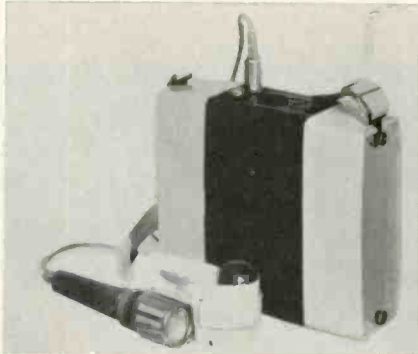

flashlight batteries. The 4-lb unit includes a directional cardioid microphone with wind screen. Net price with shoulder strap and batteries included, \$99.95. American Geloso.

### Two-Way Speaker 721

Announced is a wide-angle paging and talk-back speaker. Specifications indicate it has a frequency response of



250Hz to 13kHz, a power rating of 30w and dispersion angles of 120 deg. by 60 deg., when operated as a speaker. As a microphone, it has a reported sensitivity of -23dbm. Oxford.

### Nine-Pin Test Adapter 722

A nine pin novar color test adapter, designed for measuring the cathode current of 6JE6 and 6KM6 horizontal output tubes, is introduced. The unit

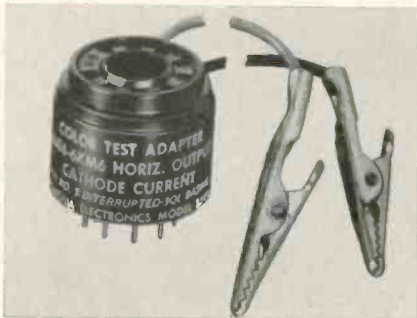

provides alligator clip test leads running from the interrupted No. 3 pin of the adapter. When the test adapter is installed between tube and tube socket, a technician can measure cathode current and adjust the circuit to operate within specifications. Net price \$3.75. Pomona.

### Chisel Sets 723

A 12-piece punch and chisel set is announced, which includes four different sizes of pin punches, a center



punch, a machine drift punch, three cold chisels, a diamond point chisel, cape chisel and round nose cape chisel. Krauter.

### FM Receiver 724

Announced is a silicon, solid-state FM/stereo receiver with a reported IHF sensitivity of 1.8µv. The receiver's amplifier is rated at 80w, music power,

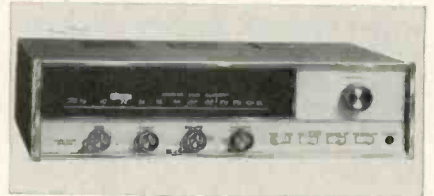

across a 4Ω load. Inputs are provided for a phonograph and auxiliary equipment. The receiver measures 16½ x 12 x 4½ in. Sherwood.

### High-Capacity Connector 725

A connector is introduced for applications requiring multiple circuit

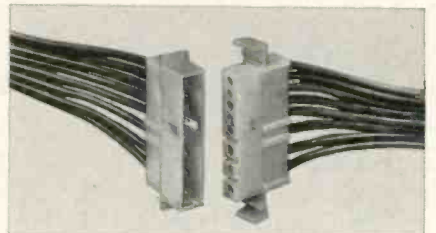

connections in a space where several circuits require high voltages. The unit features eight circuits in a flat nylon housing. Molex.

## SEMICONDUCTORS . . .

continued from page 58

sistor Q9 would vary from 2.9 to 3.1v under these conditions. The voltage drop across resistor R<sub>E</sub> would vary from ¾ to 3v ( $V = IR, 2\text{ma} \times 375\Omega = 2 \times 10^{-3}\text{a} \times 375\Omega = 0.750\text{v}, 8\text{ma} \times 375\Omega = 3.00\text{v}$ ). The voltage drop across transistor Q<sub>E</sub> would then vary from 3.45 to 1.00v [Since the voltage source equals the sum of the voltage drops in the circuit,  $V_{CC} - (V_{Q9} + V_{RE}) = V_{QE}, 7.1\text{v} - (2.9\text{v} + 0.75\text{v}) = 3.45\text{v}, 7.1\text{v} - (3.1\text{v} + 3.00\text{v}) = 1.00\text{v}$ ].

The 2.9 to 3.1v change in collector-to-emitter voltage across transistor Q9 occurred as the collector current varied from 2 to 8ma. This change would correspond to a 33⅓Ω effective resistance ( $R = \frac{\Delta V}{\Delta I} = \frac{3.1\text{v} - 2.9\text{v}}{8\text{ma} - 2\text{ma}} = \frac{0.2\text{v}}{6\text{ma}} = 33\frac{1}{3}\Omega$ ). If the transistor used as transistor Q9 has a greater beta or steeper base-to-emitter voltage vs base current curve, the effective resistance would be reduced and there would be a smaller fluctuation in voltages as the current varied.

Although we see a relatively large variation in voltages across transistor Q<sub>E</sub> and resistor R<sub>E</sub>, the voltage drop across transistor Q9 remains nearly unchanged, and as the voltage across transistor Q<sub>E</sub> and resistor R<sub>E</sub> changes, their total voltage remains nearly the same.

The function of the voltage regulating transistor may be more clearly seen in the circuit shown in Fig. 13. There a variable resistor R<sub>E'</sub> is substituted for transistor Q<sub>E</sub> and resistor R<sub>E</sub> in Fig. 11. When the value of the resistor (R<sub>E'</sub>) is 2.1K, 2ma of current flows through the resistor and transistor (Q9). This results in a 2.9v drop in potential across transistor Q9 and a 4.2v drop in potential across the resistor ( $2\text{ma} \times 2.1\text{K} = 2 \times 10^{-3}\text{a} \times 2.1 \times 10^3\Omega = 4.2\text{v}$ ). When the value of the resistor (R<sub>E'</sub>) is reduced to 500Ω, 8ma of current flows through the resistor and transistor. This results in a 3.1v drop in potential across the transistor and a 4v drop in potential across the resistor ( $8\text{ma} \times 500\Omega = 4\text{v}$ ). Although the value of the load resistor (R<sub>E'</sub>) has varied from 2.1K to 500Ω, the voltage regulating transistor has permitted the

voltage drop across the resistor to vary only from 4.2v to 4v.

If the characteristics of transistor Q9 are the same as those shown in Fig. 12, and its base is biased as shown in those curves, then the circuit shown in Fig. 6 is equivalent to that shown in Fig. 14. Transistor Q9 has the effect of providing a negative voltage source (We have been assuming in this series that voltage sources have no resistive elements.) of 3.0v, which reduces the 7.1v supply potential

to 4.1v, with a 33⅓Ω effective resistance.

When using a resistor (R6) to reduce the supply voltage (Fig. 10), an inverted signal is developed across the resistor (R6) that may neutralize the signal across resistor R5, which is to be amplified. The inverted signal developed (Fig. 14) across the effective resistance (R<sub>E</sub>) of transistor Q9 is much smaller than the signal developed across resistor R5, and the reduction in the ladder signal is insignificant.

# stability!



In one word, STABILITY is why you need a new Sencore CG141 Color King. With its exclusive thermostatically controlled heating element and its patent pending timer circuitry, the Color King maintains absolute stability from 20° below zero to 140° in the shade. Gives you the most reliable and rock solid patterns ever designed into a standard color bar generator.

Now-generates seven patterns in all: Standard RCA color bars, cross-hatch, individual vertical and horizontal lines, adjustable size dots plus two new patterns—single dot and cross that can be moved to any spot on the screen to speed up dynamic convergence. New snap tuning, channel 2 through 6; Interlace control to form a perfectly round dot; and increased chroma and sync signals make the color king a complete color analyzer too.

Get yours now — the KING OF VALUE at **\$149<sup>95</sup>**



See America's most complete line of professional test instruments — at your Distributor now.

## SENCORE

NO. 1 MANUFACTURER OF ELECTRONIC MAINTENANCE EQUIPMENT

426 SOUTH WESTGATE DRIVE, ADDISON, ILLINOIS 60101

... for more details circle 126 on postcard



## BOOK REVIEWS

**PRINCIPLES OF RF POWER AMPLIFIERS.** *Written and published by Techpress, Inc., 120 pages, soft cover. \$1.95.*

We are living in a time when nearly everyone involved in electronics is interested in semiconductor circuits — even if some tube circuits still perform certain tasks better. Apparently, as a result of the pressure for additional publications in this field, this pub-

lisher has again allowed one of its books to show a transistor circuit on the cover when there are no transistor circuits discussed in the book. (In *ELECTRONIC TECHNICIAN'S October 1966 review of PRINCIPLES OF ELECTRONIC OSCILLATORS* we indicated that a similar misrepresentation was made.) The book may, however, be of some value to technicians interested in RF power tube amplifiers. These amplifiers are discussed in considerable detail and should be easily understood by anyone having a basic understanding of electronics and simple algebra.

**HOW TO MAKE ADVERTISING WORK.** *By Burton R. Burkee. Published by McGraw-Hill Book Co., 234 pages, hard cover. \$6.95.*

Too frequently dealers in their attempt to expand their business fail to make an effective use of advertising. Although the author has not written specifically about using advertising to improve the sale and service of TV sets, the principles covered can be effectively applied to this area of the electronics field. The book does contain an interesting, easily read approach to good advertising that should improve any service-dealer advertising program. The reader may develop many important ideas and questions from having read the book. Advertising can give the service shop a bad reputation by promising better service than it can deliver. The effect can be the same as if the product were all bad. Does your advertising contain a style that will identify you even if your name was omitted? Does it reassure your customers that they have reason to remain loyal? Many American companies have the practice of spending half their corporate net profit on advertising. Check the effectiveness of your advertising by offering something which is absolutely irresistible — such as one slightly used color-TV set for \$178 (the promotion may be worth the financial loss on one sale), or make an attention-getting mistake in your advertisement — such as listing a colorless-TV set. In either case the response to the offer or error should indicate how much attention is given your advertisements. Sales can also be helped with “two-stage” advertising designed to promote followup action.

**RCA RECEIVING TUBE MANUAL.** *Written and published by Electronic Components and Devices Div. of RCA, 608 pages, soft cover. \$1.25.*

The major portion of this book (389 pages) contains technical data describing receiving type tubes. In many cases characteristic curves are included with these specifications. Also included is a section (94 pages) describing electron tube theory and related circuits. The last portion of the book contains schematics and descriptions for 30 electron tube circuits — ranging from an ac/dc radio to a CB transceiver and a B/W TV receiver. The book may be helpful to an experienced technician who is repairing a receiver without a schematic. It appears, however, to have been written mainly for either apprentice technicians who need to improve their fundamental knowledge of electron tubes and tube circuits, or the designers of electronic equipment.

## Major Breakthrough in TV Accessories... NEW from Mosley!

In response to your requests, Mosley introduces a completely NEW ‘profit building’ line of TV accessories for use with shielded and other types of twin lead cables on the market!

These solderless receptacles, line splicers, 2 and 4 set couplers, clamp the line securely so it can't pull out! Assure peak performance, especially for color. Eliminate call backs. Help simplify the cable lead-in job... for a compact, time saving installation.

Stock up now and watch your sales climb! Send for complete details.

Write: Dept. 145

**Mosley Electronics, Inc.**

4610 N. Lindbergh Blvd., Bridgeton, Mo. 63042



... for more details circle 118 on postcard

# Customers wear out the Yellow Pages getting to Jackson's

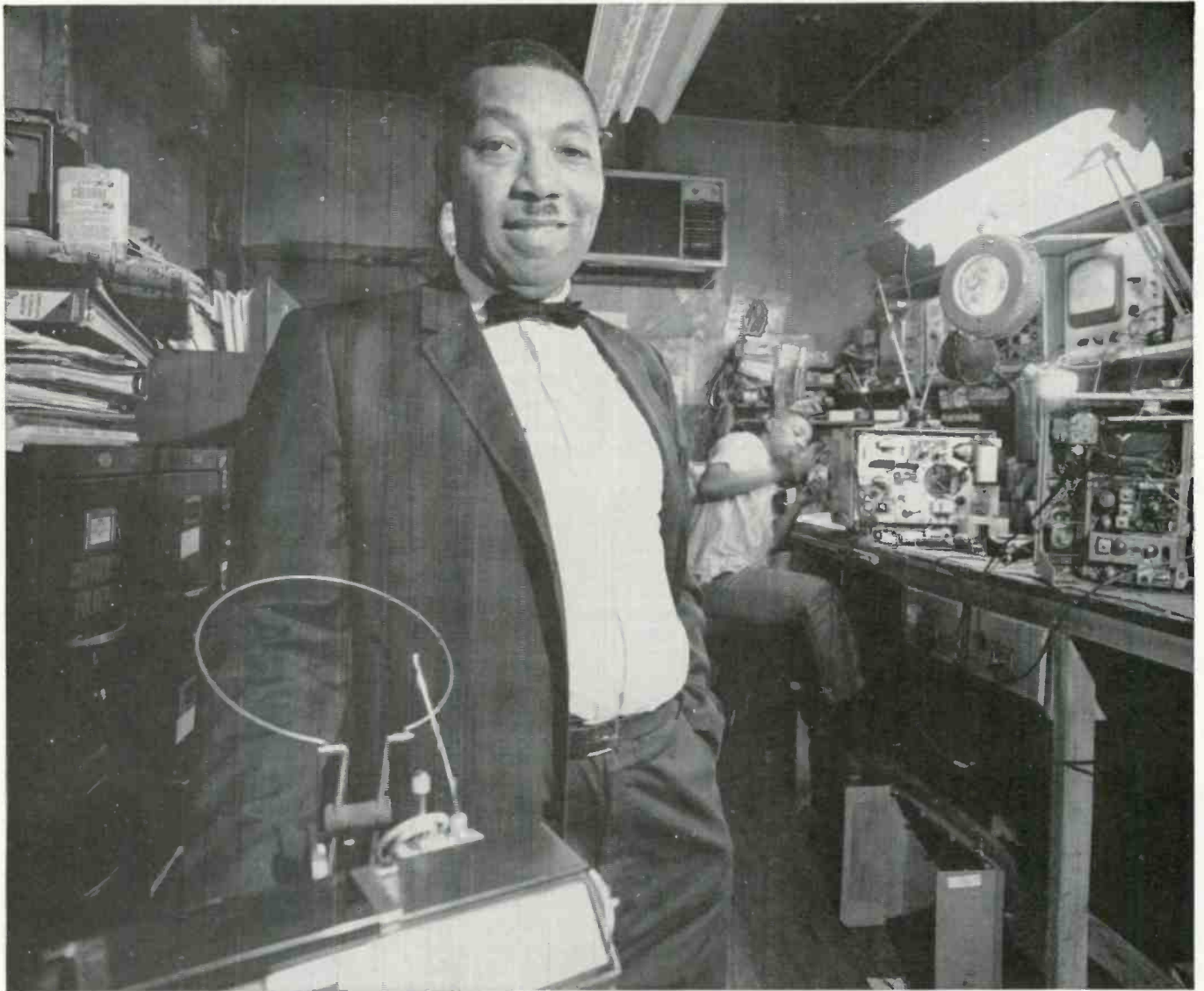

**"I've had nothing but success with the Yellow Pages,"** says Russell Jackson, owner, Jackson's Radio & Television Service, Philadelphia, Pa. "Our ad there not only identifies us as reliable and established, but also serves as a reference for customers we've served in the past. I've found they turn to the Yellow Pages when they've forgotten our phone number or address. That's more important than anything else. Even after people have been recommended to call us, they still look us up in the Yellow Pages. The phone numbers in our ad ring regularly for service or information."



Advertise for action...

**PHILCO** "SERVING THE PUBLIC OVER 35 YEARS"

**JACKSON'S  
RADIO & TV SERVICE**

COLOR TELEVISION  
ALL MAKES SERVICED

4 TRUCKS TO SERVE YOU

**ZENITH**  
THE QUALITY OF TELEVISION

**Kingsley 5-1516  
5-1775**  
JACKSON'S RADIO & TELEVISION SERVICE

**OLYMPIC**  
SERVICING TELEVISION  
1715 SOUTH ST.

RCA  
"His Master's Voice"  
SALES  
WE REPAIR  
ALL MAKES  
24 HOUR  
ANS. SERVICE

Today's customers wear out the Yellow Pages instead of themselves. This ad, under TELEVISION SERVICING, leads them to Jackson's. Call your Yellow Pages man to plan your program. Find him in the Yellow Pages under ADVERTISING — DIRECTORY & GUIDE.



**OXFORD**  
The Full Line

**Commercial Sound  
Speaker Source...**



You never compromise with fidelity or quality when you specify Oxford on all your speaker needs.

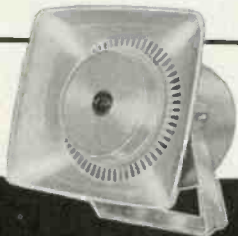

That's because Oxford electronic and sound engineers know that specialized applications require specialized developments. Oxford doesn't produce just horn or cone types, Oxford studies the application and the problem develops specific units for specific needs. You're never stuck with trying to pour a bushel basket into a pint measure. Paging and talk-back horns, outdoor hi-fi systems, P.A. systems and other commercial sound installations all find the perfect speaker for the system at Oxford.



Match your skills with the Oxford line of speakers that bring out the best in every sound installation. Write for the Oxford catalog of "speakers for every purpose" today!

**OXFORD TRANSDUCER  
COMPANY**  
A Division of  
Oxford Electric Corporation

3911 S. Michigan Ave.  
Chicago, Ill. 60653

## NEWS OF THE INDUSTRY

### ITT and ABC Reject Merger Position Of FCC and Justice Dept.

International Telephone and Telegraph Corp. and American Broadcasting Co. have charged that the Anti-trust Div. of the Dept. of Justice and the Broadcast Bureau of the Federal Communications Commission had "strikingly failed" to develop any creditable evidence against the proposed ITT/ABC merger.

The companies said that the department and the bureau had instead resorted only to "sweeping charges" that wholly ignored the facts and the basic questions of public interest inherent in the merger.

The companies' position was contained in rebuttal filings submitted to the FCC as part of the hearing procedure concerning the proposed merger, which was concluded with oral arguments before the full commission on June 1, 1967.

### G-E Recalls TV Sets

General Electric has announced a program to modify some of its large-screen color-TV sets. This program is being carried out on a national basis and should be completed by July 31.

The modification involves the replacement of the regulator tube and adjustment of the power supply. Quality control tests indicate that some of the sets produced between June 1966 and February 1967 emit soft X-radiation in excess of desirable levels. The picture tube is not involved. Although nationally recognized radiological health experts have reportedly confirmed the company's preliminary claim that emissions have not been sufficient to cause harm to viewers, approximately 90,000 of these models are to be checked. G-E's service representatives are contacting customers who purchased these specific models since last June and will make the modification without charge at the customers' convenience. Owner identification is being achieved through the mobilization of the company's entire distributor-dealer organization.

### Two Companies Develop New High-Power Cells

A D-size rechargeable sealed silver-zinc cell for industrial and consumer products has been announced by Yardney Electric Corp. The company indicates that the cell under load pro-

duces a nominal potential of 1.5v with more than 2½ times the energy density of a D-type nickel-cadmium cell. Specifications indicate that the new cell has a 5.3 a/hr capacity at 2a drain, contains 8.0 w/hr of energy and has an energy density of 32 w/hr/lb.

At 125°F these cells will reportedly operate at 100 percent of their capacity while yielding more than 75 percent of their capacity at 32°F. Yardney indicates that the price for a small quantity of these cells ranges from \$6.60 to \$9.60 each.

A battery has also been developed by General Electric at the request of the U. S. Marine Corps to produce electrical power from thin magnesium sheets and oxygen from the air, using salt water as an electrolyte. In this battery a porous cathode promotes the reaction of oxygen in the air with the water in the electrolyte and the magnesium electrode to produce an electric current. Magnesium hydroxide (milk of magnesia) is formed as a by-product.

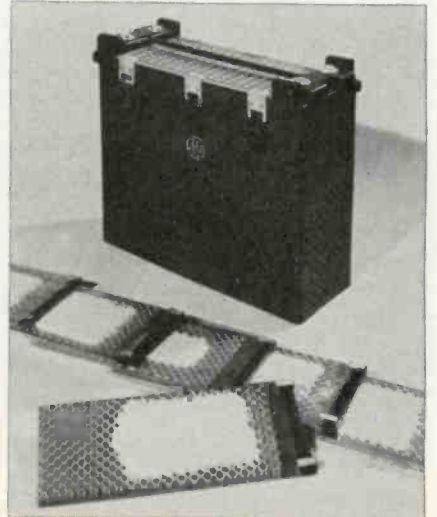

Specifications indicate that the new system produces an energy density of 50 w/hr/lb of battery weight or about five times the energy density of the average lead-acid battery.

The new power source can reportedly be refueled in about 15 minutes by removing the used magnesium anodes, emptying out the magnesium hydroxide sediment, inserting 23 commercially available magnesium plates, and adding a handful of salt and any available water.

The porous air cathodes are not consumed in the reaction, but eventually deteriorate after repeated use. These cathodes, however, may be replaced one-at-a-time, as necessary. G-E indicates that the batteries have been tested for 30 refills or nearly 400 hours use, without requiring replacement of the air cathodes. They estimate that in actual field use, cell life may be extended to 1000 hours.

... for more details circle 120 on postcard

# This Revolving Tool Caddy

## FREE

When you buy  
RCA SK-Series  
Transistors and Rectifiers—  
The Industry's Leading  
Replacement Line

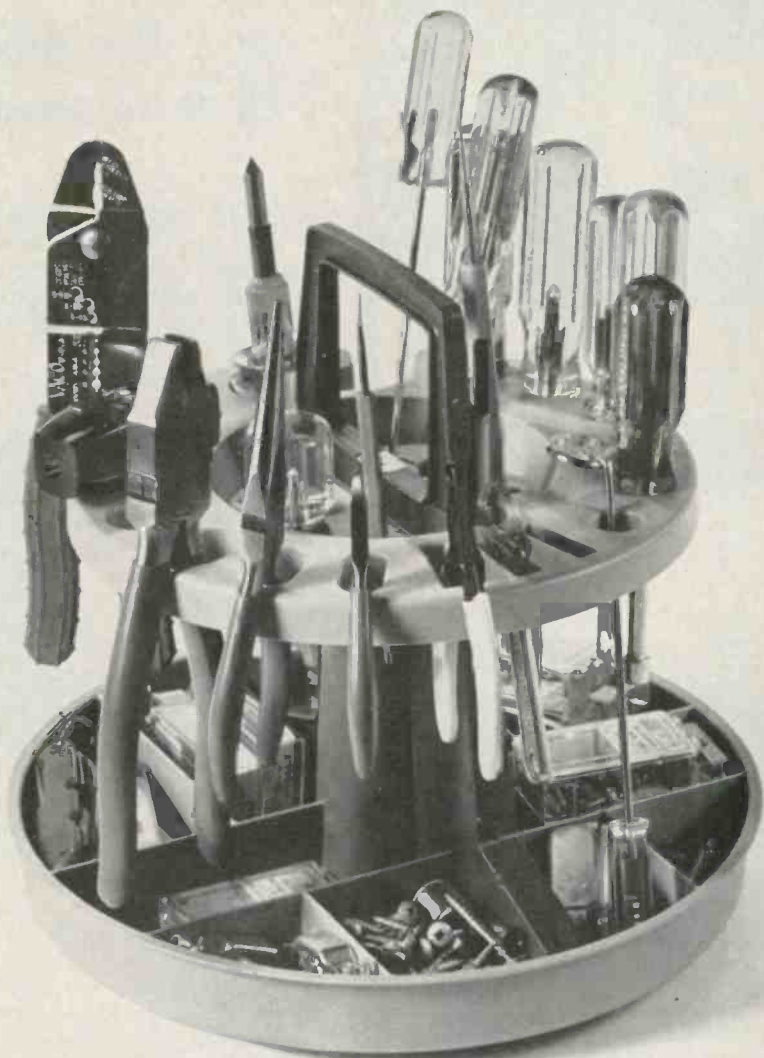

Tools and Parts not included with caddy

Here's just the tool caddy you've always needed to keep handy around the shop or home work benches. It's Rubbermaid's portable caddy that keeps tools and small parts organized and always at hand. Made of high-impact styrene and designed to revolve on eight ball bearings as a "lazy susan," the caddy is yours free—with the purchase of RCA SK-Series replacement devices from your participating RCA Distributor.

Drop by your RCA Distributor today. He has all details. Act now. Pick up your supply of the RCA SK-Series replacements and take home this brand new tool caddy as well—free—from your participating RCA Distributor.

AVAILABLE THROUGH YOUR PARTICIPATING RCA DISTRIBUTOR

RCA Electronic Components and Devices, Harrison, N.J. 07029



The Most Trusted Name in Electronics

... for more details circle 122 on postcard



RCA's carton-packed  
SK-Series "Top-of-the-Line" replacements

include 19 transistors, 2 rectifiers and 2 integrated circuits that can replace more than 9,000 solid-state devices. Cross-referenced in the RCA Solid-State Replacement Guide against both domestic and foreign types, these 23 top performing RCA types can help solve most solid-state replacement problems for experimenters, hobbyists, hams and technicians. Check your RCA Distributor for the SK-Series Replacement line and the replacement guide.



**COMPLETE TUNER OVERHAUL**



**9.95**

**ALL LABOR AND PARTS**  
(EXCEPT TUBES & TRANSISTORS)\*



**COLOR TUNERS** GUARANTEED COLOR ALIGNMENT — NO ADDITIONAL CHARGE

Simply send us the defective tuner complete; include tubes, shield cover and any damaged parts with model number and complaint. Your tuner will be expertly overhauled and returned promptly, performance restored, aligned to original standards and warranted for 90 days.

UV combination tuner must be single chassis type; dismantle tandem UHF and VHF tuners and send in the defective unit only.

Exact Replacements are available for tuners unfit for overhaul. As low as \$12.95 exchange. (Replacements are new or rebuilt.)

And remember—for over a decade Castle has been the leader in this specialized field... your assurance of the best in TV tuner overhauling.

**CASTLE**  
TV TUNER SERVICE, INC.

5713 N. Western Ave., Chicago 45, Illinois  
41-92 Vernon Blvd., Long Island City 1, N. Y.

For service in Canada write to Chicago or use reader service card in this magazine.  
\*Major parts are charged extra in Canada.

... for more details circle 106 on postcard

**Our policies are your best insurance:**



Sonotone has been the reliable, quality name in replacement phono cartridges since 1947. We've made and sold 20 million of them. When you service with Sonotone cartridges, you can be assured you are servicing with the best. *We'll stake our name on that.*

REPLACE WITH SONOTONE CARTRIDGES. There's a complete line for immediate replacement of virtually every cartridge in use today. Prove it to yourself — fill out and mail coupon TODAY for your free copy of Sonotone's 1967 "computer-programmed" cartridge replacement manual.

Send today for complete information:  
Sonotone Corporation, Dept. 107  
Elmsford, New York 10523

Just fill out and mail this coupon for your free copy of Sonotone's 1967 "computer-programmed" cartridge replacement manual.

YOUR NAME \_\_\_\_\_  
ADDRESS \_\_\_\_\_  
CITY \_\_\_\_\_  
STATE \_\_\_\_\_ ZIP \_\_\_\_\_

... for more details circle 127 on postcard

**NEWS**  
**OF THE INDUSTRY**

**Sylvania Announces New CRT**  
Sylvania's Electronic Tube Div. has announced a high-resolution one-gun, two-color information display tube for commercial, industrial and military applications.

The tube uses a red, "rare earth" Europium activated phosphor and a

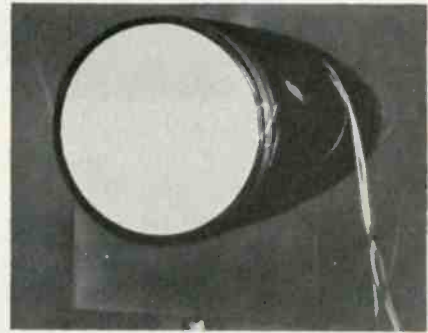

green phosphor to provide the information displays. The two phosphor layers are separated by a barrier layer. By switching the final anode voltage, the intensity of the electron beam is controlled to excite the first phosphor layers, creating a second color. High-speed voltage switching produces a two-color display that reportedly appears continuous to the observer.

Since the new tube does not have a shadow mask or combination phosphor dot pattern common to entertainment color-TV tubes, greater brightness and finer resolution is possible.

**Corning Cuts Price of 'Standard' 12 in. Bulbs**

Corning Glass Works has announced a reduction in the price of "standard 12in. TV CRT bulbs to \$2.75 each, plus about 22 cents for packing material. At the same time the company increased prices of other 12in. bulbs as part of a campaign to standardize these bulbs. It was said that the new price and standardization are designed to help encourage U.S. manufacturers to produce a small B/W TV set weighing less than 10 lb and priced at \$50 to meet future Japanese competition.

**EIA First-Quarter Sales Figures**

According to figures released by the Electronic Industries Assn. (EIA), color-TV sets, portable and table phonographs again showed sales increases at the distributor level in March.

Color-TV sets sold to dealers to-

taled 491,078, up 20.2 percent over the March 1966 number. This brought the year-through-March sales figure up to 1,161,461, or 23.3 percent above the 1966 performance for the same period.

Portable and table phonograph sales attained 313,529 units in March, an increase of 28.7 percent. This rise resulted in a first-quarter distributor sales total of 834,805 units, 21.2 percent above the 1966 initial three-month figure.

The figures for other electronic items were not so bright. The 1967 B/W TV distributor sales total at the end of March stood at 1,369,895, or 30.9 percent off from the comparable 1966 total. Console phonograph sales were down 22.1 percent, home radios declined 18.8 percent, FM radios declined 8.3 percent and auto radios sales were down 11.6 percent.

**Electronic Assn. Plans Hi Fi Show**

The 1967 New England Hi Fi & Stereo Show will be held at the Parker House in Boston, Mass., Nov. 17-19. The weekend event is sponsored by the New England Chapter of the Electronic Representatives Assn.

**RCA Enters Roadside Call-Box Market**

RCA's first push-button electronic warning system will be installed in the village of Park Forest, Ill., a suburb of Chicago. It is designed to enable motorists or "Good Samaritans" to notify a central dispatcher of a breakdown or accident merely by pressing a button on any one of a series of emergency call boxes located at intervals along a major highway.

This system is identical to those now being installed along the 40-mile Atlantic City Expressway in New Jersey and the 42-mile Maryland portion of the Capital Beltway, 196, around Washington, D.C.

The call boxes are wholly self-contained radio stations incorporating miniature, solid-state transmitters with a range of approximately 25 miles without need of a repeater. They stand on aluminum poles bolted to a concrete base and are powered by batteries that are kept charged by solar cells.

Once a push-button system has been installed on a highway, it can also be used, with minor modification, to accomplish a host of other tasks including the transmission of traffic flow information on a regular basis, the manipulation of electronically activated signals warning of accidents or fog, the detection of ice or the reporting of visibility conditions.

## Zener Diodes 400

A data sheet describes a line of zener diodes that reportedly use gold plated, pure nickel leads and are encapsulated in an alkyd-resin case with a tantalum heat sink. A diagram, rating table and characteristic curves are included. Semitronics.

## Test Instruments 401

A 12-page catalog describes a line of 23 test instruments. Included are CRT testers, color bar generators, scopes, meters, circuit analyzers, field-strength meters, tube testers, transistor diode testers and power supplies. Sen-core.

## FET Volt/Ohm Meter 402

A two-page product data bulletin provides detailed mechanical and electrical specifications for a 2½lb transistorized volt/ohm meter. The illustrated bulletin describes how dc voltages, resistance and ac RMS value measurements are made with a single selector switch knob controlling all ranges and functions. Triplet.

## Photoelectric Systems 403

A 12-page catalog illustrates a line of miniaturized light sources and photo units. It also describes a line of related amplifier modules. Photomation.

## Test Instruments 404

A line of test instruments including tube testers, socket adapters, transistor testers, meters, signal generators, tracers and scopes is described in an 8-page bulletin. Hickok.

## Nut and Screwdriver Kits 405

A bulletin describes a 14-piece, multi-purpose roll-up tool kit of nut and screw drivers designed to fit in a hip pocket. Xcelite.

## Electronic Equipment 406

A 116-page catalog includes a line of VHF communications receivers, stereo Hi-Fi equipment, CB 2-way radios, tape recorders, ham gear, test instruments, TV receivers, tools and accessories. Lafayette.

## Components 407

A 24-page replacement parts catalog is divided into five sections with an index on the front cover. The catalog provides information on composition and wirewound controls, rotary- and lever-action switches, ceramic, polystyrene and miniature

electrolytic capacitors and packaged electronic circuits. The catalog also contains specifications, dimensions and application data. Centralab.

## Power Supplies 408

A bulletin lists a complete line of power supplies having a range of 1 to 28vdc. It contains complete specifications, mechanical dimensions, pictures and prices. Plug-In Instruments.

## Power Outlet Boxes 409

Pre-wired power outlet boxes are described in a 12-page, 2-color booklet. In addition, the booklet describes solid-state motor speed controllers, in-

strument carts and carriers and a number of replacement parts and accessory items. Waber.

## Steel Equipment 410

More than 500 items including benches, cabinets, service carts, shelving, stands and lockers are described in a 48-page catalog. Penco.

## Soldering Equipment 411

An eight-page catalog lists an assortment of electric soldering equipment ranging from offset miniature soldering irons to soldering pots and a wattage controller. Electric Soldering Iron.



**CHAN NEL LOCK**  
*No. 910 GripLock*

**The Portable Vise  
You Can Carry In Your Pocket  
....And Operate with ONE HAND**

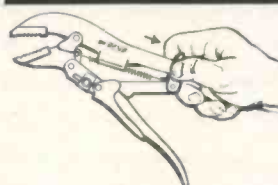

1 OPEN IT!

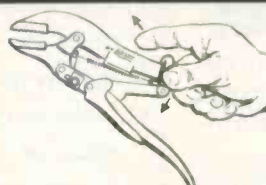

2 LET GO!

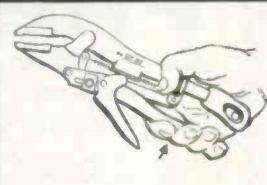

3 LOCK IT!

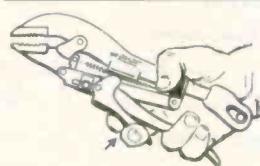

4 E-Z RELEASE!

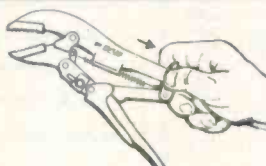

5 OPEN IT!

Easy, Fast,  
Efficient . . . . .  
And All with ONE HAND

Let us send you a copy of our  
catalog, no charge.

TOOLS BY  
**CHAN NEL LOCK**  
MEADVILLE, PA.

... for more details circle 107 on postcard



We offer You  
nothing but  
finer, faster,  
Precision  
Tuner  
Service!...



(Period)

VHF-UHF  
\$7.95

+parts & shpg.

Why pay for parts you don't need?  
Mail coupon now for free information!  
**PRECISION TUNER SERVICE**

...one of the OLDEST and LARGEST TV tuner repair firms in the world!  
Box 272E Bloomington Indiana 47401

Firm \_\_\_\_\_  
Name \_\_\_\_\_  
Title \_\_\_\_\_  
Address \_\_\_\_\_  
City \_\_\_\_\_ St. \_\_\_\_\_ Zip \_\_\_\_\_

... for more details circle 133 on postcard

## ELECTRONICS DATA GUIDE

Conversion Factors and Constants  
Equal Resistors in Parallel  
Resistors in Parallel, General Formula  
Sinusoidal Voltages and Currents

**ABSOLUTELY FREE**  
Over 40 Electronics Formulas on a Single Shirt-Pocket Guide!

Want to save the trouble of "looking it up"—or avoid the risk of remembering inaccurately—every time you need electronics data? Send for our pocket-sized Electronics Data Guide. Gives you everything from conversion factors and constants to color codes—and much more! Durable plastic for lifetime use. A "must" for men interested in electronics—provided as a service by CIE. Get your FREE Guide today. Just fill out the coupon below...then cut out on the dotted lines and mail to Cleveland Institute of Electronics, 1776 E. 17th St., Cleveland, Ohio 44114.

Name \_\_\_\_\_ (Please Print)  
Address \_\_\_\_\_  
City \_\_\_\_\_  
State \_\_\_\_\_ Zip \_\_\_\_\_

904

... for more details circle 109 on postcard

## CATALOGS AND BULLETINS

### Electronic Components 412

A 52-page catalog describes a wide assortment of electronic components including batteries, capacitors, resistors, potentiometers, switches, timers, vibrators, rectifiers, diodes and related hardware. Mallory.

### Alerting Receivers 413

A four-page bulletin describes three tone-activated receivers for 25 to 54MHz or 148 to 174MHz reception. It describes the various ways these receivers can be tone activated. Plectron.

## ADVERTISERS' INDEX

American Telephone & Telegraph Co.....	71
Amphenol Distributor Div. ....	38
Argos Products Co. ....	66
Astatic Corp. ....	26
B & K Div., Dynascan Corp. ....	2nd Cover
Bell P/A Products Corp. ....	68
Castle TV Tuner Service ....	74
Channellock, Inc. ....	75
Channel Master Corp. ....	30-31
Cleveland Institute of Electronics ....	76
Columbia Wire Products Co. ....	64
Cornell-Dubilier ....	3rd Cover
Enterprise Development Corp.....	76
Finney Co. ....	65
GC Electronics Co. ....	22
Jerrold Electronics Corp. ....	67
Mallory Distributor Products ....	25
Microflame, Inc. ....	34
Mosley Electronics ....	70
Multicore Sales Corp. ....	76
Oxford Transducer Corp. ....	72
Philco-Ford ....	20
Precision Tuner ....	76
Radio Corp. of America	
RCA Electronic Components	
& Devices ....	4th Cover, 33, 73
RCA Sales Corp. ....	27
Sarkes Tarzian Tuner Service Div. ....	19
Score, Inc. ....	32, 61, 69
Sonotone Corp. ....	74
Sprague Products Co. ....	23
Vaco Products Co. ....	34
Xcelite, Inc. ....	24
Zenith Sales Corp. ....	29, 37

Save Time  
on PC Board  
Repairs!



MODEL 100A

Melted solder disappears up hollow tip into tube

The ENDECO Desoldering Iron Removes Soldered Components in seconds... without damage!

Endeco melts solder, then removes it by vacuum • Leaves terminals and mounting holes clean • Resolders too • One-hand operation • Temperature controlled for continuous use • Ideal for use with shrinkable tubing • 4 tip sizes • Quickly pays for itself in time saved • Only \$18.75 net.

SMALLER SIZE AVAILABLE. SEE YOUR DISTRIBUTOR OR WRITE:



ENTERPRISE DEVELOPMENT CORPORATION

5123 E. 65th • INDIANAPOLIS, IND. 46220  
IN CANADA: A. C. Simmonds & Sons, Ltd.,  
100 Merton St., Toronto 7

... for more details circle 112 on postcard



WORLD'S  
FINEST  
5-CORE  
SOLDER

ERSIN  
MULTICORE  
NEW EASY  
DISPENSER  
PAK ONLY 69¢

BUY IT AT RADIO-TV PARTS STORES

MULTICORE SALES CORP. WESTBURY, N.Y. 11591

... for more details circle 119 on postcard

ELECTRONIC TECHNICIAN

# NO REWARD THE EXACT KID



Be on the lookout for the Wide Ranger. He represents CDE's wide-range electrolytic program in the TV serviceman's never ending fight for easier, faster, more profitable service calls.

It doesn't pay you to go looking for the Exact Kid—any Exact Kid.

The Wide Ranger's 200-plus replacement electrolytics do the job of the Exact Kid's thousands. So your distributor always has the wide range electrolytic you need, in stock.

That's why everybody calls the CDE **WIDE RANGER\*** a Good Guy.

**CDE** CORNELL-DUBILIER





## A PRIMARY COLOR MISSING?

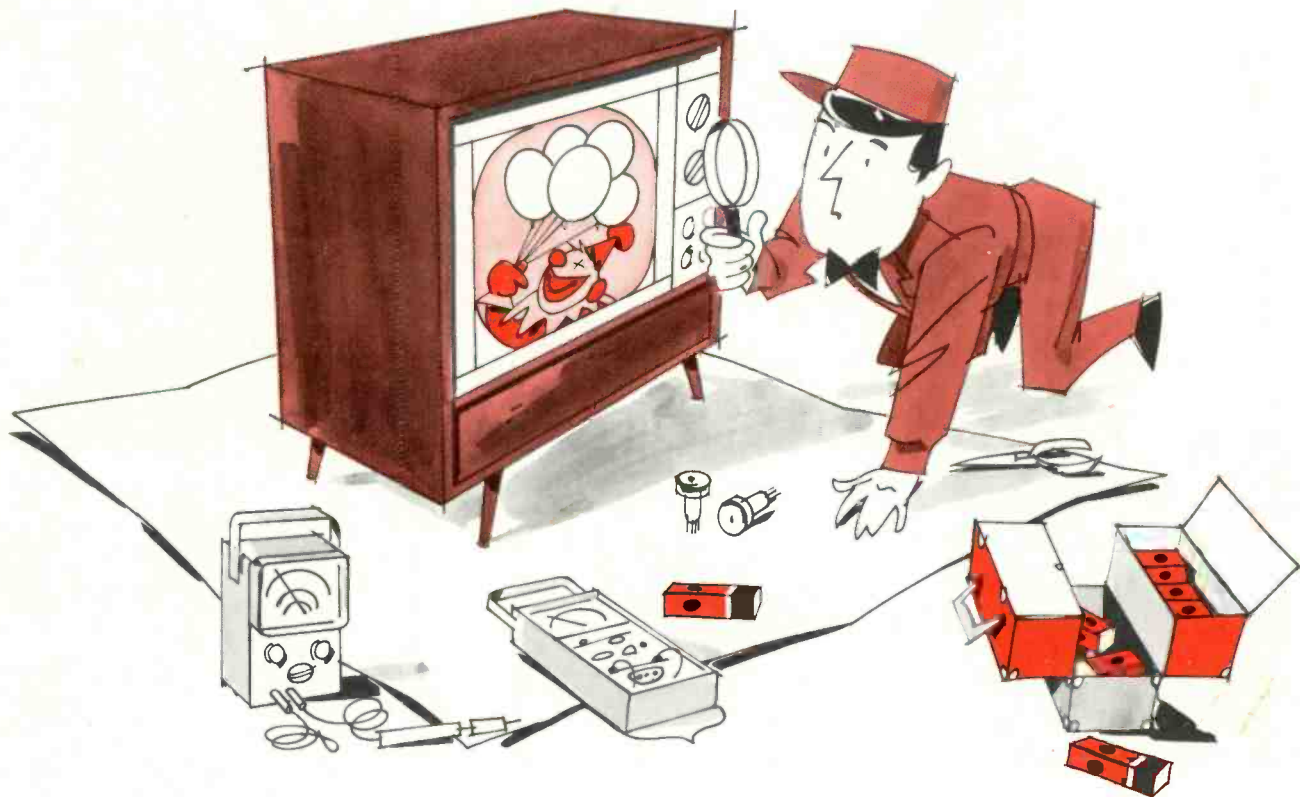

If the color picture lacks one of the primary colors, use this procedure to localize the trouble:

Switch the set to an unused channel. If the raster is tinted, follow procedure A. If the raster is normal, follow procedure B.

### PROCEDURE A (Color raster)

1. Make sure gray-scale tracking controls are set correctly.
2. Check and/or replace color-amplifier tubes. Remember that:  
white minus blue = yellow  
white minus red = cyan  
white minus green = magenta
3. If tubes are okay, measure tube-pin voltages with a VTVM or VOM. Use a tube-socket test adapter to avoid pulling the chassis.
4. If voltages are correct, use an RCA WT-115A Color Picture Tube Tester to check emission of the picture-tube guns.

### PROCEDURE B (Normal raster)

1. Check and/or replace color-demodulator tubes. Note: If you suspect a faulty demodulator tube, interchange the demodulators; a faulty tube is indicated by a shift in colors in a color picture or bar pattern.
2. If tubes are okay, measure tube-pin voltages with a VTVM or VOM. Use a tube socket test adapter to avoid pulling the chassis.
3. If any voltage is incorrect, use conventional circuit troubleshooting methods to isolate the defect.

Your RCA tube distributor is your best source for top quality RCA receiving tubes for color TV, black and white TV, radio, and hi-fi. Increase customer confidence. Always replace with RCA receiving tubes.

RCA ELECTRONIC COMPONENTS AND DEVICES, HARRISON, N. J.



The Most Trusted Name in Electronics