

WORLDWIDE & COUNTRY DISS



Servicing Foreign Radios

50¢

ASSURED ELECTRICAL ACCURACY

BASED ON MANUFACTURERS' PROCUREMENT PRINTS

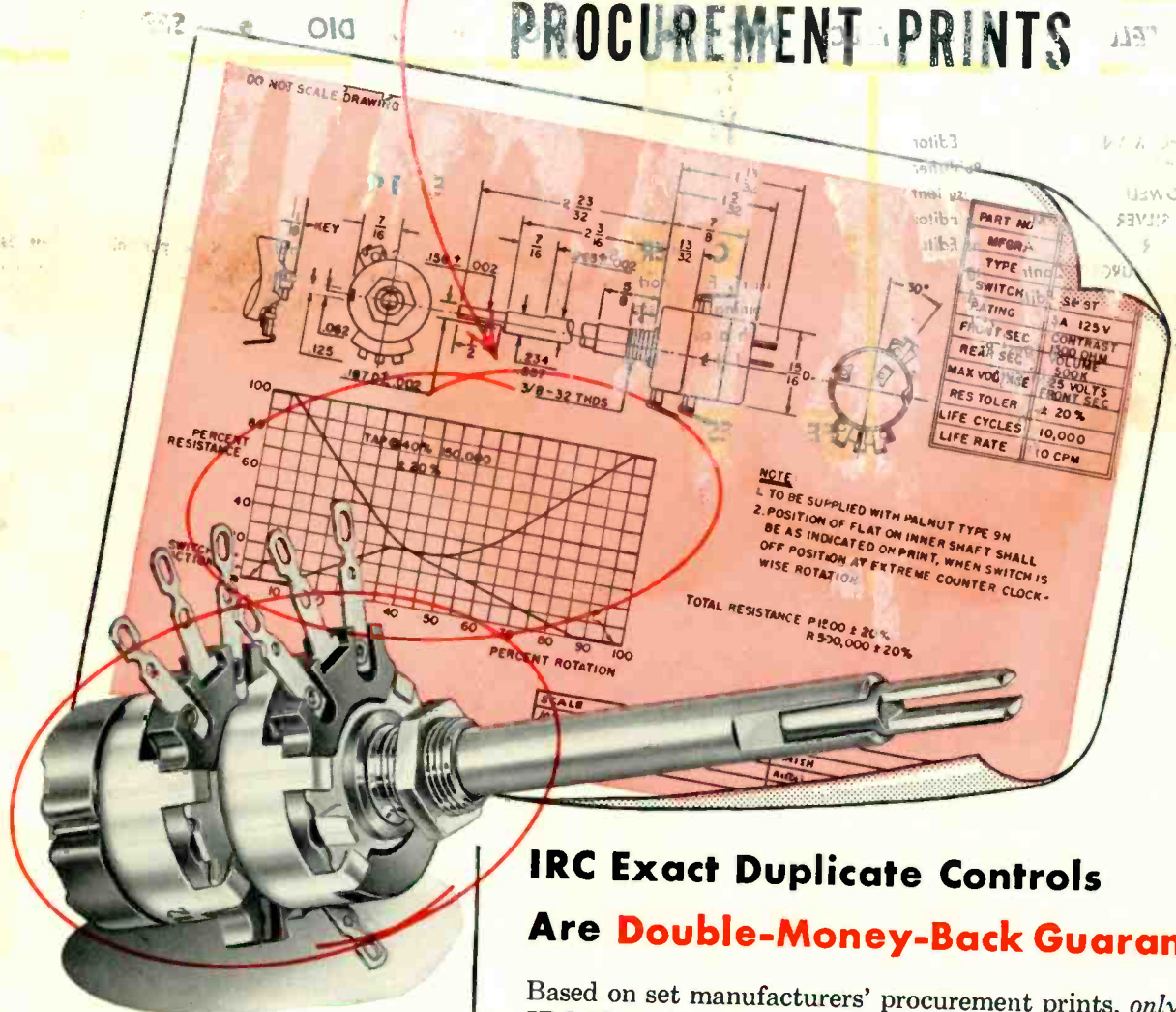

ONLY IRC GUARANTEES ACCURATE ELECTRICAL OPERATION AND SATISFACTORY MECHANICAL FIT OR DOUBLE-YOUR-MONEY-BACK

Electrical specifications of this typical manufacturer's procurement print are exactly duplicated by IRC's QJ-412 control (shown). CONCENTRIKIT assembly includes P1-206 and R1-223 shafts with B17-109 and B13-133X Base Elements and 76-1 Switch.

IRC Exact Duplicate Controls Are Double-Money-Back Guaranteed

Based on set manufacturers' procurement prints, *only* IRC Exact Duplicate Controls are double-money-back guaranteed for accurate electrical operation. This firm guarantee applies to both IRC factory-assembled Exact Duplicates *and* universal CONCENTRIKIT equivalents.

Set manufacturers' electrical specifications are closely followed.

Resistance values are carefully selected to match.

Tapers are watched carefully; IRC doesn't arbitrarily substitute tapers to obtain wide coverage.

For exact duplicate controls of guaranteed accuracy, specify IRC. Most Service Technicians do.



Wherever the Circuit Says ~~~

INTERNATIONAL RESISTANCE CO.

Dept. 573, 401 N. Broad Street, Philadelphia 8, Pa.

In Canada: International Resistance Co., Ltd., Toronto, Licensee

TECHNICIAN & Circuit Digest

TELEVISION • ELECTRONIC • RADIO • AUDIO • SERVICE

ALBERT J. CROMBIE, Editor
 COLDWELL-CLEMENTS, Publisher
 O. H. CROMBIE, Editorial Consultant
 SIDNEY C. SILVER, Managing Editor
 S. SPANHAUSER, Assistant Editor
 J. L. TOUTENBURGH, Contributing Editor
 ANNE GUTHRIE, Editorial Assistant
 CHARLES F. DREYER, Advertising Director
 ELMER KETTERER, Circuit Digest Production
 GEORGE PUGLICI, Circuit Diagrams

JUNE, 1956

FRONT COVER increase they offer such features in tube-model or portable versions as Hi-F, FM, short wave, and jacks for easy phono installation, European-made sets are becoming increasingly popular here. If you had to service one, would you know what to do with a canned selenium bridge, an ECC81, or an accumulator? No trouble at all after you've read the article on page 28.

BUSINESS DEPARTMENT

480 Lexington Ave., New York 17, N. Y.
 Telephone PLaza 9-7880

H. A. REED, General Sales Manager
 BERNARD BLOCK, District Manager
 MARSHALL FAILLACE, District Manager
 PAUL CARNESE, Business Manager
 M. H. NEWTON, Asst. Publisher
 N. McALLISTER, Asst. Business Manager
 A. O'ROURKE, Production Manager
 W. TAYLOR, Asst. Production Manager
 JOHN J. BORGHI, Controller
 A. H. POND, Asst. Controller
 W. W. SWIGERT, Credit Manager
 M. SOKOL, Circulation Records

P. H. DEMPERS, District Manager
 201 N. Wells St., Chicago 6, Ill.
 Telephone RAndolph 6-9225

CHRIS DUNKLE & ASSOCIATES
 California Representative

3257 W. 6th Street, Los Angeles 5, Calif.
 Telephone DUnkirk 7-6149

3077 Turk St., San Francisco 18, Calif.
 Telephone EXbrook 2-0377



TECHNICIAN & CIRCUIT DIGESTS, June 1956, Vol. 63, No. 6. \$50 a copy. Published monthly by Coldwell-Clements Co. Publishers also of MART including Price-Fax. Publication office, Emmett St., Bristol, Conn. Editorial, advertising and executive offices, 480 Lexington Avenue, New York 17. Telephone PLaza 9-7880.

Entered as second class matter at the Post Office at Bristol, Conn., June 10, 1954. Subscription rates: United States and Canada, \$4.00 for one year; \$6.00 for two years; \$8.00 for three years. Pan-American and foreign countries: \$7.00 for one year; \$10.00 for two years; \$14.00 for three years. Copyright 1956 by Coldwell-Clements Co., New York. Title registered in U. S. Patent Office. Reproduction or reprinting prohibited except by written authorization of publisher. Printed in U.S.A. by Hildreth Press, Inc., Bristol, Conn.

FEATURES and ARTICLES

Your Servicing Future; New Publishing Record (Editorials) 25
 "Tuning in the Picture" 26
 How to Service Foreign Radio Receivers Richard Sequerra 28
 Generator and Scope Alignment "Bugs" Robert G. Middleton 30
 Road to Service Profits "Whitey" Brayer 32
 Eliminating Vertical Retrace Lines M. G. Goldberg 34
 "Tough Dog" Corner D. Ivanditto, F. Maderaski, F. Nichols 37
 Dipole Orientation Problems A. R. Clawson 38
 Let's Look at Circuits: The Amplifier at Work Sidney C. Silver 39
 New Antennas & Accessories 41
 New Semiconductors 42
 New Electronic Products 43
 Shop Hints L. Williams, D. Valentine, S. Elliot, H. Herman 44
 New Audio Products 46

DEPARTMENTS

Editor's Memo 4 Association News 11
 Letters to the Editor 8 Catalogs & Bulletins 20
 News of the Industry 12 New Books 22
 Reps & Distributors 14 Calendar of Coming Events 27
 New Products 40

CIRCUIT DIGESTS 57

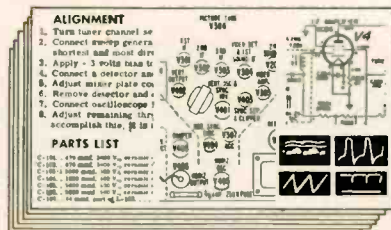

IN THIS ISSUE

CROSLEY: TV Chassis 484, 484
 EMERSON: TV Chassis 120292-P, -V, 120,299-V, 120293-T, -X, 120300-X
 HOFFMAN: TV Chassis 321, 322
 MONTGOMERY WARD: TV Models WG4011B, etc.
 RADIART: Antenna Rotor Model TR-2
 RCA VICTOR: TV Chassis KCS100B

Always insist on

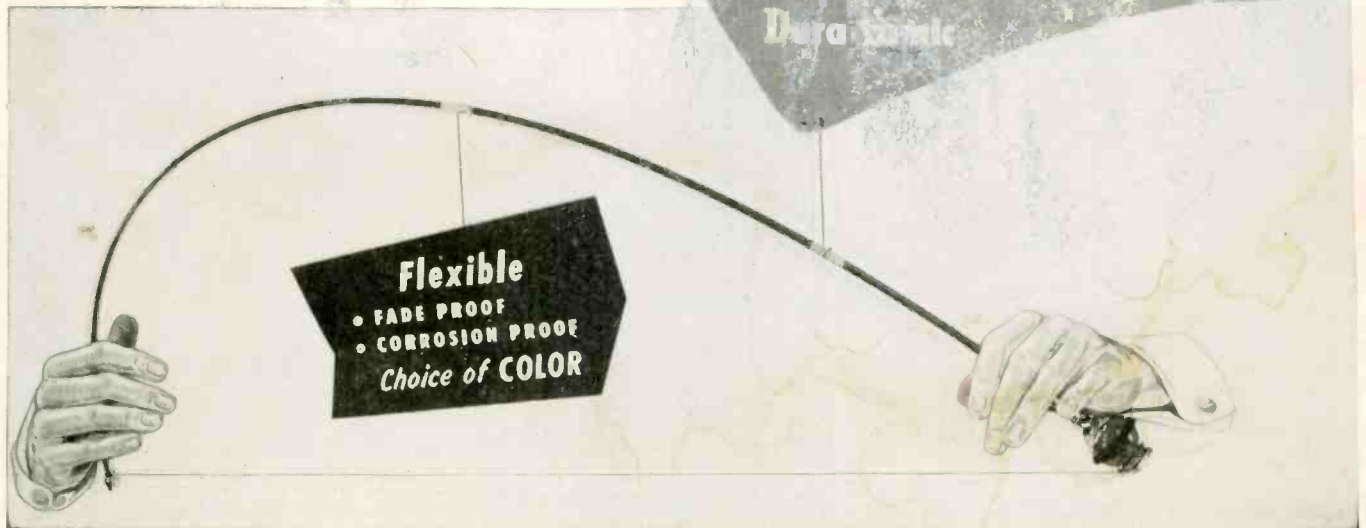

WARD AUTO AERIALS...

for:

- ★ Top quality
- ★ Customer acceptance for over 20 years
- ★ Reliable performance
- ★ Easiest installation

For every radio installation you make, a WARD AERIAL tops it off with the most dependable, acceptable and popular antenna you can buy... yet it costs no more than an ordinary aerial.

Here's the *complete* top-quality line for every requirement:

- EIGHT BALL—ever-popular favorite
- MAJORETTE—the economy model
- PHANTOM—disappearing antenna
- TWIN REAR MOUNT—midget 8-ball twins
- MIDGET PHANTOM—twin rear mounts
- SKY QUEEN—smartly styled side mount
- LONG RANGER—longer, for extra signal
- CONTINENTAL—flex-angle side mount for all foreign cars
- DURA-RAMIC®—the original Fiberglas aerial in full colors to complement the car. Can't fade, rust, warp, break or corrode.

Order your WARD AERIALS now. Keep a few on hand all the time. Keep your customers satisfied with the... *World's Finest!*

WARD

PRODUCTS CORPORATION
DIVISION OF THE GABRIEL CO.

1148 EUCLID AVE. • CLEVELAND 15, OHIO



It's easier to sell CBS

Silver Vision

the
"High-Fidelity"

Aluminized Tube

Your customer is aware that Hi-Fi does sound better . . . that it faithfully reproduces the original sound. And you can prove by demonstration that advanced-engineered CBS Silver Vision tubes can do for video what Hi-Fi does for audio.

You know Silver Vision's aluminization . . . silver-activated phosphors . . . and small-spot gun can accomplish this. But technical details do not interest the lady. She does appreciate Silver Vision's sparkling whites . . . deep blacks . . . and wide range of middle gray tones. She likes the way they can be blended to give her truly high-fidelity reproduction of the telecast picture.

Here's a tube whose performance sells it. And Garry Moore makes it still easier by convincing your women customers over the CBS Television Network: "There are no better tubes made than CBS tubes, the tubes with the Good Housekeeping Guaranty Seal." Sell the easy way, follow Garry's lead. Sell CBS Silver Vision . . . the "high-fidelity" aluminized picture tube.

Always show her the CBS carton with the Good Housekeeping Guaranty Seal.



CBS-HYTRON, Danvers, Massachusetts
A Division of
Columbia Broadcasting System, Inc.

Editor's Memo

"Empathy" is a wonderful word. The dictionary defines it as "mental entering into the feeling or spirit of a person or thing; appreciative perception or understanding." It's a kind of tuning-in to other people's thoughts and feelings, and lucky is the fellow who has this ability in full measure. He can deal with customers, boss, employees or fellow workers without strain or pain.

Perhaps the best way to develop empathy is to ask yourself how you would honestly feel were you in the other fellow's boots. The word empathy is generally applied to human beings, but one of my friends, an on-the-ball TV tech, claims he has empathy for TV receivers. At least that's what he tells his customers. (I'm never quite sure when this guy's pulling my leg.) When a housewife asks: "How did you know this was the bad part?" he replies, "I ask myself, 'If I were a television set and I couldn't stop my vertical rolling, what part of me would be ailing?' If I can't feel the trouble, my test equipment answers me."

Of course, to repair TV sets you don't need empathy (although it's most helpful in getting new customers and keeping old ones). Logic and experience will do the job quite nicely, thank you.

One tech I heard of was a bit shy on both of these qualifications. On a no-pix no-sound house call during the day he proceeded to test practically all the tubes in the series string. All checked OK, and he was about to pull the set when it dawned on him to check the wall outlet ac voltage. Dead. Fuse replacement in the house box was the cure. Moral: Take nothing for granted.

The greatest limitation on logic is the fact that many, perhaps most, people see what they want to see. There are folks who will swear the Ford is the best car ever built, and the Chevy is a dog. The next fellow will be just as vehement, except he'll swear it the other way around. Which is probably why merchandisers prefer to sell the sizzle instead of the steak.

An anecdote which illustrates logic-blindness concerns an old professor who was demonstrating a revolutionary finding. He held a frog in one hand and said, "Jump."

The frog jumped into the prof's other hand. After repeating this several times, he took out a knife and cut off the frog's legs. Again he shouted, "Jump." The frog remained motionless.

He repeated the command several times, to no avail. A look of triumph crossed the old man's face as he gazed at the unmoving frog.

"You see," the old professor told the audience, "this proves that when you cut off the legs from a frog, it becomes deaf."

Al Forman

LOOK HERE

for the right Packaged Electronic Circuit

Centralab's Free P.E.C.* Guide No. 3

- ◊ Lists 130 radio and TV manufacturers and their P.E.C. applications — showing part identification, manufacturer's part number, and Centralab catalog number.
- ◊ Tells how you can easily test Centralab P.E.C.'s with a VOM and a simple 60-cycle capacitor bridge.
- ◊ Shows schematics that guide you in using P.E.C.'s to replace entire sections of old-style circuits, thus saving time otherwise wasted trying to locate a shorted or intermittent component.
- ◊ More than 60,000,000 Centralab Packaged Electronic Circuits are now in use.

Ask your Centralab distributor for P.E.C.'s. He has 45 different types in stock. Send coupon for free copy of P.E.C. Guide No. 3.

Centralab

A DIVISION OF GLOBE-UNION INC.
902F East Keefe Avenue, Milwaukee 1, Wisconsin Y-5619

Send me free copy of Centralab
P.E.C. Guide No. 3.

Name _____
Company _____
Address _____
City _____ Zone _____ State _____

CRL

*Trademark

*SERVICEMAN... You're carrying
YOUR REPUTATION in that carton!*



It's more than just a picture tube—
it's performance, dependability and a
guarantee. And your reputation
is riding with it.

Your customers take your word for the
quality of the picture tube you install.
It's easy to assure top performance, long
dependable life and a guarantee that
means something by recommending and
installing Du Mont Twin-Screen Hi-Lite*
picture tubes. Du Mont has been manu-
facturing cathode-ray tubes for 25 years.
All of the experience in engineering,
design, and technical skills compiled
in these 25 years go into the
Twin-Screen Hi-Lite.*

The picture tube is your choice—and your
reputation. Back that reputation with a
reliable Du Mont picture tube.

**The ultimate in aluminized picture tubes.*

*IT'S
DEALERS
CHOICE*

make it...



Cathode-Ray Tube Division. ALLEN B. DU MONT LABORATORIES, INC., Clifton, N. J.

setting new selling records everywhere



AR-1

The completely **AUTO-**MATIC rotor, powerful and dependable, with a modern design cabinet. Uses 4 wire cable.

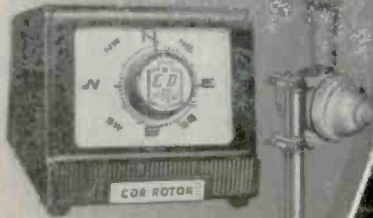

AR-2

Completely **AUTO-**MATIC rotor with thrust bearing. Handsome cabinet, uses 4 wire cable.



TR-4

The heavy-duty rotor complete with modern cabinet with **METER** control dial. Uses 4 wire cable.



AR-22

Here is the completely **AUTO-**MATIC version of the famous TR-2 with all the powerful features that made it so famous.

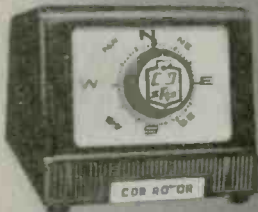

TR-11

The ideal budget all-purpose rotor with new, modern cabinet featuring meter control dial. Uses 4 wire cable.



TR-2

The heavy-duty rotor with plastic cabinet featuring "compass control" illuminated perfect pattern dial. Uses 8 wire cable.



TR-12

A special combination value consisting of complete rotor with thrust bearing. Handsome modern cabinet with meter control dial, uses 4 wire cable.



CORNELL-DUBILIER

SOUTH PLAINFIELD, N. J.



THE RADIART CORP.

CLEVELAND 13, OHIO

MOST ACCEPTABLE



FROM DELCO RADIO

come the **transformers**
with high acceptability.

You trust them...

so do your customers!



Universal vibrator transformers, produced through the combined electronic skills of Delco Radio and General Motors, meet the requirements of nearly every model of auto radio. Each is designed for easy installation and complete customer satisfaction. Laminated core inserts are stamped out of low-loss silicon steel and heat treated to maintain correct magnetic properties. Coils are precision-wound on special machines. All models have ample leads. Your UMS-Delco Electronic Parts Distributor can supply you with all models. Call him today. Remember, the Delco Wonder Bar Radio is being nationally advertised in leading consumer publications... so you are tuned in on a constantly increasing service.

Uncased Models 6055, 6065, 6067
do not include filter network

Cased Models 6060, 6064 and 6066 are made with "A" line filter network consisting of an "A" choke and .5 mfd. capacitor. Easy-mount drilling template, plus three self-tapping screws are included for your convenience.

DELCO

RADIO

DIVISION OF GENERAL MOTORS, KOKOMO, INDIANA



A GENERAL MOTORS PRODUCT—A UNITED MOTORS LINE

Distributed By Delco Electronics Parts Distributors

A complete line of original equipment service parts from the
WORLD LEADER IN AUTO RADIO

**NEW!
NEW!
NEW!**

Simpson
VARIDOT
WHITE DOT GENERATOR
model 434

VARIABLE DOT
NUMBER AND SIZE

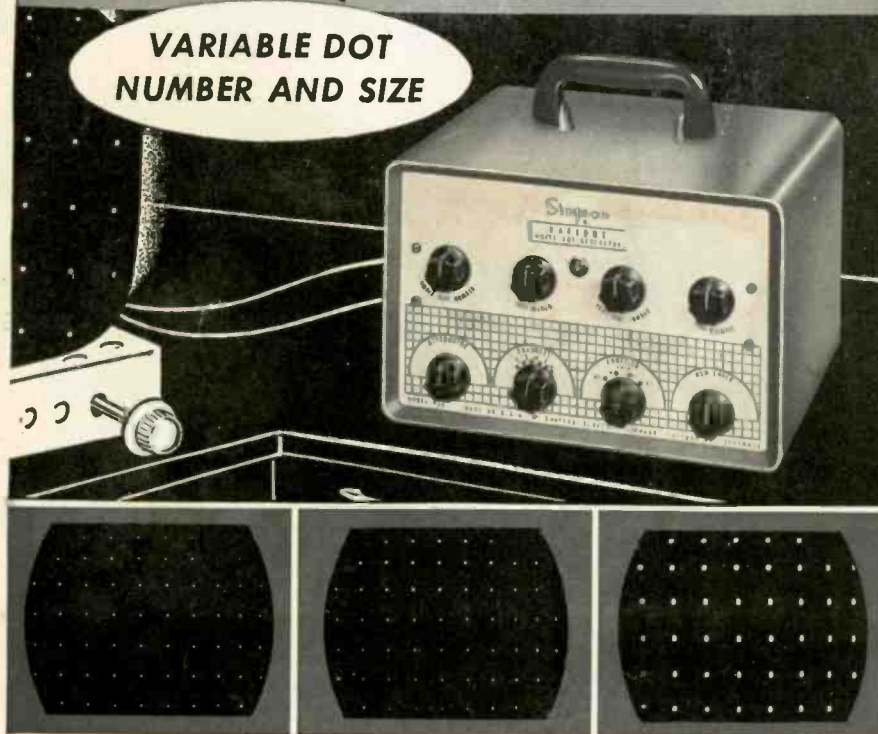

(Actual Photographs)

Provides white dot patterns with VARIABLE dot size (from 1 to 8 scanning lines, with corresponding dot widths), and variable dot number from 6 to 12 horizontal dots, and 6 to 12 vertical dots. Modulated RF output is available, operating on fundamentals from Channel 2 to Channel 6.

**THE ONLY WHITE DOT GENERATOR THAT LETS YOU
MATCH ANY RECEIVER MANUFACTURERS' RECOMMENDATIONS**

You can make convergence adjustments on color-TV receivers faster and better with the new Simpson Varidot. Use for linearity adjustments on both color and black and white.

Vertical and horizontal synchronization assures you of correct aspect ratio . . . ample attenuation . . . 300 ohm RF output.

Adjustable dot size provides a check of receiver transient response. Positive or negative video

output is excellent for accurate and fast checking of transient response of video amplifiers.

Use the new Simpson Varidot for hum checking both color and black and white receivers—a rare feature in test equipment at this price.

Portable: Approx. 11½ lbs.
Housed in Simpson gray case.

Complete with Output Cables and Operating Instructions **\$147.50**

See Your Electronics Parts Distributor, or write

Simpson
ELECTRIC COMPANY

WORLD'S LARGEST MANUFACTURER
OF ELECTRONIC TEST EQUIPMENT
5200 W. Kinz-e St., Chicago 44, Illinois
Phone: ESlebreak 9-1121
In Canada: Bach-Simpson Ltd., London, Ontario

LETTERS

To the Editor

Garage Door Operators

Editor, TECHNICIAN:

Please send us additional data on automatic garage door operators. We read your excellent article on this subject in the April issue of TECHNICIAN.

JACK KARMAN

City Auto Radio Center
Watertown, Mass.

. . . more information on automatic garage door operators.

EDWIN PRIEHLER

B & S Television
W. Trenton, N.J.

. . . please send more data on garage door operators. Your article was very informative.

JAMES D. MCKENZIE

Homer, La.

. . . kindly send additional data on automatic garage door operators.

JERRY NICOLASSEN

Tom & Jerry's TV and Appliance
Hastings, Neb.

. . . would be pleased to obtain more data on this item so I can render a better service.

FLORENZ DROESCH

Droesch Radio Service
Flushing, N.Y.

• Requests for more data from above readers and many many others on this profitable sideline are being routed to all interested manufacturers. You should hear from them soon.—Ed.

Usual Measures

Editor, TECHNICIAN:

Reference the article "Wireless Remote Speaker" in your April issue. What are the "usual corrective procedures" (to minimize TV radiation effects on AM reception) the author mentions? We are in a fringe area with many people not having TV, but a number of radio listeners cannot enjoy AM because of TV radiation.

RAY C. BOSTON

Valley TV & Radio Service
McCall, Idaho

• Briefly, correction is most effective at the offending TV set. Where interference, particularly 15,750 cps sawtooth rich in harmonics, comes through ac power source, try two 0.01 µf capacitors in series, shunted across ac line, center between capacitors grounded. Similar low-pass filter can be used at radio. Where interference is radiated, line inside of TV cabinet with metal foil, grounding foil to TV chassis, and taking care foil doesn't contact hot portions of set.—Ed.

(Continued on page 10)



MR. DEALER:

**Summer Sales
SNORING?**

or **ROARING!**

**If You're Fighting that
old "Summer Slump"...**

Superotor® is the answer!



Automatic
ELECTRONIC

Superotor

If your summer sales are snoozin' and you find it ain't amusin'
There's no need to take this lull just lyin' down.
Our Big Summer Trade-In Offer can put money in your coffer
It's the biggest, bestest deal to hit the town!

You can turn in beat-up rotors, (Three controls or two drive motors)
And get cash off on the finest one of all . . .

The Automatic Superotors turn the Doubters into Doters
You'll have the lion's share of profits by this Fall!

OTHER THOMPSON PRODUCTS
ELECTRONIC AFFILIATES

• Bell Sound Systems • Dage
Television • Ramo-Wooldridge
Corp. • Pacific Semi-Conductors, Inc.

ELECTRONICS DIVISION

Thompson Products, Inc.

2196 CLARKWOOD ROAD • CLEVELAND 3, OHIO
Available in Canada thru Atlas Radio Corp., Ltd., 50 Wingold Ave., Toronto



recommended
reading for
buyers of...



TV COMPONENTS



and TRANSFORMERS

2 NEW TRIAD CATALOGS

TV GUIDE TV-56, giving latest recommendations on Triad correct television replacements.

GENERAL CATALOG TR-56, listing the complete line of Triad transformers including 76 new items.

Ask your local TRIAD distributor or write...



4055 Redwood Ave., Venice, California



LETTERS

To the Editor

(Continued from page 8)

Living Room Repairs

Editor, TECHNICIAN:

Mr. Harry Layden's letter (favoring service in customer's home where feasible) in your April issue at least shows his intentions are good. The picture of him seated comfortably at his portable work table in the customer's living room dissecting an ailing TV fills me with admiration for his capable know-how. However, since he cannot possibly carry all of the required parts, despite his skill it is inevitable some of his patients will have to be removed to the hospital. I wonder what learned discussion then takes place between him and his customer.

O. N. TIMMONS

TV Standard Service Co.
Campbell, Calif.

Why Buss Switch

Editor, TECHNICIAN:

Would you tell me why the Montgomery Ward Model 25WG-3071B has an extra set of contacts on the on-off switch for opening the +150 volt buss from the brightness control when the set is turned off?

SUBURBAN TV SERVICE Co.

Hudson Falls, N.Y.

• Opening the 150 volt buss which feeds the pix tube cathode disconnects it from the filter capacitor at the power source, thereby removing a source of electrons when the set is turned off. This reduces or eliminates the bright spot on the screen which appears on many sets after the power is turned off.—Ed.

Licensing Pro & Con

Editor, TECHNICIAN:

This business will never gain the prestige achieved by plumbers until some form of licensing is agreed on. We need licensing and standard prices for different sections of the country. Associations are good for the industry if they don't spend their time running down the "\$3.50 boys." \$5 may be OK in New York, but \$3.50 is all right here.

COLE KIVLIN

Kivlin Radio-TV
San Antonio, Texas

Editor, TECHNICIAN:

I am opposed to licensing. Is it right that you have to pay to work? I don't think so. The State of Michigan had electrical licensing, and what a mess. Big service dealers are guilty of giving away free antennas and low price servicing to sell more Radio-TV sets.

JOHN S. PAVLOVICH, JR.

Ironwood, Mich.

Gratitude

Editor, TECHNICIAN:

Judging by some critical letters you've printed, you can't please everyone, as this story illustrates. A moocher was complaining about a mutual friend. His lament was that the mutual friend was high-hatting his old buddies. One fellow, recalling the lavish handouts and aid given to the complainant said: "Mike did a lot for you. He got you that job, paid your back rent, and dressed up your kids. You should be ashamed to talk about him this way." To which the moocher replied: "Yeh, but what has he done for me lately?" Your magazine is the most valuable one available to TV techs.

H. M. LAYDEN
Chief Technician

Judd-Bennett Co.
New York, N.Y.

Butcher-It-Yourself

Editor, TECHNICIAN:

You and your staff are doing a fine job in helping honest servicemen. I am sending you a clipping of an ad from the Wilkes-Barre Times-Leader & Evening News, which makes it rough to tell my customers why we can not do the same.

MICHAEL KUTZMONICH, SR.

Wapwallopen, Pa.

• You might point out that there is no substitute for the experience and guaranteed satisfaction which only a qualified tech offers. The ad reads: "FIX IT YOURSELF! IT'S EASY. We all have to work too hard for our money these days to spend it unwisely. In nine out of ten cases your TV set is not working because of faulty tubes. We will check them for you and if any are bad, we will sell them to you for much less than the regular selling price. If your set needs parts, we will tell you what parts are defective, and show you how to replace them YOURSELF." Do the sets ever get fixed?—Ed.

Tuner Manufacturers

Editor, TECHNICIAN:

Please send us a list of front end TV tuner manufacturers.

MB RADIO ELECTRIC SERVICE
Mercer, Penna.

• See Buyers Directory in May issue of TECHNICIAN.—Ed.

Articles Wanted!

Think you really know something about TV, radio, audio, test equipment, antennas, components, or UHF? Why not put it into an article. Emphasis, of course, should be on service technique or other practical bread-and-butter aspects. For further information, get in touch with Manuscript Editor, TECHNICIAN & Circuit Digests, 480 Lexington Avenue, New York 17, N. Y.



Fewer Returns

**RETURNS OF TUNG-SOL TUBES ARE
CONSISTENTLY LOWEST OF ALL!
HOW ABOUT YOUR RETURNS?**

It's no accident when servicemen the country over find that Tung-Sol Tubes consistently have the lowest return rate of all.

There's a reason for this outstanding record of performance and dependability: It's Tung-Sol *one-grade* quality. This one and *only one* grade of tubes is engineered to the highest initial equipment specifications. As a result—when you install Tung-Sol Tubes, you're installing the same type of tubes

leading set makers have relied upon for a long time, too.

If call backs are costing you time, money and aggravation, it's probably time you told your distributor you'd rather have Tung-Sol Tubes.

TUNG-SOL ELECTRIC INC. Newark 4, N. J.

Sales Offices: Atlanta, Columbus, Culver City, Dallas, Denver, Detroit, Melrose Park (Ill.), Newark, Seattle.

ts TUNG-SOL®
Blue Chip Quality
RADIO-TV TUBES



Miniature Lamps



Sealed Beam Headlamps



Signal Flashers



Radio and TV Tubes



Aluminized Picture Tubes



Special Purpose Tubes



Semiconductors



Color Picture Tubes

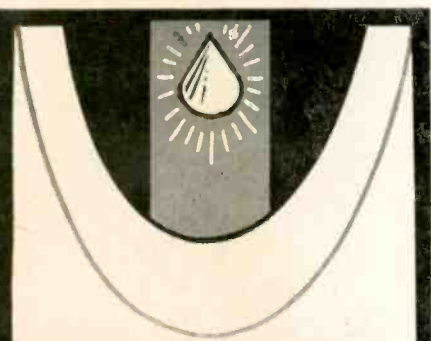

PROFIT COMES BACK!

to phono cartridge and
needle market with...

Electro-Voice®

POWER- POINT

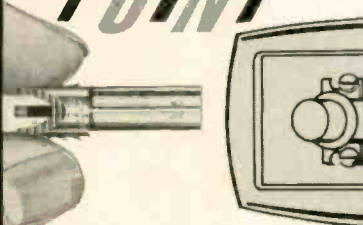

Power-Point replaces over 90% of all popular phono cartridges. Power-Point cuts inventory costs! Power-Point is easy to change! Power-Point sells on sight!

What Power-Point is: Power-Point is a ceramic phono-graph cartridge with jeweled* playing tips in a SINGLE unit—replaceable in seconds without tools! Provides fresh cartridge and two needle-tips at less cost than comparable needles alone.

Four basic types provide Power-Points for any record speed. Just \$3.95 list.

Mail the coupon for complete information.

*Superior synthetic sapphire or natural diamond.

Electro-Voice

Electro-Voice, Inc. • Buchanan, Michigan

Please send me details and specifications of the NEW Electro-Voice Power-Point.

company _____

address _____

city _____ state _____

signed _____

News of the Industry

TUNG-SOL ELECTRIC INC. has announced the appointment of ROGER S. WHITLOCK as manager of the Western Equipment Sales Div. for Electron Tubes.

DR. HERBERT S. BENNETT has been appointed to the engineering staff of Allen B. Du Mont Laboratories, Inc.

As a premium promotion local CBS-COLUMBIA dealers will offer free gifts of perfume to all women entering their shops.

WILLIAM VASSAR has joined CBS-COLUMBIA as director of engineering, and R. T. CAPODANNO has been named v-p in charge of engineering.

The supervisor of repairs at the National Instrument Factory in Calcutta, NIRODE RANJAN DAS GUPTA, recently made a three-day study of the SIMPSON ELECTRIC COMPANY's Chicago plant to observe mass production of electrical measuring instruments.

MILTON SCHINDLER, administrative assistant of SNYDER MFG. CO., appeared as guest panel member on the "Big Idea" television show on WCAU-TV.

STROMBERG-CARLSON has transferred production of Pagemaster radio paging system from Los Angeles to the Telephone Div. at Rochester, N. Y.

Dr. Alfred N. Goldsmith, consultant of the RADIO CORP. OF AMERICA, spoke on the importance of industry to the nation at the Founder's Day meeting of the MILWAUKEE SCHOOL OF ENGINEERING.

B & R ELECTRONICS CO. and ELECTRONIC CREATIONS CO., INC. have moved their offices and factories to 1178 East 180 St., Bronx, N. Y.

ROBERT A. SCHIEBER, works manager of the television-radio division, WESTINGHOUSE ELECTRIC CORP., received an award in honor of his fifteenth year of employment.

RADIO RECEPTOR'S new line of subminiature germanium diodes was exhibited at the New England Radio Engineering Meeting in Boston last month.

WESTINGHOUSE ELECTRIC CORP. has announced the appointment of SEYMOUR SILVERMAN as manager of industrial design at the television-radio division.

BURTON BROWNE ADVERTISING has estimated that its clients sold \$208,000,000.00 worth of electronic components and equipment during 1955.

The president and ten of the sales staff of PRICE'S Appliance Stores in Norfolk were awarded a "Weekend at the Waldorf" by THE MAGNAVOX CO. as a reward for having sold the greatest number of Magnavox instruments in a national sales contest.

TRIAD TRANSFORMER CORP., has announced the promotion of RALPH SEILER to Sales manager, Industrial Div.

CBS-COLUMBIA has named DAVID SOLOMON cooperative advertising manager.

A three-day RAYTHEON Tube Symposium held recently in Boston was attended by over 60 company salesmen and manufacturer's reps.

ALLEN B. DUMONT LABS., INC., has announced the appointment of GEORGE G. McCONEGHY as assistant controller.

FRANK C. ENGELHART, president of KESTER SOLDER CO., received birthday greetings from every employee at Kester's plants on the occasion of his 75th birthday.

ERIE RESISTOR CORP. has announced the appointment of MATT HOLLINGSWORTH as district manager of the Camden, N. J. sales office.

SHURE BROTHERS, INC., has recently moved into a new building in Evanston, Ill.

CENTRALAB DIV., GLOBE UNION INC., has announced the appointment of FRANK APPLE as advertising manager.

MELVIN E. KRUMREY has been named assistant manager of the Distributor Div. of QUAM-NICHOLS CO.

THOMPSON PRODUCTS, INC., Electronics Div. has offered a series of full color movie theater advertising films showing the rotator in action.

HOFFMAN ELECTRONICS CORP. has named JOHN F. DOBLE field service engineer for the northeast.

CORNELL-DUBILIER ELECTRIC CORP. announces the removal of its mid-west sales office to 5247 West Diversey Ave., Chicago 39, Ill.

THORDARSON-MEISSNER of Mt. Carmel, Ill., and HYDE SALES CO. of Denver, Colo., have just completed the establishment of a warehouse at the latter's warehouse facility at 2064 S. Bannock St. in Denver.

INSULINE CORP. OF AMERICA has become a subsidiary of the VAN NORMAN CO. of Springfield, Mass., one of the oldest companies in the machine tool industry, as announced by SAMUEL J. SPECTOR, pres. of INSULINE.

(Continued on page 14)

Something she'll be proud to own—



FREE

with your
**SYLVANIA TUBE
PURCHASES**

*Earn the complete 54-piece set
in the smart anti-tarnish chest

exclusive *Capri*

triple silverplate by Wm. A. Rogers

Watch the family's interest in your service skyrocket when you start working on the fabulous *Capri* triple silverplate. It's something anyone would be proud to own and Sylvania makes it possible for you to own it fast and free of extra cost with your purchases of "Silver Screen 85" picture tubes and Sylvania receiving tubes. You get one token for every two picture tubes or 25 receiving tubes.

When you need only 5 Sylvania tokens for a complete 4-piece setting, in no time at all you can earn a complete set of *Capri* triple silverplate.

Capri is an exclusive Wm. A. Rogers design of Oneida Limited, Silversmiths.

*Get started on your *Capri* triple silverplate right away. It's an exclusive, offered only by your Sylvania Distributor. Call him today.



*Only 5 tokens for this 4-piece
place setting.

You get one token for every two
picture tubes or 25 receiving
tubes.



SYLVANIA ELECTRIC PRODUCTS INC.
1740 Broadway, New York 19, N. Y.
In Canada: Sylvania Electric (Canada) Ltd.,
University Tower Bldg., Montreal

 **SYLVANIA®**

LIGHTING • RADIO • ELECTRONICS • TELEVISION • ATOMIC ENERGY



leads the way to

NEW Source of Profits



introduces the

FIRST DC POWER SUPPLY

to service the new

TRANSISTOR AUTO RADIOS

Services 6/12 v.
tube radios also



BE THE FIRST

TO PROFIT with this special D-612T power supply that solves a new servicing problem!

Other models for every commercial and industrial servicing need!

ELECTRO PRODUCTS LABORATORIES

4501-T Ravenswood Ave.,
Chicago 40, Illinois

FOR PRICES AND DATA SEND COUPON TODAY!

Electro Products Laboratories
4501-T Ravenswood Ave., Chicago 40, Ill.
Rush descriptive and technical data on MODEL D-612T Power Supply for Transistor Auto Radios.
Firm name _____
Address _____
City _____ Zone _____ State _____
612 Canada: ATLAS RADIO LTD., Toronto

News of the Industry

(Continued from page 12)

ROBERT L. ASHLEY has been appointed sales manager for germanium and silicon products of **RADIO RECEIVER**.

As the result of a burglary at its plant **RECOTON CORP.** warns against the purchase of its needles from anyone but the authorized sales rep.

STROMBERG-CARLSON has suspended the manufacture of TV receivers, but will continue the production of radio-phonographs and hi-fi equipment.

CORNING GLASS WORKS announces the formation of an Electronic Components Dept. to manufacture and sell glass and trimmer capacitors and film resistors.

MOTOROLA COMMUNICATIONS AND ELECTRONICS, INC., has established four geographical sales divisions and appointed the following vice presidents: **EUGENE S. GOEBEL**, **ARTHUR L. REESE**, **LOWELL E. WHITE**, **HOMER L. MARRS**, **EDWARD L. FALLS, JR.**, and **DONALD F. BRICKLEY**.

BECKMAN INSTRUMENTS INC. has announced the appointment of **THOMAS SCATCHARD** as plant manager for Berkeley Div.

CBS-COLUMBIA has announced the appointments of **TOM P. McDERMOTT, INC.**, Tulsa, Okla., and **D'ELIA DISTRIBUTORS, INC.**, Bridgeport, Conn., as distributors.

BENDIX has appointed **F. P. PURSELL** distributor for Scranton, Pa., marketing area.

"THE REPRESENTATIVES," now celebrating their 21st birthday as an organization, have moved up to trade association status with approval of their new national by-laws. Past officers of this group, meeting in New York, are forming a club of former officers who have been presented with the White Rep Insignia. **RUSS DIETHERT** of Chicago heads the club. . . . The Mid-Lantic Chapter of "The Reps" will hold its 3rd annual stag outing on June 18.

The formation of **DOUGHERTY ENTERPRISES**, manufacturers rep firm to cover Hawaii, has been announced by **GORDON DOUGHERTY**, recently resigned sales mgr. of **BRENNA & BROWNE**.

TRIAD TRANSFORMER CORP. is now represented in Oklahoma, Texas, Arkansas and Louisiana by **BRANUM SALES, INC.**

Three newly franchised distributors for their TV and radio receivers have been announced by **CBS-COLUMBIA**. They are: **STANDARD DISTRIB. CO.** in San Antonio, Tex.; **WILMOT DISTRIB CO.** in El Paso, Tex.; and **L/H APPLIANCE WHOLESALERS** in Pittsburgh, Pa.

In line with increased sales of color TV receivers, **BRUNO-NEW YORK, RCA-Victor** distrib., has just conducted a series of color TV workshops for local service techs. Set-up, adjustment, use of color test equipment and alignment were presented in the free sessions, along with a copy of a complete color service book to each attending tech.

JACK BERMAN, head of a rep firm that bears his name in Los Angeles, was feted by his staff for having received the 1956 Distinguished Salesman's Award voted him by the Sales Executive Club of Cleveland. **BRITISH INDUSTRIES CORP.** has just named the Berman outfit to represent it in Southern Calif., Southern Nevada and Arizona.

SYLVANIA TV and radio sets will be distributed in parts of Penna., New Jersey and Dela. by **PHILADELPHIA DISTRIBUTORS**.

The **SCHWANDER CO.** of St. Louis, Mo., has been franchised as distributor for **DU MONT TV** receivers, Hi-Fi units and radios in Eastern Mo. and Southern Ill.

WEN PRODUCTS, INC. gave a dinner for all its sales reps in Chicago a few days before the opening of the Electronics Parts Show.

Reps & Distributors

The Electronics Division of **THOMPSON PRODUCTS, INC.** of Cleveland has appointed **ROD BUTCHART** as its rep in Michigan. Butchart will handle sales of Superotors to radio-TV parts distributors in that area.

Representation of **JOHN F. RIDER, PUBLISHER** will be handled in western Wisconsin by **RAY R. HUTMACHER ASSOC., INC.**, located in Chicago, Ill. The rep firm will also represent **OXFORD ELECTRIC CORP.**, speaker manufacturer, in Illinois and eastern Wisconsin.

GENERAL TRANSISTOR CORP. of Richmond Hill, N. Y., adds 2 reps: **WELLER-RAHE CO.** of Cleveland for distribs in Ohio, western Penna. and West Virginia; also **JACK HEIDENREICH CO.** of Dallas for distribs and industrial trade in Texas, Arkansas and Oklahoma.

DU MONT TV set distributors are competing in a "New Dealer Derby" with valuable prizes for the most dealers signed up.

Another ANTENN-GINEERED Original

by **Snyder**
PHILADELPHIA

TORQUE-T-ANTENNA

WITH EXCLUSIVE INTERCEPTOR DISCS



WEIGHS ONLY 27 OUNCES

- NEWEST ELECTRONIC DISCOVERY
- OUTMODES OLD FASHIONED ANTENNAS
- EQUAL/BETTER THAN ANY CONICAL
- QUICKER/EASIER 1-MAN INSTALLATION
- STACKS FOR FRINGE AREAS

ATTENTION TECHNICIANS!
 1ST TIME IN ELECTRONIC HISTORY A 1/2 WAVE
 LENGTH RESONANT ANTENNA WITH ONLY
 A 1/4 WAVE LENGTH PHYSICAL DIMENSION

and Costs Less!

Unfold - Tighten - Erect

AEROVOX

PAPER TUBULAR CAPACITORS



ANY application
type
voltage
capacity
climate

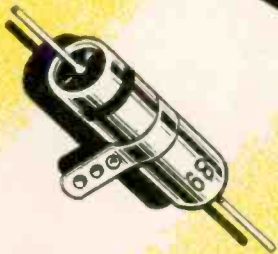

... and available at
ANY Aerovox
Distributor
at **ANY** time!

AEROVOX CORPORATION

DISTRIBUTOR SALES DIVISION
NEW BEDFORD, MASS.

In Canada: AEROVOX CANADA, LTD., Hamilton, Ont.
Export. Ad. Auriema., 89 Broad St., New York, N. Y. • Cable: Auriema, N. Y.



Association News

AEC Polls Ass'ns

The American Electronic Council, 801 So. St. Mary's St., San Antonio 4, Texas, in its efforts to form a representative national association, is polling state and local groups throughout the country on their ideas for a nationwide group. Response will be used as a guide in drawing up a blueprint for the national body.

Houston Drafts License Bill

NATESA-affiliated Houston Ass'n of TV-Electronics Servicemen, Inc., 1822 Berry Rd., Houston 16, Texas, has completed its draft of a state licensing bill to be presented at the next legislature session. Provisions include a state commission to give license exams in 3 classifications: apprentice, journeyman and electronic engineer. Licensees must put up \$500 bond against loss, damage or fraud suffered by consumers. Bill also provides for fines and license revocation on proof of malpractice.

NATESA Board Meeting

Omaha, Nebraska was the scene of the Spring Board of Directors Meeting of the National Alliance of TV & Electronic Service Ass'ns, 5908 S. Troy St., Chicago 29, Ill. Constitutional changes apportioned voting power among member groups on the basis of their local membership and granted votes to unaffiliated associate members. To enable President and Executive Director Frank Moch to devote more time to top-level executive work, some of his increasing duties will fall to newly named regional governors, who include Albert C. W. Saunders (New England Zone), Gordon Vrooman (Central Atlantic Zone), and Robert L. Kidd (South Atlantic Zone). John Graham took over as Great Lakes Governor for Fred Colton, who has resigned.

Some items covered at the Board meeting: insurance, licensing, parts-jobber relations, and factory service operations. The insurance plan is expected to be ready for operation soon. Plans for a large-scale public-relations program were approved unanimously. Friends of Service Awards were presented to Mallory, Sprague, and the tube divisions of GE, RCA, and Sylvania. A similar award to **TECHNICIAN & Circuit Digests** will be presented at a later date.

(Continued on page 18)

Seen the Saw?

INDISPENSABLE FOR RADIO-TV

CUTS 2 x 4's
IN SECONDS.
CUTS
1/2" STEEL.

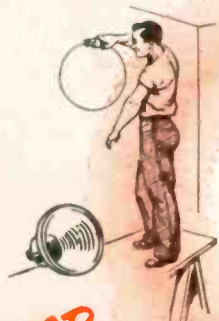

FOR CUTTING PLASTER AND WOOD, INSTALLING SPEAKERS, ETC.



FOR CUTTING PIPES FOR ANTENNA, ELECTRICAL CONDUITS, ETC.



FOR PREPARING ELECTRICAL OUTLETS, ETC.

FOR SERVICE

Like other WEN tools, this new Power Saw is compact, handy, efficient, ideal for the Service Man. Has powerful AC/DC Universal motor. Delivers 2650 - 5/8" strokes per minute. Cuts wood, plastics, metals, composition, hard rubber, etc. Acts as jig, rip, crosscut, band, hack, coping, scroll or keyhole saw. Interchangeable blades. Air stream blows dust off work.

FOR SELLING

This is the hottest selling item in electrical power tools today. It's being snapped up by professionals and amateurs alike wherever shown. And no wonder—for this saw does the work of 8 saws—more swiftly, smoothly and safely than tools costing twice as much. EVEN CUTS HEAVY LUMBER—STEEL PLATE. Price complete with 3 blades. Only \$29.95 LIST

THERE'S PERFORMANCE AND PROFIT IN EVERY WEN PRODUCT

"Quick-Hot" ELECTRONIC SOLDERING GUNS			ELECTRIC SANDERS—POLISHERS			POWER SAW
#199 K KIT \$9.95	#288 \$9.95	#199 \$7.95	#202 \$13.95	#303 KIT \$16.95	#404 HEAVY DUTY KIT \$19.95	#505 \$29.95

— ALL OPERATE ON 110-120 VOLT A.C. — 60 CYCLE —



WEN

PRODUCTS, INC.

5808 NORTHWEST HIGHWAY, CHICAGO 31, ILL.
(Export sales, Scheel International, Inc., Chicago)

No publication can match TECHNICIAN's record!!

1ST IN ADVERTISING GAIN

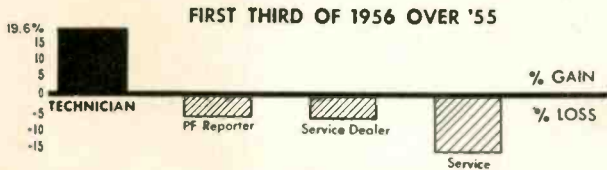

1ST IN ABC PAID CIRCULATION

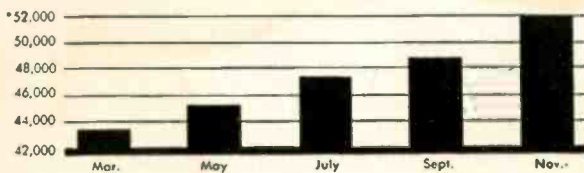

* November issue, ABC Publishers Statement, December 31, 1955.

1ST IN ADVERTISING VALUE

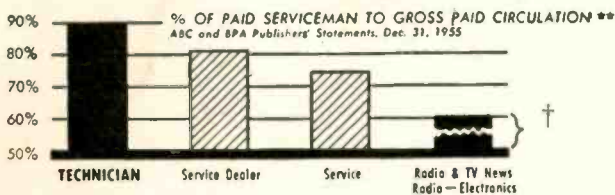

† These are not business publications classified as general magazines by ABC—and cannot furnish audited occupational breakdown.

Publication	Paid Serviceman Circulation	12 ti pg. rate	Cost per 1,000 paid service circ.
TECHNICIAN (ABC 12/31/55)	48,542	\$535	\$11.02
Service Dealer (BPA 12/31/55)	37,158	\$600	\$16.16
Service (ABC 12/31/55)	35,875	\$540	\$15.61
Service Mgt. (BPA 12/31/55)	26,145 (controlled)	\$395	\$15.11

** PF Reporter: Not an audited publication. No occupational breakdown or post office receipts showing verification of print order, are available.

The facts show **TECHNICIAN** is **FIRST** over all TV-electronic service publications

MAKE IT NO. 1 ON YOUR AD SCHEDULE

TECHNICIAN
Circuit Digests



CALDWELL-CLEMENTS COMPANY
480 Lexington Avenue, New York 17, N. Y.
Plaza 9-7880

Association News

(Continued from page 16)

Washington, D. C. Organizes

The young Television Service Ass'n of Metropolitan Washington, c/o H. Nussbaum, Washington Bldg., New York Ave. & 15th St., N. W., Washington 5, D. C., has launched its official monthly organ, the *TSA News*. A membership drive and partial reproduction of the group's by-laws highlight the issue.

TSDA Antenna Report

In an issue of *TV Service*, its official publication, the Television Service Dealers Ass'n of San Mateo County, Calif., has an interesting report on antenna failures during the stormy weather of this past winter. The owners of F & E TV of Redwood City logged the failure causes of all antennas they were called on to repair or replace. Most failures were the result of faulty installation, and most of these were caused by customer do-it-yourself work rather than by dealer installation. Needless failures were due to improper or inadequate taping, bracing and guying, and to loose connections. It was generally cheaper to replace than repair. Furthermore, many of the antennas were obsolete and should have been replaced before failure.

New Massachusetts Group

The newly organized Worcester County Ass'n of TV Technicians is making rapid strides. The first meeting brought in 20 members, with the list going to 71 for the second meeting. Over 100 are expected to be in soon. Regular officers are to be elected soon. For information contact Ed. E. Cook, M. C. Radio & TV, 13 Austin St., Worcester, Mass.

New Ass'n Name in Kansas

The Radio Service Dealers Ass'n of Kansas, Inc., has been disbanded and reconstituted as the Television Electronic Service Ass'n, of Kansas, Inc. At present, the newly constituted, incorporated TESA has 3 chapters in the state: in Wichita, in Salina, and one covering the mid-western portion of the state with meetings in Great Bend. Information for interested parties is available from E. A. Redmon, secy., Box 154, Ellinwood, Kans. or pres. W. Nichols, 333 Waco, Wichita, Kans.

Trends in Sets, Pix Tubes

Elsewhere in this issue, readers will find an item disclosing the statistics on sales of replacement picture tubes. It tends to confirm the long-term trend, evident for some time, toward 21- and 17-in. tubes as finding the greatest favor with the public. More recent developments may reverse that trend.

One of the earliest "pipe dreams" that popped up as TV became an important factor in our life was the notion of the small-size TV receiver that would compare with the large set in the living room as did the portable and table-top radios, in former days, with the large and impressive "furniture" console radios.

Earliest attempts at such smaller TV sets failed. The 3- and 5-in. picture tubes were available, but they were lost in the behemoth size of the chassis once considered unavoidable. Readers may recall the unwieldy "portable" of that time, earning its right to that designation by virtue of a carrying handle placed somewhere on a rather large and heavy case. The face of the crt could just about be found at one corner of the cabinet.

Today miniaturization techniques in component manufacture, stimulated by transistor developments, and the use of 90-degree deflection systems in smaller pix tubes, have reversed the picture. One tube manufacturer after another announces additions to his tube line in the 14-in. or under size for 90-degree systems.

The reduced crt size is now the true determinant of cabinet size. With tiny circuit components packed economically around the pix tube, cabinets need only be slightly larger than the crt. One leading maker after another is entering the "portable" or "personal" TV derby. Consumer preference may well fulfill the same cycle that we saw completed in the pre-TV radio days.

As part of the trend, we will see increased use of metal and plastic cabinets.

One cloud on the horizon, however, involves the question of servicing these sets. Technicians report that what was a minor repair or adjustment on a large set now becomes a major operation. Often a set must be completely dismantled and re-assembled to replace a small part. The bill for such a repair, of course, is relatively high, compared to the initial cost of the set, which is low. As usual, the service tech is caught in the squeeze between manufacturer and consumer.

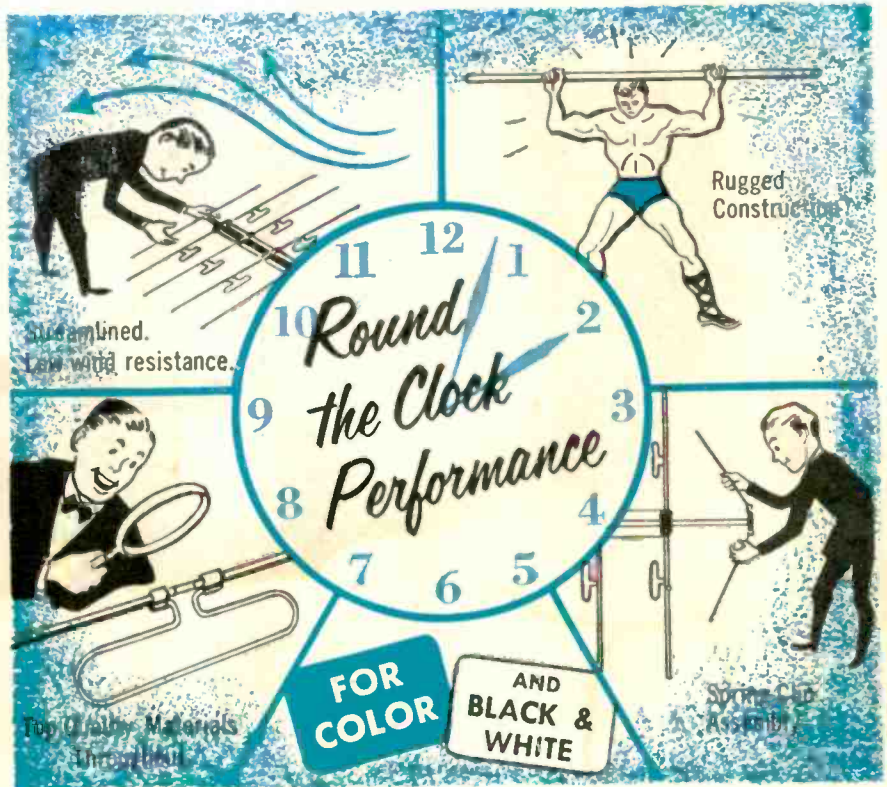

TACO

TRAPPERS[®]

Taco Trappers are **DEPENDABLE**—day in, day out through all the seasons. You can count on the Trapper design to provide outstanding performance. We call it "staying power". Performance is our most important feature. However, this is only part of the story, for starting with the materials used and ending with the streamlined appearance when installed, the Trapper has no equal. For better pictures and satisfied customers, insist on the Taco Trapper design. You'll eliminate call-backs.

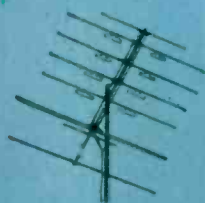

SUPER TRAPPER
for extreme fringe area installations.



TRAPPER
for fringe and near-fringe installations.



TRAPPER ROYAL
for improved low-band performance.



TRAPPER JR.
Modern an enna for high signal areas.

TACO

TECHNICAL APPLIANCE CORPORATION
SHERBURNE, N. Y.

In Canada: Hackbusch Electronics, Ltd., Toronto 4, Ont.

... another
MALLORY
service-engineered
product



New Mallory "Gems" pace setters in paper capacitors

Next time you replace paper tubulars, make sure you use these new Mallory capacitors. They give you a lot of extra value features—without extra cost.

Soldering iron heat can't loosen leads. Wires are permanently attached in the plastic end seal... can't work loose from heating or vibration.

Moistureproof construction, using a protective case of high grade mica-filled bakelite, ends worries about premature shorts due to high humidity.

True center construction protects the foil element from deformation during assembly... assures uniform quality in each capacitor.

Get your stock now, from your local Mallory distributor. Ask for Mallory "Gems"—you'll agree they're a gem of a capacitor!

P. R. MALLORY & CO. Inc.
MALLORY

P. R. MALLORY & CO. Inc., INDIANAPOLIS 6, INDIANA

- Capacitors
- Controls
- Vibrators
- Switches
- Resistors
- Rectifiers
- Power Supplies
- Filters
- Mercury Batteries

Catalogs & Bulletins

SELENIUM TESTER: Data sheet on model 610 Selenium Rectifier Tester provides full description and specs for static and dynamic load testing. Winston Electronics, Inc. 4312 Main St., Philadelphia 27, Penna. (TECHNICIAN No. B6-1)

STYLUS SALES: Folder with reply card describes available kits for stock, service and promotion of replacement phono styli; also describes reference replacement guides and promotion material. The Recoton Corp., 52-35 Barnett Ave., Long Island City 4, N. Y. (TECHNICIAN No. B6-2)

COLOR TV: 36-page bulletin on Hoffman Colorcaster sets gives complete circuit descriptions, installation and alignment procedures and includes large schematics. \$1.25. National Service Dept., Hoffman Electronics Corp., 621 E. 61st St., Los Angeles, Calif. (TECHNICIAN No. B6-3)

NEWSLETTER: The bi-monthly *B-T Labs Bulletin*, a newsletter for circulation to electronics distributors and service techs and dealers, contains information on the manufacturer's products and on latest electronic developments and techniques. Free on letterhead request. Blonder-Tongue Laboratories, 526-536 North Ave., Westfield, N. J. (TECHNICIAN No. B6-4)

POWER TRANSFORMERS: Complete electrical and physical specs on the 2K series of power transformers, designed for use in regulated power supplies, are presented in catalog bulletin "2K." Sterling Transformer Corp., 297 North 7th St., Brooklyn, N. Y. (TECHNICIAN No. B6-5)

DOOR, GATE OPERATORS: Literature describes completely-electrical operators—no compressors, oil cylinders or tubing—for all types of doors and gates, whether double, swinging, overhead, sliding, rolling, sectional, tilt-type, etc., for home, garage, commercial, and industrial uses. Robot Appliances, Inc., 7041 Orchard Ave., Dearborn, Mich. (TECHNICIAN No. B6-6)

MASONRY DRILLING: Handy table incorporating recommendations as to speeds, drill sizes, and pressure requirements when drilling all kinds of material helps solve problems encountered in using carbide-tipped masonry drills. Carboly Dept., General Electric Co., Box 237, Roosevelt Park Annex, Detroit 32, Mich. (TECHNICIAN No. B6-10)

TRANSISTOR RADIO ACCESSORIES: Four-page folder depicts and describes earphones, wrist chains, carrying cases, shoulder straps, batteries available for various Raytheon models of transistor portable radios. Raytheon Mfg. Co., 5921 West Dickens Ave., Chicago 39, Ill. (TECHNICIAN No. B6-11)

CONNECTORS: Two catalogs cover the Cannon line of electrical connectors, 12 pp. each, well illustrated. Catalog RJC-9-1956 covers plugs, receptacles, and accessories for microphones, radios, recorders, amplifiers, TV cameras, etc. Catalog ICC-3-1956 covers industrial types including battery, aircraft, and general electronic. Cannon Electric Co., P. O. Box 75, Lincoln Hts. Sta., Los Angeles 31, Calif. (TECHNICIAN No. B6-7)

KIT INSTRUMENTS: Heathkit Spring '56 Flyer, 16 pp., is condensed presentation of complete line of audio, test equipment, ham and other kits. New radiation counter kit is announced. Heath Co., Benton Harbor, Mich. (TECHNICIAN No. B6-8)

RECORD CHANGERS: Analysis sheets Nos. 103, 104, and 105 respectively give specs on the Garrard model 301 professional transcription turntable, model RC-121 "Renown" 3-speed changer, and model RC-88 "Triumph II" de luxe changer. Garrard Sales Corp., Port Washington, N. Y. (TECHNICIAN No. B6-9)

STORAGE SHELVING: Tips on planning installations and ordering shelving to meet all types of requirements include basic units and accessories, typical layouts and photos, and a shelf-capacity chart. Hallowell Div., Standard Pressed Steel Co., Box 164, Jenkintown, Penna. (TECHNICIAN No. B6-12)

WIRE & CABLE: Illustrated catalog 106 offers complete line of TV transmission lead-in, rotor cables, intercom and telephone wire, hook-up wire, power cord, and other wires and cables. Many new items are featured. Columbia Wire & Supply Co., 2850 Irving Park Rd., Chicago 18, Ill. (TECHNICIAN No. B6-13)

ANTENNAS: Brochures describe line of all-weather antennas and tuned-insulator antenna construction to prevent antenna deterioration. Myers All-weather Antenna Mfg. Corp., 350 S. Egg Harbor Rd., Hammonton 1, N. J. (TECHNICIAN No. B6-14)

ELECTRONIC EQUIPMENT: Comprehensive presentation of plugs, jacks, leads, tools and associated components illustrated and described in 80-page catalog. Insuline Corp. of America, 186 Granite St., Manchester, N. H. (TECHNICIAN No. B6-15)

SERVICE AIDS: 16 page booklet lists display signs, public relation packets, stationery and other items to aid the dealer. Available through General Electric electronic tube distributors. (Ask for B6-16)

RESISTORS: New axial-lead Blue Jacket resistors described in Bulletin M-714. These resistors, rated at 3 watts, will satisfy MIL specification performance requirements with a 35% to 50% reduction in size. Available free from Sprague distributors. (Ask for B6-17)



... another
MALLORY
service-engineered
product

**More than
60 Million
Vibrators
worth of
experience
... to bring you
the best!**

Yes, it has taken 26 years of pioneering development . . . plus the manufacturing know-how gained by making more than 60 million vibrators—60 million units worth of experience—to bring you Mallory's long-lived, premium performance vibrators.

Unique Mallory features have reduced mechanical hum to levels thought impossible a few years ago. They have extended vibrator life, and established new standards of reliability and service.

As in the past, Mallory will continue to lead the vibrator field in design and development . . . bringing you the finest in performance . . . the utmost in economy and efficiency.

Give your customers *the best*.
Be certain you order Mallory from
your distributor.

P. R. MALLORY & CO. Inc.
MALLORY

P. R. MALLORY & CO. Inc., INDIANAPOLIS 6, INDIANA

- Capacitors
- Controls
- Vibrators
- Switches
- Resistors
- Rectifiers
- Power Supplies
- Filters
- Mercury Batteries

COMPLETELY SOLDERLESS

NO SOLDER—
braid or contact

NO CRIMP—
braid or contact

AMPHENOL

NEW COAXIAL CABLE CONNECTORS

Two new time-saving, reusable, field-workable coaxial connectors are now available. The 83-850 is a *completely solderless* connector that can be assembled to RG-11/U or RG-59/U cable with a screwdriver and a pair of pliers! The 83-851 is *semi-solderless*, may be used wherever an 83-1SP has been used. Only the contact is soldered—the braid is locked mechanically by a positive-action cable clamp as in the 83-850. Both plugs are plated with corrosion-resistant cadmium.

features

COMPLETELY SOLDERLESS
83-850—no solder, no crimp
83-851—semi-solderless

FULLY RE-USABLE
attach and detach, use again and again

EASY ASSEMBLY
even in field use

applications

MASTER TV INSTALLATIONS
hotels, motels, apartment houses

LABORATORY & SERVICE
TECHNICIAN USE
speeds work, saves money

COMMUNITY TV INSTALLATIONS
for every field application

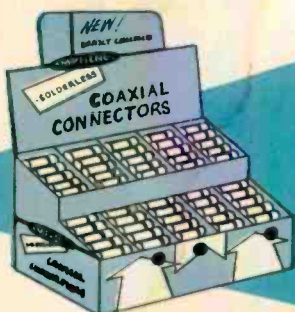

special
Watch for this solderless
connector dispenser at your Distributors!

AMPHENOL

AMERICAN PHENOLIC CORPORATION
chicago 50, illinois

New Books

HOW TO DOUBLE YOUR BUSINESS WITH INEXPENSIVE CLASSIFIED ADS. By Hubert K. Simon. Published by H. K. Simon Advertising, 48 Fifth Ave., Pelham, N.Y. 47 pages. Paper portfolio cover. \$9.95.

TV-electronic service shops generally have small advertising budgets, which makes the use of classified newspaper ads most attractive. How well these ads pay off in terms of more business depends in great measure on the appeal of the words, layout and associated factors. This concise handbook tells you how to make the most of classified ads, providing broad guidance as well as many practical examples of ads that have pulled response. There are many tricks of the trade in preparing classified ads, and many of the best ones are included in this book.

THE QUEST FOR QUALITY. By N. H. Crowhurst. Published by Norman Price Publishers Ltd., 283, City Rd., London, E. C. 1, England. 80 pages. Paper cover. \$1.50.

No. 5 in the Audio Handbook series, this compact text discusses the technical aspects of the search for high fidelity. Among the topics covered are frequency response, distortion, flutter and wow, dynamic range, equalization and stereophonics. Clearly written with 52 illustrations.

HOW TO USE AND SELECT YOUR TAPE RECORDER. By David Mark. Published by John F. Rider Publisher, Inc., 480 Canal St., New York 13, N. Y. 148 pages. Paper cover. \$2.95.

The author begins with a conventional treatment of what a tape recorder is and how it works, but he moves quickly into the device in terms of its use. Applications in home use, business, the professions, and for recording music get extended treatment, together with whatever accessories may be involved in various cases, their characteristics, and set-up. The groundwork is laid for assisting the reader who must make a choice of recorder in view of what he wants to use it for. A concluding buyers' guide lists a variety of recorders of many makes, together with characteristics and prices.

HIGH FIDELITY CIRCUIT DESIGN. By Norman H. Crowhurst and George F. Cooper. Published by Gernsback Library, Inc., 154 West 14th St., New York 11, N. Y. 303 pages. Hard cover. \$5.95.

There is a middle ground, the authors feel, between the fully versed design engineer and the "practical" putterer when it comes to putting together or modifying amplifiers or other audio circuits. It is to this in-between group of those with only elementary math and basic electronics that the material is directed. The whys and hows of design factors in terms of what one desires in the end product occupy the major portion of the book. There is also information on test procedures.

4 big ways to beat high insulating costs

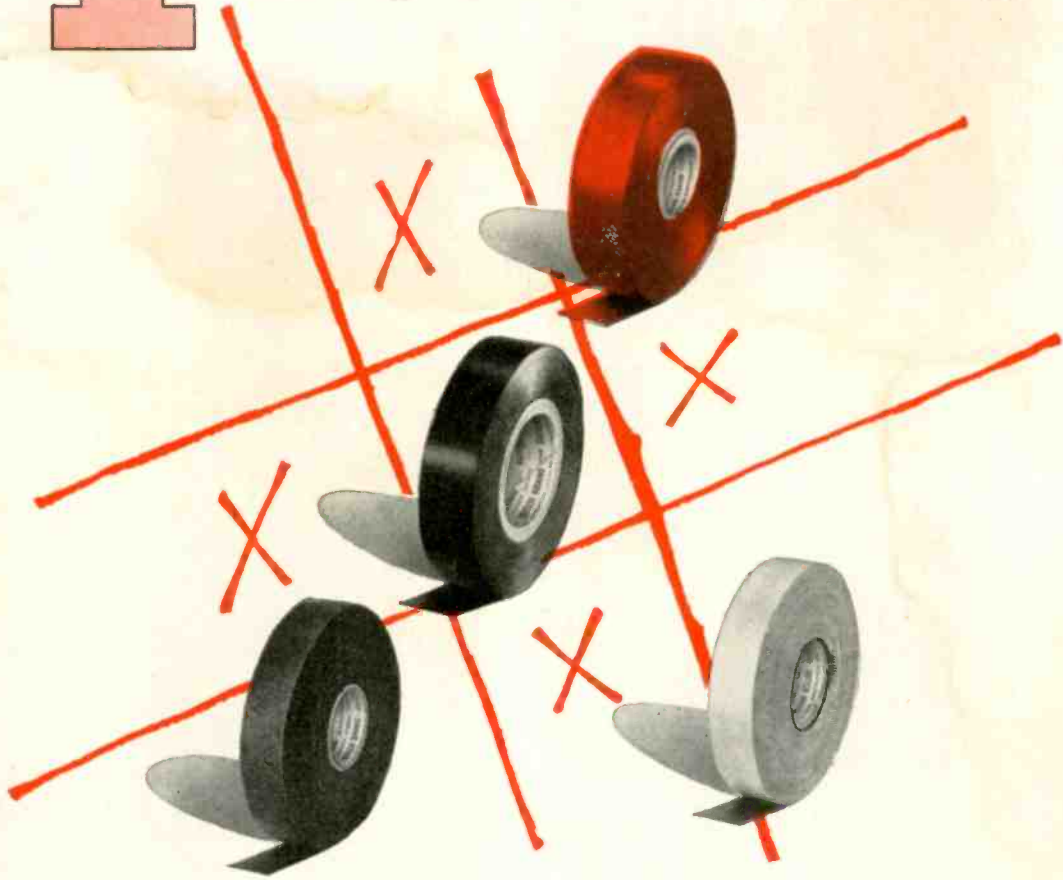

Tool up with

DUTCH BRAND'S BIG FOUR ELECTRICAL TAPES



Send for this new Big Four booklet now!

Here are facts that you can turn into dollars and cents! Dutch Brand's big, new "Big Four" booklet is packed with new ideas and methods for beating high electrical insulating costs. It tells how you can use Dutch Brand plastic tape, friction tape, rubber tape and vinyl color tape to improve electrical work . . . make jobs easier, faster and safer. You'll see exactly what these tapes will do . . . and find out how to choose the right tape to meet specifications of the job. Get a copy of this easy-to-read, well illustrated booklet for every department concerned with electrical insulation.



Johns-Manville
DUTCH BRAND
P R O D U C T S

7800 WOODLAWN AVENUE - CHICAGO 19, ILL.

"2300 RAYTHEON TUBES PERFORMANCE TESTED WITHOUT ONE FAILURE"

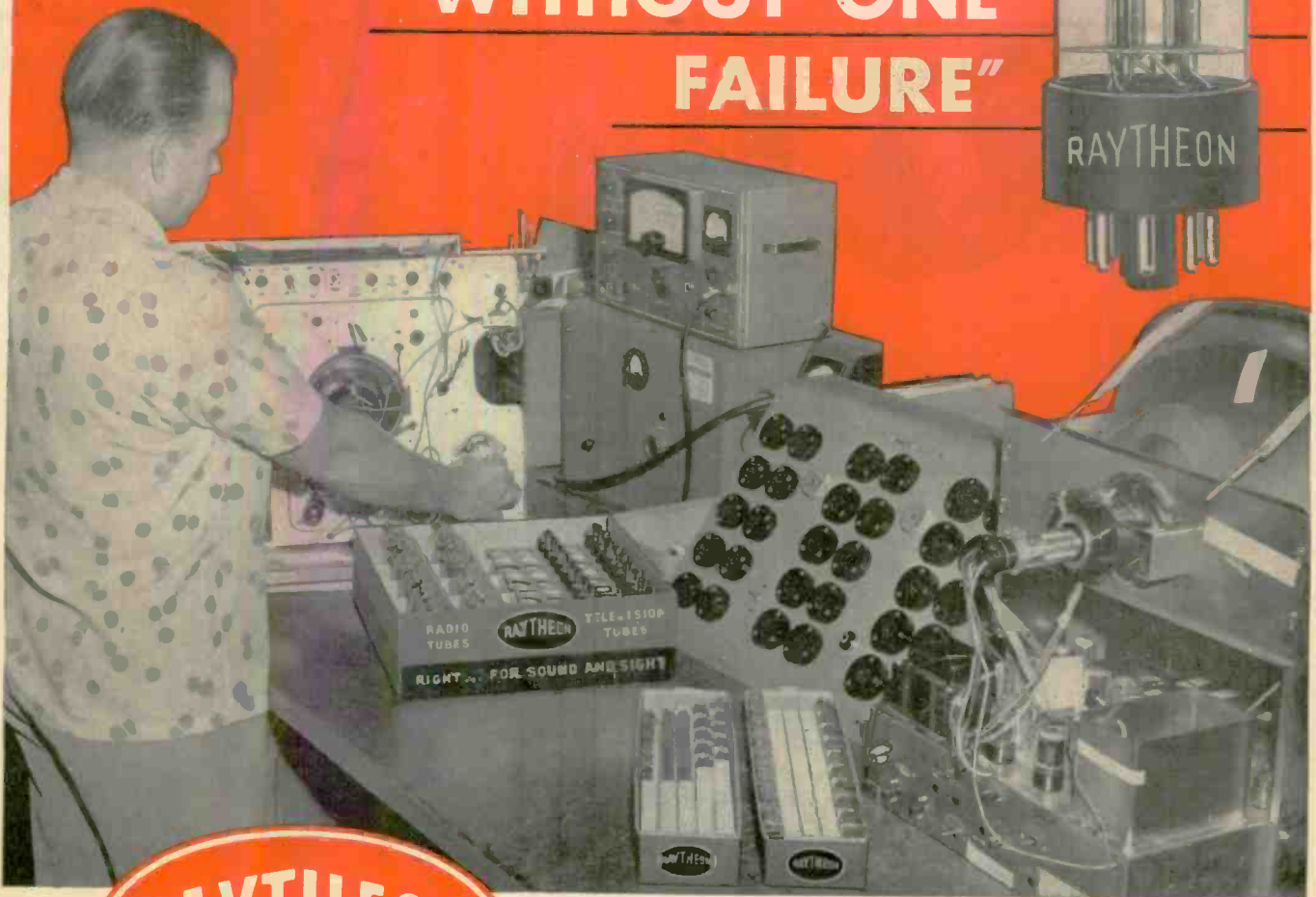

RAYTHEON RECEIVING TUBES for replacement
pass every test for performance and quality
at **HOWARD W. SAMS & CO., INC.**

The results of this thorough, impartial test of regular production Raytheon Tubes provide potent evidence that Raytheon Tubes are tops in quality and performance. Here's what the report says:

"Raytheon tubes were substituted in basic chassis, representing several hundred models. In these tests 2300 Raytheon tubes were tried in 230 different circuit applications with no apparent tube performance failure. Conditions were arranged to simulate fringe area as well as prime signal area, when testing tube types in RF, IF, Video,

Sync, Vertical Oscillator and Horizontal Oscillator Circuits. Low Voltage Rectifiers, High Voltage Rectifiers, Vertical and Horizontal Oscillator, and Horizontal Output Tube types were also checked under low line voltage conditions. No types were found incapable of providing satisfactory results in these circuits, after adjustments of service controls."

What more can we add to this conclusive proof that Raytheon Receiving Tubes are truly RIGHT . . . For SOUND and SIGHT.



RAYTHEON MANUFACTURING COMPANY

Receiving and Cathode Ray Tube Operations

Newton, Mass. • Chicago, Ill. • Atlanta, Ga. • Los Angeles, Calif.

Raytheon makes all these } Receiving and Picture Tubes, Reliable Subminiature and Miniature Tubes, Semiconductor Diodes, Power Rectifiers and Transistors, Nucleonic Tubes, Microwave Tubes



TECHNICIAN

& Circuit Digests

CALDWELL-CLEMENTS, CO., 480 LEXINGTON AVENUE, NEW YORK 17, N. Y.

Your Servicing Future

You can't help wondering about your future, your family's welfare and your opportunity for a successful career. Much depends on the prospects and potential of your chosen profession, TV-electronic servicing. Let's glance at the outlook for servicing.

PRODUCTS & SERVICES: There are three elements in making and using electronic devices: Production, Sales and Service. You can't do without any one of them anymore than a three-legged stool could do without one of its legs. Could you imagine anyone throwing away a \$250 TV set because a resistor burned out? No, service is indispensable.

PERSONAL TOUCH: Mass production and mass advertising have taken much of the personal touch out of production and sales. But service is different. It's personal. There's man-to-man contact in entering a customer's home or plant. People want a technician right in the neighborhood when a set goes on the blink; they don't want to wait for an unknown man to be sent from some distant central office. That's why auto, shoe and other repair shops have always flourished on a local basis. Also, unlike products, service isn't standard. Rather it depends on your individual ability and the customer's personal confidence in you. Local service outlets will happily be with us for many many years.

GROWTH: The United States is growing (over 166,000,000 people) and its job and business opportunities are on the increase (more than 65,000,000 employed). War or peace, the electronic specialist is a pivot point in this growth. Fast as our national ex-

pansion is, electronic servicing is growing still faster because more people are using more electronic devices. From a \$1 billion industry five years ago in 1951, TV-electronic servicing has jumped to a \$2.1 billion annual volume today. Five years from today it will be well over the \$3 billion mark, and the fellow who gets his firm footing in the field now will surely be rewarded in the coming years.

NEW FIELDS: Recent electronic developments such as color TV and transistor radios are already entering service shops in growing numbers, offering new challenges to your ingenuity, new demands to increase your skills, and new opportunities to capitalize on your knowledge. That's not all. New horizons in industrial electronics and communications are giving you the first rate chance to broaden your operating base, either as a tech working in industry or a service shop working on industrial accounts.

SIGNIFICANCE: You have good reason to be optimistic about your servicing career, and all that goes with it in long range terms of personal comfort and family security. Sure there are some difficulties ahead, as there are in all dynamic industries. But the four important things to keep in mind are:

1. Electronic servicing is indispensable.
2. Service is best offered by a local shop.
3. The nation's economy is expanding.
4. New developments are offering wonderful opportunities in consumer and industrial electronic servicing.

For a competent electronic tech—and his family—the future is bright indeed!

A New Publishing Record

The final tally on reader response to TECHNICIAN's March literature feature is in. More than 12,000 readers (that's about one out of every four subscribers) requested more than 550,000 individual pieces of literature. Furthermore, over \$8275 in cash was received for prepaid items.

Publishing experts report that this is a new record, far above any response they have ever experienced. We're very pleased to be of service to our readers.

The literature offer, combining the best of manufacturers' printed service aids, expired on April 30, 1956. TECHNICIAN is spending \$15,000 just to process all requests, and turn them over to the manufacturers. Some manufacturers received so many thousands of requests that their stock has been completely depleted. If you haven't yet received the literature you asked for, please be patient a little longer . . . we're working as fast as possible to dig out from under a new publishing record.

Tuning In the

MOONLIGHT TV PICKUP TUBE, a new image orthicon developed by RCA, is so sensitive it can pick up scenes illuminated only by moonlight. It is expected to make a whole new variety of dimly lit outdoor events available to TV viewers.

MOBILE TWO-WAY RADIO is the reason Oregon logger Jack Fischer is alive today. After his heavily loaded truck plunged 105 ft. down a canyon, he lay helpless and badly injured. Although he can't remember radioing for help, he did use his Motorola equipment to send this message which brought rescuers: "If anyone can hear me, come down here quick—I've tipped my truck over . . ."

COLOR TV ROUNDUP. Complete blueprints and detailed mass production "know how" developed by RCA are being made available to other set makers. Manufacturer's price for the RCA 255-sq. in. color pix tube has been reduced from \$100 to \$85. Backing up its color receivers about to go into production, Sylvania is opening a nationwide color training program for servicemen, starting with a one week 60-hour course, followed by local clinics running 12 and 24 hours. Westinghouse has a similar program intended to train 10,000 techs in color servicing. The training sequence in these programs start with factory engineers, then distributors, and then dealers. General Electric plans to introduce its line of color sets at the June Furniture Market in Chicago.

The gain of 70 db (power gain of 10 million) is quite a lot to get out of this amplifier, no larger than one of the fingernails in the hand holding it. Developed by Philco for demonstration purposes, the amplifier uses subminiature M-1 alloy junction transistors in a new type of direct-coupled circuit. The transistor is in production.

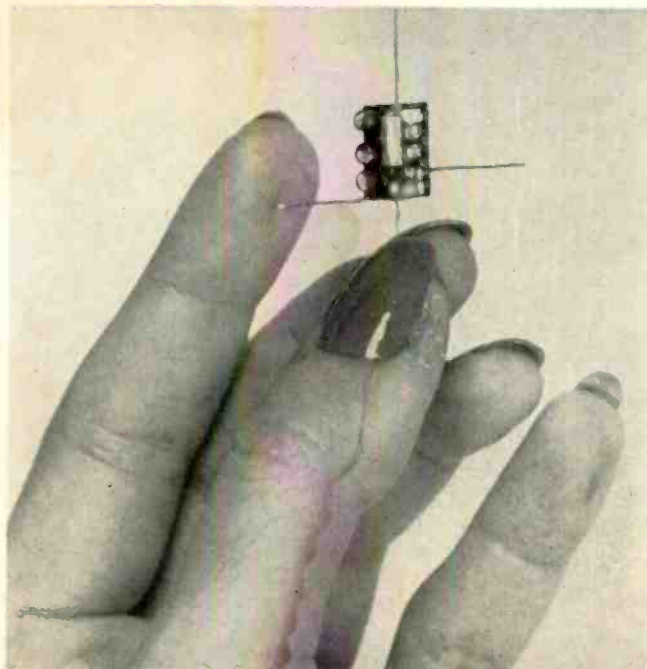

SMILING JACK



"How's business?"

ELECTRONIC PRODUCTION FIGURES forecast by the U. S. Dept. of Commerce for '56 foreshadow a record year, with \$6.8 billion in electronic products seen at factory prices. This exceeds the previous high of \$6.3 billion, set in 1953 and equalled in 1955. Sale of color receivers is expected to jump to a quarter of a billion. By year's end, auto radios and portables are expected to be dominated by transistor circuits.

JUNE 1956 NETWORK COLOR TV SCHEDULE

WEEKDAYS	
June 1, 7, 8, 11-15, 18-22, 25-29	
3:00—4:00 PM (EDT)	NBC "Matinee Theatre" (Live)
FRIDAY, June 1	
5:30—6:00 PM (EDT)	NBC "Howdy Doody" (Live)
SATURDAY, June 2	
9:30—11:00 PM (EDT)	CBS "A Bell for Adano" (Ford Star Jubilee) (Live)
SATURDAYS, June 2, 9, 16, 23, 30	
7:00—7:30 PM (EDT)	CBS "Gene Autry Show" (Live)
SUNDAY, June 3	
9:00—10:00 PM (EDT)	NBC "The Sentry" (Goodyear TV Playhouse) (Live)
TUESDAY, June 5	
8:00—9:00 PM (EDT)	NBC "Milton Berle" (Live)
SATURDAY, June 9	
9:00—10:30 PM (EDT)	NBC "Sweethearts" (Max Liebman Presents) Live
WEDNESDAY, June 13	
9:00—10:00 PM (EDT)	NBC "Kraft TV Theatre" (Live)
SUNDAY, June 17	
7:30—9:00 PM (EDT)	NBC "The Sunday Spectacular" (Live)
WEDNESDAY, June 20	
10:00—10:30 PM (EDT)	NBC "This Is Your Life" (Live)
MONDAY, June 25	
8:00—9:00 PM (EDT)	NBC "Happy Birthday" (Producers' Showcase) (Live)
TUESDAY, THURSDAY, June 26, 28	
7:30—7:45 PM (EDT)	NBC "Dinah Shore" (Live)

The above schedule applies at press time.

Picture



ORDER OUT OF CHAOS DEPT. Industry humorists have long reported that any two experts discussing "what is hi-fi?" will end up with three definitions. However, some progress is being made, at least in standardizing the terms used in advertised performance claims. Chairman Joseph N. Benjamin of the RETMA High Fidelity Subcommittee reports that group is working on standard terms so specs for competing equipment may be fairly compared.

CURBSIDE HOTEL REGISTRATION by closed-circuit 2-way TV is the latest innovation of Allen B. Du Mont Laboratories. The drive-in service, now in operation at the Temple Hotel in Pendleton, Oregon, permits guests to register without leaving their cars and go to their rooms without stopping at the lobby desk. Cars driving up to a curbside booth trigger a device that alerts a clerk in the hotel. Through a 2-way TV-audio rig, clerk and guest see and converse with each other, make arrangements. A bellboy brings registration sheet out to car, directs guest to space inside the hotel's garage, then escorts guest and luggage directly to his room. Normal time for this procedure is cut from 15 to 2 minutes. The feature attracts guests who, wearing casual driving garb, feel uncomfortable about entering the lobby. They also like the saving made possible by elimination of multiple tipping.

ATTENTION CLOCK RADIO MANUFACTURERS & INVENTORS: Many consumers are sadly disappointed with the "fall asleep to music" timer control on their clock radios. The music may be soft when they fall asleep, but the loud smack of the timer shutting the radio off jars them out of sleep. Needed: a really quiet shut-off mechanism.

CALENDAR OF COMING EVENTS

- June 27-30: Jobber-Rep-Mfrs. Conference, Breezy Point Lodge, Brainerd, Minn.
- July 16-20: 1956 Summer Market, Western Merchandise Mart, San Francisco, Calif.
- July 22-25: 1956 National Audio-Visual Convention and Trade Show, Hotel Sherman, Chicago, Ill.
- Aug. 30-31: 3rd Conference, Rocky Mountain Chapter of "The Representatives," Colorado Hotel, Glenwood Springs, Colorado.
- Aug. 22-23: 23rd Annual British National Radio Show, Earls Court, London, England.
- Sept. 9-12: 1956 Distributor Conference, Heart of America Chapter of "The Representatives," Lake Taneycomo, Mo.
- Sept. 11-12: Second RETMA sponsored Conference on "Reliable Electrical Connections," Philadelphia, Pa.
- Sept. 14-16: NATESA Annual Convention, Sheraton Hotel, Chicago, Ill.
- Sept. 26-30: High Fidelity Show, New York Trade Show Building, New York City, N. Y.
- Oct. 1-3: Canadian I.R.E. Convention and Exposition, Automotive Building, Exhibition Park, Toronto, Canada.
- Nov. 2-5: High Fidelity Show, Palmer House, Chicago, Ill.
- Dec. 10-12: Eastern Joint Computer Conference, Hotel New Yorker, New York, N. Y.

RECENT MAGNETIC STORMS which tied up communications, and even played havoc with TV in many locations, were caused by tremendous explosions on the face of the sun. Scientists described the blast as equivalent to 1,000,000 hydrogen bombs.

GOODBYE TO ANTENNA FORESTS on city roof tops, predicts Snyder Mfg. Pres. Ben Snyder. The next few years will see them moving into the living room, and they will no longer look like antennas. They will be lamps, vases and even pictures on the wall. One reason for the trend is that new TV sets are more powerful. Another is that consumers are demanding fewer roof entanglements.

RANDOM NOISE

TV PARTS
BOX SCORE

	COLOR	B&W
TUBES.....	28	18
FIXED RESISTORS..	214	126
POTS.....	31	7
CAPACITORS.....	176	126
COILS.....	66	33
TRANSFORMERS...	18	9

TOM HIGGINS TR.

SOME WEST COAST SUPERMARKETS AVERAGE \$400/MO. IN REPLACEMENT TUBE SALES

INDUSTRY EXPECTS TO PRODUCE 12,000,000 TRANSISTORS IN 1956

DID YOU KNOW...?

SOMEONE BUYS A RADIO EVERY 2 1/4 SECONDS--- THERE ARE 2 1/2 RADIOS IN THE AVERAGE HOME---

How To Service Foreign

What You Must Know about These Increasingly Popular European

RICHARD SEQUERRA
AMERICAN ELITE, INC.

• In the past seven years, there has been a heavy influx of European made radios into the United States. These imports include many fine receivers, a number of them being sold as high-fidelity instruments, including AM and FM facilities, multiple speakers and other features. Some are portable. Estimates indicate that such sets, the majority of which come from Germany and Holland, are being used here in an amount exceeding 75,000, and the number is growing all the time.

The servicing of these sets can be a profitable sideline business. The ones most likely to be encountered here are being produced by the following manufacturers: Akkord, Beker, Blaupunkt, Continental, Grundig, Phillips (Norelco), Siemens, and Telefunken. Some are being imported and distributed by established receiver manufacturers in this country, often under their own names. For example, Majestic is handling Grundig receivers in this country. Fortunately, although these Dutch-German radios differ in many respects from the domestic product, there are enough similarities among them to permit their treatment as a group.

As with all electronic equipment, the most commonly encountered trouble is tube failure. These sets are no exception. The big difference is in checking when tube failure is suspected, since European tube types are used. Fortunately, many of these European types have American

equivalents. For this reason, before going any further, the reader is directed to Table 1, which lists the European types commonly used in the foreign receivers and their American equivalents. Where there is no equivalent type, basing data is given to help in making tests.

The recommended way of checking a tube is, of course, by substitution. Where this is not possible, other methods may be followed before a special replacement is ordered. A gentle tapping of the suspected tube will often reveal intermittent conditions, microphonics, etc. A stage gain check, which may be performed with a signal generator and meter, is also useful. Visual observation for gas can be made in the conventional way.

It is also helpful if we can associate specific symptoms with the various tubes and stages. The writer's experience with tube failures runs like this: low or weak audio output—audio output tube defective, low emission in first audio amplifier, defective detector; distorted AM or FM but not both—multi-element detector tube, or either AM or FM oscillator tube defective; weak or absent AM or FM—i-f, r-f or detector tubes defective; hum on station carrier but not with set in phono position—heater-cathode leakage in one of the early (r-f, i-f) tubes. A final word on German and Dutch vacuum tubes: by and large they are made to very high standards and should exhibit a relatively low rate of failure.

The block diagram of Fig. 1 and other service information given here applies to all German sets, since dif-

ferences are largely mechanical. In the diagram, tube functions and common types are identified.

A typical power supply for a European radio is illustrated in Fig. 2. One important difference it shows from conventional supplies in domestic sets is in the use of a power transformer with a tapped primary. This permits adaptation of the receiver, by means of a line voltage switch, to a wide range of supply voltages found in Europe and in this country. Secondary voltage is upwards of 200 volts. It is applied to a full-wave bridge rectifier, instead of the half-wave rectifiers commonly found here.

Canned Selenium Bridge

The four selenium sections used to make up the bridge rectifier are not separately mounted units. All four are connected together and sealed in a can. These cans, though they differ somewhat from each other in size and shape, bear a general resemblance to our own canned electrolytic condensers. Five different versions of such canned selenium bridge rectifiers are shown in Fig. 3. The center item in the illustration is a battery, concerning which more will be said later. Failure of the rectifier may cause the fuse to blow and/or the power transformer to overheat. Replacements for these canned bridges must be secured from the manufacturer or his representatives in this country, as there is no domestic product of this nature. In a pinch, four selenium rectifiers of American make can be wired together as shown in

Fig. 1—Block diagram of European AM-FM set with typical tube types.

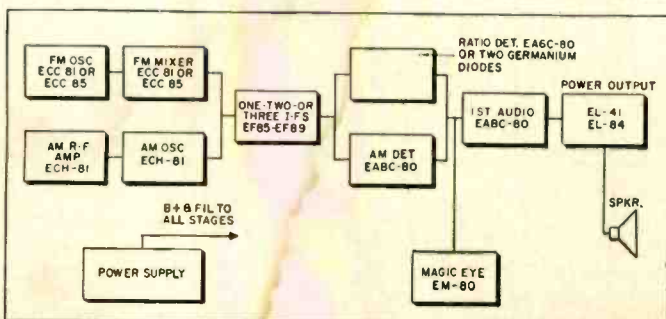
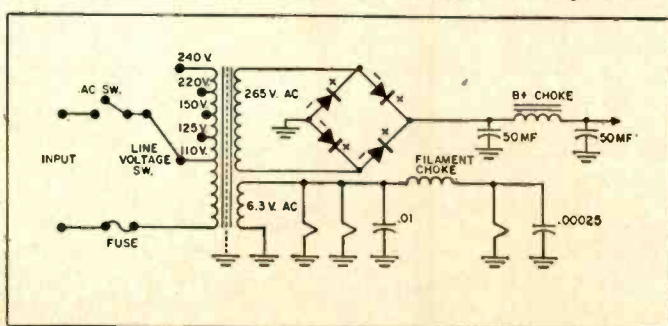

Fig. 2—Representative transformer power supply in foreign radios.



Make Radio Receivers

Sets to Do the Job; Getting Replacements for Unusual Parts

European Tube No.	American Equivalent	Description	Pin 1	Pin 2	Pin 3	Pin 4	Pin 5	Pin 6	Pin 7	Pin 8	Pin 9	Filament Voltage
DC90	None	VHF Triode	F	P	P	IC	G	G	F			1.4v
EAF42	"	Diode-Pentode	F	PP	PD	G3	G2	G1	K	F		6.3v
ECC85	"	HF Twin Triode	P2	G2	K2	F	F	P1	G1	K1	IS	"
ECH42	"	Triode-Hexode Conv	F	PH	PT	GT, GH3	GH2, 4	GH1	K	F		"
ECH81	"	Triode-Heptode Conv	GH2, 4	GH1	K, G5	F	F	PH	GH3	PT	GT	"
EF85	"	RF Pentode	K	G1	K	F	F	IS	P	G2	G3	"
EF89	"	"	IS	G1	K	F	F	IS	P	G2	G3	"
EL41	"	Power Pentode	F	P	K, G3	IC	G2	G1	K, G3	F		"
EL84	"	"	IC	G1	K, G3	F	F	IC	P	IC	G2	"
EM80	"	Magic Eye	G	K	IC	F	F	IC	P	IC	TA	"

DF91	1T4	
DF96	1AJ4	
DK92	1AC6	
DK96	1AB6	CODE:
DAF91	1S5	D = Diode
DAF96	1AH5	F = Filament
DL92	3S4	G = Grid
DL94	3V4	H = Hexode or Heptode
DL96	3C4	IC = Internal Connection
EC92	6AB4	IS = Internal Shield
EABC80	6T8	K = Cathode
ECC81	12AT7	P = Plate or Pentode
ECC82	12AU7	T = Triode
ECC83	12AX7	TA = Target

GERMANIUM DIODES	
0A150 = 1N34A	0A160 = 1N64
0A159 = 1N60	0A161 = 1N55

TABLE I

Fig. 2 to form the desired bridge.

One symptom that may crop up is distorted audio on AM, FM and phono. This is usually caused by a shorted or leaking coupling condenser or an open bypass. The only difficulty that may arise in this connection is the identification of component values, and this brings up an important point. The condensers and resistors used in foreign sets are generally not color coded. Instead they are marked with their values, but some difficulty may be encountered in reading these markings. Also schematic identification of components and their values differs from our system. It is important to know, in this connection, that *sp* is used to identify a coil, being equivalent to our use of the letter *L*. Also, *pf* is used where we would use *mmf* or *mmfd*.

Concerning alignment, both AM and FM i-f transformers are usually found in the same can. Alignment frequencies are as follows: for FM, the i-f, like ours, is 10.7 mc; for AM, the i-f is 460 kc. Alignment of r-f, i-f and detector stages is straightforward, and should create no unusual difficulties. Alignment of the

i-f system is best accomplished by the stage-gain method; for the r-f and oscillator sections, actual stations should be used. If detailed information is desired, it can be obtained from the manufacturer or his representative.

Most of these sets use a ferrite antenna for AM. It's alignment is best accomplished by finding the first station at the low end of the dial and manipulating the adjustable coil on the ferrite stick for maximum r-f gain. The dial pointer is next set for the available station that is closest in frequency to 1400 kc, and the r-f padder capacitor is adjusted on this transmission for maximum output.

Band Switching

Many or most of these receivers are multi-band affairs, designed to receive AM, FM and one band or more of short wave. The most commonly encountered method of band change-over is by means of a push-button assembly. Trouble in these assemblies is probably the most difficult likely to be encountered in servicing the foreign radios. Oscillator coils, r-f coils, resistors, capacitors, and padders are mounted directly on these mechanical arrays.

Where a noisy assembly is encountered, an application of a good contact cleaner is suggested. If a careful check shows that the trouble lies in the mechanics of the unit, it is usually advisable to replace the entire assembly. Fortunately, many of the people marketing and distributing these radios in this country offer a liberal warranty, usually running for a year. They should be considered as the primary source for all unusual mechanical and elec-

trical components not normally available through your regular jobber or distributor.

No discussion of foreign radios would be adequate without mention of the portable versions. Since they are the only portables presently available that will receive FM, they are attracting many buyers. FM re-

(Continued on page 52)



Fig. 3—Typical "canned" selenium bridge rectifier units. The large center object is the "accumulator" or battery for the portables.

Fig. 4—Circuit for charging the accumulator.

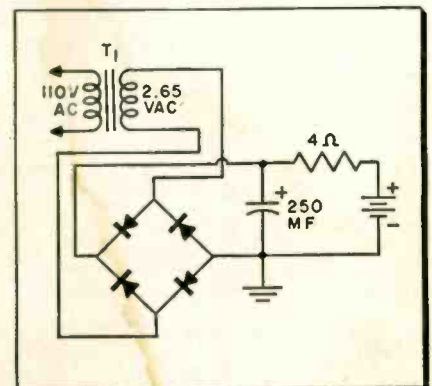

Generator and Scope "Bugs"

Answers to the Questions Manufacturers Are Most Asked by

ROBERT G. MIDDLETON
CHIEF FIELD ENGINEER
SIMPSON ELECTRIC CO.

• Many queries from technicians reach the factories where their test instruments are made concerning problems encountered in the application of sweep alignment equipment. As a result, the manufacturer is in a good position to know which difficulties are the most universally encountered ones. This is a presentation of the most common of these, together with practical solutions:

Broad Markers: Markers on response curves sometimes do not appear as anticipated. For example, Fig. 1 shows a marker on an i-f curve in undesired form. The broad and ill-defined marker is due to unrestricted frequency response in the vertical amplifier of the scope. This difficulty is encountered more often than formerly, due to the greater popularity of broadband scopes. The solution to the problem is illustrated in Fig. 2, which shows the use of an isolating resistor in series with the shielded input cable to the scope, constituting a low-pass filter.

This arrangement provides low-pass filter action because the series resistance feeds into the shunt capacitance of the shielded input cable

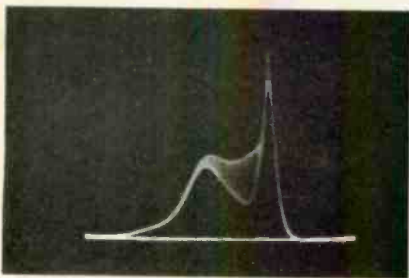
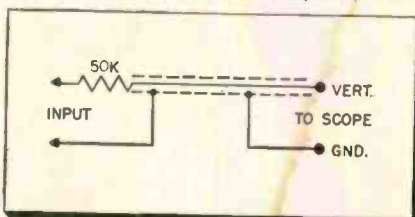

Fig. 1—Broad, indefinite marker indication.

Fig. 2—50k series resistor sharpens marker.



to form an effective integrating circuit with a suitable time constant for alignment applications. The undesired high beat frequencies that broaden the marker are eliminated.

Disappearing Markers: Sometimes the complaint is made that the marker disappears at the top of the response curve. This situation is due to overload of the i-f amplifier by the sweep signal, marker signal, or both. This difficulty is often insidious, because it may not be apparent immediately (even to the experienced observer) that overload is present. A marker run to the top of an overloaded response curve disappears as the peak is approached.

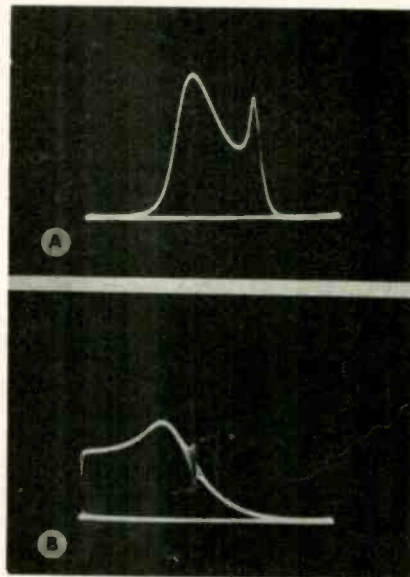

Fig. 3A—Marker on steep side of response curve has poor visibility. B—Reduction of generator sweep width improves visibility.

There is a reliable test for overload. The output from the generator is reduced, while the gain of the scope is simultaneously increased to maintain the curve height. When overload is present, it will be observed that the shape of the curve changes at the top. Reduction of generator output must be continued until no further change of shape is observed at the top of the curve; then the marker is visible.

Marking Steep Curves: Steep-

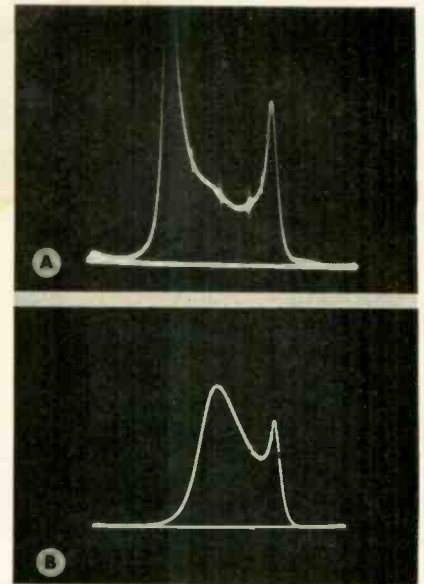

Fig. 4A—Cross-beat between test and local oscillator signals produces response curve distortion and spurious markers. B—Same curve with local oscillator of set disabled.

sided curves are often difficult to mark, unless suitable generator adjustment is utilized. An example is given in Fig. 3. The right skirt of the response curve is steep, and when the marker is run down on this side of the curve, as seen in Fig. 3A the indication becomes almost invisible.

The reduction in visibility is due to the fact that the marker extends vertically, and this region of the curve is also nearly vertical, so that curve and marker tend to merge. However, when the sweep-width control of the sweep generator is adjusted for less deviation and the scope is adjusted for more horizontal gain, the marker becomes clearly visible, as shown in Fig. 3B. Reduced sweep width lessens the apparent steepness of the skirt, so that the marker no longer coincides with the curve trace.

Spurious markers and curve distortion often result from neglecting to disable the local-oscillator tube in the receiver during i-f alignment procedures. For example, Fig. 4A illustrates a typical case, followed by the correct response curve without spurious markers (Fig. 4B) which is obtained when a suitable dummy

in Alignment Applications

Service Technicians on Problems Met in Sweep Alignment

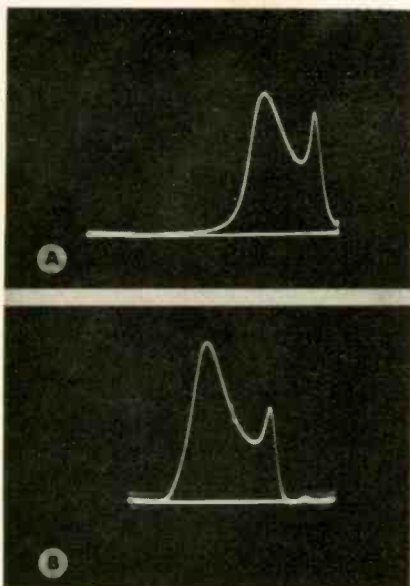

Fig. 5A—Center frequency of sweep generator set too high; curve off center. B—Proper setting of generator dial centers the curve.

tube is utilized in the front end of the receiver. Sometimes the channel-selector switch of the receiver can be turned to a non-interfering (inactive) channel, but the safest rule is to make up a dummy oscillator tube by clipping off either the plate pin or the grid pin of the oscillator section.

Remember, too, that spurious markers can be caused by radiation from generators on adjacent benches, or other strong r-f fields in the vicinity. Another less common source of spurious markers is the sweep generator itself, which may in some cases produce undesired marker output from harmonic cross-beats in the mixer section of the instrument. If the latter difficulty should be encountered, there is no ready solution except to disregard them.

Decentering of the response curve on the base line is due to incorrect tuning of the sweep generator. This situation is illustrated in Fig. 5. Beginners sometimes fall into the error of setting the sweep-generator dial to a specified center frequency, and then become puzzled in the event that the curve does not appear properly centered. It should be remembered that some beat-frequency

generators are subject to drift. Thus, although the dial may indicate correct center frequency, this may not represent actual frequency, with the result that the curve appears to the left or right of the desired position.

Experienced operators merely use the scale as a guide; the tuning control is adjusted as required to center the curve on the base line, and

Fig. 6—Four versions of same response curve: A—Low vertical scope gain. B—Low horizontal scope gain. C—Wide generator sweep width. D—Generator sweep width too narrow.

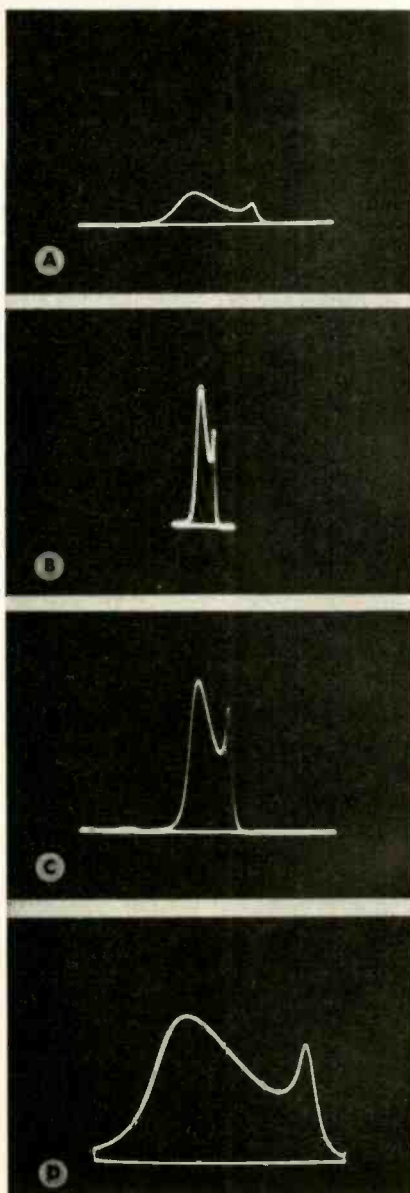

only the *marker* generator is relied upon to determine accurate frequencies along the display. If it is protested that this is an elementary matter, the fact remains that much difficulty has been observed in the field in this regard, and that it merits mention.

The apparent shape of the response curve depends upon the relative settings of scope gain controls and of the generator sweep-width control. This situation is shown in Fig. 6. Note carefully that the basic display is actually the same in these four illustrations, and that the alignment job can be completed in an identical manner, no matter which display is utilized. That is, the same curve appears in each display, although the superficial appearance differs for reasons described in the caption.

Another puzzling situation which is sometimes encountered is change in curve shape when the over-ride bias to the i-f amplifier is reduced, with a corresponding reduction in the sweep output voltage. Theoretically, the i-f response curve should

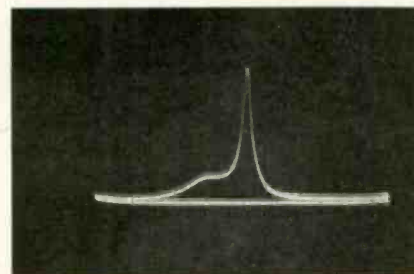

Fig. 7—Sharp peak and narrow bandwidth displayed by response curve from i-f amplifier regenerating with low value of over-ride bias.

maintain a constant shape when this test is made, and usually this is the case. But if regeneration is present in the i-f amplifier, the curve changes in shape as shown in Fig. 7, becoming abnormally peaked and narrow in bandwidth. Regeneration is a complex subject, and cannot be fully considered here; however, missing tube shields, removal of bottom shield plates from some types of i-f amplifiers, open bypass capacitors, incorrect peaking frequencies, and similar causes will usually be found responsible for regeneration. •

Road to Service Profits:



By "Whitey" Brayer,
Whitey's Radio & Television Co.
Phoenix, Arizona

It is becoming increasingly obvious to those of us who are engaged in both the sales and service end of the television industry that over the long pull ahead it will be service profits which will keep us operating. While it is true that the advent of color on a widespread, practical basis will again stimulate sales, we look to the service department for our basic revenue.

To my mind, the success of TV repair operations is based squarely on good personnel management. The volume of work which comes in, the appreciation of the customer, his desire to call us again for "repeat service" all depend on the impression which the serviceman creates on his first call.

To this end, the two dozen servicemen who make up our crew, are all meticulously dressed in white coveralls, with the firm name in red letters on the backs. Beside the service exit at the rear of the building, we have placed a full-length mirror to remind the mechanic to check on his cleanliness, hair grooming, and likewise, an electric shoe-shining machine for brown and black shoes.

Our men use a fleet of 11 repair trucks, all of which are finished in white, washed twice per week

and kept as spotless as operation in the dusty desert climate will permit. These things, we feel, contribute to the all-important first impression.

Appearance, of course, means nothing, however, if the mechanic does not know his job thoroughly, or uses manners or methods which do not measure up to his appearance. Consequently, before we place a service mechanic in his uniform and entrust him with the carrying of the firm's name and goodwill to the customer, he has gone through a detailed training course which takes into account such factors as efficiency, morale, courtesy, and ambition.

The new applicant, when he is received, goes through a "test period" which we feel is absolutely indispensable. For the first two weeks, on a full salary, and no matter how experienced he may have been, he attends training classes, which cover everything from operation of the two-way radio in the trucks to the most complex tracing of color-TV. At the end of the two weeks, each man must pass a 50-question test which I have prepared myself and which is designed to reveal whether the man is qualified both technically and from a business-building standpoint to represent us in the eyes of the public.

Following the two week period,

the new man is on probation for a period of three months. During this time, we give him an excellent opportunity to earn additional bonuses for detecting live prospects for new television equipment, and presenting them to the sales department. The same opportunity exists in suggesting and selling outside antennas.

At the end of three months, if he has passed the probationary period, the new technician is considered a full-fledged member of the team and fully trustworthy to handle any job assigned and to add to company lustre.

For the benefit of each new man, I have written a brochure, consisting of four mimeographed pages. We take up, point by point, all of the many aspects of servicing which we consider important, and which the serviceman must keep in mind.

Excerpts from "WHAT EVERY YOUNG TELEVISION TECHNICIAN SHOULD KNOW"

You are a representative of the service shop for which you work. You may be the only contact that the shop has with any particular customer. The reputation of the firm depends upon YOU. If you are interested in keeping your job, then you must be interested in the shop making money and methods of increasing the amount of business coming into that shop. IT IS UP TO YOU.

Clear Policies and Training

Here are some rules of conduct that television servicemen have found acceptable anywhere.

PERSONAL APPEARANCE

Before going to work, be sure to check your personal appearance. Clean clothes, hair neat, clean shave, clean hands and finger nails are ways of making an excellent first impression. You can feel self-confident. Self-confidence is important to anyone meeting the public.

SMOKING IN THE HOME

It is best not to smoke when working in the customer's home. It might be permissible, if you are offered a cigarette by the customer, but care must be taken in disposing of ashes and the placement of a lit cigarette. The customer can hold you and the shop liable for damage.

YOU ARE A REPRESENTATIVE

You must always remember that you are an agent of the shop, and the agreements made by you to the customer are binding to the shop. Be sure that the agreements you make with the customer are agreeable to the owner of the shop, as to the price, time and guarantee of work. If you do not know the fault in the receiver, or you are not sure, do not bind your shop to a price on that job.

DRINKING ON THE JOB

Do not accept liquor from a customer. In the first place the next customer may be strictly against liquor and not in the least broadminded about one beer. It also has been known that certain customers will offer a serviceman a drink and expect a lot of extra free service because of it.

CUSTOMER'S POINT OF VIEW

The customer may have some very poor concepts of how a television set works or how to operate it. He has worked hard to get these few bits of misconception; don't smash his months of work with one sentence. If you do, he won't like you or your ideas. Break the news to him gently and not in a positive manner. Always keep in mind that the customer is the one who indirectly pays your salary. If you let him express himself, you may get some help-

ful clues and the customer feels important, which makes him glad he called your shop. Being a diplomat is respecting the customer's point of view.

TIPPING

There are two ways of looking at tipping. The first is the obvious one, "The bird in the hand," etc. The second is that you never tip a doctor or lawyer. The reason you never tip a lawyer or a doctor is that you never tip someone on a higher or equal economic level. The minute you accept a tip you are classifying yourself lower than the person who tips you. Also, many customers will give a fifty cent tip for an hour's free work. The shop you work for may have a rule against accepting tips, and you can see why.

DON'T CRITICIZE

The only thing knocking a competitor ever accomplished was to lower the customer's opinion of the television service trade. It is also possible that you might have been the last person to work on that set.

USE A DROP-CLOTH

By placing your tools on a clean drop-cloth you will save the customer's rug from dirt and the shop's reputation. Tools or equipment should never be placed on floors, rugs, or furniture.

ADDRESS CUSTOMER BY NAME

All good salesmen know that people would much rather be addressed like this: "Hello, Mrs. Jones," instead of "Are you the lady of the house?" This also will help you save time if you should happen to get the wrong address.

FIRST IMPRESSIONS

It is not always easy for the man that is doing general service work to locate the "on-off" switch on a set that he is not familiar with, especially if the set has six to ten controls. Customers feel that if you don't know the location of the knobs, you couldn't possibly know more about the set than they do. One way around this is to ask the customer to show you the trouble they are having, such as: "Would you mind showing me the trouble you are having with this set?"

If you would like to cinch this bet, try this:

"We have found a few cases where incorrect operation has appeared as trouble, and we always like to see how the customer used the set." Never fumble over all of the controls looking for the "on-off" switch.

FOLLOW THE GOLDEN RULE

It is just as important for you to be on time when you are making a service call as it is for the customer to be home. Promise work done only if you are sure that you can repair it in that length of time. Customers become very displeased with delays in deliveries.

GIVE YOURSELF A BREAK AND NOT THE FURNITURE

Before any work is attempted on a set, remove lamps, vases, etc., from the top of the cabinet. Move all chairs, tables, etc., to allow yourself enough room to move around. You must have clean hands before you handle the customer's furniture. Do not wear black composition soles on your shoes, as they mark the floor and rugs.

RESPECT CUSTOMER'S HOME

Muddy foot-prints leave a very bad impression. Be sure to wipe your feet every time before you enter a customer's home. Be sure to leave rubbers, raincoats, and wet tool bags outside the customer's door.

IN CASE OF DOUBT, PHONE

This is a good rule, but be sure to ask the customer for permission before you use the phone. *HOUSEWIVES ARE FUSSY.*

Yes, housewives are very fussy about their bathrooms and guest towels, so it is always a good rule to avoid using them.

A FIVE-POINT FINAL CHECK

1. Be sure that there is no dirt or finger-prints on the face of the cathode ray tube or safety glass.
2. Be sure to wipe cabinet.
3. Be sure that the back is properly installed on cabinet.
4. Be sure that all trash is picked up from the floor.
5. Be sure that the furniture is replaced to its original position and that everything is in order.

Eliminating Vertical Retrace

How to Add a Blanking Network to a Set without One in

M. G. GOLDBERG

(This article originally appeared in the September 1953 issue of *TECHNICIAN*. A supplementary article by the same author on the same subject appeared in the issue of December 1955, in which references were made to the original piece. Since then, reader demand has exhausted our supply of reprints of the original. By popular demand, the September 1953 article is repeated here in slightly abridged form, although no essential information has been omitted.—Ed.)

• Many TV set owners who purchased receivers several years ago are still holding on to them for various reasons, in spite of the small-size screens with which most of these sets were equipped. The majority of these sets were made without retrace blanking circuits. Result: if the owner of an old set of this type likes a bit brighter than average picture, he is confronted with a series of annoying lines.

Most set owners would not be willing to pay any considerable sum of money to eliminate this condition. When the chassis is brought into the shop for other service work, however, such a circuit can be installed in most cases at comparatively little cost. Few customers would raise any objection to a nominal charge for

this work, and the improved performance would make for better customer-serviceman relations as well as serving as a constant reminder of the technician's competence. Many large-screen receivers also have been built without special retrace blanking circuits; in these cases it should not prove difficult to get the customer to approve the incorporation of such a circuit into his set.

Why Is Blanking Needed?

Before considering *what* to do and *how* to do it, let's first discuss some of the *whys* and *wherefores*. Figs. 1 and 2 show what happens when the customer turns up his brightness control beyond normal, as might happen during the showing of a "murky" cowboy movie. Fig. 1 shows the normal condition of operation with the brightness control set just right, so that the blanking pulse from the station blacks out the screen between points X and Y, and the bias is correct. (Assume there is no dc restorer in the circuit and that the video signal is coupled from output stage to the grid of the crt through a coupling capacitor.)

When the set owner advances the brightness a little he is unknowingly reducing the crt bias (Fig. 2). Lowering the bias brings the blanking level above the cutoff point of the pix tube characteristic; the

blanking signal from the station is now shifted toward the white area under the curve, and it no longer blacks out the horizontal lines during the vertical retrace period.

If the contrast control is advanced to feed a greater signal to the grid of the crt and thus extend the height of the blanking pulses, bringing them once again beyond cutoff, the video output stage may be overloaded, possibly introducing distortion. Dark greys also tend to become black with an excessive contrast setting, and small letters such as "o's" and "a's" fill up solid. In addition, sync clipping at the input to the sync amplifier may occur, producing picture instability.

Look once more at Fig. 2, showing conditions present when the customer has lowered the bias too much. If by some means we could increase the negative bias on the crt grid *only during the retrace period* we would get rid of the retrace lines, but the picture would remain unaffected. This is what is done by means of the circuits to be described. A negative voltage is tapped off from some point in the vertical oscillator or vertical output circuit. This voltage pulse is applied to the grid of the crt; or else a *positive* pulse is applied to the cathode of the crt; either method will achieve the desired result.

Several different methods of retrace blanking will be described.

Fig. 1—CRT input and output signals with normal circuit operation.

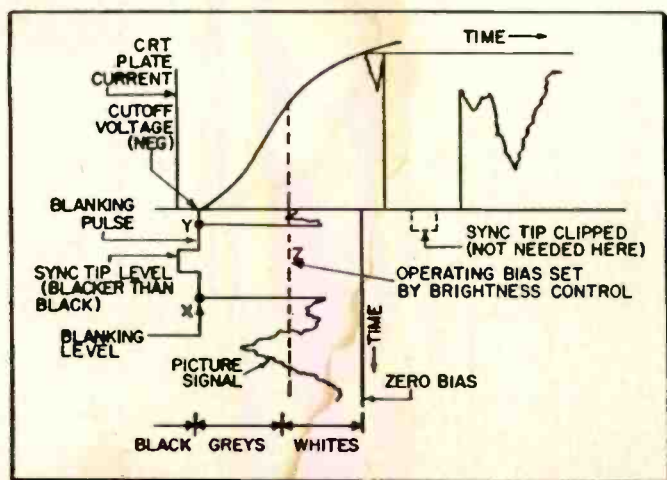
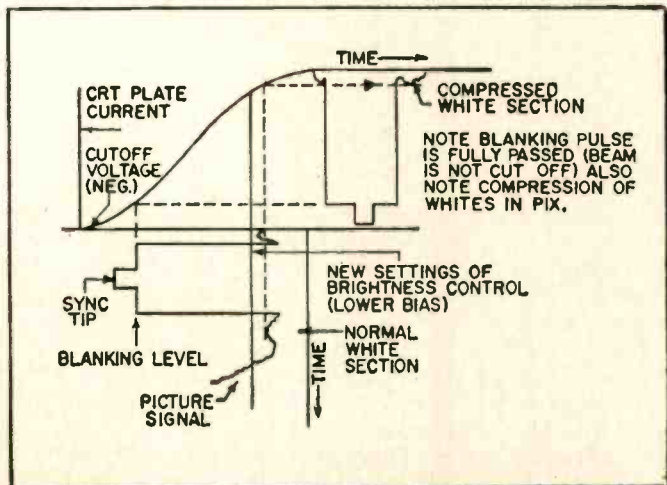

Fig. 2—Signal in CRT with brightness control set beyond normal.



Lines in Television Receivers

Less Than Thirty Minutes, Using Only a Few Components

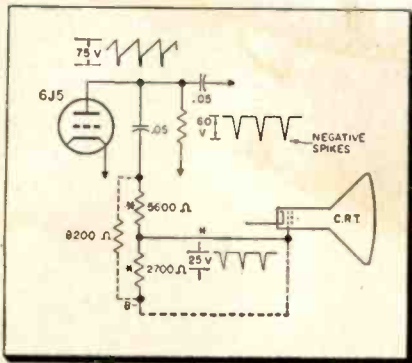

Fig. 3—Part of CRT and vertical deflection circuits in Motorola TS-14 and TS-23 TV sets.

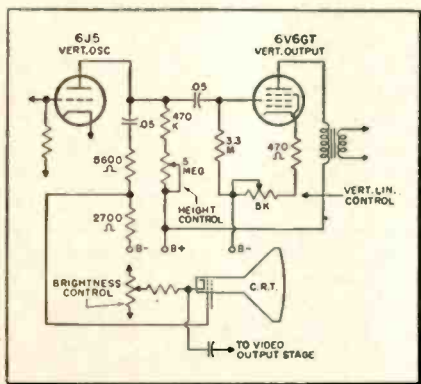

Fig. 4—Partial schematic of early Motorola TS-14 and TS-23. Original wiring is shown in dotted lines. Parts added to introduce retrace blanking have an asterisk beside them.

The technician can use his common sense in choosing a suitable circuit for the job he may have at hand.

Practical Circuits

Consider first the retrace-blanking circuit used in Motorola TS-14 and TS-23 chassis (see Fig. 3). The video signal in these sets is applied to the cathode of the crt. Note that the brightness control is in this cathode circuit. In some earlier models the grid was returned to B-, and no blanking circuit was present. With regard to these earlier models, a very simple change (see Fig. 4) makes it possible to incorporate retrace blanking.

All that is necessary is to replace the single 8200-ohm resistor with one 5600-ohm and one 2700-ohm

unit, and connect a wire from the junction of the two units to the grid of the crt (which has been disconnected from B-). The voltage divider thus formed is in series with the discharge capacitor in the 6J5 vertical oscillator circuit. The negative spike of approximately 25 volts which appears across the 2700-ohm resistor is applied to the crt grid. More pulse voltage can be secured, if needed, by reversing the position of the two resistors; at least 60 volts is available (if needed) across the two in series.

The writer has found it good practice not to attempt retrace blanking on the same tube element to which video signal is applied, as any increase in capacitance caused by added leads or components is apt to cause smear in the picture (due to increased shunting of higher video frequencies to ground). In other words, if the cathode of the crt is being fed from the video output stage, work the blanking circuit out in the grid circuit and vice versa. The brightness control may remain in either circuit without affecting the action.

Motorola & Trav-ler

The Motorola circuits of Figs. 3 and 4 use a form of multivibrator; in contrast, the Trav-ler models whose vertical circuit is shown in Fig. 5 employ a blocking oscillator. Here again the video signal is applied to the cathode of the crt; and

the brightness control is also in this circuit. A negative spike voltage of approximately 50 volts is applied to the grid of the crt through a .05 mfd capacitor. This voltage appears across the 330-k crt grid resistor, which leads to the dc restorer circuit. The method of tap-off for this vertical spike is similar to that shown in Fig. 4; only the component values are different. This circuit, with a 6C4 used as oscillator, is incorporated in Trav-ler models 12L50, 16R50, 16T50 and 16G50; a 6S4 is the vertical output tube in these sets. The method of blanking employed may be used for similar circuits in other makes of receivers.

With regard to the incorporation of retrace blanking, Philco receivers

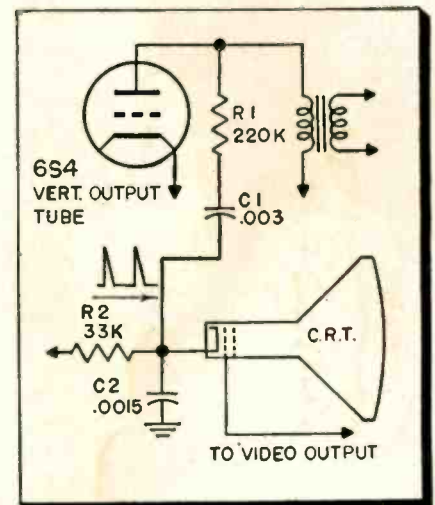

Fig. 6—Blanking circuit used in some Philco receivers. Added parts are R1, R2, C1, & C2.

Fig. 5—Blanking in Trav-Ler receivers.

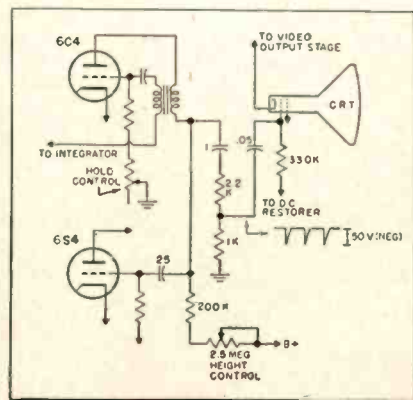
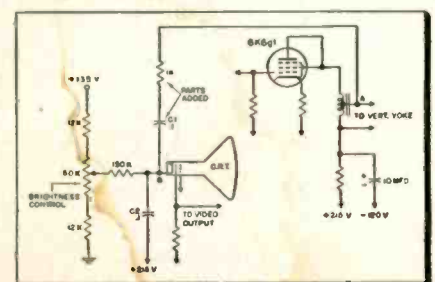

Fig. 7—RCA models with vertical autotransformer modified for retrace blanking. The two added parts are indicated by the arrows.



fall into two groups: earlier single-chassis models, and later dual-chassis sets. In the latter models, the r-f, i-f, audio and video circuits are on one chassis; the deflection and power circuits are on another and separate chassis. The two chassis are sufficiently separated to permit inclusion of a UHF tuner between them. Interconnections are by means of plugs, sockets and cables, and very careful attention should be paid to these connections when making any changes. Because of the additional complications introduced by the dual-chassis models, any serviceman interested in installing retrace blanking in such sets should contact Philco Service Headquarters in Philadelphia and ask for the copy of *Philco Service Supervisor* in which the necessary changes are plainly described, step by step.

Some Philco Sets

An example of the changes recommended is illustrated in Fig. 6. This is a skeleton schematic, and indicates the new parts to be added between the vertical output and the crt cathode circuits. These changes apply only to RF chassis units 33, 35, 37 and 38, and power chassis C2, CPI and F2; variations for other chassis types are described in the publication previously mentioned.

Note in Fig. 6 that the vertical spike is positive at the tap-off point, and is therefore applied to the cathode of the picture tube, the video signal being fed to the grid. Because the peak-to-peak voltage at the plate of the output tube is about 250 v—much more than is needed for blanking—it is dropped down to the proper amount by means of R1, R2, C1 and C2.

A series of RCA models that came out between 1949 and 1951 may be readily modified for retrace blanking. Some of these sets use an auto-transformer type vertical output transformer; others employ the two-winding type of transformer. The

same general treatment may be given to both types, with the vertical blanking spike applied to the crt cathode, as in the case of the Philco receivers previously referred to. Inasmuch as two million of these receivers, approximately, were manufactured, plenty of jobs are waiting to be done on these models alone.

Fig. 7 shows the simplified schematic for the following 1949 RCA 10 and 12-inch models: 9T246, 9T256, 9TC247, 9TC245, 9TC249. The same circuit was used in these 1950 models: T100, T120, T121, TC125, TC124, TC127. Note particularly the points marked A and B. These are the two points between which only two components need be added to do the entire job satisfactorily. Furthermore, an examination of the bottom of the chassis will show that these two points are adjacent tie points in almost the exact center of the chassis works, (A) being a green lead and (B) a yellow lead. Could anything be simpler?

Fig. 8 shows how the divider network operates to cut the approximately 100-volt pulse available down to half this amount. The 1000-ohm resistor is not essential, but is desirable for two reasons: one, it cleans up the pulse, and two, it gives a certain amount of protection in case of the breakdown of C1. This condenser should be rated at 600 volts, to minimize the likelihood of such a breakdown.

The circuit shown in Fig. 7 will remove retrace lines except at very high settings of the brightness control. If further reduction is desired, change C2 to a .05 or even a .03 mfd unit.

RCA 1949 Models

On 1949 RCA models 9T240, 9T272, 9TC240, 9TC272, and on 1950 models T164, TC165, TC166, TC167 and TC168, a two-winding vertical output transformer is used, as shown in Fig. 9. The same circuit revision may be used as in Fig. 7.

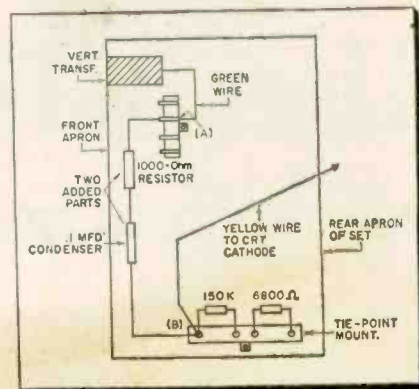

Fig. 10—Bottomside pictorial sketch shows blanking network added to 1951 RCA TV sets.

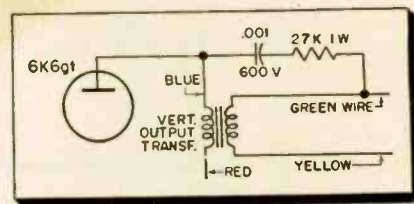

Fig. 11—Additional components (27K resistor, 0.001-mfd capacitor) to RCA 1951 models for blanking at very high brightness levels.

Point A is again the green lead to which the 1000-ohm resistor is connected; point B is only two inches away on the chassis, making the job very simple. C2 can be changed as in the previous case, if required.

On RCA 1951 models, A and B are five inches apart on the chassis (see Fig. 10). The same general change is made as in the earlier models. The '51 models referred to are 6T53, 6T54, 6T64, 6T65, 6T71, 6T75 and 6T76. To see how easy these jobs are to change over, look at Fig. 10. This sketch, which shows a fraction of the parts layout on the bottom of the last-mentioned models, pictorially indicates the tie points to which the two added parts are connected. With this sketch in view, turn the RCA chassis over, locate the two tie points, add the resistor and C1 and the job is done! If more blanking pulse voltage is required, change C2 to .02 mfd, 600 v.

When the owner of one of these RCA models wants retrace lines eliminated at far-advanced brightness control settings, the circuit shown in Fig. 11 may be added to the one previously described. This circuit provides an increased blanking pulse voltage of the proper polarity. The circuit change can be made very easily, since the points of connection are only three inches apart, with just enough separation between them for the parts to be connected in without additional wiring. •

Fig. 8—Voltage-divider of Fig. 7 redrawn.

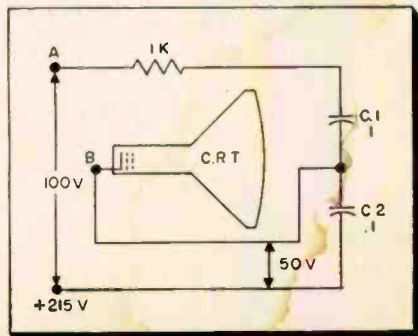
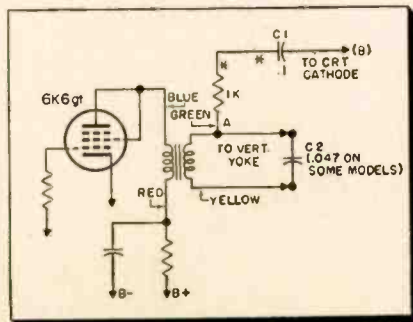
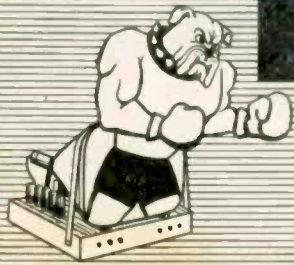

Fig. 9—Dual-winding xformer in some RCA sets; added parts marked with asterisks.





"Tough Dog"



Corner

Difficult Service Jobs Described by Readers

Chain Reaction

This started out as a simple fault on a Magnavox 21-in. receiver, 108 series. The complaint was no picture and weak sound. I replaced the 5U4 rectifier and sure enough, picture and sound came back. Getting ready to leave, I turned to close the receiver, but it wouldn't turn off. I then had to explain to the customer that the on-off switch which was shorted, needed replacement.

While I was finishing this repair, the customer complained of a ghost on the particular channel to which the set was then tuned. Separate high- and low-frequency antennas, connected to the receiver through a switch, were in use, so I reached to throw the switch in order to see whether reception was better in the other position. As I threw the switch there was a loud popping sound—and all channels were now snowy.

I soon discovered that, by placing the antenna lead-in near the chassis, I could draw an arc. Presumably the chassis was "hot," I began investigating it for further trouble. After troubleshooting, I found that one side of the power transformer primary was shorting to the chassis, as shown in the illustration. This put 110 volts ac on the chassis with re-

\$10 For Your "Tough Dog Story"

Have you tangled with a difficult or obscure service problem recently? Write it up, telling us how you licked it. Use drawings to illustrate your explanations wherever necessary. A rough sketch will do as long as it can be followed. Send it to "Tough Dog" Editor, TECHNICIAN, Caldwell-Clements, Inc., 480 Lexington Ave., N. Y. 17, N. Y.

spect to external ground. After correcting this fault, I still had to deal with the snowy pictures. This was eventually traced to a burned out antenna coil, which also had to be replaced.

How had the hot chassis burned out the antenna coil when the antenna switch was in one position? Well, investigation of the antenna showed that one of the sections had a short where the lead-in connects. The hot chassis was feeding ac through the grounded center-tap of the antenna coil, through the coil, and up through the antenna. From the defective antenna section, ac was able to return to external ground. The call had started out with a simple case of low voltage due to a weak rectifier tube. In addition to replacing the 5U4, before the call was over I had to replace an on-off switch, an antenna coil, a defective antenna section and a power transformer.—*Domenick Ivanditto, Brooklyn, N. Y.*

Vertical Sync Puzzler

Weak, intermittent vertical sync was the symptom on an Arvin chassis TE 341-1, although horizontal sync and the picture appeared unaffected. The vertical sync was also normal when the set was first turned on. However, after about 15 minutes the intermittent condition showed up, and troubleshooting was made difficult by the fact that it was of short duration.

A scope check at the output of the vertical integrating network showed a deterioration of vertical sync pulses while the trouble was occurring. Pulses would lose amplitude and change shape drastically. Waveforms were checked point-by-point back toward the video amplifier. Due to the intermittent nature of the defect, the scope had to be applied and left connected to the various test points to see how far back the pulse distortion went.

It was finally found that the condition existed as far back as the plate of the 1st video amplifier, a 6AU6, but not at the grid of this tube. A check of components in this stage finally showed that the screen bypass capacitor, a 5-mfd unit, was intermittently opening. Screen grid degeneration was evidently occurring, as a result, at the frequency corresponding to the vertical pulse, but not materially affecting other frequencies in the video bandpass.—*Frank Maderaski, Bristol, Conn.*

Power-transformer short to chassis burned out antenna coil through defective antenna section.

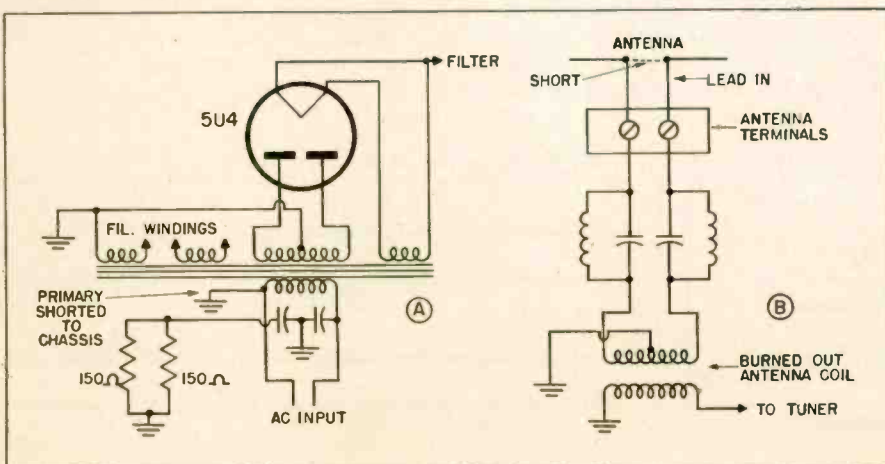

Double Trouble

On a hurry-up call from a regular customer, the complaint was that there was no sound although the picture was present. I mentally pictured a bad sound i-f, detector, etc. When I arrived on the call, what a surprise was in store for me. There was a picture, true enough, but what a picture it was. When a person's face was on the screen, for example, there was an exact duplicate of it immediately to the right of the orig-

(Continued on page 50)

Dipole Orientation Problems

Antenna Behavior May Alter Radically from Channel to Channel

A. R. CLAWSON

- Multichannel broadband antennas often comprise a dipole connected to a transmission line and a parasitic rod about 10 percent longer than the dipole. The parasitic rod, a reflector, is located behind the main dipole with respect to the direction from which transmission is being received. There may also be another rod, about 10 percent shorter than the dipole to which the lead-in is connected, and located in front of this dipole with respect to the direction from which signal is being received.

It is always desirable to orient the antenna for best reception—even if it looks backwards. In areas where several channels are to be received—and especially in metropolitan areas where there may be a multitude of reflections—the antenna may very well appear to be backwards. There is a reason for this state of affairs. An explanation will assist in meeting the sometimes puzzling reception problems that are encountered.

Dipole Configuration

Fig. 1 shows the customary set-up of a dipole and two parasitic elements. The element connected to the lead-in wire, whether driven by a transmitter or delivering power to a receiver, is always called the driven element. The element that is cut 5 to 10 percent longer and placed behind the driven element with respect to the direction of reception is called a reflector, because it tends to reflect signal back into the driven element and reinforce it. The reflector also serves to alter the directivity of the driven dipole,

whether the latter be a folded or plain dipole of 2 quarter-wave sections.

In front of the driven dipole (towards the station) is the director, cut some 5 to 10 percent shorter than the driven element. Since it serves to guide or direct signal into the driven dipole, it also augments the signal fed into the transmission line and receiver.

A simple dipole receives equally well at its front and rear. The reflector and director act to increase sensitivity at the front of the antenna (toward the station or stations) and to reduce sensitivity to the rear. The latter helps to cut down ghost-producing reflections coming in from the rear.

Many of the dipole type antennas in use for low-channel reception use the driven dipole itself and a reflector. For optimum pick-up on a given channel, a dipole should be one half-wavelength long. Many antennas of this type designed for the low band are cut for optimum performance on Channel 3, which extends from 60 to 66 mc. Since the dipole will usually be cut to favor the video carrier frequency, at the low end of this bandwidth, a half-wavelength at about 60 mc will be 7.8 ft. long. Such an antenna is shown at the bottom of Fig. 2, with the driven element having the length just given and the reflector being 8.6 ft., or somewhat longer.

Channel-2 Operation

This antenna will be fine for use on Channel 3—but many areas do not have such a channel. They may have instead a local station using Channel 2, on which matters are not



so good with the Channel-3 dipole and reflector. Note the lengths of the driven element and reflector for an antenna cut for Channel 2, shown at the top of Fig. 2. The reflector for a Channel-3 antenna is the same length as the driven element in the Channel-2 antenna. When the Channel-3 dipole-reflector combination is used for reception on Channel 2, what would normally be its reflector acts as the main pick-up element. What would normally be the driven element now acts as a director. The direction of maximum sensitivity of this antenna on Channel 2 has thus been reversed, with the gain from the rear being about twice that obtained from the front! This is the same as saying that, on Channel 2, the front-to-back ratio of the antenna has been reversed, or that it is a fraction.

The Channel-3 unit thus cannot be used to cut off a ghost on Channel 2, although, in strong-signal areas where there is no ghost, it should pick up adequate signal on the lower channel. Where a ghost from the rear creates a problem on Channel 2 (Continued on page 54)

Fig. 1—Relative lengths of dipole, reflector, and director.

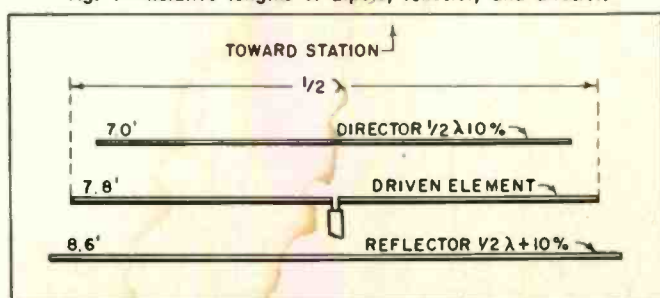
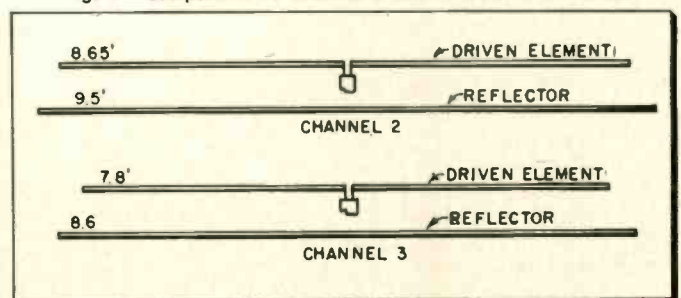
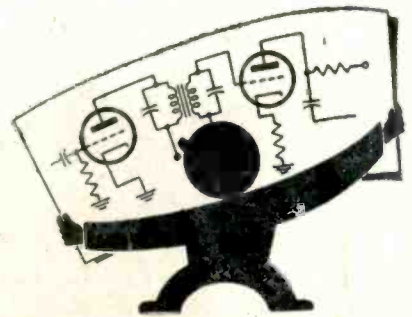

Fig. 2—Comparison of Channel 2 and Channel 3 antennas.



Let's Look at CIRCUITS



No. 8: The Triode at Work—Amplification, Phase Inversion

SIDNEY C. SILVER
MANAGING EDITOR

In electronics, as in everything else, the things we learn first and most readily come to be taken for granted after a while, without any consciously remembered explanation for their being. Thus the *how* of the basic vacuum-tube operations that underlie the science are often more quickly forgotten than relatively complex circuit configurations. The

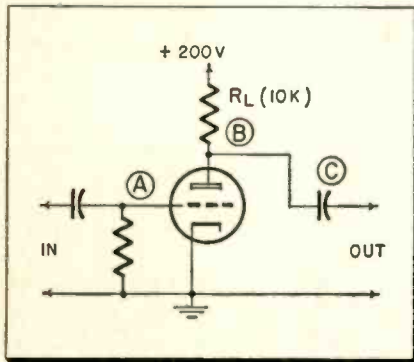

Fig. 1—Typical grid-input triode amplifier.

working of grounded-grid and cascaded amplifiers, cathode followers, and the like, though they are elementary circuits in common use, have slipped away from many of us—or so our reader mail tells us. Many a tech confesses that, while he knows perfectly well that the output of a conventional voltage amplifier is 180 degrees out of phase with the input, he cannot explain how this comes about.

Since the phenomenon of phase inversion ties in directly with the amplification process, let us contemplate the elementary amplifier of Fig. 1. For simplicity's sake, we are using a triode, resistance-coupled, without a cathode resistor. With no input to this amplifier, let us assume that, for some particular tube with given voltages at the grid, plate and cathode, 1 milliampere of current flows from the 200-volt plate supply source, through plate load resistor R_L , and thence to ground. (Or, if we

choose to think more realistically in terms of *electron* current flow, the direction is from ground, through cathode, through plate, through load resistor, and toward the 200-volt supply.)

This 1 ma of current, since it flows through the 10k resistor, produces a voltage drop across that item. Ohm's Law (E equals IR) tells us that there will be a 10-volt drop across the resistor. Therefore the full 200 volts will not appear between tube plate (point B) and ground; only 190 volts of plate voltage remains available.

The flow of current through a tube, we know, may be controlled by varying the voltage at its grid. If we make the grid more positive than it was, it will permit more electrons to pass through it to the plate. If we make it sufficiently positive, all the electrons that the cathode is capable of emitting will pass through to the plate. Positive grid increases beyond this point can no longer increase electron flow, which has reached maximum, and we have reached a condition called *saturation*.

If we reduce grid voltage (make it negative instead of positive), electrons leaving the cathode are repelled by the grid back toward the cathode, since the electrons themselves are negative and "like repels like." The cathode-to-plate electron flow is thus reduced. If we make the grid sufficiently negative, it will block off *all* electrons attempting to pass through to the plate. At this point, we reach the *cutoff* condition. The dynamic operating range of the tube lies in the region between saturation and cutoff.

Let us start by introducing a sine-wave signal at the grid, shown as waveform A in Fig. 2. At the moment of introduction, the neutral condition already set forth (with 1 ma of tube current) exists. This moment, T₁, finds the plate voltage to be 190 volts, as stated. The sine wave, a 1-volt peak-to-peak entity, swings negative (T₂) by half a volt. This reduces electron flow from

cathode to plate to half a milliampere, 0.5 ma. With this reduced current flowing through the plate load resistor, the drop across R_L is also reduced. Once again, Ohm's Law bears us out. The drop across the resistor is now only 5 volts, so 195 volts of the available 200 appears across the tube, as shown in T₂ of Fig. 2B. Though grid voltage and tube current have decreased, plate voltage has gone up.

At the next instant, T₃, the sine wave at the grid returns to its neutral value and the conditions present at the start once more prevail. At T₄, the input sine wave has swung to 0.5 volt positive (Fig. 2A) and more electron current is permitted to pass through the tube—and thus also through the plate-load resistor in series with it. Assuming that this current is now up to 1.5 ma, the drop across the resistor increases to 15 volts. Now only 185 volts of the

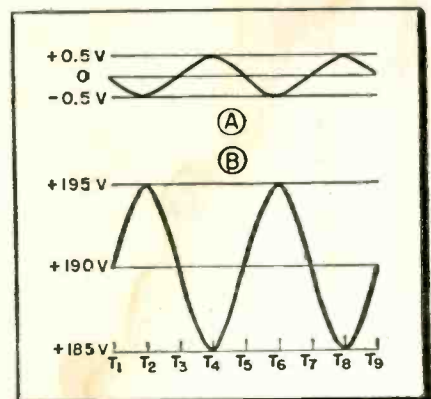

Fig. 2A—Input voltage. B—Plate output.

original 200 is impressed across the tube, from point B (Fig. 1) to ground, as shown at T₄ in Fig. 2B.

At T₅ we return to the neutral state after a complete cycle of change, and the process repeats itself from here to T₉ and beyond. We can come to some definite conclusions as to what is happening:

1. When grid voltage goes up, it also persuades current through the tube to increase. Therefore, grid

(Continued on page 48)

New Products for Technicians

Kester SOLDER



Newly packaged for the service trade is "TV-Radio Solder," a kit-sized edition of "Resin-Five" Core Solder, used in volume by many set manufacturers. Said to be non-corrosive and non-conductive with an activated flux, it works on all metals including such difficult-to-solder ones as zinc and nickel-plate. It is being marketed in place of the old "Radio Solder" (Plastic Resin-Core Solder). A counter display holds 10 of the boxes. Kester Solder Co., 4201 Wrightwood Ave., Chicago 39, Ill. and Newark 5, N. J. (TECHNICIAN No. 6-33)



B-T TV BOOSTER



Improved Model CA-1 Broadband VHF Amplifier, master TV and deluxe home booster, now features over 26 db gain on the low band and 24 db on the high band. Overall flatness is ± 2 db. All-triode push-pull circuit uses two 6J6 and two 6BQ7A tubes. Total peak output is 0.7 v for 75 ohms and 1.4 v for 300 ohms. Model CA-1 boosts all VHF channels, includes 14 db gain control. List price is \$79.50; dealer net, \$47.70 Blonder-Tongue Laboratories, Inc., 526-536 North Ave., Westfield, N. J. (TECHNICIAN No. 6-34)



Hickok CRT TESTER



Model CR5 Videochek permits rapid determination of condition or quality of the crt cathode. This check uses crt in conjunction with a neon lamp in a bridge circuit as a peak-reading vtvm. The beam current (peak) principal, essentially equivalent to light output, is employed for guns of the tetrode design (electromagnetic focus). For triode guns, a peak emission check is used to determine cathode condition. Also tests for shorts and opens. Hickok Electrical Instr. Co., 10550 Dupont Ave., Cleveland 8, Ohio. (TECHNICIAN No. 6-32)



Teleclear TUBE TESTER

Filament tester checks all TV, radio, portable and picture tubes. It is quick, foolproof and easy to use; works on 110 volts ac or dc. Neon lamp indicates condition. It also checks appliances, fuses, light or flash bulbs, wires, motors, resistors, or other equipment, and can be used to check line or other voltages. Price is \$2.95. Teleclear Co., 25 Willett St., N. Y. 2, N. Y. (TECHNICIAN No. 6-38)

G-C CHEMICAL DISPLAY

Technicians can help themselves to power spray chemicals from a new convenient merchandising display, the "G-C Spra-Koat Products" rack. 24 different products and colors are featured on the display, such as "De-Ox-Id," "Spra-Kleen," wrinkle varnish, touch-up varnish, enamels, flat paints, and others. Available at leading parts jobbers. General Cement Mfg. Co., 919 Taylor Avenue, Rockford, Ill. (TECHNICIAN No. 6-35)

Precise TUBE CHECKER

An ultra-fast tube checker, model 116, performs both emission and mutual conductance tests for most tubes. Manufacturer claims you can check 5 tubes in 4 seconds merely by rotating a switch. Model 116 also enables you to plug in 5 tubes at once and test each separately. It likewise checks transistors, gas, life, and individual sections of multi-purpose tubes. Available as a kit for \$69.95; factory wired for \$119.95. Precise Development Corp., Oceanside, L. I., N. Y. (TECHNICIAN No. 6-36)

PMC POWER SUPPLIES

Redesigned for greater ruggedness and convenience, input to these supplies is regular 115-volt 60-cycle ac. Output is adjustable from the front panel. Standard models are available with the following ranges: 2500, 5000, 10,000, 15,000, and 25,000 volts. Output is well filtered dc. Regulated models offer close output stabilization against line and load changes. Large 6-in. mirror-scale 1% kilovoltmeter shows exact output. Precise Measurements Co., 942 Kings Highway, Brooklyn 23, N. Y. (TECHNICIAN No. 6-37)

FOR MORE TECHNICAL INFORMATION ON NEW PRODUCTS OR BULLETINS

use this convenient coupon. Enter below the reference numbers for all items desired.

New Products Editor
TECHNICIAN & Circuit Digests
480 Lexington Ave.
New York 17, N. Y.

Please send me more information on the following items:

.....
My company letterhead or business card is enclosed.

Name
Address
Firm My position
City State
Business address (if different from above)

More New Products
on pages 42, 43, 46, 47

New Antennas & Accessories

S-R GROUND-UP MOUNT →

The GU-3 mounting is especially useful where chimney mounts are impractical or where tower or ground-up installations are necessary. A pair permits secure bolting of a push-up mast to side of house at 2 points. Mast diameter capacity is adjustable to $3\frac{1}{4}$ in., for heights to 50 ft. Brackets are offset to permit clearing $2\frac{1}{2}$ in. lip overhang on building. Brackets swivel to permit horizontal, vertical or diagonal mounting. Made of $\frac{1}{4}$ -in. steel stock. South River Metal Products Co., Inc., South River, N. J. (TECHNICIAN No. 6-29)

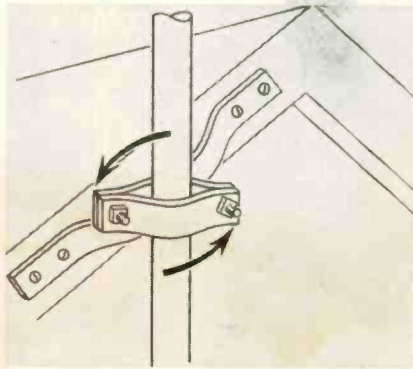

Channel MASTER TV WIRE →

"Copper-Jac," a new TV twinlead, features conductors of copperweld (a core of steel in a coating of pure copper). These conductors provide high strength and conductivity. Pure polyethylene insulation is used. Available in three colors—brown, silver and black—and with 7-strand conductors of No. 28 or No. 30 copper-weld wire. In conventional spool of 1,000 feet or economy carton (the "Feeder-Pak"), may be reeled out as needed, also containing 1,000 feet. Channel Master Corp., Ellenville, N. Y. (TECHNICIAN No. 6-25)

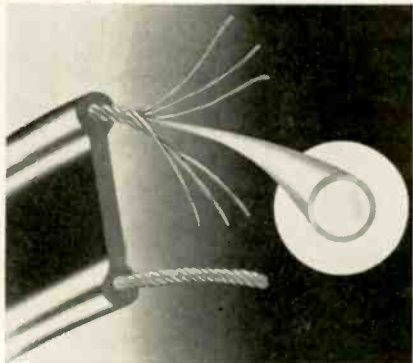

JFD UHF ANTENNAS →

All-aluminum corner reflector, model no. UHF410, features permanent rust and corrosion resistance, uses solid aluminum inline dipole with reflector assemblies for maximum UHF gain. Factory assembled unit flips to open and mount on a mast. The 4-stack Bowtie, Model No. UHF202, features rigid preassembled design. Calibrator permits peaking of response on desired UHF channels. Phasing harness creates maximum stacking gain. JFD Mfg. Co., Inc., 6101-16th Ave., Brooklyn 4, N. Y. (TECHNICIAN No. 6-27)

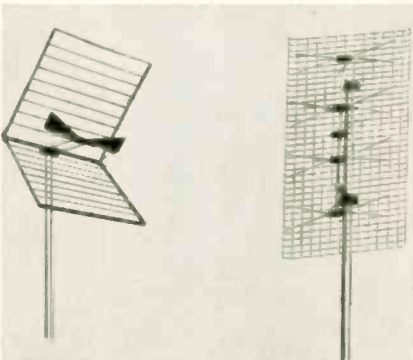

Alliance ROTOR →

Decorator models feature two harmonizing colors in the Tenna-Rotor Control Cases: Forest Green and Ivory. These are added to the standard Mahogany finish. The ability to rotate TV antennas adds to the quality and character of color reception, makes for more reliable use of color information, and thus improves color definition at the point of reception. Both models, the T-12 and the U-98, will now be available in three shades. Alliance Mfg. Co., Inc., Lake Park Blvd., Alliance, Ohio. (TECHNICIAN No. 6-26)

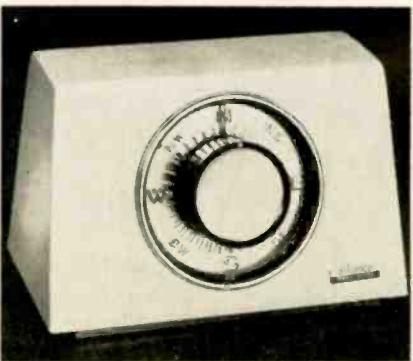

Brach VHF-UHF ANTENNA

Broadband VHF fringe antenna, the 3V, model 5603, also performs as a high-gain UHF antenna in primary areas. It has sharp directional characteristics. Gain curves show an average gain of 7 db on low VHF channels and 15 on high channels. The unit is fully pre-assembled and packed collapsed, with snap-lock design. Brach Mfg. Corp., 200 Central Ave., Newark, N. J. (TECHNICIAN No. 6-30)

Telco RATCHET MOUNT

A TV antenna mast mount with a ratchet grip can be used on chimneys or other strap mounts. It will fit all masts up to $1\frac{3}{4}$ in. diameter, is made of heavy-gage steel, double-plated to prevent rust, and comes with 24 ft. of strapping. Slip both ends of strap through ratchet-bolt slots and apply a wrench to the top nut until strap is tight. With galvanized strap (Cat. No. 9218), \$4.25; with stainless-steel strap (Cat. No. 9219), \$5.28. Television Hardware Mfg. Co. (Div. of General Cement Mfg. Co.), 919 Taylor Ave., Rockford, Ill. (TECHNICIAN No. 6-28)

Mosley ROTARY BEAM

High-gain, low-cost 10-meter rotary beam is a 3-element ham antenna using full-length director and reflector elements teamed with a shortened driven element to permit the use of a coupling transformer. This coupling system provides efficient match to a 52-ohm line. Performance figures include: 7.9 db gain; 20 db front-to-back ratio; 1.2 to 1 SWR at resonant frequency. Amateur net price is \$39.50 with hardware and instructions. Mosley Electronics, Inc., 8622 St. Charles Rock Rd., St. Louis 14, Mo. (TECHNICIAN No. 6-31)

R&R DIAL SAW

Model 200 Dial Saw is designed for light and medium duty boring, hole cutting, planing and grooving in wood, plastics and light metals in conjunction with hand or power tools, including drills. Calibrated settings permit accurate hole diameters from $1\frac{1}{2}$ to $2\frac{1}{2}$ in. Extended pilot drill permits cutting from both sides of work to a total thickness of $2\frac{1}{2}$ in. Replaceable cutting blades come in various types for use on different materials. Made of high-alloy, rust-resisting steel. Fits $\frac{1}{4}$ -in. drills. With set of blades, \$6.95. Robertson & Ruth, Box 534, Elmhurst, Ill. (TECHNICIAN No. 6-41)

For more technical information on new products, use inquiry coupon on page 40

New Semiconductors

TI SILICON RECTIFIERS

Five production silicon rectifiers feature a single grown-junction element with 1500-volt breakdown voltage, with stable operation up to 150°C, and forward current ratings up to 100 ma. The axial models, 1N543 and 1N543A, allow point-to-point wiring; types 1N544 and 1N544A are stud-mounted for maximum heat dissipation. The plug-in model, TI/680 (full-wave), can be used in many applications to replace the JAN 6X4 rectifier tube. Texas Instruments Inc., 6000 Lemmon Ave., Dallas 9, Texas. (TECHNICIAN No. 6-4)

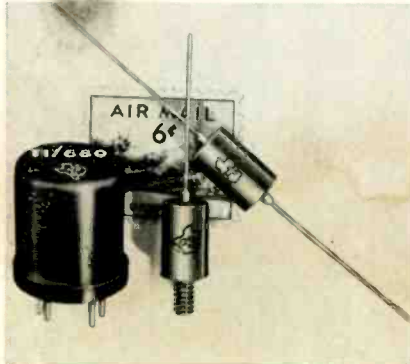

GE A-F TRANSISTORS

Ten new PNP transistors include 6 for audio output and 4 for driver stage. Linearity insures low distortion in push-pull and permits use of a pair without matching. 2N186A, 2N187A, and 2N188A, are rated at a 180 mw collector dissipation at 25°C; 2N186, 2N187, and 2N188 at 75 mw at 25°C. Drivers 2N189, 2N190, 2N191, and 2N192 have minimum power gain of 37, 39, 41, and 43 db, at 1 mw output. Prices from \$1.40 to \$2.35. General Electric Semiconductor Products, Electronics Park, Syracuse, New York. (TECHNICIAN No. 6-2)

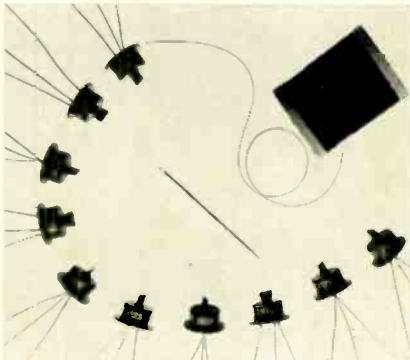

RCA A-F TRANSISTOR

The 2N175 (PNP) is designed for use in audio preamp or low-level input stages. Low noise factor of 6 db maximum and freedom from microphonism and hum result in high small-signal sensitivity in hearing aids, microphone preamps, and recorders. Low input impedance also permits direct matching to magnetic microphones and phono cartridges without transformers. Matched impedance power gain is approximately 43 db. Tube Div., Radio Corp. of America, Harrison, N.J. (TECHNICIAN No. 6-3)

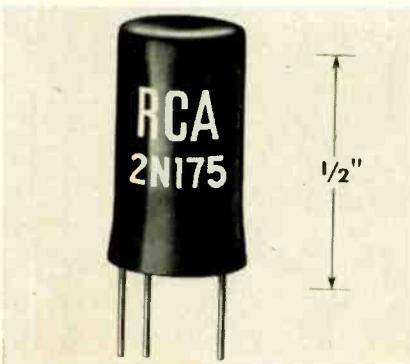

Int'l SILICON RECTIFIERS

These diodes are rated for 300 ma dc rectified output when mounted by leads in free air at ambient temperatures up to 100°C. When mounted on cooling fins, the diodes can be rated for 1.25 amps rectified output at a case temperature up to 150°C. Peak inverse voltage ratings range from 50 to 600v. Two styles: standard, for industrial applications, and magnetic amplifier types, for low leakage, in 2 current ratings for each style. International Rectifier Corp., Product Info. Dept., El Segundo, Calif. (TECHNICIAN No. 6-1)

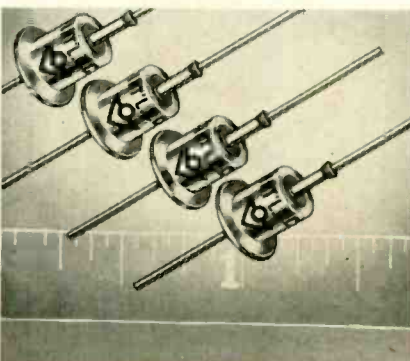

Clarostat MIN. CONTROL

Transistor series 44 composition element, 5/8" dia., 0.2-watt control is available from 500 ohms to 5 meg. Tolerance plus/minus 20% up to 100,000 ohms; 100,000 ohms and above, plus/minus 30%. Available with or without switch. Switches SPST or DPST for low-voltage applications. Controls are available for bushing or tab mounting for transistorized or other miniature circuits. Clarostat Mfg. Co., Inc., Dover, New Hampshire. (TECHNICIAN No. 6-8)

GI SILICON DIODES

With addition of a new group of stud-mounted silicon power rectifiers and 800 to 1,000 volt types, a complete line of medium-power silicon rectifiers is available. The line now ranges from 100 to 1,000 volts, with average dc output currents of 300 ma for pigtail types and 500 ma for stud-mounted types. Typical leakage currents are from 0.0005 μ a to 0.2 μ a. These diodes can do the jobs of tubes or selenium units many times their size. Automatic Mfg. Div., General Instrument Corp., 65 Gouverneur St., Newark 4, N. J. (TECHNICIAN No. 6-5)

Microwave 2-WAY DIODES

Mixer and video cartridge-type silicon diodes, formerly made only in forward or reverse polarity cartridges, now are available in reversible assemblies. This feature eliminates the need to stock diodes of both polarities. Normal polarity of the new diodes is reversed by shifting the end cap assembly to the end marked "Reversed." They interchange with standard types. The 1N415 and 1N416 series of reversible diodes are interchangeable with the 1N23 and 1N21 series of forward and reverse diodes, respectively. Microwave Associates, Inc., 22 Cummington St., Boston, Mass. (TECHNICIAN No. 6-6)

R-C MINIATURE TRIMMERS

Three air-dielectric trimmer capacitors, designated Subminiature Trimmer Series 75, are designed for tab mounting on dip-soldered printed wiring boards or screw-mounting on conventional chassis, also for transistor circuits. The capacitors measure just 25/64" x 17/32" behind mounting surface. The trimmers have minimum effective capacity range of 5, 10 and 15 mmfd. The nominal minimum capacities of the three units are 1.2, 1.2 and 1.5 mmfd respectively. Radio Condenser Co., Davis & Copewood Sts., Camden, N. J. (TECHNICIAN No. 6-7)

For more technical information on new products, use inquiry coupon on page 40

New Electronic Products

Ohmite MIN. RESISTORS →

Tiny 3-watt axial-lead, vitreous-enameled resistors are now available in values from 1 to 10,000 ohms. The line now consists of three sizes rated at 3, 5, and 10 watts. The 3-watt size is only 9/16 in. long. They are simple to mount and occupy small space, are suited for printed circuits. These power-type resistors are wire-wound, with steatite cores and a special-formula, vitreous-enamel coating. Thermally balanced to expand and contract as a unit. Ohmite Mfg. Co., 3677 Howard St., Skokie, Ill. (TECHNICIAN No. 6-20)

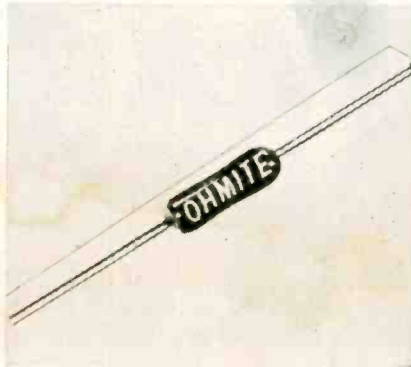

Electro POWER SUPPLY →

A 6/12-volt dc supply for servicing LPI, low-power input, 10-watt mobile communications equipment, Model "H" provides excellent regulation to handle instantaneous current requirements from standby to transmission. Delivers 6 volts to 20 amp, or 12 volts to 10 amp. Instantaneous current available to 30 amp. Includes voltmeter and ammeter. Maximum ac output ripple is less than 5 percent at full load. User's net \$66.00. Electro Products Labs., 4500 N. Ravenswood Ave., Chicago 40, Ill. (TECHNICIAN No. 6-17)

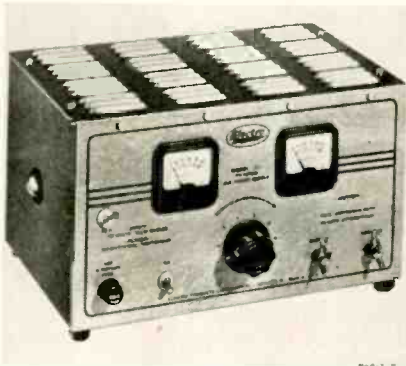

Workman FUSE-BAR →

A time-delay fused resistor, called the Fuse-Bar, is especially designed for any receiver using a fused resistor. It adds to the life of the set by delaying application of B+ voltage until tubes have warmed up. After initial installation, only fuse must be replaced in future. Offers protection against turn-on surge, increasing life of selenium rectifiers. Replaces any type of fused resistor. It is also simple to install, since no wiring is necessary. Workman TV, Inc., Teaneck, N. J. (TECHNICIAN No. 6-19)

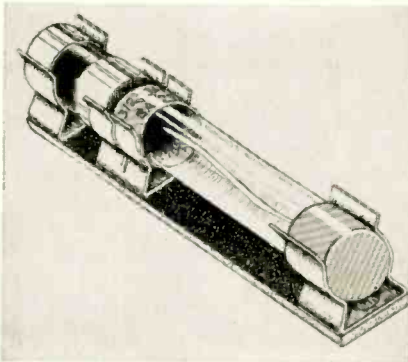

Walsco PHONO-TAPE DRIVES →

Redesigned phono-recorder drive display is a complete merchandising unit holding entire line of replacements for all major phonographs and tape recorders, old and new. Included are all 1956 motor drives, foreign and domestic. Sample of each inner compartment is shown and described on outer doors. Display speeds self-service and inventory-taking, is compact enough for wall, counter or floor use. Includes reference charts. Walsco Electronics Corp., 3602 Crenshaw Blvd., Los Angeles 16, Calif. (TECHNICIAN No. 6-18)



Motorola MOBILE RADIO

The "Private Line" radiophone provides private interference-free mobile communications and maximizes efficiency under congested or co-channel conditions. A continuous, inaudible subcarrier operates a receiver squelch circuit. Interfering signals cannot "trip" the squelch circuit, since the coded carrier is required to keep the speaker unmuted. A choice of mobile and base stations available in 25-54 and 144-174 mc bands. Motorola Communications and Electronics, Inc., Technical Information Center, 4501 W. Augusta Blvd., Chicago 51, Illinois. (TECHNICIAN No. 6-21)

Terado 6/12-VOLT CONVERTER

Here's how the Trav-Electric automatic converter works: Just insert plug into either 6 or 12 volt cigar lighter and an output voltage of 110 volts is automatically obtained. It is not necessary to turn vibrators or flip switches. For anyone with a 6-volt car, who plans to buy a car with a 12-volt system. The capacity is 60 to 125 watts, which will handle everything from electric shavers to tape recorders. Terado Company, 1068 Raymond Ave., St. Paul 14, Minn. (TECHNICIAN No. 6-22)

Miller AM TUNER KIT

High fidelity germanium-diode AM tuner kit No. 565 easily assembles into a compact cabinet (provided). The tubeless receiver has no power requirements, offers good selectivity (20kc), sensitivity, no noise or distortion, and trouble-free operation. Gain control and tuning dial. Connects to microphone or other low-level input of audio system. May be used during power failures. Price \$14.70. J. W. Miller Co., 5917 So. Main St., Los Angeles 3, Calif. (TECHNICIAN No. 6-23)

RCA H-O TUBE

Two new high-perveance beam-power tubes, 6DQ6-A and 12DQ6-A, are intended as horizontal amplifiers in high-efficiency deflection circuits. A large reserve of power capability and ratings higher than those of the 6DQ6 and 12DQ6, together with a high operating ratio of plate current to grid-No. 2 current, make possible design in which either tube can fully deflect picture tubes having deflection angles in excess of 90 degrees. The 12DQ6-A is like the 6DQ6-A except that it has a 12.6-volt/0.6-ampere heater with controlled warm-up. Radio Corp. of America, RCA Tube Div., Harrison, N. J. (TECHNICIAN No. 6-24)

For more technical information on new products, use inquiry coupon on page 40

SHOP HINTS



Tips for Home and Bench Service by Readers

Extra Hand for Soldering

Holding small parts together while soldering them can be quite a task. A piece of pressure sensitive tape, such as transparent cellophane tape, will take the place of an extra hand or so—you only have two hands, you know! The accompanying photograph illustrates the point. A capacitor and a resistor are being soldered

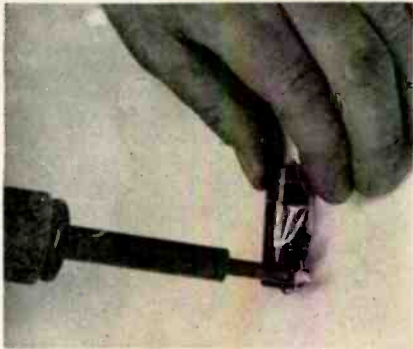

Cellophane tape is extra hand for soldering in parallel. The leads are to be kept rather short in this case. The tape is holding the resistor to the body of the capacitor. The tape may easily be removed after the soldering is completed and the "holding operation" is no longer required. In most cases, the tape can be left intact without causing any ill effects.—*L. A. Williams, Brooklyn, N. Y.*

Personalized Ads

You can boost your business by personalizing your local advertising. The radio and TV repair business has always been and will doubtless continue to be—like most smaller establishments—a friendly type of calling. Success in this field has always depended on the personality of the shop owner and sometimes of his employees, as well as on the quality of work and service rendered.

Have you ever thought that the folks in your community who have read your local ads and who pass by your establishment sometimes wonder what you, the owner of the shop, look like? Many of them doubtless have. So why not make those ads of yours a little more personal?

Try using your own picture and

the pictures of key employees in some of your ads. Ads of this type attract more attention, catch the eyes of more readers, increase business. They will also go a long way toward making you better known in your community. By using the pictures of key personnel, you can increase their personal following. Using these workers' pictures is also an important morale factor: it makes the employe feel like a more vital and more permanent part of your business.—*Dan Valentine, Salt Lake City, Utah.*

Wire Fed Through Wall

Did you ever have to run a flat lead through a hole in a wall in which a round lead was already installed? If you have, you know how difficult and tedious a job it can be. However, with a little ingenuity it becomes a snap. All you have to do is pull the round lead out of the wall by a certain amount. It should be pulled back by at least the width of the wall you wish to go through. Then, using plastic tape, tape the flat lead tightly parallel to the round lead. If you have made a good bind—not too bulky—the additional lead can be pulled through the wall with the original wire with no trouble at all.—*Sid Elliot, Miami, Fla.*

Weak Tuner Contacts

As turret-type tuners age, the contact springs, which are made out of brass, lose their springy quality. As this happens they become flatter, and the result is poor contact with

the various r-f and oscillator slugs as the drum is revolved, with impaired or intermittent reception. This condition is illustrated to the right in the accompanying illustration.

The remedy described here for this flattening has proved its success for the writer. After the individual contact springs have been brought back to original shape as much as possible, a strip of spaghetti is used to retain that shape. The writer uses polystyrene spaghetti, about 1/8 in. in diameter, and pushes it through the openings in the contact springs. This spaghetti keeps the springs open, preventing flatness and thereby assuring continued good contact between the revolving drum and the stationary springs. A strip of foam rubber with an oval cross section would be just as practical for this function. The position of the strip is shown to the left in the accompanying illustration, which is an internal view of the tuner with the turret drum removed for the sake of clarity.

If any of the contact springs are found to be broken when this job is undertaken, the entire contact plate should be replaced. The spaghetti can be run through the new springs, as a preventive measure, before the plate is mounted in the tuner. Another good practice is to remove permanently the slugs for all channels not used in the area. This gives the springs a chance to "stretch" between channels as the drum is revolved, thus prolonging life of the contacts.—*Hyman Herman, Flushing, N. Y.*

Spaghetti run through turret-tuner springs restores their shape and maintains good contact.

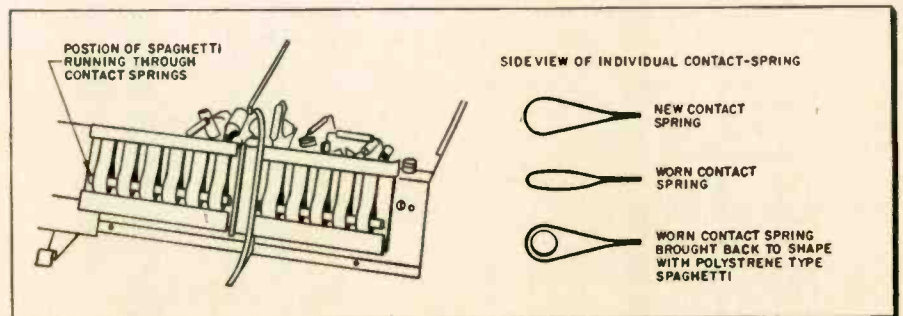



We CHALLENGE any other antenna to outperform our new

Seldom has an antenna aroused as much enthusiasm as our wonderful new Power-Helix. Its performance in Black and White and Color has been so remarkable, so outstanding, that we challenge any other antenna to surpass it.

A single bay of the new JFD Power Helix will:

OUTPERFORM a 10-element cut-to-channel Yagi on each high band channel from 7 to 13.

MATCH a 10-element cut-to-channel Yagi on channels 4, 5 and 6.

MATCH a 5-element wide-spaced cut-to-channel Yagi on channels 2 and 3.

We do not make nor should you take this challenge lightly.

It is backed by astonishing on-the-job performance under all operating conditions. You can extend to all your customers this same iron-clad guarantee of performance... whether it is a new set sale... a replacement antenna installation... or a color TV installation.

You be the judge. Try the Power-Helix. If it doesn't perform as we say... you name the forfeit.

EDWARD FINKEL, Sales Manager

POWER HELIX



COLORTENNA®

MODEL		LIST
PX911	1-Bay Power-Helix	\$35.00
PX911S	"Wide Stacked" Power-Helix	72.50



*® REGISTERED TRADEMARK

JFD MANUFACTURING CO., INC., BROOKLYN 4, NEW YORK

Go Forward with JFD Engineering!

New Audio Products

Shure CARTRIDGE KIT →

The 3 replacement phono cartridges in the RK56 Kit provide dependable replacements for 217 cartridges of 7 manufacturers, offer broad coverage for low investment. The kit contains: WC10 Ceramic Extended-Range, Improvement-Replacement Cartridge (for 132 3-speed cartridges, crystal or ceramic, single-needle or turnover); W70 Crystal All-Purpose Single-Needle (for Webster C and CX); and W72 Crystal Dual-Voltage 3-speed Turnover. List, \$22.95. Shure Bros., 222 Hartrey Ave., Evanston, Ill. (TECHNICIAN No. 6-11)



Sonotone HI-FI PICKUP →

Hi-Fi enjoyment of records can be achieved with the new "3" series of ceramic phono cartridges. The illustrated cartridge is the "3T," the popular turnover type, which plays records of all 3 speeds with two stylus tips. Diamond needles are recommended to insure top-quality performance, but the cartridges are also available with sapphire styli. Color scheme is black and gold. Equalizers and preamplifiers are not needed for these high-output cartridges. Sonotone Corp., Elmsford, N. Y. (TECHNICIAN No. 6-12)



Delco AUTO SPEAKER →

A new GM-Delco auto rear-seat speaker package is designed for simple installation, and priced to overcome cost objections. The package features a speaker (6 by 9 in.) with a 1-inch voice coil, a 3-position switch for dash-board installation, and an attractive 1-piece grille. The selector allows for rear-speaker operation only, front-speaker operation only, or both speakers operating together. United Motors Service, Div. of General Motors Corp., General Motors Bldg., Detroit 2, Mich. (TECHNICIAN No. 6-9)

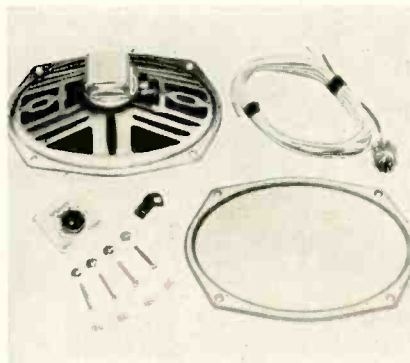

Heath HI-FI SPEAKER KIT →

The Range Extending Speaker System (Model SS-1B) has been designed to form a complete 4-way system with Model SS-1. Employing a super-tweeter and a 15" woofer, it functions between 35 and 600 cps and between 4000 and 16,000 cps. Response of the two units is ± 5 db from 35 to 16,000 cps. Styled to match Model SS-1. Exposed panels are furniture-grade plywood for finish of choice. A cross-over with balance control is included. Heath Co., 305 Territorial Rd., Benton Harbor, Mich. (TECHNICIAN No. 6-10)

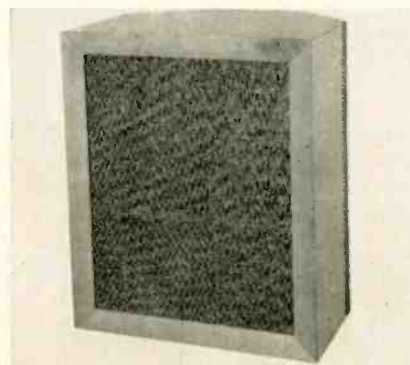

Reeves TAPE TIMER CHART

The Soundcraft Timing Chart enables the user to determine at a glance the time and length factors used in tape recording. The tape-recordist can tell how much tape he will need to record for a certain period of time or how long a certain tape will last at any recording speed. Because the chart is semi-logarithmic, it is accurate in determining length and time for short commercial and spot announcements. Sells for \$1.20. Reeves Soundcraft Corp., 103 52nd St., New York 22, N. Y. (TECHNICIAN No. 6-14)

H-K RADIO-INTERCOM

A complete radio-intercom ("Control" Model RC-5) includes a Control-Master and 4 remote speakers. Entire system mounts flush in wall, performs following functions: radio programs to any or all remotes; intercom between master and any or all remotes; monitors any or all stations from any or all others. Ideal to check children's bedrooms from any other room or rooms. Privacy switch may cut out each speaker. Retail price, \$135.00. Harmon-Kardon, Inc., Westbury, L. I., N. Y. (TECHNICIAN No. 6-13)

Interelectronics STATICLOTH

A counter display holds 36 Staticloth record cleaning cloths. Staticloth, packaged in a bright blue and yellow plastic envelope, is permanently treated to clean and lubricate records to end static noises. It reduces record returns caused by defects. Also available with the dealer's name permanently imprinted on the cloth itself, for low cost "sale" or premium use. Interelectronics Corp., Staticloth Div., 2432 Grand Concourse, New York 58, N. Y. (TECHNICIAN No. 6-15)

Miller DISC CLEANER KIT

To overcome problems encountered in some disc cleaners, such as the accumulation of dirt on cleaning cloths, Hi-Fi Technique Cleaner Kit uses a 2-step method: discs are first cleaned with a rinsable, reusable sponge and water, then sprayed with an anti-static and lubricating mist from an aerosol dispenser. Water on disc acts as vehicle to spread lubricant without further wiping. Complete kit sells for \$1.50. M. A. Miller Mfg. Co., 4th & Church Sts., Libertyville, Ill. (TECHNICIAN No. 6-16)

For more technical information on new products, use inquiry coupon on page 40

Only the 5 TOP-QUALITY brands of

STANDARD BRAND TUBES

AT SENSIBLE PRICES!

90-day RETMA guarantee • Individually boxed • 1st quality only • No rebrands or rewashed bargains • Brand new • No private brands • No rejects

FREE! Newest handy air-mail order form for your ordering convenience. Write for your free copy.
 • Lists ALL popular TV & radio types
 • Makes mail-ordering a real pleasure
 • Orders over \$25.00 (with remittance) post-paid.

TYPE	EACH	TYPE	EACH	TYPE	EACH
024	.50	6A1G	.55	7C7	1.15
1A2	1.00	6A7B	1.10	7H7	.85
1B3GT	.90	6AU6GT	1.05	7J7	1.35
1H5GT	.80	6AU5GT	1.25	7K7	1.20
1L4	.85	6AU6	.70	7L7	1.15
1L6	1.10	6AU7	.90	7M7	.95
1L4A	1.00	6AV5GT	1.25	7O7	1.00
1LAG	1.00	6AV6	.55	7R7	1.30
1LB4	1.00	6AX4GT	.85	7V7	1.30
1LC5	1.00	6AX5GT	.75	7W7	1.30
1LC6	1.00	6B4G	1.25	7X7	1.00
1LD5	1.00	6B4G	.55	7Y4	.70
1LE3	1.00	6BA7	.90	7Z4	.70
1LG5	1.00	6BC4	1.60	12A4	.85
1LW4	1.00	6BC5	.70	12A5	.70
1LM5	1.00	6BC7	1.25	12A5	.75
1N5GT	.95	6BD5	1.40	12A6	.55
1Q5GT	1.15	6BD6	.75	12A7	.95
1R4	1.00	6BE6	.70	12AUG	.65
1R5	.85	6BF5	.85	12AU7	.80
1S4	.90	6BF6	.70	12AV6	.55
1S5	.70	6BG6G	1.80	12AW7	1.00
1T4	.80	6BH6	.85	12AW6	1.00
1T5GT	1.05	6BJ6	.85	12AX4GT	.90
1U4	.75	6BK5	1.00	12AX7	.80
1U5	.70	6BK7A	1.10	12AY7	1.75
1V	.95	6BL7GT	1.15	12B7	.90
1V2	.70	6BN6	1.15	12B4A	.85
1X2B	.95	6BQ6GTA	1.40	12BA6	.65
2A4F4	1.40	6BQ7A	1.20	12BA7	.95
2D21	1.00	6BX7GT	1.25	12B06	.75
2K2	.50	6BY5G	1.30	12B16	.70
3A3	1.10	6BZ5	1.25	12BF6	.65
3A4	.55	6C4	.50	12BH7A	.95
3A5	.75	6C5	.80	12BK5	1.00
3AL5	.65	6C85	4.50	12B06GTB	1.40
3AU6	.70	6C86	.70	12B7A	.95
3AV6	.60	6C6G	.80	12B7T	1.00
3BC5	.80	6CF6	.90	12CUG	1.40
3BN6	1.05	6CG7	.85	12SA7GT	.85
3BY6	.75	6CL6	1.15	12SC7	.95
3CB6	.85	6CM6	.85	12S7	.75
3CF6	.80	6CN6	.75	12SK7GT	.75
3LF4	1.20	6CUG	1.40	12SL7GT	1.00
3Q4	.85	6DC6	.95	12SN7GTA	.80
3Q5GT	1.00	6F5	.85	12S07GT	.70
3S4	.80	6FG6	.80	12V6T	.75
3W4	.85	6G6	.85	12W6GT	.90
4B7A	1.30	6J4	3.95	14A5	1.00
4B7T	1.35	6J5	.50	14A5	1.50
5A8B	1.05	6J6	.70	14A7	.85
5AN5	1.10	6J7	.95	14A7	1.00
5A05	.75	6K6GT	.70	14B6	.85
5A5B	1.10	6K7	.90	14B7	1.00
5A7B	1.10	6K8	1.25	14E6	1.20
5AY8	1.15	6L6G	1.35	14E7	1.30
5AW4	1.15	6L6GA	1.30	14F7	1.00
5A24	.60	6L6M	1.75	14F8	1.00
5I6	.90	6M7	1.20	14H7	1.00
5T4	1.75	6Q7	1.00	14N7	1.00
5U4G	.60	6S4	.65	14Q7	.95
5U4GB	.70	6S8GT	1.10	14R7	1.30
5UB	1.10	6S7	.90	14S7	1.00
5V4G	.95	6SF5	.75	14W7	1.35
5V6GT	.70	6SF7	.95	19B6GG	2.00
5W4GT	.70	6SG7	.95	19T8	1.20
5X4G	.80	6SH7	.95	25AV5GT	1.30
5X8	1.05	6S17M	.75	25A4GT	1.10
5Y3GT	.55	6SK7GT	.75	25BK5	1.00
5Y4G	.65	6SL7GT	1.00	25B06GTB	1.40
5Z3	.90	6SN7GTA/B	.80	25C06GA	1.80
5Z4	1.25	6S07GT	.70	25CUG	1.35
6A7	1.15	6SR7	.75	25L6GT	.70
6A8M	1.15	6SS7	1.00	25W4GT	.75
6A8GT	1.10	6T8	1.05	25Z5	.80
6A84	.65	6UB	1.05	25Z6GT	.65
6AC5GT	1.15	6V38	1.30	35A5	.70
6A7	1.10	6V6GT	.65	35B7	.70
6AD7G	1.55	6V6M	1.30	35C5	.70
6AF4	1.30	6W4GT	.70	35L6GT	.65
6AF6G	1.20	6W6GT	.90	35W4	.45
6AG5	.75	6X4	.50	35Y4	.70
6AG7	1.35	6X5GT	.55	35Z5	.45
6AH4GT	.85	6XB	1.00	41	.85
6AH4GT	.85	6Y6G	.95	42	.75
6A15	1.75	7A5	.95	43	.85
6AK5	.75	7A6	.80	50A5	.70
6AK6	.80	7A7	.85	50B5	.70
6AL5	.60	7A8	.80	50C5	.70
6AL7GT	1.65	7AG7	1.00	50L6GT	.65
6AM4	1.55	7AH7	1.00	50K6GT	.90
6AM8	1.15	7B4	.80	50Y6GT	.80
6AN4	1.50	7B5	.70	50Y6GT	.80
6AN5	3.50	7B6	.80	70L7GT	1.35
6AN8	1.20	7B7	.80	80	.65
6AQ5	.70	7B8	.90	117L7GT	2.50
6AQ6	.60	7C5	.80	117N7GT	2.00
6AQ7GT	1.20	7C6	.80	117P7GT	2.00
6AR5	.75	7C7	.85	117Z3	.70
6AS5	.75	7E7	1.20	117Z4GT	1.15
6AS6	2.25	7F7	.90	117Z6GT	1.15
6AS8	1.20	7F8	1.20	5642	1.00

We stock over 1000 types including Diodes, Transistors, Transmitting and Special Purpose types.

5654/6AK5 NEW JOBBER BOXED. (SINGLES \$1.45) LOTS OF 100. EA **\$1.25**

TERMS: 25% with order, balance C.O.D. All merchandise guaranteed. F.O.B., N.Y.C.

BARRY ELECTRONICS CORP.
 Dept. T
 512 Broadway, N. Y. 12, N. Y.
 Call us day or night 24-hour telephone service
 Walker 5-7000

New Products

Weller SOLDERING AID

Heretofore available only in Weller kits, the soldering aid is a pencil-shaped colored plastic holder with one pointed metal probing end and a slotted wiring end. It can be used to hold work being raised to soldering heat, to twist wires



into tight connections prior to soldering, to untwist wires that are to be resoldered, to hold surrounding components clear of points being soldered, and in other wiring situations. Price is 50 cents. Weller Electric Corp., 601 Stone's Crossing Road, Easton, Pa. (TECHNICIAN No. 6-40)

Wall "PENCIL" IRON

In spite of its midget size (the iron weighs only 1 oz., and has a 1/8-in. tip), the new "pencil" model is built to survive production line punishment. It has thermostatic action, which controls heat so that fusing and tip-burning are eliminated. For delicate precision work

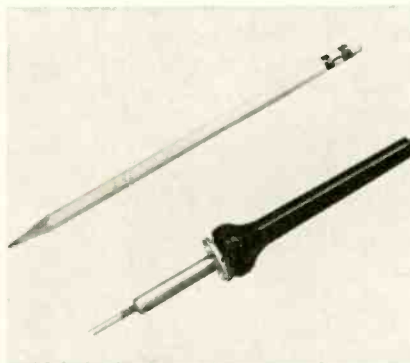

on regular radio and TV or printed circuits. It causes no interference and reaches production heat four times faster than other irons of equal tip size. "Chimney" feature keeps handle cool. UL approved. Length is 7 1/2 in. Wall Mfg. Co., Grove City, Pa. (TECHNICIAN No. 6-39)

More New Products on pages 40, 41, 42, 43

to
be
SURE!

buy
VOKAR

the original-
equipment
VIBRATOR



Leading manufacturers of original-equipment auto-radios specify Vokar vibrators as components for installation on the production-line. Why? They're sure Vokar quality never varies — will always contribute to top performance demanded of today's radios.

You too can depend on Vokar vibrators—for sure starts, longer life, silent operation. For all replacement jobs, buy Vokar Imperial or Quality Brand vibrators to be sure of satisfied customers.

Now is the time to stock up on 12-volt vibrators—ONLY TWO VOKAR IMPERIALS ARE NEEDED TO FILL ALL REPLACEMENTS!



VOKAR—preferred by leading manufacturers of auto-radios.

VOKAR

VOKAR CORPORATION
DEXTER 4, MICHIGAN

FREE



news of the month

Cornell-Dubilier's "THE CAPACITOR" is keeping over 100,000 readers abreast of the latest electronic techniques and practices. Condensed, meaty-reading articles that will make your job easier and your service better. FREE—12 times a year—mailed right to your home. Join C-D readers' club—a subscription is yours FREE for the asking.

A service of

CORNELL-DUBILIER

world's largest manufacturers of capacitors

GET ON THE LIST
FOR CORNELL-DUBILIER'S
"CAPACITOR"—YOURS

FREE

Editor—"The Capacitor"
CORNELL-DUBILIER ELECTRIC CORP.
Dept. RT-656, South Plainfield, N. J.

Yes Sir! Put me down for a FREE
Subscription to Cornell-Dubilier's
"THE CAPACITOR"

name _____
please print

address (home) _____

city _____ zone _____ state _____

my occupation or
job title is _____

Let's Look at Circuits

(Continued from page 39)

voltage is said to be in phase with tube current, including plate current.

2. Plate voltage, due to the changing drop across the load resistor, rises and falls exactly out of step—180 degrees out of phase—with grid voltage. A comparison of waveforms A and B shows that, although the plate output reproduces the frequency and shape (sine wave) of the input faithfully, the two are indeed exactly out of phase.

3. Comparison of the waveforms illustrates another point: whereas the grid input waveform swings from 0.5 volt negative to 0.5 volt positive—a peak-to-peak variation of 1 volt—the corresponding swing at the plate is from 195 volts to 185 volts—a peak-to-peak variation of 10 volts. In other words, in addition to being turned upside down at the plate, the original signal has been increased in size, or amplified. In this case, it has been amplified ten times.

4. The output signal at the plate (point B in Fig. 1) is really a varying dc voltage. It is usually necessary to separate the ac signal portion from the dc portion of the signal for subsequent use. This is easily accomplished with the coupling or blocking capacitor shown at the output. With the 190-volt average dc value stopped at the plate side of the capacitor, only the amplified sine wave of waveform B gets through to the output side (Point C in Fig. 1), but now it varies from 5 volts positive to 5 volts negative around zero.

5. Of the two functions performed—amplification and phase inversion—one may be more important than the other in a particular application. This point is made for future discussion.

6. Strictly speaking, input is applied not simply to the grid, but between grid and cathode (follow the grid-cathode circuit through the ground connection in Fig. 1). Similarly, output signal is not taken off from the plate alone, but from the plate-to-cathode circuit. In other words, there is one tube electrode that is common to both the input and output circuits. In this case, it is the cathode. While the common electrode will vary in some circuits up for future discussion, in each there will be one electrode common to input and output.

7. The phenomenon of phase inversion depends on the use of a re-

sistance-coupled amplifier, like the one shown, with a resistor as plate load, with grid input and plate output. In some other types of amplifiers, no inversion occurs.

8. Since a dc current passes through the tube and a voltage drop occurs across it, we may consider it to be a resistor of sorts—but with rather unusual properties, as we see when we try to calculate its effective resistance value. At time T1 (also T3, T5, T7 and T9) of Fig. 2, the drop across the tube is 190 volts and the current through it is 1 ma. One of the Ohm's Law formulas (R equals E/I) tells us that the tube's resistance in this circuit is 190k. However, at times T2 and T6 the drop goes up to 195 volts and the current goes down to 0.5 ma. Tube resistance is now slightly more than 123k! Similarly, at times T4 and T8, with a drop of only 185 volts and current of 1.5 ma, effective resistance goes up to 390k. Because of this strange ability to change its effective resistance with altering input conditions, tubes are sometimes referred to as variable resistors of a kind. This property opens the door to many applications, as in voltage-regulator circuits.

(Next installment: what happens when we connect a resistor to the cathode of our typical stage?)

Tube Life Marathon

Over a year ago the Lew Bonn Co., Minneapolis distributor, took a complete set of Westinghouse TV tubes from stock, put them into a TV set, turned the receiver on, chained it and locked it, then threw away the key. At the end of April 1956, the



No tube failure after 6 yrs. equivalent use.

distributor threw a party celebrating a full year of continuous operation of the set (8784 hrs.), comparable to 6 yrs. of normal use, without a single tube failure.

Chassis Conveyor System



A radio chassis conveyor system at Motorola's main plant serves both as a storage place and a means of moving chassis to work stations. Capacity is 2672 chassis and rate of movement is 3 to 9 ft. per min. With aisles around production lines cleared of chassis trucks, space is saved and plant housekeeping is improved. Model shifts on the line are now facilitated, as each conveyor unit has four shelves, one for each basic chassis.

Popular CRT Sizes

Twenty-one and 17-in. pix tubes make up 61 percent of the crt replacement market, according to Paul P. Wickman, dealer products sales mgr. of the GE Tube Dept. The most popular size, 21 in., accounts for 38 percent of all replacements. Second is the 17-in. tube, which constitutes 23 percent of replacement sales. Aluminized types have also found acceptance with the public, with 43 percent of replacements in these two popular sizes being aluminized.

GE also announces price cuts ranging from 22 to 53 percent on 5 different types of h-f transistors used in portable and table model radios.

Transcontinental Wire Net

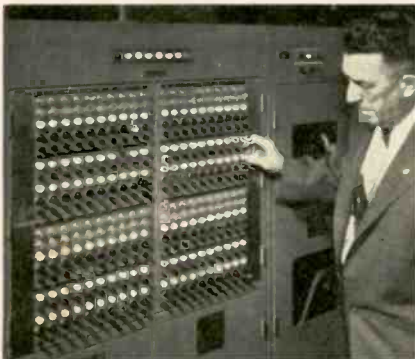

Electronic private wire system, developed by Western Union for E. F. Hutton & Co., is designed to meet the unique needs of the brokerage business. Over 2400 messages an hour can be handled automatically among Hutton's New York, Chicago, and West Coast offices. A built-in priority device handles messages in order of coded importance. The private system encompasses 18,893 mi. of telegraph circuits.

for service and lab. work

Heathkit PRINTED CIRCUIT OSCILLOSCOPE KIT FOR COLOR TV!

① Check the outstanding engineering design of this modern *printed circuit* Scope. Designed for color TV work, ideal for critical Laboratory applications. Frequency response essentially flat from 5 cycles to 5 Mc down only 1½ db at 3.58 Mc (TV color burst sync frequency). Down only 5 db at 5 Mc. New sweep generator 20-500,000 cycles, 5 times the range usually offered. Will sync wave form display up to 5 Mc and better. Printed circuit boards stabilize performance specifications and cut assembly time in half. Formerly available only in costly Lab type Scope. Features horizontal trace expansion for observation of pulse detail — retrace blanking amplifier — voltage regulated power supply — 3 step frequency compensated vertical input — low capacity nylon bushings on panel terminals — plus a host of other fine features. Combines peak performance and fine engineering features with low kit cost!

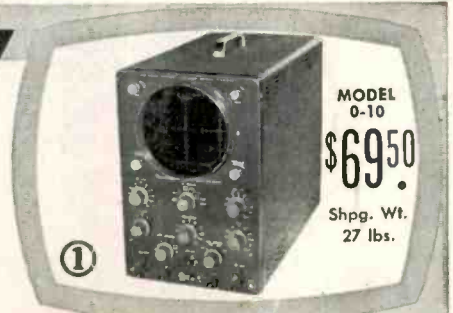

MODEL
0-10
\$69.50
Shpg. Wt.
27 lbs.



MODEL
TS-4
\$49.50
Shpg. Wt.
16 lbs.

Heathkit TV SWEEP GENERATOR KIT ELECTRONIC SWEEP SYSTEM

② A new Heathkit sweep generator covering all frequencies encountered in TV service work (color or monochrome). FM frequencies too! 4 Mc — 220 Mc on fundamentals, harmonics up to 880 Mc. Smoothly controllable all-electronic sweep system. Nothing mechanical to vibrate or wear out. Crystal controlled 4.5 Mc fixed marker and separate variable marker 19-60 Mc on fundamentals and 57-180 Mc on calibrated harmonics. Plug-in crystal included. Blanking and phasing controls — automatic constant amplitude output circuit — efficient attenuation — maximum RF output well over .1 volt — vastly improved linearity. Easily your best buy in sweep generators.



TELCO SELF-SUPPORTING tripod MAST TOWERS



FOR FAST, EASY INSTALLATION

ALL ASSEMBLED—NO GUY WIRES

Real profits on any antenna installation—Bolt the tower to the roof and that's it! No bothersome, time consuming screw eyes, guy wires and rings or turn-buckles. Get sturdy, dependable, weatherproof installations. Telco Tripod Towers are a whole roof installation in one! All assembled—ready to install. Get them at your Telco distributor now.

AVAILABLE IN 3 MODELS FOR
ANY SIZE INSTALLATION

- Model No. 9063
2 foot heavy steel gauge, plated tower
- Model No. 9144
3 foot electro-galvanized tubing tower
- Model No. 9145
5 foot electro-galvanized tubing tower

REMEMBER
THE NAME



3 Ft. Model
No. 9144

5 Ft. Model
No. 9145

2 Ft. Model
No. 9063

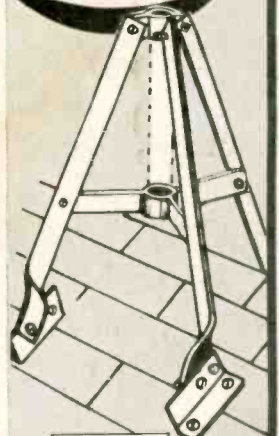

TELEVISION HARDWARE MFG. CO.

Division of General Cement-Textron American, Inc.
ROCKFORD, ILLINOIS

SEE YOUR TELCO DISTRIBUTOR NOW!

Stand-offs, mounts, arrestors . . . everything you need for every kind of TV installation . . . all at your Telco distributor.

FREE CATALOG
Send a postcard for your big free Television Hardware catalog

As easy to use as a pencil



WALL
INDUSTRIAL
SOLDERING IRONS
give you

More
BTU's...

Faster
HEAT...

Higher HEAT
CONTINUITY

Exclusive
THERMOSTATIC ACTION...

Guaranteed for the life of the iron!
Prevents excessive tip burning!

than ANY OTHER
soldering irons of equal tip size

Proved 4 times faster on the production lines of America's leading electronics firms. Complete range of sizes... scientifically designed... individually tested... for easier, surer precision work or heavy duty soldering. Operate on 110-120 volts, AC or DC! Model 18T illustrated, \$6.25 list.

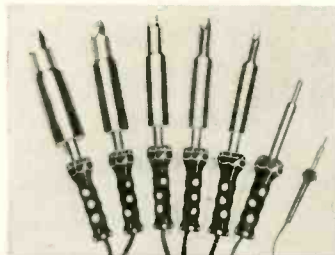

Write for FREE Catalog



WALL MANUFACTURING CO.
Grove City, Pennsylvania

OVER 20,000,000 SOLDERING PRODUCTS SINCE 1864

New!

the mosley
4-Set TV Coupler

IDEAL FOR:

- HOMES
- 4-UNIT DWELLINGS
- MOTELS
- STORES

LIST PRICE
\$6.25



The new Mosley Type 904, 4-Set TV Coupler is especially designed for metropolitan television areas... the major multi-set market!

A bridging type resistive circuit distributes the signal equally to each output and provides effective isolation between sets to eliminate interaction. Signal transfer is excellent due to the constant impedance design.

The Mosley 4-Set Coupler will serve in a multitude of uses where it is neither necessary nor economically feasible to use amplifying distribution systems. Its low cost will appeal to your customers and the simplicity of installation means extra profits... for you!

AT YOUR PARTS JOBBER

MOSLEY ELECTRONICS, Inc.
8622 St. Charles Rock Rd., St. Louis 14, Missouri

Tough Dogs

(Continued from page 37)

inal. The symptom looked more like horizontal trouble than a ghost. Although there was no intelligible sound, there were distorted growls, buzz and hum coming out of the speaker.

Changing the 6SN7 horizontal oscillator had no effect. Dynamic checking of the sound tubes showed that clicks were getting through to the speaker. Bench troubles? Bad electrolytics? The sixth sense came to the rescue. Inspection of the antenna showed that another set had been connected to it from the apartment above. In disgust, I ripped the lead away from the antenna terminals of the set and substituted an indoor rabbit-ear antenna. A clear picture was immediately available, and the buzz disappeared—symptoms apparently induced by the mismatch had gone away—but the sound was still garbled. It now sounded as though one side of the 6AL5 sound detector was burned out or dead. Changing this tube then cleared up the final trouble.

Naturally I asked the customers about the multiple images. They said they had watched the set that way for over a month, and assumed the cause was station trouble! It was only when the sound went bad that they called for service. Watch out for those friendly souls who grab onto any antenna so that they don't have to pay for one of their own.—
F. A. Nichols, Appleton, Wisconsin.

New Delco Tube Carton



United Motors Service Div. of Gen. Motors has introduced a new carton for the line of Delco electron tubes. White and orange lettering is used against a dark blue background to make reading easier at a greater distance, with adequate space provided for type identification. Labels for Delco picture tubes have been similarly redesigned.

NATESA Award to Mallory

In accepting the "Friends of Service" Award for 1955 by NATESA, on behalf of P. R. Mallory & Co., J. E. Templeton, mgr. of Mallory's distribution division, commented on the ad campaign out of which the honor grew at the NATESA Omaha meeting. After deciding to bring the



P. R. Mallory's J. E. Templeton (center) accepts 1955 "Friends of Service" Award from NATESA's V. J. Lutz (l.) and F. J. Moch (r.).

service technician's story to the TV owning public, Mallory developed this approach: To reach the right audience, *TV Guide* was chosen, with a circulation of over 4 million set-owning families in 40 regional editions. To get the idea across, light cartoon treatment was chosen to warn against the dangers of "do-it-yourself" to both owner and receiver, to publicize the complex, sensitive nature of the TV set, and to call attention to the big investment in skill and equipment of the service tech.



KESTER

Absolutely non-corrosive and non-conductive, KESTER "RESIN-FIVE" CORE SOLDER contains an activated type of resin that gives you that fast, positive action on all your jobs . . . including the most difficult.

KESTER SOLDER COMPANY
4264 Wrightwood Avenue • Chicago 39, Illinois
Newark 5, New Jersey • Brantford, Canada

SOLDER

the Talk of the Industry



an amazing new service tool...

at a Fantastically Low Price!

BOSIPT*

SOLD ONLY THROUGH DISTRIBUTORS



No more need for expensive, elaborate equipment to repair picture tubes. The convenient BOSIPT* does the job in two minutes *without removing the chassis*. Easy to set up — easier to use, it repairs filament-to-cathode and grid-to-cathode shorts in a jiffy. Restores brightness control operation. There's no bulky testing case, no extra leads required.

See your favorite Local Parts Jobber

* Burns off shorts in picture tubes
PAYS FOR ITSELF — with the first use.

REPAIRS PICTURE TUBES — in the set.

GIVES LONGER PICTURE TUBE LIFE — to regular customers.

TWO MINUTE OPERATION — saves \$40 tube.

SIMPLE AND EASY TO USE — and fits into your kit.

\$5.95 list

WORKMAN TV INC. TEANECK, N. J.
Manufacturers of Electronic SPECIALTIES

only \$3.57
DEALER NET



SOLID ALUMINUM—RUST PROOF CONTROL GUN

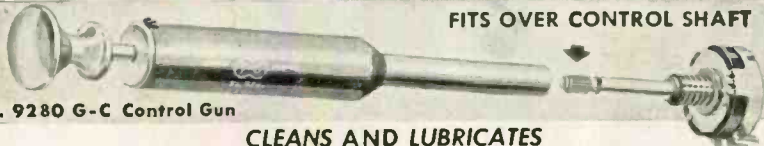

No. 9280 G-C Control Gun

FITS OVER CONTROL SHAFT

CLEANS AND LUBRICATES

NOISY VOLUME CONTROLS IN ONE SURE, FAST, EASY OPERATION

Cleans single or dual controls. Constructed of long lasting, durable aluminum, will not rust from use with any chemical normally used in the electronic industry. Simply load gun with G-C Contact Kleener and inject into control—dirt and noises disappear immediately. It's that easy. Positive, leak proof action, plunger can not pull out of gun.

GENERAL CEMENT MFG. CO.

Division of Textron American, Inc.
ROCKFORD, ILLINOIS



G-C Control Kleener
16 oz. and gallons
For use with G-C No. 9280 Control Guns—Will not harm cabinet finishes.
No. 65-16—16 oz.
No. 65-G—gallon



Control Gun Adapter
Special long shank adapter—order now.
No. 9282
Long Shank Adapter



Control Gun Adapter
Designed to adapt G-C Control Gun to auto radio controls—make your Control Kleener complete—get a set of adapters.
No. 9281 Auto Radio Control Adapter



FREE

Send a postcard to G-C for your free copy of the big, new, giant catalog.

YOUR G-C DISTRIBUTOR HAS THEM . . .

The Control Gun, Kleener and Adapters, as well as anything else you may need in your electronic technician work—many new products, stop in and see him today!

Now . . . From KAY ELECTRIC . . .

A NEW, LOW-COST LAB
QUALITY ALL-ELECTRONIC
SWEEPING OSCILLATOR
For Service Use



Ligna-Sweep

MODEL "C"

FOR ALIGNMENT OF TV, FM RADIO, VIDEO and COMPLETE VHF BANDPASS WITH AUTOMATIC GAIN CONTROL

Designed and manufactured to the same high quality standards which have made Kay the leader in instruments for laboratory and production line, the new Kay Ligna-Sweep, Model "C" gives variable center frequency and sweep width with high output automatically held constant over frequency sweep and frequency band. The following frequency ranges are covered by six switched bands.

Television: All IF and VHF channels with fundamental frequency output of 1.0 V rms into 75 ohms. Sweep width variable to at least 20 mc at VHF, 15 mc at IF.

FM Radio: Range 80-120 mc with fundamental frequency output of 1.0 V rms into 75 ohms. Sweep width variable 100 kc to at least 20 mc. 10.7 mc IF band pass with beat frequency output of 0.25 V rms into 75 ohms sweep width variable 100 kc to 2 mc.

VHF Band: Range 30 to 220 mc with fundamental frequency output of 1.0 V rms into 75 ohms. Sweep width variable to at least 15 mc.

Video: Range 100 kc to 12 mc with beat frequency output 0.25 V rms into 75 ohms. Sweep width variable 100 kc to 12 mc.

OTHER SPECIFICATIONS:

Flatness: Flat within ± 0.4 db over widest sweep.

Sweep rate: Variable around 60 cps. Locks to line frequency.

Attenuators: Switched 20 db, 20 db, 10 db and 6 db, plus continuously variable 6 db.

Frequency Indication: Direct reading calibrated dial.

Deflection Voltage: Linear sawtooth separately available. No phasing control.

Power Supply: Electronically regulated 105 to 125 volts ac, 50-60 cycles.

Price: \$350.00 F. O. B. Plant

WRITE FOR NEW KAY CATALOG

KAY ELECTRIC COMPANY

Dept. T-6

14 Maple Ave., Pine Brook, N. J.

CAldwell 6-4000

Service Foreign Radios

(Continued from page 29)

ception is achieved by use of the DC90 tube. This is a high-frequency triode with a filament rated at 1.4 volt, making it suitable for battery operation. As may well be imagined, this tube is relatively unstable, and exhibits a higher failure rate than any other European tube this writer knows of.

The only other unusual feature in the portable versions is the nickel-cadmium "accumulator," already referred to in Fig. 3. It is a 1.5-volt rechargeable battery. With a full charge, it will supply filament voltage to a 7-tube portable for 16 hours. Anyone who is interested in servicing and maintaining these sets will be expected to be able to recharge this battery at relatively frequent intervals. Construction of the charger is quite simple if the circuit and values of Fig. 4 are followed. In connection with the charging circuit, note that the accumulator has considerable capacitance between its terminals. It therefore acts as an electrolytic capacitor, supplying the additional capacitance required on the output side of the filter.

To assist in obtaining further information that may be required for any of these foreign sets and procuring replacements for items not normally made and sold in the domestic market, a list of firms in this country that are handling the foreign lines is included as Table 2. Though main offices are in the New York area, some of these organizations have contacts elsewhere in the country. The location of other out-



"Henry, you're wonderful, it's getting color."

ask the
"Man-on-the-Roof"
 why he prefers

South River

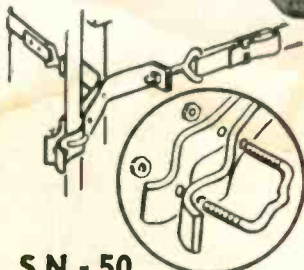

**SN - 50
 CHIMNEY MOUNT
 SNAP-IN TYPE**

with unique U-Bolt **INSTEAD OF SCREWS** for easy one hand "Spintite" fastening. Hot Dip Galvanized — 12 Ft. Straps, two to a set. Same Unique U-Bolts used on Snap-in Wall Brackets. Also Available with Stainless Steel Banding.

Write for new 1956 catalog

SOUTH RIVER
 METAL PRODUCTS CO., INC.
 South River, New Jersey

*pioneer &
 outstanding
 producer of
 finest line
 of antenna
 mounts*

Perma Power
**TV
 VOLTAGE
 REGULATOR**

**10 Volt Line
 Adjuster . . .**



At All Distributors

manufactured by
Perma Power COMPANY
 4727 N. Damen Ave., Chicago 25, Ill.
 manufacturers of electronic equipment since 1928
 Export: SCHEEL INT., Chicago

lets may be obtained from the main offices. It is also helpful to know that parts stocked by one of these organizations for replacement purposes are often usable in the lines put out by the others. •

TABLE 2

Parts and information can be obtained from the following organizations in the U. S. on European receivers. Receiver brand names are in parentheses:

(Blaupunkt)
 N. Pickens & Co.
 31 East 14th Street
 New York, N. Y.

(Grundig)
 Grundig-Majestic
 70 Washington Street
 Brooklyn, N. Y.

(Norelco)
 North American Phillips Co.
 100 East 42nd Street
 New York, N. Y.

(Siemens)
 Siemens New York, Inc.
 350 Fifth Avenue
 New York, N. Y.

(Telefunken)
 American Elite
 7 Park Avenue
 New York, N. Y.

Diapers for New Pix Tubes

Charles C. Streiter of the Allen B. Du Mont crt plant, is an old hand at diapers, having raised 4 children of his own. The load of 75 diapers per day being used at the Du Mont New Jersey plant makes him shudder.

The diapers are being used to keep "newborn" picture tubes clean. Quality control engineers at the plant have discovered that, because of its softness, freedom from lint, and high absorption qualities, the rectangular sheet is an ideal aid in cleaning out moisture and minute particles from the neck of the glass shell before the electron gun is sealed to the glass.

Satellites on Display

A diorama depicting earth satellites of today and tomorrow, and featuring an actual model fitted with electronic parts, was shown at the 10th national convention of the Armed Forces Commun. & Electronics Assoc. in Boston, Mass. This previews the real satellites that will be launched during the International Geophysical Year (1957-1958) to study ultraviolet rays, electrical currents, and the drag of whatever air may exist at altitudes from 220 to 300 mi. above the earth's surface. Announcement of the display was made by Capt. D. R. Hull, USN (ret.), a v-p of Raytheon Mfg. Co. and chairman of the convention.

MERIT, first in exact and universal replacement transformers, yokes, coils — the only manufacturer of transformers, yokes and coils who has complete production facilities for all parts sold under their brand name.

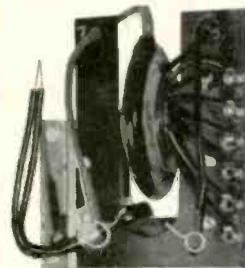

HVO-43 FOR EXACT REPLACEMENT IN AIRLINE, GAMBLE-SKOGMO, MONTGOMERY WARD, HUDSON, TELECRAFT, ARLINGTON, FAIRMONT, TRUETONE, CORONADO, WELLS-GARDNER . . . USED IN OVER 25 MODELS AND CHASSIS. Another in the complete MERIT line of exact and universal replacements—the only single source for all your transformer and coil requirements.

Merit

MERIT COIL & TRANSFORMER CORP.
 4427 NORTH CLARK STREET
 CHICAGO 40, ILLINOIS



Quickly locates "TOUGH DOGS" **Senco**
Tube and Capacitor

Leakage Checker
Model LC-2



A MUST for Servicing Grid Circuits
Dealer net **\$24.95** Wired
Complete with test leads. Simple to operate.
\$19.95 KIT

"Two Testers In One"

- Now—checks 70 critical tube types
- Quickly locates tubes with gas, grid to cathode or heater to cathode leakage, and grid emission in RF, IF and AGC Circuits.
 - Only type tester that finds all tubes causing picture overload, low sensitivity, poor sync, etc.
 - Checks all capacitors for leakage with voltage applied.

Mfg by **SERVICE INSTRUMENTS COMPANY**
At Leading Distributors!
171 OFFICIAL ROAD • ADDISON, ILL.



is "The Choice of Better Service Dealers Everywhere"

- 1 MERIT
- 2 QUALITY
- 3 RELIABILITY

The original product for quieting noisy controls and switches... the universal lubri-cleaner for TV and radio...

Say "QUIETROLE" to your distributor... be sure you get it.

NO GUM! NO GOO! NO GRIME!



Carried by recognized jobbers... everywhere!

manufactured by **QUIETROLE COMPANY INC.**
Spartanburg, South Carolina
IN CANADA: Active Radio & TV Distributors 58 Spadina Ave., Toronto 28, Ont.

Dipole Orientation

(Continued from page 38)

2, the Channel-3 antenna could be turned around. However, if reception on the other low-band channels, 4, 5, and/or 6, is also desired, reversing the antenna may create impairment of performance on these.

These considerations do not by any means render the low-band dipole-reflector combination useless. However, they do show why pointing the front of the antenna at the transmitter is not always the best policy, and throw light on the sometimes puzzling results that are obtained with this orientation, especially in metropolitan areas. Regardless of the direction from which the signal is coming, the best orientation is that which produces the best overall results. Knowing how antenna behavior changes from channel to channel with respect to the length of its elements can assist in dealing with specific reception problems.

Where a new dipole-reflector combination is being installed, knowing in advance what lengths its elements should be cut to for best results with the channels receivable in the area also help. One antenna can be chosen over another, depending upon whether it will do a better job on Channel 2 or 3. As an aid in calculating the appropriate length for a half-wave dipole on any channel, the following formula may be used: $L = 468/f$. L is the length in feet and f is the frequency in megacycles. The formula is compensated to take into account the slower speed of radio frequencies on metal. If it is desired to determine a half-wave-length in free space, the formula is $L = 492/f$.

COLOR TELEVISION

Home Study For Technicians

NOW AVAILABLE THE MOST COMPLETE, COMPREHENSIVE COLOR TV HOME STUDY COURSE ILLUSTRATED WITH NEW BLOCK-A-MATICS

This new seven-lesson HOME STUDY COURSE in COLOR TELEVISION was compiled by Albert C. W. Saunders, internationally noted author-lecturer on Radio and TV Servicing, and is the best course available today. It is just off the press with the latest technical information. Lessons are fully illustrated with simplified diagrams including BLOCK-A-MATICS—The New Look In Schematics. Also Color Illustrations.

COST OF COMPLETE COURSE ONLY \$25.00

For Particulars Write

SAUNDERS ELECTRONICS CORRESPONDENCE SCHOOL
137 Federal Street, Boston 10, Massachusetts

IDEA OF THE MONTH

Saves Time Handling Service Calls

No. 120 RADIO-TV SERVICE ORDER SIZE 4" x 7 1/4"
SUPPLIED WITH OR WITHOUT IMPRINT **\$2.95**

In triplicate with hard 3rd copy and one-time throw away carbons in each set. Ask for prices with your imprint. See them at your parts jobber.

PER 100 SETS (no imprint)

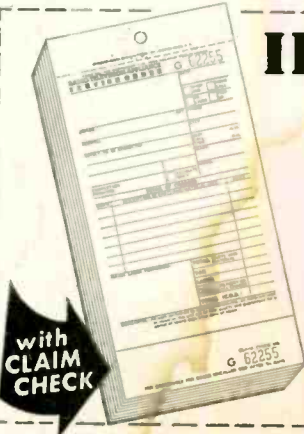

with CLAIM CHECK

WELL, don't just sit there WRITE FOR THE FREE STUFF NOW!

OELRICH PUBLICATIONS
4308 N. MILWAUKEE AVE. CHICAGO 41, ILL.
Send me FREE Service Order File, Sample Form, and Complete Catalog.

Name _____
Address _____
City _____ Zone _____ State _____

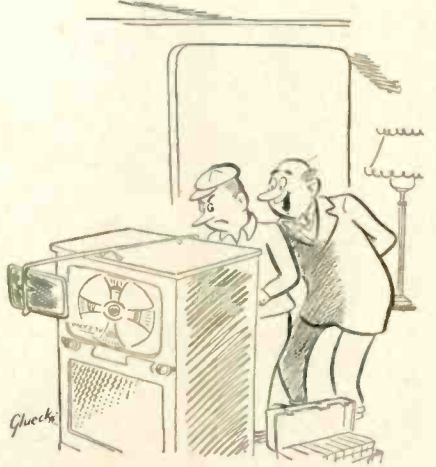

"By George! That was simple enough, wasn't it? I won't have to call you if it happens again, now will I?"

don't be vague...

insist
on
SPRAGUE

ATOMS[®]



SPRAGUE

NORTH ADAMS, MASS.

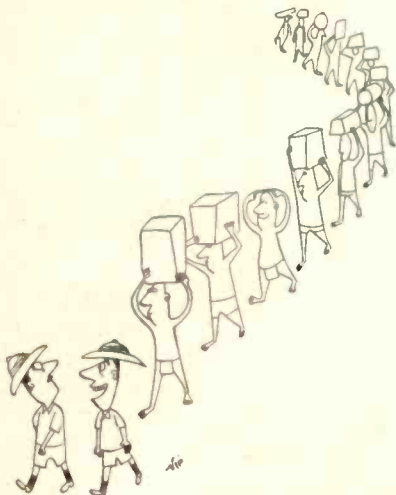

"That third guy? He's the
serviceman carrying the
JENSEN NEEDLE!"

ADVERTISERS INDEX
June 1956

Aerovox Corp.	16
American Phenolic Corp.	22
Barry Electronics Corp.	47
Belden Manufacturing Co.	Cover 3
CBS-Hytron, Div. of Columbia Broadcasting System, Inc.	3
Contralab, A Div. of Globe-Union Inc.	4
Chicago Standard Transformer Corp.	55
Cornell-Dubilier Electric Corp.	6, 48
Delco Radio Div. of General Motors Corp.	7
DuMont Laboratories, Inc., Allen B.	5
Electro Products Laboratories	14
Electro-Voice, Inc.	12
General Cement Mfg. Co.	49, 52
Heath Company	49
International Resistance Company	Cover 2
Jensen Industries, Inc.	55
Jensen Manufacturing Co.	56
JFD Manufacturing Co., Inc.	45
Johns-Manville Corp.	23
Kay Electric Co.	52
Kester Solder Company	51
Mallory & Co., Inc., P. R.	20, 21
Merit Coil & Transformer Corp.	53
Mosley Electronics, Inc.	50
Oelrich Publications	54
Perma-Power Co.	53
Quietrole Co.	54
Radiart Corp., The	6
Radio Corp. of America	Cover 4
Raytheon Manufacturing Co.	24
Saunders Electronics Correspondence School	54
Service Instruments Co.	54
Simpson Electric Co.	8
Snyder Manufacturing Co.	15
South River Metal Products Co.	53
Sprague Products Co.	55
Sylvania Electric Products, Inc.	13
Technical Appliance Corp.	19
Thompson Products, Inc.	9
Triad Transformer Corp.	10
Tung-Sol Electric Inc.	11
Vokar Corp.	47
Wall Manufacturing Co.	50
Ward Products Corp.	2
Wen Products Corp.	17
Workman TV, Inc.	51

While every precaution is taken to insure accuracy, we cannot guarantee against the possibility of an occasional change or omission in the preparation of this index.

Don't just say
CAPACITORS

Ask For Sprague By
Catalog Number

Know what you're getting...
get exactly what you want.
Don't be vague... insist on
Sprague. Use complete radio-
TV service catalog C-610. Write
Sprague Products Company,
65 Marshall Street, North
Adams, Massachusetts.

SPRAGUE[®]

WORLD'S LARGEST
CAPACITOR MANUFACTURER

for all your
**Exact Replacement
TV TRANSFORMERS**

**Specify
Stancor**

FREE

STANCOR TV Transformer
Replacement Guide listing
over 8000 models and chas-
sis of 117 manufacturers...
also STANCOR Auto Radio
Replacement Guide with re-
placement data on over 540
auto radios of 40 manufac-
turers. Available from your
distributor or by writing
Chicago Standard.



**CHICAGO STANDARD
TRANSFORMER CORPORATION**
3513 Addison Street • Chicago 18, Illinois



RT-20
17" x 24"
rectangular section
horn of glass fibre
reinforced poly-
ester. New
useful shape
for stacking
in plane
or circular
arrays.



RT-20's
in plane array



RT-20's
in circular array

ANNOUNCING **NEW**
THE ADVANCED

Jensen

PROFESSIONAL SERIES LOUDSPEAKERS

FOR INDUSTRIAL, COMMERCIAL, INSTITUTIONAL,
CIVIL DEFENSE, AND MILITARY SOUND SYSTEMS

If sound is your business, here is big news for you . . . a complete new line of loudspeakers to meet for the first time every sound system need for both entertainment and efficient, effective communication. From a fraction of a watt to 1600 watts or even more . . . for high fidelity or high efficiency coverage . . . for distributed or concentrated source projection . . . indoors or out—there is a Jensen Professional Series loudspeaker that will do the job *better, more dependably, and more economically* than ever before. Just as an example, the new Hypex Lifetime Driver Units are *guaranteed indefinitely against failure under normal use!*

Three years of product design and a background of nearly 30 years of field experience and manufacturing know-how come to you in Jensen Professional Series loudspeakers. We can't begin to illustrate or describe all the items here—nor tell you about all the new features for convenience and performance which we've built into them. Catalog 1070 tells the whole story, including valuable information on sound system design. Send for your free copy today.



DD-100
100 watt
driver

15", 20" and
24" horns



HF-100
weatherproof
2-way HI-FI
Projector



D-30 and D-40
30 and 40 watt
drivers



Four 12" and 15"
2-way and 3-way
speakers

Jensen MANUFACTURING COMPANY
6501 S. Laramie, Chicago 38, Illinois

Division of The Muter Co. • In Canada, Copper Wire Products, Ltd. Licensee



Reap Richer Profits...

STOCK AND SELL RCA RADIO BATTERIES

While batteries for portables are an all-year-round business, it's the outdoor months that really bring it into full bloom. And you reap profits from this fertile market when you advertise and merchandise RCA Radio Batteries. RCA is sowing the seeds for you... with a powerful sales promotion program and advertising on national hook-up radio and big network TV. What's more, RCA is a name your customers *go out of their way* to buy. RCA's comprehensive line meets practically every battery requirement for regular portables as well as the new transistor types. Get *your* share of the "bumper crop" of battery dollars—get in touch with your RCA distributor today.

Valerie the Seal says:
*"Profits blossom with
 RCA Batteries"*



RADIO BATTERIES
 RADIO CORPORATION OF AMERICA, HARRISON, N. J.

If it's worth
engineers'
time...



Mil. Spec.

Belden
ELECTRONIC
WIRE

The complete packaged line
—easy to use. Be sure of
the right wire engineered
for the job.

There are 1001 Belden
wires for every Radio and
Electronic requirement.

...it's worth
engineered
electronic wire

Belden

WIREMAKER FOR INDUSTRY
SINCE 1902
CHICAGO

6-8

Magnet Wire • Lead and Fixture Wire • Power Supply Cords, Cord Sets and Portable Cord • Aircraft Wires • Welding Cable
Electrical Household Replacement Cords • Electronic Wires • Automotive Replacement Wire and Cable