

TECHNICIAN & *Circuit Digests*

1956

\$ 2,100,000,000

Will You Get YOUR Share?

Preferred for modern set servicing

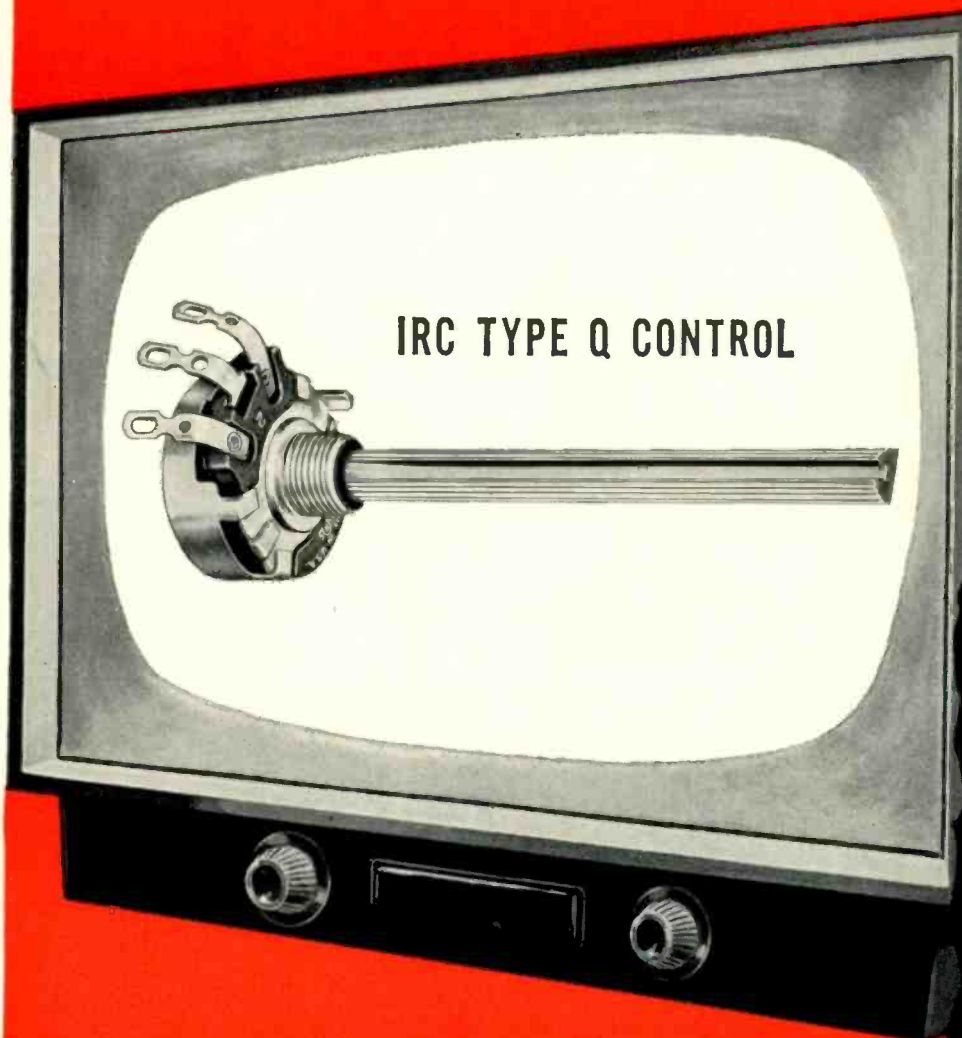

IRC TYPE Q CONTROL

Service technicians get greater coverage with less investment; more practical service features; and easier, faster installation with the IRC Type Q Control. Here's a dependable, basic control that is directly designed for modern set servicing. For appearance, performance and price . . . there's none better. So why settle for less? Tell your Distributor you want Q Controls . . . most servicemen do.



This 8 page catalog gives you all the facts . . . Send for your free copy now—

INTERNATIONAL RESISTANCE CO.

Dept. 571, 401 N. Broad St., Phila. 8, Pa.

In Canada: International Resistance Co., Ltd., Toronto, licensee

Send me Q Control Catalog DC1D.

Name _____

Company _____

Address _____

City _____ State _____

KNOBMASTER FIXED SHAFT

Q Control standard shaft is knurled, flatted and slotted —fits most knobs without alteration.

INTERCHANGEABLE FIXED SHAFTS

Exclusive IRC convenience feature—provides fast conversion to "specials", with FIXED shaft security. 15 types available.

1/4" LONG BUSHING

Accommodates all small sets, yet handles large set needs perfectly.

7 STANDARD TAPERS

Full coverage of all taper requirements is provided in the Q Control.

94 RESISTANCE VALUES

For TV, AM and FM coverage, 94 values of plain and topped controls are furnished.

QUALITY APPEARANCE

The handsome professional appearance of IRC Q Controls lets you point to your work with pride.

CUSHIONED TURN

The smooth, quality of "feel" of a Q Control contributes to customer confidence.

TYPE 76 SWITCHES

Either of two type IRC switches attached as quickly and easily as a control cover—meets all your requirements.



Wherever the Circuit Says 

TECHNICIAN & Circuit Digests

TELEVISION • ELECTRONIC • RADIO • AUDIO • SERVICE

JANUARY, 1956

M. CLEMENTS Publisher
 O. H. CALDWELL Editorial Consultant
 ALBERT J. FORMAN Editor
 SIDNEY C. SILVER Managing Editor
 ANN O'ROURKE Assistant Editor
 J. L. STOUTENBURGH Contributing Editor
 DR. A. F. MURRAY Contributing Editor
 B. F. OSBAHR Contributing Editor
 CHARLES F. DREYER Art Director
 ELMER KETTERER Circuit-Digest Production
 GEORGE PUGLICI Circuit Diagrams
 S. TANHAUSER Editorial Secretary

BUSINESS DEPARTMENT

H. A. REED V.P. & General Sales Manager
 BERNARD BLOCK District Manager
 MARSHALL FAILLACE District Manager
 P. J. CARNESE Sales Promotion Manager
 N. McALLISTER Asst. Business Manager
 MARTHA USDIN Production Manager
 A. H. POND Contoller
 W. W. SWIGERT Credit Manager
 ELMER DALTON Circulation Manager
 480 Lexington Ave., New York 17, N. Y.
 Telephone PLaza 9-7880
 P. H. DEMPERS District Manager
 201 N. Wells St., Chicago 6, Ill.
 Telephone RAndolph 6-9225
 CHRIS DUNKLE & ASSOCIATES
 California Representative
 3527 W. 6th Street, Los Angeles 5, Calif.
 Telephone DUnkirk 7-6149
 3077 Turk St., San Francisco 18, Calif.
 Telephone EXbrook 2-0377



TECHNICIAN & CIRCUIT DIGESTS, Jan. 1956, Vol. 63, No. 1, \$.50 a copy. Published monthly by Caldwell-Clements, Inc. Publishers also of MART including Price-Fax, and TELE-TECH & ELECTRONIC INDUSTRIES. Publication office, Emmett St., Bristol, Conn. Editorial, advertising and executive offices, 480 Lexington Avenue, New York 17. Telephone PLaza 9-7880. M. Clements, President; M. H. Newton, Assistant to President; John J. Borghi, Vice President and Treasurer; M. B. Clements, Secretary.

Entered as second class matter at the Post Office at Bristol, Conn., June 10, 1954. Subscription rates: United States and Canada, \$4.00 for one year; \$6.00 for two years; \$8.00 for three years. Pan-American and foreign countries: \$7.00 for one year; \$10.00 for two years; \$14.00 for three years. Copyright 1956 by Caldwell-Clements, Inc., New York. Title registered in U. S. Patent Office. Reproduction or reprinting prohibited except by written authorization of publisher. Printed in U.S.A. by Hildreth Press, Inc., Bristol, Conn.

FRONT COVER What will your share be of the record \$2-billion-plus service bill for this year? What opportunities lie ahead in sales and service? See "What's Ahead for '56!" on page 15.

FEATURES and ARTICLES

What's Ahead for '56!	15
"Tuning in the Picture"	16
Test Instruments in Color TV Service	Robert G. Middleton 18
Filter Condenser Troubles	Sol Heller 21
Connecting Hi-Fi Phono Cartridges	Norman H. Crowhurst 22
Antenna Sales and Service	John Rogers 25
Speeding up Service on Difficult Hum Problems	Joseph Amorose 26
You Can Troubleshoot Sync Faults in the Field	James A. McRoberts 28
Small-Shop Advertising	Merlyn J. Black 30
Let's Look at Circuits	Sidney C. Silver 32
"Tough Dog" Corner	G. Kimmell, E. L. Christie, W. Newell 34
Shop Hints	J. Valenti, G. Kettle, D. Phillips, G. Mancini, C. Garrett 36
New Tubes and Components	38
AC for Pleasure Craft	40
New Antenna Products	41
New Audio Products	42
Don't Overpay Your Taxes	American Institute of Accountants 44
Latest Test Equipment	48
1955 TV-Electronic Industry Statistics	57

DEPARTMENTS

Letters to the Editors	6	Association News	46
Editor's Memo	12	Reps & Distributors	53
Calendar of Coming Events	17	News of the Industry	54
New Products	50	Catalogs & Bulletins	60
New Books	62		

CIRCUIT DIGESTS

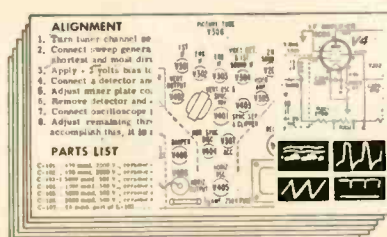

only

C·D·R Rotors

have
the

1

2

punch

1. The Most Complete Line

The CDR Rotor line is COMPLETE to every detail, with a model for every application! A distinct selling advantage because YOU can give your customer EXACTLY what is required! The RIGHT CDR Rotor for the RIGHT job.

2. Pre-SOLD For You on TV

to millions of viewers through an extensive coverage of audiences in every important TV market. Capture this pre-sold market by featuring these nationally advertised CDR ROTORS.



AR-22

Completely AUTO-MATIC version of the TR-2 with all the powerful features that made it famous.

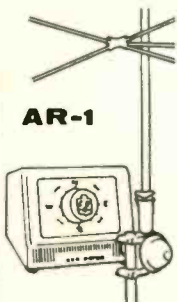

AR-1

Completely AUTO-MATIC rotor, powerful and dependable. Modern design cabinet. 4 wire cable.

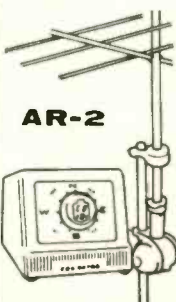

AR-2

Completely AUTO-MATIC rotor with thrust bearing. Handsome cabinet. 4 wire cable.

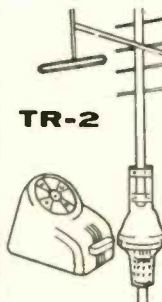

TR-2

Heavy duty rotor with plastic cabinet. "compass control" illuminated perfect pattern dial. 8 wire cable.



TR-4

Heavy-duty rotor, modern cabinet with METER control dial, 4 wire cable.

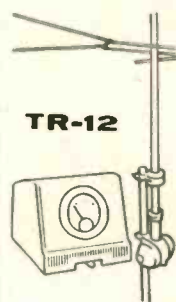

TR-12

Combination value complete rotor with thrust bearing. Modern cabinet with meter control dial, uses 4 wire cable.

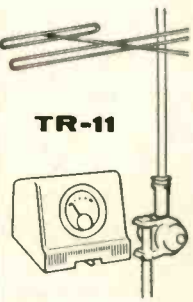

TR-11

Ideal budget all-purpose rotor, new modern cabinet featuring meter control dial, 4 wire cable.



CORNELL-DUBILIER
SOUTH PLAINFIELD, N. J.



THE RADIART CORP.
CLEVELAND 13, OHIO



Silver Vision

THE ALUMINIZED TUBE THAT IS PRE-SOLD

Sure, *you* are already sold on the advantages of aluminized tubes. You know that the CBS Silver Vision aluminized screen with its silver-activated phosphors and the CBS small-spot gun mean clearer, sharper, brighter pictures.

But your woman customer (76.9% of TV service customers are women) doesn't understand electronics or CBS advanced-engineering as you do.

She does know and respect the name CBS . . . she has confidence in Garry Moore and in the Good Housekeeping Guaranty Seal. So all you have to do is take advantage of Garry's pre-selling over the CBS Television Network. Just remind her that there are no finer tubes made than CBS Silver Vision tubes . . .

And, like all CBS tubes, they have the Good Housekeeping Guaranty Seal. She's already pre-sold by Garry Moore and national magazine advertising. You build profitable customer confidence and sales every time you recommend CBS Silver Vision tubes.



Garry Moore
famous CBS
Television Star



Show the CBS carton with the Good Housekeeping Guaranty Seal

CBS-HYTRON
Danvers, Massachusetts

A DIVISION OF
COLUMBIA BROADCASTING SYSTEM, INC.

The "K.O." is Fantastic!

Features the highest front-to-back ratios ever recorded for any TV antenna:

- **Low band:** from 20:1 to 50:1 relative VOLTAGE.
- **High band:** Up to 13:1 relative VOLTAGE.

High gain: Low band, 7 to 9 DB. High band, 8.5 to 10.5 DB. (Single bay figures). Balanced for COLOR.

Ends co-channel interference!
Knocks out "Venetian Blinds"!

Channel Masters "K.O." puts an INVISIBLE BARRIER in the path of rear signals, preventing co-channel interference. The "K.O." is completely preassembled with time-saving "Snap-Lock" Action. 100% aluminum.

LICENSED BY KAY-TOWNES ANTENNA CO., ROME, GA.

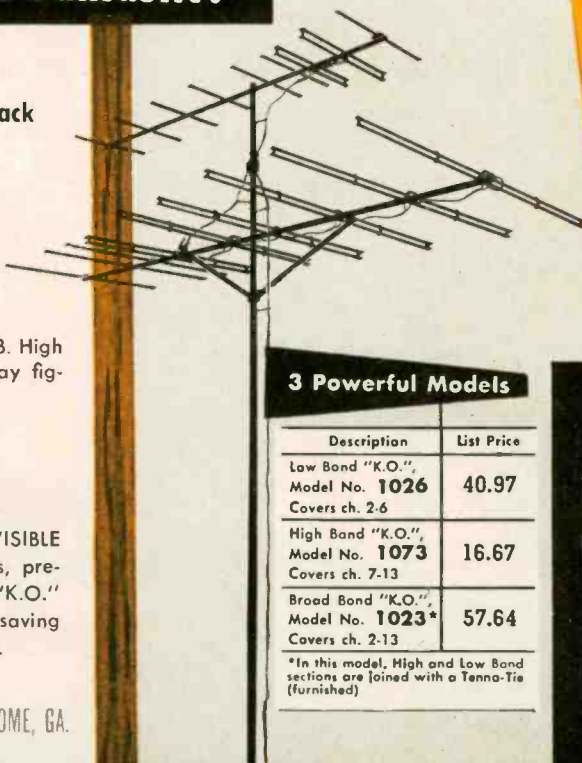

3 Powerful Models

Description	List Price
Low Band "K.O.", Model No. 1026 Covers ch. 2-6	40.97
High Band "K.O.", Model No. 1073 Covers ch. 7-13	16.67
Broad Band "K.O.", Model No. 1023* Covers ch. 2-13	57.64

*In this model, High and Low Band sections are joined with a Tenna-Tie (furnished)

New Antennas!

New Accessories!

CHANNEL MASTER

now

provides you

New expanded ACCESSORIES program! Channel Master now becomes the first and only manufacturer in the industry that can supply you with everything you need for an antenna

The ^{new} Super Fan

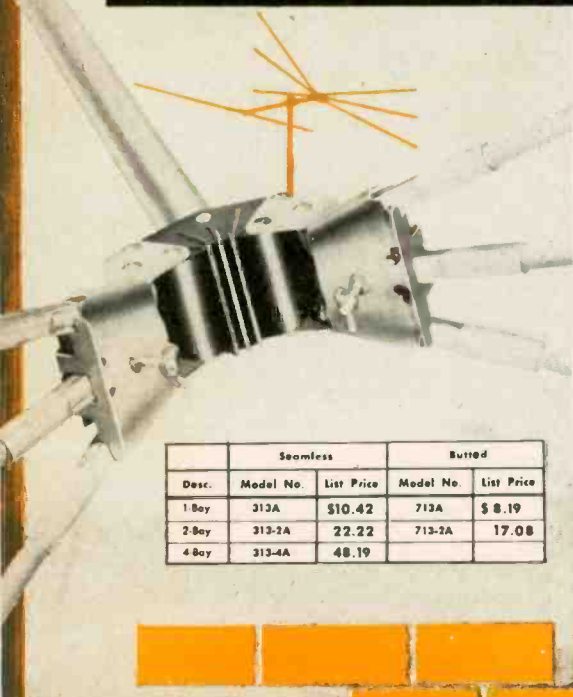

- "Super-Sembled"!
- Re-designed!
- Better than ever!

Channel Master's Super Fan is the original fan antenna. Famous for its superb quality, it has been in continuous demand for six years. Millions are in current use.

- Assembles with NO HARDWARE or tightening.
- Massive, heavy-duty, molded fan head. Unaffected by moisture and extreme temperatures.
- Reinforced elements. External sleeves prevent breakage.

Desc.	Seamless		Butted	
	Model No.	List Price	Model No.	List Price
1-Bay	313A	\$10.42	713A	\$ 8.19
2-Bay	313-2A	22.22	713-2A	17.08
4-Bay	313-4A	48.19		



CHANNEL MASTER CORP. ILLERVILLE, N. Y.

the world's largest manufacturer of television antennas and accessories

CHANNEL MASTER'S

new

TV TRANSMISSION LINE

The first TV wire
to give you the
benefits of

20

strands
per
conductor
(20/33 pure copper).

with
EVERYTHING
but the roof!

installation. From now on,
guarantee customer satisfac-
tion with a **COMPLETE**
CHANNEL MASTER
INSTALLATION —
FROM TOP TO BOTTOM.

It's a wood screw insulator



It's a machine screw insulator



All popular types and sizes available, including full assortment of specialized hardware. See your Channel Master distributor

it's got

FLEX-APPEAL!

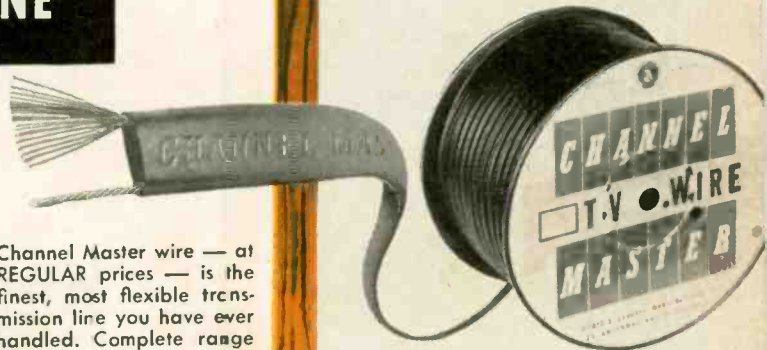

Channel Master wire — at **REGULAR** prices — is the finest, most flexible transmission line you have ever handled. Complete range of web thicknesses available. Colorful display packaging.

Two outstanding lines:

(both featuring exclusive 20-strand conductor):

"TWIN TWENTY"

- Marked every 10 feet. Saves time, ends waste.
- Full width. Available in silver or brown.
- Pure VIRGIN polyethylene.

"CHALLENGER"

Fine quality transmission line at today's **VERY LOWEST PRICES.**

new

STANDOUT insulators

Featuring this revolutionary
new **2 in 1** screw thread design!

Eliminates the need for stocking separate machine and wood screws. Cuts your inventory investment in standoffs by more than 65%.

- Needle sharp point, made possible by finer thread. Easier to work in wood. Prevents slipping on mast.
- STANDOUT buckle has **8** machined threads.
- Convenient "Taper-Tip" strapping, available in galvanized or stainless steel.



Copyright 1955, Channel Master Corp.

18 OUTSTANDING RIDER BOOKS FOR TELEVISION 18

INTRODUCTION TO COLOR TV (2nd. Ed.) by M. Kaufman & H. Thomas

Down to earth explanation of color television in easy-to-understand language, and covering everything in the color TV system.

SOFT COVER:
144 pp., 5½x8½", illus. only \$2.70

TELEVISION—HOW IT WORKS (2nd Ed.) by J. Richard Johnson

A just-published, completely rewritten and up-to-date text for the technician. Timely and universal in its scope, it covers all the latest circuits and principles applied in current TV receivers. The illustrations all have been specially prepared for crystal-clear clarity.

LEATHER FINISH MARCO COVER:
5½x8½", illus. only \$4.60

COLOR TELEVISION RECEIVER PRACTICES by Hazeltine Corp. Laboratory Staff

Supplies a great need for a readily understandable text which explains the principles of color television. It has been developed by experts, and is the finest and most complete course in the design of color television receivers.

SOFT COVER:
200 pp., 5½x8½", illus. only \$4.50

HOW TO TROUBLESHOOT A TV RECEIVER by J. Richard Johnson

Written for the newcomer and the service technician. Step by step guide explains the mental as well as physical approach to TV servicing, and the discovery and interpretation of symptoms.

SOFT COVER:
128 pp., 5½x8½", illus. only \$1.80

HOW TO INSTALL TV ANTENNAS by Samuel L. Marshall

An illustrated "Antenna Bible" that you'll refer to on every installation job. Tells you everything you need to know on installation of TV antennas.

SOFT COVER:
128 pp., 5½x8½", illus. only \$2.50

TV SWEEP ALIGNMENT TECHNIQUES by Art Liebscher

Here are all your answers to aligning TV receivers, front-end-, video, I-F or sound I-F systems. Provides accurate, time-saving methods.

SOFT COVER:
128 pp., 5½x8½", illus. only \$2.10

ADVANCED TELEVISION SERVICING TECHNIQUES

A complete advanced TV servicing course, developed at great expense by RETMA (Radio-Electronics-Television Manufacturers Association). It is being made available to you at the low, low price of just \$4.55! . . . and there has never been anything like it!

MAIN TEXT: SOFT COVER:
176 pp., 8½x11", illus. only \$3.60

LABORATORY WORKBOOK: SOFT COVER:
32 pp., 8½x11", only \$.95

TV FIELD SERVICE MANUALS WITH TUBE LOCATIONS

edited by Harold Alsberg

Here's your truly practical series of tube location and servicing handbooks. Each volume has a seven years coverage, starting with 1947.

Vol. 1: covers Admiral, Affiliated Retailers (Artone), Aimcee (AMC), Air King, Air Marshall, Allied Purchasing, Andrea, Arvin, Automatic.

SOFT COVER:
5½x8½", illus. only \$2.10

Vol. 2: covers Bendix, Capehart, CBS-Columbia, Crosley, Dumont.

SOFT COVER:
5½x8½", illus. only \$2.40

Vol. 3: covers Emerson, Fada.

SOFT COVER:
5½x8½", illus. only \$2.10

Vol. 4: covers GE, Hallicrafters, Hoffman.

SOFT COVER:
5½x8½", illus. only \$2.40

Vol. 5: covers Motorola, Philco.

SOFT COVER:
5½x8½", illus. only \$2.40

PICTURE BOOK OF TV TROUBLES

by the Rider Laboratory Staff

The only books devoted to circuit troubles; each volume dealing with a specific type of circuit, which makes for better, faster, easier servicing by the technician.

Vol. 1: Horizontal AFC-Oscillator Circuits; 46 different troubles; 65 picture tube patterns.

SOFT COVER:
5½x8½", illus. only \$1.35

Vol. 2: Vertical Sweep-Deflection Circuits; 46 different troubles; 96 picture tube patterns.

SOFT COVER:
5½x8½", illus. only \$1.80

Vol. 3: Video I-F & Video Amplifier Circuits; 60 different troubles; 72 picture tube patterns.

SOFT COVER:
5½x8½", illus. only \$1.80

Vol. 4: Automatic Gain Control (AGC) Circuits; 43 different troubles; 59 picture tube patterns.

SOFT COVER:
5½x8½", illus. only \$1.80

HANDBOOK OF 630-TYPE TV RECEIVERS

by Miller & Bierman

A book dealing with all versions of the famous 630-type receivers made up to 1955. It analyzes and explains the many modifications and circuit improvements made in this type receiver by various manufacturers, and is a book which every technician needs.

SOFT COVER:
200 pp., 5½x8½", illus. only \$3.50

LETTERS To the Editors

Retaliation

Editor, TECHNICIAN:

Take a good look at the enclosed service bulletin for one of the leading TV sets on the market. This same manufacturer is making sets today that are almost inaccessible in the home, and real dogs to repair. Since I've read this gem, I have "sold away" from this manufacturer to the tune of 150 TV sets myself, and probably influenced others in at least that amount.

BERNARD DAIEN

New York, N.Y.

• The 8-page bulletin referred to reads in part: "Simplified Television Service Procedure—for the man with limited or no training on any type of television service or for the television man who isn't familiar with — receivers. Many — television receiver repairs can be made by dealers, salesmen or others familiar only with operating a receiver, if an experienced serviceman is not available. This is possible since a very high percentage of television service calls merely require replacement of a tube or a simple service adjustment. All that is necessary is to observe what is on the screen . . . listen to the sound . . . and compare what you see or hear with the chart on the following pages. The chart then tells what to do."—Ed.

Self-Service Tube Testers

Editor, TECHNICIAN:

I have had a self-service tube tester for several months. It brings in a lot of people who test their own tubes, and then buy the tubes somewhere else, presumably wholesale. The ones who really want to buy tubes will not test their own; they want a man who knows something about TV. Most of the do-it-yourself customers are discount minded, and the distributors will get most of the retail business at 50%.

Furthermore, many tubes like 6BG6 and 6BQ6 will test gassy or short on these self-service testers. A customer placing a 6SN7 in a 6W4 socket will either pop his tube or blow a fuse. Several brands of 1B3's all show weak. Sockets are chipped by customers forcing tubes in without looking for the keyway.

In time if the chain store sells a lot of tubes, they will get the business that is being done with customers by distributors at wholesale prices. One more thing, the self-service tester will bring in mail order bargain tube buyers, who will test the tubes and send back 80% for replacement.

BENN MARKS

Homestead, Pa.

(Continued on page 10)

WRITE FOR FREE CATALOG OF THESE ECONOMICALLY PRICED BOOKS.

JOHN F. RIDER PUBLISHER, INC. 480 CANAL STREET, N.Y.C. 13, N.Y.



The QUALITY! BEAUTY! PRECISION!
 ...of a FINE WATCH

*the world's most beautiful,
 most advanced antenna rotator*



INTERCHANGEABLE ROTATORS
 Famous Superotor models "100" and "500" have both been designed for automatic operation.



Thompson Products

**Automatic
 ELECTRONIC**

Superotor.

For accuracy, dependability, and ease of control, the new Electronic Automatic Superotor is years ahead of any other antenna rotator on the market. Electronic VP* Tuning, completely silent operation, and smooth, even rotation combine to bring you instantly, automatically, the finest TV picture you've ever enjoyed.

* Vernier Precision

**OTHER THOMPSON PRODUCTS
 ELECTRONIC AFFILIATES**

- Bell Sound Systems • Dage Television • Ramo-Wooldrige Corp.
- Pacific Semi-Conductors, Inc.

ELECTRONICS DIVISION

Thompson Products, Inc.



2196 CLARKWOOD ROAD • CLEVELAND 3, OHIO
 Available in Canada thru Atlas Radio Corp., Ltd., 50 Wingold Ave., Toronto

"5,472 HOURS WITHOUT FAILURE"



Westinghouse Locked-TV Test* at Lew Bonn Company demonstrates how you can eliminate excessive call-backs!

ARE CALL-BACKS EATING UP YOUR PROFITS? Listen to this report from W. J. Heisel (at left in photo), General Manager, Lew Bonn Company, Minneapolis:

"We wanted to *prove* to our service dealers the outstanding dependability of Westinghouse RELIATRON Picture and Receiving Tubes. So we conducted a Westinghouse Locked-TV Test in our showroom. The set shown in the photo, completely equipped with *stock* Westinghouse RELIATRON Tubes, was turned on at two P.M. on April 25. As these words are written, this Westinghouse-equipped set has been operating continuously for 5,472 hours *without a single tube failure*—and it's still going strong!"

5,472 HOURS! Almost *four years* of average family viewing! This is *real* dependability. Dependability that cuts costly call-backs practically to the vanishing point. And notice . . . the tubes used in the Lew Bonn Company test *were taken right from stock*. They're the identical kinds of tubes that *you* can handle—to protect your profits, win customer confidence—simply by calling your Westinghouse Distributor. Do it today.

*This dramatic tube-endurance test was rechecked Dec. 9, 1955 when this ad went to press. On that date, the test had been operating 228 days or 5,472 hours.

6ET-4101

YOU CAN BE SURE ... IF IT'S
Westinghouse

RELIATRON® TUBES

WESTINGHOUSE ELECTRIC CORPORATION, ELECTRONIC TUBE DIVISION, ELMIRA, N. Y.

An open letter to all TV service-dealers

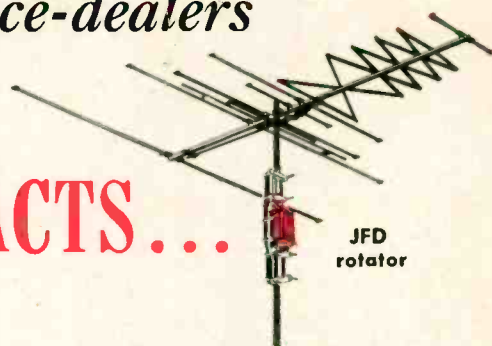

FACTS ARE FACTS...

FACTS ARE FACTS and you—as a serviceman—must be prepared to face them. All rotators eventually break down and require servicing. This usually means dismantling the antenna installation and disrupting your customer's TV enjoyment for days. It not only costs you time, effort, and money, but strained customer relations. Moreover, your cost of servicing the rotator is greater than the profit you make on the original installation.



THE ANSWER MUST BE *BUILT* RIGHT INTO THE ROTATOR. The unit must be designed to give superior performance and yet be easy to service. That is why the JFD Roto-King Rotator is the solution to your problems. To service, *simply remove the old unit and replace with a new, moderately-priced factory-sealed unit.* Service is restored in a matter of *minutes*, without loss of customer goodwill.

Your nearest JFD distributor has Roto-King Rotators in stock at attractive prices, in 4 different models to suit any location requirement. Control cases can be obtained in either mahogany, ebony, or ivory. Be sure to ask for the JFD Roto-King—the *only* rotator with the *replaceable* power cartridge.



The Roto-King Rotator was designed, engineered, and manufactured in the JFD plant.



MANUFACTURING CO., Inc.

Brooklyn 4, N. Y.

Go Forward with JFD Engineering!

(Continued from page 6)

Unity Meet

Editor, **TECHNICIAN**:

The article in the Nov. 1955 issue, p. 65, concerning the Oct. 9 unity meeting in Indianapolis warrants some corrections. According to official delegate registration cards, NATESA was outnumbered more than 2 to 1. The steering committee was composed of a majority of non-NATESA delegates.

During the entire meeting, the only motion temporarily tabled by the chair was the one by Murray Barlowe: "Form a new association. Let local groups decide whether servicemen are members or not." The chair requested that this motion be tabled for dinner adjournment, and received the approval of Mr. Barlowe and the group. After dinner, the motion by Howard Wolfson, ARTS, Chicago, "to table Mr. Barlowe's motion" was carried with no opposition. As for motions being railroaded through, it seems rather incongruous that this could be achieved by NATESA when it was outnumbered more than 2 to 1.

I realize that you did not have the official minutes at your disposal at the time you printed the article in question. Naturally, NATESA did have more representation than any other single group because it is the only truly national association with affiliates in over $\frac{3}{4}$ of the states.

This meeting was originally called by Eastern service people not affiliated with NATESA. It could have been "loaded" with non-NATESA associations if they had attended.

RICHARD E. MILLER, SR.
Secretary

Electronic Service Council
Cincinnati, Ohio.

• **TECHNICIAN** is anxious to see a unified national association encompassing all local groups. We are not partisan with respect to any one, and feel duty bound to report all responsible opposing views, which is what we attempted to do when we published Mr. Barlowe's dissenting statement.—Ed.

Associations . . . Attention!

Editor, **TECHNICIAN**:

We are organizing a service association here in Havana, and would appreciate receiving copies of association by-laws, reports on their main activities, and other information that could help us. Five years have passed since TV was established in this city, and the more than 30 independent service companies feel that it is necessary to band together. We have always found your magazine an indispensable publication for our business.

ALFREDO TORRES

Television Service Co. of Cuba
Rosa Enriquez 514, Luyano
Havana, Cuba

• Association officers can cooperate by sending requested material directly to Mr. Torres.—Ed.

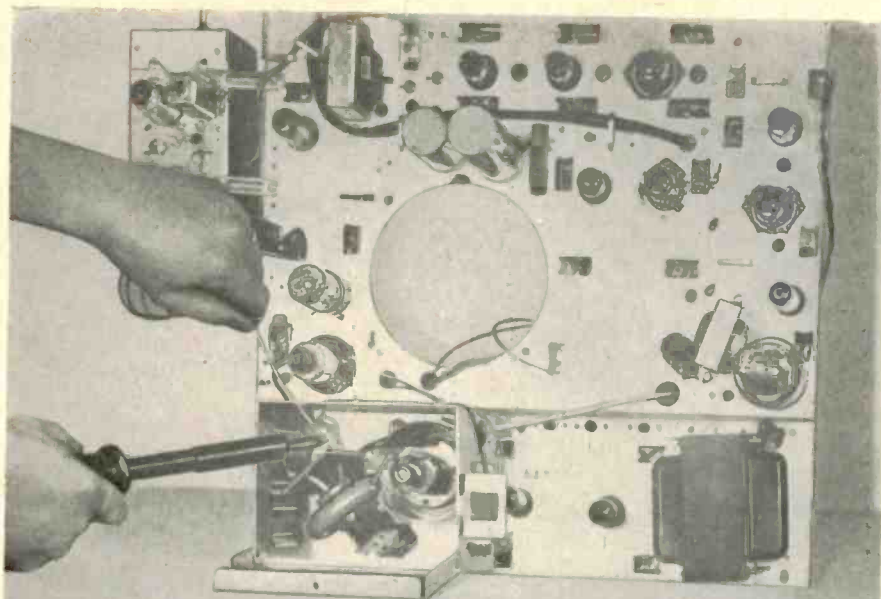

keep your servicing
on-the-go profitably, with
RCA SERVICE PARTS

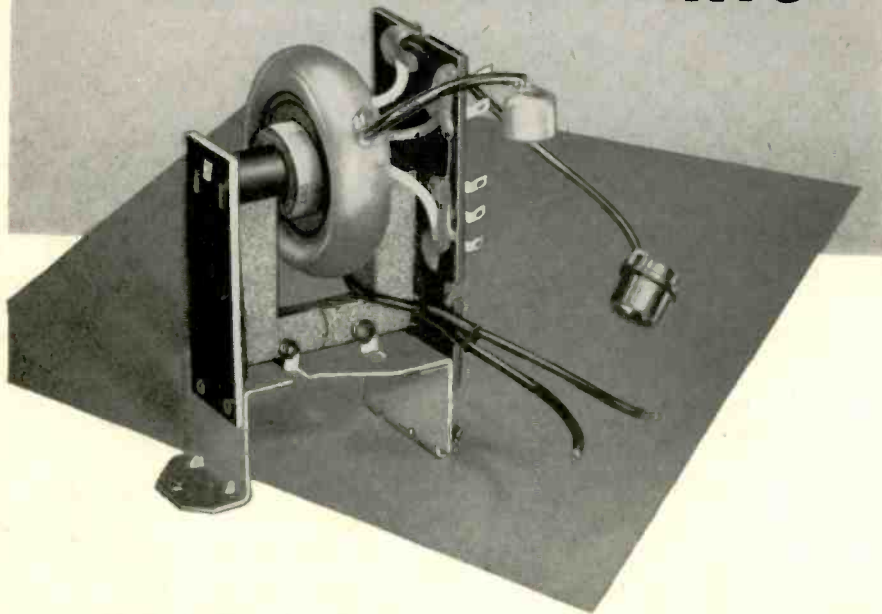

Mechanically and electrically this Horizontal-Output and High-Voltage Transformer is an exact replacement for the high-quality original used in an RCA Victor TV receiver. Like all RCA Service Parts, it is factory-tailored to cut down bench-time by fitting right, installing fast . . . without reaming, drilling, tapping, sawing, or cutting! Add outstanding performance to this ease of installation, and you'll appreciate why smart servicemen everywhere depend on RCA Service Parts to keep their servicing on-the-go profitably.

RCA Service Parts are the only genuine replacement parts
for RCA Victor radios, TV receivers, and phonographs.



SERVICE PARTS

RADIO CORPORATION OF AMERICA, HARRISON, N. J.

RCA VICTOR PRODUCTS · RCA SERVICE PARTS—made for each other!

Federal

...America's pioneer
selenium rectifier

FIRST IN PREFERENCE!

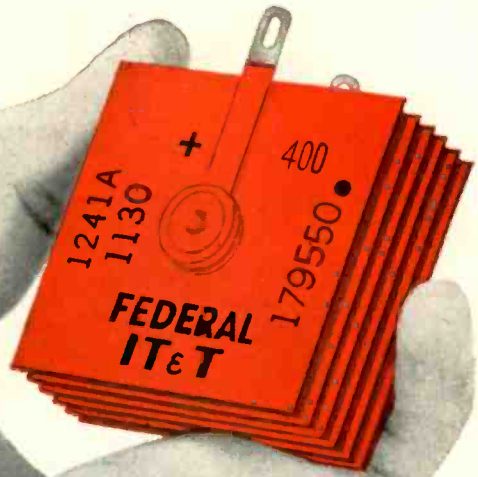

with **MORE**
Manufacturers

with **MORE**
Distributors

with **MORE**
Servicemen

More radio and TV manufacturers—through their design and component engineers—have placed their OK on Federal Selenium Rectifiers than any other make! Consequently, *more* distributors stock Federal to take care of *more* calls from servicemen for "replacement by Federal."

Literally tens of millions of Federal types have been factory-installed. Federal is OK with manufacturers because Federal means *dependable* receiver performance . . .

OK with distributors because Federal is in such high favor and big demand . . . OK with servicemen because

Federal is profitable and customer-satisfying. Whatever *your* rectifier requirements you can meet them with Federal's *Universal* and *Regular* Lines . . . one source of supply for the radio-TV industry! Write today to Dept. F-154.

Here are the clinching reasons behind Federal's coast-to-coast leadership:

- Longer life
- Higher output voltage
- Lower temperature rise
- Superior humidity resistance
- More uniform quality
- Proven mechanical construction
- 85° C. UL acceptance
- Conservative ratings
- Largest plant capacity
- More engineering know-how

Federal Telephone and Radio Company
A Division of INTERNATIONAL TELEPHONE AND TELEGRAPH CORPORATION
COMPONENTS DIVISION • 100 KINGSLAND ROAD • CLIFTON, N. J.

In Canada: Standard Telephones and Cables Mfg. Co. (Canada) Ltd., Montreal, P. Q.
Export Distributors: International Standard Electric Corp., 67 Broad St., New York

Federal



A DIVISION OF



SELL General

36 YEARS OF RADIO-BATTERY MANUFACTURING!



A COMPLETE LINE of RADIO BATTERIES!

By stocking the illustrated types, distributors and dealers can satisfy the large majority of replacement radio-battery sales. Immediate delivery on all types!



11 CONVENIENT SHIPPING POINTS! WITHIN EASY DISTANCE OF MOST DISTRIBUTORS.
Boston, Mass.; Silver Springs, Md.; Cleveland, Ohio; Atlanta, Georgia; Dubuque, Iowa; Memphis, Tenn.; Dallas, Texas; Denver, Colorado; Los Angeles, Cal.; San Francisco, Cal.; Portland, Oreg.



NEW SALES-BUILDING PACKAGING

General's new labeling stimulates impulse buying . . . makes these batteries look like what they are: *fresh, dependable, powerful, long lasting.*

AND—A COMPLETE LINE OF GENERAL MERCURY BATTERIES FOR INDUSTRIAL ELECTRONIC AND RADIO APPLICATIONS

The fine quality of General Mercury Batteries is being used in many products with transistor or electronic circuits—like Geiger Counters — Tachometers — Guided Missiles — Pocket Radios — Numerous Test Devices, etc.

Look to General for the Best in Batteries!



Editor's Memo

There's hardly any kind of work that doesn't have some occupational hazard connected with it. Eyestrain seems to be one of the leading perils for editors, which is quite understandable when you consider that my business reading last month included about 20 electronic magazines, 5 technical books, 5 business periodicals, a dozen service association reports and over 250 announcements from manufacturers. It was time well spent, but a change of pace seemed in order.

Like the sailor who takes his girl out for a rowboat ride on his day off, I took my relief in the form of more reading. I started scanning some books that hadn't been taken off the shelf (except for dusting) for a long time. I started with an interesting book on hunting, a clever murder mystery (the writer turned out to be the killer), and ended up with a few of the great classics . . . Aesop, Shakespeare and the Bible.

In these last three, I was keenly struck by the modern timeliness of the eternal truths they express. From these literary works come many of our everyday expressions, and it was interesting to note how many conditions in our industry are succinctly summed up by them.

United we stand, divided we fall (Aesop). When you think of the great need for all techs to band together, to oppose and correct unfavorable situations with concerted action, it's amazing that so many neglect to participate in their association activities.

He that maketh haste to be rich shall not be innocent (Bible). The get-rich-quick boys are present in all fields, but fortunately they are in the minority.

Delays have dangerous ends (Shakespeare). Going to clean up the shop front? Send out that thank you letter? Replace that outmoded tester? Every day it's put off costs you money.

Men often applaud an imitation, and hiss the real thing (Aesop). Here we have one of the frailties of human nature. The only solution is understanding and patience.

The written word has played such a vital role in our civilization because it reflects our society, and is a permanent record from which all may learn and grow.

One reading method I've found to be quite helpful is to thumb through the entire issue, quickly scanning each page, making a mental note of major items of interest, and getting an overall "feel" of its contents. Then after specifically examining the contents page, I go through the entire magazine, slowly and in detail, giving special attention to those features of immediate importance.

After doing this with several dozen publications, I generally have a case of mild eyestrain. But then again, that's my occupational hazard.

Al Forman

New!



TRANS-CONDUCTANCE TUBE TESTER

New Model TV-12



ALSO TESTS TRANSISTORS!

TESTING TUBES

- ★ Employs improved TRANS-CONDUCTANCE circuit. An in-phase signal is impressed on the input section of a tube and the resultant plate current change is measured. This provides the most suitable method of simulating the manner in which tubes actually operate in Radio & TV receivers, amplifiers and other circuits. Amplification factor, plate resistance and cathode emission are all correlated in one meter reading.
- ★ NEW LINE VOLTAGE ADJUSTING SYSTEM. A tapped transformer makes it possible to compensate for line voltage variations to a tolerance of better than 2%.
- ★ SAFETY BUTTON—protects both the tube under test and the instrument meter against damage due to overload or other form of improper switching.

- ★ NEWLY DESIGNED FIVE POSITION LEVER SWITCH ASSEMBLY. Permits application of separate voltages as required for both plate and grid of tube under test, resulting in improved Trans-Conductance circuit.

TESTING TRANSISTORS

A transistor can be safely and adequately tested only under dynamic conditions. The Model TV-12 will test all transistors in that approved manner, and quality is read directly on a special "transistor only" meter scale.

Model TV-12 housed in handsome rugged portable cabinet sells for only

\$72⁵⁰ NET



New Model 20,000 OHMS PER VOLT TV-60 ALLMETER



Includes services never before provided by an instrument of this type. Read and compare features and specifications below!

FEATURES

- Giant recessed 6½ inch 40 Microampere meter with mirrored scale.

- Built-in Isolation Transformer.
- Use of the latest type printed circuit and 1% multipliers assure unchanging accurate readings.

SPECIFICATIONS

- 8 D.C. VOLTAGE RANGES: (At a sensitivity of 20,000 Ohms per Volt) 0 to 15/75/150/300/750/1500/7500/30,000 Volts.
 - 7 A.C. VOLTAGE RANGES: (At a sensitivity of 5,000 Ohms per Volt) 0 to 15/75/150/300/750/1500/7500 Volts.
 - 3 RESISTANCE RANGES: 0 to 2,000/200,000 Ohms, 0-20 Megohms
 - 2 CAPACITY RANGES: .00025 Mfd. to 30 Mfd.
 - 5 D.C. CURRENT RANGES: 0-75 Microamperes, 0 to 7.5/75/750 Milliamperes, 0 to 15 Amperes.
 - 3 DECIBEL RANGES: -6 db to +58 db
- RF SIGNAL TRACER SERVICE:** Enables following the R.F. signal from the antenna to speaker of any radio or TV receiver and using that signal as a basis of measurement to first isolate the faulty stage and finally the component or circuit condition causing the trouble.
- AUDIO SIGNAL TRACER SERVICE:** Functions in the same manner as the R.F. Signal Tracing service specified above except that it is used for the location of cause of trouble in all audio and amplifier systems.

Model TV-60 comes complete with book of instructions; pair of standard test leads; high-voltage probe; detachable line cord; R.F. Signal Tracer Probe and Audio Signal Tracer Probe. Pliofilm bag for all above accessories is also included. Price complete. Nothing else to buy. ONLY

\$52⁵⁰



New Model TV-50 GENOMETER



A versatile all-inclusive GENERATOR which provides ALL the outputs for servicing: A.M. Radio • F.M. Radio • Amplifiers • Black and White TV • Color TV

R. F. SIGNAL GENERATOR: Provides complete coverage for A.M. and F.M. alignment. Generates Radio Frequencies from 100 Kilocycles to 60 Megacycles on fundamentals and from 60 Megacycles to 180 Megacycles on powerful harmonics. • **VARIABLE AUDIO FREQUENCY GENERATOR:** In addition to a fixed 400 cycle sine-wave audio, the Genometer provides a variable 300 cycle to 20,000 cycle peaked wave audio signal. • **BAR GENERATOR:** Projects an actual Bar Pattern on any TV Receiver Screen. Pattern will consist of 4 to 16 horizontal bars or 7 to 20 vertical bars. • **CROSS HATCH GENERATOR:** Genometer will project a cross-hatch pattern on any TV picture tube. The pattern will consist of non-shifting horizontal and vertical lines interlaced to provide a stable cross-hatch effect. • **DOT PATTERN GENERATOR (FOR COLOR TV):** The Dot Pattern projected on any color TV Receiver tube by the Model TV-50 will enable you to adjust for proper color convergence. • **MARKER GENERATOR:** The following markers are provided: 189 Kc., 262.5 Kc., 456 Kc., 600 Kc., 1000 Kc., 1400 Kc., 1600 Kc., 2000 Kc., 2500 Kc., 3579 Kc., 4.5 Mc., 5 Mc., 10.7 Mc., (3579 Kc. is the color burst frequency.)

MODEL TV-50 comes absolutely complete with shielded leads and operating instructions.

\$47⁵⁰ NET

Only

SHIPPED ON APPROVAL NO MONEY WITH ORDER - NO C.O.D.

TRY ANY

of the instruments on this page, for 10 days before you buy. If completely satisfied then send down payment and pay balance as indicated on coupon. No Interest or Finance Charges added! If not completely satisfied return unit to us, no explanation necessary.

MOSS ELECTRONIC DISTRIBUTING CO., INC.

Dept. D-208, 3 849 Tenth Ave. New York 34, N. Y.

Please send me the units checked. I agree to pay down payment within 10 days and to pay the monthly balance as shown. It is understood there will be no finance, interest or any other charges, provided I send my monthly payments when due. It is further understood that should I fail to make payment when due, the full unpaid balance shall become immediately due and payable.

Name _____
Address _____
City _____ Zone _____ State _____

- Model TV-12 Total Price \$72.50 \$22.50 within 10 days. Balance \$10.00 monthly for 5 months.
- Model TV-60 Total Price \$52.50 \$12.50 within 10 days. Balance \$8.00 monthly for 5 months.
- Model TV-50 Total Price \$47.50 \$11.50 within 10 days. Balance \$6.00 monthly for 6 months.

For ALUMINIZED TUBE PERFORMANCE, *plus* EXCELLENT TUBE LIFE . . . Replace with



Thanks to LUMILAC, Raytheon Aluminized Picture Tubes provide sharper pictures, high light output and superior contrast — *plus excellent tube life*. LUMILAC, — a lacquer especially blended and used exclusively by Raytheon — is the secret of superiority. This amazing lacquer produces an extra smooth, unbroken surface for the pure aluminum coating, yet leaves no gas-producing residues which could impair cathode emission and shorten tube life.

What's more, the quality of Raytheon Aluminized Picture Tubes is safeguarded by Raytheon's great ultra-modern Cathode Ray Tube Plant in Quincy, Mass. — a plant designed and built solely for the manufacture of first quality picture tubes.

Replace with Raytheon Aluminized Picture Tubes — they are best for you and your customers, too.

RAYTHEON "Lumilac" ALUMINIZED PICTURE TUBE REPLACEMENT GUIDE

RAYTHEON "Lumilac" ALUMINIZED PICTURE TUBE	REPLACES STANDARD TYPE	NECESSARY ADJUSTMENTS OR CHANGES	RAYTHEON "Lumilac" ALUMINIZED PICTURE TUBE	REPLACES STANDARD TYPE	NECESSARY ADJUSTMENTS OR CHANGES	
12KP4A	12KP4	None.	21AUP4A	21AUP4	None.	
	12QP4	Ground conductive coating. Remove ion trap.		21AUP4B	None.	
	12QP4A	Ground conductive coating. Remove ion trap.		21AVP4A	21AVP4	None.
	12RP4	Ground conductive coating. Remove ion trap.			21AVP4B	None.
16KP4A	16KP4	None.	21EP4B	21EP4	Ground conductive coating.	
	16QP4	Ground conductive coating. Change ion trap.		21EP4A	None.	
	16RP4	Check conductive coating contact.	21FP4C	21FP4	Ground conductive coating.	
	16TP4	Space may not be sufficient in some cases.		21FP4A	None.	
	16XP4	Ground conductive coating. Change ion trap.	21YP4A	21AFP4	Ground conductive coating.	
17BP4B	17BP4	Ground conductive coating.		21YP4	None.	
	17BP4A	None.	21ZP4B	21ZP4	Ground conductive coating.	
	17BP4C	None.		21ZP4A	None.	
	17JP4	Do not exceed voltage rating.	24CP4A	24CP4	None.	
17HP4B	17HP4	None.		24QP4	None.	
	17HP4A	None.		24TP4	None.	
	17RP4	None.	24XP4	Ground conductive coating.		
17LP4A	17LP4	None.	24DP4A	24DP4	None.	
	17VP4	None.		27EP4	27GP4	None.
20DP4C	20DP4A	None.	27NP4		Add filter condenser.	
	21ALP4A	21ALP4	None.	27RP4	27GP4	Ground conductive coating.
21ALP4B		None.	27NP4		None.	
21ANP4		Ground conductive coating.				
21ANP4A		Ground conductive coating.				



RAYTHEON MANUFACTURING COMPANY

Receiving and Cathode Ray Tube Operations

Newton, Mass. • Chicago • Atlanta, Ga. • Los Angeles, Calif.

Raytheon makes all these Receiving and Picture Tubes, Reliable Subminiature and Miniature Tubes, Semiconductor Diodes, Power Rectifiers and Transistors, Nucleonic Tubes, Microwave Tubes



Excellence in Electronics

TECHNICIAN & Circuit Digests

CALDWELL-CLEMENTS, INC., 480 LEXINGTON AVENUE, NEW YORK 17, N. Y.

What's Ahead for '56!

The TV-electronic servicing industry will sell an estimated \$2.1 billion of products and services in 1956, more than it ever has in a single year in its history, according to forecasts by **TECHNICIAN** editors. This record-breaking business volume is easily appreciated when one considers the continued rapid growth of electronic devices in use.

TV sets, radio receivers and audio equipment will constitute the bulk of the market, as they have for a number of years. In addition, however, home electronic and electromechanical controls, two-way radio communications and industrial electronics will become increasingly significant income producers for the relatively small, but growing, number of technicians diversifying their activities.

Some progress may be expected in improving business management in the service shop, but there is no indication of an overhaul of industry-wide proportions. If past experience is a good indicator, the majority of technicians will still pass up many profit making opportunities in sales promotion, keeping records and public relations.

Unfair competition from two sources—distributors selling wholesale to the public and unethical price-cutting operators—will continue to harass legitimate operators, but the counter-offensive guided by aggressive service associations will start to make itself felt with increasing force.

Recognizing the negative factors facing the servicing industry is only honest realism. Technicians are down-to-earth people; they don't think the sun always shines and all people smile. Nevertheless, the overall picture for 1956 is extraordinarily promising in terms of business volume and technical developments. Specifically, here are some of the things to which we can look forward:

TELEVISION: We're going out on a limb with this forecast, but reliable signs point to set sales going over the 8,000,000 mark for the first time, accounted for a total dollar volume of \$1,449,900,000 (set sales are not included in the \$2.1 billion servicing figure). Heavy accent on 21-inch screens will continue. Color TV sales will move along moderately, stepping into a very brisk pace after the summer. Color servicing will be a relatively complex affair even beyond 1956, but a good head start in circuit

simplification is in the cards. Remote controls are on the upswing. Competitive pricing will keep most set makers from designing too much servicing accessibility into the receiver. More extensive use of printed circuits, despite some obstacles, can be expected. Look forward to greater antenna design emphasis on specific models for specific conditions. Don't be surprised department: Truly portable battery-operated sets, partially transistorized TV's.

RADIO. Another sales milestone in a boom year . . . 13,000,000 radios of all kinds worth \$494,000,000. Prospects are for a jump in dealer sales of transistorized portables, particularly if price reductions are placed in effect.

AUDIO: Predictions are for 4,250,000 phonographs (\$127,500,000) and 425,000 tape recorders (\$63,750,000) to be sold in 1956. Add to this a large volume of hi-fi speakers, amplifiers and other separate audio components. Watch for the amplifier horsepower race, units rated at or close to 100 watts. Plenty of good opportunities for technicians in public address and hi-fi equipment sales and service.

TEST EQUIPMENT: Many new test instruments in all price ranges are slated for 1956. Emphasis will be on specialized function types for specific troubleshooting problems, with supplementary accent on helpful multi-purpose types. The servicing industry will spend over \$30,000,000 for test equipment, according to preliminary estimates.

TUBES: About 11,200,000 picture tubes and 470,000,000 receiving tubes will be produced in 1956. In the pix type, 80% will be in the 19-21 in. sizes and 18% in 16-18 in. screens; replacement will account for 3,200,000 tubes or almost 29%. In the receiving type, 175,000,000 tubes, or more than 37% will go for replacement. Total consumer bill for all replacement tubes: over \$410,000,000.

There's the overall picture for TV-electronic servicing in 1956—\$2.1 billion, including \$1,140,000,000 for parts and equipment, and \$960,000,000 for labor. What's ahead for 1956? A few problems and many rewards!

Tuning In the

Federal Trade Commission Rule 12, scheduled to go into effect December 28, 1955, requires that any cathode-ray-tube which employs a used envelope must be labeled "used." The rule applies even though the "used" tube is subjected to exactly the same manufacturing process and tests as a tube using new glass. RETMA, opposing this rule, contends that there is no difference in the quality of picture tubes with re-used containers from those with unused containers, if both have all new functional parts and undergo the same manufacturing processes. RETMA warned that if the tubes using repossessed glass must be so labeled, customer preference will force the repossessed glass bulbs off the market, and lead ultimately to an increase in the cost of tubes and set to the customer.

"COLD-WAR" PHONOGRAPH made by RCA can be produced for 50 cents or less. The compact, unbreakable, hand-operated device, weighing 10 oz., was designed for propaganda use behind the Iron Curtain. Unbreakable discs for the machine, playing up to 3 minutes, can be made for about 5 cents each. Samples have been delivered to the "Voice of America" for field tests.

ATOMIC BLAST in Nevada last May didn't knock out a 2-way mobile radio at the site of the blast, although the car it was in and a nearby building were demolished. Civil Defense crews were able to make immediate contact with the main station after the blast. The undamaged set, made by Motorola, illustrates the potential value of 2-way mobile radio in atom-bomb emergencies.

MORE COLOR TV ACTIVITY. Over 150 TV techs have enrolled in a color TV service course sponsored by Krich-New Jersey, RCA distributor. Philco has inaugurated a color TV school, giving 40-hour courses to techs representing all of the company's distributors, which is designed to train 20,000 servicemen ultimately. Westinghouse has started a major color TV promotion in conjunction with a contest launched by Procter & Gamble. Emerson's Pres. Ben Abrams predicts that annual color set sales will reach 3,000,000 in 1958, with retail prices at the \$300 level. For 1956 and 1957 he expects sales of 500,000 and 1,500,000, respectively.

JANUARY 1956 NETWORK COLOR TV SCHEDULE

SUNDAY, January 1	7:30-9:00 PM (EST)	NBC	"Happy New Year" (Sunday Spectacular)	(Live)
MONDAY, January 2	12:15-1:45 PM (EST)	NBC	"Tournament of Roses Parade"	(Live)
WEEKDAYS, January 3-6, 12, 13, 16-20, 23-27	3:00-4:00 PM (EST)	NBC	"Matinee Theatre"	(Live)
MONDAYS through FRIDAYS	January 3-6, 9-13, 16-20, 23-27, 30, 31	5:30-6:00 PM (EST)	NBC	"Howdy Doody" (Live)
MONDAY, January 9	7:30-9:30 PM (EST)	NBC	"Peter Pan" (Producers' Showcase)	(Live)
TUESDAY, January 10	8:00-9:00 PM (EST)	NBC	"Milton Berle"	(Live)
SATURDAY, January 14	9:30-11:00 PM (EST)	CBS	"Blithe Spirit" (Ford Star Jubilee)	(Live)
SUNDAY, January 15	3:30-5:30 PM (EST)	NBC	"The Magic Flute" (NBC Opera)	(Live)
SATURDAY, January 21	9:00-10:30 PM (EST)	NBC	"Max Liebman Presents"	(Live)
SUNDAY, January 22	3:30-4:00 PM (EST)	NBC	"Zoo Parade"	(Live)
SUNDAY, January 29	7:30-9:00 PM (EST)	NBC	"Sunday Spectacular"	(Live)
MONDAY, January 30	8:00-9:30 PM (EST)	NBC	"Music for Millions" (Producers' Showcase)	(Live)
TUESDAY, January 31	8:00-9:00 PM (EST)	NBC	"Milton Berle"	(Live)

The complete CBS January schedule is not available at press time.

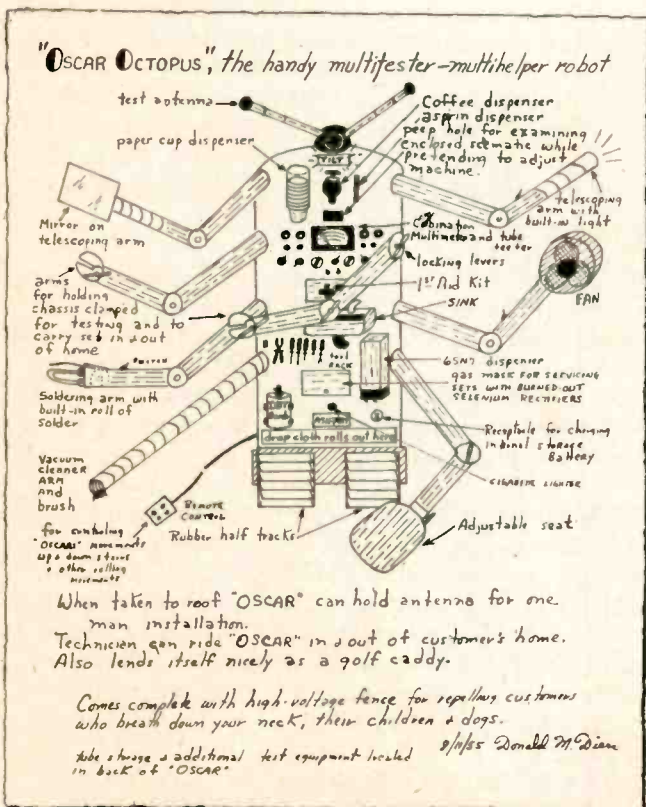

Tongue-in-cheek suggestion for ideal servicing instrument accompanied down-to-earth Technician Test Equipment Contest entry from Milwaukee tech Donald Diers. "Oscar Octopus" has everything, including kitchen sink. Contest winners will be announced in Feb. issue.

Picture

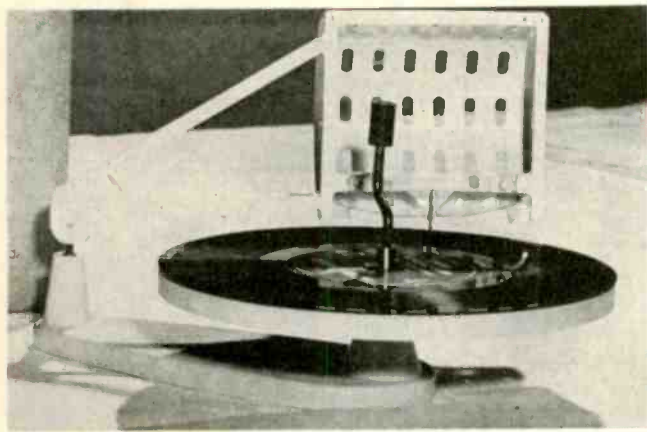

Hand-operated 50-cent phono, made for use by the Voice of America.

BY 1965, there will be more than 85,000,000 TV sets in U. S. and Canadian homes, and 50 to 60% will be color, predicts Westinghouse General Sales Manager Dan Halpin.

UNDO-IT-YOURSELF BONANZA is boosting your income, according to a survey by Trav-Ler Radio Corp. A poll taken among 10,000 service techs throughout the country indicates that hubby's or junior's tinkering with appliances before taking them to a professional has upped the repair bill 3-fold during the past 4 years. Also determined by the survey: it's mostly radios that amateurs tinker with and bug up. The heavier investment they have in their TV sets makes them a little more cautious about playing with them.

CALENDAR OF COMING EVENTS

- Jan. 9-20: Furniture Mart, Chicago, Ill.
- Jan. 15-17: National Appliance Radio & TV Dealers Assoc., 1956 Convention, Conrad Hilton Hotel, Chicago, Ill.
- Jan. 24-28: 1956 Southwestern Jobber-Rep-Mfrs. Electronic Conference, Galvez Hotel, Galveston, Texas.
- Jan. 25-26: Third Annual Industrial & Amateur Show, sponsored by Almo Radio, Penn Sherwood Hotel, Phila., Penna.
- Jan. 30- Feb. 3: American Institute of Electrical Engineers Winter Parley, Hotel Statler, New York, N. Y.
- Feb. 8-11: 1956 Los Angeles High Fidelity Music Show, Hotel Alexandria, Los Angeles, Calif.
- Mar. 2-4: Third High Fidelity Music Show, Harrington Hotel, Washington, D. C.
- Mar. 12-16: National Electrical Manufacturers Assoc., Edgewater Beach Hotel, Chicago, Ill.
- Mar. 19-22: 1956 IRE National Convention and Radio Engineering Show, Waldorf-Astoria and Kingsbridge Armory, New York, N. Y.
- Apr. 15-19: The 34th annual convention of the National Association of Radio & Television Broadcasters, Conrad Hilton Hotel, Chicago, Ill.
- June 27-30: Jobber-Rep-Mfrs. Conference, Breezy Point Lodge, Brainerd, Minn.
- July 22-25: 1956 National Audio-Visual Convention and Trade Show, Hotel Sherman, Chicago, Ill.

RECORD YEAR FOR TV SALES is well on its way, according to the Television-Electronics Fund. Production is expected to reach 8 million units for 1955, the Fund predicts through its publication, "Keeping Up," as compared to a little over 7½ million units in the previous peak year, 1950. Also noted with interest was a reversal in the trend toward manufacturing lower-priced table models. In May, nearly ¾ of all sets being made were table models. By August, table-model and console production were almost at the same level.

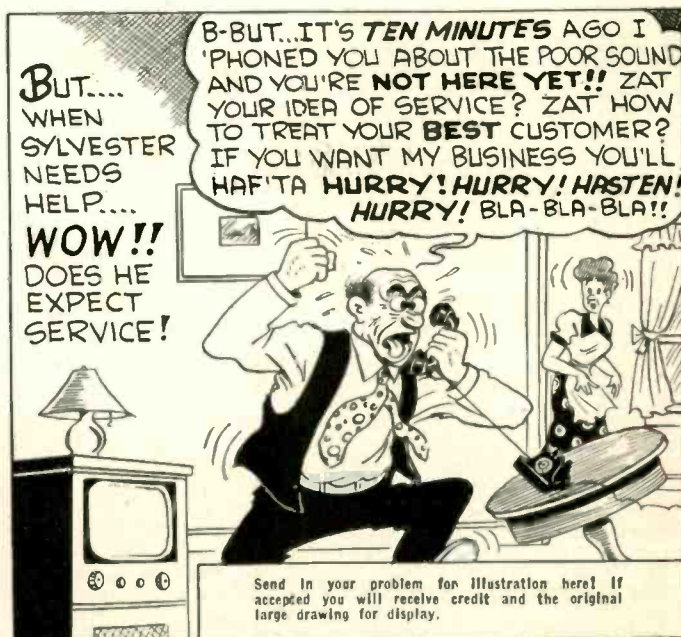
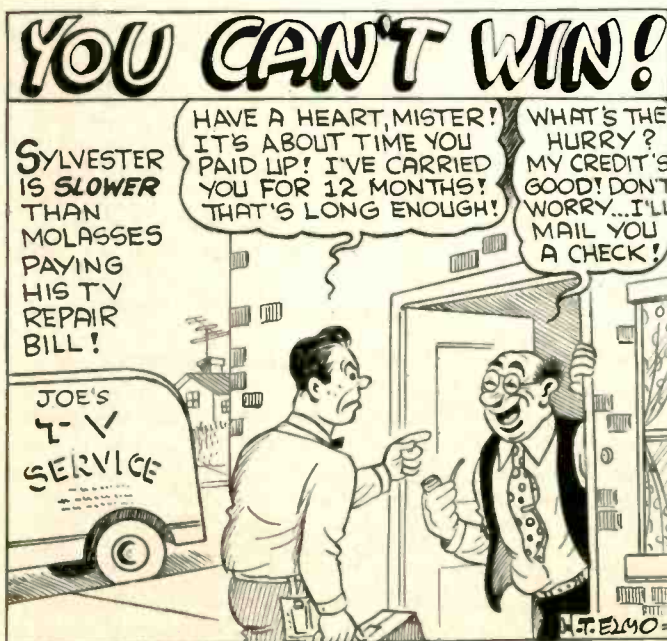

Test Instruments Used in

Part II: Desired Characteristics and Application of Video

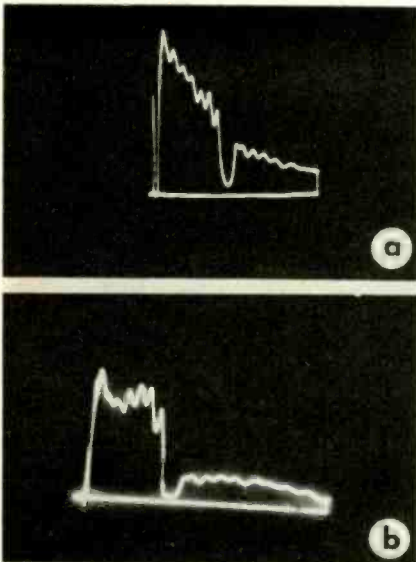

Fig. 1—Y ampl. response at (A) low signal level & (B) high level, scope gain reduced.

ROBERT G. MIDDLETON,
SIMPSON ELECTRIC CO.

- The range of signal circuits in color TV must be considerably greater than in the case of black-and-white TV circuits, because the

Fig. 2—When non-linear sweep output (A) is applied to circuit with normally adjusted response (B), curve on scope is distorted (C).

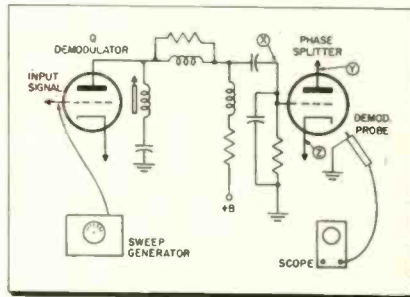
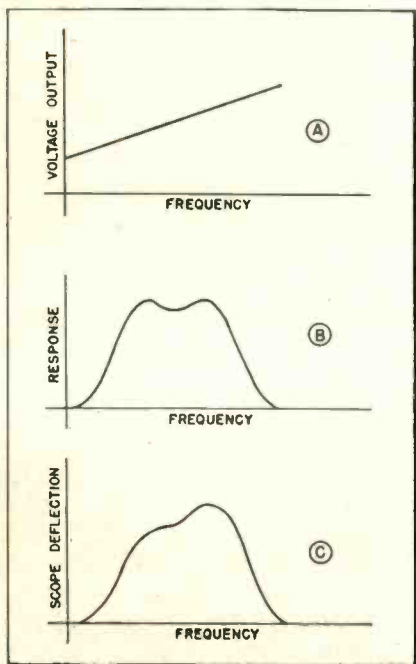

Fig. 3—Set-up for sweeping Q demodulator response. Detector probe applied to X loads ckt, distorts curve. Apply probe to Y or Z.

complete color signal is more complex than the composite black-and-white signal. The greater complexity is contributed by the color sideband signals in the range from 2.1 to 4.2 mc, as well as by the color burst. Appreciable non-linearity in operation of the Y amplifier, for example, causes cross-color, or visible beating between the chrominance and luminance components.

Hence, the video-frequency sweep generator used for testing the Y amplifier should be able to provide approximately as much signal voltage as is normally contributed by the picture detector, that is, 1 to 2 peak-to-peak volts. Fig. 1B shows the flattening and distortion of the Y-amplifier response caused by circuit faults such as low plate or screen voltage, improper value of load resistors, weak amplifier tube, or leaky capacitors causing low grid bias. Normal response is shown in Fig. 1A.

It may be noted in passing that the large dip in the response is caused by the 3.58 mc color-subcarrier trap in the Y amplifier, and that the ripple along the curve is caused by ringing in the delay line. The response of the Y amplifier is progressively attenuated in many color receivers, to minimize the visibility of cross-color due to non-linearities in picture-tube response, as well as circuit non-linearities.

Of course, if the output from the sweep generator is not flat, the curve will be distorted accordingly, as shown in Fig. 2. Distortions may also be encountered due to improper application of the equipment. To il-

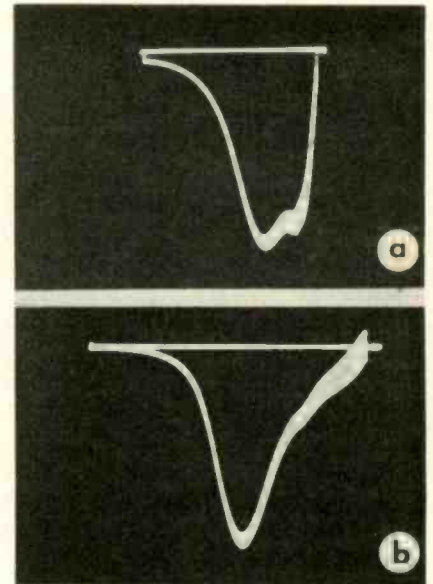

Fig. 4A—Undistorted Q demodulator response curve. B—Distorted curve with probe at X.

lustrate this point, consider the check of frequency response of the Q demodulator circuit. This test is usually made by applying the video-frequency sweep signal at the input (grid) of the Q demodulator tube, and obtaining the signal for the scope by applying a demodulator probe at the output of the Q demodulator circuit. The probe, of course, energizes the scope, as depicted in Fig. 3. Now it might be supposed that the demodulator probe could be applied at point X, which is the output lead from the Q demodulator. However, in this case, detuning of the coils and consequent curve distortion occurs, as shown in Fig. 4. The probe may be applied at points Y or Z, since these are relatively low-impedance points, and negligible curve distortion will occur.

Generator Overloads Ckt

In the event that the generator has sufficient output to overload the receiver circuit under test, this is another potential source of distortion which the technician must learn to avoid. For example, Fig. 5A shows a Q demodulator response curve distorted (detuned) due to circuit loading by the probe, and further

Color Television Service

Sweep Generator, Scope Probes, White-Dot & Bar Generators

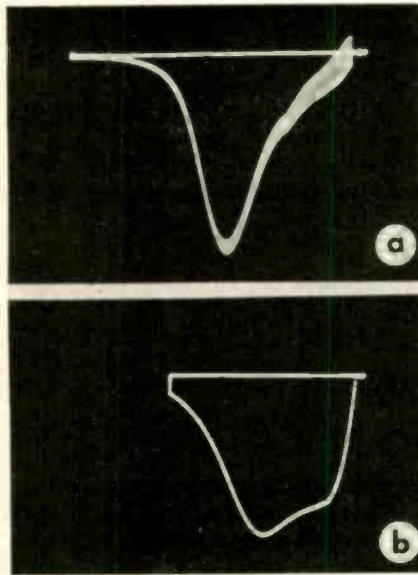

Fig. 5A—Q demodulator response distorted by applying probe to high-impedance point. B—Excessive sweep signal increases distortion.

distorted or compressed (Fig. 5B) by application of excessive output voltage from the sweep generator. The proper rule to observe is to consult the receiver service data for the normal operating voltage of the circuit under test, and to observe this value of voltage in making checks of frequency response. To determine whether overloading occurs, due to circuit defects at normal signal level, reduce the output from the sweep generator somewhat, meanwhile watching the overall shape of the response curve. The height will decrease, but the shape of the curve should remain unaffected.

When excessive "picket-fence" interference is observed on the response curve, the trouble is due to cross-talk from the horizontal sweep circuit. To clean up the curve, the horizontal output tube(s) should be removed, and the B-plus current drain restored to normal by connection of power resistors of suitable value from plate to ground and from screen-grid to ground.

Beginners in color-TV service are often surprised to observe fuzzy patterns of the type illustrated in Fig. 6, when troubleshooting the Y amplifier circuits with a wide-band

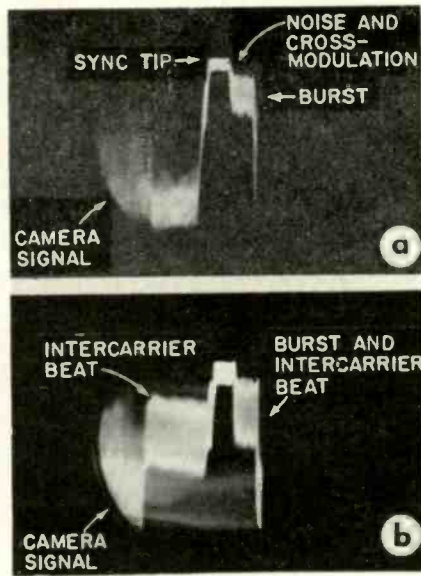

Fig. 6A—Normal appearing horiz. sync pulse with color burst. B—Incorrect tuning of receiver superimposes 4.5-mc beat voltage.

scope. The fuzzy appearance of the sync pulse is encountered only when the fine-tuning control of the receiver is misadjusted, or when the sound traps are misaligned. It is the result of the sound carrier beating with the picture carrier through the picture detector and forming a 4.5-mc beat voltage. This beat voltage is normally attenuated to approximately 50 or 60 db by the time it reaches the Y amplifier.

Use Right Probe

This intercarrier beat, of course, is invisible when the circuits are checked with a narrow-band scope. It will also be invisible on a wide-band scope if the incorrect probe is used. Some technicians erroneously believe that such waveforms can be viewed and circuit loading avoided by using a resistor in series with the scope lead. Such a resistive isolating probe arrangement "kills" the high-frequency response, and makes the wide-band scope the equivalent of a narrow-band scope. Only a low-capacitance probe should be used in making such tests. A low-capacitance probe is compensated for flat response over the complete video-frequency range.

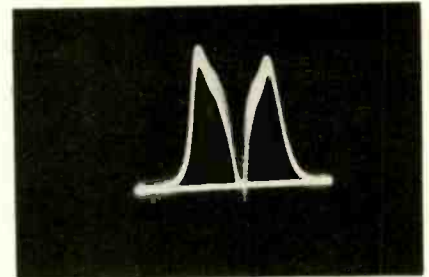

Fig. 7—"Mirror-image" chrominance circuit response curve, zero frequency at center.

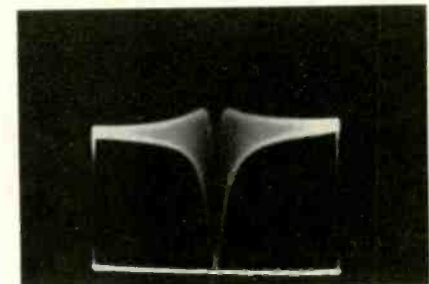

Fig. 8—Video-frequency sweep generator output, seen on scope through detector probe.

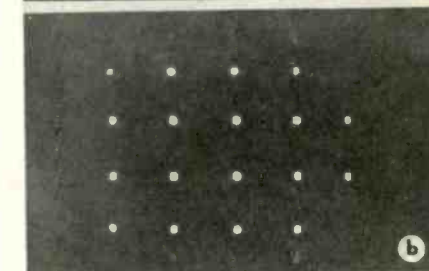
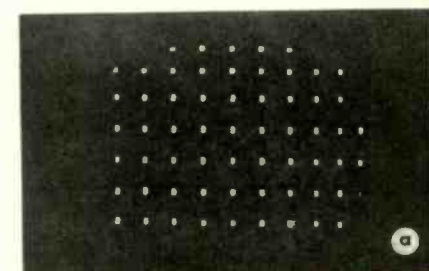

Fig. 9—Dot generator output may be variable.

Fig. 10—Bar gen. luminance signal with sync.

At other times, the opposite type of error is made; i.e., the technician may attempt to use a small capacitor in series with the scope lead to reduce circuit loading. This practice "kills" the low-frequency response. A proper understanding of the use of probes is vital for effective color-TV servicing work.

Twin-Image Sweep

The nature of the display from a video-frequency sweep generator differs from that of an r-f or i-f sweep display in that twin images are often seen, as shown in Fig. 7. This is the result of the beat-frequency principle utilized in generating the video-frequency sweep signal, combined with the fact that color circuits have extended low-frequency response, so that the user of the generator often becomes aware of the zero-frequency point (the dip in Fig. 7)—especially when sweeping chrominance demodulator circuits.

If the output from the video-frequency sweep generator is applied directly to a demodular probe, and the sweep signal is viewed on the scope screen, the pattern corresponding to the situation shown in Fig. 7 is that of Fig. 8. Zero frequency occurs in the center of the sweep, with increasing frequency to either side of zero. The "fuzz" in Fig. 8 is due to incomplete filtering of the low-frequency components by the probe. These new considerations require a little attention, but are not formidably difficult.

White-dot generators are also important in color-TV service, to ob-

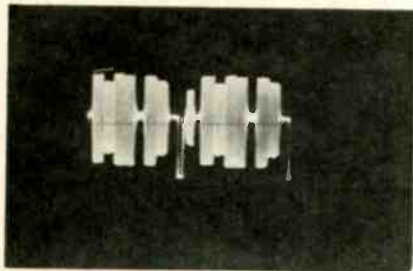

Fig. 11—Chrominance portion of bar generator output, with horiz. sync pulse and burst.

Fig. 12—Complete color-bar generator output combines all elements of Fig. 10 and Fig. 11.

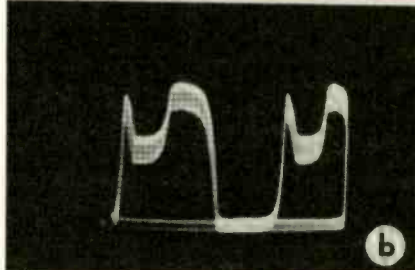
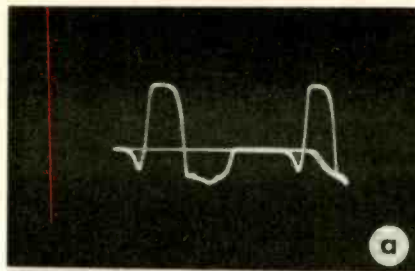
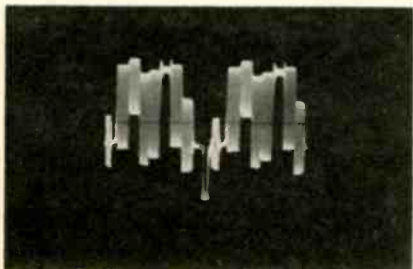

Fig. 13—Signals in receiver color detectors with bar-signal input: A&B—I & Q detectors.

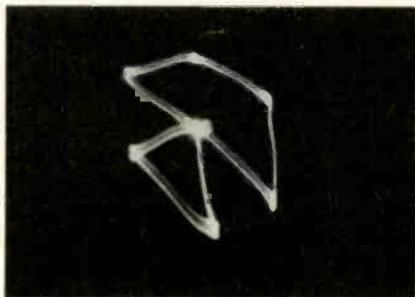

Fig. 14—Vectorimeter pattern obtained from set's color detectors with color-bar signal.

tain convergence of the three-gun color picture tube. Fig. 9 shows typical patterns produced by a white-dot generator which places the number and size of dots under the operator's control. This feature is often deemed advisable, because various receiver manufacturers recommend different numbers and sizes of dots in the pattern.

Some white-dot generators are unsynchronized, and must be supplied with external sync from the receiver under test. The more elaborate white-dot generators are synchronized, and either have simulated sync pulses or complete sync pulses. Those which are synchronized provide the most stable patterns.

It is probably safe to say that the color-bar generator is the most unfamiliar of the new instruments for color-TV service. It takes a certain amount of time for the technician to become familiar with the waveforms produced by such an instrument, but this knowledge is important for efficient color servicing. A horizontal sync pulse is developed by a color-bar generator; vertical sync is not provided in most cases, as it is unnecessary; vertical rolling in a horizontal bar pattern is not noticeable.

The complete color signal, of course, is comprised of the luminance (black-and-white) component, and of the color (chrominance) component. Fig. 10 shows the display of the luminance signal, with sync, while Fig. 11 illustrates the appearance of the chrominance signal, with sync and burst. These are combined to form the complete color-bar signal, as shown in Fig. 12.

At the output of the color detectors, typical patterns are obtained as depicted in Fig. 13A (I detector) and 13B (Q detector). These are the chrominance bar signals as seen on linear sawtooth sweep. It is also possible to apply the output from the I detector to the vertical input of the scope, and the output from the Q detector to the horizontal input of the scope to obtain a cyclogram or vectorimeter display, as illustrated in Fig. 14. The usefulness of these patterns arises in checking the color detectors for proper quadrature operation, and for relative outputs to obtain proper color balance. •

Color TV Filming Method

Speedy kinescope recording was demonstrated recently at the Kodak Research Labs in Rochester, N. Y. The new system makes it possible to record a color program on a specially prepared black-and-white film, process the film in about an hour, and then re-telecast the program in color.

The special black-and-white film employed has a great number of tiny cylindrical lenticules (small lenses) embossed on it. During filming, color components are separated by suitable light filters or other optical means, and these color values are recorded in monochrome on the film. During projection, these values are used to control color signals in the transmitter.

The development can be used by networks to make quick kinescope recordings of color programs to help overcome time-zone differences in showing programs throughout the country.

Color CRT Production

An expansion program in the Westinghouse Elmira plant, announced by R. T. Orth, v-p of the Electronic Tube Division, will facilitate early production of the new all-glass, rectangular, 22-in. color picture tube. The tube, which uses three guns and a shadow mask, was described in the November issue of *TECHNICIAN*, page 55.

Filter Condenser Troubles

Shortcuts for Interpreting Symptoms and Locating Failures

SOL HELLER

• Next to tubes, filter condensers are probably the greatest single source of trouble in the radio receiver. While the faults that develop in these units are generally simple to service, there are cases where the localization of such troubles may prove time consuming. This article will consider some of the techniques found useful for cutting down diagnosis time.

Some symptoms produced by losses in filter condenser capacitance closely resemble those caused by other component defects. The most-readily identified symptom of filter trouble is, of course, an abnormally loud hum with the volume control at minimum setting. In some cases where this residual hum is only slightly above normal, it may be necessary to make a listening test under very quiet conditions to determine whether the hum level is really excessive. (The service technician is, of course, more concerned with the noticeable distortion such hum can introduce, than the hum itself.) An off-center speaker cone and voice coil assembly can raise the hum level slightly; it is therefore desirable, in cases of slightly above-normal hum, to move the cone gently in various directions, noting whether the hum level is reduced at any particular voice coil position. If no appreciable change is observed, filter bridging tests may next be tried.

Every service tech is familiar with

Fig. 1—Open in common negative shunts both sections across choke, gives misleading indication during bridging test (dotted lines).

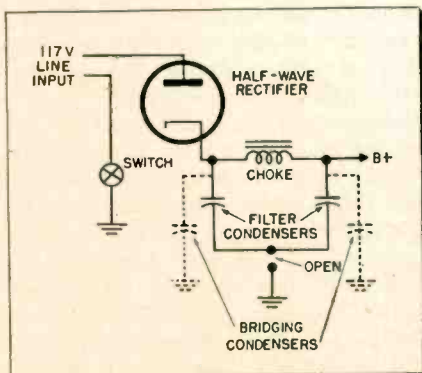

the loud characteristic hum at minimum volume control setting that an open filter at the choke input side generally produces. The author has run into less familiar symptoms of such an open-circuit, however; cases, for instance, where a loss in capacitance of the input filter (in ac-dc sets) reduced the sound volume very greatly, without introducing abnormal hum.

A weak rectifier tube is the more likely source of such a symptom; when replacement of the tube does not remedy the trouble, however, and a resistance check reveals no short-circuit, bridging the input filter is the next logical step. The B voltage may be monitored when this bridging test is made, just in case tube and filter are simultaneously bad. If the B voltage rises 10% or more when the input filter is bridged, the original filter has lost appreciable capacitance and should be replaced.

Whistles and Squeals

Whistles and squeals at high volume-control settings may be due to a loss in the capacitance of the choke output filter condenser. A defective volume control may also be responsible for such symptoms. To differentiate quickly between the two possible sources of trouble, rotate the control; if noise is heard, the control is probably the source of the symptoms. Bridging the end terminals of the control with two fingers is often a helpful test; if the whistles or squeals stop, the control is very likely to blame.

Feedback between stages is promoted when the output filter condenser loses capacitance. In one such case, moving the antenna lead-in about produced hum and squeals, leading the technician to look for troubles that didn't exist; when the output filter condenser was finally bridged, the symptoms disappeared.

A loss of capacitance in the output filter condenser can also cause slow, pulse-like sounds or beats in the receiver, in some cases; and bubbling or motor-boating sounds, in others. Sometimes a b-r-r-r-r type sound is audible at high volume-control settings. The symptoms may sound

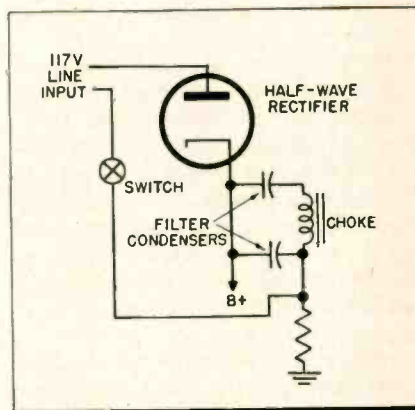

Fig. 2—Power supply with common-positive filter condenser, used in older receivers.

so much like those produced by misalignment that an unwary technician may spend considerable time touching up the alignment adjustments before he discovers the real trouble.

A defective filter condenser can produce a sound resembling motor interference. The noise is more evident at the high side of the band than it is at the low end. It is generally intermittent in character. A problem often exists of getting it to manifest itself, so that the trouble may be definitely localized to its source. Turning the set off and on in rapid succession will often bring the intermittent into its active phase.

Moving the suspect filter capacitor and its leads about, and squeezing it with the fingers, may sometimes start or stop the symptoms. If this is found to be the case, the filter condenser should be replaced. When such a definite localization of the trouble cannot be made, substitution of a new filter may have to be tried anyway; the set can be left on a number of hours afterward, while other work is being done, to see whether the trouble has really been cured.

In some cases of hum, where the serviceman is ready to swear the trouble lies in the filter condensers, bridging the old units with new ones does not eliminate the symptoms. The service tech may be right in his diagnosis, but wrong in his bridging techniques. When the common negative of a dual-section filter condenser opens, the choke is

(Continued on page 49)

Connecting High Fidelity

Ground Connections, Matching Impedance & Output Level, Hum

NORMAN H. CROWHURST

• In these days of high fidelity, everyone wants to improve the quality of his system. One thing which will do this is a new phono pickup of improved design. The problem then arises of connecting this new pickup so as to get the best from it. Almost any kind of phono pickup will work with almost any kind of pre-amplifier; but a little care is necessary in making the connections to get best results. Let's take four principal types in current use and consider the individual problems which they each involve.

Ribbon phono cartridges have very low impedance—usually a fraction of an ohm—and for this reason manufacturers of this type supply a special transformer to step the impedance up to a value suitable for working into grid. Nothing could be simpler—except that one does have to be careful about where and how to mount the transformer.

Transformers of this type are always provided with hum shielding, because hum pickup is bound to be a problem. But don't assume that the shielding alone will solve the problem completely and automatically. Any kind of shielding only *reduces* the amount of hum picked up. If you put the transformer in a strong enough field, some hum will get through. It is therefore always advisable to check the mounting of the transformer.

Hum Sources

In a record player there are at least two sources of hum: the power transformer for the amplifier, and the drive motor for the turntable. If the turntable is of a type where the drive motor is running all the time once the amplifier is switched on, then the transformer may be mounted carefully so as to minimize hum pickup with the equipment on.

But if the drive motor is switched off to stop the turntable, we do not want to have the hum come up when the turntable stops. It certainly is not very impressive to say, "Don't take any notice of that hum, it'll disappear when I put the record on." It

is even worse to have a condition where switching the motor on to start the turntable brings in a hum which was not present before. Care is therefore necessary, in equipments where the turntable is started and stopped by switching the motor on and off, to see that the mounting position gives a minimum of hum pickup with the motor both on and off.

In circuits of this kind, as well as

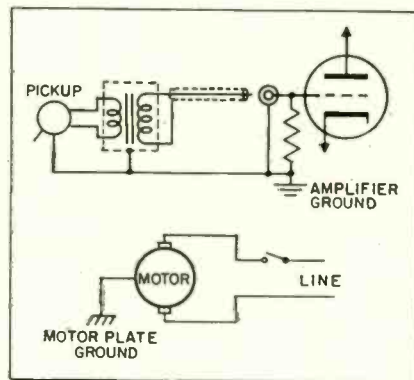

Fig. 1—Ground for motor plate is separate from ground for cartridge and xformer case.

the hum originating from the transformer or the motor, another kind of hum can result from improper grounding. It is well known that circuits of this kind, working at low level, need a good ground. What is not always realized, however, is that you can have *too good* a ground; such as when you try to make "doubly sure" by connecting a second ground.

The purpose of grounding is to make sure that no voltages stray from one place to another where they do not belong. When there are such stray voltages, the connecting of a ground must mean there will be stray currents. If these stray currents pass through a low level circuit on their way to ground, they can be as much a cause of hum as the stray voltages without a ground. So we have to be careful how we make our ground connections.

Most low level preamp circuits have a concentric type of jack connection where the center pin is the live side and the outer sheath connects to the preamp ground. It is necessary to make sure that this

outer sheath does not connect to ground by some other route, for example through the mounting of the transformer case or the metal-work of the tone arm (where a metal construction tone arm is used).

Perhaps the motor plate is grounded, or the motor is grounded to this plate. In this case *any* connection between the preamp input ground and the motor plate could have a disastrous effect on hum. The transformer should be carefully insulated from the motor plate, if it is mounted on it, and a separate ground connection should be run back to the preamp input if an internal connection is not made between the transformer case and the sheath of the input jack. This is illustrated in Fig. 1.

Moving Coil Pickups

The moving-coil type of phono cartridge has a somewhat higher impedance than the ribbon, but is still of lower impedance than the popular variable reluctance type. While the moving coil cartridge offers certain advantages, it also needs a transformer to match it to the pre-amp input.

The step-up ratio of this transformer will be not nearly so high as that required for the ribbon type. In fact the transformer for use with a moving-coil type cartridge is similar to the input transformer used for a moving-coil microphone. The actual ratio to be used depends upon the impedance of the cartridge, and the manufacturer will usually specify either a particular transformer or particular ratio. Use of a higher ratio than specified will result in a restriction of the frequency response of the cartridge at both ends. If the transformer has the correct ratio but was designed for different working impedances, the response may also not be as good as it would with a transformer designed for the specific impedance of the cartridge.

Some transformers designed for this particular purpose are of the autotransformer variety, which means the primary and secondary are connected together in series,

Phono Pickup Cartridges

Pickup, & Equalization Variations Depend on Cartridge Type

rather than of the type where both windings are separate. For this particular application, the auto-transformer type can give better frequency response and improved efficiency in comparison with the other types, provided it is correctly designed for the purpose.

With either the ribbon or the moving-coil type of cartridge, the manufacturer will generally specify a loading resistance to be used on the secondary of the step-up transformer the purpose of which is to avoid an undesirable peak at or beyond the high end of the response range. If this value of loading resistance happens to coincide with the input resistance of the preamplifier, everything is lovely; but if they do not match, then some adjustments should be made.

If the input resistance to the preamplifier is lower than the required loading resistance, then the former should be removed and a resistance of the correct value should be inserted. If the resistance of the preamplifier is higher than the recommended value, it is a simple matter to employ an add-on resistor here, calculated to bring the combined parallel value down to the recommended figure.

Most moving-coil or ribbon type cartridges will require that considerable gain be provided by the preamplifier, and so the most sensitive input provided should be used.

Practically all variable reluctance cartridges provide an output at a level and impedance suitable for matching directly into a pre-ampli-

fier without the necessity of any transformer.

The manufacturer generally recommends a suitable loading resistance here and the effect of a loading resistance on a variable reluctance cartridge is a little different from the effect just discussed in the case of the other types. The variable reluctance cartridge itself has a bigger component of inductance in its impedance characteristic than either of the other varieties. This means that operating into an open circuit will give the nearest approximation to a flat response—if a flat playback characteristic is desired. However, quite a popular method of applying some of the required playback de-emphasis consists of using a lower value of loading resistance to provide some high frequency roll-off. See *Servicing Hi-Fi Record Preamplifier Equalizers*, p. 36, November '55 *TECHNICIAN*.

Check V-R Equalization

If the specified value of resistance across the cartridge input to the preamplifier is intended to do this, then the preamplifier may need modifying to avoid improper equalization which will leave the high frequencies unbalanced.

On the other hand, it may be that a variable reluctance cartridge was used previously with this same preamplifier, and the loading resistance across the cartridge was used for part of the equalization. In this case, if the variable reluctance cartridge is replaced with a cartridge of

different type, then alteration will be necessary in the preamplifier to bring it back to its required characteristic. This method of compensation (with the load resistor) cannot be used with types other than the variable reluctance, since others do not possess a convenient value of inductance to make the method possible.

Compromise Often Needed

If a variable reluctance cartridge is loaded with a resistance equal in value to the resistance of the cartridge, quite a severe high frequency roll-off will result. Working the cartridge into an open circuit will raise the output by about 6 db at the lower frequencies, but will bring about a very much increased output at the high-frequency end of the spectrum. Obviously some compromise between loading with a resistor equal to the cartridge resistance and the open-circuit condition will be necessary to get the best response. In the absence of any figures for the correct value of resistance for a particular preamplifier, the best plan is to use a calibrated frequency response disc, and to try different resistance values until the nearest approximation to a flat overall response, including the recording characteristic, is obtained.

The ceramic cartridge has become popular of late. It has the advantage, noted with the old crystal cartridge (to which it is basically similar in construction) of a high voltage output suitable for working directly

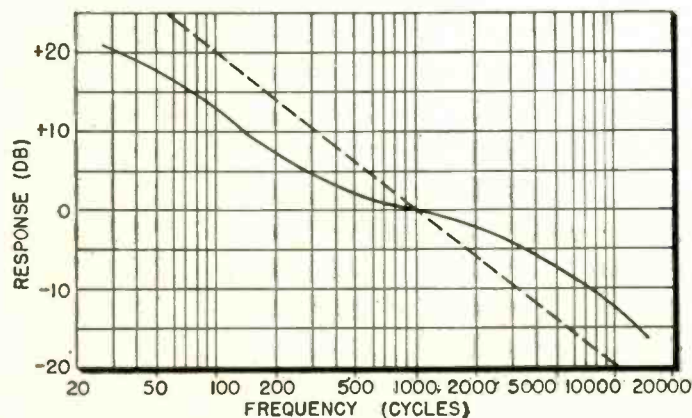
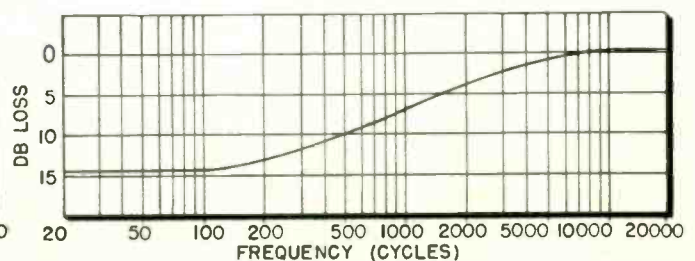

Fig. 2 (left)—Solid line shows normalized playback equalization curve. Broken line shows response of constant-amplitude pickup.

Fig. 3 (right)—Equalization needed to make response of constant-amplitude cartridge correspond to normalized playback equalization.



into a high-level grid. Some of the ceramic cartridges give output as high as 4 volts.

Another feature of the ceramic cartridge lies in its characteristic response. Other types of cartridge work on the *constant-velocity* principle, which means that a constant maximum velocity of vibration of the stylus in the groove will give a basically constant output from the cartridge. This means that, to get constant output from the cartridge, a much wider *amplitude* of movement (stylus swing) is necessary at the low frequencies than at the high frequencies. The ceramic cartridge, however, is a basically *constant-amplitude* type.

Recording Characteristic

Phono discs are cut on the basis of a velocity calibration. However, equalization is used to avoid the necessity of excessive groove amplitudes at the low frequencies and also to provide pre-emphasis at the high frequencies to reduce effective background noise. The net result is that the recording characteristic used is not very different from a constant amplitude characteristic.

Fig. 2 illustrates the practical effect of what has just been said. The solid curve represents the normal playback equalization curve, including the boost at the low-frequency end (to compensate for the cut during recording) and the droop at the high-frequency end (to compensate for the boost or pre-emphasis in recording). The broken line shows the frequency response possible with a constant-amplitude cartridge, such as a ceramic type. As can be seen,

the response of the ceramic pickup approximates the necessary equalization, except that the ceramic will provide somewhat more bass and somewhat less treble.

Response of Ceramic

The fact that a ceramic cartridge produces a high output means that it will normally be connected to a high-level input on the preamplifier; hence it will not be subjected to the equalization provided for the normal low-level phono input. In this arrangement, its frequency characteristic will nevertheless come fairly close to that of the low-level cartridges after they have been equalized. However, to get the best results, some equalization should be used to eliminate or minimize the difference between the two curves of Fig. 2. Such equalization is shown in Fig. 3. In other words, if the curve of Fig. 3 were superimposed on the broken line of Fig. 2, the resultant would follow the solid curve of Fig. 2 closely.

The desired equalization, then, roughly is approximated by a lift circuit in the middle of the range, and can easily be effected by insertion of a resistor and capacitor at an interstage coupling point. Fig. 4 shows suitable values (underlined) for use in such a correction circuit. Care should be taken, in looking for somewhere to put it, that the stage into which it is connected does not have negative feedback connected, either over just this stage or over a portion of the amplifier including this stage. If feedback is connected over such an equalizing stage, the effect of the equalization will be almost completely neutralized.

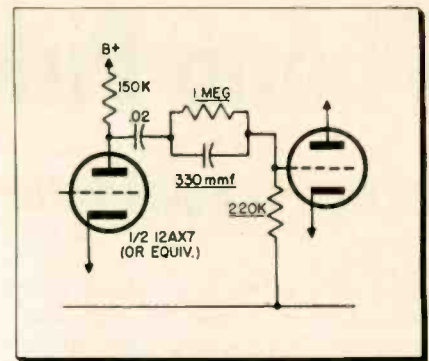

Fig. 4—Equalizing network (critical values underlined) to produce curve shown in Fig. 3.

Ceramic cartridges are generally specified merely as high impedance. To give good frequency response, however, they should be terminated by a very high impedance—at least 1 megohm. Terminating them by a lower resistance, such as a 100k, will result in a low-frequency roll-off.

Fortunately it is not necessary to use such a low terminating value because of the high output of ceramic pickups. The output can either be stepped down to a 100k input, if this happens to be the value used in the preamp, by "building out" with a 1-meg. resistor, or else the input resistance in the amplifier can be changed.

Output Load for Ceramic

Suppose the amplifier is designed to accept an input of a quarter of a volt on 100k. The ceramic cartridge, fed through a 1-meg. resistor, will still give a quarter of a volt across the 100k because the ceramic cartridge is capable of an output in the region of 2½ volts. This may be "stretching things" a little, in the sense that it may not be possible to turn the amplifier up to overload point with this arrangement. If more gain is required it should not be too disastrous to drop the value of series resistance from 1 megohm to 680k or even 470k. This will effect a compromise between slight low-frequency roll-off and good available gain.

A point to watch with any high-impedance circuit is the ground return connection. In a low impedance circuit, such as other types of pickup use, a break in either connection interrupts the program completely. But in a high-impedance circuit, a defective ground return may not be immediately obvious, because program does get through. If there is excessive hum, or broken-up reproduction, look for a broken ground connection or a cold joint. •

CARTRIDGE MANUFACTURERS

Manufacturers of all types of phonograph pickups are included in the following list. For further information on the cartridges and specific installation considerations, write to the manufacturers involved.

- American Microphone Co., 370 South Fair Oaks Ave., Pasadena 1, Calif.
- Astatic Corp., Jackson & Harbor Sts., Conneaut, Ohio
- Audak Co., 500 Fifth Ave., New York 18, N. Y.
- Brush Electronics Co., 3405 Perkins Ave., Cleveland 14, Ohio
- Capehart-Farnsworth Corp., 3702 E. Pontiac, Ft. Wayne, Ind.
- Electro-Sonic Laboratories, Inc., 35-54 36th St., Long Island City, N. Y.
- Electro-Voice, Inc., Buchanan, Mich.
- Fairchild Recording Equip. Corp., 154th St. & 7th Ave., Whitestone, N. Y.
- Fenton Co., 15 Moore St., New York, N. Y.
- Ferranti Electric, Inc., 30 Rockefeller Plaza, New York, N. Y.
- Fisher Radio Corp., 21-21 44th Dr., Long Island City 1, N. Y.
- General Electric Co., Electronics Park, Syracuse, N. Y.
- Pickering & Co., Inc., 309 Woods Ave., Oceanside, N. Y.
- Radio Corp. of America, 30 Rockefeller Plaza, New York, N. Y.
- Recoton Corp., 52-35 Barnett Ave., Long Island City 4, N. Y.
- Ronette Acoustical Corp., 135 Front St., New York 5, N. Y.
- Shure Brothers, 225 W. Huron St., Chicago 10, Ill.
- Sonotone Corp., Box 200, Elmsford, N. Y.
- The Turner Co., 909 17th St. N.E., Cedar Rapids, Iowa
- Weather's Industries, 66 E. Gloucester, Barrington, N. J.
- Webster Electric Co., 1900 Clark St., Racine, Wisc.

Antenna Sales and Service

Replacement Promotion Ideas; Shortcuts to Service Problems

JOHN ROGERS

Keep Installation Record

Keeping careful job records ought to be automatic anyhow, but a log on your antenna installations can be particularly useful in stimulating replacement sales. If you keep a card file, it is especially easy to have cards "come up" at the end of three years or so, depending on when you want to start making customers replacement minded.

The idea has proved successful in other lines. Footwear shops that specialize in children's shoes send out post-card reminders, pointing out that another pair is just about due for the growing feet. Dentists use a similar method to prod patients who haven't been in for the semi-annual checkup.

In addition to the date of the original work, your file cards should record the type of antenna used, special interference or reception problems, the use of auxiliary devices like rotators, boosters, etc. Your reminder might suggest a complete antenna-system checkup, letting the customer know that antennas deteriorate with age and that peak receiver performance depends on them.

If there were special reception problems or if new channels have gone on the air since the original work was done, you can push the latest antenna developments to overcome the difficulties. An owner of an indoor antenna bought with the set might be in a better position to invest in outdoor installation.

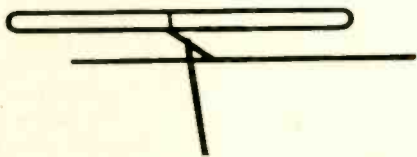

Antenna Check from Ground

When faulty antenna performance is suspected, it is often possible to check continuity of the lead-in from the ground with an ohmmeter. This shortcut is particularly appreciated when the antenna is at the top of a

good-sized mast or tower, as in fringe areas. Where the antenna's driven element—the element across which the transmission line is connected—is a folded dipole, or other type that provides dc continuity from one side of the lead-in to the other, there is no problem. Unfortunately many antennas used in fringe applications do not fall into this category.

If foresight is exercised at the time of installation of such units, later grief can be avoided. Permanently shunting a 100k resistor across the terminals of the transmission line, where they join the antenna, is a good investment. While this value is too high to upset impedances or otherwise impair performance, it is low enough to give a clear indication on an ohmmeter, if things are as they should be. A reading greater than 100k, of course, indicates a break in the line or poor contact at the antenna itself. In addition, readings lower than the value of the resistor will indicate the existence of shorting, either in the lead-in or via a leakage path through an insulator of the antenna itself. Cover the resistor with a length of spaghetti to protect it against weather effects.

Truck-Mounted Antennas

Let the world know you do installation work, as well as set repair, by mounting an antenna atop your service truck. In general, this eye-catching stunt will attract at least as much attention to you and your services as anything you can paint on the truck itself. You can dramatize the replacement theme with two antennas, side by side. One can be a simple antenna of early design and not in too good a state of repair. It can be procured from an old installation that you have replaced. The other can be an impressively new array, one your experience has shown you to be successful for the area you service.

Indoor Antenna Twin Role

Many service techs find it convenient to carry a compact indoor antenna in the kit on service calls,

for substitution checks on the performance of antenna systems. If the indoor model is well chosen, it can be used for another purpose. Many of the more recent indoor antennas show improved sensitivity; there is also a trend toward designing them for attractive appearance as well. If the set owner's antenna is an old and relatively inefficient one, although it is not defective, better reception is often obtained by the substitute. The customer sees a good argument for a new installation in front of him. If the old antenna is of the indoor type, an immediate argument for a change presents itself on the basis of the contrast in performance or appearance or both. On-the-spot sales aren't unusual.

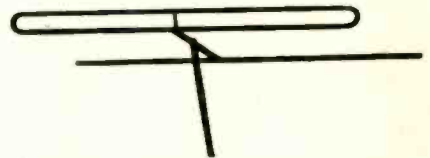

Interference Elimination

Don't let a good antenna take the rap for an interference problem; instead sell the right filter for the job. Commercially available interference detectors provide a good shortcut in this job. They consist of two sets of standard switch-selected filters, each designed for a specific type of interference. The antenna is connected to the receiver through one set of filters; the power line is connected through the other. In this way, the two principal sources for the entry of interference may be monitored. The switches are rotated for the best possible combination of filters to minimize the interference; then the standard filters thus selected are permanently substituted. Use of the detector unit is particularly convenient when intermittent interference is involved. Instead of wasting valuable time waiting for the symptoms to appear, the technician can leave the unit in place and instruct the customer to tune out interference by way of the switches when the trouble occurs. On calling back, the switch positions will tell him which permanent units need to be installed.

Speeding up Service on

While Causes Outside the Filter Network Are Less Usual, They

JOSEPH AMOROSE

• It is well known that the greater part of hum troubles in AM receivers are traced to defective filter condensers in the power supply. While hum defects arising from other causes admittedly constitute a lesser part of the total of hum repair jobs, they often provide a major part of the headaches.

Test procedures are somewhat "standardized." Technicians will ordinarily start by trying to localize the source of hum trouble. This is done by turning the volume control to minimum and tuning the receiver to a point on the dial where no signal is being received. If hum is audible, it is assumed to stem from the audio section or, through the audio, from the power supply.

If no hum has been noted in this check, the technician turns the volume up and tunes in a station signal. Any hum now becoming audible is assumed to emanate from the r-f (or

i-f) section, as the low-frequency hum voltage appears to be modulating the higher-frequency signal.

Next to defective power-supply filter condensers, the greatest number of hum complaints can probably be traced to cathode-to-heater leakage—usually in the output tubes. The problem arises most often in receivers of the ac-dc type. While such leakage may occur just as often in the tubes of transformer-operated ac-only sets, hum will not always result. Whether it may or may not result will depend upon the circuit layout of the particular tube involved. To avoid spending valuable time checking for leakage in tubes where hum cannot possibly result, it is well to become familiar with the typical tube circuits involved.

Consider the tube with 6.3-v filaments shown in Fig. 1. Cathode-heater leakage here may produce hum—if cathode K shorts to the ungrounded side of the filament (F7), as shown by the leakage path, in broken lines, to the right. One factor determining the amount of hum is the size of capacitor C1. With high capacitance (improved filtering) hum will be relatively low, possibly escaping detection. If capacitance is relatively low, hum will be higher. High amplification in the stage will also increase hum.

Leakage, But No Hum

However, if cathode K should short or develop leakage to the F2 portion of the filament, as shown by the broken-line path at the left, no hum will be produced. This is so because the source of hum, the filament circuit, is not in parallel with cathode resistor R1. However, oscillation or distortion are likely to occur, because this added cathode path may affect tube bias.

In circuits with filament supplies from a transformer winding as connected in Fig. 2, a short or leakage between cathode K and either the F2 or F7 portion of the filament may result in hum; but a short or leakage between K and center point C of the filament will cause no hum. This is so because, while there is an ac potential between either end of the filament (F2 or F7) and ground, the

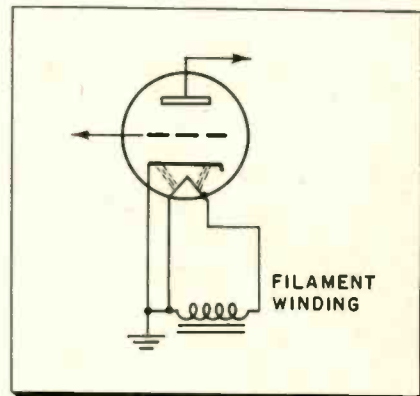

Fig. 3—No hum occurs with grounded cathode.

center of the filament is at zero level with respect to ground (the grounded center point of the filament winding).

Finally, in a filament circuit of the type shown in Fig. 3, no hum can be produced by cathode-to-filament leakage, no matter how bad that leakage may be. Since the cathode goes directly to ground, no path exists that will permit the ac voltage to get between cathode and grid.

When a receiver with hum complaint comes in, the wise technician can save time by checking the filament wiring or the schematic at a glance to ascertain whether cathode-heater leakage can at all be the cause. With wiring like that shown in Fig. 3, of course, the possibility can be dismissed at once and the technician can move on to other tests.

Another frequent cause of hum can be traced to defects in decoupling filters. In Fig. 4 we see a conventional filter of this type, shown in heavy outline: R1 and C are parts of a "voltage divider" to reduce hum that might emanate from the B supply. A defect in either component may be responsible. If capacitor C, usually an electrolytic, ages, dries out or otherwise loses capacitance, effective filtering is impaired. Hum voltage may then be injected to the plate circuit of the tube from the B supply.

In ac-only sets, better than 90 percent of hum complaints can be traced to one of the three causes already mentioned: bad power-supply filters, cathode-to-heater leakage, or faulty decoupling networks. These sus-

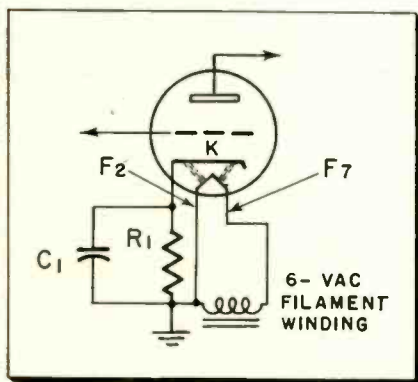
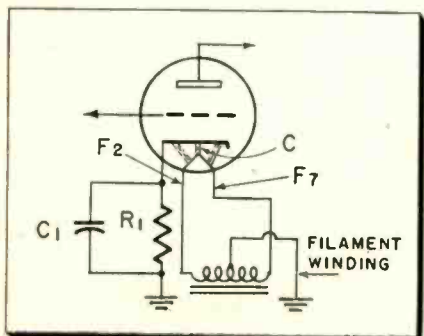

Fig. 1—Hum induced by cathode-heater leakage depends on point of leak to filament.

Fig. 2—How leakage path affects hum level where heater winding center-tap is grounded.



Difficult Hum Problems

Can Account for a Good Percentage of Hum-bugging Headaches

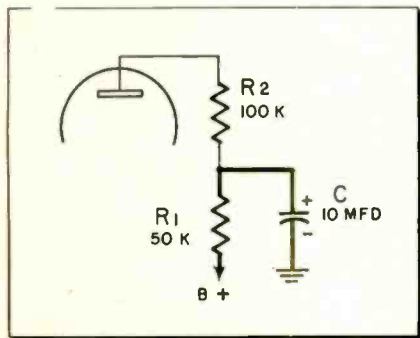

Fig. 4—Faulty decoupling may produce hum.

pect portions of the receiver would then be checked first before other localization techniques are used.

Let's turn to hum problems in receivers of the ac-dc type, where the difficulty may be more serious. Since the ac voltages developed across most tube filaments are generally greater than 6 volts, the chances of hum becoming audible under the condition of relatively low cathode-filament leakage are increased.

High Heater AC to Ground

A glance at the representative ac-dc filament hook-up shows that the voltage from tube filament to ground increases as one moves leftward in the diagram, away from ground. Set builders try to compensate for this by wiring sets so that the lowest filament-to-ground voltage will appear at the tube most likely to produce the greatest hum trouble should cathode-to-heater leakage occur: this would be the 1st audio (12SQ7, in this case). The converter (12SA7) is next, and so on.

With connections as shown, a very high filament-to-ground voltage occurs at the 50L6 output tube; consequently hum produced here in the presence of cathode-to-filament leakage will be very high. In fact, when the power-supply filter network in an ac-dc set has been eliminated as a possible cause of hum, a test for leakage in the output tube should be almost automatic.

The list of hum causes can be endless, since any receiver operated from an ac power line will have an abundance of electromagnetic fields. Receivers are usually designed to

keep trouble from this source at a minimum, but often the manufacturer's original design is not kept intact. For instance, when servicing, if the grid and plate leads or filament and grid leads are placed close to each other, or misplaced, hum from such misplacement often results. Likewise, if tube shields or other shields are removed from critical places, annoying hum voltage will frequently rear its ugly head. The wise technician will save himself a lot of unnecessary work by keeping all leads in the same position when servicing a receiver.

Often, the position of the ac cord in or along the chassis will produce hum, particularly if it runs close to some grid circuit. This frequently happens when an excessively long line cord is looped up to shorten it and placed inside the receiver. Line cords near loop aerials induce hum, too.

In circuits where high-resistance grid circuits are employed, considerable hum will develop if the grid resistor increases sharply in value. Such a radical change will also alter the grid bias, which in turn, causes distortion of the signal as well. This "double-trouble" is often an asset, however; it makes the hum defect easier to spot.

Other Hum Sources

Unshielded control-grid leads, when passing through a chassis, often produce hum. Sometimes, replacement of parts introduces a hum that was not there before. When the part is an EM speaker, it usually means the hum-bucking coil was improperly hooked to the voice coil, thus causing ripple voltages to add. To remedy, merely reverse the leads to either the voice coil or the hum-bucking coil.

What about those cases where all electrical values measure correctly, and still an annoying hum is heard? This happens most often in the ac-dc type receiver of the inexpensive variety. When all other remedies fail, a noticeable improvement can frequently be effected by substituting a lower value coupling condenser between the 1st audio tube and the output, as shown in Fig. 6.

For the usual 0.01-mfd component found here, substitute a capacitor half the value—namely a 0.005 mfd unit.

Another puzzling, hard-to-detect but easy-to-remedy hum defect is caused by leakage through the filter-condenser case to the metal band that is used to secure it to the chassis. See Fig. 7. Old, cardboard-encased capacitors in ac-dc receivers are the most frequent offenders in this respect. Many times the filters test satisfactorily, yet produce considerable hum from the cause mentioned. To test for hum from this source, remove the condenser strap (Continued on page 52)

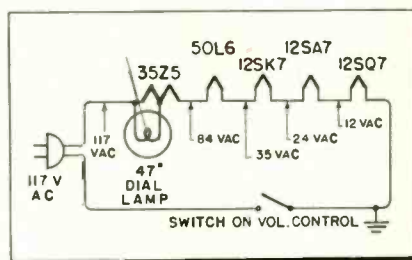

Fig. 5—High heater-to-ground ac voltages in ac-dc sets may aggravate hum problems.

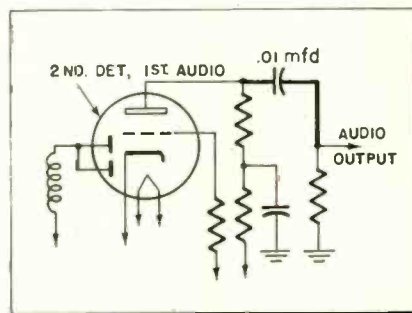
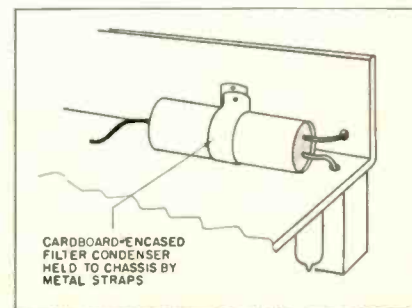

Fig. 6—High-value coupler may be culprit.

Fig. 7—Electrolytics may leak to chassis.



You Can Troubleshoot Sync

With a Jumper and No Extra Tools Beside Those Already in

JAMES A. McROBERTS

• Far more can be done to check the sync system in the field than is generally attempted. After a diagnosis of sync trouble, of course, most cases are cured by tube replacement. Beyond that, much can be done without "pulling" the chassis to the shop.

Basis of the field method is the fact that the receiver has an audio amplifier and loudspeaker, which can be used to listen for vertical sync buzz and to trace this buzz through the sync system. This vertical buzz may be heard at points A, B, C, D, E, F, G of Figs. 1 and 2, and sometimes at H. The horizontal sync is invariably present with the vertical sync, except in the vertical integrator. Even if the horizontal sync cannot be tested between F and H, the oscillator or afc may be tested and the horizontal sync followed to F. This technique will localize a defective horizontal differentiator by inference.

The ac function of the pocket voltmeter or vtvm can meter the sync at any point previously indicated. An rms meter will read approximately one-fifth to one-sixth of the peak-to-peak (p-p) values. Some test should be made to ascertain whether the sync is the signal being metered or not. This test will be described later.

Fig. 1 shows the basic equipment hookup. Special setups for the audio

and the meter tests will be considered next:

Presumably, the audio amplifier is working or the diagnosis would have been "no sound." To use the set's audio, the sound signal must be broken prior to the audio input. Removal of a sound i-f tube or shunting the signal to ground with a condenser from a sound i-f control grid or a plate will accomplish this objective; also breaking the "hot" feed to the volume control will free the audio from the sound signal.

Feed to Volume Control

The next step is to connect a jumper to the "hot" side of the audio input and to use the other end of the jumper to test for buzz at the various points of the sync system. To prevent pickup of hum, the jumper should be shielded such as is detailed in Fig. 3.

The center conductor of the jumper should be blocked with a paper condenser over 0.001 mfd. At the other end of the jumper, the central lead should have an isolating resistor in series whose value should exceed 100k, preferably 0.5 megohm. Both condenser and resistor may be placed at the free or probe end of the jumper if more convenient; however, the isolation resistor should be placed at the free or probe end of the jumper in all instances; i.e., next to the circuit to be tested.

The ac voltmeter may be hooked up in a similar fashion to the jumper

and audio. The jumper with condenser and resistor may be used to extend the meter leads if so desired. The series condenser is employed to insure that any indication is ac only, and secondarily for its blocking function to help prevent interaction. The isolation resistor is used to prevent interaction on the tested circuit. The meter will read about one-fifth to one-sixth of the peak-to-peak values on its rms scale.

The number of composite sync stages in Fig. 2 will not be the same for all receivers. In each case, a separator to pick off the sync pulses while discarding video signal is necessary, as is a clipper or limiter, and an amplifier. In some cases, all of these functions may be combined in a single stage; in others, several tubes are involved. The specific nomenclature for these stages and their functions (sometimes the two do not always coincide) is not important; all the technician is concerned with at this point is whether or not sync is present and, if it is present, how much.

Overall, sync is followed from the video take-off point through the composite sync circuits to the vertical integrator. Vertical sync may be further followed beyond that point through the vertical system. Horizontal sync is best followed from the end of the composite sync system with a meter, although some audible vertical buzz will sometimes "come through" the horizontal system.

In any meter test, proof that the

Fig. 1—Sync section block diagram, with test equipment set-ups.

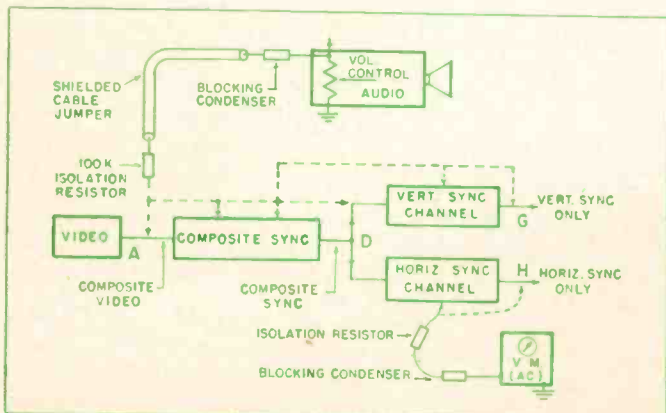
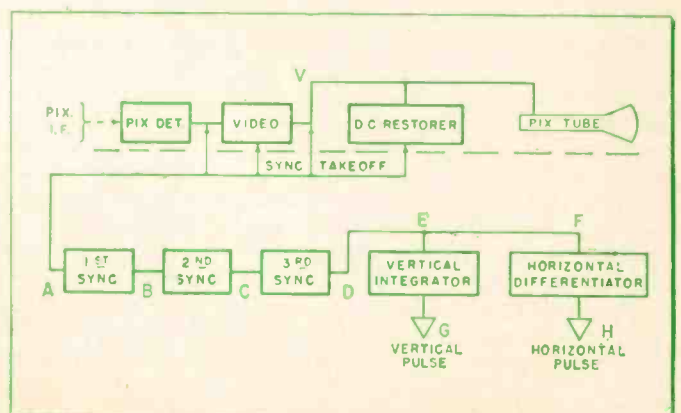

Fig. 2—More detailed block diagram of a composite sync section.



System Faults in the Field

Your Caddy, Most Sync Failures Can Be Handled in the Home

indication is due to the station signal should be made for each point tested. The test is simple: Switch to a blank channel and the sync will not be present—if you were metering the sync, the indication will disappear; if your reading remains, then you have been metering something else.

When testing the output of the vertical integrator, or intermediate points on the integrator network, the vertical oscillator should be removed or disabled to prevent kickback of pulses from it which would interfere with the test. These pulses sound almost the same as the sync buzz and may be metered similarly to the sync. A large condenser to ground from the oscillator grid will disable the oscillator if tube removal is not feasible.

A similar precaution should be employed in testing the horizontal sync from the output of the composite sync to the afc or horizontal oscillator by temporarily disabling the oscillator. Removal or disabling methods like those employed upon the vertical oscillator will also stop the horizontal oscillator from generating. Do not disable too long without removal of the output tube also.

An inverter stage is employed in some sync systems to provide a push-pull sync for afc use. Equality of sync amplitude is required in addition to presence of sync at both terminals of the push-pull output.

Output amplitudes of the sync seldom exceed 10 volts peak-to-peak and are ordinarily about one-third of this value. Due to considerable variation in design, the schematic of

the receiver should be consulted.

Fig. 4 shows a typical sync circuit. The composite video signal (V) has an amplitude of about 60-70 volts p-p, and it feeds the input of what this manufacturer calls a separator with a composite video signal of approximately 20 volts peak-to-peak. The output of the separator tube V1 is about 30 volts (p-p) of the signal with the video or picture information removed, and this indicates amplification for this tube in addition to the normal clipping. The output of V1 feeds the grid input of V2 with a drop in the p-p signal to about 10 volts. The output of V2 is the input

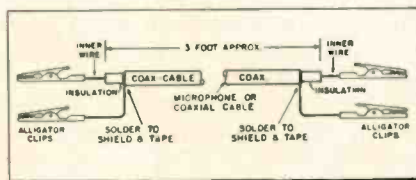

Fig. 3—Shielded jumper used in sync probing.

to the vertical and horizontal systems.

At all points the reader may listen to the vertical sync buzz except the beginning of the horizontal-only channel. At the V2 plate, both oscillators should be disabled for metering, and only the vertical for listening. The vertical oscillator should be disabled for metering or for listening for a step-by-step check of all points on the integrator.

Fig. 5 illustrates another circuit which employs a phase inverter tube for the push-pull feed to the horizontal phase detector tube V4. Here again, V is the sync takeoff and the

first point to check. This feeds the grid of V1 with some drop in signal intensity. The plate of this tube shows a gain which is transferred to the grid of V2 with some loss in the coupling network. The output of this tube feeds the inverter V3.

From this point on, the oscillator precautions (disabling) must be observed. The vertical channel begins at the cathode of V3 and ends at the input to the vertical oscillator, with the same provision for intermediate tests at integrator junction points as in the preceding case.

There are two horizontal outputs H1 and H2, as indicated, for push-pull feed to the phase detector. Note that simple removal of phase detector tube V4 is not recommended during testing. Such removal will permit the oscillator to run free, with the result that oscillator pulses will be present at points X and Y. These pulses may result in misleading readings at points H1 and H2. Only direct disabling of the oscillator itself can prevent such readings. As already mentioned, when the oscillator is thus disabled, the output tube must also be removed or disabled. Due to the simple horizontal feed, in this case, the listening test may be used at points H1 and H2, up to the terminals of the phase detector, since the condensers will permit passage of the vertical buzz. If the latter is getting through, it is generally safe to assume that the horizontal pulses are also arriving.

With a few parts that should be in the tube caddy anyhow, these methods can keep many defective sets from reaching the shop. •

Fig. 4—Schematic of typically encountered composite sync section.

Fig. 5—Another common composite sync strip, with push-pull output.

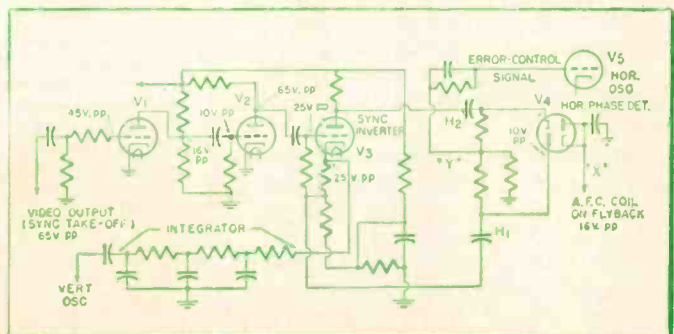
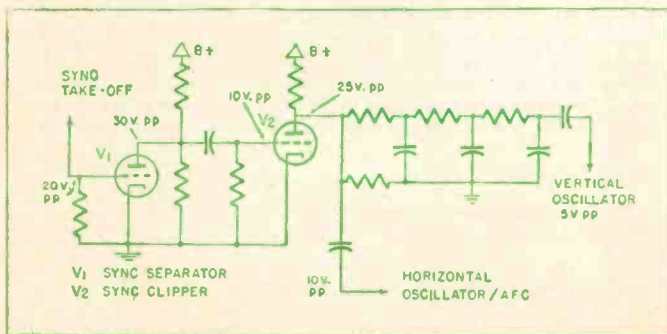

Small-Shop Advertising

Methods Geared to Your Income Can Bring up Your Customer Load

MERLYN J. BLOCK

• "I could handle about 20 percent more customers if I could get them. But it seems every time I add a new one, I lose an old one." Have you ever said that? If that's your problem, the best answer to getting more customers on your active list may be advertising.

Of course, a one- or two-man shop can't go about hiring an agency, buying half a page in a big newspaper or putting up a large billboard. However, an effective low-cost program can be worked out. The first thing to keep in mind is that the cost of advertising is a necessary cost of doing business, and must be figured as part of business overhead. The writer allots about one-half of one percent of gross income to advertising. When more customers are needed, the percentage is raised a bit; when there is more work than can be handled, the percentage is dropped.

Of the various inexpensive means of advertising, the ones found to be most useful are: word-of-mouth advertising, where one satisfied customer tells another person of your services; newspaper ads; posters placed in neighborhood shops; and door-to-door handouts. The relative usefulness of each will vary from one place to another depending on local conditions. Experience may show that you are better off concentrating your efforts in just one or two of the types mentioned. The author's results from door-to-door handbills are so much greater than those obtained through other means, that most of his budget is spent in this direction. For your own good—and at least at the beginning—try to determine how your new customers learned of your service. Keep a record on this point. It will guide you to the most efficient use of your advertising dollar.

Concerning the first method mentioned, word-of-mouth advertising, we all know that nothing sells so well as a satisfied customer and that the only way of producing satisfied customers is to give our present ones the best service possible. Beyond

this, you can give the word-of-mouth method an extra push. Before you leave a finished job, ask your customer to tell friends and neighbors about your service. Leave an extra business card to be passed on. Inquire whether he knows anyone whose set is presently in need of service. If you more or less memorize a little "farewell speech" to use as you leave a job, you'll take care of this requirement automatically after a while. You also run less risk of leaving out any important points concerning your service, like the fact that you may guarantee all work.

You'll be surprised at the number of productive leads you can get in this way, but you'll never know until you've tried it. When you do get a new lead, follow up the prospective customer within 24 hours, by phone or post card, asking whether you can be of service.

Newspaper advertising serves a useful purpose—if your budget can support a continuing series of ads. Space rates in local neighborhood-merchant papers, if one exists, generally costs less than those in the bigger city papers. Also, they generally do a better job for the small

TV service operator who prefers to concentrate his efforts in a limited area.

When you write your ad, be sure that the main features of your service are described. For example, the author operates in a limited area; his shop is in the center of the area he services so that he can get to jobs quickly; he is willing to do work in off-hours; and he guarantees his work. Accordingly, a typical ad of his will read:

DAYTIME & EVENING (to 10 PM) TELEVISION REPAIRS

We'll be there within
½ an hour of your call
Guaranteed work

JOE DOKES,
your Suburban Hts.

TV Serviceman, CEnter 1234

Try to have your ad located on the same page with TV program listings. If a person sees your ad every time he looks at the listings, it will be a logical place for him to refer back to it when his set happens to break down.

If you don't have posters in various stores in your neighborhood, run

(Continued on page 59)

An under-the-door handbill that people will save pays off in calls from new customers.

WHAT TO DO WHEN YOUR TELEVISION SET IS OUT OF ORDER

1. Check to see whether the wall outlet is "live." You may do this by plugging a lamp into the outlet. A blown fuse or faulty wiring may be responsible.
2. Be sure that the plug from the television set is firmly in the socket.
3. Check whether the antenna wires are firmly connected to the proper terminals on the back of the set.
4. Check whether the antenna wires are not broken. If your antenna is on the roof, see whether it has blown down or whether the wires have been damaged.
5. If the picture is not high enough, try turning the VERT SIZE or HEIGHT adjustment, usually on the back.
6. If the picture is not wide enough try turning the HORIZ SIZE or WIDTH adjustment, usually on the back.
7. If the picture is very fuzzy, try adjusting the FOCUS control.
8. If you received an instruction sheet with your set, refer to this for location of adjustments, and for other adjustments. It is generally not advisable to make other back or "hidden" adjustments unless you know what you are doing. Dangerous high voltages are exposed when you open the back of the set, even with the receiver turned off. There is also the danger of breaking the picture tube, which may result in personal harm as well as expense.
9. If you still cannot get the set to work, call

JOE DOKES, your Suburban Hts.

TV Serviceman

CEnter 1234

We'll be there within . . . of your call.

where do you find

PYRAMID

CAPACITORS AND SELENIUM RECTIFIERS

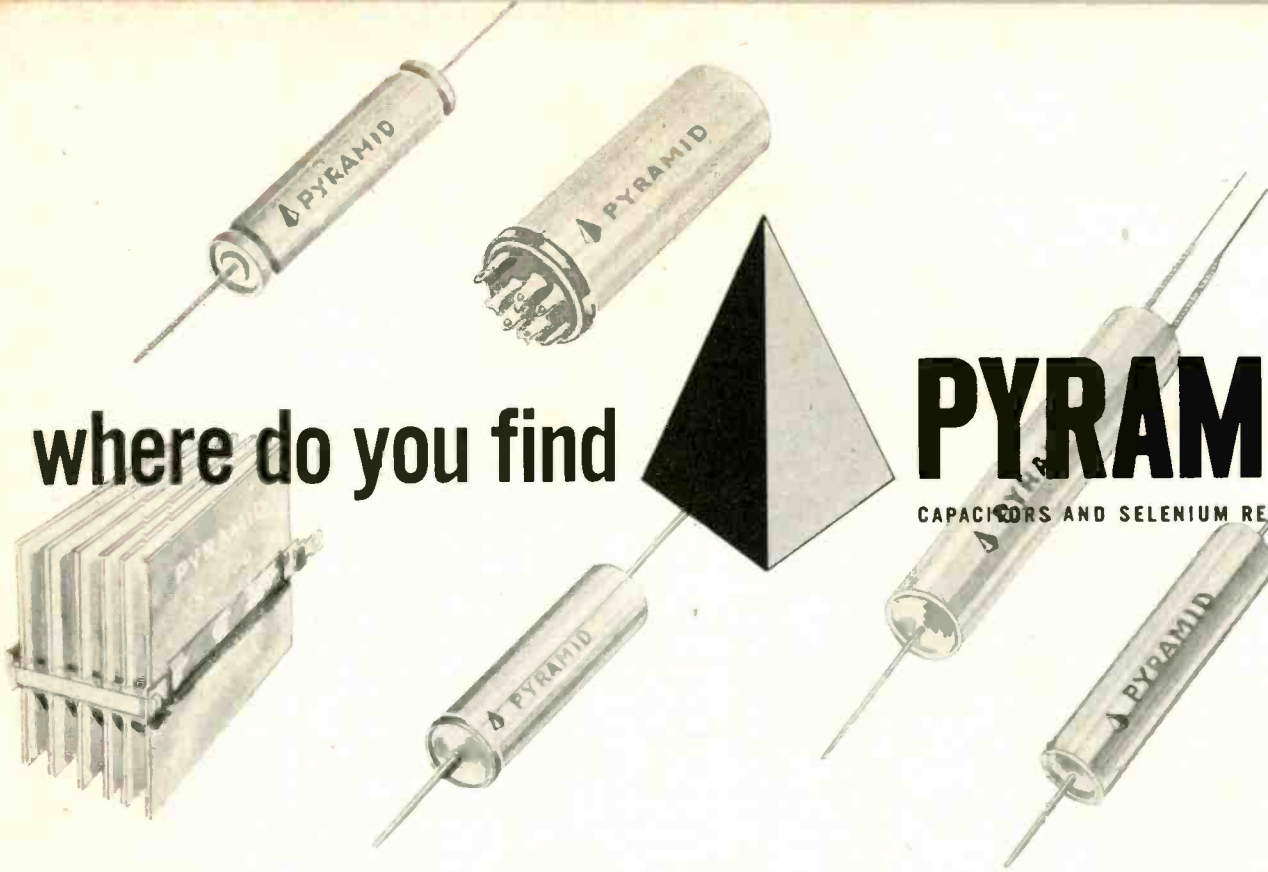

In the electronic products of all these leading brand manufacturers—where their presence testifies to PYRAMID'S high standards of quality and service.

Admiral



CROSLEY

DUMONT

Emerson



hallicrafters

Hoffman

Magnavox

Motorola

Packard-Bell

RAYTHEON



SYLVANIA

Westinghouse

ZENITH

AND you find PYRAMID as a participant in Howard Sams PHOTOFACT—the bible of radio-television-sound field servicing—which guarantees accurate replacement with PYRAMID parts and testifies to the immediate availability of PYRAMID Capacitors and rectifiers throughout the country.

Howard Sams

PF
PHOTOFACT



PYRAMID ELECTRIC CO.
North Bergen, New Jersey

THE BIG NAME IN CAPACITORS AND SELENIUM RECTIFIERS TODAY...

J. QUACKUM, D.D.S.
CUT
RATE



Insist on the

**PERFECT
REPLACEMENT**

for "original quality" results

**SUBSCRIBE
NOW!**

**DUMONT
SERVICE NEWS**

ALLEN B. DU MONT LABORATORIES, INC.
Teleset Service Dept.
257 Sixteenth Avenue, Paterson, N. J.

Enter my name on your 1956 mailing list.
Check for \$3.00 is enclosed.

Name.....

Address.....

City..... Zone..... State.....



DUMONT®

CATHODE-RAY TUBE DIVISION, ALLEN B. DU MONT LABORATORIES, INC., CLIFTON, N. J.

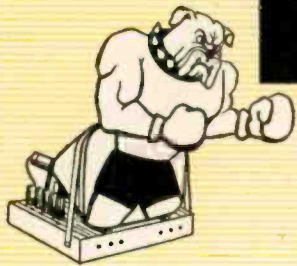

"Tough Dog"

Corner



Difficult Service Jobs Described by Readers

Fine Tuner Kills Raster

This "weirdy" was originally brought into the shop because the tuner was smoking, on what looked like a routine repair. The screen bypass condenser in the r-f amplifier, which had shorted, was replaced. Replaced with it was the screen dropping resistor. When the set was turned on the sound came up normally, but the raster had barely a trace of video. The fine tuning control was rotated to bring the picture in more clearly—and the raster conked out!

Backing off the fine tuner—that is, restoring it to its mistuned position—brought back the raster. It would have been convenient to find a short in the fine tuning condenser, but this possibility was ruled out by the fact that sound was unaffected.

Since high voltage appeared affected, tubes were replaced in the horizontal and h-v sections, to no avail. However, monitoring the boost voltage at the damper cathode gave a clue: the reading was 550 volts until the critical point in fine tuning was reached—then boost voltage suddenly dropped to about 325 volts. A check of all components in the boosted B-plus circuit and circuits supplied by it yielded nothing. Also checked without result were components in the feedback circuit from the damper to the horizontal phase detector.

To make doubly sure, a waveform check was made at the phase detector while the raster was on. The waveform coming in from the phase inverter was too low in amplitude. Since this seemed to be the result of the video signal being detuned, the fine tuner was adjusted to bring up a better looking sync pulse. It did, but the raster disappeared again! We were right back at the starting point.

Though the sync pulse now looked okay, the scope had to be re-synced to observe it. The significance of this took a while to "sync"

in: the horizontal oscillator was way off frequency! Since substitution of the horizontal oscillator had already been attempted, the 6AL5 phase detector was replaced. This cleared up the trouble; it was now possible to adjust the fine tuner for a good picture without losing the raster.

A check of the old 6AL5 showed that one diode was completely dead. Consequently, when a normal sync pulse was being received (by proper adjustment of the fine tuner), only one diode conducted and the output across the phase detector load was grossly unbalanced. The highly incorrect control voltage developed here was applied to the grid of the horizontal multivibrator, throwing it way off frequency. Since the fly-back transformer is designed for greatest efficiency at the normal horizontal frequency, adequate high voltage was not being developed.—George Kimmel, Brooklyn, N. Y.

Vert. Sweep, Raster Weak

When this set was first turned on, a very weak horizontal-line raster, showing little vertical sweep, was revealed. After a few seconds, this raster disappeared completely. Though a check revealed very low high voltage, substitution of tubes in this circuit brought no results.

As there was indication of poor vertical sweep before the raster faded, it was decided to change the 6S4 vertical output tube. When this tube was removed from the set, it was found to have been damaged by a high-voltage arc.

In the set, the second-anode lead to the crt passes close to the 6S4. It had arced through the glass of this tube to the elements, killing high voltage and the tube itself. Yet there had been none of the normal signs of arcing. A new 6S4, some insulating tape on the lead, and re-dressing the lead away from the vertical output tube did the trick.—Edward L. Christie, Roslindale, Mass.

Long-Cycle Intermittent

The complaint on this set was that it would play all right for weeks—and then it would kick out of sync horizontally. Turning the set off and then on again would restore good sync. The receiver was an Emerson using the 120169 chassis. The trouble had existed since the set was first bought, about two years ago.

It was found that switching the antenna input signal on and off would cause the horizontal oscillator (a multivibrator, as shown in the accompanying schematic) to go into the abnormal condition. This was helpful in troubleshooting. Routine checking localized the trouble to the multivibrator circuit. In successive steps, components in the oscillator grid, plate and cathode circuits were checked by substitution. The oscillator was also operated with the ringing coil shorted, and with the input grid grounded, with no effect.

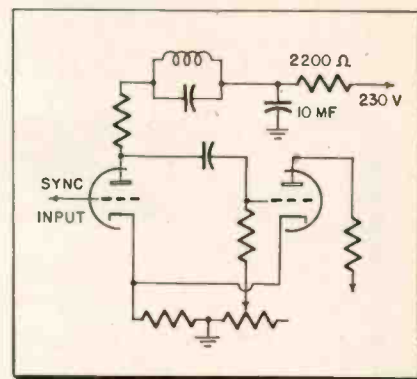

Intermittent bypass threw oscillator off freq.

Closer examination of the circuit called attention to the B-plus decoupling network, consisting of the 2200-ohm resistor and 10-mfd capacitor. It was discovered that the electrolytic condenser was intermittently opening. When this occurred, the 2200-ohm resistor was effectively added in the plate load, causing mal-operation. — Warren Newell, Fairfax, California.

Utah

**YOUR ONE
COMPLETE
SPEAKER SOURCE**

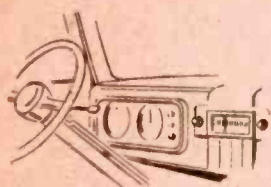

AUTO

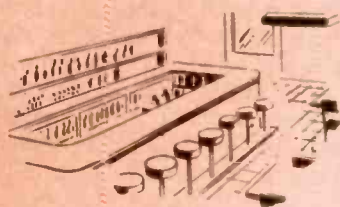

PUBLIC ADDRESS

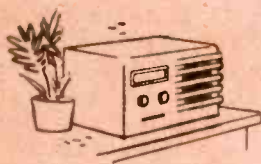

**STANDARD
REPLACEMENT LINE**



TELEVISION



SATISFACTION • SERVICE • SUPPLY

Those are the important selling qualities you have when you handle Utah Replacement Speakers—the widest, most complete line available to the trade.

You can sell satisfaction—service man satisfaction — installation satisfaction — because Utah is a quality line — pre-tested speakers which are unsurpassed for manufacturing precision and satisfactory performance.

You can sell service — give service — because you get service from Utah. Utah maintains — a special warehouse and shipping department and a policy of special attention, special handling and top priority shipping for all jobber orders.

Utah gives fast delivery service to all points because of its advantageous location in the heart of industrial America, with its excellent railroads and truck lines — short point shipping which saves you time and money.

You can be sure of your source of supply with Utah — because Utah is the oldest established line in the trade. More than 150 models and an adequate stock of each of these models is kept in stock at all times for immediate shipment.

Start stocking Utah today — the line with the selling qualities of satisfaction, service and supply — that will make you more customers — more profit.

Export Dept.—Rocke International Corp., N. Y. C.

RADIO PRODUCTS CO., INC.

1500 ADAMS STREET

HUNTINGTON, INDIANA

A WHOLLY OWNED SUSIDIARY OF NEWPORT STEEL CORPORATION

Shop Hints to Speed Servicing

Tips for Home and Bench Service Contributed by Readers

Fused Cheater Cords

To prevent the possibility of blowing the ac fuse in the home of a customer and creating the extra difficulties associated with such an occurrence, we fuse all cheater cords used in servicing. A 5-amp 125-v

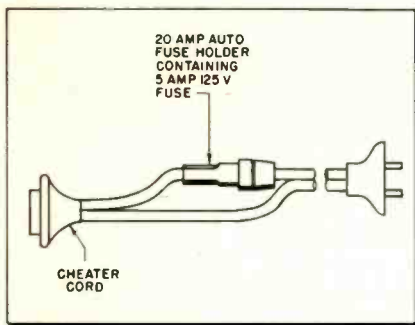

Fused cheater cords facilitate field work.

fuse is put in one leg of each cheater by inserting a plastic fuse holder, as shown in the illustration, in the cord. The holder used is the type made to accommodate a 20-amp auto-radio fuse.—*Joseph F. Valenti, Bronx, N. Y.*

Audio Xformer-Speaker Check

When no sound emanates from the speaker of a TV or radio set, it is generally necessary to know whether there is an open winding in the secondary of the output transformer or in the voice coil. To make this check with an ohmmeter, one lead to the voice coil has to be opened. A simple check, while it does make use of the soldering gun, does not require the lifting of any leads.

Turn the soldering gun on and hold it close to the suspected transformer. If transformer and speaker are both okay, hum will be induced into the output transformer from the transformer in the gun, and it will be heard clearly through the speaker. If no such hum is heard, scrape the test leads of an ohmmeter across the voice coil connections. If a noise is not heard, the voice coil is suspect. If the noise is heard, the voice coil and speaker are okay, and the secondary of the transformer comes under suspicion.—*George H. Kettle, Alamosa, Colorado.*

Substitute Shop CRT

In earlier years, it was common to mount the chassis of TV receivers separate from the picture tubes. Many such sets are now in use. Currently, separate mounting is also used for the larger picture tubes. Such chassis are easily pulled for shop repair without their picture tubes, but difficulty is experienced checking the picture in the shop. Where the volume of service warrants the investment, it is worthwhile to make up a mounted picture tube for adaptation to chassis being serviced.

A 90-degree deflection picture tube (21ACP4, in this case) has been used to make up the rig shown in the illustration. The yoke can be brought in with the defective chassis, or suitable yokes can be used on the tube with connections to a 4-prong female plug, for adapter cords to fit

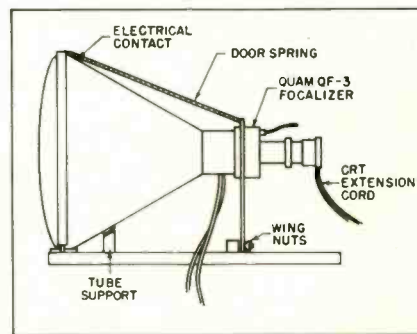

Substitute c-r tube and associated components with mount, for chassis service in the shop.

various chassis. Yokes equivalent to Merit MDF-70, MDF-74 (direct drive), and MDF-90 have worked in all cases so far, although not always giving a perfect match. The complete picture tube face will not be filled by a 70-degree yoke, of course, but this need not interfere with servicing.

Be sure to ground the tube mounting to the chassis being worked on. The focalizer and its mounting board are easily removed for changing yokes. A potentiometer can be inserted in place of the focus coil, if necessary, where one is used with the original tube.—*Don Phillips, Waterloo, Iowa.*

Solder Iron Tinning Tip

As soon as you buy a new soldering iron, or when you have to clean or re-tip one you already have, remove the tip and heat it with a blow torch to the high temperature required for melting silver solder. Flux the tip, if necessary, then allow silver solder to flow all over the soldering surface, practically plating it. When the tip has cooled, it is inserted in the soldering iron. You now have a tip which will always stay bright and never require re-flexing, re-tinning or filing. The silver coating will not deteriorate because the normal operating temperatures of the iron will not approach the melting point of silver solder.—*George E. Mancini, Methuen, Mass.*

Radio I-F Xformer Checker

A common complaint in today's 5- and 6-tube AM radios is low volume, and quite often one or both of the i-f transformers are at fault. Because defective i-f transformers may often show the proper resistance and appear to tune normally even when they are bad, it is difficult to reach a decision concerning them without going to the trouble of unsoldering all leads, removing them, and trying out a replacement transformer. A simpler and less time-consuming test substitution can be made with the unit described here.

Procure a good i-f transformer tuned to 455 kc and solder four 3-in. leads to each terminal; then attach a narrow, insulated alligator clip to each lead. The leads should be coded by using wires of different colors.

Now when an i-f transformer is suspected of being defective, simply unsolder one lead from its primary and one lead from its secondary (it generally won't matter which) to remove the old transformer from the circuit, and clip the substitute unit in its place. Check alignment. If the original unit was defective, the clip-on substitute will restore normal gain and performance. Because of the long leads, an occasional set may squeal. If it does, try reversing one or both of the windings. Squeal or no squeal, positive results can be obtained.—*Charles Garrett, New London, Connecticut.*

Speed-Up Your Work with the *All-New*
RCA SENIOR VOLT OHMYST®

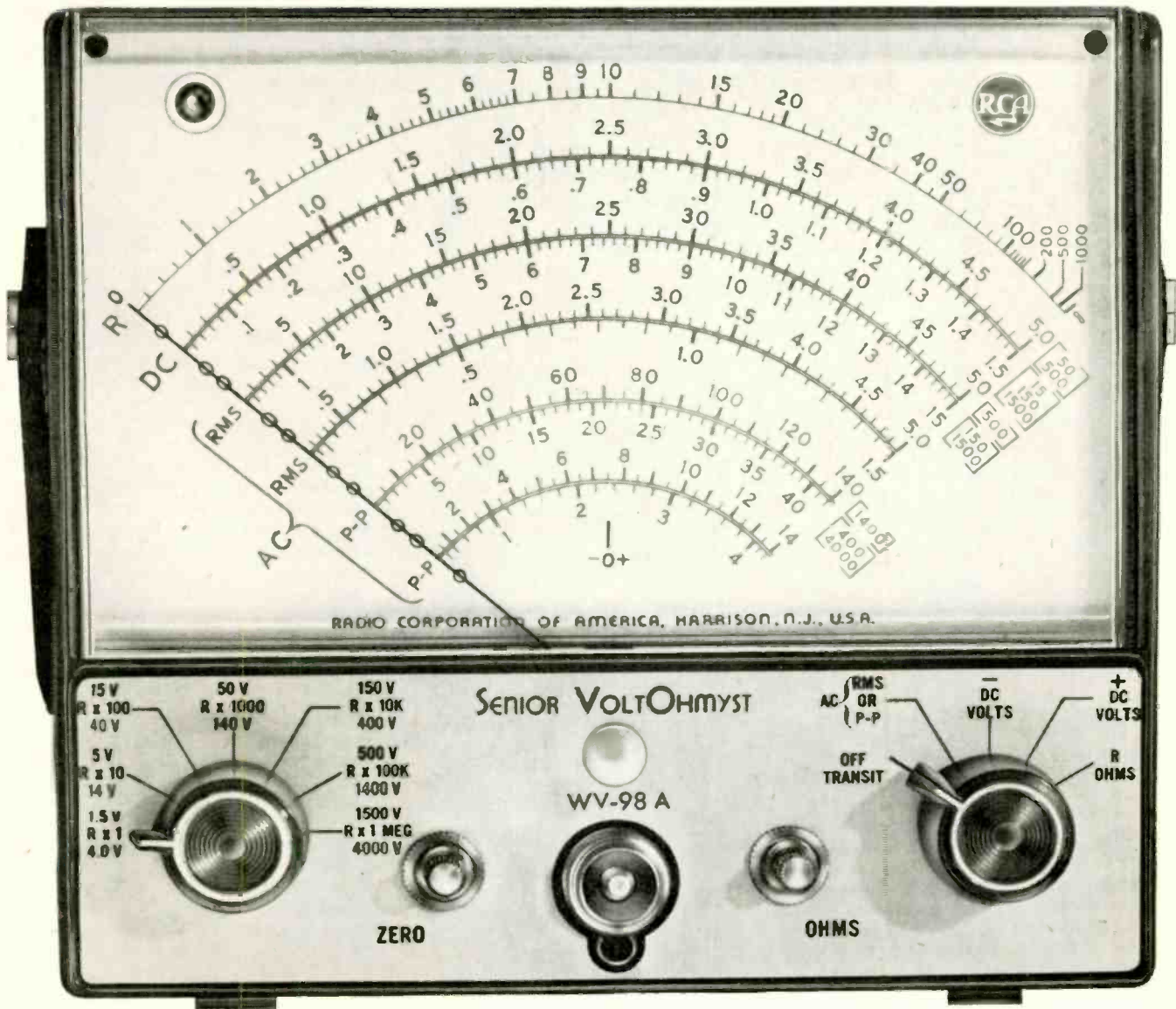

Senior VoltOhmyst, RCA WV-98A, only \$75.00 User Price* including probe and cable, instruction booklet, complete and ready-to-use . . . Shown slightly smaller than actual size.
 *Optional

new!

You can work faster, more accurately—when you own and use the new RCA WV-98A SENIOR VOLT OHMYST with the extra-large full-vision meter-face. "Speed-up" in your service work—without the slightest sacrifice in quality—means a "build-up" in your profits. Look at the easy-to-read expanded scales. Then look at some of the other advanced features you also get.

- Large, easy-to-read, wide-vision meter (6½" w).
- Expanded meter scales . . . separate peak-to-peak voltage scales.
- Accuracy of 3% full-scale on BOTH ac and dc voltage measurements.
- Sturdy, single-unit streamlined probe with built-in ac-ohms/dc switch.
- Rugged die-cast aluminum case.
- Compact design: 7" wide, 3¾" deep, 6½" high, 6 lbs.

The all-new WV-98A has all the important, time-proved performance features of earlier VoltOhmysts including direct reading of peak-to-peak voltages of complex waveforms. See this highly accurate, versatile, service instrument at your RCA Distributor! Order now.



NEW! WG-299A slim, single unit DC/AC-Ohms Probe and Shielded cable is provided with the RCA WV-98A. Probe has handy built-in switch permitting instant selection of dc or ac/ohm operation.



RADIO CORPORATION of AMERICA
 TEST EQUIPMENT

HARRISON, N. J.

® Trade Mark "VoltOhmyst" Reg. U.S. Pat. Off.

New Tubes & Components

Int. Rect. SEL. DIODES →

Subminiature selenium diode Types 6U1, 7U1 and 8U1 provide bias for tubes in electronic equipment that must withstand severe environmental conditions, temperatures—50°C to +100°C. Type 6U1 is rated for a maximum input of 156 v. rms, type 7U1, 182 v. rms and type 8U1, 203 v. rms at 1.5 ma. Applications for these types include bias supplies, relays, computers, hearing aids and electronic organs. International Rectifier Corp., Product Information Dept., El Segundo, Calif.—TECHNICIAN (Ask for No. 1-2)

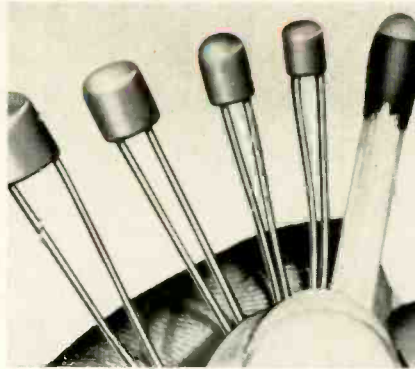

Federal RECTIFIERS →

Selenium rectifiers with new spring-steel, snap-action mount may be removed from radio or TV sets by pressing sides. No mounting hardware or installation tools required. It is assembled to the rectifier's center stud, and so constructed that when the rectifier is snapped into two parallel slots in the chassis, the chassis wall is rigidly gripped between two barbs and two curved counter springs. Components Div., Federal Telephone and Radio Co., 100 Kingsland Rd., Clifton, N.J.—TECHNICIAN (Ask for No. 1-4)

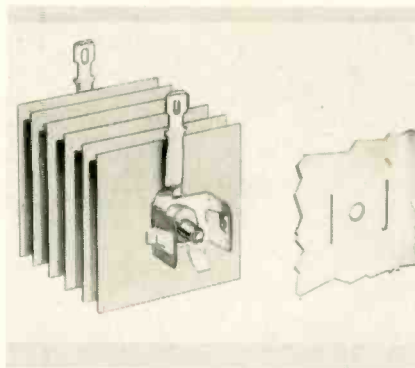

Triad FLYBACKS →

Three new correct replacement fly-back (horizontal output) transformers are designed for use in Sylvania television receivers (replacing original manufacturer part Nos. 241-0003, -0005, -0006 and 0007). These new items are electrically and mechanically interchangeable with the manufacturer's original equipment. Complete line of television replacement transformers is listed in Catalog TV-155. Triad Transformer Corp., 4055 Redwood Ave., Venice, Calif.—TECHNICIAN (Ask for No. 1-3)

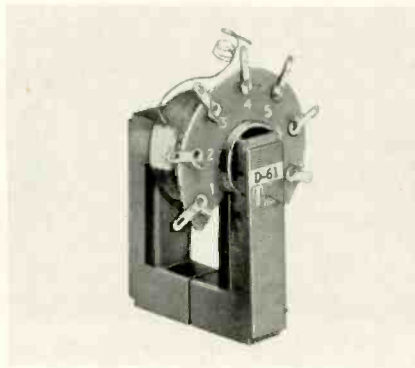

Sprague ELECTROLYTICS →

New series of electrolytic capacitors, Type 17D, meet rigid reliability requirements. Turret-terminal and mounting lugs and a special vent construction are molded into cover. The cans are covered with a corrosion-resisting insulating coating. Nineteen standard ratings covering a wide range of applications in single, dual, and triple section units are available. All are characterized by low maximum leakage current and long life. Eng. Bulletin 340. Sprague Electric Co., North Adams, Mass.—TECHNICIAN (Ask for No. 1-1)

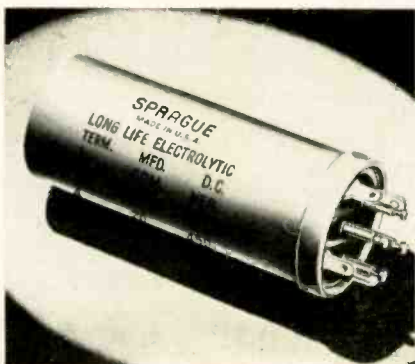

Westinghouse RECTIFIERS

For high-voltage low-current applications are five small, disk-type, tubular rectifiers named "Selenium Slims." They are available in sizes from 1/8 to 1/2 in. dia., 1 to 6 in. long, and can be obtained in assemblies of 1 to 260 cells, each rated 1, 2 1/2, 5, 10 and 20 ma dc. Reverse voltage rating is 26 rms per cell. Union Switch & Signal Div., Westinghouse Air Brake Co., Pittsburgh 18, Pa.—TECHNICIAN (Ask for No. 1-7)

RCA TUBES

Four new tubes have been added to the receiving tube line. The 6DT6 and 3DT6 are sharp cutoff pentodes for FM detector use. These 7-pin miniatures are identical, except that the 3DT6 has controlled heating time for series string circuits. Two multi-unit 9-pin miniatures with 600 ma heaters are the 6BH8 and 6AU8, each embodying a medium mu triode and sharp cutoff pentode. They are used in i-f, agc, oscillator and sync circuits. Tube Div., Radio Corp. of America, Harrison, N.J.—TECHNICIAN (Ask for No. 1-6)

Mid-West TRANSISTOR AMP

Miniature transistor audio amplifier is available in two styles. The tube type measures 1 1/2 in. high by 1 1/8 in. dia. The flat type measures 5/8 in. by 3/4 in. with a thickness of 1/8 in. They have low battery drain of 2 ma, are hermetically sealed, and offer low noise and distortion. Only 4 leads to be connected. Mid-West Coil & Transformer Co., 1642 N. Halsted St., Chicago 14, Ill.—TECHNICIAN (Ask for No. 1-8)

Raytheon TUBES

Two new tubes have been added to the receiving tube line. The 12AB5, listing at \$1.85, is a heater-cathode type miniature pentode designed for use as an audio amplifier in 12 volt auto radios. The 12BQ6GTB, listing at \$3.75, is a heater-cathode type high permeance beam power tube for TV horizontal deflection. It is the 600 ma series string version of the 6BQ6GTB. Raytheon Mfg. Co., 55 Chapel St., Newton 58, Mass.—TECHNICIAN (Ask for No. 1-5)

New Products also
on pages 41, 42, 48, 49, 50, 52

For more technical information on new products, use inquiry coupon on page 50.

Exclusive!

The First **MULTI-CHANNEL** YAGI...PRE-TUNED TO CHANNELS OF YOUR CHOICE

New! **WINEGARD**



- ... Gives You More Gain on Channels in Your Area
- ... Because it's Peaked to Channels in Your Area

There has never been an antenna like the COMBO — the first MULTI-CHANNEL TV ANTENNA that is actually PRE-TUNED TO YOUR AREA. The Combo is factory peaked in 16 different channel combinations — one of which will give you the ultimate in performance on the specific channels you want.

This is the first logical, practical TV antenna development in years. The Winegard COMBO is guaranteed to give better performance on all channels in your area, regardless of size or number of bays of the antenna you are now using.

Another original by WINEGARD!

Available in 16 Factory Pre-Tuned Combinations

Custom-Combo Model No.	Channels Peaked for												
TC3-A	2	3	4	5	6	7	8	9	10	11	12	13	
TC3-B	2	3	4	5	6	7	8	9	10				
TC3-C	2	3	4	5	6	7	8	9	10	11			
TC3-D	2	3	4	5	6				10	11	12	13	
TC3-E	2	3	4			7	8	9	10	11	12	13	
TC3-F	2	3	4			7	8	9	10				
TC3-G	2	3	4				8	9	10	11			
TC3-H	2	3	4						10	11	12	13	
TC3-I	2	3	4	5	6	7	8	9	10	11	12	13	
TC3-J		3	4	5	6	7	8	9	10				
TC3-K		3	4	5	6		8	9	10	11			
TC3-L		3	4	5	6				10	11	12	13	
TC3-M			4	5	6	7	8	9	10	11	12	13	
TC3-N			4	5	6	7	8	9	10				
TC3-O			4	5	6		8	9	10	11			
TC3-P			4	5	6				10	11	12	13	

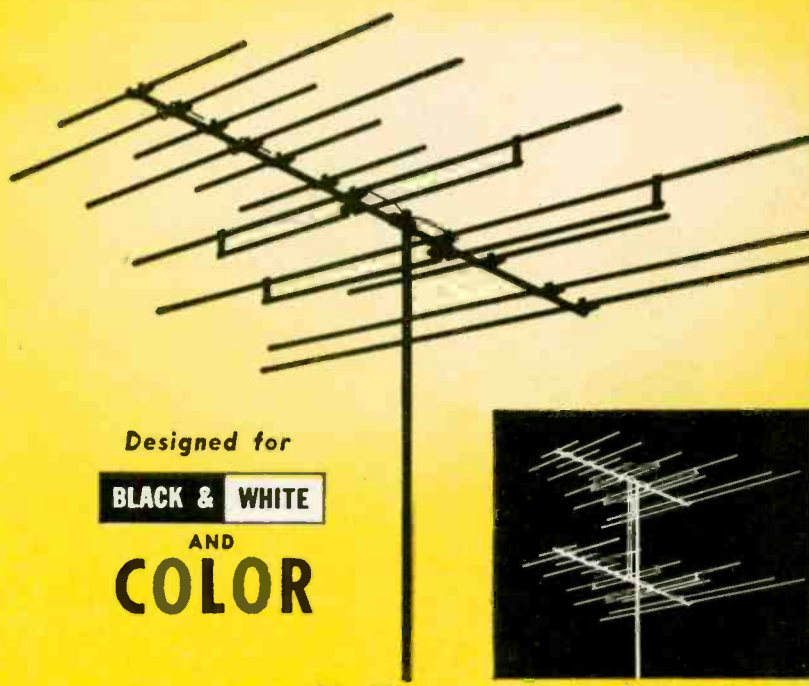

Designed for
BLACK & WHITE
AND
COLOR

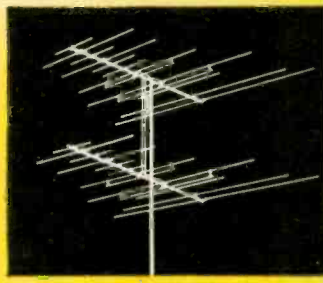

Single bay Combo — \$29.95 Double bay Combo — \$59.95

5 GOOD REASONS TO INSTALL THE COMBO:

1. Pre-Peaked to Your Channels
2. Electro-Lens* Director System
3. Completely Pre-Assembled
4. Automatic Twin-Lock Hardware
5. All Aluminum and Stainless Steel Construction

MAIL TODAY

WINEGARD COMPANY
3000 Scotten Boulevard
Burlington, Iowa

2.

Please RUSH COMBO Bulletin No. WL11135
 Address of nearest distributor

NAME OF FIRM _____

ADDRESS _____

CITY _____ ZONE _____ STATE _____

SIGNATURE _____

**NEW!
NEW!
NEW!**

Simpson
VARIDOT
WHITE DOT GENERATOR
model 434

**VARIABLE DOT
NUMBER AND SIZE**

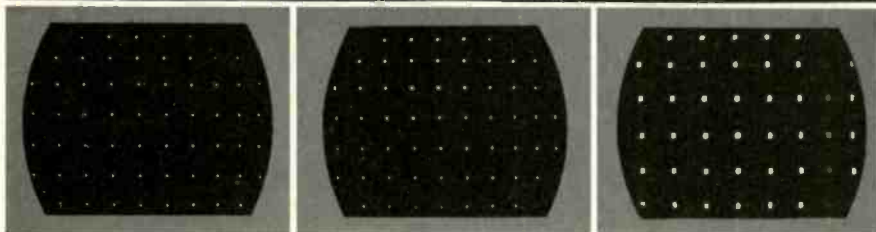
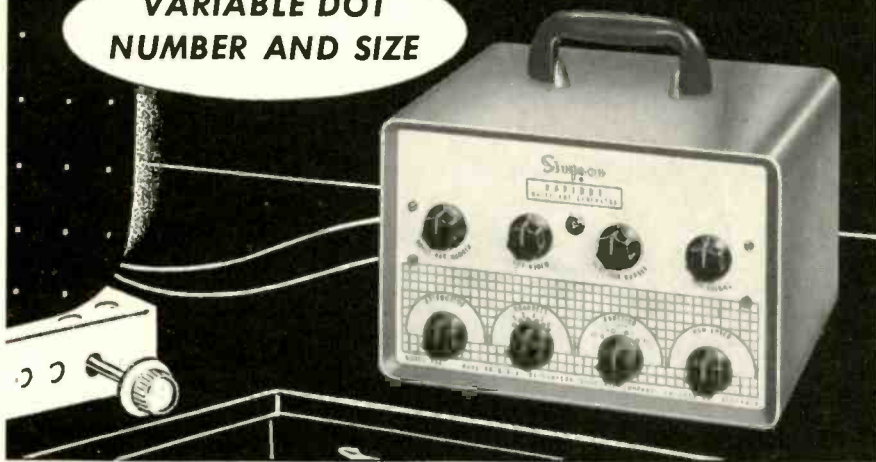

(Actual Photographs)

Provides white dot patterns with VARIABLE dot size (from 1 to 8 scanning lines, with corresponding dot widths), and variable dot number from 6 to 12 horizontal dots, and 6 to 12 vertical dots. Modulated RF output is available, operating on fundamentals from Channel 2 to Channel 6.

**THE ONLY WHITE DOT GENERATOR THAT LETS YOU
MATCH ANY RECEIVER MANUFACTURERS' RECOMMENDATIONS**

You can make convergence adjustments on color-TV receivers faster and better with the new Simpson Varidot. Use for linearity adjustments on both color and black and white.

Vertical and horizontal synchronization assures you of correct aspect ratio . . . ample attenuation . . . 300 ohm RF output.

Adjustable dot size provides a check of receiver transient response. Positive or negative video

output is excellent for accurate and fast checking of transient response of video amplifiers.

Use the new Simpson Varidot for hum checking both color and black and white receivers—a rare feature in test equipment at this price.

Portable: Approx. 11½ lbs. Housed in Simpson gray case.

Complete with Output Cables and Operating Instructions **\$147⁵⁰**

See Your Electronics Parts Distributor, or write

Simpson
ELECTRIC COMPANY

WORLD'S LARGEST MANUFACTURER
OF ELECTRONIC TEST EQUIPMENT
5200 W. Kinzie St., Chicago 44, Illinois
Phone: ESlebrook 9-1421
In Canada: Bach-Simpson Ltd., London, Ontario

AC for Pleasure Craft

The Gypsy III, "Electronic Wonder Boat," was used by the Cornell-Dubilier Electric Corp. to demonstrate application of its line of Powercon dc-to-ac converters and Quietone filters in providing interference-free use of ac home appliances on board small vessels. Heretofore, although such facilities have been made available on larger craft, prohibitive equipment costs have ruled out their use by owners of pleasure boats.

Converters costing as little as \$9.95 now make it possible to obtain regulated, sine-wave, 110-v output at 60 cps (within half a cycle) for operation of communication equipment, radar, electric mixers, TV receivers, movie projectors, phonograph players, tape recorders and a host of other home conveniences. Units are available to operate from ship batteries that put out from 6 to 32 vdc. The vibrator-powered units achieve regulated sine-wave output by use of tank circuits and saturated transformers.

In spite of the availability of ac, the interference generated by the variety of pumps, engines and motors aboard ship is capable of blotting out all forms of communication. In the past, it was practice to turn off all such equipment and permit the vessel to drift while operating communication devices. With the use of the C-D filters, it was possible to operate radar, radio and TV free of noise while the Gypsy III was under way.

In addition to economy, the converting and filtering equipment features compactness. Though the "Wonder Boat" is a 52-ft. off-shore vessel, all units needed to provide ac operation without interference were unobtrusively out of sight.

ASTRON CORP., East Newark, N. J., has been granted a patent for a process in manufacturing molded plastic capacitors.



New Antenna Products

JFD FRINGE ANTENNA

All-channel fringe antenna, the Power-Helix, features microwave helical design, used with a new flat-plane dipole system. This dipole system features staggered tuning for high gain on low channels. The construction arrangement generates transformer action for 300-ohm match. The microwave helical section delivers across the entire high band. The 1-bay Model No. PX911, lists for \$32.50. The 2-bay Model No. PX911S lists at \$67.50. JFD Mfg. Co., Inc., 6101 16th Ave., Brooklyn 4, N.Y.—TECHNICIAN (Ask for No. 1-51)

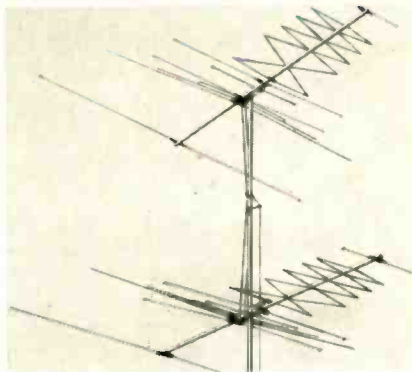

Ampli-V. MASTER SYSTEMS

Ampli-Vision master antenna system package can be installed by using only a screwdriver and conventional wire stripping tool. There are no soldered connections nor circuits to adjust. The master system also is virtually maintenance free, since failure of amplifier tubes will not disable operation. Graybar Electric Co., Inc., 420 Lexington Ave., New York 17, N.Y.—TECHNICIAN (Ask for No. 1-56)

Holloway ANTENNAS

New Expo-I.R.I.S. TV antennas are designed to eliminate co-channel, adjacent-channel and ghost interference. I.R.I.S. (Infinite Rejection Interference System), is combined with exponential design. The interfering signal is cancelled by an opposing signal of equal amplitude but opposite phase. The system consists of 2 antennas, one above the other, cancellation being accomplished by rotating one of the antennas. Holloway Electronics Corp., Fort Lauderdale, Fla.—TECHNICIAN (Ask for No. 1-54)

Snyder ANTENNA

The Torque-Tenna, model AX-100, half the size of a regular conical, minimizes roof reflection and helps wipe out ghosts. Weighing only 27 oz., it resists wind blasts. (Reflector discs are die-cut with holes.) Cost of installation is about 1/3 cost for conical types. The antenna comes completely assembled, snaps onto mast in minutes by one man. For UHF or VHF. Several can be stacked depending on the need. List price, \$7.50. Snyder Mfg. Co., 22nd and Ontario Sts. Philadelphia 40, Pa.—TECHNICIAN (Ask for No. 1-50)

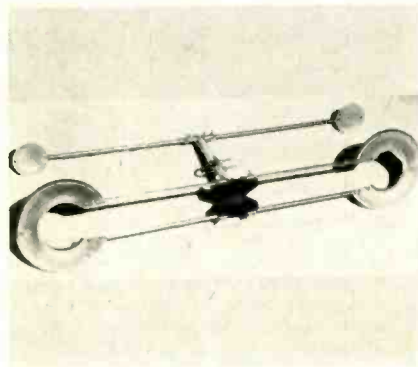

Jontz TOWERS, GUY RINGS

The new Jontz models 200, 240 and 400 towers, tested for durability, include: streamlined design incorporating taper and top section; durability due to superior joint construction plus the use of 1 1/4-in. electrically-welded steel tubular uprights.

Colored guy rings (red on 16 ga. masts and green on 18 ga. masts) simplify identification, facilitate inventory and shipping, and improve appearance. Jontz Mfg. Co., 1101 E. McKinley, Mishawaka, Ind.—TECHNICIAN (Ask for No. 1-55)

CB MULTI-YAGI

The Sky Sweep, model MYSSO, features 14 elements on the high band and 5 on the low band. It features high gain, Yagi performance on channels 2 to 13, simple snap-open design which does not require tightening of nuts or bolts. Construction is of flat design for low wind resistance. Stacking bars are available in 3 sizes: YS20-33 (favoring high band), YS20-86 (for low band) and YS20-66 for allband reception. Clear Beam Antenna Corp., 21341 Roscoe Blvd., Canoga Park, Calif.—TECHNICIAN (Ask for No. 1-53)

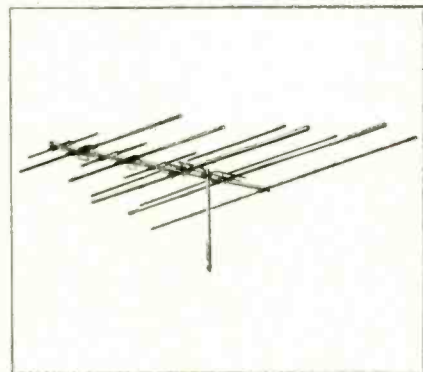

Dage REMOTE CLOSED CKT

Remote operation of closed-circuit TV cameras is provided by "servo pan and tilt" system, the "285-A Servo System." It includes a multi-lens camera controlled by a separate monitor-console. Controls allow 3 "pre-set" pan and tilt positions to be selected by pushing a button, or flexible manual control by turning a knob. Pre-set positions may be changed. The unit provides operator safety in hazardous locations, permits quick viewing of widely-spaced objectives, and assures undetected operation. The camera may be mounted on tripod or fixed. Dage TV Div., Thompson Products, Inc., Michigan City, Ind.—TECHNICIAN (Ask for No. 1-57)

Winegard ANTENNA

All you need is a hammer to install the Color-Beam, which unfolds like an umbrella, with all elements locking into place. Support mast and one end of lead-in wire are already attached to the antenna. The other end of the wire has a clip that permits fastening to the back of the TV set. Nails are furnished for securing to siding. The Color-Beam is guaranteed within a 50-mile radius of any station, has anodized finish, and works in attics or on trailers. Winegard Co., Burlington, Iowa—TECHNICIAN (Ask for No. 1-52)



For more technical information on new products, use inquiry coupon on page 50

64% of the top Engineers

PREFER AND USE

HICKOK

DYNAMIC MUTUAL CONDUCTANCE TUBE TESTERS

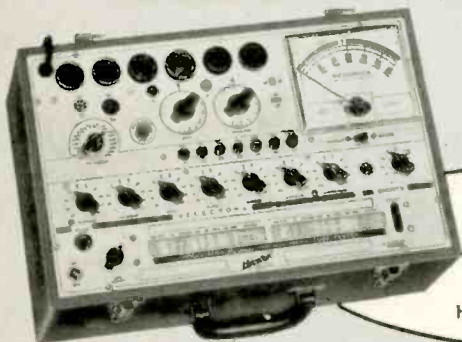

**MODEL
600A**

World's most popular
Tube Tester

"... that 600A is certainly unbeatable! I have sold 4 for you by just letting service centers use mine for part of one day. "

Harold F. Tolles, St. Johns, Mich.

"I purchased a 600A last Fall and have found it to be one of the best investments in test equipment that I have ever made. "

R. Lyfwyn, Netyl Electronics

All tube testers manufactured today fall into four major classifications.

If you use vacuum tubes in your profession, and if you ever intend to purchase a tube tester please write today for the 28 page book of Tube Tester Facts and learn the advantages of each classification in order that you will be able to more efficiently select for your requirements.

This detailed, illustrated and descriptive book also contains circuit diagrams and formulas.



THE HICKOK ELECTRICAL INSTRUMENT CO.

10523 DUPONT AVE. • CLEVELAND 8, OHIO

Gentlemen:

Kindly send me free of charge your new 28 page book of Tube Tester Facts.

NAME _____

COMPANY _____

STREET _____

CITY _____ ZONE _____ STATE _____

New Audio Products

Jensen SPEAKER KITS

Series of eight complete loudspeaker "do-it-yourself" kits ready for assembly contain the identical matched components used in factory assembled reproducers. The series range in retail price from \$184.50 to \$10.50. Included are the 3-way Imperial; KT-32 Tri-Plex, KT-21



Concerto-15; KT-22 Concerto-12; KDU-10 Treasure Chest Duette; KDU-11 Table Duette; KDU-12 Budget Duette and KTX-1 Range Extender Super-tweeter. Jensen Mfg. Co., 6601 S. Laramie Ave., Chicago 38, Ill.—TECHNICIAN (Ask for No. 1-9)

University SPEAKER SYSTEM

The Tiny-Mite 3-way system, useful where space and budget are limited, is suitable for corner or flat-wall use. The Decor-Coustic enclosure uses Model 308 8-in triaxial speaker. Horn loading, phase inversion, and direct radiation are used to achieve balanced extended



range with high output. Handles up to 25 watts of program. Measures only 19½-in. H. x 15-in. W. x 12¼-in. D. Finishes: Cherry and Blond Mahogany. University Loudspeakers, Inc., White Plains, N.Y.—TECHNICIAN (Ask for No. 1-75)

SYLVANIA Television Awards were made by a distinguished panel of judges to a number of actors, producers, TV stations and others who have contributed to raising the level of TV entertainment during the past year.

America's
NEW
Favorites!

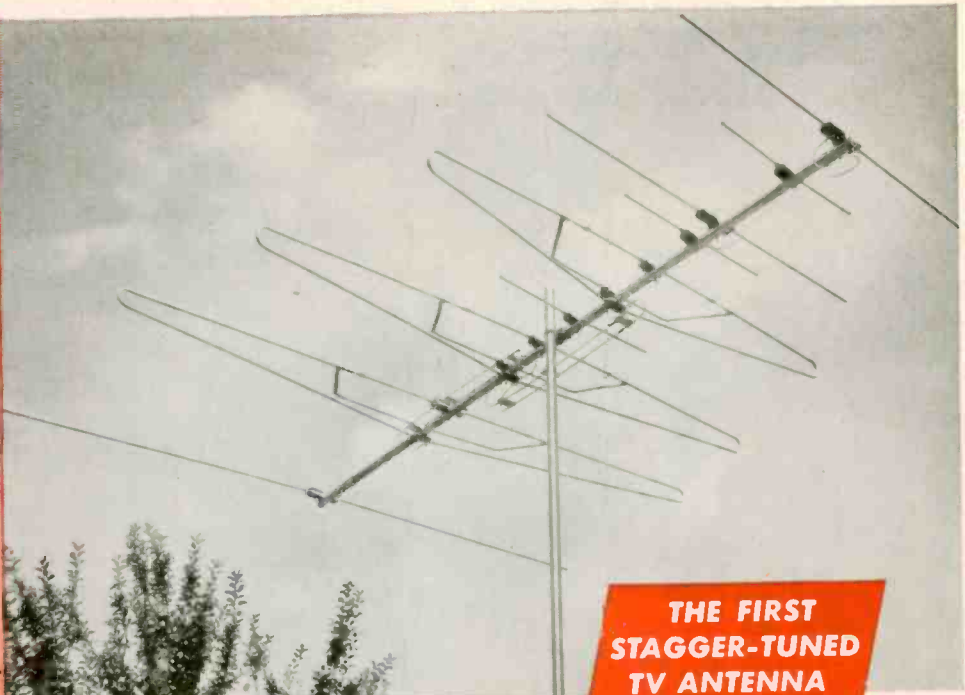

**THE FIRST
STAGGER-TUNED
TV ANTENNA**

TRIO *Zephyr Royal*

highest performance ever achieved in a TV antenna

MODEL ZR-1 PATENT NO. 2,703,840

SUPERIOR IN

- design
- workmanship
- performance

Now, the tests of TRIO engineers have been confirmed unanimously by scores of unsolicited reports from the field. Distributors, dealers and thousands of consumers have verified these tests, proving it's the best antenna ever designed. The ZEPHYR ROYAL's performance on ALL CHANNELS, 2 thru 13, is nothing short of miraculous, thanks to its revolutionary new WING DIPOLE PRINCIPLE and STAG-

GER-TUNING developed and introduced by TRIO engineers. It is pre-assembled—uses Instalok Clamps; fiberglass insulators and riveted construction, is light-weight, yet extremely rugged. For these reasons the ZEPHYR ROYAL is America's new favorite—the No. 1 Antenna—electrically and mechanically—and one bay does it!

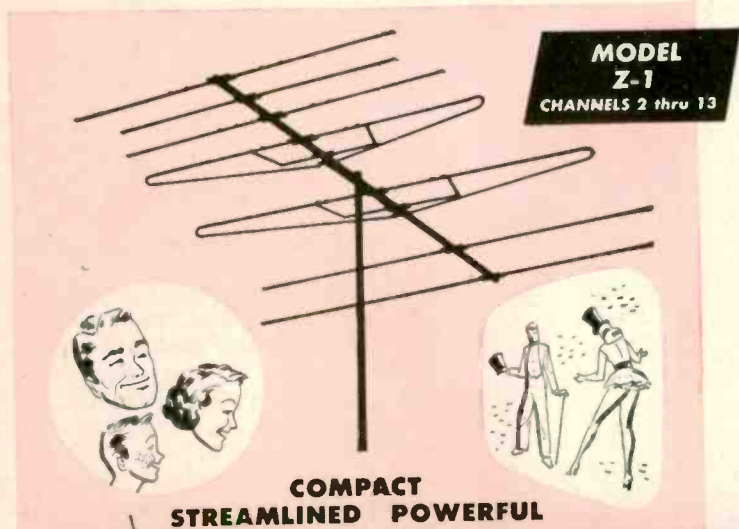

**COMPACT
STREAMLINED POWERFUL**

TRIO *Zephyr*

**more performance per dollar
than any other antenna!**

The TRIO ZEPHYR is the popular choice when the extra features of the ZEPHYR ROYAL are not required. Using two of the revolutionary new wing dipoles, the ZEPHYR will outperform any other antenna in its price range on the market. Needless to say—the ZEPHYR uses the same superior construction features found in the ZEPHYR ROYAL. For its size and weight, its performance also is nothing short of miraculous!



TRIO Manufacturing Company
GRIGGSVILLE, ILLINOIS

COPYRIGHT 1955—TRIO MANUFACTURING COMPANY

**LEADER IN
ANTENNA DEVELOPMENT**

Export Sales Div.: Scheel International, Inc., 4237 N. Lincoln Ave., Chicago, U.S.A. Cable Address: Harscheel

... another
MALLORY
service-engineered
product



Now

Mallory Selenium Rectifiers

in a convenient
protective carton

Every service man who has found selenium rectifiers damaged when thrown together on a shelf or in a bench drawer will appreciate the new Mallory package. In each compact carton you get ten stacks . . . each one in a separate cut-out compartment . . . including all the mounting hardware you need.

Stacks stay in place during shipment and in your shop. They can't get chipped or bent. They're protected right up to the instant you install them in a set.

Just as the Mallory carton is a new high in convenience, so is Mallory rectifier performance a new high in service and uniformity. Mallory-developed manufacturing techniques assure you of extra long life and low forward voltage drop in every stack you use. Get your stock today, from your local Mallory distributor.

P. R. MALLORY & CO. Inc.
MALLORY

P. R. MALLORY & CO. Inc., INDIANAPOLIS 6, INDIANA

- Capacitors
- Vibrators
- Resistors
- Power Supplies
- Mercury Batteries
- Controls
- Switches
- Rectifiers
- Filters

DON'T OVER PAY YOUR TAXES

This article is based on information supplied by the American Institute of Accountants, the national professional organization of certified public accountants.

• Whether the federal income tax rates are cut or not, you may be able to cut your own tax bill—honestly!

To do this you need to know the tax effect of various choices. Your choice of a method of handling a particular transaction can raise or lower your taxes, and sometimes you can save money by a legitimate shift of taxable income or deductions from one year to another. You are also allowed choices in your treatment of certain items in your tax return, such as depreciation costs.

Many businesses could reduce their tax burden if they were aware of the tax considerations affecting a variety of transactions. The most feasible means for many businesses to keep alert to tax saving opportunities is frequent consultation with a properly qualified advisor. If the firm retains a certified public accountant or a firm of CPAs, there should be tax consultations not just once a year when the filing date approaches, but throughout the year as decisions are made which will affect the tax.

Depreciation Methods Vary

Certain tax-saving steps are still possible at tax-filing time. One of them is the proper choice of depreciation method. The first step is to determine the estimated useful life of any asset acquired during the tax year. Every businessman should have a copy of "Bulletin F," which contains tables of "average" useful lives. It is available from the Superintendent of Documents, Government Printing Office, Washington 25, D. C., for 30 cents. The tables provide a guide, but it is not necessary to follow them exactly.

The simplest method is straight-line depreciation. It may also be the

best in your particular case. Just divide the cost (less what you expect to sell or trade in the asset for when it is replaced) by the number of years of estimated useful life, and this is the amount to be deducted each year. In arriving at the original cost, don't forget to include freight and installation charges in addition to the price paid for the equipment.

The law now specifically permits several other methods of depreciation for new assets having a useful life of three years or more. One of them is known as the declining balance method. In the first year the depreciation rate is twice what it would be under the straight-line method. The next year the same rate is applied to the amount remaining to be depreciated. This process is repeated each year.

The result is that a greater proportion of the cost is depreciated during the early years of the life of the asset.

Another Method

Another new method, known as "sum of the years' digits," has a similar effect. You should figure depreciation on a new asset in all possible ways so that you can decide which is best for you and make the proper choice.

These methods of rapid depreciation may be particularly helpful to a company which is currently making large outlays for new equipment, but the depreciation left for the later years of the asset's life will be less than under the straight-line method. The best method depends upon the circumstances of the individual company, and is also affected by such imponderables as estimates of future earnings and tax rates during the life of the asset.

Development Costs

Another choice confronting the taxpayer is whether to treat development costs as immediately deductible expenses or to amortize them over a period of years. The immediate deduction is certainly a "bird in the hand" and may be very attractive to a company which needs this tax benefit to help finance the undertaking.

The company which can afford to spread the cost over the estimated useful life (or at least sixty months if the useful life cannot be determined) may find it best to do so. This is especially likely to be advantageous for companies whose income is expected to increase. ●

(Continued in a forthcoming issue)

... another
MALLORY
service-engineered
product



Your best choice in wire-wound resistors

Whenever you replace a wire-wound bleeder, load resistor or voltage divider, you can make the job sure by using Mallory vitreous enamel resistors. From the inside out, they're built for real stability and long service.

Low temperature coefficient wire is space wound on a high quality steatite core, and is protected by a special non-porous, non-alkaline enamel coating that protects permanently against moisture and corrosion. A special design of the terminal bands assures fool-proof connection.

Mallory wire-wounds run cool, for they are conservatively rated under actual inside-chassis service. Your Mallory distributor carries them in a complete range of resistance values . . . in the popular 10-watt size illustrated, and in 5, 20, 50, 100 and 200-watt ratings. See him today!

P. R. MALLORY & CO. Inc.
MALLORY

- Capacitors
- Vibrators
- Resistors
- Power Supplies
- Controls
- Switches
- Rectifiers
- Filters
- Mercury Batteries

P. R. MALLORY & CO. Inc., INDIANAPOLIS 6, INDIANA

Association News

New Statewide Association Is Formed in California

The California State Electronics Association, newly formed, elected Keith Kirstein, Sacramento radio and TV dealer, as its first president. Other officers elected were Rex Yeager, San Francisco, vice-pres.; James Wakefield, Fresno, secy.; and Larry Schmitt, Palo Alto, treas. Officers were elected at a meeting in Fresno attended by nearly a score of delegates from associations throughout California, representing about 2000 dealers and service establishments. Full-term officers are to be elected at a general membership meeting in May 1956. During the present membership drive, which lasts until May, all local groups to join up will be considered charter members.

Ass'n Starts Publication —Santa Clara, Calif.

The Radio and Television Service Association of Santa Clara Valley, California, launched its official monthly publication, *RTA*, in November. This new undertaking underscores the vigor of the relatively young organization, which is less than a year old.

Mfr. Honored by Ass'n —Philadelphia, Penna.

One of the nation's oldest organizations of electronic service techs, Philadelphia Radio Service Men's Association, has awarded a plaque to the Radio Corporation of America in recognition of RCA's cooperation with the service industry. Presentation was made by Richard G. Devany, PRSMA president, to Charles M. Odorizzi, RCA executive vice president.

"Too Many Tubes"—NATESA

"When will we see the end of the parade of new tubes?" asks *NATESA Scope*, official publication of the National Alliance of Television & Electronic Service Associations. Pointing out that 65 types have come into existence this year so far, the publication does not quarrel with those that represent definite improvement or fulfill a need. However, it is felt that many new tubes are simply slightly altered versions of existing types or others used to fit into some particular circuit design. "Isn't it time for better design—not red hot tubes?" asks the *Scope*.



To speed service and cut the cost of replacing controls...

It pays to think of Centralab Adashaft® Radiohms®



ADASHAFT KIT
NO. AB-100

An assortment of 39 most popular controls, switches, shafts, shaft extensions, and couplers. In hinged-lid plastic box. \$15.03 suggested net price.

Patented Adashaft design gives you
any resistance

— including dual-tapped types . . .

with any shaft

12 basic shaft types from 3/8" to 10" long,
including auto types, insulating nylon, many others

*... and you can convert to
switch types with Centralab
"Fastatch" type KB line switches.*

Order Adashaft controls from your Centralab distributor. Both control *and* shaft cost no more than an ordinary control alone.

Send coupon for bulletin 42-199.

Centralab

A DIVISION OF GLOBE-UNION INC.
902A E. Keefe Avenue, Milwaukee 1, Wisconsin
Send me Centralab bulletin 42-199.

B-561

Name.....

Company.....

Address.....

City..... () State.....

NOW YOU CAN SELL THE OUTDOOR MARKET

Snyder PHILADELPHIA **7-D**

TENNA-TUNER

FOR USE WITH

Outdoor Antennas

Featuring

The Self-Contained 6-POSITION

Directronic[®] BEAM SELECTOR

GUARANTEED BETTER **TV** PIX

REDUCES / ELIMINATES

- ADJACENT CHANNEL INTERFERENCE
- CO-CHANNEL INTERFERENCE
- LOCAL ELECTRICAL DISTURBANCES
- GHOSTS
- SNOW EFFECTS

9.95

SNYDER



SNYDER MFG. CO., PHILADELPHIA 40, U. S. A.
BELLEVUE TUBE MILL, INC., PHILADELPHIA
SYNDER ANTENN-GINEERS, LTD., TORONTO 14, CANADA
WORLD EXPORT: ROBURN AGENCIES, INC., N. Y.

Latest Test Equipment

Precision AC VTVM

Model 68 is an ac-operated wide-range vtvm with a 5¼" wide-angle Pace meter of ±2% accuracy and 1% multipliers. It has 5 plus and 5 minus dc voltage ranges at 13½ megs input to 1200 v.; 5 resistance ranges to 1000 megs; 5 high-impedance rms ac ranges; 5 stabilized zero-center reference ranges for FM discriminator balancing and voltage polarity determination. R-F and high-voltage probes are also available. Precision Apparatus Co., Inc., 70-31 84 St., Glendale 27, L.I., N.Y.—TECHNICIAN (Ask for No. 1-25)

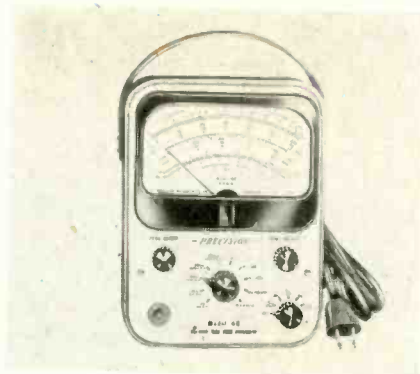

Telematic PIX TESTER

"Tele-Check" portable picture test tube and yoke assembly permits quick substitution without removing parts from set. It consists of 5AXP4 crt, universal yoke, and 6-foot extension leads for extending crt socket, anode, and yoke connections for all set makes and models. Unique feature permits assembly to be broken down in less than two minutes, using each part as a separate unit, or in combination to give widest possible application. Telematic Industries, Inc., 15 Howard Ave., Brooklyn, N.Y.—TECHNICIAN (Ask for No. 1-23)



ETI "VOLTA-CHEK"

"Volta-Chek" offers rapid methods of checking voltages applied to various elements of the crt. It checks sets with focus voltages from 400 to 3,000 v. Volta-Chek will localize the faulty circuit elements and determine whether it is the tube which is at fault or whether the trouble lies in some chassis component. It can be quickly used by merely removing the crt socket and applying Volta-Chek to the socket. Electronic Test Instrument Corp., 13224 Livernois Ave., Detroit, Mich.—TECHNICIAN (Ask for No. 1-24)



Century CRT TESTER

The Model 103 "Testivator" tests and repairs TV picture tubes by simple connection of test socket to tube base. This portable and self-contained instrument checks cathode emission, also indicates shorts, opens and leakage between elements. It activates crt cathode by removing surface contamination, restores emission to weak tubes, and clears inter-element shorts and leakage. Price is \$14.95, with test cable. Century Electronics Co., Inc., 111 Roosevelt Ave., Mineola, N.Y.—TECHNICIAN (Ask for No. 1-26)



RCA VTVM

Model WV-98A Senior VoltOhmyst has been added to the line of test equipment. Its features include all those incorporated in earlier models, including peak-to-peak measurements of complex waveforms. In addition, the new WV-98A has an extra large (6½ in. wide) meter face. A new single-unit ac/dc-ohms probe has a handy, built-in switch for instant selection of dc, ac, or resistance functions. Overall accuracy is 3% of full-scale values. DC voltages from 0.02 to 1500 v. are read on only two scales in seven overlapping "3-to-1" ranges. HV accessory probe increases range to 50 kv. WV-98A measures resistance from 0.2 ohm to 1000 megs. Radio Corp. of Amer., 30 Rockefeller Plaza, N.Y. 20, N.Y.—TECHNICIAN (Ask for No. 1-30)

Airport PIN LOCATOR

"Quick-Way Tube Pin Locator" quickly determines what each tube pin signifies at the socket base. It operates with a turn of the circular slide rule type dial. When set to tube number, it automatically selects all pin locations. Tubes covered are of the receiving types used in radio, TV, audio and other electronic equipment. A new tube log imprinted on the face eliminates obsolescence. Airport Television & Radio Co., 188 Airport Rd., Reno, Nev.—TECHNICIAN (Ask for No. 1-28)

Ind. Instr. OHMMETER

New version of the LRO low-resistance ohmmeter, Model LRO-1, retains features of its higher priced counterpart. It is self-contained, operating on a flashlight battery. Test current, never exceeds 110 ma. It is ideal for checking fuses, sensitive relay points, windings in transformers and motors, bus bars and switch contacts. Accuracy is of the order of 1½% of full scale reading. Full scale readings are 0.1, 1 and 10 ohms. Industrial Instruments, Inc., Cedar Grove, N.J.—TECHNICIAN (Ask for No. 1-29)

Hoffman DOT GENERATOR

White dot generator model CD in kit form allows dots to be fed directly to antenna terminals of the color receiver, eliminating the necessity of hooking into the actual circuitry. Use of small white dots permits more perfect adjustment of the color TV receiver for best possible convergence. Weight of unit is 6½ pounds. Overall dimensions are 5" by 9" by 6". Price is \$49.95. Hoffman Electronics Corp., 3761 S. Hill St., Los Angeles 7, Calif.—TECHNICIAN (Ask for No. 1-27)

For more technical information on new products, use inquiry coupon on page 50

Pickering PHONO PICKUP

The Fluxvalve is a magnetic pickup featuring turnover design and replaceable styli. It has high compliance for low tracking force (2-5 grams). Characteristics include: response flat to beyond 20 kc; negligible IM distortion; output of 25 millivolts at normal recording level; and medium impedance; requiring a termination of 47,000 ohms. Supplied with mounting clip for all standard arms. Plastic seals magnetic circuit. Pickering & Co., Inc., 309 Woods Ave., Oceanside, N. Y.—TECHNICIAN (Ask for No. 1-81)

Fairchild PHONO PICKUP

The 220 Series cartridge, based on the moving coil principle, features low moving mass with high compliance; excellent tracking; low needle talk; and fits changers as well as transcription arms. Specifications: response, ± 2 db 20 to 17,000 cps; output, 5 mv (± 2 db) on 1000-cps tone at velocity of 2.5 ips; impedance, 170 ohms. DC resistance of coil, 170 ohms. Fairchild Recording Equipment Co., 154th St. and Powells Cove Blvd., Whitestone 57, N.Y.—TECHNICIAN (Ask for No. 1-82)

Filtering Troubles

(Continued from page 21)

partly short-circuited (see Fig. 1) since the condenser sections are now across the choke. The resultant hum may therefore persist even when the filters are bridged. The correct procedure here is to disconnect the old filters at the positive end, before trying new ones.

In other instances where the symptoms indicate that filter trouble is present, but the symptoms do not subside when the filters are bridged, the condensers may have been incorrectly connected in the first place. This is especially likely when the set calls for a common-positive type of condenser (see Fig. 2). Replacement of such a unit with a common-negative type is sometimes attempted by a novice, with "humorous" results. ●

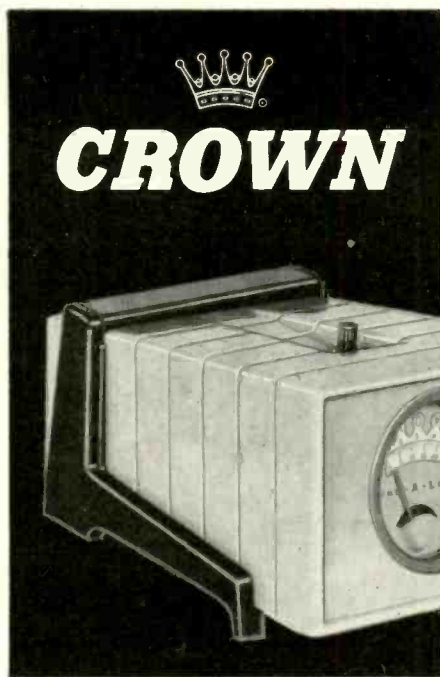

The most
RUGGED and
Dependable
Antenna
Rotator
on the
Market!

Model CAR6B in combination with Crown's exclusive Tenn-A-Liner Planter—an excellent item for an entirely new approach to antenna rotator promotion.



CROWN TWO SET COUPLER

Operates two TV sets from same antenna with excellent results on any combination of channels. No printed circuits! Low in cost . . . easy to install . . . it pays off in extra "over-the-counter" sales.

Get the complete story on the highest profit line in the TV antenna rotator field—Crown Tenn-A-Liners and the complete line of Crown TV accessories . . . Write us today!



CCG

CROWN CONTROLS Co., Inc. NEW BREMEN, OHIO

Canadian Subsidiary Crown Controls Mfg. Ltd. Export Division, 15 Moore St., New York, N. Y., Cable—"Minthorse"

New Electronic Products

Finco HI-GAIN ANTENNA →

Model B-8 provides high front-back ratios without sacrifice of gain. The mfr's. fidelity-phased elements (2 used) are interleaved with multiple directors and reflectors. Self-locking feature assures alignment. Also available: No. S-830 kit, to stack 2 B-8's for best hi-band gain and best front-back ratio on channels 3-12; No. S-860 kit, to stack 2 B-18's for best low-band gain and high front-back ratio on channels 2 and 13. The Finney Co., 4612 St. Clair Ave., Cleveland, Ohio.—TECHNICIAN (Ask for No. 1-16)

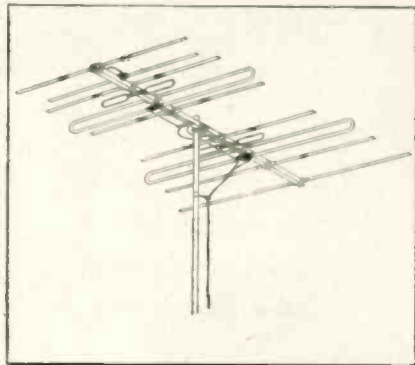

B-T CABLE STRIPPER →

Model S-1 rotary stripper for coax cables and other non-metallic tubing up to 1/2" diam. is useful for coaxial and other shielded cable for TV, audio, industrial and electrical purposes. It is machined from heavy-gauge steel and uses a standard single-edge razor blade. Depth of cut and degree of spring tension may be varied. Scale insures that correct amount of insulation and braid is removed. Lists for \$3.75. Blonder-Tongue Labs., Inc., 526-536 North Ave., Westfield, N.J.—TECHNICIAN (Ask for No. 1-18)



Mosley 4-SET COUPLER →

A new 4-set TV coupler, the #904, uses the same principles and design as the earlier Mosley #902, the popular 2-set coupler. Up to four TV sets can be coupled to one antenna with minimum of interaction and radiation between sets. Losses thru the coupler are low since close adherence to proper impedance match has been attained, and the coupler is said to be satisfactory even in weak signal areas. Mosley Electronics, Inc., 8622 St. Charles Rock Road, St. Louis 14, Mo.—TECHNICIAN (Ask for No. 1-17)

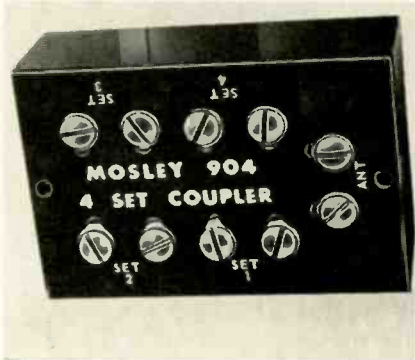

Insuline ACCESSORIES

New items include a binding post (No. 640), the Multi-Way, which permits 6 different methods of connection above panel, available in black or red tenite. Kit of 5 most used hex wrenches (No. 963) comes in leatherette case. Companion kit (No. 964) holds 6 most used spline wrenches. Different types and sizes of Hi-Fi connecting cords (Nos. 2386, 2388, 2394 & 2398) for interconnecting various types of Hi-Fi gear. Insuline Corp. of America, 186 Granite St., Manchester, N.H.—TECHNICIAN (Ask for No. 1-22)

Walco NEEDLE DISPLAY

A colorful card containing 30 (10 each) Walco sapphire, ruby and metal tipped 3-speed needles, the Walco "400" Display, is available. All needles are made with "floating action." Needles list at \$2.50 for sapphire, \$2.00 and \$1.50 respectively for ruby and metal tips. Complete cards list at \$60.00 each, with dealer cost around \$19.95. Electrovox Co., Inc., 60 Franklin St., East Orange, N.J.—TECHNICIAN (Ask for No. 1-19)

G-C PHONO DRIVE KIT

This handy phono and recorder drive kit contains a selection of the most frequently used types. The P400 Phono Kit contains 51 exact replacements for such changers and tape recorders as Webcor, RCA, Crescent, V-M, Philco, Admiral, Revere and Ampro. A reference chart for wall mounting is packed with each kit. The kit (Cat. No. P400) comes in clear plastic storage box, lists for \$26.50 (dealer net of \$15.90). General Cement Mfg. Co., 919 Taylor Ave., Rockford, Ill.—TECHNICIAN (Ask for No. 1-20)

Jerrold CABLE TAP

A device for making permanent, weatherproof cable taps without severing cable or stripping leads works with either coax or single-conductor solid or stranded cables. With coax, connection is automatically made to center conductor as well as all outer conductors. Shunt capacitance is less than 1.5 mmfd. The pressure tap greatly reduces time "on the ladder" required to make a permanent cable connection. Jerrold Electronics Corp., 23rd and Chestnut Sts., Phila., Penna.—TECHNICIAN (Ask for No. 1-21)

FOR MORE TECHNICAL INFORMATION ON NEW PRODUCTS OR BULLETINS

use this convenient coupon. Enter below the reference numbers for all items desired.

New Products Editor
TECHNICIAN & Circuit Digests
 480 Lexington Ave.
 New York 17, N. Y.

Please send me more information on the following items:

My company letterhead or business card is enclosed.

Name

Address

Firm My position

City State

Business address (if different from above)

ROHN NO. 6 TOWER "All-Purpose" Tower

Self-supporting to 50 ft., or guyed to 120 ft. Utilizes mass production techniques to give you lowest prices, yet highest profits for a tower of this type. Ideal for home and industrial requirements. Permanent hot-dipped galvanized coating inside and out. Dependability — a feature customers demand — is assured with the Rohn No. 6 Tower . . . designed to "stand up" for years to the rigors of weather and climatic conditions. Easy to climb for fast, efficient servicing. In 10 ft. sections.

ROHN PACKAGED TOWER "Space Saver" cuts storage space 300% or more!

Pat. Pending
Popular PT-48 has almost 50' of sturdy tower within a compact 8' x 20" package! "Magic Triangle" design is adapted to a pyramid shape using a wide 19" base with progressively decreasing size upward. Decreases your overhead . . . easy to transport and assemble; cuts shipping costs! Galvanized t h r o u g h - out. Available in heights of 24', 32', 40', 48', 56' and 64'.

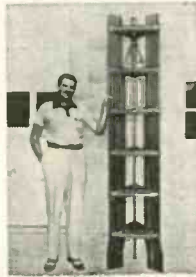

Both Towers Feature . . .

1. MAGIC TRIANGLE CONSTRUCTION

Famous wrap-around design with full 2½" corrugated cross-bracing welded to tubular steel legs.

2. INTERLOCKING JOINTS

. . . formed by swaging tower ends so that they overlap each other, becoming a single unit in structure. Proved by tests to be superior.

3. WEATHER SEALED

. . . against condensation and moisture.

4. HOT DIPPED GALVANIZING

. . . both inside and out gives the finest protective coating known. This sales point is one of the best you can offer . . . the finest quality and at lower than competitive prices!

these two **HOT DIPPED GALVANIZED**
Rohn Towers
will satisfy 90% of your TV tower needs!

HEAVY DUTY NO. 30 TOWER

Heights up to 200' or more when guyed
Self-supporting up to 60'

Sturdy communication or TV tower that will withstand heavy wind and ice loading. Heavy gauge tubular steel, electrically welded throughout.

Weather resistant, non-corrosive double coating provides durable finish.

All sections in 10' lengths. Only 2-4 manhours required for installing 50' tower! Tremendous sales potential for you in this tower!

SPECIAL INSULATOR SECTIONS are available to permit the Rohn No. 30 Tower to be used as guyed "series fed" radiators for amateur and commercial uses.

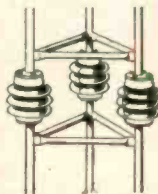

NEW LINE OF ROHN ROOF TOWERS



Four superior designed "Roof Towers" are available for inexpensive, yet sturdy roof installations. 3', 5' and 10' sizes are available.

These completely galvanized Rohn Towers have unbeatable sales appeal when this type installation is desired.

HANDLE THE COMPLETE LINE OF ROHN GALVANIZED ACCESSORIES

. . . house brackets, special bases, peak and flat roof mounts, instant drive-in bases, telescoping masts with matching bases, special Rohn Fold-Over Tower, guying brackets, UHF antenna mounts, erection fixtures, variety of mounts and supports for masts or tubing, tower installation accessories, TV service tables, mast and TV hot dipped galvanized tubing, guy rings, etc.

for • larger profits • customer satisfaction • greater ease in ordering, handling and shipping

CALL YOUR ROHN REPRESENTATIVE
FOR COMPLETE CATALOG, SALES
LITERATURE AND PRICES — OR WRITE —
PHONE — WIRE DIRECT

GET ALL YOUR REQUIREMENTS
FROM ONE RELIABLE SOURCE

ROHN Manufacturing Company

116 Limestone Avenue, Bellevue, Peoria, Illinois

Hum Problems

(Continued from page 27)

from the chassis, let the capacitor hang in the air, and turn the set on. If this eliminates hum, case-to-strap leakage is the fault. Replace the filter.

In stubborn hum cases, where no electrical abnormalities could be detected, considerable reduction of hum content has been achieved by addition of a decoupling filter in the first audio circuit, like the one

shown in Fig. 4, for instance. In many receivers this filter is lacking and it makes a worthy adjunct, especially since a resistor and condenser are not expensive.

In tracking down hum, learning to distinguish between the sound of a 60-cycle and a 120-cycle hum is invaluable. The experienced technician will find this easy to do, with practice.

In sets of the ac-dc type, most of which use half-wave rectifiers, the fundamental hum frequency found will of course be 60 cycles, regardless of what causes the hum defect. In receivers of the straight ac type

however, where a power transformer and a full-wave rectifier are usually employed, hum voltages of both the 60-cycle and 120-cycle kind will be encountered. Being able to distinguish between the two sounds will "narrow the chase." A frequent cause of 60-cycle hum is uneven or unequal emission in the full-wave rectifier tubes. Check both halves of the rectifier carefully; emission should be approximately the same.

While much more can be written on hum troubleshooting, an effort has been made to include most of the causes found by the writer after many years of experience. The list given should take care of the great majority of receivers that come in with this type of defect. •

you can
hear the
quality of
a

QUAM
Adjust-a-Cone[®]
SPEAKER

When you install a Quam speaker, listen to it carefully.

Your ears will tell you why Quam Speakers have earned the reputation of "the Quality Line."

No other replacement speaker offers you all these important quality features: patented Adjust-a-Cone[®] suspension, U-shaped pot, heavier magnetic structures, 4 threaded holes in coil pot, transformer brackets, universal mounting brackets, factory packaging, listing in Howard Sams' Photofacts.

For happier customers,

ask for QUAM, the quality line for all your speaker needs

**QUAM-NICHOLS
COMPANY**

236 East Marquette Road

Chicago 37, Illinois

Mercury DISC CLEANER

The Dis-Charger eliminates static built up on a record surface as the record is played. It contains a radioactive material which ionizes air in its vicinity. When clipped to the pickup arm it draws off static electricity generated by

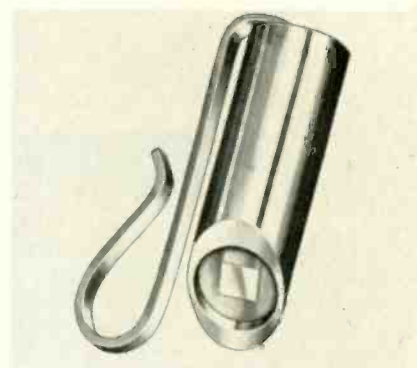

records. Life is practically infinite. Small and light weight ($\frac{1}{2}$ gram), it eliminates one cause of noisy, prematurely aging records surfaces. Body is made of plastic. Mercury Scientific Products Corp., 1725 W. 7th St., Los Angeles 17, Calif.—TECHNICIAN (Ask for No. 1-76)

Rauland HI-FI AMPLIFIER

Model 1520 DeLuxe Hi-Fi Amplifier, in a space saver cabinet 4-in. high, is finished in black with marbled gold effect. The 1520 has frequency response of ± 0.5 db, 20 to 40,000 cps. IM distortion is less than 2% at rated output. Other features include: 4 cross-over and 4 roll-off positions; loudness contour control; variable damping; rumble filter. Also included are two adjustments for balancing out hum. Rauland-Borg Corp., 3515 West Addison St., Chicago 18, Ill.—TECHNICIAN (Ask for No. 1-77)

New Products begin on pg. 38

Reps & Distributors

FRED HESS, Bradenton, Fla., has joined the staff of **PAUL HAYDEN ASSOC.** as Florida rep.

PYRAMID ELECTRIC CO. has announced the appointment of the **JERSEY ELECTRONIC SALES CO.** to handle industrial accounts in the metropolitan Northern New Jersey area.

SECO MFG. CO. announces the appointment of **TRINKLE SALES CO.**, Hatfield, Pa., and **JULES J. BRESSLER**, Union City, N. J. as new reps.

TELEX, INC., St. Paul, Minn., has named four new reps for its Electro-Acoustic Div. They are the **AL ENGLEMAN CO.**, Memphis, Tenn., **NEAL BEAR CORP.**, W. Richfield, Ohio; **FRANK C. NICKERSON CO.**, Atlanta, Ga.; and **NORTHPORT CO.**, St. Paul, Minn.

JERROLD ELECTRONICS CORP., Philadelphia, Pa., has appointed **C. P. SKENES** of Electronic Specialties Co., Washington, D.C. as jobber rep for the mid-Atlantic seaboard.

BURNELL & CO., INC., Yonkers, N. Y., has announced the appointment of **ARVIN BELL CO.**, Pasadena, Calif., as rep in that area.

CLEAR BEAM ANTENNA CORP. has appointed **F. W. MOULTHROP CO.**, San Francisco, as rep in northern California and Nevada, and added Utah to territory covered by **RICHARD LEGG**, and Ohio to **JACK RATHSBURG'S** territory.

REED MARSHALL announces opening an office as rep in Chicago, Ill., to serve the midwest area.

THE BUCKEYE CHAPTER of **THE REPRESENTATIVES** met at a cocktail party and dinner on Nov. 21 to hear the proposed new by-laws of the national association.

THE NEW ENGLAND CHAPTER of **THE REPRESENTATIVES** opened a membership drive at a dinner on Nov. 7.

ED NEMETH has opened a rep office to be known as **JERSEY ELECTRONIC SALES CO.** in East Paterson, N.J.

HOLLOWAY ELECTRONICS CORP., Ft. Lauderdale, Fla., announces the following rep appointments: **J. Y. SCHOONMAKER CO.**, Southwest; **JAMES R. NEFF**, Ind. and Ky; **ROBERT W. PETERS**, Ohio, Pa., W. Va.; **CARY CHAPMAN & CO.**, South; **J. K. ROSE & CO.**, Ill.; **ELECTRONICS PRODUCTS CO.**, Mich.; **NORMAN R. MacINNIS**, New England.

GENERAL TRANSISTOR CORP., Jamaica, N. Y., has appointed **JACK GEARTNER CO.**, Miami Beach, Fla., as rep for Florida and **S. W. GOODMAN CO.**, Baltimore, Md., for the mid-Atlantic seaboard.

IMPORTANT NOTICE: All jobbers, reps and manufacturers planning to attend the 1956 Electronic Parts Distributors Show, May 21-24, at Chicago's Conrad Hilton Hotel must register in advance by mail for all their personnel attending. *There will be no registration at the show.* Also, attendance will be policed to discourage badge-passing, and violators will be penalized. This new approach to admission control is designed

to make sure that only qualified people are present. Distributors and exhibitors should send their registrations in early. Address Radio Parts & Electronic Equipment Shows, Inc., Suite 1500, 11 S. La Salle St., Chicago 3, Ill.

JENSEN MFG. CO. has appointed the following wholesalers for its loud-speaker line: **SUEDENKUM ELECTRONIC SUPPLY CO.**, Cape Girardeau, Mo.; **HAMMOND ELECTRONICS, INC.**, Orlando, Fla.; **McCLUNG APPLIANCES**, Knoxville, Tenn.; **MILLERS RADIO & TELEVISION SUPPLY, INC.**, Oakland, Calif.; **VALLEY ENGINEERING CO.**, Los Alamos, N.M.; and **FAYSAN DISTRIBUTORS, INC.**, Buffalo, N.Y.



See*



See it on display on your service equipment distributor's counter.

See the most versatile assortment of tips ever . . . in new, handy, tubular container.

* Pick up the LUGER . . . try it for balance, ease of handling, compactness. Its twin-lamped, ventilated housing needs no stand.

No service kit complete without this fast-heating, flexible Esico LUGER . . . newest achievement in soldering guns!

FOR EVERY SERVICEMAN'S NEED . . .

Non-annealing, non-bending tip shapes and sizes for

- remote connections
- previously inaccessible chassis
- deep, confined assemblies
- long service and fast changing

FOR YOURSELF . . .

- ★ how light
- ★ how beautifully balanced
- ★ how easy to use

is this **NEW**



REG. U.S. PAT. OFF.



See it . . . GET YOURS today!

ELECTRIC SOLDERING IRON Co., Inc.

Famous for Quality Soldering Equipment Since 1927

ESICO

6455 W. Elm Street, Deep River, Connecticut

200 lbs. on a 10 ft. television mast



PERMA-TUBE supports it safely!

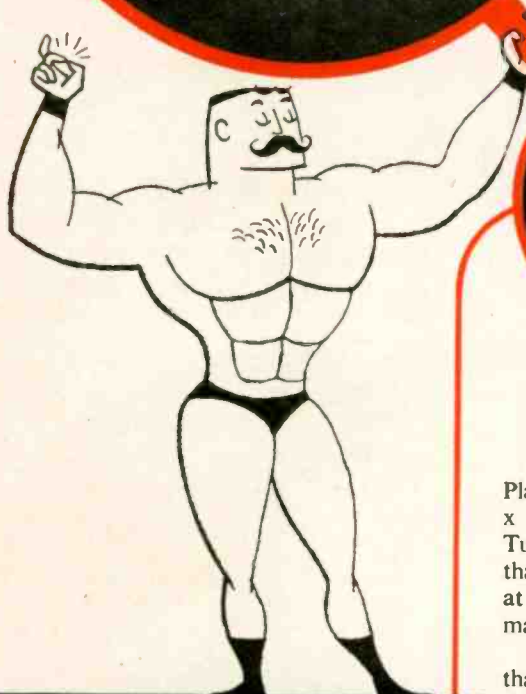

What about other masts either steel or aluminum?

MAKE THIS TEST YOURSELF

Place a 10 foot length of 1 1/4" x 16 gage (.065" wall) Perma-Tube between two tables so that 6 inches rests on a table at each end. Stand a 200 pound man at the center point.

What happens? Tests prove that Perma-Tube will support this 200 pound weight with a minimum of deflection and permanent set.

And, Perma-Tube *stays strong* because it is corrosion-proof (Perma-Tube is coated with a metallic vinyl-resin inside and out).

Other steels and the strongest grades of aluminum show serious degrees of permanent set. Why? Because they lack the special strength of J&L Steel that is used to make Perma-Tube Television Masts.

What PERMA-TUBE means to you

1. Protection for your work and your customers.
2. Freedom from damage due to storms or corrosion severe enough to destroy most other masts.
3. Better reception from the sets you install.
4. Insurance for your reputation.
5. Increased good-will and profits for you.

**J&L
STEEL**

Jones & Laughlin
STEEL CORPORATION - Pittsburgh

NEWCOMB AUDIO PRODUCTS CO. has announced the appointment of three new distributors to increase its country-wide distribution of Hi-Fi components. They are C & C RADIO SUPPLY CO., Tacoma, Wash., FAYSAN DIST., INC., Buffalo, N.Y., and SELECTRONIC SUPPLIES, INC., Peoria, Ill.

CBS-COLUMBIA has announced the appointments of SHOOK & FLETCHER SUPPLY CO. as distributor in the Birmingham, Ala. area and ALBERT J. MATHIAS & CO. as distributor for Phoenix, Ariz.

HOFFMAN ELECTRONICS CORP., Radio Div., has appointed the following new distributors: STACK ELECTRONICS, INC., Binghamton, N.Y., APPLIANCE MERCHANDISERS, INC., Boston, and GAUTREUX's ELECTRONICS SUPPLIES, INC., New Orleans.

ENTRON INC., Bladensburg, Md., has appointed ELECTROLINE TV EQUIPMENT, INC., Montreal, as distributor for eastern Canada.

U.S. RELAY CO., Los Angeles, has announced the appointment of WOODS AIRCRAFT SUPPLY, Burbank, as distributor.

JACK BERMAN CO., Los Angeles, Calif., gave a four-week course in selling to parts distributor salesmen.

ALMO RADIO CO., Philadelphia, Pa., is sponsoring a contest to find the most efficiently run service shop in its trading area. Winners will receive color test equipment.

RADIO SPECIALTIES CO., Detroit, Mich., has added a new fleet of trucks in a move to serve its increased dealer business.

MYSCOCK ELECTRONICS SUPPLY CO., INC., Buzzards Bay, Mass., has been franchised to handle Delco products for UNITED MOTOR SERVICE in the Cape Cod area.

PRECISION RADIO CO., LTD., Hawaii distributor for SYLVANIA, has begun construction of new modern quarters in Honolulu.

News of the Industry

ASTRON CORP., East Newark, announces the appointment of HERMAN C. BLOOM as assistant jobber sales manager . . . **ASTRON** initiated a conference with leading east coast manufacturers at which they discussed capacitor design and packaging for automatic assembly.

JERRY ROSE has been transferred from industrial to jobber sales for the PYRAMID ELECTRIC CO.

TECHNICIAN & Circuit Digests . . .

No. 1 publication in the TV-electronic service field!

1ST IN CIRCULATION

TECHNICIAN's unprecedented growth in paid circulation has reached an all-time high of 52,000* paid subscriptions as of the November, 1955 issue. This includes the largest paid serviceman circulation in the field. Servicemen also pay more for TECHNICIAN (\$4.00 per year) than any other service publication. None can match this growth, and in only two year's time.

* Unaudited paid circulation as of November, 1955 issue.

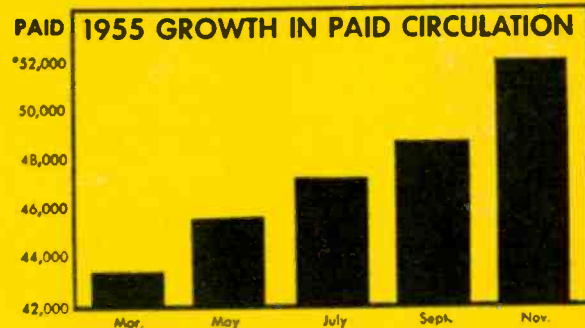

1ST IN EDITORIAL VOLUME

TECHNICIAN magazine provides the solid proof of editorial leadership inherent in its steadily growing paid circulation, coupled with more editorial pages on TV-electronic servicing and installation; editorial that puts power behind your advertising.

Publication	Total Editorial Pages January-November, 1955
TECHNICIAN	580.29
Publication B	516.33
Publication C	400.03
Publication D	391.50
Publication E	248.01

1ST IN ADVERTISING VALUE

TECHNICIAN's dominant position among the audited trade publications serving the industry is shown in the chart at the right. TECHNICIAN has the highest total and percentage of paid serviceman circulation to total paid circulation. Least waste circulation, too!

LOWEST IN ADVERTISING COSTS†

Based on the cost per 1,000 paid serviceman circulation, TECHNICIAN has the lowest advertising cost per thousand; \$12.79 to \$15.62 for its nearest competitor. TECHNICIAN gives you the most effective market penetration.

† Figures based on 12-page advertising rate.

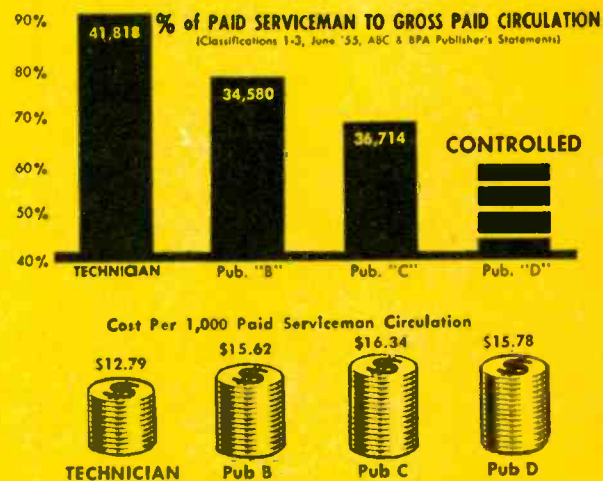

1ST TO CENSOR CUT-PRICE ADVERTISING

In order that branded products may be protected, all cut price advertising must first be submitted to TECHNICIAN for approval. Each ad is checked against TECHNICIAN's stringent standards. It is accepted only if it conforms to our requirements and if special permission has been obtained from the manufacturer whose products are to be featured.

When you seek increased sales in the \$2.1 billion TV-electronic service market, and preference for your product among service technicians . . . the facts show why TECHNICIAN is your best Ad buy! Make sure it's on your schedule for 1956.

CALDWELL-CLEMENTS, Inc., 480 Lexington Ave., N. Y. 17 • PLaza 9-7880
 Chicago: Caldwell-Clements, Inc., 201 N. Wells Street • RAndolph 6-9225
 Los Angeles: Chris Dunkle & Assoc., 3257 W. Sixth Street • DUnkirk 7-6149
 San Francisco: Chris Dunkle & Assoc., 3077 Turk Street • EXbrook 2-0377

TECHNICIAN
 & Circuit Digests



KESTER



Absolutely non-corrosive and non-conductive, KESTER "RESIN-FIVE" CORE SOLDER contains an activated type of resin that gives you that fast, positive action on all your jobs . . . including the most difficult.



KESTER SOLDER COMPANY
4264 Wrightwood Avenue • Chicago 39, Illinois
Newark 5, New Jersey • Brantford, Canada

SOLDER

TEST and REPAIR



CRT TUBES
RIGHT on the
JOB
WITH
CENTURY'S CRT
TESTIVATOR
MODEL 103 \$14.95
ONLY NET

New Profits! More Calls! Save Time! Save Trouble! Here is a key to a whole new field of profits for you. With the 103 CRT TESTIVATOR you can repair picture tubes right in the set in a matter of minutes. The TESTIVATOR TELLS YOU INSTANTLY where the trouble is and then fixes it! Here are some of the major advantages of the TESTIVATOR—It TESTS: Cathode emission. Shorts and leakage between elements. Open elements. Probable useful life of the tube. It REPAIRS: Activates the CRT cathode by removing surface contamination. Restores emission giving life to weak and dim tubes. Clears inter-element shorts and leakage. So easy to use . . . you just plug in, attach the TESTIVATOR socket to the base of the CRT and the accurate, easy-to-read indicators tell you what you must know. (Complete instructions with every unit.)

FREE BONUS OFFER—Order your 103 now and receive a handy, valuable booklet listing radio and TV tubes including CRT's which are interchangeable with no wiring changes. Another profit maker for you. Now you can always leave 'em with a picture. The TESTIVATOR IS MONEY BACK GUARANTEED.

NO RISK TRIAL ORDER COUPON

If Jobber is out of stock mail order to
Century Electronics Co., Dept. T-1
111 Roosevelt Ave., Mineola, N. Y.

Please send the Model 103 CRT TESTIVATOR on 10 day money-back guarantee.

Send Postpaid . . . I am enclosing full payment of \$14.95.

Send C.O.D. . . . I will pay \$14.95 plus postage.

Name

Address

City State

SAVE! We pay postage on all prepaid orders.

IMPORTANT NOTICE TO SUBSCRIBERS

Changes of address require four weeks' notice. Notify your Postmaster and TECHNICIAN Circulation Department at the earliest possible moment.

When ordering change, please INCLUDE IMPRINTED WRAPPER showing exactly how magazine is now addressed. This will enable us to put the change into effect with a minimum of delay.

E. H. APPLGATE has been named distributor sales manager of REGENCY DIV., I.D.E.A., INC.

WILBERT H. STEINKAMP has been appointed vice pres. in charge of sales for WESTON ELECTRICAL INSTRUMENT CORP.

ROBERT G. BEEBE has been named sales representative for the commercial sales dept. of THOMPSON PRODUCTS, INC.

THOMAS C. ANDERSON has been appointed district sales manager for the GENERAL ELECTRIC Tube Dept.'s distributor sales organization in the western regional office.

MARTY BETTAN has been appointed district sales manager in the five boroughs of New York City and Westchester County for CHANNEL MASTER CORP.

ARTHUR H. FORBES has been named assistant distributor sales manager for STANDARD COIL PRODS. CO.

HOWARD A. EHLE has been elected executive vice-president and JESSE MARSTEN senior vice-president of INTERNATIONAL RESISTANCE CO.

AMERICAN PHENOLIC CORP. has established two new positions in the distributor sales division under distributor sales manager R. E. Svoboda. Mr. R. F. Meinicke is now in charge of sales and promotion of all industrial components. Mr. JOHN UPP is in charge of TV accessory sales and promotion.

JOHN M. ENGLISBY has been appointed by RAYTHEON MFG. CO. as assistant district sales and service manager for its New York district.

JOHN D. VAN der VEER has been appointed general sales manager of TUNG-SOL ELECTRIC INC.

A P. R. MALLORY affiliate opened a \$2 million capacitor plant, to be known as P. R. MALLORY, (HUNTSVILLE) INC., in Huntsville, Ala. for the production of electrolytic capacitors.

PYRAMID ELECTRIC CO. was honored with a merit award by a national magazine in the investment field for its "excellence" in "content, typography and format" in the 1954 annual report to shareholders of the company.

The advertising and merchandising campaign for the new THOMPSON PRODUCTS' Automatic Superotor antenna rotator was announced recently to members of the RADIO PARTS CO., Pittsburgh, at a luncheon meeting held at the Park Schenley.

KENWOOD ENGINEERING CO., INC., Kenilworth, N. J., was recently issued a patent on its mount known as KENCO Parapet Mount, Model No. 106, which is designed to take antenna masts up to 1½" in dia. and can be used on walls up to 13½" thick.

1955 TV-Electronic Industry Statistics

TELEVISION

New set sales	7,800,000
\$ volume at retail	\$1,396,200,000
Discount to dealer from list	27%
Avg. trade-in allowance	\$34
Avg. age of trade-in	6 yrs.
Sets scrapped	1,400,000

TELEVISION SETS IN USE

U.S. homes* with sets	34,700,000
Secondary sets in above homes	2,300,000
Sets in business places, institutions	2,400,000
Total TV sets in U.S.	39,400,000

RADIO

New set sales	12,500,000
\$ volume at retail	\$485,000,000

RADIO SETS IN USE

U.S. homes* with sets	52,000,000
Secondary sets in above homes	40,500,000
Sets in business places, institutions	10,000,000
Automobile sets	35,700,000
Total radio sets in U.S.	138,200,000

* Includes all dwellings such as apartment hotels, etc.

ANNUAL RETAIL BILL FOR SERVICING

150,000,000 replacement receiving tubes	\$ 255,000,000
2,800,000 replacement picture tubes	\$ 100,000,000
Antennas, components, parts, instruments	\$ 620,000,000
Labor	\$ 825,000,000
Total servicing bill	\$1,800,000,000

TV-ELECTRONIC TECHNICIANS

Major service outlets	60,000
Typical bill for a single job	\$17.85
Parts jobber business accounted for	70%
Median weekly income	\$80
Average work week	50 hrs.

TUBES MANUFACTURED

Picture Tubes

Number made	10,600,000
Total manufacturer value	\$220,000,000
% used for replacement	26.4%
Sizes	19-21 in. 78%
.....	16-18 in. 18%
.....	All other 4%

Receiving Tubes

Number made	425,000,000
Total manufacturer value	\$300,000,000
% used for replacement	35.3%

TELEVISION STATISTICS 1946-1955

Year	Sets Manufactured	Total Sets in Use	TV Stations on Air
1946	10,000	8,000	5
1947	250,000	230,000	20
1948	1,000,000	1,000,000	44
1949	3,000,000	3,800,000	100
1950	7,500,000	10,500,000	107
1951	5,600,000	15,750,000	108
1952	6,300,000	21,800,000	123
1953	7,300,000	28,000,000	350
1954	7,300,000	33,000,000	415
1955	7,800,000**	39,400,000	465

**Estimated retail sales including carryovers.

at your fingertips...

CLEAR BEAM'S

5

**"EASY WAY" ANSWERS
FOR TOUGH FRINGE
INSTALLATIONS!**

**B CLEAR ANTENNA CORP.
BEAM**

CANOGA PARK, CALIF • CHICAGO, ILL.

Your Clear Beam distributor has all 5 antennas — contact him today!

It's an established fact (and you know it, too) that no one antenna can lick every fringe area problem

In view of this, Clear Beam manufactures five different types of fringe antennas — each tops in its field!

All five Clear Beam fringe antennas provide easy installation, improved picture quality and happy customers.

One of the five is the tailor-made answer to your installation headaches — and a faster way to higher profits!

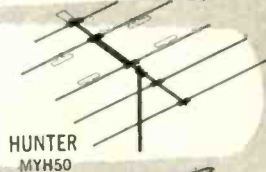
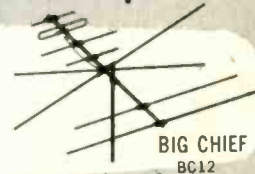
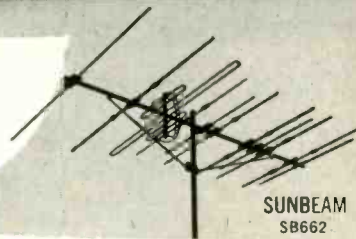

All From One Source

These four quality lines of Electronic Components may be obtained quickly and conveniently from Distributors who stock ERIE RESISTOR CORPORATION products.



ERIE Electronic Components enjoy the reputation of having the highest quality and make up the most complete line of Ceramic Replacement Capacitors. Distributor Stock items are representative of the most common types used by dealers, servicemen, experimenters, amateurs, laboratories, project engineers, and industrials.



CORNING Glass Electronic Components include the complete line of Fixed Glass Capacitors, Direct Traverse and Midget Rotary Glass Trimmer Capacitors, and various types of Low Power, Precision and High Power Glass Resistors.



ERIE-Chemelec Teflon Electronic Components are made of the most nearly perfect insulating material available, and are ideally suited to withstand high humidity, high or low temperatures, high altitudes, high voltages, and high frequency operation. It is serviceable at any temperature from -110° to 550°F for long periods with negligible change in critical electrical characteristics.



GRIGSBY-ALLISON Switches are known throughout the industry for dependable quality and smooth performance. They include a complete variety of styles for all types of applications.

ORDER NOW
From Your
ERIE
DISTRIBUTOR



ERIE ELECTRONICS DISTRIBUTOR DIVISION
ERIE RESISTOR CORPORATION
Main Offices: ERIE, PA.
Factories: ERIE, PA. • LONDON, ENGLAND • TRENTON, ONTARIO

DAVID T. SCHULTZ, currently senior vice-president and treasurer of Raytheon Manufacturing Co., will succeed Dr. Allen B. DuMont on Jan. 3, 1956 as president of Allen B. DuMont Labs., Inc. The election of Mr. Schultz is a step taken as part of a plan, voted by stockholders in Oct., to separate broadcasting from manufacturing operations, to change the corporate and capital structure, and to revitalize management.



David T. Schultz, Du Mont Labs' new president

JFD MFG. CO., INC., Brooklyn, N. Y., recently announced the opening of a Canadian manufacturing and sales division called JFD Canada, Ltd, located at 51 McCormack St., Toronto 14, Ontario.

BRUCE VINKEMULDER has been appointed distributor sales manager for CENTRALAB, div. of GLOBE-UNION INC.

for service and lab. work

Heathkit

PRINTED CIRCUIT

OSCILLOSCOPE KIT

FOR COLOR TV!

① Check the outstanding engineering design of this modern printed circuit Scope. Designed for color TV work, ideal for critical Laboratory applications. Frequency response essentially flat from 5 cycles to 5 Mc down only $1\frac{1}{2}$ db at 3.58 Mc (TV color burst sync frequency). Down only 5 db at 5 Mc. New sweep generator 20-500,000 cycles, 5 times the range usually offered. Will sync wave form display up to 5 Mc and better. Printed circuit boards stabilize performance specifications and cut assembly time in half. Formerly available only in costly Lab type Scope. Features horizontal trace expansion for observation of pulse detail — retrace blanking amplifier — voltage regulated power supply — 3 step frequency compensated vertical input — low capacity nylon bushings on panel terminals — plus a host of other fine features. Combines peak performance and fine engineering features with low kit cost!

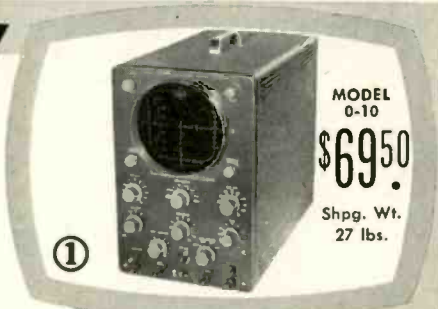

MODEL
0-10

\$69.50

Shpg. Wt.
27 lbs.

Heathkit TV

SWEEP GENERATOR KIT

ELECTRONIC SWEEP SYSTEM

② A new Heathkit sweep generator covering all frequencies encountered in TV service work (color or monochrome). FM frequencies too! 4 Mc — 220 Mc on fundamentals, harmonics up to 880 Mc. Smoothly controllable all-electronic sweep system. Nothing mechanical to vibrate or wear out. Crystal controlled 4.5 Mc fixed marker and separate variable marker 19-60 Mc on fundamentals and 57-180 Mc on calibrated harmonics. Plug-in crystal included. Blanking and phasing controls — automatic constant amplitude output circuit — efficient attenuation — maximum RF output well over .1 volt — vastly improved linearity. Easily your best buy in sweep generators.



MODEL
TS-4

\$49.50

Shpg. Wt.
16 lbs.



Heath
COMPANY
A SUBSIDIARY OF DAYSTROM, INC.
BENTON HARBOR 18, MICH.

WRITE FOR FREE CATALOG
... COMPLETE INFORMATION

Let's Look at Circuits

(Continued from page 32)

What the control does is to provide a small positive "bucking" voltage to the first grid, biasing it at the optimum point with respect to tube cutoff for a particular installation. The large resistance, R1, is put in the circuit as a safety device. It prevents an excessive positive voltage from damaging the grid if control R2 is improperly adjusted. In some designs a local-distant or area switch is used instead of the variable control. This switch will generally provide a choice of resistance values and, at the same time, adjust the agc system.

The pentagrid tube used in the sync-noise inverter circuit is often the familiar 6BE6, more commonly found in AM or FM converter service. More recent designs employ the more recently developed 6CS6, which has been tailored for this application. •

Small Shop

(Continued from page 30)

right out and have some made up now. They can be placed in drug stores, grocery stores and other shops where you can get permission to put them up. Unless you are a skillful sign painter yourself, you are better off spending a few dollars for professional-looking signs than trying to "do it yourself" outside of your own field. Initial cost for this type of advertising may seem high. However, if you budget $\frac{1}{2}$ of the total cost each month for a year (based on the intention of keeping a sign working for you in a particular place for a year), the amount is reasonable.

Handbill for New Accounts

In getting new clients, the author has found that door-to-door handouts serve him best. Post-card size (3 in. by 5 in.) handbills have served well for this purpose. At first, these cards were printed up on one side only, with the service "message." This brought in only one new customer in the first week after 100 cards were distributed. Some reconsideration of the method produced an interesting conclusion: most recipients were not in need of service at the time they received the card—and they were probably not saving the card for future reference. To get them to keep the card, you have to put something else of value on it. Using a calendar for your message helps. A weekly breakdown of TV program listings for local channels is a valuable addition to your handout. The item that seems to have the greatest attraction is the one shown in the accompanying illustration.

Everyone who owns a TV set expects at one time or another he may have trouble. When that happens, it is quite natural that he will want to make some checks himself, without necessarily trying to "do it himself," before he calls in the service technician. If you give this person some valid tips on what he can attempt himself—and on what he ought not to attempt—it will induce him to hold on to the card. It can also save you many "nuisance" calls.

To sum up, regard the price of advertising as one of the necessary costs of doing business. A well planned program can boost your business and keep your list of active customers up to the peak that you can profitably handle. •



HAVE YOU
HEARD that
our distributors
will allow you
10c credit

for each replaced

selenium rectifier

returned —

regardless of make?

The selenium situation is critical, and reclamation is necessary to meet civilian, as well as military requirements. You can help by returning every replaced selenium rectifier to your distributor for credit.

Sarkes Tarzian, Inc., RECTIFIER DIVISION 415 N. COLLEGE AVE.
BLOOMINGTON, INDIANA

In Canada: 700 Weston Rd., Toronto 9, Tel. Murray 7535

Export: Ad Auricma, Inc., New York City

Merit

FIRST IN EXACT REPLACEMENT.

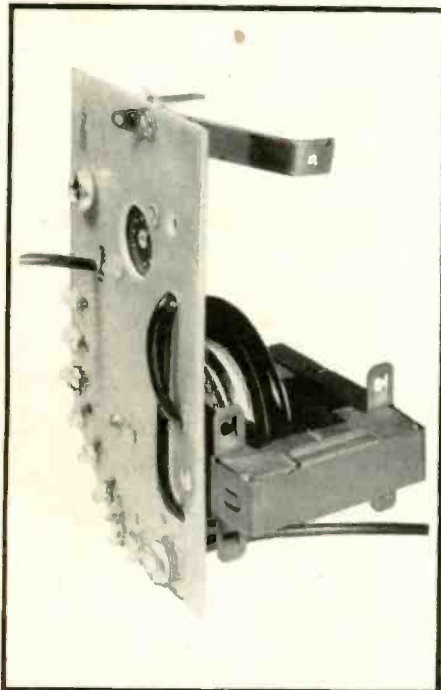

HVO-50 FOR EXACT REPLACEMENT in over 75 TRAV-LER models and chassis. Another in the complete Merit line of exact and universal transformers, yokes and coils. Merit is the only manufacturer of transformers, yokes and coils who has complete production facilities for all parts sold under their brand name.

Merit

MERIT COIL & TRANSFORMER COMPANY
4427 N. CLARK ST., CHICAGO 40, ILL.

Catalogs & Bulletins

ANTENNAS: Data sheets describe performance of new antennas designed for use in metropolitan to maximum fringe areas. The Finney Co., 4612 St. Clair Ave., Cleveland 3, Ohio (Ask for B1-1)

ELECTRONIC KITS: 50-page booklet on easy-to-build test instruments, amateur radio and hi-fi equipment. Heath Co., Benton Harbor, Mich. (Ask for B1-2)

TUBE REPLACEMENT: 2-color charts list every popular type of picture tube plus corresponding Haydu replacement tube type and its description. Available from distributors. Sales Department, Haydu Bros., Plainfield, N. J. (Ask for B1-4)

COMMUNICATION ANTENNAS: Catalog 54-295 highlights major antennas manufactured for mobile radios and amateur use. Ward Products Corp., Ashtabula, Ohio (Ask for B1-7)

TEST EQUIPMENT: Catalog 120 features major pieces of test equipment for radio, black-and-white and color TV. Triplett Electrical Instrument Co., Bluffton, Ohio (Ask for B1-8)

TRANSFORMERS: 34-page booklet describes transformers, reactors, high-q coils and filters. United Transformer Co., 150 Varick St., New York 13, N. Y. (Ask for B1-9)

TUBES: Supplement to Sylvania Technical Manual describes types 6BE8, 5BE8 and picture tube 24YP4. Sylvania Electric, Emporium, Pa., (Ask for B1-10)

DEPOSITED-CARBON RESISTORS: Comprehensive data on tests, applications, performance, etc., with detailed charts and graphs. International Resistance Co., 401 N. Broad St., Philadelphia 8, Pa. (Ask for B1-11)

RESISTORS: Bulletin 147 gives specifications and features of new small wire-wound, vitreous-enameled resistors with axial leads. Stock catalog 24 lists rheostats, potentiometers, resistors, tap switches, chokes, etc. Ohmite Mfg. Co., Ave., Long Island City, N. Y. (Ask for B1-12)

MICROPHONES: Catalog 120 gives detailed information on professional microphones for television and broadcast applications. Electro-Voice, Inc., Buchanan, Mich. (Ask for B1-13)

AUDIO: Guide containing most recent needle to cartridge to phonograph data with comprehensive cross reference chart. Recoton Corp., 52-35 Barnett Ave., Long Island City, N. Y. (Ask for B1-14)

SWEEP AND MARKER GENERATORS: Catalog 5A describes generators and color test instrument. Telonic Industries, 73 N. Second Ave., Beech Grove, Ind. (Ask for B1-15)

Problem:

2 TV Sets
1 Antenna

Answer:



2-SET COUPLER

Model TV-42
Approved for Color TV
UHF, VHF and FM



Cost: ONLY \$2⁹⁵ LIST

Features:

- Matched resistive circuit
- Flat response — 0 to 900 megacycles
- 12db inter-set isolation
- Easy to install
- Couples 2 TV sets without ghost or smear

Application:

In class A signal areas the B-T 2-Set Coupler provides the ideal low cost solution to the problem of operating two receivers from one antenna. There are other applications. For example, the TV-42 can couple a TV set and FM receiver to one antenna—or it can be used, in reverse, to couple or mix 2 antennas to one receiver.

Write for FREE BOOKLET—"TV for 2 or 3... or More"
Covers all types of Multiple TV Systems

Sold by Radio-TV Parts Distributors and Jobbers

BLONDER-TONGUE LABORATORIES, INC.

Dept. LA-18 Westfield, New Jersey



Manufacturers of TV Cameras,
TV Amplifiers, Boosters,
UHF Converters, TV Accessories
and Originators of the Masterline
and 'Add-A-Unit' Master TV Systems.

INTRODUCING YOUR NEW PROFIT MAKER

SAVE SERVICE TIME SELL MORE TUBES

MODEL GCT-5

SECO

GRID-CIRCUIT TUBE TESTER

\$29⁹⁵ Slightly higher West

Now quickly and accurately detect "positive grid" conditions in amplifier tubes used in circuits employing a high value of grid return resistance. **EXCLUSIVE!**



"HARD TO FIND" TV TUBE FAULTS LOCATED FAST!

- Poor picture contrast
- Grainy picture
- Twisting, bending or pulling of the picture
- AGC, RF, IF and Sync. Group tube faults
- Vertical jitter or bounce
- Sync. Buzz in the sound
- Any or all symptoms caused by sync. pulse compression.

Stop guessing and substitution checking, test and sell tubes with conviction on the first call, avoid embarrassing and costly callbacks.

Filament Selector Switch accommodates all the latest tubes for TV and INDUSTRIAL uses.



Another Seco Exclusive!
FLY BACK INTERVAL & INDUCTANCE ANALYZER

Checks horizontal circuits without disconnecting!

For specialized applications to meet your specific need, contact:



SECO MFG. CO.
5015 Penn Ave. So.
Minneapolis, Minn.

TEST EQUIPMENT: Catalog sheets describe vtvm, oscilloscope, generator, counter unit, radiometer. Hycon Mfg. Co., 2961 E. Colorado St., Pasadena 8, Calif. (Ask for B1-23)

VIBRATOR REPLACEMENT: Chart gives complete set model number, replacement vibrator data, buffer value and circuit information. James Vibrapowr Co., 4050 N. Rockwell, Chicago, Ill. (Ask for B1-24)

HI TEMPERATURE RECTIFIERS: Bulletin HT-1 shows ratings and characteristics of new high temperature selenium rectifiers. Sarkes Tarzian, Inc., Rectifier Division, 415 N. College Ave., Bloomington, Ind. (Ask for B1-25)

TEST EQUIPMENT: Catalog 139 describes latest instruments and includes some lower prices on several models. Radio City Products Co., Inc., Centre & Glendale Sts., Easton, Pa. (Ask for B1-26)

ELECTRONIC SUPPLIES: 1956 catalog from parts distributor. 224 pages. Radio Shack Corp., 167 Washington St., Boston 8, Mass. (Ask for B1-27)

CATHODE REJUVENATOR TESTOR: Bulletin 104 gives information on CRT Deluxe Model 400 and Economy Model 200. B&K Mfg. Co., 3726 N. Southport Ave., Chicago 13, Ill. (Ask for B1-17)

RECTIFIERS: 3 catalogs are offered, "Federal Germanium Diffused Junction Power Rectifiers," "Federal Diffused Junction Power Stacks" (1/3 smaller than existing types), and "Federal Selenium Rectifier Design Data Guide." Components Div., Federal Telephone & Radio Co., 100 Kingsland Rd., Clifton, N. J. (Ask for B1-18)

REPLACEMENT TRANSFORMERS: Catalog classifies complete line of TV replacement transformers plus others for amateur, hi-fi hobbyist or industrial user. Dept. G-25, Gramer-Halldorson Transformer Corp., 2734 N. Pulaski Rd., Chicago 39, Ill. (Ask for B1-19)

GENERAL CATALOG: 128 pages list over 26,000 items including hi-fi systems and components, TV chassis etc., phonographs, recording and public address equipment, amateur gear, tools, hardware, kits and books. Allied Radio Corp., 100 N. Western Ave., Chicago 80, Ill. (Ask for B1-20)

CONTROL GUIDE: Supplement sheets to Control Guide No. 14. Centralab, Div. Globe-Union Inc., 900 E. Keefe Ave., Milwaukee 1, Wisc. (Ask for B1-21)

REPLACEMENT GUIDES: Complete new replacement guides for the Philco and Admiral lines. Todd-Tran Corp., 156 Gramatan Ave., Mount Vernon, N. Y. (Ask for B1-22)

MOUNT & ACCESSORIES: 16-page catalog listing mounts, brackets, clamps, etc. with 4 pages devoted to new products. Kenwood Engineering Co., Inc., Kenilworth, N. J. (Ask for B1-5)



anything to trade?

As a subscriber* to the CORNELL-DUBILIER monthly magazine "THE CAPACITOR" you can use its famous "TRADING POST" section to run an advertisement* to SELL-SWAP-OR BUY all sorts of electronic equipment and services helpful to you in your business.

*NO CHARGE FOR THE AD!

*NO CHARGE FOR THE SUBSCRIPTION!
"THE CAPACITOR" comes prepaid direct to your home every month—12 times a year. 16 to 24 pages, including full technical or constructional article.

A service of
CORNELL-DUBILIER
world's largest manufacturers of capacitors

FREE EVERY MONTH

Just fill in coupon below and mail today. Our new subscription list limited so get your request in now!

Editor—"The Capacitor"
CORNELL-DUBILIER ELECTRIC CORP.
Dept. RT-16, South Plainfield, N. J.

Yes Sir! Put me down for a FREE Subscription to Cornell-Dubilier's "THE CAPACITOR"

name _____ please print

address (home) _____

city _____ zone _____ state _____

my occupation or job title is _____

New Books

CIRCUIT ANALYSIS BY LABORATORY METHODS. By C. E. Skroder and M. S. Helm. Published by Prentice-Hall, Inc., Publishers, 70 Fifth Ave., New York 11, N.Y. 376 pp. Hard cover. \$5.75.

This book has been written primarily as a guide for a lab course in electrical circuits for students who are also taking a theory course in ac-dc circuits, or already have such a background. It is replete with practical lab projects and experiments relating to measuring equipment—such as the various meters and oscillographs—and measurement techniques for the various properties of all types of circuits. Aimed specifically at the student on the engineering level, there is a wealth of information for the well grounded technician who seeks advanced information.

COLOR TELEVISION RECEIVER PRACTICES. By Hazeltine Corp. Laboratories Staff. Published by John F. Rider Publisher, Inc., 480 Canal St., New York 13, N.Y. 208 pp. Paper cover, \$4.50; hard cover, \$6.00.

While this is not the first volume to appear on color TV receiver circuits, it is a conscientious attempt to bring the reader up to date on the various methods used at the receiving end for processing and utilizing the information in the transmitted color signal. There is the necessary introduction to the principles of color TV and nature of the color signal. This is followed by a discussion of the various display devices in use and development, with emphasis on the currently popular 3-gun shadow-mask tube. Also discussed are the single-gun color-grid tube, the 3-tube direct-view display using dichroic mirrors, and the 3-tube projection arrangement. Signal decoding and receiver color synchronization circuits are also described.

FREQUENCY MODULATION (Review Series). By Alexander Schure. Published by John F. Rider Publisher, Inc., 480 Canal St., New York 13, N.Y. 48 pp. Paper cover. \$0.90.

The fundamental concept of modulating the frequency rather than the amplitude of a carrier is presented, followed by presentation of methods for producing this type of modulation, including phase-modulation techniques. The problems of propagation and reception are also treated.

SHOOT TV AND RADIO TROUBLE FAST. Prepared and published by Harry G. Cisin, Amagansett, N.Y. 40 pages. Paper cover. \$1.50.

Rapid checking of electronic troubles by symptom and source are detailed. Over 50 ac-dc radio symptoms and many TV symptoms in 11 classifications are given. Some 69 rapid circuit checks are also described, plus a short section on servicing printed circuits.

MR. SERVICEMAN:

These testers, in local stores, give you:

- FREE ADVERTISING
- UNHEARD OF TUBE SALES
- PROFITABLE SERVICE CALLS

When these testers BEAR YOUR NAME Your salesmen NEVER SLEEP

Put testers, with tubes, in DRUG, FOOD & DIME STORES

Your tube sales and service dollars WILL DOUBLE

Write for Details

DISTRIBUTOR INQUIRIES INVITED.

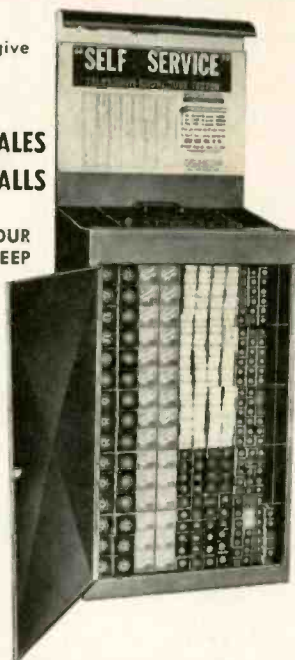

Developed and Manufactured by

AMERICAN SCIENTIFIC DEVELOPEMENT CO.

334-336 S. Main St., Ft. Atkinson, Wisc.

HUSH

Reg. U.S. Pat. Off.

Chemically engineered for tuners and switching mechanism



6 oz. Spray can

\$2.25 net

Hush comes in a 6 oz. pressure can with sufficient pressure to reach all contacts to wash-away that dirt, leaving clean and positive contacts, protected with a lasting lubricant film. Hush does not affect inductance, capacitance or resistance.

Hush also available in 2 oz., 8 oz. and 32 oz. containers. Hush is liability insured.

See your distributor or write to

CHEMICAL ELECTRONIC ENGINEERING, INC.

Matawan, N. J.



"I had a terrible night last night—dreamt we were out of JENSEN NEEDLES."

HAVE YOU SEEN
VOLTA-CHEK

PICTURE TUBE
VOLTAGE TESTER

SIMULTANEOUSLY TESTS
ALL VOLTAGES
OF THE CATHODE RAY TUBE
ELIMINATES GUESS WORK

SMALL
COMPACT
ELECTRONICALLY
ACCURATE
EASY-TO-USE



SEE YOUR DISTRIBUTOR or WRITE
ELECTRONIC

TEST

INSTRUMENT
CORPORATION

13224 IVERNOIS AVE., DETROIT, MICH.
VOLTA-CHEK MADE BY MAKERS OF THE
NATIONALLY ACCEPTED VITAMETER

CLOSING DATES FOR

TECHNICIAN
& Circuit Digests

- 1st of preceding month for all ads requiring proofs, composition, foundry work, key changes, etc.
- 10th of preceding month for complete plates only—no setting.
- 1st of month—Publication Date. Cancellations not accepted after 1st of preceding month.

CALDWELL-CLEMENTS, INC.

480 Lexington Avenue, New York 17

ADVERTISERS INDEX

JANUARY 1956

Allied Radio Corporation	63
American Scientific Development Co. 62	
Blonder-Tongue Laboratories, Inc. . . .	60
Caldwell-Clements, Inc.	55
CBS-Hytron, Div. of Columbia Broadcasting System, Inc.	3
Centralab, A Div. of Globe-Union, Inc. 46	
Century Electronics Co.	56
Channel Master Corp.	4, 5
Chemical Electronic Engineering, Inc. . 62	
Clear Beam Antenna Corp.	57
Cornell-Dubilier Electric Corp.	2, 61
Crown Controls Co., Inc.	49
DuMont Laboratories, Inc., Allen B. . .	33
Electric Soldering Iron Co., Inc.	53
Electronic Test Instrument Corp.	63
Erie Resistor Corporation	58
Federal Telephone & Radio Company 11	
General Dry Batteries, Inc.	12
Heath Company	58
Hickok Electrical Instrument Co., The . 42	
International Resistance Co.	Cover 2
JFD Manufacturing Co., Inc.	9
Jensen Industries, Inc.	62
Jones & Laughlin Steel Corp.	54
Kester Solder Company	56
Littelfuse, Inc.	64
Mallory & Co., Inc., P. R.	44, 45
Merit Coil & Transformer Co.	60
Moss Electronic Dist. Co., Inc.	13
Pyramid Electric Company	31
Quam-Nichols Company	52
Radiart Corp., The	2
Radio Corp. of America . 10, 37, Cover 4	
Raytheon Manufacturing Co.	14
Rider Publications	6
Rohn Manufacturing Company	51
Sarkes, Tarzian, Inc., Rectifier Div. . .	59
Seco Manufacturing Co.	61
Simpson Electric Co.	40
Snyder Manufacturing Co.	47
Sprague Products Co.	Cover 3
Thompson Products, Inc.	7
Todd-Tran Corp.	63
Trio Manufacturing Co.	43
Utah Radio Products Co., Inc.	35
Westinghouse Electric Corp.	8
Winegard Company	39

While every precaution is taken to insure accuracy, we cannot guarantee against the possibility of an occasional change or omission in the preparation of this index.

Since 1933

Authentic Replacements for Television . . .

all leading makes and models

.....

AUTHENTIC REPLACEMENT IS

- Always Right
- Easier to install
- Cuts service time
- Increases service profits

SERVICEMEN!
Write Dept. TF for service hints. What are your problems?

Quality Controlled

Todd

TODD-TRAN CORP.
MOUNT VERNON, NEW YORK

save up to **70%**
BUILD YOUR OWN

knight-kit CAPACITOR CHECKER KIT

Save time & trouble

Only **\$11.65**

Tests capacitors while they are still wired in the circuit! Just press a button and the "magic eye" instantly shows opens and shorts. Checks by-pass, blocking, coupling and filter condensers from 20 mmf to 2000 mfd, even when the capacitor under test is wired with a resistance as low as 60 ohms. Capacitors between .1 mfd and 2000 mfd may be tested even when in parallel with resistance as low as 2 ohms. Housed in the professionally styled Knight-Kit case. Complete kit, ready for easy assembly. Shpg. wt., 5 lbs. Model F-119. Capacitor Checker Kit. Buy Direct and Save. Only **\$11.65**

FREE Send for our 324-page catalog

Lists dozens of other low cost quality Knight-Kit test instruments, plus the world's largest selections of parts and equipment for the Service Technician. Write for FREE copy.

ALLIED RADIO

ALLIED RADIO, Dept. 25-A-6,
100 N. Western Ave., Chicago 80, Ill.

Send Kit described above. \$..... encl.
 Send Free 324-Page ALLIED Catalog.

Name.....
Address.....

WHAT'S IN A FUSE?

Only a fuse element, glass & caps?

No! Every fuse carries
with it the skill and quality of its manufacturer.

You can't reach out and touch or taste this,
you can't even be sure it will do
its job when needed except
by purchasing from a company
that has the know how of 25 years
of manufacturing fine fuses.

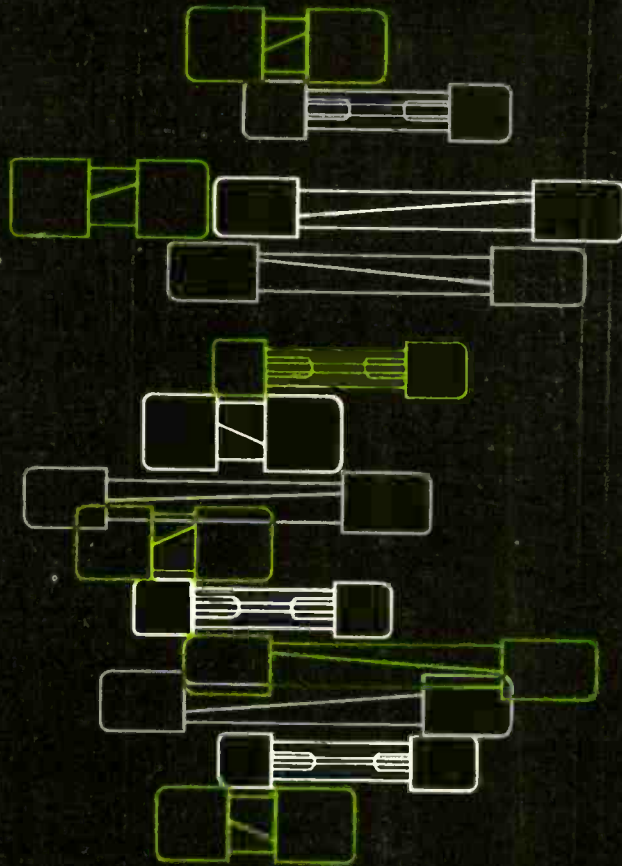

BURTON BROWNE ADVERTISING

LITTELFUSE

1865 Miner Street · Des Plaines, Illinois

capacitor replacements

FOR SETS OF THE MONTH

CAPEHART CHASSIS CX-385

Symbol No.	Rating μF @ WVDC	Capehart Part No.	Sprague Replacement
C703	50+40+20@350/100@50	850352A-1	R-2178
C704	50+30@350/8@250/20@200	850352A-2	R-2179

FADA CHASSIS 400

Symbol No.	Rating μF @ WVDC	Fada Part No.	Sprague Replacement
C47	1@150	22.70	R-1991
C52	25@50	22.66	TVA-1306
C75	50@450/80+10@350	22.101	R-2180
C76	40+10@450/40@350/100@50	22.102	TVL-4747

GENERAL ELECTRIC "O" LINE

Symbol No.	Rating μF @ WVDC	G. E. Part No.	Sprague Replacement
C312	10@25	RCE-192	TVA-1204
C401	90+40@350/50@25	RCE-210	R-2181
C402	30+30@350/50@300/100@75	RCE-211	R-2182
C402*	90+40+30+30@350	RCE-220	R-2183

* Used in Later Production

HALLICRAFTERS CHASSIS A2000D, B2000D, C2000D, D2000D

Symbol No.	Rating μF @ WVDC	Hallcrafters Part No.	Sprague Replacement
C145	20@450	45B261	TVA-1709
C149	200@150	45B265	R-1467
C109	100+10@300/20@25	45-328	R-2184
C110			
C151			
C150			
C128	140+4@300/50+4@150	45-327	R-2185
C144			
C138			

RAYTHEON CHASSIS

21T40, 21T41, 21T43, 21T44, 21T45, 21T46

Symbol No.	Rating μF @ WVDC	Raytheon Part No.	Sprague Replacement
C219	10+10@350/50@50	8C-25308	TVL-3749
C224	50@350	8C-25532	TVA-1713
C231	5@50	8C-20557	TVA-1303
C504	150@150	8C-22463	TVL-1430
C505	150@150	8C-22464	TVL-1430
C616	5@300	8C-24174	TVA-1601

DUMONT CHASSIS RA340/341, RA-342/343

Symbol No.	Rating μF @ WVDC	Dumont Part No.	Sprague Replacement
C301	5@100	03138362	TVA-1402
C302	80+20+10@400/100@50	03151429	R-2177
C303	90+40+10@400/40@25	03151428	R-2176

SPRAGUE "T-C" RULE



Use this handy pocket-size Sprague Temperature Coefficient Rule to find quickly the values of stock N750 and NPO type ceramic capacitors to connect in parallel to equal a capacitor of desired intermediate temperature coefficient of the required capacitance.

COLOR CODE CHARTS

Complete charts for color codes on all types of ceramic capacitors are on the back face of this rule.

Get your Sprague "T-C" Rules now from your Sprague distributor, or directly from Sprague Products Company, 65 Marshall Street, North Adams, Massachusetts. Only 15c each.

Sprague makes more capacitors . . . in more types . . . in more ratings . . . than any other capacitor manufacturer. Send 10¢ for the 65-page giant seventh edition TV Replacement Manual to Sprague Products Co., 65 Marshall St., North Adams, Mass., or get it FREE from your Sprague distributor.

DON'T BE VAGUE...INSIST ON

SPRAGUE

(Distributors' Div. of the Sprague Electric Co.)

Your Pledge to Mr. and Mrs. America

...TO GAIN CONSUMER CONFIDENCE

...TO BUILD BETTER BUSINESS

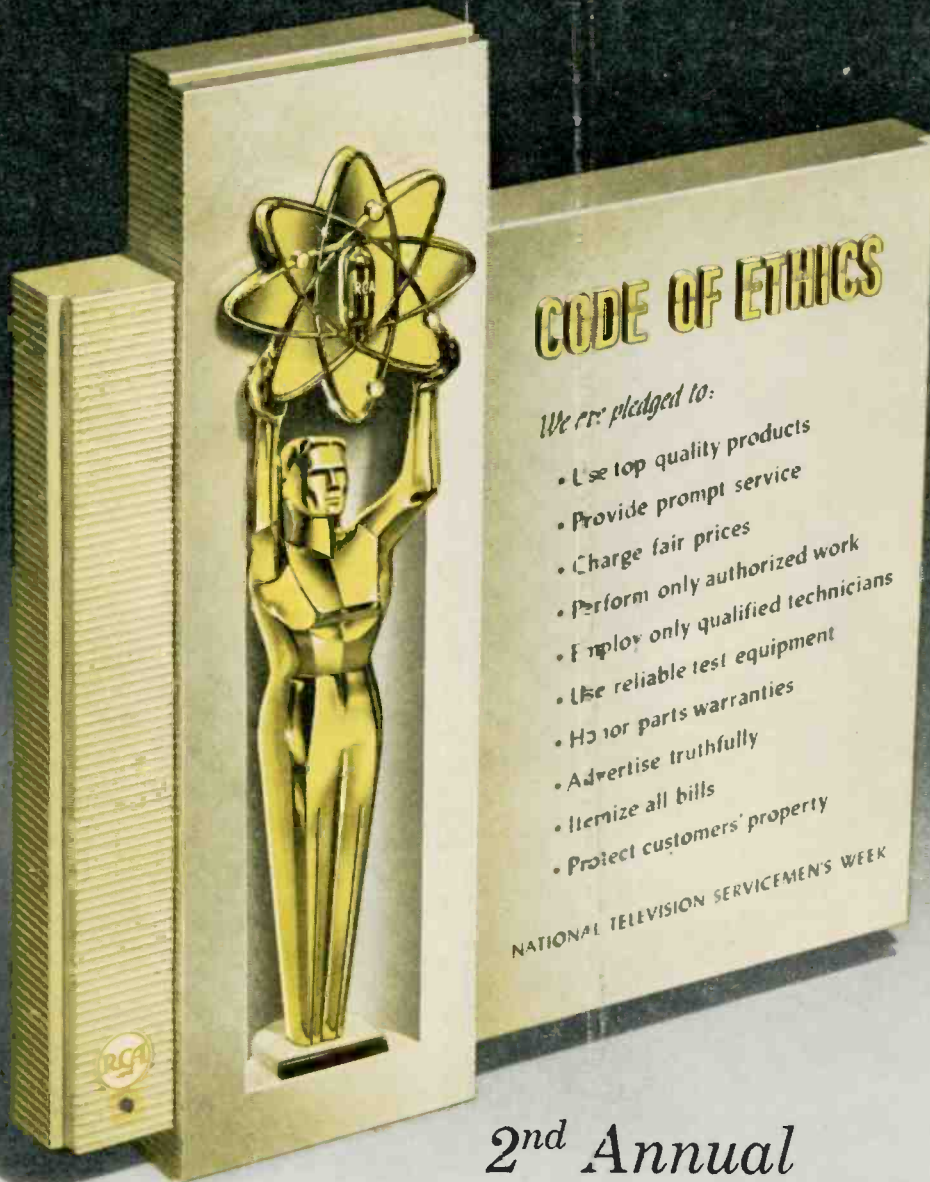

2nd Annual National Television Servicemen's Week

MARCH 5th — MARCH 10th, 1956

You, and thousands of your fellow TV Service Technicians, can proudly display this handsome "Code of Ethics" plaque in your store window, on your shop wall or counter... wherever you have the opportunity to make a consumer impression.

Designed and created by RCA on behalf of the 2nd Annual National Television Servicemen's Week, this striking symbol will help you foster lasting respect, enduring prestige, and continuing good will. And what a celebration this year's "week" will be!

Color pages in LIFE and TV GUIDE, network radio and TV spectaculars, newspaper ads, national publicity coverage, and a host of promotional material... all to help you tell the "story of your industry" to Mr. and Mrs. America.

Plan now to have a "chalk" session with your RCA Tube Distributor. He will tell you how to obtain your personal "Code of Ethics" plaque and how to plan a bang-up sales-up store promotion for the 1956 National Television Servicemen's Week.



RADIO CORPORATION of AMERICA
TUBE DIVISION
HARRISON, N. J.