

CALDWELL-CLEMENTS'

Including TV-Electronic TECHNICIAN

TELEVISION RETAILING

Radio • Appliances • Records • Servicing

In Two Sections
• Section One •



FOLLOW-UP CALLS
GOOD SERVICE
DIRECT-MAIL
RADIO-TV SPOTS
NEWSPAPER ADS
PHONE CANVASSING
PHONE DIRECTORY ADS

*7 Ways to Get
a Welcome Into
the Customer's Home!*

November • 1952



JACK BENNY
CBS-TV's Sunday Star

Jack - it took
CBS to do it!



ARTHUR
GODFREY
CBS-TV Star

Right, Arthur -
CBS-COLUMBIA
has a Great Selling Plan!

Here's What The CBS-COLUMBIA Franchise Means To You!

1 PRESTIGE

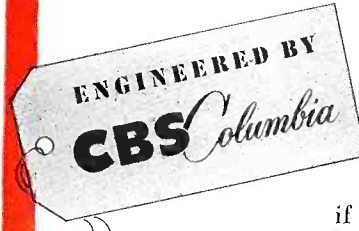

CBS is the greatest name in broadcast . . . research . . . and recordings. There is no bigger . . . no more important trade name in all television than CBS-Columbia! Remember, if it bears the tag "Engineered by CBS-Columbia," you know it's engineered for years ahead.

2 PERFORMANCE

CBS-Columbia's *Power-Tron Chassis* outperforms them all. Test after test under every conceivable reception condition has proved the *Power-Tron Chassis* to be the finest performing, most trouble-free power plant in all TV. Only the best bears the name CBS.

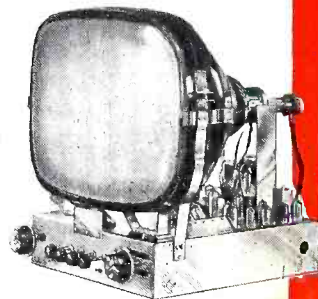

3 PROFIT

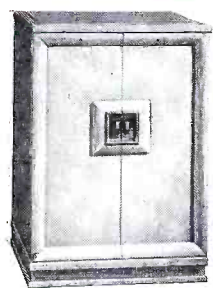

A brand-new line of the most advanced, most exciting television receivers in America! A combination of performance, beauty and price that will signify VALUE to all of your customers. Featuring low-priced LEADER models for store traffic plus STEP-UP models for easy selling-up and greater profits for you.

4 PROMOTION

An intensive advertising plan pre-selling CBS-Columbia TV sets to your customers, with strong national and local advertising *plus* a complete merchandising plan. Add to this 102 billion CBS messages a year on TV and Radio Stations all over America, and you have the pre-sell and the promotion to move merchandise *now*.



CONTACT YOUR CBS-COLUMBIA DISTRIBUTOR—TODAY!
CBS-COLUMBIA INC.

A Subsidiary of the Columbia Broadcasting System



TELEVISION RETAILING

including "RADIO & TELEVISION"
"RADIO & TELEVISION TODAY"
"TV TECHNICIAN" and
"ELECTRICAL RETAILING"

ORESTES H. CALDWELL
Editorial Director

M. CLEMENTS
Publisher

JOHN L. STOUTENBURGH
Executive Editor

EDWARD A. CAMPBELL
Managing Editor

SOLOMON HELLER
Technical Editor

RICHARD ELLANEY
Assistant Editor

DOLORES A. ALLEN
Assistant Editor

CHARLES F. DREYER
Art Director

BUSINESS DEPARTMENT

M. H. NEWTON
Business Manager

HOWARD A. REED
General Sales Manager

DIXON SCOTT
District Manager

LEE GRAVES
District Manager

G. A. DILLEN
Sales Promotion Manager

N. McALLISTER
Asst. Business Manager

A. O'ROURKE
Production Supervisor

BRANCH OFFICE
CHICAGO 6

S. M. GASKINS, Western Manager
JOHN D. LUPTON, District Manager
201 N. Wells St., Randolph 6-9225

LOS ANGELES 5

CHRIS DUNKLE & ASSOCIATES
Southern California Representative
2506 W. 8th Street, Dunkirk 7-6149

B. V. SPINETTA,
Directory and Circulation Director
WARREN S. BROWN, Circulation Mgr.

W. W. SWIGERT, Credit Manager

TELEVISION RETAILING*

November 1952, Vol. 56 No. 5. 35 cents a copy. Published monthly by Caldwell-Clements, Inc. Publication Office, Emmett St., Bristol, Conn. Editorial, Advertising and Executive Offices, 480 Lexington Ave., New York 17, N. Y. Entered as second class matter at the post office at Bristol, Conn., July 17, 1952, under the Act of March 3, 1879. M. Clements, President; Orestes H. Caldwell, Treasurer. Subscription rates United States and U. S. Possessions \$4.00 for three years. Canada \$5.00 for three years. Pan American Countries \$10.00 for three years. All other countries \$10.00 for three years. Printed in U.S.A.

*Trade-Mark Reg. U. S. Pat. Off. Copyright 1952 by Caldwell-Clements, Inc.

IN THIS ISSUE

NOVEMBER, 1952

★ *AM, FM, Television*

Cover—Seven Ways Into the Home	33
Stay Open Nights to Close More Sales	34, 35
What's Ahead—in Radio, Appliances, Records and Television	38, 39, 40, 41
UHF Comes to Portland	42, 43
N. J. Dealer Group Gets Real Results in Drive Against Price-Cutting	44, 45
How to Increase Your Yearly Turnover Rate	44, 45
For Xmas—Recorders, Phonos, Portables, Clock-Radios	62
Plus Profits in Hi-Fi	64, 65, 66, 69
Specifications of Latest Television Models	56, 58
Latest TV, Radio, Phono Players on the Market	103
TV Timetable	30
Television Sets in Use	115
Telephone Reports Reveal State of Market	

★ *Records, Phonographs, Accessories*

Holiday Bells Ring in Platter Profits	46, 47
Hartford Record Festival	48
Phono Record Market News and Trends	34, 35
Latest Records and Industry Activities	begins on page 50

★ *Electrical Appliances*

Dealer Takes White Goods Selling Out of the Red	52, 53
Electrical Appliance News	92
New Electrical Appliance Products	54
Activities in the Electrical Appliance Field	34, 35, 115

★ *TV-Electronic Technician*

"Circuit Digests" Ahead with Latest Sets	83
Servicing Keyed AGC Circuits in TV Sets. Part 2	84, 85
Servicing Vibrators With the Oscilloscope	86, 87
Improved Efficiency Through Shop Short Cuts	88
Latest Products for Servicers	90

Latest Product Specifications, Directories, etc. that have appeared in TELEVISION RETAILING:

Specifications:

Television Receivers	This Issue, p. 64
Radios, Home Receivers	Apr., '51, p. 59
Radios, Portable and Auto	Apr., '51, p. 56
Clothes Dryers	Jan., '52, p. 80
Dishwashers	Oct., '51, p. 62
Electric Ranges	Mar., '52, p. 58
Hand Irons	Dec., '51, p. 42
Ironers	Nov., '51, p. 50
Refrigerators	Sept., '51, p. 65
Room Air Conditioners	Apr., '52, p. 48
Vacuum Cleaners	July, '51, p. 67
Washing Machines	May, '51, p. 84

Directories:

Mfrs. of Radio, TV, FM, Phonos, Phono Records, Recorders, Servicing and Sound, May, '52, p. 101

Directories (Continued)

Custom Components Mfrs.	Apr., '51, p. 34
Distributors	Jan., '52, p. 117
Electric Housewares	Feb., '52, p. 46
Phono Record Mfrs.	July, '51, p. 42
Roster of Representatives	Oct., '52, p. 103
Test Instruments	May, '51, p. 100
TV & FM Antenna Mfrs.	Mar., '51, p. 36

Reference Charts:

Battery Replacement Chart	Apr., '51, p. 73
FM Coverage Areas	July, '50, part II
Four-Field Statistics	Jan., '52, p. 58
TV Sets in Use	Jan., '52, p. 59
UHF Coverage Areas	Aug., '51, p. 44



CALDWELL-CLEMENTS, INC., Publication Office, Bristol, Conn.

Editorial and Executive Offices, 480 Lexington Ave., New York 17, N. Y. Plaza 9-7880
Publishers also of TELE-TECH

MOTOROLA SCOOPS

with New Sales Winners Just

NEW SMART MAHAGONY *Clock Radio*

Again setting the industry pace, unveiling a whole new market for you—Motorola presents its newest Clock Radio. This new Clock Radio, in handsome mahogany “masterpiece” finish, adds distinction to living room or dining room, fills a very definite need for a clock in those rooms as well as

for a radio that is a styled piece of furniture. Motorola’s Mahogany Clock Radio has the famed *Golden Voice* tone with a timer that will turn on TV programs automatically.

It is out just in time for *your* Christmas profits—it will be one of your biggest traffic-builders, biggest sellers!

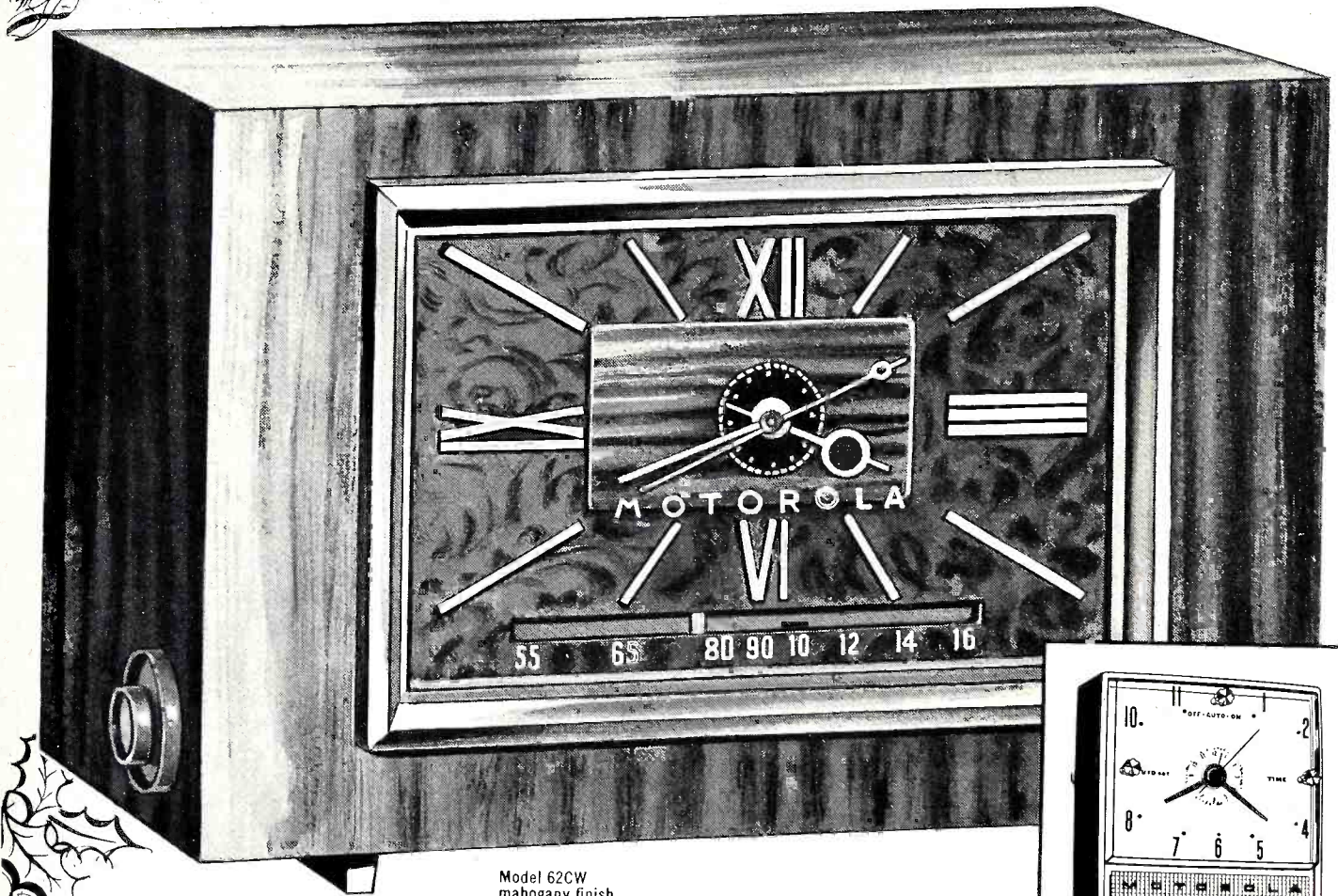

Model 62CW
mahogany finish
—\$59.95*

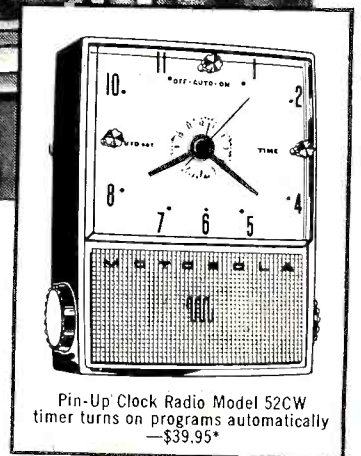

Pin-Up Clock Radio Model 52CW
timer turns on programs automatically
—\$39.95*

*Motorola moves your
Biggest Seller into More Rooms
for More Sales!*

Now for Bedroom, Kitchen, Bathroom, Den, Rumpus Room or Porch—Now you can multiply clock radio sales with the sensational **Motorola Pin-Up Clock** designed for other rooms in the house—in a choice of cherry red, leaf green, citron or off-white.

Better

*Prices slightly higher South and West.

Prices subject to change without notice.

RADIO INDUSTRY

in Time for Christmas Profits!

3 NEW STYLES IN AMERICA'S MOST POPULAR PORTABLE

Just in time for your Christmas profits—the compact “camera” case Motorola is out in three wonderful brand new styles. There's the tooled saddle-brown simulated leather style for every youngster or outdoorsman, the new Suntan simulated leather and the green simulated alligator. All AC-DC and battery, priced at just \$32.95* less batteries.

Those plus the popular royalite “camera” case and the rest of the Motorola portable line are ready to make your sales this Christmas bigger than ever before.

52B-4 Grained
Suntan
simulated leather

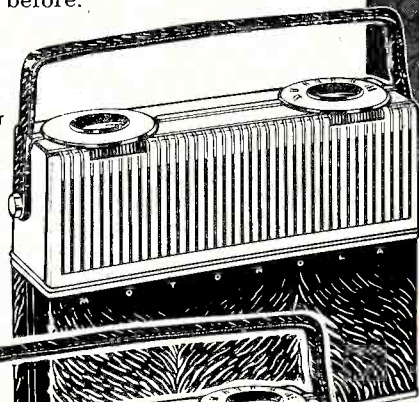

52B-3 Saddle-brown
tooled simulated
leather

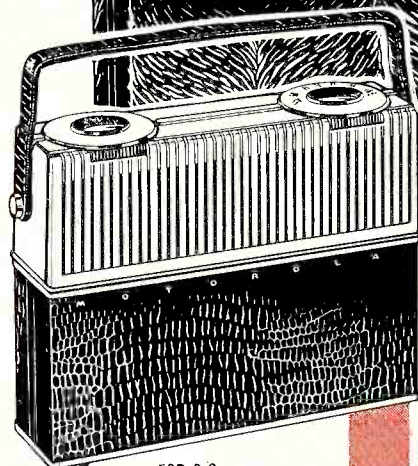

52B-2 Green
simulated alligator

*Motorola sets the pace with
new ideas, styling and engineering!*

World's largest exclusive electronics manufacturer, Motorola again scoops the industry with ideas for sales—more revolutionary firsts in efficient engineering—finer, more detailed styling! Show the complete Motorola line—discover how the name Motorola opens the door to greater profits. Yes, the new Motorola line is priced *and* styled to bring you a fast turnover and greater sales. See the new clock radios and portables—now—at your distributor's.

See **Motorola** Radios

HIS CHOICE IS

Regency

LARGEST SELLING VHF BOOSTER...

AT ANY PRICE!

FRED J. KIRKMAN, VICE PRESIDENT AND GENERAL MANAGER
BURGESS BATTERY COMPANY
PHOTOGRAPHED IN HIS HOME
FREEPORT, ILLINOIS



QUALITY FIRST... A PHILCO POLICY

NEW FROM PHILCO

EXCLUSIVE DIRECTIONAL
BUILT-IN AERIAL FOR BOTH
UHF AND VHF
ONLY PHILCO HAS IT!

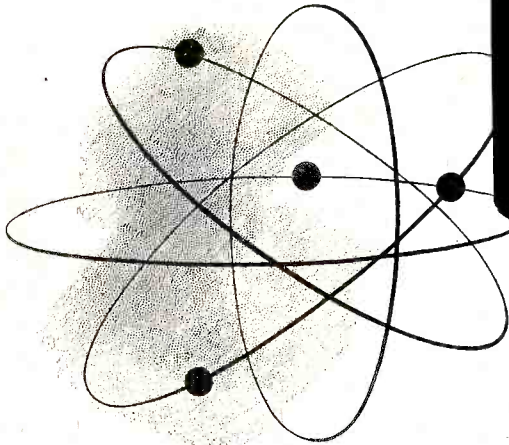

FOR **UHF** AS WELL AS VHF, IT TAKES THE AERIAL OFF THE ROOF AND THE **ROOF OFF OF TV SALES**. TELEVISION BUYERS FROM COAST-TO-COAST ARE DEMANDING THIS EXCLUSIVE PHILCO DEVELOPMENT THAT MAY EASILY **SAVE \$25 OR MORE** OVER THE COST OF A SEPARATE UHF ROOFTOP AERIAL

**JUST PLUG IN
AND PLAY!**

NO OUTSIDE AERIAL
NEEDED FOR **UHF**
OR **VHF** IN UP
TO 8 OUT OF 10
LOCATIONS

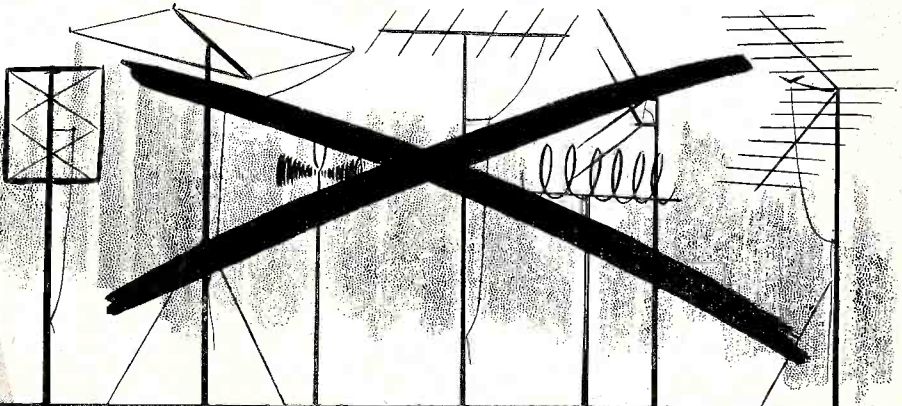

PHILCO FAMOUS FOR QUALITY THE WORLD OVER

Service
Dealers



Switch to

Snyder
PHILADELPHIA

aerials

...engineered for
profits!



NEW **Directronic**

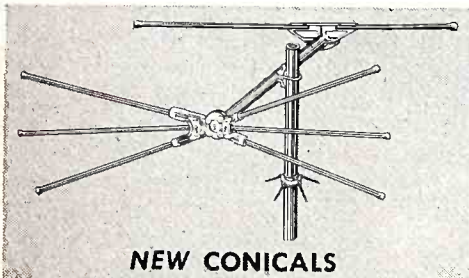

NEW CONICALS

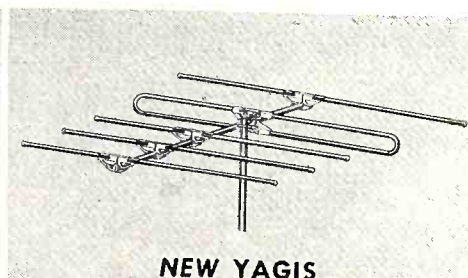

NEW YAGIS



NEW INDOORS

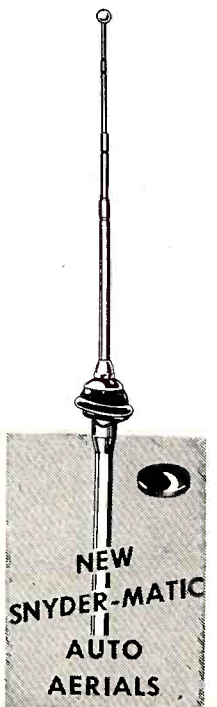

NEW
SNYDER-MATIC
AUTO
AERIALS

SNYDER MFG. CO. ANTENNA ENGINEERS
PHILADELPHIA 40, PA.

WORLD EXPORT: ROBURN AGENCIES, INC., NEW YORK 7, N. Y.
CANADIAN DISTRIBUTOR: VAN DER HOUT ASSOCIATES, TORONTO



Raytheon's

Exclusive **VU-matic**
VHF-UHF Reception
Gives You

TWO TV SETS IN ONE!

Plus Full-Range AM Radio

Greatest line-up of features in TV!

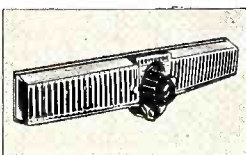

1 Vu-Matic reception—exclusive with Raytheon, built-in all-channel tuning of any VHF or UHF channel, no strips, no converters, no bulky gadgets!

2 One-knob control—one master switch controls VHF, UHF, radio and phono switch. Easy, accurate, complete.

3 "Channelite tuning"—high visibility "slide rule" tuning window shows you VHF, UHF, radio positions.

4 Finest fringe reception—because Raytheon's "Whisper Sensitive" tuner and circuitry boosts TV signals about 2½ million times.

5 "Exclus-o-tone"—earphone adapter available for individual listening.

6 Full range AM radio—with Raytheon's famous built-in antenna.

7 Tilted picture tube—eliminates reflection, is removable for easy cleaning.

8 Superb cabinetry—craftsman styled, beautifully built.

9 Big picture tube—distortion free, clear, pre-focused.

10 Easy-roll casters—are convenient, make moving simple.

11 Phono jack—included in all 1953 Continental models.

12 Full-year warranty—covers all parts, including picture tube.

All the features shown above, plus many more, are in the 1953 Raytheon "Continental" line.

Ask your Distributor about Raytheon's Assured Profit Plan!

Raytheon



RAYTHEON TELEVISION
AND RADIO CORPORATION
5921 W. Dickens Ave.
Chicago 39, Ill.



There's a Raytheon TV in both "Continental" and "Suburban" models... to fit your customers every home style and interior... to retail from \$199.95 to \$750 Federal Excise Tax and One-Year Warranty Included.

There's only one real answer to UHF

and Arvin has it now

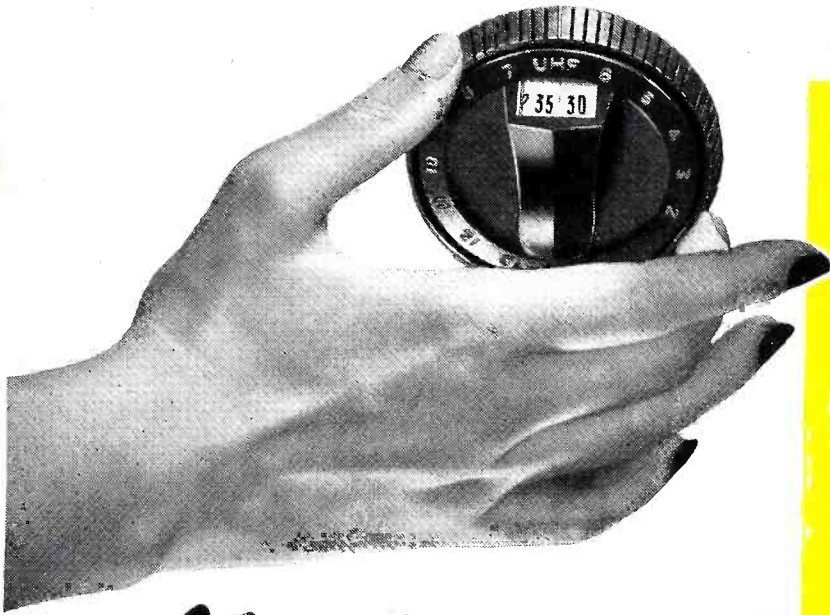

all-channel
tuning...
built-in!

The Fairmount, 21-inch open-face console, is the most popular model in Arvin's All-Channel Super 28 line. Smartly styled, solidly built cabinet in imported Honduras mahogany, has oversize casters for easy moving. Model 7218CM, \$399.95. In blonde, The Claridge, \$419.95. Same models, VHF only, \$359.95 and \$379.95.



**No strips! No converter!
No service calls!**

There's a vast difference between makeshift UHF "strips" and Arvin All-Channel tuning! The owner of an Arvin All-Channel Super 28 TV can get *all* VHF and *all* UHF stations within range—not just 12—at the turn of a single knob! And when he moves to another locality, he can get *all* the VHF and UHF stations in that area, with no adjustments, no new strips, no service call.

There's a difference, too, between a VHF set with an external UHF converter and an Arvin All-Channel Super 28 with dual tuner *built-in*. The Arvin Super 28 chassis is engineered throughout for all-channel reception. Everything is *inside* the cabinet—and *all* channels, both VHF and UHF, are tuned in on a single knob.

And there's a vast difference between sets with "provision" for all-channel tuning and the Arvin All-Channel Super 28 which has it right now! Who wants to wait to have a TV made up-to-date in some indefinite way at some indefinite future time? Arvin is the *first* TV engineered and produced with all-channel tuning *built-in*. You can profit handsomely from Arvin's leadership!

Arvin All-Channel Super 28

features 28 tubes*, sensational Phantom Filter, Dual Power, many other advantages

28 tubes including rectifiers and picture tube assure distance, picture quality and interference control that simply cannot be provided by a chassis with fewer tubes.

Exclusive Phantom Filter filters noise from the video signal, eliminating picture roll, bounce and jitter.

Dual Power and Cascade Booster Tuner build up weak signals and prevent overloading by too-strong signals. No external booster is ever needed.

Other Arvin advantages for 1953 include increased contrast, increased stability, increased audio output, increased sensitivity, and decreased noise factor.

Choice of eleven 21-inch and 27-inch consoles, superbly styled in period or modern.

A few selected distributor franchises are still available. Write R. P. Spellman, Sales Manager.

Radio and Television Division

ARVIN INDUSTRIES, Inc.

Columbus, Indiana

*Including rectifiers and picture tube.

Westinghouse

announces a great new division to
manufacture a full line of
RELIATRON™ TUBES

Receiving Tubes—
Television Picture Tubes—
Power Tubes

Westinghouse proudly announces a completely new division—*THE ELECTRONIC TUBE DIVISION*. Its aim is this: To become the leader of the industry in providing better electronic tubes and better service to all tube users.

To provide this new standard of service to all branches of the electronic tube industry, Westinghouse has equipped its new tube division with completely new production, research, and distribution facilities.

Westinghouse RELIATRON Tubes are now available; many types are on their way at this moment to distributors, dealers, equipment manufacturers, government, government contractors.

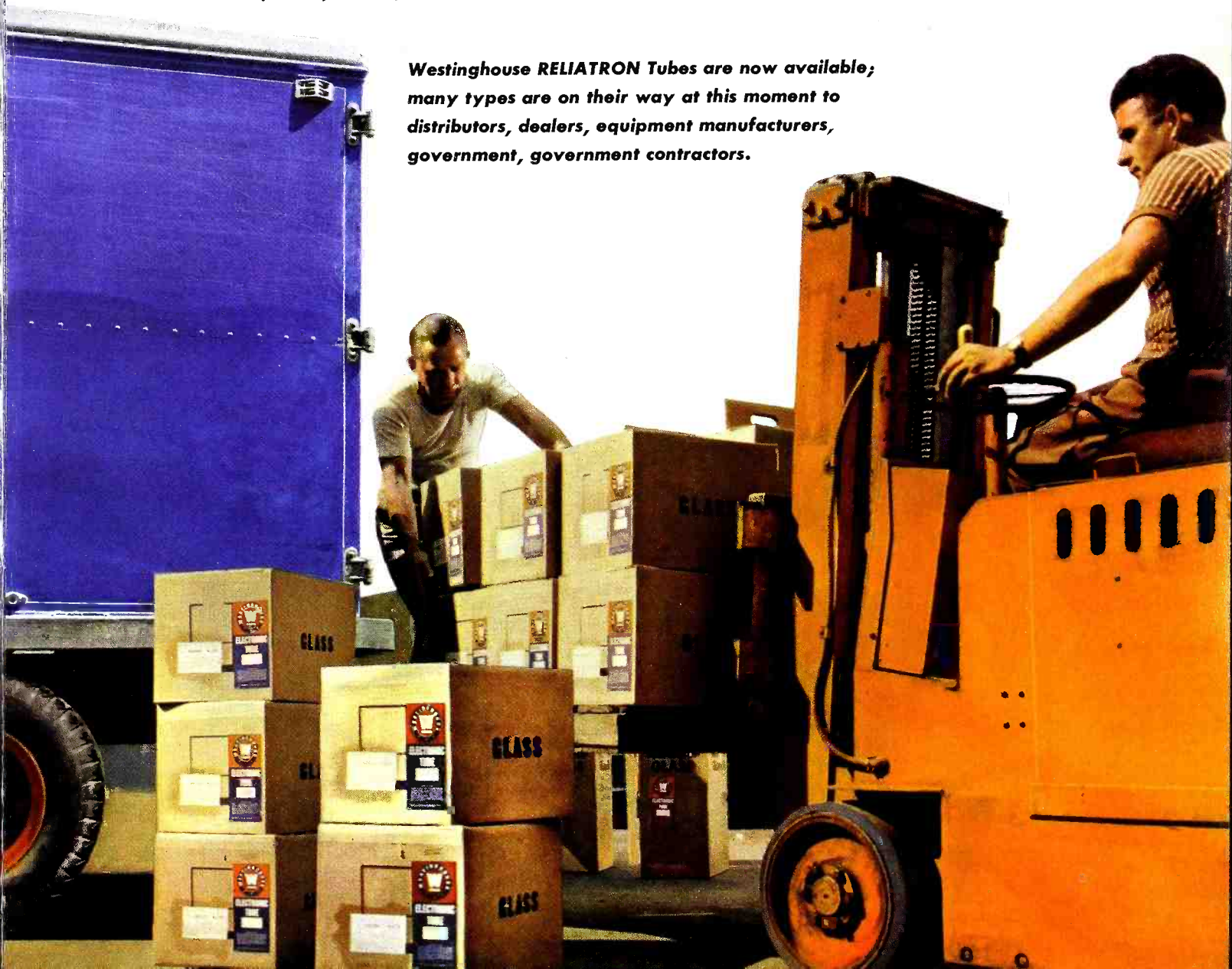

THE Westinghouse

ELECTRONIC TUBE DIVISION

- Experienced Personnel
- Modern Facilities
- Rigid Standards

Westinghouse offers the electronics industry thirty years of experience in tube development, application, and manufacture. From this experience have come many of the tube innovations that today are the basis for the electronics industry. In all cases, Westinghouse customers benefited by being first with new types. The list at the right indicates a few Westinghouse contributions.

The personnel of the new Westinghouse Electronic Tube Division comprise a brilliant engineering, production and sales team—recruited from Westinghouse's 46 manufacturing divisions and key experts from throughout the industry.

Tubes produced by Westinghouse will bear the name . . .

RELIATRON

. . . an unbreakable bond of reliability and electronics. It indicates performance and dependability on a new scale for the electronic tube industry.

Look at This Brilliant History of Westinghouse Electronic Tube Achievements:

- ★ The Westinghouse-designed WD-11 tube was the first dry battery type and was part of the first commercial radio receiver ever produced in America.
- ★ Westinghouse was the first manufacturer to develop and mass-produce tubes utilizing an indirectly heated cathode.
- ★ Westinghouse designed and produced the first ac-operated detector tube, the Type 27.
- ★ Westinghouse established the first commercial radio broadcast station, KDKA, in 1920 and thus opened the mass market for home radios.
- ★ Basic development and demonstration of the cathode ray television system was performed in Westinghouse laboratories and patented in 1929.
- ★ Westinghouse developed and introduced both electromagnetic and electrostatic types of cathode ray tubes in 1930.
- ★ Westinghouse design engineers invented the Ignitron, which solved long-standing problems of precise, high-speed switching of heavy electric currents.
- ★ Westinghouse pioneered in high-powered transmitting tubes for use in both pulsed and CW radar applications. The famous Westinghouse Type WL-530 was in the Pearl Harbor radar set which gave the warning of the approach of Japanese planes in 1941. This tube led the way to all subsequent radars.

THESE MEN LEAD THE WESTINGHOUSE ELECTRONIC TUBE DIVISION TEAM

HAROLD G. CHENEY,
General Sales Manager:

A Westinghouse tube and lamp sales executive for 31 years, Mr. Cheney was appointed General Sales Manager of the Electronic Tube Division in August, 1951. Prior to his appointment he was assistant to the general lamp sales manager and supervisor of lamp sales contracts. He was a key factor in giving to the lamp industry the stabilizing influence of Westinghouse's fair, sound business and sales policies.



JAMES L. BROWN,
Manager, Receiving
and
Cathode Ray Tube Sales:

For 14 years Mr. Brown was an electronic tube and apparatus sales executive and engineer for the General Electric Company—on the West Coast for 7 years and later as central regional sales manager for receiving and television picture tubes. He is a former purchasing agent of Hoffman Radio Company.



JOHN J. DOYLE,
Manager, Power Tube Sales:

A veteran of 25 years' Westinghouse service, Mr. Doyle was manager of electronic tube sales to distributors prior to his present appointment. Previously he was manager of electronic tube parts sales and has held various sales executive positions in the Lamp Division.

EUGENE W. RITTER,
Vice-President and Manager:

For eight years he was with the Corning Glass Works as vice-president and director, later president of the Corning Glass Works of South America. Previously he had been employed by the Radio Corporation of America for 12 years as a member of the Radio Tube Design and Development Division, manager of the Radiotron Company, later vice-president of the RCA Manufacturing Company.

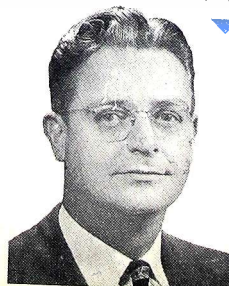

DR. E. A. LEDERER,
Manager of Engineering:

He was formerly chief engineer for National Union Radio Corporation and for 17 years was a member of the tube development staff of Radio Corporation of America. He participated in early vacuum tube development work with the Westinghouse research and engineering staffs from 1923 to 1930.





WESTINGHOUSE IN ELMIRA, NEW YORK

360,000 square feet of steel, glass and brick designed for one thing—to house the most efficient electronic tube production in the world. Here, completely modern straight-line exhaust, Lehr, and screen settling equipment produce Westinghouse RELIATRON Television Picture Tubes of unsurpassed quality. Here also are produced the famous Westinghouse line of power, transmitting, industrial and special purpose tubes. Plant layout is designed around efficient, straight production lines. Into them feed raw materials and sub-assemblies. From them, tubes enter an exacting testing cycle. To assure prompt delivery, tubes are loaded directly into trucks or railroad cars waiting on Westinghouse's own spacious rail siding. Here at Elmira, too, is located the headquarters of the Westinghouse Electronic Tube Division with sales, engineering and production management ready to extend a warm welcome to you.

WESTINGHOUSE IN BATH, NEW YORK

Located at Bath in the scenic Finger Lakes region of upstate New York, this Westinghouse Receiving Tube Plant is another 220,000 square feet of modern production efficiency. It lies only a few miles from a major source of glass tube envelopes. It is served by sidings of one of the nation's leading railroads—only hours away from all principle markets. It is less than one hour from the Elmira factory and the advice and supervision of the Division's headquarters staff. Here at Bath, the most modern cathode-coating, grid-winding, spot welding and sealax equipment is operated by the industry's leading craftsmen. Famous Westinghouse quality control standards rule from raw material to testing of finished tubes. From this plant are shipped the finest receiving tubes in the industry—Westinghouse RELIATRON Tubes.

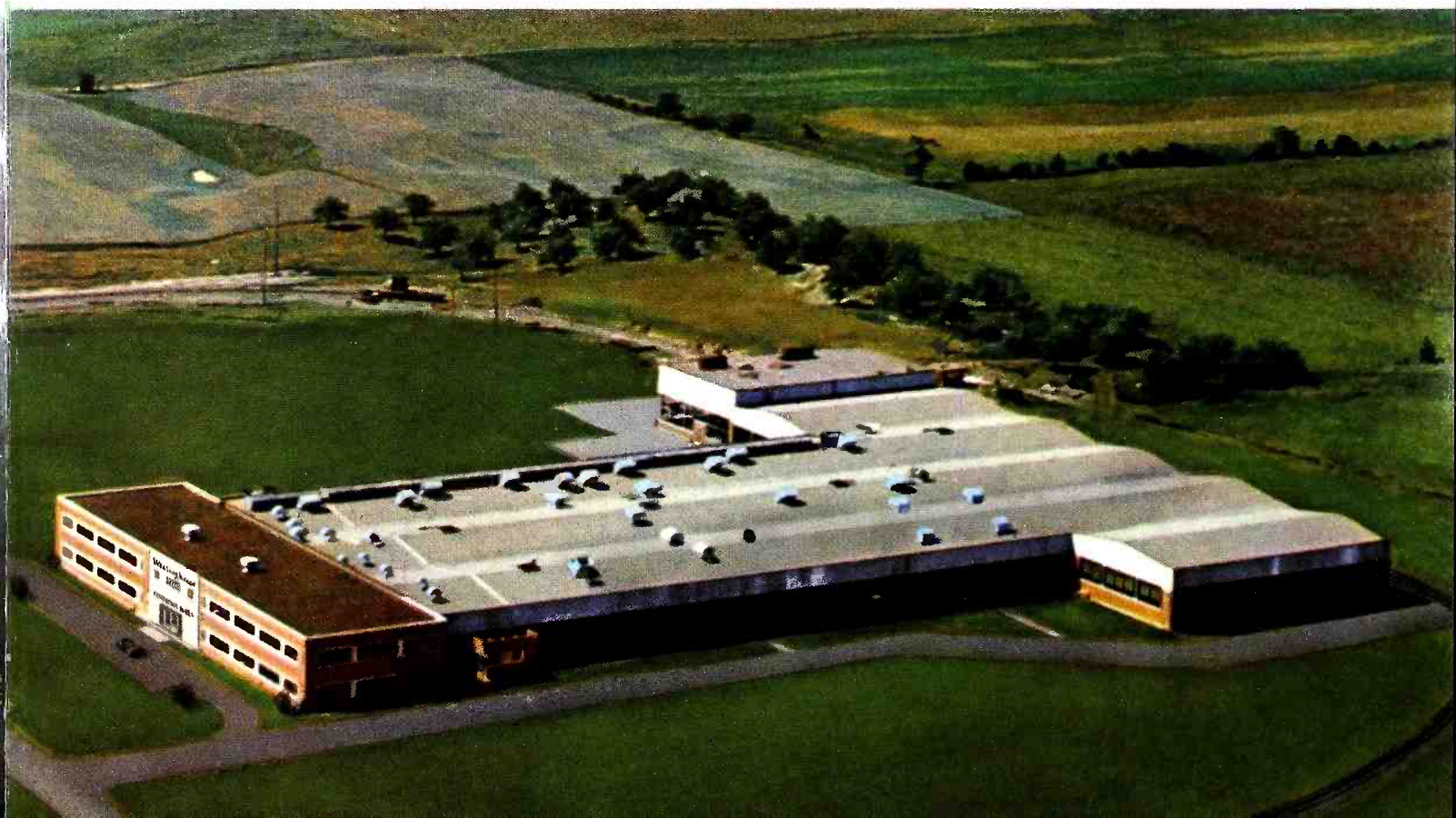

RELIATRON TUBES are backed by Westinghouse reliability

TUBE RESEARCH AND DEVELOPMENT

The Westinghouse position of leadership in electrical and electronic manufacturing is founded on the untiring efforts of its research staff. The Electronic Tube Division is already at work improving present tube types and developing new types for superior service and new applications, including UHF.

QUALITY CONTROL

RELIATRON tube performance is assured by an exacting program of quality control. Every step in the manufacture of RELIATRON Tubes—from raw materials to finished product—must meet standards which are the toughest in the industry.

ENGINEERING AND SALES SERVICES

Whatever your problem, whether you are an equipment manufacturer, government laboratory, or parts distributor, you will find Westinghouse sales representatives and application engineers in your area at your service. Sales and engineering offices are located strategically throughout the country to serve you.

ADVERTISING

Trade acceptance of Westinghouse RELIATRON Tubes will be supported by a nationwide advertising campaign second to none. Technical data, pricing service and application information are available to all tube users. Sales promotion programs for distributors and service dealers will be hard-hitting, sure sales builders. Your product or service will profit from consumer acceptance built by the tremendous national advertising of the name "Westinghouse."

DISTRIBUTORS, EQUIPMENT MANUFACTURERS, WRITE NOW

For complete information on the Westinghouse line of RELIATRON Receiving Tubes, Television Picture Tubes, and Power Tubes, write or wire Westinghouse Electric Corporation, Dept. 101, Elmira, New York. Or call your nearest Westinghouse Electronic Tube Division Sales Office.

YOU CAN BE SURE...IF IT'S

Westinghouse

WESTINGHOUSE ELECTRIC CORPORATION, ELECTRONIC TUBE DIVISION, ELMIRA, N. Y.

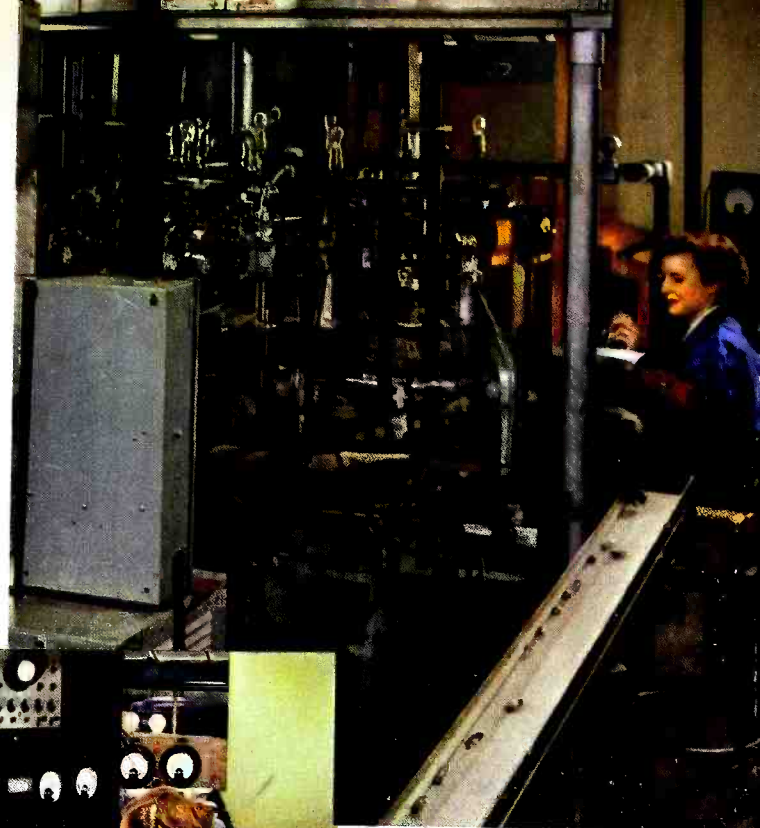

Sealex units at Bath, New York, turn out miniature tubes for government and commercial use. From here, tubes enter a rigorous program of checks and testing.

Here, an early Westinghouse WD-11 tube, one of the earliest types ever made, is shown just as it was used in the first commercial radio receivers.

This exclusively-Westinghouse quality control test set is one of a large battery of equipments which provide you with tubes of the highest quality and reliability.

Basic and application research are of prime importance in the Westinghouse Electronic Tube Division's plans. Such research has helped build the tube industry, and has made Westinghouse dominant in development.



More appliance dealers use Commercial Credit financing than any other national plan

NO NEED TO TIE UP WORKING CAPITAL

The COMMERCIAL CREDIT PLAN offers dealers everything they need in the way of financing . . . from wholesale financing of floor stocks right down to the last detail of retail financing, credit investigation, collection, adjustment and prospect follow-up. This plan enables dealers to free their working capital for use in their business.

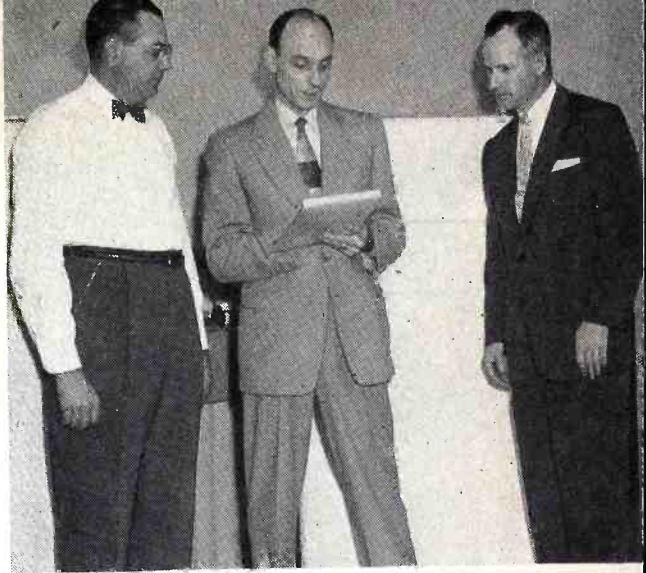

COMMERCIAL CREDIT HELPS MAKE SALES — Shown here (right) talking to two members of his organization is Mr. J. H. Baine, Jr., Vice President of The Crenshaw Co., Memphis, Tenn., users of the COMMERCIAL CREDIT PLAN throughout their entire 14 years of business. The Crenshaw Company likes the flexibility and complete service COMMERCIAL CREDIT offers . . . also the aid that it gives customers in buying products they couldn't afford to buy outright.

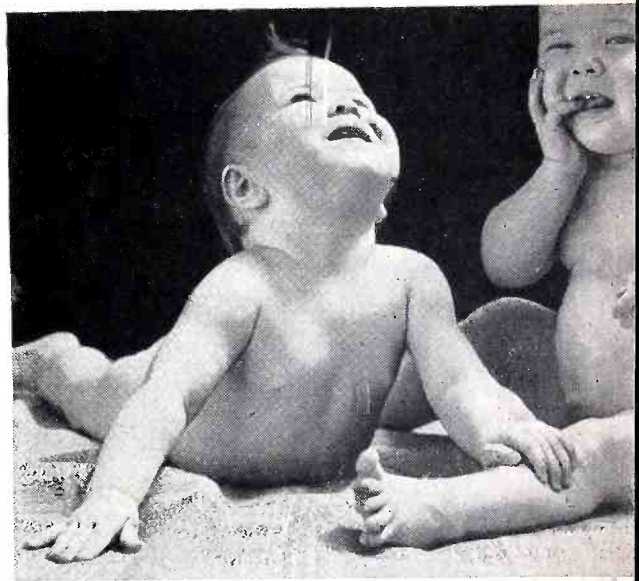

FIND OUT HOW COMMERCIAL CREDIT HELPS BUSINESS LOOK UP — Ask your distributor for a copy of "Buy and Sell with Sound Financing," or contact your nearest COMMERCIAL CREDIT office. This interesting pamphlet gives complete details on COMMERCIAL CREDIT's many benefits. There is no obligation.



COMMERCIAL CREDIT CORPORATION

A subsidiary of Commercial Credit Company, Baltimore
. . . Capital and Surplus over \$125,000,000 . . . offices
in principal cities of the United States and Canada.

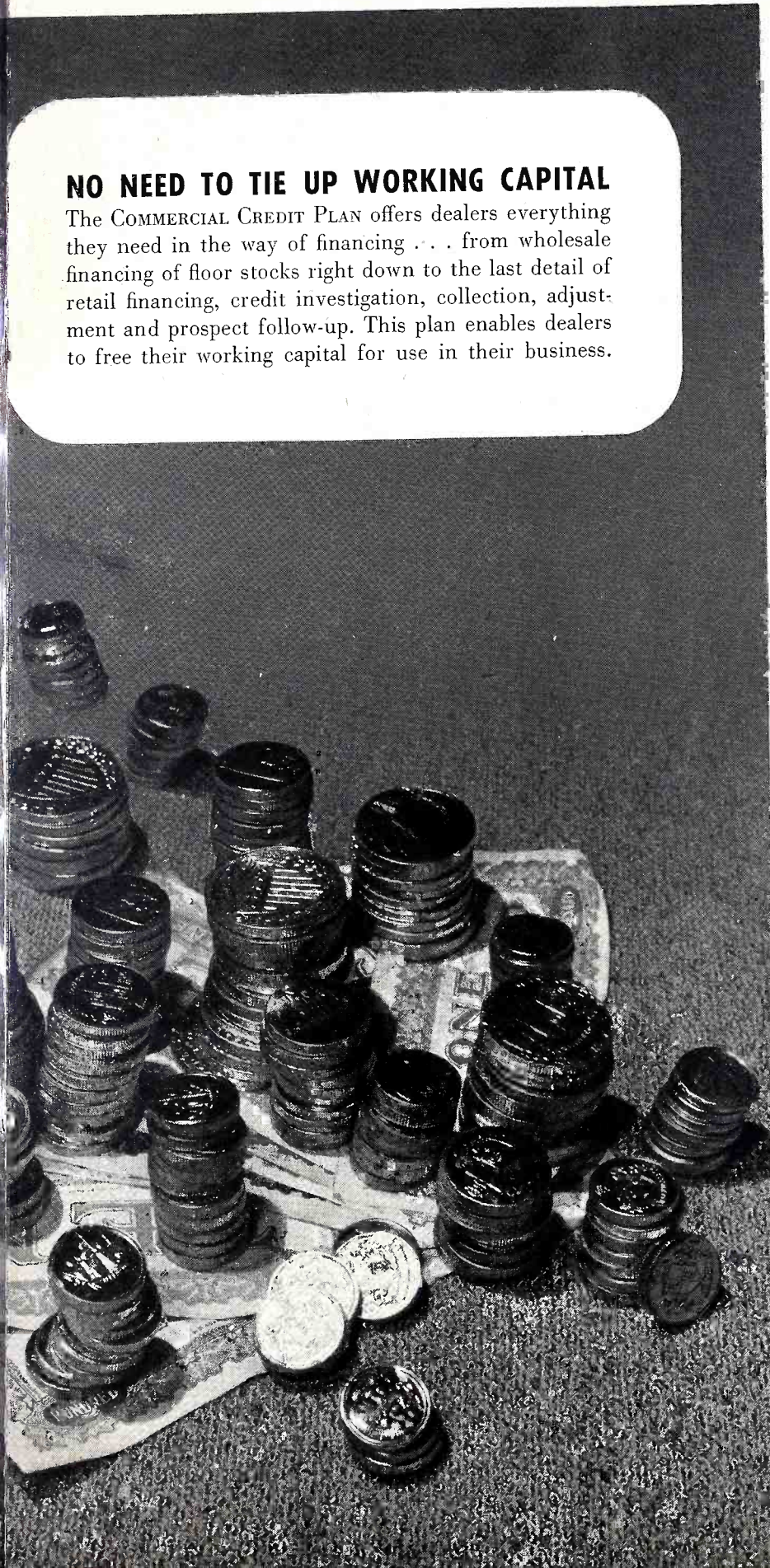

Landslide vote elects Telechron timers!

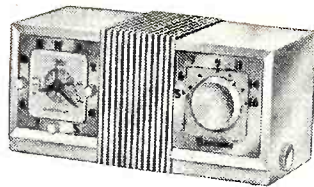

FIRESTONE

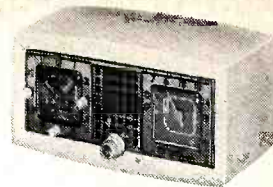

TRUETIME

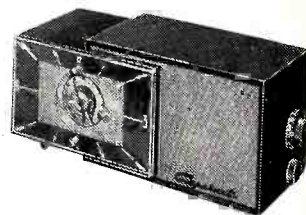

CAPEHART

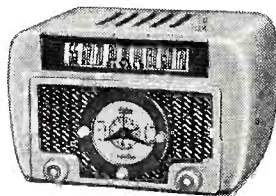

DE WALD

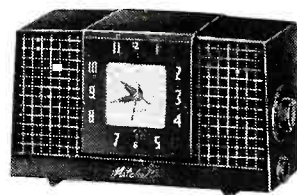

MITCHELL

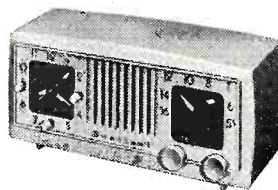

SENTINEL

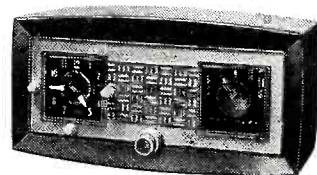

RAYTHEON

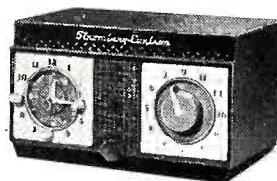

STROMBERG-CARLSON



CROSLY

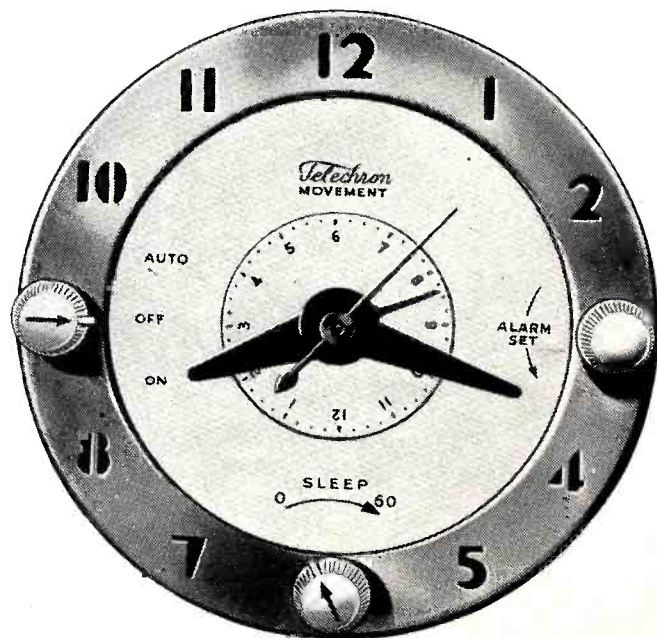

Telechron is a trademark for products of Telechron Dept., General Electric Co., Ashland, Mass.



Look, five gifts in one!

a clock-radio with a Telechron clock-timer

... gives you these Christmas gifts for every member of the family

- 1 WAKES YOU TO MUSIC:** Wakes you to your favorite music... the gentle, soothing sound of your favorite tunes... the soft, comforting hum of your favorite records... the clear, crisp tones of your favorite radio stations.
- 2 STARTS YOUR COFFEE:** Starts your coffee... the gentle, soothing sound of your favorite tunes... the soft, comforting hum of your favorite records... the clear, crisp tones of your favorite radio stations.
- 3 TELLS TIME:** Tells you the time... the gentle, soothing sound of your favorite tunes... the soft, comforting hum of your favorite records... the clear, crisp tones of your favorite radio stations.
- 4 KEEPS YOU ENTERTAINED:** Keeps you entertained... the gentle, soothing sound of your favorite tunes... the soft, comforting hum of your favorite records... the clear, crisp tones of your favorite radio stations.
- 5 HELPS YOU TO SLEEP:** Helps you to sleep... the gentle, soothing sound of your favorite tunes... the soft, comforting hum of your favorite records... the clear, crisp tones of your favorite radio stations.

25 LEADING CLOCK-RADIO MAKERS VOTE TELECHRON FIRST

© 1952 General Electric Co. All rights reserved. The Telechron trademark is a registered trademark of General Electric Co. in the U.S. and other countries.

This full-color, center-spread ad appears Nov. 22 in The Saturday Evening Post to send Christmas business your way. Prepare now with a display of clock-radios with Telechron timers.

25 leading brands vote Telechron timers first

—in quality, value, and customer acceptance

Want to know why 25 leading clock-radio makers chose Telechron timers?

They studied the record of Telechron timers . . . the timers that pioneered the clock-radio market; how many hundreds of thousands have been in continuous use for years. They studied the construction of Telechron timers . . . quality materials, superior lubrication and dependable operation. They considered the sales advantage of the exclusive signal alarm available on Telechron timers . . . its extra wake-up insurance about 10 minutes after radio turn-on. And they weighed the value of the Telechron trademark . . . its prestige with the buying public.

But you're the man to profit most from these advantages. Make sure the clock-radios you sell are equipped with Telechron timers. They mean greater assurance of greater sales. Telechron Department, General Electric Co., 1411 Homer Ave., Ashland, Mass., U.S.A.



*More POWER to you...
with the Radiart TV Booster*

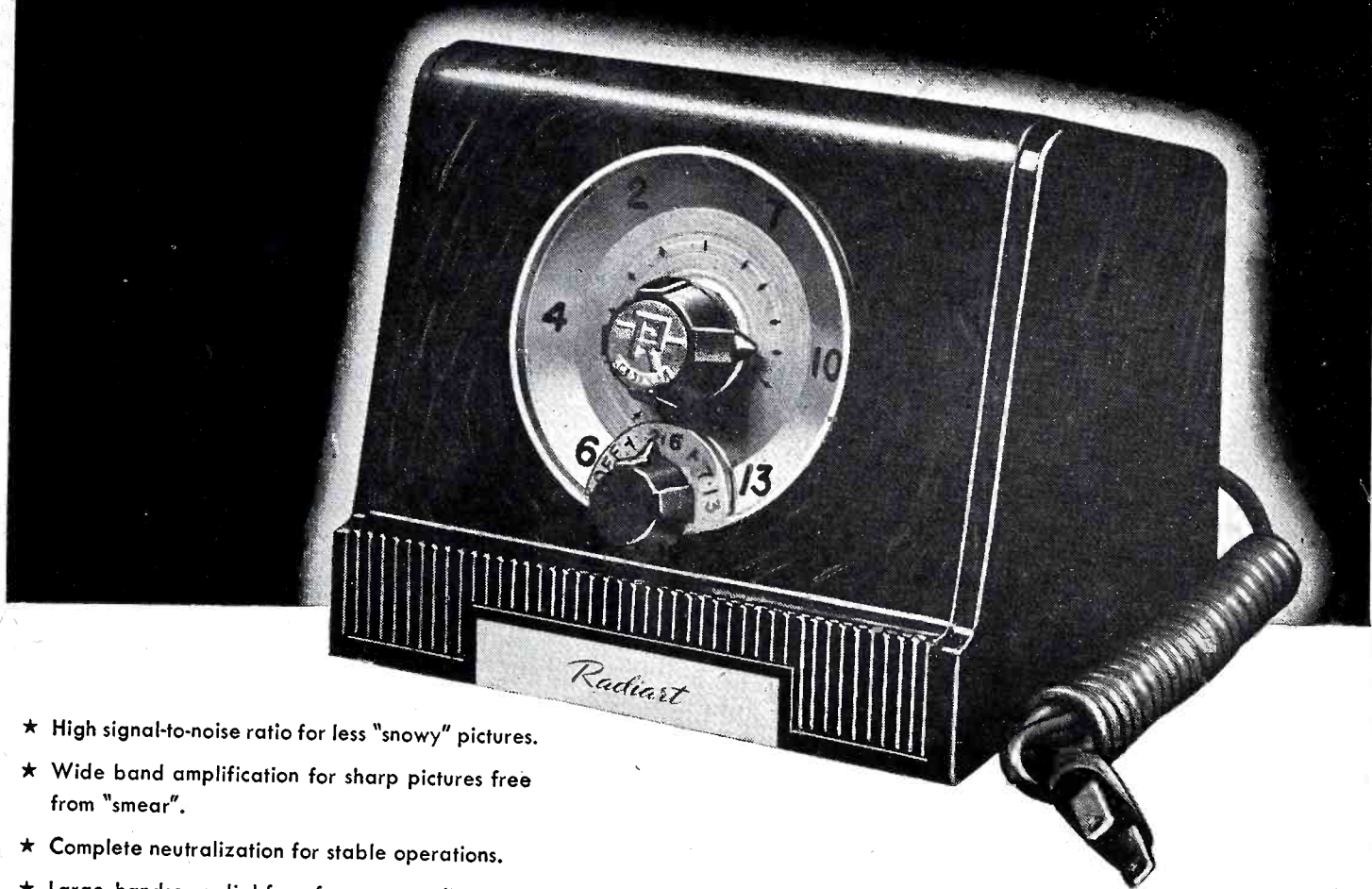

- ★ High signal-to-noise ratio for less "snowy" pictures.
- ★ Wide band amplification for sharp pictures free from "smear".
- ★ Complete neutralization for stable operations.
- ★ Large, handsome dial face for easy reading.
- ★ Operates on 115 V. A. C., 60 cycle current.
- ★ Attractively styled cabinet with mahogany grained polished finish . . . matching the rotor control cabinet . . . together making the TV TWINS . . . the ideal combination for the MOST in TV reception.

Here's the power boost needed to get the MOST from any TV set! It improves the picture because it increases contrast . . . minimizes ghosts, snow and interference and actually STRENGTHENS the signal! Easily installed — simple in operation — a welcome addition to any home.

The Perfect Partner to the CDR Rotor...they go together



THE RADIART CORPORATION CLEVELAND 13, OHIO

VIBRATORS • AUTO AERIALS • TV ANTENNAS • ROTATORS • POWER SUPPLIES

TELEVISION RETAILING • November, 1952

YOU GET AN AFTER-CHRISTMAS SALESMAN WITH EVERY NEW ZENITH YOU SELL

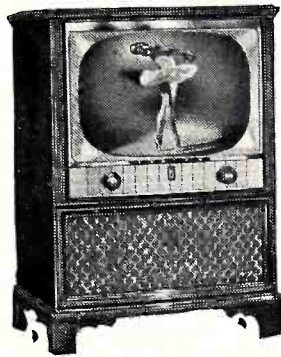

When you sell a Zenith television receiver during the Christmas rush, you do more than pocket a profit. You put an enthusiastic salesman and demonstrator to work for you—for free!

For Zenith Quality TV makes *satisfied* customers. Even small hidden parts far exceed standard specifications to assure long, trouble-free performance that makes boosters of buyers.

And there are so many things for the Zenith owner to show off and brag about to friends. There's the big, fine grain picture with clean contrasts that makes viewing a pleasure even

in a small room. There's one-knob tuning that brings in perfect sound and picture even when tuned blindfolded.

There are exciting exclusives as optional equipment: the "Lazy Bones" Remote Control, the "Private Phone" TV Earphones for the hard-of-hearing.

These features turn anyone who gets a Zenith for Christmas into an after-Christmas salesman for you. And just to be sure that every one gives the whole sales story, tell customers about these Zenith advantages, too:

- **Long Distance Reception.** 1953 Zenith TV pulled in 20% clearer pictures up to 25% farther than leading makes tested against it in 17 fringe areas.
- **Built-In "Picturemagnet" Antenna.** Compare the picture it pulls with any other built-in antenna. You'll see why Zenith ends need for outside antenna in so many locations where an inside aerial never worked before.
- **Any-Channel Reception.** Addition of exclusive Zenith channel strips ready any Zenith ever sold for any new UHF or VHF telecast.
- **Big 17, 21 and 27-inch Screens.** Cylindrically shaped front of picture tube permits wide angle viewing. Room-light reflections go below eye level.
- **Fine Furniture Styling.** Elegant Period cabinets, dramatic Moderns. Table, console and combinations.

FOR SELLING QUALITY, FEATURE ZENITH

ZENITH
REG. U.S. PAT. OFF.
♦ LONG DISTANCE ♦ **RADIO**
and TELEVISION

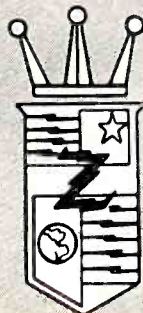

COPR. 1952, ZENITH RADIO CORPORATION, CHICAGO 39, ILLINOIS



HERE IN A NUTSHELL ARE THE

Hotpoint

A FULL LINE OF PROVED PRODUCTS

A full line of major appliances thoroughly proved through engineering leadership, public acceptance, customer satisfaction, trouble-free operation, and dealer profit.

● **Hotpoint Electric Ranges . . .** Hotpoint manufactured the first electric range back in 1910 and has since produced more than 3 million. Hotpoint was first to produce a completely automatic range with automatic oven time and temperature controls, and was first with the hermetically glass-sealed Calrod® Heating Unit. Hotpoint engineered and perfected Pushbutton Cooking, and will continue to lead, with a complete line of 1953 ranges featuring Super Calrod Units and king size Super Ovens.



● **Hotpoint Refrigerators and Food Freezers . . .** Hotpoint engineered and perfected the first combination Refrigerator-Freezer, and was first to introduce the Butter Bin. Hotpoint's Thriftmaster® Unit—the original hermetically sealed refrigerating unit—enjoys the most trouble-free record in the industry. Hotpoint Food Freezers were the first with removable storage baskets and the aluminum freezer liner which have now become the standard of the industry. The convenience features of Hotpoint Super-Stor refrigerators and freezers are unequalled throughout the world. Hotpoint will continue to lead the industry in 1953 with its revolutionary new Frost-Away system.

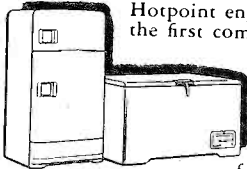

● **Hotpoint Dishwasher and Disposalls®** . . . Hotpoint introduced the first practical Automatic Electric Dishwasher over 22 years ago, and was first with gasketless door front-opening and top-inlet rotary spray. Hotpoint was first with the double-washing and double-rinsing cycles, and was first with electric-heat drying. Hotpoint engineered the first electric food-waste disposer with a control cover which governs the rotation direction of the reversible impeller. Hotpoint simplified disposer installation with the Disposalls that can be rotated 360° to fit existing plumbing connections, and will continue to lead the field in 1953 with amazing new developments.

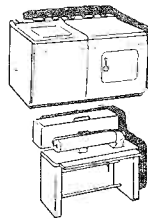

● **Hotpoint Home Laundry Appliances** . . . Hotpoint features a complete line of Home Laundry Appliances—Automatic Washers, Electric Dryers and Rotary Ironers. Hotpoint revolutionized the Dryer industry with the first sealed-chamber electric Dryer. Hotpoint introduced the first single-control Automatic Washer when it designed the WOND-R-DIAL, and was the first major manufacturer to employ fluid-drive in washers. Hotpoint will continue to lead the field in 1953 with sales-impelling new developments in the Home Laundry field.

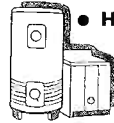

● **Hotpoint Electric Water Heaters . . .** Hotpoint pioneered the electric Water Heater and has produced over one million or 1/3 of all those in use today. Hotpoint engineered the first pressurized conduction heating—Calrod Magic Circle Heat, and developed the double-throw thermostat for faster hot water recovery. Hotpoint will lead the field in 1953 with a complete line of conventional and table-top models.

Hotpoint

... The Full-Line

RANGES • REFRIGERATORS • DISHWASHERS • DISPOSALLS® • WATER HEATERS
HOTPOINT Co. (A Division of General Electric Company) 5600 West Taylor Street • Chicago 44, Illinois

PROVED ADVANTAGES IN THE...

Full-Line Franchise!

PROFIT-PROVED MARKETING PRINCIPLES

A completely coordinated and proved retail merchandising program to pre-sell Hotpoint products, plus a program of expanding facilities to back up Hotpoint's faith in the future of the major electric appliance business.

● Hotpoint was the first electric appliance manufacturer to promote its products through national advertising. Always a leader in national magazine advertising, Hotpoint now triples its advertising impact with its new radio and television smash-hit—"The Adventures of Ozzie and Harriet"—on a full coast-to-coast radio and television network.

- Liberal local dealer cooperative advertising.
- Hotpoint pioneered and developed the successful full-line selling technique... multiple sales through ensemble selling of complete All-Electric Kitchens and Home Laundries.
- A year 'round promotional program backed by a full line of products to create appliance sales and profits the year 'round. No off-season sales slumps.
- Comprehensive sales training program for group or individual training.
- Kitchen planning tools and techniques to expand multiple sales and ensemble selling.
- One source of supply with all the advantages of coordinated promotional programs, preferential service, simplified accounting and credit benefits, plus the complementary effect each product in the line creates for the others.

● Hotpoint's full recognition of the fact that its success and growth are, in a large measure, dependent upon the volume in which it is able to distribute its products to the consumer through retail dealerships. Therefore, it is, and always will be, Hotpoint's

foremost business policy to place at the disposal of its dealers every selling advantage within its power.

Hotpoint—the world's largest exclusive manufacturer of electric appliances—supports its faith in the future of the appliance business with—

- The world's largest range plant devoted exclusively to the manufacture of Hotpoint Ranges.
- The world's newest refrigerator plant devoted exclusively to the manufacture of Hotpoint Refrigerators.
- Seven other huge plants devoted to the manufacture of a full line of better Hotpoint products for more people at less cost.
- Expanded engineering program of research and development to even further Hotpoint's product superiority.
- Continued introduction of new proved products to expand All-Electric Living to every room in the house.

This 18 Point Franchise Program covers the advantages enjoyed by Hotpoint dealers. Before re-franchising, why don't you talk to your Hotpoint distributor and get the entire profit story. If you're interested in growth, expansion, and profits, Hotpoint's Full-Line Franchise was developed with you in mind.

Franchise of **PROVED** Products!

FOOD FREEZERS • AUTOMATIC WASHERS • CLOTHES DRYERS • ROTARY IRONERS • CABINETS

22Db GAIN OVER A TUNED DIPOLE

MOST POWERFUL TV ANTENNA EVER DEVELOPED FOR HOME USE

FRINGE & OUTER FRINGE AREAS

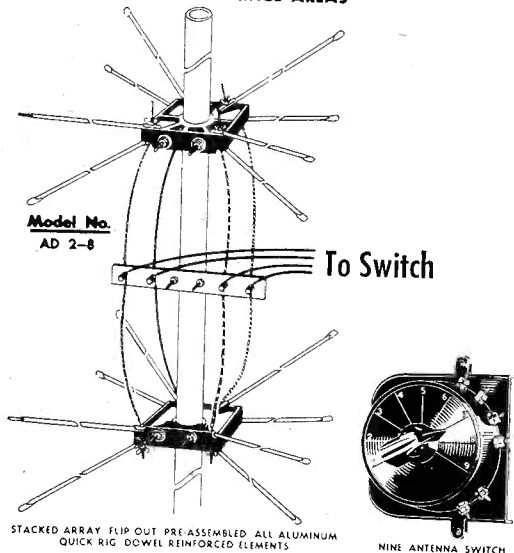

- 10 Times More Powerful Than Stacked 10 Element Yagis ..

- Extends Fringe Area Reception for an additional 40 Miles

plus

• Motorless **ALL DIRECTION** And **BROAD BAND**

UHF-VHF RECEPTION

- Preassembled Quick Rig Flip Out Assembly
- Less Than 1/2 Cost of Single Channel Stacked Yagi
- U. S. Pat. Nos. 2,585,670, 2,609,503—Others Pending

MONEY-BACK GUARANTEE

To Outperform Any Present Day Antenna Array Using a Rotomotor, Including Stacked 10 Element Yagis, 4-Bay Conicals, Fans, Double V's Etc.

LIST PRICE

\$27.60

MODEL AD 2-8

ORDER NOW—DON'T DELAY

**ALL CHANNEL
ANTENNA CORPORATION**
70-07 Queens Blvd. • Woodside 77, N. Y.

Radio and TV Receiver Production

Sept. 1952	TV		Radio
	Home Battery	Auto Clock	
			309,459
			138,622
			228,290
			178,456
Total	719,310		854,827

First nine months through Sept. 1952	TV		Radio
	Home Battery	Auto Clock	
			2,561,018
			1,005,668
			2,020,350
			1,128,817
Total	3,666,407		6,715,853

Year 1951	5,562,000	12,895,000
Year 1950	7,520,000	14,630,000

Broadcast Stations in U.S.

Stations on Air	AM 2360	FM 628	TV 110 VHF & 1 UHF
Under Construction (CPs)	132	68	38 UHF & 11 VHF
Applications Pending	265	11	296 UHF & 445 VHF

West Coast Audio Fair

Preliminary plans for the Audio Fair-West Coast were discussed at a recent dinner meeting by interested southern California sound equipment distributors, representatives and manufacturers. Dates have been set for February 5, 6 and 7, 1953. W. L. "Bill" Cara, 4245 Normal Ave., Hollywood 29, Calif., was elected Fair manager, and a temporary advisory committee was named pending appointment of a permanent 6-man committee consisting of 2 distributors, 2 representatives and 2 manufacturers. Particular emphasis was placed on the fact that the Audio Fair-West Coast will be conducted in the interest of the audio industry as a whole. Contracts for exhibition space will be available shortly, and all communications should be made direct with the Fair manager. Attending the initial meeting were "Cap" Kierulff, Kierulff Sound Corp.; Milt Ealy and Dick Hastings, Ealy and Hastings; Ernie Van Leeuwen, Magnetic Recorders Co.; Harry Shaffer and Jack Gunter, Hollywood Electronics; W. L. Cara, Fair manager; Lee Owens, Lee H. Owens Co.; H. P. Swanson, Radio Products Sales Co.; Jim Pelham, Figarts Radio Supply; George Tivy, Geo. S. Tivy Co.; Boyd E. McKnight, Minnesota Mining & Mfg. Co.; Dave Marshank, Marshank Sales Co.; Gene Rothman, Hollywood Radio Supply, Inc.; Robert Newcomb, Newcomb Products Co.; Wayne Graham, Radio Recorders Equipment Co.; and Phil Kudler, Universal Radio Supply Co.

Southwestern Reps 4th Annual Conference Plans

The Southwestern Chapter of "The Representatives" announce that arrangements have been completed for the Fourth Annual Southwestern Electronic Conference to be held in January 1953 at the Fort Clark Ranch, Brackettville, Texas. Preliminary surveys indicate that this conference will break all attendance records.



"ON THE BEAM" WITH CROSLLEY TV

AMERICAN KITCHENS
BENDIX
CROSLLEY
CROSLLEY BROADCASTING CORPORATION
CORPORATION
HORN
LYCOMING
NEW IDEA
SPENCER HEATER

You can see it **BETTER** on a CROSLLEY

DEALER "CLICKS" WITH CROSLLEY AFTER TRYING OTHER BRANDS



Steve Pendleton was first to offer free home trials in Seattle, Washington.

Bored with retirement, Steve Pendleton jumped back into business when he opened a television store in Seattle.

Steve wasn't too successful at first—but when he added the Crosley line everything seemed to "click."

"I had been stressing *quality and dependability*," explained Steve Pendleton, "and Crosley had both. I wanted a well-known brand backed by national advertising—and again Crosley had it. In short, I was sold on Crosley and I sold Crosley.

"I sold a lot of Crosleys by renting them," said Steve. "Once my customers saw Crosley's superior performance, they wanted to *keep* their sets. I allowed them to use their paid rental fees as down payments."



Wide Crosley TV assortment backs up Steve Pendleton's consistent and friendly advertising. He stresses quality, performance, dependability... "and Crosley has them all!"

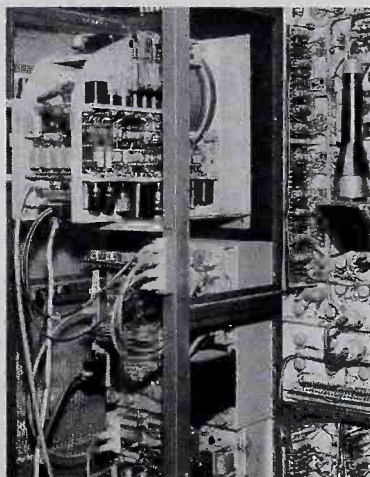

All Crosley sets are adjusted to this test transmitter's broadcast.

SPECIAL TRANSMITTER TESTS EVERY CROSLLEY BEFORE IT LEAVES THE FACTORY

This special transmitter produces the technically perfect TV signal which every Crosley set is *factory-adjusted* to receive. A television set *must* be good if it passes the rigid testing of this transmitter. And *every* Crosley set must and *does* pass the Tele-Test before it leaves the factory. That's why Crosley sets normally need no further adjusting. This careful testing backs up your selling message, "You can see it better on a Crosley TV."

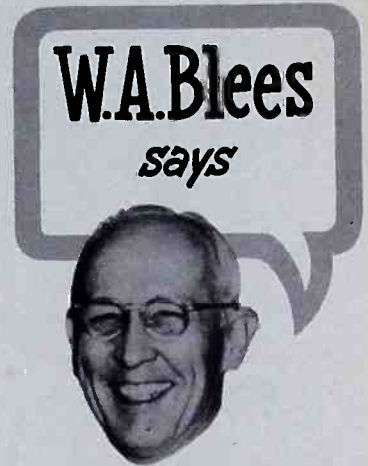

"There are definite reasons why a dealer should carry one line today. For one thing, it is very difficult for him to try to follow the policies of many different companies, particularly in their service and promotional activities.

★ ★ ★

"Advertising these different products leaves the public confused as to what kind of dealer he is. His advertising loses continuity.

★ ★ ★

"However, when he advertises the products of one company, each ad that he runs helps every other product in the line, and he creates confidence in his customer's mind. In other words, the dealer becomes convincing, and he does not have to resort to cutting prices merely to develop a sale.

★ ★ ★

"Both dealer and manufacturer benefit when a dealer handles only one line. Loyalty and friendship build up over a period of years which couldn't exist in any other way.

★ ★ ★

"We stand ready to help dealers see that they are properly located with the right size building; work with them to get their financing on a sound basis; help them organize both from a management and sales standpoint; and assist them in active sales and promotion activities.

★ ★ ★

"We are in a new and different kind of market and we must change our ways if we are to succeed!"

"ON THE BEAM"..... with CROSELY TV



SKILLED CRAFTSMEN USE ONLY FINEST WOODS TO MAKE CROSELY TV CABINETS

Every Crosley cabinet is expertly crafted and styled by skilled cabinetmakers. They're all fine wood—mahogany, blond, maple. Not a metal or plastic cabinet in the line.

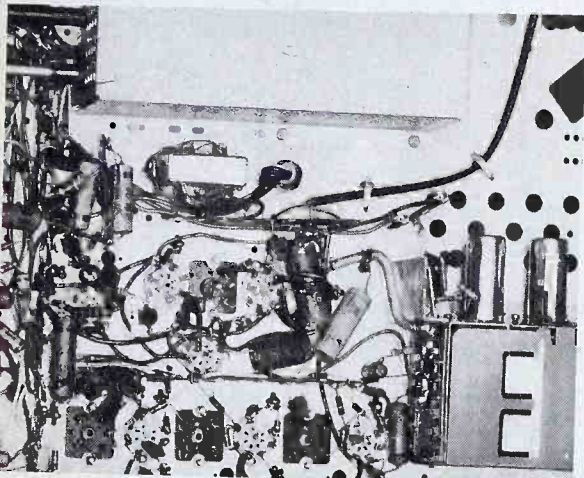

CROSELY'S PRECISION CIRCUITRY ADDS SENSITIVITY—CUTS SERVICE CALLS

30 years of electronic experience go into every Crosley television set. The new and advanced Crosley circuitry is designed to receive sharper, clearer pictures and make field service simple.

TV Rentals Turn Trade-ins Into Profitable Business

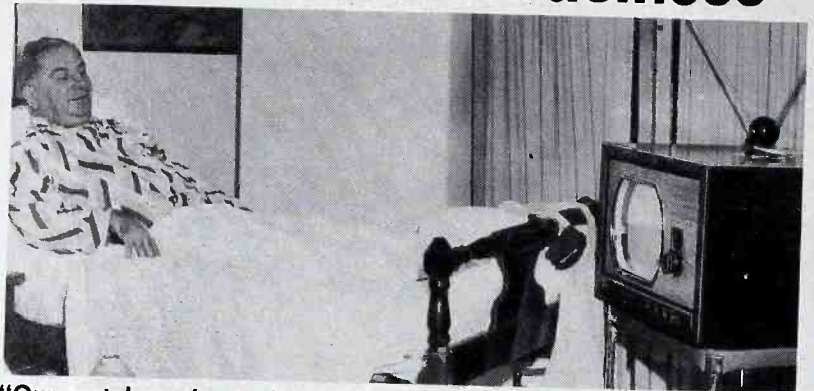

"Our rental service to hospital patients keeps our name constantly before the public," says Bill Bigner, Cincinnati Crosley dealer. "Those who rent our sets think of us first when they buy a new TV."

What do you do with your old trade-in sets? Bill Bigner, Cincinnati Crosley dealer, rents them and makes money! Not only does he make extra profits from rentals—but he now can afford to offer

higher trade-in allowances toward new, big-screen Crosley TV sets. That means more trade-in business. Bill rents his old sets to hospitals, convalescent homes and business organizations.

**WIN
\$5⁰⁰**

with your best sales story
Send your story to
"On the Beam,"
Crosley, Cincinnati
25, Ohio

"After installing a television set, or any other appliance, our serviceman calls the store. The store manager asks the customer if she is completely satisfied with the installation and does she fully understand how to operate the set. If she does not, the serviceman tells her everything she should know. This personal interest builds good will, extra sales and cuts down on a lot of useless and expensive service calls."
Harry J. Miller, THE LITTLE RADIO SHOP, 607 Wynnewood Road, Philadelphia 31, Penna.

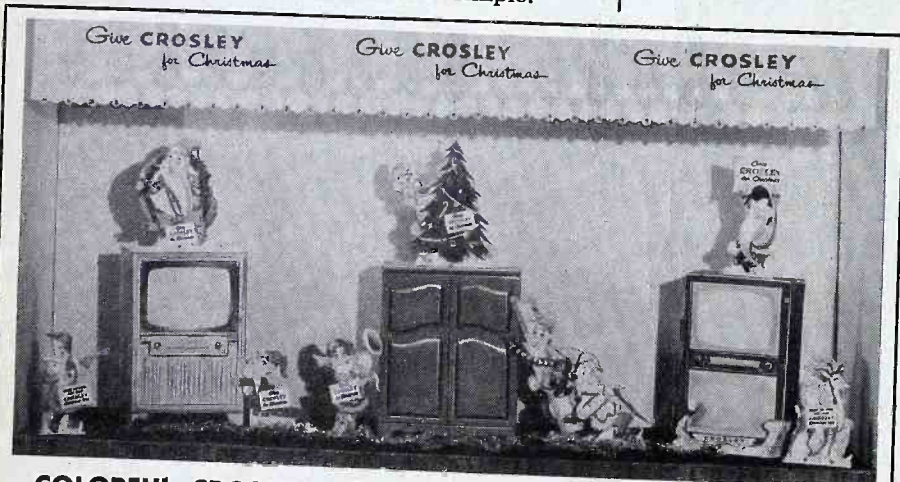

COLORFUL CROSELY STORE DISPLAYS TO BRIGHTEN YOUR CHRISTMAS SALES

See how Crosley's bright Christmas pixies beckon the window shopper into the store! They can do the same business-catching job for you! Call up your Crosley distributor today. He's ready to put these pixies to work in your window.

TUNING IN THE DEALERS



"About 3 years ago we decided to handle only Crosley. Since then our TV sales volume has increased steadily. Crosley's distributor, The Capital Paper Company, backed us up all the way with plenty of sales and service help. We're convinced our decision to handle only Crosley was one of the most profitable business moves we've ever made."
Mr. R. W. Greenberg, Kirk Furniture Co., Indianapolis, Indiana



"Price-wise and discount-wise the 1953 Crosley TV line is the hottest on the market. The line is properly merchandised from the low-priced leaders right to the big consoles. Our salesmen find it little trouble to step customers up from the leaders to higher-priced custom sets."
Mr. S. Ackerman, Barrett's, Indianapolis, Indiana



the key to
better television
performance...

Unlike most components in the TV set, the shortcomings of the picture tube cannot be made up through adjustments of the associated circuitry.

The end result, the picture, sells the set. Because they know they can depend upon the consistently high quality, more and still more set manufacturers are specifying Du Mont Teletrons.

There is nothing finer. So insure peak performance by specifying Du Mont Teletrons. Technical data on the many sizes and types, sent on request.



DU MONT
*Teletrons**

CATHODE-RAY TUBE DIVISION

ALLEN B. DU MONT LABORATORIES, INC., CLIFTON, N. J.

*Trade-Mark

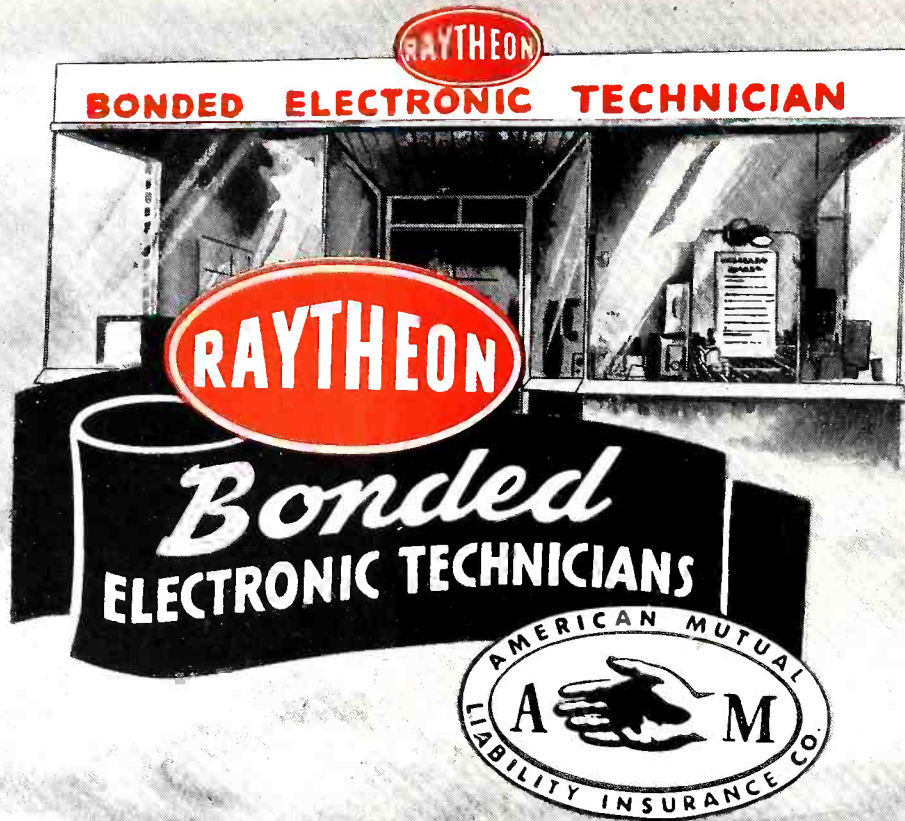

GIVE YOUR BUSINESS A LIFT...

with the

RAYTHEON Bonded Electronic Technician Program!

The above seal means a good deal to every Service Dealer who can display it. Thanks to Raytheon's national magazine and radio advertising, the public accepts this seal as the mark of a capable, reliable thoroughly honest Service shop — a shop whose technical ability, business ethics and *Bond* are above reproach.

Once a Service Dealer gains this consumer confidence he has cleared the biggest hurdle in the race for more volume and profit.

And here's the best part of all. If you can qualify as a Raytheon Bonded Electronic Technician, this priceless sales stimulator *is yours without cost.*

Raytheon has financed this program for over six years as their investment in your future.

Better contact your Raytheon Tube Distributor today, and see if you can qualify for this exclusive sales advantage.

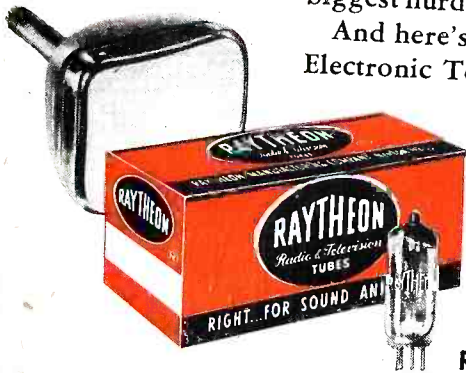

RIGHT... FOR SOUND AND SIGHT®

RAYTHEON MANUFACTURING COMPANY

Receiving Tube Division
 Newton, Mass., Chicago, Ill., Atlanta, Ga., Los Angeles, Calif.

RAYTHEON MAKES ALL THESE:



Excellence in Electronics

RECEIVING AND PICTURE TUBES • RELIABLE SUBMINIATURE AND MINIATURE TUBES • GERMANIUM DIODES AND TRANSISTORS • NUCLEONIC TUBES • MICROWAVE TUBES

Bendix TV



scores again!

Now . . . low-priced table models that look exactly like big consoles!



Ideal display space
for books, bric-a-brac

The Michigan
Model 21T3
with Model 200 M Base



Drawer can accommodate
3-speed record changer

The Michigan
Model 21T3
with Model 201 M Base



Provides stylish setting
for floral arrangements

The Arizona
Model 21X3
with Model 300 B Base



Ample storage space for
magazines, TV schedules, etc.

The Arizona
Model 21X3
with Model 301 B Base

*...and how the public
is going for 'em!*

For real "sock" appeal to budget-minded customers, you can't beat these handsome new Bendix 21" table models. As your own eyes tell you, they *do* look just like full-scale consoles.

The trick is the cleverly-designed, *exclusive* Bendix bases — far superior in appearance and utility to any other table model bases on the market. The Bendix bases measure 25" wide, 22 $\frac{5}{8}$ " deep, and 16" high. In combination with the new receivers, they form an attractive 38"-high unit that any prospect would be glad to own.

No surprise then that customers are going for this great new Bendix* TV styling development *in a big way*. And so are Bendix dealers! Why don't *you* get full details on the Bendix profit story?

*REG. U. S. PAT. OFF.

One more way that  helps you sell more and profit more!

AVIATION CORPORATION — THE NAME MILLIONS TRUST

BENDIX RADIO TELEVISION AND BROADCAST RECEIVER DIVISION

BALTIMORE 4, MARYLAND

Revere's new highs in recording quality brings you

new highs in profit!



High in praise of Revere's fidelity is Elena Nikolaidi, outstanding Metropolitan star.

Now REVERE brings *balanced* tone to tape recording! It's a difference your customers can hear . . . a difference that brings you new highs in tape recorder profits.

Voices and music play back as real as life . . . from a whisper to the highest soprano note. Revere brings fidelity heretofore obtainable only in expensive professional broadcast equipment.

Then—when you show your prospects how easy the Revere Tape Recorder is to operate and to carry—and mention the low price—you've a sale that sings the "high notes" in profit.



Cash In Now on the Trend to Tape Recording

The age of the tape recorder is here—for any age! More and more people are becoming interested in tape recording . . . not only for home and study use, but also for business and sales training. By displaying a complete line of Revere Tape Recording equipment now, at the upsurge of tape recording interest, you profit from the "ground floor" UP!

Revere "Balanced-Tone" Tape Recorder

Balanced Tone Control gives fidelity comparable to professional broadcast equipment. Exclusive Index Counter permits instant location of any part of the recorded reel. Instantaneous automatic key-controls. Two full hours of play . . . light-weight portability, and magnificent styling.

T-700—Complete with microphone, radio attachment cord, 2 reels (one with tape) and carrying case \$225.00
TR-800—Same as above with built-in radio \$250.00

T-500—Deluxe—2-hour play \$179.50
TR-600—Deluxe—Built-in radio . . . \$219.50
T-100—Standard—1-hour play . . . \$169.50
TR-200—Standard—Built-in radio. \$209.50

You're Backed By THE STARS!



When famous concert and stage stars personally use and endorse Revere—you know you're on the right bandwagon! Names like Artur Rubinstein, Gladys Swarthout, Mario Lanza, Tony Martin, Patti Page, Dan Dailey—all ardent Revere users—help you sell Revere!



REVERE CAMERA CO. • CHICAGO 16, ILLINOIS

*So Superior it can be
sold with a One Full Year
Guarantee—in writing!*

Ready for *immediate delivery*, here is a sensational new TV value from Hallicrafters! The gleaming, modern plastic cabinet frames a big 20" tube with non-glare tilted glass front. And this new set is *sensibly priced* to give dealers a good profit plus an edge on competitive makes. Priced to give *customers* top value for their TV dollars!

Hallicrafters Model 1075—Unmatched picture quality in 20" rectangular tube. Clean, modern lines executed in rich mahogany finish. Control panel is in smart Hallicrafters Smokey Black. Easy tuning—steady, clear picture.

Model 1074 available in blonde.

Now! An Exciting New Example of **Hallicrafters TV Quality**

**A BEAUTIFUL NEW 20" TABLE MODEL, PRICED TO GIVE CUSTOMERS
TOP VALUE...TO GIVE DEALERS A GOOD PROFIT!**

*Quality...Easier to Sell
because it's easier to prove!*

Claims of quality can be made by many. Proof of quality can be assured by few.

Among all manufacturers in the United States today, Hallicrafters has the largest experience in building precision instruments of communication using television frequencies!

The Hallicrafters name and Hallicrafters performance are famous around the world and Hallicrafters equipment is used by 33 governments.

Why follow the false prophets of profitless *low* prices or out-of-reach *high* prices? Major in the quality that's *easier* to sell—Hallicrafters quality—easier to prove—guaranteed to your customers in writing.

Phone, wire or write for complete details today...
Hallicrafters Company, Chicago 24, Illinois.

*Profit with Hallicrafters...
the Quality Line at Sensible Prices!*

hallicrafters Guarantee

*to your customers
—in writing!*

"Every Hallicrafters Television Receiver is built with such remarkable precision that we give you a written warranty on *all parts* for *one full year* from date of purchase, at *no extra cost!* You take no chances on costly replacements. Each Hallicrafters set is precision-built for *guaranteed* quality and your protection is in writing!"

hallicrafters

World's Leading Manufacturers of
Precision TV and Radio

MODEL 127 HF "CATALINA" PLUG-IN FONOGRAF Automatic 3-speed "push-off" plugs into radio, TV or amplifier. Russet and cream (R-127 HF), burgundy (B-127 HF) available. \$61.50. 127-27 HF equipped for plug-in of magnetic cartridge. \$56.75. 127-270 HF equipped with G.E. Triple-Play Cartridge. \$62.50. UL approved.

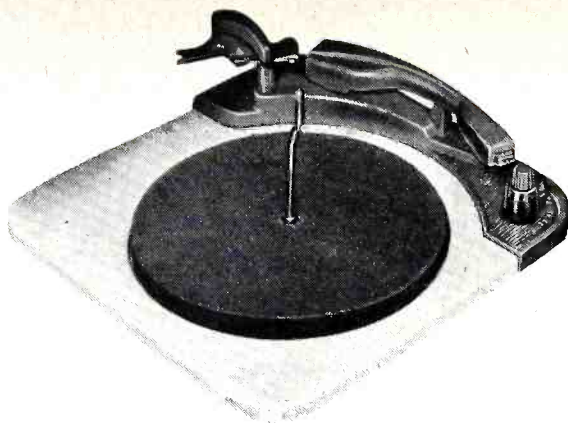

MODEL 121 DISKCHANGER Automatic 3-speed for modernizing or dated combinations. Forest green or gray (F-121), burgundy (B-121) available. \$49.50. 121-270 equipped with G.E. Triple-Play Cartridge. \$51.75



MODEL 126 HF DISKCHANGER Automatic 3-speed "push-off" for replacement or high-fidelity custom installations. Russet and cream (R-126 HF), burgundy (B-126 HF) available. \$55.50. 126-27 HF equipped for plug-in of magnetic cartridge. \$50.50



THE COMPLETE NEW **Webcor**® LINE

FOR '53

NEW STYLING...

NEW COLORS... NEW PRODUCTS

MODEL 122 "DECORATOR" PLUG-IN FONOGRAF Automatic 3-speed plugs into radio, TV or amplifier. Forest green (F-122), burgundy (B-122) available. UL approved. \$53.75



MODEL 123 "JUBILEE" FONOGRAF Automatic 3-speed fono for any room. Forest green (F-123), burgundy (B-123) available. UL approved. \$63.50



MODEL 134 "MAESTRO" FONOGRAF Manual 3-speed in portable base reflex case. Forest green and gray (F-134), burgundy (B-134) available. UL approved. \$49.00

MODEL 124 "HOLIDAY" FONOGRAF Automatic 3-speed portable fono. Forest green (F-124) burgundy (B-124) available. Luggage-type case. UL approved. \$87.50

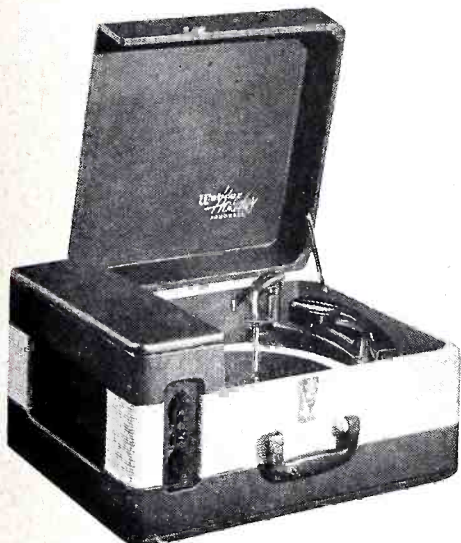

MODEL 166 PORTABLE AMPLIFIER
High-fidelity amplifier with 8-watt, push-pull circuit. 10-inch speaker. Phono and microphone inputs with separate tone and volume controls. Use as P.A. system. Burgundy case. U.L. approved. \$68.75

MODEL 125 PORTABLE DISK-CHANGER Automatic 3-speed portable Diskchanger. Mate for 166 Amplifier. Burgundy carrying case. \$68.50. UL approved.

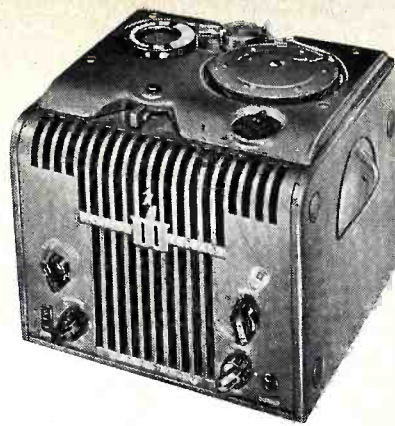

MODEL 181 WIRE RECORDER
High-fidelity head, automatic stops, semiportable metal case. UL approved. \$104.50



MODEL 288 WIRE RECORDER
High-fidelity console response. Automatic stops. Simple controls. Burgundy case. UL approved. \$157.50



► Webcor shows the way with the industries newest, finest and most complete line since the invention of the phonograph.

The Webcor line for '53 is new from top to bottom—new units, new features, new colors and designs. There's a new Webcor unit for every purpose and every price bracket in your market—and it's yours for new sales in '53!

The new Webcor line is backed by new advertising to create the want, new sales promotion to create the traffic and new display material to help you make the sale!

You owe it to yourself to see, hear and sell the new Webcor line for '53!

Prices shown slightly higher in the west

Prices subject to change without notice

All music sounds better on a **Webcor**[®]
manufactured by Websfer-Chicago, Chicago 39, Illinois



MODEL 210 TAPE RECORDER
Up to two hours on one reel. Two speeds in both directions. Automatic stops. Burgundy luggage-type case. UL approved. \$197.50

MODEL 129 "AUTHENTIC" FONOGRAF Automatic 3-speed "push-off" fono for high-fidelity music in home. Khaya mahogany (129-1) \$168.50. Antique fruitwood (129-2) \$178.50 available. UL approved.



MODEL 136 "MIDGE" FONOGRAF
Low-cost manual 3-speed fono in compact case. Forest green fono and cream (F-136), burgundy and cream (B-136), tan and cream (T-136) available. UL approved. \$29.95

MODEL 135 "LARK" FONOGRAF
Manual 3-speed portable at moderate cost. Forest green (F-135), burgundy (B-135) available. UL approved. \$39.95

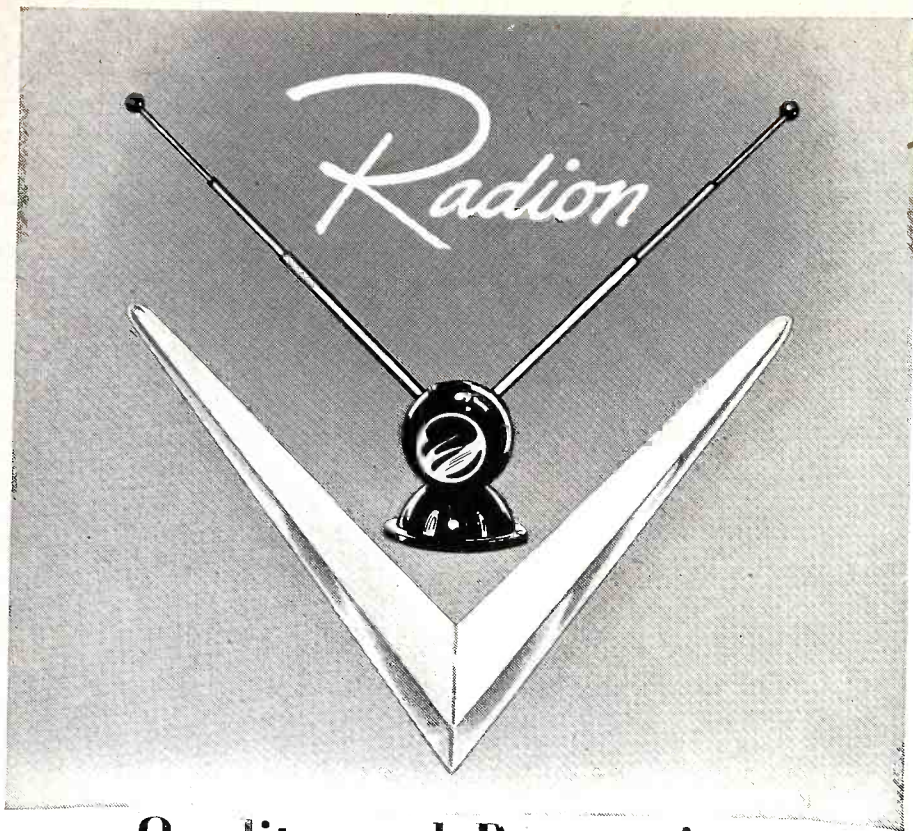

Quality and Reputation sells antennas too!

Many motor cars look the same, but there's a difference . . . and there's a difference in TV antennas too! Be sure of sales . . . use the antenna folks know for quality . . . they use in 1 out of every 6 installations . . . the Radion Metropolitan! It's the *original* indoor antenna and still the best seller.

Because Radion is built better, easiest to install, simplest for customer to operate, Radion saves your profits. Deliveryman or customer installs it . . . service calls are minimized. Customers are pleased because Radion does the job . . . and keeps TV set price low.

Sell quality and you sell satisfaction . . . specify Radion, best selling because it's best!

Radion's New Lightning Arrester Fits All Twin Leads, Mounts Anywhere

Now, one arrester is all you need carry! Phenolic model at \$1 list; deluxe Porcelain is \$1.50 list. Counter-packaged low-priced to give you volume sales!



Radion

SEND TODAY
FOR RADION PROFIT PLANS

THE RADION CORPORATION
1130 W. Wisconsin Ave. • Chicago 14

TELEVISION SET OWNERS, NOV. 1, 1952

Market Area	No. TV Stations	TV Sets in Use
Atlanta	3	210,000
Baltimore	3	430,000
Binghamton	1	93,500
Birmingham	2	128,000
Boston	2	980,000
Buffalo	1	298,000
Charlotte	1	167,000
Chicago	4	1,300,000
Cincinnati	3	354,000
Cleveland	3	680,000
Columbus	3	235,000
Dallas-Fort Worth	1	195,000
Davenport-Rock Island	2	146,000
Dayton	2	209,000
Denver	1	45,000
Des Moines (Ames)	1	95,500
Detroit	3	785,000
Erie	1	94,500
Grand Rapids-Kalamazoo	1	186,000
Greensboro	1	101,000
Houston	1	186,000
Huntington	1	96,000
Indianapolis-Bloomington	1	312,000
Jacksonville	1	71,500
Johnstown	1	178,000
Kansas City	1	234,000
Lancaster	1	172,000
Lansing	1	106,500
Los Angeles	7	1,300,000
Louisville	2	156,000
Memphis	1	152,000
Miami	1	111,000
Milwaukee	1	370,000
Minneapolis-St. Paul	2	340,000
Nashville	1	82,000
New Haven	1	338,000
New Orleans	1	120,000
New York	7	3,260,000
Norfolk	1	129,000
Oklahoma City	1	97,600
Omaha	2	146,000
Philadelphia	3	1,180,000
Phoenix	1	42,000
Pittsburgh	1	515,000
Portland Ore.	1	15,000
Providence	1	238,000
Richmond	1	147,000
Rochester	1	166,000
Salt Lake City	2	81,000
San Antonio	2	96,000
San Diego	1	127,000
San Francisco	3	470,000
Schenectady	1	234,000
Seattle	1	180,000
St. Louis	1	442,000
Syracuse	2	180,000
Toledo	1	213,000
Tulsa	1	81,000
Utica	1	78,000
Washington	4	410,000
Wilmington	1	124,000
Not Interconnected		
Albuquerque	1	19,000
Brownsville	1	11,600

Total for All Stations 19,739,700

ESFETA Favors State Licensing of Technicians

The most important business transacted at the recent meeting of New York's Empire State Federation of Electronic Technicians Associations, Inc., was the motion introduced and passed that "ESFETA, Inc., is in favor of state licensing of radio and TV electronic technicians, this license to be so designed that standards of competency and ethics will be stabilized in order to protect the public."

N. Y. Reps Are Hosts

The members of the Industry Relations Committee, National Board of Governors and National officers of "The Representatives" of Radio Parts Manufacturers, Inc., were extended an official invitation by committee member John Kopple to be guests of the New York Chapter at their regular monthly meeting in October. James Pickett, president, Jules Bressler, vice-president, and Dan Bittan, long-time senior member, joined Mr. Kopple as hosts at the luncheon and dinner.

**35% PROFIT
FOR YOU!**

Arvin Radio Christmas Special

Here's what you get:

- 2 Arvin Cosmopolitan Radios, Model 651T (1 Ivory, 1 Willow Green)
- 1 Arvin International Short Wave Receiver, Model 655 SWT
- 3 Arvin Sleepytimer Clock-Radios, Model 657T (1 Ivory, 1 Willow Green, 1 California Tan)

**Includes
FREE
display
material**

(worth \$2.70)

Set and display items all packed together in one carton — order at least two deals so you can display one in your window and one inside your store.

Total list prices \$219.70
 Regular dealer cost 153.92
SPECIAL DEALER COST
DURING THIS OFFER, ONLY... 142.80

Total profit for you **\$76.90**

An actual profit of 35% on the radios alone!

And in addition, you get FREE...

- One big, beautiful Santa Claus display and 5 Santa Claus cut-outs, regularly... \$1.90
- One Santa Claus window poster and 4 window streamers, regularly... .30
- 50 Arvin Full Line Folders, regularly... .50

Free display items worth **\$2.70**

**This offer ends
Dec. 1st!
ACT NOW!**



*These are the Arvin
Christmas Special Radios
—tops in gift appeal:*

- A** Arvin Sleepytimer—Most beautiful of all clock-radios. Telechron clock and automatic timer; follow-up buzzer alarm; appliance outlet. Arvin Velvet Voice Radio with 5 tubes including rectifier. Model 657T \$39.95
- B** Arvin Cosmopolitan—Exquisitely styled with lighted pointer and gold-plated plastic numerals; 5 tubes including rectifier, automatic volume control, Velvet Voice tone with Magna-Bass amplifier. Model 651T \$29.95
- C** Arvin International—Newest short wave receiver for foreign broadcasts, or standard AM. 5 tubes including rectifier; amazing range and tone. Satin-gold pointer, edge-lighted dial. Model 655 SWT \$39.95

Radio & Television Division
Arvin Industries, Inc., Columbus, Indiana

2 Quick Steps

and you're set for

UHF

on any Panoramic Vision*
STROMBERG-CARLSON



1. Replace unused VHF coil tuning strip with UHF strip — without removing the chassis. A screw driver is your tool kit! (Stromberg-Carlson Panoramic Vision models have provision for up to six UHF replacement strips.)



2. Insert UHF channel number on new Channel Selector Dial. This you do with your finger tips! New Channel Selector Dial provides for the insertion of new UHF panel numbers at the point on the dial where the new station is to be received. Complete set of numbered inserts for UHF shipped with each instrument.

In any TV market you're right with Stromberg-Carlson!

Right with quick adaptability for UHF . . .

Right with proved superior performance even in difficult fringe areas . . .

Right with Panoramic Vision* — more picture visibility, wider viewing angle than any other 21" TV . . .

Right with models and prices for every taste and budget . . .

Right with a discount structure that gives you up to 5% more than standard discounts! For a big, profitable holiday business—



YORKSHIRE—421CDM2
21-inch
Chippendale console
in Honduras mahogany
veneers, curved doors.
\$479.50 **

Other
Panoramic Vision
models
from \$295.

“There is nothing finer than a

STROMBERG-CARLSON®

Stromberg-Carlson Company, Rochester 3, N. Y.

*Patent applied for.

**Zone 1.

Includes excise tax.

Installation and warranty extra.

TELEVISION RETAILING

Reading "Radio & TELEVISION,"
"RADIO & TELEVISION TODAY,"
"TV TECHNICIAN" and
"ELECTRICAL RETAILING"

O. H. CALDWELL, Editorial Director



M. CLEMENTS, Publisher

Stay OPEN Nights to CLOSE More Sales!

Today, there's a trend away from keeping stores open evenings. And this in spite of the fact *that in more than 90 per cent of all cases both husband and wife jointly decide on purchases of big-ticket TV sets and appliances.*

And in spite of the fact, too, that a great majority of all sales of big-ticket items are made at night—either in the store or in the home.

Since very few male prospects are night watchmen, able to go out and buy TV sets and appliances during the day, and since a great many married women are working these days, the volume-minded dealer doesn't need to be sold on the idea that the evening is the best time to sign 'em up on the dotted line. In the case of television, with all of the best programs on at night, evening selling is a must.

The Day to Line Up—the Night to Sign Up Prospects

In our field, particularly so far as the more expensive products are concerned, customers follow a well-defined pattern. They size up and compare products during the day, and while they do occasionally buy then and there, most of them go home and discuss the proposed purchase in the evening. Such "shoppers" in search of expensive products are often housewives "scouting" the stores, or they may be men employed in the neighborhood who "read" show-windows or who drop in to ask some quickie questions. *However we view the situation, it's a fact that the daytime looker is the nighttime buyer.* In order to capitalize upon this familiar routine, the dealer needs to obtain names of all store visitors, to stay open evenings for the convenience of his customers, and to have his salesmen make more night calls in the home.

Longer Hours Will Spiral Sales Volumes in All Stores

One of the present drawbacks to evening selling is the unwillingness on the part of many salesmen to work at night. But some dealers are getting around this objection by setting up shorter daytime hours for their salesmen in order to compensate them for after-dark services. Still others have been able to convince salesmen that "overtime" selling is highly profitable, selling the idea through fat commission checks.

Because it must cater to the existing buying habits of consumers, the business establishment in this field must gear its hours to the convenience of its customers.

If your store is a sick friend, staying up with it nights will pay off handsomely. If it's in a healthy condition, evening activities will keep it flourishing.

What's Ahead! — in Radio,

TV MARKET TRENDS: Shortages of television receivers came almost overnight to numbers of communities where dealers had been reluctant to place large orders when sets were plentiful . . . Heavy shipments to newly-opened TV areas and production bottlenecks some of the factors causing the spot shortages. . . . For some months ahead, TV prices will probably go in one direction—up. . . . And so will production! . . . Many smart merchandisers are not taking TV shortage rumors too seriously, so far as the future is concerned.

WATCH FOR CHRISTMAS BUSINESS this year to be far ahead of 1951, perhaps as much as a 20 per cent increase in TV, radio, major appliances and phono records. Small appliances will be outstanding sellers in all markets with supplies and selections adequate.

GREAT MANY FOLK WHO OWN SMALL-SCREEN TV sets these days are keeping them as "second" receivers when they buy new ones, with only about 4 per cent of sales involving trade-ins. In New York the percentage is higher because the area has had TV for a long time. However, the all-out promotional effort in New York using ads and air-time to plug sales of reconditioned sets isn't because there are so many of them on hand. It's been chiefly used as a door-opening, selling-up technique.

FOOD FREEZERS IN SHORT supply in some areas, and are selling well. A number of leading dealers doing a bang-up, and legitimate job in tie-ins with food suppliers, and look for good business in the future, not foreseeing any serious threat from super food markets as sellers of this appliance.

DIVERSIFICATION OF LINES PLANS by some big companies through acquisition of other manufacturers' plants caused a few headaches among certain distributors because of franchising problems, but right now it appears that all such problems have been ironed out by several of the largest wholesalers in the country. And on the subject of diversification, it can happen that a very well-known appliance maker will enter the home TV-radio field. (Please don't ask us who!)

LARGE INDEPENDENT DEALERS watching open credit accounts with an eagle eye these days as some erstwhile prompt payers react slowly to current bills. Merchants blame this condition on the ever-increasing cost of living.

CONSUMERS ARE SKEPTICAL about shortage talks. In Philadelphia, a salesman truthfully pointed out that all but one model in a current line of TV sets were in short supply; that the particular receiver the customer wanted was the last one the store had in stock. The would-be purchaser walked out in a huff!

MORE THAN A THOUSAND LETTERS received in two weeks by J. G. Bradburn, owner of Lil' Pal Stores, Houston, Texas, when he asked listeners for comment on his radio show, "Music of the Masters." Bradburn's stores do an outstanding job in selling phono records in the Houston area.

GRIST FROM THE RUMOR MILL: Right now there's a great deal of negotiating going on for the purchase of this-and-that manufacturing business by some of the biggies. Watch for surprising developments, with still another company adding a refrigerator-freezer line and laundry equipment to its present set-up . . . Don't be surprised to see a TV-radio manufacturer fair-trade his products; also a record maker . . . One of the largest Eastern distributors ready to do some brand-switching . . . Two prominent small appliance makers huddling over idea of bringing out room air conditioners . . . Some of the big men pooh-poohing the idea that there'll be any shortage of TV sets.

AND MORE RUMORS: One manufacturing sales exec steering away from considering super food markets as outlet for food freezers, and concentrating on established dealers in this field . . . Big firm still burning midnight oil over plan to launch a "complete" Hi-Fi home unit, and another just about ready to break with that tape recorder we told you about in a previous issue . . . TV manufacturer making a survey to determine the size of the DC market in the country . . . Laundry equipment maker will bring out that automatic shortly after the first of the year.

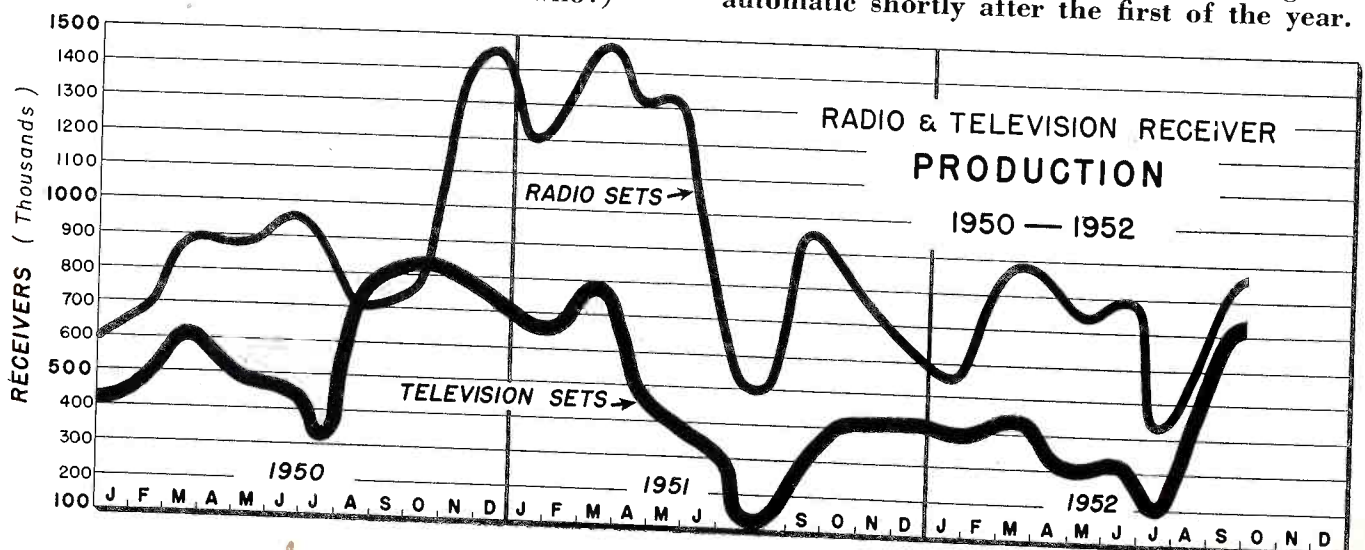

Appliances, Records and Television

TV SERVICE VOLUME WILL RUN far ahead this year over last. Though some departments were slow for the first four months of '52, business commenced really picking up in May and has been going great guns ever since, being especially active in July, September and October.

IF THIS ISN'T PROSPERITY, what is it? If consumers wanted to pay off all their installment debts tomorrow they could do so and still have several billion dollars left over, points out Robert Oare, chairman of the American Finance Conference executive committee.

IMPROVED BUSINESS ALREADY NOTED along the first section of Richmond, Virginia's "Broad Street Beautiful," the most modern street lighting project in the country, which when completed, will cost \$87,400.

LARGE RETURN FROM A MAILING. After an effective ad campaign for TV service business, D. Bernard Simon, owner of the Music House Stores in western New York, decided to spot-check his technicians' work. He sent out return postal cards, carrying the theme, "Please sign my report card," asking customer questions concerning quality of work, promptness, courtesy, etc. Returns were a fabulous 25 per cent! Carrying the program one step farther, Simon mailed out a thank-you letter to respondents, offered them a small gift if they'd drop in the store. Incidentally, about 95 per cent of the replies praised service and servicers.

TALKS ABOUT SHORTAGES IN TV SETS AND RADIOS having little or no effect on either dealers or consumers, with both willing to believe it when they see it.

For latest telephoned reports

from all sections of USA on the

STATE OF THE MARKET

See right-hand page next preceding

Index to Advertisers at rear of this issue

"TELEVISION SHOULD ENABLE A REVIVAL of personalized democracy which, in simpler times, was attained through the town meeting or through public debates between candidates."—Dr. E. W. Engstrom, VP in charge of RCA Laboratories Division.

"SUBSTANTIAL BUYING POWER EXISTS TODAY in the form of private savings . . . A decrease in military production related to a steady growth in overall production should mean less taxes and relatively more consumer purchasing power."—Secretary of Commerce Charles Sawyer.

"THE DAY OF EASY PROFITS IS NO LONGER WITH US, and, as a corollary, the day of easy expenses is likewise gone."—Don G. Mitchell, president, Sylvania Electric Products.

SUCCESSFUL EASTERN RETAILER'S weekly payroll in his service department alone is now larger than the total amount he took in during the entire first year he went into business a quarter century ago!

Level of Installment Debt Is Lower Today

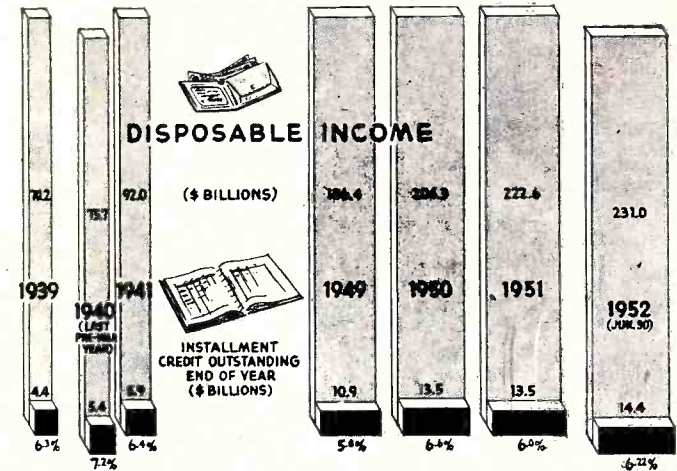

Source: Federal Reserve Board and Department of Commerce

Proportionate to income after taxes, Americans owe far less today on installment credit than they did in 1940, the last pre-war year. In that year they owed 7.2 per cent of disposable income. In 1952, the number of dollars owed is above 1940, but the figure represents only 6.22 per cent of the amount of money people have to spend.

REMEMBER 'WAY BACK WHEN those deep bass, boom-boom tones were real selling features in radios . . . And when only the most skilled technicians could install a new dial-drive cord in those big Majestics in less than 10 minutes? . . . When dealers used five-and-dime-store chill trays as giveaways to clinch refrigerator sales? (And look at the gimmicks and gismos coming as standard equipment in the units today!) . . . And the days when home laundry products came in green color only, and how long it took the manufacturers to find out that householders wanted 'em in white or black and white? . . . Those huge round dials on radios? . . . The 50-foot antennas needed on AM sets?

Future Events of Interest to Readers

- Nov. 9-15: National Television Week.
- Jan. 5-16: The International Home Furnishings Market, Merchandise Mart, Chicago.
- Jan. 26-30: Eleventh International Heating and Ventilating Exposition, International Amphitheatre, Chicago, Ill.
- Feb. 2-6: Western Winter Market, Western Merchandise Mart, San Francisco, Calif.
- Feb. 5-7: West Coast Audio Fair, Los Angeles, Calif.
- Mar. 23-26: IRE National Convention, Grand Central Palace & Waldorf-Astoria Hotel, N. Y. C.
- April 18: Seventh Annual Spring Technical Conference, IRE, Cincinnati.
- May 18-21: 1953 Electronic Parts Show, Conrad Hilton Hotel, Chicago, Ill.
- Sept. 14-17: National Electronic Distributors Assoc. Fourth Annual Convention and Manufacturers' Conference.

On the Way—



COMBINATIONS

Here are four wonderful combinations . . . four profitable ways to meet the demand for a family Christmas gift.

All have new "easy-to-play" features . . . storage space for records . . . "Golden Throat" tone system. All are beautifully styled in fine-wood cabinets.

Separate TV and radio-phonograph controls on television combinations.

Ask your RCA Victor distributor about them today!

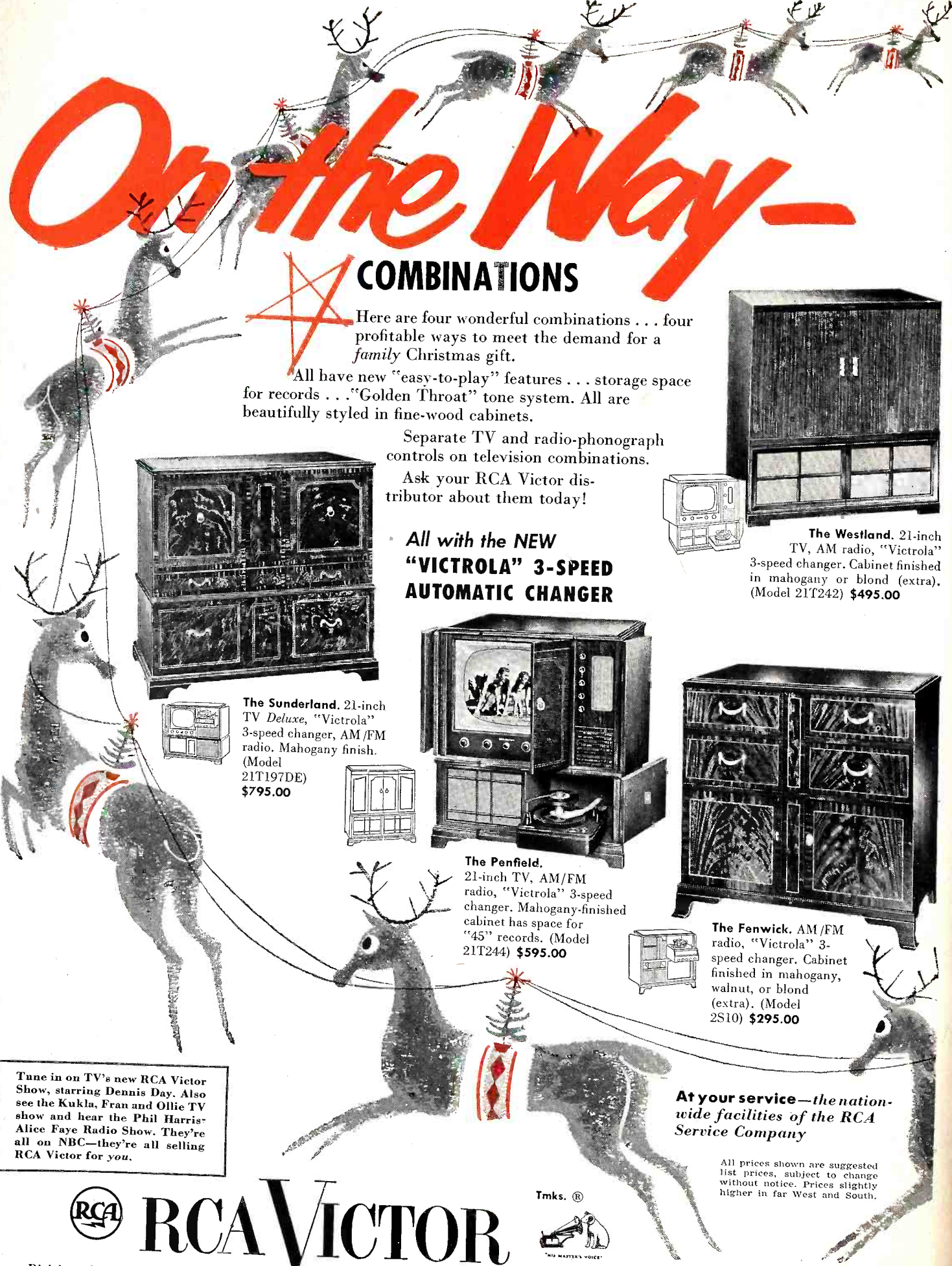

The Sunderland. 21-inch TV *Deluxe*, "Victrola" 3-speed changer, AM/FM radio. Mahogany finish. (Model 21T197DE) \$795.00



The Penfield. 21-inch TV, AM/FM radio, "Victrola" 3-speed changer. Mahogany-finished cabinet has space for "45" records. (Model 21T244) \$595.00

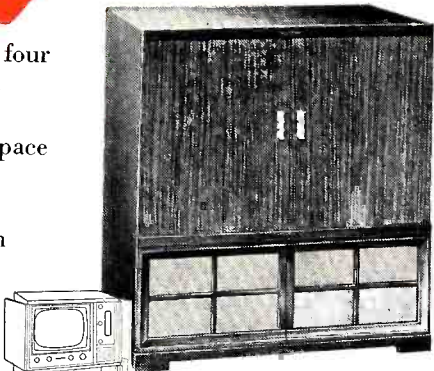

The Westland. 21-inch TV, AM radio, "Victrola" 3-speed changer. Cabinet finished in mahogany or blond (extra). (Model 21T242) \$495.00

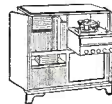
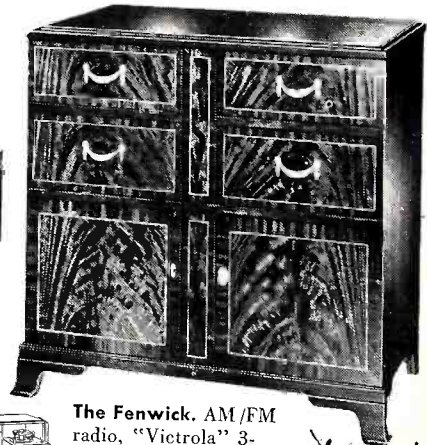

The Fenwick. AM/FM radio, "Victrola" 3-speed changer. Cabinet finished in mahogany, walnut, or blond (extra). (Model 2S10) \$295.00

Tune in on TV's new RCA Victor Show, starring Dennis Day. Also see the Kukla, Fran and Ollie TV show and hear the Phil Harris-Alice Faye Radio Show. They're all on NBC—they're all selling RCA Victor for you.

At your service—the nationwide facilities of the RCA Service Company

All prices shown are suggested list prices, subject to change without notice. Prices slightly higher in far West and South.



RCA VICTOR

Tmks. ®



Division of Radio Corporation of America

WORLD LEADER IN RADIO . . . FIRST IN RECORDED MUSIC . . . FIRST IN TELEVISION

10 GREAT NEW SETS FROM RCA VICTOR JUST IN TIME FOR CHRISTMAS!

TV SETS with the "MAGIC MONITOR" circuit system that acts like an engineer inside your set



21-inch Benton. Clear-cut, modern styling. Swivel-base cabinet finished in mahogany, walnut or limed oak. (Model 21T175DE) **\$495.00**

Two new 21-inch TV sets to round out RCA Victor's great 1952 Deluxe line—each with the "Magic Monitor" circuit system, that automatically screens out static, steps up power, and ties best picture to best sound.

Each has *deluxe* engineering for interference rejection in tough reception areas.

Each has *extra* tubes, *extra* circuits, *extra* components for the finest all-round picture quality in television today. Truly—they're *Television Deluxe!*



21-inch Farmington. Striking open-face contemporary console design. Finished in mahogany, walnut, or blond (extra). (Model 21T166DE) **\$399.50**

RADIOS For more fall and Christmas sales, these five superb new RCA Victor gift items:

- a new "Personal" table radio that outperforms much larger sets.
- a clock-radio that's no bigger than a clock!
- two powerful new AM/FM radios, perfect chair-side companions!
- a new portable radio that will pick up stations beyond the range of ordinary portables!
- Ask your RCA Victor distributor about them today.

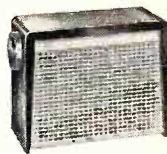

"Personal" Table Radio. Less than 6" high . . . the first of its size to have the famed "Golden Throat" tone system. Two-tone finish in black-and-beige or tan-and-ivory. (Model 2R51 series) **\$29.95**

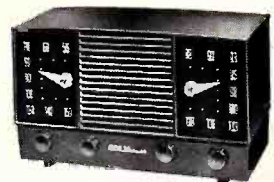

Forbes. AM/FM radio with separate dials for AM and FM. Cabinet finished in maroon plastic. (Model 2XF91) **\$59.95**. Also **Townley**, deluxe AM/FM table model. In maroon, ivory, green, red and beige finishes. (2XF931 series) at **\$64.95**



"Globe Trotter." New extra-long-range portable with greatly improved reception. Ultra-sensitive 3-gang condenser . . . "Golden Throat" tone system. Finished in dove-gray plastic. Battery, AC or DC operation. (Model 2BX63) **\$44.95** less batteries.



"Personal" Clock-Radio. Only 8 inches wide! Has famed "Telechron" clock movement. Comes in black-and-gray combination, ivory, red, and two-tone gray finishes. (Model 2G511 series) **\$39.95**



RCA Batteries are radio-engineered for extra listening hours. Make sure your customers get 'em.

PORTLAND UHF

By telegraph from
TELEVISION RETAILING's
special correspondent in Portland.

Chaotic conditions here on UHF tuning equipment. Large distributor oversold 10 per cent on sets. One manufacturer installing converters at factory on emergency basis. Another using hand-made turret strip tuners and is 90 per cent behind on UHF equipment on sets sold to dealers and customers. Others are in same boat.

UHF antennas in fair supply. V-type producing good results. Reception trouble is mainly ghosts from

buildings and adjacent hills. Such interference being corrected in most instances by use of Yagi-type sharp angle type aerial made exclusively for Channel 27. Good results obtained by raising regular aerial 4 or 5 feet or pointing it in slightly different direction. Another trouble is dead spots behind hills. Station on high hill at edge of city and many residents at foot of hill unable to receive. Station may place cap on top of its antenna to straighten out uneven pattern which goes for long distances in some directions but only short ones in other directions.

No price-cutting here yet, but one

outfit moved in from another state with some sets and started to trim prices, but was persuaded by BBB and distributors to refrain.

60 to 70% of sets sold with contracts, varying from \$60 to \$100 a year. Average price \$69.50 which includes service and installation. Some dealers selling 90-day contracts at \$64 including all-wave antenna and installation. Many customers are buying sets without service contracts. And many dealers fear year contracts because of newness of UHF and uncertain range of fringe areas which could vary as station is adjusted.

A few days before Portland's first TV station went on the air, the city's largest neighborhood store, Harold Kelley's, staged a live closed-circuit broadcast in the store. Nearly 3000 neighborhood residents crowded to witness the event—by actual count at the door. Many waited on the sidewalk for hours to get a glimpse of a TV camera in action and witness the result on Kelley's screens. Since the station, KPTV, went on the air, the store has been selling sets as fast as they could be shipped by air freight, rail and truck, a typical example.



• The Nation's first commercial UHF station is on the air!

And Portland, Oregon is going wild over television, with consumers buying right and left, and manufacturers, dealers and distributors trying desperately, and it may be added, effectively, to lick numerous and diverse technical and merchandising problems.

At the end of the first two weeks after Empire Coil's KPTV went on the air from its hilltop hastily-erected station in West Portland an estimated 8,000 sets were sold, including the few receivers bought during the two weeks before the station unexpectedly went on the air.

Sell 15,000 Sets

And by the first of this month, November, KPTV's owner, Herbert Mayer, estimates that 15,000 TV receivers will have been sold!

But there are and have been plenty of headaches. Empire Coil Company wasn't expected to have this first commercial UHF station on the air before Thanksgiving. Instead, with equipment rushed across the country by truck express and a double crew erecting the station, KPTV went on the air September 20. The construction crew couldn't even wait for the concrete to dry, so they finished the station building with cement blocks!

Shortage Headaches

To begin with there were insufficient sets to satisfy the demand, and there are still shortages. Another headache was the shortage of tuning equipment and antennas, to say nothing of a dearth of technicians to deal with a new sort of TV broadcasting, and facing as they did, conflicting claims by manufacturers. During the first two weeks, only about 1,000 sets were actually in use in Portland homes, the large balance being sets on which dealers had collected down payments but hadn't been able to deliver.

Reception is described as being good to excellent within approximately 25 miles of the station, with the fringe UHF areas extending as far as 45 miles in directions where mountains do not block out signals.

Interference Problem

Surprise headache was interference experienced on sets using 41 MC IF's, from taxi and utility company communication systems. Sets using the older 20-25 MC IF were not afflicted.

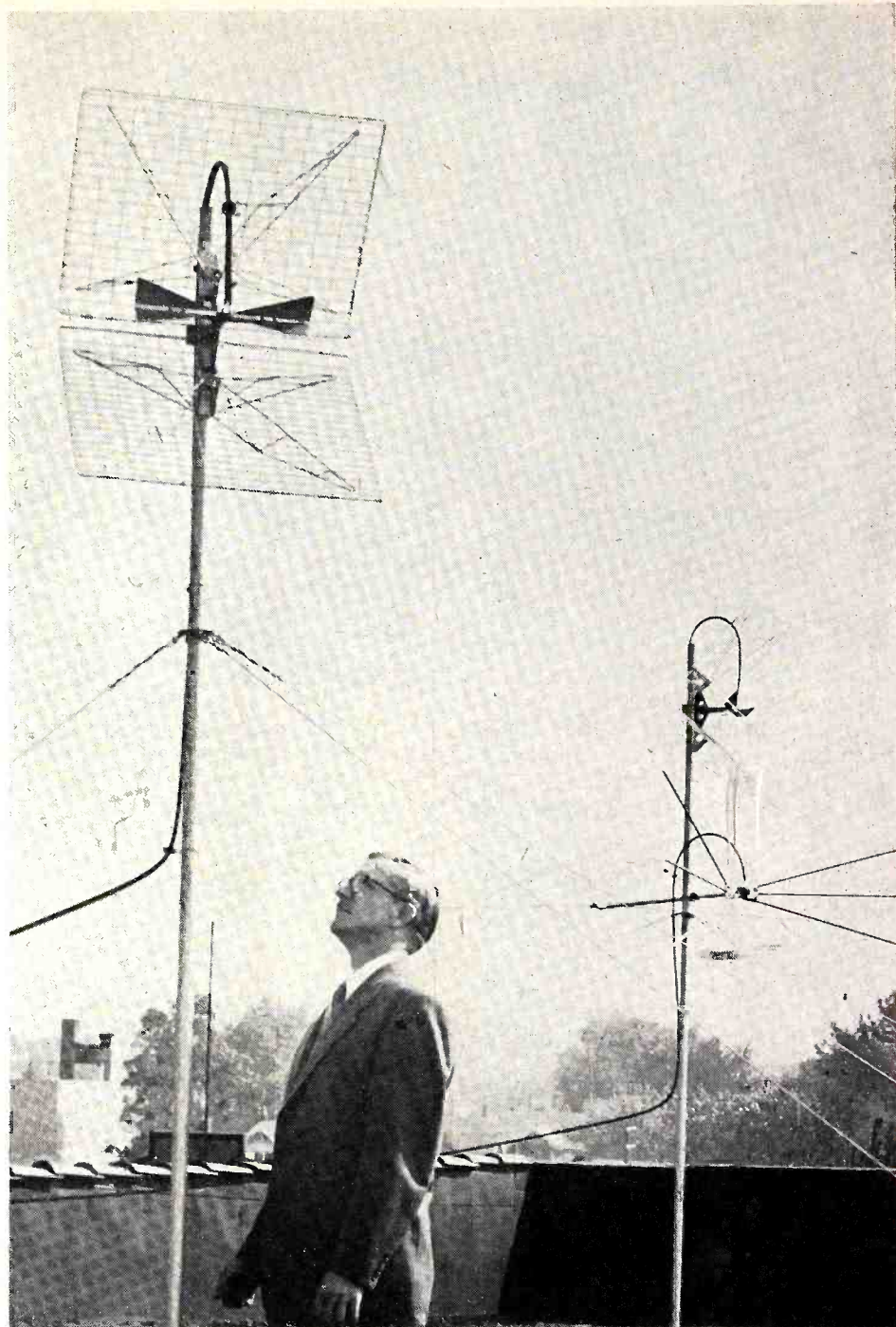

First combination UHF-VHF TV antenna in the nation to be used for reception of several sets, forerunner of installations to be used on apartment houses and other stores, was installed on one of Portland's largest TV-appliance stores, just as KPTV went on the air. It brought sightseers from miles around to see the unusual contraption, unusual even to those from other areas already enjoying TV. Portland became the first U. S. city to have UHF telecasting. (The store is Harold Kelley's.)

The city's largest department store Meier & Frank, started off with a few sets with all-channel tuners and some with UHF strip tuners, but the store like many another, was sending receivers into homes with temporary adaptors and an iron-clad guarantee that the necessary permanent tuning equipment would be installed as soon as available.

From a merchandising viewpoint, the cooperative action by the Portland Better Business Bureau and manufacturers, distributors and dealers was swift and effective.

A quick meeting called by Man-

ager Lyle Janz organized a BBB distributors' committee which raised \$300 each from some 20 wholesalers to finance a newspaper advertising campaign warning the public not to deal with gyms and citing the trouble experienced in Denver. Full-page ads were run in the two major Portland daily papers.

However, great care was taken not to scare the public away from TV, as other BBB's had been accused of doing in certain instances. "We aim at a conservative program of advising the public on how to buy and

(Continued on page 40)

PORTLAND UHF

(Continued from page 39)

how to choose a reliable dealer, and not to scare them away from TV purchases," declared Janz.

As part of the program, retail dealers are being enrolled in the BBB, many of them turning out to be well established stores that have added a TV department recently. They have been given a special rate of \$25 each to defray policing expense for the industry. This fee compares with the usual minimum of \$35 and extending upward to \$600 and more, depending on the size of the business. Each membership applicant must subscribe to the following 10-point code of advertising, sales and service ethics:

1. I/We will serve the public with honest values.
2. I/We will tell the truth about what is offered.
3. I/We will tell the truth in a forthright manner so its significance may be understood by the trusting as well as the analytical.
4. I/We will tell customers what they want to know—what they have a right to know and ought to know about what is offered so that they may buy wisely and obtain the maximum satisfaction from their purchases.
5. I/We will be prepared and willing to make good as promised and without quibble on any guarantee offered.
6. I/We will be sure that the normal use of merchandise or services offered will not be hazardous to public health or life.
7. I/We will reveal material facts, the deceptive concealment of which might cause consumers to be misled.
8. I/We will advertise and sell merchandise or service on its merits and refrain from attacking my/our competitors or reflecting unfairly upon their products, services, or methods of doing business.
9. If testimonials are used, I/we will use only those of competent witnesses who are sincere and honest in what they say about what I/we sell.
10. I/We will avoid all tricky devices and schemes such as deceitful trade-in allowances, fictitious list prices, false and exaggerated com-

BEFORE YOU PURCHASE YOUR  SET...

KNOW THESE FACTS!

There is no reason to put off buying a television set now. Any one of the leading makes, properly installed, will give you and your family years of enjoyment with a minimum of service expense. Knowing a few simple facts about Portland's television, your dealer and the set you are considering will keep you from making the expensive mistakes which plagued buyers in other new TV localities.

KPTV, the first Portland station scheduled for operation, will telecast on an Ultra High Frequency, Channel 27. While this will be the first commercial UHF station in the world, viewers who have seen experimental UHF telecasts say that they compare very favorably to usual VHF (Very High Frequency) telecasts.

BE SURE your TV set will receive UHF. Unless your TV set is designed or equipped for UHF reception you will not be able to watch KPTV telecasts.

REPUTABLE franchised dealers sell and service established-brand TV sets. Their guarantee of satisfaction on the sets they sell is backed by the manufacturer's warranty. To keep his franchise a dealer must conform to highly ethical standards. **KNOW YOUR DEALER.**

BEWARE OF TV "GYPPOS" ...

this is what happened in Denver
When the first TV station opened in Denver, "gyppos" and opportunists, in opposition to legitimate TV dealers, flooded the market with obsolete and "off-brand" sets. When these sets required service, purchasers were unable to locate the "gyppos" who had sold them inferior sets and worthless service policies. A similar situation can be averted here in Portland if you **KNOW YOUR DEALER.**

PORTLAND BETTER BUSINESS BUREAU

IN CO-OPERATION WITH THE PORTLAND TELEVISION SET DISTRIBUTORS
811 PARK BUILDING April 1952

YOU CAN buy a service policy with your TV set. Your franchised dealer will explain the details of the maintenance and parts agreement on your set. Since a service policy is your assurance of satisfactory set performance, it is extremely important to know that you are buying from a reputable dealer who will be in business during the life of this agreement.

PROPER antenna installation is essential to good TV reception. It is false economy to spend a sizable sum for a TV set and try to economize on an antenna. Your franchised dealer will recommend the type of antenna best suited to your set and your locality.

YOUR BETTER BUSINESS BUREAU

has on file the names of responsible, franchised TV set dealers and their distributors who have voluntarily supplied information on the make and models of sets they sell, and the services they offer. This information is available to you through the Portland Better Business Bureau.

TV Surprise in Denver
In Denver, television took the public by surprise, for the first week after receiving authorization. Everybody wanted a TV set immediately, and sets were purchased right off trucks bringing them into town. Many of the sets hastily brought to Denver were obsolete models which had not found a ready sale elsewhere.

IF IN DOUBT... CHECK ON THE SET MODEL AND TV SERVICE CONTRACT OFFERED BY CALLING CA 9522

This is the full-page advertisement published by the Portland Better Business Bureau in both major Portland daily newspapers as KPTV went on the air and the public became wild for TV sets. Major hope was that "gyppos" wouldn't operate on the public, as they had in Denver.

parative prices, bait advertising, misleading free offers, fake sales and similar practices which prey upon human ignorance and gullibility.

About 500 dealers have been signed up, and Janz says that 99 per cent are "firms about which there can be little doubt of their integrity."

By the end of this month, dealers foresee a more stable situation, and

brisk business. But up to now, the situation has been fabulous. One small dealer, who just opened for business after graduating from a technical school, reported selling a carload of TV sets during the first week of broadcasting.

A distributor says he could have sold 4,000 receivers the first week if he'd had UHF tuners.



Even while KPTV was on the air, which was only sporadically in its first weeks, the city's largest department store, Meier & Frank, supplied closed circuit full-time programs for every set on its TV floor covering a half block. Crowds from the first day were so thick the store lost count of its visitors. It guessed "at least several thousand during the more crowded days." Newspapers ran special television sections.



(Left) Live TV closed-circuit broadcast staged by Harold Kelley's. Neighborhood girls and boys participated in an amateur show in a "studio" set up in the midst of refrigerators, ranges and TV sets. (At the Right) The Portland evening paper ran a 42-page special TV section and the morning paper followed a week later with a 32-page section. To keep advertising free of "gyp artists," newspapermen cooperated with BBB. Here Morrie Sharp, ad manager of the Oregon Journal, and Lyle Janz, manager of the

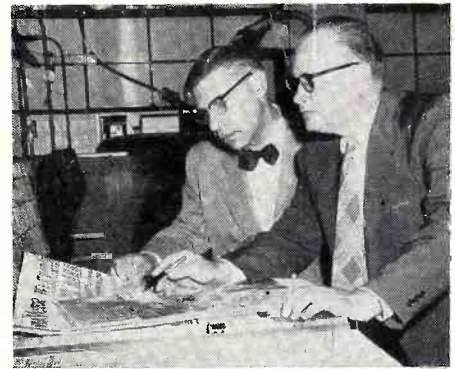

BBB, check copy for the 40-page Journal TV section. (Below) First taste of TV came when retailers and radio stations staged closed circuit telecasts before KPTV was in operation. This view shows part of the crowd at the armory where Portland radio stations with TV applicants staged a TV show witnessed by thousands. Another was held in the city auditorium and a third, sponsored by a department store, covered a full block on the lower floor of a downtown parking lot and drew an estimated 250,000.

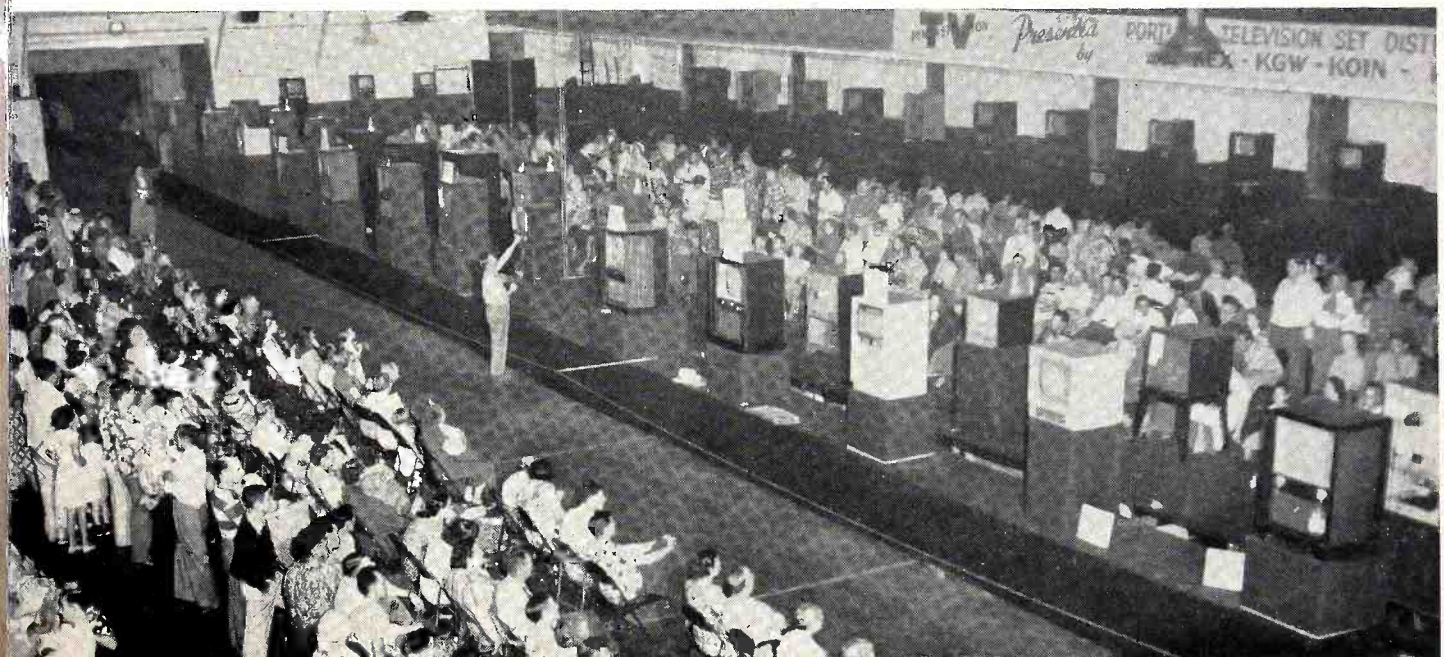

New Jersey Dealer Group Gets Real Results in **DRIVE AGAINST**

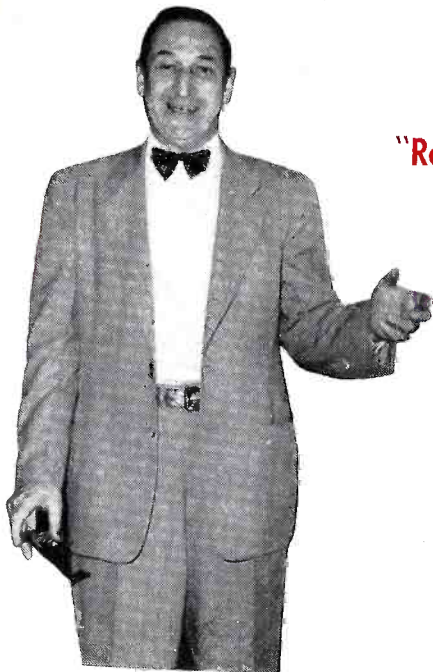

"Realistic Approach!"

Jack Rosenberg, president of the Association, interviewed in his store, Center Appliance Co., Irvington, is more than gratified with results of the program and with the cooperation of the member dealers and distributors. "The method of operation is a realistic approach to the price-cutting situation, and it's really working," he says, in describing this project.

nally intended. (And the association obtained pledges of support from leading local distributors.)

2. Dealers will tag all products in show-window and on floor with list prices only.

3. No dealer will advertise cut prices on "damaged" merchandise.

4. Each distributor should have available lists of prices he charges merchants, showing quantity discounts, etc.

5. No dealer shall keep his store open Sundays and legal holidays.

6. A pledge from the distributor to eliminate "inside" deals.

• A two-year-old New Jersey dealer association, with about 250 active members, is being successful in curbing price-cutting activities through use of a unique cooperative project. At a meeting, reported in the August issue of this magazine, members of the Greater New Jersey Appliance Dealers Association, after a stormy session, adopted the following platform:

1. Dealers will use cooperative ad money in the manner that was origi-

About the Area Covered by The New Jersey Dealers Association

Territory considered to be part of metropolitan New York (New York and northeastern New Jersey)—Total population: 12,831,914

Population, Newark, N. J. — 438,776

Population, Jersey City — 300,447

New Jersey metropolitan area made up of consumers in all income brackets. Heavy industrial activities in larger cities. Wealthy and middle-income residents in suburbs. Many commute daily to businesses in New York.

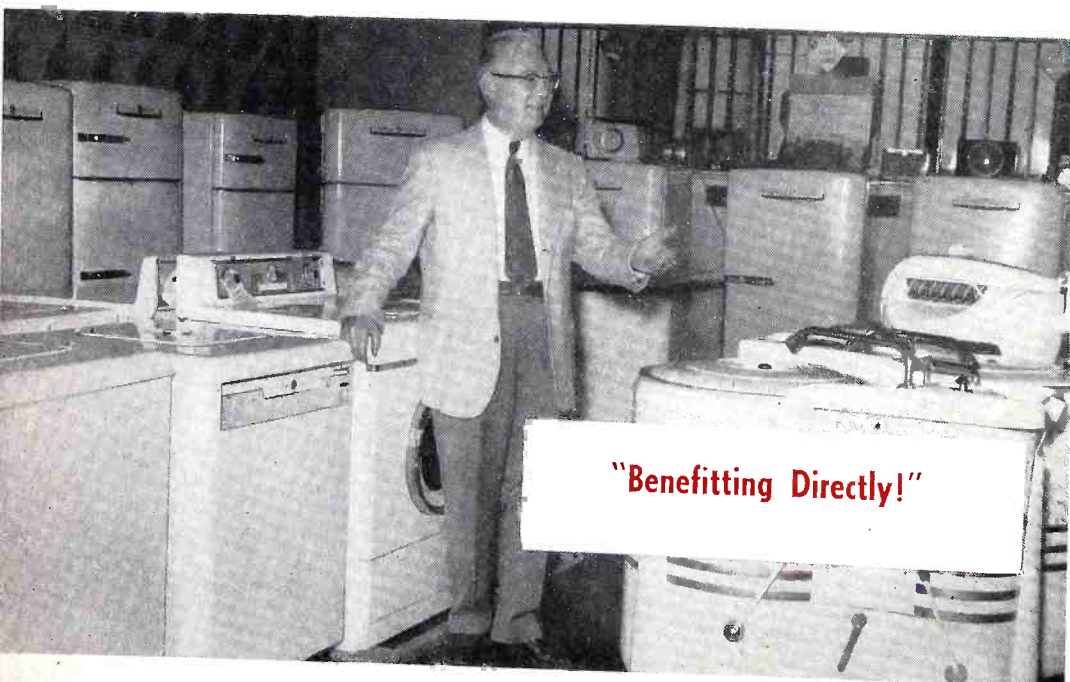

"Benefitting Directly!"

Now, after the plan had been in effect for a couple of months in an area where price-cutting was running rampant, a field survey by editors of *Television Retailing* reveals that remarkable results have been achieved. A brief report follows:

Though there are "trouble spots" in some areas where dealers are us-

"Dealers participating in the Association's drive to curb price-cutting advertising are benefitting directly as a result," says Tim O'Shea, treasurer of the Greater New Jersey Appliance Dealers Association, who heads T. C. O'Shea & Company, East Orange, selling TV and appliances.

PRICE-CUTTING

Program Puts Brakes on Off-List Co-Op Ads. Distributors Supporting Retailers in Drive Against Madhouse Merchandising

ing price-cutting ads, in most of the territory, members are sticking to their agreement, using list prices in advertisements and tagging merchandising with lists.

In some localities, an official of the Association advises that the project is "99 per cent effective."

Cooperating stores have noticed sharp decline in chiseling by customers, and as a result, are enjoying increased profits.

Over the whole picture there has been a marked reduction in price-cutting in stores, which, of course, is due partly to improved business conditions, but in no small measure to the activities of the Association.

Distributors are continuing to cooperate in policing co-op advertising funds.

There is a marked improvement in relationships between competitive dealers. (A number of members suggested that the editors see certain other nearby merchants "who are cooperating.")

One of the chief reasons that the project is working out so well is because it is strictly a voluntary proposition. No policing is done, and members are not told how to run their businesses, nor are they pledged not to cut prices. Another reason is that conditions had become so acute in the territory that even the most hardened advocates and practitioners of all-out price-cutting realized that it was time to call a halt, and are now cooperating in making the project a success.

The program, aimed to cut down the barrage of cut-price advertising with which the consumer has been bombarded, requires that all co-op ads be run "straight" as prepared by distributor or manufacturer—that is the copy would not include any cut prices, nor would other products be mentioned or included on the same page. Terms such as "Liberal Allowance" are permitted, of course, and it is also considered ethical to advertise a manufacturer's reduced list price on a current or out-dated product, either in newspapers or in show-windows.

Photographs of a few of the dealers actively participating in the Association's ambitious program appear on these pages.



Partners Peter Lambuster, left, and John Raymond, right, who operate the Amherst Appliance & Supply Co., East Orange, N. J., describe the Association's program as tremendously successful, and have found that it has stopped a lot of shopping around for price by customers. Both Lambuster and Raymond are trustees of the Greater New Jersey Appliance Dealers Assn., and the former is secretary.

Greater New Jersey Appliance Dealers Assn.

OFFICERS: Jack Rosenberg, President; Tim O'Shea, Treasurer; Peter Lambuster, Secretary; Lou Baron, Jack Brennan, Leo Kaplowitz, Michael Tobia, Vice-Presidents.

TRUSTEES: Moe Zimmerman, Brick Church Appliance Co., East Orange; Peter Lambuster, Amherst Appliance & Supply Co., E. Orange; Tim O'Shea, T. C. O'Shea & Co., East Orange; Lou Baron, Hunter & Co., Union; Jack Brennan, Brennan Radio & Television Co., Jersey City; Leo Kaplowitz, Jersey Tire Co., Inc.; Perth Amboy; S. Peskin, S. Peskin & Co., Newark; J. Rosenberg, Center Appliance Co., Irvington; Robert Rosenberg, Union Radio & Television Co., Elizabeth; J. Rothausser, Rothausser Radio, Newark; Michael Tobia, Tobia's Hillside Appliance Co., Hillside; C. Schultz, Prince Range Co., Newark.

"The Association's program is working out very well," says Thomas Salamone, manager of Powers, Inc., big Newark TV-appliance dealership.



How to Increase Your

Because Fixed Expenses Do Not Rise in Proportion to Upped

• Stock turnover is one of the most talked-about indexes of efficiency in a retail store. It means the length of time it takes for the average stock of merchandise to be sold. It is expressed as the number of times the stock turns within the course of a year.

High stock turn may be a sign of decreased inventory or increased sales volume. In either case it is an index of business efficiency.

When you increase your stock turn and your sales volume remains static, you thereby reduce your inventory. This may be demonstrated by an example.

Suppose you operated a business where you bought certain merchandise only at the beginning of each year and sold it out completely by the end of the year. In that case you would turn your stock over only once. If your cost of goods were \$6,000 for each \$10,000 in sales and if your gross margin were \$3,500, then you would make a net annual profit of \$500 per \$10,000 of sales on such merchandise.

Assume that you were able to increase your stock turns from one to ten times a year but that your annual sales remained at \$10,000 all that time. In this situation your average inventory investment would drop from \$6,000 down to \$600.

Your net profit would remain at

\$500 during all this time. Your net profit per dollar of investment, however, would increase. With one stock turn you would have \$.08 1/3 of net profit per dollar of investment and with ten stock turns you would have \$.83 1/3.

There is a practical qualification to this course of procedure. You may reduce your inventory to the point where you interfere with the choice of your customers and thus obtain a lower sales volume.

This difficulty does not arise when you increase your stock turn by expanding your sales volume. When you do that you do not merely increase your profit relative to your investment. You increase it in absolute terms as well.

Take again the case of the business where you bought \$6,000 worth of certain goods once a year and sold it for \$10,000. Consider the effects of raising stock turn by expanding sales volume.

If you were able to keep the same amount of stock on hand but sell it twice during the year instead of once, then although you might have had only \$6,000 worth of goods on hand at any time, nevertheless your cost of goods for the year would have totalled \$12,000. Your gross volume would have doubled and your net annual profit would have doubled to \$1,000.

Now assuming that you could without any other change increase your sales by turning your stock, not once or twice, but ten times during the year, you would indeed have fantastic profits on the basis of your original type of operation. Although you had only \$6,000 worth of stock at any time your total cost of goods would be \$60,000. Your gross margin would be \$35,000 and your net annual profit would be \$5,000.

This net annual profit would be 83 1/3 per cent of your original inventory investment of \$6,000. But the story does not end here. A high stock turn brings you many indirect benefits.

Some Expenses Rise

Some of your expenses rise along with the sales but not all of them. This is because you have two kinds of expense, fixed and variable. Usually over half your expenses are variable.

Your fixed expenses do not rise in proportion to the increased sales. You pay the same rent, light and heat. You have the same fixtures and equipment. These items remain constant in annual dollar cost.

Some of your other expenses rise in proportion to sales. But most of them do not rise as fast as your sales themselves rise. Your selling expense, delivery expense, servicing cost and other expenses increase with your sales, but not in the same proportion.

Selling More in Same Space

Now it is perfectly true that these savings are a result of the increased sales rather than the increased stock turn. Nevertheless, it probably would be impossible for you to keep your expenses down and handle this increased volume of sales unless you did so by increasing your stock turn. It is the increased turnover that would make it possible for you to sell more goods in the same space in a given length of time.

You will benefit from having fresh stock. You will cut down the possibility of loss through obsolescence.

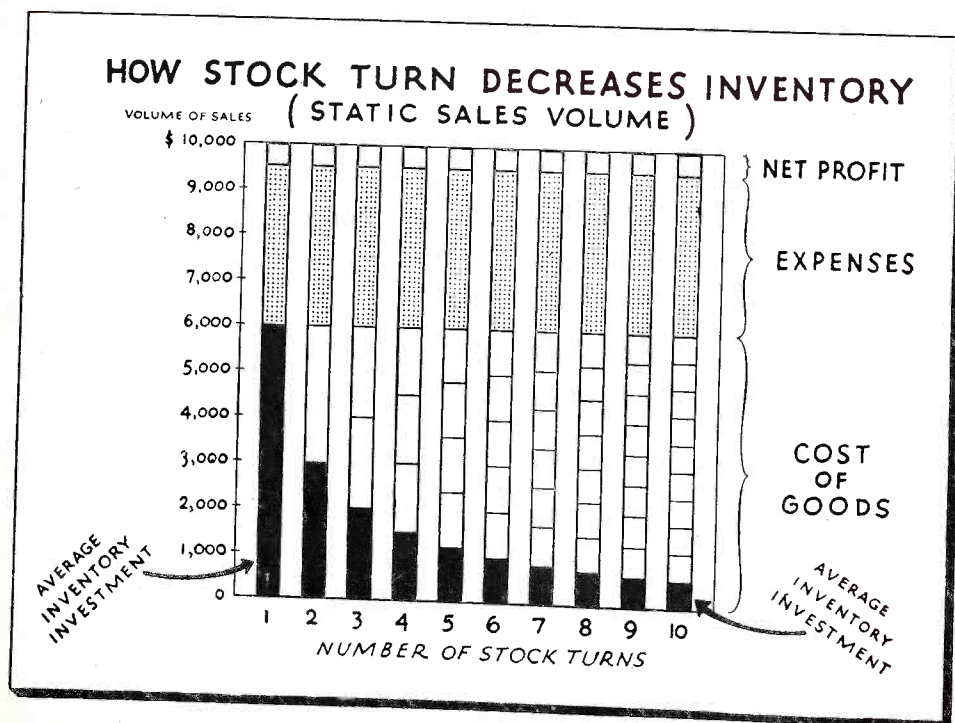

Yearly Turnover Rate

Volume, Extra Profits Can Be Made in Selling More Merchandise

With a high stock turn you are also more likely to have what your customers want. They are aware of new products and prompt sale of old products enables you to be in a position to buy new ones first in your trading area. Your reputation is enhanced.

TV sets and electrical appliances are bulky merchandise. The item of storage space is an important one in this field. High turnover enables you to operate with less storage space and with a lower cost of handling.

Another result of increased sales volume through turnover is that you can sometimes reduce your cost of goods by obtaining quantity discounts thus giving yourself a greater margin.

All in all, you might well reach an extra profit through indirect savings that would equal your direct profit. Thus, if it were possible to turn your stock ten times in the example cited, your net profit would be \$10,000 instead of \$5,000.

The Ideal Situation

There is one great mental reservation you should make when you consider this subject of stock turnover. As we have seen, it bears an intimate relationship to the profit you make on your stock investment. From a practical standpoint this profit varies directly with the amount of credit you can obtain from your suppliers.

To a certain extent you can substitute this credit from your suppliers for higher stock turn and still make the same profit per dollar of your own investment. The only qualification to this is that you may lose the value of interest on your money which results from cash discounts that you fail to take.

Probably the answer to this is that you should try to get as generous credit terms as possible from your suppliers and at the same time work for as high a turnover as possible.

You will then be approaching the ideal situation for a TV-appliance retailer. This would be to sell all your merchandise before you have to pay for it. Your only investment

then would be your fixed investment. In that situation you would obtain the maximum possible return on your invested capital.

Fantastic heights of stock turn, as mentioned already, are usually attained at the expense of sales volume. This is because a very high stock turn can be reached only at the expense of ample assortments of merchandise.

The typical inventory turnover for a profitable TV and electrical appliance store is five times a year. This is the mark at which you should shoot. If you have a lower inventory than this the chances are you are not operating your business as efficiently as you can.

The rate of stock turn in your store as a whole no doubt will partly reflect the proportion of goods of each type that you carry. If you handle almost entirely slow moving lines the chances are that it will be quite difficult for you to hit the rate of five stock turns a year. Evidence is that a slight mark under this with that kind of goods will not be disastrous.

The problem of maintaining a profit for the entire store revolves around learning which departments can be made to show a profit and which are being operated at an ac-

tual loss. The process of doing this is called "departmentalizing" your store.

In order to departmentalize your store, group your products into several major departments insofar as types of products are concerned. Do not have too many departments or the burden of detail becomes too great.

Allocating Various Expenses

The departments you will carry depends upon the type of lines you handle. You may find, for example, that a natural grouping of your store may be somewhat as follows:

- TV and radios
- Major electrical appliances
- Electric housewares
- Records and accessories
- Service
- Non-electrical lines

Your next step is to allocate the expenses of each of these departments.

The number of square feet occupied by each department can be used as the basis for allocating some of the overhead expenses. Of course this square footage must be weighted according to the location of each department. The floor space

(Continued on page 60)

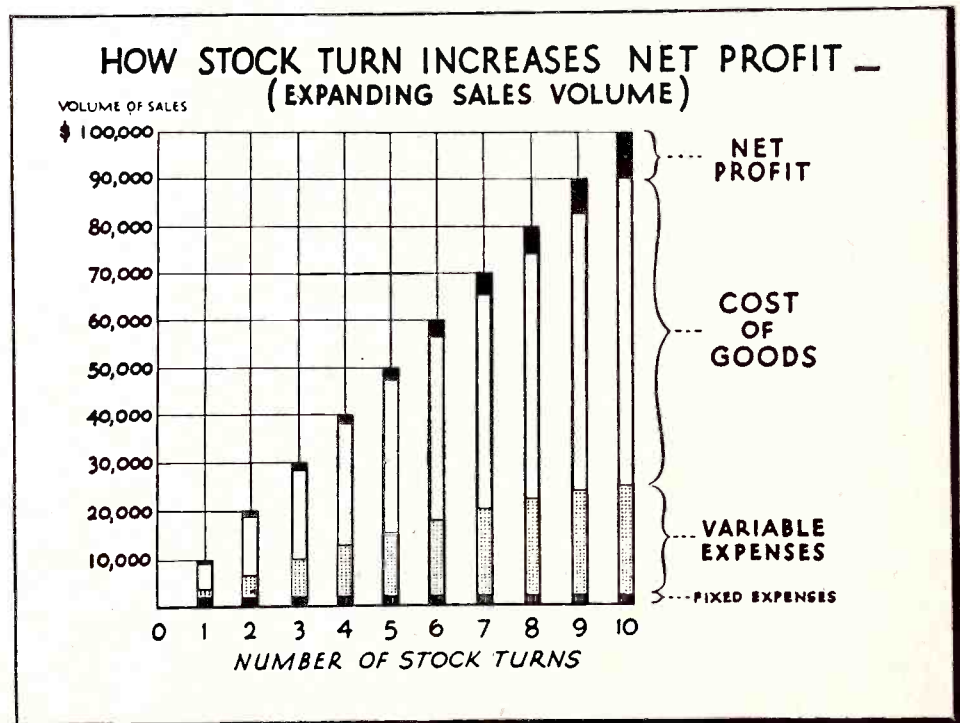

HOLIDAY BELLS

Cash In on Expected

• Almost everyone who walks into your store during the holiday season has someone in mind for whom no gift has been selected. Perhaps they include a favorite aunt (She'd probably love a new full-length opera recording.) or a teen-age relative (How about the new dance album by his or her favorite band?) or the neighbor's children (Unbreakable kiddie records are just the thing). As a perfect gift for someone special as well as "a little something just for the thought," records are practical because of their compactness, and offer a wealth of enjoyment for all ages.

Offer Them Suggestions

Take a customer who comes in for service, or to buy a TV set, an appliance, or any other item you stock. Everyone's always open to a gift suggestion, and many will appreciate your reminding them what a wonderful present records make.

Of course, little aids like special Christmas Eve delivery, gift-wrapping and cards, gift record packages attractively wrapped up in plain view, and return privileges will help, too.

Let's consider some more things to get those records off the shelf.

First of all, there are certain records which you can count on to be in demand, such as *White Christmas*, *Auld Lang Syne*, etc. A display of these discs at the front of the store will enable the customer to pick them up himself on the way to the record counter, thereby saving both the salesman's time and his own. Pricing everything possible saves time and often induces a customer to buy an item, especially if he's shy about asking the cost. Let your customers know that a small deposit will hold their purchase, be it an album or a big-ticket item. Concentrate too on the fine instruments (phonographs, tape recorders, radios, etc.) you have for sale. Record departments create a huge volume in store traffic, and this in turn leads to sales of the higher-priced items. Give lots of attention to the low-priced classical series such as Decca "4000", RCA Victor "Bluebird", Columbia "1500" etc., being released by so



Ring In Platter Profits

Avalanche of Holiday Sales

many record companies. A "bargain" is always attractive to a budget-wise consumer.

Record companies are expecting to hit a new sales peak in '52, and are going all-out with some fine recordings. Note the Christmas tree on the left-hand page for a glimpse of what the season is offering in Christmas albums.

As far as kiddie records are concerned, there's practically no limit to their sales possibilities. Diskeries are expending almost as much time and effort on items for junior listeners as movie magnates do on some of their lavish productions.

For example, RCA Victor's "Alice in Wonderland", MGM's "Ali Baba and the Forty Thieves", Capitol's wonderful "Bozo" series, Decca's stories of "Babar" and "Raggedy Ann" and Columbia's fine children's discs starring popular artists such as Rosemary Clooney, not to mention companies like Young People's Records, who make kiddie records exclusively.

Recorded scores from movies or plays make a lovely gift either for those who didn't get to see the shows themselves, or for those who did enjoy them personally and would like to retain musical listening pleasure through records. Many of the popular shows, such as "South Pacific", "Showboat", "Don Juan in Hell", "New Faces of 1952", and also motion pictures like "The Merry Widow", "Hans Christian Andersen", and "An American in Paris", are available on wax and are eagerly sought after by record-buyers.

Additional Pointers

Classical records should be actively promoted. The purse-strings are naturally a little looser at Christmas time, and it's easier to sell a more expensive record. Arturo Toscanini's recording of Beethoven's *Symphony No. 9* for RCA Victor, and Edward Kilenyi's brilliant piano work on Chopin's *Sonatas in B Minor* and in *B-flat Minor* for Remington are only two among the many works of the great master composers now available. This is the time, too, to push sales of full-length operas — for instance *La Boheme*, *Orfeo ed*

Euridice, and *La Traviata*.

There are some things it might help to keep in mind during the coming Yuletide. For instance —

Although holidays do mean a hectic time for salesmen, remember that courtesy insures repeat business.

Be sure you're well-stocked on all types of records, and don't forget the last-minute shopper. Have what he wants on hand.

Lionel Barrymore works on his MGM recording of *Rip Van Winkle*.



Sammy Kaye listens to his Columbia Christmas Serenade

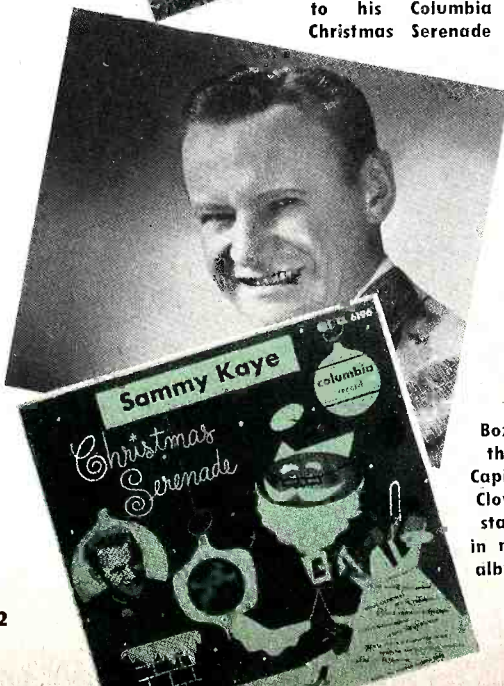

Kathy Beaumont recording RCA Victor's *Peter Pan*



Decca's new Xmas album features Guy Lombardo in *Jingle Bells*



Bozo the Capitol Clown stars in new album



Festival Boosts Disc Sales

RIAA Event Draws 10,000 to Hartford Auditorium. Noted Stars Appear



Belmont Record Shop set up a lively exhibit; used big banner in window.

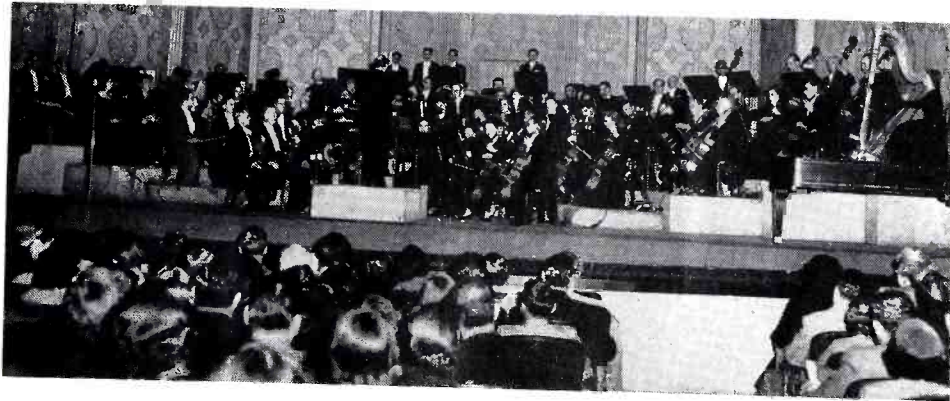

Andre Kostelanetz conducting the Hartford Symphony Orchestra before crowd of 3,300 people.

The Record Shop, owned by Ralph Collucci, used traffic-stopping display to plug Hartford's Record Festival which stimulated interest in music in the trading area.



Attractive window at G. Fox and Company store.



•The newly-formed Record Industry Association of America staged its first promotion, the "Greater Hartford Record Festival," September 30 to October 4, in the Connecticut city. The event was highly successful in stimulating interest in music in the Hartford area, and quite effective in boosting sales of phono records.

Manufacturers brought millions of dollars worth of live talent to the Bushnell Memorial where about 10,000 people attended the various sessions in the auditorium. The Festival was widely publicized through use of co-op newspaper advertising, radio time, window streamers, counter cards, restaurant table "tent" cards and direct-mail pieces. Newspapers and radio stations went all out in cooperating with manufacturers, distributors and dealers in promoting the event.

There were four separate concerts for the classical, folk, popular and children's record fans. Among the noted recording stars who made personal appearances were Andre Kostelanetz, Mitch Miller, Walt Jaworski, Pee Wee King, Redd Stewart, Carson Robison, Eileen

(Continued on page 68)

a **NEW** type
of TV table
from . . .

Admiral

Now available
from your **Admiral**
distributor

Suggested
Retail Price **\$795**



Take one look at this Admiral TV table and you'll say, "Why didn't someone think of this long ago?"

It's so practical! Just one size that fits all current Admiral table television models and many other makes . . . no multiple models to stock. Seamless steel tubing construction supports up to 500 pounds . . . no glue joints to loosen. Ball-bearing casters for easy rotation . . . even permit set to be rolled from room to room. Choice of attractive mahogany, ebony or walnut finish. Priced so low you can afford to include the table at no extra charge when necessary to clinch the sale of a table TV receiver.

Admiral Lightning Arresters — Recommend a lightning arrester with every installation to prevent damage to receiver and to improve reception by blocking static charges before they affect the picture. Admiral Lightning Arresters are furnished with hardware for easy mounting anywhere . . . require no wire stripping. UL approved. Available in porcelain or high-dielectric plastic.

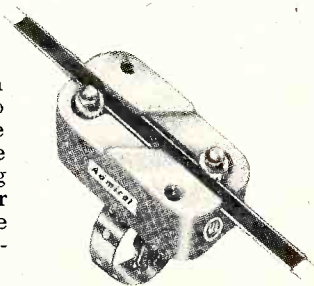

Call your **Admiral Distributor** for
ADMIRAL TV ANTENNAS
TV MASTS and TOWER EQUIPMENT
MOUNTING HARDWARE and ACCESSORIES

Admiral Corporation, Accessories and Equipment Division, Chicago 47, Ill.

News of the Record Industry

Decca

Peggy Lee and Gordon Jenkins have made some beautiful music together. Their new disc, *River River* and *Sans Souci* won't make quite the splash that their *Lover* did, but it's certainly an interesting record that should merit a good bit of listening. Both lyric and orchestration are a bit unusual, with up-to-par performances by both artists.

Decca's "4000" Gold Label offers the Lamoureux Orchestra under the baton of Ferenc Fricsay playing Berlioz' *Roman Carnival Overture* and Dukas' *The Sorcerer's Apprentice*. The latter is famous for its purely musical qualities.

Four Aces' Album



Invading the album market is a hot new one by Decca's Four Aces (above). One of the fastest-rising vocal groups in the country, the quartet, featuring Al Alberts, sings I'LL NEVER SMILE AGAIN, HEART AND SOUL, TAKE ME IN YOUR ARMS, and others that should make this one of the fastest-selling albums around. It's available in all three speeds.

RCA Victor

From Leonard Sillman's *New Faces of 1952* comes a new RCA Victor single pop record. Eartha Kitt, with orchestra conducted by Anton Coppola sings the very blase tune, *Monotonous*. Flip features Alice Ghostley singing *Boston Beguine*. Both artists are from the original Sillman cast, and the record is available in either 45 or 78 RPM.

RCA Victor is offering "six-in-one" albums, which combine the records with an illustrated story book, with outline pictures to be colored, and a special puppet theatre with hand puppets and dummy admission tickets. All are incorporated with the records in a $7\frac{1}{2} \times 7\frac{1}{2}$ " four-color album. Listing at \$1.00 plus tax and available in either one 45 RPM or two 78 RPM records,

these albums present such artists as Fran Allison, Al Hodge, the original "Captain Video," Jane Pickens, and

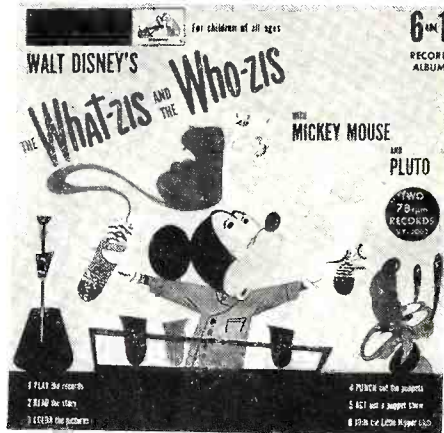

Frank Milano, the "voice of Little Nipper," as well as the original Disney voices of Donald Duck and Mickey Mouse. Available to dealers are colored floor merchandiser, special window streamer, and assortment of co-op ads.

Capitol

Jean Sablon, internationally-known French singer, stars in a new album on the Capitol label. It's titled "Songs of a Boulevardier", and includes many of his most requested numbers. . . . Keep a sharp eye on the very novel Frances Faye recording of classic *Night And Day*. . . . And don't forget to give a listen to Capitol's Mickey Katz's Yiddish creations of *Shleppin' My Baby Back Home* and *Patcha-me*.

Cole Plays Favorites In New Cap Album



The ten talented fingers of Nat Cole are emphasized in his new long-playing Capitol record entitled "Penthouse Serenade." Though millions are familiar with his vocal stylings, comparatively few know Nat as a pianist of brilliant technique and intimate style. Selections include *ROSE ROOM*, *LAURA*, *IF I SHOULD LOSE YOU* and the *PENTHOUSE SERENADE*.

Columbia

When the new motion picture "Hans Christian Andersen" comes to your local movie house, perhaps you could arrange with the manager of the theatre to feature a display (if not the actual records themselves for sale) at the candy counter or in the lobby during the run of the film. Playing some of the Columbia recordings of the Frank Loesser songs from the film during intermission might spark sales, too. Doris Day and Donald O'Connor sing a very cute ditty (reminiscent of *Baby, It's Cold Outside*) entitled *No Two People*; Tony Bennett, backed by Percy Faith and his orchestra, sings the lovely ballad *Anywhere I Wander*; and Paul Weston and his orchestra with the Norman Luboff Choir play *Wonderful Copenhagen*, a big waltz production. The Columbia artists have turned out some fine sides, and all three discs have definite possibilities.

Autry-Clooney Team On New Christmas Disc



Rosemary Clooney and Gene Autry (above) are bidding for another *RUDOLPH THE RED-NOSED REINDEER* with their new waxing of *LOOK OUT THE WINDOW* (The Winter Song) backed by *THE NIGHT BEFORE CHRISTMAS SONG*. Rosie's had lots of success with children's records, and of course every youngster is familiar with Gene. This disc has a fine chance to hit the kiddie sales peak.

MGM

Everyone knows and loves the age-old, ever-fresh tale of *Ali Baba and the Forty Thieves*. Well, Lionel Barrymore and MGM Records got together and made an album dealing with this legend from "The Arabian Nights." The music was composed by Mr. Barrymore and conducted by Walter Schumann. The noted actor's narration is excellent and will keep pint-sized ears glued to the phonograph. Kids (and probably grown-ups as well) will really enjoy this. Available in all three speeds.

There's no telling where or when Tom and Jerry will turn up next, so it isn't very surprising to find out that MGM's beloved cat and mouse are now

(Continued on page 96)



FROM A.M. TO P.M. **V-M** PHONOGRAPHS and
THEY'RE ALL BUYING **V-M** RECORD CHANGERS!

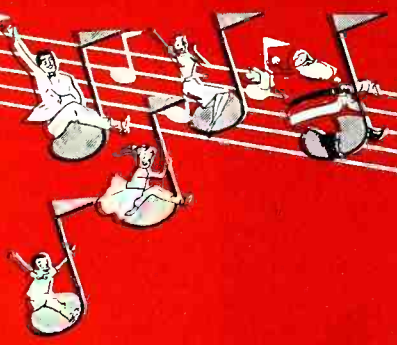

V-M tri-o-matic
985 Portable

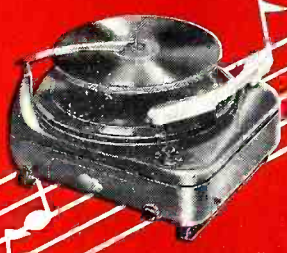

V-M tri-o-matic
972 Phonograph



V-M tri-o-speed
150 Portable

Yes, V-M is THE "hot" phono line this season. It's because V-M gives you and your customers all the most popular features including . . . famous Siesta Switch, tri-o-matic® spindle, completely jamproof operation, automatic playing of all size, all speed records, top quality amplifying system, beautiful luxury styling . . . all at the right price! V-M models from \$29.50 up.



V-M tri-o-speed
110 Portable



V-M tri-o-matic
920 Changer



V-M tri-o-matic
951 Changer



V-M 45 Spindle

V-M Pre-Sells YOUR Customers!
with a dynamic, FULL COLOR half-page in
American Weekly Special Christmas Shopping Issue on November 30th: two-color advertisements in December Seventeen and Esquire. See V-M's two-color ad in the November Better Homes & Gardens! Check V-M ads in November and December issues of Collier's and Sunset! It all-adds up to big Christmas buying influence on hundreds of your customers . . . profitable sales for you!

V-M CORPORATION BENTON HARBOR, MICH.
WORLD'S LARGEST MANUFACTURER OF RECORD CHANGERS



How Allen's Took

White Goods Selling



"It's a good idea to open a sales conversation with an extraneous remark or two to break the ice," says Waxman, shown demonstrating a range.

• Like many other stores, Allen's Radios & Appliances in Cincinnati, Ohio, was doing a good job on major appliances before the advent of TV. But when the television boom began, it caught Allen's off guard. Following the bandwagon enthusiastically, they lost temporary sight of the importance of white goods. As a result, appliance sales started to slip until they hit a record low, representing only 25 per cent of total volume in a store where they had formerly accounted for 75 per cent of the business.

It was at this point that owner, Allen Waxman, began to take stock. He realized that he was losing sales through neglect of appliances—sales that would have meant a possible hundred thousand dollars worth of additional business.

"A complete change of attitude was necessary in order to regain a balanced business," Waxman relates. "First, the salesmen had to be impressed with the importance of talking white goods, and of trying to get a double sale—both a television set and an appliance—whenever possible. We then began to allot more

When All-Out TV Activity Store's Volume, Cincinnati

advertising to major appliances, and even rearranged the store, bringing white goods to the front."

But this shift of emphasis isn't the whole story behind Allen's successful appliance operation. Traffic building ideas, well planned displays, completeness of stock, effective sales methods and customer service and satisfaction, frequent advertising and promotions—all combine to make Waxman one of Cincinnati's leading independent dealers.

The store is located on a busy thoroughfare in downtown Cincinnati, where the right window display will attract a large number of "walk-in" customers. "We've learned that a dollar item brings more people into the store than any other special," says Waxman. And to prove his point he cites the ice cube tray—a two dollar value priced at an even dollar—displayed right in the center of the window: "We've sold from three to four hundred of these each week this past Summer."

The trays are kept in the back of the store, which means that each sale brings the customer clear through the show-room. Since the trays must be wrapped while the customer waits, he has time to look at other merchandise, and any indication of spontaneous interest in an item is quickly capitalized on by one of the two floor salesmen. These trays have led to sales on every major appliance in the store, in addition to producing volume on all traffic items!

Specials like these trays remain in the window as long as they are seasonal and continue to bring in

Highlights of This Successful Store's Operation

- Dollar "specials" bring in the show-window "reader"
- Friendliness keeps customers on the active list
- Servicers are trained and compensated for getting leads
- Add-on financing plan builds volume
- Up to \$30,000 in sales from booths in local home and food shows

Out of the Red

Caused Appliance Sales to Drop From 75 to 25% of Dealer Moved Swiftly to Regain a Balanced Business

customers. In the winter a low-priced toaster or iron may be used as a traffic building display; last Christmas a television lamp was featured.

A clean uncluttered look is Waxman's rule for effective display, and regular and specially priced items are given about equal window space. While regular merchandise is changed frequently, specials are displayed longer, and the special price is kept on the item even after it has been removed from the window. For, "the best draw on a specially priced major appliance frequently comes after it has disappeared from the shopper's sight," says Waxman. "Many times customers are moved to come into the store only after they believe they have missed a good buy."

Inside the store, display is almost fixed, and merchandise is arranged for psychological effect as well as to create an attractive appearance. Ranges, washers, and other major appliances are in the front; refrigerators, because they are taller, are

located in the center; and radio and television sets are displayed in the rear of the 26 x 90 foot show-room.

"We have found that most people are willing to walk to the back if they are seeking entertainment items," explains Waxman, "while appliances do not draw them as readily." The cashier's window, also located in the rear of the store, brings additional traffic past all of the merchandise every day.

"We carry three lines of ranges and washers; two of refrigerators, freezers and dryers; one of sewing machines, vacuum cleaners and ironers; and four leading and two minor makes of television," says Waxman. "Since all these lines are name-brands which can be bought at any number of Cincinnati stores, it is essential that we sell Allen's right along with the merchandise, so that the customer will not only come back to us for future needs, but will suggest that his friends buy here as well."

How is this accomplished? First, and most important factor, is the es-



Earl Welch looks over a washer taken as a trade-in. The two service departments are important in turning up prospects for both TV and white goods sales at the Allen store.

tablishment of a friendly relationship between the customer and store, as opposed to the usual cold retailer-customer relationship found in many big city sales transactions. Allen's salesmen are instructed always to strive to learn a few personal facts about each shopper. And they have learned that they can break down barriers and better begin to gain the customer's confidence by opening a sales conversation with an extraneous remark or two.

As the sales talk progresses, a customer's intelligence is never underrated; he is given the complete story on the merchandise. Waxman has seen this pay off innumerable times as a customer who has walked out returns "sold," because he didn't receive a full story at another store.

It only takes about a half an hour for the salesman to explain the merchandise thoroughly, give a good closing argument, and consummate the sale, if all goes well. Those cases that prove hard to close, however, are usually helped along by the introduction of new blood. When a stalemate is reached the salesman may say, "I'd like you to meet the

(Continued on page 74)

Allen Waxman, seated, owner of Allen's Radios & Appliances, Cincinnati, talks over advertising plans with vice-president Harvey Egberman. 75 per cent of ad budget goes into direct-mail activities.



Appliance New Products

Bendix AUTOMATIC IRONER

Bendix resumes the manufacture and marketing of ironers with its new model containing two functional exclusive features. It has a retractable shoe and three open ends of the roll. Motor housing is below the work surface of the ironer. The new model has gray-green

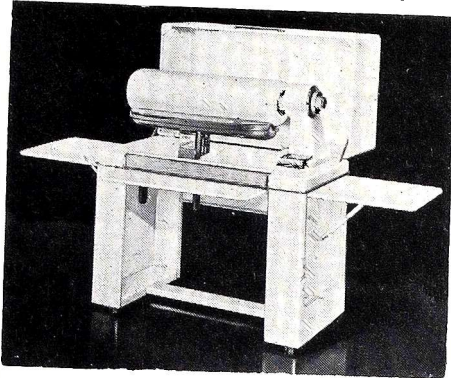

plastic and chrome trim and features a thermostat at each end of the shoe, both of which can be operated singly. Another feature is the concentration of controls in one dial. Unit also has adjustable height control and equalized ironing pressure. Bendix Home Appliances, Div. Avco Mfg. Corp., South Bend, Ind.—TELEVISION RETAILING.

Coolerator AIR CONDITIONERS

Four new room air conditioner models, designed to meet the requirements of all markets, appear in 1/3 HP, 1/2 HP, 3/4 HP, and 1 HP sizes. The first three sizes will fit into a 24-inch window. Thermostatic control, variable speed operation and reduced projection into the room are also featured. Coolerator Co., 218 W. First St., Duluth 1, Min.—TELEVISION RETAILING.

Coolerator FREEZER LINE

The new Coolerator line of upright freezers is highlighted by a 32 cu. ft. 2-door model with 1127 lb. food capacity. Runner-up is a 25 cu. ft. model with door racks and 24.8 sq. ft. of shelf space. Holds 882 lbs. An 18.3 cu. ft. model providing frozen food storage space of 641 lbs. completes the line of 1953 Coolerator upright freezers. Coolerator Co., 218 W. First St., Duluth 1, Min.—TELEVISION RETAILING.

GE AUTOMATIC TRAVEL IRON

The new GE completely automatic travel iron weighs only 1 1/2 lbs and operates on both AC and DC. It has a special "Dial the Fabric" control that can easily be set as desired, and the high-precision thermostat then maintains correct ironing temperature and prevents overheating. Folding handle and double thumb rests are also featured. Fair trade price is \$12.95, carrying case included. General Electric Company, Bridgeport, Conn.—TELEVISION RETAILING.

Eureka "ROTO-MATIC"

The new cannister vacuum cleaner, representing more than two years' engineering and design effort, is of lightweight construction. It has swivel top

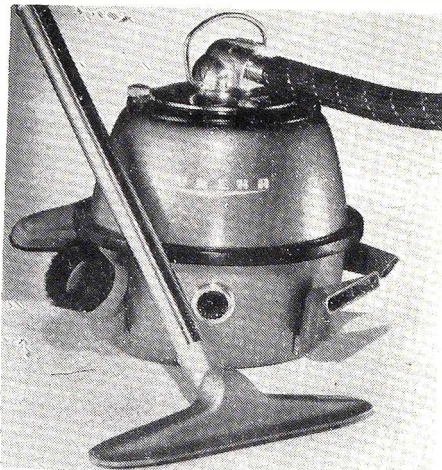

permitting room cleaning from one position and exclusive clip-on holders for attachments. Retail at \$69.95. Eureka Williams Corp., Bloomington, Ill.—TELEVISION RETAILING.

The CALANDA

The new precision-made sewing machine from Switzerland, the Calanda, can sew over 2,000 stitches a minute. The patented Selecto-stitch enables users to perform every conceivable type of sewing operation. Besides zig-zag sewing, the Calanda has a gear-driven full rotary motor, sealed oil tank for

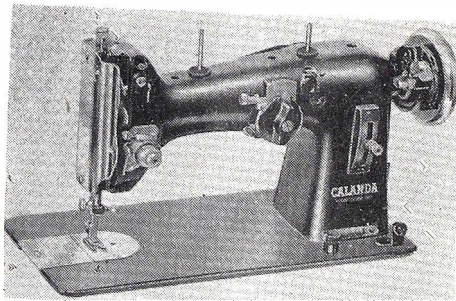

automatic lubrication, drop feed and is styled in furniture-type cabinets. It sews straight or reverse, button holes, buttons and clasps, embroiders, appliques, monograms, darns, overcasts and sews zig-zag, all without any attachment. Exclusive U.S. importer of Calanda is Elite Sewing Machine Corp., 15 Moore St., New York, N. Y.—TELEVISION RETAILING.

Perfection ELECTRIC RANGES

Two new model electric ranges are the L201 and L200, both 21" wide. Model L201 has four double-coil Chromalox surface units each with 7 heat speeds, while L200 has three surface units. L201 has automatic oven pre-heat. Otherwise ovens and broilers are identical. Both are banquet-size, with auto-

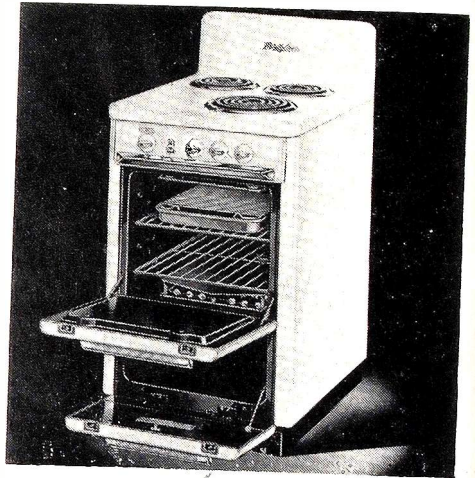

matic heat control and both have smokeless broilers. Broiler units are 3000 watts, bake units, 2100 watts. Both have an electric outlet on the control panel and a pan-storage compartment placed just below the oven. Finished in white titanium porcelain enamel, with ovens lined in black porcelain. Perfection Stove Co., 7609 Platt Ave., Cleveland 4, O.—TELEVISION RETAILING.

Allied GRAND APPLIANCE CADDY

The new model 5040 Grand appliance caddy is especially designed to move and lift refrigerators, ranges, washers and other heavy equipment. A hand or foot operated hydraulic lift is built into the frame of a two-wheel hand truck. Hydraulic mechanism has novel 4-speed control which matches lifting speed to load. Smooth operation prevents damage to appliances. A web safety sling is standard equipment on the caddy, which is rated at 500 lbs. capacity with lifting height of 54". Allied Mfg. & Sales Co., 201 N. Wells St., Chicago 6, Ill.—TELEVISION RETAILING.

Electromode WALL HEATERS

Redesigned down-flo automatic wall heaters (Model WA) have full length louvered grill, silver gray hammertone finish, cast-aluminum enclosed heating element, steel cabinet, factory-sealed quiet motor and fan and built-in power cut-off safety switch which prevents overheating. Down-flo principle distributes heat evenly at floor level. Has adjustable thermostat to provide automatic room temperature control within an adjustable range from 55 to 85 degrees. Electromode Corp., 45 Crouch St., Rochester 3, N. Y.—TELEVISION RETAILING.

More New Products
And Appliance News
Elsewhere in This Issue

Only two belong to the "400"

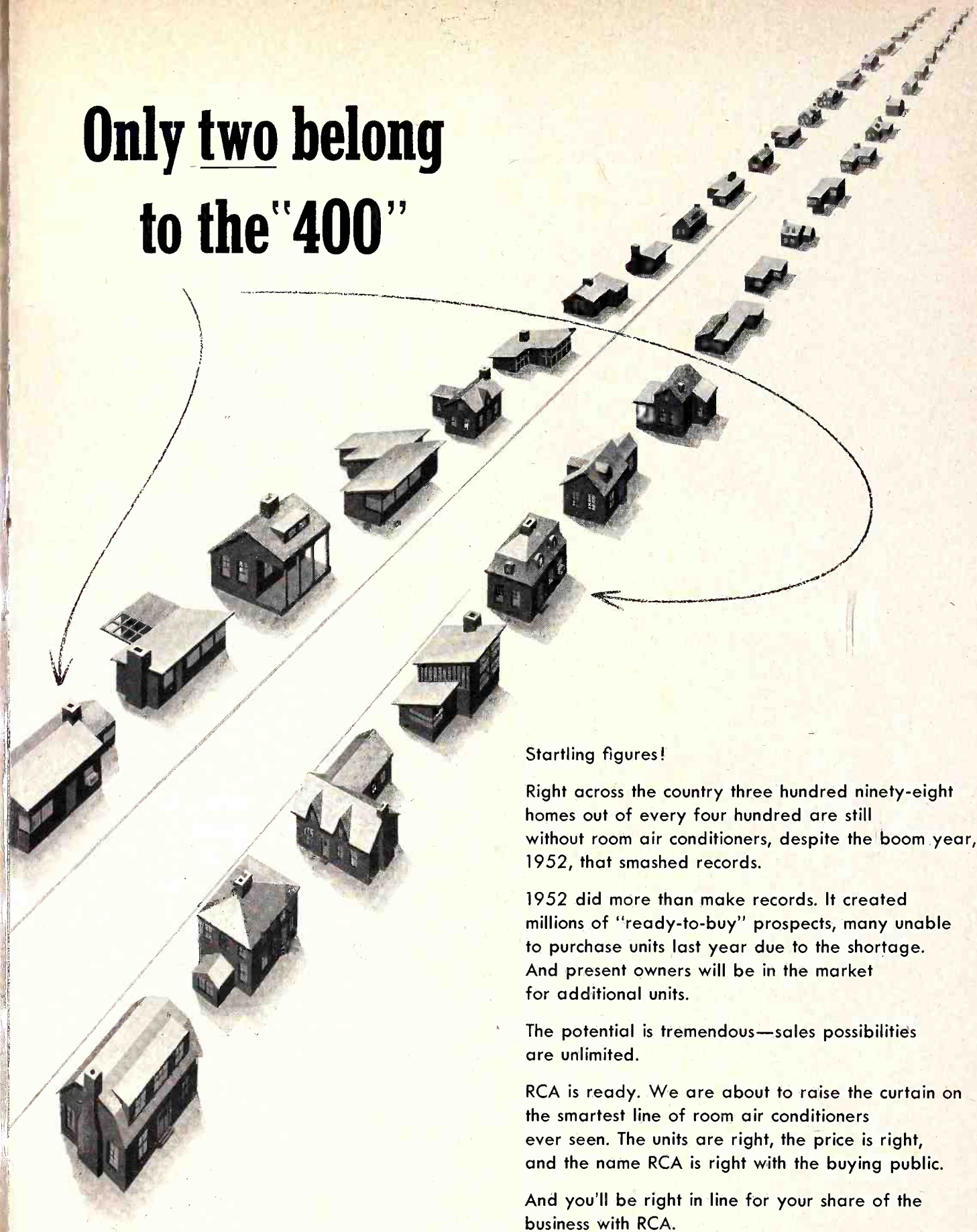

Startling figures!

Right across the country three hundred ninety-eight homes out of every four hundred are still without room air conditioners, despite the boom year, 1952, that smashed records.

1952 did more than make records. It created millions of "ready-to-buy" prospects, many unable to purchase units last year due to the shortage. And present owners will be in the market for additional units.

The potential is tremendous—sales possibilities are unlimited.

RCA is ready. We are about to raise the curtain on the smartest line of room air conditioners ever seen. The units are right, the price is right, and the name RCA is right with the buying public.

And you'll be right in line for your share of the business with RCA.

RCA Room Air Conditioners

RCA VICTOR DIVISION
RADIO CORPORATION OF AMERICA



New 21-Inch TV Sets

Magnavox PLAYHOUSE 21

The Playhouse 21 is a 21-inch TV console of modern design with inclined picture tube for reduction of room re-

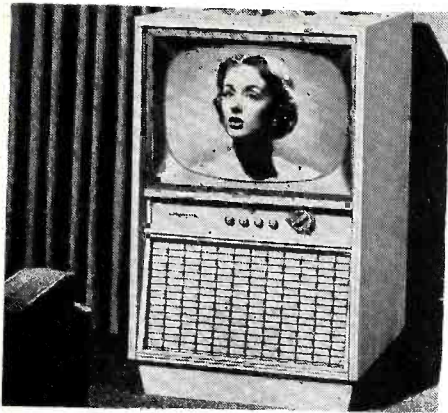

lections and inclined loudspeaker for better sound projection. The Playhouse 21 lists at \$359.50 in white oak and \$339.50 in mahogany. Magnavox Co., Fort Wayne 4, Ind.—TELEVISION RETAILING.

Sylvania 21-INCH CONSOLE

The Huntington, 21-inch console model 176M incorporates "Halolight," a border of light that surrounds the picture, plus the Stratopower 508 chassis.



The Huntington is available with built-in UHF reception. Suggested list in mahogany is \$449.95. In blond, model 176B, \$469.95. Sylvania Electric Products, Radio-Television Div., 254 Rano St., Buffalo 7, N. Y.—TELEVISION RETAILING.

Stromberg-Carlson PRICES

Price increases have been announced on the Stromberg Classic 21 models as follows: 421-C5R (red) from \$545. to \$565.; 421-C5B (ebony) from \$545. to \$565.; 421-C51 (ivory) from \$545. to \$565. Complete list of models and prices will be found in "Selling Features of the Latest TV Sets," elsewhere in this issue.

Fada TABLE TV

The "Potomac," model 21T is a 21-inch table model in the DeLuxe "Imperial" series which features "power plus" control and "rite-tone" sound

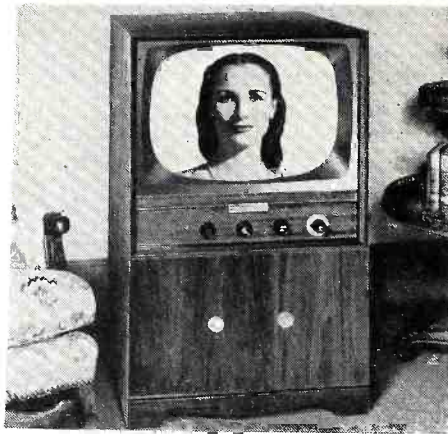

with fully adjustable tone control. New slanted cylindrical picture tube and picture window eliminate reflections from room lights. Fada Radio and Electric Co., Belleville, N. J.—TELEVISION RETAILING.

Mattison TV CONSOLE

The "Heritage" is a 21-inch full-door console with prominently grained heavy mahogany cabinet. Utilizes 32-tube Mattison Silver Rocket 630 chassis with



tuneable built-in booster for better DX reception, cascade tuner, illuminated channel selector. List price of model 21X-HE-6A is \$550. Mattison Television & Radio Corp., 893 Broadway, New York 3, N. Y.—TELEVISION RETAILING.

Motorola NEW PRICES

List price increases ranging from \$10. to \$20. have been put into effect on 7 of the 33 models in the current Motorola line. The receivers whose prices are affected are in the 21-inch console category only. Complete list of models, prices and specifications is shown in "Selling Features of Latest TV Sets," elsewhere in this issue.

RCA VICTOR TABLE TV

A new 21-inch TV set, the "Crandall," lowest-priced set of this screen size to be offered by RCA Victor, carries a suggested retail price of \$259.95 and is a table model featuring a wood cabinet finished in maroon. The "Crandall" can be converted to a console with the addition of a matching base for an additional \$20. Model number of the set is 21T207, of the complete assembly, 21T207EN. Set has a built-in phono jack, with phono switch located on the front of the instrument. RCA Victor Div., Radio Corp. of America., Camden, N. J.—TELEVISION RETAILING.

Andrea TV CONSOLE

The "Brittany," model W2C-VM21 is a 21-inch console in French Provincial cabinet with full doors listing at \$519.95. Includes AM radio and is available with VHF tuner which can receive UHF by



adding strip, or with built-in tuner for complete UHF coverage. Features include keyed AGC, built-in antenna, tone control and phono jack. Andrea Radio Corp., 27-01 Bridge Plaza N., Long Island City 1, N. Y.—TELEVISION RETAILING.

Westinghouse NEW TV SETS

Five new TV sets have been added to the Westinghouse line; two 20-inch table sets, one modern mahogany-finish 20-inch console, and two 21-inch combinations. New models are the Prescott (724T20), 21-inch plectone finish table model at \$259.95; Clayton (725T20) 20-inch mahogany finish table set, Barrington (718K20) modern 20-inch console with mahogany finish at \$299.95, Warfield (732C21), modern styled combination 21-inch TV with AM-FM radio and 3-speed record player in mahogany at \$499.95, and the Laurelton (733C21) with the same features, in blond at \$525. All prices include tax and warranty. Westinghouse Electric Corp., Television-Radio Div., Sunbury, Penna.—TELEVISION RETAILING.

only from Admiral!

21" TV

at price of other 17's



Model 121DX11—Admiral 21" TV with new "DX-53" chassis in smart, stain-resistant cabinet. Price subject to change without notice. Fed. Tax and warranties included.



43% bigger picture for the same money!

Bigger—yes—but that's not all! You get an amazingly *better* picture, too. Because it's powered by Admiral's extraordinary new "DX-53" chassis . . . five years in the making . . . that delivers strikingly superior pictures in *any* location. Yours, too, is the proved advantage of *guaranteed* UHF reception, provided by Admiral's famous Cascode Turret Tuner. See this terrific value, and its companion models at your Admiral Distributor's now. It's the most exciting new line in television.

\$199⁹⁵

NO FINER PICTURE AT ANY PRICE!

Admiral . . . WORLD'S LARGEST TELEVISION MANUFACTURER

Xmas Gift Suggestions

Capehart CLOCK RADIOS

The new Capehart "Deluxe 6" clock radio, model TC-62, has been styled after the popular TC-20. The modern plastic cabinet is being produced in 5

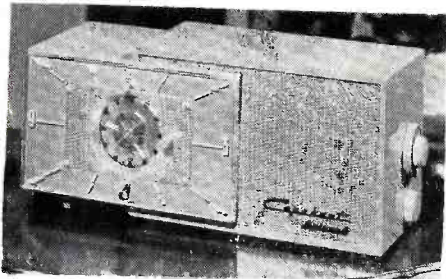

colors and the clock face has been redesigned for "at-a-glance" reading. New circuit offers improved sensitivity, selectivity and tonal quality. List price is \$49.95. Capehart-Farnsworth Corp., Fort Wayne 1, Indiana.—TELEVISION RETAILING.

Waters Conley PHONOGRAPH

Added to the new Phonola and Melodier line of phonographs is the Phonola TK-139T. Presented in linen leatherette covered in green and tan with



white piping, the competitive 3-speed unit plays all sizes of records. Two-tube amplifier and heavy duty loudspeaker are incorporated, with full range tone and volume controls. Waters Conley Co., Rochester, Minn.—TELEVISION RETAILING.

Califone PHONOGRAPHS

High fidelity is emphasized in the new 1953 line of Califone phonographs and transcription players. Among the sixteen new models are several which reproduce the entire audible range. The Hi-Fi models have GE cartridges, Jensen or Jim Lansing speakers and distortion free amplifiers said to be flat from 30-15,000 cps. "Varipole" permits varying of the turntable speed over a wide range above and below normal. Line ranges from Model 5J at \$57.95 to Model 40V at \$249. Califone Corp., 1041 N. Sycamore Ave., Hollywood 38, Calif.—TELEVISION RETAILING.

RCA VICTOR CLOCK RADIO

This "personal" clock radio (model 2C511) is said to be probably the smallest instrument of its kind to reach the market. Clock and radio station numer-

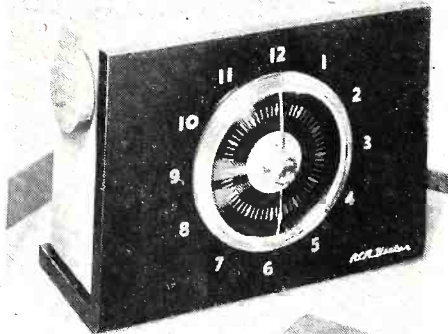

als are combined in a single dial. 2C511 is black and gray; 2C512 is ivory; 2C513 is red and 2C514 combines tones of beige. Suggested retail in all finishes is \$39.95. RCA Victor Div., Radio Corp. of America, Camden, N. J.—TELEVISION RETAILING.

Shura-tone PHONOGRAPH

New "Howdy Doody" model UAP is a portable acoustic phonograph. It is in the same solid wood "treasure chest" designed case as the popular amplified models B and C, covered with washable plastic coated material which is



printed in full color drawings showing all the characters of the popular Howdy Doody TV show. Retail for \$17.95. Shura-Tone Products, Inc., 440 Adelphi St., Brooklyn 17, N. Y.—TELEVISION RETAILING.

Admiral TV PRICES

Higher production and materials costs have caused a price increase of approximately five percent on some Admiral TV consoles and combinations, it has been announced. Complete list of models, prices and specifications will be found in "Selling Features of Latest TV Sets," elsewhere in this issue.

Zenith RADIO-PHONO

Model K666, the "Malabar," is a table radio-phonograph with Zenith Dialspeaker, combining 7½-inch loudspeaker and radio dial in one unit. Has built-in Wavemagnet antenna, Cobra-

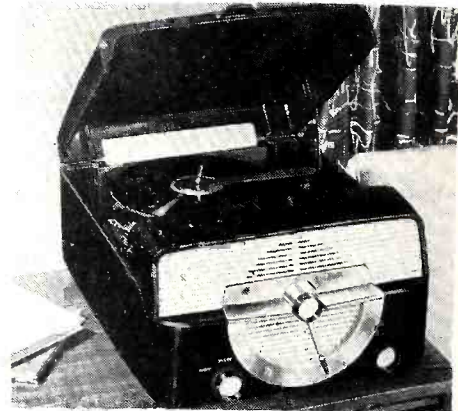

matic variable speed record player covering all speeds from 16 to 85 RPM. Modern cabinet is of maroon plastic. Malabar carries suggested list of \$99.95. Zenith Radio Corp., 6001 W. Dickens Ave., Chicago 39, Ill.—TELEVISION RETAILING.

Hudson JUNIOR JUKE

Called the "Disneyland" model 11, this addition to the Junior Juke line of kiddie phonographs features an all wood cabinet, is plexitone painted in red or blue and has clever 3-dimen-



sional plastic decals of well-known Disney cartoon characters such as Mickey Mouse, Donald Duck and Pluto. Contains two tubes, 4-inch speaker, crystal pickup and single speed Alliance motor. Hudson Electronics Corp., 110 E. Third St., Mt. Vernon, N. Y.—TELEVISION RETAILING.

Clinton RECORD PLAYER

The "Royalty Line" includes the model 550B radio and 3-speed phonograph combination, incorporating 5-tube AC-DC radio with separate tone and volume controls and phono-radio changeover switch. Phono consists of Webster dual needle arm and 3-tube audio amplifier. Cabinet is covered in washable 2-tone leatherette in a choice of colors. Clinton Sales Corp., 103 Lafayette St., New York 13, N. Y.—TELEVISION RETAILING.



JOIN THE SWING TO

SYLVANIA



AMERICA'S FASTEST GROWING TELEVISION



THE KENSINGTON (172M)

Corner Console with HALOLIGHT. Typical of Sylvania's advanced cabinet styling is this breathtaking new Corner Console Ensemble. Gracefully fashioned in French Provincial Style, the Kensington is an inspired piece of furniture art. Features the famous Stratopower "508" Chassis, 21" cylindrical picture tube, corner cuses optional. Available with built-in UHF reception. Also in Maple (172K).

SYLVANIA DEALERS everywhere are chalking up sensational sales records with the great new Sylvania TV Line for 1953.

And no wonder. This year's Sylvania Line has everything . . . bigger, better-than-ever HALOLIGHT, the sensational all new Stratopower Chassis for outstanding performance in any locality and cabinet styling that's the talk of the industry!

Feature by feature, there's more sell in Sylvania TV than anything offered to the public today. Your Sylvania distributor has the facts to prove it. Check with him—now!



THE HUNTINGTON (176M)
21" Console with HALOLIGHT

YOUR SALES WILL Z-O-O-O-M WITH THE FINEST LINE IN SYLVANIA HISTORY!



THE LEXINGTON (178M)
21" Three-way Console
Combination with HALOLIGHT



THE PARKRIDGE (126M)
21" Mahogany Veneer Console

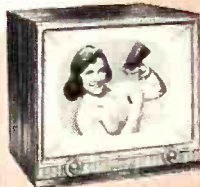

THE ARLINGTON (175M)
21" Table Model with HALOLIGHT



THE MONTCLAIR (177M)
21" Console with HALOLIGHT



THE SHEFFIELD (24M3)
20" Console with HALOLIGHT



THE FAIRFAX (150L)
17" Table Model



THE DONCASTER (72M11)
17" Mahogany Veneer Table Model



THE CLAREMONT (22B11)
20" Blonde Table Model

CONTACT YOUR SYLVANIA DISTRIBUTOR NOW

Learn about Sylvania's Selective Dealer Program that Assures Bigger Profits for Sylvania Dealers.

©Sylvania Trademark



SYLVANIA TV

with better-than-ever

HALOLIGHT*

The Original Frame of Light That's Kinder to Your Eyes!

Increase Your Turnover Rate To Increase Your Profits

(Continued from page 45)

in the front of your store is worth more than in the back. Allocate on this basis your expenses for rent, heat, light and power. Allocate the cost of window displays according to the square feet of space devoted to each department. Weigh this figure with the length of time the items in each department appear in the window as well as the number of square feet they occupy.

Total sales volume is the basis upon which to allocate such expenses as advertising, delivery, office expense, telephones and telegrams and general expense to these departments.

The volume of sales on a credit basis is the proper way to allocate bad debts and collection expense by departments.

It is often possible to allocate directly to each department the cost of a store's equipment and depreciation used in the department. Usually also, the salaries of your employes can be allocated on a direct basis. It may be necessary for you to analyze the time spent in each department by your help.

You will, of course, make some errors of judgment in allocating your expenses. The point is that even if some mistakes are made, you get a much clearer idea of the cost of each department.

It is then possible to compute the profit or loss for each department. To do this you take the net sales of the products in that department over a period of time. You subtract from it the cost of goods sold. Next you subtract your total expenses for the department. The remainder, if any, is your profit. If the total expenses exceed the difference between your net sales and cost of goods sold, you have a loss instead of a profit.

These figures should be placed in a tabulation in order to make it possible to make comparisons among departments. The figures should be reduced to percentages with the net sales 100 per cent. This tabulation will look like this.

	Net Sales
Less	Cost of Goods Sold
Equals	Gross Margin
Less	Expenses
Equals	Net Profit or Loss

Compute also the stock turn for each department separately. Place this index of activity for that department in the same tabulation to permit direct comparison among all your departments.

The way to compute the stock turnover for each department is to divide your total sales for a year by the amount of your average inventory taken at selling prices in that department.

To determine your average inventory, start at the time of your last physical inventory of stock. Perhaps you take a physical inventory of all your departments only once a year. If you do this, say at the end of the year as of December 31st, put this down as your first inventory figure. To this figure add the amount of your purchases at their sales value during the month of January. From this sum, subtract your total sales in January. You will then have an approximate inventory as of January 31st.

Find Average Inventory

If you repeat this every month you will have twelve inventories at retail price. To this add your physical inventory taken at the end of the year. This makes thirteen inventories in all. Divide this number by thirteen and you will have an average inventory.

The subject of margins will take on a new aspect after you have obtained the figures for each department in your store. The margin of profit on any line of products is not important in itself. Instead it is related to the turnover for that department. The reason for this is that the important figure is that of annual profit.

Any department of the business which is operating at close to the borderline of loss should be scrutinized with great care. You may take one of several steps to improve the condition of that department.

If the margin and net profit are satisfactory but the turnover is low, perhaps you can reduce the inventory. Perhaps by special promotion, by moving the location of the department or by education of your sales force you may be able to in-

crease the sales of this department and consequently the turnover.

If in your judgment you can neither increase the sales of the department nor reduce the inventory it may be possible for you to reduce the expenses of the department or mark up the prices.

Size Up Situation

Some departments in your store may not be great profit makers but may be of the type which will help your other business. This is especially true if they are traffic getters for your store. It may also apply to the operation of your service department. The value to you of departmentalized figures for such a department is that it shows you the point at which you can break even and thus not allow the department to be a hidden drain on the profits of the rest of your business.

Whether or not you carry a department that is on the danger line of loss depends upon your judgment as to the value of the department to your store as a whole. If you cannot improve the condition of some departments you may be able to eliminate them entirely to the betterment of your business.

You have already scrutinized each line of goods in your store to see if it fits your own natural abilities, your trading area and your store location. You are now in a position to apply the final test for any merchandise in your store. This is, that it stand on its own feet and contribute something constructive to your store. Only in this way can you make the greatest possible profit for your store as a whole.

Move products out quickly and you get fresh stock, and do more business with but slightly increased "fixed" expenses.

Another case history of the Profitable Magnavox Franchise



Evan R. Moon
Merchandise Manager
Major Appliance Department
Joske's of Texas
San Antonio, Texas

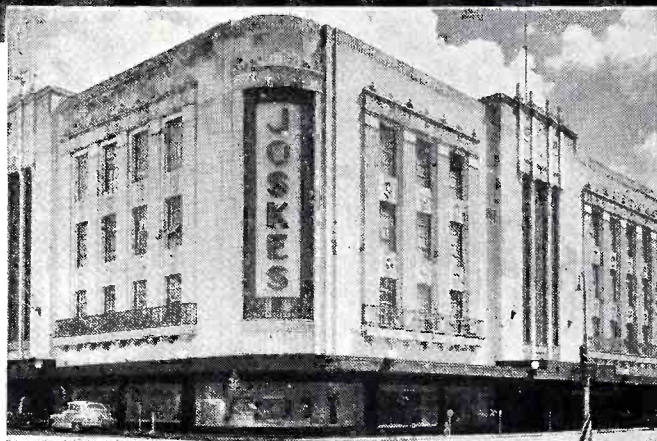

Joske's of Texas, San Antonio, Texas

"Joske's of Texas" reports:

"Among the Magnavox principles contributing to our success is the protected distribution policy which eliminates chiseling dealers and back-door distributor deliveries." *Evan R. Moon*

- "This year Joske's celebrated their fifth anniversary as a Magnavox dealer. The event was marked by three record sales months—1200 Magnavox instruments during May, June and July!
- "In addition to the Magnavox protected distribution policy, Mr. Moon credits the following reasons for Joske's big success with Magnavox instruments:
- "Minimum service costs, which have a

definite mark-up percentage value.

- "The radiation of complete satisfaction and good-will from our thousands of Magnavox happy users—a powerful sales influence.
- "The fact that Joske's employees are so enthusiastic about Magnavox products. A high percentage have Magnavox instruments in their homes.
- "We want to thank you," wrote Mr. Moon, "for the splendid cooperation, fine merchandise, the profit opportunities and the excellent policies of Magnavox. We are proud of our association with you."

7 REASONS WHY

Magnavox is the best franchise for building a sound, profitable business—

- 1** Protected Markets. **2** Direct Dealings. **3** Longest Discounts. **4** Reliable Prices.
5 More Advertising Dollars Per Dealer. **6** Sound Merchandising Help. **7** Staunchest Owner Loyalty.

the magnificent

BETTER SIGHT . . . BETTER SOUND . . . BETTER BUY
Magnavox

television - radio - phonograph

COAST-TO-COAST THE STORY IS THE SAME . . . for a sound, profitable, long-term business, Magnavox is the BEST franchise.

Plus Profits in Hi-Fi

Retailer's Personal Touch Needed to Cash in on Growing Public Interest in High Quality Sound

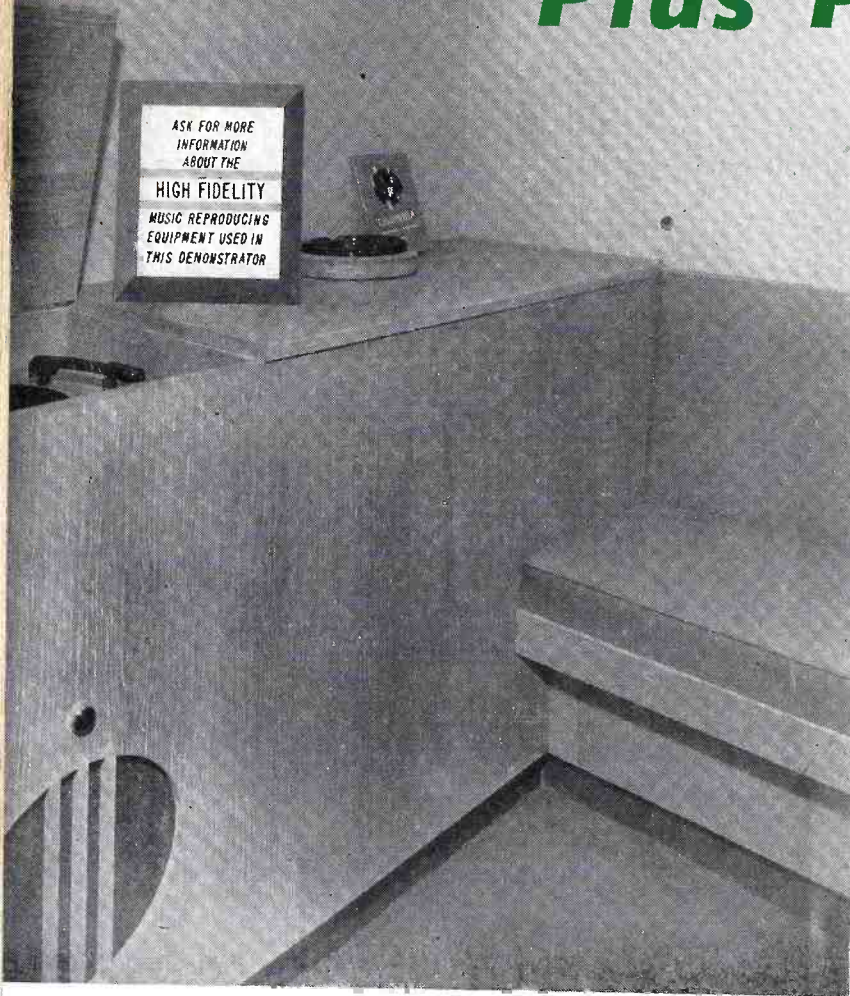

Radio-TV dealers handling phono records have potential customers for custom sales walking in their store every day. A high-fidelity demonstrator in the record booth, properly merchandised, can stimulate customer interest in the dealer's facilities for custom home installations.

"It reproduces with true definition every instrument, every tone, every pitch of voice or instrument, throughout the entire scale of audible sound."

● So read an advertisement for a loudspeaker in a 1926 issue of *Radio Retailing*. It is exemplary of the quest for high quality sound reproduction which has been going on ever since the first acoustical phonograph was made more than 50 years ago.

The first phase of this quest was sparked by the efforts of engineers to produce some semblance of realism in the sound of radios. In 1927 one radio manufacturer boasted that his radio had tone as good as (acoustical) phonographs! Other ads emphasized volume, "mellowness," "resonance," etc.

In the second phase, the engineers finally succeeded in outstripping the industry. Geared to produce millions of instruments every year, the radio-TV manufacturers have been forced to seek the largest common denominator, aimed to satisfy most of the people most of the time. Meanwhile, more or less unfettered

by commercial considerations, the audio engineers have been able to attain a degree of realism thought unattainable even as recently as 10 years ago.

These details would not be of much significance to dealers were it not for the fact that Hi-Fi is beginning to develop into a commercial market.

The industry had convinced itself that the public had a "tin ear," and wouldn't appreciate anything better than it was getting. But the facts in the matter have proven otherwise. A good deal of money has been spent—and a good deal more will be spent—by the public in the direction of high fidelity.

Before we seem to go off the deep end on this matter of high fidelity, let us clarify a few points. When we say that there is a growing market potential in this field, we do not necessarily mean that 50 million families will buy a \$150 loudspeaker . . . although there are more of these being sold than you would imagine. What we do mean, is that interest has been stimulated in attaining something *better*. Each customer will find his own level when it comes to

price and quality. That which the customer buys may or may not come up to the audio engineer's standards of "high fidelity."

For this reason, it is perhaps more accurate to use the expression "custom" rather than "Hi-Fi." The significant thing is that the consumer is buying, not a ready-made instrument, but rather a selection of components which, when assembled, will produce his own custom-made instrument. The chief motivating factor behind this selection is better quality sound.

There is an additional factor, however, and that is what we might call the "furniture aspect" of the custom field. Not only do the customers want better sound, but in many cases they also want better furniture . . . or at least, custom designed furniture, or perhaps "built-in" arrangements.

The radio dealer—and especially those who sell phonograph records—is the "natural" outlet for this type of merchandise. He has the know-how to handle it and sell it. He has already well established avenues of supply for it. It "fits" appropriately into his displays of other music-producing merchandise. And the customer has already learned to come to him for products of this type, and for advice on such products. In addition, the dealer's service department is a natural adjunct for the installation and servicing of these products.

Dealer on the "Inside"

But, "natural" or not, if radio-TV-record dealers do not supply a service on this merchandise, somebody will, since the public has a habit of getting what it wants. On the other hand, if our dealers will cash in on the natural aptitudes they have for the job, they should find the going easier than it is for some of the outsiders who are trying to get into the act.

Two questions will inevitably arise from the dealer who is considering this step: first, is it worthwhile, and second, how do I go about it?

(Continued on page 68)

ENJOY Bigger PROFITS

with DuMont

Additional sets not shown

DuMont de Luxe DEVON
17". Plug-in for record player. Mahogany or limed oak veneers. \$279⁹⁵

DuMont MILFORD
21". Mahogany or limed oak veneers. Built-in antenna. \$279⁹⁵

DuMont SHELburnE
21". Period cabinet of fine mahogany veneers. Built-in antenna. \$399⁹⁵

DuMont de Luxe WICKFORD
21". Plug-in for record player. Cabinet of fine mahogany veneers. \$439⁹⁵

DuMont de Luxe BANBURY
21". Plug-in for record player. Fine mahogany or limed oak veneers. Also limed oak with raffia panels. \$439⁹⁵

DuMont de Luxe SOMERSET
21". Drawer for optional record player. Fine veneers in mahogany or blond. \$449⁹⁵

DuMont de Luxe WIMBLEDON
21". Plug-in for record player. Fine mahogany veneers. \$479⁹⁵

DuMont de Luxe WHITEHALL, Series II
21". Plug-in for record player. Fine mahogany veneers. \$499⁹⁵

DuMont de Luxe DYNASTY
21". Chinese Chippendale cabinet of fine mahogany veneers. Drawer for optional record player. \$499⁹⁵

DuMont de Luxe FLANDERS
21". Plug-in for record player. French Provincial cabinet of fine fruitwood finish. \$549⁹⁵

DuMont de Luxe ROYAL SOVEREIGN
30-inch direct-view DuMont tube . . . world's largest. Built-in FM radio. Plug-in for record player. Hand-rubbed mahogany finish. \$1,795⁰⁰

*All prices are suggested retail, subject to change. No extra charge for Federal Excise Tax and Warranty. Prices slightly higher in South and West. Limed oak and blond model prices slightly higher than shown.

with DuMont

NOW SELL 16 GREAT DU MONT TELESETS* WITH PRICE "STEP-UPS" FROM \$199⁹⁵ TO \$1,795⁰⁰**

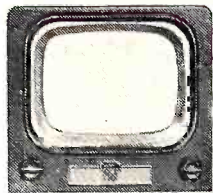

DuMont CLINTON
17" rectangular DuMont tube. All-wood cabinet. Plexitone finish in bracken brown or blond. Built-in antenna. \$199⁹⁵

See how well it pays to hold the *Selective* DuMont Dealer Franchise! Now, as DuMont extends its new line into every price field, DuMont extends its profits to dealers!

All of these new "Step-up" DuMonts carry strongly competitive discounts. All have features that will gain sales against any competition. And all have DuMont's "Proof You Can See" . . . the instant proof of better pictures and cabinets that wins customers on the spot.

\$349⁹⁵



DuMont BEVERLY
21". Fine mahogany or limed oak veneers. Built-in antenna. \$349⁹⁵

\$375⁰⁰

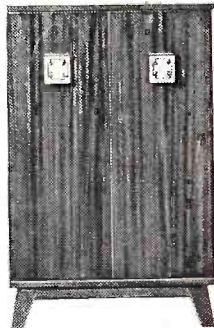

DuMont RIDGEWOOD
21". Fine mahogany or limed oak veneers. Built-in antenna. \$375⁰⁰

DU MONT QUALITY \$199⁹⁵**
Teleset prices now begin at

*Trade Mark

SEE MAJOR LEAGUE FOOTBALL AT THE STADIUM. IF YOU CAN'T, THEN SEE IT ON DU MONT TELEVISION!

IN ACTION! — THE NEW YORK FOOTBALL GIANTS

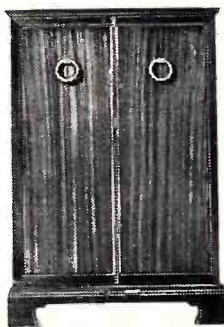
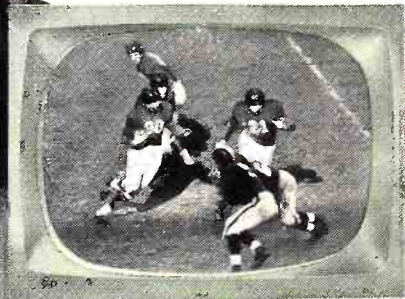

DuMont WAKEFIELD
21". Fine mahogany or limed oak veneers. Built-in antenna. \$389⁹⁵



DuMont de Luxe NEWBURY
21". Drawer for optional record player. Fine mahogany or limed oak veneers. \$459⁹⁵

PROOF YOU CAN SEE IS PROOF YOU CAN SELL!

THE SELECTIVE DU MONT FRANCHISE

is more valuable than ever today!

ASK YOUR DU MONT DISTRIBUTOR FOR FULL DETAILS, OR WRITE TO: Allen B. DuMont Labs., Inc., Television Receiver Div., East Paterson, N. J.

Selling Features of

Model No.	LIST PRICE (incl. Tax and Warranty)	TUBE SIZE (inches)	TYPE	AM-FM PHONE JACK	SWF
Admiral Corp., 3804 Cortland St., Chicago 7, Ill.					
17DX11	172.95	17	TP		AS
17DX19	180.95	17	TP		AS
17DX11	180.95	21	TP		AS
17DX12	212.95	21	TP		AS
17DX16	202.95	21	TW		AS
17DX15	202.95	21	CW		AS
17DX19	202.95	21	CW		AS
17DX17	212.95	21	CW		AS
17DX24	212.95	21	CDW		AS
17DX15	212.95	21	CW		AS
17DX16	212.95	21	CW		AS
17DX17	212.95	21	CW		AS
17DX24	212.95	21	CW		AS
17DX27	212.95	21	CDW		AS
17DX16	212.95	21	CDW		AS
17DX17	212.95	21	CDW		AS
17DX26	212.95	21	CDW		AS
17DX15	212.95	21	CW	AM-PH	AS
17DX14	212.95	21	CW	AM-PH	AS
17DX17	212.95	21	CW	AM-PH	AS
17DX14	212.95	21	CW	AM-PH	AS
17DX18	212.95	21	CDW	AM-PH	AS
17DX18	212.95	21	CDW	AM-PH	AS
17DX18	212.95	21	CDW	AM-PH	AS
Air Marshall Corp., 12 E. 44 St., New York 17, N. Y.					
	149.95	17	TW		AS
Andrea Radio, 27-01 Bridge Plaza N., Long Island City NY					
AVM-1	272.00	21	TP		AS
AVM-2	272.00	21	TP		AS
AVM-3	272.00	21	TP		AS
AVM-4	272.00	21	TP		AS
AVM-5	272.00	21	TP		AS
AVM-6	272.00	21	TP		AS
AVM-7	272.00	21	TP		AS
AVM-8	272.00	21	TP		AS
AVM-9	272.00	21	TP		AS
AVM-10	272.00	21	TP		AS
AVM-11	272.00	21	TP		AS
AVM-12	272.00	21	TP		AS
AVM-13	272.00	21	TP		AS
AVM-14	272.00	21	TP		AS
AVM-15	272.00	21	TP		AS
AVM-16	272.00	21	TP		AS
AVM-17	272.00	21	TP		AS
AVM-18	272.00	21	TP		AS
AVM-19	272.00	21	TP		AS
AVM-20	272.00	21	TP		AS
AVM-21	272.00	21	TP		AS
AVM-22	272.00	21	TP		AS
AVM-23	272.00	21	TP		AS
AVM-24	272.00	21	TP		AS
AVM-25	272.00	21	TP		AS
AVM-26	272.00	21	TP		AS
AVM-27	272.00	21	TP		AS
AVM-28	272.00	21	TP		AS
AVM-29	272.00	21	TP		AS
AVM-30	272.00	21	TP		AS
AVM-31	272.00	21	TP		AS
AVM-32	272.00	21	TP		AS
AVM-33	272.00	21	TP		AS
AVM-34	272.00	21	TP		AS
AVM-35	272.00	21	TP		AS
AVM-36	272.00	21	TP		AS
AVM-37	272.00	21	TP		AS
AVM-38	272.00	21	TP		AS
AVM-39	272.00	21	TP		AS
AVM-40	272.00	21	TP		AS
AVM-41	272.00	21	TP		AS
AVM-42	272.00	21	TP		AS
AVM-43	272.00	21	TP		AS
AVM-44	272.00	21	TP		AS
AVM-45	272.00	21	TP		AS
AVM-46	272.00	21	TP		AS
AVM-47	272.00	21	TP		AS
AVM-48	272.00	21	TP		AS
AVM-49	272.00	21	TP		AS
AVM-50	272.00	21	TP		AS
AVM-51	272.00	21	TP		AS
AVM-52	272.00	21	TP		AS
AVM-53	272.00	21	TP		AS
AVM-54	272.00	21	TP		AS
AVM-55	272.00	21	TP		AS
AVM-56	272.00	21	TP		AS
AVM-57	272.00	21	TP		AS
AVM-58	272.00	21	TP		AS
AVM-59	272.00	21	TP		AS
AVM-60	272.00	21	TP		AS
AVM-61	272.00	21	TP		AS
AVM-62	272.00	21	TP		AS
AVM-63	272.00	21	TP		AS
AVM-64	272.00	21	TP		AS
AVM-65	272.00	21	TP		AS
AVM-66	272.00	21	TP		AS
AVM-67	272.00	21	TP		AS
AVM-68	272.00	21	TP		AS
AVM-69	272.00	21	TP		AS
AVM-70	272.00	21	TP		AS
AVM-71	272.00	21	TP		AS
AVM-72	272.00	21	TP		AS
AVM-73	272.00	21	TP		AS
AVM-74	272.00	21	TP		AS
AVM-75	272.00	21	TP		AS
AVM-76	272.00	21	TP		AS
AVM-77	272.00	21	TP		AS
AVM-78	272.00	21	TP		AS
AVM-79	272.00	21	TP		AS
AVM-80	272.00	21	TP		AS
AVM-81	272.00	21	TP		AS
AVM-82	272.00	21	TP		AS
AVM-83	272.00	21	TP		AS
AVM-84	272.00	21	TP		AS
AVM-85	272.00	21	TP		AS
AVM-86	272.00	21	TP		AS
AVM-87	272.00	21	TP		AS
AVM-88	272.00	21	TP		AS
AVM-89	272.00	21	TP		AS
AVM-90	272.00	21	TP		AS
AVM-91	272.00	21	TP		AS
AVM-92	272.00	21	TP		AS
AVM-93	272.00	21	TP		AS
AVM-94	272.00	21	TP		AS
AVM-95	272.00	21	TP		AS
AVM-96	272.00	21	TP		AS
AVM-97	272.00	21	TP		AS
AVM-98	272.00	21	TP		AS
AVM-99	272.00	21	TP		AS
AVM-100	272.00	21	TP		AS
AVM-101	272.00	21	TP		AS
AVM-102	272.00	21	TP		AS
AVM-103	272.00	21	TP		AS
AVM-104	272.00	21	TP		AS
AVM-105	272.00	21	TP		AS
AVM-106	272.00	21	TP		AS
AVM-107	272.00	21	TP		AS
AVM-108	272.00	21	TP		AS
AVM-109	272.00	21	TP		AS
AVM-110	272.00	21	TP		AS
AVM-111	272.00	21	TP		AS
AVM-112	272.00	21	TP		AS
AVM-113	272.00	21	TP		AS
AVM-114	272.00	21	TP		AS
AVM-115	272.00	21	TP		AS
AVM-116	272.00	21	TP		AS
AVM-117	272.00	21	TP		AS
AVM-118	272.00	21	TP		AS
AVM-119	272.00	21	TP		AS
AVM-120	272.00	21	TP		AS
AVM-121	272.00	21	TP		AS
AVM-122	272.00	21	TP		AS
AVM-123	272.00	21	TP		AS
AVM-124	272.00	21	TP		AS
AVM-125	272.00	21	TP		AS
AVM-126	272.00	21	TP		AS
AVM-127	272.00	21	TP		AS
AVM-128	272.00	21	TP		AS
AVM-129	272.00	21	TP		AS
AVM-130	272.00	21	TP		AS
AVM-131	272.00	21	TP		AS
AVM-132	272.00	21	TP		AS
AVM-133	272.00	21	TP		AS
AVM-134	272.00	21	TP		AS
AVM-135	272.00	21	TP		AS
AVM-136	272.00	21	TP		AS
AVM-137	272.00	21	TP		AS
AVM-138	272.00	21	TP		AS
AVM-139	272.00	21	TP		AS
AVM-140	272.00	21	TP		AS
AVM-141	272.00	21	TP		AS
AVM-142	272.00	21	TP		AS
AVM-143	272.00	21	TP		AS
AVM-144	272.00	21	TP		AS
AVM-145	272.00	21	TP		AS
AVM-146	272.00	21	TP		AS
AVM-147	272.00	21	TP		AS
AVM-148	272.00	21	TP		AS
AVM-149	272.00	21	TP		AS
AVM-150	272.00	21	TP		AS
AVM-151	272.00	21	TP		AS
AVM-152	272.00	21	TP		AS
AVM-153	272.00	21	TP		AS
AVM-154	272.00	21	TP		AS
AVM-155	272.00	21	TP		AS
AVM-156	272.00	21	TP		AS
AVM-157	272.00	21	TP		AS
AVM-158	272.00	21	TP		AS
AVM-159	272.00	21	TP		AS
AVM-160	272.00	21	TP		AS
AVM-161	272.00	21	TP		AS
AVM-162	272.00	21	TP		AS
AVM-163	272.00	21	TP		AS
AVM-164	272.00	21	TP		AS
AVM-165	272.00	21	TP		AS
AVM-166	272.00	21	TP		AS
AVM-167	272.00	21	TP		AS
AVM-168	272.00	21	TP		AS
AVM-169	272.00	21	TP		AS
AVM-170	272.00	21	TP		AS
AVM-171	272.00	21	TP		AS
AVM-172	272.00	21	TP		AS
AVM-173	272.00	21	TP		AS
AVM-174	272.00	21	TP		AS
AVM-175	272.00	21	TP		AS
AVM-176	272.00	21	TP		AS
AVM-177	272.00	21	TP		AS
AVM-178	272.00	21	TP		AS
AVM-179	272.00	21	TP		AS
AVM-180	272.00	21	TP		AS
AVM-181	272.00	21	TP		AS
AVM-182	272.00	21	TP		AS
AVM-183	272.00	21	TP		AS
AVM-184	272.00	21	TP		AS
AVM-185	272.00	21	TP		AS
AVM-186	272.00	21			

Latest Television Sets

MFR. and Model No.	LIST PRICE (Incl. Tax and Warranty)	TUBE SIZE (Inches)	AM-FM PHONO PHONO JACK	UHF
General Electric Co. (continued)				
21C206	469.95	21	CDW	AC
21T4	319.95	21	TW	AC
21T5	339.95	21	TW	AC
21C200	369.95	21	CW	AC

MFR. and Model No.	LIST PRICE (Incl. Tax and Warranty)	TUBE SIZE (Inches)	AM-FM PHONO PHONO JACK	UHF
Hallcrafters Co., 4401 W. 5 Ave., Chicago 24, Ill.				
1051	199.95	17	TP	AC
1052	209.95	17	TP	AC
1053	259.95	21	TW	AC
1054	269.95	21	TW	AC
1055	279.95	21	TW	AC
1056	289.95	21	TW	AC
1057-U	339.95	21	TW	AI
1060	339.95	21	CW	AC
1061	359.95	21	CW	AC
1062	369.95	21	CW	AC
1063	399.95	21	CDW	AC
1067	595.00	21	CW	AC
1068	625.00	27	CW	AC
1010	219.95	17	TW	
1052U	249.95	17	TW	

MFR. and Model No.	LIST PRICE (Incl. Tax and Warranty)	TUBE SIZE (Inches)	AM-FM PHONO PHONO JACK	UHF
Hoffman, 6200 S. Avalon Blvd., Los Angeles 3, Calif.				
7M109	199.95	17	TW	AS
7M112	229.95	17	TW	AS
7B113	239.95	17	TW	AS
21M121	279.95	21	TW	AS
21B122	289.95	21	TW	AS
21M115	319.95	21	TW	PJ AS
21B116	329.95	21	TW	PJ AS
21M305	329.95	21	CW	AS
21B306	339.95	21	CW	AS
21P307	339.95	21	CW	AS
21M308	389.95	21	CW	PJ AS
21B309	399.95	21	CW	PJ AS
21P310	399.95	21	CW	PJ AS
21M506	379.95	21	CW	AS
21B507	389.95	21	CW	AS
21P508	389.95	21	CW	AS
21M700	449.95	21	CW	PJ AS
21B701	459.95	21	CW	PJ AS
21P702	459.95	21	CW	PJ AS
21M709	775.00	27	CW	PJ AS
21M903	485.00	21	CW AM-PH	AS
21B904	495.00	21	CW AM-PH	AS
21P905	495.00	21	CW AM-PH	AS
21M900	775.00	21	CW AM-FM-PH	AS
21B901	795.00	21	CW AM-FM-PH	AS
21P902	795.00	21	CW AM-FM-PH	AS

MFR. and Model No.	LIST PRICE (Incl. Tax and Warranty)	TUBE SIZE (Inches)	AM-FM PHONO PHONO JACK	UHF
Jackson Industries, 50 E. Cullerton St., Chicago 16, Ill.				
217T		17	T	
221T		21	T	
221C		21	C	
321C		21	C	AM
621		21	CD	AM
27CD		27	CD	
477T		21	TL	

MFR. and Model No.	LIST PRICE (Incl. Tax and Warranty)	TUBE SIZE (Inches)	AM-FM PHONO PHONO JACK	UHF
Jewel Radio Corp., 900 Passaic Ave., E. Newark, N. J.				
17TW-7	199.95	17	TW	AS
17CW-7	239.95	17	CW	AS
21TW-7	249.95	21	TW	AS
21CW-7	279.95	21	CW	AS

MFR. and Model No.	LIST PRICE (Incl. Tax and Warranty)	TUBE SIZE (Inches)	AM-FM PHONO PHONO JACK	UHF
Kaye-Halbert Corp., Culver City, Calif.				
012M	*249.95	20	TW	PJ AS
114W	*269.95	21	TW	PJ AS
114M	*279.95	21	TW	PJ AS
114PR	*299.95	21	TW	PJ AS
122M	*299.95	21	CW	PJ AS
124W	*329.95	21	CW	PJ AS
124M	*339.95	21	CW	PJ AS
124PR	*359.95	21	CW	PJ AS
104M	*399.95	21	CW	PJ AS
104PR	*419.95	21	CW	PJ AS
154M	*399.95	21	CDW	PJ AS
164M	*449.95	21	CDW	PJ AS
144B	*459.95	21	CW	PJ AS
144B/W	*469.95	21	CW	PJ AS
145	*469.95	21	CW	PJ AS
146	*469.95	21	CW	PJ AS
425M	*499.95	24	CW	PJ AS
425PR	*519.95	24	CW	PJ AS
426M	*549.95	24	CDW	PJ AS
426PR	*569.95	24	CDW	PJ AS

MFR. and Model No.	LIST PRICE (Incl. Tax and Warranty)	TUBE SIZE (Inches)	AM-FM PHONO PHONO JACK	UHF
Keeney & Co., J. H., 2600 W. 50 St., Chicago 32, Ill.				
	229.95	17	TW	AS
	264.95	20	TW	AS
	289.90	21	TW	AS
	274.95	17	C	
	299.95	20	C	
	329.25	21	C	

MFR. and Model No.	LIST PRICE (Incl. Tax and Warranty)	TUBE SIZE (Inches)	AM-FM PHONO PHONO JACK	UHF
Lion Mfg., 2640 Belmont Ave., Chicago 18, Ill.				
Magnavox Co., Ft. Wayne 2, Ind.				
MV33J	279.50	17	CW	AT
MV91L	550.00	21	CDW AM-PH	AT
MV68L	695.00	21	CDW AM-FM-PH	AT
MV104H	249.50	20	T	AT
MV42H	395.00	20	CDW	AT
MV88H	498.50	20	CDW AM-PJ	AT
MV89H	545.00	20	CDW AM-FM	AT
MV83H	550.00	20	CDW AM-FM-PH	AT
MV100L	445.00	21	CDW	AT
MV45L	445.00	21	CDW	AT
MV90L	595.00	21	CDW AM-FM-PH	AT
MV103H	269.50	20	CW	AT
MV102L	379.50	21	CW	AT
MV106L	289.50	21	CW	AT
MV107L	339.50	21	CW	AT
MV93L	695.00	21	CDW AM-FM-PH	AT
MV110M	595.00	27		AT
MV110MP	750.00	27		AT

MFR. and Model No.	LIST PRICE (Incl. Tax and Warranty)	TUBE SIZE (Inches)	AM-FM PHONO PHONO JACK	UHF
Majestic Div., Wilcox-Gay, 385 4 Ave., N.Y. 16, N.Y.				
30	189.95	17	TL	AS
17T20	219.95	17	TW	AS
17T21	229.95	17	TW	AS
17C30	239.95	17	CW	AS
17C31	249.95	17	CW	AS
34A	259.95	21	TW	AS
35A	269.95	21	TW	AS
32	289.95	21	CW	AS
33	299.95	21	CW	AS
21F88	339.95	21	CDW	AS
21F89	359.95	21	CDW	AS
21F86	399.95	21	CDW	AS
21T20	279.95	21	TW	AS
21T21	289.95	21	TW	AS
21C30	309.95	21	CW	AS
21C31	319.95	21	CW	AS
21D50	359.95	21	CDW	AS
21D51	379.95	21	CDW	AS
21P60	489.95	21	CDW AM-FM-PH	AS
21P61	519.95	21	CDW AM-FM-PH	AS
21P70	569.95	21	CDW AM-FM-PH	AS
21P71	599.95	21	CDW AM-FM-PH	AS

MFR. and Model No.	LIST PRICE (Incl. Tax and Warranty)	TUBE SIZE (Inches)	AM-FM PHONO PHONO JACK	UHF
Mattison TV & Radio, 893 Broadway, N. Y. 3, N. Y.				
27BB6	499.50	27	CW	PJ AS
21BB8	399.95	21	CW	PJ AS
17BB6	369.95	17	CW	PJ AS
21006	495.00	21	CDW PH-PJ	AS
21HE6	525.00	21	CDW PH-PJ	AS
21BE6	525.00	21	CDW PH-PJ	AS
21RF6	650.00	21	CD FM-PJ	AS
27RI6	795.00	27	CD FM-PJ	AS
27FP6	595.00	27	CD FM-PJ	AS
17QU6	495.00	17	CD	PJ AS
21QU6	550.00	21	CD	PJ AS
17U6	495.00	17	CD	PJ AS
20CA6	550.00	20	CDW	PJ AS
21QUA6	595.00	21	CDW	PJ AS
17D16	429.00	17	CDW	PJ AS
20D16	495.00	20	CDW	PJ AS
17C06	429.00	17	CDW	PJ AS
20C06	495.00	20	CDW	PJ AS

MFR. and Model No.	LIST PRICE (Incl. Tax and Warranty)	TUBE SIZE (Inches)	AM-FM PHONO PHONO JACK	UHF
Meek Ind., John—see Scott				
Mitchell Mfg. Co., 2525 N. Clybourn, Chicago 14, Ill.				
T172M	269.50	17	CW	FM-PJ AC
T212M	329.50	21	CW	FM-PJ AC
Motorola Inc., 4545 Augusta Blvd., Chicago, Ill				
17T13	179.95	17	TP	AC-AT
17T11E	189.95	17	TP	AC-AT
17T11	199.95	17	TP	AC-AT

MFR. and Model No.	LIST PRICE (Incl. Tax and Warranty)	TUBE SIZE (Inches)	AM-FM PHONO PHONO JACK	UHF
Motorola, Inc. (continued)				
17T12W	219.95	17	TW	AC-AT
17T12	229.95	17	TW	AC-AT
17T12B	239.95	17	TW	AC-AT
17K14W	259.95	17	CW	AC-AT
17K14	269.95	17	CW	AC-AT
17K14B	279.95	17	CW	AC-AT
17K15	299.95	17	CW	AC-AT
17K15B	309.95	17	CW	AC-AT
17K16	319.95	17	CW	AC-AT
17F13	449.95	17	CW AM-PH	AC-AT
17F13B	469.95	17	CW AM-PH	AC-AT
21T3	229.95	21	TP	AC-AT
21T4E	249.95	21	TP	AC-AT
21T4	259.95	21	TP	AC-AT
21T5	279.95	21	TW	AC-AT
21T5B	289.95	21	TW	AC-AT
21C1	289.95	21	CW	AC-AT
21C1B	299.95	21	CW	AC-AT
21K4W	319.95	21	CW	AC-AT
21K4	329.95	21	CW	AC-AT
21K4B	349.95	21	CW	AC-AT
21K5	389.95	21	CW	AC-AT
21K5B	409.95	21	CW	AC-AT
21K6	419.95	21	CW	AC-AT
21K7	449.95	21	CDW	AC-AT
21F2	575.00	21	CW AM-PH	AC-AT
21F2B	600.00	21	CW AM-PH	AC-AT
21F3	650.00	21	CW AM-PH	AC-AT
21F3B	675.00	21	CW AM-PH	AC-AT
27K1	695.00	27	CW	AC-AT

MFR. and Model No.	LIST PRICE (Incl. Tax and Warranty)	TUBE SIZE (Inches)	AM-FM PHONO PHONO JACK	UHF
National Co., 61 Sherman St., Malden, Mass.				
TV-1701	†269.95	17	TW	
TV-1725	†319.95	17	CW	
TV-1729	†339.95	17	CDW	
TV-2029	†419.95	20	CDW	

MFR. and Model No.	LIST PRICE (Incl. Tax and Warranty)	TUBE SIZE (Inches)	AM-FM PHONO PHONO JACK	UHF
Olympic Radio & TV 34-01 Ave., Long Island City 38, N.Y.				
17T40W	189.95	17	TP	
17T48	209.95	17	TW	
17C44	269.95	17	CW	
17K41	329.95	17	CDW	AM-PH
17K42	359.95	17	CDW	AM-PH
20T47	229.95	20	TP	
20T46	249.95	20	TW	
20C45	299.95	20	CW	
20K43	399.95	20	CDW	AM-PH
17T20B	259.95	17	TW	
17C24	269.95	17	CW	
17K32	279.95	17	CDW	AM-PH
21T27	279.95	21	TW	
21C28		21		

Selling Features of Latest TV Sets

(Continued from page 65)

MFR. and Model No.	LIST PRICE (Incl. Tax and Warranty)	TUBE SIZE (Inches)	TYPE	AM-FM PHONO JACK	UHF
Philco (continued)					
2152L	349.95	20	CW		AT
2255	349.95	21	CW		AT
2255L	369.95	21	CW		AT
2260	369.95	21	CW		AT
2262	399.95	21	CW		AT
2264	389.95	21	CDW		AT
2266	399.95	21	CW		AT
2266L	419.95	21	CW		AT
2268	439.95	21	CDW		AT
2269	469.95	21	CDW		AT
2270	499.95	21	CDW		AT
2271	499.95	21	CDW		AT
2272	429.95	21	CDW		AT
2272L	449.95	21	CDW		AT
2273	459.95	21	CDW		AT
1883	369.95	17	CW	AM-PH	AT
1884	429.95	17	CW	AM-PH	AT
1886	469.95	17	CDW	AM-PH	AT
1886L	499.95	17	CDW	AM-PH	AT
2183	479.95	20	CW	AM-PH	AT
2285	599.95	21	CDW	AM-PH	AT
2285L	629.95	21	CDW	AM-PH	AT
2286	649.95	21	CDW	AM-FM-PH	AT
2287	775.00	21	CW	AM-FM-PH	AT
1853R	399.95	17	CW	AM-FM-PH	AT
2228R	399.95	21	TW		AT
2266R	469.95	21	CW		AT
2266R	489.95	21	CW		AT
2269R	539.95	21	CDW		AT
2270R	569.95	21	CDW		AT
2271R	569.95	21	CDW		AT
2273R	529.95	21	CDW		AT
2285LR	699.95	21	CDW	AM-PH	AT
2285R	669.95	21	CDW	AM-PH	AT
2286R	719.95	21	CDW	AM-FM-PH	AT
2287R	845.00	21	CW	AM-FM-PH	AT
Philharmonic Radio & TV, New Brunswick, N. J.					
920	219.95	20	TW	PJ	AS
9120	249.95	20	CW	PJ	AS
9820	299.95	20	CDW	PJ	AS
9121	279.95	21	CW	PJ	AS
9821	399.95	21	CDW	PJ	AS
924	379.95	24	CW	PJ	AS
9821-DM	369.95	21	CDW	PJ	AS
Pilot Radio Corp., 37-06 36 St., Long Island City, N. Y.					
TV271	†299.50	17	TW	PJ	AT
TV273	†359.50	17	CW	PJ	AT
TV291	†359.50	20	TW	PJ	AT
TV293	†425.00	20	CW	PJ	AT
TV274	†475.00	17	CDW	AM-FM-PJ	AT
TV294	†575.00	20	CDW	AM-FM-PJ	AT
RCA Victor Div., Camden, N. J.					
17T200	199.95	17	TM	PJ	AC
17T211	279.95	17	CW	PJ	AC
17T220	299.95	17	CDW	PJ	AC
21T207	269.95	21	TM	PJ	AC-AT
21T207	289.95	21	TM	PJ	AC
21T208	289.95	21	T	PJ	AC
21T208EN	309.50	21	TW	PJ	AC
21T217	349.50	21	C	PJ	AC
21T218	385.00	21	CW	PJ	AC
21T227	399.50	21	CDW	PJ	AC
21T228	408.50	21	CDW	PJ	AC
21T229	429.50	21	CDW	PJ	AC
21T242	525.00	21	CDW	AM-PH	AC
21T244	595.00	21	CDW	AM-FM-PH	AC
17T250DE	279.95	17	TW	PJ	AC-AT
17T261DE	339.50	17	CW	PJ	AC-AT
21T159DE	359.50	21	TW	PJ	AC-AT
21T166DE	419.50	21	CW	PJ	AC-AT
21T174DE	459.50	21	CDW	PJ	AC-AT
21T175DE	525.00	21	CDW	PJ	AC
21T176DE	450.00	21	CDW	PJ	AC-AT
21T177DE	475.00	21	CDW	PJ	AC-AT
21T178DE	495.00	21	CDW	PJ	AC-AT
21T179DE	525.00	21	CDW	PJ	AC-AT
21T197DE	795.00	21	CDW	AM-FM-PH	AC-AT
Radio Craftmen Inc., Chicago 40, Ill.					
C202-CH	336.80	17, 20, 21, 24			AS

MFR. and Model No.	LIST PRICE (Incl. Tax and Warranty)	TUBE SIZE (Inches)	TYPE	AM-FM PHONO JACK	UHF
Radio & Television, Inc., Brunswick Div., 119 W. 57 St., N. Y. 19, N. Y.					
KP-221	399.50	21	CDW	PJ	AS
MA-221	399.50	21	CDW	PJ	AS
2400	435.00	24	CW	PJ	AS
Raytheon TV, 5921 W. Dickens Ave., Chicago 39, Ill.					
M1733	199.95	17	TL		AT
M1734	239.95	17	TL		AT
C1733	259.95	17	CW		AT
C1736	269.95	17	CW		AT
M2107	249.95	21	TL		AT
C2108	339.95	21	CW		AT
C2110	349.95	21	CW		AT
C2109	379.95	21	CW		AT
C2111	359.95	21	CW		AT
C2112	429.95	21	CW	AM-PJ	AI
C2113	449.95	21	CW	AM-PJ	AI
C2114	479.95	21	CDW	AM-PJ	AI
C2115	499.95	21	CDW	AM-PJ	AI
C2116	499.95	21	CDW	AM-PJ	AI
RC-2117	750.00	21	CDW	AM-PH	AI
Regal Electronics, 605 W. 130 St., New York 27, N. Y.					
17T20	†199.50	17	TW		AS
17C20	†217.50	17	CW		AS
20T20	†239.95	20	TW		AS
20C20	†259.95	20	CW		AS
21H20	†299.50	21	CDW		AS
24C20	†397.50	24	CW		AS
Scott Radio Laboratories, 1020 N. Rush St., Chicago 11, Ill.					
1000TC	1595.00	24	CDW	AM-FM-PH	AS
1510TA	895.00	20	CDW	AM-FM-PH	AS
1000CA	1195.00		CDW	AM-FM-PH	AS
1510AA	595.00		CDW	AM-FM-PH	AS
924W	695.00	24	CDW		AS
821C	395.00	21	CW		AS
821D	475.00	21	CDW		AS
821T	345.00	21	TW		AS
817C	345.00	17	CW		AS
817T	295.00	17	CDW		AS
Sentinel, 2100 Dempster St., Evanston, Ill.					
454-TW	199.95		TW		AS
454-TM	229.95		TW		AS
455-TM	269.95		TW		AS
456-CM	339.95		CW		AS
456-CB	349.95		CW		AS
457-CM	369.95		CDW		AS
457-CB	379.95		CDW		AS
458-TM	259.95		TW		AS
459-TM	299.95		TW		AS
459-TB	309.95		TW		AS
460-CM	379.95		TW		AS
460-CB	389.95		CW		AS
461-CM	419.95		CDW		AS
461-CB	429.95		CDW		AS
461-FP	439.95		CW		AS
462-CM	575.00		CW		AS
463-CM	625.00		CDW		AS
463-CB	645.00		CDW		AS
Setchell Carlson, Inc., New Brighton, Minn.					
531	349.00	21	CW		AS
531-WR	369.00	21	CW	AM-PJ	AS
5301	389.00	21	CW	AM-PH-PJ	AS
53	299.00	21	TW		AS
53-WR	319.00	21	TW	AM-PJ	AS
Shaw TV, 195 Front St., Brooklyn 1, N. Y.					
121	350.00	21	TW	PJ	AS
1521	439.95	21	CDW	PJ	AS
421	459.95	21	CDW	PJ	AS
2621	489.95	21	CDW	PJ	AS
2221	519.95	21	CDW	PJ	AS
2321	549.95	21	CDW	PJ	AS
3321	549.95	21	CDW	PJ	AS
921	589.95	21	CDW	PJ	AS
2021	589.95	21	CDW	PJ	AS
2521	609.95	21	CDW	PJ	AS
3421	639.95	21	CDW	PJ	AS

MFR. and Model No.	LIST PRICE (Incl. Tax and Warranty)	TUBE SIZE (Inches)	TYPE	AM-FM PHONO JACK	UHF
Shaw TV (continued)					
3521	659.95	21	CDW	PJ	AS
3021	719.95	21	CDW	PJ	AS
2727	749.95	27	CDW	PJ	AS
2827	829.95	27	CDW	PJ	AS
Sheraton Television Corp., Red Bank, N. J.					
17MC10	299.95	17	TL	PJ	AS
17MC20	299.95	17	TW	PJ	AS
21MT10	289.95	21	TW	PJ	AS
21BT10	279.95	21	TW	PJ	AS
21MC10	299.95	21	CW	PJ	AS
21BC10	319.95	21	CW	PJ	AS
21MD10	339.95	21	CDW	PJ	AS
21BD10	359.95	21	CDW	PJ	AS
27MD10	599.95	27	CDW	PJ	AS
530DX10	219.95	20	CH	PJ	AS
Shevers Inc., Harold, 123 W. 64 St., New York 23, N. Y.					
217P	199.95	17 1/2	TL		AS
318	159.95	17	TW		AS
318A	199.95	21	TW		AS
319	229.95	17	TW		AS
319A	279.95	21	TW		AS
323	299.95	21	TW		AS
323A	399.95	27	TW		AS
Sightmaster Corp., 111 Cedar St., New Rochelle, N. Y.					
17E52	†199.00	17	TW	PJ	AC
20K52	†595.00	20	CDW	PJ	AC
20E52	†299.00	20	CW	PJ	AC
Sound Laboratories, 323 E. 48 St., New York 17, N. Y.					
5230	695.00	21	CDW	AM-FM-PH	AS
Spartan Radio-Television, Jackson, Mich.					
5301	209.95	17	TP		AS
5302	219.95	17	TP		AS
5325	269.95	17	TW		AS
5326	279.95	17	TW		AS
5340	289.95	21	TW		AS
5341	299.95	21	TW		AS
5342	339.95	21	TW		AS
5343	349.95	21	TW		AS
5352	289.95	17	CW		AS
5353	299.95	17	CW		AS
5362	329.95	17	CW		AS
5363	339.95	17	CW		AS
5380	349.95	21	CW		AS
5381	369.95	21	CW		AS
5382	389.95	21	CW		AS
5383	389.95	21	CW		AS
5384	449.95	21	CDW		AS
5386	469.95	21	CDW		AS
5392	629.95	21	CDW	AM-PH	AS
5393	639.95	21	CDW	AM-PH	AS
Sterling—see Atlantic Video					
Stewart-Warner, 1300 N. Kostner Ave., Chicago 51, Ill.					
17T-9202G	199.95	17	TW		AS
21T-9132A	349.95	21	TW		AS
21T-9210A	269.95	21	TW		AS

Where do the real TV PROFITS lie?

In lowering your service costs? •

In a franchise that stands up? •

Are they in higher discounts? •

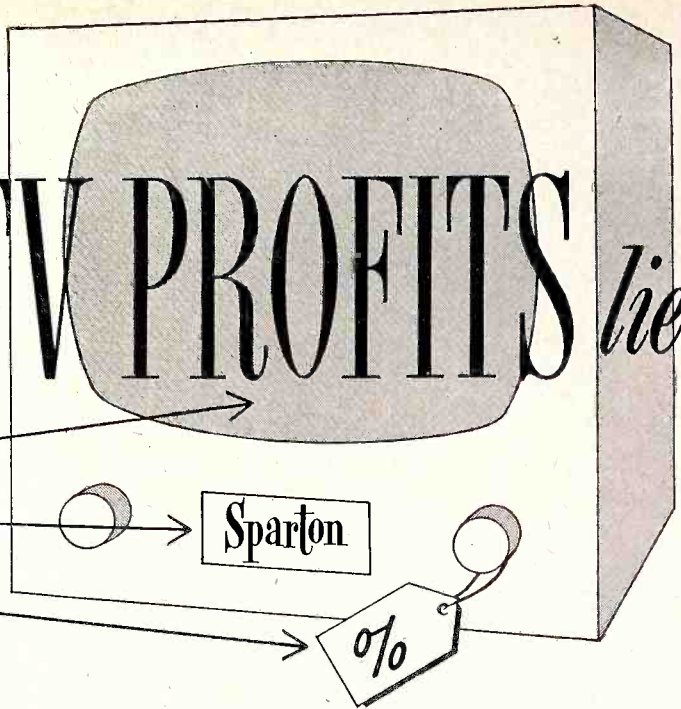

Any dealer who watches his total *net* knows it takes all three. And Sparton dealers *get* all three!

Across the board, Sparton dealers receive probably the longest discounts in TV today *plus* up to 3% retroactive discount. But that's not all. Sparton dealers know 70% of vital functioning parts in every set they receive are manufactured by Sparton to *Sparton* standards; many extra assembly steps are performed by hand to insure trouble-free operation. The result: Sparton dealers *keep* their profits, don't pass them out for service repairs.

Sparton dealers are protected by a controlled franchise,

too. It guarantees exclusive selling rights in a shopping area, eliminates dumping and price slashing. Sparton dealers buy direct from the factory. They don't split profits with a middleman; they are never forced to handle other lines just because the middleman has them to sell.

If you're not already a Sparton dealer, why not investigate? Get full details from your Sparton District Merchandiser or write direct. *Sparton Radio-Television, Jackson, Michigan.*



Model 5382—
The 21" Carrington

List: \$379⁹⁵

(Federal excise tax and warranty included)



Model 5301—
The 17" Danbury

List: \$199⁹⁵

(Federal excise tax and warranty included)



Model 5386—
The 21" Courtney

List: \$459⁹⁵

(Federal excise tax and warranty included)



Model 5340—
The 21" Glenhurst

List: \$279⁹⁵

(Federal excise tax and warranty included)

Sparton ads in *Post, Collier's, Holiday* and *Time* sell these Cosmic Eye stars right on the magazine page!



THE SUPERB

Sparton

THE SET THAT STAYS SOLD

THE Unbeatable Combination

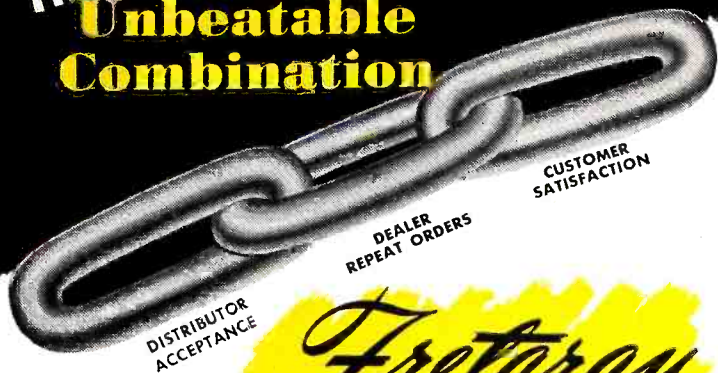

Fretaray

The Finest
in High-Gain
All-Channel

ANTENNAS

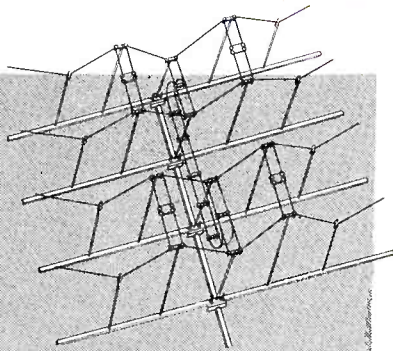

Illustrated:
FRETCO all-channel
Fretaray Antenna

Only the Fretaray provides the links for this Unbeatable Combination with proven customer enthusiasm for its matchless reception and superior quality.

All backed by a solid campaign of national advertising in leading magazines, plus newspaper mats, literature and catalog sheets.

Fretco

INCORPORATED
Pittsburgh 19, Pennsylvania

Record Festival

(Continued from page 48)

Barton, Benny Goodman, Bill Hayes, Bill Kenny, Les Paul, Mary Ford, Fran Warren, Hugo Winterhalter, Cindy Lord, Toni Arden. Among those who performed for the children were Bozo, the Capitol Clown, Oscar Brand, Frank Luther and the Sandpipers.

It is estimated that the RIAA spent about \$15,000 on the event, which was the first industry-wide cooperative program ever undertaken in the record field. Gross receipts from admissions ran to about \$10,000. The Association may hold similar Festivals in other cities, it was learned, although no official announcement has been made. Association officials point out that the pattern established in Hartford can be followed by newspapers, radio stations, etc., in staging cooperative Festivals of their own in working with local dealers and distributors.

Profits in Hi-Fi

(Continued from page 62)

The first of those two questions is relatively easy to answer, since for the dealer already selling instruments (radio, TV, phonographs) and records, custom-Hi-Fi is plus business. We are not suggesting that the dealer dispose of all his worldly goods and follow us into the wilderness. All he needs to do is to complete his present line of merchandise. We believe, for instance, that a dealer who sells phonographs and/or combinations should also sell needles and records, and vice versa.

The second question, how to sell it, involves getting customers, making displays, training sales personnel and promoting the sale of the merchandise—the same factors involved in selling all your other lines.

Finding prospects, however, does not necessarily mean developing a whole new clientele. Many of your customers who already own radio-phonograph equipment and/or who come to your store for records are already prospects. A simple display of a Hi-Fi setup is often sufficient to elicit interest from these people who have already been stimulated by what they have read in the magazines or heard at a neighbor's home. In addition, many of these people are dissatisfied with their

(Continued on page 72)

Get on the Bandwagon with DeWALD'S New Television Policy

- NEW MODELS • NEW LOW PRICES
17", 20", 21" — Table and Console Models
- PROFITABLE DISTRIBUTOR AND DEALER MARK-UP
- PRICE PROTECTED . . . YOUR PROFITS ASSURED
- QUALITY PROVEN . . . SATISFACTION GUARANTEED
By 35 years of know-how, reliability and financial stability
- FREE ONE-YEAR WARRANTY
On television tubes and parts
- A COMPLETE RADIO LINE
Clock Radios - Portables - Table Models
Radio-Phonograph Combinations

Private-Label
and Contract
accounts
solicited

WRITE—PHONE—WIRE—TODAY
for the attractive
De WARD PROPOSITION
in your territory

in
RADIO
and
TELEVISION

for
SOMETHING
BETTER,
it's

DEWALD

DEWALD RADIO MFG. Corp. 35-15 37th Ave., Long Island City 1, N. Y.

Selling Features of Latest TV Sets

(Continued from page 66)

MFR. and Model No.	LIST PRICE (Incl. Tax and Warranty)	TUBE SIZE (Inches)	TYPE	AM-FM PHONO JACK	UHF
Romborg-Carlson (continued)					
421CDM2	†479.50	21	CDW	PJ AS	AS
421C5M	†485.00	21	CDW	PJ AS	AS
421C50	†495.00	21	CDW	PJ AS	AS
421C5Dec.	†565.00	21	CDW	PJ AS	AS

MFR. and Model No.	LIST PRICE (Incl. Tax and Warranty)	TUBE SIZE (Inches)	TYPE	AM-FM PHONO JACK	UHF
Avania Elec. Prod. Inc., Radio TV Div., Buffalo 7, N. Y.					
72M11	199.95	17	TW	AC	AC
72B11	209.95	17	TW	AC	AC
155M	239.95	17	TW	AC	AC
155A	249.95	17	TW	AC	AC
150L	269.95	17	TW	AC	AC
150A	279.95	17	TW	AC	AC
22M11	269.95	20	TW	AC	AC
22B11	279.95	20	TW	AC	AC
22M2	339.95	20	TW	AC	AC
120M	329.95	21	TW	AT-AS	AS
120B	339.95	21	TW	AT-AS	AS
175M	389.95	21	TW	AT-AS	AS
175B	399.95	21	TW	AT-AS	AS
73M11	269.95	17	CW	AC	AC
73B11	279.95	17	CW	AC	AC
23M11	309.95	20	CW	AC	AC
23B11	319.95	20	CW	AC	AC
23M1	389.95	20	CW	AC	AC
23B1	409.95	20	CW	AC	AC
126M	369.95	21	CW	AT-AS	AS
126B	379.95	21	CW	AT-AS	AS
176M	449.95	21	CW	AT-AS	AS
176B	469.95	21	CW	AT-AS	AS
74M2	359.95	17	CDW	AC	AC
74B2	379.95	17	CDW	AC	AC
24M3	429.95	20	CDW	AC	AC
177M	479.95	21	CDW	AT-AS	AS
177B	499.95	21	CDW	AT-AS	AS
172M	499.95	21	CDW	AT-AS	AS
172K	499.95	21	CDW	AT-AS	AS
178M	649.95	21	CW	AM-FM-PH AT-AS	AS
178B	669.95	21	CW	AM-FM-PH AT-AS	AS

MFR. and Model No.	LIST PRICE (Incl. Tax and Warranty)	TUBE SIZE (Inches)	TYPE	AM-FM PHONO JACK	UHF
Tele King Corp., 601 W. 26 St., New York 1, N. Y.					
K73LW	169.95	17	T		
K74	199.95	17	TW		
K72	249.95	17	TW		
K72B	269.95	17	TW		
K71	289.95	17	CW		
K72B	309.95	17	CW		
KD71	329.95	17	CDW		
KD72B	349.95	17	CDW		
KD71X	359.95	17	CDW	AM-PH	
KD71XB	379.95	17	CDW	AM-PH	
K22	229.95	20	TW		
K21	299.95	20	TW		
K221	339.95	20	CW		
K22B	359.95	20	CW		
K11	319.95	21	TW		
K11B	339.95	21	TW		
KD11	599.95	21	CDW		

MFR. and Model No.	LIST PRICE (Incl. Tax and Warranty)	TUBE SIZE (Inches)	TYPE	AM-FM PHONO JACK	UHF
Tele King Corp. (continued)					
KD11B	429.95	21	CDW		
KD12M	429.95	21	CDW		
KD12C	429.95	21	CDW		
KD13	399.95	21	CDW		
KD11X	459.95	21	CDW	AM-PH	
KD11XB	489.95	21	CDW	AM-PH	
KD27	595.00	27	CDW		
KD28	629.95	27	CDW		
KC11	359.95	21	CW		
KC11B	379.95	21	CW		

MFR. and Model No.	LIST PRICE (Incl. Tax and Warranty)	TUBE SIZE (Inches)	TYPE	AM-FM PHONO JACK	UHF
Trans-Vus—see Jackson					
Trav-Ler Radio Corp., 571 W. Jackson Blvd., Chicago 6, Ill.					
217-31	*144.95	17	TW	AS	AS
217-32	*159.95	17	TW	AS	AS
217-33	*189.95	17	CW	AS	AS
217-37	*169.95	17	TW	AS	AS
220-34	*169.95	20	TW	AS	AS
220-35	*189.95	20	TW	AS	AS
221-36	*229.95	21	CW	AS	AS

MFR. and Model No.	LIST PRICE (Incl. Tax and Warranty)	TUBE SIZE (Inches)	TYPE	AM-FM PHONO JACK	UHF
Universal Major Appliance, Lima, Ohio					
UTV240CM	569.95	24	CW	AC	AC
UTV21-2DCM	429.95	21	CDW	AC	AC
UTV210CM	369.95	21	CW	AC	AC
UTV21TM	299.95	21	TW	AC	AC
UTV20TM	229.95	20	TW	AC	AC
UTV-21-0CB	379.95	21	CW		
UTV-21-2DCB	445.95	21	CDW		
UTV-21-2DCKP	489.95	21	CDW		
UTV-21-2DCFP	499.95	21	CDW		
UTV-24-0CB	589.95	24	CW		

MFR. and Model No.	LIST PRICE (Incl. Tax and Warranty)	TUBE SIZE (Inches)	TYPE	AM-FM PHONO JACK	UHF
Vidaire Mfg. Co., 576 W. Merrick Rd., Lynbrook, N. Y.					
Standard	379.95	20	CW	PJ AS	AS
Modern	419.95	20	CDW	PJ AS	AS
Economy	249.95	17	TW	PJ AS	AS
Mod. Deluxe	489.95	20	CDW	PJ AS	AS
Regent	459.95	20	CDW	PJ AS	AS
Arlington	509.95	20	CDW	PJ AS	AS

MFR. and Model No.	LIST PRICE (Incl. Tax and Warranty)	TUBE SIZE (Inches)	TYPE	AM-FM PHONO JACK	UHF
Video Products—see Sheraton Television Corp.					
Westinghouse Electric Corp., TV-Radio Div., Sunbury, Pa.					
H-706T16	189.95		TP	AT	
H-681T17	199.95		TP	AT	
H-704T17	229.95		TP	AT	
H-700T17	249.95		TW	AT	
H-701T17	259.95		TW	AT	
H-699K17	269.95		CW	AT	

MFR. and Model No.	LIST PRICE (Incl. Tax and Warranty)	TUBE SIZE (Inches)	TYPE	AM-FM PHONO JACK	UHF
Westinghouse Electric Corp. (continued)					
H-702K17	289.95		CW	AT	
H-703K17	299.95		CW	AT	
H-708T20	259.95		TP	AT	
H-724T20	259.95		TW	AT	
H-725T20	269.95		TW	AT	
H-718K20	299.95		CW	AT	
H-692T21	299.95		TW	AT	
H-710T21	299.95		TW	AT	
H-713K21	359.95		CW	AT	
H-695K21	369.95		CW	AT	
H-714K21	369.95		CW	AT	
H-715K21	389.95		CW	AT	
H-720K21	425.00		CDW	AT	
H-721K21	425.00		CDW	AT	
H-722K21	475.00		CW	AT	
H-688K24	625.00		CDW	AT	
H-730C21	595.00		CW	AM-FM-PH AT	
H-732C21	499.95		CW	AM-FM-PH AT	
H-733C21	525.00		CW	AM-FM-PH AT	

MFR. and Model No.	LIST PRICE (Incl. Tax and Warranty)	TUBE SIZE (Inches)	TYPE	AM-FM PHONO JACK	UHF
Zenith Radio, 6001 Dickens Ave., Chicago 39, Ill.					
K1812R	199.95	17	TL	AS	
K1812E	209.95	17	TL	AS	
K1815R	219.95	17	TL	AS	
K1815E	229.95	17	TL	AS	
K1820R	239.95	17	TW	AS	
K2235R	279.95	21	TW	AS	
K1820E	249.95	17	TW	AS	
K2229E	279.95	21	TP	AS	
K2230R	299.95	21	TL	AS	
K2230E	309.95	21	TL	AS	
K2240R	319.95	21	TW	AS	
K2240E	329.95	21	TW	AS	
K1846R	269.95	17	CW	AS	
K1850R	289.95	17	CW	AS	
K1850E	299.95	17	CW	AS	
K2258R	349.95	21	CW	AS	
K2260R	379.95	21	CW	AS	
K2263E	399.95	21	CW	AS	
K2266R	429.95	21	CDW	AS	
K2266E	429.95	21	CDW	AS	
K2267E	449.95	21	CDW	AS	
K2268R	499.95	21	CDW	AS	
K2270R	449.95	21	CW	AS	
K2270H	459.95	21	CW	AS	
K2872R	695.00	27	CDW	AS	
K1880R	449.95	17	CDW	AM-FM-PH AS	
K2286R	499.95	21	CDW	AM-FM-PH AS	
K2287R	599.95	21	CDW	AM-FM-PH AS	
K2290R	750.00	21	CDW	AM-FM-PH AS	
K2291E	695.00	21	CDW	AM-FM-PH AS	
K2873E	750.00	27	CDW	AS	

T—Table M—Metal PJ—Phono Jack AT—Add New Tuner
 C—Console L—Leatherette AI—As Is CH—Chassis
 D—With Doors W—Wood AS—Add Strip * Tax Extra
 P—Plastic PH—Phonograph AC—Add Converter † Warranty Extra

In some instances, prices slightly higher in certain localities. Tax and Warranty included in prices unless indicated by * and/or †. Models and prices are reproduced from the latest information received from the manufacturers up to press time.

HOW TV CHANNELS FIT INTO THE COMPLETE BROADCASTING SPECTRUM

This chart shows how the "air" has been allotted for commercial educational, public safety, entertainment and other purposes. Present VHF-TV (Channels 2-13) gets about 1% of the total, UHF-TV (14-83), 6%

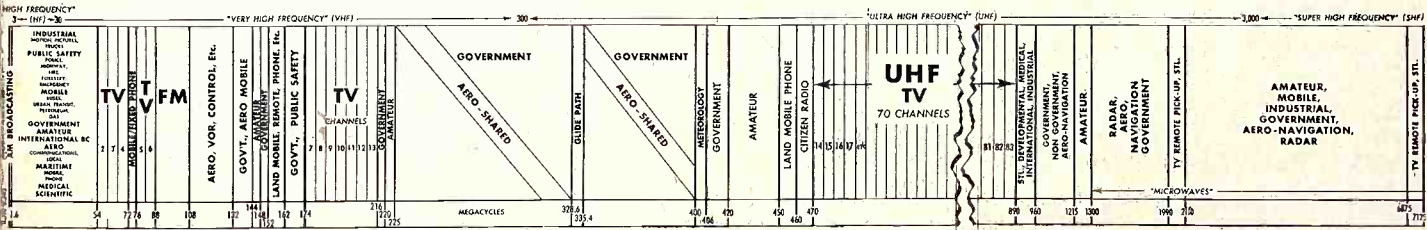

DON'T BE MISLED BY LOW LIST PRICES!

...It's The Net Profits That Count!

Don't let the allure of low list prices divert your selling effort from profitable channels. Tele King's story is still the sweetest story ever told... the story that never grows old... the story of greater profits! Yes, for greater profit and less service headaches, Tele King is the set worth selling!

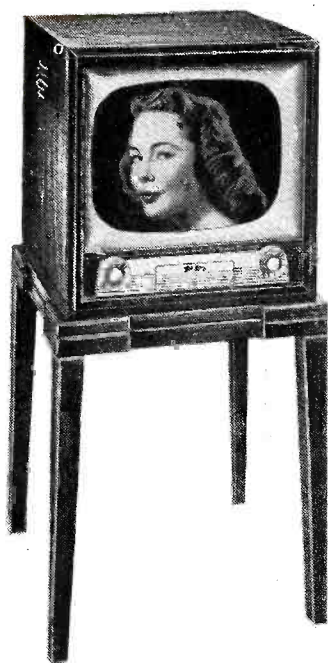

K11 — Open-front 21" Table Model TV, with removable glass front and new non-glare feature. Contemporary styling, in ageless mahogany, hand-rubbed to a lustrous finish. Also available in limed oak.

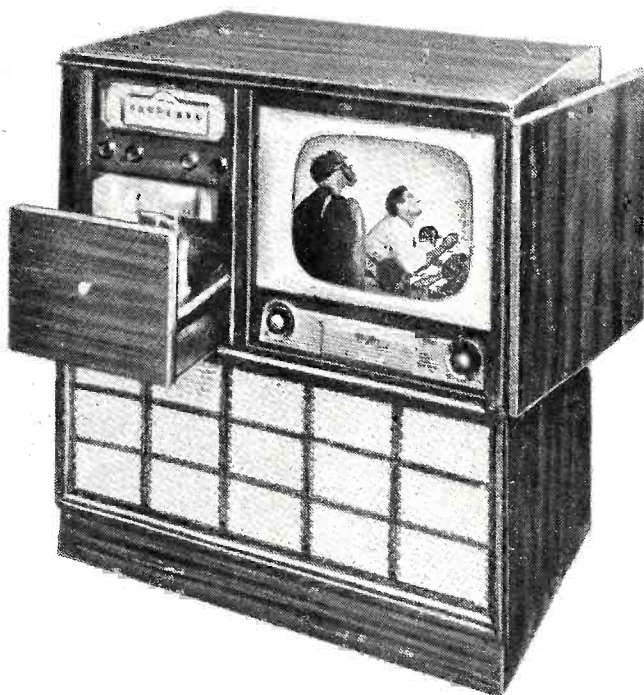

KD71X — 17" TV, Phono, Radio. Mahogany Console model in graceful 18th Century motif. The complete home entertainment unit. Also available with 21" TV. Both models available in limed oak.

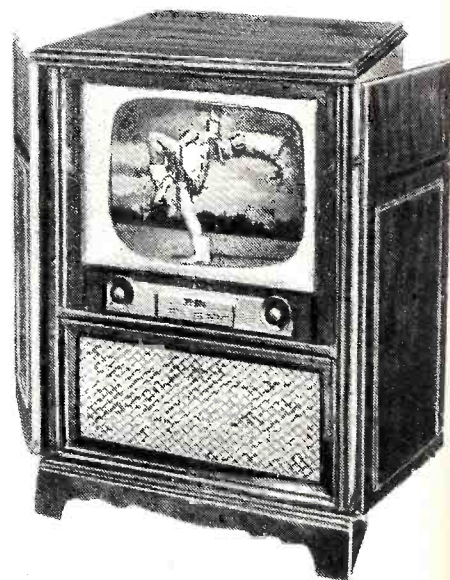

KD13—21" Console TV, with removable glass front and new non-glare feature. Traditional Early American, in luxurious mahogany, hand-rubbed to set off its matchless grain and color.

All Sizes... All Styles

... All Superb — All

Tele King

 CORPORATION

601 West 26th Street, New York 1, N. Y.

DON'T WORK FOR PEANUTS — SELL TELE KING, AMERICA'S NO. 1 PROFIT LINE!

For Xmas —

Active Promotion By Dealer Can Result in Large Volume in These Big-Profit Products

Recorders, Phonos, Portables, Clock-Radios

Cash in on Record Players

• Small phonos are naturals as Christmas gifts, and today there are a great many models available in a wide range of prices. The dealer can buy quite heavily as this time and in return for a comparatively small investment can offer a large variety of models to his customers. Furthermore, such an investment appears to be quite sound since the phonograph is a year round seller which he can carry over, and which isn't likely to drop in price. Still another good feature in stocking players is that they are not "dated" like some other merchandise. People will readily accept a phono player without asking or caring whether it's this year's model.

A mass display of players in the window and in the store will attract attention. The low-priced jobs should be conspicuously price-ticketed, and a special appeal should be made to the parents of small children as well as to those who have youngsters in schools and colleges. Ask every store visitor to consider a phono as a gift. Advertise phonos in newspapers, over the air, and by direct-mail.

Recorders Are Naturals

People who want to give something different will find the magnetic recorder just what Santa Claus ordered. As pointed out in previous articles, the recorder sale doesn't involve trade-ins, there isn't much competition, and not much price-cutting. As with the phono player, customers won't demand this year's model, so the dealer can stock an adequate inventory without worrying about having to carry over a few units.

One best bet to get a satisfactory volume of sales in recorders this year is to set up some sort of demonstration center, and to ask each and every person who comes into your store to "hear himself as others hear him." Another good place to get leads is from local music schools and from music departments in public schools. Having obtained such lists of names, the store's salespeople can commence making a telephone canvass. No lost motion here, since the folk being called are already well qualified prospects. See feature article entitled, "This Christmas—They'll Buy the Big-Ticket Items Early," in Oct. issue for ideas on display in order to interest the early-bird shopper or to nudge the procrastinator into buying early for Christmas.

It'll Pay to Push Portables

Carry-about sets are big Christmas sellers, and make no mistake about that. Many a dealer has been unable to supply the demand for portables during the Yuletide season, and that's just why he should

make certain that this year he'll have enough to go round. Portables are colorful, "versatile" products, and good investment merchandise since they too can be carried over without fear of obsolescence.

Here's one way to up volume in the carry-about sets: Make it a hard and fast rule in your store that each salesperson show a portable set to each and every customer. Let the store visitor handle the set, operate it, and consider its many features which go to make it the ideal Christmas gift. Early in the game suggest that a portable be set aside for the customer for delivery on Christmas Eve. Offer to have it gift-wrapped on the "inside" and "rough-wrapped" on the "outside" so that the immediate purchaser can take it home to hide in the closet until the big day arrives.

Whatever you do be sure to stress the fact that the portable is a year-round receiver. It is most important to drive home this point to the older customers who may think the carry-about is just something the kids lug around during the Summer. Remember: portable saturation is very low, so the potential's

quite high. Portables are *easy to sell*, but like other products, they must be sold. They won't jump at your customers and ask to be taken home.

Time to Promote Clock-Radios

Brother, here's the newest star performer in the radio field, and everywhere in the country it's responded satisfactorily to active sales promotion. For Christmas, 1952, the clock-radio will solve many a gift problem, and will ring up additional profits for the merchant who uses this product's outstanding features to sell it as the ideal gift.

Like the other merchandise described on this page, the clock-radio is sound investment stock. It sells all the year, and won't become dated, or rather out-dated. Because it can be carried over, the dealer is justified in buying as large a stock as he can afford at this time, (No price drops seem likely.) Such procedure is good business since a large selection of models, colors, etc., will help speed up sales.

In suggesting the clock-radio as a gift, for heaven's sake let's not assume that the customer knows all about this new product. It isn't enough to say it's a "clock-radio", and then wait for the customer to say, "oh," or "so what?" Let's tell 'em that it's as modern as a flying saucer, and as versatile as an electronic computer. If it's one of the units having all of the features, tell them that it's a fine radio, a self-starting accurate electric clock, and an electric servant which turns appliances on and off at pre-determined times, and that it lulls one to sleep with music and wakes 'em up with it, too.

Hoffman New Plant and Offices

Hoffman Radio Corp., Los Angeles, has moved its sales, advertising, sales promotion, publicity and market research departments to a new plant at 3764 S. Broadway Place, Los Angeles, Calif., according to H. Leslie Hoffman, president. The location is two blocks from the main administrative offices. The new factory has an aggregate of some 44,000 square feet. There will be no change in personnel except the addition of several new employees. The quarters vacated by the group at 6200 S. Avalon will be used for expansion of the TV engineering division and cabinet design.

Philco-Mort Farr Sponsor Penn Games via WCAU Radio

University of Pennsylvania football games broadcast via WCAU Radio are co-sponsored this year by Philco Distributors, Inc., Philadelphia, and Mort Farr, a leading dealer in the greater Philadelphia area, it was recently announced by J. D. Hawkins, general manager of Philco Distributors. Said Hawkins, "It is appropriate that Philco sponsor the Penn games during its 60th anniversary year, inasmuch as the Philco "Golden Grid" tuner, an outstanding engineering advance in television in 1953, has a decided football connotation."

Profits in Hi-Fi

(Continued from page 68)

present equipment but haven't gotten around to the problem of doing something about it.

It is possible for the dealer to have two or three "packages" which will cover all possible types of customer. These would represent equipment which he, the dealer, feels are the best buys in their field and the ones he would recommend (personally and professionally) to the customer. Actually, having qualified the customer as outlined above, he would only need to offer each individual customer one package, saying, "This is exactly what you need, and I have found through exhaustive tests that it is the best that your money can buy." Such an approach, based on expert opinion, gives the customer confidence that he is making the right choice.

From the furniture angle, there are three approaches to be covered. First, there are ready-made cabinets available, some of which can be carried in stock, and the rest sold from photos. Second, there is the specially built furniture or the adaptation of existing pieces of furniture. An arrangement can be made with a cabinet maker or furniture maker who can do this work on a contract basis. Third, there is the "built-in" angle. Here again, this can be covered on a contract arrangement with a cabinet maker.

At least one sales person should be conversant with the demonstration equipment and the jargon of the Hi-Fi trade. Every customer who comes into the store should be apprised of the existence of your custom department and the services it offers, and an attempt should be made to qualify them as to the equipment they now own. This should be done anyway with record customers—to make sure that they get the right speed record, and to find out what sort of needle they would need (preparatory to suggesting that they buy a new one). TV customers should also be checked for the possible sale of a combination, or a phonograph attachment, and the answers to these questions may determine whether the customer can be set up for a Hi-Fi sale.

We don't expect custom sales to take the place of anything of the magnitude of TV or appliances, but they can mean important plus business to the dealer who goes out after them.

Quality

Design

SALES

Model TT-30
21" x 21"

Model TT-40
24" x 21"

Protected by U.S. Patent

Entire upper portion of all tables (top and rails) completely rotates with our nationally famous ball bearing center unit: eliminates warping or binding under any weight.

The TELEVISION TABLE that rotates!

This model is typical of our volume-producers which have everything . . . quality (top grade veneer) . . . design (blend with any and every room) . . . and sales-appeal (proven by the volume which our tables are creating).

You can have your choice of this model or any of our other models in mahogany, limed oak or blonde. ORDER TODAY!

Our new, multi-colored literature is available without obligation. Write for it now.



Sold through recognized distributors only.

Universal WOODCRAFTERS inc.
of LA PORTE, Indiana

The Nation's
Leading Furniture
Specialists to
the Radio and
Television Industry

G-E ULTRA-VISION SWEEPS COUNTRY!

**SIDE-BY-SIDE COMPARISONS
WITH ALL COMERS CREATE
LANDSLIDE ORDERS FOR G-E!**

Make the great "show-down test" right in your store in broad daylight! Put any TV set you have in stock — yes, ANY set regardless of price — up against G-E Black-Daylite TV with Ultra-Vision. Tune in the same program *yourself* on both sets. The difference is so startling you realize here is black and white contrast that's been impossible in *any* TV until now. Here's why: G-E Ultra-Vision is the only TV in the world with the G-E Aluminized 21-inch tube . . . *plus* the new G-E Stratopower Chassis (267% more pull-in power than previous sets) . . . *plus* the G-E dark-tone, tilted safety glass that increases contrast, banishes annoying glare.

Get your order in now so you'll be locked to cash in on the sweeping nationwide success of new G-E Ultra-Vision. Phone your General Electric television distributor today.

General Electric Co., Receiver Dept., Syracuse, N. Y.

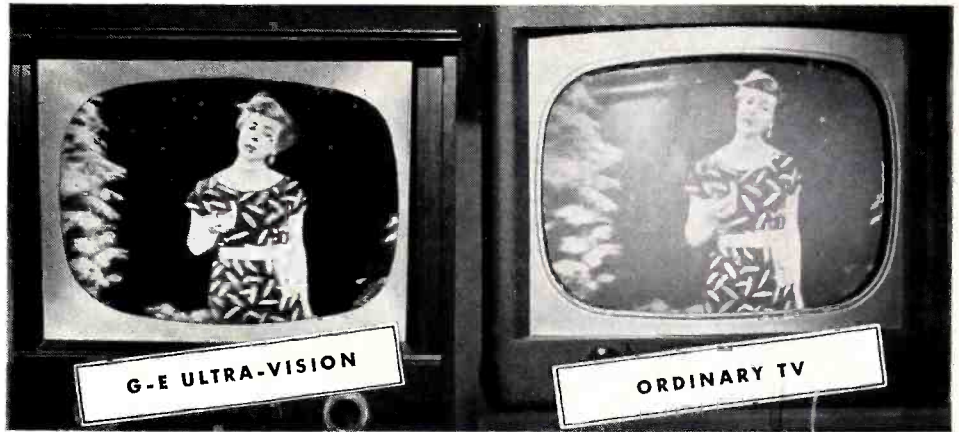

Here's an actual photograph taken of two TV sets side by side receiving the same telecast program. Both sets were subjected to the same blinding floodlights to illustrate the extreme difference in black-to-white ratio under the most adverse circumstances. You will get the same proof of superiority of G-E Ultra-Vision in comparison with any TV set under any degree of illumination—from brightest daylight to the darkest room.

 **BLACK-DAYLITE TV** 
ENGINEERED FOR BOTH VHF AND UHF



JACILLE BALL, Star of CBS Television's "I Love Lucy!"

World's only TV with 21-inch G-E Aluminized Picture Tube that mirrors light toward you, sharpens contrast, increases picture brightness up to 100%. Tilted dark-tint safety glass and cylindrical tube give the widest range of picture tones ever achieved, virtually banish all glare and reflections for TV's easiest viewing.

Model 21C206. Finest example of American Provincial design in genuine black cherry veneers. Beautiful matching half doors. 21" tube. Easy-moving, concealed swivel casters. **\$449.95***



*Includes Federal Excise Tax, one-year Factory Warranty on picture tube and 90 days on parts. Slightly higher West and South. All prices subject to change without notice.

You can put your confidence in—

GENERAL  ELECTRIC

Balanced Sales

(Continued from page 53)

owner of the store." At this point the customer not only begins to feel a little important, but probably feels a surge of friendliness as well. "For," says Waxman, "an introduction to the owner is a way of presenting the inside picture to the shopper: the store; the salesman; the boss. And the customer is bound to feel flattered by such special attention."

One additional opportunity for

the salesman to learn more about his customer comes when it's time to make out the credit application. Each salesman acts as his own credit man, takes the information, and makes the recommendation, although Waxman's is the final word, of course. By the time the customer leaves the store he is usually called by his first name, and since Allen's stands behind their merchandise all the way, nothing is apt to interfere with the friendly feeling once it is established. A dissatisfied customer will be given full credit on merchandise in 30 days.

This entire method of customer

treatment makes it easy for Allen's to "use the user," and pays off heavily in future sales. And when a customer is instrumental in sending in a buyer, a gift of merchandise is given—never cash.

Allen's maintains a service department for radio, television and appliances which keeps two men in the store and four on the outside busy constantly.

Each serviceman has an opportunity to enter homes every day; to talk with housewives; and to observe what they need in the way of appliances. Names of promising prospects are turned over to the original salesman, who then checks the credit record. If it is good, the prospect is invited into the store by telephone. The salesman informs the customer that her credit record with the store has been so excellent that Mr. Waxman has authorized him to give her a gift, if she will come in and pick it up. The gift—usually a half a dozen glasses or a tray—provides the salesman with an opportunity to talk with the customer, and if a sale results the serviceman is compensated.

Successful Ad-on Plan

An "add-on" plan used by the store in financing, makes these additional sales easy to arrange. After a buyer makes six consecutive payments he is automatically eligible to buy something else without an additional down payment. The contract is extended for 24 months, including the balance of the previous account, and credit on the difference of the carrying charge is also issued on the old account. Under this system, payments on an additional purchase generally don't exceed the previous payment by more than a few dollars.

Although Allen's advertises "no down payment," they always find the customer anxious to pay something in order to cut down the installments. This, plus "easy terms" is the theme of all institutional ads Allen's runs.

"You can get direct results from advertising only by contacting the customer direct," comments Waxman. "In our six years of business we have accumulated thousands of names, both of active and inactive accounts, and we are concentrating on reaching them through direct-mail. This will account for 75 per cent of our advertising this year."

Included in the program are mailing pieces sent with monthly state-

(Continued on page 76)

Everybody Wins with Miller

... and it's CASH!

Sell "Miller Needles" and Cash In!

• NO CONTESTS • NO PREMIUMS

CASH FOR EVERYONE!

50,000 servicemen, dealers, etc. will win

Here's How:

Each Label Has a Cash Value!

WITH MILLER NEEDLES you COLLECT REAL CASH!

M. A. Miller Manufacturing Co.

New Address | 4th & Church Streets
Libertyville, Illinois

Retain each label from every MILLER REPLACEMENT NEEDLE or CARILLON DYNAMIC CONVENTIONAL NEEDLE. . . . Turn them in to M. A. MILLER MFG. CO. whenever you want—for CASH!

100 Labels	from cards or packages you receive	\$500
	(or more at same rate)	
50 Labels	from cards or packages you receive	\$225
25 Labels	from cards or packages you receive	\$100

This offer is subject to all federal, state and local regulations

You are cordially invited to visit our new factory.



RELIABLE MANUFACTURER FOR OVER 35 YEARS

"Manufacturers of the world's largest line of long-life playback and recording needles"

GREATEST PLUS IN TV SALES

Now, Olympic brings you an exclusive feature that is designed and engineered to substantially increase TV sales. It is a real improvement over present day television . . . not in any sense a gimmick. Your customers will appreciate and value it. You can do an honest, convincing selling job because it is the greatest PLUS feature in television.

We give you:

AN *Olympic* EXCLUSIVE...

TELETIMER TV

URNS ON AND OFF *automatically*

(... A BEAUTIFUL CLOCK TOO!)

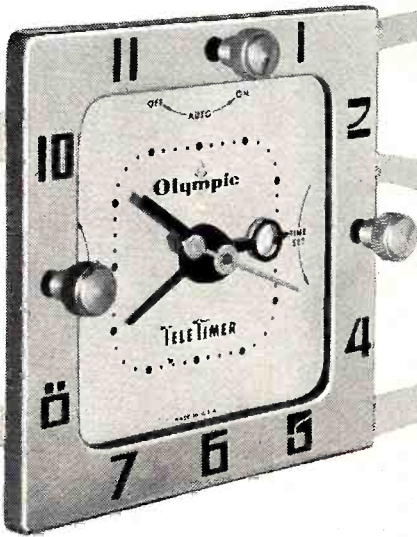

TELETIMER
... THE GREATEST **PLUS** VALUE
IN TELEVISION

New Olympic Tele Timer is easy to operate, easy to demonstrate, easy to understand! It is the most powerful TV sales builder of the past 5 years. Built right into the set...Tele Timer is an amazing feature that attracts, interests and sells your most reluctant prospects. See the new Olympic line with exclusive Tele Timer today! Remember...

Dollar for Dollar Olympic is Your Best Buy!

Olympic
America's Favorite
TELEVISION

OLYMPIC RADIO & TELEVISION, INC. LONG ISLAND CITY 1, NEW YORK

Balanced Sales

(Continued from page 74)

ments as well as frequent mailing on both regular and special seasonal merchandise. The remainder of Allen's advertising budget is absorbed by television spot announcements and newspaper ads. The latter, which formerly represented 75 per cent of advertising, has been cut considerably, although Allen's appears in one or the other of the three local papers perhaps four times a week with an institutional,

TV service, or regular merchandise ad.

Only Sunday advertising done in the newspaper is institutional, as Allen's can't compete with the department stores who run their big promotions on that day. Too, Waxman likes to run specials and promotions on an item during the height of its season to attract those who can't pay the regular price.

Participation in the local "Food Show" and "Home Show" comprises Allen's two biggest annual promotions, and their effects are felt favorably throughout the year. Take the "Food Show," for example, held

this past August. It draws approximately 350,000 people to the zoo grounds in two weeks, where local business men take a varying number of booths to display their merchandise.

Although most merchants do not count on much sales volume at this event, Allen's succeeds in doing from 25 to 30 thousand dollars at each show from four booths devoted entirely to refrigerators and washers, and an additional ten to fifteen thousand through the year as a direct result of the promotion.

How is this outstanding record achieved? The same way as it is in the store: through sales methods which combine friendliness with a complete story on the merchandise. There are no give-aways, and no literature is distributed. Only concession to the give-away trend at affairs of this kind is made by keeping the refrigerators stocked with soft drinks for the children and beer for the grown-ups; along with jars of cheese. These items are given only during the sales conversation, however, for Waxman wants the people to come in without the offer of anything free.

Television, which is not promoted at these events, is given additional impetus throughout the year by the special services Allen's sells at a low price. These include Spring cleaning, Fall adjustment, and Winter check, and they keep the service department busy in addition to providing the salesmen with an opportunity to talk to the customer about buying a new or second set. Television trade-in allowances are large only on special purchase sales, for Allen's relies on sound selling rather than price to bring in sales.

By devoting attention to every line in the store, rather than concentrating on just the merchandise most in demand, Allen's has regained a balanced business, even inventories, and an ever increasing volume.

Posey in Nat'l Union Post

Vin Ulrich, manager of National Union's renewal sales division, has announced the appointment of William W. Posey as district manager for the Chicagoland territory. He will handle distributor sales of N.U. receiving tubes, Videotron television picture tubes, panel lamps and picture tube checkers. Posey's headquarters will be at 2800 Milwaukee Ave., Chicago, Ill.

Hytron Address Change

Hytron Radio & Electronics Co. announce that their mailing address has been changed from 76 Lafayette Street, Salem, Massachusetts, to 100 Endicott Street, Danvers, Mass.

It's NEW... a design that offers the ULTIMATE in signal gain—with all-channel range! Field tests by servicemen acclaim its performance as outstanding... and its speedy FOLD-OUT design makes it fast and economical to install! Highest quality construction—for long trouble-free service!

See for yourself... send for charts and graphs and make your own comparisons—

Address your request to Dept. A.

READY SOON
a new TV antenna
for UHF channels
WATCH FOR IT!

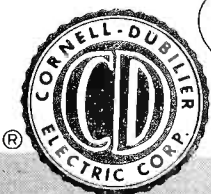

CONSISTENTLY DEPENDABLE

CORNELL-DUBILIER

SOUTH PLAINFIELD, NEW JERSEY



- CAPACITORS
- ANTENNAS
- ROTORS
- VIBRATORS
- CONVERTERS

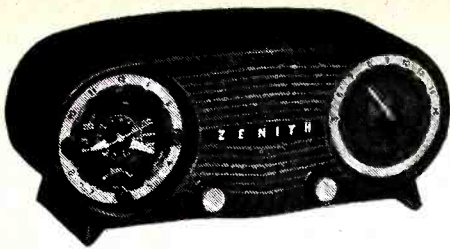

The Clock Radio—a beautiful “wake-up” radio with a richer tone than the ordinary low-priced set has. In Swirl Walnut or Ebony plastic. Model K515, to retail at \$34.95.*

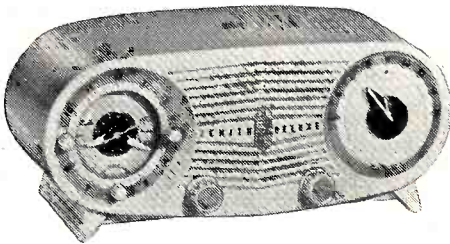

The De Luxe Clock Radio—lulls you to sleep, wakes you gently, has a “Sleepyhead” Buzzer and appliance outlet. Exceptionally rich tone. Model K518, to retail at \$39.95.*

Wake up to the new “do-re-mi” in clock radios

SEE ZENITH'S NEW COMPLETE LINE for step-up selling



The new Super De Luxe—a clock radio with all the de luxe features described above, plus one more tube for extra distance. Truly “super” in style and tone. Model K622, to retail at \$49.95.*



The FM-AM Clock Radio—the only one of its kind in the world. A 7-tube set, with all automatic features, plus Zenith's Super-Sensitive FM. Model J733, to retail at \$74.95.*

There's been a big change in radio listening habits. And Clock Radios are the key to new sales opportunities.

People are going for these musical timers for kitchens and living rooms as well as bedrooms—to turn on the coffee, to tune in TV, to do lots of things besides waking them up and lulling them to sleep.

And now—Zenith comes out with the most complete line of Clock Radios in the business, to catch every kind of prospect for you.

The more you have to offer, the more sales you make. You'll pay off with the Zenith Clock Radio line—the little sets that take little counter space, for extra “do-re-mi.”

**Prices slightly higher on West Coast and in far South*

ZENITH
LONG DISTANCE RADIO
and TELEVISION



ZENITH RADIO CORPORATION, Chicago 39, Illinois

Also Makers of Fine Hearing Aids

COPR. 1952

Servicing AGC

(Continued from page 85)

tive point in the brightness control circuit. The positive voltage fed to the plate is changed to a negative one by the conduction of the delay tube.

-2.4 V is fed to the AGC-controlled RF amplifier in the presence of weak signals. Approximately 0 volts is fed to the controlled video IF stages at this time. (Practically all of the -2.4 V AGC voltage is used up across R-155 and R-156, very little remaining across R-158 to be fed back to the video IF stages.) Thus, some negative voltage is developed and fed to the RF stage, but practically no AGC voltage is supplied to the video IF stages, when weak signals are coming in.

In the presence of medium and strong signals, the positive signal voltage fed to the grid of the AGC amplifier overcomes the negative cut-off bias, and the tube conducts, producing an AGC voltage.

If the AGC delay tube becomes defective, weak signals may not be satisfactorily received, since the reduced bias of the RF amplifier may cause enough signal to be transferred to the AGC amplifier to prematurely bring it out of cut-off and produce an AGC bias at the grids of the controlled video IF stages.

An AGC threshold control is present. It is adjusted with weak signals coming in, and is set to a point where the receiver just begins to overload when the contrast control is advanced to maximum.

Servicing of this circuit is similar to that of the other circuits discussed. A scope can be used to check plate and grid waveforms. If these waveforms are absent, incorrect in amplitude or imperfectly shaped, the circuit points between plate and grid and the source of each waveform can be scope-checked, to help find the source of the trouble.

When scope tests are inconclusive, DC voltage and resistance tests will prove helpful.

All-Channel Shows Fringe TV Antenna

Distributors at the NEDA convention at Atlantic City, as well as members of the press, witnessed a successful demonstration of the patented All Direction Antenna manufactured by the All Channel Antenna Corporation of Woodside, N. Y. This antenna was demonstrated at the hotel and visitors were invited to see the antenna, model AD 2-8, bring in the following stations at a flick of the nine-position switch, without the use of a booster: New York (100 air miles) channels 2, 4, 5, 7, 9, 11; New Haven (160 miles) channel 6; Philadelphia (65 miles) channels 3, 6, 10; Wilmington (70 miles) channel 7; Baltimore (125 miles) channels 2, 11, 13 and Washington, D. C. (150 miles) channels 4, 5, 7, 9.



it takes
half the time
and
half the manpower

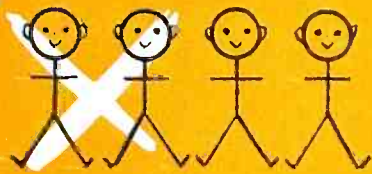

to install
Alprodco

AIRCRAFT
ALUMINUM TOWERS



TO YOU, THAT MEANS . . .
MORE PROFIT PER INSTALLATION!

Alprodco, Inc.

Dept. A



KEMPTON, INDIANA
MINERAL WELLS, TEXAS
DUBLIN, GEORGIA



THE BEST WAY TO REAP MORE PROFITS!

STOCK PRESTIGE- LEADING

Capehart

RSVP*

When you sell a Capehart to a customer, you've made a long-term investment that will make profits for you now and in the future. For Capehart quality performance and workmanship assure you of complete customer satisfaction—satisfaction that turns *first* customers into *permanent* customers. Only Capehart provides the brilliance of Crystal-Clear Picture . . . world-famous Symphonic-Tone . . . the new chassis with *Reserve Supply Video Power for clearer, brighter pictures . . . and cabinetry that is the standard for styling and craftsmanship. A Capehart franchise may be available in your territory . . . see your Capehart distributor or write Fort Wayne.



The CAPEHART "Monticello." Smartly-styled cabinet—with life-like 21-inch Crystal-Clear Picture, exclusive Symphonic-Tone, new Extra Power Margin chassis. Only . . . **\$349⁹⁵****



The CAPEHART "Charlestown." For those who must economize in space, but demand the finest. 21-inch Crystal-Clear Picture, Capehart Symphonic-Tone System. Amazing Extra Power Margin chassis. **\$399⁹⁵**** Only

Capehart 

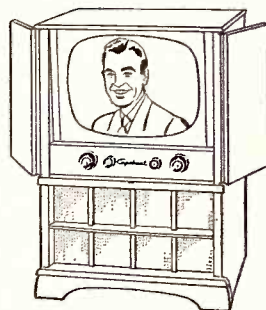
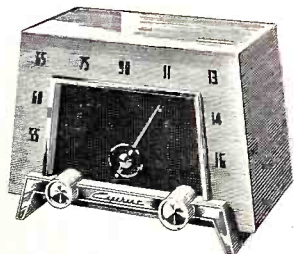

The CAPEHART "Deluxe 6" Clock Radio (Model TC-62). The world's most beautiful, most imitated clock radio. 6-tube performance, an accurate clock, a superb radio, turns on appliances. In rich green and choice of other decorator **\$49⁹⁵**** Only

The CAPEHART Table Radio (Model T-522). As distinctive in styling as it is in performance. Automatic volume control, tone compensation, Vernier tuning. Plastic cabinet in choice of rich decorator colors. **\$29⁹⁵**** Only

CAPEHART-FARNSWORTH CORPORATION, Fort Wayne 1, Indiana
An Associate of International Telephone and Telegraph Corporation

**Zone 1 price.

**AMPHENOL
-INLINE*
ANTENNA**

**Teamed together for
BETTER TV PICTURE QUALITY**

**AMPHENOL
TUBULAR
TWIN-LEAD**

AMPHENOL

The vast majority of TV technicians are agreed that the Amphenol Inline is the best choice in a broadbanded antenna. The Amphenol Inline has uniform gain over all the VHF channels with more signal strength than any other all-channel antenna on the market. In addition, the Inline is packaged for an easy, quick installation, including mast, twin-lead and insulators. And, the Amphenol Inline is strong too! The installer knows that he will not be called back in a few weeks or months to repair or replace broken, defective or unsatisfactory elements. The Inline is built to take all the punishment of severe weather conditions and will continue to provide a strong, steady signal to the TV set years after its installation.

Amphenol Tubular Twin-Lead is ideal for all TV installations and has proved to be the one economical answer for sea coast and other weather troubled areas. Because of its extremely low-loss and constant impedance, unaffected by weather conditions or age, Amphenol Tubular Twin-Lead is recommended by leading authorities for UHF TV reception. The low-loss characteristic makes this the ideal twin-lead for fringe areas and installations requiring long lengths of twin-lead.

See your Authorized Amphenol Distributor for your free copy of this 20-page booklet containing information on all the factors that influence Better TV Picture Quality.



AMERICAN PHENOLIC CORPORATION
1830 SOUTH 54TH AVENUE • CHICAGO 50, ILLINOIS

27" TV
\$499⁹⁵*
LIST

only from
STEWART-WARNER



*Slightly higher west and south.

Another Sensational Stewart-Warner Value!

**STEWART
SW
WARNER**

Deluxe 1953 model priced \$100 to \$200 below other 27" TV... with full dealer discount to you! This magnificent mahogany console has all 21 advanced features that make every 1953 Stewart-Warner TV "21 ways better"... Power Booster... Syncro-Brain circuit... Continuous Tone Control... Built-In-Provision for U.H.F. An exclusive combination of 21 great features you find only in Stewart-Warner. Wire, phone, or write for name of your Stewart-Warner Distributor.

21 ways better

STEWART-WARNER ELECTRIC • Division of Stewart-Warner Corp.
1300 N. Kostner Ave., Chicago 51, Illinois
Foremost Manufacturer of Radar, Communications, and other Precision Electronic Equipment for the U. S. Government.

GE Appoints Riegelman



Herbert Riegelman (above) has been appointed manager of marketing for the receiver department of the General Electric Company, it was announced by Willard H. Sahloff, general manager of the department.

McDonald Lauds Theatre TV

Commander E. F. McDonald, Jr., president of Zenith Radio Corp., recently told a meeting of Zenith distributors that he heartily approves of theatre television and hopes for its expansion to thousands of theatres. He said, however, that theatre TV should not have a monopoly on great events, because this would mean that TV set owners would not be able to watch them in their homes. At present there are only some 12 million movie seats in the U.S., while the home TV audience numbers nearly 60 million persons. He also said that it would be unfair to force sports or other producers to put their important spectacles on home TV at a financial disadvantage to themselves. He cited subscription TV as a means to provide a home box office.

Belden Open House

Belden Manufacturing Co. recently held open house in its Chicago, Ill., and Richmond, Ind., plants for families and friends of its employees to celebrate its 50th anniversary. Over 11,000 attended the celebrations which were held in the two plants.

Important Webcor Promotions

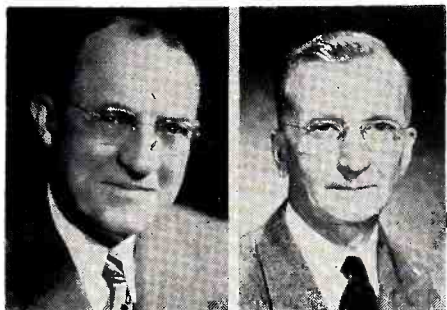

R. F. Blash (left) president of Webster-Chicago Corp., has been elected chairman of the board and Donald MacGregor (right), formerly vice-president in charge of manufacture for Zenith Radio Corp., has been elected to succeed him as Webcor president. Before joining Zenith, Mr. MacGregor was with Webcor nine years.

Meck TV Survey Results

Word-of-mouth recommendation is the most important factor in the choice of television sets, a study by Meck Television, Inc., retail chain subsidiary of Scott Radio Laboratories, indicated. When asked what had determined their choice of a TV set, 41% of 170 set owners in Washington, D. C. mentioned the recommendations of friends and neighbors. Only 38% mentioned "brand name" and 21% said they had been influenced by the recommendation of the dealer. "Earlier findings in this survey revealed that people who don't own TV sets spend a great deal of time watching at friends' homes," said John S. Meck, Scott president. "This means

that millions of people are exposed many times to various sets in operation and hear the comments of the owners before they make their own choice. It explains why brand names do not dominate the television market as they do other fields. Emphasis instead is on performance and value in the minds of a large segment of the public.

Lane on Westinghouse Staff

Joe Chapman Lane, Jr., has been named advertising staff representative for the Electronic Tube Division, Westinghouse Electric Corporation, it was announced recently by H. G. Cheney, sales manager.

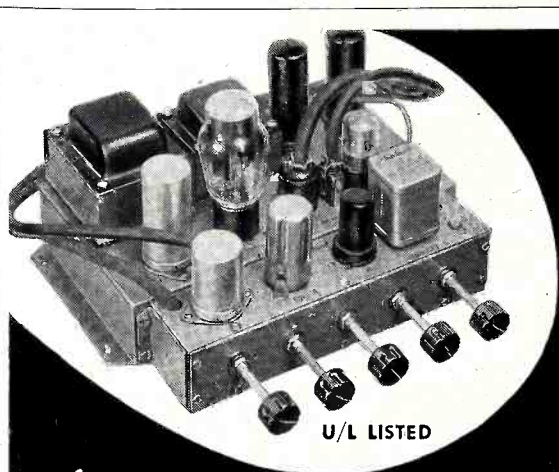

Rauland High-Fidelity 1825 Phonograph Amplifier

U/L LISTED

*** TOPS FOR CUSTOM INSTALLATIONS!**

EXCLUSIVE! Detachable Remote Preamp

Here's unlimited flexibility for custom installations! Preamp is detachable; has universal mounting features permitting positioning to meet mechanical requirements of any installation. Mounts horizontally, vertically, inverted, etc. Compact; only 2 3/8 x 2 3/8 x 1 1/2".

+1DB, 40 TO 20,000 CPS

25 Watts Output.....5% harmonic distortion
20 Watts Output.....2% harmonic distortion
15 Watts Output.....1% harmonic distortion
(Measured at 100, 400 and 5000 CPS)

- 5-Position Frequency Cut-off
(Noise and Scratch Suppression
12 db per octave)
- Boost Type Tone Controls
- Dual Volume Controls
- Dual Input Selector
- Plug-In Equalizer

Percentage Intermodulation Distortion taken at 60 and 7,000 cycles with 4 to 1 ratio:
2 Watts—.54% (home level); 10 Watts—2%; 15 Watts—3.2%.

The RAULAND Model 1825 High-Fidelity Phono Amplifier puts you on top in the custom-installation market. Outstanding in its mechanical advantages—amazing in its performance—there's nothing on the market comparable for features and value. Available for immediate delivery from stock. Get the full details today!

See your RAULAND-BORG Distributor for full information on the RAULAND 1825 High-Fidelity Phono Amplifier. Compare its features and price! Get your profitable share of the big market for quality custom installations with this fast-selling amplifier. It's tops for the advanced features and value custom-builders appreciate and want.

SOUND
EQUIPMENT

Rauland

INTER-
COMMUNICATION

RAULAND-BORG CORPORATION • 3523-L Addison St., Chicago 18, ILL.



The only lightning arrester with the strain relief LIPS is
 manufactured by JFD. *A patent is its proof!*
 The twin-lead will bend only at a point separate from your contact—
 therefore, your twin-lead cannot break away.

Only the exclusive JFD strain relief lip prevents the
 contact washers used in all arresters from ripping your lead-in
 apart, strand by strand until the wire is torn through and
 the picture on your screen obliterated. Write for Form 84.

FOR RIBBON TWIN-LEAD

No. AT105 ("Little Giant" with hardware for wall
 or window sill mounting) List \$1.25

No. AT105S ("Little Giant" with UL approved stainless
 steel strap for pipe mounting) List \$1.50

No. AT102 ("Jumbo" with UL approved stainless steel
 strap for Universal Mounting) List \$2.25

FOR TUBULAR TWIN-LEAD

No. AT103 ("Jumbo" with UL approved stainless steel
 strap for Universal Mounting) List \$2.25

Available with four color, sales producing counter display, on request

JFD MFG. CO.

BROOKLYN 4, N.Y.
 BENSONHURST 4-9200

*World's Largest Manufacturer
 of TV Antennas and Accessories*

the secret is in the lips

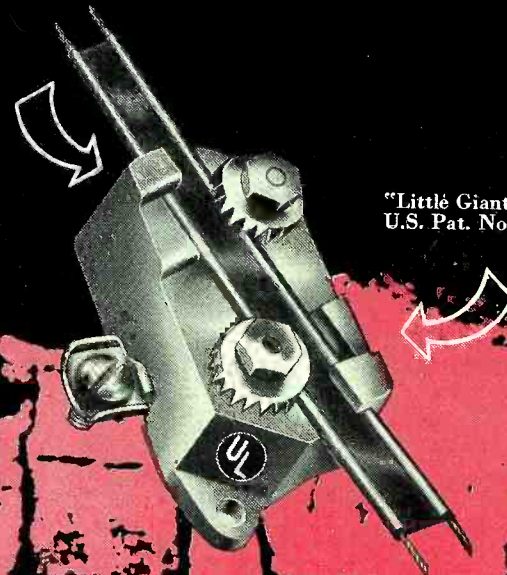

"Little Giant" Lightning Arrester
 U.S. Pat. No. D-4664

the secret is in the lips

the secret is in the lips

TV-Electronic

TECHNICIAN*

Section of **TELEVISION RETAILING**
Including Radio Service and Sound
* Trademark

"Circuit Digests" Lead with Latest Sets

Dealers and Servicemen Say Schematics Fill Basic Need in Shooting Trouble

CIRCUIT DIGEST WILL FILL A LONG-STANDING NEED in the TV service field. A large percentage of the service work on new receivers is performed during the first month of operation, long before schematics on them are available. Please see that we get your publication every month. *B.D., Arkansas.*

I THINK YOU HAVE SOMETHING. The only sets which give us nightmares are the latest ones out, with their new tubes, hot-shot circuits and NO SCHEMATICS. *Circuit Digest* is the best yet. Those were all good sets for me in your number 1 issue. *B.S., California.*

WE DEALERS SPEND THOUSANDS of dollars with the manufacturers, yet have been unable to get diagrams to get new sets working, until your *Circuit Digest*—now our brightest hope! *L. B. K., California.*

WORDS FAIL TO EXPRESS my feelings for this publishing "first." Although I have only had the material a few days, occasion has arisen twice to use it. Please accept my sincere thanks for doing what you are attempting to do for the service technician. *H.D.W., Georgia.*

YOUR PUBLICATION WILL FILL A REAL NEED, since it is often difficult to secure data and schematics on new sets without great delay. *Circuit Digest* puts information in the technician's hands when he needs it most. I'm all for it. *J. A., Virginia.*

CIRCUIT DIGEST HELPS FILL IN A BAD GAP in servicing new receivers. *C.M., Florida.*

YOUR NEW SECTION is a honey, and money to servicemen who do everything but swear when they don't have a diagram for a set that has just appeared. *P.H.S., Indiana.*

It is quite generally agreed in the industry that most of the first year troubles in TV sets actually occur in the first 90 days of operation. This seems to be especially true of a new line. Servicemen, then, obviously need technical information and schematics on new sets *when they're new*. There has been a continuous hue and cry from the technicians all during these first six years of TV for prompter action in supplying manuals. *Television Retailing* introduced its *Circuit Digest* feature two months ago in an attempt to fill this need. The excerpts printed on this page are from but a few of the hundreds of letters sent us, pointing out how enthusiastically this new service is being received.

CIRCUIT DIGEST SAVES US THE TROUBLE of contacting the manufacturers to obtain information needed on new circuits. We use *Circuit Digest* instead. *F.E.B., New Jersey.*

WE REALLY APPRECIATE this type of technical information . . . It is concise and put together in small volume without losing any technical details. *R.L.J., California.*

I FIND CIRCUIT DIGEST condensed, yet most comprehensive . . . It gives you the information needed, while eliminating excessive reading. *B.B.W., Alabama.*

FROM THE SHOW-WINDOW IN FRONT to the back wall of the service shop, *Television Retailing* is a "must"! *K. E. S., Indiana.*

IN MY STORE customers demand I answer a variety of questions about TV. Now, with your *Circuit Digests* I have up-to-date data at my finger tips. *S. F., New York.*

SOMEONE HAS FINALLY COME OUT WITH a service every technician needs: Advance schematics of popular sets. Keep up the good work. *R.K., C.R., New York.*

IN THESE DAYS OF THE QUICK BUCK, it is refreshing to find a magazine that is willing to give its reading public an added service. I am not looking for a prize, just trying to show my appreciation. I have taken *Television Retailing* for years, and it has never let me down. *F.E.W., Maine.*

THE WEALTH OF MATERIAL contained in *Circuit Digest* is amazing, considering the limited amount of space available. *H.A., New York.*

CIRCUIT DIGEST IS THE ANSWER to a serviceman's dream. *J.W.O., Missouri.*

THE INFORMATION IN CIRCUIT DIGEST IS THE ABSOLUTE MINIMUM NEEDED. I find it very useful and timely. Please let me know how to get information every month for use in our service department. *W. R., California.*

IT'S GOOD, IT'S GREAT, I like it. *T.O., Missouri.*

TV-ELECTRONIC TECHNICIAN IS THE FINEST THING we've seen for a long time. It will definitely make our work much easier. *T.F.N., Indiana.*

FOR RETAILERS and service establishments your excellent magazine stands at top of list. *D. M. D., Wisconsin.*

Servicing Keyed AGC

Part 2. Representative Troubles in Typical Circuits.

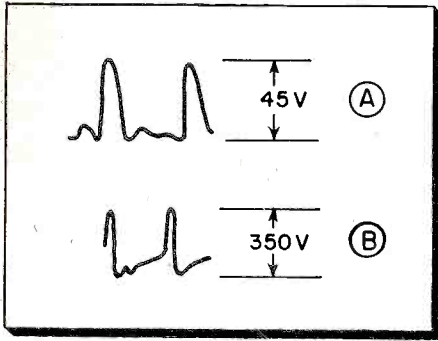

Fig. 2. (A) Hor sync waveform at AGC tube grid. (B) Flyback waveform, AGC tube plate.

• In last month's article, we outlined the operation of the keyed AGC circuit shown in fig. 1.

Troubleshooting in this circuit will be facilitated if a scope is available. When the circuit is operating normally, the composite video signal will be seen at the grid of V-305. If the scope frequency setting is advanced to fifteen or thirty thousand cycles, horizontal sync pulses should be observed (see fig. 2A). Their normal peak-to-peak amplitude in this circuit is 45 V.

A 350 V peak-to-peak flyback pulse waveform resembling the one shown in fig. 2B should be seen on the scope screen when the scope leads are connected between the plate of the AGC keyer and ground.

Defects in the AGC circuit, or in other circuits that affect the AGC circuit, can kill both picture and sound. A defective video amplifier, for example, can eliminate the sound signal. With the video amplifier operating normally, its plate current produces a voltage drop across R-318 (as well as other resistors in series with R-318) that makes the grid of the AGC tube 130 V positive to ground. The cathode of the AGC tube is 150 V positive to ground. The bias of V-305 is therefore -20 V.

If the video amplifier becomes inoper-

ative, and its plate current stops flowing, it will no longer produce a voltage drop across R-318. The upper end of R-318 will therefore be as positive as its lower end, instead of being less positive, as it is under normal conditions. The grid voltage of V-305 will therefore also be more positive. The excessive conduction of V-305 that results will produce an excessive AGC voltage that will cut off the RF amplifier as well as the controlled video IF stages.

Since the sound signal is taken off at the plate of the 2nd video IF amplifier, it will be more readily eliminated by a rise in AGC voltage than if it were removed at the mixer plate. The picture will also be killed, when the sound is cut off.

Faced by such symptoms, in a receiver of this type, the alert serviceman will try substituting a new video amplifier, as well as front-end and 1st video IF tubes, before he starts more elaborate circuit tests.

If the AGC circuit becomes completely inoperative (due, say, to a defective AGC tube) the sound volume will increase, while the picture disappears. This rather surprising circuit characteristic may be analyzed as follows:

Video amplifier V-306 is direct-coupled to video detector V-304A. The grid return resistor of V-306 is R-314. R-314 is also the load resistor for V-304. Therefore the bias of video amplifier V-306 is determined by the voltage de-

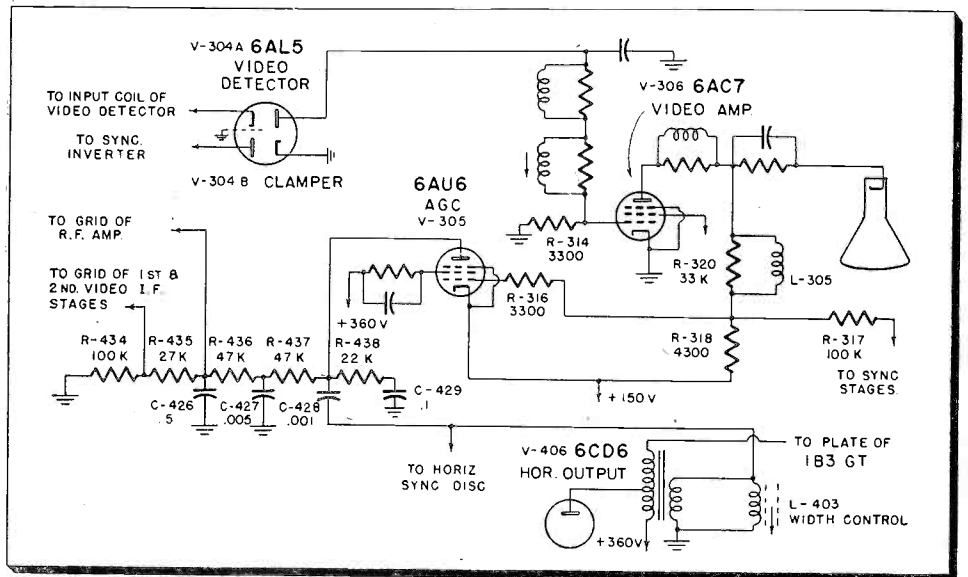
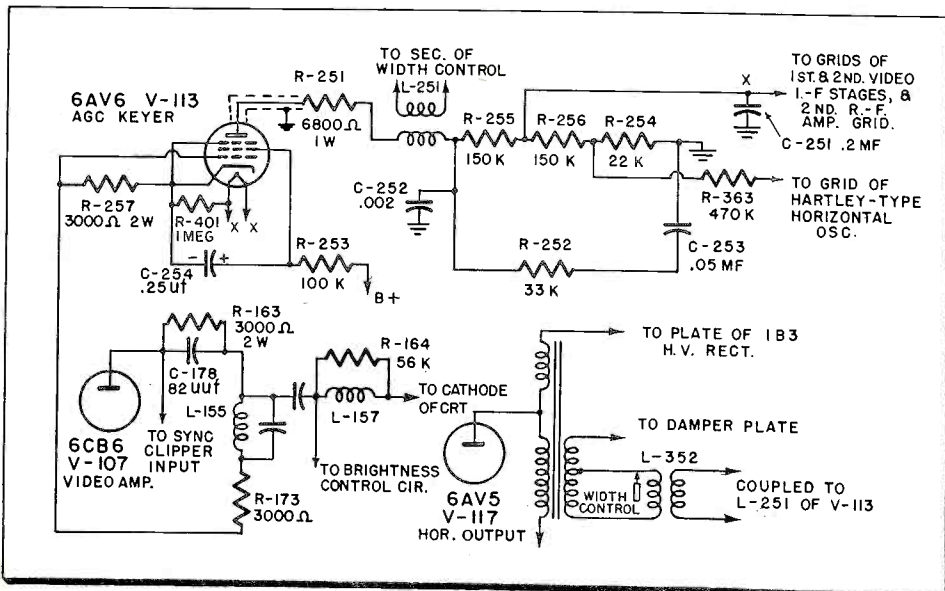

Fig. 1. (above) Representative keyed AGC circuit, used in Admiral 24D1, 24E1, 24F1, 24G1 and 24H1. Fig. 3. (below) Keyed AGC circuit used in GE Models 17C110 and 17C111.

veloped across R-314. This voltage depends on the current through R-314, which in turn, depends on the signal input to the video detector. If the signal input to V-304 becomes excessive—as it will when the AGC bias is lost—the video amplifier bias developed across R-314 may become so negative that V-306 is cut off, killing the picture.

At the same time, the loss of AGC bias in the RF amplifier and 1st video IF stages will increase the sound signal level. Therefore, if the sound volume seems above normal, and the picture is absent, a quick replacement of the AGC tube would seem the best-advised service procedure, when a receiver containing the circuit described is encountered.

In fig. 3, the keyed AGC circuit used in GE models 17C110 and 17C111 is shown. The flyback pulse is coupled to the AGC keyer through a transformer, instead of a condenser, as in the previous circuit. The grid of the Hartley-type oscillator employed to generate the horizontal deflection voltage is attached through R-363 to the AGC line. This



Circuits in TV Sets

TV-Electronic
TECHNICIAN
Section

Symptoms They Produce. Trouble-shooting Procedures.

connection is probably made to stabilize the AGC circuit action.

C-252, R-252 and C-253 filter out the flyback pulses from the AGC line. The plate lead of V-113 is shielded, probably to prevent induction of the high-amplitude flyback pulse into nearby circuits. In other respects, the circuit is similar to the preceding one.

To check whether the AGC circuit is operating, V-113's grid may be shorted to cathode, and the AGC bias produced between point X and ground measured. This bias should be -30 V or more. If it is, the keyer and horizontal deflection system are probably working OK.

The grid is shorted to eliminate the video signal input applied to the keyer. The possibility of trouble in the stages preceding the keyer is thus isolated. If the AGC voltage measured with the grid shorted to cathode is normal, but is not normal when the grid is unshorted, trouble in the video amplifier or some stage preceding it is indicated. Trouble in the grid circuit of the keyer is also a possibility.

When the AGC circuit is inoperative, negative pictures are likely to result, due to the overloading of various receiver stages. One of the more obscure things to check for in such a case is a defect in the width control. When the flyback pulses at the plate of the keyer are missing, or have insufficient amplitude, an open, partial short or complete short may be present in either the width control, or the winding coupled to it. Resistance checks with the width control primary and secondary disconnected will verify whether any defect is present here.

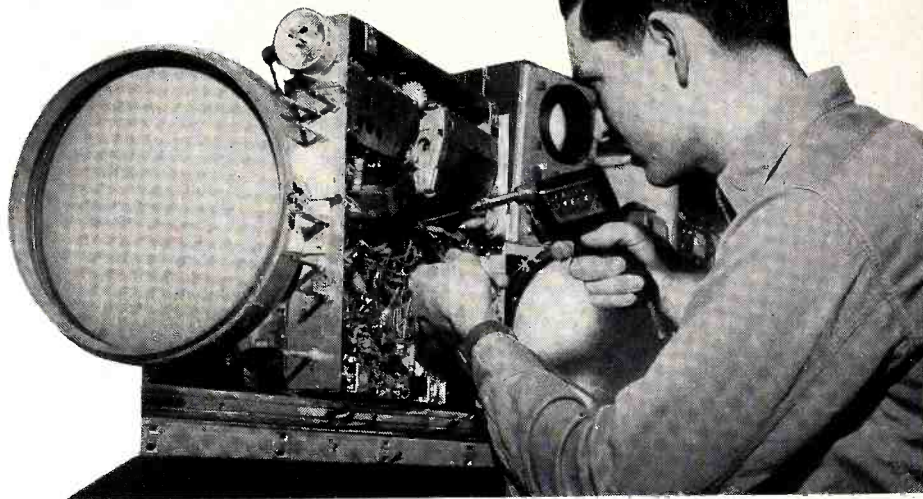

Scope tests at different points in the AGC line will reveal the trouble when flyback pulses are not being filtered out of the AGC feed-line. The 15,750-cycle pulses will be measurably apparent on the scope screen in such a case, instead of being absent.

Other defects, foreign to simple and delayed AGC circuits, but quite chummy with the keyed AGC network we have been describing, may be cited.

Distorted picture and sound, due to damping tube trouble is one of them. The AGC tube's AC plate voltage is taken off across the width control, which is in the damper circuit. If the damper tube becomes gassy, the irregular, highly non-linear conduction that it produces will change the voltage waveform appearing across the width control. Since this voltage is fed to the AGC tube's plate, the AC plate voltage of V-305 will be incorrectly shaped,

constantly changing at an irregular rate, and incorrect in amplitude. The AGC-controlled stages will therefore be fed an improper control voltage, possibly causing distortion in both picture and sound.

Proper operation of the keyed AGC circuit requires that the horizontal sweep be in synchronism with the incoming composite video signal. Under such conditions, the flyback pulse appears at the plate of V-305 at the same time that the horizontal sync pulse appears at the grid, and conduction for a very short interval, within fairly precise time limits, results.

When the horizontal sweep is *not* in synchronism with the incoming signal, however, plate and grid pulses on V-305 will no longer be in step, and the AGC tube may conduct at times other than the correct intervals, causing the AGC bias to vary rapidly, instead of remaining stable.

Improper AGC bias can therefore be the result of a fault in the horizontal deflection system of the receiver, particularly the horizontal AFC circuits. The obvious conclusion is, make sure that horizontal synchronization is ok, before trouble-shooting the AGC circuit proper. Say for instance that the sound signal is imperfect, and horizontal synchronization is also poor. Knowing the circuit, the serviceman would correct the horizontal sync trouble before he works on the sound symptom, because he knows that the sync trouble can be the daddy of the sound defect, via the AGC system.

A third keyed AGC circuit is shown in fig. 4. In this circuit, delayed and keyed AGC features are combined. The AGC amplifier is highly biased in the presence of weak incoming signals, and is practically cut off, in spite of the flyback pulses at the plate. The only negative AGC bias developed is due to the conduction of V-105B, the delay tube. The plate of this tube is fed to a posi-

(Continued on page 78)

Fig. 4. Keyed AGC circuit used in Crosley Models 511-447MU, 5L-459MU, CH321-4.

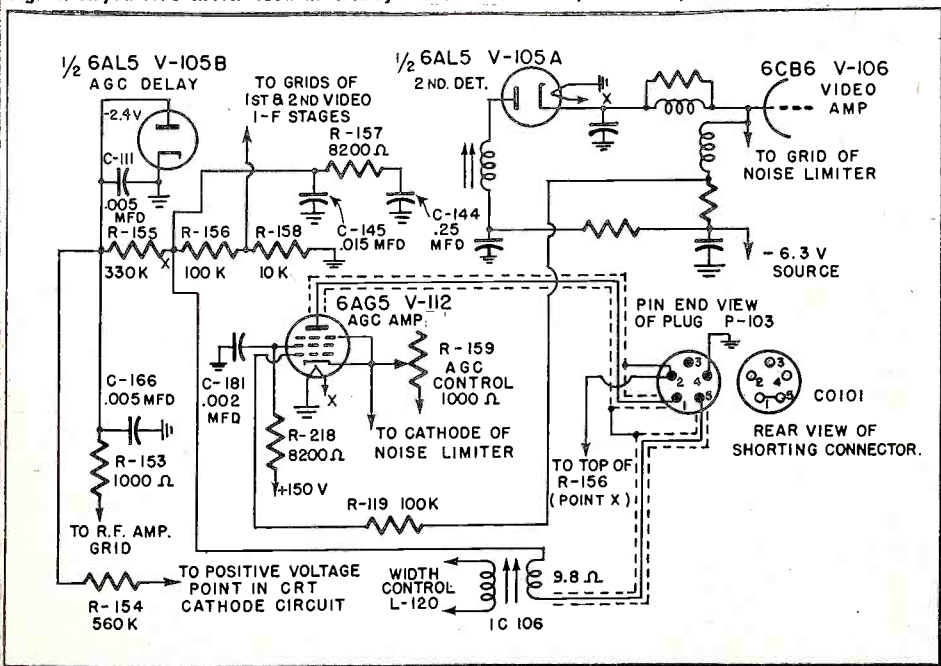

Servicing Vibrators

Maintenance of Synchronous and Non-Synchronous Types Through

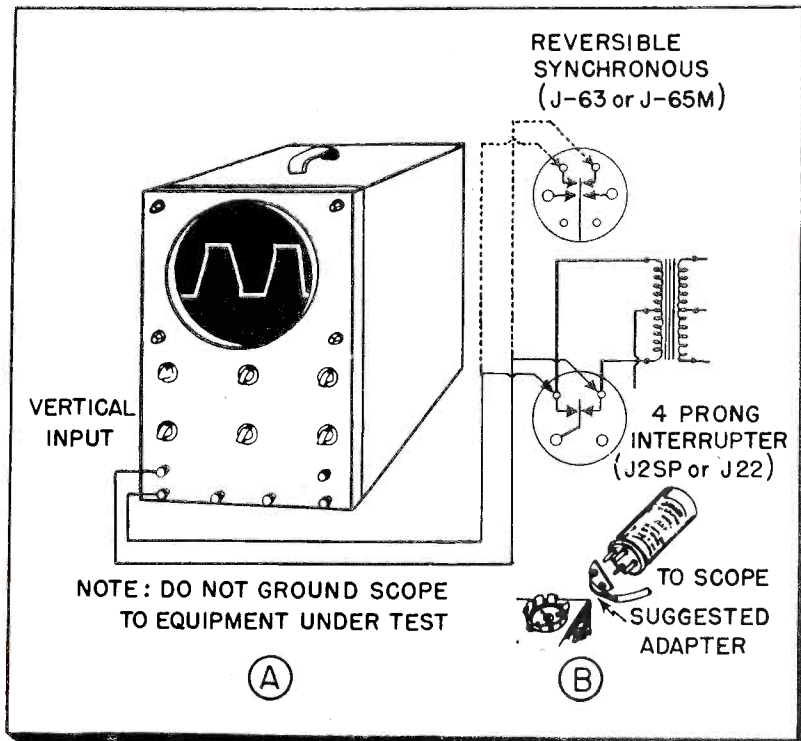

Fig. 1—A) Vibrator connections to oscilloscope. B) Adapter set-up.

• The oscilloscope is a valuable tool in the proper maintenance of vibrators and vibrator power supplies. The understanding and interpretation of the operating waveform of a vibrator will give the servicer important information on the vibrator and its associated components. "The picture tells the story."

The oscilloscope employed may be any standard type having an internal sweep circuit. The vibrator waveform is best observed across the primary contacts of the vibrator. These primary contacts are connected to the vertical input of the scope. This connection applies to both general types of vibrators, the interrupter (non-synchronous) and the synchronous. Fig. 1A is a pictorial diagram that shows the circuit hook-up to be made in each case; two common types of auto-radio vibrators are assumed. The proper primary contact connection to other types of vibrators can be ascertained by referring to a suitable vibrator replacement guide.

To simplify the testing of units during operation, a thin adaptor can be readily constructed, as shown in Fig. 1B, with correctly attached leads inserted between the vibrator and socket.

The following oscilloscope adjust-

ments are made, previous to an inspection of the waveforms:

1—The vibrator contact connections are applied to the vertical input of the oscilloscope, and the vibrator power supply turned on.

2—The "synchronization selector" knob on the scope is set to "internal."

3—The sweep frequency range control is set to approximately 30-100 CPS.

4—Initially, the "sync" control should be at zero setting.

5—The "fine frequency" sweep control should be adjusted until two full square waveforms are stopped on the screen.

6—The "sync" control should be advanced until the waveform is stationary on the screen. The final setting is normally at a low level—15% or lower.

Advantages of Waveform Tests

Variation of all other controls to center and focus the waveforms can be made to suit the operator.

A few general comments re waveform analysis may be in order, before we make the analysis proper. Through waveform analysis, it is possible to ascertain the general condition of vibrator-powered equipment. More specifically, we can:

1—Anticipate the remaining life of a vibrator in service.

2—Ascertain the cause of excessive "hash" noise in the receiver, and determine whether it is due to the vibrator, or some other component.

3—Check new vibrators for proper operation.

4—Detect bad buffers or shorted transformers.

5—Observe excessive secondary or load currents.

6—Determine the cause of poor output voltage, localizing it to the vibrator, or its associated power supply, or the rest of the receiver.

Variations in Waveforms

The service engineer must remember that the vibrator is an electro-mechanical device of considerable complexity. Each individual unit in proper operation will show some variation in waveform from the ideals illustrated in fig. 2 and 3. This individuality must be kept in mind when interpreting waveforms. Experience will permit the proper interpretation of vibrator waveforms.

Fig. 2, sketches A-E, illustrate the waveforms obtained in an interrupter or non-synchronous type vibrator. This type of vibrator has contacts operating at the primary low voltage only. Rectification is achieved by other means (than vibrator action). Steady load conditions were maintained during the tests, as indicated by the waveforms.

Normal Waveform

Waveform 2A shows no bounce during contact closures. The broken lines on the diagonal are indicative of good buffer action. A new vibrator with proper buffer will show these breaks under test. As contacts wear, the contact closure is reduced, and the buffer closure will increase, tending to produce a solid line (instead of a broken one).

2B is an illustration of a condition called *single-stepping*. Single-stepping indicates a poor starting action. A vibrator that shows single-stepping on starting voltages of 5.5 V or more is either defective or worn. In service it will fail in a short period through fuse-blowing or poor output. Proper vibrator operation requires full reed-contact operation.

2C shows *contact bounce*. The waveform indicates a worn vibrator, in the case of a used unit. The service result will be lower output voltage and a very high "hash" level.

An extreme bounce like the one

With the Oscilloscope

'Scope Waveform Checks. Normal and Abnormal Wave Shapes.

shown in 2C should not be thought of as the result only of dirty contacts—such a condition is occasionally found in a new component, and is due to poor vibrator adjustment. Dirty contacts generally show up as very small-amplitude bounces in the contact waveform. A short period of operation will normally correct this condition when it occurs in a new vibrator.

Unbalanced Closure; Arcing

The *unbalanced closure* indicated in 2D is the result of poor adjustment or, in some instances, a bad buffer. Try another vibrator in the circuit, to find out whether or not the original one is defective. If the trouble lies in the vibrator, the unit may give partial service, but is a poor risk. This is the typical vibrator that "sticks" after short service.

2E indicates arcing at contacts. The trouble can lie either in the vibrator or its associated circuit. Try another vibrator to pin down the source of the fault. If the waveform becomes normal, the original vibrator is defective; if it

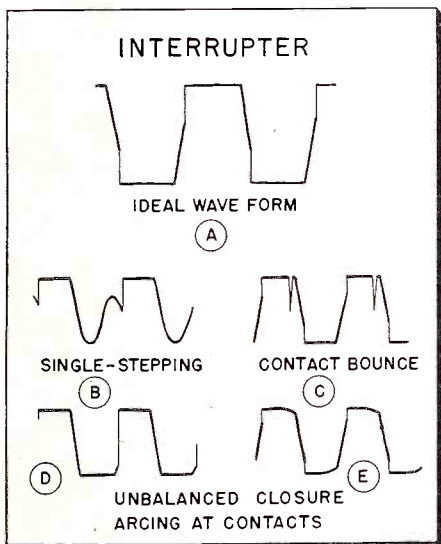

Fig. 2—Normal and abnormal vibrator waveforms for non-synchronous vibrator.

remains abnormal, a component in the associated circuit is to blame.

If circuit trouble is indicated, check the buffer first, then the rectifier, filter and external circuit. If the fault has been traced to the vibrator, the unit should be discarded.

The synchronous-type vibrator has both primary contacts at low voltage and secondary contacts at high voltage. The second set of contacts close slightly after the primary ones, and provide output rectification. The waveform ob-

served across the primary contacts show this secondary contact operation in the form of a small voltage drop when the contacts connect the load. (See fig. 3A).

3A is the ideal wave, and shows no bounce during contact closure. The peaks or horns at the beginning and end of each closure are the secondary rectifier contacts closing later and opening sooner than the associated primary contacts. Note the same broken buffer closure line characteristic of interrupter vibrators. As the vibrator wears, the line becomes longer, and manifests decreasing break. This ideal waveform shows perfect timing of contacts, which results in high output and low "hash" level.

Secondary Spacing

3B shows a condition known as *wide secondary spacing*. The secondary contacts close later, and open sooner, than they normally do. The condition results in lowered voltage output, and a higher level of "hash." Service failure of the unit will not ordinarily occur as a result of this defect. The lower output voltage and "hash" level should be judged for acceptability.

3C represents a condition known as *close secondary spacing*. This condition will result in contact arcing and fuse-blowing in vibrator operation. A synchronous vibrator that produces waveforms lacking horns or tips should be removed from service.

Care in Interpretation

Care should be taken in interpreting the condition present when this waveform appears for a synchronous vibrator. If the secondary load is off (i.e., the set is not warmed up) or circuit trouble is present, the waveform obtained may resemble the one characteristic of a normally-functioning interrupter vibrator. The trouble in such a case can be localized by substituting a vibrator in known good condition for the one present, and noting results.

3D—*secondary contact bounce*—illustrates a fault that will result in lower voltage output and high "hash" level. In a vibrator with service, the waveform is an indication of imminent failure due to too low voltage output. The condition is normally caused by reduced secondary contact pressure due to wear. Care should be exercised that small-amplitude ripple, produced by dirty contacts in some new units, is not interpreted as true contact bounce.

3E—*primary contact bounce*—indicates a condition that will result in the

same operating problems as secondary contact bounce.

The following general maintenance notes may prove helpful. A good vibrator for six-volt equipment is designed and tested for the following standards of performance:

1—Low voltage starting—i.e., 5 V or lower.

2—Good waveform at nominal six

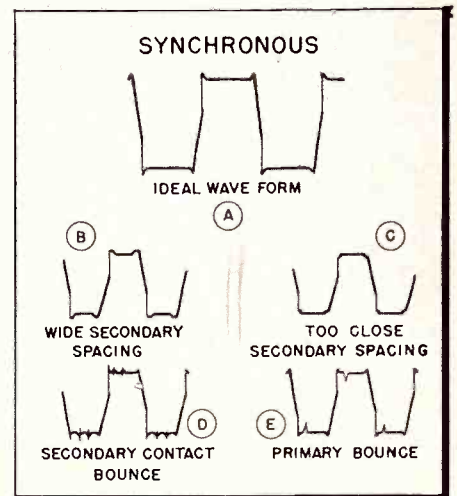

Fig. 3—Normal and abnormal waveforms for synchronous vibrator.

volts, indicating high voltage output and low generated "hash" level.

3—Operation at over-voltage for normal mechanical performance, and, in synchronous units, absence of arcing.

The technician can use these measures of performance as a guide to vibrator condition. New units can be tested for good performance before insertion. Contact dirt, from shelf life and oxidation, can be observed and run off before placing the component in service.

Dating Vibrators

Vibrators should be marked with "date in service" for correct measure of performance. With this data on the unit, hours of service can be readily calculated. Good maintenance for vibrators involves observation of the waveform of the unit in service, when the associated equipment is undergoing bench tests. It is possible to anticipate vibrator failure from normal wearing out through service life data and waveform analysis.

Removal of a vibrator in the last twenty-five per cent of its normal life is far less expensive than its replacement when it fails completely, since a separate maintenance job will be necessary at such a time. (From a booklet published by the James Vibrapower Company.)

Shop Shortcuts Speed Servicing

Tips for Home and Bench Service Contributed by Readers

Clock-Radio Repair

When the clock mechanism of a clock-radio fails to operate, remove the back cover of the clock by unscrewing it, and check to determine if line voltage is being applied to the coil of the electric clock assembly. This will eliminate the line cord as a source of

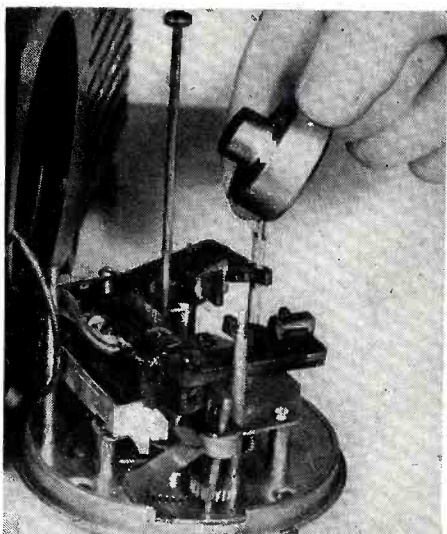

the trouble. If line voltage is present here, and the coil shows a continuity reading on an ohms check, the rotor mechanism is probably bad. While coils seldom fail, the sealed-in rotor mechanism (shown held in fingers in photo) often becomes defective, and requires replacement. The rotor is easily removed when the laminated sections which fit around it have been loosened. An exact replacement is necessary, due to gearing. *H. Leeper, 1346 Barrett Ct., N.W., Canton, Ohio.*

Safety Trick

Whenever a hole is drilled in an appliance or its containing cabinet, the possibility is always present that the drill chuck may dent or otherwise mar the surface when the drill breaks through. To insure against this hazard, slide a rubber grommet over the bit and up to the chuck, to act as a buffer and cushion the blow. *Edward Mayover, 1501 N. 61st Street, Phila. 31, Pa.*

Handling A Nut

It is sometimes necessary to thread a nut over a screw in an inaccessible place that does not readily permit this operation. To achieve the desired result more readily, lay the nut down on a metal surface; place a piece of solder on top of the nut, and tap the solder lightly with a hammer. The solder will stick to the nut, providing a convenient handle with which to hold the nut in place while starting the screw. When the operation is over, a slight tug will remove the solder. *Henry Joseph, Box 22, Gardenville, Pa.*

SHOP HINTS WANTED

Payment of \$5.00 will be made for any service hint or shop kink accepted by the editors as usable on this page. Unacceptable items will be returned to the contributor. Send your ideas to "Technical Editor, TELEVISION RETAILING, 480 Lexington Ave., New York 17, New York."

Re-Wiring Aid

On some TV and radio repair jobs, it is necessary to unsolder and then resolder a considerable number of wires. Replacing a three or four-deck rotary switch, for instance, is a job of this nature. In following the schematic when the disconnected wires are put back, difficulty often arises in keeping track of the wire connections that have been made, and those that have not been made. An easy way to deal with this problem is to place a sheet of thin Lucite over the diagram, and mark off each connection as it is completed by penciling a red "X" at the appropriate spot on the Lucite (see sketch). Much

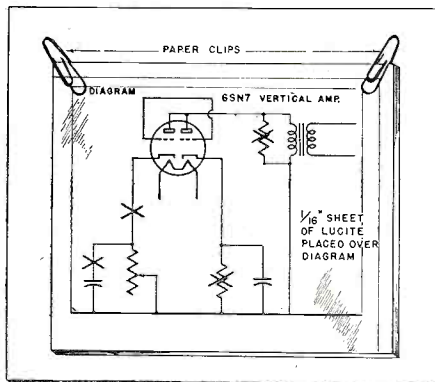

tracing and retracing of connections is eliminated by this procedure, and the progress of the work can be noted at a glance. Also, the diagram is kept clean and unmarked for future use. A Dixon "Phano" pencil should be used for writing on the Lucite. Cellophane may be used in place of the Lucite. *Joseph Amorose, Amorose Radio, R-4 Hungary Road, Richmond, Va.*

Prolonging "Mike" Life

Moisture often gets inside crystal microphones (even though they are sealed against it) damaging the crystal element, with resultant loss of sensitivity and frequency response. When this happens, place the "mike" for twenty-four hours in a clean, dry airtight can containing one pound of fresh silica gel, and it will behave like new, with the beneficial effects lasting a long time. *Harry J. Miller, 607 Wynnewood Road, Phila. 31, Pa.*

Faster Tuner Service

Here is an aid to faster (VHF) tuner service for the many technicians who service one make of receiver more than others. The gadget to be described was used on RCA sets (KCS43, 34, 45); a similar device was employed on Spartan receivers. It saves time in those cases when TV tuners must be removed from their chassis for servicing.

When a repair on a tuner has been made, the question of whether it is

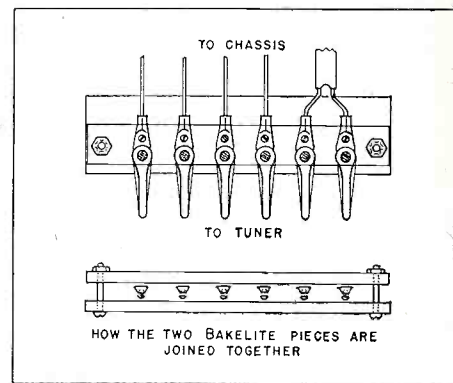

successful arises. The method of temporary connection shown in the sketch makes it possible to connect up the tuner very rapidly, for test purposes. Instead of cutting wires of the proper size, and adding them between the tuner and chassis each time a tuner is serviced, connections are clipped on.

The gadget consists of a piece of insulating material such as Bakelite or Lucite, with alligator clips bolted to it. The number and placement of the clips depend on the type of tuner with which the unit is to be used. The clips must be spaced so that they will contact the proper points on the terminal strip used on the tuner (RCA sets use such terminal strips). Wires are connected to the clips and made long enough to reach the chassis, when the tuner is on the bench. (These long leads do not upset tuner performance, in my experience). Clips are also placed on the free ends of the wires, for connection to the tuner circuit. In cases where the antenna input circuit of the tuner is brought out to a pair of adjacent terminals through a section of twin-lead, a length of twin lead line is used on the clips which connect to these terminals. Over the top of the clips is placed another piece of Bakelite; this second piece is fastened to the first one by a bolt through each end. The holes in the top piece are made large enough to permit its free movement up and down over the bolts. To connect the unit to the tuner, all that is necessary is to squeeze the two pieces together (this opens the clips); connect the clips to the terminal strips; then release the pressure on the two pieces. *Robert G. Seymour, 567 Elm Grove, Elgin, Ill.*

THE WORLD'S FIRST BROAD BAND YAGI!

CHANNEL MASTER'S *new* futuramic



The first antenna ever built that combines . . .

- Broad band coverage *with the*
- High gain and directivity of the Yagi

*Designed for service TODAY and TOMORROW --
in these 3 booming VHF markets:*

Horizontal
Polar Pattern

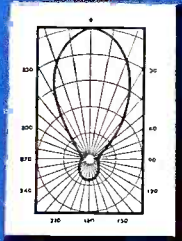

**BOOM
BRACED**

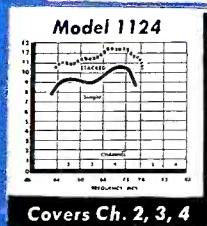

- Areas in which the FCC has ordered VHF stations to change channels (on the same band).

When a channel-shift takes place, the thousands of single-channel Yagis in use will become obsolete overnight. Unless such antennas are all changed on the same day the shift takes place, the set owner will have to get along without television for a period of time. However, you can install the Futuramic NOW. It will provide better reception than conventional Yagis on the present channels — and when the shift occurs, this superior reception will continue on the new channel without interruption!

- Areas in which a new VHF station is being added to the present one.

The great number of single-channel Yagis

now in use will not bring in the new channel. If an additional Yagi is installed, it will have to be tied into the present installation with separate leads and a switching system. However, ONE Futuramic will do the job of BOTH antennas — at lower cost — with better results on both channels.

- Areas served at present by two or more VHF stations (on the same band).

In such areas, the installation man has had to compromise between conventional broad band antennas, and separate Yagis for each channel. Only the Futuramic will give you the full advantages of both. It combines highest gain and sharpest directivity with simple, economical installation.

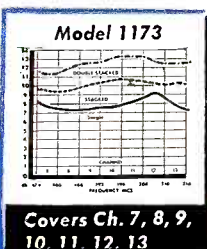
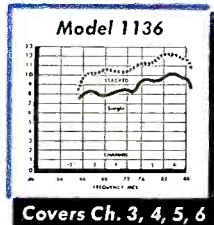
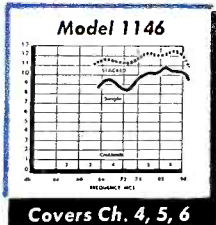
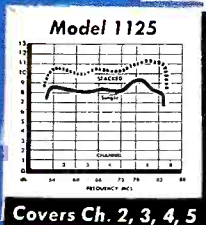

Model No.	Channels Covered	List Price
1173	7, 8, 9, 10, 11, 12, and 13	\$20.83
1124	2, 3, and 4	\$40.97
1125	2, 3, 4, and 5	
1136	3, 4, 5, and 6	
1146	4, 5, and 6	

SHATTERS all performance records!

- Channel for channel, the Broad Band Futuramic will outperform any conventional SINGLE-CHANNEL Yagi.
- On each of its specified channels, one single Low Band Futuramic will outperform any 4-bay conical or fan array.
- A single High Band Futuramic will outperform any 2-bay conical or fan array on every channel from 7 to 13.
- A high-low Futuramic combination is the most sensitive array ever devised for all-channel VHF reception.
- And the Futuramic uses Channel Master's famous Z-Match system for maximum stacking gain.

Write for complete technical literature.

CHANNEL MASTER CORP.

ELLENVILLE, N. Y.

MEMBER

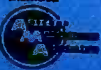

New Hi-Fi Equipment

Markel RECORD CHANGER

The Markel "Playmaster" 3-speed record changer, which plays all records on both sides in proper sequence without turning them over is now available with the "Pfan-Tone" pickup. The new pickup is said to provide very good



tracking and permit a wide range flat response with extremely low distortion. The Pfan-Tone pickup is also adaptable to earlier 3-speed Playmasters. Markel Electric Products, Inc., Buffalo 3, N. Y.—TELEVISION RETAILING.

Masco HI FI AMPLIFIER

The "Concert Master" is a 20-watt high fidelity amplifier with remote preamp, stated to have less than .2% harmonic or intermodulation distortion at 20 watts, from 20-40,000 cps. Response $\frac{1}{2}$ db 10-50,000 cps at 20 watts. 8-position switch selects proper equalization for all records, radio tuner, TV tuner, tape recorder. 5 turn-over frequencies provided, as well as loudness control, selector switch for GE, Audak, Pickering and Clarkstan magnetic pickups, separate bass and treble controls. Available with or without preamp. Mark Simpson Mfg. Co., 32-28 49th St., Long Island City 3, N. Y.—TELEVISION RETAILING.

E-V HI FI CABINET

"Peerage" is a new sound equipment console to make high fidelity reproduction more conveniently available in the home. Unit is designed to accommodate any combination of popularly-known tuners, amplifiers and record changers. Tuner panel tilts out for good visibility.

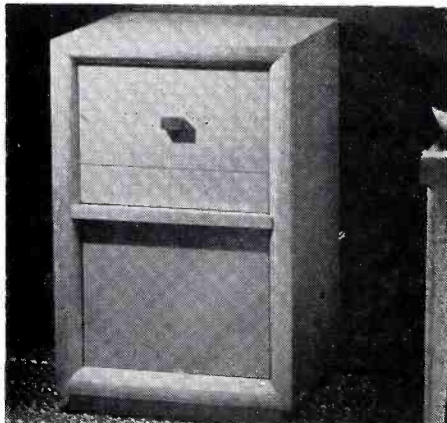

Available in tropical mahogany or blond Korina, the Peerage is designed to complement the E-V Aristocrat folded horn enclosure. Net price in mahogany (does not include tuner, amplifier or changer) is \$78.00. Electro-Voice, Inc., Buchanan, Mich.—TELEVISION RETAILING.

Craftsmen C-800 TUNER

Successor to the popular Craftsmen C10 and RC10 tuners, the C-800 is a high fidelity FM-AM tuner which incorporates front-panel selected equalization for AES, LP or European recording characteristics. Also featured is a double shadow tuning eye, front panel control for AFC cutout when tuning

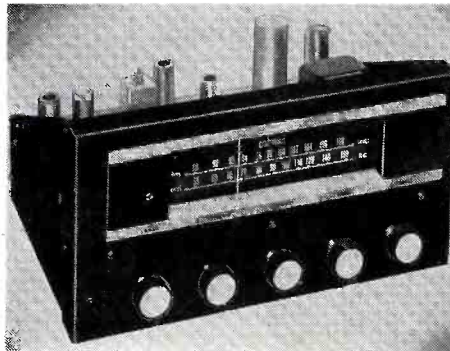

weak stations, and continuously variable bass and treble controls from 15 db boost through 15db attenuation, with flat position marked. Total complement is 15 tubes, dealer price \$159.50. The Radio Craftsmen, Inc., 4401 N. Ravenswood Ave., Chicago 40, Ill.—TELEVISION RETAILING.

Nova HI FI FURNITURE

Nova Wall Units provide ready-made elements for storage walls, built-in cabinets, bookshelves, etc. without the necessity for cabinet work. The units can be used individually or in whatever combination fits the needs or tastes of the customer. Provided unpainted or in a variety of stains and finishes. Latest addition to the line of wall units is a ceiling-high Hi-Fi cabinet providing space for radio, phonograph, TV, loudspeaker and for record storage. Speaker enclosure is provided with blank baffle and grille cloth. Doors conceal all units when not in use. For complete information, write Nova Sales Co., a subsidiary of the Homasote Co., Trenton 3, N. J.—TELEVISION RETAILING.

Fisher AUDIO CONTROL

Model 50-C master audio control is a remote control preamp with 5-input selector, record characteristic selector, independent bass and treble controls plus overall volume control. Unit features

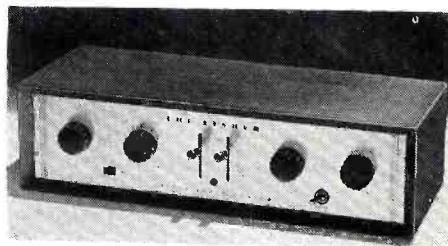

high gain with negligible distortion, utilizing all triodes with DC filaments, cathode follower input and two cathode follower output stages and self-contained power supply. Fisher Radio Corp., 41 E. 47 St., New York, N. Y.—TELEVISION RETAILING.

Altec LOUDSPEAKERS

New line of high quality duplex loudspeakers includes the 601A (12-inch, 20-watt), 602A (15-inch, 20-watt) and 604C (15-inch, 35-watt). Compared with the previous line of Altec speakers, the new units are said to have wider frequency ranges, smoother frequency response and less distortion. All three



have multicellular horns for extended range and wide-angle distribution. Dividing network for the 601A and 602A provides crossover at 3000 cycles; on the 604C at 1600 cycles. Altec Lansing Corp., 9356 Santa Monica Blvd., Beverly Hills, Calif., and 161 Sixth Ave., New York 13, N. Y.—TELEVISION RETAILING.

University WOOFER

Model C15W is a 15-inch low-frequency loudspeaker designed for dual or multi-speaker Hi-Fi installations. Maker states that the new speaker provides an extension of the low-frequency limit to a lower value, a higher conversion efficiency (requiring a minimum of amplifier power) and reduction of harmonic and intermodulation distortion. A special feature of the two-layer



voice coil winding is the provision for a choice of output impedances (4 to 20 ohms). Can be used with amplifiers up to 50 watts in multiple speaker systems; response is 30-3000 cps, with maximum sensitivity between 30-1200 cps. List price is \$115.00. University Loudspeakers, Inc., 80 South Kensico Ave., White Plains, N. Y.—TELEVISION RETAILING.

-the last word
in fringe area
reception

the **RADIART**
V*8 TELEVISION
ANTENNA

Here is what one jobber
says about the V-8...

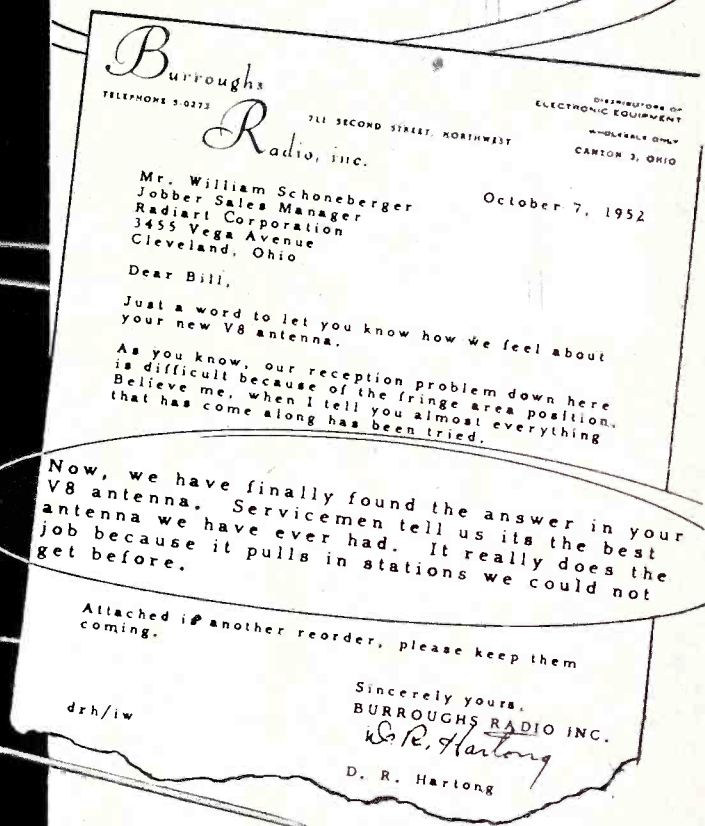

Quick Fold-Out Design
For Easy One-Man Installation



THE **RADIART** CORPORATION CLEVELAND 13, OHIO

VIBRATORS • AUTO AERIALS • TV ANTENNAS • ROTORS • POWER SUPPLIES

Electrical Appliance News

Personnel Changes at Palmer

J. W. Bostwick, general sales manager of the McCray Refrigerator Co., Kendallville, Ind., and its recently-acquired subsidiary, the Palmer Manufacturing Corp., Phoenix, Arizona, has announced that Jack Canady, formerly sales promotion manager, has been promoted to sales manager of Palmer, and that George W. Benson has been appointed assistant advertising manager for both concerns.

Cory and Fresh'nd-Aire Sales Forces Consolidated

J. W. Alsdorf, president of Cory Corporation, manufacturers of Cory, Fresh'nd-Aire and Nicro household appliances, has just announced plans for the immediate consolidation of the Cory and Fresh'nd-Aire national sales organizations. The sales of Fresh'nd-

Aire air treatment products were previously handled through manufacturers sales representatives. In the future all Fresh'nd-Aire products will be sold by the Cory full time national field selling organization.

Zeller in New Maytag Post

Frank L. Zeller, former service manager for the Maytag Newark Branch office in New Jersey, has been named a regional sales manager for eighteen counties in North Carolina, it was recently announced by The Maytag Company at Newton, Iowa. Counties included in Zeller's sales territory in North Carolina are: Anson Cabarrus, Davidson, Davie, Forsyth, Hoke, Mecklenburg, Montgomery, Moore, Randolph, Richmond, Rowan, Scotland, Stanley, Stokes, Surry, Union and Yadkin.

Jet 99 Health-Pac-Kit

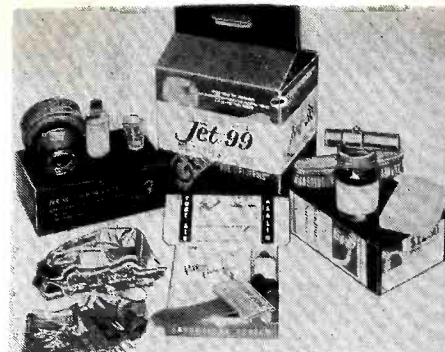

Landers, Frary & Clark's Fall and Winter Jet 99 sales campaign promotes health in the home through the vacuum cleaner. A special Health-Pac-Kit has an ensemble of four individual cleansing and germ destroying kits plus a hair dryer. Total value is \$39.98, and the kit may be secured by any customer trading-in her old cleaner for a new Jet 99.

RCA Victor Takes On New Subsidiary—Estate Appliance Corp.

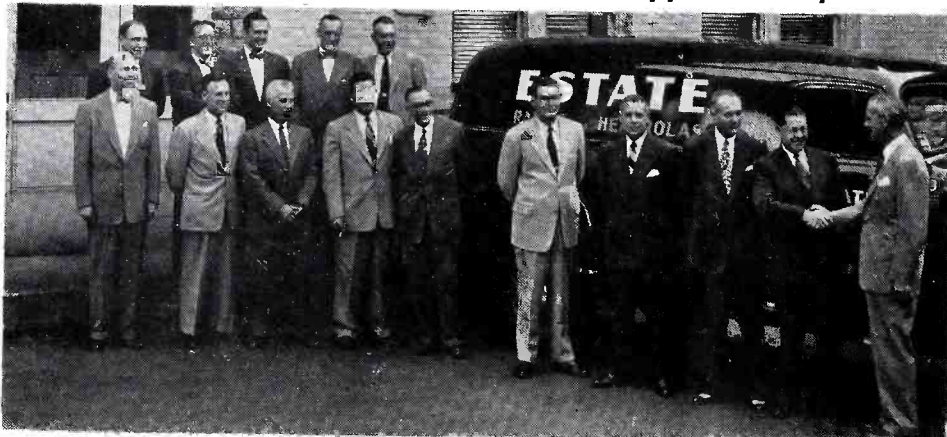

Officials discuss policy at first meeting at new RCA Victor subsidiary—RCA-Estate Appliance Corp., Hamilton, Ohio. Left to right (back row) Robert Ireland, Estate controller; Herbert Brunn, assistant general attorney for RCA Victor Division; Gordon P. Hentz, Estate general sales manager; Gordon R. Kemp, Estate vice-president; S. A. Walton, assistant to the director of accounting, RCA Victor. (Front row) Lewis W. Selmeier, Estate advertising manager; Ellsworth Simms, Estate chief engineer; J. M. Clifford, assistant director of personnel, RCA Victor Division; Dick Blenkinship, Estate production manager; Harry Dolf, Estate factory superintendent; A. F. Watters, director of personnel of RCA Victor Division; H. M. Winters, RCA Victor director of region offices; Charles M. Odorizzi, operating vice-president of RCA Victor Division; Robert A. Seidel, RCA Victor vice-president; Cecil M. Dunn, now president of The Estate Stove Co., who is now president of the new RCA subsidiary.

Leaders of New Nash-Kelvinator-Altorf Bros. Combination



After concluding arrangements for Nash-Kelvinator Corp.'s purchase of controlling interest in Altorf Bros. Co., the Peoria, Ill., home laundry equipment firm, officials of both firms are shown above, left to right: A. W. Altorf, president of ABC; C. T. Lawson, vice-president in charge of Kelvinator sales; George W. Mason, president and chairman of Nash-Kelvinator; and Henry W. Altorf, vice-president of ABC. The ABC line and a new Kelvinator laundry equipment line will be in production.

Appointments at Thor

John R. Hurley, president of Thor Corporation, has announced the following appointments: Frank J. Simpson has been made vice-president in charge of sales, and will headquarter in the company's administrative offices in Chicago; Thomas R. Chadwick has been appointed general sales manager for the home appliance manufacturer; and Dan R. Nighswander has been appointed product manager for Thor washers and ironers. Additional appointments include: J. Ross Simms to succeed Frank J. Simpson as southern division sales manager and Paul J. Buchen to succeed Thomas R. Chadwick as central division sales manager.

Arvin Fair Trades Products

Arvin electric housewares will be "fair traded" in all states where Fair Trade laws apply in order to help stimulate fair business competition and aid small retailers. Arvin fair trade retail prices as follows: model 6000 automatic Coffee-Perk, \$29.95; model 4200 automatic Pop-Up toaster, \$22.95; model 3550 custom Letric Cook, \$29.95; model 2100B electric iron, \$9.95; model 2100R electric iron, \$10.95; model 2200 electric iron, \$11.80; model 2300 electric iron, \$12.95; model 5600 heater, \$34.95; model 5100 Cool-R-Hot electric fan-heater, (1650-watt heating unit) \$21.95; model 5000 Cool-R-Hot electric fan-heater (1320-watt heating unit) \$21.10; model 91A heater, \$11.40; model 224 heater, \$12.95; model 223 heater, \$14.85; models 223A and 223B heaters \$15.95; model 52B heater, \$11.95.

Deepfreeze Appointments

Howard H. Mayberry has been appointed Deepfreeze zone manager at Indianapolis in the territory of W. R. Johnson, Deepfreeze district manager whose headquarters are in Chicago. Zone manager Earl M. Vaught will have headquarters in St. Louis under the direction of Deepfreeze district manager George A. Schlosser, Jr., of Kansas City.

It's *Telrex* across the nation

-FOR UHF!

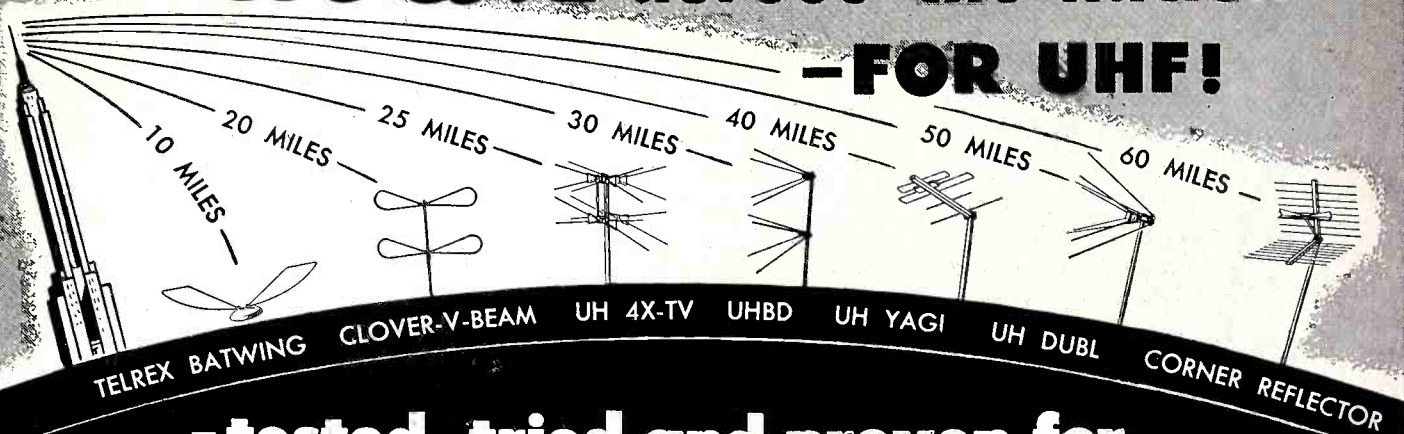

- tested, tried and proven for every reception area, near or far!

You can depend on Telrex for all your UHF antenna requirements. The same sterling-quality construction featured in VHF models combined with reliable factory ratings assure antenna satisfaction of every UHF installation. The complete Telrex line for UHF

includes famous Conical-V-Beams, Fishbones, Yagis and Bat Wings. There's a Telrex UHF antenna for every area—city, suburban or remote-from-transmitter. When you think of UHF or VHF—think of Telrex!



Bat Wing Model

FOR UHF AND VHF
RANGE—FROM 5 TO 10 MILES

Telrex

HURRICANE-BUILT to survive bad weather!

Weather durable materials and superb workmanship continue to make every genuine Telrex antenna super dependable under all climatic extremes. You can be sure of your antenna installation, if it's a Telrex!

"CONICAL-V-BEAMS" are covered by Patent No. 23,346

CANADIAN and FOREIGN PATENTS PENDING

Clover-V-Beam

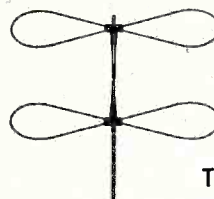

UHF AND VHF ANTENNA

RANGE—FROM 10 TO 20 MILES

Model UH 4X-TV

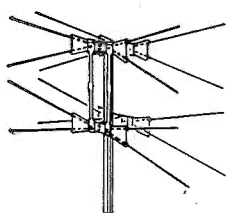

FOR UHF ONLY

RANGE—FROM 15 TO 25 MILES

Model UHBD

UHF AND VHF SERVICE

RANGE—FROM 10 TO 30 MILES

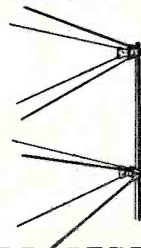

UH Duplex Yagi

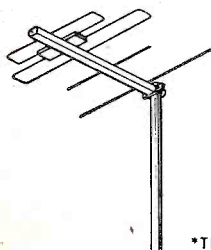

FOR UHF ONLY

RANGE—FROM 10 TO 40 MILES

*TRADEMARK REGISTERED

UH DUBL Conical-V-Beam

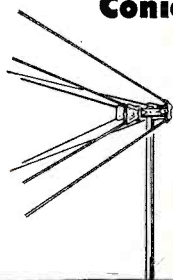

FOR BOTH UHF AND VHF

RANGE—FROM 10 TO 50 MILES

Corner Reflector

UHF SERVICE ONLY

RANGE—FROM 10 TO 60 MILES

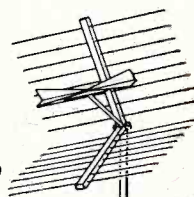

WRITE FOR CATALOGS ON UHF, VHF AND FM ANTENNAS, NOW!

New illustrated literature contains complete specifications and technical data in addition to installation hints. Call or write Telrex today!

Telrex INC.
CONICAL-V-BEAMS*

AMERICA'S STANDARD OF COMPARISON

Originators and Manufacturers of "CONICAL-V-BEAMS" — Insist on *Telrex* the Original!

ASBURY PARK 2, N. J.

"KNOW-HOW" and "WHERE-WITH"

Phono Record News

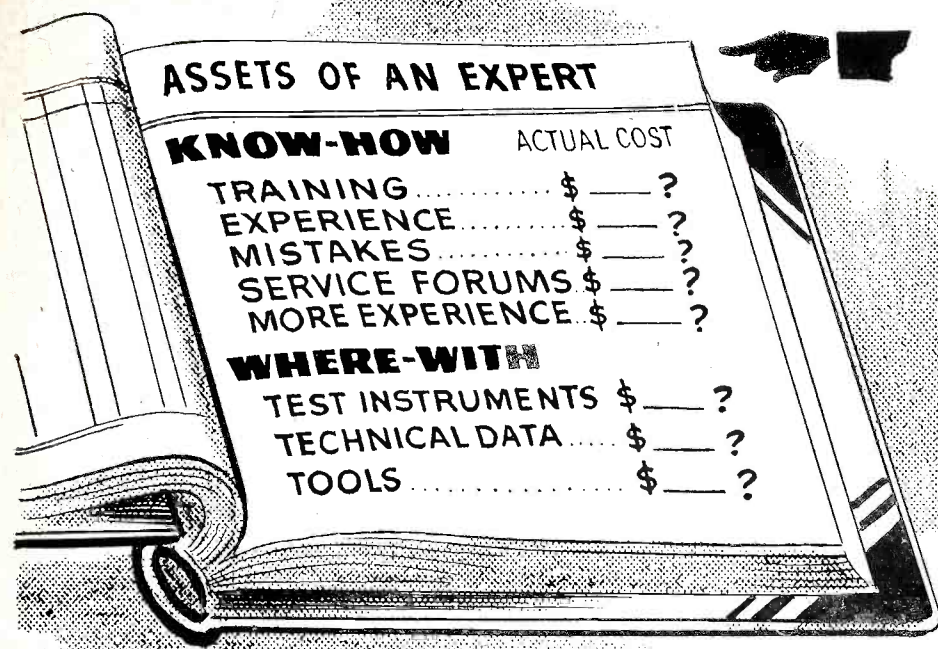

A **TECHNICIAN** with thorough electronic training and adequate experience has the "know-how" that radio and television owners will pay for when their sets are in trouble. When the technician has invested in testing instruments and other technical aids for diagnosing trouble, he has the "where-with" to help convert this "know-how" to efficiency and profits.

Every technician realizes that all of the "know-how" that it is possible to acquire (through study, experience, and mistakes) is not worth much until he can make it pay off. If he were to stop and figure how much his "know-how" actually cost him over the years, in both time and money, he would be amazed at the amount. The average technician spends thousands of dollars before he is classed as an expert. The "where-with" investment is small by comparison.

Successful service technicians always consider the dollars and cents invested in training, experience, testing instruments and other technical aids when they establish their service charges. They know that the only reason any technician can consistently locate trouble in minutes instead of hours is because, he has *both* the "know-how" and the "where-with."

Since 1927

SUPREME

Testing Instruments

"SUPREME BY COMPARISON"

MULTI-METERS • TUBE TESTERS • COMPOSITE VIDEO GENERATORS • OSCILLOSCOPES
 SIGNAL GENERATORS • VACUUM TUBE VOLTMETERS
 PANEL METERS • SPECIAL PURPOSE INSTRUMENTS FOR GOVERNMENT AND INDUSTRY

Supreme, Incorporated

Greenwood 5, Mississippi

(Continued from page 50)

in the wide open spaces of Texas. Their latest single is *Tom and Jerry and the Texas Rangers*. Like all the popular fun-loving discs of the pair, this recording goes 'round and 'round with plenty of laughs and excitement per groove. The story is by Elmer Gregory and narration by Bret Morrison. There's action a'plenty for the junior cowboys of the home-type variety.

Appointments at Columbia Records

Columbia Records, Inc., has recently named James Hunter to the post of vice-president and director of production engineering and research. In this newly-created post, Hunter will deal exclusively with development of production innovations. Herbert M. Green- spon, formerly assistant to Hunter, has been appointed director of production to supervise the day-to-day operation of Columbia's factories.

Norman A. Adler has been appointed general attorney and will be in charge of the company's Law Department, including among his functions general legal problems as well as the supervision of artists' contracts, copyrights and trademarks. Kenneth E. Raine, Corporate Secretary, has been assigned new duties. He will continue to represent the company in all legislative matters and will, in the future, place greater emphasis on his duties as director of industrial relations, relinquishing the administration of the company's more general legal problems to **Mr. Adler**.

Westminster

This month, Westminster is releasing a wealth of fine music. Beethoven's *Symphony No. 9 in D Minor, Op. 125* and *No. 1 in C Major* are presented by the Orchestra of the Vienna State Opera conducted by Hermann Scherchen and feature the voices of Magda Laszlo, Hildegard Roessel-Majdan, Petre Monteanu and Richard Standen. Liszt's *Concerto No. 1 in E Fl. Maj.* and *No. 2 in A Maj.* for piano and orchestra are performed by Edith Farnadi at the keyboard. Ginette Doyen, pianist, presents Chopin's *Ballade in G Minor, Op. 23*, *Ballade in A Minor, Op. 38*, *Ballade in F Minor, Op. 52* and *Ballade in A-flat Major, Op. 47*. The Randolph Singers perform *Italian Madrigals* by Monteverdi and Gesualdo.

Remington

Famed pianist Edward Kilenyi performs two of Chopin's most important keyboard works in his recording of the *Sonata in B Minor* and the *Sonata in B-flat Minor*. The coupling of these two important Sonatas constitutes a major

(Continued on page 96)

Right for you...

right for your customers...

MALLORY
UHF
CONVERTER

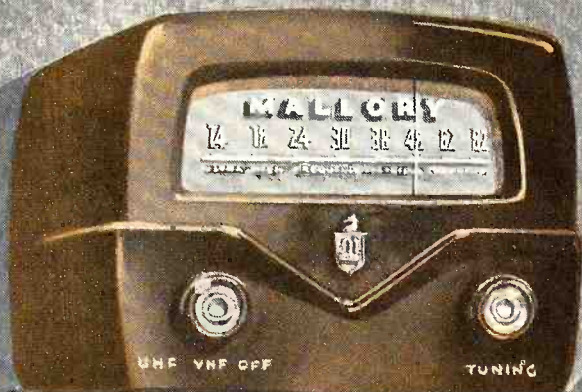

Easy to sell...

Easy to install...

Easy to use...

Just look at all these special Mallory UHF Converter features. They're bound to boost your profits... give your customers the kind of UHF reception they expect.

- Reception of *all* UHF channels for *all* TV sets.
- No sacrifice of any VHF channels.
- Fast, easy installation... no interruption of customer use of set.
- Built-in UHF antenna... gives satisfactory reception within reasonable distance of transmitter.
- High quality picture definition plus easy tuning.

And that's not all! The Mallory UHF Converter—no bigger than a small table radio—has been tested and proved in the laboratory and in the field.

ASK YOUR MALLORY DISTRIBUTOR TODAY for complete information about the Mallory UHF Converter. And get him to tell you about the advertising and sales promotion program that will help boost your sales.

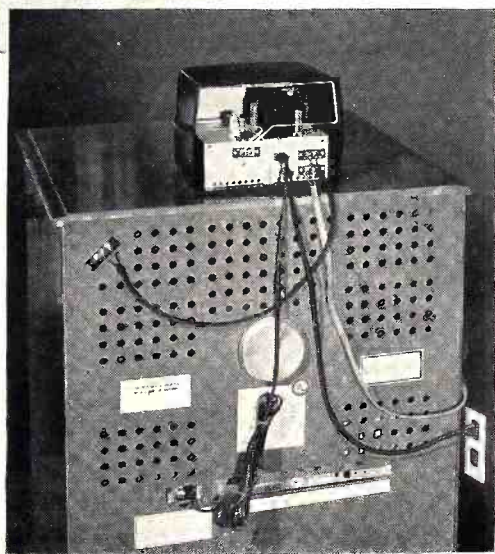

SO EASY TO INSTALL!

You need no special tools to install the Mallory UHF Converter. Do the job right in your customer's home—fast... easily... in just two simple steps. Connect antenna leads and power lines. That's all!

*Make Sure...
Make it Mallory*

P. R. MALLORY & CO., Inc.
MALLORY

CAPACITORS... CONTROLS... VIBRATORS...
SWITCHES... RESISTORS... RECTIFIERS...
VIBRAPACK* POWER SUPPLIES... FILTERS

APPROVED PRECISION PRODUCTS

P. R. MALLORY & CO., Inc., INDIANAPOLIS 6, INDIANA

ASTATIC REPLACEMENT CARTRIDGE GUIDE FOR RCA 45 RPM PLAYERS, PLAYER ATTACHMENTS AND RECORD CHANGERS

When you replace cartridges match the excellence of the records themselves to give your customers the full enjoyment of 45 RPM.

ASTATIC leadership in the pickup cartridge replacement field has no greater evidence than in the brilliant performance of the models AC-J and CAC-J on 45 RPM Records. Precision engineered and manufactured, to meet the higher requirements in smooth, wide range response, tracking excellence and similar factors, these superior Astatic units are your greatest assurance of enthusiastic customer satisfaction . . . of maximum business volume from the ever-growing swing to 45 RPM.

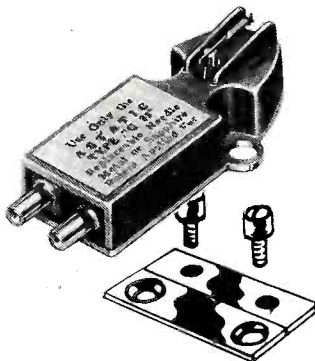

**ASTATIC MODEL CAC-J
CARTRIDGE**

Installs in RCA 45 RPM Players and Record Changers with Simple Adaptor Plate. Plate Screws in Pickup through Large Holes; Cartridge to Plate through Small Holes. LIST PRICE, \$7.50.



**ASTATIC MODEL AC-J
CARTRIDGE**

Installs in RCA 45 RPM Players and Record Changers with Special Weight Mounting Screws Inserted in Rear Holes of Mounting Bracket. LIST PRICE, \$8.90.

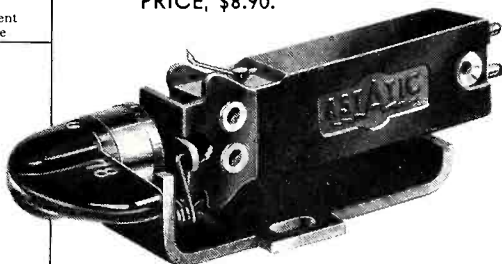

**POPULAR ASTATIC MODEL
ACD-2J TURNOVER
CARTRIDGE**

Popularity leader of conventionally designed turnover cartridges. Smoother response, superior tracking and lower needle talk—at 33 $\frac{1}{3}$, 45 or 78 RPM—due to mechanical drive system with reduced inertia. Complete with turnover assembly and knob. LIST PRICE, \$10.00.

ASTATIC AC-J AND CAC-J CARTRIDGES FIT THIS COMPLETE LIST OF RCA 45 RPM PLAYERS AND RECORD CHANGERS		
Player Model No.	Original Cartridge Used	Astatic Replacement Cartridge
9EY3	74625 or 74067	AC-J or CAC-J
9EYM3	74067	"
9EY31	74625	"
9EY32	74625	"
9EY35	74067	"
9EY36	74067	"
9IY	74067	"
9IYM	74067	"
9Y7	74067	"
9Y51	74067 or 74625	"
9Y510	75375	"
45EY	74625 or 74067	"
45EY3	74625 or 74067	"
45EY4	74625 or 74067	"
45EY15	74625 or 74067	"
45J	74067	"
45J2	75476	"
Changer Model No.	Astatic Replacement Cartridge	
RP-168	AC-J or CAC-J	
RP-190	"	
RP-186	"	

Write for complete Astatic Cartridge Replacement Guide for all RCA Phonographs and Record Changers, Form No. S-55.

EXPORT DEPARTMENT

401 Broadway,
New York 13, N. Y.
Cable Address:
Astatic, New York.

Astatic crystal devices manufactured under Brush Development Co. patents



Phono Record News

(Continued from page 94)

drawing-card for fans of Chopin and those who appreciate fine piano playing. The Rome Opera Company is presented on the Remington label in two extremely popular operas—Verdi's 3-act *La Traviata* and Puccini's *La Boheme*, a 4-act opera. The former stars Mme. Frances Schimenti as Violetta and the latter has as its leading tenor Giacomo Lauri-Volpi. These recordings are of high calibre and authenticity and are offered to opera-lovers at low cost.

Columbia "1500" Series

Columbia Records has introduced a new Extended Play 45 RPM single disc series featuring classical, popular, hillbilly and children's selections. The new records provide up to eight minutes of music on a 7" 45 RPM disc and offer as many as four complete selections on a single platter. Masterworks Extended Play records will be priced at \$1.51 plus tax, while popular, hillbilly and children's discs of this type will be priced at \$1.40 plus tax. Discs are issued weekly in five groups of 10. Designated the "1500" series, the new releases are packaged in special individually designed jackets.

MGM Introduces Lion Records

MGM Records has announced the introduction of a new low-priced long-playing label called Lion Records. Ten-inch 33 $\frac{1}{3}$ RPM records will retail for \$1.69 plus federal tax. First release on the Lion label is "Designed For Dancing" featuring Tommy Tucker and his Orchestra. Eight of the most popular tunes of the day are included. Lion Records will be marketed through MGM Records' distributor network and will be offered to dealers at the same discounts as regularly-priced releases. Dealers will be protected by the usual cooperative advertising allowances and return privileges.

New Vocatron Display

"Ask for a Demonstration" is the theme of a new Vocatron portable intercom counter display being made available to dealers by the Vocaline Company of America, Inc., Old Saybrook, Conn. In the form of an eye-catching arrow, the display "points" to a Vocatron intercom on which it stands. Thus the display takes no more space on a counter or shelf than the compact intercom itself.

Mosher is Merit Rep

Bob Mosher, formerly with Art Cerf & Co., will call in the New England territory for Merit Coil & Transformer Corp., Chicago, it was recently announced by Bill Barron, sales manager.



"WHY SHOULD I INSIST ON **CBS-HYTRON**?"

"**YOU PROFIT MORE!**
HERE ARE
5 BIG REASONS WHY"



1. CBS-HYTRON IS FAMOUS . . . EASY TO SELL. The magic letters "CBS" are plugged for you on radio and TV station breaks . . . 102 BILLION times a year! CBS is known and respected by *all* your customers. CBS-Hytron is the profitable brand with endless sales assistance.



2. CBS-HYTRON SPECIALIZES IN RECEIVING TUBES. Since 1921, CBS-Hytron has concentrated on receiving types. Practice makes perfect. Put those years of know-how to work for you. Let time-proved CBS-Hytron dependability cut call-backs . . . make more money for you.



3. CBS-HYTRON LEADS IN TV TUBES. You know them. CBS-Hytron TV originals: 1AX2, 1X2A, 6BQ6GT, 12A4, 12B4, 12BH7, 12BY7, 12BZ7, 25BQ6GT, and the original rectangular 16RP4. Even CBS-Hytron standard TV tubes are designed-for-TV . . . tested-for-TV . . . to give you peak performance and profit.



4. CBS-HYTRON IS ULTRAMODERN. CBS-Hytron is the tube of the future. Made in the world's most modern plants. On manufacturing equipment years ahead of the rest of the industry. CBS-Hytron advanced design and precision construction keep you always ahead. Give your tomorrow's trouble-free performance today.

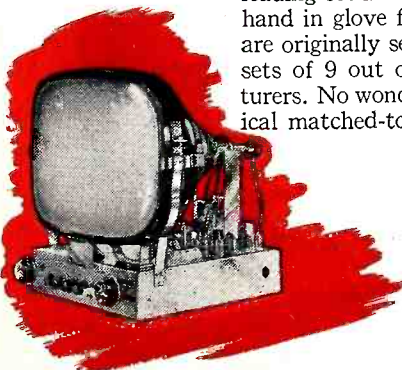

5. CBS-HYTRON IS MATCHED-TO-THE-SET. Combined engineering skills of leading set makers and CBS-Hytron work hand in glove for you. CBS-Hytron tubes are originally set-engineered right into the sets of 9 out of 10 leading set manufacturers. No wonder CBS-Hytron is your logical matched-to-the-set replacement tube.

IT PAYS TO BE FUSSY! Just any standard brand won't do. If you want: Trouble-free, advanced performance. Maximum customer satisfaction. Minimum call-backs. More profit. Five big reasons point the way: Insist on CBS-Hytron!



CBS-HYTRON
Germanium Diodes

Complete data yours for the asking. Write CBS-Hytron, DANVERS, MASS., today.



Distributors In the News

Midstates Distributing Corp., 102 S. Crouse Ave., Syracuse, N. Y., has been named distributor for Du Mont television receivers in the Syracuse area. Midstates' territory includes Binghamton and Watertown, N. Y., in addition to Syracuse. The new distributor is already franchising dealers for the Du Mont line, in the area.

Bowers Wholesale, Corporation of Norfolk recently had an estimated 100,000 Virginians "sit in," on the recent dealer meeting they put on to

show the new Bendix automatic home laundry line. A full half-hour show over WTAR-TV in the form of a fashion show presented the story of the Bendix tumble-action washer. The fashion theme blended beautifully with the showing by stressing that this type washer will safely and automatically wash the new miracle fabrics like Dacron, Orlon, Dynel, and Acrilan. A Norfolk department store provided five models and fashions of the new fabrics. Dealers were enthused about both the product and the program.

Soo Hardware Company, Marquette, Michigan, has been named by Blackstone Corporation, Jamestown, N. Y., as distributor for their products, which in-

clude household washers, dryers, and ironers. The territory covered by this distributor will comprise the upper peninsula of Michigan and the following counties in the state of Wisconsin: Iron, Marinette, Forest, Oneida, Long-lade, Viles, Florence, and Lincoln.

Bison Electrical Co., Inc., of 1135 Main St., Buffalo, N. Y., has been appointed distributor for CBS-Columbia television receivers. Bison will cover the northwest part of New York State. Edward R. Arundell is the president of the company and will be responsible for the sale of the CBS-Columbia television line.

J. M. Oberc, Inc., Detroit, Mich., is the new distributor of Arvin radio and television in the southern Michigan territory. In addition to Arvin, Oberc will also distribute Lindemann & Hoverson (L. & H.) electric ranges, refrigerators, water heaters and freezers, and Remington air conditioners.

Parts distributors will be interested in the new attractive display stand that makes point-of-sale exhibition and merchandising of speakers a far easier and more effective job. The stand, produced by Atlas Sound Corp., 1451 39th St., Brooklyn, N. Y., is shipped to distributors at no charge along with a small order for Atlas Models HU-15V and/or HU-24V paging and talk-back speakers.

Goldhamer, Inc., 2239 East 14 St., Cleveland, O., has been named distributor of the Steelman phonograph line in the Cleveland area, according to a recent announcement by J. N. Ryan, Steelman sales manager. The Steelman Phonograph and Radio Co., Inc., are manufacturers of portable phonographs, automatic changer units, phono-radio combinations, kiddie phonographs and educational units.

Kaye-Halbert Distributors, Inc., West Coast television manufacturers, recently appointed The Moore Company as distributors in the state of Oregon. Located at 1415 S. W. Alder St., Portland, Ore., The Moore Company will also cover territories in the western part of Idaho, the southern part of Washington and along the northern California border.

O'Donnell-Dunigan, Inc., 499 Court Street, Rochester, N. Y., has been appointed exclusive Arvin radio and television distributor for Rochester and surrounding territory. The firm plans an intensive dealer coverage, merchandising and promotion campaign on Arvin. New York counties included in the O'Donnell-Dunigan franchise are Monroe, Wayne, Livingston, Ontario, Seneca, Yates, Steuben, Schuyler and Chemung.

M. O. Hollis, secretary-treasurer of Raybro Electric Supplies, Inc., Florida distributor firm, has announced the following:
(Continued on page 100)

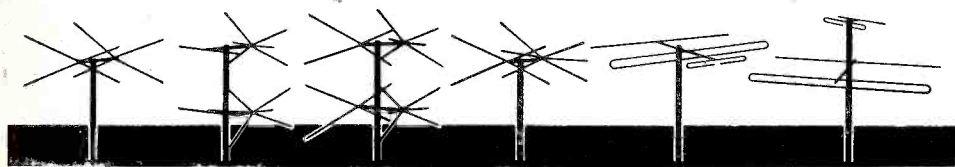

CRC-001 Conical with interchangeable elements. 2 or 3 element dipole with conical or horl. reflector. Single or stacked.
CRS-002 Stacked conical with high frequency element. Also available in Single Bay, No. CRC-002.
CRS-003 All-Wave. High-Gain stacked conical. High signal-to-noise ratio. Also in Single Bay, No. CRC-003.
CRC-004 Single 3-element dipole with conical reflector. Also available in a Stacked Array, No. CRS-004.
CIL-001 Inline, Quick Rig folded dipole for all channels. Max. signal strength. Also in kit, less mast, CIL-001-LM.
CHL-001 Hi-Low Quick Rig folded dipole. All channels. Maximum signal strength. Also in kit, less mast, CHL-001-LM.

Do it right the first time

INDOOR
for all modern receivers

CONICALS
all with interchangeable elements

INLINE
for top signals on all channels

HI-LOW
for separate elements and separate orientation when needed

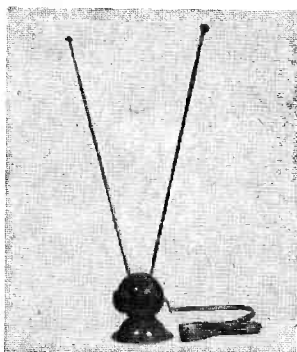

CASS TV-FM INDOOR

Model CIA-001 for use with all modern TV receivers, giving good reception in most cases where outdoor antennas cannot be used.

with

CASS ANTENNAS

and

TV-RADIO HARDWARE

In addition to bringing you a thoroughly engineered line of antennas for normal outdoor and indoor use, CASS gives you great flexibility and adaptability in meeting difficult situations arising from location, multi-directional signal sources, interference, erection, etc. This means satisfaction to the customer and full profit to you because, in most cases, it enables you to

**MEET ALL CONDITIONS
SPEED UP INSTALLATIONS
PROVIDE BETTER RECEPTION**

**KEEP DOWN INVENTORIES
AVOID PRICE COMPETITION
SAFEGUARD YOUR PROFITS**

CASS antennas are available in Regular or Thrift lines and are priced to net you real profits because you fix your own markup.

Write for complete details

Choice territories open for distributors

CASS MACHINE COMPANY Electronics Division

NOTED FOR FINE MACHINE PRODUCTS FOR 15 YEARS

691 Antoinette

TRinity 1-4360

Detroit 2, Michigan

STANCOR NEWS BULLETIN

NEW STANCOR TRANSFORMERS



A-4747—Input transformer for single button mic. or low imp. line to single grid. Pri.: 70 ohms; sec. 1,300,000 ohms. Turns ratio, 1:137. Ideal for mobile transmitter use.



A-3335—Output transformer for P-B plates to V.C. An economical unit used with 6V6's and inverse feedback. 10,000 to 6-8/3.2-4 ohms. Max. pri. DC, 40 ma., 10 watts.



P-6468—Filament transformer for a pair of Elmac 4-250A's where CT is operated near ground potential. Sec. 5.0V. CT, 30 amps., RMS insul. 2500V.



P-6410—Electrostatically shielded isolation transformer designed for servicing small receivers, amplifiers and test equipment, 50-60 cycle. Conservatively rated at 50 watts.

Ask your Stancor distributor for Bulletin 450R for additional information on these and other new Stancor transformers.

NEW TELEVISION REPLACEMENT TRANSFORMERS



A-8125—Vertical blocking oscillator. Used in over 600 models by 21 manufacturers. Turns ratio, 1:4.2; height 1 3/8". mounting centers 1 3/4".

P-8170—Power transformer, used in 48 models by Andrea, Bendix, Kaye Halbert, and Magnavox. Plate supply 380-0-380 AC volts, 220 DCMA. Rect. fl. 5V. at 3 amps., other filaments, 6.3 at 1.2, 6.3 at 5.0 and 6.3 at 7.0.



P-8171—Power transformer replacement for Air King part A10109. Plate supply 375-0-375 AC volts, 225 DCMA, rect. fl. 5V. at 3 amps. Other filaments 6.3 at 2.0 and 6.3 at 9.0.

See Bulletin 451 on these new Stancor TV replacements.

STANCOR CR TUBE BOOSTER



A CR tube rejuvenator with many extra features suggested by the Stancor Serviceman Advisory Board. A light, compact unit that requires no soldering and no connecting to the AC line. It has extra long, 18" leads between the booster and its connector. Can be installed anywhere in the set. Auto-former type, with a hi-lo switch permitting a choice of two degrees of brilliancy. Supplied complete with bracket and screws for chassis or cabinet mounting.

P-8192...\$2.94 Dealer's net

FREE!

The new Stancor Simplified Television Transformer Replacement Guide, the most complete and the most concise ever published. Covers over 4400 TV models and chassis. All replacements are listed by manufacturers' original part number for instantaneous reference. Available from your distributor or from Stancor directly.



Stancor transformers are listed in Howard W. Sams Photofact Folders and in John Rider's Tek-Files

STANDARD TRANSFORMER CORPORATION

3594 ELSTON AVENUE, CHICAGO 18, ILLINOIS

GLAMORIZE YOUR DELIVERIES

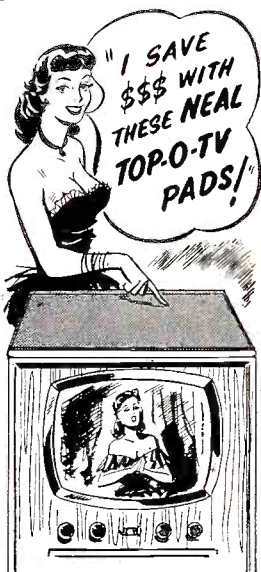

It shows what you think of your merchandise

What it means to YOU

- Customers say, "How nice you handle your television sets" . . .
- Customer does not look for scratches on these kind of deliveries . . .
- Clean the sets in your store and set them in your customer's house spotless . . .

IT PAYS BIG DIVIDENDS
Order Today



Enclose check for items marked below. Immediate delivery C.O.D.'s. Guaranteed to be as represented.

- No. 350 17" Table Model Cover for TV \$9.50
- No. 351 21" Table Model Cover for TV 12.50
- No. 300 30" Wraparound Console Cover 16.50
- No. 301 36" Wraparound Console Cover 18.95
- No. 222 42" Hooded Type COMB. TV or Range Cover 19.95
- No. 200 4'-12" Refrigerator Wraparound Cover 22.95
- No. 90LD E-ZEE-LIFT Kit—300 pound capacity 12.95
- No. 100HD E-ZEE-LIFT Kit 1200 Pound capacity 19.95
- No. 400 Top-O-TV Pads for Showroom. Kit contains 12 Pieces, all sizes. (Wool) 11.50

Circular on request

NEAL PRODUCTS CO.
MARLBORO 35, MASSACHUSETTS



#222 x #60LD



#350



#200 x #100

Creating \$ALES for YOU with Consumer Advertising!

with Television Spots Throughout the country

with TV Consumer Magazine Ads Throughout the country

\$9.95 LIST PRICE

*U. S. Patent No. 2,495,579 Canadian patents 1951

Available at leading jobbers!

The Genuine HI-LO TV Spiral-Tenna Model 101 (indoor)

Hi-Lo TV ANTENNA CORP.
3540 N. Ravenswood • Chicago 13, Illinois

Now! CUSTOM BUILT TELEVISION at Volume Prices!



The illustrated 21" open-face console is typical of our quality merchandise. No finer TV sets produced anywhere.

A few choice territories available for experienced representatives with dealer following.

Stratford TELEVISION

Our assembly lines are rolling . . . producing in quantity the famous custom built sets which have made Stratford a "name" in the industry. Priced so low that your volume sales are assured . . . let's hear from you today!

- Your choice of 17", 20", 21"
- Table models and consoles
- Finished in mahogany or limed oak
- Standard RTMA requirements
- Include ALL the exclusive features you find in most expensive sets
- Write for YOUR DEAL today . . . from factory to you!

We manufacture sets for private labels . . . large merchandisers are invited to write for particulars.

Stratford

TELEVISION CO.

Write for free illustrated literature, no obligation.

2555 West 21st Street
Chicago 8, Illinois
CUSTOM BUILT TELEVISION

MORE

RECOTON Phoneedles

are sold by retailers
than any other brand in the world!

There's a reason—Recoton's Reputation for Quality is world famous. Music lovers ask for Recoton needles. Give them what they want!

RECOTON

World Famous for Quality

147 West 22nd St. • New York 11, N.Y.



DISTRIBUTORS

(Continued from page 98)

lowing organization changes: W. T. Brown has been appointed Miami branch manager; J. C. Key, Jr., has been promoted to assistant manager of the Miami branch; C. V. Brown, formerly branch manager in Miami, has moved to Tampa and will be administrative assistant, working with general management; Gordon Friday has been promoted to manager of lighting and lamp department statewide and will move to Tampa headquarters; George N. Jack has been transferred to the St. Petersburg branch and appointed branch manager; C. A. Fields has been transferred to Tampa to the customer service department; J. L. Hargrove, Jr., has been transferred from the price and edit department in Jacksonville to the St. Petersburg branch and will handle customer service in that branch. Hollis stated that the changes were necessitated by the ever-increasing business and to place Raybro in a better position to serve their customers.

Maurice S. Despres, chairman of Dale-Connecticut, Inc., of New Haven, and Admiral Corporation's first distributor, has announced the transfer of the distribution of Admiral products to a newly-formed firm, Connecticut Appliance Distributors, Inc. Dale will continue to distribute electronic parts and special equipment. George R. Wolf, former prexy of Dale-Connecticut, will be president of the new company while Despres will become board chairman. The new firm will have the same address as Dale-Connecticut—140 Ferry St., New Haven.

Westinghouse TV Sales Up

Joseph F. Walsh, sales manager of the Westinghouse TV-radio division, recently stated that sales of Westinghouse television and radio receivers have shown such significant increases throughout the nation during the recent months that production is now at record high. He also stated that the entire line of Westinghouse radios is sold out and no further radio orders will be accepted for the balance of this year. Strongest factors believed responsible for the sales boom are the Westinghouse sponsorship of the political convention, plus the weekly "Pick The Winner" show series of 26 political debates which reach 70,000,000 viewers and listeners on television and radio. The television-radio division had previously announced a substantial increase to its overall advertising expenditures in magazines, newspapers and other media.

Burcaw is Rider Rep

John F. Rider, sales manager of John F. Rider Publisher, Inc., 480 Canal St., New York 13, N. Y., has announced the appointment of Ken C. Burcaw as sales representative for the state of Michigan. Burcaw was formerly sales manager for Cornell-Dubilier Electric Corp.

PHOENIX IS FIRST AGAIN!

FIRST WITH SENSATIONAL
DUOTENNA

2-DIRECTIONAL

ALL-CHANNEL
Speed-Tenna

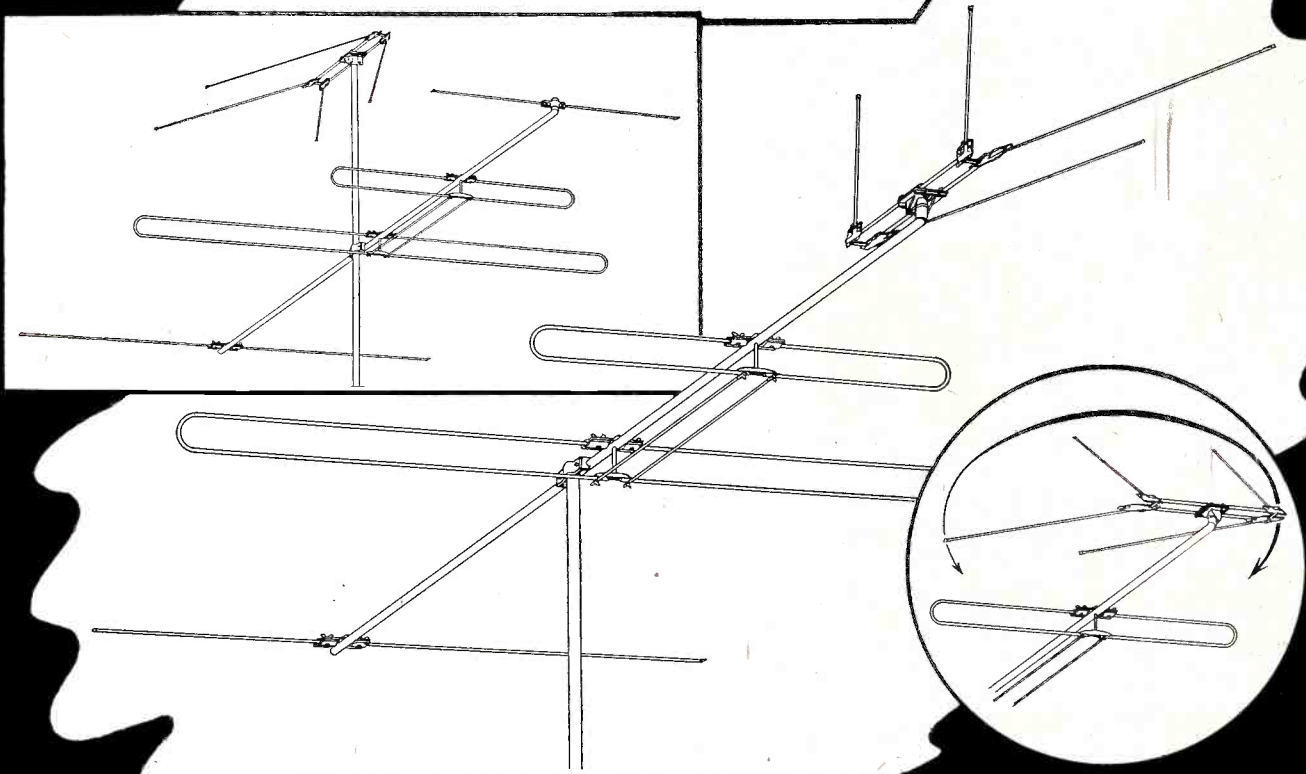

FIRST DUO-DIRECTIONAL ANTENNA
DESIGNED FOR BOTH UHF AND VHF!

HIGH GAIN ON ALL CHANNELS 2-83

Phoenix revolutionizes the antenna field with this
amazing new aerial concept. GET ALL THE FACTS!

PHOENIX ELECTRONICS, Inc. LAWRENCE, MASS.

Insist upon

ELECTRONIC HARDWARE IN HANDY RE-USABLE HINGED COVER PLASTIC BOXES

it's the new



LIST PRICE 50c
Subject to
Dealers Discount

NOW YOU CAN BUY all your radio-TV hardware—240 different items—in sturdy, re-usable *Hinged Cover*, plastic boxes. Make your work bench neater and handier. Look for . . . ask for . . . the *Hinged Cover* hardware in the G-C self-service display at your distributor.



BUY WHERE YOU SEE THIS DISTRIBUTOR'S DISPLAY — HE HAS THE COMPLETE STOCK

SPECIAL OFFER TO SERVICE MEN — Handy steel rack for your bench or shop wall . . . holds 30 G-C Hinged Cover hardware boxes. See your distributor for details.

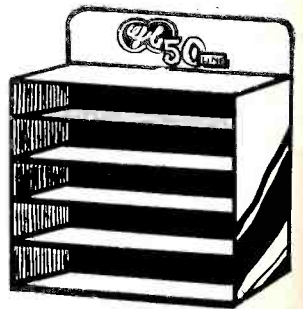

**GENERAL CEMENT MFG. CO.,
ROCKFORD, ILLINOIS, U.S.A.**

RCA Victor Promotes Toney



James M. Toney (above) has been appointed director of distribution for the consumer products department, RCA Victor Division, Radio Corporation of America, it was announced by Joseph B. Elliott, vice-president in charge of consumer products. He was formerly director of public relations for the Division.

Bruno-New York to Distribute Duotone

Steve Nester, president of the Duotone Company, Keyport, N. J., recently announced the appointment of Bruno-New York, Inc., as a full line distributor of Duotone products. The Bruno organization will handle Duotone's entire needle line in addition to Duotone's supplementary items.

Coblentz at Du Mont

O. Robert Coblentz, 875 Malcolm Ave., Los Angeles, has been named western division manager for Allen B. Du Mont Laboratories, Inc., it has been announced by Dr. Allen B. Du Mont, president. He will make his headquarters at the Du Mont offices at 1136 N. Las Palmas, Los Angeles, Calif.

Elect Grimes President

Edmund L. Grimes, executive vice-president, controller and director of the Commercial Credit Company, Baltimore, was recently elected president of the Controllers Institute. A member of the Institute since 1945, the new president has been chairman of its Committee on Federal Taxation for the last two years. The Institute is a non-profit organization of controllers and finance officers from all lines of business—banking, manufacturing, distribution, utilities, transportation, etc.

CBS-Columbia Names Barron

David H. Cogan, president of CBS-Columbia Inc., the television set manufacturing subsidiary of the Columbia Broadcasting System, recently announced that Mort D. Barron has been appointed to the position of assistant sales promotion manager. Barron will primarily be responsible for the design of point-of-purchase displays, literature and dealer cooperative advertising, as well as assisting CBS-Columbia advertising manager Gerald Light in other promotional functions.

Judges Hold Session At GE's "Bigger Summer Business" Contest



Judges in GE's "Bigger Summer Business" contest for dealers look over entries of contest finalists at NEDA convention in Atlantic City. Left to right are G. A. Bradford, manager of advertising for the GE tube department; Mort Farr, president of NARDA; John T. Thompson, manager of GE replacement tube sales; and John F. Rider. George Wedemeyer, retiring NEDA president, and Howard Sams also took part in the judging. Winners were C&W Television Service, Inc., Cambridge, Mass.; Department 84, Harris Co., San Bernardino, Calif.; and Young's Radio & Television, Chicago, Ill. Winners will receive a new Dodge panel truck. The contest encouraged dealer sales promotion.

TIMETABLE of NEW TV STATIONS COMING on the AIR

A geographical listing of the 60 new commercial TV stations and 9 noncommercial educational outlets for which post-freeze FCC grants and construction permits had been issued through October 4, 1952. Information on expected start of telecasting is from operator's estimate furnished TELEVISION RETAILING.

STATE AND CITY	CALL LETTERS	CHANNEL	DATE ON AIR	STATE AND CITY	CALL LETTERS	CHANNEL	DATE ON AIR
ALA.: Mobile	WKAB-TV	48	December, '52	Syracuse (NCE)	*	43	*
Montgomery	WCOV-TV	20	March '53	OHIO: Akron	WAKR-TV	49	Winter, '53
ARK.: Little Rock	KWFT	17	*	Massillon	WMAC	23	March, '53
CALIF.: Fresno	KMJ	24	*	Youngstown	*	21	*
Los Angeles (NCE)	*	28	*	Youngstown	WFMJ-TV	73	*
COL.: Denver	*	20	*	Youngstown	WKBN-TV	27	*
Denver	KBTW	9	October 12, '52	ORE.: Portland	KPTV	27	Sept. 18, '52
Denver	KFEL-TV	2	July 21, '52	PA.: Harrisburg	WHP-TV	33	*
Denver	*	26	*	New Castle	WKST-TV	45	January, '53
CONN.: Bridgeport	WICC-TV	43	January, '53	Reading	WEEU-TV	33	July 1, '53
Bridgeport	*	49	*	Reading	WHUM-TV	61	December, '52
New Britain	WKBN-TV	30	January, '53	Scranton	*	73	*
FLA.: Ft. Lauderdale	WITV	17	*	Scranton	WGBI	22	April 1, '53
Ft. Lauderdale	WFTL-TV	23	March, '53	York	WNOW-TV	49	Feb. or Mar., '53
ILL.: Peoria	WEEK-TV	43	March, '53	York	WSBA-TV	43	Nov., '52
Rockford	*	39	Feb. or Mar., '53	Wilkes-Barre	*	28	*
IND.: South Bend	*	34	*	Wilkes-Barre	*	34	*
KANS.: Manhattan (NCE)	*	8	*	S. C.: Columbia	WNOK-TV	67	Jan., '53
KY.: Ashland	*	59	*	Columbia	WCOS-TV	25	Spring, '53
LA.: Baton Rouge	WAFB-TV	28	Feb., '53	TENN.: Chattanooga	*	43	*
MASS.: Fall River	*	46	May, '53	Chattanooga	*	49	*
New Bedford	*	28	*	TEX.: Austin	*	18	*
Springfield-Holyoke	WWLP	61	January, '53	Austin	KTBC-TV	7	December 1, '52
Springfield-Holyoke	WHYN-TV	55	March, '53	Austin	*	24	*
MICH.: Ann Arbor	WPAG	20	*	El Paso	KROD-TV	4	December, '52
Flint	WCTV	28	January, '53	El Paso	KTSM-TV	9	January, '53
Saginaw	*	12	*	Houston (NCE)	*	8	*
MISS.: Jackson	*	25	*	Lubbock	KDUB-TV	13	Before Nov. 5, '52
NEB.: Lincoln	*	57	*	VA.: Roanoke	WROV-TV	27	December, '52
N. J.: Asbury Park	*	58	*	Roanoke	WSLS-TV	10	January 1, '53
N. Y.: Albany (NCE)	*	17	*	Spokane	KHQ-TV	6	Spring, '53
Binghamton (NCE)	*	46	*	Spokane	KXLY-TV	4	December, '52
Buffalo (NCE)	*	23	*	HAWAII: Honolulu	KGMB-TV	9	April-June, '53
New York City (NCE)	*	25	*	PUERTO RICO: San Juan	WKAQ-TV	2	April, '54
Rochester (NCE)	*	21	*				

* Information not available at press time. (NCE) Noncommercial educational.

See also Caldwell-Clements Statistics in World Almanac, Encyclopaedia Britannica, National Industrial Conference Board "Fact Book," and "Information Please" Almanac

Arvin Names Managers



Pearson (Red) Graham (above) of Pittsburgh, has been appointed Arvin district manager in the West Virginia, western Pennsylvania and western New York state territory. William F. Turner of Indianapolis has been appointed field sales representative for Arvin in Michigan. Announcement was made by Gordon T. Ritter, director of Sales of the electric housewares division of Arvin Industries, Inc., Columbus, Ind.

Goldsmith Joins Sonora



Henry Goldsmith has been appointed manager of the Sonora brand sales division of Sonora Radio & Television Corp., Chicago, it was announced by Joseph Gerl, firm president.

Golenpaul Addresses PRSMA



In keeping with the Pennsylvania Radio Servicemen's Assoc. (PRSMA) policy of having one monthly meeting devoted to a talk by one of the leading service experts, Charles Golenpaul, jobber sales manager of Aerovox, recently entertained the group of over 250 servicemen with amusing stories and pertinent service information. James T. Daly, president of the Association, also addressed the meeting.

People in the News

Turner Appoints Moss



Thomas H. Moss has been appointed assistant sales manager of the Turner Co., Cedar Rapids, Iowa, it was announced by R. P. Evans, president of the company.

They Like the Coffeematic



A pair of Texans are dazzled by the starry reflections on Universal's Coffeematic with Wilbur Dixon (right), district manager, looking on at a recent Landers, Frary & Clark, sales training meeting. Left and center: "Andy" Anderson, buyer and manager, Hall Wholesale Co., Dallas; Walter Darden, buyer and manager, Huey Philp Hardware Company, Dallas.

Karl in Stewart-Warner Post



George Karl has been appointed manager of the research and market analysis department of Stewart-Warner Electric, the radio and television division of Stewart-Warner Corp., it was announced by Edward L. Taylor, sales manager.

RCA Victor Promotes Haber



Julius Haber (above) has been appointed director of public relations for the RCA Victor Division, Radio Corporation of America, it was announced by C. M. Odorizzi, operating vice-president of the division.

JFD Names Leslie



Mort Leslie (above) has been appointed assistant sales manager of JFD Manufacturing Company, Inc., Brooklyn, New York.

Tung-Sol Makes Two Promotions



L. E. Cotsen (left) has been promoted to manager of renewal sales, Tung-Sol Electric, Inc., it was announced by R. E. Carlson, vice-president in charge of sales. Walter R. Ohlsen (right) is now manager of the Eastern sales division.

Raytheon TV Sales Help

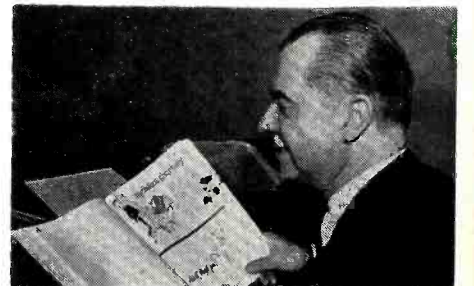

James Butler, sales promotion manager of Raytheon Television and Radio Corp., Chicago, studies his company's new book of store-traffic builders and sales aids. This colorful guide is available to all distributors and dealers in conjunction with the company's 1953 line.

SYLVANIA PICTURE TUBES

Out-perform, out-last all others tested!

Fifty minutes on . . . ten minutes off . . . hour after hour for 500 consecutive hours, Sylvania Picture Tubes were tested side by side with the tubes of other leading manufacturers.

These intensive tests, made under punishing, accelerated voltages were conducted under supervision of an outside, independent laboratory. Checks were also taken over a 3-month period for emission, leakage, color, light out-put, grid control, and other characteristics.



impartial testing company
proves **SYLVANIA**
picture tubes
are Finest!

Read the remarkable record.

The chart at right tells the story. Note that *only* Sylvania Picture Tubes showed no failures. And, in over-all point quality, *Sylvania won over all other brands by a wide margin.*

These important conclusions definitely place Sylvania Picture Tubes in the highest rank. They also mean the highest in trouble-free operation . . . better business . . . more satisfied customers for every dealer who orders Sylvania Picture Tubes. For full details about these important tests write today to: Sylvania Electric Products Inc., Dept. R-2411, 1740 Broadway, New York 19, New York.

SYLVANIA



RADIO TUBES; TELEVISION PICTURE TUBES; ELECTRONIC PRODUCTS; ELECTRONIC TEST EQUIPMENT; FLUORESCENT TUBES, FIXTURES, SIGN TUBING, WIRING DEVICES; LIGHT BULBS; PHOTOLAMPS; TELEVISION SETS

United States Testing Co.

1415 Park Ave., Hoboken, N. J.

Test No. E-5095
August 8, 1952

Manufacturer	Number of Tubes Tested	Number of Failures	Overall Point Quality
A	8	1	81
B	8	1	78
C	8	6	62
D	8	1	83
E	8	4	67
F	8	5	42
G	8	4	52
H	8	5	30
SYLVANIA	8	NONE	92

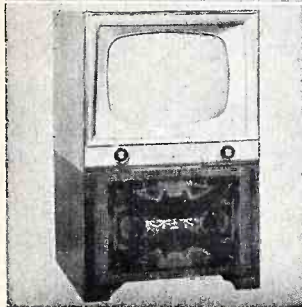

THERE IS A
Ridgeway
TV TABLE OR BASE

- For Every Television Set
- For Every Home Decor
- For Every Buyer's Purse

Every Ridgeway TV table and base, from designing board to the finished product, is built in the Ridgeway owned and operated furniture plant. This has made possible the consistent high quality and low prices that has made it America's No. 1 line.

Distributors! Chain Stores! Department Stores! Dealers!
Write for full information and illustrated brochure.



New York Sales Offices, TV Division
LOUIS R. GOLDMAN & CO.
251 West 42nd St., New York 36, N. Y.

Boss Appointed By RCA Victor



William E. Boss (above) is now manager of television market development for the RCA Victor home instrument department.

Admiral To Distribute Brach Couplers

The Admiral Corporation will distribute the newly-developed Brach low-priced two and four-set couplers, models 477 and 478, through their nationwide organization. Model 477 lists at \$5.45 and model 478 at \$6.95. In order to provide more successful sales of Brach products through Admiral Distributors, special arrangements have been made whereby Brach jobber representatives will train Admiral distributor personnel in the application and installation of Brach Mul-Tel products. The new Brach Mul-Tel products and all other Brach products will continue to be distributed through Brach's expanded jobber network.

STATEMENT REQUIRED BY THE ACT OF AUGUST 24, 1912, AS AMENDED BY THE ACTS OF MARCH 3, 1933, AND JULY 2, 1946 (Title 39, United States Code, Section 233) SHOWING THE OWNERSHIP, MANAGEMENT, AND CIRCULATION OF

TELEVISION RETAILING

TELEVISION RETAILING—TV-Electronic Technician Edition published monthly at Bristol, Conn., for October 1, 1952.

1. The names and addresses of the publisher, editor, managing editor, and business manager are: Publisher, M. Clements, Rumson, N. J. Editor, Orestes H. Caldwell, Catrock Road and Bible St., Cos Cob, Conn. Managing Editor, John L. Stoutenburgh, 20-41 Seagirt Ave., Far Rockaway, N. Y. Business Manager, M. H. Newton, 583 W. 215th St., New York, N. Y.

2. The owner is (if owned by a corporation its name and address must be stated and also immediately thereunder the names and addresses of stockholders owning or holding one per cent or more of total amount of stock. If not owned by a corporation, the names and addresses of the individual owners must be given). Caldwell-Clements, Inc., 480 Lexington Avenue, New York 17, N. Y.; M. Clements, Rumson, N. J.; O. H. Caldwell, Catrock Rd. and Bible St., Cos Cob, Conn.

3. The known bondholders, mortgagees, and other security holders owning or holding 1 per cent or more of total amount of bonds, mortgages, or other securities are: (If there are none, so state.) None.

4. Paragraphs 2 and 3 include, in cases where the stockholder or security holder appears upon the books of the company as trustee or in any other fiduciary relation, the name of the person or corporation for whom such trustee is acting; also the statements in the two paragraphs show the affiant's full knowledge and belief as to the circumstances and conditions under which stockholders and security holders who do not appear upon the books of the company as trustees, hold stock and securities in a capacity other than that of a bona fide owner.

(Signed) ORESTES H. CALDWELL
Sworn to and subscribed before me this 29th day of September, 1952.

WM. A. KANE
Notary Public, State of New York
No. 60-7152550
Qualified in Westchester County
Certs. filed with N.Y. Co. Clerk & Register
Term expires March 30, 1954

PENTRON
Foot Control
STOPS, STARTS
THE PENTRON
TAPE RECORDER
and PLAYERS



4 HOURS
RECORD-PLAYBACK
with REEL ADAPTER

9T-3C
\$179.50

list
Complete
without reel adapter

USES

For transcription, lectures, conferences and slide-film presentations in business and institutions.

Now!... in combination with its fast-selling tape recorder and players Pentron offers a Foot Pedal Attachment that instantly starts, stops program material at will, from a distance. Press to start... press to stop. Leaves both hands free. Simple (five minute) screwdriver installation. Send for complete information.

See... Hear ALL the Features That Make Pentron Your Greatest Profit Maker!

MULTI-SPEED
PENTRON
TAPE RECORDER

THE PENTRON CORP.

221-RF EAST CULLERTON STREET, CHICAGO 16, ILLINOIS
CANADA: ATLAS RADIO CORP. LTD., TORONTO, ONTARIO



the perfect link for

HIGH-FIDELITY TV

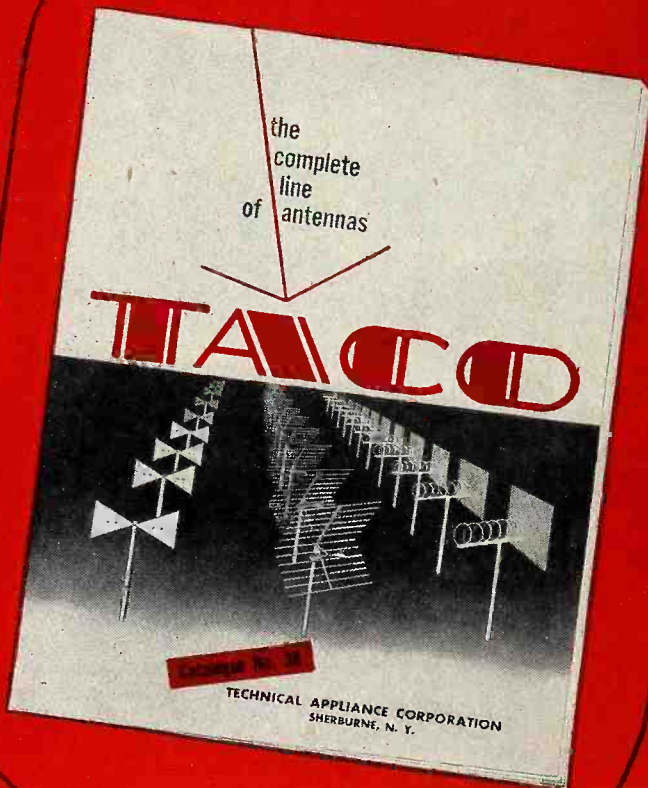

Hi-Fi TV depends on these plus features — antenna gain — high signal-to-noise ratio — full 6 MC response — controlled impedance-matching of the antenna system. Since 1938 TACO has led in production of quality television antennas, all having these plus features. It is little wonder that *all* the fine installations are TACO-equipped.

Your copy of TACO Cat. No. 38
-- the installers handbook **FREE**
-- at your jobber, or by writing to...

TECHNICAL APPLIANCE CORPORATION, Sherburne, N. Y.
In Canada: Stromberg-Carlson Co., Ltd. Toronto 4, Ont.

CASH PRIZE! ENTER THE TACO OLD ANTENNA CONTEST—ASK YOUR JOBBER FOR DETAILS!

a "TESCO" exclusive
the **ROCKETENNA**



by T-V PRODUCTS CO.

- ✓ Amazingly Powerful Reception
- ✓ Rugged All-Aluminum Construction
- ✓ Lifetime Factory Warranty

Complete factory Preassembly features sensational "Quick-as-a-Wink" construction. No Nuts or Bolts to Tighten... rugged rivet assembly prevents damage by wind and-storm vibration.

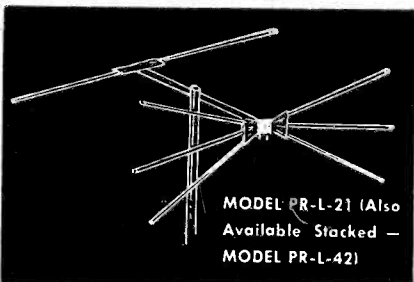
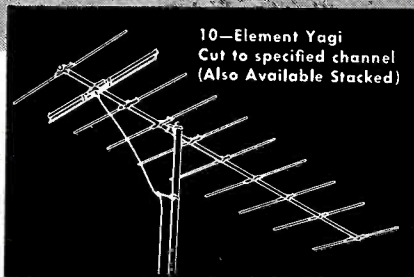

ANOTHER "TESCO" PRODUCT

T-V

Write for New Complete Catalog R

PRODUCTS CO.

152 SANDFORD ST. • B'KLYN, N. Y.



Mosher Appointed G-C Rep

The R. D. Mosher Company, Needham, Mass., was recently appointed sales representative for the General Cement Manufacturing Co., Rockford, Ill., according to R. G. Ellis, general sales manager. Headed by R. D. (Bob) Mosher, the firm will cover the entire New England territory for G-C, manufacturers of electronic hardware, parts and accessories.

Admiral Ups Some Prices

W. C. Johnson, vice-president-sales of Admiral Corporation, has announced that increasing production and materials costs have resulted in the following price changes: Clock-radio (5X21, 22, 23), which formerly listed at \$29.95, \$32.95 and \$34.95, now retails for \$32.95, \$34.95 and \$36.95. Admiral's deluxe clock-radio, (5A32, 33), which originally listed for \$37.95 and \$39.95, has been increased \$2. Radio-phonograph combination (5Y22) formerly retailed for \$69.95 and now is listed at \$79.95.

Miller Announces Rep List

The Miller Television Company, Burbank, California, a pioneer in the field of antenna developments, has announced its complete list of representatives. The reps and their territories are: Earl K. Moore, 562 Sizler Ave., New Orleans—Louisiana and Mississippi; R. A. Adams, 17636 Edinborough Rd., Detroit—Michigan area; Edward Hoffman, 1641 Scheffer Ave., St. Paul—Minnesota area; S. W. Goodman, 32 W. Biddle St., Baltimore—Maryland, Washington, D.C., and Virginia; Robert Amos, 2014 Dudsonbury Circle, Dallas—Oklahoma and Texas; Jerry Rogers, 104 Catalpa Terrace, Springfield, Mass.—Massachusetts, Connecticut, Rhode Island, and upper New York State; Eugene R. Loeb, 5052 N. Shoreland Ave., Milwaukee—Wisconsin; Leonard Minthorne, Weatherly Building, Portland—Oregon and Washington; Robert O. Whitesell, 2202 E. Washington St., Indianapolis—Indiana and Kentucky; A. W. Arnold, 1321 Rosedale Ave., Chicago—Illinois area; Richard Osborne, 1044 S. Parkview, Los Angeles—Southern California area; Sherwood French, 721 Garland Drive, Palo Alto—Northern California area; Walter Brauer, 15631 Lakewood Heights Blvd., Cleveland—Western Pennsylvania, Ohio and West Virginia; Tom Cox, RD 1, Greenland, Pa.—Eastern Pennsylvania and Delaware.

Walsco Storage Tray

Handy storage trays, designed to hold up to 20 sliding-lid plastic containers and enable service men to keep small hardware items neatly stacked and easily available is being offered to service men who purchase Walsco 50 Line packages. A descriptive label, showing the item and part number, appears on each plastic box for quick identification of items in the tray, which can be mounted on the service man's wall or placed on a shelf or work table.

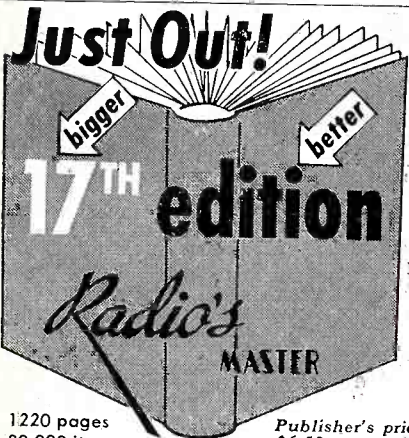

- 1220 pages
- 80,000 items
- 8,000 illustrations
- 8" x 11" — 5 lbs.

Publisher's price \$6.50—your price through your regular parts distributor \$1.95.

The right part when you need it for service

This permanent, hard cover Official Buying Guide of the electronic-TV parts and equipment industry with its comprehensive detailed index, eliminates the need for maintaining files of small catalogs and manufacturers' literature. Radio's Master catalogs 90% of TV and electronic equipment. Not merely part number listings—complete descriptions, specifications and illustrations written and compiled by each manufacturer. Enables you to make comparisons or substitutions right now!



UNITED CATALOG PUBLISHERS, INC.
110 Lafayette St., New York 13

89-5332

MY-900

*Clearbeam's
Greatest
Antenna Yet!*

CLEARBEAM
BURBANK CALIFORNIA

TRIO ANNOUNCES SENSATIONAL NEW **ZIG-ZAG** ANTENNA

Patent Pending

- ★ **Higher Gain than any Yagi!**
- Plus
- ★ **All-Channel VHF Performance!**

Here's the greatest advance in TV antennas since TRIO'S introduction of the dual channel yagi! The sensational new TRIO ZIG-ZAG antenna is basically a multiple element yagi type antenna on each channel, yet one 2-bay antenna — and in some models a single bay antenna — covers all VHF channels!

This sensational antenna has sharper directivity and higher front-to-back ratio. It provides snow-free pictures, and fade-free sound even in the most remote fringe areas.

Tremendous forward gain is accomplished without long, bulky, arrays that operate on only one channel. With the new fringe area model ZIG-ZAG antenna, one bay provides tremendous gain on all low channels, 2 thru 6, and the other bay provides similar high gain on channels 7 thru 13.

HOW THIS AMAZING ANTENNA WORKS

Trio ZIG-ZAG antennas utilize a new principle whereby an array is composed of a series of elements, one or more of which is resonant on any one channel while the remaining elements, which are non-resonant on that channel, provide parasitic voltages having the proper phase relative to the direct voltage. These act as very efficient directors and reflectors. All elements are directly connected to the lead-line.

The various models, listed below, are designed to provide a simple installation for all areas, from metropolitan to extreme fringe. Two bay models, like the single bay models, are operated with a single 300 ohm lead-in to the set, with less than a 3:1 standing wave ratio.

8 MODELS FROM WHICH TO CHOOSE:

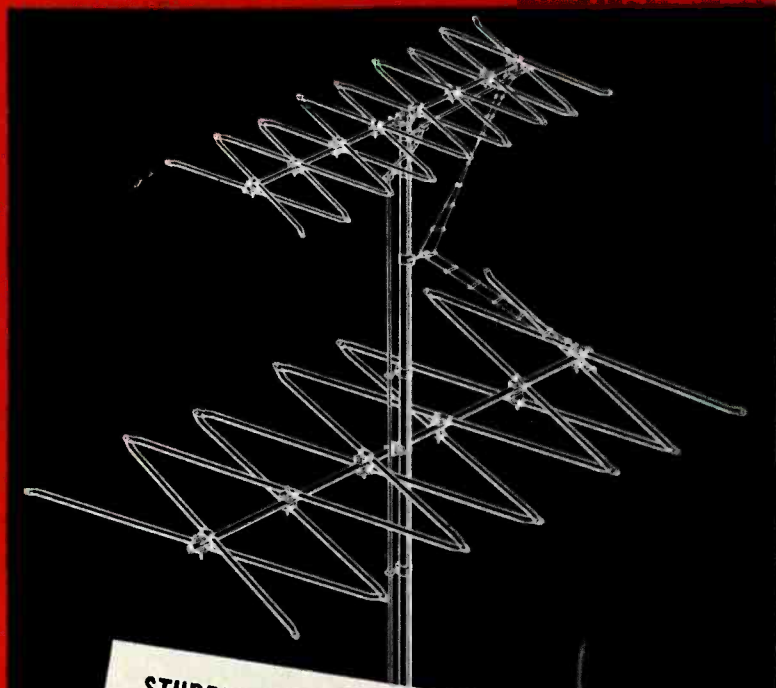

STURDY, VIBRATION-PROOF CONSTRUCTION
 Rugged strength is designed into all models. Antenna is shipped with all hardware mounted on the boom with the exception of the mast clamp. Complete assembly consists only of matching color-coded elements to the color-coded boom and tightening nuts which furnish clamping action. Complete assembly is accomplished in minutes.

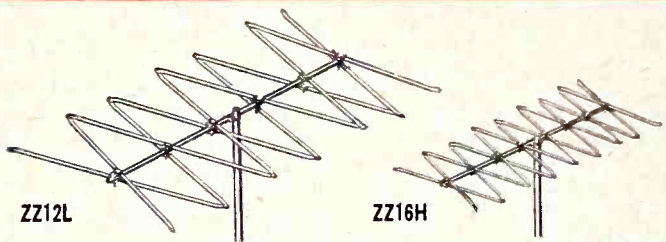

FOR EXTREME FRINGE RECEPTION — ZZ16H provides over 14 DB voltage gain as compared with a resonant reference dipole on Channels 7 thru 13; and ZZ12L provides gain of 12 to 14 DB on Channels 2 thru 6. Gain of the ZZ12L is 12 DB on Channels 2 and 3 and is 14 on Channels 4, 5 and 6. These models have narrowest forward lobe and highest front-to-back ratio and should be used in areas where co-channel interference is a problem.

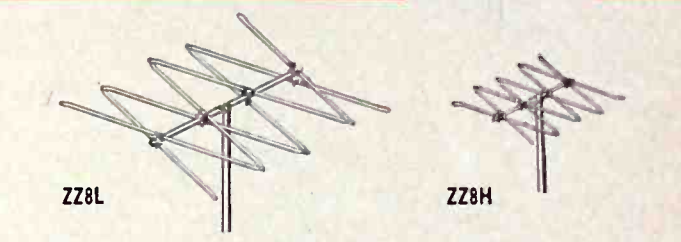

FOR NORMAL FRINGE RECEPTION — Where maximum gain is not necessary, these models are ideal. The ZZ8H for Channels 7 thru 13 and the ZZ8L for Channels 2 thru 6. Voltage gain is 9 DB on Channels 2 and 3 and 11 DB on Channels 4 thru 13. These models have patterns comparable to a well designed multi-element single channel yagi.

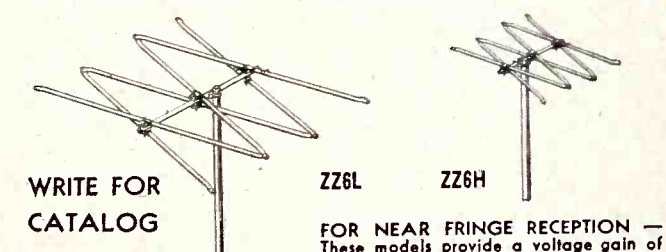

WRITE FOR CATALOG

FOR NEAR FRINGE RECEPTION — These models provide a voltage gain of 8 to 9 DB on Channels 2 thru 13. These models have pattern and gain comparable to a cut-to-channel yagi. ZZ6L covers Channels 2 thru 6. ZZ6H covers Channels 7 thru 13.

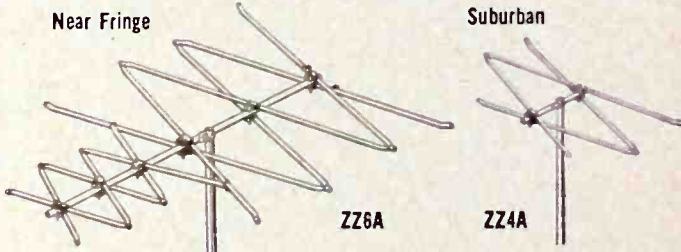

SINGLE BAY ALL-CHANNEL RECEPTION — Model ZZ4A is a single bay antenna providing adequate gain and directivity on all channels, 2 thru 13, in suburban areas. Model ZZ6A is also an all-channel single bay antenna providing greater gain for near fringe use.



TRIO MANUFACTURING COMPANY • GRIGGSVILLE, ILLINOIS



Tung-Sol "Quality Control" recognizes but one standard. All Tung-Sol Tubes meet the highest original equipment requirements of leading radio and tv set manufacturers! Use Reliable Tung-Sol Tubes.

TUNG-SOL ELECTRIC INC.
Newark 4, N. J.

Sales Offices: Atlanta • Chicago • Culver City
Dallas • Denver • Detroit • Newark

TUNG-SOL MAKES:

All-Glass Sealed Beam Lamps, Miniature Lamps, Signal Flashers, Picture Tubes, Radio, TV and Special Purpose Electron Tubes.

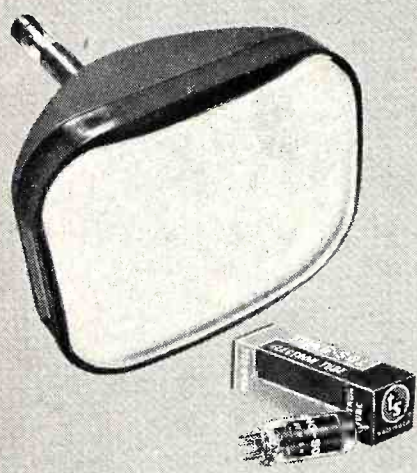

TUNG-SOL®
RADIO, TV TUBES, DIAL LAMPS



Here's a real lively "stopper" to attract attention to your place of business and emphasize the quality of your service. Colorful—bright red and two shades of blue. 15 inches high. Your jobber salesman will tell you how to get one.

NEDA Elects Officers

Newly elected officers of the National Electronic Distributors Association include: W. D. Jenkins, Radio Supply Co., Richmond, Va., president; Dahl W. Mack, Scranton Radio & Television Supply Co., Scranton, Pa., 1st vice-president; Gerald E. Murphy, Electronic Supply Corp., Battle Creek, Mich., 2nd vice-president; Max I. Epstein, Federated Purchaser, New York, N.Y., treasurer, and J. Howard Klein, All-State Distributing Co., Dallas, Tex., secretary. Aaron Lippman, Aaron Lippman & Company, Newark, N.J., was unanimously reelected as chairman of the board. Retiring officers are George Wedemeyer, Wedemeyer Electronic Supply Co., Ann Arbor, Mich., president; Mr. Jenkins, 1st vice-president; Byron C. Deadman, Northern Radio & Television Co., Green Bay, Wisc., 2nd vice-president; H. E. Ruble, SREPCO, Inc., Dayton, Ohio, treasurer and Harry Stark, Stark Radio Supply Co., secretary. Members of the Nominating Committee chaired by Anthony Dybowski, Dymac, Inc., Buffalo, N. Y., included Bill Kerlin, Shuler Supply Co., New Orleans, La., J. G. Prestwood, Jr. Prestwood Electronics Co. Augusta, Ga.; Roger Fjelstad, General Radio, Inc., Seattle, Wash.; Albert Steinberg, Albert Steinberg & Co., Philadelphia, Pa., and H. Tory Horn, Western Electronic Supply Co., Seattle, Wash.

New Pennwood Numechron Rep

Pennwood Numechron Company has announced that it will be represented on the East Coast by Edward I. Shurack, and that the sales office will be: Edward I. Shurack, 230 Fifth Ave., New York 1, N. Y.

JFD UHF ANTENNAS

A full line of UHF antennas is being marketed, including rhombics, single and stacked V's, corner reflectors and a combination Jetenna-UHF antenna. The latter, Jetenna 283, combines the fan-front Jetenna with a broad band

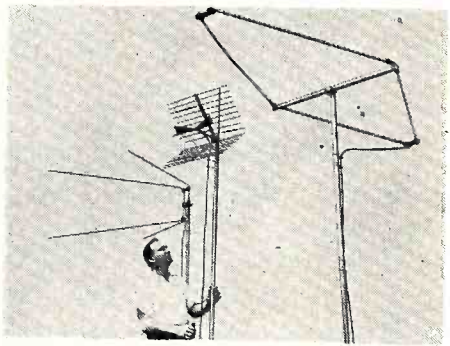

triangular dipole UHF antenna. A single lead-in is used. The UHF stacked-V provides rising gain with rising frequency, said to be over 12 db. The corner reflector offers up to 12 db gain. The rhombic also has a rising gain characteristic with frequency. A special catalog for the UHF antennas will be available. JFD Mfg. Co., Inc., 6101-16th Ave., Brooklyn 4, N.Y.—TELEVISION RETAILING.

GE Public Relations Program Will Aid TV Technicians

General Electric plans a four-point public relations program to combat "an attitude of suspicion in the public mind towards the TV serviceman." John T. Thompson manager of GE tube replacement sales, said that the program must be headed by electronic components manufacturers and actively endorsed and supported by distributors and dealers. He claimed that unorganized dealers cannot, by themselves, change the tide of public opinion and pointed out that suspicion of the serviceman has become a threat to the entire industry. The first two points in Thompson's program, presented before the NEDA Convention, recognize the need for increased understanding between manufacturers and distributors and distributors and service dealers. Third, he said, distributors and manufacturers must help the serviceman to improve his operations. Dealers should be trained in efficient business practices, effective promotion, and advertising their policies of honest billing and good work. Fourth, manufacturers and distributors must tell the public directly of the merits of the serviceman. "Denying the statements made about the TV serviceman isn't going to correct the situation. What is needed is a positive attack on the problem," said Thompson. He cited a full-page advertisement in support of television servicemen which the Tube Department ran in *Life* and *Collier's*. Thompson said that the serviceman was an honest, conscientious "professional" who is a necessary part of television enjoyment.

RMS Production Expansion

Radio Merchandise Sales, Inc., announces a recent expansion in their facilities for producing TV open transmission line. When first introduced, RMS officials say some resistance was offered to the new type of line simply because it appeared to have less durability than conventional wire lines. Tensile strength pullout test results, however, show the strength of open line to be as good as that for many types of twinex. New RMS open line production machinery is now turning out, in addition to #18 gauge Copperweld (40% copper jacket over 60% steel core) line, solid copper open line. Both types are also available with Formvar high frequency protective coating.

New Plant for Spico

Spiraling Products Co., Inc., New York City, manufacturers of the Spico line of indoor television antennas, recently announced the plans for moving their manufacturing facilities from 62 Grand Street in N. Y. to a new modern plant on Henrietta St. at Duffy Ave., in Oyster Bay, N. Y. According to Milton Spirt, president, the ever-increasing demand for the Spico "Super Phantom" indoor TV antenna has made the expansion mandatory.

only **WARD** antennas assure you

The new "TROMBONE" and
"U-VEE" Antennas are the first
practical antennas
to cover all channels

both UHF and VHF . . .

Fully proved . . . Thousands in use in UHF areas prove

"U-VEE'S" and "TROMBONE'S" performance

. . . Thousands of "TROMBONE'S" in use in fringe
areas, prove their specific adaptation
to these hard-to-reach locations.

Install "TROMBONE" and "U-VEE"
now and be prepared for any new
stations, whether VHF or UHF. Use
this extra protection to sell more TV
sets, too.

Get the "TROMBONE" and the
"U-VEE" at Your Distributor Today.

write for catalogue

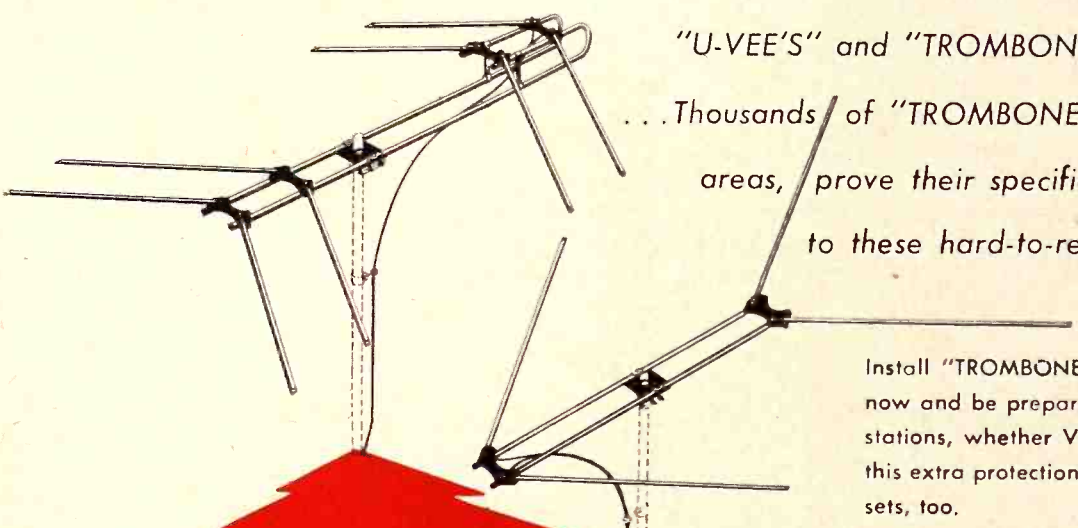

The **Trombone** provides high gain on all channels VHF and UHF. It is specifically designed for fringe areas.

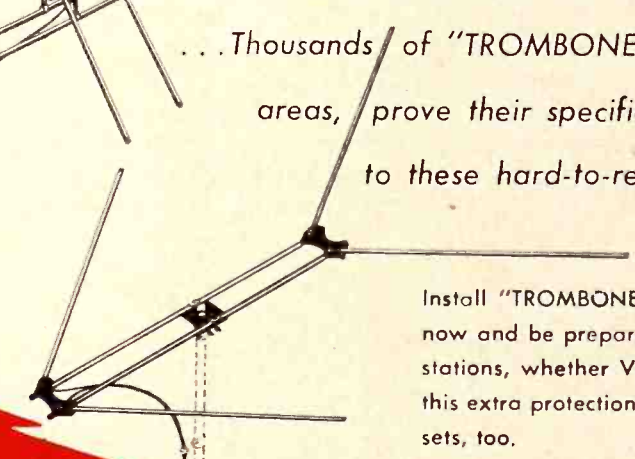

The **U-Vee** similar to the "TROMBONE", with high gain on all channels VHF and UHF, is designed for metropolitan areas.



THE WARD PRODUCTS CORPORATION

Division of The Gabriel Company

1523 East 45th Street • Cleveland 3, Ohio

In Canada: Atlas Radio Corp., Ltd., Toronto, Ont.

Trav-Electric

\$15⁹⁵
LIST

Model 6-1160



MIGHTY MIDGET CONVERTER

Just plug into Cigar Lighter on Dash

Converts 6 volts D.C. to 110 volts A.C. 60 cycles 40 watts.



PORTABLE PHONOGRAPH

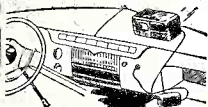

IN THE CAR - IN THE TRUCK



DICTATING MACHINE



ELECTRIC SHAVEN



IN BOATS

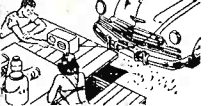

AT PICNICS - OUTINGS

Ideal for phonographs and turntables at beach, or picnic.

Radios, short wave or broadcast bands in car, truck and cabin, etc.

Small dictating machines . . . ideal for salesmen, business or professional men.

Electric shaver works beautifully when it is plugged into Trav-Electric. A great time saver.

Boats—the 110 volts A.C. operates radios, lights, etc.

Ideal for outdoor musical entertainment from table radio to phonographs, including most wire and disc recorders.

Fully Guaranteed THOUSANDS IN USE FULL DEALER AND JOBBER DISCOUNTS.

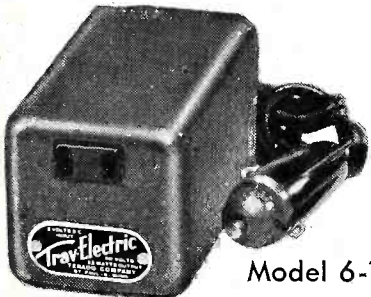

Model 6-1160

Size 2½" x 2½" x 3½"

TERADO Company

Mfrs. of Precision Equipment
1068 Raymond Ave., St. Paul 14, Minn.

OPS Again Slaps Price Ceilings on Parts

Price ceilings on TV, radio, phono parts, which were suspended last August, have been restored by OPS. The RTMA has protested against the action which it calls "arbitrary," and has sent a telegram to Director Tighe E. Woods urging that the order be rescinded until industry has a hearing. Following the protests, OPS amended the effective date from Oct. 15 to Oct 21, and set a hearing for Oct. 21.

Zenith Appoints Bryant

Paul Bryant has been named Western sales manager of Zenith Radio Corporation, according to an announcement by L. C. Truesdell, vice-president of radio and TV.

Pincus Heads Motorola-N.Y.

Edward L. Pincus has been named president of Motorola-New York, Inc., announces William H. Kelley, national vice-president in charge of sales. Allen Williams, now vice-president in charge of operations of the New York branch has been named assistant sales manager of the parent company.

JFD's 10 Millionth TV Antenna

The management of the JFD Manufacturing Co., Inc., of Brooklyn, N. Y., has announced production of its 10 millionth TV antenna since the start of production in 1946. The firm is now producing between 9 and 10 thousand aerials per working day.

Sonora Announces New Policy

Joseph Gerl, president of Sonora Radio & Television Corp., has announced a new policy by which specially-fine TV-radio-phonograph combinations are sold through one exclusive retailer in each major selling area. These combinations all feature a 21" screen, plus radio and a 3-speed phonograph. Sonora insists on a full dealer mark-up for these combinations with step-ups all along the line. All sets will be fully tested to insure perfect reception and sharp pictures in all TV broadcasting areas.

Crest CRT REJUVENATOR

Model "D" is a new picture tube rejuvenator designed to operate with all series filament television receivers. Certain receivers on the market require a

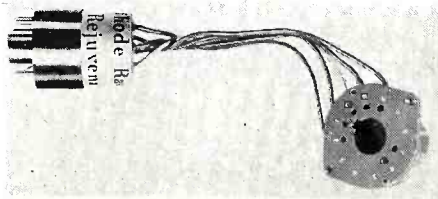

series filament type rejuvenator, the maker states. Dealer net is \$3.10. Crest Laboratories, Whitehall Bldg., Far Rockaway, N.Y.—TELEVISION RETAILING.



Where You Need it! When You Need It!

NOW—no more halted work, no more writing to the factory for missing instruction sheets. Tough identifying labels giving complete application and hook-up data are affixed to all Halldorson components. This provides maximum convenience in original installations or reuse at some later date. The same data appears on each box for instant identification.

This is only one of Halldorson's many aids designed to save your valuable time. Look to Halldorson for the biggest variety of transformer components, plus the newest for TV. Ask your distributor for your copy of Halldorson's great new catalog and TV Replacement Guide... today. The Halldorson Transformer Co., 4500 N. Ravenswood Ave., Chicago 40, Ill. Dept. TR11



HALLDORSON

QUALITY Transformers SINCE 1913

EXPORT: Intex Co., Inc., 136 Liberty St. New York 36, N.Y. Cable Address: Intexcom, N.Y.

South River

★ ★ NEWS ★ ★

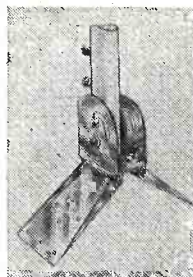

PEAK & FLAT ROOF MOUNT Model PFM-1

(New improved model with drop lock feature)

Heavy-gauge steel, embossed for extra strength, hot dip galvanized. Adjustable flaps permit mounting on any peak, flat or pitched roof. Mast socket, mounted on swivel, drops and locks securely. It accommodates masts to 1-5/8" O.D. With hardware.

South River Antenna Mounting Accessories are carried by every leading TV Parts Jobber from coast to coast.

Write for your copy of our new 1953 catalog.

SOUTH RIVER METAL PRODUCTS CO., INC.
SOUTH RIVER, N. J.

PIONEER AND OUTSTANDING PRODUCER OF FINEST LINE OF ANTENNA MOUNTS

What Rauland means by "Perfection Through Research"

Rauland is one of the few companies devoting so much top engineering talent full time to picture tube improvement and perfection.

The result of this painstaking research has been to give you many more picture tube advancements since the war than has any other manufacturer . . .

more dependability and faster installation in the field for service dealers and service men . . . and greater assurance of customer satisfaction when you install Rauland replacement tubes.

That's why more and more jobbers, dealers and service men are standardizing on Rauland replacement tubes.

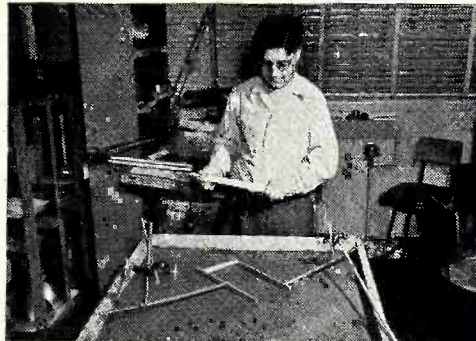
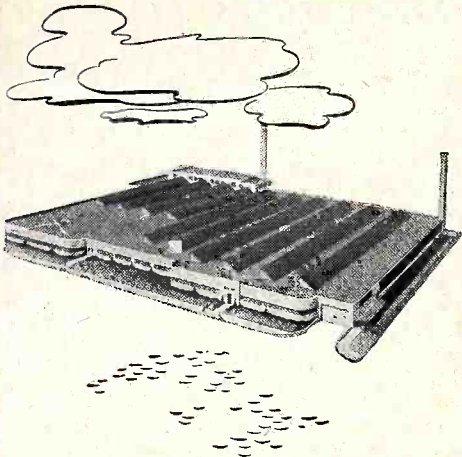

Rubber model for studying electron optical designing—basis for Rauland's exclusive Indicator Ion Trap.

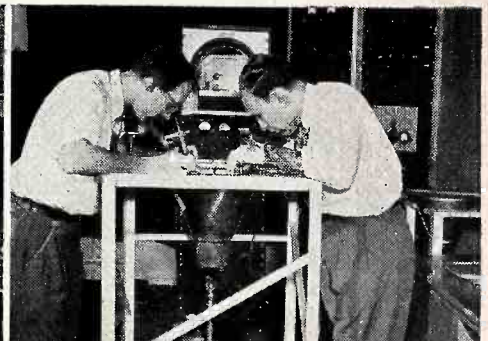

Alignment of the screen and parallax mask of tri-color tube containing approximately a million fluorescent dots.

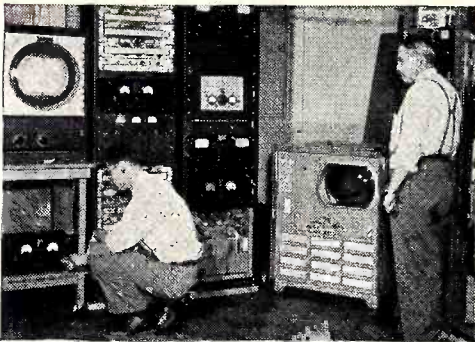

All-electronic tri-color tube in electronic receiver system (left) in comparison with mechanical system (right).

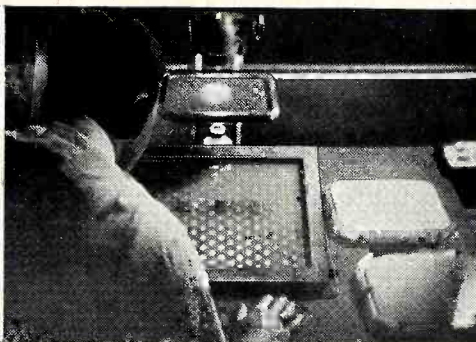

Inspection and checking of perforations .0075" in diameter in masks of tri-color picture tubes.

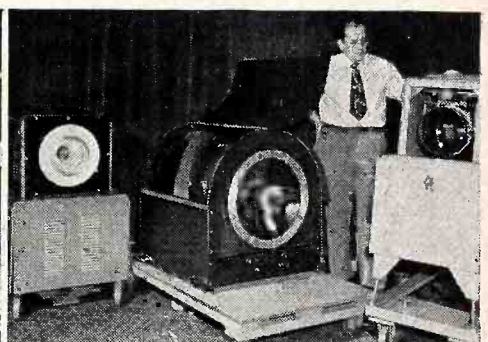

Rauland large-screen projectors using three different optical systems, all of which give theater-size pictures.

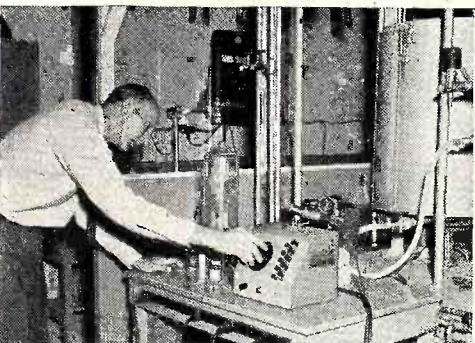

Careful study of the formation of thin metallic films in a vacuum . . . basis for the aluminizing of tubes.



Examination with polarimeter permits careful control of strains for superior glass-to-metal sealing.

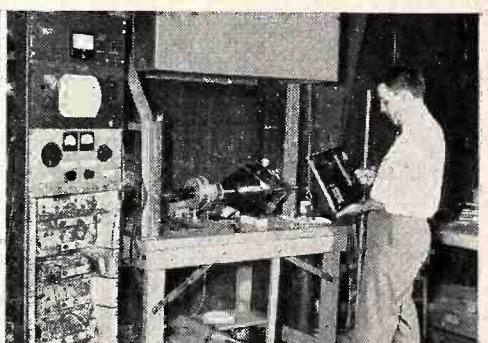

A physicist using a Rauland-developed radiation meter in checking X-ray radiations from cathode ray apparatus.

THE RAULAND CORPORATION



Perfection Through Research
4245 N. KNOX AVENUE • CHICAGO 41, ILLINOIS





Kansas City, Mo. Service, and where to obtain it, is featured in this poster that works fulltime for the serviceman whose name and number show prominently at center. Floodlighting increases the board's usefulness.

Now—for the first time—

FULL-SIZE BILLBOARD ADVERTISING FOR TV-RADIO SERVICEMEN!

Another G-E "first!" Colorful 24-sheet posters spotlight the serviceman's name and phone number —tell owners *who to call for service!*

● Coast to coast, big G-E-tube posters in full colors are answering the query of TV-radio owners: where can I go for reliable, experienced service? Simultaneously, the billboards meet the serviceman's need to tell customers where his shop is located, how to phone him.

G-E-tube posters are a thrifty and productive advertising medium for the serviceman. Hundreds of postings already have been contracted for. They are located where customers-to-be see them, and their large size assures attention. In every case, the serviceman's name, address, and phone number appear in bold type in the center of the poster.

Assisted energetically by G-E tube distributors, G.E. is proud to have pioneered this business-getting aid for servicemen! *Tube Dept., General Electric Co., Schenectady 5, N. Y.*

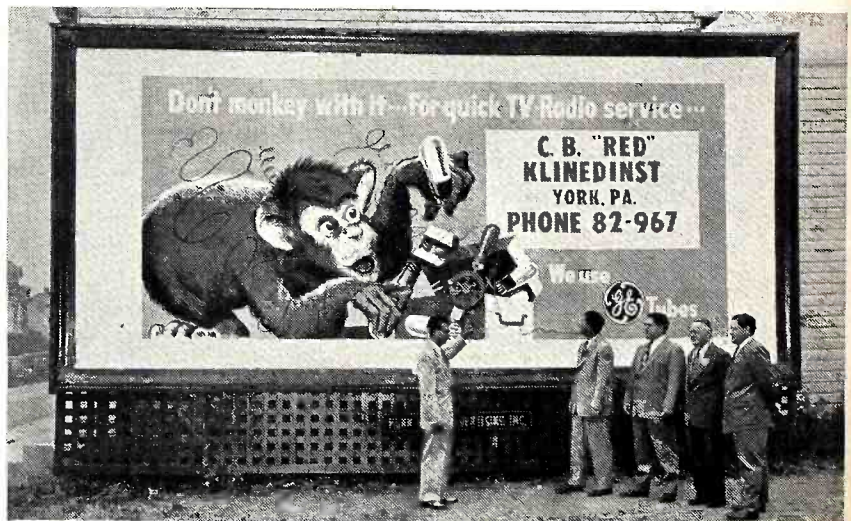

York, Pa. Beside a busy street, this board is seen, read, and remembered by thousands of TV-radio owners who walk or drive past.

GENERAL  ELECTRIC

161-1A6

Telephoned Reports from All Sections Reveal

STATE of the MARKET

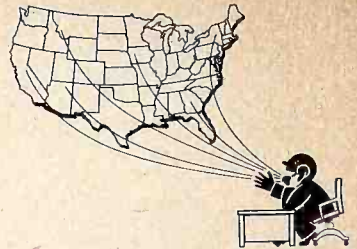

NEW YORK

BIZ IN BIG CITY PICKING UP, and is fairly good but not what it should be. . . . Short-ages of some fast-moving TV sets. . . . Refrigerators slow, but food freezer biz fairly good. . . . Auto washers moving well. . . . Price-cutting still going on but there's a decline in ads offering drastic cuts. . . . Record sales healthy, with one of biggest dealers 30% ahead of last year, but merchants are hard put trying to keep up with flood of new releases.

BOSTON

MOVING AHEAD. A steady climb in sales since Labor Day. . . . Some TV set shortages, especially in certain 17-inch models. . . . Record sales holding up well, but there's still price-cutting. . . . Good activity in food freezers.

LOS ANGELES

SALES SPURT HERE WITH POST-CONVENTION LULL A THING of the past. . . . Inventories low with some shortages in TV sets and white goods. . . . Dealer credit satisfactory.

DENVER

ON FIRE AGAIN WITH TV SELLING, and they expect to have sold 100,000 sets by Jan. 1. . . . KBHV, city's second station, began regular broadcasting Oct. 12 on Channel 9, with reception coverage far beyond all expectations. Strong signals from here to Cheyenne, Wyo., Colorado Springs, etc., indicate service will be extended to area within radius of 100 miles. . . . Business in other products good.

PHILADELPHIA

MARKET STRONG AND CLIMBING with sharp increases expected. . . . Some TV sets in short supply, with phono records selling at a brisk rate. . . . Service volume holding up well. . . . Food freezers and laundry equipment moving at a lively pace.

CHICAGO

SALES PICKUP IN WINDY CITY, with biz described as "good but not phenomenal" by a leading dealer. . . . Spot shortages of some wanted TV sets, and a few major appliances hard to get. . . . Freezers and ranges selling well. . . . Look for sharp sales climb soon.

DALLAS

TV COMING TO LIFE following break in hot weather, and watch for sales to really step out when new station opens at Austin next month. . . . Re rumored shortages of some TV sets, one local expert says because promotional low-priced jobs are nailed to floor in order to sell up. . . . Air conditioners, which went well last year, should be star sellers next Summer.

DES MOINES

SALES BIGGER AND BETTER than ever before in city's history. . . . Temporary shortage of some TV sets and receiving tubes. . . . New TV stations a year away.

SALT LAKE CITY

TV SETS SELLING WELL IN FRINGE areas, a bit slow in the city. . . . Expecting shortages of TV receivers here before long. . . . Appliances moving fairly well, with but a few shortages. . . . Supplies of parts adequate except for a few types of tubes. . . . Service departments enjoying a good volume of business.

NASHVILLE

BRISK MARKET IN TV SETS with low-priced models scarce. . . . A leading merchant's television sales up nearly 50% over last year. . . . White goods slow right now, but expected to pick up. . . . Dealers will go in heavily for room air conditioners. . . . Phono records quite active. . . . Increasingly large number of sales here being handled via time-payment plans.

BUSINESS COMES BACK WITH A BANG!

ALL-IN-ALL THE OUTLOOK'S ROSY, and business seems bound to be good well into '53. . . . New stations will keep TV sales steady through the coming year. . . . Small appliances will go well this Xmas, and are moving fast in most markets. . . . Portables and clock-radios selling well. . . . White goods outlook good, and air conditioner sales could double in '53. . . . Service volume will spiral in '53. . . . Looking back, sales volume slumped (service biz rose) during World Series as many folks sat with eyes glued to TV screens, and salespeople didn't want to be bothered by customers. . . . for PORTLAND SITUATION WHERE THE FIRST UHF STATION IN THE U.S. CAME ON THE AIR SEPTEMBER 20, SEE SPECIAL ARTICLES IN THIS ISSUE.

Your Hottest Line For Christmas Gift Selling!



IF IT PLAYS
RECORDS
SYMPHONIC
BUILDS IT!



3-SPEED CO-ED MODEL 729
**One of the Great New Models
in the Symphonic '53 Line!**

Revolutionary in design, years ahead in performance, priced for immediate sales appeal! New luggage type train case that is distinctively different, heavy duty 3-speed motor, full range tone control, switch and volume control. Gabardine blue pin-seal grain pyroxilyn covering, lined with Irish linen pattern leatherette, two luggage locks.



Also available in basket weave beige and Nile green coverings with smart contrasting trims and bindings.

Write for New Symphonic Illustrated Dealer Brochure
With Complete Line Information

SYMPHONIC RADIO & ELECTRONIC CORP.

160 North Washington St., Boston 14, Mass.
N.Y. Office: 1926 Broadway, New York 23, N.Y.

For Quick Christmas SALES!

The Original "Tenna-Boat"

Indoor Antenna

now has in-direct lighting from cockpit — interior of boat is completely illuminated



Pat.
App.
For

- Beautiful ceramic of finest quality
- Best performance
- Eye-appeal to create sales
- Ease of operation—move boom of boat to orient for peak reception.
- Tuning condenser assures perfect impedance match.

Model TB 400
\$1295 list price
Model TB 400-L
\$1495 with light

TELEVISION LAMPS for Christmas sales—Write for information on these fast-sellers TODAY!

SOLD through JOBBERS ONLY!
Write for new Literature!



Tricraft Products Co.

1535 North Ashland Ave.
Chicago 22, Ill.

Do you carry

DOMONT or Capehart

TV SETS?

Wrap them up in water-repellent Webb Wrapabouts! Safe from hazards of rough handling during the rush of holiday business; secure from winter weather damage. Snug Wrapabouts combine rugged, quilted pads and cushioned flaps. Pads fasten to sides; flaps cover tops of TV sets.

**FOUR WRAPABOUT MODELS FIT
ALL SIZES OF EVERY MAKE**

Soft flannel lining prevents scarring and scratching of veneers or mirror finishes. Wrapabouts slip on easily, can be used over and over again for clean, safe delivery that builds confidence and good will.

Write for Wrapabout Sizes and Prices



WEBB MANUFACTURING CO.
1920 N. 4th Street • Philadelphia 33, Pa.

Better Mul-Tels mean
better reception

Brach has them!



Cast Aluminum Box



Plastic Mahogany Box

#300-300 Now \$10.95	#477 \$5.25
2-Set Coupler	2-Set Coupler
#300-72 Now \$11.95	#477-S \$5.45
4-Set Coupler	2-Set Coupler
#72-72 Now \$11.95	#478 \$6.95
4-Set Coupler	4-Set Coupler

- Complete filter action insured by Brach's factory adjusted coils.
- No loading effects between connected television sets.
- Model 477-S is aluminated; the only coupler shielded from the inside.



MANUFACTURING CORP.

Division General 200 Central Ave. Newark 4, N. J.
Bronze Corp

INDEX TO ADVERTISERS — NOVEMBER, 1952

Admiral Corp.	49, 57	Radio Corp. of America	36, 37, 55, Cover 4
All Channel Antenna Corp.	20	Radion Corp.	30
Alprodco, Inc.	78	Rauland-Borg Corp.	81
American Phenolic Corp.	80	Rauland Corp.	113
American Television & Radio	117	Raytheon Mfg. Co.	24
Arvin Industries, Inc.	8, 31	Raytheon Television & Radio Corp.	7
Astatic Corp.	96	Recoton Corp.	100
Bendix Radio Television and Broadcast Receiver Corp.	25	Regency Div., IDEA	4
Brach Mfg. Corp.	116	Revere Camera Co.	26
CBS Columbia, Inc.	Cover 2	Ridgeway Div., Gravely Novelty Furniture Co.	106
Capehart-Farnsworth Corp.	79	Snyder Mfg. Co.	6
Cass Machine Co.	98	South River Metal Products Co., Inc.	112
Channel Master Corp.	89	Sparton Radio-Television	67
Clear Beam TV Antennas & Accessories	108	Standard Transformer Corp.	99
Commercial Credit Corp.	13	Steelman Phonograph & Radio Co., Inc.	118
Cornell-Dubilier Electric Corp.	76	Stewart Warner Electric, Div. of Stewart Warner Corp.	80
Crosley Div., Avco Mfg. Corp.	21, 22	Stratford Television Co.	100
DeWald Radio Mfg. Corp.	68	Stromberg-Carlson Co.	32
DuMont Labs. Inc., Allen B.	23, 63	Supreme, Inc.	94
Fretco, Inc.	68	Sylvania Electric Products	59, 105
General Cement Mfg. Co.	102	Symphonic Radio & Electronic Corp.	116
General Electric Co.	73, 114	T-V Products	108
Halldorson Co.	112	Technical Appliance Corp.	107
Hallicrafters Co.	27	Teledyne Dept., General Electric Co.	14, 15
Hi-Lo TV Antenna Corp.	99	Tele King Corp.	70
Hotpoint Co.	18, 19	Telrex, Inc.	93
Hytron Radio & Electronics Co.	97	Terado Co.	112
JFD Mfg. Co.	82	Tricraft Products Co.	116
LaPointe-Plascomold Corp.	Cover 3	Trio Mfg. Co.	109
Magnavox Co.	61	Tung-Sol Electric, Inc.	110
Mallory & Co., P. R.	95	United Catalog Publishers, Inc.	108
Miller Mfg. Co., M. A.	74	Universal Woodcrafters, Inc.	72
Miller Television Co.	118	V-M Corp.	51
Motorola, Inc.	2, 3	Ward Products Corp.	111
Neaf Products Co.	99	Webb Mfg. Co.	116
Olympic Radio & Television, Inc.	75	Webster-Chicago Corp.	28, 29
Peerless Products Industries	118	Westinghouse Electric Corp.	9-12
Pentron Corp.	106	Zenith Radio Corp.	17, 77
Philco Corp.	5		
Phoenix Electronics Inc.	101		
Radiart Corp.	16, 91		

ATR

Makes it easy

to DEMONSTRATE AND TEST D.C. APPARATUS FROM A.C. LINES



“A” BATTERY ELIMINATORS

For DEMONSTRATING AND TESTING AUTO RADIOS

New Models . . . Designed for testing D.C. Electrical Apparatus on Regular A.C. Lines. Equipped with Full-Wave Dry Disc Type Rectifier, Assuring Noise-less, Interference-Free Operation and Extreme Long Life and Reliability.

ATR

✓ NEW MODELS

✓ NEW DESIGNS

✓ NEW LITERATURE

“A” Battery Eliminators, DC-AC Inverters, Auto Radio Vibrators
See your jobber or write factory

AMERICAN TELEVISION & RADIO CO.
Quality Products Since 1931
SAINT PAUL 1, MINNESOTA—U. S. A.

Ask the Man who Knows

JOHN MILLER



Q. My customers are interested in Ultra High Frequency. What has Miller done about it?

A. First in Portland. Miller Antennas are flowing in a steady stream into the Portland area. Complete findings and results will be announced shortly showing Miller again the leader with a competitive price and the same 100% guarantee.

200% increase in business in the past three months testifies to the national acceptance of the Miller Antenna line. Get only guaranteed Antennas with the Miller line.

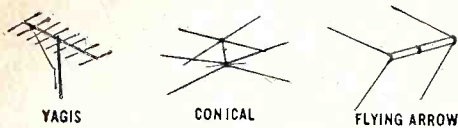

MEMBER
ANTENNA
MANUFACTURERS
ASSOCIATION

Miller
TELEVISION CO.

2840 NAOMI • BURBANK, CALIF.

New Sylvania Plant

At the dedication of the new Electronics Division headquarters of Sylvania Electric Products Inc., president Don G. Mitchell stated that the new multi-million dollar building was a "symbol of tomorrow." He predicted that the spectacularly growing "wonder science" of electronics would produce devices that will greatly increase industrial production. The 50,000 sq. ft. plant, which employs approximately 850 persons, is headquarters of the administrative, sales, engineering and manufacturing staffs of the Electronics Division, and is the site of the principal manufacturing operations.

RCA Victor Parts Directory

To facilitate servicing of RCA Victor television sets, a comprehensive, 142-page "Service Parts Directory" (SP-1014), containing schematic diagrams, parts lists, and top and bottom chassis views for the 71 1950 and 1951 RCA Victor TV receivers, has been announced by the RCA Victor Tube Department. The TV receivers are indexed by model name, model number and chassis number. The RF tuner chassis number appears on each schematic.

Fretco Appoints Fisher

Appointment of Anton C. Fisher as sales and advertising manager for its line of television antennas, Fretline chimney mounts and towers, has been announced by Fretco Incorporated, 1041 Forbes St., Pittsburgh 3.

This Is "Alex Lewyt Month"

Lewyt distributors are putting on special promotions this month to honor Alex Lewyt, president of the Lewyt Corporation, it has been announced by Walter J. Daily, vice-president and manager of the Brooklyn, N. Y. vacuum cleaner firm. Mr. Daily credited Tom Joyce, president of Raymond Rosen, Inc., Philadelphia's Lewyt distributor, with having originally suggested the idea, following the successful completion of the "Sell Daily for Daily" promotion in July, which showed a sales increase of 83% over July, 1951.

Channel Master Movie

Channel Master Corporation, Ellenville, N.Y., has announced the completion of the first motion picture ever made on the subject of television receiving antennas, "The Antenna Is the Payoff". A full-length film in sound and full color, the movie is narrated by Ed Thorgerson and is presented as an educational service for the benefit of everyone in the television industry that buys, sells, or installs antennas. Covering basic and advanced antenna theory in easy-to-follow stages, the movie, in a straightforward, factual manner, answers the questions most frequently asked about TV antennas. Channel Master distributors throughout the country are now planning free group showings of the movie to dealers in their areas.

STICK TO Steelman FOR SALES AND PROFITS!

★ tops in
STYLING

★ tops in
ENGINEERING

★ tops in
VALUE



OVERTURE Model 3D3—Budget priced 3-speed portable. All size records; heavy duty elliptical Alnico front speaker; 1 tube plus rectifier; 2 watt output; low distortion; full range volume and tone control; reversible cartridge arm; tan or blue linen-like case.

Write for catalog and complete details.

STEELMAN PHONOGRAPH & RADIO CO., INC.
12-30 Anderson Ave., Mt. Vernon, N. Y.

GOLDEN WAND INDOOR Television ANTENNA

3-section Admiralty Brass dipoles will not rust or stick.

20 square inch heavily weighted brass prevents tipping even with one dipole extended horizontally.

Model TG-62

\$6.95

LIST



PEERLESS PRODUCTS INDUSTRIES
812 N. Pulaski Rd., Chicago 51

SOLVED!

One of TV's Greatest Problems

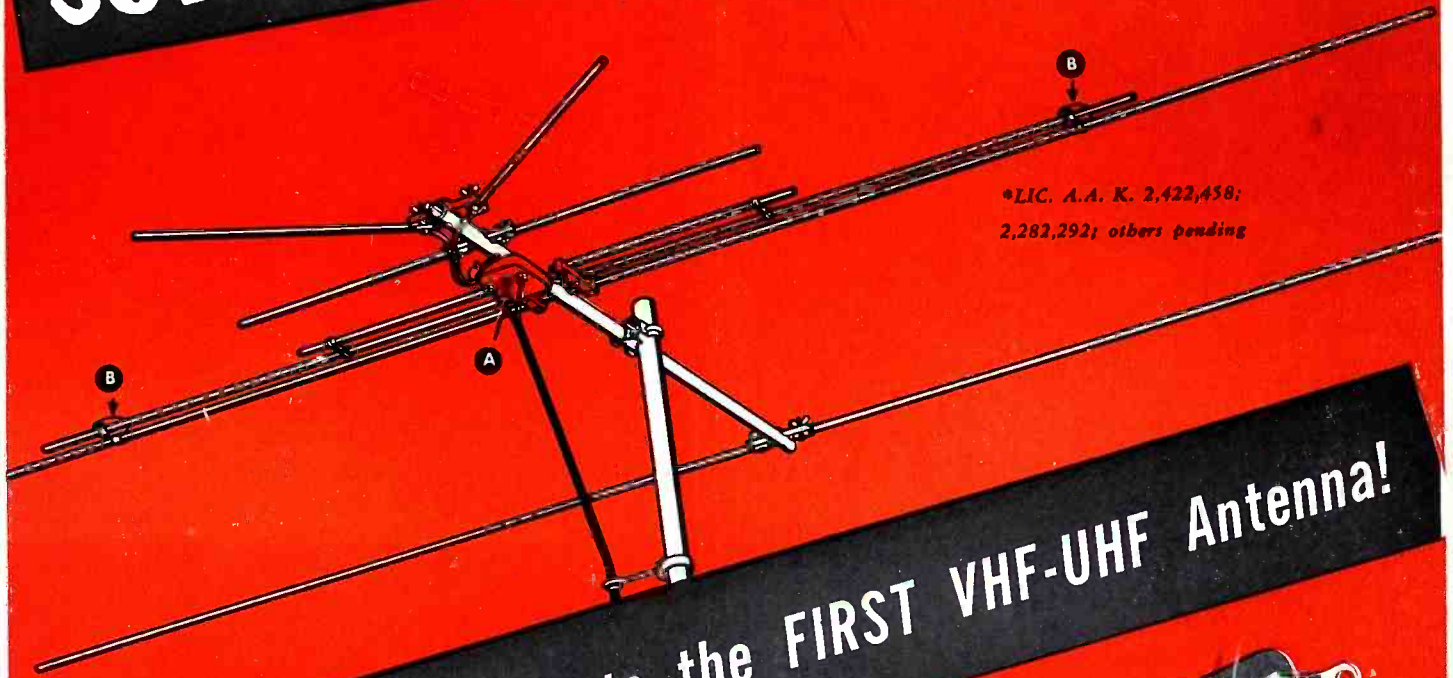

*LIC. A.A. K. 2,422,458;
2,282,292; others pending

VEE-DX Perfects the FIRST VHF-UHF Antenna!

The New ULTRA Q-TEE

All-Channel **2-83** VHF - UHF

Now there is an all-channel Ultra Q-Tee for every VHF-UHF requirement for both primary and fringe areas. The Ultra Q-Tee for primary areas on all channels, both VHF and UHF (2-83). The Ultra Q-Tee Suburban for all channels on VHF and fringe area UHF. Employing eight printed circuit channel separators, the Ultra Q-Tee is by far the finest combination VHF-UHF antenna yet perfected. It eliminates the need for two or more antennas, multiple transmission lines and switches. Single bay design gives it excellent rooftop appearance and good wind resistance. Pre-assembled construction makes it fast and easy to install using a single transmission line. What's more—it is low in price. The Ultra Q-Tee (primary area) lists at only \$14.25. The Ultra Q-Tee Suburban (fringe area UHF) lists at only \$17.60.

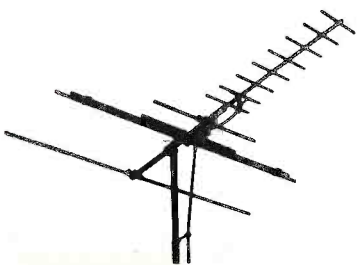

THE ULTRA Q-TEE SUBURBAN

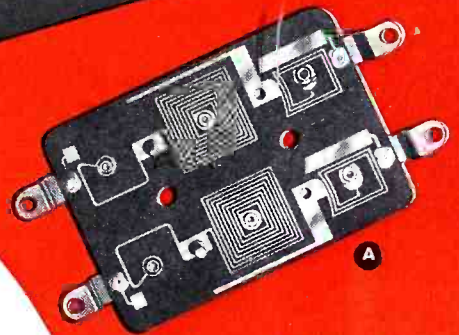

The ULTRA Q-TEE Employs Eight Printed Circuit Channel Separators

Secret of the Ultra Q-Tee's sensational operation is the unique and patented* printed circuit band reject filters (channel separators). The two round filters (B) separate the VHF channels. The large rectangular six-section printed circuit filter (A) was developed especially for separation of the UHF channels and makes possible the use of a single transmission line. Write for literature!

LAPINTE-PLASCOMOLD CORP.

ROCKVILLE, CONNECTICUT

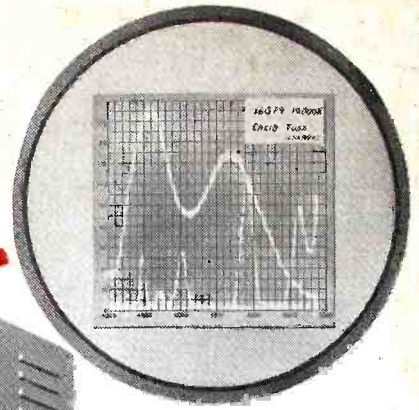
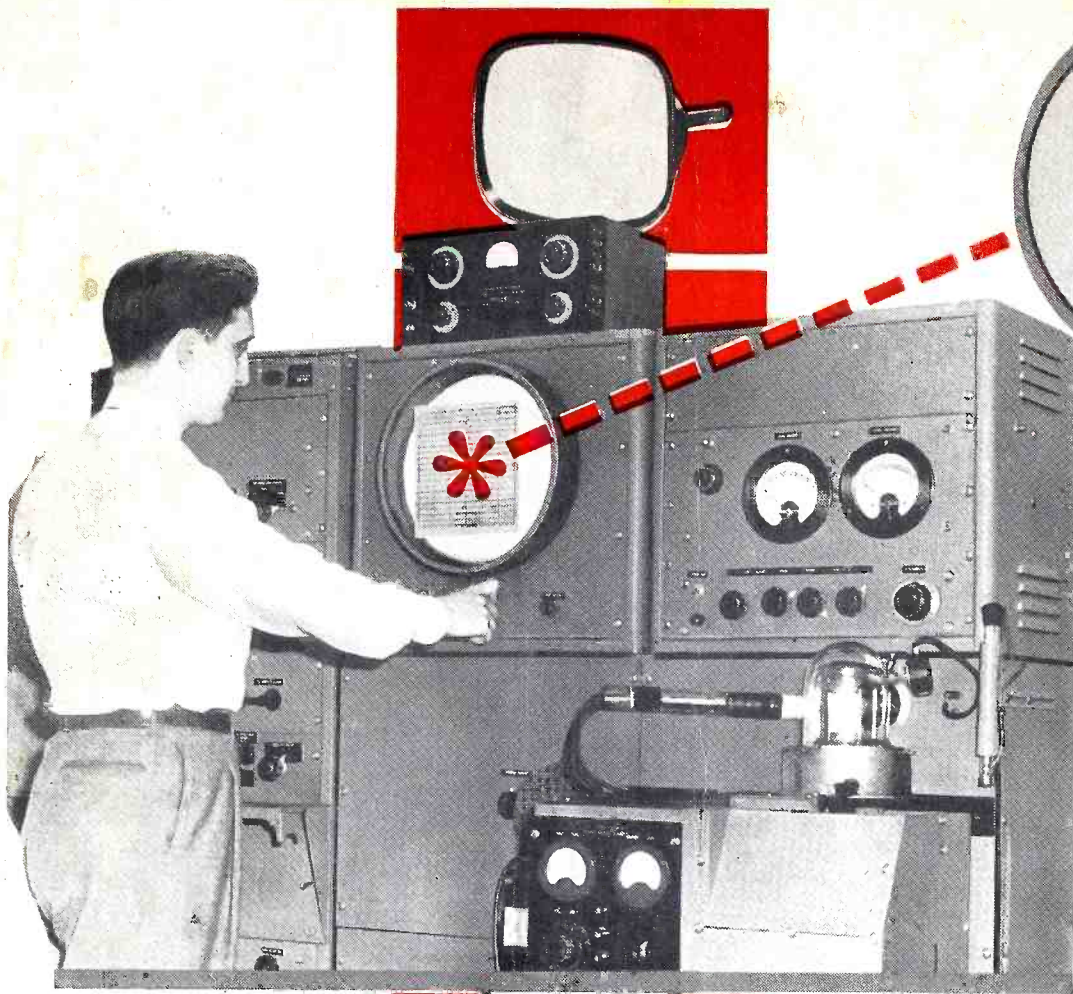

Electrical "pictograph" shows the white is right!

How we get **white** that's just right

for RCA picture-tube screens

MIX BLUE AND YELLOW paint and you get green. But mix "blue" and "yellow" phosphors and you get *white* . . . or what appears white to the eye. So it is that the fluorescent screen of a picture tube consists of about two billion tiny "blue" and "yellow" luminescent crystals. By the principle of *color addition*, the colored light from the individual crystals stimulates the eye to give the *impression* of white light.

The problem is you can get white that is yellowish, or white that is bluish . . . depending on the blend of the "blue" and "yellow" phosphors. Getting a white that's *just right* for picture-tube screens is

no easy trick. It calls for extremely precise *color control* of the phosphor.

RCA does it with a *spectroradiometer*. This instrument permits very accurate measurement of the *shade* of the "blue" and "yellow" phosphors. Based on this information, batches of "blue" and "yellow" phosphors are selected and blended to give the desired shade of white. Each blend is tested in a pilot run of picture tubes, and these tubes are also measured on the spectroradiometer. Only when a pilot run shows the desired white is a blend approved for production use. Result: "*Off-color*" picture tubes never reach your shop.

RCA's constant vigilance at all stages of manufacture is your assurance that only top-quality RCA Kinescopes leave the factory. In this way, RCA closely guards its own reputation . . . and yours as well.

With RCA Receiving Tubes, as well as RCA Kinescopes, TOP-QUALITY CONTROL makes the difference.



RADIO CORPORATION of AMERICA
ELECTRON TUBES

HARRISON, N. J.