

TV • AM • FM • Appliances • Records • Servicing

RADIO & TELEVISION RETAILING

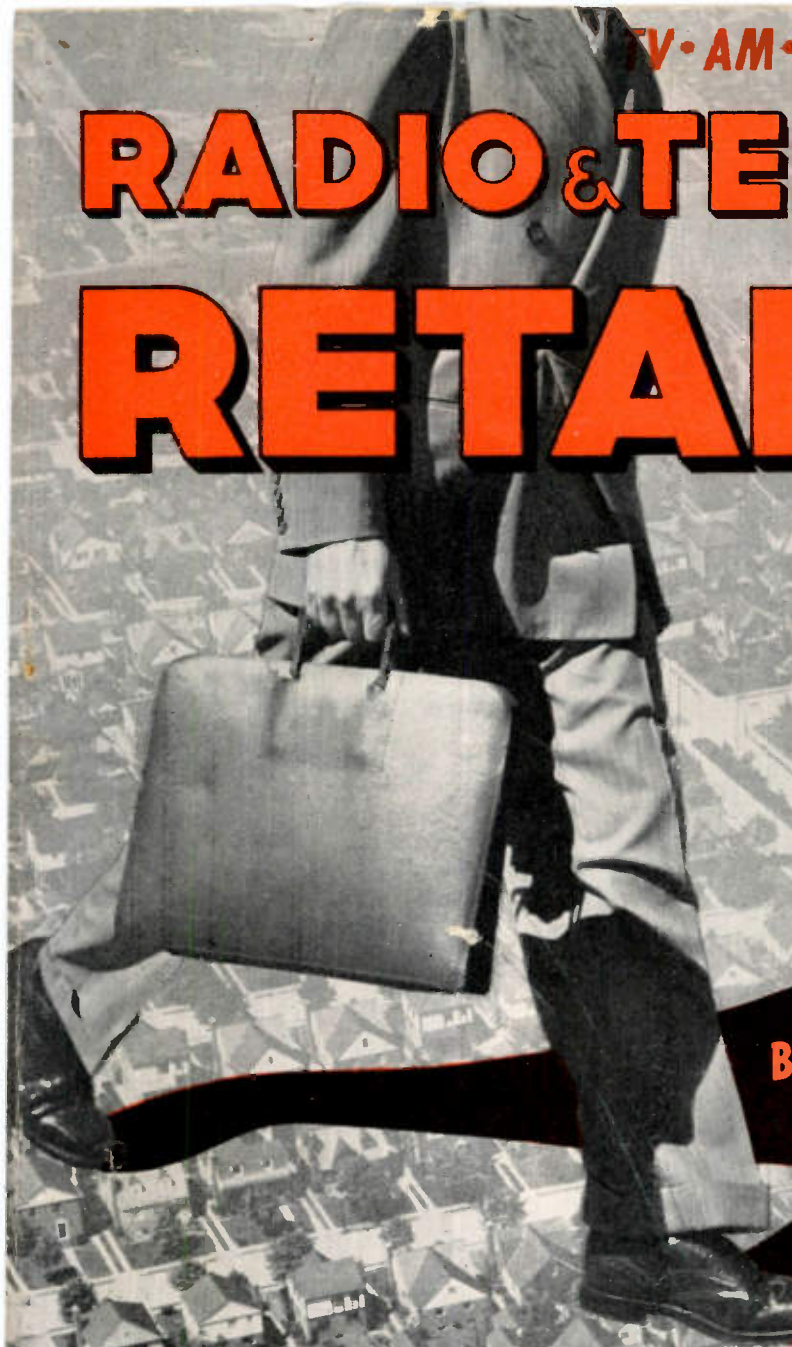

BUSINESS
Belongs to the Man
WHO GOES OUT AFTER IT!

See Article "FIGHT THE SUMMER SLOW-DOWN
WITH OUTSIDE SELLING" in this issue

Mr. Lyle Denny, Owner,
Denny's Radio & Electric Co.,
Saranac, Mich.
Y 9/51
277
8217
1414

The Chicago
PARTS SHOW
May 21-23

May • 1951

CALDWELL-CLEMENTS, INC.

FAIRCHILD AERIAL
SURVEYS, INC.

IMMEDIATE DELIVERY!

giant 17" screen



\$199⁹⁵
Slightly higher South and West

ANNIVERSARY MODEL 17 M3. Giant 17 inch screen. Ebony black metal cabinet. Gold knobs and mask. Big, clear, steady picture. Adaptable for color converter and UHF.

**FEATURED IN BIG SPACE NEWSPAPER ADVERTISING CAMPAIGN
IN 55 MAJOR TELEVISION MARKETS**

Tie in with this sales producing promotion. Merchandising aids, newspaper mats available through your Air King distributor.

**30th
Anniversary
Special**

AIR KING

**America's only
Custom-tuned
Television**

AIR KING PRODUCTS CO., INC. • 170 53RD STREET, BROOKLYN 32, N. Y.
While at the Chicago Radio Parts Show, be sure to visit the Air King Exhibit at Room 1454, Merchandise Mart

RADIO & TELEVISION RETAILING

Including "RADIO & TELEVISION"
"RADIO & TELEVISION TODAY"
and "ELECTRICAL RETAILING"

ORESTES H. CALDWELL
Editorial Director

M. CLEMENTS
Publisher

JOHN L. STOUTENBURGH
Executive Editor

EDWARD A. CAMPBELL
Technical Editor

JOHN G. McGEOY
Assistant Editor

CHARLES F. DREYER
Art Director

BUSINESS DEPARTMENT

M. H. NEWTON
Sales Manager

HOWARD A. REED
Assistant Sales Manager

A. O'Rourke
Production Supervisor

N. McALLISTER
Director, Reader Service

**BRANCH OFFICE
CHICAGO 6**

S. M. GASKINS, Western Manager
JOHN D. LUPTON, District Manager
201 N. Wells St., Randolph 6-9225

LOS ANGELES 5

CHRIS DUNKLE & ASSOCIATES
Southern California Representative
2506 W. 8th Street, Dunkirk 7-6149

CIRCULATION DEPARTMENT

B. V. SPINETTA
Circulation Director

W. W. SWIGERT
Credit Manager

RADIO & TELEVISION RETAILING*

May, 1951, Vol. 53, No. 5, 35 cents a copy. Published monthly by Caldwell-Clements, Inc., 480 Lexington Ave., New York 17, N. Y. PL. 9-7880. M. Clements, President; Orestes H. Caldwell, Treasurer. Subscription rates United States and U. S. Possessions \$2.00 for one year, \$3.00 for two years, \$4.00 for three years. Canada \$3.00 for one year, \$4.00 for two years, \$5.00 for three years. Pan American Countries \$4.00 for one year, \$5.00 for two years, \$6.00 for three years. All other countries \$5.00 for one year, \$7.50 for two years, \$10.00 for three years. Printed in U.S.A. Entered as second class matter, November 16, 1950, at the Post Office at New York, N. Y., under the act of March 3, 1879.

*Trade-Mark Reg. U. S. Pat. Off.
Copyright 1951 by

CALDWELL-CLEMENTS, Inc.
Publishers also of TELE-TECH

IN THIS ISSUE

MAY, 1951

★ *AM, FM, Television*

COVER—Business Belongs to the Man Who Goes Out After It
WHAT'S AHEAD—In Radio, Appliances, Records and Television..... 33, 34, 35
FIGHT the SUMMER SLOW-DOWN with OUTSIDE SELLING..... 38, 39
HOW a TOP SALESMAN SELLS MORE TV SETS..... 40, 41
The CHICAGO PARTS SHOW..... 62, 63, 64
NEW EQUIPMENT..... 72
SELLING MORE PORTABLES..... 44
NEW RADIO, TV and PHONO MODELS..... 46
LATEST TELEVISION RECEIVER SPECIFICATIONS..... 77, 78
SALES TIPS and PROFIT-POINTERS..... 60
TAKE THE TAX OFF TV..... 86, 87

★ *Records, Phonographs, Accessories*

SELL MORE CHILDREN'S PHONO RECORDS..... 54, 55
SALES BUILDING DISC RELEASES and PROMOTIONS..... 56
News of the Record Industry..... Begins on page 80

★ *Electrical Appliances*

New MODELS for INCREASED APPLIANCE SALES..... 58
LATEST WASHING MACHINE SPECIFICATIONS..... 84
SALES TIPS on SELLING APPLIANCES..... 60
COLORADO DEALER CLICKS WITH FARM TRADE..... 42

★ *Servicing and Sound*

The MARKET for SOUND..... 89
SERVICING VERTICAL SWEEP CIRCUITS in TV SETS..... 90, 91
The FM SYSTEM in BRIEF..... 92, 93
HOW the ELECTROSTATIC FOCUS TUBES WORK..... 94, 95
SPECIFICATIONS OF TEST INSTRUMENTS..... 100
SERVICING PORTABLE RADIOS..... 102
NEW AIDS for the SERVICER..... 72

**Latest Product Specifications, Directories, etc.,
that have appeared in RADIO & TELEVISION RETAILING:**

Specifications:

Recorders—
Music and Speech..... Apr. '50, p. 62
Room Air Conditioners..... Mar. '51, p. 60
Home Radios..... Apr. '51, p. 58
Portable and Auto Radios..... Apr. '51, p. 56
Washing Machines..... May '51, p. 84
Television Receivers..... May '51, p. 77
Test Instruments..... May '51, p. 100

Directories:

Distributors..... Jan. '51, p. 115
TV & FM Antenna Mfrs..... Mar. '51, p. 36
Custom Component Mfrs..... Apr. '51, p. 34

Reference Charts:

FM Coverage Areas..... July '50, part II
Battery Replacement Chart..... Apr. '51, p. 73
Four Field Statistics..... Jan. '51, p. 38

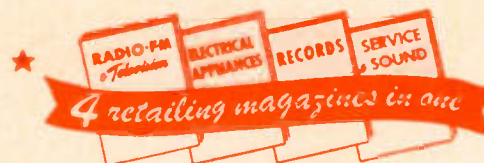

Caldwell-Clements, Inc., 480 Lexington Ave., New York 17, N. Y.

Hop aboard **ARVIN'S**

great Sunshine Special

The perfect Springtime **Combination Offer**



This Arvin Flash-Fold
Portable Chair **\$6⁹⁵**
(retail price)

PLUS This Arvin
Portable Radio **\$18⁹⁵**
(less batteries)

together worth **\$25⁹⁰**

Sell both profitably for **\$22⁵⁰**
LIMITED TIME ONLY



Here's a real "natural" to perk up spring and early summer sales! It's the perfect combination package that budget-conscious vacationers and week-enders can't resist. The portable is Arvin's light-weight (4 lbs.), powerful 446P battery model with superhet circuit, Velvet-Voice tone, improved PM

speaker . . . Sandalwood or Burgundy. The Portable Chair is Arvin's all-purpose style PR-200 with super-strong steel frame and durable canvas back and seat. Folds flat in a flash. Together, they'd cost \$25.90—but you sell both at the special combination price of only \$22.50—and make a good profit!

FREE! Eye-catching window trim and dynamic newspaper mats with your orders!

Don't Delay—Write, Wire, or Phone your Distributor for full details . . . Now!

Television and Radio Division, ARVIN INDUSTRIES, Inc., Columbus, Indiana
(Formerly Nablitt-Sporks Industries, Inc.)

ARVIN — Television

with a Difference!

Available again!



Television's greatest Price and Value Leader!

Available for delivery again—Arvin's high quality, low-priced 4080T, the biggest little TV set on the market!

Sell its high quality and rock-steady pictures to budget-conscious prospects . . . use it as a leader . . . merchandise it as the perfect "second set." Features include 8½" No-Glare Black Tube, Service-Free AC circuit, two-knob tuning. Order now for immediate delivery.

Model 4080T **\$129⁹⁵***

Choice of Mahogany, Lined Oak, Willow Green Finishes. Table extra.



Beautiful . . . and budget priced. It's your answer to higher prices and Regulation W. No-Glare 12½" Tube, phono-jack, built-in antenna, AC operation. Rich imported mahogany veneer high-styled console.

Model 2126CM **\$199⁹⁵***



Get the jump on competition with this sensational table model that lends itself to promotion . . . and sales. Rock-steady pictures, Velvet-Voice tone, 2-knob tuning, phono-jack—every wanted feature.

Model 2121TM **\$189⁹⁵***

*All prices plus tax and warranty, slightly higher in zone 2. All Arvin television receivers are designed for easy conversion to receive color broadcasts transmitted under established FCC standards.

Some Franchises still open—write, wire or phone your distributor

Television and Radio Division, ARVIN INDUSTRIES, Inc., Columbus, Indiana

(Formerly Noblitt-Sparks Industries, Inc.)



Play This
Winning Combination
OF

TV PROFIT MAKERS

50-STATIONS-50



MODEL HIR TENNA-ROTOR is the only fully automatic rotator. Just set it and forget it. Your antenna turns to the proper position and stops. North—East—South—West—direction indicator dial shows exact antenna position at all times. Extremely accurate!

THIS NEW TV BOOSTER features one simple control. Automatic on-off switch gives maximum, uniform high gain on all channels—quick to install. An excellent companion item to the Tenna-Rotor. The New Alliance Tenna-Scope!

NATION-WIDE TV ADVERTISING PRE-SELLS! Tenna-Rotor is the only TV accessory backed by a powerful, sustained television campaign—national in scope. Alliance Tenna-Rotor offers faster installation with 4-conductor "Zip" cable. Works in any weather. 1-year guarantee. U. L. approved.

ALLIANCE MANUFACTURING COMPANY • Alliance, Ohio

Every Philco Television Chassis Must Pass this Unique Test of Operation

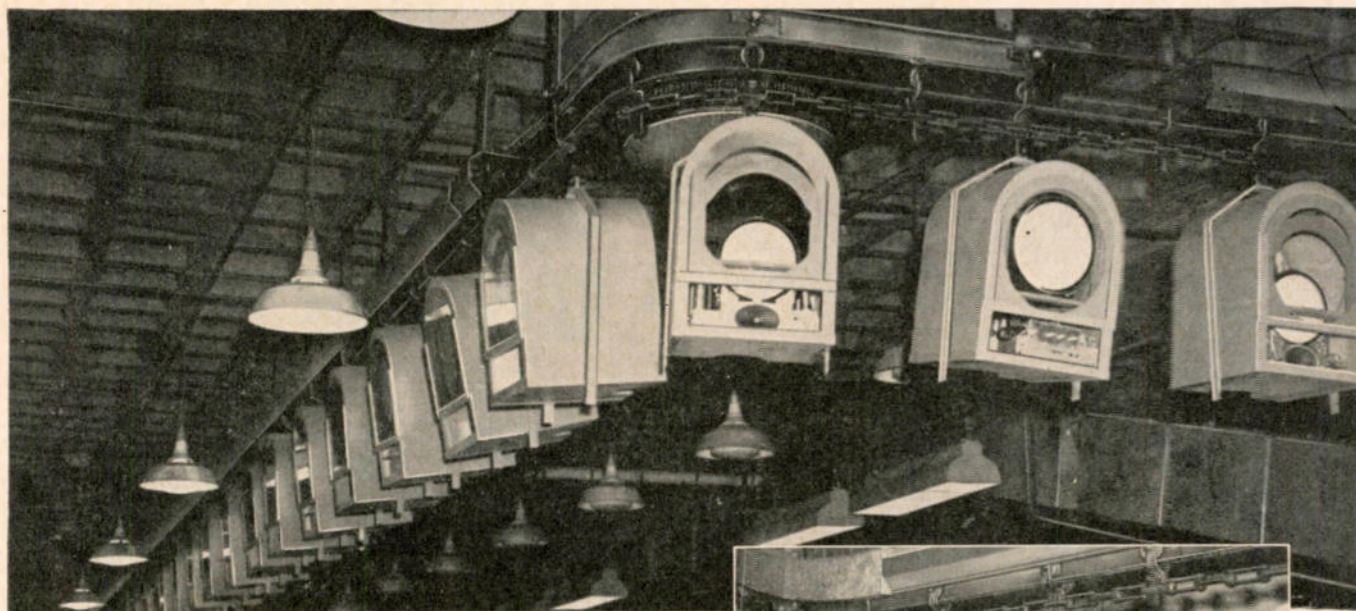

Famous Philco "Hot Run" Test

Here is a test without equal in the television industry that typifies the *extra* care, the *extra* painstaking attention to detail that goes into the making of every Philco television set. It's called "hot run testing", because each chassis, as it travels on overhead conveyor, is operating exactly as it would in a typical home. Picture and sound quality are checked enroute. Though costly, it shows how Philco takes every precaution to insure performance and dependability in the customer's home.

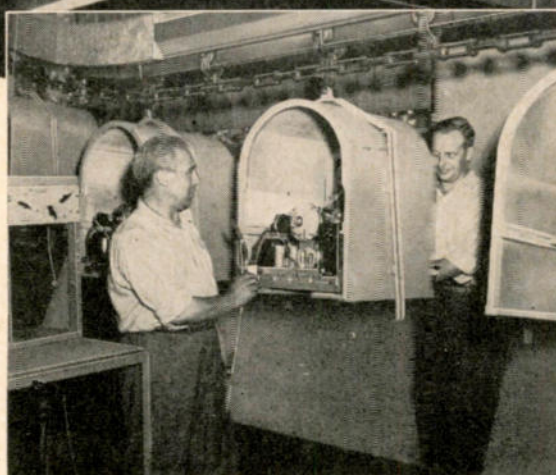

***It's Extra Precautions Like This . . . Plus
Leadership in Research and Engineering that make***

PHILCO *FIRST IN QUALITY*

YOU HEAR IT wherever television is sold...Philco for 1951 with its exclusive Balanced Beam *True-Focus* picture is the sensation of the industry . . . *first* in quality, and *first* in performance! This overwhelming acclaim for Philco's brighter, clearer picture and for Philco's powerful, dependable performance is once again a tribute to Philco leadership in research and engineering, and to all those standards of design and manufacture that have

made the Philco name *famous for quality the world over*. In many new ways, too . . . like the test illustrated above . . . Philco quality is guarded so that it will be delivered to the user with its built-in performance and dependability unimpaired. That's why the verdict today is overwhelming . . . Philco is the *quality* leader of the television world, with the truest picture, the finest performance, the greatest values in TV history.

what's in the HAT?

You'll
Find Out
at
Booth 673



MAY PARTS SHOW

May 21 • 22 • 23

Stevens Hotel, Chicago

V-M CORPORATION Benton Harbor, Michigan

"OUR CALL-BACK EXPENSE SCARED US!"



"Customers' sets kept giving us trouble. That was before we standardized on quality tubes . . . G-E tubes!"

Says

MIKE FILDERMAN, Vice-President
Phillips Radio Company
2012 Shannon Place, S. E.
Washington, D. C.

"Today we don't worry, as we did once, about call-back expense endangering profits. Quality tubes, which we use 100 percent, have done away with our most common cause of receiver trouble—tube failures. When our men finish one service job, they can go on to another knowing it's unlikely the first customer will ask for a return visit. Believe me, that saves plenty when you're servicing TV sets on yearly contract—and Phillips has about 15,000 contracts in the Washington, D. C., area . . . Quality and G-E mean the same thing to us! We feature G-E tubes; we find they keep our call-backs down, our men productive, our profits up."



It's a habit with customers, to ask to see the G-E label on tube cartons . . . so Phillips Radio and other service dealers have discovered. No name excels General Electric in public acceptance—means more quality-wise, builds greater user confidence.

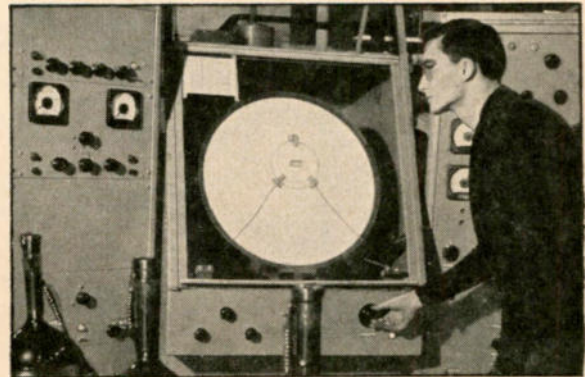

Every G-E picture tube is carefully tested for electrical and screen characteristics. Here brightness is being measured, and the screen area inspected for any blemishes. Many other tests follow. G-E tubes are pre-checked for superior performance!

FOR QUALITY TUBES TO CUT DOWN YOUR CALL-BACKS, SEE YOUR G-E TUBE DISTRIBUTOR!

GENERAL  ELECTRIC

181-KAB

Chosen by the Experts!

Comparative Test Again Proves Sylvania Television Engineering Leadership!



GEORGE MAHER
Executive Secretary
National Association
of Broadcast Engineers
and Technicians

National Association
of Broadcast **NABET** Technicians

NATIONAL OFFICE
ROOM 843 - 80 EAST JACKSON BOULEVARD
CHICAGO 4, ILLINOIS
WAGAH 2-2488

March 30, 1951

Mr. J. K. McDonough
Sylvania Electric Products Inc.
Radio and Television Division
254 Rano Street
Buffalo 7, N. Y.

Dear Mr. McDonough:

It occurred to me that you will be interested in a recent comparative test which we made of leading television sets.

We were contemplating the purchase of a television set for the lobby of our headquarter offices here in Chicago.

We lined up the sets made by various manufacturers and subjected them to the most careful analysis and tests. The result was that we decided to buy a Sylvania set. It was apparent to all of us that the picture of the Sylvania was outstanding.

The effect of this decision has been rather significant within our own organization. I understand that several of our officials have chosen Sylvania sets for their own homes.

Since these tests were carried on entirely within our own organization, we believe that credit should be given where credit is due for your excellent engineering achievement.

I may add that no one connected with Sylvania had any part in arranging these tests nor in the conclusion which was reached.

Sincerely,

George Maher

GEORGE MAHER
Executive Secretary

GN:k



Demonstrate with a **SYLVANIA!** It Means Profit to You!

See! Hear! Compare! Sell SYLVANIA!

For Name of Your Nearest Sylvania Television Distributor, Contact
Sylvania Electric Products Inc., Radio & Television Division, 254 Rano Street, Buffalo 7, New York



Symbol of Superiority



Porcelain vase executed by the brilliant Danish designer, Gerhard Henning; recognized by many of the world's most esteemed pottery experts as a true symbol of some of the finest porcelainware produced in the twentieth century.

Henning vase courtesy Metropolitan Museum of Art

tel-o-tube . . .
symbol of picture
tube superiority

All Sizes Immediately Available for Conversion and Replacement

As a symbol of picture tube superiority, Tel-O-Tube too, has gained the recognition and esteem of many of the world's most renowned television experts. Outstandingly superior craftsmanship, unmatched performance, and record-breaking longevity are only three of the many reasons why these men—men who know picture tubes—have come to recommend Tel-O-Tube as the ideal tube for both original and replacement equipment. Today, Tel-O-Tube's complete line of cathode ray tubes is being offered for immediate availability—an excellent opportunity to find out for yourself how truly fine a picture tube can be!

The GREATEST Names In Television
PROTECT Their Names With Tel-O-Tube

See Our Display at
the Chicago Parts Show
Room 632, Stevens Hotel

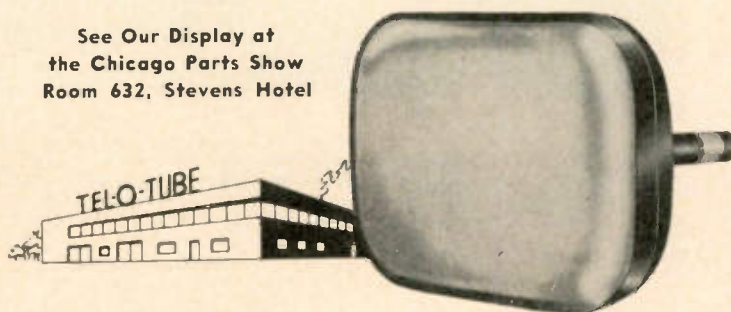

WRITE . . . WIRE . . . PHONE . . .
DEPT. TR



TEL-O-TUBE Corporation of America

EAST PATERSON, NEW JERSEY

Sales Office: TEL-O-TUBE Sales Corporation, 580 Fifth Ave., New York 19, N. Y.

"Leading the League"

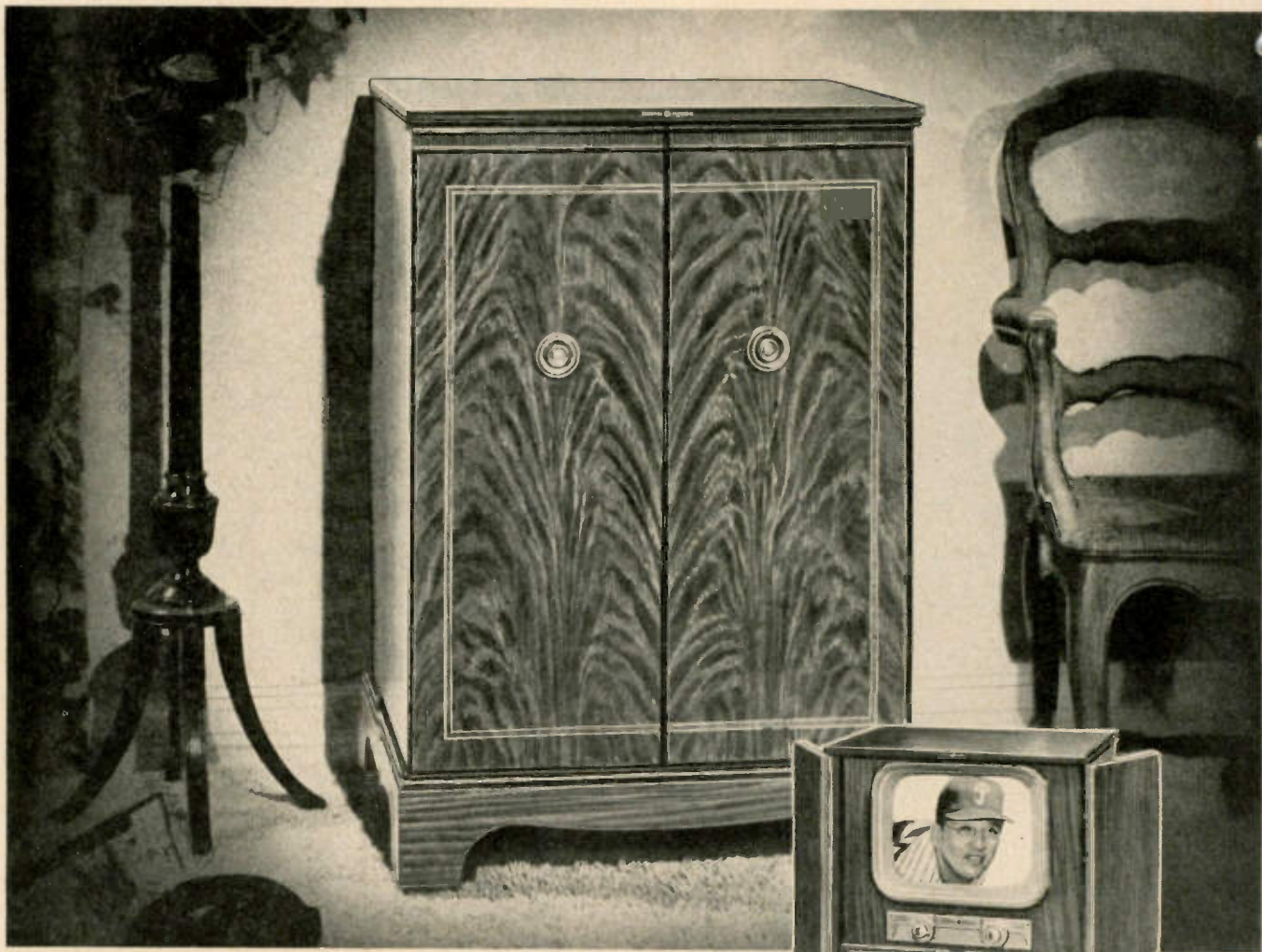

G.E.'s finest 17". Beautiful example of 18th century styling. Genuine mahogany veneers, hand-rubbed to a satin luster. Highly-figured full-length doors with custom antique door pulls. Concealed

swivel casters for easy moving in any direction. 17" G-E rectangular black tube. G-E electronic tubes team up with the G-E picture tube for peak performance. Model 17C109.

\$399.95*

Incl. Fed. Excise tax

You can put your confidence in—

GENERAL

in performance!

JIM KONSTANTY—
Philadelphia Phillies' re-
lief hurler. Voted "most
valuable player" in Na-
tional League in 1950.



*To enjoy baseball
at its best—go to
the ball park
regularly!*



BLACK-DAYLITE TELEVISION

PERFORMANCE—and we mean quality of picture, ease of tuning, downright consumer satisfaction—that's what sells the new 17-inch G-E's and keeps them sold. Compare G-E yourself with *any other make*. You'll be amazed at the crystal-clear, life-size pictures on the 17" G-E rectangular black tube. You'll find there's no easier tuning—a single control gives best picture, best sound, automatically. And what eye appeal! The cabinets shout class—no simulated finishes, no imitations. Nothing but the finest blond and mahogany veneers, hand-rubbed to a satin luster. Here's the line you can sell with pride and profit. Call your General Electric television distributor today.

General Electric Company, Receiver Division, Syracuse, New York

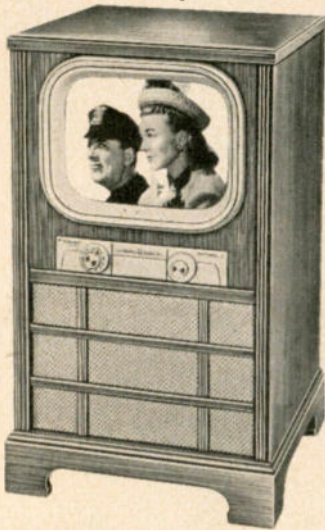

17C105. Handsome cabinet in genuine mahogany veneers. Big-as-life pictures on G.E.'s famous 17" rectangular black tube. Concealed non-marking swivel casters for easy moving. **\$349.95***
Incl. Fed. Excise tax



17C101. 17" G-E rectangular black tube. Handsome blond veneered cabinet with finely-figured doors and concealed non-marking swivel casters for easy moving in any direction. **\$399.95***
Incl. Fed. Excise tax



17T2. 17" G-E rectangular black tube. Hand-rubbed genuine mahogany veneered cabinet—not just mahogany finish but genuine mahogany wood. G.E.'s fastest-selling table model. **\$289.95***
Incl. Fed. Excise tax

*Installation and picture tube protection plan extra. Prices subject to change without notice. Slightly higher West and South.



ELECTRIC

Floyd Makstein, field engineering
manager at **Emerson** recommends

Simpson MODEL 480 GENESCOPE

FOR TV-FM SERVICING

This is what Floyd Makstein of EMERSON says about the Simpson Model 480 Genescope: . . . "The Simpson Model 480 Genescope far surpasses the standards required in the servicing and aligning of all TV-FM receivers.

The wide frequency response and the 25 millivolt sensitivity of the oscilloscope, combined with the required fundamental signal sources which are provided in the AM & FM oscillator sections, simplifies the accurate aligning of all TV receivers, including those with intercarrier systems.

In addition, the large, easy-to-read dials, having a 20-1 vernier control and 1000 division logging scale, cuts down on servicing time."

Mr. Makstein concludes . . . "The compactness of the complete unit will be a big factor in many of the service shops where space is at a premium. We are sure that the whole TV industry appreciated your efforts in raising the engineering standard in servicing." Emerson Service personnel know that modern FM and TV development and servicing demand test equipment made to the most exacting standards.

They prefer the Simpson Model 480 Genescope because it is the most accurate, flexible and convenient instrument available. The Genescope will render many years of uninterrupted service and always produce accurate results.

SIMPSON ELECTRIC COMPANY
5200 W. Kinzie St. • Chicago 44, Illinois • Phone: COLumbus 1-1221
In Canada: Bach-Simpson, Ltd., London, Ont.

**THESE RANGES SHOW HOW
MUCH THE SIMPSON GENESCOPE CAN DO FOR YOU**

FREQUENCY MODULATED OSCILLATOR	AMPLITUDE MODULATED OSCILLATOR
Band A: 2-120 megacycles	Band A: 3.3-15.6 megacycles
Band B: 140-260 megacycles	Band B: 15-75 megacycles
Sweep width variable from zero to 15 megacycles	Band C: 75-250 megacycles
Sweep rate 60 cycles per second	30% modulation at 400 cycles or unmodulated
Specially designed frequency sweep motor	Continuously variable attenuator
Continuously variable attenuator	Visual method of beat frequency indication
Crystal calibrator: 5 megacycles \pm .05%	OSCILLOSCOPE
Audio Oscillator 400 cycles	Vertical sensitivity: 25 mv per inch
Output Impedance 75 ohms	Horizontal sensitivity: 70 mv per inch
Step attenuator for control of output	Linear sweep frequency: 2 cycles to 60 kilocycles
	60 cycle sine sweep
	Frequency essentially flat to 200 KC. usable to over 3 megacycles

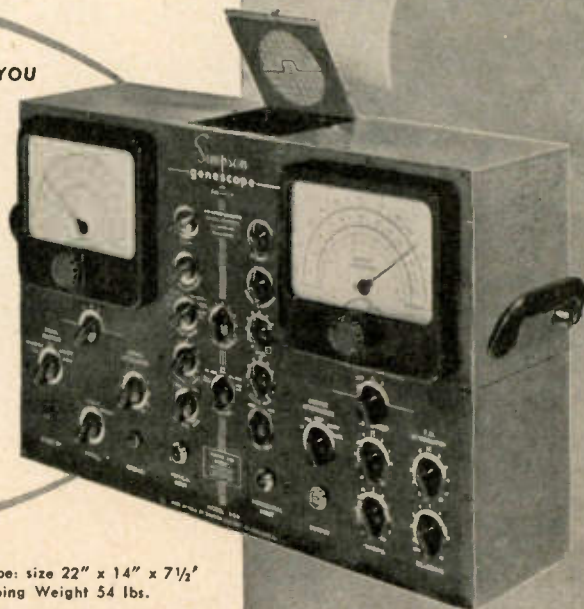

Simpson Model 480 Genescope: size 22" x 14" x 7 1/2"
Weight 45 lbs. Shipping Weight 54 lbs.

DEALER'S NET PRICE complete with Test Leads and
Operator's Manual, \$395.00.



IT PAYS TO DO BUSINESS WITH Westinghouse

This Westinghouse television chassis with exclusive Westinghouse Single Dial Tuning, is your assurance of profitable sales through the months ahead.

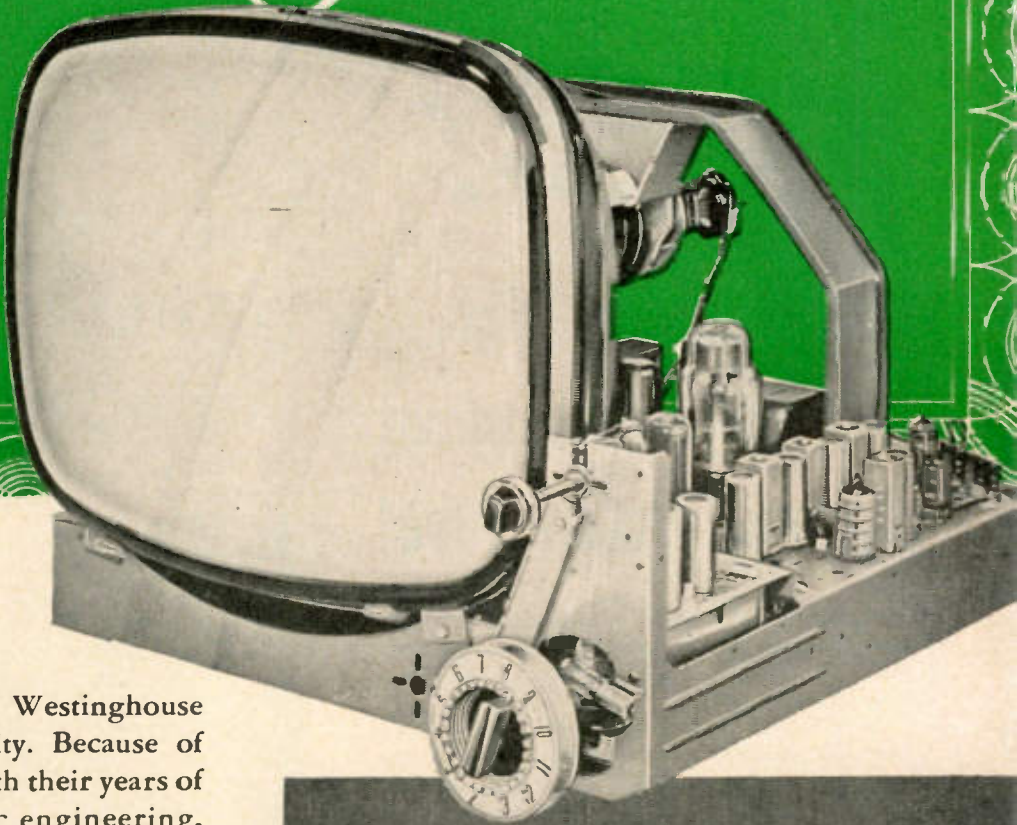

No matter how critical the times, Westinghouse never makes substitutions in quality. Because of their vast buying power, coupled with their years of experience in advanced electronic engineering, Westinghouse will maintain top quality and performance in television throughout these days of shortages and substitutions.

Changes will be made as they always have been . . . but these changes will *increase* the efficiency of the sets. New materials, which Westinghouse has been developing and testing for many months, are so great an improvement over former materials, that Westinghouse will continue to use them, even when the emergency is over.

This means BUSINESS AS USUAL for Westinghouse dealers . . . with top-quality merchandise . . . peak performance . . . fewer service calls . . . good mark-up . . . and GREATER PROFIT!

See your Westinghouse Distributor now!

YOU CAN BE SURE . . . IF IT'S

Westinghouse

WESTINGHOUSE ELECTRIC CORPORATION



NEW MODEL

The Rutledge . . . (654T17)

containing the superior Westinghouse chassis with big 17" black glass rectangular picture tube and Single Dial Tuning. Handsome, streamlined, lightweight, durable plastic case in mahogany color.

TELEVISION-RADIO DIV. • SUNBURY, PA.



**"HURRY, HURRY, HURRY!
DON'T MISS THIS NEW,
SIMPLIFIED SERVICING BOOK!"**

FREE!

**only until May 31st ...
with the purchase of one
Sylvania Picture Tube!**

Don't let this offer expire without your getting a copy of this splendid, fact-packed servicing manual. Filled with time-saving shortcuts and valuable servicing hints.

Now it's yours absolutely FREE from your Sylvania Distributor with the purchase of just one Sylvania Picture Tube, of any type. But the offer expires May 31st. So, act NOW! Write or call your distributor TODAY!

**SAVES TIME! SAVES MONEY! SOLVES
SCORES OF SERVICING PROBLEMS!**

This book contains 48 pages of pictures, diagrams, and easy-to-follow instructions covering:
Radio Servicing . . . Signal Tracing, Alignment, AVC and AFC Checking, Measurement of Voltages, Signal Levels, Power Output, Band Width and much more.

TV Servicing . . . Signal Tracing, Bandwidth Measurements, Wavetrapp Checking, Sound Channel Tests and Alignment, Low and High Voltage Checks, Signal and Deflection Voltage Measurements, and numerous other subjects.

Audio Amplifier Servicing . . . DC, AC, and Signal Level Measurements; Tone Control, Fidelity, Gain Tests, Distortion, Power Output, and Noise Level Measurements; Signal Tracing, and Speaker Matching.

Miscellaneous Applications . . . 19 different applications of VTVM including Detecting Gassy Tubes, Checking Capacitors, Q Measurement, Turns Ratio Measurement, Impedance Checking.

**Servicing Radio
and Television with
a Vacuum Tube
Voltmeter**

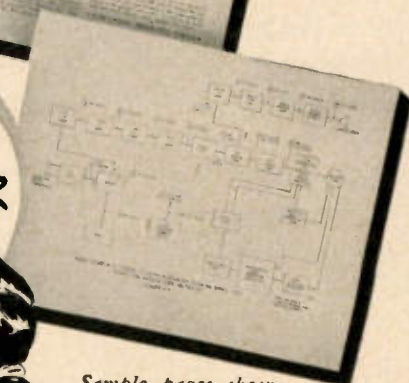
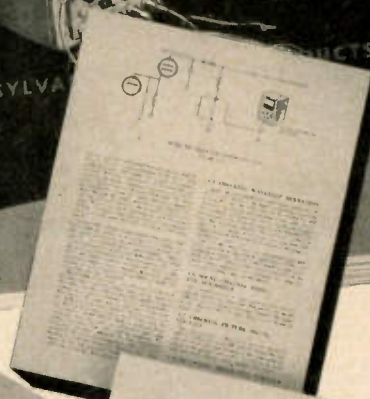

**"DON'T DELAY,
CALL YOUR
SYLVANIA DISTRIBUTOR
NOW!"**



Sample pages showing detailed, easy-to-read diagrams.



SYLVANIA ELECTRIC

RADIO TUBES; TELEVISION PICTURE TUBES; ELECTRONIC PRODUCTS; ELECTRONIC TEST EQUIPMENT; FLUORESCENT TUBES, FIXTURES, SIGN TUBING, WIRING DEVICES; LIGHT BULBS; PHOTOLAMPS; TELEVISION SETS

Raytheon pulls 'em in

the pictures!



"... Tujunga is not . . . in a fringe area . . . we are in the IMPOSSIBLE AREA . . . Raytheon Television is the only set that homeowners in Tujunga, Sunland and Verdugo Hills have ever been able to 'really' get a picture on."

David Myron

VERDUGO HILLS MUSIC CO.
Tujunga, California



the prospects!



"Our prospects are immediately impressed by Raytheon's beautiful cabinet design and after a demonstration of its performance, especially on distance, the salesmen soon turn the prospect into a customer."

Frank Huttinger

B & H ELECTRIC COMPANY
Toledo, Ohio



You're sure of **DEPENDABILITY** when you sell

Raytheon *tv*



THE STARLIGHT
Model RC-1720



Statements like these are almost standard at the Raytheon plant. Dealers are impressed with the way Raytheon TV pulls in the pictures . . . and, consequently, pulls in the customers, too. And with the beautiful additions to its 1951 line, Raytheon really has something that can be told and sold.

For information on how you, too, can profit with Raytheon, contact your Raytheon distributor or write us.

BELMONT RADIO CORPORATION
5921 W. Dickens Ave., Chicago 39, Ill.
Subsidiary of Raytheon Manufacturing Co.

List prices range from \$279.95 to \$750.00
INCLUDING FEDERAL EXCISE TAX
AND 1-YEAR WARRANTY

RAYTHEON
TELEVISION

THE INCOMPARABLE

Capehart

MAKES SELLING 4 WAYS EASIER!

1.

Finest cabinetry offered today—distinguished designs, heirloom quality

2.

Richer, clearer pictures from the famous CX-33 chassis

3.

The fabulous Capehart Symphonic-Tone System, breath-taking sound, true fidelity

4.

priced realistically—to widen your market

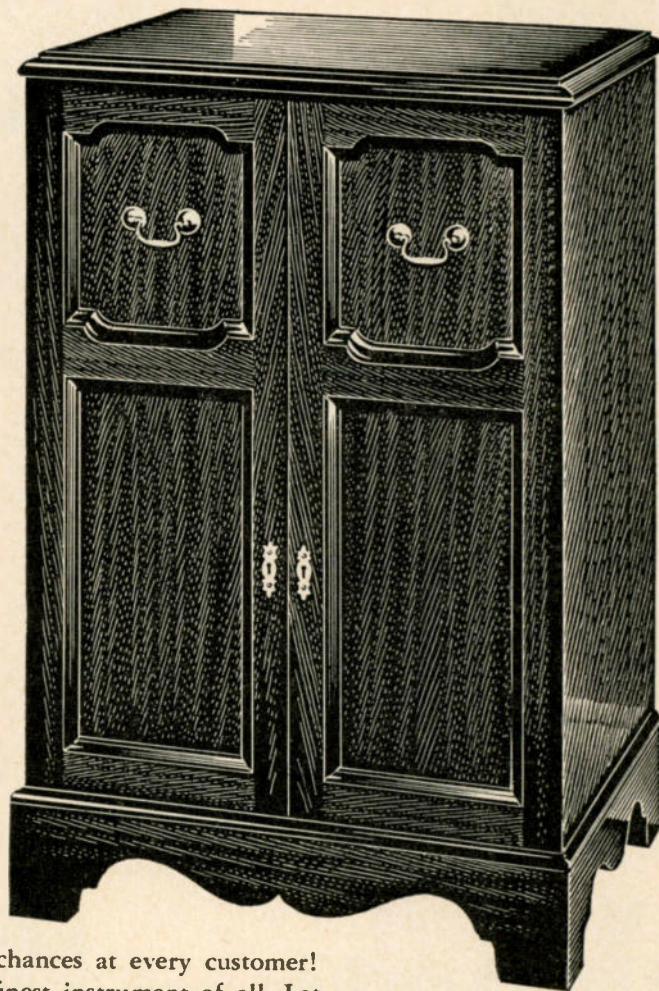

The CAPEHART "Virginian"

A Lee Stone design in Chippendale styling at its very best. Deeply paneled doors fold against sides. 17-inch rectangular tube for picture of photographic quality. Capehart Symphonic-Tone System.



The CAPEHART "Spinnet"

Perfect combination of best features of table model and console. Beautifully finished in rich mahogany veneer. 17-inch rectangular tube for brighter, clearer pictures. World renowned Capehart Symphonic-Tone System.

GET NOT ONE but *four* chances at every customer! Show them Capehart, the finest instrument of all. Let them hear its breath-taking true-to-life sound... let them look at the brighter, clearer, sharper picture. Point out the fine details of the distinguished cabinet work, the craftsmanship construction. Then tell them how little it costs to own a Capehart. Ten-to-one you've made a sale!

New CX-33 Chassis

Produces sharpest, clearest, steadiest picture yet attained. Establishes new standards of performance. Gives new service-free operation.

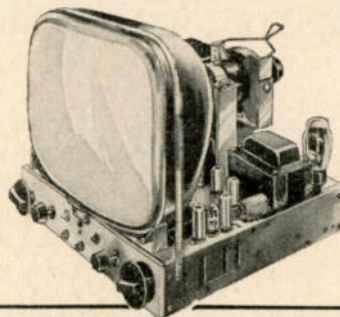

CAPEHART-FARNSWORTH CORPORATION, Fort Wayne 1, Indiana

An Associate of International Telephone and Telegraph Corporation

Commercial Credit financing offers more advantages to dealer and his customers

MORE dealers finance *more* home appliances with COMMERCIAL CREDIT than through any other national financing plan! That's because COMMERCIAL CREDIT offers *more* advantages, gives *broader protection and benefits* to both buyer and seller.

COMMERCIAL CREDIT offers you a *complete* financing package . . . from wholesale and floor stock down to the last detail of property insurance, credit investigation, collection, adjustment and prospect follow-up.

Write, wire or phone the COMMERCIAL CREDIT office nearest you. Our local representative will be glad to call at your convenience and explain how COMMERCIAL CREDIT can serve you *better* by providing you with dependable financing from factory to customer.



Wholesale Financing Plan Helps Dealers Keep Stock Up. COMMERCIAL CREDIT provides you with the financing you need to keep your floor and warehouse stocks at their best level . . . allows you to take advantage of quick deliveries to close more sales and make more profits.

Insurance Protects Customers. Under the COMMERCIAL CREDIT PLAN, your customers receive 1) Property Insurance Protection, in event of damage to, or loss of, the merchandise, as defined in the policy . . . and 2) Life Insurance Protection, which cancels unpaid balance in event of purchaser's death. (Life Insurance not available in California)



Over 300 Offices Offer Nationwide Service. COMMERCIAL CREDIT's wide facilities help speed credit checks . . . aid in completing time payments when customers move out of your community . . . offer service on other features of the COMMERCIAL CREDIT PLAN.

COMMERCIAL CREDIT CORPORATION

A subsidiary of Commercial Credit Company, Baltimore . . .
Capital and Surplus over \$100,000,000 . . . more than 300
offices in principal cities of the United States and Canada.

EIGHT WAYS BETTER!

1. Wholesale Financing
2. Fast Credit Approval
3. Life Insurance Protection
4. Property Insurance Protection
5. Automatic Sales Follow-up
6. Tested Collection Service
7. Builds Customer Good Will
8. Nationwide Facilities



Licking co-channel ~~INTERFERENCE!~~

30 db

FRONT-TO-BACK RATIO

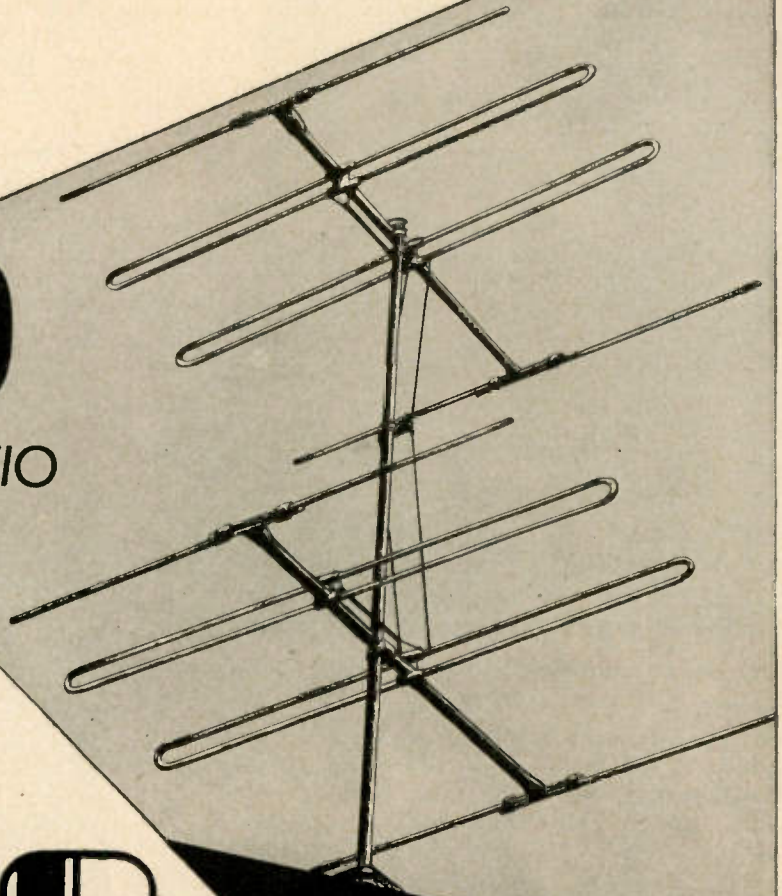

The New

TITANIC

Special **TWIN-DRIVEN YAGI**

THIS IS IT—the answer to co-channel interference.

Better than twice the front-to-back ratio of previous antenna designs.

Gain comparable to regular Twin-Driven Yagi.

Pinpoint directivity eliminates

other forms of interference picked up at antenna.

Comes tuned for any low-band channel, either stacked or single.

TECHNICAL APPLIANCE CORPORATION

SEND FOR
ENGINEERING
BULLETIN
NO. 65

SHERBURNE, N. Y. IN CANADA: STROMBERG-CARLSON CO., LTD., TORONTO 4, ONT.

Percy Faith's first choice...

IS THE OVERWHELMING CONSUMER CHOICE, TOO!

In rehearsing his orchestra and polishing his famous arrangements, Percy Faith relies heavily on his new Model 288 Electronic Memory Wire Recorder.

He can now hear every beat and tone exactly as his listeners will, through the newly-designed *natural voice* play-back sound chamber.

But that's only one new feature to add to the Webster-Chicago list. Another sensational extra is a new non-spill recording head.

No wonder the 288 is 'way out in front for quality and performance... at the lowest price.

And no wonder your sales will soar, because the Webster-Chicago Electronic Memory Wire Recorder is the choice of consumers, too!



WEBSTER-CHICAGO

5610 Bloomingdale, Chicago, Ill.

Electronic Memory



the Ultimate in

Magnetic Recording



Dictation Machines



Diskchangers



Tape Recorders



Portable Fonographs



Home Fonographs

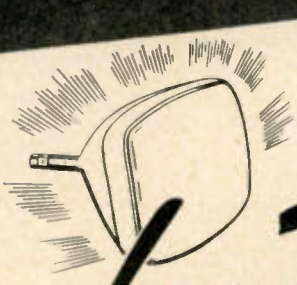

Fountain of youth*

A Zetka picture tube stays young . . . stays brilliant always . . . is sharply focused . . . safe . . . long lived. There's no old, dull, tired look on the face of a Zetka tube. It will always reflect the brightness of your reputation, because only Zetka utilizes the power-tube method of producing pace-setter picture tubes.

In addition, each and every Zetka tube (no spot checking permitted) is set-tested in the factory before being shipped. Here indeed is proof positive that Zetka is by far your best buy in picture tubes. Rectangulars and rounds in 16", 17", 19" and 20".



THE SAFEST PICTURE TUBE
IN THE WORLD . . .



zetka*

THE ARISTOCRAT OF TELEVISION TUBES

Most Trusted Name in Picture Tubes

zetka

TELEVISION TUBES, INC. 131-137 GETTY AVE. • CLIFTON, N. J.
For 37 years, Zetka has been a respected name in the radio and television industry.

South Pacific • Kiss Me Kate
Out of This World

Gentlemen Prefer Blondes
and now...

THE NEWEST
SMASH BROADWAY
SUCCESS

A
TREE
GROWS
IN
BROOKLYN

with

SHIRLEY BOOTH • JOHNNY JOHNSTON and other
members of the Original Broadway Cast

Music by Arthur Schwartz • Lyrics
by Dorothy Fields

**More money-makers
for May**

Andre
KOSTELANETZ
Plays
THE MUSIC OF
VINCENT YOUMANS

Dorothy
KIRSTEN
Sings
SONGS OF
JEROME KERN

Columbia brings Broadway to all America
... more record customers to you!

COLUMBIA  **RECORDS**

First, Finest and Foremost in Recorded Music

Here's the **BOOSTER** that says
"YES" to all your demands...



the New
AUTOBOOSTER

THE *FULLY AUTOMATIC* TV-FM BOOSTER



Here at last is a TV Booster that gives you gain up to nine times, full band width for undistorted video and audio on all channels, plus — the newest development in booster design — completely automatic operation.

The ITI AUTOBOOSTER turns itself on and off and is automatically tuned by the normal operation of the TV receiver. No confusing array of knobs — no unsightly mess of wires — You can install the ITI AUTOBOOSTER in the back of the receiver, out of sight. You get all the improved performance, all the fine picture quality that this precision-engineered booster can give you with none of the trouble of tuning, none of the exposed wiring usually involved in booster operation.

Customer acceptance is assured, too, because no customer instruction is needed. After it's installed, all you can see is the improved picture.

- ✓ **AUTOMATIC ON-OFF**
- ✓ **AUTOMATIC TUNING**
- ✓ **CONCEALED INSTALLATION**
- ✓ **SINGLE OR DUAL INPUT**
- ✓ **HIGH UNIFORM GAIN**

**BUY THE BOOSTER
 THAT SAYS "YES"
 to all your PROBLEMS**

WRITE FOR SPECIFICATION SHEET
 ORDER AUTOBOOSTER FROM
 YOUR JOBBER TODAY!

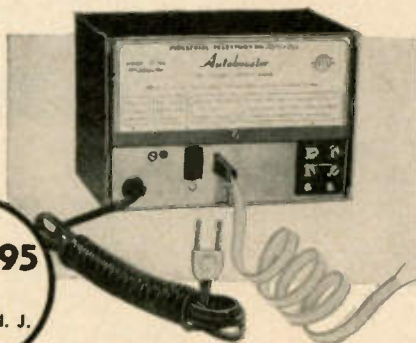

LIST
\$44.95

F. O. B.
 CLIFTON, N. J.

BOOSTER CHECK LIST

AUTOBOOSTER	A	B	C	D	E	F
Automatic On-Off	YES	YES	YES	NO	NO	NO
Automatic Tuning	YES	NO	NO	NO	NO	NO
Concealed Installation	YES	NO	NO	NO	NO	NO
Full Bandwidth (All Channels)	YES	NO	YES	YES	NO	NO
Amplifies FM Band	YES	YES	NO	NO	YES	NO
Single or Dual Input	YES	NO	NO	NO	NO	YES
Gain 19db on Low Channels 2 - 6 FM	YES	NO	NO	NO	NO	NO
Gain 14 db on High Channels 7 - 13	YES	NO	NO	NO	NO	NO
Made by a TV Receiver Manufacturer	YES	NO	NO	NO	NO	NO

THE ONLY TV BOOSTER
 DESIGNED AND MADE BY A
 TV RECEIVER MANUFACTURER



INDUSTRIAL TELEVISION, INC.

359 LEXINGTON AVE. - CLIFTON, N. J. - GREGORY 3-0900

Du Monts

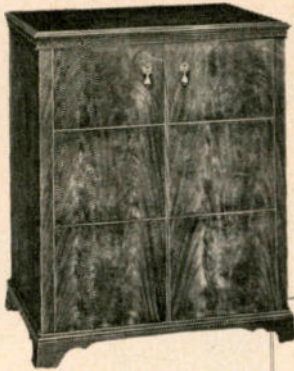

THE MT. VERNON,
by Du Mont

19-inch, direct-view tube; FM radio;
plug-in for record player.
Cabinet of fine mahogany veneers.

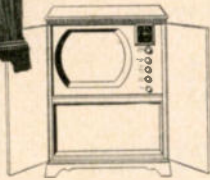

Do More For Dealers

There is one name in every field that carries the acknowledged leadership and unchallenged prestige that mean greater profit opportunity for dealers. In television receivers that name is Du Mont.

Du Monts do more for dealers because of the widespread acceptance of the Du Mont name, the smart styling of all Du Mont receivers, and the wealth of extra-value features that make them easy to *demonstrate . . . easy to sell.*

The dependable, uninterrupted performance of Du Mont Telesets*, week after week, month in and month out, minimizes the problem of service. That's why Du Mont owners are satisfied owners. That's why Du Mont sales are all *profit sales.*

On every count, Du Monts do more for dealers . . . and that is why in 1951, more than ever before, a Du Mont Authorized Dealership is *television's most coveted franchise.*

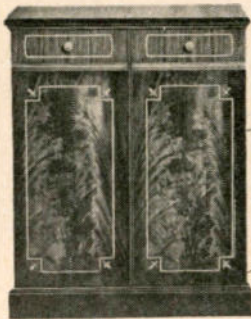

THE WESTBURY SERIES II, by Du Mont,
with 19-inch, direct-view tube; FM radio; plug-in for
record player. Cabinet of fine mahogany veneers.

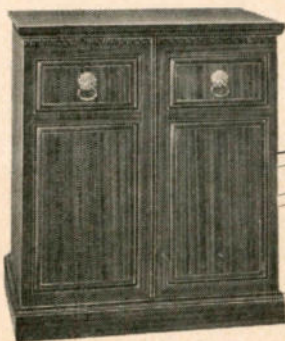
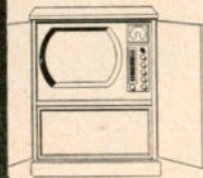

THE SHERBROOKE, by Du Mont,
with 19-inch, direct-view tube; built-in AM-FM radio;
3-speed automatic phonograph.
Cabinet of fine mahogany veneers or blond finish.

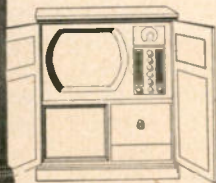

20th
YEAR
AS PIONEER
DU MONT

first with the finest in Television

*Trade Mark

Copyright, 1951, Allen B. Du Mont Laboratories, Inc., Television Receiver Division, East Paterson, N. J., and the Du Mont Television Network, 515 Madison Ave., N. Y. 22, N. Y.

EDITORS ARE SHOWN HOW EASILY TV OWNERS CAN CONVERT SETS FOR UHF

Practical Demonstration Proves Present Sets Not Outdated for Ultra-High Frequency Reception

By ROCKY CLARK

Radio & Television Editor, Bridgeport Post

BRIDGEPORT, CONN., April 11.—If you own a screwdriver, you can convert your TV set for ultra-high frequency reception so easily, so quickly that the job is usually done in two or three minutes—if you own the right type of set.

A large audience of leading newspaper and magazine science editors witnessed this amazingly simple method of UHF conversion here today at the first public demonstration of ultra-high frequency reception on a current model TV set.

The editors learned how easily and inexpensively a TV owner can convert his present set if the manufacturer has foreseen the coming of ultra-high frequency and has prepared the set for its reception.

The Federal Communications Commission recently announced plans for licensing 1,807 new television stations—most of them in the ultra-high frequency transmitting channels—in addition to the 107 VHF stations now in operation.

Ever since this announcement was made, present and prospective TV owners have been fearful that their sets might be obsolete, or that the expense and trouble of conversion might be prohibitive.

Their fears on both counts were al-

layed by today's demonstration, sponsored by the Crosley Division of Avco Manufacturing Corp. Transmitted from the National Broadcasting Company's experimental station KC2XAK at Success Hill, Conn., an ultra-high frequency program was viewed by the members of the press on the screen of a current model Crosley TV Set taken at random from the stock of a Bridgeport television and appliance store.

The program was received with striking clarity and fidelity, completely fulfilling the promise of interference-free pictures received in the UHF television band.

Conversion troubles? Heavy expense? A newspaperman from the audience at the Hotel Barnum was handed a screwdriver and asked to do the conversion job. Loosening two wires leading from the back of the set, attaching them to a simple, inexpensive device known as the Crosley Ultratuner, and connecting the Ultratuner to the set, he did the

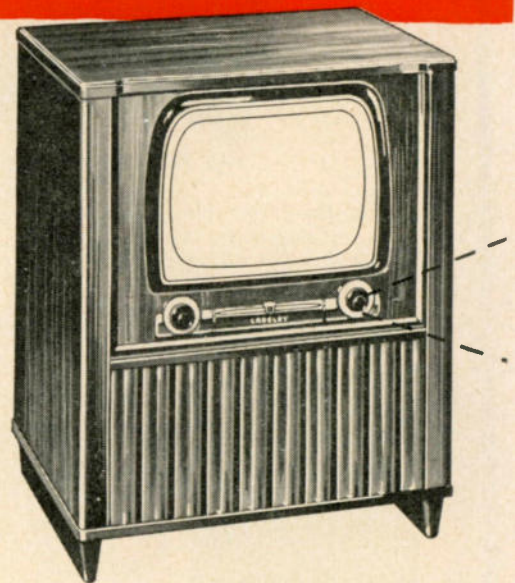

trick in less than three minutes.

He then tuned the Ultratuner to the UHF telecast as simply and precisely as selecting a program on VHF channels. Placed on top of the TV receiver, the Ultratuner is housed in an attractive cabinet no larger than a small table radio.

The secret of this simplified conversion method was explained by Crosley engineers, who said that provision for UHF reception has been made in the design and construction of all Crosley sets built in the past two years.

As a result, he explained, conversion does not require dismantling the set and replacing or adding new parts in the TV receiver, and no service or expert electronics help should be needed.

THE PACE-SETTING DESIGNS ARE

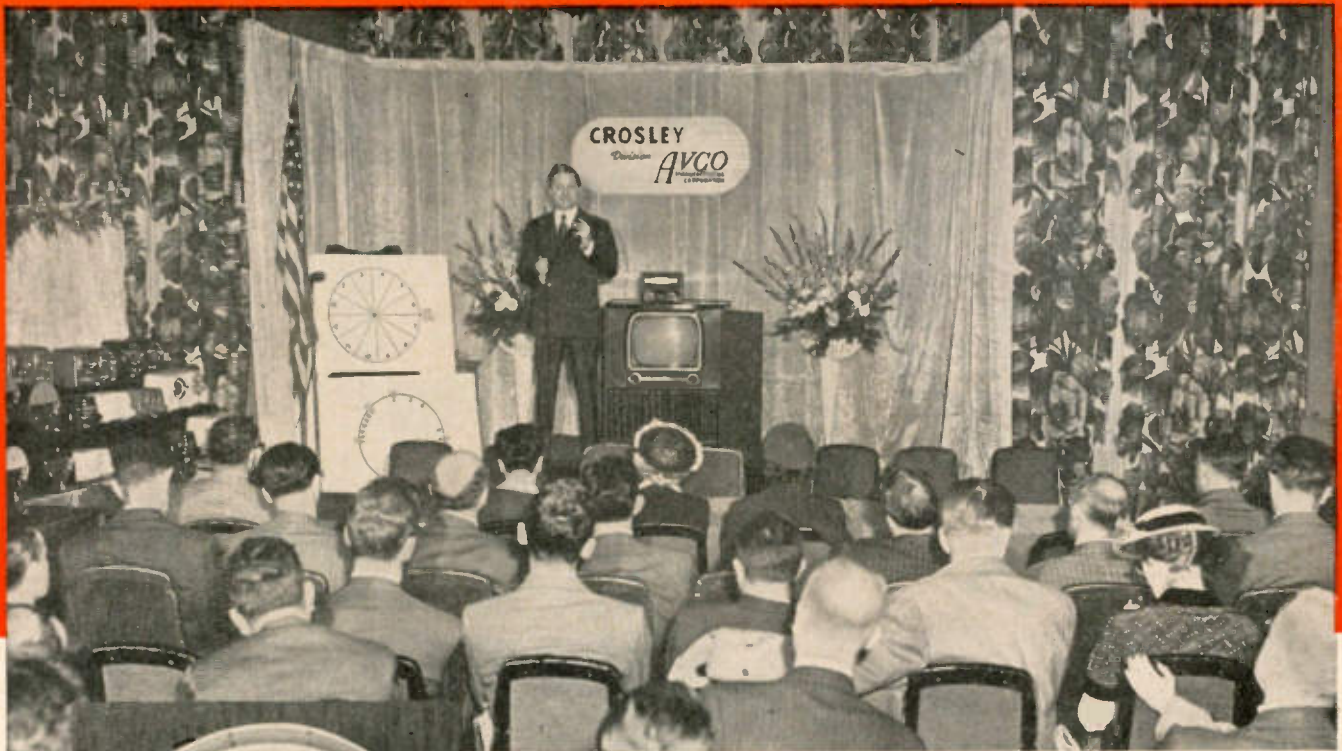

Leading newspaper and magazine science editors witness Crosley's amazingly simple method of UHF conversion in its first public demonstration.

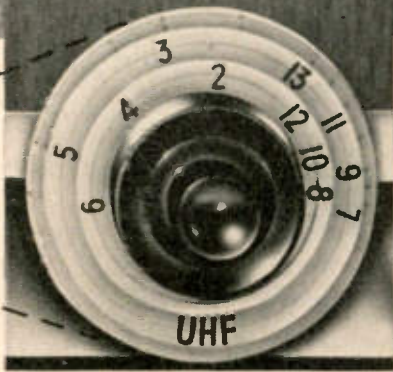

Here's why Crosley TV is No UHF Conversion Problem

As far back as early 1948, Crosley started preparing for the coming of ultra-high frequency television—in two ways:

1. In the Chassis. In every Crosley TV Set built in the past two years, provision has been made in the circuit for the reception of UHF. It's so easy that with a screwdriver, your customer can do the complete job himself—just by hooking up two wires on the outside of the set—in two or three minutes. His only outlay will be the cost of the inexpen-

sive Ultratuner when and if UHF telecasts begin in your area. No adjustments, no removal of chassis, no unnecessary service calls needed. No parts need be changed or added in Crosley-built sets. Your customer simply takes the Ultratuner home under his arm and installs it with about as much

ease as putting a bulb in a reading lamp. It's just that simple.

2. In the Tuner. Crosley employs *continoustuning* with its famous Unituner. In the picture above, you will note "UHF" marked on the dial between Channels 6 and 7. At this point (122-132 megacycles) is located the best selection for a UHF interference-free conversion channel. Most other manufacturers' television sets—with tuners of the "click" or "jump" type—have not provided for this channel.

YOU CAN SELL CROSLY TODAY—with even *greater* confidence! You can assure your customers that they

are buying a set today that is built for the future—not one that will be obsolete or too expensive to convert to UHF reception.

Again, Crosley sets the pace in electronics by being first with an easy UHF conversion method. We have given these facts to the public through the editorial press and full-page newspaper announcements which we think will help to clarify the confusion on UHF to the advantage of all television dealers.

The Crosley Ultratuner will give every Crosley owner a full range of UHF channels and a full range of VHF channels without sacrificing a *single* VHF channel.

You'll get it *all* completely, clearly, economically on a Crosley. For further details about the Crosley TV line, write us for the name of your nearest Crosley Distributor: Crosley Division, AVCO Manufacturing Corporation, 1329 Arlington St., Cincinnati 25, Ohio.

Better Products for Happier Living

Shelvador® Refrigerators...Freezers...Sinks...Garbage Disposers...Radios
Electric Ranges...Electric Water Heaters...Steel Kitchen Cabinets...Television

CROSLY DIVISION



CINCINNATI 25, OHIO

COMING FROM CROSLY!

CROSLY
Family Theatre
TELEVISION

SENTINEL PORTABLES
PEP UP YOUR SALES!



Alive

Alive with power!
Alive
with selling impact!

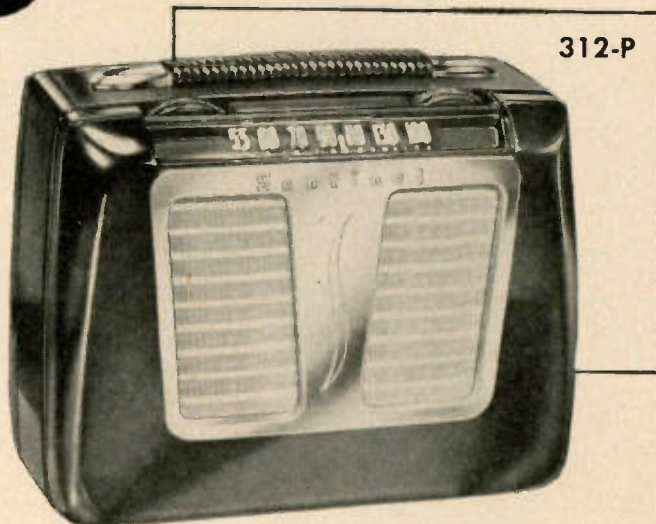

312-P

This Sentinel portable has a 3-gang condenser, tuned R. F. Stage and many additional engineering refinements—brings in distant stations loud and clear when ordinary sets cannot. Operates on AC, DC, or long-life self-contained batteries.

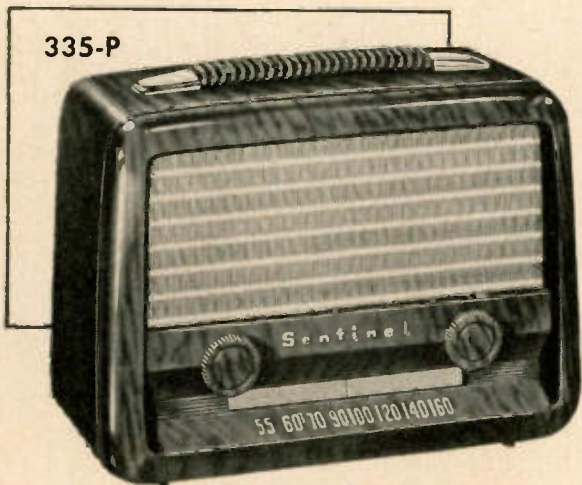

335-P

Thrillingly smart colors. Supremely stylish lines. *Patrician White*—*Palisade Brown*—*Forest Green*—*Tuscan Red*—all beautiful to see and hear. Operates on AC, DC or self-contained batteries.

Sentinel Portables Now "POPPING" PROFITS!

Portables sell in spring and summer like Christmas trees in December—if they are *Sentinel!* For *Sentinel* combines super-performance with smart styling to produce portables that pay prompt profits wherever displayed.

This year, more than in many years past, portables are having a big play. Boys and girls in training camps—vacationists more eager than ever to keep in touch with national and world events—all add up to more sales of portables.

Cash in on this live demand. Order your stock of *SENTINEL* portables now to insure prompt delivery. Call your *Sentinel* distributor—or *Sentinel* direct TODAY!

Sentinel®

SENTINEL RADIO AND TELEVISION • EVANSTON, ILLINOIS



ALL RANGES WITH THIS ONE CONTROL

Just *one* knob—extra large—easy to turn—flush with the panel, controls all ranges. This one knob saves your time—minimizes the chances of “burn-outs” because you don’t have to remember to set another control. You can work fast with Model 630 with your eyes as well as your hands. Look at that scale—wide open—easy to read, accurately. Yes, this is a *smooth TV tester*. Fast, safe, no projecting knobs, or jacks, or meter case. Get your hand on that single control and you’ll see why thousands of “Model 630’s” are already in use in almost every kind of electrical testing



**Model
630**

FOR THE MAN WHO TAKES PRIDE IN HIS WORK

Triplet

TRIPLET ELECTRICAL INSTRUMENT COMPANY • BLUFFTON, OHIO, U.S.A.

NEW INDICATOR ION TRAP

*A
Rauland
"Exclusive"*

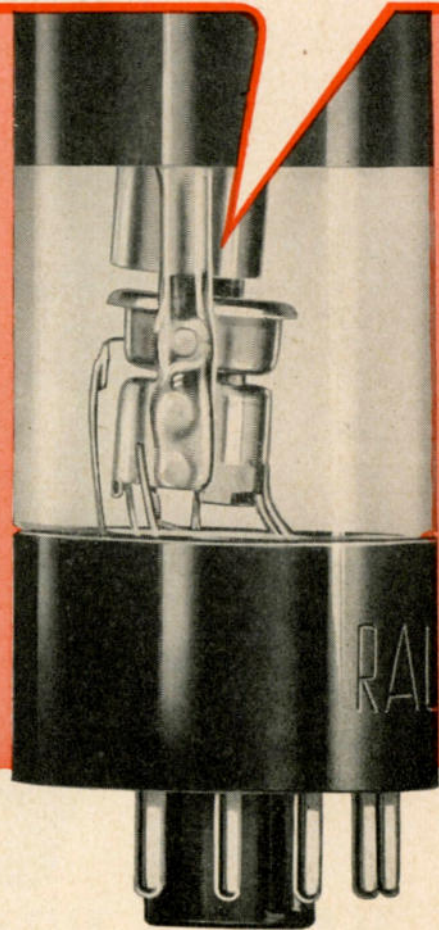

Speeds Service — Builds Profits

Rauland's new Indicator Ion Trap is winning the cheers of more service men and dealers every day—because of the time and trouble it saves in Ion Trap Magnet adjustment, and because it eliminates mirrors and guesswork.

Now it's a matter of seconds to adjust the ion trap magnet with absolute precision. The service man simply moves the magnet until the signal glow is reduced to minimum.

This important new Rauland development is incorporated in all Rauland tubes produced today—as a feature of Rauland's new Tilted Offset Gun. This gun offers the additional advantages of using only a single Ion Trap Magnet and of maximum sharpness of focus.

Only Rauland offers this advanced feature—one of half a dozen post-war developments from Rauland.

For further information, write to . . .

RAULAND

The first to introduce commercially these popular features:

Tilted Offset Gun

Indicator Ion Trap

Luxide (Black) Screen

Reflection-Proof Screen

Aluminized Tube



THE RAULAND CORPORATION



Perfection Through Research

4245 N. KNOX AVENUE • CHICAGO 41, ILLINOIS



CASH IN ON THE STRONGEST SELLING STORY IN THE INDUSTRY



Emerson LIFE-TESTED Television and Radio



Biggest Advertising Campaign in Emerson History Produces HEAVY EMERSON TURNOVER . . . GREATER PROFITS

Emerson Life-Tests are FACTS! Scientific proof of Emerson's better performance and longer life.

These facts are revealed in a vast advertising campaign in every major market in the country

. . . building an unprecedented demand for Emerson LIFE-TESTED Television.

Take the line of least resistance . . . Tie in NOW! Contact your Emerson Distributor Today!



17-Inch Rectangular Model 687, \$379.95



17-Inch Rectangular Model 696, \$299.95

Prices Include Excise Tax and Warranty



14-Inch Rectangular Model 662, \$179.95

AC-DC Table Radio Model 652, \$19.95



3-Way Portable Model 646, \$29.95 (Less batteries)

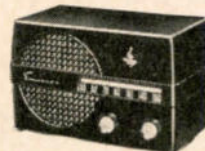

20-Inch Rectangular Model 694, \$499.95

Every 5 Seconds Someone buys an Emerson . . . America's Best Buy!

EMERSON RADIO AND PHONOGRAPH CORP., NEW YORK 11, N. Y.

Prices slightly higher in South and West

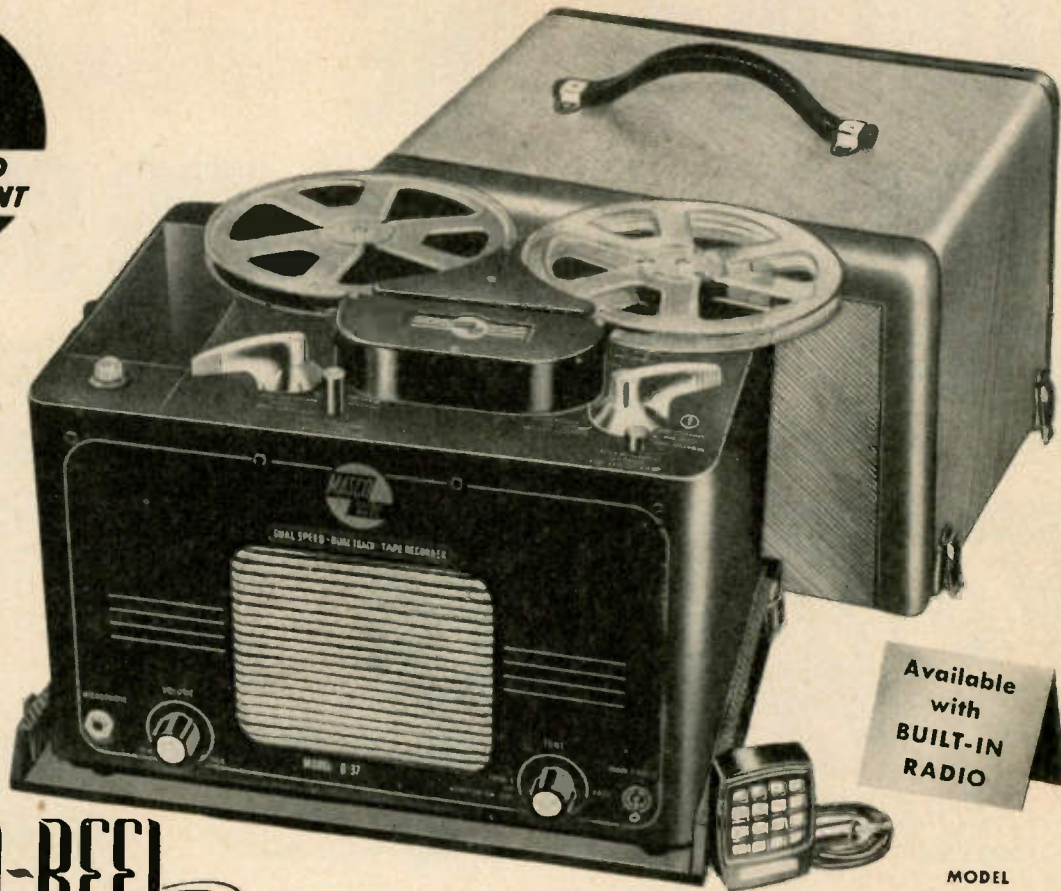

Available with
**BUILT-IN
RADIO**

MODEL
D-37

SOUND-REEL



**Dual Speed—Dual Track
MAGNETIC TAPE RECORDERS**

All 5 Points of Superiority Plus

Many More

- Instantaneous push button speed selection, 7.50 in./sec. or 3.75 in./sec., with Automatic Tone-Equalization for each speed
- Full frequency range—professional tone quality
- Up to 2 hours recording and playback time
- Proved Performance, thoroughly field tested and acclaimed everywhere
- Amazingly light weight, yet rugged. Cast zinc & aluminum components

AVAILABLE IN 6 MODELS

LIST PRICES

D-37 (illustrated) Complete portable recorder with carrying case	\$243.00
D-37R Complete portable recorder with carrying case, with AM tuner	*286.20
DC-37 Complete portable recorder with metal cover and lock	243.00
DC-37R Same as above but with self-contained AM tuner	*286.20
LD-37 Complete recorder less carrying case	221.40
LD-37R Complete recorder, less carrying case, with AM tuner	*264.40

*Plus Federal Excise Tax
West of Rockies add 5%

Additional Features

- Capstan driven—negligible wow and flutter.
- Volume level indicator.
- Monitor speaker built-in.
- Record pushbutton prevents accidental tape erasure.
- Inputs...for microphone, for external radio or phonograph.
- Outputs...for earphone monitoring, external speaker or for existing audio system.
- Finish...beautiful spruce green hammertone.

Write for your copy of Tape Recorder Catalog #TR-51



MARK SIMPSON MANUFACTURING CO., Inc.
32-28 49th Street, Long Island City 3, N.Y.

SOUND SYSTEMS and ACCESSORIES

RAvenswood 8-S810-1-2-3-4

POWER IN PERFORMANCE!

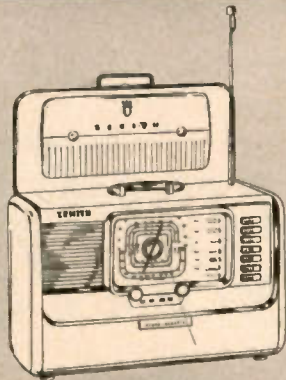

NEW ZENITH SUPER TRANS-OCEANIC

—world's finest, most powerful radio, it's in a class by itself! Designed to perform under the most difficult conditions . . . virtually anywhere, ANYTIME!

- 7-BAND WORLD-WIDE RECEPTION
- WEATHER and MARINE COVERAGE
- COMPLETELY HUMIDITY-PROOFED
- PLAYS on TRAINS, PLANES and SHIPS

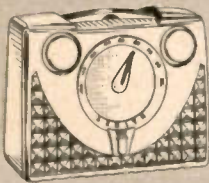

MODEL "401"

Built to OUTPERFORM any other portable in its price class! DialSpeaker design for better tone. Maroon or Gray. AC, DC or Battery.

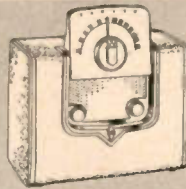

THE UNIVERSAL

Plays even where other portables fail! Tip-Top dial is easy to read. Black or Brown leather-grained case. AC, DC, or Battery.

POWER IN PROMOTION!

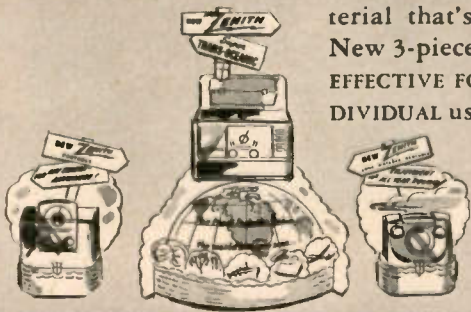

Display material . . . promotion material that's *really* SALES-PACKED! New 3-piece portable display that's EFFECTIVE FOR FULL LINE . . . OR INDIVIDUAL usage. Dealer Promotion

Kit . . . contains *everything* for a record-breaking Portable Year! Streamers, stuffers, hard-selling newspaper ads.

POWER IN ADVERTISING!



National ad-campaign KICKS-OFF a sales drive in your own neighborhood. The result . . . sales volume in portables that you've never realized before!

ZENITH RADIO CORPORATION, CHICAGO, 39 OVER 30 YEARS OF "KNOW-HOW" IN RADIONICS EXCLUSIVELY

**ZENITH
POWER
IN
PORTABLES
MEANS
ZENITH
SALES**



STROMBERG-CARLSON...

First with "24s"

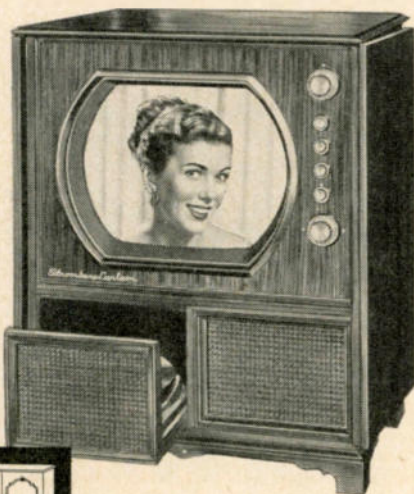

The Stancliffe

24-inch combination. AM-FM radio... 3-speed fully automatic phonograph. \$975.00* Zone 1

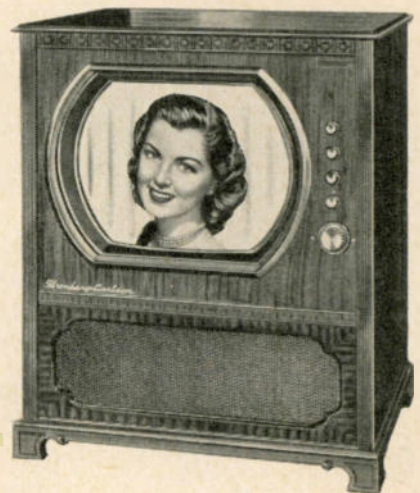

The Radcliffe

24-inch console. Phono jack. Beautiful mahogany cabinet. \$675.00* Zone 1

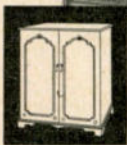

Stromberg-Carlson introduced 24-inch television in November, 1950. Designed especially for home use, it has been a big traffic-building, sales-clinching success right from the start.

• Pictures as big as a newspaper page—356 square inches—with impact and realism that's breath-taking.

- Exclusive "long-life" tuner brings in clearest, steadiest picture yet—even in difficult areas.
- Concert-like tone from 12-inch full-floating speaker.
- Beautiful, compact cabinetry, decorator-designed, in choice Honduras mahogany veneer, completely hand-rubbed.

Other exciting 1951 models—17-, 19- or 20-inch tubes, \$299.95* to 975.00* Zone 1

"There is nothing finer than a
STROMBERG-CARLSON®

Stromberg-Carlson Company, Rochester 3, N. Y.—In Canada, Stromberg-Carlson Co., Ltd., Toronto

*Includes excise tax.

RADIO & TELEVISION RETAILING

Including "RADIO & TELEVISION,"
"RADIO & TELEVISION TODAY,"
and "ELECTRICAL RETAILING"

O. H. CALDWELL, Editorial Director



M. CLEMENTS, Publisher

SHORTAGES OF TV SETS BEFORE NEXT FALL a possibility if curtailment of manufacture (because of sales slow-down now at hand) continues. Look at it like this: While inventories are heavy at the dealer level they are being exhausted at a normal pace, and *are not being replenished*. Many times, the radio-TV industry has been unable to fill a quick and unexpected consumer demand for products underproduced during a dull period.

MEANWHILE, MANY DEALERS ARE COMPLAINING that the manufacturers, or at least some of them, have proven themselves to be "fair-weather" friends, leaving the dealers without sales help or encouragement during these merchandising doldrums. Some merchants commenting on the situation say that the only help they can get nowadays in the way of promotional material and cooperation involves the buying of more merchandise which they do not want.

ON THE OTHER HAND, SOME OF THE LEADING SALES executives in manufacturing firms say that the retailers and their salesmen have been ruined by too many easy sales, and that they have forgotten how to fight for business.

BETWEEN NOW AND THE START of Autumn, our guess is that TV set prices will be lowered by many manufacturers, and that a number of "promotional" models with price tags this low will hit the market. If, as predicted in a foregoing paragraph, a famine takes place, say some time in September, watch for prices to firm up again.

"SHORTAGES" HAVE ABOUT BEEN FORGOTTEN nowadays with products pushing out the warehouse walls. Manufacturers, especially those in radio-TV, are geared up to such phenomenally high production, that barring forthright shortages of raw materials and/or manpower they could produce for a full consumer market and a full-scale war at the same time.

SMART DEALERS ALWAYS TRY to sell one of two things to every customer who has a defective picture tube in an old set. 1. They try to get the owner to trade in the old receiver for a new one, and, 2. in cases where customer doesn't want to buy a new unit, they try to sell conversion to a larger screen size.

ONE BIG SHOW IN '52!—Radio parts manufacturers and distributors are pretty well agreed that one national radio parts show a year is enough—in place of the two present gatherings, one in May and one in September. The extra cost to the industry, of the present duplication, exceeds a million dollars a year—with manufacturers' outlays estimated at \$500,000, distributors expenses at \$400,000, and reps \$100,000. While each show has its own devoted defenders with proper pride of accomplishment, the present National Emergency points the need for combining forces in the public interest. That is why, after completing present obligations for the 1951 May and September exhibits as planned, thoughtful leaders are urging the trade to concentrate on "One Big Show for '52!"

RECALLING THAT AT THE END OF 1950 manufacturers of consumer goods were planning on the probability of all-out conversion to war work, John M. McKibbin, Westinghouse VP, points out that "In a very few short months the whole scene has shifted from production problems to marketing problems."



PRESENT "PLATEAU" MARKET HAS EVERYBODY GUESSING, and is raising hob with planning attempts on the part of manufacturers, distributors and dealers. For more than a year the industry has been on a roller-coaster, riding sales peaks, plateaus and valleys. Today's Number One question is how much (or how little) to make (using available materials), and how much (or how little) to buy. In the meantime, manufacturers, wholesalers, and retailers continue to put the heat on in a drive to reduce inventories.

"THE LONG RANGE PICTURE FOR LATE '51 and 1952—unless the demand is further reduced by more stringent credit controls and higher excise taxes—is one of shortage in all major electrical appliances."—D. A. Packard, household sales manager, Kelvinator Div.

What's Ahead!—in Radio,

RENEWED INTEREST IN UHF marked by a controversy. One group states conversion can be made easily by plugging in new UHF strips in the tuners in place of present VHF strips. Opponents say only way to get reasonably acceptable reception will be with an external converter which will be very easy to add. Frequency assignments are not yet final, and this together with problems of getting stations on the air, and receivers to the public indicates that it will be late '52 or '53 before UHF becomes a reality.

AUTHORITY FOR REGULATION W CONTROLS expires June 30. Big fight on to eliminate the Regulation or to change its terms to prevent further impractical and unbalanced controls on instalment sales. Opponents claim that W, under present conditions is not necessary. It was put into effect to check inflation, and to save essential materials. Industry groups optimistic in their efforts to get the Federal Reserve Board to allow TV trade-ins to be applied against the 25 per cent down payment required by the control.

TV TOOK A RIDE IN CHICAGO recently as the first television receiver installed in a private car was unveiled by its owner, Wm. B. MacDonald, Jr., of the Mid-State Corp. The custom-built installation was engineered by H. Gronsky of Central Television Service in Chicago, and it features a Zenith set with a 12½ inch screen. The antenna is mounted on the trunk and is operated by an electrically driven rotor for directional beaming.

INNOVATIONS GALORE IN MIAMI STORE!

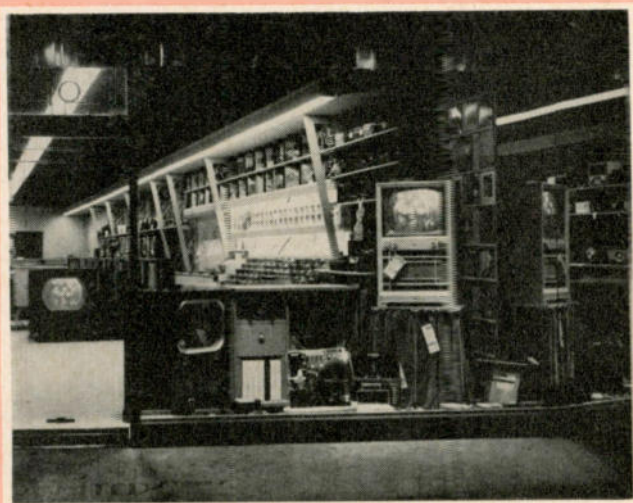

The all-glass front of the new Associated Stores' outlet at 40 W. Flagler St., Miami, uses peach tinted mirrors as side walls. A very pleasing effect is produced in reflections. Since a great many buses stop in front of the store, the "sidewalk mirrors" are always well "patronized", especially by women. This storefront features "live" TV sets, and is a magnet in drawing people into the store. Inside, more than a hundred sets, hooked to a master antenna system, are in actual demonstration. In record department, the entire stock is on display so that customers may serve themselves. There are 4 stand-up booths with glass partitions.

SOME OF THOSE DEALERS WHO have been selling consistently at so much off to consumers, now worrying about publicly establishing such low prices under the new Ceiling Price Regulation.

DEALERS IN SOME SECTIONS reporting a healthy demand for traded-in television receivers. Priced low, the sets move fast, 7" table models going for an average of about \$50 in at least one market. Trade-in offers continue to highlight dealer advertising.

SALESMANAGERS IN SOME OF THE LARGEST STORES worried about increasing turnover of salesmen, and by low-grade salesmanship persisting in spite of efforts to train men to do a good job. One sales executive is going to try outside follow-up calls. He finds that men who sell only on the inside refuse to obtain the names of prospects, and lose interest the minute the customer raises an objection. Another angle to combat: cliques of cynical salesmen who brand ambitious co-workers "hungry."

TV COMMERCIALS RECEIVED a viewers' vote of approval in the findings of a survey of public attitudes toward television advertising made by Scott Radio Labs among a random selection of families in the Chicago area. Less than one in five set owners found the commercials "objectionable", while nearly half said they are "good" or "very good." The remaining one-third said they are "unobjectionable."

IF PRESENT SOFT MARKET CONTINUES, it's more than likely that we'll see a trend toward encouragement of heavy production of consumer products. Such encouragement may come about through easing up on certain controls and regulations. Many top government officials are completely sold on the tenet that plenty of merchandise in a competitive market is the best buffer against inflation.

"FIRMS WHICH CONTINUE AGGRESSIVE ADVERTISING . . . are building future markets for their products. Firms which stop or greatly restrict their advertising, lose their brand or trademark acceptance to the public view."—M. R. Wilson, Thor general sales manager.

"TOO MANY OF US ARE TRYING TO FIGURE OUT why the public demand has slowed up; why more people are not coming into the store; why it is harder to close a deal. Instead of trying to figure out the answers, better use of our time could be put to figuring out what to do about it. When business slows up there is only one answer—increase the sales effort. That might mean putting on more salesmen; it might mean more advertising; it might mean starting a direct mail campaign; it might mean starting a telephone canvas. Regardless of what direction of such increased activity you took, it certainly would mean better sales."—From bulletin issued to dealers by the Harry Alter Co., Chicago distributing firm.

Appliances, Records and Television

NUMBER OF ADDITIONAL ITEMS including radio-TV sets, electric housewares, musical instruments, but excluding major appliances, now being priced under "frozen markup" regulation CPR 7, OPS. Extension means that specified merchandise will be removed from the pricing of the General Ceiling Price Regulation and will be priced by use of chart upon which retailer will show the cost, selling price and the markup in effect in his store for each of the new items on March 31, 1951, the "list date" for the new commodities. Dealers should obtain copies of CPR 7, Amendment 2 from OPS in Washington or from local offices.

WITH INCREASED SALES OF RECORDS AND RECORD PLAYERS, dealers are urged to sell needles and accessories more vigorously. One prominent merchant requires each sales-person to show a good needle to each disc customer, stressing the features. This dealer claims it isn't enough to ask, "How are you fixed for needles?", or some similar question which usually accomplishes just nothing in most cases. "Show 'em," is his motto.

Merchandising Legislation in Various States

WITHDRAWN FROM THE WISCONSIN LEGISLATURE in the face of heavy opposition from trade groups was a bill to repeal the state fair trade act, permitting manufacturers to establish minimum resale prices for their trade-marked products. . . . A fair trade act repealer was killed earlier in New Mexico.

IOWA'S HOUSE OF REPRESENTATIVES killed a proposed unfair trade practices act, to outlaw below-cost sales. . . . A law enacted in New Mexico repealed a requirement for licenses for dealers using trading stamps.

PROPOSALS TO IMPOSE STATE income taxes on cooperatives competing with private business have been raised as issues in several states this year, but with negative results thus far. Such bills already have been rejected in Colorado and Montana.

3 PER CENT SALES TAX on almost all products passed by the Georgia legislature just prior to adjournment of its 1951 session. Seeds, fertilizers, insecticides, exempt.

"GIMMICKED" AND "DOUBLE-TALK" ad copy by a number of retailers in some of the big cities, in efforts to move heavy inventories of TV sets and appliances, being vigorously attacked by Better Business Bureaus.

DOING A GOOD JOB IN SELLING REBUILT appliances. A Southern dealer is able to get higher than usual prices because of the top-flight reconditioning job he does plus merchandising them in an atmosphere where customers do not feel that they are buying someone's "cast-off" products. Used products are sold in a separate section of the store, where such merchandise gets the same sort of good display and surroundings as do the new items. Classified advertising, listing specific articles keeps customers coming into the store.

"T'WON'T BE FUNNY WHEN YOU TRY TO GET a 36" TV set inside a standard door. You may not have to cut the cabinet and tear down the door frame but you'll have to do plenty of maneuvering to get it in. Why can't the cabinet makers figure out a way of split-

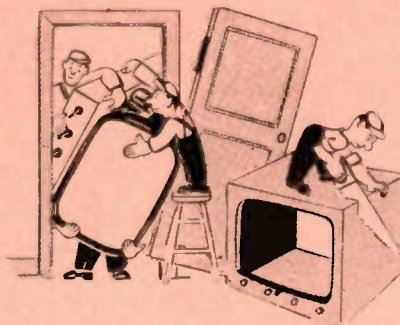

ting the cabinet so that, in tight places, the installer can remove the chassis, 'jockey' it through the door; split the cabinet via some sort of 'tongue and groove' effect, and take the two pieces inside too?"—From "Television Mis-Information," issued by Sheldon Electric Co., Irvington, N. J.

BILLS TO OUTLAW ALL "TIE-IN" SALES, in which a customer is forced to buy something he doesn't want in order to purchase what he wants, have been introduced in Connecticut, Minnesota and New York.

FUTURE EVENTS OF INTEREST TO READERS

May 13: Mother's Day.		Dealers Association Mid-Year Meeting, Stevens Hotel, Chicago, Ill.	Aug. 20-24: New York Gift Show, Hotels Statler and New Yorker, N. Y.
May 21-23: 1951 Parts Distributors Conference and Show, Stevens Hotel, Chicago, Ill.	July	1-6: New York Lamp Show, Hotel New Yorker, N. Y.	Aug. 22-24: Pacific Electronic Exhibit, Civic Auditorium, San Francisco, Calif.
May 21-25: N.A.E.D. 43rd Annual Convention, Hotels Chelsea and Ambassador, Atlantic City, N. J.	July	16-19: National Assoc. of Music Merchants 50th Annual Convention and Trade Show, Palmer House, Chicago, Ill.	Sept. 3-7: Boston Gift Show, Hotel Statler, Boston, Mass.
June 4-7: Radio & Television Manufacturers Association Meeting, Stevens Hotel, Chicago, Ill.	July	16-20: Western Summer Market, Western Merchandise Mart, San Francisco, Cal.	Sept. 11-13: Radio Parts Distributors' Convention (NEDA), Cleveland Auditorium, Cleveland, Ohio.
June 17: Father's Day.	July	30-Aug. 10: Chicago Gift Show, La-Salle Hotel and Palmer House, Chicago, Ill.	Sept. 16-20: Philadelphia Gift Show, Hotel Benjamin Franklin, Philadelphia, Pa.
June 18-28: Home Furnishings Market, American Furniture Mart & Merchandise Mart, Chicago, Ill.	July	19-22: 4th Western Housewares Show, Biltmore Hotel, Los Angeles, Cal.	Sept. 23-27: Washington Gift Show, Hotel Willard, Wash., D. C.
June 25: National Appliance and Radio	Aug.		Oct. 8-12: National Hardware Show, Grand Central Palace, N. Y.



...Dollar for

RCA VICTOR 19-inch

What Quality!

Customers know they get more for their money when they buy big-screen RCA Victor. It's *Million Proof* quality—now proven in over 2 million homes! Big, clear, steady pictures. Quality performance means fewer call-backs, fewer complaints. Choice of finishes and mahogany costs no extra!



Table Television . . .

The YORK

RCA Victor's biggest screen size, in an exciting table model for budget-conscious shoppers. Handsome modern cabinet is finished in walnut, mahogany, or lined oak (9T105). Matching base, optional—extra.



2-door Console . . .

The HILLSDALE

Certainly the best buy in 19-inch console television. Famous Million Proof performance. Beautiful two-door cabinet, phono-jack for plugging in "Victrola" 45 Attachment. Finished in walnut, mahogany, or lined oak. (9T126)



ONLY RCA VICTOR HAS
THE "GOLDEN THROAT"

RCA VICTOR—World Leader in Radio . . . First in

Dollar your Best Seller in Television

**What Demonstration
— Selling!**



Flick the set on. Let customers see the clear, steady pictures on the big-as-life screen. New picture pick-up gives *best possible* reception. Pictures are *locked in place* by Eye Witness Picture Synchronizer. Let them *hear* the rich, balanced tone of the "Golden Throat" . . . and the magic power of the large, supersensitive Electro-Dynamic speaker.

—How can you miss?

...and what a Line!

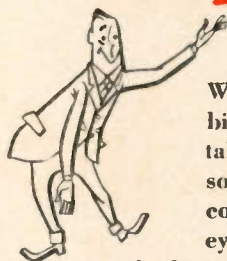

We mean a *complete* line! Even in the big 19-inch size there's an RCA Victor table model, two superbly styled consoles, and one of the handsomest 19-inch combinations shoppers ever set their eyes on. And don't forget *price*. Heading up the biggest, most realistic sell-up line in the industry, there's RCA Victor 19-inch television priced for every shopper's budget.

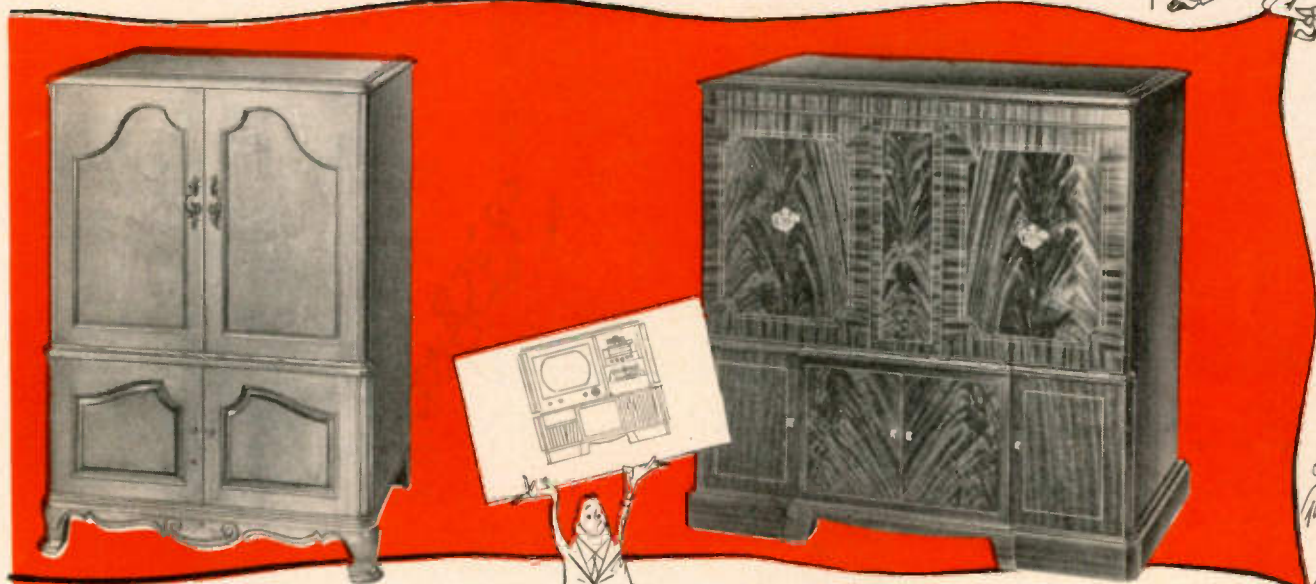

4-door Console . . .

The NEW PROVINCIAL

Striking Provincial-style cabinet houses striking 19-inch television. The Traditional fan's delight—superbly styled, beautifully finished in maple, mahogany or walnut. Includes phono-jack. (9T128)

19-inch Combination . . .

The SEDGWICK

19-inch television with complete home entertainment: powerful AM-FM radio plus 2 automatic record changers, one for "45" records and one for 78-33 $\frac{1}{2}$ speeds. Extended Tone Range for even greater sound quality. Finished in walnut or mahogany. (9T147)

RCA VICTOR



DIVISION OF RADIO CORPORATION OF AMERICA

ONLY RCA VICTOR MAKES THE "VICTROLA"

"Victrola"—T.M. Reg. U.S. Pat. Off.

Recorded Music . . . First in Television

Fight the Summer Slow-Down

Plan Now to Get the Jump on the Seasonal Slump. Calls on Old Customers,



The outside field is richer than ever before, and it's "under-worked." When traffic falls off in the store, the salesman can bring the "store" and its products to the home where sales can be made under relaxed conditions.

they can use the same method to obtain more business. They have known it for years, and agree that it's the Number One way to make more sales, whether efficiently-operated activities in the outside field consist of cold canvassing, follow-up calls, working on direct leads, or a combination of all such methods, the results will always be satisfactory.

To get the jump on the summer slump, the merchant should plan now to devote more sales effort in the field. There are four sets of "prospects" in the homes in all communities. First, there are the regular customers who are continually in the market for new things. Second, there are the good prospects who have called at the store, or who have been contacted in the home in the past, and third, there's the great number of "suspects" living in the territory, who can be reached via cold canvass. Fourth among the prospects for more sales are the non-competitive merchants and business men in one's town or city. The latter can be sold TV sets, electric fans, air conditioning units, and many other products.

Salesmen have to eat 365 days a year, but many work hard only during the busy seasons, and are content to do little more than swivel-chair duty during the hot months. Such practice eats into the store's profits and

Here's a picture (below) of the swivel-chair salesman in action—or is it without action? In spite of the fact that he has to eat 365 days in a year, he is willing to coast along during the summer months, while smarter salesmen are out getting the sales. He won't follow a hot lead because the weather's too hot. The remedy for slow business is hard work. When store sales slow down, the alert merchant keeps his salesmen busy in the field. He knows that his overhead, like Tennyson's "Brook," goes on forever.

• Many years ago we told our readers that business belongs to the man who goes after it. This statement is just as true today as it was then, and so far as the coming summer is concerned, we'll change the saying a bit to read that "business belongs to the man who goes *out* after it." Because store traffic falls off sharply in the summer in almost all communities, and because overhead continues, outside selling is seen as the very best method to use in maintaining a satisfactory sales volume during the hot months.

Politicians usually maintain campaign headquarters, but few depend solely upon such headquarters to pull votes. They know that the prime method for securing votes is accomplished by personally canvassing the voters. It's a simple proposition. The more people the fit candidate can meet and talk with the more votes he is likely to get. Dealers know that



With Outside Selling

New Customers and Prospects Will Bring in Extra Business

is bad for the salesman's morale. The merchant who lines up a busy summer selling campaign will have a happier, more prosperous salesforce, and a greater volume of business. Such a campaign can be undertaken by stores of all sizes, even those with but one salesman.

Since he will find many people at home during summer evenings, this is perhaps the best time to make calls. Folk will be working in gardens or sitting on porches, and under such conditions the salesman is able to bypass the formality of ringing a bell, and being greeted at the door.

Take Products With You

The smart salesman will take some product with him on his calls. He may want to have a room air conditioner in his car to show the prospect. Or he may take along a portable radio, a three-speed changer, a vacuum cleaner or an electric fan. If he knows the prospect or customer, he can carry the item with him to show the customer. On cold canvass calls, however, this technique being a bit on the abrupt side may not work out so well. On such occasions, he can describe the product, and offer to show it if agreeable to the resident. In this instance, bear in mind that we are speaking about "outside-outside" calls, the ones where the salesman finds the people out in their yards. In cases where he rings a doorbell, he *should* bring the product with him to the door. Reasons back of all this are as follows: If Salesman A knows the Joneses well, they'll be interested in seeing that portable radio he's carrying, whether or not they're in the market for one. They won't greet him with a statement to the effect that they already have a radio, and, hence, are "not interested." If, on the other hand, he barges into Mr. Stranger's yard with an electric fan, it gives Mr. Stranger the cue to say he doesn't want to buy one. The reason for bringing the product to the door on calls where the householder is in his home is simple. If the salesman tells the prospect that he'd like to show him a vacuum cleaner that's in his car, it's more than likely that the householder will tell him not to bother about it.

The store having more than one salesman should map out a realistic call plan. Each man should be required to make a certain number of visits per day. It's up to the dealer to decide whether these calls should be made on established customers, prospects, or should be cold canvassing ones.



There's business in the business district, too, for the enterprising salesman. He can sell TV sets, fans, room air conditioners and many other products to non-competitive merchants.

Many dealers find it difficult to get salesmen to make evening calls. In such cases, a new time schedule is often the answer. Under such plan, the salesman is given certain hours off during the day to compensate for time spent in making evening calls. No matter what arrangement is made, the smart dealer will carefully supervise outside selling activities, mapping out orderly campaigns, and demanding simple sales reports from his men. Men who are obliged to fill out sales reports will be happier as a result. Such practice brings an orderly pattern into selling, eases consciences, provides valuable data for the store, and lets the boss know what's going on.

So far as time is concerned, the follow-up of hot prospects brings the quickest results, with the call on old customers a close runner-up. Cold canvassing is a long-range proposi-

tion, requiring a considerable investment on the part of the dealer in cases where he pays salesmen salaries of any kind, however small. Cold canvassing by straight-commission men is an attractive arrangement for the merchant, but men who will work on straight commission, without a drawing account are hard to find.

Outside selling is good medicine to take for the slow-business bugaboo. Few establishments are so busy all day long that they cannot spare a few hours of any salesman's time. With conditions so perplexing in this market, the dealer who is now planning to sell outside of his store this summer has nothing to lose and everything to gain.

In spite of promised shortages, business wasn't what dealers expected it to be after the first of the year. And while the sales level was rela-

(Continued on page 52)

SWIVEL-CHAIR DRAMA IN FOUR ACTS



(1) Procrastination (2) Relaxation (3) Estivation (Summer "hibernation") (4) Culmination (A visit from the sheriff)

How a Top Salesman

"Bob" Stulb Specializes in Nailing Down Those Hard-to-Get Orders. Each Day a Busy



↑ "Bob" Stulb, salesman and TV-radio salesmanager for the Grunewald Company, New Orleans, starts the morning going over an order for new merchandise with Glen "Smitty" Smith, of Walther Brothers, local distributors.



↑ Here, Stulb extends a cordial invitation to a customer to visit the store. The prospective purchaser has called to inquire about a receiver advertised in the morning paper. No outside men are employed in the department, so every effort is made to get the customer into the showroom for a demonstration.

"Bob" Stulb okay's ads. He's shown above, right, looking over a proof submitted by an advertising salesman for the *New Orleans Item*.

↓ "Give a call to each of these people whose sets were installed day before yesterday," Stulb tells his secretary. "Make sure they're satisfied with the reception they are getting." Follow-up phone calls are made two days after every sale.



• The best method to use in selling television sets, according to a man who ought to know, is to make the prospect feel at home. "That's why," says J. "Bob" Stulb, in charge of radio and television sales for the Grunewald Co., 325 Baronne Street, New Orleans, "I like to sell to a family. Then the decision can be made on the spot. But the trick is in using the exact opposite of high pressure—making them feel at home."

This is not to say that Stulb, who does active selling in addition to supervising the sales work of other men, advocates letting the sale presentation wander aimlessly around. He is a believer in urging customers to buy, but handling the sales situation so skilfully that the family feels at home and the decision to sign the order comes as a matter of natural course.

"Bob" Stulb is no theorist in these matters. A leading New Orleans wholesaler, Walther Brothers, terms him one of the top TV and radio retail salesmen in the territory. Proof of his ability comes when he handles one of the tasks he has assigned to himself: The taking over from other salesmen of seemingly lost sales, and converting these remote prospects into customers.

"We do not go outside to sell," Mr. Stulb points out. "All of our selling is done inside the store. That's why I consider it important to handle what we call the 'turn-over'. That's when a salesman turns over a prospect he seems to be losing. From my point of view, people wouldn't come into the store if they weren't interested in television itself, in the national brands such as Philco, Westinghouse, Admiral, Crosley, RCA Victor, DuMont, Emerson and Scott, that we sell—and in Grunewald's as a store from which to buy."

How does a top TV salesman get the orders from these "turn-overs?" First step, Stulb points out, is to begin without any plan at all. "By that, I mean that each customer presents an individual problem," he says. "It does not pay to present the same thing in the same way to every prospect. First, I try to find out what the customer wants. Until I know what the prospective customer has in mind, I'm not in position to present one of our sets as the solution to his problem." Bob Stulb has been in radio and—more lately TV, selling for over twenty years. In that time he has learned to qualify prospects by casual conversation in order to discover their aims. "And I like to place them by type," he says. "There are certain

Sells More TV Sets

One, as He Trains Others, Makes Follow-Up Calls, Talks With Distributors' Field Men

kinds of customers whom it is easier to sell than others. For example, a complete family is the best. I like to have all the members on hand. Then there is no question of having to come back with Papa before the decision can be made.

"The hardest kind of customer to sell is frequently the particular one who comes in with a friend. Just as the prospect gets sold, let's say, on a specific make, up pops Mrs. Friend with the suggestion that her Whoozis brand is a nifty one. Always it's something we do not have in stock—sometimes an off-brand or house-brand of another store. I try to get around that by selling the dependability of the nationally-known names that we feature.

"An important angle in sizing up prospects is to try to distinguish between those who are ready to buy and those who are not—the people who have already made the purchasing decision, and those who are only trying to sort of sell themselves. Each requires a different kind of treatment. The first group gets facts about brands, and I make a strong effort to pin down a make preference rather than let the customer's attention wander among many. The second group needs to be sold the enjoyment of the medium itself. I don't try to pressure these undecided people into buying on the spot. It's better to let them make their own decision later. They'll come back when they do."

Regarding sales training, Stulb has no hard and fast rules. "Instead of formal meetings, I like to put pointers over in impromptu man-to-man talks with the individual salesmen," he says. "That way, I can give each man suggestions that he personally needs. I can find out what his individual problems are and help him to find a solution."

In the final analysis, the most important angle of television salesmanship that Bob Stulb practices is to "make the customer feel at home."

"Television," he points out, "is something to be enjoyed in the home. It's been my experience that a homey atmosphere is a selling aid. We have comfortable easy chairs. I like to get my prospects seated in these before the particular set in which I have pinned down their interest. Every set on our demonstration floor is plugged in and ready to turn on. I try especially to break down the shyness of the children so that Mama and Daddy will feel more at ease. I talk to the youngsters to center their interest upon whatever program is being telecast. When the cowboy shows are on, that is easy."

Use These Steps Urges "Bob" Stulb

- Make customers feel at ease.
- Pin customer's interest on one make.
- Qualify each and every customer.
- Get the youngsters interested.

At right, "No customer likes to be treated as a 'ticket number', or something like that," says Stulb. He follows up every service or adjustment call personally, and makes sure that each new set that goes out is operating satisfactorily. Stulb is shown in this photo talking with John Fong, radio-TV technician.

Below, in the afternoon, Stulb demonstrates a set to the prospect who had called in the morning. The youngsters are made to feel at home, and are included in the general conversation.



(Below) Stulb confers with Pierre Clemenceau, active manager of Grunewold's store, and grandson of the famed "Tiger" of France. Sales policies at this store are slanted toward keeping customers satisfied in order to obtain repeat sales, and customer-recommended business.

Below, right, is TV set Stulb sold earlier in the afternoon, and it's on the way to the home of the customer. Getting customers to concentrate on one make, and the ability to shape his sales presentation to various types of would-be purchasers, helps Stulb close many sales.



Colorado Dealer Clicks With the Farm Trade

Appliance Business Linked to Implement Sales, a Profit-Producing Formula

• Ted Scheierman is a Colorado appliance dealer who does an enormous volume among farmers mainly because his business is skilfully geared to fit in with the known buying habits and desires of the people in his territory.

He runs the newest and biggest store in Berthoud, Colo., and his sales floor is neatly lined with ranges, refrigerators, washers, ironers, and other new appliances. All this mer-

chandise is kept moving at a lively clip because Scheierman speaks the farmer's language when it comes to making a sale.

The store is bright, clean, streamlined and strictly up-to-the-minute; it never gives the impression that used merchandise is featured along with the new.

Scheierman will take in farm machinery, livestock, used appliances or furniture as trade-ins. He has been

doing it successfully for years. He knows that the modern farmer is the owner of a lot of miscellaneous equipment; nearly every farm has some unit around the place that is no longer useful. Most farmers are natively "traders" anyway; so Scheierman heads straight for this market.

Stages "Farm Auction"

At this store, the appliance business is linked with implement sales and farm machinery repair. After Scheierman collects enough used machinery in trades, he stages a big "farm auction" and gets rid of it, usually at a profit. If the traded-in machinery does not sell, his shop men tear it down and sell it as scrap iron.

The traded-in appliances are disposed of in three different ways. They are (1) Advertised locally as bargains. (2) Sold to other dealers in industrial towns or where there are larger groups of lower-income buyers, or they are (3) taken to community auctions.

Reputation Brings Sales

Berthoud farmers get the idea that Scheierman understands farm equipment problems and is willing to deal in nearly all types of equipment used on the farm. They get the habit of talking to him whenever they need something. It leads to many outright sales of new appliances.

Scheierman has, in fact, got so far into the agricultural picture that he now owns a farm of his own, rented to a tenant operator. Some of the implements and livestock acquired on trades at the store, go to his farm. The farm is, of course, mainly an investment and is not a major factor in how the store is run.

This Colorado retailer does not do a great deal of newspaper display advertising, or direct mail work. His display ads, run in the local paper, the Berthoud Bulletin, are mostly announcements of brand new products or improved models. He prefers modest ads, run in the farm listings of newspaper classified sections. He has found that rural readers watch these columns very closely. He likes to use detailed listings, giving some specifications of the merchandise offered.

Nearly every ad does, however, carry the secret to the Scheierman success, "We'll Trade With You!"



The brightly-lighted Colorado store (above) is getting to be a landmark for farmers in the Berthoud area. Although Scheierman has heavy traffic in used appliances, the showrooms of the store (below) are kept shining with the very latest in new merchandise.



IMPORTANT

MR. DEALER— How would you like to start ALL OVER with TV?

Overnight, a million more homes are prospects for TELEVISION.

Yesterday, they were beyond the service range of television and had no value to you.

Today, you can get into the untouched fringe area—of the unsold homes awaiting this sensational new receiver design. *People who couldn't buy TV before—* Plenty of prospects—with plenty of money.

A New Meck "Red-Head" TV Chassis doubles the range of good reception. Here is "year-ahead" engineering—no 1949-50 model with ersatz parts.

THE "RED-HEAD" PERFORMANCE GUARANTEES BIG SALES— IN NEW AREAS

- Performs brilliantly in fringe areas and poor signal locations.
- Built-in Booster—at no extra cost.

- Built-in booster doubles the range of the built-in antenna—may save the cost of an outdoor installation.

- Pictures are virtually interference-proof. Lock-tite synchronizers keep unequalled picture stability against auto and electrical interference.

We Saw This Situation Coming

This model was on the drawing boards late last summer—by November, it was being field tested. Instead of working day and night to overstock you with old models, *we anticipated the job that will keep you on top in the TV business, today.*

If you want—not price cuts—but a big new market—ready to buy on your demonstrations, write or wire me, today.



John A. Meck
PRESIDENT

JOHN MECK INDUSTRIES, INC.
PLYMOUTH, IND.

NOW A MILLION MORE HOMES WILL BUY TV—

THAT'S THE MARKET FOR THE "RED-HEAD"

Push Sales of Portables

Year Round Business for the Smart Merchant Who Uses

Modern Methods to Merchandise Carry-About Sets

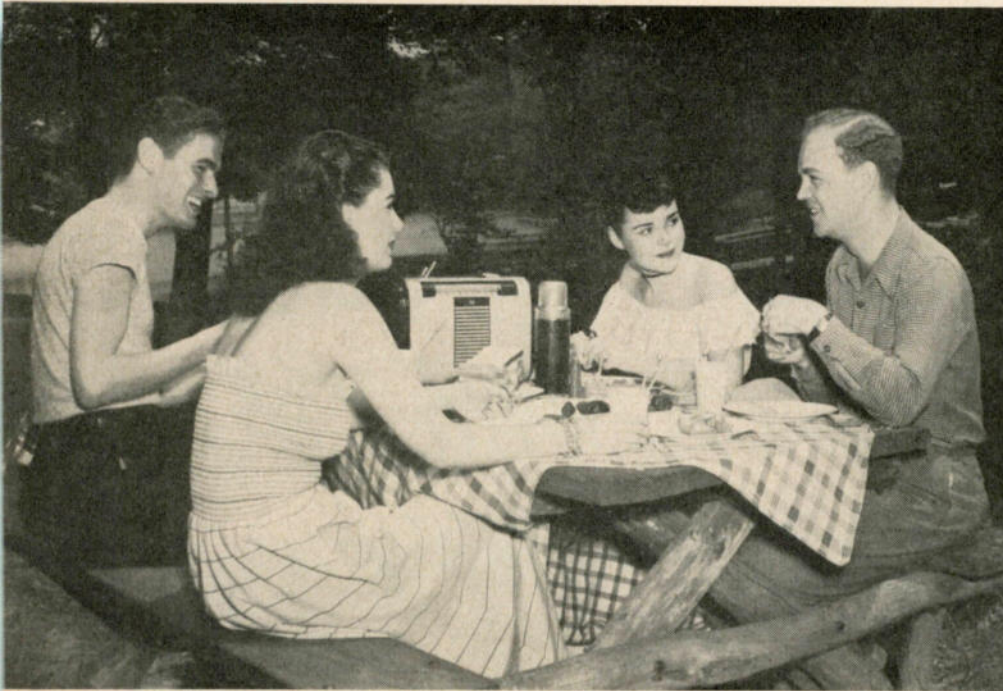

Many people just "never think" of taking a portable along on their pleasure trips. You'll have to tell 'em if you want to sell 'em.

• Portable radios can be used all year round. And they can be sold all year round, too, by the dealer who starts promoting them now.

Despite the fact that carry-about sets can be used and enjoyed practically anywhere at any time of the year, most people think of them in connection with summertime activities such as camping, picnicking, vacationing, etc. So now that summer is coming on, the alert dealer should take advantage of this seasonal thinking and start making folk in his area "portable conscious."

In advertising and in the store, plug portables as the ideal gift, because summer brings with it many graduations, proms, weddings and other gift-giving occasions. And remember, the person who buys a portable as a gift may also buy one for himself. Maybe not at the same time, maybe not until the Fall hunting season or until Christmas, but the present is a good time to plant the seed.

The various outdoor activities in your community also offer "seed-planting" opportunities. Many social, athletic and political clubs as well as churches have outings. Signs posted in the group headquarters might suggest taking along a portable radio on the trip. And such groups often sponsor card parties or other events to help finance their outings. A port-

able radio donated as a prize for such events will be well received and will provide a lot of good, inexpensive advertising for the dealer.

Excursion boats, bus terminals, travel agencies and railroad stations also offer opportunities for the dealer to plug his portables. Posters at such places will be seen by folk while they're thinking of their trip, and while they're in the mood to imagine themselves enjoying a portable radio while on that trip. Exchange advertising can often be arranged whereby, for example, a dealer displays in his store a poster which lists the rates and schedule for "Blank Lines Excursion Boats," and in return, the dealer's sign advertising portables is displayed near the ticket office at the "Blank Lines" lake or river boat landing. This, too, is effective advertising, and costs the dealer nothing.

An arrangement with the local bank somewhat similar to the before-mentioned ones could prove to be another promotional stunt well worth the effort. Most banks have "Vacation Clubs," which accounts are usually closed out about this time of year. Printed folders which might be left near the "Vacation Club" window at the bank will reach the account holders at a very opportune time: when they're thinking about vacations, and while they've still got the money in

their hands. Perhaps a tie-in ad, together with the bank, built around a "savings" theme, or a "vacation" theme, would prove to be of mutual advantage and could be distributed by both the bank and the dealer.

Make a habit, if you don't already do it, of using a portable yourself. Take it with you whenever you go for a walk or to make a call. You'll actually make sales right on the street to people who comment about the set or ask you the ball game score. It's under conditions like this that folk really appreciate how useful a portable is, and they wish they had one too, even before you mention it.

Customers who buy home radios or TV sets, too, are always prospects for a portable radio sale. There's much opportunity here for approaches like "Your new set will give you a great deal of entertainment, and with a portable radio, you can take your entertainment right with you when you leave the house."

The service department is another source of good leads. Any portable owner who has left the batteries in the set all winter and found that they've badly corroded, should be a perfect prospect for a new model. Even those whose sets are still working might well be interested in a newer and lighter model. And remember the possibilities in battery sales. Servicemen and dealers alike should, on every service call and on every sale, inquire as to whether or not the customer owns a portable. If not, a portable sale may well result, and if the customer does own a portable, it is very likely that he needs new batteries, and perhaps a servicing job.

Window and store displays can be used, too, to show the many occasions when a portable adds enjoyment. Don't rely on the customer to think of uses, but make suggestions like: on fishing trips, on the lawn, in summer bungalows and motor camps, on picnics and, of course, at the beach. And don't forget others like: take a portable along when you go ice-skating on the pond, or, carry it from room to room as you do your housecleaning, or countless other uses perhaps more applicable to your locality.

Remember though, to plug the fact that portables are so useful and enjoyable in all seasons. Keep pointing out how portables can be used all year round and you'll boost your year round sales; but start doing it now, while folk are in that "portable radio mood" that comes on each summer.

THE SET THE *Experts* OWN!



TELEVISION CAMERAMAN
Steve Wagner, Chief Cameraman
Leading Chicago TV Station



TELEVISION NEWS EDITOR
Ted Materna, Writer and Editor
Publisher "National TV Directory"



TELEVISION DEALER
Elmer Copeland
Leading Chicago TV Dealer!

hallicrafters

PRECISION TELEVISION

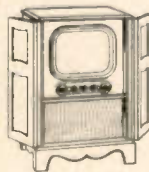

MODEL 17848

Mahogany, Oak, Maple—
17" Rectangular Tube; in
graceful Chippendale design.
Deluxe chassis with the
dynamic tuner.

hallicrafters TV
THE SET THE EXPERTS OWN!

WORLD'S LEADING MANUFACTURER OF
PRECISION RADIO AND TELEVISION
CHICAGO 24, ILLINOIS

New Radio and TV Sets

This and following pages describing manufacturers' new merchandise are compiled by our editors. This information is presented as a news service to our readers entirely without any advertising consideration whatsoever.

Packard-Bell TV LINE

The Founder's Masterpiece Series of television and radio sets includes 20-inch and 17-inch TV tube sizes. These are available in TV-radio-phono combinations, TV consoles with full-length doors, and open-face consoles. All three cabinet styles in both tube sizes are available in mahogany, walnut, maple, or blond oak. Completing the line are 17-inch table models available in mahogany and blond mahogany finishes. Packard-Bell Co., 12333 W. Olympic Blvd., Los Angeles 64, Calif.—RADIO & TELEVISION RETAILING.

Starrett "RIVIERA"

Model 37BM1, the Riviera, has been added to the TV line. Mahogany period styled cabinet features full length doors. This 17-inch model lists for \$359.95, tax



included. Starrett Television Corp., 601 W. 26th St., New York 1, N. Y.—RADIO & TELEVISION RETAILING.

Mitchell RADIO & TV

Included in the new line are two table radios, the Nocturne, available in walnut at \$24.95 or ivory at \$29.95, and the Madrigal, which lists at \$34.95 in walnut and \$39.95 in ivory. Also offered is the Caravan, 3-way portable radio. Finished in maroon, the Caravan lists at \$39.95. In TV, a 17-inch Living Image set is being released, listing at \$303.95 in mahogany and \$313.95 in blond finish. Mitchell Mfg. Co., 2525 Clybourn, Chicago, Ill.—RADIO & TELEVISION RETAILING.

Kaye-Halbert "CAMBRIDGE"

A new addition to the 1951 television line has been announced. Called the Cambridge, the new set is a knotty pine version of the present Cambridge model. Along with the knotty pine cabinet there are new refinements in the control knobs as well as a new type mask. These improvements in controls and masks will appear on all new models. Kaye-Halbert Corp., 3555 Hayden Ave., Culver City, Calif.—RADIO & TELEVISION RETAILING.

Magnavox TV LINE

New models added to the TV line include the Chippendale, with 20-inch rectangular tube and 12-inch speaker. It lists at \$495. The Shoreham, shown here, available in blond and maple finish as well as mahogany, lists at



\$445. It, too, features a 20-inch TV tube and 12-inch speaker. Magnavox Co., Fort Wayne 4, Ind.—RADIO & TELEVISION RETAILING.

Steelman RADIOS

The new radio line includes a leather table model, 5100, \$24.95; a plastic table model, 5101 and a wood table model, 5102, \$29.95; another plastic table model, 5103, \$32.95; a wood table model, 555, \$99.95; three leather models, 505, \$46.95; 515, \$49.95; and 525, \$52.95. Shown here is the model 5101, the



Trouper, 5-tube superhet. Steelman Phonograph and Radio Co., 12-30 Anderson Place, Mt. Vernon, N. Y.—RADIO & TELEVISION RETAILING.

Regal 20-INCH TV SETS

New additions to the Regal TV line feature 20-inch picture tubes. They include one table model, 20T22; two open-face consoles, 20C22 and 20C31 (also available with AM-FM radio, model 20C36); two full door consoles, model 20D36 with FM-AM radio, and model 20D22; and one 3/4 door console, model 20HD31, also available with FM-AM radio as model 20HD36. Regal Electronics Corp., 603 W. 130th St., New York 27, N. Y.—RADIO & TELEVISION RETAILING.

Meck RED-HEAD TV

Shown here is a new 20-inch Meck TV set which incorporates the new "Red-Head" chassis. This new chassis will also be used in the 17-inch console and 17-inch table model. The set shown

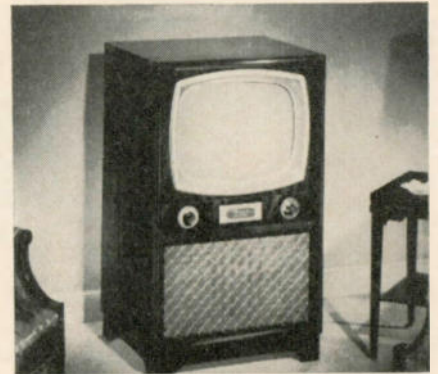

will retail for about \$350 plus tax and warranty. Set also features the removable mask. John Meck Ind., Liberty St., Plymouth, Ind.—RADIO & TELEVISION RETAILING.

Emerson TABLE TV

A 14-inch rectangular table television receiver, the model 662, shown here, has been announced. Housed in a figured walnut Bakelite table cabinet, the set lists at \$179.95, including tax and



warranty charge. Emerson Radio & Phonograph Corp., 111 Eighth Ave., New York 11, N. Y.—RADIO & TELEVISION RETAILING.

Air King 17-INCH TV

Model 17M3, a 17-inch table model, listing at \$199.95, has been introduced to celebrate the thirtieth anniversary of the company. In an ebony black metal cabinet, the set features mask and knobs in gold finish. Air King Products Co., Inc., 170 53rd St., Brooklyn 32, N. Y.—RADIO & TELEVISION RETAILING.

Micronet FM RADIOS

Recently announced is the model RD-02, personal pocket FM radio. This 6 ounce set measures 5x2 1/2x1" and contains a built-in telescoping antenna. It runs on self-contained batteries. Hearing aid type speaker. Covers full FM band and TV sound on channels 5 and 6. Micro-Electronic Products, Inc., 11 West 5th St., Peru, Ind.—RADIO & TELEVISION RETAILING.



"...the Webster-Chicago Fonograf has been named to receive the Fashion Academy Gold Medal Award for 1951..."

"... styling achievement ... famed reputation for mechanical perfection ... new thought in exterior design ... superlative craftsmanship ... ease in operation ... fashion awareness ... sincere congratulations."

Those quotes are taken from the Fashion Academy letter telling us that the Webster-Chicago Fonograf has been awarded their Gold Medal for 1951.

It means a lot to us ... and to *you!*

Now we can stock, sell, profit—with the only phonograph ever to be awarded the Fashion Academy Gold Medal Award.

Sell the complete line of Webster-Chicago Fonographs—always the leader in performance, and now the recognized leader in design too!

WEBSTER·CHICAGO



5610 W. Bloomingdale Ave., Chicago 39

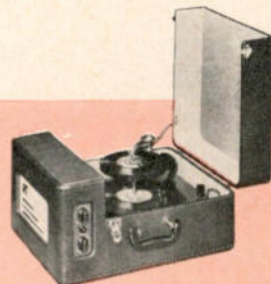

Model 621 Portable Fonograf



Model 601 Table Top Fonograf



Model 130 Portable Fonograf

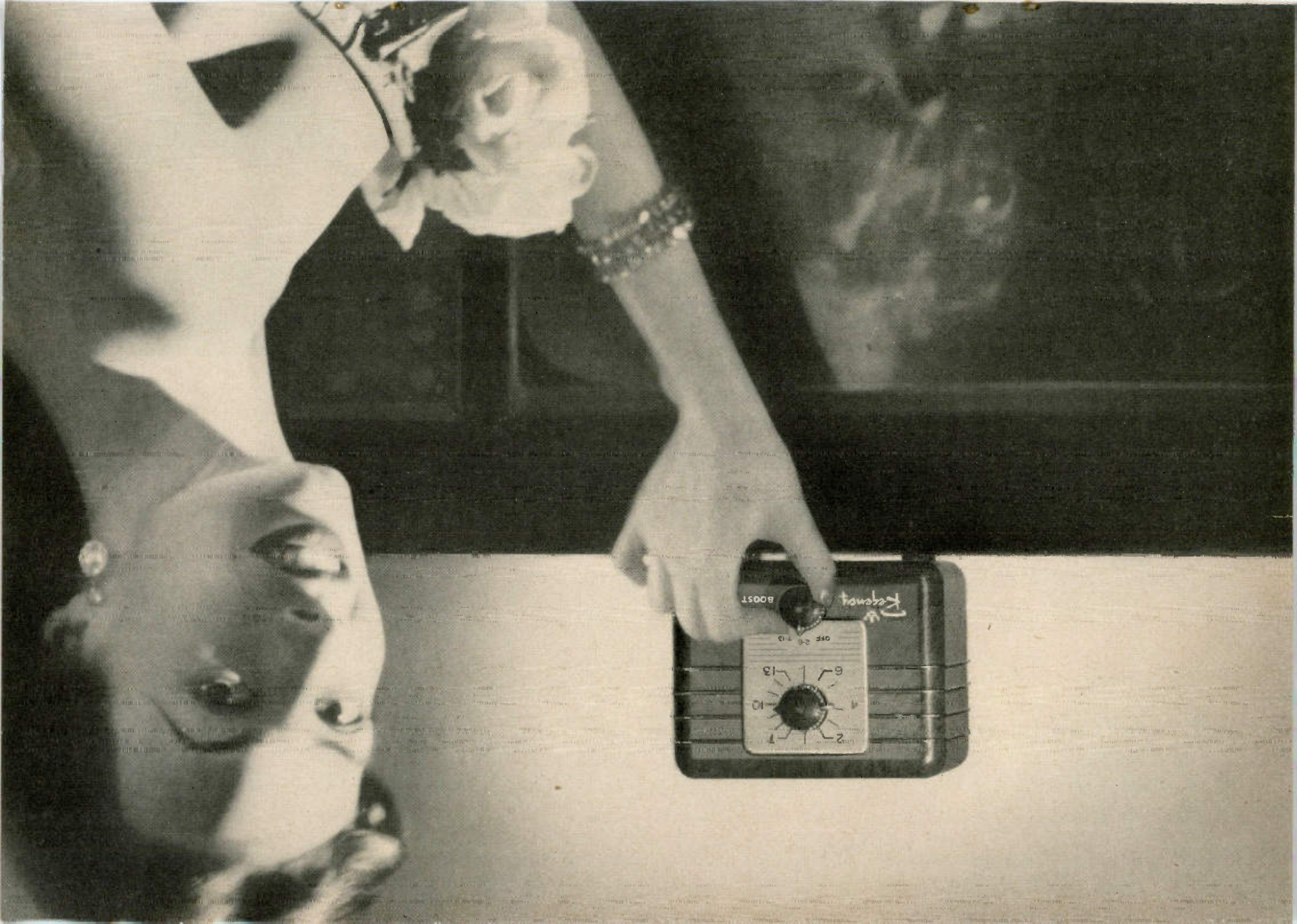



*Largest
Selling Booster*

AT ANY PRICE!

Regency

Beats All For Value The PHILHARMONIC Power-Packed Radio Clock



Suggested List
\$29.95
Model 511
Ebony

VARIETY OF
CABINET COLORS
SLIGHTLY HIGHER

Dealers—Distributors are invited to inquire about available territories.

Value, the secret of the PHILHARMONIC Story, makes this new 4-tube and rectifier Clock Radio your best-seller. A radio loaded with power . . . a clock that reaches perfection . . . skillful engineering to bring unsurpassed listening pleasure and service . . . and in a luxuriant bakelite cabinet befitting any decor. This PHILHARMONIC Clock Radio is just the set to arouse drowsy sales!

FEATURES: Extra-sensitive iron core stick-loop type antenna; Vernier tuning; Full-vision slide rule dial; Automatically turns on pre-selected radio shows; Sleeper Switch automatically turns off radio in 90 minutes; DELUXE MODEL: Utility Socket automatically turns on radio and any appliance at a pre-set time; Absent-Minded Switch turns off radio in two hours. Special manual ON and OFF switch operates radio from appliance socket separately.

Philharmonic Radio and Television Corp. 
General Offices and Plant: New Brunswick, N. J.

Heavy Attendance Seen For Chicago Music Show

Plans for the Golden Anniversary Trade Show and Convention of the National Association of Music Merchants, July 16-19, are rapidly taking shape at the Association's Chicago headquarters.

The applications for exhibit space are being returned by the exhibitors and from all present indications space demands will be equally as heavy as in previous years. The Association has taken care to make available additional exhibit space for musical merchandise exhibits as well as radio-television displays.

Where in past years the 7th floor has been used almost exclusively for exhibits of band and orchestra instruments and musical merchandise, the demands have been so great that additional space has been provided on the 9th floor of the Palmer House. The popularity of the 9th floor and its diversified merchandise will be more evident this year than last year. Many firms previously exhibiting merchandise of this type in the Exhibit Hall are contracting for 9th floor space. In future years the Trade Show management believes that the 9th floor will become as important in musical merchandise exhibits as is the 7th floor. Pianos, organs and their accessories, together with chimes and carillons will occupy the entire 8th floor. Piano and organ exhibits will again be one of the outstanding features of the Show.

Radio and television exhibits will occupy the entire 6th floor together with the Club Floor, Mezzanine and the new addition of the Red Lacquer room.

The Red Lacquer room has been opened for radio-television exhibits for the first time in the history of the Show, and of the Palmer House as well. This new space was made available in an effort to meet the requirements of several firms wishing club floor space. The Red Lacquer room is on the 4th floor of the hotel. The room has been divided into three sections designated at "A", "B" and "C", containing an approximate square footage of 1800 feet per section.

A heavy attendance is again expected and should equal or exceed the 8100 persons attending the 1950 Show. Over half of these persons directly represented some 2000 music stores. Other groups of persons attending included store buyers, distributors, manufacturers, press and radio.

Thurrow Appointment

H. M. Carpenter, president of Thurrow Distributors, Inc. of Tampa, Jacksonville, Miami, West Palm Beach, Orlando, and Tallahassee has announced the appointment of C. E. Morgan as electronics and radio parts manager of the Orlando Branch, 625 West Central Ave.

insuline Conical television INSTALLATION KITS

Everything you need to
do a complete install-
ation . . . all in one
package! Saves Time
Reduces Labor Costs.

INCLUDES
ANTENNAS and MASTS

Installing antennas when you have all the necessary elements is a comparatively simple job. That is why Insuline's Installation Kits are meeting such widespread acceptance. These packaged TV installation kits include single and stacked array antennas for fringe area reception, masts, lead-in wire, and all hardware. Excellent reception for every type or make receiver.

TV Accessory Installation Kits



Everything needed to install any type outdoor antennas — Kits for roof, wall and chimney mountings.

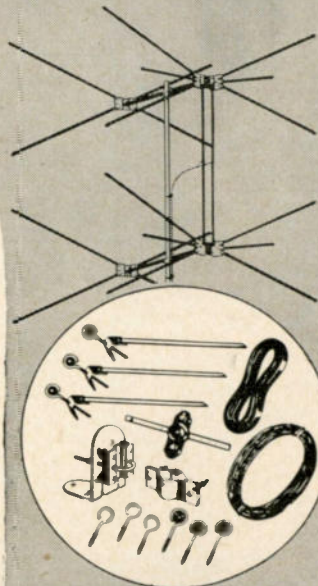

FREE! New catalog of TV Antennas and accessories. Write Dept. RR-5.

Visit our Booth No. 406 at the Ports Show



insuline CORPORATION OF AMERICA

INSULINE BUILDING • 36-02 35th AVENUE • LONG ISLAND CITY, N. Y.
West Coast Branch and Warehouse: 1335 South Flower Street, Los Angeles, Calif.
Exclusive Canadian Sales Agents: CANADIAN MARCONI COMPANY, Toronto

Gift Wrap Booklet

To show dealers how glamorous electric housewares can look, the Dennison Manufacturing Company in support of the Electric Housewares Gift Campaign sponsored by the Electric Housewares Section, National Electrical Manufacturers Association, has designed these attractive gift-wrapped electric housewares packages. Dealers can get instructions on how to wrap appealing packages — simply and quickly—from the booklet, "How to Gift Wrap the Dennison Way" available at their local Dennison stationery dealer.

Browne Designs Shield



Dr. Burton Browne, president of the Burton Browne Advertising Agency, 619 N. Michigan Ave., Chicago, Ill., has designed the shield shown here for ad insertions during the defense effort and which he is making available to all advertisers interested in giving a portion of their paid advertising to the government.

N.A.E.D. Show Theme

The integration and operation of the electrical distributor in the preparedness program will be the theme of the 43rd Annual Convention of the National Association of Electrical Distributors, according to an announcement by Chas. G. Pyle, executive director of N.A.E.D. The Convention, which opens on May 21 at Atlantic City and ends May 25, will be held in the Ambassador and Chelsea Hotels with meetings in the Westminster Hall of the Chelsea.

Code of Ethics

A publishers' and manufacturers' "Bill of Rights" for the electronics parts industry, recommending strict adherence to a code of ethics which clearly differentiates between paid space and publicity, was set up by joint resolution of the Association of Electronic Parts and Equipment Manufacturers and the Sales Managers Club Eastern Group in separate meetings of the two groups.

NEDA Honors Stallman

Honoring Arthur C. Stallman, national president and past director of NEDA, the Empire State Chapter of that association entertained on March 17 with a testimonial dinner at the Hotel Onondaga in Syracuse, New York. The chapter members expressed appreciation to Mr. Stallman of Ithaca, New York, and member of the chapter, for his generous donation of time and effort away from his own business in behalf of NEDA and independent wholesale parts and components parts distributors.

Electronic Testorama



Kierulff and Company, 820 West Olympic Blvd., L. A. 15, Calif., recently announced the opening of their Electronic Testorama which features over 100 different models from more than 10 different manufacturers, according to Cap Kierulff, dealer dept. manager. Each unit can be demonstrated under actual working conditions.

Visit Our Suite in The Blackstone Hotel During the Chicago Radio Parts Show

THE SET THE ENTIRE INDUSTRY HAS WAITED FOR...

200 MILE RECEPTION

SENSATIONAL NEW!

Sheraton

SUPER VIDEO

DX

20" CONSOLE



The set that opens up new TV markets for you. The Sheraton Super Video DX 26-tube chassis will bring in perfect reception up to 200 miles, without the use of boosters or complex antenna arrays. The industry's most powerful television receiver... it will work where no other set has been able to operate before. It's the set to feature... NOW!

DEPARTMENT STORES, CHAIN STORES, APPLIANCE STORES:

This sensational achievement in long range television is also available under your own label. The 20" console with Super Video DX chassis is the answer for increasing your sales volume. Write or call for complete details!

DEALERS in Weak Signal Areas... Get Out of the "Fringe" of TV Sales! Promote SUPER VIDEO The Amazing Long Range Receiver

Private Label Manufacturers for the Nation's Leading Dept. Stores

SHERATON TELEVISION CORP.

200 River Street • Red Bank, N. J. • Affiliate of Video Products Corp.

DISTRIBUTORS - REPRESENTATIVES Choice Territories Now Available!

Outside Selling

(Continued from page 39)

tively high, so were stocks in stores all over the country. Many an establishment could have made out well with outside selling, but neglected this important phase. Too many sat around waiting for sales. Too few went out looking for them.

At the time this article was written, dealer inventories were high, and sales volumes were low in relation to such inventories. Many a merchant was beset with financial worries, and was in a rat-race with competitors equally anxious to reduce store stocks and meet obligations. Yet in spite of this situation all too many dealers

were content to try only to bring the mountain to Mohammed—the customer to their stores, through high-pressure ads offering all sorts of inducements. Too few followed up even the hottest leads. Too many were willing to kiss ten prospects goodbye to get one fast sale. Work in the outside field, the most lucrative of all methods, was overlooked by numbers of retailers. In the wild scramble to get a name on the dotted line, red-hot prospects walked out of hundreds of stores without invitation to return, and without any attempt on the part of salespeople to obtain names.

Such techniques are a complete reversal of methods used in pre-war days. When business fell off then, sales activity in the outside field was stepped up. People in those days knew they were consumers in a buy-

er's market. During the recent sales slow-down, customers were treated as though a seller's market existed. If they didn't turn out to be on-the-spot buyers they were brushed off in a great many stores.

Desperation selling, such as has been going on for the past couple of months or more, is bad business all around. It reduces the dealer's profit, and it has a bad effect on the store's customers. It wouldn't be fair to blame the dealer too much for the frantic measures taken to unload merchandise. A merchant who is heavily overstocked, and hard put to meet his obligations is likely to take a dim view of long-range selling activities. But the salient fact remains that even under such conditions it will pay off well to get out in the field, even if it means just following up those prospects who have expressed interest in buying.

What business will be like this summer is anybody's guess. The future holds so many uncertainties that no merchant can foresee accurately the things to come. However, he does know from past experience that his store traffic will fall off, and for this reason he will be wise to plan an outside selling campaign, which should include, at the least, the following up of prospects, whose names he should obtain in the store.

Ever since the end of World War II, the outside field has been wide open, and more or less under-worked. In the summer this field is especially inviting since the salesman has longer hours in which to work outdoors, and, in addition, he'll find a lot of folk playing and working in their yards and gardens. The average customer likes to have the salesman "bring the store" and its products to the home, where under highly relaxed conditions many sales can be made.

FOR PROFITABLE PROMOTIONS

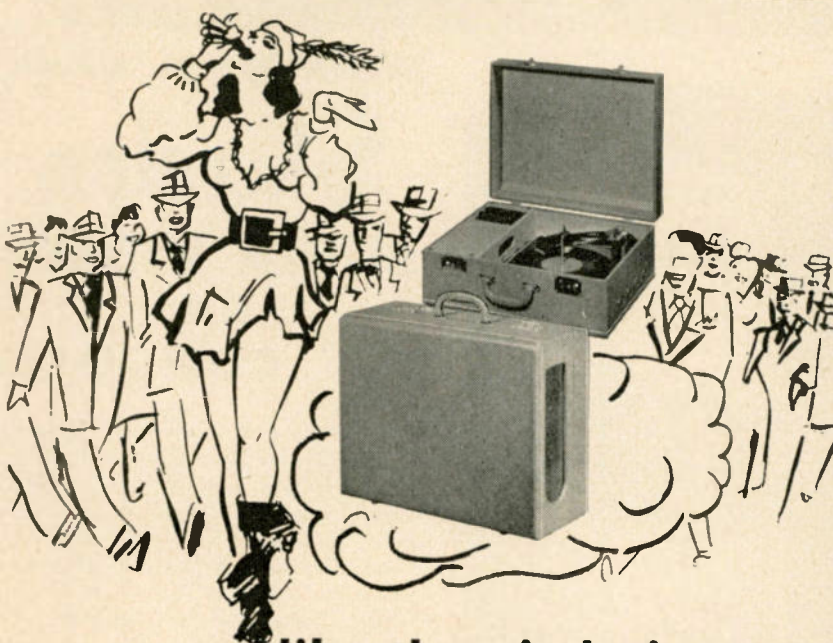

like the piper...

LIKE THE PIED PIPER IN THE FAIRY TALE THE JACKSON PORTABLE RADIO-PHONOGRAPH LINE WILL LEAD CUSTOMERS INTO YOUR STORE.

- Top changers and chassis
- Liberal cooperative advertising
- London tan on heavy wood cases
- Crowd stopping prices
- All Brass Hardware
- Full Profit Margin

MODELS

JP30 3 SPEED MANUAL PHONOGRAPH	JP50 3 SPEED MANUAL RADIO-PHONOGRAPH
JP70 3 SPEED AUTOMATIC PHONOGRAPH	JP90 3 SPEED AUTOMATIC RADIO-PHONOGRAPH

WRITE, WIRE OR PHONE

IF YOU VISIT THE MAY PARTS SHOW, DON'T LEAVE CHICAGO UNTIL YOU SEE JACKSON'S SENSATIONAL NEW

TV PROMOTIONAL LINE
PRICED TO CAPTURE THE MARKET

JACKSON INDUSTRIES

500 EAST 40TH STREET • LIVINGSTON 8-7700 • CHICAGO, ILL.

Farm Appliance Market

"The fact that 90 percent of America's 6 million farm homes will have electricity by the end of 1951 should emphasize the growing value of this vast untapped market to electric appliance dealers," Edward R. Taylor, general sales manager, Hotpoint, Inc., declared at a recent distributor meeting. Farm electrification has increased 79 percent in 15 years from 11 percent in 1935 to 90 percent in 1951. Since current estimates place the value of this huge market well over \$500 million a year for appliances alone, the farmer will spend over \$2 billion for appliances by 1954.

More Electricity Used

According to a report by the U. S. Dept. of Agriculture, Rural Electrification Administration, nearly 380,000 consumers were added to REA financed systems during 1950. This brings the total number of consumers of REA plans alone to 3,420,000.



MOTHER'S DAY

She'll record household memos, club and committee reports, favorite radio programs for future listening, "voice letters" to children away at school.



FATHER'S DAY

For business and home use. Dad will enjoy adding commentary and music to his home movies, capturing the youngsters' voices, recording home talent.



WEDDINGS

Fun for entertaining in their new home, marvelous for recording memorable events. They can even have permanent recordings of their actual wedding ceremony to cherish always.



GRADUATIONS

Invaluable in starting a career in business, in music, or the professions! Too, young people enjoy recordings of their friends' and families' voices, concerts and plays, anything they want to "hear again!"

For gift-buying occasions, here's a

gifted idea for extra profits!

As an unusual and useful gift, Revere Tape Recorder opens additional sales opportunities.

Prepare now for the second-biggest gift season of the year! Mother's Day, Father's Day, graduations, weddings, create a natural new market for Revere Recorder sales. As a gift item, Revere is that "something different and useful" that your customers want!



SELLS ON DEMONSTRATION

The success of dealers who display and demonstrate the Revere Recorder has been phenomenal! Now, by featuring Revere from the gift angle, an even greater, fresh, new sales potential is opened.

Your customers will marvel at Revere's unexcelled fidelity of sound, its unusual compactness and lightweight portability, and its remarkably low price! In addition, such outstanding features as fast rewind and forward speeds . . . full hour's listening on every reel . . . erasable, re-usable tape, easily edited with scissors and Scotch tape . . . simplified controls . . . and handsome, luggage-style case . . . make it the unquestioned leader in the entire recording field.

Write today for complete information—and start getting your share of extra profits!

REVERE CAMERA COMPANY • CHICAGO 16



MODEL T-100

With microphone, radio attachment card, 2 reels (one with tape), and carrying case.

\$16950

Revere

TAPE RECORDERS

World's Largest Manufacturers of Magnetic Tape Recorders



RECORDER COMBINATION

Tape recorder with built-in radio. Records directly from radio by turn of switch. Model TR-200.

\$20950

Sell More Children's Phono

Use the Many Means Available to Reach Parents and

Kiddies for More Sales in This Growing Field

• A terrific sales potential exists in the children's record field for the dealer who will go after it. The market is vast, and now, as summer approaches, there will be more opportunity than ever before for the alert dealer to increase his income and to build a solid foundation for year-round sales in this field.

More kiddie record releases are now being offered by record manufacturers than ever before, which means a greater selection the dealer can offer his customers. And they're better records too, offering music and stories with appeal directed toward children of various ages and temperaments.

Another factor assisting the dealer in children's records is the greater emphasis being placed on education derived from activities outside the classroom. Child psychologists and teachers are more and more appreciating the fact that children are continually learning, whether in or out of the classroom, and more and more are they urging parents to direct the play hours of children along educational lines. In the classroom, too, emphasis has been shifted from the old "hickory stick" methods to "learn as you play" methods. All of this new interest in child education presents a potential bonanza to the enterprising dealer in children's records who will tell folk what he has to offer because he has a product which is an answer to the current trend.

The wise kiddie record merchant makes his sales appeal to both the children and the parents. It might be said that he makes his *appeal* to the children, and his *approach* to the parents, for in most sales of children's articles, it's the urging of the child plus the consent of the parents which closes the sale. In most cases it's the parent who shells out for a pur-

Tell Parents About These:

Musical Stories
Singing Games
Hymns
Entertainment
Children's Folk Tales
Participation Records
Stories
Fairy Tales
History Lessons
Adventure Tales
Music Appreciation
Nursery Rhymes
Musical Games
Children's Classics
Educational Lessons
Bible Stories

chase and consequently it's the parent who must be convinced that the purchase is worthwhile. But just as children have proven to be such good salesmen in the case of TV sets, a child who wants children's records can be a great force in adding to a dealer's sales.

There are at present many parents who know little or nothing of children's records, and even if their children were to want such records, would consider it an unnecessary extravagance. Little do they realize that these records are of the same quality as adult's records, nor do they realize what a wealth of material is available for the entertainment and education of their children. The smart dealer will tell them, and by so doing he will

At right are two suggested layouts for kiddie sections. Curved front corner layout (A) might be decorated as a bandbox or merry-go-round. Rectangular layout (B) might be done up as a house, cave, etc. Seating room is provided for both kiddies and their parents.

open the door to a vast market right in his own area.

"But," the dealer may say, "we do advertise. What more can we do?" And the answer is: Plenty! One prime avenue into this field is the school. Parent-teacher groups are always eager to bring new ideas into the school. By the simple process of arranging a short talk and demonstration before the local parent-teachers association, and explaining the whys and wherefores of children's records, along with a few well-chosen examples to point out the available educational benefits, any dealer can create new interest and increase his sales overnight. He can urge the use of children's records by the school itself, during recreation periods, or even in the classroom lessons, and he will

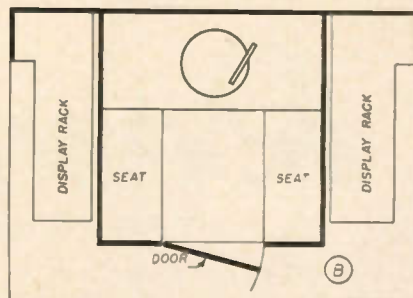
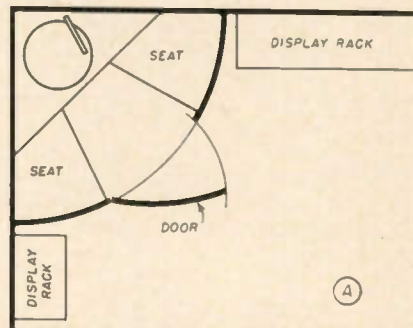



Records This Summer

at the same time be reaching parents who will also think of the records in terms of their own homes. If well planned, such a talk will not only result in the sale of more children's records, but of more playing equipment as well.

Arrangement made directly with the school for the purchase of playing equipment and records, or even as a gift from the dealer will increase sales tremendously. The effectiveness of this influence is shown in those cases where dealers have arranged similar set-ups. Sales have skyrocketed especially on those same records which were played at the school.

Any such "introduction" which the dealer can arrange now will reap increased sales throughout the coming summer, when both parents and children will look about for more ways to spend the extra leisure time children will have. If they don't know now what you have to offer, they probably won't learn about it during the summer, so get in there before the schools close, and tell them what you have to offer. Except at the school, you won't get another chance to contact so many potential kiddie record customers in one group.

Don't overlook the possibilities in your local "summer schools." Many of these are simply organized recreation centers, presenting a wonderful opportunity for demonstrations, tie-ins, and promotion by the enterprising dealer.

Another good source of promotional tie-ins which will be still more important during the summer is the local movie theater. Many movie houses feature special kiddie shows on Saturday mornings. Arrangements can be made with theater managers for the playing of kiddie records in the theater before the show starts, and in the theater lobby. Posters and handbills distributed at the theater, and tying-in with the records being played, offer the dealer a chance to advertise to a very select audience. Other stunts, such as the awarding of kiddie records as contest prizes,

etc., can easily be arranged at the theater, and if properly managed, will result in new sales for the dealer.

Still another source of added sales for the dealer is in the radio and television programs. Like with the movies, this represents a good year-round source which will take on even more importance during the summer. These specially edited programs specifically for children, which are being sent via radio and television into millions of homes, are doing much to influence the wants and choices of both parents and children. Keep alert for any opportunity to tie-in with these programs. Many of the program characters are also available on records and present excellent opportunity for tie-ins. Also, the dealer can take advantage of the time and money which some of the sponsors have put into their shows by noticing how appeals are made to both children and parents. Some of the visual appeals used on television are quite effective, and the dealer may be able to fashion his own store displays after them.

The appeal within the store also should be directed at both the parents and the children. This applies not only to the sales talk, which should include a pointing out of the educa-

tional and entertainment benefits, variety of selection, etc., for the benefit of the parent, and a demonstration for the benefit of both parent and youngster, but applies also to the visual appeal and store layout.

Many ideas may be devised for "cute" kiddie section layouts in the store, but the layout which is practical from a sales standpoint is the one which includes room for the parent. Any small "doll house" arrangement used as a listening booth will of course have much appeal for children, but will at the same time exclude the parent. A juvenile motif is quite in order in laying out a kiddie corner, but be sure to include adult-size proportions for listening booths and playing equipment.

The record jackets and album covers will be enough in themselves to sell the children, but descriptive posters and "group" labels should be used for the benefit of parents.

On the matter of the "grouping" of children's records, stay away from any grouping by age. Such a classification is at best a vague one, and should be used only for the dealer's own reference. Classifying a display rack as "Records for Children Age (Continued on page ??)

Tie-ins with theaters which run special "kiddie shows," result in ideal prospect crowds such as the one shown below attending a parent-teacher sponsored show at a Loew's theater.



Disc Sales Builders

Recent Phono Record Releases and Promotions to Up Summer Sales

RCA Victor stars Dinah Shore and Robert Merrill are shown here in the RCA recording studios cutting sides for "The King and I." The new album



features Dinah, Bob, Patrice Munsel and Tony Martin with Al Goodman's and Henri Rene's orchestra in a collection of hits from the new Rodgers and Hammerstein musical. Album has just been released by Victor on all three speeds.

Two new Columbia Records kiddie releases mark the first appearance on records of "Sparkie," leading character of the popular children's radio network program, "No School Today."



Called "Guess What I Am" and "Guess Who I Am," one of the discs features the high-pitched Sparkie voice in songs which give clues to the identity of various animals and objects. The other disc couples "Little Red Caboose" and "Run, Rabbit, Run." Discs were done by "Big Jon" Arthur, who also acts as master of ceremonies on the radio program.

MGM Records' recently inaugurated kiddie series, "Uncle Leo's Records For Young Folks," including "Sonny the Bunny" and "Peter Cottontail," will soon include "Tom and Jerry at the Circus," "Singing Games," "Pat and the Pixies," and "Mother Goose

Parade." Also in the Uncle Leo series are "Flick, the Fire Engine," "Horton Hatches the Egg," "A Kiddie Korn-cert by the Korn Kobblers," and Betty Martin productions of "The Three Little Pigs," "The Gingerbread Boy," and "There Were Three Indians." Future Uncle Leo releases will include "Cinderella," by the Lyn Duddy Singers; "Guess Who, Guess What," by the Melodeons; "I'm a Little Teapot" by Judy Valentine; "Punky the Punkin'," "Gaffy, the Goofy Gobbler," and several others. These will be backed by promotion with special emphasis upon disc jockeys programming kiddie fare and parent teachers organizations.

Decca Records newest children's disc releases feature "The Lone Ranger," famed western hero of radio since 1933. Decca has prepared four singles, on 78 and 45 RPM, each con-

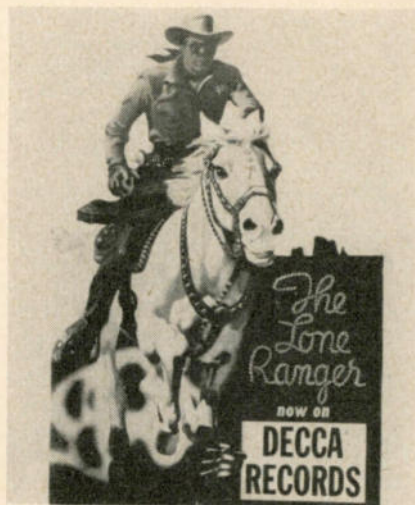

taining a complete story by the original cast. The discs are for home playing only. Counter-card shown here is part of a large dealer promotion package including ad mats, displays, circulars, etc. Decca is also releasing another Ray Bolger disc offering the "Foot Foot Song" and "I'm Glad I'm Not a Rubber Ball," in which Ray instigates a "join-in sing" for the youngsters.

A new Capital Records promotion of its Bozo the Clown records and Bozo Approved records includes a motion picture, still pictures, display material, give-away items, advertising suggestions and aids. Scene here from the movie, called "Bozo's Circus," shows the star, Bozo, the Capitol Clown. Entire package, designed for big store promotions, is available from Capitol distributors. It includes an

outline of sequences for the "Bozo Circus" movie and suggested publicity



stories for stores to use.

Peter Pan Records has added "Puff 'N Toot" to recent big selling children's discs "Alice in Wonderland" and "Marching Songs." Available on



78 and 45 RPM, this story of a little train is being promoted, along with other Peter Pan discs, by a series of "Peter Pan Parties," to be sponsored nationally. Most recent party was scheduled in conjunction with the Israel Orphan Asylum.

Mayfair Records has released two new kid discs. "Alice in Wonderland," contains four selections from the Walt Disney film. The other new disc, "Me and My Teddy Bear" is backed by "Pepi the Puppet." Both discs are



done in winning style by the Lady in Blue, June Winters, with Hugo Powers' orchestra.

(Continued on page 82)

Here's One FOR THE RECORDS!



RADIO-PHONO COMBINATION

... and what a 3-speed combination it is! Made with built-in sales appeal, the Symphony answers all your needs for a fast-selling, trouble-free radio-phonograph. There's no dead stock on your shelves when you feature the Symphony ... it's a consistent profit-maker throughout the year!



TRIO
MODEL 573



- high quality radio with full tone control
- 3-speed record player for 33 1/3, 45 and 78 RPM
- heavy duty, oversized PM speaker for quality tone
- 5-tube, with 7-tube performance
- lightweight pickup arm with 2-way reversible cartridge
- handsome slide rule dial for easy tuning
- smartly-styled luggage carrying case in tan Weymolin alligator leatherette
- 110-120 volts, A.C. 60 cycles
- LIST PRICE: \$69.95

**SYMPHONIC RADIO
& ELECTRONIC CORP.**

160 WASHINGTON ST., NORTH · BOSTON 8, MASS.

Television & Appliance Retailing

Section of RADIO & TELEVISION RETAILING

This and following pages describing manufacturers' new merchandise are compiled by our editors. This information is presented as a news service to our readers entirely without any advertising consideration whatsoever.

Coolerator REFRIGERATORS

Five supplementary refrigerators are being introduced. All long door models, two of them measure 28½" wide, the other three are 24½" wide. The RD-1104 and the RC-1103, both 10⅓ cu. ft. models, feature four zones of cold.



Model RB-182 is an 8.2 cu. ft. size; models RC-181 and RC-180 are both 8.1 cu. ft. models. Coolerator Company, Duluth, Minn.—RADIO & TELEVISION RETAILING.

Verd-A-Ray BULBS

A new light bulb, especially designed for TV viewing, has been announced. Called the Verd-A-Ray TeeVee Light, the new bulb features a frosting which filters most of the unnecessary infrared and ultra-violet rays to produce a soft light. Available in most standard wattage ratings for single and three-way lamps. Verd-A-Ray Corp., Toledo 5, Ohio—RADIO & TELEVISION RETAILING.

VCA VIDEOLUX TV

Latest addition to the Videolux TV line is the model M-20, shown here. Available in mahogany as well as limed oak, the M-20 utilizes an RCA 630 type

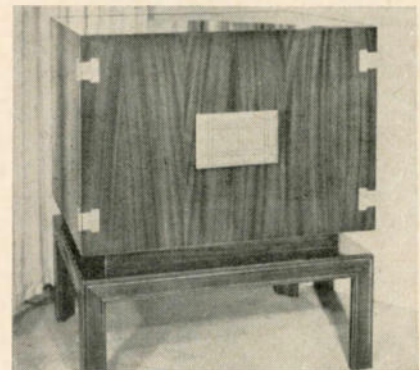

chassis and lists for \$665.00. Video Corp. of America, 229 W. 28th St., New York 1, N. Y.—RADIO & TELEVISION RETAILING.

Hotpoint DRYER

A new moisture-free electric clothes dryer has been introduced. Condenses water vapor from the heated air by means of a cold water spray, which also washes out the lint. The moisture and lint are then pumped to a sink or drain outlet. Hotpoint, Inc., 5600 W. Taylor St., Chicago 44, Ill.—RADIO & TELEVISION RETAILING.

Telechron IVY CLOCK

A new electric kitchen clock, Ivy, with twin plant containers, has been introduced. The case is white with color styled vases in red, grey, green and

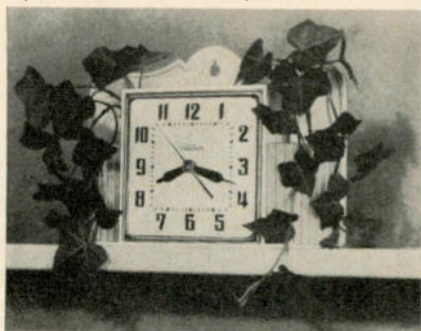

yellow. Will stand on shelf or hang on wall. List price is \$7.95 plus tax. Telechron, Inc., Ashland, Mass.—RADIO & TELEVISION RETAILING.

Cadillac REFRIGERATOR

A new, 8 cu. ft. home refrigerator has been announced. Includes a 28 lb. capacity frozen food compartment. Temperature control features nine positions. Weighs 225 lbs., measures 28" wide,

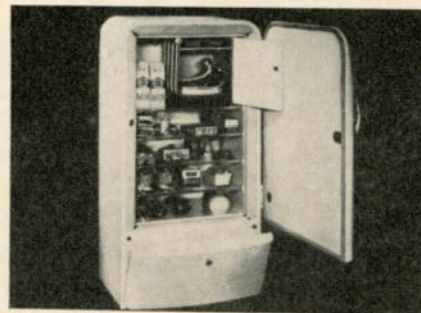

57" high, and 25" deep. List price is \$259.95. Cadillac Electronics Corp., 19 W. 26th St., New York, N. Y.—RADIO & TELEVISION RETAILING.

Multiple 19-INCH TV

This 19-inch set features remote controls which operate up to 40 feet from the set. All controls are located on the remote panel. Cabinet measures 24x36-x24". Has a heavy duty 12" speaker. Multiple Television Mfg. Co., 987 Hege-man Ave., Brooklyn 8, N. Y.—RADIO & TELEVISION RETAILING.

Philco KITCHEN TOOLS

A seven piece stainless steel kitchen tool set, with heat and stain resistant handles and wall hanger, was announced recently. Complete with screws and instructions for mounting, the set is packaged as a gift item. Available through distributors or the Accessory Division of the Philco Corp., C & Tioga Sts., Phila., Pa.—RADIO & TELEVISION RETAILING.

Raytheon "STARLIGHT"

New console, the Starlight, model RC-1720, combines 17-inch rectangular tube TV with AM radio and 3-speed phono. Two control knobs work the

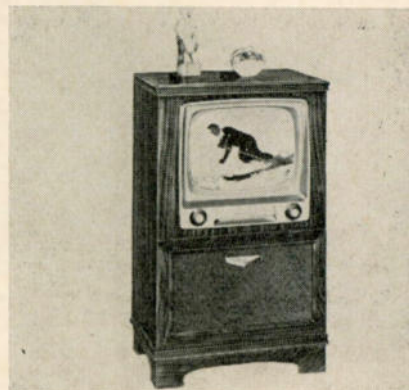

entire unit. Cabinet is of mahogany veneers. Belmont Radio Corp., 5921 W. Dickens Ave., Chicago 39, Ill.—RADIO & TELEVISION RETAILING.

Meck TV SET

Shown here is the model JM-720C, latest addition to the TV line. This set, to retail for less than \$400, features a

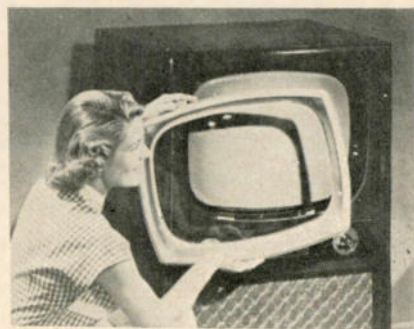

20-inch tube with removable mask, permitting easy cleaning of the mask and tube face. Since the picture tube can be installed through the front of the cabinet, it is shipped to dealer in a separate carton. John Meck Industries, Inc., Liberty St., Plymouth, Ind.—RADIO & TELEVISION RETAILING.

*They'll take
the words
right out of
your mouth...*

It's timed by a
Telechron timer.

A Telechron timer?
It can't
run wrong.*

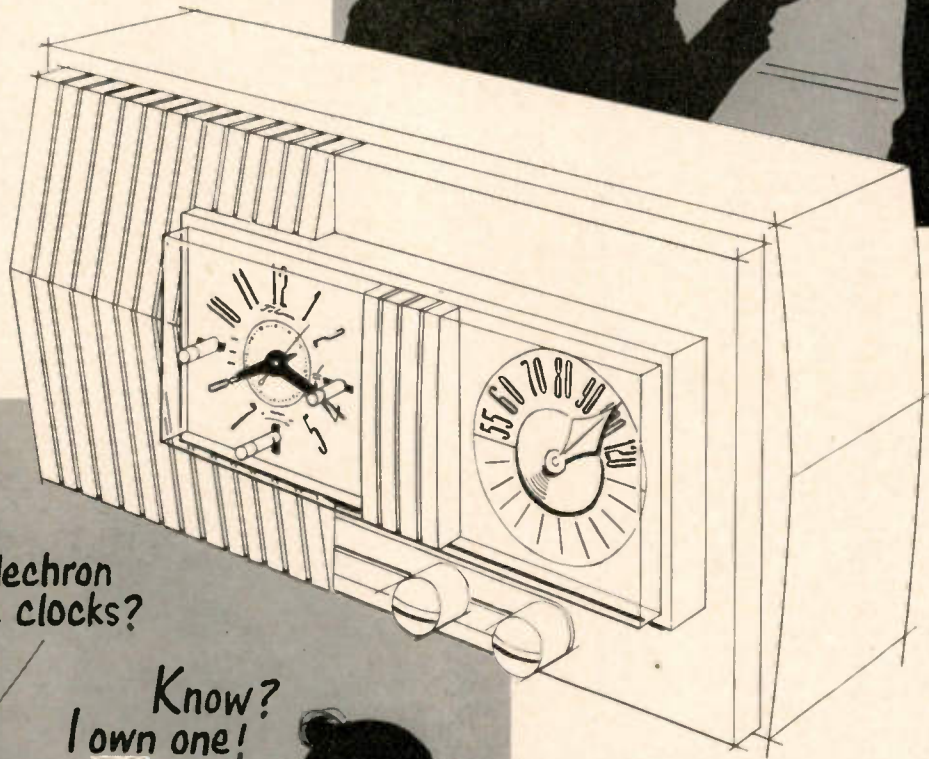

You know
about Telechron
electric clocks?

Know?
I own one!

Telechron
TIMERS
*The Low-Cost Plus
that Clinches the Sale*

...and that will clinch the sale

Moral: Customers do recognize the Telechron name with pleasure. Cash in on the enthusiasm of more than 10 million owners of Telechron electric clocks . . . and those influenced by widespread Telechron advertising. Push clock radios equipped with Telechron timers. Non-competitive with TV, these convenient radios turn themselves on and off automatically . . . act as alarm clocks, lull owners to sleep with music, help brew coffee, are wonderful servants to have around.

TELECHRON INC., 145 MAIN STREET, ASHLAND, MASS. A GENERAL ELECTRIC AFFILIATE.

* Telechron Synchro-Sealed Motor is synchronized perfectly with local electric power plants, so it has to run right.

Television Receiver Specifications

MAKER'S NAME and MODEL NUMBER	LIST PRICE (Incl. Tax)	TUBE SIZE (Inches)	TYPE	AM, FM, PHONO, JACK	MAKER'S NAME and MODEL NUMBER	LIST PRICE (Incl. Tax)	TUBE SIZE (Inches)	TYPE	AM, FM, PHONO, JACK
Admiral Corp., 3800 Cortland St., Chicago, Ill.					Belmont (Raytheon) Continued:				
14R12	199.95	14	T-P		C1724	389.95	17	C-W	
16R11	199.95	16	T-P		M1711	279.95	17	T-L	
16R12	209.95	16	T-P		M1712	289.95	17	T-L	
17K11	269.95	17	T-P		M1713	299.95	17	T-W	
17K12	249.95	17	T-P		Bendix TV & Radio, E. Joppa Rd., Baltimore 4, Md.				
27K12	299.95	17	C-P		C200	479.95	20	C-W	FM
27K15	339.95	17	C-W		C172	399.95	17	C-W	FM
27K16	349.95	17	C-W		C174	299.95	17	C-W	FM
27K17	359.95	17	C-W		T173	279.95	17	T-W	FM
27K25	369.95	17	C-W		T170	239.95	17	T-W	FM
27K26	389.95	17	C-W		Berger Communications, 109-01 72nd Rd., Forest Hills, L. I., N. Y.				
27K27	409.95	17	C-W		PHY1106		16-0	T-W	J
27K35	379.95	17	C-W		Bace Television Corp., S. Hackensack, N. J.				
27K36	399.95	17	C-W		B20RCF		20	T-W	
27K46	419.95	17	C-W		Bell Television, Inc., 552 W. 53 St., N. Y. 19, N. Y.				
221K16	439.95	20	C-W		T445	259.95	17	T-W	
221K35	469.95	20	C-W		C446	299.95	17	C-W	
221K36	489.95	20	C-W		D447	359.95	17	C-W	
221K26	509.95	20	C-W		D448	379.95	17	C-W	
221K28	525.00	20	C-W		C449	379.95	20	C-W	
37K15	449.95	17	C-W	AM-PH	D450	439.95	20	C-W	
37K16	469.95	17	C-W	AM-PH	Brunswick Radio & TV, 119 W. 57th St., N. Y. 6				
37K27	499.95	17	C-W	AM-PH	5820	469.95	20	C-W	J
37K35	499.95	17	C-W	AM-PH	5816	399.95	17	C-W	J
37K36	519.95	17	C-W	AM-PH	1116	369.95	17	C-W	J
37K28	525.00	17	C-W	AM-PH	6161A	329.95	17	C-W	J
321K35	599.50	20	C-W	AM-PH	BT17A	299.95	17	T-W	
321K36	619.50	20	C-W	AM-PH	Cadillac Electronic Corp., 19 West 26th St., N. Y.				
321K15	695.00	20	C-W	AM-PH	1651	307.70	17	T-W	
321K16	725.00	20	C-W	AM-PH	1652	349.53	17	C-W	
321K27	795.00	20	C-W	AM-PH	1653	381.37	17	C-W	
321K18	795.00	20	C-W	AM-PH	1653	402.56	17	C-W	
321K46	845.00	20	C-W	AM-PH	Calbest Eng. & El. Co., 828 N. Highland Ave., Hollywood 38, Cal.				
321K47	895.00	20	C-W	AM-PH	5116		16-0	CH	J
321K49	895.00	20	C-W	AM-PH	5116R		16	CH	J
Andrea Radio Corp., 27-01 Bridge Plaza N., Long Island City, N. Y.					5117		17	CH	J
TVL-12	264.95	12-0	T-W	FM-J	5119		19-0	CH	J
TVL-16	359.95	16-0	T-W	FM-J	5120		20	CH	J
CVL-16	485.50	16-0	C-W	FM-J					
COVL-16	579.50	16-0	C-W	FM-PH					
COVL-19	840.00	19-0	C-W	FM-PH	Capehart-Farnsworth Corp., 3702 E. Pontiac St., Ft. Wayne 1, Ind.				
Automatic Radio Mfg. Co., Inc., 122 Brookline Ave., Boston 15, Mass.					321AM	299.95**	17	T-W	FM
709	119.95*	7-0	T	AM	321B	319.95**	16	T-W	FM
P-490	139.95*	7-0	Port.	AM	320M	339.95**	17	C-W	FM
5116R	269.95*	16	C	AM	320B	359.95**	17	C-W	FM
5160	299.95*	17	C	AM	322RAM	379.95**	17	C-W	FM
5019	389.95*	19-0	C	AM	322RAB	399.95**	17	C-W	FM
5020	389.95*	20	C	AM	324M	449.95**	17	C-W	FM
Air King Products Co., Inc., 170 53rd St., Brooklyn 32, N. Y.					324RB	475.00**	17	C-W	FM
17M3	199.95	17	T-M		325M	750.00**	17	C-W	AM-FM-PH
17M1	249.95	17	T-M		335M	550.00**	20	C-W	FM
17M2	259.95	17	T-M		337M	1000.00**	19-0	C-W	AM-FM-PH
1771	279.95	17	T-W		Cascade TV Co., 153 Chestnut Ave., Irvington 11, N. J.				
17C7	299.95	17	C-W		F36	1980.00	5-0	M-X	
17C5	339.95	17	C-W		LD120	845.00	20	M-W	
17C5 BI	354.95	17	C-W		LD117	399.00-432.00	17	C	
17C2	399.95	17	C-W		Certified Radio Labs., 5507 13th Ave., Brooklyn, N. Y.				
17K1	499.95	17	C-W	AM-FM-PH	5120-12		12-0	K	
20C1	399.95	20	C-W		5120-16		16-0	K	
20C2	469.95	20	C-W		Conrac Radio Labs., 5507 13th Ave., Brooklyn, N. Y.				
Air Marshal Corp., 81 Willoughby St., Brooklyn 1, N. Y.					15P36	444.95	16-0	C-W	J
B17T	199.95	17	W		26B36	444.95			
Arvin Ind., Inc., Columbus, Ind.					24M36	429.95	16-0	C-W	J
4080T	141.23	8-0	T-M	J	25W36	429.95			
2123TM	187.04	12-0	T-W	J	23M390	510.95	20	C-W	J
2121TM	207.74	12-0	T-W	J	27M40	510.95	20	C-W	J
2126CM	219.00	12-0	C-W	J	27W40	510.95	20	C-W	J
2120CM	239.04	12-0	C-W	J	28B40	525.95	20	C-W	
2161TM	262.23	16	T-W	J	29P40	525.95	20	C-W	
2160CM	294.01	16	C-W	J	32M44	744.95	24	C-W	
2160CB	304.61	16	C-W	J	33B44	759.95	24	C-W	
2164CM	325.80	16	C-W	J	34P44	759.95	24	C-W	
2164CB	346.99	16	C-W	J	Crosley Div., Arlington St., Cincinnati 25, Ohio				
2124CCM	324.56	12-0	C-W	AM-FM-P	11-445	349.95	16	C-W	J
2162CCM	410.56	16	C-W	AM-PH	11-459	289.95	16	T-W	J
4162CM	378.77	16	C-W	J	11-442	299.95	17	T-W	J
4162CB	399.96	16	C-W	J	11-453	369.95	17	C-W	J
Atwater TV Corp., 360 Furman St., Brooklyn, N. Y.					11-447	399.95	16	C-W	J
316	229.95	16	T-W		11-460	399.95	17	C-W	J
717	299.95	17	T-W		11-444	579.95	17	C-W	J
817	369.95	17	C-W		11-446	359.95	16	C-W	AM-PH
1017	409.95	17	C-W		11-443	479.95	19	C-W	J
2201	439.95	20	T-W		11-454	499.95	19	C-W	J
2001	519.95	20	C-W		11-458	479.95	19	C-W	J
4200	795.95	20	C-W	AM-FM-PH	De Wald Radio Mfg. Corp., 35-15 37th Ave., Long Island City, N. Y.				
Ansley Radio & TV., 85 Tremont St., Meriden, Conn.					ET-1020	212.95	10	T-W	
729	445.00*	16-0	C-W	J	ET-190D	424.45	20	C-W	
750	475.00*	17-0	C-W	J	ET-171	424.80	17	C-W	AM-PH
Belmont Radio Corp., (Raytheon), 5921 W. Dickens Ave., Chicago 39.					ET-170	286.58	17	T-W	
RC2005	750.00	20	C-W	AM-FM-PH	ET-140	233.95	14	T-W	
C2001	525.00	20	C-W		ET-172	380.65	17	C-W	
C2002	550.00	20	C-W		Allen B. Du Mont Labs., Inc., E. Paterson, N. J.				
C2006	469.95	20	C-W		Sherbrooke	795.00	19-0	C-W	AM-FM-PH
RC1720	469.95	17	C-W	AM-PH	Westbury II	625.00	19-0	C-W	FM-J
RC1718	499.95	17	C-W	AM-PH	Westminster II	1750.00	19-0	C-W	AM-FM-PH-R
RC1719	499.95	17	C-W	AM-PH	Ardmore	469.95	19-0	C-W	FM-J
C1714	349.95	17	C-W		<i>(Continued on page 77)</i>				
C1715	359.95	17	C-W						

0—Round
□—Rectangular
T—Table

C—Console
CH—Chassis
K—Kit

X—Projection
W—Wood
P—Plastic

M—Metal
L—Leatherette
P—Phonograph

J—Phono Jack
*Price does not incl. tax
**Zone 1 only

Note: Basic list prices are shown. In some instances, prices are slightly higher in certain localities.

Late price changes appear on pages following.

Everybody's Tuning it!

"THE STANDARD BOOSTER"



Model B-51

in tune with the tuner

The new and improved "Standard TV Booster" is daily winning greater acceptance by dealers and customers alike in every Television market.

Here is the booster that gives real customer satisfaction, superior performance, trouble-free operation. The Model B-51 is engineered by a company that has demonstrated the greatest TV tuner know-how in the business.

Have your local distributor show you the outstanding features and money-making possibilities of this great new "Standard TV Booster."

Standard COIL PRODUCTS CO. INC.

CHICAGO • LOS ANGELES • BANGOR, MICHIGAN



The "Standard Tuner" is used by over 75 TV set manufacturers. Nearly 50% of the TV sets made today are equipped with this outstanding front-end.

See Us at Booth 680
Parts Show — Stevens Hotel

Parts Show Program Stresses

Nationally Known Authorities to Talk on Selling, Financing, Material Availability.

• Nationally known authorities on sales, finance and manpower, as well as industry leaders and a prominent government official will participate in nine seminars and discussion periods at the 1951 Parts Distributors Show educational program at the Stevens Hotel, Chicago, May 21-23d. Exhibits will be outstanding and will feature a great many new and improved parts and products.

An outstanding government official is scheduled to head a discussion of material availability and regulations, at the first session, 9:30 A.M. to 10:30 A.M., Monday, May 21st, according to Jack A. Berman, educational committee chairman. This will be followed by a seminar on parts distribution in the light of today's activities, lead by Robert L. Sprague, of Sprague Electric Co., board chairman of the Radio-Television Manufacturers Association, and Herbert Clough, of Belden Mfg. Co. (10:45 A.M.-11:45 A.M.). Monday's sessions are open to all.

Seminar on Finance

On Tuesday, May 22nd, a leader in banking and financial circles will head a seminar on financial problems of parts distributors (9:30-10:30 A.M.); to be followed by a talk by James R. Hawkinson, professor of marketing at Northwestern University, on methods of compensating parts distributor salesmen (10:45-11:45 A.M.). These sessions are for management only. A third session on Tuesday, for sales personnel (9:30-12N) will feature the famed "Three Horsemen" from Milwaukee, Jim Dornoff, Les Falk and Al Herr, all top flight sales executives.

Business Methods

On Wednesday, Jerome A. Gottschalk, prominent management engineering consultant, will discuss effective use of manpower by distributors (9:30-10:30—management only); followed by a panel of three prominent distributors: Alex Brodsky, of Allied Radio; George Barbey of George Barbey & Co., and Ralph Julius, of Radio Sales & Service, whose topic will be inventory control systems in use by parts distributors (management only). Frank Mansfield, of Sylvania Electric, will head a panel for sales personnel on the topic, "How to Determine If You Are Getting Your Share of the Parts Distributor Market" (9:30-10:30). At the 10:45-12N session, a panel of three well-known men in their fields: Sid Harman of

Sponsors of the Show

Assn. of Electronic Parts & Equipment Manufacturers, West Coast Electronic Manufacturers Association, National Electronic Distributors Association, Radio-Television Manufacturers Association, Sales Managers Club (Eastern Division).

Dates—May 21 to 23.

Place—Hotel Stevens, Chicago

Title of Show—The Parts Distributors Conference & Show

Operated by: Radio Parts & Electronic Equipment Shows, Inc.

David Bogen Co.; Roy Laird of Ohmite and Bill Barron of Merit, will conduct a panel for sales personnel on "How to Improve Your Sales of Replacement Parts, Sound Equipment and Industrial Items."

"Success Story" Film

An added feature of the Tuesday morning session for sales personnel is to be a showing of the sound-film "The Bettger Story," based on Frank Bettger's book, "How I Raised Myself from Failure to Success in Selling."

Jerome J. Kahn, Show president, pointed out that the seminars and conferences have been scheduled to allow for maximum attendance at Exhibition Hall and in the display rooms on the fifth and sixth floors of the Hotel Stevens during the afternoons, with the programs arranged so that there are no conflicts of interest.

"Aisle of Trade Names"

This year's "Aisle of Trade Names" at the Show will keynote a long-range program to keep the industry's product brands and trade marks in customers' minds regardless of what shortages, curtailments and scarcities do to the supply replacement and repair parts during the national emergency period, Helen Staniland Quam, of Quam-Nichols Co., Chicago, chairman of the Show trade names display committee, said.

The Parts Distributors Show Aisle of Trade Names this year will feature nearly two hundred trade names—a virtual Who's Who of the parts replacement industry which will go a long way toward reminding distributors that brand names and trade marks are a valuable stock in trade of an alert distributor business.

List of Exhibitors—

Products to be Shown

Brand new item or items reported by manufacturers are enclosed within brackets ().

AEROVOX CORP. Booth 411. Mica, paper, electrolytic capacitors; ceramic capacitors, test instruments. (Metalized paper capacitors, filter capacitors, resonant capacitors.)

ALTEC LANSING CORP. Booth 302. Room 607. Complete line microphones, loudspeakers, transformers. (AM-FM tuner for home and industrial music systems; home music amplifier; 820A corner furniture type home loudspeaker; 1400 series industrial amplifier, designed for disaster use.)

ALLIANCE MFG. CO. Booth 322. Tenna-Rotors, boosters, motors and turntables.

ALPHA WIRE CORP. Booth 420. Wire and cable.

AMERICAN MICROPHONE CO. Booth 671. Microphones, phono pickups.

AMERICAN PHENOLIC CORP. Booth 207. Room 550A-551A. Connectors, wire assemblies, harnesses, RF trans. lines, FM, TV, amateur antennas, sockets, plugs, terminal blocks, coaxial cable. (Submersion-proof connectors, "Rulan" cable, new plugs, connectors, Teflon cable, "Auto-Dial" TV antenna rotator control unit.)

AMERICAN RADIO & HARDWARE CO. Booth 125. Radio & TV parts & accessories.

AMERICAN TV & RADIO CO. Booth 419. ATR DC-AC inverters, ATR battery eliminators, ATR a-to radio vibrators, heavy duty inverter type vibrators. (ATR super heavy duty inverters.)

AMPERITE CO. Booth 311. Amperite microphones, Kontak microphones, delay relays and ballast tubes.

ANCHOR RADIO CORP. Booth 131. Television pre-amplifiers.

APPROVED ELECTRONIC INST. CORP. Booth 107. AM-FM tuner, field strength meter. (Mixer, pre-amplifier for Williamson amplifier.)

ASTATIC CORP. Booth 216. Room 542A-544A. Microphones, phono pickups and pickup cartridges, cutting heads, FM and TV boosters, and accessories. (Booster, microphone and pickup cartridges.)

ATLAS SOUND CORP. Booth 213. Room 553. Loudspeakers, loudspeaker support stands, microphone support stands.

AUDAK CO. Room 523. Polyphase reproducers, tuned ribbon reproducers & recording heads.

AUDIO DEVICES INC. Booth 315. Room 602A. Audiorecording discs, Audiotape magnetic recording tape, Audiofilm magnetic recording film, Audiopoints. (Audiofilm.)

BARKER & WILLIAMSON, INC. Booth 322. Coils, capacitors, components & test equipment.

BELDEN MFG. CO. Booth 405. Radio wire & cable.

BELL SOUND SYSTEMS INC. Booth 223. Room 613A-615A. High fidelity amplifiers, tape recorders, sound equip., inter-coms.

DAVID BOGEN. Room 610-611. Bogen amplifiers, school systems, intercom systems; Challenger amplifiers & intercoms; Middlesex radio console cabinets & TV consoles.

BRITISH INDUSTRIES SALES CORP. Booth 301. GARRARD 3-speed automatic record changer; Ersin multicore solder, amplifiers, speakers, KT66 tubes.

BRUSH DEVELOPMENT CO. Booth 678. Microphones, headphones, Hushatone, record cutter and magnetic recording components. (New group of headphones featuring unusually uniform frequency response.)

BURGESS BATTERY CO. Booth 587. Complete line of dry batteries.

BUSSMAN MFG. CO. Booth 113. Buss fuses, Fusetron dual-element fuses of all types.

CAMBURN, INC. Booth 119. TV antennas & accessories; auto radio antennas.

More Sales, More Profits

Many New Products, Parts to be Shown. Record-Breaking Attendance Expected

CENTRALAB. Div. Globe-Union, Inc. Booth 573. Variable resistors, ceramic capacitors, switches.

CHANNEL MASTER CORP. Booth 547. Conical and -n type antennas, Yagi antennas, high-low antennas, and antenna mounting accessories.

CHICAGO TRANSFORMER CO. Booth 676. Room 65A-536A. Audio & power transformers, filter reactors. New line of 400-cycle transformers for military.)

CHRISTAL AROSTAT MFG. CO. INC. Booth 580. Wire and carbon resistors, new replacement controls and resistors for TV. (Carbon potentiometer; TV rep'l manual.)

EAR BEAM TELEVISION. Booth 24. TV antennas, twinlead. (T-Match Yagi, open line permanent low loss TV lead.)

EVELAND ELECTRONICS, INC. Booth 116. Rooms 619. Loudspeakers, lightning arrestors, etc. (Deflection yokes.)

FLORIAN UMBIA WIRE & SUPPLY CO. Booth 204. TV cords, cordsets, cables, radio-TV hookup wire, guy and wind wire, microphone cable. (Rotor cable, display panel.)

SOLIDATED WIRE & ASSOC. COMPANIES. Booth 117. Radio, electronic, TV & automotive wires.

TINENTAL ELECTRIC. Booth 9. Rectifier tubes and photo tubes. Truvac gauges.

VERWELD STEEL CO. Booth 108. Radio & TV rods, grounding wire, guy strand; twin-lead, group cables, hook-up wire, geophysical cable, resistor condenser pigtails, grid supports & lead-in wire and electronic tubes.

WINISH WIRE CO. Booth 683. Complete line of cords and TV wires and cables.

WINDMILL TRANSFORMER CO. Booth 205. Transformer chokes, coils. ("Modern" line of transformers and core-treatment units.)

WELKE ELECTRIC WORKS. Booth 222. Electric drilling irons and solder guns.

W. B. DUMONT LABORATORIES, Room 521-522. Complete lines of cathode ray tubes, and electronic parts including TV FM tuners, deflection yokes, flyback transformers. (Operating 30" tube and electro-static focus-for tubes compared with electromagnetic focus type.)

WINDMILL ONE CO. INC. Booth 210. Recording and playback needles, recording blanks, recording tapes, misc. parts. (Repl. needles.)

WINDMILL JERRY, INC. Rooms 700-701A. Magnetic tape recorders.

WINDMILL ELECTRONIC INSTRUMENT CO. Booth 202. Signal generators, tube testers, volt-ohm milliammeters, battery eliminators, probes, crystals. (#555. volt-ohm millimeter; #526 pocket volt-ohm millimeter; model 101 decade box.)

WINDMILL ELECTRONIC MEASUREMENTS CORP. Booth 6. Test equipment. (Tube and battery tester.)

WINDMILL ELECTRO PRODUCTS LABORATORY. Booth 418. Battery eliminators, 6 volt DC power supplies.

WINDMILL ELECTRO-VOICE MFG. CO. Booth 320. Room 658A-59A. Microphones, phono cartridges, HF loudspeakers, boosters. (#654 broadcast microphone.)

WINDMILL ELECTROVOX CO. INC. Booth 120. WALCO: replacement needles, Master Control Index, "Rotenna".

WINDMILL THERMISTOR CORP. Booth 318. Room 512-513. General purpose temperature compensating & high voltage thermistors & trimmers; button silver mica capacitors.

WINDMILL ESPEY MFG. CO. Booth 579. AM-FM radio receiver chassis, AM-FM radio receiver tuners-self powered, AM-FM radio receiver tuner & power supplies. (Communication set—540 KC to 30 MC.)

FEDERAL TEL. & RADIO CO. Rooms 620-621. Rectifiers and cable.

FREED TRANSFORMER CO. Booth 305. Transformers, reactors, precision measuring instruments.

GEE-LAR PRODUCTS CO. Booth 102. Radio & TV knobs, TV chimney mounts, wall mounts, vent mounts, stand-off insulators, TV accessories. (New TV mount.)

GENERAL CEMENT MFG. CO. Booth 416. Room 507. Radio & TV accessories. (New TV roof Mounts.)

GENERAL ELECTRIC CO. Booth 590. Room 521A. Receiving & TV receiving tubes, germanium diodes, speakers, variable reluctance cartridges, tone arms, test equipment.

GENERAL INDUSTRIES CO. Booth 219. Rooms 619A-620A. Electric phonograph motors, tape & disc recorders.

GRAYHILL CO. Booth 309. 300-ohm twin line connectors, test clips, tap switches, PB switches, snap switches.

GUARDIAN ELECTRIC MFG. CO. Booth 414. Focus coils, deflection yokes, centering rings, radio type relays, solenoids. (Newest design deflection yoke.)

HALLDORSON CO. Booth 114. TV-radio transformers and reactors. (TV transformers.)

HALLICRAFTERS, INC. Booth 576. Room 605A-607A. Comm. receiver & Xmitters; all-wave broadcast receivers & long-wave portable FM-AM tuner; UHF TV converter. (2 new receivers, 1 new tuner, UHF TV converter.)

HAMMARLUND MFG. CO. Booth 417. Variable capacitors, communications receivers. (Super Pro HQ129X-SP600J.)

HICKOK ELECTRICAL INSTRUMENT CO. Room S15A-517A. Radio & TV test equipment, tube testers, signal generators, vacuum tube volt-meters, cathode ray oscilloscopes. (650 TV Tracometer, TV marker generator.)

HI-LO ANTENNA CO. Booth 112. Hi-Lo TV spiral antennas.

HYTRON RADIO & ELECTRONICS CORP. Booth 408. Radio receiving tubes, TV picture tubes.

ILLINOIS TRANSFORMER CO. Booth 122. Room 639-640. Replacement transformers for radio and TV.

INDIANA STEEL PRODUCTS CO. Booth 412. Room 509A. Permanent magnets, beam benders for TV tubes.

INDUSTRIAL DEVELOPMENT ENG. ASSOC. INC. Booth 27. DB-410 Regency TV signal booster.

INDUSTRIAL PRECISION PRODUCTS. Room 658.

ILLINOIS CONDENSER CO. Booth 130. Complete line of electrolytic capacitors including radio, TV, and latest military design and types.

INSULINE CORP. OF AMERICA. Booth 406. Room 556. Auto & TV aerials, metal goods, component parts. (Tripl-kwik auto aerial.)

INTERNATIONAL RESISTANCE CO. Booth 677. Volume controls, resistors, promotional kits. (IRC type LCL loudness control.)

JACKSON ELECTRICAL INSTRUMENT CO. Booth 421. Radio-TV electronic test equipment. (New cathode ray tube tester & new pattern generator.)

JAMES VIBRAPOWR CO. Booth 208. Radio vibrators, vibrator power supplies. (James patented right-angle drive vibrator.)

J-B-T INSTRUMENTS, INC. Booth 410. Room 657. Rotary selector switches, 14 and 20 position, laminated or molded types; lever switches, elapsed time meters and electrical instruments. (Vibrating reed frequency meters including new 1/2" and 3/2" sealed type.)

JENSEN INDUSTRIES. Booth 316. Room 616. Complete line of phono needles. (Jensen Acoustic Tape.)

JENSEN MFG. CO. Booth 402. Rooms 504-505. Loudspeakers, reproducers, cabinets, impedance matching transformers.

J.F.D. MFG. CO. Booth 313. Room 534. TV antennas, mounts, lightning arrestors, transmission wire, screw eyes, ballasts, regulators and accessories; radio parts, ballasts, wire, resistance cords, tools. (Picture tube cover and TV voltage regulator.)

E. F. JOHNSON CO. Booth 133. Radio, electronic products. VFO.

JERSEY SPECIALTIES. Booth 25. Room 637. TV lead-in wire.

KESTER SOLDER CO. Booth 220. Solder, soldering fluxes and soldering accessories.

LAPOINTE-PLASCOMOLD CORP. Booth 691. Room 660. TV antennas & accessories, towers, lightning arrestors. (Heavy duty pre-assembled Yagi antenna. New high gain stacking kits for Yagi antenna.)

LECTROHM, INC. Booth 674. Room 626.

LENZ ELECTRIC MFG. CO. Booth 212. Room 659. Insulated wires, cords, cables for radio, TV, electronic instruments & parts.

LITTELFUSE, INC. Booth 214. Room 553A. Fuses and fuse mountings.

LOWELL METAL PRODUCTS CORP. Booth 121. Ceiling baffles, wall type baffles and horns. (Re-entrant horn with acoustical filtering changer.)

P. R. MALLORY & CO., INC. Booth 586. Vibrators, vibrapacks, capacitors, filters, volume controls, switches & jacks, resistors, inductors, rectifiers, power supplies. (Dual concentric Midgetrols.)

MARKEL EL. PRODS. INC. Booth 571. Room 638A. Phono record changers.

MERIT COIL & TRANSFORMER CORP. Booth 689. Radio-TV transformers & components. (HV07 flyback with Universal mounting. (77J1 type.)

JAMES MILLEN MFG. CO. Booth 217. Electronic components, lab. equipment including synchrosopes, oscilloscopes, delay lines and magnetic metal shields. (Wide-range grid dip meter coverage from 220 kc to 300 mc.)

M. A. MILLER MFG. CO. Booth 105. Replacement phono needles; carillon dynamic conventional needle. (Carillon dynamic shockproof bumper needle & latest replacement needles.)

MODERNAIRE MFG. CO. Room 661A.

NATIONAL CO. INC. Booth 575. Communication receivers, TV & component parts.

NATIONAL UNION RADIO CORP. Booth 103. TV picture tubes, radio, TV receiving & transmitting tubes, special purpose electronic tubes. (Cathode ray tube checker.)

NEWCOMB AUDIO PRODUCTS CO. Booth 415. Room 604-605. Full line of sound equipment; PA systems, amplifiers, transcription players, rack & panel equipment.

OAK RIDGE PRODUCTS CO. Booth 10. Portable TV test equipment, 100 series TV antennas. (20,000 ohm per volt multimeter.)

OHMITE MFG. CO. Booth 307. Rheostats, resistors, tap switches, RF chokes, dummy antennas, attenuators.

OPERADIO MFG. CO. Rooms 634A-635A. Intercoms, tape recorder, amplifier, sound equipment.

OXFORD ELECTRIC CORP. Booth 312. Room 529. Loudspeakers, miniature lamps.

PARK METALWARE CO. INC. Booth 319. Screwdrivers, nut drivers, pliers, wrenches, combination type. (Uni-Driver.)

PAR-METAL PRODUCTS CORP. Booth 422. Cabinet enclosures for radio transmitters & electronic cabinets.

PEERLESS PRODUCTS. Booth 126. Golden Wand G-84TV indoor antenna; Golden Wand 50TV indoor antenna. (Wall insulator for twin-line.)

PENN BOILER & BURNER MFG. CORP. Booth 682. Room 661. TV towers, mast hardware. (40' ungued tower—self supporting.)

PENN TV PRODUCTS CO. Booth 686. Room 619. Universal base roof mounts for TV antennas, universal peak roof mounts, chimney mounts; floating guy wire rings & collars, guy wire clamps; swivel-type base mounts.

PENTRON CORP. Booth 124. Room 502. 9T3 dual speed tape recorder, MM4 audio mix electronic mixer, accessories for magnetic recorder.

PERM-O-FLUX CORP. Booth 684. Room 524A-526A. Loudspeakers, high-fidelity headset assemblies, earphone units.

PERMO, INC. Booth 413. Phono needles, recording wire, recording tape. (Permo Long-Life Phonograph and Needle Facts.)

PHILMORE MFG. CO. Booth 585. Room 513A. TV kits, TV chassis, cabinets, crystal sets, headphones, crystal detectors, aerial kits, voltage doublers, automatic gain control kits, 2 & 3 tube AC-DC kits.

PHOENIX ELECTRONICS, INC. Booth 110. Room 604A. TV antennas, mounts, hardware & accessories.

PICKERING & CO. INC. Room S20. Variable reluctance cartridges, Pickering Model 190 Arm, Pickering Model 132E Record Compensator, Pickering Model 230H Pre-amplifier, Pickering Model 180L Loudspeaker.

(Continued on page 64)

Chicago Show Exhibitors

(Continued from page 63)

PRECISION APPARATUS CORP. Booth 304. Room 501. Test & measuring instruments for AM-FM-TV and industrial application. (#CR30 cathode ray tube tester.)

PREMAX DIVISION, CHILSHOLM-RYDER CO. Booth 135. Antennas, mounting, insulators, fixed, mobile and marine for commercial, police, amateur services. Govt. antennas (unclassified types), TV antennas, ground rods, accessories. (Stainless steel center-loaded, automatically operated antenna for marine and commercial use.)

PRESTO RECORDING CORP. Room 507A. Tape, disc recording & transcription equipment with associated amplifiers & accessories. Blank recording discs. (Tape transport mechanism driven by any 16" transcription turntable.)

PYRAMID ELECTRIC CO. Booth 572. Complete industrial-military line of oil-paper condensers, dry electrolytics in twist-mount cans and in metal & cardboard tubes, paper capacitors in glass-end seal tubes. (Paper capacitors in glass-end seal metal tubes, temp. range -55 to + 125° centigrade. Pyramid "Glasseeal".)

QUAM-NICHOLS CO. Booth 578. Room 560. Adjustable-Cone speakers, "Focalizer" units and "Focalizer" kits, ion traps.

RACON ELECTRIC CO. Booth 118. Room 533A. Reentrant loudspeakers, driver units, horns, tweeters, microphone stands. (Dual 40-watt railroad speaker.)

RADELCO MFG. CO. Booth 23. Auto & TV antennas, TV antenna mounting accessories and lightning arrestors.

RADIART CORP. Booth 409. Room 528A-530A. Power supplies, vibrators, car aerials, TV antennas, rotators. (New rotator & antenna.)

RADIO APPARATUS CO. Room 612A. Policealarm & Monitoradio communication receivers & antennas. (Fixed frequency receiver & transmitter.)

RADIO CITY PRODUCTS CO. Room 618A. Vacuum tube voltmeters, tube testers, signal tracers, sweep generators, AF-RF-FM signal generators, high voltage-HF multimeters, volt-ohm milliammeters, oscilloscopes, test testers, square wave generators. (Broad coverage signal generator.)

RADIO CORPORATION OF AMERICA. Booth 209. Room 504A-505A. Tubes, parts, test equipment, batteries.

RADIO CRAFTSMEN, INC. Booth 403. RC1D1 & RC200 TV receivers; FM-AM tuners; HI-FI amplifier. (FM Tuner.)

RADIO MERCHANDISE SALES, INC. Booth 3. Antennas, boosters, accessories. (Completely pre-assembled Yagi antennas.)

RADIO RECEPTOR CO. Booth 203. Selenium rectifiers.

RAM ELECTRONICS, Rm. 662A. Fly-back transformers, horizontal transformers, deflection yokes, width-linearity coils.

RAULAND-BORG CORP. Booth 314. Room 622A-623A. PA systems, Amplical intercom. systems, centralized radio & sound dist. systems.

RAULAND CORP. Booth 310. Cathode ray TV tubes.

RAYTHEON MFG. CO. Booth 591. Radio & TV receiving, cathode ray subminiature & special purpose tubes; industrial, transmitting & hearing aid tubes; rugged tubes, radiation counter tubes, voltage regulator tubes, crystal diodes, transistors, magnetrons, klystrons & voltage stabilizers.

RECOTON CORP. Booth 215. Phono & replacement needles, cutting styli, recording blanks. (Magnetic recording tape.)

REEVES SOUNDCRAFT INC. Booth 111. Room 537. Soundcraft TruLume TV picture tubes, blank recording discs, magnetic recording tape, 16mm and 35 mm magnetic recording film, air-design custom built transformers, magnetic tape for special applications. (8mm and 16mm Magna-Stripe film; Remington Rand Vericolor TV camera.)

REK-O-KUT CO. Room 557A. Challenger deluxe recorder. Recitalist phonograph (Rhythm Master variable speed phonograph.)

JOHN F. RIDER, INC. Booth 303. TV Manuals, Rider AM-FM Manuals, Rider Public Address Equipment Manual; radio, TV & electronics textbooks. (Rider's Television Manual Volume 6; Vacuum-Tube Voltmeters, revised; Encyclopedia on Cathode Ray Oscilloscope and Their Uses.)

HOWARD W. SAMS & CO. Booth 407. Howard W. Sams & Co., Inc. Photofact publications.

SANGAMO ELECTRIC CO. Booth 221. Room 556A. Fixed Mica paper and electrolytic capacitors; time switches.

WALTER L. SCHOTT CO. Booth 109. Antennas, hardware, radio chemicals, alignment tools. (Walsco "T-VIEW" Lamps.)

SHELDON ELECTRIC CO. Booth 201, Room 630A-631A. Sheldon Telegenic picture tubes, spring action plugs, Tapmaster cord sets, Tapmaster cube taps, Sheldon and Flash fluorescent starter switches. (Sheldon receiving tubes, time-delay relays.)

SHURE BROS. Booth 588. Room 557. Microphones, phono pickups, tape recording heads, acoustic devices. (New small unidyne microphone.)

SIMPSON ELECTRIC CO. Booth 581. Room 537A. Panel instruments, radio and TV test equipment.

MARK SIMPSON MFG. CO. Booth 679. Room 600-603A. Amplifiers, sound systems, intercoms, plant and industrial sound equip., transcription players, magnetic tape recorders, TV boosters. (2-stage TV booster; dual-speed magnetic tape recorders, and transcription players.)

HERMAN H. SMITH, INC. Booth 308. Barrier terminal blocks, insulated phone tip jacks, insulated phone tip plugs, insulated banana plugs and jacks; non-insulated jacks and banana plugs; non-insulated phone tip plugs; test leads, neutralizing tools, aligning tools, wrench sets and TV accessories and electronic components and hardware.

SNYDER MFG. CO. Booth 681. TV aerials & accessories, auto aerials, mike stands, TV masts.

SOLA ELECTRIC CO. Booth 582. Sola constant voltage transformers and special adaptations.

SONIC INDUSTRIES. Room 536. TV boosters, antennas, audio amplifiers. (TV booster Model 117.)

SPIRLING PRODUCTS CO. Booth 225. Room 512A. Indoor TV antenna, automobile & outdoor antennas, component parts. (Model TV5D1 Phantom antenna & Model TV503 Super Phantom antenna with optimum matching stub with adjustment knob.)

SPRAGUE PRODUCTS CO. Booth 583. Dry electrolytic, paper, ceramic, mica capacitors; Tel-Ohmike resistor-condenser checker, interference filters, Koolohm wire wound resistors. (High voltage ceramic capacitors.)

SQUARE ROOT MFG. CO. Booth 211. Room 654A-655A. Coronasealed transformers; glass, ceramic high voltage condensers; coils; TV antennas. (Coronasealed horizontal output transformer for TV.)

STANDARD COIL PRODUCTS CO. Booth 680. TV booster, TV tuner, and replacement parts.

STANDARD TRANSFORMER CORP. Booth 401. Rooms 500-501A. Transformers, reactors, power supplies, filters, transmitters. (Two new lines of plate transformers.)

STANDARD WOOD PRODUCTS CORP. Booth 11. TV cabinets; bass reflex cabinets, radio-phono cabinet, (companion to bass reflex cabinet; chairside radio-phono cabinet.)

SWITCHCRAFT INC. Booth 115. Switchcraft "Littel-Jax", "SF-Jax", "LF-Jax", "T-Jax", "M-Jax", "Extension-Jax", "Littel-Plug", "Lug-Plug", "Standard Phone Plug", "Flat Plug", "Littel Switch", "(FF-Switch", "RS-Switch", and "Lev-R Switch". (Military types of jacks and switches.)

SYLVANIA ELECTRIC PRODUCTS INC. Booth 574. Room 560A-561A. Receiving tubes; picture tubes, electronic products; advertising & sales promotions for distributors.

TALK-A-PHONE CO. Booth 218. Rooms 61DA-611A. Inter-com systems, amplifiers, PA equipment. (Traffic-controlled inter-com unit.)

TECH-MASTER PRODUCTS CO. Room 549. Improved 630 type TV chassis & kits; TV conversion kits; booster kits, AGC kits; TV components; adjustable pix tube mounting brackets. (New lo-cost "Universal" TV kit.)

TECHNICAL APPLIANCE CO. Booth 21. TV antennas and distribution systems. (RF power amplifier for TV distribution.)

TEL-O-TUBE CORP. OF AMERICA. Room 632. Cathode ray tubes, TV picture tubes. (Electrostatic tubes.)

TELREX INC. Booth 687. "Conical-V-Beams", TV antennas; installation accessories. (New series of TV antennas.)

THOMAS ELECTRONICS. Booth 682. Cathode ray tubes (cathode ray tube checker; 6AL5 and 6AU6 miniature tubes).

THORDARSON ELECTRIC MFG. CO. Booth 22. Meissner Div. Products: coils, tuners, amplifiers; Thordarson Div. Products: transformers, amplifiers. (Automatic voltage regulator; specialty transformers.)

TRIAD TRANSFORMER MFG. CO. Booth 404. Room 601-602. Small electronic transformers, including oover, chokes, filaments, audio components, filters, toroids, geophysicals, etc. (Amplifier kits and miniature audio transformers.)

TRICRAFT PRODUCTS CO. Booth 206. Indoor, outdoor TV antennas.

TRIMM RADIO MFG. CO. Booth 129. Headsets, plugs, jacks, patchcords & misc. replacement parts.

TRIPLETT ELECTRICAL INSTRUMENT CO. Booth 675. Room 532A. TV service equipment and meters. (#660 watt voltmeters for locating shorts and overload; #3434 sweep-marker generator.)

TUNG-SOL LAMP WORKS, INC. Booth 104. Room 516. Receiving, special purpose and TV picture tubes; dial lamps.

THE TURNER CO. Booth 577. Room 519A-520A. Microphones, TV boosters. (Two new model 50D "Aristocrat" high quality dynamic and model 60X "Competitor" low cost crystal.)

TELE-MATIC INDUSTRIES. Booth 106. TV antenna, installation accessories, TV sundries. (Mast caps, couplers, conical stabilizers.)

UNITED TRANSFORMER CORP. Booth 584. Transformers, reactors, bypass, lopass bandpass and other types of audio filters. (Special types of hermetic transformers.)

UNIVERSITY LOUDSPEAKERS INC. Booth 127. Room 539A. Commercial, industrial, HF and military type loudspeakers. (New cone speaker, new driver unit.)

VACO PRODUCTS CO. Booth 307. Screw drivers, nut drivers, solderless terminals.

V-M CORP. Booth 673. Room 561. Tri-O-Matic record changers, Tri-O-Matic phonos, Tri-O-Speed phono.

VERI-BEST ELECTRONICS. Booth 101. Antennas and mounts. (Bazooka antenna.)

WALDOM ELECTRONICS INC. Booth 589. Speaker cones and Crome components. (Universal auto control head and TV items.)

WARD-LEONARD ELECTRIC CO. Booth 123. JAN resistors, Vitrohm resistors, Vitrohm rheostats, magnetic relays, magnetic contactors.

WARD PRODUCTS CORP. Booth 685. Automotive, FM & TV antennas. (2 new receiving and transmitting antennas.)

WEBSTER-CHICAGO CORP. Booth 317. Record changers, photographs and accessories. (Model 106 record changer for original installation or replacement.)

WELLER MFG. CO. Booth 592. Soldering guns. (Models WS-100 & WD-135.)

WESTON ELECTRICAL INST. CORP. Room 613-614. Panel instruments, electronic test equipment, AC & DC portable test instruments. (#1411 Industronic DC amplifier.)

THE WORKSHOP ASSOCIATES. Booth 128. Room 509. TV antennas and accessories, examples of special Workshop antenna developments.

Accessories, Parts, Tools

Dumont 70 DEGREE YOKE

Edge to edge sharp focus, accompanied by increased sensitivity, is claimed for the new DuMont Series Y2A deflection yoke announced recently by the Electronic Parts Division of Allen B. Dumont Laboratories, Inc., East Paterson, N. J. It is stated that the improved performance is obtained even though the size of the yoke has been reduced. A ferrite core is employed and the windings are distributed to allow for better focus at the edge of the picture tubes, even in the largest size tubes. It is designed for the presently popular 60 to 70 degree picture tubes and can be obtained for either conventional transformer circuits or the new auto-trans-



former direct-drive circuits. It can be supplied with various networks and lead-lengths, or without any networks or leads wired in. It comes packed with installation instructions and Dumont distributors are stocking it presently. Operating temperatures up to 90 degrees C., and voltages up to 4 KV between any windings or to the frame are specified for this line of yokes. Electronic Parts Division, Allen B. Dumont Laboratories, East Paterson, N. J.—RADIO & TELEVISION RETAILING.

Penn TV HARDWARE

A new line of hardware items for TV antenna mounting has just been offered by Penn Boiler & Burner Mfg. Corp. As complements to the Penn Teletowers, Thriftowers and Tennamast, these various styles of pole base mounts have competitive list prices and are made in several sizes to accommodate all masts from 1 inch outside diameter to 2 inch outside diameter. Also included in the line are guy ring and collar sets from 1 1/4 inch, inside diameter to 2 inch, inside diameter. The three different styles of pole base mounts all have adjustable sockets and fit all common mast sizes. Penn Boiler & Burner Mfg. Corp., Lancaster, Pa.—RADIO & TELEVISION RETAILING.

Audax RELUCTANCE PICKUP

The Audax Polyphase reproducer L-6-G is now available with a connector unit for the Garrard changer. It is a two needle turn-over magnetic cartridge, said by its maker to be the only variable reluctance cartridge which not only has separate needles, but incor-

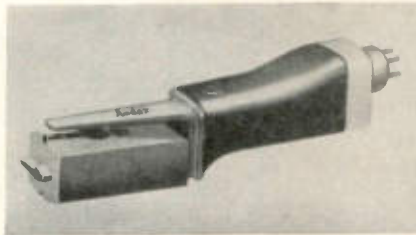

porates them both in one unit. It is a high output cartridge, and the sapphire or diamond stylus is easily replaceable by the consumer. The L-6-W is the same reproducer with an adaptor for the Webster changer. Literature and prices may be had from the Audax Co., 500 Fifth Ave., New York 18, N. Y.—RADIO & TELEVISION RETAILING.

Industrial TEST LIGHT

A new test light featuring greater voltage range and constructed to withstand the most rugged use is designated as the LO-VOLT Test Lite Model #1300. The new item is encased in a plastic housing that will stand abuse which would break the average glass test light. No special handling is necessary. Flexible leads with heavy durable coverings 10" long are terminated in convenient spring clips. The plastic bulb lights up in an easily seen brilliance on any voltage from 3 to 25 volts AC or DC. It is especially adaptable for use with low voltage controls such as thermostats, etc., and may also be used with a battery supply to test for continuity. A second model is offered as the LO-VOLT Test Lite model #1300 covering a range of from 6 to 50 volts AC or DC. Industrial Devices, Inc., Edgewater, N. J., RADIO & TELEVISION RETAILING.

Turner MICROPHONE

The new "Aristocrat," finished in chrome is styled as a pencil-type microphone. Maker says response is 50 to 15,000 cps, plus or minus 2.5db. The Aristocrat is omnidirectional and comes in impedances of 15,200,500 ohm or high. Sensitivity is -56 db. Swivel-type mount for stand, boom or quick disconnection for hand use. For specifications and prices write the Turner Co., Cedar Rapids, Iowa.—RADIO & TELEVISION RETAILING.

C-D CAPACITORS

New by-pass and feed-through vehicular capacitors for the suppression of radio frequency interference have been announced by Cornell-Dubilier. Hermetically sealed and built to withstand extremes of vibration, shock and for operation over temperature range from -55° C. to +85° C. The MC series will be provided with three bracket styles. The NF 10072 will be equipped with a universal mounting bracket. All have terminal studs with fastener screws. The MC series is designed for by-pass applications; the NF series for feed-through. Bulletin NB-140 is available from Cornell-Dubilier Electric Corporation, South Plainfield, N. J.—RADIO & TELEVISION RETAILING.

Telematic CONICAL STABILIZER

For conical elements which vibrate in the wind and often fall out of the antenna assemblies completely a wooden shafted rigid member with steel jaws at each end is now made by Telematic Industries. It is a practical light weight



stabilizer which will fit both 3/8" and 1/2" elements. Cat. no. CS-21 conical stabilizer is ready for immediate delivery from Telematic Industries, Inc., 1 Joralemon St., Brooklyn, N. Y.—RADIO & TELEVISION RETAILING.

Woodland PEAK MOUNT

An adjustable mount which will accommodate from 3/8" to 1 1/2" masts, made of heavy-gauge steel with a socket which tilts for easy installation is now available at a list price of \$2.00, distributors net \$.90 from the Woodland Mfg. Co., 416 Woodland, Toledo 2, Ohio.—RADIO & TELEVISION RETAILING.

Clarostat POTENTIOMETER

A new control developed by Clarostat Mfg. Co. to exceptionally rigid mechanical and electrical specs will operate properly under extreme conditions of temperature, humidity, vibration, fungus and corrosive condition, it is said. Molded in bakelite by the Clarostat Mfg. Co., Inc., Dover, N. H.—RADIO & TELEVISION RETAILING.

News of the Present Market

IN SPITE OF NATION-WIDE SALES DECLINE, and voluntary price reductions by manufacturers, there's still talk of price roll-backs on products in our fields. For a great many years, the industry has "automatically" reduced prices in buyer's markets; raised them in seller's markets. As a rule, products cost much more to make and sell in a buyer's market, and merchandise is likely to be in short supply. In the past couple of months the situation reversed itself. The heavy inventories were expensive to make, expensive to sell, but price reductions had to be made to move them.

ALUMINUM VERY HARD TO GET, yet only 35 per cent allocated to government work. Copper still tight, but more twin-lead available, reflecting slow-down in sales of TV sets. Some transmission line has been coming to this country from abroad. Lead-in wire using 2 solid conductors on market.

PROGRESSIVE DEALERS REALIZE the importance of personable TV servicemen in building up good-will on home calls. Following is a portion of an ad one merchant ran recently in the *New York Times*: "We want several smiling outside servicemen..."

"IT IS NOT GOOD BUSINESS to advertise merchandise by saying 'Buy now, before the proposed increase of the excise tax to 25%.' This is bad advice. First, the knowledge that there is any excise tax on instruments could affect sales as it has on items where a retail excise tax applies. Second, if the proposed increase does not materialize there is customer resentment."—From National Assn. of Music Merchants bulletin.

PHONO RECORD MANUFACTURERS not worried about material situation since most of them have adequate amounts of vinyl plastics on hand.

GOLDEN ANNIVERSARY, CONVENTION & SHOW by National Association of Music Merchants will be held at Chicago's Palmer House, July 16-19. Events scheduled are: Monday, July 16—Golden Anniversary luncheon and ladies' annual tea; Tuesday—Annual meeting, merchandising records forum; Wednesday—Management, sheet music & merchandising accessories forums; anniversary banquet; salesmanship and repair forums will be held on Thursday.

BASEBALL SEASON HAS ALREADY HAD a favorable effect on TV receiver sales in most sections, and will continue to influence many a fan to buy between now and the start of the World Series.

TV SATURATION, 1951—Because it is now recognized that television stations regularly reach out far beyond the 40-mile radius originally expected, the broadcasters, beginning with 1951, are counting their markets in terms of 60-mile-radius circles. NBC's latest saturation figures on total homes and total TV sets in such areas, are here computed for the following cities (previously reported for 40-mile radius in our February issue, page 27).

Milwaukee	60%	Cincinnati	56%
San Diego	48%	New York	57%
Minneapolis-		Philadelphia	61%
St. Paul	55%	Cleveland	56%
Los Angeles	57%	Boston	65%

THE FEDERAL RESERVE BOARD HAS BEEN REQUESTED by an industry group organized by RTMA to modify Regulation W to permit TV set trade-ins to be applied against the 25 per cent down payment required on radio and TV sales.

PICTURE TUBE DATA CHART

Compiled for your use

BY

DUMONT

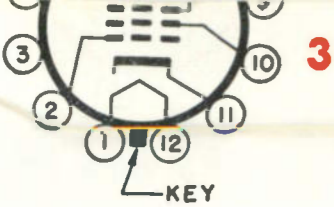

12L

BULB OUTLINE INFORMATION

IMPORTANT NOTE: All bulb outline information is given in inches. Unless otherwise stated outline information for "A", "B", "C", or "D" types is identical to that given for the basic type.

Bulb Outlines

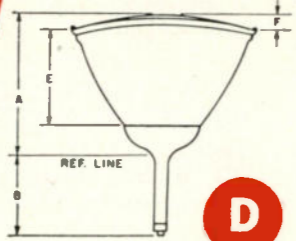
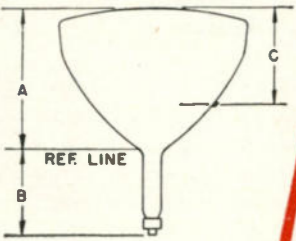
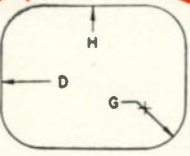
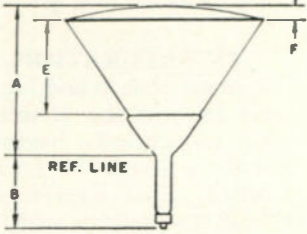
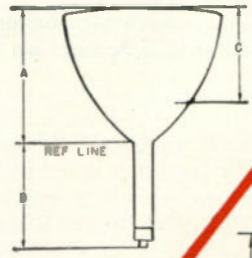

Basic Type	See Outline	A	B	C	D	E	F	G	H
10BP4	A	$9\frac{7}{16}$	$8\frac{3}{16}$	$7\frac{1}{8}$					
10CP4	A	$9\frac{7}{16}$	$7\frac{3}{16}$	$7\frac{1}{8}$					
10EP4	A	$9\frac{7}{16}$	$8\frac{3}{16}$	$7\frac{1}{8}$					
10FP4	A	$9\frac{7}{16}$	$8\frac{3}{16}$	$7\frac{1}{8}$					
10MP4	A	$9\frac{7}{16}$	$7\frac{9}{16}$	$7\frac{1}{8}$					
12JP4	A	$10\frac{1}{2}$	7	$7\frac{3}{8}$					
12KP4	A	$10\frac{1}{2}$	$7\frac{1}{2}$	$7\frac{1}{2}$					
12LP4	A	$10\frac{1}{2}$	$8\frac{1}{4}$	$7\frac{1}{2}$					
12QP4	A	$10\frac{1}{2}$	7	$7\frac{1}{2}$					
12RP4	A	$10\frac{1}{2}$	7	$7\frac{3}{8}$					
12TP4	A	$10\frac{1}{2}$	$8\frac{1}{4}$	$7\frac{1}{2}$					
12UP4	B	$10\frac{5}{8}$	8			$7\frac{1}{2}$	$\frac{5}{16}$		
12VP4	A	$10\frac{1}{2}$	$7\frac{1}{2}$	$7\frac{1}{2}$					
14BP4	C	$9\frac{9}{32}$	$7\frac{17}{32}$	$6\frac{21}{32}$	∞			$2\frac{3}{4}$	∞
14CP4	C	$9\frac{9}{32}$	$7\frac{15}{32}$	$6\frac{5}{8}$	∞			$2\frac{3}{4}$	∞
14DP4	C	$9\frac{9}{32}$	$7\frac{15}{32}$	$6\frac{21}{32}$	∞			$2\frac{3}{4}$	∞
14EP4	C	$9\frac{9}{32}$	$7\frac{3}{16}$	$6\frac{21}{32}$	∞			$2\frac{3}{4}$	∞
14FP4	C	$9\frac{9}{32}$	$6\frac{7}{8}$	$6\frac{5}{8}$	∞			$2\frac{3}{4}$	∞
15AP4	A	$13\frac{9}{16}$	$6\frac{15}{16}$	$6\frac{9}{16}$					
15CP4	A	$13\frac{1}{2}$	8	$6\frac{1}{4}$					
15DP4	A	$13\frac{9}{16}$	$6\frac{15}{16}$	$6\frac{1}{4}$					
16AP4	B	$14\frac{11}{16}$	$7\frac{9}{16}$		11		$\frac{7}{8}$		
16CP4	A	$14\frac{7}{8}$	$6\frac{5}{8}$	$10\frac{7}{8}$					
16DP4	A	$12\frac{7}{8}$	$8\frac{3}{16}$	$7\frac{1}{2}$					
16EP4	B	$12\frac{3}{4}$	$6\frac{7}{8}$			$9\frac{11}{16}$	$\frac{7}{8}$		
16FP4	A	$13\frac{1}{4}$	7	$9\frac{1}{4}$					
16GP4	B	$10\frac{3}{8}$	$6\frac{7}{8}$			$7\frac{5}{16}$	$\frac{1}{2}$		
16HP4	A	$12\frac{1}{8}$	$8\frac{3}{8}$	$7\frac{1}{2}$					
16JP4	A	$13\frac{1}{4}$	$7\frac{1}{8}$	$9\frac{1}{4}$					
16KP4	C	$11\frac{1}{4}$	$7\frac{1}{2}$	$6\frac{7}{16}$	∞			$3\frac{1}{4}$	∞
16LP4	A	$14\frac{7}{8}$	$7\frac{3}{8}$	$7\frac{1}{2}$					

Basic Type	See Outline	A	B	C	D	E	F	G	H
16MP4	A	$13\frac{1}{4}$	$7\frac{1}{2}$	$7\frac{15}{16}$					
16QP4	C	$11\frac{1}{4}$	$7\frac{7}{8}$	$7\frac{5}{8}$	∞			$3\frac{1}{4}$	∞
16RP4	C	$11\frac{1}{4}$	$7\frac{1}{2}$	$7\frac{5}{8}$	∞			$3\frac{1}{4}$	∞
16SP4	A	$10\frac{5}{16}$	7	$7\frac{7}{16}$					
16TP4	C	$11\frac{1}{4}$	$6\frac{7}{8}$	$7\frac{5}{8}$	∞			$3\frac{1}{4}$	∞
16UP4	C	$11\frac{1}{4}$	$6\frac{7}{8}$	$7\frac{5}{8}$	∞			$3\frac{1}{4}$	∞
16VP4	A	$10\frac{5}{16}$	$6\frac{7}{8}$	$7\frac{1}{4}$					
16WP4	A	$10\frac{5}{16}$	$7\frac{1}{2}$	$7\frac{7}{16}$					
16XP4	C	$11\frac{1}{4}$	$7\frac{1}{2}$	$7\frac{5}{8}$	∞			$3\frac{1}{4}$	
16YP4	A	$10\frac{5}{16}$	7	$7\frac{7}{16}$					
16ZP4	A	$14\frac{7}{8}$	$7\frac{3}{8}$	$7\frac{7}{16}$					
17AP4	C	$11\frac{3}{4}$	$6\frac{7}{8}$	$7\frac{1}{8}$	21			$2\frac{5}{8}$	27
17BP4	C	$11\frac{3}{4}$	$7\frac{1}{2}$	$7\frac{1}{8}$	21			$2\frac{5}{8}$	27
17CP4	C&D	$11\frac{5}{16}$	$7\frac{3}{16}$		$26\frac{1}{2}$	8	$\frac{3}{4}$	$3\frac{3}{8}$	$28\frac{5}{16}$
17FP4	C	$11\frac{3}{4}$	$7\frac{1}{2}$	$7\frac{1}{8}$	21			$2\frac{5}{8}$	27
17GP4	C&D	$11\frac{5}{16}$	$7\frac{3}{16}$		$26\frac{1}{2}$	8	$\frac{3}{4}$	$3\frac{3}{8}$	$28\frac{5}{16}$
19AP4	B	$14\frac{3}{8}$	$7\frac{1}{8}$				$9\frac{1}{8}$	$1\frac{3}{8}$	
19DP4	A	$14\frac{3}{8}$	$7\frac{1}{8}$	$7\frac{3}{16}$					
19EP4	C	$13\frac{5}{8}$	$7\frac{1}{2}$	10	∞			$2\frac{1}{2}$	∞
19FP4	A	$14\frac{3}{8}$	$7\frac{5}{8}$	$8\frac{1}{16}$					
19GP4	A	$14\frac{3}{8}$	$6\frac{7}{8}$	$8\frac{1}{16}$					
19JP4	C	$13\frac{5}{8}$	$7\frac{3}{16}$	10	∞			$2\frac{1}{2}$	∞
20BP4	A	20	8	14					
20CP4	C	$14\frac{1}{4}$	$7\frac{3}{16}$	$7\frac{1}{2}$	$26\frac{1}{2}$			$3\frac{9}{16}$	$34\frac{3}{32}$
20DP4	C	$14\frac{1}{4}$	$7\frac{1}{2}$	$7\frac{1}{2}$	$26\frac{1}{2}$			$3\frac{9}{16}$	$34\frac{3}{32}$
20FP4	C	$14\frac{1}{4}$	$7\frac{1}{2}$	$7\frac{1}{2}$	$26\frac{1}{2}$			$3\frac{9}{16}$	$34\frac{3}{32}$
20GP4	C	$14\frac{1}{4}$	$7\frac{1}{2}$	$7\frac{1}{2}$	$26\frac{1}{2}$			$3\frac{9}{16}$	$34\frac{3}{32}$
22AP4	B	$15\frac{5}{8}$	$7\frac{1}{4}$				$11\frac{5}{16}$	$1\frac{7}{8}$	
24AP4	B	$15\frac{11}{32}$	$6\frac{27}{32}$				$16\frac{3}{4}$	$1\frac{7}{16}$	
30BP4	B	$14\frac{1}{16}$	$7\frac{3}{16}$				$11\frac{7}{32}$	$2\frac{5}{16}$	

DUMONT

CATHODE-RAY TUBE DIVISION

Allen B. Du Mont Laboratories, Inc.

750 BLOOMFIELD AVENUE

CLIFTON, N. J.

First with the Finest in T.V. Tubes

Latest Aids for the Technician and Installer

Insuline INSTALLATION KITS

A series of eight television antenna installation kits, designed to meet practically all receiving requirements in either primary service or "fringe" areas is now available. The simplest kit contains a single conical antenna, five foot mast and 50 feet of lead-in wire. The others are progressively more elaborate, the largest kit containing a stacked conical aerial, ten-foot mast, base mount, guy wire, 100 feet of lead-in lightning arrester clamps, insulators, etc. All kits are neatly packaged for ease of handling. They are available through jobbers or from the Insuline Corp. of America, 36-02 35th Ave., Long Island City, N. Y.—RADIO & TELEVISION RETAILING.

Telematic MAST COUPLER

A new coupler for connecting short sections of antenna mast together without tools is being made by Telematic Industries. Providing a highly rigid coupling without any screws or hardware and requiring no use of tools, it

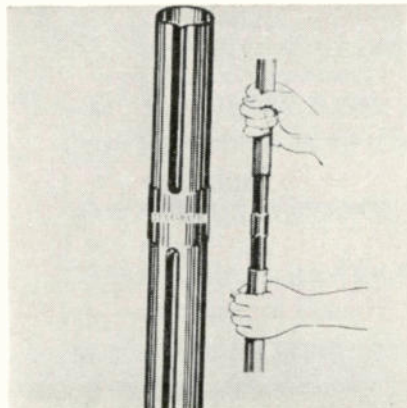

is provided in two sizes; to fit 1 1/4" O.D. mast and 1" electrical conduit. Available now from Telematic Industries, Inc., 1 Joralemon St., Brooklyn, N. Y.—RADIO & TELEVISION RETAILING.

Warner ANTENNA

A new television antenna called the Super-Sensi-tv is said by the manufacturer to reduce "ghosts" and minimize fading on all channels, especially in fringe and low signal areas. It has a high front-to-back ratio combined with a narrow angular pattern, reducing noise and interference to a minimum. Stated gain is 6 db on lower channels and 5 db on the higher. Extreme ease of assembly is a feature, and the antenna comes packaged in complete kit form, with a 5 foot mast, two stand-offs, mast and boom clamps and instructions. Overall dimensions when assembled are front element 85", rear element 66", crossarm 60". List price is \$24.95. Quantity discounts are available from Warner Products Corp., 1512 W. Jarvis Ave., Chicago 26.—RADIO & TELEVISION RETAILING.

Ansley SCHOOL PHONOGRAPHS

A line of phonographs designed with the requirements of school and instructional use in mind has been announced by the Arthur Ansley Mfg. Co. Designated Audio-Aid, these phonographs range in size and price from a portable model through kindergarten and table size to the large Console model. All have three speed turntables, separate indicator lights for both phono motor and amplifier, and AC-only transformer power supplies for safety. The largest model has a high-fidelity amplifier, two speakers, provision for FM-AM tuner or tape recorder, which are available as built-in accessories, and dual tone controls. All models except the smallest, the portable, have mike connections and may be used for small PA systems. Arthur Ansley Mfg. Co., Doylestown, Pa.—RADIO & TELEVISION RETAILING.

Barb City PLUG-IN BOOSTER

A new idea in boosters has just been released for use in TV receivers which need a little more gain. This booster is an extra stage of IF amplification which is mounted on a plug which goes into the socket of one of the IF stages. The booster then receives the IF tube which was removed and the set is back in

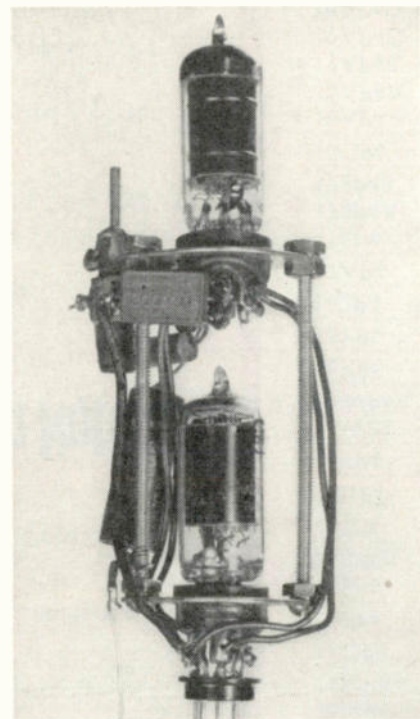

operation with an additional stage of gain. There are no connections to make other than plugging in the booster and the two tubes. The plug-in booster is available at a list price of \$9.95 from Barb City Industries, Inc., 1150 S. 4th St., DeKalb, Ill.—RADIO & TELEVISION RETAILING.

Clarostat MINIATURE CONTROLS

The series 48 composition-element sub-miniature controls recently developed by Clarostat are cased in bakelite, and measure 5/8" diam., 3/8" deep. Values up to 3 megohms linear, and tapers to 1 megohm. Available with round or slotted shaft, and may be strapped together for dual unit operation. Clarostat Mfg. Co., Inc., Dover, N. H.—RADIO & TELEVISION RETAILING.

Nemco AUTO ANTENNA

A new and easy-to-mount radio antenna for automobile installation has been announced by the National Electronic Mfg. Corp., of Long Island City, N. Y. Called the Nemco "Triple-Kwik," it is made of chrome-plated brass, fits the fender or cowl of most modern cars,

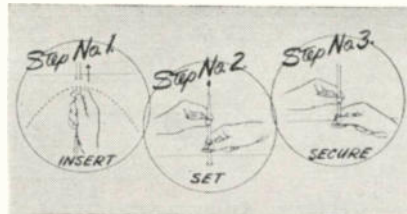

is rustproof and rattle-free, and comes with a three-foot shielded lead-in cable with Delco and Motorola fittings, according to the manufacturer. It telescopes in three sections and lists at \$5.50. Available from the West Coast office at 1335 South Flower St., Los Angeles, Cal., or from National Electronic Mfg. Corp., Long Island City, N. Y.—RADIO & TELEVISION RETAILING.

Standard REFLEX CABINET

Designed for properly baffling 12" and 15" loudspeakers the model RX bass reflex cabinet is made of 3/4" wood with interior acoustic padding and adjustable port opening. It comes in five different wood finishes, weighs 60 lbs., and measures 36" high, 16" deep, and



24" wide. Manufactured by the Standard Wood Products Corp., 43-02 38th St., Long Island City.—RADIO & TELEVISION RETAILING.

Power-Grip WRENCH

"Power-Grip" wrench is a handy tool for applying a strong grip on small parts in close quarters. Length is 5 inches, head thickness only 1/8", adjustable from 0 to 1/2" grip. Made of fine alloy steel, it is guaranteed unbreakable and costs \$1.50 from the Colman Tool & Machine Co., Box 364, Amarillo, Texas.—RADIO & TELEVISION RETAILING.

Sonar TAPE RECORDER

Included in the new line of tape recording equipment which Sonar Radio Corp. is producing is a professional quality tape recorder at the medium

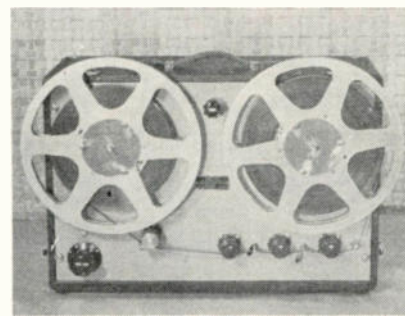

price level. The machine runs at 7 1/2 inches per second, is within 3 db of 30 to 10,000 cps at 2% distortion and can be monitored during playback. Sonar Radio Corp., 59 Myrtle Ave., Brooklyn, N. Y.—RADIO & TELEVISION RETAILING.

El-Tronics RADIO ALARM

The model RA-10A electronic radio alarm is a capacity-operated burglar alarm system and fire detector. It has a sensitivity which can be controlled so as to trip the alarm at the approach of a person several feet away, or it may be made to operate only when the protected object is actually touched. The device is connected by a wire to any ungrounded metal object which then becomes an antenna, or it may be actuated by an antenna consisting of a piece of metal or screening under a rug. The radio alarm RA-10A has circuits in it to compensate, the manufacturer states, against changes in temperature, humidity, weather and line voltage. It will go off at approximately 160 degree F. acting as an automatic fire alarm. It will turn on a bell, horn, gong, light, or almost any desired electrical device. After 1 1/2 minutes of sounding the alarm it goes off, and in 90 seconds is ready to go again. This feature provides for uninterrupted operation during long unattended periods. The device is a standard capacity-operated relay incorporating a bridge balanced circuit and is available at a list price of \$139.50 from El-Tronics, Inc., 2647-67 N. Howard St., Philadelphia 33, Pa.—RADIO & TELEVISION RETAILING.

Ureco FM TUNER

A new FM tuner is now on the market for use in custom installations and for adding FM to existent sets. The manufacturer has included automatic drift compensation and a transformer power supply in addition to an on-off switch which connects a phono in place of the tuner when the tuner is turned off. A

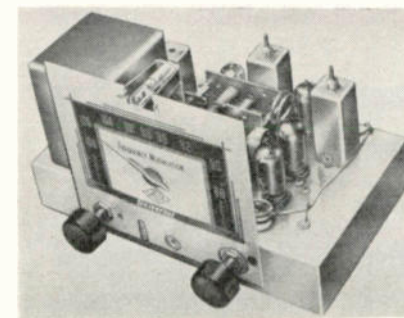

vernier drive dial is calibrated in MC for the FM band, and the dial light indicates on-off. The circuit is of the type which is quiet between stations. It employs five tubes and a rectifier and is in the low cost field. Manufactured by Universal Television Mfg. Co., 196 Bowery, New York 12.—RADIO & TELEVISION RETAILING.

Columbia 4-CONDUCTOR WIRE

Rotators may be connected to their control units now by means of a 4-conductor wire made by the Columbia Wire & Supply Co. This new item is also available in 5-conductors. The wire is twisted to make a compact cable. Columbia Wire & Supply Co., 2850 Irving Park Rd., Chicago.—RADIO & TELEVISION RETAILING.

Ansley COMBINATION

A new high-fidelity chassis for radio-phonographs is now being made by the Arthur Ansley Manufacturing Company. It has a separate speaker enclosure which fits into any corner of a room, occupying a space 32" wide, 36" high, and 17" deep. The enclosure houses a 15" coaxial high-quality loudspeaker in a bass-reflex designed cabinet which may be painted to match walls or woodwork. Using triodes with negative feedback and fixed bias feeding a very heavy output transformer, the amplifier is intended for the serious music listener. A three speed changer with variable reluctance pickup, and an AM-FM tuner which includes a tuning eye are housed in a chairside cabinet which comes in mahogany finish. The chairside is 26" long, 17" wide and 25" high. The entire combination lists for \$695. Other finishes available at extra cost. Descriptive bulletin will be mailed on request. The Arthur Ansley Manufacturing Company, Doylestown, Pa.—RADIO & TELEVISION RETAILING.

Littelfuse HOLDER BOX

Pigtail fuses may now be carried together with their holders in a handy transparent box. After the 10 holders and fuses have been used the box is convenient for small parts, screws,

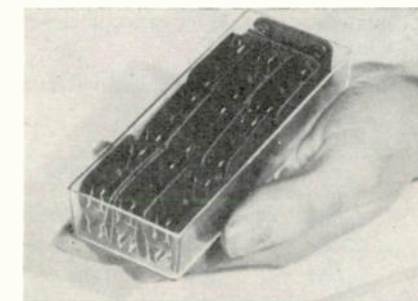

needles, etc. The box is transparent plastic and the holders are the well known snap-on type which eliminate need for soldering on new pigtail fuses. The box is free with purchase of fuses from jobbers. Made by the Littelfuse Co., Inc. Chicago, Ill.—RADIO & TELEVISION RETAILING.

Astatic PHONO CARTRIDGE

A cartridge to fit the Admiral snap-in tone arm is the latest offering of the Astatic Corp. This three prong crystal phono cartridge makes available a choice of either high output or medium output voltage from the cartridge to fit the requirements of the amplifying circuit. The new cartridge terminals exactly fit the three receptacles found in

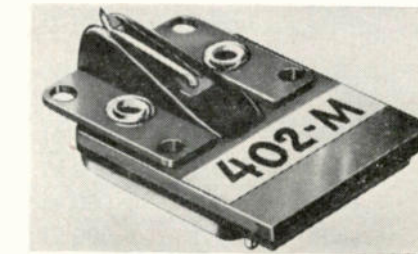

the Admiral arms, and thus will serve as an exact replacement unit. The crystal cartridge is available through all distributors. Astatic Corp., Conneaut, Ohio.—RADIO & TELEVISION RETAILING.

BT BOOSTER

A booster for TV called the Antensifier which turns itself on and off automatically by means of an automatic thermo-relay switch is now manufactured by the Blonder-Tongue Labs. Quick installation, attractive leatherette cabinet, small size for hidden operation, and high gain are the features. It uses four twin-triodes to get push-pull operation double-peaked on the high and low TV bands. The list price is \$57.50. Blonder-Tongue Laboratories, Yonkers, N. Y.—RADIO & TELEVISION RETAILING.

IMPORTANT

To obtain a comparison among the tube types listed, focus current is specified for the following standard comparative conditions, which do not necessarily imply typical operating conditions.

COMPARATIVE OPERATING CONDITIONS

Focus Current or Focusing Electrode Voltage	Anode Volts	Neg. Grid #1 Cut Off Volts	Grid #2 Volts
(see listings)	12,000	33-77	300

ALL TYPES listed employ a white fluorescent screen of medium persistence.

HEATER VALUES are 6.3 volts, 0.6 amps.

Code and Specification Notes

- EXT = external conductive coating
- RT-G = rect. with gray face
- RD-C = round with clear face
- RD-G = round with gray face
- FF = frosted (or etched) face
- MB = metal-backed screen
- CQ = see Type 12QP4A for suggested replacement
- Q = suggested replacement for Types 12JP4 and 12RP4
- CD = for replacement see Type 15DP4
- * = Types employ RTMA Focus Coil #109 (approx. 470 ohms); all others RTMA Focus Coil #106 (approx. 264 ohms).

Data is based on latest information available from the RTMA Data Bureau.

◀ = Du Mont Teletrons

Basings

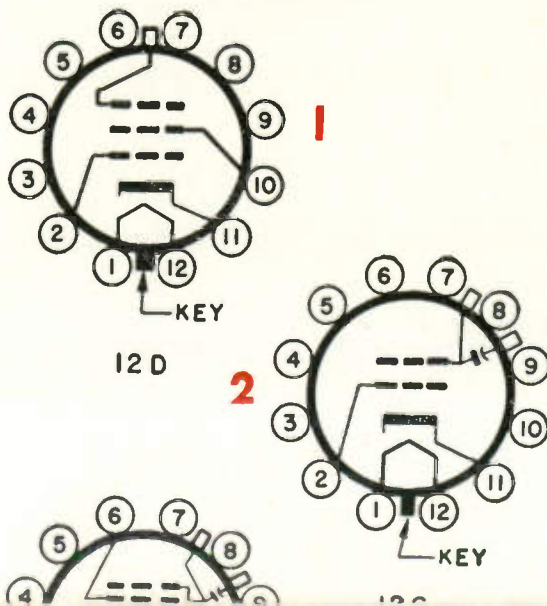

Type	Code	Basing	Overall Length (inches)	Outside Dimensions (inches)	Min. Useful Screen Size (inches)	Deflection Angle (degrees)	Radius of Face Curvature (inches)	Envelope	Contact	Ion Trap Magnet	MAX. DESIGN CENTER VALUES (Volts)	Comparative Focusing Electrode Volts	
16GP4A	RD-C	12D	17 ¹¹ / ₁₆	15 ⁷ / ₈	14 ³ / ₈ dia.	70	40	Metal	Cone lip	Single	14,000	410	100*
16GP4B	RD-G-FF												
16GP4C	RD-C-FF												
16HP4	RD-C-EXT	12D	21 ¹ / ₄	15 ⁷ / ₈	14 ¹ / ₂ dia.	60	56 ⁵ / ₁₆	Glass	Cavity	Double	14,000	410	110
16HP4A	RD-G-EXT												
16JP4	RD-C-EXT	12D	20 ³ / ₄	16 ¹ / ₈	15 dia.	60	27	Glass	Cavity	Double	14,000	410	120
16JP4A	RD-G-EXT												
16KP4	RT-G-EXT	12D	18 ³ / ₄	11 ¹ / ₂ x14 ³ / ₄	10 ¹ / ₈ x13 ¹ / ₂	70 diag.	27	Glass	Cavity	Single	16,000	410	90*
16KP4A	RT-G-EXT-MB												
16LP4	RD-C-EXT	12D	22 ¹ / ₄	15 ⁷ / ₈	14 ¹ / ₂ dia.	52	56 ⁵ / ₁₆	Glass	Cavity	Double	14,000	410	95*
16LP4A	RD-G-EXT												
16MP4	RD-C-EXT	12D	21 ³ / ₄	16 ¹ / ₈	14 ³ / ₄ dia.	60	27	Glass	Cavity	Double	14,000	410	95*
16MP4A	RD-G-EXT												
16QP4	RT-G	12D	19 ⁹ / ₁₆	11 ¹ / ₂ x14 ³ / ₄	10 ¹ / ₈ x13 ¹ / ₂	70 diag.	27	Glass	Cavity	Double	16,000	410	130
16RP4	RT-G-EXT	12D	18 ³ / ₄	11 ¹ / ₂ x14 ³ / ₄	10 ¹ / ₈ x13 ¹ / ₂	70 diag.	27	Glass	Cavity	Double	14,000	410	100*
16SP4	RD-C-EXT	12D	17 ⁷ / ₁₆	15 ⁷ / ₈	14 ¹ / ₂ dia.	70	56 ⁵ / ₁₆	Glass	Cavity	Double	14,000	410	100*
16SP4A	RD-G-EXT												
16TP4	RT-G-EXT	12D	18 ¹ / ₈	11 ¹ / ₂ x14 ³ / ₄	10 ¹ / ₈ x13 ¹ / ₂	70 diag.	27	Glass	Cavity	Single	14,000	410	100*
16UP4	RT-G	12D	18 ¹ / ₈	11 ¹ / ₂ x14 ³ / ₄	10 ¹ / ₈ x13 ¹ / ₂	70 diag.	27	Glass	Cavity	Single	15,000	410	100*
16VP4	RD-G	12D	17 ⁷ / ₁₆	15 ⁷ / ₈	14 ¹ / ₂ dia.	70	56 ⁵ / ₁₆	Glass	Cavity	Single	15,000	410	100*
16WP4	RD-G	12D	17 ³ / ₄	15 ⁷ / ₈	14 ¹ / ₂ dia.	70	56 ⁵ / ₁₆	Glass	Cavity	Double	15,000	410	100*
16WP4A	RD-G-EXT									16,000	410	100*	
16XP4	RT-G	12D	18 ³ / ₄	11 ¹ / ₂ x14 ³ / ₄	10 ¹ / ₈ x13 ¹ / ₂	70 diag.	27	Glass	Cavity	Double	15,000	410	100*
16YP4	RD-G-EXT	12D	17 ⁷ / ₁₆	15 ¹ / ₈	14 ¹ / ₂ dia.	70	56 ⁵ / ₁₆	Glass	Cavity	Single	14,000	410	95*
16ZP4	RD-G-EXT	12D	22 ¹ / ₄	15 ⁷ / ₈	14 ¹ / ₂ dia.	52	56 ⁵ / ₁₆	Glass	Cavity	Single	14,000	410	95*
17AP4	RT-G	12D	18 ⁵ / ₈	12 ¹ / ₄ x15 ³ / ₈	10 ³ / ₄ x14 ¹ / ₄	70 diag.	27	Glass	Cavity	Single	16,000	410	100*
17BP4	RT-G												
17BP4A	RT-G-EXT	12D	19 ¹ / ₄	12 ¹ / ₄ x15 ³ / ₈	10 ³ / ₄ x14 ¹ / ₄	70 diag.	27	Glass	Cavity	Single	16,000	410	95*
17BP4B	RT-G-EXT-MB												
17CP4	RT-G	12D	18 ¹ / ₂	12 ¹ / ₄ x15 ¹ / ₁₆	11x14 ⁵ / ₈	70 diag.	30	Metal	Cone lip	Single	16,000	410	95*
19AP4	RD-C												
19AP4A	RD-G												
19AP4B	RD-G-FF	12D	21 ¹ / ₂	18 ⁵ / ₈	17 ³ / ₈ dia.	66	28	Metal	Cone lip	Single	19,000	410	140
19AP4C	RD-G-MB												
19AP4D	RD-C-FF												
19DP4	RD-C-EXT	12D	21 ¹ / ₂	18 ⁷ / ₈	17 ³ / ₈ dia.	66	60	Glass	Cavity	Double	19,000	410	140
19DP4A	RD-G-EXT												
19EP4	RT-G-EXT	12D	21 ¹ / ₈	13 ³ / ₁₆ x17 ¹ / ₁₆	12x16	70 diag.	27	Glass	Cavity	Double	19,000	410	95*
19FP4	RD-C-FF	12D	22	18 ⁷ / ₈	17 ³ / ₈ dia.	66	60	Glass	Cavity	Double	19,000	410	95*
19GP4	RD-G	12D	21 ¹ / ₄	18 ⁷ / ₈	17 ³ / ₈ dia.	66	60	Glass	Cavity	Single	19,000	410	100*
19JP4	RT-G	12D	20 ¹ / ₁₆	13 ³ / ₁₆ x17 ¹ / ₁₆	12x16	70 diag.	27	Glass	Cavity	Single	18,000	410	95*
20BP4	RD-C	12D	28	20	18 ³ / ₄ dia.	54	30	Glass	Metal Cap	None	20,000	410	122
20CP4	RT-G												
20CP4A	RT-G-EXT	12D	21 ⁷ / ₁₆	14 ¹ / ₁₆ x18 ¹ / ₁₆	12 ³ / ₄ x17	70 diag.	40	Glass	Cavity	Single	18,000	410	95*
20DP4A	RT-G-EXT	12D	21 ³ / ₄	14 ¹ / ₁₆ x18 ¹ / ₁₆	12 ³ / ₄ x17	70 diag.	40	Glass	Cavity	Single	18,000	410	95*
22AP4	RD-C	12D	22 ⁷ / ₈	21 ¹ / ₁₆	20 ¹ / ₄ dia.	70	27	Metal	Cone lip	Single	19,000	410	105*
22AP4A	RD-G												
24AP4	RD-G	12D	23 ⁵ / ₈	24 ¹ / ₈	22 ³ / ₈ dia.	70	40	Metal	Cone lip	Single	16,000	410	100*
24AP4A	RD-G-MB												
30BP4	RD-G	12D	23 ⁹ / ₁₆	30 ¹ / ₈	28 ¹ / ₄ dia.	90	40	Metal	Cone lip	Single	30,000	410	95*

ELECTROSTATIC FOCUS TYPES

Type	Code	Basing	DIMENSIONS (inches)			Deflection Angle (degrees)	Radius of Face Curvature (inches)	Envelope	Contact	Ion Trap Magnet	MAX. DESIGN CENTER VALUES		Comparative Focusing Electrode Volts
			Overall Length	Outside Dimensions	Min. Useful Screen Size						Anode Volts	Focusing Electrode Volts	
17FP4	RT-G-EXT	12L	19 ¹ / ₄	12 ¹ / ₄ x15 ³ / ₈	10 ³ / ₄ x14 ¹ / ₄	70 diag.	27	Glass	Cavity	Single	18,000	5000	2300-3100
17GP4	RT-G-FF	12L	19 ⁵ / ₁₆	12 ¹ / ₄ x15 ¹ / ₁₆	10 ¹ / ₁₆ x14 ³ / ₈	70 diag.	30	Metal	Cone lip	Single	16,000	4500	2300-3100
20FP4	RT-G	12L	21 ³ / ₄	14 ¹ / ₁₆ x18 ¹ / ₁₆	12 ³ / ₄ x17	70 diag.	40	Glass	Cavity	Single	18,000	5000	2300-3200
20GP4	RT-G-EXT	12L	21 ³ / ₄	14 ¹ / ₁₆ x18 ¹ / ₁₆	12 ³ / ₄ x17	70 diag.	40	Glass	Cavity	Single	18,000	5000	2400-3200

New Test Instruments, Equipment Speed Servicing

Electro-Voice MICROPHONE

A new moderately-priced microphone for fine public address installations has been produced by Electro-Voice, Inc. This is a dynamic microphone which has been designed to eliminate blasts from wind and breath without impairing the frequency response. The pickup pattern is omnidirectional or it can be tilted for aiming at sound source. It can be suspended from a boom, mounted on a desk or floor stand, or carried about easily because it is small, measuring 1 1/16" in diameter and 10" long. List price is \$65.00 Electro-Voice, Inc., Buchanan, Mich.—RADIO & TELEVISION RETAILING.

Gonset RADARRAY

A new TV antenna with a gain claimed to be equal to or greater than that of a rhombic array is now on the market. It uses two driven elements and a reflecting curtain of 13 elements to get its high gain characteristics. The array is designed for greatest gain on the high channels, but can be used in most areas to give good reception on the low band also. The list price is \$33.20 and accessory parts, such as the matching transformer for stacking two Radarrays at \$2.95, are available. Gonset Co., 72 E. Tujunga St., Burbank, Cal.—RADIO & TELEVISION RETAILING.

Lyons ADJUSTABLE SHELVING

Adjustable steel-wood shelving is now being offered to supplement their regular line of steel shelving, the Lyon Metal Products Corp. states. Rigid steel uprights support the hard wood shelves in such a way that bolts are used to attach the shelves to the uprights. A pressed steel clip attaches each shelf so that the only tools needed are a



hammer and a screwdriver. The shelving is available in sizes of three feet wide and 12 or 18 inches deep, with a height of seven feet. It is available through local dealers throughout the country or from Lyons Metal Products, Inc., Aurora, Ill.—RADIO & TELEVISION RETAILING.

Philco HIGH-V CONDENSERS

A new line of high-voltage condensers designed for high temperature applications was announced in working voltage ranges of 3000, 5000, 6000, and 10,000 volts DC. These condensers are rated for operation up to 85 degrees C. and are housed in a newly designed molded phenolic casing said to be humidity resistant, non-inflammable and mechanically sturdy. Special precautions have been taken in the design to minimize corona. Each condenser is stamped with the voltage rating and capacity. They are available from regular Philco distributors.—RADIO & TELEVISION RETAILING.

Triplet TEST OSCILLATOR

This is a wide-range oscillator with a large illuminated dial which also serves as an On-Off indicator. Five ranges from 165 KC to 40 MC on fundamentals, and two harmonic ranges, 36 MC to 120 MC are provided. Either high or low output is available with a switch, and a fine adjustment of output

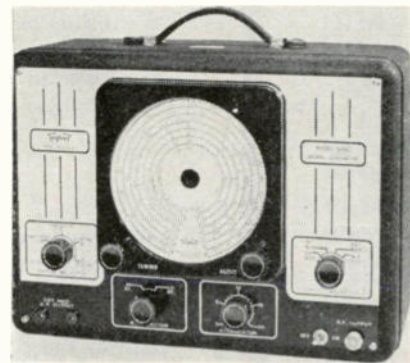

is also provided. Internal modulation adjustable, 0% to 100% (400 cps) external modulation can also be adjusted, and will make use of any audio frequency. All RF and AF circuits are double shielded with copper plated steel shields. The case measures 15 11/32" x 11 1/32" x 6 1/4" and has a carrying handle. The test oscillator weighs 14 1/2 lbs. Triplet Electrical Instrument Co., Bluffton, Ohio.—RADIO & TELEVISION RETAILING.

Taco TWIN YAGI ANTENNA

A new antenna designed to minimize co-channel interference with a front-to-back ratio of about 30db consists of two yagis pointing in opposite directions. Due to the construction of the antenna a close match is said to be maintained to 300 ohms. This antenna is as rugged as the regular twin-driven yagi and is available for use as a single antenna or as a stacked array. Each consists of a director, two driven elements, and a reflector. The terminals are located at the rear folded dipole driven element. Technical Appliance Corporation, Sherburne, N. Y.—RADIO & TELEVISION RETAILING.

Javex TV WALL PLATE

As part of their antenna distributing system Javex, of Garland, Texas, is making a new type of wall-mounting plate for 300 ohm TV line terminals. Special feature of the item is that it does not require cutting into the wall or base-

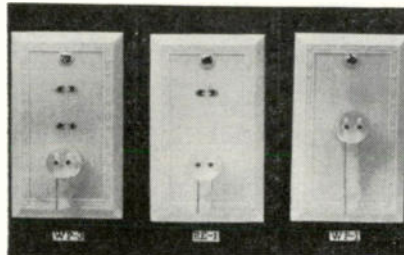

board, but simply screws onto the surface. The wall plate, called a surface box, can provide a neat termination for a 300 ohm lead-in whether the lead comes through the wall or, as in the case of masonry, it has to run on the surface. It is scored and recessed on the underside to accommodate the lead. Complete with plugs and mounting screws, the units are available in ivory or brown from the Javex Company, Garland, Texas.—RADIO & TELEVISION RETAILING.

Sun PORTABLE PHONO

A new, portable 3-speed phonograph has been announced. Housed in a tan leatherette luggage-type case, it features an 8-inch speaker and Garrard 3-speed record changer. Standard model has an Astatic LQ-D crystal pickup. A second model at slightly higher cost is equipped with a GE RPX-050 triple play cartridge and built-in GE-UPX-003 pre-amplifier. Sun Radio & Electronics Co., Inc., 122 Duane St., New York, N. Y.—RADIO & TELEVISION RETAILING.

DX Products COMPONENTS

A complete line of yokes, ion traps, and horizontal output transformers is now being produced by the DX Radio Products Company. Designed as jobber replacements, these components are claimed to conform exactly to the specification of the original components. DX Radio Products Co., Inc., 2300 W. Armistage Ave., Chicago 47, Ill.

Clarostat TV BALLAST TUBE

A new TV ballast tube replacement has been announced by Clarostat Mfg. Co. Intended for use in the TV receivers of Pilot Radio, it is type 35-37. The company makes 74 standard numbers for exact-duplicate replacements, and 10 more "universal" types which they state cover over 85% of all replacements. Available at regular jobbers. Clarostat Manufacturing Company, Inc., Dover, N. H.—RADIO & TELEVISION RETAILING.

V-M CHANGER

Outstanding features of the new V-M Tri-o-matic record changer are that it will play manually, turns off automatically after the last record is played, and



can intermix different size records. It plays all three speeds, and will handle up to 12 of either the 33's or 45's. The V-M Corporation, Benton Harbor, Mich.—RADIO & TELEVISION RETAILING.

Allied PORTABLE LIFT

A hand truck with a hydraulic lift built in is now on the market for use in moving loads up to and beyond 500 lbs. One man can operate this lift which will move heavy boxes, barrels, and crates. It will raise objects up to 54 inches off the floor, and has a hydraulic lever which moves the object 1 1/4" with each stroke. A foot pedal



provides controlled lowering. It may be used as an ordinary heavy duty hand truck when not in use as a lift. Rubber tires on aluminum wheels are provided for use over rough floors. Further information may be obtained from Allied Mfg. & Sales Company, 4700 Rice Street, Chicago 51, Ill.—RADIO & TELEVISION RETAILING.

GE TONE ARM For Custom INSTALLATION

For custom installations a new high quality tone arm is now available. The FA-21-A is designed for the GE magnetic cartridge and is easily installed on any turntable. Complete absence of arm resonance, low mass, low friction, and high vertical compliance in the cartridge all contribute to the non-groove jumping ability of this arm to give the best possible results with very slight wear. An arrow is shown on the top of the tone arm to aid in placing the needle at the proper place on the record. Immediate delivery from the Receiver Division, General Electric Corp., Syracuse, N. Y.—RADIO & TELEVISION RETAILING.

T.V. Wire Products LEAD-IN

Transmission wire which has less than 1/6th the loss of good-quality conventional lead-in of the twin-lead type is stated to be growing enormously in popularity by the maker, T.V. Wire Products. Open line is made up of two

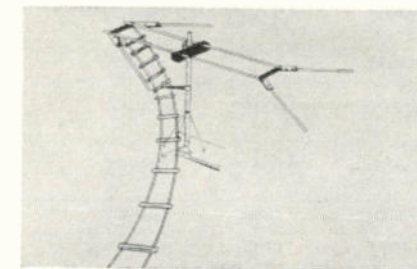

wires separated every six inches by polystyrene bar spacers. This makes the air between the wires the dielectric and helps keep the db/ft. loss low. It is also claimed that resistance to atmospheric conditions, even under salt-spray situations, is permanent. This open line should find use in fringe areas where every db of signal strength is important and long lead-in runs steal that signal strength in many cases. Manufacturer states that at 200 mc. the loss per 100 ft. is only .5 db. Available from T.V. Wire Products, Los Angeles, Calif.—RADIO & TELEVISION RETAILING.

Tensor 'SCOPE CALIBRATOR

For use with an oscilloscope and associated equipment in the testing and alignment of electronic equipment, the Tensor A-42F oscilloscope calibrator provides not only a control of RMS voltages from .0005 to 100 volts but a continuous monitor of the output voltage. It is calibrated directly in peak-to-peak volts as well as RMS values and db. Complete with instructions it costs \$24.95 direct from Tensor Elec. Dev. Co., Inc., 343 Classon Ave., Brooklyn.—RADIO & TELEVISION RETAILING.

Crown ANTENNA ROTATOR

A weather sealed drive unit redesigned to give greater strength and more turning power is the feature of the Crown antenna rotator. Available with two different models of

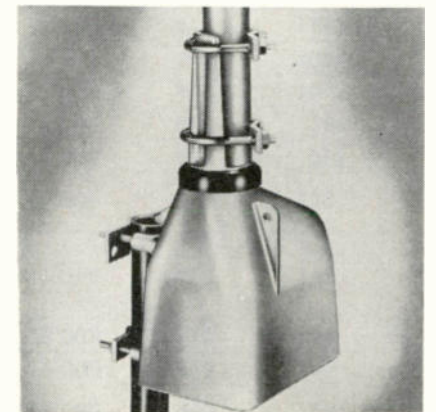

control boxes, it can be observed at all points of its rotation by the indicators, one model having a light which flashes a code at each point of the compass, the other having a needle which follows on a compass dial the rotation. Crown Controls Co., Inc., New Bremen, Ohio.—RADIO & TELEVISION RETAILING.

RMS ANTENNA INSULATOR

A new type of especially strong plastic insulator will be used on all RMS TV antennas henceforth, the company announced recently. This insulator, often the weak point in an antenna, is made of a new Monsanto plastic which has not only the necessary insulating properties, but is so strong that it cannot be cracked even by a blow from a hammer, the company said. Radio Merchandise Sales, Inc., 1165 Southern Blvd., New York 59, N. Y.—RADIO & TELEVISION RETAILING.

Thordarson VOLTAGE REGULATOR

New low cost automatic voltage regulator designed to provide sure protection to electric motors or other electrical appliances from damage resulting from excessive fluctuations of line voltage. Rated at 750 Va, the "Power Guard" utilizes a power transformer with tapped windings and is electrically adjusted to keep the output voltage within certain prescribed limits. One popular model, for example, adds 25 volts to the output when line input drops to 95 volts. It also will automatically "step-down" 25 volts if line surge exceeds 130 volts. Relay is chatter-proof and the unit itself is filtered to prevent interference to radio or TV. Thordarson-Meissner Mfg., Div. Maguire Industries, 500 W. Huron St., Chicago 10, Ill.—RADIO & TELEVISION RETAILING.

Television Receiver Specifications

MAKER'S NAME and MODEL NUMBER	LIST PRICE (Incl. Tax)	TUBE SIZE (Inches)	TYPE	AM, FM, PHONO, JACK	MAKER'S NAME and MODEL NUMBER	LIST PRICE (Incl. Tax)	TUBE SIZE (Inches)	TYPE	AM, FM, PHONO, JACK
DuMont (Continued from page 60)					Hoffman (Continued):				
Westerly	519.95	19-0	C-W	FM-J	891	499.95	19	C-W	J
Mt. Vernon	535.00	19-0	C-W	FM-J	892	520.00	19	C-W	J
Brookeville	419.95	17	C-W	FM-J	950	565.00	16	W	AM-FM-J
Revere	469.95	17	C-W	FM-J	951	550.00	16	W	AM-FM-J
Burlingame	459.95	17	C-W	FM-J	960	675.00	19	W	AM-FM-J
Tarrytown	675.00	17	C-W	AM-FM-PH	961	650.00	19	W	AM-FM-J
Sumpter	289.95	17	T-M	J	962	675.00	19	W	AM-FM-J
Carlton	329.95	17	T-M-W	J	Industrial Television Corp., 359 Lexington Ave., Clifton, N. J.				
Strathmore	379.95	17	C-W	J	776		17	T-W	
Park Lane	429.95	17	C-W	J	1176		17	C-W	
Andover	439.95	17	C-W	J	1576		20	C-W	
Royal Sovereign	1795.00**	...-0	C-W	FM-J	1T82R	595.00	20	C-W	} Remote Control-J
					379	495.00	20	C-W	
Emerson Radio & Phono Corp., 111 8th Ave., New York.					International TV Corp., 238 William St., New York 7, N. Y.				
662	179.95	14	T-P		1751	199.95	17	T-W	J
676	299.95	17	T-W		1752	219.95	17	C-W	J
676B	309.95	17	T-W		1753	299.95	17	C-W	J
680	299.95	17	T-W		1755	299.95	17	C-W	J
696	299.95	17	T-W		2050	299.95	20	C-W	J
684	329.95	16-0	C-W		1653	279.95	16-0	C-W	J
685	359.95	16-0	C-W		1651	179.95	16	T-W	J
666	499.95	16-0	C-W	AM-FM-PH	2053	329.95	20		
666B	529.95	16-0	C-W	AM-FM-PH	Jackson Industries, Inc., 500 E. 40th St., Chicago.				
686	349.95	17	C-W		17xC	229.95	17	C-W	
686B	359.95	17	C-W		17xT	199.95	17	T-W	
687	379.95	17	C-W		1400T	219.95	14	T-W	
687B	399.95	17	C-W		1400TB	234.95	14	T-W	
688	439.95	19-0	C-W		1700T	269.95	17	T-W	
689	459.95	19-0	C-W		1700TB	284.95	17	T-W	
689B	479.95	19-0	C-W		1700C	319.95	17	C-W	
690	479.95	19-0	C-W		1700CB	339.95	17	C-W	
690B	509.95	19-0	C-W		2000C	449.95	20	C-W	
692	459.95	20	C-W		2000CB	479.95	20	C-W	
693	479.95	20	C-W		3170C	449.95	17	C-W	AM
693B	499.95	20	C-W		3170CB	479.95	17	C-W	AM
694	499.95	20	C-W		5120C	599.95	20	C-W	AM-FM
694B	529.95	20	C-W		5120CB	639.95	20	C-W	AM-FM
Fada Radio & Electric Co., Inc., Belleville, N. J.					Kaye-Halbert Corp., 3555 Hayden Ave., Culver City, Cal.				
S4C40	289.95	14	C-W		731W, M, B	309.95	17	T-W	J
S7T65	285.95	17	T-W		733W, M, B	349.95	17	C-W	J
S7C20	339.95	17	C-W		033W, M, B	419.95	20	C-W	J
S7C30	339.95	17	C-W		734W, M, B	439.95	17	C-W	J
S20C10	449.95	20	C-W		034-W	499.95	20	C-W	J
R1045	289.95	12-0	T-W		735	429.95	17	C-W	J
R7C25		17	C-W		035	519.95	20	C-W	J
R7C15		17	C-W		736	409.95	17	C-W	J
General Electric Co., Syracuse, N. Y.					The Magnavox Co., Fort Wayne Ind.				
17T1	269.95	17	T-W		MV21J	289.50	17	T-W	
17T2	289.95	17	T-W		MV31J	298.50	17	C-W	
17T3	299.95	17	T-W		MV33J	359.00	17	C-W	
17C103	319.95	17	C-W		MV78J	498.50	17	C-W	AM-FM-PH
17C104	339.95	17	C-W		MV72J	525.00	17	C-W	AM-FM-PH
17C105	349.95	17	C-W		MV77J	525.00	17	C-W	AM-FM-PH
17C107	379.95	17	C-W		MV29H	395.00	20	C-W	
17C108, 109	399.95	17	C-W		MV41H	475.50	20	C-W	
17C110	379.95	17	C-W	J	MV43H	485.00	20	C-W	
17C111	399.95	17	C-W	J	MV42H	495.00	20	C-W	J
20C150		20	C-W	J	MV76H	745.00	20	C-W	AM-FM-PH
20C151		20	C-W	J	MV165H	795.00	20	C-W	AM-FM-PH
24C101	775.00	24-0	C-W	J	MV168H	795.00	20	C-W	AM-FM-PH
16K1	499.95	16	C-W	AM-FM-PH	MV43H	485.00	20	C-W	J
16K2	519.95	16	C-W	AM-FM-PH	MV45H	495.00	20	C-W	J
Hallcrafters Co., 4001 W. 5th Ave., Chicago, Ill.					Majestic Radio & TV, (Div., Wilcox-Gay Corp.), 70 Washington St., Brooklyn, N. Y.				
17810C	249.95	16	T-L		70	199.95	17	T-P	J
17804C	279.95	17	T-L		72	289.95	17	T-W	J
17819	299.95	17	T-W		73	299.95	17	T-W	J
17814	299.95	17	T-W		712	269.95	17	C-W	J
17815H	319.95	17	T-W		700	329.95	17	C-W	J
17812	329.95	17	T-W		701	339.95	17	C-W	J
17813	339.95	17	T-W		1710	359.95	17	C-W	J
17811H	349.95	17	T-W	AM	715	369.95	17	C-W	J
17816	359.95	17	T-W	AM	717	379.95	17	C-W	J
17817	369.95	17	T-W	AM	1720	389.95	17	C-W	J
20823	399.95	20	T-W		1721	409.95	17	C-W	J
17824	349.95	17	C-W		7PR12	489.95	17	C-W	AM-FM-PH
17825	399.95	17	C-W		7PR13	509.95	17	C-W	AM-FM-PH
17838	399.95	17	C-W		902	469.95	19-0	C-W	J
17848	439.95	17	C-W		903	499.95	19-0	C-W	J
17849	449.95	17	C-W		9P4	539.95	19-0	C-W	PH
17850	449.95	17	C-W		9P5	569.95	19-0	C-W	PH
17860	550.00	17	C-W	AM-PH	9PR8	599.95	19-0	C-W	AM-FM-PH
17861	575.00	17	C-W	AM-PH	9PR9	629.95	19-0	C-W	AM-FM-PH
20872	399.95	19-0	C-W		Mars Television, 112-33 Colonial Ave., Corona, N. Y.				
20882	479.50	20	C-W		Hampton	584.95	16-0	C-W	J
20990	695.00	20	C-W	AM-PH	Versailles	675.00	20	C-W	J
20990S	695.00	20	C-W	AM-PH	Regent	715.00	20	C-W	J
20994	695.00	20	C-W	AM-PH	Warwick	624.95	16-0	C-W	J
25885	695.00	24-0	C-W		Dartmouth	1350.00	20	C-W	PH
14808	199.95	14	T-L		(Continued on page 78)				
Hoffman Radio Corp., 3761 S. Hill St., Los Angeles, Cal.									
634	309.95		T-W	J					
635	229.95		T-W	J					
866	439.95	16	C-W	J					
867	429.95	16	C-W	J					
868	439.95	16	C-W	J					
876	399.95	16	C-W	J					
877	389.95	16	C-W	J					
878	399.95	16	C-W	J					
890	520.00	19	C-W	J					

□—Round
 □—Rectangular
 T—Table

C—Console
 CH—Chassis
 K—Kit

X—Projection
 W—Wood
 P—Plastic

M—Metal
 L—Leatherette
 P—Phonograph

J—Phono Jack
 *Price does not incl. tax
 **Zone 1 only

Note: Basic list prices are shown. In some instances, prices are slightly higher in certain localities.

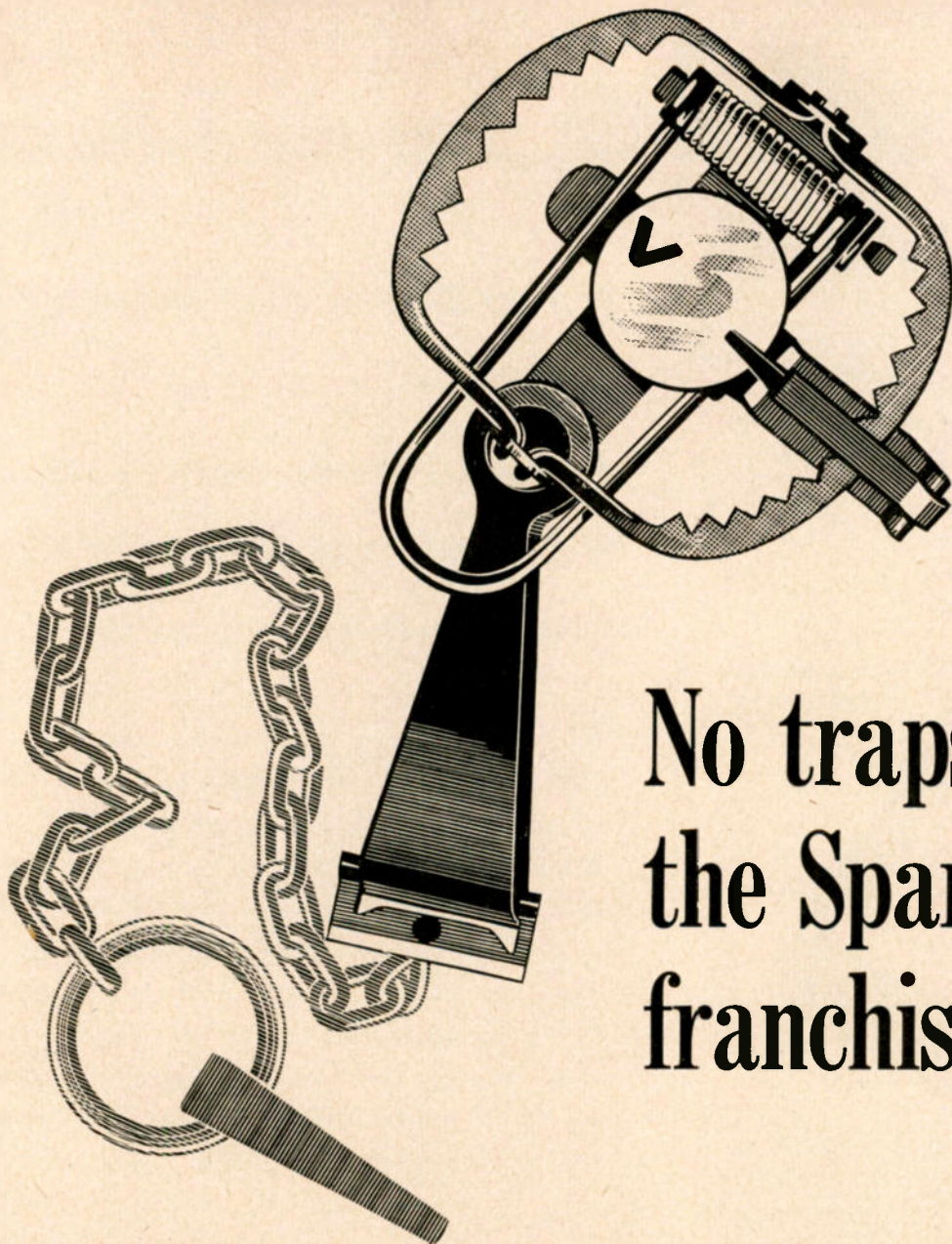

No traps in the Sparton franchise

Does your TV franchise turn out a snare when the selling's a little tough? A trap of price cutting, dumping, multiple mark-ups, over-franchising and other clamps on profits?

Not if you're a Sparton dealer! Sparton dealers are protected by the SCMP—Sparton Cooperative Merchandising Plan—the original TV franchise providing one exclusive dealer in a community.

No competition on the same line down the street. You are the only Sparton dealer around! And your Sparton prices are periodically guaranteed (current prices have been protected since January, through June 30).

Since Sparton sells direct to you, you get higher quality receivers, competitively priced . . . backed by aggressive national advertising and a generous local cooperative program that works entirely for you in your area. And with Sparton superior engineering, service costs are pared to the bone.

The TV market is there. The profits are there. All you need is a franchise that holds up. Why not write and ask whether the Sparton franchise is still available in your community? By the way, you might note that Sparton spelled backwards is *no traps!*



You get all five...with RCA Batteries



PERMANENT DISPLAY SIGN

Here's an 8 by 20 inch display sign providing triple sales impact for counter or window. Helps you sell Portable Radios, Radio Service, and RCA Batteries.

1. **Top Brand Acceptance**
2. **Unique Selling Aids**
3. **Radio Trade Distribution**
4. **Completely Rounded Line**
5. **Radio-Engineered quality**



**RCA BATTERY
FACT-FINDER**

A fast answer to quick battery sales. Just set index pointer, press the release—and the Fact-Finder opens with the battery information you want before you. Contains prices, techni-

cal data on the complete RCA line, interchangeability directory, and the Battery complement of 590 portable radios of 32 manufacturers...always at your fingertips.

RCA is *first* with the greatest array of selling aids in the field . . . *all geared to the radio trade.*

And . . . *the selling power* of the RCA Trade-Mark makes it *easy* for you to move RCA Batteries. You gain a satisfied customer every time.

Remember, too, that RCA Batteries are *radio-engineered* for *extra* listening hours . . . with a type for practically every renewal requirement.

So—starting now—push RCA Batteries. Build a profitable repeat business with virtually no competition from non-radio outlets.



**ILLUMINATED
GIANT BATTERY
DISPLAY**

A flashing beacon that attracts battery sales. Stands 12" high—comes complete with bulb, 6' cord, and detachable flasher-unit.

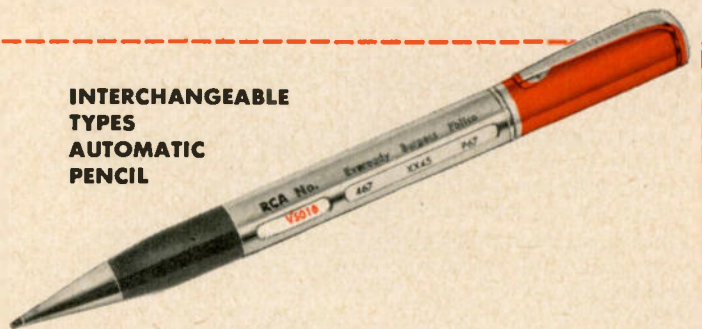

**INTERCHANGEABLE
TYPES
AUTOMATIC
PENCIL**

Revolving mid-section tells at a glance the stock numbers on the ten fastest-moving, interchangeable types of four leading battery brands . . . the types that comprise 85% of your interchangeability problems!

Learn how you can get these selling aids at no cost to you by contacting your RCA Battery Distributor today!



RADIO CORPORATION of AMERICA
RADIO BATTERIES
HARRISON, N. J.

New Phonos

V-M PHONOS

Newly styled phono line includes the model 975 or 980 (shown here), with the Tri-O-Matic 950 record changer, two tube plus rectifier amplifier and 4x6" speaker. Model 150 Tri-O-Speed phono



is a 3-speed manual player and two tube plus rectifier amplifier and 4x6" speaker. V-M Corp., Benton Harbor, Mich.—RADIO & TELEVISION RETAILING.

Symphonic PHONOS

The complete line of phonographs includes model 500, 3-speed player attachment; models 503 and 508, manual 3-speed phonos; models 518, 528 and 538, single speed manual portables; three speed manual portables, models 513, 523, 533, and 539; a 3-speed changer attachment, model 543; 3-speed table top changer phono, model 549; and 3-speed portable changer phono, model 559. Model 573 is a 3-speed manual phono-radio portable combination; and model 583 is a 3-speed changer phono-radio portable. Completing the line is the model 578, two speed unit, playing up to 16-inch disc size. Symphonic Radio & Electronic Corp., 160 N. Washington St., Boston, Mass.—RADIO & TELEVISION RETAILING.

Jackson PHONOS

Four new phonograph models have been announced. Model JP30, 3-speed manual unit in portable carrying case lists for \$34.95; model JP50, 3-speed manual phono-radio combination in portable case lists for \$49.95; model JP70, shown here, 3-speed automatic



phono, lists for \$69.95; and model JP90, 3-speed automatic phono-radio combination, lists for \$84.95. All models feature tan vinylite covered wood cases and all brass hardware. Jackson Industries, 500 W. 40th St., Chicago 15, Ill.—RADIO & TELEVISION RETAILING.

Children's Discs

(Continued from page 55)

2-6" serves only to eliminate consideration of a number of records in the next age group which would be perfectly suited for the child in question. Children's mental ages, likes and dislikes, temperaments, etc., vary greatly from one child to the next, so that a grouping merely by age serves no real purpose, except, as has been mentioned, as a rough guide for the dealer's use. Perhaps a grouping according to general type, such as "Ad-

venture," "Songs," "Stories," etc., would be much more suitable. If a record salesman asks questions about the child involved, and then makes suggestions as to type from one or more of these groups, the suggestions will not only be far more appropriate, but will be better received by the parent because they were made specifically for his or her child.

Most important, though, is to get out NOW, before the summer comes on, and contact those potential customers through schools, movies, etc., and you'll keep your cash register ringing throughout the summer months and create more year-round business in the children's record field.

How to Sell More

JENSEN NEEDLES

Put me on Your
COUNTER
I'll sell Needles



a new

needle will restore
original brilliance...

BUY A *Jensen*
NEEDLE

FREE: This attractive display, measuring eight inches in width and eleven inches in height, is available through your distributor or by writing to Jensen Industries, Inc.

Now Available

Jensen Acoustic (magnetic recording) Tape

Jensen INDUSTRIES, INC.
332 South Wood Street, Chicago 12, Illinois

Jensen NEEDLES

... Preferred by
leading phonograph manufacturers.

A complete price selection
from 50¢ to \$2.50

New Discs

(Continued from page 56)

Voco Records is featuring three kiddie albums: "Kiddie Favorites," "Western Favorites," and "Mother



Goose Favorites." Each album contains four 7" colored vinylite discs, retails at \$1.25.



Adventure Records' new dual release featuring Lanny Ross in a "Song Trip Around the World," covers the folk melodies and lesson-type lyrics of twelve countries. The two discs, available on 78 and 45 RPM, received some good promotion recently when they were plugged by Eleanor Roosevelt in connection with her United Nations activities.

Sales Builders

LeMire RECORD BRUSH

A new velvet finish brush for cleaning Vinylite and plastic records has been introduced. The brush itself can be cleaned with cleaning fluid. List price is \$4.95. Le Mire Products, 870 Seventh Ave., New York 19, N. Y.—RADIO & TELEVISION RETAILING.

Midwest RECORD CABINET

A new record cabinet, called the "space-miser" has been announced. Designed to accommodate 100 records, the lower section will hold an additional

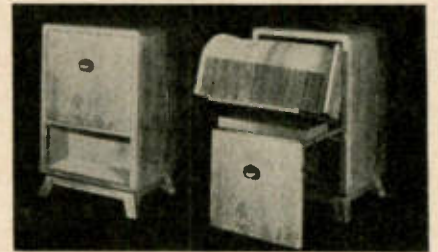

60 records in conventional albums. Available in oak, mahogany or walnut finish. Midwest Furniture Co., 1034 Elm St., Rockford, Ill.—RADIO & TELEVISION RETAILING.

Peerless LP ALBUM

New album for LP records is a loose leaf type. Padded covers are made of imitation Morocco leather in red and blue. Album is shipped with 8 or 10 acetate pockets which hold the record and its cardboard jacket. List price for 10" album is \$7.00; 12" is \$8.00. Peerless Album Co., Inc., 800 Union St., Brooklyn 15, N. Y.—RADIO & TELEVISION RETAILING.

Web-Cor Air Shows



Webster-Chicago Corporation takes its sales story right to the customer in Portland, Oregon in the form of remote broadcasts of a 3 1/2-hour disk jockey show from various Portland dealers' windows. Webster-Chicago sponsors the shows with United Radio Supply, Inc., its Portland distributor, and various Web-Cor dealers.

"HERE IT IS!"

★ A big, fully illustrated 20 page book for EASY merchandising of the complete line of replacement needles!

★ Contains complete SIMPLIFIED information on replacement needles!

RECOTON Simplified REFERENCE GUIDE

Has carefully compiled, EASY-TO-FOLLOW Reference Guide!

FREE!

Includes cross-indexing of other needles for EASY checking!

★ Saves you time, work and money because it's EXTRA-EFFICIENT, EASY-TO-USE!

★ To be previewed at the Chicago Parts Show!

SEE US AT THE PARTS SHOW BOOTH 215

RECOTON CORPORATION
251 FOURTH AVENUE • NEW YORK 10, N. Y.



TONE ARMS— STYLI



Type UPX-006

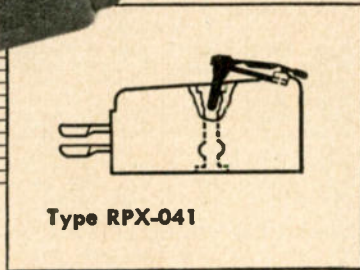

Type RPX-041

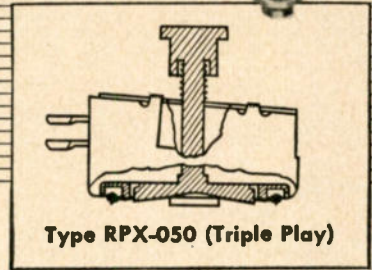

Type RPX-050 (Triple Play)

**...still available
...still tops**

HERE'S PLUS BUSINESS!

Use G-E phono Preamplifiers to sell *modernization* to your customers. Self-contained for easy installation, these units are ready to operate when connected to a power source. They provide sufficient amplification to enable the Variable Reluctance Cartridge to be used with any standard phonograph.

PRODUCT shortages? Sure. But there's *never* a letdown in the *quality* of G-E phono-accessories . . . and the items shown above are still available to manufacturers, jobbers, dealers and servicemen.

The G-E tone arm is built to accommodate the famous G-E Triple Play Cartridge (also in stock). It's equipped with ball bearings for smooth lateral movement . . . special light weight alloy keeps the arm mass to a minimum . . . stylus pressure is *constant at 6-8 grams for all three speeds* to reduce record wear. Plainly marked selector knob projects through the top of the arm—a single twist

places either stylus in playing position.

General Electric's high compliance Baton Stylus with diamond or sapphire tip is unsurpassed in its field. Stock it in quantity—give your customers listening quality that lasts.

MANUFACTURERS: Your production requirements of General Electric phono-accessories can still be filled. General Electric application engineers have suggestions that will help you design a better product. Call or wire us today for details. *General Electric Company, Parts Section, Electronics Park, Syracuse, New York.*

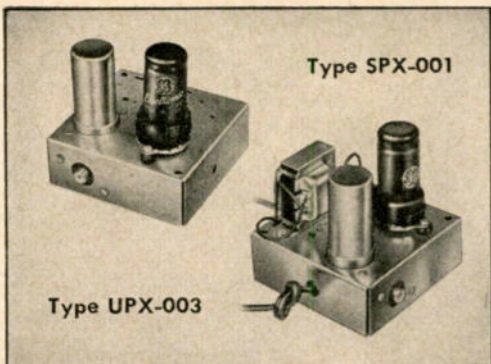

General Electric Company, Section 2651
Electronics Park—Syracuse, N. Y.

Please forward information on the G-E phono accessories checked:

- Variable Reluctance Cartridges Replacement Styli Phono Preamplifiers Tone Arms

NAME _____

ADDRESS _____

CITY _____ STATE _____

GENERAL  ELECTRIC

Electric Washing Machines

Prices and Sales Features on Current Models

List prices include tax unless otherwise specified. Clothes capacity is dry weight.

ALTORFER Bros. (ABC) Peoria, Ill.

Wringer types
Model 409P uses agitator and 1/4 HP motor. Model 210, also an agitator type, has 9 lb. clothes capacity.
Automatic type
The ABC-O-Matic, agitator type unit, requires no bolting down. 12 gallon water capacity.

APEX Mfg. Co., Cleveland 10, Ohio

Wringer types
All models have agitators. Four models having 10 lb. clothes capacity are: 1012, \$159.95; 1013, \$149.95; 1014, \$139.95 (all available with pump for additional \$10) and model 1019, \$159.95. 9 lb. capacity model 1015 is \$134.95; \$144.95 with pump. 8 lb. model 1017 is \$119.95; \$129.95 with pump. All use 1/4 HP motor.
Automatic types

Two 8 lb. clothes capacity models with "bouncing basket" agitator. Model 3005 is \$319.95; \$329.95 with pump. Model 3004 is \$329.95; \$339.95 with pump.

APPLIANCE Mfg. Co., Alliance, Ohio

Wringer types
Model 50, \$119.95; clothes capacity, 8 lbs. Water capacity, 16 gals. Models 60 at \$129.95, 80 at \$139.95, & 90 at \$159.95 have following capacities: Clothes—10 lbs. Water—19 gals. All models use agitators; have 1/4 HP motors. Discharge pump \$10.00 additional on all washers.

AUTOMATIC Washer Co. (Laundry Queen) Newton, Iowa.

Wringer Types
Models 500, 501, \$109 & \$129, respectively, have following capacities: Water capacity—24 gals. Models 502 & 503 list at \$159 & 179, respectively; have following capacities: Water capacity—25 gals. All models use agitators; have 1/4 HP motors. Discharge pump \$10.00 additional on all washers.

BARTON Corp., West Bend, Wis.

Wringer types
Model 52, \$119.95; R72, \$129.95; C72, \$139.95; C72S, \$149.95. (All prices Zone 1). All models have following capacities: Clothes—10 lbs. Water—25 gals. All use agitators, and have 1/4 HP motors. Discharge pump, \$10.00 extra on all washers. R72 has patented double-duty agitator, ribbed tub. C72 has double duty agitator, patented water deflector tub. Lovell "Feather Touch" wringer. C72S has 3 washing & wringing speeds, double duty agitator, water deflector tub & Lovell "Feather Touch" wringer.

BENDIX Div., Avco Mfg. Corp., South Bend, Indiana.

Semi-Automatic types
Model N, 8 lb. clothes capacity, agitator model lists for \$189.95.

Automatic types
Model H 8 lb. clothes capacity, agitator type lists for \$229.95. Models G-312 and B212, \$299.95 and \$249.95 respectively, are both 9 lb. clothes capacity. The B-212 requires bolting down.

BLACKSTONE Corp., Jamestown, N. Y.

Automatic
Model 150, \$385, has clothes capacity of 8 lbs., water capacity, 41 gals. No bolt-down necessary. Requires permanent water connection. Uses agitator, and has 1/3 HP motor. Clothes loaded at top. Price includes delivery, installation & 1 year warranty service.

Wringer types
Models 330 & 130A sell at \$159.95 & \$134.95, respectively; both have 10 lb clothes capacities; are equipped with 1/4 HP motors. Models 132A & 136 sell at \$124.95 & 104.95, respectively; wash 8 lbs. of clothes, and use 1/4 HP motors. All use agitators, \$10 extra on all models for water discharge pump. All prices listed are for Zone 1.

CHICAGO Mfg. Co., Chicago, Ill.

Portable types
All agitator models. XL-18, 2 lb. clothes capacity, lists for \$28.95. Three 3 lb. clothes capacity models: XL-19, \$33.95; 2602, \$37.95; and 2601, \$42.95. All models have 1/50 HP motors.

DEXTER Co., Fairfield, Iowa.

Wringer types
Model 507E Twin Tub, \$204.95, FOB factory, has 7 lb. clothes capacity in each tub; 17 1/2 gal. water capacity in each tub. Model 503E, \$139.95, FOB factory, washes 8 lbs. clothes; water capacity, 19 gals. 502E lists at

\$119.95, FOB factory, washes 7 lbs clothes with 17 1/2 gals. water. Water discharge pump, \$10 extra on all models. All equipped with agitators & 1/4 HP motors.

EASY Washing Machine Corp., Syracuse, N. Y.

Spin-dry types
Model 30SS & model 50SS wash 9 lbs. clothes; use 16 gals. water. Both equipped with Spiralators (agitator types with spiral shaped vanes). Both have 1/3 HP motors. 30SS features 3-minute automatic spin-rinse, using but 3 gals. warm water & handy swing faucets that save live hot suds for re-use—rinse-fill & empty washer. Model is also equipped with safety over-load switch.

Wringer type
Model 1015WP washes 9 lbs clothes, with 16 gals water. Equipped with Spiralator & 1/2 HP motor.

FRIGIDAIRE Div. GMC., Dayton, Ohio

Automatic
Model W0-65, \$304.75, loads at top. Washes 8 lbs clothes. Water capacity—10 gals. No bolt-down or permanent water connection necessary. Pulsator washing method. Motor size—1/3 HP. Select-O-Dial control controls a normal washing period automatically, and in addition, permits shorter or longer washing periods, from 2 to 10 mins. Washer water switch provides 100° water or water as hot as can be supplied. Other features: signal light; Rapidry spin, with new single tub revolving at 1140 RPM to extract water from clothes.

GENERAL Electric Co., Bridgeport, Conn.

Automatic types
Model AW6A8, \$399.95, washes 9 lbs clothes and has a water capacity of 57 gals. Motor—12 amps, 115 V. Model AW584 lists at \$329.95, washes 9 lbs. clothes; water capacity, 40 gals.; Motor—1/3 HP. Both load at the top, use agitator system of washing, and neither require bolting down nor permanent water connection.

Wringer types
Model AW462 lists at \$179.95. Clothes capacity—10 lbs.; water capacity—19 gals. Motor—1/2 HP. Models AW362, AW162 & AW062 list at \$149.95, \$139.95 & \$119.95, respectively. Capacities: clothes—8 lbs., water—17 gals. AW361, AW161 & AW061 come without pump, at \$10 less than last three prices listed here. All GE wringer types use agitator systems; have 1/3 HP motors.

HORTON Mfg. Co., Ft. Wayne, Ind.

Wringer types
Model 494, 8 lb. clothes capacity, model 417, 8 1/2 lb. clothes capacity, and model 491, 9 lb. clothes capacity, are all agitator type. They list for \$114.95, \$139.95, and \$149.95 respectively. Pump is available at \$10 extra.

Automatic type
Model 500, at \$299.95, has 10 lb. clothes capacity, uses agitator.

HOTPOINT Inc. Chicago 44, Ill.

Automatic type
Model LC-3, at \$329.95, has an 8 lb. clothes capacity. Needs no bolting down. Has 1/2 HP motor and agitator. Spin tub for drying. Water capacity is 14 gals.

LANDERS, Frary & Clark (Universal), New Britain, Conn.

Wringer types
Models WM-2701, WM-2704 & WM-2705 list at \$169.95, \$159.95 & \$149.95, respectively. Prices include water discharge pump. Without pump—deduct \$10. All wash 9 lbs clothes. Water capacities of all models—21 gals. All types use agitator washing method; have 1/3 HP motors. Models WM-2701 & WM-2704 have Super-Safe Control-o-Roll wringers. WM-2701 has 2-speed transmission, enabling user to do 100% of the laundry, eliminating so-called "wash-bowl wash."

MAYTAG Company, Newton, Iowa.

Automatic type
Model AMP lists at \$279.95; has 13.6 gal water capacity. Agitator system is used. Powered by 1/3 HP motor. Clothes are loaded at the top, and no bolt-down or permanent water connection is necessary.

Wringer types
Models E2L & J2L list at \$179.95 & 144.95, respectively. Water capacities, both models—18.1. Motor HP—1/3. Model N2L lists at \$124.95, and has a 15.6 gal. water capacity. Uses agitator. All wringer models available with water discharge pump at \$10 extra. E2L series can be had with timer at \$10 extra.

NAXON Utilities, Chicago 45, Ill.

Wringer type
Model MAJ retails at \$69.95. Washes 5 lbs clothes; has 11.5 gal water capacity. Equipped with 1/4 HP motor. Uses agitator system. The retail price includes automatic water discharge pump. Automatic electric wringer avail-

able at \$16.95 extra. Agitator stops when pump operates. Weighs only 39 lbs and fits under kitchen table or sink. Has recessed toe base and is equipped with rollaway casters.

NORGE Div. of Borg-Warner Corp., Chicago 54, Ill.

Wringer types
Three 1/4 HP, agitator type models, CW-207, with 8 lb. clothes capacity, \$114.95; CW-210 and CW-211T, both with 9 lb. clothes capacity, list for \$139.95 and \$154.95, respectively. The latter model has an automatic timer cut-off. Pump is available for all models at \$10 additional.

Automatic type
Model AW-502, with 18 1/2 lb. clothes capacity, requires bolting down. Uses 1/3 HP motor; tumbler action. List price is \$339.95.

ONE MINUTE Washer Co., Kellogg, Iowa.

Wringer types
Model 745 lists at \$114.95, not incl. tax, in Zone 1. Clothes capacity—9 1/2 lbs. Water capacity—14 gals. Models 746 & 747 list at \$124.95 and \$134.95, respectively, tax not included, in Zone 1. These two models wash 10 1/2 lbs clothes; use 15 1/2 gals of water. 748 lists at \$144.95, Zone 1, tax not included. Washes 12 lbs clothes, with 18 gals water. All models are equipped with 1/2 HP motors and use agitators.

SPEED QUEEN Corp., Ripon, Wis.

Wringer types
Five 1/4 HP models, all agitator type, and all available with or without pump. Models A-948, 648, and 548 have 20 gal. water capacity. Model A-748 has 23 gal. water capacity. Prices range from \$99.95 to \$164.95.

TAYLOR Corp., Alliance, Ohio

Wringer types
Two agitator type models, model JW-5, 2 lb. clothes capacity, at \$49.95 without pump; and model JW-6, 4 lb. clothes capacity at \$69.95 including pump.

THOR Corp., Chicago, Ill.

Semi-Automatic type
Model 244C washes 8 lbs. clothes; water capacity—11 gals. No bolt-down or permanent water connection necessary. Uses agitator, and is equipped with 1/3 HP motor. Loads at top.
Wringer types
Model 492: Clothes capacity—8 lbs. Water capacity—15 gals. Model 495 washes 9 lbs. clothes; water capacity—19 gals. Both these models are equipped with agitators & 1/3 HP motors.

VOSS Bros. Mfg. Co., Davenport, Iowa.

Wringer types
All following models have 8 lbs clothes capacities, using 17 gals water. All are Floating agitator-equipped, and powered by 1/4 HP motors. Model 50A, \$109.95; 50B, \$134.95; 50C, \$154.95; 50C(S) \$159.95 (stainless steel tub); 50F, \$154.95. Models 50C, 50CS, 50 F, equipped with automatic electric timer. Water discharge pump available at \$5.00 extra.

WESTINGHOUSE Electric Corp., (Laundromat), Mansfield, Ohio

Automatic types
Model L-5 lists at \$299.95, washes 9 lbs clothes. Needs no bolting down or permanent water connection. Water capacity—9 1/2 gals. Model RL-1 lists at \$239.95, has same water & clothes capacity as L-5, but requires bolting down. Both models use inclined axis principle of washing; Motor ratings of both: 60 cycl.; 115 V; 7 amps; 1725 RPM. Both loaded from inclined front. Weight-to-Save door eliminates guesswork in Judging load sizes. Other features: Water Saver, single dial control; sealed-in steel transmission. Also: Buoyant Power suspension to control vibration on L-5. Full-Fill water control. Transmission guaranteed 5 yrs after year of manufacture.

WHIRLPOOL Corp., St. Joseph, Mich.

Automatic types
Model 50155 lists at \$309.95 in Zone 1. Model 501560 lists at \$329.95 in Zone 1. Both wash 9 lbs clothes with 16 1/2 gals of water; use agitators & 1/3 HP motors; load at top. No bolt-down or permanent water connection on either model. 501560 has Suds Miser, permitting water from 1st washing to be stored until ready for second load. Other features on both automatics: Violet ray lamp, push-button door release, 3-temp water selector. Also: buzzer notifies when washing is finished. 5 year warranty on transmission—all models.

Wringer types
Model 91205 lists at \$99.95; washes 7 lbs clothes. Water capacity 16 1/2 gals. Models 91226, 91235 & 91245 list at \$124.95, \$144.95 & \$164.95, respectively, in Zone 1. Capacities: Clothes—9 lbs. Water—18 1/4 gals. All use agitator, 1/3 HP motors.

Be Sure of Your Installations – Get the *Aptitude-Tested* RG/U TRANSMISSION LINE CABLES

RG-5/U
APTITUDE RATING No. 8236

Frequency (Mc)	Attenuation per 100 ft
100.	2.65
200.	3.85
300.	4.80
400.	5.60

RG-8/U
APTITUDE RATING No. 8237

Frequency (Mc)	Attenuation per 100 ft
100.	2.10
200.	3.30
300.	4.10
400.	4.50

RG-11/U
APTITUDE RATING No. 8238

Frequency (Mc)	Attenuation per 100 ft
100.	1.90
200.	2.85
300.	3.60
400.	4.35

RG-54A/U
APTITUDE RATING No. 8239

Frequency (Mc)	Attenuation per 100 ft
100.	2.90
200.	4.20
300.	5.50
400.	6.70

RG-59/U
APTITUDE RATING No. 8241

Frequency (Mc)	Attenuation per 100 ft
100.	3.75
200.	5.60
300.	7.10
400.	8.30

For use with television antenna.

RG-58/U
APTITUDE RATING No. 8240

Frequency (Mc)	Attenuation per 100 ft
100.	4.10
200.	6.20
300.	8.00
400.	9.50

For use with radio frequency transmission, video, test equipment, and pulse transmission.

You know what you are doing when you use Belden RG/U Transmission Line Cables—they're aptitude rated. They are designed from the start to provide desirable electrical characteristics, and rigid manufacturing control assures constant, unwavering quality. You can safely put Belden Wire to work for you, and know for sure how it will perform. You can know, too, that it will have the stamina to stay loyally on the job for years. For trouble-free installations, specify Belden Radio Wires.

Belden Manufacturing Company
4697 W. Van Buren Street
Chicago 44, Illinois

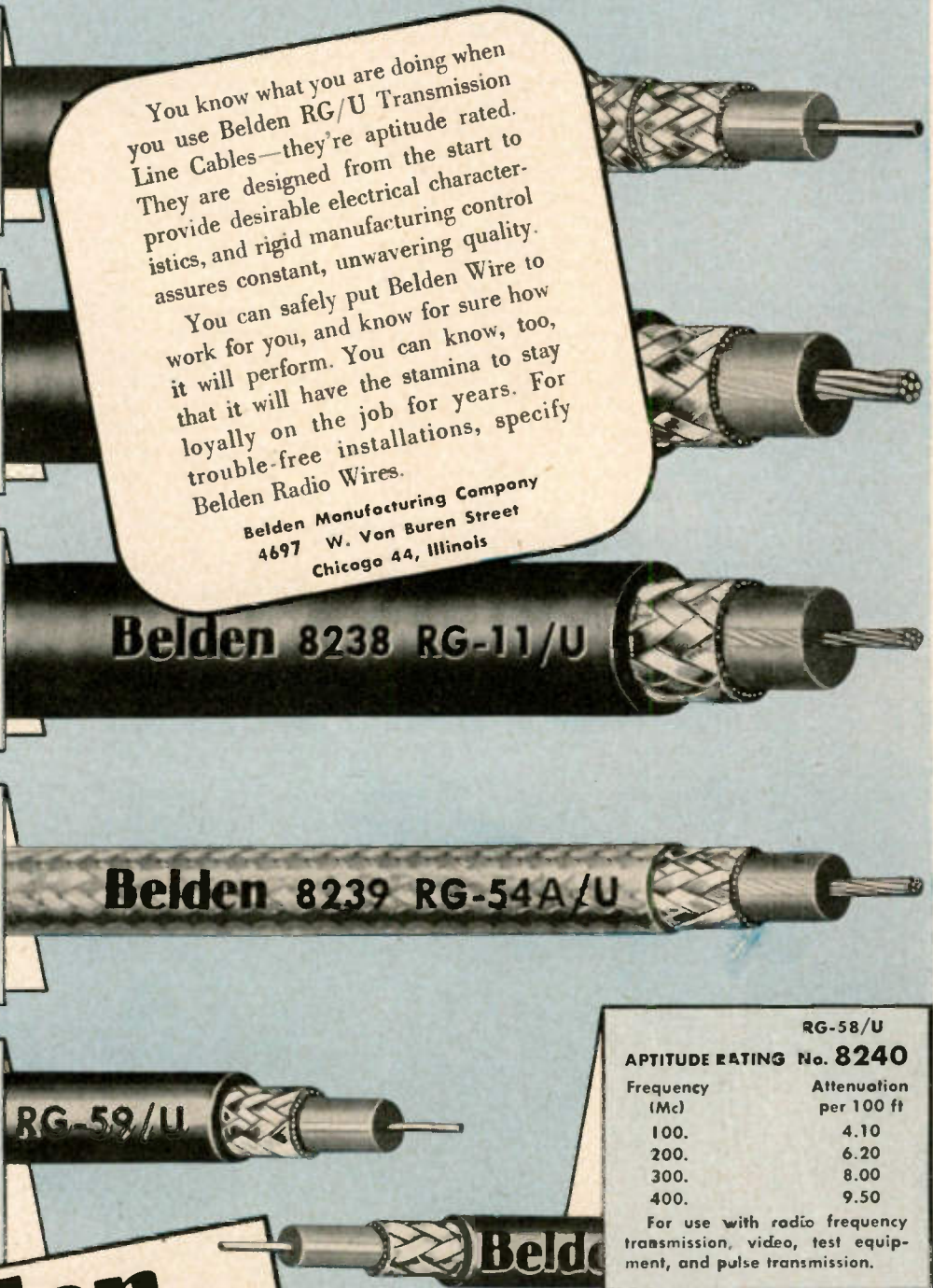

Belden
Radio WIRE The *Aptitude-Tested* **LINE**

Extra Dollars in Dishwashers!

Specialized Effort Needed Despite Product's Great Appeal

• Washing dishes is one of the most boring and distasteful jobs the housewife has to cope with. Almost every woman coming into the store will go along with this statement. High up on the "want" list of a great many modern-minded women is the electric dishwasher, but getting the prospective purchaser's name on the dotted line is something else again, for in spite of their terrific appeal, dishwashers won't sell themselves. They must be sold. With the present low saturation, the dishwasher, while an old product, is actually "new" due to increased promotional effort put back of it, and hence, must be sold vigorously and enthusiastically. When the dishwasher saturation point commences approaching that of electric refrigerators, housewives will buy the units readily.

In instances where a merchant continues to employ sketchy demonstration set-ups and half-hearted salesmanship in presenting dishwashers, he will find a high lost sale rate, and a lot of walk-outs. In cases where he merchandises this product effectively he will bat a high sales average, and will get clean sales, without trade-ins, and, better yet, will find that he is selling to a market where price cuts or other concessions are seldom requested.

A leading dealer reports that he has never received a single refusal to an invitation to demonstrate a dishwasher, nor has he ever heard any woman say that she didn't want one! Dealers have found that "live" dishwashers operating in show windows or in the store are Number One traffic stoppers. All over the country, merchants who've sold a number of dishwashers have obtained much of this business from satisfied users who have provided the

dealer with leads. With the great interest in this appliance, apparent at every hand, the smart retailer sees a chance to sell these big-ticket products in volume, and he does something about getting this added business. To begin with, he makes sure that his "live" demonstrators are actually "alive", and that the units are properly displayed, and backed up by advertising and sales messages stressing that dishwashers are a genuine investment because they provide all of the following features: 1. They save labor, eliminating that odious dishwashing chore. 2. They do away with "dishpan" hands. 3. They reduce breakage. 4. They keep those hard-to-keep servants happy. 5. The initial cost is small; the life of the equipment long, and remarkably trouble-free. 6. For the housewife who does her own work, the dishwasher is the great emancipator. It removes the bugaboo of hand-washing a great stack of dishes, glasses, etc. after the party. 7. The dishwasher provides a much more sanitary way of washing dishes, since the water can be hotter than that used in the old method, and since the entire washing and rinsing method is a "sealed-in" operation.

Prime prospects for dishwashers are the dealer's old customers, every store visitor (who should be given a demonstration), and local builders.

The dishwasher is extremely simple to operate and to demonstrate, and the dealer who will stress its advantages, and will work a little harder on his prospects can do a big job, and get plenty of repeat business.

The demand measured in terms of want is phenomenally large. The profit-minded dealer is finding ways to cash in on this terrific interest.

Free Father's Day Ad Service Is Offered

The 1951 Father's Day free mat and advertising service for stores has just been mailed by the Father's Day Council to every newspaper in the United States and to the department stores and men's wear and other retailers who are members of the Council.

This ad service incorporates complete suggested ads for Father's Day, June 17th. The copy is flexible so as to accommodate all types of merchandise in every field. The institutional portions stress the Father's Day Dinner idea as well as the merchandise gifts. The service is generously illustrated with attractive pen and ink cartoon style drawings which may be run independently as teaser copy or as a part of larger ads. The official Father's Day poster is shown in varying sizes. There are also mats of the illustrated Father's Ten Commandments. There are merchandise mats in half tone for gift and fashion news columns.

Tie-in Campaign

Included also is an outline for a tie-in campaign for each city as well as order forms for the mats themselves and an added help is the order form for the point-of-sale material which the Council offers at cost. Copies of this advertising service may be obtained by addressing Father's Day, 50 East 42nd Street, New York 17, New York.

Material Shortages Cut Vae Cleaner Production

Factory sales of standard-size household vacuum cleaners in March were 19.6 percent below those of March, 1950, totalling 290,242 units compared to 361,014, according to industry-wide figures recently announced by C. G. Frantz, secretary-treasurer of the Vacuum Cleaner Manufacturers' Association.

Effects Being Felt

March was the first month since January, 1949, to show a drop from the comparison month of the preceding year. The downward turn was attributed by the industry to Washington's limitations on metals and materials required for manufacturing the appliance. Factory sales have been at a virtual dead level for three months, the March total being within 1 percent of 287,177 units sold in February.

Further evidence of the industry's decrease in production was contained in the factory sales figure for the opening quarter of this year, 859,724 units compared to 873,679 in the same period of 1950, a loss of 1.6 percent, and a counter-seasonal drop of 2.9 percent from 885,511 in the final quarter of 1950.

All women want dishwashers, and good salesmanship will get results.



BIGGEST POTENTIAL MARKET

IN THE BUSINESS!

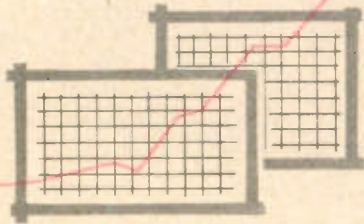

- 37 million American homes are prospects for automatic electric dishwashers and less than 2% of the market has been saturated.
- Good Housekeeping Magazine surveys indicate 32.8% of these homemakers are actually *planning to buy an automatic electric dishwasher now*.
- More families are buying Hotpoint dishwashers each week than in our *best pre-war year*.

HOTPOINT FIRST IN DISHWASHERS!

FIRST in Sales . . . Hotpoint's sales of electric automatic dishwashers far exceed those of any other manufacturer.

FIRST with Front Opening . . . Hotpoint was the first to offer an automatic dishwasher with front opening—for greater ease in loading—for uninterrupted work surface—for convenient installation under counters or cabinets—for use of overhead, down-rinsing spray.

FIRST with Electric-heat Drying . . . Hotpoint was the first to provide electric-heat drying with its forced hot air circulation for faster drying with clean, hot air.

FIRST in Customer Demand . . . Hotpoint Automatic Dishwashers rank first among dishwashers wanted most by most people. You can get your share of the profit in this fastest growing appliance market with low investment. The turnover is rapid and there are no trade-ins.

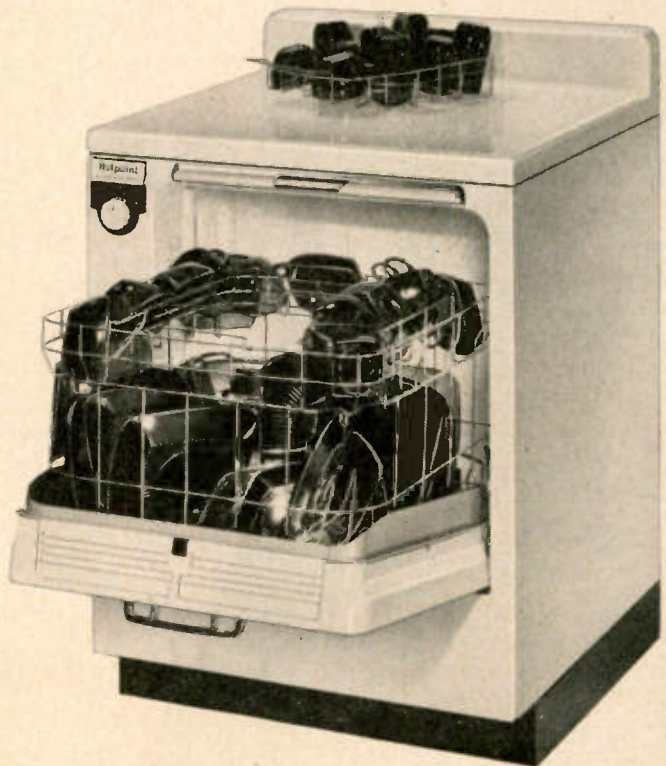

Hotpoint Full-Line Leadership

The Hotpoint line includes every major electric appliance for kitchens and home laundries—each an outstanding leader in its field. Talk to your Hotpoint distributor about the Hotpoint Full-Line Franchise.

Switch to Hotpoint! **FOR FULL LINE LEADERSHIP**

RANGES • REFRIGERATORS • DISHWASHERS • DISPOSALLS® • WATER HEATERS • CABINETS
FOOD FREEZERS • AUTOMATIC WASHERS • CLOTHES DRYERS • ROTARY IRONERS

HOTPOINT, Inc.

(A General Electric Affiliate)

5600 W. Taylor St., Chicago 44, Illinois

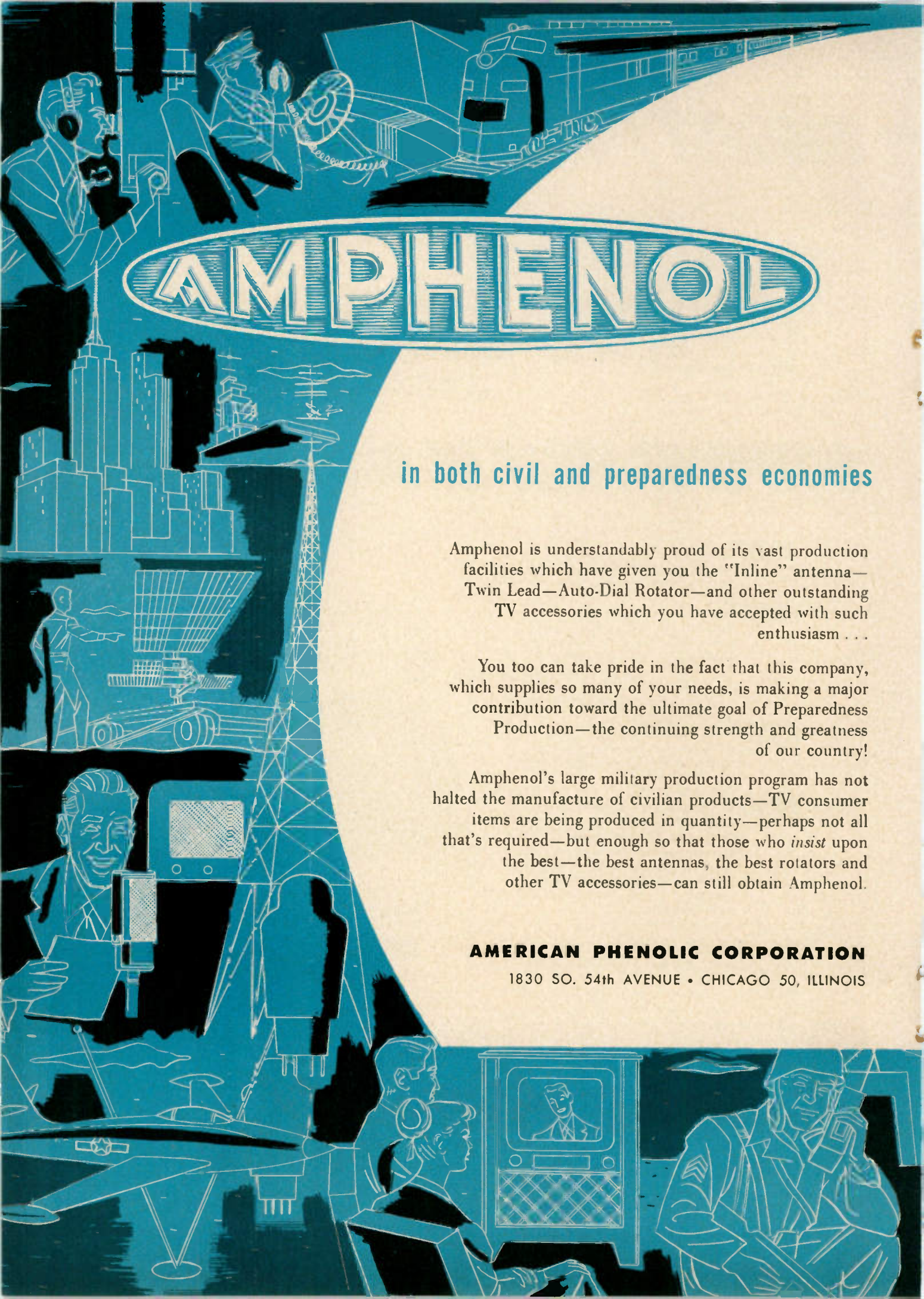

AMPHENOL

in both civil and preparedness economies

Amphenol is understandably proud of its vast production facilities which have given you the "Inline" antenna—Twin Lead—Auto-Dial Rotator—and other outstanding TV accessories which you have accepted with such enthusiasm . . .

You too can take pride in the fact that this company, which supplies so many of your needs, is making a major contribution toward the ultimate goal of Preparedness Production—the continuing strength and greatness of our country!

Amphenol's large military production program has not halted the manufacture of civilian products—TV consumer items are being produced in quantity—perhaps not all that's required—but enough so that those who *insist* upon the best—the best antennas, the best rotators and other TV accessories—can still obtain Amphenol.

AMERICAN PHENOLIC CORPORATION

1830 SO. 54th AVENUE • CHICAGO 50, ILLINOIS

SERVICE & SOUND

Section of RADIO & TELEVISION RETAILING

Sound Planning Pays

Save Time and Money by Preparing the PA Job in the Shop

• Along with the speeded-up techniques of radio and TV servicing the alert dealer should make sure that PA installation projects are not taking too much time at the job location. In the past, with plenty of time at his disposal, the service installer has often piled an amplifier, microphone, coils of wire and a speaker or two (still boxed) into his truck and ridden off merrily to the job, with no idea of what's to be done there beyond "installing a PA system!"

Sloppy Work Is Costly

To envision some of the time-consuming, money-wasting things that occur when such lack of preparation occurs, let's look at Joe Doakes, a serviceman who knows sound, but is still sloppy and easy-going to the extent that he never thinks about doing the job quickly and efficiently. Joe gets to the job and finds that he's got a concrete wall to go through, but he forgot to get star drills large enough to accommodate the heavy, rubber-covered cable he's using on this job. Or he's left the extension bit at the shop and has a 12-inch wooden partition to go through. Back to the shop to get the tools! After he's returned with the right tools to do the job, he finds that the record player won't operate. Why? It's been in a carton for six months and has such a flat on the idler that it won't budge. So back to the shop for a new idler! Or maybe Joe is getting smart by now—he'll leave the player alone and work on the mike-amplifier-speaker chain, and pick up a new idler when he has to get something else from the shop!

So he runs his line, puts the proper connectors on each end (if he remembered to bring them), connects the speaker up and plugs in the mike. What happens? If Joe is lucky today he gets feedback. Our guess is that he gets no sound at all because the rectifier or some other tube is dead. 5Y3s and 5U4s have a habit of sometimes breaking under vibration that other tubes seem to avoid most of the

time, but Joe didn't bother to check the amplifier in the shop. So now he makes a trip back, or sends his helper. After all, he can figure it isn't really an extra trip—didn't he have to go back to get that idler anyhow?

Don't Rely on Memory

By now you get the idea, we're sure. Proper preparation and laying-out of the job in the shop cut the on-the-job time in half, save unnecessary trips back and forth between the store and the customer's place, and impress the customer with a businesslike way of operating that lets him know he's getting his money's worth from a professional organization.

Use a checklist of what's going into the installation, and see that it's actually checked, item by item, as the truck is loaded. Don't rely on memory. If the job is fairly simple even the cable can be precut to length and the connectors put on it, saving that particular job for the shop where you've

got a third hand—the vise—to speed up the operation. Whether the job is simple or complicated, it will pay off in time and gasoline to draw a sketch, however rough it may be, of the entire installation, and under each unit such as *loudspeaker*, list the actual items that are needed—for example: loudspeaker, baffle box, bolts or screws for fixing speaker to baffle, screws or hook for putting baffle in place, grommets (if used) for leading cable out of baffle. You must have gone over the actual layout at least once to estimate it, so why not make that going over a little more thorough, and include measuring the footages needed so that the cables can be made up and connectors put on beforehand, cutting on-the-job time?

Check the items in the list on this page before going out on any PA job, and you'll find your PA installations speeded up and more cleanly put together. And you will find, too, that your customers will have more respect for your firm and your work.

Installation Check-List

1. Have you a rough sketch of the job to check with?
2. From this sketch make a list of major units; mikes, spkrs, etc.
3. Stack them on the floor together and check each one for needed bolts, screws, connectors, holders, cushions, knobs, etc.
4. Has the amplifier been test-run for 8 hours, (or twice for 3-5)?
5. Have you written down exact footages needed? Or, for complicated jobs, a minimum footage figure?
6. Does every cable length and speaker, mike, player, etc., have its plug or connector soldered on before leaving the shop?
7. Have you got tools for every wall or connection you may run into at the location of the job?

Servicing Vertical Sweep

Use of Scope and Calibrator Speed Troubleshooting.

• The vertical section has been selected because although it is somewhat simpler than the horizontal section, in each case the methods for troubleshooting are closely parallel. There have been two main trends in the design of the vertical oscillators employed in modern receivers. The first to be widely used was the blocking oscillator type, which employed a transformer for the dual function of getting feedback from the output of the oscillator back to the input (to sustain oscillations) and for injecting the sync signal into the grid and mixing it with the feedback signal. The other commonly used method is the familiar multivibrator circuit, in which the feedback is from a second tube or tube section back to the first section through an R-C network. This type is coming into much wider acceptance as sets become simpler and smaller. The circuit of Fig. 1 is that of the GE 12T3, very slightly simplified, and is typical of present practice. A quick review of its operation is in order.

Integrating Network

After the composite sync pulses are amplified, they must be separated—the vertical pulse, being 60 cps is a low audio frequency, and can be separated from the relatively high frequency of the horizontal pulses by using a filter with a fairly long time constant. This long time constant merely smooths out the fast pulses

(horizontal—15,750 cps) and does not greatly change the slow, or low frequency, vertical pulses. This filter network is called the integrating network, and its configuration is quite standard in most sets. It is shown in figure 2A. The values may change from set to set, but they are always similar in size. From the integrating network the sync pulses are fed to the vertical oscillator. (Also called the vertical multivibrator, blocking and discharge tube, etc.) The pulses are used to trigger, or set off the vertical oscillations. They maintain the vertical sweep in exact *synchronism* with the vertical sweep at the transmitter.

After being shaped by the integrating network, the vertical sync pulse is passed to V2, the vertical deflection output tube, where it is amplified. Part of this amplified pulse is now sent back to the grid of the first generator tube, V1 through R1 and C1. The values of these two parts are chosen so as to rule out amplification by V1 of any little bit of the horizontal pulse that may be left in the composite sync signal even after it leaves the integrating network. V1 amplifies the vertical pulse fed to it from V2, and from V1 plate it goes, along with the incoming sync pulse from C1, on back over to the grid of V2. Thus a continuous oscillation is maintained, with the sync pulses coming in from the sync amplifying section through the integrating network to keep the multivibrator working at the right speed. The vertical hold R₆ is

set so that V1-V2 would be a little bit slower than 60 cps if the sync pulse didn't come in, so that the sync pulse may furnish the actual triggering of the sweep.

Now that the grid of V2 is working properly the plate circuit, consisting of the plate of V2, the primary of T2, the vertical output transformer, and the B supply, is receiving its pulses of current at a rate of 60 cps., and the transformer T2 supplies these pulses of power to the vertical deflection yoke as the vertical sweep.

Signal Trace With Scope

Many technicians prefer to use a scope for signal tracing in vertical or horizontal circuits, and we incline to that view too. If the signal gets lost even though most voltage readings are right it's easy and fast to touch the scope lead progressively to the integrating network, oscillator grid, plate, output grid, and finally plate, and then to the secondary of the vertical output transformer. Remember here that you've got plenty of B plus to worry about, so use the rule of one hand behind you, or one hand in your pocket, while chasing the scope input lead through the set. This signal tracing with an oscilloscope will be found to be easier than the method of using a VTVM once you are accustomed to knowing what to look for at the usual check points because if a VTVM were used first, and failed to reveal the defect by improper electrode voltages, you would still have to use the scope. This way, the first step is eliminated. In connection with 'scope signal tracing it is wise to make full use of manufacturers or other service literature. These usually show photographs or simple outline drawings of the wave shapes to be expected in normal operation at each check point. Notice one thing in looking for these wave shapes; they may be drawn as they really are—not as they'll show up on a 'scope which has a fairly limited high frequency response. With a little practice you'll have no trouble in knowing what differences to expect in the published wave shapes and what you get on your scope. (All radio servicemen who use a 20,000 ohm per volt meter are easily able to mentally compensate for the difference between what their meter reads and what it really means in circuits of high or relatively high impedance.)

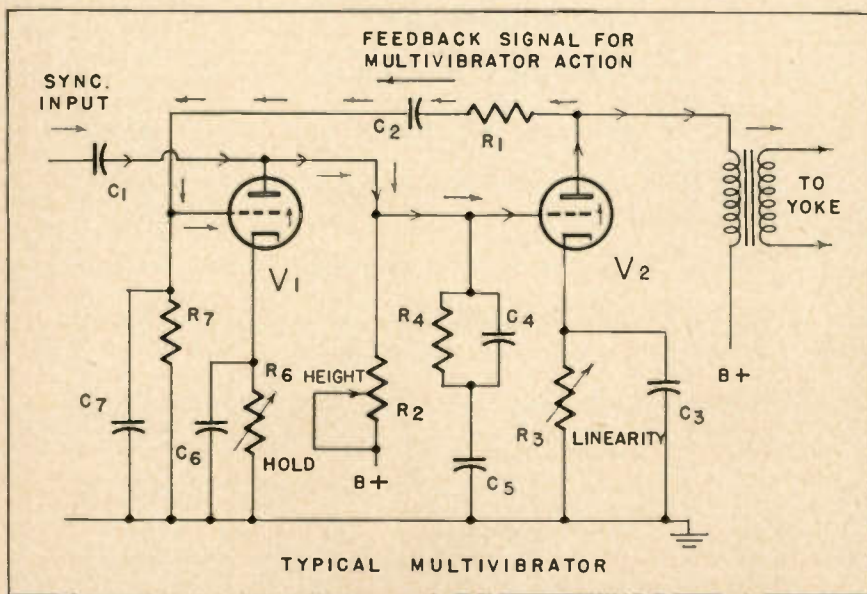

Circuits in TV Sets

Present Day Circuits Are Getting Simpler

A voltage calibrator is standard equipment in the best shops, being hooked right onto the scope input at all times so that input voltages can be instantly measured and compared with the values given in the service notes. The calibrator has a switch which, in the "Off" position allows connection directly to the scope, as though the voltage calibrator were not there. It also functions as a variable control of the input voltage to the scope. In this way it provides a method of finding out quickly where the vertical signal is being lost or attenuated. There are several excellent voltage calibrators now on the market. This tool has long been used as an aid in the laboratory, where the scope also was employed for years before it found such widespread use in TV servicing. Now top technicians are finding that leaving the voltage calibrator permanently attached to the input of the scope saves motion and time.

Common Troubles

Troubles in the vertical section of the set are among the most straightforward to handle. As with all types of TV failures, they will, a great deal of the time, be nothing but tube failure. So naturally we will pull and try new tubes first in the oscillator, then in the vertical output socket. If the set has a vertical buffer, or a vertical discharge tube, these are tried also. There is one vertical trouble which cannot be cured by working in the oscillator or output stages, however. It is called the keystone effect. When the raster has a trapezoidal shape, when one side is longer up and down than the other, it is caused by trouble in the vertical deflection coil. The most usual cure for this is to replace the deflection yoke.

More common troubles are caused by failures or changes in the circuit components. The commonest trouble is the one which causes the customer to say, "I get only a thin white line." This is well known and indicates, of course, a complete lack of vertical deflection. After trying tubes, which we will from here on assume are the first thing attempted in all normal repair procedures, we check for B voltage on the plates. If that is found to be present, we go next to the cathodes, and if we get 2 to 13 volts there we're usually safe in assuming that the tube is drawing current. In some circuits,

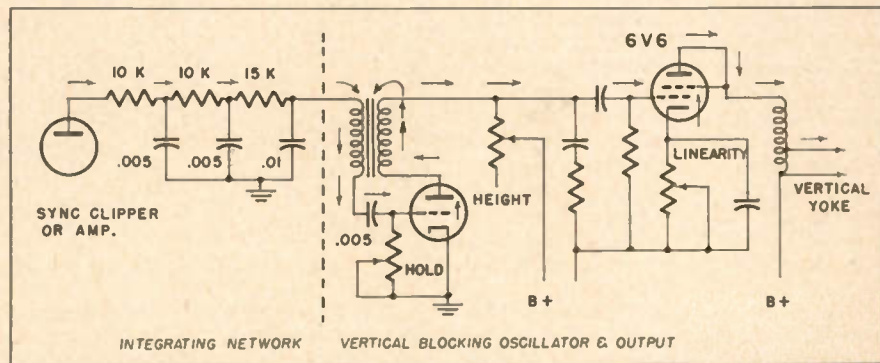

especially the oscillators, it is okay to have 100 to 150 volts positive on the cathode. Just jump over to the grid to be sure it has a comparable voltage, ten or so volts lower than the cathode. If you have this grid bias developed, the oscillator is almost always working, and the trouble lies beyond it. If no oscillations are present, then the ohmmeter is the tool for finding out why. At this point, the service notes are the best reference, and sometimes it's a little tricky to find a leaky condenser or an open in an oscillator circuit, so read that meter carefully, and use the right scale.

Less common than the "thin white line", but not unusual, is the folded-up, or "curtain-raising" effect. In this the vertical height is insufficient, and the bottom edge of the picture is bent back up over itself. This is due to a defect in the input of the oscillator, and in the circuit of fig. 1 would be caused either by a leaky condenser, C7, or a change in the resistance of R7, or R6. A shorted condenser C6 might produce a similar result, due to shifting the operation of the tube onto the wrong part of the amplification curve.

Improper Height

Inadequate picture height could be caused by a number of changes in the circuit constants. A frequent cause of this is a rise in the value of the plate

charging resistance. Another cause would be shorted turns in the sweep output transformer or a cathode condenser C3 being too small, or becoming open. These would produce poor linearity, and possibly inadequate height also, depending on the exact circuit values involved. Almost any improper potential on the elements of the output tube might result in insufficient height, and certainly low emission of the tube would be a fault to watch out for. This would ordinarily have been taken care of, had good troubleshooting procedures been followed, as the first step in the initial examination of the set in the customer's home.

Inadequate height combined with a complete absence of vertical synchronization usually indicates a short in the cathode circuit of the sweep generator tube. In this circuit, a short in either the hold control or the condenser parallel with it would be the guilty components. Finally there is a whole raft of faults tied up with too much height, poor vertical linearity and the inability to control either properly. In this case the use of the voltage calibrator to check on the size of the input signal, and comparison of this with the value given in the service data would reveal the defect at once. It is a smart idea to have good equipment in the service department, in this case, scope and voltage calibrator. But the only thing that will service sets well is the right use of the tools.

This is the first of a series of articles on troubleshooting of modern TV receivers. We will not only analyze the design of typical sets but will include representative new trends such as the present promised swing to electrostatic focus types. Each article will discuss the operation of a particular section of an average set, and the theory of frequently used differing systems. We will, in addition, be concerned with specific troubles which can crop up in the customer's set and methods for locating these troubles.

Brief Explanation of How

Fourth of a Series of Articles on FM Detectors;

By Solomon Heller

• Before we consider how an FM discriminator works, we should have a clear idea of what is fed into it. This requires a review of (1) what goes on at the transmitter and (2) what takes place in the receiver sections preceding the discriminator.

Now, sound waves do not have sufficient energy to travel great distances. The studio performer's ya-ta-ta-ta-ta must therefore be changed into an equivalent electrical wave, so that it can be broadcast.

The electrical waves into which the sound signals are first changed are of audio frequencies—i.e., 50 to 15,000 cycles. Now, these electrical waves cannot be broadcast, because the frequencies at which they operate don't have the pep to travel great distances. They must therefore be carried by higher frequencies, which do have the energy needed to travel from the transmitter, to the different receivers in the transmitter's service area. The

process by which the audio frequencies are handed over to higher radio frequencies is called *modulation*.

The higher frequencies to which the audio signals are given would not, if fed into an audio amplifier, cause the original audio information to be reproduced. The frequencies would first have to hand back the original audio ones, before this desired blessing came to pass. This second process is called *demodulation*, or *detection*.

Carrier Frequency Shifts

When the FM system of transmission is employed, the audio signals are changed into radio frequencies as follows:

A radio frequency wave, called a *carrier wave*, is made to shift in frequency when audio signals are combined with it in a certain way. The extent of the frequency shift, that is, the amount that it shifts, is determined by the *amplitude* of the audio signal. The rate, or speed, with which

the shift takes place is determined by the *frequency* of the audio signal. Since frequency and amplitude are the most important characteristics of any audio signal, the changes in the carrier produced by the audio signal contain all the information present in the latter.

Suppose the carrier is 88 mc, and the audio note is a 30-cycle, 4 v peak-to-peak signal (see fig. 1). The 4-volt amplitude of the audio signal will cause the carrier to shift to, say, a maximum of 88.025 mc on the audio signal's positive swing, and a minimum of 87.075 on the audio signal's negative swing. The *rate*, that is, the frequency, at which the carrier shifts back and forth between 88.025 mc and 87.75 mc, will be 30 cycles per second.

Let's take a second example—a 1000-cycle audio signal with a peak-to-peak amplitude of 8 v. The 8-volt amplitude of this 2nd signal will cause the carrier *frequency* to change twice as far as before, or from 88 mc to 88.05 mc at the positive maximum of the audio cycle, and from 88 mc to 87.95 mc at the audio cycle's negative minimum. The rate at which this frequency change, or *deviation*, takes place will be 1000 cycles per second. In both of these examples, the center frequency, which is called the *resting frequency*, has been 88 mc. The amount of *deviation*, or swing, or change of frequency has been caused by the amount, or strength (amplitude) of the audio signal. The maximum *deviation* of the FM carrier permitted by the FCC is ± 75 kc. This means that the largest audio signal at the transmitter is not permitted to shift the carrier more than 75 kc above or below its center, or *resting frequency*. In this way, then, audio signals are converted into corresponding frequency deviations.

Reversed at the Receiver

At the receiver, the process just described is reversed. The frequency variations are converted back into corresponding amplitude variations, or audio signals. This is not done at the receiver right away. First, the advantages of superhet action (selectivity, better gain) are obtained, and the r-f carrier is changed into an i-f carrier (see fig. 2). This i-f carrier is amplified, then applied to a limiter, which removes any noise associated with the carrier. Finally, the i-f carrier is demodulated or detected. That is, the frequency deviations of the i-f carrier (which are exactly the same as those of the original r-f car-

Fig. 1—A) 30-cycle 4-v audio signal at transmitter. B) Effect of modulating FM carrier with audio signal shown in (A). When the audio signal increases in amplitude, the carrier frequency rises. When the audio signal decreases in amplitude, the carrier frequency goes down. Note that the duration of the audio signal, and the time it takes the modulated carrier to shift back and forth from its center frequency, is the same— $1/30$ sec. Therefore the audio frequency is the same as the rate of change of the carrier. C) Waveform that results when the frequency-modulated carrier is converted back into an amplitude variation. When the carrier frequency is rising, the amplitude of the demodulated wave is greatest; when the carrier frequency is decreasing, the amplitude of the demodulated wave is least.

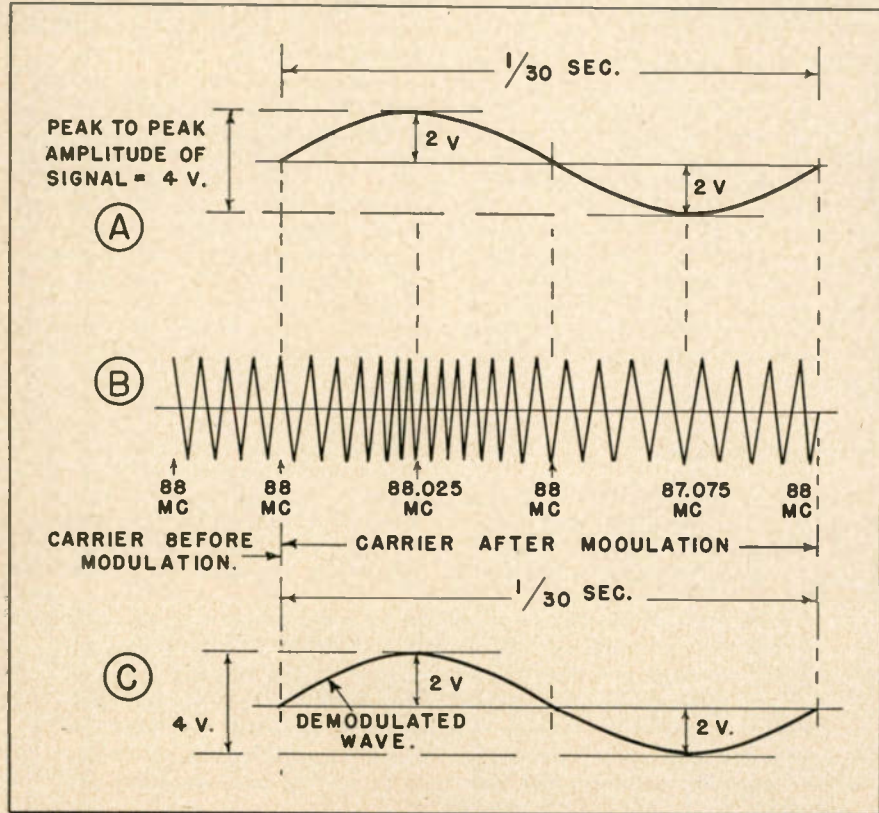

the FM System Operates

How the Audio Modulates the Carrier Frequency

Fig. 2—Block diagram of typical FM receiver. When a ratio detector is employed in place of a discriminator, a limiter stage is not usually present.

rier) are changed into corresponding amplitude variations (see fig. 1c).

This gives us 1 of the 2 basic characteristics of the audio signal: amplitude. The second basic characteristic, frequency, is already present, and nothing need be done about it, except to make sure that this characteristic is retained. To illustrate: the frequency deviations of the carrier occur at a certain rate, depending on the frequency of the audio signals that produce them. If the frequency deviations are changed into corresponding amplitude variations, the amplitude variations will still occur

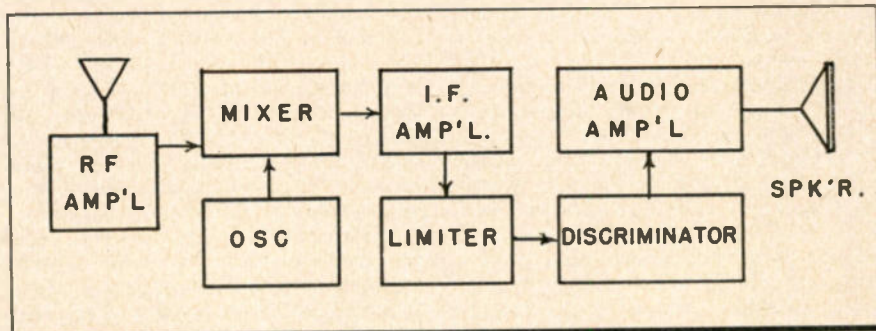

at the same rate—i.e., the rate or frequency of the original audio signal (see fig. 1c). Thus the frequency as well as the amplitude characteristic of the audio signal is reproduced, and

the twins of the sounds created at the transmitter's studio pour into our eager—or not so eager—ears.

Next month: How the discriminator works.

Shop Shortcuts Speed Servicing

Intermittent Lektals

I'd like to have a nickel for every set that has come across my bench where tube pins made intermittent contacts in lektal sockets! For a while I assumed that the socket was defective and replaced it, which is sometimes quite a job in a small, cramped chassis. I have discovered that this condition is a quite logical result of the pin-holder in the socket spreading open when the tube is bent from side to side to get it "unlocked." Therefore I tried tightening these pin-holders by pressing a small screwdriver between the wafer and the metal pin-holder. By squeezing the pin-holder together, I caused it to get a good grip on the tube again, and eliminated the intermittent condition. This has saved me a lot of trouble, and I pass it on for what it's worth to other servicemen. *Sanford Radio Service, Towson, Maryland.*

Curing Distorted Speakers

A trouble that we have been finding on new radios that use a PM speaker seems to crop up when one side of the voice coil is made fast to an eyelet and that is grounded to the speaker frame. The symptom is distortion that sounds like an overloaded speaker or a badly matched output transformer, or a sticking voice coil. To clear this trouble, unsolder the lead from the eyelet, and also unground the lead of the output trans-

former and then run a lead between the two ungrounded points. We have found that this results in a new-sounding radio. *Chet's Radio Service, 320 Salem St., Medford 5, Mass.*

Salvage Tube Sockets

More than once I came across octal wafer sockets that broke down between pins. After replacing quite a few over a period of time, I devised the following procedure: Since the breakdown occurs in the form of a carbonization between adjacent pins, an air gap introduced between two pins would be as good an insulator as

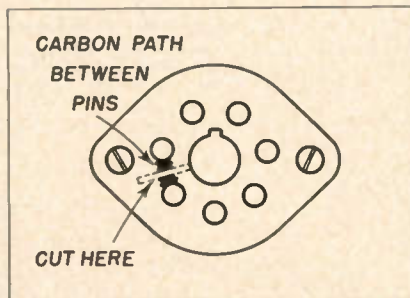

can be devised. So I used a key-hole hack saw to cut a slot from the center key of the socket to the space between the pins. In most cases, the short occurred between pins 2 and 3, while pin 2 was ground, pin 3 B plus. *David M. Rice, TV Station WABD, New York, N. Y.*

Soldering Iron Stand

This "tip" is so simple that I imagine a lot of servicemen may have thought of it already. The market has been flooded lately with these spring-clip type holders for holding tools, brooms, etc., on a wall. It occurred to me, when I saw a friend of mine using one to hold his shaving brush in the medicine cabinet, that it might

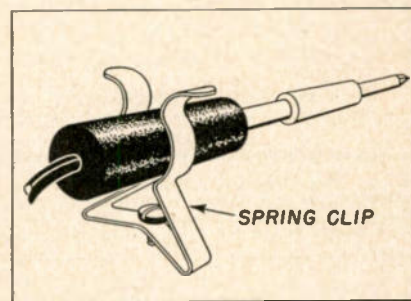

work to hold a soldering iron up off the bench, and so do away with the rather cumbersome sling that I had. So I screwed one of these clips down on the bench, and I find that it has quite adequate strength to hold my 125-watt iron. You can either hold the iron or the handle, depending on how large a clip you get. The handle is better, as then the clip doesn't conduct the heat away from the iron and into the bench. *M. LeGoff, New Orleans, La.*

How the Electrostatic

New Methods Help Save Critical Material—Easier for Technician

• First official announcement of impending changes in circuitry for coming TV receiver production came from leading industry laboratories recently when the detailed results of their research programs aimed at reducing the amounts of critical materials used in TV chassis were announced. These changes were made in line with government cuts in these materials, and warnings of more cuts to come. The changes which were developed, and which have been publicized and offered to the industry as a public service, center first around ways of using less copper and cobalt, and second with saving iron and brass.

Conservation Step

It will be noted that eliminating cobalt, which TV uses mainly in Alnico V magnets, calls for the use, ordinarily, of an electro magnetic speaker field, which uses copper. Pres-

ent plans therefore are to use a very small speaker magnet, thus reducing the amount of cobalt needed, or to use Alnico III, which is less efficient than Alnico V, but uses no cobalt. PM focusing to save copper is out, because although an average focus coil takes away about 2 lbs. of copper, the use of a strong PM focus ring would require too much cobalt. So electrostatic focus is the answer here.

When TV was several years younger the change was made from electrostatic focus and deflection to magnetic focus to get better control of the electron beam. Among other reasons, manufacturing techniques at that time were not adequate to allow as good focus with electrostatic means as could be obtained with a magnetic system. But now factory alignment and construction of the electron gun is possible which will allow focusing with electrostatic methods comparable to that possible with present

magnetic focus. In addition, magnetic focus calls for a fairly heavy DC current, which means more copper for the power transformer. Electrostatic focus will be accompanied by the use of smaller power supplies, and Philco will switch to voltage doubler operation from the line (using seleniums) which will give a B supply of about 250 volts.

Most of the major tube manufacturers have already announced production of electrostatically-focused tubes, so it looks as though we'll be using them for a long time ahead. Incorporation of these tubes into current TV set production will be starting within a month or two.

The greatest use of "electrostatics" (as they are called) will be in the 14, 17, and 20-inch sizes, and they will be physically interchangeable with the most popular magnetic-focused types of those sizes. The main change in the circuits required for the picture tubes will be in the obtaining of the DC potential for the focus anode. In most cases this will be about one-fourth (25%) of the voltage supplied to the second anode, which in most large tube sets is now 12 to 15 kilovolts.

Needs Supply Voltage

The circuit diagram shows one form of circuit which could be used to supply the voltage to the focus electrode. It will be seen that when the power-supply output voltage varies due to fluctuations in the line, the second anode voltage will also vary. But so will the focus anode voltage! Since the sharpness of the focus in these types depends primarily on the ratio of the two voltages supplied to these two electrodes—the second anode and the focusing anode—the sharpness of focus will be fairly independent of line variations.

You will observe from the accompanying drawing that the gun is a little more complicated than have been the guns used in magnetic focus tubes, but this simplifies the job of the technician although it calls for more careful control of factory production of the electron gun. In the past the setting of the focus coil by the technician was often a compromise between best focus, no neck shadow, and centering. That will no longer be necessary. In place of centering with the focus coil there will be used a small centering magnet, which need not use cobalt, just behind the deflection yoke. See the pictorial sketch of the electron-gun assembly. The elements of the gun have been designated: G_1 , as

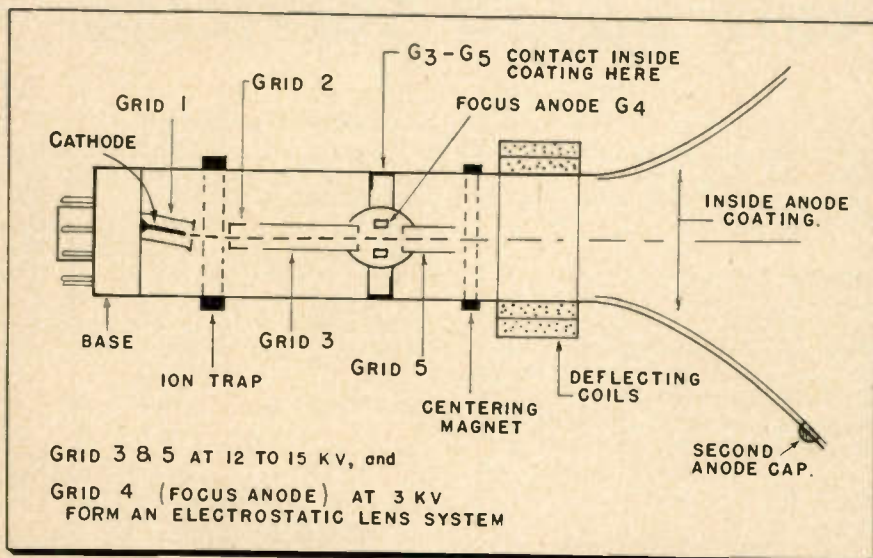

Above: Cross section pictorial of a typical electrostatically focused gun assembly. Note the electrostatic lens system formed by G_3 , G_4 , & G_5 . Below: diagram of one method for obtaining focus anode voltage. Points A, C, or other places on the primary of output transformer may be used to get 3-4 KV AC pulses needed for rectification.

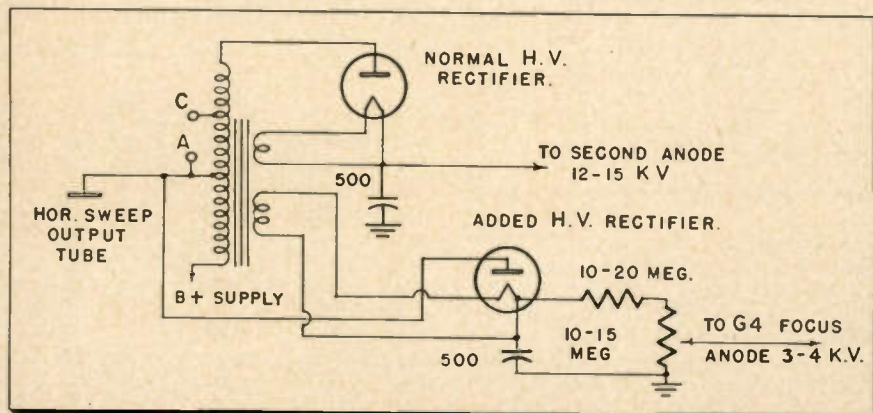

Focusing Tubes Work

to Adjust—More Independent of Line Fluctuations

usual, the control grid, G_2 , still the screen grid, G_3 , connecting to the inside coating of the tube—second anode, and the focus anode G_4 . G_5 is connected to G_3 , and is part of the focus system, along with G_3 and G_4 .

A comparison of the voltage supply requirements will show differences in the two types of focusing.

An ion trap will still be necessary to bend the ion beam whether it is (a) a single trap to properly direct the beam from a bent gun, or (b) a double trap, to bend the beam for getting rid of the ions, then bending the electron stream back. Regardless of the method of focus, ions are still almost 2000 times as big as electrons, and can still damage the screen if allowed to strike it. The electrostatic focus type requires a little larger signal at its grid than the electromagnetic focus type, but this will not be a serious problem, since most sets have had more than enough output at the picture tube grid in the past.

Uses Standard Base

It will not be necessary to go back to the types of tube base and socket used on the 7JP4 and other early electrostatic-type picture tubes. The same standard base as is now employed with modern picture tubes can be used on the electrostatic-focus tubes by having a small high-voltage-insulated cover for the one tube prong (usually pin number 6), which will get the high focus anode voltage of between 2.5 and 3.5 thousand volts. Use of this tube will be easier for the serviceman since he will have no longer the problem of focus and centering with the same neck assembly. On the other hand, he will have a slightly greater number of circuit components to keep in proper operating order.

The advantages of the electrostatic-focus picture tube then, are first, the saving of critical materials for defense, and second, easier adjustment by the technician. The disadvantages are the need for greater quality control by the manufacturer (and consequently slight increase in cost—which increase will be offset by the lowered cost of the external tube neck assembly), and a more complicated circuit in the high voltage supply, including another rectifier tube and a couple of small parts.

It is expected that there will be adequate supplies of electromagnetic focus tubes on hand for present sets now in homes if industry goes about necessary conservation, and this is a good first step in that direction.

		Electrostatic	Electro-Magnetic
G1	Control Grid	33-77	33-77
G2	Screen Grid	275-325	275-325
G3	Second Anode	12-15 KV	12-15 KV
G4	Focusing Anode	2.5-3 KV	not used
G5	Second Anode	12-15 KV	not used

The New Leader!

Yagi

By Clear Beam

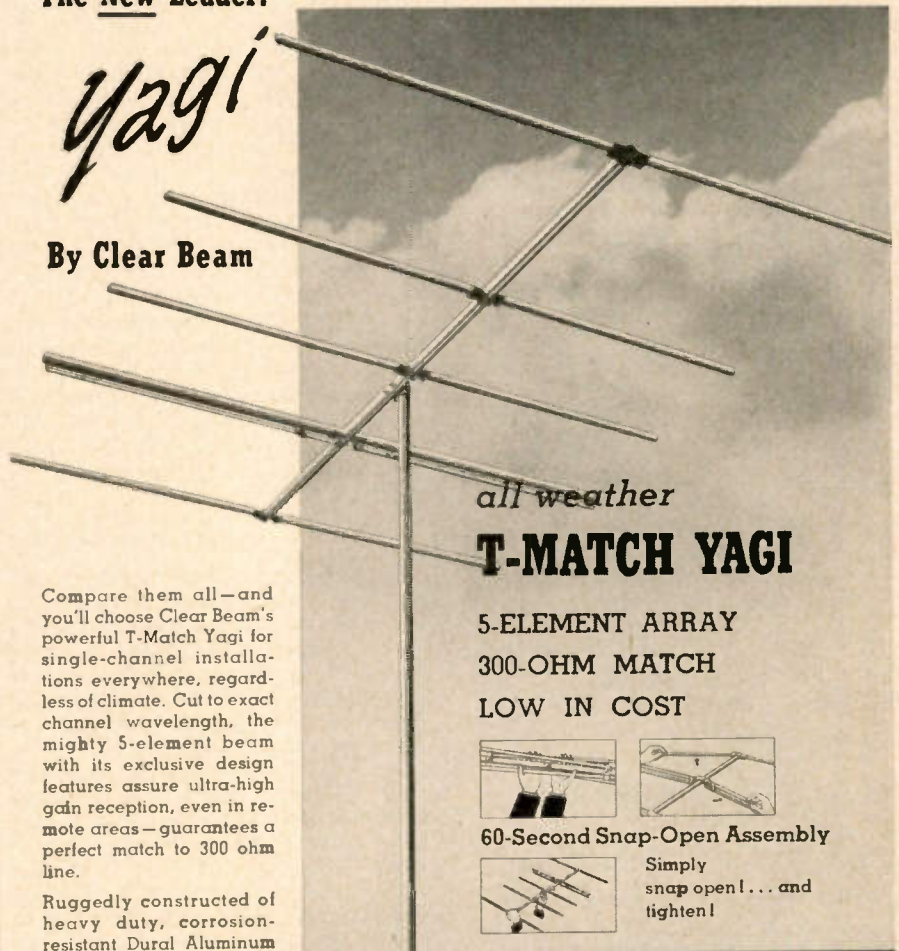

all weather

T-MATCH YAGI

5-ELEMENT ARRAY

300-OHM MATCH

LOW IN COST



60-Second Snap-Open Assembly



Simply snap open!... and tighten!

Compare them all—and you'll choose Clear Beam's powerful T-Match Yagi for single-channel installations everywhere, regardless of climate. Cut to exact channel wavelength, the mighty 5-element beam with its exclusive design features assure ultra-high gain reception, even in remote areas—guarantees a perfect match to 300 ohm line.

Ruggedly constructed of heavy duty, corrosion-resistant Dural Aluminum for dependable, all-weather performance, the Clear Beam T-Match Yagi assembles in one-minute flat... slashes installation time... insures customer satisfaction now and for the years ahead.

Compare them all... compare the features and the surprisingly low price... and you'll choose "Clear Pictures... Clear Profits... with CLEAR BEAM!"

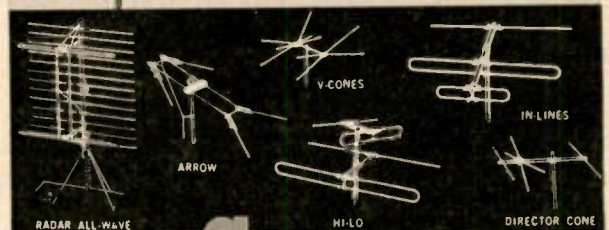

A COMPLETE LINE OF QUALITY

ANTENNAS TO MEET EVERY TV RECEPTION REQUIREMENT

Clear Beam

Antennas

CLEAR BEAM ANTENNAS 618 No. La Brea Ave. Los Angeles 36, Calif. YOrk 1682

Miniservicing and the Battery Portable

A Review of Some Carry-About Set Troubles and Their Repair

• The advent of warmer weather in many parts of the country, possibly coupled with the emphasis civil defense planners are placing on the importance of the non-AC powered receiver in these uncertain times, will bring many battery and three-way portables out of the closets and into the service shop. Whether these jobs will provide an increased income for the dealer, or only stimulate the aspirin market, will depend to a great extent on the servicemen's approach.

Of course the battery portable is subject to the usual failures of home radio receivers, and the usual servicing procedures should be followed when a defective unit appears in the shop. There are, however, several important differences between portables and home receivers, and each of these differences may give rise to difficulties for the serviceman who does not take them into account.

Physical Size

The small size of the average portable, and the truly miniature construction of the "personal" portable, can be the indirect cause of many a problem. An example of this is the audio feedback frequently caused by a microphonic audio tube mounted

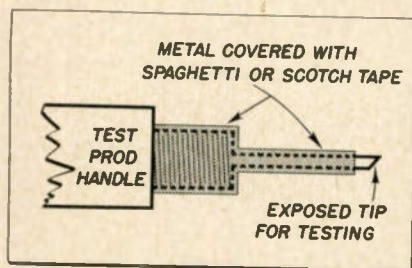

Fig. 1. Insulated test prod for use in crowded chassis, as in battery portables. Use is especially recommended as aid to saving 1 volt tube filaments.

right against the frame of the speaker. It need not always even be up against the speaker frame to howl. This feedback is sometimes hard to spot as microphonism, since it may occur at all volume levels. The cure, of course, is to replace the offending tube. Don't throw that tube away, though, it may be perfectly satisfactory for substitution-testing in other sets.

The chassis that performs normally on the bench, but which is inoperative in the cabinet, is another headache

due to "miniaturization." The parts are mounted so close together in the little fellows that the slight amount of "squeeze" put on the chassis when it is slipped into its cabinet is sometimes sufficient to short a pair of un-insulated leads. Watch for dangerously close spacings between leads before you put the set back into its shell. If you've had to get into the wiring in any of the really tight corners of the chassis, more than usual care should be taken in dressing the leads for adequate spacing. A length of spaghetti tubing slipped over a previously uninsulated lead may mean another satisfied customer, and may prevent an unprofitable and annoying return call.

In working on these small chassis a conventional test prod can be a source of trouble. Many an expensive filament has been blown by an accidental short to ground while the technician was trying to get the prod on another socket terminal. The sleeved test prod illustrated in Fig. 1 can pay for itself in one job if it saves one 1S4 filament.

Low Current-drain

In order to conserve battery life, the tube manufacturers have gone to great lengths to provide us with tubes which consume very little filament power. It is the availability of these tubes which has made the portable practical. Low current-drain tubes do bring problems, though. While the tubes used in conventional receivers have a large reserve of emission available, and will function well long after passing their prime, the low-drain battery-type tubes don't seem to stand up quite as well in some applications. Many cases of an inoperative set have been traced to a 1R5 or 1LA6 converter tube which tests okay but simply refuses to oscillate. This is generally because the emission has fallen off slightly and insufficient reserve is available. A reading of the voltage developed across the oscillator grid leak should be one of the first tests applied to every inoperative portable.

Frequently with 3-way portables the substitution of a new converter tube will temporarily put the portable back into operation. But not for long. If, as is often the case the filament dropping resistor has changed value (as it often has, due to construction being near or below proper wattage

rating) then the filament supply voltage will be a little low. A new tube, having good emission will usually operate even though its applied filament voltage is low, but after running for a few hours it also refuses to oscillate. The only cure here is to change

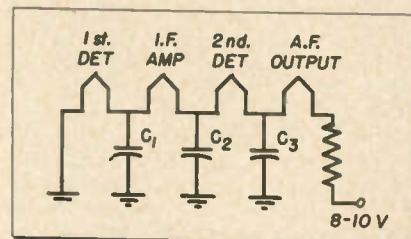

Fig. 2. Decoupling capacitors to isolate the filaments of a battery portable from each other. C_2 is usually a large audio by-pass.

the filament supply dropping resistor. It is usually OK to bridge another one of about ten or more times the value of the one already in use across that one. A positive check on the condition here described is to notice whether or not the set works OK with new batteries, even after a new tube has stopped oscillating on AC.

Another problem peculiar to the battery portable can be traced to the fact that in such sets the filaments are usually connected in series. This complicates the decoupling problem between stages, and at least one high-capacity electrolytic and two or more small bypass capacitors are generally used to tie the various filament terminals to ground. Some of these bypass units develop a fairly high impedance to some frequencies, in time, and audio or r.f. feedback may result. The cure, in the audio feedback case, illustrated in Fig. 2, is to strap a .01-uf paper capacitor across the big electrolytic. If the problem is that of r.f. or i.f. feedback a small mica condenser across the i.f. stage filament bypass should clean things up.

Effects of Climate

Portables frequently find themselves in surroundings quite foreign to the average home radio. A portable taken out in the family boat for a day's sailing can get quite damp inside, and can provide the serviceman with a load of trouble. If you suspect that unusual moisture conditions have rendered a set inoperative, a

(Continued on page 108)



No Margin for Error Here...

★ The screeching wail of a fired missile as it rockets to its target strikes awe in the heart of every man. Sights are set . . . targets are tagged — and the gunner fires. The guiding hand behind the scenes is the man up front . . . it is he who indicates the position of the target. His radio message must get through to the gunners. His communications must be dependable . . . must be in peak working order always. **NO MARGIN FOR ERROR HERE!** That is why his electronic devices have **RADIART VIBRATORS** specified for them. Reputation built up over the years for dependability and continued peak performance has stemmed from superiority in engineering design and controlled manufacture. This same skill of design and manufacture is basic in every **RADIART** automotive vibrator — it pays to put this skill to work for you.

When It's Needed the Most . . . **RADIART Quality Meets the Challenge**

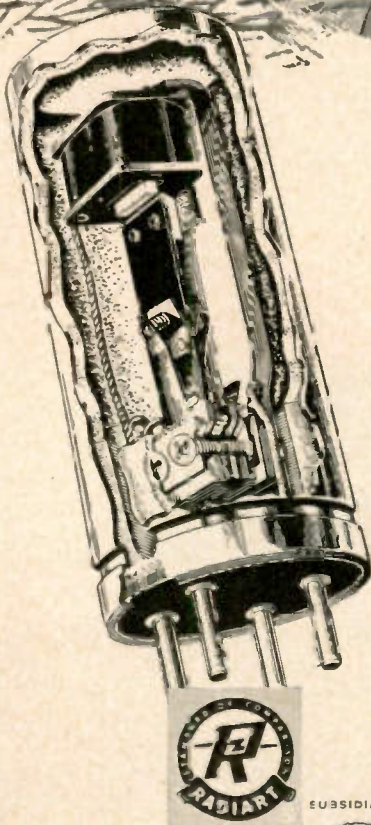

THE RADIART CORPORATION CLEVELAND 2, OHIO

VIBRATORS • AUTO AERIALS • TV ANTENNAS • ROTATORS • POWER SUPPLIES



..... FRANK J. MOCH—President of National Alliance of Television and Electronic Service Associations, Chicago.



..... MORTON BINDER—President of Television Engineers, Inc., Chicago.

"We believe in replacing picture tubes with



..... ART RHINE—President of Rhine Television, Yonkers, N. Y.

..... JOE McMILLIAN—President of A-1 Television and Radio Co., St. Louis, Missouri.



..... T. W. ST. CLAIR—General Manager of Wholesale Television Service Corporation, Columbus, O.



..... JAMES HAUSMAN—President of Central Radio Television Service, Chester, Pennsylvania.



—AS ADVERTISED IN THE SATURDAY EVENING POST

BURTON BROWNE ADVERTISING

Admiral

Meck

Bendix
Television

Magnavox

Tele King

Westinghouse

Olympic

Motorola

Hoffman

PILOT

Lyon & Healy

Imperial

Packard Bell

hallicrafters



Thomas Photo-tron

the **Exact** original equipment!"

These executives, heading six of the biggest TV service organizations in the United States, represent the experience gained through hundreds of thousands of house calls and shop jobs. As presidents of companies employing hundreds of technicians they know the value of replacing picture tubes with the exact original equipment. Their experience proves that this exact replacement saves them money because it means fewer call-backs, longer set life and more satisfied customers.

THOMAS PHOTO-TRON Picture Tubes are the exact original equipment used by the 20 famous TV set makers listed below. Servicemen everywhere know you take no chance when you replace with Thomas because you replace with the exact tube you are taking out. If the set is not listed in the 20 famous brands listed below you make the set perform better by using a THOMAS PHOTO-TRON picture tube!



Thomas-Simpson

BONUS PLAN

Ask your THOMAS distributor for complete details on how you can obtain SIMPSON Test Equipment *without cost.*

CROSLLEY

Tele-tone

Starrett

Kaye-Halbart

SCOTT



Thomas Photo-tron

PICTURE
TUBE

Calbest



THOMAS ELECTRONICS, Inc.
Passaic, New Jersey

Test Instrument Manufacturers

Key to Test Equipment

O	Oscilloscopes
TG	TV & FM Sweep Generators
MG	Marker Generators
RG	RF Generators
AO	Audio Oscillators
VV	Vacuum-tube Voltmeters
MM	Multi-meters (not VTVM)
ST	Signal Tracers
CT	Cathode-ray Tube Testers
TT	Tube Testers
CT	Condenser Testers
MF	Field Strength Meters
VR	Voltage Regulators
VC	Voltage Calibrators
M	Meters

Aerovox Corp., 740 Belleville Ave., New Bedford, Mass.—CT
 Altec Lansing Corp., 1161 N. Vine St., Hollywood, Cal.—AO
 Approved Electronic Inst. Corp., 142 Liberty St., New York 6, N. Y.—O, TG, MG, RG, VV, MF

Bradshaw Inst. Co., 42 Flatbush Ave., Brooklyn 17, N. Y.—O, MM, RG, CT
 Bud Radio, Inc., 2118 E. 55th St., Cleveland 3, Ohio—AO, MF
 Burlington Inst. Co., 203 N. 3rd St., Burlington, Iowa—M

Chicago Industrial Inst. Co., 536 W. Elm St., Chicago 10, Ill.—VV, MM
 Clarkstan Corp., 11927 W. Pico Blvd., Los Angeles 34, Cal.—AO
 Clippard Inst. Lab., Inc., 1125 Bank St., Cincinnati 14, Ohio—RG, ST, CT
 Clough-Brenne Co., 6014 Broadway, Chicago, Ill.—RG, AO
 Coastwise Electronics Co., Inc., 130 N. Beaudry, Los Angeles, Cal.—TG, RG, AO, ST
 Cornell-Dubilier El. Corp., South Plainfield, N. J.—CT

Daven Co., 191 Central Ave., Newark, N. J.—AO, VV
 Dayco Radio Corp., 915 Valley St., Dayton 4, Ohio—TT
 Allen B. Dumont Labs., Inc., 750 Bloomfield Ave., Clifton, N. J.—O, VC

Electronic Development Labs., 4851 W. Division St., Chicago 19, Ill.—O
 Electronic Inst. Co., 276 Newport St., Brooklyn 12, N. Y.—O, TG, MG, RG, AO, VV, MM, ST, TT
 Electronic Measurements Corp., 423 Broome St., New York 13, N. Y.—RG, VV, MM, TT
 El-Tronics, Inc., 2647 N. Howard St., Philadelphia 33, Pa.—O, AO, TG

Feiler Engineering Co., 945 W. George St., Chicago 14, Ill.—O, RG, VV, ST

General Electric Co., Electronics Park, Syracuse, N. Y.—O, TG, RG, OA, MM, TT
 Grem Engineering Co., 206 8th Ave., Brooklyn 15, N. Y. O, RG, AO, TT

Heath Co., Benton Harbor, Mich.—O, TG, RG, AO, VV, MM, ST, TT, CT
 Hewlett-Packard Co., 395 Page Mill Road, Palo Alto, Cal.—TG, RG, AO, VV
 Hickok Electrical Inst. Co., 105 14 Dupont Ave., Cleveland 8, Ohio—O, TG, MG, RG, VV, MM, ST, TT, VC

Industrial Devices, Inc., 22 State Road, Edgewater, N. J.—MM

Jackson Electrical Inst. Co., 18 S. Patterson Blvd., Dayton 1, Ohio—O, TG, MG, RG, AO, VV, TT, CT
 J.B.T. Instruments, 441 Chapel St., New Haven, Conn.—MM
 J.F.D. Mfg. Co., Inc., 6101 16th Ave., Brooklyn 25, N. Y.—VR

Kay Electric Co., Pine Brook, N. J.—TG, MG, RG

Marion Electrical Inst. Co., Manchester, N. H.—M
 Measurements Corp., Boonton, N. J.—TG, MG, RG, AO, VV, MF
 Millen Mfg. Co., Inc., 150 Exchange St., Malden, Mass.—O

Monarch Mfg. Co., 2014 N. Major St., Chicago, Ill.—RG

National Co., Inc., 61 Sherman St., Malden 48, Mass.—MF

Oak Ridge Products, 3701 S. Veron Blvd., Long Island City, N. Y.—TG, RG, M

Philco Corp., Accessory Div., C & Tioga Sts., Philadelphia 34, Pa.—O, TG, RG, VV, MM, ST, TT
 Precise Measurement Co., 942 Kings Highway, Brooklyn 23, N. Y.—M
 Precision Electronics, Inc., 641 Milwaukee Ave., Chicago 22, Ill.—VV, ST
 Precision Apparatus Co., Inc., 92-27 Horace Harding Blvd., Elmhurst, N. Y.—CT
 Premier Electronic Labs., 382 Lafayette St., New York 3, N. Y.—RG, MM

Radio Corp. of America, Tube Div., 415 S. 5th St., Harrison, N. J.—O, TG, RG, AO, VV, TT
 Radio City Products Co., Inc., 152 W. 25th St., New York, N. Y.—O, TG, MG, RG, VV, MM, ST, TT
 Radio Frequency Labs., Inc., Boonton, N. J.—MF
 Roller-Smith, 1760 W. Market St., Bethlehem, Pa.—MM

Schauer Machine Co., 2043 Reading Rd., Cincinnati 2, Ohio—Vibrator analyzer
 Shallcross Mfg. Co., Jackson & Pusey Ave., Collingdale, Pa.—M

Silver, McMurdo Co., Inc., 417 Lafayette St., New York, N. Y.—TG, MG, RG, AO, VV, MM, MF, ST
 Simpson Electric Co., 5208 W. Kinzie St., Chicago 44, Ill.—O, TG, MG, VV, MM, MF, TT
 Special Products Co., 9115 Brookville Rd., Silver Spring, Md.—ST
 Sprague Products Co., 89 Marshall St., N. Adams, Mass.—CT
 Superior Inst. Co., 227 Fulton St., New York 7, N. Y.—TG, RG, MM, TT, ST
 Supreme, Inc., Greenwood, Miss.—O, TG, MG, RG, AO, VV, MM, ST, TT, CT
 Sylvania Electric Products, Inc., 1740 Broadway, New York 18, N. Y.—O, TG, RG, VV, MM, TT, CT

Telequip Radio Co., 2559 W 21 St., Chicago, Ill.—O, TG
 Television Equipment Corp., 238 William St., New York 8, N. Y.—O

Tensor Electric Development Corp., 343 Classon Ave., Brooklyn 72, N. Y.—VC, M
 Triplett Electrical Inst. Corp., Harmon Rd., Bluffton, Ohio—O, TG, MM, TT

Trylon Radio Labs., 1136 N. American St., Philadelphia 23, Pa.—O, TG, MG, RG, AO, VV, MM, MF, ST, TT, VR
 Thordarson Div., Maguire Industries, 500 W. Huron St., Chicago 10, Ill.—VR

Thomas Electronics, Inc., 118 9th St., Passaic, N. J.—CT

Waterman Products Co., Inc., 2445 Emerald St., Philadelphia 25, Pa.—O
 Weston Electrical Inst. Corp., 614 Frelinghuysen Ave., Newark 5, N. J.—VV, MM, TT

Du Mont 3-Point Program

A three-point program calling for increased factory promotional activity, intensified merchandising efforts at distributor and dealer levels and greater emphasis on service was adopted at the recent distributor panel meeting held by the receiver sales division, Allen B. Du Mont Laboratories, Inc. The three-point program was adopted following a series of reports by each of the panel representatives on their regional market problems and recommendations and an all-afternoon open discussion which followed.

New Meck Wholesalers

Two new distributors have been appointed to handle the Meck line of television receivers in the states of North and South Carolina, it has been announced by John S. Meck, president of John Meck Industries.

Appliance Service Corporation, Charlotte, N. C., will handle distribution to Meck sets in North Carolina. The firm is headed by Cal Mitchell. The entire state of South Carolina will be served by Carolina Electric Appliance Company, Columbia, S. C. E. M. Longmier is president.

POWERFUL All Channel

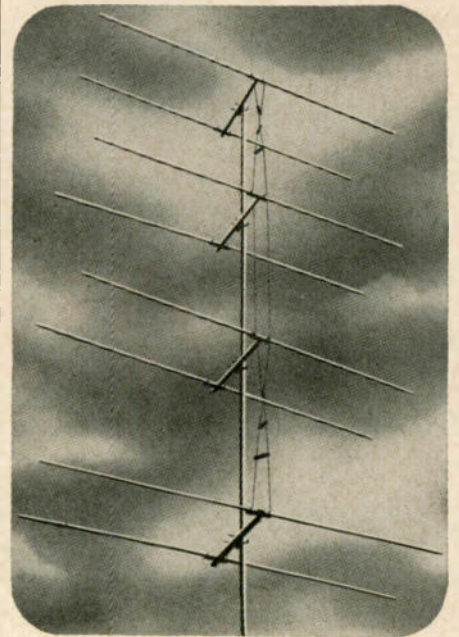

VEE-D-X COLINEAR

This exclusive VEE-D-X antenna was developed to fill the need for more powerful all-channel reception in primary as well as fringe areas. Besides producing higher gain throughout the TV spectrum, the Colinear may be cut to any single high channel for sharp directivity, yet will resonate on low channels regardless of high channel selected. Like the VEE-D-X JC Yagi, the Colinear is completely pre-assembled. It is also the lowest priced four-bay array ever manufactured. The LaPointe-Plascomold Corporation, Windsor Locks, Conn.

Another great

VEE-D-X

first

NEW STACKED ARRAYS

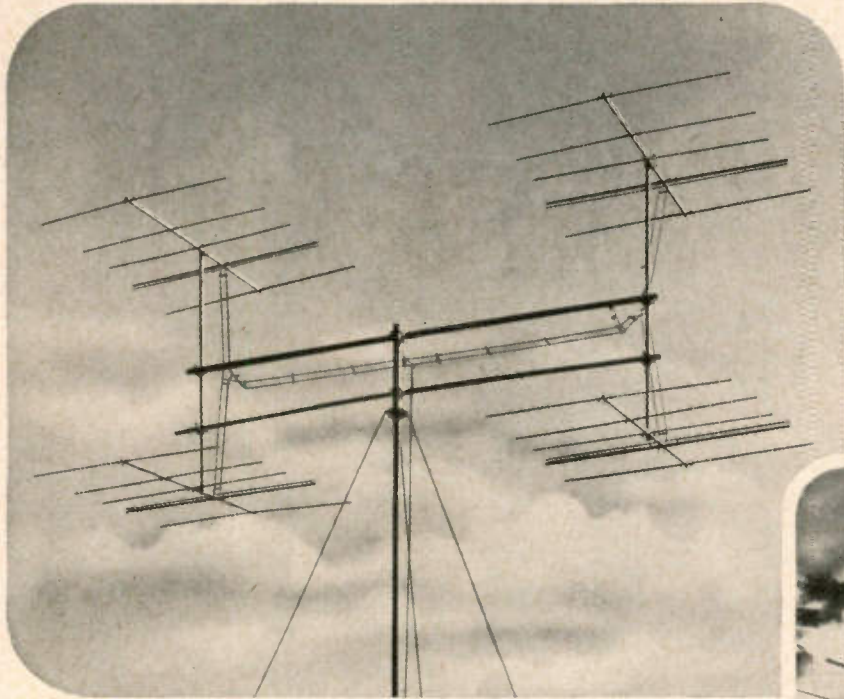

Four Stacked Side-by-side JC Array — a radically new type of array developed for highest gain in hilly and mountainous terrain. Provides powerful long distance reception.

OF THE **JC** YAGI

**PRODUCE SHARP,
CLEAR PICTURES
AT AMAZING DISTANCES**

SUPER POWERFUL

For Single Channel Performance

VEE-D-X — largest producer of Yagis — brings you new stacked arrays that provide still higher gain and further reduce noise interference. Perfected by VEE-D-X engineers in collaboration with a foremost authority on wave propagation, these stacked arrays make a world of difference in picture quality. In addition to the already popular double stacked array with half-wave spacing, you can employ double stacked arrays with full-wave spacing and half-wave four stacked, either vertical or side-by-side. Choice of array depends on area terrain and reception conditions.

THE LAPOINTE PLASCOMOLD CORPORATION
Windsor Locks, Connecticut

CHICAGO SHOW
BOOTH NO. 691
DISPLAY ROOM 660

VEE-D-X

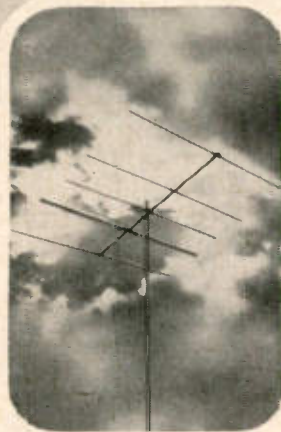

Standard JC Yagi Array — unsurpassed for all normal single-channel requirements.

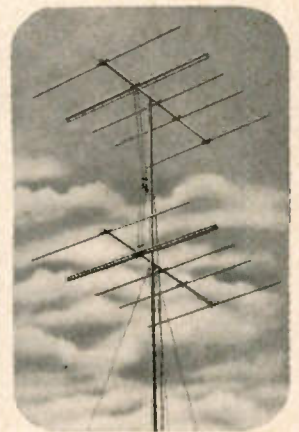

Double Stacked JC Array with half-wave spacing. Provides added gain and better signal-to-noise ratio.

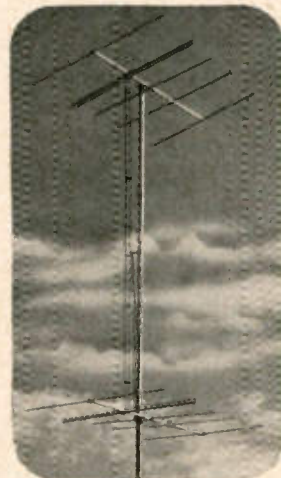

Double Stacked JC Array with full-wave spacing. Provides highest possible gain in low noise areas.

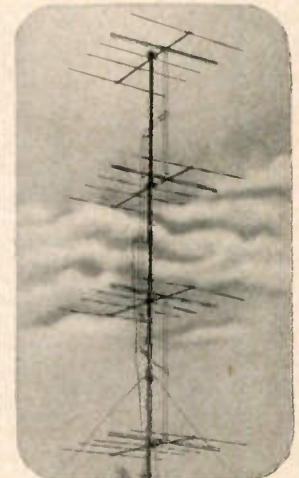

Four Stacked Vertical JC Array provides extremely high gain and excellent improvement of signal-to-noise ratio. Ideal for long distance reception areas with relatively flat terrain.

BUILDERS OF THE WORLD'S MOST POWERFUL ANTENNAS

Television Receiver Specifications

MAKER'S NAME and MODEL NUMBER LIST PRICE (Incl. Tax) TUBE SIZE (Inches) TYPE AM, FM, PHONO, JACK

(Continued from page 78)

Snaider TV Corp., 540 Bushwick Ave., Brooklyn, N. Y.				
P520	5TP4-X	C-W	SW-FM
1230	12-0	C-W	SW-FM
1630	16-0	C-W	SW-FM
1930	19-0	C-W	SW-FM
1221	12-0	C-W	J
1621	16-0	C-W	J
1921	19-0	C-W	J
MPJ521pj	5TP4-X	M	
Spartan Radio-Television, Jackson, Mich.				
5101	17	T-W	
5102	17	T-W	
5103	17	T-W	
5152	17	C-W	
5153	17	C-W	
5154	17	C-W	
5155	17	C-W	
5156	17	C-W	
5157	17	C-W	
5158	17	C-W	
5170	20	C-W	
5171	20	C-W	
5182	17	C-W	AM-FM-PH
5183	17	C-W	AM-FM-PH
Starrett Television Corp., 601 W. 26th St., N. Y.				
17BM1	17	T-W	J
37BB1	17	C-W	J
27BM1	17	C-W	J
20BM1	20	C-W	J
30BM1	20	C-W	J
37BM1	17	C-W	J
Scott Radio Labs, Inc., 4541 N. Ravenswood Ave., Chicago 40, Ill.				
510TC-2	17	C-W	AM-FM-PH
310T	17	C-W	AM-FM-PH
800-B21	20	C-W	AM-FM-PH
710	17	C-W	
910	20	C-W	
AC-17	17	C-W	
AT-17	17	T-W	
Stewart-Warner El., 1300 N. Kostner Ave., Chicago 51.				
9202-DA	17	T-W	
9202-DB	17	T-W	
9202-DD	17	T-W	
9200-C	16	C-W	
9200-D	16	C-W	
9202-C	17	C-W	
9202-E	17	C-W	
9202-F	17	C-W	
9200-G	16	C-W	
9121-A	16	C-W	AM-FM-PH
9121-B	16	C-W	AM-FM-PH
9122-A	19	C-W	AM-FM-PH
Stromberg-Carlson Co., Rochester, N. Y.				
119M5M	19-0	C-W	AM-FM-PH
119RPM	19-0	C-W	AM-FM-PH
119CDM	19-0	C-W	J
119CM	19-0	C-W	J
17C2M	17	C-W	J
24RPM	24-0	C-W	AM-FM-PH
24CM	24-0	C-W	J
317RPM	17	C-W	AM-PH
317TM	17	T-W	J
Sylvania Electric Products, Inc., 254 Rano St., Buffalo, N. Y.				
4120M	14	FM	
1110X, 1210X	16-0	T-W	FM
7110X	17-0	T-W	FM
7120W	17	T-W	FM
7120M	17	T-W	FM
7120B	17	T-W	FM
221M	20	T-W	FM
4130M	14	C-W	FM
7130W	17	C-W	FM
7130M	17	C-W	FM
7130B	17	C-W	FM
5130W	19-0	C-W	FM
5130M	19-0	C-W	FM
7140M	17-0	C-W	FM
5140M	19-0	C-W	FM
5140B	19-0	C-W	FM
7150M	17	C-W	AM-FM-PH
5150M	19-0	C-W	AM-FM-PH
Symphony Radio & TV Corp., 825 W. Pico Blvd., Los Angeles, Cal.				
100A	17	T	
200B	20	C	
3-C	20	C	
Tele King Corp., 601 W. 26th St., New York, N. Y.				
172	17	T-W	
174	17	C-W	
117CA	17	C-W	AM-PH
916	16-0	C-W	
916CAF	16-0	C-W	FM-AM-PH
920	20	C-W	
920CAF	20	C-W	FM-AM-PH
203	20	T-W	
203LD	20	T-W	
202	20	C-W	
202LD	20	C-W	
1014	14	T-W	
1016	16	T-W	

MAKER'S NAME and MODEL NUMBER LIST PRICE (Incl. Tax) TUBE SIZE (Inches) TYPE AM, FM, PHONO, JACK

Trad TV Corp., 1001 First Ave., Asbury Park, N. J.				
T1720	219.95	17	T-W
C1720V	249.95	17	C-W
C2020	319.95	20	C-W
CD1620	319.95	16-0	C-W
C02020	399.95	20	C-W
C01630	399.95	16-0	C-W
C02030	429.95	20	C-W
Tech-Master Prod. Co., 443-5 Broadway, N. Y.				
1630	189.50	10, 12, 14	CH
1930	182.50	10, 12, 14	CH
1930T	199.50	10, 12, 14	CH
1930D	199.50	10, 12, 14	CH
630019 Kit	159.50	10, 12, 14	CH-K
630S19	154.50	10, 12, 14	CH-K
5116	105.75	10, 12, 14	CH-K
Tele-tone Radio Corp., Bayway Terminal, Elizabeth, N. J.				
359	229.95	17	T
345	249.95	17	T-W
335	259.95	16	C-W
352	279.95	17	C-W
358	289.95	17	C-W
357	269.95	17	T-W
365	279.95	17	T-W
355	319.95	17	C-W
331, 332, 333	399.95	17	C-W
360	419.95	20	C-W
Telegrip Radio Co., 2559 W. 21st St., Chicago 8.				
T216L	199.95*	16	T-L
C316MF	219.95*	16	C-W
T416D	249.95*	16	T-W
C516D	279.95*	16	C-W
T417D	269.95*	17	T-W
C517D	299.95*	17	C-W
C617D	344.95*	17	C-W
C519D	369.95*	19-0	C-W
C619D	399.95*	19-0	C-W
C720D	399.95*	20	C-W
C820D	429.95*	20	C-W
Trav-ler Radio Corp., 571 W. Jackson Blvd., Chicago.				
114-1	179.95	14	T-W
114-2	199.95	14	C-W
63R50	249.95	16	T-W
64R50	279.95	16	C-W
65G50	279.95	16-0	C-W
117-3	329.95	17	C-W
16R60	349.95	16	C-W
20A50	399.95	20	C-W
16R70	399.95	16	C-W
Video Corp. of America, 229 W. 28 St., N. Y. 1, N. Y.				
750CDM	349.95	17	C-W
912CM	369.95	19-0	C-W
2020CCM	399.95	20	C-W
2025CCM	439.95	20	C-W
2091CM	449.95	20	C-W
P-20	689.95	20	C-W
C-20	739.95	20	C-W
M-20	665.00	20	C-W
Video Products Corp., 16 West St., Red Bank, N. J.				
630	Up to 20		CH
630DX	Up to 20		CH
Westinghouse El. Corp., Sunbury, Pa.				
H645T17	279.95	17	T-P
H640T17B	289.95	17	T-W
H639T17	309.95	17	T-W
H641K17	369.95	17	C-W
H643K16	375.00	16-0	C-W
H646K17	399.95	17	C-W
H647K17	425.00	17	C-W
H642K20	495.00	20	C-W
H633C17	535.00	17	C-W
H634C17	560.00	17	C-W
Zenith Radio Corp., 6001 Dickens, Chicago.				
H2229R	289.95	17	T-W
H2230R	299.95	17	T-W
H2230E	309.95	17	T
H2438R	369.95	16-0	C-W
H2252R	369.95	17	C-W
H2253E	379.95	17	C
H2241R	399.95	17	C-W
H2439R	399.95	16-0	C-W
H2437R	429.95	16-0	C-W
H2437E	449.95	16-0	C-W
H2447R	449.95	19-0	C-W
H2445R	499.95	19-0	C-W
H2254R	459.95	20	C-W
H2242R	515.00	20	C-W
H2242E	525.00	20	C-W
H3068R	549.95	17	C
H3274R	625.00	17	C
H3273E	649.95	17	C
H3477R	745.00	19-0	C
H3478E	795.00	19-0	C
H3284R	750.00	20	C

O—Round
□—Rectangular
T—Table

C—Console
CH—Chassis
K—Kit

X—Projection
W—Wood
P—Plastic

M—Metal
L—Leatherette
P—Phonograph

J—Phono Jack
*Price does not incl. tax
**Zone 1 only

Note: Basic list prices are shown. In some instances, prices are slightly higher in certain localities.

"At Your Service..."

(TOLD WITHOUT WORDS)

by Standard Register System users

You say it to all your customers every day.

Not in words . . . but by the manner in which your business is conducted by your people. *Your* confidence . . . confidence that all your operations are "under control" . . . helps build *customer* confidence and loyalty.

You know that you are better able to handle every transaction with the aid of a time-saving STANDARD REGISTER system. This hand-writing *business machine* gives you exact, detailed, loss-proof records of every sale or service rendered—in as many copies as needed to inform all concerned. The system serves to simplify bookkeeping, billing, tax-reporting, control of inventory . . . to furnish completely the *basic facts* for control of your whole business.

Make *your* Standard Register system give you all the advantages it's capable of. Send for *Business Aids*—the free tabloid in which other customers in your own line of business tell how they are making the most of systems similar to yours. Consult your Standard Register representative for any assistance he can give.

Standard Registers and Forms provide . . .

- Fast, easy, accurate record writing.
- Useful copies for all purposes.
- Security from loss or alteration: consecutive numbering, locked-in copy.

Standard Register

Kant-Slip, the original marginally punched

Continuous Forms

Simplify record writing

FORM-FLOW REGISTERS • THE REGISTRATOR PLATEN

Offices in all principal cities

CUSTOMER'S COUPON

The Standard Register Company
1305 Campbell St., Dayton 1, Ohio

I'd like to see Business Aids—by and for customers in our line of business.

Name _____

Company _____

St. Address _____

City _____ Zone _____ State _____

Build Your Profits With BURGESS



BURGESS

Is the Only Complete Line!

Stock up on BURGESS Portable Radio Batteries now and cash in during the BIG Portable Radio season. When you stock BURGESS you make every sale because BURGESS makes a battery to fit every radio!



Quality has made Burgess the Foremost Name in Radio Batteries!



The new BURGESS Flat Cell offers customers more hours of useful battery life and extra reserve power in the same overall space. ALL BURGESS Batteries are made with the finest ingredients obtainable and are manufactured under scientifically controlled conditions to assure unmatched quality!

plus Most Intensive Advertising Campaign in Burgess History!

Powerful 2-color ads will sell BURGESS Batteries to the readers of BIG national magazines reaching millions of readers. BURGESS advertising will sell the battery buyers who read general, men's, and outdoor magazines. Tie in with this BIG BURGESS campaign and boost your battery profits.



Free

1951

Replacement Guide!

LISTS MORE THAN 100 MANUFACTURERS—MORE THAN 1600 RADIO SETS!

Mail Coupon Today!

BURGESS BATTERY COMPANY
DEPT. RD-51, FREEPORT, ILLINOIS

Please send a copy of new 1951 BURGESS Replacement Guides.

Name

Firm

Address

City Zone State

Arvin TV SETS

To supply small screen TV sets, Arvin has revised production on model 4080, 8 1/2-inch set listing at \$129.95, in mahogany, willow green and sandalwood; and four 12 1/2-inch sets including table models at \$169.95 and consoles at \$199.95. Arvin Industries, Inc., Columbus, Ind.—RADIO & TELEVISION RETAILING.

McMurdo PORTABLE RADIO

The Trans-World, shown here, is a 3-way, 3-band portable receiver. Housed in luggage type cabinet, it operates on 110 to 220 volts AC or DC and on bat-

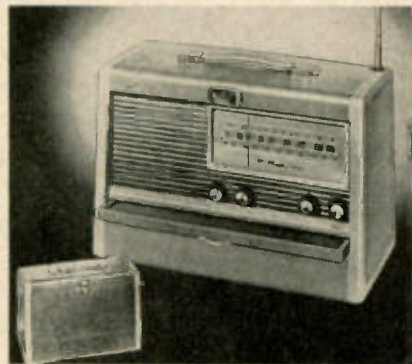

teries. Called model 6331 in the new line, the set weighs a little over 12 pounds, less batteries. McMurdo Silver Company, 417 Lafayette St., New York 3, N. Y.—RADIO & TELEVISION RETAILING.

Pilot TV & FM SETS

Model 164, 16-inch black face tube table model, and model 167B, 17-inch black face consolette have been added to the line. The table model uses an 8-inch speaker, the consolette has a 12-inch speaker. Both sets have phono jacks and both are housed in mahogany veneer cabinets. Pilot Radio Corp., 37-06 36th St., Long Island City 1, N. Y.—RADIO & TELEVISION RETAILING.

Sheraton 20-INCH TV

The new Sheraton "Super-Video DX" TV receiver, shown here, was announced recently. Set features a 20-

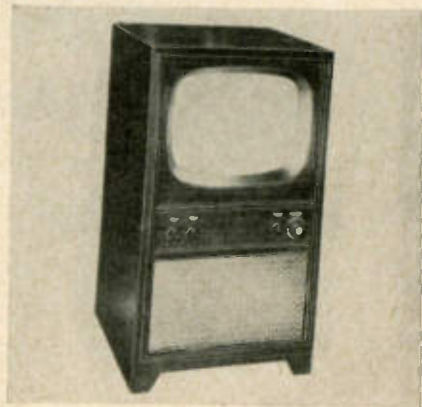

inch TV tube and 26-tube chassis. Sheraton Television Corp., c/o Video Products Corp., 2061 Broadway, New York, N. Y.—RADIO & TELEVISION RETAILING.

STAY TUNED IN!

Always
There's [^]a NEWS Program
from the TELETOWER

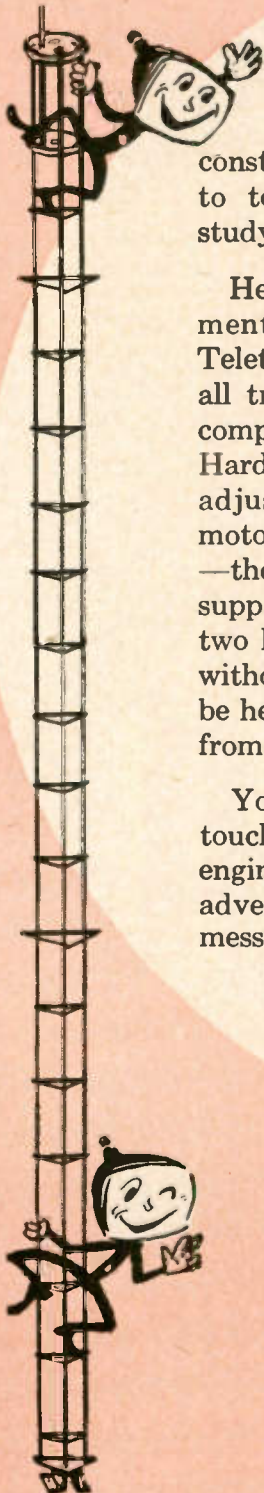

Teletower always has... does... and always will... place "high priority" upon development engineering. It was constant design study that pushed Teletower to top position in sales. *Continuing* design study will keep it "the tower in your future."

Here are just a few of Teletower's development engineering achievements: (1) The Teletower itself... today's "best seller" among all tripods—(2) The Thrifttower... the field's competitive-price leader—(3) The Tenna-Mast Hardware line of pole base mounts—(4) The adjustable roof mount—(5) The universal motor mount—(6) The built-in base—(7) And—the very newest—a "revolution" in antenna supports: the *new* baseless tower that supports two hundred and fifty pounds of stack weight without using a single strand of guy wire! You'll be hearing *plenty* more about this one soon... from Penn... from dealers... from set-owners.

You'll be robbing your future if you lose touch with today's developments in tower engineering. Watch this publication for our advertising... and watch your mail for timely messages from the Teletower.

STAY TUNED IN...

TO Teletowers!

A FEW DEVELOPMENT ENGINEERING ACHIEVEMENTS OF JUST ONE YEAR!



Pole Base Mount. Durable aluminum base with adjustable socket to accommodate 1" O.D. tubing to 2" pipe. Competitively priced.

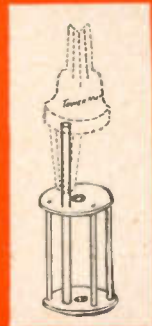

Universal Motor Mount. Fixed pole extending 9" beyond top of tower makes this mount easy to adapt to all antenna rotors. Centers on Alliance... firm, off-center mounting for other types.



Built-in Base. Permits raising tower on severest slope after base is fastened to roof. Heavy plate takes tower thrust.

PENN Teletowers
Thriftowers
Tenna-Mast

PENN BOILER AND BURNER MFG. CORP.
LANCASTER, PA.

2

useful
tools
for
reaching
those
cramped
corners

MIGHTY HANDY

in a "tight spot"

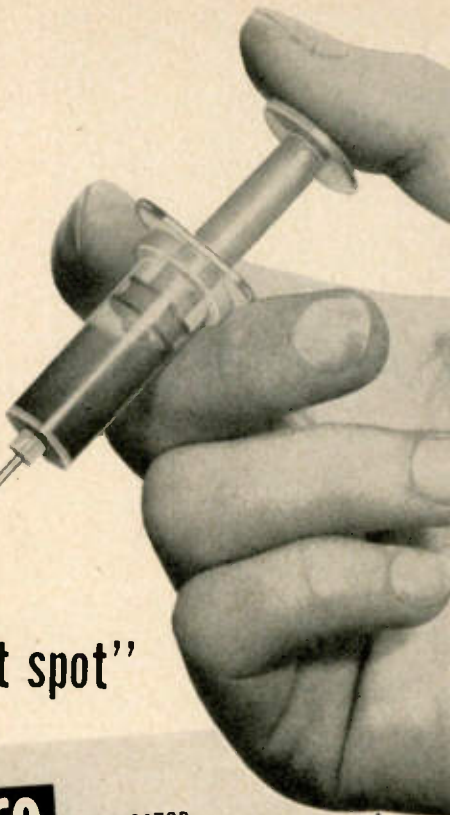

WALSCO LUBRICATOR

Designed to reach the many cramped and hidden points in radio, TV sets and record changers. Ideal for applying light greases and oils. Syringe-type plunger releases desired amount of lubricant.

ONLY 48c DEALERS NET*

WALSCO CONTACTENE INJECTOR

Permits application of contact chemicals to volume controls and switches without unsoldering connections or taking controls apart. Finest surgical-grade needle and oil-resistant, neoprene bulb.

ONLY 45c DEALERS NET.*

WRITE
FOR BULLETIN
NO. 60-R

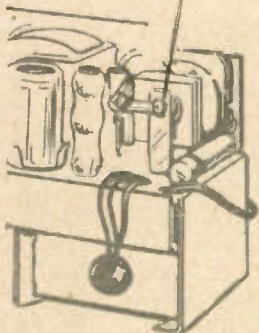

... AND SPECIFY FAMOUS QUALITY WALSCO RADIO CHEMICALS



CONTACTENE



NO-OX



WALSCOLUB "B"



TUNERLUB

*SOLD EXCLUSIVELY THROUGH JOBBERS EVERYWHERE. PRICES SLIGHTLY HIGHER IN CANADA.

WALSCO

WALTER L. SCHOTT CO.

Los Angeles 18, California • Chicago 6, Illinois

GE Training Kit



Two General Electric Receiver Division salesmen, D. S. Beldon (left), radio sales manager, and R. E. Noth, sales training manager, study the new portable radio sales training kit "Selling More GE Portable Radios," which is now being sent to dealers.

New Scott Dealers

Scott Radio Laboratories, Inc. has added sixteen new dealers to its list of franchised "distinguished dealer" outlets for its line of radio-phonograph and television sets, it has been announced by John S. Meck, president.

The new franchises have been issued to:

American Beauty Music Company, Rockford, Ill.; M. Corren & Sons, Stockton, Calif.; Woods Piano and Furniture Company, Birmingham, Ala.; Rhodes-Carroll Furniture Company, Birmingham, Ala.; The B. L. Taylor Electric Company, St. Helena, Calif.; North Shore Music Company, Lynn, Mass.

Also, Swayne Latham Tires, Inc., Memphis, Tenn.; Cook & Nichol Appliances Inc., Memphis, Tenn.; Modern Appliance Shop, Celina, Ohio; Whiteley's, Susanville, Calif.; Bennett Music House, Wichita, Kansas. Patrick Silk, Newport News, Va.; W. J. Davis Music House, Saginaw, Mich.; Miller Radio & Service Company, Dubuque, Ia.; Home Supply Company, Dubuque, Ia.; and Taylor Radio Company, Hattiesburg, Miss.

Award by Hotpoint



E. R. Taylor, general sales manager Hotpoint, Inc., congratulates John J. Goreman, who accepted George A. Hughes award for outstanding educational program to broaden markets and increase dealer sales of electric dishwasher equipment for the Philadelphia Electric company of Philadelphia.

Say!.. I'd Just Love to Meet You!



... and you'll want to meet me, too ... especially after I tell you all about myself ... how you and I could become bosom pals and really go places together. You'll see and prove to yourself that I have everything your customers desire ... that I embody only the best in electronic developments, providing two full hours of continuous performance with top fidelity. Take it from me ... I'm the first and only gal in my field offering $3\frac{3}{4}$ and $7\frac{1}{2}$ per second speeds plus super-speed forward and rewind ... and an editing key permitting corrections while playing ... my automatic features offer dependable, easy operation and prevent accidental erasure, spillage and breakage. And, mister ... if you want to see sales appeal in action ... then watch your customers' sales resistance melt when I thrill them with one of my demonstrations. I'm immediately available ... and impatient to meet you ... I can be reached at

The PENTRON Corporation, 225-DA East Cullerton St., Chicago 16, Ill.

be sure to make a date today ... huh?

Affectionately,

Miss Duo-Speed

P.S. I'll be waiting ... in person ... for you at Booth 124, Room 502, Hotel Stevens, May 21-23 ... if you come to Chicago.

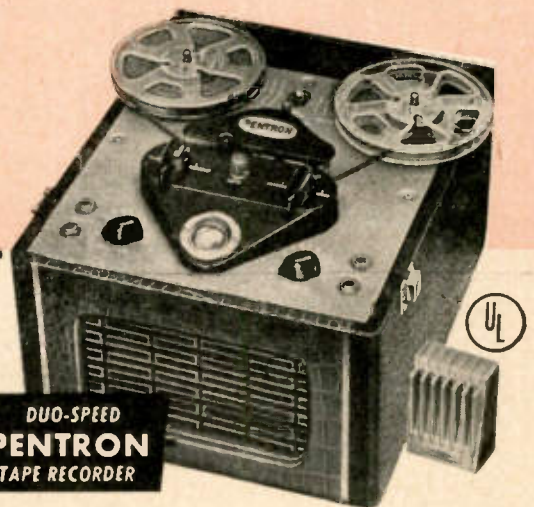

**DUO-SPEED
PENTRON
TAPE RECORDER**

Complete with Accessories **\$179.50**



\$59.50

PENTRON AUDIO-MIX

You'll love the professional-type electronic mixer for *all* audio systems. Meets the most exacting requirements for multiple microphone recording on tape, wire or disc ... or for public address systems. Four controls permit audio blending on each of four channels simultaneously.

Complete Line of Accessories Offer Repeat Profits

Backed by Sales Aids, National Advertising to Homes, Schools, Churches, Musicians, Professional People

Export Agents: SCHEEL INTERNATIONAL, Inc., Chicago

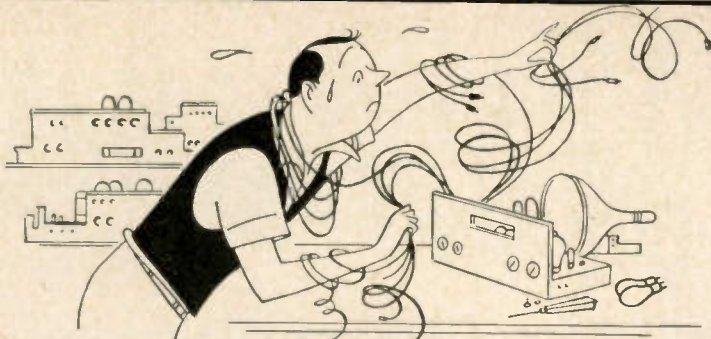

HELP! HELP! HELP!

Let John F. Rider help you untangle your servicing problems. RIDER MANUALS AND BOOKS have guided tens of thousands of servicemen on to better servicing and greater profits. They can be your "good right hand," too! Order from your Jobber today!

RIDER MANUALS

Now, more than ever, it is urgent that you have at your fingertips the priceless servicing data that can be found ONLY in RIDER MANUALS.

Rider TV Manual Vol. 6



ACCURATE . . . AUTHENTIC . . . FACTORY-AUTHORIZED TV servicing information DIRECT from 66 MANUFACTURERS. Big 12" x 15" page size, and all pages filed in place. Large, easy-to-read diagrams. Everything you need to speed servicing and satisfy your customers.

Exclusive Features:

- ALL TV production runs and changes from August, 1950 through January, 1951.
- Circuit action descriptions.
- Unpacking and installation material.
- Signal waveforms for troubleshooting.
- COMPLETE alignment data.
- COMPLETE parts list.
- Circuit changes.

Equivalent of 2320 pages (8 1/2" x 11") plus Cumulative Index Volumes 1 through 6 . . . \$24.00. With all 6 RIDER MANUALS you will own the world's greatest compilation of TV servicing information. SEE YOUR JOBBER TODAY!

Now Available!

RIDER MANUAL Vol. XXI



FACTORY-AUTHORIZED servicing material from 61 manufacturers . . . AM-FM-Auto Radios-Record Changers-Disc and Tape Recorders. Coverage from December, 1949 through October, 1950. 1,648 pages PLUS Cumulative Index Volumes XVI through XXI. . . \$21.00

Television Manual Volume 6 (Plus Index)	\$24.00
Television Manual Volume 5 (Plus Index)	24.00
Television Manual Volume 4 (Plus "How It Works" Book and Index)	24.00
Television Manual Volume 3 (Plus "How It Works" Book and Index)	24.00
Television Manual Volume 2—In new, larger page size 12" x 15". (Plus "How It Works" Book and Index)	24.00
Television Manual Volume 1 (Plus "How It Works" Book and Index)	19.80
Volume XXI	21.00
Volume XX	22.50
Volume XIX	22.50
Volume XVIII	19.80
Volume XVII	9.90
Volume XVI	22.50
Volume XV	19.80
Volume XIV to VII (each volume)	15.00
Volume VI	19.80
Abridged Manuals I to V (one volume)	1.50
Master Index, Covering Manuals Vol. I to XV	18.00
PA Equipment Manual, Volume I	

RIDER BOOKS

Practical books, written by men with actual firing line experience . . . help you increase your knowledge . . . save you time and money.

BEAT THE TUBE SHORTAGE



RECEIVING TUBE SUBSTITUTION GUIDE BOOK

by H. A. Middleton
For TV-AM-FM Receivers
and Allied Equipment

This amazing book shows you how to keep radio and TV sets working even though exact tube replacements are unavailable. 2500 radio and television tube substitutions listed, TV receiver filament wiring; heater substitution wiring instructions; tube types classified by functions . . . plus other important data you must have in order to keep receivers going. 224 pages, 8 1/2" x 11" durable paper cover. . . . Only \$2.40

ENCYCLOPEDIA ON CATHODE-RAY OSCILLOSCOPES AND THEIR USES

by John F. Rider and Seymour D. Usion



This is the ONLY book that so fully describes the oscilloscope . . . its application in servicing, engineering, research. It contains thousands of time-saving and work-saving references, charts, waveforms, etc. More than 70 different models are described with specifications and wiring diagrams. 992 pages, 8 1/2" x 11". 3000 illustrations. 22 chapters, completely indexed. . . . Only \$9.00

TV INSTALLATION TECHNIQUES

by Samuel L. Marshall



Here are facts you should know about wind surfaces, mounting requirements, etc. Here is accurate data on receiver adjustment in the home. Here are municipal regulations in all major TV areas. Here is complete information on mechanical and electrical considerations. 330 pages, 5 3/8" x 8 3/8". 270 illustrations. Cloth bound. . . . Only \$3.60

OTHER BOOKS FOR THE SERVICEMAN

TV Master Antenna Systems	\$5.00
TV and Other Receiving Antennas	\$6.00
Radio Operator's License Q & A Manual, 2nd Edition	\$6.00
The Business Helper	\$2.00
FM Transmission and Reception	\$3.60
TV Picture Projection & Enlargement	\$3.30
Broadcast Operator's Handbook	\$3.30
Understanding Vectors and Phase	Cloth Cover \$1.89 Paper Cover \$0.99
Inside the Vacuum Tube	\$4.50
Understanding Microwaves	\$6.00
Servicing by Signal Tracing	\$4.00
Installation and Servicing of Low Power Public Address Systems	\$1.89
Vacuum Tube Voltmeters (Revised)	\$4.50
Automatic Frequency Control Systems	\$1.75

JOHN F. RIDER PUBLISHER, Inc. • 480 Canal St., New York 13, N. Y.

Portables

(Continued from page 96)

good dry-out under a Reflectorflood should precede the usual servicing procedures. A good way to prevent unpleasant returns on a job like this—when you are reasonably certain that the owner will pull the same trick again—is to bake the chassis out for a couple of hours in a household oven set to about 100 degrees, and then a quick spray of under-chassis components, and coils, with Krylon or similar dope. If the offender is a three-way portable, be careful to keep the Krylon off the line dropping resistor, or any other parts liable to run hot.

The Home Mechanic

A comment almost every serviceman handling battery portables will run into is: "It played until I put in those batteries I bought here yesterday." Don't make this one any harder for yourself than it has to be. The chances are the customer knocked a couple of tubes loose while struggling with the battery connections, and replaced them in the incorrect sockets. A good manual or the set manufacturer's bulletin should set you straight on this one with little delay.

Watch, too, for bent tube pins on miniatures. Very often a customer will have taken all of the tubes out of the set to get them tested, and will not only put them back in the wrong sockets, but also will bend several pins out of alignment. By proceeding with caution such pins can be straightened and the tube salvaged.

The set which plays on battery but not on AC is a familiar story to most radio men. Don't overlook the most likely trouble here when the set has a line cord dropping resistor. Presence of B plus voltage on the plates, but absence of filament voltage should call for a continuity check on the resistor section of the line cord. If it tests open the most likely spot is the point of connection to the AC plug.

The presence of the batteries themselves in a battery portable can lead directly to corrosion problems if the batteries have been run down and allowed to remain in the set. If you get one of these messes in the shop, check the variable condenser bearings and tube pin connectors after the general cleanup. Corrosion and failure in odd spots can often be traced to burst cells.

The wide fluctuations of temperature, humidity, and sand and gravel, can bring many battery portables into the service establishment. We've seen sets where the owner "tightened those loose screws . . ." (i.e. trimmers, of course) and where knowledge of missing tubes was disclaimed by the owner. Anything can happen to a battery portable—and it will!

NEW ELECTROSTATIC RECTANGULAR 20FP4

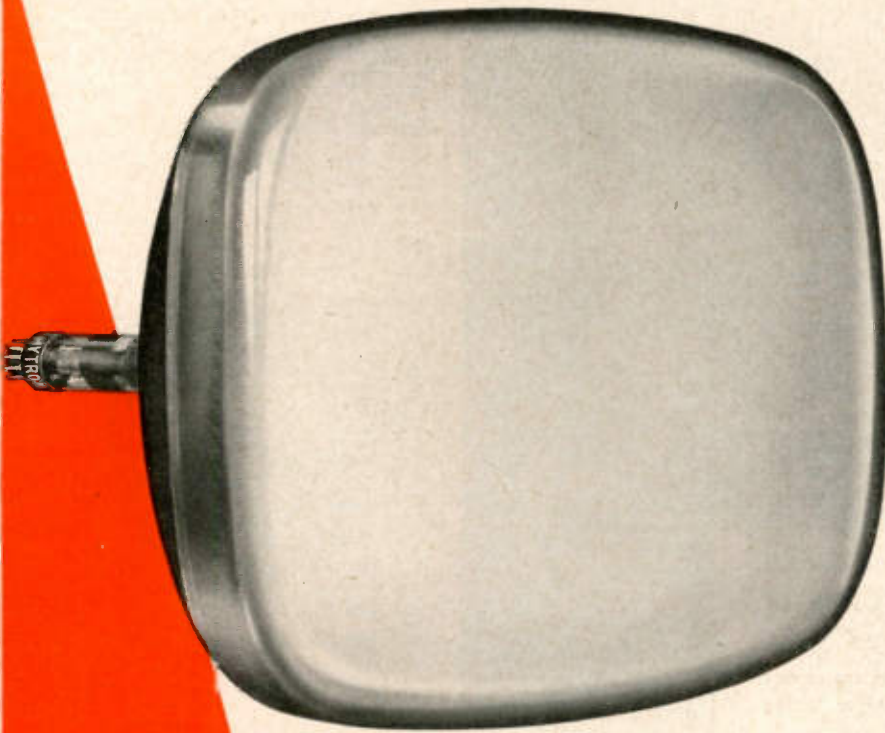

ANOTHER
HYTRON FIRST
FOR YOU

To its logically designed original *studio-matched* rectangular, Hytron now adds new advantages: the cobalt-and-copper savings of electrostatic focus.

The original Hytron electrostatic type 20FP4 eliminates the magnetic focus unit. Uses a single-field ion-trap magnet. Yet the 20FP4 gives you unsurpassed, clear, sharp pictures . . . despite economies in associated components enforced by defense needs.

Seeing is believing. Watch for this newest Hytron first from the world's most modern picture-tube plant. You'll be seeing it, buying it soon. You'll marvel at its sharp pictures, even at lower line voltages.

Again you'll say it pays to stay out front in picture tubes. It pays to insist on Hytron's original *studio-matched* rectangulars . . . choice of 9 out of 10 leading TV set makers.

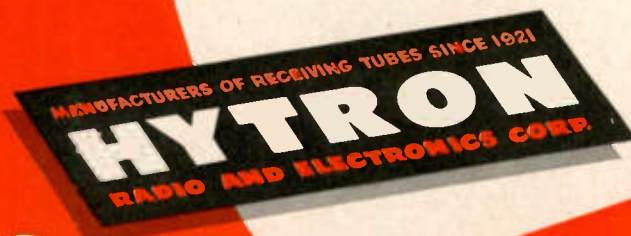

MAIN OFFICE: SALEM, MASSACHUSETTS

HAVE YOU
GOT YOUR COPY?

The new 5th edition of the Hytron Reference Guide for Miniature Electron Tubes is out. See your Hytron jobber. Get your free copy of this old friend brought up to date today.



SHOUT- FROM THE ROOFTOPS!



Ranger COMMANDAIR

Still the Lowest Priced
Highest Value Conicals
on the
market today!

CONICAL
ANTENNAS

Engineered to Outperform!
Priced to Outsell!

Dealers, Installers and Distributors everywhere acclaim JFD "Commandair" Conicals. They know from experience that feature for feature, dollar for dollar, JFD "Commandairs" are today's greatest conical antenna buy. Electrically superior, structurally stronger, they represent JFD's supreme achievement of years of pioneering in antenna design and manufacture. Add up the many extras you get with JFD "Commandair" Conicals and you'll see why it's the "sell-out" line for '51.

**NEW! IMPROVED! BETTER-THAN-EVER
ELECTRICALLY AND STRUCTURALLY!**



★ All-aluminum reinforced crossarm and heavy-duty U-bolt for longer lasting strength.

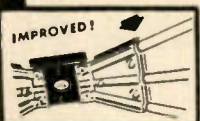

★ All-aluminum heavy gauge brackets with 3 full-length channels for secure anchoring of elements.

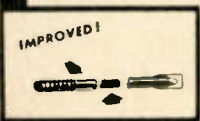

★ All-aluminum elements with hardwood dowels for extra rigidity. Serrated surfaces for tight, non-slip grip.

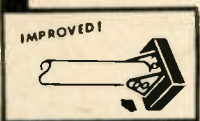

★ All-aluminum "take-off" support, with double solid rivets, anchors crossarm to element bracket.



★ All-aluminum bracket of unique design takes any combination of element arrangements to best suit location.

See us at
Booth No. 313
and Display Room
No. 534 at the
Chicago Parts Show.

JFD

MANUFACTURING CO., Inc.

6103 E 16th AVE., BROOKLYN 4, N. Y.
FIRST in Television Antennas
and Accessories

*All aluminum features are subject
to future government restrictions.

Philharmonic CLOCK-RADIO

A new clock-radio listing for \$29.95 has been announced. Called model 511, in an ebony bakelite cabinet, the set

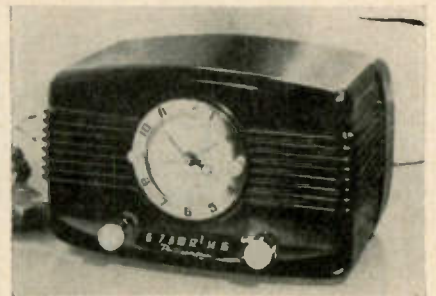

will turn on automatically, and then turn off again within 90 minutes. Philharmonic Radio & Television Corp., 119 W. 57 St., New York, N. Y.—RADIO & TELEVISION RETAILING.

Ferrar RADIOS & PHONOS

All new phonographs contain a Garrard automatic changer, model RC-80, and 8-inch speaker. Model GA-31 includes a three-tube amplifier; model GA-41 has a four-tube amplifier; and model GA-51 has a five tube amplifier.



All models are portable. The radio line contains one table model, T-61B, 6-tube AC-DC set receiving broadcast and shortwave; and two consoles: C-61B, 6-tube chassis and C-81D, 8-tube chassis. Both consoles also receive shortwave, and feature 8-inch Jensen speakers. Ferrar Radio and Television Corp., 55 W. 26th St., New York 10, N. Y.—RADIO & TELEVISION RETAILING.

Califone PHONO

A new portable, 3-speed automatic phono (shown) has been announced. Covered in Pyroxylin fabric, the unit lists for \$84.95 plus tax. Entire set turns

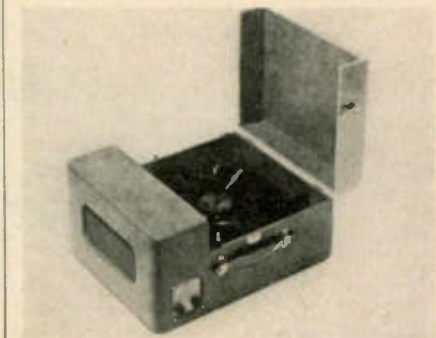

off when last record is finished. Plays all sizes intermixed. Also announced was a manual, 3-speed phono listing at \$54.95 plus tax. Califone Corp., Hollywood 38, Calif.—RADIO & TELEVISION RETAILING.

FREE! Brochure describing entire line of JFD "Ranger COMMANDAIRS" now available. Write for Form No. 87 today.



DON'T LET HIM "PITCH" YOU

**BLACK
IS
WHITE...**

INSIST ON

Sheldon "Telegenic" Picture Tubes

where **BLACK IS BLACK-**

WHITE IS WHITE- *and between*

ALL THE NATURAL

INTERMEDIATE SHADING!

This FULL RANGE of picture tones seen only on Sheldon "Telegenic" Picture Tubes, makes possible MAXIMUM CONTRAST with CLARITY . . . with NO EYE STRAIN and NO GLARE . . . whether on a Velour Black or clear face screen . . . whether viewed in daylight or under artificial light.

Superior picture quality is the reason why Sheldon Picture Tube production has been stepped up to 5,000 daily! This production increase is made possible by another recent installation of the most modern in-line exhaust unit in the industry.

SHELDON ELECTRIC CO.

A Division of ALLIED ELECTRIC PRODUCTS INC.
68-98 Coit Street, Irvington 11, N. J.

Branch Offices & Warehouses:
CHICAGO 7, ILL., 426 S. Clinton St. • LOS ANGELES 26, CAL., 1755 Glendale Blvd

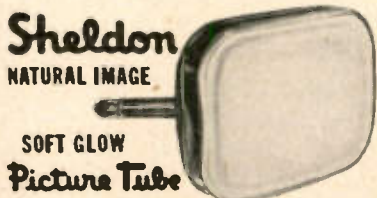

Manufacturers of
SHELDON TELEVISION PICTURE TUBES
CATHODE RAY TUBES • FLUORESCENT
LAMP STARTERS AND LAMP HOLDERS
SHELDON REFLECTOR & INFRA-RED
LAMPS • PHOTOFLOOD & PHOTOSPOT
LAMPS • TAPMASTER EXTENSION CORD
SETS & CUBE TAPS • SPRING-ACTION
PLUGS • RECTIFIER BULBS

**WRITE FOR VISUAL PROOF
OF SHELDON'S SUPERIOR PICTURE QUALITY!
MAIL COUPON TODAY**

Sheldon Electric Co., 68 Coit St., Irvington 11, N. J. B

Send Proof of Picture Quality
 "Characteristics and Dimensions" Wall Chart
 "Television Mis-Information"
 "Ion Burns—How to Prevent Them" Brochure
(They're free — but PLEASE PRINT)

Name _____ Title _____
 Company _____
 Street _____
 City _____ Zone _____ State _____

VISIT BOOTH NO. 201, PARTS DISTRIBUTOR SHOW, STEVENS HOTEL, CHICAGO, MAY 21-23.

© 1951—ALLIED ELECTRIC PRODUCTS INC.



Introducing...

A new SHURE family of crystal and ceramic fine-groove and standard cartridges

SPECIAL CRYSTAL MODEL W31AR and Ceramic Model WC31AR are unsurpassed for replacement of RCA "45" R.P.M. Changer Cartridges (ideal for 33 1/3 R.P.M. too!)

Unique needle design provides the easy needle replacement everybody has been looking for—and protects cartridge from mechanical shock.

THESE NEWLY DEVELOPED CARTRIDGES PROVIDE:
Easy Cartridge Installation • Maximum Fidelity • Easy Needle Replacement

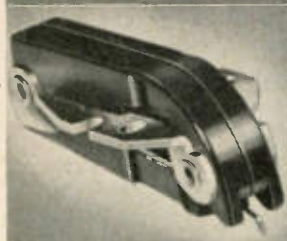

Universal, light-weight aluminum mounting ears will fit either 1/2" or 3/4" mounting.

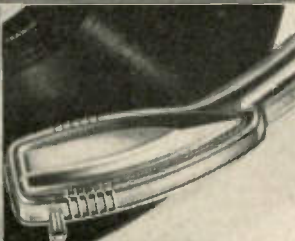

Response-frequency characteristic designed to complement record response for maximum fidelity and minimum noise.

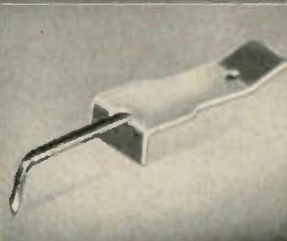

New, specially designed needle with broad shank and finger-nail grip bar. Long-life osmium point.

THIS NEWLY DEVELOPED SERIES OF CARTRIDGES

is the last word for first-place reproduction at low cost. So easy to install, the Serviceman will ask for them over and over again. High vertical compliance of the especially designed needle protects the crystal and ceramic elements from "drop-shock" damage.

Model	Type	List Price	Output Voltage	Needle Force	Shure Needle No.	Code
W31AR	Crystal 33 1/3 & 45 R.P.M.	\$6.50	2.1 V	7 grams	A53MG	RUGEB
WC31AR	Ceramic 33 1/3 & 45 R.P.M.	6.50	.65 V	7 grams	A53MG	RUGED
WC33B	Ceramic 78 R.P.M.	6.50	.75 V	9 grams	A52A	RUGEL
W36B	Crystal All-Purpose	6.50	2.5 V	9 grams	A56U	RUGEN
WC36B	Ceramic All-Purpose	6.50	.7 V	9 grams	A56U	RUGER

Shure Patents Pending.
Licensed Under Patents of Brush Development Co.



SHURE BROTHERS, Inc. ★ Manufacturers of Microphones and Acoustic Devices
225 W. Huron St., Chicago 10, Illinois • Cable Address: SHUREMICRO

Motorola RADIO-PHONO

A new FM-AM radio phonograph console has been introduced. The new model (91FM21) sells for \$299.95, and



is housed in a mahogany cabinet of modern design. Tone arm of the phono may be handled while in motion without injury to the mechanism. Motorola Inc., 4545 Augusta Blvd., Chicago 51, Ill. —RADIO & TELEVISION RETAILING.

Majestic TV PRICES

Model 70, shown here, 17-inch rectangular tube table model, has been repriced from \$239.95 to \$199.95. Also announced was a price change on the



model 712, 17-inch mahogany console from \$299.95 to \$269.95. Majestic Radio & Television, 70 Washington St., Brooklyn 1, N.-Y.—RADIO & TELEVISION RETAILING.

Cadillac 17-INCH TV

A new 17-inch table model TV set has been added to the line. The new set,

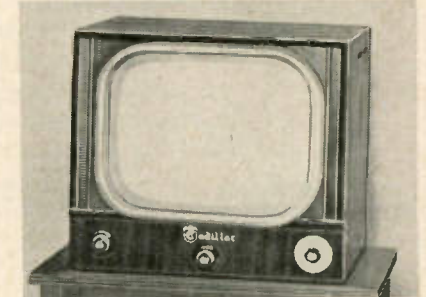

shown here, is the Sutton, in mahogany cabinet, and lists for \$189.95. Cadillac Electronics Corp., 19 W. 26th St., New York, N. Y.—RADIO & TELEVISION RETAILING.

Jensen ACOUSTIC TAPE

New recording tape has been announced. Available in 150, 600 and 1200 foot sizes wound on plastic reels, both paper and plastic base. List prices range from 75¢ to \$5.50. Jensen Industries, Inc., 329 S. Wood St., Chicago 12, Ill.—RADIO & TELEVISION RETAILING.

"This Seal means a 'Good Deal' to me!"

"My Television and Radio sets are pretty big investments to me. That's why I insist that they be serviced by a Raytheon Bonded Electronic Technician — a technician whose work is backed by a cash bond — whose skill and integrity are above reproach."

The RAYTHEON Bonded Electronic Technician Program means a *good deal* to you, too. If you can qualify for this important honor, your 90-day guarantee on TV and Radio repairs is cash-protected up to \$400.00 by a *bond*. You receive a Registered Certificate, Identification Cards, Creed Displays and Decals and a host of other sales helps and shop aids — all designed to tell the world you're a completely capable, thoroughly reliable service dealer—a dealer with whom customers can deal with complete confidence. And yet, this great sales stimulator *costs you nothing* — it's Raytheon's investment in your future.

If you're interested in getting head and shoulders above your competitors, better ask your Raytheon Tube Distributor if you can qualify for this exclusive sales asset.



RIGHT... for
SOUND and SIGHT



RAYTHEON MANUFACTURING COMPANY

Receiving Tube Division

Newton, Mass., Chicago, Ill., Atlanta, Ga., Los Angeles, Calif.

RADIO AND TELEVISION RECEIVING TUBES, CATHODE RAY TUBES, SPECIAL PURPOSE TUBES, SUBMINIATURE TUBES, MICROWAVE TUBES

Excellence in Electronics

CONTRACT 100

NEW ASTATIC CARTRIDGE REPLACES ADMIRAL 78 RPM SNAP-IN CARTRIDGE

(Admiral
Part No.
A1372)

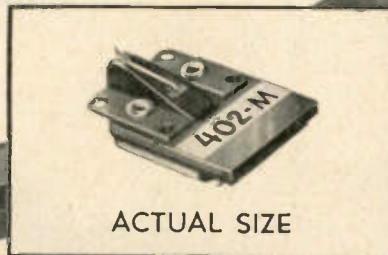

ACTUAL SIZE

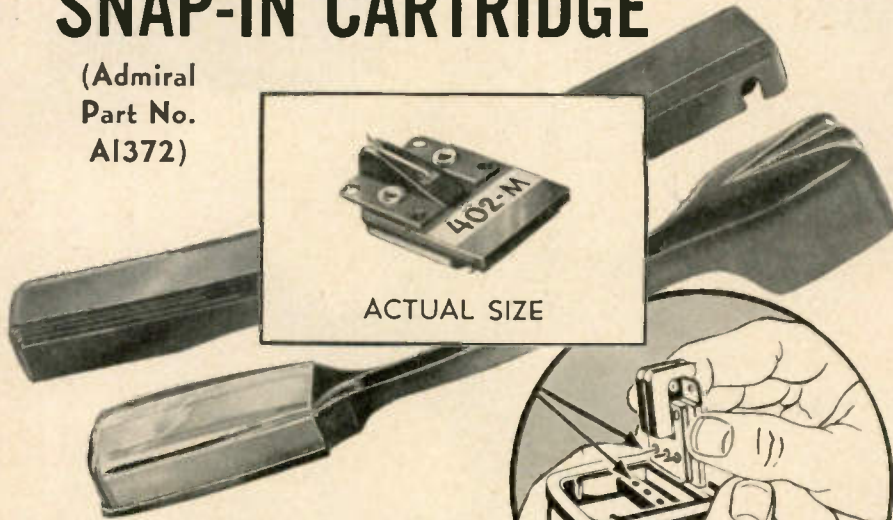

**Special Astatic Model
402-M Ceramic Cartridge
is Designed for Simple
Plug-in Installation**

INSTALLING Astatic's special new 402-M Ceramic Cartridge in the Admiral Arms for which it was designed is a simple matter of inserting the three-prong terminals in the three snap-in receptacles found in these arms. Snap-in action holds the 402-M securely in place and nothing else need be done.

Top-notch performance is assured. Output of the 402-M has been increased above that of similar cartridges. Light weight and minimum needle pressure are additional advantages. Astatic type "G" replaceable needle with 3-mil precious metal tip is employed.

SPECIFICATIONS

Model No.	List Price	Minimum Needle Pressure	Output Voltage 1000 c.p.s. 0.5 Meg Load	Frequency Range c.p.s.	Needle Type	Approx. Net Wt. in Grams	Code
402-M	\$6.90	12 gr.	0.7* *Audio-tone Test Record	50 to 10,000	G-78 (osmium tip)	8	ASWZN

Write for new Astatic Form No. 51, Complete Reference Chart on Astatic Cartridges which are Replacements for various Admiral Phonographs and Phonograph Combinations.



Emerson Radio Show



Fred Robbins, emcee for "Robbins' Nest" radio program, chats with Vivian Blaine. "Robbins' Nest" is now sponsored by Emerson Radio and Phonograph Corp. In cooperation with Emerson dealers.

Big RCA Victor Campaign

An extensive advertising and promotion campaign designed to build attendance at professional baseball games during 1951 has been launched by RCA Victor as part of a program sponsored by the RTMA. Plans for the campaign were announced by J. B. Elliott, vice-president in charge of RCA Victor Consumer Products and chairman of the Sports Committee of RTMA.

The campaign is to be tied in with the celebration this year of baseball's Triple Anniversary—the 75th anniversary of the National League, the 50th of the American League, and the 50th of the National Association which represents all the minor leagues.

RCA Victor's promotion and advertising will continue throughout the 1951 season, including the World Series.

As described by Mr. Elliott, the RCA Victor campaign includes national magazine, newspaper, radio, and television advertising, and a wide variety of promotions, all urging attendance at the ball parks.

Gets W-G Recordette



Former McAllister professor, Glenn Clark of St. Paul, Minnesota, is presented with a Wilcox-Goy Recordette-3 by emcee Tommy Bartlett on a recent coast-to-coast NBC "Welcome Travelers" broadcast.



MODEL
12300

Entirely
NEW

The 3 Speed
MILWAUKEE
Automatic
Record Changer

**Equipped With The Newest And
Most Reliable Multi-Speed Motor**

Check These

MILWAUKEE
"Exclusives"

- ✓ EXCEPTIONALLY FAST CYCLE CHANGE TIME
- ✓ PATENTED ANTI-SKATE DEVICE ELIMINATES NEEDLE SKATE OR SKID WHEN LANDING
- ✓ VERTICAL AND LATERAL TONE ARM FRICTION REDUCED TO A BARE MINIMUM
- ✓ PATENTED COMPENSATING COUNTERBALANCE ASSURES UNIFORM NEEDLE PRESSURE ON ONE RECORD OR A FULL STACK
- ✓ ALL NORMAL ADJUSTMENTS MADE FROM TOP SIDE OF CHANGER

aTTRACTED by the performance and efficiency of the completely new MILWAUKEE 3-Speed Automatic Record Changer, foremost manufacturers of phono-combinations are specifying this dependable equipment in volume quantities. It is backed by the extensive production facilities and fifteen years of research and engineering experience of the Milwaukee Stamping Company. Use this 3-Speed unit to replace obsolete 1 and 2 speed record changers. Furnished with base or pan with proper A-C cord and sound cord to play through the amplifying system of any T-V set or radio. When we say that the new MILWAUKEE Record Changer "has everything," here's what we mean:

- Shuts off automatically after playing last record and returns tone arm to rest.
- Records shuttle from newly developed center spindle.
- Records supported at two points for ease and convenience of loading—minimizes record center hole wear—no cumbersome arms or bars.
- New quick-acting velocity trip-timing is integrated with turntable.
- Single switch control action.
- Extremely simple setting arrangement to play various size records. Automatic and "fool-proof".

Visit the "MILWAUKEE" Suite at the Stevens Hotel
During the Parts Show, Chicago, May 21 to 24, 1951

MILWAUKEE STAMPING COMPANY
MILWAUKEE 14, WISCONSIN

**"When did you
last change your
Phono-Cartridge?"**



**That's your
\$70 (Million) question,
Mr. Service-Dealer!**

Right now . . . 10,000,000 old style, heavy, stiff-acting phono-cartridges in existing record players are *obsolete*. They limit reproduction. They rapidly wear out valuable records. They should be replaced immediately with *modern, lightweight, compliant* cartridges that guarantee greater record enjoyment, longer record and needle life. Current cartridges that operate inefficiently should be replaced, too.

So check the cartridge on every job . . . ask every record player owner this simple question: *"When did you last change your phono-cartridge?"* You'll render a service your customers will appreciate—you'll sell replacements like never before—you'll make more money!

Now for better playing, record saving performance . . . REPLACE . . . MODERNIZE with easy-to-install E-V Cartridges. Exclusive features of E-V Torque Drive make it ideal for fast and slow speed records. Has extra-high voltage-compliance ratio. No bearings or bushings to deteriorate. Simplified design permits maximum replacements with fewer models. Single and dual needle types. Used today in original equipment of many leading manufacturers.

Make the Finger-Tip Compliance Test



**Modern,
compliant
needle system**

**Old style,
stiff-acting
needle system**

Electro-Voice

422 CARROLL STREET • BUCHANAN, MICHIGAN
Export: 13 East 40th St., New York 16, N.Y., U.S.A. Cables: Arlab

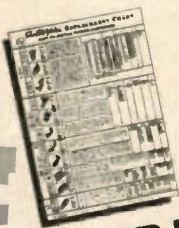

FREE!

REPLACEMENT CHART

Large, Complete Replacement Chart. Gives handy cross-reference and valuable data. Tells when to replace a phono-cartridge. Ask your E-V Distributor or send for it now.

Electro-Voice, Inc., Dept. R5-1
422 Carroll St., Buchanan, Michigan

Send FREE Cartridge Replacement Chart

Name (PLEASE PRINT)
Address
City Zone State

SERVICE TECHNICIAN DEALER RECORD FAN

Presents Tele King



Harvey L. Pokrass, president of Tele King Corp., presents a 19" Tele King console television set to Miss Chrystal Jackson as Bill Slater, emcee of WOR'S "Luncheon At Sardi's" program congratulates her. Miss Jackson was the winner of a contest conducted by "Luncheon At Sardi's" in conjunction with Paramount's current picture "The Mating Season."

NU to Build New Plant

National Union Radio Corporation has purchased 50 acres of land in northeast Philadelphia as the site of a new electronics center, with construction to be started immediately on the first unit at a total investment of over \$6,000,000. The announcement of this move was made by Kenneth C. Meinken, president of National Union.

Andrea Promotion

A powerful advertising theme which stresses the Andrea television receiver's "trouble-proof" performance, will be given wide use through a number of effective sales promotional items prepared for dealers, Lynn Eaton, general sales manager of Andrea Radio Corporation, has announced.

C-D Ad Manager



Emil J. Maginat, above, has been appointed manager of advertising for Carnell-Dubiller Electric Corp., South Plainfield, N. J. Mr. Maginat is known throughout the industry from his association of over twenty-five years in the servicing, retailing, wholesaling and manufacturing phases of the business.

ONE STANDARD—*The best that can be made*—
For Initial Equipment and Replacement



TUNG-SOL

RADIO, TV TUBES, DIAL LAMPS

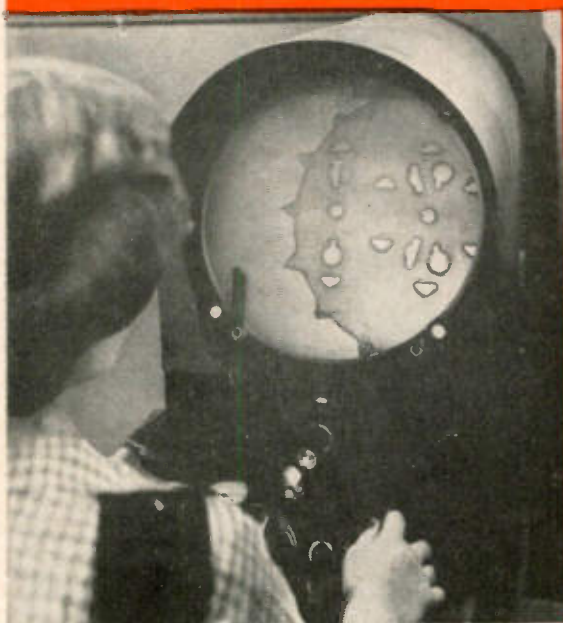

Optical comparator
is used to check mica
disc specifications
to thousandth-inch
accuracy.

TUNG-SOL LAMP WORKS INC., Newark 4, N. J.—Sales Offices: Atlanta
Chicago • Dallas • Denver • Detroit • Los Angeles • Newark

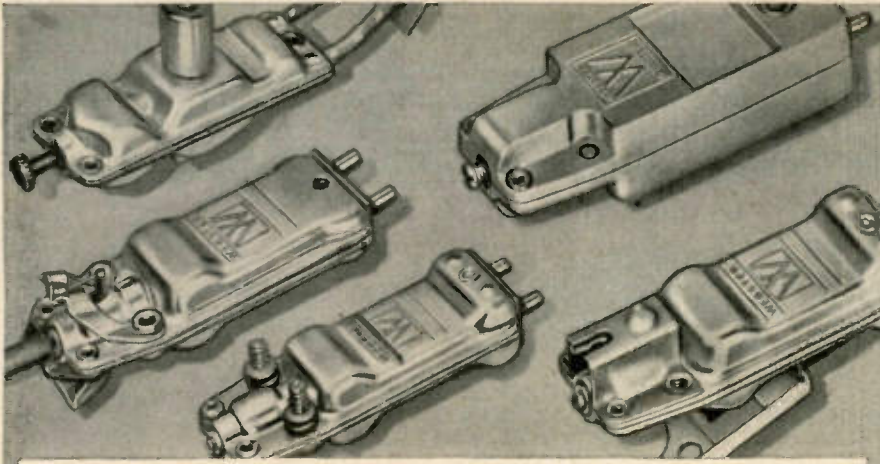

WEBSTER ELECTRIC one of the original
manufacturers of crystal cartridges

FOR OVER **20** YEARS
a complete line of cartridges

Engineered to meet your requirements

Webster Electric has been making cartridges for years and years . . . starting way back when cartridges were nearly as big as baseballs. The line of cartridges has constantly changed and improved to meet current requirements. Each year has brought improvements until cartridges are now available in thumb-nail size and versatile enough to meet the requirements of 78, 33 $\frac{1}{3}$ and 45 RPM.

Webster Electric has the experienced engineers, manufacturing know-how and long-range experience to make cartridges to meet all of the industry's requirements.

When you need a new cartridge submit your problem to Webster Electric. When your record players or changers are equipped with Webster Electric cartridges, you can be assured of the best in dependable performance.

Webster Electric Company, Racine, Wis., Established 1909

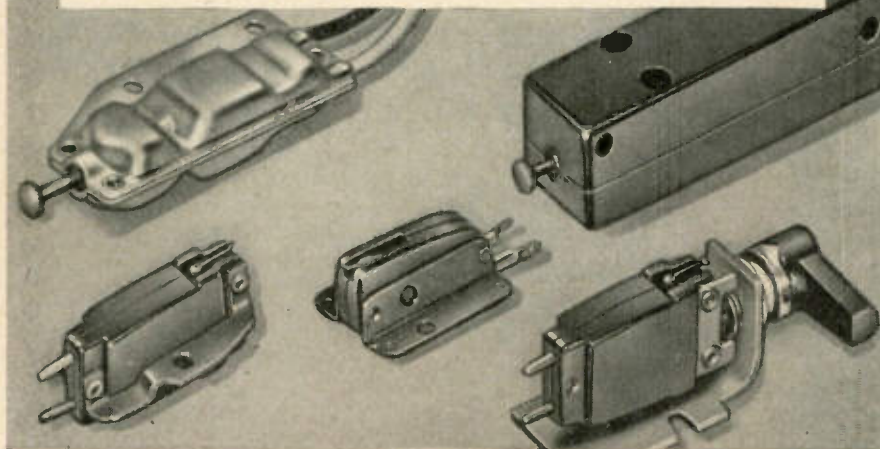

WEBSTER ELECTRIC
RACINE ♦ WISCONSIN

"Where Quality is a Responsibility and Fair Dealing an Obligation"

Wilcox-Gay Sales Up

The 1950 operations of the Wilcox-Gay Corporation, Charlotte, Michigan, reflect the benefits of its merger with the Garod-Majestic companies, it was disclosed in its recent annual report. The company reports net sales of \$8,002,572 for the year ended December 31, 1950, which is four times the volume of \$1,943,994 in the preceding year. Earnings after taxes were \$28,205 vs. a loss of \$755,761 in 1949. In the first eight months of 1950, prior to the merger with Garod-Majestic, sales amounted to \$1,953,947, which resulted in a loss of \$444,720. In the last four months of 1950 after the merger, sales amounted to \$6,048,625 with net profits, after taxes, of \$472,925. This is an all time high in sales and earnings for any four month period in the history of this 18 year old company.

In Sparton Position

Henry L. Pierce, general sales manager of Sparton Radio-Television, has announced the recent appointment of Wm. H. Higgins as field manager. Mr. Higgins is undertaking field work with district merchandisers and key dealers. This includes both merchandising and sales training work. Mr. Higgins was formerly sales manager of U.S. Television Company and his home is in the New York area.



- Heavily weighted, non-tilt, Bakelite base
 - Holds firmly in any position
 - Three-section Telescopic antenna
 - All-position orientation
 - All-Channel reception
 - Neat in design
 - Blends with any room decor
 - Provision for wall or window mounting
 - Supplied with transmission line
- Engineered to give ultra fine reception at any desired angle. It's heavily-weighted base, 4" in diameter, insures stability.

CAMBURN, INC. 32-40 57th STREET
WOODSIDE, L. I., N. Y.

Write for Camburn Catalog R-5



MILLIONS WANT IT! AMPRO MAKES IT!

World's Lowest Priced Tape Recorder!



Records Anything!
Plays Back Instantly!
Records Permanently or Erases Tape Over and Over!



BIGGEST MARKET SINCE TELEVISION



PARENTS PERMANENTLY RECORD BABY'S FIRST WORDS! Ampro is the ideal family recorder for reunions, weddings, anniversaries, parties and other special events.

DOCTORS RECORD RESEARCH FINDINGS . . . LAWYERS RECORD CASE MATERIAL. Professional men and women welcome this easy, inexpensive way to keep records.



BUSINESSMEN, EXECUTIVES, SALESMEN USE IT FOR DICTATION. This new tape recorder makes a simple-operating low cost dictation unit . . . dictation can be erased from tape for use over and over.



EDUCATORS, SOCIAL WORKERS USE IT FOR AUDIO EDUCATION. Teachers find the new Ampro Tape Recorder a helpful guide toward instructing through sound.



ONLY AMPRO GIVES YOU THESE 8 SELLING POINTS TO CLINCH THE GREATEST MASS MARKET AT THE

World's Lowest Price **\$119⁷⁵** Complete

1. Lowest First Cost!
2. Greatest Operating Economy!
3. Light, Compact (17 lbs.)!
4. Easy to Thread, Operate!
5. Big 5" x 7" Speaker!
6. Instant Stop Switch!
7. No Accidental Erasing!
8. External Speaker Outlet!

Just put this new low cost tape recorder on your counter—you'll be amazed at the traffic it'll stop—you'll be mighty pleased how easily it sells. Let your customers work it themselves. Once they see how simply it operates—how much *real* fun it is—all you need do is suggest a few uses and you've made a sale! Parents want it for keeping baby's voice, recording family events, party fun, music—professional folks use it for record keeping, dictation, training employees and students. Just about everyone in town is a potential prospect for this new self-seller. Get the complete money-making facts on an Ampro franchise—mail coupon today!

DON'T DELAY... WRITE TODAY!

AMPRO CORPORATION RTR-5-51
 A General Precision Equipment Corporation Subsidiary
 2835 N. Western Ave., Chicago 18, Illinois
 I am interested in complete information on a franchise for the new AMPRO Tape Recorder. I am a () Dealer () Distributor.
 Name.....
 Firm Name.....
 Address.....
 City..... State.....

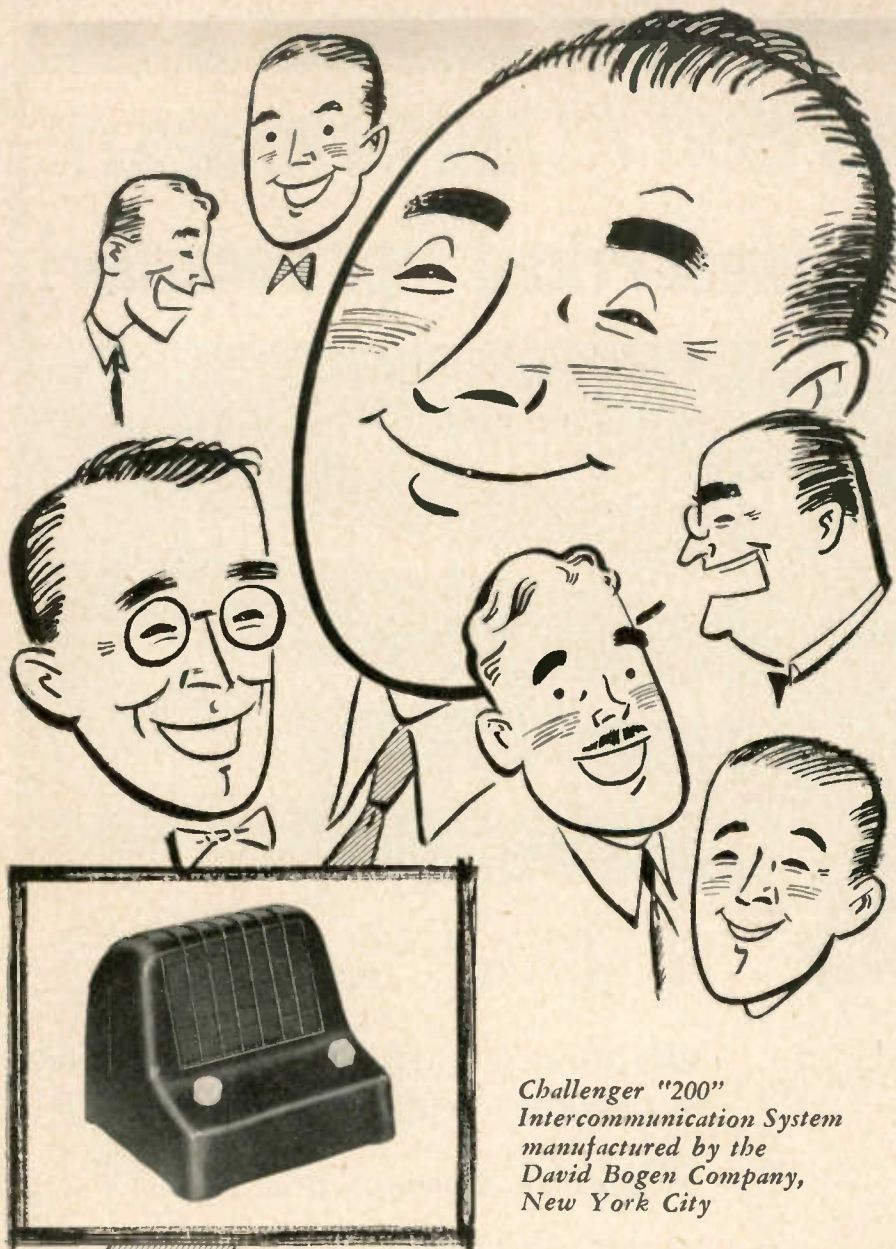

*Challenger "200"
Intercommunication System
manufactured by the
David Bogen Company,
New York City*

**we're
happy**

Sound reproduction is of the utmost importance to the David Bogen Company. We, at Oxford, are happy because OXFORD SPEAKERS are used in David Bogen products.

We're pleased with this testimony that we meet the most critical demands for high fidelity performance.

For over a quarter of a century Oxford has been manufacturing speakers to the most exacting requirements. We're happy that we can provide the most complete speaker line . . . for TV, FM, AM, Auto, PA and outdoor applications.

Visit Booth #312
and Display Room #529
Hotel Stevens
May Parts Show

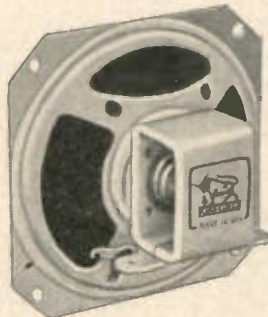

*Leading jobbers carry
OXFORD SPEAKERS.
Write for your copy of
our latest catalog.*



OXFORD ELECTRIC CORPORATION

3911 South Michigan Avenue • Chicago 15, Illinois
EXPORT: ROBURN AGENCIES, NEW YORK CITY

Rider Names Slawson



William "Bill" Slawson, above, has been named general sales manager by John F. Rider, president of John F. Rider Publishers, Inc., 480 Canal St., New York. Mr. Slawson will attend the Parts Distributors' Conference and Show in Chicago with John Rider, Bill Marcus and Stan Schlenger.

GE Sales Training

"Sales Through Service" is the theme of training meetings now being conducted on a national scale by General Electric distributors for major appliance dealers and their servicemen. Although the meetings are intended primarily to train personnel on servicing major appliances, considerable attention is given to the subject of customer satisfaction.

New Symphonic Plant

Symphonic Radio and Electronic Corporation of Boston, will open a modern new branch plant in Wakefield, Mass., located at 16 New Salem Street, it was announced by M. H. Cogan, Symphonic president. Incorporated as Wakefield Wood Industries Inc., the new Symphonic branch will



M. H. Cogan

manufacture portable carrying cases for the entire line of 17 models. Plans are also in the making for the production of radio and television cabinets. Occupying the entire 20,000 square foot area formerly used by a furniture manufacturer, the Symphonic Wakefield branch will employ over 100 people at peak production, turning out approximately 1000 carrying cases daily.

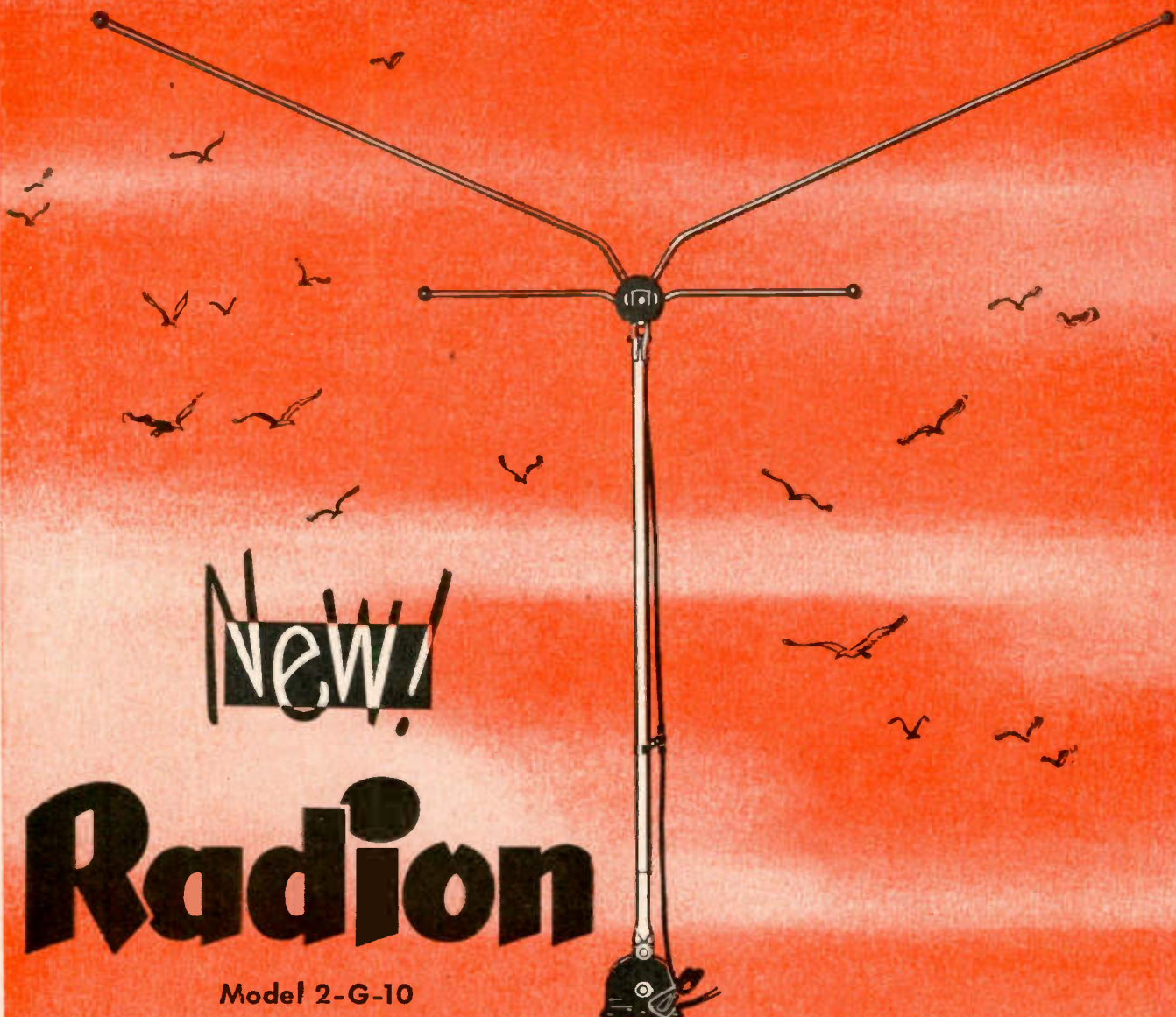

NEW!

Radion

Model 2-G-10

"The Suburban"

Again, as so often in the past, *Radion* provides a terrifically effective "shot in the arm" for your TV set-sales! "*The Suburban*" cinches those outlying prospects for you as fast as close-in orders are cinched by that old established standard of the industry, *Radion* Model TA-49, "The Metropolitan."

Radion cuts installations from hours to minutes—kills that "high cost" bugaboo that slows up sales

—saves you time and money, helps build your sales volume. Ask your jobber! Or write direct. TODAY!

The Suburban—Model 2-G-10—Gull-wing conical antenna for up to 25 miles from transmitter, all channels. Copper coated steel with silver-gray baked enamel finish; plated hardware; universal mounting base for speedy installation on wall, roof, window or in the attic, with no tools needed except pliers and screwdriver.

Completely factory assembled with 300-ohm lead-in and necessary mounting hardware. Individually packaged. Packed six to a master carton; shipping weight, 28¼ lbs. List, \$12.50.

2,000,000 RADIONS

HAVE PAID GOOD PROFITS TO DEALERS!

Write:

THE RADION CORPORATION, 1137 MILWAUKEE AVE., CHICAGO 22, ILLINOIS

Walco

... prime
manufacturers of

JEWEL AND ALLOY TIPPED NEEDLES

for the Nation's record playing equipment



Installed as original equipment in leading makes of phonographs. In its large, modern, plant Walco manufactures more than 80 types of needles, many of which go into the finest and best known phonographs as original equipment.

Preferred for replacement. Those seeking needle replacements identical with original equipment choose Walco for good-as-new performance. Most often, Walco Replacement Needles are made at the same time and on the same equipment as the originals.

A new concept in merchandising enables dealers to "sell" replacement needles. The Walco C-I (Controlled Inventory) Plan and Master Control Index provides dealers with a system for needle Profits—

1. Identifies and helps sell the correct replacement needle for *any* phonograph by indexing all phonographs by model number, cartridge, and needle.
2. Furnishes dealers **FREE OF CHARGE** with a continuing information service on replacement needles for all phonographs. (Data on 1951 models is going out to Index owners now.)
3. Helps dealers control inventories to keep them at a minimum for maximum profit.

Get the facts on the C-I Plan and at the same time learn how you can get *free of charge* the Walco Master Control Index—the sure profitable method for increasing your customer-reputation for service.

WRITE FOR NEW CATALOG RR315

Walco

TRADE
NAME
OF

ELECTROVOX

CO.,
INC.

60 Franklin Street
East Orange, N. J.

WIDER PROFIT MARGIN!

with the new ...

TELE-TUNE TV BOOSTER ANTENNA



sensational!

write or call today

CITY TOOL ACCESSORIES CORP.

3831 West Lake Street • Chicago 24

new!

4

**QUICK-SELLING
FEATURES**

- Vastly improves reception of television sets.
- Rejects and reduces "Ghosts," Noise and "Snow."
- Provides additional pickup.
- Enhances any room with its rich appearance.

Elected Vice-Presidents



Thomas O. McDavid (left) and Carl J. Zink (right) have been elected vice-presidents of Commercial Credit Corp. They will be responsible for further developing the company's national activities in the industrial field comprising home appliances, television and radio sets, air conditioning and commercial equipment according to E. C. Wareheim, president of Commercial Credit Company.

New Meck Wholesalers

John S. Meck, president of John Meck Industries, Inc., has announced the appointment of Taran Distributing Company, Miami, Florida, as distributor for the Meck line of television receivers. The firm, headed by Sam Taran, also has offices in Jacksonville. Its operations will cover distribution of the Meck sets along the east coast of Florida.

Du Mont Appointment

The appointment of W. C. (Bill) Hitt of 1169 South Broadway, Los Angeles 15, as sales representative to jobbers for Du Mont Teletrons, is announced by the Cathode-ray Tube Division of Allen B. Du Mont Laboratories, Inc.

Enters Replacement Field

Further expansion of activities of Sarkes Tarzian, Inc., TV parts manufacturer, was made known recently by Sarkes Tarzian, when he announced the appointment of Charles L. Cade, as director of distributor sales for the Tarzian organization.

Stromberg Campaign



Poster in above picture is part of a drive by Stromberg-Carlson Company to get all dealers to plug the baseball league anniversaries this year. Posters urge public to "support your favorite baseball team."



HOME STUDY COURSE in TELEVISION SERVICING

... based on the experience of the RCA Service Company

Now available to the Industry

Here's *your* golden opportunity to take the time-tested RCA Service Company course on television receiver servicing... to earn a valuable RCA Institutes' certificate that can lead straight to a better job at higher pay.

Now, for the first time, *you* can take the same basic course that has already been given to the thousands of RCA's own servicemen... an easy-to-understand home-study course based on the actual experience of the RCA Service Company in servicing thousands of home television receivers.

Cost is *low*... only \$9 a unit for 10 units or \$90 total, on an easy pay-as-you-learn plan. And value is *high*... the certificate of completion issued by RCA Institutes is known and honored throughout the radio-electronics industry.

Never before available to anyone outside RCA. Now offered to *you* through RCA Institutes, one of America's oldest and most respected technical training schools. Course covers most major makes and types of TV receivers. Designed specially for men already in electronics; therefore no kits

or paraphernalia are required. Handed entirely by correspondence. Available *exclusively* to men in the radio-television-electronics field. Not offered to the general public, or under the G.I. Bill.

ENROLL NOW! Mail the coupon *today*. Don't miss your great opportunity to take this proven course. If you're just getting started in TV, it will make you a *good* serviceman. If you're already *good*, it can't help but make you *better!* Send the coupon... get on the reservation list... **NOW!**

LOWER RATES FOR GROUPS!

If any employer in the radio-electronic industry desires to enroll six or more of his employees for this course, lower rates will apply. A special group application form is available for employers desiring to take advantage of this offer.



RCA INSTITUTES, INC.

A SERVICE OF RADIO CORPORATION of AMERICA
350 WEST FOURTH STREET, NEW YORK 14, N.Y.

MAIL COUPON TODAY!

RCA INSTITUTES, INC.
Home Study Department, RT-551
350 West Fourth Street
New York 14, N. Y.

Without obligation on my part, please reserve a place for me in your *home study course on television servicing* and send me full details. No salesman will call. I understand I must be employed in the radio-TV-electronics field to qualify for the course.

Name _____
(Please Print)

Address _____
(Street)

City _____ Zone _____ State _____

New GE Department

The organization of the General Electric Company's newly created Traffic Appliance Department was announced by Charles K. Rieger, general manager. Robert E. Boian has been appointed manager of marketing; Edwin R. Koester, manager of manufacturing; Frank Stehlik, comptroller; William H. Dennler, manager of the heating device division and Robert Orr, manager of the vacuum cleaner and fan division. David C. Spooner and Robert O. Fickes will continue in their respective positions as managers of the automatic blanket and clock divisions.

Presentation Marks 25 Years With Clarostat



Left to right: Victor Mucher, president of Clarostat Mfg. Co., Dover, N. H.; Ev Gordon, export staff; John Mucher, chairman of the board; Jacob Mucher, retired company executive; and Norman Simons, export staff. The occasion is the presentation of inscribed wrist watches to Gordon and Simons marking their 25 years of service with Clarostat.

the standard by which quality is measured!

TECH-MASTER Television

Your quality-minded customers wisely choose TECH-MASTER because our equipment is superior. . .

- 1 ENGINEERING wise!
- 2 CIRCUIT wise!
- 3 COMPONENT wise!

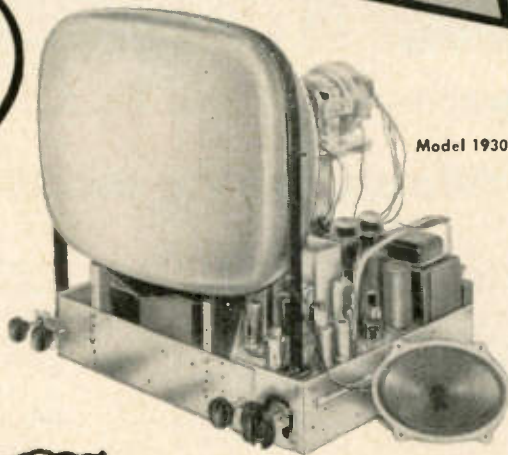

TECH-MASTER PRODUCTS

- Improved 630 Type chassis.*
- New 630 Type Kits.
- LO-COST Universal TV Kits.
- Conversion Kits.
- Adjustable Kine Tube Mounting Brackets.
- Booster Kits.
- AGC Kits.
- Quality TV Components.

* Suited for all picture tubes from 12" round to 20" rectangular. Also available with FM Tuner, Phono Jack and Push-Pull Audio.
Write Dept. RR-5 for literature.

Only TECH-MASTER manufactures a complete line of Custom Quality TV chassis. The superior quality of our product is the result of advanced engineering and pledged determination to produce the optimum in television reception. You cannot obtain a finer or more "up-to-the-minute" TV receiver than a TECH-MASTER.

Something new in TV!!!
Only TECH MASTER has it!!!
Display Room 549
Chicago Radio Parts Show

TECH-MASTER PRODUCTS CO.

443-445 Broadway • New York 13, N. Y.



CBS May Acquire Hytron

The boards of directors of Columbia Broadcasting System, Inc., and Hytron Radio & Electronics Corp., have agreed, subject to approval of stockholders, that the assets and business of Hytron will be acquired by CBS through an exchange of stock. When the transaction is completed, the TV and radio tube manufacturing business of Hytron, and the TV and radio set manufacturing business of Hytron's subsidiary, Air King Products Co., Inc., will continue under the management and direction of its present officers.

Westinghouse Appointees

Herbert E. Plishker, manager of advertising and sales promotion for the Westinghouse Lamp Division since 1938, has been appointed manager of lamp sales, the company has announced. He succeeds Russell E. Ebersole who as staff assistant to Ralph C. Stuart, vice-president, now is in charge of all commercial activities for the Lamp Division. Plishker is succeeded as manager of advertising and sales promotion by Harry L. Niederauer.

New Regional Manager

Leonard S. North, formerly manager of the Sentinel TV Chicago distributorship has been appointed a regional manager of the Sentinel Radio Corporation, according to E. G. May, director of sales. North will manage the central territory, including the states of Michigan and Kentucky, along with southern Ohio and southern Illinois, west Tennessee and eastern Missouri.

Crest in New Quarters

Albert J. Eisenberg, vice-president of Crest Television Laboratories, Inc., manufacturers of electronic test equipment, announced the opening of new quarters in the Whitehall Building, Far Rockaway, N. Y. The plant and general offices will occupy two floors.

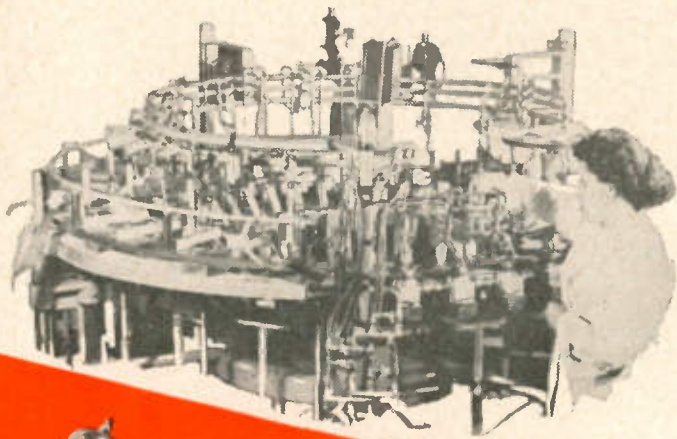

This 32-head exhaust unit, shown at the left, is one of the many specially designed machines used by Haydu Brothers to insure the high vacuum of all small tubes at high production rates. Stage-tests at intervals throughout production guarantee complete *quality control!*

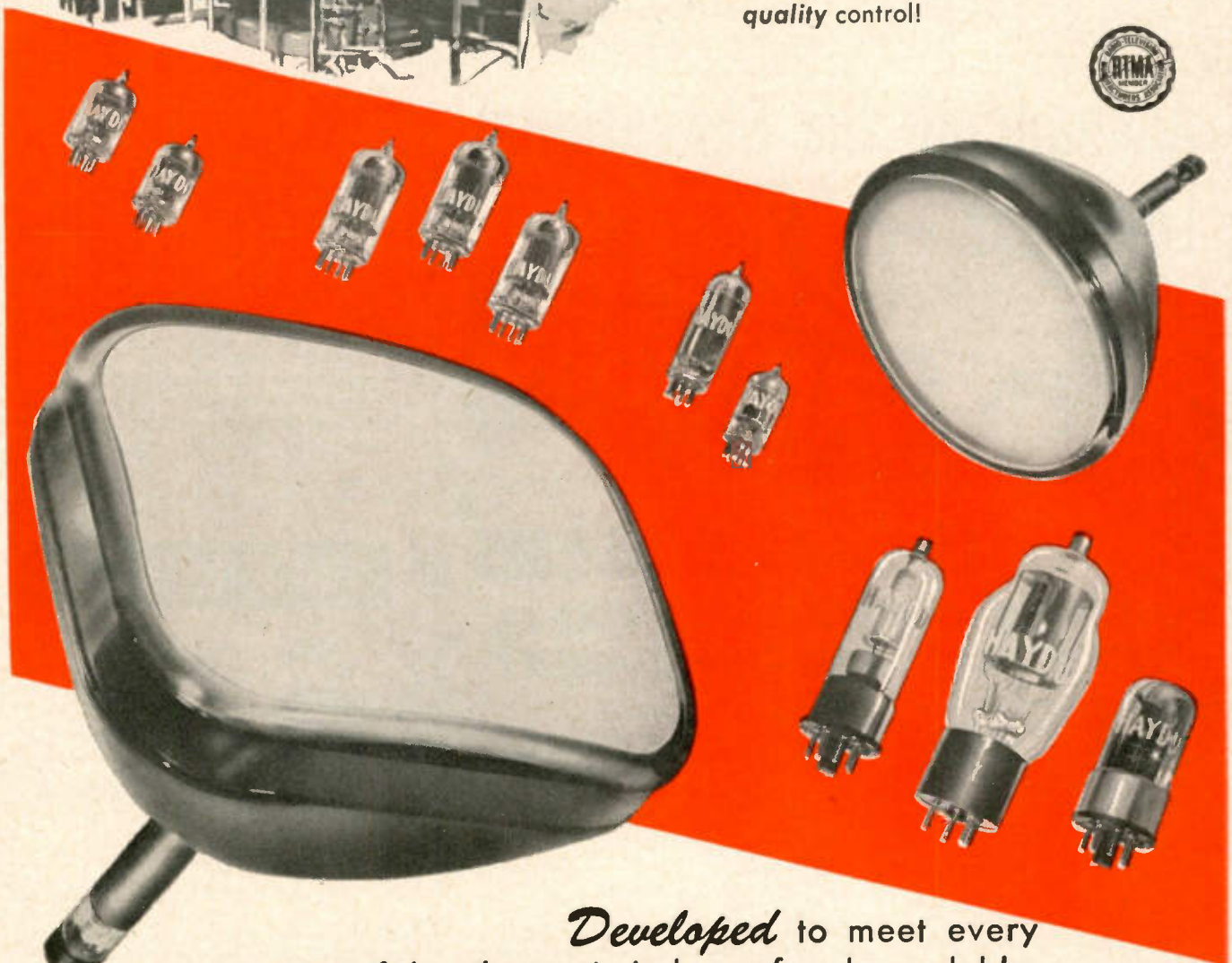

Developed to meet every requirement of the electronic industry for dependable, high-performance vacuum tubes.

Built to exacting standards of precision using the latest production equipment.



Guaranteed by the name...

HAYDU
BROTHERS
 PLAINFIELD, NEW JERSEY

Sponsors Raytheon Drive

Main T.V. Supply Company, Akron, Ohio parts distributor, has announced its appointment by Raytheon as the sponsoring distributor of the well-known Raytheon Bonded Dealer Program in the area served by their Port Huron, Michigan branch operation. At a recent regular meeting of the new Port Huron Service Dealers Association held at the Hotel Lauth, Thomas Williams, president of the organization, turned the meeting over to Robert Lowrie, manager of Main T.V. Supply Co., Port Huron, for the purpose of introducing the Raytheon Bonded plan to the leading dealers in the Port Huron area. The meeting

was a very popular one and the Raytheon plan was most enthusiastically received by the many dealers present. Elmo Kemp of Kemp's Radio, Port Huron was appointed chairman of Program for the Port Huron Service Dealers Association.

New JFD Display

Following its No. AT102 "Jumbo" Lighting Arrester Display, the JFD Manufacturing Company, Brooklyn, New York, is now making available to the trade its new No. AT105 "Little Giant" Arrester Display. This is part of the JFD nation-wide dealer-distributor sales promotion program.

New Starrett President

After prolonged negotiations, the Starrett Television Corp., 601 West 26th St., N.Y., has replaced R. D. Burnet with a new president, Frank D. Langstroth, formerly general manager of sales and commercial relations of the Lansdale Tube Company, a wholly-owned subsidiary of the Philco Corp. Mr. Langstroth has been connected with the radio industry for the past 25 years in both tube and radio manufacturing. He began his career in California in sales and service for the old Grigsby-Grunow Co., and moved to Chicago for factory training in 1929. From there, he managed sales and technical relations in the Wholesale Radio Service Company, New York.

Joins Pentron Corp.

Henry Schneider, formerly with Stewart—Warner, has joined the Pentron Corporation, 221 East Cullerton St., Chicago, manufacturers of magnetic recorders and electronic equipment. He will be a special assistant to Irving Rossman, director of purchasing for Star Products, Sound Incorporated and the Pentron Corporation. In this capacity, he will take over the recently expanded facilities now being readied for their Government production.

Announcing the Sensational

Low Cost

telrex

VANGUARD

SERIES



CONICAL-V-BEAMS*

OFFERING OUTSTANDING TELREX PERFORMANCE AND DEPENDABILITY

DESIGNED for results and profits! High performance, extra low priced, the VANGUARD will outperform and outsell any comparably priced TV antenna anywhere. Vanguard Conical-V-Beams have engineered design that guarantees finest reception, conservative ratings that assure top performance and super-rugged construction that means long, trouble-free service life. The next time you need antennas, order Vanguard by Telrex. Don't settle for less than the best—particularly when the price is right. Call or write for complete illustrated catalog and prices, now!

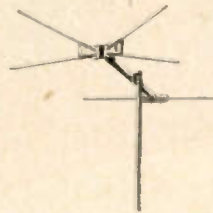

MODEL VM-2X

uni-directional, Conical-V-Beam with reflectors.

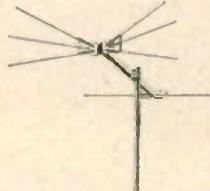

MODEL VU-2X

uni-directional, Modified Conical-V-Beam with reflectors.

MODEL VM-4X

uni-directional, Stacked Conical-V-Beam with reflectors.

MODEL VU-4X

uni-directional, Stacked, Modified Conical-V-Beam with reflectors.

FOR COMPLETE DETAILS WRITE FOR FORM V-2, TODAY!

Be sure it's a "CONICAL-V-BEAM"
—Look for the TELREX® Trademark

• REGISTERED TRADE MARK

Produced under re-issue
Patent No. 23,346.
Copyright 1951



telrex INC.

CONICAL-V-BEAMS* ASBURY PARK 2, N. J.

AMERICA'S
STANDARD OF
COMPARISON

HEPPNER



Again leads

WITH A NEW

UNIVERSAL ION TRAP

for use with 90%
of the TV picture tubes

By the use of a simple clip developed by HEPPNER, the magnetic strength of the trap may be varied, making it a universal ion trap for replacement purposes.

Features

- Clip varies magnetic strength
- Speeds up service work
- Eliminates multiple stacking
- Single magnet, snap-on type
- Competitively priced

Heppner is the world's largest producer of Ion Traps—Specialist in PM focusing devices, horizontal output transformers, P.M. centering devices.

Buy from the Leader

If jobber doesn't stock, write direct to

HEPPNER MFG. CO., ROUND LAKE, ILL.
Telephone Round Lake 6-2161

Sylvania Names Gunn



D. W. Gunn has been named equipment sales manager of the radio and television tube division of Sylvania Electric Products, Inc. Formerly assistant to the general sales manager, he will now be responsible for administering the equipment sales organization and will also supervise activities of the Sylvania district offices.

Mitchell Appointment

The Mitchell Manufacturing Co., of Chicago and the St. Anthony Corporation of Clearwater, Florida announced the appointment of the Mass Brothers Department Stores of Tampa, St. Petersburg and Ybor City as dealers for Mitchell's window-type room air conditioners.

New Zenith Plant

Excavation work has begun for Zenith's mammoth new manufacturing and assembly plant at 1500 N. Kostner Ave., on the west side of Chicago, it was announced by Commander E. F. McDonald, Jr., Zenith president. The plant, when completed, will be comparable in size to Zenith's main factory located two and one-half miles to the west and will be utilized for manufacturing components and the assembling and testing of electronic equipment for the military services. When the present emergency is over, Zenith expects to use the Kostner Avenue property to expand its manufacture of radio and television receivers for civilian consumption.

Lifetime Guarantee



The Raytheon tuner, shown above, will now carry a lifetime guarantee on all its parts. W. L. Dunn, vice-president of Belmont Radio Corp., manufacturer of Raytheon TV, has announced. The warranty will apply to all parts of the tuner except its two tubes, which will be covered by Belmont's one-year warranty.

GE Pushing Portables

A window display and special sales promotion material for General Electric's new line of portable radios, models 605-606 and 610-611, is now available to dealers. The window display features a "reversible" poster depicting Mother's Day, Father's Day, June weddings, and graduation on one side; scenes of Spring, Summer, Fall, and Winter on the other side.

GE television sets and other GE radios will be shown as part of the display. A blow-up of a national magazine advertisement appears in the foreground.

Conlon-Moore Washers

Received too late for inclusion in the Washing Machine Specifications on page 84, the washing machine line of the Conlon-Moore Corp., 1806 S. 52nd Ave., Chicago 50, Ill., is as follows: Model 724, 17 gallon water capacity wringer type, lists for \$114.95; model 725, 20 gallon water capacity wringer type, lists for \$124.95. Both models are without pump, and both are available with a pump at \$10 additional. Also available is the model 25G, 20 gallon water capacity model equipped with gasoline engine, listing at \$169.95.

1951 Edition

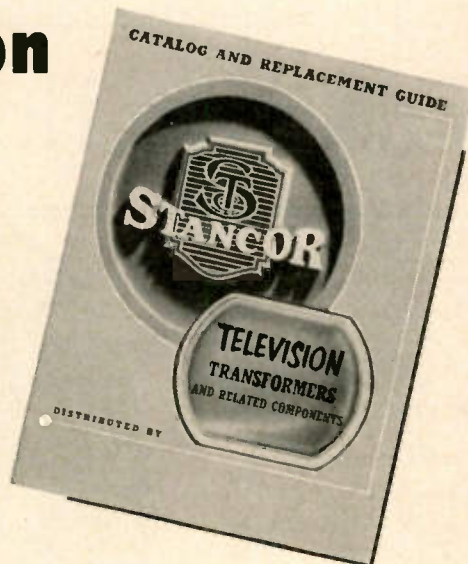

*Ready,
NOW!*

STANCOR'S

New

TV TRANSFORMER CATALOG AND REPLACEMENT GUIDE

Lists:

- Over 900 TV receiver models and chassis made by 71 manufacturers.
- Complete specifications, dimensions and prices of 75 STANCOR transformers and related components for replacement and conversion.

TAKE THE GUESSWORK OUT OF YOUR TV SERVICING! GET YOUR FREE COPY NOW AT YOUR STANCOR DISTRIBUTOR



STANDARD TRANSFORMER CORPORATION

3586 ELSTON AVENUE, CHICAGO 18, ILLINOIS

SEE US AT THE
1951 PARTS DISTRIBUTORS CONFERENCE & SHOW
MAY 21-23 STEVENS HOTEL, CHICAGO-BOOTH 401-SUITE 1005

Intensified Sales Campaign by Du Mont

Intensified merchandising and advertising programs designed to move merchandise on dealers' floors were main topics of the quarterly regional sales managers meeting of the receiver sales division, Allen B. Du Mont Laboratories, Inc., Walter L. Stickel, national sales manager reported. At the same time, Stickel declared that Du Mont would continue to focus its efforts on class, quality-type merchandise.

"Product prestige, stability and exclusivity have always been Du Mont hallmarks," he said. "To this product prestige, we are adding a well-

planned, aggressive sales program to aid Du Mont dealers during the important few months ahead."

At the meeting Du Mont's advertising and sales departments presented several dealer advertising-merchandising plans designed to invite retail movement, get prospects into showrooms, and build prospect lists. Among the plans presented were a trade-in program, tied in with Du Mont's 20th anniversary, a baseball promotion, designed to build store traffic and at the same time help increase sports attendance, an amplified "use the user" program, traffic building promotions built around Du Mont "Royal Sovereign" and "Westminster Series II" receivers, contests, etc.

Famous for Firsts

DR. HIDETSUGU YAGI

World famous scientist, originator of the YAGI antenna principle.

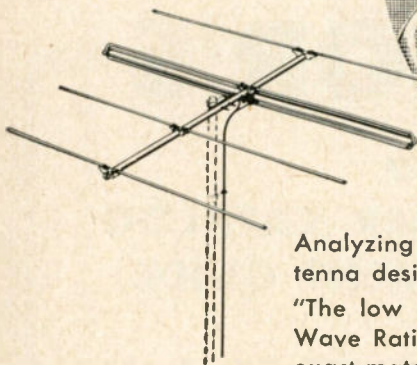

Analyzing the Ward engineered YAGI TV antenna design, Dr. Yagi recently wrote:

"The low numerical value of Voltage Standing Wave Ratio as recorded is . . . the proof of the exact matching between circuit elements. In this regard, I highly esteem the excellent ability of your engineers."

Ward antennas are the result of over 20 years of design and production experience. Ward, the oldest and largest exclusive manufacturer, builds the world's finest antennas.

WARD

WORLD'S LEADING EXCLUSIVE
MANUFACTURER OF
ANTENNAS

THE WARD PRODUCTS CORP.

Division of The Gabriel Co.

1523 East 45th St., Cleveland 3, Ohio

IN CANADA

Atlas Radio Corporation, Toronto, Ontario, Canada

New JFD Plant

Julius Finkel, president of the JFD Manufacturing Company, Brooklyn, has announced the purchase of a site for the construction of a new 120,000 square foot plant. The additional manufacturing space will be used to



Top: Julius Finkel, president. Below: left, Albert Finkel, vice-president; right, Edward Finkel, secretary.

double the present rate of production of JFD products. Construction will commence as soon as materials become available. Also purchased was a factory for the specific manufacture of electrical plugs and other components.

Brach "Outstanding Jobber" Is Named

The Brach Manufacturing Corporation of Newark, N. J., has announced that its most outstanding jobber in Washington, D. C., on the Brach "Two Set Coupler" promotion is Silberne Radio and Electronics Company.

Mr. Silberman, president of the Silberne Company, has caught the enthusiasm of the Brach promotion and stated in an interview with Brach representatives that: "In Washington, D. C., we have a two set television market, and Washington servicemen and dealers have found that the Brach 'Two Set Coupler' completely solves the installation problem where two sets are installed under the confines of one roof." Mr. Silberman further stated, "Television sets that are connected to the Brach 'Two Set Coupler' have better reception than when connected to individual antennas because of the interference elimination action of the 'Two Set Coupler'."

Air King Appointment

D. H. Cogan, president of Air King Products Co., Inc., manufacturers of TV receivers, radios and wire recorders has announced the appointment of Frank Guthrie as field assistant to the president. Mr. Guthrie's duties will include administration and coordination in a liaison capacity as field assistant to the president.

Radiart Names Stroempel



Frank J. Stroempel, above, has been named as executive assistant to Milton S. Roth, jobber sales manager of the Radiart Corporation, TV antenna and accessory manufacturer.

GE's Two Appliance Depts. To Meet Growing Market

Establishment of two separate departments to be responsible for the manufacture and sale of major appliances and small appliances has been announced by the General Electric Company. The two departments have been created out of the Appliance & Merchandise Department "more effectively to meet the demands of the growing market for household electrical equipment," Roy W. Johnson, executive vice-president, said.

Clarence H. Linder has been appointed general manager of the Major Appliance Department and Charles K. Rieger becomes general manager of the Traffic Appliance Department, Mr. Johnson announced. The move follows Mr. Johnson's announcement that the Company is planning to expand its major appliance activities at a multi-million-dollar "Appliance Park" to be established in the Middle West.

Meet at Palm Springs



Ernest Alschuler, president of Sentinel Radio Corp., Evanston, Ill., Mrs. Alschuler, and Joy Olsen, welcome Bill Lear, winner of the Collier Trophy for his automatic pilot invention.

Jewel Appointments

Jewel Radio Corporation announces the appointment of Bert C. Tievy as executive assistant to the president. In addition to the policy-level responsibilities of this newly created position, he will also assume the recently vacated general manager's post. Mr. Tievy was associated with RCA Communications, Inc. for over two decades during which time he spent a number of years in South America where he served as communications consultant to the governments of Argentina, Brazil, Chile, Peru and other countries. During the war Mr. Tievy was RCA Communications Liaison Officer

to the Allied governments in Washington and was RCA representative at the first meeting of the United Nations in San Francisco. More recently, in collaboration with Dr. Syngman Rhee, President of the Republic of Korea, Mr. Tievy was largely responsible for the establishment of the first direct radio circuit between Korea and the United States.

Other additions to the executive staff of Jewel Radio Corporation include Gerald M. Moch as director of purchases and Leonard H. Lieberman as director of advertising and public relations. Mr. Lieberman will also serve as assistant sales manager.

A STAR PERFORMANCE!

EUREKA

EUREKA TELEVISION and TUBE CORPORATION.....Write today!

What makes a star performance? Concentrated effort of all concerned to give you superior quality . . . careful attention to the smallest details of construction and assembly . . . that's the story at Eureka . . . that's what makes every Eureka Picture Tube a really star performer!

for full information on all round and rectangular tubes!

..........Manufacturers of Cathode-Ray Tubes and Electronic Products
69 Fifth Avenue, Hawthorne, New Jersey.....Telephone Hawthorne 7-3907



ANOTHER
"Green Gem"
TRIUMPH

THE NEW *Rauland* 32 WATT P. A. AMPLIFIER

Here's the universally applicable amplifier with remarkably complete P.A. facilities, unprecedented flexibility and brilliant new "Green Gem" styling. Features 3 microphone inputs (each convertible for use with a low-impedance mike by use of a plug-in transformer); 2 phono inputs with dual fader; true electronic mixing and fading on all 5 inputs; separate bass and treble tone controls; provision for remote mixing of 3 mikes. Housed in deluxe cabinet finished in new dark green hammerloid; metallic bronze control panel set in a perforated aluminum finish front section.

SPECIFICATIONS:

Power Output: 32 watts at 5% or less total harmonic distortion, measured at 100, 400 and 5000 cycles. 48 watts peak output.

Gain: Mike—128 db (2 meg); 115 db (100,000 ohms); 115 db (150 ohms). Phono—82 db ($\frac{1}{2}$ meg). Voltage required for rated output: High imp. input—.005; low-imp.—.0004; Phono—.3 volts.

Frequency Response: ± 1 db, 40 to 20,000 cps.

Output Impedances: 4, 8, 16, 166 (70 volts), 250, 500 ohms.

Hum and Noise Level: 73 db below rated power output (unweighted).

Tubes: (10); 3-6SQ7, 3-6SC7, 2-6L6, 1-5U4G, 1-6X5GT.

The new RAULAND 1932 P.A. Amplifier offers maximum facilities, a world of dependable power, superb tonal performance, and distinctive new styling. This incomparable combination of excellence gives you a real selling edge. The RAULAND 1932 Amplifier is available for immediate delivery. Get full details on this outstanding new P. A. equipment today!

See your RAULAND-BORG Distributor for full information on the complete RAULAND Public Address Line—the line that builds Sound profits.

Electroneering is our business

SOUND
EQUIPMENT

Rauland

INTER-
COMMUNICATION

RAULAND-BORG CORPORATION • 3523-L Addison St., Chicago 18, Ill.

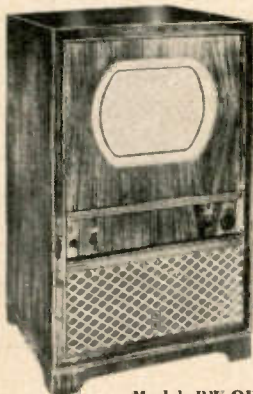

Model RW-OF

TELEVISION CABINETS

STOCK LINE

16" — 17" — 19" — 20"
to fit RCA and other Chassis

AT THE RIGHT PRICE

Walnut, Mahogany, Blonde, Ebony, Maple,
Chinese Chippendale, Inlaid Leather.

QUALITY CABINETS FOR THE TRADE

Send for our descriptive catalogue RT or visit our show-
rooms and look over our most comprehensive line.

Manufacturers Since 1904

ROBERT WOLFF WOODCRAFT CORP.

1125 Union Ave., N. Y. 58, N. Y. Phone: KIlpatrick 2-6800

TV Home Study Course By RCA Institutes

To alleviate the growing shortage of trained TV servicemen, RCA Institutes, Inc., New York City, has opened to the industry a highly specialized, field-tested Television Home Study Course which covers installation, servicing techniques and the basic theory of TV receivers. The course is limited to working members of the radio and television industry, and previous service experience is not required. Self-employed independent radio and TV servicemen are also eligible for enrollment.

Developed jointly by the RCA Service Company and RCA Institutes for use in training RCA Service Company technicians, the course resulted from 14 months' study in the field. During this period, study course engineers of RCA Institutes worked side by side with RCA Service Company training specialists and technicians in the company's branch offices, in its work



Left to right, Gen. G. L. Von Duesen, president RCA Institutes; Bernard Grob, director, Home Study Department, RCA Institutes.

shops, and on the job. From this day-to-day study emerged the essential information and background required to develop a study course that could be included with any technician's professional assignments.

Representing a combination of practical "how it works" information with pre-tested "how to do it" techniques, the course is planned to extend the work potential of the existing manpower pool by supplementing the knowledge and improving the techniques of servicemen on the job. The underlying principles of television are presented in simple, non-mathematical language.

A detailed course outline, together with further information, tuition rates and enrollment forms is available on request from Home Study Division, Room 300, RCA Institutes, Inc., 350 West 4th Street, New York 14, N. Y. Special rates are offered to employers desiring to enroll six or more employes.

Queen for a Day



Left to right: James B. Hofer, Arvin district manager; Jack Bailey, emcee of the "Queen for a Day" radio show; Mrs. Nadine Gorman, of Gardena, Calif.; and Raymond P. Spellman, director of sales for Arvin. Occasion is the presentation of an Arvin TV set to Mrs. Gorman, which was top prize won by her when she was chosen as Queen.

Crosley Names Ward

Appointment of C. J. Ward, formerly regional manager of the Cincinnati region, to be regional manager for the New York region of the Crosley Division, Avco Manufacturing Corp., was announced by W. A. Blees, Avco vice-president and Crosley general sales manager.

Magnavox Promotion

Urging its select list of dealers to rely on sound promotion, incentives for their salesmen, and the advertising of value rather than price to maintain television sales volume in today's market, The Magnavox Company has been highlighting a special two month promotional effort by listing its 20-inch Shoreham television receiver at \$395, down \$50 from its normal list price of \$445, effective April first. Frank Freimann, Magnavox president, announced that for the two month period of April and May the Shoreham would be sold at the lower price to provide dealers with an outstanding promotional tool. "The Shoreham represents an outstanding value even at its regular price," he said. "We have large backorders on hand at the higher price, enough to absorb over half of our scheduled production, and this temporary new pricing of the Shoreham will make it the greatest value in the 20-inch field."

New GE Product Manager

A new position, with broad responsibility for various product planning activities, has been established in the sales organization of General Electric's Tube Divisions here, it was announced today by E. F. Peterson, manager of sales. R. V. Bontecou has been appointed to the position with the title of product manager, tube divisions. He will be in general charge of product planning activities and marketing research of the tube divisions.

New Rep Office

Emmet J. Tydings has announced the opening of offices at 903 Plaza Bldg., Pittsburgh 19, Pa., as manufacturers' representative for radio, television and electronics.

New Telematic Lab

The new enlarged modern research laboratory of Telematic Industries, Inc., Brooklyn, N.Y., manufacturers of antennae, accessories and electronic components, will be headed by James J. Hill, well known in the electronics field. Mr. Hill was formerly associated with Communications Products Company as vice-president in charge of research.

Sentinel Distributors

The Sanborn Electric Company of 311 North Illinois St., Indianapolis, has been appointed distributor for the full line of Sentinel television and radio in central Indiana, as announced by E. G. May, director of sales at Sentinel.

New Magnecord Head

John S. Boyers, formerly chief engineer and assistant treasurer of the corporation since 1946, has been elected president of Magnecord, Incorporated. The firm manufactures high fidelity magnetic tape recorders for the broadcast, industrial and educational markets.

Here's a name that means something . . .

McMurdo

SILVER

Radio

**QUALITY • VALUE
DEPENDABILITY**

*Something DIFFERENT
in Radios that will Boost
Sales and Profits!*

McMurdo Silver radio receivers guarantee the finest reception in any part of the world where signals are broadcast . . . on any regular or short-wave band . . . on any standard domestic or foreign power supply. . . and, where desired, on battery operation.

McMurdo Silver radios cannot be matched anywhere . . . at ANY price for performance, electronic craftsmanship and dollar value.

**VISIT US AT THE BLACKSTONE
DURING THE CHICAGO PARTS SHOW!**

Outstanding Radio Engineering Since 1914

McMurdo Silver Co. Inc. 417 Lafayette St., New York 3, N. Y.



**"Trans-World"
Portable**
(Model 6332)

- Luggage-Type Cabinet
- All-Wave Reception (530KC-18MC)
- Climate Sealed Construction
- Slide-Door Front
- Telescopic Antenna
- Super-powered Audio
- Tuned RF Stage



**Multi-Band
Deluxe**

- (Model 6221)
- Richly grained Walnut plastic cabinet
 - Two-Band Reception (530 to 1700 KC, 5.7 to 18 MC)
 - Console-Tone Audio
 - Climate Sealed Construction
 - Self-contained, high gain antenna
 - Full vision expanded slide-rule dial
 - Automatic volume control

EVERYONE WANTS AN "ORIGINAL"



A copy is never as good as the original. That's why TRIO TV Antennas are "wanted" antennas. TRIO has consistently led the industry in developing better, more efficient antennas. Never "just like" another, every new TRIO model is original and represents an improvement over any existing TV antenna.

* MODEL 445, the famous Single-bay TRIO Yagi for TV channels 4 & 5. Supplied less mast and transmission line.

* Patent Pending — No licensing arrangements granted for duplicating principle of this antenna.

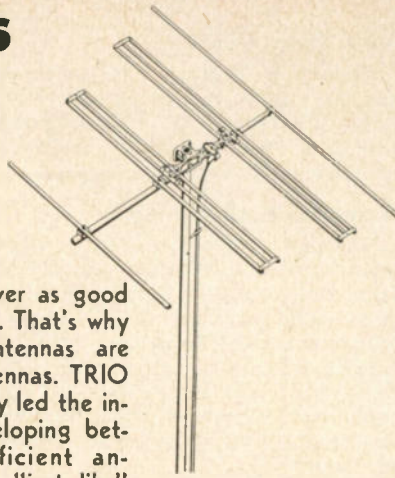

TRIO YAGI SETS THE PACE

An example of TRIO's original design is the amazing dual channel TRIO Yagi — a single-bay 4 element yagi that provides full 10 DB gain on two channels! Available for channels 4-5 and 7-9, this revolutionary antenna makes bulky stacked arrays obsolete by providing excellent fringe area TV reception where other antennas fail!

HOW IT WORKS

Antenna consists of 4 elements whose function is different on the two channels. For example: in Model 445, the elements, on channel 4, act as reflector, dipole, director, director, in that order; while on channel 5, the same elements act as reflector, reflector, dipole and director. Careful design insures proper impedance match with standard 300 ohm lead.

COMPARE THESE ADVANTAGES

- Provides gain on both channels 4 and 5 (or 7 and 9) Equal to Any Two conventional 4-element yagis!
- One bay replaces bulky stacked array!
- One lead replaces old-style 2-lead systems!
- Less weight-per-gain than any other TV antenna!
- Greatly reduced installation costs for complete TV coverage!
- Can be stacked for additional gain.

Model 445. Single or stacked Yagi for Channels 4 & 5.

Model 479. Single or stacked Yagi for Channels 7 & 9.

Model 645. "Controlled Pattern" System consisting of 2 bays offset stacked and "Phasitron." Eliminates co-channel interference. For Channels 4 & 5.

Model 679. "Controlled Pattern" System for Channels 7 & 9.

Model 304. Single Channel Yagi with Double Dipole for Channels 2 to 13.

Model 604. Same as Model 645 except for single channel operation.

WU in TV Servicing

Western Union Services, Inc., is a television service company set up by the Western Union Telegraph Company to service home TV sets, and antennas. Starting with a pilot operation handling only Dumont sets in three N. J. counties, Director S. M. Barr, a vice-president of Western Union, stated that Western Union Services will expand to other makes and to the rest of the country in the future. WU hopes to make use of what they believe is the public's confidence in their reputation for reliability to put the operation over.

Jerrold Expansion

Production, laboratory and office facilities of Jerrold Electronics Corporation, manufacturer of multiple television antenna systems, have been greatly expanded with a move just completed to new plant space at 26th and Dickinson Sts., Philadelphia, it was announced by Milton J. Shapp, president of the company.

Crosley's New UHF Tuner

Recently demonstrated in Bridgeport, Conn. was the Crosley Ultra-tuner, a converter which adapts any present VHF set to UHF reception. About the size of an FM tuner, and connecting to the VHF receiver in much the same fashion, with only a screwdriver. The TV set plugs into the converter, and the converter then plugs into the wall socket previously used by the TV set. In this way the power and antenna connections are switched for either UHF or VHF reception.

DuMont Displays

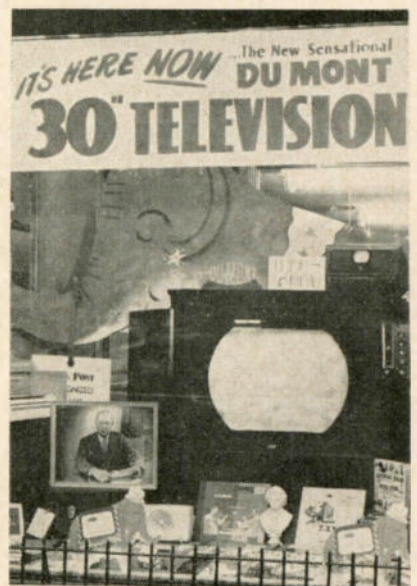

Window displays, featuring the new DuMont 30" Royal Sovereign receiver were placed in seven key New York outlets recently to mark the receiver's introduction to the public. They drew a good deal of attention in the New York area.



TELEVISION TROUBLE SHOOTER

Sells on Sight—48 page book, size 10¾ x 8¾"

Clear directions to make adjustments, understand antenna problems, locate tube troubles, etc.

Many orders are received from radio, electronic and television dealers, starting with 12 to 50 copies, which have increased with repeat orders to 100 to 300 copies and the repeats are continuous because the public and service men are eager buyers.

Retail price 50¢ Trade discount according to quantity

AUTHENTIC PUBLICATIONS, INC., 145 W. 57th St., N. Y. 19



E-V Ad Program

← Al Kahn, president of Electro-Voice (center), Jack Harper, ad manager (left), Wed Soules, sales manager (right), and Henry Teplitz, ad agency (rear) discussing some of the material in the comprehensive program of ads, selling aids and merchandising ideas for the phonocartidge replacement-modernization promotion launched by E-V for distributors and service-dealers.

GE Names H. K. Smith To Head Division

H. K. Smith has been appointed manager of the Marketing Services Division of General Electric Company's Electronics Department at Syracuse, it was announced by E. H. Vogel, manager of marketing.

Rider Book Breaks Records

"Receiving Tube Substitution Guide Book" by H. A. Middleton, published by John F. Rider Publisher, Inc., 480 Canal St., New York, has established a sales record for the organization.

Selling more than 50,000 copies since it appeared last December, the book, distributed through electronics parts jobbers, sold more copies over a comparable period of time, than any other Rider publication. Covering 2,500 tube substitutions, with accompanying wiring instructions and original and substitute tube socket illustrations, the book answers the vital need of servicemen, engineers, laboratories, etc., for a replacement and substitution manual during a period of extreme tube shortages.

Tube Identification

The Raytheon Receiving Tube Division recently announced the publication of a brand-new and modern Tube Shelf Identification system which is now available through Raytheon radio and television tube distributors throughout the country. This Raytheon designed identification plan serves a practical and functional purpose by providing an orderly arranged method of maintaining distributor and dealer tube stocks that is quickly available and easily inventoried.

New Hoffman TV Line

Received too late to be included in the specifications listed on page 77; announcement of the new Hoffman television receiver line follows: model 638, 14", \$209.95; model 639, 14", \$199.95; model 636, 17", \$319.95; model 637, 17", \$309.95; model 886, 17", \$369.95; model 887, 17", \$359.95; model 880, 17", \$409.95; model 881, 17", \$399.95; model 882, 17", \$409.95; model 884, 17", \$450.00; model 885, 17", \$460.00; model 896, 19", \$459.95; model 897, 19", \$449.95; model 893, 20", \$520.00; model 894, 20", \$499.95; model 895, 20", \$520.00; model 953, 17", \$565.00; model 954, 17", \$550.00; model 960, 20", \$675; model 961, 20", \$650; and model 962, 20", \$675.00



EXTENDS ITS OPEN INVITATION TO JOIN MISTER TALK AND MISTER HEAR IN DISCUSSING MUTUAL MERCHANDISING PROBLEMS. JOIN OUR "SOUND FIDELITY" PARTY WHILE YOU ARE ATTENDING THE RADIO PARTS AND ELECTRONIC EQUIPMENT SHOW BEING HELD AT THE STEVENS HOTEL IN CHICAGO, MAY 21ST THROUGH MAY 23RD. OUR FACILITIES EXIST FOR YOUR USE, SO... DON'T HESITATE TO DROP IN. TAKE HOME AN INDIVIDUALIZED CARICATURE DRAWING OF YOURSELF WITH OUR COMPLIMENTS. ROOMS 700 AND 701A.



EICOR, INC., 1501 W. CONGRESS ST., CHICAGO 7, ILLINOIS

Still **BIGGER** and **BETTER** than ever!



Proven
Quality
Since
1921

THE NEW 1951 LINE OF

DEWALD

High Definition **TELEVISION**
and Superperformance **RADIO**

Bigger screens . . . better pictures . . .
finer performance . . . lovelier cabinetry.
14", 16", 17", 20"—choose your picture
size. ALL WITH BUILT-IN ANTENNAS.

Model ET-171
TV
17" RADIO
PHONOGRAPH
COMBINATION

See the new line at
the Blackstone Hotel
during the Chicago
Parts Show May 21-
23.

JOBBER-REPRESENTATIVES: Some choice terri-
tories now available. Write for full information.

in
RADIO
and
TELEVISION

for
SOMETHING
BETTER,
it's

DEWALD

DEWALD RADIO MFG. Corp. 35-15 37th Ave., Long Island City 1, N. Y.

"QUICK-AS-A-WINK"

ASSEMBLY

IS THE TERRIFIC NEW
FEATURE OF OUR

YAGI • SUPER "V"
STRAIGHT AND FOLDED DIPOLE
IN-A-LINE
ANTENNAS

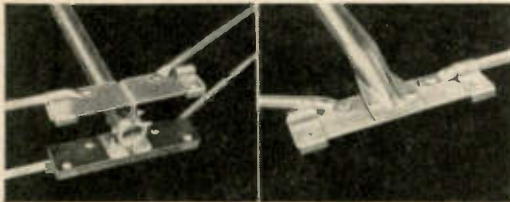

OPEN—SNAP AND IT'S LOCKED

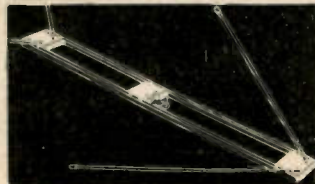
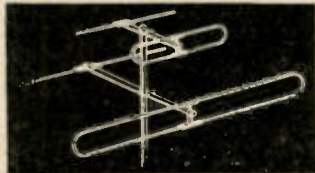
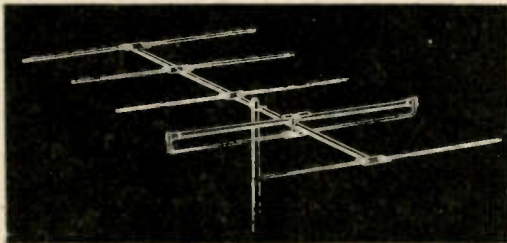

REVOLUTIONARY! AMAZINGLY FAST!
SUPERBLY DESIGNED! There aren't
enough superlatives to describe this new-
est of new, fastest of fast assembly meth-
ods on the market today! Take the an-
tenna out of the box and in a matter of
seconds it's ready to use, "Quick as a
Wink,"—it's up. No screws—no wing nuts
—no screw drivers—no needless loss of
time. AND THAT'S NOT ALL! Look at
the photo at the left and note the rear
end of the boom . . . clamped shut, but
with no weak point as in others. Note
the sturdy construction in the front end—
built to withstand all kinds of weather for
a long, long time. These are only a few
of the many reasons T-V Products Com-
pany Antennas are your top buy today.
"Hot off the Press"—our new catalog
showing the complete Conical, Yagi,
straight and folded Dipole, In-A-Line, and
Super "V" antenna lines along with the
many fine antenna mounts and accessories
—yours for the asking.



← THIS TRADE MARK MEANS
TOPS IN VIDEO • LOOK FOR IT!

T-V PRODUCTS

COMPANY

152 Sandford St., Brooklyn 5, N. Y.
Address all inquiries to Dept. RT

Telrex Patent

The original Telrex Patent No. 2,518,297 which was issued for conical antennas has now been reissued by the United States Patent Office. Although the original patent has three claims, the reissue patent has seven claims which are very much broader in its terms. The Reissue Patent bears No. 23,346 and is dated March 20, 1951. It is also assigned to Telrex, Inc.

GE Sales Course

Approximately 100 television servicemen have enrolled in a special television training course sponsored by the General Electric Tube Divisions at San Antonio, Texas, and the San Antonio Radio and Television Association. The course, scheduled to be conducted the second and fourth Tuesday of each month, will continue for 18 sessions.

Ionospheric Project

Two VEE-D-X antennas, of the Yagi type, are now being used on an ionospheric project under the auspices of The School of Electrical Engineering Cornell University, Ithaca, New York. The project, announced Dr. Henry G. Booker, associate of the school, is being conducted in an effort to explain the long distance scattering effect of FM and TV frequencies.

NARDA Names Chairmen

Twelve leading retailers of the appliance, radio and television industry were honored by appointment to chairmanship of major committees of the National Appliance and Radio Dealers Association. Announcement of the appointments was made by Mort Farr, NARDA president. The committee chairmen include: H. B. Price, Jr., president of Price's, Inc., Norfolk, Va. and NARDA vice-president, policy committee; Julius Kovach, Paramount Good Housekeeping Shop, Kenosha, Wisc., trade-in guide committee; Joseph Fleischaker, Electric Appliance Store, Louisville, Ky., awards committee; James Lee Pryor, Wilmington, Del., and Herb Names, Herb Names, Inc., Denver, Colo., reception committee; Richard Galvin, Television Company of Maryland, Baltimore, publicity committee; C. M. Davidson, Davidson & Co., Miami, resolutions committee; F. E. Morrison, Rockford Standard Furniture Co., Rockford, Ill., entertainment committee; Clarence Bode, J. Kornely Hardware Co., Milwaukee, Wisc., national advisory committee on national, state and local unity; George Hiebing, Davenport, Iowa, national advisory committee on standardization policies; Ted Simmons, Hartford, Conn., national advisory committee on the certified television installation and service program; E. O. Kuehn, General Radio and Supply Co., Belleville, Ill., NARDA representative to the national farm electrification conference.

5-Star Features
PHOENIX YAGI



NEW! SENSATIONAL GAIN!

- * FAST, EASY QUICK RIG!
- * 300 OHM IMPEDANCE!
- * EXCLUSIVE MAST CLAMP DESIGN!
- * LICKS INTERFERENCE FROM GHOSTS AND NOISE!
- * CUTS THE CALLBACK NUISANCE!

CLEARER, SHARPER PICTURES

- * Speed-Tennas
- * Speed-Mounts
- * Hardware

HIGH GAIN INLINE



SEE US AT THE SHOW, BOOTH 110.

PHOENIX ELECTRONICS, Inc. LAWRENCE MASS.

New TRAV-ELECTRIC Model
STURDY MINIATURE CONVERTER
 2½" x 2½" x 3½"
 60 CYCLE AC.
 40 WATTS
 110 VOLTS

Just plug into CIGAR LIGHTER



operates
Radios, Shavers
Turn-Tables
Small Dictating Machines
 etc.
\$15.95
 List Price

Model 6-1160

 IN BOATS	 IN THE CAR - IN THE TRUCK
 AT PICNICS - OUTINGS	 ELECTRIC SHAVER
 PORTABLE PHONOGRAPH	 DICTATING MACHINE

Terado Company - 1068 Raymond, St. Paul 8, Minn.

At last - the perfect
REPLACEMENT NEEDLE!



RETAIL PRICE
\$20.00*

The Genuine...
 the Enduring...
DUOTONE
 "diamond"

* FOR POPULAR TYPE SINGLE NEEDLES (Others Slightly Higher)

Here's the needle that lasts and lasts and lasts! The new Duotone Diamond Replacement Needle with wear-resisting qualities that protect records from the ravages of "flats" and other wear-distorted needle shapes. The Duotone Diamond is the nearest thing to a really permanent needle ever produced—outplays, outwears and costs less per playing than any other type made. For the first time, Duotone offers these professional quality needles at a price every record enthusiast and music lover can afford!



FREE! It's new—the only complete REPLACEMENT GUIDE!



Most complete needle guide ever published. Lists all standard makes of record players and the correct needle for each! Both needles and cartridges are clearly illustrated to simplify selection. For your FREE copy in generous wall chart size—fill in and mail coupon to Duotone Company, Keyport, New Jersey.

AVAILABLE NOW!
 AS4-LP DIAMOND for COLUMBIA LP PLAYERS
 RS8-LP DIAMOND for RCA 45 and LP PLAYERS

Please rush new illustrated needle Guide to:

NAME

FIRM

STREET

CITY STATE

there's only ONE

APPROVED POWER SUPPLY



SEE YOU AT BOOTH 418

Patent Pending

New Low Cost "BJ" JUNIOR Saves Time, Money Servicing DC Equipment

Demonstrate and test car and marine radios... relays, phone circuits, instruments, other low voltage devices.

Model "B" 6 Volt DC Power Supply 1 to 20 Amps. for Heavy Duty Applications

OVER 2 MILLION Battery Radios Offer Huge PROFIT Market!



NEW MODEL "S" BATTERY ELIMINATOR WITH SELENIUM RECTIFIER

CONVERT BATTERY RADIOS TO AC ALL-ELECTRIC

Battery radios in city and rural areas offer you big profit opportunities. Converts any 1.4 volt, 4 to 6 tube battery radio to an efficient AC radio...

SEND COUPON



Electro Products Labs. 4499-JS Ravenswood Ave., Chicago 40, Ill.

Send literature, name of nearest source.

Name

Address

City State

IN CANADA: ATLAS RADIO CORP. LTD., TORONTO

Blees Sees Competitive Sales Race Continuing

New limitations on the use of critical materials will not halt the competitive race for sales in the major appliance and television fields...

The Crosley sales chief expressed confidence that, barring full-scale war, substantial supplies of most appliances will be produced in the months ahead.

Crosley will continue to push all its product lines with aggressive advertising, sales and promotion campaigns, he revealed.

Philco Names Kuneau

John Kuneau, director of public relations and member of the management operations committee of Philco Corporation...

Magnavox Promotion

Urging its dealers to rely on sound promotion, incentives for their salesmen, and the advertising of value rather than price to maintain television sales volume in today's market...

New Merit Catalogs

In keeping with its advertising headline—"Watch Merit for TV In '51", Merit Transformer Corporation, 4427 North Clark St., Chicago 40...

SERVICE-MEN!

REEVES Soundcraft Laboratories afford you the best in television picture tubes at prices consistent with such quality.

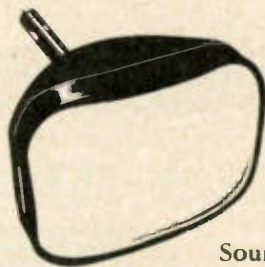

Soundcraft rectangular television filter tubes are available in 16", 17" and 20" sizes.

You can use and recommend them with assurance because they are backed by the greater integrity and experience of the Reeves name...

REEVES Soundcraft CORP.



TWENTY YEARS OF LEADERSHIP IN SOUND ELECTRONICS 10 EAST 52nd STREET, NEW YORK 22, N. Y.

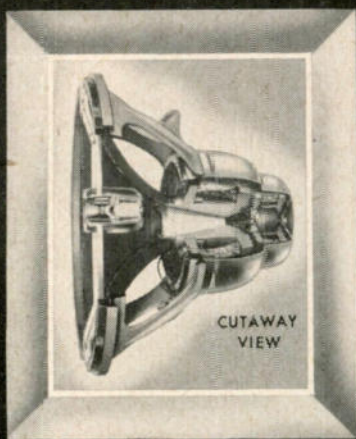

"no one has ever heard a G-610 who didn't want one!"

We believe this statement is literally true . . .

The Jensen G-610 Loudspeaker System brings you clear, clean, life-like reproduction with thrilling transport-to-the-original such as you have never heard before. Of course G-610's are in short supply, for the government has restricted cobalt for Alnico V magnets — and the G-610 has more magnetic energy than any speaker ever built. But when restrictions are relaxed and G-610's are again plentiful, then be sure you get a G-610 . . . NO ONE has ever heard one who didn't want one!

Furnished complete with Crossover and Control Network illustrated below.

Jensen
MANUFACTURING COMPANY

Division of The Muter Company

6601 So. Laramie Ave. • Chicago 38, Illinois

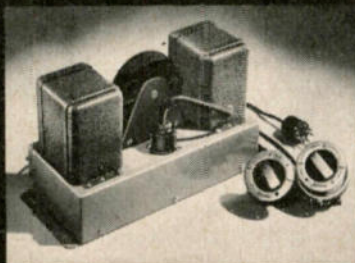

Industrial Precision Products Co. at Show

Industrial Precision Products Co., 325 N. Hoyne Ave., Chicago, will exhibit the following products at the Parts Show: Chimney & vent pipe mounts, wall mounts, mast bases, Apex mounts, porcelain products; clover and conical antennas, ground rods, wire rope, thimbles, clamps; all types of stand-offs, twin-line stripper, nuts and bolts. This information was received too late to include in list of exhibitors appearing elsewhere in this issue.

Segal Appointment

Henry P. Segal, president of the Henry P. Segal Company of 143 Newbury St., Boston, has announced the appointment of a new sales representative. He is Duncan Dana of 920 Hale St., Beverly Farms, Mass. Mr. Dana was formerly employed by the National Company of Malden. He was also employed by the Sylvania Electric Products of Salem, in the Special Products Engineering Department doing experimental electronic construction for the engineers.

New Sessions Catalog

The Sessions Clock Company has published a new catalog of clock movements and switch timers, illustrating the complete line of available units. This catalog is offered as a buying and engineering guide for specialty clock manufacturers, design engineers, and for all users of clock timing movements who want a superior product at lowest cost. Dimensional drawings and complete specifications are included. For a copy, write The Sessions Clock Company, Forestville, Conn., and ask for Bulletin No. CM-11.

Westinghouse TV Show

Plans for a new 13-week television show, called the "Westinghouse Summer Theater," were announced by John M. McKibbin, vice-president in charge of consumer products for the Westinghouse Electric Corporation. The new show, which will appear while Westinghouse "Studio One" takes its annual summer vacation, is scheduled to start Monday, June 18.

New Kaye-Halbert Set

The Kaye-Halbert Corporation of Culver City, Calif., manufacturers of television receivers, announced the forthcoming release of the Harry Kaye signature model, HK-024. This model is an open face console with a 21" screen and will be available in walnut, mahogany, and limed oak. Factory list prices are \$299.95 for the walnut; \$319.95 for the mahogany; \$339.95 for the limed oak.

The Hottest item since the picture tube!



the TURRET BOOSTER

- Operates on Intermediate Frequency—one setting for all channels.
 - Removed or installed without disrupting wiring of set.
 - Fully concealed within set—no exterior units.
 - Improves reception—increases video output 15% upwards.
 - Improves receivers having poor sound (Emphasis placed on sound by IF coil adjustment.)
 - Comes on when receiver is on—no extra switches to complicate the tuning of the receivers.
- *Less additional tube.

WRITE FOR FURTHER DETAILS

Money Back Guarantee

BARB-CITY INDUSTRIES, INC.
1151 FOURTH ST. • DEKALB, ILL.

Stromberg-Carlson Contest

Stromberg-Carlson's nation-wide window display contest, participated in by dealers in all television territories, was won by Stone and Thomas, Stromberg-Carlson dealer of Charleston, West Virginia. An all-expense trip for two to Bermuda was the first prize, and the number of photographs of exclusive Stromberg-Carlson windows submitted in the contest was proof of the popularity of this and the other prizes offered. The awards were based on originality and ingenuity of the dealer in displaying the cabinets as fine furniture, plus emphasis on the big picture theme and on combinations as home entertainment centers. All types of dealers entered the contest.

Philco Appointment

Herbert J. Allemang, who is widely known as a management consultant, has been appointed vice-president, executive staff of Philco Corporation, it was announced by William Balderston, president. Mr. Allemang in his new capacity will head the forward planning program of Philco. For the past 13 years, he was a senior partner of Stevenson, Jordan and Harrison, Inc., noted firm of management consultant. During the past two years, he took an increasingly active part in consultation on long-range planning for Philco.

Air King Introduces "30th Anniversary" TV Set



D. H. Cogan, president of Air King Products Co., Inc., introduces the firm's "30th Anniversary" TV set to Harry Lee of Morley Bros., Detroit distributor of Air King products. Left to right are: Mr. Cogan, Mike Scott, New England rep for Air King, W. J. Billmeyer of Morley Bros., A. J. Stobbe, vice-president in charge of production of Air King, R. D. Payne, Air King sales manager, and Harry Lee, appliance div. manager of Morley Bros.

Cadillac Representatives

Cadillac Electronics Corp., New York City, manufacturers of TV receivers and home refrigerators, have added two more manufacturer's representatives, it was announced by I. R. Ross, president. D. L. Dale, St. Paul, will cover the state of Minnesota and Dot Sales, Cleveland, has been named for Ohio.

Join For Defense Work

Sightmaster Corp. and Transvision, Inc. have joined facilities on defense work, it was announced by Michael L. Kaplan, president of Sightmaster Corp. The combination will enable the companies to handle much larger contracts than either company could handle separately.

MITCHELL Room Air Conditioners

The Profit "Shot-in-the-Arm" for your Summer Appliance Business!

HERE'S WHY

3 BIG SELLING FEATURES

- Dyna-Cooler
- Turbo-Dryer
- Air Scoop

Longest Margins for Biggest Earnings

Acclaimed Everywhere the World's Finest

Ride the MITCHELL selling wave in 1951, with these exclusive advantages. Get set right now for profits—write today for complete details on the money-making MITCHELL dealership.

MITCHELL MFG. COMPANY
Chicago 14, Illinois
Makers of the World's Finest Room Air Conditioners

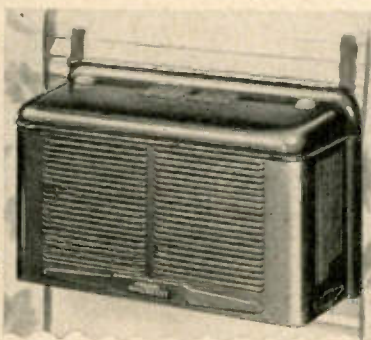

MITCHELL is better than ever in '51!
get your share of this big volume business

WRITE FOR THE PROFIT FACTS

ACT NOW

MITCHELL MFG. COMPANY
2523 N. Clybourn Ave., Chicago 14, Ill.

Send me all the facts and quote me dealer prices at once on MITCHELL Room Air Conditioners

Dealer's Name _____

Address _____

City _____ State _____

By _____



Featuring

8 INTERCHANGEABLE, REINFORCED ELEMENTS

• GUARANTEED RECEPTION—ALL CHANNELS

• MOST ADVANCED DESIGN TO DATE

• FAST AND EASY INSTALLATION

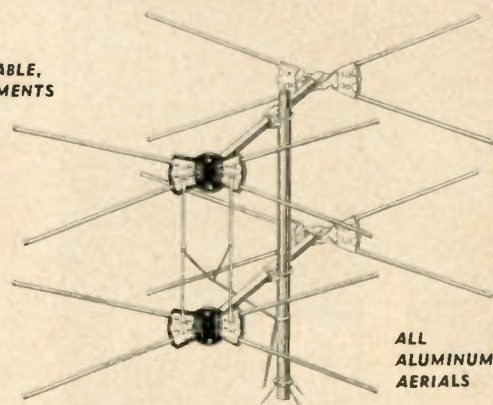

ALL ALUMINUM AERIALS

No. 1 KIT FOR FRINGE RECEPTION

Stacked conical array as shown
1 pr. Q Bars
10 foot Mast
75 feet of matched 300 ohm twinlead
1 Swivel Base
1 Guy Ring

100 ft. Guy Wire
3 3-in. Wood Screw Standoffs
2 Mast Standoffs
3 Lag Screw Eyes
Above complete in one carton
Dealer's Price—\$15.95

No. 2 KIT FOR LOCAL RECEPTION

1 Conical Array
5 ft. Mast Section
1 Chimney Mount
55 feet matched 300 ohm twinlead

3 3-in. Wood Screw Standoffs
1 Mast Standoff
Above complete in one carton
Dealer's Price—\$10.95

Shipped direct—any quantity. Approx. wts. 10 lbs. Send check, money order or C.O.D.

CHESTER ELECTRONICS, Box 34, Sta. H, Toledo 13, O.
Manufacturers' agents

Be Safe! Be Sure!
with a **FULL-SIZED VEE-D-X ARRESTER**

COSTS NO MORE THAN A MIDGET

2 WIRE RW-200 \$125 LIST	4 WIRE RW-204 \$150 LIST
--------------------------------	--------------------------------

2-WIRE RW-300 \$200 LIST
For extra heavy duty. An air gap plus resistors provide double protection.

THE LaPOINTE-PLASCOMOLD CORP.
Windsor Locks, Conn.

INDEX TO ADVERTISERS

MAY, 1951

Air King Products Co., Inc.	Cover 2
Alliance Mfg. Co.	4
American Phenolic Corp.	88
American Television & Radio Co.	139
Ampro Corp.	119
Anchor Radio Corp.	Cover 3
Arvin Industries, Inc.	2, 3
Astatic Corp.	114
Authentic Publications, Inc.	132
Barb-City Industries, Inc.	137
Belden Mfg. Co.	85
Burgess Batteries	104
Camburn, Inc.	118
Capehart-Farnsworth Corp.	16
Chester Electronics	138
City Tool Accessories Corp.	122
Clear Beam Antennas	95
Columbia Records	21
Commercial Credit Corp.	17
Crosley Div., Avco Mfg. Corp.	24, 25
DeWald Radio Mfg. Corp.	134
DuMont Labs., Inc., Allen B.	23, 65, 17-65
Duotone Co.	135
Eicor, Inc.	133
Electro Products Labs.	136
Electro-Voice, Inc.	116
Electrovox Co., Inc.	122
Emerson Radio & Phonograph Corp.	29
Eureka Television & Tube Corp.	129
General Electric Co.	7, 10, 11, 83
Hallcrafters Co.	45
Haydu Brothers	125
Hepppner Mfg. Co.	126

Hotpoint, Inc.	87
Hytron Radio & Electronics Corp.	109
Industrial Television, Inc.	22
Insuline Corp. of America	50
Jackson Industries	52
Jensen Industries, Inc.	81
Jensen Mfg. Co.	137
JFD Mfg. Co., Inc.	110, 140
LaPointe Plascomold Corp.	100, 101, 139
McMurdo Silver Co., Inc.	131
Meck Industries, Inc., John	43
Milwaukee Stamping Co.	115
Mitchell Mfg. Co.	138
Newcomb Audio Products Co.	140
Oxford Electric Corp.	120
Penn Boiler & Burner Mfg. Corp.	105
Philco Corp.	5
Pentron Corp.	107
Philharmonic Radio & Television Corp.	50
Phoenix Electronics, Inc.	135
Prentice-Hall, Inc.	140
Radiart Corp.	97
Radio Corp. of America,	36, 37, 80, 123, Cover 4
Radion Corp.	121
Rauland Corp.	28
Rauland-Borg Corp.	130
Raytheon Mfg. Co.	113
Raytheon Television Corp.	15
Recoton Corp.	82
Reeves Soundcraft Corp.	136
Regency, Inc.	48, 49
Revere Camera Co.	53
Rider Publisher, Inc., John F.	108
Schott Co., Walter L.	106
Sentinel Radio & Television	26
Sheldon Electric Co.	111
Sheraton Television Corp.	51
Shure Brothers, Inc.	112
Simpson Electric Co.	12
Simpson Mfg. Co., Inc., Mark	30
Sparks-Withington Co.	79
Standard Coil Products Co., Inc.	61
Standard Register Co.	103
Standard Transformer Corp.	127
Stromberg-Carlson Co.	32
Sylvania Electric Products, Inc.	8, 14
Symphonic Radio & Electronic Corp.	57
Tech-Master Products Co.	124
Technical Appliance Corp.	18
Telectron, Inc.	59
Tel-O-Tube Corp. of America	9
Telrex, Inc.	126
Terado Co.	135
Thomas Electronics, Inc.	98, 99
Trede Associates, Inc.	140
Trio Mfg. Co.	132
Triplett Electrical Instrument Co.	27
Tung-Sol Lamp Works, Inc.	117
T-V Products Co.	134
Video Products Corp.	51
Y-M Corp.	6
Ward Products Corp.	128
Webster-Chicago	19, 47
Webster Electric Co.	118
Westinghouse Electric Corp.	13
Wolff Woodcraft Corp., Robert	130
Zenith Radio Corp.	31
Zotka Television Tubes, Inc.	20

While every precaution is taken to insure accuracy, we cannot guarantee against the possibility of an occasional change or omission in the preparation of this index.



VIBRATORS!
By every test

ATR

is Best!

ATR
AUTO RADIO VIBRATORS
have Ceramic Stack Spacers



A COMPLETE LINE OF VIBRATORS . . .
Designed for Use in Standard Vibrator-Operated Auto Radio Receivers. Built with Precision Construction, featuring Ceramic Stack Spacers for Longer Lasting Life. Backed by more than 19 years of experience in Vibrator Design, Development, and Manufacturing.

ATR PIONEERED IN THE VIBRATOR FIELD.

✓ **NEW MODELS** ✓ **NEW DESIGNS**
✓ **NEW LITERATURE**

"A" Battery Eliminator, DC-AC Inverters
Auto Radio Vibrators
See your dealer or write factory

ATR

AMERICAN TELEVISION & RADIO CO.
Quality Products Since 1931
SAINT PAUL 1, MINNESOTA-U.S.A.

THE WORLD'S LEADING TWIN LEAD TELEVISION LIGHTNING ARRESTER

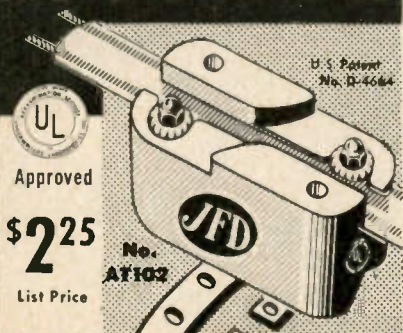

completely waterproof

JFD SAFE TV GUARD

Protects television sets against lightning and static charges. Simple to install everywhere and anywhere... no stripping, cutting or spreading of wires. More than 500,000 in use today!

See your jobber or write to —

JFD MANUFACTURING CO., INC.
6103-E 16th Ave., Brooklyn 4, New York
FIRST in Television Antennas and Accessories



Approved

\$225

List Price

No. AT102

Jensen Mfg. Scrap Drive



Shown in the picture is Thomas A. White, Jensen Mfg. Co. president, right, initiating a drive to reclaim Alnico V magnets from old speakers. In center is Dr. Burton Browne, president of the Burton Browne Advertising Agency. At left is Bill Schoning of Lukko Soles Corp., Chicago distributor. Jobbers from all over the country are getting boxes from Jensen for servicemen to put their discarded speakers into. Contributions by jobbers to the scrap drive will be recorded by Jensen and allowances made for them in allocations from the company in the future.

Shura-Tone Expansion

In its third expansion move within two years, Shura-Tone Products, Inc., Brooklyn phonograph manufacturer has leased an additional 6500 foot factory at 440 Adelphi St., Brooklyn.

New Hudson Package

A new box, incorporating a new multi-colored design, is now being featured in the packaging of Hudson Miniature Lamps. This box holds ten different lamp bulbs, is partly covered with clear acetate for easy reference. The complete line of miniature lamps, manufactured by the Hudson Lamp Company will be distributed to the jobber trade by the parent firm, Oxford Electric Corp., 3911 S. Michigan, Chicago 15, Ill.

Aerovox Vice-President

W. Myron Owen, president of Aerovox Corporation, has announced the election of Charles E. Krampf to the office of executive vice-president. Announcement followed an election by the board of directors held after the annual stockholders' meeting. Mr. Krampf succeeds Bert Conway of Detroit, who will remain with the corporation on a consulting basis and as a member of the board of directors.

Circle-X Representative

A. de Laski, sales manager for Circle-X Antenna Corp., has announced that Hundley R. Gover, 500 Law Bldg., Charlotte, No. Carolina, has been appointed manufacturer's representative for the states of North and South Carolina and Tennessee; and Haggerty Sales Company, 1507 W. Saratoga St., Ferndale 20, Michigan, has been appointed to cover Michigan.

Let us REBUILD those defective or damaged TV TUBES

just as we are now doing for manufacturers, department stores, chains and large service organizations.

- ✓ Better than most new tubes . . . of a substantial saving.
- ✓ Quick! . . . saves you time, trouble and money. 24 to 48 hour exchange service in most types.
- ✓ Guaranteed! . . . for one year. Remember, new tubes have 6-month limit.

What is "REBUILDING"?

Everything new except the glass. We replace the fluorescent screen, give you a new black background, brand new gun and tube base.

The Rebuilt Tube that is Better than New

Write Dept. A for details and prices

Manufacturers
&
Distributors
of
Electronic
Equipment

**TRADE
ASSOCIATES
INC.**
161 So. 4th St., Brooklyn 11, N. Y.
Phone EVERgreen 8-5363

Just Published!



TELEVISION SERVICING

by Walter H. Buchsbaum

Get this brand new, complete handbook for sure-fire working knowledge of TV installation, maintenance and troubleshooting. Tells you step-by-step procedures for audio IF alignment, video IF alignment, aligning RF amplifiers, mixers, oscillators, etc. All possible defects classified for ready reference, thoroughly analyzed to show what is wrong and why . . . and what to do to correct the defect. No mathematical knowledge needed! Practical, authoritative, up-to-the-minute, the perfect handbook for set owners, trainees, and repairmen.



Symptoms of defective operation easily recognized, quickly corrected by illustrations, diagrams and how-to-do-it facts in this new book.

USE IT 10 DAYS FREE

Coupon below brings you "Television Servicing" on FREE trial for 10 days, without obligation. Mail it NOW.

PRENTICE-HALL, Inc., Dept. M-RTR-551
70 Fifth Ave., New York 11, N. Y.

Send me, for 10 DAYS' FREE TRIAL, "Television Servicing." I will return it in ten days and pay nothing—or keep it and send \$1.35 down (plus postage) and \$2 monthly for 2 months.

NAME

ADDRESS

CITY..... STATE.....

SAVE! Send \$5.35 with this coupon, and we'll pay postage and packing

"HAVE YOU HEARD
THE SOUND OF QUALITY?"



NEWCOMB SOUND IS BETTER

- Manufacturers of public address, mobile, phonograph, musical instrument and wired music amplifiers • Portable systems • Portable phonographs and radios • Transcription players • Rock and panel equipment.
- Write today! Circle items of interest and indicate whether you are a Dealer, Parts Jobber or Sound Specialist.
- NEWCOMB AUDIO PRODUCTS CO.
• DEPT. A, 6824 LEXINGTON AVE.
• HOLLYWOOD 38, CALIFORNIA

PERFORMANCE IS WHAT COUNTS!

ANCHOR'S

superiority of performance
remains unchallenged!



THE ANCHOR *Suburbanite*

Single-Stage Booster—for low signal areas in or near cities. Assures consistently good reception up to 75 miles.

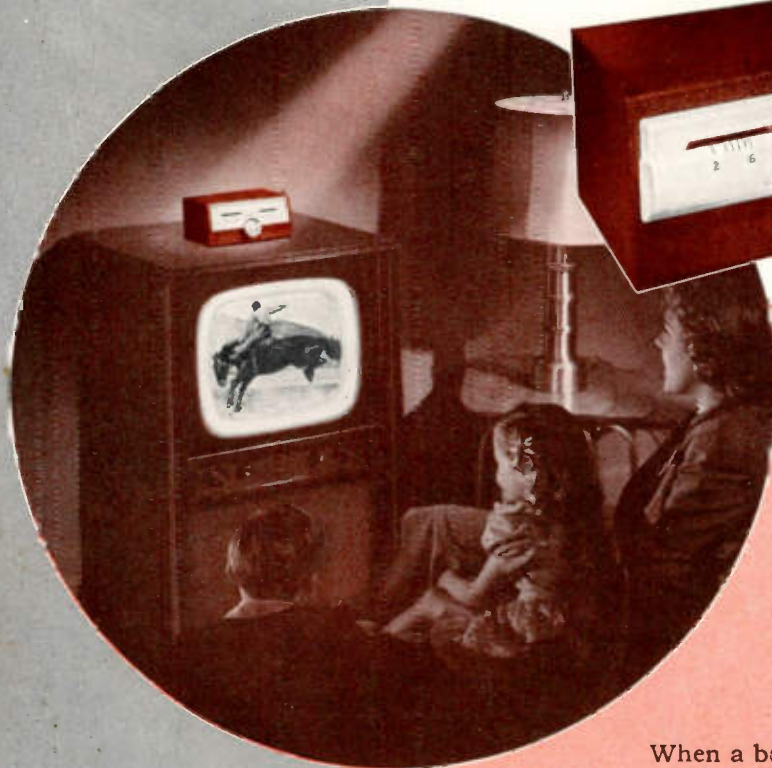

THE ANCHOR *Granger*

Two-Stage Booster—recommended for distant rural areas. Assures consistently good reception for over 100 miles.

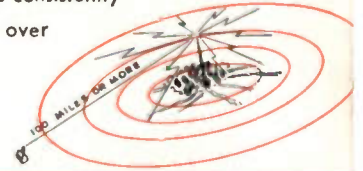

Despite critical material shortages, Anchor not only is offering the same high quality standards so widely hailed by the TV set industry, itself, but it is still making as many boosters as a year ago. To meet the current unprecedented demand, however, Anchor would have to expand, which is naturally not possible now! Therefore they have had to institute a very strict allocating system. No preference on deliveries to anyone has been or ever will be practiced.

When a booster is needed to complete a perfect installation, Anchor's outstanding performance under all conditions has made it the first choice of those who buy and sell. So always buy the best—first!

See us at the RADIO PARTS SHOW, Booth 131.
Visit us in our suite, Room No. 1519-20.

ANCHOR ENGINEERING ALWAYS A YEAR AHEAD!



ANCHOR RADIO CORP.

2215 SOUTH ST. LOUIS AVENUE • CHICAGO 23, ILLINOIS

THE QUALITY OF RCA TUBES IS UNQUESTIONED

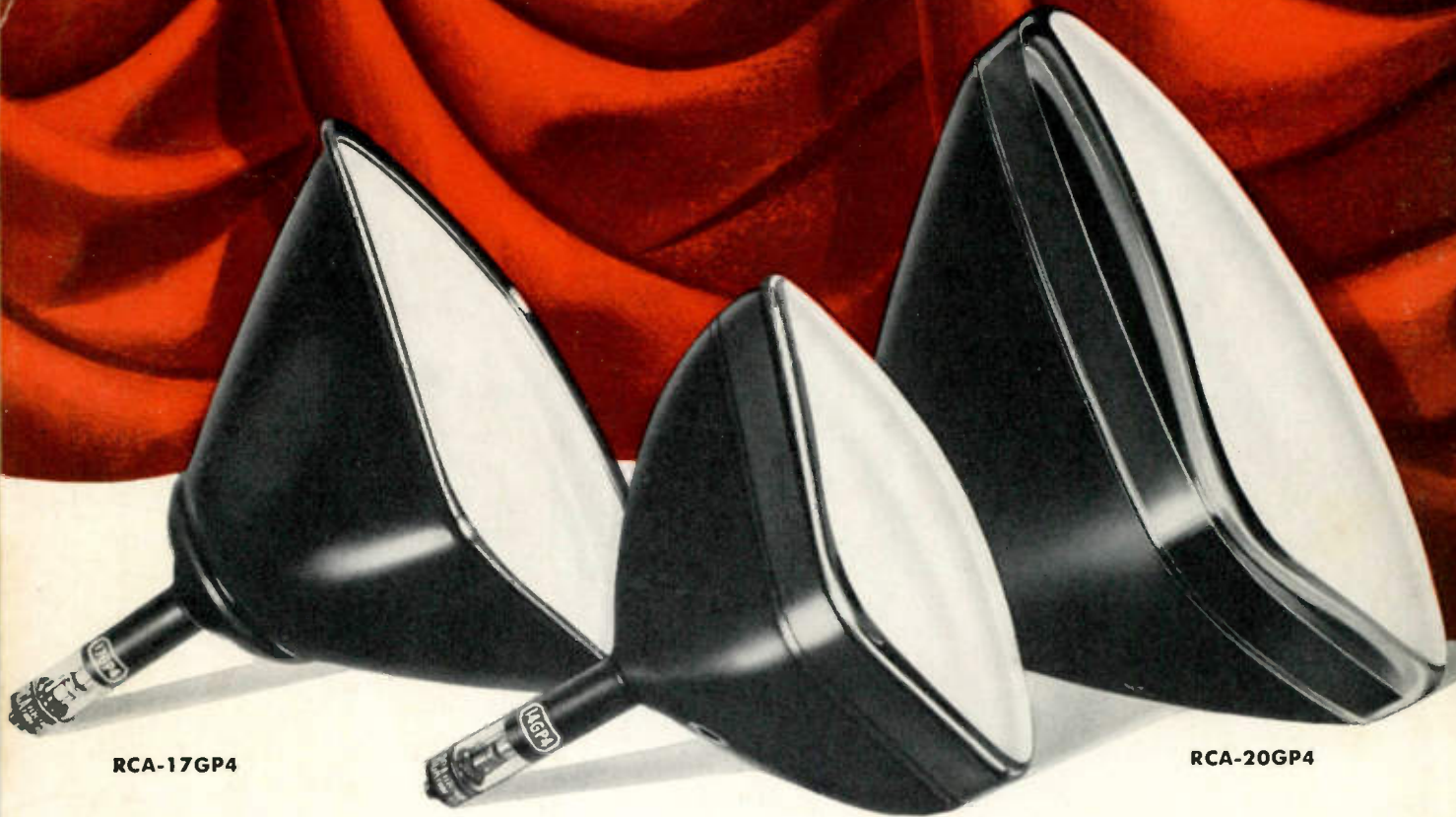

RCA-17GP4

RCA-20GP4

RCA-14GP4

ANOTHER IMPORTANT RCA

Engineering Advance...

Electrostatic Focusing

for television picture tubes

... and how it will benefit you



Once again, RCA engineering has made an important technical advance that benefits the entire industry—by developing an improved method of electrostatic focusing. Electrostatic focusing has now been incorporated in three new RCA rectangular kinescopes.

The new tubes require no focusing coil or focusing magnet. They provide pictures of the same high quality obtained from magnetic-focus types.

It will be a while before you as a dealer or a serviceman will have occasion to stock these electrostatic-focus kinescopes. But... because the tubes permit important savings in critical materials, manufacturers can produce more television receivers upon which your future business will depend.

In the meantime, RCA is producing sufficient quantities of its magnetic-focus kinescopes to meet your current replacement requirements.

Keep informed... stay in touch with your RCA Tube Distributor



RADIO CORPORATION of AMERICA
ELECTRON TUBES
HARRISON, N. J.