

RADIO & TELEVISION RETAILING

IN TWO PARTS • PART ONE

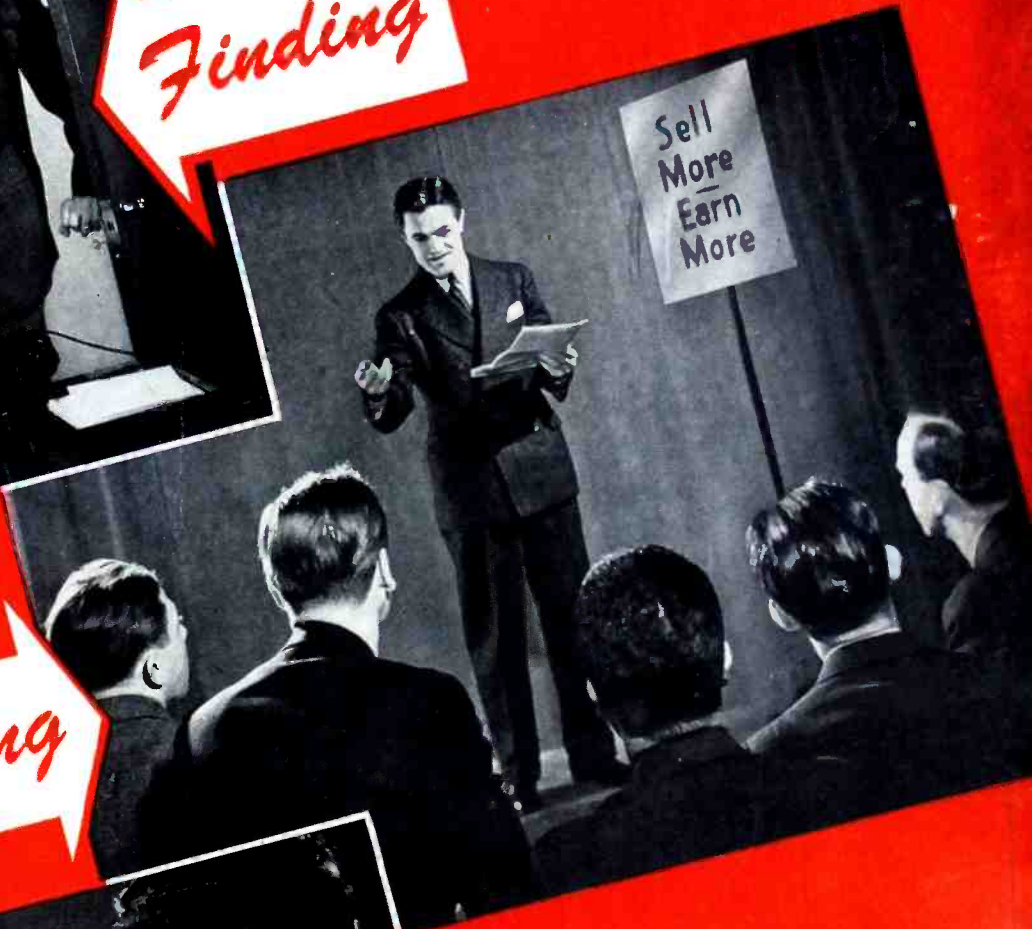

Finding



Training



*Paying Salesmen
to Sell*

AM, FM, TV, Electrical
Appliances, Records and
Phonographs, Recorders,
Servicing and Sound
(See pages 38, 39)

February
1950

Soft-Lite Full View

rectangular 16" tube



AIR KING '50 LINE Hit of Furniture Market

First Sets Ready for Delivery!

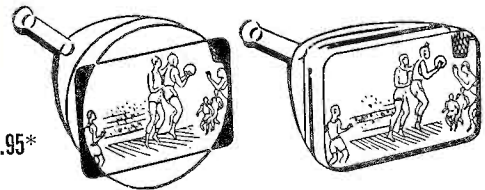

A-2017R
THE PRINCESS **\$279.95***

Exactly as telecast! Pictures received in "perfect shape"... no lost corners, no waste screen area...glare-free filter glass face gives soft light, sharper contrast! New screen fits in more compact cabinets—more beautiful than ever—makes possible amazingly low prices. Get your orders in NOW!

* Prices slightly higher West of the Rockies



A-2016R
THE REGINA **\$299.95***

air king

...has everything!

AIR KING PRODUCTS CO., INC. - 170-53rd St., Brooklyn, 32, N.Y.
NATIONAL DISPLAY—1454 Merchandise Mart, Chicago 54, Illinois

RADIO & TELEVISION RETAILING

IN THIS ISSUE

FEBRUARY, 1950

PART ONE

Including "Radio & Television" and
"Radio & Television Today"

Established in 1922
as ELECTRICAL RETAILING

•
ORESTES H. CALDWELL
Editorial Director

•
M. CLEMENTS
Publisher

•
JOHN L. STOUTENBURGH
Executive Editor

RUTH MORRIS
Records Editor

EDWARD A. CAMPBELL
Technical Editor

CHARLES F. DREYER
Art Director

•
BUSINESS DEPARTMENT

M. H. NEWTON
Sales Manager

HOWARD A. REED
Asst. Sales Mgr.

EDWIN WEISL, JR.
District Manager

A. O'ROURKE
Production Supervisor

N. McALLISTER
Director, Reader Service

•
BRANCH OFFICE
CHICAGO 6

S. M. GASKINS, Western Manager
JOHN ROMANCHAK, District Manager
201 N. Wells St. Randolph 6-9225

•
CIRCULATION DEPARTMENT

B. V. SPINETTA
Circulation Director

•
W. W. SWIGERT
Credit Manager

•
RADIO & TELEVISION RETAILING*

February, 1950, Vol. 51 No. 2. 35 cents a copy. Published monthly by Caldwell-Clements, Inc. Publication Office, 1309 Noble St., Philadelphia 23, Pa. Editorial, Advertising and Executive Offices, 480 Lexington Ave., New York 17, N.Y. M. Clements, President; Orestes H. Caldwell, Treasurer. Subscription rates United States and U. S. Possessions, \$2.00 for one year, \$3.00 for two years, \$4.00 for three years. Canada \$3.00 for one year, \$4.00 for two years, \$5.00 for three years. Pan American Countries \$4.00 for one year, \$5.00 for two years, \$6.00 for three years. All other countries \$5.00 for one year, \$7.50 for two years, \$10.00 for three years. Printed in U.S.A. Entered as second class matter February 21, 1949, at the Post Office at Philadelphia, Pa., under the act of March 3, 1879.

*Trade-Mark Reg. U. S. Pat. Off.

Copyright 1950 by

CALDWELL-CLEMENTS, Inc.

Publishers also of TELE-TECH

★ *AM, FM, Television*

COVER—Finding, Training, Paying Salesmen

WHAT'S AHEAD—In Radio, Appliances, Records and Television	55, 56, 57
FINDING, TRAINING AND PAYING OUTSIDE SALESMEN	58, 59
WHAT DEALERS ARE DOING TO INCREASE SALES	60, 61
TV SALES CHECK LIST	62
LATEST TV RECEIVERS AND RADIO SETS FOR 1950	64, 65
TV MAKERS SPONSOR VIDEO SHOWS	68, 69
WHAT CAN THE DEALER DO ABOUT PARKING PROBLEMS?	76
COST OF DOING TV BUSINESS—1950	78
ATTRACT G.I. REFUND MONEY THE RIGHT WAY	92

★ *Records, Phonographs, Accessories*

HIT THE SALES JACKPOT WITH CURRENT RECORD FAVORITES	66, 67
RECORD INDUSTRY NEWS	80

★ *Electrical Appliances*

1950 NEW APPLIANCE LINES	70, 71
HAS THE REFRIGERATOR SALES PATTERN CHANGED?	74

★ *Servicing and Sound*

TV SERVICE HINTS	85
IMPEDANCE CONSIDERATIONS IN TV ANTENNA DESIGN	86, 87
TELEVISION TECHNICIAN	90
NEW SOUND & PA PRODUCTS	91
NEWS OF THE INDUSTRY	Begins on p. 94

Photo Credits

Ewing-Galloway	Cover, 76
A. Devaney, Inc.	p. 92
E. Krainin	Antenna Check-up Chart, Editorial

PART TWO—ANTENNA CHECK-UP CHART

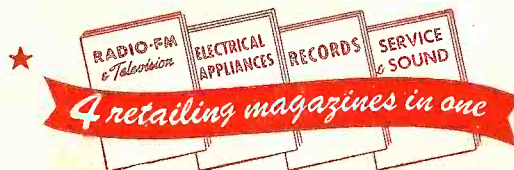

CALDWELL-CLEMENTS, INC.
480 LEXINGTON AVE., NEW YORK, N. Y.

MILNER TV MAST

At Last! A Sectional ALL-ALUMINUM Mast— Height to 100 feet—Lowest Cost

Before you recommend any television mast look at the MILNER TV MAST. Here's the best mast for TV, perfect for owners in the "fringe areas." The all-aluminum MILNER MAST is light yet strong: 100 foot mast complete with fittings weighs under 110 pounds.

Available in 10 foot lengths with fittings for ground, side-of-building, or any type of roof installation, a MILNER MAST can be installed to

any height up to 100 feet. Lowest-priced mast on the market, it also saves on freight shipments — over 50% less than comparable masts of other material.

Home owners will welcome this rust-proof, non-corrosive and durable MILNER MAST with its streamlined, gleaming beauty. Point for point the MILNER MAST surpasses all others. You can sell and recommend them.

COMPARE THESE FEATURES:

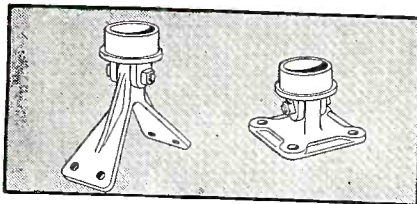

Can be placed anywhere—bases designed for ground or flat installations, for side of building or any type roof.

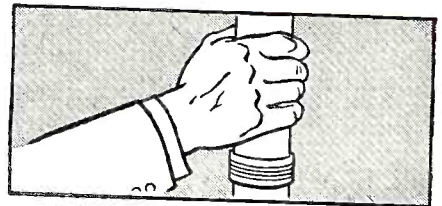

Adjustable after installation; can be manually rotated at base for best reception.

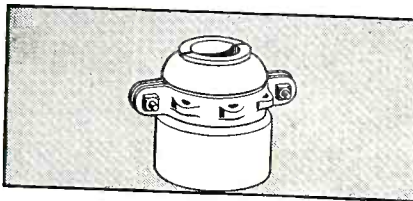

All-aluminum fittings—universal top with adapters to fit any size antenna.

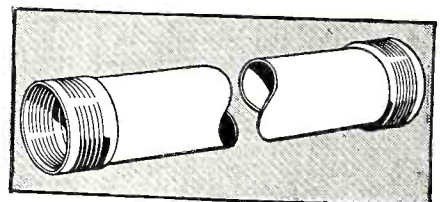

Tubing is joined by a special rolled thread design—(patent applied for). Each 10 ft. section weighs only 7 1/4 pounds.

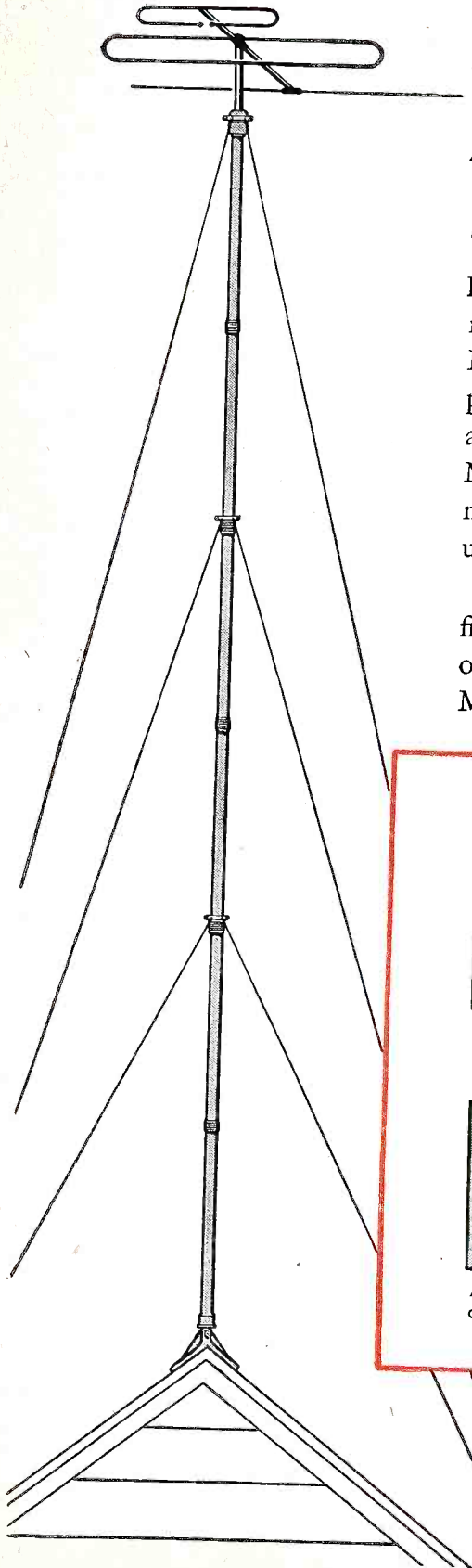

For full information, write to:
MILNER MANUFACTURING COMPANY
Jackson, Mississippi

1950 is the PHILCO YEAR in TELEVISION!

THE announcements made by Philco at the turn of the year have been hailed by dealers everywhere as conclusive evidence that Philco, the industry leader for 19 straight years, is ready to assume its full role of leadership in television for 1950. Conclusive evidence, too, that the buying public may look to Philco . . . as they have over the years . . . for the *value leaders of the television world!*

**At Every Price,
PHILCO CHALLENGES
ALL COMPARISON
for Performance and Quality**

Leadership in value is only one part of the 1950 Philco story in television. Leadership in performance, picture quality and dependability is an even greater and more important part. New circuit developments and a sensational new High Sensitivity Tuner give these new Philco models, at their lower prices, better performance than ever before . . . *yes, performance that challenges all comparison at every price!* And in addition, a rigid system of quality control that will reflect itself in *lower service costs and satisfied customers* for every Philco dealer.

The cue for television dealers everywhere in these new Philco announcements is that *Philco is the line to concentrate on in 1950 . . . the line that simplifies your investment and gives you the biggest opportunity for television profits. Sensational values . . . unmatched performance . . . unsurpassed quality . . . unequalled consumer demand . . . yes, 1950 is the Philco year in television!*

**PHILCO for '50 . . .
QUALITY FIRST!**

Now Ready from Philco . . . Another TV Bombshell!



**16 Inch
"No Glare"
Console
Ensemble**

One of a series of new 16 inch Philco television sets. Model 1600.

\$299⁹⁵*

*Plus Tax and
Warranty*

Big, 145 sq. in. picture, "No Glare" Optical System, and Electronic Built-In Aerial. Mahogany veneer cabinet. Also, new console models 1632 and 1633.



12½ Inch Television Combination

Philco 1476-W Sensational value with 12½ inch picture and Philco 3-Speed Record Changer . . . plays all records, all sizes, all speeds automatically. FM-AM radio. Electronic Built-In Aerial. Walnut veneer cabinet. Also, 1476-M in exquisite Mahogany!

\$399⁹⁵*

*Plus Tax and
Warranty*

**Prices slightly higher in South and West.*

**YOUR SYLVANIA TUBE
CARTONS ARE WORTH 2¢
IN TRADE!**

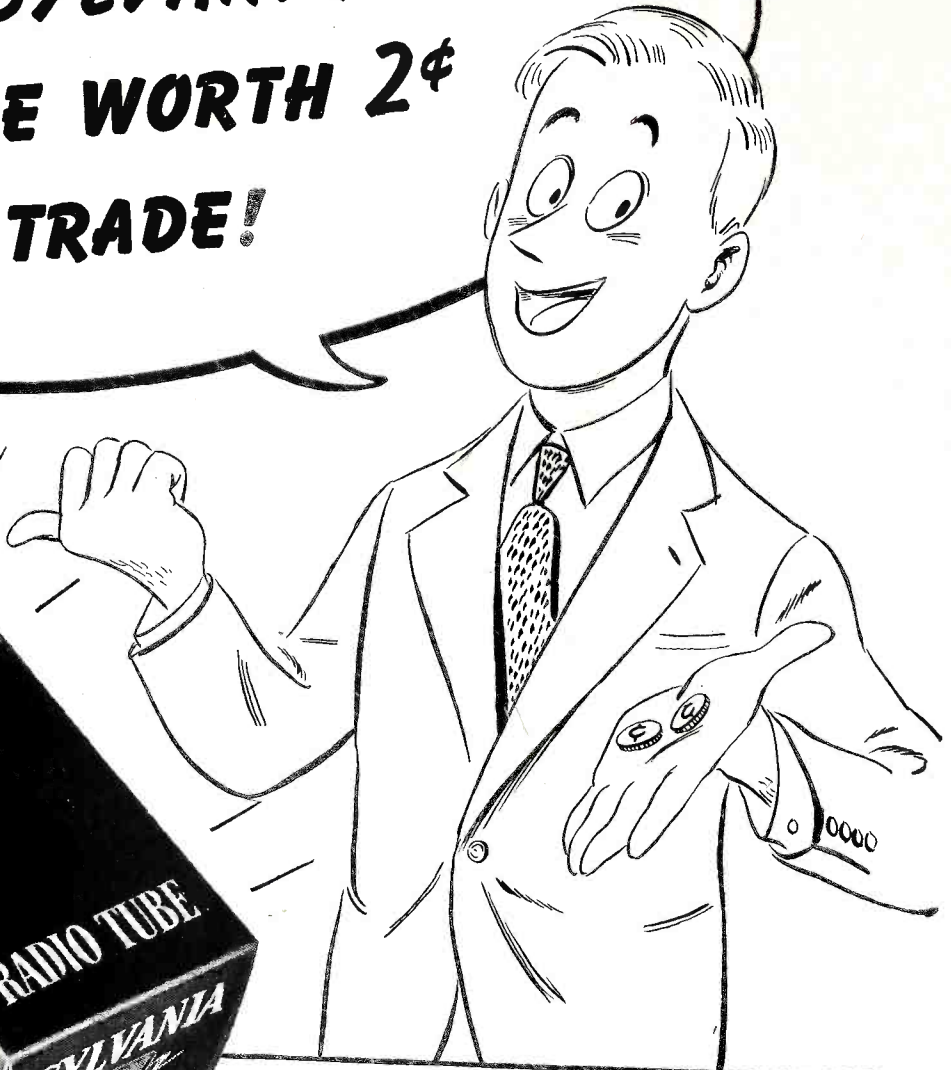

**Ask your
distributor
TODAY—
about Sylvania's
big tube carton
trade-in deal!**

**DURING FEBRUARY, MARCH AND
APRIL YOUR EMPTY SYLVANIA CAR-
TONS ARE WORTH 2¢ EACH AT YOUR
DISTRIBUTOR'S when applied against
the purchase of...**

- SYLVANIA ADVERTISING MATERIAL
- MORE SYLVANIA TUBES
- SYLVANIA TEST EQUIPMENT

SYLVANIA  ELECTRIC

RADIO TUBES; CATHODE RAY TUBES; ELECTRONIC DEVICES; FLUORESCENT LAMPS, FIXTURES, WIRING DEVICES, SIGN TUBING; LIGHT BULBS; PHOTOLAMPS

RADIO & TELEVISION RETAILING • February, 1950



Majestic

MIGHTY MONARCH OF THE AIR

Now Mightier Than Ever

With the Most Sensational Values for Television's Biggest Year

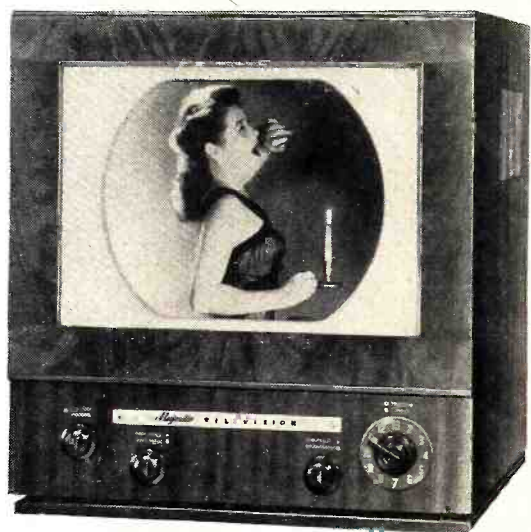

12½" TABLE MODEL **\$ 199⁹⁵**
 IN GENUINE
 MAHOGANY CABINET

12½" Table Model . . . in Genuine Mahogany . . . \$199.95
 12½" Console in Genuine Mahogany . . . \$249.95
 16" Table Model . . . in Genuine Mahogany . . . \$269.95
 16" Console in Genuine Mahogany . . . \$299.95
 19" Console in Genuine Mahogany . . . \$449.95

**With the Exclusive MAJESTIC
 Built-in "Channelized" Antenna**

Make way for the most thrilling TV name in the land!
 Make way for the MAJESTIC conception of engineering,
 performance and value! Make way for the millions of
 Americans who have been waiting for the kind of television
 that only MAJESTIC can provide! The Mighty TV Mon-
 arch for 1950 is here... and it's good news for every
 dealer in the country!

**Sell MAJESTIC... A Household Name
 In Electronics For Over 20 Years!**

Immediate Delivery From Your MAJESTIC Distributor

Majestic RADIO AND TELEVISION CORP.

70 WASHINGTON STREET • BROOKLYN 1, NEW YORK



16" CONSOLE
 IN GENUINE
 MAHOGANY
 CABINET
\$299⁹⁵

Please clip this corner to your
 letterhead and mail to us for
 details of the MAJESTIC
 PROFIT PLAN FOR
 1950.

Not One—but

Two Great

BUSINESS NAMES

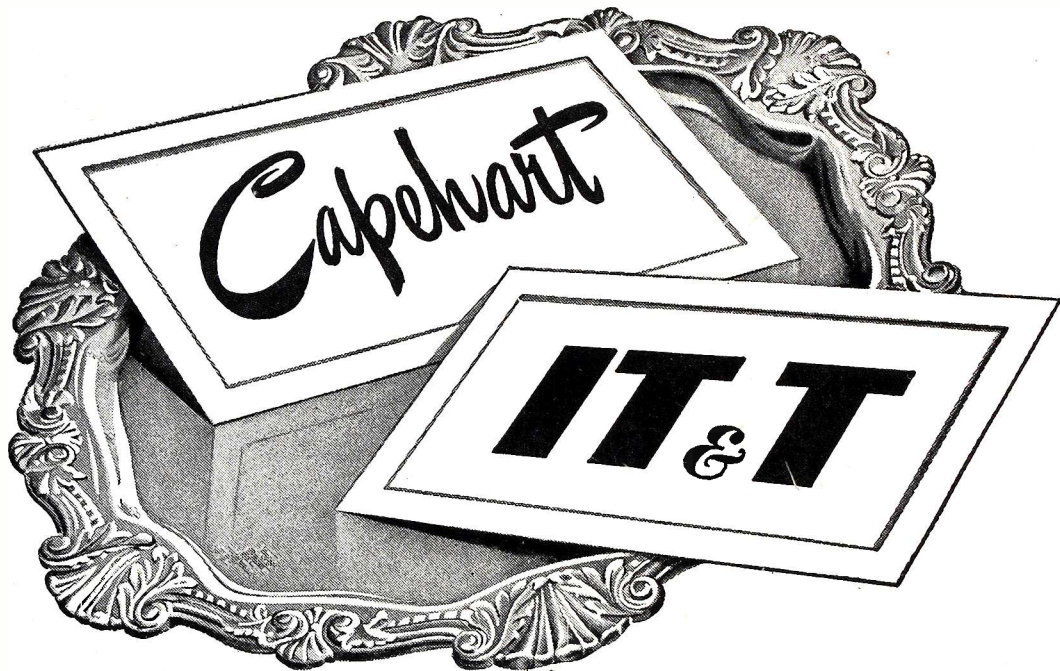

... combine to make *Capehart*
the **TELEVISION Leader!**



The Capehart Nocturne. Big 16-inch picture tube. Needle sharp television. Master-crafted cabinet in mahogany finish. With Polatenna, Capehart's built-in aerial.

All Capehart dealers profit from the world-wide engineering, manufacturing and merchandising experience of not one—but *two* great organizations.

Today full-color national advertising campaigns featuring the Capehart television line in nine leading magazines and two newspaper Sunday supplements are being run by *both* Capehart-Farnsworth Corporation and Interna-

tional Telephone and Telegraph Corporation. Dealer selling aids including display material, local newspaper advertising material, and literature support these campaigns to the hilt.

So, behind the sales efforts of every Capehart television dealer are not one but *two* great business organizations dedicated to making Capehart *the* television success of the year!



CAPEHART-FARNSWORTH CORPORATION
Fort Wayne, Indiana

IF IT'S NEW...

KEN-RAD DEALERS HAVE IT!

YOU'RE in the driver's seat as radio-TV serviceman, if you stock and sell Ken-Rad tubes. Backed by General Electric's vast research and development facilities, Ken-Rad engineers provide you at all times with outstanding new designs. You can service late-model receivers in your neighborhood knowing that the Ken-Rad complete line of tubes, TV-picture, metal, glass, and miniature, includes the advanced types to be found in new circuits... like the pace-setting gated-beam 6BN6 shown here (heater 6.3 v, 300 ma), or its 12BN6 companion (heater 12.6 v, 150 ma). . . . Get the service business that goes to the dealer who has the new types—who handles Ken-Rad tubes! It's new and profitable business, and builds prestige for your shop. . . . Phone or write your Ken-Rad distributor today!

HOT THIS MONTH!

Here's a clear-all-wires news item! Ken-Rad 1950 advertising help is ready and on its way to you via your distributor. There are sales-getting small ads for newspaper use—postcard mailers that pull—spot announcements for your local radio station. Add these to the fine Ken-Rad displays and other promotions, and you as an alert Ken-Rad dealer have "what it takes" to profit from the active tube market in your area.



6BN6 MINIATURE

Typical Operating Conditions, TV Application

Plate supply voltage	175 v
Plate load resistance	.22 megohms
Accelerator voltage	85 v
Cathode resistance	145 to 400 ohms
Minimum signal voltage for limiting action	1.25 v RMS
Audio output voltage	12.5 v RMS

KEN-RAD *Radio Tubes*

PRODUCT OF GENERAL ELECTRIC COMPANY

Schenectady 5, New York

The gated-beam 6BN6 does three tubes' work. It functions as a limiter, discriminator, and audio-amplifier in new TV and FM receivers. You'll be servicing sets soon with 6BN6's in their circuits, and replacements will be in order. Make sure you have this essential new miniature when you need it... and other up-to-the-minute tube types... by stocking the Ken-Rad brand!

182-JAR

Simpson

INSTRUMENTS THAT STAY ACCURATE

Presents

the **New!**
MODEL 303

VACUUM TUBE VOLT-OHMMETER

... A Worthy Companion
of the 260

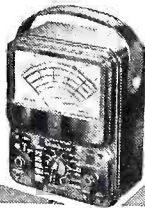

SPECIFICATIONS

DC Voltage

Ranges—1.2, 12, 60, 300, 1200 (30,000 with Accessory High Voltage Probe)

Input Resistance—10 megohms for all ranges

DC Probe—with one megohm isolating resistor

Polarity reversing switch

Ohms

Ranges—1000 (10 ohms center)

100,000 (1000 ohms center)

1 megohm (10,000 ohms center)

10 megohms (100,000 ohms center)

1000 megohms (10 megohms center)

AC Voltage

Ranges—1.2, 12, 60, 300, 1200

Impedance (with cable) approx. 200 mmf shunted by 275,000 ohms

AF Voltage

Ranges—1.2, 12, 60

Frequency Response—Flat to 100,000 cycles

Decibels

Ranges—-20 to +3, -10 to +23, +4 to +37,

+18 to +51, +30 to +63

Zero Power Level—1 M. W., 600 ohms

Galvanometer

Zero center for FM discriminator alignment and other galvanometer applications

R. F. Voltage

(Signal tracing with Accessory High Frequency Crystal Probe)

Range—20 volts maximum

Frequency—Flat 20 KC to 100 M.C.

105-125 V., 60 cycles

Size 5 1/4" x 7" x 3 1/8" (bakelite case). Weight: 4 lbs.

Shipping Wt.: 6 1/2 lbs.

Dealer's Net Price Model 303, including DCV Probe, ACV—Ohms probe and Ground Lead—\$58.75; Accessory High Frequency Probe, \$7.50

Accessory High Voltage Probe, \$14.85

Also available with roll top case, Model 303RT—\$64.75

Smaller and Handier for Greater Portability

A worthy companion of the world-famous Model 260 is this brand new addition to the Simpson line—the Model 303!

Skilled Simpson engineers spent months of painstaking research in the laboratory to produce the Model 303, which is one of the most versatile instruments ever made for TV servicing. This ruggedly constructed instrument offers the maximum in portability because it is approximately 60% smaller than other vacuum tube volt-ohmmeters. However, no sacrifice has been made in readability. The 303 has a large 4 1/2" meter, despite its handy compactness.

One of the many features of the 303 is its low current consumption. The AC voltage range is wider than on any other similar instrument—from 1.2 volts minimum to 1,200 maximum. Like all other instruments bearing the Simpson name, the Model 303 is an instrument of highest quality at an amazingly low price.

SIMPSON ELECTRIC COMPANY

5200-5218 West Kinzie Street, Chicago 44, Illinois
In Canada: Bach-Simpson, Ltd., London, Ontario

TELL THE *Inside* STORY TO

SELL **RAYTHEON** 20/20 TELEVISION

REVOLUTIONARY, NEW 16 INCH TRIANGULAR SCREEN—138 SQ. IN.

Now you see ALL the action because the rectangular tube uses ALL the viewing surface!

DRAMATIC PICTURE DETAIL

Sharp, brilliant picture assures years of outstanding T.V. enjoyment. Glareless Gray picture tube

SIMPLIFIED CONTROL KNOBS—EASY TO OPERATE

All adjustments on the front—easy to get at
Volume off and on—
Brightness—Contrast—
plus new continuous tuner

NEW CONTINUOUS TUNER GIVES PRECISE PICTURE CLARIFICATION

Hairline-sharp, fingertip picture adjustment (synchronized with sound) as simple and easy as tuning a radio.

PRE-FIXED, ULTRA SHARP FOCUS

Centers picture—locks in "Sharp Focus" position.

ADJUSTABLE BUILT-IN "RAYTENNA" AERIAL

Most houses and apartments need only RAYTHEON'S aerial for perfect reception.



STURDY—RUGGED RUBBER SHOCK-MOUNTED PRECISION-BUILT CHASSIS

Years of trouble-free performance—because of RAYTHEON'S superior electronic engineering.

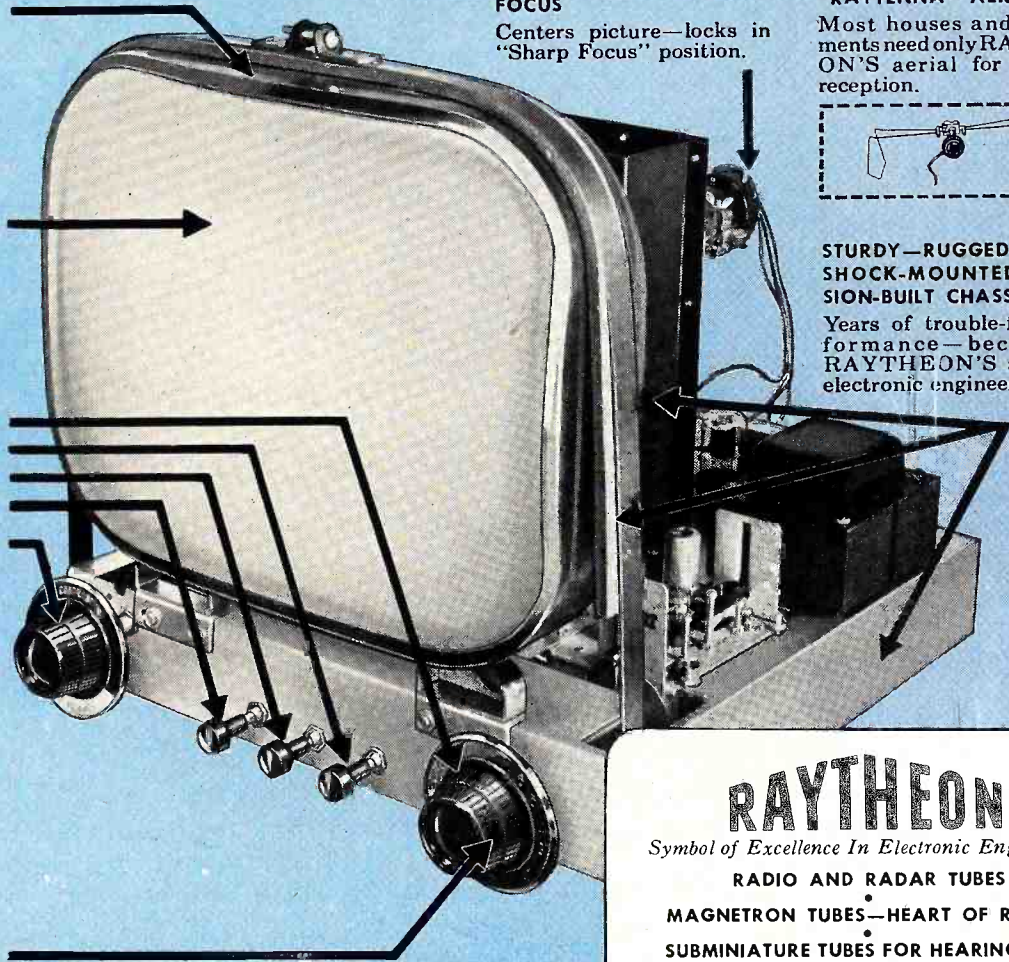

RAYTHEON

Symbol of Excellence In Electronic Engineering

RADIO AND RADAR TUBES

MAGNETRON TUBES—HEART OF RADAR

SUBMINIATURE TUBES FOR HEARING AIDS

MARINE SAFETY DEVICES INCLUDING THE FATHOMETER* AND SHIP RADAR

MICROWAVE RELAY SYSTEMS FOR T. V. F. M. FACSIMILE

F.M. A.M. T.V. TRANSMITTING EQUIPMENT

2-WAY MOBILE RADIO EQUIPMENT

DIATHERMY TUBES

SONIC OSCILLATORS FOR PROCESSING FOODS, DRUGS, COSMETICS

RADIO PHONOGRAPHS—RECORD CHANGERS

ELECTRONIC PHOTO-FLASH EQUIPMENT

ELECTRONIC WELDING DEVICES

DIELECTRIC HEATING MACHINES

20/20 TELEVISION RECEIVERS

RADIO TRANSFORMERS

*Reg. U.S. Pat. Off.

SALES APPEAL *Inside and Out!*

CHOICE OF DESIGN—Modern contemporary in table models, tasteful conservative in floor models.

QUALITY FINISH—Dark, rich mahogany or blonde finishes.

CONTEMPORARY STYLE—Each cabinet is styled to blend with any setting.

MINIMUM SERVICE REQUIREMENTS—RAYTHEON sets are precision-built—not "assembly jobs."



The Silver Anniversary
138 Sq. In. \$299⁹⁵

WRITE, WIRE OR PHONE FOR FRANCHISE DETAILS

BELMONT RADIO CORPORATION

Subsidiary of Raytheon Manufacturing Corp.

5927 W. DICKENS, CHICAGO 39, ILL.

Sales Dynamite!



BLACK-

It's NEW! It's TERRIFIC!
140% GREATER RANGE OF PICTURE TONES



ORDINARY TELEVISION

*Blacker Blacks!
 Richer Greys
 Whiter Whites!*



For a sales-clincher, just show G-E Black-Daylight TV next to ordinary TV. Your customers can sit further away from G-E Black-Daylight TV, yet they'll see it even better! At the same distance it appears closer, more alive! They'll see TV as the camera sees it. There's no annoying glare or reflection.



G-E BLACK-DAYLIGHT TELEVISION

A SIMPLE DEMONSTRATION SHOWS THE ASTONISHING DIFFERENCE — CLINCHES SALES!

Now—you can sell TV which offers your customers the *full* black-to-white range of picture tones . . . TV which is not only finer by actual test but *so much* finer that a dramatic yet simple side-by-side comparison *proves* it beyond all doubt. Here is a TV picture so incredibly advanced that it puts new wallop in the old phrase: sells on sight! Your G-E distributor will gladly prove that THE

AMAZING, ENTIRELY NEW G-E BLACK-DAYLIGHT TELEVISION OFFERS YOU ALL THIS SALES DYNAMITE:

1. Amazing **black-daylight** picture, tests show 140% greater range of picture tones than ordinary television
2. Hand-rubbed, polished cabinets veneered in matched, genuine mahogany
3. Deepest blacks for finest contrast—greater picture detail

4. Daylight brightness for greater eye comfort of lighted room viewing
5. No annoying glare or reflection
6. Automatic Sound . . . just tune picture . . . sound is right every time
7. Built-in antenna, wide-angle screen, simplified controls
8. G-E developed Alnico 5 speakers, acclaimed for superb tone

**Plus tax, installation. Prices slightly higher West and South—subject to change without notice.*



MODEL 12T3—12½" picture tube table model. Beautiful cabinet veneered in genuine mahogany with inlaid trim. **\$229.95***



MODEL 12C107—12½" tube console. Genuine mahogany veneered cabinet on swivel casters, adjusts to any viewing angle. **\$279.95***

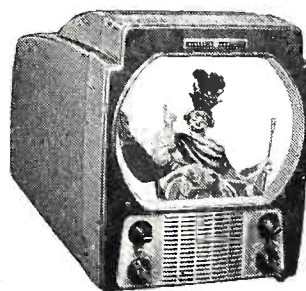

MODEL 10T6—G-E price leader! Compact, rich rosewood molded plastic cabinet—fits any table. 10 inch picture tube. **\$179.95***

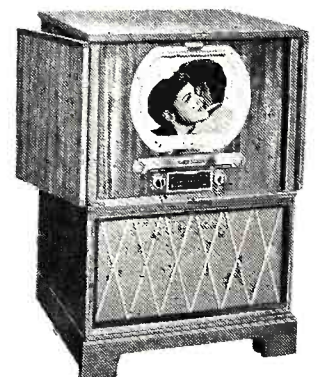

MODEL 12C109—12½" picture tube. Genuine mahogany veneered cabinet on swivel casters. Smartly styled doors. **\$299.95***

DAYLIGHT TELEVISION

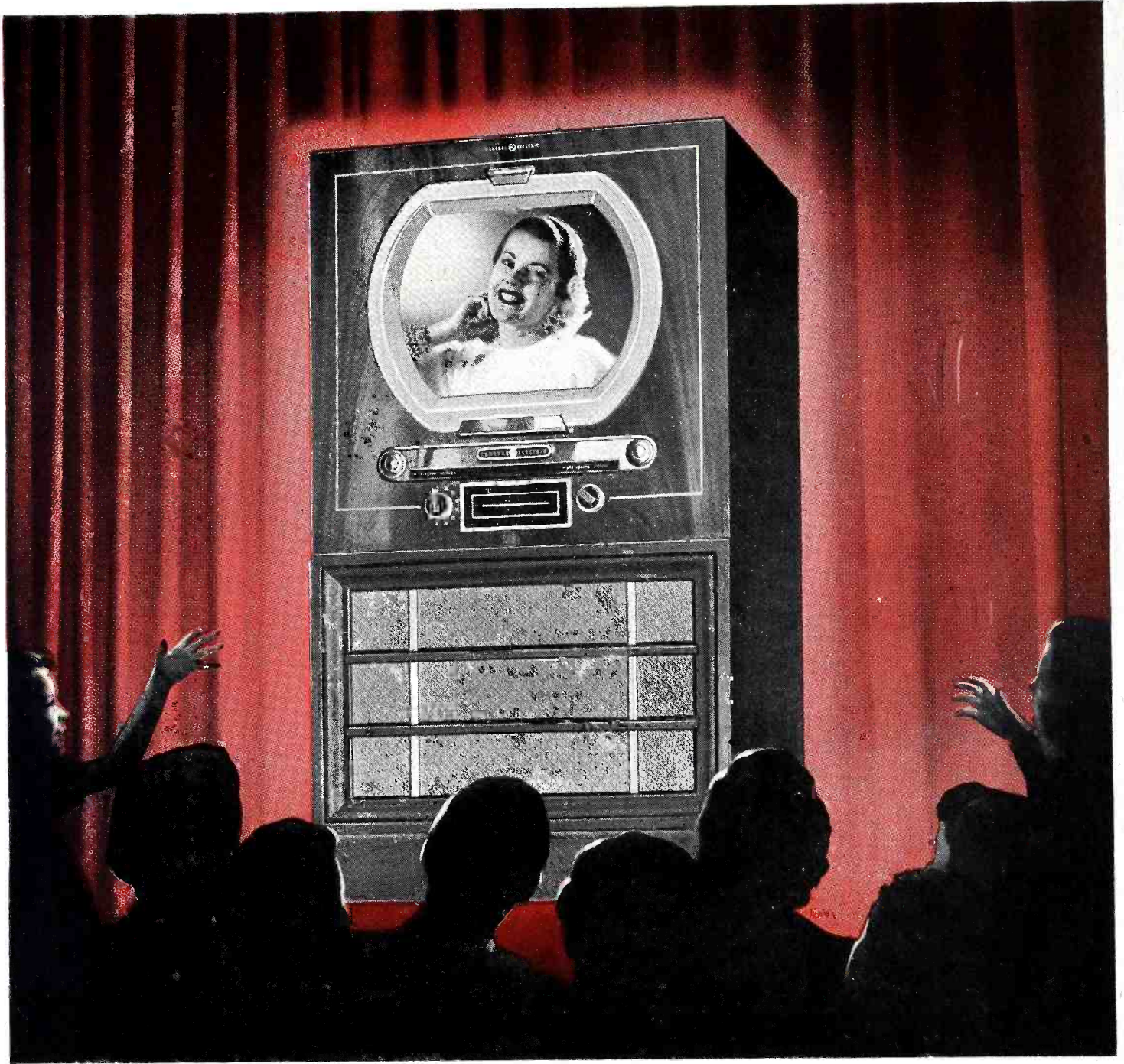

You can put your confidence in—

GENERAL  **ELECTRIC**

**"NOTHING IS TOO GOOD
FOR MY FAMILY—**

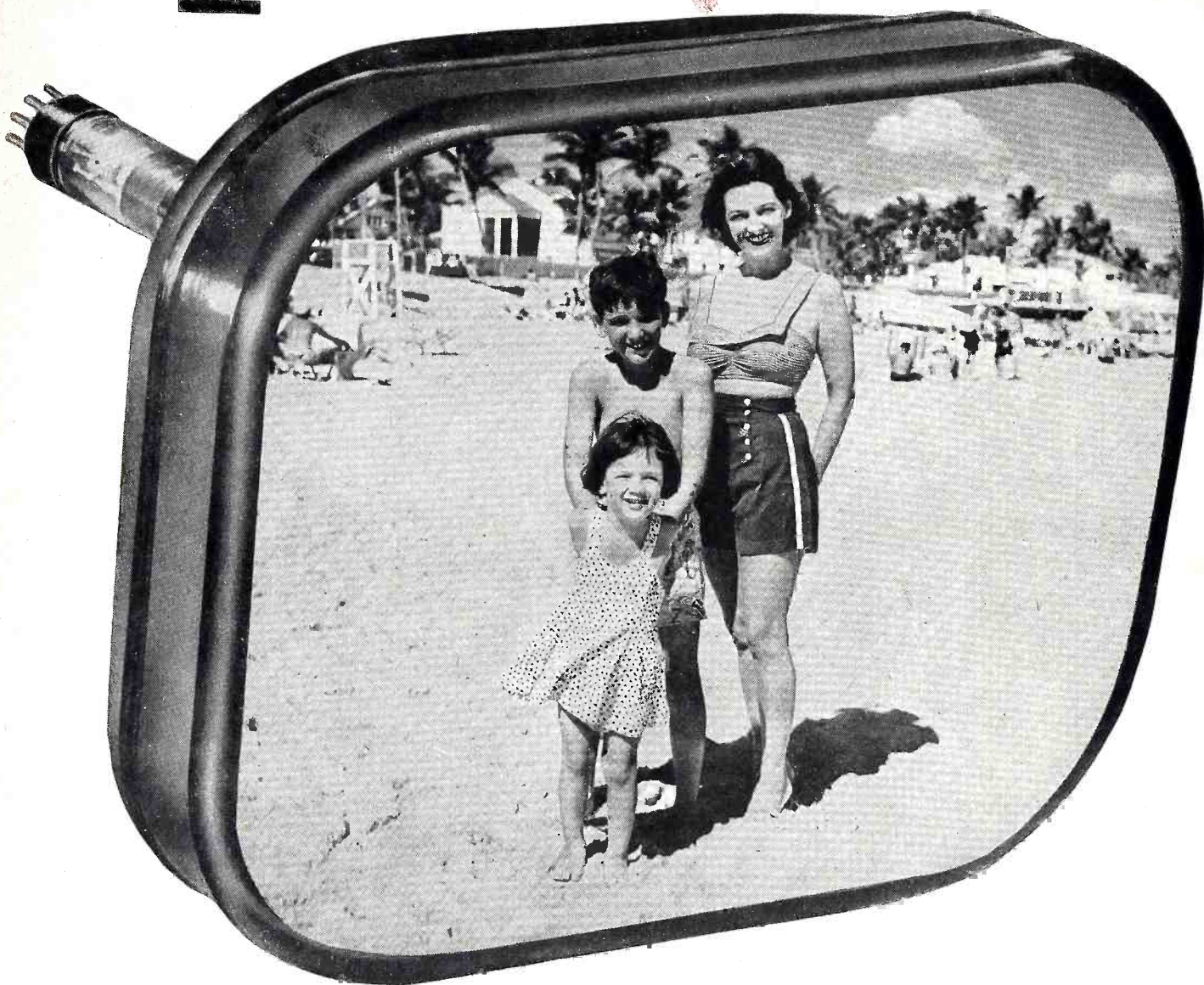

WE BUY THE BEST—Sheldon!"

YOUR CUSTOMERS WANT THE BEST tube possible in the television sets in their homes. They want their families to enjoy pictures as only Sheldon "Telegenic" Tubes can show them—where Black is Black, White is White . . . and between, all the natural intermediate shadings. They want their families to have "round-the-clock" viewing in daylight, artificial light or darkness *without glare, without eyestrain.*



Give them Sheldon "Telegenic" Picture Tubes!

WRITE for Descriptive Literature on these **NEW All-Glass Tubes:**
 10", 12½" and 16" Velour Black • • • 16" 52° Deflection Angle,
 interchangeable with glass-metal 16AP4 • • • 16" Rectangular •
 Short 16" 70° Deflection Angle 17½" overall • • • 19" 70° Deflection Angle.

SHELDON ELECTRIC CO.

Division of Allied Electric Products Inc.

68-98 Coit Street, Irvington 11, N. J.

Branch Offices & Warehouses: CHICAGO 7, ILL., 426 S. Clinton St. LOS ANGELES 6, CAL., 2559 W. Pico Blvd.

SHELDON TELEVISION PICTURE TUBES • CATHODE RAY TUBES • FLUORESCENT STARTERS AND LAMP HOLDERS • SHELDON REFLECTOR & INFRA-RED LAMPS
 PHOTOFLOOD & PHOTOSPOT LAMPS • SPRING-ACTION PLUGS • TAPMASTER EXTENSION CORD SETS & CUBE TAPS • RECTIFIER BULBS

→ **VISIT THE SHELDON BOOTH NO. 326 AT THE I.R.E. SHOW, MARCH 6-9, GRAND CENTRAL PALACE, N. Y. C.** ←

IN TWO PARTS—PART TWO, FEBRUARY, 1950

RADIO & TELEVISION RETAILING

CALDWELL-CLEMENTS, INC. • 480 LEXINGTON AVENUE, NEW YORK 17, N. Y.

Sure of the **BEST PICTURE QUALITY**

INSTALL AN

INLINE* ANTENNA

Here is a high gain TV Antenna—it is high gain because the antenna elements are of proper length and spacing, one in front of the other, inline—thus building a stronger signal. Laboratory and field tests prove the principle of inline construction to be superior in providing the best electrical characteristics. Mechanically the construction is proved under all extreme weather conditions—Amphenol antennas are rugged and will give years of trouble free service. Any TV set will provide best picture quality with an Amphenol INLINE* Antenna.



Standard Amphenol INLINE Antenna No. 114-005 is complete with 75 feet of 300 ohm transmission line.

Model 114-009 is the same as the Standard without the lead-in wire.

*Amphenol INLINE Antennas are manufactured under U.S. Patent No. 2,474,480.

AMPHENOL

AMERICAN PHENOLIC CORPORATION

1830 SO. 54TH AVENUE

CHICAGO 50, ILLINOIS

**For Better
TV Pictures**

ANTENNA

Check-Up!

FROM ROOF TO SET AT LEAST ONCE A YEAR



ANTENNA

elements may be rusted, loose, broken, pointed in the wrong direction, due to weathering, winds, storms, etc.

CONNECTION



corroded, which would cause static, flashes in picture.

DOWN LEAD

line may be hardened and cracked, or stretched and loose; may be frayed, and bare wire may be touching metal, or the conductors may be broken.

ARRESTER

may be missing, rusted, broken, have loose connections, be disconnected, or be improperly located.

MAST

may have rusted, bent, loosened, or may need guying.

BRACKETS

and clamps can be rusted, loose, bolts pulled out of wall . . . or no longer holding mast in proper position.

INSULATORS

may have rusted and broken, or pulled out of mounting, or may be too few in number to secure line.

LEAD-IN

may be frayed or broken where it enters house through windows, hole in floor, etc., or be grounded on casement.

CONNECTIONS

to set may be frayed, broken, loose, shorted, or unsightly due to relocation of receiver.

GROUND

may be missing or poorly connected to mast and/or arrester. May require heavier ground conductor.

For Better Pictures —

CHECK-UP ★ TUNE-UP ★ TUBE-UP

Published & Copyrighted by Caldwell-Clements, Inc.

**RADIO & TELEVISION
RETAILING**

FEBRUARY 1950

480 Lexington Ave., New York 17, N. Y.

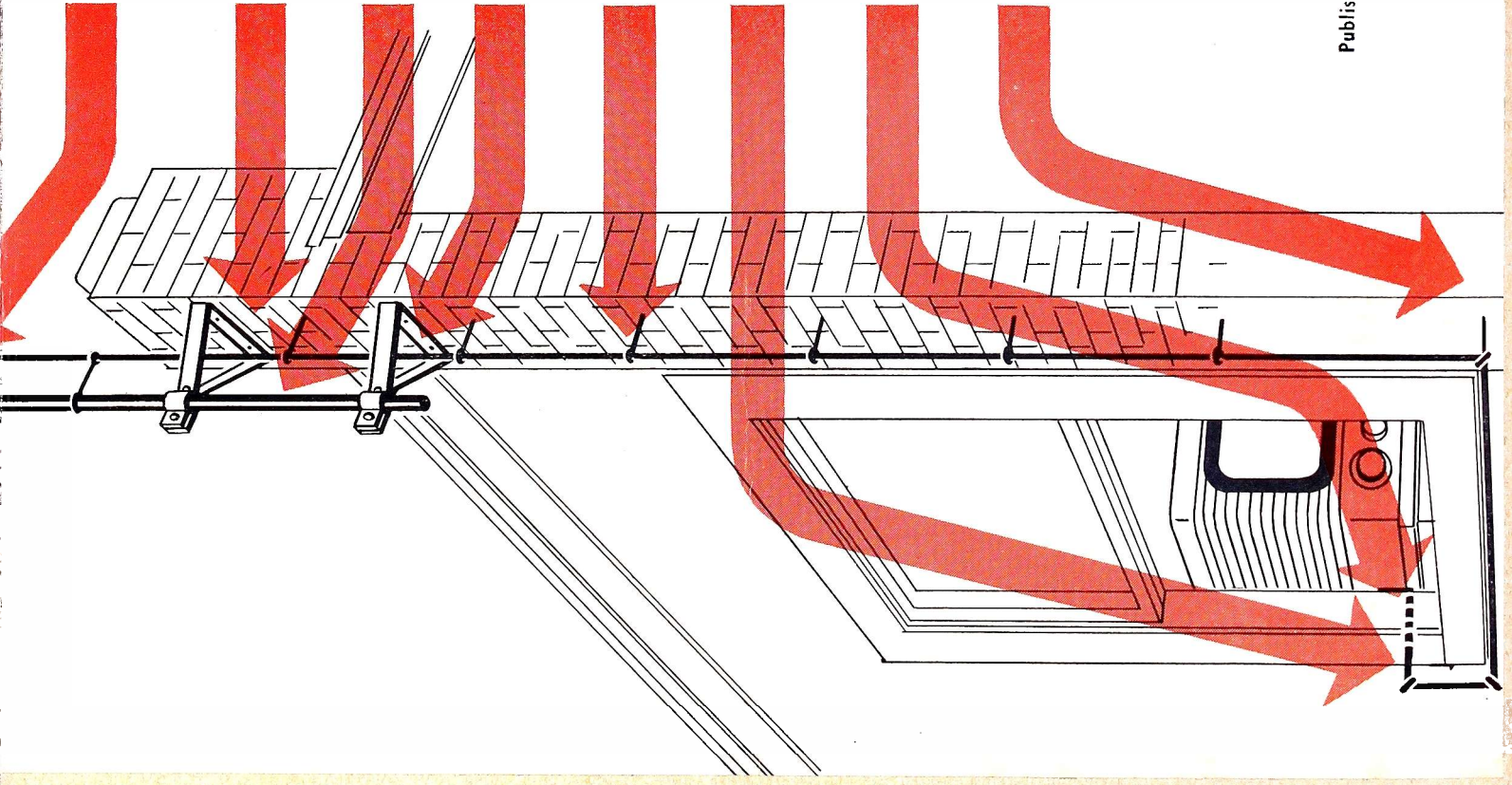

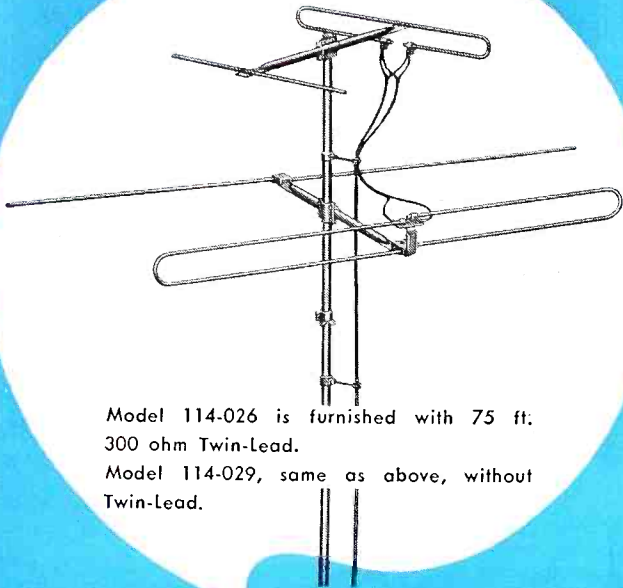

Model 114-026 is furnished with 75 ft. 300 ohm Twin-Lead.
Model 114-029, same as above, without Twin-Lead.

PIGGY-BACK

The Amphenol "PIGGY-BACK" antenna is designed for those areas with two TV stations, one high band and the other in the low band, located in different directions. The "Piggy-Back" makes possible individual direction orientation for the high and low bands station.

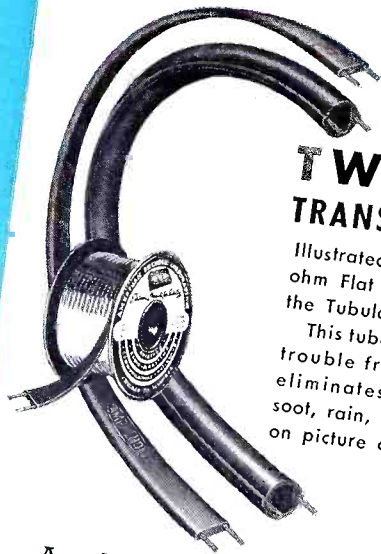

AMPHENOL TWIN-LEAD TRANSMISSION LINES

Illustrated are the Amphenol 300 ohm Flat Twin-Lead 14-056 and the Tubular Twin-Lead 14-271. This tubular twin lead provides trouble free installations and eliminates the effects of dirt, soot, rain, snow, wind, and dew on picture clarity.

Amphenol Twin-Lead and cables have always been the choice of well informed radio and TV users and installers. Both flat and round 300 ohm transmission lines by Amphenol fill the most exacting requirements. TV users and installers have found that, in sea coast areas where salt deposits accumulate or where soot and dirt collect on the Twin-Lead or in any area where sunlight is strong, Amphenol's weather-resistant brown polyethylene gives two to three times the service of ordinary twin leads.

New AMPHENOL LIGHTNING ARRESTOR



The "National Electric Code" requires that all antenna installations must be protected by the use of approved lightning arrestors. Amphenol's new lightning arrester 155-338 meets these requirements and carries the Underwriters Laboratories seal of approval. The arrester is simple to install, compact and efficient in its protection. Play safe, Use Amphenol.

AMPHENOL

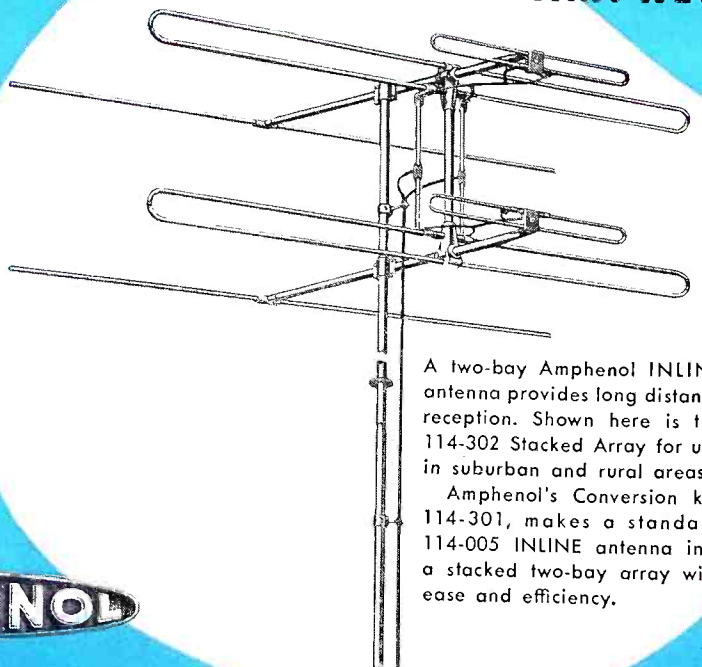

A two-bay Amphenol INLINE antenna provides long distance reception. Shown here is the 114-302 Stacked Array for use in suburban and rural areas. Amphenol's Conversion kit, 114-301, makes a standard 114-005 INLINE antenna into a stacked two-bay array with ease and efficiency.



Value



your customers can SEE

ARVIN Visible Value TELEVISION

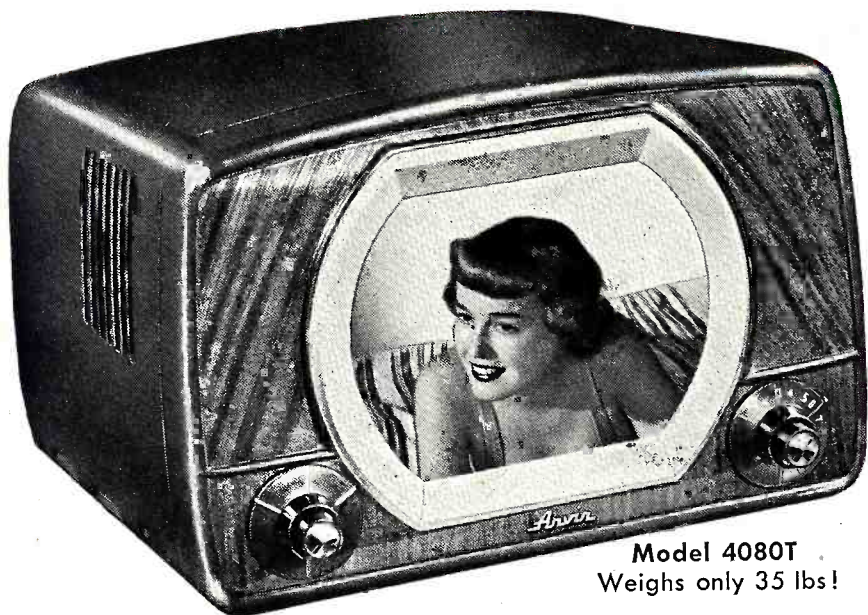

Model 4080T
Weighs only 35 lbs!

New 8½" Table Model

with BIG SET Features.

Makes a
Perfect "Second Set"

\$129.50*

Federal Excise
Tax—\$1.26

• No-Glare Black Tube for better contrast • Simplified tuning; only two visible groups of controls • Service-free electro-magnetic circuit • Straight AC operation for longer tube life • Horizontal automatic frequency control locks picture in even with high interference levels • Delayed automatic gain control • Beautiful cabinet in lacquer mahogany finish • Set designed to comply with Underwriters' standards • Today's top 8½" TV value!

You can SEE the difference!

Radio & Television Division
NOBLITT-SPARKS
INDUSTRIES, INC.

Columbus, Indiana



Model 3121TM

Same model in beautiful mahogany eye-level console, \$279.50*

Deluxe 12½" Table Model

Big screen quality
television at a
truly low price

\$229.50*

Federal Excise Tax—\$1.47

with Built-in Versi-Tenna and phonograph jack

This is the super-powered de luxe Arvin TV that performs rings around others even in fringe areas! Easy to tune as a radio. 92 sq. in. of clear, undistorted picture. Expertly engineered, beautifully styled, and loaded with fast-selling performance features! Table to match at small extra cost.

*Slightly higher in Zone 2

Announcing the newest **WORLD'S**

Featuring the automatic Electronic Servant— 7 amazing services — no increase in prices!

★ Nearing the million mark, General Electric Clock-Radios reach an all-time high in popularity. Now, with more features per dollar than any other radio made, G-E Clock-Radios with the new automatic Electronic Servant are headed for sensational new sales records. What other radio wakes you to music, lulls you to sleep, turns appliances on and off (coffee-makers and a dozen other electric appliances), tells time even in the

dark, is an accurate G-E electric clock, a fine-tuned radio and an electronic reminder? Here's radio's hottest item that knows no season! What a natural for red-hot promotion—and it's ready for you now! If you want to share in this success, don't lose a minute in getting the whole story from your G-E radio distributor, or write to

*General Electric Company, Receiver Division
Electronics Park, Syracuse, New York.*



CLOCK-RADIOS

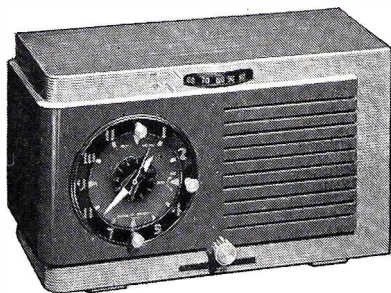

Model 508—Performs all 7 amazing services. This new, deluxe G-E Clock-Radio comes in a bleached mahogany plastic cabinet. **\$39.95***

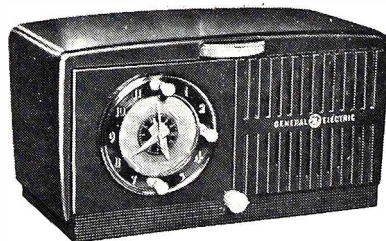

Model 505—World's most useful radio in a rich rosewood plastic cabinet. Performs all seven amazing services. Note the same low price. **\$34.95***

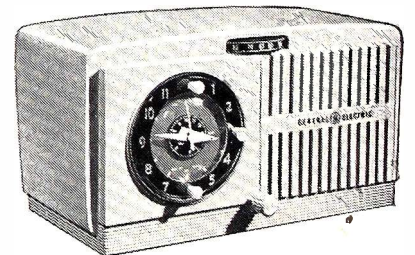

Model 506—All 7 sensational services of the new G-E Clock-Radio in a smartly styled ivory plastic cabinet. **\$36.95***

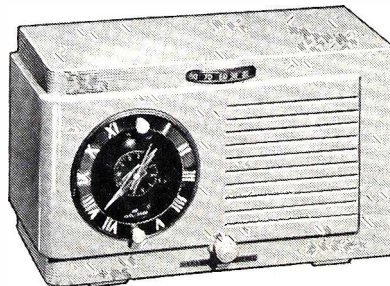

Model 501—G-E "Wake-up-to-music" Clock-Radio. If you doze off, it buzzes until you do get up. G-E electric clock has luminous hands. Lovely ivory plastic cabinet. **\$31.95***



Model 500—Same General Electric "Wake-up-to-music" Clock-Radio as Model 501, left, but in a handsome rosewood plastic cabinet. G-E price leader—tremendous value. **\$29.95***

**Prices slightly higher West and South—
subject to change without notice.*

MOST USEFUL RADIO



LULLS
YOU TO
SLEEP!



TURNS
APPLIANCES
ON AND OFF!



WAKES
YOU TO
MUSIC!



FINE-TONED
TABLE
RADIO!



TELLS TIME
EVEN IN
THE DARK!



ELECTRONIC
REMINDER!



ACCURATE G-E
ELECTRIC
CLOCK!



100 90 80 70 65

GENERAL ELEC

Model 507

STUNNING NEW PLASTIC CABINET IN BRILLIANT BURGUNDY!

All 7 features of the world's most useful radio . . . all the beauty, the sales-appeal of a cabinet in stunning burgundy plastic. Radio has G-E

Dynapower speaker, built-in antenna, superheterodyne circuit. G-E Electric Clock has luminous hands and dial markings. Model 507. **\$35.95***

You can put your confidence in—

GENERAL  ELECTRIC

The **FAMOUS GENUINE**
JENSEN MODEL 510
COAXIAL SPEAKER

BEST AT ANY PRICE - - -

Comparative tests with the most expensive types of two-way speakers will prove that the Jensen Model 510 is the best regardless of price.

The new, wide-angle acoustic lens of the "510" is an example of Jensen leadership in loudspeaker engineering. By adapting optical principles to acoustics, this lens acts in conjunction with the h-f horn to distribute h-f radiation uniformly over a wide angle. This insures constant balance and high quality reproduction throughout the whole room.

Whether the "510" is used for broadcast monitoring, professional sound reproduction, or for home entertainment systems, the advanced Jensen electroacoustic design assures the finest performance.

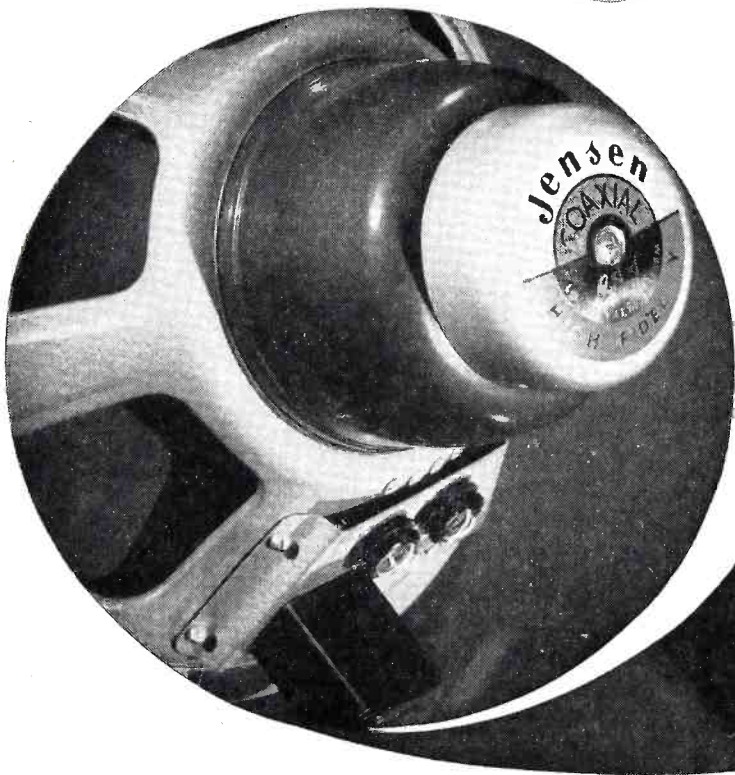
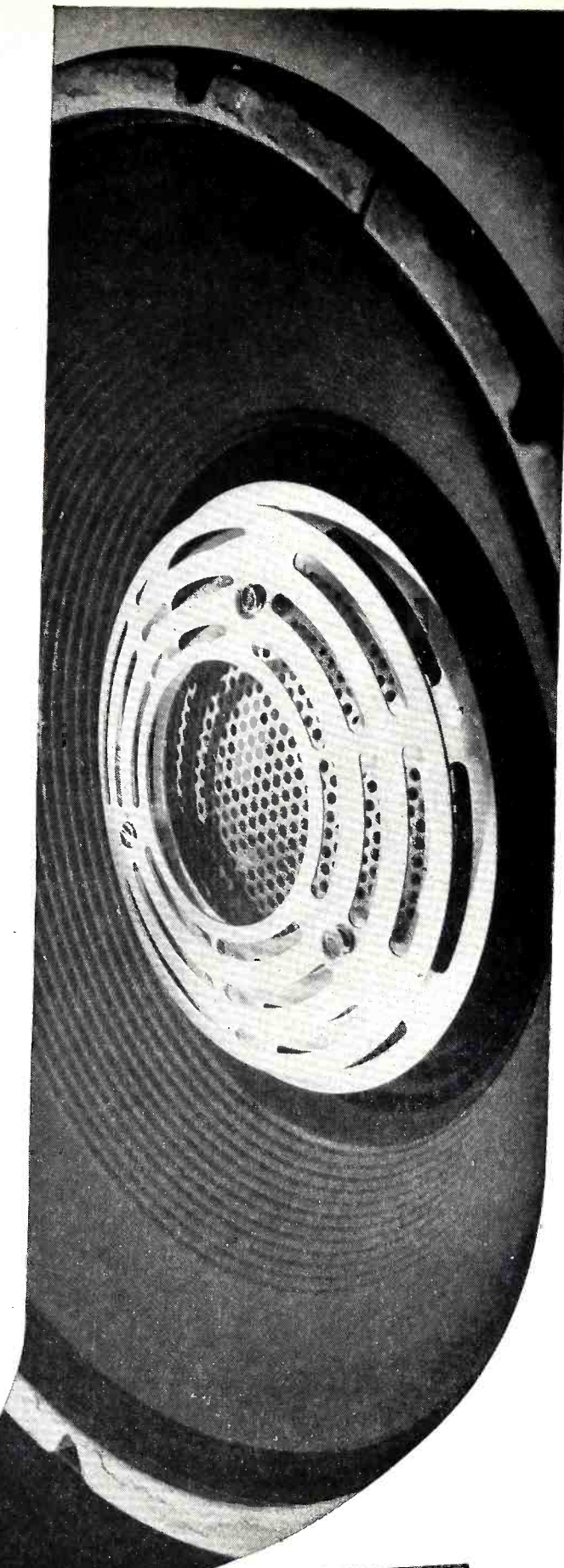

JENSEN MANUFACTURING COMPANY DIVISION OF THE MUTER COMPANY
 6625 South Laramie Avenue, Chicago 38, Illinois • In Canada: Copper Wire Products, Ltd., 351 Carlaw, Toronto

Here's why you'll get your big profits from **RCA VICTOR** again in '50...

As 1949 bowed out . . . there were over 3,700,000 television receivers in use in the United States. And more were RCA Victor than any other make!

Two prime factors in establishing RCA Victor's leadership were:

1. Top quality at the lowest possible price.
2. Enthusiastic dealer selling support.

Now—for 1950—RCA Victor is maintaining its share of this "partnership for profit" by offering your customers a brand-new line of television receivers with more value than ever before. Spanking new receivers have new improvements developed through RCA Victor's never-ending search for ways to provide a better instrument for the lowest possible price.

To reap your share of waiting profits . . . display and merchandise this sensational new RCA Victor line so that customers will flock to you for the much-in-demand RCA Victor Eye Witness Television. Remember, you're backed by the gigantic new RCA Victor advertising and promotion campaign for 1950 that tops anything you've ever seen!

But while you're concentrating on television—don't forget to push RCA Victor "45" for bigger-than-ever instrument and record profits in '50! Here again—RCA Victor brings you brand-new "45" instruments to satisfy the skyrocketing demand for "45's".

Curious to see these new RCA Victor super profit-makers for '50? *Turn the page!*

RCA VICTOR



DIVISION OF RADIO CORPORATION OF AMERICA

These 3 lead **RCA VICTOR'S**

... **they fit any budget!**

Here they are . . . RCA Victor's brand-new, low, low price television receivers in the 10-inch, 12½-inch and 16-inch fields. Each has the top quality found in every RCA Victor instrument—yet design and engineering efficiency have made it possible to offer them at amazingly low budget prices.

Make these 3 models your "sell-up" leaders to the more expensive RCA Victor television receivers. Point up their amazing dollar value. And when you start to "sell-up"—you'll find that the RCA Victor line offers you a steady, unbroken climb in prices that lead you to more sales . . . more profits!

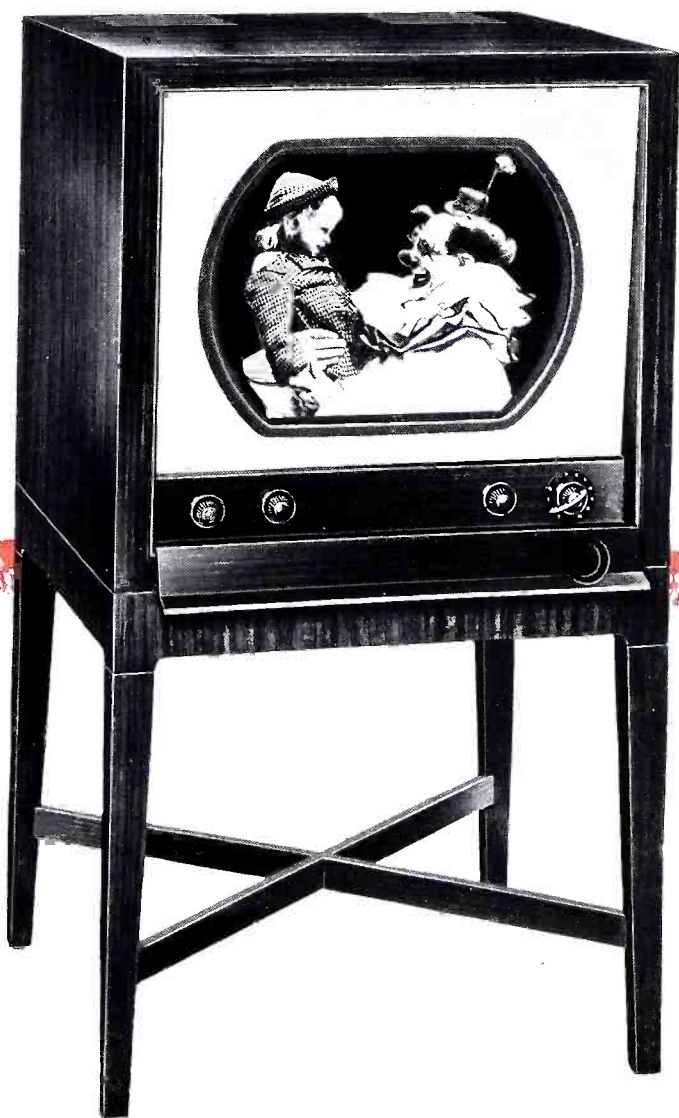

RCA Victor T164—Giant 16-inch Eye Witness pictures held steady by the RCA Victor Eye Witness Picture Synchronizer; phono-jack to plug in RCA Victor's "45" record changer; fine cabinet with choice of finishes; matching Console Base (with or without built-in antenna) at moderate extra cost.

new "SELL-UP" television line

RCA Victor T100—10-inch picture tube; improved RCA Victor Eye Witness Picture Synchronizer; RCA Victor Automatic Multi-Channel Station Selector; phono-jack to plug in RCA Victor's "45" record changer; matching Consolette Base (with or without built-in antenna) at moderate extra cost.



RCA Victor T120 — The RCA Victor "Tel-Ensemble"... really de luxe 12½-inch television for your customers. Big 12½-inch screen; RCA Victor Eye Witness Picture Synchronizer; phono-jack to plug in RCA Victor's "45" record changer; with built-in antenna. The lovely support completes this fashionable furniture setting.

RCA VICTOR



FIRST IN TELEVISION

ALL NEW-ALL "45"



RCA Victor 45J

World's fastest automatic record changer attachment. Beautiful, compact cabinet. Plays up to 50 minutes of recorded music at the touch of a button. Sensational "live-talent" performance that music lovers everywhere are raving about.



RCA Victor 45EY

Fastest, surest, automatic record changer complete with built-in speaker and amplifier . . . not an attachment! Gives up to 50 minutes of clear, life-like musical entertainment at the merest touch of a button.



RCA Victor 9Y51

Compact table-model radio-phonograph in modern maroon plastic cabinet. Sensational "45" record changer plus an exceptionally fine RCA Victor radio. Superb, extrasensitive speaker.

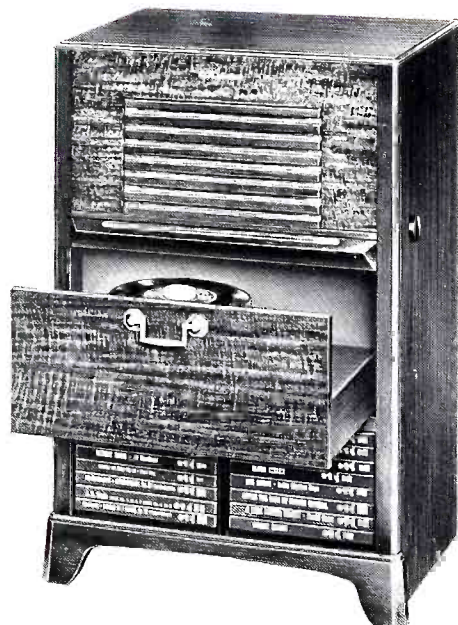

RCA Victor 9W51

Smallest console Victrola radio-phonograph ever made . . . just 28 inches high, 18 inches wide! AM radio with "Golden Throat" tone system, plus "45" record player. Storage space for 140 records.

"Victrola"—T.M. Reg. U.S. Pat. Off.

"45" IS SWEEPING

ours for greater profits in '50!

In full production to meet the skyrocketing demand for "45"!

During 1949 RCA Victor's sensational new "45" system of recorded music out-sold all others by a *wide* margin. With over 2,000 musical selections to choose from—customers made "45" record sales 35% to 50% of total record sales for many dealers.

Prospects for '50 are even brighter . . . with this line of "45" instruments that offer your customers unbeatable performance, unbeatable value for their dollar.

Get these new "45's" on your display floor, fast! Watch them set a new high for record profits in '50!

RCA VICTOR



FIRST IN RECORDED MUSIC

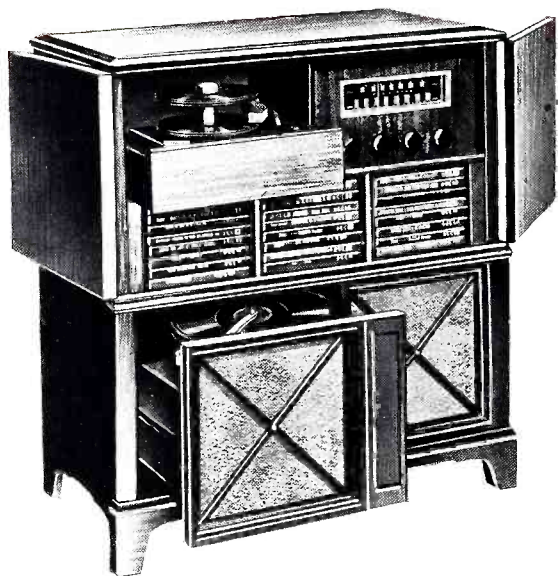

RCA Victor A78

Handsome cabinet housing RCA Victor "45" record changer; plus a separate changer for both 78 and 33 $\frac{1}{3}$ rpm records; plus AM-FM radio. Famous "Golden Throat" tone; 12-inch speaker.

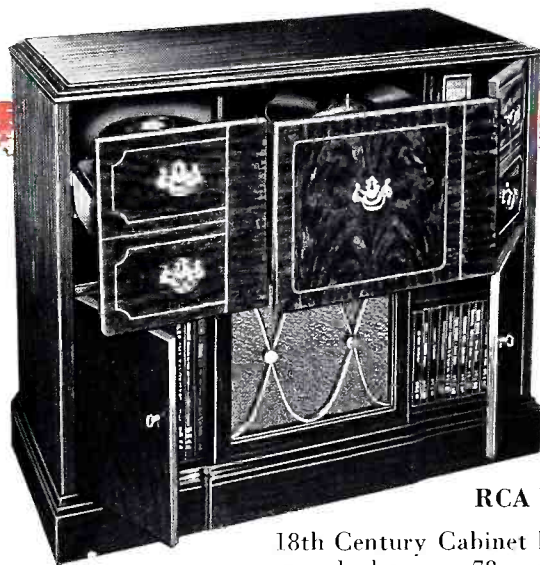

RCA Victor A106

18th Century Cabinet housing "45" record changer; 78 and 33 $\frac{1}{3}$ rpm record changer (plays intermixed 10" and 12" records of same speed); FM and AM radio.

**YOUR CUSTOMERS GET "45's" WITH THESE
NEW 1950 TELEVISION SETS, TOO!**

See them illustrated on the preceding pages:

RCA VICTOR TA128
RCA VICTOR TA129

RCA VICTOR TA169
RCA VICTOR S1000

THE COUNTRY!

Here's a NATURAL... for 2-way profits

RCA Victor 9X571



The new RCA Victor 9X571 has tone never heard before in a table model!

Because it's a big hit with everybody, the 9X571 will bring you table-model radio profits like you never had before. And to realize even bigger dollar profits, demonstrate the 45J with this set. Your customers will be amazed at the performance this pair gives . . . and you know how effectively a demonstration sells the "45."

RCA Victor 45J



RCA VICTOR



DIVISION OF RADIO CORPORATION OF AMERICA

World Leader in Radio... First in Recorded Music... First in Television

NOW

Radion



GOES OUTDOORS

... to Keep on Selling T-V for you!

HERE'S that package conical antenna you've wanted, to sell T-V where an indoor antenna isn't enough.

Here's the closer you've needed, for T-V volume in a more competitive market.

Anyone can install it, and it cuts installation costs to \$9.95.

Radion TA-51 Window-Mount Antenna is the ONLY outdoor antenna with full channel coverage and full orientation... mounts anywhere outdoors.

Absolutely nothing to assemble! Individually packed one to a carton, six to a master carton—ready to mount anywhere outdoors and go to work instantly.

Rugged! Completely weatherized. Triple chrome-plated 2-section steel telescope mast and 4-section dipoles. Black oxide base, full swivel for any angle mounting. Dielectrically correct black Bakelite head. No lightning arrester needed. Screw it in place, set it in one universal position, and forget it!

You need Radion TA-51 like baby needs shoes. For T-V sales action, mail the coupon now or contact your Radion Distributor at once!

Cuts installation cost.

Anyone can install it, anywhere.

Comes fully assembled.

Full channel coverage. Full orientation. Set it! Forget it!

\$9.95

SELL T-V
the QUICK,
EASY WAY

WITH RADION TA-51... WINDOW-MOUNT!

RADION TA-51

Fully assembled in individual cartons. Shipped, six in a master carton. Ready for delivery now.

RADION TA-49

The recognized leader for all Indoor Installations... over 750,000 in use today... List price, \$6.95.

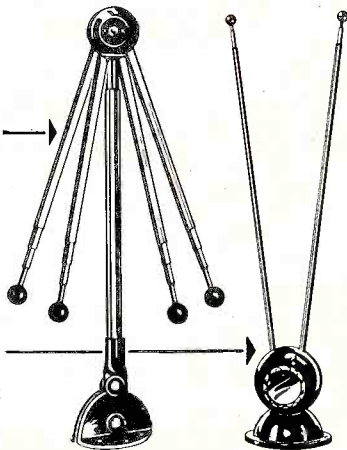

The RADION CORPORATION
1137 Milwaukee Ave., Chicago 22, Illinois

Name.....

Address.....

City..... State.....

New 1950 Models



Admiral

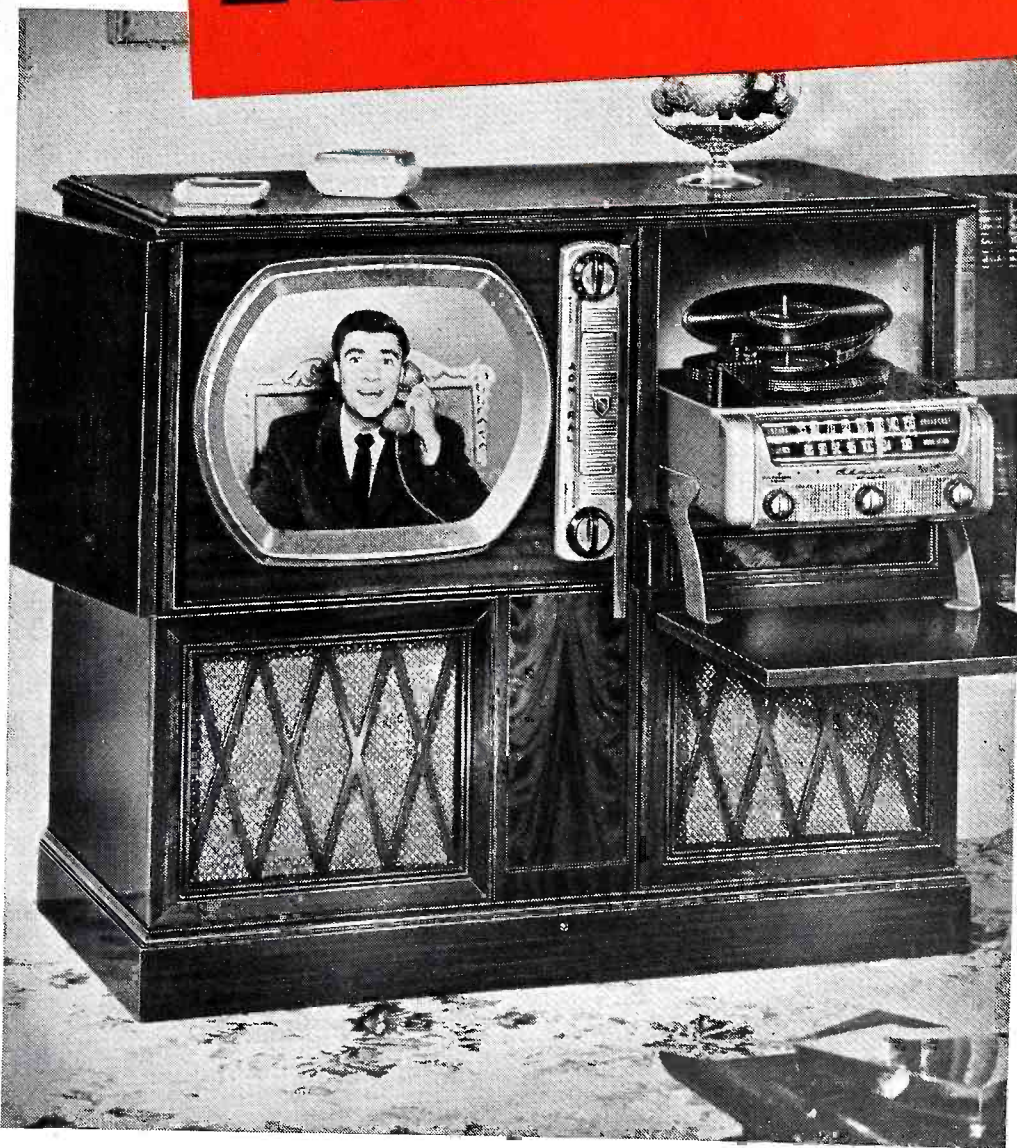

First
in performance

First
in value

First
in features

36X36—(16" Tube). Custom-quality 18th Century TV console combination. Superpowered chassis. Dynamagic FM/AM Radio. "Triple Play" Phonograph. Hand-rubbed walnut, mahogany or blonde cabinet. In walnut,

\$499⁹⁵



12X12—(12½" Tube). New low price table television sensation. In smart mahogany color cabinet, **\$179.95**



32X15—(12½" Tube). Thrilling new television combination. Walnut or mahogany. In walnut only **\$299.95**

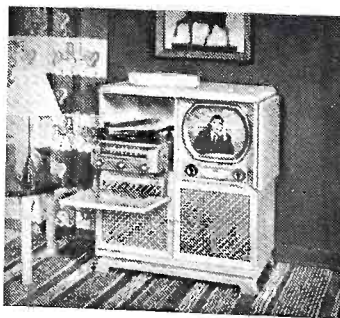

32X27—(12½" Tube). New television combination sensation in mahogany or blonde cabinet. Mahogany, **\$399.95**

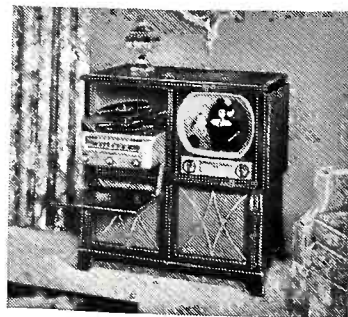

32X36—(12½" Tube). Admiral 3-way TV combination in traditional walnut or mahogany. Walnut, **\$379.95**

1st in television

WITH THE CLEAREST PICTURE OF THEM ALL!

● Sensational superpowered chassis... brings in pictures as clear as the movies even in outlying "fringe" areas.

● 12½", 16" and 19" full-vision tubes... new rectangular 4 x 3 "aspect ratio" tubes. Wide choice of cabinet styles.

● Built-in directional Roto-Scope antenna... one-knob automatic tuning... automatic gain control... balanced contrast circuit... improved sharp focus.

● "Triple Play" Automatic Phonograph... one spindle... one tone arm... one needle for all RPM speeds, all record sizes.

● Dynamagic FM/AM Radio... most compact... powerful.

22X12—(12½" Tube). TV Console at a sensational price. Pictures clear as the movies. Built-in Directional Roto-Scope antenna. Sturdy modern cabinet. Mahogany color,

\$199⁹⁵

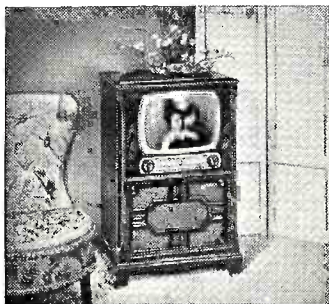

26X46—(16" Tube). Admiral TV combination. Rectangular tube. Walnut or mahogany. In walnut, \$299.95

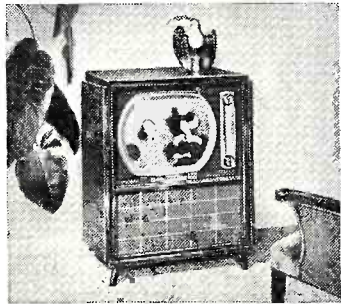

29X16—(19" Tube). Ultra modern mahogany or blonde television console. In walnut, a sensation at \$495.00

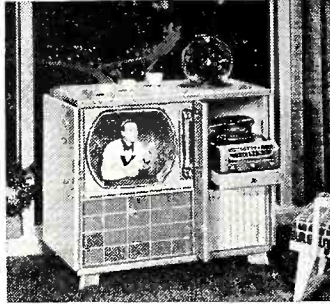

39X17—(19" Tube). Superb new TV combination in modern mahogany or blonde. Mahogany, \$695.00

Admiral
Presents Two Great Shows
Every Week on Television

●
"Stop the Music," ABC-TV
NETWORK, THURSDAYS, 8 PM, EST

●
"Lights Out," NBC-TV STATIONS,
MONDAYS, 9 PM, EST

Prices slightly higher south and west... subject to change without notice. Tax extra.
Admiral Corporation, Chicago 47



TELEVISION DEALERS! RIDE THE ALLIANCE TENNA-ROTOR

"CASH IN ON TV ADVERTISING"

Gravy Train!

NEW!
Direction Indicator Control Model Now Available!

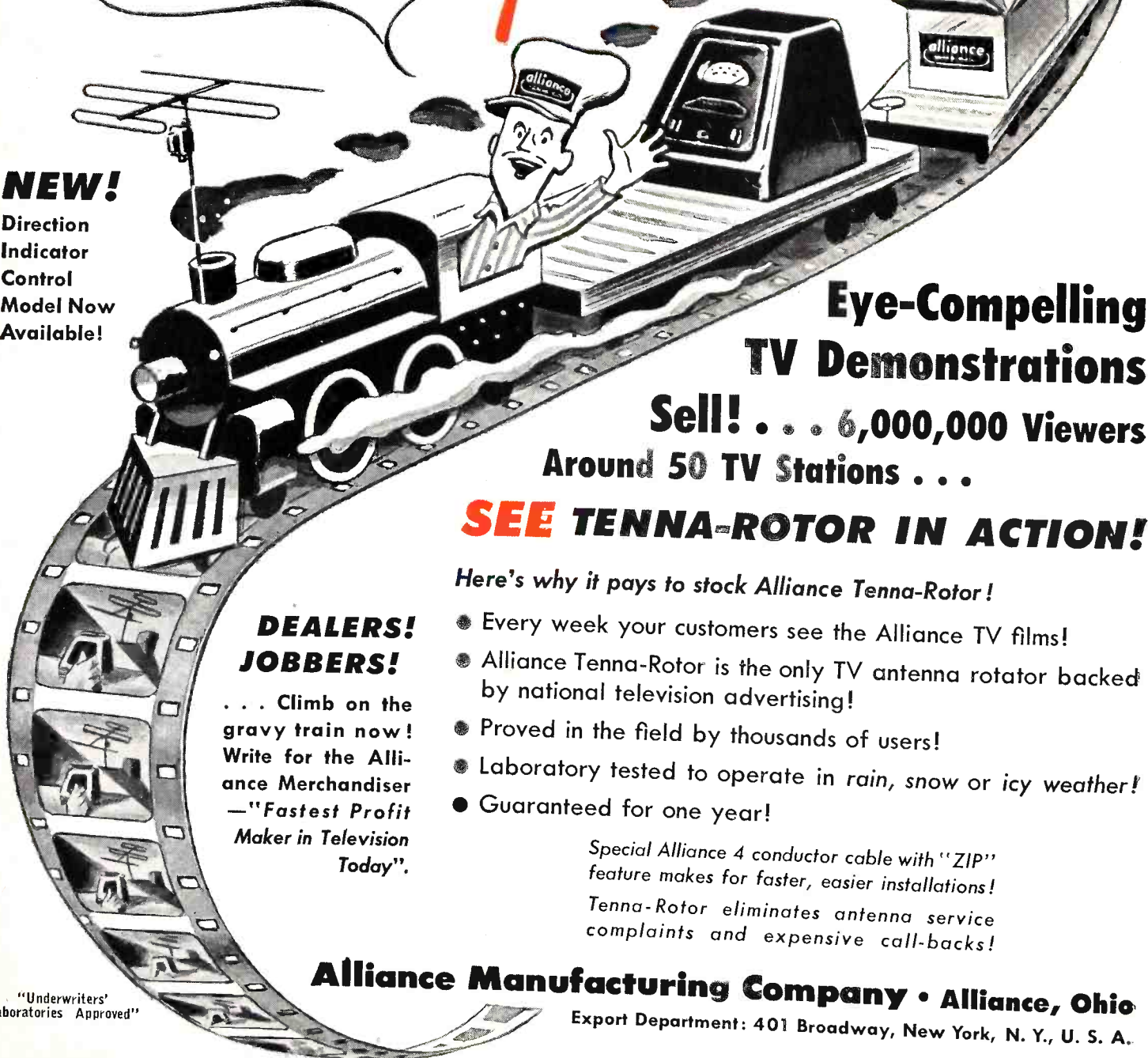

Eye-Compelling TV Demonstrations

Sell! . . . 6,000,000 Viewers
Around 50 TV Stations . . .

SEE TENNA-ROTOR IN ACTION!

Here's why it pays to stock Alliance Tenna-Rotor!

DEALERS! JOBBERS!

. . . Climb on the gravy train now!
Write for the Alliance Merchandiser — "Fastest Profit Maker in Television Today".

- Every week your customers see the Alliance TV films!
- Alliance Tenna-Rotor is the only TV antenna rotator backed by national television advertising!
- Proved in the field by thousands of users!
- Laboratory tested to operate in rain, snow or icy weather!
- Guaranteed for one year!

*Special Alliance 4 conductor cable with "ZIP" feature makes for faster, easier installations!
Tenna-Rotor eliminates antenna service complaints and expensive call-backs!*

Alliance Manufacturing Company • Alliance, Ohio

Export Department: 401 Broadway, New York, N. Y., U. S. A.

"Underwriters' Laboratories Approved"

1950 Zenith "Black" Tube Television With New "Super-Range" Chassis

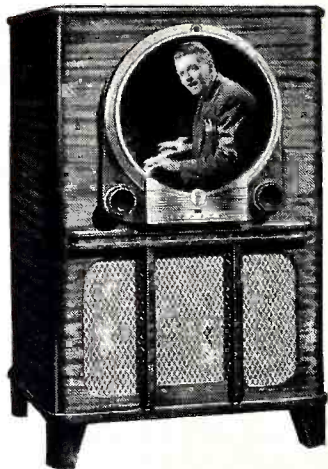

New Zenith "Adams"

An unprecedented value in television entertainment. With new Glare-Ban "Black" Tube—television's greatest picture improvement! Has "Big B" Giant Circle Screen and sensational new "Picturemagnet" built-in aerial. Plus Zenith's exclusive One-Knob Automatic Tuning and convenient Duo-Picture Control Switch. In handsome cabinet of genuine mahogany veneers.

\$269⁹⁵*

Plus Federal Excise Tax

Of course, Zenith Has a Built-In Antenna—the Amazing "Picturemagnet"—Plus the New Super-Sensitive Circuit—Giant-Picture Screen and Many Other Zenith "Firsts"

Never before have there been such amazing television improvements available to you as in these new Zeniths! Zenith† gives you pictures with great depth and detail—photographic realism. Sensational Zenith Glare-Ban "Black" Tube (Blaxide) increases picture clarity—eliminates objectionable blur and glare. And now in many locations, no need for a separate aerial inside or out with Zenith television... just plug in, and Zenith's exclusive "Picturemagnet" does the rest.

Yes, of course Zenith has a Built-In Antenna—
PLUS These Sales-Proven Zenith Features

- ★ **One-Knob Automatic Tuning**—one twist brings in station, picture, sound. Does automatically what on many other sets takes up to 5 or 6 manual tuning operations.
- ★ **"Gated" Automatic Gain Control**—Zenith's exclusive, automatic protection against "picture flutter."
- ★ **Genuine Armstrong FM Sound**—the FM of the experts. Glorious toned, static-free, even in worst storms!
- ★ **Giant Circle Screen with Picture Control**—gives you a choice of circular or rectangular pictures at the flick of a finger!

ZENITH TELEVISION

New Zenith "Lincoln"

Quality television at its finest! New Zenith Glare-Ban "Black" Tube—gives greatly improved picture clarity in lighted rooms. With "Giant C" Giant Picture Screen and Zenith's exclusive built-in "Picturemagnet" aerial. Simplified One-Knob Automatic Tuning and convenient Duo-Picture Control Switch. An exquisite console in genuine mahog-
\$359⁹⁵*
any veneers.

Plus Federal Excise Tax



ZENITH TELEVISION

Zenith has the great values



ZENITH RADIO CORPORATION
6001 West Dickens Avenue, Chicago 39, Illinois

*Suggested retail prices. West Coast prices slightly higher. Prices subject to change without notice.

New Zenith "Van Buren"

Television FM-AM Radio-Phonograph Combination. With new Glare-Ban "Black" Tube and "Big B" Giant Circle screen. Has Zenith's new built-in "Picturemagnet" aerial plus exclusive Duo-Picture Control and Simplified One-Knob Automatic Tuning. Matchless radio reception with Zenith's new Super-Sensitive FM and famous Long-Distance AM. Revolutionary new 3-Way Cobra† Tone Arm and Record Changer plays all records, all sizes, all speeds—automatically! All exquisitely combined in a superb "Queen Anne" cabinet of genuine ma-
\$489⁹⁵*
hogany veneers.

Plus Federal Excise Tax



SELLING FEATURES GALORE!

The Best is now

NO OUTSIDE ANTENNA
 New BILT-IN-TENNA eliminates rooftop antenna in good signal areas. No adjustment necessary. In weaker signal areas, outside antenna can be attached.

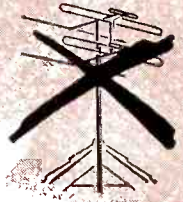

Better

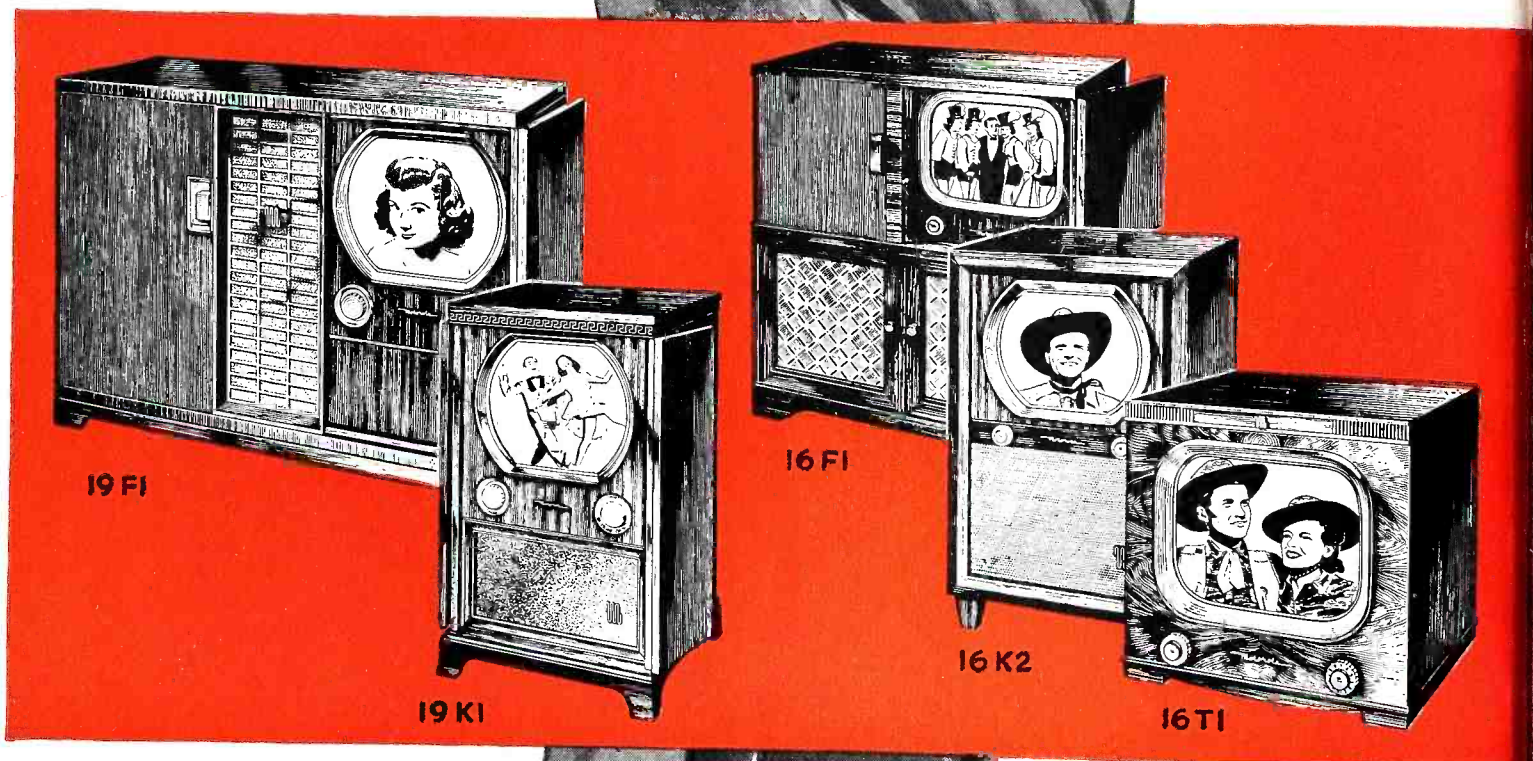

Motorola's brand new 1950 TV is the hottest line in the industry! Dozens of extra-value features plus those listed at right make it the most-wanted, fastest-moving television line yet developed. Motorola blankets the entire market with 8½" to larger-than-life-size 19½" screens... original cabinet designs in both period and modern Furniture Styling... prices to fit every man's budget. Contact your distributor now!



BRAND NEW 1950

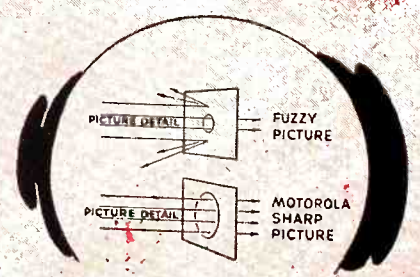

INCREASED PASS BAND
 The pass band has been increased to 3.7 megacycles for improved picture definition and sharpness.

NEW RF AMPLIFIER TUBE

New Radio Frequency Amplifier Tube inhibits picture fading—assures better "fringe area" operation.

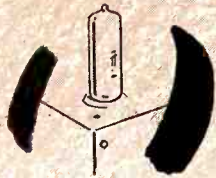

NEW DIODE DETECTOR TUBE

Circuits have been stabilized at peak efficiency by a new Diode Detector Tube.

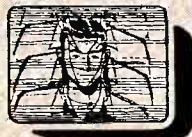

NEW RF STAG — NEW SENSITIVITY

Increased sensitivity is now provided with a new improved RF stage and a newly developed Converter Circuit.

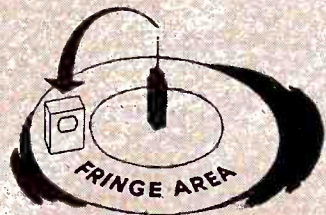

than ever before!

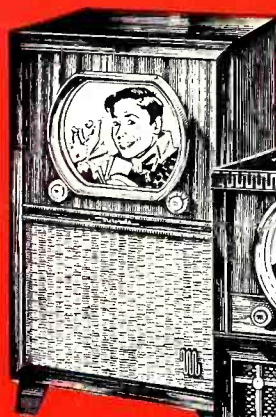

12 K1



12 K2

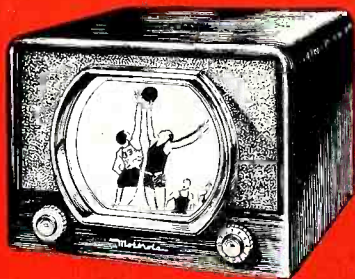

10 T2

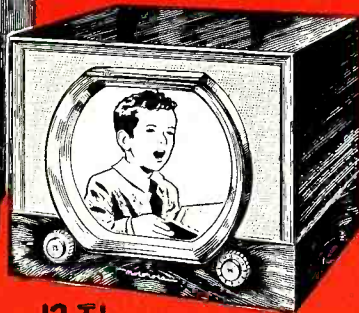

12 T1



9 L1



9 T1

Motorola TELEVISION



ONLY 2 SIMPLE CONTROLS

Just two controls—turn set on—select your station—that's all!

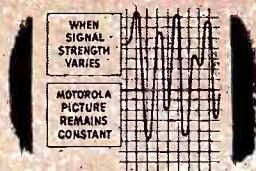

NEW "FLYWHEEL" A.F.C. SYNCHRONIZATION

A new Automatic Frequency Control circuit operates like a flywheel—holds picture steady through noise and signal strength changes.



NEW TUBE MOUNTING

Picture tube is cushioned by additional rubber supports to reduce shock and minimize breakage.

CONTACT YOUR MOTOROLA DISTRIBUTOR NOW! • MOTOROLA INC. • 4545 Augusta Blvd., Chicago 51, Illinois

RCA VICTOR announces . . .

Recordings of the World's Greatest Music and Artists at ALL phonograph speeds!

RCA POLICY

1. To make available to the public RCA-Victor's unsurpassed library of the **WORLD'S GREATEST ARTISTS AND MUSIC** recorded for all record players: 45-rpm; 78-rpm; 33 $\frac{1}{3}$ -rpm.
2. To give the public **RECORDINGS** of the finest **ARTISTS** and the finest **MUSIC**.
3. To achieve through our instruments and records the finest possible musical **REPRODUCTION**.
4. To make available to the public the achievements of world-renowned scientists and en-

gineers at work in the RCA Laboratories. Through scientific research and development they created the incomparable "45" system. Through further progress they have also succeeded in including the same matchless tonal qualities in the new and improved RCA Victor long-playing records.

Laurem Johnson

President
Radio Corporation of America



The RCA "45" gives you

UNMATCHED TONE QUALITY

The 45-rpm record has the finest tone quality in the history of the phonograph art. Only the "quality zone" of the record's surface is used, and the music comes to you completely free of distortion and surface noises. There is a full range of sound—clear and brilliant.

MUSIC YOU WANT WHEN YOU WANT IT

One of the fundamentals of musical enjoyment is *selectivity*; complete freedom of choice in what you hear. And that's what you get in RCA Victor's "45". You buy and you play "The Music *YOU* Want When You Want it!" It's simpler, it's more satisfying, and it saves you energy, time and money.

The "45" has the widest possible range of musical selection—popular, classical, folk, musical comedy—whatever the music lover wants. The present "45" catalog numbers more than 2,000 selections, and is growing daily.

WORLD'S FASTEST RECORD CHANGER

The "45" record player contains the fastest and simplest automatic changer ever developed. Operating within the central spindle post, the changer handles up to ten records with a time lapse of only 5 seconds between each one. It is silent, and it cannot damage your records. Moreover, there is no needle to change, for the player uses the famous RCA Victor "Silent Sapphire" permanent point pick-up.

Just stack ten records on the spindle and, with the touch of a button, you can enjoy more than fifty minutes of music without touching the player again.

CONVENIENCE AND ECONOMY

The "45" record is made of non-breakable vinyl plastic, wafer-thin and only 6 $\frac{7}{8}$ inches in diameter. And they are all the same size, making for ease and convenience in storage. Each record has a longer playing life—up to ten times as long.

The smallness and lightness of the new "45's" enable a new degree of speed and economy in their distribution. This means a *better record at less cost* to you!

See the RCA Victor "45". Hear it! And you, too, will enjoy music at its recorded best!

45-RPM RECORDS

The "45" is here to stay and is destined to lead all other types of recorded music.

We will continue to record both classical and popular selections on the 45-rpm records.

The "45" meets the demands of music lovers, who want their tunes and songs on single disks, easy to select and simple to play. It offers the world's greatest music and the finest artists, reproduced with the highest fidelity.

So great has been the American public's acceptance of RCA Victor's new 45-rpm system that today, only nine months after its introduction—this revolutionary advance has set a new standard of musical enjoyment in the phonograph field.

In recent weeks, sales of "45" records soared to a rate of more than 20,000,000 a year, and the new record players were being sold at the rate of 65,000 a month.

It is a smashing triumph in recorded music!

78-RPM RECORDS

In the interest of millions of homes still equipped for playing such records, and as long as there is a demand for them, RCA Victor will supply a complete catalog of conventional 78-rpm records. Every new selection will be available on both "78" and "45" disks.

33 $\frac{1}{3}$ -RPM RECORDS

To serve those music lovers who wish to play certain classical selections on long-playing records, RCA Victor will introduce on or about March 1, a new and improved, non-breakable

long-playing record (33 $\frac{1}{3}$ -rpm) made possible by an exclusive RCA Victor processing method which insures high quality and tonal fidelity.

Selections from our musical library suitable for long-playing records will feature such great orchestras as:

The Boston Symphony under Koussevitzky and Munch, the Boston Pops and Arthur Fiedler, the NBC Symphony under Toscanini, RCA Victor Chorale and Orchestra under Robert Shaw, the San Francisco Symphony Orchestra under Pierre Monteux; Leopold Stokowski and his Orchestra, Igor Stravinsky, and such outstanding recording artists as Licia Albanese, Marian Anderson, Jussi Bjoerling, Alexander Brailowsky, Mischa Elman, Eileen Farrell, Heifetz, Vladimir Horowitz, José Iturbi, Allan Jones, William Kapell, Dorothy Kirsten, Fritz Kreisler, Wanda Landowska, Mario Lanza, Jeanette MacDonald, Dorothy Maynor, James Melton, Yehudi Menuhin, Robert Merrill, Nathan Milstein, Paganini Quartet, Jan Peerce, William Primrose, Artur Schnabel, Set Svanholm, Gladys Swarthout, Ferruccio Tagliavini, Blanche Thebom, Leonard Warren and Whittmore and Lowe.

Orders for the new RCA Victor long-playing records are now being booked for delivery in March.

VICTROLA* PHONOGRAPHS

The RCA Victor 1950 line of Victrola* phonographs and radio-television combinations includes instruments that play all three speeds—45, 78 and 33 $\frac{1}{3}$ rpm. All of these 3-speed instruments feature an independent "45" record player in order that the fullest advantages of "45" quality and simplicity can be enjoyed.



RCA VICTOR



"Victrola"—T. M. Reg. U. S. Pat. Off.

DIVISION OF RADIO CORPORATION OF AMERICA

PIONEER AND WORLD LEADER IN RECORDED MUSIC

Good News **FOR TV SERVICE MEN**



"THE STANDARD BOOSTER" A new high gain TV preamplifier that assures your customers studio clear reception. This means plus profits for you by boosting your TV set sales in fringe areas. "The Standard Booster" features 2 knob control... continuous tuning, eliminates a switch from high to low channels... printed circuit trouble free operation.

*"The Standard Booster"
For Fringe Areas*



**Tomorrow's Market... Here Today
FOR TWO GREAT PRODUCTS
"THE STANDARD BOOSTER"
"THE STANDARD TUNER"**

**"Over 1,000,000
Standard Tuners
Now In Use"**



"THE STANDARD TUNER" is nationally recognized as the accepted replacement tuner by the trade. Incorporated as original equipment in over a *million* TV sets produced by the majority of the outstanding manufacturers. This is the tuner for you. It gives higher sensitivity... quick interchanging of channel inductors... adaptable to U.H.F. See your jobber for details.

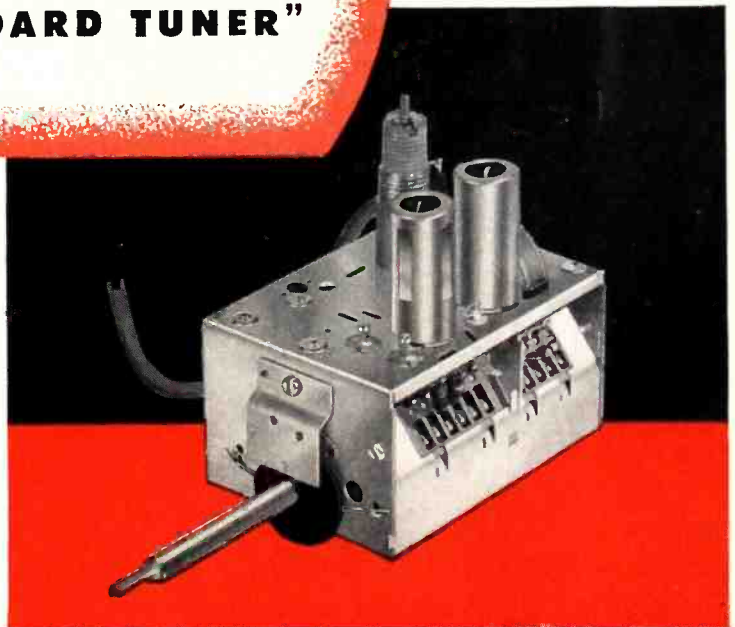

Standard COIL PRODUCTS CO., INC.

CHICAGO • LOS ANGELES • BANGOR, MICHIGAN

Build your profits and expand your TV service business now with these two great "Standard" products. Write today for complete profit information, specifications and performance data.

STEWART-WARNER

Huge 12½"
PICTURE TUBE

"A-M"
RADIO

"F-M"
RADIO

"3 Speed"
PHONO



Plus

ALL THESE
EXCLUSIVE
FEATURES!



3 SPEED PHONO
Plays all sizes, all
speeds—automatically!

only
\$349⁹⁵

SLIGHTLY HIGHER
WEST AND SOUTH

Here's the greatest merchandising opportunity in the television field! Complete family entertainment at the price of television alone! And it's being featured in Stewart-Warner's powerful advertising campaign NOW! Act today!

Sensation!

EXCLUSIVE

Channel-Eye Tuning

1 Click—and amazing lighted eye instantly spots channel or station call letters! No more searching in the "dark" for TV stations!

EXCLUSIVE

Uni-Panel Control

Imagine! Everything centered on one easy-to-use panel! TV, AM-FM Radio and 3 Speed Phono! Quick, automatic, accurate!

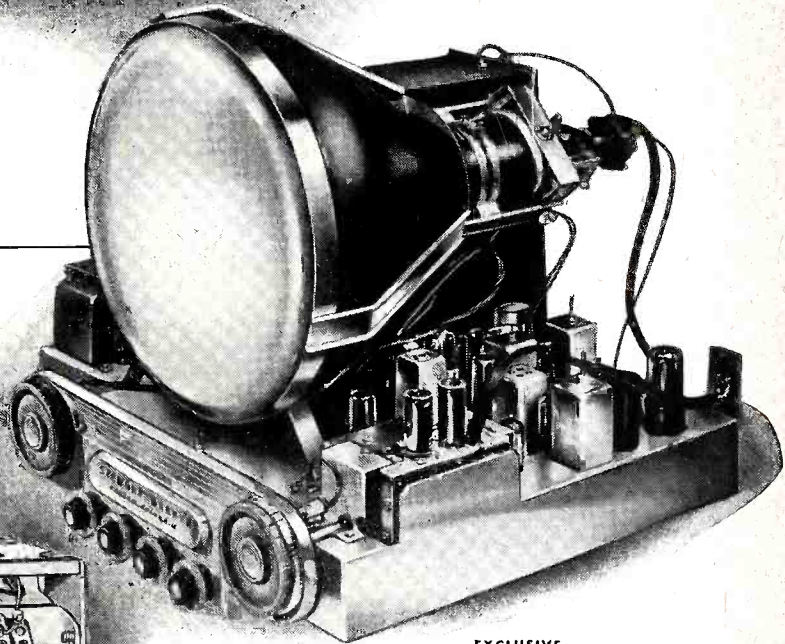
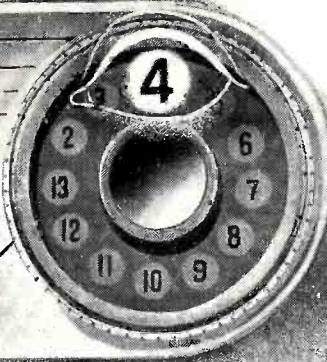

EXCLUSIVE

Dyna-Power Chassis

Added power assures clearer, brighter, sharper pictures from unheard-of distances! 27 tubes plus 3 rectifiers.

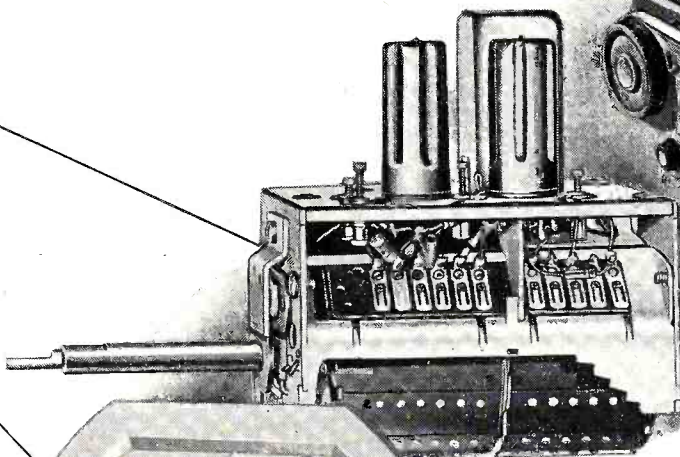

EXCLUSIVE

Miracle Turret Tuner

Provides reception of proposed U.H.F. channels by quick adjustment! No converter is needed!

EXCLUSIVE

Picture Quality

Compare Stewart-Warner picture quality—see the amazing difference! The brighter, sharper picture that defies comparison with any other set—at any price!



EXCLUSIVE

Built-in Aerial

Compactly located inside Mahogany Cabinet. Cannot be seen from exterior. Eliminates costly installation.

See Your

STEWART-WARNER

Distributor Today!

Television Industry Adopts Another Rauland "First"!



1 The Rauland-developed aluminized tube—giving the most brilliant picture in Television.

2 The light-weight 12" metal tube — still available only from Rauland. And now . . .

3

THE SENSATIONAL NEW RAULAND LUXIDE SCREEN WITH ITS VISIBLY BETTER CONTRAST AND CLARITY

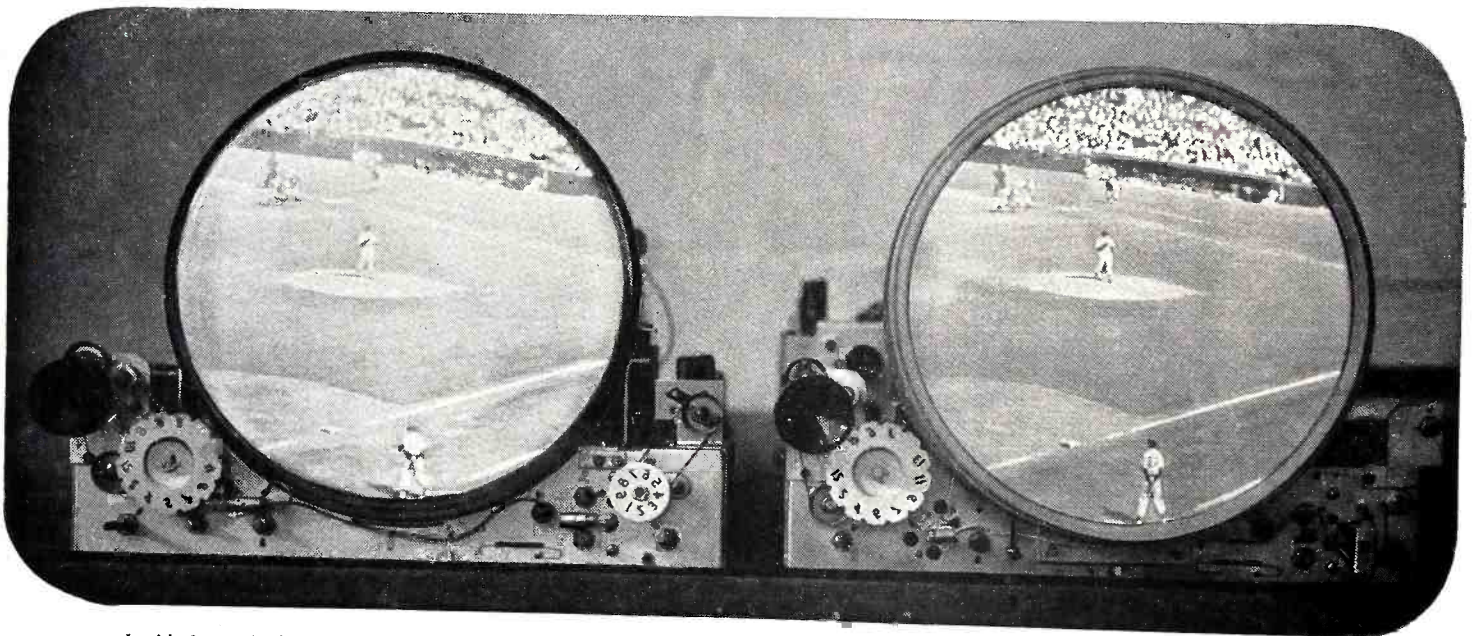

Luxide Screen (right) shows how improved contrast and clarity under high ambient light eliminates "washing out." (Standard tube at left.)

No single improvement in Television has won such quick and enthusiastic public acceptance as the Rauland Luxide Screen (black) picture tube—pioneered by Rauland from its conception to its present universal acceptance.

Rauland—first manufacturer of tubes of this type—received its initial production quantity of Luxide tube faces in mid-June, 1949. Sets featuring these new tubes were announced to the public in September. The public received them with such enthusiasm that the Television industry, almost without exception, has already adopted this Rauland-developed idea and now offers it under a variety of names.

The Rauland Luxide Screen improves picture quality by greatly reducing two former troubles—first, reflection of ambient light and second, halation within the tube face. The results to the viewer are a great reduction in apparent "blurring" and a much improved contrast and clarity, especially in lighted rooms. The improvement is so impressive that it has been given considerable editorial publicity.

Rauland is glad to have made another important contribution to the Television industry and the Television viewing public. The headline-making Luxide Screen is an additional example of Rauland's "Perfection Through Research."

THE RAULAND CORPORATION



Perfection Through Research
4245 N. KNOX AVENUE • CHICAGO 41, ILLINOIS



Profits climb when you use

G-E SPEAKERS

...WITH MOUNTING BRACKETS AT NO EXTRA COST!

HERE'S the answer to a serviceman's prayer! Time-saving mounting brackets that solve dozens of awkward replacement problems are now available at no extra cost with

every General Electric small-size speaker you get from your distributor or jobber! Adjustable up, down, or sideways, these brackets save your time and simplify tough jobs.

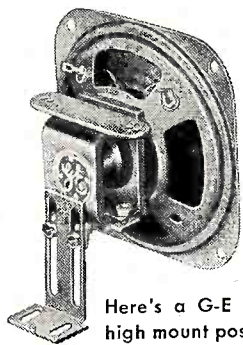

Here's a G-E 4" unit in high mount position. Note how bracket eliminates an awkward blocking job, helps turn out neater, cleaner work.

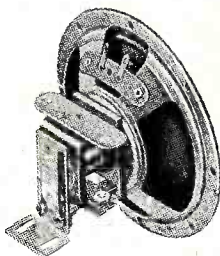

Bracket can be adjusted up or down to fit the cabinet problem. This G-E 5" Round speaker is especially designed for service replacement.

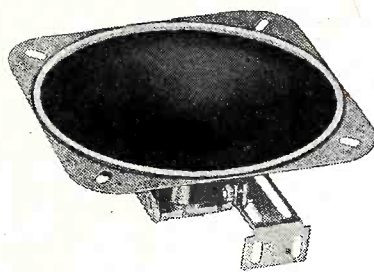

Lateral mounting feature of bracket saves fingers, time and temper. Screws hold bracket arms and speaker securely and permanently in place.

How To Build Customer Goodwill

Your customer gains confidence in you when you replace with components of the best quality. When you install a G-E speaker in his set, tell him about its advantages—

- ★ Aluminum Base Voice Coil—a famous G-E feature! High humidity won't warp it! Extremes of temperature won't affect it!
- ★ Much higher power handling capacity... Tough, all-weld construction... G-E Alnico 5 Magnet, securely and efficiently mounted, steady as a rock.
- ★ Power, sensitivity, fidelity! More of everything for his money!

Call your G-E distributor or jobber today!

*Mail coupon for
Free Sample Bracket!*

This offer open only to radio and TV servicemen!

General Electric Company, Bldg. 1, Section 50262
Electronics Park, Syracuse, New York

Send me free sample bracket and all the facts on G-E Small-Size Speakers.

NAME _____

FIRM _____

ADDRESS _____

CITY _____ STATE _____

You can put your confidence in—
GENERAL  ELECTRIC

**SIGN OF THE WORLD'S
MOST Profit-Protected
television dealers . . . all set to
STRIKE IT RICH in 1950**



**PROTECTED PROFITS FOR
SELECTED FRANCHISE DEALERS**

- direct-to-dealer selling!
- discounts up to 40%!
- exclusive in your selling-area!
- generous promotion cooperation!
- decorator designed cabinets!
- America's most complete price line, \$199.95 to \$1295!
- best merchandising ideas in T.V.!
- **AND THE ONLY WARRANTY** that gives your customer "maker-to-user" assurance: the sensational Starrett Opticlear Warranty Record Album!

The LINCOLN, 16" tube Console, AM-FM, 3-speed automatic record changer. \$1095.00
The WASHINGTON, same model, with Breakfront top. \$1295.00

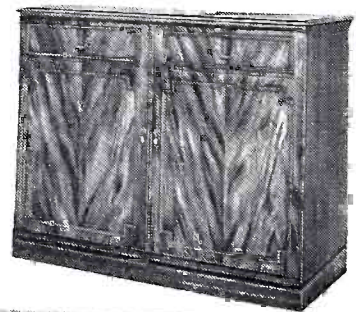

STARRETT TELEVISION Corp.

601 West 26th Street, New York 1, N. Y.

The JAMES MONROE, 16" tube Console, AM-FM, 3-speed automatic record changer. \$479.95

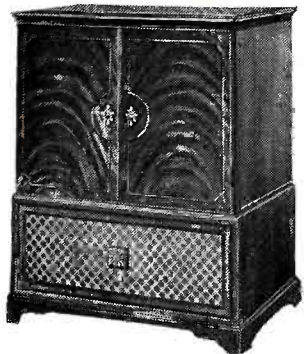

The JOHN HANCOCK, 16" tube Console, AM-FM, 3-speed automatic record changer. \$795.00

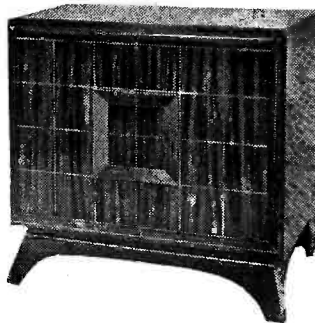

The CLEVELAND, 16" tube Console, AM-FM, 3-speed automatic record changer. \$895.00

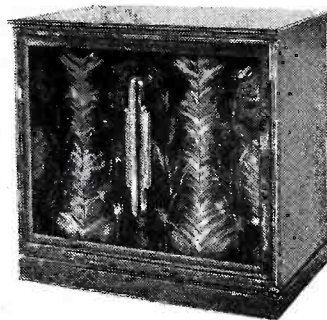

Starrett

Opticlear

TELEVISION

with exclusive, scientifically Film-Freed* picture tube, and built-in antenna

America's most complete price line \$199.95 to \$1295

The HENRY HUDSON, 16" tube Table Model. \$299.95

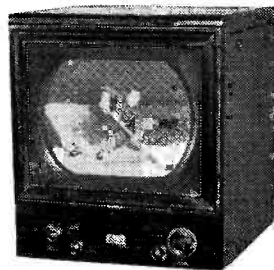

The COSMOPOLITAN, 16" tube Breakfront, AM-FM, 3-speed automatic record changer. \$1295.00

The GOTHAM, same model, without Breakfront top. \$1095.00



The NATHAN HALE, 12 1/2" tube Table Model. \$199.95



The ROBERT E. LEE, 16" tube Console, with doors. \$399.95

The HENRY PARKS, same model, without doors. \$369.95



The JEFF. DAVIS, 12 1/2" tube Console, with doors. \$299.95

The SAM HOUSTON, same model, without doors. \$279.95



DISCOUNTS
up to **40%**

AND FOR EVEN MORE BUSINESS in 1950
Starrett BRINGS YOU
THE FABULOUS, NEW
"Room-Service"
Starrett COOLATRON
AIR-CONDITIONER
with exclusive built-in DE-FUMIDOR

Exclusively selected for the:
"Good American Home"



STARRETT TELEVISION Corp.

601 West 26th Street, New York 1, N. Y.

*pats. pending

BLACK TUBE—with built-in neutral density filter for sharper images

AUTOMATIC TUNING—For easy consumer operation

SHORT NECK 16" TUBE—For new console beauty

NON-GLARE SAFETY GLASS—Cuts interfering reflections

They've Got Everything
INCLUDING PRICE!

H-F INTER-CARRIER SYSTEM—Fewer components, less trouble, better performance

TWO-KNOB CONTROL—For simplified tuning, for easy selling

BUILT-IN ANTENNA—Amazing performance without expensive installation

RECTANGULAR TUBE—For table model compactness

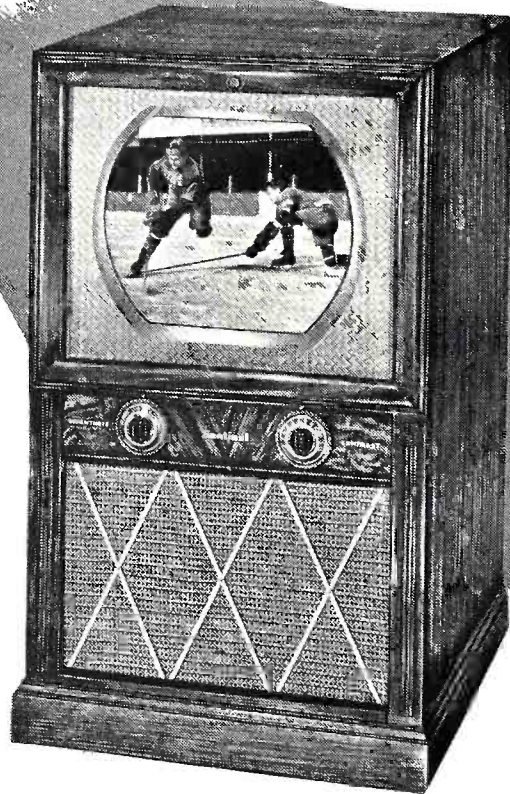

2 Marvelous New Sentinels

*to Spark
Midwinter
Sales!*

Exciting! Live! Positively nothing like this ever before! Sentinel here shows you the way to reach and hold profitable volume throughout the winter and spring! Two new models that round out the red hot Sentinel line. All priced to give you the fast turnover that you need. Contact your Sentinel Distributor or Sentinel directly—now!

Sentinel Radio and Television
EVANSTON, ILLINOIS

33^{1/3} RPM

78 RPM

45 RPM

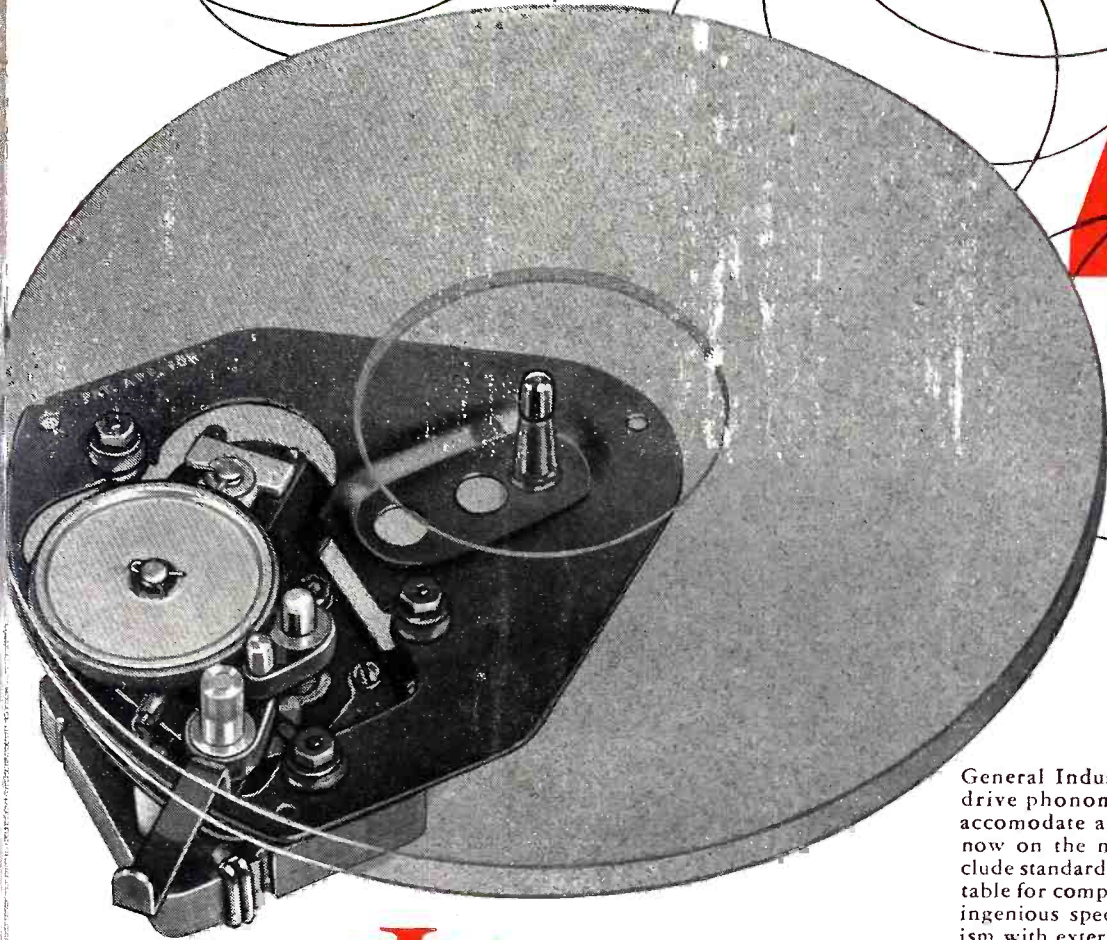

General Industries' newest rim-drive phonomotor, designed to accommodate all types of records now on the market. Features include standard narrow-flange turntable for compact installation, and ingenious speed-change mechanism with external shift lever.

This model for manual operation. Many variations are available to record-changer manufacturers.



MODEL TS (ALL THREE SPEEDS)

Here's the turntable that puts you right in the middle of the profitable market for consoles, table models and portable phonographs that will play all three types of records. Simple and fool-proof in operation, the Model TS incorporates all of the advanced engineering features which have long distinguished GI's *complete* line of Smooth Power phonomotors, recorders and record-changer recorders.

Quantity price quotations, specifications and blueprints mailed immediately upon request. Write today to:



The GENERAL INDUSTRIES Co.

DEPARTMENT I • ELYRIA, OHIO

A whole new concept
of Television

CROSLEY

Ultra-Fidelity TV

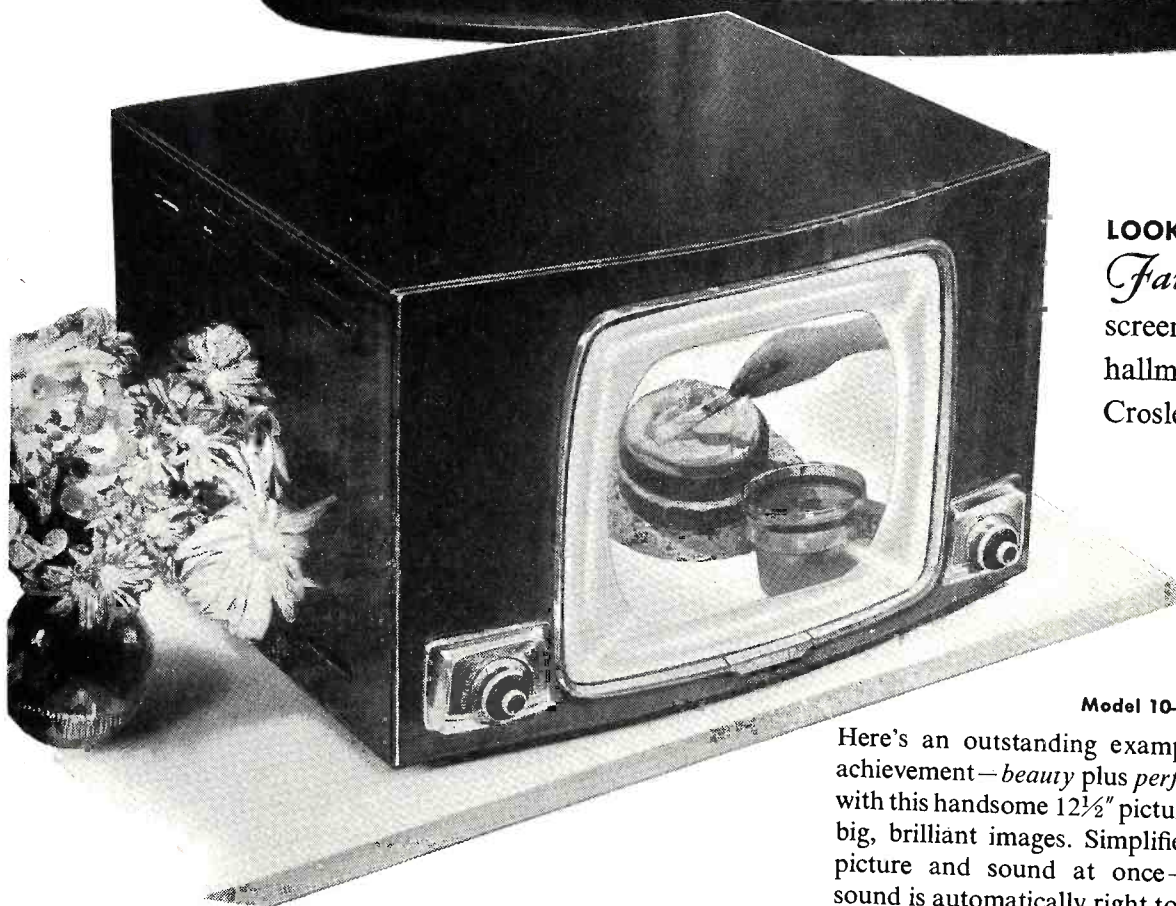

LOOK FOR THIS
Family Theatre
screen, exclusive
hallmark of
Crosley TV receivers.

Model 10-404

Here's an outstanding example of Crosley television achievement—*beauty plus performance!* You'll sell both with this handsome 12½" picture tube table model. Gives big, brilliant images. Simplified controls tune in both picture and sound at once—when picture is right, sound is automatically right too. Styled in hand-rubbed Cordovan-finished mahogany veneer.

From any viewing angle

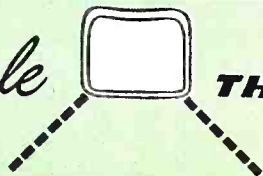

THE CLEAREST PICTURE!

Vision

THAT BUILDS TV SALES!

Crosley adds *sales vision* to every phase of product development, relying on more than technical skill and experience to build the kind of TV sets your customers will buy. Here, from Crosley, is the TV line designed from every angle to make 1950 your greatest television year.

Crosley's **New Concept of Performance**—new wide-angle screen . . . Unituner that makes TV tuning as easy as radio tuning . . . fade eliminator that virtually eliminates fading, "air-plane flutter," and other interference . . . high sensitivity for long distance . . . built-in antenna . . . *independently mounted cathode ray tube that makes servicing far easier.*

Crosley's **New Concept of Beauty**—superbly designed cabinets . . . handsome furniture that any woman will be proud to have in her living room for years to come . . . planned for family convenience, with a big viewing screen at the comfort level . . . simple controls located for easy, relaxed tuning—when picture is right, sound is right too . . . picture tube framed by the well-designed contours of a theatre proscenium arch.

The Crosley Trademark is your assurance that the product embodies the finest engineering and skilled manufacturing for today's ultimate in TV performance.



Model 10-412

Here's a handsome console with a big, bright 12½" picture tube. The cabinet is in Cordovan-finished mahogany veneer (Model 10-418 has similar cabinet without doors).



Model 10-401

This beautiful, low-priced table model has a big 10" picture tube. Carefully engineered to give Crosley Ultra-Fidelity TV performance in a beautiful cabinet of polished mahogany-finished plastic.



Model 10-414

A magnificent new Crosley TV console, styled in fine Cordovan-finished mahogany veneer. Bright clear pictures on a huge 16" picture tube (Model 10-416 has same big 16" picture tube, but special open face cabinet).

CROSLEY

1329 ARLINGTON STREET, CINCINNATI 25, OHIO

DIVISION



Better Products for Happier Living

Shelvardor* Refrigerators . . . Home and Farm Freezers . . . Electric Ranges . . . Electric Kitchens . . . Steel Cabinets
Sinks . . . Electric Disposers . . . Electric Water Heaters . . . Radios . . . Radio Phonographs . . . Television

the 3 **D**'s for Profitable Sales

Display

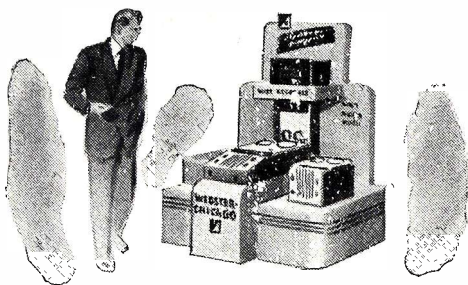

Display the attractive Webster-Chicago Wire Recorders in some conspicuous spot in your store. It will attract attention, it will draw many inquiries—especially if you back it up with some of the attention compelling Webster-Chicago display material.

Demonstrate

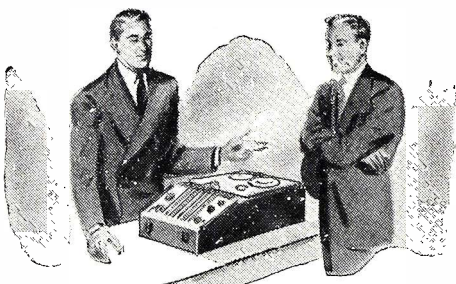

Demonstrate the efficient Webster-Chicago *Electronic Memory Wire Recorders*. *With no other product* does a prospect so quickly begin to associate himself with the actual merchandise as he does with the Webster-Chicago *Electronic Memory Wire Recorder*. Once your prospect has heard his own voice played back—you are on your way to a profitable and mutually satisfying sale.

Deliver

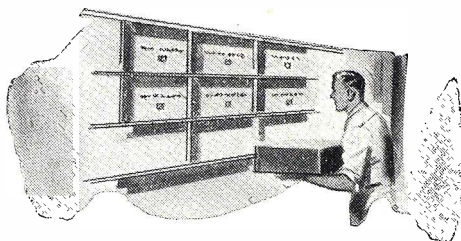

Back up your display and demonstration practices with an adequate stock so that you can give immediate delivery. "I can get it for you in a few days" isn't half so effective as "will you take it with you or shall we deliver it?"

THE FAMOUS WEBSTER-CHICAGO *Electronic Memory* WIRE RECORDERS



Model 180

The completely portable *Electronic Memory Wire Recorder*. Handsome, sturdy all wood carrying case covered in attractive burgundy leatherette. **\$149.50***

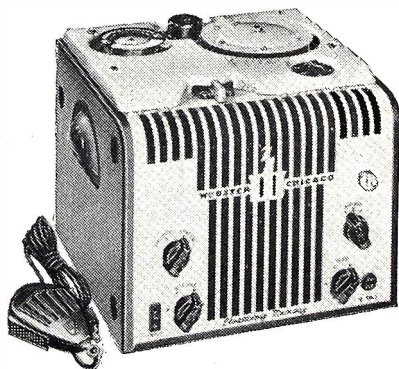

Model 181

The heavy duty, all purpose Wire Recorder for permanent or semi-permanent installation. **\$114.50***

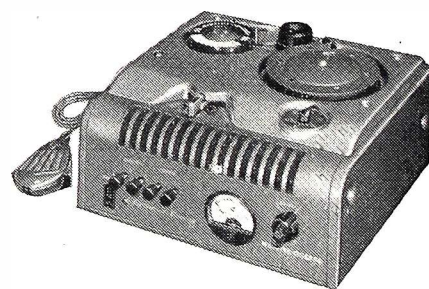

Model 178

The ideal model for installation in the record compartment of a radio console. Takes programs direct from radio independent of radio volume. **\$107.50***

**Slightly higher west of the Rockies.*

For "Sound" Profit... **DISPLAY, DEMONSTRATE AND DELIVER**



WEBSTER-CHICAGO

5612 WEST BLOOMINGDALE AVENUE

CHICAGO 39, ILLINOIS



ADMIRAL • ARVIN • BELMONT • BENDIX • CAPEHART

It's smart to use the Television Tubes

CROSLY • DEWALD • DUMONT • EMERSON • FADA

TV Set Manufacturers choose ...

FARNSWORTH • GAROD • HALLICRAFTER • MOTOROLA • OLYMPIC

PHILCO • PILOT • RAY

SENTINEL

SPARTON •

STROMBERG-

CARLSON •

TELE-TONE

TRAVELER

WESTINGHOUSE • ZENITH

RAYTHEON
Quality
Television Tubes

Television servicemen minimize their tube-to-tube variation bugaboo by using the same TV tubes leading set manufacturers use — *Raytheon Quality Television Tubes*. The wealth of experience Raytheon gained in the development and manufacture of tubes for video amplifiers in Radar applications, is proving invaluable in the production of high efficiency tubes for modern TV receivers. Raytheon instantly recognized that the normal industry test tolerances of many tubes being used in video applications were not close enough for perfect perform-

ance in today's television receivers. A new, stricter set of test tolerances and more rigid quality standards were introduced with the result that Raytheon Quality TV Tubes save many a headache for manufacturer and serviceman.

Save time and trouble — save money — safeguard customer goodwill — standardize on Raytheon Quality Television Tubes.

RAYTHEON CATHODE RAY TUBES come in all the most popular types. For peak video performance, specify Raytheon Television Picture Tubes as well as all other Raytheon Television Type Tubes.



RAYTHEON

RAYTHEON MANUFACTURING COMPANY

Radio Receiving Tube Division

Newton, Mass., Chicago, Ill., Atlanta, Ga., Los Angeles, Calif.

Excellence in Electronics

RADIO RECEIVING TUBES, TELEVISION TUBES, CATHODE RAY TUBES, SPECIAL PURPOSE TUBES, SUBMINIATURE TUBES, MICROWAVE TUBES

Here is the greatest Store Traffic,

EMERSON PERFORMS

Emerson Sets ALL TIME Value Record
With Magnificent New Models, Exclusive Performance Features,
Greatest Dollar-for-Dollar Buys In The Industry
READY FOR IMMEDIATE DELIVERY...

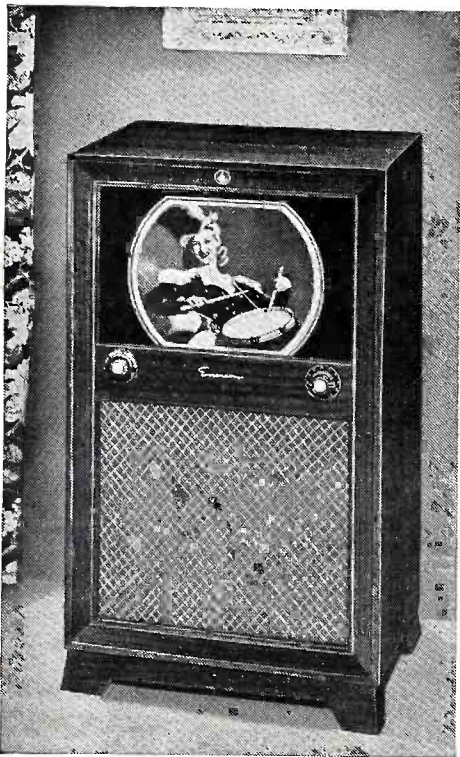

MODEL — 654

12½" Console with Emerson expanded GLAREPRUF picture tube. 12" Sealed Unit Dynamic Speaker. Automatic, pre-tuned, built-in Antenna. Choice, polished mahogany cabinet.



MODEL — 629

16" filtered, GLAREPRUF picture tube. Easy Twin-Dial Simplomatic tuning. 12" Speaker. Built-in Antenna. Luxurious, satin finished mahogany cabinet in decorator design.



MODEL — 649

235 Sq. In. colossal projection screen. Razor sharp, super powered Long Distance reception. Built-in Antenna. A sensational first in the low-price field for Home-Theater TV.

Emerson Radio



THE SET UP TO

Turnover, Profit Story in the Industry—

WHERE OTHERS FAIL!



MODEL — 651

16" Life-size picture tube. Staticlear FM tone. Long-distance circuit. Built-in Antenna. Simple Twin-Dial controls. Compact mahogany cabinet. Greatest value in LIFE-SIZE television.

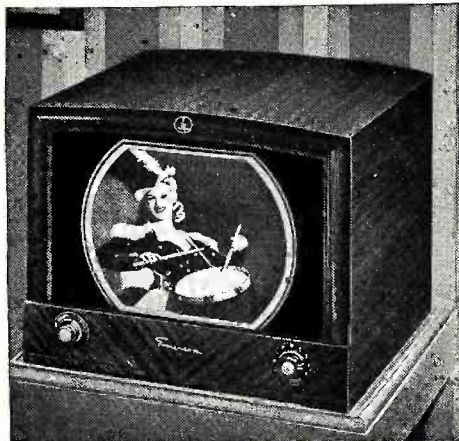

MODEL — 650

12½" truly magnificent table model. Superpowered circuit for Long-distance reception. Automatic, pre-tuned built-in Antenna. Genuine mahogany custom-made cabinet. Compact.

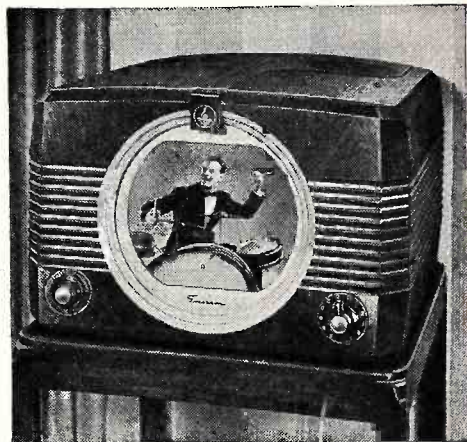

MODEL — 648

10" *Expan-Scope* picture tube. Remote control button from up to 20 feet away *doubles* image for giant close-ups. Powerful Built-in Antenna. Smartly styled, compact, lightweight.

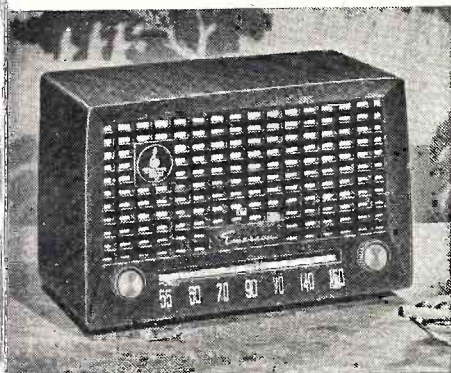

MODEL — 653

AC-DC all new, superpowered super-heterodyne circuit. Inclosed Super Loop antenna. Sealed Unit Alnico 5 Speaker. In rich walnut or ivory Bakelite with modern designed grille.

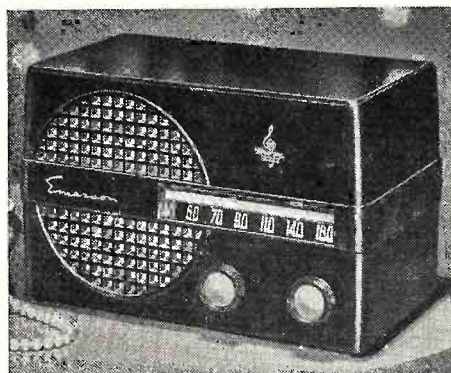

MODEL — 652

LEADER in performance and value. Another Emerson Style *First*. Extra sensitive circuit. New sturdy-grip controls. Beautiful ebony or ivory Bakelite cabinets.



MODEL — 634

3-SPEED record player and powerful superheterodyne radio. Plays *all* size records, all speeds *automatically*. Shock-proof tone arm. Powerful internal antenna. Smart, easy-to-carry mahogany cabinet with lid.

and Television

GET YOUR NET UP



REG. T. M.

PHILCO

Presents to **RADIO DEALERS**
and **SERVICE MEN**

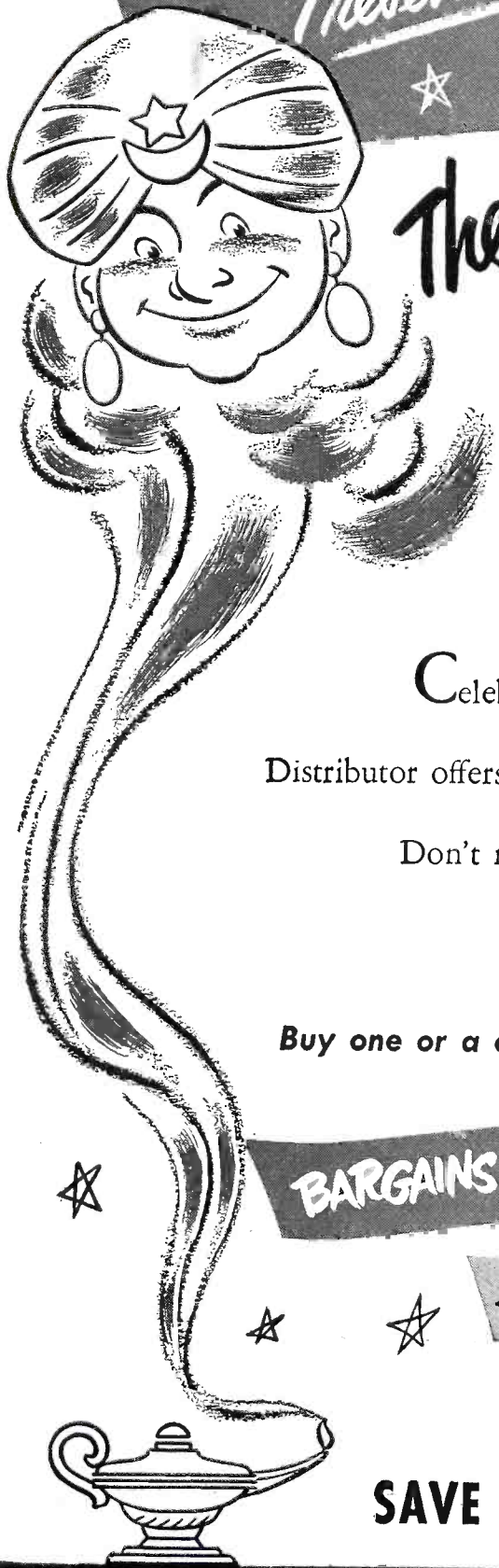

The "FABULOUS FIFTY"

Celebrating the half-way mark in the 20th century your Philco Distributor offers you Fifty Fabulous Specials on *Philco Parts and Accessories*.

Don't miss this tremendous opportunity to stock up on the parts you need at sensational savings.

Buy one or a dozen — or just look 'em over. Come in today!

BARGAINS FOR EVERYBODY

HURRY! HURRY! Come on the Run!

SURPRISE OFFERS BEYOND BELIEF

SAVE NOW at Your PHILCO Distributor

Radio's Outstanding Low-Priced Set!

ARVIN Model 440-T



**Kidproof!
Shatterproof!**

14.⁹⁵

in Six Smart Colors

- Fox Hunt Red
- Willow Green
- Banana Yellow
- Burgundy
- Ivory
- Sand Bronze

**BRIGHT WITH COLOR!
PACKED WITH POWER!**

New SALESMAKER DISPLAY COLOR! MOTION!

Ask your Arvin Distributor how to get this commanding display



This big 26" x 20" full-color display will command instant attention in your window and on your counter! Holds all six colors of fast-selling Arvin Model 440-T —automatically suggests color schemes to your customers. Ties in with Arvin's great national advertising and identifies you as headquarters for Arvin super-values. Place your initial package order with your Arvin Distributor NOW!



Watch for ARVIN'S powerful Spring national advertising
in Saturday Evening Post, Country Gentleman and Progressive Farmer

Radio & Television Division

NOBLITT-SPARKS INDUSTRIES, INC., COLUMBUS, INDIANA

<p>2" x 3" PM Speaker—0.125 watt; resonant frequency, 250-365 cps; 1.5 oz. magnet; voice-coil impedance, 11.8 ohms (at 1000 cps); rim mounting.</p>		<p>5" PM Speaker—3 watts; resonant frequency, 150-200 cps; 1.47 oz. magnet; voice-coil impedance, 3.2 ohms; rim or pot mounting.</p>		<p>5" Field-Coil Speaker—3 watts; resonant frequency, 150-200 cps; 450-ohm, 65-ma. field; voice-coil impedance, 3.2 ohms; rim or pot mounting.</p>	
	<p>4" PM Speaker—3 watts; resonant frequency, 170-225 cps; 1.47 oz. magnet; voice-coil impedance, 3.2 ohms; rim or pot mounting.</p>	<p>High Fidelity at a new low price . . .</p>  <p>The new 51551 15" Duo-Cone Speaker—Frequency response, 40 to 12,000 cps; 25 watts power-handling capacity; wide-angle radiation. Suggested list price, \$55.00.</p>			<p>4" x 6" Field-Coil Speaker—3 watts; resonant frequency, 150-200 cps; 450-ohm, 65-ma. field; voice-coil impedance, 3.2 ohms; rim mounting.</p>
<p>4" x 6" PM Speaker—3 watts; resonant frequency, 150-200 cps; 1.47 oz. magnet; voice-coil impedance, 3.2 ohms; rim or pot mounting.</p>				<p>5" x 7" PM Speaker—6 watts; resonant frequency, 120-140 cps; 1.47 oz. magnet; voice-coil impedance, 3.2 ohms; rim mounting.</p>	
	<p>12" PM Speaker—12 watts; resonant frequency, 70-85 cps; 2.15 oz. magnet; voice-coil impedance, 3.2 ohms; rim mounting.</p>		<p>12" Field-Coil Speaker—12 watts; resonant frequency, 70-85 cps; 1000-ohm, 70-ma. field; voice-coil impedance, 3.2 ohms; rim mounting.</p>		<p>8" PM Speaker—8 watts; resonant frequency, 75-95 cps; 2.15 oz. magnet; voice-coil impedance, 3.2 ohms; rim mounting.</p>

Now... a quality line of replacement speakers from one dependable source

Quality-engineered for dependable performance . . . and priced for replacement needs . . . the RCA line of standard speakers offers you a great selling potential.

From the superb 15" high-fidelity duo-cone to the 2" x 3" elliptical—each RCA speaker is designed with top engineering skill, made of the best materials, and mass-produced under rigid quality-control methods.

RCA's PM and field-coil types meet practically all replacement requirements. All 4", 4" x 6", and 5" speakers are supplied with a universal mounting bracket that

saves time in mounting either clinch-type or strap-type output transformers.

Look to RCA—and your RCA distributor—as a dependable

source for all of your replacement speaker requirements. For full details on the complete line, ask your RCA distributor for Bulletins 2F892 and 3F620.

Check these important features!

- ✓ Moisture-resistant voice-coil suspension—unaffected by humidity changes.
- ✓ Rugged mechanical construction with welded housing assembly.
- ✓ Exclusive clamping spring permanently locks Alnico V magnet in larger sizes of PM speakers.
- ✓ Mechanical filter ring in 12" speakers cuts needle scratch and 10-kc. whistle.
- ✓ Rugged—Dustproof resistant—Rustproof resistant.
- ✓ Adjustable voice-coil mounting in 12" speakers.
- ✓ Rim mounting designed to RMA standards.



RADIO CORPORATION of AMERICA
ELECTRONIC COMPONENTS
HARRISON, N. J.

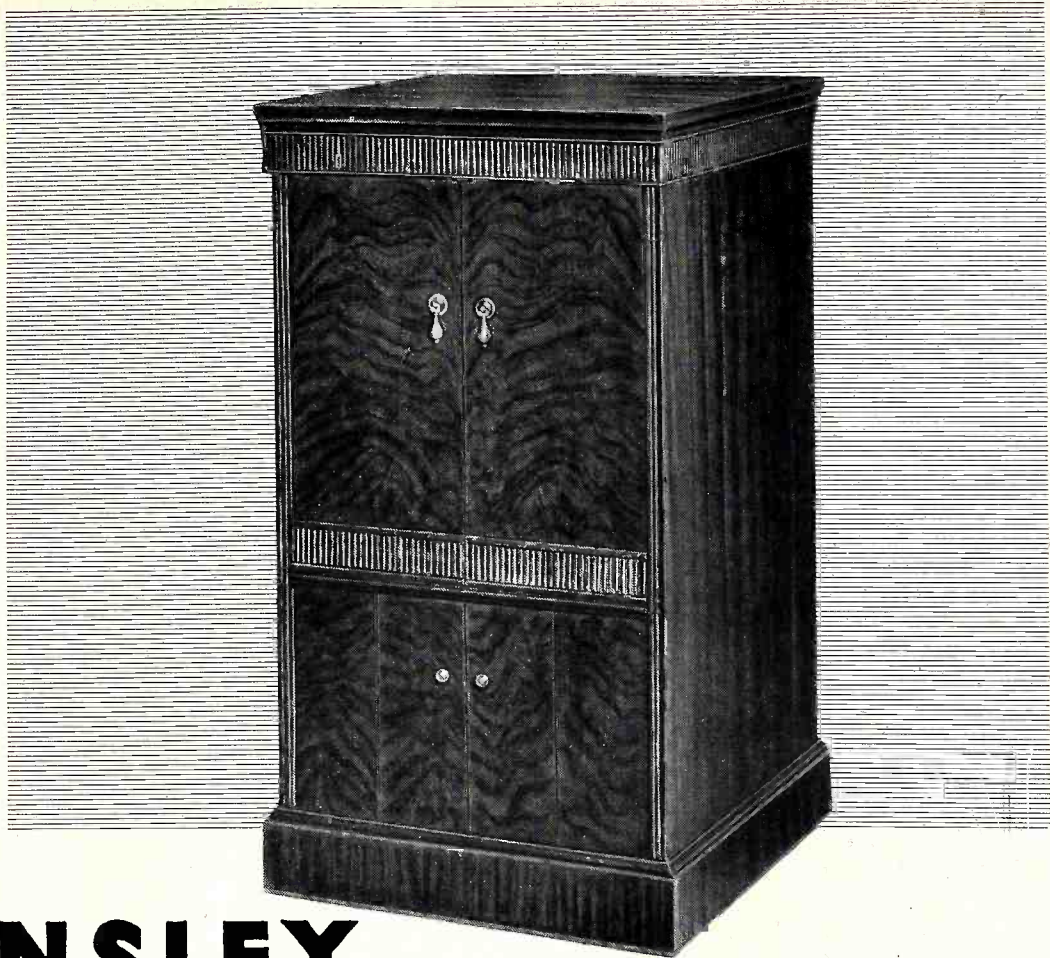

ANSLEY

FIRST CHOICE OF AMERICA'S FIRST FAMILIES

introduces a distinguished new 19" model

THE IMPERIAL
\$565

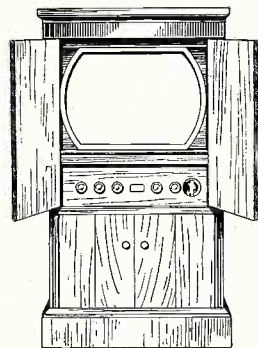

For over 25 years, more famous names of radio, stage, screen, and the music and literary worlds have chosen Ansley than any other make. For your most discriminating customers who want fine furniture as well as the best sound and picture that modern engineering can provide, we offer the incomparable Ansley Imperial . . . worthy of its show place in the finest home.

Extra-sensitive 27 tube chassis plus 4 rectifiers and kinescope. Full voltage doubler, automatic frequency control, 12" extra-heavy magnet PM speaker. Exquisite cabinet of matched crotch-mahogany and ribbon-stripe mahogany with folding doors.

Inquiries are invited from reputable distributors seeking a high quality line. A number of choice markets are still available.

ANSLEY RADIO AND TELEVISION, INC. • 41 ST. JOE'S AVENUE • TRENTON, N. J.

That's Right...

MECK ISO-RAMIC TELEVISION AND... STILL AT ROCK BOTTOM RETAIL PRICES!

Dealer discounts up to 40%... and absolutely no padded retail prices. We know this is the profit deal you need. Our survey of 5,000 dealers proves it... with almost unanimous agreement.

Stop trading dollars... start now to make yourself some real money out of TV—by getting aboard the MECK Profit Bandwagon! It's the 1950 Television Line that gives dealers unheard-of discounts up to 40%—the longest margins in the entire industry!

The MECK Television Line is a complete line—giving your customers a wider choice of top quality TV. The performance is there—the style is there—the profit is there. Write—wire—or call TODAY—for the full story on MECK Television, the TV line that gives you DISCOUNTS UP TO 40%.

40%

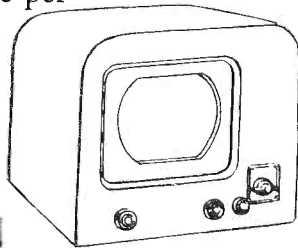

TOPS IN TABLETOPS
Value-plus MECK 10" Tube Model XN. Genuine mahogany cabinet. **\$139⁹⁰**
RETAIL

QUEEN OF THE GIANT SCREEN

16" Tube Console Model XSA.
Rich, hand-rubbed mahogany cabinet.
Built-in antenna. Powerful ISO-RAMIC Circuit assures bright, uniformly lighted picture **\$299⁹⁰**
RETAIL

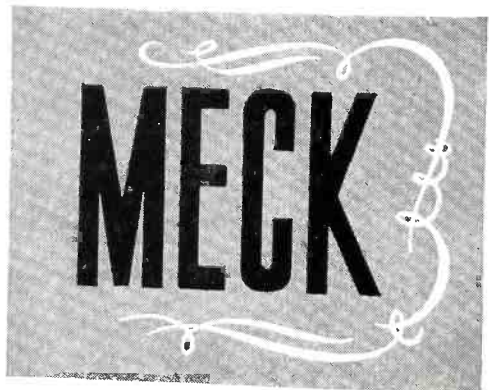

JOHN MECK INDUSTRIES, INC.
PLYMOUTH, INDIANA



Beautiful Full Size Genuine Mahogany Cabinets—
No "Make-Shift" Finishes or Construction

The BEST **and the BIGGEST** **use**

COMMERCIAL

CREDIT

SERVICE

Of the many millions of home appliances sold "on time" all over America, more are financed on the Commercial Credit Plan than through any other national financing company.

The *leaders* use Commercial Credit service because it has more advantages for both buyer and seller than typical financing arrangements.

Many of today's leading distributors and dealers attribute a large part of their success over the years to the cooperative spirit and friendly help of the Commercial Credit people who serve them locally.

Commercial Credit service will help you, too, to increase your volume and profit in time-payment sales.

Ask your Commercial Credit representative to give you the full details.



Helps Dealers Make
More SALES • More PROFITS
More
SATISFIED CUSTOMERS

COMMERCIAL CREDIT CORPORATION

A Subsidiary of

Commercial Credit Company Baltimore, ■ Capital and Surplus Over \$100,000,000

MORE THAN 300 OFFICES IN PRINCIPAL CITIES OF THE UNITED STATES AND CANADA

You have what they want

Big-as-Life

on these great new 19-inch
Stromberg-Carlsons!

Yes, your customers want bigger pictures.

Here is the *biggest* direct-view of all—203 square inches on a 19-inch tube!

So big you can actually see the stars in close-up *big as life!*

And on top of that, you have these other great Stromberg-Carlson value features to talk about—

- ▶ **TOP TUNING**—no bending or crouching to tune station or picture. Tuning controls cleverly concealed at top front.
- ▶ **BUILT-IN "TELATENNA"**—eliminates need for outdoor or indoor antennas in good signal areas.
- ▶ **BRIGHT, CLEAR PICTURE**—can be viewed close up or from across the room.
- ▶ **TRUE-TO-LIFE TONE**—with balanced acoustical system, tone control, and 12-inch speaker.

In big-as-life pictures, in solid value all along the new 1950 line, Stromberg-Carlson has what your customers want—it has what you want—to make this your **BIGGEST** year in television!



The NEW YORKER

BIG-AS-LIFE 19-inch picture. True-to-life tone. Exceptional performance even in "fringe" areas. Cabinet designed for traditional or modern setting, in selected mahogany veneers. (TC-19-LM2) **\$539⁵⁰***

In blond avodiré veneers. (TC-19-LA2) **\$549⁵⁰***

*Plus excise tax. Slightly higher in South and West.

® *There is Nothing Finer than a*

STROMBERG-CARLSON

Stromberg-Carlson Company, Rochester 3, N. Y. — In Canada, Stromberg-Carlson Co., Ltd., Toronto

RADIO & TELEVISION RETAILING

Including "Radio & Television"
and "Radio & Television Today"

Established in 1922
as ELECTRICAL RETAILING

O. H. CALDWELL, Editorial Director

M. CLEMENTS, Publisher

MARKED IMPROVEMENT NOTICED in some of the old-established, slow-to-take-hold TV areas, due to better programming or better programming on the way, plus increased sales effort on the part of retailers.

TERRIFIC DEMAND AND SHORT SUPPLY of TV sets saw dealers in a wild scramble during the recent holidays. First, merchants went scurrying about trying to get receivers, and next they really had their hands full installing. The rush extended well into last month with dealers busy making permanent installations of temporary ones.

MORE SERVICE DEPARTMENT REVENUE for the man who goes after the business. Watch for full details on running a Tune-Up, Tube-Up, Check-Up campaign in the April issue of this magazine. Owners will be glad to put millions of old radio sets and phono players into good working order—and numbers of TV receivers, too, if the need to do so is stressed by the dealer.

JUMPING RIGHT INTO THE MIDDLE of the recent shortage market in TV sets, a number of private brand makers have cleaned up, banking some real folding money.

"AN ENCOURAGING DEVELOPMENT IN THE automatic electric dishwasher field is the entrance into competition of a number of other manufacturers, indicating that this appliance is receiving greater consumer acceptance."—H. L. Andrews, vice-president in charge of the Appliance & Merchandise Department, General Electric Company.

FOUR INGREDIENTS FOR SUCCESS in business outlined by Carl V. Haecker, RCA Victor merchandise display manager: (1) Aggressive sales planning. (2) Aggressive advertising. (3) Aggressive window display. (4) Aggressive point-of-sale display.

SPRING IS RIGHT AROUND THE CORNER, and it's time to plan a bang-up business in portables, vacuum cleaners, laundry equipment, and a bit later, room coolers.

LOOK FOR A FLOOD OF NEW co-op ad and promotion plans by manufacturers who've been busy revamping set-ups available to dealers.

EVENING SELLING OF TV IN THE STORE and in the home is a must. As one dealer put it, "The husband buys the make, the wife buys the cabinet, and in nearly all cases you have to get them together in order to obtain a buying decision."

"I BELIEVE THAT WITHIN FIVE YEARS— by the end of 1954—there will be about 20,000,000 television receivers in American homes. This will mean a total viewing audience at that time of approximately 75,000,000 people."—Brig. General David Sarnoff, chairman of the Board, Radio Corporation of America.

"SO FAR AS INITIAL TV EQUIPMENT is concerned, there isn't the slightest worry about saturation. Countless TV sets remain to be sold and installed. On top of all that, there is the pleasing "upping" of TV set owners from smaller-screen earlier sets to later larger-screen sets. It seems very much as though we have an automobile trade parallel."—Victor Mucher, president, Clarostat Mfg. Co., Inc.

ADMIRAL CORPORATION HAS PUR-CHASED the 64,000 square foot General Mills plant in Bloomington, Ill. Admiral expects to ultimately employ 1200 people at the new factory, first in the manufacture of radios; later in television sets.

"BY USING HOME TRIAL demonstrations the sales of clothes dryers can be increased tremendously. In case after case, dealers have reported that 80 percent to 90 percent of the dryers in homes on free trial are kept there by the housewife."—F. M. Mitchell, manager Laundry Equipment Div., Frigidaire.

Status of TV

The following stations are expected to go on the air this month: WSYR-TV, Syracuse, N. Y.; KEYL, San Antonio, Tex.; WHAS-TV, Louisville, Ky.; WOI-TV, Ames, Iowa; WJIM-TV, Lansing, Mich.; and WKZO, Kalamazoo, Mich. Sets in use as of February 1: 4,300,000

What's Ahead!—in Radio,

LOOK FOR GREATER SALES ACTIVITY this Spring over last. Reasons: Reduced inventories, particularly of distressed merchandise, plus a more settled buying attitude on the part of the consumer.

TRENDS NOTED AS A MONTH OF 1950 PASSES: Some folded record departments reopening. . . . Increase in number of factory field people out helping dealers sell appliances. . . . With supplies short, many merchants agreeably surprised by results obtained through pushing sales of radio receivers. . . . Credit buying on the upswing. . . . TV in-home trial offers on the increase. . . . Replacement sales potential on weather-beaten, rusted TV antennas greater than you think. . . . Manufacturers, wholesalers and dealers viewing the New Year with the greatest optimism ever displayed. . . . Look for brand-switching spree by merchants to continue in '50.

"WE MUST DO MORE AS AN INDUSTRY to convince people of the convenience of electricity. This is an old story to us but it is not well sold yet when there are 18 million Americans today who lack washing machines; 25 millions lack vacuum cleaners; many more have inadequate supplies of hot water, and most homes today still are without the service of dishwashers and garbage removers."—R. L. White, president, Landers, Frary & Clark.

DEALERS WOULD LIKE TO SEE a forthright return to the old "protected territory" set-up where they'd be given commission on any and all sales made within their franchised territory.

ALL OVER THE COUNTRY, dealers have been hauling out stacks of slow-moving records; liquidating them over bargain tables.

NEW RADIO REPLACEMENT PLAN announced by John Meck Industries of Plymouth, Indiana, makes it possible for dealers to replace sets brought in for repairs with new sets, returning the defective receiver to the plant for reconditioning for resale. All Meck models from \$11.95 to \$44.95 are covered by the new policy.

THE OUTSTANDING NEW MARKET for mahogany has been for television cabinets, the Mahogany Association points out, stating that this wood is used in ninety to ninety-five percent of all TV models produced.

A NEW INDUSTRY COMMITTEE, composed of both RMA members and non-member companies, to develop further plans for educational "Town Meetings" of TV dealers, was arranged at a conference in Chicago.

MORE SERVICE DEPARTMENT REVENUE for the man who goes after the business. Watch for full details on running a Tune-Up, Tube-Up, Check-Up campaign in the April issue of this magazine. Owners will be glad to put millions of old radio sets and phono players into good working order—and numbers of TV receivers, too, if the need to do so is stressed by the dealer.

THE BIG 1950 PARTS DISTRIBUTORS SHOW is all set for Chicago's Hotel Stevens, May 22-25. The event is sponsored by the Radio Manufacturers Assn., the National Electronic Distributors Assn., the Association of Electronic Parts and Equipment Manufacturers, the Sales Managers, Eastern group, and the West Coast Electronic Manufacturers Association, and is operated by the Radio Parts and Electronic Equipment Conference and Shows, Inc.

TV SETS IN TAVERNS, HOTELS and other public places, though they may have a screen visible from a great distance, often provide a loudspeaker at the screen only so that patrons cannot hear in the rear unless the volume is so loud that it is uncomfortable. By use of extension loudspeakers giving more even sound distribution, more people will have a chance to comfortably see and hear the program. Sound dealers will profit by suggesting this improvement to all commercial TV users.



WITH TV THE TOPIC OF GREATEST interest in entertainment and educational circles, the dealer who doesn't try to get his name in the local papers in connection with news about video is certainly missing a bet. Reporters and editors are always on the lookout for stories with television angles, and the retailer is certainly the logical source.

MANY TV PARTS AND MUCH TV installation material still in short supply, report some jobbers. Pipelines are beginning to fill, but slowly.

COAST-TO-COAST TELEVISION is not far off, with high costs of transmission its main deterrent, Dr. Thomas T. Goldsmith, director of research, Allen B. Du Mont Laboratories, told a television symposium at the American Association for the Advancement of Science convention.

Appliances, Records and Television

AS COMPETITION INCREASES look for a continuation of lowered TV set prices. Drops have, fortunately, come at a time when the industry has no large stocks of finished products on hand.

INVENTORIES STILL LOW THOUGH heavy production is commencing to catch up with demand. Look for it to take several more months of heavy output to fill up the pipelines.

SPEAKING ABOUT THE MAY PARTS SHOW, William O. Schoning, president of Lukko Sales Co., Chicago, says: "Each year it educates an increasing number of manufacturers to the necessity of developing the line, the merchandising technique and policies. It stimulates the thinking of our suppliers because it creates competition for the customers attention during show week. Change and progress are the two most important business getting factors in this industry. I wonder . . . how many manufacturers would just sit back and continue to make the same thing each year, packaged the same way, sold in the same manner . . . if it weren't for the prodding which the annual industry market gives them each May."

IN A MESSAGE TO HIS DEALERS, Harry Alter, president of Chicago's Harry Alter Co., distributing firm, points out that while many dealers close their books on December 31 and file their income taxes as of that date, they may close them at any time that suits them best. (He suggests August 31.) To make a change from a calendar to a fiscal basis, it is necessary, though, to obtain approval from the U. S. Revenue Department. Arrangements can be made through an experienced accountant.

A SLAP AT BACKDOOR SELLING COMES from the Louis O. Bowman organization, wholesalers of Richmond, Va. The firm sends its dealers a certificate, simulating an insurance policy, pledging that the products it handles will be sold only to those legitimately entitled to buy at wholesale.

"GROUP YOUR ELECTRIC HOUSEWARES. MAKE A REAL DISPLAY OF THEM. Assign to at least one person the responsibility for being the specialist on these items. . . . Plan for window displays. Ask your distributor or manufacturer for help in display and promotional ideas."—Stanley M. Ford, vice-president, Chicago Elect. Mfg. Co., and chairman of the Electric Housewares Section, NEMA.

FARM MARKET LOOKS GOOD as the nation's farmers start 1950 with mortgages and other debts at the lowest point in history; savings at all-time high. Rural dealers are looking forward to a banner year in sales of radio, TV, and large and small electrical appliances for the farm home.



SMALL FRY ARE TOP TV "salespeople," dealers are finding out. Having seen video shows in the homes of neighbors, the kids really put the pressure on their parents, such pressure usually resulting in purchase of a set. The smart dealer "sells" the kids along with Mr. and Mrs.

EVEN THOUGH DISHWASHERS ARE GAINING public acceptance more rapidly than any other major appliance since the automatic washer, they are still luxury items appealing chiefly to higher income families, as shown by the fact that 60.3 percent of the machines sold last year went into homes valued in excess of \$15,000. The number of dealers handling dishwashers in '49 increased an estimated 18 percent over 1948, whereas 10 years ago less than five percent of the dealers were in this business. The foregoing views of the dishwasher industry were expressed by Edward R. Taylor, Hotpoint sales manager, in an interpretation of a consumer survey by the company.

FUTURE EVENTS OF INTEREST TO READERS

FEB. 1-2: National Assn. of Music Merchants (NAMM), Regional Conference, Shamrock Hotel, Houston, Tex.

FEB. 6-10: Western Winter Market, Merchandise Mart, San Francisco.

FEB. 20-23: Michigan Retail Hardware Assn., Trade Show & Convention, Grand Rapids.

MAR. 6-9: IRE Show, Grand Central Palace, N. Y.

APR. 14-22: National Electric Housewares Week.

MAY 22-26: Parts Distributors' Conference & Show, Hotel Stevens and Exhibition Hall, Chicago.

JUNE 12-16: National Association Electrical Distributors, Convention Hall, Atlantic City, N. J.

JULY 16-19: National Assn. of Music Merchants (NAMM), Music Industry Trade Show & Convention, Palmer House, Chicago.

AUG. 7-19: U. S. International Trade Fair, Chicago Coliseum, International Amphitheater and Navy Pier, Chicago.

AUG. 27-SEPT. 1: Radio Parts Distributors' Convention (NEDA), Cleveland Auditorium, Cleveland, O.

Finding, Training and

Actual Dealer Set-Up Shows Effective Way to

• It is fairly well established now that 1949 can be considered the year when the consumer pocketbook really began to tighten up and selling started in earnest. We had been saying "the honeymoon is over" ever since the war ended, but it finally came to pass.

All over the country merchants became aware of the need for better

X. In addition to advertising, the firm gets "leads" on good men from all sorts of sources. For instance, an energetic insurance man, a former automobile salesman, a salesman who has been calling on foreign-language-speaking people, all may be attracted to the organization.

Having obtained suitable persons,

chandise. Maintain adequate service facilities.

B. Advertise the establishment so thoroughly that every man, woman and child will hear of it.

C. Cover the territory with salesmen.

Using voting districts as a guide, the trading area was divided into five parts. Each salesman was assigned to a territory which was his to cultivate exclusively. He was provided with a list of all the people in his territory. He is expected to call on every home, and making a "direct" approach, obtain complete information as to the products now owned (make, age, etc.), history of relationship with the firm, and other pertinent data. All such information goes into a filing system.

This is a "protected territory" system, and as a reward for thoroughly cultivating all the residents of this territory, the salesman receives a commission on all business coming from it. If he makes the sale himself, he gets full commission. If someone else makes the sale, he receives a "protection" commission. Protection commissions are 3% on radios and appliances and 2% on television. The regular commissions are 10% on radios and appliances and 7% on television. Television commissions are smaller because this item is relatively easier to sell, and because the dealer himself receives from 5 to 12% less discount on TV. In certain instances, expense allowances for salesman's car are arranged.

The salesmanager may approve putting certain people who promote business and obtain prospects—commonly called "bird-dogs"—on a "lead commission" basis. In such cases, where the lead is turned over to a salesman, the commission arrangement is as follows: TV—3% for the lead and 5% for the salesman; Appliance and radio—5% for the lead and 7% for the salesman.

Unassigned areas are called "open" territories. A salesman may put in a card for a prospect in the open territory, and will receive 30 days protection on such a carded account. If another salesman makes the sale in such a case, the carding salesman will re-

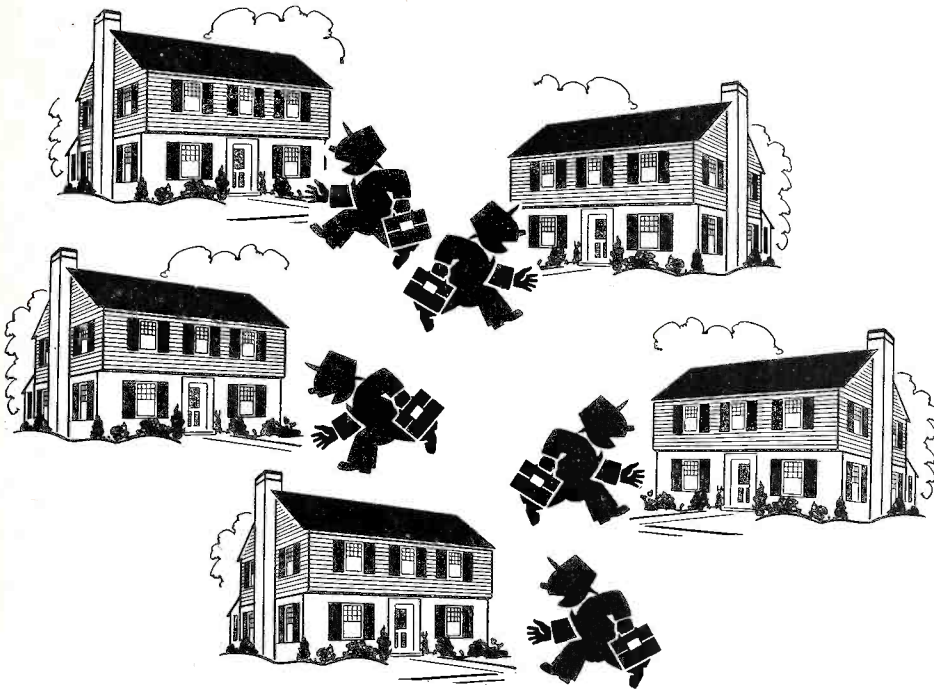

The protected territory is divided into five sections. (Voting districts.)

salesmanship, for new methods of increasing sales, and for stepped up sales activities in general. Because of upped overhead, shorter discounts, increased sales resistance, decreased floor traffic, and customer "switching" from one store to another, dealers have found it necessary to explore every profitable means to increase volume.

Outside selling in particular has gathered considerable emphasis in the more competitive markets. The plan outlined in this article is based on an active campaign of outside selling. The details of this plan (which was developed by a successful radio-appliance dealer who prefers to be anonymous) offer many valuable suggestions for readers who are just instituting a new sales campaign, or who are dissatisfied with their present mode of operation.

The first and most difficult step in building a sales force today is to find acceptable people, according to Dealer

Dealer X says that a sound plan, affording a good income for willing workers must be put into effect in order to hold the organization intact.

The backbone of the plan is the following set of tenets:

1. Maintain list prices.
2. Go out after business.
3. Back up the salesmen with training, a realistic pay plan, and with a business set-up to attract and hold customers.

The three phases of the plan of execution are equally simple and direct:

A. Provide an attractive store well-stocked with a good selection of mer-

Dealer X's salesmen come from all walks of life. Experience in this field is not necessary.

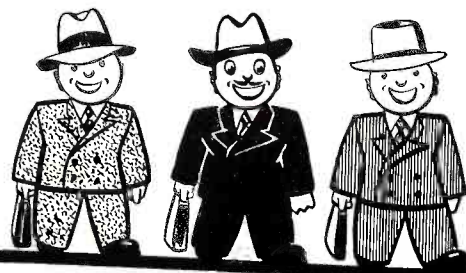

Paying Outside Salesmen

Increase Volume, Attract Good Men—Various Compensation Plans

ceive half the commission. After 30 days the account is "open" again.

The store is manned by the sales-manager and one or more salesmen (depending on the necessity of the season). The latter are outside salesmen who are "rotated" for store duty every week.

It is the overall function of the manager to select and train salesmen, to direct their daily activities, to demonstrate to salesmen how to obtain prospects by actual canvassing in the field, to help salesmen close difficult sales, and generally assist them in their activities. Sales meetings are held every morning at 8:30.

On the floor, the manager will contribute his sales effort in behalf of and for the credit of the various salesmen. He closes orders in behalf of salesmen, and they receive protection commission for such orders as provided for in the "exclusive territory" and "card-file-open territory" protection plans. He does no selling for himself.

The other salesman (or men) on the floor operates the same way, since practically every person who walks in is in some salesman's exclusive territory. He will receive full commission on uncarded "open" accounts.

The salesmen themselves demonstrate all products to their customers,

dealer can afford in the form of a "straight commission" is the most advantageous to the salesman, and that such a plan puts the greatest premium on good salesmanship. Salesmen's commissions are earned and due when the merchandise is billed to the customer or time-payment papers are executed. The payment of commissions operates on two plans, at the choice of the salesman. The "monthly-settlement" plan is designed to pay the salesmen their entire commissions earned each

store will be reasonably safe in making advances to him. The salesman will not be allowed to "go in the red" more than one month's draw at any time. On the other, hand, if his commissions

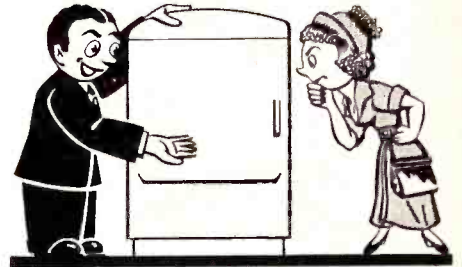

Dealer X's salesmen make their own demonstrations.



Thorough sales training pays.

month, so distributed that they will receive checks on the 15th and the end of the month. The "drawing account plan" is designed to level out and make more constant the salesman's pay over the months. The amount of the draw, paid semi-monthly, is based on the salesman's past record, but is on the "low side" of his past average so the

are accumulating at a higher rate than his monthly draw, he will either be paid additional commissions earned as of the end of each month, or his draw may be adjusted accordingly.

New salesmen whose "past average" cannot readily be determined are started on a salary-plus-over-ride basis until they find their "niche." On a salary of \$200 per month, the firm pays 2% on TV and 3% on appliances up to \$5000 sales per month. The commission rate is increased on a sliding scale. On \$10,000 per month sales, the salesman receives 5½ on TV and 6% on appliances.

This plan, which places emphasis on outside selling on a commission basis, has proved quite successful—not only in sales, but in attracting good salesmen because of the earning possibilities.



The compensation plan must provide high earning potential for willing workers.

and there is no "selling home demonstrator." It is believed that the man makes better sales presentations if he learns the function and operation of the products he sells sufficiently well that he can give a home demonstration of the product after it is sold. This gives the salesman another reason for contact with the customer under favorable circumstances, and a valuable opportunity to secure information about other products needed by the user, and for obtaining prospects from the user.

It is believed that a job which pays the salesman the maximum amount the

THE "X" PLAN FOR MORE PROFITABLE SALES

1. Obtain good salespeople and train them thoroughly.
2. Maintain an attractive store.
3. Offer outstanding service.
4. Carry a large selection.
5. Work territory effectively.
6. Sell at list-prices.
7. Have a realistic salesman-compensation program.
8. Advertise consistently, forcefully.
9. Build up card-files of valuable facts.
10. Hold old customers—obtain new ones.

What Dealers Are Doing

Sales Meeting a Day Is Success Formula

TRAINS HIS SALESMEN: owner of **The Appliance Mart, Billings, Montana**, C. C. Musburger, who once made fame as a top sales manager for a vacuum cleaner company believes, "You can't hire salesmen. You have to train 'em." He knows from experience that commissions alone will never serve as a continuous inducement to enthusiastic selling. That is why his men never start a day without their morning sales conference. This is their opportunity to hear a pep talk, which includes the latest developments about their products. Here, each man has a turn in giving a sales pitch about some item and the others are quick to criticize. This, "getting it off their chests" period is considered the most important feature of the day's work.

"An alert sales manager, like a general in the battlefield, must start each campaign with a few words of advice and encouragement. And any sales manager worthy of the title, whether he be owner or employee, should be worth more than all the salesmen he can train.

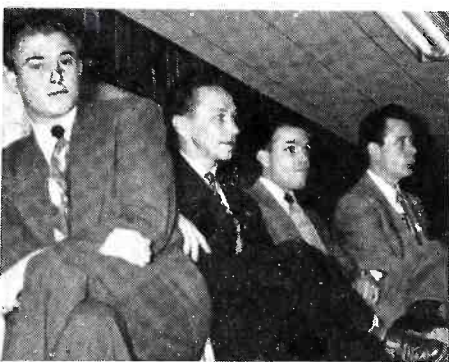

Shown are Appliance Mart salesmen laying plans for the day's selling activities.

"The four salesmen from The Appliance Mart work in two teams. Carl Rogeness and Oliver Dickey compete in a weekly competition with a team composed of Al Guidice and Jerry Haider. The teams alternate, one day in the store and one day in the field. This helps to prevent monotony and keeps them abreast of developments.

High team in gross sales each week is guest to the loser for a supper.

"Prospects are secured in many ways, not the least important of which is the tried and true 'cold turkey' ringing of doorbells.

"A key point in the sales conferences is a simple five-way program of conducting a sale. It is simple enough to become a habit and is the real basis for the consistent selling program in this store.

"Broken down these points line up as follows: A salesman who has taken time to learn something about his prospect or, in the case of ringing doorbells in a neighborhood, has given thought to the type of people dominating the area, suits his appearance, actions, and personality to the situation and approaches his prospects in a light favorable to them.

Creating Desire

"His pre-study of prospect or neighborhood tells him what should interest a particular person or family. It might be the ability to discuss phases of the prospect's work, a neat display of flowers in a yard is proof enough that horticulture will bring a warm response. Flowers in a neat arrangement also show evidence that quality will be appreciated above price if handled correctly.

"Thus armed the salesman is ready to secure undivided interest on the part of the prospect because he can talk his language. This, then will enable him to go directly into his own interesting story. Interesting because, while it concerns his product, it is told in a manner that makes it a personal matter for the prospect.

"Working consistently toward his main goal the alert salesman senses when a desire has been created and proceeds immediately toward a close.

"The above routine may take several visits and it may well be completed on the spot. But, if handled in the manner outlined, and with no waste motion, it will be a big help to the 'old law of averages.'"

PHONO RECORD SELLING with that personal touch used in ads by **The Radio Center, New Orleans**, inviting prospective customers to "write or phone Nancy Jones." Store was written up in this publication in the November, 1949, issue. Firm's slogan, "The Home of Home Appliances."

EFFECTIVE, ECONOMICAL ADVERTISING pays off for **MacArthur & Patten, Prospect Park, Pa.** Firm bought a duplicating machine, sends out personal messages on postal cards to a

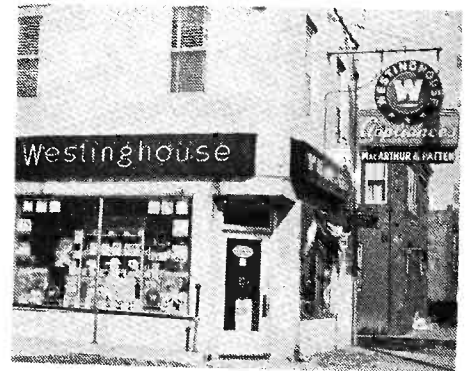

carefully checked list. On one mailing, 50% of those to whom an announcement was sent responded and made purchases. The firm sells radios, appliances, records; specializes in top-flight service.

WEEKLY "TELEVISION PARTIES" sell for **Tucker's Radio & Appliance Store** in Philadelphia. Advance invitations by mail and phone bring about 25 prospects to watch a popular program such as Milton Berle. A curtain is drawn blocking off a small section in the rear of the store which has been equipped with special lighting and comfortable chairs. A brief speech after the show acquaints prospects with the set's features and the budget plan of purchasing. Then buffet refreshments are served and salesmen chat informally showing any other merchandise in which they can attract interest.

to Increase Sales

Sells Up Those Phono Record Customers

DISCS SELL INSTRUMENTS, according to the proprietors of the **Redwood Radio & Electric Co.**, Redwood City, Calif., the store's excellent sales volume in television receivers and radio consoles is a result of its service and record departments. Owners Bill Laib and Owen Carstarphen report that approximately 75% of total sales were made to customers who originally came in to buy a new record or have a small service matter taken care of.

Redwood Radio opened its sleek new store at 2114 Broadway, with lots of fanfare. Radio and recording artists were present at the recent opening, and large crowds of people attended the initial festivities. The present location of Redwood Radio more than triples the space occupied by the firm in its previous establishment. The store has approximately 3000 feet of floor space; plate glass display windows which provide passers-by with an excellent view of the store interior; and a modern exterior, with the latest developments in architectural and structural design.



Dude Martin and partner sing for the opening night crowd at Redwood Radio & Electric Company.

Folk music is particularly popular in the vicinity, and Redwood Radio does a profitable business of selling this type of discs. As shown on the illustrations on this page, cowboy ballads have a strong appeal with the audience. In addition, the store maintains a large stock of "high-brow" and rare foreign folk discs. The record department has

continued to flourish, along with radio and TV sales.

Manager Bill Laib emphasizes that "The important thing I've discovered about radio and TV retailing is that your customer's needs come first. And his needs don't stop with buying. Every time we install TV, one of the



Owners W. J. Laib, left, and Owen Carstarphen, right, are congratulated by E. W. Butler, manager, Redwood City Chamber of Commerce.

store owners makes a personal call on the customer, checks the installation, watches reception, and guides the buyer in getting the best out of his instrument. In that way, we get to know people's requirements right in their homes. Then we can provide the prompt maintenance service they need for TV, keep in stock the records that will be wanted for their players, and maintain the finest equipment for repairing radios."

Redwood Radio does an exceptionally good business selling console radios in the \$150-200 price categories. Ernie Meissner, repair and installation manager for the company, points out "We hardly need advertise—and yet we can sell all the consoles we can buy in the medium price class . . . there is a big demand from small home owners for a good AM-FM radio receiver and record player."

Friendly, efficient sales policies, and top-flight servicing has developed a valuable following of customers for this progressive California dealership, which has been in business about three years.

LARGE TELEPHONE BILL every month pleases **World Television, Inc.**, Cleveland, Ohio, because it means that rural sales are up. The firm encourages customers to call the store, local and long distance and reverse charges. Technique boosts sales in out of town areas. "Builds good-will, too," says Samuel Brown, owner-manager.

"PARLOR ATMOSPHERE" IMPRESSES CUSTOMERS. Jim Sullivan, proprietor of **Briscoe Electric, Valpariso, Ind.**, faced a problem in the merchandising of larger, more expensive television receivers and radio consoles.

"How can I get the customers to relax and really enjoy demonstrations of these top-price appliances?" he asked himself.

He found the answer in the creation of a "demonstration parlor," in which he invested about \$500 for materials and carpentry. It sits in one corner of his store, completely enclosed.



Effective demonstration pays.

There he has a carpeted floor, simulated venetian blinds, papered walls, plants and individual table lamps for soft lighting. The 12 x 15' room has helped to sell a number of television receivers, some as high as \$1800 in price, in a few months.

"It has paid off handsomely," he reports, "and will continue to do so as I advertise it and get more and more people acquainted with its hominess."

Check List to

UP 1950 TV SALES



GEAR UP NIGHT SELLING, both in the store and in the home. More than 90 per cent of all TV set sales are husband-wife propositions. . . . See 'em together!

FOLLOW-UP PROSPECTS. Get names of store visitors; use your own list of customers. Contact by personal call; by phone, by letter. Consistent follow-up gets results.

SELL PRODUCT AND PROGRAM with enthusiasm, and with imagination; to boost your volume.

HAVE DEMONSTRATION MODELS performing at peak at all times. Don't make complicated demonstrations. Provide comfortable seating arrangements for the viewers.

KNOW COMMON CUSTOMER OBJECTIONS and how to answer them effectively. Many a prospect who's on the fence can be signed up if his doubts are dispelled by salesman.

ADVERTISE CONSISTENTLY, effectively. Stress your service set-up and know-how.

KEEP IN-STORE AND SHOW-WINDOW displays attractive, attention-getting. Change displays often.

WEIGH COMPETITIVE OFFERS, such as meter-plans, rentals, free home trials for possible adoption.

Gear plans to buying habits in your trading area. Make it easy to buy.

SELL THE CHILDREN! Youngsters are the best salesmen for TV sets.

WORK WITH BANKS, CIVIC AND RELIGIOUS GROUPS in promoting television in your community.

USE TV USERS TO GET LEADS. Be sure to make after-sale calls on customers. They'll appreciate it.

STAGE IN-STORE TV "SHOWS." Send out special invitations to your list of prospects.

MAKE DRIVE TO TRADE IN those small-screen jobs in your community. They all want big pictures.

COOPERATE WITH YOUR local broadcasters. You'll find them interested in getting a big audience.

KNOW YOUR TERRITORY RECEPTION-WISE, and you'll be in a position to tell prospective customer a lot about what sort of picture he can get. You'll eliminate service headaches.

INVESTIGATE USE OF "FREE-LANCE" salespeople. "Bird-dogs" make money for many dealers.

HAVE COMPETITIVE TIME PAYMENT plans. They'll help clinch many a good sale in television.

TRAIN YOUR SERVICERS TO SELL. Your customers have confidence in the TV technician.

USE MANUFACTURERS' SALES AIDS in selling and in training sales personnel; as display pieces.

SELL A GOOD ANTENNA INSTALLATION to keep a satisfied customer following as one of the best sources of leads any television merchant can have to increase volume.

The 20 TV sales angles on this page represent ideas that can be employed to boost television set sales during 1950. The themes, published at greater length in past issues of this magazine, have been boiled down to give the reader a quick look at all of the things successful merchants are doing to keep TV sales on the ball. Business in '50 will go to the sales-maker — not to the mere order-taker.

DU MONT LEADS THE INDUSTRY... WITH

*quality
control*

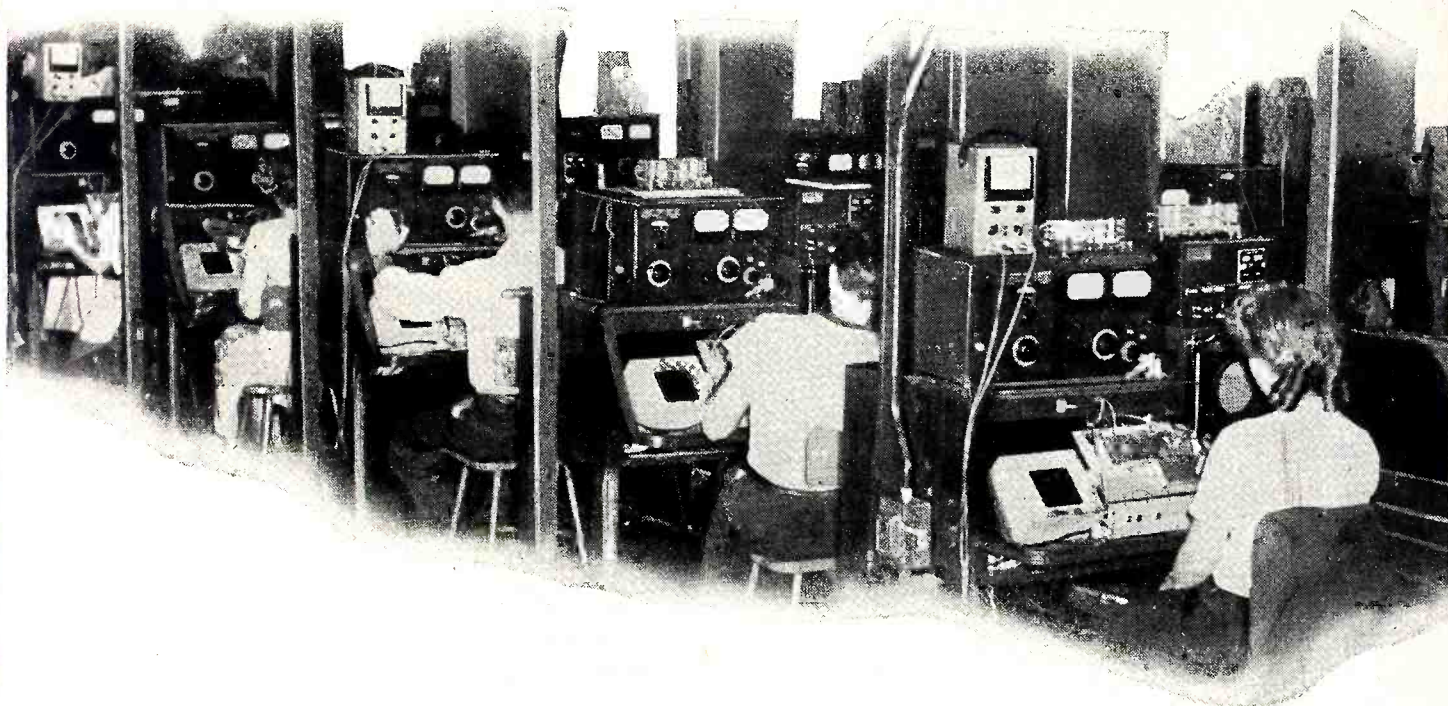

Among component manufacturers, Du Mont is known as the most exacting buyer in the industry. Du Mont inspectors are in the suppliers' plants regularly; then all parts are checked again and re-tested as they are received at the Du Mont assembly plant.

Du Mont Quality Control extends through the entire manufacturing process, guarding against the possibility of defective parts or workmanship at every point.

Du Mont vigilance in manufacture and testing is a big help to the Du Mont dealer — it means the kind of customer satisfaction that builds a successful business.

Invite your prospects to see the Morey Amsterdam Show over the DuMont Television Network. Morey is a great salesman.

DU MONT *First with the finest in Television*

Copyright 1950, Allen B. DuMont Laboratories, Inc.

Allen B. DuMont Laboratories, Inc. Television Receiver Div., East Paterson, N.J., and the DuMont Television Network, 515 Madison Ave., N.Y. 22, N.Y.

Latest TV Receivers

G.E. 1950 TV LINE

Five new TV receivers have been introduced, including the first G.E. 19-inch set, the model 19C-101 (shown) in mahogany cabinet with doors, casters, and 12-inch loudspeaker. All the sets have a built-in antenna, and all except the 19C-101 feature the "Black Daylight" tube.



Model 10-T-6, 10-inch table set in plastic cabinet, lists at \$179.95; 12-T-3, 12½-inch table set in mahogany cabinet is \$239.95, 12C-107, 12½-inch console with casters and 12-inch loudspeaker is \$289.95, and 12C-109, 12½-inch console with doors, casters, and 12-inch loud speaker, is \$319.95. General Electric Co., Electronics Park, Syracuse, N. Y.—RADIO & TELEVISION RETAILING.

Crosley TV SETS

The "Family Theatre Series" TV receivers are designed to look like a stage, and to permit viewing from anywhere in the room. Two 16-inch consoles and a 12½-inch table set are in mahogany, while the 10-inch table set has a plastic cabinet. The

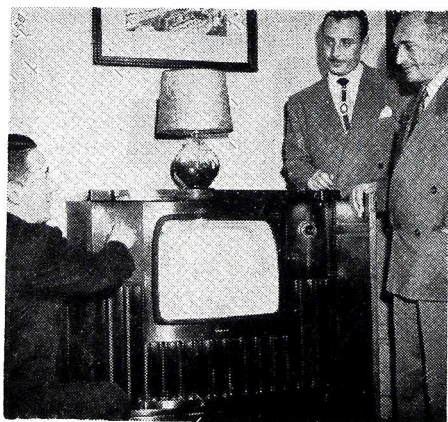

10- and 12-inch table sets are \$199.95 and \$279.95 respectively, while the 16-inch consoles are \$399.95 and \$499.95. All four are for TV-only, and incorporate built-in antenna. Crosley Div., Avco Mfg. Corp., Cincinnati, Ohio.—RADIO & TELEVISION RETAILING.

Emerson 1950 TV LINE

Five new models are spearheaded by the 10-inch model 648 featuring Expanscope circuit and retailing at \$179.95. All the sets contain built-in antennas. A console, model 629, with 16-inch tube, has a list price of \$329.50. In addition, the new line includes model 650, a 12½-inch table model at \$229.50, model 654, a 12½-inch console at \$249.50, and model 651, a 16-inch table set at \$289.50. Emerson Radio and Phonograph Corp., 111 Eighth Ave., New York 11, N. Y.—RADIO & TELEVISION RETAILING.

Air King TV SETS

New models incorporate the new rectangular-faced picture tube, built-in antennas and automatic gain control. Model A-2017R (shown) is a 16-inch table set in



mahogany cabinet. Model 2016-R is a 16-inch console in mahogany cabinet. Both models have 20 tubes. Air King Products Co., Inc., 170-53rd St., Brooklyn 32, N. Y.—RADIO & TELEVISION RETAILING.

Philco 1950 TV LINE

Seven new models are highlighted by model 1403, 12½-inch table receiver in walnut cabinet, with built-in antenna, retailing for \$199.95. The other 6 models, all 12½-inch sets with built-in antennas, in-

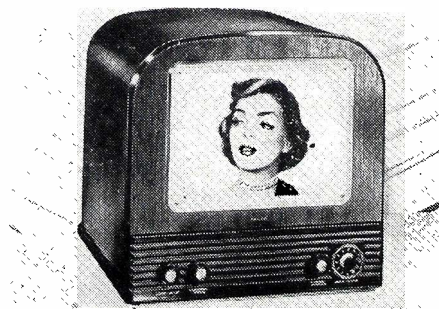

clude 4 consoles and 2 table sets. One console, model 1484, is a combination, providing FM-AM radio and 3-speed phono, and is priced at \$479.95. The popular console model 1443 is continued in the 1950 line. Philco Corp., C and Tioga Sts., Philadelphia 34, Penna.—RADIO & TELEVISION RETAILING.

Admiral 1950 LINE

The ten models in the new line include 1 table set, 4 consoles, and 5 console-combinations. Lowest price in the line is a 12½-inch plastic table model at \$179.95. The 1950 version of Admiral's plastic console features one-knob automatic tuning, built-in antenna, and 12½-inch picture



tube, and is priced at \$199.95. Top of the line is a 19-inch console with AM-FM radio and 3-speed automatic changer. Only 12½, 16 and 19-inch tubes are included in the new line. Admiral Corp., 3800 Cortland St., Chicago, Ill.—RADIO & TELEVISION RETAILING.

RCA 1950 TV LINE

Highlights of the new line are the first sets featuring RCA's new short-necked 16-inch tube with "Filterglass" face plate, a 10-inch metal cabinet table set at \$169.95, and the first RCA console instruments incorporating phonograph facilities for all 3 record speeds. The latter provide a sepa-

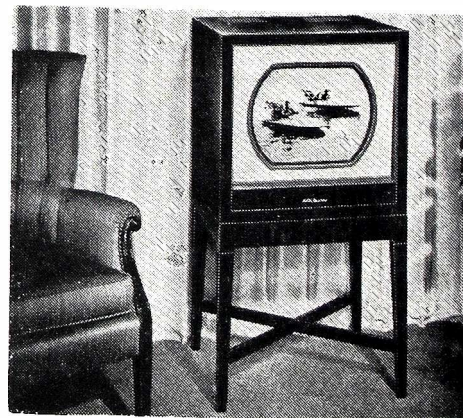

rate 45 RPM changer. Of the 14 new models, 1 is 10-inch, 6 are 12½-inch (2 with FM-AM radio and 3-speed phono), and 7 are 16-inch (2 with FM-AM radio and 3-speed phono). Model T-164 (shown) is a 16-inch table set with concealed controls, built-in antenna and phono jack, listing at \$299.95. RCA Victor Division, Camden, N. J.—RADIO & TELEVISION RETAILING.

and Radio Sets for 1950

Zenith RADIO-PHONOGRAPHS

The "Chippendale" and "Hollywood" are new radio-phonograph consoles, with FM-AM radio, 3-speed changer, and 12-inch speaker. The mahogany Chippendale retails at \$279.95, while the blond Hollywood is priced at \$289.95. Zenith Radio Corp., 6001 W. Dickens Ave., Chicago 39, Ill.—RADIO & TELEVISION RETAILING.

Jewel CLOCK-RADIO

The "Wakemaster" model 915, said to be the lowest priced clock-radio on the market, combines a Telechron clock move-

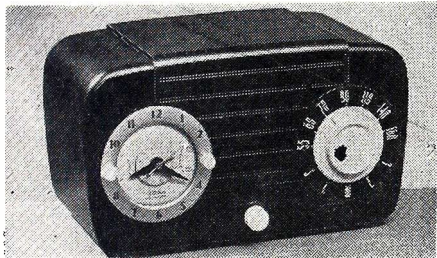

ment with a radio of 4 tubes including rectifier, housed in color-molded plastic cabinet. List price is \$19.95. Jewel Radio Corp., 10-40 45th Ave., Long Island City 1, N. Y.—RADIO & TELEVISION RETAILING.

Regal PORTABLE RADIO

Model P-175 is a 3-band, 3-way (AC, DC, battery) portable radio, covering the broadcast band as well as the 2-6.3 MC and 6.2-18.5 MC short wave bands. The

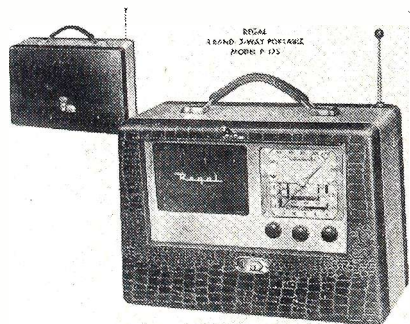

wood cabinet is covered with simulated leather, and is provided with built-in telescopic antenna. List price is \$79.50. Regal Electronics Corp., 603 W. 130th St., New York, N. Y.—RADIO & TELEVISION RETAILING.

Stromberg-Carlson TV SETS

Three new 19-inch and three 12½-inch consoles have been added to the line, the latter featuring "opera glass" tuning. The Chinese Classic model includes 19-inch picture, FM-AM radio and 3 speed record changer, to retail at \$965. The New Yorker is a 19-inch TV-only console priced at \$539.50. The Emperor II is a Georgian styled TV-only console with 19-inch picture, priced at \$645. The three 12½-inch sets are all TV-only. Stromberg-Carlson Co., Rochester 3, N. Y.—RADIO & TELEVISION RETAILING.

Magnavox RADIO-PHONOGRAPHS

The "Wedgewood" and the "Avenue" are radio-phonograph consoles in which a television chassis may be added when desired in a portion of the record-storage



compartment. Both receivers provide FM-AM radio and 3-speed phonograph, with 12-inch loudspeaker. The contemporary-styled Avenue lists at \$219.50, while the Wedgewood is \$275. Magnavox Co., 2131 Beuter Rd., Fort Wayne 4, Ind.—RADIO & TELEVISION RETAILING.

Du Mont WELLINGTON

The "Wellington" is a console combination with 15-inch TV tube, FM-AM radio, and 3-speed changer. In a traditionally-

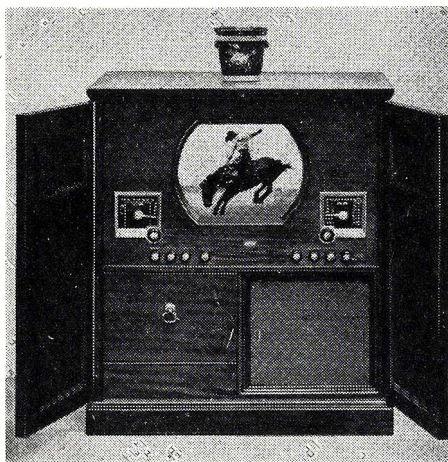

styled cabinet, this model retails for \$645. Allen B. D Mont Labs., 515 Madison Ave., New York 22, N. Y.—RADIO & TELEVISION RETAILING.

Hallicrafters TV SET

Feature of the new line is the use of rectangular picture tubes. A comparison of the current 16-inch table set with last year's Hallicrafters set with the same size picture reveals a reduction of approximately ½ the cabinet bulk and a saving of \$40 in retail price. The new set measures 17½ inches wide by 18¾ high and 19¾ deep, and retails for \$279.95. The Hallicrafters Co., 4401 W. 5th Ave., Chicago, Ill.—RADIO & TELEVISION RETAILING.

Arvin TABLE RADIOS

The new model 440T has been introduced in six distinctive "decorator" colors. Retailing at \$14.95, the sets have unbreakable one-piece steel cabinets in geranium

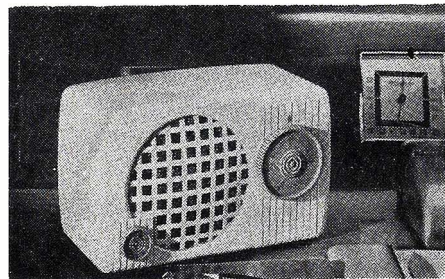

red, banana yellow, gardenia cream, willow green and sand bronze, and are U-L approved. Noblitt-Sparks Industries, Inc., Columbus, Ind.—RADIO & TELEVISION RETAILING.

Templetone 16-INCH TV

Model 16K1 is a 16-inch TV-only console in wood cabinet, with automatic gain control and plug-in antenna, 10-inch loudspeaker. Templetone Radio Mfg. Corp., 220 East 42nd St., New York, N. Y.—RADIO & TELEVISION RETAILING.

Majestic TV LINE

The 1950 Majestic line features 8 new TV sets, starting at \$199.95 for a 12½-inch table model. All of the new receivers are housed in mahogany cabinets, and incorporate built-in antennas. Models include a 12½-inch console at \$249.95, a 16-inch table set at \$269.95, a 16-inch console at

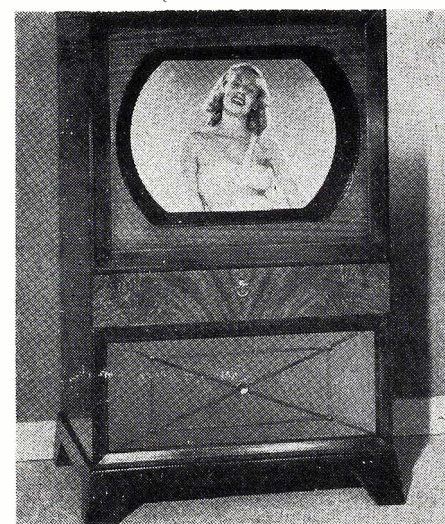

\$299.95, and a 19-inch console at \$479.95. The Majestic Radio and Television Corp. is headed by Leonard Ashbach, who recently acquired the Majestic trade name, trade marks, goodwill, patents, dies and molds. Majestic Radio and Television Corp., 70 Washington St., Brooklyn 1, N. Y.—RADIO & TELEVISION RETAILING.



*Hit the
Sales
JACK-POT
with
Current
Record
Favorites*

Noted conductor Sir Thomas Beecham, has recorded several works with the Columbia Symphony Orchestra, and expects to record additional works for Columbia Records with The Royal Philharmonic Orchestra in London.

Cornetist Pete Daily is featured in some earthy Dixieland on his first Capitol album.



▲ Cliff Steward, maestro, debuts with Coral in "On San Francisco Bay" and "Good Night, Little Girl, Good Night."

▼ Songs from technicolor film "Nancy Goes to Rio" done by the stars who sing them on the screen in this MGM release from the sound-track.



• Artists and albums pictured on these pages will get a big promotional push from the manufacturers. In addition, dealers would do well to watch the following: RCA Victor's Vaughn Monroe looks like he's coming up with another hit in "Bamboo" (take advantage of RCA Victor's heavy exploitation.) Also on the label, Ralph Flanagan's "Rag Mop" and the dueting Tony Martin and Fran Warren in "I Said My Pajamas," are sellers.

Columbia Records' release of the original cast recording of "Gentlemen Prefer Blondes" promises to be the fourth hit in the "Kiss Me Kate", "South Pacific", and "Miss Liberty" success cycle.

Bing Crosby's "Chattanooga Shoe Shine Boy" and "Bibbidi-Bobbidi-Boo" is going great for Decca. The label also has Red Foley doing the "Chattanooga" ear-catcher.

Coral's Connie Haines follows up her initial success with "Sugar Coated Lies" and "Me Myself and I." The Ames Bros.' recording of "Rag Mop" is also good.

In addition, St. Valentine's Day provides a good opportunity for displays of some new love ballads, sentimental albums, or specialized children's sets.

Of course, customers are still very much aware of the "speed" situation, with the recent RCA Victor announcement (see p. 80) causing much comment. Selling the three speeds is one thing; but of even greater importance to merchants is the buying of the platters in their proper percentages. Now is the time to start keeping tabs on customer playing equipment and preferences.

Pert Teresa Brewer has been doing some top song-selling on successive London releases. Her latest, "Music!, Music!, Music!" still whirling high.



J.S. Bach

Passacaglia and Fugue in C Minor

transcribed by Respighi

San Francisco Symphony Orchestra

Pierre Monteux, conductor

Pierre Monteux conducts the San Francisco Symphony Orchestra in another outstanding contribution to RCA Victor's catalog of noteworthy Bach recordings to commemorate the 200th anniversary of the composer's death.

Jerry Gray, former arranger for the late Glenn Miller, has been added to the Decca talent roster. Gray did the scoring for Decca's new "Club 15" album, and is featured on his own discing of "By the Waters of Minnetonka" coupled with "Crew Cut," both excellent for the dance set.



TV Makers Sponsor Video Shows

Dealers Utilize Goodwill, and Profit from Extensive Television Publicity and Coverage



The phenomenal success of the Kukla, Fran and Ollie show, sponsored by RCA Victor three days a week over 54 stations, has brought forth enthusiastic comment from dealers across the country. Retailers have found that by identifying themselves with the popular TV show, they reap maximum benefits from this national-local advertising.



Westinghouse's dramatic presentation "Studio One" features the best in acting, producing and writing talent. Shown is a knock-down, drag-out fight from a recent vehicle, "At Mrs. Beams" starring Eva Gabor and John Baragrey. The live show is seen on 17 different stations; it is kinescoped across the country on 14 additional stations.

Two TV programs sponsored by Admiral are "Lights Out" and "Stop the Music." Left, is a scene from the mystery thriller "Lights Out" shown on Monday evenings. "Lights Out" is also kinescoped. On the right, raccoon-coated Bert Parks clowns during a dance sequence illustrative of the flapper days, during the audience participation feature "Stop the Music," the first half of which is sponsored by Admiral on ABC on Thursday nights.



Pictured on these pages are some of the leading television shows sponsored by television manufacturers. Future issues will feature additional photos and comment on other video manufacturers' shows. Dealers across the country are cashing in on the additional advertising and customers gained from the large TV audience.

Many of the television companies are working locally with dealers in sponsoring co-operative TV shows. Interested dealers are advised to contact distributors for further information. In addition, more and more network shows are being seen in areas beyond the cable connections by kinescope.



Crosley offers televiewers the panel show, "This Is Show Business," (CBS TV, Sunday, 7:30 p.m., EST). On the left is Cliff Fadiman, Master of Ceremonies, smiling at guest panelist Faye Emerson. Regular panel members George S. Kaufman and Abe Burrows are seated.



Morey Amsterdam (second from right) shown during a zany scene from the Morey Amsterdam Show, sponsored on Thursday nights at 9:00 p.m. (EST) by the television receiver sales division, Allen B. DuMont Labs.

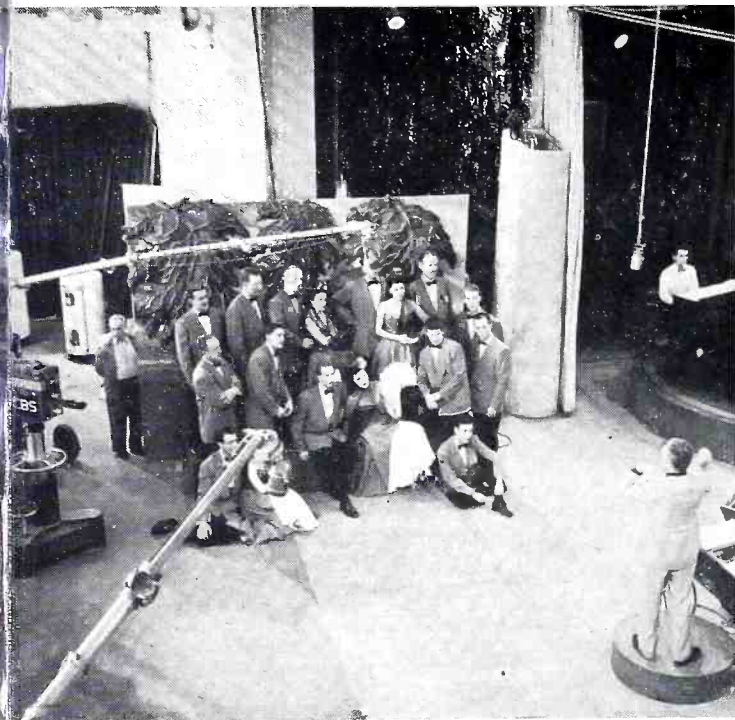

Club and orchestra are picked up by the TV camera during a Fred Waring rehearsal. The program, sponsored by the General Electric Co., is seen 7, 9 p.m. (EST) on CBS.

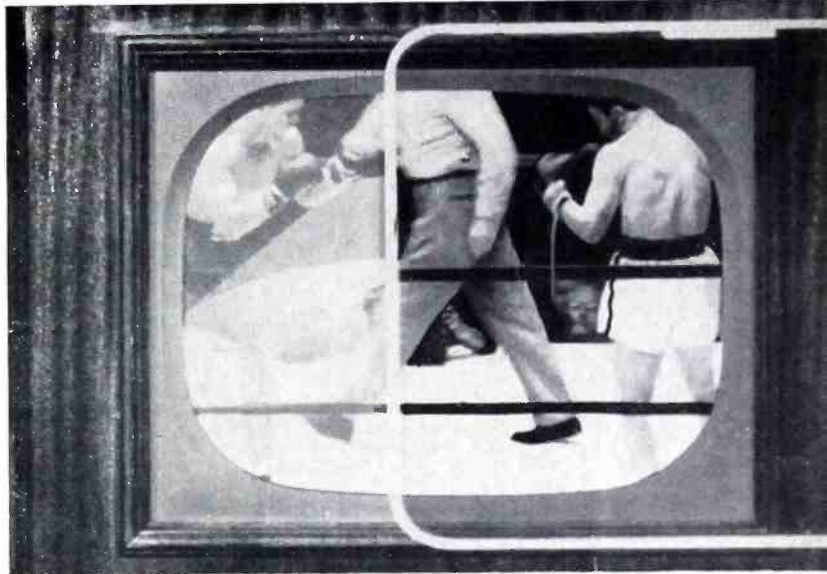

The Pioneer Scientific Corp., utilizes spot announcements over TV stations to advertise its Polaroid TV filter. Shown is a typical Polaroid spot, as seen by TV audiences.

The Philco TV Playhouse, seen Sunday evenings on NBC at 9:00 p.m. (EST) and points West via kinescope features outstanding dramatic entertainment. Pictured is a crucial moment from the televised performance of "Rebecca."

In cooperation with New York dealer, Radio Television, Stromberg-Carlson sponsors "Tropic Holiday" on Sunday nights. The company participates in local TV programs in key cities including the series of "Crusade in Eu-films on WHAM-TV in Rochester.

The Hoffman Radio Corp., Los Angeles, sponsors numerous local TV shows including amateur hour and college games. A typical program on KLEE-TV, Houston, Texas, spots a local high school group and grid player each week. Shown is pep squad from San Jacinto High School.



1950 New Electrical

Universal RANGE

"Select-A-Range" electric range provides opportunities to plan kitchens with flexibility; enables facilities to be matched to specific requirements of each consumer.



"Convenience Level" oven featured to enable homemaker to see right into the oven from a standing position, Select-A-Range is comprised of three basic interchangeable, independent, self-contained units, consisting of an oven, surface cooking unit, and a roomy storage cabinet. More than 25 different arrangements can be created from these three basic modular units. Fear-

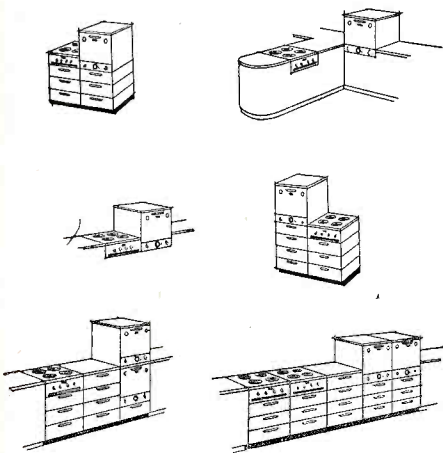

A few of the many range designs available

tured is a complete oven with one-piece enamel-lined interior, Thermostat control and preheat push button, automatic timer, minute minder, signalites to indicate when oven is on for bake and broil, smokeless slotted broiler grid and no-warp broiler pan, surface units with four fast heating thrift units, swivel mounted for easy cleaning; conveniently located surface controls with adjustable 7-heat control switches; extra heavy gauge steel storage cabinet. Landers, Frary & Clark, New Britain, Conn.—RADIO & TELEVISION RETAILING.

Leonard REFRIGERATORS

Ten new Leonard refrigerators, including four Super Deluxe models with 11 to 12 cu. ft. of storage capacity, introduced by the company. Suggested retail prices on the four Super Deluxe models, all refrigerated from top-to-base, are: model

LTM, 12 cu. ft. two-door combination refrigerator-freezer, \$449.95; LMM, 11 cu. ft., with full-width frozen food chest and secondary cooling system for extra-humid refrigeration, \$389.95; LFM, 11 cu. ft., with full-width frozen-food chest, \$339.95; LVM, 12 cu. ft., with side-mounted frozen food chest, \$299.95.

In the medium-price field, two deluxe 8 cu. ft. models, both with across the top freezer chests, are model LRL, priced at \$279.95, and model LRK, at \$249.95. Other models and prices are: LRE, 8.6 cu. ft., \$229.95; LRB, 7 cu. ft., \$214.95; LRC, 6.1 cu. ft., \$199.95.

Leading model in the super deluxe series is the LTM, with a capacity of 11.9 cu. ft., priced at \$449.95. Features across-the-top frozen food chest with its own door. Super deluxe models LMM, LFM and LVM are priced at \$389.95, \$339.95 and \$299.95, respectively. Leonard Div., Nash-Kelvinator Corp., Detroit 32, Mich.—RADIO & TELEVISION RETAILING.

Westinghouse APPLIANCES

Refrigerator shown, called "Frost Free" ADA-96, removes all frost from the refrigerator's freezer walls before it can build up. It then automatically disposes of the defrost water by quick evaporation. Unit is 9.6 cu. ft. refrigerator-freezer combination and carries a suggested list price of



\$399.95. Freeze chest freezes and stores 41 pounds of foods and ice. The "Frost Free" defrosting cycle is automatically set in motion each time the refrigerator has been successively opened 60 times.

"The Rancho" electric range, shown,

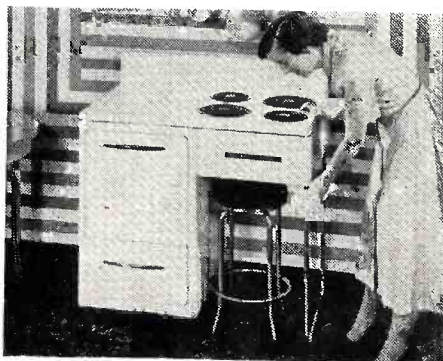

features a new design with the appearance of a knee-hole desk, for use in small kitchens, and where its unique styling matches interiors. Suggested list is \$159.95.

Range is 38 inches wide and has four surface Corox units, two 8-inch and two 6-inch. Features automatic oven heat control and can be equipped with a platform lamp and oven timer. Also has Tel-A-Glance controls for surface units, an oven thermostat and a convenience outlet. Two other range models were introduced by the company. "The Commodore," which sells for \$199.95, is 40 inches wide; "The Champion" deluxe range with a suggested retail price of \$259.95 is accentuated by a Fresnel glass lens which concentrates the fluorescent light on the work surface of the range.

Also shown by Westinghouse is a new front opening top-loading automatic dishwasher designed for ease and flexibility of installation. The dishwasher retails at the following list prices: 48-inch electric sink, \$374.95; 24-inch cabinet, \$284.95; and the undercounter model, \$254.95. The Waste-Away garbage disposer is an accessory for the electric sink and is sold for \$124.95. Westinghouse Electric Appliance Div., Mansfield, O.—RADIO & TELEVISION RETAILING.

Kelvinator RANGES

Complete new line of six electric ranges for 1950 shown by Kelvinator. New models include two deluxe automatic ranges, two apartment house models, and two low-priced 29-inch-width ranges which may be fitted with either of two types of lamp-and-timer accessories. Deluxe top model, ER-509, unit has a completely automatic cooking control, and dual-interval minute timer. Dual-interval minute-timer accurately times periods from 15 seconds to six minutes, or from 21½ to 60 minutes. Three 7-heat units plus a two-way up-and-down unit are grouped at the left side of the range. A series of white and colored signal lights on the control panel indicates which of the range elements are in use; fluorescent top light, two appliance outlets, and a warmer drawer are additional features. Priced at \$309.95.

Other range models include model ER-507, which features an accurate automatic oven timer and electric clock; dual interval minute timer; white plastic and chrome control-knobs mounted on recessed, sloping control panel; three seven-heat surface units; two-way up-down unit; retail price is \$279.95. Six different combinations of features are possible in the two new economy ranges, models ER-503 and ER-502, priced from \$215.95 to \$189.95, depending on the equipment. Designed for kitchens where floor area is at a premium, range models ER-541 (\$164.95) and ER-501 (\$154.95) are 21 inches wide and 25 inches deep. Kelvinator Div., Nash-Kelvinator Corp., Detroit 32, Mich.—RADIO & TELEVISION RETAILING.

Duchess WASHERS

1950 line consists of four models at prices of \$89.95, \$99.95, \$109.95 and \$129.95. The lowest price is the model 50 with a 7 lb. capacity tub. The models 60, 80 and 90, have a capacity of 10 lb. dry clothes. Model 90 features a heat retaining jacket on the tub. Appliance Mfg. Co., Alliance, O.—RADIO & TELEVISION RETAILING.

Appliance Lines

Philco APPLIANCE PRODUCTS

Refrigerator line features a horizontal evaporator in all new models, with line stressing greater values, engineering and design improvements. Full-width horizontal Quick Chiller is an extra cold zone, 7 to 15 degrees colder than the main food compartment, and gives wide opportunity for varying uses. Full length door models which offer real refrigeration all the way to the floor, a refrigerator with a huge 2 cu. ft. built-in home freezer, 14 cu. ft. two-in-one refrigerators and a full 11 ft. refrigerator in the dimensions of an 8 ft. cabinet are other developments in the line.

Electric ranges shown featured double-

and steel frame construction are other features. Shown is range model 408, the style leader, with two complete ovens, all automatic cooking controls grouped at right for convenience and safety, and the "Broil-Under-Glass" feature.

A 12 cu. ft. chest type freezer has been added to the line. Model EH-121 provides more space at the top of the freezer with 70% of the storage space above knee level. In addition, the new line of Philco single room air conditioners offer many style and performance refinements. Three new window models and four console types, including two water cooler models, were shown. Philco Corp., Philadelphia, Pa.—**RADIO & TELEVISION RETAILING.**

Admiral APPLIANCES

Refrigerator, shown, stands 4½ feet high and a little over 2 ft. wide and deep; has capacity of 9.1 cu. ft. Full-width freezing



oven ranges, "Broil-under-Glass" feature, and the revolutionary Philco broiler designed to broil foods in their own cooking vapors and retain the natural juices. The nine models include three double-oven styles, three single-oven styles and two spacesaver or apartment size ranges. Automatic cooking, fast heating surface units

compartment holds 37 lbs. frozen foods; drawer below freezer holds additional 16 pounds. Models in line maintain temperature of 20 degrees below zero in the re-designed freezer compartment which holds from 72 to 84 pounds of frozen food and 18 pounds of ice cubes. Prices and models are: 7 cu. ft. "Master," \$189.95; "Deluxe," \$214.95; 9.1 cu. ft. "Master," \$239.95; "Deluxe," \$259.95; 11.1 cu. ft. "Master," \$279.95; "Deluxe," \$299.95; 14.1 cu. ft. "Deluxe," \$339.95. In the Dual-Temp line, the 10.6 cu. ft. size is priced at \$399.95, the 13.5 cu. ft. size at \$449.95.

Admiral's electric range line consists of six different units; the smallest is a new home model, the largest a two-oven unit which features "flex-O-heat," a device whereby any heat temperature can be used for cooking instead of the usual factory set temperatures, an oven automatic barbecue and a simplified timing device. Retail prices for the line are from \$154.95 to \$349.95. Admiral Corp., Chicago.—**RADIO & TELEVISION RETAILING.**

Starrett AIR CONDITIONERS

Initial line includes two window models, of ½ and ¾ H.P. size, encased in metal; two console units, ¾ and 1 H.P. models, housed in cabinets bearing the same quality design as the Starrett television sets. The air conditioning units are being merchandised through the company's TV dealers. Starrett Television Corp., 601 W. 26 St., New York, N.Y.—**RADIO & TELEVISION RETAILING.**

Radio - TV Contents of "Electrical Merchandising" Ordered Limited to 4¼% of Reading Matter, 15% of Advertising

• We have had many inquiries about the December 8, N. Y. Supreme Court decision against McGraw-Hill, limiting their "Electrical Merchandising's" publication of radio-television reading and advertising matter, in the suit brought by Caldwell-Clements.

In 1941 McGraw-Hill's "Radio & Television Retailing" and Caldwell-Clements' "Radio & Television Today" were merged under Caldwell-Clements' operation as a constructive service to the radio industry by Caldwell-Clements and McGraw-Hill.

Through Caldwell-Clements' purchase of "Radio & Television Retailing," McGraw-Hill acquired a stock interest in Caldwell-Clements and held such minority interest until February, 1948, when the stock was repurchased by Caldwell-Clements and McGraw-Hill completely ousted.

At that time, McGraw-Hill in its sales contract, agreed not to "start, operate or interest itself directly or indirectly in publishing any publication primarily in the field of distribution of radio and television sets, parts and accessories" until at least April, 1951.

As we interpreted the language and understood the purpose of this agreement, no issue of "Electrical Merchandising" would devote more editorial space to radio-television or would contain more radio-television advertisements than the average of "Electrical Merchandising's" issues from February 1945 through January 1948. McGraw-Hill did not interpret the contract the same way as we did, so Caldwell-Clements went to court to obtain a ruling on the meaning of the contract.

Judge's Decision

On December 8, 1949, Mr. Justice Dickstein, of the New York Supreme Court, decided the case in a way that upholds our interpretation of the contract. In the words of the judge:

McGraw-Hill "had earlier divested itself of its radio-television property, restricted its freedom of competition, and now seeks to re-enter the field in unlimited degree* It enlarged participation in a manner which the parties agreed would not be done.*** It had for itself closed the door to**

radio and television for such treatment."

Order Means 2½ Pages TV

On January 13, Justice Dickstein ordered McGraw-Hill's "Electrical Merchandising" to limit its radio-television reading pages to less than 4¼% of the total reading pages of any issue. On the basis of recent issues (which have averaged 60 reading pages) total TV-radio reading material would thus be held down to about 2½ pages per issue. This includes the total of all radio-TV feature material, new-product descriptions, trade news, picture pages, etc.

Also Judge Dickstein has ordered that radio-TV advertising in any issue of "Electrical Merchandising" be limited to 15% of the total advertising contents of that issue.

In addition to the above severe restrictions, the Judge has stipulated that even with this limited radio-TV material, emphasis shall not be given any matter that would make the magazine appear primarily radio and television in character.

UNIVERSAL
presents

the first major advance

Here it is! The sensational *Select-a-Range* with the exclusive "Convenience-Level" oven!



NO STOOPING! NO BENDING!

RIGHT OR LEFT HAND OVENS!

DOUBLE THE STORAGE CAPACITY!



NOW! RIGHT OR LEFT HAND OVENS! "Convenience-Level" can be set to any desired height, right or left, for tall or short people to eliminate back-breaking stooping, squatting and bending!

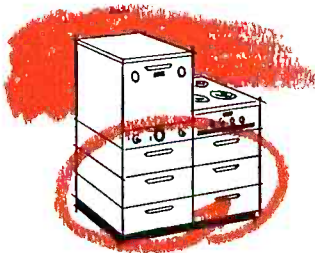

NOW! 100% MORE STORAGE SPACE! Increased storage drawer capacity provides more than twice as much utility space as conventional ranges! *All* your utensils are now at your fingertips!

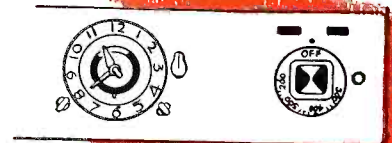

NOW! SAVE TIME WITH AUTOMATIC COOKING! Automatic Clock starts and stops oven without attention. Automatic push-button Pre-Heat Control. Just set it ... then forget it. No watching or guessing!

in Electric Range Design in 25 years!

THE *Select-a-Range*

IT'S NEW!

IT'S REVOLUTIONARY!

IT'S EXCLUSIVELY UNIVERSAL!

New markets for you! . . . Greatly increased turn-over with reduced inventory! . . . Exclusive, dramatic "Convenience-Level" oven! . . . More sales through kitchen planning flexibility! That's why...

EVERY DEALER SHOULD HAVE THIS AMAZING NEW KIND OF RANGE IN HIS STORE!

1. The Select-a-Range gives you the widest range line in the industry. Now you can sell a range for the smallest cottage or the largest mansion . . . from minimum to maximum cooking requirements. Now you can sell the building market with a range designed and priced for any project . . . new building or modernization. Now you can sell the institutional market with a range big and flexible enough to meet requirements.

Here are new markets, broader markets never before open to you in range selling!

2. One Select-a-Range on your floor is all the inventory you need to do a complete selling job compared with 6 or 8 models of a conventional line. Instead of turning over your range investment four times a year, for example, Select-a-Range turnover is 24 times! Just one Select-a-Range gives you a line of more than 25 models!

Reduced inventory . . . increased turnover . . . equals greater range profit for you!

3. Select-a-Range is the *only* range with the much desired no-stoop "Convenience-Level" oven. Surveys show that over 25% of your customers want a *high* level oven. Now they can have it . . . it's exclusively Universal . . . a "Convenience-Level" oven at the height your customer selects . . . exactly as she wants it.

Here is a great sales advantage for you that no other range line can match!

4. Select-a-Range *multiplies* your opportunities to sell complete kitchens . . . 25 arrangements to meet your customer's most exacting whims. Your kitchen planning problems are simplified with fresh new designs by the nationally famous Royal Barry Wills . . . Select-a-Range models and other sales helps.

Call your Universal distributor today or write immediately to Landers, Frary & Clark for complete details. Be the first in your town with the sensational Select-a-Range!

OVER 25 VARIATIONS FROM 3 BASIC UNITS!

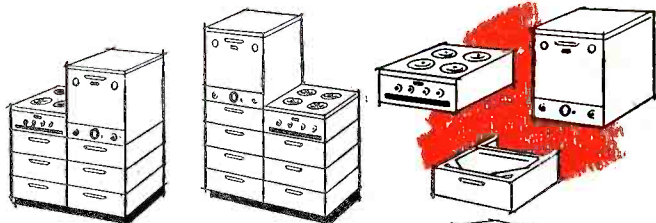

Typical right-hand oven. Left-hand extra high oven.

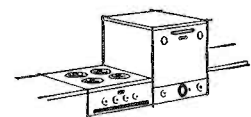

Minimum low cost arrangement.

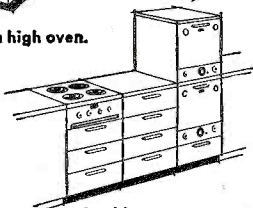

Double oven arrangement.

Royal Barry Wills

nationally famous small homes designer, has planned six new startling kitchens around the sensational Select-a-Range. Featured in Select-a-Range national advertising, they have also been included in your kitchen planning kit to help you sell!



UNIVERSAL

LANDERS, FRARY & CLARK, NEW BRITAIN, CONN.

Has the Refrigerator Sales Pattern Changed?

Failure to Re-establish Pre-War Seasonal Peaks Suggests Trend to Year-Round Merchandising

• As the accompanying graph of refrigerator sales reveals, pre-war factory sales were pretty well concentrated during the months March-June, with sales at the retail level generally accepted to be a hot-weather phenomenon.

With the war four years behind us, however, monthly sales are continuing on an entirely new tack, with no significant peaks during the whole year. Perhaps the most outstanding fact revealed by the postwar sales is that the second half year has a slight edge over the first, with a surprising spurt in the last four months, a traditionally dull season for refrigerators before the war.

It was relatively easy to interpret this condition for the first two to two-and-a-half years after the war, since the factories were understandably producing at capacity all year-round in an effort to make up for the lost war years and get back up to peak production.

New Sales Trend

There is a feeling now, however, that we may not ever return to the old hot-weather-only refrigerator complex. A consideration of the factors involved will show many points on the affirmative side of this argument.

In the early days of the mechanical refrigerator, the principal home refrigerant was ice. Ice is, naturally, most perishable in the summer, and least necessary in the winter. As a matter of fact, many families did without it altogether in the winter, using a "cold room," window box, or other means of utilizing the natural cold outdoors.

The refrigerator, then, had to try to replace the ice-box. In the course of the thirty-odd years that refrigerators have been on the market, however, the American home pattern has been greatly changed. The use of perishable foods (and now frozen foods) has greatly increased due to the growing number of refrigerators in the home, as well as in railroad cars for the shipment of perishables, and in wholesale and retail establishments where food is stored prior to sale. Families who have enjoyed the convenience of refrigerators for any length of time now feel that they cannot do without them, regardless of the time of year. If a refrigerator were to become worn out and inoperative in the winter, there is hardly a family which

1949 Sales of Refrigerators By Sizes Show Trend to Larger Boxes

Less than 4 cu. ft.	.00002%
4 cu. ft.	.01 %
5 cu. ft.	.06 %
6 cu. ft.	18.2 %
7 cu. ft.	33.0 %
8 cu. ft.	26.9 %
9 and 10 cu. ft.	18.0 %
11 and 12 cu. ft.	3.7 %
13 cu. ft. and up	.03 %

would wait for warm weather before replacing it.

The replacement market, is in fact, a strong point in the leveling off of year round sales, since, as we have previously suggested, replacements are bought all year round.

The tremendous increase in new families which we have experienced during and after the war has in the large consisted of "second generation" refrigerator users who would not dream of furnishing a home without having a refrigerator at the head of the list. These purchasers have bought regard-

less of the weather, as soon as they found a home.

The same may be said, for that matter, for all young people growing up now and who will grow up in the future—as refrigerator saturation increases, so will the numbers of young people whose only association with ice is in cubes . . . just as most young people today do not know what it is to be without a radio.

More Rural Users

The tremendous growth of rural electrification has swelled these numbers, and will continue to increase the numbers of people who take mechanical refrigeration for granted.

On the other side of the ledger we have some very valid arguments in support of the traditional seasonal nature of refrigerator sales. Everybody knows that summer brings out the worst in old refrigerators. With a greater difference between room temperature and inside-box holding temperature, refrigerators have to work harder. Old units show up squeaks and knocks, run longer, are more critical of leaky door gaskets and poor insulation—ice cubes are more in

(Continued on page 95)

Percentage of total year's sale of refrigerators registered each month, showing pre-war March-June peak and postwar shift to end-of-year selling. Source: National Electrical Manufacturers' Association; percentages and averages by RADIO & TELEVISION RETAILING research staff.

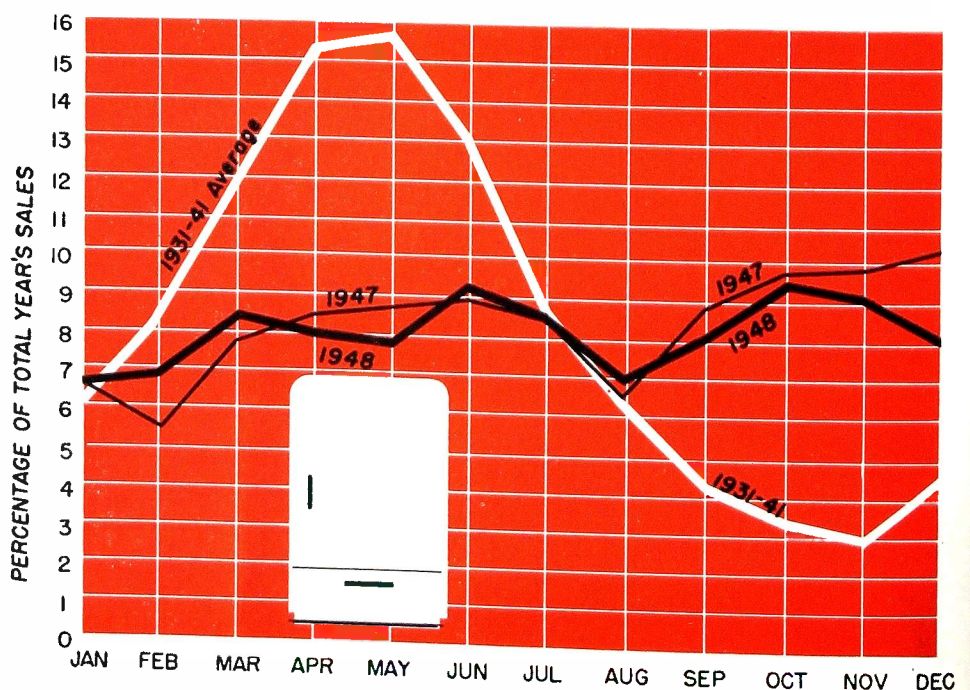

Focused on the facts for '50!

These are the facts!

- 1 1950 is slated to be the best year yet.
- 2 Picture-size preference is predominantly for the 12½" and 16" tube sizes.
- 3 Price alone will not sell sets... consumers have their eye on quality features.



THE WESTINGHOUSE 610T12,

shown here, is designed to help you capitalize on these facts:

Pricewise, it's competitive.

Productwise, it has performance and quality that can't be matched at anywhere near this price.

The Westinghouse 610T12 is a natural for *home demonstration*. The sensational ELECTRONIC MAGNIFIER, with choice of *full vision* picture or GIANT CLOSE-UP, plus superb tone make this set a sales clincher. A bonus feature for you is the fact that its quality will assure trouble-free service for a long time to come, building good will and repeat business for you.

The Westinghouse 610T12 has a full complement of tubes (no short-cuts in circuit performance). It is super-sensitive for long-range reception, has improved "road block" circuit features that eliminate interference troubles, and automatic controls for simple operation (with no concealed control knobs).

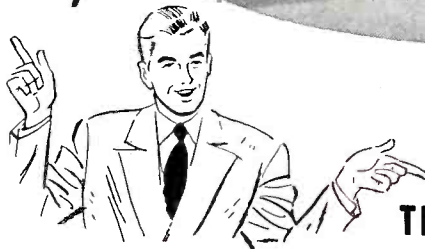

Compare

THESE SALES FEATURES:

- **BIG 12½-INCH "BLACK" GLASS TUBE** — non-glare brilliance and sharper contrast.
- **AMAZING ELECTRONIC MAGNIFIER** — with a flip of the control knob you switch from *full vision* to GIANT CLOSE-UP picture, with the center of interest as large as a 16" tube gives. Exclusive eyelid shutters automatically frame picture.
- **BUILT-IN ANTENNA** — Electronically tuned.
- **DISTINCTIVE CABINET** — Model 610T12 (mahogany); Model 614T12 (blond, frosted oak) smartly simple in design.
- **PHONOGRAPH PLUG-IN & SWITCH** — permit use of record player attachment.
- **PRE-TUNED** — pre-tuned to receive all U. S. channels, complete with ultra-high frequency adapter plug-in.

Feature for feature Westinghouse wins, with a complete TV line!

See your Westinghouse Distributor about this pace-setting low priced set, now!

YOU CAN BE SURE... IF IT'S **Westinghouse**



What Can the Dealer Do About

PARKING PROBLEMS?

● Over the telephone, Mrs. Smith is telling her favorite retailer that she was unable to get in to see that washer she's interested in because *she couldn't find a place to park her car*. No, she doesn't want the dealer to send a machine to her home for demonstration, but will try to get in another day.

All over the country, merchants are hearing customers' tales of woe concerning the parking problem, and the situation is usually most acute as it affects those dealers in high-rent, heavy traffic Main Street locations. "Plenty of Parking Space" is an ad theme being used more and more by the stores in outlying districts or by those in sections having adequate private or public parking facilities.

Since the parking problem is becoming more serious every day, dealers need to make a strenuous effort to help in planning parking projects in their respective communities.

Traffic Control Plans

In some cities, dealers who have heavy investments in centrally located stores are trying to protect their stakes through various plans. Some are paying taxi fares for patrons. Still others provide "courtesy" coins for customers to use in parking meters, and are offering to reimburse shoppers for charges imposed by operators of private parking lots.

While numbers of towns and cities have what may be considered adequate parking facilities set up in lots near the main shopping sections, the great majority are still unable to take care

of anything but a very small number of those seeking to park their cars while visiting the stores.

Community Cooperation

Retail dealers in many sections are working hard with civic organizations to find answers to parking problems, and many worthwhile solutions have been found where geographic conditions permitted. But in numerous other towns, particularly the older ones, there just isn't any room available, with the result that planners end up completely stymied. Lack of parking facilities has been responsible for the moving by a considerable number of dealerships to "fringe" locations where the shopper can park without difficulty at any time.

One old-established dealer in a thickly populated suburban area reports that he has been losing customers consistently for a long period of time because of the difficulty experienced by people in visiting his store. A number of his one-time customers admitted that they had switched because of the mid-town parking situation.

One of the "hidden" costs imposed on the dealer by the lack of parking space lies in the increased demands made upon him to deliver merchandise, even such items as electric light bulbs. Those shoppers lucky enough to park cars within walking distance of the main drag are seldom willing to carry packages, however small.

In "hopeless" areas, merchants can either move to new locations or make the best of the situation by stressing

free delivery, and whatever "meter" or private parking fee-paying inducements that happen to be available.

In those places where far-sighted planning offers possibilities, dealers need to consider the town's parking problem their own bread-and-butter affair, doing all they can to help the powers that be arrive at some solution. The parking problem will never "iron itself out." Left alone it will grow steadily worse as more and more cars are put on the road.

Action Necessary

Traffic experts who have traveled through numbers of the nation's towns and cities have reported many cases where parking situations could be relieved by a complete revamping of existing regulations. In some instances, many more cars could be fitted into available space if methods of parking were to be changed. City fathers are sometimes lax in permitting the playing of favorites by authorities who let certain car owners violate parking rules without punishment. Now and then a reshuffling of taxi "stands" can be made to provide more space for parking.

In his own interests the dealer needs to associate himself with local activities concerned with parking. Groups of merchants, operating as committees have, in numbers of instances, come up with workable ideas resulting in helping the motorist find a place to leave the family car while patronizing the stores in the neighborhood.



Television Triumph

"The Mid-Century Series"

... behind these beautiful doors lies hallicrafters' fulfillment of television's great promise!

NEW, RECTANGULAR TUBE!

HIGH-CONTRAST "BLACK" TUBE!

INCREASED SENSITIVITY

PIN-POINT PICTURE DETAIL

BUILT-IN ELECTRONIC ANTENNA

GREATER PICTURE STABILITY

CLEARER, BRIGHTER PICTURE

11 NEW, BEAUTIFUL, DECORATOR CABINETS

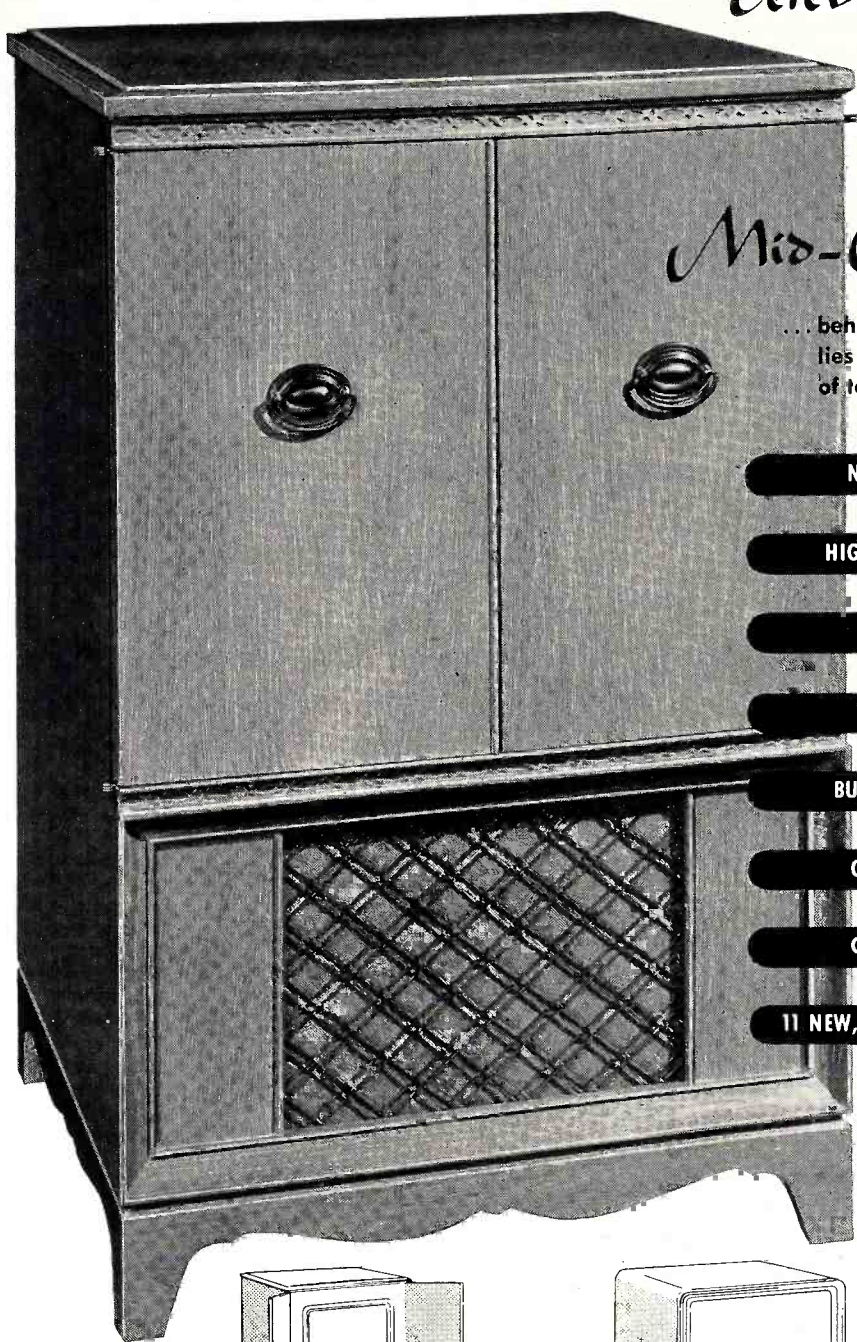

Tune in
"HALLICRAFTERS HOLLYWOOD QUIZ"
M.B.S., 5:45 P.M. SATURDAY

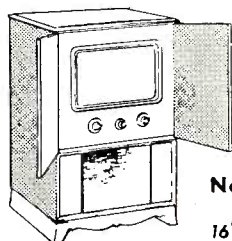

No. 760

16" Consolette

A beautiful new design,
amazingly priced.

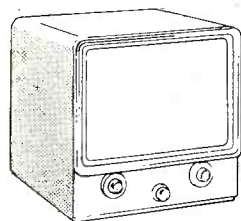

No. 745

16" Mahogany Table Model

A terrific scoop for holders
of Hallicrafters franchise.

the hallicrafters co. 4401 West Fifth Avenue, Chicago 24, Illinois

Cost of Doing TV Business - 1950

Short Discounts May Be Offset By Increased Volume, Fast Turnover

• Postwar retailing has been characterized by increased costs, coupled with reduced discounts in many lines, especially TV, putting a "squeeze" on the dealer's margin of profit. This has led some radio-appliance dealers to say they can't afford to promote TV . . . "Who can make money on 27%?"

With over 800 million dollars worth of TV receivers sold in 1949, many dealers who were complaining "You can't make money on TV" are driving around in Cadillacs. This suggests that there is more to be considered than the percentage of discount offered by the distributor.

It has been a fairly well established fact for many years that the average gross margin of radio-appliance retailers is about 35%. This means that the gross margin, or gross profit (which is the difference between sales and the cost of goods—or that which is left after the goods are paid for) is 35% of the sales figure. This 35% covers expenses and net profit.

The assumption is that if merchandise carries a trade discount (the difference between the dealer's cost and the suggested retail price, based on the selling price as 100%) of less than 35%, the store will lose money.

On closer examination, we find that the gross margin of a store is an average of all transactions, covering merchandise with many different discounts. The expenses which this margin must

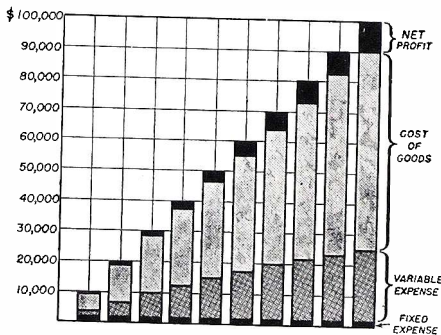

Fig. 1—How expanding sales volume increases net profit. As explained in the text, variable expense does not increase as fast as sales. Cost of goods on this graph is always 65% of sales.

cover can vary widely, too—both in dollars, and as a percentage of sales.

Back in the so-called "normal" days before the war (let's take 1939-41 as an example) almost all discounts ran 40% or better, with many an extra 10 and 5 thrown in as an incentive, plus cash discounts for prompt payment, and quantity discounts—and yet the store's margin was seldom over 35%. Some of the reasons for this were: slow turnover, mark-downs, high commissions to salesmen, costly trade-ins, and free service.

In what can now be considered TV's first big year, 1948, when the discounts were the shortest, every one of these before-mentioned five factors was absent. The "clean" selling of TV meant a reduction in the "hidden" costs which are usually listed under "miscellaneous expense."

The increased volume which many dealers have enjoyed as a result of TV has also resulted in another expense reduction. This reduction stems from the fact that the expenses of a store are of two types: fixed expenses (such as rent, heat, light) and variable expenses (such as selling expense, delivery expense). As volume increases, only the variable expenses increase, so that the total expense, as a percentage of sales, does not increase as fast as the sales volume. This means that as sales volume increases, the expense percentage goes down, leaving more net profit—which permits profitable operation even with short discounts. This theory was originally developed to show that a business could operate at a profit selling below list to the consumer, due to the resultant higher volume. This latter idea does not hold up, however, because when your competitors follow suit, you no longer have a price advantage and you don't get the necessary volume.

If volume can be successfully attained by legitimate means, however (by aggressive selling of "wanted" merchandise), costs as a percentage of sales will go down surprisingly as the accompanying graph shows. Even the cost of sales-help will remain fixed for a long while due to the fact that most sales-clerks or salesmen can handle a lot more work if they can get the business.

Discounts Lengthening

In this connection, we can quote from the story of the Fred A. Schmidt store in St. Louis, which appeared in the December, 1949, issue of RADIO & TELEVISION RETAILING. Doing a volume of \$150,000 a year, Mr. Schmidt said, "We can get three times as large and still get by with 7 salespeople, without making it necessary for any customer to stand around and wait."

As TV selling becomes more competitive, some of the old costs are returning (commissions to salesmen, and mark-downs) but the trade discounts are also rising to offset this. Among the brands, some of the lesser known ones are offering higher discounts; and among the models of a particular brand, the slower moving types carry higher discounts. Little added discounts are creeping in—such as cash

and quantity discounts which hardly existed a year ago, free delivery, etc.

All things considered, the merchant who is guided rather than ruled by operating percentages and ratios will come out in the black as long as he carefully analyzes his costs and fully understands where his money comes from and where it is going. RADIO & TELEVISION RETAILING has always recommended that dealers diversify, protecting themselves not only from lulls or slumps which may occur in any one line, but also from the "profit squeeze" which may result from selling nothing but a low discount line. On the

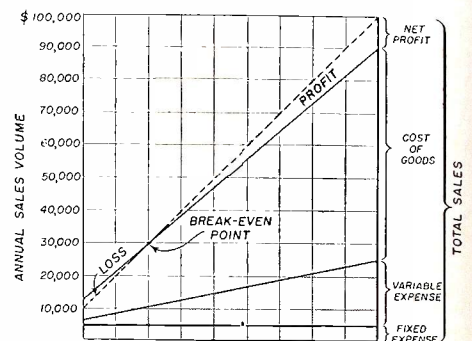

Fig. 2—The pattern of fig. 1 applied to a particular store with a 1948 volume of \$50,000. Dotted line shows sales volume from \$10-100,000, with a loss indicated below \$30,000.

other hand, lines with unusually long discounts should be given close scrutiny and purchased with care—if the merchandise is too hard to move, you may eventually have to cut that discount in half to get the item out of the store.

Fixed expenses should be carefully examined to make sure that they are not out of line with the store's average sales volume or potential. Perhaps the rent is not in proportion to the desirability of the location; perhaps a switch from filament to fluorescent lighting, or an improved heating system is indicated to effect economies in the "fixed" costs. On the "variable" side, increasing expenses may be in order if they will result in improved sales volume and faster stock turnover. Service departments and trade-in services should be designed to operate at a profit, as no drain on the profit can be tolerated when discounts are at a minimum while selling is getting more difficult. And finally, ordering must be done realistically and optimistically, as more sales were lost in the last six months of 1949 because of a lack of merchandise than because of any resistance on the part of the consumer. To get the sales volume that you need in order to make your location pay off, you must have the merchandise to display, to demonstrate, and to deliver.



WE'RE STILL IN
THE **RADIO** BUSINESS

Seems as though everything nowadays is TV . . . TV . . . TV. We've had so much TV news for you! Hytron's new 16RP4 rectangular picture tube. Hytron's new low-cost deflection-circuit tubes: 1x2, 6BQ6GT, 6U4GT, 6W4GT, 25BQ6GT, and 25W4GT. And many more Hytron designed-for-TV tubes coming.

But we're still in the *radio* business — both of us. Radio still is king. We realize that. Also that most service problems are still radio — not TV. You can depend on Hytron *radio* tubes. Whether it is the original Hytron GT . . . miniature . . . G . . . metal . . . or loctal. For a-c/d-c, portable, f-m, phono, or auto radio. Hytron will strive to give you the most dependable *radio* (as well as TV) replacement tubes.



OLDEST MANUFACTURER OF RECEIVING TUBES
HYTRON
RADIO AND ELECTRONICS CORP.



MAIN OFFICE: SALEM, MASSACHUSETTS

Relax! LET HYTRON TOOLS EASE YOUR WORK

SOLDERING AID 49c net

TUBE LIFTER 15c net

TUBE TAPPER 5c net

BY THE MAKERS OF HYTRON TUBES

FREE
New Hytron Tool Catalogue. Describes all the famous Hytron service-shop tools to date: Soldering Aid, Tube Lifter, 7-Pin and 9-Pin Straighteners, Tube Tapper, and Auto Radio Tool. Find out how these Hytron tools can ease your work. Mail the coupon today.

HYTRON RADIO & ELECTRONICS CORP.,
Salem, Massachusetts

I want to know how the Hytron tools can help me make more money. Please send me the free Hytron Tool Catalogue at once.

(PLEASE PRINT)

NAME.....

STREET.....

CITY.....

STATE..... R.R.

Record News Notes

In a statement of policy with respect to RCA Victor records, Frank M. Folsom, president, Radio Corporation of America, made public the company's plans to make available its artists and classical library on new and improved long-playing 33 $\frac{1}{3}$ rpm records. In making the announcement Mr. Folsom stressed the success of the 45 rpm record system in attaining nation-wide public acceptance.

Mr. Folsom stressed the following points: 1. To make available to the public RCA Victor's library of great artists and music recorded for all record players—45 rpm, 78 rpm, and 33 $\frac{1}{3}$ rpm. 2. To give

the public recordings of the finest artists and the finest music. 3. To achieve through its instruments and records the finest possible musical reproduction. 4. To make available to the public the achievements of scientists and engineers at work in the RCA Laboratories.

The 33 $\frac{1}{3}$ discs will be introduced on or about March 1. From time to time new recordings will be available as appropriate additions to the long-playing repertoire, in addition to those from the catalog. All new selections will be available on both 45 rpm and 78 rpm discs. The RCA Victor line of Victrola phonographs and radio-television combinations includes instruments that play all three speeds—45, 78 and 33 $\frac{1}{3}$ rpm; all instruments feature an independent "45" record player.

Artie Shaw with Decca



Popular band maestro, Artie Shaw, left, signs a three year exclusive Decca recording contract. Smiling approvingly are Milton Rackmil, center, Decca president, and Dave Kapp, vice-president.

RCA Victor's Little Nipper album, "Howdy Doody and His Air-O-Doodle," adapted from the popular television show, shows indications of becoming one of the biggest-selling children's albums, according to Larry Kanaga, general sales and merchandise manager.

Columbia Records, Inc., has undertaken an extensive advertising and promotion program on behalf of its 7" LP Microgroove records, according to Ken McAllister, director of advertising and promotion for the company. The campaign stresses the many LP advantages of economy, quality and space-savings inherent in the Columbia 33 $\frac{1}{3}$ LP system. Included are: national ads; window displays; cooperative advertising; radio announcements and spot plugs; presentation and sales kits for distributor salesmen.

Leonard Bernstein, the brilliant young American conductor, has signed an exclusive recording contract with Columbia, announced Edward Wallerstein, president. Mr. Bernstein will also perform as a piano-soloist and interpreter of his own compositions.

Leonard Schneider, vice-president and general manager, Decca Records, Inc., has announced the appointment of Mort L. Nasatir as director of advertising.

Coral Records, Inc., has announced the signing of the following to exclusive recording contracts: Harry Babbitt; Martha Tilton; Dick Robertson; Leighton Noble; Cliff Steward; The Pine-toppers; Al Sears and Eva Carter.

"Growing Music Interest Offers Attractive Opportunity for Music Merchants," is stressed by Louis G. LaMair, president, American Music Conference, in a statement for retailers. Mr. LaMair recommends the following points to aid merchants in taking advantage of the more receptive market being created: Interest your community in music; cooperate with music teachers; sponsor a school instruction class; sell music by means of advertising, direct mail, displays, etc.; employ the "Moving Ahead with Music" film; use available printed material; make music lessons "fun"; utilize national publicity; assist in local field work; make it easy and interesting for people to learn.

KIND *to record*
KIND *to ear*
KIND *to purse*

the Magic Touch

Fidelitytone

LONG LIFE PHONOGRAPH NEEDLES

FROM 50c to \$5.00

PERMO, Incorporated
CHICAGO 26,

SERVICE & SOUND

Section of **RADIO & TELEVISION RETAILING**

TV Service Hints

Eliminating High Voltage Arcs; Admiral 21A1 Chassis Modified for Greater Sweep Width; Series Filament Continuity with CRT Removed

Greater sweep width is required for 16-inch sets using a rounded-end picture window than for the rectangular type mask. The schematic at the right shows changes incorporated into the Admiral 21A1 chassis stamped run "19" or higher. A new horizontal output transformer, linearity control and width control are employed, plus a few component changes such as the plate load R436 (formerly 270K), the 6BG6 cathode bypass C424 (formerly .25) and the horizontal linearity filtering (C444, 445, 446 and R461). A different escutcheon and associated parts are, of course, employed.

Arcing or Corona in 16" Sets

Arcing or corona in the 2nd anode supply circuit of the picture tube will generally produce a sharp crackling noise in the sound of the receiver, a faint hissing sound, or an odor of ozone. It can also cause the raster to vary in brightness. Arcing or corona is generally aggravated by conditions of high humidity.

If the noise in sound, hissing sound, or odor of ozone stops when the 2nd anode connector is disconnected from the chassis, the difficulty is in or at the picture tube mounting assembly. If these symptoms persist after disconnecting the 2nd anode connector, the difficulty will be found in the chassis.

In general, the exact spot of arcing or corona can be located by close observation in the dark or under subdued light.

If arcing or corona is located in or at the picture tube assembly (stops when the 2nd anode lead is disconnected), the remedy may be found in the following: 1) Arcing or corona from the front of the picture tube (cone or screen) to the picture tube window. Clean picture tube and picture tube screen. If the picture tube window is plastic, it should be cleaned only with a dampened chamois or a soft lint-free cloth. A plastic dust-repellent may be used. Do not use other cleaners, such as carbon-tet, or kitchen-type cleaners. 2) Arcing

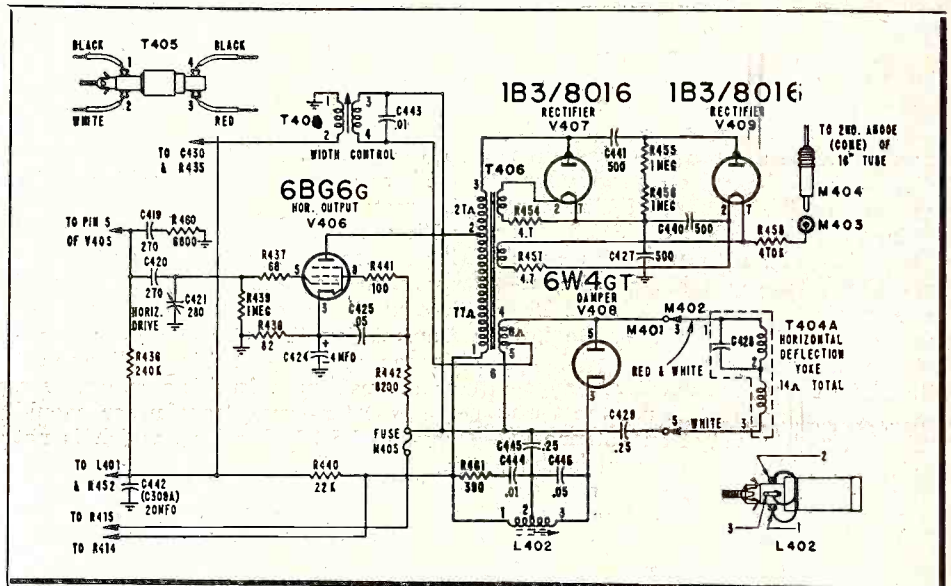

or corona inside connector on the 2nd anode lead. Push the connector together for good contact. Check for clean, unfrayed connection.

If arcing or corona is located in the 2nd anode supply in the chassis (does not stop when 2nd anode lead is disconnected), the remedy may be found in the following: 1) Arcing or corona between or across components mounted on the 1B3/8016 rectifier tube mounting strip. Make proper clearances, tighten mounting screws, check soldered connections for good tight joints with no sharp points. Clearance between the corona ring (below the 8016 socket) and the chassis should be approximately $\frac{3}{4}$ inch. Check for leakage across 500 mmfd. condensers. Clean surface of condensers, tube sockets, phenolic mounting strip, etc. with carbon-tet. Clean dust off tube glass. 2) Arcing or corona between terminals, leads or windings of horizontal output transformer. Clean terminals and surfaces, check for protruding edges of solder or strands of wire. If arcing occurs between wire leads, separate

leads. If insulation on leads is not burned badly, the surface of the wire may be cleaned with carbon-tet and the part may still be usable.

—Courtesy Admiral Corp.

Series Filament Continuity

In receivers with series lighting of the filaments, the removal of the picture tube during alignment or troubleshooting breaks the continuity of the heater circuit for all tubes and a substitute resistor or suitable filament element must be used to restore continuity. A defective type 6SN7GT tube with a good heater may be used for this purpose. Saw or clip off all base pins except the filament pins, 7 and 8. They will readily insert into the CRT socket pin openings #1 and #12. This will restore continuity and provide proper voltage division on the filament strings. The keyway on the 6SN7GT will not line up with the keyway slot in the CRT socket, but it will not interfere with the insertion of the tube into the socket.—Courtesy General Electric Co.

Impedance Considerations

in TV Antenna Design*

**Low Impedance of Long Range Yagis May Be Overcome
By Varying Number and Size of Elements in the Dipole**

• Since the primary purpose of an antenna is to deliver energy to the input of a receiver, it may be thought of as a signal generator with the receiver as the load. It is well known that the greatest amount of energy is delivered into a load when the impedance of the load is equal to the impedance of the output terminals of the generator. This becomes a major problem with antennas designed for long-range "fringe" reception.

The simple half-wave dipole antenna does not have sharp directional response, nor does it achieve high gain. Therefore, other antenna types have been developed to produce a directive pattern or a higher signal level, or both. In any of these antennas, the radiation resistance will depend on various factors such as the number of elements, spacing between elements, and the method by which the energies from these elements are combined. (An antenna is said to be resonant at one frequency if, at that frequency, the impedance behaves as a pure resistance with no inductive or capacitive components. It is convenient to use the term "radiation resistance" of an antenna in this sense.) The radiation resistance will ordinarily be quite different from the 70 ohm result obtained with the simple half-wave dipole, and may be either more than or less than that figure.

In television installations, the most familiar types of antennas utilize parasitic elements (elements which have no electrical connection to the driven element, and which obtain their effect by a spacing and length such that the energy re-radiated will combine with the energy from other sources with a phase relationship in which the voltages will add or cancel, as desired) such as one reflector, one reflector and one director, one reflector and two or three directors. Each of these will have a radiation resistance quite different from a half-wave antenna, with the radiation resistance decreasing as the number of elements is increased and as the spacing between them is decreased. The curves in Figure 1 show some of the simpler cases. It can be seen that a Yagi array with the optimum spacing of $\frac{1}{8}$ wavelength will have a radiation resistance of approximately 3 ohms (An antenna with four or more elements is

usually called a Yagi array, and "C" in figure 1, with 3 parasitic elements in addition to the driven element, is such an array). Such an antenna would provide a very poor impedance match for 300 ohm line, and therefore poor power transfer. As a matter of fact the losses with this coupling (300 to 3, or 100 to 1) would be 20 DB, a power ratio of 100:1. In other words, the power ratio is the same as the impedance ratio reduced to the lowest terms.

Since the Yagi type array has the advantage of very high gain as well as sharp directional response, it may often be desirable to use such an antenna, and it will then be necessary to provide a better match so as not to lose the gain in the power transfer.

There are two ways to achieve this: by matching the antenna to the line with a transformer, or by raising the impedance of the antenna (by its construction) to match the line. It is well known that a quarter-wave length of transmission line of the proper impedance may be inserted in the line to act as a transformer. In this case, however, the quarter-wave transformer would have to be 30 ohm line, which is not readily available.

The second method consists of modifying the dipole itself in such a way that its radiation resistance is raised. In the so-called folded-dipole, for instance, if the paralleled element is of

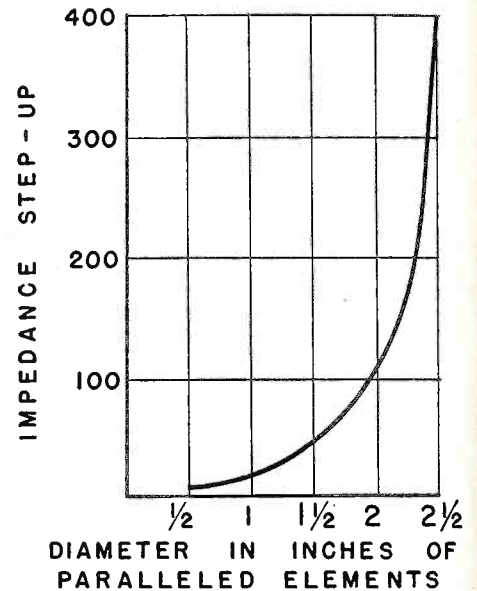

Fig. 2 Curve for determining diameter of parallel element in double folded dipole.

the same diameter as the active element, the radiation resistance is approximately four times that of a simple dipole, or in other words, about 300 ohms. The addition of more such paralleled elements to the dipole will increase the radiation resistance still further. For instance, a "double" folded dipole consisting of 4 elements would have a radiation resistance of 1120 ohms

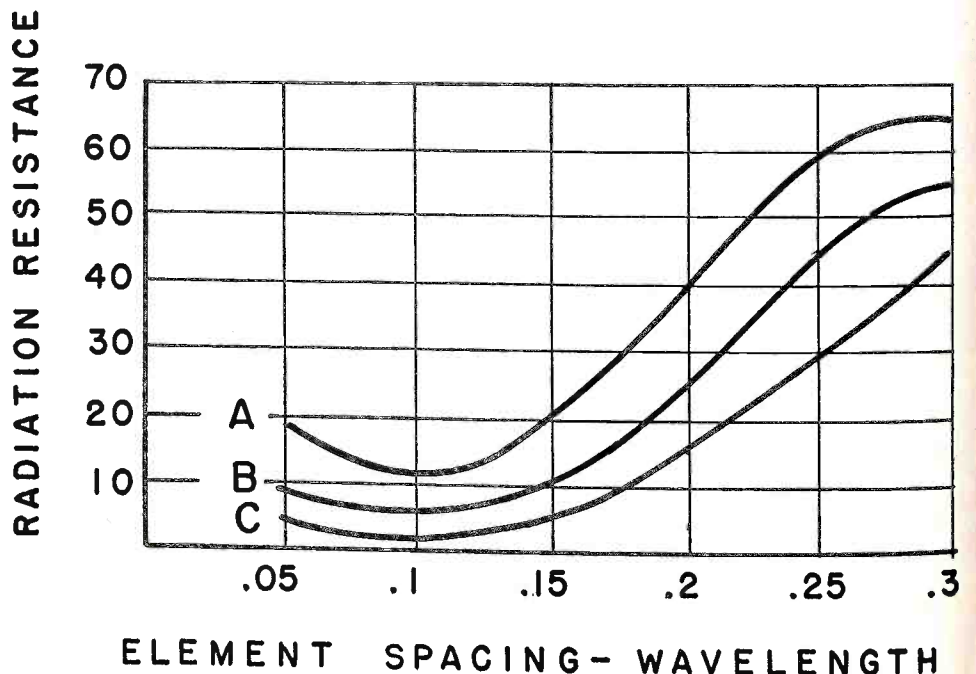

Fig. 1 Radiation Resistance and Spacing: A—one parasitic element. B—two parasitic elements, equally spaced. C—three parasitic elements, equal spacing between them.

* By G. N. Carmichael, Chief Engineer, Trio Mfg. Co., Griggsville, Ill. Formulas and text references have been omitted for the sake of clarity, but are available on request to the Technical Editor of RADIO & TELEVISION RETAILING.

(that is, by itself, with no reflectors or directors). A Yagi with this type of driven element would have a radiation resistance of approximately 50 ohms. This is quite an improvement over the original model (at 3 ohms) but still a ratio of 6 to 1 (300 to 50) or a loss of about 8 DB.

Still further increase in the impedance of the antenna can be obtained if the diameters of the elements of the folded dipole are different. For instance, if a folded dipole (considered to have an impedance of 300 ohms) were to consist of an active element of $\frac{1}{4}$ " diameter tubing and a paralleled element of 1" diameter tubing with a spacing of 2" between them, the impedance will be 630 ohms.

Still Higher Z Possible

Since we already discovered that compounding the folded dipole by adding more elements in parallel raised the impedance, we are not surprised to find that a dipole consisting of an active element $\frac{1}{2}$ " in diameter paralleled by two other elements with a 1" diameter, and spacing from the active element of 2" has a radiation impedance of 3430 ohms. A Yagi with such a dipole would have a radiation resistance of 147 ohms, which puts us on the right track, and close to the desired result.

Figure 2 gives the impedance step-up for a dipole consisting of an active element of $\frac{1}{2}$ " diameter tubing paralleled by two other elements spaced $1\frac{1}{2}$ " center to center from the active elements and for various diameters, to illustrate how these factors affect the impedance of an antenna. A different

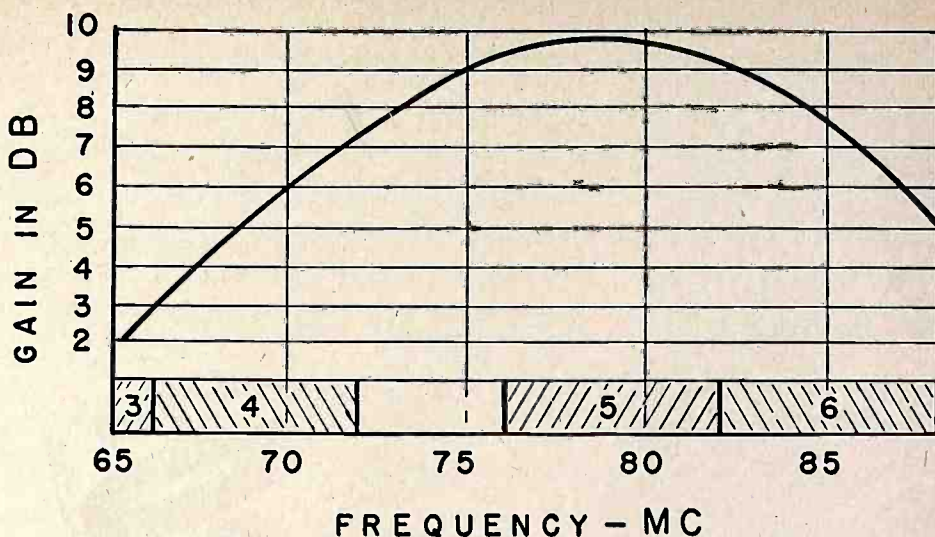

Fig. 3 Gain vs. frequency for Trio model 304-5

diameter of the active element, or a different spacing between elements would, of course, produce different results, but the curve would be similar in appearance.

One Yagi type antenna based on these principles is made by the Trio Mfg. Co., and consists of a double folded dipole with a reflector and two directors. The spacing and lengths of the parasitic elements are designed to provide the best compromise between the three primary objectives of a fringe TV antenna, namely, high forward gain, broad frequency response, and high front-to-back ratio. The spacings are approximately $\frac{1}{4}$ wave from reflector to dipole,

and $\frac{1}{8}$ wave from dipole to first director, and $\frac{1}{8}$ wave between directors. The dipole consists of a $\frac{3}{8}$ " active element paralleled by two $\frac{5}{8}$ " elements to provide a match to conventional 300 ohm line.

It should be pointed out that "broad band" in this connection does not mean "all channel," but rather broad band with respect to the channel for which the antenna is cut. The gain curve for the Trio Yagi antenna shown in Fig. 3 is that of an antenna cut for channel 5, which shows that the gain is down approximately 4 DB at a frequency 10% off the resonant frequency of the antenna.

New Products

Insuline TV PROBE

The Kilovoltmeter is a high voltage probe which extends the range of existing DC voltmeters by 15,000 volts. It is 8½



inches long and is fitted with a 5-foot test lead. Models are available for 50, 100 and 200 microampere movements. Net price is \$8.95. Insuline Corp. of America, 3602—35th Ave., Long Island City 1, N. Y.—RADIO & TELEVISION RETAILING.

RCA TV COMPONENTS

A new complement of tubes and components for horizontal deflection and high voltage supply for 10BP4 and 12LP4 type kinescopes includes output Xformer 217T1 with built-in sockets for 2 high voltage

rectifiers, and a new width control, linearity control, and yoke (205D1) associated with this Xformer. Tubes for use in this system are: 6AU5, beam power amplifier for horizontal output, and 1V2 9-pin miniature high-voltage half-wave rectifier. For more information write Tube Dept., RCA Victor Division, Camden, N.J.—RADIO & TELEVISION RETAILING.

Triplet V-O-M

Model 630 volt-ohm-mil-Ammeter features mirrored scales, greater accuracy through use of $\frac{1}{2}$ % resistors, and 5½-inch meter.

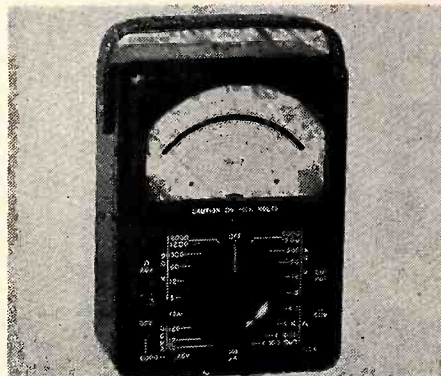

6 DC and AC voltage ranges to 6000 volts, 5 DC current ranges, DB, Output, and Resistance ranges from 0 to 100 megohms. Triplet Electrical Instrument Co., Bluffton, Ohio.—RADIO & TELEVISION RETAILING.

Caliri SOLDERING GUN

Cal-88 is a high-speed soldering gun with a single pole electrode. Entire gun weighs 1½ lbs. Two-heat trigger provides



either 100 or 150 watts. A built-in fuse protects the transformer against overloads. Price of the Cal-88 is \$14.95. Caliri Mfg. Co., Inc., 45 Washington St., West Orange, N.J.—RADIO & TELEVISION RETAILING.

Shore TV ANTENNAS

The "Tilted Diamond" antenna is an application of the simulated cone type of antenna which is said to be superior to conventional "conical" types, achieving all-channel reception with a relatively flat impedance characteristic without too narrow a beam on Channel 13. A discussion of the principles involved, as well as illustrations and descriptions of the Diamond antennas is obtainable in a booklet from Shore Engineering, Inc., P. O. Box 325, Long Branch, N. J.—RADIO & TELEVISION RETAILING.

HERE IT IS...

The First Word In PERFORMANCE
... The Last Word In DESIGN!



THE RADIART TELE-ROTOR

For Clear Sharp Pictures and
Perfect Trouble-Free Performance

MORE **POWER** TO YOU

(More Than You'll Ever Need)

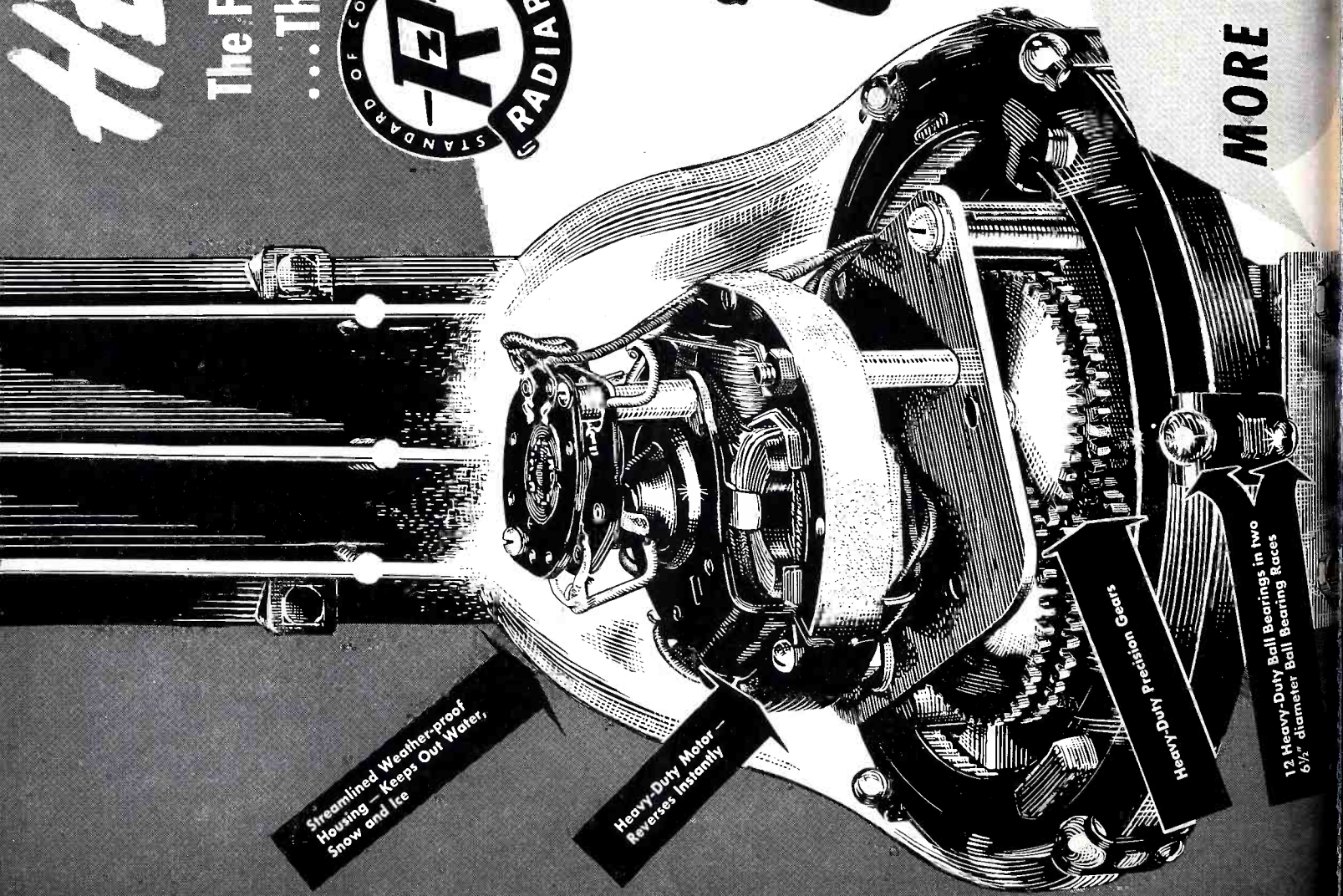

Streamlined Weather-proof
Housing - Keeps Out Water,
Snow and Ice

Heavy-Duty Motor -
Reverses Instantly

Heavy-Duty Precision Gears

12 Heavy-Duty Ball Bearings in two
6 1/2" diameter Ball Bearing Races

Nothing Like It — It Is Beyond Comparison

CHECK THESE FEATURES

- Handles Heavier Loads With Ease ... As Much As 150 Pounds
- Streamlined Weather-proof Design ... Durable Sturdy Construction
- 12 Heavy-Duty Ball Bearings in two 6½" diameter Ball Bearing Races
- Heavily Reinforced Die-Cast Housing
- Heavy-Duty Precision Gears
- Positive Stop at End of Rotation
- Will Handle 7/8" to 2" diameter Upper and Lower Masts
- Heavy-Duty Motor — Reverses Instantly
- Mast, Tower or Platform Mounting
- Four Heavy-Duty Guy-Wire Lugs
- Completely Weather-Sealed ... Factory Lubricated For Life

The television industry has been looking for something like this ... and it took RADIART to produce it! THIS is the last word in ROTATORS ... the finest! ... BECAUSE IT HAS EVERYTHING! It wasn't developed overnight but is the result of fourteen solid months of research and development! BUT ... it has been worth it ... BECAUSE IT MEASURES UP TO RADIART STANDARDS ... The quality level that makes RADIART PRODUCTS THE STANDARD OF COMPARISON!

Available in the Following Models:

- TR-1 ... rotator with control box \$39.95
- TR-2 ... compass control rotator with "Perfect Pattern" dial \$44.95

A Combination You Can't Beat ...

It's a Radiart Antenna with a Radiart Tele-Rotor

Will Handle 7/8" to 2" dia. Upper and Lower Masts

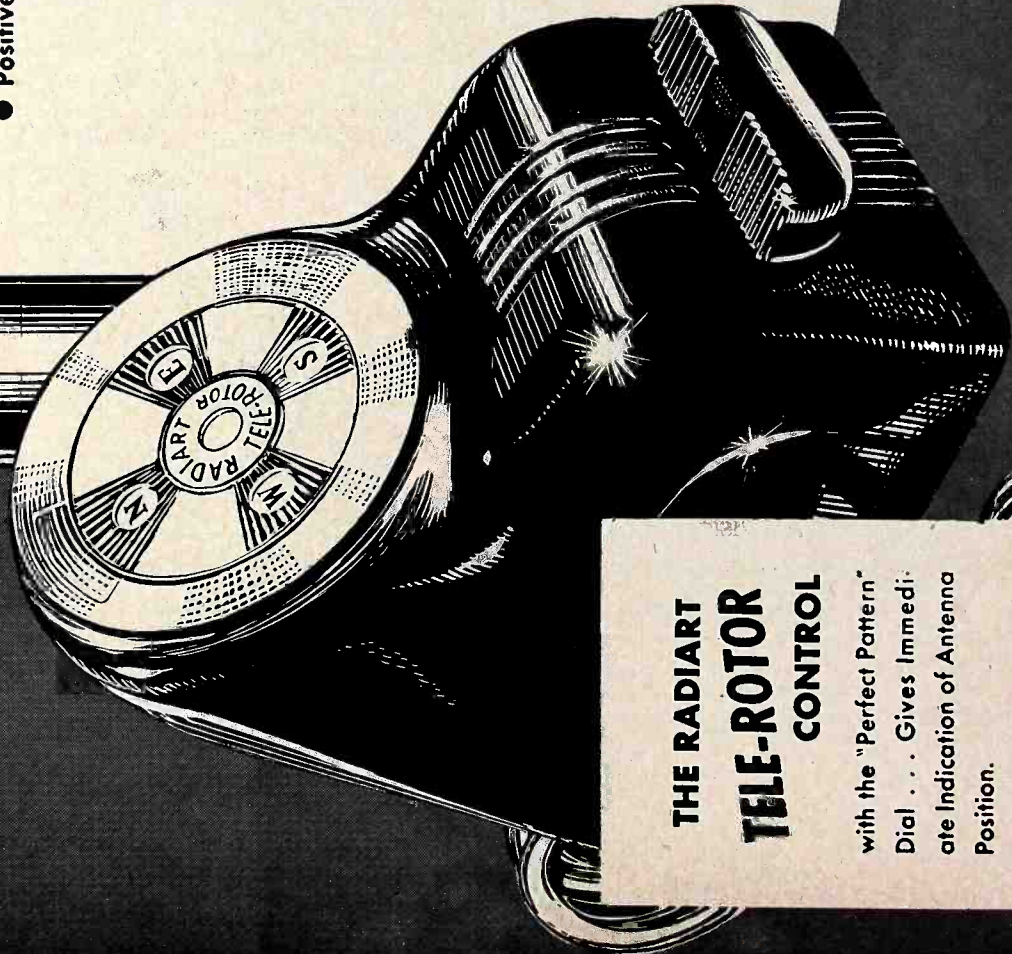
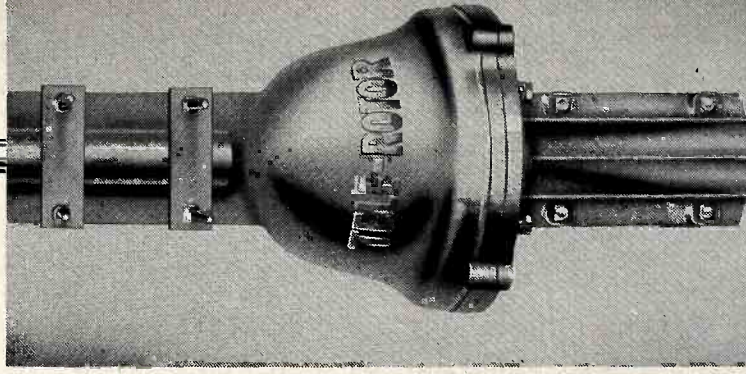
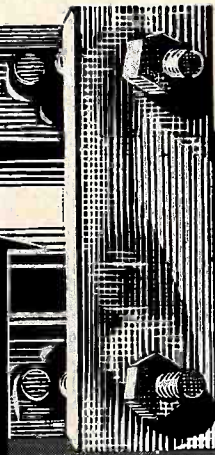

THE RADIART TELE-ROTOR CONTROL

with the "Perfect Pattern" Dial ... Gives Immediate Indication of Antenna Position.



IT'S RIGHT WHEN IT'S RADIART

THE **RADIART** CORPORATION
CLEVELAND 2, OHIO



- ROTATORS
- VIBRATORS
- TV ANTENNAS
- AUTO AERIALS
- POWER SUPPLIES

Television Technician

Section of RADIO & TELEVISION RETAILING

Crown GUY RINGS

The Crown Roller Bearing Guy Ring permits orientation of TV antenna mast without loosening or resetting guy wires.

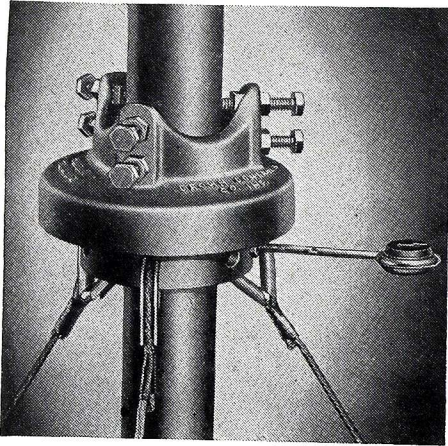

A stand-off insulator is furnished with the ring. List price of the guy ring is \$7.95. Crown Controls, Inc., New Bremen, Ohio.—RADIO & TELEVISION RETAILING.

Supreme TV Testers

Three instruments provide all functions and measurements necessary to install, adjust, test and repair TV receivers without a TV station signal on the air. Model 665 composite video generator makes available a complete video signal in accordance with FCC standards; model 675 provides an RF signal from 4.5 MC to 216

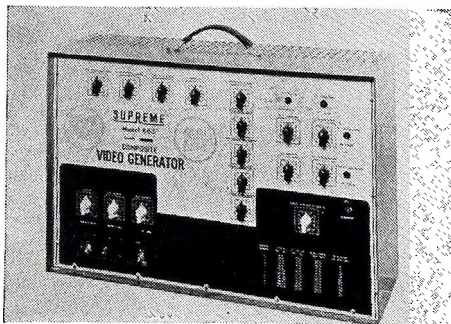

MC, covering all IF's as well as FM and TV carriers, which can be modulated by the video signal generator to produce the complete TV signal; and model 660 wide range 5-inch oscilloscope can be used for visual observation of response obtained with the signals produced by the other two generators. For more information, write Supreme, Inc., P. O. Box 552, Greenwood, Miss.—RADIO & TELEVISION RETAILING.

G-C SERVICE MIRROR

"Third Eye Miro-Pix" is a mirror to facilitate TV servicing from the rear of the receiver. The mirror is mounted on a telescopic adjustable stand which permits adjustment to the proper height, and also collapses for easy carrying. The mirror lists at \$5.95. General Cement Mfg. Co., 919 Taylor Ave., Rockford, Ill.—RADIO & TELEVISION RETAILING.

Best Vue TV ANTENNA

The CO"X"20 is a multi-purpose conical TV antenna which can be adapted for (1) high and low frequency, (2) Dipole and reflector, (3) Stacked array, or (4) Sepa-

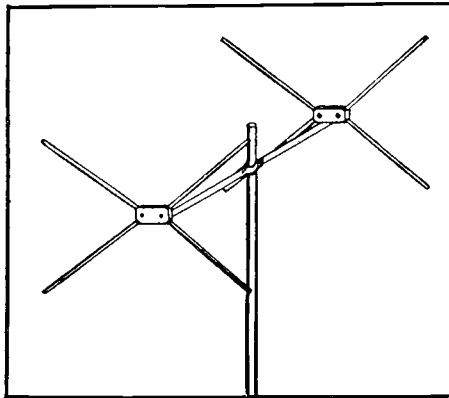

rate installations. Designed for all-channel response, the antenna is said to be suitable for 72, 150 or 300 ohm line. Best Vue Products, 247 Centre St., New York, N. Y.—RADIO & TELEVISION RETAILING.

Unimac CHIMNEY MOUNT

Model UCH-4 chimney mount for TV antenna masts features fast erection time. One bolt on each of the two units lock-clamps the steel strapping in place and takes up the slack as well. Sets consist of two pre-assembled units complete with all hardware and 2 12-foot bands. Marvin Radio-Television, 89th at Buckeye Road, Cleveland 4, Ohio.—RADIO & TELEVISION RETAILING.

Decimeter TVI TRAPS

Three TVI wave traps designed to slide around 300-ohm twin-lead require no cutting of the lead-in, and no ground con-

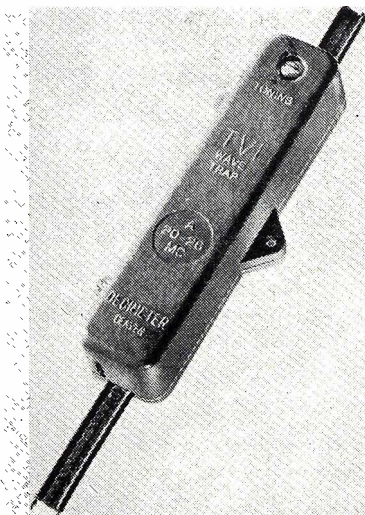

nection. The three models are designed to attenuate TV interference in three ranges: A, 20-26 MC; B, 25-35 MC; and C, 88-108 MC. Decimeter, Inc., Denver, Colorado.—RADIO & TELEVISION RETAILING.

Webb TV WRAPABOUT

The TV Wrapabouts are adjustable padded, quilted covers for use in handling TV sets in warehouses, on trucks, during servicing and for home delivery. Available in 4 models, the adjustable covers are designed to fit everything from a table model to a console combination up to 44 inches wide by 25 deep and 42 high. For circular, write Webb Mfg. Co., 4th and Cambria Sts., Philadelphia 33, Penna.—RADIO & TELEVISION RETAILING.

Hot Nails STANDOFFS

Due to the special construction of these "nails," the maker claims it is possible to drive them into brick, mortar, concrete, and even masts of steel or aluminum, making it unnecessary to drill holes. The "nails" are furnished with a polyethylene insulator for either 300 ohm line or coax. Suggested list price is 7c each. Hot Nails, Inc., 40 West 4th St., New York, N. Y.—RADIO & TELEVISION RETAILING.

Federal MAGNIFIER

The Federal Electronic Magnifier provides a "giant close-up" TV picture and is said to be easily attachable to a TV set

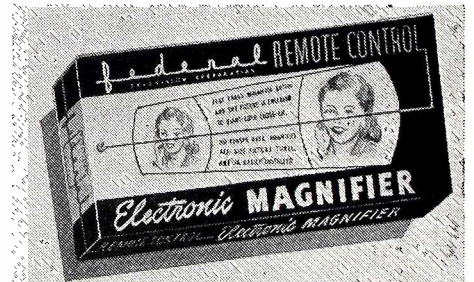

by a serviceman. Comes complete with 25-foot extension cord for remote operation, complete instructions. List price is \$24.95. TV Development Corp., 1819 Broadway, New York, N.Y.—RADIO & TELEVISION RETAILING.

RMS TV ANTENNAS

The RMS line of TV antennas now includes the "Versacone" and "Jackknife" models. Versacone is a conical, all-channel antenna which is adaptable in various arrays by shifting of rods in the reflector and insulator plates. The Jackknife is a completely pre-assembled all-channel antenna that has no loose parts and requires no manipulation of the rods, in conical, folded and straight dipole models. Radio Merchandise Sales Co., Inc., 550 Westchester Ave., New York 55, N.Y.—RADIO & TELEVISION RETAILING.

Aero TV ANTENNA

"Aero-Tenna" is an indoor TV antenna of the "V" type mounted on a heavy ceramic base designed to prevent tipping over. Dipoles are of the extension type to permit adjusting for best reception. Retail price is \$6.95 each. Aero Needle Co., 619 N. Michigan Ave., Chicago 11, Ill.—RADIO & TELEVISION RETAILING.

New Sound and PA Products

University FILTER

Model 4410 is a crossover network of the LC type for use with coaxial or duplex loudspeaker systems. This accessory provides a proper attenuation rate at a



crossover of 600 cycles. A high frequency attenuator is supplied for balancing highs and lows to suit the listener. University Loudspeakers, Inc., 80 S. Kensico Ave., White Plains, N. Y.—RADIO & TELEVISION RETAILING.

Utah LOUDSPEAKERS

New coaxial speakers feature wider range, smoother response, greater sensitivity and lower resonance. Two sizes are offered: a 15" woofer and 5" tweeter (model CSP15P-5) and a 12" woofer with a 3" tweeter (model CSP12J-3). Also an-

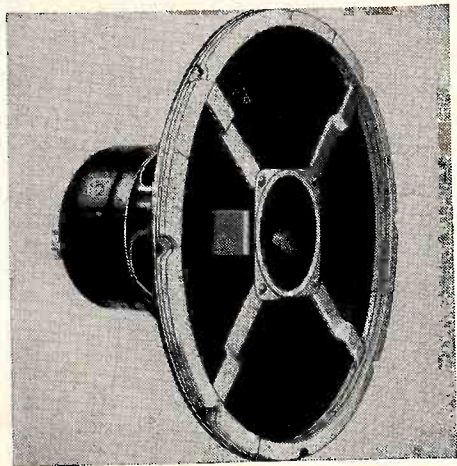

nounced are five new TV replacement speakers, a 6-inch weatherproof outdoor speaker, and a 2-inch intercom speaker. Bulletin No. 201 gives complete information on these new units. Utah, Inc., 1123 E. Franklin St., Huntington, Ind.—RADIO & TELEVISION RETAILING.

Holl Audio SPEAKERS

Series 400 two-way theatre loudspeaker system for music and speech with 400-cycle crossover, frequency response 30 to 15,000 cycles. The high frequency section is a multicellular horn of wood construction. The low frequency horn is driven by 3 25-watt 12" PM speakers. The whole unit is provided with an attractive enclosure. List price is \$650. Other high fidelity units from \$145. up. Holl Audio Industries, Box 1230, Hollywood, Calif.—RADIO & TELEVISION RETAILING.

Scott NOISE SUPPRESSOR

Noise suppression for phonograph record reproduction is provided in the new "Dynaaural" units, said to be of professional quality. The Dynaural converter is for use with crystal pickups, and the

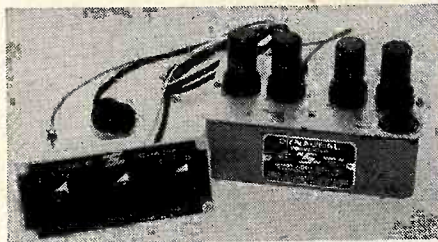

Dynaaural preamplifier is an additional unit for use with low level magnetic pickups. Remote controls are provided, including a variable turnover control to compensate for different recording characteristics. Herman Hosmer Scott, Inc., 385 Putnam Ave., Cambridge 39, Mass.—RADIO & TELEVISION RETAILING.

Wright-Zimmerman SPEAKER

Model 300 dynamic reproducer is a 3-inch PM speaker in a stainless steel case which can be connected directly to any radio, and is especially suited as an

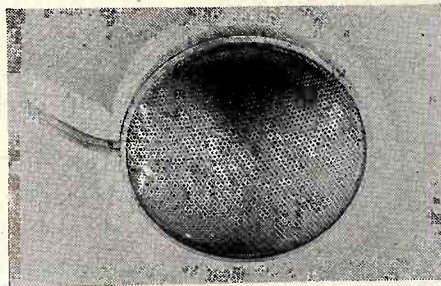

under-pillow speaker. The unit may also be used as a dynamic mike by the addition of two stages of amplification. List price is \$6.95. Wright-Zimmerman, Inc., New Brighton, Minn.—RADIO & TELEVISION RETAILING.

GE TWIN-STYLUS CARTRIDGE

A twin-stylus variable reluctance phono cartridge, model RPX-050, is now available, for playing both conventional and microgroove records. Changing from one stylus to the other is accomplished by depressing and turning a knob on top of the cartridge. Stylus pressure on both types of records is 1/4 ounce. The twin stylus is replaceable as a unit with sapphire tips. G-E Receiver Division, Electronics Park, Syracuse, N. Y.—RADIO & TELEVISION RETAILING.

Audio RECORDING TAPE

Two new plastic-base tapes have been added to the line of paper-base Audiotape. All the Audiotapes are available on 1250-foot reels. The paper-base Audiotapes, formerly selling at \$4.50 and \$5.00, have been reduced in price to \$3.50 list. Audio Devices, Inc., 444 Madison Ave., New York 22, N.Y.—RADIO & TELEVISION RETAILING.

Masco TWEETER

Model HFT-100 high frequency is designed to provide wide range response in the upper register, to be used in conjunction with a cone speaker without filter

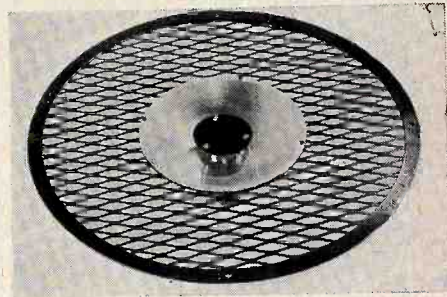

network. The screen with high frequency unit attached is fastened over existing cone. The two speakers are series connected. Mark Simpson Mfg. Co., Inc., 32-28 49th St., Long Island City 3, N.Y.—RADIO & TELEVISION RETAILING.

Newcomb AMPLIFIER

A new 25 watt audio amplifier is available for school auditoriums, churches, theatres, etc., with a frequency response from 20-20,000 cps. Six inputs are provided, five for microphone and one for phonograph with built-in preamp to permit use of magnetic pickups. A bandwidth control is provided, as well as tone controls. Visual indicators tell the operator the power output in watts and indicate distortion. Newcomb Audio Products Co., 6824 Lexington Ave., Hollywood 38, Calif.—RADIO & TELEVISION RETAILING.

Webster PHONO CARTRIDGE

A new universal cartridge, the Featheride Type A1, is said to fit almost all record changer arms, and will play any combination of record speeds. Tracking pressure is 7 grams. Replaceable needles fit into friction chucks. Webster Electric Co., 1900 Clark St., Racine, Wis.—RADIO & TELEVISION RETAILING.

RCP SIGNAL TRACER

Model 777A "Dynatracer" is a new model signal tracer; features high amplification, with a calibrated meter for accurate indications. Maximum of 10,000: 1 ladder

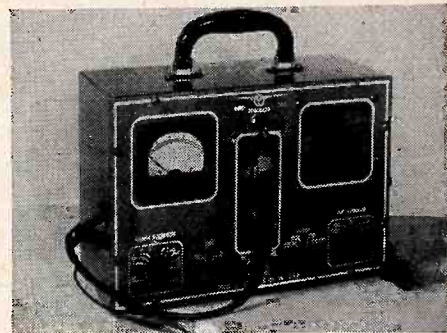

attenuator pad is provided. Sensitivity is 10,000 microvolts for full scale deflection. Covers 160 MC. Dealer's net is \$41.50. Radio City Products Co., 152 W. 25th St., New York 1, N.Y.—RADIO & TELEVISION RETAILING.

Attract G.I. Refund Money

the Right Way!



and-part" flavor. Messages must be sincere logical bids exactly the same as those directed to any prospective purchaser.

The fact that so many of those receiving the refunds favor buying television sets is all the more reason that we should make it easy for them to buy video receivers.

The dealers who are capitalizing in the right way on the

great potential demand are doing good business with the ex-G. I.'s who may alone buy as many as a million TV sets in 1950. Results of a survey made among its ex-G. I. employes by Raytheon showed that 27 per cent now own video receivers and that 14 per cent of the total plan to buy them. Of the 73 per cent who do not own TV sets, approximately one-fifth said they plan to buy them with their insurance refunds.

The dealer who will get his share of this tremendous business now available is the man who goes about it the right way. He's the dealer who stays open nights, who has good merchandise, good service and competitive terms available to the prospective purchasers in his trading area. Many merchants are offering veterans products to be paid for "when you receive your refund check." Armed with lists of veterans living in their trading areas, numerous dealers are sending out direct-mail pieces to such lists; still others are using window signs, radio time, etc., to attract the ex-G. I.

The wide distribution of the refund money insures that effects will be felt far and wide. Veterans in every part of the country are and will be getting checks from the government, and because of the method of paying in numerical order by serial number, the effects will be felt for a long period of time, making the project considerably more than a flash-in-the-pan proposition. For this reason, dealers need to continue their sales promotion directed toward the ex-G. I. In addition, because of the fact that the payment receipts will be long drawn-out, merchants should expect a steady flow of business rather than a deluge.

Because of the high costs of living, and the still acute housing shortage, most former G. I.'s, it is believed, will continue to proceed cautiously with their spending of the insurance rebates, and the chief appeal to them will be made by the merchant who has something real and tangible to offer.

Our industry has much to offer in exchange for a share of the rebate funds. In television, it offers superb entertainment and education on a money-saving basis. In the comfort of his own home, the former member of the Armed Forces and the members of his family can see the world before them, at a cost far lower than any entertainment obtainable on the "outside." In the appliance end he can save time and money through the labor-saving miracles of the modern Postwar Age, and in recorded music and modern phono changers the best in music is his to enjoy.

Truly, we have much to offer the ex-G. I., and the best way to get our share of his business is to stress the many advantages to *him* our industry holds forth—backed up with the right kind of after-sale maintenance.

• A considerable portion of the three billion dollars which has commenced flowing to ex-G. I.'s as refunds on insurance policies they carried during the late war is earmarked for the purchase of products in our field. Many of the sixteen million men and women vets to whom checks are being sent will buy television sets, large and small appliances, phono players and records. Many will spend money to have old radios and appliances serviced.

However, the fact that so much of the vast sum has already been "mentally" set aside for purchases in our field shouldn't lull any merchant into the belief that the one-time G. I. will make a beaten path to his door to part with his money. Early experience shows that the vets are not falling into lines in front of stores—just rarin' to get rid of their cash. There is evidence, too, of a very real bid by other industries, notably in the automotive field, for the potential new business created by the huge refund payment.

In order to get our share of sales we must attract the veteran to our products. We must attract him on the basis of value and not attempt to sway him upon emotional grounds.

One of the biggest things the dealer in our field can offer the ex-G. I. is service. Having participated in what may almost be described as a semi-pushbutton war, today's veteran knows a great deal about the value of proper installation and maintenance. Service should be stressed in all instances; by word of mouth and in advertising copy directed to the former member of the Armed Forces. Copy should avoid the "give-us-your-money-and-we'll-kiss-

1 Person in Every 9 Is a World War II Veteran

If the population of your town is:	There are about this many veterans:	Who will get approximately this amount of money:
900	100	\$ 17,500
9,000	1,000	175,000
90,000	10,000	1,750,000
900,000	100,000	17,500,000

BETTER TV RECEPTION . . . FASTER INSTALLATION

Protect your profits by selling and using

MAGNE-ROTOR*



ANTENNA MOUNTS



Approved
UNDERWRITERS
LABORATORIES

For peak reception in fringe areas or close in.

PERFECT PUSH-BUTTON CONTROL

You can sell armchair video control and make TV installation a one-stop proposition. Install Magne-Rotors with TV receivers. They are Underwriters approved. Use C. & G. chimney mounts and wall brackets. Besides giving your customers better reception, you get these great advantages:

FASTER INSTALLATION
resulting in lower costs and greater profits for dealers.

NO MORE CALL-BACKS
Not necessary to reorient antenna. Less service expense.

MOTORLESS ROTATION
Patented magnetic principle, minus faults of other types.

FINGERTIP CONTROL
Providing peak reception in fringe areas or close in.

RUGGED AND SAFE
No turning by wind; unaffected by weather; will not burn out if stalled.

UNBEATABLE PRICE
Lowest because it's simplest. Others are 30 to 66% higher.

EXCELLENT MARKUP
Full distributor-dealer discounts. Handled by leading distributors everywhere.

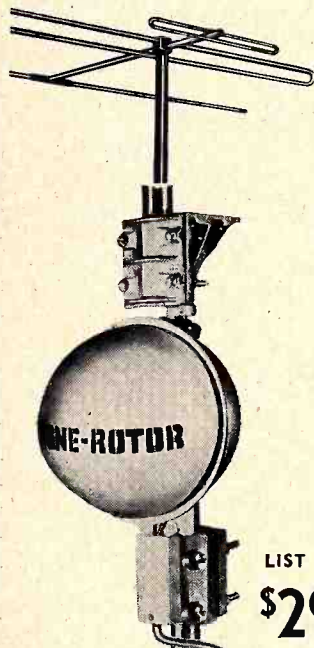

LIST PRICE
\$2995

Other Features

- ▶ Full 360° turn in either direction.
- ▶ Will not coast when turned off.
- ▶ Locks at any point.
- ▶ Weight under 6 lbs.
- ▶ Control unit plugs into any 110V line.

* Patent Pending

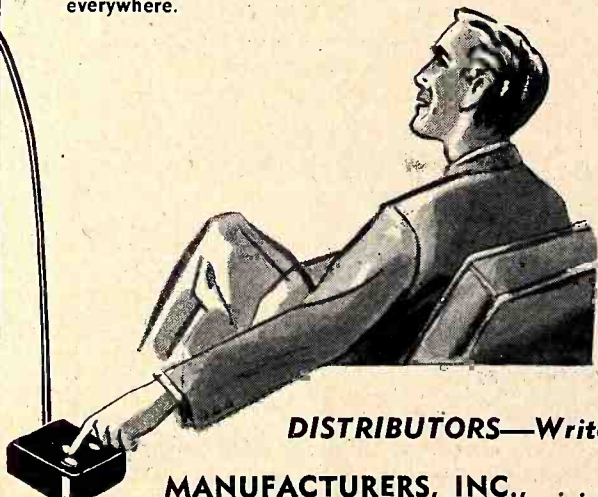

For speeding up installations of all TV and FM antennas

CHIMNEY MOUNTS and WALL MOUNTS

C. & G.-2 CHIMNEY MOUNT

Offset bracket mounting

Easy to install. Bracket is made of non-corroding steel, 1½-in. wide. Two 12-ft. galvanized straps with eye-bolts attached to each strap. Note method of clamping and locking strap.

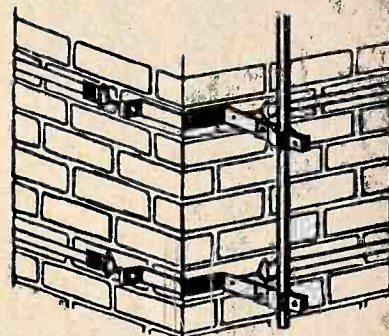

Detail of C. & G.-2 mounting →

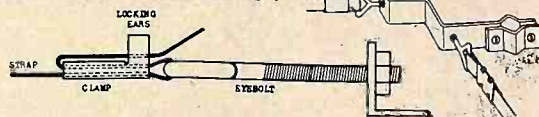

C. & G.-3 Y-TYPE MOUNT CHIMNEY MOUNT

Made of heavy gauge steel and weather-proof plating. Two 12-ft. galvanized straps with eye-bolts attached to each strap.

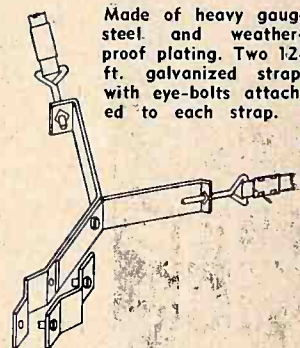
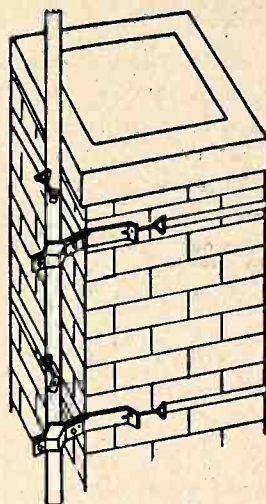

C. & G. GROUND ROD 4-ft., copper-plated, 3/8th round rod

C. & G.-Y WALL MOUNT For wood or masonry. Clearance 7 1/2 inches.

C. & G.-W WALL MOUNT Rugged weatherproof bracket. Clearance 4 inches.



DISTRIBUTORS—Write for prices and COMPARE

THE C. & G. TOOL

MANUFACTURERS, INC., 39 MAIN ST., EAST-ORANGE, N. J.

-- ALPRODCO --

TOWERS of "aircraft" ALUMINUM

ASSURES SPARKLING RECEPTION

for

TV FMA^M

• LIGHT
• INEXPENSIVE

ONLY

\$1.15

PER FOOT

- Weight of one pound per foot assures safe, easy installations.
- Available in knocked down or factory assembled six foot sections.
- Attractive "life-time" beauty with no maintenance worries.
- Heights up to 120 feet may be safely used.
- Self-supporting (no guy wires needed) to heights of 24 feet.
- Aircraft Aluminum of spring tempered alloys is used exclusively in Alprodc Towers.

WRITE FOR FREE LITERATURE

Part No.		Dealer net price
T-6	Standard 6' Tower (knocked down)	\$6.91
AT-6	Standard 6' Tower (assembled)	8.56
MK-1	Mast Kit, including top angles and mast bracket	1.80
B-1	Hinged Base Plate	2.10
S-4	4" Standoff Support Bracket	1.15
S-12	12" Standoff Support Bracket	1.70
GB-1	Guy Bracket, each	.07

SOLD THROUGH LEADING DISTRIBUTORS

IF YOUR TERRITORY IS NOT REPRESENTED ORDER FROM FACTORIES

• STRONG

ALPRODCO INC.

(B) Factories at either, Dept. Y, Mineral Wells, Texas, or Dept. Y, Kempton, Indiana

Distributing Capehart

Rowles Sales Co., San Antonio, Texas, has been appointed distributor in southwestern Texas for the Capehart line of television receivers and phonograph-radios, it has been announced by C. R. Ward, sales manager of Capehart-Farnsworth Corp.

Pioneer Names Pollet

Pioneer Scientific Corp., New York, has appointed Benjamin A. Pollet advertising and sales promotion manager, it was announced by George Hinman, president. Mr. Pollet will work closely with Hunter Delatour, who will continue as sales manager in the marketing of his company's items—Polaroid television filters, Polaroid photographic filters, and Polaroid sun glasses.

GE Appoints Carvill

Edwart T. Carvill has been appointed assistant manager of General Electric appliance sales in the Southeastern district, it has been announced by A. M. Sweeney, general sales manager of the Company's Appliance & Merchandise Department.

New Bendix Line

Bendix Radio Div. of Bendix Aviation Corp., Baltimore 4, Md.: The new line consists of a 12½-inch table model at \$199.95, a 12½-inch console at \$239.95, and the 16-inch console at \$299.95. All three are TV-only sets featuring "dark face" picture tube and built-in antenna.

DuMont Sales Convention

The first convention in the history of the receiver sales division, Allen B. DuMont Laboratories, Inc., was held January 11, in Chicago, when distributors from seventeen key cities in the Mid-Western territory met at the Drake Hotel.

In addition to a complete discussion on DuMont's 1950 merchandising policies, the meeting marked the first demonstration of DuMont's sales training plan by Walter L. Stickel, sales manager, to DuMont outlets in the field. The plan was introduced to the press in New York recently.

Every facet of the television receiver business was discussed, with heavy emphasis on sales, promotion, advertising and service.

Zenith District Manager

James M. Scales has been appointed Zenith's district sales manager for the Northwestern territory, according to an announcement made by L. C. Truesdell, sales manager of household radio and television, Zenith Radio Corporation.

Scales' territory includes Denver, Billings, Portland, Salt Lake City, Seattle, and Spokane.

Refrigerator Sales Patterns

(Continued from page 74)

demand, and longer freezing time of old boxes is high-lighted, along with the difficulty of getting trays out—and, with more perishables to store, inadequacy of storage space, and (in many cases) absence of a freezer compartment are brought into prominence. And, of course, many boxes actually give up the ghost under this strain.

For these reasons, it is maintained by many that the approach of hot weather will always signal an increase in refrigerator sales, "when things get back to normal." Service organizations, and especially those handling commercial jobs, will strongly second this motion, since summer is when they do their greatest volume of work.

In analyzing these factors to "guesstimate" future trends, it is certainly difficult to determine what is "normal" in an industry which has been continuously growing since its inception. There is no valid pre-war "average yearly production" figure, since production steadily gained year by year during all the years up to 1941. Sales passed the million mark in 1934, passed 2 millions in 1937, and passed 3 millions in 1941. 1948 was the greatest year ever, with sales of over 4 million, and 1949 easily topped that.

Growth to Continue?

It seems likely that this growth will continue, due to the ever-increasing number of wired homes, the increasing numbers of "second generation" users, and the increasing requirements for replacement boxes as well as "second" units in homes already equipped.

Dealers can certainly influence the future trend if they will assume that the present year-round sales of refrigerators are "here to stay" and continue to vigorously display, promote, and sell refrigerators during the whole year. Manufacturers have already commenced to cultivate this tendency by introducing new models in what used to be "off season," namely fall and winter. Manufacturers' advertising campaigns are also pushing their products during these seasons, as well as the rest of the year.

Seasonal merchandise should hold no attraction to the dealer, who must clear it out at the end of the season or carry it over (or store it) until the next peak, when it will have been superseded by new models. Therefore we expect the dealers will attempt to maintain the status quo by continuous promotion of this biggest item in the appliance field.

Motorola Wholesalers

Major Appliances, Inc., Miami, has announced its appointment as distributor for Motorola radios and television in the state of Florida.



'the proof of the PUDDING!'

Impartial and exhaustive tests prove that the new **MODEL IT4-SUPER SONIC TV/FM AMPLIFIER** delivers a higher usable gain with full bandwidth and higher signal to noise ratio than other leading brands at any price!

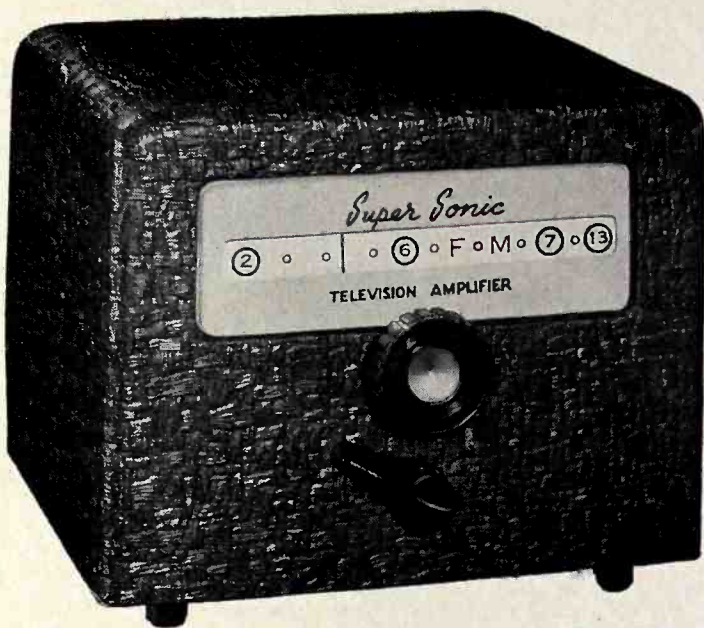

model
IT4

SUPER SONIC TV/FM AMPLIFIER

\$ **32**⁵⁰
List

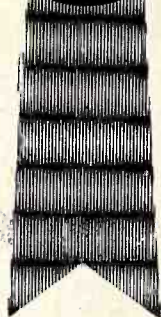

- Improves TV reception in weak signal areas, with or without outdoor antenna.
- Continuous tuning of all 12 TV channels, also FM with ONE knob control.
- Reduces electrical, diathermy interferences and minimizes "ghosts and snow" effects.
- Frequency range: 50 mc to 220 mc, continuously tuned.
- Bandwidth: 6 mc. minimum all channels.
- Insertion gain: Minimum of 18 db at any frequency with 300 input and output impedances.
- Highest signal to noise ratio.
- Input and Output Impedances: 300 ohm balanced to ground and 72 ohms unbalanced.
- Inductances wound with PURE SILVER wire.
- All moving contacts heavily silver plated.

CHOICE TERRITORIES STILL AVAILABLE

Write for Free Brochure to Dept. RR 1

SONIC INDUSTRIES INC.

"MANUFACTURERS OF DUOSONIC PHONOGRAPHS"

221 WEST 17th STREET, NEW YORK 11, N. Y.

In Fair Weather or **FOUL...**

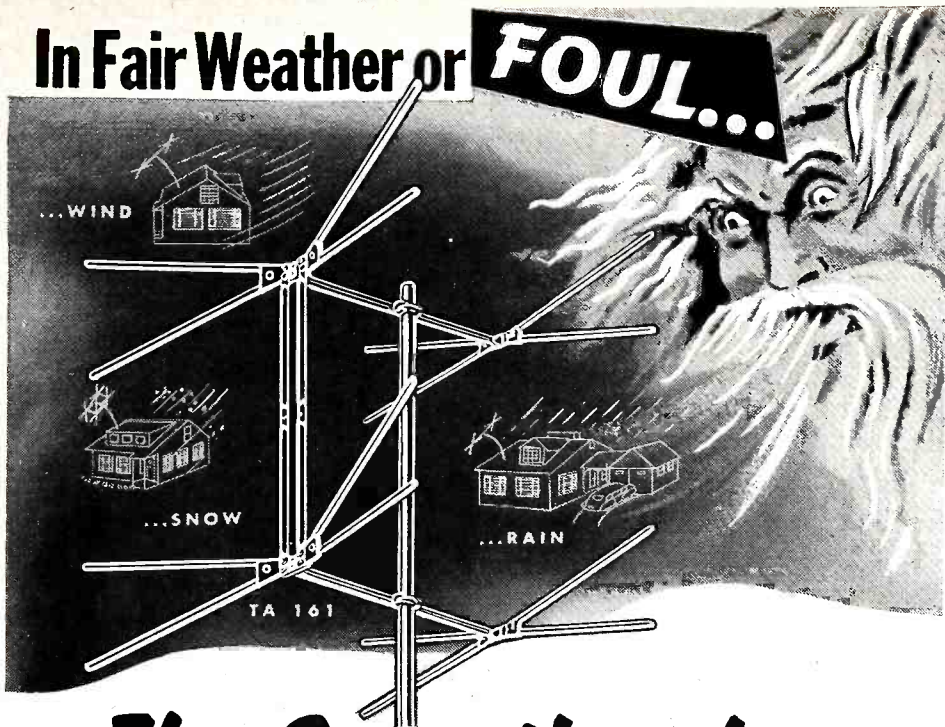

The Sensational...
JFD "D-Xer"
ALL-ALUMINUM
CONICAL ANTENNAS

- ARE STRONGER!**
- MORE ECONOMICAL!**
- FASTER SELLING!**
- MORE PROFITABLE!**

Rugged construction. The only Conicals with reinforced elements. Will not bend, sag, sway or whip. Withstand all kinds of rough weather — wind, snow, rain, hail, etc.

Feature-for-feature, quality-for-quality, performance-for-performance, JFD "D-Xer" All-aluminum Conicals give more for the money than any other antenna. The smart serviceman looks for the reinforced element.

The proof of a product's popularity is in the reorder. Daily, our list of reorders grows longer and longer.

"D-Xer" Conicals sell faster — more easily. They require minimum servicing. Once put up, they stay put up — and they stay sold!

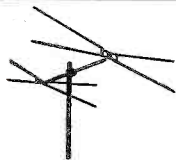

TA 160

TA 161... Double "D-Xer" All-Band Conical. 1/4 wave-length stacked. Provides exceptionally high DB gain on both bands. Channels 2 to 13.

TA 162... same as TA 161, but 1/2 wave-length stacked.

TA 160... "D-Xer" All-Band Conical, channels 2 to 13 and FM. Good front-to-back ratio on all TV frequencies.

TA 164... "Super D-Xer" Double Stacked Conical, channels 2 to 13 and FM. Complete with mast-supported aluminum jumper harness. Unsurpassed for bringing in weak signals over long distances.



WRITE FOR FREE BULLETINS

Now...right now...put your name on the JFD list to receive informative bulletins of JFD "D-Xer" Conicals, and all other fast-moving, profitable JFD products.

BUY YOUR TV ANTENNAS AND ACCESSORIES FROM ONE SINGLE DEPENDABLE SOURCE OF SUPPLY
... JFD

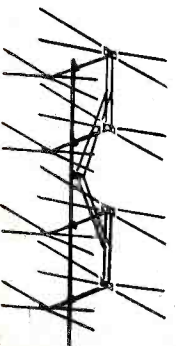

TA 164



MANUFACTURING CO., Inc.

6103 16th AVENUE, BROOKLYN 4, N. Y.

FIRST in Television Antennas and Accessories

Tele-tone Appointee



James N. Ryan, above, has been named assistant general sales manager of Tele-tone Radio Corp., it was announced by Morton M. Schwartz, general sales manager.

New Hytron Tube Plant

Two of the industry's veterans, Bruce A. Coffin, president, and Lloyd H. Coffin, treasurer, of Hytron Radio & Electronics Corp., recently laid the cornerstone of Hytron's new television picture tube plant at Newburyport, Mass. Ultra-modern, the new plant is designed especially for mass production of television picture tubes. With it, Hytron will expand its production of these tubes begun nearly a year ago. Three thousand tubes will roll off the new production lines daily. The tubes will range in size up to twenty inches. They will be of round design and of the new rectangular design recently originated by Hytron.

Hytron will thus increase materially its manufacturing facilities. The extra space of this new picture-tube plant, added to Hytron's present facilities, will give Hytron a total of approximately 400,000 square feet. Starting in 1921 with only 6 employes, Hytron now employs approximately 2500 persons. The new TV picture tube plant will add approximately 300 more.

Pilot TV Veterans



The five men behind this new TV receiver of the Pilot Radio Corp., Long Island City, were with the company 21 years ago when Pilot conducted the first regularly scheduled telecasts over its experimental station. Shown l. to r. are: Harry Givre, James Benjamin, Isador Goldberg, president, Emanuel Gilmore and Solomon Eskinazy. The pilot set pictured is the 12 1/2 inch unit with matching supporting cabinet.

Air King Appoints Olchak



R. D. Payne, manager of sales, Air King Products Co., Inc., Brooklyn, N.Y., announced the promotion of Samuel Olchak to advertising and sales promotion manager. Mr. Olchak retains previous position of commercial service manager.

Ashbach Buys Majestic

Majestic Radio and Television Corporation, a household name in electronics for over 20 years, has announced a complete line of television and radio receivers.

Majestic is headed by Garod president Leonard Ashbach of Chicago, who recently acquired the Majestic trade name, trademarks, goodwill, patents, dies, and molds. In a press statement, Mr. Ashbach announced that he will continue to advertise and publicize the new world-famous Majestic trade mark and slogan: "Majestic-Mighty Monarch of the Air".

RMS New Address

Sid Pariser, president of Radio Merchandise Sales, Inc., manufacturers of a complete line of television antennas, preamplifiers, and accessories, announces the removal of its factory and offices to 1165 Southern Blvd., New York 59, N. Y.

Emerson Officers



Emerson Radio & Phonograph Corp., announced the election of three new officers. Shown is Commodore John D. Small, elected a vice-president, who will serve in that capacity in addition to his present position of executive assistant to the president. Abraham Rosen was promoted from controller to assistant treasurer, and A. A. Vogel, from assistant controller to controller.

ALREADY A COAST-TO-COAST HIT!

The NEW BURGESS FLASHLIGHT BATTERY

Power Packed In Steel and Plastic

CHROME PROTECTED TO CHECK POWER WASTE!



DESIGNED FROM THE INSIDE OUT TO GIVE YOU MORE SALES AND NEW PROFITS!

ONLY BURGESS GIVES ALL THESE FEATURES!

CHROME PROTECTION!



Curbs out-of-use power waste. This EXCLUSIVE feature guarantees longer life and freshness! *Only* BURGESS

Flashlight Batteries are Chrome Protected to check interior action when battery is not in use.

SEALED IN STEEL AND PLASTIC!



Power loss in the NEW Burgess Flashlight Battery is prevented by machine-sealing the tough plastic outer casing and the steel cap directly into the battery top.

MODERN, EYE-CATCHING STYLE!



Only BURGESS Flashlight Batteries have such a sales-producing design. The distinctive BURGESS stripes are recognized instantly by your customers—they are the mark of engineering skill and know-how that has made BURGESS first choice of scientists and explorers.

ENGINEERED DESIGN!

New, improved construction permits the use of a big full size mix core and big zinc can to give longer life!



GUARANTEED!

The BURGESS reputation for quality and dependability has made it the foremost name in radio batteries. Every BURGESS Flashlight Battery carries the guarantee of this reputable, long-established manufacturer.

STOCK UP NOW!

And Cash in on the Promotion of This Sensational, New Flashlight Battery!

Big, two-color ads in Collier's and an expanded list of other leading magazines feature the NEW Burgess Flashlight Battery to millions of users. Be ready for increased BURGESS sales with a good stock of the *new* BURGESS Flashlight Batteries in the new display cartons. Order from your BURGESS distributor.

BURGESS BATTERIES

**WHAT LEGAL TEXTS
ARE TO THE ATTORNEY
RIDER BOOKS
ARE TO THE
ELECTRONIC TECHNICIAN**

**The New CATHODE-RAY
TUBE AT WORK** by RIDER et al

The greatest and most complete reference book ever written on the Cathode-ray tube! It is a practical, down-to-earth encyclopedia about five times the size of the old standard text. Starting with basic theory of cathode-ray tube operation, it proceeds through application in scopes and TV receivers...with full and clear explanations for uses in every field and research activity which employs a cathode-ray oscillograph. All scopes produced and sold during the last 10 years, more than 70 different models are described completely — with schematic wiring diagrams. Almost 500,000 words and about 3,000 illustrations are incorporated in more than 900 pages. It is a book which will enjoy years and years of daily use. 22 chapters. Page size 8½x11" \$9.00

**THE THEORY AND PRACTICE OF
30-1000 MC RECEIVING ANTENNAS**

by Arnold B. Bailey

This book is a rare combination of theory and practice that:

- 1.—Clearly explains and teaches
 - 2.—Can be used as a daily work reference
- Reflecting world-wide knowledge of the antenna art, it clearly explains the theory behind the performance of every type of 30-1000Mc receiving antenna on the commercial market, leaving the reader with a full understanding of why each behaves as it does. And since the author has resolved the mathematics of antenna problems into graphs, charts and tables — it can be put to good use by all. Designed to serve all men whose livelihood depends on getting the most out of an antenna system, it is equally important to the antenna design engineer, television technicians, electronics schools, students, radio amateurs . . . More than 500 pages, 6 x 9", cloth bound. . . . \$4.50

OTHER RIDER BOOKS

- Radio Operator's License Q and A Manual. The radio operator's license manual with the discussion follow-thru — It makes the answers more understandable and also teaches. 608 pages. \$6.00
- TV Picture Projection and Enlargement. Explains TV receiver optics and removes the mystery from projection and enlargement processes. 192 pages \$3.30
- FM Transmission and Reception, 416 pages \$3.60
- The Oscillator at Work. 254 pages. \$2.50
- Broadcast Operator's Handbook. 278 pages. \$3.30
- Inside the Vacuum Tube. 420 pages. \$4.50
- Servicing by Signal Tracing. 370 pages. \$4.00
- Understanding Microwaves. 396 pages. \$6.00
- A-C Calculation Charts. 168 pages. \$7.50
- Vacuum Tube Voltmeters. 188 pages. \$2.50
- Business Helper. 144 pages. \$2.00
- Radio Amateur's Beam Pointer Guide. 32 pages. \$1.00
- Automatic Frequency Control Systems. 154 pages. \$1.75
- Installation and Servicing of Low Power Public Address Systems. 208 pages. \$1.89
- Understanding Vectors and Phase. 158 pages. Cloth Cover \$1.89 Paper Cover \$1.00
- Radar — What it is. 80 pages. \$1.00

RIDER BOOKS

JOHN F. RIDER PUBLISHER, INC.
480 Canal Street, New York 13, N.Y.

New Technical Products

Du Mont OSCILLOSCOPE

Type 292 oscilloscope with 3" tube features compact size and light weight (21 pounds). Vertical sensitivity is .4 rms volt, horizontal is .56 rms volt, to produce 1" deflection. Sweep frequencies are available from 8 to 30,000 cps. Additional information may be obtained from Allen B. Du Mont Labs, Inc., 1000 Main Ave., Clifton, N. J.—RADIO & TELEVISION RETAILING.

Vaco SCREW-HOLDER

"Klipxon" screw-holding screw drivers for getting screws into and out of tight places feature a screw-holding spring tension device on the shaft of the screw-driver. The holder may be pushed up out of the way when not needed. Seven sizes of Klipxon screw-drivers are available to cover various needs. Vaco Products Co., 317 E. Ontario St., Chicago 11, Ill.—RADIO & TELEVISION RETAILING.

JFD TV ANTENNAS

The new "Commandair" line of antennas features all-aluminum corrosion-resistant construction, and is available in 3 models: standard conical, conical with high frequency element, and conical with 3-element dipole. All are available in either single bay or ¼ wave stacked arrays. Literature describing the line is available from JFD Mfg. Co., Inc., 6101 Sixteenth Ave., Brooklyn 4, N.Y.—RADIO & TELEVISION RETAILING.

Artisan TRUCK BODIES

A number of different types of all-steel service truck bodies for easy installation on truck chassis include side boxes and compartments for storage of parts and tools, and racks for carrying ladders. Model 60KD is 75" long and 71½ inches wide, with 46½" bed. For complete information write Artisan Products, Inc., 3490 W. 140th St., Cleveland, O.—RADIO & TELEVISION RETAILING.

Philco TV ANTENNAS

Biconical antennas 45-1673, 1674 and 1675 are respectively single, two-stack and four-stack antennas for broad-band, all-channel reception. High front-to-back ratio and 150-ohm non-varying center impedance are claimed for the antennas, which list at \$18.00, \$36.00, and \$75.00, respectively. Philco Corp., Accessory Division, C & Tioga Sts., Philadelphia 34, Penna.—RADIO & TELEVISION RETAILING.

Clear Beam TV ANTENNAS

The Clear Beam V-Cone line of TV antennas features a plastic head on the driven element which protects connections to lead-in from shorting in rain, from sea-air, etc., as well as from weathering. Antennas are available in 3 models: for "normal," "fringe" and "low signal" areas. Address inquiries to Clear Beam Antennas, 618 N. La Brea Ave., Los Angeles 36, Calif.—RADIO & TELEVISION RETAILING.

E-V "SPHEREX" MIKE

The "Spherex" is a high output, low cost omni-directional crystal microphone for conference recording, round table discussions, home recording, amateur radio, PA and similar use. Features claimed are:

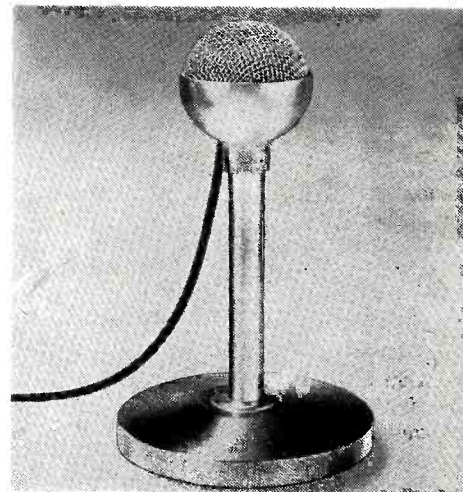

360 degree polar pattern, substantially flat response from 60-7000 cycles, output level —50 db, high impedance. Model 920-8 lists at \$16.50 with 8 ft. cable. Electro-Voice, Inc., Buchanan, Mich.—RADIO & TELEVISION RETAILING.

Burgess FLASHLIGHT BATTERY

New "chrome protected" flashlight batteries feature a tough plastic outer casing, a steel cap machine-sealed directly into the battery top, and more effective insulation of the zinc can. Longer life, and less deterioration when not in use are claimed for the new batteries. Burgess Battery Co., Freeport, Ill.—RADIO & TELEVISION RETAILING.

Industrial TESTER

Model 900 Volt-Amp Tester plugs in between line and appliance, motor or other electrical device, and provides simultaneous voltage and amperage readings off two dials. Two neon indicators are employed, which extinguish at the voltage and amperage readings indicated by adjustable knobs. A multiplier switch is provided for different ranges. Industrial Devices, Inc., Edgewater, N. J.—RADIO & TELEVISION RETAILING.

Acrosound TRANSFORMERS

These output transformers are designed for frequency response of plus or minus 1 DB from 10 to 40,000 cps, with negligible harmonic and intermodulation content at high power levels. The transformers are available in 6 models for most popular tube combinations, include a special unit for triode connected 807's. Full descriptive information and suggested circuit arrangements for Hi-Fi use are available from Acro Products Co., 5328-30 Baltimore Ave., Philadelphia 43, Penna.—RADIO & TELEVISION RETAILING.

Additional New Products
Elsewhere in this Issue

New Products

Raytheon TV TUBE

Raytheon has announced the addition to their line of a 16-inch all-glass TV picture tube, the 16LP4. The tube employs magnetic deflection and focus and has an electron gun designed for use with an external ion trap. Raytheon Mfg. Co., 55 Chapel St., Newton 58, Mass.—RADIO & TELEVISION RETAILING.

International RECTIFIERS

Miniature selenium rectifiers for use in radios, TV sets and other electronic equipment are available with maximum peak inverse voltage ratings of 380 volts, in current ratings of 75 ma., 100 ma., 150 ma., 200 ma., 250 ma., 300 ma., and 350 ma. Catalog available on request from International Rectifier Corp., 6809 So. Victoria Ave., Los Angeles 43, Calif.—RADIO & TELEVISION RETAILING.

Energy TV TOWER

Telescopic tower for TV antennas comes in 3 and 4 section units. The 4-section is 68 feet extended and the 3-section is 54 feet. Extension to full length can be accomplished by a hand hydraulic pump in about 15 minutes. Best reception can be determined when raising the tower, and pumping can be stopped at this point. In case maintenance is required, tower can be let down and pumped back up. Energy Farm Equipment Co., Monticello, Iowa.—RADIO & TELEVISION RETAILING.

Smith MILLIVOLT-DETECTOR

To extend the sensitivity of an oscilloscope for TV alignment work, the Millivolt-Detector detects and provides linear amplification for TV signals from 10 mv to 10 v. The Detector has a 2 v output, handles carrier frequencies between 300 KC and 2500 MC. Smith Industries, P.O. Box 238, Ballston Spa, N.Y.—RADIO & TELEVISION RETAILING.

E-V PHONO CARTRIDGES

Series 12, basic 3 crystal cartridges for 78 RPM, replace over 150 standard models. Series 34 cartridges can be used in every RCA 45 RPM changer. Series 16 twin-tip cartridges are designed for Webster 256 and 356 changers, play all three speeds without weight change. Bulletin No. 105 describing these three series, with complete specifications, available on request from Electro-Voice, Inc., Buchanan, Mich.—RADIO & TELEVISION RETAILING.

C & G TV CHIMNEY MOUNTS

Type 2 offset bracket type for mounting TV antenna masts on chimneys places the mast on a side of the chimney. Type 3, Y-type bracket places mast on corner of chimney. Both types provide two vise-type clamps to hold mast, held to chimney with galvanized straps. Simple clamp permits anchoring strap to eye-bolt after adjusting to proper length. C & G Tool Mfg. Inc., 39 Main St., E. Orange, New Jersey—RADIO & TELEVISION RETAILING.

WHAT A BASIC, LEGAL REFERENCE LIBRARY IS TO THE ATTORNEY...

RIDER MANUALS

ARE TO THE ELECTRONIC TECHNICIAN



to the **ATTORNEY**

...the field of legalisms is exacting and highly detailed. There are complex problems to be untangled, narrow paths to travel. The lawyer's BASIC library provides COMPLETE, ACCURATE and AUTHENTIC DATA on laws...with interpretations and decisions, both old and new. His library gives him the information he needs to bring his own case to a successful conclusion.



to the **ELECTRONIC TECHNICIAN**

...the science of electronics is more exacting, more highly detailed. AM-FM-TV and allied equipment all have their different servicing problems. The Electronic Technician's BASIC Library of RIDER MANUALS gives him the COMPLETE, ACCURATE, FACTORY-AUTHORIZED DATA that he needs to bring each servicing problem to a successful, speedy and profitable conclusion.

--- YOUR JOBBER HAS THEM NOW! ---

Smith MILLIVOLT-DETECTOR

To extend the sensitivity of an oscilloscope for TV alignment work, the Millivolt-Detector detects and provides linear amplification for TV signals from 10 mv to 10 v. The Detector has a 2 v output, handles carrier frequencies between 300 KC and 2500 MC. Smith Industries, P.O. Box 238, Ballston Spa, N.Y.—RADIO & TELEVISION RETAILING.

E-V PHONO CARTRIDGES

Series 12, basic 3 crystal cartridges for 78 RPM, replace over 150 standard models. Series 34 cartridges can be used in every RCA 45 RPM changer. Series 16 twin-tip cartridges are designed for Webster 256 and 356 changers, play all three speeds without weight change. Bulletin No. 105 describing these three series, with complete specifications, available on request from Electro-Voice, Inc., Buchanan, Mich.—RADIO & TELEVISION RETAILING.

C & G TV CHIMNEY MOUNTS

Type 2 offset bracket type for mounting TV antenna masts on chimneys places the mast on a side of the chimney. Type 3, Y-type bracket places mast on corner of chimney. Both types provide two vise-type clamps to hold mast, held to chimney with galvanized straps. Simple clamp permits anchoring strap to eye-bolt after adjusting to proper length. C & G Tool Mfg. Inc., 39 Main St., E. Orange, New Jersey—RADIO & TELEVISION RETAILING.

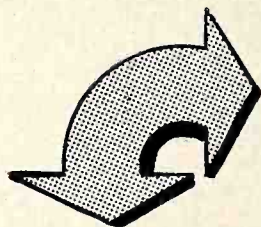

RIDER TV MANUAL VOL. 3

Larger page size, 12" x 15". All pages in place, with diagrams and related text more closely positioned. Giant pages are retained, but now have only one fold for greater convenience and durability. Complete, Accurate, Factory-Authorized Data from 74 manufacturers. 441 models. 243 chassis. An absolute "must" for every Serviceman in every TV area.

Equivalent of 2032 pages (8½" x 11") Plus Cumulative Index Volumes 1, 2 and 3, Plus the famous RIDER "HOW IT WORKS" Book... **\$21.00**

RIDER MANUAL VOLUME XX

What a Manual this is! Complete, Authentic, Reliable, Factory-Authorized Data from 74 manufacturers. 1776 pages, with every page filed in its proper place...Easier to read and use than ever before. Covers AM, FM, Auto Receivers, Record Changers and Tuners...Covers receivers to November, 1949. RIDER...and RIDER ALONE...gives you the information you need WHEN AND HOW YOU NEED IT! Get Volume XX today!

\$18.00 Including Cumulative Index, Volumes XVI through XX, Plus the Famous RIDER "HOW IT WORKS" Book.

RIDER MANUALS

Television Manual Volume 3 (Plus "How It Works" Book and Index).....	\$21.00
Television Manual Volume 2 (Plus "How It Works" Book and Index).....	\$18.00
Television Manual Volume 1 (Plus "How It Works" Book and Index).....	\$18.00
Volume XX	\$18.00
Volume XIX	\$19.80
Volume XVIII	\$19.80
Volume XVII	\$16.50
Volume XVI	\$ 8.40
Volume XV	\$19.80
Volume XIV to VII (each volume).....	\$16.50
Volume VI	\$12.50
Abridged Manuals I to V (one volume).....	\$19.80
Master Index, Covering Manuals, Vols. I to XV	\$ 1.50
PA Equipment Manual, Vol. I.....	\$18.00

NOTE: Are you receiving your copy of "Successful Servicing"? It's Rider's own publication of interest to every Serviceman. Write for it...It's FREE!

JOHN F. RIDER PUBLISHER, Inc., 480 Canal Street, New York 13, N. Y.
Export Agents: Rocke International Corp., 13 E. 40th St., N. Y. C. Cable ARLAB.

RIDER MANUALS mean SUCCESSFUL SERVICING

NOTE: The Mallory TV Service Encyclopedia, 1st TV Edition, makes reference to only one source of TV receiver schematics — Rider TV Manuals.
NOTE: The Mallory Radio Service Encyclopedia, 6th Edition, makes reference to only one source of radio receiver schematics — Rider Manuals.
NOTE: The C-D Capacitor Manual for Radio Servicing, 1948 Edition No. 4, makes reference to only one source of receiver schematics — Rider Manuals.

MERIT

SINCE 1924—FINE RADIO PARTS

News

FREE!

MERIT TV "REPL" GUIDE

JAN. 1950 ISSUE

**60 MANUFACTURERS—
400 MODELS—MOST
COMPLETE, UP-TO-DATE
LISTING**

Get this easy-to-use, time-saving guide to correct replacements for all popular television receivers. Simplifies servicing, cuts repair-bench time. Write us today for your free copy.

USE MERIT TV!

ONE SOURCE FOR

TV Tape-Marked Components:
Powers, Blocking Oscillators,
Vertical Outputs, Focus Coils,
Deflection Yokes, Flybacks.

WATCH FOR
Merit's future
issues of the
TV "Repl"
Guide.

TAPE-MARKED TO HELP YOU!

Handy tape marking on every Merit Transformer shows permanent hookup data for quick reference. Originated by Merit



MERIT

TRANSFORMER CORP.

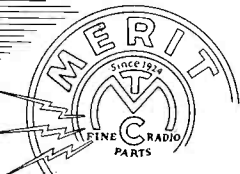

4419 NORTH CLARK ST., CHICAGO 40, ILL.

NEW



\$29²⁰
LIST

UNTUNED PREAMPLIFIER FOR WEAK SIGNAL RECEPTION MODEL S-504 TELEBOOSTER

- No tuning required—all channel reception.
 - Amplification of the order of 20 db over entire VHF TV range.
 - Input and output 300 ohms.
 - Handsome appearance—professional styling.
 - 3 position Hi-Lo and OFF switch. In OFF position antenna is connected directly to TV set.
 - Uses 2—6AK5 VHF pentodes and 1—12AT7 VHF duo triode for maximum performance.
 - Exceptionally long life; uses selenium rectifier; all components conservatively rated.
- WRITE FOR DESCRIPTIVE LITERATURE

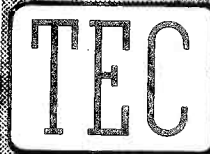

TELEVISION EQUIPMENT CORP. 238 WILLIAM ST., NEW YORK 7, N. Y.

New Catalogs

Olympic Radio and Television, Inc., 34-01 38th Ave., Long Island City 1, N. Y.: A new booklet has been made available for dealers, designed for the retail salesman who has never had the opportunity to watch a TV set being constructed, and who has little or no technical background to support his sales arguments. Booklet is entitled "A Tour of a Modern Television Plant."

Hamilton Mfg. Co., Two Rivers, Wis.: A new, 16-page booklet on clothes drying and home laundry planning is printed in color, and covers the construction, operation, benefits and features of the Hamilton dryer. It is being offered free in ads appearing in national consumer magazines.

Federal Telephone and Radio Corp., 100 Kingsland Road, Clifton, N. J.: A new bulletin gives complete specifications for Federal selenium rectifier stacks and miniature selenium rectifiers, including circuits, dimensions.

The Workshop Associates, 66 Needham St., Newton Highlands, Mass.: A 4-page brochure describing Workshop high-gain Beacon antennas contains information on principles, performance, installation and complete electrical and mechanical specifications. Copies are free.

Describes Sylvania's TV "Pay-Back" Service Plan

The following statement on Sylvania's TV servicing plan was prepared by R. K. Pew, director of service, Sylvania Television:

• In developing a service plan for Sylvania television, we felt a new method was needed whereby the television owner paid a net amount for installation and service which was more equitable with the amount of service required. It was also necessary to devise a plan where the owner's money would be deposited in safe hands and that his servicing agency be reliable and prompt.

At the same time, the servicing agency should receive payment for all services rendered on each contract, his bookkeeping and paper work should be at an absolute minimum and an adequate supply of spare parts should be readily available.

For the retail dealer who sells the service contract and performs the necessary paper work involved, there would be some financial compensation for this service.

The Sylvania "Pay Back" plan accomplishes all of the foregoing objectives without additional first cost to the customer. The service contract is between the customer and the factory. The factory holds the amount of the contract fee. With the contract, the customer is issued a coupon book containing a number of coupons, each good for one service call.

At the expiration date of the contract, the unused coupons are turned in to the factory for cash refunds. On some contracts up to 55% of the contract price may be refunded to the customer if he has not experienced trouble during the year.

Local service contractors are carefully selected to do the work under contract with the factory. A similar arrangement is available to retail dealers who handle their own service work. These service agencies install and maintain the receivers during the term of the contract. The contractor is paid a fixed amount for a standard installation at the time of installation. He is paid for each service call made (the number of calls per contract are unlimited) at the time his reports are forwarded to the factory. At the termination of each contract, the contractor is given a bonus for each unused coupon on the contracts he has handled. All parts are guaranteed to the contractor for the term of the contract.

Parts distribution is made through local parts distribution houses who maintain adequate stocks of all replacements parts at all times.

The Sylvania "Pay Back" Service Plan is advantageous to the retail dealer inasmuch as he has a "local" service contractor to service his customers' receivers regardless of where the customer may be located. He is assured that his customer will have good service. The dealer is paid a commission by the factory for each service contract.

telrex
CONICAL
"V" BEAM
ANTENNAS

INSTALL THESE SUPER HI-GAIN ANTENNAS FOR BETTER TV AND FM RECEPTION IN ALL AREAS

- THE ONE ANTENNA FOR ALL CHANNELS PLUS FM
- NO HIGH FREQUENCY HEAD NEEDED
- BETTER THAN 12 DB FRONT TO BACK RATIO ALL FREQUENCIES
- MODELS FOR EVERY INSTALLATION NEED
- CONICAL WINDOW MOUNTS FOR APARTMENT HOUSES

TO BE SURE IT'S A CONICAL "V" BEAM
... LOOK FOR THE TELREX TRADEMARK

... true conical performance without bulky metal cones

Take a tip from Telrex! Look beyond the set for the cause of weak signals, ghosts and reflections. In many cases the antenna installation is the source of trouble. For sharper, brighter pictures follow the lead of thousands of other satisfied Telrex users. Install a Telrex Conical Antenna of proven performance—the antenna with the highest gain and highest signal noise ratio—on ALL channels. Telrex delivers the full strength of the signal received to the set with negligible loss, and with practically no reflections or ghosts. For local, congested or fringe reception areas, your one best buy is Telrex!

ALL TELREX ELEMENTS ARE MADE OF HIGH STRENGTH DURAL

PATENTS PENDING
COPYRIGHT 1949

Ask your distributor for complete data or write for illustrated catalog.

Telephone—ASBURY PARK 2-7252

telrex INC.
CONICAL ANTENNAS

AMERICA'S OUTSTANDING TELEVISION BEAM

ASBURY PARK 2, N. J.

Nation-wide
ACCEPTANCE
on Proven Superiority



ANCHOR
TV PRE-AMPLIFIER

SOUTH BEND, IND.—"We have found Anchor TV Pre-Amplifier to be superior in performance to anything else on the market. It has been a profitable item on which we have built up dealer good will."

COMMERCIAL SOUND & RADIO CO.—A. E. Kester, Pres.

PHILADELPHIA, PA.—"Anchor Booster's consistency, its high gain and its performance in outer fringe areas have built for it a reputation which cannot be beat in our area. The excellency of this product has opened up many television areas and many additional sales in Television Receivers, their component parts and accessories."

RADIO ELECTRIC SERVICE COMPANY OF PENNSYLVANIA
Albert N. Kass, Sales Manager

Here are several messages from enthusiastic distributors all over the country!



ANCHOR has established general acceptance and good will for good boosters through its own top notch performance . . .

The unanimous, proven verdict of users! Anchor's engineering has not been approached in its efficiency—nor will it ever be. For Anchor's booster-specialization has developed this outstanding leadership and will continue.

Why then be satisfied with imitations? It is ANCHOR that is every day building the demand for the most reliable Booster—making more sales for dealers—adding good will.

DEPENDABILITY—WITH INSTANT SALES APPEAL

With 2½ times average gain (Voltage Ratio), and guaranteed coverage of low and high band, ANCHOR wins your customers with its compact, beautifully styled, precision construction. Also by their pride in knowing they are getting the best!

Tie this Anchor Booster into every television sale.

Get in touch with your jobber at once.

LIST PRICE \$37.50

ANCHOR ENGINEERING ALWAYS A YEAR AHEAD

ANCHOR
RADIO CORP.
2215 S. St. Louis Ave.
Chicago 23, Ill.

Tricraft presents . . .

The new "VIDIETTE"
indoor TV antenna

model "700"



by the ORIGINATORS of the electrically-tuned antenna

NO PUSHING AND PULLING OF RODS

Change stations without effort . . .

Simply move knob to channel desired . . . you are automatically electrically tuned in and reception comes BOOMING in.

ATTRACTIVE . . . SMALL . . . COMPACT

Priced for volume sales

Individually boxed . . . 24 units to a carton

Shipping weight, 32 lbs.

Write for illustrated literature today

TRICRAFT ANTENNAS are available at all leading jobbers

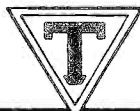

Tricraft Products Co.

1535 North Ashland Ave., Chicago 22, Ill.

Manufacturers of complete line of Television, FM and AM antennas and accessories

HERE IT IS THE EASY TO ERECT
ENERGY HYDRAULIC
TELEVISION MAST

An all hydraulic sectional Television Mast extended with hand pump or power unit. Raised and lowered as service requires.

EASY INSTALLATION.

ENERGY Masts can be installed in a short time, either clamped to side of building or set in concrete away from buildings. Only two men needed. Weight of 60 foot Mast is 300 pounds, 22 feet in length collapsed. Hand or power pumps can be furnished.



- ONE MAST CAN SERVE MANY OUTLETS.
- MAST WILL WITHSTAND 100 MILE WIND.
- MANUFACTURED IN THREE AND FOUR SECTIONS. No guy wires needed.

- RECOMMENDED FOR TWO-WAY TAXI RADIO INSTALLATIONS.
- ENERGY PORTABLE HYDRAULIC DEMONSTRATION ANTENNA.

Smooth quick operation ideal for commercial car demonstration.

For any test location, can be set up in a few minutes.

Write today for literature and prices.

ENERGY FARM EQUIPMENT CO.
Monticello, Iowa

Tele-Tone 1950 TV LINE

Featuring built-in antennas and automatic gain control, the new line is led by a 10-inch plastic table model priced at \$129.95. A 12½-inch table set in wood

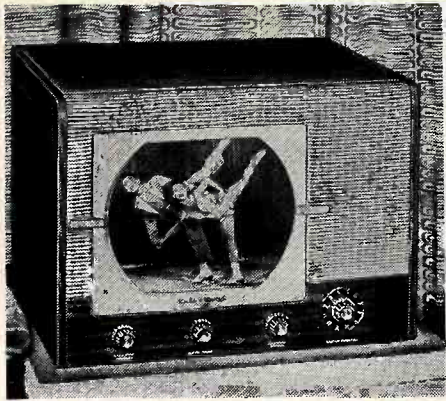

(shown) is priced at \$169.95, while the 16-inch table model with rectangular picture tube is \$249.95. A 16-inch console retails at \$279.95. Tele-Tone Radio Corp., 540 W. 58th St., New York 19, N. Y.—RADIO & TELEVISION RETAILING.

Atwater 1950 LINE

The new line of TV sets features a 19-inch console combination (model 135) with AM-FM radio, built-in antenna, and a plug for phono attachment. This model lists for \$449.95. A 12½-inch table model, No. 351, lists at \$219.95. Line also includes a 16-inch console combination (No. 513) with AM-FM radio and phono jack, at \$349.95. Atwater Television Co., 360 Furman St., Brooklyn, N.Y.—RADIO & TELEVISION RETAILING.

RCA AM-SHORT WAVE RADIO

Model 9-X-651 is a plastic table model radio receiving the broadcast band plus the

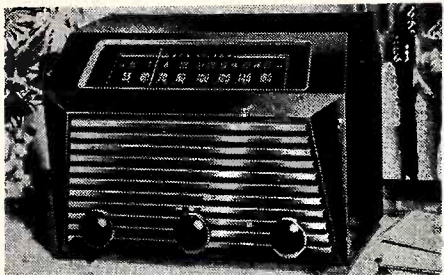

16, 19, 25, 31 and 49 meter short-wave bands. A phono jack is provided. Retail price is \$34.95. RCA Victor Div., Camden, N. J.—RADIO & TELEVISION RETAILING.

Telequip TV SETS

The new line includes a 16-inch TV set to retail at \$239.95 in the table model (TS-316) and \$269.95 in the console (CS-16). Only 12½-inch and 16-inch models are included in the 8 new receivers, the price leader being a 12½-inch table set (TS-12) priced at \$179.95, while a 12½-inch console (CS-312) is \$209.95. Four "De Luxe" models range from \$199.95 for a 12½-inch table set to \$299.95 for a 16-inch console. Telequip Radio Co., 1901 S. Washenaw, Chicago 8, Ill.—RADIO & TELEVISION RETAILING.



WEBSTER ELECTRIC
Teletalk
1620 W. 1ST. OFFICE

*quality intercommunication
for small business
and specialized
departments!*



The "butcher, the baker, the candlestick maker" along with a host of other small businesses will find this new Webster Electric "Teletalk" to their liking as a time saver . . . further to their liking because it is a quality unit at a low, reasonable price. Special departments of large businesses also find that it meets their requirements.

Dealers find that it is more profitable to handle and sell quality intercommunication . . . it builds good will and gives customer satisfaction. Those interested should write for full information on open territories.

*Where fewer speakers are required, the price is less. Price shown is less installation.

WEBSTER  **ELECTRIC**

Webster Electric Company, Racine, Wisconsin • Established 1909 • Export Dept.
13 East 40th Street, New York 16, N. Y., Cable Address: "Arlab," New York City.

"Where Quality Is a Responsibility and Fair Dealing an Obligation"

Telrex Lowers Prices

Telrex, Inc., manufacturers of conical "V" Beam antennas, has announced price reductions averaging between 15 to 22% on its complete line of TV antennas and accessories. The new price schedule, incorporating the usual Telrex inventory protection plan, has been posted to all Telrex distributors. The jobbers are informed that quality and design remain unchanged and that Telrex antennas will continue to feature dural elements.

"The new, lower prices," according to a statement by M. D. Ercolino, president of Telrex, Inc., "are made possible by new, improved production methods. The new addition to our plant, coupled with the acquisition of additional

engineering talent," Mr. Ercolino added, "has more than trebled our capacity and places us in an excellent position to meet the rising demand for our quality products and engineering services. New specially designed equipment rationalizes to the utmost every step in our manufacturing operations. As a direct result." Mr. Ercolino added "we are now able to offer our Telrex quality antennas at prices within reach of every TV set owner."

Telrex, Inc., has designed and manufactured antennas since 1921. As one of the leading manufacturers of TV antennas in the United States, it is especially identified with the development and introduction of the Conical "V" Beam for TV reception.

Tele King 1951 LINE

7 New models include 1 ten-inch, 2 twelve-inch, 3 sixteen-inch, and 1 nineteen-inch receiver. Model 510, 10-inch table set in wood cabinet, is \$159.95, model 812,

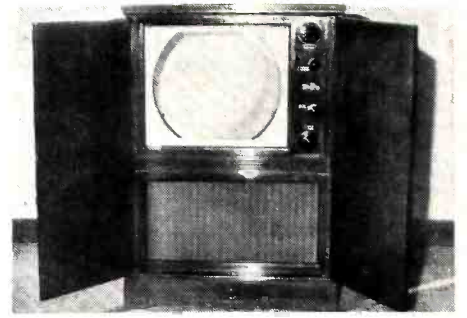

12-inch wood table set, is \$199.95, and model 516, 16-inch table model with rectangular tube, is \$269.95. Model 919, 19-inch console (shown) is \$479.95. Tele-King Corp., 601 W. 26th St., New York 1, N. Y.—RADIO & TELEVISION RETAILING.

G.E. RADIOS

A new table radio-phonograph, model 129, features a 3-speed automatic changer and a dual stylus for playing all types of records, with a 5 tube-plus-rectifier radio and 5-inch loudspeaker. List price is \$89.95. Also announced is a new clock-



radio line consisting of 6 models, 4 of which have an appliance timer and convenience outlet capable of handling up to 1100 watts. The line (models 500, 501, 505, 506, 507, 508) range from \$29.95 to \$39.95. General Electric Co., Electronics Park, Syracuse, N. Y.—RADIO & TELEVISION RETAILING.

Starrett TV CONSOLETTA

The "Sam Houston," 12½-inch TV consolette, is the first set to incorporate the newly developed Starrett 19-tube chassis. The set includes built-in antenna, and Starrett's "Film-Freed" picture tube. In mahogany cabinet, the Sam Houston retails at \$279.95. Starrett Television Corp., 601 W. 26th St., New York 1, N. Y.—RADIO & TELEVISION RETAILING.

National TAPE RECORDER

Model MR 6000 features 2 hours of recording time by utilizing multiple-channel recording on a 2-inch wide tape. Tape speed is 7.5 inches per second, and recording or playback is possible in both forward and reverse directions. National Recorders, Inc., 7120 Melrose Ave., Los Angeles 46, Calif.—RADIO & TELEVISION RETAILING.

Jensen
REPLACEMENT NEEDLES
Fit Your Cartridge

Added Profits
FOR SERVICE TECHNICIANS AND DEALERS

Do you know that surveys show 92% of all post war record players need a new needle? A Jensen needle restores original brilliance to phonographs. Record players take on new life with tonal qualities that had been forgotten. Jensen makes a replacement needle to fit any cartridge or record player.

FREE REPLACEMENT NEEDLE WALL CHART
Send for Jensen's Replacement Needle Wall Chart and new Cross Reference Chart, listing the complete information needed for quick and easy selection of the proper replacement needle.

Jensen INDUSTRIES, INC.
329 S. Wood St., Chicago 12, Ill.

Garod TV SETS

The 1950 line includes the Custom Model 1674 in mahogany cabinet with doors, providing 16-inch picture tube, built-in



antenna and dual loudspeakers, lists at \$379.95. Garod Electronics Corp., 70 Washington St., Brooklyn 1, N. Y.—RADIO & TELEVISION RETAILING

Strong Acceptance of Black Tube for TV

Enthusiastic acceptance has been given to the so-called "black" TV picture tube, by the public and the set manufacturers as well as the makers of glass bulbs for TV tubes, according to the Rauland Corporation of Chicago, which introduced the "Luxide Screen" to the public September 1, 1949. Various descriptions as "Black," "Glareban," "Filter Face," "Blaxide," and other terms, the new type face plate for picture tubes is said to improve picture quality by reducing the destructive effect of room lighting on picture contrast. An additional feature is the marked reduction of halation, also a picture quality deteriorating factor, which is caused by internal reflection from the screen phosphors. According to the Rauland Corp., few TV sets are now being offered which do not incorporate this new type picture tube.

Janette Appointment

Janette Manufacturing Co., Chicago, builders of gear-motors and rotary converters, announce the appointment of W. H. SaLee as general sales manager. Ogden J. Maag will continue as assistant sales manager. Frank C. Hartmann, who recently joined the company, will assist Mr. Maag.

Sell Snyder Masts

Announcement has been made that Ontario Research Corporation of 2218 W. Ontario St., Philadelphia, has been designated sole selling agent for Snyder Manufacturing Company's TV masts of Walker Dualcoted steel.

The announcement came from Richard Morris, newly appointed sales manager of Ontario, who pointed out the features of the Snyder mast.

New RCA Service Policy

In line with the trend toward lower prices for TV receivers, the RCA Service Company has put into effect a new low-cost owner contract. The new contract plan will be available as an alternative choice for purchasers of RCA Victor TV sets who desire a smaller initial cost than that required for the complete coverage contract. The new plan provides installation, warranty of parts and tubes (including kinescope) for one year, unlimited service for 90 days, and after that a preferred flat rate of \$5.75 per call for service as needed, with contract prices starting at \$22.95 with a built-in antenna and \$39.95 with an outdoor antenna for

10-inch sets. Comparable charges for 12½-inch models are \$24.95 and \$44.95, and for the 16-inch models \$29.95 and \$49.95. Prices will be slightly higher for combination instruments, and in outlying areas, but the preferred flat rate charge for service calls will be \$5.75 for all models.

Sylvania Appointments

The appointment of George C. Connor as general sales manager for the Photoflash Division and Alfred C. Viebranz as general sales manager of the Electronics Division of Sylvania Electric Products Inc. was announced by R. H. Bishop, vice-president in charge of sales.

Cletron Loudspeakers are gaining preference BECAUSE of



Model PM-10G

1. Finer tone amplification with better aluminum voice coils that dissipate heat faster.
2. Stronger construction—(a 3" speaker supports 300 lbs.).
3. Non-fluttering because of vulcanized cones and spiders.
4. Fully weather-proof—(will even play when fully submerged in water).
5. Millions are chosen each year by the most expert radio technicians.
6. The Cletron line is complete with an Alnico 5 or E.M. speaker for every need.
7. Beautiful blue-grey Hammerloid finish, infra-red baked.
8. Individually packed in sturdy corrugated cartons.

Cletron Radio and TV loudspeakers handle greater power without distortion or overheating. No warping. No buckling. No corrosion.

Write or wire now for your best buy in Speakers. It's CLETRON.

CLEVELAND ELECTRONICS, INC.

6613 EUCLID AVENUE • CLEVELAND, OHIO

MORGAN EXPORTING CORP. • 458 Broadway Avenue • New York, New York

Cletron The Choice of Expert Radio Technicians

New Appointments in GE Tube Division

Three new appointments have been announced in the Tube Divisions of the General Electric Company by J. M. Lang, manager.

E. F. Peterson has been named manager of sales of the divisions, with headquarters at Schenectady.

L. B. Davis has been appointed manager of the receiving tube division at Owensboro, Ky.

K. C. DeWalt has been appointed manager of the cathode ray tube division at Electronics Park, Syracuse, N. Y.

(A third unit of the Tube Divisions—the industrial and transmitting tube di-

vision—is managed by G. H. Henyan who has held that position since August, 1948.)

Tele-tone Names Gunther

Tele-tone Radio Corp. has appointed H. U. Gunther Co., 1013 Penn Ave., Pittsburgh, as distributors of its complete television and radio line, it was announced by Morton M. Schwartz, Tele-tone general sales manager.

The Gunther Company will have exclusive distribution franchises in western Pennsylvania, eastern Ohio, northern West Virginia, and western Maryland.

Philco Ups Production

Philco Corporation is planning to greatly expand its television receiver production and sales in 1950, it has been announced by William Balderston, president, who says that his company will manufacture and sell between 750,000 and 800,000 television receivers this year.

"The excitement and the growth of television have exceeded even the most optimistic forecasts and predictions, Mr. Balderston pointed out. "The industry's production has increased from 200,000 receivers in 1947 to 1,000,000 in 1948 and to about 2,700,000 in 1949. All signs point to a further substantial increase during 1950 with a potential sales demand for more than 4,000,000 television receiver this year."

Zenith Reorganizes Its Field Sales Set-Up

The demand of a rapid expansion in its volume of business has compelled Zenith Radio Corporation to reorganize completely its field sales organization. Announcement of the change-over was made by L. C. Truesdell, Zenith's sales manager of household radio and television.

Under the new set-up, the United States is divided into six regions with a regional manager over each to direct Zenith sales activities. Further each region is subdivided into districts. District sales managers handle these areas and report directly to the regional manager.

The New York region includes New England, eastern New York and Pennsylvania; New Jersey, Delaware, Maryland, and Washington, D. C. The Atlanta region is bordered by Virginia and Tennessee on the north; eastern Arkansas, Mississippi, and southern Louisiana on the west.

Cleveland's area includes western Pennsylvania and western New York state; West Virginia; northern Kentucky, Ohio; and eastern Michigan. The midwest, with its center in Chicago, extends from Michigan, Indiana, and Kentucky west to Nebraska, the Dakotas and eastern Missouri; from the U. S. border on the north to Arkansas on the south.

The Dallas region comprises the southwestern states from Texas to the lower border of Nebraska, west to include Wyoming and Colorado, and east almost to the Mississippi river. The region of San Francisco embraces all the western coastal states plus Arizona, almost all of New Mexico, and Utah, Idaho, and Montana.

In organizing the new sales set-up, Truesdell pointed out, each regional manager was selected because of his past experience as a Zenith district sales manager.

Ray L. Hoefler is to supervise the New York territory; Edgar F. Lindgren, Atlanta; Hugh H. Boyer, Cleveland; Irving H. Herriott, Chicago; James H. McKee, Dallas; and Clarence Pagel, San Francisco.

ANNOUNCING DUOTONE'S

"BIG 50" DEAL

ON BEST SELLING SHOCKPROOF NYLON NEEDLES*



Guaranteed shockproof!
Demonstrate it by actually *bouncing* the whole tone arm on a record! Long lasting . . . up to 5,000 plays!

50% more advertising for the needle with greater acceptance than any other on the market!

50% cooperative advertising offer. Hard selling, carefully prepared to really *move* needles . . . yours, upon authorization, on a 50-50 cooperative basis.

50 dollar deal. You pay only \$50 for 3 cards of Nylons and 2 Stars . . . you get **FREE** ten nylon needles worth \$25! The whole deal complete in one package!

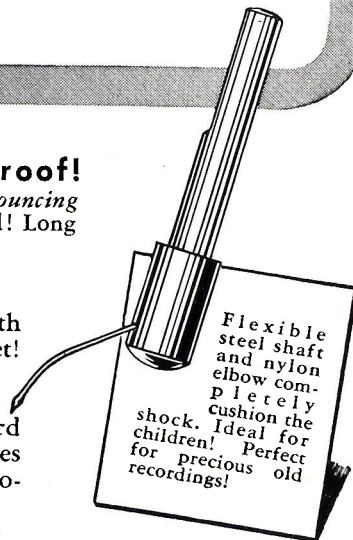

IT'S THE DEAL OF THE YEAR! STOCK UP NOW!

See your jobber or write Duotone direct.

*PAT. PENDING



DUOTONE

DUOTONE COMPANY
799 Broadway, New York 3, N. Y.

New Catalogs, Manuals and Selling Aids

Radio Corp. of America, Tube Department, Harrison, N. J.: A second volume of the RCA Television Pict-O-Guide has been published and contains more than twice as many pictures and a greatly expanded text to supplement the information in the first book. The book may be obtained from wholesale distributors by users of RCA, Cunningham and RCA Victor tubes.

Newark Electric Co., 242 West 55th St., New York 19, N. Y.: The new 1950 catalog features kits, sets, parts and accessories, covering all types of radio, TV, electronic and sound equipment. A special section covers high fidelity FM, AM and phono instruments for custom installation. Catalog available free on request.

Hickok Electrical Instrument Co., 10523 Dupont Ave., Cleveland 8, Ohio: Technical Study No. 342 covers modern AM, FM and TV servicing with the oscilloscope, with actual diagrams of wave shapes drawn from a scope screen. This 50-page booklet is available at \$1 per copy by writing H. D. Johnson at the Hickok company.

John F. Rider, Publisher, Inc., 480 Canal St., New York 13, N. Y.: Rider Manual Volume 20, the latest volume in the series of manufacturers' authorized data has been announced as a January, 1950, publication. AM, FM, auto receivers and record changers are covered. A "How It Works" book with cumulative index for vols. 16-20 is a feature.

Lafayette Radio, 100 Sixth Ave., New York 13, N. Y.: The "High Fidelity Music Guide" is a concise, 12-page booklet by David Randolph, music consultant for Lafayette. The requirements of high fidelity are outlined, with suggested components for custom installations, installation and cabinet information. The booklet may be had by writing this firm.

Radio Corp. of America, Tube Department, Harrison, N. J.: The 1950 edition of the RCA Tube Dept.'s "Tube Reference and Calendar Notebook" is now available from RCA tube distributors. A miniature encyclopedia, the book is prepared especially for radio and TV service dealers, engineers, technicians, amateurs, and purchasing agents. Receiving tube data, battery charts, and TV service data are among the items covered.

N. V. Philips Gloeilampenfabrieken (The Netherlands): Fundamentals of Radio Valve Technique by Ir. J. Deketh is an up-to-date work dealing with the physical principles, the latest constructions and the properties of radio receiving and amplifying tubes. Available in English, the book comprises 547 pages and 384 illustrations and sells for \$4.75. Distributed in the U. S. by Elsevier Publishing Co., 215 Fourth Ave., New York, N. Y.

Takes Capehart Line

Appointment of Seattle Radio Supply Inc., Seattle, Washington, as distributors for the Capehart line of television receivers and phonograph-radios in western Washington is announced by C. R. Ward, sales manager of Capehart-Farnsworth Corp., Ft. Wayne, Ind., a subsidiary of the International Telephone and Telegraph Corp.

G. A. Reeves is president of the firm, which also distributes Horton washers and Coolerator refrigerators. A. L. Lee is vice-president; Norton Clapp, secretary and treasurer, and James K. Dooley, sales manager.

Trad Enlarges Plant

Trad Television Corp., Asbury Park, N. J., is in the process of constructing its own cabinet manufacturing plant on the company's premises at Asbury park, according to Alex Brown, sales manager.

Best Vue Appointments

Milt Gold, president of Best Vue Products, 247 Centre St., New York City, has announced the appointments of Joseph Greene and Jerome Parker as representatives handling the Best Vue antenna line in New York.



MODEL 12 CT—Special Console
—Expanded 12½" Picture—Turret-type tuner—10" speaker—In beautiful Mahogany Veneer—List **\$249.95**

MODEL 16 CT—Supreme Console
—Giant 16" Rectangular Picture—14,000 volt anode supply for specially brilliant picture—Turret-type tuner—10 inch speaker—In beautiful Mahogany Veneer.
List..... **\$299.95**

MODEL 19 CT—Grand Console
—Tremendous Expanded 19" Wide Angle Picture—Turret-type tuner—10 inch speaker—In Mahogany Veneer.
List..... **\$399.95**



MODEL 12 RPT—Combination 12½" TV—Radio-Phono—Automatic shut-off record player—Intermixes 10 and 12 inch records—Plays any records: 33½ LP; 45 and 78 RPM—2 Knob Control on TV—Radio-Phono and TV operate independently of one another—**\$449.50**
Turret-type tuner. In Mahogany Veneer—List.....



MODEL 112 CT—Expanded Picture—8 in. speaker—In beautiful Mahogany Veneer. List **\$159.95**
12½" Screen

IT'S STRIKING!

Jackson TELEVISION

Designed By John Bergan,
America's Foremost Furniture Stylist

- RCA Licensed
- Complete Fuse Protection
- 2 Knob Control
- Built-in Antenna
- True FM Sound
- Picture and Sound Interlocked
- AFC on Horizontal Control

MODEL 16 RPT—Combination 16" TV—Radio-Phono—Same as 12 RPT but with GIANT 16 INCH RECTANGULAR PICTURE. Entire face of the tube is utilized. Special 14,000 volt anode supply for brilliant picture. Mahogany Veneer. List **\$499.50**

ALL MODELS AVAILABLE IN BLONDE

JACKSON INDUSTRIES, INC.
58 EAST CULLERTON STREET, CHICAGO 16, ILLINOIS

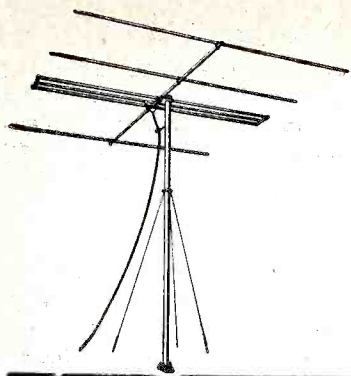

TRIO ANNOUNCES SOMETHING *new* IN YAGIS

A new type double folded dipole developed by Trio solves Construction and Engineering problems to give improved performance and sturdy light weight.

High Gain—10 db on optimum channel.

High Front-to-Back Ratio—over 25 db. Maximum suppression of minor lobes to give sharp directional pattern.

Ease of Assembly and Installation—6 bolts for complete assembly.

Light Weight—only 5 lbs. for channel 5, 2¼ lbs. for channel 9.

Flexibility—more than one bay may be mounted on mast with independent orientation of each.



List price with mast and mounting hardware, Channels 2-6 **\$35.00**

Antenna bay only Channels 7-13 less mast **\$14.95**

Order Model No. 304 by channel number. If not available through your jobber, write for details. Choice distributor territory still available.

TRIO MANUFACTURING CO., GRIGGSVILLE, ILL.

NOW! Everything you want to know about . . .



New! Illustrated! Authoritative!
Includes COLOR TELEVISION

Just off the press; a GOLD MINE OF INFORMATION about television servicing and trouble-shooting, fully illustrated, clearly explained. It's a complete, up-to-the-minute explanation of television, including UHF, Color TV, new adapters, converters and practical applications. Shows you step-by-step, how to repair, adjust, align, service all makes . . . how to locate and correct troubles in a hurry. Edited by COYNE television experts. Easy-to-follow instructions. The perfect reference book and practical working guide for radio and TV servicemen and retailers, broadcasters, instructors, students, industrial libraries . . . for **everyone** interested in keeping up with the swift advance of modern television. At your book dealer or get your copy today on 7-Day Trial Offer.

**SEND NO MONEY
INSPECT 7 DAYS
AT OUR RISK**

Send no money. Just fill out handy coupon below. Pay postman only \$4.25 plus C. O. D. postage. After 7 full days, you must be satisfied or return for prompt refund. No risk! Mail coupon TODAY!

ORDER TODAY—TRIAL OFFER COUPON

Educational Book Publishing Division
COYNE ELECTRICAL & RADIO SCHOOL
500 S. Paulina St., Dept. 20-E3, Chicago 12, Ill.
YES! Rush your new PRACTICAL TELEVISION SERVICING and Trouble-Shooting Manual on trial offer. I will pay postman \$4.25 plus postage. Book may be returned in 7 days for prompt refund.

Name
Address
City Zone State
 I am enclosing \$4.25. You pay postage. Same Money-back Guarantee.

Today's Biggest Value
in 3-speed Portables!

V-M

Model
8025-A

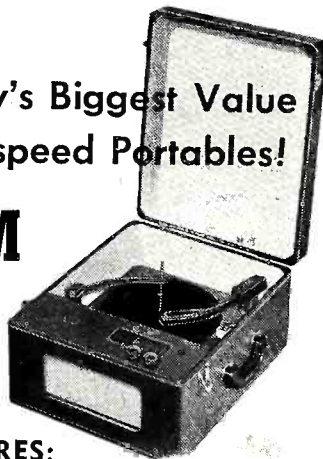

FEATURES:

- FULLY AUTOMATIC OPERATION for all records—33-1/3, 45, & 78 rpm.; 7", 10" and 12".
- AUTOMATIC SHUTOFF after last record.
- AUTOMATIC INTERMIX, 10" and 12" records of same speed.
- TONE AND VOLUME CONTROLS.
- 5" ALNICO SPEAKER.
- BEAUTIFUL LEATHERETTE CASE.
- Utilizes well-known V-M Tri-O-Matic Record Changer, preferred by most manufacturers of Radio-Phono-TV combinations.

LIST PRICE \$69.95

Get full details today from your local jobber.

V-M CORPORATION
Benton Harbor, Michigan

David Davis Joins GE



David Davis, shown, has been appointed merchandising coordinator for radio and television receivers in the General Electric Company's Electronics Department, announced Ernest H. Vogel, manager of marketing for the department.

Admiral Wholesalers

The appointment of the Irion Co., 2159 Mills St., El Paso, Texas, as exclusive distributor of Admiral refrigerators, ranges, television and radio-phonos, has been announced by W. C. Johnson, Admiral vice-president in charge of sales. The building location of the new distributor, equipped with air-conditioned offices and a showroom with ample warehouse space, is served by both railroad trackage and truck loading facilities. The officers of the firm are: C. H. Irion, president and general manager, and D. A. Williams, secretary and treasurer.

Magnavox Appointment

Robert J. McDonald has been appointed district sales manager for The Magnavox Company with headquarters in Philadelphia, according to Frank Freimann, executive vice-president. His territory will comprise eastern Philadelphia, southern New Jersey and Delaware. Mr. McDonald is widely experienced in radio - phonograph - television and appliance fields.

Uses Webster Unit



Sam Eskin, folk song collector, is shown on one of his travels about the country, recording music on the spot with a Webster Electric Ekotape recorder-reproducer.

Malling in GE Sales Post

Edward A. Malling has been appointed sales manager for component parts in the General Electric Receiver Division at Electronics Park, according to an announcement by W. M. Skillman, manager of sales for the division.

Malling will have responsibility for the sale of parts to initial equipment and distribution accounts, Skillman said. This includes the sale of such items as loudspeakers, television receiver components, antennas, phonograph tone arms and the variable reluctance cartridge.

First City-wide Disposal Installation Announced

The first complete, city-wide installation of garbage disposals coming at a time when the appliance is beginning to gain national recognition as a municipal health and economy measure should do much to broaden the market for this appliance, opening a new area of dealer profits. This was the comment of Ralph C. Cameron, noted consultant on municipal installations and authority on sanitation, who went to Jasper, Indiana, to initiate steps which resulted in the unique trial project of installing disposals in every home in the town of 5,000.

The move culminates two years of discussions between Jasper officials and Cameron since plans for a new sewage treatment plant were made public in 1947. The national municipal authority is administrative assistant to the vice-president of Hotpoint, Inc.

"As a result of the forward action of this town to eliminate garbage wagons and cans once and for all, there are dozens of communities studying similar action throughout the nation," Cameron said. "The testing and home demonstration techniques developed in Jasper will be valuable to authorities everywhere as the 'Jasper' project spreads."

National "Slip-Pak"



The "Slip-Pak," shown, is a new type of forms holder for use in retail stores; available in a variety of sizes. The National Cash Register Co., Dayton, O., has placed the units on the market.

New Rep Committees

Los Angeles chapter of The Reps recently met and appointed 1950 committees. Dave Marshank heads the ethics and grievances group, with Gerald B. Miller, Norman Neely, Carl A. Stone and W. C. Hitt.

George Davis and William Patterson head publicity with Al J. Rissi and Milton Ealy the welfare committee. Carl A. Stone chairmans inter-industry relations with Jerry Hill, Harry Lasure, Dave Marshank and W. C. Hitt. Howard Saul heads membership with James Hill and Walter Harmon. John T. Hill is program chairman with Bob Boniface and

Ralph Reid, and new industry chairman is J. van Groos and Conrad R. Strassner, Frank B. Koessler, Norman Marshank, Wiley M. Doran and Fred Ireland.

Duchess Wholesalers

The Teleking Corporation of New Jersey, with headquarters in Newark, N. J., has been appointed exclusive distributor for Duchess washers. The territory is northern New Jersey, and Rockland County in New York. The announcement of this appointment was made by F. W. McGrath, vice-president in charge of sales, Appliance Manufacturing Company, Alliance, Ohio.

U/L LISTED

Rauland

High-Fidelity 1825 Phonograph Amplifier

*** TOPS FOR CUSTOM INSTALLATIONS!**

EXCLUSIVE! Detachable Remote Preamplifier

Here's unlimited flexibility for custom installations! Preamplifier is detachable; has universal mounting features permitting positioning to meet mechanical requirements of any installation. Mounts horizontally, vertically, inverted, etc. Compact; only 2 $\frac{3}{8}$ x 2 $\frac{3}{8}$ x 11".

- 5-Position Frequency Cut-off (Noise and Scratch Suppression 12 db per octave)
- Boost Type Tone Controls
- Dual Volume Controls
- Dual Input Selector
- Plug-In Equalizer

+1DB, 40 TO 20,000 CPS

25 Watts Output.....5% harmonic distortion
20 Watts Output.....2% harmonic distortion
15 Watts Output.....1% harmonic distortion
(Measured at 100, 400 and 5000 CPS)

Percentage Intermodulation Distortion taken at 60 and 7,000 cycles with 4 to 1 ratio:
2 Watts—.54% (home level); 10 Watts—2%; 15 Watts—3.2%.

The RAULAND Model 1825 High-Fidelity Phono Amplifier puts you on top in the custom-installation market. Outstanding in its mechanical advantages—amazing in its performance—there's nothing on the market comparable for features and value. Available for immediate delivery from stock. Get the full details today!

See your RAULAND-BORG Distributor for full information on the RAULAND 1825 High-Fidelity Phono Amplifier. Compare its features and price! Get your profitable share of the big market for quality custom installations with this fast-selling amplifier. It's tops for the advanced features and value custom-builders appreciate and want.

Electroneering is our business

SOUND
EQUIPMENT

Rauland

INTER-
COMMUNICATION

RAULAND-BORG CORPORATION • 3523-L Addison St., Chicago 18, ILL.



Here's the answer to the TV Dealers' prayer—A tripod and 30 foot mast for quick home demonstration installation. Completely portable—yet ideal for permanent installations, too.

Tripod opens to 9 foot spread. Each foot staked for additional stability. Completely assembled and tipped up at site by one man in 10 minutes.

REPRESENTATIVE WHOLESALER
AND DEALER INQUIRIES
INVITED - WRITE

UNIVERSAL PRODUCTS CO.
4100 TAYLOR AVENUE
RACINE, WISCONSIN

Chatten Resigns From North American Philips

L. J. Chatten, prominently associated with the radio and appliance industry for a number of years, has resigned as director, vice-president, and general commercial manager of the North American Philips Company. He will remain with the company until the end of March. Mr. Chatten has announced no definite plans for the future except that following a short vacation he intends to continue his activities in the radio and television field.

Novel Starrett Warranty

Starrett Television Corp., New York City, is giving a Starrett warranty phonograph album, consisting of a 7-inch two-sided recording, as its official guarantee terms with every Starrett set sold. The album has a modern four-color cover, and is entitled "Our Word Is Your Bond." The recording is a friendly message, welcoming the new owner into the Starrett family.

"Mary Proctor" Ironing Method With Proctor Iron

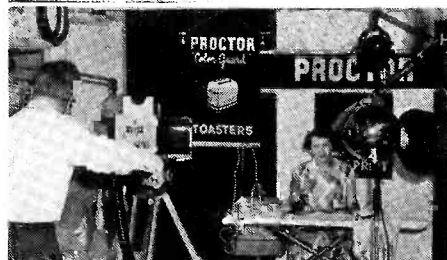

"Mary Proctor Day" at a super market in Oakland, Calif., featured a television demonstration of the Mary Proctor sit-down ironing method before the cameras.

New Arvin Jobbers

Radio Products Sales Co., 1501 S. Hill St., Los Angeles, has signed a franchise with Noblitt-Sparks Industries, Inc., for exclusive distribution of its Arvin radios, television receivers and appliances in Los Angeles and surrounding territory, says an announcement from Raymond P. Spellman, Arvin's radio sales manager. Charles Sexton is president of the West Coast distributing company, M. L. (Bob) Kane is radio sales manager and D. H. Dumas has charge of television sales.

Standard Coil Event



Glenn E. Swanson, president, Standard Coil Products Co., Inc., of Chicago, Los Angeles and Bangor, Mich., announced the production of the company's millionth TV tuner. Pictured above, right, Mr. Swanson, receiving the millionth tuner from John R. Johnson, plant superintendent of the Los Angeles factory.

TVCA

Television Cabinets

CUSTOM QUALITY at PRODUCTION PRICES



AVAILABLE FOR 16" and 19" ROUND OR RECTANGULAR TUBES

HEIGHT 42"
WIDTH 30"
DEPTH 25"

SUNBURST GRILLES OPTIONAL

CONSOLE MODELS WITH FULL-LENGTH DOORS, featuring

Piano Finish . . . Master Craftsmanship
Finest Mahoganies . . . Leather Doors
Modern Cabinets in Bleached or Cordovan Mahogany.

TELEVISION CABINET CO. OF AMERICA

2436 Grand Concourse, Bronx 57, New York
Telephone LUdlow 4-2502

NEW PRECISION ELECTRONICS MUSIC AMPLIFIER

the undisputed "Best" or your money refunded

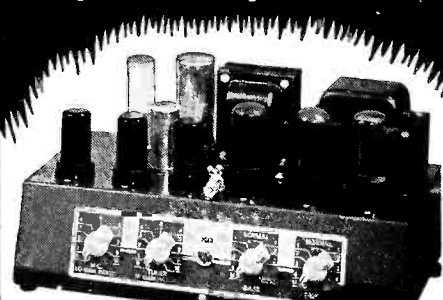

MODEL 100 PG \$49.50

Performance limited only by your input and output components. For any magnetic or crystal pickup, radio, or microphone. Multiple impedance to match any speaker.

Also available in models 50 PG and 200 PG. Write for literature and name of your nearest jobber.

PRECISION ELECTRONICS, Inc.
641-643 MILWAUKEE AVENUE
CHICAGO 22, ILLINOIS

SPECIALISTS IN SOUND...

RCA Dealer Help

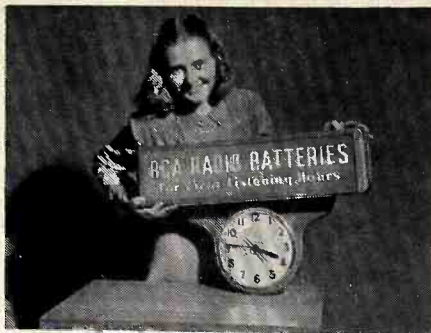

Combination "fireball" and clock sign, suitable for window or interior display, has been announced by the RCA Tube Department as a sales-promoting fixture for RCA battery dealers.

Open New Sams Plant

Howard W. Sams & Co., Inc., analytical engineering laboratories, and publishers of radio, television and electronic manuals, is now located in its new plant at 2201 E. 46th St., Indianapolis 5, Indiana, according to an announcement released by Howard W. Sams, president. The new building, comprising 30,000 sq. feet of daylight air conditioned floor space will house the entire operation of this business, which presently occupies four locations in Indianapolis and two in Chicago.

A seven-year agreement enables Howard W. Sams & Co., Inc., to purchase the modern steel, brick and glass building after a rental period from the Tows-ley Estate of Indianapolis.

Name Schottenberg

The LaPointe Plascomold Corporation, Unionville, Conn., manufacturers of the VEE-D-X television line, announces the appointment of Ray T. Schottenberg as their representative for southern New Jersey, eastern Pennsylvania, Maryland, Delaware and the District of Columbia.

Hotpoint Disposall



The Hotpoint garbage Disposall is dramatized in this window display featuring the device as part of the electric "clean-up center," with labeled food waste that can be whisked away when cold water is turned on.

IMPROVE YOUR METHODS — INCREASE YOUR BUSINESS

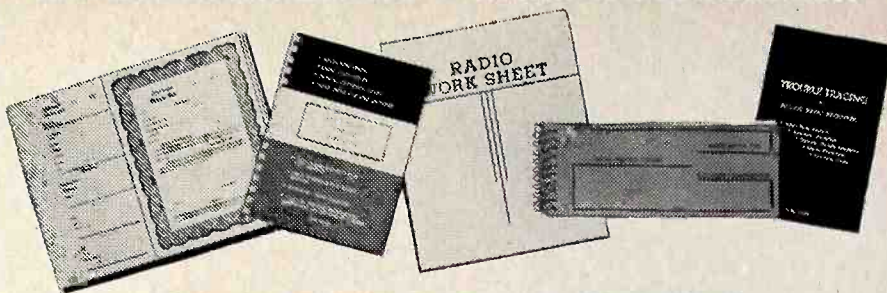

BUSINESS BUILDERS BY OELRICH PUBLICATIONS

TV-1—TELEVISION SERVICE PLAN—Book of 100 serially numbered contract forms for TV Service Dealers and Installers. Your profit or losses at a glance. Two part forms printed in rich brown provide owner certificate and registry stub. Stub remains in book showing complete details of installation, service and your costs in time and material. Durable maroon cover, spiral bound to open flat. Series available 101-1100 in books of 100

TV-1—Book of 100 Contracts\$2.25

WS-1 RADIO SERVICE WORKSHEET

Show your customer full details on his repair job including the things that are never brought to his attention. 38 possible minor repair check-offs and spaces provided for parts used, tubes and services. A valuable aid to building customer good will. Size 8 1/2" x 11" x 3/8".

WS-1 Pad of 50 sheets\$.60

RB-1 3rd Edition—RADIO SERVICE STANDARD RATE BOOK

Comprehensive pricing system and code of ethics covering each type of Radio in six separate sections, outlining general service procedures and rates for various types of repair service. Retail prices on standard parts, tubes and crystal cartridges, plus flat rates for pick-up, delivery, estimates and alignment. Battery, dial belt, ballast tube cross index. 54 pages—plastic spiral bound to open flat. Many other features

RB-1—per copy\$1.00

TT-1—TROUBLE TRACING IN AC-DC RADIO RECEIVERS

Down to earth servicing data easily read and understood. All material devoted to servicing of A.C.-D.C. sets. Test cases, individual parts analysis, alignment procedures, service methods, plainly written with technical terms held to a minimum. 50 pages

TT-1—per copy\$1.00

SR-1 RADIO SERVICE RECORD—Book of 100 Job tickets serially numbered consisting of customer's claim check, repair tag, and permanent 4 x 6" record card. Book spiral bound to open flat. Space for dealer rubber stamp. Numbers available: 1001-2999 in groups of 100. Size 9 1/2" x 4" x 1".

SR-1—Book of 100 Job Tickets\$1.25

TV-1, WS-1, SR-1 SAMPLE SHEETS AVAILABLE ON REQUEST.
PLACE YOUR ORDER NOW. NO C.O.D.'s PLEASE.

RADIO TELEVISION SUPPLY CORP.

4339 W. ARMITAGE AVE.

CHICAGO 39, ILL.

FITS ANYWHERE!

- ★ Only 15/16" in dia.
- ★ Features Clarostat stabilized element.
- ★ Tapers. Also with one tap.
- ★ Knurled aluminum shaft, standard.



THE TINY CONTROL FOR THE FULL-SIZED JOB!

★ Just the thing for extra-tight spots — Clarostat's 15/16" control. Quite a lot smaller than the usual carbon controls but handles the load.

And typically Clarostat construction:

No-wiggle no-wobble aluminum knurled shaft; velvety-smooth rotation; longest-wearing element; special alloy contact arm; easy-to-solder tinned terminal lugs; and QUIET! It's a honey!

★ Ask your Clarostat jobber for these 15/16" controls. Ask for latest Clarostat catalog — or write us.



Controls and Resistors

CLAROSTAT MFG. CO., INC. • DOVER, NEW HAMPSHIRE • In Canada: CANADIAN MARCONI CO., LTD. Montreal, P. Q., and branches

NEW!

OHMITE OHM'S LAW CALCULATOR



NOW HAS... PARALLEL RESISTANCE AND SLIDE RULE SCALES!

ONLY 25c

Redesigned! This new, improved version of the famous Ohmite Ohm's Law Calculator—popular the world over with servicemen, engineers, and students—now has scales for solving parallel resistance problems, and a standard slide rule. More useful than ever!

ONLY ONE SETTING REQUIRED

Solves Ohm's Law and many parallel resistance problems—simply, quickly, and accurately—with only one setting of the slide. Covers a range of values encountered in electronic and moderate power applications.

HANDY POCKET SIZE

Only 9" by 3"—fits the pocket. Slide rule scales multiply, divide, and find squares and square roots.

Be Right with

OHMITE

Reg. U.S. Pat. Off.

RHEOSTATS • RESISTORS • TAP SWITCHES

SEND FOR YOURS, TODAY

OHMITE MFG. CO.,
4888 Flournoy St.,
Chicago 44, Ill.

Send my new OHMITE Calculator. I enclose 25c in coin.

NAME.....
ADDRESS.....

Walsco Sales Program

The growing momentum of the television market has spurred promotional plans of the Walter L. Schott Company, Los Angeles, for the "big push" on Walsco antennas. Company officials claim they have something to "shout about" and will outline the exclusive features of Walsco TV Antennas to the consumer and to the trade.

"Only Walsco" will be the theme of a new and vigorous advertising program designed to emphasize the exclusive advantages of Walsco Antennas. Among these will be Walsco's silicone treated styron molded insulator which, according to Walter L. Schott Company, prevents dust particles and moisture from adhering. . . a frequent cause of lost efficiency. Walsco officials also claim the exclusive use of marine type high tensile chromium-aluminum alloys for elements, with a "yield point" 94% higher than ordinary aluminum. These new elements are said to be resistant to corrosion even in beach areas where they may be exposed to salt spray.

Another exclusive feature that will play a big part in Walsco promotion plans is the use of butt-seamed tubing for elements. The design of this tubing provides a higher modulus of elasticity . . . actually prevents breaking of elements even in extreme weather. The Walsco laboratories have set up special facilities for wind-tunnel testing antennas to withstand storms.

Walsco company officials have indicated their primary objectives to be: (1) stimulate consumer consciousness of TV antenna; (2) build dealer confidence in Walsco; (3) gain enthusiastic job support; (4) offer jobbers a profitable, competitively priced and price protected antenna line.

Meck Distributors

Turnquist Brothers Co., 1807 E. Olympic Blvd., Los Angeles, has been awarded franchise distribution rights for television and radio receivers manufactured by John Meck Industries, Inc., Plymouth, Ind.

Rauland Representative

Jack Young of Dallas, Texas, has been appointed as representative for the Rauland Corp., manufacturers of television picture tubes, to handle territory including the states of Texas, Oklahoma and Arkansas, according to F. W. Guthrie, sales manager.

Appoint W. H. Connor

The appointment of W. H. Connor with headquarters at 1590 Eudora, Denver, Colo., as sales representative for the territory of Wyoming, Utah, Colorado and New Mexico, is announced by Clarostat Mfg. Co., Inc., manufacturers of resistors, controls and resistance devices, of Dover, N. H.

Jiffy-Rig-

A Story without Words

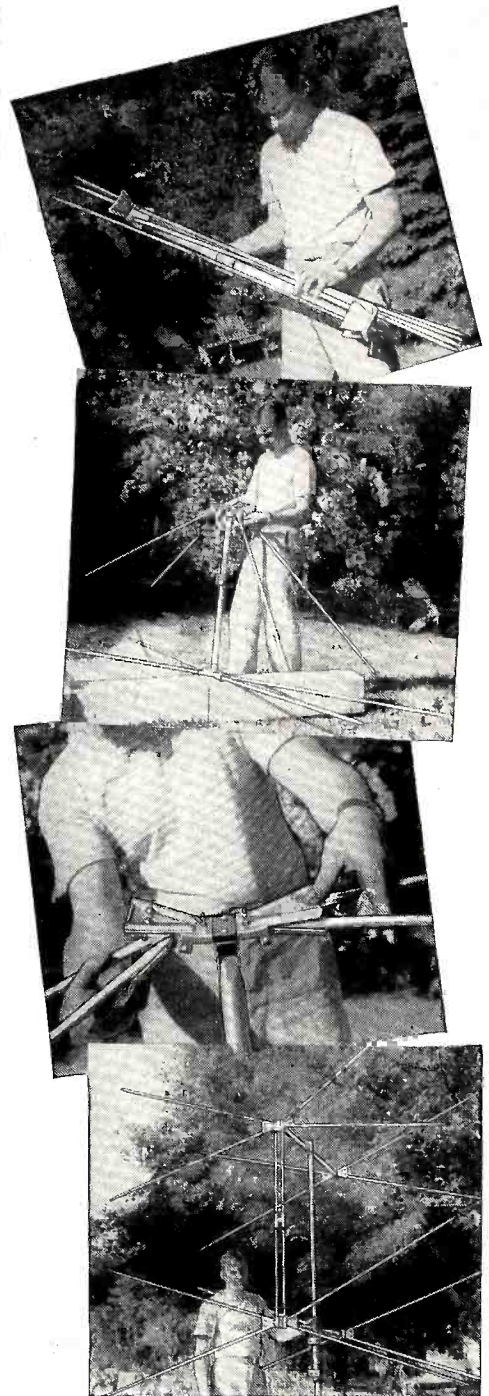

**GET THE FACTS ON TACO
ASK YOUR JOBBER TODAY**

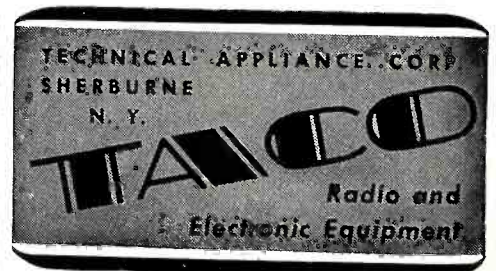

In Canada: Stromberg-Carlson Co., Ltd.,
Toronto 4, Ont.

At last—a built-in booster!

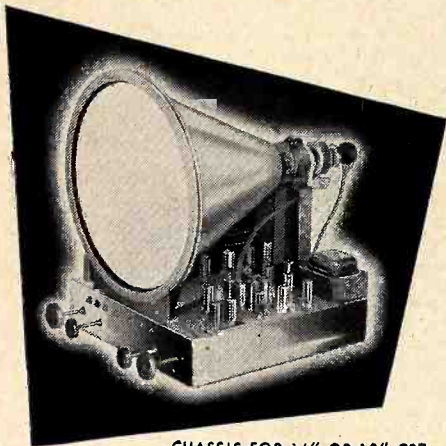

CHASSIS FOR 16" OR 19" CRT
25 TUBES PLUS 4 RECTIFIERS

... brings 'em in
out of the snow



FRINGE AREAS

now can enjoy excellent reception without cumbersome, costly external boosters! Craftsmen Television alone gives you a built-in booster that literally brings a picture right out of the "snow"—gives a 10 db. video boost simply by shifting a knob! Unparalleled performance, and it will not interfere with audio reception.

HI-FIDELITY SOUND available through cathode-follower audio output. And RC-100 television—engineered from the mounting bolts up for big picture operation—is twice as sensitive as before! Automatic phase control of both vertical and horizontal synchronization guarantees perfect interlace. Keyed AGC, too. Will accommodate UHF channels.

COMPLETE THE PICTURE with Craftsmen high fidelity audio—RC-8 FM-AM tuner featuring automatic frequency control that entirely eliminates drift, and RC-2 high fidelity amplifier.

THE RADIO
craftsmen
INCORPORATED

Write for information—or send 50¢
for instructions and schematics.

Dept. D, 1617 S. Michigan Ave., Chicago 16, Ill.

Promote RCA Officials

Election of five vice-presidents of the Radio Corporation of America was announced by Frank M. Folsom, president of RCA, following a meeting of the board of directors. All of those elected are associated with the RCA Victor Division.

The new officers are: Henry G. Baker, vice-president and general manager of the home instrument department; Richard T. Orth, vice-president and general manager of the Tube Department; John S. Carter, vice-president and director of the Finance Department; Paul A. Barkmeier, vice-president and general manager of the Record Department, and Harold R. Maag, vice-president and Western manager of the RCA Victor Division.

Clarostat Names Stroum

The appointment of Sam Stroum whose headquarters are at 2229 - 22nd Ave. N., Seattle, Wash., as sales representative for the territory of Washington, Oregon, Idaho and Montana, effective immediately, is announced by Clarostat Mfg. Co., Inc., Dover, N. H.

C & G Appointment

Louis Simpson, sales manager of C & G Tool Manufacturers, Inc., 39 Main St., East Orange, N. J., has announced the appointment of Radio Electric Service Company, Philadelphia, as a distributor of the C & G line of antenna mounting accessories. C & G manufacture the Magne-Rotor antenna rotor and a full line of chimney mounts, wall mounts, U-bolts and ground rods.

ITI Drops Premium Charge

Industrial Television, Inc., has announced that the premium charge for sets using the "black" 12½" CRT is being deleted from future billing.

Since the inception of the black tube a charge of \$10.00 has been added at the retail level, but now the list prices are \$239.50 for the Century 12½" model 821 Table Topper and \$299.50 for the Century 12½" model 921 consolette, both utilizing the new CRT which gives improved contrast and definition.

Rectangular TV Tubes In Air King Receivers

D. H. Cogan, president of Air King Products Co., Inc., Brooklyn, N. Y., manufacturers of radios, wire recorders and television receivers announced the first use of rectangular tubes in 2016R console model and 2017R table model television receivers.

These rectangular tubes have been given the name "Soft-Lite Full View" television. The rectangular tubes will show the picture exactly as it is televised from the transmitting television station. There will be no loss of view from cut corners or any type of masking.

**CORROSION-
PROOF!**

Snyder
PHILADELPHIA

TV

**MASTS
OF
walker**
Conshohocken

**DUALCOTED
STEEL**

DEVELOPED AND ENGINEERED ESPECIALLY FOR TELEVISION AERIALS.

Tough flexible coating on inner and outer tube wall.

Prevents corrosion from salt, acids, caustics.

Will not crack or chip.

SOLE SELLING AGENT
**ONTARIO
RESEARCH CORP.**

An Affiliate of
SNYDER MFG. CO.

2218 W. ONTARIO ST.
PHILA. 40, PA.



Reach for **BIGGER PROFITS** in your Service Dept.!

PHOTOFACT lays dollars right smack in your hand

SAVE TIME
BOOST OUTPUT
SIMPLIFY WORK
CUT PARTS STOCK

Proved in
Hundreds of
Service
Shops!

Your service department will show *bigger* profits with PHOTOFACT on the job! It's the *only* Service Data based on actual laboratory analysis of all postwar AM, FM and TV receivers. Uniform, accurate, complete—it helps your men turn out *more jobs in less time!* It standardizes proper servicing procedures, cuts errors and waste, minimizes your parts stock inventory. PHOTOFACT *pays for itself* because it saves time and labor, because it *guarantees* bigger radio repair profits. Put PHOTOFACT to work on your service bench *now*—you'll earn the thanks of your men—and *you'll earn more!*

FREE! Photofact Folder of your choice!

Learn for yourself—at our expense—how PHOTOFACT earns bigger radio repair profits for you! Ask for a **FREE** Folder covering any postwar AM, FM or TV receiver of your choice. Examine it. Put it to work at your service bench—then judge for yourself.

WRITE FOR FREE FOLDER TODAY!

HOWARD W. SAMS & CO., INC.

HOWARD W. SAMS & CO., INC.
2205 EAST 46TH ST., INDIANAPOLIS 5, IND.

- Send **FREE PHOTOFACT** Folder covering following receiver
- Send full details on the PHOTOFACT Service Data Library.

Name

Address

City Zone State

Attn.

New Sheldon Tube

In keeping with Allied's policy of providing jobbers, manufacturers and the television industry in general with the latest advances in picture tube development, Nathan Chirelstein, president of Allied Electric Products, Inc., Irvington, N. J., announced that his firm is now producing its new, rectangular screen all glass gray-black picture tube. This latest addition to the Sheldon line will be known as 16RP4, Mr. Chirelstein revealed.

Measuring 10 $\frac{1}{8}$ " x 13 $\frac{1}{2}$ " x 18 $\frac{3}{4}$ ", the Sheldon rectangular picture tube makes possible the use of smaller cabinets with new design possibilities. The new Sheldon rectangular tube takes approximately the same cabinet space as the conventional 12 $\frac{1}{2}$ " round tube.

Hoffman Radio Expands

Hoffman Radio Corp., Los Angeles, is opening new territory for its 1950 line of TV sets, according to R. J. McNeely, director of sales. Jenkins Music Company, wholesale division, Kansas City, Mo., replaces the Oklahoma-Hoffman Distributing Co. (Tulsa), formerly Hoffman distributor in that area. The Jenkins territory will embrace the western portion of Missouri and the states of Kansas and Oklahoma. Kenneth Gillespie is general manager.

Ansley Now Selling Through Distributors

Bernard Fein, president of Ansley Radio & Television, Inc., has announced that the company has decided to sell its radio and television receivers through distributors on an exclusive basis in all TV areas instead of the direct-to-dealer arrangements formerly used. In New York and Los Angeles, where the company maintains its own service and warehouse facilities, Ansley will continue to sell on the direct-to-dealer basis.

"It is our opinion that the distributor is best qualified to handle the problems of warehousing and servicing of dealers," Mr. Fein stated, "and we have accordingly made arrangements to start taking on exclusive distributors for all areas."

Deluxe TV Cabinets

Robt. Wolff Woodcraft Corp., 1125 Union Ave., Bronx, N. Y., manufacturers of wood products for 45 years, are now utilizing most of their facilities in producing a deluxe line of television cabinets for the trade. These cabinets are made in various woods by master craftsmen, who devote all their time working on high quality wood products.

In GE Sales Post

Monte M. Wheeler has been appointed sales manager of the General Electric Company's automatic blanket and sunlamp division, it has been announced by David C. Spooner, Jr., division manager.

NO MATTER HOW YOU LOOK AT IT

PHOENIX
Speed-Mounts
and
Speed-Tennas
DO A BETTER JOB!

Strong—light in weight—fast, easy installation. Engineered to give highest quality electrical performance . . . and designed to withstand the toughest weather conditions. Pre-assembled—no loose hardware.

ANTENNA MAST STAND-OFF INSULATORS
Famous PAM-11—faster, stronger, easier to install—genuine Polyethylene inserts—attaches to any mast in just 10 seconds.

AT LEADING JOBBERS

PHOENIX

ELECTRONICS, Inc.
Lawrence, Mass.

WRITE FOR NEW CATALOG

ADVERTISERS

February, 1950

Admiral Corp.	26, 27	Noblitt-Sparks Industries, Inc.	13, 49
Air King Products Co., Inc.	Cover 2	Ohmite Mfg. Co.	112
Alliance Mfg. Co.	28	Olympic Radio & Television, Inc.	Cover 3
Alproco, Inc.	94	Ontario Research Corp.	113
American Phenolic Corp.	Part 2—Insert	Permo, Inc.	80
Anchor Radio Corp.	102	Philco Corp.	3, 48
Ansley Radio & Television, Inc.	51	Phoenix Electronics, Inc.	114
Belmont Radio Corp.	9	Precision Electronics, Inc.	110
Bond Equipment Co.	116	Radiart Corp.	88, 89
Burgess Batteries	97	Radio Corp. of America ..	17-24, 32, 50, Cover 4
C. & G. Tool Manufacturers, Inc.	93	Radio Craftsmen, Inc.	113
Capehart-Farnsworth Corp.	6	Radio Television Supply Corp.	111
Claroostat Mfg. Co., Inc.	111	Radion Mfg. Co.	25
Cleveland Electronics, Inc.	105	Rauland Corp.	36
Commercial Credit Corp.	53	Rauland-Borg Corp.	109
Commercial Trades Institute	116	Raytheon Mfg. Co.	45
Coyne Electrical & Radio School	108	Rider Publisher, Inc., John F.	98, 99
Crosley Div., Avco Mfg. Corp.	42, 43	Sams & Co., Inc., Howard W.	114
DuMont Labs., Inc., Allen B.	63	Sentinel Radio & Television	40
Duotone Co.	106	Sheldon Electric Co.	12
Easy-Up Tower Co.	115	Simpson Electric Co.	8
Emerson Radio & Phonograph Corp.	46, 47	Snyder Mfg. Co.	113
Energy Farm Equipment Co.	102	Sonic Industries, Inc.	95
General Die & Stamping Co.	114	South River Metal Products Co., Inc.	116
General Electric Co.	7, 10, 11, 14, 15, 37	Standard Coil Products Co., Inc.	33
General Industries Co.	41	Starrett Television Corp.	38, 39
Hallicrafters Co.	77	Stewart-Warner Corp.	34, 35
Hytron Radio & Electronics Corp.	79	Stromberg-Carlson Co.	54
Jackson Industries, Inc.	107	Sylvania Electric Products, Inc.	4
Jensen Industries, Inc.	104	Technical Appliance Corp.	112
Jensen Mfg. Co.	16	Television Cabinet Co. of America	110
JFD Mfg. Co., Inc.	96	Television Equipment Corp.	100
Landers, Frary & Clark	72, 73	Telrex, Inc.	101
Majestic Radio & Television Corp.	5	Trio Mfg. Co.	108
Meck Industries, Inc., John	52	Tricraft Products Co.	102
Merit Transformer Corp.	100	Universal Products Co.	110
Milner Mfg. Co.	2	V-M Corp.	108
Motorola, Inc.	30, 31	Webster-Chicago Corp.	44
		Webster-Electric Co.	103
		Westinghouse Electric Corp.	75
		Zenith Radio Corp.	29

While every precaution is taken to insure accuracy, we cannot guarantee against the possibility of an occasional change or omission in the preparation of this index.

*Top Value
in TV
Towers*

Easy-Up

MODEL 300 "ROTA-TOWER"

- ★ Strong steel tube construction, all-electrically welded
- ★ Multiple cross-braces—90 in each 10 foot section
- ★ Saves many man-hours. Shipped pre-assembled—only 5 minutes to complete
- ★ Entire assembly hot-dip galvanized
- ★ Rotatable 360° to orient antenna after installation
- ★ Built-in ladder—safe to climb
- ★ Light—less than 1½ lbs. per foot of height
- ★ Quiet in the wind— all rounded surfaces
- ★ Hinged base— fits peaked or flat roof— tip up from any of four directions
- ★ Neat, trim, unobtrusive
- ★ Wide choice of heights
- ★ Minimum guy support needed

ONLY \$64⁵⁰ LIST for basic 30-ft. model complete

Actual photo of Easy-Up "Rota-Tower" with two extensions, elevating stacked Amphenol antenna and Alliance rotator 50 ft. above 30 ft. rooftop.

Also, extra-heavy-duty square and triangular towers for heights to 100 feet.

Easy-Up Tower is a quality product through and through ... Built to make your installation job just as simple as possible ... Your most economical way to elevate TV antennas for clearest reception.

See your jobber, or write

Easy-Up Tower Co.

3800 KINZIE AVENUE
RACINE • WISCONSIN

New TV Lines

Motorola, Inc., 4545 Augusta Blvd., Chicago 51, Ill.: A new 16-inch TV-radio-phonograph built around the new rectangular tube (16F1) in a mahogany cabinet is priced at \$399.95. Two table models featuring a rectangular 16-inch tube are available at \$269.95 (16T1, mahogany), and \$279.95 (16T1B, limed oak). A 12½-inch table model is priced at \$189.95, and 5 other 12½-inch sets in the line scale up to \$279.95. A portable 8½-inch set at \$149.95, a 10-inch table set at \$169.95, and three 19-inch sets round out the line.

Wilcox-Gay Corp., 604 W. Seminary St., Charlotte, Mich.: New models include Model O-402, 12½-inch console at \$239.50, Model O-426 16-inch console at \$329.50, and model O-302, 12½-inch table set at \$219.95.

Sylvania Electric Products, Inc., 1280 Main St., Buffalo, N.Y.: Prices on the new line are as follows: 177, 10-inch table, \$169.95; 125, 12½-inch table, \$199.95; 114, 12½-inch console, \$249.95; 090, 16-inch console, \$379.95; 128, 6-way 12½-inch console, \$399.95; 197, 12½-inch console with doors, \$299.95; 245, 12½-inch console without doors, \$269.95; 247, 16-inch console without doors, \$349.95; and model 246, 12½-inch table set, \$229.95.

Magnavox Co., 2131 Beuter Rd., Fort Wayne 4, Ind.: Metropolitan, 12½-inch table set is \$249.50; the Constellation II, 16-inch table set is \$299.50 in mahog-

Crosley Officials Meet with N. Y. Distributor



Shown at a celebration given by the Crosley Distributing Corp., in New York are these Crosley officials: W. A. Blees, vice-president of Avco Manufacturing Corp. and general sales manager of the Crosley Division; John W. Craig, Avco vice-president and Crosley general manager, and three representatives of the Crosley Distributing Corporation—Bert Cole, vice-president and general manager, Irving Sandberg, general sales manager, and Paul Hilton, assistant to the general manager in charge of advertising and promotion.

any; the Broadway, 12½-inch console is \$299.50; The Shoreham "200," 19-inch console is \$495. The line includes 3 additional 16-inch consoles, and 5 TV-radio-phono combinations, 4 of which have 16-inch tubes, ranging in price from \$469.50 to \$995.

Philco Corp., C and Tioga Sts., Philadelphia 34, Penna.: Three 16-inch receivers and two TV-radio-phono combinations round out the line. Model 1632 and 1633 are 16-inch consoles, while model 1600 is a 16-inch table set. The 1400 series consoles provide 12½-inch picture, AM-FM radio, and 3-speed automatic record changer.

Noblitt-Sparks Industries, Inc., Columbus, Ind.: The new Arvin 8½-inch metal cabinet TV table set retails for \$129.50. The set has 16 tubes plus 2 rectifiers.

Raytheon Mfg. Co., 60 East 42 St., New York 17, N.Y.: Highlighting the new line are four "Silver Anniversary" models—so named because 1950 marks Raytheon's 25th year in business. Prices range from \$199.95 for a 12½-inch table model to \$329.95 for a 16-inch console. The complete line consists of 8 table and console models with 12½- and 16-inch picture tubes.

PRINT YOUR OWN POST CARDS

COMPLETE OUTFIT
only \$7.50

Amazing results in sales, inquiries and contacts . . . saves time and money . . . very easy to use. GEM STENCIL DUPLICATOR is ideal for Advertising, Announcements, Notices, Labels, Forms, Price Lists—hundreds of

uses for every type of business and organization. Comes complete with all supplies, instructions and 60-page Book of Ideas.

FREE TRIAL OFFER: Try it before you buy it! Write and a GEM OUTFIT will be sent you postpaid. After 10 days, send only \$7.50 or return the GEM, no questions asked. The GEM must sell itself; you be the judge.

BOND EQUIPMENT CO.

DEPT. 125 — 6633 Enright
St. Louis 5, Mo.

SEND NO MONEY • FREE TRIAL OFFER

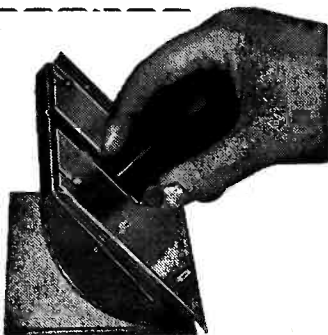

C.T.I. TRAINED MEN ARE AVAILABLE!

Each month C.T.I. graduates ambitious young men who have completed an intensive course in Radio and Television maintenance and repairing. *Their training has been practical.* They've learned by working on modern equipment under personal, expert supervision. *If you need a trained technician,* we invite you to write for an outline of our course, and for a prospectus of the graduate. (No fees, of course.) Address:

Placement Manager, Dept. P110-2

COMMERCIAL TRADES INSTITUTE

1400 Greenleaf

Chicago 26

1 Out of Every 2 Outdoor Installations Is made with

SOUTH RIVER PRODUCTS

Write for catalog describing Chimney Mounts, Wall Brackets, Pipe Mounts, etc.

WARNING . . . South River Chimney Mounts are patent protected. Imitations and infringements are being prosecuted. See U. S. Patent No. 2482575.

South River Metal Products Co., Inc.

Dept. RR, 17 Obert Street,

South River, N. J.

LINES WANTED

We Will Purchase for Cash Your
Surplus or Excess Stocks of

ELECTRIC FANS

ELECTRIC MOTORS

EXHAUST BLOWERS

AIR COMPRESSORS

ELECTRICAL APPLIANCES

We Will Purchase Any Quantities

Write complete details including quantity, description,
packing & price.

BOX 1250

RADIO & TELEVISION RETAILING

480 Lexington Ave., New York 17, N. Y.

HERE'S THE **SET**

THAT **SET** THE PACE AT THE
CHICAGO
FURNITURE MART!



THE VARSITY
XL 210

12½ inch genuine
Mahogany table-top
model

\$ 179⁹⁵

Slightly higher west of Rockies

Olympic
Star☆brite TELEVISION

Chicago called it the hottest line at the Show!
11 new models..... 12½" to 19"..... including
a 16" three-way home-theatre period console.
Write for full details!

Olympic Radio & Television Inc. • 34-01 38th Avenue
Long Island City 1, N. Y.

A clear selling



field



You can sell **MORE RCA Batteries** because...

RCA BATTERIES give you a clear selling field—they're distributed primarily to the radio trade!

You have less competition from non-radio neighborhood stores. Sell RCA Batteries and repeat sales stay with **YOU!**

RCA Batteries are *radio-engineered* for *extra* listening hours. The completely rounded line covers *virtually all* renewal requirements.

Closely co-ordinated production meets seasonal demand, assures fresh stock always.

RCA provides the greatest array of battery selling aids in the industry—all geared to the *radio trade*.

Smart packaging, competitive prices and "the greatest name in radio" are compelling reasons why RCA Batteries are your best buy by far.

See your RCA Battery Distributor for fast, reliable service.



RADIO CORPORATION of AMERICA
RADIO BATTERIES

HARRISON, N. J.