

ELECTRONIC TECHNICIAN

Including 16 pages of
Circuit Digests

M. E. A. GURTONSKI
SERVO ELECTRONICS
1501 LANCASTER AVE
READING PA
TN7-58N A2 5F991M

SERVICING
DIODE PHASE DETECTORS

50¢

October, 1957

NEW from V-M
The FIRST and ONLY Portable Tape Recorder to
Play STACKED and STAGGERED Stereo Tapes!

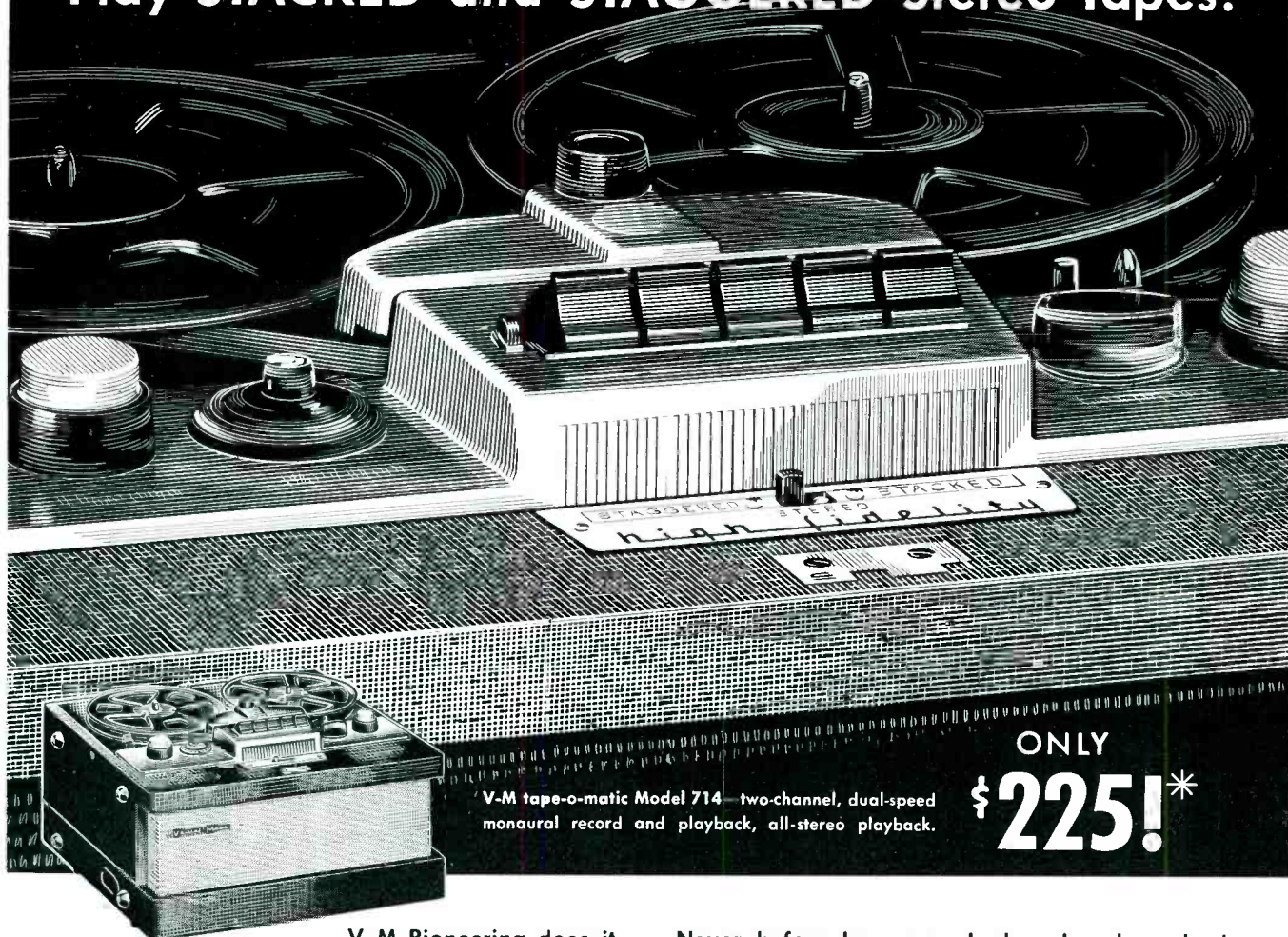

V-M tape-o-matic Model 714—two-channel, dual-speed
 monaural record and playback, all-stereo playback.

ONLY
\$225!*

V-M Pioneering does it again! Now you can sell a portable tape recorder without equal anywhere. **BRAND NEW Model 714 tape-o-matic®** plays **Stacked AND Staggered** stereo tapes at the flip of a switch! It's all yours—and with it goes the full profit margin V-M always gives you!

Never before have you had such sales edge! Not since V-M introduced the **FIRST** popular-priced stereo-play tape recorders have you had the market all to yourself like this! And think what this **NEW V-M** development can mean to you in tape sales: You'll sell your entire recorded stereo tape inventory—**stacked OR staggered!**



The Voice of Music Stereo Tape Library.

Silk, Satin and Strings, dreamy pop favorites. Big Beat with Mike, Mike Simpson and his Big Band. Lighting the Torch, Jay Norman Quintet with Vocalist Nancy Wright. Symphony of Dance, Musical Arts Symphony conducted by Leonard Sorkin. Christmas in Stereo, the John Halloran Chorus and the Sorkin Strings.

TO HELP YOU SELL: THE FIRST STEREO PROMOTION OF ITS KIND!

THE VOICE OF MUSIC STEREO TAPE LIBRARY is the hottest early-Fall promotion ever! With every V-M stereo tape-o-matic you sell, you can include a sensational "stereo starter set" of **FIVE** stereo tapes recorded especially for V-M! Top tunes, top stars, a deluxe boxed **VOICE OF MUSIC STEREO TAPE LIBRARY**, attractively packaged! It's a Genuine \$40 value!

But that's not all! Your V-M distributor will back you up with a complete program — mat ads, in-store displays, window banners! **YOU NEVER HAD IT SO GOOD!**

What's more, this is your **BIG OPPORTUNITY** to sell the complete Voice of Music portable tape recorder line — Models 710 and 711 — as well as the **ALL NEW Model 714!** Remember, simple V-M Stereo Conversion Kits adapt them both to play **EVERYTHING** in stereo tapes!

Call your Voice of Music distributor. Sample shipments are beginning now. Promotional material will follow early in October. Get set for the hottest fall business in history! Sell a Unique **NEW PRODUCT** with a crowd-pulling **NEW PROMOTION!**

*Slightly higher in the West.

the Voice of Music®

V-M CORPORATION • BENTON HARBOR, MICHIGAN

WORLD'S LARGEST MANUFACTURER OF PHONOGRAPHS AND RECORD CHANGERS

ELECTRONIC TECHNICIAN

Circuit Digests

TELEVISION • ELECTRONIC • RADIO • INDUSTRIAL AUDIO

October, 1957

ALBERT J. FORMAN Editor
 M. CLEMENTS Publisher
 O. H. CALDWELL Editorial Consultant
 ROBERT CORNELL Technical Editor
 B. V. SPINETTA Assistant Editor
 A. O'ROURKE Assistant Editor
 CHARLES F. DRYER Art Director
 PAT DRUMM Editorial Assistant

Address all mail to
 480 Lexington Ave., New York 17, N. Y.
 Telephone Plaza 9-7880

BUSINESS DEPARTMENT

H. A. REED General Sales Manager
 N. McALLISTER Production Manager
 M. N. WINQUIST Accounting Manager
 M. RAMSAY Accounting Supervisor
 M. RUBIN Circulation Manager
 S. LA MACCHIA Asst. Circulation Mgr.
 P. H. DEMPERS Regional Manager

5010 Howard St., Skokie, Ill.
 Telephone ORchard 5-1355

CHRIS DUNKLE & ASSOCIATES
 California Representative

740 S. Western Ave., Los Angeles 5, Calif.
 Telephone DUNkirk 7-6149

J. KIMBALL Manager
 420 Market St., San Francisco 11, Calif.
 Telephone DOuglas 2-9183

BERNIE EDSTROM Regional Manager
 2169 Eldred Ave., Cleveland 7, Ohio
 Telephone LAKewood 1-7900



ELECTRONIC TECHNICIAN & Circuit Digests, October 1957. Vol. 66, No. 4. \$5.00 a copy. Published monthly by Electronic Technician, Inc., an affiliate of Caldwell-Clements Co. Publication office, Emmett St., Bristol, Conn. Editorial, advertising and executive offices, 480 Lexington Avenue, New York 17. Telephone Plaza 9-7880.

Entered as second class matter at the Post Office at Bristol, Conn., June 10, 1954. Subscription rates: United States and Canada, \$4.00 for one year; \$6.00 for two years; \$8.00 for three years. Pan-American and foreign countries: \$7.00 for one year; \$10.00 for two years; \$14.00 for three years. Copyright 1957 by Electronic Technician, Inc., New York. M. Clements, Chairman of the Board; H. Reed, President; A. Forman, Executive Vice-President. Title registered in U. S. Patent Office. Reproduction or reprinting prohibited except by written authorization of publisher. Printed in U.S.A. by Hildreth Press, Bristol, Conn.

FRONT COVER

Against a background of waveforms found in phase detector circuits, two semiconductor diodes are shown. This type of circuit is one of the many growing applications of semiconductor devices. See servicing article on page 28.

FEATURES and ARTICLES

It's Audio Time; Toll TV Tests Authorized (Editorial) 25
"Tuning in the Picture" 26
Servicing Selenium & Germanium Diode Phase Detectors D. Felin 28
Test Equipment for Second Echelon Hi-Fi Servicing . . N. H. Crowhurst 30
VTVM Antenna Orientation W. J. Smith 34
Insurance Plan for Technicians 34
"Tough Dog" Corner A. Consiglio, C. W. Sheppard 35
Industrial Electronic Burglar Alarms A. Lytel 36
Will Factory Service Put Independents Out of Business H. P. Bridge 38
Shop Hints W. H. Brakes, L. Larson 40
Two TV Programs on One Channel 42
Right or Wrong in Labor Relations 42
New Audio Products 48
Latest Test Instruments 50
New Components 52
New Products Review 55

DEPARTMENTS

Editor's Memo	4	Calendar of Coming Events	27
Letters to the Editor	8	New Products	44
News of the Industry	12	New Books	56
Reps & Distributors	16	Audio Newsletter	58
Catalogs & Bulletins	20	Association News	59

CIRCUIT DIGESTS

69

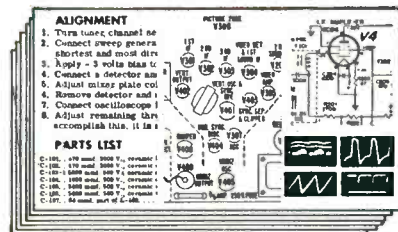

IN THIS ISSUE

(16 pp. latest schematics—see last page)
HOTPOINT: TV Chassis M3
STANDARD COIL: "Fireball" tuner
WEBCOR: Hi-Fi Imperial Tape Recorder Models 2816/96
WESTINGHOUSE: TV Chassis V2371 series
ZENITH: TV Chassis 12A20/20Q

A wonderful offer
 from the
**RAYTHEON RECEIVING
 TUBE DISTRIBUTORS**
 who sponsor
 the Raytheon Bonded Dealer
 Program . . .

at no added cost . . .

GROUP for Raytheon who by preference

Now, Registered Bonded Dealers can gain personal security for themselves and their families — automatically increase their life insurance coverage, through their regular purchases of Raytheon Receiving Tubes. The amount of coverage is determined by the quantity of Receiving Tubes the dealer buys.

The New England Mutual Life Insurance Company has created a Group Life Insurance Plan for Raytheon Bonded Electronic Technicians — a plan offered exclusively by Raytheon Distributors who sponsor the Bonded Dealer Program. Any such Distributor who meets the necessary requirements for setting up a Group Life Insurance Plan for Bonded Dealers may give them this valuable protection without the necessity of a physical examination. Check with your Raytheon Sponsoring Distributor and see if he has it available to you.

If you're not at present a Raytheon Bonded Dealer, better see your Sponsoring Distributor as to whether you can qualify. You'll find being a Raytheon Bonded Dealer a real asset to you. You'll find using Raytheon quality receiving tubes is a big help, too.

** Administered and underwritten by New England Mutual Life Insurance Company*



RAYTHEON MANUFACTURING COMPANY

Receiving and Cathode Ray Tube Operations

NEWTON 58, MASS. CHICAGO, ILL. ATLANTA 6, GA. LOS ANGELES 7, CALIF.
 55 Chapel Street 9501 Grand Ave. (Franklin Park) 1150 Zonolite Rd. N.E. 2419 So. Grand Ave.

Raytheon makes
 all these

} Receiving and Picture Tubes, Reliable Subminiature and Miniature Tubes,
 Semiconductor Diodes and Transistors, Nucleonic Tubes, Microwave Tubes.



Excellence in Electronics

LIFE INSURANCE*

Bonded Electronic Technicians
use RAYTHEON RECEIVING TUBES



SUPER

RELIABLE!

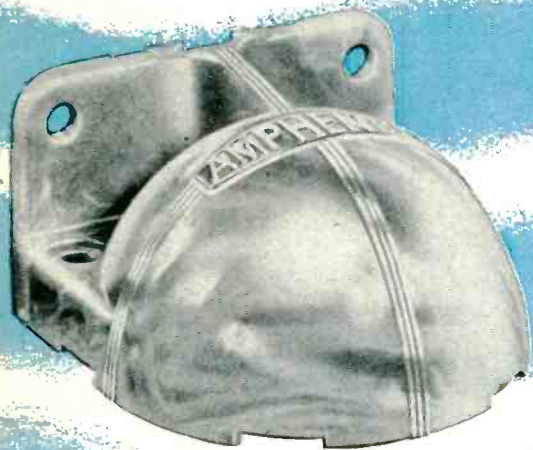

AMPHENOL

TV Color COUPLER

New design ideas in performance, appearance and mounting make AMPHENOL's Color-Couplers best for coupling of Color and/or Black & White TV sets as well as FM radio. Incorporating a super reliable resistive network, Color-Coupler provides

1. Effective isolation
2. Low insertion loss
3. Almost perfect impedance match
4. Flat signal response (a must for Color TV)
5. Built-in twin lead strain relief
6. Horizontal or vertical mounting

To Help You Merchandise this superior coupler AMPHENOL provides a free 3-color counter-top display. Included with each standard package of 9 114-097 2 set Color-Couplers, this eye-catching display mounts 6 Color-Coupler cartons for reach-and-buy action!

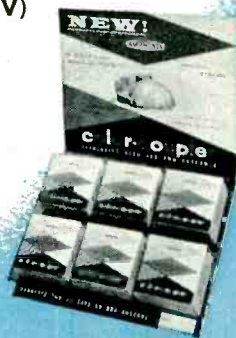

Color-Couplers are also available as three and four set models. Your AMPHENOL Distributor has all the data.



AMPHENOL ELECTRONICS CORPORATION
chicago 50, illinois

Editor's Memo



One trouble with doing electronic maintenance work professionally is that you're apt to forget many of the fundamentals. From a practical viewpoint this isn't very important; you can troubleshoot without extensive theory. Some technicians go so far as to believe that it's a hindrance to clutter up your mind with too many basic details.

Up to a point I agree. You don't get paid to learn theories; your success is tied to physical accomplishments in repair and installation. That's why you find most of the articles in *ELECTRONIC TECHNICIAN* prepared from the practical viewpoint, but basic theory is never eliminated.

My preoccupation with fundamentals stems from a recent experience. We ran across a fairly common circuit, and were discussing the details of operation. Between two technical editors, two electronics instructors and a crackerjack technician we couldn't come to a full agreement! So we turned to the textbooks. Not one in 20 different books or the manufacturer's literature could offer a satisfactory explanation. Well, we finally thrashed it out, but it showed us how far we've removed ourselves from understanding certain advanced theory.

There's an old anecdote, which we'll convert to a miniaturized shaggy-electron story, about a hot shot benchman. For 25 years he had been coming into the shop, cleaning up all the tough dogs none of the other fellows could figure out. TV set, thyatron control, hi-fi amplifier, mobile radio . . . it made no difference; he licked them all.

The only thing peculiar about this fellow is that every morning when he came into the shop, the first thing he'd do is unlock his tool box, look at a little piece of paper inside, and lock the box up again. He refused to tell anyone what was written on the paper.

One day, after converging a color set with a double intermittent, nature took its toll. This expert among experts passed away.

In order to turn over the deceased man's property to his bereaved widow, the other technicians in the shop had to force open the mysterious tool box. Curious beyond words, they reached for the secret paper. What was it their ace troubleshooter had referred to every morning?

They opened the paper. Written on it was:

$E = IR$

Al Forman

to

do more

...today and tomorrow!



The first
low priced
tube tester
to provide
**DUAL SENSITIVITY
SHORT TEST**

Triplet Model
3413-B Tube Tester
\$79.50

BURTON BROWNE ADVERTISING

And here are just 2 answers that tell you why.

Question:

Why Will Triplet Model 3413-B "do more" tomorrow?

Answer:

Because it will test *any new tube*. Unlike testers with preset panels of test sockets which become obsolete with the release of a new tube, Triplet flexibility of switching allows a set-up to test any new tube.

Question:

Why Will Triplet Model 3413-B "do more" today?

Answer:

Because it combines provision for conventional short test (0.25 megohms) with high sensitivity leakage test (2.0 megohms) — will test series string tubes without adapter. At only \$79.50 today's and tomorrow's biggest value.



And for the ultimate in laboratory quality testing examine **MODEL 3423 MUTUAL CONDUCTANCE TUBE TESTER** \$199.50. Proportional Mutual Conductance testing of *all* radio and TV tubes plus selenium rectifiers, crystal diodes, pilot lamps, thyratrons, transistors, etc., by a new patented circuit.

At leading Parts Distributors everywhere, see the finest and most complete line of test equipment by

TRIPLET

Triplet Electrical
Instrument Company
Bluffton, Ohio

53 years of experience.



FOR RESTAURANTS, NIGHT CLUBS
Neat, trim, unobtrusive, the MLC is a superb little performer too. Delivers clean, sweet music and voice reinforcement that overcomes noise and dead spots.



SOUND AND AMUSEMENT TRUCKS
The versatile, dependable MLC efficiently handles all types of program material without harsh, annoying blare prohibited by many town ordinances.



PATIOS, SWIMMING POOLS, LAWNS
Here's weatherproof high fidelity that is also low in price. With the MLC, you can economically extend a music system outdoors and retain hi-fi quality.



TO ADD HI-FI TO P.A. SYSTEMS
In paging applications, the MLC penetrates high noise levels... its wide frequency range adds deep richness to music reproduction. Here's double duty, double value!

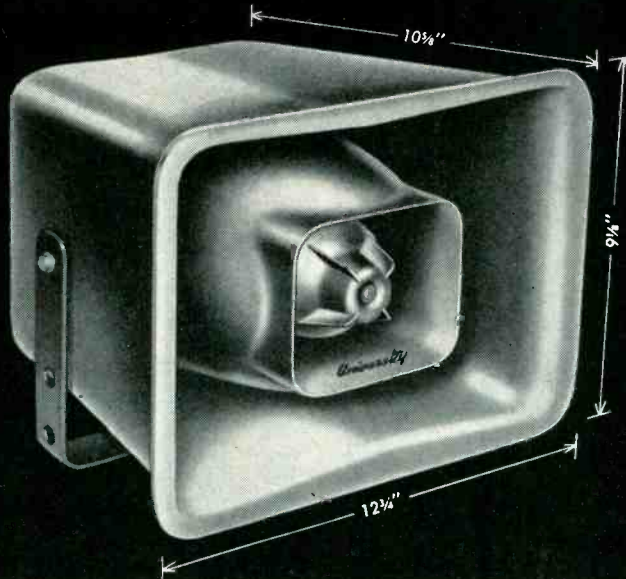

NEW...UNIVERSITY DUAL-RANGE MLC

Weatherproof Super-Compact Speaker System for Voice and Music

Now...real high fidelity never before available in a rugged, small size, weatherproof speaker system. Unique wide-angle, dual folded horn design with separate low and high frequency drivers. Dependable, easy to install, low in cost, the MLC offers these outstanding features:

BETTER LOWS: Balanced "compression" folded horn, starting with 6" throat and energized by top quality woofer driver provides *more* lows than other designs.

BETTER HIGHS: Driver unit tweeter with wide angle horn transmits more highs with greater uniformity . . . high frequency response that you can hear!

BETTER EFFICIENCY: Dual range theater type system permits uncompromising design of the woofer and tweeter sections for greatest efficiency. Penetrates noise with remarkable fidelity and intelligibility.

LESS DISTORTION: *Separate* low and high frequency driver systems reduce intermodulation and acoustic phase distortion found in other systems which use two different horns on a single diaphragm.

MORE DEPENDABLE: Experienced mechanical engineering and careful electrical design meet the challenge of diversified application and environmental hazards. Rugged and conservatively rated—you can *rely* on the MLC.

SPECIFICATIONS: Power Capacity, 15 watts; Frequency Response, 150-15,000 cps; Impedance, 8 ohms; Dispersion, 120°; Sound Pressure Level, 117 db taken at 4 ft., 750-1250 cps with 1 cps sweep; Dimensions, Bell Mouth 12 3/4" W x 9 1/2" H, Overall Depth 10 3/4"; Shipping Weight, 10 lbs.; \$54.50 List.

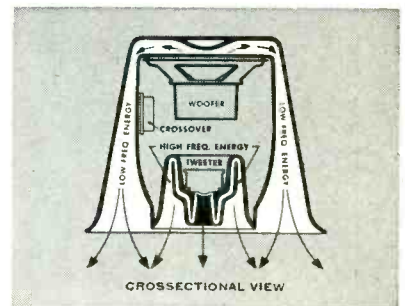

FOR HEAVY DUTY APPLICATION...

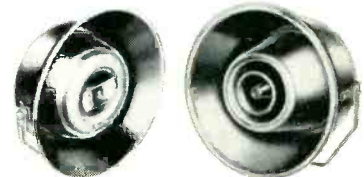

MODEL BLC

MODEL WLC

MODEL BLC employs same design principles as the MLC except for heavy duty 8" woofer with uniform response from 70 cps, exclusive "reciprocating flare" wide-angle tweeter and has 25 watt power capacity. Exceptionally shallow depth, only 9", ideal for close quarters. **\$86.00 List.**

MODEL WLC, largest of the series, has 30 watt power capacity, 12" super-efficient woofer with response from 50 cycles, heavy duty radial tweeter . . . and a decade of successful performance in concert halls, rinks, auditoriums, stadiums and outdoor theaters throughout the world. **\$250.00 List.**

LISTEN

University sounds better



UNIVERSITY LOUDSPEAKERS, INC., 80 SOUTH KENSICO AVENUE, WHITE PLAINS, N. Y.

40%

**DUMONT
POSITIVE
QUALITY**

FEWER CALLBACKS*

A positive fact about
Du Mont Positive Quality . . .

Du Mont Picture Tubes cut callbacks due to
tube failure by 40%. Consider what
this means to you — fewer callbacks,
greater profits.

Ask your distributor about
Du Mont Positive Quality Picture
Tubes and Electronic Tubes.

- Send name and address for
your free copy of the Du Mont
Replacement Tube Chart.

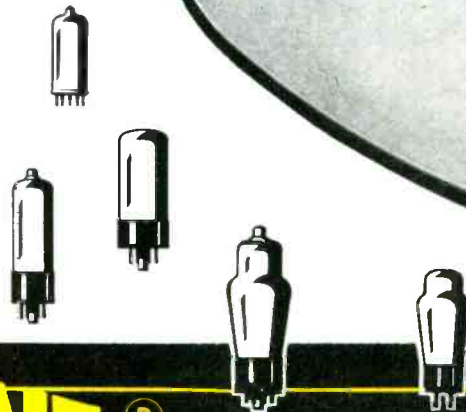

*Based on actual
engineering figures.

DUMONT [®]

Television Tube Division

Allen B. Du Mont Laboratories, Inc., Clifton, N. J.

Looking for new numbers?

All the hot ones are in Centralab's new, free PEC* Guide

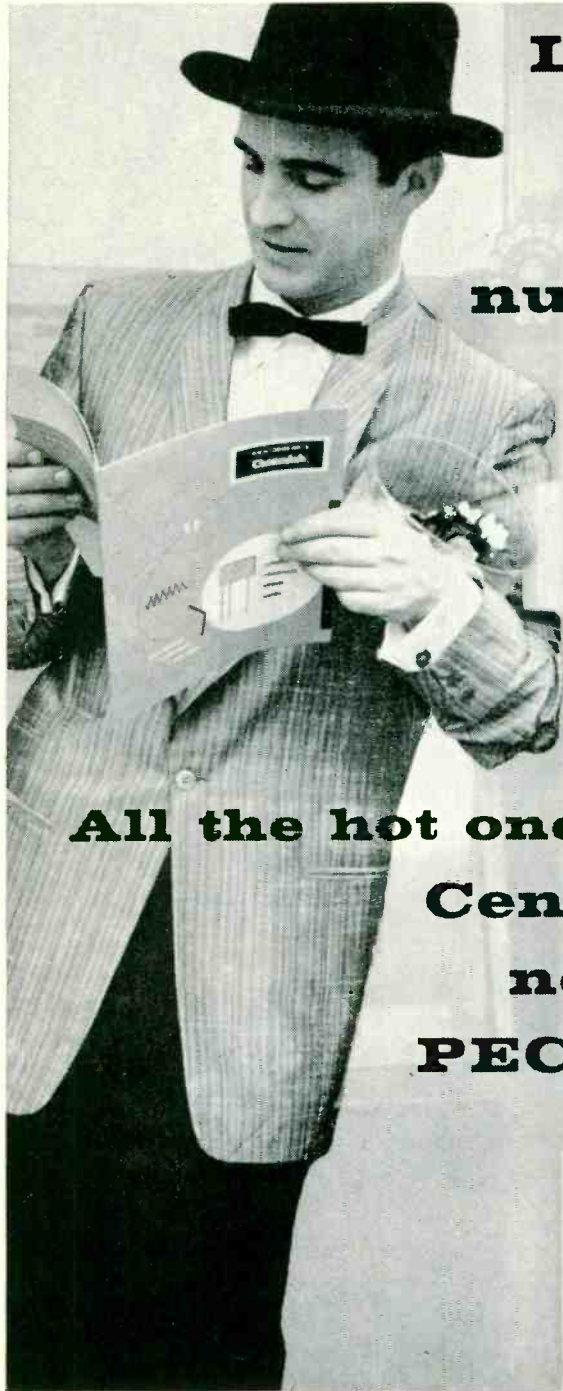

Twenty-five fresh new beauties to choose from. Currently keeping company with the entertainment industry's most popular chassis.

Brand-new edition of the Discriminating Serviceman's Guide — loaded with vital statistics, on both the old favorites and the new models. Gives practical techniques for testing — how to tell good ones from bad.

Get the lowdown on what models have been engaged, and where, by 130 radio and TV manufacturers.

These are facts it pays to have — you encounter more and more of these slim, trim PEC's every day. Over 75,000,000 now in circulation.

These beauties are waiting to be picked up at your Centralab distributor. Write us for your copy of PEC Guide No. 4.

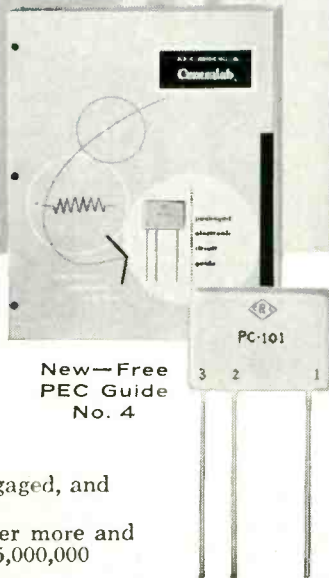

New—Free
PEC Guide
No. 4

Centralab A DIVISION OF GLOBE-UNION INC.
902J EAST KEEFE AVENUE • MILWAUKEE 1, WISCONSIN

*Trademark

LETTERS

To the Editor

FLYWHEEL NEEDED

Editor, ELECTRONIC TECHNICIAN:

I have a Westinghouse TV Model V2192-AA chassis with no high voltage. I have replaced all tubes with known good ones in the high voltage and sync. sections. Also checked resistance of yoke and flyback and all are perfect. All parts have been checked or replaced in oscillator, sync. and output circuits. The boost caps have been replaced and no luck. The output grid drive is about -22 volts. The high cap has been checked. The wave form on the grid of the 6AU5 is perfect. The only thing I find wrong is the screen grid of the output tube is 320 volts. Is there something I have overlooked? Any help will be greatly appreciated. I suspect the flyback, although it checks good.

ALFRED RICCIARDI

Wrentham Radio & TV Service,
Wrentham, Mass.

• The problem is an interesting one. Like some of the round and round we go AGC systems, this chassis relies on the boost voltage to power the horizontal output and one half of the oscillator stage. As you probably know, no horizontal output means no boost voltage, no boost voltage means improper oscillator action which, in turn, means improper horizontal output. Judging from the high screen voltage on the 6AU5, it is probably not conducting. Check the cathode and grid circuits and measure the bias voltage using the d-c function of the VTVM. The drive signal must be high enough to overcome the bias in order for the tube to conduct. There have been situations where connections to socket terminals were good, but a broken or defective screen grid terminal prevented contact with the tube itself. Under such conditions it would be advisable to take readings from the tube pins directly.—Ed.

ADDRESS CHANGE

Editor, ELECTRONIC TECHNICIAN:

In the August issue of Electronic Technician you gave the address of Fada Radio & Electric Co. in answer to a request by Harold T. Wolfe, Salem, Ohio. I wrote to that address in search of information and was told that their service department has been discontinued and was referred to Edlie Electronics Inc., 154 Greenwich St., New York 6, N. Y.

JAMES A. BUCKLEY

36 Carolina Ave.,
Providence, R. I.

New Products Begin on p. 44

GOOD-ALL CAPACITORS



The "Capacitor of Tomorrow"

600-UE Mylar* Dielectric • Molded in Epoxy**

NEW to the replacement market! Widely used by leading equipment manufacturers.

The 600-UE is created by the skillful combination of new "wonder materials," and Good-All's advanced design, exclusive production technique and tight quality control. It is ideal for replacement use in today's modern circuitry.

FEATURES: • Low leakage • High stability • Long, trouble-free life • Rugged construction • Extremely reliable service in humid climates

SUPERIOR QUALITY • COMPETITIVE PRICE

DU PONT

***MYLAR**® is DuPont's trade name for their amazing space-saving polyester film. This thin, tough film makes an ideal capacitor dielectric. Its inherent electrical stability and exceptional dielectric strength contribute greatly to the trouble-free service of the 600-UE.

SHELL

****EPON**® is Shell's trade name for their epoxy resin wonder plastic molding compound base. Far superior to common molding materials, Epon forms an extremely rugged moisture-tight case. Leads adhere securely to the compound. High dielectric strength is also an attractive feature of this tough, dense material.



GOOD-ALL ELECTRIC MFG. CO.

Distributor's Division • 26 RITTENHOUSE PLACE • ARDMORE, PENNSYLVANIA

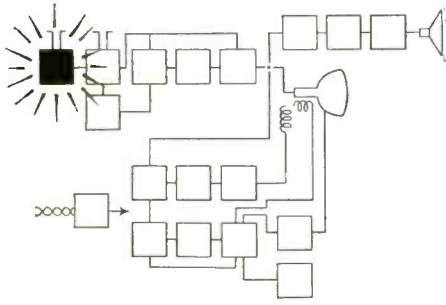

Life-test comparison chart below shows oscillator activity versus hours of life of new G-E 6AF4's and standard 6AF4's.

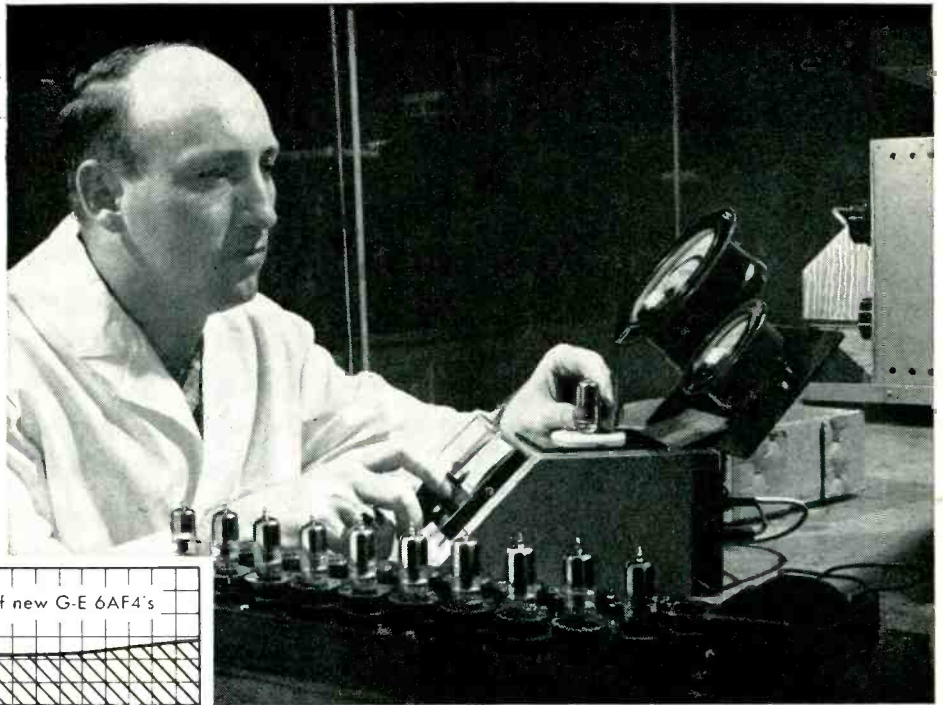

ABOVE: General Electric Design Engineer J. G. Tucker checks, for oscillator activity, new G-E 6AF4 tubes that are undergoing life test.

LEFT: Effect of tube operation over long periods on new vs. standard 6AF4's is shown by the chart. Tests of many thousand tubes are represented. Note that the oscillator activity of new G-E 6AF4's averages a straight horizontal line, whereas standard 6AF4's show a sharp, sudden drop . . . meaning rapid loss of picture quality.

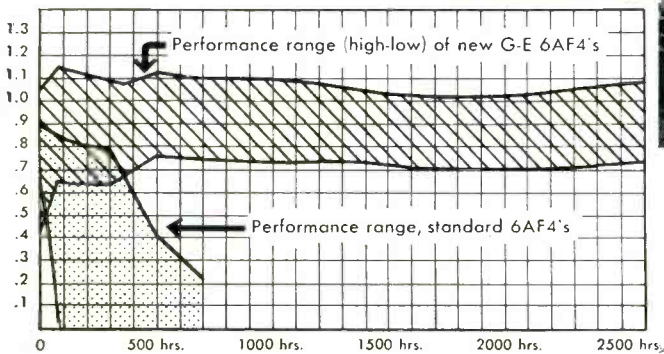

Now . . . from General Electric . . . a long-life 6AF4 for sustained high-quality u-h-f TV reception!

Only General Electric can give you . . . in the long-life 6AF4 u-h-f oscillator tube . . . the tube industry's newest, most effective means for making friends of service customers. Installing a new General Electric 6AF4 cuts snow, brings a clear picture that will retain its high quality. Tests prove that after 2500 hours and more of service, this u-h-f oscillator tube performs just as well as one freshly taken from a carton!

Virtually no receiving tube is called on to undergo the same electrical "stresses" as a 6AF4. With small electrodes and close spacing to meet low-inductance, low-capacitance demands of up-to-900-mc operation, current density is 5 to 6 times that of other triodes.

Consequently, extremely high cathode emission is called for. The plate and grid, subjected to high tem-

peratures, must resist gas-forming tendencies that would destroy tube efficiency. Stiff requirements like these have meant short life for 6AF4's. Now General Electric, through creative design, combines new materials with new manufacturing and test methods to give TV-technicians and set-owners a 6AF4 that *for the first time* is fully as efficient and dependable as other tubes.

The same long-life performance is being built into General Electric's 2AF4, 2AF4-A, 3AF4-A, and 6AF4-A.

Outstanding examples like this of ever-higher quality, of design steadily improved, make General Electric tubes the best you can install. Phone your G-E tube distributor at your earliest opportunity! *Distributor Sales, Electronic Components Division, General Electric Company, Owensboro, Kentucky.*

Progress Is Our Most Important Product

GENERAL  ELECTRIC

161-1A10

SAVE MANY WAYS

You pay nothing extra for cabinet

Cabinets stack neatly with others

28 clearly identified compartments

Spend much less time ordering



with **IRC**[®] Resist-O-Cabinets

Four "Savingest" Assortments

IRC Resist-O-Cabinets come complete with a colorful all-metal cabinet and any one of four resistor assortments. All resistors are guaranteed fresh and packed in the cabinet at the factory. Cabinets are yours at no extra charge. They have 4 "non-spill" drawers with 28 clearly identified compartments. Design permits neat stacking.

Assortment	No. 3A 2 Watt	No. 4A ½ Watt	No. 5A 1 Watt	No. 6A Combination
Contents	120 BTB 2 Watt Fixed Composition and BW-2 Insulated Wire Wound Resistors. 33 different values from 4.7 ohms to 1 meg-ohm.	150 BTS Fixed Composition Resistors. 28 different values from 47 ohms to 10.0 megohms.	125 BTA Fixed Composition Resistors. 28 different values from 47 ohms to 4.7 megohms.	Combination of 139 ½, 1, and 2 Watt Resistors and Type DCF Precistors. 68 types — 32 different values from .47 ohms to 5 megohms.
List Price	\$39.60	\$25.50	\$31.25	\$31.65
Your Price	\$24.00	\$15.00	\$18.75	\$18.85

ORDER FROM YOUR IRC DISTRIBUTOR

Radio and TV technicians who use IRC Resist-O-Cabinets call them the "savingest" resistor deal they know of. Here's why. You save time and trouble in ordering—all of the resistors most used in TV repair work are pre-selected for you. You save money—you not only get resistors at regular dealer price, but also a handsome all-metal cabinet at no extra charge. And you save time on the job—you know what you have—and you have what you want when you want it. To trim costs and fatten profits, buy resistors in IRC Resist-O-Cabinet assortments.

Whenever the Circuit Says



INTERNATIONAL RESISTANCE CO. Dept. 571, 401 N. Broad St., Phila. 8, Pa. In Canada: International Resistance Co., Ltd., Toronto, Licensee

The Case of The Serviceman WHO SAVED A MARRIAGE!



Smith wanted to watch the fights; Mrs. Smith insisted on "This Is Your Wife". Fights they got, since a second set was within their means but there was only one antenna and no multi-set coupler they tried had worked satisfactorily.



"You won't need another antenna with this 'NEW' Jerrold Multi-set COUPLER", said the TV Serviceman. "Its special design allows for equal distribution of the signal with *exceptionally low loss* and without smearing or ghosting"

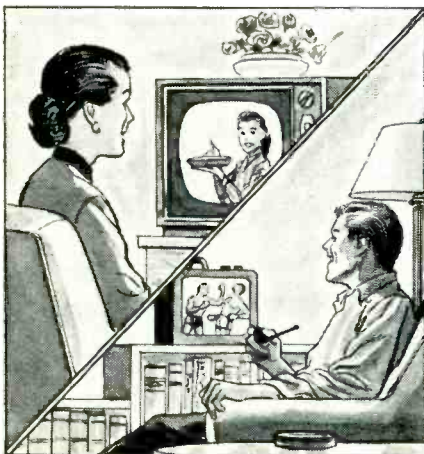

The Jerrold multi-set coupler took only minutes to install... now, both the Smiths watch their favorite TV shows.



UNIVERSAL MOUNTING

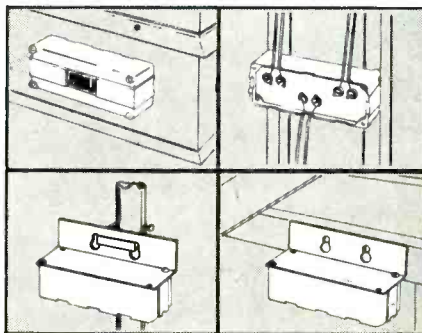

- On the baseboard. Connectors completely concealed.
- In the attic or basement with terminals exposed for ease of servicing.
- Outdoors, on the antenna mast or on the side of the house.

New! JERROLD LOW LOSS COUPLERS

Available in 3 models

- M-2—for strong signal areas . . list \$3.50
- MF-2—for fringe areas list 4.50
- MF-4—up to 4 sets—all areas . list 5.75

Engineered for V.H.F., U.H.F., Color reception. See your Jerrold Distributor or write for complete information to Dept. P.D. #20

JERROLD ELECTRONICS CORPORATION

Main Office: 23rd & Chestnut Streets, Philadelphia 3, Pa.

Export Representative: C.B.S. International, New York 22, N.Y.

LOOK TO JERROLD FOR AIDS TO BETTER TELEVIEWING

News of the Industry

INTERNATIONAL RESISTANCE CO. announces the recent appointment of **GERALD AUSTIN LEE** to salesman, Philadelphia office.

GENERAL ELECTRIC names **C. GRAYDON LLOYD**, Syracuse, as general manager of the speciality electronic components dept.

HYCON ELECTRONICS names **O. H. MACKLEY** as Vice President and General Manager.

ERIC M. FARR has been named manager of manufacturing services for **WESTINGHOUSE** television-radio div.

ROBERT T. REID has been appointed sales representative in the New York metropolitan area for rectifier products of the components div., **INTERNATIONAL TELEPHONE & TELEGRAPH CORP.**

THORDARSON-MEISSNER has appointed **JOHN COSTELLO** to the sales, stock and customer-service staff.

ALLEN B. DUMONT LABS. reports the appointment of **LEONARD T. DONNELLY** as manager of component sales.

HYCON MFG. CO. has appointed **MATTHEW JAMES LEONARD** as Vice President, Customer Relations.

JOHN RYAN has been appointed General Manager of **PHILCO DISTRIBUTORS**, New York Div.

CHARLES GOLENPAUL, Vice President of **AEROVOX CORP.**, has been elected President of the **ELECTRONIC INDUSTRY SHOW CORP.**

ALFRED H. GREBE has been promoted to the post of Chief Engineer for **FILTERS, INC.**

AMERICAN PAMCOR, INC. announces the appointment of **DONALD F. MIERSCH** as General Sales Manager.

RAYTHEON MFG. announces a new and unique Good-Will Business Builder Program for independent service dealers. This new program has been created by **RAYTHEON** to assist independent service dealers in stimulating service business.

(Continued on page 16)



Your Independent Service Advertising Program expands with your purchases of CBS tubes

One of a new series of full-page ads appearing in TV GUIDE



This family cook is your independent service-dealer. He's that busy neighbor who somehow finds time to be scoutmaster of his son's troop. He has his radio and TV service business in your town . . . and he knows he'll stay in business there only as long as he does superior work. In fact, when he works for you, he bets his family's bread and butter he'll do a better job . . . and he will.

for your radio and TV repairs, call the man who cares . . . your **INDEPENDENT SERVICE-DEALER**

He actually bets his family's bread and butter he'll do a better job for you . . . his business success depends upon it.

He is a highly skilled technician, trained and equipped to service promptly all makes of radio and TV sets at a fair price. So next time your radio or TV needs repairs, call the man who cares. Call your independent service-dealer.



Look for this emblem . . .



For the best in entertainment tune to CBS.

Whenever your set needs a new tube, ask to have it replaced with a CBS tube. There are no better tubes made.



CBS-HYTRON, Danvers, Mass.
A Division of Columbia Broadcasting System, Inc.

We know you like your Independent Service Program and want it expanded. We know it from a nation-wide survey . . . and from your increasing purchases of CBS tubes. May we remind you: each time you buy CBS tubes, you support your own independent service-dealer campaign. Keep it going . . . keep it growing . . . always specify CBS tubes.

SUPPORTING MATERIAL ALSO EXPANDS

- "The Independent Service Business and Your Future" booklet
- Independent Service decal
- 10 new postal cards
- 16 new advertising mats
- Radio and television scripts
- Consumer booklet "On the Care of a Television Set"

Ask your CBS Tube distributor for this tie-in material . . . or write for illustrated broadside PA-181.



CBS-HYTRON— Danvers, Massachusetts
A Division of
Columbia Broadcasting System, Inc.

FOR THE BEST IN ENTERTAINMENT TUNE TO CBS

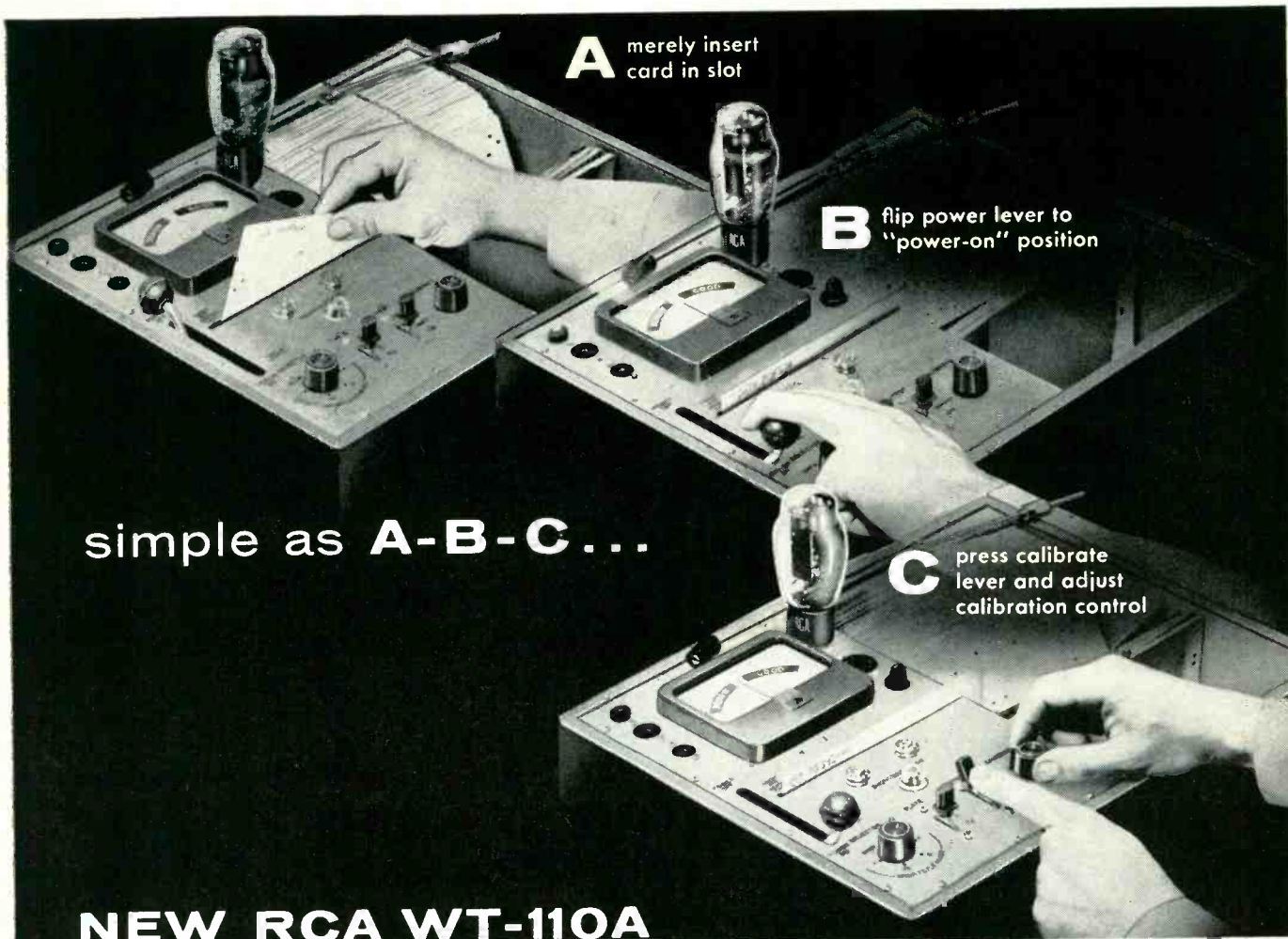

A merely insert card in slot

B flip power lever to "power-on" position

C press calibrate lever and adjust calibration control

simple as **A-B-C...**

NEW RCA WT-110A AUTOMATIC TUBE-TESTER

means more service profits!

Dollar for dollar, feature for feature, you'll find RCA's WT-110A the fastest, most accurate automatic punched-card tester you can buy today. It's a virtually *obsolescence-proof design* ... from the exclusive RCA 700-card capacity magazine file that always keeps the pre-punched cards in type number sequence, to the fully automatic circuit setup (including *all* operating voltages) and the easy, do-it-yourself punch card accessories available to keep the tube-card file up-to-date!

See and test the WT-110A at your local RCA Distributor. Prove to yourself what a boost in business, prestige, profits the RCA-WT-110A can mean!



TEST EQUIPMENT
RADIO CORPORATION OF AMERICA
Electron Tube Division, Harrison, N. J.

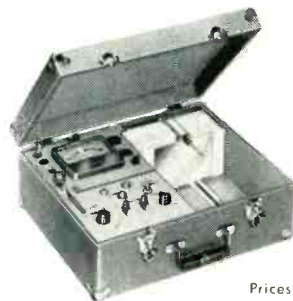

All this for
\$199.50

USER PRICE (Optional)
Prices higher in Hawaii and Alaska

- automatically sets up socket connections, and all operating voltages such as heater, signal, plate and screen voltages, and bias (both fixed and cathode).
- checks tubes for transconductance, gas, shorts, and leakage between elements.
- automatically selects correct conditions from 220 possible combinations of heater voltage (from 0.1 volt to 120 volts) at currents up to 4 amps., 10 bias voltages and 11 values of cathode resistors.
- tubes, such as rectifiers, tested under heavy load currents up to 140 ma per plate.
- high-and-low sensitivity ranges for leakage tests.
- 12-volt plate and screen supply for testing new auto-radio tubes.
- meter protected against burnout.
- test card provided for checking instrument.
- 239 pre-punched cards supplied with instrument cover 95% of currently active TV tubes. Pre-punched accessory cards available.
- active card magazine capacity—350; storage capacity—350. .a total capacity of 700 cards.



THE WING DIPOLE

IS THE VERY HEART OF AN ANTENNA

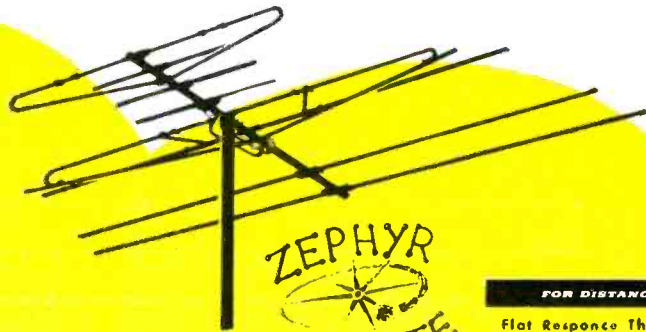
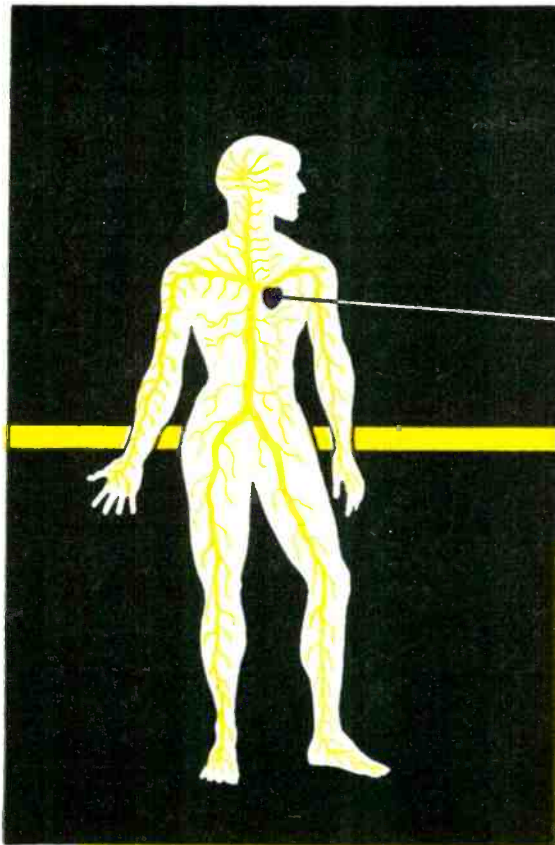

ZEPHYR MITE

FOR DISTANCE

Flat Response That Gives Good Reception on Both Black & White & Color

EXTENDED "WING" DIPOLE

The Heart Of the Antenna With The Increased Power and Sensitivity Of The "WING" DIRECTOR Exclusive Features Of The TRIO ZEPHYR FAMILY ANTENNAS THE LINE WITH PROTECTION

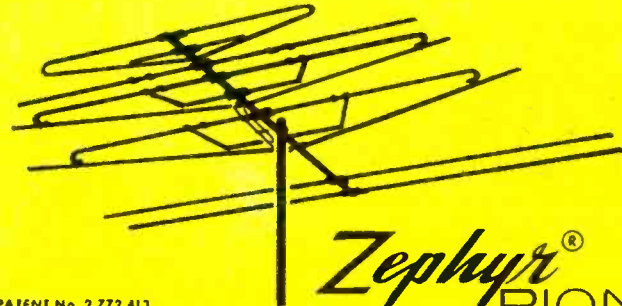

Zephyr PIONEER

FOR EXTREME DISTANCE

Uses The

EXTENDED "WING" DIPOLE

And The

"WING" DIRECTOR

COLLINEAR DIRECTOR

for increased gain on the highs

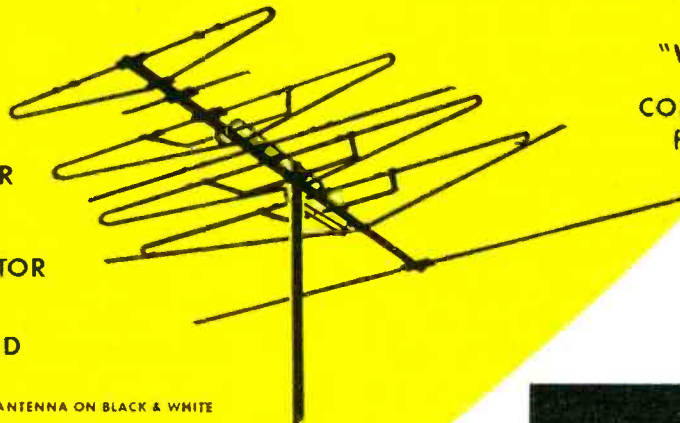

ZEPHYR ROYAL®

FOR THE MAXIMUM

In TV Enjoyment

New

EXTENDED "WING" DIPOLE

With The

"WING" DIRECTOR

COLLINEAR DIRECTOR

STAGGER - TUNED

THE NATION'S BEST PERFORMING ANTENNA ON BLACK & WHITE EXCELLENT FOR COLOR RECEPTION

U.S. PATENT No. 2,772,413
CANADIAN PATENT No. 541,670



TRIO Manufacturing Company
GRIGGSVILLE, ILLINOIS

Export Sales Div., Scheel International Inc., 5909 N. Lincoln Ave., Chicago, U.S.A.

Cable Address: HARSHEEL

COPYRIGHT 1957 TRIO MFG. CO.

A Complete Line Of

CONICALS CONICAL-YAGI'S
SINGLE CHANNEL YAGI'S
MULTI CHANNEL YAGI'S
UHF Indoor & Outdoor



RIDER Service "Aids"

For the Technician Who Wants to Get Ahead

TV - RADIO - AUDIO - ELECTRONICS

fabulous "picture-book" course

BASIC TELEVISION

by Dr. Alexander Schure

This new 5 volume addition to the famous "picture book" courses is the most understandable presentation of black and white television receiver theory at the basic level ever published.

Complete 5-volume course employs the famous Rider "picture book" method to explain basic theory of black and white television. Text is supported by more than 450 large carefully prepared interesting and informative drawings that make the explanation of each important idea crystal-clear. There is one idea, one thought in both text and picture on each page.

It starts with the transmitter and discusses in detail the following subjects: Volume 1, the transmitter; the handling and the operation of the camera; formation of the picture signal and the general content of the transmitter. Volume 2 covers the organization of the entire TV receiver treating each section individually from antenna to picture tube. Volumes 3, 4 and 5 treat with TV receiver circuit explanations. Each volume covers a specific number of sections in the receiver.

Valuable to both the professional technician and the beginner because it is so comprehensive, so accurate and so easy to read and understand. However, it is specifically directed towards those technicians who are in the early stages of their career—and to beginners. Ideal for apprentice training in every service organization which is conducting an on-the-job training program. Perfect to keep handy in the shop for reference.

#198—soft cover, 5 vols. 590 pages (approx.) \$10.00 per set. 198-H all 5 volumes in a single cloth covered binding, \$11.50.

3rd SUPPLEMENT to the RECEIVING TUBE SUBSTITUTION GUIDEBOOK by H. A. Middleton

A must for every technician! Contains more than 830 latest receiving tube substitutions • more than 200 picture tube substitutions • more than 230 American to European tube substitutions • more than 200 European to American tube substitutions • a cumulative index listing the tube types treated in the basic book and all 3 supplements. It pays for itself almost immediately!

Soft cover, 72 pp., 8½ x 11", illus. #139-3 Only \$1.35

RECEIVING TUBE SUBSTITUTION GUIDEBOOK by H. A. Middleton

#135, soft cover, 224 pp., 8½ x 11", illus., \$3.00

FIRST SUPPLEMENT

#139, soft cover, 48 pp., 8½ x 11", illus., \$.99

SECOND SUPPLEMENT

#139-2, soft cover, 48 pp., 8½ x 11", illus., \$.99

REPAIRING TELEVISION RECEIVERS by Cyrus Glickstein

The most modern completely practical book, written by an expert with long experience in television receiver repair. Devoted to troubleshooting and repair techniques which are modern, yet down-to-earth. Covers the use of simple as well as elaborate test equipment of all kinds. Profusely illustrated.

Soft Cover, 212 pp., 5½ x 8½", illus. #191 Only \$4.40

REPAIRING HI-FI SYSTEMS by David Fidelman

This book deals with finding the troubles and repairing faults in hi-fi equipment with no test instruments—simple equipment—and elaborate equipment. Encompassing the repair of high fidelity equipment such as tape recorders, record players and changers, AM and FM tuners, preamplifiers, amplifiers and loudspeakers, the approach is in a gradual, easy-to-understand, down-to-earth manner. Typical troubles are analyzed and repaired through a system of logical steps.

Soft cover, approx. 170 pp., 5½ x 8½", illus. #205 only \$3.90

ADVANCED TV SERVICING TECHNIQUES

by Zbar and Schildkraut
A complete advanced TV servicing course, developed by the Radio-Electronics-Television Manufacturers Association. Shows how to use every conceivable type of test equipment, how to service every part of a TV receiver. Explains latest techniques. Soft cover, 8½ x 11"
MAIN TEXT, 192 pp., illus. #161 \$3.60

LABORATORY WORKBOOK, 32 pp. #161-2 \$.95

TV PICTURE TUBE-CHASSIS GUIDE

by Rider Lab Staff
No busy service technician can afford to be without this easy-to-use TV tube type chassis guide. It covers all picture tube types used in TV receiver production from 1946 to February 1957—over 7,000 listings. This reference guide is organized by chassis number, and in some cases, by models so that the technician can immediately locate the correct picture tube type simply by knowing the chassis number. #204 Only \$1.35

IF YOU WANT THE BEST IN TV SERVICE INFORMATION

PHILCO G E EMERSON SYLVANIA ZENITH WESTINGHOUSE
ADMIRAL RCA MOTOROLA HOFFMAN CROSLLEY PACKARD-BELL

Covers Production 1950-1956

RIDER'S NEW S D O SERVICE
(Single diagram only)

ONLY 50¢ PER CHASSIS AT YOUR LOCAL JOBBER

MUST READING FOR EVERY TECHNICIAN

HOW TO INSTALL & SERVICE INTERCOMMUNICATION SYSTEMS by Jack Darr

#189, soft cover, 152 pp., \$3.00

SERVICING TV AFC SYSTEMS

by John Russell, Jr.

#192, soft cover, 128 pp., \$2.70

SERVICING TV VERTICAL & HORIZONTAL OUTPUT SYSTEMS by Harry Thomas

#150, soft cover, 176 pp., \$2.40

TV TUBE LOCATION & TROUBLE GUIDE (RCA)

by Rider Lab Staff

#194, soft cover, 56 pp., \$1.25

HANDBOOK OF 630-TYPE TV RECEIVERS

by Miller & Bierman

#174, soft cover, 200 pp., \$3.50

HOW TO USE METERS

by John F. Rider

#144, soft cover, 144 pp., \$2.40

HOW TO USE TEST PROBES

by A. Ghiradi & R. Middleton

#165, soft cover, 176 pp., \$2.90

HOW TO SERVICE TAPE RECORDERS

by C. A. Tuthill

#167, soft cover, 160 pp., \$2.90

NOW AVAILABLE!!!

RIDER'S TV 21

The only source of unabridged, factory prepared and factory accurate TV receiver servicing information.

LIMITED PRINTING

Reserve your copy at your jobber. If your jobber does not handle Rider manuals, write direct.

Rider books, manuals; S D O are available at your Parts Jobber. Look for the Rider Bookseller. If these books are not available, order direct.

T10

(News continued from page 12)

GENERAL TRANSISTOR CORP. announces that **ELSIN ELECTRONICS Corp.** has become a subsidiary . . . new sales offices for **GTC** have been opened at 95-27 Sutphin Blvd., Jamaica, N. Y.

JENSEN MFG. CO. announces an expansion of its activities in Mexico with the culmination of a new arrangement for both the manufacture and sale of speakers in Mexico.

CBS Tube Div. of **COLUMBIA BROADCASTING** is currently publishing a series of "Tube Tips" designed to provide answers to many of the tube and semi-conductor problems of independent service technicians.

INTERNATIONAL RECTIFIER CORP. of El Segundo has recently occupied two new facilities, bringing the number of plant buildings in the area to seven.

Reps & Distributors

BRACH MFG. CORP. announces the appointment of five new sales reps: **RON MERRIT** to handle Wash., Ore., Idaho, Mont. and Alaska; **J. Y. SCHOONMAKER CO.** to cover Texas, Okla., Ark. and La.; **BILL PAYSER** will cover Colo., Wyo., Utah and New Mexico; **EBERLE-SCHAAR** will promote the Brach line in Va. and **DOUGHERTY ENTERPRISES** in Hawaii.

FRANK ABBETT and **WALTER HUSTIS** have been named Sales Reps for **CORNELL-DUBILIER** products in the New England area.

REEVES SOUNDRAFT CORP. has named **F. A. DOUGHERTY CO.** to represent them in Ohio, West Va. and Western Penna.

AMPEREX ELECTRONIC CORP. has appointed three new reps: **MEL PEARSON & CO.** will cover West-Central U.S., **DWIGHT SMITH** will service distributor accounts in Ill. and Mich. and **THOMAS BEIL CO.** will cover Dela.; Md.; Washington, D. C.; Eastern Penna. and Southern N. J.

ANDREA RADIO CORP. names **DIMOND-GROSS ASSOC.** as reps for its TV, hi-fi and radio line in the New England states.

WORKMAN TV INC. has appointed the **EBERLE-SCHAAR CO.** to represent them in the Mid-Atlantic territory.

RADIO RECEPTOR CO. has appointed **NORTHERN STATES SALES CO.** as a distributor sales rep for its selenium rectifiers and germanium diodes.

NEWARK ELECTRIC CO. of Chicago has been appointed distributor for **MOTOROLA** Semiconductor devices in the greater Metropolitan Chicago area.

STANDARD SUPPLY CO. has been named sponsoring distributor for the **RAYTHEON** Bonded Electronic Technician Program in the Utah trading area.

JOHN F. RIDER PUBLISHER, INC. 116 West 14th Street, New York 11, N. Y.

TRIO[®]

Color Antennas

Specifically designed for color



TRIO[®] **COLORITE**

recommended for both color and black and white reception in areas formerly using conical and conical-yagi installations

small and compact *for easier installation and improved outside appearance.*

flat frequency response *a necessity for good color reception*

U.S. PATENT No. 2,772,413
CANADIAN PATENT No. 547,670

magna **chrome** element system

The Magni-Chrome element system consists of an EXTENDED WING DIPOLE accurately coupled with a precision V'ed dipole. This combination is designed to magnify the chromatic characteristics of the incoming color signal to assure true, full-color reception. The foiled dipole is V'ed at the exact

angle that gives greatest gain and band width when used in conjunction with the EXTENDED WING DIPOLE. Extremely flat frequency response across the entire VHF band is obtained together with improved gain.

for the ultimate in color reception



TRIO[®] **COLOR-ROYAL**

high forward gain *Sharper, Clearer Pictures High Signal-to-Noise Ratio*

flat frequency response *Improved Contrast on Black & White - Perfect Reproduction of the Color Signal*

highest front-to-back ratio *For Freedom From Co-channel Interference*

tri-stop reflectors

Used in combination with the "Wing" and Collinear directors give exceptionally high front to back ratio while maintaining optimum gain on all channels.

THE LINE WITH PROTECTION



TRIO[®] Manufacturing Company
GRIGGSVILLE, ILLINOIS

Export Sales Div., Scheel International Inc., 5909 N. Lincoln Ave., Chicago, U.S.A. Cable Address: HARSCHEE

COPYRIGHT 1957 TRIO MFG. CO.

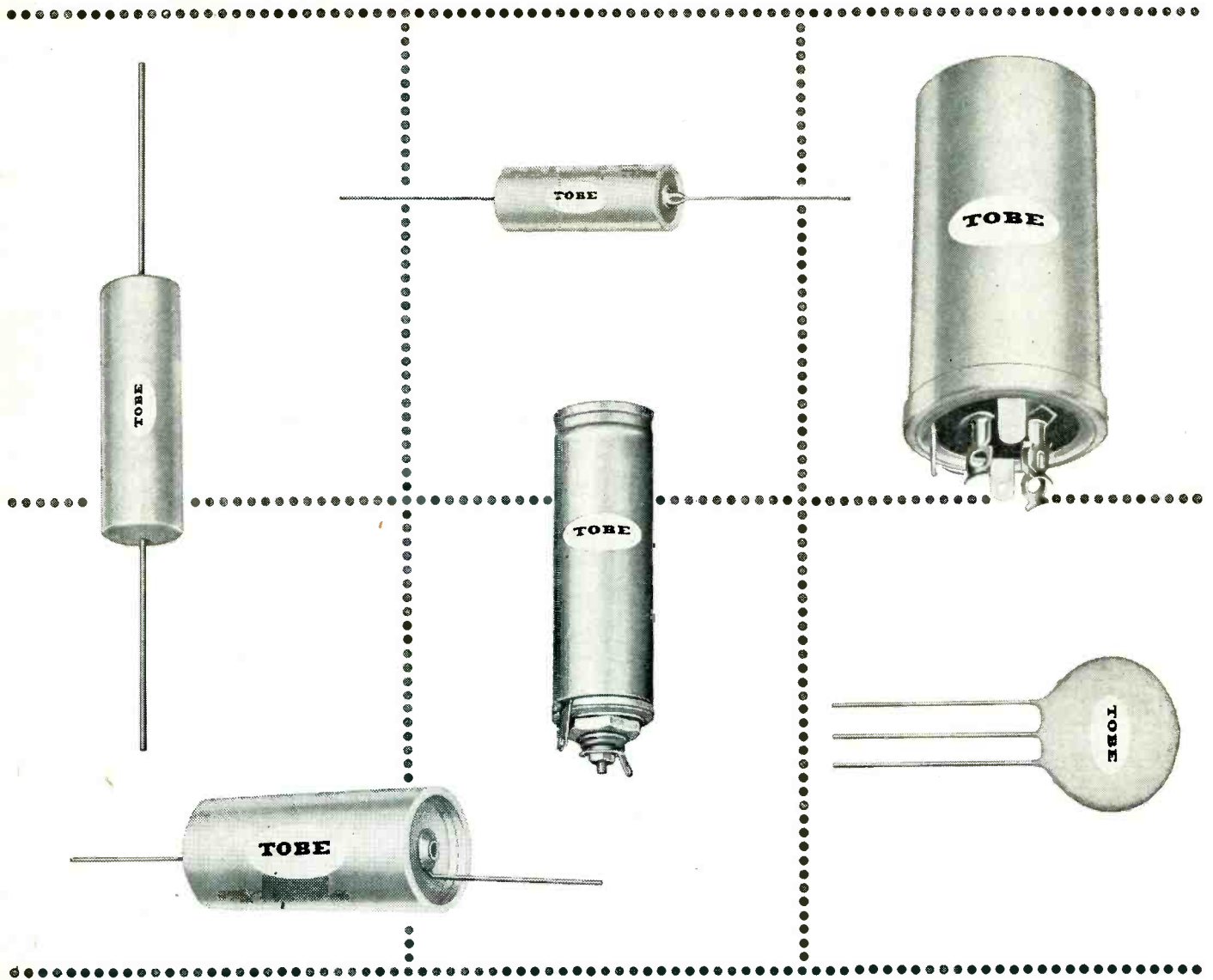

thousands of servicemen have happily discovered

TOBE QUALITY SERVICE CAPACITORS

have you?

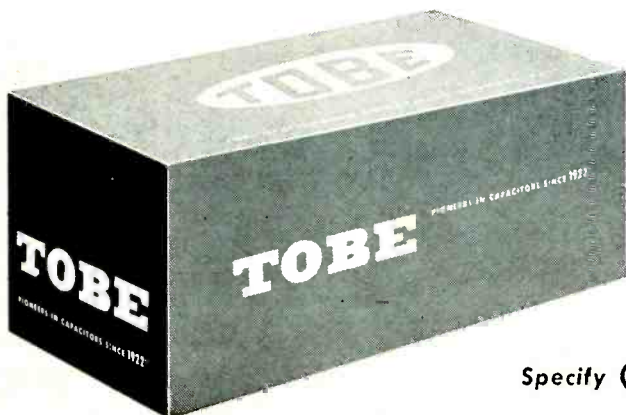

Specify **TOBE** Capacitors • Pioneers since 1922

To install or service COLOR-TV...

you must have these 5 new Walsco tools

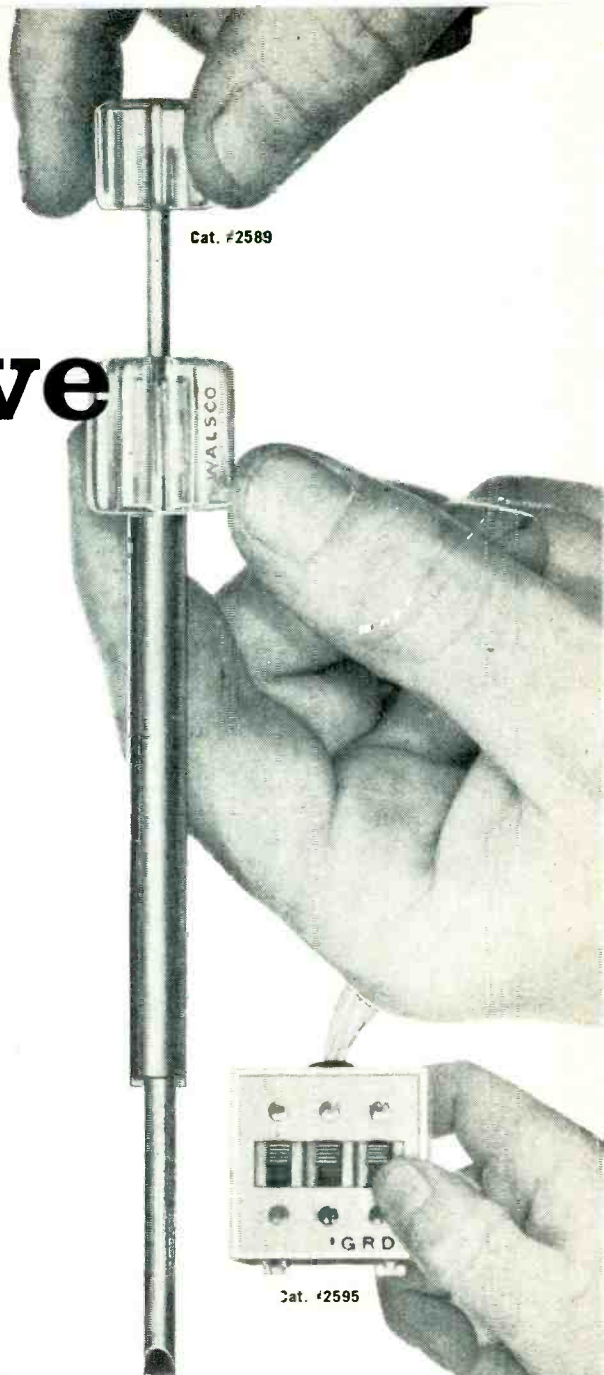

Cat. #2589



Cat. #2548

Specially designed . . . absolutely essential to make Color-TV servicing easy and profitable!

Cat. #2548 NEW WALSCO COLOR-TV INTERLOCK CHEATER.

Lets you service color sets with rear panel removed. Blocks grounding of high voltage supply. Special design permits safe insertion of high voltage probe. Net \$94

Cat. #2590 NEW WALSCO COLOR-TV DEGAUSSING COIL.

Required to eliminate stray magnetic fields prior to purity adjustments. Made to standard industry specifications; enclosed in molded plastic cover. Momentary switch safely de-energizes coil without pulling plug.

Cat. #2590 with momentary switch Net \$16.90. Cat. #2591 without switch.. Net \$14.90

Cat. #2589 NEW WALSCO COLOR-TV ALIGNMENT TOOL.

Adjusts and aligns all concentric controls on color, as well as black-and-white sets. Makes two separate adjustments at the same time: outer shaft aligns outer control shaft, inner shaft aligns inner control shaft. Net \$1.19

Cat. #2595 NEW COLOR-TV GRID GROUNDING BOX.

Essential for grounding controlled grids of color tube to permit convergence and matrix adjustments. Special "insulation piercing" terminals make application easy. Net \$5.10

Cat. #2596 NEW WALSCO TV COLOR VIEWER.

Balanced optical filters speed accurate color phase and matrix adjustments on all color TV sets. . .without using an oscilloscope. Net \$1.50

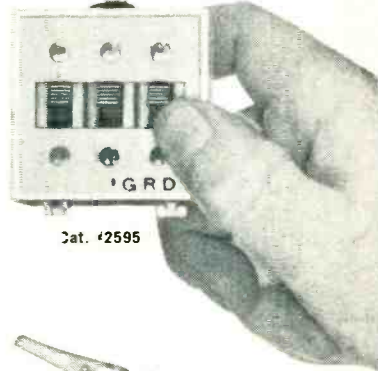

Cat. #2595



Cat. #2596



Cat. #2590



Walsco
ELECTRONICS MANUFACTURING COMPANY
a Division of Textron, Inc.

100 West Green Street, Rockford, Illinois

Western Division:
3225 Exposition Place, Los Angeles 18, California
In Canada:
Altas Radio Corp., Ltd., 50 Wingold Avenue, Toronto, Canada

FREE!
Special folder
explaining how to use
these new Color-TV tools...
ask your jobber or write direct.

look what **\$24⁵⁰** buys
in test equipment!

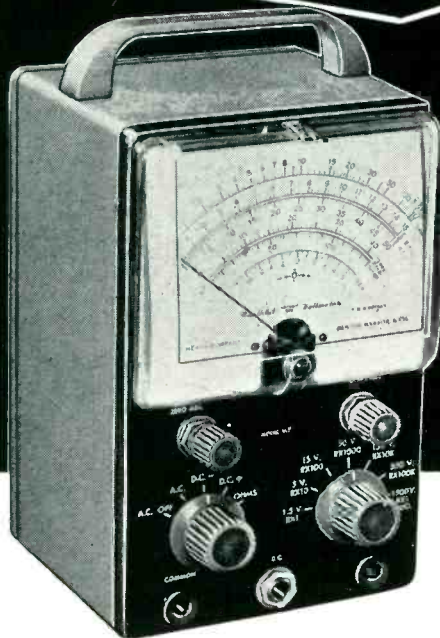

**HEATHKITS
GIVE YOU
TWICE AS MUCH
equipment for
every dollar
invested**

The famous model V-7A Vacuum-Tube-Voltmeter is a perfect example of the high-quality instruments available from Heath at 1/2 the price you would expect to pay! Complete, only **\$24⁵⁰**

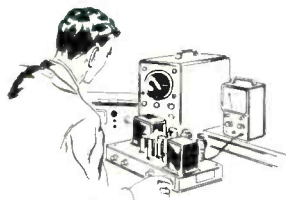

Get the most out of your test equipment budget by utilizing HEATHKIT instruments in your laboratory or on your production line. Get high quality equipment, without paying the usual premium price, by dealing directly with the manufacturer, and by letting engineers or technicians assemble Heathkits between rush periods. Comprehensive instructions insure minimum construction time. You'll get more equipment for the same investment, and be able to fill your needs by choosing from the more than 100 different electronic kits by Heath. These are the most popular "do-it-yourself" kits in the world, so why not investigate their possibilities in your particular area of activity! Write for the free Heathkit catalog now!



Contains detailed descriptions of Heathkit models available, including VTVM's, scopes, generators, testers, bridges, power supplies, etc.



Also describes Heathkit ham gear and hi-fi equipment in kit form. 100 interesting and profitable "do-it-yourself" projects!

FREE catalog

Mail coupon below for your copy—Now!

HEATH COMPANY
A SUBSIDIARY OF DAYSTROM, INC.,
BENTON HARBOR 18, MICHIGAN

Name _____
Address _____
City & Zone _____
State _____

Catalogs & Bulletins

CAPACITORS: 12-page bulletin, "How to Use Capacitors," describing the why, where and how of industrial capacitor applications. Bulletin GEA-5632B available from General Electric Co., Schenectady 5, N. Y. (ELECTRONIC TECHNICIAN No. B10-1)

RESISTORS: 4-page bulletin describing a new kind of precision resistor, the Riteohm Series 77 metal film resistor. Outlined in full detail are complete characteristics compared with MIL specifications, resistance range, dimensions, and other important data. Bulletin 155 available from Ohmite Mfg. Co., 3661 Howard St., Skokie, Ill. (ELECTRONIC TECHNICIAN No. B10-2)

HI-FI: 6-page catalog describing company's line of hi-fi equipment in both kit and factory-wired form. Included are full specifications on the HF61 Master Control Preamplifier, HF60 60-watt Ultra-Linear Power Amplifier with Accro TO-330 Output-transformer, etc. Form A5 available from Electronic Instrument Co., Inc. 33-00 Northern Blvd., Long Island City 1, N. Y. (ELECTRONIC TECHNICIAN No. B10-3)

CONTROL GUIDE: A new pocket control guide with 121 pages of hundreds of new listings on the latest and most up-to-date replacement control information. Guide No. 6 available at 20 cents from Centralab, Div. Globe-Union Inc., 900 E. Keefe Ave., Milwaukee 1, Wisc. (ELECTRONIC TECHNICIAN No. B10-4)

SELENIUM RECTIFIER: 12-page illustrated bulletin discussing the advantage of "Selenium Rectifiers for High Voltage DC Power Supplies." The economics of selenium rectifiers versus high voltage rectifier tubes is also covered. Available from Beta Electric Div., Sorensen & Co., 333 E. 103rd St., New York 29, N. Y. (ELECTRONIC TECHNICIAN No. B10-5)

LAMINATE FOR PRINTED CIRCUIT APPLICATIONS: 4-page bulletin giving comprehensive data on size and thickness, properties, current-carrying capacities, foil, copper finish, post-etching suggestions, handling recommendations, etc. Bulletin LT-2 available from International Resistance Co., 401 North Broad St., Philadelphia 8, Penna. (ELECTRONIC TECHNICIAN No. B10-6)

TRANSISTORS: Bulletin G-120 describes company's line of PNP and NPN transistors for radio, r.f., and i.f. applications. Also contains valuable information on 4-, 6- and 7-transistor radio kits together with accompanying circuit diagrams. Available from General Transistor Corp., 91-27 138th Place, Jamaica 35, N. Y. (ELECTRONIC TECHNICIAN No. B10-7)

The
"GEM" of them all--

ROHN

TOWERS

Rohn Towers are the only complete line of towers... from the No. 6 "all purpose" tower which is most suitable for TV installations, to the giant No. 40 communications tower. Hot-dipped galvanized finish is featured in the entire line.

No. 6 Tower is ideal for heights 50-120'. Features Magic Triangle construction that assures great strength, stability and durability. Stocking Rohn No. 6 Towers means you can fulfill practically all tower needs!

No. 40 Communications Tower for extreme heights and heavy duty work. Uses large 18" equilateral triangular design which allows heights up to 300 ft.

or lesser heights where considerable strength is needed. Used widely

for radio communication and micro wave throughout U. S. Sell this tower for these requirements existing in your locality.

Both the No. 6 and No. 40 Towers are in 10" sections and are easily installed without special equipment.

Also available: No. 30 Towers and a unique space-saver PACKAGED TOWER, the latter available in heights from 24' to 64'.

ROOF TOWERS

5 "Superior Design" roof towers in heights from 2½' to 10'. Most all models are collapsible for easy shipping and storage. All models ideal answer for quick, inexpensive roof top installation. Get full information on this fine line of roof towers.

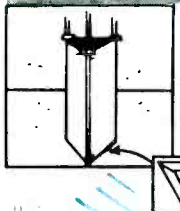

NEW BASE

"Same day" installation base available NOW for No. 6 and P. T. Tower! Use this unique base that permits "on the spot" erection and "on the ground" assembly. Towers are then merely "walked up" into position.

Telescoping MASTS

Heavy-duty hot-dipped galvanized steel tubing and rigid joints give extraordinary strength. Quick installation... mast attached to base—antenna fixed, then mast hoisted quickly to desired height. Utilizes special clamp and guy ring arrangement. Flanged interior section; crimped exterior section gives you a mast that won't pull apart with unequalled stability. Complete with guy rings and necessary erection parts. In 20, 30, 40 and 50 ft. sizes. Bases and ground mounts available.

ROHN "superior design" LINE

TUBING

True hot-dipped galvanized tubing coating both inside and out. Machined to perfection... available with 6" expanded end or plain—and in either 5' or 10' lengths. Painted if desired also available.

ACCESSORIES

A full line of accessories are available—all—Hot Dipped Galvanizing! Some of the items are: rotor posts, house brackets, eave brackets, peak and flat roof mounts, instant drive-in bases, hinged base sections, telescoping mast bases, guying brackets, UHF antenna mounts, erection fixtures, and a variety of mounts and supports for masts or tubing.

ROHN offers these exclusives

- Hot-dipped galvanizing • unequalled design and engineering
- mass production for low cost • universal customer acceptance
- pioneer manufacturers • complete line.

SEND COUPON TODAY!

"World's Largest Exclusive Manufacturer of TV-Communications Towers"

ROHN Manufacturing Co.

**116 LIMESTONE, BELLEVUE
 PEORIA, ILLINOIS PHONE 4-9156**

GET COMPLETE DETAILS AND CATALOG NOW

Rohn Mfg. Co., 116 Limestone, Bellevue Peoria, Ill.

Gentlemen: Please rush me complete details on the full line of Rohn Towers and Accessories.

FIRM _____
 NAME _____ TITLE _____
 ADDRESS _____
 CITY _____ STATE _____

PYRAMID CQM

1. High reliability, ideally suited for computer requirements.
2. Highest purity aluminum used.
3. Molded terminals for tight permanent seal.
4. Low leakage current.
5. Long shelf life.
6. Low equivalent series resistance.

Computer circuits require electrolytic capacitors of the highest reliability. Pyramid type CQM capacitors fill this requirement. They are made with electrodes of the highest purity aluminum obtainable (99.99%) and specially formulated electrolytes. Carefully inspected materials, coupled with controlled manufacturing methods, produce a capacitor capable of meeting the most exacting computer specification.

The capacitors are made in high purity aluminum containers hermetically sealed with molded tops held in place by rolling the can rim securely over a buna rubber gasket. The terminals are molded into the top. These terminals and the buna rubber gasketing insure a tight, permanent seal.

Two types of terminals are available: (1) a screw type terminal with tapped inserts, (CQM); (2) a lug type terminal, with anti-rotational locks, swaged to solid aluminum inserts, (CQML).

Internal connections to the aluminum inserts are made with straps of the same high purity aluminum as the electrodes. This feature contributes to low leakage and long shelf life.

Pyramid type CQM capacitors may be ordered in various capacitance and voltage combinations ranging from 45,000 mfd at 5 WVDC to 850 mfd at 400 WVDC. Container diameters are 1 $\frac{3}{8}$ ", 2", 2 $\frac{1}{2}$ " and 3". The height for all units is 4 $\frac{1}{8}$ ". Other sizes, or units for special applications may be obtained by inquiring of Pyramid's Engineering Department.



NEW FROM PYRAMID

PYRAMID TQ

1. Designed for high reliability electronic equipment, telephone networks, and industrial control systems.
2. Wide temperature range: -20°C. to +85°C.
3. Hermetically sealed aluminum can.
4. Low leakage current.
5. Long life, trouble free operation.
6. Manufactured under quality controlled conditions.

Present day electronic equipment, telephone network systems, and industrial control systems, where a high degree of reliability is essential, require capacitors having a long life.

Pyramid Electric Company introduces type TQ, a high quality electrolytic capacitor which will meet the requirements of design engineers today and for some time to come.

From raw material to finished product, the Pyramid type TQ is manufactured under controlled conditions and constant supervision.

Type TQ Capacitors are available in single, dual and triple capacitances. They vary in voltage range from 6 to 450 working volts DC. Can sizes are available in 1" diameter x 2 $\frac{1}{2}$ " length, 1" x 3", 1" x 3 $\frac{1}{2}$ ", 1" x 4", 1 $\frac{3}{8}$ " x 2 $\frac{1}{2}$ ", 1 $\frac{3}{8}$ " x 3 $\frac{1}{2}$ " and 1 $\frac{3}{8}$ " x 4".

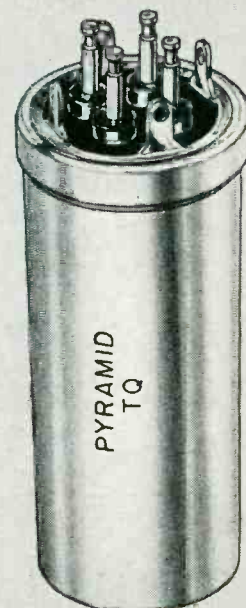

For complete specifications write for technical bulletin.



PYRAMID ELECTRIC CO.

NORTH BERGEN, NEW JERSEY

TO BRING OUT THE BEST
IN EVERY HI-FI SYSTEM...



Sell and install the NEW G-E VR_{II} cartridge

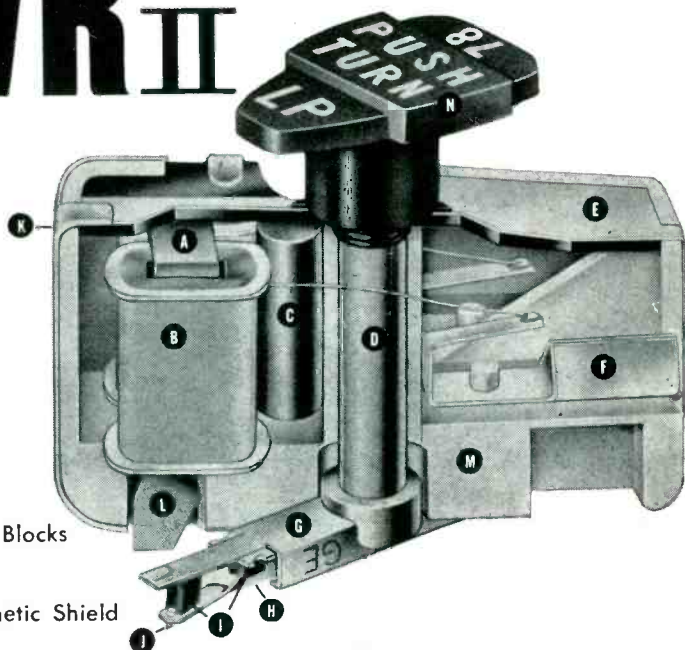

- Ⓐ Highly permeable laminations
- Ⓑ Hum-cancelling wound coils
- Ⓒ Alnico V Magnet
- Ⓓ Pivot Post
- Ⓔ Electrostatic Shield
- Ⓕ Plug-in Terminals
- Ⓖ "T"-Channel
- Ⓜ VR II Clip-In-Stylus
- Ⓛ Special G-E Damping Blocks
- Ⓜ Stylus Jewel
- Ⓚ Mu-Metal Electromagnetic Shield
- Ⓛ Magnetic Pole Pieces
- Ⓜ Plastic Body
- Ⓝ Triple Play Knob

Only a genuine G-E VR II gives your customers all this:

New Full-Range Reproduction—General Electric's new VR II makes faithful reproduction from 20 through 20,000 cycles a glorious reality!

New 4-Gram Tracking Force—Lateral compliance has been extended to 1.7×10^{-6} cm per dyne, permitting a tracking force of only 4 grams to minimize record and stylus wear.

Instant Clip-In-Tip Stylus—Stylus replacements can be made at home without removing cartridge from tone arm. There's no need to discard an entire dual assembly when only one tip is worn.

New Electrostatic Shielding—New shield prevents pickup of electrostatic interferences and hum; also

grounds stylus assembly so that electrostatic charges cannot build up from record surface.

New Lightweight Construction—Reduced in size and weight—with new stylus guard, terminals and knob—the General Electric VR II will withstand continued use under the most exacting conditions.

The new G-E VR II cartridge is being announced to the public in a heavy schedule of advertisements now running in major Hi-Fi and general magazines. Do you have enough stock to meet the demand?

Specialty Electronic Components Dept., Section HFS10, West Genesee Street, Auburn, N. Y.

In Canada: Canadian General Electric Company, 189 Dufferin Street, Toronto 3, Canada.

Progress Is Our Most Important Product

GENERAL  ELECTRIC

YOUR INSTALLATION VOLUME CAN BE GREATER!

If you're *not* a Channel Master Dealer you are probably not getting your share of the *really profitable* antenna installation business. Hundreds of dealers have doubled and even tripled their antenna sales *in less than one year* when they

switched to Channel Master and featured the famous T-W antenna. In fact, far more T-W antennas are bought than any other fringe area antenna. There must be good reasons for this. Below are listed but a few of them.

How much installation business are you losing every week? ...because you don't feature the CHANNEL MASTER® T-W

Put these extra selling advantages to work for you!

Superior PERFORMANCE! Outperforms any all-channel antenna ever made! Revolutionary "Traveling Wave" design delivers highest front-to-back ratios (better than 10:1) — top gain over the entire VHF range.

Stronger CONSTRUCTION! Super-strong in every detail of construction: Twin-Boom — the only antenna with 2 full length crossarms; 2 Super-Nests — the most powerful grip that ever held an antenna to the mast; Line-Lok — absorbs all transmission line tension; 7/16" dia. elements.

Bigger NATIONAL ADVERTISING! More than 75,000,000 advertising messages in America's leading national magazines. Now saturation coverage with big-space ads blanketing 173 prime outdoor antenna markets.

LIVE LEADS galore! Tens of thousands have already responded to Channel Master's Free "Antenna Check-Up Kit" offer — repeated in new national ads. Based on experience, 50% — and more — of these leads are converted into actual sales.

Local CO-OP ADVERTISING! The most liberal advertising allowance in the industry — so you can run your own local promotions. Channel Master dealers have the widest array of mats, radio and TV spots, and display materials.

Promoting ANTENNA REPLACEMENTS! Channel Master's national advertising hammers home the theme of antenna obsolescence — opening new markets for you!

7-element
model no. 350
5-element
model no. 351
3-element
model no. 352

Call your Channel Master distributor now!

© Reg. U.S. Pat. Office and Canada

model no.
354-1

NEW "INSTALL-IT-YOURSELF" ANTENNA KIT featuring new 2 ELEMENT T-W ANTENNA

Including: • 2-element T-W
• Combination 4 ft. x 1 1/4" aluminum mast and Universal Tripod Mount • 3 Mounting Nails with Neoprene sealing washers • 50' 80 mil wire
• 6 - 3/8" Standouts • 1 Standout Strap.

A COMPLETE
ANTENNA
INSTALLATION
IN ATTRACTIVE
3-COLOR
DISPLAY CARTON

Designed for top performance in suburban and metropolitan areas. Powerful "Traveling Wave" principle provides the 2-element T-W with better all around performance than a stacked conical.

Promotionally Priced at \$29⁹⁵ list



CHANNEL MASTER CORP.

ELLENVILLE, N. Y. copyright 1973 Channel Master Corp.
WORLD'S LARGEST MANUFACTURER OF TV ANTENNAS AND ACCESSORIES

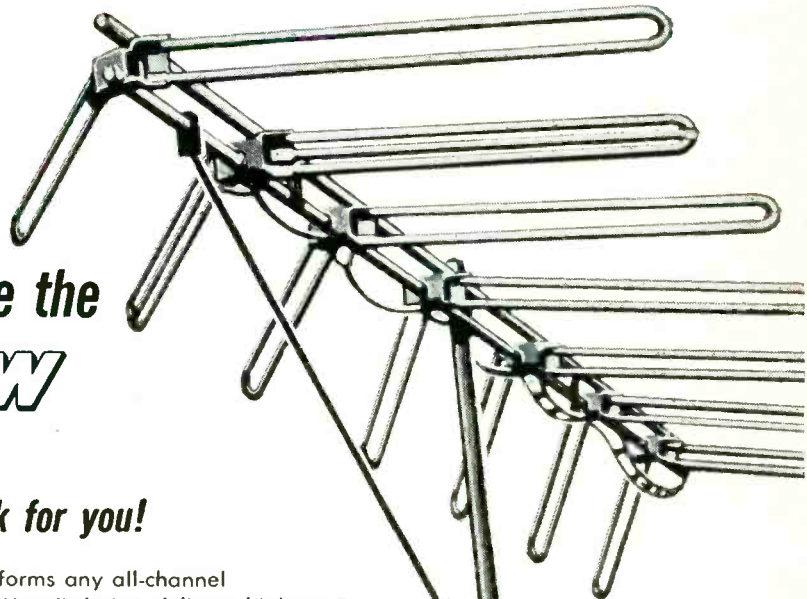

ELECTRONIC TECHNICIAN

Including
Circuit Digests

It's Audio Time!

It seems that during the fall of each year, music lovers, audiophiles and hi-fi bugs perk up. Yes, it's high fidelity show time. In September there are two different hi-fi shows in Chicago, and a smaller show in Cincinnati. This month, during the week of Oct. 7, there's the giant Institute of High Fidelity Manufacturers exhibition in New York City at the Trade Show Building. The New England High Fidelity Music Show is at Boston's Hotel Touraine, Oct. 18-20, while a local show will be held in Miami at the same time.

These shows are growing increasingly popular, making more people aware and desirous of audio equipment. Thus, while TV sales did soften a bit this year, hi-fi sales kept increasing. The result is that a growing portion of the electronic technician's income is being derived from audio sales and servicing.

As we pointed out in our August editorial, TV is still the overwhelming source of servicing income, and will no doubt continue to be for many years. However, look how important audio work is be-

coming. This year the servicing industry will derive \$82,800,000 from home hi-fi servicing, and \$57,400,000 from public address installation and repair.

That's not all. Technician-dealers will sell \$23,400,000 of home hi-fi "component" equipment, \$27,300,000 of packaged audio for the home, and \$13,000,000 in public address equipment. These sales are in addition to the servicing figures noted.

Included in this issue is another in our series of articles designed to prepare TV specialists for audio work. It's called "Second Echelon Hi-Fi Servicing," which offers a substantial amount of practical data.

So if you're within traveling distance of a hi-fi show, put on your comfortable walking shoes, and take a look at the wide variety of audio gear on the market. More and more of this equipment will be coming into your shop for repair. More and more of your customers will be inquiring about audio purchases.

Yes, the fall season is audio time . . . and time for you to be ready to serve your audio-oriented customers!

Toll TV Test Authorized

On Sept. 18, the Federal Communications Commission authorized TV stations to conduct three-year trial transmissions of subscription (pay-as-you-see) TV. However, this approval was subject to several important limitations. Each station must submit its plan for conducting the tests to the FCC, which will not act on the applications before March 1, 1958. Consideration will be given on an individual basis, but no commitment was made that any applications would actually be granted.

Toll TV has been one of the most controversial subjects in the industry. The companies who have been in the vanguard of the fight for acceptance are about five in number. They maintain that subscription TV will bring entertainment features, such as plays and first-run movies, which have not been available to video viewers before. They maintain that the public should have the choice of making its own decision.

Arrayed in opposition are the networks, numerous manufacturers and the largest service association. They maintain that fee TV would destroy free TV, that very little would be added in the way of

new programs, and that set owners have the right to expect all broadcast channels to be available free as they always have been. In addition, bills are pending in both houses of Congress, which would in effect prohibit pay TV.

Another aspect of subscription TV is the wired system. Since cable TV does not require air transmission or FCC approval, it bypasses most objections to toll TV. A wired system in Bartlesville, Okla., is in pilot operation. How well it succeeds will have great impact on all toll TV.

The devices developed for toll TV are varied (see page 42 for the latest), but the object is the same: a decoder unscrambles the picture for the user for a fee; the viewer without a decoder sees only the scrambled picture on the particular channel.

As we see it, it's still a speculative question whether toll TV will ever become a standard element in communications and entertainment. The coming year should be decisive in this regard. 1958 is the target date for the government, the industry and the public to make up its mind.

Servicing

Selenium & Germanium

Operation And Troubleshooting Of The Horizontal

DICK FELIN

• The purpose of a horizontal phase detector is to maintain proper horizontal oscillator frequency. It does this by comparing a sample of the horizontal-oscillator waveform in the receiver with the horizontal sync pulse. When both are in proper phase relationship with each other, the detector will not produce any corrective voltages. If, on the other hand, the oscillator is running ahead or behind, the phase detector will develop a control voltage which can correct the speed of the horizontal oscillator.

The negative going sync pulse is applied to the cathodes of both diodes through a coupling capacitor C1, as shown in Fig. 1. Capacitors C2 and C3 provide a path to ground through diodes D1 and D2 respectively, and effectively place the diodes in parallel with respect to the sync pulse. The voltages developed across the load resistors R1 and R2 are equal and opposite, they cancel each other and produce an output of

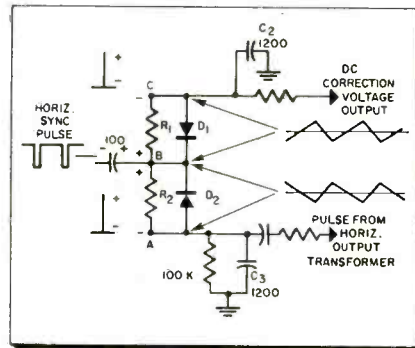

Fig. 1—Basic horizontal AFC phase detector.

zero volts. At the same time the coupling capacitor C1 becomes charged as shown, and places a positive voltage on the cathode of both diodes and prevents them from conducting between sync pulses.

A sample of the horizontal oscillator waveform is taken usually from a tap on the horizontal output transformer, and is passed through a differentiating network to shape this signal into a sawtooth. The sawtooth voltage is fed into the circuit at point A. The amplitude of the

sawtooth is not sufficient to cause the diodes to conduct. This is because of the bias imposed on the diodes by the coupling capacitor. Therefore, the sawtooth signal is impressed across the load resistors. Since as much of the sawtooth signal is above the zero reference line as below, the d-c component, which is in effect the average of the a-c component, is zero. The sawtooth voltage developed across each load resistor with respect to point B is as shown in Fig. 1. Neither the incoming sync pulse nor the sawtooth wave by itself can cause the circuit to produce a d-c correction voltage. Only that portion of the sawtooth that occurs at the instant of the sync pulse will have any effect on the output of the phase detector. If the sync pulse occurs in the exact center of the retrace portion of the sawtooth, as shown in Fig. 2A, equal and opposite voltages will be developed and the output voltage will still be zero. If the oscillator is slow, the sync pulse will occur before the retrace passes through its a-c axis, Fig. 2B. Therefore, some of the sawtooth voltage will be added to the sync

Fig. 2—The phase relationship between the horizontal sync pulse and a feedback pulse from the receiver's horizontal output circuit determines the amplitude and polarity of the control voltage. When both pulses are in proper phase, the output of the detector is zero.

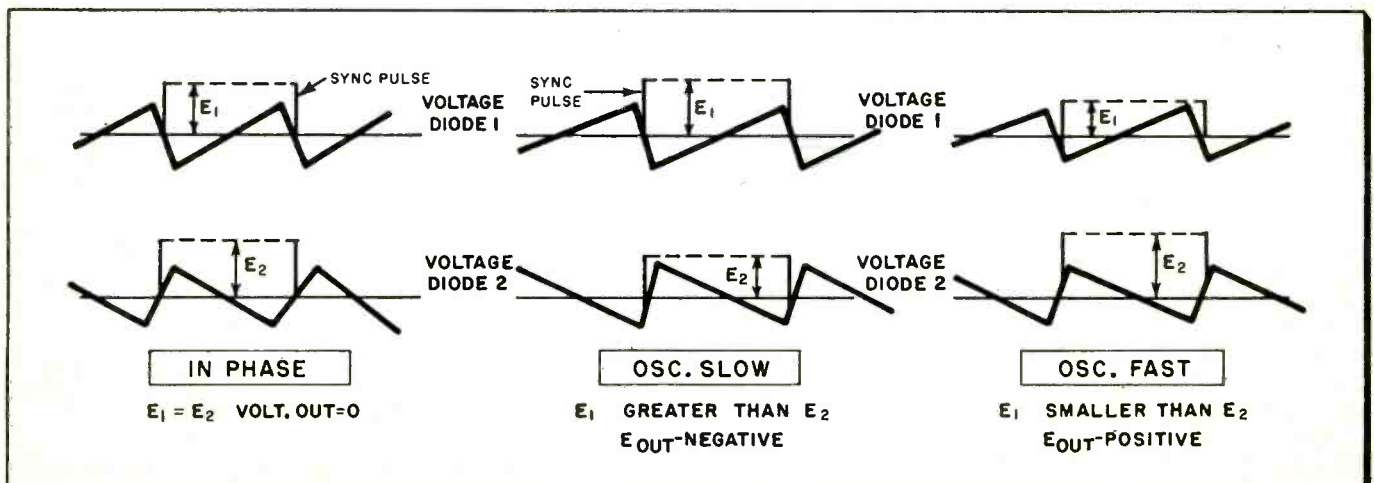

Diode Phase Detectors

Automatic Frequency Control, Antihunt & Filtering Circuits.

pulse voltage on R1 and subtracted from R2.

Because the voltage developed across R1 is greater, the detector will produce a negative d-c voltage. If the oscillator is fast, the sync pulse will occur after the retrace passes through its a-c axis as in Fig. 2C. Conditions of operation are just the opposite of the action described for a slow oscillator, and the output voltage of the detector circuit will be positive.

Frequency Control

The frequency of the horizontal multivibrator is controlled in the following manner. If the correction voltage applied to the grid of the first triode, is positive, it causes the cathode voltage to rise. This extends the cut-off time of the second triode and lowers the oscillator frequency. Conversely, a negative control voltage lowers the cathode potential, shortens the discharge time of the coupling capacitor to the second triode and increases the firing rate.

In actual applications some departure from a truly balanced network may be noted. Fig. 3 is a typical circuit which may be found in GE, Hotpoint, and other makes. Some variations in component values and placement may be found, but basically the circuits are the same. In all cases the diodes should be a matched pair. Stray capacitance and other reactances will upset what might otherwise be a balanced arrangement. In order to obtain linear response to deviations on either side of the normal frequency, it may be necessary to apply some form of bias to the horizontal multivibrator. Capacitor C250 is used to balance the capacitive reactance across the diodes. The difference in load resistors R250 and R251 helps establish a desirable biasing voltage on the grid of the first triode. It should be noted that this grid's resistive network consists of R254, R251, R250 and R253. A filter network which has the

effect of making the oscillator respond to an average correction voltage, furnished by several sync pulses, is composed of C253, R254 and C254. This action makes the circuit immune to noise pulses of short duration. As in most controlling devices, some consideration must be given to such things as over-controlling and delay in response. An antihunt circuit composed of R255 and C256 has the effect of zeroing the control voltage as the oscillator reaches the correct speed. A defect in this circuit can cause a "gear-tooth" picture.

Troubleshooting

To eliminate the unnecessary removal of good horizontal phase detector diodes, and before suspecting any other circuit defects, first check for proper adjustment of the horizontal stabilizer and hold controls. This can be accomplished simply by

shorting out the diodes to check the free running speed of the oscillator. If the free running speed is more than 2 bars out of sync, the trouble is probably due to improper adjustment. Under these conditions, ground test point VI and apply a weak signal to the antenna terminals; place a 1,000-ohm resistor across the stabilizer coil and adjust the horizontal-hold control as close to the proper speed as possible. The picture should be floating slowly back-and-forth. Remove the resistor and adjust the coil so that the picture floats again. If the stabilizer coil had not been properly set previously, removal of the resistor will cause the picture to be 2 or more bars out of sync. Remove the ground from the test point.

One of the troubles encountered is a condition which causes the raster to disappear when a signal is applied, but reappear when the

(Continued on page 65)

Fig. 3—A typical horizontal AFC phase detector using selenium and germanium diodes.

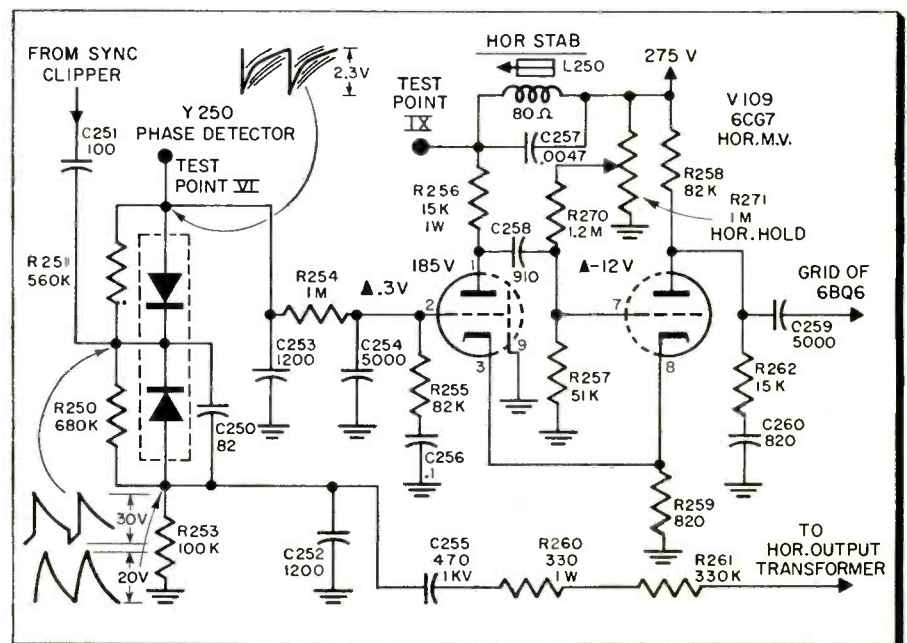

Test Equipment For Second

How To Find And Measure Peak Distortion, Hum, Frequency Response

NORMAN H. CROWHURST

• In the September 1957 issue of *Electronic Technician* in the article on, "Planning to Develop a Hi-Fi Service Center," I have discussed the use of proper test equipment and the division of servicing into three separate echelons of maintenance. Also pointed out was the possibility of getting started with the test equipment already on hand. How to duplicate laboratory test conditions in the field, without precision type meters, signal generators, etc., and without an immediate outlay of capital, is of course a matter of concern. While there is no substitute for quality equipment, there are several procedures that may be used to solve this problem during the transition to specialized quality instruments for audio work.

For example, let us consider the use of a VTVM which has been in service for several years. Its frequency response, calibration and linearity may have deteriorated from its original specifications. For ordinary servicing this meter may still be quite adequate. For checking the manufacturer's specifications within a reasonable degree of accuracy it is of questionable value. It so happens that a classic procedure

for certain audio measurements can be made with a voltmeter whose frequency response and calibration could be neglected, providing certain other pieces of equipment were on hand.

A calibrated adjustable attenuator inserted between the signal generator and the amplifier could be adjusted to drop the signal as much as the amplifier builds it up. The calibration marks on the attenuator would then indicate the gain of the amplifier, usually in db's. Since the only requirement for the voltmeter, in this case, is to determine when the two signals are equal, its frequency response and calibration is not a factor.

The procedure that follows is perhaps one of the most interesting approaches to a high fidelity amplifier test set-up. The beauty part of it is that a high degree of accuracy can be obtained with most of the equipment already on hand.

The oscilloscope and signal generator used in the input/output comparator method need not be the types that have a 0.1% distortion figure. However, the lower the distortion figure, the greater the advantage when more elaborate equipment is used. The important thing for a sine-wave oscillator using this method of test is for the waveform to look reasonably like a sine wave.

Otherwise the voltmeter readings would not be correct.

One of the better, more expensive oscillators, will probably include an attenuator and matching arrangement to suit the input on different amplifiers, preamplifiers, etc. But for a start these can be rigged up as required with ordinary half-watt resistors.

Attenuator

To obtain the required input voltage within reasonable limits, don't use resistors greater in value than about 100K ohms or lower than about 10 ohms in the input circuit. If values higher than 100K ohms are used, self-capacitance of the wiring is likely to affect the readings and produce phase shifts at the very high frequencies, as well as giving opportunity for pick-up of hum. Use of resistances lower than 10 ohms is likely to cause inductive troubles. Wiring inductance can produce wrong readings at the very high frequencies and also cause inductive pickup of hum.

Sometimes only two resistors will be required to produce the necessary attenuation for the input circuit. These should be worked out on the basis of allowing the oscillator to give almost its maximum output—usually about 10 volts, when

Fig. 1—Attenuator and impedance matching network enables proper signal input voltage with minimum distortion. Part A and B shows a

single 40 to 1, and a two-step, approximately 1,000 to 1 voltage divider arrangement. Part C is an attempt at obtaining impedance match.

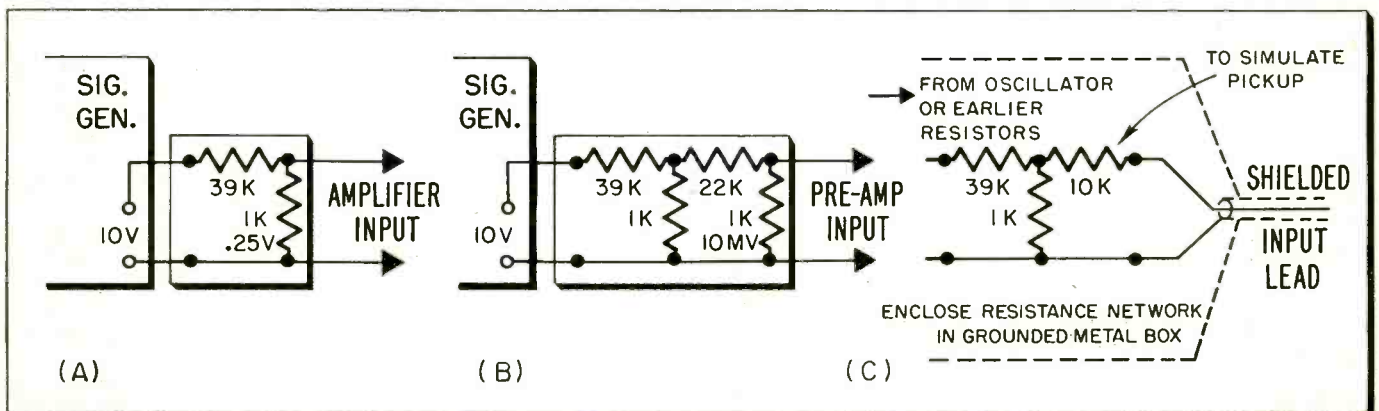

Echelon Hi-Fi Servicing

And How To Look Into A Feedback Loop Without Disabling It.

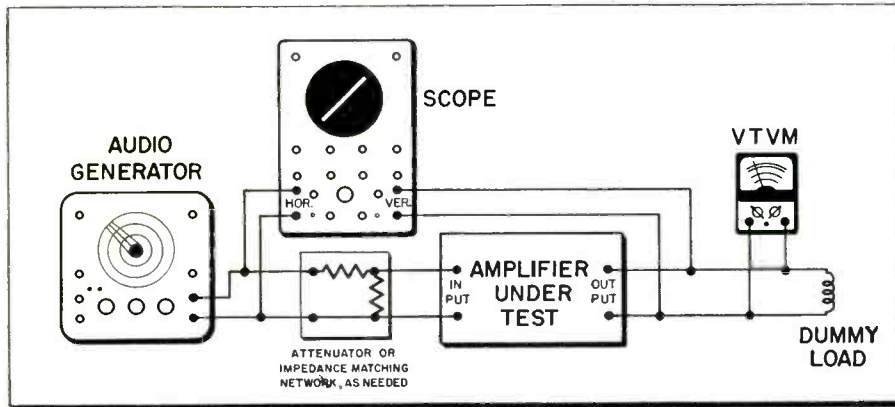

Fig. 2—A typical scope-generator setup for the signal input/output comparator method.

compensated control. It is desirable to maintain impedance match between all components. The resistor network when properly set up can attenuate the signal to a desirable level and maintain match at the same time. An L, T, or H type pad may be used. For simplicity a voltage divider network configuration may be used at the expense of some impedance match. A variable attenuator, constant impedance arrangement is highly desirable.

A dummy load resistor is needed to match at least one of the amplifier's output taps. Use the highest tap possible. The resistor should have a sufficient wattage rating to handle the output load. If necessary, several resistors may be used to obtain proper ratings. In most cases 50 or 60 watts is adequate.

If the amplifier includes a pre-amplifier for phono or other low level inputs, the attenuator resistors should be modified to reduce the 10 volts from the oscillator so as not to overdrive the preamplifier. If, for example, only 10 millivolts is needed, it would require a 1,000 to 1 resistance ratio. This is rather a big step to make with only two resistors. Two steps, of say 40 to 1, and 25 to 1, would be a more convenient way of doing this to avoid

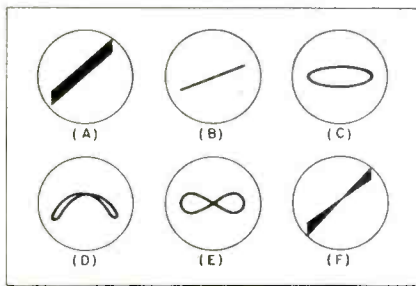

Fig. 3—Typical traces showing different types of hum. Single and double loops indicate 60 and 120-cycle hum respectively. A form of hum modulation present only with the signal is shown in part F.

the amplifier is being driven to its rated output, with the gain controls set at maximum. If, for example, the amplifier is of the basic amplifier type (not including a preamplifier) that requires 0.25-volts input to give rated output, the resistors should be in the ratio of 40 to 1. For simplicity, resistors of 1K ohms and 39K ohms will serve to give a suitable ratio, as shown in Fig. 1A. One reason for using the maximum output of the signal generator is to avoid the unpredictable loading effect of an output level control in those generators which do not have a com-

Fig. 4—Checking the amplifier action excluding feedback, without disabling it.

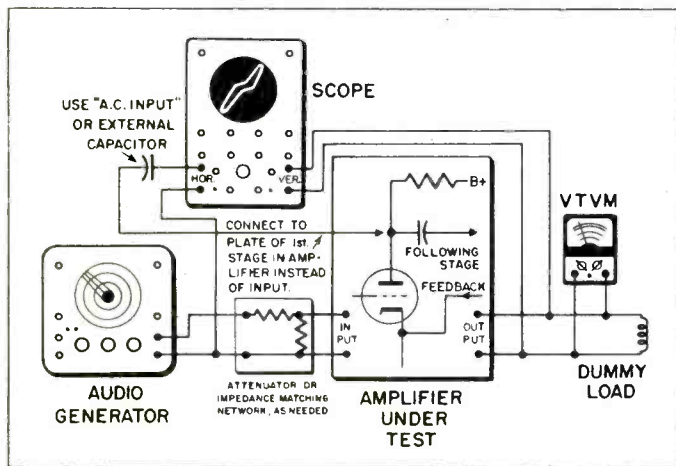
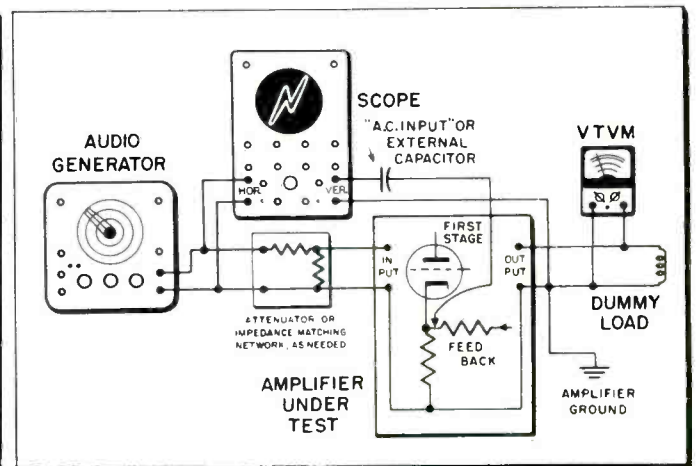

Fig. 5—Comparing the feedback waveform signal with the input signal.



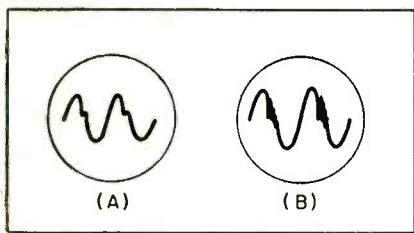

Fig. 6—Notch distortion at A and how it is affected by feedback is shown at B.

undesirable effects; as shown in Fig. 1B.

If the amplifier or preamplifier input calls for a high impedance input and is provided with a shielded lead, it is well to simulate the source resistance of the pickup; which may be in the region of 10K ohms or 20K ohms. This may be accomplished by inserting an additional resistor in series with the input to the shielded lead as shown in Fig. 1C.

Connect the type of resistive network selected between the signal generator and amplifier. Attach the dummy load and connect the horizontal and vertical inputs of the scope as shown in Fig. 2. Just in case you are wondering why a dummy load and not the speaker itself is used. One reason is that the landlord and other tenants may ask you to depart for other places. The amplifier tests are performed, for the most part, with the gain control fully advanced. Secondly, most manufacturers use a resistive load to establish a standard. Since the speaker load will vary depending upon frequency, room, baffle and other acoustic conditions, speaker characteristics, etc., the chances of arriving at anything resembling the standard are very slim. The desired output level should be arrived at by controlling the amplitude of the input signal. Most manufacturers will specify the level for testing. In the field, the technician may elect to look at the amplifier when it is putting out its rated output power.

Set the oscillator to 1,000 cycles and permit all the equipment to warm up. The scope should show a

Fig. 7—Possible patterns obtainable when checking frequency response. Pattern at left, in each case, is at midrange.

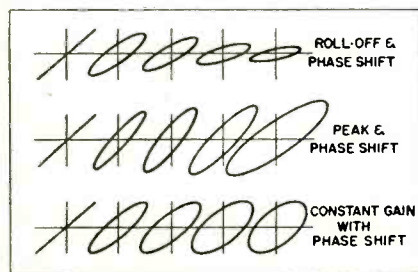

sloping line at an angle of 45°. The direction of the slope may be from left to right or right to left, depending upon the phase relationship between the input and output of the amplifier and also any phase reversal in the scope itself.

Tracing Hum

If the trace is double or thickened, as in Fig. 3A, it is most probably due to hum generated in the amplifier. First check all ground connections; also check for adequately shielded high impedance connections. If excessive hum is still present, then check the amplifier, stage-by-stage by moving the scope's vertical probe back one stage at a time. Hum could be caused by inadequate B+ filtering, defective tubes and upsets in the tube heater circuits. If uncertain as to where the hum is coming from, a good method of

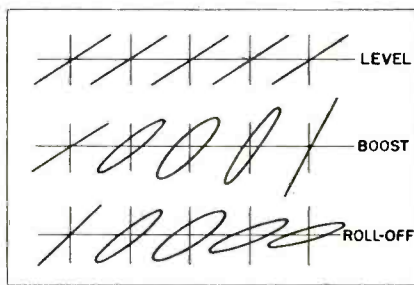

Fig. 8—Typical waveforms obtained when checking the boost or rolloff response.

checking is to switch the scope's time base control from the "external" position to the "line" position. This compares the amplifier output against a 60-cycle sine-wave horizontal sweep. Turning the oscillator down to zero will leave just the hum output. The vertical deflection can now be turned up until a pattern becomes visible. A sloping line or a single loop, as shown in Fig. 3B or 3C is an indication of 60-cycle hum and may be due to a defect in the filament string, or a cathode-to-heater short in an a-c heater line.

If it takes the form of a double loop or a curved line as in Fig. 3D or 3E, it is an indication of 120-cycle hum. This can usually be attributed to improper filtering of the B+ supply. Defective electrolytics are usually the cause of this type of trouble.

If, as the oscillator is turned up, with the input/output arrangement, the sloping line thickens at the ends instead of being a double trace all the way up as shown in Fig. 3F, it could be due to hum modulation. This is a form of hum that does not show up when the signal is not

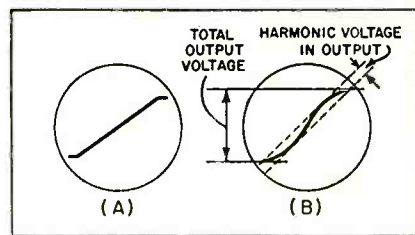

Fig. 9—Point of leveling off indicates clipping level. S curve shows harmonics.

present but modulates the signal as soon as audio passes through the amplifier. It usually occurs in the output stage of a push-pull amplifier due to inadequate B+ filtering. If the output tubes use a separate supply point for their screen grids, check the electrolytic capacitor in this circuit too. Hum modulation of this type can be quite disconcerting to a high fidelity enthusiast. It is not noticeable as a separate entity in the form of hum, but it produces a "broken-up" effect on parts of the program.

Distortion

We can now go on to consider different kinds of distortion at 1,000 cycles. Slowly increase the input to the amplifier. The straight line should stay very straight until maximum output is approached, then there should be a slight flattening at both ends. If the trace opens out into a loop or shows any peculiar curvature then a tube somewhere in the circuit may not be operating properly.

If there is a serious asymmetry in the way the line opens out, that is the curvature or kink appears at one end only, that too is probably due to some tube operating under improper bias or plate supply conditions. The VTVM may be used to check for proper voltages, or the scope may be used to trace the waveforms through and find at what point in the amplifier it first shows distortion.

This can prove rather a complicated procedure in a feedback amplifier, unless the feedback is removed before applying this signal tracing technique. To do this, cut the input signal, because removal of feedback will increase the gain of the amplifier by about 10 to 1. Adjust the input so that the output is the same as before and see whether or not there is about the same kind of distortion. It should show up more, because previously the feedback was reducing it. Having determined that the amplifier is now behaving essentially in the same manner, it should now be easier to

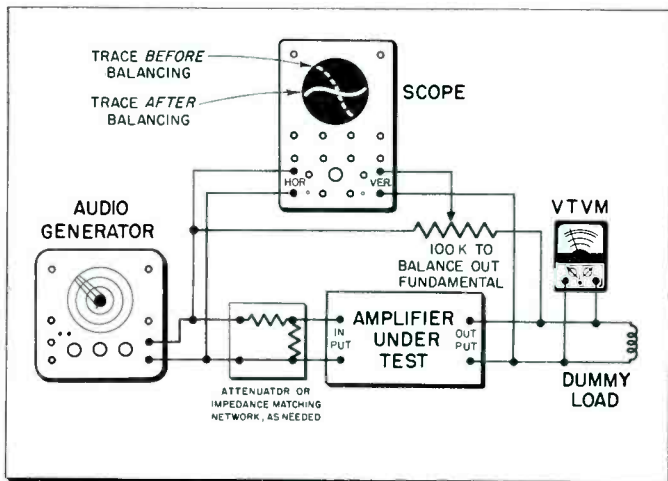

Fig. 10A—Balance control bucks out the fundamental. The harmonic distortion waveform can be measured to within a fraction of 1%.

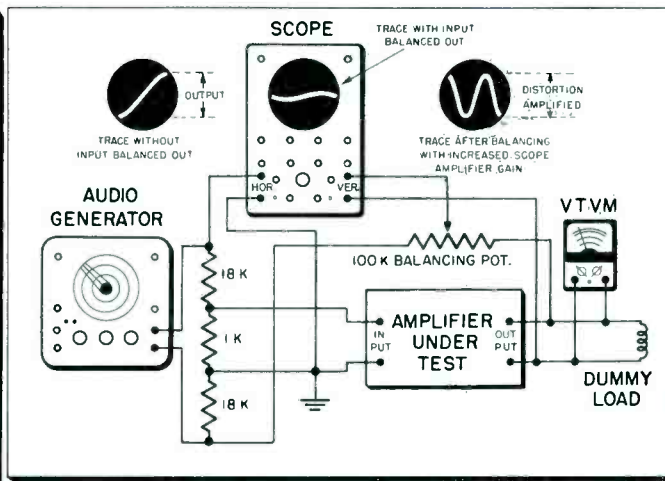

Fig. 10B—Phase inversion arrangement used to obtain an opposite fundamental signal. Balance control then equalizes these signals.

pin down the trouble.

Sometimes, however, the distortion shows up only when the feedback is connected. This may at first seem like a rather odd condition. The distortion may not be any less by removing the feedback, but it takes a different form. It is no longer concentrated at one point on the waveform, but is a more general kind of a curvature. This indicates that addition of the overall feedback is in some way interfering with the performance of the amplifier.

Under these circumstances the only thing to do is to check the amplifier with the feedback still connected. This is another advantage of the comparator scope method. Leave the scope's vertical probe connected to the output, move the horizontal probe from the input and try applying it to different stages of the amplifier. Fig. 4 shows the connection to the plate of the first stage. This will compare the output against the input and thus indicate the amplifier behavior excluding feedback, but still allow the feedback to cause any peculiar effect its removal might stop.

Another technique that can be used, is to examine the waveform of the feedback signal compared with the input signal. To do this, leave the scope's horizontal probe on the input and connect the vertical probe to the cathode of the first stage, where the feedback is connected, as in Fig. 5.

Measuring Distortion

While this method does not measure IM, it does measure harmonics in a much more informative way than the usual harmonic-distortion meter. Even though the re-

sult achieved is an estimate rather than an accurate precision measurement. In a good quality amplifier the 45° line at 1,000 cycles should be extremely close to straight and show no opening out into a double line or loop until the clipping level is reached. Then it will suddenly turn over, at the same time, at both ends of the line as in Fig. 9A.

Turning the level up until clipping just shows, the output voltage can be read and the output power calculated, from the formula:

$$P = \frac{E^2}{R}$$

P being the power in watts, E the output voltage in volts and R the load resistance in ohms. In a good amplifier clipping shows up surprisingly well. It is easily possible to see a distortion that would measure only a fraction of 1% using a harmonic meter. This is because this distortion is so very sudden and distinct in its nature.

Remove Feedback

If some curvature begins to show up before the clipping point is reached, it may be instructive to investigate a little further the cause of curvature. If it is only very slight and the deviation does not amount to more than one hundredth of the total height of the line, which can be seen on a modern scope by careful examination, as shown in Fig. 9B, it means the distortion is less than 1% and probably nothing to worry about. But if it is more than this it is well to investigate and find the cause of this distortion.

A good way of exaggerating the effect may be to see what shows up without including the effects of

feedback. To do this merely move the horizontal probe from the oscillator to the plate of the input tube of the amplifier as shown in Fig. 4. This now compares the input against the output of the amplifier with the feedback connected, but without showing the effects of the feedback. We are now measuring what the amplifier does inside its own feedback loop. To trace down to the actual point where distortion occurs, the vertical probe can be moved back from the output terminals of the amplifier, a stage at a time, until the point is reached where the trouble first appears.

Remove Fundamental

To obtain an estimate of the actual amount of distortion, buck out the fundamental from the vertical deflection. To do this, a part of the signal may be taken directly from the oscillator, but it should be out of phase with the output from the amplifier. Fig. 10A shows a simple arrangement and requires the use of a 100K ohm potentiometer, as a balance control.

As most amplifiers have the output in phase with the input, using feedback from the transformer secondary to the cathode of the input stage, a phase reversal is needed to achieve the desired effects. This can be done by modifying the oscillator connections as shown in Fig. 10B. Adjust the potentiometer so that the voltage from the input and output from the amplifier to the scope's vertical input are both equal. Balance occurs when the trace becomes horizontal, and all that is left is the curvature without the slope as shown in Fig. 10B. Now increase

(Continued on page 66)

VTVM Antenna Orientation

Adapter Enables VTVM To Measure AGC Voltage At Antenna Site.

WARREN J. SMITH

• In the absence of a field-strength meter, it is possible for one man to use a portable VTVM to orient an antenna for maximum signal pickup. A couple of simple clip-on adapters permit readings to be taken from the top of the mast.

For open-circuit type antennas, such as conicals and V's, the adapter shown schematically, is used. It places the AGC voltage on the transmission line. The resistors perform the function of preventing the signal from shorting to the chassis and the capacitors prevent AGC voltage from shorting through the antenna coil at the receiver input. After the adapter has been clipped into the circuit and a station selected at the receiver, the VTVM is taken to the roof and the antenna direction adjusted for maximum indication on the meter.

For closed-circuit antennas like the folded dipole, the capacitor-adaptor is used in addition to the AGC take-off unit. It is inserted in series with the transmission line

above the point of AGC measurement. This prevents the AGC voltage from shorting through the antenna.

Many late model TV receivers have an AGC test point on top of the chassis which makes this method of antenna orientation comparatively easy. However, in receivers where the AGC bus is difficult to reach without pulling the chassis, it can be brought up on top with a vector

socket adapter, placed under the AGC or detector tube. In this case, the isolation resistor R_1 should be increased to approximately 150,000 ohms.

The adapters can be enclosed in small plastic parts boxes. All leads can be terminated with alligator clips. This protects the components from damage and makes the adapters handy to use as well as convenient to carry. •

Adapter places AGC voltage on TV antenna transmission line. By monitoring this voltage it is possible for one man to orient the antenna for maximum signal pickup.

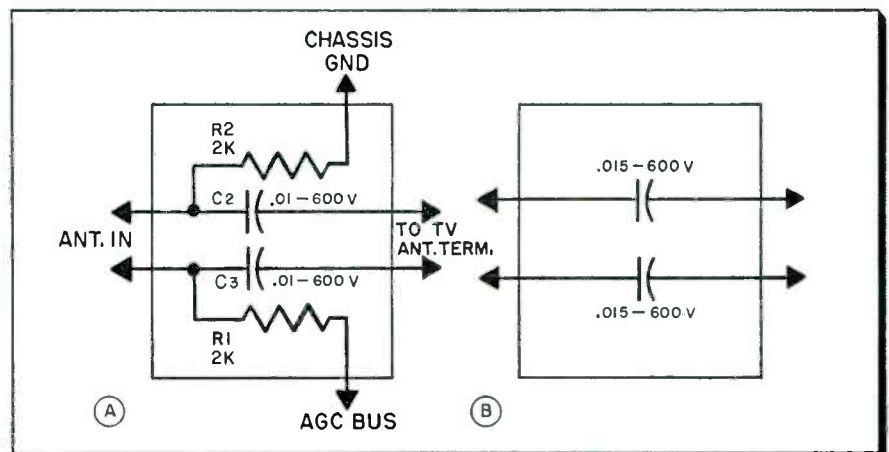

Insurance Plan For Technicians

• Good business practice dictates that electronic technicians have sufficient liability, fire, theft, automobile and other insurance to protect them against unexpected emergencies. Just as important is adequate family protection through life insurance. This comes under the heading of good family management.

Insurance experts believe that electronic service operators are among those who are seriously under-insured. People who depend on you—wife, child, parent—can be placed in dire financial straits with your passing.

Therefore, it is with considerable interest that we note the announcement of a group life insurance plan by Raytheon Mfg. Co., to be spon-

sored by many (though not necessarily all) of its tube distributors for technicians. The plan is underwritten by New England Mutual Life Insurance Co., Boston, Mass.

Ramifications

There are two important ramifications to this plan, one national, one personal. The national effect goes far beyond technicians and the electronic industry; it may have a profound impact on manufacturer-dealer relations in all industries, and will no doubt be closely watched by leaders in various fields. The reason for this broad attention is that in the past group life insurance plans are generally restricted exclusively to

full-time company employees. If this pioneer group plan is as successful as many expect it to be, other manufacturers and other industries may follow suit to cement closer bonds with dealers by extending benefits previously reserved only for their own employees. Furthermore, there is no reason why dealer-group plans must be limited to life insurance; eventually it could even cover hospitalization, fire, liability, etc.

From the personal viewpoint, this group insurance plan bolsters the protection technicians provide for their families. As a side benefit, it stimulates technicians into thinking of the various insurance problems which must be faced and resolved.

(Continued on page 63)

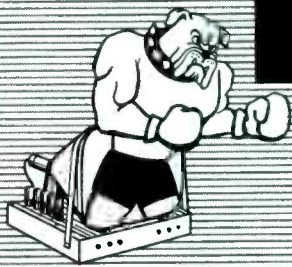

"Tough Dog"



Corner

Difficult Service Jobs Described by Readers

Troublesome Shortcut

A house call took me to a Capehart CX-31 suffering from a very faint washed out picture and no sound. Adjusting the AGC pot had no effect. After appropriate tube changing, the chassis was turned on its side and a few voltages were measured with the trusty miniature VOM. The trouble was quickly located. The 565-ohm B-minus bleeder between the 60-volt buss and ground was open; it caused the AGC amplifier to conduct heavily and cut off the front-end and i-f stages. A 600-ohm, 10-watt resistor was soldered across the open candohm, and that was that. Little did I know that I had just built into this set a pretty nasty tough dog and call-back.

Two days later I got the call to look at the set again. This time the trouble was an intermittent over-

Open resistor left in circuit caused intermittent AGC action on a Capehart CX-31.

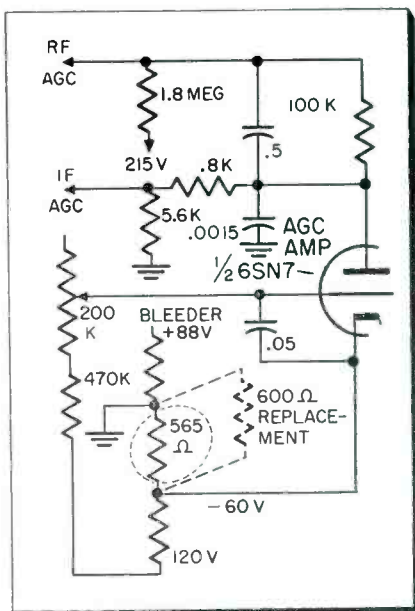

load condition. Half heartedly, tube changes and voltage checks were tried again; but this time the set was pulled to the shop. Once on the bench, as usual, the set played fine. The first check made was the 600-ohm resistor across the opened candohm, it read 600 ohms on the nose.

After a while the set popped into overload and the serious trouble shooting started. Once it was established that there was no negative voltage on the i-f grids, the AGC buss was checked out thoroughly. Next, another long wait before the picture overloaded again. The only place that there was some negative voltage (-10 volts) was on the plate of the AGC amplifier. Since the diagram I was using didn't contain correct socket voltages it made the analysis even tougher. However, replacing the 1.8 meg resistor to B+ and lifting all the capacitors in the AGC amplifier plate circuit yielded no results. I concluded that more than -10 volts was needed. One voltage, however, was definite. The cathode of the AGC amplifier should read -60 volts and instead it read -50. This slight change, plus the fact that I knew the bleeder was OK failed to cause concern; especially after I re-checked the bleeder with the ohmmeter.

Still the -10 volts probably was too low and after checking out the AGC threshold circuitry it was decided that something had to be done about the cathode voltage. Reading it again was a lucky move. This time it read -35 volts instead of the -50 it read before. At last I established that the -60 volts buss was intermittently varying from -35 volts to -50 volts to -60 volts. Lifting the 600-ohm resistor off the candohm and lifting the candohm off ground cured the set. What was

happening was that the 565-ohm candohm wasn't completely open, it would partially and sometimes completely restore itself. In either case once it put itself back into the circuit, it lowered the -60 volt buss enough to bias off the AGC amplifier.

I don't need to say I'll never take the short cut of using the existing lugs on a power resistor again.—
Alfred Consiglio, Bronx, N. Y.

Persistent Oscillator

The set is a Motorola 2-Way Radio and Transmitter, AC Utility Model L43G-3-SP1, and has 2-Channels. The complaint was, Channel 1 works satisfactory, but Channel 2 was dead. This looked like a simple case of a bad tube in the Channel 2 oscillator. A new tube was tried with no results. The set was still dead on
(Continued on page 57)

Channel 1 tube caused birdies on Channel 2.

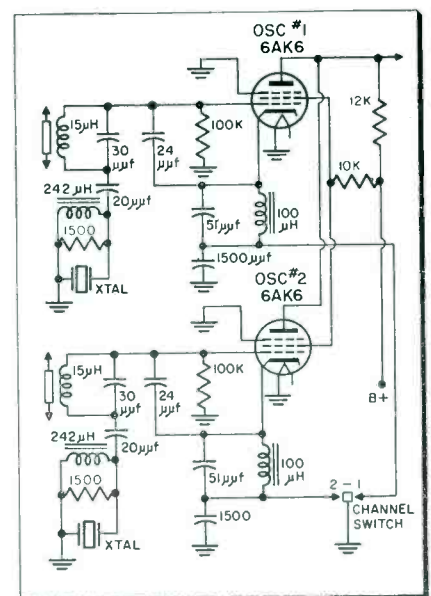

Industrial Electronic

Transistors And Modern Electronic

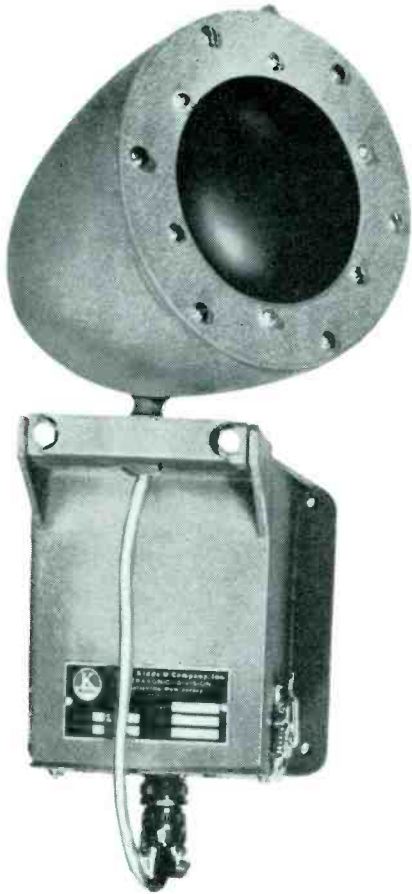

Fig. 2A—Modulated black-light projector.

ALLAN LYTEL
ELECTRONICS LAB.
GENERAL ELECTRIC CO.

• Industrial electronics encompass just about every phase of modern living. It not only enables us to have more comforts and possessions, it also affords us with the ability to protect these goods from intruders and other compromising activities. It can do this on a continuous basis and under the most adverse conditions. Electronic technicians have been servicing these units for years, and shall continue to do so. With the advent of electronic and other wireless type of systems, the technician with the TV, radio and electronics background will be in even greater demand than ever. The older systems which depended upon a trip mechanism or a broken wire to trigger the alarm could be serviced by most electricians and other people familiar with house wiring. However the modern systems are strictly for the electronic technician.

A simple alarm system uses a complete circuit of metal tape fixed to the windows and doors of a house or store with a relay in series.

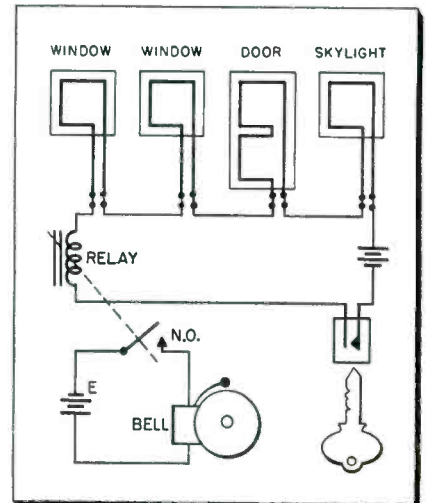
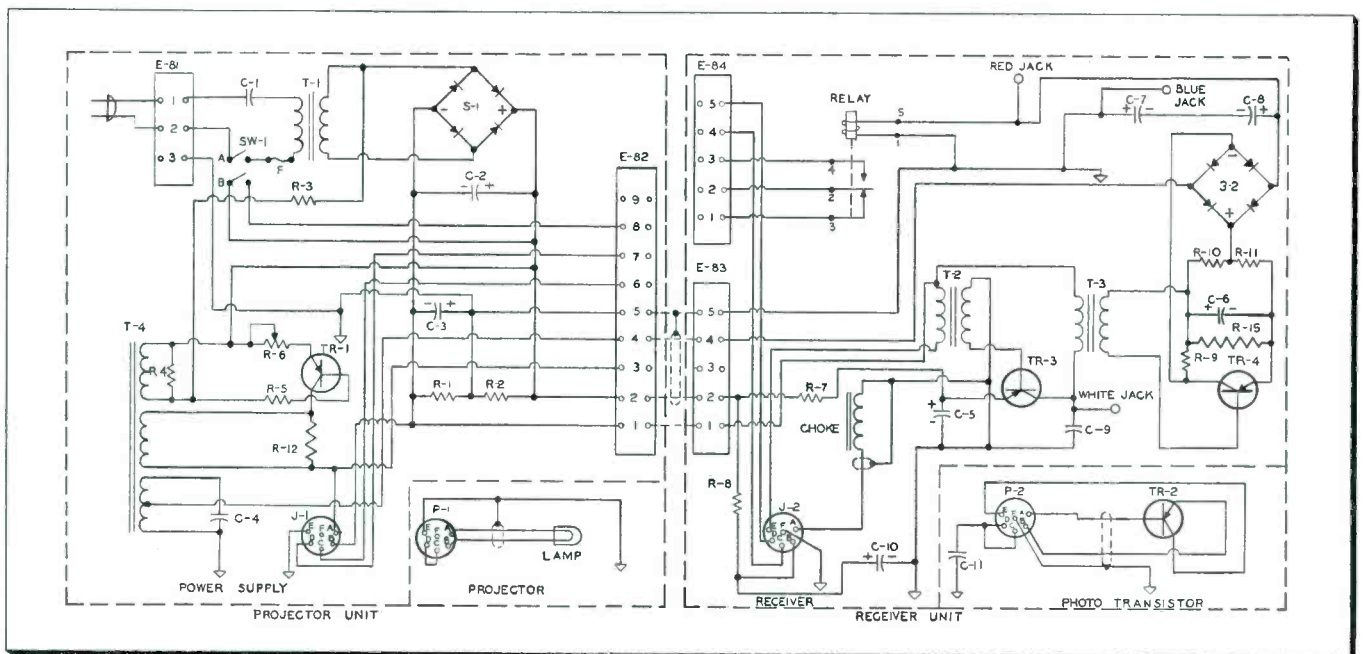

Fig. 1—Simple series relay alarm circuit.

Breaking this tape trips a relay and sets off an alarm. The newer alarm systems use tubes and transistors to provide more convenient and better alarm circuits.

Fig. 3—Modulated, "black-light beam" transmitter and receiver. Burglar alarm operates from batteries or 115-volt, 60 cycle line.



Burglar Alarms

Circuitry Provide Increased Security.

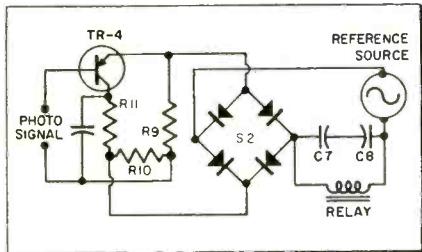

Fig. 4—Selenium rectifier phase detector.

A relay circuit for burglar protection of the series type is shown in Fig. 1. Windows, doors and other openings are protected by a thin conductive tape. Any interruption of this series circuit breaks the current flow and the normally open (N.O.) contacts close, causing an alarm.

Transistor Photo-Alarm

Light-beams and photoelectric relays are also used in alarm systems. A modern version of such a system used transistors. The transistorized photo-electric alarm shown in Fig. 2 consists of a projector and a receiver. A low-visibility beam modulated at a specified frequency is projected across the protected area. An infra-red filter makes the beam invisible even in the presence of smoke. Any interruption of this "black-light" immediately transmits an alarm signal. Any attempt to bypass the system by substituting another light beam disturbs the frequency and triggers the alarm. Tampering with the projector, receiver or housing, or breaking a line will also trip the alarm. The system operates at ranges up to 1000 feet. Through the use of mirrors, the beam can be made to go around corners and completely encircle an area. An operating margin of at least 80% reduction of the normal maximum light source intensity is provided to prevent accidental alarms due to gradual loss in output or efficiency.

A schematic of this type of alarm is shown in Fig. 3. The system may be operated from a 115-volt, 60-cycle line, or a 12-volt battery. The

a-c voltage is connected through SW-1A and fuse F (1.6 amp) to the primary of T-1. The transformer is a saturable type and together with capacitor C-1 forms a voltage regulator. This maintains a constant d-c supply of approximately 12 volts which is independent of line-voltage variations. When a 12-volt battery is used the positive lead is connected

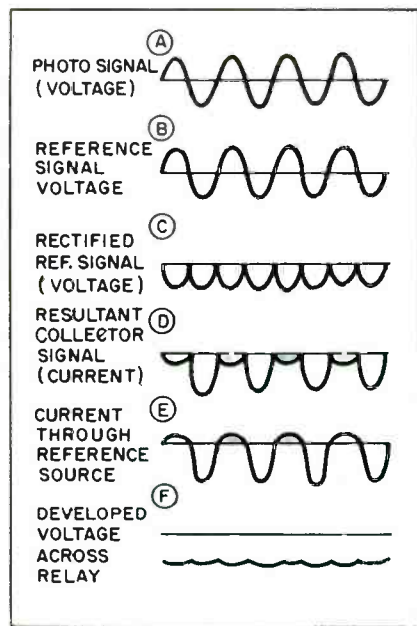

Fig. 5—Relay is closed in normal operation.

to terminal 8 and the negative lead to terminal 1 on strip E-82. In normal operation, the battery is trickle-charged from the power supply. In the event of an a-c power failure, the battery automatically assumes the load and thus prevents failure of the alarm system.

Modulation of the light beam is obtained electronically. The oscillator circuit consists of the power transistor TR-1, oscillator transformer T-4, resistors R-4, R-5, and R-6, and capacitor C-4. C-4 and its associated winding tune the oscillator to approximately 60 cycles. The center-tap is connected to terminal 4 of strip E-82 and supplies an a-c voltage-to-ground of about 20 volts.

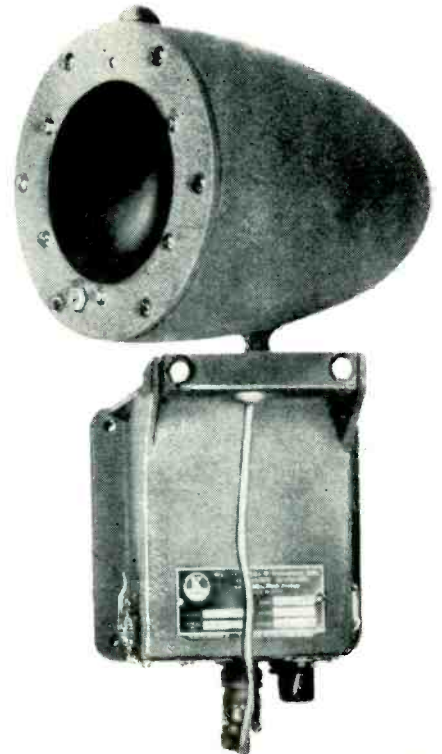

Fig. 2B—Transistorized photoelectric relay.

The lamp has a varying d-c current passing through it which causes the intensity of the light to vary in step with the frequency of the oscillator.

Terminals 6 and 7 of strip E-82 are connected to pins C and D of J-1. The corresponding pins on plug P-1 are shorted by a jumper, thus providing a means for the remote detection of tampering with the connection of P-1 and J-1.

(Continued on page 64)

Fig. 6—Loss of light or improper frequency opens relay and causes an alarm.

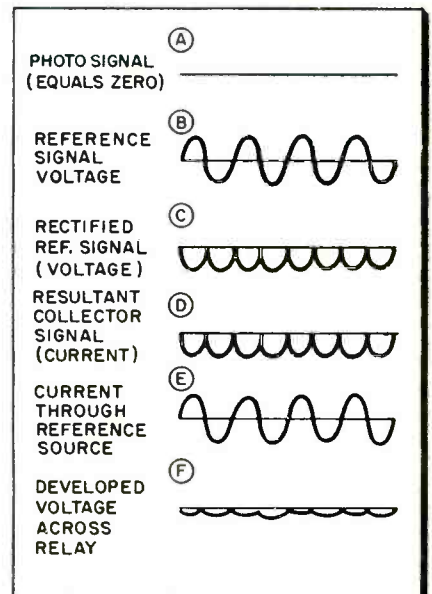

Will Factory Service Put

"Not by a long shot," says the author, "but you'll

HARRY P. BRIDGE

(Here's one man's evaluation of a most important and controversial issue. It's based on the author's many years as a top electronic merchandiser in close contact with the servicing field. Whether you agree or disagree with him, you'll find his observations food for serious thought.—Ed.)

• Poor service can make even the best television or radio set look bad to the man who owns it. This simple fact is often cited as the main reason why set manufacturers should have factory-controlled service organizations. Actually, however, it is only part of the story—and an extremely secondary part at that.

The real reason why set manufacturers might consider going into the service business is that they have suddenly realized that servicing is big business. Independent service technicians have been living on top of a gold mine all these years without fully realizing it. One statistician has estimated that by 1958 servicing may reach the startling total of over \$2.5 billion.

This figure explains why any set manufacturer might now take a good look at the possibility of building a nationwide service organization of his own, even though he may have relied on independents in the past.

No doubt he fondly believes he can assure better service to his set owners than they have been getting. Far more important, however, is the possibility that service might show him a juicy profit in its own right.

Jobbers who rely on independent servicemen for the bulk of their business are frankly concerned. Independent technicians have the jitters. To hear many of them talk, one might think that within a few years there will be nothing to do but surrender their independence and take a job with some nationwide service organization.

Nothing could be farther from the truth.

To be sure, a number of independents will go out of business within the next few years. However, most of these would fail under any condition, with or without additional service competition from set manufacturers. Any business that has grown as fast as servicing is sure to attract its share of men who, regardless of how good they may be technically, are unfitted to conduct a modern business operation in the face of well-managed competition.

Factory Color Service

Another reason often given for the coming of more factory-controlled servicing is the complicated nature of color TV. This, again, is pure bunkum.

Color TV will not be any serious problem for competent technicians. In fact the switch to color should be far easier than the really big jump from radio to black-and-white TV ten years ago. That was a really tough change-over . . . not only because TV was so much more complicated than radio, but also because the change came so fast. There was almost no time to train for the work before thousands of TV set owners were clamoring for service.

Color TV has been much slower in coming commercially. As a result, it won't catch the great majority of independent servicemen unprepared. Many have already taken special color training courses. Moreover, it is estimated that a good black-and-white TV technician can master the intricacies of color TV in a couple of weeks.

It is worth noting that the confusion in the earlier days of black-and-white TV resulted in a lot of criticism of servicing in general, much of which was not the serviceman's fault. Actually, he was no more to blame for the confusion than were set manufacturers who failed to warn him in advance what would be necessary or to equip him promptly with needed service training and data.

Much the same situation existed in the early days of radio. To the everlasting credit of the independent service profession, most of its members learned fast, and they learned well. New sets were sold faster and in far greater quantity than would have been possible under any other service method. Manufacturers in those days were neither equipped for service, nor did they want to be bothered with it.

Then came TV, with a lot of new and more acute service problems. Here again, after the brief period of highly excusable confusion, independent servicemen came to the rescue.

Thus, in this brief backward look this much becomes clear: Although they have never received proper recognition for it, it is an indisputable fact that independent service technicians have played a tremendous part in building the entire radio-TV-electronic industry. Their record to date is a good one. It is extremely doubtful if things would have been any better under any other method, including complete control of servicing by set manufacturers.

Consequently, it seems quite clear that no set manufacturer today could honestly say he was forced to start his own service organization in order to assure set owners getting proper service at fair prices. He can say, however—and with all justification—that he is now impelled to enter servicing because it has become a big, profitable business and because he believes he can cut himself a nice slice of it by adopting better service business methods.

Free Competition

This sort of reasoning gets right down to the heart of the democratic way of doing things. Competition is the backbone of free trade. No one, including independent servicemen, will get very far simply by complaining about it or by attempting to stand on their past record.

The only way to stop it is to beat it—and that, after all, shouldn't be as difficult as it sounds.

Independents Out Of Business?

have to be on your toes to use your natural advantages."

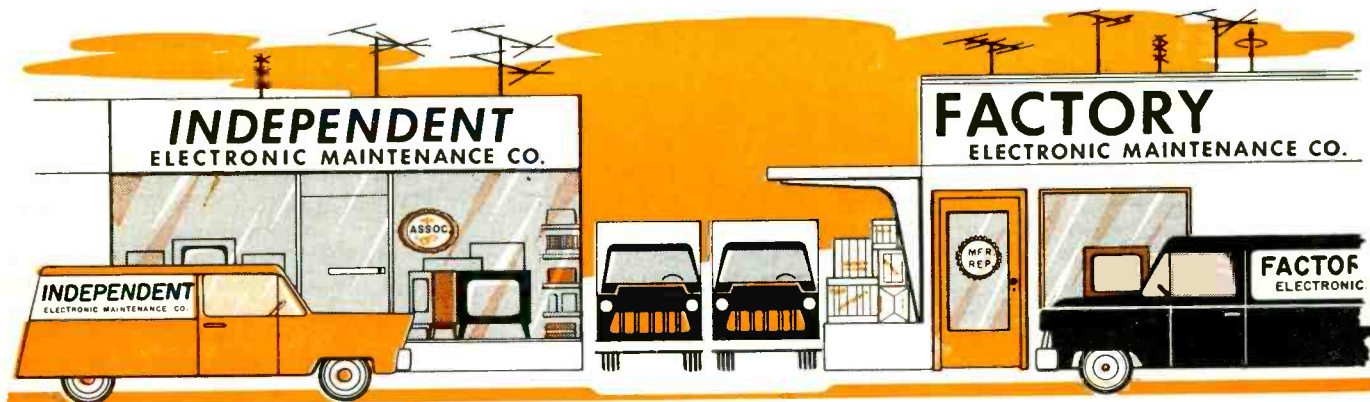

Loose talk about factory service knocking thousands of efficient independents out of business is alarmist nonsense. Certainly, it isn't substantiated by the outlook.

For one thing, there are over 40 million TV sets and three times that many radios in American homes today. With relatively few exceptions, these are not and probably never will be covered by manufacturers' service contracts. If no more new sets were ever sold, these existing receivers would support a big independent service industry for many years.

Every year, from five to 7,000,000 new TV sets and from 10 to 14 million radios are added to this list. Most important will be the coming of age of color TV.

Still another factor is that almost every mention of factory controlled service seems to take for granted that everyone who buys a new television set will also rush to buy the manufacturer's service contract providing one is offered. Here, again, is a notion that simply isn't true.

Researcher Elmo Roper, reporting for RCA, states that in 1949 when TV was new and many set buyers were afraid they couldn't get suitable service otherwise, 75% of them bought service contracts. In 1955, however, only 11% of all set owners held service contracts. Evidently, many of them soon learned it was just as satisfactory and a good bit cheaper besides to buy service from

independent operators as they needed it.

No matter what happens, not all set manufacturers will see fit to establish service organizations. Many, including some of the largest, will continue to rely on independents just as they have in the past. For all of its rich potential, service on a vast national basis is still a big gamble from a set manufacturer's standpoint—and it is a gamble along different business lines for which they are not necessarily fitted.

Best Service

In the long run, we can pretty well take for granted that set owners will go where they get the best service for their money. Certainly there is no secret formula by which a set maker can guarantee more in this respect than can a good independent operator. The manufacturer's nationally-known name is by no means a perfect substitute for the long-time personal knowledge of his community that is literally the independent's birthright.

The manufacturer who sets up for factory service has to hire the same kind of men. Then he has to train them and equip them. He has to pay the same general business overhead plus some that the independent doesn't even have—and show a substantial profit besides.

He has to do this in thousands of different localities, meet different

local conditions, handle things by remote control through branch and district managers, and face many other problems including possible competition on his own level from other set manufacturers as well as that of well-known independents whose business cost and profit requirements are probably well below his.

But let's not make any mistake about it, factory-controlled competition can be tough, *because it will be efficient*. It will help eliminate inferior workmanship.

By the same token, it should serve to put service competition on a higher level; up-grade prices that can and should be charged for the work; and, in general put service on a more business-like basis.

Certainly there is nothing in such a prospect that should scare any efficient independent or make him feel his world is coming to an end. Chances are he has been arguing for just this sort of up-grading of servicing and working for it through his local association for years.

It will simply mean that he must tighten his belt, put more thought and planning into his business, adopt aggressive methods and give customers the kind of service that will keep them happy.

There is no real advantage held by the set manufacturer's service organization that the efficient independent operator cannot match.

(Continued on page 62)

SHOP HINTS



Tips for Home and Bench Service

I-F Code Interference

In some locations, powerful code transmitters are in operation on frequencies close to the most commonly used i-f frequency of 455 kc. The radiated signal from these transmitters is often strong enough in nearby locations to cause objectionable code interference in radio receivers.

Where such interference is present, the most practical method of elimination is to completely realign the radio receiver using a different i-f frequency. In most cases a lower i-f frequency will reduce the interference but in some locations a higher frequency will be necessary. The amount of frequency shift necessary will depend upon the strength of the interfering signal as well as its relation to 455 kc. It has been found that in severe interference locations, a frequency difference of 20 to 30 kc may be necessary to completely eliminate the interference.

If the range of i-f adjustment is insufficient to enable a transformer winding to be peaked at the desired lower frequency, a ceramic capacitor of 10 μf to 15 μf can be added in parallel with that transformer winding in order to change the adjustment range.

When the receiver is aligned with an i-f frequency other than 455 kc there will be a tracking error in which the dial pointer will not indicate correctly the frequency of the broadcast station being received. The tracking error is in direct relation to the amount of frequency shift. This tracking error may sometimes be partially compensated for by shifting the position of the dial pointer to give correct indication at 600 kc before aligning at the high frequency end of the dial.

The following is a listing of the transmitters which are most likely to cause i-f interference:

WSF	442 kc	New York, N.Y.
WSC	460 kc	Tuckerton, N.J.
KPH	460 kc	Bolinas, Calif.
KOK	464 kc	Paramount, Calif.
WSE	464 kc	Jacksonville, Fla.
WOE	472 kc	LaTana, Fla.

In addition, temporary experimental transmitters are in operation with unmodulated carriers as follows:

K12XAJ	450 kc	Pt. Mugu, Calif.
K12XAJ	450 kc	Cambridge, Mass.
K12XAJ	450 kc	Hampton, Va.
K12XAJ	470 kc	Pt. Mugu, Calif.
K12XAJ	470 kc	Cambridge, Mass.
K12XAJ	470 kc	Hampton, Va.

RCA Radio & Victrola Service Tips, Camden, N.J.

Battery Eliminators For Transistor Car Radios

Hybrid and transistor car radios may be operated satisfactorily from the ordinary battery eliminator by the addition of the filter network shown in the diagram. As these sets have a low drain, a 3 to 5 ampere choke will pass sufficient current. The shorting switch by-passes the choke when regular sets are under test and when more current is needed. With this switching method,

SHOP HINTS WANTED

ELECTRONIC TECHNICIAN will pay \$5 for acceptable shop hints. Unacceptable items will be returned. Use drawings to illustrate wherever necessary. A rough sketch will do as long as it can be followed. Send your hints to "Shop Hints" Editor, ELECTRONIC TECHNICIAN, 480 Lexington Ave., N. Y. 17, N. Y.

no extra terminals are needed to connect the transistor sets. The extra filter capacitor is always in the circuit and provides better filtering action even with the choke shorted out. The voltmeter connection should be attached to the output side of the choke, to allow for the voltage drop across the choke, and to indicate the actual voltage delivered to the unit under test. The two extra components may be mounted externally if there is insufficient room in the original power-supply cabinet.—Wm. H. Brakes, New Westminster, B.C.

FM on TV

Many customers I have come across have expressed the desirability of having FM radio reception, but do not wish to put money into an FM receiver or tuner. The
(Continued on page 49)

Modified battery eliminator can be used to service transistor and hybrid auto radios.

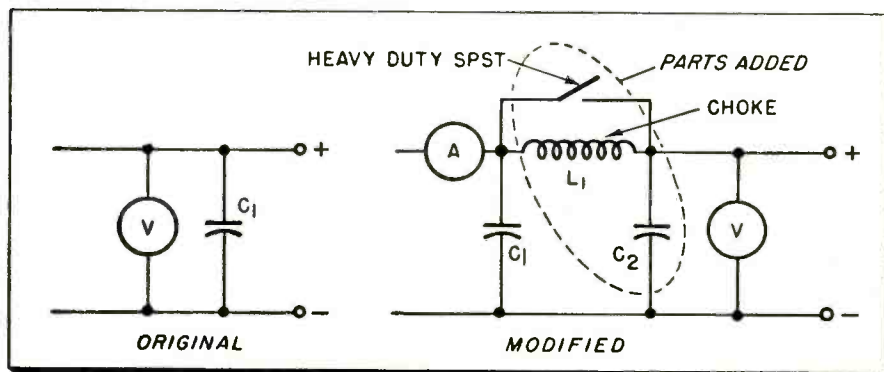

ONE REASON OUT OF MANY

why ELECTRONIC TECHNICIAN has 13,565 more professional service technician subscribers and some 15% more advertising pages** this year than the second largest TV-electronic-audio trade publication in the field . . . over 70% more ad pages than the third magazine!*

*It's because ELECTRONIC TECHNICIAN gives its readers, in addition to quality, the largest number of editorial pages . . . over 131 pages more so far in 1957** . . . over 887 more editorial pages since 1954 . . . than the next publication.*

*June 1957 ABC statements, classifications 1 and 2
**Jan.-Sept. 1957

Two TV Programs On One Channel

• A new approach to TV broadcasting techniques that might provide an additional program on each of the TV channels now in use, was announced by Blonder-Tongue Laboratories, Inc. of Newark, N. J. The company has presented its plan to the FCC. Joseph H. Kerner, spokesman for the company, stated that the new method, called Bi-Tran, might

provide the scientific break-through to the solution of many TV broadcast problems, including Pay TV, and various public service needs.

The Bi-Tran proposal will undoubtedly require modification of present TV station equipment to enable two programs to be transmitted simultaneously on the same channel. Channel 2, for example, could be

designated 2A and 2B; channel 4 could be designated 4A and 4B, etc. The doubling of channel facilities would be accomplished by a method described as a Contra-Phase Multiplexing Process. This method involves the transmission of two different pictures in the same band-width. A series of positive
(Continued on page 60)

Both A & B transmissions are received at the set. Only one program is visible, the other can be selected when a proper decoding

signal is received. Unlike scrambled transmissions, it does not make the existing channel unusable for non-pay or other programs.

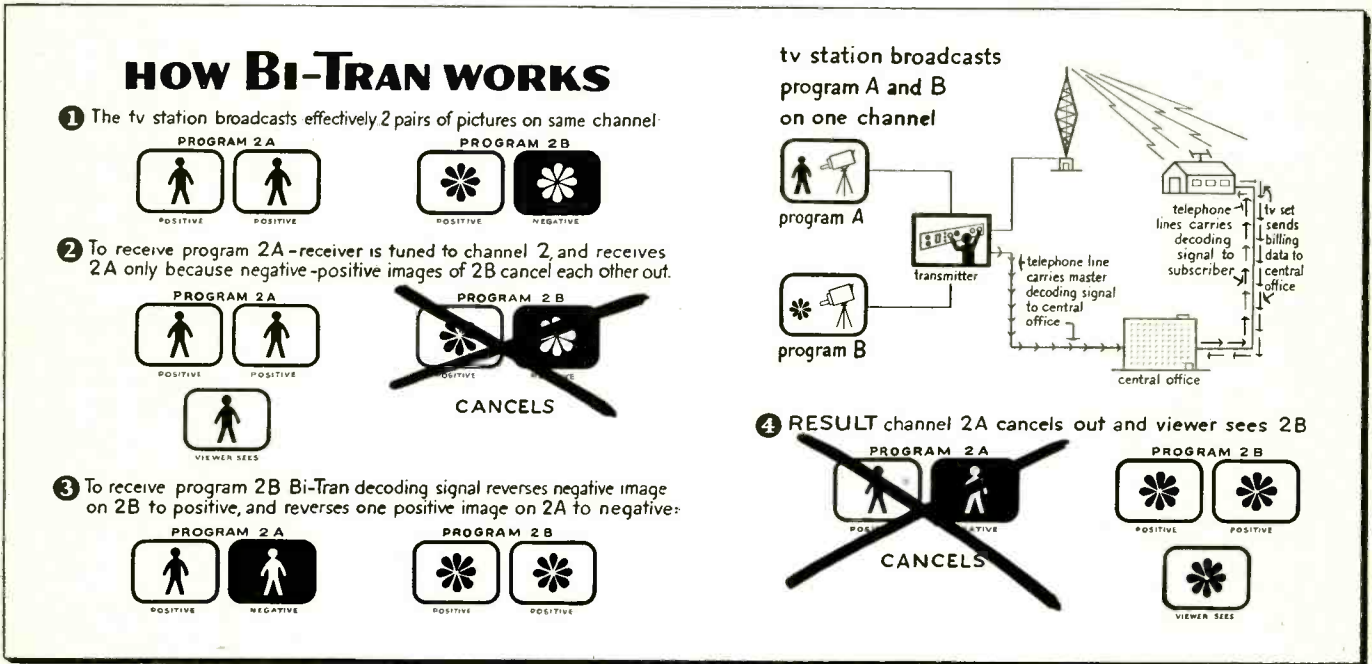

Right Or Wrong In Labor Relations

A roundup of day-to-day employer-employee problems and how they were handled. Each incident is taken from a true-life grievance which went to arbitration. Names of some principals involved have been changed.

IS GRANTING LEAVE-OF-ABSENCE MANDATORY?

What Happened:

The company rule regarding leave of absence reads as follows:

"Leaves of Absence exceeding two weeks shall not be granted. These leaves must be requested on a form provided by the personnel office."

Charles Quarrez went to the personnel office and got the required form. He filled it out and indicated

that he wanted a ten-day leave to attend his cousin's wedding in a distant city. The following day he was told by his manager that his request



for leave was turned down because he couldn't be spared at this time, while certain "rush" orders were backed up.

Quarrez felt that the company was quite unfair in denying him the leave, and that it had no right to do so. He claimed that the rule only said that the leave could not exceed two weeks, and had to be requested on a special form. He had complied with the rules.

The manager replied that the company had to be the judge of when a leave was to be granted, and the reason for the leave as well as the company's needs had to be taken into consideration. Quarrez still felt that he had a right to the leave, and took the case up to arbitration.

Was the manager:

RIGHT WRONG

What Arbitrator William W. Waite Ruled: "The proper discharge of normal management responsibilities

(Continued on page 60)

give them

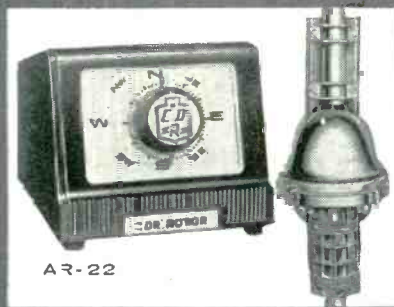

AR-22

what they want...

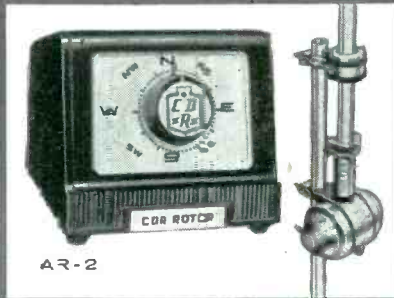

AR-2

give them—
CDR
ROTORS

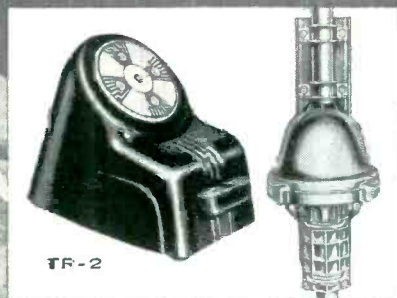

TR-2

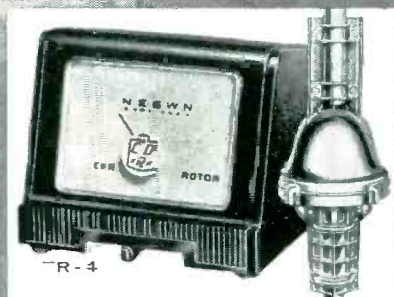

TR-4

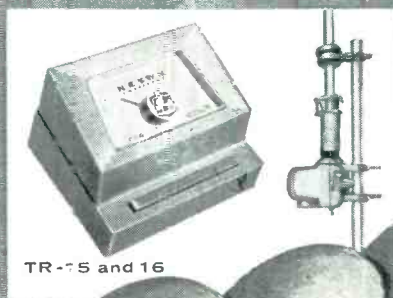

TR-5 and 16

It's easy for you to give your customers EXACTLY what they want...and at the same time EXACTLY what is BEST for them...because CDR ROTORS are the single answer! The complete line with a model for every need...proven performance and dependability through years of experience. This combination has made CDR ROTORS the favorites everywhere...that is why your customers should have CDR ROTORS!

Especially important for color TV reception. Critical tuning requirements call for CDR Rotors.



CORNELL-DUBILIER
SOUTH PLAINFIELD, N.J.



THE RADIART CORP.
CLEVELAND 13, OHIO

New Antenna Products

For more free information, fill in coupons and mail to ELECTRONIC TECHNICIAN, 480 Lexington Ave., New York 17, N.Y.

As described in ELECTRONIC TECHNICIAN send me more data on the Channel Master Matchmaker 2-set coupler. (10-5)

Name

Address

Company

City

State

As described in ELECTRONIC TECHNICIAN send me more data on the Taco Anodized Golden Topliner antenna. (10-6)

Name

Address

Company

City

State

As described in ELECTRONIC TECHNICIAN send me more data on the 1958 Zephyr family of antennas by Trio. (10-7)

Name

Address

Company

City

State

As described in ELECTRONIC TECHNICIAN send me more data on the JFD IMP standoff insulator. (10-8)

Name

Address

Company

City

State

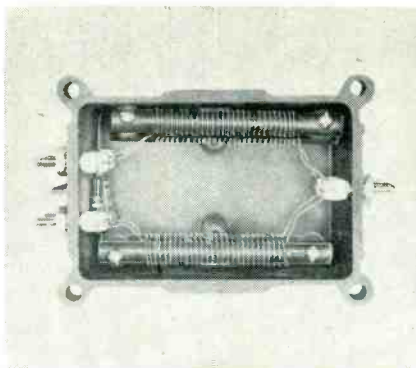

← Channel Master COUPLER

The Matchmaker is a completely new type of 2-set coupler based on the Diplexer principle. It divides the signal equally to both sets without interaction between the sets. Other features are: holds insertion loss to the absolute minimum 3 db; prevents signals of both sets from interacting with each other; maintains 300-ohm impedance match; and prevents any impedance variation at one receiver from affecting the signal at the other. Channel Master Corp., Ellenville, N. Y. (ELECTRONIC TECHNICIAN 10-5)

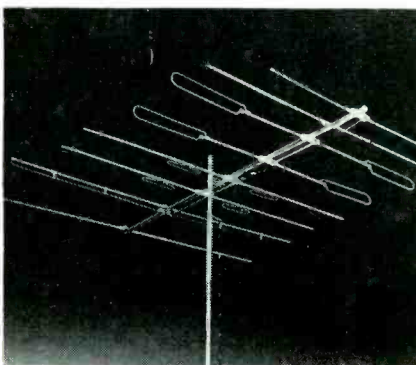

← Taco ANTENNA

A new TV antenna called the Golden Topliner incorporates an improved "paddle" design on the driven dipoles for greater bandwidth. A Power-Pack is used to provide maximum electrical current transfer from antenna to transmission line. The elements are swung into operating position and locked automatically. They are available as single or stacked arrays with a choice of wide or close spacing depending upon frequency. Technical Appliance Corp., Sherburne, N. Y. (ELECTRONIC TECHNICIAN 10-6)

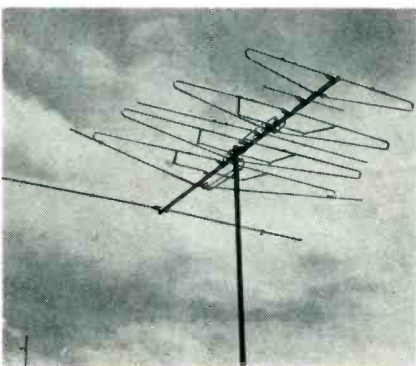

← Trio ANTENNA

The new 1958 Zephyr family antennas consist of improved models of the Zephyr-Mite, Zephyr Pioneer and Zephyr Royal. All three antennas feature the extended wing dipole, a new and improved version of the wing dipole. The Zephyr Royal shown makes use of the extended wing dipole, the conventional wing dipole, a collinear director, and the wing director. It is stagger-tuned to provide flat frequency response. Trio Mfg. Co., Griggsville, Ill. For color and b & w reception. (ELECTRONIC TECHNICIAN 10-7)

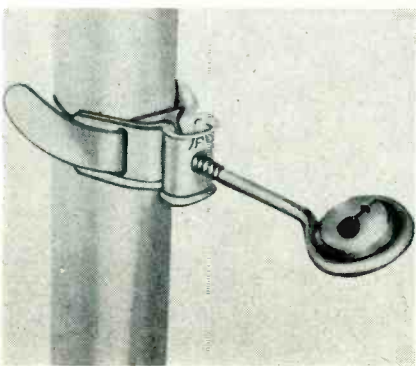

← JFD STANDOFF INSULATOR

New universal strap standoff insulator features the IMP buckle. It utilizes a double-seated thread lock which exerts two separate tensions on the wood screw as it is tightened. This progressively increases the pressures on the outer and inner thread insuring a slip-proof installation. The buckle is made of heavy-gauge steel. The strap electro-galvanized or stainless steel. JFD Electronics Corp., 6101 16th Ave., Brooklyn 4, N. Y. (ELECTRONIC TECHNICIAN 10-8)

NEW! Simpson

IN-CIRCUIT HORIZONTAL SYSTEM ANALYZER

MODEL 382

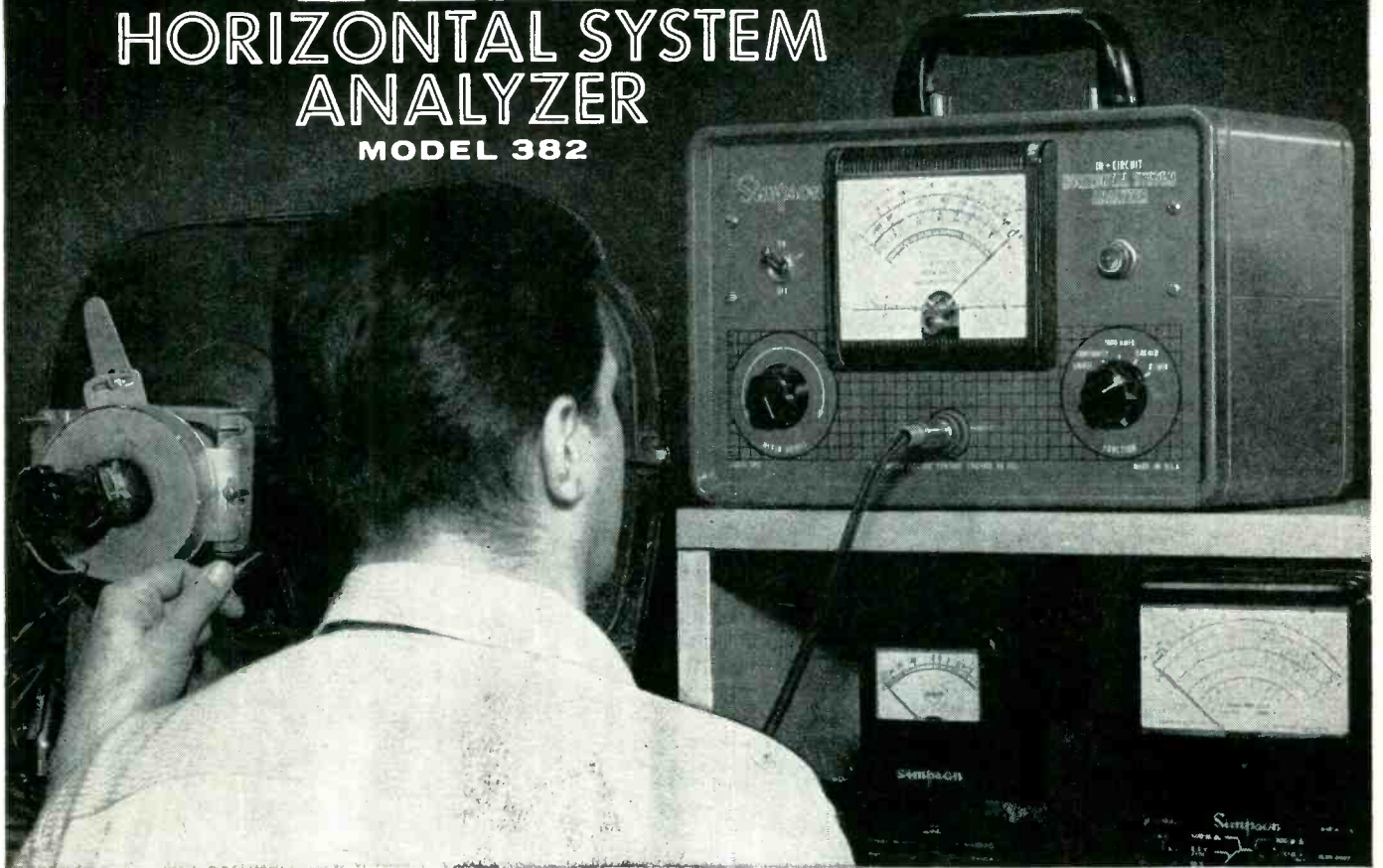

- saves time in running checks on TV horizontal deflection systems
- tests capacitors, too!

Model 382 is the world's most complete "testing package" for analyzing TV horizontal deflection systems. With this *one* instrument, you can:

- (1) Check any winding in the horizontal system (transformer or yoke) for *shorts* and *opens*. Even one shorted turn is clearly indicated on a large 4½" meter. Uses reliable, time-proven Q-type test.
- (2) Check flyback and yoke system IN-CIRCUIT (disconnect only plate cap of output tube). High-Q systems are checked on a quick-reading, Good-Bad scale (most present day sets use the High-Q system); low-Q systems on comparative logging scale.
- (3) Measure capacitance value (and check for open capacitors)—direct-reading scales indicate

from 10 mmf to 0.1 mfd—no bridge to balance. Measures capacitance to better than 10%.

(4) Make continuity checks of *any* wire-wound component, such as width coils, linearity coils, oscillator transformers; check capacitors for direct shorts; check out wiring harnesses, switch contacts, etc. Can check many other components for Q, either directly or by logging scale.

With Model 382, preliminary tests of horizontal systems can be made *in-circuit*. Then, if desired, individual tests can be made of each winding and component in the system. Over-all size of Model 382 is 7¼" x 8" x 11⅜". Compare this *complete IN-CIRCUIT* Horizontal System Analyzer with any competitive unit, and you will choose the Simpson Model 382.

Model 382 with
special test cable and
Operator's Manual...

\$69⁹⁵



See Your Jobber, or Write for Bulletin No. 2082

SIMPSON ELECTRIC COMPANY

5200 W. Kinzie Street, Chicago 44, Illinois • Phone: EStebrook 9-1121 • In Canada: Bach-Simpson Ltd., London, Ont.
WORLD'S LARGEST MANUFACTURER OF ELECTRONIC TEST EQUIPMENT



Build today's profits with
MALLORY
Mercury BATTERIES

—the batteries of tomorrow!

The amazing mercury battery, pioneered by Mallory, helped make practical the remarkable new pocket-size transistor radios. Tiny, powerful, long-lasting, Mallory Mercury Batteries are the fast-growing line that will bring you profitable sales today . . . even greater sales tomorrow.

Mallory Mercury Batteries excel in long shelf life . . . in service life and economy in transistor portables. To help spark your sales, you get the backing of year 'round promotion and strong advertising in magazines like The Saturday Evening Post, Time, Newsweek, Business Week and TV Guide.

See your Mallory distributor today, and get full facts on the full line of Mallory Mercury and Zinc-Carbon Batteries.

For vacuum-tube portables,
 sell Mallory Zinc-Carbon
 Batteries . . . unsurpassed
 for performance.



P. R. MALLORY & CO. Inc.
MALLORY

P. R. MALLORY & CO. Inc., INDIANAPOLIS 6, INDIANA

- Capacitors
- Vibrators
- Resistors
- Power Supplies
- Mercury and Zinc-Carbon Batteries
- Controls
- Switches
- Rectifiers
- Filters

RCA TUBES & TRANSISTORS

The 6DT8 and 12DT8 are high-mu twin triodes of the 9-pin miniature type. They are intended for use as combined oscillator-mixer and r-f amplifier tubes in cathode-drive or grid-drive circuits of FM tuners. The two units of each type are effectively isolated from each other by an internal shield having a separate base-pin terminal.

The 2N274 is a small, hermetically sealed drift transistor of the germanium p-n-p type. It is designed primarily for r-l amplifier service in very compact military, mobile, and communications equipment and in entertainment-type receivers operating at frequencies covering the AM broadcast band and up into the short-wave bands. This transistor is also suitable for use as an r-f amplifier or as a mixer-oscillator.

The 2N398 is a junction transistor of the germanium p-n-p alloy type. It is specifically designed for high-voltage "on-off" control applications, such as in neon indicator circuits, relay puller circuits, incandescent lamp driver circuits, and direct indicating counter circuits of electronic computers. Radio Corp. of America, RCA Tube Division, Harrison, N. J. (ELECTRONIC TECHNICIAN 10-27)

GE POWER TRANSISTOR

2N451 silicon power transistor is capable of dissipating 85-watts at 25° C. It has a nominal collector saturation resistance of 2 ohms and a maximum collector current rating of 5 amps. General Electric Co., Semiconductor Products Dept., Electronics Park, Syracuse, N. Y. (ELECTRONIC TECHNICIAN 10-26)

Transval TRANSISTOR POWER SUPPLY

A new, easy to install, low cost transistorized replacement for vibrators in two-way mobile radio communications equipment is unique in that it has the extra capacity necessary to operate both the transmitter and receiver units. The unit is designed for

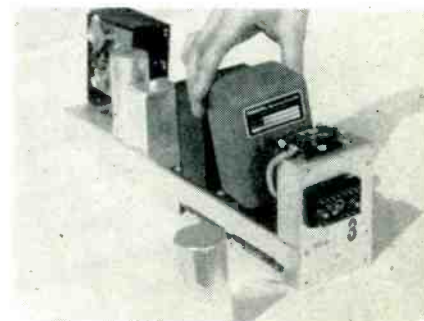

12-volt systems and is capable of switching over 9 amps dc and will operate on both positive or negative sources. The vibrator replacement has no moving parts. Transval Engineering Corp., 10401 Jefferson Blvd., Culver City, Calif. (ELECTRONIC TECHNICIAN 10-61)

M-H TETRODE TRANSISTOR

The new transistor is expected to have wide application in the audio field. It faithfully reproduces input signals, and is expected to reduce the amount of circuitry required in high-fidelity amplifiers. The power tetrode is more easily stabilized than existing transistors where thermal runaway is a problem. It is designed to operate on a 28-volt system and can carry up to 10 amps. Minneapolis-Honeywell Regulator Co., Semiconductor Products Division, 2753 Fourth Ave. S., Minneapolis 8, Minn. (ELECTRONIC TECHNICIAN 10-25)

Corning CAPACITORS

Two new subminiature fixed glass radial lead capacitors were designed to be used on printed circuit boards. Both capacitors measure less than 0.1" thick, making them particularly suited for vertical mounting in small, high-rated circuits. WL-4, the smallest, is 0.3" x

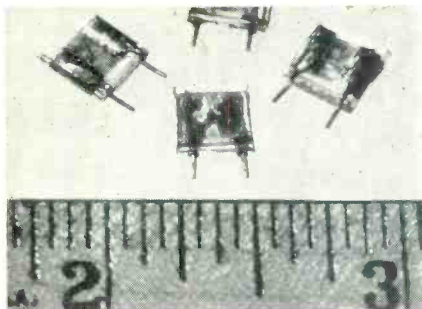

0.3" and may be obtained in values up to 1000 μf at 300 volts. The WL-5 is larger (0.3" x 0.5") and ranges up to 2200 μf . The WL-4 is currently being used in the U. S. Army receiver-transmitter helmets. Corning Glass Works, Newton St., Corning, N. Y. (ELECTRONIC TECHNICIAN 9-57)

Valco CAPACITORS

Val-Cap Ultra Sub-Miniature Ceramic Capacitors range from 47 to 100,000 μf . The smallest measures only 0.1" x 0.1" x 0.1". Rated voltage is 100 to 200 WVDC; up to 1000 WVDC available. The performance characteristics in these extremely small capacitors are

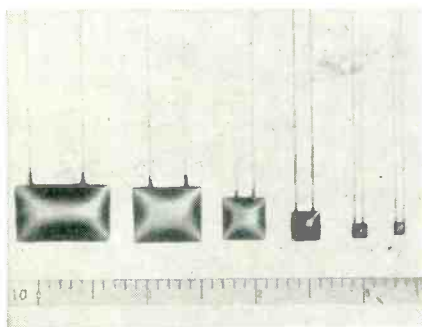

made possible by a new high density ceramic material, possessing a very high dielectric constant and stable temperature coefficient. Valco Division, National-El Ray Corp., 11815 Vose St., North Hollywood, Calif. (ELECTRONIC TECHNICIAN 10-63)

... another
MALLORY
service-engineered
product

New **MALLORY** Dual Controls



Put an end to service delays such as awaiting parts—and those long “shopping tours” and “special orders” for factory built replacements

Mallyory's new dual replacement controls service just about any standard model TV set and home or auto radio. Your Mallyory distributor counter man will build a control to your exact specifications—in just 30 seconds. See your Mallyory Distributor—TODAY.

P. R. MALLORY & CO. Inc.
MALLORY

- Capacitors
- Vibrators
- Resistors
- Power Supplies
- Mercury and Zinc-Carbon Batteries
- Controls
- Switches
- Rectifiers
- Filters

P. R. MALLORY & CO. Inc., INDIANAPOLIS 6, INDIANA

New Audio Products



For more free information, fill in coupons and mail to ELECTRONIC TECHNICIAN, 480 Lexington Ave., New York 17, N.Y.

As described in ELECTRONIC TECHNICIAN send me more data on the Sonotone "5" Series Cartridges. (10-1)

Name

Address

Company

City State



← Sonotone CARTRIDGES

The "5" Series cartridges offer the high output, the self-equalization and the problem-free performance of the "2T" cartridges—plus wider, more even response and greater compliance. The turn-over model for 78 and 45-33 speeds is priced at \$8.50 with sapphire needles. Simple to fit to any standard arm, it will improve the performance of old sets without the use of special equalizers and preamplifiers. Sonotone Corp., Elmsford, N. Y. (ELECTRONIC TECHNICIAN 10-1)

As described in ELECTRONIC TECHNICIAN send me more data on the new Astatic microphones Models M332 and 332-S. (10-2)

Name

Address

Company

City State

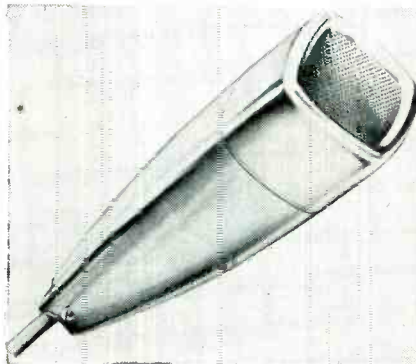

← Astatic MICROPHONE

A new low-cost high-fidelity crystal microphone, model M332, is designed for both hand and lavalier use and is specified for tape recording and PA systems. Frequency response is 30 to 15,000 cps with an output level of -57db. It is a precision made microphone. List price for Model M-332 is \$17.90 which includes an 8-foot shielded cable, lavalier, and stand adaptor. Model 332-S also includes a built-in on-off switch and lists for \$19.90. The Astatic Corp., Conneaut, Ohio (ELECTRONIC TECHNICIAN 10-2)

As described in ELECTRONIC TECHNICIAN send me more data on the Wharfedale ready-to-play 3-way speaker system in sand-filled baffle. (10-3)

Name

Address

Company

City State

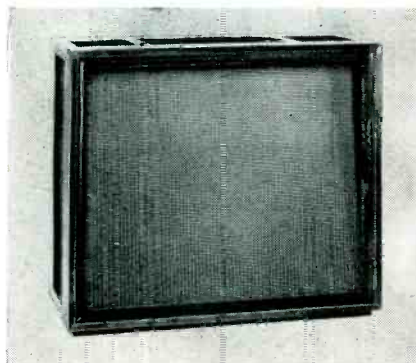

← Wharfedale SYSTEM

The new system includes a special group of 12", 10", and 3" speakers, tuned and integrated with a sand-filled baffle. Key to the unusual performance of the new system is its omni-directional quality which makes it possible to position the system anywhere in the room. There is no cabinet resonance. Two styles of the SFB/3 system are available: the "Windsor" Deluxe shown and the "Warwick" custom. British Industries Corp., 80 Shore Rd., Port Washington, N. Y. (ELECTRONIC TECHNICIAN 10-3)

As described in ELECTRONIC TECHNICIAN send me more data on the Collaro record changers and transcription type tone arm. (10-4)

Name

Address

Company

City State



← Collaro RECORD CHANGER

Two new models are equipped with a new, transcription-type tone arm. Features include: 4 speeds; manual switch; automatic shut-off; automatic intermix, plays 7", 10", or 12" records in any order; heavy duty 4-pole, shaded pole induction motor; heavy, rim weighted balanced turntable; muting switch and pop-click filter; removable heavy rubber turntable mat; jam-proof machinery; and pre-wiring for easy installation. The Rockbar Corp. 650 Halstead Ave., Mamaroneck, N. Y. (ELECTRONIC TECHNICIAN 10-4)

Shop Hints

(Continued from page 40)

following is a way of enabling a customer to switch to one or possibly two desired FM stations on his TV receiver. The FM band (88-108 mc) is sandwiched in between channels 6 and 7. If either channel, or both, is unused in your area, it is a simple matter to tune these slugs to the desired FM station. The customer will now be able to enjoy his favorite ball game or some background music. I have used this method with success in my area. Channel 7 is occupied and so I use Channel 6.—*Lee Larson, Ferndale, Mich.*

• It is also possible, in some areas, to obtain 24-hour weather reports, aeronautical, radio navigation and government stations. These services operate on a frequency range of 108 to 174 mc. It is far less expensive to purchase an FM receiver than to have the CRT and other parts of the TV set going while listening to FM.—*Ed.*

Independent Technician Program Expanded

As a result of a recent nation-wide survey of independent technicians, CBS Tubes has announced a further expansion of its independent service dealer advertising and sales promotion begun this spring. The survey disclosed that 85% of the dealers surveyed want the program continued and expanded.

CBS Tubes has prepared a twelve-page booklet, "The Independent Service Business and Your Future," that explains the entire program in detail and shows the independent how he can put to work the many supporting materials: decals, postal cards, ad mats, radio and TV scripts, consumer booklet, etc. This PA-163 booklet is obtainable free from CBS Tube distributors, or from CBS-Hytron, Danvers, Mass.



"Brother, will I write this outfit a nasty letter!"

Ward's New Complete Disappearing

AUTO ANTENNA

MODEL DCF-3C

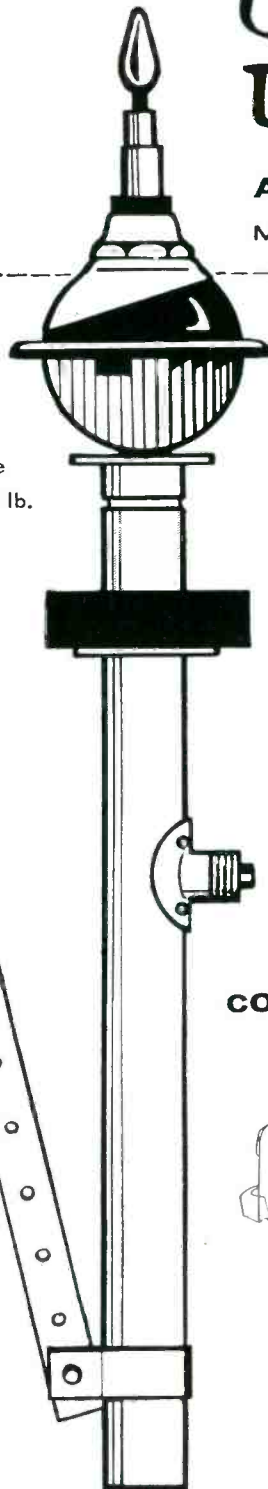

Model DCF-3C
54" lead cable

Shipping wt—1 lb.
12 to master carton, 12 lbs.

NEW flame tip for streamlined appearance and better reception.



NEW water-seal grommet for double fender... the *ONLY* disappearing antenna specially designed to fit Chevy and other cars with double fender.

NEW lightweight aluminum shield tube for easier handling and better reception characteristics.

NEW lead take-off for much easier installation.

COLLAPSES FROM 45" TO 1"

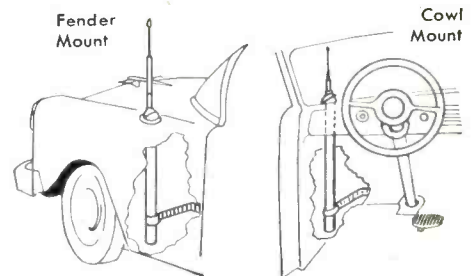

It's a new, fast-selling model; car owners will demand on sight. Makes car washing easier. Adds a top-quality appearance to any car. Avoid disappointment—order *NOW!*

NEW ▶
reinforcing
bracket for
sturdy mounting

Ward PRODUCTS CORP.

DIV. OF THE GABRIEL COMPANY

1148 EUCLID AVE. • CLEVELAND 15, OHIO

IN CANADA, ATLAS RADIO CORPORATION • 50 WINGOLD AVE • TORONTO, ONTARIO

Latest Test Instruments

For more free information, fill in coupons and mail to ELECTRONIC TECHNICIAN, 480 Lexington Ave., New York 17, N.Y.

As described in ELECTRONIC TECHNICIAN send me more data on the Paco VTVM Kit Model V70 (10-9)

Name _____

Address _____

Company _____

City _____ State _____



← Paco VTVM KIT

The Model V-70 VTVM kit features: 7 d-c and RMS a-c ranges up to 1,500 volts; 7 peak-to-peak voltage ranges up to 4,000 volts; 7 ohmmeter ranges up to 1,000 megohms; 5-inch Acrylic cased PACE meter; an attractive, easy reading, two-color panel; and a rugged, ripple-finished steel cabinet. Dimensions are 7½" x 5¾" x 4½". Accessories include an r-f crystal probe and a high-voltage probe. Paco Electronics Co. Inc., 70-31 84th St., Glendale 27, Long Island, N. Y. (ELECTRONIC TECHNICIAN 10-9)

As described in ELECTRONIC TECHNICIAN send me more data on the Heath Color Bar and Dot Generator Model CD-1. (10-10)

Name _____

Address _____

Company _____

City _____ State _____



← Heath GENERATOR

The Model CD-1 combines the two basic color service instruments, a Color-Bar Generator and White-Dot Generator in one versatile portable unit. Produces white-dots, cross hatch, horizontal and vertical bars, 10 vertical color bars, and a new shading bar pattern for screen and background adjustments. Variable r-f output on any channel from 2 to 6. It has a crystal-controlled sound carrier. Heath Co., 305 Territorial Rd., Benton Harbor, Mich. (ELECTRONIC TECHNICIAN 10-10)

As described in ELECTRONIC TECHNICIAN send me more data on the new B&K Model 650 Dyna-Quik dynamic mutual conductance tube tester. (10-11)

Name _____

Address _____

Company _____

City _____ State _____

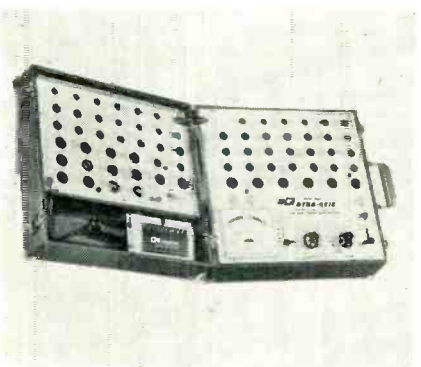

← B&K DYNAMIC TESTER

The new Model 640 Dyna-Quik checks over 99% of the tubes most widely used. It tests each section of multiple tubes separately for GM, Shorts, Grid Emission, Gas Content, and Life. Shows tube condition on "Good-Bad" scale and in micromhos. Transistor tester checks all types. Measures front-to-back ratio of germanium, silicon diodes, selenium, and silicon rectifiers. B&K Mfg. Co., 3731 N. Southport Ave., Chicago 13, Ill. (ELECTRONIC TECHNICIAN 10-11)

As described in ELECTRONIC TECHNICIAN send me more data on the Electro filtered DC power supply Model NFB. (10-12)

Name _____

Address _____

Company _____

City _____ State _____



← Electro POWER SUPPLY

New, specially filtered d-c power supply, with less than ¾% ripple at top load provides higher efficiency. Its output is from 0 to 32 volts with current loads from 0 to 15 amperes while operating on a 115 volt 50/60 cycle input. Model "NFB" has a front panel circuit breaker and a full-view voltmeter. For convenience there is a 15-amp on-off switch and pilot light. Electro Products Laboratories, 4500 N. Ravenswood Ave., Chicago 40, Ill. (ELECTRONIC TECHNICIAN 10-12)

Executive Sees Automation As Vital Asset

• Automation, with its vast promise of higher productivity can become a "vital asset" to our national economy and to the security of the Free World in the Cold War against Communism, Brig. General David Sarnoff, Chairman of the Board of the Radio Corp. of America declared.

Addressing the 34th annual conference of the Life Office Management Association, General Sarnoff said that far from being a threat to the American economy, automation can "contribute immeasurably to the prosperity we seek for ourselves and for all mankind."

Noting that the new Soviet strategy of "peaceful competition" proclaimed by Communist party boss Nikita Khrushchev puts a premium on economic weapons, he said:

"Over the years, the key to America's economic strength has been its rising productivity. In our efforts to continue—and to accelerate—this rise, automation can be a vital asset."

Boon, not Bane

To the American economy, automation holds out the promise of being a boon rather than a bane, General Sarnoff said. In answer to the "calamity criers" who picture it as a threat of dire trouble, he cited past revolutionary developments of the machine age and pointed out they actually created more jobs than they eliminated.

Electronic Development

After noting some of the tremendous accomplishments already scored by electronics in business and industry, General Sarnoff mentioned three fields in which he expects dramatic developments in the future.

1. Medical diagnosis: Electronic computers ultimately will aid the doctor in examinations and diagnosis by storing in their "memory" not only the best medical knowledge of the day—the symptoms, for example, of the various diseases—but also the previous medical record of the patient involved, such as cardiogram, blood pressure, temperature and blood count. By scanning this information, fed to it on tape, this "diagnostic robot" can give the doctor an instantaneous picture of any important changes in the patient, General Sarnoff said.

2. Personal Radio Communication: "With a tiny gadget about the size of a pack of cigarettes, you will be able to carry on a conversation with
(Continued on page 53)

Short description of a Small Efficient TV System...

1 antenna .. IN
8 set lines .. OUT
10 db signal .. GAIN

all with
the



DISTRIBUTION AMPLIFIER

model DA8-B

approved
for
Color-TV

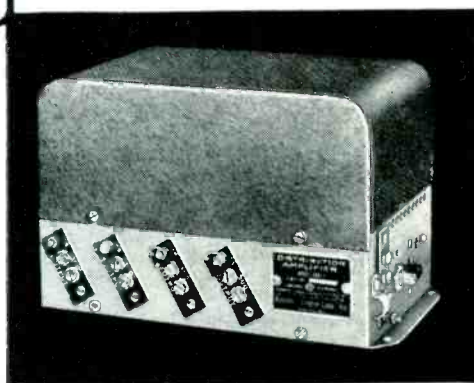

\$94⁵⁰ List

Ideal for garden apartments, motels, TV showrooms, deluxe home installations and other small TV systems. The DA8-B is a broadband, all-channel unit that requires no tuning, impedance matching devices, preamps or other special fittings.

Features and Specifications:

- Low noise all-triode circuit
- More than 10db gain on all VHF Channels
- Inter-set isolation in excess of 22db
- Provision for 75-ohm cable or 300-ohm twin lead
- Prevents overload through 10:1 gain control range
- Built-in power supply
- Designed for continuous duty operation

NOTE: For larger systems, Blonder-Tongue will furnish Free planning service on request.

Sold by Radio-TV Parts Distributors and Jobbers.

Write for Installation Details and FREE Booklet—"TV for 2 . or 3 . or More"

Dept. T-10

**BLONDER-TONGUE
LABORATORIES, INC.**

9 Alling St., Newark 2, N. J.

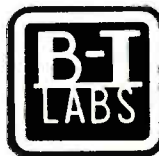

Manufacturers of TV Cameras,
TV Amplifiers, Boosters, Converters,
Accessories and Originators of the
Masterline and 'Add-A-Unit'
Master TV Systems.

New Components

For more free information, fill in coupons and mail to ELECTRONIC TECHNICIAN, 480 Lexington Ave., New York 17, N.Y.

As described in ELECTRONIC TECHNICIAN send me more data on the Centralab Ultra-Kap capacitor. (10-13)

Name

Address

Company

City State

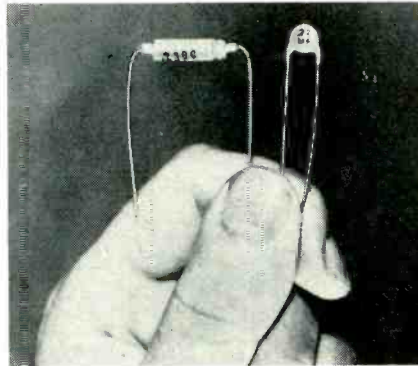

← Centralab CAPACITOR

The new micro-miniature disc capacitor is designed to meet the small size, high capacitance demands of transistor circuitry needed in by-pass and coupling applications. This capacitor, trademarked Ultra-Kap, is intended to meet stringent demands of space, performance, and economy and features extremely low power factor. It is suitable for portable, electronic equipment, hearing aids, radio, TV, etc. Centralab, Division of Globe Union Inc., 900 E. Keefe Ave., Milwaukee 1, Wisc. (ELECTRONIC TECHNICIAN 10-13)

As described in ELECTRONIC TECHNICIAN send me more data on the Sprague capacitor replacement kits. (10-14)

Name

Address

Company

City State

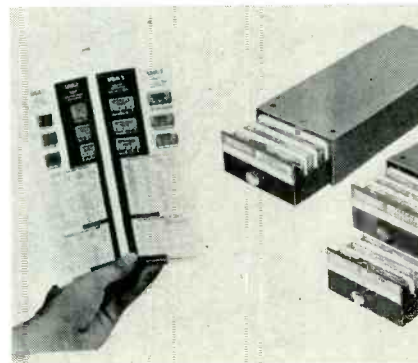

← Sprague CAPACITOR

Ceramic Capacitor Kits, CK-2, CK-3, and CK-4 contain all the popular ratings. They are neatly stored and indexed in miniature filing cabinets. CK-2 contains an assortment of 150 of the most needed Ceramite disc capacitors. CK-3 contains an assortment of 75 disc capacitors. CK-4 contains three each of four different "Universal" ceramic capacitors, which can be made to answer 90% of all ceramic capacitor replacement needs. Sprague Products Company, North Adams, Mass. (ELECTRONIC TECHNICIAN 10-14)

As described in ELECTRONIC TECHNICIAN send me more data on the Astron subminiaturized electrolytic capacitor. (10-15)

Name

Address

Company

City State

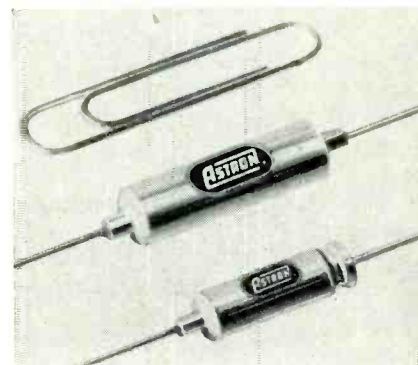

← Astron CAPACITORS

Two subminiaturized capacitors are especially designed for transistorized circuits and low voltage d-c equipment. Types EE (epoxy end fill) and EM (spun end with rubber bushing) are extremely small hermetically sealed electrolytics (from $\frac{3}{16}$ " x $\frac{1}{2}$ " to $\frac{1}{4}$ " x $\frac{3}{4}$ "). They have applications in hearing aids, pocket radios, and many other miniature units. Available in voltages of 1, 3, 6, 8, 16, 26, and 50. Astron Corporation, 255 Grant Ave., East Newark, N. J. (ELECTRONIC TECHNICIAN 10-15)

As described in ELECTRONIC TECHNICIAN send me more data on the IRC Type PW-20 resistor. (10-16)

Name

Address

Company

City State

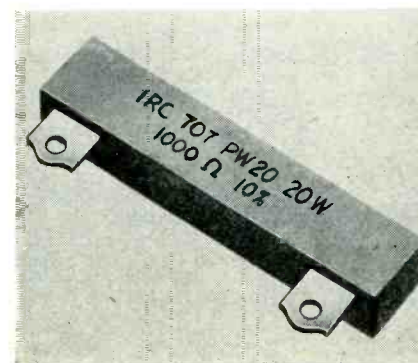

← IRC RESISTOR

A high-temperature resistor, featuring lug terminals and radial leads, Type PW-20, combines a unique design with a high degree of automatic assembly, and offers practical possibilities for cost savings. It is particularly recommended for applications requiring an actual wattage dissipation of 20 watts or less, and where the operation is at high ambient temperature. International Resistance Company, 401 N. Broad St., Philadelphia 8, Pa. (ELECTRONIC TECHNICIAN 10-16)

(Continued from page 51)

friends or business associates wherever you happen to be—on the golf course, on a fishing trip, or even on a trans-Atlantic flight. Your receiver will have a decoding unit that will respond to only one of a million or more possible arrangements of pulses sent out from a transmitter. In this way, you will be assured of complete privacy in your conversation, even though you will be on the largest party line in the world.”

3. Voice-Controlled Electronic Systems: “Basic studies already have led to the development of a rudimentary phonetic typewriter that can type a few simple words and phrases spoken into a microphone. Through experiments with this system and further development of the novel principles employed in it, we can expect to achieve new and versatile systems capable of ‘understanding’ and carrying out verbal orders.

“The business man of the future may well dictate his interoffice memos and personal letters directly to an electronic typewriter that will produce them phonetically in response to his voice,” General Sarnoff said.

“We may also look forward to the day when spoken instructions will be used to control the programming and operation of computers in business. To be really fanciful, we might picture the householder of the future talking into a little pocket transmitter to issue such instructions as ‘dishwasher on,’ ‘thermostat 72 degrees,’ and so on—activating controls which cause each of these things to happen instantly.”

In the business field, General Sarnoff said, it is not unreasonable to envisage the day when all branch offices will be linked with the home office through communications systems integrated into the computer system to perform accounting and other operations.

“Insurance policy records, which now occupy five or ten floors of a skyscraper office building, will ultimately be condensed on a few hundred reels of magnetic tape and stored in a single room,” General Sarnoff continued. “An employee who wants some specific information on your policy or mine will simply press a button or dial a code number. The electronic memory will be searched at lightning speed, and the desired information will appear instantly on a television-like screen on the employee’s desk.

“Great as the accomplishments of industrial and commercial electronics have been so far, we are still in the pioneering stage.” •

GET YOURS NOW!

SONOTONE

**PHONOGRAPH
MODERNIZATION
MANUAL**

SECOND EDITION
PRICE 10 CENTS

ELECTRONIC APPLICATIONS DIVISION
SONOTONE CORPORATION
ELMSFORD, N. Y.

**PACKED WITH
VALUABLE INFORMATION**

- Advantages, operation and use of ceramic cartridges
- Replacement data

IT'S FREE!

This handy booklet will help you make proper and intelligent use of the amazing new Sonotone Ceramic Cartridges. It will enable you to make profitable replacements, modernizing your customer's phonograph. It will give him extra satisfaction and bring you prestige.

Be sure to get your up-to-date manual.

Just fill in the coupon and mail to Sonotone. Attach to a postcard if you wish.

SONOTONE® Corporation

Department
Elmsford, N. Y.

Please send me, without cost or obligation, a copy of the newly revised "SONOTONE Phonograph Modernization Manual."

NAME _____

ADDRESS _____

CITY _____ ZONE _____ STATE _____

Electro

ADVANCED DESIGN
DC POWER SUPPLIES



Specially designed . . . not a conversion

IMPROVED D-612T

now better than ever . . .
at same low cost!

\$44.95 net

LESS THAN $\frac{1}{2}$ % RIPPLE
(up to 5 Amperes)

DC POWER FOR . . .

TRANSISTOR Portables

TRANSISTOR Auto Radios

TUBE Auto Sets

- Dual Range—0-8 and 0-16 V., continuously variable.
- 10 Amperes continuous duty up to 12 V.
- 20 Amperes intermittent service.

NEW DUAL RANGE EFB . . .

. . . for laboratory and design work on transistor circuits and electronic equipment.

1/10% ripple 0-16 or 0-32 V.

Carbon brush-type variable transformer for smooth voltage control.

SEND TODAY FOR NEW BULLETINS



**ELECTRO
PRODUCTS
LABORATORIES**

4501-T North Ravenswood Ave.
Chicago 40, Illinois

CANADA: Atlas Radio Ltd., Toronto

7436

IT'S WONDERFUL

to find something—

when you need it!

That's *WHY* we've made up, for **ELECTRONIC TECHNICIAN SUBSCRIBERS . . .** a new supply of modern, sturdy, blade-type magazine **BINDERS**, size 8½" x 11¼". (The first lot was sold out).

These **BINDERS** hold 24 issues of **ELECTRONIC TECHNICIAN** securely and conveniently . . . and are made of dark red heavy-duty bookcover material—with steel spine and 24 steel blades. They will preserve for you the valuable technical information and "know-how" in *every* issue of **ELECTRONIC TECHNICIAN . . .** and keep your copies conveniently at hand.

Gold-embossed on front cover and back binding.

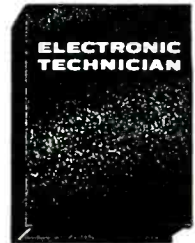

\$3.25 each—Postpaid

(for Canada & Foreign—add

50¢ postage)

ELECTRONIC TECHNICIAN

480 Lexington Ave.

New York 17, N. Y.

107

New Product Review

Jerrold COUPLERS

Extremely low-loss antenna couplers permit connection of more than one TV receiver to a single antenna. Different couplers for strong and fringe areas are available. Fringe area models feature a-c isolation between receiver and antenna. All models are engineered for VHF or UHF reception, as well as undistorted passage of color signals. Jerrold Electronics Corp., 23rd & Chestnut Sts., Philadelphia 3, Pa. (ELECTRONIC TECHNICIAN 10-17)

Alliance GENIE LIFT-A-DOR

The new radio controlled garage door operator cannot be triggered by accident, and requires no FCC license. The device automatically unlocks, opens, lights, closes and locks any overhead garage door at the push of a button in the owner's car. A limited-range, low frequency system prevents jamming or false activation of the unit by stray radio signals. The Alliance Mfg. Co. Inc., Alliance, Ohio. (ELECTRONIC TECHNICIAN 10-23)

Perma-Power CRT RESTORER

Model K-101 TV tube restorer locates and corrects for: open cathode; heater-cathode short; open grid; control grid-cathode short; low emission; and combinations of these. List price is \$5.50. Perma-Power Co., 3100 N. Elston Ave., Chicago 18, Ill. (ELECTRONIC TECHNICIAN 10-29)

Kay VARI-SWEEP

The Vari-Sweep Model IF is a complete alignment instrument and features: continuously variable center frequency from 4 to 120 mc with direct readings from an individually calibrated frequency dial; continuously variable sweep widths; continuously variable frequency marker from 2 to 135 mc giving separate direct readings from an individually calibrated frequency dial; and up to 11 crystal controlled fixed markers. Kay Electric Co., 14 Maple Ave., Pine Brook, N. J. (ELECTRONIC TECHNICIAN 10-50)

Ohmite RESISTORS

New metal film resistors can be used at full 1/4-watt rating in an ambient 150°C, or up to 1/2 watt at 105°C. The Series 77 employ no wire for the resistance element, yet have all the desirable characteristics of wire wound resistors. Reactance is exceedingly low due to the absence of wire coils, and can be used in high frequency and pulse circuits for which wire wound units are unsuitable. Ohmite Mfg. Co., 3657 Howard St., Skokie, Ill. (ELECTRONIC TECHNICIAN 10-20)

RCS FLUSH CUT SAW

Model 250 Super Saw has an overall length of 16" (minus sawblade), weighs 8 lbs, and is equipped with a 1/2 horsepower 5.0 amp motor, for heavy-duty cutting applications. It delivers 2500 strokes per minute. The blade cuts right through nails or other obstructions. A rocker guide permits direct cuts into wood or comparable material; no starting hole is necessary. R.C.S. Tool Corp., P. O. Box 661, Bloomington, Ill. (ELECTRONIC TECHNICIAN 10-51)

Belden WIRE

Hook-Up Wire conforming to MIL spec 16878-B will be available in both plain vinyl jacket, and in vinyl with a nylon jacket, in 16 through 26 gauge, and in 10 solid and 9 striped colors. All of these wires have stranded, tinned copper conductors and 0.010" vinyl thermoplastic insulation. They are available in 100' and 1,000' square spools. Belden Mfg. Co., 4647 W. Van Buren St., Chicago 44, Ill. (ELECTRONIC TECHNICIAN 10-22)

Mallory VIBRATOR

Gold Label vibrators are exceptionally quiet in operation. They feature the unique new buttonless-contact construction which lengthens vibrator life and eliminates problems of sticking contacts and insures positive starting. P. R. Mallory & Co. Inc., 3029 E. Washington St., Indianapolis 6, Ind. (ELECTRONIC TECHNICIAN 10-19)

G-H TRANSFORMER

Teenyformer is so small that it is completely hidden by the normal eraser on a lead pencil. Its actual dimensions are 0.203" x 0.297" x 0.297". 700 Teenyformers weigh less than one pound. The Teenyformers are designed for transistor applications. Gramer-Halldorson Transformer Corp., 2734 N. Pulaski Rd., Chicago 39, Ill. (ELECTRONIC TECHNICIAN 10-21)

Entron AMPLIFIERS

The unity gain, 4-output model BA-4; 10db gain, 4-output model BA-400; and the 25 db gain, 2 output model BA-250 VHF TV bridging amplifiers are for 75-ohm systems and will handle up to 0.2 volts per channel, maximum output. The new amplifiers feature single control adjustable equalization and adjustable gain. Plug-in attenuators insure less than 0.5db thru-line loss. Silicon power rectifiers contribute to low power consumption and very long life. Entron, Inc. P. O. Box 287, Bladensburg, Md. (ELECTRONIC TECHNICIAN 10-52)

Precision VOM

The new Model 120M high sensitivity, multi-range VOM features a mirrored-scale which makes possible high accuracy readings by eliminating parallax. Also featured are: 1/2% tolerance multipliers and a 1% accuracy Pace meter which provides ±1 1/2% accuracy on all d-c functions and ±3% accuracy on all a-c ranges; and a separate function selector position for -d-c volts and -d-c milliamperes. Sensitivity is 20,000 ohms/volt dc and 5,000 ohms/volt ac. Precision Apparatus Co. Inc., 70-31 84th St., Glendale 27, Long Island, N.Y. (ELECTRONIC TECHNICIAN 10-18)

B&K CRT ADAPTER

A new, low-cost CRT Adapter for testing and rejuvenating color TV and 110° picture tubes is designed for use with the Models 400 and 350 cathode rejuvenator testers. The C40 tests each gun of the color picture tube separately for continuity, inter-element shorts, opens, leakage, emission and cut-off voltage. By comparing the emission readings of red, green, and blue guns, difficult color troubles can be isolated and detected. B&K Mfg. Co., 3731 N. Southport Ave., Chicago 13, Ill. (ELECTRONIC TECHNICIAN 10-24)

FOR MORE TECHNICAL INFORMATION ON NEW PRODUCTS OR BULLETINS

use this convenient coupon. Enter below the reference numbers for all items desired.

NEW PRODUCTS EDITOR, ELECTRONIC TECHNICIAN
480 Lexington Ave., New York 17, N. Y.

Please send me more information on the following items:

.....
My company letterhead or business card is enclosed.
Name
Address
Firm My position
City State

New Books

TRANSISTOR CIRCUITS. By Rufus P. Turner. Published by Gernsback Library, Inc., 154 W. 14th St., New York 11, N. Y. 160 pages. Paper cover. \$2.75.

A collection of more than 150 practical, usable transistor circuits. Except for occasional instances, no space is devoted to theory. All circuits were tested by the author in his own laboratory. The book will save many hours of design time.

GUIDE TO BROADCASTING STATIONS 1957-58. Compiled by the staff of "Wireless World", 10th Edition. Published by Iliffe & Sons Ltd., Dorset House, Stamford St., London S.E.1, England. Size 7 $\frac{1}{4}$ " x 4 $\frac{3}{4}$ ". 80 pages. Paper Cover. 2s 6d. Many hundreds of amendments have been made in preparing the material for this edition, and the information has been checked against measurements made at the B.B.C. Receiving Centre at Tatsfield, Surrey. The tabulated information giving frequency, wavelength and power of over 2,000 short-wave stations of the world, and some 750 long and medium-wave transmitters in Europe, is listed geographically and in order of frequency. The present chaos

among broadcasting stations in Europe may be judged from the fact that some 350 transmitters are operating on frequencies not allocated to them under the international plan drawn up at Copenhagen in 1948. Other features include international allocation of call signs.

CBS ENGINEERS HANDBOOK. Compiled and published by CBS-Hytron. Tube Division of Columbia Broadcasting System, Inc., Danvers, Mass. 650 pages. Soft cover. Snap-on 16-ring metal binder.

Technicians desiring more comprehensive electrical and mechanical data and characteristic curves will find this new handbook most convenient. Contains data for over 1000 tubes and 300 curves, printed in two colors. Complete RETMA data and curves are given for current receiving and TV tubes, regardless of make. Also full data and curves for CBS semiconductors are given. Unique basing diagrams employ twin circles to distinguish immediately one section from another of multi-section tubes. Both the new Engineer's Handbook and the more abbreviated CBS Technician's Handbook are available from CBS tube distributors.

ORRadio TAPE REEL

A new 5 $\frac{3}{4}$ -inch Irish Tape reel offers many advantages over the standard 5-inch reel. It has a professional type hub, 2 $\frac{1}{4}$ " diameter, the same size hub as the 7" reel. A larger opening in the reel provides easier access to the

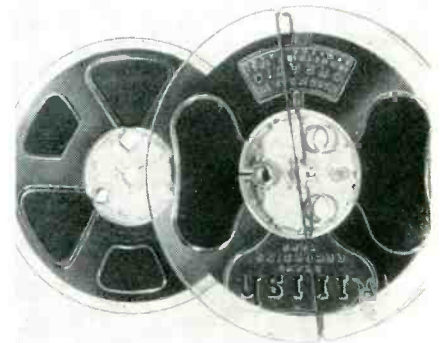

threading eye. Available with 600-ft and 900-ft lengths. In the Irish Double Play tape, it carries 1200 feet. ORRadio Industries, Inc., Shamrock Circle, Opelika, Ala. (ELECTRONIC TECHNICIAN 10-40)

IRC RESISTORS

High temperature wirewound resistors rated at 5, 7, 10 and 20 watts, designated as PW-5, PW-7, PW-10, and PW-20 respectively, are wound on glass-fibre cores and sealed in a rectangular ceramic case. The 20-watt resistor is equipped with tinned brass terminals. Others have tinned copper axial leads. Can be used in TV and other electronic circuits requiring up to actual wattage rating, or less, of these resistors. International Resistance Co., 401 N. Broad St., Philadelphia 8, Pa. (ELECTRONIC TECHNICIAN 10-41)

SPECIALY PRICED DURING OCTOBER

TIMED RIGHT FOR YOUR BIG TV SERVICE SEASON!

SAVE 2 CANS \$1.89

NEW ACTIVATED FORMULA

now with NEW FORMULA

ELECTRICAL CONTACT CLEANER and LUBRICANT

GENERAL CEMENT

No. 8666X

G-C SPRA-KLEEN

2 CANS FOR \$1.89 DEALER NET

VALUE \$2.40

special this month

2 CANS \$1.89

SEE YOUR G-C JOBBER NOW!

NOW, WHEN YOU NEED IT, is the time to stock up on G-C SPRA-KLEEN . . . the easy-to-use electrical contact cleaner and lubricant in the power spray can. Brushless, clean, convenient . . . SPRA-KLEEN makes servicing easier. Buy now and save during this special sale!

FREE G-C CATALOG . . . send postcard today!

GENERAL CEMENT MFG. CO.

Division of Textron Inc.

400 SOUTH WYMAN STREET

ROCKFORD, ILLINOIS

Tough Dog

(Continued from page 35)

Channel 2. A wattmeter was connected to the antenna terminal. This showed that both channels were delivering the rated amount of power to the antenna; so it must be off frequency on Channel 2. The frequency meter was set up and the frequency checked. Channel 1 checked on frequency, Channel 2 had birdies 100 kc's on each side of the center frequency. Another new tube was tried; no results. Then a new crystal was substituted; no results. Finally, each part in the oscillator circuit of Channel 2 was disconnected and checked or replaced; no results. The oscillator just would not stay on frequency. More by accident than anything else, Channel 1 oscillator tube was removed and Channel 2 then settled down and worked properly. The tube was reinserted in the socket and the trouble developed again. A new tube was placed in Channel 1 oscillator and both channels worked normally. The tube removed from Channel 1 was checked for leakage on the tube tester and showed nothing wrong. It was then checked for leakage with an ohmmeter. Still this showed it was no worse than the new tube that had been put in the circuit. Nothing could be found wrong with this tube, and it functioned satisfactorily in other circuits. Further checking proved that this tube when placed in the oscillator circuit would oscillate continuously when the transmitter was on regardless of the position of the channel switch and was beating against the Channel 2 oscillator when the set was in the Channel 2 position; thus causing the birdies.

Since having this trouble in this set, I have had the same thing happen in two other similar sets using the same transmitter strip.—*Carl W. Sheppard, Rolla, Missouri.*

WIN \$10.00!

ELECTRONIC TECHNICIAN will pay \$10.00 for acceptable Tough Dogs. Unacceptable items will be returned. Use drawing to illustrate wherever necessary. A rough sketch will do as long as it can be followed. Send to "Tough Dog" Editor, ELECTRONIC TECHNICIAN, 480 Lexington Ave., N. Y. 17, N. Y.

Amperex TUBE

The ECC85/6AQ8 is a miniature, high-mu, high-transconductance twin-triode tube specifically designed for use in AM and FM receivers as a grounded-grid or grounded-cathode r-f amplifier and as a self-oscillating frequency converter or cascode amplifier. Through the use of an internal shield, separating both triode sections, it reduces oscillator relations from the antenna of the receiver to an extent not obtainable with previously available twin-triodes. Higher transconductance permits increased front-end gain and lower noise. Amperex Electronic Corp., Special Pur-

pose Tube Division, 230 Duffy Ave., Hicksville, L. I. N. Y. (ELECTRONIC TECHNICIAN 10-28)

Switchcraft PHONO JACKS

Standard assemblies of phono jacks and plugs molded to the cable (with shielded handle) are available in both the straight and right-angle types. Standard cable assemblies designed for hi-fidelity and other audio equipment may be used for inter-connecting amplifiers, tuners, microphones, etc. Switchcraft, Inc., 1328 N. Halsted St., Chicago 22, Ill. (ELECTRONIC TECHNICIAN 10-60)



ALL OVER THE U.S.

Utah STANDS for
UNSURPASSED SERVICE

Yes . . .
ALL OVER THE U.S.
UTAH STANDS for UNSURPASSED SERVICE

Yes, all over the U. S.—Utah stands for Unsurpassed Service.

US—Utah and the Service Man—because Utah stands behind you—the Service Man.

Utah stands behind you—with a speaker name that for over 30 years has signified the finest in quality, design, engineering and production.

Utah stands behind you with a speaker that gives installation performance. You can sell customer satisfaction with a Utah—because Utah gives performance satisfaction.

Utah stands behind you—with a secure source of supply. Leading jobbers all over the U. S. handle Utah—because Utah has the finest and widest line of replacement speakers available to the trade.

Utah your one complete speaker source auto * Rear Deck Kits * Standard Replacement * Television * Public Address * High Fidelity * Outdoor * Inter-Com * Wood & Metal Baffles

Utah is your one, complete satisfactory speaker source. When you order speakers today — **THINK**—then order Utah.

Get your **FREE** copy of the latest Utah Catalog S-157 listing over 100 replacement speakers. Available at your distributors or write direct.



RADIO PRODUCTS CORPORATION
HUNTINGTON • INDIANA

Export Dept. Fidevox International, Chicago, Illinois



Audio NEWS LETTER

AUDIO-MASTER CORP., 17 E. 45th St., New York City, has just released "Audiotone," a complete self-contained sound system. It includes a 5-watt, hi-fi, push-pull amplifier with inverse feedback, and has a frequency re-

sponse from 60-12,000 cycles. Contained also are dual hi-fi speakers, (8" woofer and 3" tweeter with crossover network) and a bass reflex baffle cabinet with plastic hi-fi acoustic grill. Weighs 15-1/2 lbs. and sells complete at \$79.50.

PICKERING introduces revolutionary stylus. Molded of high impact durable phenolic plastic, the "T-Guard" stylus assembly carries the

conical diamond stylus in its center, out of reach of possible damage. The design permits quick change. Standard assemblies are the 1/2, 1, and 2.7 mil diamond and the 1 and 2.7 mil sapphire. Available on order are: 0.8, 2.5, and 3 mil diamond; and 2.5 and 3 mil sapphire.

MASCO announces a three in one electronic converter, Model CV-12, to be used in case of power failures. It operates on a 6 or 12 volt automobile battery. Is capable of maintaining a 110-volt a-c output at 130 watts constant or 150 watts intermittently. Size is 7" wide x 8-1/2" deep x 8-1/2" high and is completely portable. Lists at \$105.00.

NEW HI-FI RECORD CHANGER is being introduced by GLASER-STEERS CORP., 20 Main St., Belleville, N. J. It's the model GS 77 four-speed changer with these features: "Speedminder" device which automatically selects correct turntable speed; with standard groove stylus in play position, changer automatically operates at 78 rpm; with micro-groove stylus, it automatically intermixes 33 and 45 rpm records without regard to size or sequence. Change cycle is 5 seconds, with turntable pausing during cycle. Single control knob sets all operations. Industrial design by Jon W. Hauser Associates. Audiophile net is \$59.50 less cartridge. Ad agency is Jack Gilbert Associates.

ELECTRONIC INSTRUMENT CO. announces an agreement with HEGEMAN LABS., Glen Ridge, N. J., for exclusive rights to manufacture and distribute the latter's speaker system, to be known as the EICO Standard Speaker System.

RECOTON CORP. announces the appointment of the Morris Taylor Co. as its rep for the Mid-Atlantic and Southern states.

MINNEAPOLIS-HONEYWELL has unveiled a power tetrode transistor designed for hi-fi equipment. It operates at 28 volts, can carry 10 amps.

independent
survey
shows



Why do electronic technicians prefer Quam speakers? In filling out their survey questionnaires, they mentioned such reasons as:

- Adjust-a-Cone Suspension
- High quality dependable performance
- Adjustable mounting bracket
- Better construction
- No call-backs

Thank you, Mr. Serviceman. We appreciate the vote of confidence.

QUAM

is
first
again!

Brand Name Surveys of Chicago, Illinois, asked 22,000 service technicians from coast to coast, "What brand of replacement speakers do you prefer?" Overwhelmingly, from Maine to California, the preference was for Quam. In fact, twice as many servicemen now prefer Quam as the next most popular brand—and as many prefer Quam speakers as the other three leading brands combined! This is the fourth consecutive year in which Quam has led the Survey.

QUAM-NICHOLS COMPANY

226 EAST MARQUETTE ROAD • CHICAGO 37, ILLINOIS
CANADA:

A.T.R. Armstrong, Ltd., 700 Weston Road, Toronto 9, Ontario
D. Eldon McLennan, Ltd., 1624 W. Third Avenue, Vancouver 9, B.C.

Association News

ESFETA Meets

The Empire State Federation of Electronic Technicians Associations, Inc. held its regularly scheduled meeting in Ithaca, New York, with Ben DeYoung acting as host member and representing Ithaca. Recently elected Eastern V.P. of NATESA, Bert Lewis, was in attendance and representing Rochester. One of the major issues discussed was that of licensing. President Dan Hurley pointed out that there was a possibility that Captive Service would benefit from a governmental licensing program because, as he stated, possibly 30% of the practicing technicians would be eliminated leaving an expanded market for the manufacturer.

Robert Henderson, delegate from Long Island stated that the self licensing program instigated in their area hasn't brought any noticeable response from the public as was expected. George Carlson, Secretary reported that Jamestown's Self-Certification Program has resulted in public response, but only so long as the individual members advertise their membership and as long as the association constantly presents the Certification program to the public through newspaper and other forms of advertising. The next meeting of ESFETA will be held November 10 in Rochester, N. Y., with Norbert LeMay, Pres. of Rochester as acting host.

TSG Public Relations

Appointment of Len Gross as executive secretary, advertising and public relations counsel for the San Francisco Television Service Guild was announced this week by Ned Gramlich, president of the Guild. Gross is a partner in Gross and Roberts, San Francisco advertising and public relations firm.

In addition to his executive secretary duties, his first assignment will be development of an advertising and promotion program to educate the general public concerning the Guild and its members.

NATESA Advertising

After almost two years of investigation, meetings and planning, NATESA is now able to offer each

member of each local affiliate a chance to participate in the National Advertising and Publicity Program. The program calls for ads in several of the top magazines, newspaper ads on a local level, radio and TV "spots" on a national level, listing in the "yellow pages" of the phone directory, "Operator 25" service, and use of direct-mail. Individual members of local affiliates will be "franchised" and allowed to participate. Window valances, truck decals, letter-heads, bill-heads, mailing pieces, etc., will be available at cost.

ETSAM Elects

Electronic Technician's Service Association of Maine elected Bob Crapo, Pres.; Don Morse, V.P.; Paul Davis, Sec.; Joe Bruni, Sgt. at Arms; Tom Waugh and Emery Galli on the executive Board.

ETG Elects

The Electronic Technicians Guild, Greater Lowell Chapter, elected Albert Giddis, Pres.; Robert Hudon, V.P.; Alfred Nickerson, Sec.; Louis Landry, Director.



STOP CB* WITH C-D



*STOP SERVICE CALL BACKS with Cornell-Dubilier's popular "UP" Twist Prong Electrolytics—specified by leading manufacturers as original equipment, adopted by "profit-conscious" technicians and the top choice for wide-coverage replacement service. Call-back-free dependability is the big reason why more C-D Capacitors are in use today than any other make. Complete catalog available. Write to Dept. RT-107 Cornell-Dubilier Electric Corp., South Plainfield, New Jersey. SAVE TIME AND MONEY—INSIST on C-D Twist Prong ELECTROLYTICS.

stop call backs...insist on

CORNELL-DUBILIER CAPACITORS

SOUTH PLAINFIELD, N. J.; NEW BEDFORD, WORCESTER & CAMBRIDGE, MASS.; PROVIDENCE & HOPE VALLEY, R. I.; INDIANAPOLIS, IND.; SANFORD, FUQUAY SPRINGS & VARINA, N. C.; VENICE, CALIF. & SUB.: THE RADIART CORP., CLEVELAND, O.; CORNELL-DUBILIER ELECTRIC INTERNATIONAL, N. Y.

"OUTPERFORMS THEM ALL"



I. J. Saltzman, *Globe Sound Service, Jamaica, N. Y., experienced commercial sound engineer, says: "On side by side comparison test, the CJ-44 outperforms them all."*

NEW!
ATLAS "King Cobra-Jector"

CJ-44



Shown with GB-1 Universal Mounting Bracket

Complete with "Acousti-Match" Built-in Driver Unit

List \$72.50
NET \$43.50

A wide-angle, all-purpose, all-weather Public Address Speaker, complete with integral high-power super-efficient "Acousti-Matched" driver unit. "Acoustic-Matched" means "Controlled Response" within the frequency limits most useful in P. A. and high level music reproduction. "Controlled Response" offers conversion efficiency never before obtainable in high-powered speakers. "Controlled Response" results in smooth reproduction — free from peaks which so often create and sustain acoustic feedback.

The CJ-44 conserves costly amplifier output power — fewer speakers do a complete job. The speaker horn is easily rotated for horizontal or vertical dispersion patterns.

The CJ-44 is the only high-powered P. A. speaker that can be equipped with the new Atlas Universal Mounting Bracket, permitting quick and secure directional adjustment on both planes. Simple to make a horizontal or vertical adjustment as a final "touch-up" to the installation.

The CJ-44 is designed for the "tough jobs." No gimmicks, no fluffs, no wild claims — just a reliable super-efficient speaker for all applications.

Input Power: 30 watts constant
50 watts peak
Input Impedance: 16 ohms
Response: 150-9,000 cps
Dimensions: Bell 23" x 13";
Over-all length 19"
Net Weight: 16 lbs.

Write for free Catalog 57.



ATLAS SOUND CORP.

1445-39 St., Brooklyn 18, N. Y.
Atlas Radio Ltd., Toronto, Canada

2 TV Programs 1 Channel

(Continued from page 42)

or negative signals enable picture A or picture B to be visible on the TV screen while the other picture is cancelled. For example, if A is the program viewed, only positive signals would be apparent; the B program would not intrude on A because of the cancelling effect of the positive and negative signal components.

If the Bi-Tran System were applied to Pay TV programming, the primary free program will be received normally by the TV receiver. The alternate program, however, would only become visible and audible by the addition of coded electronic signals. These coding and decoding signals would be carried via existing telephone wires in the home, without disturbing regular telephone service. The viewer could switch to the "B" portion of the channel, thereby selecting a Pay TV program. No other action would be required. The decoding signals would be brought to the set and at the same time information would be transmitted back to the telephone central office, indicating the program selected. This feature would greatly simplify the collection of funds from the home viewers inasmuch as these funds would be added to the telephone bill.

The signal transmitted back to the telephone central office serves to determine for the broadcaster the size of the audience. Bi-Tran offers possible solutions to many complex problems of broadcast TV transmission. The military could make excellent use of this system because coded secret or classified informa-

tion could be transmitted and could not be deciphered by unauthorized persons. Doubling the number of TV programs would also permit educational programs and public service information as required by police and fire departments and hospitals to be transmitted by the Bi-Tran method while retaining all existing channel programming.

It was also pointed out that the "B" portion of the signal that is sent through the telephone lines for Pay TV could be sent through the air. It would enable free reception of twice as many programs. This could conceivably eliminate the need for additional allocation of frequencies, especially in those areas which already have the maximum number of assigned channels. •

Labor Relations

(Continued from page 42)

requires that the company have control over the number and type of employees on duty. Even though the published rule does not specifically indicate that leaves are within the discretion of management, it would be most unrealistic and impractical to assume that it was intended to allow workers individually to decide when and to whom leaves are to be granted. The rule must be interpreted to mean that leaves of over two weeks will not be granted unless the circumstances are most unusual, whereas shorter leaves will be granted at the company's discretion. Grievance denied."

CAN YOU FIRE AN EMPLOYEE WHO LEAVES EARLY WITHOUT HIS BOSS' SPECIFIC OKAY?

What Happened:

Tom Harty wanted the following afternoon off. Employer Wiggins said he didn't see how he could be spared as they were short three men. The boss added that if the jobs Harty was on were completed by noon the next day, he'd tell Harty and let him off. The next morning, supervisor Henderson told Harty he'd better get a move on if he wanted to get off at noon. Later, Henderson signaled to Harty to speed up and then knock off. At noon Harty left. He was fired for leaving work without permission. "Not guilty!" said the worker because:



"How do you read me? . . . over . . ."

1. By the time I left, it was obvious to anybody that the job would be finished that day. In fact, it was done by 3:30.
2. Several men saw the hand signs the supervisor gave me, and they all agree it meant I could knock off. He had the authority to let me leave.
3. I just caught a glimpse of the boss at a distance that morning. If he'd been close by, I'd have double checked with him. But I didn't want to leave my work to try to track him down.

The boss replied:

1. Harty shouldn't have left without my specific permission. If he had checked with me at noon, I would have told him, in fact, that I couldn't spare him that afternoon.
2. Whether or not the work was sufficiently completed was a matter of judgment, and I'm the only one who could be a judge of that.
3. Henderson doesn't remember giving Harty any signals. Even if he did, it was probably horse-play. Anyhow, Harty should have checked with me.

Was the Foreman:

RIGHT WRONG

What Arbitrator Harold Dworet ruled: "Harty was told to check with the boss, which he did not do. He was wrong in his failure to do this. He had no right to be the one to determine whether work was sufficiently completed and when to leave. However, he had some reason to believe the leave was granted to him by the actions of Henderson and the hand signs Henderson made to him. If Henderson had no part in this, there would be no question but that management had cause to discharge Harty. True, Harty might have stretched a point, or might have had sufficient reason to interpret the signs from his supervisor. Inasmuch as this is controversial, the arbitrator sees fit to give the employee benefit of doubt. Harty, although mostly to blame, should not be blamed for actions of others which were misleading to him—whether intentional or not. Harty should be reinstated with all rights unimpaired, and compensated for all time lost since his discharge."

Empire SPEAKER

The "CAR-FI II" is designed so that one model can fit practically any make or model automobile. The injection moulded cabinet is made of high-impact, high-gloss styrene, to insure ruggedness. The new 2½" x 10" rectan-

gular speaker has a silicon treated cone, to resist water damage. The unit can be mounted on the back of the front seat. Installation above the knee level of the occupants in the rear seat does not interfere with entering or leaving the car. Available with or without a universal harness. Empire Electronics, Inc., 22022 Woodward Ave., Ferndale 20, Mich. (ELECTRONIC TECHNICIAN 10-37)

Harvey-Wells HYVOLT

This unit provides a completely adjustable source of high voltage (0-15KV). Its primary purpose is to provide insulation, dielectric and cable

test information. It has been found useful for many other things, such as an aid for locating open circuits, etc. It is a reliable source of high voltage for CRT anodes, etc. Harvey-Wells Electronics, Inc. Southbridge, Mass. (ELECTRONIC TECHNICIAN 10-35)

R-Columbia CHEATER CUBE

To save time on TV service calls, new cheater cubes plug into the back of the TV set to get a three-way source of electric power. Model A for RCA type interlock and Model B for Zenith type interlock. 79¢ each, dealer net. R-Columbia Products Co. Inc., Highwood, Ill. (ELECTRONIC TECHNICIAN 10-36)

Which of these salaries is most like yours?

\$109 or \$128
per week per week

As a result of a survey of men now employed in electronics, we have found that technicians with FCC commercial licenses predominantly earn more than those without.

The survey shows that over 49% of those who answered and have their FCC licenses earn over \$125 per week. We can help you get the knowledge necessary for the FCC license. Mail the coupon today.

Men with Technical Know-how earn 17% more salary in these fields

- ✓ Two-way radio
- ✓ Microwave relay
- ✓ Home electronics
- ✓ Industrial electronics
- ✓ Radar

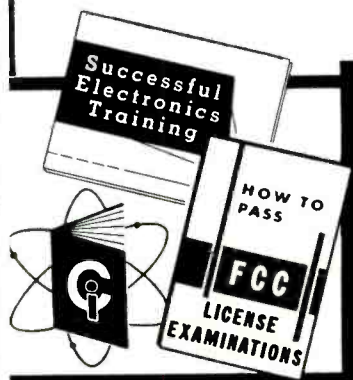

CLEVELAND INSTITUTE OF RADIO ELECTRONICS

Desk T-8, 4900 Euclid Bldg., Cleveland 3, Ohio

Please rush the Free booklets to

Name

Address

City

Accredited by the National Home Study Council

Factory Service

(Continued from page 39)

In short, there is nothing in the entire prospect that any independent serviceman has to fear except perhaps the matter of determining whether or not his own business methods are in tune with the changing times.

It is squarely up to him whether he stays in business and continues to prosper—or meekly succumbs to business-like competition and throws in the sponge.

Evaluating Independents

Specifically, here are some of the points on which every independent owes it to himself to judge his business while there is yet time:

1—In addition to doing good service work, does he do it on an efficient, business-like basis?

2—Does he charge enough to show a fair profit and provide the right kind of equipment that customers expect of a successful, dependable service business? (Remember, manufacturer's service competition will seldom if ever be on a price basis. The real competition will be in competent work at fair prices that permit a fair profit. From sad experience, set owners have learned that cheap prices may simply mean cheap replacement parts; poor workmanship and maybe "gypping.")

3—Does he have an efficient looking shop in a suitable location; a good-looking truck and the right kind of equipment?

4—Does he keep up to date on new service methods and techniques?

5—Has he taken at least a preliminary course in servicing color TV?

6—Does he dress neatly and professionally and make a good impression in customers' homes?

7—Does he take an active part in his community?

8—Does he regularly invest a fair percentage of his profits in advertising?

9—Does he carry a suitable listing and small advertisements in the local classified telephone directory?

10—Does he make it clear to customers that he uses only full-quality parts by well-known manufacturers?

11—Does he handle service calls promptly and deliver sets "as promised?"

12—Is he a member of a strong, active local service organization of independents working to up-grade their profession?

13—Does he cooperate with quality component manufacturers and parts distributors in their efforts to boost the independent service profession?

14—Does he read good technical and business magazines?

15—Does he invest a regular part of his time, not just in fixing sets, but in studying ways and means of building his business?

16—Does he study the business-build-

The Customer is Always Right!

you'll find whatever they ask for in
RECOTON'S REFERENCE GUIDE!
that's why it's easier to sell

RECOTON REPLACEMENT NEEDLES

The World's Finest Phoneneedles

RECOTON CORPORATION
52-35 Barnett Ave., Long Island City 4, N. Y.

In Canada: Quality Records, Ltd., Toronto

the specs are the proof ...
the **BEST BUYS** are **EICO**
for COLOR & Monochrome TV servicing

NEW TV-FM SWEEP GENERATOR & MARKER #368



= 368
Factory-wired
and tested
\$119.95
Also available
as kit
\$69.95

Entirely electronic sweep circuit (no mechanical devices) with accurately-biased inductor for excellent linearity. Extremely flat RF output; new ACC circuit automatically adjusts oscillator for maximum output on each band with minimum amplitude variations. Exceptional tuning accuracy; edge-lit hairlines eliminate parallax. Swept Oscillator Range: 3-216 mc in 5 fundamental bands. Variable Marker Range: 2-75 mc in 3 fundamental bands; 60-225 mc on harmonic band. 4.5 mc Crystal Marker Oscillator, crystal supplied. Provision for External Marker. Sweep Width 0-3 mc lowest maximum deviation to 0-30 mc highest maximum deviation. 2-way blanking. Narrow range phasing. Attenuators: Marker Size, RF Fine, RF Coarse (4-step decade). Cables: output, scope horizontal, scope vertical. Deep-etched satin aluminum front panel; rugged grey wrinkle steel case.

See the 50 EICO models of tests instruments and hi-fi equipment **IN STOCK** at your neighborhood distributor. Write for **FREE** Catalog T-10

Prices 5%
higher on
West Coast

EICO 33-00 Northern Blvd.
Long Island City 1, N. Y.

BINDERS FOR YOUR CIRCUIT DIGESTS

... to hold your schematics for
convenient reference
\$2.95 each—Postpaid
Canada—please add 50¢ for additional mailing costs

ELECTRONIC TECHNICIAN

480 Lexington Ave.
New York 17, N. Y.

Please ship "ELECTRONIC
TECHNICIAN Circuit Digests
Binders." I enclose \$.....

(please print)

Name

Street & No.

City Zone .. State

ing methods of other service shops (including manufacturer's) to learn ways of improving his own?

Certainly there is no magic about these factors. But simple as they are, they represent the difference between success and failure in a business that has now grown to a mature, competitive stage. •

Insurance Plan

(Continued from page 34)

The Raytheon group life insurance plan is frankly an incentive to purchase the company's tubes. Only independent Raytheon bonded electronic technicians may participate.

Eligibility

To be eligible, the technician agrees to purchase a certain average number of Raytheon tubes every month. The technician and his partners (but not the technician's employees) are then insured at no charge, the distributor footing the bill. The total amount of insurance depends on the standing tube order: Minimum is 75 to 150 tubes per month for \$1,000 of insurance; 150 to 225 tubes, \$2,000; for every additional 75 tubes, the insurance goes up \$1,000 to a limit of \$10,000 for 750 or more tubes.

Partners share equally in the insurance, but a minimum of \$1,000 each is required. Insurance for those reaching 65 years old is reduced 50%. No medical examination is required. If the policy is terminated, there are conversion privileges to other types of insurance.

For years certain manufacturers have extended various aids and services to their dealers. It is hoped that plans such as group life insurance will broaden the pattern of benefits. •

CORRECTION

"TRIO the leader in '55"

This was the headline of the advertisement published in error on page 27 of the Sept. 1957 issue of ELECTRONIC TECHNICIAN. It resulted from our printer picking up the incorrect engraving. The advertiser, Trio Mfg. Co., Griggsville, Ill., did furnish the correct engraving (see page 17 this issue), and is entirely blameless.

Our sincere apologies to Trio and to any reader who may have been inconvenienced by our inadvertent error.

A New CONCEPT IN AMPLIFIER KIT

Construction

The ERIE AUDIO-AMPLIFIER KIT

featuring
"PAC" and an ERIE Embossed Wiring Board

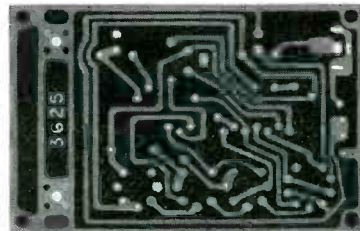

MODEL
PAC-AMP-1

With these Plug-in Components:

- ERIE "PAC" (Pre-Assembled Components)
- ERIE EMBOSSED BOARD
- OUTPUT TRANSFORMER
- FILTER CAPACITOR
- VOLUME CONTROL and SWITCH
- TUBE SOCKETS
- CAPACITORS
- TONE CONTROL
- TUBES

SPECIFICATIONS FOR ERIE STANDARD AUDIO-AMPLIFIER

- Frequency Response: 30 cycles to 12,000 cycles ± 0 , -3.5 db.
- Sensitivity: 0.56 volt RMS (input at 1 KC) for 4 watt output.
- Power Output: 4 watts • Input Impedance: 2 megohms.
- Output Impedance: 4 ohms • AC Power Consumption: 17 watts.
- Overall Dimensions: 6 $\frac{1}{8}$ " L x 4 $\frac{1}{8}$ " W x 3 $\frac{7}{8}$ " H • Shipping Weight: 2 lbs.

See and hear it at
your local distributor
or *Write* for
nearest source.

ERIE Electronics Distributor
DIVISION
ERIE RESISTOR CORPORATION
ERIE, PA.

MORE ACTIVE! EFFECTIVE!

KESTER "RESIN-FIVE" CORE SOLDER



THE BEST FOR TV-RADIO WORK . . .

EVERYTHING ELECTRICAL - Kester "Resin-Five"

Core Solder is better and faster than any solder ever developed. It has an activated flux-core that does a perfect job on all metals including zinc and nickel-plate. The flux residue is absolutely non-corrosive and non-conductive.

Available in all practical Tin-Lead Alloys; 40/60, 50/50 and 60/40 in diameters of $\frac{3}{32}$ ", $\frac{1}{16}$ ", $\frac{3}{64}$ ", $\frac{1}{32}$ " and others.



Printed Circuit Soldering On Copper-etched boards use 60% Tin - 40% Lead Alloy . . . for those that are Silver-surfaced use 3% Silver-61 $\frac{1}{2}$ % Tin-35 $\frac{1}{2}$ % Lead

KESTER SOLDER COMPANY

4264 Wrightwood Avenue, Chicago 39, Illinois • Newark 5, New Jersey, Brantford, Canada



FROM TRIAD

YOKE SERVICING SIMPLIFIED

CHANGE THIS

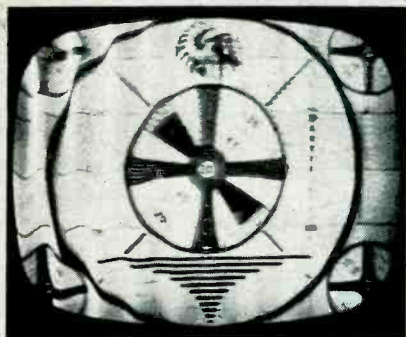

This is caused by improper value of horizontal damping network—or network mounted on wrong terminal.

TO THIS

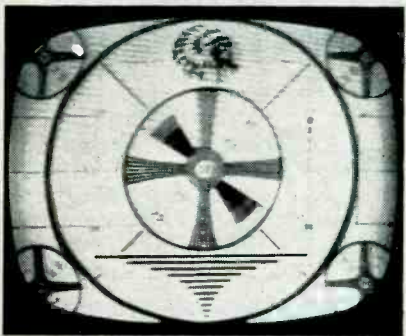

WITH THIS

FLYBACK	YOKE	NETWORK	VERT. OUT
738079 D-44	708176 Y-19(-3)	NW-1	738081 A-111X
738068 D-43	708174 Y-41(-3)	NW-1	738066 A-118X
738078 D-95	708174 Y-41(-3)	NW-4	738076 A-118
738099 D-81	708176 Y-19(-3)	NW-1	

Correct yoke servicing* information as listed in Triad's Television Replacement Guide TV-57. It is available at your distributor.

*Bonus information to the PTM offered only by Triad.



4055 REDWOOD AVENUE, VENICE, CALIF.
812 E. STATE STREET, HUNTINGTON, IND.
A SUBSIDIARY OF LITTON INDUSTRIES.

Burglar Alarms

(Continued from page 37)

Power is supplied to the receiver by the interconnecting cable from strip E-82 in the projector to strip E-83 in the receiver. Pulses of modulated light falling on the photo-sensitive junction of TR-2 modulate the collector current.

This 60-cycle current is transformer-coupled to the amplifier transistor TR-3. Capacitor C-9 corrects the phase of the amplified signal which is fed to the phase detector stage TR-4.

The phase detector circuit shown in Fig. 4 is the selenium rectifier S-2, transistor TR-4, bias resistors R-9, R-10, and R-11 and C-6. This detector compares the phase and amplitude of the signal from the photo-transistor to the a-c signal, which is fed directly to the receiver through terminals 4 and 5 of strip E-83. Since both of these signals are developed in T-4, their phase (after slight correction) is the same. This results in a filtered d-c voltage across the relay which holds it energized.

Normal

Fig. 5 part "a" shows the signal resulting from the modulated light striking the photo-transistor. Part "b" shows the directly coupled a-c signal or reference voltage. In part "c" the reference voltage is shown after rectification. It is applied to the collector of TR-4 as a negative 120-cycle pulsating d-c signal. When a negative pulse of photo voltage is applied to the detector base and simultaneously applying a negative pulse to the collector of TR-4 it will result in drawing more current through the collector circuit, as shown in part "d". By drawing more current in the collector circuit at alternate half cycles, more current will be drawn through the relay in one direction than the other as shown in part "e". Filtering the varying d-c (by means of C-7 and C-8) produces an average d-c volt-

age which is applied to the relay; this holds it energized, as in part "f." The relay contains both a normally open and normally closed contact. The normally open contact is available at terminal 1. The normally closed contact is available at terminal 3 and the armature is connected to terminal 2 on strip E-84. Terminals 4 and 5 are connected to pins C and D, of J-2. The corresponding pins of plug P-2 are shorted by a jumper, thus providing a means for remote detection of tampering with the connection between J-2 and P-2. Capacitor C-11 provides an a-c ground to prevent induced a-c on the tamper line from being picked up on the photo-transistor signal line.

Alarm

Fig. 6 shows the operation of the system with a loss of light at the receiver, or the normal "alarm" condition. The reference voltage is applied in the same manner as shown in part "b" and appears as a negative 120-cycle d-c pulse at the collector of TR-4 as in part "c." Since there is no signal applied to the base of transistor TR-4, the current through the reference source results in a net d-c value of zero across the relay; the negative current swing is equal in amplitude to the positive current swing.

If a light of different frequency is applied to the photo-transistor the polarity of the d-c voltage across the relay reverses at a rate equal to twice the difference between the light frequency and the reference voltage frequency. This results in a momentary drop-out of the relay at each reversal. If the frequency difference is faster than the relay can follow, the relay will stay de-energized.

The system may be set up according to the requirements of a particular situation. The relay may be used as a normally open or normally closed contactor.

ILLUSTRATION CREDITS: Walter Kidde & Co.

Author Lytel will describe the ultrasonic burglar alarm system in a forthcoming issue.—Ed. •

C-1	1 mfd. 600V	R-1	470 ohm 1 W	Relay	8-100 W.K. & Co., Inc.
C-2	2000 mfd. 12V	R-2	1500 ohm 1/2 W	S-1	F.W.B. 11-110 600 ma.
C-3	250 mfd. 25V	R-3	10 K	S-2	F.W.B. 11-102 20 ma.
C-4	1 mfd. 200V	R-4	1 K 1/2 W	SW-1	D.P.S.T. Switch
C-5	100 mfd. 3V	R-5	15 ohm or 30 ohm 1/2 W	T-1	Power Transformer
C-6	50 mfd. 6V	R-6	20 ohm Adj. 10 W	T-2	Audio Transformer
C-7	10 mfd. 25V	R-7	47 K 1/2 W	T-3	Audio Transformer
C-8	10 mfd. 25V	R-8	160 K 1/2 W	T-4	Oscillator Transformer
C-9	.022 mfd. 400V	R-9	120 K 1-2 W	T-5	Choke Coil
C-10	50 mfd. 6V	R-10	3.3 K 1/2 W	TR-1	Power Amplifier Transistor
C-11	.1 mfd. 200V	R-11	470 ohm 1 W	TR-2	Photo Transistor
Fuse	1.6 amp. SLO-BLO	R-12	100 Ω	TR-3	First Amplifier Transistor
Lomp	G.E. No. 55 6-8V	R-15	15 1K 1/2 W	TR-4	Second Amplifier Transistor

industrial
electronic
servicing

plus

OHMITE[®]
quality
components

equals

satisfied customers
and higher profits
for YOU

Industrial electronic servicing is profitable business for you. Especially when you stock and replace with dependable Ohmite components... the line your industrial customers know and prefer. With Ohmite you eliminate call backs, insure quality replacement, build customer satisfaction, and increase your industrial (and home) electronic servicing business. Service such industrial equipment as mobile radio, aircraft and marine radar and radio, electronic controls for factory processes and automation, industrial P.A. and intercom systems, and—medical and dental electronics. It's a big market!



BROWN DEVIL[®] RESISTORS
Vitreous-enameled.
In 5, 10, and
20-watt sizes.

**MOLDED
COMPOSITION
POTENTIOMETERS
TYPE AB**



Resistance material is solid molded, noise-free. Rated at 2 watts.

LITTLE DEVIL[®] COMPOSITION RESISTORS



Meet all MIL-R-11A requirements. Available in 1/2, 1, and 2-watt sizes in all standard RETMA values.

Also:

RHEOSTATS
PRECISION RESISTORS
RELAYS
R.F. CHOKES

BE RIGHT WITH

OHMITE[®]

DEPENDABLE RESISTANCE UNITS

OHMITE MANUFACTURING CO.
3687 Howard Street, Skokie, Illinois

Diode Phase Detectors

(Continued from page 29)

channel selector is placed on an off-channel position or the antenna removed. A check of the circuit, with signal applied, will show that the high voltage is low.

A defect in the phase detector circuit, or an unbalanced pair of diodes, may produce a voltage which can extend the cut-off time of the second triode and lower the oscillator speed to the point where very little or no high voltage is derived from the flyback transformer. This is due to the transformer's loss of efficiency at the lower oscillator frequency. As soon as the sync pulse is removed by removing the signal, the circuit will be operating with only the feedback pulse voltage, and even though the diodes are unbalanced, no correction voltage of any consequence will be developed. Continuous failure of diodes could be due to slight leakage in the sync coupling capacitor C251 or horizontal feedback pulse coupling capacitor C255.

Testing

The best method for testing the diodes is to check them under actual operating conditions in the circuit. The following checks will give an accurate indication of the serviceability of these units.

Shorted or Open: The presence of a positive voltage at point B in Fig. 1 indicates that diode 2 is neither shorted nor open. Adjust the horizontal frequency to be completely out of sync. If the voltage at point C is within 2 volts of point A, then diode 1 is neither shorted nor open.

Balance: Adjust the horizontal oscillator to be out of sync 10 bars or more in either direction to the left or right and measure voltages at points A and C. Do the same after adjusting the oscillator to be out of sync in the other direction. In each test the voltages at A and C should be within 1½ volts of each other.

If the diodes do not meet the requirements of all three tests they should be replaced. Special care should be exercised when soldering new diodes into place. Use a pair of long-nose pliers as a heat-sink between the point being soldered and the diode body, and a low-wattage soldering iron. •

**MORE INCOME
IN 1957-58
FOR INDEPENDENT
TV TECHNICIANS!**



Receiver...
precision-engineered
"for those who want the
finest"... is a non-
competitive line.

**GENEROUS COMMISSIONS
THRU EXCLUSIVE
PROFITABLE TV
TECHNICIAN FRANCHISES
NOW AVAILABLE**

You can recommend ATR with the pride and assurance of your own know-how and the reputation and craftsmanship of AMERICAN TELEVISION & RADIO

✓... as original sets
✓... as replacement sets
✓... as the No. 1 set in two-set homes
✓... and for special chassis installations (without cabinet)

OPEN FACE
MODEL ALSO
AVAILABLE

UNEQUALLED
IN
PERFORMANCE

UNMATCHED
IN QUALITY
CONSTRUCTION

UNSURPASSED
IN
BEAUTY



FOR FULL INFORMATION —
WRITE TODAY FOR COLORFUL
BROCHURE SHOWING THE
NEW LINE OF ATR TV SETS

ALSO MANUFACTURERS OF DC-AC INVERTERS,
"A" BATTERY ELIMINATORS, AUTO RADIO VIBRATORS

ATR AMERICAN TELEVISION & RADIO CO.
Quality Products Since 1931
SAINT PAUL 1 MINNESOTA-U S A

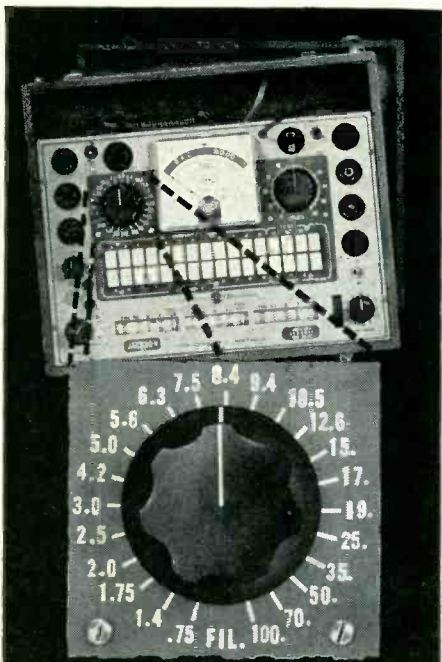

**23 Separate
Heater Voltages
on the Dynamic®
JACKSON 648A
Assure Accurate
Tests for all
Series-String Tubes
...The Correct Voltage
for Every Known or
Presently Planned Type.**

YOU CAN MODERNIZE YOUR PRESENT 648
New 648 FV Kit provides same heater
voltages as the new 648A Tester. Only
four wires to solder. Installs in minutes.
Available from your distributor now.

JACKSON
ELECTRICAL INSTRUMENT CO.

*"Service Engineered"
Test Equipment*

16-18 S. Patterson Boulevard • Dayton 2, Ohio
In Canada: The Canadian Marconi Company

Second Echelon Hi-Fi

(Continued from page 33)

the scope's vertical gain to measure more accurately the curvature, which is really the distortion component.

If the gain switch is turned up to $\times 10$, a trace equal in height to the length would represent 20% distortion. If the gain switch is turned up to $\times 100$ (if height of the trace were equal to its length) it would represent 2%. This means a fraction of 1% can now be read to quite good accuracy. It should be realized in this calculation that turning the potentiometer to buck off the fundamental at the same time turns down or attenuates the amount of curvature shown due to distortion. Because an exact midpoint was chosen, the full scale on the scope will be 2%, and not 1%, on the $\times 100$ range.

The distortion reading taken in this way will differ a little from that taken by a distortion meter which registers average distortion and not peak distortion. This method of measurement gives the peak harmonic components of distortion measured against the peak value of fundamental; which actually gives, in most instances, a somewhat higher percentage than the usual one quoted by a distortion-meter measurement. However, it does mean that a figure of say 0.5% measured in this way is really a better figure than 0.5% measured with a harmonic-distortion meter.

The particularly useful feature of the method is that the fundamental need not be almost perfect to start with, because the bucking-out circuit uses the same waveform at both input and output. With a distortion meter, only the fundamental frequency is filtered, so the measurement cannot discriminate between distortion caused by the amplifier and that already present at its input, from the oscillator. •



"Well, it's about time—we've missed two programs already!"

WANTED

SERVICE DEALERS

Too many No-Profit TV Sales and Service Calls Got You Down? Why not investigate the profitable custom-TV market, where there's a big profit on each sale and installation . . . catering to discriminating customers, such as professional men, blue bloods, and the selective leaders of the community. Besides, you can even sell more equipment and service, by providing a whole custom package of TV and hi-fi. Write now, Box No. 9, c/o this magazine, for profit making info.

INJECTORALL

THE NEEDLE DOES THE JOB!

TUNER CLEANER
with
INJECTOR NEEDLE



NEW!
Wax-Free
lubricant
added, keeps
tuners and
controls
cleaned
longer.

The Injector
Needle cleans
and lubri-
cates where
you need it...

You can reach hard-to get at
wafers without pulling tuners apart or even
removing chassis from cabinet. DON'T WASTE
PRECIOUS CHEMICALS! YOU NEVER SPRAY AIR!

INJECTORALL CO.

2081 Shore Parkway Brooklyn 14, New York



"You're sewing with my
JENSEN NEEDLE
again, I see."

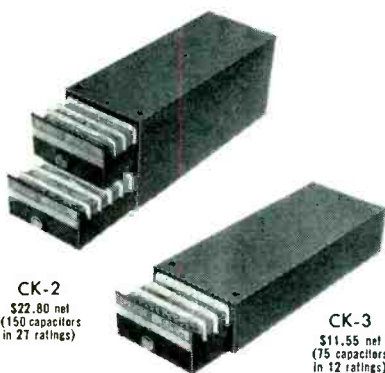

CK-2
\$22.80 net
(150 capacitors
in 21 ratings)

CK-3
\$11.55 net
(75 capacitors
in 12 ratings)

SPRAGUE CERAMIKITS*

help speed
TV-Radio servicing

Sprague CERAMIKITS contain all the popular ceramic capacitor ratings... neatly stored and indexed in sturdy steel cabinets... ready to use. There's no fumbling or confusion... the ceramic capacitors you need most are at your finger tips. Pay only for the capacitors... *get the cabinets free.* • Be sure to see the Sprague CERAMIKITS at your distributor, or write for Data Sheet M-711, Sprague Products Company, 65 Marshall St., North Adams, Mass.

*Trademark

INDEX TO ADVERTISERS

October, 1957

Acme Electric Corp.	67
American Television & Radio Co.	65
Amphenol Electronics Corp.	4
Atlas Sound Corp.	60
Belden Manufacturing Co.	Cover III
Blonder-Tongue Laboratories, Inc.	51
CBS-Hytron	13
Centralab Div., Globe-Union, Inc.	8
Channel Master Corp.	24
Cleveland Institute of Radio Electronics	61
Cornell-Dubilier Electric Corp.	43, 59
Deutschmann Corp., Tube DuMont Laboratories, Inc., Tube Division	18 7
EICO	62
Electronic Technician	54, 62
Electro Products Laboratories	54
Erie Resistor Corp.	63
General Cement Manufacturing Co.	56
General Electric Co.	10, 23
Good-All Electric Mfg. Co.	9
Heath Co.	20
Injectorall Co.	64
International Resistance Co.	11
Jackson Electrical Instrument Co.	66
Jensen Industries, Inc.	67
Jensen Manufacturing Co.	68
Jerrold Electronics Corp.	12
Kester Solder Co.	63
Mallory & Co., Inc., P. R.	48, 49
Ohmite Manufacturing Co.	65
Pyramid Electric Co.	22
Quam-Nichols Co.	58
Radiart Corp.	43, 59
Radio Corporation of America	14, Cover IV
Raytheon Manufacturing Co.	2, 3
Recoton Corp.	62
Rider Publisher, Inc., John F.	16
Rohn Manufacturing Co.	21
Simpson Electric Co.	45
Sonotone Corp.	53
Sprague Products Co.	67
Triad Transformer Corp.	64
Trio Manufacturing Co.	15, 17
Triplett Electrical Instrument Co.	5
University Loudspeakers, Inc.	6
Utah Radio Products Corp.	57
V-M Corp.	Cover II
Walsco Electronics Manufacturing Co.	19
Ward Products Corp.	47

While every precaution is taken to insure accuracy, we cannot guarantee against the possibility of an occasional change or omission in the preparation of this index.

YOU CAN STOP A FLUCTUATING VOLTAGE CONDITION

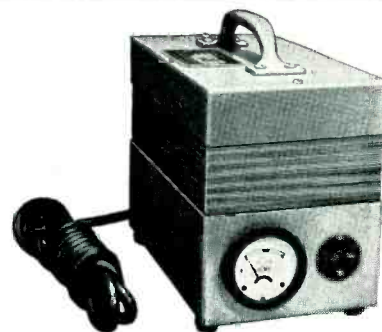

WITH THIS ACME ELECTRIC AUTOMATIC VOLTAGE STABILIZER

If you're harassed with a television or other electronic equipment installation that just won't operate right, chances are that a fluctuating voltage condition exists and prevents tubes and other components from functioning properly.

One sure way of making voltage behave is with the Acme Electric automatic voltage stabilizer. Regardless whether the input voltage ranges from 95 to 130 volts, the output voltage will automatically be corrected to 115 volts \pm 3%.

Another feature to remember, this unit uses no current unless the TV set is in operation. An automatic relay disconnects primary circuit under "no load" conditions and automatically connects circuit when load is applied to the secondary circuit. Secondary voltage is indicated on voltmeter while unit is in operation. Furnished complete, ready to plug-in. See this Acme Electric Automatic Voltage Stabilizer at your dealer.

ACME ELECTRIC CORPORATION
8810 WATER STREET CUBA, NEW YORK

Acme  Electric
TRANSFORMERS

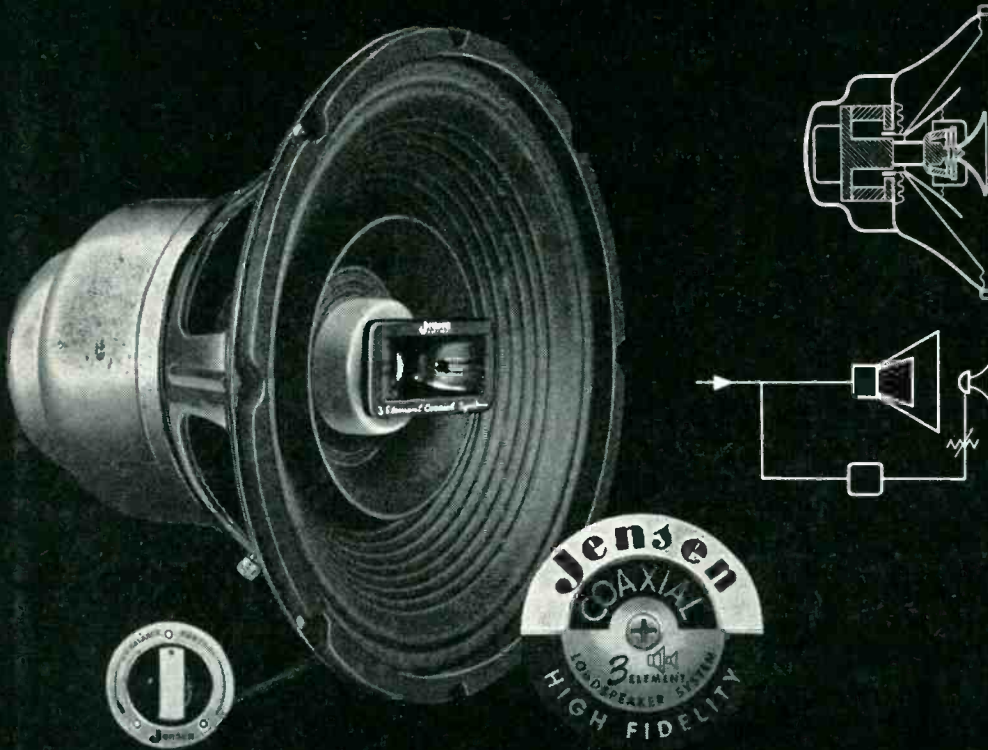

NEW Jensen COAXIAL 3-ELEMENT HI-FI LOUDSPEAKERS

You'll spend less for more performance
... get traditional **Jensen** quality!

If you're looking for hi-fi performance outclassing anything remotely similar on the market today ... with more performance ... more easy-on-the-ears listening quality ... at less than you'd expect to pay, then don't fail to investigate Jensen's 4 new Coaxial 3-Element models.

There are three radiating elements driven by two voice coils. H-F unit is a compression driver supertweeter 4000-15000 cycles; woofer-midchannel is a separately driven dual cone unit, with the small cone dispersing and smoothing the 2000-4000 cps. region. The whole skillfully blended combination rates at 30-15000, low end depending on enclosure. H-F control tunes it up smoothly to suit the ear. Choice of 12-inch CX-120 (1 lb. magnet) at \$49.50 or CX-225 (1 3/4 lb.) at \$59.50; 15-inch CX-150 (1 lb.) is \$66.50, CX-255 (1 3/4 lb.) only \$76.50. Write now for free complete condensed Catalog 165-B.



KTX-3 "STEP-UP" KIT

If you have the urge to improve your speaker later, you can have a full 3-way system by adding this compression horn midrange unit (600-4000 cps). Net \$62.50.

Jensen

MANUFACTURING COMPANY
6601 South Laramie Ave., Chicago 38, Illinois

In Canada: J. R. Longstaffe Co., Ltd., Toronto
In Mexico: Radios Y Television, S.A., Mexico D.F.

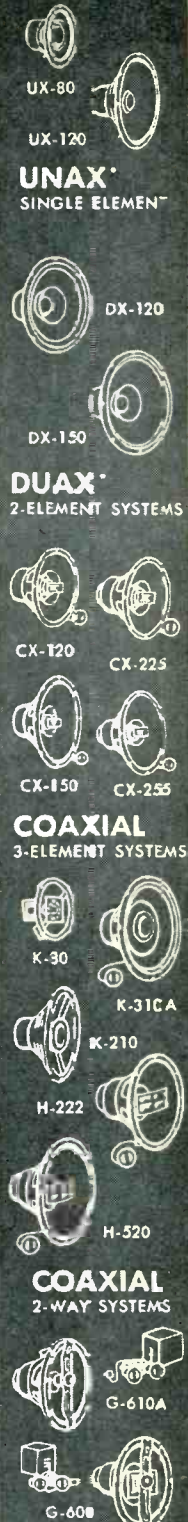

TRIAxIAL[®] and TRIAx[®] 3-WAY SYSTEMS

THE
WORLD'S
MOST
COMPLETE
HIGH
FIDELITY
LOUDSPEAKER
LINE

*T. M. Reg.

Belden 8275 CELLULINE 300 OHM DHF TRANSMISSION LINE PAT. NO. 2782251

If it's worth the cost of installation...

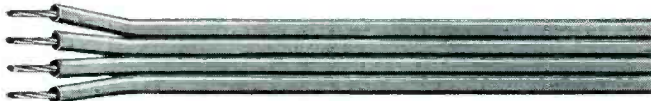

8464



...it's worth the cost of engineered cable

Belden 8230 WELD OHM-300 OHM TRANSMISSION LINE

Belden

TRANSMISSION
LINES

•
ROTOR CABLES

Superior Cables engineered for the job—
In a complete line for every requirement.
Packaged for easy handling.

"More items from the Complete Belden Line"

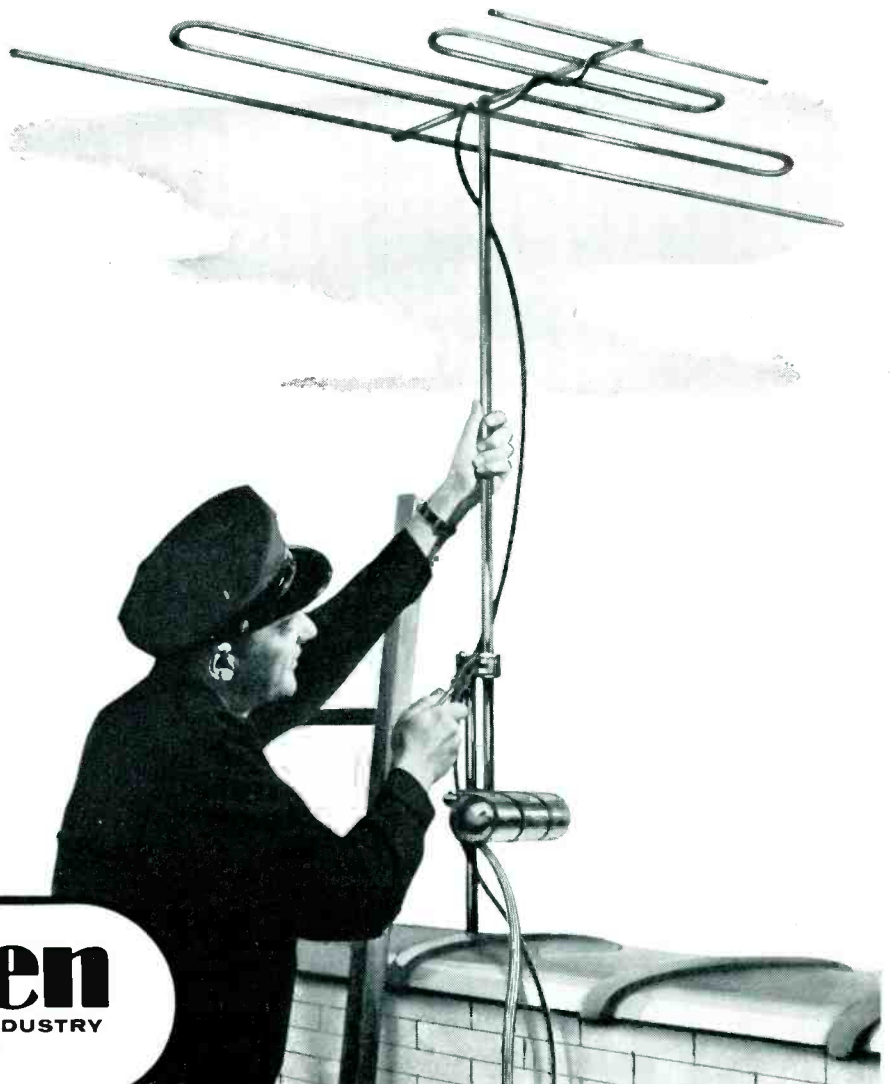





Belden

WIREMAKER FOR INDUSTRY
SINCE 1902
CHICAGO

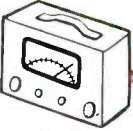
91-8

Magnet Wire • Lead Wire • Power Supply Cords, Cord Sets and Portable Cord • Aircraft Wires
Welding Cable • Electrical Household Cords • Electronic Wires • Automotive Wire and Cable

Here's how to make picture tube profits: First, you need your everyday tools  plus good test equipment (RCA)  plus your skill  and knowledge  Then, you need top-quality, dependable RCA Silverama  Picture Tubes that rejuvenate nearly any make of set,  and make friends of your customers. And, finally, you need the sales "tools", too. And these RCA makes available to you in abundance. See your Authorized RCA Tube distributor for the most powerful merchandising aids available, including these two brand new headliners:



ILLUMINATED SERVICE SIGN. This new, compact, TV Service Sign with flasher, tells 'em you handle the best TV tubes on the market, the brand they know best—RCA Silverama.



SAFE-TV MAT. This "how-did-I-ever-do-without-it-before" heavy rubber protective mat prevents face plate damage to out-of-chassis picture tubes.

Put these and a world of other new, fresh RCA promotion aids to work for you. With all these aids to help you sell the top picture tube brand in the industry, plus RCA newspaper and magazine ads, TV commercials, booklets, folders, ad mats, seals, and other hard-hitting promotional items, you can't miss making those big ticket, big mark-up, easy-to-make picture tube dollars.



PICTURE TUBES
RADIO CORPORATION OF AMERICA

Electron Tube Division, Harrison, N. J.