

NOV 49

RADIO & TELEVISION RETAILING



46 Golden Selling Days till Christmas

November • 1949

CALDWELL-CLEMENTS, INC.

MAKE EVERY ONE COUNT!

AM, FM, TELEVISION, ELECTRICAL APPLIANCES, RECORDS & PHONOGRAPHS, HOME RECORDERS, SERVICING AND SOUND

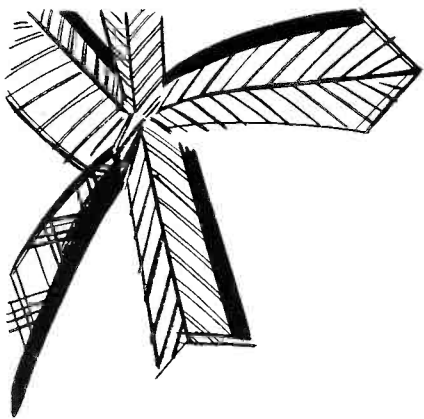

Discover a New
and Richer Market
with . . .

The Mallory Midgetrol



The first $\frac{1}{16}$ " diameter
Replacement Control Line

How much business did you let slip through your fingers last year? Good business! Big business! All because you couldn't get controls small enough to service personals, portables and auto radios!

This year, discover how profitable these jobs can be. Stock up on the $\frac{1}{16}$ " Mallory Midgetrol and discover more business with a lower inventory!

WIDER APPLICATION—The small size lets you service portables, auto radios and small AC-DC receivers requiring $\frac{1}{16}$ " controls.

SIMPLER INSTALLATION—The new and unique flat shaft design of the Mallory Midgetrol saves installation time with *all* types of knobs.

LESS INVENTORY—Electrical characteristics allow you to use the Mallory Midgetrol to replace $\frac{1}{8}$ " as well as $\frac{1}{16}$ " controls. Since no special shafts are required, you carry fewer controls in stock.

NEW FEATURES—NEW FEATURES!

NEW SIZE	NEW SHAFT	NEW SWITCH	NEW CONTACT
NEW DESIGN	NEW EXTENSION	NEW ELEMENT	NEW TERMINAL
	NEW TWO-POINT SUSPENSION		

Don't Miss the Mallory Television Service Encyclopedia.
Get Your Copy From Your Mallory Distributor . . . Only 35c!

P. R. MALLORY & CO. Inc.

MALLORY

CAPACITORS . . . CONTROLS . . . VIBRATORS . . .
SWITCHES . . . RESISTORS . . . RECTIFIERS
VIBRAPACK* POWER SUPPLIES . . . FILTERS

*Reg. U. S. Pat. Off.

APPROVED PRECISION PRODUCTS

P. R. MALLORY & CO., Inc., INDIANAPOLIS 6, INDIANA

RADIO & TELEVISION RETAILING

IN THIS ISSUE

NOVEMBER, 1949

Including "Radio & Television"
and "Radio & Television Today"

Established in 1922
as ELECTRICAL RETAILING

•
ORESTES H. CALDWELL
Editorial Director

•
M. CLEMENTS
Publisher

•
JOHN L. STOUTENBURGH
Executive Editor

RUTH MORRIS
Records Editor

EDWARD A. CAMPBELL
Technical Editor

CHARLES F. DREYER
Art Director

•
BUSINESS DEPARTMENT

M. H. NEWTON
Sales Manager

HOWARD A. REED
Asst. Sales Mgr.

EDWIN WEISL, JR.
District Manager

A. O'ROURKE
Production Supervisor

N. McAllister
Director, Reader Service

•
BRANCH OFFICES
CHICAGO 6

S. M. GASKINS, Western Manager
JOHN ROMANCHAK, District Manager
201 N. Wells St. Randolph 6-9225

LOS ANGELES 14

DUANE WANAMAKER
610 S. Broadway
Mutual 2161

•
CIRCULATION DEPARTMENT

B. V. SPINETTA
Circulation Director

•
W. W. SWIGERT
Credit Manager

•
Radio & Television Retailing*

November, 1949, Vol. 50, No. 5, 35 cents a copy. Published monthly by Caldwell-Clements, Inc. Publication Office, 1309 Noble St., Philadelphia 23, Pa. Editorial, Advertising and Executive Offices, 480 Lexington Ave., New York 17, N.Y. M. Clements, President; Orestes H. Caldwell, Treasurer. Subscription rates United States and U. S. Possessions \$2.00 for one year, \$3.00 for two years, \$4.00 for three years. Canada \$3.00 for one year, \$4.00 for two years, \$5.00 for three years. Pan American Countries \$4.00 for one year, \$5.00 for two years, \$6.00 for three years. All other countries \$5.00 for one year, \$7.50 for two years, \$10.00 for three years. Printed in U.S.A. Entered as second class matter February 21, 1949, at the Post Office at Philadelphia, Pa., under the act of March 3, 1879.

*Trade-Mark Reg. U. S. Pat. Off.

Copyright 1949 by

CALDWELL-CLEMENTS, Inc.
Publishers also of TELE-TECH

★ *AM, FM, Television*

COVER—46 Golden Selling Days Till Christmas

WHAT'S AHEAD—In Radio, Appliances, Records and Television... 37, 38, 39

SIX STEPS THAT GOT 20,000 ACCOUNTS 42, 43

METHODS THEY'RE USING TO SELL MORE TV 44, 45

FM SALES PROMOTION PAYS 46

NEW RADIO, TV SETS 48

LATEST DEALER PROFIT-MAKERS 50

HOW TO CHARGE FOR PROFITABLE TV SERVICE 52, 54

★ *Records, Phonographs, Accessories*

PLANS TO PUSH SALES FOR CHRISTMAS 67

PROMOTE CHILDREN'S DISCS FOR XMAS 68, 69

NEWS OF THE INDUSTRY 70

★ *Electrical Appliances*

MAKE FARM SALES RISE IN THE FALL 73, 74, 76

NEW APPLIANCE PRODUCTS 75

ELECTRICAL APPLIANCES OF INTEREST TO DEALERS 77

★ *Servicing and Sound*

GATED, PULSED OR KEYED AGC 79

TV RECEIVING ANTENNA 80

TELEVISION TECHNICIAN 82

NEW UNITS FOR PA 84

NEWS OF THE INDUSTRY 85

Photo Credits

Ewing Galloway 74

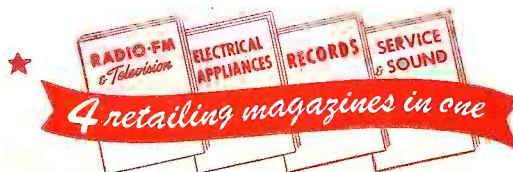

CALDWELL-CLEMENTS, INC.
480 Lexington Ave., New York, N. Y.



#9 PLAYBOY ★ Beautifully styled, custom-built, hand-rubbed cabinet in mahogany or walnut. ★ Scientifically designed 2-tube amplifier. ★ Heavy duty speaker. ★ Full range volume control. ★ Featherweight pickup arm for longer record life. ★ Size: 13 1/4" x 10 1/2" x 3". ★ A.C. only. ★ 78 RPM.



#08 PREP ★ Attractive wood cabinet covered in red, blue or ivory simulated leatherette. ★ Scientifically designed 2-tube amplifier. ★ Full range volume control. ★ Powerful front grille speaker to give maximum volume and quality tone. ★ Featherweight pickup arm. ★ Size: 11" x 10 1/2" x 7". ★ A.C. only. ★ 78 RPM.



#19 MY PAL ★ A real traveling companion in grained red leatherette finish. ★ Two-tube amplifier. ★ Lightweight pickup arm. ★ Heavy duty speaker. ★ High quality performance. ★ Size: 12" x 9 1/2" x 5". ★ A.C. only. ★ 78 RPM.



#18 TEEN AGER ★ A player of outstanding quality and performance. ★ Housed in beautiful cabinet. ★ Covered in two-tone simulated leatherette, red or blue. ★ Powerful amplifier. ★ Heavy duty speaker. ★ Lightweight pickup moisture-proof crystal for longer record life. ★ Size: 12 1/2" x 12 1/2" x 6 1/4". ★ A.C. only. ★ 78 RPM.



#28 CO-ED ★ A self-contained record player plays any size record with cover closed. ★ A player of discrimination for quality performance. ★ Powerful amplifier. ★ Heavy duty Alnico #5 speaker. ★ Separate full range tone control. ★ Separate switch and volume control. ★ Featherweight pickup arm with moisture-proof crystal. ★ Sturdy heavy-duty motor. ★ Handsome ostrich finish leatherette covered. ★ A player of quality and value. ★ Size: 13" x 13" x 7". ★ A.C. only. ★ 78 RPM.

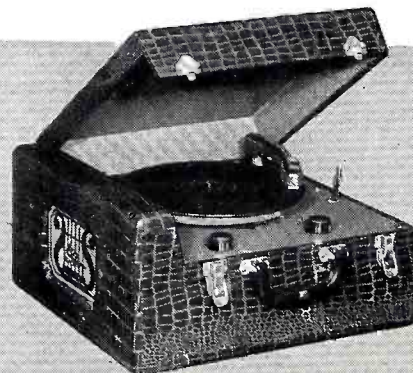

#38 VARSITY ★ DeLuxe portable in two-tone natural brown alligator finish leatherette. ★ Plays 10" or 12" records with cover closed. ★ High fidelity 3-tube amplifier of superb tonal quality. ★ 5 1/2" audiotrium PM speaker. ★ Featherweight pickup arm with a sealed moisture-proof crystal equipped with a permanent needle of over 5,000 playings eliminating surface noise and prolonging life of the record. ★ Full range tone control from bass to treble. ★ Separate volume control and switch. ★ Precision long service motor. ★ Size: 15 1/2" x 14 1/4" x 7 1/4". ★ A.C. only. ★ 78 RPM.



#39-3 VARSITY TRIO ★ Sensational and new 3-speed record player for 33 1/3, 45 and 78 RPM records. ★ Heavy duty precision motor and simplicity in change of speed. ★ Newly designed 6-gram lightweight reproduction arm with 2-way crystal and needles of over 5,000 playings each. ★ Just a flick of the finger will change the arm from

Presenting

SENSATIONAL LINE OF RECORD PLAYERS

Engineered and designed for excellent performance. Approved nationally in homes, schools and institutions. Featuring modern styling. ★ New and improved circuits. ★ New Pickup Arms. ★ New Automatic Changers. ★ Single Speed, Double Speed and Triple Speed. ★ Symphonic is the by-word in the record player field. ★ For the discriminating public where quality and performance counts. ★ Biggest values for the dollar than ever.

#89 SYMPHONY ★ A compact portable radio and automatic record changer. ★ Beautiful carrying case in natural brown or blue alligator durable leatherette. ★ Housing a 6-tube high fidelity radio. ★ Built-in loop. ★ Slide-rule dial. ★ Heavy duty speaker. ★ Sensationally new RCA type 45 RPM record changer. ★ Plays with cover closed. ★ Size: 15 1/2" x 13" x 7 1/2". ★ A.C. only

#89-3 SYMPHONY TRIO ★ Same as above but with single three speed motor and single arm with two way crystal to play 78-45 or 33 1/3 micro-groove.

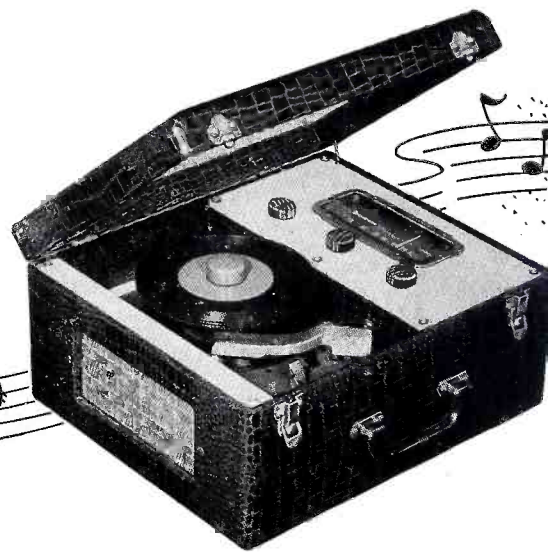

Symphonic Record Players Perform a New High



Symphonic
 SYMBOL OF SUPERIORITY

#69 COLLEGIATE ★ RCA designed record changer for 45 RPM. ★ Featherweight pickup arm with permanent "sapphire" needle. ★ Scientifically designed high fidelity 3-tube amplifier. ★ Full range tone control. ★ Separate volume control and switch. ★ Heavy duty permalloy #5 Alnico speaker. ★ Smartly styled portable carrying case in five fashion colors: lipstick red, navy blue, sky blue, seafoam green, alligator brown; glazed leatherette, trimmed with polished hardware, two locks and keys with matching color plastic handle. ★ Cosmetic size case: 8" x 9 1/4" x 12 1/2". ★ Weight 12 1/2 lbs. ★ A.C. only ★ 45 RPM.



#69-3 COLLEGIATE TRIO
 Three speed player for 79-45 or 33 1/2 microgroove with two-way crystal.



#79 CAMPUS ★ A complete portable unit exquisitely housed in a simulated blue or red alligator leatherette case. ★ 3-tube high fidelity amplifier. ★ Separate tone and volume control. ★ Powerful quality speaker. ★ RCA designed 45 RPM record changer with "sapphire" needle. ★ Size: 12" x 9" x 8". ★ A.C. only.

RMA
 RCA Licensed Manufacturers

in Music Pleasure!

#MG/101 UNIVERSAL
 ★ Plays through your radio. ★ Small compact mahogany finish cabinet. ★ Featherweight pickup arm of less than 6 grams with long life needle of 1 mil radius. ★ Equipped with four-foot leads and phono-jack. ★ Precision phonograph motor of 33 1/2 RPM to play LP records supplied with adapters for change-over to 45 RPM vinylite records. ★ Size 12" x 11 1/2" x 3". ★ A.C. only. 33 1/2 or 45 RPM.



microgroove to regular type record. ★ High fidelity super-three-tube amplifier. ★ 5 1/2" quality speaker. ★ Separate tone and volume control. ★ A custom built instrument designed for the utmost in music enjoyment of all types of records. ★ Handsome carrying case covered in blue durable alligator leatherette trimmed with brass grille and hardware. ★ Size: 15 1/2" x 14" x 7 3/4". ★ A.C. only. ★ 33 1/3, 45 or 78 RPM.

#78 TRANSCRIPTION PLAYER ★ Ideal for professional use, schools, sales meetings or home use. ★ DeLuxe portable case. Sturdy construction. Covered in natural brown alligator leatherette. ★ Plays standard or 16" transcription records with cover closed. ★ 3-tube super performance amplifier for quality reproduction. ★ 6 1/2" high fidelity extra heavy duty #5 Alnico speaker. ★ Full range volume control. ★ Separate tone control to give you all highs and lows for your desired pleasure. ★ Professional-type pickup arm with QT crystal for transcription or regular record use. ★ Two heavy duty motors especially designed for playing recorded records at 33 1/3 and 78 RPM. ★ Size: 21" x 17 1/2" x 7 1/2". ★ A.C. only. ★ 33 1/3 and 78 RPM.



#48 STUDIO ★ Automatic record player with foolproof changer. ★ DeLuxe amplifier. ★ Heavy duty speaker. ★ Separate tone and volume controls. ★ 5,000 playings. ★ Quality player for years of enjoyment. ★ Size: 13" x 13" x 7". ★ A.C. only. ★ 78 RPM.



#49-3 STUDIO-TRIO ★ A three-speed deluxe foolproof automatic record changer with only one pickup arm which reproduces all types of records — 33 1/3, 45 and 78 RPM. ★ No needle adjustment pressure necessary. ★ Super three-tube amplifier. ★ Heavy duty speaker. ★ Separate tone and volume control. ★ Smartly designed cabinet covered in ostrich leatherette. ★ Size: 13" x 13" x 7". ★ A.C. only. ★ 33 1/3, 45 and 78 RPM.



#58 FRATERNITY ★ Portable automatic record changer. ★ Solidly constructed cabinet finished in blue alligator leatherette. ★ 3-tube super performance amplifier of superb quality reproduction. ★ 5 1/2" high fidelity heavy duty speaker. ★ Full range tone control. ★ Separate volume control and switch. ★ Lightweight pickup arm equipped with pinpoint deluxe needle for over 5,000 playings eliminating surface noise and prolonging life of the record. ★ Play and change automatically 10" and 12" records with cover closed. ★ Cabinet size: 17 1/2" x 13" x 9". ★ A.C. only. ★ 78 RPM.



#59-3 FRATERNITY-TRIO ★ DeLuxe 3-speed foolproof automatic record changer with one featherweight pickup arm and reversible crystal with two needles. ★ A flick of the finger will adjust to play 33 1/3, 45 or 78 RPM. ★ 3-tube super amplifier. ★ 5 1/2" heavy duty speaker. ★ Separate tone and volume control. ★ Plays all types of records with cover closed. ★ An outstanding player of beauty and quality. ★ An outstanding with blue durable leatherette. ★ A.C. only ★ 33 1/3, 45 and 78 RPM.

SYMPHONIC RADIO & ELECTRONIC CORP.
 292 MAIN STREET · CAMBRIDGE, MASS.



says EDWARD CROXEN

General Service Manager of Hallicrafters

In addition to providing all necessary signal sources, the new Simpson Genescope includes a high sensitivity oscilloscope of unique advanced design, complete in every detail. Sensitivity 25 millivolts per inch. Wide band response to 3 megacycles or more. Equipped with a high frequency crystal probe for signal tracing. AM and FM oscillator sections provided with large, easy to read dials with 20-1 vernier control and 1000 division logging scale. Revolutionary, Ingenious, Exclusive output termination provides for various receiver impedances, either direct or through an isolating condenser.

Step attenuator for control of output.

Size: 22"x14"x7 1/2". Weight 45 lbs. Shipping Weight 54 lbs.

DEALER'S NET PRICE complete with Test Leads and Operator's Manual \$375.00

the hallicrafters Co.
MANUFACTURERS OF RADIO AND ELECTRONIC EQUIPMENT

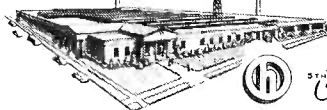

511 AND KOSTNER AVENUES
Chicago 24, Ill.

Mr. Ray Simpson, President
Simpson Electric Company
5208 West Kinzie Street
Chicago 44, Illinois

Dear Mr. Simpson:

Congratulations! The Simpson Model 480 FM-TV Genescope is the perfect instrument for the proper alignment of all FM and TV receivers.

In addition to providing all necessary signal sources, the new Simpson Genescope includes a hi-

CHECK THESE RANGES AND YOU WILL SEE HOW MUCH THE SIMPSON GENESCOPE CAN DO FOR YOU

RANGES FREQUENCY MODULATED OSCILLATOR

Band A—2-120 megacycles
Band B—140-260 megacycles
Sweep width variable from zero to 15 megacycles
Sweep rate 60 cycles per second
Specially designed frequency sweep motor
Continuously variable attenuator
Crystal calibrator—5 megacycles $\pm .05\%$
Audio Oscillator 400 cycles

AMPLITUDE MODULATED OSCILLATOR

Band A—3.2-16 megacycles
Band B—15-75 megacycles
Band C—75-250 megacycles
30% modulation at 400 cycles or unmodulated
Continuously variable attenuator
Visual method of beat frequency indication

Modern FM and TV development and servicing requires the use of test equipment made to exacting standards. With this in mind Simpson offers you the Genescope with the assurance that everything possible has been done to make it the most accurate, flexible and convenient instrument available. The Genescope will render many years of uninterrupted service and always produce accurate results.

HERE'S THE SIMPSON—MODEL 479 TV-FM SIGNAL GENERATOR

Exactly the same circuits, ranges and functions as the Model 480, described above, with the exception of the oscilloscope.

Size 17"x14"x7 1/2". Weight 34 lbs.
Shipping Weight 40 lbs.

DEALER'S NET PRICE with Test Leads and Operator's Manual \$245.00

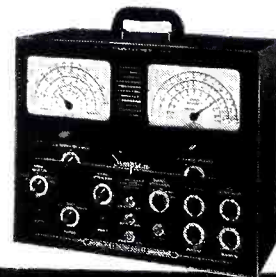

Simpson
INSTRUMENTS THAT STAY ACCURATE

SIMPSON ELECTRIC COMPANY

5200-5218 WEST KINZIE STREET • CHICAGO 44, ILLINOIS
In Canada: Bach-Simpson, Ltd., London, Ont.

★ ★ ★ ★
 EPOCH MAKING NEW TRIUMPHS HERE FROM PHILCO LABORATORIES

1950 TELEVISION NEWS

★ ★ ★ ★
 PHILCO RESEARCH NOW OBSOLETE'S OUTDOOR AND INDOOR TV AERIALS

AMAZING PHILCO BUILT-IN AERIAL SWEEPS THE NATION!

PHILCO SUPER-POWER FOR FINEST PERFORMANCE IN ALL LOCATIONS

Yes, the amazing performance of 1950 Philco television with Built-In Aerial depends on a new super-power circuit with vast increase in sensitivity, plus new exclusive features.

Pictures are not only bigger but better . . . with finer contrast and greater clarity. Famous Philco Wide-Screen gives the utmost in enjoyment for the price you pay. New Philco High Gain Auto-Selector tunes all 12 Stations And

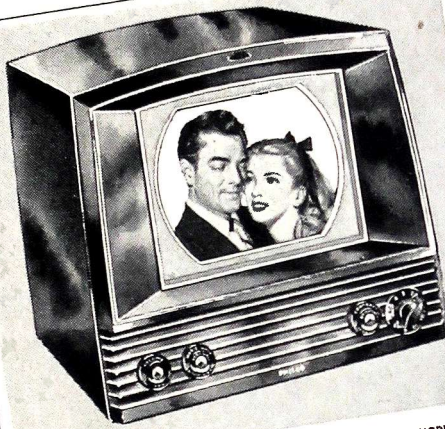

AERIAL BUILT-IN and completely concealed in the cabinet. New Philco super-sensitive television circuit gives you sharpest, clearest pictures ever on big 6 1/2 square inch screen. High Gain Automatic Station Selector tunes all 12 television channels. Destructive Mitsubishi plastic cabinet.

MODEL 1104
\$229.95
 The Best \$229.95

TELEVISION COMBINATIONS

AMERICA'S BUYERS HAIL "PLUG IN AND PLAY" TELEVISION

No Aerial of Any Kind Needed on the Roof or on the Set . . . No Installation Cost!

Philco research has put the television aerial *inside the cabinet*—completely out of sight! It's hailed everywhere as the television invention of the year . . . the Philco Electronic Built-In Aerial System. Far more than an aerial alone, this newest Philco advance is a complete *electronic system* with a simple control that tunes it to any station.

In up to 8 out of 10 locations

IT'S THE BIG PROFIT NEWS IN TELEVISION!

Yes, appliance dealers everywhere acclaim the Philco development of the *Electronic Built-In Aerial System* as the greatest merchandising opportunity in television history. It's another dividend of Philco pioneering research . . . opening the floodgates of TV promotion . . . leading

the way to the most profitable fall and winter selling season of *all time!* By far the "hottest" proposition for the customer and dealer, Philco for 1950 brings to the appliance dealers of America the fulfillment of the promise of 19 years of merchandising leadership!

Concentrate on Philco

EVERY *Capehart* **DEALER HAS**
THE OUTSTANDING TELEVISION
SALES STORY OF THE YEAR!

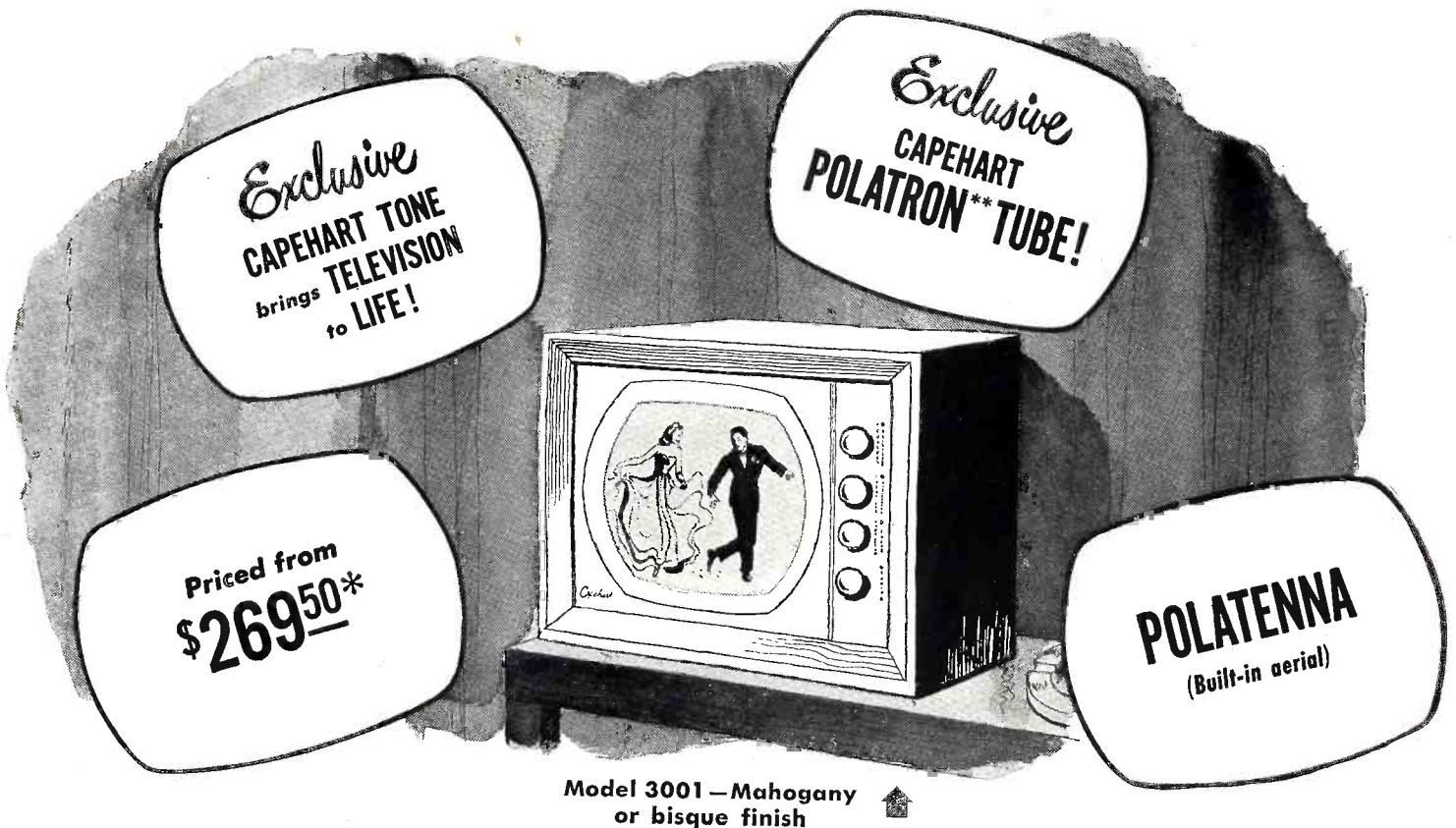

Model 3001 — Mahogany or bisque finish

WHAT A WINNING COMBINATION Capehart dealers have for support today! . . . Capehart true-timbre tone . . . Polatron** tube . . . Polatenna, Capehart's built-in aerial . . . and a modestly priced line held to fighting-trim size!

Every Capehart dealer has a line of products that is now backed by the financial strength and the technical resources of the great International Telephone and Telegraph Corporation. Through the association of Capehart and I T & T, Capehart now adds I T & T research facilities to round out its own advanced laboratory techniques.

You can profitably sell television by Capehart! Because you have the prestige of a quality line with a record of customer satisfaction. Because you are backed by powerful national advertising. And because you have the further benefit of the Capehart discount policy which permits a *profit* on merchandise that is sensibly priced to *sell*.

GET IN TOUCH with your nearest Capehart distributor. Or, if you are a distributor, call direct. There are still a few choice franchises available.

*Western prices slightly higher

**T. M. Reg.



CAPEHART-FARNSWORTH CORPORATION

Fort Wayne, Indiana

In Radio and Television Tube Sales

1949 IS A G-E YEAR!

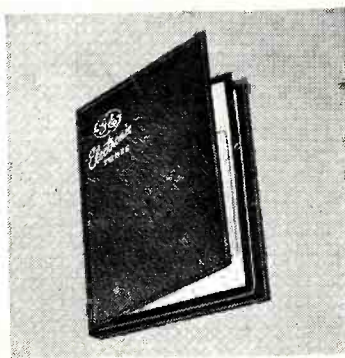

The G-E Pocket Office turns your job-time into more dollars by making cards, forms, and records available in convenient form.



TECHNI-TALK—G. E.'s down-to-earth service magazine edited by practical men for practical men—assists you in building repair business.



G. E.'s new shop garments—smart, serviceable—are a big hit with tube dealers and repairmen everywhere.

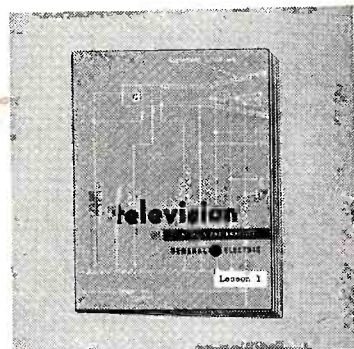

The General Electric TV-service course helps you profit from television's great new market for tubes, parts, and service.

and now... THE HANDY G-E TUBE PULLER!



Latest of a series of helps that speed your work, increase your sales, and upgrade your profits, the new G-E tube puller cuts time on the job materially. Now you'll find it quick and easy to remove tubes without the risk of burns, shock, or cuts from fractured glass.

Regular glass types, metal tubes, 7- and 9-pin miniatures—all yield to this universal device, which smoothly extracts tubes no matter how firmly wedged in their sockets. The puller is made of heavy rubber—your fingers are fully protected and insulated. It's simple to use; long-lived.

Ask your G-E tube distributor about this ingenious tube puller—how to obtain one . . . fast! Inquire, if you haven't before, about the other aids to sales mentioned on this page; also, about the folder describing the many G-E advertising helps that are ready to go to work for you. Stock the tubes that are easy to sell because you get more practical help in selling them . . . G-E tubes! *Electronics Department, General Electric Company, Schenectady 5, N. Y.*

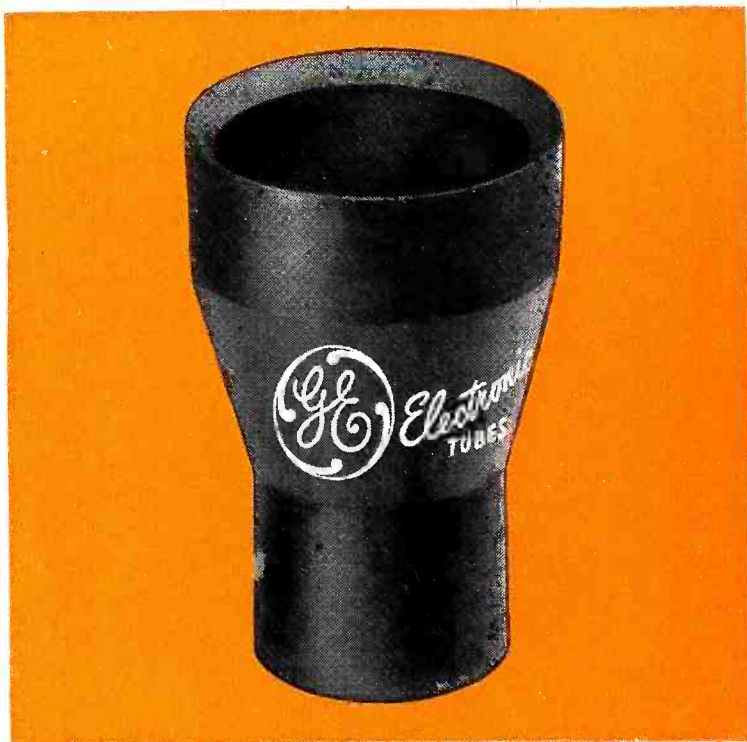

You can put your confidence in—

GENERAL ELECTRIC



181-HA7

New proof that the Tribune reaches Chicago's best market for hardlines



Thousands of visitors trooped in and out of the 78 Festival homes, 32 of which were furnished and decorated.



The crowds gave new proof of the size and responsiveness of the audience reading the Tribune every day.

Shown are scenes at some of the 78 demonstration homes opened for 30 days during the third annual Home and Home Furnishings Festival, staged by the Chicago Tribune and 15 trade groups representing over 11,000 builders, retailers and manufacturers of home merchandise.

Visitors at the homes, of which 32 were completely furnished and decorated, ran as high as 5,000 a day at a single home. Total attendance was expected to surpass by far last year's figure of nearly 1,000,000.

To launch the event, the Chicago Tribune on Sept. 11 published a 4-section supplement featuring some 140,000 lines of advertising of appliances and other home items, placed before the families who account for the bulk of the hard lines sold in metropolitan Chicago.

This event demonstrated in

another way why, during the first six months of 1949, general advertisers of radios, television sets, refrigerators, and other home appliances, housing equipment and supplies placed in the Tribune 208.9% more lineage than they placed in any other Chicago newspaper—and 26.0% more than they placed in all other Chicago newspapers combined.

To reach Chicagoland's largest, most responsive group of prospects for your merchandise, and to do so most effectively and economically, build your promotion around the Chicago Tribune. Rates per line per 100,000 circulation are among America's lowest.

Chicago Tribune

THE WORLD'S GREATEST NEWSPAPER

September average net paid total circulation:
Daily, Over 955,000—Sunday, Over 1,525,000

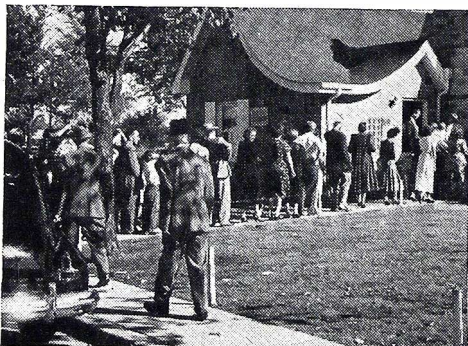

Chicago is thoroughly pre-sold on homes and everything that goes into homes.



The Chicago Tribune offers direct, effective access to your best prospects here.



Advertisers of hard lines make the Tribune their No. 1 Chicago medium.



Festival crowds demonstrated the breadth and penetration of Tribune circulation in Chicago and suburbs.



Prospects for homes are good prospects for you. You reach more of them through the Chicago Tribune.



The crowds that turned out point up your sales opportunities throughout the multi-billion dollar Chicago market.

REGAL

FAMOUS FOR
ELECTRONICS
SINCE 1929

DUPLICATE
OF FAMOUS
RCA CHASSIS

The Leader In
**GIANT 16-IN.
TELEVISION**

- ★ Regal Television Offers You Value You Can Feature!
- ★ Regal Television Offers You Performance You Can Sell!
- ★ Regal Television Offers You Proven RCA Circuits Only!
- ★ Regal Television Offers You Greater Profit! Discounts!
- ★ Regal Television Offers You Years of Dependability!



CONSOLE MODEL CD31
16-in. Television
31 Tube Chassis

140- sq. inch screen. Big 12-inch PM speaker. Voltage Doubler for greater picture brilliance. Synchronized FM sound. Magnificent cabinet of rich mahogany veneers.

397 50

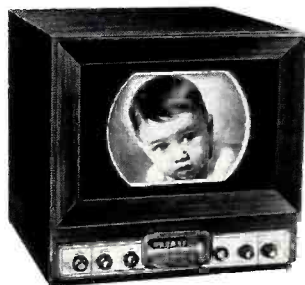

TABLE MODEL 16T36
16-in. TV plus
AM-FM Radio

36-tube chassis. 140-sq. in. screen. FM band, 88 to 108 MC. AM band, 535 to 1650 KC. Voltage Doubler for greater picture brilliance. Mahogany veneer cabinet.

397 50



TABLE MODEL 16T31
16-in. Television
31-Tube Chassis

140-sq. in. screen. Oval PM Speaker. Voltage Doubler. Synchronized FM sound channel. Improved Regalok. Smart Mahogany Veneer Cabinet.

367 50

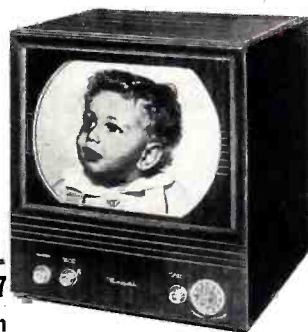

TABLE MODEL 1637
16-inch Television

Super-powered AC chassis. 140 sq. in. screen. Large Oval EM speaker. Minimum operating controls. Power transformer for extra safety. Protected shock points. Mahogany veneer cabinet.

ONLY 297 50



CONSOLE MODEL CD36
16-in. Television
plus FM-AM Radio

Powerful 36-tube chassis. 140-sq. in. screen. FM band 88 to 108 MC. AM band 535 to 1650 KC. Large 12-inch PM speaker. Voltage Doubler. Magnificent cabinet of rich mahogany veneers.

447 50

Regal Offers A Liberal Discount to All Dealers. Write for Full Information.

REGAL ELECTRONICS CORPORATION
603 WEST 130th ST., NEW YORK 27, N. Y.

8

New General for big

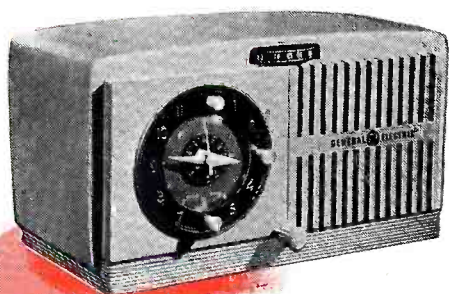

Model 65—New "Wake-up-to-music" Clock-Radio with amazing Slumber Switch. Lulls you to sleep, wakes you to music—automatically. Beautiful table radio . . . dependable G-E clock, tells time in the dark. Ivory plastic. **\$36.95***
Model 64, rosewood plastic—**\$34.95***



Model 218—New FM-AM Table Radio. Quality FM at a new low price. Genuine Armstrong FM plus powerful AM radio. Rich rosewood plastic cabinet. **\$49.95***



Model 165—New! 5-Tube 3-Way Portable. Especially designed to bring in faraway stations! 3 times as sensitive as previous models! Improved Dynapower speaker. AC-DC battery switch. **\$39.95***
(less batteries)



Model 143—New 3-Way Portable Radio. Only \$29.95*—and it's a G-E! AC-DC batteries. Powerful, lightweight. Beautiful maroon plastic cabinet. **\$29.95***
(less batteries)



Here are gifts that will make Christmas sales history for you! General Electric radios, jam-packed with new features, popular-priced, outstanding in quality! Here are gifts to appeal to *all* tastes, *all* budgets! Clock-radios, portables, table sets—they all add up to the hottest holiday line in G-E history! Cash in on it! Act fast—get in touch with your G-E radio distributor or write today to *General Electric Company, Receiver Division, Electronics Park, Syracuse, New York.*

*Prices slightly higher West and South—subject to change without notice.

Electric radio values holiday sales!

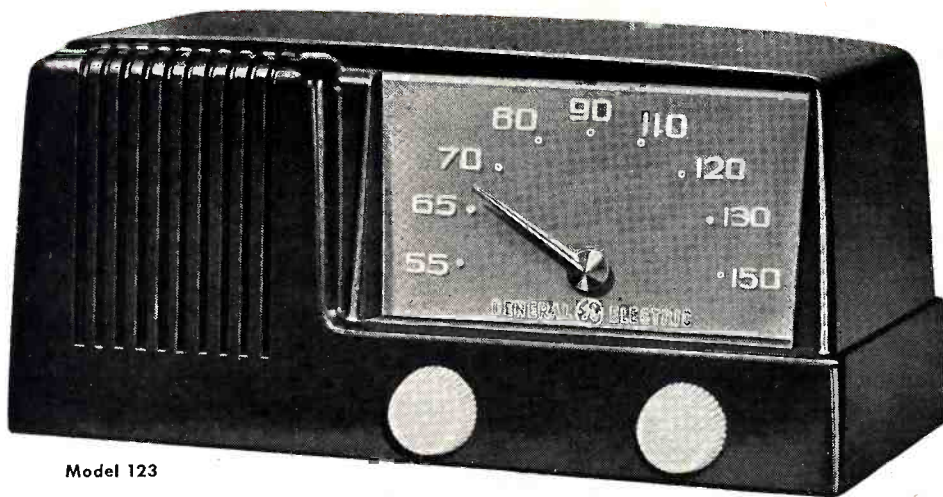

Model 123

◀ **Model 123—G-E Price Leader.** Streamlined, low-slung G-E beauty delivers performance right up there with sets costing many dollars more. Dial light, brass pointer. Rosewood plastic. Enclosed dial. **\$19.95***
Model 124, ivory plastic—**\$22.95***



Model 226—Deluxe Table Radio. Outperforms many consoles! New, richer bass formerly thought impossible in a set of this size. AC-DC. Mahogany plastic. **\$29.95***



◀ **Model 136—BIG—In Everything But Price.** Not a midget model—but a full-sized table radio. Over 12" wide, over 8" high! Not a midget performer—Dynapower speaker for good tone. Ivory Plastic. **\$26.95***
Model 135, mahogany plastic—**\$24.95***



Model 145—Famous Very Thin Portable. Slender—only 2 3/4" deep. Lovely maroon plastic case, gold-colored control panel. AC-DC batteries. Closing lid shuts off battery power. **\$44.95***
(less batteries)

You can put your confidence in—

GENERAL



ELECTRIC

Tele King IS

PERFECTED

TELEVISION

ONE DAY *Tele King*

SHIPMENTS...

*as high as the
Empire State Building*

We've doubled our production space . . . under one roof . . . we've more than doubled our rate of production, to supply ever-increasing demand from coast-to-coast for more and more *Tele King* perfected television receivers—soon we hope to catch up on back orders and there will be sets for you, too.

Wire or write.

The *Tele King* sets are so beautiful that no photo will do them justice. Dollar for dollar they are the lowest price "quality sets" in the world. One of the largest TV outlets reports that service calls on sets made by us are by far less than any other sets they carry.

KING SIZE SCREEN

PERFECTED TELEVISION

Tele King

CORP.

601 WEST 26th STREET • NEW YORK, N. Y.

ONLY THE NEW TYPE Q CONTROL

Gives You these Advanced Features for Modern AM, FM and TV Servicing

**REVOLUTIONARY
TYPE Q CONTROL
LEADS THE FIELD IN
CONVENIENCE FEATURES**

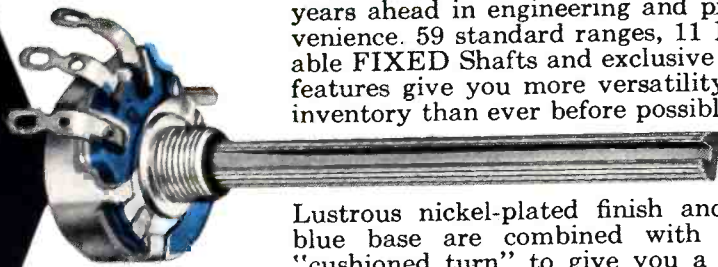

Here's a control for Radio Technicians that's years ahead in engineering and practical convenience. 59 standard ranges, 11 Interchangeable FIXED Shafts and exclusive convenience features give you more versatility with lower inventory than ever before possible.

Lustrous nickel-plated finish and distinctive blue base are combined with a smoother "cushioned turn" to give you a control that looks, "feels" and performs better than any you've ever used.

**OUTSTANDING APPEARANCE
VERSATILE KNOB MASTER SHAFT
INTERCHANGEABLE FIXED SHAFTS
MODERN SMALL SIZE
SMOOTHER ROTATION**

Resilient Retainer Ring provides cushioned turn—a new sensation in operation

PRE-EMINENT ELECTRICAL FEATURES

½ watt rating—wider coverage
Famous IRC resistance element
Identical electrical rotation with or without switch
Wider range—500 ohms to 10 megohms

OUTSTANDING MECHANICAL FEATURES

Molded base accurately aligns parts
Salt spray materials and finishes
Two locating lugs provided

EASILY ATTACHED IRC SWITCHES

WIDE REPLACEMENT COVERAGE

59 values
Stock list shows Radio and TV uses
Type Q IRC Volume Control Kit available
Basic stock numbers unchanged

MECHANIZED PRODUCTION

Complete mechanization of production and testing eliminates hand operations and assures maximum uniformity

ATTRACTIVE NEW PACKAGING

Controls, shafts and switches individually packaged
Complete instruction sheet with each item

For complete details, ask your IRC Distributor or use the handy coupon to obtain your FREE copy of new Catalog DC-1.



enlarged cross-section

KNOB MASTER FIXED SHAFT

This 3" long fixed shaft is standard on the Q Control. 90% of all AM, FM and TV ¼" knobs can be accommodated without alteration, except cutting to length. It is knurled, flattened and slotted, and ends spread easily for worn or oversize knobs. Shaft inserts are no longer needed.

The Knob Master Fixed Shaft combines with compact 15/16" design and ¼" long bushing to provide the industry's most adaptable small control.

11 INTERCHANGEABLE FIXED SHAFTS

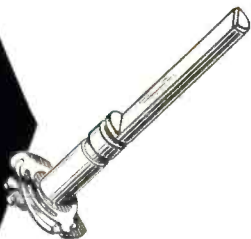

Now it's easy to adapt standard controls to "specials". Resilient Retainer Ring, an outstanding control design advancement, permits ready adaptability to any of 11 special FIXED shafts in less than a minute—using only a knife or screwdriver. Shafts are FIXED and permanent! They will not wobble.

Interchangeable Fixed Shafts are sealed in cellophane and individually packaged. Simple instructions are included in each carton.



**INTERNATIONAL
RESISTANCE CO.**

401 N. Broad St., Phila. 8, Pa.

In Canada: International Resistance Company, Ltd., Toronto, Licensee

Wherever the Circuit Says 

INTERNATIONAL RESISTANCE CO.

401 N. Broad St., Phila. 8, Pa.

Please send my free copy of Q Control Catalog DC-1.

Name

Address

City Zone State

IT'S A NATIONWIDE SENSATION . . .

THE BIG CROSLEY MILLION-DOLLAR GIVEAWAY!

Ever since the starting date—October 15—customers have been going to Crosley Dealers for details on the big Crosley Million-Dollar Contest Giveaway. The whole promotion is helping dealers to build active prospect lists and stimulate interest as never before.

It's the most spectacular merchandising event in appliance history! Crosley sparked off the idea with plans for a \$1,000,000 giveaway. But Crosley Dealers all over the country were so enthusiastic that cash and merchandise prizes now amount to

MORE THAN \$2,000,000!

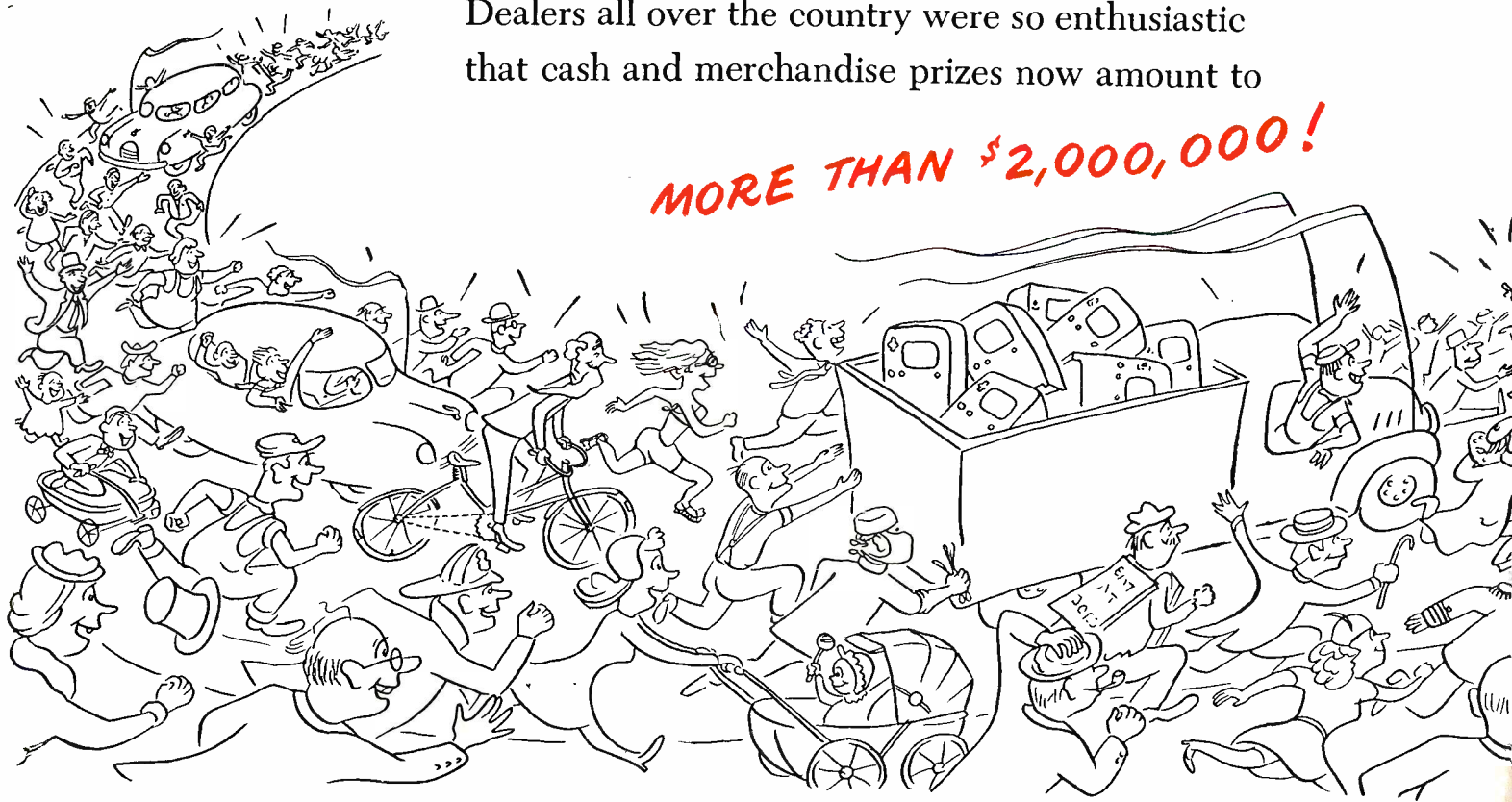

Everywhere Folks Are Talking Crosley

—now's your opportunity to take immediate advantage of the Crosley name. Feature it in store promotions, mailing pieces, displays, advertising.

And This Is Just a Starter!

The Crosley Million-Dollar Giveaway is only a forerunner of big things to come. There'll be plenty more . . . exciting Crosley promotions . . . colorful display material . . . magnificent new Crosley products designed for brilliant performance.

Consistent Advertising Keeps the Ball Rolling.

There'll be no letup in the growing demand for Crosley. Everywhere folks will see and hear about Crosley . . . in colorful magazine ads, newspaper ads, over the radio, on big, new TV programs.

Right Now, during a period of *only 2 months*, Crosley is supporting you with an advertising campaign costing...

1½ MILLION DOLLARS!

For Full Details on Crosley products, contact your nearest distributor. Or write: Crosley Division, Avco Manufacturing Corporation, 1329 Arlington Street, Cincinnati 25, Ohio

CROSLEY

DIVISION

**BETTER PRODUCTS FOR
HAPPIER LIVING**



Shelvador* Refrigerators... Farm and Home Freezers
... Electric Ranges... Electric Kitchens... Steel Cabinets... Sinks... Electric
Disposers... Electric Water Heaters... Radios... Radio Phonographs... Television

and of course, they're electric!

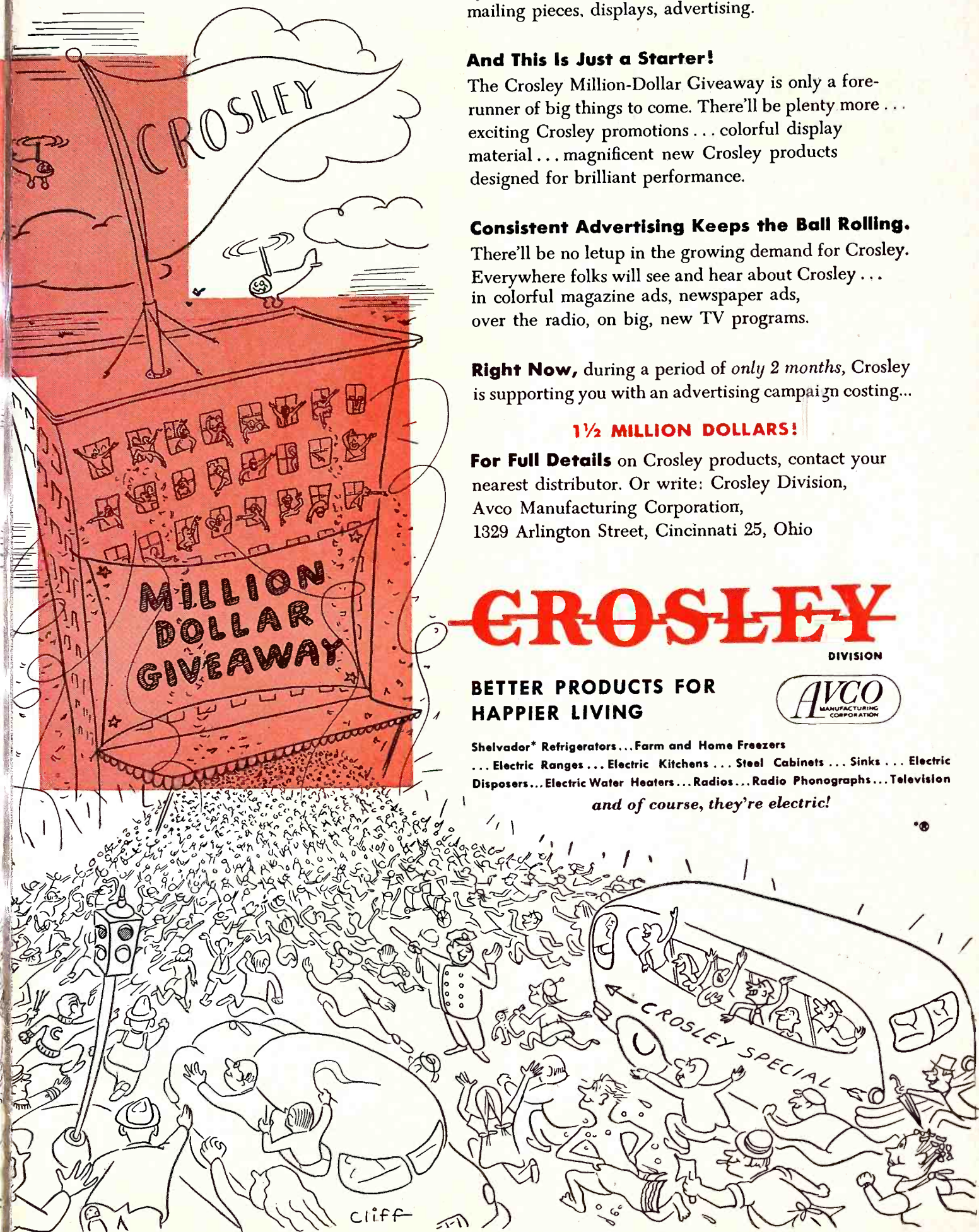

Knockout!



12 1/2" Console

\$ **239⁹⁵**

WALNUT
FINISH

(MAHOGANY FINISH \$249.95)

BIG MARK-UP

FAST TURNOVER FOR YOU

LIST PRICE GUARANTEED 60 DAYS

air king

MODEL
A-2012

AIR KING PRODUCTS CO., INC. • 170-53rd St., Brooklyn 32, N.Y.

has everything

RADIO & TELEVISION RETAILING • November, 1949



**MORE
HOURS
OF
SERVICE
•
MICROPHONE
CABLES**

Every Type for Every Service

Belden
Radio WIRE

Your store is

SYLVA

"Bulls



Big, smashing, sales-making ads in your local newspapers!

Hard-hitting campaigns for *Movie-clear* TV aimed right at your customers!

Huge, generous cooperative ad program—

helps you sell your market with your own local newspaper ads! Free mats, of course!

"Minute Movie" cooperative ad program!

You pay only part of the cost of this sure-fire local advertising medium!

Solid training for your sales personnel!

Sound slide films give your salesmen a story that *sells!*

POWERFUL PUBLICITY CAMPAIGNS IN YOUR LOCAL AREA!

the center of the

NIA



TELEVISION

eye" Sales Campaign!



Point-of-sale displays that SELL!

Window banners! Counter cards! "Open chassis" displays! Flasher display! "Check-chart" display! Decals! *Everything* you need to make your store *Movie-clear* TV headquarters!



A wealth of sales aids!

18-page line folder in color! 6-page envelope stuffer in color! Knob tags! Salesmen's "Sales story" pocket cards! "Pay-Back" service contract folder!



SYLVANIA TELEVISION

MANUFACTURED BY COLONIAL RADIO CORPORATION
1280 MAIN STREET, BUFFALO 9, N. Y.

A Wholly Owned Subsidiary of Sylvania Electric Products, Inc., Manufacturers of Cathode Ray Tubes; Radio Receiving Tubes; Electronic Devices; Fluorescent Lamps; Fixtures; Electric Light Bulbs; Photolamps; Radio and Television Receivers.

*Trademark

BIG SCREEN TV CONSOLES

TELEVISION OF
TO-MORROW - TODAY!

FADA

*proven by actual test to be
the peers in their class for
performance and value . . .*

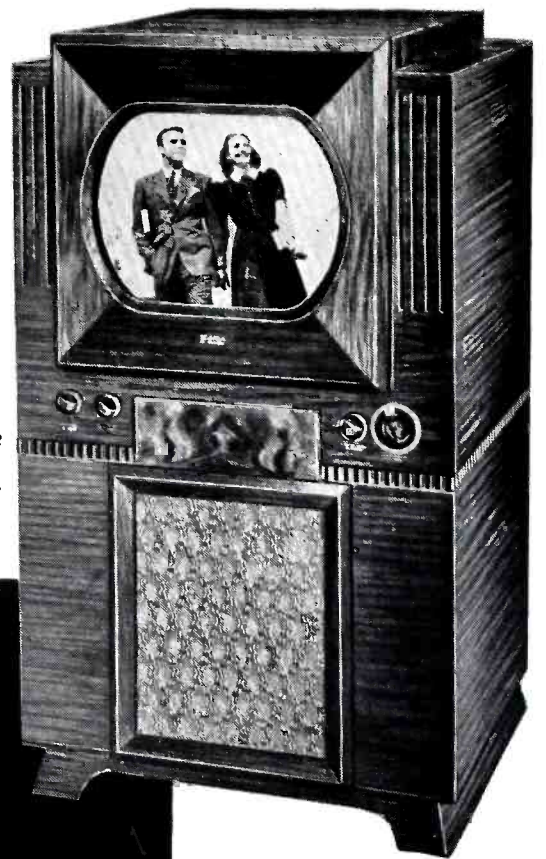

Model 940
91 SQ. IN. SCREEN
FULL 30 TUBES

12½ Inch direct view
tube. Miracle 10 Inch
Concert quality Speaker.
Beautifully designed
console cabinet of rich
mahogany veneer.
List \$349.95

**CAPTURE
YOUR CUSTOMER
ATTENTION
IMMEDIATELY**

Model 965
145 SQ. IN. SCREEN
FULL 31 TUBES

16 Inch direct view
tube. Large 10 Inch
Concert quality Speaker.
Classic design ma-
hogony veneer hand-
rubbed console cabinet.
List \$449.95



Yes, really BIG, BIG picture screens
that give tops in television performance.
Fringe areas hold no terror for these
models because actual tests prove there
are none finer. Exquisite custom-built
mahogany veneer console cabinets.

that **LEAD THE VALUE PARADE**

"Pioneers in Radio and Electronics Since 1920"

FADA RADIO & ELECTRIC CO., INC.

BELLEVILLE, N. J.

"Why we recommend Rauland

to our dealers..."



Photograph by
Fabian Bachrach

by *Louis M. Herman*

Head of The Louis M. Herman Company, Boston, and for two decades a leader among New England jobbers

"Rauland television picture tubes are our choice because the aluminized tubes offered by Rauland combine highest product quality and universal acceptance by our customers as a better replacement tube than ordinary ones—better by reason of giving better definition with more brilliance and because no ion trap magnet is required, the adjustment of which is very critical. Incidentally, we have yet to experience the first failure of a Rauland picture tube. Naturally, as we profit more from better satisfied customers, we recommend Rauland to our dealers."

A Rauland Replacement Gives Users a "Better-than-New" Picture!

Yes, actually users get a better picture from a Rauland aluminized replacement tube than they saw when their sets were brand new. They get better contrast... up to 80% brighter pictures... and the sharp definition that comes from the elimination of stray light. Every Rauland replacement tube means a delighted customer.

Eliminates Critical Ion Trap Magnet Adjustment

Rauland's aluminized tubes need no ion trap magnet—never develop ion spot! This eliminates the danger of the replacement tube being damaged as the result of faulty adjustment of the magnet. If such damage occurs it is not protected under any tube manufacturer's warranty and the loss must be borne by the dealer or customer.

Boosts Filter Sales Too

With everybody talking about filters today, you cash in with Rauland aluminized tubes, because their extra brightness gives a bright, sharp picture through even a heavy filter.

10 Ways Better

1. More brilliance
2. Better contrast
3. Better definition
4. Greater fidelity
5. No ion spot
6. No cathode glow
7. No magnet
8. No circuit problem
9. Replaces any magnetic tube
10. Any filter can be used

THE RAULAND CORPORATION



Perfection Through Research

4245 N. KNOX AVENUE • CHICAGO 41, ILLINOIS



new models... new prices

new



THE 605T12—
12½-INCH TABLE MODEL WITH
Electronic **MAGNIFIER**

New picture clarity with a choice of the full-vision picture or the giant electronic close-up . . . new built-in antenna . . . adaptable to UHF . . . phono-jack provided for record player attachment.

new

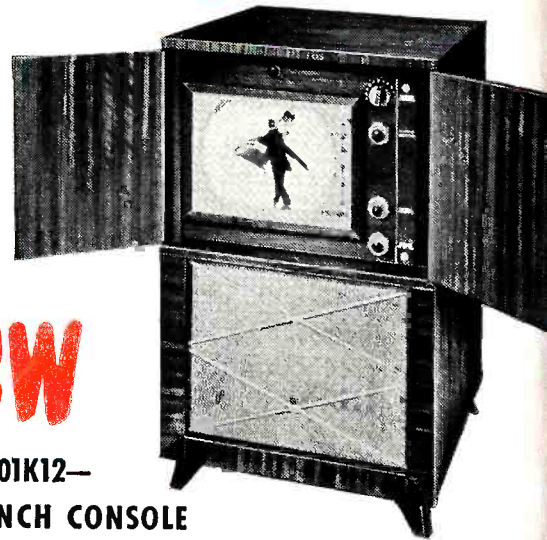

THE 601K12—
12½-INCH CONSOLE
IDEAL WHERE SPACE IS LIMITED

Beautiful clean-lined cabinet in mahogany or blonde . . . built-in antenna . . . adaptable to UHF, phono-jack provided for external record player . . . syncro-tuning of sight and sound—when the picture is sharply tuned, sound is perfect, too.

new
BUILT-IN
ANTENNA

on all these new
Westinghouse
receivers

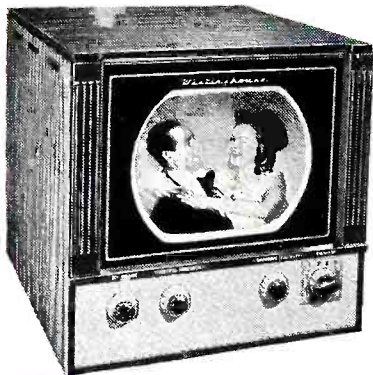

new THE 604T10—10-INCH
TABLE MODEL AT A
DOWN-TO-EARTH
PRICE

A real sales leader . . . top performance at an amazing low price . . . improved sensitivity for bright, steady pictures in fringe areas and better pictures everywhere . . . all Westinghouse circuit features . . . built-in antenna . . . adaptable to UHF . . . cabinet of solid mahogany and mahogany veneers.

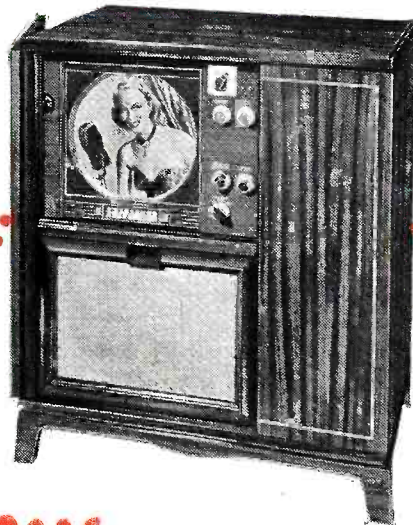

new THE 603C12—12½-INCH
TELEVISION, AM-FM RADIO,
THREE-SPEED RECORD PLAYER

Everything your customers want for home entertainment! Electronic Magnifier gives big-picture television, standard radio and exclusive Westinghouse Rainbow Tone FM. Automatic record player ends record confusion . . . plays all speeds and all sizes of records on market today. Built-in antenna . . . TV adaptable to UHF.

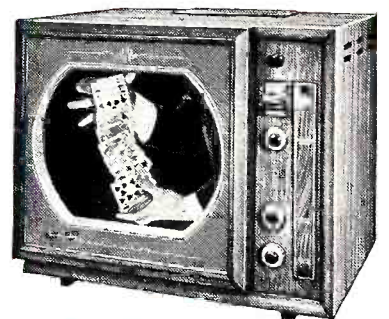

new THE 600T16—GIANT
160-SQUARE-INCH
PICTURE FROM 16-INCH TUBE

Your prospects who want a big direct-view picture will want the 600T16 . . . biggest picture from any 16-inch set . . . built-in antenna . . . adaptable to UHF . . . phono-jack provided for record player attachment . . . new high sensitivity . . . cabinet of solid mahogany and mahogany veneers.

YOU CAN BE SURE... IF IT'S

...new proof THAT

Westinghouse

MEANS BUSINESS IN TELEVISION

BIG PICTURE AT SMALL-PICTURE PRICE!



A flip of the
Electronic Magnifier
turns regular size pictures

to GIANT electronic close-up



NOW IS THE TIME TO GET
A WESTINGHOUSE TELEVISION
FRANCHISE

Send the coupon or call your
Westinghouse distributor.

Home Radio Division
Westinghouse Electric Corporation
Sunbury, Pa.

I am interested in a Westinghouse television franchise. Please have your representative call.

NAME.....

COMPANY.....

ADDRESS.....

CITY.....ZONE.....STATE.....

Westinghouse

ANNOUNCING A REVOLUTIONARY NEW PORTABLE FORMS-HOLDER

THE *National** **SLIP-PAK***

WITH SMOOTH, HARD WRITING SURFACE AND EXCLUSIVE HAND-REST

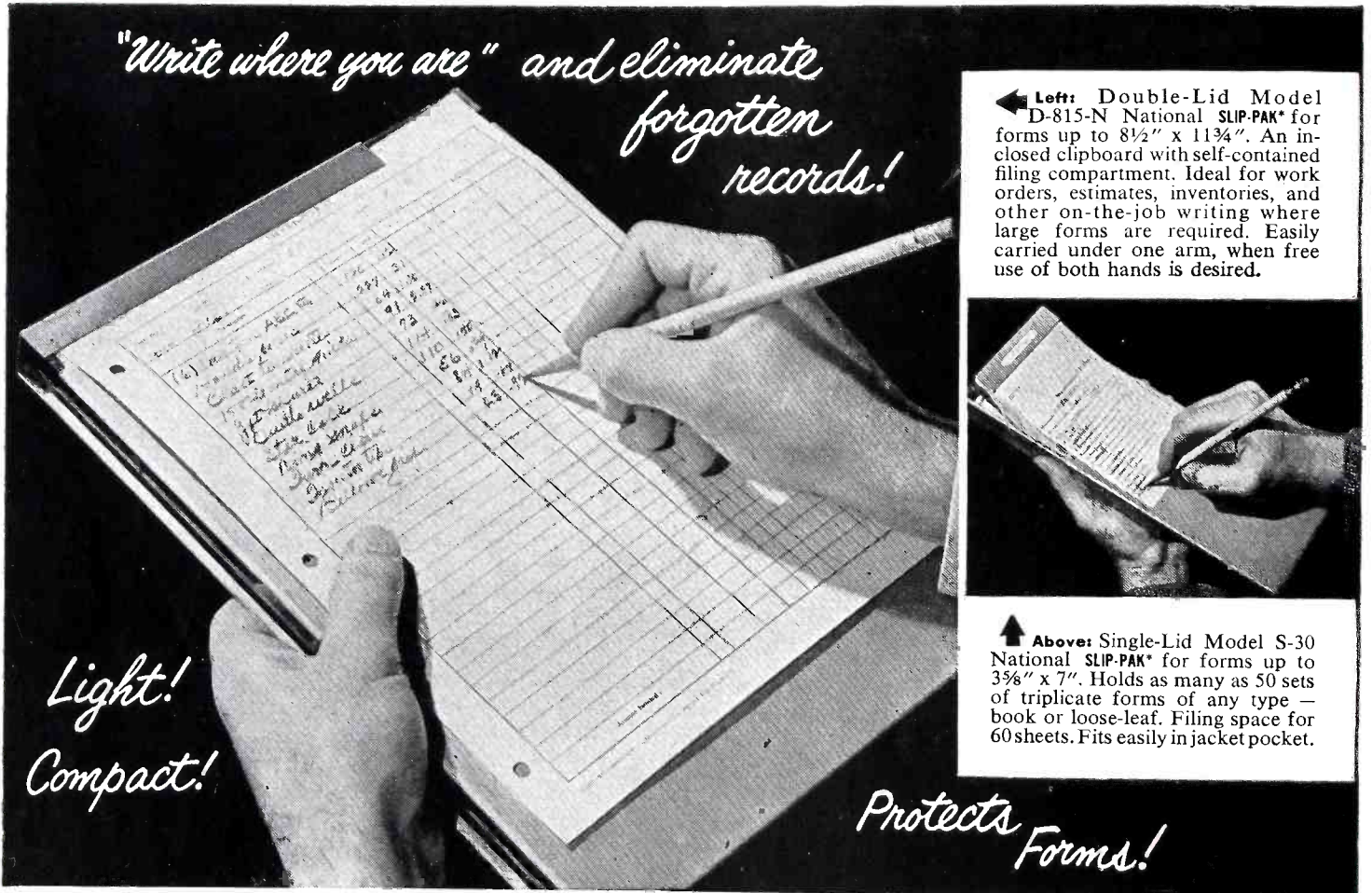

"Write where you are" and eliminate forgotten records!

*Light!
Compact!*

Protects Forms!

← **Left:** Double-Lid Model D-815-N National SLIP-PAK* for forms up to 8½" x 11¾". An enclosed clipboard with self-contained filing compartment. Ideal for work orders, estimates, inventories, and other on-the-job writing where large forms are required. Easily carried under one arm, when free use of both hands is desired.

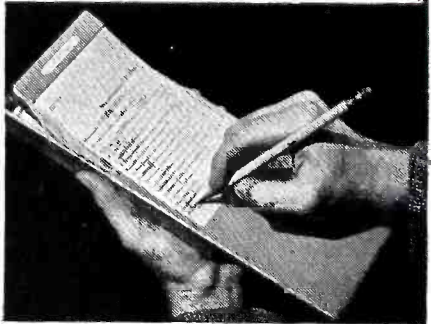

↑ **Above:** Single-Lid Model S-30 National SLIP-PAK* for forms up to 3⅝" x 7". Holds as many as 50 sets of triplicate forms of any type — book or loose-leaf. Filing space for 60 sheets. Fits easily in jacket pocket.

HERE'S HOW SLIP-PAK* WORKS:

Slide SLIP-PAK* protective lid open, and flip out top set of forms.	Slide lid under forms. Its firm writing surface assures clear, legible copies.
When writing near bottom of forms extend lid as a hand-rest.	File copies in secure, convenient, self-contained filing compartment.

Two other Standard sizes :

Single-Lid Model S-40 for forms up to 4¾" x 7".
 Double-Lid Model D-30 for forms up to 3⅝" x 6¾".
 (All form dimensions are maximum. Each SLIP-PAK* takes a wide variety of smaller forms.)

Wherever forms are written by hand, National SLIP-PAK* combines *speed* and *convenience* with *clearer*, more *legible* records. When closed, National SLIP-PAK* protects your forms from dirt, dust, weather, and handling.

Note the "extended hand-rest," exclusive SLIP-PAK* feature. When writing at the bottom of a form, slide the lid back, and it becomes a hand-rest which assures more legible writing. National SLIP-PAK* is simple to use . . . reloads in 10 seconds . . . no hinges, levers, or gadgets!

*Trade marks

Priced from \$2.75 to \$5 plus taxes and postage (in United States, only). Order yours today from your nearby National Cash Register Company office. Or, write to the Company at Dayton 9, Ohio.



THE NATIONAL CASH REGISTER COMPANY

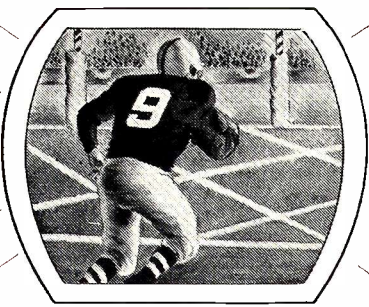

ARVIN SCORES
in Market after Market!

ARVIN

Visible Value



TELEVISION

you can SEE the difference!



CLEARER, BRIGHTER, STEADIER PICTURES!



SIMPLER, EASIER, FASTER TUNING!



5 BIG-VALUE, FAST-SELLING MODELS!

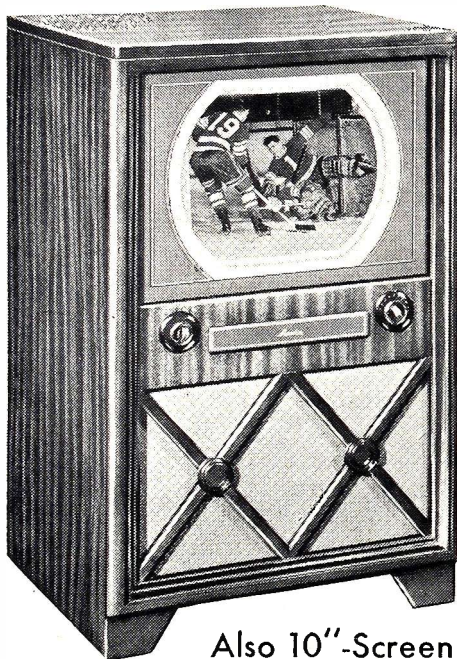

MODEL 3160 CM

**GIANT 16"-SCREEN
 CONSOLE**

\$399⁵⁰*
Plus Federal Tax

Here's the Arvin TV value of values—the terrific triumph that stops competition cold! All Arvin's famous features in an outstandingly beautiful mahogany console showing a picture that actually measures 14 $\frac{3}{8}$ by 11 $\frac{1}{4}$ inches! Compare it for beauty . . . compare it for picture . . . compare it for price . . . it's a standout value that means more "big unit" sales for Arvin dealers!

MODEL 3120 CM CONSOLE

12 $\frac{1}{2}$ " SCREEN **\$299⁵⁰***
Plus Federal Tax

Also 10"-Screen Table Model at \$219⁵⁰* and
 10"-Screen Console at \$249⁵⁰*



MODEL 3121 TM

**BIG 12 $\frac{1}{2}$ "-SCREEN
 TABLE MODEL**

\$249⁵⁰*
Plus Federal Tax

Gives your customers the *larger* pictures they want at the *lower* prices they want to pay! Oversize 12 $\frac{1}{2}$ -inch direct view screen shows full 92 sq. in. of undistorted picture—clicked into perfect focus as easy as tuning a radio! Arvin's exclusive MAGIC MODERATOR controls wavering and drifting. Super power brings in station clearly, even in fringe areas. Mahogany finish. Table to match at slight extra cost. An unbeatable sales-value in its field!

ARVIN PRICE PROTECTION GUARDS YOUR PROFITS!

Radio and Television Division
NOBLITT-SPARKS INDUSTRIES, INC.
 Columbus, Indiana

* Slightly higher in Zone 2.

from now on...

WATCH

Starrett

**ALL
THIS
PLUS
ALL
THE
PROFIT
FOR
STARRETT
SELECTED
FRANCHISE
DEALERS**

plus DISCOUNTS UP TO 40%

plus AMERICA'S MOST COMPLETE LINE,
\$249.95 to \$1295

plus PRICE PROTECTION ON BOTH LIST
AND COST!

plus BIG TUBES ONLY ... 12½" to 20"
... MOST SALEABLE!

plus TOP QUALITY, SUPER SENSITIVE
CHASSIS—For extra fringe area sales!

plus THE BIGGEST AD COOPERATION
DEAL IN TV!

PLUS EXCLUSIVE OPTICLEAR! EXCLUSIVE
FILM-FREED TUBES!

PLUS AMERICA'S MOST BEAUTIFUL
DECORATOR CABINETS!

STARRETT TELEVISION CORP. 601 W. 26th ST., NEW YORK 1, N. Y.

- **OVER 21 MILLION ADS** between now and Christmas alone! Saturday Evening Post! Fortune! New Yorker! Time! Field & Stream! Town & Country! Wall Street Journal! Journal of Commerce! Gourmet! New York Times Magazine! Newsweek Magazine! American Weekly!

- **STARRETT'S PROMOTIONS ARE ALL OUT TO BRING STARRETT DEALERS A BIG PERCENTAGE OF THE 80,000,000 AMERICANS WHO ARE HUNGRY FOR TELEVISION!**

- **THUNDERBOLT PROMOTION NOV. 13 IN THE AMERICAN WEEKLY** makes TV selling history! Full Page! Full Color!

- **STARRETT CONSUMER WARRANTY!** MOST ORIGINAL, MOST POWERFUL SELLING AID IN TV!

- **STARRETT MAT SERVICES, MAILERS, POSTERS, SIGNS, DEALER AIDS** ARE THE HARDEST-HITTING SELLERS IN THE INDUSTRY!

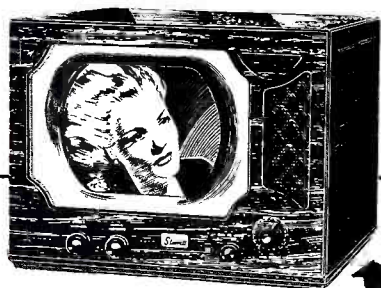

from **THE NATHAN HALE**
\$249.95
with 12½" picture tube

to **THE COSMOPOLITAN**
\$1295
16" picture tube

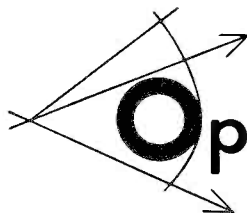

Starrett

 **Opticlear**

TELEVISION

Some Exclusive Areas Still Open ... Phone, Wire or Write:

*pats. pending

†prices slightly higher in West ifed. tax additional

STARRETT TELEVISION CORP. 601 W. 26th ST., NEW YORK 1, N. Y.

The Greatest Selling Idea in Radio—

✓ **Emerson**
perfected the
small radio!

✓ **Emerson**
pioneered prices
down to everyone's
reach!

✓ **Emerson**
promoted radio-
for-every-room!

NOW!

EMERSON INTRODUCES

the *Personal* pride, the
Personal convenience,
the *Personal* pleasure
of a *Personal* Emerson
radio for every mem-
ber of the family.



"The kids love that hot music but I don't
get very near the way I solved the radio
traffic problem" in this house with....

"My Own Personal Emerson"



Smartest home-happiness idea in years!
That's what thousands are saying about the new
EMERSONS—now priced so low everyone can enjoy
his own *Personal* radio.

At long last, you can bring to all members of
the family the programs they want, *when* they
want them.

There's a *Personal* EMERSON for every purse and
every purpose. Your dealer will show you a beau-
tiful variety of Table-models, Portables, Pocket-
fitting Intimates. Each brings you the famous tone,
power and performance that has made EMERSON
the world's largest maker of home radios. And each
is priced at *less than any* comparable receiver on
the market.

Choose the *Personal* EMERSON Radios your fam-
ily needs, today. You'll find them an amazingly
inexpensive way to multiply radio fun and con-
venience in your home.

Emerson
Radio and Television
Emerson Radio and Phonograph Corporation, New York 11, N. Y.

For Better Style, Tone, Performance, Value—Emersonize Your Home

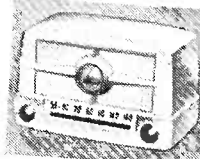

Designed for Pleasure... Un-
matched tone, power, range and range!
Improved superheterodyne circuit!
Super-sensitive built-in antenna. Just
plug in and play AC-DC. In ivory at
\$19.95; Ebony, \$14.95. Model 357



Famous "Fan-Tenna"... Powerful
3-B portable for AC-DC and last-
ingest, with amazing new antenna
that swings out like a fan. Just 6 1/2"
high. Plays everywhere. Less batter-
ies, costs only... \$29.95. Model 613



"Midget" Marvel... smallest phono-
radio ever! Only 7 1/2" high, 10 1/2"
wide. Plays up to ten 45 rpm records
on fastest changer ever built. Magnif-
icent tone. Long range radio. Slide-
rule Dial. Only \$49.95. Model 635



Baby Grand... FM-AM masterpiece.
The pure, deep velvet tone quality of
price, Full Frequency Modulation
(FM) band, full Standard (AM)
radio. Only \$49.95. Model 556

More and more Independent Television Service Men
Say "Emerson Is Your Best Buy"

Four-Way Sensation... Imagine, in
this single compact receiver you get
... 1. Giant size 10" television; 2.
Full F.M. radio; 3. Full A.M. radio;
4. Plug-in and dial control for at-
tachement of any speed record play-
er and away the
greatest buy in tele-
vision..... Model 621

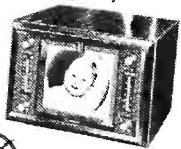

Emerson ULTRA WAVE **Television**

FIRST ADVERTISEMENT TO APPEAR IN FULL-COLOR IN LIFE, NOVEMBER 14th

And Emerson has put its money on the line to put money in your
till... NATIONAL MAGAZINE FULL COLOR, FULL PAGES AND SPREADS,
full color window and interior displays, window streamers, folders and direct mail,
PLUS big-space daily newspaper ads.

GET BEHIND "MY OWN PERSONAL EMERSON" FOR YOUR OWN PERSONAL PROFIT!
ONLY EMERSON HAS THIS STORY... ONLY EMERSON CAN TELL THIS STORY!



(Reg. T.M.)

Emerson Radio and **ULTRA WAVE** **Television**

Emerson Radio and Phonograph Corporation



New York 11, N. Y.

Sheldon "Telegenic" Picture Tubes are GUARANTEED FOR 13 MONTHS...



Miss Connie Corrado
Inspector
Sheldon Electric Co.

Because . . . **THEY STAND UP!**

"I KNOW THAT SHELDON 'TELEGENIC' PICTURE TUBES ARE GOOD. I INSPECT THEM."
They are custom-made. They have a life of more than 4,000 hours.

Sheldon
NATURAL IMAGE
SOFT GLOW
Picture Tube



WRITE for the new descriptive sheet about these outstanding 10", 12" and 16" flat-face, all-glass tubes. Sheldon Television Picture Tubes are guaranteed against defects in design and workmanship for a period of 13 months from date of shipment from Sheldon's factory or branch warehouses. This guarantee, with a definite expiration date, is printed on a sticker attached to each tube.

SHELDON ELECTRIC CO.

Division of Allied Electric Products Inc.

68-98 Coit Street, Irvington 11, N. J.

Branch Office & Warehouses: Chicago 7, Ill., 426 S. Clinton St. Los Angeles 6, Cal., 2359 W. Pico Blvd.

TELEVISION PICTURE TUBES • CATHODE RAY TUBES • FLUORESCENT LAMP STARTERS AND LAMPHOLDERS • SHELDON REFLECTOR AND INFRA-RED LAMPS
PHOTOFLOOD AND PHOTOSPOT LAMPS • SPRING-ACTION PLUGS • TAPMASTER EXTENSION CORD SETS AND CUBE TAPS • RECTIFIER BULBS

Best Christmas sales ever with Crosley...

**Designed and built
to give the clearest
TV picture**

Christmas for Crosley TV dealers promises to be the biggest in history because Crosley has what the public wants—bright, steady, clear pictures in gorgeous cabinets that match fine furniture. Crosley's outstanding features do a *double job* for you. They help you make sales; they minimize repair and replacement problems.

Features like these build the popularity of Crosley TV:

- **ELECTRONIC PICTURE STABILIZER**, for extra steadiness
- **MICRO-ADJUSTED CIRCUIT**, for faithful image reception
- **UNDISTORTED PICTURE**, assured by 4 to 3 aspect ratio
- **HEAVY-DUTY CONSTRUCTION**, for heavy-duty service
- **CONTINUOUS TUNER**, most trouble-free tuning method
- **REPEATED FACTORY INSPECTIONS**, to meet top standards



9-425

The "PORTA-VISION," lightweight, portable TV, that gives clear, lifelike pictures on a bright 7" picture tube. Cased in brown leatherette.



10-401

A handsome 10" picture tube table model, encased in smart, durable cabinet of molded mahogany plastic. With simplified tuner that selects bright, clear pictures in a single operation.



10-414

A magnificent new TV console encased in rich mahogany veneer. With a huge 16" picture tube that gives brilliant, lifelike reception. (Model 10-416 similar to the 10-414 pictured here, but without doors).

FULL-YEAR CATHODE RAY TUBE GUARANTEE
The big picture tube, heart of each Crosley TV set, is guaranteed for a full year.

NOTE: With the continuous tuner in Crosley TV, future provision can be made to secure reception on proposed UHF channels based on present standards.

SUPERB NEW CROSELY RADIOS — A Model for every Purse and Purpose

Here's your chance to cash in on profitable Christmas retailing with Crosley radios too. There's a model to meet every demand.



9-214 ML

A magnificent radio-phonograph console, housed in a superb cabinet of rich mahogany veneer. Full-range FM radio, powerful AM radio, and two-speed automatic record player.



10-127

A beautiful new table model radio designed especially for full-toned, static-free FM reception. With powerful standard AM radio too and special built-in antenna. Attractive mahogany plastic cabinet.



10-304

The "PLAYTIME," smartly styled lightweight portable radio in durable plastic case. In choice of three colors.

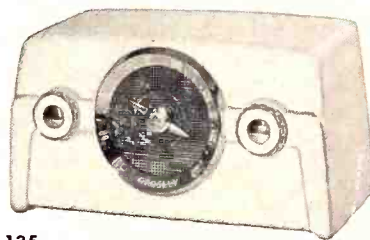

10-135

The new Crosley Kitchen Radio—the *only* radio ever designed and built expressly for the kitchen. Gleaming white Dulux finish cabinet, with polished chrome trim. Superb AM radio with tone quality usually heard only in large console radios.

SELL AND GROW WITH CROSELY. For full details about profitable retailing with Crosley, contact your nearest Crosley distributor. Or write: Crosley Division, Avco Manufacturing Corporation, 1329 Arlington Street, Cincinnati 25, Ohio.

CROSELY

DIVISION



Better Products for Happier Living

Shelvardor* Refrigerators...Farm and Home Freezers...Electric Ranges
Electric Kitchens...Steel Cabinets...Sinks...Electric Disposers
Electric Water Heaters...Radios...Radio Phonographs...Television

and of course, they're electric!

®

Here's What Dealer-Service Men Are Saying About The RAYTHEON *Bonded* ELECTRONIC TECHNICIAN PLAN

MARYLAND
William Doulog
Apex Radio Service
Baltimore, Md.
The bond certificate really does build confidence in my customers

MINNESOTA
James & McDonald
McDonald Radio Service
Minneapolis 7, Minn.
Program has eliminated need for estimates and increased business 100%

MISSOURI
Lynn R. Moore
Lebanon Radio Sales & Service
Lebanon, Mo.
My shop is the only one in town bonded. I have more repair work than all the others.

NEBRASKA
William K. Briza
Briza Radio & Television Service
So. Omaha, Neb.
This is a very good program and also installs additional confidence in customers

OKLAHOMA
David R. Gray
Gray's Radio Service
Duncan, Okla.
We are proud of our "bond certificate" and it is well displayed

NEW YORK
George's Radio Service
Yonkers, New York
Results have been most complimentary and satisfactory

OHIO
Walter H. Horton
Kenis Radio Sales & Service
Xenia, Ohio
We have found us a bonded dealer that it sure pays off "thanks to Raytheon"

ARKANSAS
J. H. Wyatt
J. H. Wyatt Radio Service Co.
Searcy, Arkansas
Your program has done very much to build customer confidence

NEW JERSEY
I. Marks
Marks Radio Service
Trenton, N. J.
Gives customers confidence in repair jobs when our bonding is pointed out.

MISSOURI
L. E. Baker
Baker Electronics
Kansas City, Mo.
Appreciate the service very much and feel our customers have more confidence in us.

FLORIDA
H. F. Nolan
Nolan's Radio Service
Tallahassee, Fla.
I have had a bonded shop now for almost 4 years and I'm glad for the good reputation

CONNECTICUT
Bert E. Keller
The Electronic Shop
Westport, Conn.
Excellent Public Acceptance campaign and dealer aid program

LOUISIANA
N. Proutt
Delta Radio Service
New Orleans, La.
I find that by displaying my bond certificate helps business

CALIFORNIA
T. M. Howan
Apples Radio
Berkeley, Calif.
This has been a fine program and we like it very much

PENNSYLVANIA
Frank P. Battilo
Frank's Radio Shop
Pittsburgh, Pa.
People have more confidence in my shop

HERE'S WHAT THE PLAN IS:

The dealer who displays this Certificate wipes out all doubt in his customers' minds as to the quality and dependability of his radio service work. He offers a 90-day BONDED guarantee on his radio set repair work and replacement parts, backed by *American Mutual Liability Insurance Co.*'s assets of close to a hundred million dollars. YET, IT COSTS HIM NOTHING!

Ninety per cent of all Raytheon Bonded Dealers report that they are making it the feature of their own advertising programs.

The Raytheon Tube Distributor in your area has this Bond for you — if you qualify. It doesn't cost you a cent, but at one fell swoop it sweeps away mistrust — the biggest barrier to volume and profit.

Get in touch with your Raytheon Distributor. Ask him how to become a BONDED ELECTRONIC TECHNICIAN.



NEW!

**RAYTHEON
CATHODE RAY TUBES**

Television Picture Tubes of genuine Raytheon quality are now available in all popular types. For peak video performance, specify Raytheon Radio and Television Tubes.

RAYTHEON

RAYTHEON MANUFACTURING COMPANY

Radio Receiving Tube Division
Newton, Mass., Chicago, Ill., Atlanta, Ga.,
Los Angeles, Calif.

Radio Receiving Tubes, Cathode Ray Tubes,
Special Purpose Tubes, Subminiature Tubes,
Microwave Tubes

America's Smart Set

Admiral

FIRST in TELEVISION

More than ONE out of every TWO television combinations sold is an Admiral . . . more than 57% of the entire industry output!

The first six months of 1949 have witnessed the rise of Admiral Corporation to leadership in America's fastest growing industry . . . television. Note these comparisons:

For the first six months of 1949 total sales of the television industry were 206% greater than for the first six months of 1948.*

Television sales of Admiral Corporation, however, were 450% greater . . . an increase more than double that of the television industry. And Admiral sales for the second six months are expected to be 167% greater than for the second six months last year.

Prominent in Admiral's growth is the dominant position it has achieved in television combinations. This type of set receives television, AM and FM radio, and includes, in Admiral's case, a phonograph that automatically plays all types of records.

*During the first six months of this year, Admiral built and sold more television combinations than all other makes combined . . . more than 57% of the entire industry output.**

When all types of television sets are considered, consoles and table models, as well as combinations, Admiral currently is producing approximately 25% of the entire industry output measured in dollar value.

From the beginning Admiral recognized that television is more than a plaything for high income groups . . . recognized television's potentialities for bringing a rich variety

*RCA Licensee Figures

of entertainment and education, day in and day out, to those needing the entertainment and education most . . . the lower income groups.

Immediately, therefore, Admiral began the application of mass production methods to the manufacture of television. The economies obtained were regularly passed on to buyers in the form of better television sets at lower prices. Other manufacturers necessarily followed Admiral's leadership. The result has been a constantly expanding market for television.

Within the last few weeks an amazing transformation has taken place in the nature of the demand for television. Until just recently many people still classed television as a novelty, a fascinating invention, but a purchase that could wait until other things had been bought.

Today television has arrived. It is "first" on the shopping lists of millions of families. The demand exceeds anything anticipated, or even dreamed of. Its future growth now can be foreseen patterned after the radio industry, with not one, but two or more television sets in the typical American home.

For this next stage of television's growth Admiral now is planning, just as it did for the first . . . to give even greater values, and thus make available to the maximum market all the entertainment and education television has to offer.

Admiral Corporation CHICAGO 47, ILLINOIS

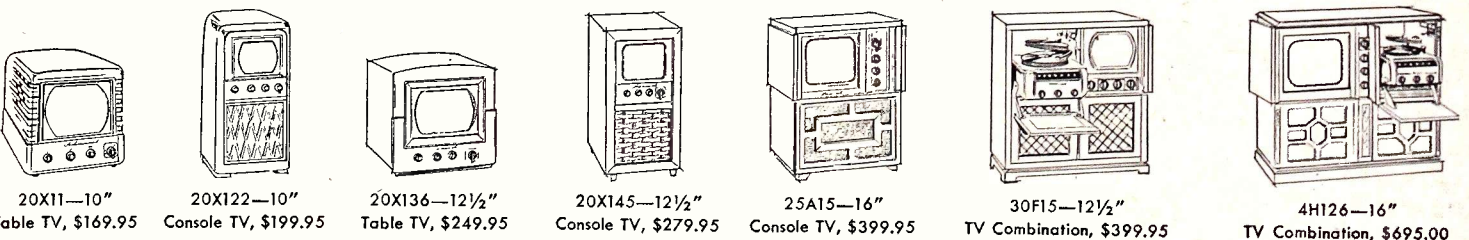

Some prices slightly higher south and west—subject to change without notice

★ SEE! HEAR! ON TELEVISION! SPONSORED BY ADMIRAL! "STOP THE MUSIC," ABC-TV NETWORK, THURSDAYS, 8 P.M., EST ALSO "LIGHTS OUT," ALL NBC-TV STATIONS STARTING NOVEMBER 7

PROTELGRAM

offers **LOWEST PRICE**

BIG PICTURE TV



• Biggest picture . . . highest quality . . . at the lowest price. That's what your television customers are looking for. That's what you have to sell when you feature PROTELGRAM-equipped receivers.

PROTELGRAM provides big, *life-size* pictures that are *true-to-life*, easier on the eyes. And, best of all, PROTELGRAM offers your customers big-picture television at the *lowest price per square inch of viewing area*—as little as 35¢ per square inch for the giant 4' x 3' size.

Check the exclusive PROTELGRAM features. They are yours to sell in any of the famous-name receivers that feature PROTELGRAM.

Note the imposing list of leading manufacturers who now use PROTELGRAM. Others will soon be announced. Watch for them. This big swing to PROTELGRAM can mean bigger profits for you because it makes available to your customers a choice of PROTELGRAM-equipped sets to fit every taste and every pocketbook.



The PROTELGRAM system of projection television consists of a special 2½" cathode-ray tube, a projection box containing the optical system and a new, compact high-voltage unit.

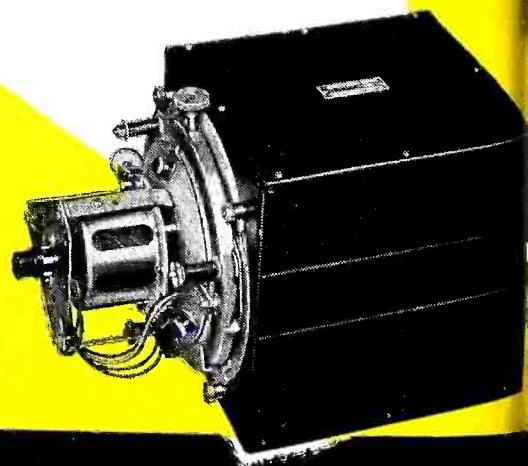

An Exclusive Development of

Check THESE SALES FEATURES

THREE SIZES—ALL BIG

You can offer your customers a choice of three PROTELGRAM screen sizes, all big—16" x 12" (192 square inches); 18" x 13½" (234 square inches) and a 4' x 3' (1728 square inches) image projected on a home movie screen.

All three PROTELGRAM pictures are larger than can be provided in the same viewing shapes by the biggest direct-view tube now in production.

LOW MAINTENANCE COST

The sensational 2½" PROTELGRAM picture tube costs less to replace than the popular size direct-view tubes. So maintenance costs are low, low, low.

LOW PRICE

PROTELGRAM offers lowest price per square inch of viewing area for high-quality, big-picture television!

QUALITY PICTURE—EASIER ON THE EYES

Your customers will enjoy PROTELGRAM'S easier-on-the-eyes dark gray screen that cuts glare and distortion. They will see a picture of true photographic quality that reproduces glare-free whites, soft grays and velvety blacks.

A leading optometrists' association, in its official publication, found PROTELGRAM to be "particularly noteworthy from the standpoints of ease and comfort of viewing."

DEPENDABLE PERFORMANCE

Back of PROTELGRAM are millions spent on research, over 15 years of development by the world's greatest electronics laboratories. PROTELGRAM is carefully engineered, thoroughly field-tested to guarantee long-lived dependability and trouble-free operation.

These famous manufacturers now feature PROTELGRAM

**ANSLEY
AUTOMATIC
BRUNSWICK
DE WALD
EMERSON
FADA
FISHER
PILOT
SCOTT**

STEWART-WARNER

Get the facts today from the above manufacturers on the outstanding sales and profit advantages of the PROTELGRAM-equipped receivers. Or write direct to North American Philips Company, Inc., 100 East 42nd Street, New York 17, N. Y.

NORTH AMERICAN PHILIPS

NOW—STROMBERG-CARLSON 19-inch "Emperor"

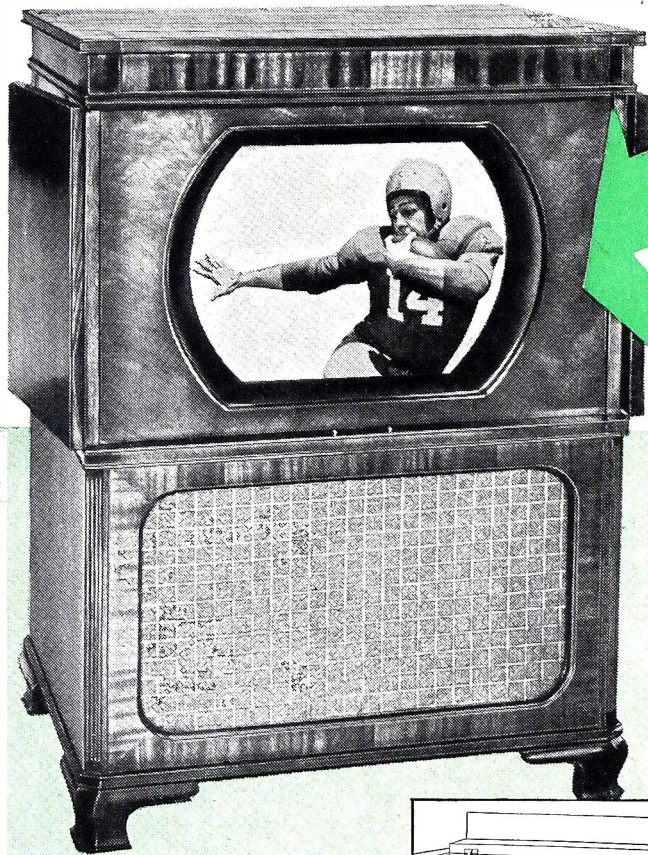

\$645⁰⁰*

**TOP
VALUE
in TV**

YOU'RE ON TOP . . . when you show and sell these highly profitable new Stromberg-Carlson EMPERORS!

TOP PICTURE SIZE—for direct view—with a 19-inch tube giving an immense, brilliantly-detailed 203-sq.-in. picture! And the focus is sharper—because the tube is short-bodied, with shorter throw of the beam. The plate-glass tube face is coated to reduce room reflections and glare!

TOP TUNING—with panel at top front concealing the simplified controls! No crouching or bending!

TOP VALUE—highly competitive in the large-picture field! The EMPEROR, with its 19-inch tube, Top Tuning, powerful fringe reception, famous Stromberg-Carlson tonal fidelity, 45 rpm compartment and closed-door smartness—*offers you powerful sales clinchers to close highly profitable big console sales!*

THE EMPEROR

Dramatic, and smartly styled, with full-opening doors. Short-bodied picture tube makes possible ideal cabinet proportions. In finest solid mahogany and mahogany veneers, #TC-19-LM \$645.00*

(Slightly higher in blond avodiré veneers, #TC-19-LA)

**19-INCH TUBE • TOP TUNING
COMPARTMENT FOR 45 RPM CHANGER
SUPERB FRINGE RECEPTION
HIGH FIDELITY SOUND**

*Slightly higher in South and West.
Plus installation and \$1.62 excise tax.

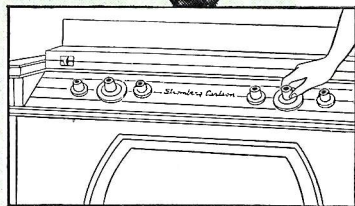

See it better  Hear it better

STROMBERG-CARLSON

THERE IS NOTHING FINER

Stromberg-Carlson Company, Rochester 3, N. Y.—In Canada, Stromberg-Carlson Co., Ltd., Toronto

RADIO & TELEVISION RETAILING

Including "Radio & Television"
and "Radio & Television Today"

Established in 1922
as ELECTRICAL RETAILING

O. H. CALDWELL, Editorial Director



M. CLEMENTS, Publisher

IF THE STEEL STRIKE CONTINUES for several months, look for shortages in large and small appliances. In the first place, supplies of steel held by manufacturers are low, and second, inventories of finished products in the hands of manufacturers, wholesalers and retailers are away down. If a genuine famine does result, look for a round of list price increases which could be caused by the return to gray-market steel buying by manufacturers.

AS MORE AND MORE PEOPLE BUY larger screen TV sets, look for a flock of small-picture receivers being traded in, though many will keep them as "second" sets for another room in the house.

SO FAR AS COLOR TV is concerned, some dealers say that their customers are not at all hot and bothered; that many would be unwilling to spend any extra money for it, that still others actually prefer black and white. As to those who're "waiting" for color, merchants point out that there is always a ready excuse at hand for postponing decisions to buy now.

UNIQUE STOCK-SELLING IDEA launched by Allied Electric Products, Inc., Irvington, N. J., manufacturer of Sheldon TV tubes, and a number of electrical items. The firm used big-space ad in the New York Times; illustrated the offer to sell shares with pictures of the product it makes; stressed the point that it was offering stock without the services of an underwriter.

LONERGAN MANUFACTURING COMPANY has acquired the Refrigeration Corporation of America, which has been a unit of the Noma Electric Corporation, and will move the activities of the Refrigeration Corp., makers of food freezers, from Perth Amboy, N. J., to the Lonergan plant at Albion, Michigan. The Michigan firm makes space heaters, furnaces and ventilating fans.

MILWAUKEE WILL HAVE ALMOST 40,000 TV sets in use November 1, the Milwaukee Journal estimates, basing the figure on results of a TV survey it recently made.

LOOK FOR MORE "NEWS" to pop in the phono record field shortly after the first of the year, though "speeds" differing from the existing three are not likely to be involved in the coming activities.

EXCISE TAX REPEAL A dead issue so far as 1949 is concerned. All indications point toward a vigorous campaign for repeal in '50—an election year.

SLEW OF ELABORATE SALES "PACKAGES" being distributed by manufacturers. Such kits contain selling info, ad copy, data on lines, reproductions of national advertisements, samples of direct-mail pieces, and, of course, order blanks.

THE SEVENTH TOWN MEETING of Radio Technicians, sponsored by RMA, will be held November 1, 2 and 3, in the U. S. Chamber of Commerce Auditorium, Washington, D. C., according to Robert C. Sprague, chairman. Sponsored by the Electric Institute of Washington, local distributors and the Mid-Lantic Chapter of "The Reps", the meeting will mark the first appearance of RMA president, Raymond Cosgrove at a Town Meeting. Wayne Coy, FCC chairman has been invited. Speakers include John A. Meagher, TV specialist of the RCA Tube Department, R. W. Kreuger, American Phenolic Corp., John F. Rider; Anthony Wright, The Magnavox Co.

LOOK FOR THIS CHRISTMAS season to be the biggest in sales of electric clocks. Ample selection and low price will boost volume.

Status of TV

The following stations are expected to go on the air this month: KRLD-TV, Dallas, Tex.; WSAZ-TV, Huntington, W. Va.; WNBK-TV, Binghamton, N. Y.; KOVB, Tulsa, Okla.; and WKTV, Utica, N. Y. Sets in use in the U. S. as of November 1 have reached 2,825,000, with 91 stations on the air.

What's Ahead!—in Radio,

BIG RETAIL OUTLETS STILL experiencing high rate of salesman job-switching. "My stock turnover rate is eight," one merchant said, "my personnel turnover fifteen." Perhaps he was joking, but the situation is quite critical. Large operators report that while the "deadwood" variety is willing to stick, the good man is always looking for something else.

VACUUM CLEANER SALES DOWN IN THE U. S., though many aggressive dealers are doing a bang-up business in them via intensified in-store and outside activities. Biggest jobs in selling vacs appear being done by those whose stores are known as repair headquarters since they get many trade-in opportunities.

TELEVISION "FACTS OF LIFE" to be presented to viewing audiences via 22 20-second and one-minute movie films prepared by the RMA in co-operation with the Television Broadcasters Association. Covering such subjects as set focussing and operation, proper viewing positions to avoid eye-strain, recognition of various types of interference, etc., the films have been

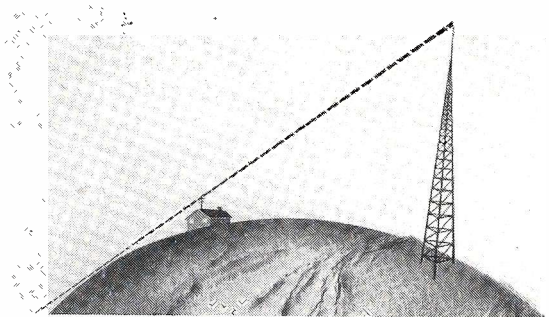

offered without charge to every TV station in the country. Many of the ideas in the films resulted from suggestions made by technicians at the Town Meetings held throughout the country, which were fostered by the RMA. The accompanying photo is a still from one of these films, which describes the nature of "line of sight" TV reception.

"THE SERIOUS BUYING RESISTANCE which developed early this year as the result of the public's confusion—stemming from the introduction of new records requiring different playing mechanisms—is rapidly melting away"—Richard A. O'Connor, president, The Magnavox Company, Fort Wayne, Ind.

SENDING OUT A REGULAR BARRAGE of penny postcards to an average of 1,800 prospective customers once every three or four weeks through the year has proven to be most effective low-cost advertising for a Colorado dealer, according to executives of the National Association of Music Merchants.

THE ALL-OUT CONFIDENCE IN THE TV man on the part of the consumer is being capitalized on by retailers who are training their technicians to be salesmen as well as service and installation engineers. A standing rule in one dealership is that its servicemen suggest trading in every small-picture set they work on in a customer's home.

AS PREDICTED HERE, THE PHONO record business is perking up. The industry, dead on its feet but a short time ago was stimulated by the "three-speed" activity, and with the exception of the juke box field, is being boosted now by television. In addition, the radio and the movies continue to plug sales of platters.

ONCE AGAIN "DEALS" ARE BEING featured in automobile advertising copy, a trend noted with interest in the TV business—now a healthy and lusty competitor for the consumer dollar.

CHARGES THAT CERTAIN "BROADCASTING INTERESTS" are using color TV as a stoplight in a futile attempt to halt the growth of the TV industry, were made by John Meck, head of John Meck Industries. "They're stopping at nothing to help slow down the inevitable depreciation of their broadcasting properties," he said.

AN AVERAGE OF ABOUT 95 per cent of American magazine reading families own flashlights, if the combined results of surveys made by seven leading magazines are any criterion, according to W. S. Allen, Olin Industries executive. The Olin organization markets Bond and Winchester brands.

NEW DEVICE ANSWERS PHONE automatically. Developed by Electronic Secretary Industries, Inc., Milwaukee, the "Electronic Secretary" answers phone and "tells" when the owner will return or where he can be reached. Another model available will record a message left by the person calling.

REALLY PLUGGING SERVICE! Gerhard's, with four stores, two in Ambler, and two in Glenside, Pa., stresses its service in all ad copy. A recent circular and ad, celebrating the firm's fourth birthday, used the following phrases: "Our Service Makes the Best Products Better," and "Where Even the Sale Is a Service."

A NEW "READY-PLUMBED" automatic dishwasher is being shipped to dealers by Hotpoint. The machine is built into a complete sink equipped with a new faucet that allows the housewife to control water temperature and volume by a single lever.

Appliances, Records and Television

TV TRADE-INS SELL LIKE HOT-CAKES, report dealers who are active in merchandising bigger picture sets to their customers. Right now, such merchants are making satisfactory profits on both the new set and the old one they take in; put in shape for resale.

A NEW PORTABLE ELECTRIC HEATER with a rotating reflector that throws both radiant and fan-forced heat throughout a room has been announced by the General Electric Company's automatic blanket and sun lamp division. The new product pulls 1320 watts; retails at \$15.95, including excise tax.

WITH CERTAIN RESTRICTIONS on attendance removed, look for a record-breaking number of visitors at next annual Parts Show in Chicago in May.

FIX THE TV SETS IN THE HOME or in the shop? For answers to this question be sure to read "How to Charge for Profitable TV Servicing" in this issue. Article also deals with repair and installation charges.

A UNIQUE TWO-WAY RADIO communications system for relaying taxicab calls is now being used by Edward Johnson and his wife at Paulsboro, N. J. Johnson arranged with General Electric for installation of two-way radio equipment in his home and cab. Now phone calls come in directly to his wife at home who relays them to the radio-equipped cab. Installation of the GE radio communication unit has increased calls and saved considerable gasoline expense, according to Mr. Johnson. The equipment operates in the 152-162 megacycle frequency band.

"DISTRIBUTORS AND RETAILERS HAVE GAINED their 'second wind' so to speak and are now attempting to put some real selling behind their merchandising efforts. They are also buying more cautiously—selecting only those items of definite consumer benefit and appeal and not loading their inventories indiscriminately."—Walter M. Schwartz, Jr., president Proctor Electric Company.

"ELECTRIC HOUSEWARES" IS THE NEW designation for small appliances chosen by the National Electrical Manufacturers Association.

LOYALTY TO A BRAND BY THE DEALER is a priceless asset to the manufacturer since such loyalty is reflected in customer good-will toward the make. Nowadays, it's being noted that merchants using the most cooperative ad space are those who have utter confidence in the products they're plugging. No amount of pressure can induce a smart retailer to spend a dime co-op-wise with a firm that hasn't cooperated with him in other ways as well.

PAUL REVERE SHOULD HAVE HAD ONE!—First radio equipped horse in the country, ridden by a Miami cop, who listens to a call from headquarters over a Motorola "Handie - Talkie" unit. City plans to equip 13 horses with the two-way radios.

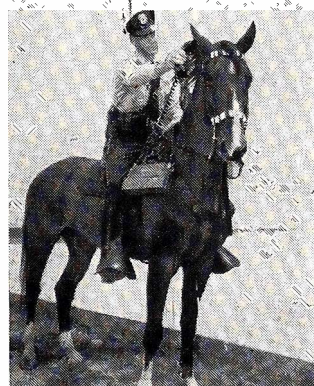

"I OWN STOCK IN THE COMPANY", is a phrase being heard more often than ever before by dealers. Customers usually buy the product of the maker whose stock they've invested in, all other things being equal, and today the number of stockholders is vast; many of them in the low-income group.

YOU NEVER KNOW WHAT WILL catch the viewer's eye in show window displays. One merchant decided to feature a flock of handirons; showed them standing on a fold-up ironing board. Results: In almost every instance where customers asked about irons they inquired about the ironing boards which the dealer didn't stock then, but put in later to fill demand.

FUTURE EVENTS OF INTEREST TO READERS

NOV. 14-18: National Electrical Manufacturers Assn., Chalfonte-Haddon Hall, Atlantic City, N. J.

NOV. 14-18: 6th All-Industry Air Conditioning & Refrigeration Exposition, Atlantic City, N. J.

DEC. 4-7: The American Society of Refrigerating Engineers, 45th Annual Meet, Edgewater Beach Hotel, Chicago.

DEC. 21-22: National Farm Electrification Conference, Stevens Hotel, Chicago.

JAN. 30-31: National Assn. of Music Merchants, (NAMM), Board of Directors, Midyear Meeting, Shamrock Hotel, Houston, Tex.

FEB. 1-2: National Assn. of Music Merchants, (NAMM), Regional Conference, Shamrock Hotel, Houston, Tex.

FEB. 6-10: Western Winter Market, Merchandise Mart, San Francisco.

MAY 22-26: Parts Distributors' Conference & Show, Hotel Stevens and Exhibition Hall, Chicago.

JULY 16-19: National Assn. of Music Merchants (NAMM), Music Industry Trade Show & Convention, Palmer House, Chicago.

*Here's the Christmas gift item
to build your*

THE



RCA VICTOR 9JY brings music lovers the glorious tone of the amazing new 45 rpm System through their present set. It's a compact plug-in unit that tucks into a console storage compartment. And, it's a sure-fire sales catcher at \$12.95!

store traffic!

RCA VICTOR 9JY
is setting new
sales records at

ONLY \$12⁹⁵

**LOWEST PRICE IN
HISTORY FOR AN
AUTOMATIC
RECORD CHANGER!**

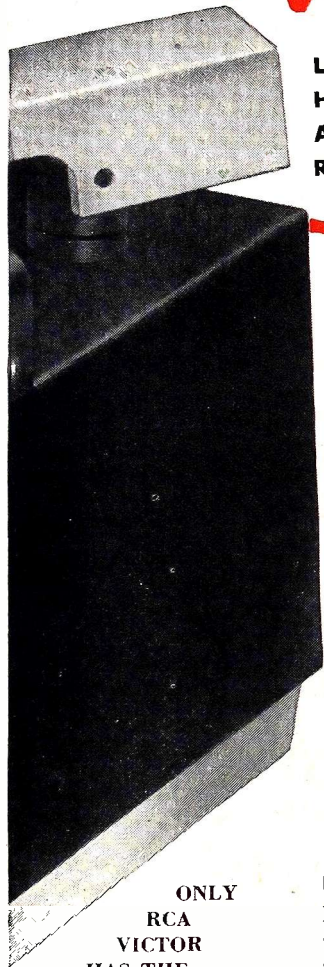

**ONLY
RCA
VICTOR
HAS THE
"GOLDEN
THROAT"**

**ONLY RCA VICTOR
MAKES THE VICTROLA**



**LOW COST, DISTORTION-FREE
RECORDS!**—New "45" records
are low priced—have that
"under a buck" selling appeal.
They wear up to 10 times longer
—center holes don't wear out,
edges don't chip, playing sur-
faces are protected.

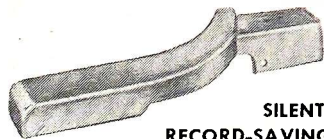

**SILENT,
RECORD-SAVING
PICKUP!**—New "Silent Sapphire"
pickup eliminates needle chatter
and surface noise. Customers are
assured of better sound . . . longer
record life.



COMPACT AND LIGHT!—
Changer unit occupies
less than half the space
of other types. Table
models are easily carried
from room to room.

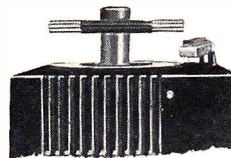

WORLD'S FASTEST RECORD-CHANGER!
—Trigger action speed customers
rave about! Plays up to ten records
with speedy, silent, hardly notice-
able changes . . . And the mecha-
nism is foolproof . . . trouble-free!



CONVENIENT 7-INCH SIZE!—
More than 150 single records
or 18 symphonies fit in one
foot of bookshelf space. And
they're non-breakable vinyl
plastic, with a surface-saving
shoulder that means much
longer life . . . greater value.

**Here's why RCA VICTOR "45"
is the "system of the future"!**

RCA VICTOR



DIVISION OF RADIO CORPORATION OF AMERICA

RCA VICTOR—World Leader in Radio . . . First in Recorded Music . . . First in Television

Nationwide Roundup of Methods They're Using to

Hard-Hitting, Aggressive Techniques Employed to Penetrate the "Second Layer" of TV Purchasers

● Initial sales of TV receivers in "television cities," while they included many middle and lower-income families, found the greater percentage of receivers going into the upper bracket homes. Now that the cream has been skimmed off, the selling emphasis has switched from those few customers who can pay cash for an \$800 set to the many who will buy a \$200 set on time. The accelerated offensive to penetrate the second "layer" has in most cases meant dropping the quieter lines of approach such as, "Look, We Have Television," and "Immediate Delivery on TV Sets," to more aggressive techniques reminiscent of real pre-war selling days.

The editors of RADIO & TELEVISION have surveyed TV selling methods in 32 cities around the U. S. (see list elsewhere on this page) in order to outline to its readers the techniques that large percentages of active dealers are using in those areas to increase their TV volume.

While sales stories 8 months ago were mostly concentrated on picture quality (clear, bright, sharp, steady pictures), most current copy is directed at the pocket-book. New low prices are highlighted, along with easy terms and absence of extras in connection with antenna installation.

Dealers in practically every city surveyed were offering "Convenient Budget Terms," while in cities where the sales pace is more accelerated, specific terms were outlined:

- "Small down payment, up to 24 months to pay"
- "10% down, years to pay"
- "\$20 down, \$3.30 weekly"
- "Only \$6.50 monthly"
- "Pay only 47¢ a day"
- "Only a few nickels a day"

In six cities the greatest percentage



of dealers were offering time-pay plans with "No Money Down."

Meters and special "banks" were offered by numbers of dealers in the larger cities to point up the fact that it is easy to pay for television as you can "play as you pay." Most ads were careful not to mention specific mechanics of the meter plan, such as how long it takes to pay, whether there is an

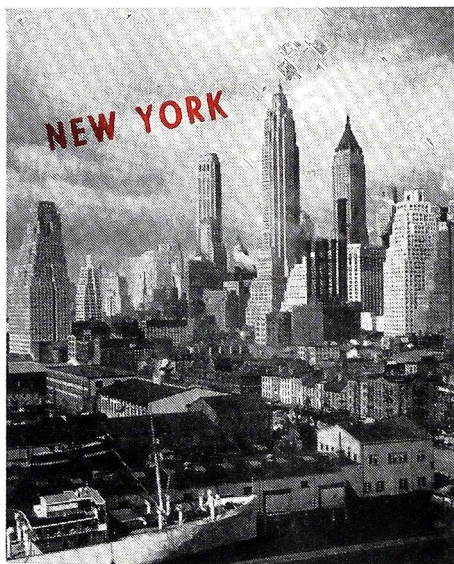

extra charge for the meter, etc. Specific checks by our editors revealed that in most cases customers signed a routine time-payment contract which called for a definite monthly payment to be met regardless of whether there was sufficient money deposited in the meter to cover it. Many salesmen were found selling customers away from the meter after they got into the store since a regular 10%-down-24-months-to-pay contract offered smaller interest charges.

Very few stores were found offering "Free Installation," although many were capitalizing on the new built-in antennas, as well as the more common indoor types:

- "Install It Yourself (with a special portable antenna)"
- "Just Plug It In—Free Indoor Antenna"
- "No Outside Aerial Needed in Most Locations"
- "Complete With Inside Antenna—Nothing Else to Buy"

A variation of some of the foregoing themes, which usually turned out to be an indoor antenna offer, stated: "\$10 additional includes Fed. tax, normal installation, and factory guarantee."

Free Home Trial and Free Home Demonstration is being offered by numerous dealers in cities large and small. Many are using spot radio time to suggest that customers call the store and a set will be delivered and installed in their homes within the day, for a free trial. In some cases phone calls are accepted at night as well as in the day, although a few spot checks showed that delivery was deferred until the next day on the excuse that every available man was tied up with installations that evening.

While apparently confined to cities where TV is more or less new, invitations to come and see special events on TV in the store at night are still being offered and in many cases enthusiastically patronized. Special local events such as football games, ceremonies, etc., are made capital, as well as national events such as the World Series.

"Tele-Theatres" in stores as a permanent feature where customers are always welcome to view TV under optimum conditions are also aggressively exploited to bring customers into the store, while in some places city-wide TV "conventions" produced cooperatively by dealer-associations, distributors and manufacturers have proved powerful sales stimulants.

Trade-in offers, though not widespread as yet, are gaining in numbers, some with more or less "quiet" invitations to "Trade in Your Old Radio" and some

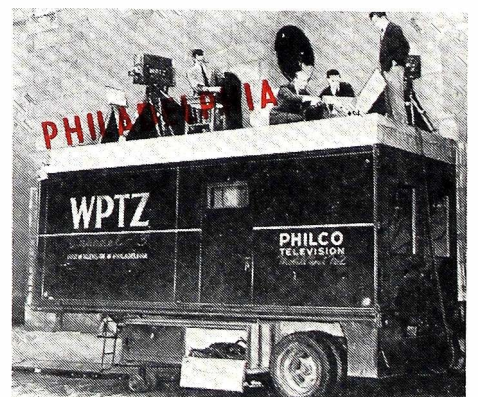

with a more blatant "Up to \$100 trade-in on your old radio." Better Business Bureaus have frowned on such offers, however, if it has been established that the customer could get the set as cheaply with or without a trade-in.

Stores in cities on the coaxial cable network, and cities where network programs are reproduced via "kinescope re-

SELL MORE TELEVISION

32 CITIES COVERED IN SURVEY

The following list of the cities covered for this article includes small and large towns in every geographical area now reached by TV. A total of 56 cities now have TV stations.

Albuquerque, N. M.
Atlanta, Ga.
Boston, Mass.
Buffalo, N. Y.
Charlotte, N. C.
Chicago, Ill.
Cincinnati, O.
Dallas, Tex.
Detroit, Mich.
Ft. Worth, Tex.
Grand Rapids, Mich.
Greensboro, N. C.
Jacksonville, Fla.
Kansas City, Mo.
Los Angeles, Calif.
Louisville, Ky.

Miami, Fla.
Milwaukee, Wis.
New Haven, Conn.
New Orleans, La.
New York, N. Y.
Oklahoma City, Okla.
Omaha, Neb.
Providence, R. I.
Richmond, Va.
Seattle, Wash.
St. Louis, Mo.
San Diego, Calif.
San Francisco, Calif.
Schenectady, N. Y.
Toledo, O.
Washington, D. C.

cordings" have given prominence in their ads and displays to the well-known national programs which can now be seen as well as heard, such as

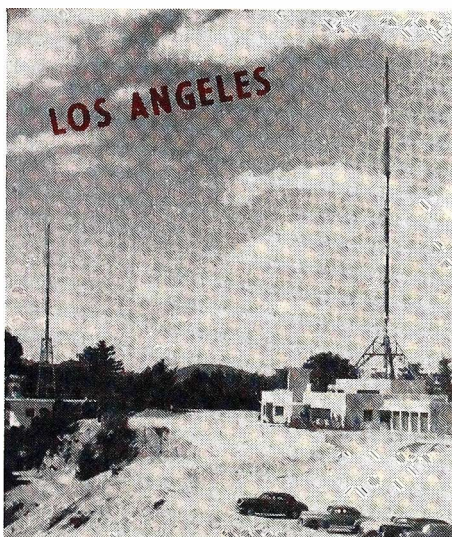

Arthur Godfrey's Talent Scouts, We the People, Stop the Music, Blind Date, Suspense, Who Said That, etc. Others, alert to special events, have suggested that the public buy TV sets in order to be "ready" when the local station is connected into the coaxial cable.

It is probably true that although considerable hard-hitting, customer-drawing ad copy has been used by TV dealers so far, "You ain't seen nothin' yet!"

Dealers who are planning to go "all out" in their effort to get a sizable share of the TV business in their cities are urged to season their efforts with a little common sense to avoid giving a black eye to their whole profession

by methods which the BBB's might consider "shady."

Examples of such shady techniques are seen in ads which announce "nationally famous" brands of sets at ridiculously low prices when no stretch of the imagination could include the brand offered in that category; ads in which "RCA Licensed" or "Dumont Tube" are featured with the set brand omitted in such a way that the customer is given the impression that the receiver in question is an RCA or a Du Mont set; and ads in which the description and price of one set are placed alongside a picture of a larger and more expensive model.

Going "all out" need not necessarily mean the use of misleading statements to lure suckers into the store. It can

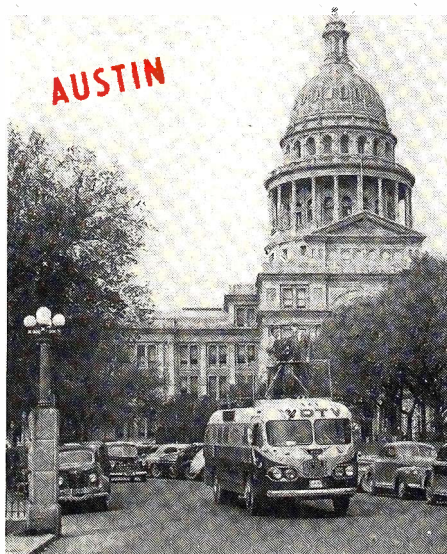

mean stepping up the present sales pace both as to the extent and the enthusiasm of the promotional and advertising program.

A study of newspaper advertising around the country is enlightening, not only because of what is seen, but also because of what is not seen. Taking the country as a whole (that is, that portion of it where TV is broadcast), it is surprising how little space is used by how few retailers—surprising in view of the large numbers of manufacturers who are offering co-op ad funds and free mat services to their distributors and dealers.

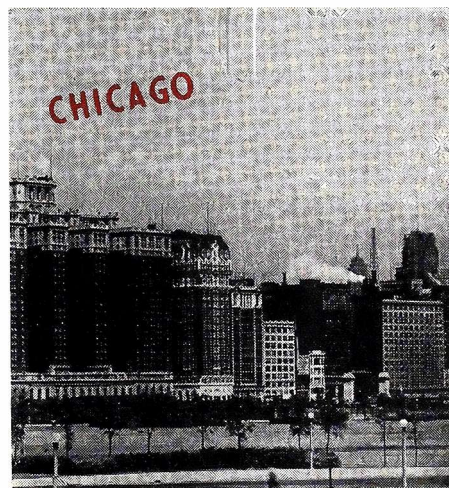

The fact that consistent local advertising pays off in TV sales is partly proven by the fact that the cities where newspapers carry the most retail TV advertising also show the largest percentage gains in "sets in use" each month.

We have found that in some cities which have had TV for a year or more, retailers gave up promoting TV as soon as customers stopped flocking in of their own accord, out of curiosity. This was probably due to the fact that television was announced as the eighth wonder of the world. When dealers found that it was not such a wonder that the merchandise walked off the floor, they wrote it off as a flash in the pan. We know now that, wonderful as it is, television is merchandise like anything else in the store, and has to be promoted to be sold. The editors of RADIO & TELEVISION RETAILING do not recommend the methods reported on this page as the best way to sell more TV—as a matter of fact, we would recommend selling a little more on product and a little less on price—but we do predict that in television as with other products, the stores which squeak the loudest will get the most sales.

Six Steps that Got 20,000

• The salesman knocked boldly upon the front door. "Good morning, Mrs. Jones," he said when the housewife had opened it. "I am from the Radio Center. I would like to tell you how you can get a new television set to replace that old radio which has been giving you so much trouble lately—and not even know you're paying for it."

"Our salesmen make thousands of calls like that," says George Marcuse, co-owner of the big, modern Radio Center, located on South Claiborne Avenue in New Orleans, La. "We do not cold canvass. We follow good, strong leads only. And we get the leads from all kinds of sources. We have a force of 'bird-dogs' in every walk of life who turn in the names of prospects to us."

Thanks to his practice of "bird-dogging" sales, drumming home his selling messages day after day in the newspapers and hour after hour over the air, and doing little but important things that help to open prospects' doors and minds to his salesmen, George Marcuse has seen the Radio Center grow in the three years since it was first opened to the point where, today, it boasts 20,000 charge accounts.

"To show what a whopping number of accounts that is," Mr. Marcuse says, "let me cite the fact that the biggest department stores do not top our account list by too much. New Orleans has 600,000 people—about 125,000 families. One family out of six as an account is pretty good going!"

How did the Radio Center build such a large account list in three short years? "We broke down the sales promotion plans into six steps," Mr. Marcuse says. "The six certainly paid off. They are the selling steps that the store still uses and—as far as my partner, Loris Levy and I can see at present, will continue to use."

Get the Prospects

Advertise Wisely

Follow All Leads

Smart Store Layout

Render GOOD Service

Train Salespeople

The first two steps of the Marcuse-Levy six step system involve means for getting good prospects into touch with good salesmen. Neither of the partners believe in using the time for which the store is paying its salesmen in "cold" calls upon people, many of whom are not prospects at all. The first step, then, deals with actual prospects.

"Bird-dogs," Mr. Marcuse explains briefly, "are to appliance selling what real bird-canines are to hunting. They sniff out the prospects, then point them for our salesmen."

"A bird-dog is a guy in any walk of life who comes into contact with the consumer in his home.

"He might be a milk man. Many of the bird-dogs are. He might be a brush salesman, delivery boy, meter reader—anybody. He earns his money by looking for radio and appliance needs. For example, he might note—as in the case cited above—that the prospect's radio was giving her trouble. He might note an old-fashioned ice box, or a clothes rubbing board instead of a washing machine.

"His procedure when he notes these things is to suggest to the prospect that she can have a lot more fun out of life by purchasing a new appliance from the Radio Center. At the same time, our bird-dog hands the customer a printed card, with the suggestion that it be presented at the Radio Center for special attention. The card identifies the customer, when he shows it, as a sound prospect worth working on strongly, and it tells us who the bird-dog was.

"Then, the bird-dog turns in the name of this consumer to us. A salesman follows through with a house call—unless the customer beats him to it by coming down to the store.

"The bird-dogs are paid commissions on their sales, just as are the regular salesmen. So it is to their interest to sniff out as many hot prospects as possible. The commissions are paid only if a sale is closed, of course. The bird-dogs have quotas to meet, just as do the regular salesmen."

Strong Ad Copy

"We have at least one ad—and usually two small insertions—in one or all three of the daily newspapers of New Orleans," says Mr. Marcuse. "Every day, the newspaper reader gets hit a minimum of once with a Radio Center advertisement. In addition, we buy forty-four radio spots a week. In these, we drum away at the products—that will bring people into our store. Mr. Levy and I believe in plenty of hard-selling advertising. But not in waste. So when one advertising line, or an advertised appliance, doesn't seem to be pulling its weight in sales and traffic, we switch without delay to another selling line and to another appliance for our advertised offer.

"Last, we send out a fair amount of direct mail. This goes to the account list—the store's best customers, the persons who buy more here than new, colder customers."

After the advertising and the hot tips of the store's bird-dogs have developed prospects for selling, the Marcuse-Levy system has three more steps for

65,000 phono records are stocked to provide wide selection in the disc department.



Accounts

getting the order, and a last step for insuring the good salesmanship that is necessary in order for the other steps to click.

Once the names of good prospects have been secured—through ad answers or bird-dog tips—then begins the next step in the 20,000 account selling process.

"We wouldn't have latched onto twenty thousand accounts, or even onto two thousand, by waiting in the store for the customers to buy from us," Mr. Marcuse points out. "In this competitive field, it's necessary to go out and sell. Our salesmen alternate their days. One day is spent on the selling floor, the next out knocking on doors.

"What makes it a profitable procedure for us is the fact that the salesmen knock on open doors—not the closed doors of cold-call prospects."

Importance of Layout

The leader departments of the Radio Center are located toward the rear. "As a result," Mr. Marcuse explains, "the customers have to walk past our expensive radio displays and our major appliance displays in order to reach the record department, the inexpensive radio section, and the repair department. We have these major appliance displays arranged so that the customer can't simply walk through them. He is forced to see and notice the displays."

The record department is a real leader section. "We stock 65,000 records," Mr. Marcuse says.

There is a special "Magnavox Room" for the display of fine radios and ex-

A special Magnavox room that's really "plush" is maintained at Radio Center. Comfortable seating facilities have been provided for customers.



The Radio Center in New Orleans stands out after dark. The store was sales-engineered for efficiency.

pensive TV sets. It is air-conditioned, and truly "plush." There is a comfortable, deep sofa, and extra-comfortable chairs. "Fine radios and video sets are sold by sound and sight," Mr. Marcuse explains. "The customer can absorb the fine sound, and appreciate the rich appearance, of an expensive set if you put it in an expensive atmosphere, and allow him to relax so that the silky tones of the set can be fully enjoyed."

Inexpensive radios and portable radios are displayed in a special "Browsing Section." The selling is partially self-service here. "The reason," explains George Marcuse, "is that we want the customers to listen to several models, walk around them, compare the looks, and otherwise sell themselves. They do, too, in the 'Browsing Section.'"

Service Facilities

Service is a much-overworked word. But at the Radio Center in New Orleans, it has a real meaning. When John Customer rolls up to the door of this store in a taxicab, the store will foot the taxi tab. "It's not a big outlay of money," says Mr. Marcuse, "but it makes the customers like us. More important—it gets them into the store, where we can sell them. It brings them to our store instead of to some other appliance and radio outlet."

The Radio Center's sales force has been trained to give instant attention to every customer who enters the store (except in the portable radio department where the customers are expected to browse). "I know how annoying it is to me when I go into another store and have to stand around before I can be waited on," says the boss of the Radio Center, "and I do not want people to experience the annoyance

here that I have encountered in some other retail outlets."

The repair department, too, gives fast service. "Too many radio repair men," says Mr. Marcuse, "will promise the customer's radio any day he wants it back—and then throw it on a shelf and forget it. But here, when we say the set will go out Tuesday, it goes out Tuesday definitely.

"Furthermore, our prices on repairs are extremely low. We look upon repair business as a good developer of new sales leads. The repair department shows a profit to be sure, but not such a whopping profit as to discourage new prospects from bringing in their damaged radios.

"I am proud of the fact that we have one of the best radio and appliance sales forces—I think it is the best—in New Orleans," says George Marcuse. "In the end, it is the salesman who accounts for the sale, after advertising and special gimmicks have unearthed the prospects.

Sales Training

"Training is no one-time proposition here. It is a continuing business. We have regular training sessions. Some of them are lectures, some discussion sessions, some showings of movies, slides and other visual training gimmicks that the manufacturers and wholesalers make available to us.

"Our sales force is not only good (and kept so), but it is sold on the Radio Center as a good firm to work for. Altogether, there are 35 store employes, not counting the eighty-odd bird-dogs. For all of them, we hold picnics, dances, get-togethers. We ask for and welcome selling suggestions from everybody in the organization."

FM Sales Promotion Pays



Davee in front of his store. Under canopy, not shown, is one of his six FM speakers which attract a host of West Point listeners. Photo by World-Herald News Service.

Nebraska Dealer, Warren Davee, Pipes Programs to "Network" of Six Speakers in Various Parts of City.

John and Joe Rezac, West Point twins and ham operators.

Now Mr. Davee is best known for his work in the field of FM. He has a bang-up receiving set which benefits nearly everybody in West Point.

Mr. Davee's set is located in his radio service and repair center. The programs, however, are not confined to his shop. They are piped to a network of six speakers.

One of the speakers is in his shop, another under the canopy of the drive-in outside.

Three doors north of his shop he installed a speaker in the rear of August Schmidt's tire shop. Six doors north he placed two speakers in Warren Wendt's billiard hall.

About a block away he rewired an old console in the Hotel West Point for FM reception.

When reception is bad on regular AM broadcasts during big sports events Mr. Davee's loud speakers draw fans like flies.

"The night of the Louis-Wolcott fight," Mr. Davee recalled, "about 150 persons gathered under the canopy in front of my shop. Huge electric flashes came with each clap of thunder. Folks in autos tried their car radios and got nothing but bam! bam!"

Mr. Davee became interested in FM many years ago

When he learned The World-Herald was putting in an FM station he put up a 42-foot dipole reflector. Engineers were doubtful that he could receive that far off. On July 1, 1946, he heard the first program broadcast over KOAD, 55 airline miles away.

As other stations came on the air he picked them up—KSCJ-FM, Sioux City; KFMX, Council Bluffs; KFOR-FM, Lincoln; KFAB-FM, Lincoln. He used sensitive antennae, rebalanced his receivers and found he could pick up FM signals that were considered impossible to receive beyond the horizon.

"I experimented with all types of antennae and location," Mr. Davee recalled. "I found I was getting stations as far away as Birmingham, Ala.; Columbus, Ga.; Greenville, S. C., and St. Louis." He has peaked up an eight-tube set to a very high sensitivity which feeds into four-tube public address amplifiers and into the six speakers.

"It's not how much you pay for an FM receiver, it's how you make it work," he maintains. "It must be properly installed, with a good antenna and high quality speaker."

Group in Hotel West Point lobby listening to Davee's piped-in FM programs. Photo by World-Herald News Service. Davee has become known over a wide area as an outstanding FM-TV expert through his technical know-how and smart publicity stunts. Newspaper write-ups feature pioneer dealer.

• Dealer Warren Davee, veteran radio-man of West Point, Nebraska, who has been reading this magazine since 1926, has certainly put FM on the map in his community. His efforts in promoting static-free radio have not gone unrecognized. He has gained fame over a wide area as an expert in FM and in television, and his novel "network" system has proved to be a first-rate idea, headlined by the Omaha World-Herald as a "Boon to West Point." Occupying space three columns wide, the write-up was illustrated with photographs. Excerpts from the article follow:

Citizens of West Point are more than a little proud of—and thankful for—their pioneer radio man, Warren R. Davee.

Mr. Davee's fame as a radio fan dates back 22 years, when he received recognition for his rudely fashioned experimental set in television. Helping him were



ANOTHER SENSATIONAL MECK TELEVISION VALUE

Big 10 inch tube
only \$**139**⁹⁰ RETAIL
65 sq. in. DAYLIGHT PICTURE



Hand-Rubbed Mahogany Cabinet

Rock-bottom price for top quality television with big margin that will build your profits. Has every feature your customers want at the price they want to pay. Model XN-752, \$139.90



Low Prices — Big Margins. Get on the Meck Profit Line

JOHN MECK INDUSTRIES, INC.
Plymouth, Indiana



16" Tube, 145 Square Inch Screen, Mahogany Console, only \$**29900**

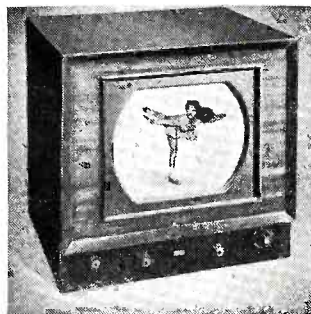

16" Tube, Tabletop, 145 Square Inch Screen, Mahogany Cabinet only \$**27900**

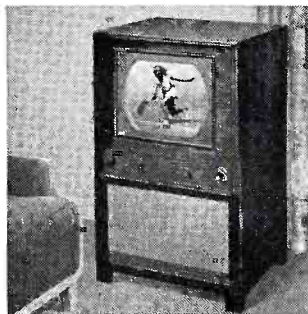

12½" Tube, 96 Square Inch Screen, Mahogany Console, only \$**24900**

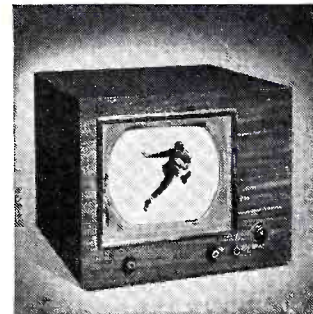

12½" Tube, Tabletop, 96 Square Inch Screen, Mahogany Cabinet only \$**21900**

Newest AM, FM, TV Receivers

Dumont 19-INCH MODELS

Three new 19-inch models have been added (in addition to the previously announced Bradford). The Mansfield is a straight TV console with doors, and will sell for \$645. It contains 35 tubes. The Westwood, with 30 tubes, will retail for

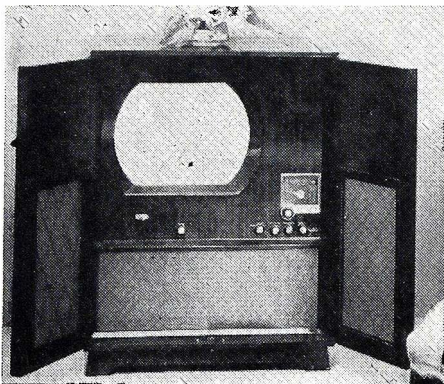

\$545, and the Fairfield, with 30 tubes and record-player attachment, will retail for \$495. All three sets feature expanded direct-view picture of 203 square inches. Allen B. Dumont Laboratories, Inc., East Paterson, N. J.—RADIO & TELEVISION RETAILING.

Stewart-Warner TV LINE

Three table model TV sets and three TV consoles comprise the newest additions to the firm's television line. Model 9103B, 12½-in. table set, is priced at \$239.95, 9104-A, 12½-in. table set with AM-FM radio and phono jack, is \$279.95, and the third table model, 9100-J, 10-in. set, is

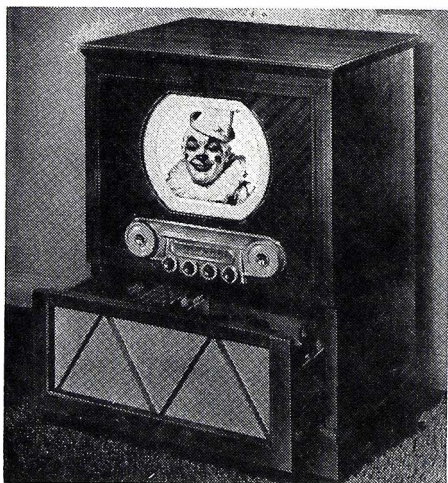

\$209.95. Model 9103-C, 12½-in. console, is \$289; 9104-B, 12½-in. console with AM-FM radio and 3-speed record changer, retails for \$349, while the third console, model 9105-A, has a "Protelgram" projection picture on a 13x18-inch screen, AM-FM radio and 3-speed changer. Lists for \$795. Model 9104-B is shown. Stewart-Warner Corp., 1826 Diversey Pkwy., Chicago 14, Ill.—RADIO & TELEVISION RETAILING.

Zenith TV RECEIVERS

Twelve new TV sets have been added to the line, featuring the built-in "Picture-magnet" aerial, "Glare Ban" picture tubes, and a duo picture control which allows choice of "Giant Circle" or rectangular-shaped picture. Prices range from \$249.95, for the "B" screen Claridge TV-FM table model in pyroxylin cabinet to \$625. for the "C" screen Sheraton console with AM-FM radio and 3-speed record changer. The twelve models include the "B" screen table model mentioned above, three "B" screen consoles, four "C" screen consoles, and four "C" screen radio-phono-tele consoles, including the Sheraton. Zenith Radio Corp., 6001 W. Dickens Ave., Chicago 39, Ill.—RADIO & TELEVISION RETAILING

Starrett TV SET

The "Henry Parks" model is a 16-inch console for television only, with 22 tube chassis including 2 rectifiers and picture tube. The mahogany cabinet is equipped with a built-in antenna. A feature of the

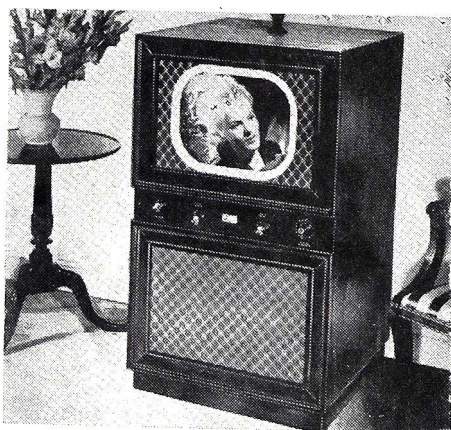

set is "film-freed" picture tube, a process said to eliminate the formation of a dulling film over the screen. Retail price is \$399.95. Starrett Television Corp., 601 W. 26th St., New York 1, N. Y.—RADIO & TELEVISION RETAILING.

RCA TABLE RADIO

Model 9-X-641 is designed for greater selectivity and sensitivity, and utilizes 5 tubes plus rectifier, a 3-gang condenser

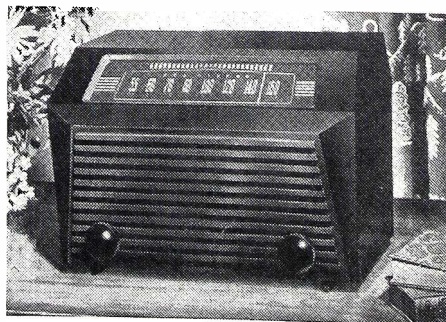

with tuned RF stage, and jack for record player attachment. Suggested list price is \$29.95. RCA Victor Div. of RCA, Camden, N. J.—RADIO & TELEVISION RETAILING.

Crosley TABLE RADIO

Model 10-127 is a new FM-AM table model with 7 tubes plus rectifier. The set features improved distance reception, high quality sound, and built-in antennas for

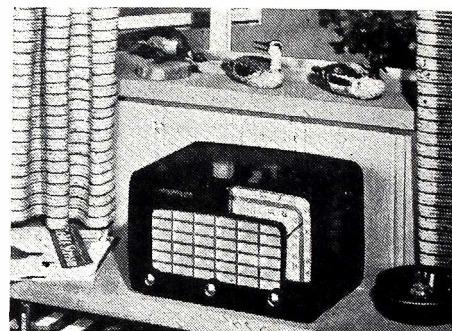

both AM and FM. Also announced is an all-white plastic AM table set especially designed for use in the kitchen. Crosley Div., Avco Mfg. Corp., Cincinnati, Ohio.—RADIO & TELEVISION RETAILING.

DeWald RADIO-PHONO

Model B-614 is a table model radio-phonograph combination for dual speed (33 1/3 and 78) operation. Two tone arms are provided. Radio has 5 tubes plus rectifier. List price is \$59.95. DeWald Radio Manufacturing Corp., 35-15 37th Ave., Long Island City 1, N. Y.—RADIO & TELEVISION RETAILING.

National TV RECEIVERS

Two new models are being produced, the TV-1225, 12½-inch console, and the TV-12W, 12½-inch table set. The TV-1225, with 10-inch loudspeaker, retails for \$299.95, and the TV-12W, with two 6-inch

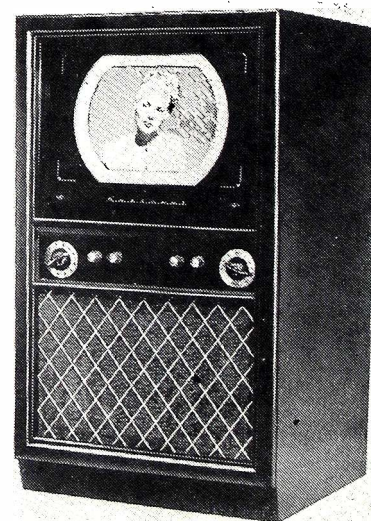

speakers, lists at \$269.95. The firm has also announced a new price on 10-inch table model TV-10W of \$229.95, 7-inch table model TV-7W has been reduced to \$129.95, while 7-inch metal table model is now \$119.95. TV-1225 is pictured. The National Co., Malden, Mass.—RADIO & TELEVISION RETAILING.

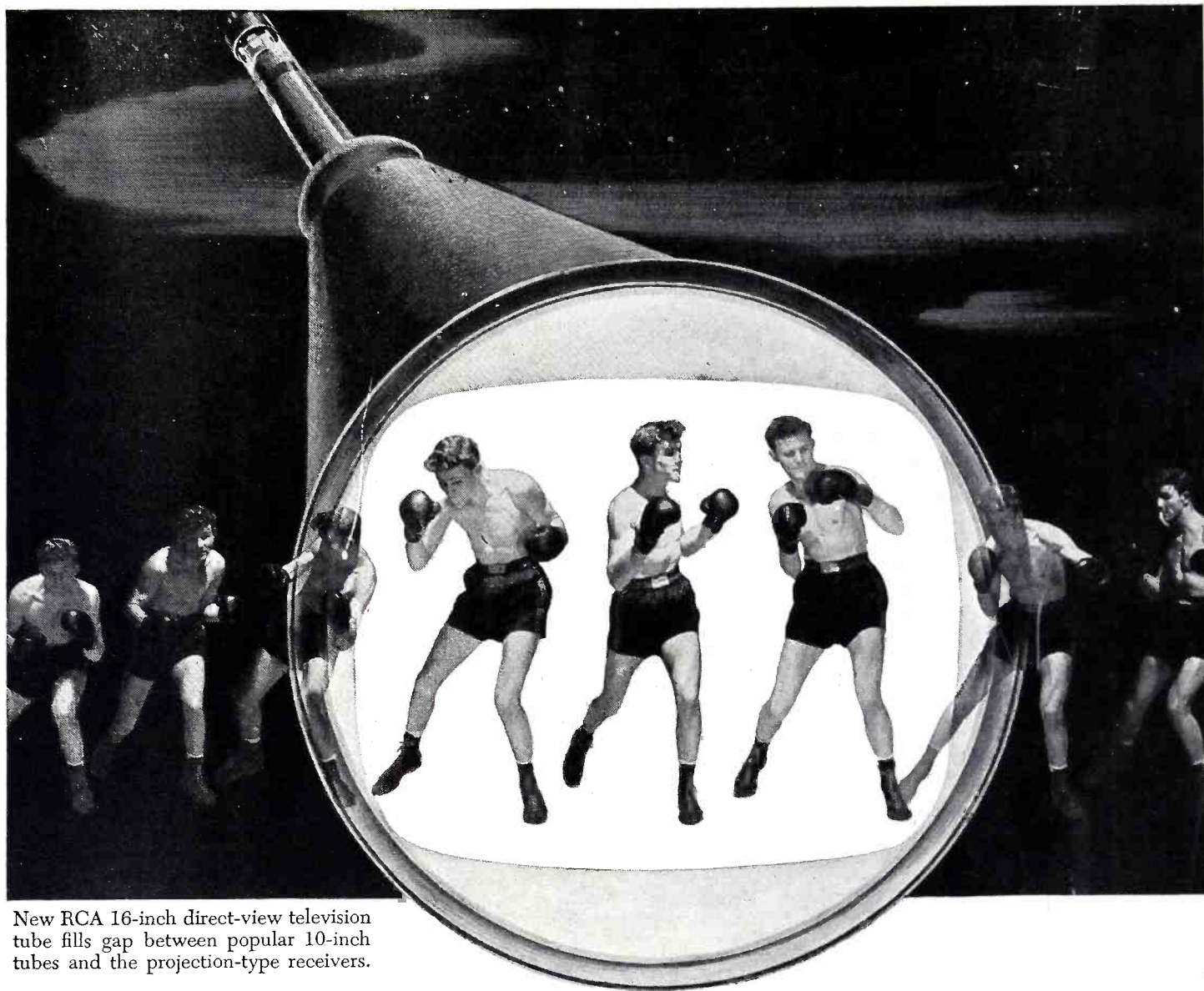

New RCA 16-inch direct-view television tube fills gap between popular 10-inch tubes and the projection-type receivers.

"Inside story" of a bigger, brighter
picture on your television screen

The screen on which you are accustomed to seeing television is the face of an electron tube—on which electrons “paint” pictures in motion.

And the size of the picture, unless projected, is determined by the size of the tube.

Working to give you *bigger, brighter* pictures, RCA engineers and scientists developed a new way to make large, direct-view television tubes. They found a

method of “welding” large areas of glass and metal... while keeping a vacuum-tight seal!

Using this development—ideally suited to mass production—RCA can now build television tubes of light, tough metal... using polished glass for the face, or “screen.”

An achievement of research

Development of this new television tube is a continuation of basic television research which

began at RCA Laboratories. Such leadership in science and engineering adds *value beyond price* to any product or service of RCA and RCA Victor.

• • •

Examples of the newest advances in radio, television, and electronics—in action—may be seen at RCA Exhibition Hall, 36 West 49th Street, New York. Admission is free. Radio Corporation of America, Radio City, New York 20.



RADIO CORPORATION of AMERICA
World Leader in Radio — First in Television

Latest Sales-Builders

Motorola AM-FM CONSOLE

Model 79K21 is a console radio incorporating FM and AM in a hand-rubbed mahogany cabinet, equipped with 6 tubes plus rectifier and a 10-inch speaker. Built-

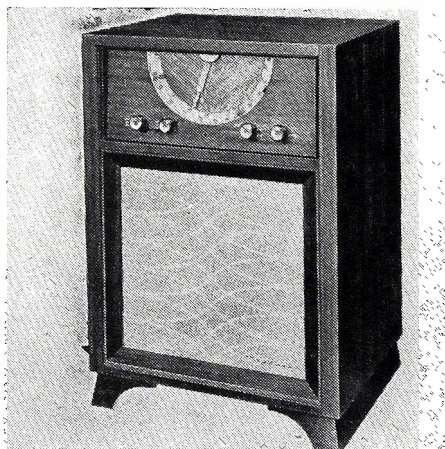

in antennas are provided, and a jack for attaching an external record player. The new model is priced at \$99.95. Motorola, Inc., 4545 Augusta Blvd., Chicago 51, Ill.—RADIO & TELEVISION RETAILING.

Magna AMPLIFIER-PHONO

Model E includes a 14-watt amplifier, 10-inch loudspeaker, and turntable suitable for 10" or 12" records. It has been de-



signed for blending one or two guitars and simultaneously playing a phonograph record. List price is \$89.50. Magna Electronics Co., 3709 W. Jefferson Blvd., Los Angeles 16, Calif.—RADIO & TELEVISION RETAILING.

Sonora TV RECEIVERS

Model 292, 10-inch table model, uses 24 tubes plus 2 rectifiers and picture tube. Model 295 is a 12½-inch table set, and model 297 is a 12½-inch console. All three have automatic gain control, 12-channel tuner, mahogany veneer cabinets. Sonora Radio & Television Corp., 325 N. Hoyne Ave., Chicago 12, Ill.—RADIO & TELEVISION RETAILING.

Admiral TV MODELS

Admiral's first 10" table set, model 20X11, comes in a compact plastic cabinet and will retail at \$169.95. Model 20X122, an adaptation of the "Wonder Set," 10"

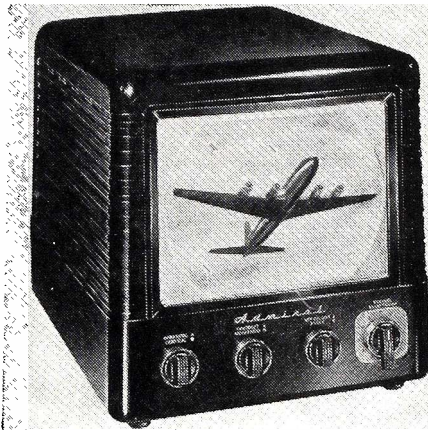

plastic cabinet console, will retail at \$199.95. Both models feature Admiral's new built-in "Roto-Scope" directional antenna. Admiral Corp., 3800 Cortland St., Chicago 47, Ill.—RADIO & TELEVISION RETAILING.

Arvin TV LINE

The new line includes model 3100, 10-inch table model priced at \$219.50, model 3101, 10-inch console at \$249.50, model 3120, 12½-inch console at \$299.50, model 3160, 16-inch console at \$399.50, and a 12½-inch table set retailing at \$249.50. Ten and 12½-inch models have 22 tubes including picture tube, plus 2 rectifiers, 16-inch model has 22 tubes including picture tube plus 4 rectifiers, and all models have automatic gain control. Noblitt-Sparks Industries, Inc., Columbus, Indiana.—RADIO & TELEVISION RETAILING.

Symphonic RECORD PLAYERS

Sixteen models are included in the 1950 line of record players. Varsity Trio Model 39-3, shown, plays all three speeds with a single turnover tone-arm. This model is cased in blue alligator leatherette with

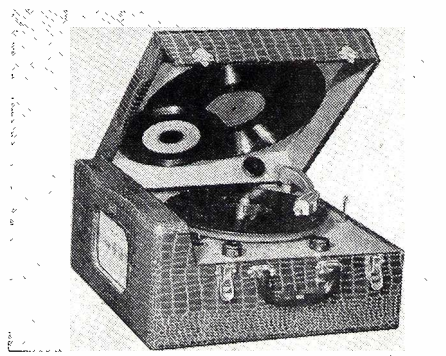

brass fittings, and incorporates 3-tube amplifier and 5½-inch speaker. Other models include attachments, single-speed players, and table radio-phono combinations. Symphonic Radio and Electronic Corp., 292 Main St., Cambridge, Mass.—RADIO & TELEVISION RETAILING.

Westinghouse TV LINE

The "electronic magnifier" to provide enlarged pictures of the central action on the TV screen, and built-in antennas are featured in the five new models. Prices range from a 10-inch table model (H604T10) at \$199.95 to a console with 12½-inch tube, AM-FM radio and 3-speed record changer (H603C12) at \$450. Other models include the H601K12, 12½-inch console at \$325., H600T16 16-inch table model at \$375., and H605T12, 12½-inch table set at \$269.95. Westinghouse Electric Corp., 306 Fourth Ave., Pittsburgh 30, Penna.—RADIO & TELEVISION RETAILING

Packard-Bell TV LINE

The line includes 10, 12½ and 16-inch receivers in table model, console and console combination types. Model 2297-TV De Luxe, shown, is a 12½-inch TV only console with doors, in blonde. Chassis incor-

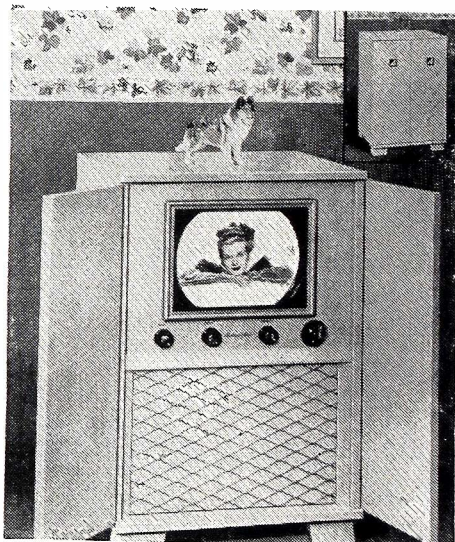

porates 22 tubes including 2 rectifiers and picture tube, automatic gain control and 10-inch speaker. The "Telecaster" cabinet may be rolled to the most convenient position for viewing. Packard-Bell Co., 3443 Wilshire Blvd., Los Angeles 5, Calif.—RADIO & TELEVISION RETAILING.

Vu-All TV FILTER

The Vu-All filter, said to eliminate glare from TV pictures, is provided with a flexible, adhesive border which will easily stay in place when pressed against the screen of the set. The plastic screen is a neutral gray color. J. M. Gordon Laboratories, 437 Tenth Ave., New York 1, N. Y.—RADIO & TELEVISION RETAILING.

Audio-Master 3-SPEED PHONO

This small, lightweight playback machine has a 3-speed motor, a reversible twist crystal cartridge which contains 2 needles for standard and long-playing discs, and an 8-inch loudspeaker. Price is \$64.50. Audio-Master Co., 1650 Broadway, N. Y.—RADIO & TELEVISION RETAILING.

NOW a COMPLETE moderate price line!

Jewel RADIOS

MODEL 935

JEWEL "WAKEMASTER" WITH LULLABY SWITCH
Clock radios from \$19.95 to \$31.95



★ With one setting, Model 935 lulls you to sleep to music, then shuts itself off. Next morning, wakes you to music... automatically! If you doze, Wakemaster buzzes. Use as clock, radio or electronic reminder — separately or together. Superhet radio with 5 tubes including rectifier, TELECHRON sweep-second alarm movement, self-enclosed DURALOOP antenna.

MODEL 956

JEWEL TABLE RADIO
\$14.95 to \$19.95



Tomorrow's styling today — in the bold dial, controlled by new Jewel vernier drive. Superhet circuit, 5 tubes including rectifier. Self-contained loop antenna. A sure traffic-builder!

MODEL 955

JEWEL "NUGGET"
\$9.95 to \$12.95

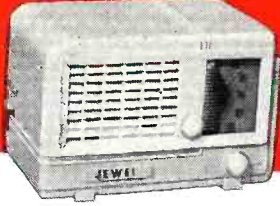

Beautiful performance... beautiful styling. Superhet circuit, 1650-540 kilocycle tuning range, Alnico 5 speaker. New Jewel vernier drive with sweep dial. Only 5 1/8" high, 7 7/8" wide, 4 7/8" deep! Unusual Value!

MODEL 960

JEWEL TABLE RADIO
\$19.95 to \$24.95

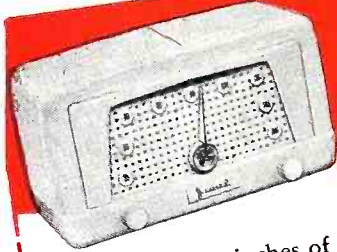

Over 30 square inches of dial face! Note plaque-type numerals, ornamental indicator. Superhet, 2 "K-Tran" I.F. transformers, 5 tubes including rectifier. Enclosed DURALOOP antenna.

**DISTRIBUTORS!
FACTORY REPS!**

Territories still available. Write today!

MODEL 814

JEWEL "TEE-NEE"
\$17.95 less batteries
Ivory, Maroon or Beige



★ Tiny battery-operated portable... small as your hand! 4 tube superhet; self-contained loop antenna; large Alnico 5 speaker; "sound-focus" feature. All-plastic cabinet with plastic shoulder strap.

MODEL 949

JEWEL "GOLDEN"
\$19.95 less batteries
"Crocodile" or 2-tone covering

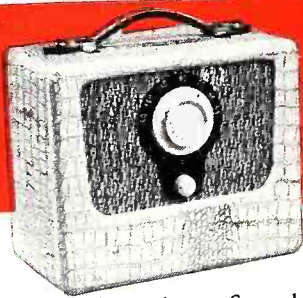

★ New AC-DC-battery portable with room-size volume. Superhet, 4 tubes plus selenium rectifier, large Alnico 5 speaker, self-contained loop antenna. Model 970—Same, but battery operation only. Less batteries, \$16.95

All Jewel plastic cabinets are moulded in pure plastic colors — not painted or sprayed. Talk this strong competitive feature!

MODEL 901

JEWEL "TRIXIE"
\$34.95 less batteries
Green, Red, Brown python saddle-stitched leatherette.



★ AC-DC-battery portable with exclusive "sound-focus" feature. Superhet; 4 tubes plus selenium rectifier, self-contained loop antenna. Plays with lid open or closed. Slightly higher in genuine leather.

All prices slightly higher West of Rockies. Prices subject to change without notice.

Jewel RADIO CORPORATION

10-40 45th Avenue, Long Island City 1, N. Y. Cable Address: JEWELRAD, New York

How To Charge for Profitable TV Servicing

Efficient Methods Needed to Keep Prices Down, Profits Up.



*The 4th Installment of a Series
By E. A. Campbell, Technical Editor*

● Television service is the same as radio service except that, just as the Mississippi river compares with the Hudson, there's more of it. More money will have been spent this year on the installation and repair of TV sets than has ever been spent in one year on radio service, and this sum is expected to double in 1950 and double again in 1951. The only concern the dealer need have is that he gets his share of the business, and that he doesn't lose money on the business he gets.

TV service has been somewhat complicated up to now by the precedent set by receiver manufacturers in offering a one-year installation and guarantee contract for a fixed fee. Most service organizations which have attempted to work within this fee, either as agents for manufacturers or as competitors, have found it meant operating precariously close to the break-even point. In some cases, it meant operating in the red, and for a few, eventual bankruptcy.

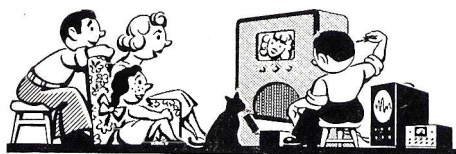

Several signs point to an end to this type of operation in the near future. First of all, some manufacturers feel that TV is well enough established in public acceptance that it no longer needs what amounts to "gilt-edged security" to encourage public confidence. Such long-term guarantees as have been offered TV buyers were practically unknown to the radio industry, and many producers have reverted to the more familiar 90-day warranty. In the second place, price trends in general

are down, and the only way to reduce the price of an already too cheap service contract is to reduce the duration of it.

Finally, the fact that many such contracts are virtually insurance policies, and as such may be considered illegal in some states, is forcing a reevaluation of these "policies," particularly with respect to renewals.

But to return to the similarities and differences between radio and TV servicing, TV sets have more parts and tubes, they run hotter, and viewers are more critical of their operation and more insistent about their prompt and efficient repair. Consequently the serviceman can expect TV sets to require much more service than radios, and the individual jobs will usually take longer. On a time and materials basis, the process of pricing a job would be the same as outlined in the 1st installment of this series, which described a formula for pricing radio service work, except that actual bill would probably be higher for a TV job.

Practically all TV repair jobs will involve a trip to the customer's home, whereas probably more than 75% of the radio jobs are brought into the shop. Therefore, the first thing the dealer must establish is a policy with regard to charging for outside-shop calls. If a time and/or mileage basis is used, the customer may take exception to the charge—either on the premise that "it didn't take that long to get here," or that "the last call the man made was only two doors away." Complaints of this sort may be obviated by fixing a flat fee which averages out most calls.

Let us suppose that the greatest distance the store will send its truck is 20 miles. This might take 40 minutes, and if charged at the rate of \$3.00 an hour plus 6¢ a mile would come to \$3.20 times two (for the return trip) or \$6.40. Since this is the most it might cost the dealer, he can presume that the average would be considerably less than that. This would depend somewhat on how the particular merchant finds his customers spread out, but in this instance, supposing uniform distribution, a flat fee of about \$3.00 per outside call would probably strike a good average.

The next thing to consider is whether the set will be fixed in the house or

brought to the shop. It will be to the merchant's advantage to fix as many sets on the spot as possible. This is due to the fact that in most cases, the time consumed in going to the customer's house, removing the chassis, returning to the shop, and then delivering the set after fixing will be longer than the time consumed in repairing the set. It stands to reason that when the serviceman has gone to the trouble of traveling to the customer's home and removing the

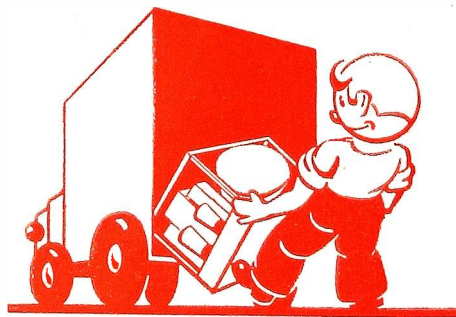

chassis, he might as well take a look at it.

If he comes equipped with a high sensitivity multimeter or VTVM, plus a kit of tubes, schematics and small replacement parts, he can fix the average set in less than an hour and save the expense of a return trip. Most servicemen, however, return the set to the shop if a major component replacement (such as a transformer) or an alignment is needed. This is partly because it would tie up one man too long on a job, and because it makes a bad impression on the customer if it takes too long to repair the set (in the presence of the customer, that is).

The actual repair work, whether performed in the home or on the bench, can be done on a flat fee basis or on our time-and-materials-plus-overhead (expenses and profit) formula. Both methods find favor in some quarters.

Under the flat fee basis, every repair job has a flat price, based on an average amount of time spent on this type of job. A list of such repair charges (labor only) would be similar to the list of radio service charges reproduced in the July (1949) installment of this series, and might include such things as: replace power filter condenser, \$4.00; replace power transformer, \$8.00; alignment of complete chassis, \$5.00, etc.

(Continued on page 54)

DU MONT LEADS THE INDUSTRY WITH

big screen

TELEVISION



Today, with the whole trend to bigger and bigger screen sizes, DuMont is out in front with the Life-size screen—an honest 203 square inches on the new short-neck 19-inch tube.

This is not only the largest tube in quantity production, it offers many other advantages. Its short neck gives a shorter beam throw and a sharper focus; it fits in a smaller, better proportioned cabinet.

From the very start, DuMont has been the industry's leading advocate of big-screen, direct-view television. DuMont has been making 20-inch tubes since 1939. Now everybody is climbing aboard the big-screen band-wagon—but don't forget, it's still DuMont in the driver's seat.

DUMONT *First with the finest in Television*

Copyright 1949, Allen B. DuMont Laboratories, Inc.

Allen B. DuMont Laboratories, Inc. • General Television Sales Offices and the DuMont Television Network, 515 Madison Ave., New York 22 • Home Offices and Plants, Passaic, N. J.

Profitable TV Servicing

(Continued from page 52)

Under the other method, we have suggested adding together the net cost of the part replaced and the actual cost of the labor time involved, and adding to this sum a percentage which would cover expenses and yield the desired profit.

The actual markup percentage is determined by dividing the desired percentage gross margin (expenses plus profit) by the cost percentage. For instance, if the desired margin is 35%, the cost will be 100% — 35% or 65%. The markup will be 35/65 or 54% (in round figures). In other words, if we add 54% to the cost (labor plus parts) to get the retail price, the gross margin will then be the desired 35% of the retail price.

Once the dealer arrives at his desired markup percentage, he can readily add it on to the cost of any job to obtain the customer's charge, and feel sure that this charge covers all expenses and returns him the desired profit.

A typical job report might then read as follows:

Customer's complaint: no picture, no brilliance.
 Removed chassis from cabinet, tested, and found no high voltage due to faulty tube type 6BG6G. Replaced tube, checked operation of set, replaced chassis in cabinet.
 Labor: .5 hour @ \$2.50 .. \$1.25
 6BG6G .. 2.68

Cost .. 3.93
 Markup (54%) .. 2.12
 Transportation (flat charge) .. 3.00

Customer's charge .. \$9.05

For the customer's bill, the markup would not be shown separately, so that it might read as in the panel at the right.

When such a call came in on the phone, the person receiving it would have to analyze the complaint carefully to make sure it was not antenna orientation which was needed, since that might require 2 men. He would also explain to the customer that there is a flat transportation charge of \$3.00 (if such is the case) and a minimum charge of (for instance) \$1.00 in addition to transportation. The latter would cover cases where nothing is actually wrong except that the customer is not operating the set correctly, or where the customer is experiencing interference from something like diathermy which is not within the set, or where he declines to have a repair performed after finding out how much it is likely to cost.

In the event that the dealer gives a guarantee on the work done, it would be mandatory that the servicer check to find the cause of the trouble. If, for instance, the tube mentioned above "burned out" because insufficient bias

was permitting it to draw too much current, a replacement tube would soon go the same way, and the dealer would be obligated to replace it free of charge, wiping out his entire profit on the first call.

It has been found advisable for the serviceman to record the conditions under which he air-checked the set after repairing it in the customer's home. For instance, if there were more than one station in the area but only one was on at the time and it was broadcasting a test pattern and test tone, the technician would make a note of this. The reason for this is that when the husband gets home, he may say, "I thought they were going to fix the sound but it's still distorted," or "that white line still appears on the left of the picture on channel 10." Now, neither of these facts was reported in the original complaint, and the conditions under which the technician repaired the set, as noted on the report, made it impossible for him to accidentally discover them. The person handling the phone call can easily ascertain this from the report without trying to find the technician who did the job to discover if he can remember whether the sound was o. k. on Mr. Jones' set.

Since we are discussing "out-of-warranty" service, and since, as we have pointed out, the bill for such service calls will inevitably run higher than radio service, it is essential that the dealer keep the bill down as low as possible. Otherwise the customer is likely to look for someone else to fix the set next time, even though the work done was satisfactory.

The best way to "keep the bill as low as possible" is to use efficient methods, so that no time is wasted on

the job. This means well-trained technicians, adequate test equipment, and efficient techniques. It also means uniform handling of similar types of work, and careful control of the mechanics of receiving, dispatching, handling and billing service work. And finally, it also means careful purchasing of replacement parts so as to have the needed part or tube when and where it is needed; and taking advantage of discounts, both for promptness and for quantity, and being on the lookout for special "deals" which may mean a price advantage on an item or items.

With the retail price of TV receivers falling, we can expect that, as it was with radios, the public will expect service to cost less—even though this is unreasonable from the point of view of the servicer. It also means that sets are getting in the hands of lower income groups who are not accustomed (and cannot afford) to pay large sums for repair work. These are additional reasons why efficient methods, careful planning and careful buying must be employed to keep TV out-of-warranty service charges as low as possible.

And finally, there is one further criterion which must be considered before the final decisions are made as to transportation charges, minimum charges, and time-and-material service charges. This criterion is the practices of your competitors. Keep a watchful eye on them to be sure you are within bounds, although you need not follow them to the letter if you feel that your prices are sound, fair, and as low as possible. If one of your competitors is giving his profits away in order to build up trade, it is not necessary for you to follow him into bankruptcy. (To be continued)

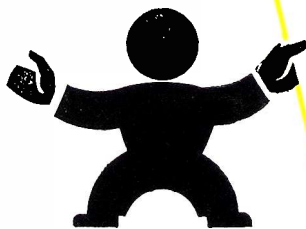

CITY RADIO & TELEVISION CO.

To: Mrs. R. D. Jones
44 Camargo Club Drive

Nov. 1

Customer's complaint: no picture, no brilliance.
 Removed chassis from cabinet, tested, and found no high voltage due to faulty tube type 6BG6G. Replaced tube, checked operation of set, replaced chassis in cabinet.

Labor: .5 hour @ \$3.85 .. \$1.93
 6BG6G tube .. 4.12
 Transportation .. 3.00
\$9.05



Where does a merchant get his customers?



FOLKS near his store...folks on the other side of town...newcomers and oldtimers...they're all prospects for the merchant who runs a growing business.

How can he reach them effectively? Through radio and newspaper advertising? Yes. Through window displays? Yes again. But to these important media he should add the

buying guide that 9 out of 10 shoppers depend on...the 'yellow pages' of the telephone directory.

Your name and sales message in the 'yellow pages' work 24 hours a day...every day...to help guide prospects your way. Use this important buying guide to remind buyers WHO you are, WHAT products or services you sell...and WHERE you are located.



AMERICA'S
BUYING
GUIDE FOR
60 YEARS.

FOR FURTHER INFORMATION, CALL YOUR
LOCAL TELEPHONE BUSINESS OFFICE



Announcing the most spectacular Radio-Television History...



New—Sensational—Exclusive! Of course, Zenith has a Built-In Television Antenna—the Amazing "Picturemagnet"—Plus the Glare-Ban "Black" Tube and many other Zenith "Firsts"

\$289⁹⁵*

Plus Federal Excise Tax

New Zenith "Saratoga"

An unprecedented value in television entertainment. With new Glare-Ban "Black" Tube—television's greatest picture improvement! Has "Big B" Giant Circle Screen and sensational new "Picturemagnet" built-in aerial. Plus Zenith's exclusive One-Knob Automatic Tuning and convenient Duo-Picture Control Switch. In handsome cabinet of genuine mahogany veneers.

Never before have there been such amazing television improvements available to you as in these new Zeniths! Zenith† gives you pictures with great depth and detail—photographic realism. Sensational Zenith Glare-Ban "Black" Tube greatly increases picture clarity—eliminates objectionable blur and glare. And now in many primary areas, no need for a separate aerial inside or out with Zenith television. Just plug in, and Zenith's exclusive "Picturemagnet" does the rest.

Yes, of course Zenith has a Built-In Antenna—

PLUS These Sales-Proven Zenith Features

- ★ **One-Knob Automatic Tuning**—one twist brings in station, picture, sound. Does automatically what on many other sets takes up to 5 or 6 manual tuning operations.
- ★ **"Gated" Automatic Gain Control**—Zenith's exclusive, automatic protection against "picture flutter."
- ★ **Genuine Armstrong FM Sound**—the FM of the experts. Glorious toned, static-free, even in worst storms!
- ★ **Giant Circle Screen with Picture Control**—gives you a choice of circular or rectangular pictures at the flick of a finger!

ZENITH TELEVISION

New Zenith "Lexington"
Quality television at its finest! New Zenith Glare-Ban "Black" Tube—gives up to 60% more picture clarity in lighted rooms. With "Giant C" Giant Picture Screen and Zenith's exclusive built-in "Picturemagnet" aerial. Simplified One-Knob Automatic Tuning and convenient Duo-Picture Control Switch. An exquisite console in genuine mahog- **\$399⁹⁵***
Plus Federal Excise Tax

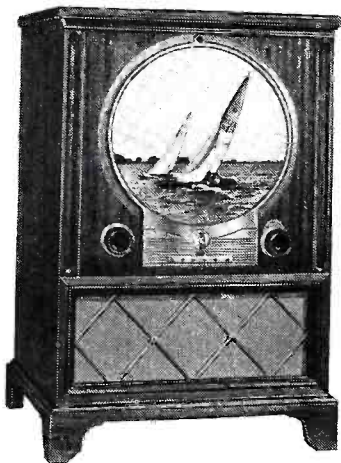

ZENITH RADIO CORPORATION

**All at the lowest prices
ever offered for
Highest Quality Television**

See all these exclusive new Zenith features—then compare. Discover for yourself why Zeniths are easier to sell, faster to move and are better profit builders for you. See why today, more than ever, it pays to make Zenith your *first* line in television.

ZENITH TELEVISION

New Zenith "Regent"

Television FM-AM Radio-Phonograph Combination. With new Glare-Ban "Black" Tube and "Big B" Giant Circle screen. Has Zenith's new built-in "Picturemagnet" aerial plus exclusive Duo-Picture Control and Simplified One-Knob Automatic Tuning. Matchless radio reception with Zenith's new super-sensitive FM and famous Long-Distance AM. Revolutionary new 3-Way Cobra Tone Arm and Record Changer plays all records, all sizes, all speeds—automatically! All exquisitely combined in a superb "Queen Anne" cabinet of genuine ma- **\$489⁹⁵***
Plus Federal Excise Tax



array of new selling features in all and only Zenith has them!

World's Easiest New Way to Play Records Plus New Super-Sensitive FM and Long-Distance AM

Now sensational new Zenith radio-phonograph combinations that completely revolutionize record playing! No needles or center posts to adjust. No complicated gadgets. In one new Zenith, a *single* Cobra† automatically plays 7, 10 and 12 inch records . . . 33½, 45 and 78 R.P.M.! In another new Zenith, a single Cobra automatically plays all 7 inch records, 33½ or 45 R.P.M.!

And in radio, Zenith's new super-sensitive FM continues to lead as the most sensational value ever offered the public. Assures clear, static-free reception even in remote "fringe" FM areas and where ordinary AM sets are almost useless! In addition famous Zenith Long-Distance† AM provides amazingly more powerful and more sensitive Standard Broadcast reception. Gives performance your customers can't resist.

Call your Zenith Distributor right away for a reservation on all these sensational new models. Get ready now for your biggest year—with Zenith!

6001 W. Dickens Ave., Chicago 39, Illinois

New Zenith "Trans-Oceanic"

New edition of the Aristocrat of all portables—now more sensitive and more powerful than ever. Exclusive Wavemagnets bring in Standard Broadcast coast-to-coast plus Short Wave on any of five separate international bands. Plays where ordinary portables won't—in boats, trains, planes, remote areas. Works on thrifty long-life battery **\$9995*** and on AC or DC.

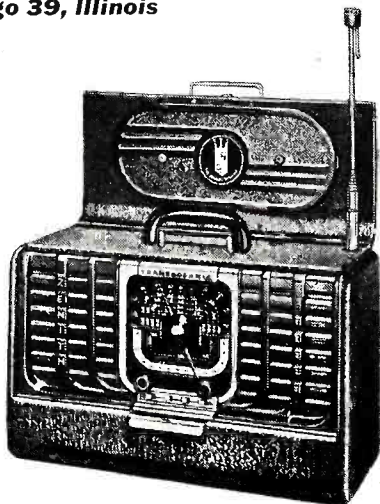

*Suggested retail prices. West Coast prices slightly higher. Prices subject to change without notice.

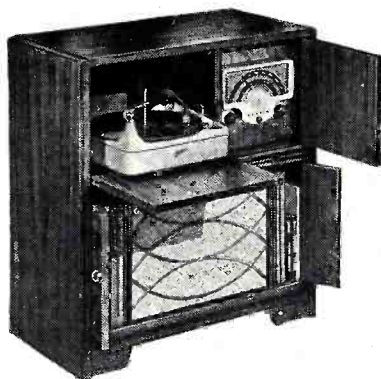

New Zenith "Bradbury"

Sensational new FM-AM Radio-Phonograph combination — offers the world's easiest way to play all type records. Revolutionary 3-Way Cobra Tone Arm and automatic record changer plays 7, 10, 12 inch records . . . 33½, 45, 78 R.P.M. Gives superb radio reception with Zenith's new super-sensitive FM and famous Zenith Long-Distance AM. Stunning period cabinet of figured walnut finished **\$23995*** hardwoods.

ZENITH RADIO

New Zenith "Zephyr"†

Unquestionably the quality leader in its field. New Zenith improved Consol-Tone† gives the tone richness and volume of a large set. Famous Wavemagnet† pulls in signals sharp and clear—minimizes static and interference. Alnico 5 speaker assures amazing fidelity. Smartly styled in sparkling black or swirl walnut plastic with large sweep circle **\$3495*** dial. AC, DC.

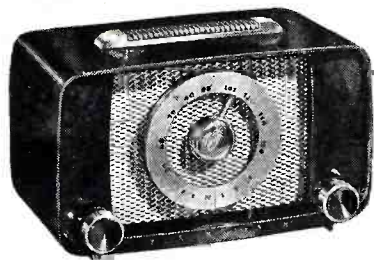

ZENITH RADIO

New Zenith "Super-Triumph"

Top FM-AM value of the year! New super-sensitive Zenith-Armstrong FM with patented powerline Antenna, and famous Zenith Long-Distance AM. Exclusive Wavemagnet . . . big Alnico 5 Speaker . . . tone control . . . on/off indicator . . . easier-to-tune "Cut-Away" Dial. Beautiful swirl walnut plastic cabinet with "Flexo-Grip" **\$5995*** handle. AC, DC.

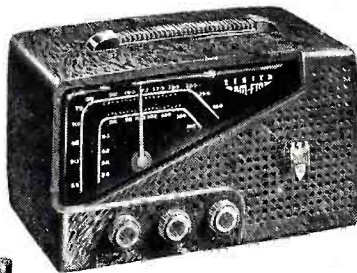

Zenith has the great values

there's always a market for value
 ..and everyone values **MAHOGANY**



Just as genuine Mahogany is the mark of quality, so these labels are the mark of genuine Mahogany. They are issued by The Mahogany Association to protect you and your customers from substitution . . . to help you sell Mahogany.



Sure it's a buyers' market. But that's only another way of saying VALUE market—customers simply want more for their money. And, one and all, they know they're *getting* more when they buy genuine Mahogany.

Its reputation is sold beforehand—its beauty sells on sight. *You* have only to sell the value of the individual piece . . . construction . . . design . . . workmanship. And for this you have the best sales aid of all: "Facts to Help You Sell Mahogany." Free! Tells you exactly where to look for furniture value . . . exactly how to sell it.

There's *always* a market for value—always a market for Mahogany!



facts to help you sell MAHOGANY

This free booklet has all the answers to the questions customers ask. Helps sell period pieces and modern . . . all-Mahogany items . . . solid Mahogany . . . plywoods . . . veneers. Tells you what to look for, how to promote it. A handy guide to your Mahogany Book, too! Write today, for "Facts to Help You Sell Mahogany."



MAHOGANY

ASSOCIATION, INC.

Suite 803 C, 75 East Wacker Drive Chicago 1, Illinois

"AFTER ALL . . . THERE'S NOTHING LIKE MAHOGANY"

RAYTHEON 20/20 TELEVISION

GIVES YOU ALL THESE
**SURE-TO-SELL
FEATURES**



- "RAYTENNA" BUILT-IN AERIAL
- ULTRA SENSITIVITY FOR FRINGE AREA RECEPTION
- ONE-TOUCH CONTROL FOR PICTURE AND SOUND
- SYNCRO-MATIC STABILIZER
- PRE-FIXED SHARP FOCUS

PLUS SUPER-CIRCLE SCREEN

IT LOOKS LARGER!
IT IS LARGER!

176 SQUARE INCH PICTURE IN 16-INCH SETS

THE CRITERION

16-inch Criterion
176 sq. in. picture
(115 volts AC) ... Only **\$339⁹⁵**

Your Television prospects want the biggest picture for the money. *And you can give it to them in Raytheon 20/20 TeleVISION*—along with a bulging list of extra-value features that add up to easier sales, faster profits, enthusiastic customers. One look will tell you, too, that Raytheon 20/20 TeleVISION prices are customer-winning, that Raytheon features are sure-selling.

THE RAYTHEON NAME MEANS FINER TELEVISION ENJOYMENT FOR YOUR CUSTOMERS!

Long a research leader and a supplier to the electronics world, Raytheon now lends its engineering skill to the production of TeleVISION sets which provide the finest in TV reception—at low prices that make news, stimulate television sales, and bring you new customers.

OFFER MORE PICTURE FOR THE MONEY IN RAYTHEON

16-inch Challenger 176 sq. in. picture	\$299⁹⁵
12½-inch Suburban 110 sq. in. picture	\$249⁹⁵
12½-inch Console 110 sq. in. picture	\$279⁹⁵
10-inch Ranger 74 sq. in. picture	\$189⁹⁵

(All 115 volts AC)
(Prices slightly higher in West and South)

RAYTHEON 20/20 TELEVISION

BELMONT RADIO CORPORATION *Subsidiary of Raytheon Manufacturing Company*
5927 WEST DICKENS AVENUE, CHICAGO 39, ILLINOIS

**Field Tested!
Proven in Actual Use!**

Sentinel CLEAR-A-MATIC

TUNING

*And Built-in
Antenna!*

Here is perfection and simplicity in tuning —ONE turn of ONE knob tunes in the channel of your choice. Steady and clear, with full rounded natural tone quality. Sentinel Clear-a-matic tuning, the system that has been tried and proven in thousands of sets in use today.

"Critical" areas won't bother Sentinel users, either; Sentinel's extra-powerful receivers get good performance even in difficult fringe areas. You're headed for top profit with Sentinel!

Designed, Priced for Volume

The new Sentinels are ready to ship. They come in strikingly handsome cabinetry. And, as always, Sentinel's pricing means quick, profitable turnover. Be first with the finest! Contact your Sentinel Distributor now!

413 TVM

Thoughtfully conceived, expertly designed, carefully engineered and magnificently produced. Sells on sight! Undistorted 92 sq. in. picture area.

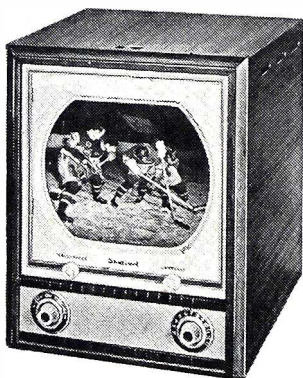

412 TVM

More for your TV dollar! Full 62 square inches of picture. In a beautiful handrubbed mahogany cabinet.

Fits most anywhere. Performs beautifully.

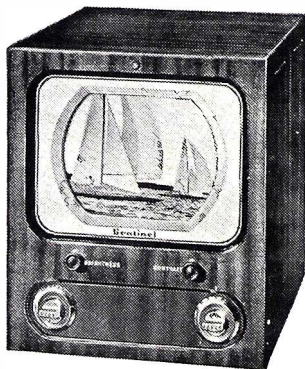

415 CVM

The finest in television . . . gives clear-as-a-bell pictures of 92 square inches.

Beautiful mahogany console, to grace any home or office. A pride and joy to look at and to hear.

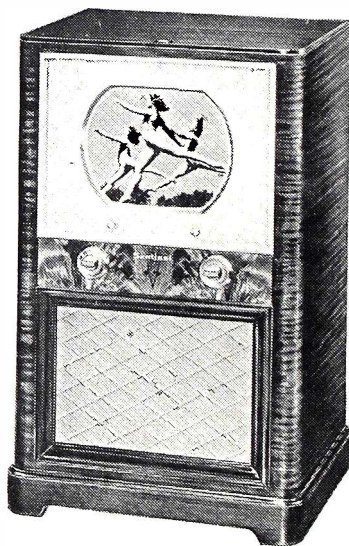

YOU TRAVEL THE
PROFIT ROAD WITH

Sentinel
Radio and Television
EVANSTON, ILLINOIS



And Sentinel's new, profitable, full line radios!

314-I—Sound money-maker! Simplified slide-rule dial, automatic volume control makes tuning-in quick and easy.



316—3-way personal portable. Light-weight. 4" Personality, Colors. Exciting in tan, red, white or green.



333-W—FM-AM at a price that sells! Built-in antenna. Loaded with sales appeal! Ideal for that extra radio, in any home.



331-W—Priced for volume sales! Radio's grandest achievement in design and engineering. A little beauty.



332-I—Super sensitive for long-range reception. Full range tone control. Beautiful walnut finish plastic.



big volume sales!

See Bee

plenty of profit in . . .

TELEVISION'S NEWEST DEVELOPMENT

plug-in-tenna

- makes television amazingly simple to operate
- does away with antennae installation
- soundly engineered, easily installed
- approved by Underwriters Laboratories
- a product proved and tested over two years

Think what this means to retailers everywhere! Here is an item to be sold with practically every television set on the retailers' floor regardless of make, model or size. Also the plus sales-replacements on sets already in use—. Fits into any electrical outlet. Just plug in for clear, forceful signals. It hides away behind any T.V. set—no more unsightly gadgets in the room. Plug-in-tenna is completely unique . . . a product head and shoulders above any other. That's why we say, with Plug-in-tenna you can *plug in* on extra T.V. sales!

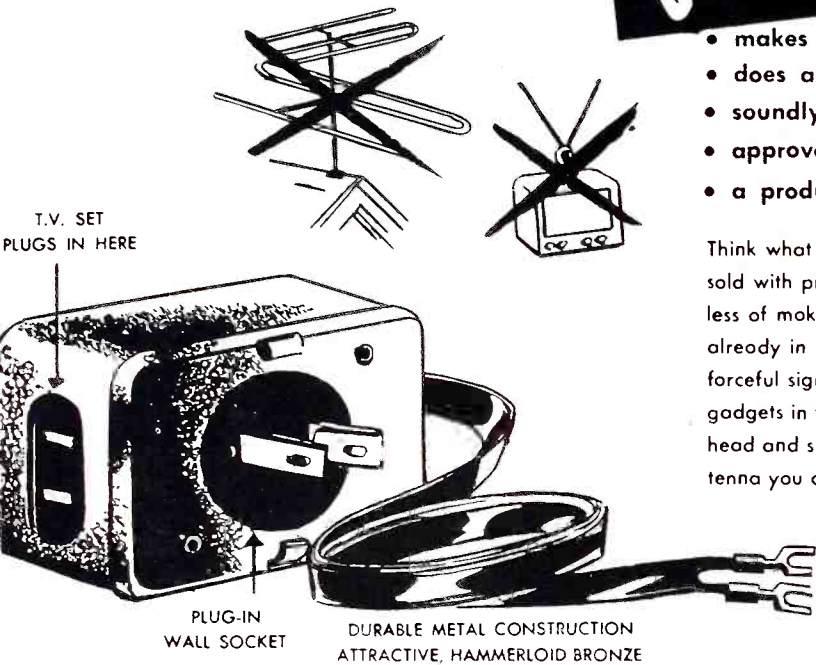

retail price, only **\$5⁹⁵**

Patent Pending—Trade Mark Reg. U. S. Pat. Off.

These extra selling appeals mean extra \$ for you!

1. No antenna installation, either outside, inside or built-in. Just plug in!
2. Any television receiver is now completely portable . . . move it anywhere, wherever there's an electrical outlet.
3. Non-directional, eliminates the bug-a-boo talk about where reception is best. Plug-in-tenna gets best reception anywhere you plug it in.
4. Controls are eliminated. Plug-in-tenna works without any antenna dial adjustments.
5. Unsightliness gone! Plug-in-tenna hides away behind the set, out of sight in an ordinary wall socket.

Mail this coupon to get carton prices, terms, etc. Get ready to "clean up" on TV's newest development. Remember—First you had roof antennas, next indoor type followed by window type. Then came the "built-in" and now it's the Plug-in-tenna—the simple, easy, better solution to most antenna problems.

MAIL COUPON TODAY.

12 individually packed units in each counter display carton.

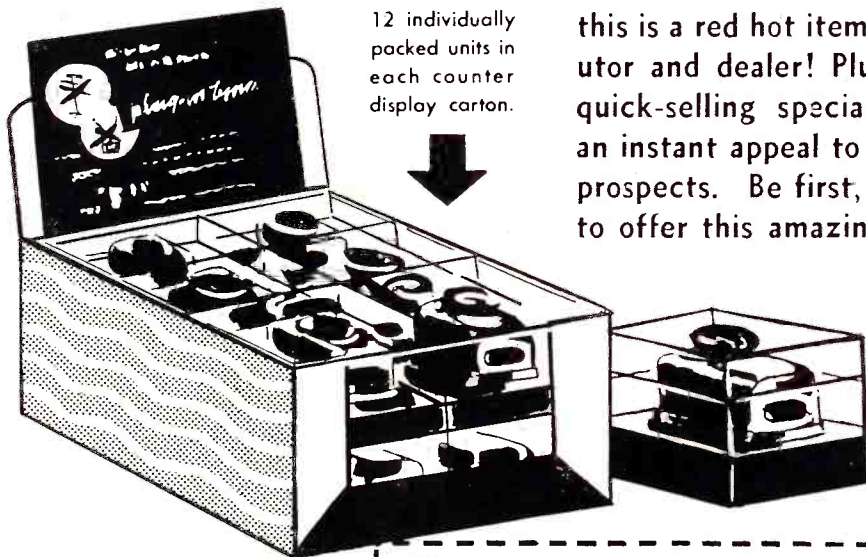

this is a red hot item for the distributor and dealer! Plug-in-tenna is a quick-selling specialty that makes an instant appeal to TV owners and prospects. Be first, in your market, to offer this amazing new product.

Each unit in a beautiful, clear plastic box.

Garrett-Buckley 624 S. Michigan Ave., Chicago, Illinois

Please send further information and price structure.

Your Name

Company

Address Zone State

If dealer, name your distributor

It's the biggest
RCA VICTOR
Eye Witness
Television —

IN A CABINET OF DISTINCTION

It's the 9PC41

Through this luxurious RCA Victor instrument . . . housed in a beautiful cabinet of 18th century design that's a lovely addition to *any* home . . . your customers see their favorite football games on a screen nearly the size of a newspaper page.

To preserve the authenticity of the traditional design, the screen can be lowered into the top of the cabinet when the set is not in use.

The 9PC41, like all RCA Victor instruments, has fast turnover because it offers your customers highest possible quality at a fair price. Sell the *entire* RCA Victor line for *more satisfied customers . . . greater profits!*



ONLY RCA VICTOR



HAS THE "GOLDEN THROAT"

RCA VICTOR



DIVISION OF RADIO CORPORATION OF AMERICA

Here's why your profits are greater with this RCA VICTOR

*Higher quality and outstanding selling points of
ALL RCA VICTOR instruments keep turnover high!*

Push the 9PC41 for football!



Your customers get a seat on the 50-yard line with this great 300 square inch (15" x 20") viewing screen . . . the biggest with RCA Victor Eye Witness Television. Screen locks in vertical position for most advantageous television viewing.

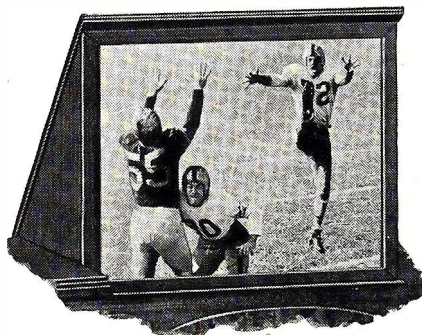

SHARPEST BLACK-AND-WHITE CONTRAST EVER IN PROJECTION TELEVISION—

It's RCA Victor's all-silicate-face picture tube that does it. And pictures are electronically locked in tune by RCA Victor's improved Eye Witness Picture Synchronizer. Glorious "Golden Throat" tone brings the full excitement of the game right into your customer's home.



SPLENDID 18TH CENTURY TRADITIONAL CABINET—

The lovely cabinet of the 9PC41 portrays all the splendor of the 18th Century traditional design. The great 300 square inch screen can be lowered into it when the set is not in use. Available in fine mahogany, rich walnut, or modern blond finish.



PLUS a demonstration clincher!

With Model 9PC41 you can offer your customers a remote control unit at no additional charge. This 3" x 4" unit, finished to match the cabinet, permits adjustment of the Contrast and Brilliance Control from the viewer's armchair. It has a 25-foot extension cord. An impressive demonstration point to help you sell!

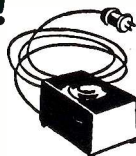

ONLY RCA VICTOR
MAKES THE VICTROLA.

"Victrola"—T. M. Reg. U. S. Pat. Off.

RCA VICTOR—World Leader in Radio . . . First in Recorded Music . . . First in Television



What a show!

A recent intensive survey discloses that among the major television set manufacturers, more than 75% use Sylvania cathode ray tubes!

This impressive showing is a tribute to the research and quality production techniques employed by Sylvania.

You can take advantage of this ready acceptance by having a complete stock of the various types of these television picture tubes so widely used by set makers—who in turn, of course, sell to *your* regular customers. See your Sylvania Distributor about the complete line! For complete data write *Sylvania Electric Products Inc., Dept. R-2111, Emporium, Pa.*

These leading television set manufacturers use Sylvania Television Picture Tubes

Admiral • Air King • Andrea • Ansley • Automatic
 Bendix • Crosley • DeWald • Emerson • Fada
 Farnsworth • Garod • Hallicrafters • Hoffman
 Magnavox • Midwest • Motorola • National • Olympic
 Packard-Bell • Philco • Pilot • Raytheon-Belmont
 Regal • Scott • Sentinel • Silvertone • Sperton
 Stromberg-Carlson • Tele-King • Tele-tone • Temple
 Trav-ler • Westinghouse • Zenith

SYLVANIA ELECTRIC

Arvin Values THAT SPELL

BIG CHRISTMAS

PROFIT\$!

Climax of 30 years of
OUTSTANDING ARVIN VALUES!

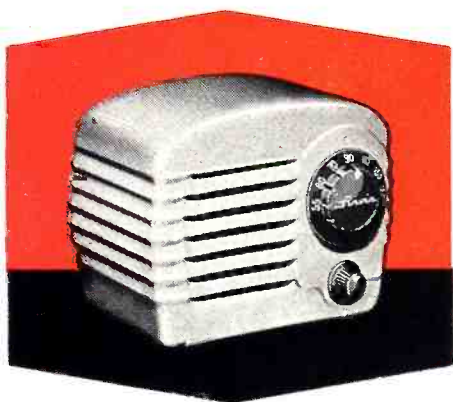

◀ MODEL 341T \$12⁹⁵

Instant gift appeal for the parent whose child requires a personal radio! Just right for gift-giving to travelers, hospital patients, and students, too! Shatterproof, kidproof cabinet in Sandalwood finish with Burgundy trim. AC/DC superhet. Exceptional performance. Underwriters' listed.

MODELS 356-357T \$16⁹⁵ ▶

A stand-out for beauty and value! Smart Willow Green or Sandalwood color with gold finish fittings. AC/DC superhet with 5 tubes including rectifier. Modern finger-tip tuning; built-in antenna. Far and away the finest value in its price class, a sure-profit-builder for your Christmas selling season.

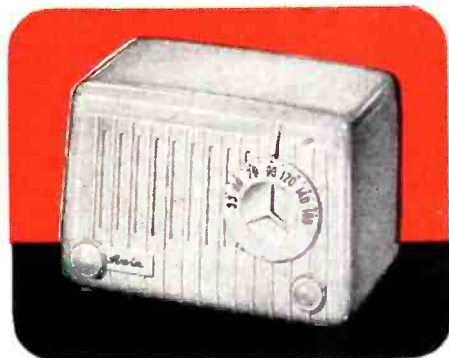

MODEL 160T \$34⁹⁵ ▶

Walnut Finish

Compare with any other set in the 6-tubes-including-rectifier class and watch this great Arvin capture all the honors! AC/DC superhet; 3-gang condenser; one stage of tuned radio frequency; separate tone control. Underwriters' listed. Also in Ivory Finish, Model 161T, \$36.95.



▲ MODELS 358-359T \$19⁹⁵

Supreme value champion in the 5-tube group (four tubes plus rectifier). Beautifully styled in Willow Green or Sandalwood finish with gold fittings. Extra-capacity Alnico V speaker provides rich tone. Built-in antenna. Extra high gain circuit for exceptional selectivity and sensitivity. Underwriters' listed.

Radio and Television Division

NOBLITT-SPARKS INDUSTRIES, INC.

Columbus, Indiana



◀ Super-powered Portables

MODELS 350-351P \$34⁹⁵*

Arvin Portables are year-round gift favorites! Super-powered for super-reception anywhere. Compact, modern styling in Jade Green or Kingfisher Blue. Operates on batteries, AC or DC. Alnico V speaker. Underwriters' listed.

* less batteries



LONDON

RECORDS

SPECIAL LONG PLAYING RELEASE

33 1/3 R. P. M.

LPS. 83

FANTASIE IN C MAJOR Op. 15, "THE WANDERER"
(Schubert)

Clifford Curzon (Piano)

LPS. 85

PIANO MUSIC OF VILLA-LOBOS

Ellen Ballon (Piano)

Impressoes Seresteiras (Minstrel Impressions)
(from "Ciclo Brasileiro")

A Maré Encheu (Full Tide) • Passa, Passa, Gaviao
(Go, Go, Away Hawk) • Pobre Cega (Poor Blind
Woman) • O Pintor de Cannahy (The Artist of
Cannahy) • Alma Brasileira (Soul of Brazil)

LLP. 93

**PATRIE OVERTURE (Bizet). JEUX D'ENFANTS—Ballet
Suite (Bizet).**

The National Symphony Orchestra. • Conductor,
Roger Desormière

LPS. 109

OPERATIC RECITAL BY MARIA REINING.

Maria Reining (Soprano) and Paul Schoeffler
(Baritone). • Zurich Tonhalle Orchestra. • Conductor,
Hans Knappertsbusch

Der Rosenkavalier—Marschallin's Monologue
(R. Strauss) • Tannhäuser—Elisabeth's Gebet
(Wagner) • Tannhäuser—Dich Teure Halle (Wagner)
Die Meistersinger—Duet of Eva and Sachs (Wagner)

LLP. 114

CONCERTO No. 5 in E FLAT MAJOR "THE EMPEROR"
Op. 73 (Beethoven)

Clifford Curzon (Piano). The London Philharmonic
Orchestra. Conductor, George Szell.

LPS. 89

SYMPHONY No. 40 in G MINOR (MOZART) (K. 550)

The London Philharmonic Orchestra. Conductor,
Erich Kleiber

LLP. 6

SHÉHÉRAZADE—Symphonic Suite (Rimsky-Korsakov)

The Paris Conservatory Orchestra Conducted by
Ernest Ansermet

LLP. 71/72 2-12" RL Records \$11.90 Tax Incl.

GILBERT AND SULLIVAN OPERETTAS

By the D'Oyly Carte Opera Company

H. M. S. PINAFORE

with the New Promenade Orchestra conducted by
Isadore Godfrey

LLP. 10

MUSIC OF JOHANN STRAUSS

Acceleration Waltz • Roses From The South
Waltz • Blue Danube Waltz • Emperor Waltz

The New Symphony Orchestra Conducted by
Josef Krips

LPS. 32

MUSIC OF OLD VIENNA — Oscar Straus

Waltz Dream:—Overture • Chocolate Soldier:—
March—My Hero—Waltz • From Strauss to Straus

The New Symphony Orch. conducted by Oscar Straus

LPB. 60

STANLEY BLACK — LATIN RHYTHMS

Rhumba-Tambah • Linda Chilena • Adios • La Mulata
Rumbera • Canto De Ausencia • Condena • The
Breeze And I • Rustic Samba

Stanley Black and his Concert Orchestra

LLP 12" Red Label \$5.95 LPS 10" Red Label \$4.95 LPB 10" Blue Label \$3.95

RECORDS

Section of **RADIO & TELEVISION RETAILING**

Plans to Push Christmas Sales

COLUMBIA

Columbia Records, Inc., Christmas promotion theme is "First On Every Christmas Gift List." Available to dealers are:

1. Window Display — record-buying family grouped around a moving Santa Claus complete with flashing lights. Measures 25 x 36 inches.

2. Pennant Streamers—bright series of seven double-sided four-color figures (Santas, tree bulbs, Xmas tree, Xmas stocking, and a group of carolers) which will do wonders for store interiors when strung across on wires, string or partition.

3. Santa Claus Counter Card—dimensional display in brilliant color; each Santa holds six album covers.

4. Christmas Mailing Piece—Listings of suggested gifts from the Columbia catalog, with plug for LP player attachments. Perfect for use as a mailer, stuffer, and counter distribution.

5. Christmas Gift Wrap—wrapping paper for LP records; helps promote multiple sales.

6. Christmas Gift Booklet—16-page booklet lists hundreds of items from catalog. Booklet is attached to a label featuring the Christmas theme which may be affixed to counters, booth walls, etc.

7. Children's display—three dimensional elephant ridden by a Santa Claus.

8. Christmas Hangers—four colorful hangers that list outstanding listings from the catalogs, plus special Christmas items.

9. Christmas Posters — eye-catchers that plug the children's records, Christmas music of foreign lands, Christmas music of our country.

10. Folk Music Display—plugs Gene Autry's top-selling Christmas records and LP records of "Country Christmas Songs."

11. In addition, numerous co-operative advertising mats are available to dealers. Plus an intensive national ad campaign scheduled to run in 19 publications.

Worthy of mention in Columbia's Christmas plans is the Playtime Record series for children. Discs 25c each. The 7-inch records are packaged in specially designed envelopes, are unbreakable, and feature top recording artists. Dealers have a 100% exchange privilege for this series.

DECCA:

Christmas material available from Decca for the promotion of records, albums, Decca long-play records, and accessories, includes:

1. Santa Claus Christmas Display—Six-color display with large picture of Santa Claus; 31 x 43 inches mounted; features "Twas the Night Before Christmas," Fred Waring, Pennsylvanians and Chorus; "Christmas Greetings," Bing Crosby, Andrews Sisters; "Merry Christmas," Bing Crosby; and "The Littlest Angel—Lullaby of Christmas" (DLP only) featuring Loretta Young and Gregory Peck respectively. Albums are on both 78 and 33 1/3 rpm. Display is suggested for use as a center piece for window display around which to group other material. Utilizing children's phonograph also suggested.

2. Christmas Album Hanger—includes Xmas sets in 2 speeds; also the DP-80 model phonograph; 11 x 30 inches.

3. Christmas Singles Hanger—11 x 30 inches; first section shows new Christmas releases; second section, balance of Christmas singles including all singles from albums listed in reverse numerical order showing couplings.

4. Children's Unbreakable Records Hanger—Includes all latest releases; "Age Chart" featured for use as a guide.

5. Accessories Hanger—9 x 18 inches; includes models DP-71, DP-80 and DP-50. Listed without prices.

RCA VICTOR

RCA Victor has completely revised its children's series, with the "Little Nipper" series of unbreakable albums and records designed for easy use by children. It is a completely streamlined, modernized album collection of top children's favorites. Twenty-one albums are now available in picture and story-book album form. Available on both 78 and 45 rpm, the "Little Nippers" are backed by large advertising and promotional plans and feature the slogan, "When You Buy For Children—Choose a 'Little Nipper'."

Current line has strong attraction for all age groups. For children under six there is "Mother Goose," "Raggedy Ann," "Three Little Pigs," "Little Black Sambo," and "The Little Engine That Could." These last three also appeal to children from 6 to 9. For children up to 12 and 13 the following are suggested: "Snow White," "Bambi," "Peter and the Wolf," "How the Circus Learned to Smile," and "Pinocchio." For children from 9 to 13 "Lore of the West," "Pecos Bill," "Johnny Appleseed" is suggested. For children of any age there is "The Night Before Christmas."

Eight of the albums contain full color picture books. The stories have been dramatized in a way which has a strong appeal for children, with special style full of excitement, suspense and dramatic stops with sound effects. A variety of color and animation displays have been prepared to aid the dealer's selling campaign.

1. Fun Fare Display—Suggested for use in conjunction with either model 9JY or model 9EY3 instruments; transforms the unit into a replica of a side show tent at a circus. Circus theme is carried through with four adjoining panels, simulating billboards, designed to display 45 rpm albums. "Little Nipper" appears as a barker.

2. Merry-Go-Round display — De-

(Continued on page 70)



RCA Victor

RCA Victor's "Little Nipper" series (see symbol upper left) is designed for immediate appeal to children. "Little Nipper" peeps out of the lower right hand corner of the albums; sometimes his bark on the record is the signal for the young listener to turn the page.

Also shown are two "Little Nipper" greeting cards which provide children free-of-charge with an opportunity to mail holiday greetings, with characters from the "Little Nipper" albums offering the greetings.

Promote Children's Discs

Columbia

This gay three-dimensional display is an adaptable unit, suitable for use in many key spots in the store.

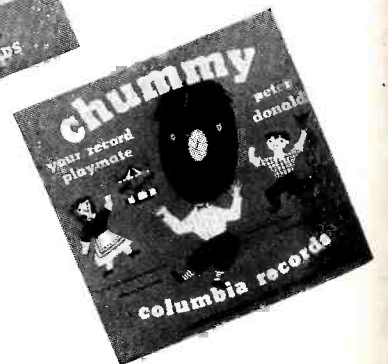

Also illustrated are several top albums of Columbia's children's promotion.



Capitol

for Xmas

MGM

Label has a variety of children's albums available all of which are being on a big seasonal push.



Mercury

"Two Ton" Baker's kiddie record series for the label have been successful.



DECCA UNBREAKABLE RECORDS FOR CHILDREN

STORIES

- The Churkendoose
- Genie the Magic Record
- Little Orley's Adventures with The Little Engine—The Happy Bird
- Little Orley
- The Little Fiddle
- The Little Tune that Ran Away
- Peter and the Wolf
- Peter Rabbit and Other Tales
- Sholem Aleichem's Tales from the Old Country
- Tubby the Tuba

SONG-STORIES BY FRANK LUTHER

- Babar Stories
- The Gingerbread Boy and Chicken Licken
- Goldilocks and the Three Bears
- Happy the Harmonica and the Tick Tock Shop
- Health Can Be Fun
- The Little Red Hen
- Manners Can Be Fun
- The Shoemaker and the Elves
- The Three Billygoats, Gruff

BIBLE STORIES: READINGS BY CHARLES LAUGHTON

- David and Goliath
- The Fiery Furnace
- Garden of Eden
- Noah's Ark

FOR CHILDREN WHO ASK QUESTIONS

- What Are Stars?
- What Makes Rain?
- Why Do I Have to Go to Sleep?

DRAMATIZED STORIES

- Alice in Wonderland
- A Christmas Carol
- The Happy Prince
- Ichabod—Rip Van Winkle
- Ichabod
- The Selfish Giant

SONGS BY FRANK LUTHER

- Get Along Little Dogies
- Home on the Range
- Mother Goose Songs
- Nursery Rhymes, cu-101
- Nursery Rhymes, cus-5
- Sleep, Baby, Sleep
- Songs of Safety
- Thirty-three Children's Songs
- Winnie the Pooh Songs

CHORAL FAVORITES BY FRED WARING

- Grandma's Thanksgiving
- Nutcracker Suite
- The Song of Christmas
- A Visit from St. Nicholas

Decca

Decca's children's hanger will feature unbreakable records only; shown above are the titles to be listed. Not shown, but to appear prominently in the final display, is the "age chart" to serve as a guide for consumer buying.

Bing Crosby's "Ichabod" album, tells the story of "The Legend of Sleepy Hollow," available at 78 rpm and 33 1/3 rpm.



3 GREAT NEW TITONES

meet changing pickup needs!

NOW a full line of Titone's amazing ceramic pick ups—made by famous Sonotone! All with these great basic features: Full frequency (response from 50 to 10,000 cycles.) Bell-like supertone makes new or old players thrilling. Climate-proof, moisture-proof, fungus-proof! Lightest pressure saves needle wear, revives worn records. NO needle talk! NO crystals, magnets, filaments to fail. NO pre-amplifiers. Performs perfectly for years!

3 NEWEST! TITONE MICROGROOVE PICKUP

For all 45 and 33 1/3 rpm players. Highest compliance and 5 to 6 grams needle pressure give minimum wear on record and needle! Aluminum case—1-mil permanent sapphire needle.

Order #W 7530 \$7.95 list

2 NEWER! TITONE 3-MIL PICKUP

New superlight aluminum pickup complements famous original Titone pickup below. 15 grams needle pressure gives unparalleled reproduction, lowest wear!

Order #W 7540 \$7.95 list

1 NEW! ORIGINAL CERAMIC TITONE

Within a few scant months in widest use from coast to coast! Plays at 20 grams needle pressure. Used instead of the newer aluminum Titone above for changers requiring over 15 grams pressure to "flip" records.

Order #7500 \$7.50 list

NO TONE LIKE TITONE



Call your Jobber or write to SONOTONE, Box 5, Elmsford, N. Y.

Industry Notes

Frank M. Folsom, president, Radio Corp. of America, emphatically denied all rumors to the effect that RCA Victor will abandon its "45 rpm" phonograph and record system. . . . Mario Lanza is getting a big RCA Victor build-up.

Edward Wallerstein, president, Columbia Records, Inc., announced the appointment of Goddard Lieberston as executive vice-president of the company.

All new MGM records are to be pressed on the company's non-breakable Metrolite material. The discs will be priced the same, 60¢ (plus tax).

Coral Records has signed the following new artists: Jon and Sondra Steele; Heine, and his Polka Band; and Owen Bradley.

Plans For Xmas

(Continued from page 67)

signed for use with either model 9JY player or model 9EY3 self-contained phonograph. Unit is a gaily colored and illustrated replica of a carousel and mounts on the spindle of the 45 rpm instrument. It is rotated by the motion of the 45 rpm unit. Features illustrations of familiar Walt Disney characters.

3. Roy Rogers Corral display—an animated unit featuring the cowboy astride his horse "Trigger." This is a power display which plugs into any AC outlet.

4. Kiddie Versions of the 9EY3 45 rpm self-contained unit—One player designed as a Walt Disney unit, paneled with pictures of characters from Disney films; retails at \$39.95. Other set is a Roy Rogers special, refinished with pictures of Rogers, Trigger and Western scenes. "Peter and the Wolf" album is given with the former unit; "Roy Rogers' Lore of the West" with the latter.

5. "Little Nipper" catalog features full-page illustration of each album on every page.

6. "Little Nipper" greeting cards provide children with opportunity to mail holiday greetings to their friends.

7. Two-color window streamer.

8. Four teaser counter giveaways which tell part of an album, and end with "If you want to know the rest . . . listen to the RCA Victor album . . ."

MGM

MGM Records has prepared especially for Christmas promotions:

1. 30-inch Christmas wreath in full color; features photos of a variety of MGM artists.

2. 18-inch replica of wreath, designed for use in windows, or for hanging from chandelier cords, etc.

3. 18-inch cut-out of Leo the Lion dressed as Santa, carrying a pack of MGM gift records.

4. Series of co-operative ads, complete with mats and proofs for dealer use.

5. Special Christmas hanger listing latest Christmas material.

Correction on London Records Ad, Page 66

LPS 85 is now known as LPB 85 RL (\$5.95) and the selections listed under LPS 85 are now on the "A" side of LPB 85. The following records are on the "B" side of LPB 85: "Music of Chopin," Ellen Ballon, Piano: Nocturne No. 5 in F# Major, op. 15, no. 2; Etude No. 4 in C# Minor, op. 10, No. 4; Etude No. 7 in C Major, op. 10, No. 7; Nocturne No. 8 in D flat Major, op. 27, No. 2; The Scherzo No. 3 in C# Minor, op. 39.

Jensen REPLACEMENT NEEDLES
Fit Your Cartridge

Now available...are Jensen Replacement Needles to fit the cartridges in the tone arm of many phonographs. It is only logical that these fine needles are brought to you by Jensen, "oldest name in sound engineering," and precision manufacturers of quality styli for the world's finest music.

Whether sapphire or osmium tipped, they incorporate the latest developments in acoustical sciences and provide full tonal range and long life with "fidelity all the way."

Write for descriptive Jensen Replacement Needle Chart listing these needles, catalog numbers, size, needle point material, name of cartridge the Replacement Needle is designed to fit, name of phonograph using the cartridge and, of course, list price.

JENSEN INDUSTRIES, INC.
329 S. Wood Street, Chicago 12, Ill.

RIGHT FOR EVERY RECORD

The V-M "100" Record Player

Plays all records, all sizes, all speeds—with all the original beauty of the music faithfully reproduced.

Plugs into an AC outlet—has its own amplifying system—tone and volume controls—Dual-Needle Reversible Cartridge—special Adapter furnished for large-center-hole records.

Get full details today from your local distributor on the new V-M line of 3-speed changers and players.

V-M Corporation
BENTON HARBOR, MICHIGAN

**FOR EASIER,
QUICKER SALES—**

SELL THE SENSATIONAL EASIER PLAY OF RCA VICTOR "45" RECORDS

**Talk up EVERY feature
of the Victrola "45" system!**

- Superior tone
- No distortion. All music recorded in the "quality zone"
- Low cost
- Simple, trouble-free
- Easier to load—no more "spindle-seeking"
- Non-breakable records
- Small, easy-to-store records
- Color-coded for easy selection
- New releases every week

Every record fan *knows* 45 rpm records are better, from the moment he sees and hears them play, and hears you point out the simple facts! . . .

EASIER SELECTION: RCA Victor "45's" are *color-coded!*

EASIER LOADING: the small, light records are easier to stack; and there's no "spindle-seeking," thanks to the big center-hole. Records almost slip on by themselves!

EASIER OPERATION: stack of ten "45's" plays *at one touch of a button*. No problems with different-sized records—they're all the same size!

EASIER HANDLING, EASIER STORAGE: no heavy-weight albums to heft around! Just light-as-a-feather, non-breakable plastic platters.

Put across this easier-play story, along with the facts on better sound and lower cost—and you'll get yourself more and MORE customers for RCA Victor "45" records!

RED SEAL RECORDS

ONLY **95¢**

(plus excise tax)

ALL OTHERS

ONLY **65¢**

WORLD'S FASTEST AUTOMATIC CHANGER

NOW ONLY **\$12⁹⁵**

VICTROLA "45"

RECORDS AND PLAYERS

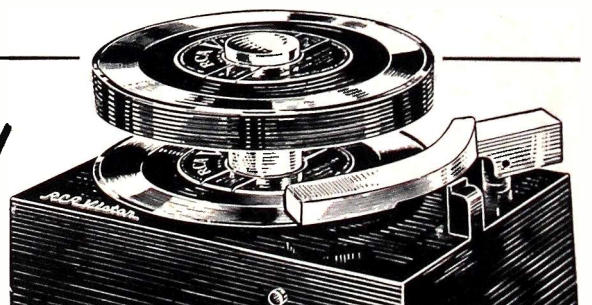

RCA VICTOR DIVISION, RADIO CORP. OF AMERICA
"Victrola"—T. M. Reg. U. S. Pat. Off.

"Hit that target!"

The cash market for major appliance sales has been plowed under and run over. The real pay-dirt now lies in the time payment field.

You can score here, frequently and profitably, if you have the right kind of finance plan to offer your customer and the right kind of financing "know how" and service to protect your profits.

This is where your Commercial Credit representative can help you. Every detail of sound financing service is in the complete package he offers you.

Why not have him in...today...for a heart-to-heart talk? You'll benefit by it.

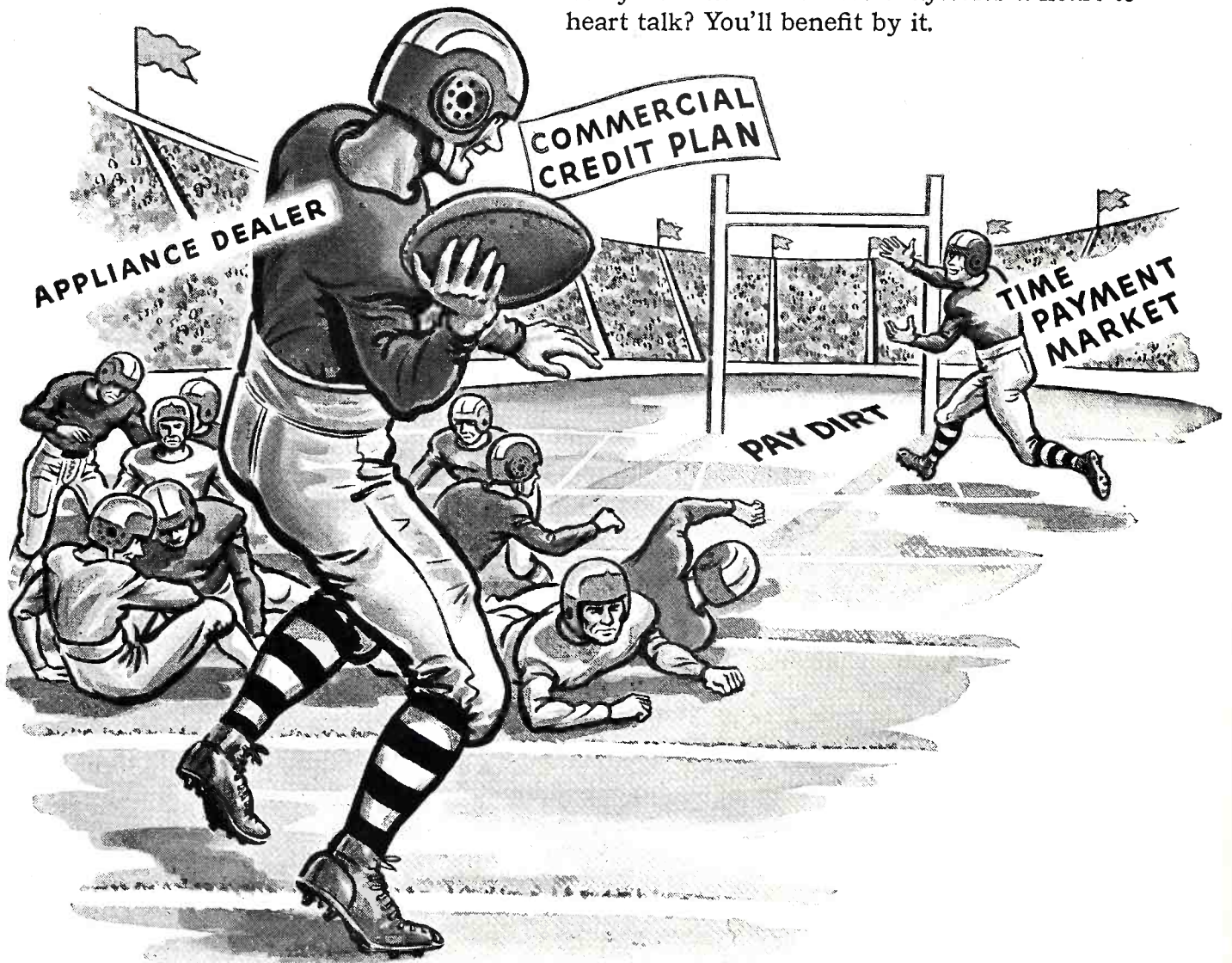

COMMERCIAL CREDIT CORPORATION

A Subsidiary of

Commercial Credit Company, Baltimore • Capital and Surplus \$100,000,000

MORE THAN 300 OFFICES IN PRINCIPAL CITIES OF THE UNITED STATES AND CANADA

ELECTRICAL APPLIANCES

Section of **RADIO & TELEVISION RETAILING**

Make Farm Sales RISE in the FALL

• The good farmer is a good customer for the enterprising dealer to cultivate. The farm market is one of the richest in America, and it bids fair to remain so in spite of the fact that farm produce has dropped in price while farm operating costs have been rising.

The farmer is a prospect for many products. He buys modern labor-saving equipment for the operation of his business and his home. He buys radios, combinations and phono records for the entertainment of his family, and is a sure-bet to own a TV set as soon as program coverage reaches his community.

According to one dealer, the farmer needs ten times as many appliance units as does the city dweller, and these products can be sold profitably by the merchant who gives the farmer what he wants in the way of good service and fair treatment.

Successful rural dealers find the typical farmer to be a loyal customer, not likely to switch from one store to another without good cause, and they find that farmers are most sincere in their desire to make payments with the utmost punctuality. In return, farmers expect the retailer to live up to all guarantees, to be able to render fast, efficient service; to give them the most for their money, and to sell without pressure.

Those dealers having farms lying within their territories are eyeing this market with a great new interest as the Fall season approaches. The farmer, like everyone else these days, is spending cautiously, and the alert merchandiser is striving to make his store and his general business operation attractive to the farmer. He must do a good job of this, too, in order to compete successfully with rural co-ops and mail-order houses still vigorously bidding for such business.

In many localities, the Fall is the best time to call on the farmer. In the first place, this season often finds the

farmer with more time on his hands than he has during the Spring, and, in addition, after harvest, he usually has more money to spend for his home and farm.

On the way are the country fairs, and these events bring profits to many dealers who exhibit at them, setting up displays of radios and electrical appliances at which they meet their old friends, the customers. When properly operated, the country fair exhibit can be made to pay.

Alert dealers are always right on the job when the farm is hooked up for the first time to the high-lines. The advantages of immediate use of products

are most fresh in the farmer's mind at the time when the magic servant, electricity, makes its initial bow.

Following are articles telling how certain dealerships located in agricultural districts are cultivating farm business along original lines. One dealer in the South brings his products to the newly-electrified farmer. Another goes out to the farm, carries the family to the store in his car, and returns them home after a tour through the establishment. It will be noticed in reading the articles, that successful merchants depend heavily upon their service facilities to attract and hold farmers as friends and customers.

Brings His Products TO THE FARM



Mrs. Moss sells in the store.

One morning just before the juice was turned into a new REA power line in Smith County, Tennessee, a truck load of appliances arrived in the community it traversed and began contacting the farm homes as soon as they were served.

(Continued on page 74)

SERVICE SELLS Farm Customers

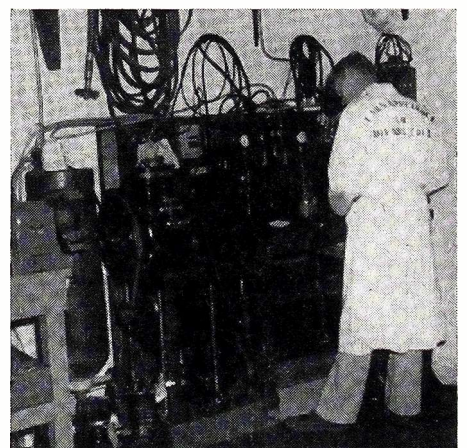

25% of total floorspace is devoted to service department, visible to public.

• Putting a well-organized service department "on display" where every incoming farmer can be quickly impressed with it has helped William E. Sears, of

(Continued on page 76)

Brings His Products to the Farm

(Continued from page 73)

This load of products belonged to Smith County Appliance Company at Carthage and the truck driver was hoping to sell them to the farm families in whose homes the kilowatts were to be turned loose.

The driver-salesman was Farmer Carter (that's his first name). He went into each home while the fever of anticipation was still burning in the housewife's heart. He talked washing machines, electric refrigeration, cooking and everything else of which she had been dreaming during her "unelectrified existence."

Before he got to the end of that power line Carter had sold out the entire load. Electric fans, toasters, percolators, irons and other traffic appliances were eagerly taken. He installed many of the latest model radios and radio phonograph combinations, and took in the obsolete battery sets on which the families had been doing their long-distance listening.

In many homes Carter didn't even have to make a demonstration. They had already made up their minds about what they wanted and were impatiently waiting to put them to work as soon as the darkness of the countryside could be shattered by this new form of illumination.

This incident shows how one dealer stays on the alert to take advantage of a new bonanza-market that will not only be with us for a long time to come but still has nearly half the rural market waiting to be served. Every new rural family has to start from scratch.

Good Prospects

Smith county has a number of new REA territories opening up and Smith County Appliance Company is not missing any bets on any farm that hooks up. Its truck gets there while the thrill of this drudgery-relieving service is new and begins demonstrating the gadgets that will do the relieving. The managers of this firm know that the longer a newly energized farm home gets used to doing without the new appliances the more sales resistance it will offer.

But even at that, they know that no family is going to buy all its needs at first and all of them will be fine prospects for all time to come. Whenever Carter finds a newly served customer reluctant about buying, he offers to leave a demonstrator appliance for free use. For example, he will drive up to a farm home a few days after the juice is turned on and tell Mrs. Sally Housewife he wants to lend her the free use of a washing machine to do her family wash for the next week or so. When she gets the feel of how much more delightful it is to do pushbutton washing than to accomplish it by main strength and awkwardness, Carter has no trouble leading her to the dotted line. If she buys he takes up the demonstrator and leaves a new machine. He finds this an ideal way to sell refrigerators, radio-phonographs, home freezers and what have you. It is rare indeed that such a demonstration fails to make a sale. However, the offer is made only to housewives who have an actual need

Farmers Do Business Where—

**Good service shines
Where products are priced competitively
No sales pressure is used
Fair treatment is practiced
Guarantees are lived up to
Selection is adequate
Good brands are stocked.**



for such an appliance and are able to make the payments. While selling the families along the new REA lines, the salesman makes note of all appliance needs the prospect doesn't fill at the time and catalogs them for future solicitation.

One of the good things about the new rural market is the fact that the average farmer not only has to start from scratch on electric power needs, but he needs ten times as many units as the average city home. He has not only a home to be wired but barns, tenant houses, and other buildings. He needs an automatic water system, he raises great quantities of perishable products to be refrigerated, he needs milk coolers and power milkers for his dairy. One important labor-saving need is for power motors for all kinds of work that has hitherto been done by muscle-power-drudgery such as milk separating, churning, corn shelling, grindstone turning, etc. Recently Smith County Appliance sent a salesman to a newly hooked-up community and he sold one or more motors at every single farm.

One way the Smith County salesman breaks down reluctance is to show the farmer that the new appliance he is offering is an investment and not a luxury. He shows him, for example, that a power milker for 40 cows will eliminate the need for 3 human milkers whose wages are three times what they were before the war. He shows Mrs. Housekeeper that the weekly wages she pays a washwoman will more than meet the weekly installments on an electric washer. When the Smith County salesman puts the matter up to them like that he shatters sales resistance like nobody's business.

Sometimes the firm gets a delightful windfall from the most obstinate customer. There was one old farmer, for example, who seemed utterly "immune" to every sort of labor-saving, money-saving appeal that the salesman could

offer in the form of electrical equipment. He had done without such conveniences all his life and seemed blissfully content with only a lighting system that didn't have to be set off with a match.

After many fruitless efforts the firm wrote him off as a hopeless prospect.

The very next day after the last give-up effort the old farmer walked into the Smith County Appliance Company's store at Carthage, and without waiting to hear the familiar "Can I help you?" he bought a refrigerator, washer, iron, sandwich grill and hot plate. The next morning his married son came in and bought a washing machine, refrigerator and iron. The store salesman had a suspicion that both father and son were reacting to feminine pressure back home.

Service Important

In selling these REA prospects Smith County Appliance has been carefully building another important source of income. That is the servicing of rural equipment they or any dealer sells. There is a service shop connected with the store to which the truck brings in radios, washers, irons, and other appliances. Other equipment is serviced right on the farm. The salesman who is out soliciting new sales checks equipment already in use for needed service.

The Smith County Appliance Store is owned by Walter H. Moss and Calvin Davis. The company gets an inside start on much of the REA business by wiring many of the farm buildings to be cut in. While doing the wiring its servicemen have a fine opportunity to talk up the electrical equipment that will make the kilowatts pay off when they are turned loose on the premises.

The two partners and other salesmen stay in the country promoting new sales, while Mrs. W. H. Moss, wife of one of the owners, manages the store and sells the drop-in customers.

Appliance Profit-Makers

Gibson REFRIGERATORS RANGES, FREEZER

Two new models featuring space saving, introduced: Each has in excess of 7 cu. ft. of storage capacity; exterior dimensions are

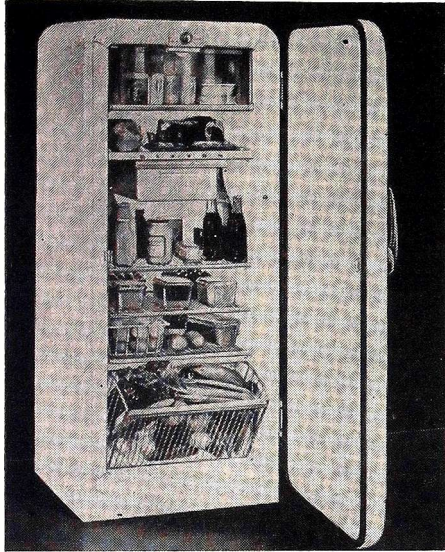

24½ inches wide by 58½ inches high. Automatic light illuminates food cabinets. Both models are available with either right or left hand doors at no extra cost. Model 720 shown has Freez'r Locker, Fresh'ner Shelf and features Gibson Cold Modulation; 11.9 sq. ft. shelf area; two ice cube trays, sliding crisper, wire storage bin. Suggested retail price is \$189.95. Model 700 has simple, accurate control, oversize freezing unit, two ice cube trays, snap-seal door latch.

Other products shown include: the Touch-A-Tap refrigerator with built-in cold drinking water supply, new deluxe electric ranges with concealed oven units located outside the oven itself, automatic push button ranges in moderate price class, new 10 cu. ft. chest type home freezer. Gibson Refrigerator Co., Greenville, Mich.—RADIO & TELEVISION RETAILING.

GE IRONERS

Automatic rotary ironer, AR-22, retailing for \$99.95 announced. Rotary is housed in compact white cabinet, a chromium plated shoe provides 96 square inches of ironing surface. A knee lever automatically controls starting and stopping of the roll; emergency release handle provided; toggle switch controls current; pilot light shows when current is on.

A redesigned flatplate with a single heating element which conducts heat evenly to all parts of the ironing shoe also introduced. Single thermostat maintains smooth range of temperature. Flatplate has recommended national price of \$229.75. General Electric Co., Bridgeport, Conn.—RADIO & TELEVISION RETAILING.

Hotpoint RANGES

1950 model electric range line highlighted by two deluxe pushbutton models RD-7 double oven range and single model RD-6. Features 1600 watt "instant heat" Calrod unit. Both ranges have pushbutton controls that light up in different colors to show set-



tings of four surface units and ovens. RD-6 model has raisable deep cooker calrod unit to increase flexibility. Line is rounded out by three conventional models with switch controls for surface units and two apartment house models. Hotpoint, Inc., 5600 W. Taylor St., Chicago 44 Ill.—RADIO & TELEVISION RETAILING.

Thor WASHERS

Automatic washer, model 244 C, shown, features improvements such as factory sealed mechanism for greater durability



and increased water capacity in the outer tub. Water spout located in center of machine at the back feeds water through an air gap, permitting housewife to control water temperature and pressure without having to remove the washer's lid.

The company's two larger wringer washers, the Deluxe Super Agitator washer, and the Super Agitator washer also represent improvements in exterior design and mechanical performance. Thor Corp., Chicago 50, Ill.—RADIO & TELEVISION RETAILING.

Crosley NEW APPLIANCES

A complete line of 1950 Shelvador refrigerators, a complete line of all steel wall and base cabinets, kitchen sinks and electric waste food disposers, and custom and deluxe water heater models have been introduced by the company.

Shown are the Shelvador refrigerator model DB-9, featuring: separate, horizontal

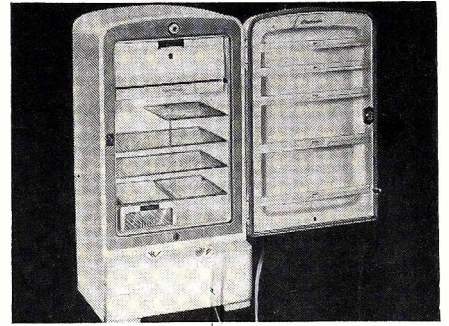

freezer; frozen storage compartments; restyled with sturdy white plastic shelves. Also illustrated is the custom cabinet sink 54" model CF-5400 with single bowl and twin drain boards; shown is the electric waste food disposer that fits under the sink.

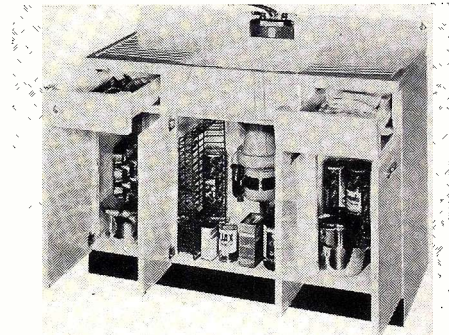

Other new products in the company's line include: 3.2 cu. ft. freezer which holds up to 112 pounds of frozen foods; model UB-9 Shelvador refrigerator which stores up to 22 lbs. of frozen foods; electric water heater, model CM 52 DE, automatic custom model, equipped with double immersion-type heating element that heats water directly. Crosley Div., Avco Mfg. Corp., Cincinnati, O.—RADIO & TELEVISION RETAILING.

Westinghouse VACUUM CLEANER

New, lower-priced upright vacuum cleaner to sell at a suggested list of \$39.95 introduced. The cleaner is full-size and features self-adjusting handle that automatically adjusts to any position for storage, normal or low cleaning, and automatic nozzle adjustment for all types of rugs. New model is equipped with a headlight, quiet fan and ¼ h.p. motor. Cleaner is finished in black and grey, with maroon trim. A seven piece set of attachments sells for \$13.95. Westinghouse Electric Corp., Mansfield, O.—RADIO & TELEVISION RETAILING.

Service Sells Farm Customers

(Continued from page 73)

Sears Appliance Company, Arvada, Colorado, to sell a large number of electrical home appliances to northern Colorado farmers.

With Frigidaire for 20 years before becoming a retailer himself in this small Colorado town, Sears is a strong believer in service as part of a merchandising operation, and consequently, both his success and the store itself are built around the service department.

"In all cases, we have found, the farmer will buy from the dealer who guarantees reliable, fast service, since many of them have had bad experiences in attempting to get electrical equipment of one kind or another repaired in a hurry," says Sears.

The handsome Sears store, on a main highway leading into Arvada, sells a territory comprising a trading area of around 16,000, plus all of Jefferson County, replete with wheat and corn farms, truck gardening acreages, and a lot of livestock ranches. The showroom is completely modern, with seven large display windows behind which are neat displays of refrigerators, ranges, washing machines and commercial equipment. Neon signs and bright interior fluorescent fixtures make the store an eye-catcher during the night hours, when scores of local farmers come to town for movies or late shopping.

Instead of hiding away the service department in the rear of the building, Sears has made it the store's most prominent feature. The repair shop occupies 25% of the total space, behind broad, white-framed windows which separate it from the salesfloor, but make it easy for appliance prospects to see neat rows of lathes, presses, milling machines, condenser testers and other repair equipment. Lighting is intensified in the department for this reason, entirely for giving the visitor a "better look at repair facilities." Mechanics on duty wear white coats lettered "Sears Appliance Company."

"Knowing that the farmer looks first for service and then for the appliance, we insist on taking most of the rural prospects into the service shop and showing them around," says this dealer. "We think this is the most effective merchandising step we can take, inasmuch as the usual farmer is bound to tell others what he saw. We take pains to illustrate what each machine or unit is for, and wind up with the farmer's complete confidence."

The shop is neatly departmentalized, and features complete power tools for making many needed parts and repairs. Outstanding equipment includes an enclosed sheet metal booth for spraying solvent for cleaning compressors and refrigerator parts or electric motors, a neat five-valve charging panel with pressure meters and polished brass controls for delivering freon and methyl refrigerants to compressors under repair, and an impressive row of refrigerant pressure bottles racked at the rear. In the right front corner is a compressor test bench with all controls and meters for checking head pressure and refrigerating capacity, plus the electric motor repair bench with rows of instruments and dials.

Good Arrangement

At the rear are 48 neat bins for small washing machine, refrigerator and range parts, the general small appliance repair bench, and paint spray equipment for cabinet refinishing. On a heavy table is a lathe for turning down motor armatures, making rod parts, and at another point a milling machine for washing machine gears and parts. All benches and equipment are painted, with galvanized metal work-surfaces, and numbered drawers for parts or hand tools. The walls are done in white, and are refinished often enough to keep up the meticulous appearance which Sears finds his most valuable service-selling asset.

Sears thus plays up the service department at every opportunity. He points out to visiting farmers that the department has a crew of three outside servicemen, available at quick notice anywhere in the county for warranty

maintenance or domestic repair service at \$2.50 per hour plus parts. This low rate always appeals to farmers, and is feasible because of the heavy volume always on schedule. Each repairman out on the job wears a white coat in the customer's kitchen which never fails to make a lasting impression.

Sears Appliance Company promotes the farm market in several fruitful ways. First, each of the servicemen is trained in selling, and receives a 2% commission on all appliances sold through his initial effort, and 5% on commercial refrigeration which Sears likewise handles. "The 2% is plenty of incentive to keep the men fighting LP gas competition," the dealer said. "Each man turns in a report on any need for appliances which he couldn't close himself, and we rush a salesman out as soon as possible. In many instances servicemen have sold new refrigerators where the old box needed too expensive repairs to fool with it, and having put that across, have gone on to sell automatic washers and even home freezers. Our mechanics see five or more farm families per day during the busy season, and their contacts are among the most valuable method of prospecting we have developed."

Sears has one full-time outside salesman in addition to himself, both covering the entire countryside, bringing farm families into the store and returning them to their homes at appointed schedules. "That's a service which all farm prospects appreciate," Sears said.

The store recently distributed 5900 fliers of a newspaper ad, listing appliance lines and services, with the invitation, "We'll call for your family and bring you back." These are distributed box by box over all RFD routes at regular intervals, and Sears has found this to be most effective. In addition he uses farm journals and country newspapers, concentrating on one appliance after another, and always with a high degree of success.

Trade-Ins Popular

An excellent "calling card" in prospecting among new farmers is the large stock of trade-in refrigerators and other appliances which the store usually has to offer. The well-equipped service shop makes it possible for Sears to take trade-ins profitably on almost all major appliances, which are completely reconditioned, refinished, and sold at a small profit in the same showroom with the new appliances.

Penny postcards are used regularly for keeping in touch with unsold prospects. After an appliance is sold, Sears or his salesman calls on the purchaser, demonstrating the appliance, and guaranteeing service. File cards are kept on all installations which include a penciled map showing the most direct route to the farmhouse, which are of much assistance to servicemen on repair calls.

One of the most valuable service assets of the organization is a complete stock of exchange motors, which eliminate tedious hours of repair work out in the farm territory. When a washer or refrigerator breaks down for this reason, the serviceman checks the card file, and brings out a replacement motor, which is installed while the old one is repaired in the service shop. This means that few appliances are out of service in farm homes for more than a few hours—and that Sears Appliance Company consistently earns the goodwill of the farm market.

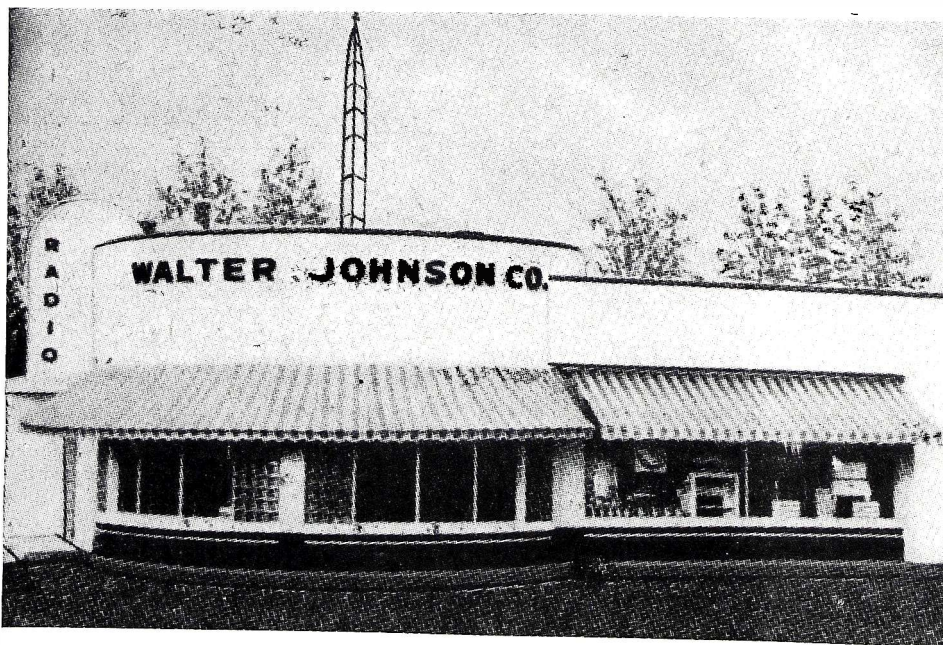

A successful rural dealership is the Walter Johnson Co., Siren, Wisconsin. Johnson does a big business in a small community; maintains attractive store shown in photo.

New Electrical Appliances

Coolerator REFRIGERATOR

Coronet model RB75 full length refrigerator lists at \$189.95. Designed in super space saver cabinet that is only two feet wide and 57 3/5 inches high, unit has a capacity of 7 1/2 cu. ft. Safe storage

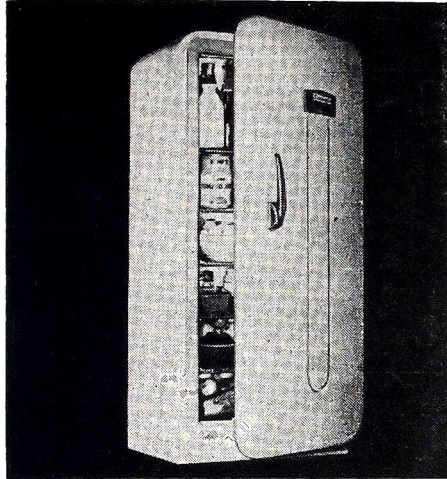

temperatures maintained throughout the entire cabinet. "Zero-Lator" compressor eliminates need for false bottom in the cabinet; U-type evaporator which offers storage capacity for more than 20 lbs. frozen foods; five roomy shelves; temperature control has ten steps; spring loaded snap-action lock. Coolerator Co., Duluth, Minn.—RADIO & TELEVISION RETAILING

Monitor WASHER

Model 6-P aerator washer; features greater washing capacity, more powerful model,

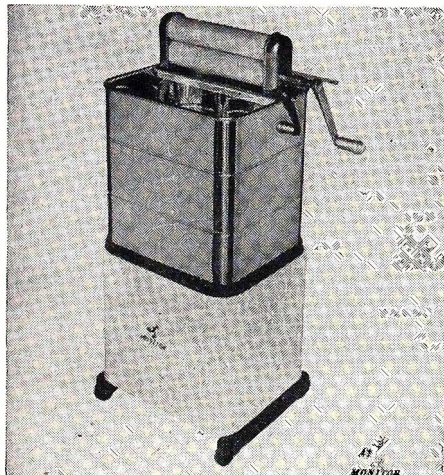

larger, balloon type wringer. Washer has a separate electric pump that empties the washer. Priced at \$69.95. Monitor Home Appliances, Riverdale, New York, N. Y.—RADIO & TELEVISION RETAILING

Shok-Pruf OUTLET COVERS

Conceals dangerous electric outlet openings against prying children's hands. No

wires to touch to install. Place cover over outlet and fasten with screw. Slide "secret panel" to insert plug. If plug is removed, panel slides back over openings. Hayman-Standard Products Co., Phila., Pa.—RADIO & TELEVISION RETAILING.

Telechron CLOCKS

Six new electric clocks in the moderate price range. Shown, upper row (l. to r.): "Colonnade," mahogany wood case, red alarm hands, gold-colored hour and minute hands; control-a-tone alarm; price \$7.95; "Coronado," bell alarm in dark mahogany with gold-colored metal sweep second hand, price \$12.50; "Kirkwood," bell alarm in mahogany with gold-colored bezel, price

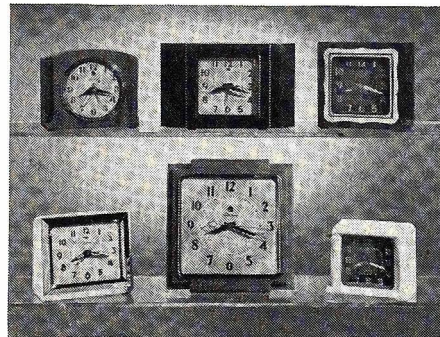

\$8.95. Lower row (l. to r.): "Nocturne," bedroom alarm clock in ivory with gold-colored bezel, price \$6.95; "Stewardess," kitchen clock in red, white, ivory or blue plastic case, price \$4.95; "Tempo," ivory bedroom alarm with luminous hands, price \$4.95. All prices are plus tax. Telechron Corp., Ashland, Mass.—RADIO & TELEVISION RETAILING.

Westinghouse WASHER

RI-1, streamlined version of Laundromat automatic washer, retails at a suggested price of \$219.95, which is \$80 below the deluxe model. Washer is designed to be bolted down for permanent installation; has identical washing cycle and self-cleaning action as the deluxe model; single-dial control; sealed-in-steel transmission; sloping front for ease of loading and unloading. Westinghouse Electric Corp., Mansfield, O.—RADIO & TELEVISION RETAILING.

Syncro HONE SHARPENER

Electric hone sharpener employs magnetic honing action; device has no wheels, belts or gears and requires no oiling. To operate, plug into outlet, press the positive on-and-off starter button, and hone with both hands free to hold object. Unit is 6 inches by 7 inches by 5 inches high; complete with cord, plug and 3 interchangeable honing stones, one convex, two flat, for \$10.50. Syncro Corp., Rochester, Mich.—RADIO & TELEVISION RETAILING.

Whirlpool WASHER

Deluxe automatic washing machine features: Agiflow action, with a new agitator designed to give laundry in the machine increased flexing; an ultra-violet germicidal lamp, as a sanitary measure with clothes getting ultra-violet rays through en-

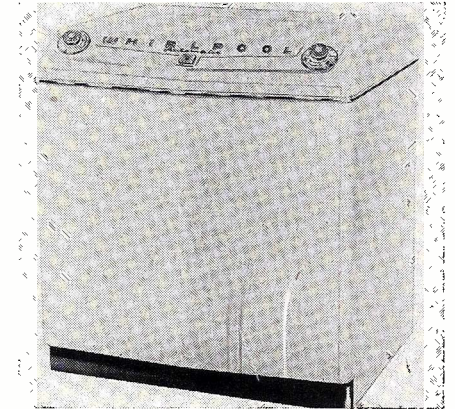

tire wash, rinse and spin dry cycles; and the Cycle-Tone buzzer, which sounds during last minute of the time period user has selected for the load in the tub. Automatic also has the exclusive Suds Miser and the Seven Rinses feature. The Whirlpool retails at \$299.95 with the Suds Miser, and \$20 less without it. Nineteen Hundred Corp., St. Joseph, Mich.—RADIO & TELEVISION RETAILING.

Refrigerated BARS

Shown is de luxe refrigerated console, available in 18th century and contemporary styles. Console is available in mahogany, walnut or limed oak. Features: 3.5 cu. ft. refrigerated storage space; 3 aluminum ice

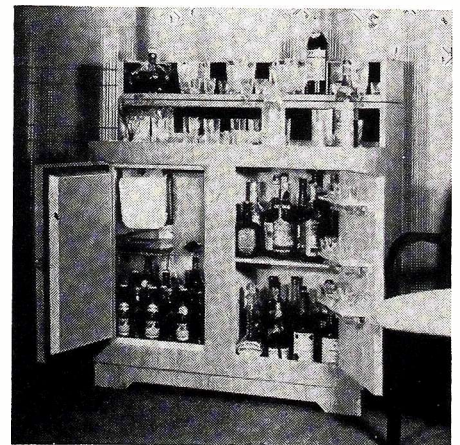

cube trays; glass defrosting utility tray; 15 qt. stainless steel container; mirror-backed serving section; built-in Yale cabinet locks and keys. Unit is 42 inches high, 42 inches wide. Refrigerated Equipment Sales Corp., 19 W. 44th St., New York 18, N. Y.—RADIO & TELEVISION RETAILING.

OUT FRONT... at a new low price



10¢
SUGGESTED LIST PRICE



Sell 'em like soda pop... in the easy-to-sell, handy-to-have Carry Kit.



NOW... chalk up new selling records with the best "A" battery money can buy!

Here's selling history in the making!... RCA's famous VS036 "Sealed-in-Steel" A Battery with the special "Radio Mix" now costs no more than an ordinary flashlight cell!

Stop and think of this in terms of turnover and extra profits—and you'll agree that the RCA VS036 is today's best buy in batteries by far.

Customers are quick to note the

extra listening hours they get from RCA-VS036s... actually 25 per cent more than from ordinary flashlight batteries in high-drain portables! That brings 'em back for more!

Remember, too, that you can stock up on VS036s with no need to worry about shelf life. *The RCA-VS036 stays fresh for years.*

Get sales action with the RCA "Magic Motion" illuminated display. See your RCA Battery Distributor today about the new RCA "Magic Motion" Illuminated Display expressly designed to help you sell more VS036 A batteries at the new low price. See the display in action, and you'll want one or more immediately for your window or counter.

ALWAYS KEEP IN TOUCH WITH YOUR RCA BATTERY DISTRIBUTOR



RADIO CORPORATION of AMERICA

HARRISON, N. J.

SERVICE & SOUND

Section of **RADIO & TELEVISION RETAILING**

Gated, Keyed or Pulsed AGC

Better Immunity to Noise and Fast Fading Claimed For Circuit Used by Zenith, Emerson, Raytheon, Admiral and Others

• Automatic gain control has long been considered a necessary and desirable feature of TV receivers, and it is rapidly approaching universal use now that circuits have been developed which are simpler (that is, less expensive) and more trouble-free. The contrast control has remained one of the least understood of the operative controls from the standpoint of the consumer, and AGC assures him a fairly good picture without change of controls in the face of widely varying signal strengths on different channels. It also protects him to a large measure from airplane fading, and at the same time makes it almost impossible for him to overload the picture to the point where it is a stark, shimmering black and white with no shading.

In radios, AVC provides a DC control voltage proportional to the average carrier level, but in TV the peak carrier level must be measured, since the average carrier level varies with the average illumination of the scene being transmitted.

A peak detector can be obtained by adjusting the operating voltages so that the tube conducts only when the signal goes above a certain level. In the case of the TV signal, this would be above the blanking, or 75% modulation level.

Since the area between 75% and 100% modulation is the sync signal, it has been conventional to rectify the sync peaks in the neighborhood of the picture second detector and use the resultant DC as bias on the rf and if amplifiers.

Noise Measured By AGC

The time constant of such an AGC circuit had to be long enough to average out both horizontal and vertical sync pulses since these pulses vary considerably in width. Otherwise the AGC would interpret these variations in average DC as signal variations, and limit the signal whenever a vertical pulse came through. With this relatively slow time constant, the circuit would not respond rapidly to airplane fading.

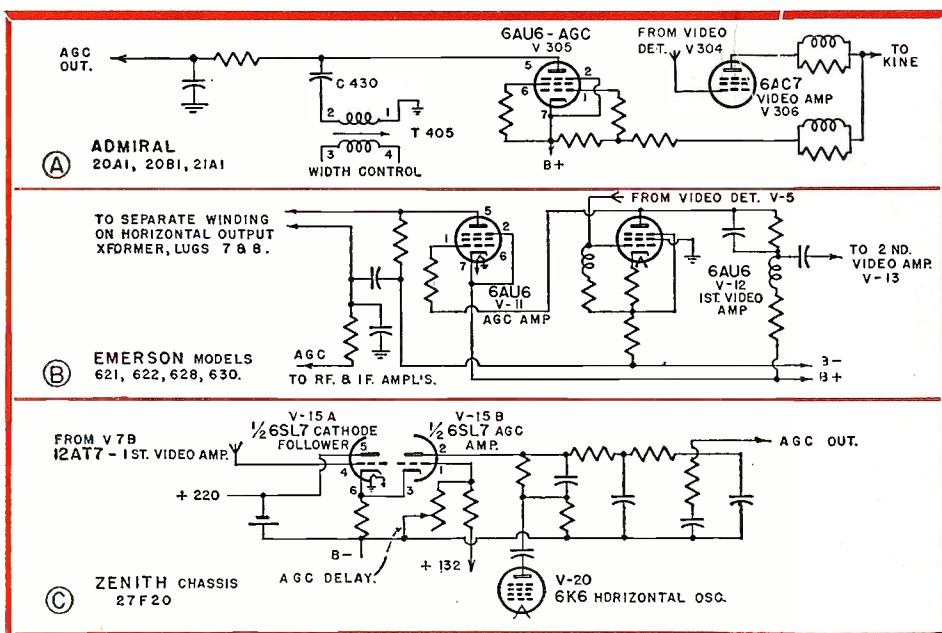

But the main difficulty with ordinary AGC circuits is that noise peaks would be measured along with sync peaks, and so would have an undesirable fading or flashing effect on the picture.

The new type of AGC goes up into the "rear end" of the receiver to get its control, namely to the horizontal oscillator or the horizontal output transformer. In a typical case, the AGC amplifier gets its plate voltage from one of these two sources, and is therefore "pulsed" or "keyed." Hence the term pulsed AGC, or keyed, or gated AGC. Actually, the more conventional type of AGC was also in a sense pulsed, since it measured the sync pulses. However, it was "open" to receive information between sync pulses, if any noise peaks (for instance) should appear as high or higher than the sync. The differentiating feature about keyed AGC is that it is pulsed at the horizontal rate (15,750 cps), and is therefore "closed" to noise most of the time and "open" only during the horizontal sync pulses.

The time constant can be faster because the system is not operative during vertical pulses, which is another feature of this type. The advantages of this system are, then, relative immunity to noise, and to fast fading due to airplane reflections.

Three examples are shown. In the Emerson circuit, plate voltage for the AGC amplifier (V-11) is obtained from a separate winding on the output transformer. In the Zenith circuit, the AGC amplifier (V-15B) obtains its plate voltage from the 6K6 horizontal oscillator. In the Admiral sets, a secondary winding on T405 (width control) serves as a source of pulsed plate voltage for the AGC amplifier (V305) through capacitor C430. In all three cases, the output of the first video amplifier supplies the signal to the grid of the AGC amplifier tube. In the case of the Zenith, it also acts as a noise clipper, being biased so that noise pulses do not produce a plate current change, and therefore do not appear in the output.

Quadrature Phasing

TV Receiving Antenna

**Variable Directivity Without Mechanical Rotation
Achieved With Both Roof and Built-In Types**

● The decided advantages obtained by the use of mechanically rotated TV receiving antennas are well known—especially in multi-station areas where it is not possible to obtain maximum amplitude, ghost-free reception on several channels with any one position of the antenna. However, the added problems of installation and maintenance suggest the desirability of obtaining variable directivity without mechanical rotation. Such an antenna has been developed, embodying quadrature phasing. The phasing principle is adaptable to either outdoor or built-in types. The built-in type is being utilized by several set manufacturers, including Halli-crafters and Tele-tone, and gives an effective "orientation" feature without any physical movement inside the cabinet, or of the cabinet itself.

Basically, the system consists of crossed horizontal dipoles at right angles to each other, with means of varying their electrical phasing. Taken separately, the dipoles can be considered as having the familiar figure-eight radiation pattern. When the two crossed dipoles are excited 90 degrees out of phase, two figure-eight patterns are formed at right angles to each other, so that there is a lobe in every quadrant, and the distribution of the radiated field is approximately circular, or omnidirectional. This principle is sometimes used to get omnidirectional reception with FM receiving antennas. Varying the phasing between the elements will produce lobes and nulls (due to addition and cancellation effects) in a manner which effectively amounts to rotation of the major lobes through 180 degrees. The result is that by varying a phasing control placed at the receiver, the operator changes the configuration of the lobe pattern and so in effect "orients" the antenna.

In practice, the crossed-dipoles (in the case of an outdoor antenna) are mounted on one mast, and two down-leads are run to the receiver, one from each dipole. At the phasing control near the receiver, the four conductors of the two downloads are tied to the stator plates of a condenser. The rotor, which can be turned by the operator by means of a shaft and knob connection, feeds a single lead-in to the receiver antenna terminals.

To obtain relatively uniform results over both TV bands, the outdoor an-

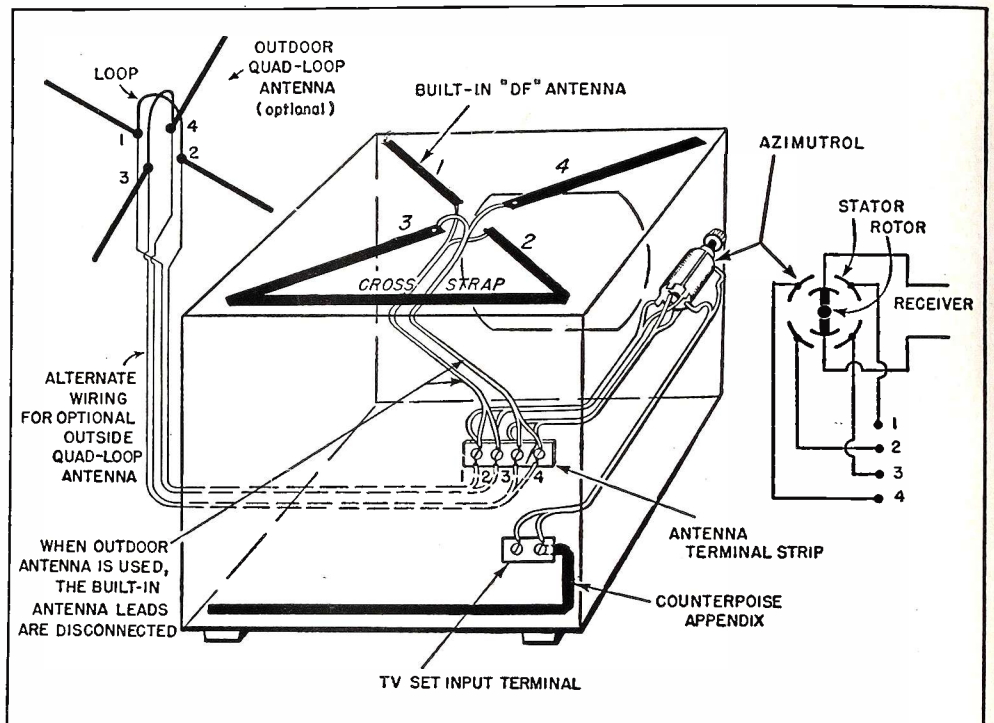

Fig. 1: Both the outdoor and built-in antennas are shown in this composite view. In either case, 1 and 2 make one dipole, 3 and 4 make the other.

tenna was designed with a special type of dipole consisting of a straight dipole (to resonate at channel 2) bridged across its center terminals by a loop (to resonate at channel 7). By combining these two conditions, it was found possible to obtain a substantially flat response throughout the desired range. Using a tuned folded dipole at each channel frequency as a standard of comparison, the response is said to be on the order of 1 DB higher on channels 7-13, 0 DB on channels 4-7, and minus 1.2 DB on channel 2. This dipole is said to have a more directional pattern than the reference antenna, and further, it developed that a thirty degree physical displacement of the loop with respect to the horizontal portion of the dipole made possible a proper phasing-in of the signals from the two sections (high and low band) of the system. If further directivity is desired, both sections can be adjusted to a V configuration. With this adjustment it is possible to vary the pattern from that of an ordinary dipole to one having a forward lobe roughly 30 degrees in width, with a front-to-back ratio of approximately two to one.

The average impedance of the an-

tenna is 180 ohms at channel 11 and 240 ohms at channel 2, so that a satisfactory match for twin-lead and 300-ohm receivers is obtained. For 72-ohm sets, a matching pad is suggested.

Variable Phase Control

Phasing the two down-leads is accomplished in a device which we have referred to above as a variable condenser. The name of this device is "Azimutrol." In size it measures approximately 4 inches long and 1½ inches in diameter. With the outdoor antenna, the azimutrol is provided in a small box suitable for positioning on top of the receiver, and on the built-in types (of which more will be said later), it is mounted in the cabinet, with only the shaft and knob showing on the outside.

In construction, the Azimutrol resembles a small cylinder with a concentric shaft extending from one end. The wall of the cylinder is actually made of four plates, insulated from each other, each of which is a quarter of the cylinder. These plates are the stator plates of the condenser, and each

(Continued on page 86)

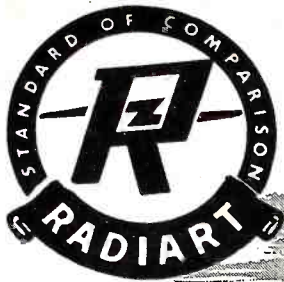

Radiart
features

**THE
Lowest Priced Quality Line**

OF TV CONICAL ANTENNAS



**\$22.95
List**

**THE DOUBLE STACKED
"LAZY X" ARRAY . . .**
for improved gain in low
signal strength areas —
also where a higher
signal-to-noise ratio is
desired . . . Model LZX-2

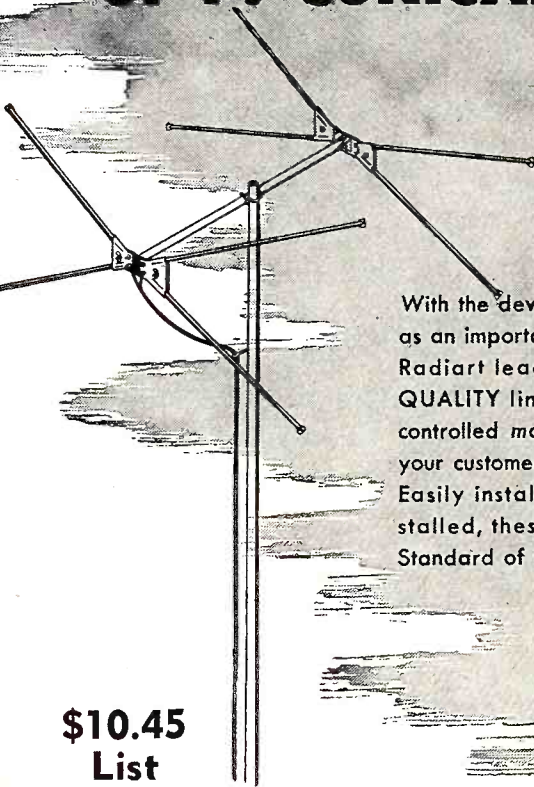

**\$10.45
List**

THE SINGLE BAY "LAZY X"
... for primary service areas
..... Model LZX

With the development of the conical type antenna
as an important factor in television reception . . .
Radiart leads the way with the lowest priced
QUALITY line. Precision engineering . . . quality
controlled manufacture combine to give you and
your customers the greatest value for the dollar!
Easily installed . . . and rigidly sturdy when in-
stalled, these Radiart products truly are "The
Standard of Comparison."

The QUAD-STACK "LAZY X"
Array . . . easily assembled
and installed for the ultimate
in all channel fringe area
reception Model LZX-4

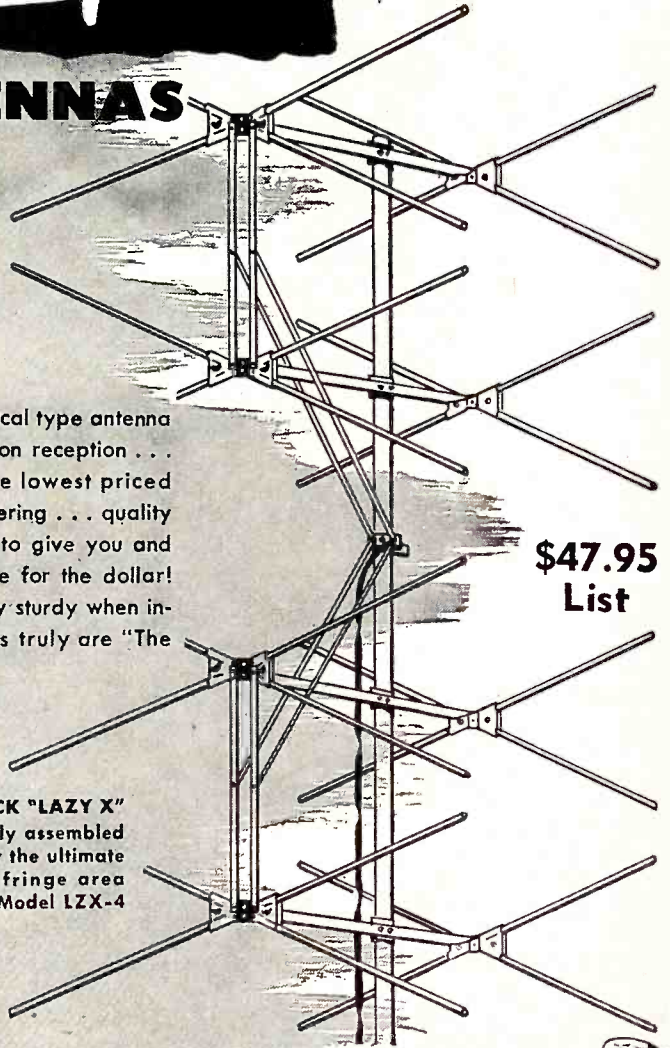

**\$47.95
List**

DEALERS:

For Special "Quantity Prices" . . . See Your
Radiart Jobber About These BULK PACKED
Models:

- Model LZX-6B—six unassembled LZX
bays in one carton.
- Model LZX-6BQ—same as above PLUS
3 pairs jumper bars . . . a good DEAL
—more for your money.



IT'S RIGHT WHEN IT'S RADIART!

THE RADIART CORPORATION
CLEVELAND 2, OHIO

Manufacturers of the Famous Red Seal Vibrators



Television Technician

Section of RADIO & TELEVISION RETAILING

Trio FRINGE TV ANTENNA

Model 304-5 is a 4-element Yagi designed for high forward gain and sharp directional characteristic for fringe TV reception. A double folded dipole is used to provide a match for 300-ohm line. This antenna is available for each of the 12 channels, though considerable gain may be expected on adjacent channels. List price is \$35.00. Trio Mfg. Co., Griggsville, Ill.—RADIO & TELEVISION RETAILING.

Amphenol INDOOR TV ANTENNA

"Telestar" model 114-024 is said to provide uniform response over the entire TV bands without tuning. Two sets of alu-

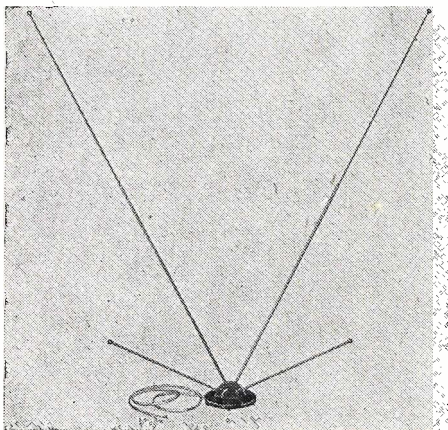

minum rods (one for low, one for high band) are mounted in a molded polystyrene base which is weighted against tipping. American Phenolic Corp., Chicago 50, Ill.—RADIO & TELEVISION RETAILING.

Universal TV TOWER

The Universal tower for TV antennas comes in three 10-foot prefabricated sections constructed of galvanized steel. 10-foot extensions up to 70 feet are available. Hinged tower feet permit mounting on peaked or flat surface. 30-foot tower weighs 70 lbs. Universal Products Co., 4100 Taylor Ave., Racine, Wis.—RADIO & TELEVISION RETAILING.

Peerless INDOOR TV ANTENNA

The "Golden Wand" comprises two "V" type dipoles of three-section telescoping brass tubing set in plastic insulators and mounted on a swivel base. Supplied with 300-ohm lead-in, model G84TV lists at \$6.95. Peerless Products Industries, 81216 N. Pulaski Road, Chicago 51, Ill.—RADIO & TELEVISION RETAILING.

Airweight ALUMINUM LADDER

Aluminum ladder suitable for use by TV installation teams and other service applications weighs only 1 1/4 pounds per foot. U-channel siderail holds in place two rungs for each step, grooved to prevent slipping. Newark Ladder and Bracket Co., Inc., Clark, N. J.—RADIO & TELEVISION RETAILING.

Decimeter TV BOOSTER

The "Professional" TV preamplifier uses a 2-stage balanced triode amplifier and 3 tuned circuits on each channel. Gain of over 30 db is claimed with constant band-

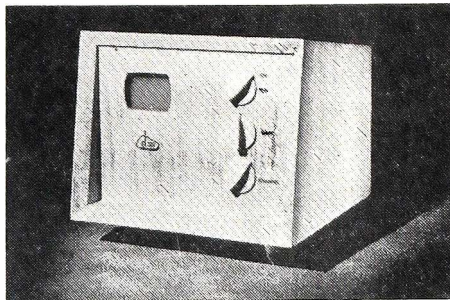

width and uniform amplification of sound and picture on all channels. The No. 200 Contemporary in Philippine mahogany is pictured. Decimeter, Inc., Denver, Col.—RADIO & TELEVISION RETAILING.

Modern-Aire CHIMNEY MOUNT

TVB-104 chimney mounts fit at the corner of chimney, are held in place with 3/4" strapping. A set of two is used to hold a TV antenna mast in place, and lists for \$3.25. Spacing of the two brackets may be varied to suit. Each set is provided with two 12-foot rolls of strapping. Modern-Aire Mfg. Corp., 4432 West Roosevelt Road, Chicago 24, Ill.—RADIO & TELEVISION RETAILING.

Precision INTERFERENCE TRAP

The "TV Clarifier" may be installed between the antenna and the receiver or between the AC outlet and the receiver

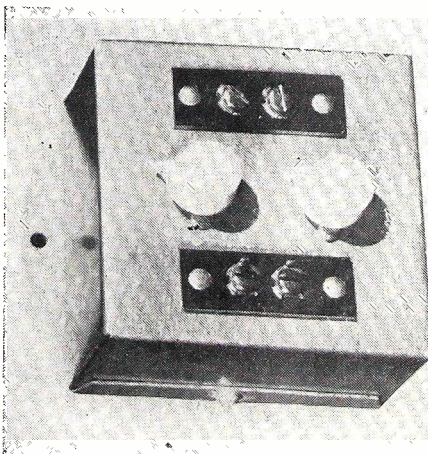

and consists of two variable condensers in parallel with fixed inductance, and may be tuned to trap out unwanted RF or power line interference. List price is \$7.50. Precision Electronics, Inc., 643 Milwaukee Ave., Chicago 22, Ill.—RADIO & TELEVISION RETAILING.

Vee-D-X FRINGE TV ANTENNA

Model RD-13 four bay array for long range TV reception has been modified and improved so that the "Q" or matching section is no longer needed to tune the antenna for maximum performance on one channel. The new model is said to have increased front to back ratio, and a relatively constant center impedance of 280 ohms over the both TV bands. LaPointe-Plascomold Corp., Unionville, Conn.—RADIO & TELEVISION RETAILING.

JFD CONICAL ANTENNA

No. TA166 Inline Conical is designed for sharper directivity and higher gain across both TV bands. Three conical units are

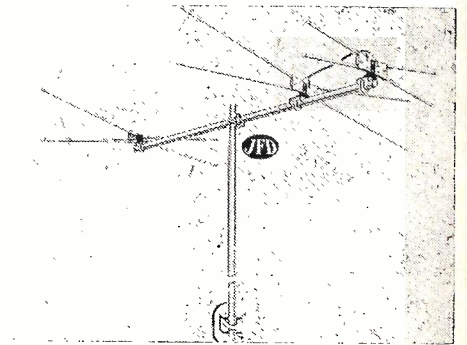

provided, two driven, and one reflector. Direct coupling to 72,100 or 300 ohm line may be used. JFD Manufacturing Co., Inc., 6101 16th Ave., Brooklyn 4, N. Y.—RADIO & TELEVISION RETAILING.

Ampower TV-FM ANTENNA

"Powertenna" utilizes the power line for an antenna. The line cord of the set plugs into the device, and the device into the wall. 300-ohm twin lead is provided to connect to the receiver antenna terminals. The antenna is non-directional, and lists for \$3.95. Ampower Co., 109 W. Hubbard St., Chicago 10, Ill.—RADIO & TELEVISION RETAILING.

Gee Bee PLUG-IN-TENNA

"Plug-In-Tenna" provides an antenna for TV receiver through a connection to the power line. The small device plugs into the wall, the receiver line cord plugs into it, and a piece of twin-lead is provided to connect to the receiver antenna terminals. Reception is said to be non-directional. Retail price is \$5.95. Garrett-Buckley, 624 S. Michigan Ave., Chicago, Ill.—RADIO & TELEVISION RETAILING.

Flextron TWIN-LEAD STRIPPER

The Flextron wire stripper strips 300-ohm lead quickly with any desired length of bare conductors. A portion of the stripped leads has some insulation left on to provide for attaching lugs. Price is \$3.95. Electro-Steel Products, Inc., 112 N. Seventh St., Phila. 6, Penna.—RADIO & TELEVISION RETAILING.

BUY THE BEST • THE V.O.M.A. THAT DOES MORE

MORE FOR YOUR MONEY 

NOTE THESE SENSATIONAL IMPROVEMENTS:

- ★ Individual Scales with separated spacing are easy to read.
- ★ Large 5½ Inch Meter In Special Molded Case Under Panel.
- ★ Resistance Scale Markings from .2 Ohms to 100 Megohms—Zero Ohms Control Flush With Panel.
- ★ Only One Switch—Has Extra Large Knob 2½" Long—Easy To Turn—Flush With Panel Surface.
- ★ Enclosed New Molded Selector Switch and insulated resistor housing in unit construction.
- ★ All Resistors Are Precision Film or Wire Wound Types For Permanent Accuracy.
- ★ Batteries Easily Replaced—Balanced Double-Contact Grip. Spiral Spring—Battery for Ohms test due to low drain insures shelf-life usage.



Triplet Model 630

\$37.50
Dealer Net

In the relatively short time since Model 630 was introduced to the trade it has steadily risen to the top in sales. The reason is obvious. Here is a Volt-Ohm-Mil-Ammeter that does more . . . has proven components . . . and will give a lifetime of satisfaction. All the engineering skill and facilities of the industries' largest manufacturer of Volt-Ohm-Mil-Ammeters joined forces to make it outstanding in every way. Look over all the features and you too will buy Model 630.

TECH DATA

D.C. VOLTS: 0-3-12-60-300-1200-6000 at 20,000 Ohms/Volt
 A.C. VOLTS: 0-3-12-60-300-1200-6000 at 5,000 Ohms/Volt
 D.C. MICROAMPERES 0-60 at 250 Millivolts
 D.C. AMPERES 0-12 at 250 Millivolts
 D.C. MILLIAMPERES 0-1.2-12-120, at 250 Millivolts
 OHMS: 0-1000-10,000; (4.4 Ohms and 44 Ohms center scale)
 MEGOHMS: 0-1-100 (4400-440,000 at center scale)
 DECIBELS: -30 to +4, +16, +30, +44, +56, +70
 OUTPUT: Condenser in series with A.C. Volt ranges
 High voltage Probes available, extra; also plug-in shunts for other current measurements to suit special needs.

Laboratory Standard Model 630-A—All scales on this model are hand drawn and hand stepped, used with mirror for extreme accuracies, beyond the average servicing needs of the model 630.
Triplet Model 630-A Dealer Net \$47.50

VOMA JR.—A NEW VOLT-OHM-MIL-AMMETER

Handy "POCKET-SIZE LABORATORY" By Triplet

VOMA Jr. MODEL 666-R has many of the design features of the popular Model 630:

1. Switch and controls flush with panel.
2. Enclosed molded selector switch.
3. Exclusive Unit construction-resistor housing integral with switch.
4. Resistors Precision wire wound and permanent film type.
5. Resistance Measurements to 3 Megohms.
6. Batteries with spiral spring contacts, easily replaced.

VOMA Jr. MODEL 666-R . . . \$24.50
U.S.A. Dealer Net Price

Note: Model 666-HH The Original Pocket-Size Lab—still a favorite with many. U.S.A. Dealer Net \$22.00.



TECH DATA

D.C. VOLTS: 0-10-50-250-1000-5000, at 1000 Ohms/Volt
 A.C. VOLTS: 0-10-50-250-1000-5000, at 1000 Ohms/Volt
 D.C. MILLIAMPERES: 0-10-100, at 250 Millivolts
 D.C. AMPERES: 0-1, at 250 Millivolts
 OHMS: 0-3000-300,000 . . . (20-2000 at center scale)
 MEGOHMS: 0-3 . . . (20,000 ohms center scale)

Precision first . . . to Last



TRIPLET ELECTRICAL INSTRUMENT COMPANY • BLUFFTON, OHIO, U.S.A.
 In Canada: Triplet Instruments of Canada, Georgetown, Ontario

New Units for PA and Sound

Jensen COAXIAL SPEAKER

Model H-510 employs a direct radiator low end with a separate high frequency horn and compression driver for the high channel. Polar pattern of the high fre-

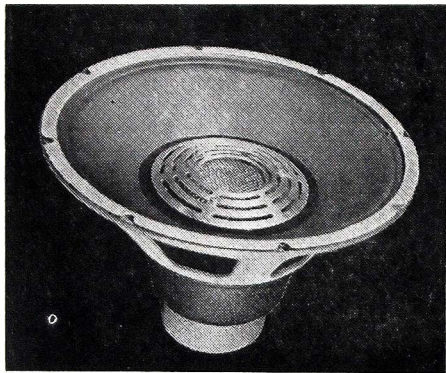

quency horn is enhanced by use of an optical lens principle, with off-set circumferential slots. This yields a polar pattern that is uniform over an unusually wide angle out to very high frequencies. Jensen Mfg. Co., 6601 S. Laramie Ave., Chicago, Ill.—RADIO & TELEVISION RETAILING.

Geraton AMPLIFIER

AF amplifier provides dual channels with separate gain controls and features small size (8 1/4" long, 4 wide and 5 high) and light weight (four pounds). Output impedances are 3.7 and 500 ohms, price is \$37.50. Geraton Research and Development Corp., 2115 N. Charles St., Baltimore 18, Md.—RADIO & TELEVISION RETAILING.

RCA LOUDSPEAKER

The RCA 515S1 is a 15-inch, duo-cone, high fidelity speaker designed for high-quality radio and TV receivers and other sound applications. Power handling capacity is 25 watts, and useful response range from 40 to 12,000 cycles. Each section of



the dual cone is driven by its own voice coil. Over the range of cross-over frequencies the two cones vibrate as a single cone, but the smaller cone will not vibrate at the lower audio frequencies, making a crossover network unnecessary. Tube Dept., RCA, Harrison, N. J.—RADIO & TELEVISION RETAILING.

University PA DRIVER UNITS

Model PA-30 series driver units are designed for high power outdoor applications, and are completely waterproof, and provided with built-in matching transformer for both constant voltage and constant impedance systems. Model PA-30 is for con-



tinuous high-intensity levels of speech and music up to 10 KC. Model PA-30-C is specially designed for chime music. For further information write University Loudspeakers, Inc., 80 S. Kensico Ave., White Plains, N. Y.—RADIO & TELEVISION RETAILING.

Oak Ridge TESTER

Model 101 tester contains a range of substitute condensers from .001 to .5, 600 v.; 30 mfd, 450 v. to 150 mfd, 150 v.; resistors from 100 to 100,000 ohms, 2 watt; a vari-

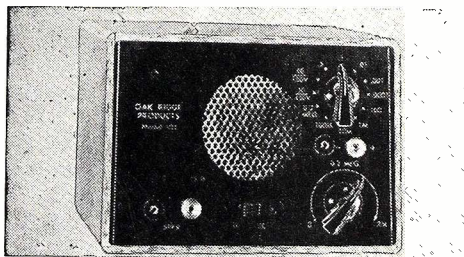

able potentiometer 0-2 meg. and a test speaker with connections to either voice coil or transformer. Oak Ridge Antenna Mfg. Div., Video Television, Inc., 239 E. 127th St., New York 35, N. Y.—RADIO & TELEVISION RETAILING.

Audak PHONO CARTRIDGE

The Polyphase Reproducer is designed to play the various types of discs with a single unit. Wide range performance is claimed. Output about 30 m.v., high or low impedance, pressure 7 grams, replaceable sapphire or diamond styli. Audak Co., 500 Fifth Ave., New York 18, N. Y.—RADIO & TELEVISION RETAILING.

Amperite MIKE STAND

Microphone stand for desk, pulpit, and footlight use is an aluminum casting, finished in gray. Weighing one pound, the stand lists for \$6.00. Amperite Co., Inc., 561 Broadway, New York 12, N. Y.—RADIO & TELEVISION RETAILING.

Electro-Voice 45 RPM CARTRIDGE

Series 34 torque drive crystal phono cartridge has been designed as replacement in RCA 45 RPM changers. Response

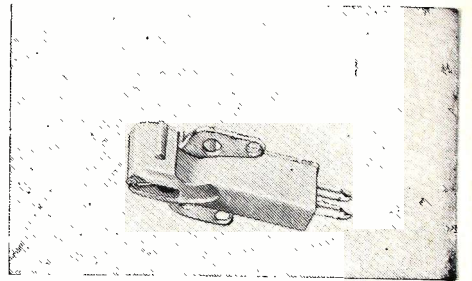

is said to go beyond 10 KC, tracking pressure 5 grams, output 1.1 volt at 1000 cycles. Price with osmium needle \$6.50, with sapphire needle \$7.50. Electro-Voice, Inc., Buchanan, Michigan.—RADIO & TELEVISION RETAILING.

Brociner-Klipsch SPEAKER

The Brociner-Klipsch dual-horn reproducer is available in period or modern styled cabinets for the home. Characteristics claimed for the speakers are: frequency response flat from 30 to 15,000 cycles, free

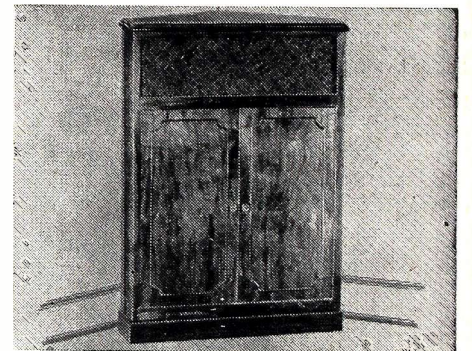

from transient response and hangover, with higher efficiency and more realistic tone than possible with direct radiators. Brociner Electronics Laboratory, 1546 Second Ave., New York 28, N. Y.—RADIO & TELEVISION RETAILING.

Sprague CONDENSERS

Type TVQ capacitors for TV receiver use are designed to combine special operating requirements with small size. Type TVQ are 6000 volts capacitors for 85 degree centigrade, high humidity operation. Complete description is given in bulletin M-433. Sprague Products Co., North Adams, Mass.—RADIO & TELEVISION RETAILING.

Aerovox CAPACITORS

"Aerolite" metallized-paper tubulars are designed for capacitance stability with temperature change and protection against voltage surges, combined with extremely small size. Available in ratings from .01 to 2 mfd., voltages of 200, 400 and 600. The 200 v. 2 mfd. size measures 2 3/32 x 1 1/8 inches. Aerovox Corp., New Bedford, Mass.—RADIO & TELEVISION RETAILING.

New Polaroid Filter

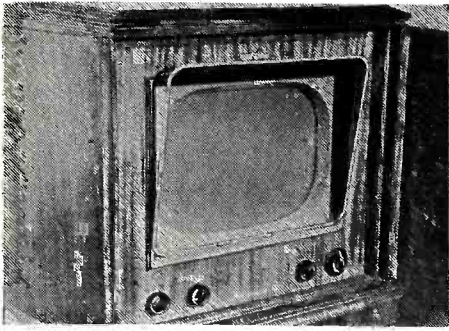

The De Luxe filter incorporates the "glare-lock" feature, designed to trap day and night time reflections, in addition to the other features of the original filter. The De Luxe filter also utilizes two layers of outside protective coating, one on each side, to give body and rigidity, as well as a frame and brackets for easy attachment.

Federal Television Sets

Due to the late arrival of the data on TV sets manufactured by the Federal Television Corp. of 139 Duane St., New York, N.Y., this information was unavoidably omitted from the Television Receiver Specifications recently published in this magazine. The firm is currently marketing 17 models, including 6 twelve-inch sets and 11 sixteen-inch models. Prices range from \$359.50 for the "Mohawk," 16-inch television only table set, to \$1795. for the "Scarsdale," breakfront console with AM-FM radio and 3-speed record changer, 16-inch picture tube.

Form TV Dealers Groups

A National Television Dealers Association has been formed, and incorporated under the laws of the state of Maryland, with headquarters at 402 Washington Building, Washington 5, D. C. The purposes of this association are to promote the best interests of retail television dealers, to unite members of the television retailing industry in all lawful measures for its common good, and to those ends to engage in any or all proper trade associations. Edwin A. Dempsey is executive director of the association.

Warren Mfg. Executive



Sidney Sachs, treasurer Warren Mfg., division of Bradley Sales, New Haven, Conn. The firm makes the Warren line of TV antennas, a magnifier, and TV antenna accessories. They sell direct to dealers.

Radiodyne

TRADE MARK REG.

is the COMPLETE LINE

You can cut installation costs, gain customer satisfaction and increase your sales volume by switching to Radiodyne engineered TV Antenna Accessories . . . a name that has meant quality in the radio industry for many years. Here is the profitable Radiodyne line for 1950:

TOWERS

KNOCKED DOWN ALL-ALUMINUM — 32' to 44' high. Specially treated aluminum tubing and aluminum stampings.

ELECTRICALLY WELDED STEEL — 18' to 98' high. Complete with mast and hardware. Heights up to 98' attainable with extra 10' extensions.

MASTS 19' to 46' high. Made of rolled steel and treated to resist rust and elements.

HARDWARE A full and complete line of all types of heavy duty hardware, specially plated for longer life, to meet today's installation demands.

PLATFORMS Protect your customer's roof.

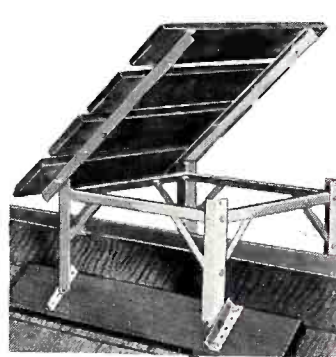

Install the new Hinge-Top Tower Platform . . . provides the fastest and most convenient way of mounting light TV Towers on flat or peaked roofs. You merely bolt the tower to the hinged platform, then raise it to an upright position and lock hinged top. The Hinge-Top Platform permits

easy inspection of tower or antenna at any time.

GUY RINGS New All Steel Swivel Guy Rings

are inexpensive and permit proper orientation of arrays without removing, twisting, or resetting guy wires. Easy to attach and fits any mast from 0 to 2 1/16" O.D. Also available is the heavy duty Swivel Guy Ring made of cast aluminum.

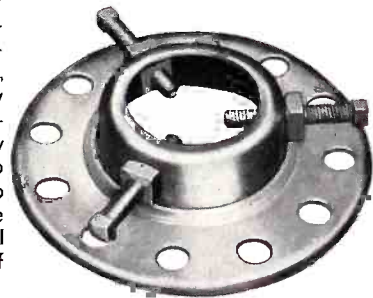

Radiodyne

TV ANTENNA ACCESSORIES

For additional information write to:
WESTERN COIL & ELECTRICAL CO.

Established 1915
216 STATE ST. RACINE, WIS.

Big News-More Sales-Greater Profits!



telrex
SPECIAL SERIES
CONICAL ANTENNAS

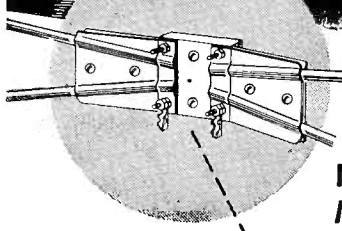

1/3 lower cost!

NEW ELEMENT MOUNTING CLAMP
MAINTAINS QUALITY—LOWERS COSTS

Simplified design saves on materials, production operations, packing and makes shipping more economical. Telrex engineering assures high performance, long service life on all special models. The new Special Series Telrex Antennas for TV and FM are priced a full third lower than Telrex DeLuxe Models. Now distributors and dealers can offer Telrex engineered Conical "V" Beams in a price range to meet customer needs. The new Special Antennas are efficiently designed, honestly built and priced. Find out, now, how you can improve TV and FM installations at lower, sales-stimulating prices with genuine Telrex Conical Antennas.

SPECIAL MODELS
AVAILABLE NOW

- \$1X-BD \$5.75 LIST**
- \$2X-BD \$11.50 LIST**
- \$2X-TV \$11.25 LIST**
- \$4X-TV \$24.00 LIST**

TELREX SPECIAL AND DELUXE ANTENNAS
COVER CHANNELS 2 TO 13 AND FM RADIO

DELUXE MODEL 2X-BD
 Bi-Directional Stacked Conical "V" Beam
 Broad Band - Full Audio and Video Band Pass
 Low Vertical Angle
 Extremely High Signal to Noise Ratio
 Constant Center Impedance
 Uses 72, 150 or 300 Ohm Transmission Lines
 Self-Adjusting Mounting Clamp

DELUXE MODEL 4X-TV
 2 Bay Uni-Directional Conical "V" Beam
 Broad Band - Full Audio and Video Band Pass
 Low Vertical Angle, Minimum Reflections - Maximum Signal to Noise Ratio
 4 to 1 Front to Back Ratio
 All Frequencies
FOR ULTIMATE HI-GAIN, USE TELREX MODEL TV-8X

HOLD SERVICE CALLBACKS TO A MINIMUM WITH
SERVICE-TESTED, HI-GAIN TELREX CONICALS

For better TV installations, use Telrex "V" Beams — the antennas that give you highest gain and constant center impedance on all frequencies. There's

a Telrex Hi-Gain Antenna to meet the requirements of every locality in all types of signal areas. Ask your distributor for catalog or write direct.

ALL TELREX ELEMENTS ARE MADE OF HI-STRENGTH DURAL

PATENTS PENDING
 COPYRIGHT 1949

Ask your distributor for complete data or write for illustrated catalog.

TELEPHONE — ASBURY PARK 2-7252

telrex INC.

ASBURY PARK 2, NEW JERSEY

AMERICA'S
 OUTSTANDING
 TELEVISION
 BEAM

TV Antenna

(Continued from page 80)

is provided with a lug. The four conductors of the two downleads are connected to these four lugs in such a way that the two leads from one dipole are connected to plates which are across from each other on the cylinder. The rotor plates (two in number) consist of quarter-sections of a slightly smaller cylinder. They are attached to the shaft so that they are opposite each other, and they rotate within the inner surfaces of the stator plates.

Thus we have a condenser with two rotor plates and four stator plates which fit around the rotor like a cylinder wall fits around a piston. In addition to being a condenser, the rotor plates are coated with graphite, and also act as a variable resistor. A certain amount of stray inductance is included in the electrical design of the unit, so that it actually consists of an R-L-C phasing network. The receiver antenna terminals are connected to the rotor plates, as mentioned above.

When the two rotor plates are rotated within the four stator plates, it can be visualized that at one moment they will be directly under stator plates 1 and 3, and with a quarter turn they would be under plates 2 and 4. The next two quarter turns would bring them under the same plates but in opposite phase. Any intermediate positions would put them partly under each of two adjacent plates to varying degrees according to the amount of rotation, thus varying the phase continuously.

The same phasing control can be used for built-in antennas, but a different physical configuration of the antenna is necessary to reconcile the space limitations imposed by the cabinet and the desirability of approaching resonant lengths. The crossed dipoles must be considerably shorter, and it was found necessary to connect a cross-strap between the ends of two dipole sections to bring about inductive loading to accomplish resonance at the lower frequencies. A counterpoise appendix was added to act as a further load to the output of the phasing control. At low frequencies the pickup from this appendix is either additive or subtractive to the signal depending on the setting of the phasing control.

The antennas and phasing control described above are patented by the Square Root Mfg. Corp. of Yonkers, N. Y.

New TV Receiver

The Philmore Manufacturing Co., Inc., of New York, makers of kits and chassis adapted from the RCA 630TS circuit, has announced a complete TV receiver in console cabinet. Called the "Commodore," the receiver incorporates 31 tubes including 16-inch picture tube, and will retail for \$395.

NOW!

this **AMAZING PROFIT** *offer*

to **DISTRIBUTORS & DEALERS**

Gives you the greatest incentive ever offered to
sell the Perfect, the Finest Television Filter

TRANSMIRRA *Image Definer*

(U.S. Pat. #2,461,464)

LOOK AT THIS PROFIT

which we pass on to you from savings due to curtailed expense

Size	Distributor Price	Dealers Price	List Price
7"	1.65	2.50	7.50
10"	2.85	4.14	12.95
12"	3.15	4.60	14.50
15-16"	4.15	6.10	19.50
20"	7.75	11.50	37.50

Filters for Rear Projection Screens are available.

(Prices F.O.B. NEW YORK CITY)

This is the same Original Patented Light Filter especially pigmented and designed for Television, which imitators have tried but failed to duplicate.

You can now get the genuine and best Televi-

sion Filter at the price of imitations.

This is the Filter which Television Technicians and Eye-Doctors Buy, Use and Recommend. You can distribute or sell it with Confidence and Profit.

Distributorships Available

write or phone:

TRANSMIRRA PRODUCTS CORP.

1650 BROADWAY, NEW YORK 19, NEW YORK

TELEPHONE: PLAZA 7-6430

"TELEVISION LOOKS AHEAD"

in the

January 1950 Marketing and Statistical Issue



The Preferred Publication
of the TV-Appliance Retailers

NEVER BEFORE an opportunity like this . . . because Radio & TELEVISION RETAILING stands out in the field like a 16" tube or projection model alongside small table sets. Here's the issue of the year, in the magazine of the field, the issue that will be read, that will be referred to, all through 1950.

NEVER BEFORE an opportunity like this for TV manufacturers. Selling will be tougher in 1950. But Radio & TELEVISION RETAILING carries the bulk of TV set advertising . . . always has . . . right down to the top 6,000 dealers across the nation, the top dealers who can make your brand sell fast . . . sell faster.

NEVER BEFORE an opportunity like this to make inserts, spreads, color pages work as they never have before. IMPACT here means more dealers, more response than anywhere else. Use the top TELEVISION paper to sell TELEVISION in 1950. Use the TV magazine to sell TV sets through TV dealers. There's nothing like it!

SELLING RADIOS, RECORDS, APPLIANCES, PARTS? Then you know you need look no further. Radio & TELEVISION RETAILING is the "Big Four" magazine to reach dealers who sell all these volume-building products. USE ONE PAPER—TO SELL ALL YOUR MARKET—at the lowest rates per ,M anywhere.

*New surveys prove that RTR is, like NEVER BEFORE, the preferred dealer paper. ADVERTISING earns its keep here!

In 1950, use Radio & Television Retailing to sell like sixty—Schedule January now

28,000 Audited Circulation — including 6,000 of the country's largest retailers.

CALDWELL-CLEMENTS, INC.

480 Lexington Ave., New York 17
PLaza 3-1340



Frank Rose, left, and David Mytelka, right, of Mytelka & Rose, Inc., 850 Broad St., Newark, N. J., have been appointed exclusive northern New Jersey distributors for Capehart Television.

Air King Appointment

R. D. Payne, manager of sales, Air King Products Company, Inc., Brooklyn, N. Y., manufacturers of radios, wire recorders and television receivers has announced the appointment of Jack Crosson as field sales manager.

STATEMENT OF THE OWNERSHIP, MANAGEMENT, CIRCULATION, ETC., REQUIRED BY THE ACT OF CONGRESS OF AUGUST 24, 1912, AS AMENDED BY THE ACTS OF MARCH 3, 1933, AND JULY 2, 1946.

Of RADIO & TELEVISION RETAILING, published monthly at New York, N. Y., for Oct. 1, 1949.

1. The names and addresses of the publisher, editor, managing editor, and business manager are: Publisher, M. Clements, Rumson, N. J. Editor, Orestes H. Caldwell, Catrook Road and Bible St., Cos Cob, Conn. Managing or Executive Editor, John L. Stoutenburgh, 564 Riverside Dr., New York, N. Y. Business Manager, M. H. Newton, 583 W. 215th St., New York, N. Y.

2. The owner is (if owned by a corporation, its name and address must be stated and also immediately thereunder the names and addresses of stockholders owning or holding one per cent or more of total amount of stock. If not owned by a corporation, the names and addresses of the individual owners must be given. If owned by a firm, company, or other unincorporated concern, its name and address, as well as those of each individual member, must be given.) Caldwell-Clements, Inc., 480 Lexington Avenue, New York 17, N. Y. M. Clements, O. H. Caldwell, Charles A. Petersen, Trustees, 480 Lexington Ave., N. Y. C. M. Clements, Trustee, Rumson, N. J. O. H. Caldwell, Trustee, Catrook Rd. and Bible St., Cos Cob, Conn. Charles A. Petersen, Trustee, 474 Senator St., Brooklyn, N. Y.

3. The known bondholders, mortgagees, and other security holders owning or holding 1 per cent or more of total amount of bonds, mortgages, or other securities are: (If there are none, so state.) None.

4. Paragraphs 2 and 3 include, in cases where the stockholder or security holder appears upon the books of the company as trustee or in any other fiduciary relation, the name of the person or corporation for whom such trustee is acting; also the statements in the two paragraphs show the affiant's full knowledge and belief as to the circumstances and conditions under which stockholders and security holders who do not appear upon the books of the company as trustees, hold stock and securities in a capacity other than that of a bona fide owner.

5. The average number of copies of each issue of this publication sold or distributed, through the mails or otherwise, to paid subscribers during the 12 months preceding the date shown above was: (This information is required from daily, weekly, semi-weekly, and tri-weekly newspapers only.)

(Signed) ORESTES H. CALDWELL.
Sworn to and subscribed before me this 28th day of September, 1949.
BELLE M. PHILLIPS,
Notary Public New York and
Westchester County.
(My commission expires March 30, 1950.)

BRACH NEWS

Published by L. S. BRACH MFG. CORP. Founded 1906

Amazing "6-Bar" Antenna Extends TV Sales Areas

LIGHTNING ARRESTER ENDS STATIC DISTORTION

The Brach Rare Gas Arrester provides greater viewing satisfaction and maximum protection of delicate TV set parts from damage and interference by lightning and induced voltages. Every set should be protected by this low-cost insurance against expensive overload damage. TV owners will appreciate addition of the Brach Rare Gas Lightning Arrester for improved television reception. Make this positive addition to EVERY installation. UL listed.

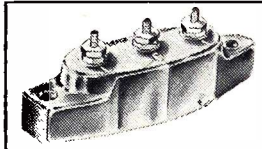

SECURE, SIMPLE ASSEMBLY

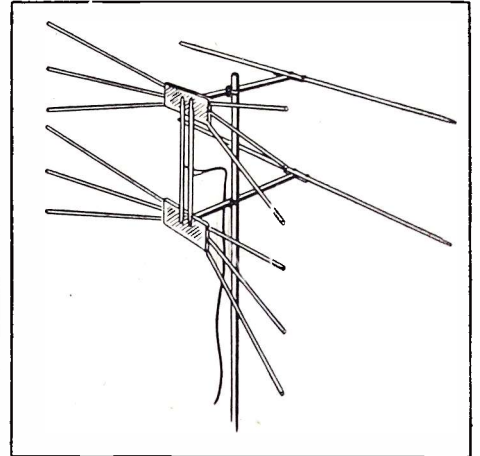

4-SECTION "INTENNA" FEATURES STYLE, SERVICE

Latest and finest indoor antenna is the Brach Superview INTENNA. Brach engineers, working hand-in-hand with one of America's foremost housefurnishings designers, developed the new 4-section telescoping INTENNA with an eye to beauty as well as function. Arms, extended from a polished marbled Tenite base, tuck away to a compact 14 inches—extend to almost four feet. Positive spring-tension between sections assures peak reception without signal loss on all channels.

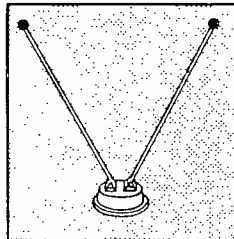

TABLE . . . WALL . . . OR WINDOW

The marbled Tenite base is colored to blend with any fine wood finish. A special key-hole hanger permits the INTENNA's suspension from a wall to save space. It may be hung from outside the window for improved reception on troublesome channels. The INTENNA is an item that sells on sight because it looks good, performs better.

The 6-BAR, Brach's latest bid for bigger sales in your TV Department, pushes the fringe extra miles beyond your normal trading area. Based on an improved 6-element design, the 6-BAR features ruggedness, and bite-bite, insulated element-clamps, which grip tempered aluminum tubing. Clamping operation consists of merely tightening wing nuts. Superior Brach design permits unlimited stacking possibilities, to meet almost any situation.

ALL-CHANNEL RECEPTION

The Brach 6-BAR, with a fast-held 15° tuning angle, maintains a low standing wave ratio which permits direct coupling to 72, 150 or 300-ohm transmission line with a minimum energy-transfer loss. Its exceptional front-to-back ratio on all frequencies and high signal-to-noise ratio make it the ideal all-channel antenna. Gain and directivity rises with frequency, aiding in the elimination of multipath reception on all channels.

DESIGNED for TOP PERFORMANCE

Dealers everywhere can depend on this latest product of Brach TV antenna research — featuring fan-type elements for high-impedance, and Vee-Beam alignment for a narrow high-gain lobe — to boost their antenna sales thru more satisfaction.

See your jobber or write today for catalog sheets.

L. S. BRACH MFG. CORP.

200 CENTRAL AVENUE, NEWARK 4, NEW JERSEY

WORLD'S OLDEST AND LARGEST MANUFACTURERS OF ANTENNAS AND RADIO ACCESSORIES

Tenna-Rotor on TV

Using television to sell its Alliance Tenna-Rotor—a television antenna rotating device—the Alliance Manufacturing Company is appearing with a regularly scheduled series of six television sound films over most of the major television stations. Each film is an actual demonstration of the product. The opener starts right out with a typical action view of an Alliance Tenna-Rotor, turning a television antenna on a housetop. Then the scene shifts to the living room where a close-up of a television screen, together with a viewer who is operating the Tenna-Rotor is shown. The demonstration is clear and

convincing—it shows fuzzy reproduction of a television picture and how the image comes up sharp and clear with the simple flick of a lever located at the set.

Philips Appointments

Pieter van den Berg, president of North American Philips Company, Inc., announces the appointment of T. James Reed as plant manager and M. J. Mc-Nicholas as purchasing agent.

Both appointments are at the firm's Dobbs Ferry, New York, plant—where a re-equipment program to step up production of television projection systems, picture tubes and components is under way.

Use STANCOR EXACT DUPLICATE TRANSFORMERS

Every call-back you make means lost time and profits. Why take a chance with transformers that "almost fit?" You're sure of a good job and a satisfied customer when you use Stancor *Exact Duplicate* transformers for TV servicing. These units meet the exact specifications, electrically and physically, of the original components. Representative types are listed below.

Vertical Blocking - Oscillator Transformer. *Stancor Part Number A-8121.* Exact duplicate of RCA type 208T2. For generation of 60 cps required to drive grids of vertical discharge tubes.

Plate and Filament Transformer. *Stancor Part Number P-8156.* Exact duplicate of RCA type 201T6 used in model 630TS receiver.

Deflection Yoke. *Stancor Part Number DY-1.* Exact duplicate of RCA type 201D1. For use with direct viewing kinescopes such as 7DP4 and 10BP4.

Focus Coil. *Stancor Part Number FC-10.* Exact Duplicate of RCA type 202D1. For use with magnetically focused kinescopes such as RCA type 10BP4.

Horizontal Deflection Output and HV Transformer. *Stancor Part Number A-8117.* Exact duplicate of RCA type 211T1. For use with direct viewing kinescopes, such as types 7DP4 and 10BP4.

For complete specifications and prices of these and other Stancor TV replacement components, see your Stancor distributor or write for Television Catalog 337.

For
profitable
TV
servicing

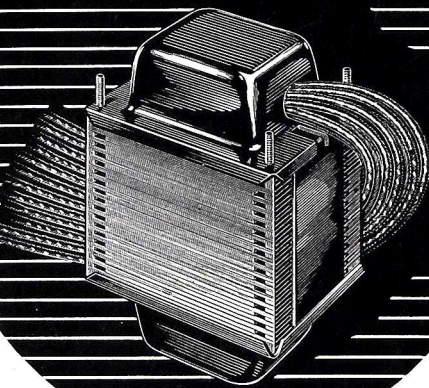

NEW—Ask your Stancor distributor for your copy of the latest edition of Stancor's TV Components Replacement Guide, Bulletin 338B. Lists Stancor replacement parts for 108 TV receivers made by 37 manufacturers. Or write us today.



STANDARD TRANSFORMER CORPORATION
3586 ELSTON AVENUE • CHICAGO 18, ILLINOIS

Hints on Dressing Christmas Windows

The displays should stimulate buying desire.

They should offer suggestions to the gift-seeker.

Products having more than one operating feature should be described via card.

To speed selling, use price-tickets on all items.

The above technique results in customers asking to see the \$... so-and-so in the window. Price-barrier's been hurdled.

Identify products which may confuse the passerby.

Use attractive material to enhance appearance of large sets and appliances. Don't set 'em in rows.

Don't exhibit items not in stock, unless you explain that they're available for future delivery.

Use fireproof decorative material.

In windows you don't propose to change, be sure to arrange so that they can be "freshened" without creating havoc.

Use safe wiring in lighting displays.

Make sure that motion-devices are in good condition so that you won't have to service them in the window.

Set time-clocks to keep lights on later. Hook motion devices, extra lights, etc., on time-clock.

Don't use "series" Xmas tree light sets in windows.

Eliminate "steaming" through use of fans; glare and reflection via backdrops, etc.

Use large sign announcing "keeping-open" hours.

Arrange articles you'll have to sell out of window so they can be had without ruining display.

Reps for Circle "X"

The Circle "X" Antenna Corporation, a subsidiary of Continental Copper and Steel Industries, Inc., announces through its president, W. Hickson, that Gerald Wilson, 403 Second St., Jackson, Mich., and R. W. Farris Co., 406 W. 34th St., Kansas City 2, Mo., have been appointed as representatives for the firm. The Lawrence Elliott Co., 17409 Glendale Ave., Cleveland, O., has been named representative for Kentucky, and LeRoy Schenck, 9 W. Park St., Newark, N. J., as its representative for New York State including New York City and northern New Jersey.

Garrett-Buckley Offer New Type TV Antenna

The triple problem of high installation costs, directional character of conventional built-in aerials, and the unsightliness of indoor antennas for television sets has, according to the officials of the Garrett-Buckley Radio and Television Corp. of Chicago, been solved with the appearance on the market of their Gee-Bee Plug-In-Tenna. The small device is designed to plug into an AC outlet, with the TV line-cord plugged into it, and the receiver antenna terminals connected to it by a piece of twin-lead. The unit is to retail at \$5.95. Distribution is through TV and radio jobbers, parts dealers, and wholesalers of electrical goods. Jack Buckley, president of the producing firm, estimated that production of the device will rise to 100,000 units cumulatively within the next six weeks.

Gross Firm Expands

In their newest expansion move, Gross Distributors, Inc., have taken over the upper four floors of the new Gross Building located at 214-216 West 14th Street, New York 11, N. Y. The sales, operations, merchandising, credit, service and parts departments are now joined with the executive staff to provide a more efficient total organization for the benefit of dealers and manufacturers.

The new facilities include a large and well designed showroom ample in scope to display all their lines to best advantage including: Stromberg-Carlson television, Stromberg-Carlson sound and intercommunication equipment, Blackstone home laundry equipment, Lewyt vacuum cleaners, Deepfreeze home freezers, Matic-Maid portable dishwashers, All American automatic dishwashers.

In Tele-Tone Sales Post

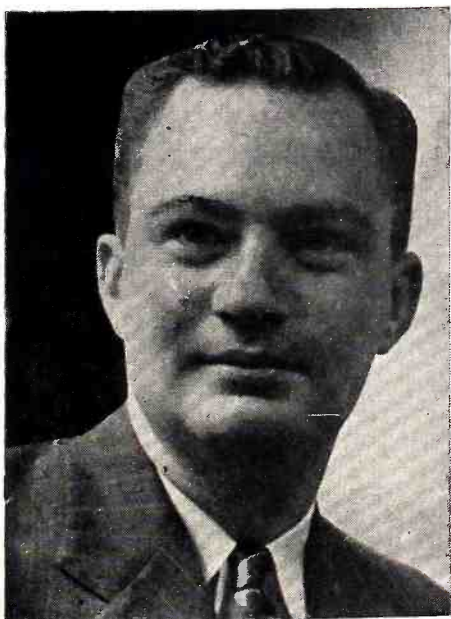

Sydney Jurin, above, has been appointed sales manager for Tele-tone National Corp., New York City, it was announced by Morton M. Schwartz, general sales manager of Tele-tone Radio Corp., the parent company.

NEW TOWER MODELS

BY

Easy-Up

Proudly introduced by Easy-Up — the leading name in TV antenna towers — these advanced models give you

- NEW** Greater Strength
- NEW** Permanence — galvanized
- NEW** "Rotability"
- NEW** Ease of installation
- NEW** Built-in ladders
- NEW** Quietness in wind
- NEW** Wider choice of models and heights

ALL AT NEW LOW PRICES!

MODEL 300 | **\$64.50**
"ROTA-TOWER" | LIST

A very light but sturdy rotatable tower, particularly suited for residences. Basic model, weighing but 40 lbs., has two pre-assembled 10-ft. tower sections and 10-ft. pole which mounts the antenna pole. Additional sections give heights to 60 feet. 90 cross-braces per section, with steps for climbing. Join sections with only three bolts. Tip tower up from any of four sides. Rotate it 360°, after installation, to orient antenna.

\$95.00 | **MODEL 400 (Triangular)**
LIST | **HEAVY DUTY**

A lightweight deluxe tower for commercial or heavy-duty residential use. Basic model consists of three pre-assembled 10-ft. sections and weighs 72 lbs. 10-ft. extensions provide heights to 100 ft. Numerous cross-braces (140 per section) give exceptional strength and provide steps for climbing. Hinged feet for ease of erection. Rotating feature available.

\$125.00 | **MODEL 500 (Square)**
LIST | **EXTRA HEAVY DUTY**

Similar to above, but having four-sided construction for heaviest antenna arrays. Weight 96 lbs.

See your jobber, or write

Easy-Up Tower Co.

3800 KINZIE AVENUE
RACINE • WISCONSIN

Snyder Free Trial Offer

Snyder Mfg. Co., of Philadelphia, is making available a free trial offer on its '50 line of Redi-Mount TV aerials.

Issued directly to servicemen in selected areas, through jobbers and distributors, the Snyder company is offering a ten day free trial on a Redi-Mount TV aerial of either conical or hi-lo type.

Commenting on this move, Dick Morris, sales manager, said, "This offer is absolutely unqualified. Any serviceman can get a Snyder TV aerial without obligation. He can install it and test

it in every way he wishes. If, after ten days, the serviceman is not fully satisfied with the aerial, he may return it and the company will pay all shipping charges both ways. If the serviceman is fully satisfied with the aerial, he may keep it and he will be billed through the jobber or distributor."

New Blackman Address

O. S. Gerstman announces the removal of the Blackman Sales Company to the new combined offices, showrooms and warehouse from 141 So. Kings Rd. to 8373 Melrose, Los Angeles 46.

RCA Victor Names Seidel

Robert A. Seidel has joined RCA Victor as vice-president in charge of



distribution. He has headquarters in Camden. Mr. Seidel was formerly vice-president and comptroller of the W. T. Grant Co.

New Du Mont Wholesalers

Appointment of two new distributors in the middle-western and Texas territories has been announced by Ernest A. Marx, general manager of the receiver sales division, Allen B. Du Mont Laboratories, Inc. This brings the total of Du Mont's national television receiver distributors to thirteen. Both new appointments are already in effect.

General Utilities Corporation, 647 West Virginia St., Milwaukee, has been appointed exclusive distributor for Du Mont Telesets in the Milwaukee area, formerly serviced by Joseph H. Moss, Jr., now Du Mont's Central States regional manager.

S. H. Lynch Company, 2101 Pacific St., Dallas, will be the sole distribution outlet for the Dallas territory in Texas. The Lynch appointment is the second distributorship awarded in Texas. Edwin Flato Co., 305 Velasco St., Houston, having been previously appointed distributor for southern Texas.

Starrett Names New Reps

Expanding its sales and factory representative force to give Starrett dealers close "man-to-man" cooperation all along the line, Mitchell Fein, vice-president of Starrett Television Corp., has announced the appointment of E. E. Sayre, as regional sales manager, and appointments of factory representatives covering lower California, Oklahoma, Texas, Arkansas and Louisiana.

The Nelson R. Thomas Agency, 2155 East 7th St., Los Angeles, has been appointed as factory representative for all of lower California. This agency is managed by Ralph R. Thomas.

All of Texas, Oklahoma, Arkansas and Louisiana, will be covered by Lynn Dickerson Appliances, Merchants' and Manufacturers' Building, Houston, Texas. The firm will have four men traveling throughout the territory.

FRINGE AREA TV DEALERS

We wish to announce that we are now able to make prompt shipment of our

1950 MODELS

HIGH GAIN TV RECEIVING ANTENNAE

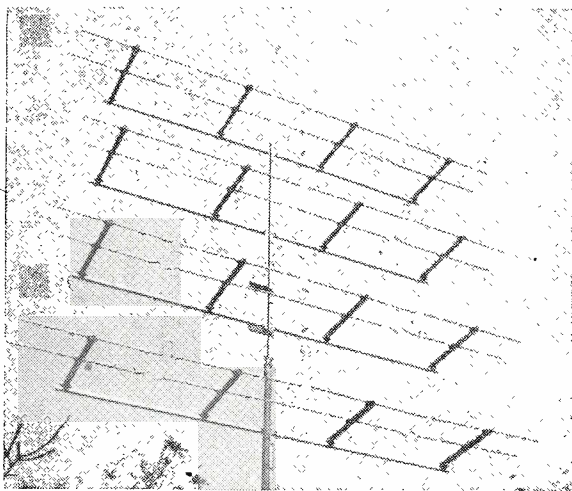

This 32-Element Channel 11 U.H.F. TV Beam has a Power Gain 127 times over a folded dipole peaked on the same frequency.

Our standard line consists of 8 and 16 Elements for the Low Band; also 8, 16 and 32 Elements for the High Band.

Write today for Literature, Prices and Exclusive Dealers Franchise

U. H. F. RESONATOR COMPANY

(Formerly of Rye, New York)

224 SEVENTH STREET

RACINE, WISCONSIN

New Books, Pamphlets, Sales Aids

Westinghouse Electric Corp., 306 Fourth Ave., Pittsburgh 30, Penna.: "Electrical Products for Farm and Home," a catalog designed for selling in the rural market, includes illustrations and complete descriptions of all Westinghouse products that can be used on farms. Write for booklet #B-4042.

John F. Rider, Publisher, Inc., 480 Canal St., New York 13, N. Y.: Rider Television Manual Vol. 3, scheduled for publication in November, will be published in a new size, approximately 12 x 15 inches to accommodate large circuit diagrams which were formerly folded. The regular Rider Manual Vol. 20, also out in November, is the same physical dimensions as heretofore.

Federal Telephone and Radio Corp., Publication Dept., 67 Broad St., New York 4, N. Y. "Reference Data for Radio Engineers," 640 pages, with over 800 charts and tables, plus an extensive index, covers all phases of radio, TV, UHF and radar, broadcasting, electro-acoustics, etc., \$3.75 per copy.

Allied Radio Corp., 833 W. Jackson Blvd., Chicago, Ill.: has announced publication of its new 1950, 196-page catalog, covering everything in radio and electronics. This buying guide may be had without charge on request.

Sylvania Electric Products, Inc., Emporium, Penna.: Revised edition of comprehensive technical manual on radio receiving tubes and CR tubes covers 637 tubes, contains 418 pages. Priced at 85¢ per copy, the new manual may be had from Sylvania distributors or directly from Emporium, Penna.

International Rectifier Corp., 6809 S. Victoria Ave., Los Angeles 43, Calif.: Bulletin PC-649 the new International line of selenium self-generating photo-electric cells, including data on construction, performance and application, as well as prices. Available without charge on request.

John F. Rider, Publisher, Inc., 480 Canal St., New York 13, N. Y.: "TV Picture Projection and Enlargement," by Allen Lytel, of Temple University, 192-page illustrated book covering the theory of light, optics, and TV optical systems, together with description of commercial sets utilizing these principles. Price \$3.30.

Federal Telephone and Radio Corp., 900 Passaic Ave., E. Newark, N. J.: "Federal Miniature Selenium Rectifier Handbook," 48-page booklet covers basic theory, design and application data for 23 types of selenium rectifiers, including 38 circuit diagrams. Priced at 25¢, the handbook may be obtained from jobbers and distributors of Federal rectifiers, or by writing the firm direct.

Electro-Voice, Inc., Buchanan, Michigan: Bulletin #153 describes the E-V twin-tip torque drive phono cartridge, #152 gives complete data on the E-V series 2200 (RCA type 45) phono pickup, #151 gives complete information on the series 2000 and 2100 phono pickups for
(Continued on page 94)

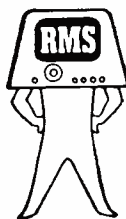

Gets terrific results

ON ALL CHANNELS!

RMS PREAMPLIFIER SP-4

This new superbly engineered preamplifier provides an average gain of 4 to 6 times—over the entire television range . . . and actually rejects a high percentage of outside interference. It features individually shielded input, output and power sections with the entire unit shielded against outside and television receiver interference.

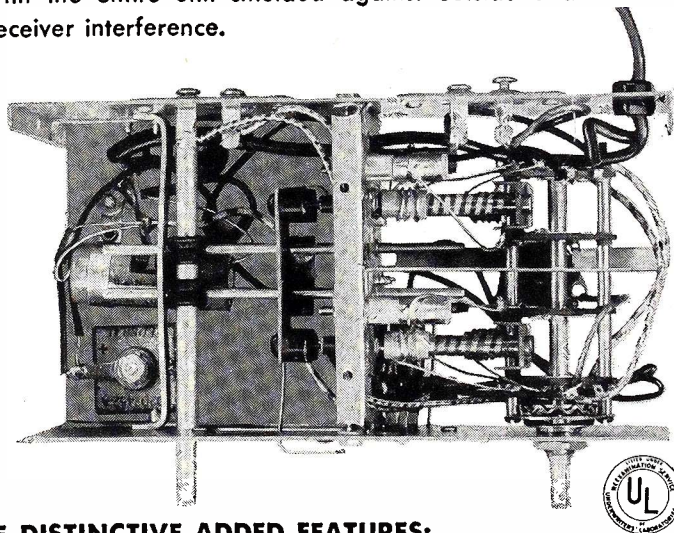

COMPARE THESE DISTINCTIVE ADDED FEATURES:

- Efficient placement of components permits full use of tuning circuits with no loss in leads.
- Input and output iron-cores assure maximum resonance at the desired frequency.
- Isolation-type transformer eliminates shock hazard from chassis.
- Coils wound with flat ribbon for maximum efficiency at high frequencies.
- Pilot light indicates preamplifier is in use and is separately colored for each band.
- Single knob simplified tuning. Distinctively crafted cabinet.

Servicemen . . . dealers! Improve unsatisfactory installations; make new customers where reception has not been obtainable. Use RMS Preamplifier SP-4. Now available at your local jobber. For further information, write

Radio Merchandise Sales Inc., N. Y. 55, N. Y.

(Continued from page 93)

all three speeds, #104 describes the complete E-V microphone line, #154 illustrates and describes the new model 911 crystal and 611 dynamic microphones, and bulletin #150 describes the break-in touch-to-talk mike stand. Copies of these bulletins may be obtained on request.

General Cement Mfg. Co., Rockford, Ill.: No. 150-S supplement to the G-C 150 catalog describes the G-C line of television products, which include TV antennas, towers and mounting accessories and receiver servicing tools. Obtainable free on request.

Gee-Lar Products Co., 4741 W. Montrose Ave., Chicago 41, Ill.: 16-page

illustrated catalog shows the entire line of Gee-Lar knobs for radios, TV and sound equipment, and Gee-Lar laminated and molded octal tube sockets. Catalog available on request.

Crescent Industries, Inc., 4140 W. Belmont Ave., Chicago 41, Ill.: "Wholesale Distributor Resale Catalog" gives descriptions, illustrations and prices on the complete Crescent line of wire recorders, phono players and changers, and PM and EM loudspeakers.

Sylvania Electric Products, Inc.: "How to Service Radios with an Oscilloscope," 72-page instruction booklet contains more than 90 diagrams, tables and schematic circuits, including many waveform patterns. The booklet, priced at

\$1.00 per copy, may be obtained from the firm's radio division, 500 Fifth Ave., New York 18, N. Y.

Simpson Electric Co., 5200 W. Kinzie St., Chicago 44, Ill.: Catalog No. 16 is a 50-page illustrated catalog covering the Simpson line of measuring and test equipment, including the model 480 FM-TV Genescope. A copy may be had free on request in writing.

Philco Corp., Service Div., "A" Street and Allegheny Ave., Philadelphia 34, Penna.: A series of lessons on TV servicing has been prepared for the service technician covering all phases of receiver operation, installation, servicing, alignment and troubleshooting. The complete kit of 11 lessons may be purchased from Philco distributors for \$2.85.

Nelda Publications, Inc., 855 Ave. of the Americas, New York 1, N. Y.: The Nelda Looseleaf Subscription Service provides photos, model numbers, prices and specifications of leading brands of TV, radios, appliances, clocks, silverware, photo equipment, and related lines. Weekly price-revision bulletins and monthly new-model illustrated supplements are included in the service, designed to facilitate selling, buying, and promotion planning in retail stores. For information on the cost of this service, write the publisher direct.

Shure Brothers, Inc., 225 W. Huron St., Chicago 10, Ill.: Illustrated catalog No. 159 describes the complete line of microphones, mike accessories, and acoustic devices. No. 160 covers Shure phono pickups and replacement cartridges. Both catalogs available on request.

Approved Electronic Instrument Corp., 142 Liberty St., New York 6, N. Y.: A 10-page illustrated catalog in color describes the Approved line of test equipment, and TV, FM and AM kits, with complete specifications and price for every item. Available on request.

JFD Mfg. Co., Inc., 6101 16th Ave., Brooklyn 4, N. Y.: Catalog TV100 provides illustrations and complete specifications of the JFD line of TV antennas, antenna mounting accessories, filters and boosters. Available on request.

Howard W. Sams and Co., Inc., 2924 E. Washington St., Indianapolis 7, Ind.: "The Recording and Reproduction of Sound," by Oliver Read, covers theory of sound and sound recording, and the application of various types of sound equipment (microphones, pickups, loudspeakers, amplifiers, etc.). 304 pages, 180 illustrations, price \$5.00.

John Wiley and Sons, Inc., publishers, 440 Fourth Ave., New York 16, N. Y.: "Elements of Sound Recording," by John G. Frayne and Halley Wolfe, of Western Electric Co. in Hollywood. Illustrated with 480 drawings and photographs, the book explains the basic philosophy of different sound recording arts, as well as practical techniques and applications, including acoustics, loudspeaker systems, etc.

Switchcraft, Inc., 1328 N. Halsted St., Chicago 22, Ill.: Catalog No. S49 gives complete descriptions, including elec-

(Continued on page 95)

MORNING, SEPTEMBER 21, 1949

SNYDER MAKES "HEAD-LINES" WITH AMAZING LOW PRICE

"Insert and Tighten" Construction in Added Line

HEAD-LINE TV AERIALS

795 LIST

Complete Hi & Lo Arrays

ATTENTION
Jobbers-Distributors
Write for '50 catalog and
protected territories plan.

• Genuine bakelite insulator
• 1/2-inch aluminum elements
• Cadmium plated hardware
• Universal mast bracket

Quick and Easy Installation

Insert and Tighten!

SNYDER MFG. CO.

ANTENN-GINEERS®
PHILADELPHIA 40, PA., U. S. A.

Export: Roburn Agencies, Inc., N. Y.
New York Area Distributor: H. L. Dalis, Inc.
Phila. Area Distributor: Almo Radio Co.

trical characteristics and engineering scale drawings, of the Switchcraft line of switches, plugs, jacks and associated hardware for radio and sound applications. Prices are included. Available on request.

Standard Transformer Corp., 3580 Elston Ave., Chicago 18, Ill.: Bulletin DD338B is a 4-page reference catalog of Stancor TV replacement components, including transformers, chokes, deflection yokes and focus coils for use in 108 popular TV receiver models. Available from Stancor distributors, or by writing direct.

Wirt Co., 5221 Greene St., Philadelphia 44, Penna.: Catalog W170 gives complete descriptions and specifications of Wirt wire-bound power resistors, rheostats and potentiometers, rotary and slide switches, suppressors, strip resistors, regulators, etc. Available on request.

Lowell Metal Products Corp., 1531 Branch St., St. Louis 7, Mo.: Catalog No. K10-49, 8-page illustrated catalog covering the Lowell line of metal speaker baffles for ceiling and wall mounting. New in the line are combination speaker baffles and circline fluorescent light fixtures for ceiling mounting. Catalog available on request.

Lippin Named by Meck

B. H. Lippin, Inc., New York City, experienced sales organization, has been appointed Eastern sales representative for John Meck Industries, Inc., Plymouth, Ind., manufacturers of television and radio receivers, it was announced by John Meck, president.

In Vidcraft Position

Edward T. O'Toole has been appointed assistant general manager of the Vidcraft Television Corporation, New York, it was announced by Michael J. Kingsley, executive vice-president.

Mr. O'Toole had been active in newspaper and radio work in New York and New England before his appointment.

Tele King Officials



The appointment of Harvey Pokrass, left, as president, and Edward Berliant as executive vice-president of Tele King Corp., New York City, was announced by the board of directors of the company.

Chester Wilcox Resigns

Chester Wilcox, founder, and for over thirty years, head of the Wilcox-Gay Corp., Charlotte, Mich., has resigned his position as president and treasurer because of ill health. He will continue his financial interest and will remain as a member of the company's board as well as consultant to the new management.

Dr. Emil E. Mayer, who has served twelve years as a member of the board, has accepted the position of president and treasurer.

Fred D. Gearhart, well known in financial circles and a member of the board of directors of Wilcox-Gay for the past five years, has been appointed chairman of the board.

Large Attendance at PRSMA Convention

The Radio and Television Service Convention and Exhibit recently presented by the Philadelphia Radio Service Men's Association in the Town Hall in Philadelphia was enthusiastically received by technicians, radio service dealers and distributors from a wide area. Over 50 booths with exhibits by local distributors and national manufacturers vied for attention with an excellent program of lectures and demonstrations presented by engineers and executives widely known in the industry.



Rembrandt

REG. U.S. PAT. OFF.

Master
in the Art of
Television

presents
Dual Eye Appeal

REMBRANDT television sets — hand-crafted for faultless reception . . . treat your eyes with superb cabinet masterpieces in large, direct-vision, view screen. (12½", 15½", 19" table models and consoles.)

. . . treat your eyes with superb cabinet masterpieces in *hand-finished* Mahogany, Walnut, Blond Mahogany, Knotty Pine, Maple, Oak or Chinese Pastels.

Continuous tuning for all 13 channels and entire FM bands *automatically* locked-in pictures.

ALL REMBRANDT TELEVISION SETS EMBODY THE FINEST IN FM RADIO

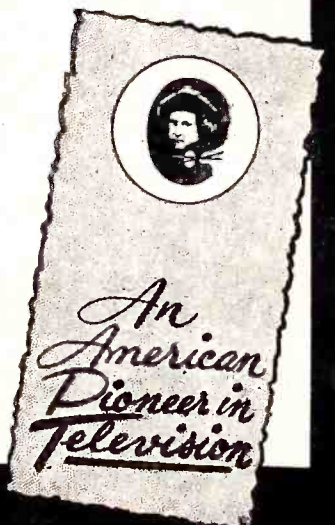

DISTRIBUTORS: A Few Choice Areas Available

REMINGTON RADIO CORPORATION
White Plains, N. Y.

New Arizona Jobber for Zenith Products

The Electrical Equipment Company has been appointed distributor of Zenith radio and television products in Phoenix and thirteen of Arizona's fourteen counties, it was announced by H. C. Bonfig, vice-president of Zenith Radio Corporation.

The new Zenith distributor, located at 424 N. Central Ave., Phoenix, occupies 20,000 square feet with both office and warehouse facilities in a brick building there.

Officers of the concern are: Sam Kahan, president; Mrs. Samuel Kahan, vice-president; and Harold Divelbess, secretary and treasurer.

Open Times Square Store in Hempstead, N. Y.

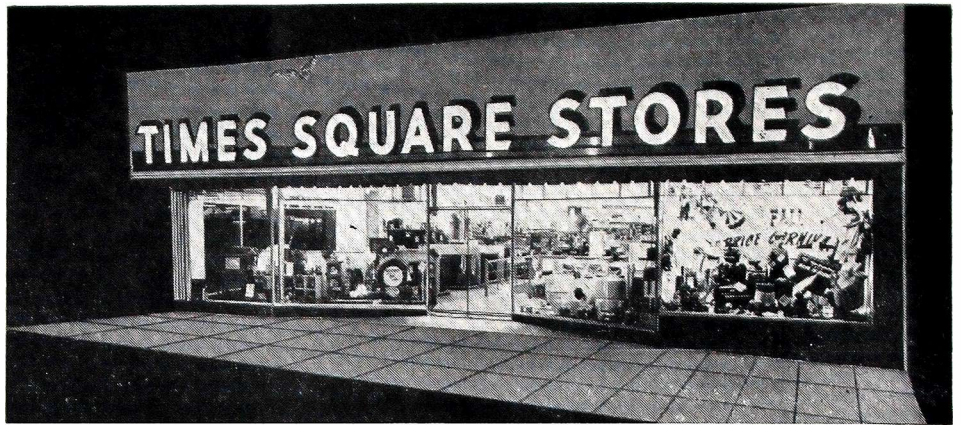

The new Times Square Stores unit, above, is located at 110 Main St., Hempstead. 15,000 sq. ft., double-decker store, has a 50 ft. front and 150 ft. depth. Design emphasis is on full-vision.

A Monday 'Must' For Top Management . . .

MARTIN CODEL'S

AUTHORITATIVE NEWS SERVICE OF THE VISUAL BROADCASTING ARTS AND INDUSTRY



Every Monday morning, hundreds of top radio executives start their working week by reading Martin Codel's newsletter, TELEVISION DIGEST. In only five years this service has become the "bible" of the policy-makers in every branch of TV . . . telecasting, manufacturing, distribution, and allied fields. Its list of subscribers is a literal "Who's Who" in TV and Radio.

TELEVISION DIGEST has reached this outstanding position because it does a thorough, authoritative job of reporting and analyzing trends and developments in TV . . . and does it in a minimum of reading time. If you need to know what's happening in America's fastest-growing industry, then you, too, should be a TELEVISION DIGEST subscriber.

A complete service • Weekly Newsletter • TV-AM-FM Directories • Weekly Addenda • Regular Supplements of Current and Permanent Reference Value

Write or Wire for Samples & Rates

Television Digest
WITH AM FM REPORTS
1519 CONNECTICUT AVE. N. W.
WASHINGTON 6, D. C.

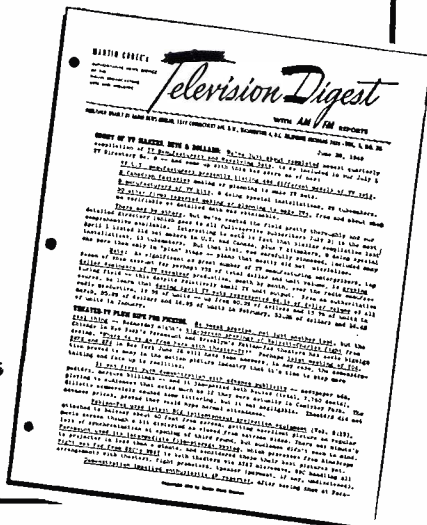

Sams Provides Data for Service Associations

In response to many requests for information concerning the organizing and running of a radio service technicians' association, Howard W. Sams, of Indianapolis, publisher of "Photofact" circuit diagrams, has reprinted the constitution and manual of procedure of the Radio Electronic Technicians Association of Canada. It was felt that this material covered the details of the organization and operation of Service Associations so thoroughly it could well be used as a guide by any other group in forming an association. The Sams Company will supply this information to any service association requesting it on their regular organization letterheads.

Emerson Appointments

Emerson Radio & Phonograph Corporation has appointed Frank Schroeder art director and Edward Kantrowitz advertising production manager, according to an announcement by Harold R. F. Dietz, sales promotion manager.

Tung-Sol Executive



H. Merel Darling, shown, has been named vice-president of Tung-Sol Lamp Works, Inc., Newark, N. J., and its subsidiaries. The boards of directors also announced the election of George E. Hallett to the office of controller.

Distributes Sylvania TV

Victor H. Meyer & Co., Inc., 312 Fifth Avenue, New York, have been appointed Metropolitan New York distributors for Sylvania television receivers,

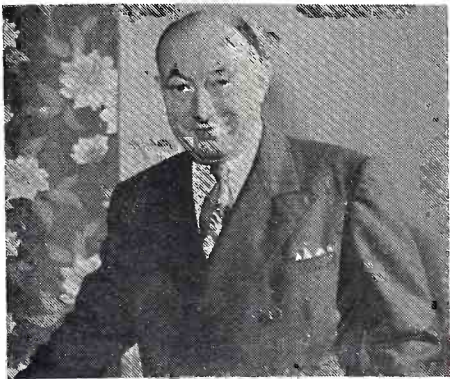

VICTOR H. MEYER

ers, it is announced by Larry Bagg, national sales manager for Sylvania.

The Meyer Company have been distributors of radio and electrical appliances for over 25 years.

Cites Big Admiral Growth

Rise by Admiral Corporation to "first place in television" has been announced by R. A. Graver, Admiral's vice-president in charge of television and radio. Mr. Graver's announcement was based on production reports submitted by television manufacturers in connection with various patent licenses.

"While it is true," Mr. Graver said, "that the entire television industry has advanced at a rate rarely equalled in the history of American enterprise, Admiral's own growth has far outpaced that of the industry as a whole."

"For the first six months of 1949 total sales of television manufacturers reporting their sales as patent licensees were 206 per cent greater than for the same period in 1948. Admiral's gain, however, was 450 per cent, more than double that of the entire reporting industry."

Rep for Columbia Wire



Columbia Wire & Supply Co., Chicago, Ill., national distributors for Anaconda Densheath Television and radio wire and cables, announces the appointment of Ben Joseph, above, as their New York representative.

New Garod Wholesalers

Garod Electronics Corporation has appointed Philadelphia Wholesale Distributors, Inc., as its exclusive wholesale distributing agency for "Tele-Zoom" television and their new low-price straight TV line in Philadelphia and the eastern Pennsylvania territory, according to an announcement from Louis Silver, vice-president and sales manager.

Vue-Scope Lens Display

Vue-Scope television lens display is smartly designed to look like a television set . . . with three simulated "screens" instead of one . . . it displays the three fastest-selling Vue-Scope

models mounted in place. This revolving unit lets Vue-Scope Lenses sell themselves.

Valued by the firm at \$25, dealers can get this new display free, by stocking Vue-Scope Lenses.

New Macy Executive

Victor M. Ratner will become vice-president in charge of sales promotion, public relations, and advertising for Macy's New York, effective November 1st, it was announced by Richard Weil, Jr., president. Since 1947, Mr. Ratner has been vice-president in charge of advertising and sales promotion for the Columbia Broadcasting System, for both radio and television.

Multiple Television Reception

WITH THE **JERROLD**

MUL-TV SYSTEM*

DEMONSTRATE ALL THE TV RECEIVERS IN YOUR STORE AT ONE TIME, SIDE BY SIDE

TUNE ANY RECEIVER TO ANY CHANNEL WITHOUT ANTENNA SWITCHING

Over 150 leading department stores and radio dealers, in local and fringe areas, are already using the Jerrold Mul-TV System with as many as 110 TV receivers operating simultaneously. Increase your TV sales and profits by installing the Jerrold Mul-TV System in your store.

For complete information mail this coupon today.

MAIL THIS COUPON TODAY

Send Mul-TV catalog and instruction manual to:

Name.....

Street address.....

City..... Zone..... State.....

JERROLD ELECTRONICS CORPORATION

121 NORTH BROAD ST., PHILADELPHIA 7, PA.

* A distribution system for multiple television reception

Masco Price Guarantee

In a recent bulletin to its distributors the Mark Simpson Manufacturing Co. referred to its price protection guarantee issued in 1947, affirming that all promises made at that time were still in force. The guarantee reads:

"Masco has instituted a policy of guaranteeing your company against price reductions. Under this guaranty you will be entitled to a merchandise credit to the extent of any price decrease put into effect by Masco with respect to any Masco unit purchased from us within four months prior to such reduction and which is your inventory at the time of such reduction. All units on this invoice are covered by this guarantee."

Associated to Expand

Welburn Guernsey, president of Associated Stores, Inc., announces the withdrawal from the market of the listing of the stores "For Sale," as previously advertised in this publication. Instead, Guernsey has advised of plans for a complete modernization of the company's six stores located in Tampa, Miami, Orlando, Lakeland, Sarasota and St. Petersburg, Fla. Such improvements will begin in January, 1950, and include new modernistic store fronts, new fixtures and decorative schemes, sound-proofed demonstration salons—especially constructed for television viewing and all stores air-conditioned throughout. Other expansion plans will be announced at a later date.

New Schwarz Store

John A. Schwarz, Inc., 73-year-old Brooklyn dealership, will open a new store on the outskirts of Hempstead, N. Y., early next year. The store will be operated in the manner of a way-side shop with a parking space large enough to accommodate more than fifty cars on a 1¼-acre plot.

The impressive two-story white brick structure with an area of more than 36,000 square feet will be located at the busy intersection of Hempstead Turnpike, Fulton Ave., Front St., and Hempstead Ave. It will have a frontage of 160 ft. on Fulton Ave., with a large expanse of windows which permit passersby to look directly into the store on three sides.

The decorative treatment inside and outside is to be in a modern style and designed for convenience of customers and personnel. A self-service Otis elevator will be installed.

PEERLESS "GOLDEN WAND"

The All-New Indoor TV Antenna for High Performance at Low Cost

The Peerless model C84-TV proves that in a great majority of cases, the customer needs no outdoor antenna. And you do not waste your time or profits on the roof. You can sell Peerless with confidence because it works where others won't.

Special Features

3-SECTION TELESCOPING SOLID BRASS TUBING.

BRASS DIPOLES AND SWIVEL BRACKET ARE BRUSHED TO GOLDEN SATIN FINISH.

BASE IS GOLD-FINISHED. ALL RUSTPROOF AND NON-TARNISHING. DIPOLES AND TERMINALS HELD IN POLYSTYRENE INSULATORS. NO SHORTS.

INGENIOUS SLOT IN INSULATOR RELIEVES STRAIN ON TERMINAL. NO BROKEN WIRES.

SWIVEL BRACKET MOUNTED ON HEAVY WEIGHT BASE, FELT PADDED. UNIT SWIVELS WHILE BASE REMAINS STATIONARY.

PHOSPHOR BRONZE SHIMS FOR ELECTRICAL CONTACT BETWEEN TUBING.

COMES COMPLETE WITH 8 FEET OF 300-OHM TRANSMISSION LINE.

FULL 12-CHANNEL TV RECEPTION PLUS FM.

COMPETITIVELY PRICED

Standard carton holds 25 individually boxed antennas. Shipping weight 50 lbs.

CHOICE TERRITORIES FOR DISTRIBUTORS AND REPRESENTATIVES.

DEALER INQUIRIES INVITED



PEERLESS PRODUCTS INDUSTRIES

812 N. Pulaski Street

Chicago 51, Ill.

Distributing Norge

Allied Appliance Co., Boston, has been appointed exclusive distributor of Norge home appliances in the New England territory. The new distributorship succeeds the L. J. McAllister Company. Announcement of the change in Boston distributorships is made by John A. Underwood, vice-president in charge of sales, Norge division, Borg-Warner Corporation.

Lamp Modernization Method Is Announced

A new, inexpensive method of modernizing existing table and floor lamps to produce more light and softer, less glaring illumination has been introduced by the Home Lighting Department of the Westinghouse Lamp Division, Bloomfield, N. J.

The conversion is accomplished by replacing low wattage, inside-frosted bulbs now used in single- or two-socket lamps in most homes, with a single Westinghouse 150-watt, R-40, White Indirect-Lite bulb. The sides of this large mushroom-shaped bulb are coated to reduce direct glare and to give a good diffusion of light downward.

Table and floor lamps with shades of 14 inches or more in diameter can be modernized easily by substituting the new six-inch-wide harp for the narrow harp found on most single-socket lamps. In the case of two-socket lamps, a single socket is wired on and the wide harp installed. For lamps already equipped with a wide harp, all that is necessary is to screw the Indirect-Lite into the socket.

To encourage the remodeling of existing lamps and to make the most essential parts easy to obtain, the Noma Electric Corporation, 55 West 13th Street, New York City, has prepared an envelope containing a finial and a new, wide, under-socket harp. The White Indirect-Lite together with the modernization envelope has a suggested retail price of \$1.65.

New Television

Mars TV CONSOLE

The "Academy" features a 16-inch, flat-faced, all-glass picture tube in mahogany console cabinet. Chassis has 31 tubes, and



operation is said to be exceptional at long distances. Retail price is \$399.00. Mars Television, Inc., 29-05 40th Road, Long Island City, N. Y.—RADIO & TELEVISION RETAILING.

I.T.I. TV SETS

Two new "Century" television receivers are equipped with I.T.I.'s new non-directional built-in antenna, said to eliminate the need for expensive outdoor antennas in many cases, and which does not require

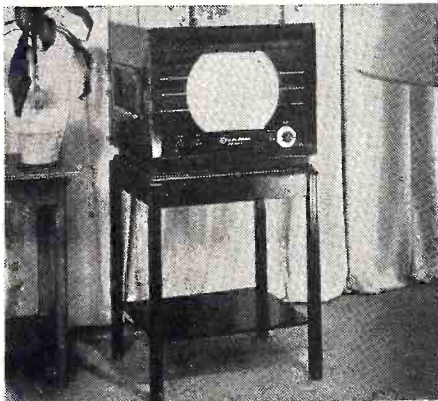

movement of the set for best performance. Model 821 is a 12½-inch table model retailing at \$239.50. A 12½-inch console, model 921, lists at \$299.50. Industrial Television, Inc., 359 Lexington Ave., Clifton, N. J.—RADIO & TELEVISION RETAILING.

Daleo TV CABINETS

A complete line of console, consolette and table model television cabinets is available in both traditional and modern styles. These cabinets are produced for any TV chassis and picture tube size, and feature hand-rubbed finishes of walnut, mahogany, or bleached mahogany. Daleo Enterprises, 752 East 137th St., New York 54, N. Y.—RADIO & TELEVISION RETAILING.

Philco Service Promotion

The service division of the Philco Corporation has prepared a promotion package consisting of advertising pieces, banners, and a sign, all designed to promote a "rejuvenation" campaign for home radios which are inoperable and stored away, and sets which are in constant use but not working properly. The promotion kit will cost service dealers \$5.00.

Karet with Pentron

Paul A. Sahlins, president of The Pentron Corp., manufacturers of magnetic wire and tape recorders, announces the appointment of R. M. Karet

to the board of directors of the firm. Mr. Karet will also act in the capacity of national sales consultant for the company. Irving Rossman, vice-president, has taken over the duties of sales manager.

Brach Sales Executive

C. Philip Galloway, sales manager of the L. S. Brach Manufacturing Corporation, of Newark, N. J., recently named Joseph F. Bozzelli, assistant sales manager. Mr. Bozzelli will supervise and direct a new television antenna promotion for the Brach Corporation, active in the electronic and electrical fields for over forty-two years.

INTRODUCING NEW IRC PRECISTORS

Here is the precision resistor you've been hunting. IRC's new Deposited Carbon PRECISTOR combines accuracy, stability and economy!

PRECISTORS are principally designed for uses where carbon compositions are unsuited and wire wound precisions too expensive. They are excellent in television, voltmeter multiplier, and high frequency circuits. PRECISTORS are supplied in 2 sizes: Type DCF—200 ohms to 5 megohms and Type DCH—500 ohms to 20 megohms.

Your IRC Distributor has new PRECISTORS packaged in sturdy plastic cases . . . fully protected against scratches and jars. Characteristics are printed on the case, and range, type and tolerance are given on the resistor. Ask to see new IRC PRECISTORS when you visit your Distributor!

IRC also manufactures a complete range of Wire Wound Precision Resistors. 1% accuracy is standard, but closer tolerances to 1/10 of 1% are available at slightly higher prices. Highest quality materials combined with skillful winding technique make IRC Precision Wire Wounds the choice of leading instrument makers. International Resistance Co., 401 N. Broad St., Phila. 8, Pa. In Canada: International Resistance Co., Ltd., Toronto, Licensee.

INTERNATIONAL RESISTANCE CO.

Wherever the Circuit Says 

GUARANTEED
ACCURACY
1%

PLUS

STABILITY
OVER LONG
PERIODS

PLUS

LOW
COST

PLUS

WIDE RANGE
OF
VALUES

PLUS

PRECISION
PACKAGING
in tubular
plastic case



Big Pre-Christmas Ad Campaign by Starrett

Full-page, full-color advertising in the *American Weekly* highlights Starrett Television Corp.'s national consumer advertising for peak pre-Christmas selling. Media selected is directly geared to prospective customers for both the Starrett "Metropolitan" moderate-priced line and its "Custom" series, Starrett announced.

National publication advertising started in September in the *Journal of Commerce*, the *New York Times Magazine*, the *Wall St. Journal*, the *New Yorker*, *Time*, *Gourmet*, *Fortune*, *Town & Country*, *Field & Stream* and the *Saturday Evening Post*.

Permo Price Reduction

A sharp reduction in the list prices of Fidelitone paper-based recording tape were announced by R. F. Goetzen, assistant sales manager of Permo, Inc., Chicago.

The new list prices for Fidelitone paper-based tape are: \$3.50 for the 1200 foot length on the 7-inch reel; and \$2.25 for the 600 foot length on the 5-inch reel.

"Due to the increased market for magnetic tape recorders," said Goetzen, "the demand for high quality recording tape has also increased. So our price reduction—and meeting of competitive prices—is justified."

New Recorders

Lear TV-AM-FM-Recorder

Model W D-302-TV combines a 12-inch TV set, AM-FM radio, wire recorder, LP record changer, 15-inch Stephens loud-

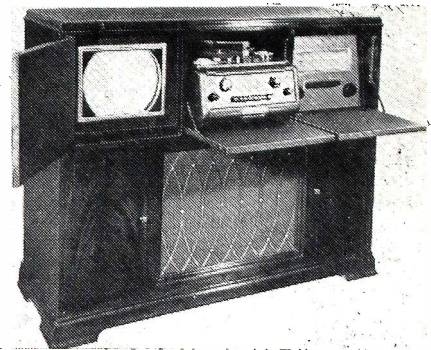

speaker, and incorporates 52 tubes plus rectifiers. It will be produced in both mahogany and blonde cabinet finish. Lear, Inc., 110 Ionia St., N. W., Grand Rapids 2, Mich.—RADIO & TELEVISION RETAILING.

Webster TAPE RECORDERS

Model 105 Ekotape self-contained single unit tape recorder and model 107 two unit (one containing recorder mechanism, the other the amplifier and chassis) model are

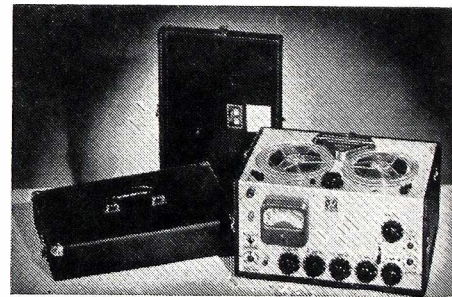

new professional tape recorders designed for broadcast applications. VU meters are provided on both, and two speeds on the 107 (7½ and 15"/sec.), one speed on the 105 (7½). Webster Electric Co., Racine, Wis.—RADIO & TELEVISION RETAILING.

Ampro TAPE RECORDER

The new tape recorder weighs only 15 pounds complete and retails for \$94.50, said to be the first of its kind under \$100. Recording is "dual track" at 3¼ inches per second, or two hours on a 7-inch reel



of tape. A timing indicator is built-in, to facilitate location of a particular portion. Recording may be made from microphone, radio or phonograph, and a 4x6-inch speaker is provided for playback. Ampro Corp., 2835 N. Western Ave., Chicago 18, Ill.—RADIO & TELEVISION RETAILING.

This is it!

**A TELEVISION
BOOSTER THAT
REALLY DOES THE JOB**

THE ANCHOR TV-PRE-AMPLIFIER

*Here's What Others Say!**

"IT DOES HAVE MORE USEABLE GAIN THAN ANY OTHER 'BOOSTER' I HAVE SEEN, YIELDING SNOW-FREE PICTURES UNDER THE MOST DIFFICULT CONDITIONS."

JOHNSON & ELLIOTT
MONTICELLO, N. Y.

**An unsolicited statement from an independent service engineer.*

**NOT MERELY ANOTHER BOOSTER — ANCHOR
WILL POSITIVELY DO EVERYTHING AS
CLAIMED OR YOUR MONEY BACK**

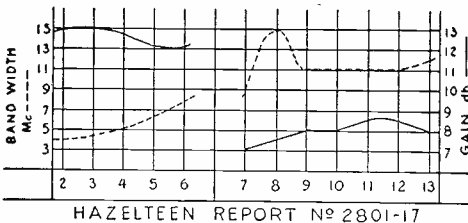

**IT'S NEW — DIFFERENT
HAS AMAZING PERFORMANCE**

An ANCHOR TV-PRE-AMPLIFIER will out-perform any similar equipment in its class. Don't take anything less than the best—don't take anything less than ANCHOR.

Check These Features

- 4 mc minimum Bandwidth on all channels
- Impedance matching to receiver
- Simultaneous iron core tuning of grid and plate
- 2½ times average gain (Voltage Ratio)
- Guaranteed coverage of low and high TV-Band

Carefully, thoroughly engineered, ANCHOR TV-PRE-AMPLIFIER is a product of long research—it is compact, beautifully styled and precision built to give outstanding, trouble-free performance. When you install an ANCHOR TV-PRE-AMPLIFIER you give your customers the best. Don't wait—don't miss this—see your jobber today. LIST PRICE \$37.50

Dealer aids available — Write for Further Information



ANCHOR
RADIO CORP.
2215 S. St. Louis Ave.
Chicago 23, Ill.

RCA Victor Official on TV

TV sets alone will provide \$18,500,000 in increased revenue for the electric power companies this year, said Dan Halpin, manager of the Television Receiver Sales Division, RCA Victor, in a talk before the 14th annual conference of the International Association of Electrical Leagues.

Jewel Radio Line

Jewel Radio Corp., 10-40 45 Ave., Long Island City 1, N.Y., has announced a complete restyling of its new 1950 radio line. Bronislaw Zapolski, product designer, has based the new line on designs of functionalism, originality and compactness.

New Hotpoint Appliances

Hotpoint, Inc., is shipping to dealers a new 8 cu. ft. refrigerator in the medium price class, and two combination refrigerator-freezers, priced competitively, with conventional "two zone" models. An 11 cu. ft. freezer, developed to meet the demand in rural areas for greater freezing capacity is scheduled to arrive in stores in December.

Astatic, Ward Lecture

The Astatic Corp. and Ward Products Co. gave demonstrations and technical lectures before NEDA officers, directors and guest distributors who were present for the NEDA board of directors meeting in Cleveland.

Pariser Names Friedman

Sid Pariser, president, Radio Merchandise Sales, Inc., New York City, manufacturers of a complete line of television antennas and accessories, has announced the appointment of Al Friedman as chief engineer and national field service representative.

IRC Sales Meetings

"Make Up Your Mind—Sell the Whole Line!" was the theme of the International Resistance Company's 3-day sales conference in Hershey, Pa. Highlights of the conference, held for 65 sales reps, were discussions and demonstrations of new IRC products, plus a presentation of selling techniques.

Texas Jobber Expands

The growth and progress of the South Texas Appliance Corporation, wholesale distributors of appliances and housewares, are reflected in the new quarters of the firm at 641 South Flores St., San Antonio, among the most modern and complete in the south Texas area.

The firm, organized in February, 1936, specializes in wholesale distribution of nationally-advertised products in San Antonio and surrounding trade areas comprising nearly 85 counties.

Big Crosley Contest

A giveaway "to top all giveaways" burst upon a giveaway-conscious American public with the announcement of a \$2,000,000 contest by the Crosley Division, Avco Manufacturing Corporation.

W. A. Blees, Avco vice-president and Crosley general sales manager, revealed the details at a press showing of the company's new 1950 line of home appliances at the Hotel Commodore, New York.

He described the contest as "the simplest to enter and easiest to win—and by far the biggest—giveaway in history. To enter, it will be necessary only to

write in a few words 'Why I Should Be Given a New 1950 Shelvador.'"

The giant contest in which Crosley, its distributors and dealers will give away an estimated \$2,000,000 in cash, complete steel kitchens, and refrigerators, opened October 15 and continues through November 30.

Du Mont Sales Executive

F. A. Lyman has been appointed assistant national sales manager, of the receiver sales division, Allen B. Du Mont Laboratories, Inc., Ernest A. Marx, general manager of receiver sales, announced.

Eicor Scores Again

WITH A
**SMART NEW TAPE
RECORDER**



THE EICOR

MODEL 15

Retails at
\$134⁹⁵

Slightly higher on West coast

The new Model 15 is unrivalled in price, performance, profit! Styled for faster turnover...engineered for lower service costs and real customer satisfaction. Now with new sales-appeal, in rich russet brown leatherette and plastic bead trim.

Order a set today. Dollar for dollar, feature for feature—Model 15 is the value the public is waiting for.

- Lowest price—hi-fidelity tape recorder on the market.
- Smart Airplane luggage case 9" High—16" Long—12" Wide.
- Two-Track, Full Hour-Long Sound Tape.
- New Large separate compartment for microphone, cord, and extras.
- 5 Tube, A.C. Amplifier (inc. Separate Oscillator Tube).
- New "Elapsed Time" Markings.

America's Greatest Value



1501 W. Congress Street
Chicago 7, Illinois

Write Today for Prices and Discounts

2-L

Prelude to Profit

Introducing
the New

Trans-Vue

ARISTOCRAT 400

The
"Tele-Receiver
of Tomorrow"

TODAY!

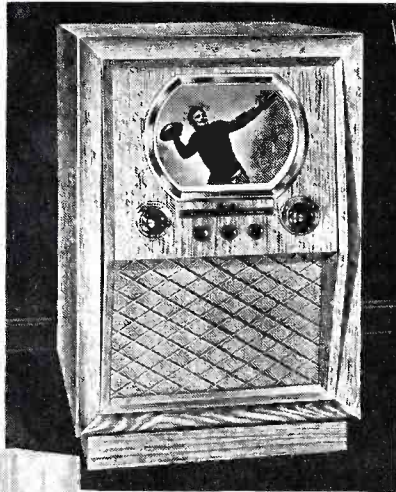

97 Square Inches Of Visual Fidelity • Cabinetry In The Finest Tradition • Available in Lined Oak, Blonde and Mahogany.

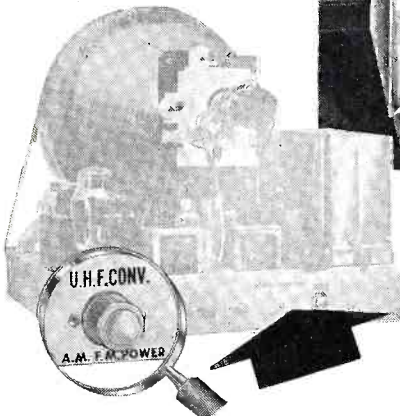

FIRST WITH THE U.H.F. ADAPTOR BUILT RIGHT INTO THE CHASSIS—no rewiring necessary—merely plug in the U.H.F. convertor when available.

The ARISTOCRAT 400 Incorporates These 10 Outstanding Features:

- | | |
|----------------------------------|---------------------------------|
| 1. Synchro-Set Tuner! | 6. Automatic Tone Compensation! |
| 2. Picture Synchronization! | 7. Built-In Antenna! |
| 3. Eye-Level-Angle-Compensation! | 8. Fringe Area Reception! |
| 4. Keyed Automatic Gain Control! | 9. AM-FM Plug-In Adaptor! |
| 5. Perma-Magnet Focalizer! | 10. Phonograph Plug-In Adaptor! |

Limited Distributorships Still Available.

Write or Phone

Trans-Vue

CORP.

1139-41 S. WABASH AVE.
CHICAGO 5, ILLINOIS

If You Qualify We Will Extend The Longest Discounts
In The History Of The Industry!

**NEW Tricraft
"3000" Series**

"X" ANTENNAS (Hi-Lo Conical Type)

- PRE-ASSEMBLED AT FACTORY, READY TO INSTALL (no loose parts)
- Matches 72, 150 and 300 ohm impedance
- All-wave, high gain on all channels
- Durable construction of finest aluminum (will not rust)
- Quality at the right price
- Excellent all-around performance eliminates constant servicing and maintenance

Tricraft "X" ANTENNAS are furnished in single, double or quad element assembly, with or without masts.

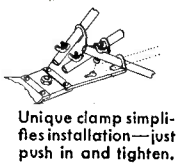
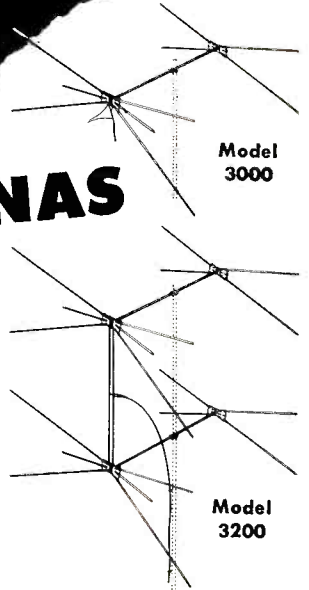

Available at leading jobbers.

Write for technical information, literature and prices.

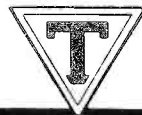

Tricraft Products Co.

1535 North Ashland Ave., Chicago 22, Ill.

Manufacturers of complete line of Television, FM and AM antennas and accessories

Get into the

PROFITABLE REPLACEMENT MARKET

with T.E.I. Quality Tubes!

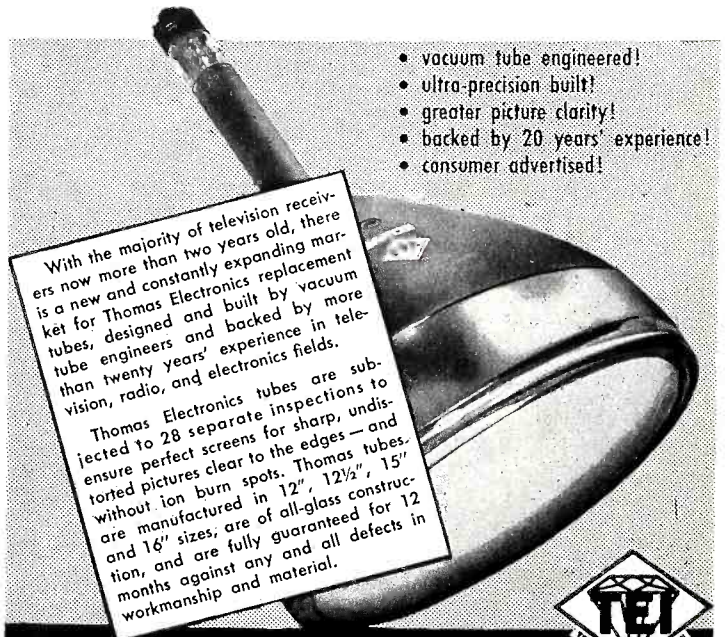

- vacuum tube engineered!
- ultra-precision built!
- greater picture clarity!
- backed by 20 years' experience!
- consumer advertised!

With the majority of television receivers now more than two years old, there is a new and constantly expanding market for Thomas Electronics replacement tubes, designed and built by vacuum tube engineers and backed by more than twenty years' experience in television, radio, and electronics fields.

Thomas Electronics tubes are subjected to 28 separate inspections to ensure perfect screens for sharp, undistorted pictures clear to the edges — without ion burn spots. Thomas tubes are manufactured in 12", 12½", 15" and 18" sizes; are of all-glass construction, and are fully guaranteed for 12 months against any and all defects in workmanship and material.



Write TODAY for complete engineering data and price list!

THOMAS ELECTRONICS, Inc.

118 Ninth Street Passaic, New Jersey

Bolin and Clemens in New Westinghouse Posts

Roger H. Bolin, formerly advertising manager of the Westinghouse Electric Corporation's Appliance Division at Mansfield, Ohio, has been named assistant to J. M. McKibbin, vice-president and general manager in charge of consumer products for Westinghouse, according to a recent announcement by Mr. McKibbin.

Succeeding Mr. Bolin at his Mansfield post will be J. R. Clemens, formerly assistant manager of appliance advertising.

Proctor Production Up; Toasters on Allocation

A return to the allocation system of distribution until the end of this year has been decided upon by the Proctor Electric Company, Philadelphia, electrical appliance manufacturer.

This disclosure was made by Joseph Tiers, sales manager for distributor sales, in a letter sent out to all distributors. With a production increase the plant is now operating at its maximum single shift capacity.

According to Mr. Tiers, there is little doubt but that the automatic toaster business is returning to its pre-war seasonal pattern. This means that about 40 per cent of distributor sales occur during the last four months of the year. Because the toaster business is so seasonal, it just isn't practical between now and the time the toasters will be needed to hire and train a second shift, hence the decision to allocate the plant's capacity for the balance of the year. Quality toasters are still at a premium, he said, and the company has been forced to back-order on both of its current models.

Maytag Regional Manager

The Maytag Company, of Newton, Iowa, has announced the appointment of Thomas H. Coblentz as a regional manager in charge of 35 counties in northwest Kansas. He will work under Claire G. Ely, manager of the Kansas City branch office.

Mr. Coblentz was associated with the Winchell Maytag and Manufacturing Company, Inc., at Ft. Scott, Kansas, as store manager and salesman previous to his new assignment in the Kansas City Branch.

New Duchess Distributors

F. W. McGrath, vice-president in charge of sales for Appliance Manufacturing Company, Alliance, O., announces the appointment of the following distributors for Duchess Washing Machines.

Appliance Distributors, Inc., 33 Commercial St., Portland, Maine; Electrical Wholesalers, Inc., 911 North West St., Raleigh, N. C.; Ideal Sales Co. 1522 Acushnet Ave., New Bedford, Mass.; McWhorter, Weaver & Co., Nashville 3, Tenn.

NOW *Astatic Research* AIDS TELEVISION
PROGRESS WITH THE

Channel Chief

MODEL AT-1
TELEVISION
BOOSTER



New Astatic Booster Has Gain Equivalent to Two Ordinary Boosters . . . Covers All 12 Channels with Very Uniform Gain . . . Eliminates Sacrifice of Good Sound for Good Picture, or Vice Versa, with Dual-Tuning.

ADDITIONAL IMPORTANT FEATURES

1. Self-contained power supply operating from 115 volt, 60 cycle AC power line.
2. On-off switch allows booster to be switched in or out of the circuit at will.
3. Recessed pilot light indicates when booster is on.
4. Beautiful, furniture-finish mahogany cabinet (8½" wide x 6½" high x 7¾" deep) to complement fine home furnishings.
5. Simple to install and operate—complete instructions with each unit.

ASTATIC RESEARCH—which has led the march of progress in various sound reproduction fields since the company first pioneered in crystal microphones, phonograph pickups, cartridges, parts and accessories—now brings major new advantages in reception and tuning to the television field. The new Astatic device which makes it all possible is the Channel Chief, Model AT-1, a radically improved type of television booster. The common failing of many boosters—showing a "peak" on some channels and "fall-off" on others—has been eliminated. The Channel Chief provides extremely high gain—equivalent of two conventional boosters—uniform on all 12 television channels. Its dual controls allow separate tuning of picture and sound, with no sacrifice of one for the other. Or, if one signal is weak and the other adequate, both controls may be adjusted to the weaker to bring it in strong. A variable gain control permits reduction of signal strength to prevent picture distortion when the signal input is greater than that required for good definition. Altogether, the results are the considerable extension of fringe areas, good reception in areas previously rated as unsatisfactory, easier tuning and added selectivity on any receiver, elimination of the need for expensive outdoor antennas within service areas. The increased selectivity serves to reduce drastically, or eliminate, interference from adjacent channels, amateur and commercial fundamentals and harmonics in the receiver's I.F. range, FM stations and oscillators of nearby FM, TV and short wave receivers. No other booster can do so much . . . for your installation and service business, for the television receiver owner. Write for added details.



★ WARNING!

South River Chimney Mounts are patent protected. Imitations and infringements are being prosecuted.
See U. S. Patent No. 2482575

South River Metal Products Co., Inc.
17 Obert Street, South River, New Jersey

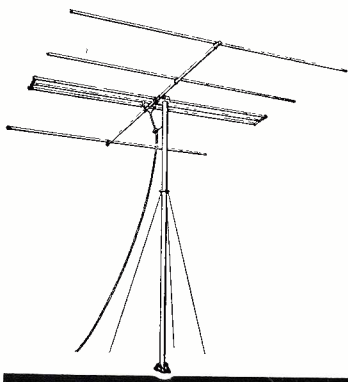

TRIO ANNOUNCES SOMETHING *new* IN **YAGIS**

A new type double folded dipole developed by Trio solves Construction and Engineering problems to give improved performance and sturdy light weight.

High Gain—10 db. on optimum channel.

High Front-to-Back Ratio—over 25 db. Maximum suppression of minor lobes to give sharp directional pattern.

Ease of Assembly and Installation—6 bolts for complete assembly.

Light Weight—only 5 lbs. for channel 5, 2¼ lbs. for channel 9.

Flexibility—more than one bay may be mounted on mast with independent orientation of each.

List price with mast and mounting hardware,
Channels 2—6 **\$35.00**

Antenna bay only for high band—less mast **\$14.95**

TRIO MANUFACTURING CO., GRIGGSVILLE, ILL.

MANY ways to ship...



but only ONE RAILWAY EXPRESS

Before you ship—Ask yourself these questions—

1. Will the carrier be able to handle my shipment, regardless of its size or weight?
2. Is it a complete service, with pick-up and delivery?
3. Is it a dependable service, with national coverage?
4. Will I be dealing with one responsible carrier?
5. Will the charge be all-inclusive?

You can say YES to every question when you use RAILWAY EXPRESS, America's COMPLETE shipping service, because only RAILWAY EXPRESS can offer you ALL these advantages. For dependable, economical shipping, where and when you need it, specify and use RAILWAY EXPRESS every time!



NATION - W I D E R A I L - A I R S E R V I C E

RCA 12½-INCH CONSOLE

Model 9-TC-245 is a 12½-inch television only console with 12-inch loudspeaker, and phono jack for attaching external record



player. Suggested retail price is \$299.50 in walnut or mahogany, and \$319.50 in limed oak. RCA Victor Div. of RCA, Camden, N. J.—RADIO & TELEVISION RETAILING.

Admiral TV SETS

Rounding out its current line, this firm has announced 3 new receivers: Model 24X15 10-inch console TV-radio-phono combination at \$299.95, model 20X145 console 12½-inch

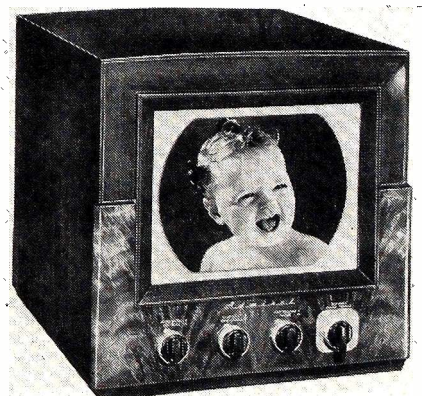

set at \$279.95, and model 20X136. wood table model 12½-inch set (shown) at \$249.95. Admiral Corp., 3800 Cortland St., Chicago 47, Ill.—RADIO & TELEVISION RETAILING

Taco HI-BAND YAGI ANTENNA

Model 957 provides a folded dipole with reflector and 2 directors for high gain, high directivity, and high front-to-back ratio. Type 957-8 is peaked for channels 7, 8 and 9; 957-10 covers channels 9, 10, 11; and 957-12 covers 11, 12 and 13. Bulletin 53 available from Taco jobbers. Technical Appliance Corp., Sherburne, N. Y.—RADIO & TELEVISION RETAILING.

Printup TV ANTENNA

The new JP-TV high gain vertical array antenna is designed for all channel, bi-directional coverage with only one lead-in required. The novel arrangement of elements makes possible mounting flat against a wall (inside or outside), chimney, etc., without necessity of mast, mounting base and other accessories. Net price is \$12.95. John Printup Antenna Co., 8543 Glencoe Circle, Milwaukee 13, Wis.—RADIO & TELEVISION RETAILING.

Servicing Equipment

Approved TV FIELD STRENGTH METER

Model A-460 provides for actual measurement of TV station signal strength, measurement for orientation of antennas, comparison of antennas, measuring receiver local oscillator radiation, measuring

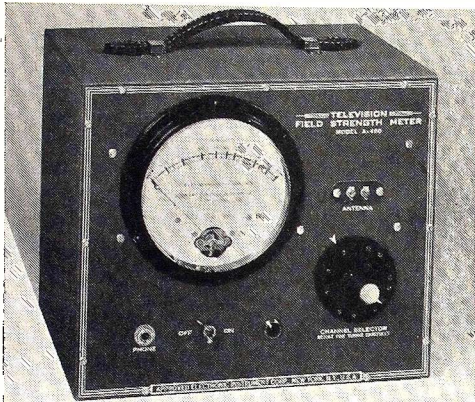

interfering signals, and checking efficiency of boosters. The unit incorporates a 12-channel TV front end, 6 tubes plus germanium crystal diode, lists for \$79.50. Approved Electronic Instrument Corp., 142 Liberty St., New York 6, N. Y.—RADIO & TELEVISION RETAILING.

Radio Kits SWEEP GENERATOR

Kit model SW-5 covers a range of 2 mc to 226 mc. Variable phasing, variable sweep width and sweep output for scope

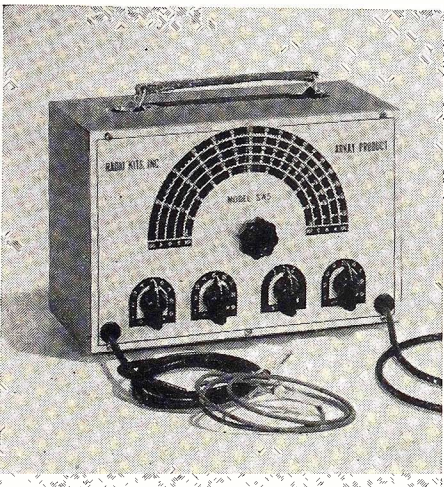

are provided. The complete kit sells for \$22.95. Radio Kits Co., 120 Cedar St., New York 6, N. Y.—RADIO & TELEVISION RETAILING.

C.M.L. TV ANTENNA SWITCH

The Select-O-Vision antenna switching system makes it possible to utilize several antennas, each oriented for maximum reception on some channel or channels, which may be selected at will with a push-button switch. Switching is done remotely, with the switch on the antenna mast, so that a single down-lead suffices. Up to twelve antennas may be used with the device, which has a dealer net of \$23.97. Communications Measurements Laboratory, Inc., 120 Greenwich St., New York 6, N. Y.—RADIO & TELEVISION RETAILING.



The Invisible TV-FM Power Line Antenna

POWERTENNA

- Excellent reception on all channels.
- Banishes unsightly indoor or outdoor antennas.
- Makes installation simple and inexpensive.
- Non-directional — unaffected by movement in a room.
- Connect to set and plug in — that's all.

By isolating the TV receiver from the voltages of the power line by means of suitable capacities and impedances, a high-frequency signal is obtained. The phasing network in the POWERTENNA transfers the signal energy from the power line to the antenna terminals of the receiver.

Stock it . . . Pep up sales . . . Reduce Installation Costs . . . 24 units in Standard Carton . . . Fast moving . . . Inexpensive . . . Order today . . . List only . . . **\$3.95**

Distributor and Dealer Inquiries Invited

ROLLAN SALES CORP.

527 S. Wells St.
Chicago 7, Illinois

LOOK

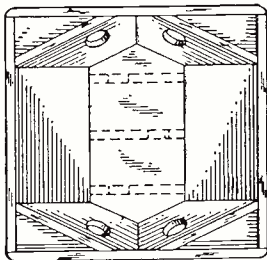

**Inside
the
Baffle!**

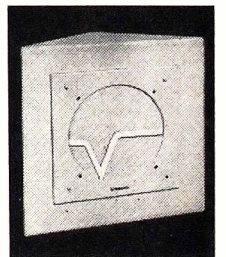

and you will see why leading sound engineers insist on
**VIBRALOC "PRESSURE CONTROLLED"
SPEAKER Baffles***

- Built-in Acoustic Network.
- Achieves the ultimate in wide-range sound reproduction.
- Natural Voice—True-tone Music.
- Efficient — Economical — Distinctive.
- Adaptable to widely varying requirements.
- Heavy Plywood Construction — Leatherette Covered — Choice of Colors.

Write for descriptive catalog.

*U. S. PAT. #2337213

PATENTED ACOUSTIC PRODUCTS
Vibraloc corporation
425 BUSH ST., SAN FRANCISCO 8, CALIF.

TOPS IN PERFORMANCE

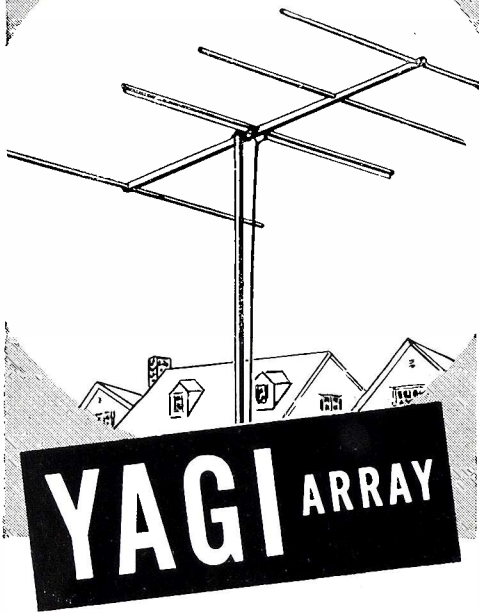

Here is the most sensational single channel performer. The YAGI array has achieved astounding results because in it Vee-D-X engineers have successfully combined every desirable feature for optimum performance. Compare what this YAGI offers you!

- Four element beam cut especially for each particular channel
- High forward gain and sharply directional
- Stepped-up driven element affords excellent match to 300 ohm transmission line. (Can also be supplied for 72 ohm match.)
- Exceptionally high front to back ratio helps reject unwanted signals
- Fabricated from highest quality 61 ST duraluminum (3/4" O.D. elements)
- Extremely light weight, easy to assemble, and neat appearing

STACKED ARRAY

To provide additional gain and improve signal to noise ratio on any one channel, two YAGIS can be stacked together. Also several arrays may be mounted on the same mast and directed to different transmitters.

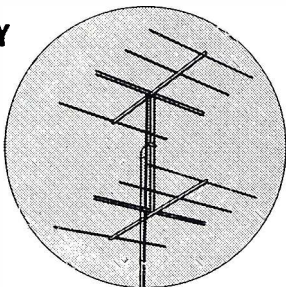

VEE-D-X

VEE-D-X means video distance

LaPointe Plascomold Corp., Unionville, Conn.
Send new catalog and prices on the YAGI array and other Vee-D-X television accessories.

Name.....
Company.....
Street.....
City..... Zone..... State.....

ROSTER OF NATIONAL AND CHAPTER OFFICERS OF "THE REPRESENTATIVES"

NATIONAL OFFICERS

William E. McFadden, president,
150 East Broad St., Columbus 15, Ohio
J. Y. Schoonmaker, 1st vice-president,
2011 Cedar Spring, Dallas 1, Texas
Wilmer S. Trinkle, 2nd vice-president,
2601 Broad St., N., Philadelphia 32, Pa.
Norman B. Neely, 3rd vice-president,
7422 Melrose Ave., Hollywood 46, Calif.
Russ Diether, secretary-treasurer,
2323 West Devon Ave., Chicago 45, Ill.

BOARD OF GOVERNORS

Leslie M. DeVoe, chairman,
4014 Washington Blvd., Indianapolis 5, Ind.
Irvin I. Aaron,
3704 N. Eleventh St., Milwaukee 6, Wisc.
Robert E. Breuer,
250 W. 57th St., New York 19, N. Y.
Fred R. Ellinger,
6663 Northwest Hwy., Chicago, Ill.
R. W. Farris,
406 W. 34th St., Kansas City 2, Mo.
Samuel K. Macdonald,
1531 Spruce St., Philadelphia 2, Pa.
David N. Marshank,
672 So. Lafayette Park Pl., Los Angeles 3, Calif.

INDUSTRY RELATIONS COMMITTEE

Paul R. Sturgeon,
25 Huntington Ave., Boston 18, Mass.
Dean Lewis,
1797 Solano Ave., Berkeley 7, Calif.
L. C. McCarthy,
9 South Clinton St., Chicago 6, Ill.
James Millar,
P. O. Box 116, Station C, Atlanta, Ga.
Joseph Sprung,
254 West 31st St., New York 1, N. Y.

NOMINATING COMMITTEE

Dan R. Bittan, chairman,
53 Park Place, New York 7, N. Y.
Leonard Allen,
201 E. Water St., Syracuse 1, N. Y.
Fred B. Hill,
255 First Ave., N., Minneapolis 1, Minn.
Ralph James,
4130 First Ave., So., Seattle 4, Wash.
Grant Shaffer,
1980 Lawrence Ave., Detroit 6, Mich.

MEMBERSHIP COMMITTEE

Norman Kathrinus, chairman,
1218 Olive St., St. Louis 3, Mo.
William T. McGary,
4030 Chouteau Ave., St. Louis 10, Mo.
Gordon Moss, Box 428, Greeley, Colo.
A. J. Nelson, Box 2244, Denver 1, Colo.
Ernest K. Seyd, Longhill Rd., Andover, Conn.

CHAPTER OFFICERS

CHAPTER	PRESIDENT	VICE-PRESIDENT	SECRETARY AND	TREASURER
Buckeye	John O. Olsen, 1456 Waterbury Rd., Cleveland 7, Ohio	J. C. Lehner, 4301 Daisy Ave., Cleveland 9, Ohio	E. C. Edwards, 2123 E. 9th St., Cleveland 15, Ohio	
California	Dan J. Rudat, 383 Brannan St., San Francisco 3, Calif.		Elmer C. Hodges, 1264 Folsom St., San Francisco 3, Calif.	
Chicagoland	R. Edward Stemm, 21 E. Van Buren St., Chicago 5, Ill.	Alec K. Gianaras, 2345 W. Devon Ave., Chicago 45, Ill.	Royal J. Higeins, 600 S. Michigan Ave., Chicago 5, Ill.	W. H. Ellinger, 6663 Northwest Hwy., Chicago, Ill.
Dixie	Brower Murphy, 5 Ivy St., NE, Atlanta 3, Ga.	R. H. Van Dusen, 940 Lake Elbert Dr., Winter Haven, Fla.	John J. Cota, 5 Ivy St., NE, Atlanta 3, Ga.	
Empire State	W. F. Seeman, 248 Delaware Ave., Buffalo 2, N. Y.	J. H. Wawter, 351 Berryman Dr., Buffalo 21, N. Y.	Joseph Marsey, 74 Park Ave., Rochester, N. Y.	Marshall T. Ball, 74 Niagara St., Buffalo 2, N. Y.
Gopher	Jack Heimann, 1215 Harmon Pl., Minneapolis 3, Minn.	Fred B. Hill, 256 First Ave., N., Minneapolis 1, Minn.	A. J. Warner, 5022-29th Ave., So., Minneapolis, Minn.	
Hoosier	Charles Southern, 1135 Lincoln Tower, Ft. Wayne 2, Ind.	Bruce L. MacPherson, 601 Ft. Wayne Bank Bldg., Ft. Wayne 2, Ind.	James L. Wright, 4241 Melbourne Rd., Box 276, RR 17 Indianapolis 44, Ind.	
Los Angeles	Gerald B. Miller, 1051 N. Havenhurst Dr., Hollywood 46, Calif.	H. A. Kittleson, 623 Guaranty Bldg., Hollywood 28, Calif.	Wm. H. Wallace, 1206 Maple Ave., Los Angeles 15, Calif.	Lewis E. Sperry*, 2734 Glendon Ave., Los Angeles 34, Calif.
Mid-Lantic	A. R. Relinger, 3617 N. 8th St., Philadelphia 40, Pa.	J. C. Muggleworth, 313 Taylor Ave., West Collingswood, N. J.	Howard J. Fairbanks, 401 N. Broad St., Philadelphia 8, Pa.	R. F. Brookfield, 55 Cricket Ave., Ardmore, Pa.
Mississippi Valley	Harry G. Hurd, 2332 Locust St., St. Louis 3, Mo.	L. E. Jaques, 8112 Tulane Ave., University City 5, Mo.	William T. McGary, 4030 Chouteau Ave., St. Louis 10, Mo.	
Missouri Valley	James P. Kay, 3760 Broadway, Kansas City 2, Mo.	H. Courtney Roes, 1805 Grand Ave., Kansas City 8, Mo.	Zell S. Myers, 4550 Main St., Kansas City 2, Mo.	
New England	Glenn M. Hathaway, 238 Main St., Cambridge 22, Mass.	Harold A. Chamberlain, 31 Milk St., Boston 9, Mass.	Walter T. Hannigan, 43 Leon St., Boston 15, Mass.	
New York	William Gold, 306 E. 23rd St., New York 10, N. Y.	John Kopple, 60 E. 42nd St., New York 17, N. Y.	Ben Joseph, 551 Fifth Ave., New York 17, N. Y.	
Pacific Northwest	James J. Backer, 2321 Second Ave., Seattle 1, Wash.	Verner O. Jensen, 2616 Second Ave., Seattle 1, Wash.	Ralph James, 4130 First Ave., So., Seattle 4, Wash.	
Southwestern	R. M. Campion, P. O. Box 4116, Station A, Dallas 8, Texas	Earl J. Smith, 505 No. Ervay St., Dallas 1, Texas	Hal F. Corry, 3522 Gillon Ave., Dallas 5, Texas	
Wolverine	H. P. Haggerty, 10226 Woodward Ave., Detroit 2, Mich.	William S. Lee, 508 Charlevoix Bldg., Detroit 26, Mich.	Grant Shaffer, 1980 Lawrence Ave., Detroit 8, Mich.	

* Executive secretary.



BIG NEWS!
ABOUT LITTLE CAPACITORS

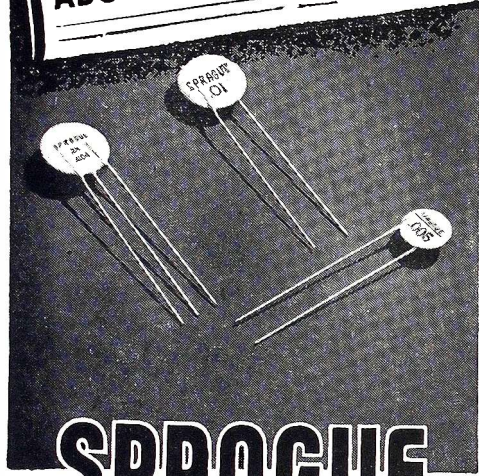

SPRAGUE DISC

CERAMIC BYPASS AND COUPLING CAPACITORS

These new ceramic units—no bigger than a dime—find dozens of bypass and coupling uses in both standard and FM as well as television equipment. They have higher self-resonant frequencies than conventional capacitors and fit neatly across miniature tube sockets. They're covered with a tough, protective coating which guards against moisture and heat. Sprague Disc ceramics are available in both single and money-saving dual capacitors.

Use Sprague Disc ceramics whenever circuits call for ultra-compact, bypass or coupling capacitors. Each unit is clearly stamped with capacitance. All capacitors are rated at 1000 v. test, 500 w.v.d.c.

See these remarkable new capacitors at your Sprague distributor today! Write for bulletin M 431.

SPRAGUE PRODUCTS COMPANY

Distributors' Division
 of the Sprague Electric Company
 NORTH ADAMS, MASS.

RCP MARKER GENERATOR

Model TV50 provides marker signals from 5 to 250 mc for visual alignment of TV. Crystals of any size from 1 mc up may be used in the crystal holder which

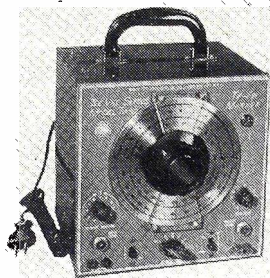

is provided. Unit utilizes 2 tubes plus VR tube and rectifier, and operates on AC. Radio City Products Co., Inc., 152 West 25th St., New York 1, N. Y.—RADIO & TELEVISION RETAILING.

EMC SIGNAL GENERATOR

Model 500K signal generator supplied in kit form covers a range from 150 KC to over 30 MC on fundamentals and over 100 MC on harmonics. 400 cycle internal

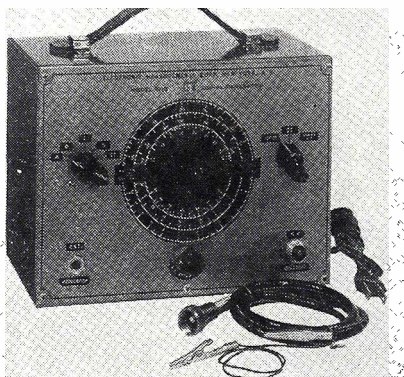

modulation is provided. The complete kit sells for \$18.75, or fully wired for \$28.75. Electronic Measurements Corp., 423 Broome St., New York 13, N. Y.—RADIO & TELEVISION RETAILING.

"Flash" TV ANTENNAS

The Flash line features spring-lock action which holds the element rigid with a stainless spring steel spring. Hand tightening of wing nuts braces the elements against winds. Included in the line are straight, folded and conical antennas, wall and chimney mounts, and mast stand-off insulators. Brooklyn Television Co., 1630 St. John's Place, Brooklyn 33, N. Y.—RADIO & TELEVISION RETAILING.

Transvision ANTENNA SYSTEM

A master amplified television antenna system has been designed to provide for multi-set operation in apartment houses, hotels, hospitals, etc. Signals are amplified many times and distributed to any number of television outlets in the building. In dwellings of 60 families or more, installation may be done at no cost to the owner, tenants being charged a reasonable fee for use of the system. For more details, write to Transvision, Inc., New Rochelle, N. Y.—RADIO & TELEVISION RETAILING.

Play Safe! Use Reliable TELEVISION REPLACEMENTS

Television requires the most durable, heat-and-moisture-resistant components you can get. In capacitors, that means Sprague. You'll have no profitless call-backs with extra-dependable Sprague TV capacitors.

SPRAGUE TELECAP* MOLDED TUBULARS

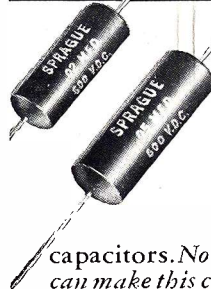

Only Telecaps are molded in heat-resistant Bakelite phenolic, oil-impregnated, and then solder-sealed—just like metal-encased oil-paper capacitors. No other manufacturer can make this claim! Ratings from 600 to 10,000 volts.

SPRAGUE ATOM® and TWIST-LOK* DRY ELECTROLYTICS

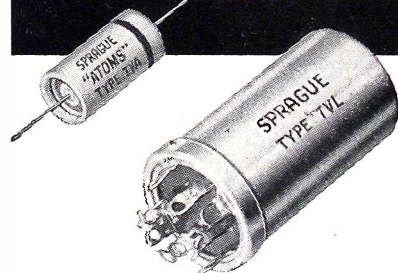

The most complete line of television electrolytics. Engineered especially for tough TV replacement applications, Sprague's new Type TVA Atom and Type TVL Twist-Lok electrolytics stand up under the extremely high temperatures, high ripple currents and high surge voltages encountered in TV receivers.

Write for Sprague Bulletin M-429

SPRAGUE PRODUCTS CO.
 (Distributors' Division of the Sprague Electric Co.)
 NORTH ADAMS, MASS.

★Trademark

Jobber Advisory Group Named for 1950 Show

A distributors' advisory committee, made up of ten of the industry's leading jobbers, was named by Jerome J. Kahn, president of the Radio Parts and Electronic Equipment Shows, Inc., to consult with the directors and management of the 1950 show on ways and means of making the exhibit of major interest and service to the jobbers.

William O. Schoning, of Lukko Sales, Chicago, was named chairman, and Aaron Lippman, of Aaron Lippman Co., Newark, vice-chairman of the distributors' advisory committee, which includes: Sam Poncher, Newark Electric, Chicago; Lewis J. Bonn, Lew Bonn Co., Minneapolis; Merle Applebee, Burstein-Applebee, Kansas City; H. L. Dalis, H. L. Dalis, Inc., New York; William A. Wilson, Hughes-Peters, Inc., Columbus, Ohio; R. V. Weatherford, R. V. Weatherford Co., Glendale, California; Milton L. Deutschmann, Radio Shack Corp., Boston; John Stern, Radio Electric Svc. Co. of Pa., Philadelphia.

Lear Representatives

John Sharpe, national sales manager for Lear, Inc., of Grand Rapids, Mich., who has headquarters in Los Angeles, has announced that the U. S. sales area has been divided into nine sections and that the following factory representatives have been appointed:

Hal F. Corry 3522 Gillon Ave., Dallas

5, Tex.; Harrell, Atcheson & Adams, Inc., P. O. Box 2158, Greensboro, N. C.; Dean A. Lewis, 1617 Oxford St., Berkeley 9, Calif.; Edwin F. Liddle, 18925 Grand River Ave., Detroit 23; Oren H. Smith, 225 W. Huron St., Chicago 10;

F. C. Somers & Co., 1805 Grand Ave., Kansas City, Mo.; J. C. Van Groos, 1436 N Serrano, Hollywood, Calif.; A. W. Korbs, 30 Ottawa Ave., Grandville, Mich., and Jim Walthew, Boeing Field, Seattle 8, Wash.

Big Campaign to Push Sales of Alliance Tenna-Rotor



Seen planning the series of spot demonstrations with sound film in more than 25 key TV cities for Alliance Mfg., Alliance, Ohio, makers of the Tenna-Rotor, are, left to right, standing: Miles C. McKearney, account executive, Foster & Davies, Inc., advertising agency, Cleveland, Ohio; "Jack" Treacy, NBC division manager of spot sales; seated, left to right: John Bentia, Alliance sales manager; Harold Gallagher, sales manager, WNBK, Cleveland, and Hal Sweitzer, sales department, Alliance Mfg. Co.

The TENNA-TRAILER

AND TELESCOPING MAST

FOR FAST, LOW-COST
DEMONSTRATION AND
INSTALLATION OF

TV & FM

saving time and money
for dealers, service and
installation firms.

Quickly raised or lowered for transportation or demonstration. Best location is found quickly by simply moving trailer with mast extended. Height, 51 feet. Can set up, attach antenna and demonstrate in 30 minutes.

Sturdy disk-wheel trailer with coupler. Heavy fenders and floor. All aluminum-spray-painted. Trailer accessories available. Priced so low that you can easily afford it.

Write direct or
see your jobber.



Mfd. by PRICE TENNA-TRAILER COMPANY

660 E. Walnut St.

Phone 408

Watska, Illinois

"Did over \$5,000 additional business
installing ESPEY chassis" De Young, Ithaca, N. Y.

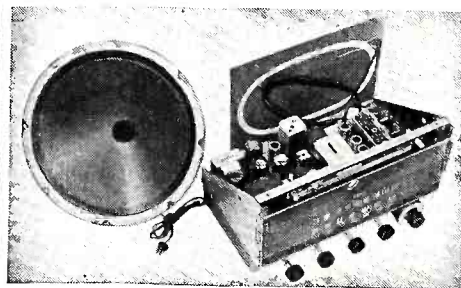

There Are Thousands of Out-Moded Radios in Your "Back Yard" Just Waiting to Be Replaced — At Your Suggestion

Here is the custom-built AM-FM chassis that means **BIGGER PROFITS** for you!

SPECIFICATIONS

Supplied ready to operate, complete with tubes, antennas, speaker and all necessary hardware for mounting in a table cabinet or console, including escutcheon. Power requirements 105/125 volts AC, 50/60 cycles. Power consumption—85 watts.

Chassis Dimensions: 13½" wide x 8½" high x 10" deep.

Carton Dimensions: (2 units) 20 x 14½ x 10¾ inches.

Net Weight 16½ pounds each.

Sold through your favorite parts distributor.

The NEW ESPEY model 511

FEATURES

1. AC Superheterodyne AM-FM Receiver.
2. Improved Frequency Modulation Circuit, Drift Compensated.
3. 12 tubes plus rectifier and electronic Tuning Indicator.
4. 3 dual purpose tubes.
5. Treble Tone Control.
6. 6-gang tuning condenser.
7. Full-range bass tone control.
8. High Fidelity AM-FM Reception.
9. Automatic volume control.
10. 13 watt (max.) Push-Pull Audio Output.
11. 12 inch PM speaker with Alnico V Magnet, 25 watts rating.
12. Indirectly illuminated Slide Rule Dial.
13. Smooth, flywheel tuning.
14. Antenna for AM and folded dipole antenna for FM Reception.
15. Provision for external antennas.
16. Wired for phonograph operation.
17. Multi-tap output trans., 4-8-500 ohms.
18. Licensed by RCA.
19. Subject to RMA warranty, registered code symbol #174.

Makers of fine radios since 1928.

ESPEY

MANUFACTURING COMPANY, INC.

528 EAST 72nd STREET, NEW YORK 21, N. Y.

WRITE FOR CATALOGUE
KD3 CONTAINING COMPLETE SPECIFICATIONS
ON THIS AND OTHER
MODELS.

Blacklidge Heads Manufacturing Group

James M. Blacklidge, of Standard Transformer Corp., Chicago, was elected chairman of the Association of Electronic Parts and Equipment Manufacturers at the annual election of officers at Chicago.

A. L. Tuttle, of Centralab, Milwaukee, was named vice-chairman; Helen Staniland Quam, of Quam Nichols Co., Chicago, was elected treasurer for her fourteenth consecutive term, and Kenneth C. Prince, Chicago, was named executive secretary for the fifteenth year.

President Blacklidge announced the following committees for the new year:

Industrial Relations: Roy S. Laird, Ohmite Co., chairman; R. M. Gray, Rauland-Borg Corp.; F. F. Rowell, Jr., Guardian Electric Mfg Co., and John L. Robinson, Croname, Inc.

Catalog: Kenneth A. Hathaway, Ward-Leonard, chairman; Bayard H. Clark, Jensen Mfg.; William H. Barron, Merit Coil; Milton H. Roth, Radiart, Inc., and Charles W. Hahne, Thordarson Electric.

Credit: Joe Morin, Shure Bros., chairman; H. A. Staniland, Quam Nichols, and D. H. Shaw, Howard W. Sams & Co.

Social: Ralph Brengle, Potter & Brumfield, chairman; Francis F. Florsheim,

Columbia Wire, and C. A. Hansen, Jensen Mfg.

Educational: J. A. Berman, Shure Bros., chairman; Ben Boldt, Amphenol, and W. S. Hartford, Webster-Chicago.

Membership and Attendance: A. L. Tuttle, Centralab, chairman; Alfred

Crossley, Electro Products Labs., and John H. Cashman, Radio Craftsmen, Inc.

Publicity: Helen Staniland, Quam Nichols, chairman; Ralph Brengle, Potter and Brumfield, and Jerome J. Kahn, Standard Transformer Corp.

Sylvania Execs Launch New TV Line



Sylvania executives at the preview of the new television sets are: l. to r.: Donovan H. Tyson, controller; Walter E. Poor, chairman of the board; H. W. Zimmer, vice-president of operations; G. R. Holden, vice-president and assistant to the president; R. H. Bishop, vice-president in charge of sales; J. S. Learoyd, secretary; Larry Bagg, sales manager, Colonial Radio Corp., wholly-owned Sylvania subsidiary; H. R. Shaw, chief engineer, television design Colonial Radio; Joe Quick, executive vice-president, Colonial Radio Corp., and Dr. R. M. Bowie, manager of the Sylvania physics laboratory.

perfect CORDination

Electrical appliances work like a team with CORNISH Cords and Plugs. Sure contact, long wear—and an end to CORDelirium with

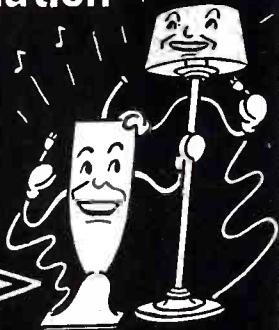

CORDS and CORD SETS

APPROVED BY UNDERWRITERS LABORATORIES

Selected by leading manufacturers... why not by YOU

A full line of Flexible Cords for the Repair and Service Industry, obtainable through Jobbers and Distributors

CORNISH WIRE COMPANY, INC.

15 Park Row New York 7, N. Y.

Sound from the ceiling



A PROFITABLE MARKET for DISTRIBUTORS, SERVICEMEN and CONTRACTOR DEALERS

Ideal for
WIRED MUSIC
TV EXTENSION
SPEAKERS
COCKTAIL LOUNGES
RESTAURANTS
HOTELS
TAVERNS
DEPARTMENT STORES
FACTORIES
CUSTOM SET BUILDERS
HOME CONSTRUCTORS, ETC.

LOWELL Flush Mounting Ceiling Baffles quickly and easily solve the problem of speaker location and sound quality in thousands of places where conventional speakers would be unsuitable or in the way.

Model BL8-A, illustrated, has "floating conical action" and gives excellent low level response. Provides CONTROLLED SOUND with even distribution over 360°. Mounts to ceiling by 4 bolts. 14 3/4" dia. at top; 4 7/8" deep . . . all hardware furnished. Finished in any colored lacquer to match surroundings.

Write today for new catalog covering the complete line of Lowell baffles.

"Heard Everywhere"

LOWELL METAL PRODUCTS CORPORATION

1531 Branch St., St. Louis 7, Mo.

LOWELL

**"THEATRE - SIZE TELEVISION"
FOR PLACES WHERE CROWDS
GATHER**

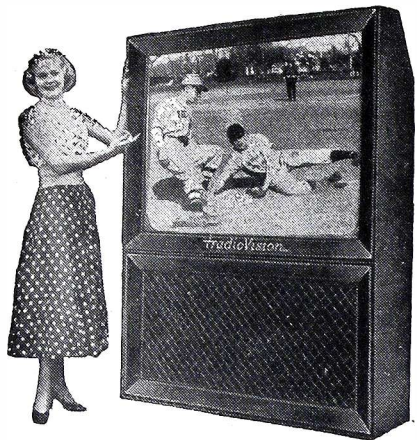

*...it's
radioVision!*

4 Ft. x 3 Ft. Picture \$1,695

3 Ft. x 2 Ft. Picture 1,495

Western Prices Higher

Cabinet dimensions: H 71 1/4" W 54" D 29 1/2"

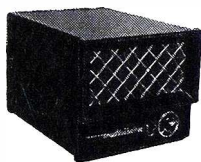

With remote control unit, auxiliary speaker and FM tuner

Control unit dimensions: H 12 1/2" W 14" D 19"

If you want relief from the cut-price competition on home sets . . .

If you want large unit sales with a big margin of profit for you . . .

If you want the commercial TV business that's rightfully yours . . .

Then *...it's
radioVision!*

—Now being installed in hundreds of prestige locations including Jack Dempsey's restaurant in New York.

—Guaranteed free conversion to color or channel changes for two years.

—Unique plug-in assembly for fast servicing and anti-obsolence.

**TRAD
TELEVISION CORP.**

New York Office and Showrooms
377 Fourth Avenue MURRAY HILL 3-9757

Revere TAPE RECORDER

New magnetic tape recorder utilizes twin-track recording to provide a full hour's time on a single reel. Features include:

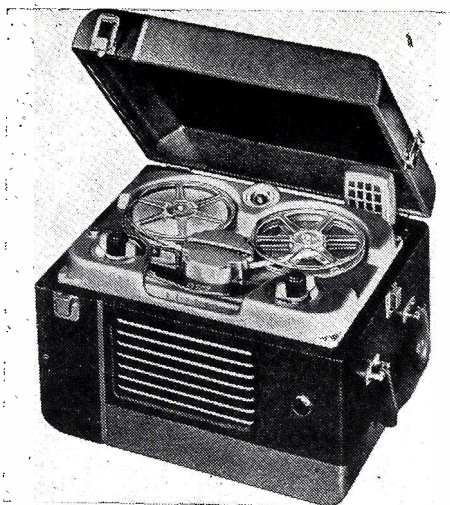

time and footage indicator, 5x7 inch speaker, microphone and radio attachment cord. List price is \$159.50. Revere Camera Co., 320 E. 21st St., Chicago, Ill.—RADIO & TELEVISION RETAILING.

Pentron TEL-E-MAT

Tel-E-Mat is a telephone answering device that automatically answers the phone, delivers a pre-recorded message to the caller, and records the caller's message.

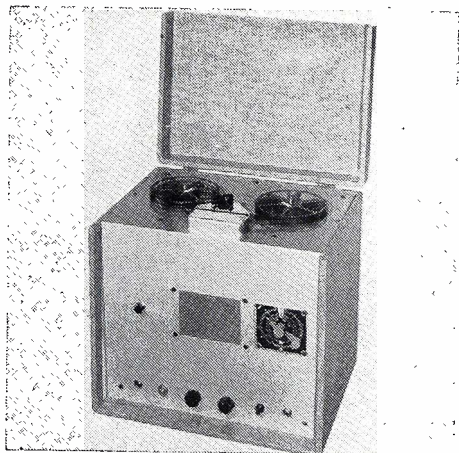

Messages are recorded on magnetic tape. Any number of messages up to one hour may be accommodated. Pentron Corp., 611 W. Division St., Chicago, Ill.—RADIO & TELEVISION RETAILING.

**Woundwood
TV ANTENNA MAST**

A new material, "woundwood," said to be the only commercially made plywood tubing, is used for these masts. Features claimed for the mast are: it is lighter and stronger than comparable wood or metal products, won't rust or corrode, won't buckle or bend, and won't shatter on impact with the ground. It is sold in packaged units containing sections to be joined together and erected in connection with bases, brackets, booms and similar equipment included in the package. Self-supported masts will stand up to 26 feet without guys. Guyed masts available to any height. Manufactured by Southern Industries of Maryland, Inc., and distributed by Special Purpose Products Co., 155 Perry St., New York 14, N. Y.—RADIO & TELEVISION RETAILING.

**SELLS
ITSELF!
GET THAT
EXTRA
PROFIT!**

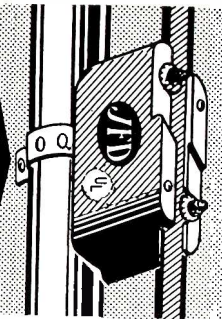

**JFD SAFE TV GUARD
Lightning Arrester**

Protects Television Sets Against Lightning and Static Charges **\$225** LIST

The ONLY Twin Lead Lightning Arrester Approved by UL for Outdoor-Indoor Installation.

SIMPLE TO INSTALL... attaches to any grounded object, at any position between antenna and the set, indoor or outdoor.

NO WIRE STRIPPING or **CUTTING** or Spreading of lines necessary. 300 ohm impedance... does not unbalance line.

One Dozen To Package with FREE Self-Selling Display Cards | Advertised in Consumer Publications To Help Your Sales

JFD MANUFACTURING CO., Inc.
6111 16th Avenue
Brooklyn 4, N. Y.
FIRST IN TELEVISION ANTENNAS AND ACCESSORIES

CHAMPION

**STEEL
TELEVISION TOWERS**

FOR THAT
FRINGE AREA

**STURDY
EASILY ERECTED
PRICED RIGHT
GUYED TOWERS**

45 Feet
65 Feet
85 Feet
(Extra 20' Sections Available for Greater Heights)

**SELF-SUPPORTING
TOWERS**

40 Feet
53 Feet
67 Feet
80 Feet

DEALERS and JOBBERS
WRITE FOR LITERATURE

NORMAN M. SEWELL, Inc.
LANSDALE PA. TITUSVILLE FLORIDA

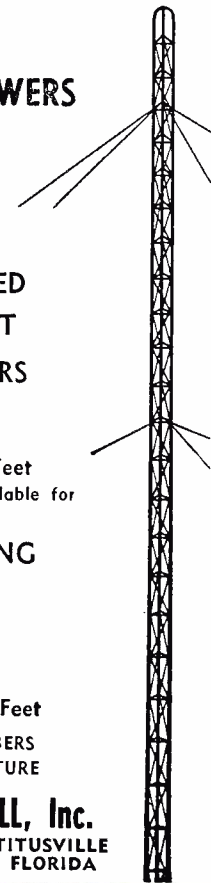

SPECIAL—10-DAY FREE TRIAL

Electronically
Rotated Antenna
DEALERS List Price **27⁵⁰**
SERVICE MEN

See article in this issue of Radio & Television Retailing

Prove for yourself that the Quad-Loop roof top antenna is the equal of mechanically rotated antennas costing up to four times as much installed. Test Quad-Loop, a sensation at the R. M. A. Parts Show, in your own service department for ten days.

Send no money. Write today on your business letterhead. We will ship C.O.D. a complete Quad-Loop roof top antenna. You pay only \$16.50. Jobbers protected.

If you are not satisfied that the Quad-Loop will substantially increase your sales and profits, return the antenna. Your money plus the freight charges will be sent by return mail. Write today. **No antennas will be shipped unless you include the name and address of your jobber.**

First with Electronic Rotation
Greatest Producer of Built-In TV Antennas
in the World

SQUARE ROOT

MANUFACTURING CORPORATION
901 Nepperhan Avenue Yonkers 3, N. Y.

Improved TV Reception



with a Drake High Pass Filter

Easily installed in the Antenna Lead-In at the TV Receiver, the Drake High Pass Filter improves TV reception by attenuating all unwanted signals from zero to 50 megacycles. The filter is especially effective in suppressing signals from the following sources which may enter the receiver at the I. F. frequency and disrupt reception of the picture and sound.

Shortwave Broadcast Stations
Industrial R. F. Heating Equipment
Diathermy and X-Ray Equipment
Amateur Transmitters
Electrical Appliances

Unlike wavetraps which are selective and require tuning, the Drake High Pass Filter attenuates all signals from zero to 50 megacycles with no adjustment. In many fringe area installations the filter greatly improves picture reception of high band stations by reducing noise pickup (snow) by the antenna and lead-in.

Model TV-300-50HP for 300-Ohm Twin-Lead Cable
Model TV-72-50HP for 72-Ohm Small Coaxial Cable
Either Model **\$5.95** list

Sold through leading distributors everywhere.

The R. L. Drake Co.
11 Longworth St. Dayton 2, Ohio.

Electro POWER SUPPLY

Electro model "B" power supply will deliver from 3 to 9 volts (DC) with a rating of 6 volts at 20 amperes continuous and 35 amperes instantaneous. Designed for testing and operating auto radios, the model "B" utilizes selenium rectifiers and provides variable voltage for other uses. Electro Products Laboratories, Inc., 549 W. Randolph St., Chicago 6, Ill.—RADIO & TELEVISION RETAILING.

Aerovox ELECTROLYTICS

The type PRS multi-section "Dandee" midget can electrolytics feature reduced size combined with construction features which facilitate wiring in tight places. Stud terminals, replacing the conventional rivet-type, are provided with insulation, and the pig-tail leads are also insulated. Aerovox Corp., New Bedford, Mass.—RADIO & TELEVISION RETAILING.

In-Res-Co MIDGET RESISTORS

Type IR resistors are designed for application where space is at a minimum. IR units are wire-wound to plus-minus 1% tolerance, and are said to withstand rough usage, intermittent overload, moisture and fungus. A typical unit (28,000 ohms) is $\frac{3}{8}$ " in diameter and $1\frac{1}{2}$ " long for 5-watt rating. Instrument Resistors Co., 1036 Commerce Ave., Union, N. J.—RADIO & TELEVISION RETAILING.

Telex EARSET

The Earset is a single-phone headset that slips onto the ear and weighs only $\frac{1}{2}$ ounce. Headband and accompanying pressure on head are eliminated by the Earset, which is available for either low or high impedance. Telex, Inc., Telex Park, Minneapolis 1, Minn.—RADIO & TELEVISION RETAILING.

Tele King INDOOR TV ANTENNA

Tee-Vee-Tenna and Tele-Indicator consist of two 3-section telescoping dipoles plus a circular indicator card which can be placed under them so the customer can mark the direction of best reception for each station. The antenna may be oriented in a flat horizontal plane with the two open ends of the "V" facing the station, said to be a unique feature. Retail price of the 2 items is \$4.95. TeleKing Corp., 601 W. 26th St., New York, N. Y.—RADIO & TELEVISION RETAILING.

C-D FEED-THRU CAPACITORS

Type 742 series of feed-through mica capacitors are designed for use in auto receivers for radio noise by-pass. They are also useful in FM and TV equipment because of their excellent high-frequency response. Size including mounting foot is $1\frac{1}{4}$ x $\frac{7}{8}$ inches. Ratings: .0001, .00015, .00025, .0003 mfd., 300 WVDC. Cornell Dubilier, South Plainfield, N. J.—RADIO & TELEVISION RETAILING.

MERIT

NEWS

MERIT HAS COMPLETE - EXACT TV REPLACEMENTS

★
When MERIT says it, it's News!

Merit jobbers can now offer exact replacements for RCA and other popular makes. All independent servicemen will welcome this news. Merit's TV Replacements fully maintain Merit's famous standards of quality. Buy them with complete confidence.

New MERIT CATALOG No. 4911 is now ready. Shows all TV Replacements in regular line. Write for your copy. All catalog items in stock.

POWER TRANSFORMERS

Type No.	List Price	H.V. Secondary Rectifier	D.C. Volts	M.A. Volts	Amp.	Fil. Volts	Wdgs. Amp.	Mtg. Center
P-3061	\$25.00	362-362	295	5	6	6.3	5	$3\frac{1}{2} \times 4\frac{1}{2}$
						6.3	5	
						5	2	
P-3063	\$20.00	360-360	250	5	3	6.3	9	$3\frac{1}{2} \times 4\frac{1}{2}$
RCA Repl.						6.3	.8	
						5	2	

Dimensions

Type No.	H	W	D	Mtg. Type
P-3061	$6\frac{1}{4}$	$3\frac{3}{4}$	$4\frac{3}{4}$	C
P-3063	$5\frac{1}{4}$	$3\frac{3}{4}$	$4\frac{3}{4}$	C

VERTICAL OUTPUT TRANSFORMER

Type No.	List Price	Turns Ratio	Pri. to Sec.	Mtg. Centers	Mtg. Type
A-3035	\$5.25	10:1		$1\frac{1}{2} \times 2$	EV

Dimensions

H	W	D
$3\frac{1}{2}$	$2\frac{1}{4}$	$2\frac{1}{2}$

VERTICAL BLOCKING OSCILLATOR TRANSFORMER

(A highly popular unit of outstanding efficiency)

Type No.	List Price	Turns Ratio	Pri. to Sec.	Mtg. Centers	Mtg. Type
A-4000	\$2.75	1:4.2		$1\frac{1}{2}$	J

DIMENSIONS

H	W	D
$1\frac{3}{4}$	$2\frac{1}{4}$	$1\frac{1}{2}$

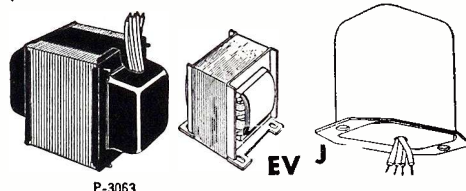

PRODUCTS OF MERIT

ANNIVERSARY 25
MERIT
COIL & TRANSFORMER CORP.
441 1/2 NORTH CLARK ST., CHICAGO 40, ILL.

TV BUYERS WANT TOP-NOTCH CABINETS!

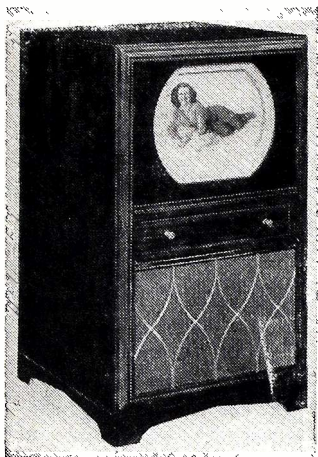

DALEO

MAKES FINER CABINETS FASTER,

AT LOWEST COSTS!

CONSOLETTES CONSOLES — TABLE MODELS

True furniture beauty and quality for eye-catching sales power! Made-to-order and stock for all types and finishes, all chassis and C.R. tubes. MANUFACTURERS! JOBBERS! DEALERS! ... write for quotation or catalog R to ...

DALEO ENTERPRISES

752 E. 137 St. New York 54, N. Y. Manufacturer and sole distributor for Majestic Arts. Cabinet-crafters to the electronic, furniture and decorating industries for 35 years.

GE Consumer TV Aid



To aid dealers and consumers to easily and properly adjust TV receivers, General Electric is making this instruction card available for dealers, and will include it on future receiver shipments from the factory.

Truesdell in Zenith Post

Leonard C. Truesdell has been appointed sales manager for household radio and television by Zenith Radio Corporation, it has been announced by H. C. Bonfig, vice-president and director of sales.

Bonfig said that creation of a new office in the company was necessitated by Zenith's steadily expanding production in all of its manufacturing divisions. Truesdell will be responsible for all sales activities of the household division.

Hallcrafters Jobbers

Three new distributors for Hallcrafters new television line were announced by Rollie J. Sherwood, general sales manager of The Hallcrafters Co., Inc., Chicago. The World Radio and Appliance Co., Toledo, has been selected to cover Toledo and western Ohio. In Kansas City and surrounding area, distribution will be through Dealers Wholesale. The Hall Wholesale Co. will handle the line in Dallas, Tex.

New Positions for Arvin Executives

Harlan Foulke, vice-president of Noblitt-Sparks Industries, Inc., Columbus, Indiana, has been named general manager of the Arvin radio and television division of the company, and Ray Spellman has been appointed sales manager of the division, according to announcement by Glenn W. Thompson, president of the company. Working with Mr. Spellman are the following district managers, and the territories each will cover on Arvin radio and television:

Ben Jones, eastern territory; Warren Pringle, New York and Middle Atlantic territory; Walt Davis, southeastern territory; Allen McGehee, western Pennsylvania, Ohio and northern New York state; Les Graham, Indiana and Michigan; Palmer McMahan, Wisconsin, Illinois and Missouri; John Wayne, Minnesota, Missouri, Nebraska, Colorado, Iowa, Kansas and Montana; Walter Moreland, Arizona, Oklahoma, Texas, Arkansas, Louisiana, Tennessee and Mississippi; James Hofer, Idaho, Oregon, Utah, Washington, California and Nevada.

Portable TRI-TUBE Antenna MASTS



TELEVISION FM · AMATEUR COMMERCIAL

LOW COST

LIGHT

QUICK

EASY

Mast section is triangular in construction using 1" ID steel tubing with proper bracing, all electric welding. Lower unit is 20 ft. long hinged on frame with locking device. Levelling device compensates for position of vehicle on any test location. Upper unit is a smaller triangle and telescopes into lower unit on rollers, which allow smoother operation. Cable and drum provided with pin assembly for safety and locking into any height. Antenna mast can be set up by two men in a few moments... NO GUYS — NO WRENCHES — NO BOLTS All bolts have 'T' handles. Demountable by removing two bolts in four minutes. Aluminum painted ready to mount.

#250 Basic Unit Complete 50 ft., 10 ft. pole
#251 Same as 250-Orientation at Any Height
#252 Same as 251, with Antenna Height 70 feet
Dealer & Distributor Inquiries Invited

A. A. PETERS TRI-TUBE MASTS

231 N. 7th Allentown Pa.

SHIPPED F. O. B. ALLENTOWN, PA.

\$295 and up



FREE! Send for it NOW!

ALLIED'S NEW 1950 CATALOG!

196 PAGES— Everything in Radio and Electronics



GET RADIO'S LEADING BUYING GUIDE

Service Technicians and Engineers: ALLIED's 1950 Buying Guide brings you all the new releases and money-saving values—from the world's largest stocks of test instruments, amplifiers, P.A. systems and equipment, tubes, parts, tools, books and accessories—ready for instant expert shipment. Send today for your FREE new 196-page ALLIED Catalog.

ALLIED RADIO CORP., DEPT. 25-L-9
833 W. Jackson Blvd., Chicago 7, Ill.

Send FREE New ALLIED Catalog.

FREE

Name.....

Address.....

ALLIED RADIO

Enjoy the ADDED Beauty of Your Lighted Tree in MOTION . . .

KASSON ELECTRIC CHRISTMAS TREE TURNER

Revolves 3 times a Minute

Adjustable to most Tree Sizes!



Ideal for holiday windows and for Christmas displays throughout the store. Sturdy, dependable A.C. motor. Will last for years

Modern Merchandise Displays Need LIGHTED MOTION!

New Model 712 revolves 3 RPM while permitting novel, self-contained lighting effects, or operation of electrical devices. 200 lbs. capacity. 18" dia. turntable. Will revolutionize your window trim!

KASSON Roto-sho ELECTRIC TURNTABLES



• Write for complete turntable catalog! GENERAL DIE AND STAMPING CO. Dept. TV, 262 Mott St., New York 12, N. Y.

ADVERTISERS

November 1949

Admiral Corp.	33	Peerless Industries	98
Air King Products Co., Inc.	16	Peters, A. A.	114
Allied Radio Corp.	114	Philco Corp.	5
American Telephone & Telegraph Co.	55	Phoenix Electronics, Inc.	104
Anchor Radio Corp.	100	Price Tenna-Trailer Co.	110
Astatic Corp.	103		
		Radiart Corp.	81
Belden Mfg. Co.	17	Radio Corp. of America 40, 41, 49, 62, 63, 71, 78, Cover 4	
Belmont Radio Corp.	59	Radio Merchandise Sales, Inc.	93
Brach Mfg. Corp., L. S.	89	Railway Express Agency	106
		Rauland Corp.	21
Caldwell-Clements, Inc.	88	Raytheon Mfg. Corp.	32
Capehart-Farnsworth Corp.	6	Regal Electronics Corp.	9
Chicago Tribune	8	Remington Radio Corp.	95
Colonial Radio Corp.	18, 19	Rider Publisher, Inc., John F.	116
Commercial Credit Corp.	72	Rollan Sales Corp.	107
Cornish Wire Co., Inc.	111		
Crosley Div., Avco Mfg. Corp.	14, 15, 30, 31	Sentinel Radio & Television	60
		Sewell, Inc., Norman M.	112
Daleo Enterprises	114	Sheldon Electric Co.	29
DeWald Radio Mfg. Corp.	104	Simpson Electric Co.	4
Drake Co., R. L.	113	Snyder Mfg. Co.	94
DuMont Laboratories, Inc., Allen B.	53	Sonotone Corp.	70
		South River Metal Products Co., Inc.	103
Easy-Up Tower Co.	91	Sprague Products Co.	109
Eicor Magnetic Tape Recorder	101	Square Root Mfg. Corp.	113
Emerson Radio & Phonograph Corp.	28	Standard Transformer Corp.	90
Espey Mfg. Co., Inc.	110	Starrett Television Corp.	26, 27
		Stromberg-Carlson Co.	36
Fada Radio & Electric Co., Inc.	20	Sylvania Electric Products, Inc.	18, 19 & 64
		Symphonic Radio & Electronic Corp.	2, 3
Garrett-Buckley	61	Technical Appliance Corp.	105
General Die & Stamping Co.	114	Tele King Corp.	12
General Electric Co.	7, 10, 11	Television Digest	96
		Telrex, Inc.	86
International Resistance Co.	13, 99	Thomas Electronics, Inc.	102
		Trad Television Corp.	112
Jensen Industries, Inc.	70	Transmira Products Corp.	87
Jerrold Electronics Corp.	97	Trans-Vue Corp.	102
Jewel Radio Corp.	51	Tricraft Products Co.	102
J.F.D. Mfg. Co., Inc.	112	Trio Mfg. Co.	106
		Triplett Electrical Instrument Co.	83
LaPoint Plascomold Corp.	108	U.H.F. Resonator Co.	92
London Records	66	V-M Corp.	70
Lowell Metal Products Corp.	111	Vibraloc Corp.	107
Mahogany Associations, Inc.	58	Waters Conley Co.	105
Mallory & Co., Inc., P. R.	Cover 2	Western Coil & Electrical Co.	85
Meck Industries, Inc., John	47	Westinghouse Electric Corp.	22, 23
Merit Coil & Transformer Corp.	113	Wind Turbine Co.	115
Motorola, Inc.	Cover 3		
		Zenith Radio Corp.	56, 57
National Cash Register Co.	24		
Noblitt-Sparks Industries, Inc.	25, 65		
North American Philips Co., Inc.	34, 35		

While every precaution is taken to insure accuracy, we cannot guarantee against the possibility of an occasional change or omission in the preparation of this index.

TRYLON

Announces

**... THE FIRST
PRACTICAL,
EASY-TO-INSTALL,
LOW COST
TV MAST**

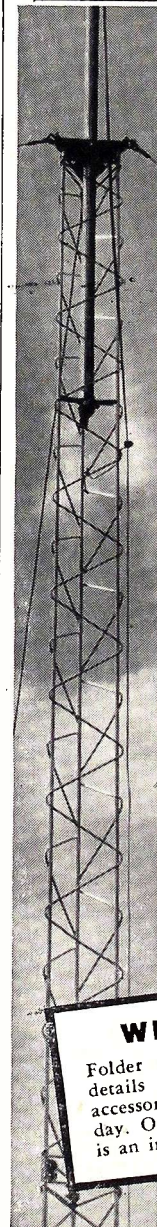

- Easy to handle—easy to climb
- Mounts any type of TV antenna
- 40' Trylon mast and antenna installed by 2 men in 3 hours or less—at mast cost of about \$1 per foot!

Now you can get all the height you want for TV antennas—at little more than the cost of makeshift mast devices—and twice as easily installed! Trylon TV Antenna Masts are made in handy 10' sections. They weigh only about 2 lbs. per foot! Sections can easily be joined for mast heights of 20', 30', 40', 50' or 60' as desired. Triangular in shape, formed of double-welded "serpentine" steel rod construction, they can be mounted on either flat or peaked roofs and climbed like a ladder. Clamp-on working platforms are available for installation or adjustment of antennas. Safe, durable, fully tested in numerous installations.

WRITE TODAY!

Folder and price list giving full details of Trylon TV Masts and accessories now available. Write today. One out of every 4 TV users is an immediate prospect!

WIND TURBINE CO.

Tower and
Antenna Division

WEST CHESTER • PA.



"What a Stethoscope is to a Doctor, Rider Manuals are to me!"



"Rider Manuals enable me to diagnose the trouble quickly, prescribe the correct solution, and cure the ailing set speedily, efficiently, profitably. I recommend them to every serviceman, because I know that you can turn to Rider Manuals for all the information you need on any set brought into your shop."

J. H. Classen
Classen Radio Service
1489 Perry, Wichita, Kansas

From Kansas to Kentucky, New York to Mexico, stretching all over the United States, the family of Rider-equipped servicemen is building a strong, faithful and profitable following. You, too, should join this ever-growing family. All material contained in Rider Manuals is factory-authorized. It originates at the manufacturer, and is compiled by Rider in easy, quick-to-grasp form. You and your men can locate the trouble faster and solve the problem better. You'll satisfy customers and get the price you ask for a job well done. Moreover, you are free to call upon the Rider staff of technicians at any time for any sort of help pertaining to your business. Rider and Rider alone offers such an authoritative, reliable and comprehensive service for the radio and television servicing industry. Join the Rider family today... and watch the difference it makes in your business.



On the way!

NEW RIDER TV-3

GREATER IN SIZE! ALL PAGES IN PLACE! EASIER TO USE!

Rider again points the way to successful TV servicing. The Rider TV Manual Volume 3 is bigger and better in every way. New and enlarged page size, 12 x 15 inches. All pages are collated in position. Double spreads, triple spreads and giant pages have been retained to assure clarity and ease of reading...but triple spreads and giant pages now have only ONE fold for greater durability. Easier to use because there are fewer pages to turn. Easier to read because diagrams and related text are more closely positioned. TV-3 is more compact, more complete...fully covering everything you should know about each receiver. More than 60 manufacturers are listed in the equivalent of approximately 2000 pages (8½ x 11), PLUS Cumulative Index Volumes 1, 2 and 3, PLUS "How It Works" Book. Reserve Your Copy Today.

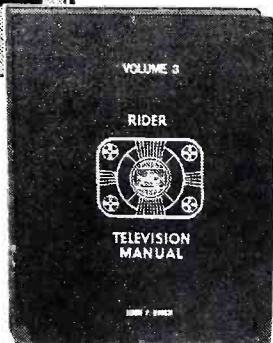

RIDER MANUALS

Television Manual, Vol. 2	\$18.00	Volume XIV to VII (each vol.)	\$16.50
(plus "How It Works" and Index)		Volume VI	12.50
Television Manual, Vol. 1	18.00	Abridged Manuals I to V (one volume).....	19.80
(plus "How It Works" and Index)		Record Changers and Recorders	9.00
Volume XIX	19.80	Master Index, Covering Manuals, Vols. I to XV	1.50
Volume XVIII	19.80	PA Equipment Manual, Vol. I	18.00
Volume XVII	16.50		
Volume XVI	8.40		
Volume XV	19.80		

Coming Soon!

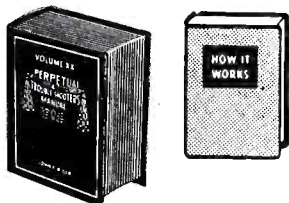

NEW RIDER MANUAL VOL. XX

Covering the latest AM, FM and Auto Receivers. Complete in every respect, this volume will have the added advantage of text and double spreads assembled in position.

Another Rider First!

RIDER PA MANUAL

The first industry-wide Public Address Equipment Manual, covering amplifier production of 147 manufacturers from 1938 to 1948. 2024 Pages PLUS "HOW IT WORKS" Book.

COMPLETE ONLY **\$18.00**

NOTE: Are you receiving your copy of "Successful Servicing?" It's Rider's own publication of interest to every Serviceman. Write for it... it's FREE!

ANOTHER NOTE: The C-D Capacitor Manual for Radio Servicing, 1948 edition No. 4, makes reference to only one source of receiver schematics — Rider Manuals.

RIDER MANUALS mean SUCCESSFUL SERVICING

JOHN F. RIDER PUBLISHER, Inc.,
480 Canal Street, New York 13, N. Y.
Export Agent: Rocke International Corp., 13 E. 40th St., N.Y.C.
Cables, ARLAB.

NOTE: The Mallory Radio Service Encyclopedia, 6th edition makes reference to only one source of radio receiver schematics — Rider Manuals.

put the world's greatest
salesman to work for you
this Christmas

tie in with the big

Motorola HOLIDAY SALES PROMOTION!

NATIONAL ADS IN . . .

Life - New Yorker - Parade - This Week
Saturday Evening Post - Time
American Weekly - Better Homes & Gardens
House Beautiful - Collier's
Esquire - Fortune - Sunset

TOTAL
CIRCULATION **47,617,665**

**COMPLETE
PROMOTION
AND DISPLAY
PACKAGE
READY NOW**

WRITE, WIRE OR PHONE

YOUR MOTOROLA DISTRIBUTOR





Get the "Tune-Up" Campaign flier from your RCA Tube Distributor for the whole story on RCA's "Tune-Up" Campaign

NOW—TIE-IN WITH "TUNE-UP"...

RCA's campaign to tap new business for you

OVER 10 MILLION RADIOS need servicing! How many will YOU service? Because most people think the repair price will be too high, millions of sets stay unserviced.

Now—RCA offers you a way to overcome the public's reluctance to have faulty radios checked . . . a year-round, *personalized* promotion campaign.

Now—you can offer your customers, through professional posters, displays,

mailing pieces, advertisements and spot radio announcements, a special tune-up job *at your own price*. The promotion pieces tell the customer just what he will get for his money!

Here's your chance to make extra profits from one of the greatest service promotion campaigns ever launched! Lose no time in getting the special flier that tells the whole story. *Your RCA Tube Distributor has a copy waiting for you.*

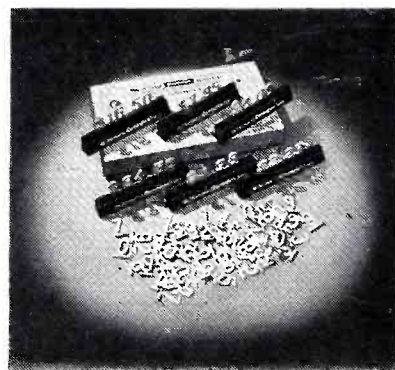

Now—The RCA Pricing Kit! Price your merchandise and make more sales! Use this Kit to price merchandise—in the window, on counters, and in the store. Learn how to get your Kit today . . . see your RCA Tube Distributor while the supply lasts!

ALWAYS KEEP IN TOUCH WITH YOUR RCA TUBE DISTRIBUTOR



RADIO CORPORATION of AMERICA

ELECTRON TUBES

HARRISON, N. J.