

1947 SEPTEMBER

RADIO RETAILING
& Television

CALDWELL-CLEMENTS, INC.

RADIO·FM

APPLIANCES

DIRECTORY

RECORDS

SERVICE

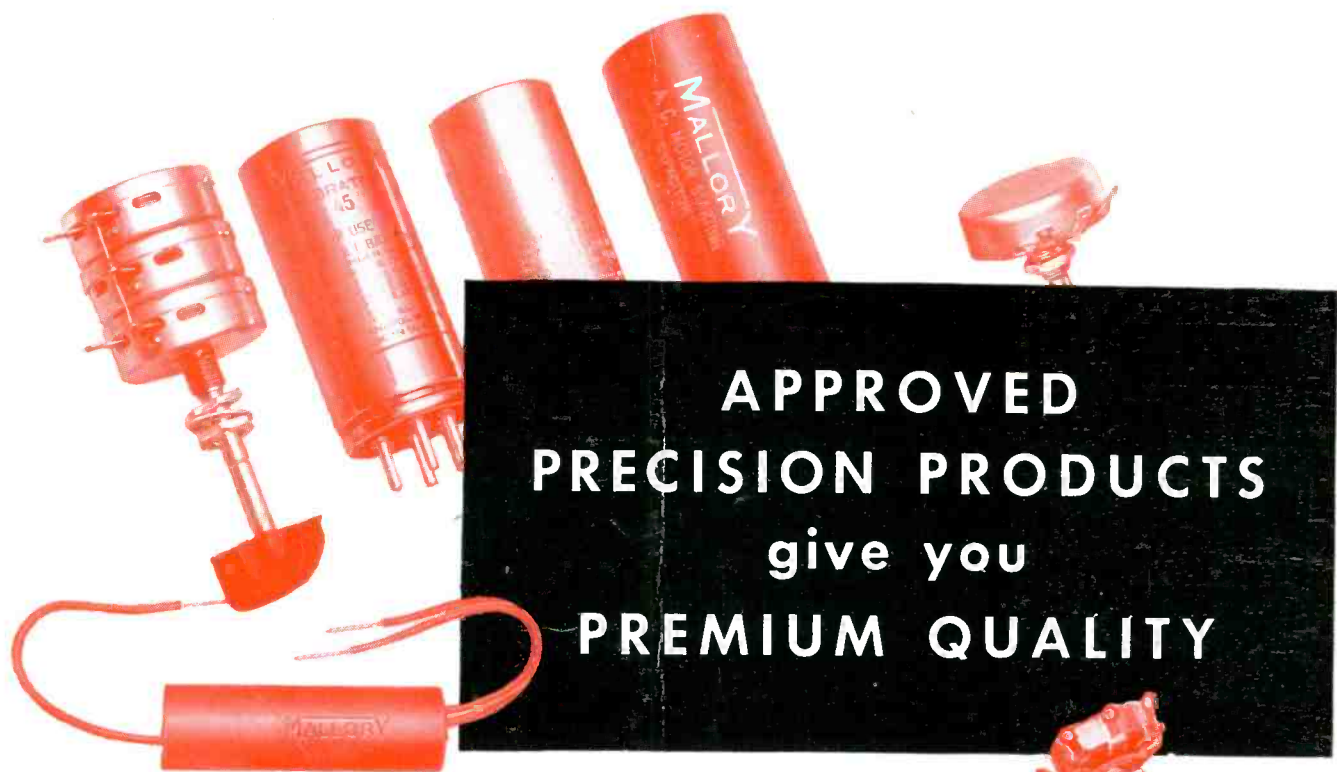

**...sold by conveniently located distributors
who are willing and able to help you**

There are 1700 electronic items in the Mallory catalog—vibrators—capacitors—controls—all Approved Precision Products—that have that “extra something” it takes to make a winner: **PREMIUM QUALITY!** Fifteen years of performance have proved that Mallory quality gives longer life, better accuracy, greater dependability to every job you do.

That’s why more Mallory-made vibrators are in use today than all other makes combined... why Mallory capacitors enjoy a nationwide recognition for superiority... why Mallory controls are preferred for closer tolerances and extra dependability by service engineers everywhere.

Remember that Mallory offers you Approved Precision Products in *complete* lines—lines available through conveniently located distributors who have the ability and desire to serve you well—with *premium quality* products at no extra cost.

YOU EXPECT MORE AND GET MORE FROM MALLORY

P. R. MALLORY & CO. Inc.
MALLORY

VIBRATORS . . . VIBRAPACKS* . . . CAPACITORS . . .
VOLUME CONTROLS . . . SWITCHES . . . RESISTORS
. . . FILTERS . . . RECTIFIERS . . . POWER SUPPLIES.

*Reg. U. S. Pat. Off.

APPROVED PRECISION PRODUCTS

P. R. MALLORY & CO., Inc., INDIANAPOLIS 6, INDIANA

RADIO & Television RETAILING

Including RADIO & Television TODAY

ORESTES H. CALDWELL
Editorial Director

M. CLEMENTS
Publisher

JOHN L. STOUTENBURGH
Executive Editor

DARRELL BARTEE
Managing Editor

HAROLD R. ELLIS
Technical Editor

RUTH MORRIS
Records Editor

M. R. LABATT-SIMON
Assistant Editor

CHARLES F. DREYER
Art Director

BUSINESS DEPARTMENT

LEE ROBINSON
Sales Manager

M. H. NEWTON
Business Manager

EDWIN WEISL, JR.

R. A. WHITE

A. R. FISKE

Promotion Manager

BETTY HALL
Production

CIRCULATION DEPARTMENT

B. V. SPINETTA
Circulation Director

W. W. SWIGERT
Credit Manager

BRANCH OFFICES

CHICAGO 6

R. J. FITZPATRICK, Manager
S. GASKINS

207 N. Wells St. RAN. 9225
LOS ANGELES 5

THE ROBERT W. WALKER CO.
634 S. Lafayette Park Pl.
Drexel 4388

SAN FRANCISCO 4
68 Post St. Sutter 1-5568

RADIO & Television RETAILING

September 1947, Vol. 46, No. 3. 25 cents a copy. Published monthly by Caldwell-Clements, Inc. Publication Office 1309 Noble St., Philadelphia 23, Pa. Editorial, Advertising and Executive Offices 480 Lexington Ave., New York 17, N. Y. M. Clements, President; Orestes H. Caldwell, Treasurer. Subscription rates United States and Latin American countries \$1.00 for one year, \$2.00 for three years. Canada \$1.50 for one year, \$3.00 for three years. All other countries \$2.00 for one year, \$4.00 for three years. Printed in U.S.A. Entered as second class matter March 20, 1947, at the Post Office at Philadelphia, Pa. under the act of March 3, 1879. Member of Audit Bureau of Circulations. Copyright by Caldwell-Clements, Inc., 1947.

*Trade-Mark Reg. U. S. Pat. Off.

IN THIS ISSUE

SEPTEMBER, 1947

★ **Radio, FM, Television**

COVER—The Big Four	43
EDITORIAL—Get Out and Get Busy	44
RADIO, APPLIANCES, RECORDS & TELEVISION TODAY	48
WHAT THE CUSTOMER IS THINKING	50
SALES AND SERVICE EXPAND TOGETHER	52
NEW LINES FOR NEW FALL SALES	

★ **Directory Section** Begins opposite Page 52

RADIO, PHONOGRAPH, FM, TELEVISION	Directory Page	2
ELECTRICAL HOME APPLIANCES	Directory Page	6
RECORDS AND ACCESSORIES	Directory Page	10
SERVICE AND SOUND	Directory Page	12

NEW LINES FOR FALL	72
MORE NEW LINES READY	76

★ **Records, Phonographs, Accessories**

COVER—Platter Profit Pointers	79
EDUCATIONAL DISCS	81
HARVEST DISC DOLLARS	82
BIG MONEY IN DISCS	84
NEW PHONO LINES	88
NEWS OF THE RECORD INDUSTRY	Begins on page 90

★ **Electrical Appliances**

COVER—Sell More Appliance Service	103
SELL MORE DOOR TO DOOR	105
NEW ELECTRICAL APPLIANCES	106
LIGHTING INDUSTRY NEWS	110
THE BATTERY BUSINESS	112
SERVICING APPLIANCES	114
THE HEATER IS A HIT	116
NEWS OF THE INDUSTRY	Begins on page 117

★ **Service and Sound**

COVER—Tune Up Service Profits Now	121
RELIGIOUS PA	123
REPLACING CRYSTAL PICKUPS IN PHONO-RADIO COMBOS	124
TROUBLESHOOTING MODERN FM CIRCUITS	126
AUDIBLE SIGNAL TRACERS HANDLE FM, AM AND TELE	128
NEW PA UNITS FOR FALL INSTALLATIONS	130
NEW BENCH AIDS SPEED SERVICE	132

TELEVISION TODAY	138
FM SALES NEWS	140
SALES TIPS AND PROFIT POINTERS	142
JOBBER IN ACTION	144

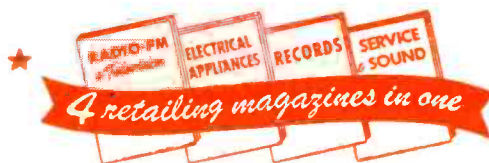

**29,000 COPIES
THIS ISSUE**

Member of
**AUDIT BUREAU
OF CIRCULATIONS**

CALDWELL-CLEMENTS, INC.

Publication Office 1309 NOBLE ST., PHILADELPHIA 23, PA.
Editorial, Advertising & Executive Offices 480 LEXINGTON AVE., NEW YORK 17, N. Y.

Announcing

SCOTCH *Sound Recording* **TAPE**

BRAND

OFFERING HOME AND PROFESSIONAL RECORDERS A NEW STANDARD OF TONE FIDELITY AND EASE OF HANDLING



Developed in the research laboratories of the 3M Company . . . the world's largest manufacturers of pressure-sensitive adhesive tapes . . . "SCOTCH" Sound Recording TAPE is now available in quantity for immediate delivery. No other magnetic recording medium can offer all these advantages:

1. Better frequency response at slow recording speeds—due to "SCOTCH" Sound Recording Tape's extremely thin, uniform magnetic coating.
2. Low noise level because of uniform dispersion of particles and mirror-like surface.
3. Higher Coercive Force—350 oersteds—insures higher frequency response and greater signal strength.
4. Flat surface and large area provide positive contact with the pick-up and give greater dynamic range.
5. Uniform width control in manufacture insures even, constant tracking.
6. Adequate space on $\frac{1}{4}$ inch width for multiple sound tracks.
7. The non-magnetic tape backing between the layers of magnetic coatings in the roll prevents "cross-talk."
8. Easy to handle. No snarls, backlashes, or kinks.
9. Freedom from breakage. Resin treated backing provides a tensile strength of 8 to 10 pounds.
10. Can be marked on back to indicate start and stop of different sound sequences in the same roll.
11. Easily edited by snipping out unwanted portions and then taping together with "SCOTCH" transparent Tape.
12. Perfect reproduction for several thousand playbacks. Erases clean with low power—no special erase head required.

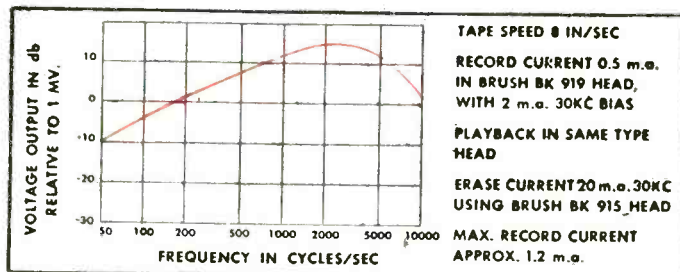

*Licensee of Armour
Research Foundation*

Made in U. S. A. by **MINNESOTA MINING & MFG. CO.** Saint Paul 6, Minn.
THE 3M COMPANY

Philco has launched the Greatest Local Newspaper Advertising Campaign in Radio History!

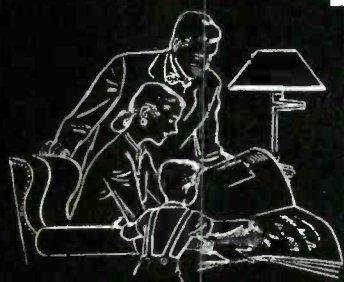

All over the country, you've been seeing it in your local newspapers...the start of the most powerful, concentrated advertising campaign ever released in the radio industry. It is planned and paid for by Philco and your Philco distributor to set the pace for your return to old-fashioned, two-fisted advertising and promotion.

"Selling Days are Here Again." After six long years of "shortage merchandising", now is the time for action...for doing all the things you used to do to create traffic, to make sales, to promote your business. Again you can look to Philco, the leader, as you did through all the years that built the radio business, for the advertising support you need to put "fire" into

your promotions. Magazine advertising, radio advertising and now local newspaper advertising, in huge, walloping, full page units.

Yes, now is the time to get back to old-time selling. Philco is back, promoting the radio business and your business in the hard-hitting way that won leadership for 17 years. Tie-in your efforts where they will yield the greatest results. Concentrate your ads, your windows, your floor displays on Philco. Impartial surveys show again that Philco is preferred by 2 and 3 to 1 over the next nearest brands. It's the line that's easiest to sell because it's the name the public wants.

Let's get going. *Selling days are here again!*

for 17 years America has said:

When there's a Choice, it's a **PHILCO**

LABOR has a holiday from
 transformer service, when
 the installations are Merit-
 Made. The Merit "know
 how" in design and con-
 struction is summed up in
MERIT QUALITY.

MERIT COIL & TRANSFORMER CORP.
 TELEPHONE
 4427 North Clark St. Long Beach 6311 CHICAGO 40, ILL.

The Publishers Sound Off . . .

RARE COPY and a roaring "first" in this business is this issue of **RADIO & Television RETAILING**, featuring the products and suppliers of *four* industries. We are the first to wrap it up in one book, whether you call it first edition, blue book, or bible. It is the much-demanded directory and list-all buyers' guide to the key merchandise handled by our leading retailers.

INTO FOCUS at last comes the television picture in the U. S. and there's climbing to be done on the band wagon. The pictures are reaching a delighted one-fifth of the nation and they're calling the new industry a \$300 million a year job by '48. Fall sports will give it an additional shove. A beautiful total of 89,000 TV units were produced to Sept. 1st this year; the guy who snorted is now trying to buy one.

FM TRAVELS likewise fast, with 60 to 70 new transmitters going on the air monthly. Music master Petrillo sounds favorable to FM programming and there's hardly a hurdle left, with popular-priced sets making a new stir in the mass market. Big-wigs say sets sans FM will be obsolete within six months.

FLYING SAUCERS is the term for the current output of phono records and their movement across retail counters. The sustained consumer interest in all styles of combinations of course means that a pile of platters goes with each unit, along with needles (that's the point) and accessories.

SIESTA'S END in the merchandising of appliances is still hard for the trade to realize. The honeymoon is so well over that the first domestic brawl is well under way; people are getting hurt. Lining for the cloud: the tremendous amount of appliance business waiting for those who knock on the door and ask for it.

MAINTENANCE MEN in the service, sound and parts business are heard to say that "we're through repairing junk for peanuts." When they start in on the expensive TV-FM-COMBO units, they assume the status of experts working on valuable home-entertainment instruments for appropriate fees. The business has new life, new profits, new horizons.

IN OTHER WORDS there's a wave of certified optimism in all our branches—in radio, appliances, records and service. This Fall, it's singularly great to be a "Big Four" dealer.

—THE PUBLISHERS

Some Stars are Born...Others are Built by

GAROD

And the brightest one for 1948
is the NEW

"Starlet"



**3½ POUNDS
OF GLAMOROUS
PERSONAL RADIO**



Enterprising radio merchandisers will hitch their "Sales" to the GAROD "Starlet". It's a tiny triumph of design that is a "natural" sales booster. Weighs only 3½ pounds with batteries. Packs in traveling bags, sits on end tables... it's tiny enough to slip into a coat pocket.

\$29⁹⁵

GAROD ALONE BUILDS THE "Starlet"



- ★ Ideal personalized gift.
- ★ Plays instantly when opened.
- ★ Shuts off automatically when lid is closed.
- ★ Finished in Metal and Plastic 2-tone color combinations.

PHONE YOUR DISTRIBUTOR OR WRITE US DIRECTLY FOR FREE DETAILS.

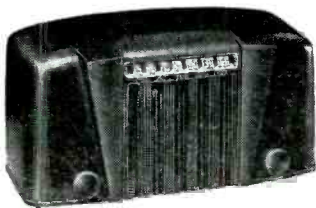

"Ensign"

A full-size AC-DC Garod, outstanding in the field. Heavy Alnico speaker. Handsome walnut plastic cabinet.

\$19⁹⁵

"Luxury Portable"

3-way AC-DC Battery. Weighs only 6½ pounds with batteries. Featuring full 5" Speaker.

\$39⁹⁵ Less Batteries



GAROD RADIO



GAROD RADIO CORPORATION • 70 WASHINGTON STREET • BROOKLYN 1, N. Y.

THE NEW Bendix Facto-Meter

OPENS THE DOOR TO GREATER FM SALES

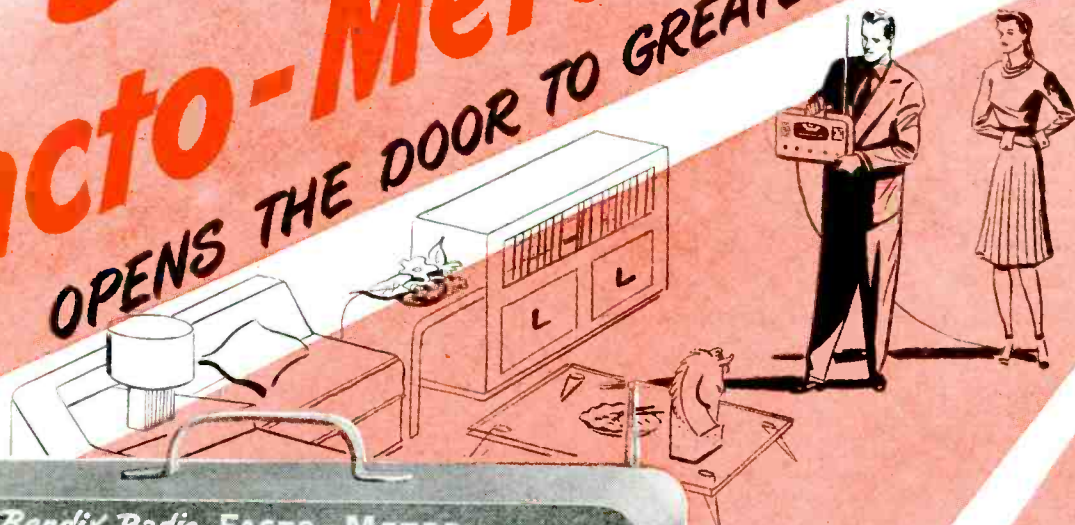
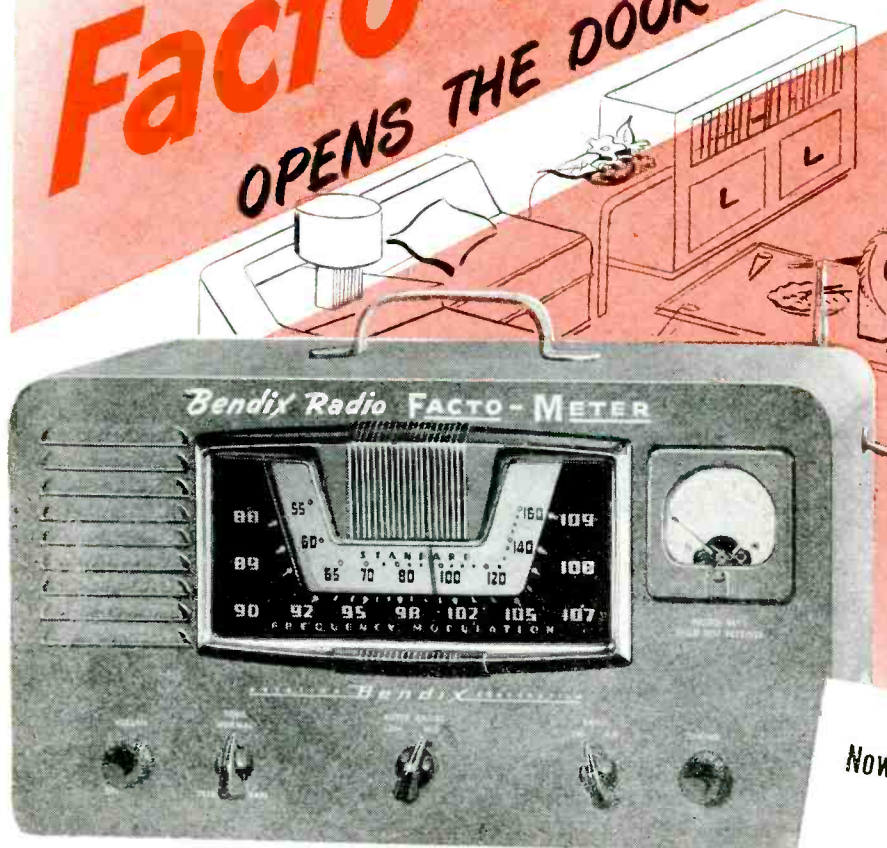

EXPLAINS FM! . . . SELLS FM!

Now you can demonstrate clearly the vast difference in FM reception—right in the prospect's home! The Facto-Meter provides both AM and FM reception enabling the listener to make a direct comparison. Furthermore, you can show where the FM set should be installed for maximum power and efficiency—often making possible the elimination of an expensive antenna installation. Here's the ideal way to *Sell* FM by *Showing* FM! See it at your nearest Bendix Radio Distributor!

AVAILABLE TO ALL RADIO DEALERS EVERYWHERE FROM BENDIX DISTRIBUTORS . . . COMPLETE WITH SPECIAL COVER, FM MERCHANDISING KIT AND SELLING AIDS.

Now You Can Show Your Prospects
IN THEIR OWN HOME . . .

1. Why they ought to have FM radio!
2. How it sounds right in their own home!
3. Whether they need an aerial!
4. Where to place the FM set for maximum range and reception!



BENDIX RADIO DIVISION of
BALTIMORE 4, MARYLAND





**WHAT'S NEXT-BEST TO HAVING YOUR SERVICE SHOP
LOCATED ON A FAMOUS BUSY CORNER?**

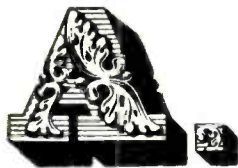
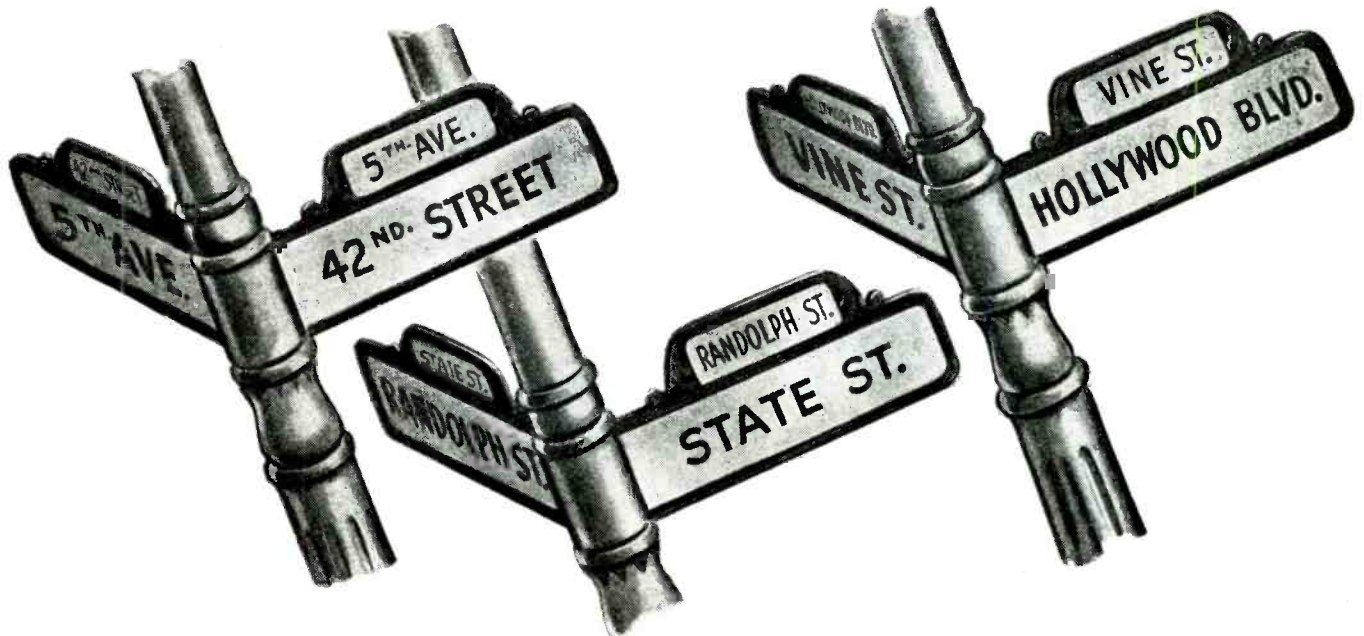

DISPLAY AND HANDLE GENERAL ELECTRIC TUBES!
The popular G-E monogram draws trade to you.



**RADIO
TUBES**

Public confidence in a well-known, respected product is the voltage that sparks sales. Let radio owners know that you install and sell G-E tubes, and you've taken the first big step toward increasing your volume of business.

Postwar buyers are demanding "name" merchandise. With G-E tubes, you offer customers the brand-name that LEADS in quality, reliability, and engineering advancement . . . stamping you

as a preferred source for tube purchases and trustworthy radio repair work.

Greater patronage of your shop, a bigger volume of service work, faster tube turnover—all these come packaged in the familiar orange-and-blue General Electric cartons. Act *now* to reap the reward that will accrue from establishing your shop as local G-E tube headquarters! *Electronics Department, General Electric Company, Schenectady 5, New York.*

And General Electric helps you actively promote your business! Write for Sales-aids Booklet ETR-51, which describes the colorful G-E line of tube window displays, direct-mail pieces, and numerous other items useful for widening your client-list and selling more service, tubes, and parts.

GENERAL  ELECTRIC
176-F9-8810

FIRST AND GREATEST NAME IN ELECTRONICS



ENGINEERED
AND
Styled
TO LEAD THE FIELD!

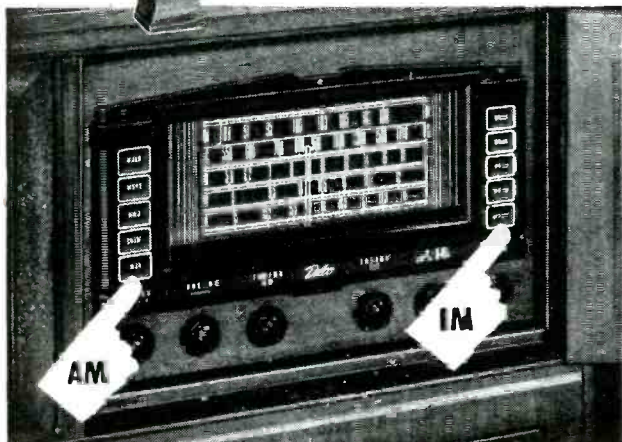

PUSH-BUTTON TUNING ON BOTH AM AND FM!
This is only one of the many features that put the new Delco Combination ahead of the field. With 14 tubes, plus rectifier, this Combination also provides three short-wave bands and a record player that handles fourteen 10-inch or ten 12-inch records, with automatic shut-off.

DELCO RADIO

A GENERAL MOTORS PRODUCT

Delco radios are distributed nationally by United Motors Service. See your United Motors distributor about the Delco radio line.



The New **DELCO RADIO** *Combination*

STYLE-WISE and performance-wise, the new Delco Combination sets entirely new standards of radio value!

Its advanced engineering is apparent in such features as the 15-inch speaker for finer reproduction . . . the 24 different base and treble combinations . . . the ball-bearing roller mechanism for the phonograph . . . the precision-designed selector blades that prevent record-chipping . . . the lightweight tone arm with *jeweled-point* pick-up . . . and many more.

Its superb styling is evident in the graceful lines and exquisite workmanship of the 18th-Century cabinets. Two models are available—R-1251 in walnut, and R-1252 in mahogany—both furniture pieces of authentic distinction.

To see and hear *the best of all that's new in radio*, ask your United Motors Service distributor to demonstrate the new Delco Radio Combination and other popular models.



MODEL A-400
\$13⁹⁵
 SLIGHTLY HIGHER
 WEST OF ROCKIES

AIR KING *Minstrel...*
 ...designed for selling!

Here is a new, compact quality radio at a price that is sure to stimulate consumer buying today! The Air King Minstrel "has everything"—amazing power—rich tone—quality construction—and a price that will overcome consumer resistance.

FEATURES THAT YOU CAN SELL!

Four tubes (including rectifier) superheterodyne • Automatic volume control • Exclusive Air King Circuit • Alnico V PM Speaker • AC-DC • Size: 7" long x 5½" high x 4½" deep • Model A-400 Ebony \$13.95, Available in 3 colors.

Another **AIR KING** spectacular value!

IN WALNUT
\$19⁹⁵
 SLIGHTLY HIGHER
 WEST OF ROCKIES

Perfection in plastic cabinet design plus superb tone, extreme sensitivity and precision engineering make the Air King Prince the outstanding radio value of the year—one of the best buys in the entire industry.

CHECK THESE FEATURES:

Precision die-cut antenna • Modern, illuminated airplane type dial • Five tubes (including rectifier) superheterodyne • Latest Air King circuit design • Alnico V PM Speaker • 2 Gang rubber mounted tuning condenser • Beam power pentode audio system • AC-DC • Size: 9¼" long x 6" high x 5½" deep • Available in Walnut (model A-511) and Ivory (model A-512; \$21.95).

The Royalty of Radio Since 1920

AIR KING
RADIO

Division of HYTRON RADIO & ELECTRONICS CORP.



★ We Have a Limited Number of Distributor and Dealer Territories Open ★

Write or wire (New Address): Air King Products Co., Inc., 170 53rd Street, Brooklyn 32, N. Y. • Export Address: Air King International, 75 West Street, New York 6, N. Y.

When you buy **FM**

... either in a transmitter, a receiving set or in other radio apparatus ... you are entitled to and should insist on obtaining the full advantages of genuine frequency modulation as invented, perfected and patented by Dr. Edwin H. Armstrong. These are the companies which are authorized and licensed to use the genuine Armstrong System of Frequency Modulation.

- Airadio, Inc.
- Ansley Radio Corporation
- Browning Laboratories, Inc.
- Canadian Marconi Co.
- Collins Audio Products Company, Inc.
- Cover Dual Signal Systems, Inc.
- Doolittle Radio, Inc.
- Electric and Musical Industries, Ltd.
- Espey Manufacturing Company, Inc.
- Fada Radio and Electric Company, Inc.
- Finch Telecommunications, Inc.
- Freed Radio Corporation
- Garod Radio Corporation
- General Electric Company
- Hallicrafters Company
- Howard Radio Company
- Fred M. Link
- Magnavox Company, Inc.
- Maguire Industries, Inc.
- Minerva Corporation of America
- Pilot Radio Corporation
- Scott Radio Laboratories, Inc.
- Radio Engineering Laboratories, Inc.
- Stewart-Warner Corporation
- Stromberg-Carlson Company
- Templetone Radio Manufacturing Corp.
- Wilcox-Gay Corporation
- Western Electric Company, Inc.
- Westinghouse Electric Corporation
- Zenith Radio Corporation





Maria Montez—starring in the United Artists release "ATLANTIS", a Seymour Nebenzal production.

Now—wake up to extra sales with the

"WAKE-UP-TO-MUSIC"
GE CLOCK-RADIO

These General Electric clock-radios are the fastest selling radios in America. Demand is tremendous. Get your share of these easy sales.

G-E clock-radios are a double value. A radio and an electric alarm clock combined. There's a model for every taste—at prices for every purse. For full information on these money-makers write your General Electric radio distributor or General Electric Company, Receiver Division, Electronics Park, Syracuse, N. Y.



What beauty! Beauty of tone, beauty of cabinet in this G-E Clock-Radio, Model 62. Genuine ivory plastic. Plenty of power. Superheterodyne circuit. Built-in Beam-a-scope antenna. Big (4") Dynapower Speaker. Latest model, accurate G-E electric clock. Also available in rosewood plastic, Model 60.

AN INVITATION: Visit our permanent display, 11th Floor, Merchandise Mart, Chicago.

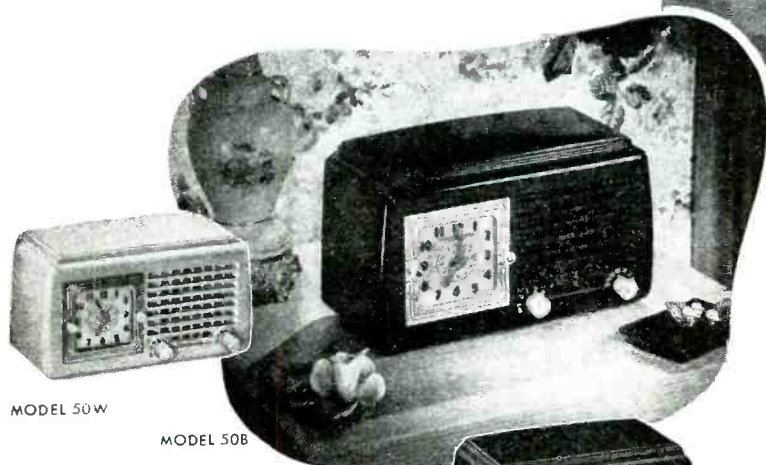

MODEL 50W

MODEL 50B

MODEL 50

Popular priced—these gem-like G-E clock-radios are a double value—radio and clock in one dainty cabinet. Everybody's a prospect. Available in ivory, lustrous black, or rosewood plastic.

GENERAL GE ELECTRIC

LEADER IN RADIO, TELEVISION AND ELECTRONICS

PORTABLES • TABLE MODELS • CONSOLES • FARM SETS • AUTOMATIC PHONOGRAPH COMBINATIONS • TELEVISION

2 NEW LEADERS ARE BORN...

Emerson

Emerson Radio Compact Model 547

Remarkable new AC-DC Superheterodyne in Ivory Plastic with superlative Style, Tone, Performance and Value features.

Oversize Alnico 5 Permanent Magnet Speaker—LARGER Super-Loop Antenna—Illuminated Sliderule Dial and many new chassis developments.

A new SURE-FIRE leader!



\$19⁹⁵



GREAT NEW EMERSONS FOR "HOT" PROMOTION

Here is Emerson Radio engineering at a new high peak! Two new leaders to jolt public attention and BUYING ACTION—to put new zip into your entire business!

They have EVERYTHING you ever saw in

small radio—BETTER Style, Tone, Performance and Value—and they're priced for VOLUME sales and profit.

Get the facts from your Emerson Radio distributor NOW.

EMERSON RADIO & PHONOGRAPH CORP. • NEW YORK 11, N. Y.
WORLD'S LARGEST MAKER OF SMALL RADIO

AND A GREAT PROMOTION FOLLOWS...

Radio

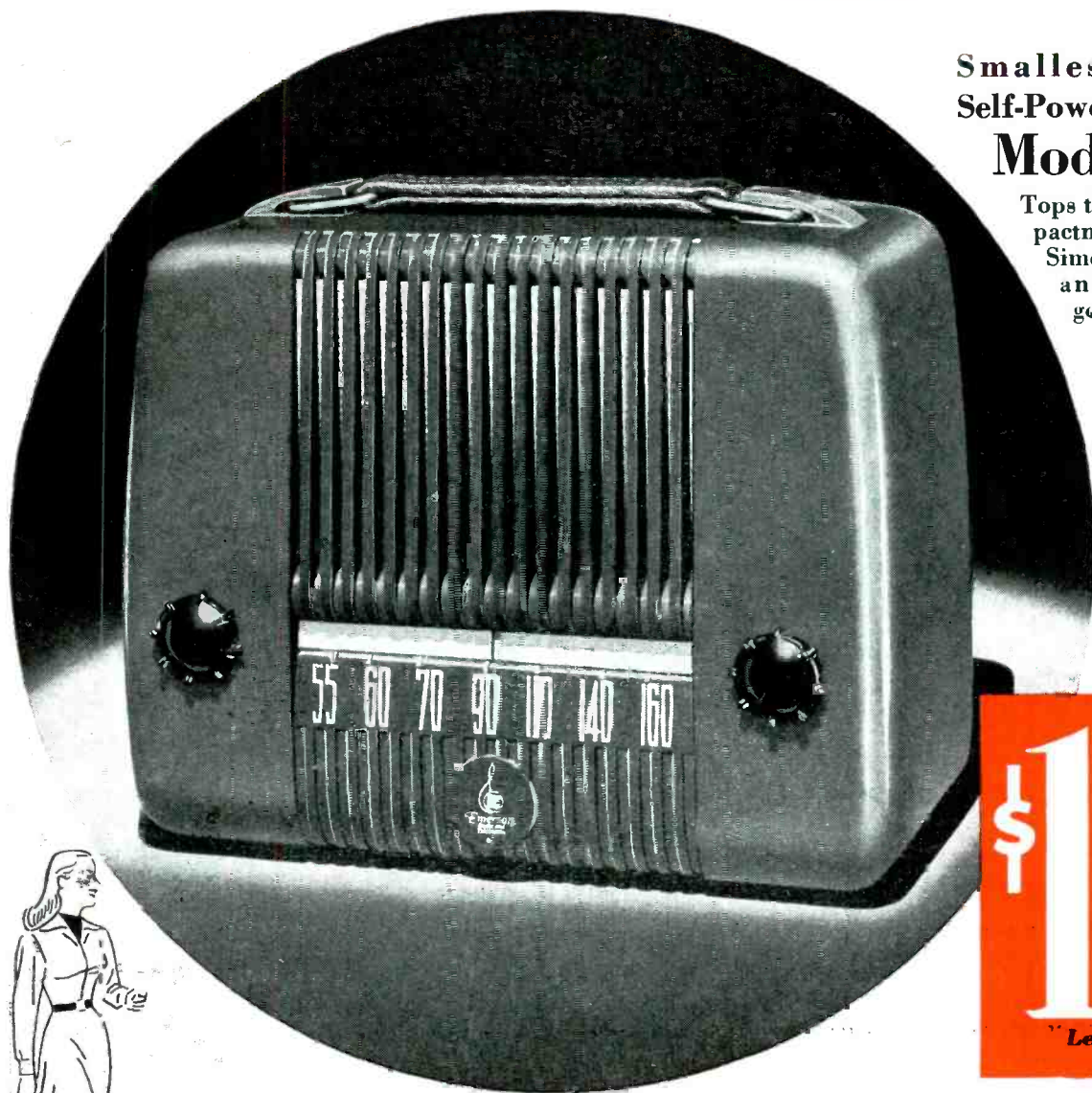

Smallest Emerson Self-Powered Portable Model 560

Tops them all — in compactness, in beauty, in Simon Pure Performance wherever it goes!

Maroon plastic cabinet, 8½ in. wide—with sturdy carrying handle. Oversize Alnico 5 Permanent Magnet Speaker and over-size Super-Loop Antenna. Sliderule dial. Uses long-life batteries.

\$19⁹⁵
Less Batteries



CASH IN ON \$6,500,000.00 ADVERTISING-PROMOTION

Featuring these two new models — boosting the entire Emerson radio line — the biggest campaign in radio history is now under way.

National magazines, hundreds of newspapers,

radio broadcasts, point-of-sale promotion and a wide range of special features focus public attention on windows and stores of participating dealers. Get on the bandwagon NOW!

EMERSON RADIO & PHONOGRAPH CORP. • NEW YORK 11, N. Y.
WORLD'S LARGEST MAKER OF SMALL RADIO

GET MORE OUT OF LIFE WITH TELEVISION



Illustrated: The Westminster—
with Television, FM-AM Radio,
Automatic Phonograph—Cabinets
designed by Herbert Rosengren.
Interior by W. & J. Sloane.

Get the most out of television with Du Mont prestige

As the World Series and the football season bring television to
a new level of interest the Du Mont franchise makes its
holder television capital of his community.

This much-sought dealership is restricted to the outstanding stores in each market.

DU MONT

First with the finest in Television.

DU MONT TELEVISION STATION

WABD

is broadcasting all the home games of the
NEW YORK YANKEES
BOTH DAY AND NIGHT

ALLEN B. DU MONT LABORATORIES, INC. • GENERAL TELEVISION SALES OFFICES AND STATION WABD, 515 MADISON AVE., NEW YORK 22, NEW YORK • HOME OFFICES AND PLANTS, PASSAIC, NEW JERSEY
Copyright 1947, Allen B. Du Mont Laboratories, Inc.

'Since Broadcasting Began'

FADA Radio

'The Radio of
To-Morrow,
To-Day.'



Model P80 . . . Setting the new mode in Personal Portables . . . Tri-Powered AC-DC Superheterodynes. Plays anywhere AC-DC current or on self-contained batteries. Cabinets of sparkling Walnut, Maroon, Genuine Ivory Plastic. Gleaming Ebony Plastic

\$34.95 List
Less Batteries

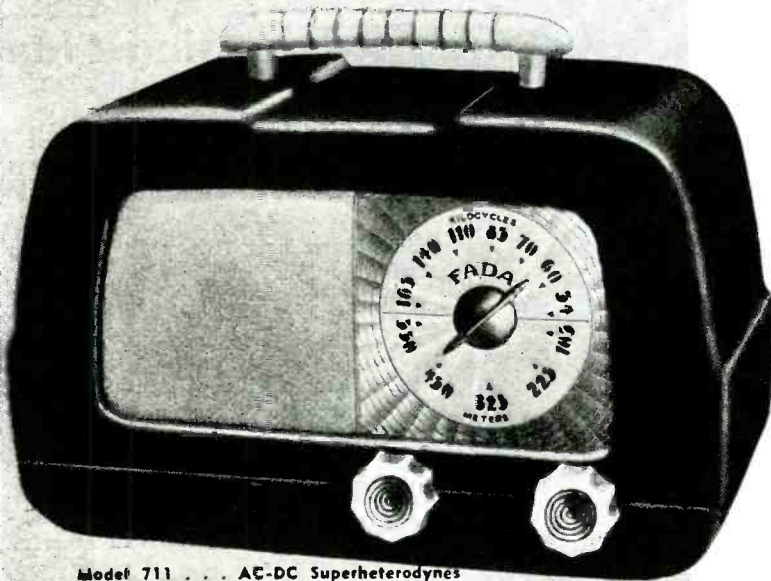

Model 711 . . . AC-DC Superheterodynes in colorful "FADA-LJCENT" cabinets. All Alabaster, Alabaster with Red, Maroon with Alabaster, Mottled Blue with Alabaster, Onyx with Alabaster. Choice of five colors.

\$29.95 List

THRILLING Color Symphony

IN THE RADIO of
TO-MORROW . . . TO-DAY

by

FADA Radio

*Pre-eminent in radio
glamour color plastics*

Fada's reputation for outstanding style design and cabinet color plastics is again brought to the fore with these two new brilliant FADA receivers 700 and P80. Jobbers and dealers from coast to coast acclaim them as the most uniquely styled and the most colorful anywhere, quick sellers and sure to attract volume sales.

Fada Models 711 and P80

are ultra modern . . . streamlined receivers featuring Decorator Color Plastics to complement any room color scheme.

FADA RADIO & ELECTRIC COMPANY, INC.
BELLEVILLE, NEW JERSEY

it
pays
many
ways

to
use
the

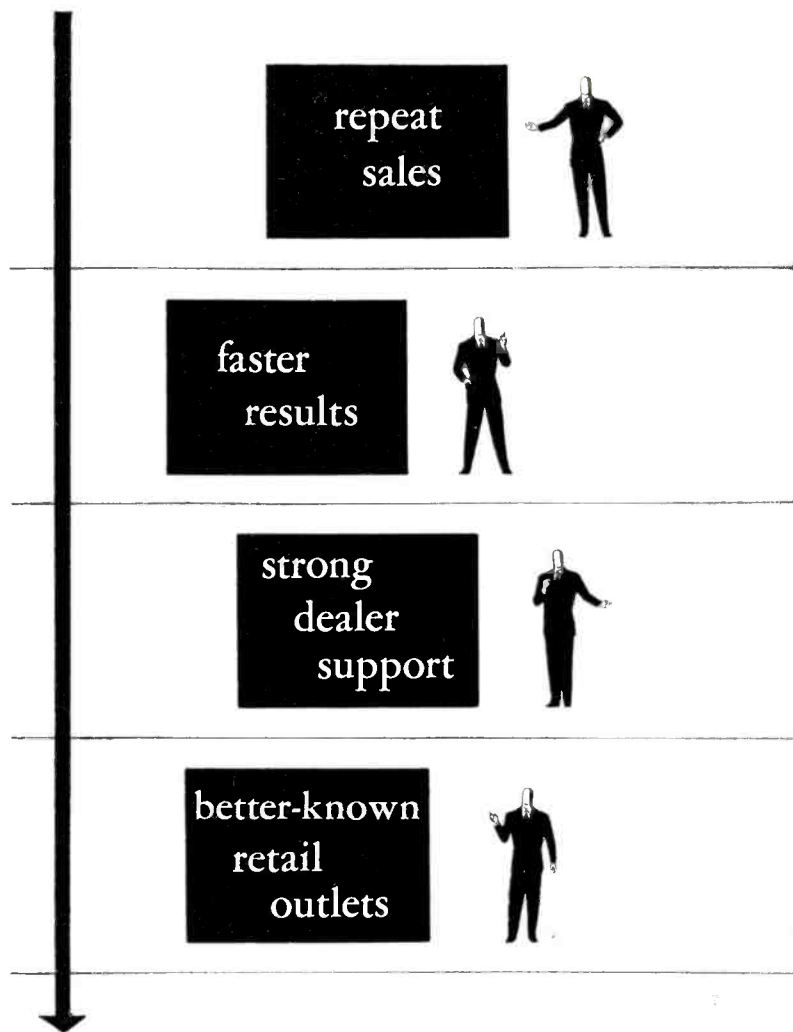

CHICAGO TRIBUNE'S Selective Area Advertising Plan

YOUR advertising funds do a better job . . . get faster results in the Great Chicago Market when you take advantage of the Tribune's Selective Area Advertising Plan.

Here, in this area — large enough to take all or the greater part of the production of many manufacturers — you and your dealers will have the kind of campaign you want . . . one aimed directly at the market each dealer serves. Prospects will know exactly where they can buy your product, you'll work in close cooperation with your dealers, and the result: more sales in the multimillion-dollar Chicago Market.

UNDER THE PLAN—

EACH DEALER GETS:

- 1 Selective coverage of his local market.
- 2 Prominent display of his name and location.
- 3 The low rate of just 2½¢ a line!

YOU GET:

- 1 Better identification of your local outlets.
- 2 Enthusiastic dealer support.
- 3 Advertising that pays off right away!

The Selective Area Advertising Plan offers manufacturers increased benefits from the Tribune's comprehensive Durable Goods Study.

To learn how this plan fits your own specific needs, contact the nearest Tribune representative as shown below.

No other advertising plan gives your dealers such prominent identification . . . none is tailored for such quick results as the Tribune's Selective Area Advertising Plan. And no medium penetrates the Great Chicago Market like the Tribune. Tribune rates per line per 100,000 circulation are among the lowest in America.

Chicago Tribune

The World's Greatest Newspaper

July average net paid total circulation:
Daily, over 1,030,000 • Sunday, over 1,500,000

MEMBER: AMERICAN NEWSPAPER ADVERTISING NETWORK, INC., FIRST 3 MARKETS GROUP, AND METROPOLITAN SUNDAY NEWSPAPERS, INC.

A. W. Dreier, Chicago Tribune
810 Tribune Tower, Chicago 11

E. P. Struhsacker, Chicago Tribune
220 E. 42nd St., New York City 17

Fitzpatrick & Chamberlin
155 Montgomery St., San Francisco 4

W. E. Bates, Chicago Tribune
Penobscot Building, Detroit 26

Admiral the hottest line in the Radio Industry!

Leads the field
in table radios

With this Big Package
5-tube, \$25 Value Sensation

\$17⁹⁵

Model
"10"
(EBONY)

Slightly higher in Western Zone

For years Admiral has led the industry in the manufacture and sale of Table Model Radio-Phonograph Combinations with automatic changers. Now, Admiral is making a bid for undisputed leadership in the field of table radios as well. At \$17.95 Model 7T10E is unquestionably the "hottest" number on the market. Altogether, nine models are included in the line priced up to \$29.95 to provide increasingly profitable "step-ups" for you. Included are two different chassis, seven plastic models, and two terrific wood jobs. Get in touch with your Admiral distributor today for full details.

See next page
with more value
SENSATIONS!



FM

(Frequency Modulation)

Frequency Modulation as developed by Admiral offers all the well known benefits of FM—PLUS several additional advantages, thanks to Admiral's sensational "ratio detector" FM circuit. To mention only two: (1) absolute freedom from between-station noise while tuning; (2) far simpler identification and rejection of false tuning points. Both features are easily demonstrated on your floor. Truly, FM at its best!

Automatic Radio-Phonograph Admiral's peerless achievement in FM-AM radio and record playing. Easy, full view record free FM. Permeability-tuned throughout sensitivity. Dual R. F. stage. Variable tone and Bass boost. FM and AM Aeroscopes. 8" speaker. Tilt-tuning Lucite dial. Large record compartment. Cabinet of choice veneers: Mahogany or Blond.

\$289⁹⁵

RC-10 (Matched Album Cabinets) Both useful and beautiful. Specifically designed to go with Model 7C73 console. Quality tongue and groove construction. Styled to double as end table or bookcase. Matched set of two cabinets holds 40 records. Also sold singly. In rich Walnut, Mahogany, or Blond veneers.



62 (Automatic Radio-Phonograph) America's best-priced nationally advertised console combination. Dynamic speaker—bass boost—and other engineering achievements. Beautiful walnut veneer cabinet. An amazing value that's taking the public by storm!

\$129⁹⁵



7T01 (AC-DC) Engineered and styled to strict Admiral specifications. A table set that picks up distant stations without effort. "S-t-r-e-t-c-h" dial. Smart louver grille. Beautifully molded in gleaming plastic. Ebony, Mahogany, or Ivory.

\$22⁹⁵

Ebony

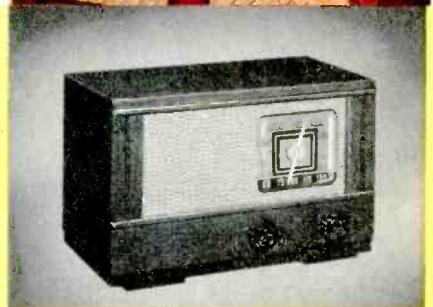

7T15 (AC-DC) You'll like its looks... you'll like its performance and tone. From tip to toe a superbly styled table model equally at home in living room, bedroom, or kitchen. Quality-engineered and crafted in smart walnut veneer.

\$29⁹⁵



7T12 (Farm Radio) Brings urban reception to non-electrified areas. Streamlined mahogany all-plastic cabinet which completely conceals standard "AB" battery pack. Iron core tuning for best tone. 6" Alnico speaker. Economizer switch.

\$37⁹⁵

Less battery



7T06 (Farm Radio) Performance on a par with city sets! Operates on standard long-life "AB" battery pack protected by economizer switch. 6" Alnico speaker. Iron core tuning. Modern Walnut veneer cabinet.

\$44⁹⁵

Less battery

Admiral

Priced to bring in store traffic!



7RT43 (6 Tubes) Automatic Radio-Phonograph. World's best table combination for the home, parties, schools, clubs. Variable tone control. In matchless walnut veneer hand-rubbed throughout.

\$99⁹⁵



7RT42 (6 Tubes) Automatic Radio-Phonograph. A fast seller that's rocking the industry back on its heels! Variable tone control. Modern wedge-edge cabinet in top-grade walnut veneers. Hand-rubbed.

\$89⁹⁵

7RT41 (6 Tubes) Automatic Radio-Phonograph. It has everything... compact, tasteful styling, rich tone, great volume! Variable tone control, bass compensation. A great value sensationally priced!

\$69⁹⁵



7C73 (FM-AM) proudly presents and automatic loading. Stationary for maximum control. Super 12" Auditorium record storage Walnut, Mahogany.



Portable Pleasure..

Admiral
"THIN MAN"
PORTABLE RADIOS

7P34 (AC-DC-Battery) A portable patterned after the finest luggage. Exclusive saddle-stitched case in rich-grained leatherette. Triple-tuned R. F. for amazing performance.

\$54⁹⁵

7P33 (AC-DC-Battery) The perfect portable companion... plays *anywhere* under the sun! Triple-tuned R. F. gives brilliant reception. Lightweight, luggage-style case in rich-grained black. Travel scope extra.

\$49⁹⁵



7P35 (AC-DC-Battery) Not shown. New! New! NEW! Sensational luggage-type portable covered in GENUINE CORDOVAN! Incomparable beauty, tone and performance!

\$79⁹⁵

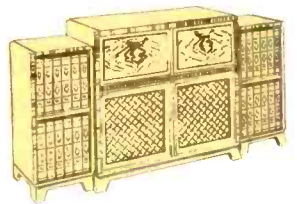

All Admiral Radio-Phonographs feature the sensational new **Miracle Tone Arm**—the greatest advance in record playing since the invention of the phonograph.



7C
lou
na
en,
ne
pu

TWO BIG FEATURES IN THE NEW 1948

Admiral

DUAL-TEMP[®]
REFRIGERATOR

1
No defrosting!



2

**Automatic
Moistrol**

**NO DRIP-TRAY
TO EMPTY**



What a boon! Homemakers everywhere welcome news like this! Admiral's new Moistrol (moisture control) entirely eliminates the bother of emptying a drip-tray. Excess moisture now is automatically evaporated *outside* the moist-cold compartment. Nothing to empty . . . nothing to worry about . . . more room for food . . . far more sanitary . . . a time and work saver! Here's additional proof of superior Dual-Temp design that is proving such a revelation to homemakers.



Also . . .

- Built-in Freezing Locker
- Two Temperature Controls
- Purified By Sterilamp
- High Relative Humidity
- Easy-To-Clean Design
- 5 Year Protection Plan



MAKING TUBES IS EASY..



It
YOU KNOW HOW!

GLASS—FLAME—SEAL

Glass — flame — seal. Sounds easy. Just slip a glass bulb down over the mount assembly. Then by cleverly directed gas flames seal bulb and stem flare together.

Yes, there is a catch in it. A directed flame applied to glass may cause severe thermal shock. Local expansion and contraction then result in strain or fracture. Such thermal shock must be avoided by gradually raising the temperatures of both bulb and stem before hitting them with intensely hot flames. Without scientific control, permanent strains would be set up which might cause cracks — immediately or at some future time. The finished tube would become an "air leaker" and useless.

As this multihead rotary sealing machine indexes, fingers of gas flame — mixed with air delicately proportioned to achieve the proper temperature — warm, shape, and seal bulb to flare. Because it is shielded from the flames by the bulb, the stem is preheated before loading. This preheat temperature is maintained throughout sealing by hot air blown up under the flare. The continual stream of hot air also shapes the seal. Concentrated flames cut off the bulb cullet. In high speed operations, the sealing and subsequent exhaust operations are performed on the same machine.

A precision machine carefully controlled by the glass expert makes this working with glass easy. Gives you a combination which assures you once again of trouble-free performance from your Hytron tubes.

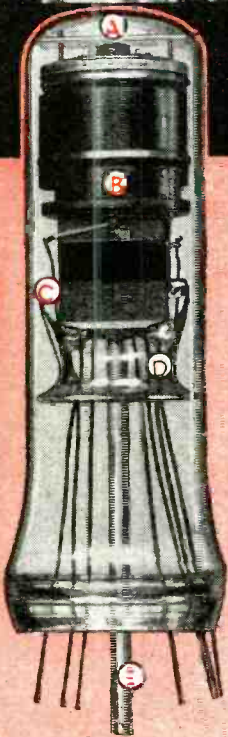

- A Outer bulb
- B Mount
- C Stem
- D Flame
- E Exhaust tube

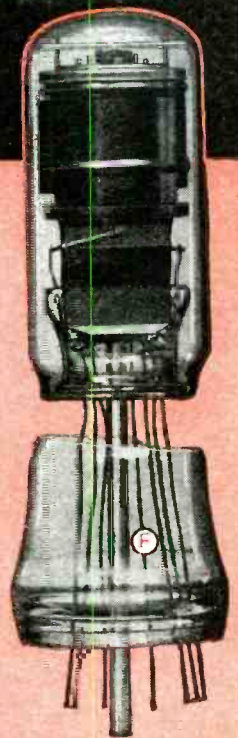

Sealed-in mount ready for exhaust. Cullet (F) cut off by gas flames is discarded.

SPECIALISTS IN RADIO RECEIVING TUBES SINCE 1921

HYTRON

RADIO AND ELECTRONICS CORP.

MAIN OFFICE: SALEM, MASSACHUSETTS





Another distinguished name...

Colen-Gruhn Co., Inc. of New York is the latest name to be added to the small but growing list of distributors selected to represent Hallicrafters new series of fine radio-phonograph consoles and television receivers. Other outstanding distributors and dealers are invited to learn further details by sending coupon at right to Hallicrafters, 4401 W. 5th Ave., Chicago, Ill.



Illustrated here is the Model 404-S, a combination of musical perfection, radio precision and top quality cabinet work. In handcrafted combinations like this you find FM at its best, radio and musical reproduction at its richest. Hallicrafters models in this series range in price from \$295.00 up to \$750.00 for the most technically perfect, finest quality television receivers available.

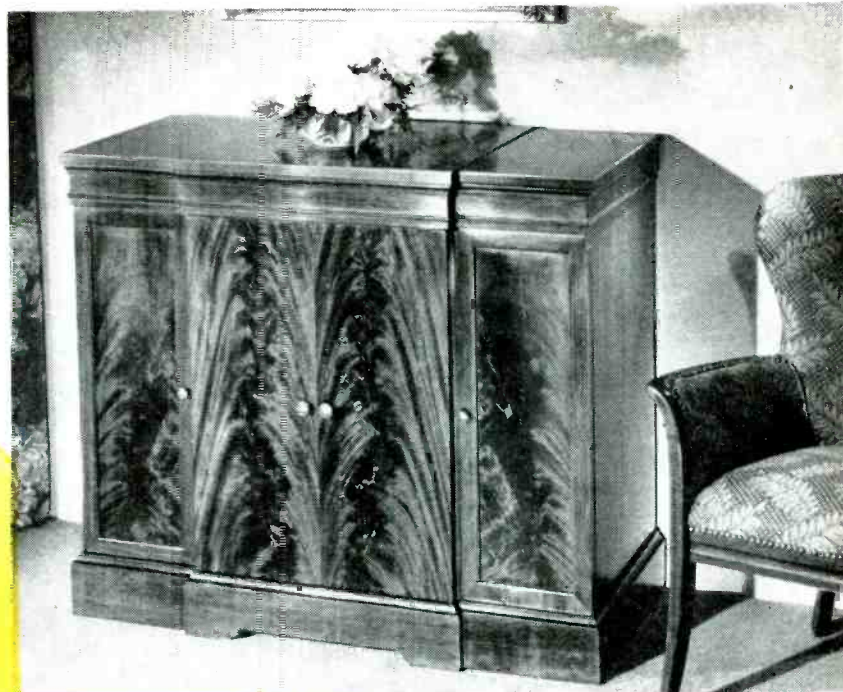

There is no other radio like Hallicrafters. Backed by more than 15 years' specialized experience in the development of high frequency, high fidelity radio equipment, Hallicrafters is extending acceptance of its top quality products into general consumer markets. By radio engineers, radio amateurs and by millions of communications-trained veterans Hallicrafters has long been known as "the radio man's radio." This great reputation, justly deserved, is one on which you can capitalize with profit to yourself and satisfaction to your customers.

*in Hallicrafters New System
of Restricted Representation . . .*

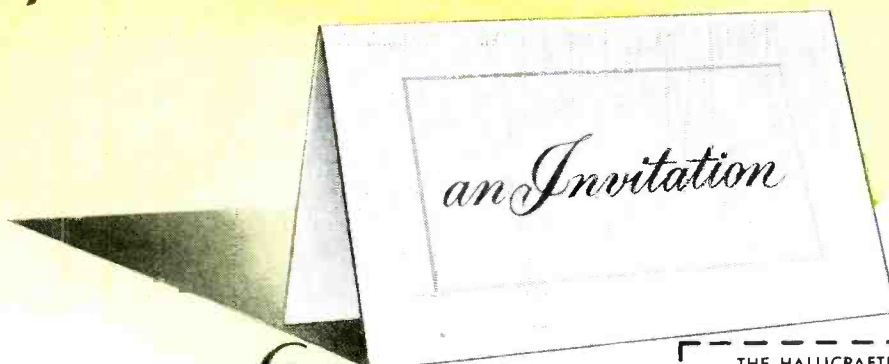

Learn more about Hallicrafters new system of selected representation.

BUILDERS OF *Skyphone* AVIATION RADIOTELEPHONE

© 1947

hallicrafters RADIO

THE HALLICRAFTERS CO., MANUFACTURERS OF RADIO AND ELECTRONIC EQUIPMENT, CHICAGO 16, U. S. A.

Sole Hallicrafters Representatives in Canada: Rogers Majestic Limited, Toronto-Montreal

THE HALLICRAFTERS CO.
4401 W. 5th Ave., Chicago, Ill.

Gentlemen: We are interested in further details about your new system of representation on radio-phonograph combinations. Please send details.

Firm Name _____

Address _____

City _____ State _____

By _____



Reflecting the finest traditions of 18th Century furniture design, the "Chippendale," Farnsworth's Model GK-143, combines FM reception with Farnsworth's improved automatic record changer and storage space for record albums.

NO DARK CORNERS FOR THIS NUMBER!

The leader in Farnsworth's *streamlined* line of

phonograph-radio combinations with FM

This is *it* . . . the sales leader in the profit-full line of Farnsworth automatic phonograph-radio combinations with FM. You'll want it right up in your window, and in your feature display area. By its appearance alone, you'll find the "Chippendale" giving your store the "quality look" that comes to every Farnsworth dealer.

But wait until you *hear* it! Wait until you and your customers hear *all* the sets in Farnsworth's *streamlined* FM line! *Then* you will realize how the seventeen years of pioneering in electronic research has enabled Farnsworth to

develop the finest in this new art. *Then* you will understand why Farnsworth's basic engineering know-how . . . Farnsworth's development of trouble-free record changers . . . have contributed to Farnsworth's reputation for *quality* products.

Then you will realize, all the more, how your Farnsworth Selected Dealer Franchise means more profit to you!

Farnsworth Television & Radio Corporation, Fort Wayne 1, Indiana.

FARNSWORTH

TELEVISION • RADIO
PHONOGRAPH - RADIO

Farnsworth Radio and Television Receivers and Transmitters • Aircraft Radio Equipment • Farnsworth Television Tubes • Halstead Mobile Communications and Traffic Control Systems for Rail and Highway • the Farnsworth Phonograph-Radio • the Capehart • the Panamuse by Capehart

WARD sets the stage

—for a “boom”
in FM and
Television
aerial sales

An intensive consumer advertising campaign in the Saturday Evening Post and leading newspapers is convincing millions of present and prospective FM and Television set owners that:

- (1) *Quality reception is difficult, if not impossible, without a good outside dipole antenna.*
- (2) *Ward “Magic Wand” FM and Television Aerials offer the finest FM and Television reception at modest cost.*

Alert radio dealers are finding this campaign exceedingly helpful in creating extra sales and profitable installation jobs. In addition these dealers are winning satisfied customers who can now enjoy the true beauty of FM or television reception.

Available in straight or folded dipoles for both FM and television bands (reflector kits available), Ward “Magic Wand” Aerials are products of the world’s largest makers of aerials for car and home.

Listing at only \$9.00 to \$12.00 (reflector kit \$5.25) they are priced to encourage volume sales and an adequate profit margin.

Phone or see your nearest Ward distributor today for full details on how to capitalize on this hard-hitting consumer advertising for Ward “Magic Wand” FM and Television Aerials; or write direct to:

THE WARD PRODUCTS CORPORATION

1523 East 45th Street, Cleveland 3, Ohio

DIVISION OF THE GABRIEL COMPANY

EXPORT DEPT.: C. W. Brandes, Mgr., 4900 Euclid Ave., Cleveland 3, Ohio.
IN CANADA: Atlas Radio Corp., 560 King St., W., Toronto, Ont., Canada.

As Advertised
in the
Saturday
Evening
POST

WORLD'S
LARGEST MAKER
OF AERIALS
FOR CAR AND HOME

WARD
Magic Wand
FM AND
TELEVISION
AERIALS

FM-TELEVISION AERIAL OPPORTUNITY!

WARD PRODUCTS CORP.
1523 East 45th St., Cleveland 3

Please advise how I can profit from your national advertising for “Magic Wand” FM and Television Aerials.

NAME _____

COMPANY NAME _____

ADDRESS _____

STATE _____ CITY AND ZONE _____

MY JOBBER IS _____

Sell them where they live

Home Hours are Happy Hours
with a
Westinghouse Radio-Phonograph



1

DOMINATING NATIONAL ADS—Over 28 million radio prospects will be reached in POST Oct. 11—LIFE Oct. 27—COLLIER'S Oct. 18—COUNTRY GENTLEMAN Nov.—PROGRESSIVE FARMER Nov.—CAPPER'S FARMER Nov.

2

FREE AD-MATS AND RADIO SPOTS—9 ready to run ad-mats... 12 radio spots... hard working local advertising to back up your local promotion and help move merchandise off your floor.

3

EYE-CATCHING 4-COLOR BILLBOARD INSERT—Display it prominently in your store or window... it will high spot the important sales features of the 166... the perfect family radio-phonograph.

4

POWERFUL RETAIL SELLING HELPS Attractive 2-color envelope stuffer and broadside that sell the sales advantages of the 166, 153, 167, 168, 169 and 171... each tells your direct-mail customers about the outstanding utility, convenience and performance features of these sets.

Tune in Ted Malone, Monday through Friday, 11:45 A. M., E.D.T., A.B.C. Network

RADIO'S

with this smashing

WESTINGHOUSE RADIO FAMILY FIRESIDE CAMPAIGN for OCTOBER

For Fall . . . when days get shorter, and the family spends more evenings at home, a complete Family Fireside planned promotion package will move Westinghouse radios off your sales floor. Here is everything to make a successful retail promotion: national magazine advertising, local newspaper and radio advertising, a window display, store display and direct mail—all tied in with the newest, hottest radio line in the business.

THESE OUTSTANDING SETS ARE FEATURED:

THE 125 . . . a console radio in capsule form that is packed with features for you to sell.

THE 171 . . . a compact 3-in-1 instrument . . . a LIFT-OUT, carryabout radio, an automatic record changer, *more* record storage space than most big consoles.

THE 153 . . . an automatic radio-phonograph with the revolutionary LIFT-OUT carryabout radio. *Twice* the utility of ordinary table radio-phonographs.

THE 166 . . . concert hall performance in a cabinet masterpiece. Features Electronic Feather Tone arm, Automix Changer, Rainbow Tone FM and *extra large record storage space*.

THE 167 . . . a modern console combination providing true-to-life reproduction of programs and records . . . has Electronic Feather, Automix record changer and Westinghouse Rainbow Tone FM. Extra large record storage.

THE 168 . . . a smartly styled radio-phonograph with Westinghouse Rainbow Tone FM, the beautiful Rainbow Dial, Speed Changer and *full width album storage space*.

THE 169 . . . a magnificent radio-phonograph in a cabinet of fine matched mahogany veneers . . . Electronic Feather Tone arm, Automix record changer, dual speakers, Rainbow Tone FM, twin record compartments.

HOME RADIO DIVISION, WESTINGHOUSE ELECTRIC CORPORATION • SUNBURY, PA.

FIRST NAME IS **Westinghouse**
RADIO TELEVISION

ARVIN

ARVIN

ARVIN

ARVIN

ARVIN

ARVIN

ARVIN

ARVIN

ARVIN

ARVIN

ARVIN

ARVIN

ARVIN

ARVIN

ARVIN

THE RADIO OF TOMORROW...

Today!



FM/AM
MODEL 182TFM
\$74⁵⁰

Prices slightly higher in Zone 2

• Now Arvin dealers have FM . . . and what an opportunity it offers! Compactly designed in mahogany veneer and dazzling lucite this set is a step into the future! But more than that, it's an 8-tube superheterodyne plus selenium rectifier, with 15 tuned circuits, 5-gang condenser and topflight engineering in every detail for thrilling performance on both FM and AM. And, like every radio in the popular Arvin line, it's priced for the mass market, fast sales, and big volume. Ask your Arvin distributor for information on specifications, pricing and deliveries . . . now!

ARVIN

. . . the name on many profit-building products from

NOBLITT-SPARKS INDUSTRIES, INC. • Columbus, Indiana



Santa looked swell in his slack suit

AN OLD-FASHIONED "Christmas rush" in July? Yes, it happened—to Sparton dealers, *this year!*

The new Sparton Challenger line, introduced in July—the supposed "off season" for radio sales—brought a blizzard of orders wherever it was released. And the blizzard's getting bigger every day!

Astounding? Not at all; it only proves what we've been telling you all along. *That a superior line, competitively priced and backed up by punch-packing advertising and promotion, will sell in any market—any time!*

And the answer is S.C.M.P.—SPARTON CO-OPERATIVE MERCHANDISING PLAN—the plan that benefits dealer and consumer by cutting distribution costs. Under S.C.M.P. there is no dumping, no over-franchising. Only one dealer in each community holds the Sparton franchise; shipments are made directly to him. And all of Sparton's national

advertising and promotion works locally for him and him alone.

During the old, easy days of the seller's market, we kept reminding you that S.C.M.P. was the dealer's lifeline for the day when competitive selling got rough. Brother, that day has arrived!

Perhaps the Sparton franchise is still available in your community. Ask us about it today.

THE SPARKS-WITHINGTON COMPANY
JACKSON, MICHIGAN

ONE *Sparton*
DEALER

in each community

Check These
Profit-Increasing Features

- One exclusive dealer in each community
- Direct factory-to-dealer shipment
- Low consumer prices
- National advertising
- Factory prepared and distributed promotion helps
- Seasonal promotions
- Uniform retail prices
- Products styled by outstanding designers

Sparton Radio's Richest
Franchise

A HOT, SHORT LINE AT LOW PRICES



MODEL 7-BM-46-PA—Automatic radio-phonograph in blended walnut or mahogany veneers. With 10" speaker, "roll-out" phonograph drawer. Has three wave bands.

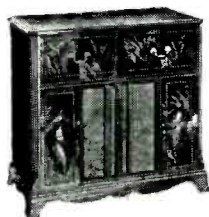

MODEL 10-BM-76-PA—Automatic radio-phonograph with FM. "Roll-out" phonograph drawer. Finished in choicest mahogany or walnut veneers.

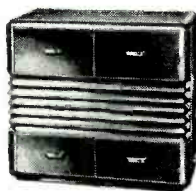

MODEL 10-AM-76-PA—Automatic radio-phonograph with FM. "Roll-out" phonograph drawer. Modern design cabinet of natural or blonde mahogany veneer.

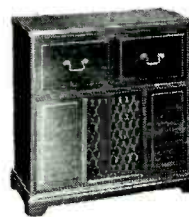

PERIOD MODEL—No. 1007—Automatic radio-phonograph with FM, in mahogany veneer. Also the Modern Model in Golden Wheat finish; Contemporary Model in mahogany veneer.

SMALL SET
WINNERS, TOO!

See the new Sparton portable (Model 608) for battery, AC/DC current.

See the new Sparton utilities (Models 100 & 101) in ivory or ebony finish.

See the new Sparton table automatic (Model 201) with big set performance.

Make Your Store **AUTO**



SIX PUSH-BUTTONS!

Individual buttons for automatic tuning of five stations plus manual tuning. Advanced Philco Electronic Tuning System adds a new fascination to push-button tuning. Light shows which button is "on"

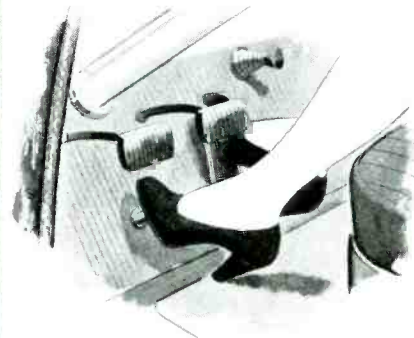

FOOT CONTROL!

Step on it to tune in programs and change stations. No need to take your hands from the wheel, or your eyes from the road. Available as optional equipment. Profitable sell-up!

Cash in

on Philco's Greatest Auto Radio Promotional Campaign

Get a head start . . . displaying, promoting and selling the hottest new line of Philco Auto Radios ever offered. Sure-fire post-war features the public is hungry for! Better performance that you can demonstrate! Custom Styling that *sells itself* on sight! Your Philco Distributor has *everything* you need to make this profitable business roll in. Ask him about the famous Philco "Share-the-Cost" Cooperative Advertising Plan.

- DISPLAY STANDS
- BANNERS
- PENNANTS
- WINDOW STREAMERS
- WALL POSTERS
- LITERATURE
- HANDBILLS
- RADIO ANNOUNCEMENTS
- NEWSPAPER ADS



RADIO Headquarters!

FEATURE THE SENSATIONAL

PHILCO

1948 MODELS

PHILCO, the Leader in Auto Radio for
17 years, brings you a brand new line
for all modern cars... Six DeLuxe and Popular
Priced Models with spectacular selling features
...the finest values at every price level!

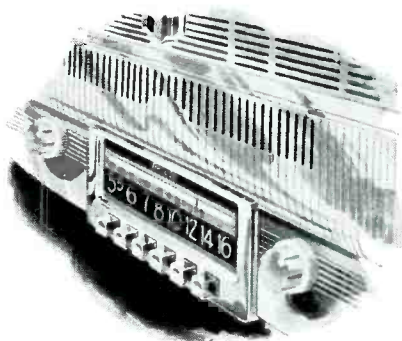

CUSTOM-STYLED !

Automatic and manual control units
are custom-styled for each instrument
panel. They perfectly fit and har-
monize like a factory installation !

**SEE YOUR
PHILCO DISTRIBUTOR
TODAY!**



SHORT-WAVE !

New model gives world reception
on all short-wave bands up to 18
megacycles, plus Standard Broad-
casts. Push-button band switching.

Clarion presents *NEW* models

NEW low prices
NEW profit deal



THE CLARION "CHUM" MODEL 114-1
Powerful—Compact—Weatherproof \$44.95
Aluminum and Plastic 3-Way with
Personal Set, AC-DC 5-Battery batteries

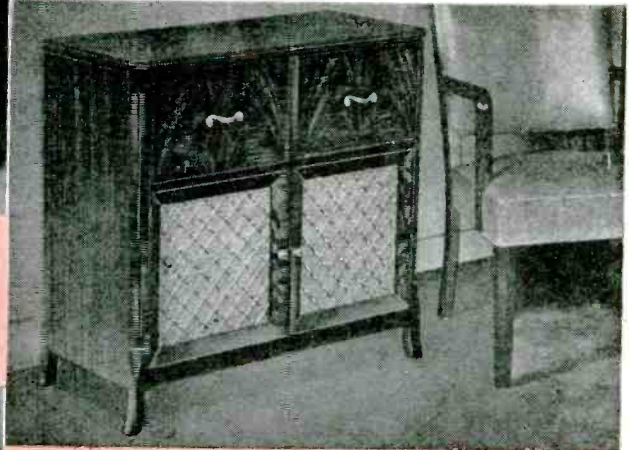

Model 12810—The FM-AM Masterpiece \$219.95
Same cabinet with AM-Shortwave \$199.95



Model 12310 — The Fleet-wood, AM-Short-wave \$179.95



Model 12708 — The New Clarionette



Model 11305 — The Symphonette Table Combination



Model 11011 — The Clarion Portable, AC-DC or Battery



Model 12101 — The FM-AM Aristocrat Table Model



Model C-131 — The AM Aristocrat, Power-packed Table Set mahogany \$41.95



Model C-102 — The Manhattan, AC-DC Table Radio \$27.95 mahogany



Model 11801—AC-DC Table Model \$17.95 mahogany

Phone your local Clarion distributor now or write direct to the
WARWICK MANUFACTURING CORPORATION

4640 W. HARRISON STREET • CHICAGO 44, ILLINOIS

AMAZING NEW MERCHANDISING PLAN

Helps YOU Sell Television Sets These 12 Ways!



DISPLAYS
SALES LITERATURE
ELECTRIC SIGN
PROGRAM SERVICE
WINDOW STICKER
CO-OP ADS
DIRECT MAIL
16 PAGE BOOKLET
UST TELE-NEWS
PROMOTION KIT
LEAD SERVICE
MAT SERVICE

DEALERS—ACT NOW! CASH IN ON TERRIFIC DIRECT MAIL CAMPAIGN to TAVERNS, CLUBS, BARS

UST's 14-way promotion plan for taverns and restaurants is recognized as television's most unusual selling campaign! Over 41,000 licensed liquor licensees are now receiving broadsides, letters, countless facts, testimonials on UST's Tavern sets. . . . Already three-fourths of all BIG PICTURE projection sets in public places are UST . . . over 500,000 persons every week see UST Tavern sets!

If you act quickly, your name can be listed as an Authorized UST Dealer in this campaign. Don't miss out—write now for information about becoming a UST DEALER!



FREE ! FREE ! FREE !

Send for a 16-page booklet, "HOW TO SELL TELEVISION SETS PROFITABLY." A must for any television dealer. Send card or letter to Dept. C (Dept. D for Radio & Tel. Retail), United States Television Mfg. Corp., 3 West 61st St., New York City. Circle 6-4255

(All prices protected under Feld-Crawford Act. Prices 5% higher west of the Rockies.)

Another "first" from the United States Television Mfg. Corp., the "One Year Ahead" company . . . first in "Big Picture" projection television . . . first in the stores with "Big Picture" sets for home and clubs . . . first with a GIANT SCREEN fully 3 1/3 square feet! And now first again with big scale merchandising aids for television dealers!

- 1—COMPLETE SALES LITERATURE. Illustrating the various UST home sets; in both modern and period styles; FREE
- 2—POINT-OF-SALE DISPLAYS. Two beautiful two-color easel displays illustrate both the Tele-sonic and the Tele-Symphonic; FREE
- 3—COMPLETE MAT SERVICE. Logotypes, illustrations, slogans, selling points, and trade marks; FREE
- 4—UST TELE-NEWS. Periodic newsletter for UST Dealers; packed with valuable sales suggestions and latest television news; FREE
- 5—16 PAGE BOOKLET: "HOW TO SELL TELEVISION SETS PROFITABLY!" Jammed from cover to cover with facts about America's newest growth industry; tells you whom to sell television to first; what they will ask you; how to demonstrate; countless other tips for you and your sales force! As many as you need for sales staff; FREE
- 6—WEEKLY PROGRAM SERVICE. Keeps you informed about all programs in your television area; an invaluable guide to help you demonstrate properly! FREE
- 7—WINDOW STICKER. FREE
- 8—LEAD SERVICE and general Consultation service; FREE
- 9—PROMOTION KIT. Complete set of all dealer aids and units of the 12-way merchandising plan in one kit . . . a packaged "sales talk," for salesmen. FREE.
- 10—CO-OPERATIVE ADVERTISING PLAN. Cost shared with UST.
- 11—CONTINUOUS DIRECT MAIL CAMPAIGN. YOU are listed. Shared Cost.
- 12—ELECTRIC SIGN. Unusually attractive sign reminding your customers night and day you are authorized to carry the full UST line. 8-colors!

"One Full Year Ahead"



UNITED STATES TELEVISION

MFG. CORP.

3 WEST 61st STREET, NEW YORK 23, N. Y.

Telephone Circle 6-4255

It's a sell of a situation . . .

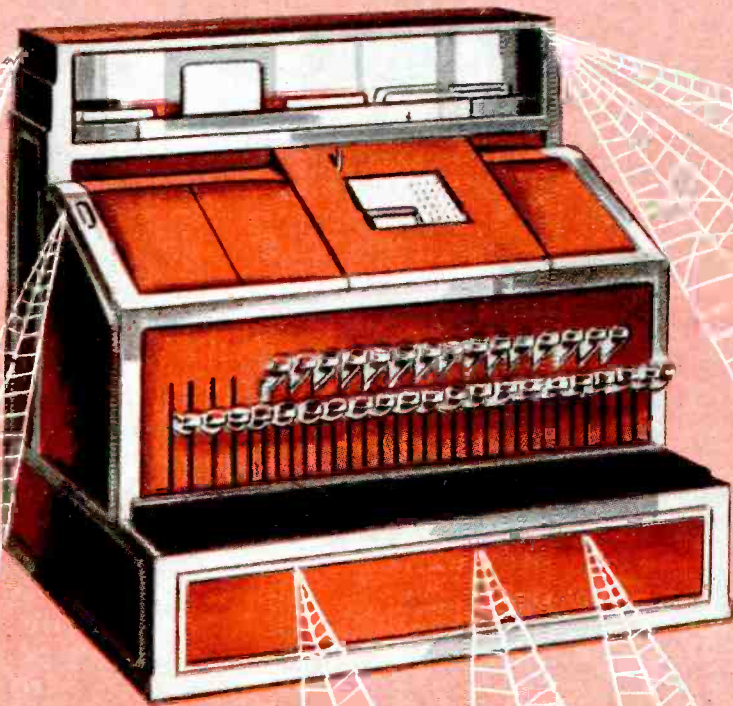

So your cash register *isn't* gathering cobwebs . . . yet. So your sales haven't come to a halt . . . yet. BUT . . . and check this with your own experience . . . dealers in all kinds of merchandise are practically spang-dab in the middle of a situation that calls for REAL SELL.

That's right, SELL. Old fashioned, down to earth, give 'em their money's worth SELL. The kind of SELL that doesn't grow on buying-sprees . . . the kind of SELL that means work for every man, jack in the dealer's organization . . . the kind of SELL that's based on products of quality and proved performance standards.

Are you set for such a situation? Well, check your position with the Crosley line-up. You'll find plenty to think about. For example, you'll find that . . .

THIS CALLS FOR A **sell-ebriation**



Sure and it's the famous Crosley Shelvador* . . . the only refrigerator on the market that gives a dealer an outstanding, *exclusive* sales edge! That 28 feet of front-row food is a feature that has so much eye appeal . . . so much downright practical "help-women" appeal . . . such a powerful buy appeal

. . . that gimmicked-up and gadgeted-up refrigerators just aren't in the picture. And this "Speed Way For Meals" is backed up by the kind of beauty, the kind of refrigeration refinements that match that way-out-in-front feature—the Shelvador*! Do Crosley dealers have good reason to SELL-EBRATE? Well, you've had a peek view of one. Now let's raise another question:

CROSLEY *Shelvador**

MODEL SE947

® TRADE MARK REG. U. S. PAT. OFF.

CROSLEY RANGES? THEY **ex-sell!**

Why? Because they give women *THE BASIC 4* for easier, better cooking . . . and because they give Crosley dealers *THE BASIC 4* for easier, better selling!

That goes for *gas and electric* models. Both have: (1) OVER-SIZE OVEN, (2) WAIST-HIGH BROILER, (3) KALORIE KEEPER INSULATION, (4) SPEED-UP SURFACE UNITS. And in addition, gas and electric models have their own distinctive features . . . features that form a firm foundation for building range sales.

Ready for another quick sales picture? Then consider this . . .



all right!



**YOU WON'T sell EVEN YOUR BEST FRIEND
... OR WILL YOU?**

You won't . . . if he wants a thrifty, kitchen-size frozen food cabinet . . . and you haven't anything that measures up to the Crosley FROSTMASTER! Yes sir, the FROSTMASTER answers every demand for practical, efficient, frozen food storage for the average family. This smart, compact unit holds 100 pounds of frozen foods . . . freezes 15 to 18 pounds of meat or poultry, up to 10 pounds of properly processed vegetables.

That isn't all! The Crosley FROSTMASTER is *designed to fit kitchens*; its 36 inches high (exactly the standard work-surface height), 29 3/4" wide, 26 1/2" from front to back. It fits flush to walls, flush to floors . . . works right in as a supplementary unit that really belongs in the most modern kitchens. Toe space is recessed . . . the gleaming finish cleans as easily as a china dish . . . and, well—when it comes to frozen foods (and it's coming to them faster every day!) the Crosley FROSTMASTER gives Crosley dealers the hottest cold-cash proposition on the market!

sell-ective IS THE WORD FOR RADIOS!

Yes, and it also describes shoppers on the look-out for the best radio buy. They're mighty selective . . . they look at price, they look at performance, they look at features. And the dealer who wants to make sales has to offer all three.

Crosley dealers can do just that. For example, there's the small table model Rondo that's smart and new from every view . . . the luxurious Carrollton that has the famous Crosley Floating Jewel† Tone System as well as too-many-to-mention other outstanding features . . . the years-ahead Crosley Spectator Table Model Television Set that puts television within reach of every home. That's only hitting the high spots, but it leads right up to this point . . .

†Patented.



THE CROSLY CARROLLTON

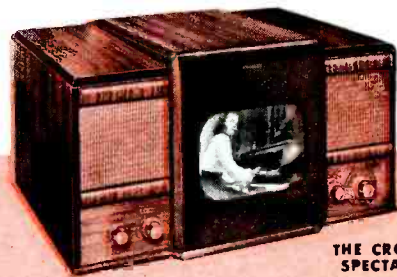

THE CROSLY SPECTATOR



THE CROSLY RONDO

now's the
time to
give 'em sell!

You know that the starting point for any selling program is merchandise that gives *you* something you CAN SELL . . . some extra advantage your prospective customers can see, or hear, and always enjoy. That's why Crosley dealers are glad "It's A Sell Of A Situation."

CROSLLEY

Division—**AVCO** Manufacturing Corporation Cincinnati 25, Ohio

© 1947 Crosley Division—Avco Manufacturing Corp.

Shelvador* Refrigerators • Frostmasters • Kitchen Cabinets and Servisinks • Ranges
Radios • Radio-Phonographs • FM • Television • Short Wave • Home of WLW

Zenith is *FIRST* with the **FEATURES THAT COUNT**

It's the industry's Style-Leader Line!



Model 12H090

**31 years of Radionics
Exclusively Pays Off
Now With Pace-Setting,
Sales-Making Features**

Now that the pendulum is swinging back, and shoppers are looking for honest value, Zenith is more popular than ever. For these great sets are designed and built to come out way ahead in any "hands-down" competitive value comparison.

Zenith helps you sell with *features* . . . demonstrable features prospects notice and want. Here, too, is superior *performance*, made possible by Zenith's rigid adherence to quality standards for components and workmanship. Zenith gives you *styling* leadership, by consistent development of style features that set the pace for the industry.

Yes, Zenith backs you up with *value* that makes sales . . . value made possible by the knowledge and experience gained in more than 31 years of Radionics Exclusively.

ONLY ZENITH OFFERS SALES FEATURES LIKE THESE



COBRA TONE ARM

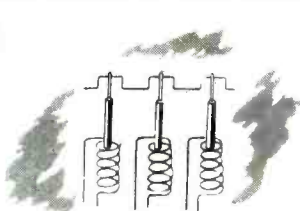

ARMSTRONG FM



ROTOR WAVEMAGNET



RADIORGAN

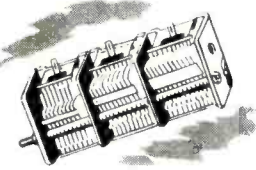

3-GANG CONDENSERS



SILENT-SPEED RECORD CHANGER

Keep An Eye On



Zenith Radio Corporation • 6001 Dickens Ave • Chicago 39, Ill.

versatile, enjoyable and profitable

...THE NEWEST **Recordio**
T. M. REG. U. S. PAT. OFF.
by **WILCOX-GAY**

Trim and compact, this newest RECORDIO offers your customers *complete* home entertainment. Equipped with an automatic record changer that slides out at a finger touch, the Manhattan makes recordings from its own microphone or self-contained radio . . . easily, economically.

Don't sell half a radio. Sell RECORDIO . . . with all of the things your customer wants . . . radio—phonograph—record changer—and *home recorder* . . . all housed in this space-saving walnut or mahogany console. Priced to win customer approval in a price-conscious market.

NEW LIGHTWEIGHT "MIKE"
 that fits neatly into the palm of the hand. Sensitive crystal type with glass cloth grill.

6x9 ELLIPTICAL SPEAKER
 to bring out the deep, full-fidelity tones from radio, phonograph or recordings.

THE Manhattan
MODEL 6B45

PUSHBUTTON SELECTION
 of radio or microphone recording—radio—phonograph—public address system.

SHOCK-MOUNTED TURNTABLE
 driven by constant speed, heavy-duty motor for accurate recording reproduction.

RECORD CHANGER-RECORDER
 slides out for easy operation. Plays 12" or 10" records with amazing fidelity.

AMPLE RECORD STORAGE SPACE
 to hold all of your favorite record albums, RECORDIO albums and recording discs.

See your distributor or wire...

WILCOX-GAY CORPORATION • CHARLOTTE, MICHIGAN

134-M

Exclusive



SCOTT DEALERS

now enjoy the added advantage of being exclusively franchised to handle the most amazing Noise and Scratch Suppressor* ever developed.

A great new boon for lovers of recorded music is now in the hands of dealers with the Scott franchise—available alike to present owners and new buyers of today's Scott radio-phonograph.

It is Scott's special adaptation of a radically new Dynamic Noise and Scratch Suppressor* for the Scott radio-phonograph! It makes old records sound new, new shellac records sound like Vinylites, and modern high-fidelity Vinylite records sound superb—virtually noiseless, therefore even more musical.

This Dynamic Noise and Scratch Suppressor is actually an electronic "filter" that screens out noise frequencies—high and low—but lets the music through. And because the ear hears less noise, it hears more music!

Designed and engineered especially for the Scott, and available in no other instrument, this revolutionary new Dynamic Noise and Scratch Suppressor has given Scott dealers another Scott "plus"—another added advantage they have been quick to appreciate and happy to use.



SCOTT RADIO LABORATORIES, INC.

4450 Ravenswood Avenue, Chicago 40, Illinois

**Licensed under Hermon Hosmer Scott patents pending*

TEMPLE DOES IT AGAIN!

A
Top-performing
SUPER HETERODYNE

for only

\$12⁹⁵
(walnut)



MODEL G-418

The TEMPLE "SUPER"

Yes, a smart-looking, top-quality, genuine Super Heterodyne of medium size (not a midget), in a non-breakable cabinet. Highly sensitive, selective and powerful. Famous Temple quality. Packed eight (8) to a carton. Available in 4 colors—walnut, ivory, Chinese Red, powder blue.



*The Value-Scoop of the Year!
priced for Volume sale with a*

TOP-HIGH RETAIL PROFIT MARGIN

*you can't afford to overlook
ORDER YOURS TODAY!*

TEMPLETONE RADIO MFG. CORP.
NEW LONDON, CONN.

Executive Offices — 220 E. 42nd St., New York, N.Y.

Some Territories still available for salesmen. Write. Give details.

"Where FM also means Finest Made"

available now...for immediate delivery

"COMBINETTE IN FM" features 8 tubes, plus selenium rectifier, operates on AC or DC, 3 stages of i.f. amplification, 5" speaker, built-in line cord antenna, "console-type" mahogany cabinet 14" x 11" x 8", receives FM independently or as tuner with any AM set.

Manufactured by:

AIRADIO INCORPORATED, Stamford, Conn.

Hundreds of FM broadcasters and industry leaders who have seen and heard "the people's FM" recognize this combination FM receiver-tuner as just what the people want - just what broadcasters need - just what dealers can sell!



Priced low enough to make fine FM a reality to all,

suggested retail price . . . **\$56.95**

orders are being filled as received - and dealers will get prompt attention from exclusive sales agency, **ELECTRONICS, INC.**

934 Bowen Building, Washington 5, D. C., Phone REpublic 8181

The great feature thousands are asking for...

Strobo-Sonic Tone

— only Stewart-Warner has it!



THE MUSIDORA—today's superior FM-AM console combination. Two models: the De Luxe with intermix changer and 2 album compartments; the Master with standard changer and one compartment. Full-cycle AC tonal range.

THE CONSOLETTA—the new AM radio-phonograph that performs like a big console! Smooth AC performance, so important for fine records. Automatic changer handles up to 12 discs. Detachable legs quickly convert this set to a table model.

AM TABLE RADIO—never has so much pure enjoyment been engineered into a set this size! Radair Antenna, 5 tubes plus rectifier, tone control, powerful reception. Ivory plastic with ruby-red controls.

Stewart-Warner dealers alone can answer the demand for "the tone that's picture-clear." In both AM and FM-AM sets, Stewart-Warner is winning customer preference everywhere with the tone so faithful you can understand each word . . . distinguish every instrument . . . hear music in its true dimensions, picture-clear. True quality—priced for the buyers' market!



THE BALLADEERS—today's superior FM-AM table sets. Full depth Strobo-Sonic Tone! AC-DC, 7 tubes plus rectifier, PM dynamic speaker, 2 built-in Radair Antennae. Handsome in both walnut and desert tan.



AIR PAL—built like a watch, smaller than a phone, yet it's a full-power AC-DC radio that plays anywhere you plug it in! Beautiful jewel-box display . . . gold and satin . . . sets it off for what it is—a console in a jewel case!

A Model for Every Purpose—a Radio for Every Room

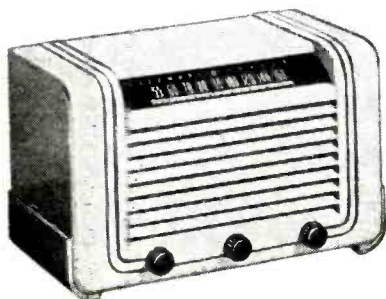

Stewart-Warner

FM Radios AM Radio-phonographs Television

CHICAGO 14



ILLINOIS

All through the house...

there's a place for **STROMBERG-CARLSON**

Entertainment is a many-sided family affair —and Stromberg-Carlson's rounded line lets you take full advantage of that fact.

For the main radio in the living room—and for every listening spot in the home—your

customers will appreciate the incomparable performance and appropriate styling of a Stromberg-Carlson.

A well-timed suggestion can sell many an *additional* Stromberg-Carlson for you!



Proud Possession!

"HEPPLEWHITE" . . . for the living room. FM-AM radio-phonograph combination in authentic 18th Century design. Automatic record changer with automatic stop. Hand-rubbed mahogany veneers.

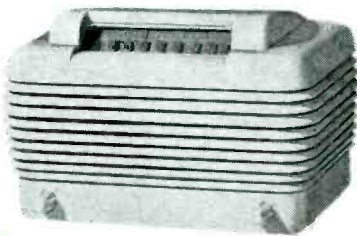

Kitchen Helper!

"DYNATOMIC" . . . table model, AC-DC, of unusual power and tonal richness. In ivory or brown plastic cabinet.

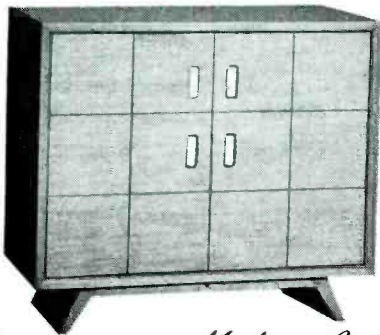

Modern Living!

"NEW WORLD" . . . for library or den. FM-AM radio-phonograph, bleached mahogany cabinet, disappearing doors. Automatic record changer with automatic stop.

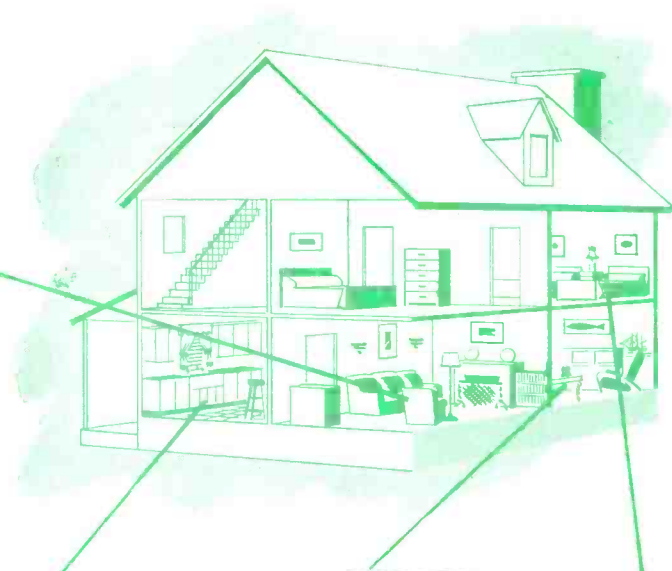

Perennial Favorite!

"SALEM CHEST" . . . for living room or bedroom. FM-AM radio-phonograph. Automatic record changer with automatic stop. Hand-rubbed mahogany.



All through the house...

There is nothing finer than a

STROMBERG-CARLSON

Rochester 3, N. Y.

Radios, radio-phonographs, FM and television, sound equipment, industrial and intercommunication systems, telephones and switchboards.

RADIO & Television RETAILING

Including Radio and Television Today

O. H. CALDWELL, Editorial Director



M. CLEMENTS, Publisher

Get Out and Get Busy!

"These are not depression times, they are *boom* times," an outstanding figure in merchandising in this field told a group of dealers at a meeting not long ago.

And he was telling the plain, unvarnished truth.

Never before has a peacetime employment rate been at so high a level.

Never before has the public had so much money in banks and in its pockets as it has at this time.

Never before in the history of the nation has the need for new radio and appliance merchandise been as great.

The foregoing statements are not bromides. They are cold facts.

Why then, has purchasing slowed up? How long will such slow-up period last?

In the order of their importance, the following factors appear to be responsible for the present and *temporary* situation:

1. Inefficient salesmanship and sales promotion.
2. The housing situation.
3. Over-priced, unwanted merchandise. (Stocks of which are fast dwindling).

We see then that it isn't because the people *cannot afford* or *do not want* the merchandise that sales are not what they should be. First, it's because we are not *asking* them to buy, or not asking them the *right way*. Items two and three will take care of themselves—and *soon*.

While we're waiting for new homes to be built, and surpluses to fade out of the picture, let's do something.

Let's get out and replace all the outmoded, worn-out, broken-down, expensive-to-operate equipment in the hands of the *many* householders in our respective communities. Let's sell 'em new products via the salesmanship route.

Remember—the public has the money to buy, and the desire to buy. It's up to us to make their desire burst into *buying action*.

What's Ahead!—in Radio,

MOST CONSUMERS NO LONGER BELIEVE that radio and appliance prices are due to drop soon. Leading manufacturers feel that prices will, for the most part, stay where they are now, but look for some to rise slightly due to the increased cost of steel, hiked to a \$6 per ton average.

OPINION DIVIDED ON WHAT AFFECT DEATH OF REGULATION W, next November, will have on retail buying. Some merchants believe that unrestricted credit terms will stimulate buying. Others, while agreeing that it will certainly needle sales, foresee wildcat competition in terms to be offered doing more harm than good. One sure result of the end of the regulation will be that each and every dealer's business operation method will undergo a change, affecting selling and bookkeeping.

DEALERS REPORT INCREASING REQUESTS for credit on the part of their customers. Most retailers are tightening up on their "open" charge account business, preferring to swing over to use of finance agencies. Such procedure on the part of the merchant is an ahead-looking one because right now collection problems are practically nil.

ONE OF THE SUREST SIGNS OF A RETURN to competitive selling is seen in the recent launching of sales contests by jobbers and manufacturers, and in the planning of similar events by many of the large dealers.

COMBINATION GERM-KILLER, HEATER, AIR CIRCULATOR is announced by Simpson Engineering Co., P. O. Box 568, New Haven, Conn. The unit is enclosed in a portable metal cabinet. The lamp, the blower unit and the heater are all controlled from one switch on top of the cabinet.

DISC MAKERS CATERING TO BABY-CARRIAGE TRADE, and on up into the roller-skating age group, with a flood of new children's records. When the Christmas selling season rolls around again, retailers will find numbers of new juvenile phono records to help meet the steadily growing demand.

A HUNDRED MILLION FLUORESCENT TUBES will be made in the year 1950, predicts a Westinghouse Lamp Division executive who sees fluorescent production hitting 75 million for 1947.

NEW SEWING MACHINE OPERATES WITHOUT bobbin or shuttle. Named the "Monroe," the appliance will be made by Lion Mfg. Corp., Chicago, and will be sold by dealers from coast to coast. The first model, a portable with full 8-inch head, weighing only 16 pounds, will incorporate all exclusive features of console models to be introduced later next year.

RADIO MANUFACTURERS REPORT A GROWING TREND on the part of the public in favor of blond finish cabinets. Seems the "blonds" fit in well with modern home decorative themes.

WHEN FEDERAL CONTROLS ARE LIFTED from the time-payment picture Nov. 1, dealers will have to tie up twice as much money in financing as they did in the past, a banker told a group of members attending a meeting of the National Retail Furniture Assn. The speaker said that the credit terms recommended by most finance agencies, would be as follows: Refrigerators—10 to 20% down, with 24 to 30 months to pay. Food Freezers—20 to 25% down, 18 to 24 months to pay. Ranges—10 to 20% down; 24 to 30 months. Washers and Ironers—20% down; 18 months. Vacuum Cleaners and Sewing Machines—20%; 12 months. Large Radios—20%; 18 months. Small Radios—25%; 12 months.

RUMORS OF AN IMPENDING widespread shortage of electric power in the U.S. have been characterized as unwarranted and untrue by Charles E. Oakes, president of the Edison Electric Institute. "Although the early postwar growth of demand for electricity has exceeded expectations . . . all customer demands will be met in 1947 and in the year following," said Mr. Oakes.

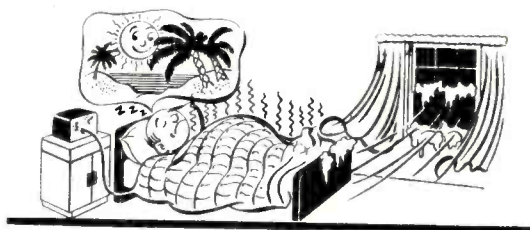

WITH THE SUMMER VACATION SEASON nearly at an end, progressive retailers are planning all-out promotion campaigns to boost sales of health and comfort appliances for the return to in-home living on the part of the customer. Heat pads, electric blankets, therapeutic lamps, vibrators and space heaters are a few of the items to be featured.

BELL & HOWELL COMPANY HAS PURCHASED the Microfilm Recording Co., of Chicago. All microfilm equipment manufactured and sold by Bell & Howell will be marketed under the trade name, "Micro-Filmo."

ONE OF THE FIRST HOTELS in the country to make electric sleeping comfort available to its guests, the Hotel Lowry in St. Paul, is offering its patrons a choice of conventional blankets or GE automatic ones in their rooms when they register.

Appliances, Records and Television

HOME INCANDESCENT LAMP SUPPLY almost back to normal on standard numbers, but some photo bulbs are still under-counter sales items.

"AS WASHERS SCARCELY WORTH CONDITIONING for resale begin reappearing in dealers' back rooms it becomes timely to remember the publicity value of presenting these dogs to needy families or to appropriate organized charities. Reporting the gift to the newspapers should be part of the transaction, of course."—William Shaw, American Washer and Ironer Manufacturers' Association.

SOME OF THE FEATURES OF RAYTHEON'S Home Precipitator include an efficiency of 85 to 90% as compared with only 10 to 20% obtainable from the best mechanical filter; the appliance removes ninety percent or more of all airborne dirt when used in conjunction with a warm air furnace (of which there are over nine million in use in the U. S.), and the new air cleanser is cheap to operate, drawing but 50 watts.

"THE COLLEGE OF SELLING KNOWLEDGE," launched by Stromberg-Carlson, will end October 11. The intensive course goes by mail directly to the home of the dealer's salesman, and prizes valued at \$12,500.00 are offered. The better salesmanship campaign was launched August 4.

TELEVISION HEADLINES of the both-barrels type are now being used throughout the country by dealers and distributors to announce the arrival of video sets in their areas. One of the suggestions was: "We Are Radio Obstetricians—We Deliver Television!"

"SELL PORTABLES ALL THE YEAR 'ROUND," Westinghouse sales executive J. H. Stickle urges. He suggests telling the customer how the portable is suited to use in every room in the home, and emphasizing that "in addition" the owner can carry it with him on outside trips of all sorts.

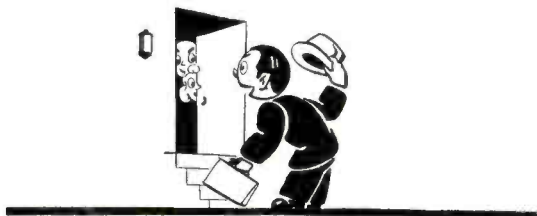

"MAKE THE MOST OF DOOR-TO-DOOR selling while it's still a novelty to the householder," one successful retailer suggests. "Right now," he continues, "people are genuinely receptive to the canvasser because door-bell-ringers are few and far between."

MORE BUSINESS FOR RADIO APPLIANCE RETAILERS and for the industry as a whole comes about as a result of competition between taverns. In television areas the operator of the modern bar and grill knows video is a must, along with air conditioning and a jukebox whose records are kept up to the minute.

25 BANKS NOW COOPERATING IN ELECTRICAL Association of Philadelphia's promotion designed to sell more electric kitchens. The banking institutions provide floor space for miniature set-ups, built to scale. The series of miniature kitchens consists of 12 designs.

ELECTRICITY CONTINUES TO WAR ON INSECTS. Among the latest devices to combat crawling and flying pests is an automatic electric insecticide sprayer, a single filling of which will kill flying insects in an area of 500,000 cubic feet. Other products on the market include a specially-coated incandescent lamp that transmits only the yellow portion of the spectrum to repel insects; electric screens; a DDT-coated wire screen that encloses an ordinary light bulb, and an electrically-heated unit that utilizes the steam vaporization principle.

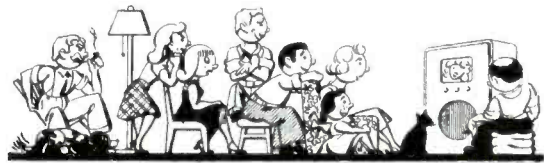

TELEVISION SELLS ITSELF! When friends or relatives drop in and see the family grouped in front of the video receiver (see cartoon above this item), the desire to own becomes very strong, dealers are finding. That's why it's so important to follow-up all sales. One live-wire merchant always asks his television customers to keep him in mind when visitors express interest in the home-owner's set. Offers the user prizes for leads which result in sales.

THE TELE-TIDE IS COMING IN! Beverage Media surveyed the liquor on-premises licensees . . . bars to you . . . during the Spring, to discover in New York City that 1 out of 5 have it—Television . . . Today, it is estimated that not less than three out of five are featuring video. That's how fast TV is moving into taverns in New York. From what we've seen it isn't far behind elsewhere. Next month, RADIO & Television RETAILING will have a "how-to" feature article on tele tavern installation.

ADMITTING THAT "IMMEDIATE DELIVERY" IS A HACKNEYED phrase, one merchant, nonetheless, admits that it's still a necessary one to keep before the public eye. He reports that a customer, whom he'd served for fifteen years, reported to him that she had bought a refrigerator from a competitor upon the premise that the boxes on display in her favorite dealer's store were "still only samples."

"Golden Throat" Demonstration

Perfect tone reproduction of **RCA Victor** "Golden Throat" again

The dramatic "Golden Throat" Demonstration was given at the RCA EXHIBITION HALL, July 21 to August 2. Hundreds of piano technicians, radio dealers, and private radio owners heard the "Golden Throat" of the RCA Victor "Crestwood" reproduce sound so perfectly that even *critical ears* could not detect a single flaw.

Here, as at the NAMM Convention in Chicago, audiences were convinced that the "Golden Throat" is really the finest tone system in the history of RCA Victor.

Here, again, no one who witnessed the performance was able to identify correctly the source of the music . . . the piano on the stage before them, or the piano being broadcast by the "Golden Throat" tone system of the RCA Victor "Crestwood." (A standard model of this Victrola radio-phonograph was used. No special adjustments were made.)



How two pianos demonstrated perfect tone reproduction of the RCA Victor "Golden Throat"

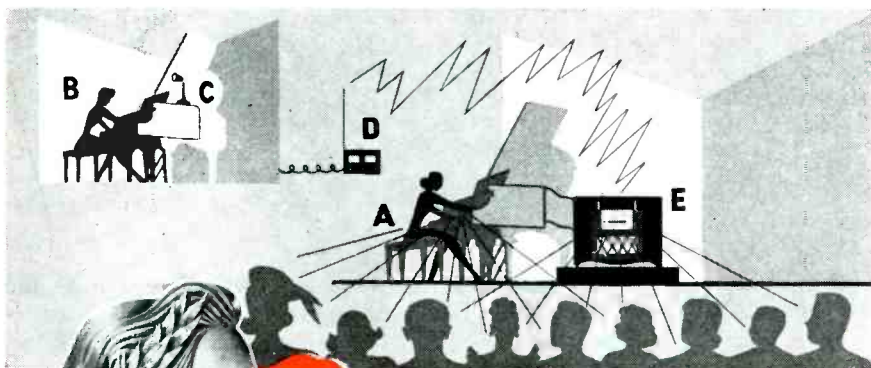

The two-piano team of Carlile and Wayne performed in the dramatic "Golden Throat" Demonstration.

Miss Carlile played piano (A) on stage before the audience. Miss Wayne played piano (B) in a studio in another part of the building. A microphone (C) picked up the sound from piano (B) and fed it to a transmitter (D) which broadcast to the RCA Victor "Crestwood" (E).

The two pianists played alternately . . . passing the melody smoothly back and forth so that the audience heard continuous music. *But only part of it came from the piano on the stage . . . the rest was heard from the "Golden Throat" tone system of the RCA Victor "Crestwood."* And, the audiences were amazed as they heard the "Golden Throat" reproduce the tones of the piano with perfect fidelity.



"Golden Throat"

is the exclusive new RCA Victor 3-way sound system . . . produced by RCA's 27 years of electronic engineering skill and Victor's 48 years of leadership in the reproduction of sound.

Listen to
RCA Victor
create sales
for you...
on the RCA Victor
show — "Music
America Loves Best"
over your nearest
NBC station every
Sunday 2:00 P.M.,
E.D.T.

a spectacular success in New York

amazes critical listeners!



"Golden Throat" perfect tone reproduction means more RCA Victor sales for you!

HERE'S WHAT TWO LISTENERS SAID!

The RCA Victor "Golden Throat" reproduced the tone of the piano so perfectly, no one present could distinguish the broadcast from the original.

Byron Whitehill

Bronx, N. Y.

Frankly, I was skeptical at first, but this demonstration soon changed my mind. The "Golden Throat" reproduced the tone of the piano so perfectly I was unable to tell the difference between the piano on the stage and the piano broadcast through the RCA Victor instrument.

Lillian Davies

New York City, N. Y.

Now, you can offer your customers the listening performance they have been waiting for . . . all the beauty of the artists' performance as clear as though each performer was right in their living rooms.

All RCA Victor instruments, from the popular priced 65X1 to the superb "Crestwood," have the exclusive "Golden Throat" tone system. The same engineering principles that produce such glorious tone in the "Crestwood" have been used in the smaller sets. All RCA Victor instruments give your customers greater brilliance, higher fidelity . . . dollar for dollar a more perfect performance than *any* other instrument.



The "Crestwood" . . . Star performer of the great RCA Victor line of instruments. Here, the "Golden Throat" tone system reaches its peak performance.

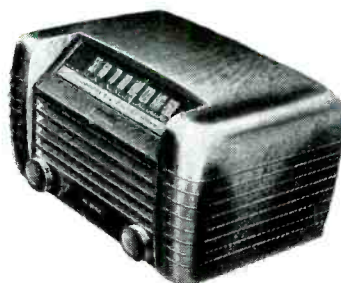

The 65X1. The "Golden Throat" tone system in this instrument gives it performance superior to *any other* radio in the same class.

ONLY RCA VICTOR MAKES THE VICTROLA

RCA VICTOR  

"Victrola"—T. M. Reg. U. S. Pat. Off.

DIVISION OF RADIO CORPORATION OF AMERICA

AM I ACTING TOO QUICKLY?
 SHOULD I THINK IT OVER!
 WILL IT SOON BE OBSOLETE?
 WILL IT LOOK AS GOOD AT HOME?
 WILL IT MEAN FURTHER INVESTMENT?
 IS THE SALESMAN TELLING THE TRUTH?

What the Customer

CAN I GET IT CHEAPER?
 SHALL I DECIDE LATER!
 CAN I GET SERVICE ON IT?
 WHY DID I THINK OF IT IN THE FIRST PLACE?
 IS IT AS GOOD AS MRS. BROWN'S?

● "Very well, then. I'll take the refrigerator."

These words are greatly relished by the hard-working appliance salesman. But the customer may duck the issue and say, "Thank you, I guess I won't decide today." This means that the immediate sale has been lost.

Just before the customer makes the decision is a critical time. It comes after the demonstration and the sales presentation have been made—when the salesman has finished his talking and the prospect's specific questions have been answered. It is the time when the customer gives at least some indication as to whether it's yes or no.

At this point, the typical shopper has a mind full of private doubts. The average salesman knows what these doubts are because he makes purchases himself. For instance, he knows that just before he makes his decision about buying a set of golf clubs, his mind is sometimes crowded with reasons why he should *not* take the step. The usual series of thoughts runs something like this:

"Maybe I can get it cheaper at the other store. I probably could get along without it for a while, anyway. It may be that prices will come

Salesmen Should Be Ready to Answer the Queries Which Come Just Before the Sale

down a little later on. I wish I knew more about the manufacturer. I imagine that this salesman is telling me the truth, but after all, he wants to make the sale. The price really isn't too high, I suppose, if the quality is what it should be. But how can I be sure?"

And so on. Customers can think of many, many reasons why they should not buy. After all, the easiest course is to continue the status quo. The line of least resistance would be to walk out of the store without making any decision and facing any of its consequences. And, of course, most customers have a basic impulse to hold on to their money. Another very human characteristic is to put things off.

Also, a great many prospects get the feeling that they are being very

sensible and thrifty if they do a lot of shopping around, or if they compare a number of values in a whole string of stores. Of course, the customer often does very little actual investigation, but he keeps thinking that he will, and it becomes a popular excuse for putting off a purchase.

This hesitancy on the part of the shopper is fundamentally easy to deal with because it is based on human nature. Salesmen who have had very little training can readily become experts in this regard, if they give the matter some thought.

Action Is Needed

As the buyer's market develops to more striking proportions, this business of knowing what the customer is thinking becomes increasingly important. More than ever, a salesman dislikes to lose a sale, particularly after he has taken extra pains and effort to sell and demonstrate his merchandise to the best of his talent. It is always a bad thing for a store to lose sales regularly at a critical point in the sales procedure and it is specially unfortunate under today's conditions.

The fact is, if a customer gets to the point of saying "I'll think it

SHALL I BUY A NEW HAT INSTEAD!

COULDN'T I GET ALONG WITHOUT IT?

WILL IT LAST?

WILL THE REST OF THE FAMILY LIKE IT?

SHALL I LOOK AROUND!

Is Thinking

CAN I GET IT WHOLESALE?

IS THE MANUFACTURER A GOOD ONE?

IS IT THE VERY LATEST?

CAN I BUY IT ON TIME?



over" he will very likely stick to this decision, even though he arrived at it in a very casual way. He may not like the idea of being talked out of it, particularly if the salesman changes his manner at all and becomes slightly argumentative. The best method is to make an energetic effort to avoid an unfavorable decision in the first place.

Knowing the Answers

Salesmen can do this by simply answering all the typical questions in the customer's mind. In general it appears to be better, at this stage of the game, to accent the sound value of the product, rather than to review the surface glamour or the more superficial qualities of the merchandise. When a prospect gets to the point of actually digging up the cash for the product, the most winning sales argument concerns its long-range qualities and its durability rather than its detailed characteristics.

For instance, a salesman might better say, "I'm sure you'll be more than satisfied with this unit for many years to come," rather than making some additional comments about the beautiful chrome trim of the thing.

The final parts of the sales talk are more effective when they re-state the fact that a genuinely sound value is being offered now, in this store, supported by dealer service and manufacturer's reputation, unquestionably appropriate and ideally designed for the customer's use.

It may be necessary for a salesman to repeat himself several times on this score. A resourceful retailer will, however, know how to say the same thing in a different way in order to make the point emphatic and effective.

Flexible Salesmanship

A dealer will often see the need for selecting one or two of these general points to emphasize. Although most customers are wondering whether they "should look around," in some cases this line of action does not even occur to the prospect and it would be foolish for the retailer to make a special point out of the fact that his store can compare very favorably with other local ones. A salesman can usually tell, during the interview, which of the customer's doubts is the most pronounced. He should concentrate on solving that problem.

Sometimes a salesman becomes extra enthusiastic about a new feature of an appliance, perhaps because the industry, within itself, recognizes that it is a real improvement. It may be that this particular feature happens to be of little interest to an individual customer, due to his special preferences or tastes. Certainly, in an instance of this sort, it is a waste of time to keep pounding this feature. This illustrates how, in a sales summary, a number of perfectly good features have to be checked out of the conversation, in order to get the most done at the right moment.

It is a fact that the personalities, motives and requirements of customers have tremendous variations. But if there's one thing they are likely to have in common, it's a standard set of doubts which arise just before making a purchase. A salesman can be prepared for these, and can increase his sales by realizing in advance that he must have a complete set of appropriate answers.

All the selling skill in the world is of no immediate value unless the merchandiser is in good form during the last few minutes of his presentation. The conclusion is that a salesman should "watch the wind-up."



Much of the dealer's contact with the public stems from this bench. McGowan therefore gives it extra attention — with accuracy, convenience, comfort and speed getting the emphasis.

Sales and Service Expand Together

● The sales volume at the McGowan store in St. Paul, Minn., is moving along at such a healthy clip that the firm recently moved into expanded and remodelled quarters in the "loop" district.

And because the company believes so strongly in the team of sales-and-service, the McGowan repair department is now given a big separate expansion of its own. In taking the step, the firm combined a special sales interest in records with a long-time interest in servicing, and the result is an exceptionally interesting

blend of maintenance and merchandising.

Hereafter all repair work of the company will be done in a newly opened shop on Grand Avenue at Dale Street, instead of in the retail store as formerly. The management feels that a shop centrally located between downtown and the midway district will give faster service to customers because pick-ups and deliveries can be made more quickly.

The new store has a daylight work shop which speeds up work and enables technicians to work faster

and more comfortably. This new work room is efficiently laid out with all parts set out circularly around the bench. All parts are easily available to the workers and are binned according to numbers.

Stock of components is so large that practically 98% of all radio repair work can be done with no waiting to get parts. Customers benefit by such quick service. The shop maintains regular pick-ups and deliveries on both large and small instruments. Pick-ups are made on call.

Separate Shop Opened for Flourishing Repair Business in Minnesota

As the McGowan store specializes in selling the large radio-phonograph combinations, naturally the repair of these instruments is a specialty. McGowan employs three workmen specially trained in this phase of service. This was found to develop more satisfaction on the part of customers.

Doing the Job

One man specializes in outside calls where the work may be done in the home. Another gives full time to radio-phonograph repair of machines brought into the shop, while a third spends full time on small radios.

"A part of the repair shop is used for sales," reports H. J. Gruber, manager of the shop. "In a store located in a neighborhood community such as this, there is always demand for radios, records, and small appliances. Although the major part of our work is repair, we are going to emphasize records. We consider discs to be live items high in continual demand, and they build steady repeat business valuable in keeping our repair section before the public."

Table model radios are shown on one side of the shop on a series of built-in wall shelves. There are a few large radio-phonograph combinations on the floor, and an array of small appliances.

Racks at the side and the front of the shop, and near the desk section which divides the sales end of the shop from the work section, hold records. Albums are arranged at one side and single records where they can be easily obtained for customers near the desk. Low display units along the inside of the window hold the bright colored albums.

Interesting Display

Windows stress the sales section of the shop, displaying albums, small radios and small appliances. The shop is located at a juncture of two car lines and has much traffic past its windows.

Heavy sales are being made in children's records, found to be a good repeat item. A booth at one side of the shop provides plenty of room for privacy in listening.

No attempt has been made to "cut corners" on any of the store fixtures of display equipment. The plan is to make the entire lay-out comfortable and efficient for the McGowan staff as well as the customers. The management does not believe in the pol-

icy of getting by with only the bare essentials necessary for attracting customers to the store and selling them. Neither does McGowan try for effects that are spectacular or tricky in store facilities; the emphasis is on the fixtures, which are attractive, efficient, clean and sturdy.

An example of this is seen in the service department, where the planning of the shelving is certainly a match for any of that in direct view of the public. But you cannot do good work, day after day, unless

your facilities allow you consistent speed and convenience in routine jobs.

McGowan's interest in repeat business indicates how its main policies are formed. Customers do not come back unless they are satisfied, and this store makes a point of handling shoppers so that they'll "remember and return." Sometimes it's a case of just a few courteous words to a disc buyer, and sometimes it's a careful and thorough handling of a complicated repair job.

The Factors Of Good Service

1. Shop equipment modern and complete.
 2. Good working conditions at benches.
 3. Technical know-how for all jobs.
 4. Promptness on deliveries to customers.
 5. Good stocks of replacement parts.
 6. Sensible specialization among technicians.
 7. Constant study of new circuits.
-

In the record department, this dealer gets attention via a general simplicity and neatness.



New Lines for New Fall Sales

Musaphonic COMBO

Model 45 "Westchester" radio-phonograph, equipped with chassis, record changer, audio and speakers systems of Musaphonic line. Full length doors; behind left one is roll-out phono drawer and space for 140 records—right door opens on control panel and Multiweave speaker grille of burnished decorative metal. Cabinet in modern style—genuine white ash with lattice effect on doors, clear finish.

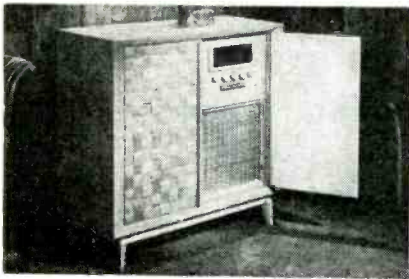

Measures 41 $\frac{3}{8}$ " high by 43 inches wide by 19" deep. \$820. Receiver Division, General Electric Co., Bridgeport, Conn.—RADIO & Television RETAILING.

Farnsworth COMBO

Model GK-115 console AM-FM-phonograph, ac superhet with 12" Alnico 5 speaker, pushbutton tuning. Two built-in antenna—shielded rotatable one for AM, plus dipole for FM. Tunes 540 to 1620 kc and 88 to 108 mc, AVC, travelite dial, band spread type tuning for FM. Beam



power output, push-pull amplification, RF amplifier. Farnsworth automatic record changer Type P 56 MP with automatic stop. Lightweight tubular tone arm, sapphire stylus, handles ten 12" or twelve 10" records. Mahogany veneer cabinet, solid top, metal grilles. Measures 34" wide by 36" high by 18 $\frac{1}{2}$ " deep. Farnsworth Television & Radio Corp., Ft. Wayne, Ind.—RADIO & Television RETAILING.

Philco COMBO

Model 1256 table radio-phonograph with automatic record changer. Beam pentode audio system, 5 tubes plus rectifier, PM

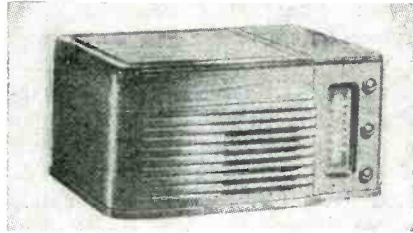

speaker. Tone control, built-in aerial. Featherweight tone arm, permanent needle. Philcote cabinet in walnut \$124.94; in mahogany, \$129.95. Philco Corp., Tioga & C Streets, Philadelphia, Pa.—RADIO & Television RETAILING.

Garod PORTABLE RADIO

Model 4A1 portable personal battery receiver, 4-tube superhet with Alnico speaker. Tunes 550 to 1600 kc, lucite dial over inlaid cloisonne design. Antenna built in lid. Operates on 1 $\frac{1}{2}$ v. "A" battery plus 67 $\frac{1}{2}$ v. "B" unit. Case in two

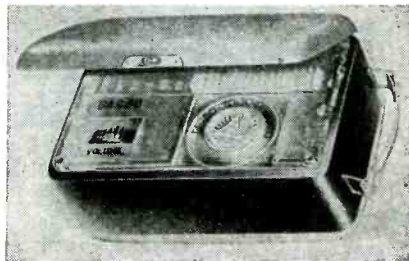

tone color combinations, alligator-grain plastic back and front. Vinylite strap handle. Provision for use of metallic initials, to be placed on the set by the dealer as a method for "personalizing" the receiver. Matching shoulder strap available. Measures 6 $\frac{1}{2}$ " by 3 $\frac{1}{4}$ " by 4 $\frac{1}{8}$ ". \$29.95 less batteries. Garod Radio Corp., 70 Washington St., Brooklyn 1, N. Y.—RADIO & Television RETAILING.

Emerson PORTABLE

Model 551—A portable 3-way superhet receiver with hinged removable cover. Plays on ac, dc, and batteries. Five tubes plus rectifier. 5" PM dynamic speaker.

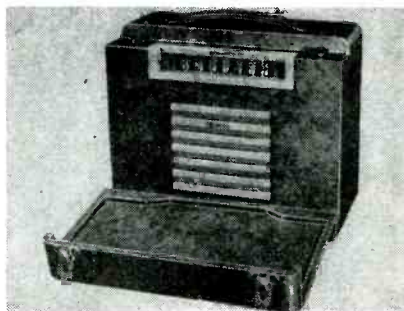

three-gang condenser. Cabinet of simulated leather, \$49.95 less batteries. Emerson Radio & Phonograph Corp., 111 Eighth Ave., New York, N. Y.—RADIO & Television RETAILING.

Majestic COMBO-RECORDER

Model 7YR752 table ac radio-phonograph-wire recorder, with microphone and spool of wire. Records from radio, mike



or record. Tunes 535 to 1620 kc, Alnico 5 PM speaker. Plays 10" or 12" discs manually, long-life needle, crystal pickup. Tone-compensated volume control. Modern design cabinet measures 12 $\frac{3}{16}$ " high 17 $\frac{5}{16}$ " wide by 14 $\frac{3}{4}$ " deep. Majestic Radio & Television Corp., St. Charles, Ill.—RADIO & Television RETAILING.

Clarion PORTABLE RADIO



"Chum" Model 11411 three-way personal portable in streamlined design "all-weather" case. Ac, dc or battery, with battery life rated at over 50 hours of intermittent playing. Selenium rectifier circuit. Housed in light weight aluminum, finished with baked-on enamel in choice of several colors. Front and back covers of Polystyrene plastic. Offered in combination with shadow-box display. Warwick Mfg. Corp., 4640 W. Harrison St., Chicago 44, Ill.—RADIO & Television RETAILING.

(Continued on page 72)

RADIO *& Television* RETAILING DIRECTORY

SEPTEMBER 1947

"Big
4"
PRODUCTS

<i>Radio</i>	Directory page 2
<i>Appliances</i>	Directory page 6
<i>Records</i>	Directory page 10
<i>Service</i>	Directory page 12

COPYRIGHT, 1947, CALDWELL-CLEMENTS, INC.

For the purpose of checking violation of the publisher's copyright or other misuse of this directory, the products or listings have been coded. While these lists may be used for mailing purposes by individual manufacturers, any use of the lists by publishers or commercial mailing services, or any reproduction of the lists in part or whole is strictly prohibited.



RADIO & Television RETAILING • CALDWELL-CLEMENTS, INC.

480 LEXINGTON AVE., NEW YORK 17

Receivers, and Phonographs

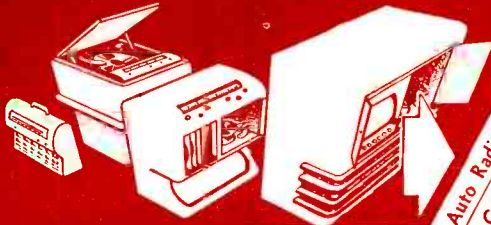

	Auto Radios	Camera & Vest Pocket	Portable, Battery	Portable, Battery & Electric	Table Models	Consoles	FM Home	FM Tuners	FM Tuners (for AM sets & PA)	Television only	Television & AM	Combinations, FM & AM	Combinations, Radio-Phono	Combinations, Recorder-Phono	Phonographs, Recorder-Radio	Phonograph	Phonographs, Electric	Hand-Wound	Recorders, Acoustic,	Recorders, Wire	Converters, Tape	Converters, FM	(Low band to high band)	Kits, radio	Kits, television	Communication Sets, amateur	Communication, Commercial
DuMont Laboratories, Inc., Allen B., 515 Madison Ave., New York 22, N. Y.																											
Duo-Sonic Radio Corp., 700 Elton Ave., New York 55, N. Y.																											
Duval Radio & Television Corp., 423 Grove St., Jersey City 2, N. J.																											
Dynamic Television Associates, Inc., 135 Prince St., Brooklyn 1, N. Y.																											
DYNAPHONE—See Ansley Radio Corp.																											
Dynavox Corp., 40-05 21st St., Long Island City 1, N. Y.																											
Eckenroth Co., 32 Ross St., Brooklyn 11, N. Y. MUSAGRAN																											
Eckstein Radio & Television Co., 918 LaSalle Ave., Minneapolis 2, Minn. KARADIO																											
Effem Radio Products Co., 5170 Easton St., St. Louis, Mo.																											
Electromatic Mfg. Co., 83 University Pl., New York 3, N. Y.																											
Electronics, Inc., 934 Bowen Bldg., Washington 5, D. C. COMRINETTE																											
Electronic Laboratories, Inc., 122 W. New York St., Indianapolis 4, Ind. ORTHOSONIC																											
Electro-Technical Industries, 121 N. Broad St., Philadelphia 7, Pa. TELEKIT																											
Emerson Radio & Phonograph Corp., 111 Eighth Ave., New York 11, N. Y. JEFFERSON-TRAVIS																											
Emor Radio, Ltd., 490 E. 118th St., New York 35, N. Y.																											
Empire Mfg. Co., 1304 W. 8th St., Amarillo, Texas. GRIDIRON																											
Espey Mfg. Co., 528 E. 72nd St., New York 21, N. Y.																											
Fada Radio & Electric Co., 525 Main St., Belleville 9, N. J.																											
Farnsworth Television & Radio Corp., 3700 E. Pontiac St., Fort Wayne 1, Ind., PANAMUSE, CAPEHART																											
Federal Telephone & Radio Corp., 1001 S. Second St., Harrison, N. J.																											
Fiske Products, Bedford, N. Y.																											
FM Specialties, Inc., 168 Washington St., New York 6, N. Y.																											
FREED-EISEMANN—See Freed Radio Corp.																											
Freed Radio Corp., 200 Hudson St., New York 13, N. Y. FREED-EISEMANN																											
Garod Radio Corp., 70 Washington St., Brooklyn 1, N. Y.																											
GAY-TONE—See Alsam Products Co.																											
Geib, Inc., 1757 N. Central Park, Chicago 47, Ill. PLAY-A-TUNE																											
Gem Phono Mfg. Co., 33 West 66th St., New York 19, N. Y.																											
Gem Radio & Television Co., 639 10th Ave., New York 19, N. Y.																											
General Electric Co., Receiver Div., Electronics Park, Syracuse 1, N. Y.																											
General Television & Radio Corp., 2701 Lehmann Ct., Chicago 14, Ill.																											
Giffilian Brothers, Inc., 1815 Venice Blvd., Los Angeles 6, Calif.																											
Great American Brands, Inc., 11 W. 42nd St., New York, N. Y.																											
Greene Co., L. Charlton, 9 Elliot St., Watertown 72, Mass.																											
GRIDIRON—See Empire Mfg. Co.																											
Halicrafters Co., 4401 W. 5th Ave., Chicago 24, Ill.																											
Hamilton Associated Industries, Inc., 325 W. Huron St., Chicago 10, Ill. CAROUSEL																											
Hammarlund Mfg. Co., 460 W. 34th St., New York 1, N. Y.																											
Helco Mfg. Corp., 1282 Burke Ave., Bronx 67, N. Y.																											
Herold Mfg. Co., 1 Romney Pl., Scarsdale, N. Y.																											
Hoffman Radio Corp., 3761 S. Hill St., Los Angeles 7, Calif.																											
Howard Radio Co., 1735 Belmont Ave., Chicago 13, Ill.																											
Industrial Television, Inc., 36 Franklin Ave., Nutley 10, N. J.																											
International Detrola Co., Beard at Chatfield, Detroit, Mich. DETROLA																											
Jackson Industries, Inc., 1708 S. State St., Chicago 16, Ill.																											
Jason Electronics Co., 1331 Halsey St., Brooklyn 27, N. Y.																											
JEFFERSON-TRAVIS—See Emerson Radio and Phonograph Corp.																											
JEWEL BOX—See Compressor Corp. of America.																											
Jewel Radio Corp., 583 6th Ave., New York 11, N. Y. BELLTONE																											
KARADIO—See Eckstein Radio & Television Co.																											
Kingston Radio Co., 1415 N. Webster St., Kokomo, Ind.																											

Receivers, and Phonographs (Continued)



Auto Radios	Camera & Vest Pocket	Portable, Battery	Portable, Battery & Electric	Table Models	Consoles	FM Home	FM Tuners (for AM sets & PA)	Television only	Television & AM	Television & FM	Combinations, FM & AM	Combinations, Radio-Phono	Combinations, Recorder-Radio	Phonographs, Television-	Phonographs, Electric	Hand-Wound	Recorders, Acoustic	Recorders, Wire	Converters, Tape	Kits, radio	Kits, radio (Low band to high band)	Kits, television	Communication Sets, amateur	Communication, Commercial
-------------	----------------------	-------------------	------------------------------	--------------	----------	---------	------------------------------	-----------------	-----------------	-----------------	-----------------------	---------------------------	------------------------------	--------------------------	-----------------------	------------	---------------------	-----------------	------------------	-------------	-------------------------------------	------------------	-----------------------------	---------------------------

Sandwich-Bowen Corp., 4712 Bethesda Ave., Bethesda 14, Md.																								
Scott Radio Laboratories, Inc., 4541 N. Ravenswood Ave., Chicago 40, Ill.																								
SCOTTIE—See Remler Co.																								
Sentinel Radio Corp., 2100 Dempster St., Evanston, Ill.																								
Setchell-Carlson, Inc., 2233 University Ave., St. Paul 4, Minn.																								
Signal Electronics, Inc., 114 E. 16th St., New York 3, N. Y.																								
Simpson Mfg. Co., Mark, 32-38 49th St., Long Island City, N. Y. MASCO																								
SKY WEIGHT—See Continental Electronics, Ltd.																								
Sonata Electronics Corp., 624 S. Michigan Ave., Chicago 5, Ill. TRELA																								
Sonora Radio & Television, Inc., 325 N. Hoyne Ave., Chicago 12, Ill.																								
Sparks-Withington Co., 2400 E. Ganson Ave., Jackson, Mich. SPARTON																								
SPARTON—See Sparks-Withington Co.																								
Sportsview Television Co., 387 Bushwick Ave., Brooklyn 6, N. Y.																								
Steelman Radio Corp., 742 E. Tremont Ave., Bronx 57, N. Y.																								
STERLING—See Sugar Electric Products, Inc.																								
Stewart-Warner Corp., 1826 W. Diversey Parkway, Chicago 14, Ill.																								
Stromberg-Carlson Co., 100 Carlson Rd., Rochester 3, N. Y.																								
Sugar Electric Products, Inc., 319 W. 48th St., New York 19, N. Y. STERLING																								
Sultan Recording Co., 834 Penobscot Bldg., Detroit 26, Mich.																								
Symphonic Radio & Electronic Corp., 292 Main St., Cambridge 42, Mass.																								
Tech-Tone Products, Inc., 211 E. Main St., Gloucester, Mass.																								
TELEKIT—See Electro-Technical Industries																								
Telegrip Radio Co., 1801 S. Washburn Ave., Chicago 8, Ill.																								
Telesonic Corp. of America, 5 W. 45th St., New York 19, N. Y.																								
Tele-Tone Radio Corp., 609 W. 51st St., New York, N. Y.																								
Television Development Labs., Inc., 252 W. 64th St., N. Y.																								
Televox, Inc., 451 S. 5th Ave., Mt. Vernon, N. Y.																								
Telicon Corp., 851 Madison Ave., New York 21, N. Y.																								
TEMPLE—See Templetone Radio Mfg. Corp.																								
Templetone Radio Mfg. Corp., New London, Conn. TEMPLE																								
TOM THUMB—See Automatic Radio Mfg. Co.																								
Tone Products Corp. of America, 351 Fourth Ave., New York 10, N. Y. MERRY-GO-SOUND																								
Tradio, Inc., Asbury Park, N. J.																								
Transvision, Inc., 385 North Ave., New Rochelle, N. Y.																								
Traveler Radio Corp., 571 W. Jackson Blvd., Chicago, Ill.																								
TRELA—See Sonata Electronics Corp.																								
Trylon Radio Laboratories, 3945 N. Broad St., Philadelphia 40, Pa.																								
ULTRATONE—See Audio Industries																								
U. S. Television Mfg. Corp., 3 W. 61st St., New York 11, N. Y.																								
VAGABOND—See ARC Radio Corp.																								
Viewtone Television & Radio Corp., 81 Willoughby St., Brooklyn 1, N. Y.																								
Warwick Mfg. Corp., 4640 W. Harrison St., Chicago 44, Ill. CLARION																								
Waters-Conley Co., 501 First Ave., N. W., Rochester, Minn. PHONOLA																								
Watterson Radio Mfg. Corp., 2700 Swiss Ave., Dallas, Texas																								
Webster-Chicago Corp., 5610 W. Bloomingdale Ave., Chicago 39, Ill.																								
Wells-Gardner & Co., 2701 N. Kildare Ave., Chicago 39, Ill.																								
Westinghouse Electric Corp., Radio Receiver Div., Sunbury, Pa.																								
Wilcox-Gay Corp., Charlotte, Mich. RECORDIO																								
WiRecorder Corp., 7055 Intervale, Detroit 4, Mich.																								
Yale Industries, Inc., 1170 Broadway, New York 1, N. Y.																								
Zenith Radio Corp., 6001 Dickens Ave., Chicago 36, Ill.																								

and Health Appliances



Miracle Electric Co., Div., Miracle Products, Inc., 36 South State St., Chicago 3, Ill.
 Monitor Equipment Co., 640 W. 249th St., Riverdale, New York 63, N. Y.
 Morton Appliance Co., 666 Lake Shore Drive, Chicago 11, Ill.
 Motionair, Inc., 3319 E. Slauson Blvd., Los Angeles 11, Calif.
 National Enameling & Stamping Co., 270 No. 12th St., Milwaukee 1, Wis. NESCO
 National Engineering & Mfg. Co., 213 W. 19th St., Kansas City 8, Mo.
 NESCO—See National Enameling & Stamping Co.
 New Haven Clock & Watch Co., 133 Hamilton St., New Haven, Conn.
 Noblitt-Sparks Industries, Inc., Columbus, Ind.
 ARVIN
 NUMECHRON—See Pennwood Numechron Co.
 Nu-Tone, Inc., Merchandise Mart, Chicago 54, Ill.
 Peariplan Mfg. Co., 123 No. 3rd St., Philadelphia 6, Pa. VIBRA TONE
 Pennwood Numechron Co., 7249 Frankstown Ave., Pittsburgh 8, Pa. NUMECHRON
 Portable Electric Heater Co., 424 Benton St., Detroit 1, Mich. YOUNG
 Premier Vacuum Cleaner Div., General Electric Co., 1900 Superior Ave., Cleveland 14, Ohio
 Prevore Electric Mfg. Corp., 122 18th St., Brooklyn 15, N. Y.
 Radiant Heater Corp., 521 5th Ave., New York 17, N. Y.
 Regina Corp., 54 W. Cherry St., Rahway, N. J.
 Rheem Mfg. Co., 570 Lexington Ave., New York 22, N. Y.
 Rittenhouse Co., A. E., East St., Honeoye Falls, N. Y.
 Robbins & Myers, Inc., Springfield, Ohio
 ROYAL—See Geier Co., P. A.
 Samsun United Corp., 1700 University Ave., Rochester 10, N. Y.
 SANITIZOR—See Air-Way Electric Appliance Corp.
 Scott & Fetzer Co., W. 114th & Locust Ave., Cleveland 2, Ohio. KIRBY
 SELETRON—See Arnold Clock Corp.
 SENTINEL—See Ingraham Co., E.
 Sessions Clock Co., 61 E. Main St., Forestville, Conn.
 Seth Thomas Clocks Div., General Time Instruments Corp., Thomaston, Conn.
 Signal Electric Mfg. Co., Menominee, Mich.
 SILENT BREEZE—See Holcomb & Hoke Mfg. Co.
 Smith Mfg. Co., F. A., 255 N. Union St., Rochester 2, N. Y. FASCO
 Solar Electric Corp., 121 Central Ave., Warren, Pa.
 Son-Chief Electric, Inc., Winsted, Conn.
 SPLEND-AIRE—See Metal-Tex Corp.
 Sprouse Co., V. E., Columbus, Ind. AIR MOVERS
 SURF SEASON-AIR—See G-M Laboratories, Inc.
 Sutton Corp., O. A., KFH Bldg., Wichita 2, Kans.
 VORNADO FAN
 Swartzbaugh Mfg. Co., 1336 W. Bancroft St., Toledo 6, Ohio. EVERHOT
 SWEEPER-VAC—See Holland-Rieger Div., Apex Rotarex Corp.
 Sylvania Electric Products Co., 500 5th Ave., New York, N. Y.
 Telechron Corp., Ashland, Mass.
 Teufen Appliance Co., 49 Central Ave., Cincinnati 2, Ohio.
 Thermador Electrical Mfg. Co., 5119 District Blvd., Los Angeles 23, Calif.
 Titan Mfg. Co., 290 Terrace, Buffalo 2, N. Y.
 Trilmont Products Co., Walnut St. & 24th St., Philadelphia 3, Pa.
 Trutone Products Co., 303 W. 42nd St., New York 18, N. Y.
 UNIVERSAL—See Landers, Frary & Clark.
 Vacuum Cleaner Supply Co., 5981 Broadway, Chicago 40, Ill. MASTER DE LUX
 Verd-A-Ray Corp., 615 Front St., Toledo 5, Ohio.
 VIBRA TONE—See Peariplan Mfg. Co.
 Victor Electric Products, Inc., 2950 Robertson Ave., Cincinnati 9, Ohio. VICTRON
 VICTRON—See Victor Electric Products, Inc.
 Vidrio Products Co., 134 W. 54th St., Chicago 9, Ill.
 VORNADO FAN—See Sutton Corp., O. A.
 Wade-Youmans Co., 223 Hester St., Alliance, Ohio.
 CHROM-EVER
 Warren Simpson Corp., 110 E. 3rd St., Mt. Vernon, N. Y.
 AIRFLOW
 Welch Co., W. W., Glenn Bldg., Cincinnati 2, Ohio.
 AIR-FLIGHT
 Westelox Div., General Time Instrument Corp., LaSalle, Ill.
 Westinghouse Electric Corp., Lamp Div., Bloomfield, N. J.
 Westinghouse Electric Corp., Appliance Div., Mansfield, Ohio
 Winslow Mfg. Co., 114 Manhattan St., Stamford, Conn.
 Wittie Mfg. & Sales Co., 1414 S. Wabash Ave., Chicago 5, Ill.
 Wright, Inc., 2233 University Ave., St. Paul 4, Minn.
 YOUNG—See Portable Electric Heater Co.

Bulbs, Incandescent
 Bulbs, Fluorescent
 Chimes, Door
 Cleaners, Hand
 Cleaners, Tank
 Clocks, Brush Driven, Upright
 Fans, Electric
 Fans, Circulating
 Heaters, Exhaust
 Heaters, Space
 Heaters, Space Combination

Blankets, electric
 Coolers, electric
 Dryers, room-compressor type
 Dryers, hair
 Lamps, infra red
 Lamps, ultraviolet
 Pads, heating
 Shavers
 Sterilizers, bottle
 Vibrators

AIR-FLO—See Warren Simpson Corp.
 Berger Electric Co., 109-01 72nd Rd., Forest Hills, L. I. N. Y.
 Carrier Corp., 302 S. Geddes St., Syracuse, N. Y.
 WEATHERMAKERS
 Casco Products Corp., 512 Hancock Ave., Bridgeport 2, Conn.
 Champion Lamp Works, 600 Broad St., Lynn, Mass.
 Collman Mfg. Corp., 421 W. 12th St., Erie, Pa.
 CORONET—See Lektron Corp.
 Duro Test Corp., 2321 Boulevard, No. Bergen, N. J.
 ELECTRESTEEM—See Electric Steam Radiator Corp.
 Electric Steam Radiator Corp., 1 Electric Ave., Paris, Ky.
 ELECTRESTEEM
 Electrical Industries, Inc., 42 Summer Ave., Newark, N. J. ELECTRA-SERVE
 EMPIRE—See Metal Ware Corp.
 EVERHOT—See Swartzbaugh Mfg. Co.
 Frigidaire Div., General Motors Corp., 300 Taylor St., Dayton 1, Ohio
 General Electric Co., 1285 Boston Ave., Bridgeport 2, Conn.
 General Electric Co., 5 Lawrence St., Bloomfield, N. J.
 General Electric Co., Nela Park, Cleveland, Ohio
 Gravin Corp., 107 E. Main St., Rochester 4, N. Y.
 Hamilton Beach Co. Div., Scovill Mfg. Co., Racine, Wis.
 Hanksraft Co., 1007 E. Washington Ave., Madison 3, Wis.
 Hanovia Chemical & Mfg. Co., 233 New Jersey Railroad Ave., Newark 5, N. J.
 Hytron Radio & Electronics Corp., 76 Lafayette St., Salem, Mass.
 Knapp-Monarch Co., 3501 Bent Ave., St. Louis 16, Mo.
 Landers, Frary & Clark, 47 Center St., New Britain, Conn. UNIVERSAL
 Lektron Corp., 525 W. 45th St., New York 19, N. Y.
 CORONET
 Lobl Mfg. Co., Cambridge St., Middleboro, Mass.
 WARM-O-HOT
 Manning-Bowman & Co., Pratt & Miller Sts., Meriden, Conn.
 Metal Ware Corp., 1702 Monroe St., Two Rivers, Wis.
 EMPIRE
 Miracle Electric Co. Div., Miracle Products, Inc., 36 So. State St., Chicago 3, Ill.
 Monitor Equipment Co., 640 W. 249th St., Riverdale, New York 63, N. Y.
 Morton & Associates, Inc., Henry J., Boulevard Bldg., Detroit, Mich.
 National Stamping & Electric Works, Div., Eureka Williams Corp., 2250 W. Lake St., Chicago 24, Ill.
 WHITE CROSS
 Pacific Mfg. Corp., 5308 Blanche Ave., N. E., Cleveland 4, Ohio
 Palmer Mfg. Corp., 2200 W. Filmont, Phoenix, Ariz.
 SNO BREEZE
 Penetray Corp., 615 Front St., Toledo 5, Ohio
 Philco Corp., C & Tioga Sts., Philadelphia 34, Pa.
 Radiant Heater Corp., 521 Fifth Ave., New York 17, N. Y.
 Remington Rand, Inc., Bridgeport, Conn.
 Rheem Mfg. Co., 570 Lexington Ave., New York 22, N. Y.
 Robeson Rochester Corp., 46 Sager Drive., Rochester 7, N. Y. ROYAL-ROCHESTER
 ROYAL-ROCHESTER—See Robeson Rochester Corp.
 Schick, Inc., 45 Garden St., Stamford, Conn.
 Simson Engineering Co., P. O. Box 508, New Haven, Conn.
 SNO BREEZE—See Palmer Mfg. Corp.
 Solar Electric Corp., 121 Central Ave., Warren, Pa.
 Son-Chief Electric, Inc., Winsted, Conn.
 Sperti, Inc., Beech & Kenilworth Sts., Cincinnati 12, Ohio
 Sunbeam Corp., 5600 Roosevelt Rd., Chicago 50, Ill.
 Sutton Corp., O. A., 501 KFH Bldg., Wichita, Kans.
 Swartzbaugh Mfg. Co., 1336 W. Bancroft St., Toledo 6, Ohio. EVERHOT
 United Thermostable Corp., 16 W. 60th St., New York 23, N. Y.
 UNIVERSAL—See Landers, Frary & Clark
 Vidrio Products Co., 134 W. 54th St., Chicago 9, Ill.
 Walker Co., Middleboro, Mass.
 WARM-O-HOT—See Lobl Mfg. Co.
 Warren Simpson Corp., 110 E. 3rd St., Mt. Vernon, N. Y.
 AIR-FLO
 WEATHERMAKERS—See Carrier Corp.
 Westinghouse Electric Corp., Lamp Div., Bloomfield, N. J.
 Westinghouse Electric Corp., 246 E. 4th St., Mansfield, Ohio
 WHITE CROSS—See National Stamping & Electric Works, Div. of Eureka Williams Corp.
 Wittie Mfg. & Sales Co., 1414 S. Wabash Ave., Chicago 5, Ill.

Phonograph Records and



<p>A-1 Records of America, 16 East 43rd St., New York 17, N. Y. ACME—See Celtic Record Co. Adventure Record Co., 1600 Broadway, New York 19, N. Y. Aladdin Recordings, Inc., 4918 Santa Monica Blvd., Hollywood 27, Calif. Alco Recording Co., 8913 Sunset Blvd., Los Angeles 46, Calif. AMBASSADOR—See Enterprise Records, Inc. Apollo Records, Inc., 342 Madison Ave., New York 17, N. Y. Arista Records, Inc., 512 Pennsylvania Ave., Baltimore 1, Md. Aristocrat Record Corp., 7508 Phillips Ave., Chicago 49, Ill. Atlas Record Co., 6263 Hollywood Blvd., Hollywood, Calif. Audience Records, Inc., 230 Park Ave., New York 17, N. Y. TOP-TEN Ballen Record Co., 1515 Jefferson St., Philadelphia 21, Pa. 20TH CENTURY Banner Records, Inc., 1674 Broadway, New York 12, N. Y. Belda Record & Publishing Co., Pasadena 1, Calif. TALKING KOMICS Bell Records, Inc., 1658 Broadway, New York 19, N. Y. Bell Record Co., 315 Royal Hawaiian Ave., Honolulu, Hawaii Berger Recording, 109-01 72nd Rd., Forest Hills, L. I., N. Y. Besa Records, 1849 3rd Ave., New York 29, N. Y. Bibletone, Inc., 354 4th Ave., New York 10, N. Y. BIG TOWN—See Trilon Record Mfg. Co. Black & White Record Co., 4910 Santa Monica Blvd., Hollywood 27, Calif. COMET Blue Note Records, 767 Lexington Ave., New York 21, N. Y. BRUNSWICK—See Decca Records, Inc. Bullet Recording Co., 2320 12th Ave., South, Nashville 4, Tenn. Capitol Records, Inc., Sunset and Vine, Hollywood 28, Calif. Cardinal Record Co., 521 5th Ave., New York 17, N. Y. Celtic Record Co., 152 West 42nd St., New York 18, N. Y. ACME Chicago, Indianapolis & Louisville Railway Co., 608 So. Dearborn St., Chicago, Ill. MONON Classic Records, 516 W. 55th St., New York, N. Y. Coala Record Co., 1291 6th Ave., New York 19, N. Y. Columbia Records, Inc., 1473 Barnum Ave., Bridgeport 8, Conn. COMET—See Black & White Record Co. Commodore Record Co., 674 3rd Ave., New York 17, N. Y. Concert Hall Society, Inc., 250 West 57th St., New York 19, N. Y. LIMITED EDITIONS Continental Record Co., 265 West 54th St., New York 19, N. Y. CORDION—See Scandinavia Music House, Inc. Coronet Records, Inc., 1629 Broadway, New York, N. Y. Cowboy Record Co., 138 North 12th St., Philadelphia 7, Pa. Crown Records, 8 East 41st St., New York, N. Y. C.R.S. Historical Records, 2060 1st Ave., New York 29, N. Y. Day Distributing Co., 709 E. 29th St., Los Angeles, Calif. MILTONE DC Records, 1425 Van Buren St., N. W., Washington 11, D. C. Decca Records, Inc., 50 West 57th St., New York 19, N. Y. BRUNSWICK DeLuxe Record Co., 19 East Elizabeth Ave., Linden, N. J. Diamond Record Corp., 1650 Broadway, New York 19, N. Y. Disc Company of America, 117 West 46th St., New York 19, N. Y. DOWNBEAT—See Specialty Records, Inc. Eastern Record Mfg. Corp., 5501 43rd Street, Laurel Hill, L. I., N. Y. Empire Record Corp., 2060 1st Ave., New York 19, N. Y. LYRIC Enterprise Records, Inc., 8111 Santa Monica Blvd., Hollywood 46, Calif. AMBASSADOR Exclusive Record Co., 1055 No. Fairfax Ave., Hollywood, Calif. Fantasy Records, 489 5th Ave., New York, N. Y. Folkcraft, 7 Oliver St., Newark, N. J. Four Star Records, Inc., 210 N. Larchmont, Los Angeles 4, Calif. GILT EDGE Franwil Record Co., 427 Orange Ave., W. Haven, Conn. Funnyface Records, Inc., 107-09 Continental Ave., Forest Hills, L. I., N. Y. Gala Records Corp., 350 5th Ave., New York 1, N. Y. GILT EDGE—See Four Star Records, Inc. Globe Record Co., 4714-16 South Hoover St., Los Angeles 37, Calif. Gold Seal Records Co., 333 North Michigan Ave., Chicago 1, Ill. GREETINGSONG—See Picturtone Records, Inc. Hargail Music Press, 130 West 56th St., New York 19, N. Y. Harmonia Records Corp., 1328 Broadway, New York 1, N. Y. Herzog Recording, E. I., 811 Race St., Cincinnati 2, Ohio. RADIO ARTIST Hollywood Rythms Recording Co., P. O. Box 162, Culver City, Calif. Howard Recordings, Mary, 37 East 49th St., New York 17, N. Y. H.R.S. Records, Inc., 303 5th Ave., New York 19, N. Y. Hy-Tone Mfg. & Dist., 1611 S. Wabash Ave., Chicago 16, Ill. Imperial Record Co., 137 N. Western Ave., Los Angeles 4, Calif. INTERNATIONAL—See Phonograph Records, Inc. Jewel Record Co., 7620 Sunset Blvd., Hollywood 46, Calif. Jubilee Record Co., 760 10th Ave., New York 19, N. Y. Juke Box Record Co., 7 West 46th St., New York 19, N. Y. JUMP—See Turntable Jupiter Record Corp., 12 West 18th St., New York 11, N. Y. Keynote Recordings, Inc., 522 5th Ave., New York, N. Y. King Record Co., 1540 Brewster St., Cincinnati 7, Ohio. QUEEN LIMITED EDITIONS—See Concert Hall Society, Inc. Lissen Records, Inc., 255 W. 43rd St., New York, N. Y. Living Language Div., Crown Publishers, 419 4th Ave., New York, N. Y. LYRIC—See Empire Record Corp.</p>	<p>Majestic Radio & Television Corp., 900 North St., Elgin, Ill. MAJOR—See Valentine, Inc., Thomas J. Manor Record Co., 313 W. 57th Street, New York 19, N. Y. Mar-Kee Records, 49 W. 55th St., New York, N. Y. Mayfair Record & Recording Corp., 1650 Broadway, New York 19, N. Y. Mello-Strain Records, Ltd., 1658 Broadway, New York 19, N. Y. Mercury Record Corp., 839 South Wabash Ave., Chicago 5, Ill. MERRY-GO-SOUND—See Tone Products Corp. of America. Mertone Recording Co., 1005 N. 6th Ave., Pensacola, Fla. M-G-M Records, 701 7th Ave., New York 19, N. Y. MILTONE—See Day Distributing Co. Monitor Equipment Co., 640 W. 249th St., Riverdale, N. Y. TOP-TEN ALBUMS MONON—See Chicago, Indianapolis & Louisville Railway Co. Musette Publishers, Inc., 113 West 57th St., New York 19, N. Y. Musicraft Records, Inc., 245 E. 23rd St., New York, N. Y. Music You Enjoy, Inc., 420 Lexington Ave., New York 17, N. Y. National Disc Sales Co., 1841 Broadway, New York 23, N. Y. Night Music Records, 6400 Bartlett St., Pittsburgh 17, Pa. Olympia Record Co., 147 Ridge Road, Lackawanna 18, N. Y. Palda Record Co., 8406 Lyons Ave., Philadelphia 42, Pa. Pearl Record Co., Covington, Ky. Phonograph Records, Inc., 32-58 62nd St., Woodside, L. I., N. Y. INTERNATIONAL Picturtone Records, Inc., 38 Tiffany Place, Brooklyn 2, N. Y. GREETINGSONG Pilot Radio Corp., 37-06 36th St., Long Island City 1, N. Y. PILOTONE PILOTONE—See Pilot Radio Corporation President Records, 712 Louisiana St., Little Rock, Ark. QUEEN—See King Record Distributing Co. RADIO ARTISTS—See Herzog Recording, E. T. Radio Corp. of America, RCA Victor Div., Camden, N. J. Rainbow Records, Inc., 156 West 44th St., New York 18, N. Y. Record Guild of America, 1451 Broadway, New York 18, N. Y. TINY TUNES Resol Mfg. Corp., 103 East 125th St., New York 35, N. Y. ROCKING-HORSE—See Synthetic Plastics Sales Co. Sacred Records, Inc., 207 West Pico Blvd., Los Angeles 15, Calif. Savoy Record Co., Inc., 58 Market St., Newark 1, N. J. Sav-Way Industries, Box 117, Harper Station, Detroit, Mich. VOGUE Scandinavia Music House, Inc., 625 Lexington Ave., New York 22, N. Y. CORDION S. D. Records, 8 S. Dearborn St., Chicago 3, Ill. S & G Records, 1401 Mateo St., Los Angeles, Calif. Seeco Records, Inc., 1893 5th Ave., New York, N. Y. Seva Record Corp., 45 East 49th St., New York 17, N. Y. Signature Recording Corp., 601 West 26th St., New York 1, N. Y. Skating Rhythms Recording Co., P. O. Box 1838, Santa Ana, Calif. Song-of-the-Month Club, 79 Wall St., New York 5, N. Y. Sonora Radio & Television Corp., 730 5th Ave., New York 19, N. Y. Specialty Records, Inc., 311 Venice Blvd., Los Angeles 15, Calif. DOWNBEAT Standard Phono Co., 163 West 23rd St., New York 11, New York Starr Record Co., P. O. Box 1073, San Antonio 6, Texas Sterling Records, Inc., 7 West 46th St., New York 19, N. Y. Stinson Trading Co., 27 Union Square, West, New York 3, N. Y. Sultan Recording Co., 834 Penobscot Bldg., Detroit 26, Mich. Sun Recording Corp., 260 East 161st St., Bronx 51, N. Y. Super Discs, Inc., 1110 7th Street, N. W., Washington, D. C. Synthetic Plastic Sales Co., 461 Eighth Ave., New York 1, N. Y. ROCKING-HORSE TALKING KOMICS—See Belda Record & Publishing Co. Tara Irish Records, Inc., 4903 Girard Ave., Philadelphia 31, Pa. Tempo Record Co. of America, 8534 Sunset Blvd., Hollywood 46, Calif. Tiffany Products, Inc., 200 West 57th St., New York 19, N. Y. TINY TUNES—See Record Guild of America Tone Products Corp. of America, 351 4th Avenue, New York 10, N. Y. MERRY-GO-SOUND TOP-TEN ALBUMS—See Monitor Equipment Corp. TOP-TEN RECORDS—See Audience Records, Inc. Town & Country Record Co., 4068 Easton Ave., St. Louis 13, Mo. Trilon Record Mfg. Co., 3123 San Pablo Avenue, Oakland 8, Calif. BIG TOWN Tune-Disk Records Corp., 1415 Locust St., Philadelphia 2, Pa. Turntable, P. O. Box 622, Hollywood 28, Calif. JUMP TWENTIETH CENTURY RECORDS—See Ballen Record Co. Universal Recording Corp., 20 North Wacker Drive, Chicago 6, Ill. Valentino, Inc., Thos. J., 1600 Broadway, New York 19, N. Y. Vanguard Records, 787 Washington St., New York 14, N. Y. Verne Recording Corp. of America, 1724 Madison Ave., New York 29, N. Y. Vitacoustic Records, Inc., 20 North Wacker Drive, Chicago 61, Ill. VOGUE—See Sav-Way Industries Vox Productions, Inc., 236 West 55th St., New York 19, N. Y. Winant Productions, Inc., 300 West 43rd St., New York 18, N. Y. Willida Records, 1595 Broadway, New York, N. Y. Yale Record Co., 87 High St., Montclair, N. J.</p>
---	--

Record Accessories

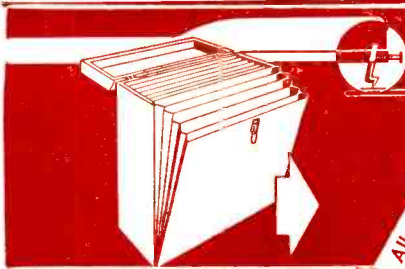

Albums
Blanks, Home Recording
Brushes, Record
Cabinets, Record
Holders, Home Record Storage
Needles, Portable Record, etc.
Racks for Store Display
Systems, Indexing
Counters & Booths

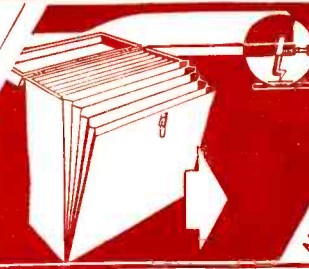

Albums
Blanks, Home Recording
Brushes, Record
Cabinets, Record
Holders, Home Record Storage
Needles, Portable Record, etc.
Racks for Store Display
Systems, Indexing
Counters & Booths

Acton Co., H. W., 370 7th Ave., New York 1, N. Y.
BRILLIANTONE
Adelphia Industries, 419 Arch St., Philadelphia 6, Pa. NATIONAL
Aero Needle Co., 619 North Michigan Ave., Chicago 11, Ill. AEROPPOINT
AEROPPOINT—See Aero Needle Company
Album Corp. of America, 239 St. Marks Ave., Brooklyn 17, N. Y.
Audio Devices, Inc., 444 Madison Ave., New York 22, N. Y. AUDIODISCS
AUDIODISCS—See Audio Devices, Inc.
Bell Radio Co., 125 East 46th St., New York 17, N. Y.
Bialis Mfg. Co., 330 South Paulina St., Chicago 12, Ill.
Bitter Construction Co., A., 721-723 East 133rd St., New York 54, N. Y.
Bonot Co., 114 Manhattan St., Stamford, Conn.
BRILLIANTONE—See Acton Co., Inc., H. W.
Brush Development Co., 3405 Perkins Ave., Cleveland 14, Ohio
Cardinal Co., Louisville, Ohio
Cardwood Products Corp., 201-209 South Second Ave., Mt. Vernon, N. Y.
Chicago Album & Specialty Co., 503 S. Jefferson St., Chicago 7, Ill.
Columbia Industries, 19th Ave. & 36th St., Long Island City 5, N. Y. DISC-PLAY
Columbia Records, Inc., Bridgeport, Conn.
COMBINETTE—See Morton Co., R. P.
Cordell Industries, 41 East 32nd St., New York, N. Y.
Daval Co., 19 West 44th St., New York, N. Y. REGINA
DISC-PLAY—See Columbia Industries
Duotone Co., 799 Broadway, New York 3, N. Y.
Eckenroth Co., 32 Ross St., Brooklyn 11, N. Y.
Electrovox Co., 31 Fulton St., Newark 12, N. J. WALCO
Ellar Woodcraft Corp., 431 West 28th St., New York, N. Y.
Ellis Mfg. Co., 130 West 3rd St., New York 12, N. Y.
FIDELITONE—See Permo, Inc.
Flexograph, Inc., Hamilton Bldg., Ripon, Wis. LUXURATONE
Furniture Specialties Co., 310 Commercial Trust Bldg., Phila. 12, Pa.
Gatti, Inc., Aurele M., 1909 Liberty St., Trenton 9, N. J. SAPHONIC
Gem Phono Mfg. Co., 33 West 46th St., New York 19, N. Y.
Globe Albums, Inc., 3811 3rd Ave., New York 57, N. Y.
Great American Brands, Inc., 11 West 42nd St., New York 18, N. Y.
Hamilton Associated Industries, Inc., 325 West Huron St., Chicago 10, Ill.
Home Recording Products Corp., 50 Mill Road, Freeport, L. I., N. Y. MELODISC
Industrial Sapphire Mfg. Co., 131-35 Avery Ave., Flushing, L. I., N. Y. NORRIS FLAME-TIP
International Merit Products Corp., 254 West 54th St., New York 19, N. Y. MERITONE
Jensen Industries, Inc., 329 South Wood St., Chicago 12, Ill.
JFD Mfg. Co., 4109 Fort Hamilton Parkway, Brooklyn 19, N. Y.
Kane Mfg. Corp., 1451 Broadway, New York 18, N. Y.
LUXURATONE—See Flexograph, Inc.
LYRIC—See Replogle Globes, Inc.
Matthews Co., Howard, 22 West 26th St., New York, N. Y.

MELODISC—See Home Recording Products Corp.
Melody Record Supply Co., 314 West 52nd St., New York 19, N. Y.
MERITONE—See International Merit Products Corp.
Monitor Equipment Co., 640 West 249th St., Riverdale, N. Y.
Morton Co., R. P., 666 Lake Shore Drive, Chicago 11, Ill. COMBINETTE
NATIONAL—See Adelphia Industries
National Hollywood, 1475 El Mirador Drive, Pasadena 2, Calif.
NORRIS FLAME-TIP—See Industrial Sapphire Mfg. Co.
Peerless Album Co., 352 4th Ave., New York 10, N. Y.
Permidex Corp., 3184 Villa Ave., New York 58, N. Y.
Permo, Incorporated, 6415 Ravenswood Ave., Chicago 26, Ill. FIDELITONE
Pfanstiehl Chemical Co., 104 Lakeview Ave., Waukegan, Ill.
Philco Corp., C & Tioga Sts., Philadelphia 34, Pa.
Poland Bros., Inc., 305 S. Sharp St., Baltimore 1, Md. PRESS-A-REC
Portofonic Mfg. Corp., 4116 1st Ave., Brooklyn 31, N. Y.
PRESS-A-REC—See Poland Bros.
Presto Recording Corp., 242 West 55th St., New York 19, N. Y.
Progressive Album Co., 59 Pearl St., Brooklyn 1, N. Y.
Radio Corp. of America, Camden, N. J. RCA Victor Record Div.
Rainbo Record Mfg. Corp., 4335 W. 147th St., Lawndale, Calif.
REC-ALBUMS—See Symons Associates, L. H.
REC-CARRIER—See Shawline, Inc.
RECOBIN—See Recordex Corp.
REC-O-CHEST—See Rose Trunk Mfg. Co.
Recordaid, Inc., 5521 North 5th St., Philadelphia 20, Pa.
Record Plate Co., 16 E. Holly St., Pasadena, Calif.
Record Shop, Chambersburg 1, Pa.
Recordex Corp., 32 University Place, New York 3, N. Y. RECOBIN
Recordise Corp., 395 Broadway, New York 7, N. Y.
Recoton Corp., 251 4th Ave., New York 10, N. Y.
Redi-Rack Corp., 141 West 24th St., New York 11, N. Y.
Reeves Soundcraft Corp., 10 East 52nd St., New York 22, N. Y.
REGINA—See Daval Co.
Replogle Globes, Inc., 315 No. Hoyne Ave., Chicago, Ill. LYRIC
Roberts Industries, Salisbury, Md.
Rose Trunk Mfg. Co., 163 Newport St., Brooklyn 12, N. Y. REC-O-CHEST
SAPHONIC—See Gatti, Inc., Aurele M.
Shawline, Inc., 117 West 25th St., New York, N. Y. REC-CARRIER
Stuart Mfg. Co., 172 Morgan Ave., Brooklyn 6, N. Y.
Symons Associates, L. H., 345 Hudson St., New York 14, N. Y. "TIP-LOC" REC-ALBUMS
TIP-LOC—See Symons Associates, L. H.
United Loose Leaf Corp., 233 Spring St., New York 13, N. Y.
WALCO—See Electrovox Co.
Webstar-Chicago Corp., 5610 W. Bloomingdale Ave., Chicago 39, Ill.
Wilcox-Gay Corp., Charlotte, Mich.

Pilotuner...The Standard of FM Performance



Demonstrate a

PILOTUNER

on Every Service Call!

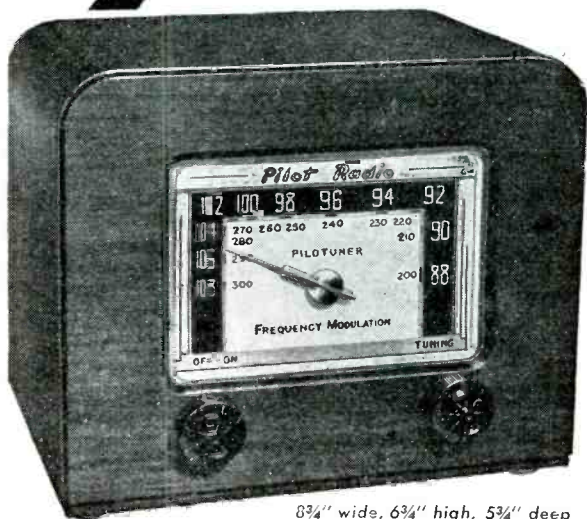

8¾" wide, 6¾" high, 5¾" deep

• Pilot Radio's sensational FM PILOTUNER, which instantly adds fine Frequency Modulation reception to ANY radio, is the most amazing nation-wide success the industry has known in years. It needs but to be heard to be sold! Don't pass up this rich avenue of new business. Have EVERY service man carry a PILOTUNER on EVERY service call. Let him attach it to ANY radio, and show how it delivers the finest FM reception yet achieved—at ANY price! The PILOTUNER retails at only \$29.95 (slightly higher west of the Rockies). Stock it—demonstrate it—see how it "flies" out of your store!



Pilot

RADIO CORPORATION

37-06 36th St., Long Island City, N. Y.

MAKERS OF PILOTONE VINYLITE RECORDS • PIONEERS IN SHORT WAVE • FM • TELEVISION

Collier's holds to America's

"The Age of Acquirement"



Dollar for dollar your advertising budget goes farther in Collier's than in either of the other "Big 3" weeklies. For FEWER DOLLARS you can penetrate the market deeper with more insertions . . . more weeks of national coverage. And you reach a greater percentage of the 25 to 45 year age group—the "Age of Acquirement"—the men and women who know what they want and are ready to buy.

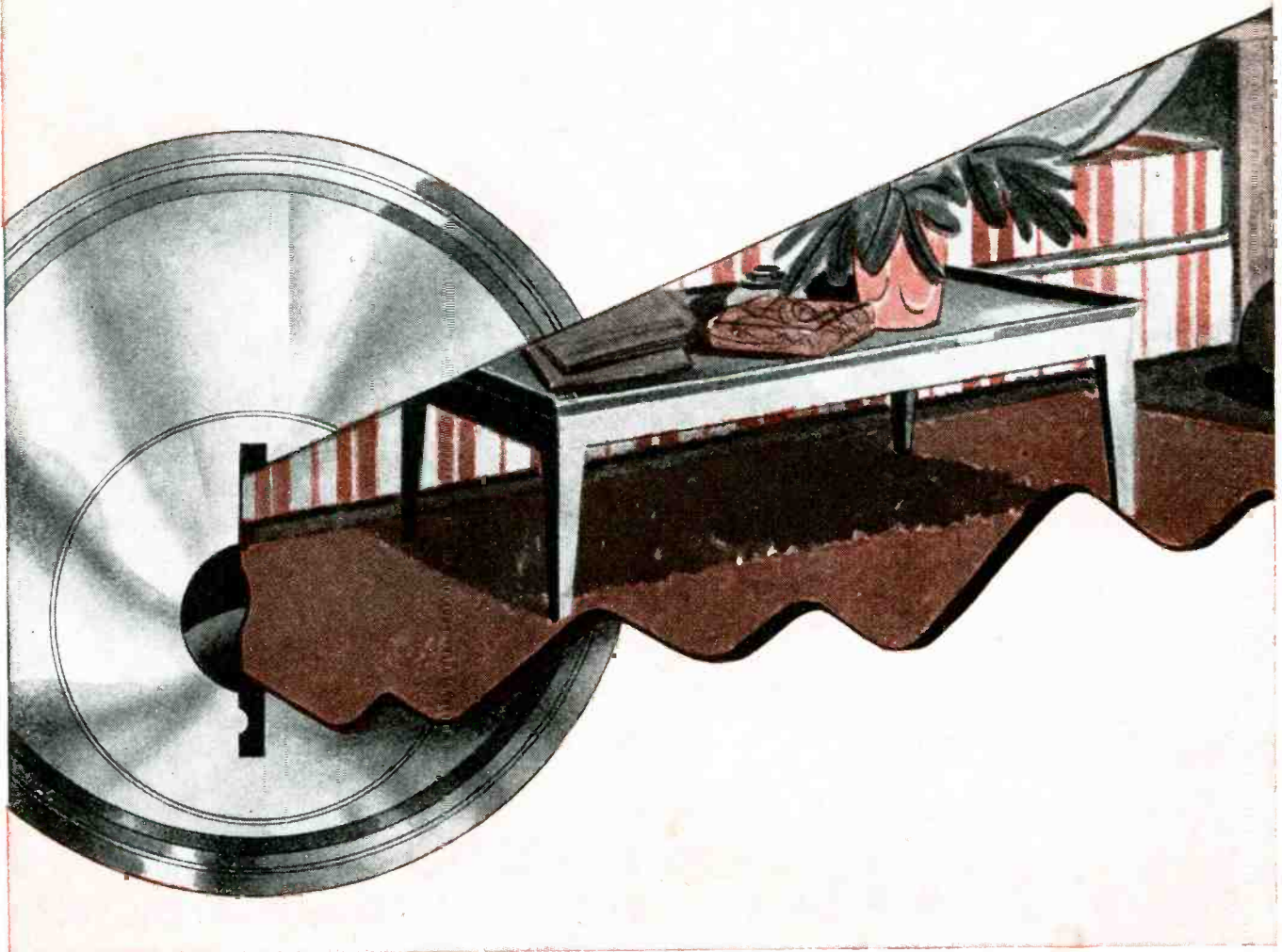

the low-cost key Richest Market...



Collier's
for Action!

New Lines for Fall

RCA-Victor RADIO



Model 66X12 table ac-dc superhet with Golden Throat tone system, 5 tubes plus rectifier. Two-point tone control, built-in magic loop antenna, AVC. Antique ivory finished plastic cabinet with concentric rectangular louvres and high-finished brass-toned ornament in the center. Slide rule type dial with a pointer that frames calibration numbers. Measures 8 $\frac{1}{4}$ " high by 13 $\frac{1}{2}$ " wide by 7 $\frac{1}{4}$ " deep. \$36.95. (Model 66X11 is same chassis in walnut plastic cabinet, \$34.95) RCA Victor Division, Radio Corp. of America, Camden, N. J.—RADIO & Television RETAILING.

Tele-tone PORTABLE RADIO

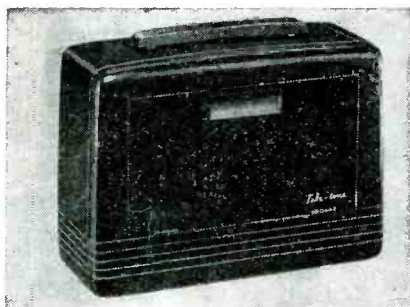

"Constellation" model three-way portable receiver, ac, dc or 67 $\frac{1}{2}$ -volt battery. Drop door front, loop aerial, 4 tubes plus rectifier. Full vision slide rule dial, AVC. Comes in 4 colors—ebony, ivory, sand or maroon. Measures 9 $\frac{3}{4}$ " by 6 $\frac{1}{2}$ " by 3 $\frac{7}{8}$ " and weighs 5 $\frac{1}{5}$ lbs. Tele-tone Radio Corp., 609 W. 51st St., New York, N. Y.—RADIO & Television RETAILING.

UST TELE RECEIVER

Model T-502 (1948) compact console Tele-Symphonic video AM-FM receiver with 54 $\frac{1}{2}$ sq. in. picture. Automatic fre-



quency control, short wave, automatic picture lock-in. Automatic record changer—choice of Seeburg, Webster or Gerrard units handling ten 12" or twelve 10" discs. Picture position planned for more comfortable visibility. Plate safety glass over picture, simplified controls. Two cabinet styles—Georgian design (illustrated) of dark mahogany with selected genuine matched crotch veneers, or modern design of bleached mahogany. Measures 36" wide by 40" high by 22" deep. \$895 including tax; installation with 3 months service is extra. United States Television Mfg. Corp., 3 W. 61st St., New York 23, N. Y.—RADIO & Television RETAILING.

DeWald Portable RADIO

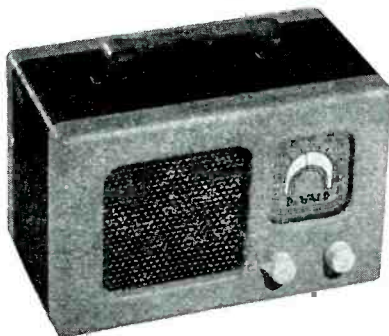

"Companionette" Model B400 portable personal battery radio, tuning 540 to 1700 kc. Dynamic speaker, 4 tube-superhet, AVC, easy-vision tuning dial, self-contained Looplenna. Uses two flashlight battery cells plus one No. 467 Eveready (or equivalent). Two-tone leatherette case measures 8 $\frac{1}{4}$ " long by 4 $\frac{1}{2}$ " deep by 5" high. \$20.95 less batteries. DeWald Radio Mfg. Corp., 35-15 37th Ave., Long Island City, N. Y.—RADIO & Television RETAILING.

Telekit VIDEO KIT

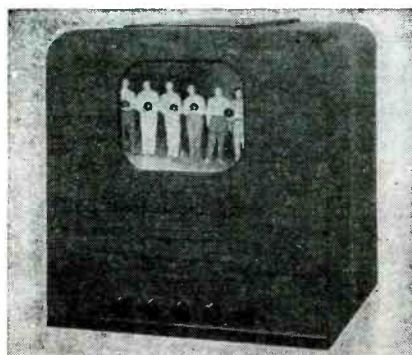

Model 10 television receiver kit with 10" picture tube. Television Training Institute interlock circuit for vertical and horizontal synchronization. Three separate power supplies, pre-tuned IF coils, 5-band switching device. Photos, diagrams and complete instruction for easy assembly. Local Telekit service stations to give help and advice. \$124.50 less tubes. Tubes are \$64.50; cabinet is \$29.50. (Model 7, with 7" picture tube is \$77.50 less tubes). Electro-Technical Industries, 121 N. Broad St., Philadelphia 7, Pa.—RADIO & Television RETAILING.

Admiral COMBO



Model 7C73-9A1 console AM-FM radio-phonograph, 9-tube ac superhet with 12" Alnico 5 speaker. Beam power output, separate AM and FM circuits from power supply. Tunes 540 to 1610 kc for AM and 88 to 108 mc for FM, built-in Aeroscope. Two r-f stages with miniature tubes, permeability tuned throughout. Tilt tuning, bass compensation, AVC, indirectly lighted lucite dial. Record storage space. Cabinet of modern period design—mahogany, walnut or bleached mahogany veneers, inlaid molding. French gold handles. Measures 37 $\frac{3}{4}$ " wide by 36 $\frac{7}{8}$ " high by 16 $\frac{9}{16}$ " deep. \$289.95 for any finish. Admiral Corp., Chicago 47, Ill.—RADIO & Television RETAILING.

Recordio COMBO

Model 7E40 "Traditional" recorder-radio-phonograph with AM or FM-AM as optional feature. Makes recordings from its own mike or built-in radio. Pushbutton function control, large-area, low-impedance antenna loop, 12" PM dynamic speaker. Separate cutting stages, electron-ray tuning and recording volume indicator, microphone booster stage. Slide-out changer-recorder with new pickup cartridge. Large record storage compartment with extra shelf. Mahogany finish cabinet of traditional English period design, solid top construction. Measures 37 $\frac{3}{4}$ " wide by



16 $\frac{1}{2}$ " deep by 37 $\frac{3}{8}$ " high. \$375 plus estimated \$75 for FM chassis. Wilcox-Gay Corp., Charlotte, Mich.—RADIO & Television RETAILING.

(Continued on page 76)

Olympic is first with **FM** at a popular price!



Olympic FM/AM Table Model #7-532

\$39.95
IN
WALNUT

(Ivory slightly higher)

Look at that retail price!
Look at these specifications!

- FM and standard broadcast!
- Full-range tone control!
- Plays anywhere, AC/DC!
- Built-in antennae!
- Illuminated slide-rule dial!
- Full-sized, beautiful table model cabinet in Walnut or Ivory plastic!
- Famous Olympic tone quality!
- To retail for only \$39.95!

Act fast. Shipments begin in September. For further information and descriptive literature, wire or write Olympic Radio and Television, Inc., Long Island City 1, New York.

REMINDER! Olympic's deluxe period console combinations at *popular prices* are becoming the talk of the trade. No sets of comparable quality are available at anywhere near Olympic's prices. Other Olympic models from \$14.95 list. Write for full particulars.

Olympic Radio & Television, Inc.

34-01 38th AVENUE, LONG ISLAND CITY 1, NEW YORK



Clear as a Bell

NEW AM AND FM-AM Radio-Phonographs

by

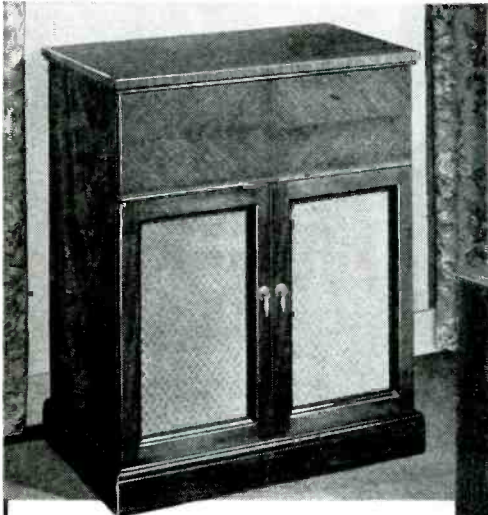

MODEL WTRU-254. The hottest selling console on the market! Priced from \$50 to \$75 below any comparable model! Complete home entertainment—Standard Broadcast, Short Wave, Automatic Phonograph! A top quality console, fine furniture in choice mahogany veneers. With album storage space. Today's biggest console value—gives you the edge on combination sales! **\$149.95**
Model WKRU-254. With FM-AM, **\$179.95**

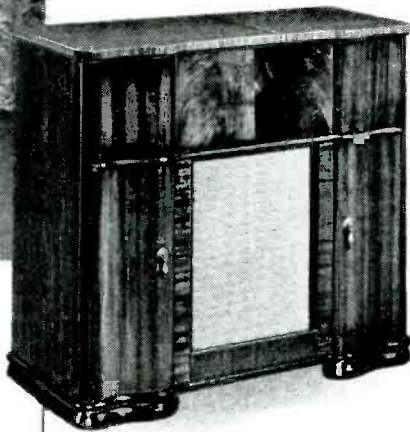

MODEL RMR-245. You'll do a big console business with this magnificent model! It's big (two record storage compartments)—it's fine furniture in rich mahogany—it's complete—Broadcast, Short Wave, Automatic Phonograph! And it's sensibly priced—within the budget of the mass market buyer. It's the model that means volume combination sales! . . . **\$240.00**
Model WLRU-245.
With FM-AM **\$275.00**



MODEL RMR-219. Top-quality combination at an unchallenged price! Luxurious proportions, SONORA-crafted in choice mahogany veneers. Two album storage compartments. Broadcast, Short Wave, Automatic Phonograph. Complete home entertainment, priced to draw in your trade, designed to sell! **\$235.00**
Model WLRU-219. With FM-AM, **\$270.00**
Model WLRU-220. With FM-AM in the beauty of rare Primavera woods, **\$280.00**

(Prices slightly higher in the Far South and West of the Rockies.)

SENSATIONAL FM-AM PLASTIC TABLE MODEL

MODEL WEU-262. Brighten your sales with SONORA'S table model masterpiece! Here's thrilling FM reception and "Clear as a Bell" standard broadcast in a plastic table model cabinet that deserves an "Oscar" for its brilliant styling. Timed right, priced right to take your trade by storm. They want FM. They want fine styling and quality. Give them this SONORA sensation and watch them buy! In Mahogany. **\$59.95**
Model WEU-240. In Ivory. **\$62.95**



SONORA—YOURS FOR STEADY, GOOD BUSINESS

SONORA Franchised Dealers are backed by a 3-Point Policy that has for its goal continuous sales and customer satisfaction—the requirements for steady good business:

QUALITY—Every SONORA model is designed and built to deliver "Clear as a Bell" tone. SONORA styling is market-conscious. SONORA produces fine furniture—crafted in its own wood factory.

DEPENDABLE DEALING—SONORA plays squarely with its Dealers. There's no obsolescence in SONORA merchandise. SONORA helps you move merchandise—protects your investment.

SENSIBLE PRICES—Each and every SONORA model is priced to appeal to mass market buyers—pledged to give more value, more quality, more enduring satisfaction for your customers' money.



COMPLETE HOME ENTERTAINMENT AT ITS BEST

SONORA RADIO & TELEVISION CORP.
325 NORTH HOYNE AVE., CHICAGO 12, ILLINOIS

So New, So Different

and



Clear as a Bell

**5 STEADY
SELLERS**



THE NEW "NIGHTINGALE" BED LAMP-RADIO . . .

Smartest bedtime story ever told! A bed reading light that's kind on the eyes. A "Clear as a Bell" radio for bedtime entertainment. Styled like a dream in gleaming plastic. Compact, fits any bed. Packed with appeal for all of America—this SONORA "First" sells itself on your sales floor. You'll find SONORA'S "Fun in Bed" model a sure-fire seller!

Model WCU-246.
Ivory Plastic . . . \$29.95



Radio Originals

Look to SONORA for the *new* and *different*! Look to SONORA for sales-stimulating models that spark new business for you in every season of the year. Here's the kind of *original* merchandise that means steady good business for you!

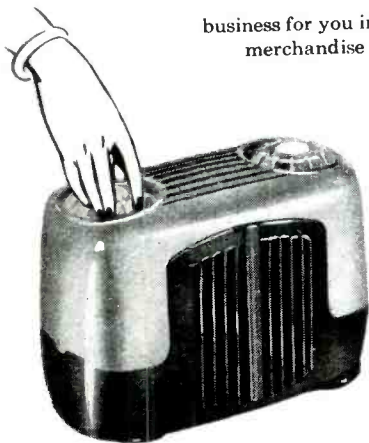

THE "TOP-TUNER"

Here's a fast-selling SONORA original with irresistible eye appeal. Unique in its tasteful styling, rich with "Clear as a Bell" tone—*plus* push-button tuning! Sensibly priced to sell. Here's a model that's *new* and *different*—a table model sales-activator if there ever was one!

Model WAU-243. Ivory . . . \$29.75

*(Prices slightly higher
in the Far South and
West of the Rockies.)*

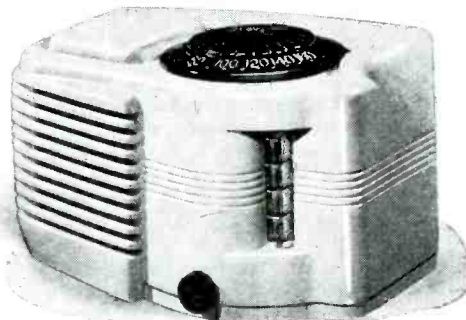

THE SPARKLING NEW "GEMS"

Infinitely smart, refreshingly new—here are the most delightful of all small radios! Jewel-like in their perfection, the "Gems" are the perfect "extra" radio—yet they're truly good enough to serve as the "main" set in the home. For sheer radio cheer and charm in any room, there's nothing like the "Gems!" Available in three lovely colors to meet all the tastes of your trade.

Model WJU-253. Mahogany . . . \$17.95
Model WJU-252. Ivory . . . \$18.95
Model WJU-251. Buff-Burgundy Combination . . . \$19.95

HOME RADIO ENTERTAINMENT AT ITS BEST

SONORA RADIO & TELEVISION CORP. • 325 NO. HOYNE AVE., CHICAGO 12, ILLINOIS



MODEL RDU-209. Smartest table model on the market. Fashioned in rich walnut veneers. Powerful AC-DC Superhet \$39.95



MODEL RBU-175. Features the modern plastic vogue everyone wants. AC-DC Superhet. Mahogany . . . \$23.95
Model RBU-176. Ivory . . . \$25.95

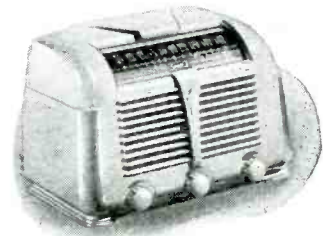

MODEL RZU-248. A peerless plastic model of rare appeal. Powerful, sensitive Superhet. Mahogany . . . \$32.95
Model RZU-222. Ivory . . . \$34.95



MODEL WGFU-242. The popular "Serenade"—America's most distinctive table Radio-Phono. In Mahogany . . . \$39.95
Model WGFU-241. Ivory . . . \$42.50



MODEL RWF-78. The perfect Electric Phonograph—the best-seller in its field. "Clear as a Bell." Mahogany . . . \$24.95
Model RWF-238. Ivory . . . \$26.95

More New Lines Ready

Westinghouse COMBO

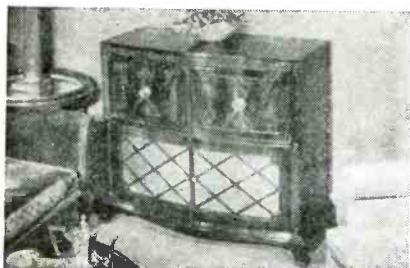

Model 166 radio-phonograph AM-FM console combination with 12 tubes. Electronic Feather tone arm, extra space for record storage, automatic intermix disc changer. Fine-furniture cabinet in mahogany or blonde. Approximately \$379.95. Westinghouse Electric Corp., Sunbury, Pa.—RADIO & Television RETAILING.

Telex HEARING AID

Model 97 hearing aid with air-cushioned, pivot-mounted microphone. Sound aperture of new design—made of opalescent plastic recessed below the case to eliminate noise from clothes rubbing over microphone area. Stainless steel components include battery contacts, clip and case hinge. Case is shelf-locking book-type design of two types of thermosetting material—American Cyanamid Melmac and Plaskon Melamine. Silver spray shielding on interior of case, for protection against neon lamps, etc. Telex, Inc., 1633 Eustis St., Minneapolis 2, Minn.—RADIO & Television RETAILING.

Peirce WIRE RECORDER

Portable magnetic wire recorder, design for office dictation and transcription. Complete with either microphone or foot control. Will reproduce music at manufacturer-guaranteed frequency response of 150 to 5,000 cps at plus or minus 3 db, in addition to voice sounds of desk or phone conversations, inventory taking, news reporting, etc. Special clutch permits frequent and immediate change-over from listening to recording position. Four-way



mixer system for recording multiple conversations. Peirce Wire Recorder Corp., 132 Sherman Ave., Evanston, Ill.—RADIO & Television RETAILING.

TV RECEIVER ASSEMBLY

Television set covers 13 video channels, furnished complete with all components. Low voltage power supply using full wave rectification. Five i-f picture stages of amplification, two sound i-f stages with limiter and discriminator, two video stages of amplification. Complete with

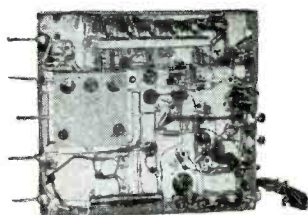

10" picture tube plus 29 RCA tubes. Balanced 300-ohm line to antenna input, aligned and tested. All circuits are delivered wired, tested, tuned and tubed. Dipole antenna with 60-ft. lead-in. 12" PM speaker, advanced sync separator. Complete assembly data and schematics. Chassis measures 19" by 17" by 3". \$229.50. f.o.b. Brooklyn. (\$259.50 with 12" picture tube). Television Assembly Co., 387 Bushwick Ave., Brooklyn 6, N. Y. RADIO & Television RETAILING

Sonora RADIO

"Gem" model ac-dc superhet receiver tuning 535 to 1720 kc. PM dynamic speaker, 4 tubes, antenna built into line cord—no aerial or ground needed. Plastic-molded

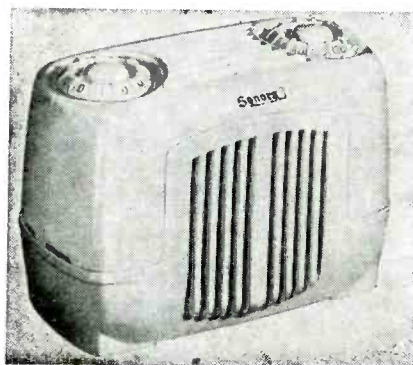

cabinet measures 7 $\frac{3}{4}$ " by 4 $\frac{1}{4}$ " by 5 $\frac{3}{8}$ ". Choice of three colors—walnut at \$17.95; ivory at \$18.95; and the buff-and-burgundy combination at \$19.95. Sonora Radio & Television Corp., Chicago 12, Ill.—RADIO & Television RETAILING.

Gray SET SILENCER

Extension cord plugs in between receiver plug and wall outlet, and carries two push-buttons for silencing set during objectionable "commercials," phone-calls, etc. Push-buttons can be set for different time intervals of shut-off before restoring program. This "Commercial Control" is made by Gray Development Corp., Box 1001, Beverly Hills, Calif. Eastern distributor is Theodore Malcolm, 525 Lexington Ave., New York 22, N. Y. Retail price \$2.95.—RADIO & Television RETAILING.

Motorola COMBO



Model 65F12 table radio-phonograph ac superhet with automatic record changer. Dynamic speaker, 2-position tone control on radio and phono. Aero-Vane built-in loop antenna—outside aerial connection. Tunes 535 to 1620 kc. "Floating Action" changer handles ten 10" or eight 12" discs. Record release spindle to insure longer record life, silent cartridge to minimize record noise. Manual play position for playing one record at a time. Illuminated slide-rule dial. Modern design cabinet in walnut veneer, measures 17 $\frac{1}{2}$ " wide by 11 $\frac{3}{4}$ " high by 16 $\frac{3}{4}$ " deep. Motorola, Inc., 4545 Augusta Blvd., Chicago, Ill.—RADIO & Television RETAILING.

DeJur EXPOSURE METER

Dual-Professional "Lifetime" exposure meter for amateur or professional photographers—new design uses either reflected or incident light to give more accurate calculations of exposure speeds and aperture settings. Eliminates "averaging" of several readings. Lifetime guarantee. \$32.50 with case. DeJur Amsco Corp., Northern Blvd., at 45th St., Long Island City, N. Y.—RADIO & Television RETAILING.

Magnavox COMBO

"Windsor" model radio-phonograph with three chassis—one each for AM, FM, and shortwave. Four speakers, coupled to 45-watt amplifier through a frequency dividing network for more realistic tonal reproduction, 21 tubes. Improved record changer with "pianissimo" pickup, storage room for 250 records behind paneled doors. Cabinet of breakfront, fine-furniture design.



in antique finished Escanaba knotty pine or genuine old world mahogany. \$750. Magnavox Co., 2131 Bueter Rd., Ft. Wayne 4, Ind.—RADIO & Television RETAILING.

Meissner

PRESENTS THE NEW BREWSTER LINE OF TABLE MODEL RADIOS

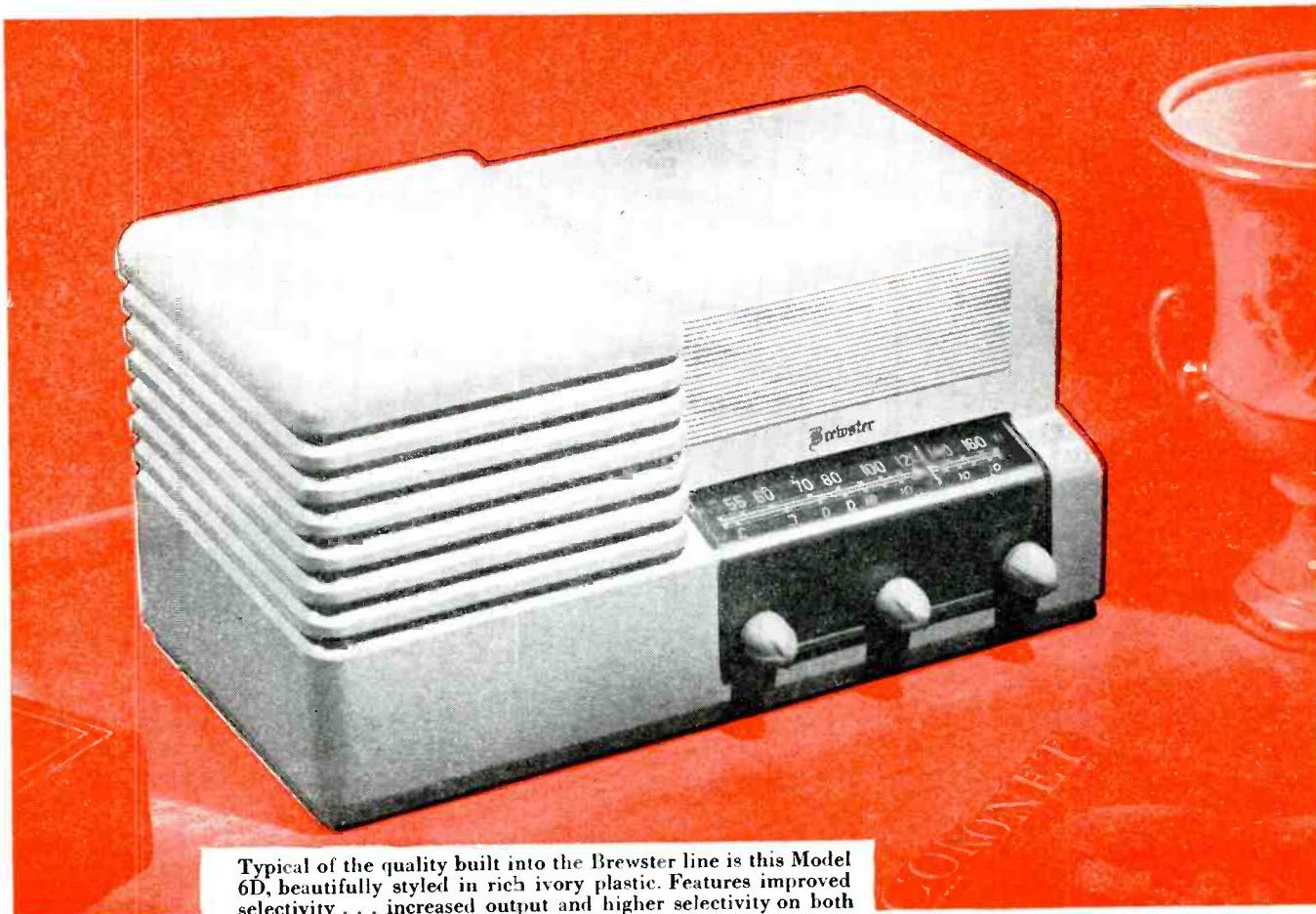

Typical of the quality built into the Brewster line is this Model 6D, beautifully styled in rich ivory plastic. Features improved selectivity . . . increased output and higher selectivity on both broadcast and shortwave bands. Broadcast 540 to 1400 kcs, short-wave 5.75 to 18 mcs. Built-in loop antenna . . . 5 tubes plus rectifier. Operates on 110 volts AC or DC.

Here in these new Brewsters is the outstanding line you have been waiting for! Superbly designed, unmatched for sheer beauty of tone, these completely new sets reflect the skill and craftsmanship that have made the name Meissner a byword for quality in the trade. Encased in cabinets of surpassing charm, they are easily superior to anything now being offered in this field.

Smartly designed, quality engineered, these sets are being manufactured by Meissner for exclusive distribution through parts jobbers only. No quotas, no high-pressure tactics, no "special deals", no sales direct to dealers or special distributors . . . in fact, nothing that might even remotely interfere with your merchandising this new, exclusively-jobber line to the hilt. More than this . . . Meissner unconditionally guarantees the prices on these new Brewsters against reduction for the balance of the year.

This complete line is available for delivery NOW. Wire or write today for full information, prices and illustrated folder.

Meissner

**ELECTRONIC DISTRIBUTOR AND
INDUSTRIAL SALES DEPARTMENT**

MAGUIRE INDUSTRIES, INCORPORATED
936 NORTH MICHIGAN AVENUE • CHICAGO 11, ILLINOIS

EXPORT DIVISION • SCHEEL INTERNATIONAL INCORPORATED
4237 NORTH LINCOLN AVENUE, CHICAGO 18, ILLINOIS • CABLE ADDRESS HARSHEEL

18 years of leadership-

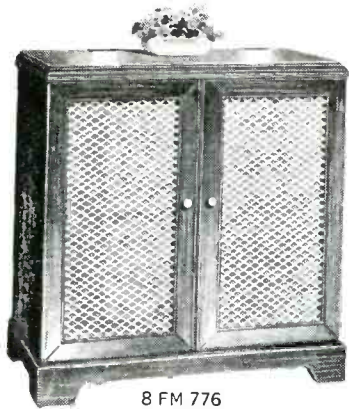

8 FM 776

FM and AM reception. Features the exclusive Noise-Gate circuit that virtually banishes interference. Pull-out automatic record changer. Choice of mahogany, walnut, or blonde finish.



12 FM 779

Your customers won't believe its price! Compares with radio-phonograph combinations costing many dollars more. Features the exclusive FM Noise-Gate circuit, for finer FM reception, further range, less interference. Automatic record-changer. Beautifully styled.

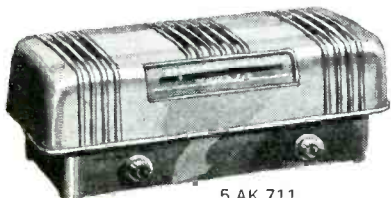

5 AK 711

The colorful Room Mate—baby-sized, and unbeatable in its class! The plastic case comes in a variety of colors, to please every one. Trouble-free performance, far better tone and reception than your customers expect for its price!

CAN BUILD BIGGER PROFITS FOR YOU!

More for your customers—more in exclusive engineering features, more in styling, more in performance—and at less money! That's what Majestic dealers have to offer.

A complete line, featuring models in every price range, for every taste . . . that's what Majestic dealers have to offer.

A name that has been associated with fine radio products for eighteen years—that's what Majestic dealers have to offer!

And—a carefully integrated merchandising plan—dealer helps galore—selling assistance—a smashing national advertising campaign—that's what Majestic dealers get! Investigate now. Waiting won't make you any money!

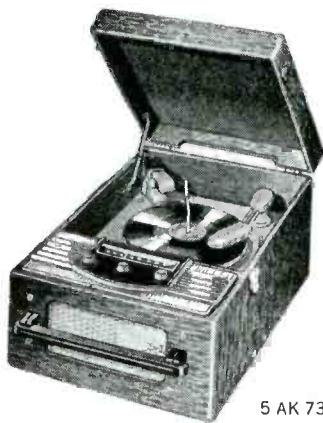

5 AK 731

The ever-popular Frolix—the back-to-schooler's dream radio-phonograph! Light, easy to carry in its handsome case! Automatic record changer. Frolix gives more for the money than any other combination near its price!



7 YR 752

The Majestic Wire Recorder—newest thing in electronics. Customers are fascinated by its ease of operation—its many uses. Combines recorder with radio-phonograph. The newest, hottest addition to the Majestic line—and sells for appreciably less than comparative models!

Majestic
 MONARCH OF THE AIR
 MIGHTY
 NOW MIGHTIER THAN EVER!

RECORDS

Section of **RADIO & Television RETAILING**

Platter Profit-Pointers

FALL SEASON sees trek toward "indoor living" starting again. Retail record sales start upswing this time of the year because folks spend more time at home, and spend more money on "at-home" entertainment.

HOMEMAKERS are more keenly aware of decorating defects when they return from summer vacations, and Autumn is the usual time for "refurnishing." Dealers should stress the importance of furniture storage-cabinets and record albums to customers.

"TIMING is as important in selling as it is in sports," explains one prosperous record dealer. He estimated that approximately 90% of his accessory sales were "tagged-on" to the original order, by being properly suggested at precisely the right moment.

EDUCATIONAL DISCS are an important part of many a record manufacturer's catalog, and they should occupy an equally prominent position in the dealer's store. The beginning of the school year is a particularly good time to hop on the "back-to-school-bandwagon" for those extra sales. (See story page 81.)

AVAILABILITY of most record players should yield the record retailer many "big ticket" sales. Customers who preferred not to buy last

winter, or who waited for the "later" models, will definitely be in the market for a phonograph this season.

LENDING A HELPING HAND to dealers who are busy making plans for Christmas orders of records and accessories, is **RADIO & Television RETAILING's** 1947 Directory. Dealers will find a complete coverage of manufacturers and merchandise in this issue.

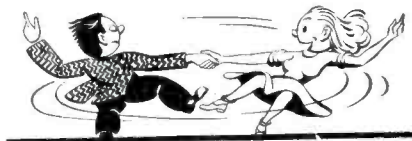

PARTIES to celebrate Halloween, Thanksgiving, football victories, or anything else that comes to mind, are the dealer's cue to bigger and better sales. In addition to the dance records, which the youngsters will go for, college songs, music for group singing, and novelty records can be suggested as extra discs to make the get-together a gay affair.

POSSIBILITY OF a Petrillo tiff with record manufacturers before the end of the year has many retailers wondering. Disc-makers though, are unanimous in opinion that even if the worst should happen, they can still keep stores supplied with re-issues and oldies that are in demand.

RECORDING ARTISTS going in for vaudeville tours in a big way. Booking agents have found that public wants to see its disc favorites in the flesh. Dealers should check with local vaude outlets and find out which platter personalities are scheduled for personal appearances, and plan tie-in windows.

THE \$64 QUESTION in record merchandising is: "Do customers know what they want before they come into the store, or do they decide afterward?" It should make no difference to astute merchants, however, for both categories are in a "buying mood," and receptive to sales talk.

NEW RECORD LABELS are still cropping up all over the country. Midwest has had the greatest influx, with local firms concentrating on hillbilly and religious recordings, as well as popular catalogs which feature names well-known in corn-belt cities.

RECORD PACKAGING is receiving more and more attention from the disc-makers, with cellophane envelopes, novelty folders, and colorful design all coming in for their share of the spot-light. Concentrated effort devoted to the way the records "look" is paying off, dealers find. Merchandise display is facilitated, and discs practically "sell themselves" on visual appeal.

Cash in on your RCA VICTOR ads next month!

POP 11,700,000 ads in "LIFE," "LOOK," and 6 other mags! They display a menu for October that's all gravy for you: new Como and Beneke albums plus a smooth and sultry coupling from a sensational new RCA Victor star!

NOW BACK IN SUPPLY!

A lot of sales are made in these monthly books—"RCA Victor Record Review" and "In the Groove." Next month's ads will remind your customers to ask you for them . . . so check your RCA Victor Distributor to meet your need.



TEX

BENEKE

"Prom Date" (Album P-183, \$3.15). The Miller Orchestra wraps up 8 of the most popular campus tunes. A brand-new album with terrific appeal for every taste . . . every locality! Catch the first rush of sales with an early window display.



PERRY

COMO

"Sentimental Date With Perry" (Album P-187, \$3.15). Eight great favorite songs get the touch of Como's magic! Next month's announcement ads will set off a sellout, so be sure to have plenty of stock on hand . . . and in sight.



BERYL

DAVIS

"It All Came True" and "One Little Tear is an Ocean"—With Toots Camarata and his Orchestra (RCA Victor 20-2426). It's the new hit record by a zooming new star. Get set for next month's Beryl Davis promotion!

RED SEAL 8,200,000 full-page ads! Your "LIFE" page puts sell behind the entire October release and features 3 of the headliners. 2 "TIME" pages feature Horowitz and Maynor.



VLADIMIR HOROWITZ, Pianist: Mendelssohn's *Wedding March and Variations after Liszt*—Horowitz. RCA Victor Red Seal Record 11-9693. Full page in "TIME" Oct. 6.

(Prices shown are suggested list, exclusive of taxes.)



DOROTHY MAYNOR, Soprano: *Sacred Songs*. With the RCA Victor Orchestra, Sylvan Levin, Conductor, and Joseph Fuchs, Violinist. M-1043, \$3.85. Full page in "TIME" Oct. 20.



PAGANINI QUARTET *Quartets No. 7, 8 and 9, Op. 59* ("Rasoumovsky No. 1, 2 and 3")—Beethoven. M/DM-1151, \$5.85; M/DM-1152, \$4.85; M/DM-1153, \$4.85. To be featured in "LIFE" Oct. 27.



PEERCE & WARREN: Three Operatic Duets: *O Mimi tu piu non torni*—La Bohème; *Solenne in questora and In vano Alvaro*—La Forza del Destino. RCA Victor Orch.; Jean Paul Morel, Erich Leinsdorf, Conductors. M/DM-1156, \$2.85. To be featured in "LIFE" Oct. 27.



ELEANOR STEBER: Mozart Arias: *Non so piu cosa son, Guinse Alsin il momento, Deh vieni non tardar*—Marriage of Figaro; *Torture unabating, Firm in thy decision*—Abduction From the Seraglio. RCA Victor Orchestra, Jean Paul Morel, Cond. M/DM-1157, \$3.85. To be featured in "LIFE" Oct. 27.

Big "pop" and Red Seal Sellers are featured on your RCA Victor Show, Sundays (2 PM, EDT, over all NBC stations). Follow up with a tie-in promotion!

RCA VICTOR RECORDS



Educational Discs

Many Extra Dollars to Be Garnered from Specialized Sales Effort

● The start of the school season this month should provide many record retailers with an excellent opening wedge into the field of educational discs. Records that "instruct as well as entertain," have been enthusiastically endorsed by educators and parents, and are rapidly finding their way into the class-room and homes.

The head of the board of education of a big western city sends out monthly bulletins to school principals recommending specific record releases for classroom use. Many schools allot ample portions of their budget to maintain a good record library. Platter dealers can certainly profit from the flurry discs have created in educational circles; they have everything to gain by hopping on the "back-to-school bandwagon" with tie-in displays and a concentrated sales effort.

Dealers are actually rendering a service to the community, and building goodwill for their stores, by setting up a good educational disc display. Records which are used in the classrooms of the neighborhood school, or which are in the school's library, should be listed for all to see. In addition, a list of supplementary discs can be easily compiled by the retailer to serve as a guide for parents.

Effective Display

To announce the establishment of the educational disc department, the dealer should plan a colorful "school days" window, stressing this "painless" form of education. A simple, yet effective display can be evolved through combining girl and boy mannequins listening to a record player, with a large blackboard in the background and chalk notations which get the point of the display across to viewers.

Direct mail contact with members of local parent-teacher groups describing the latest "educational" disc releases, is another form of promotion which usually pays off.

The record companies have been eager to acquaint the public with their efforts in the field of "education" and are expanding their catalogs in this direction.

RCA Victor's newly recorded "Library of Records for Elementary



Grades," will be available this month. Containing 83 unbreakable records, packaged in 21 albums, the complete set is available for \$98.75, or at \$4.75 per album of four records.

The basic needs and desires of primary and upper grades are considered in these RCA Victor albums, which fall into the following categories: Basic rhythmic activities, basic listening activities, basic singing activities, singing games, Christmas album, Indian album, rhythm bands, patriotic songs of America.

Large Selection

Dealers will find many records listed in the general catalogs of the record companies which can be included in any list of suggested records. However, in addition to many of the albums listed under "children's" in its catalog, RCA Victor especially suggests the "Children's Treasury of Music," which was prepared for the help of mothers in the home who wish to present standard types of music to their children, rather than for presentation in the schools.

Operatic, instrumental and vocal albums of interest to upper grades in high schools, recommended by RCA Victor include: "Treasury of Grand Opera" (M-1074, \$4.85), "Heart of La Boheme" (DM-980, \$6.00), "Boris Godounoff" (DM-1000, \$6.00), "Highlights From Madame Butterfly" (DM-1068, \$3.85), "Carmen" (DM-1078, \$7.00), "Scenes From Wagner Operas" (DM-979, \$5.85).

Instrumental albums: "Hungarian Dances" (M-1053, \$3.00), "Kreisler Program" (M-1044, \$3.00), "Lincoln Portrait" (DM-1088, \$2.85), "Organ Recital" (M-1091, \$3.85), "Rossini Overtures" (DM-1037, \$4.85), "Symphonic Dances" (DM-1066, \$3.85), "Till Eulenspiegel's Merry Pranks" (DM-1029, \$2.85).

Vocal RCA Victor albums suggested: "Cantata No. 78 Thou My Wearied Spirit" (DM-1045, \$4.85),

"Folk Songs and Ballads" (M-1086, \$3.00), "Sacred Songs Sung by Dorothy Maynor" (M-1043, \$3.85), "Songs My Mother Taught Me" (11-9153, \$1.00).

Columbia Records catalog also contains a variety of delightful and entertaining educational albums for children. Topping the list are the dramatic doings of Basil Rathbone, in: "A Christmas Carol" (M-MM-521, \$4.00), "Peter and the Wolf" (M-MM-477, \$4.00), "Robin Hood" (M-MM-583, \$5.00), "Treasure Island" (M-MM-553, \$4.00), "Hansel and Gretel" (M-MM-632, \$5.00), "The Adventures of Oliver Twist and Fagin" (MM-700, \$4.00). Other dramatic presentations in the same vein are Errol Flynn's "The Three Musketeers" (M-MM-659, \$5.00), and Maurice Evans' presentation of "Six Excerpts From 'Hamlet'" (M-MM-651, \$4.00).

Additional Columbia albums and singles which can be recommended to round out the lessons learned in music appreciation classes include: "The Young Person's Guide to the Orchestra" (MM-703, \$4.00), "Hansel and Gretel" (MOP 26, \$15.00), "The Sorcerer's Apprentice" (12584-D, \$1.00), "Brazilian Piano Music" (M-MM-692, \$3.25), "Brahms Waltzes" (17407-D, \$.75), "Variations on 'Pop Goes the Weasel'" (4368M, \$.75), "Hungarian Rhapsody, No. 2" (12437D, \$1.00), "Suite Francaise" (MX268, \$3.00), "Music of Morton Gould" (MM668, \$5.00), "Gayne 'Ballet Suite'" (M-MM-664, \$4.00), "Pictures at an Exhibition" (M-MM-641, \$5.00).

Suggested Albums

Decca's "Songs of Safety" records with Frank Luther may be included in any dealer's set-up of discs that "instruct." The same label's "American Heritage" album, provides listeners with insight into American poetry and history.

Disc Co. of America has a wide choice of albums for inclusion in an educational disc display. Suggested from its "folk," "children's albums," "ethnic series," and "documentary" categories are: "America's Favorite Songs, Vol. I and Vol. II" (607, 633, \$3.15 each), "John Jacob Niles —

(Continued on page 102)

Harvest



- 1 RCA Victor's Joseph Szigler performs both solo violin parts in the Bach "Concerto in D Minor."
- 2 Comedy star Eddie Conner is featured in his own album of skits, issued by Top-Ten Records.
- 3 Baritone Alan Dale has waxed "On the Old Spanish Trail" for Signature.
- 4 Freddie Stewart, recording for Capitol.
- 5 Mercury heart-throb, Vic Damone, and his "Ivy" discing crew catching on.
- 6 Josh White sings a tune tribute to the late FDR on new Disc release.
- 7 The zanies of the MGM Record label, The Korn Kobbler, at a wax session.
- 8 Dorothy Shay, the "Park Avenue Mill-billy," made history for Columbia Records during a recent exploitation campaign in Flat River, Mo.



Disc Dollars from Sales

End of Summer Will See New Upsurge in Platter Profits

CLASSICAL WORKS

BACH: "Concerto in D Minor for Two Violins and Orchestra," Jascha Heifetz, violinist, RCA Victor Chamber Orchestra, Franz Waxman, conductor. RCA Victor M or DM 1136

This album is the answer to a music lover's dream—Heifetz playing both solo violin parts. Since dream cannot be realized in the concert hall, the only way to hear this virtuosity is to listen to the album, and customers will be fascinated by Heifetz' performance.

BORODIN-GLAZOUNOFF, BERLIOZ: "Beecham Favorites," Sir Thomas Beecham, Bart., and the London Philharmonic Orchestra. RCA Victor M or DM 1141

Personal Beecham favorites, selections from "Prince Igor" and "The Trojans," cover the three records.

DEBUSSY: "Sonata No. 3 for Violin and Piano," **RAVEL:** "Berceuse," Zino Francescatti, violin, Robert Casadesus, piano. Columbia X-MX-280.

This Debussy sonata is tenderly interpreted by Francescatti and Casadesus.

DVORAK: "Symphony No. 1 in D Major," The Cleveland Orchestra, conducted by Erich Leinsdorf. Columbia M-MM-687

Customers who are familiar with the "New World" symphony will appreciate being exposed to more of Dvorak's colorful native music, as well as the music students who know this work.

RACHMANINOFF: "The Bells," Choral symphony for orchestra, based on poem by Edgar Allan Poe; Jacques Rachmilovich conducting the Santa Monica Symphony Orchestra, with Hollywood First Methodist Church Choir. Disc 804

Rachmilovich broadcast this symphony this past Spring, and the response was enthusiastic by public and musicians alike; portion of proceeds is allotted to Rachmaninoff Fund for needy musicians.

STRAUSS: "Le Bourgeois Gentlehomme," Pittsburgh Symphony Orchestra, Fritz Reiner, conductor. Columbia M-MM-693

Mood and manner of Moliere's comedy recaptured in sparkling Strauss music and Reiner rendition.

WAGNER: "A Wagner Program," Arturo Toscanini and the NBC Symphony Orchestra. RCA Victor M or DM 1135

"Siegfried Idyll," "A Faust Overture," and "Ride of the Valkyries," are included in this outstanding collection, under the masterful baton-wielding of Toscanini.

LIGHT CONCERT FAVORITES

"HOLIDAY FOR STRINGS," David Rose and his orchestra. MGM 3
Rose's title tune, "Holiday for Strings," as well as the modern "4:20 A. M.," "Manhattan Square Dance," and old favorites like "Laura" and "Estrellita" included in album.

"KOSTELANETZ FAVORITES," Andre Kostelanetz and his orchestra. Columbia M-MM-681
Old stand-bys like "Jalousie," "Romance," "Ritual Dance of Fire," and "Yours Is My Heart Alone," receive the melodious Kostelanetz treatment.

STRAUSS: "Die Fledermaus, Waltzes," Leopold Stokowski and the Hollywood Bowl Symphony Orchestra. RCA Victor 10-1310

Popularity of Stokowski's symphonic interpretation of other Strauss waltzes, makes this disc a sure-fire bet for dealers.

"THE STUDENT PRINCE," Al Goodman and his orchestra, with Earl Wrightson, Mary Martha Brinley, Donald Dame, Frances Greer, and the Guild Choristers. RCA Victor K-8

All the enchantment of this sentimental Romberg operetta is preserved and recaptured on wax, in this excellent Goodman offering. The top songs of the show, plus melodious overture, have been recorded.

WOLF - FERRARI, STRAUSS,

RIMSKY-KORSAKOV: "Dance of the Camorristi"—"Tritsch-Tratsch Polka"—"Flight of the Bumble Bee." Carnegie Pops Orchestra conducted by Abravanel. Columbia 7566-M

Three favorites combined on a single 12-inch disc for several very pleasant minutes of listening.

VOCAL ARTISTS

PONS, LILY: "Chansons," sung in French, with orchestra conducted by Abravanel and Kostelanetz. Columbia M-MM-689

Pons' bell-like tones are heard to best advantage in the lovely "Chere Nuit," and Darius Milhaud songs, included in this "impressionistic" album.

TOUREL, JENNIE: "Jennie Tourel in Rossini Arias" (sung in Italian), with the Metropolitan Opera Orchestra conducted by Pietro Cimara. Columbia M-MM-691

Mezzo-soprano Tourel sings four arias from "Barber of Seville," "Cinderella," "The Italian Girl in Algiers," and "Semiramide."

Popular Music

CARLE, FRANKIE: "The Glow-Worm"—"Penguin at the Waldorf." Columbia 37567

The first side is a novelty excellently adapted to Carle's way with a piano.

CASE, RUSS: "As Years Go By"—"Secrets." RCA Victor 20-2344

Both sides are based on classical themes, the first by Brahms, the flip-over on a Tchaikovsky melody. Case embellishes the two with strings and brass for an unusual treatment.

CAVALLARO, CARMEN: "Love Will Keep Us Young"—"Brahms' Hungarian Dance." Decca 24103

The Cavallara pianistics features the Brahms side; Bob Allen does the waltz vocal chorus on the turnover.

(Continued on page 86)

Big Money in Discs

Energetic Mother-Daughter Team Shows

● The rustic, inviting appeal of the Northwest has been incorporated into the interior decorating scheme of The Record Shop, Seattle, Wash. Esther Whitefield, and her mother, Mrs. Elva Whitefield, co-owners of this flourishing Fifth Avenue store in the heart of Seattle's metropolitan district, have endeavored to cater to their customer's musical tastes in an atmosphere of cordial hospitality.

Rapid Growth

Five years ago the mother-daughter duo opened the store for business with a record inventory of approximately \$3000. The phenomenal growth of the Whitefield's record activities is further evinced by the fact that their current yearly inventory is \$14,000, with a yearly turnover rate of 11.

Categories of stock carried during

those first years consisted of 85% classical discs. The pace of the war changed customer's musical tastes, the Whitefield's found, and today the classical-popular ratio is evenly divided. Esther Whitefield feels, however, that slowly but surely, the trend is reverting back to an increased demand for classical recordings.

The store itself consists of a number of inviting "corners"—bordered by "symphonic," "children's" and "jazz" records. Heavy cedar ceiling beams cut across the width and length of the store. Cabinets and accessory trimmings are of this same rustic cedar. Indirect lighting enhances the appearance of the whole interior of the store, from the pale green ceiling, the ivy-patterned wall-paper, to the bright red davenport. An extra note of informality is achieved by throwing a bear-skin across the counter.

As the customer enters the store,

the symphonic works are seen at his left. The Whitefields attempted an innovation in displaying classical albums—and installed thin horizontal aluminum shelves and filed the albums "sideways." Customers seem to like this arrangement because the titles can be read easily.

Good Symphonic Trade

The Record Shop specializes in imported recordings of classical works, and the comfortable "symphony corner" has become a mecca for music lovers. Posters telling of future Seattle and Minneapolis Symphony Orchestra concerts are posted, and customers are encouraged to relax and listen to recordings from past and future programs. A bulletin board is prominently displayed listing programs and pictures of featured artists.

To the right as one enters the store is the record counter and al-



◀ Cedar ceiling beams, ivy-patterned wall-paper, comfortable couch and chairs and flowers are effectively combined in this cozy "symphony corner." Note horizontal album storage-display shelves for classical sets.

▼ Esther Whitefield stands in front of the popular record racks, which are situated on the right-hand side of this Seattle store. Listening booths are located on both sides of the alcove. Pine cones and cedar panels carry out decorating scheme.



for *Enterprising Dealers*

What Records Can Do in Seattle Store

ESTHER WHITEFIELD SUGGESTS SELLING POINTERS:

1. Know what the public wants
2. Capitalize on value of promotional tie-ins
3. Maintain a "personal service" relationship with customers
4. Keep careful inventory
5. Make store a pleasant place in which to browse and buy

bum displays of chamber, violin, and piano music. The popular records are also located on this side of the store. Listening booths are in the rear, with an over-head balcony containing stock-room space and a small office.

Friendly Service

Self-selection is encouraged to a certain extent, but the Whitefields prefer to make friends of their customers, and never ignore an opportunity to talk with them. Both mother and daughter feel that wise buying of discs by the dealer is an important success factor, and combine their knowledge of what the public wants with potential future demand, when placing platter orders.

The Record Shop is located a few doors from one of Seattle's largest theatres, and tie-ins with local movies is a function of normal business operations at this store. The White-

fields have found that artists and tunes which they have promoted by tie-in displays outsell all other discs.

In fact, this concentration on good tie-in window displays garnered a prize trip to New York, with all the trimmings, for Mrs. Whitefield and daughter. The Whitefields walked off with top honors in RCA Victor's contest for dealers presenting the best "Night and Day" window display tying in with the movie.

Abundant energy, a knack for knowing what discs to buy and feature, and wise use of promotional material have combined to enable the Whitefields to build a successful business in a few short years. Future plans call for continuing along the same tried and proven lines of endeavor that have proved to be so profitable and popular in the past.

► One side of the Whitefields' RCA Victor prize-winning window in the "Night and Day" movie tie-in contest. The other store display window featured the opposite "Night" theme, utilizing the same scheme and back-drop ideas.

▼ Not the least part of the reward for the winning window, was a personal meeting with star Perry Como. Here Miss Esther Whitefield, Singer Como, and Mrs. Elva Whitefield, are snapped at the radio studio after a broadcast.

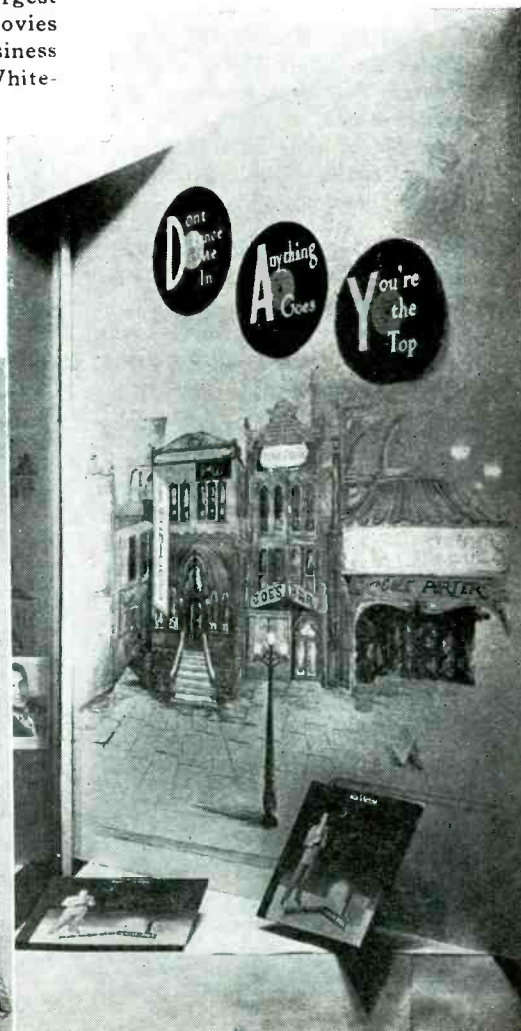

Harvest Disc Dollars from Sales

(Continued from page 83)

CROSBY, BING: "Kokomo, Indiana"—"I Still Suits Me." Decca 24100

"Kokomo," from the film, "Mother Wore Tights," has the Crosby voice blending with the Skylarks; flip is a duet with Lee Wiley.

DALE, ALAN: "On the Old Spanish Trail"—"Ho-Ho-Kus, N. J." Signature 15124

Accompanied by Ray Bloch and his Swing Seven, Dale does some rhythmic crooning on these two sides.

DAMONE, VIC: "Ivy"—"I Have But One Heart." Mercury 5053

The Hoagy Carmichael "Ivy" tune is rising in popularity; so is Damone, who has currently completed several Eastern night-club engagements.

DAVIS, BERYL: "You're Breaking in a New Heart"—"Mother, Mother, Mother." RCA Victor 20-2354

This is the second release by Britain's popular songstress—and it's in the groove.

DAY, DORIS: "I'm Still Sitting Under the Apple Tree"—"When Tonight Is Just a Memory." Columbia 37568

"Apple Tree" side is a follow-up novelty to oldie, "Don't Sit Under the Apple Tree. . . ."

DOSH, JOE: "Apple Blossom Wedding"—"Ask Anyone Who Knows." Continental C-11001

Dosh has been heard on several radio shows, and is currently getting big waxery build-up.

DOYLE, BOBBY: "Jealous"—"Angel Spells Mary"; "There But for You Go I"—"The Heather on the Hill." Signature

Bobby Doyle's smooth vocalizing goes over great, particularly on the Brigadoon tunes, "Heather" and "There But for You."



Eugene Conley, tenor, newly signed by Vox Records.

ELMAN, ZIGGY: "And the Angels Sing"—"Three Little Words." MGM 10047

"Angels Sing" is an Elman tune that won him many fans, who are still rooting for Ziggy today.

FONT, RALPH: "Habenera"—"Candi." Apollo 1073

Pianist Font does two old favorites, with a rhythm accompaniment.

GOODMAN, BENNY: "Dizzy Fingers"—"Tattletale." Capitol B439

Two pieces to display to best advantage Goodman technique and virtuosity.

GOODMAN, BENNY - KENTON, STAN: "Happy Blues"—"Them There Eyes." Capitol A40022

This twosome teamed together for the first time, to make this novelty jazz waxing, complete with running commentary and brilliant music.

JAMES, HARRY: "Love and the Weather"—"Forgiving You." Columbia 37588

Good dancing to Marion Morgan's lyricizing on the first side, and Buddy Di Vito on the flip.

KING COLE TRIO: "That's What"—"Naughty Angeline." Capitol B437

"Angeline," a neat discing; "That's

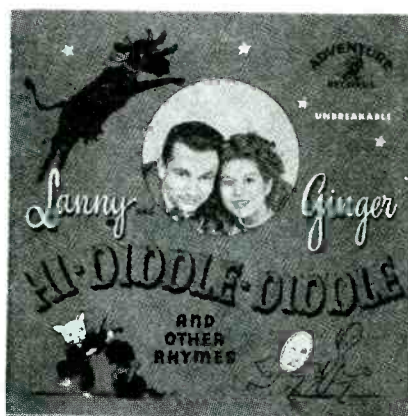

Cover of new Adventure Records album for children.

What" features Nat Cole "scatting" through entirety of disc.

KRUPA, GENE: "Gene's Boogie"—"Disc Jockey Jump." Columbia 37589

First side has Carolyn Grey on the vocals; reverse is a pure Krupa instrumental.

KYSER, KAY: "Naughty Angeline"—"It's Kind of Lonesome Out Tonight." Columbia 37561

A bouncing melody and dreamy tune combined on this disc, with Harry Babbitt vocals.

LAINE, FRANKIE: "All of Me"—"Mam'selle." Mercury 5048

Described by the press releases as "cuddly" and "drooley," this Laine disc is aimed at the teensters.

LAURENZ, JOHN: "When I Write My Song"—"Auf Wiedersehn." Mercury 5060

Baritone Laurenz has appeared in several movies; his mellow bary is pleasing to the ear.

LOESSER, FRANK: "Bloop Bleep." MGM 10044

"Bloop Bleep" is Loesser's tune, and with this recording he joins the



Molly Picon, has recorded "Busy, Busy" for Banner. ranks of the many other tunesmiths who have turned vocalist.

LUND, ART: "What Are You Doing New Year's Eve"—"Naughty Angeline." MGM 10046

"New Year's Eve" is a catchy ballad headed for top tune compilations; reverse is a bouncy rhythm tune that Lund does with ease.

PASTOR, TONY: "I'm Sorry I Didn't Say I'm Sorry"—"The Lady From Twenty-nine Palms." Columbia 37562

Ballad and novelty tune—with Tony coming in for his share of the lyrics on both.

RICHARDSON, LEE: "Deep Six Blues"—"You Gave Me Everything but Love." Apollo 1072

Luis Russell's orchestra provides accompaniment to Richardson's blues lamentations in a deep baritone.

SHORE, DINAH: "Kokomo, Indiana"—"You Do." Columbia 37587

Both tunes are from the film, "Mother Wore Tights."

SMITH, KATE: "Tomorrow"—"Feudin' and Fightin'." MGM 10041

Two fast sides, latter "mountain-er" type tune, swung by Kate, with assistance of Four Chics and Chuck.

(Continued on page 99. For Foreign, Folk, and Children's Records Categories See pages 99 and 101)

FIRST FULL-LENGTH OPERA RECORDING
EVER MADE DIRECT FROM THE STAGE
OF THE METROPOLITAN OPERA HOUSE

HANSEL AND GRETEL

COMPLETE ON

Columbia Masterworks Records

A

Metropolitan Opera Association Production

Not only the first opera ever to be recorded in its entirety on the Metropolitan stage, but the first complete recording of Humperdinck's loved fairy tale classic.

Here is charming music the whole family loves —performed by great opera stars. Feature it now!

With Risé Stevens, Nadine Conner, Thelma Votipka, John Brownlee, Claramae Turner, Lillian Raymond, and Max Rudolf conducting the Chorus and Orchestra of the Metropolitan Opera Association. Two volumes with libretto. Columbia Masterworks Set MOP-26 \$14.70*

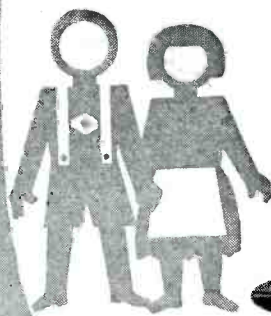

IMPORTANT! When your customers are buying these choice Columbia Records, it's the logical time to recommend the Columbia "Tailored Tip"† Sapphire Needle for ideal record reproduction. Plays up to 10,000 sides. \$1.50 †Trade-mark.



*Price shown is exclusive of taxes and subject to change without notice.

**CONTACT
YOUR**

COLUMBIA RECORDS

DISTRIBUTOR FOR STOCK

Trade-marks "Columbia", "Masterworks" and  Reg. U. S. Pat. Off.

New Phono Lines

Latest Disc-Playing Equipment and Accessories

Record Album VISUALIZER

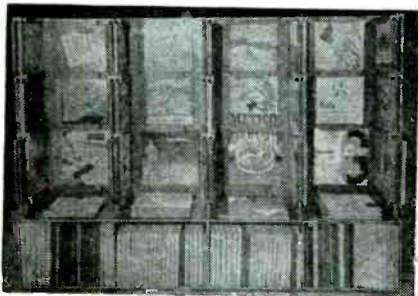

Display merchandiser for store use in showing more albums in small space. Popular model shows 32 ten-inch and 16 twelve-inch albums, with storage space for 90 more. (Classical model holds 32 twelve-inch and 16 ten-inch). Sturdy construction of seasoned wood and masonite finished in light oak lacquer. Can be used in combination with other Record Shop display racks of same height. Measures 76" wide by 15" deep by 53 1/2" high. \$55. The Record Shop, 32 N. Main St., Chambersburg, Pa.—RADIO & Television RETAILING.

Norris Paraglide NEEDLE

Phono needle with solid sapphire shaft and tip. Parabolic point is flame processed (jewel is rotated in flame 3000 to 3600 degrees) for better fit into record grooves. Balanced for smooth gliding; designed for better tone reproduction and less surface noise. High lustre finish to protect records. Triple inspected by microscope and shadowgraph. Packaged in clear view plastic containers. Accompanied by registered guarantee certificate. \$5. (Four others in Norris line of rubies and sapphires—\$1.50 up). Industrial Sapphire Mfg. Co., Inc., 131-35 Avery Ave., Flushing, N.Y.—RADIO & Television RETAILING.

Emerson PORTABLE PHONOGRAPH

Model 548 portable record player with automatic changer. Three-tube amplifier, jewel on-off indicator. Tone arm and turntable retainers. 6" round Alnico 5 PM dy-



amic speaker. Simulated leather cabinet, durable carrying handle. \$59.95. Emerson Radio & Phonograph Co., 111 Eighth Ave., New York, N. Y.—RADIO & Television RETAILING.

Gramavox PHONOGRAPH

Model FF record player with 5-tube amplifier, for music lovers or for professional transcription playback. Dual speed motor handles all standard discs up to 16" to 78 or at 33 1/3 RPM. Two-piece case, with detachable cover, speaker with extra baffle area, 12 ft. speaker cable. Profes-

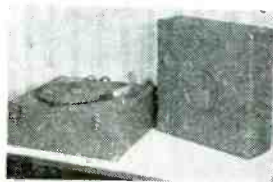

sional lightweight tone arm, permanent sapphire stylus. Recessed design of tone and volume controls, easily accessible. Gramavox Radio & Phonograph Co., 799 Broadway, New York, N. Y.—RADIO & Television RETAILING.

Majestic NEEDLE

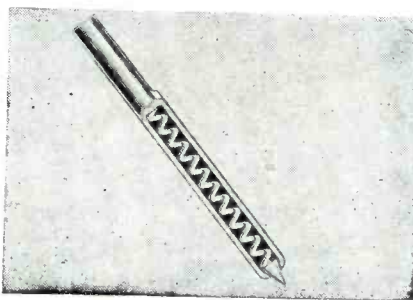

"Dura Jewel" phonograph needle with retractable spring-cushioned sapphire point. Duralumin shank is hollowed out for compressed helical bronzed coil spring, to give steady and flexible pressure on tip. Mirror polished point. Guaranteed for 2 years. \$3.75 (Two companion needles with Eequalloy tips are \$1 and \$1.50) Majestic Radio & Television Corp., Elgin, Ill.—RADIO & Television RETAILING.

Ellis RECORD CABINET

Model 1500 record cabinet of ribbon striped mahogany and birch. Room for about 50 average-sized popular albums. Brass grille door (Model 1510 has wood panel door). Measures 16" by 26" by 30". \$50 to \$80 retail. Ellis Mfg. Co., 130 W. 3rd St., New York 12, N. Y.—RADIO & Television RETAILING.

Farnsworth DISC CHANGER

Model P-56MP automatic disc changer with Tone Clarifier, magnetic pickup, lightweight tubular non-resonant tone arm.



Three-position control switch for (1) "old record", reproducing at lower frequencies and cutting noise, (2) "new record" at middle frequencies, and (3) "wide range" at high frequency. Handles 10" and 12" records only on their edges and drops them on column of air. Base measures 12" by 14 1/2". Farnsworth Television & Radio Corp., Ft. Wayne, Ind.—RADIO & Television RETAILING.

Trylon PHONOGRAPH

Model 60-compact table record player, ac. with Featherweight Shure "Glider" crystal pickup, Alnico 5 PM speaker, 2-tube amplifier. Built-in scratch filter, bass compensation, handles 10" or 12" records. Plywood cabinet, covered with Dupont-coated fabric, decorated with kiddie decals. Trylon Radio Laboratories, 3955 N. Broad St., Philadelphia 40, Pa.—RADIO & Television RETAILING.

JFD NEEDLE

Ruby sapphire phono needle, top one of eleven new needles by JFD—eight for phono, one sapphire for juke boxes, and two cutting styluses. Ruby sapphire quar-

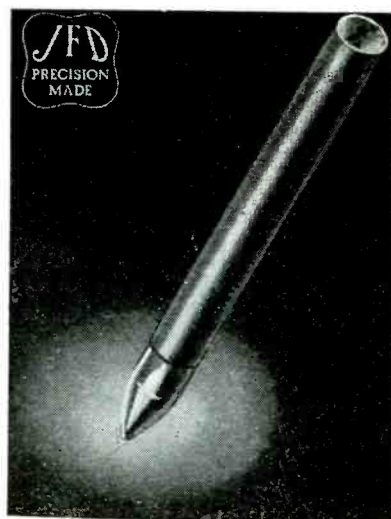

anteed forever by registered certificate. Individually packaged and mounted on 3-color self-selling display cards. JFD Mfg. Co., Inc., 4117 Ft. Hamilton Parkway, Brooklyn 19, N. Y.—RADIO & Television RETAILING.

**EXCLUSIVE PHONOLA
DISTRIBUTORS EVERYWHERE***



Phonola

ACOUSTIC AND ELECTRONIC PHONOGRAPHS

Since 1916 The Name To Remember

Phonola is proud of its more than a quarter century record of leadership in the portable field, and proud too, of the fast-growing network of exclusive distributors . . . with others being added to give world wide coverage.

Eastern Sales Office

17 E. 42nd St. • New York 17, VA. 6-2079

Midwestern and Western Sales Office

224 S. Michigan Ave. • Chicago 4, HAR. 1880

*Factory and Engineering Laboratory
Rochester, Minn.*

WATERS CONLEY COMPANY

ROCHESTER, MINNESOTA

- ARIZONA, Phoenix
Albert Mathias & Company
- ARKANSAS, Little Rock
Home Appliance Distributors of Ark.
- CALIFORNIA, Los Angeles
Sues, Young & Brown, Inc.
- CALIFORNIA, San Francisco
H. R. Basford Company
- CONNECTICUT, Hartford
Roskin Distributors, Inc.
- DISTRICT OF COLUMBIA, Washington
Columbia Wholesalers
- FLORIDA, Jacksonville
Cain and Bultman, Inc.
- GEORGIA, Atlanta
The Yancey Company, Inc.
- ILLINOIS, Peoria
Williams, Inc.
- INDIANA, Indianapolis
Radio Equipment Company
- IOWA, Des Moines
The Roycraft-Iowa Company
- KENTUCKY, Louisville
Electric Appliance Distributors of Ky.
- LOUISIANA, New Orleans
Walther Brothers Company
- MAINE, Portland
Farrar-Brown Company
- MARYLAND, Baltimore
Joseph M. Zamoiski Company
- MASSACHUSETTS, Boston
Columbia Wholesalers, Inc.
- MICHIGAN, Detroit
Republic Supply Corp.
- MINNESOTA, Minneapolis
The Roycraft Company
- MISSOURI, Kansas City
Federal Distributing Company
- MISSOURI, St. Louis
The Artophone Corporation
- NEW JERSEY, Newark
E. B. Latham and Company
- NEW YORK, Albany
Roskin Brothers, Inc.
- NEW YORK, Buffalo
Western Merchandise Dists., Inc.
- NEW YORK, Middletown
Roskin Brothers, Inc.
- NEW YORK, New York
Times-Columbia Dists., Inc.
- NEW YORK, Rochester
Chapin-Owen Company, Inc.
- NEW YORK, Syracuse
Onondaga Supply Company
- NORTH CAROLINA, Charlotte
Southern Bearings and Parts Co.
- NORTH DAKOTA, Fargo
The Larson Company
- OHIO, Cincinnati
Modern Distributing Company
- OHIO, Cleveland
Strong, Carlisle & Hammond Co.
- OREGON, Portland
Appliance Wholesalers
- PENNSYLVANIA, Philadelphia
Trilling and Montague
- PENNSYLVANIA, Pittsburgh
Keys Electric Company
- RHODE ISLAND, Providence
Simons Distributing Company
- TENNESSEE, Memphis
Woodson & Bozeman, Inc.
- TEXAS, Dallas
The Southwestern Company, Inc.
- TEXAS, El Paso
Albert Mathias & Company
- TEXAS, Houston
Crumpacker-Covington Company
- TEXAS, San Antonio
Southern Equipment Company
- VIRGINIA, Richmond
B. T. Crump Company, Inc.
- WASHINGTON, Seattle
Radio Television & Appliance, Inc.
- WEST VIRGINIA, Charleston
Charleston-Electrical Supply Co.
- WISCONSIN, Milwaukee
Radio Specialty Company

(Partial List of Phonola Distributors)

Big Foreign Disc Field, Says Continental Prexy

(Donald H. Gabor, president, Continental Record Co., Inc., New York City, prepared the following article exclusively for RADIO & Television RETAILING.)

Everybody has been watching the big "boom" all over the country in foreign language and international records. Since the re-birth of the record industry eight years ago, these records have reached new heights in popularity.

Even record retailers who are located in neighborhoods with practically no foreign-born population have

established very profitable volumes on their international and foreign language records and found that even during the recent summer "slump," their sales did not "nose-dive" with other records but continued to sell on an even keel because of their staple, "standard" nature. It is important to note that the amount of obsolescence in foreign language and international records is practically nil. They are just as salable today as they were yesterday and as they will be tomorrow.

An interesting development has been the "Americanization" of the tastes of buyers of foreign language

and international records. At one time, virtually all records for this market were pressed from foreign masters. Today, however, the majority of foreign masters are re-recorded in a more American tempo by artists in this country, many of whom have developed as "name" artists in this highly specialized field.

Suppose we examine the market for these records. To begin with,



Donald H. Gabor

the nucleus of the international market is, of course, the tremendous foreign language population in this country which has been estimated at over eleven millions. This group is still more or less concentrated in certain sections of the country and is supplemented by the even larger group of native born Americans of foreign parentage who are spread around in every state of the Union.

Sales Going Up

Both these groups are buyers of both foreign language vocal records as well as instrumentals of foreign origin. However, these same instrumentals, usually referred to as "International Records," are being sold in increasing quantity to the general public by merchandising minded retailers who sell Polish records to this last group as "polkas" and Hungarian records as "Hungarian Gypsy Music" without the slightest difficulty.

Upwards of twelve million foreign language and international were sold in this country last year and all indications point to an even greater sale this year.

Bechet with Columbia

Columbia Records, Inc., has signed Sidney Bechet, jazz musician, to its artist roster. Bechet, virtuoso of the soprano saxophone, has recorded several releases.

750,000 BOUGHT AT \$5.00 EACH

THE FAMOUS DUOTONE "STAR" SAPPHIRE

It must be good!

No wonder Duotone's "Star" Sapphire leads the parade! Its highly polished genuine sapphire tip lengthens record life, eliminates distortion and surface noise... gives months of sparkling reproduction. The only needle laboratory-tested on the record. Guaranteed.

Other Duotone Needles priced from 25¢ to \$50. At better music counters.

Comes in attractive lucite souvenir case

DUOTONE
DUOTONE COMPANY
799 Broadway, New York 3, N. Y.
Stephen Nester, President

HITCH YOUR WAGON TO A "Star!"

More than 2,000,000 money-spending, music-loving prospects see these hard-hitting Duotone national advertisements every month of the year.

TIE IN—KEEP DUOTONE UP FRONT!

We've built up a strong buyer acceptance for the "Star" Sapphire and other famous Duotone products. So, take advantage of an already "softened" market and push Duotone for all you're worth. Watch your efforts pay off in more sales—more profits.

DUOTONE
DUOTONE COMPANY
799 Broadway, New York 3, N. Y.
Stephen Nester, President

EXPORT DEPARTMENT: American Steel Export Co., Inc., 347 Madison Ave., New York 17, N. Y.

WEBSTER CHICAGO

**Solid Advertising and Merchandising Support
to increase your sales and profits**



Webster-Chicago, the top line of record changers, phonographs and wire recorders, back you with hardhitting national advertising and solid merchandising.

WIRE RECORDERS

IN LEADING MAGAZINES having a combined readership of more than **65 MILLION** each issue. Webster-Chicago advertising reaches the people in your community — your prospects and customers. Webster-Chicago national advertising — regularly scheduled — backs you up **100%**.



NYLON PHONOGRAPH NEEDLE

AT POINT OF SALE — Webster-Chicago offers a complete **ADVERTISING** and **SALES PROMOTION** service — supplying you with free mats, mailing pieces, consumer literature, window and counter displays, and permanent counter merchandisers. Get in touch with your Webster-Chicago distributor today.

WEBSTER  CHICAGO
5610 BLOOMINGDALE AVE., CHICAGO 39

The Choice of Music Lovers



FREE MAT SERVICE

POINT OF SALE LITERATURE

DISPLAY MATERIAL

RECORD CHANGERS
PHONOGRAPHS



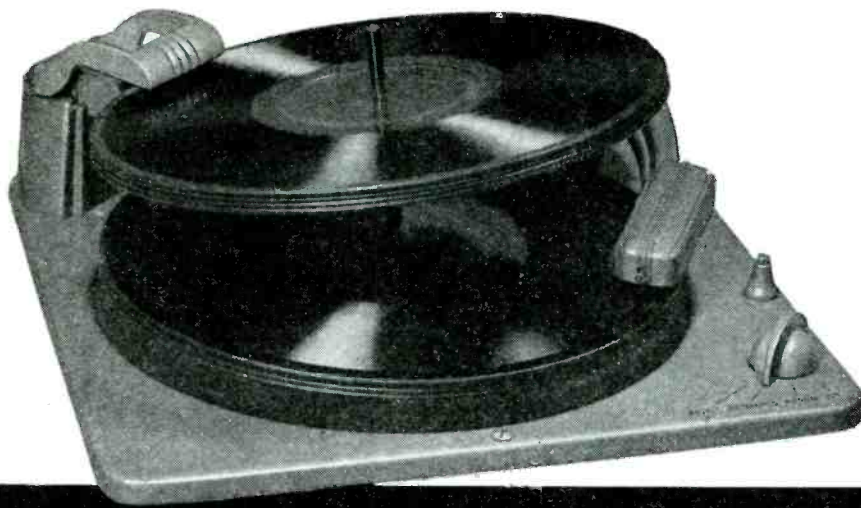

You can say THIS about the latest
MILWAUKEE Record Changer
AND STAND BACK OF EVERY WORD!

- **IT'S RUGGED**—a fine musical instrument which, at the same time, has been designed and built to "stand up and deliver" under all kinds of treatment from all kinds of people. Pick-up arm can be handled while in operation, without damage.
- **IT'S SIMPLE**—not a single gear, belt, pulley or casting in the entire mechanism. Further mechanically simplified to provide the most efficient form of mechanical operation.
- **IT'S QUIET**—free from disturbing mechanical noises. Quiet rapid cycling; silent playing.
- **IT'S AUTOMATIC**—in the full sense of the word . . . not just *some* of the time but **ALL** the time. With the new Ejector Assembly, shuttle operates positively, regardless of thickness or condition of records. Downward tilting of records and selective shuttling action eliminates possibility of dropping more than one record at a time.
- **IT PLAYS BEAUTIFULLY**—the featherweight, resonance-free pick-up provides high fidelity reproduction of the most sensitive recordings or delivers the full-throated crescendo of a robust Sousa march with equal faithfulness.

CHECK THESE

- ✓ Jamproof—impossible to throw unit out of cycle.
- ✓ Patented turn-table spiral actuates cycle with efficiency and dispatch.
- ✓ New, semi-spherical single knob control for all playing positions.
- ✓ Handles up to 12 ten-inch records or 10 twelve-inch records.
- ✓ Incorporates primary features of highest-priced record changers in a very nominally-priced unit.



As "standard equipment", or as an improved type of replacement unit, the MILWAUKEE RECORD CHANGER deserves your serious consideration. Write for further details.

MILWAUKEE STAMPING COMPANY

807 SOUTH 72nd STREET, MILWAUKEE 14, WISCONSIN

Our 53rd Year of Quality Production



Columbia Vocal Artists



Photographed on the Metropolitan Opera Stage during Columbia's recording session of "Hansel and Gretel," are singing stars Rise Stevens, right, and Nadine Conner. This is the first full-length opera to be completed under Columbia's contract with the Metropolitan.

RCA Victor Waxes Opera

RCA Victor Records has completed recording "Four Saints in Three Acts," an opera in English by composer-critic Virgil Thomson, with libretto by the late Gertrude Stein, according to James W. Murray, vice-president in charge of RCA Victor record activities.

According to J. L. Hallstrom, general merchandise manager for the RCA Victor record department, the recorded version of "Four Saints in Three Acts" will be released as a red seal record drama album containing five twelve-inch records and a printed text of the opera, which has a prologue and four acts.

The cast included many singers who participated in the premiere of the work, which received considerable publicity because of the unusual libretto and the cellophane costumes worn by the all-Negro cast.

Majestic Dealer Help



"But now couldn't you just let Eddy Howard try it by himself for awhile?"

Cartoons like the above are available to Majestic record dealers as display posters.

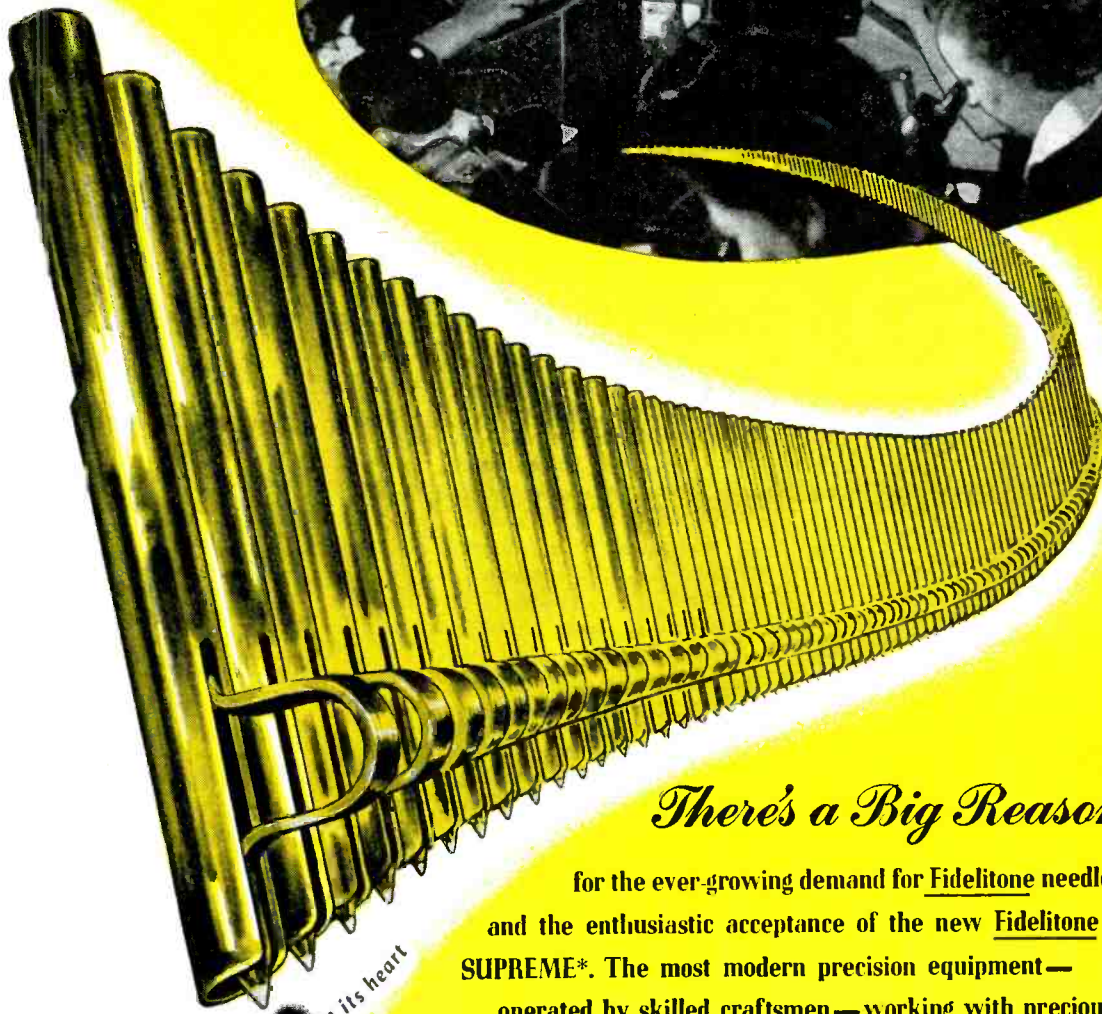

the needle with  Spring in its heart

There's a Big Reason

for the ever-growing demand for Fidelitone needles and the enthusiastic acceptance of the new Fidelitone SUPREME*. The most modern precision equipment—operated by skilled craftsmen—working with precious metals—producing patented designs—regularly inspected during and after manufacture—is the answer.

All this assures the finest needles—of unvarying uniformity—the most for the money; assurance to you of repeat patronage.

The greatest needle of them all is

\$2.50

Beautifully packaged
in a useful record brush



PERMO, Incorporated
CHICAGO 26

More Permo Needles sold than all other longlife needles combined

Fidelitone Supreme

FLOATING
POINT
NEEDLE

THE MUSIC THAT
Never GROWS OLD
ON
CONTINENTAL
Records

THE Music
OF THE OLD WORLD

POLISH
ITALIAN
GREEK
JEWISH
GERMAN
FRENCH
IRISH
SCANDINAVIAN
LITHUANIAN
HUNGARIAN
BOHEMIAN
CROATIAN
SLOVENIAN
SLOVAK

THE Music
OF THE AMERICAS

POLKAS
RACE
HILLBILLY
WESTERN
RHUMBAS
SAMBAS
BOLEROS
POPULAR
ALBUMS

Send for our complete
catalog of over 3000 re-
cordings, growing since
1939.



CONTINENTAL RECORDS

NEW YORK, 265 West 54th Street
CHICAGO, 549 West Randolph St.
CLEVELAND, 626 Huron Road
DETROIT, 415 Brainard Street

Permo Representatives and Execs at Sales Banquet



Permo, Inc., held a gala Fidelitone party for its full-time field representatives at the Edgewater Beach Hotel, Chicago, during its fourth annual four-day sales meeting. Shown at the banquet for company officials and their wives, honoring the representatives are (l. to r.): Hudson, Indianapolis; Fortey, Boston; Suits, New York; Gene Steffens, Permo's vice-president and general sales manager; Van Natter, Atlanta; Hopper & Halliday, Denver; Ryan, Buffalo; McFadden, Columbus; Crowley, Chicago; Goetzen, assistant sales manager; Strother, Dallas; Marsh, Seattle; Smith, Los Angeles.

Peerless Index Albums

The Peerless visible album, features a changeable index which appears on the outside of the album. A Pliofilm cover can be removed from the steel bound frame, and the index inserted. Sturdily built with a rounded wood back and finely bound in fabricoid, the album is cloth bound on the inside for extra strength. The 10-inch size sells for \$2.00, the 12-inch size for \$2.50.

Sacred Distributor

The Radio and Television Equipment Co. of Santa Ana, has been named distributor for Sacred Records in southern California, according to an announcement by Earle E. Williams, Sacred's president.

Winant Kiddie Albums

Following the success of their initial album, "It's Fun to Eat," Winant Productions, New York City, have announced two new releases based on the same instructional entertainment pattern. The two new releases, "Pick 'Em Up and Put 'Em Away at Toytime," and "It's Fun to Be Neat," respectively, teach the child to put away his playtoys and care for his clothing. In each album, new characters are introduced in verse, and set to music. The records are packaged individually in colorful book-like picture folders, depicting the characters and carrying the lyrics so that the child can sing right along with the record. The albums are in Vinylite, and retail at \$1.49 each.

RCA Victor Installs Model Display Window



This model display window has been installed by RCA Victor in the company's new showrooms in Camden, N. J. for use in the exploration and demonstration of merchandising techniques. Shown is a display which emphasizes the value of integrating records and record albums with radio-phonograph consoles.

NEW!
Presto's
Dual-Motor,
Direct Drive!

▶ The new Presto 64-A transcription unit combines a number of radical improvements which are of first importance to broadcast stations, recording studios, and industrial and wired music operators.

▶ The turntable is directly gear-driven at both $33\frac{1}{3}$ and 78.26 rpm and two separate motors are employed — one for each speed. Speed may be changed instantly at any time by turning a mercury switch, without damage to the mechanism. *No frictional, planetary, or belt operated elements are used in this new drive mechanism.*

▶ The following points are of interest: *Motors*—Two 1800 rpm synchronous. *Speed*—Total speed error is zero. *Noise*—At least 50 db below program. *Starting*—Table on speed in less than one-eighth revolution at $33\frac{1}{3}$ rpm. *Adjustment*—Construction is very rugged and no attention whatsoever is required — except lubrication.

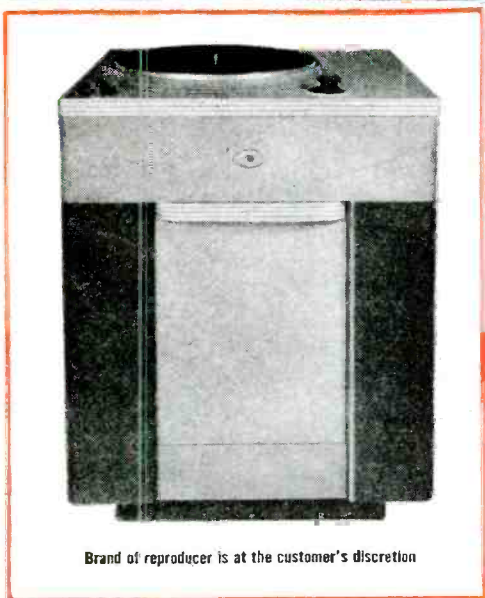
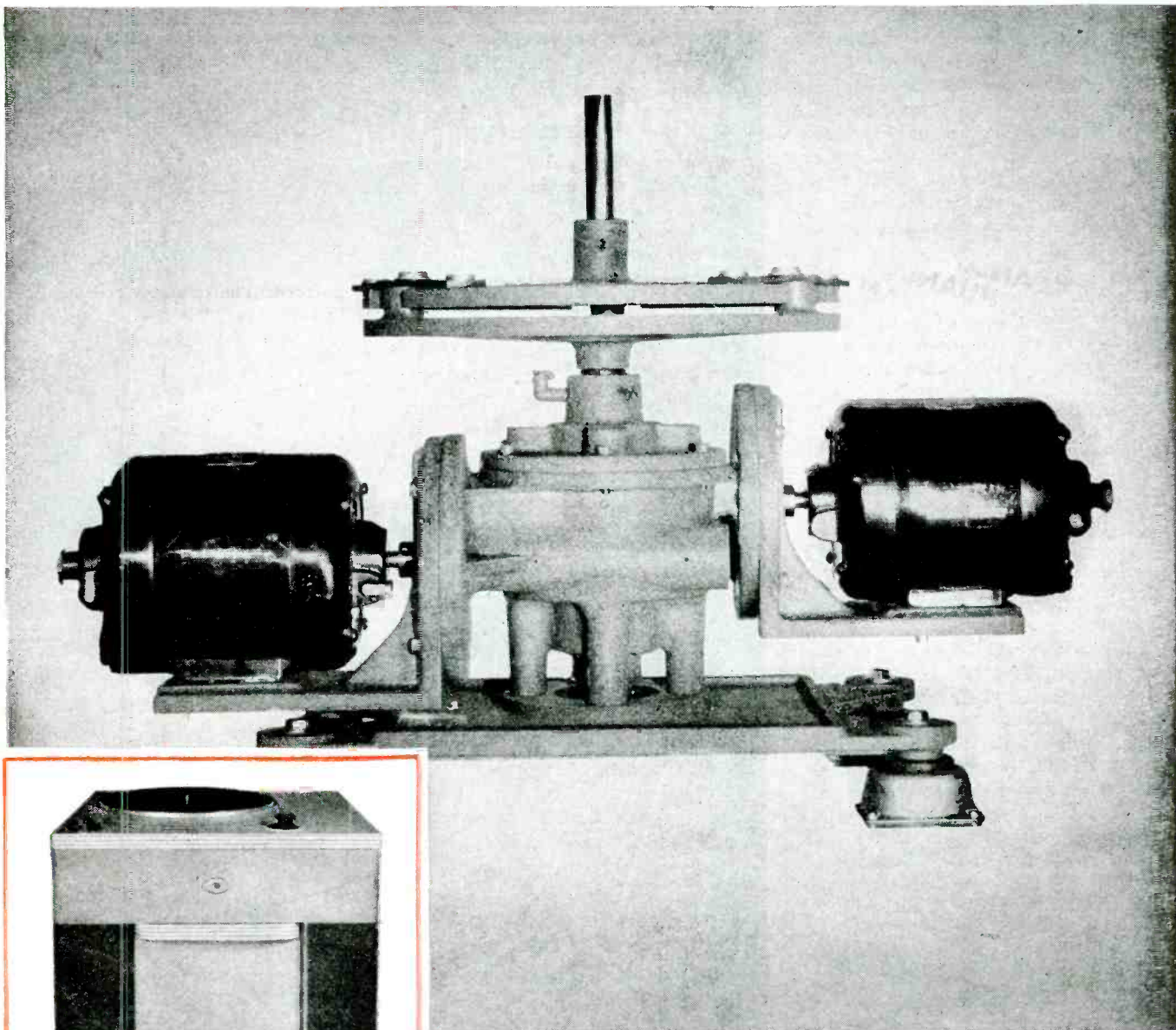

Brand of reproducer is at the customer's discretion

PRESTO RECORDING CORPORATION

243 West 55th Street, New York 19, N. Y. • Walter P. Downs, Ltd., in Canada

FREE! Presto will send you free of charge a complete bibliography and digest of all technical and engineering articles on disc recording published since 1921. Send us a post-card today.

Columbia Export Head

Columbia Records, Inc., has announced that Rudi Tolnay has been appointed export sales manager and will make his headquarters in Bridgeport, Conn. Mr. Tolnay was previously Columbia's district manager in the Philadelphia, Harrisburg, Wilkes-Barre, Baltimore area.

Rainbow Promotions

Rainbow Records, New York City, held a number of specialized promotions in connection with the introduction of its new album, "Romeo Loves Juliet." A series of "D-Days," for disc jockeys was held in large cities, featuring special programs devoted to the new album on their stations. Preview performances for record dealers were held in Boston, Philadelphia, Baltimore and New York, at which the artists featured in the album were presented to the audience.

Dealer aids include a calendar of the album cover, easel cards, and special promotion postcards. Distributors' salesmen were provided with a press book, promoting the album.

Concert Hall Jobbers

Concert Hall Society, New York, specializing in high fidelity classical recordings of unusual kind, has announced the following new distributors: LeRoy H. Bennett Co., San Francisco; Wilford Bros. Co., Los Angeles.

The most recent additions to the Concert Hall Society list of general releases are the Tchaikowsky Second Piano Concerto, Shura Cherkassky, soloist; the Schubert String Quartet No. 1, played by the Guilet Quartet; "Danzon Cubano" by Aaron Copland, a two-piano single played by the composer and Leo Smit; and "Humoreske" by Robert Schumann, recorded by the French master pianist, Paul Loyonnet.

Sacred Records Appointee

Howard Reed, previously connected with the sales department of Sacred Records, Inc., has been named to supervise distribution and sales of new religious musical packages for radio ministers and stations, according to Earle E. Williams, president. Sacred plans to create each package around some special type of music such as choir, organ, quartet, instrumental and soloists and use its nationally known Christian artists in producing them.

Prima with RCA Victor

Louis Prima and his band have been signed to an exclusive RCA Victor contract, James W. Murray, vice-president in charge of RCA Victor record activities announced. Emphasis will be divided between rhythm, production numbers, novelty tunes and Prima originals, several of which are under consideration as platter material.

New Federal Needle

The Federal Sapphire Products Co., Elmhurst, N. Y., announce a new

Euphonic phonograph needle, introduced as the first in a complete line of needles and accessories. The "Federal Euphonic" has a diamond lapped, micro polished sapphire tip for longer life and less record wear. Duraluminum precision formed shank, provides spring action to minimize needle talk and record scratch. The "Federal Euphonic" is micro inspected and shadowgraphed and retails at \$2.50.

An attractive counter display card which mounts twelve needles for easy selling, is available.

VITACOUSTIC Record Hits mean *Record Sales*
"LIVING SOUND"

Record history was made when VITACOUSTIC became the first independent record company to hit a million sales with one record.

WATCH **VITACOUSTIC** for more and better hits!

FOR YOU, MR. DEALER

A high-powered dealer aid program provides you with streamers, mailing pieces, album displays and "Disk-Pac" — "Disk-Play" (the exclusively patented combination display envelope) for stimulating sales. A consistent advertising campaign is carried on to build up popularity and consumer interest.

There's a Vitacoustic Distributor near you!

VITACOUSTIC Records
"LIVING SOUND"
CHICAGO · NEW YORK · HOLLYWOOD

GENERAL OFFICE & STUDIOS
42nd FLOOR
20 N. WACKER DRIVE
CHICAGO 6, ILL.

Vox Records Expands

George H. Mendelssohn, president of Vox Records, announced that Vox is currently operating nationally, with 22 distributors, merchandising records in albums only. In a move to broaden the scope of the Vox catalog, Mendelssohn announced the formation of a new "contemporary" series to be directed by vice-president Larry Green, and Bill Simon.

The new "Spotlight Series" has been defined as: "Designed to throw the phonographic spotlight on outstanding and significant personalities in the musical world. Toward this end albums issued will feature material that we feel has contributed to the development of new art forms based on the expressions of authen-

tic folk material and attitudes. This includes improvised jazz, folk songs and dances, European specialties, operettas, etc."

Apollo Signs Three Harpers

The Three Harpers, harmonica group, have been signed by Apollo Records, New York City. Billy Daniels, is another newly signed Apollo artist.

Tiffany Distributors

Tiffany Productions, New York City, has announced the appointment of the Garden State distributors, Newark, N. J., as jobbers for the northern N. J. vicinity. Ruth Chatterton is featured in Tiffany's recent children's album, "Revolt of the Alphabet."

Permo Dealer Help

Permo, Incorporated, manufacturers of Fidelitone floating-point needles, has a new dealer help ready. It features an actual Fidelitone Master needle in its package, surrounded by a brilliant display background in a multitude of colors. This easel-display is available through all Fidelitone distributors.

In addition to being a sales stimulator of exceptional effectiveness, the board carries a tamper-proof needle supply on its back—an ingenious stock and dispenser unit. To fill, the dealer removes the lid from a one-dozen-tube of Master needles and lets them drop into the dispenser chamber.

New Tempo Disc Bag

Tempo Record Company of America, Hollywood, Calif., has announced that all Tempo custom made records are to be individually packaged in heat-sealed cellophane bags. Richard Weil, in charge of advertising and sales promotion for the company, explained that "In delivering our records thus, we're giving the ultimate consumer our personal assurance that the record he buys comes to him in the same perfect condition as when it received its final rigorous inspection at our pressing plant."

NAMM Membership Peak

The National Association of Music Merchants (NAMM), has announced that under the direction of George L. Byerly, chairman of the membership campaign committee, NAMM membership forged to its all-time high during the recent trade show and convention. Mr. Byerly, in announcing his retirement as committee chairman, praised the cooperation received from his entire committee and the many co-workers throughout the country. Hugh F. Randall, newly-elected secretary, was appointed chairman of the membership committee.

New Electrovox Plant

The Electrovox Co., manufacturers of Walco phonograph needles, announce the acquisition of a new and larger plant at 66 Franklin Street, East Orange, New Jersey.

Branch offices will remain unchanged at 224 S. Michigan Avenue, Chicago, Ill., and in Los Angeles, Calif., at 2216 West 11th St.

R. G. Walcutt, vice-president, states that stepped-up demand for needles by both radio-combination manufacturers and the general consumer made it imperative for the company to enlarge production facilities.

VITA *acoustic* from Coast to Coast

"LIVING SOUND"

Maryland Dist. of Cal.
BARNETT DISTRIBUTING CO.
8 West 20th Street
Baltimore, Maryland

Sa. Texas
CROWE-MARTIN DISTRIB. CO.
1619 La Branch
Houston 3, Texas
1123 Commerce
San Antonio, Texas

Colorado Utah Idaho New Mexico
Wyoming Montana
DAVIS SALES COMPANY
1010 Seventeenth Street
Denver, Colorado

North Carolina Virginia
DIXIE RECORD SUPPLIERS
731 West Cary Street
Richmond, Virginia

Vitacoustic Records are distributed by top organizations throughout the country, ideally located to give you fast service. Our hits reach our distributors immediately after pressing. There's a Vitacoustic Distributor near you.

Western Arkansas No. Texas
Oklahoma
DOBBS-SKINNER, INC.
2624 Elm Street
Dallas, Texas

South Carolina
F & F ENTERPRISES
114 Hay Street
Fayetteville, N. C.

Mississippi
GRIFFIN MUSIC CO.
607 West Capital
Jackson, Mississippi

Cincinnati Area
Kentucky
KLAYMAN'S DISTRIBUTING CO.
521 West Sixth Street
Cincinnati, Ohio

Illinois Wisconsin Indiana
JAMES H. MARTIN, INC.
1407 Diversey Parkway
Chicago, Illinois

Mass. Maine Vermont
New Hampshire Rhode Island
MASS. MUSIC DISTRIBUTORS
1269 Tremont Street
Boston, Mass.

No. Calif. No. Nevada
Washington Oregon
MELODY SALES CO.
369 Sixth Street
San Francisco, Calif.

Missouri Kansas Nebraska
MILLNER RECORD SALES
110 North 18th Street
St. Louis, Missouri

Tennessee E. Arkansas Louisiana
MUSIC SALES CO.
680 Union Avenue
Memphis, Tennessee

Canada
MUSICAL PARADE SUPPLIERS REG.
274 St. John Street
Quebec, Que., Canada

Michigan
PAN-AMERICAN RECORD DISTS.
3747 Woodward Avenue
Detroit, Michigan

Ohio
PAN-AMERICAN RECORD DIST.
633 Huron Road
Cleveland, Ohio

Ontario
RECORD DISTRIBUTING CO.
1018 Queen Street, West
Toronto, Ontario, Canada

Alabama
RECORD SALES COMPANY
2117 Third Avenue, North
Birmingham, Ala.

Georgia
RECORD SALES COMPANY
351 Edgewood Avenue
Atlanta, Georgia

Iowa South Dakota
RENIER RADIO & TELEVISION CO.
531 Main Street
Dubuque, Iowa

Eastern Pennsylvania Delaware
DAVID ROSEN
855 North Broad St.
Philadelphia, Pa.

Florida
TARAN DISTRIBUTING CO.
Miami, Florida
90 Riverside Avenue
Jacksonville, Florida

Western Pennsylvania
West Virginia
TRIANGLE RECORD DISTRIBUTORS
1901 Fifth Avenue
Pittsburgh, Pennsylvania

Minnesota
North Dakota
VITA RECORD DISTRIBUTING CO.
1350 East 61st Street
Chicago, Illinois

Sa. Calif. Ariz. S. Nevada
VITA RECORD DISTRIBUTING CO. OF CALIF.
2822 West Pico Blvd.
Los Angeles, Calif.

New York Connecticut
No. New Jersey
VITA RECORD DISTRIBUTING CO. OF NEW YORK
7523 Empire State Bldg.
New York, N. Y.

distributors of the Newest Music Sensation "LIVING SOUND"

**A NEW RECORD
CABINETS PRICED
for TODAY'S MARKET!**

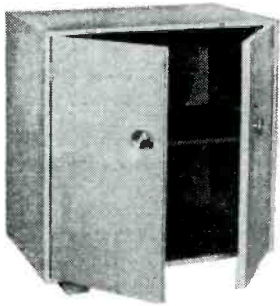

**Swedish Modern
Sectional
Record Cabinets**

Covered in
Simulated Leather

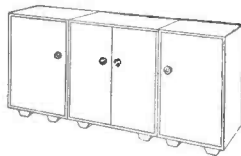

No. 700—Double tier cabinet 18 x 30 x 32"—constructed of heavy half-inch plywood covered with eggshell twill back simulated leather. Two flush doors 13/16" thick oak with concealed radio hinge, cast brass knobs. Cabinet interior lined with maroon simulated leather. Packed one to carton. Approximate weight 65 lbs.

38⁹⁵

No. 701—Same construction features as No. 700—18 x 18 x 32"—single door—choice of left or right hand opening. Packed one to carton—Approximate weight 28 lbs.

19⁵⁰

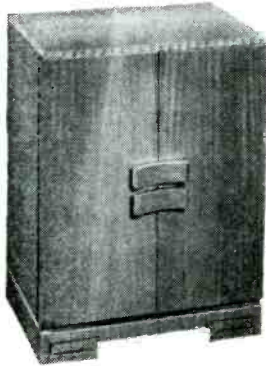

**CHINESE MODERN
RECORD CABINET**

No. 500—24 x 18 x 32"—constructed of 3/4" mahogany or walnut veneer with solid doors. Concealed full-length piano hinges. Invisibile dividers for albums. Hand rubbed satin finish in mahogany, walnut or bleached blonde. Packed one to a carton. Approximate weight 50 lbs.

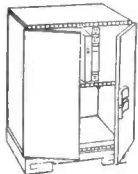

39⁹⁵

All Cabinets
Immediate
Delivery
F. O. B.
Philadelphia, Pa.

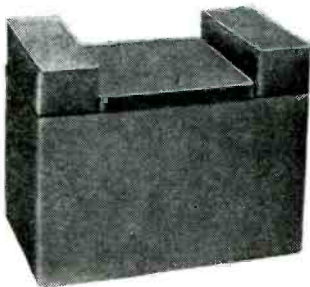

**MULTI-PURPOSE
RECORD BAR
Upholstered in
Simulated Leather**

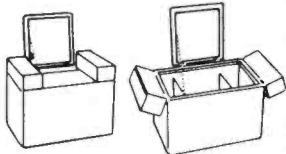

No. 325—Holds up to 130 records—size 26 x 15 1/2 x 20 1/2". All outside covering in heavy moleskin back simulated leather, padded with 100% cotton felt. Comfortable as an easy chair. Maroon, green, yellow, eggshell, blue. Packed one to a carton. Weight 45 lbs.

12⁹⁵

Write for Catalog of Record Cabinets—\$11.95 to \$39.95

FURNITURE SPECIALTIES CO.

Commercial Trust Building

15th & Market Streets, Philadelphia 2, Pa.

Your **1947**

"Big 4"

DIRECTORY

is in **THIS** issue of

**RADIO & Television
RETAILING**

Including Radio and Television Today

**Use it as a Buying Index — now
and for 12 months to come**

The first and only postwar directory of "Big 4" merchandise for retailers is a 1947 reappraisal of sources of supply telling WHO makes WHAT in the four main groups of products sold by retailers—radio, appliances, records and service. Many of the listings are supplemented by advertisements giving further information. Although this issue has the usual four-section makeup, the directory material is concentrated in one place, beginning on page 53 for quick, easy reference.

Note these features

- ✓ Up-to-the-minute product listings.
- ✓ Compact yet comprehensive.
- ✓ Convenient quick-finding arrangement.
- ✓ Fingertip sources of supply for dealers, distributors and service establishments.

Whether you need a complete line or a single product, write to the manufacturer at once asking for full details, mentioning this directory.

CALDWELL-CLEMENTS, INC.

480 Lexington Avenue, New York 17, N. Y.

Disc Dollars

(Continued from page 88)

THE MODERNAIRES: "Something in the Wind"—"The Turntable Song." Columbia 37569

Catchy lyrics, smartly sung feature both sides.

TORME, MEL: "One for My Baby"—"A Little Kiss Each Morning." Musicraft 15107

"Whispering" Torme, with his definite rhythmic flair, sings his way pleasantly through the two sides.

VAUGHAN, SARAH: "Body and Soul"—"Everything I Have Is Yours"; "I'm Through With Love"—"Lover Man." Musicraft 494,499

With a sense of deep blues, the inimitable Vaughan gal vocalizes the four sides.

WHITE, JOSH: "The Man Who Couldn't Walk Around"—"Apples, Peaches and Cherries." Apollo 157

Proceeds from this disc go to Infantile Paralysis Fund; first side is a tribute to FDR.

WHITING, MARGARET: "You Do"—"My Future Just Passed." Capitol B438

"You Do" from musical film, "Mother Wore Tights"; flip is from another movie, "Safety in Numbers."

"AMERICAN WALTZ ALBUM," Ray Bloch and his Orchestra. Signature

Melodious waltz collection, with "The Shadow Waltz," "Alice Blue Gown," and "Three o'Clock in the Morning" bringing back memories.

"CLASSICS IN BLUE," Lena Horne. Black & White

Mercury Promotion



"Kokomo, Indiana," Mercury waxing by Two Ton Baker, was the basis of a promotional campaign right in the city of the same name. McClellan's, local store, featured the display shown.

"Frankie and Johnny Fantasy," "Beale Street Blues," and "My Man's Gone" included in this blues collection by Lena Horne.

"TANGO WITH CUGAT," Xavier Cugat and his orchestra. Columbia C-132

Latin-American rhythm favorite comes up with "tango" tunes, that are familiar to everyone. "Jalousie," "La Cumparsita" and "Adios Muchachos" included.

"WALTZ TIME," Abe Lyman and his orchestra. Columbia C-136
Eight famous waltz numbers, rang-

ing from "La Golondrina" to "I'm Falling in Love With Someone," presented by Abe Lyman.

NOVELTY MUSIC

"AMOS N' ANDY"; Top Ten Records (Audience Records, Inc.)

Radio duo perform in series of sketches entitled: "Amos and the Kingfish Learn About Politics," "Andy and the Kingfish Parking the Car," "Kingfish Examines Andy for Eye Glasses," "Kingfish Sells Andy

(Continued on page 100)



HERE IS A SOUND MERCHANDISING CAMPAIGN OF REAL DEALER . . .

VALUE!



DON'T BREAK PRECIOUS RECORDS!

PEERLESS PROTECTO-FLAP ALBUMS will protect your records against slippage and breakage. No matter how you turn them, these ingenious albums will keep your records IN, and dust and dirt OUT. Bound in sturdy leatherette and handsomely embossed in three colors, PEERLESS PROTECTO-FLAP ALBUMS hold 12 records, and cost no more than ordinary blank albums.

*Reg. U.S. Pat. Off.

PEERLESS gives you a sure-fire promotion featuring the exclusive Protecto-Flap Albums

FREE
4 smart mat ads designed for eye-buy sales appeal

PLUS
50% of your ad space cost

\$1.15 STANDARD
10 INCH ALBUM

\$1.40 STANDARD
12 INCH ALBUM

DELUXE LIBRARY MODEL

10 Inch Size **\$1.75**

12 Inch Size **\$2.00**



CLOTH BOUND ON INSIDE FOR ADDED STRENGTH

STORE NAME

#101-2

Consult with your Peerless distributor to get in on this profitable promotion

Standard of The Industry For Over 25 Years

The **PEERLESS** ALBUM COMPANY

352 Fourth Avenue,

New York 10, N. Y.

AUTOMATICALLY PLAYS TWELVE 10" OR TEN 12" RECORDS

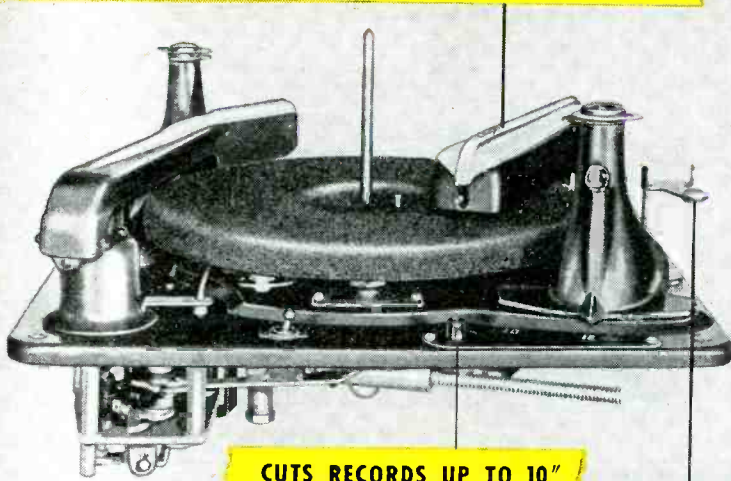

CUTS RECORDS UP TO 10"

ONE SIMPLE LEVER ADJUSTMENT

GI-RC130
Combination Record-
Changer Recorder

Smooth Power COMBINATION RECORD-CHANGER • RECORDER



GI-RM4 Rim Drive, Heavy-Duty
Electric Recording Motor



GI-R90 Dual-Speed, Home
Recording and Phonograph
Assembly



LX Rim Drive, Constant-Speed
Electric Phonograph Motor

Your customers will like the simplicity and fine performance of this unique combination *Smooth Power* unit.

They'll enjoy the ease of operation with one simple lever for quick changing from one size record to another, to remove records or to set for manual operation and recording. They'll appreciate the smoothness and quietness of the record-changer. They'll admire the brown iridescent finish and streamline plastic trim on self-indicating "Reproducer" and "Recorder" arms.

And, of course, they'll value the quiet, vibration-free operation of the *Smooth Power* Motor.

Send for details. Ask us for complete information on this popularity-building combination that can add new sales appeal to your products . . . and on the complete line of *Smooth Power* Phonomotors and Recorders.

THE GENERAL INDUSTRIES Co.

DEPT. MV

ELYRIA, OHIO

Disc Dollars

(Continued from page 99)

Insurance" and an episode in which "Amos Explains 'The Lord's Prayer.'"

"**JACK BENNY**" with *Mary Livingstone, Rochester: Top Ten Records (Audience Records, Inc.)*

Benny's radio characterization carried on in comedy skits: "The Violin Lesson," "Schizophrenia," "Getting a Haircut," "Getting a Shave," "A Letter From Mary's Mother," and "America's Foremost Violinist."

"**EDGAR BERGEN**" with *Charlie McCarthy & Mortimer Snerd: Top Ten Records (Audience Records, Inc.)*

Series of sketches revolve around Bergen's trials and tribulations with his two dummies. Titles include: "Ventroliquism Exposed," "A Lesson in Life Saving," "Underwear by Mail Order," "Glass Blowing," "The Grammar Lesson," and "The Three Little Pigs."

"**GEORGE BURNS & GRACIE ALLEN**": *Top Ten Records (Audience Records, Inc.)*

Five comedy acts, with Mel Banc and Bill Goodwin are included in the sketches: "Sugar Throat Sings Again," "The French Long Underwear Maker," "Gracie Discovers a Movie Star," "What Every Old Husband Should Know," "What Every Young Bride Should Know."

"**EDDIE CANTOR**": *Top Ten Records (Audience Records, Inc.)*

Eddie tells his life story in 7 parts: "Cantor's Hall of Records," "How Old Is Cantor?" "Cantor's School Days," "Cantor's Fool Days," "Cantor Flunks His Physical," "The Girls in Cantor's Life."

"**FIBBER MCGEE & MOLLY**": *Top Ten Records (Audience Records, Inc.)*

Jim and Marian Jordan are featured in 6 episodes entitled: "A Fascinating Hunk of Natural History," "It's All Greek," "A Visit to the Dairy," "Strictly Off the Record," "Wallace Wimpole Drops In." and "A Few Notes on Piano Tuning."

"**ED 'ARCHIE' GARDNER**," of *Duffy's Tavern: Top Ten Records (Audience Records, Inc.)*

Sketches in album include: Archie and George Raft in "The Sympathetic Part," Archie and Deems Taylor in "Deems, Dem & Dose," Archie and Nigel Bruce in "Flatbush on the Thames."

(Continued on page 101)

FOLK MUSIC

ALLEN, ROSALIE: "On Silver Wings to San Antone"—"I'll Never Grieve." RCA Victor 20-2333

First side tells story of a gal flying to her love; reverse is in a "lonesome" mood. Rosalie is a spirited singer on both.

HILL, SMILIN' EDDIE, and the Tennessee Mountain Boys: "I Never See My Baby Alone"—"The Little Shirt My Mommy Made for Me." Apollo 158

Radio's Smilin' Ed Hill with favorites of "Grand Old Opry."

SONS OF THE PIONEERS: "You Never Miss the Water Till the Well Runs Dry"—"Will There Be Sagebrush in Heaven?" RCA Victor 20-2350

First side is a clever tune, with an introductory "talk" refrain; flip is a typical cowboy lament.

TUTTLE, WESLEY: "Why Do I Love You, Oh Why"—"If You Ever Need a Friend." Capitol A40021

Tuttle's baritone voice goes through these two Westerns with rhythm and bounce.

WILLIS, BOB, and His Texas Playboys: "How Can It Be Wrong"—"Punkin' Stomp." Columbia 37564

"Stomp" is a lively dance number for swinging your partner.

CHILDRENS

"CHOPIN, HIS STORY AND HIS MUSIC," Vox Music Master Series

Latest release in the lives of famous composers, with musical illustrations. This set follows albums on the lives of Beethoven, Mozart, Tchaikovsky and Schubert.

"HONEST ABE," Continental 38

The story of Abraham Lincoln, dramatically presented by the Continental Playhouse. Album aimed at grade and high school students, as well as grown-ups.

"TWEEDLE DE DEE AND TWEEDLE DE DUM," Eddie Cantor. Musicraft N-11

Eddie Cantor takes the kids on a unique "United Nations" trip around the world on a magic carpet—to a musical accompaniment by Carmen Dragon.

FOREIGN MUSIC

ARMANDO and His Jack's Band: "Escambao"—"En Tu Ausencia." Seeco 610

First side is a calypso number; about-face a bolero.

GARZA, EVA: "Sera Por Eso"—"Frio En El Alma." Seeco 609
Two bolero tunes.

JOSKA, MAKY Gypsy Orch.: "Hungarian Gypsy Csardases." Continental MR-79, MR-80

Instrumental csardases of four sections of old Hungary.

PICON, MOLLY: "Busy Busy"—"Believe It Or Not." Banner B2016

Molly Picon has recorded these two tunes, which will be sure-fire hits with her many fans.

(Continued on page 102)

A New One!

The latest combination that opens the public's pocket book... just hatched — "Hi-Diddle-Didle," with Lanny and Ginger of network fame. another ADVENTURE unbreakable.

YOU CAN'T KID THE PUBLIC
and

WE CAN'T KID THE DEALERS

Especially these days! Both the public and the dealer want cold, hard facts that mean COLD CASH! They want proved puddings... and these unbreakable Adventure Records are just that! Age-proven tales... With production worthy of their titles! It's the combination that spells RECORD SALES!

All Adventure Albums contain TWO 10" UNBREAKABLE RECORDS IN COLORFUL ALBUM
List \$2.89, tax incl. Dealers cost \$1.79, incl. Fed. tax.

Brason Associates
3508 North Clark Street
Chicago, Illinois
Fidelity Records Division
of Midget Music
Jacksonville, Texas

Order through your local distributor:

Garden State Distributing Co.
98 Lock Street
Newark, N. J.
Music Suppliers of New England
17 Chadwick Street
Boston, Mass.

Scott-Crosse
1423 Spring Garden Street
Philadelphia, Pa.
Sultan Distributing Co.
12727 Linwood Avenue
Detroit, Michigan

A few choice territories still available.
Contact National sales representative:



MIDTOWN Distributing Company
1674 Broadway, New York, N.Y.
ADVENTURE RECORDS

MULTIPLY YOUR MOVES WITH alliance MOTORS



• Millions of Alliance Phonomotors made for the radio industry bring mass-production "know-how" to the manufacture of Alliance Powr-Pakt Motors . . . motors from less than 1-400th h.p. on up to 1-20th h.p.

And so, besides driving turntables, record changers and tuning devices, Alliance motors are vital power links in modern operations which call for more motion—remote control—automatic action!

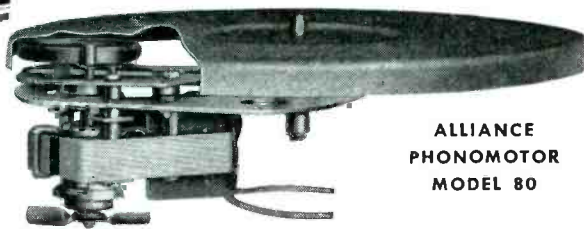

ALLIANCE PHONOMOTOR MODEL 80

WHEN YOU DESIGN ... KEEP

alliance

MOTORS IN MIND

ALLIANCE MANUFACTURING COMPANY • ALLIANCE, OHIO

Bagshaw's famous needles (since 1892)

Ever since the first "talking machine," Bagshaw Needles have been famous for quality. They are the best known and most widely distributed phonograph needles on the market.

BRILLIANTONE STEEL NEEDLES
BRILLIANTONE BLUE STEEL NEEDLES
BRILLIANTONE BRASS PLATED NEEDLES
TAPER-TONE NEEDLES
ACTONE TRANSCRIPTION NEEDLES
ARISTOCRAT NEEDLES
STEEL CRAFT NEEDLES
HI-FIDELITY NEEDLES
PETMECKY "MULTI-TONE" NEEDLES
JUMBO NEEDLES
AUTO-CHROMATIC NEEDLES
BRILLIANTONE RECORDING NEEDLES

Send for New Catalog "E" and Current Price Lists

H. W. ACTON CO., Inc.

Sole Distributor
370 SEVENTH AVE., NEW YORK 1, N. Y.

CLOSING DATES FOR

RADIO *Television* RETAILING

5th of preceding month for all ads requiring proofs, composition, foundry work, key changes, etc.

10th of preceding month for complete plates only—no setting.

1st of month—Publication Date.

Cancellations not accepted after 5th of preceding month.

Caldwell-Clements, Inc.

480 LEXINGTON AVENUE
NEW YORK 17

Disc Dollars

(Continued from page 101)

RIVERO, RITA MARIA: "Ven"—
"Asi Eres Tu." Seeco 596

"Ven" is a rhythmic song; reverse is a bolero.

SABLON, GERMAINE: "Mon Homme"—"Mon Legionnaire."
Continental C-1401

Two old French torch songs, sung by this entertainer, who made quite a hit recently in the New York clubs.

"SONGS OF LUCIENNE BOYER,"
(Sung in French, and recorded in France.) Columbia M-MM-694.

Album of songs noted cafe entertainer made famous during the war years.

"THE SONGS OF CHARLES TRENET": International Records #3

Six Gallic love songs, done in Trenet's intimate style.

YANKOVIC, FRANK: "Bye-Bye Baby Polka"—"Be Happy Polka." Continental C-1201

Polka instrumentals.

Educational Discs

(Continued from page 81)

Early American Folk Carols" (732, \$3.93), "American Legends" (725, \$3.93), "Funnybone Alley" (606, \$3.15), "Rhythm Band Music" (742, \$2.89).

More recommendations from the Disc catalog include: "American Indian Songs and Dances" (161, \$8.66), "Hebrew and Palestinian Folk Melodies" (902, \$4.72), "American Documentary" (360, \$3.93).

Continental's "Honest Abe," the story of Abraham Lincoln (No. 38), is directed toward grade and high school students.

Vox albums of the lives of famous composers (Chopin, Beethoven, Mozart, Tchaikovsky and Schubert), with music, are worthy additions to an educational disc listing. Foreign language speaking and reading courses such as those put out by Crown Publishers and Linguaphone, will be of interest to the older scholar.

Specialty records which teach cartooning, how to sing, how to play an instrument, etc., may be included by the dealer in his "educational" record department. Platters which tell religious stories, bible stories, and which offer singing of hymns are also worthy of a place in the dealer's new department, if these are not covered by his stock of "children's" discs.

Retailers may find that they have many of the records mentioned in stock. It is just a matter of assembling these discs in a prominent place.

ELECTRICAL APPLIANCES

Section of *RADIO & Television* RETAILING

How to Sell More Appliance Service

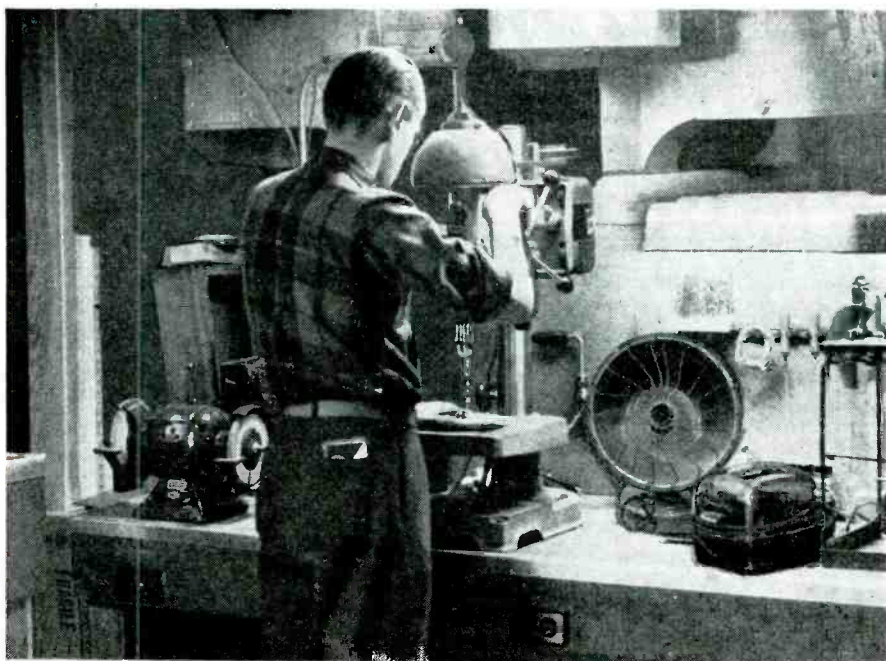

Active salesmanship on appliance service keeps the shop busy, and the profits rolling in. Every home has products needing repair. Ask for the business.

Almost any merchant can double his present appliance repair volume if he goes about it the right way. Since all repair jobs come from the customer, the dealer must go to the customer for this extra business.

There are two ways to increase appliance service volume. Number one is via personal contact. Number two is through an advertising campaign.

A combination of both the above methods will do wonders if followed through consistently and intelligently.

Every customer who comes into the store bringing an article for repair is a definite prospect for other work, too. In almost every case, the servicer who goes into the home can sell service in addition to that specifically requested by the householder.

In other words, to get more business ask for more business.

As a rule, a customer brings in a repair job, or calls for the servicer to come to the home to repair appliances which are presently out of order, but in addition to such emergency repairs there are many other products which are not operating up to par, or which need re-wiring to make them safer to use.

One of the best ways to up service volume is to offer to make an inspection of all the radios and electrical appliances in the customer's home. After the "survey" has been made, the dealer should submit a proposal to the home-owner, listing the products needing service, the sort of service work suggested, and, if required, an estimate of each job and the total for all.

The customer usually appreciates the offer to go over all of his equipment, putting it in first-class order, thus making the appliances easier to operate, safer and improved in appearance.

Direct mail can be used to good advantage in soliciting for more repair work. In all instances, copy should list all of the various devices, and should provide space for the customer to check off those things he wishes fixed.

A List Helps

Such a list is valuable, too, in selling via personal contact. It helps the dealer and the customer. If the former reads a number of items aloud to the customer, he may just hit upon something needing repair which the customer has overlooked. On occasions when the shopper has to wait in the store, such list may be handed to the customer with the suggestion that there may be some appliances listed thereon which need expert attention.

In addition to out-and-out breakdowns, there are always many other maintenance services which should be attended to. For instance, under the category of needing services from an "appearance" and safety angle, we find re-wiring jobs on floor, table and therapeutic lamps, as well as on refrigerators, washers, table appliances, vacuum cleaners, etc., and cleaning and buffing work on the above and many other types of equipment. Too, the average household is always in need of new appliance cord sets, extensions and so forth.

Lubrication services can be sold for refrigerator motors, washer motors and gear-cases, ironers, vacuum cleaners as well as for numerous

(Continued on page 117)

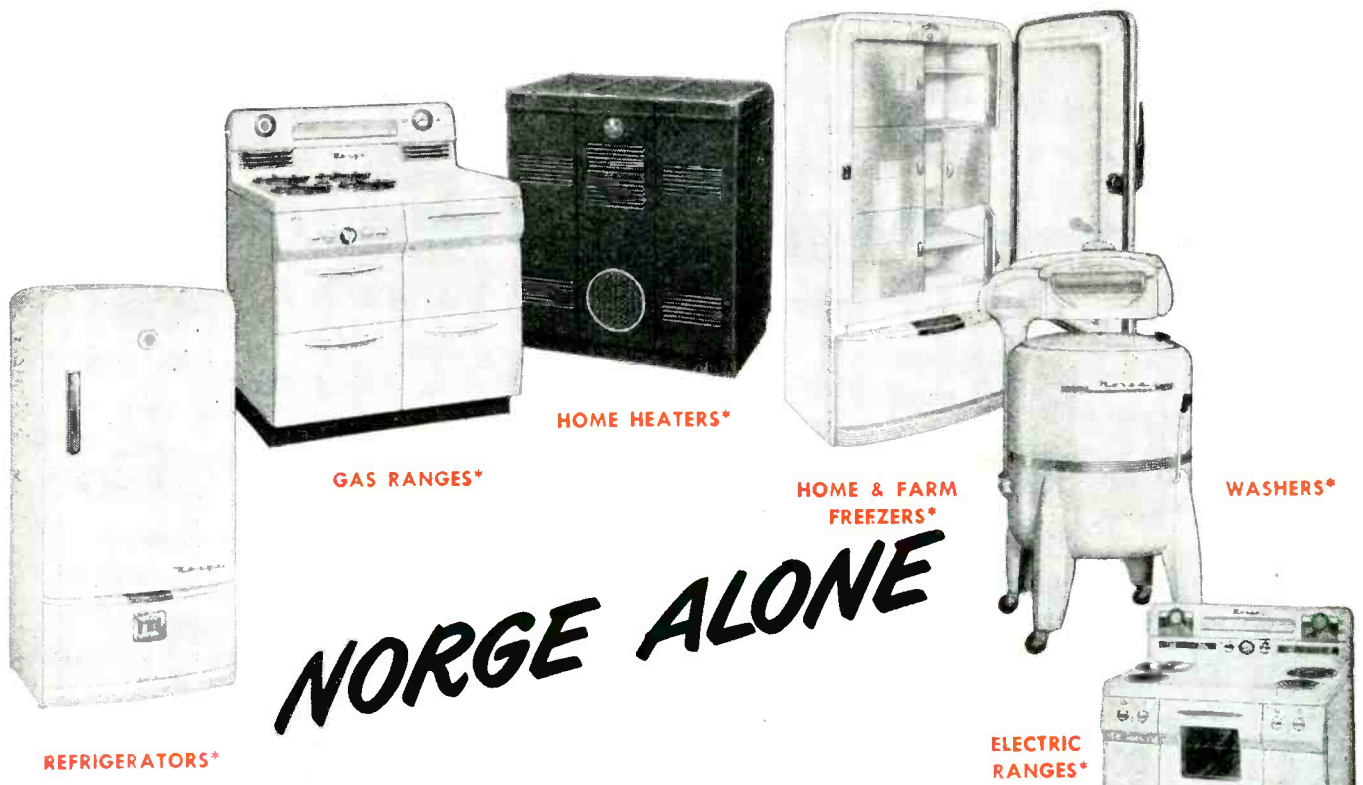

NORGE ALONE

*offers under one brand name
a share in ALL THESE MARKETS*

As a Norge retailer, you stand to get a greater share of the biggest appliance market ever! For only Norge offers you seven great lines under one nationally advertised brand name . . . seven types of major appliances available through one distributor. Each product is a fast-moving, big-ticket item in its own right . . . each paves the way for profitable tie-in sales.

These are a few of the reasons why, no matter where you go, you'll find that "the best dealer in town sells Norge!" Norge Division, Borg-Warner Corporation, Detroit 26, Michigan.

"THE BEST DEALER IN TOWN SELLS NORGE"

***ESTIMATED NATIONAL SALES FOR 1947**

Refrigerators	3,349,620 units
Electric Ranges	868,420 units
Home Heaters	1,250,000 units
Washers	2,636,275 units
Home and Farm Freezers	341,165 units
Gas Ranges	2,000,000 units
Electric Water Heaters	434,210 units

THAT'S WHY WE SAY:

*When you're in Norge
you're in Big Business!*

Norge products, distributed worldwide, are typical examples of the values made possible by the American system of free enterprise.



**SEE
NORGE
BEFORE YOU BUY**

Sell More Door-to-Door

Up Vacuum Cleaner Volume by

Taking the Appliance to the Customer

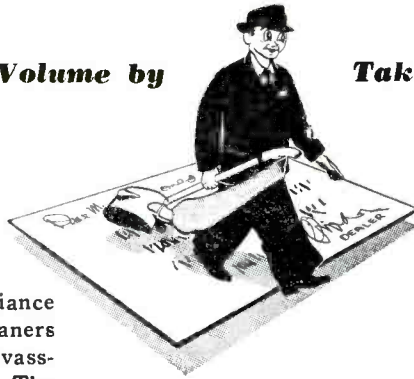

● The independent radio/appliance retailer can sell vacuum cleaners profitably via door-to-door canvassing in a "prepared" territory. The dealer's salesmen can make good money, and can enjoy the job making it if proper training is given them—if intelligent steps are taken to make sure that the home-owners are made familiar with the dealer's firm name, and the brands of cleaners carried.

If salesmen are chased out on their own to try to sell vacs in "unconditioned" localities scattered all over the place, they will run into tough sledding, and most of them will throw in the sponge in a short time.

The retailer who isn't fooling when he decides to do a real, man-size job selling vacuum cleaners door-to-door, plans to take the following steps: 1. He prepares the territory for canvassing. 2. He selects and trains salesmen. 3. He assigns definite territory to each man.

Preparation of the field means that he must convey to each householder the knowledge that he is a reputable, well-established merchant; that he sells dependable merchandise, and that he is *soliciting* business.

He conveys such messages through use of some or all of the following agencies: The telephone, direct-mail, local radio stations, newspaper advertising, hand-bills.

Planned Visits

When Dealer Smith mails out a card reading, "Good News We now have a stock of the famous Blank Vacuum Cleaners, and our representative will CALL ON YOU within the next few days to demonstrate the advantages, etc., etc.," it doesn't necessarily follow that the lady of the house will greet the solicitor with a great big smile—and an order.

But it does mean that the message usually serves to remove the surprise element associated with the "cold turkey" call.

When Mrs. Jones opens the door

of her home and finds a man with a vacuum cleaner there, she is surprised, and is on the defensive, unless she has been told that such a call would be made.

Training Salesmen

Now and then a householder will buy, or accept a cleaner for trial from the salesman when he calls because the members of the family discussed the territory-preparing message, and reached a decision to purchase or try the product.

Selecting and training men for outside selling isn't a pushover proposition for the merchant. As pointed out in articles which have appeared in previous issues, the dealer must select men who are temperamentally suited to the rigors of door-to-door work.

Having secured the right sort of individuals, a thorough training period is next in order. The men must be schooled to take all sorts of setbacks in their strides. They should be urged to do thorough door-to-door canvassing, without "skipping" or jumping from place to place. They need to be taught how to use direct, courteous approaches when the door is opened to them.

Such questions as whether the salesman should carry a cleaner with him on calls, or should leave the appliance in his car parked nearby, should be settled in advance.

Most authorities on merchandising believe that it is better to have the salesman carry the appliance he is offering for sale. Some others say that when the housewife sees a man with a vacuum cleaner at the door she will often pretend that she's not at home, but such condition should not prevail to any great extent today as it did in the times when everybody and his brother was out ringing doorbells.

In favor of carrying the appliance

to the door is the directness of the proposition. "The man is selling vacuum cleaners," the housewife says to herself, and if she is at all interested in buying one, the necessity for the salesman to explain his mission has been bypassed.

Old-time salesmen will listen to "blue-sky" sales talks with tongue in cheek, but numbers of newcomers will get damaging let-down feelings when they find out that the outside field is no Garden of Eden, as it was painted by the over-zealous person, but a tough territory where sweat and worn-out shoe leather bring all sorts of receptions—door-slaming by a few, courteous turndowns by many others, and sales under the old law of averages.

Outside selling conditions and results should not be exaggerated to the prospective salesperson. He should be told that he *can* make money, but should also be acquainted with the true facts of life associated with this truly American form of merchandising.

Territory allotment should be thoroughly planned. The "toughest" sections should be divided, and each man should have plenty of room to move about in.

Assigning Territories

It is always a good practice to "protect" the respective territories. A salesman may call at a home and after demonstrating a cleaner may get an "I'll think it over" decision from the prospect, who later may come into the store and buy. In such cases the salesman should get his full commission no matter who closed the deal on the sales floor.

One of the things greatly in favor of selling vacuum cleaners door-to-door is the fact that the general public has accepted such technique, expects it to be done that way, and, doubtless, in the future, as it was in the past, more cleaners will be sold via this method than through any other way.

There's money in canvassing with cleaners, but it's a game where preparation and know-how is all important if profitable practice of this selling art is to be achieved.

Refrigerators

Washers

Ironers

Ranges

Vacuum Cleaners

Food Freezers

New Electrical

Proctor TOASTER

Model 1481, automatic pop-up toaster, will reheat cold toast through exclusive color-guard thermostat. Oval in shape. Toasts to any color desired. "light, medium

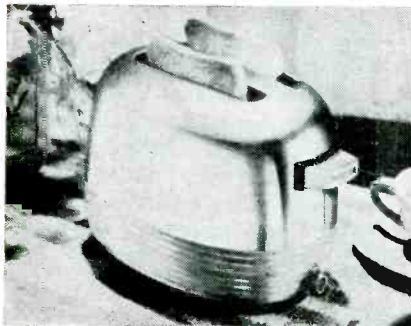

or dark." Sliding crumb tray, removable from the rear, permits easy cleaning of toaster. List price, \$22.00. Proctor Electric Co., Philadelphia, Pa.—RADIO & Television RETAILING.

Mell-O-Chime CHIME

"Vanguard" model electric door chime available in a duo of long-tube styles. Model "3" has 3 tubes, of length and size to permit maximum resonance. Model "2" has two tubes instead of three. Plastic housing of antique ivory, decorated with a tulip medallion. Mell-O-Chime and Signal Corp., 119 S. Jefferson St., Chicago 6, Ill.—RADIO & Television RETAILING.

Air Clear IONIZER

Home-size ionizer, destroys odors electrically. Goes into action with high or low concentrations of Ozone. Styled in a catalin cabinet. General Ozone Corp., 17 W. 60 St., New York 23, N. Y.—RADIO & Television RETAILING.

Drain-O-Matic FOOD ELIMINATOR

Waste food eliminator has two-directional operation of its waste shredding elements; the direction of rotation of the rotary shredder is automatically changed, by a reversing switch, at the start of each operating period. Special safety feed spout provides safe continuous feed operation by the housewife. Powered by a 1/4 H.P. motor. Unit is of all-metal construction and weighs approximately 45 lbs. Unit fits all types of sinks which have 3 1/2" to 4" drain openings. Rousselle Corporation, 1673 E. 82 Place, Los Angeles 1, Calif.—RADIO & Television RETAILING

Hamilton CLOTHES DRYER

Clothes dryer features: time control switch which can be set for any drying period; automatic thermostat; electric fan exhausts moisture while clothes revolve with a tumbling action. Electric models 600-E and 800-E are 39 inches high, 31 inches wide, and 27 1/2 inches deep. Dryer is fin-

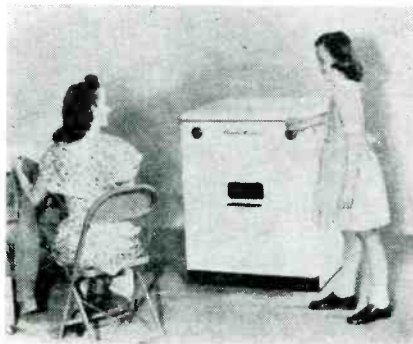

ished in white high lustre baked enamel, with trim in red plastic and chrome. Hamilton Mfg. Co., Two Rivers, Wis.—RADIO & Television RETAILING.

Thermador RANGE

Built-in electric range is a compact, stainless steel one-piece cooking unit with a separate standard-size stainless steel oven. Both units are installed as permanent fixtures in any part of the kitchen, at any height. The cooking top consists of three heating units and a 5-quart deep well cooker. The separate oven gives extra oven space and is easily installed. Front measures 20" wide by 24" high, and fits

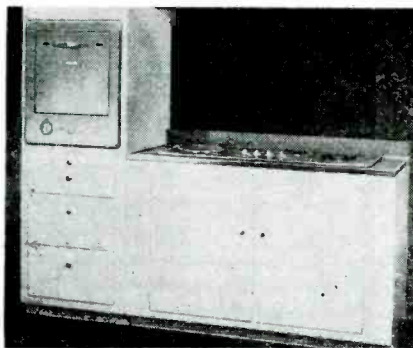

into most cabinets. None of the features of the conventional range oven have been sacrificed in designing it for the built-in model. Thermador Electric Mfg. Co., Los Angeles, Calif.—RADIO & Television RETAILING

Norge ELECTRIC RANGE

Fully automatic divided-top electric range has glass-doored oven with warmer beneath and utensil storage compartments on either side; seven position burner and

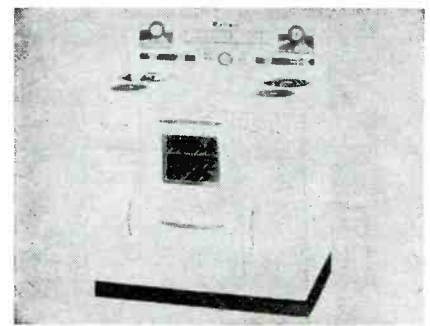

deep-well switches; safety switch on rear panel. Automatic controls turn on oven. Deep-well cooker or appliances plugged into convenience outlet at pre-determined times, and cut off current also, after desired cooking interval has elapsed. Automatic preheating device raises oven temperatures quickly to required heat for proper baking, then shuts off to permit other controls to maintain temperature. Norge Div., Borg-Warner Corp., Detroit, Mich.—RADIO & Television RETAILING.

Casco HEATING PAD

Sinus and muscle electric heating pads applies moist heat. Safe for use with wet dressings, pad has wetproof castex body. Two thermostats provided for each heat. Equipped with washable hospital sheeting slipcover with two tie tapes. Retail at \$4.90, plus tax. Casco Products Corp., Bridgeport, Conn.—RADIO & Television RETAILING.

Hollywood HAIR DRYER

Model A-1, hair dryer has a hood that is made of spun aluminum; finished in baked hammertone enamel. Hood tilts backward. Stand is fabricated of aluminum and steel and is fully collapsible and adjustable for height. Hollywood Industries Inc., Hollywood, Calif.—RADIO & Television RETAILING.

Marvel STORAGE LOCKER

Model 101 quick freeze storage locker has capacity of 12 cu. ft. Size: 72 inches long, 30 inches wide, 34 inches high. 5-inch thickness of approved insulation. Storage compartment has smooth inside surface. Stainless steel top with sides of baked-on white enamel. W. Allen Rogers Industries, Inc., Demopolis, Ala.—RADIO & Television RETAILING.

Home Appliances

★ Toasters
★ Roasters
★ Hand Irons
★ Mixers
★ Clocks
★ Cobb Makers

Frigidaire WASHER

Household washer, completely automatic; washes clothes, rinses them twice, and spins them damp-dry. One adjustment on the control dial necessary. Exclusive "pul-sator" washes with "live-water" action—an up-and-down motion. Washer does

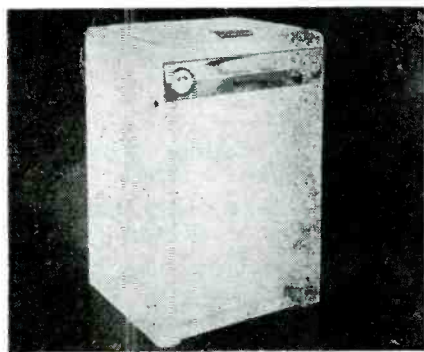

not require bolting to the floor to operate. Finished in life-time porcelain, inside and out. Frigidaire Div., General Motors Corp., Dayton, O.—RADIO & Television RETAILING.

Waste King PULVERATOR

Odorless, clog-proof. Food wastes put down drain opening, and the water turned on, with waste matter ground into particles and swirled away. Unit installed in any sink with a drain opening of 3½ to 4 inches in diameter. Given Mfg. Co., Los Angeles, Calif.—RADIO & Television RETAILING.

Beauty-Vac MASSAGE UNIT

Facial massage unit fits snugly in the hand; built into the device is an alternating suction pump that "pats" the skin. Comes in attractive plastic leather case, equipped with two rubber suction cups, one for use on face and neck, the other around the eyes and nose. Hollywood Beauty Products, Inc., 6411 Hollywood Blvd., Hollywood 28, Calif.—RADIO & Television RETAILING

Cir-Q-Laie FAN & VENTILATOR

Air-circulating and room-conditioning unit, with double utility feature—combination exhaust and cooling fan for all-purpose use. Designed for use in all rooms, unit is sturdily-made, light in weight, and powered by fractional horsepower motor. Cir-Q-Laie Co., Inc., 60 E. 42 St., New York 17, N. Y.—RADIO & Television RETAILING

GE HEATING PAD

Waterproof heating pad, model PS 6A2, is intended for the application of both

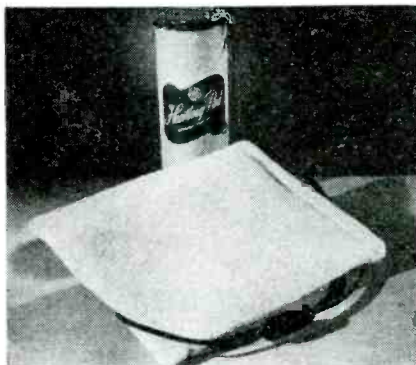

wet and dry heat. Unique carton has metal top and bottom, and may be used as a knitting bag with label removed. Pad has thermostat for maximum heat control safety and flexibility. General Electric Co., 1285 Boston Ave., Bridgeport, Conn.—RADIO & Television RETAILING.

Hoover ELECTRIC IRON

Automatic electric iron features handle and heat control design. Handle is brown plastic, shaped to fit hand. Wide back of handle provides extra hand support, and smooth thumb rest is molded in one with the handle. Precision heat selector is directly beneath the handle, with large, easy-to-read "pancake" dial. The dial is marked according to the fabrics to be ironed. Iron has wide heel rest; rubber guide on handle provides permanent cord. Cover is of rigid chromium plate steel. A low angle bevel at the point facilitates ironing under buttons. Iron comes in medium weight, 4¼ pounds; and light 3¼ lbs. The Hoover Co., North Canton, O.—RADIO & Television RETAILING.

Tyler HOME FREEZER

Model HU-9F, 9 cu. ft. capacity upright home freezer. For smaller homes or apartments. Tyler Fixture Corp., Niles, Mich.—RADIO & Television RETAILING.

Metallic Industries RANGETTE

Striped chrome plated stove unit; "life-time" solid black glazed cooking elements; 3-heat rotary switches; removable drip pan. Available with sturdy steel cabinet finished in baked white enamel, with cutlery drawer, removable shelf and 2 towel hangers. Metallic Industries, 7319 New Utrecht Ave., Brooklyn, N. Y.—RADIO & Television RETAILING.

Westinghouse IRON

Light weight streamlined automatic hand iron with aluminum base and cover; cast-in Corox heating element. Weighs 3 lbs.; has ironing surface of 27 square inches. Bi-metallic thermostat controls the temper-



ature, and gives heat control for fabrics. Heel rest; 6 ft. cord permanently attached. Westinghouse Electric Corp., Electric Appliance Div., Mansfield, O.—RADIO & Television RETAILING.

Floor O Matic FLOOR MACHINE

Floor unit scrubs, waxes, polishes and buffs floors. Weighs 18 lbs. Operates on ac or dc. machine is equipped with two sets of interchangeable brushes, and one set of attachable buffing pads. Additional attachments include steel wire brushes, steel wool pads etc. Retail at \$69.50 (\$72.95 west of the Rockies). Floor-O-Matic Inc., 780 E. 134 St., New York 54, N. Y.—RADIO & Television RETAILING

Royal Rochester MIXER

Utility kitchen mixer for mixing drinks, beating eggs, batters etc. Features hi-speed air-cooled motor. No adjustments to make; constructed of stainless steel. Rubber covered cord, extra 7 ft. length. Finished in various colors. Retail price, \$9.95. Robeson-Rochester Corp., Rochester 7, N. Y.—RADIO & Television RETAILING

Waters Conley HOME PASTEURIZER

Home pasteurizer thermostat holds milk in correct temperature range until the timer automatically turns the heat off and starts the buzzer when pasteurization is complete. Size: 9½ inches by 13 inches over all. Waters Conley Co., Rochester, Minn.—RADIO & Television RETAILING



CLEAN UP THIS FALL WITH

REALLY **NEW** POST-WAR CLEANERS THAT ARE FEATURE-PERFECT FOR GREATER SALES

UNIVERSAL'S POST-WAR CLEAN-AIR CLEANER

- **EXCLUSIVE "TATTLE-TALE" LIGHT** flashes red when dirt bag needs emptying. Assures efficient operation at all times for faster, more efficient home cleaning.
- **EXCLUSIVE "INSTANT-SEAL" HOSE CONNECTION** provides quick, suction-tight seal of hose to cylinder. Easy to connect—easy to disconnect. Won't let go until released.
- **EXCLUSIVE "THREAD-PICKING, SELF-CLEANING NOZZLE"** picks up lint, hair, thread, fuzz. Can't clog. Won't drag or seal rugs. Slips easily under furniture.
- **EXCLUSIVE NEW "SUPER-POWER MOTOR"** provides 20% more powerful suction. Cleans, sprays, demoths, shampoos, polishes, deodorizes and purifies air while cleaning.



"TATTLE-TALE" LIGHT tells when dirt bag needs emptying

UNIVERSAL'S FEATURE-PERFECT BRUSH-TYPE CLEANER

- **EXCLUSIVE HIGH-LOW "SUCTION-REGULATOR"** eliminates sealing and drag in cleaning small rugs.
- **RUG-ADJUSTING NOZZLE** adjusts automatically to any rug surface.
- **ALL-METAL CONSTRUCTION**—streamlined, rugged, easy-to-handle.
- **OVERSIZE "VIBRO-BRUSH"** loosens stubborn dirt.
- **RUBBER PISTOL-GRIP HANDLE** with fingertip control switch.
- **"TOUCH-TOE" HANDLE CONTROL** for simple three position adjustments.
- **"DAY-GLO" HEADLIGHT** is handy in cleaning dark corners and closets.
- **"NO-MAR" BUMPER** with 3-side protection, extra high in front.

13 SPECIALLY DESIGNED ATTACHMENTS FOR THOROUGH CLEANING EVERYWHERE

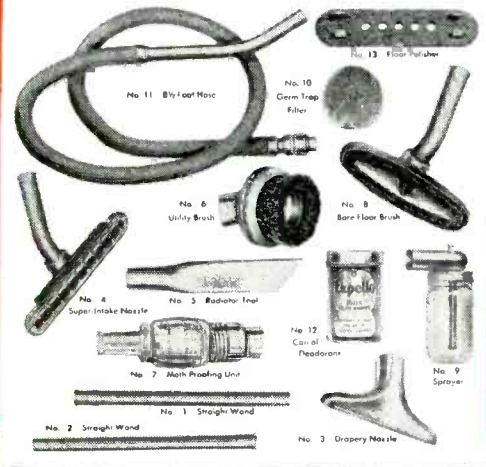

"HIGH" for the Large Rugs

"LOW" for the Small Rugs



AMERICA'S MOST COMPLETE LINE OF HOME CLEANING AND FLOOR MAINTENANCE EQUIPMENT

AMERICA'S LEADING CLEANERS!

PLUS

THE MOST **TERRIFIC** IMPACT EVER PUT
BEHIND A LEADING VACUUM CLEANER LINE

THIS IS IT! Universal has *the* really new post-war cleaners... has *the* features... and we're really going to shout about it this fall as we've never shouted before. Blanketing every market, large and small, UNIVERSAL is going to tell its *extra value, extra feature* story over and over. In dominating, full-page magazine advertising starting with a powerful, full-color page in the October 14th "LOOK". On more than a thousand eye-stopping billboards in 120 major markets. In hard-hitting newspaper ads in 163 key major markets. In 2,425 county weeklies completely covering the small town-rural market. We're not missing a single market... a single trading area.

The theme is "No Need to Wait for '48". It will pre-sell women on UNIVERSAL'S really new features... will send them into your store *now*. See your Universal distributor for tie-in window displays, counter cards, ad mats and folders.



**POWER-PACKED, FULL-PAGE,
FOUR-COLOR MAGAZINE ADVERTISING
REACHING MILLIONS**

**COMPLETE SMALL TOWN-
RURAL COVERAGE IN
2,425 COUNTY WEEKLIES**

**OVER 127 MILLION
READER IMPRESSIONS IN
163 KEY-MARKET NEWSPAPERS**

**OVER 1,000 BILLBOARDS
IN 120 MAJOR MARKETS**



Score a clean sweep of your cleaner market this fall. Make this history-making campaign ring your cash register by tying in with it... in your display windows, on your sales floor, in your local advertising.

The Campaign Breaks in October... See Your Universal Dealer Today

UNIVERSAL

LANDERS, FRARY & CLARK • NEW BRITAIN, CONN.

Lighting Industry News

GE Extends Operating Range of Its Slimlines

With extensive laboratory and field researches just completed, the Lamp Department of General Electric Company has announced that the operating range of its slimline lamps has been extended to 300 milliamperes, with no change in rated lamp life.

These long, thin fluorescent lamps—ranging up to 8 feet in length—previously had a current range of 100 to 200 milliamperes. The extended current range applies to all GE slimline lamps now in stock, the announcement stated.

By increasing the current rating of the lamp, more light per foot is obtained. According to General Electric lighting specialists, operation of the slimline lamps at the higher current ratings will be found particularly applicable for industrial and commercial lighting fixtures, and in show cases, wall cases, show window lighting or wherever high light output per foot of lamp is paramount.

Animated Window Display

Sylvania Electric Products, 500 Fifth Ave., New York City, will send details of its animated window display to sell infra-red lamps, to dealers requesting same.

Novel Lamp Sales Idea

When bulbs of all sorts become plentiful enough again, one retailer who is situated in a wealthy suburban area, plans once again to include a "re-lamp the entire house" campaign along with his outside selling efforts. He was most successful with this before the war. Had his own men install all of the new bulbs, putting the old ones back in sleeves and urging the customer to keep them around for "spares."

Fluorescents for Home

Are you getting your share of the kitchen fluorescent business? The dealer who goes out after fluorescent sales will find that almost every housewife in his territory wants someone to sell her this modern form of lighting for the kitchen, and often, too, she is in the market for fixtures for playrooms, studies, etc.

Fluorescent Lamp Guard

The Den-El Equipment Co., 688 18th Ave., Irvington 11, New Jersey, announces a new fluorescent lamp guard that supports the ends of fluorescent lamps and prevents their falling out of lamp holders. The new guard has proven valuable in preventing accidents, work interruptions and tube breakage particularly in industrial plants and in the presence of vibration.

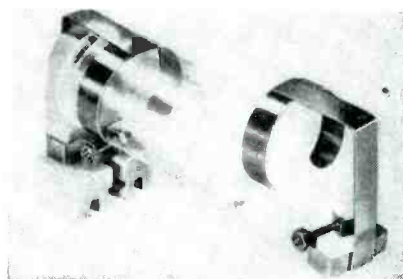

The Den-El Guard is easily installed permanently with a machine screw and nut. Made of stainless steel for lasting good appearance, and because of its special resilience is quickly sprung aside for cleaning or relamping. Available in two sizes for 40 watt and 100 watt lamps. Complete details will be supplied on request to the manufacturer.

Sylvania Announces Price Cut on Xmas Bulbs

A reduction of over 24 per cent in the price of fluorescent Christmas tree lights, which were introduced two years ago by Sylvania Electric Products, Inc., is announced by Lewis Gordon, assistant to the vice-president in charge of sales. A string of seven lamps, which formerly sold for \$6.50, will now cost \$4.95, and the list price for individual bulbs will be 45 cents instead of 60 cents apiece. Experience in producing these comparatively new type Christmas lights, according to Mr. Gordon, has made it possible to reduce their price at this time.

The fluorescent Christmas bulbs have a screw type base and are independently operated so that a fluorescent bulb may be used in the same type incandescent string, or a string

of fluorescent lamps may be added to a string of incandescent Christmas tree bulbs by just plugging it into the socket.

Round in shape and white when not in use, the bulbs light up in five pastel shades of coral, green, maize, blue and orchid, making the entire tree glow.

Besides providing an unusual decorative effect, the fluorescent tree lamps have several advantages over customary incandescent bulbs. Each lamp burns about four watts of current and has an average life of 1,000 hours. Because they burn cool, the lamps help to retard drying up of the tree.

Developed by Sylvania Electric Products, Inc., and announced for the first time in 1945, these lights need no special auxiliary equipment in order to operate, although they are made with the same type fluorescent powders that go into fluorescent tubes for regular residential and commercial use.

The sets will be distributed by three string manufacturers: Miller Electric and Royal Electric of Pawtucket, R. I., and Leo Pollock Company of New York City.

Should Know How to Sell Therapeutic Lamps

Make sure that your clerks know the difference between infrared and ultra-violet lamps. Though huge advertising campaigns are doing much to enlighten customers, too many of them still do not know about the various functions of the therapeutic bulbs. Briefly, infrared provides penetrating heat for the relief of aching muscles; heat for hair-drying, etc., but they *do not* tan the skin. Ultra-violet lamps provide Vitamin D, and they cause tanning. Some types of sunlamp give off infrared rays, too, but usually to a very limited degree.

Re-Lamp Entire Home

By pointing out that bulbs blackened by use are costly to operate because the user doesn't get all of the illumination he pays for, the dealer is often able to get the customer to agree to permit him to re-lamp the entire house.

Simplify your BOOKKEEPING Job



REGISTER every transaction by hand...

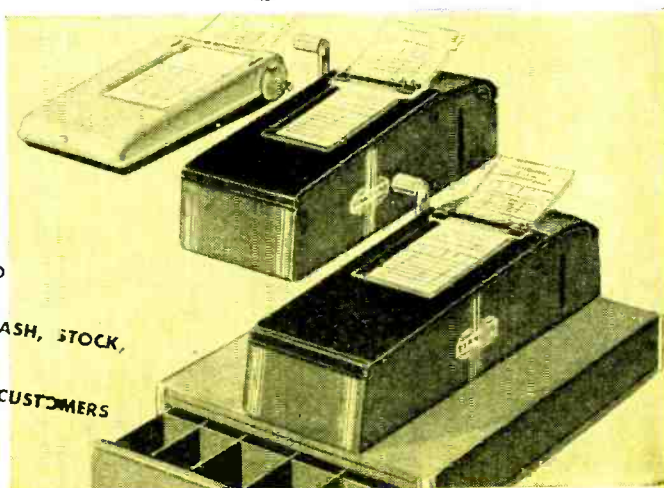

the modern STANDARD REGISTER way!

DISCOVER how much easier, *faster*, you can make the records you need—with the Standard Form-Flow Register. Learn how it simplifies bookkeeping, tax and financial reports. See how it checks carelessness, misunderstandings, dishonesty...protects your cash, merchandise, *people* involved in every transaction. And see how it helps give you the fast, accurate picture of inventory you need, today. Mail the coupon, *now*, learn *all* the ways a Standard Register can help you operate more profitably.

FREE! WRITE FOR FOLDER which tells how Standard Form-Flow Registers and pre-tested Standard Register systems can give you more complete records with less writing, less work—in your particular business.

**THE
STANDARD REGISTER COMPANY**

Manufacturers of Registers and Forms
for ALL Business and Industry
DAYTON 1, OHIO

Pacific Coast: Sunset McKee-Standard Register Sales Co., Oakland 6, Calif. Canada: R. I. Crain Ltd., Ottawa. Great Britain: W. H. Smith & Son, Ltd., London

**Appliance
Dealers**

GET THESE SPECIAL BENEFITS

- All records clear, legible at one writing.
- Copies for customer, office, delivery and locked-in audit records.
- Foolproof check against lost records.
- Fixed responsibility, including delivery receipt.
- No confusion on terms of sale, payment or delivery instructions.
- Complete legal contract and copies with one customer signature.

○ THE STANDARD REGISTER COMPANY ○
 ○ Dept. 1309, Dayton 1, Ohio ○
 ○ Please send me Free Standard Register Business Digest which tells me how I can write better records in my business...easier...simpler...faster! ○
 ○ NAME..... ○
 ○ COMPANY..... ○
 ○ STREET..... ○
 ○ CITY.....ZONE...STATE..... ○

The Battery Business

"Sales of Cells" Now Mean Bigger Profits for Retailers

● Dealers have a new interest in the battery business.

Many a radio/appliance retailer is beginning to see the importance of establishing his store as the battery-replacement center of his community. The ever-increasing "sales of cells" is developing into a traffic-building and register-ringing proposition that means real cash income of impressive size.

A part of this revival of interest is due to retailers' experience this summer in selling batteries for portable radios. They found that the demand was good and that it meant customer contact and extra repair jobs. They also found that battery units had been improved, the number of types had been increased, and that the business was, generally speaking, a "clean" and profitable one.

Many Types in Demand

There are almost enough uses for batteries now in the picture to justify setting up a "battery department." Most familiar to radio men, of course, are the packs for the portable sets—including those for the average-sized 3-way receiver, the "personal" type of radio, and the miniature or pocket-style unit. Then there are the packs for the millions of farm sets now in use, and a steady interest in batteries for hearing aids. In the "light" classifications are the familiar cells for flashlights, batteries for electric lanterns, and an ever-increasing demand for photoflash batteries.

In addition, the cells are widely used for door bells and chimes, transmitters, telephones, ignition, and the operation of hobbyists' gadgets. All this market is within reach of the radio/appliance retailer, and it gives him at least a dozen popular items to sell and to use as traffic builders.

Due to the fact that most batteries are small items, there has been much emphasis among the suppliers on point-of-sale displays. Many of these are of the counter-supply type, so that the stocking of the merchan-

dise is simple and convenient for the dealer. Much of the business is self-service. This has been going on for so long in the battery business that the manufacturers are veteran experts in this type of display, and retailers get an excellent deal as a result of their long experience. Retailers now have a choice of displays that are bright, smart and effective—all sizes, types, and colors.

Running in national magazines are a number of sales-stimulating ads on



batteries of several types. These displays are making the public sensitive to the performance and durability of the cells, and they give the retailer the benefit of million-dollar promotion. They stir up interest in improvements and changes in the product and remind the buying public of the values now available.

Create Store Traffic

Naturally one of the most important advantages of selling batteries is the effect that it has on store traffic. Among the other so-called "traffic" items, a customer may leave the store without making a choice, but if he wants a battery he has a real need for same, and he buys one.

Radio men have said that it is dead

easy to transform a battery customer into a prospect for radio sales-or-service. When people talk about radio power, they naturally think about how the radio is working and also how the other sets in their possession are working. This can readily lead to sales or service for any type of receiver, and it certainly is not far-fetched to imagine how the sale of a 10c battery can lead to the placing of a \$200 radio order.

In the case of the very popular flashlight batteries, the extra-sales trend may run to merchandising the many different types of new flashlights, or many other items in which this type of cell is used. In fact, the dealer who has a complete, fresh stock of batteries may expect extra patronage from a surprising number of groups. These include photographers, hobbyists, youngsters, mechanics, experimenters, etc., all of which have special needs for regular supply.

Buyers Are Interested

Or, the traffic-pulling display of flashlight cells may be strategically placed among other higher priced traffic items to which the dealer wishes to call attention. Whether or not the battery has a direct relation to other types of merchandise sold or serviced in the store—it is still much-sought by the public and of course every dealer knows the value of having people stream through his aisles.

Also, some dealers like the idea of increasing the number of battery "reminder" displays shown around the store. If enough of these are in evidence, it has been found that customers are reminded that they need a cell or two, and an extra sale is made. Here again, the fact that batteries are the small-unit type of merchandise—flexible and adaptable to many different kinds of counter and window display—becomes an advantage to the retailer.

In conclusion, the small-but-mighty battery can be regarded as a powerful little merchandiser for the cell-conscious dealer.

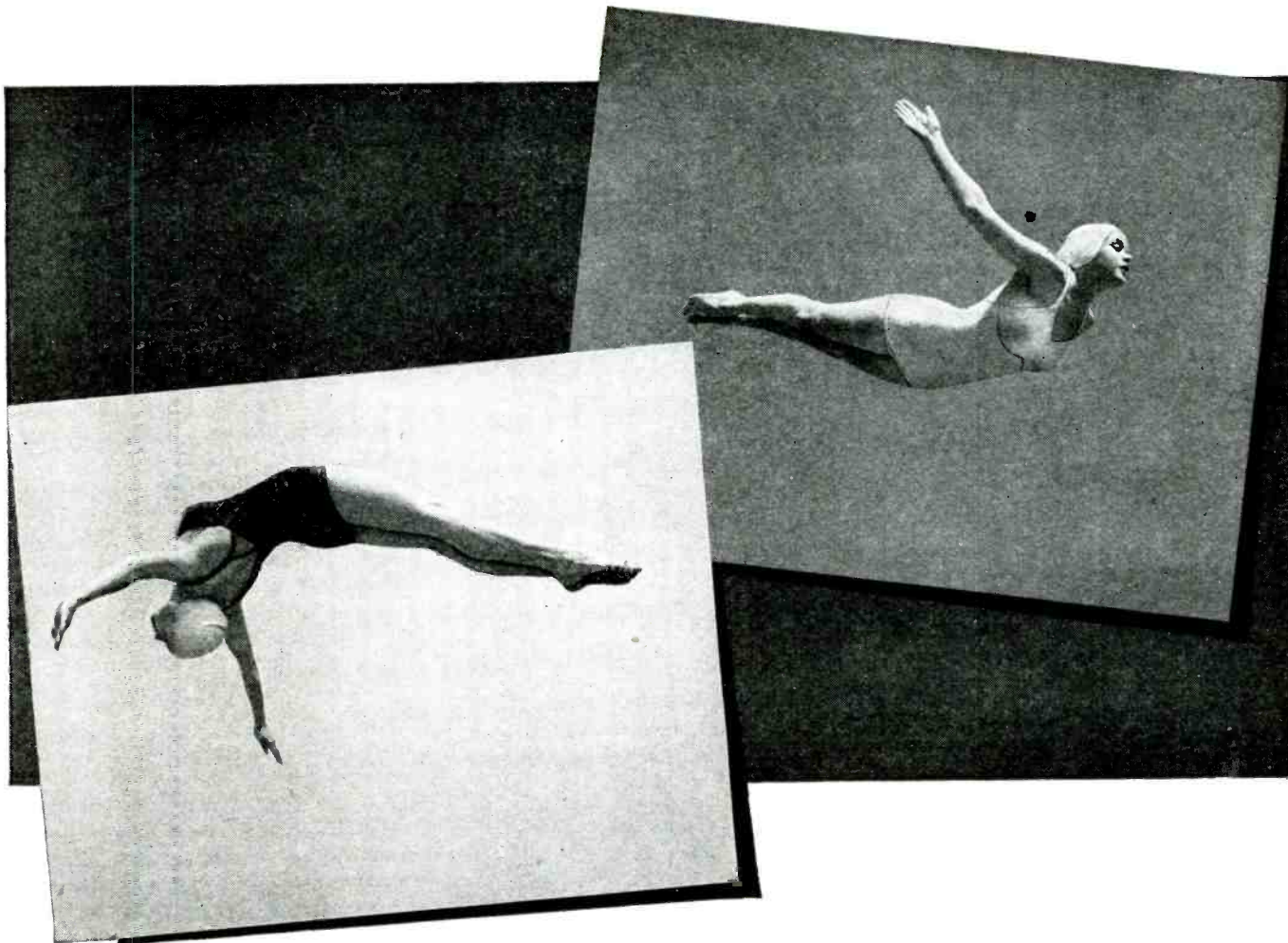

Which one will be **TOMORROW'S CHAMP?**

You've really got to know how to size 'em up — whether you're predicting the next diving champion or picking tomorrow's top sales-winners from the nation's radio and appliance lines.

Through many years of experience, as an independent national distributor . . . through close familiarity with many lines under all varieties of market conditions . . . Graybar has sharpened its talent for picking best-sellers.

And, *because* it is an independent, self-directing organization, Graybar is *free* to select and recommend lines on the basis of saleability. At the same

time, because of its long-established service of economical national distribution, Graybar has the confidence and cooperation of top-flight radio and appliance manufacturers.

Result: Graybar dealers throughout the nation get unbiased, reliable recommendations from our Merchandising Specialists. They get a wealth of business-building assistance as well — plus the convenience of obtaining leading lines of merchandise from a near-by Graybar warehouse. *Merchandising Department, Graybar Electric Company . . . offices and warehouses in over 90 principal cities.* 4788

When a product is recommended by Graybar, you can be sure it is (1) easy to sell, (2) honestly advertised, (3) backed by a warranty which protects both dealer and consumer.

recommended by
Graybar

RADIOS, COMBINATIONS • MAJOR APPLIANCES • TRAFFIC APPLIANCES

Servicing Appliances

Checking Door Seals On Refrigerators

The necessity of a tight door seal cannot be over emphasized. The proper method of determining a good door seal should be practiced.

The old method of using a piece of paper or a feeler gauge to check the door gasket sealing effectiveness is of little value on late model cabinets.

The door gasket can grip a .002" thickness of paper and still permit considerable air to leak through. Probably the most practical method of checking the door seal is by light.

Make up an extension cord using a 75 watt lamp. The cord should be made from small, thin fixture wire so that the gasket will permit easy closing when the door is closed on the wire. By locating the 75 watt lamp on the center shelf of the refrigerator as near the front as possible, the slightest leak in the door gasket can be detected with the door closed, by visible rays of light.

The light rays can be seen through an opening that would exert slight pressure on a piece of paper .001" thick. Poor door seal is, in most cases, caused by improper strike adjustment. The procedure for adjusting the strike is explained under strike adjustment.

The above information comes from the service department of the Kelvinator Division of the Nash-Kelvinator Corp.

On-Off Switch Repairs On Ray-Vector Heater

The following directions for repairing the switch on the Ray-Vector heater are provided by The Schwartzbaugh Mfg. Co., Toledo, Ohio:

1. Lay heater on its back, remove guard, feet, and trim band.
2. Remove reflector element assembly by first removing four small screws found along the flanges of the reflector ends. Push about 10" of the cord through the heater and pick up the reflector assembly by the flanges on the end and lift right-hand end so that the terminal studs pass through the small elongated notch in the right end of the heater body. Then move the assembly to the right until the safety switch clears the left-hand end of the body. This ex-

poses the On-Off Safety Switch, which is mounted on the left-hand side of the reflector.

3. If the phosphor bronze switch blade is distorted, it should be straightened. If terminal studs in the side of the reflector are loose, they must be tightened and checked for an electrical ground. The nuts which secure the switch assembly to the terminal studs must also be tight. The safety switch should remain closed until the heater is tipped forward beyond 45° from the vertical position. The switch should open when the heater is placed face down. Minor final adjustments can be made by: a. Turning the small adjusting screw located near the fixed end of the phosphor bronze switch blade. Note: This is for new switch with adjusting screw included. b. Bending the phosphor bronze switch blade slightly near its fixed end until the proper clearance is obtained. Note: This is for new switch without adjusting screw.

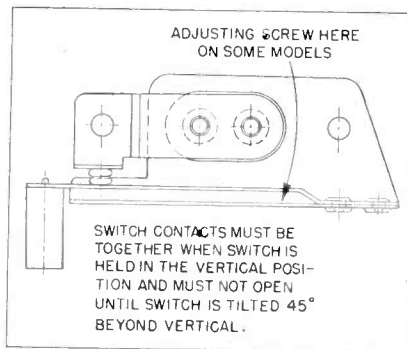

The On-Off Switch should cause the contact to break at approximately $\frac{1}{16}$ " within the "off" position, and the insulating tip should clear the switch blade assembly completely when in the "on" position. If necessary, the wire operator of the On-Off switch can be bent slightly to obtain the necessary clearance.

4. The re-assembly is the reverse of the above procedure. Care should be used to avoid striking the safety switch against the body when re-assembling.

Never use any kind of polish on plastic emblems, escutcheon plates, trim, etc., on various electrical appliances. Clean nickel plate with a dry cloth, chromium plate with a damp one.

Checking Trouble in Vac Cleaner Motors

When a vacuum cleaner motor is running, a long yellow arc across the commutator indicates an open circuit. When a motor is running, a long blue arc across the commutator indicates an open circuit. A rough commutator causes a yellowish-blue spark. Never try to clean the commutator of an armature by filing it on a lathe, as this may short the bars. Do not use sandpaper as this will roughen it and cause it to spark. A little piece of cloth saturated with gasoline will quickly remove all of the black carbon or whatever substance may be on the commutator.

Check Armature

The armature is really the heart of the motor and requires an accurate check to be sure that it is right. An armature that is not performing properly will reduce the speed of the motor and this in turn means the cleaner will not have the proper suction. An armature may be burned out, or it may have an internal short, an opening in the windings, or a burnt segment in the commutator.

The foregoing information comes from the Premier Vacuum Cleaner division of General Electric Co.

Jacobs Launderall

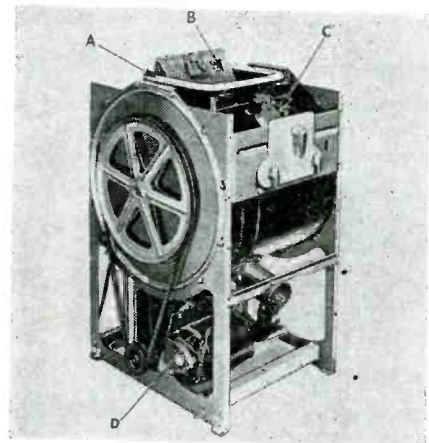

Pictured above is front view of Launderall's complete chassis assembly, showing (A) Top-Fil-Dar tub gasket; (B) washing cylinder loading door; (C) Softi-Latch mechanism; (D) 1/4 horsepower motor.

On toaster come-back calls where the complaint is improper toasting, and where everything seems to check all right, it is good practice to operate the device under actual conditions—using bread.

Strange footprint ?



Not at all.

Not for the radio equipment and appliance dealers who advertise in the 'yellow pages' of their telephone directories.

Why?

Because shoppers *do* look in the 'yellow pages' first for buying information.

Because these shoppers *do* look for dealers who handle the particular brands they want . . . who offer the service they need.

Because the 'yellow pages' *do* help form buying habits.

Because it's a natural advertising medium for you.



For further information, call your local telephone business office.

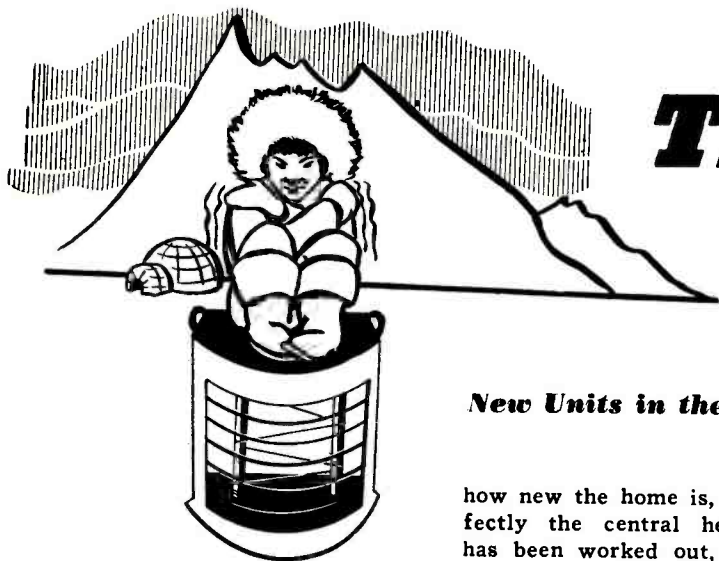

The Heater Is a Hit!

New Units in the Electric Field Are Real Money-Makers

● A careful look at today's market for electric space heaters indicates that these units have profit possibilities that are strictly first-rate. It's a market that will really interest almost any cash-minded retailer when the first chill day of the early winter comes along.

September and October are two months that mean ACTION in the heater business. The Fall is the time when the merchandiser must decide on his stock and do his ordering under the new conditions, so that he will be ready for the first sales of a season that promises to be a honey.

The electric heater has always had its points as an example of clean merchandise. It's a product with no installation problems, easy to demonstrate, well supported by national advertising, with prices low enough to create traffic. All of these features are important to the dealer, particularly if he's trying to get himself into the stride of the buyers' market.

Many Uses Developed

For sales in 1947-48 there are enough new and different types of heaters to give the retailer a valuable and impressive variety of models. Among the newer types are those which double as fans for summer; portable electric steam units; and those which have cast-type heating elements. All these are supplied in new designs with the "rough edges" long since removed—the streamlining done as ably and efficiently as American industry knows how to do it. The safety factor has been taken care of, and the over-all convenience is way up.

One of the best ways to merchandise heaters is to operate on the theory that they have many uses for the average family. And no matter

how new the home is, and how perfectly the central heating system has been worked out, the need for portable heating or drying is still present in several corners of the house. The ins and outs of air circulation are sometimes puzzling to the new home-maker but he will respond to an appliance that actually delivers comfort, when the retailer knows his facts. It is not necessary for the merchandiser of space heaters to go as far into the matters of temperatures, air circulation and humidity as the seller of air conditioning plants. But he should nevertheless know a few of the basic facts that govern the movement of air in a room.

The heater is an item that's very strongly backed up by point-of-sale materials, especially this Fall. For the dealer who means business this time, it will be easier for him to show the units colorfully and effectively in his store. Unlike some of the so-called promotional "orphans" of the appliance business, the heater has its own streamers, display cards, plus all kinds of backgrounds and "silent salesmen." They make the store seem seasonal and interesting.

In point of national advertising, the heaters no longer tag along behind the major appliance lines. They are shown in big color spreads in national magazines and become "wanted" merchandise in short order.

AMONG MANUFACTURERS OF ELECTRIC HEATERS

Appliance Industries of America, 666 Lake Shore Drive, Chicago, Ill.

Bersted Mfg. Co., Fostoria, Ohio

Chicago Electric Mfg. Co., 6333 W. 65th St., Chicago, Ill.

Dominion Electrical Mfg. Co., Mansfield, Ohio

Eagle Electric Mfg. Co., Inc., 23-10 Bridge Plaza South, Long Island City, N. Y.

Electric Steam Radiator Corp., Paris, Ky.

Electromode Corp., Rochester, N. Y.

Emerson Electric Mfg. Co., 1824 Washington Ave., St. Louis, Mo.

General Electric Co., 1285 Boston Ave., Bridgeport, Conn.

Knapp-Monarch Co., 3501 Bent Ave., St. Louis, Mo.

Landers, Frary & Clark, 47 Center St., New Britain, Conn.

Miracle Electric Co., Chicago 3, Ill.

Monitor Equipment Corp., Riverdale, N. Y.

Noblitt-Sparks Industries, Columbus, Ind.

Radiant Heater Corp., 521 Fifth Ave., New York, N. Y.

Redi-Electric Co., 141 W. 24th St., New York, N. Y.

Samson United Corp., 1700 University Ave., Rochester 10, N. Y.

Sunbeam Corp., 5600 Roosevelt Road, Chicago, Ill.

Swartzbaugh Mfg. Co., 1336 Bancroft St., Toledo, Ohio

Thermador Electric Mfg. Co., Inc., 5119 S. Riverside Drive, Los Angeles 22, Calif.

Trilmont Products Co., 24th at Walnut St., Philadelphia, Pa.

Westinghouse Electric Corp., Electric Appliance Division, Mansfield, Ohio

Wittie Mfg. & Sales Co., 1414 S. Wabash Ave., Chicago 5, Ill.

Sales & Service

(Continued from page 103)

small appliances such as food mixers, juicers, liquefiers, hair dryers, etc.

The average customer is well sold on the necessity for keeping appliances safe and well lubricated, and it is up to the dealer to sell such maintenance service to the householder. It is natural for most customers to put off having repair work done until the time comes when the product breaks down completely.

The dealer who sells service intelligently will make money for himself and will make friends of his customers. There is a wealth of satisfaction in the knowledge that one's home electrical servants are in tip-top condition, and the smart dealer who contributes to such feeling on the part of the customer is lining himself up for more maintenance, and, for more sales of new products as well.

Many appliance retailers are electrical contractors, and for them the solicitation for more repairs on equipment is bound to result in more electrical work, too. Such merchant can sell additional outlets, new circuits, lighting fixture repairs, outdoor lights, etc.

In addition to selling repairs on utility items, there is much business to be had in servicing entertainment equipment, with radio, of course, heading the list. Keeping receivers in perfect operating condition should be the aim of every dealer. Certainly such is the inherent desire of every owner which makes the whole selling affair one of mutual benefit.

Try a repair business-increasing drive and see if the results are not more than gratifying. Make every endeavor to inspect all of the radios and appliances in the home. Every time you have a specific item to repair, ask the customer if he hasn't some other equipment needing service.

Seasonal Product

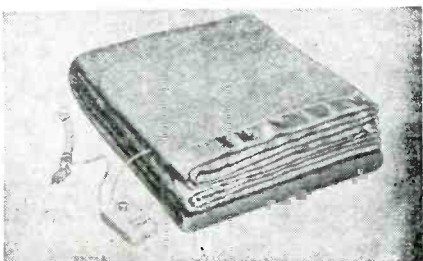

The new Everhot electric blanket No. 920, from Swartzbaugh Mfg. Co., Toledo 6, Ohio, is 75% wool, rose or blue, packaged in clear plastic bag, \$41.95. Single spiral wire, flexible and waterproof insulated. Control unit in white plastic box, with temperature selector dial, glow light, on-off, safety thermostats. Measures 72" by 90".

Announcing . . . a revolutionary New Proctor Never-Lift Iron!

MAKES IRONING EASIER TWO WAYS

Sit-Down Ironing
Amazingly easy . . . made possible by the "IRON THAT LIFTS ITSELF!"

Lady be seated. Yet iron faster, easier, better. This iron lifts itself . . . stands without tilting. That's why it's the "only iron" for Sit-Down Ironing.

Here it is . . . the completely new, brilliantly designed 1948 Proctor Never-Lift Iron, with a host of amazing new features.

See it and you'll call it a miracle. A touch of your finger and it lifts itself on its ingenious, cool, safer leg support. Pressure of your palm brings it instantly down for work . . . the leg support snaps completely out of the way.

Never was ironing so easy . . . but that's not all. See that new Rayon Safety Signal. It shows green when the iron is safe for rayon, red when it is too hot.

Note the big, easy-to-read fabric dial. See the cool, plastic shield cover to prevent scorched knuckles . . . the rugged built-in cord.

It's the most brilliant iron achievement of Proctor's decades of fine iron manufacture. See it now wherever fine electric appliances are sold.

© A TOUCH HERE LIFTS IT

A TOUCH HERE AND IT'S READY TO GO

THE OPENING GUN . . .
this ad reproduced in a full color double-page spread in the NOVEMBER 1st issue of the SATURDAY EVENING POST

New Rayon Safety Signal

Clear Vision Fabric Dial

New Fabric Control Dial

New Overboard Thermometer

No Lift No Tilt No Twist

It's new... it's exclusive... it's...

PROCTOR

PROCTOR ELECTRIC COMPANY, PHILA. 40, PA.

For efficient repair, 154 factory approved Proctor service centers. 1948 is exact . . . see local authorized Proctor retailer.

© 1947 P. E. Co.

PROCTOR IS USING THE WHOLE ARSENAL FOR THE GREATEST NEVER-LIFT IRON IT EVER BUILT

★ **FOUR-COLOR ADS** in the **NOVEMBER ISSUES** of **THESE MAGAZINES . . .**

★ TRUE STORY ★ BETTER HOMES & GARDENS ★ McCALLS
★ SATURDAY EVENING POST ★ GOOD HOUSEKEEPING
★ AMERICAN HOME ★ LADIES HOME JOURNAL

PLUS ADS IN 11 OTHER NATIONAL MAGAZINES!

Ask your distributor about this great new improved Never-Lift iron and the **FREE** promotional tie-in package!

Low^o Saturation in Appliances

In the 1947 consumer analysis of the St. Paul Minnesota, market, made by the *St. Paul Dispatch-Pioneer Press*, retail merchants in the trading area are aided in estimating their sales potentials for appliances through study of the various "saturation-point" figures.

In addition to aiming at selling the "don't have's," the retailer counts heavily on the replacement business. Typical of conditions in many cities, the St. Paul survey finds, for instance, that 22.9 per cent of the families interviewed do not own a vacuum cleaner. The 77.1 per cent who have this appliance own a variety of 73 makes.

60.4 per cent do not own electric food mixers, and 91.5 per cent do not own electric roasters. Next to radio, owned by 98.9 per cent of those interviewed, comes the electric hand iron, owned by all but 2.0 per cent of the families quizzed. 114 different makes are in the hands of those in the St. Paul market.

10.3 per cent have electric ironing machines (47 makes); 85.1, washing machines (104 brands); 13.3 own electric ranges; 32.2 own sewing machines; .2 per cent have dishwashers.

Included in the 74.1 per cent who have electric refrigerators are 68 makes, the survey shows.

57.0 per cent of the families (53,721) have one radio; 32.7 have 2 sets; 8.1 own 3 radios; 1.7 four receivers; .4 per cent, 5 receivers (350 families); 32 families

Midwest Merchandisers Ready to Go



This group of Gibson dealers from the Kansas City, Mo., and Wichita, Kan., areas were recent guests of the wholesale division of Jenkins Music Co., Gibson's distributor there, at Kansas City's Phillips Hotel. Featured speakers were Earl S. Nobles, Gibson's divisional manager, and John L. Stephens, sales promotion manager for the manufacturer.

have six sets, and 94 homes reported seven radios each. 3.9 per cent own frequency modulation receivers.

Consumer preferences for features in a new radio stacked up as follows: Automatic record changer, 41.8 per cent; television, 35.7; FM, 32.7; regular broadcasting, 27.7; short wave, 8.3; don't know, 2.4.

New washers led the want-to-replace appliance list, followed by vacuum cleaners, irons, refrigerators, food mixers, ranges, sewing machines and ironers, respectively.

Bendix Appliances at New Production Peak

The production accomplishments of Bendix Home Appliances, Inc., South Bend, Ind., which assembled 296,000 automatic washing machines in the first half of 1947, have been summarized in a statement by Judson S. Sayre, president.

Mr. Sayre said that personnel, flexibility of operations, intelligent planning and tightly-knit co-ordination were responsible for the production peak which "shattered all records of the company."

The output, reaching high gear in February and maintaining a monthly average of just under 50,000 units, was achieved in the face of almost insurmountable material shortages, Mr. Sayre pointed out. He had special praise for the Bendix men who made it possible to produce in six months "a total which approached our entire pre-war output of 335,000 units."

Stage Set for Peak Promotion



Expanded promotional activity of Philco Corp., a history-maker for the firm, is explained here by James H. Carmine, vice-president in charge of merchandising. For Philco's 133 jobbers and nationwide sales force, Mr. Carmine told how the record-breaking ad drive will include radio, television, newspapers, national magazines, etc.

New Planned Kitchen Trend, Hotpoint Reports

Some 3,000,000 prospective appliance buyers of the U. S. want their equipment in a "planned" kitchen, Edward R. Taylor, merchandising manager, Hotpoint, Inc., reported in a recent address marking the record sale of the "Your Next Kitchen" planning guide. Hotpoint hit the three million mark in sales of the 44-page illustrated kitchen booklet, in its 34th month. The pieces were sold at 10¢ by dealers and directly by the manufacturer from couponed advertisements.

Heads Appliance Research

Ralph L. Benson is the new head of the refrigeration and appliance section of the research and advance development department of the Crosley Division—Avco Mfg. Corp., according to L. M. Clement, director of research and engineering.

*instant hot water...
instant sales...*

with **THERMOJET**
**THE ONLY 100% AUTOMATIC
FAUCET WATER HEATER**



Every home-owner will "go" for the new streamlined THERMOJET. *Easy to use, easy to sell*, THERMOJET is truly a merchandising miracle.

Fully insulated, *fully guaranteed* for one year—THERMOJET can be installed by any member of the family. THERMOJET fits any standard faucet—simply slip it on and plug into electric outlet. Red signal light goes on. Turn faucet handle which acts as a switch—hot water flows instantly. There is no waste of current or hard-to-get fuel.

Every home in your community represents an *instant sale*. Cash in on the biggest profit-making household appliance ever produced. Take advantage of our national consumer advertising campaign reaching 15,000,000 American homes every month.

Order now for September and early Fall delivery.

THERMOJET works on AC current only. Meets all safety and durability standards.

Available FREE for store promotion—appealing counter and window displays, mats and booklets.



Patented U. S. Patent Office

THERMO ELECTRIC CORP. OF AMERICA
55 WEST 42nd STREET, NEW YORK 18, NEW YORK

Now! TRILMONT puts the heat on, to get YOU greater heater volume!

Now! The 1948
TRILMONT Safety*
ELECTRIC HEATER

Equipped with the New
TRILMONT Safety
CORD SWITCH

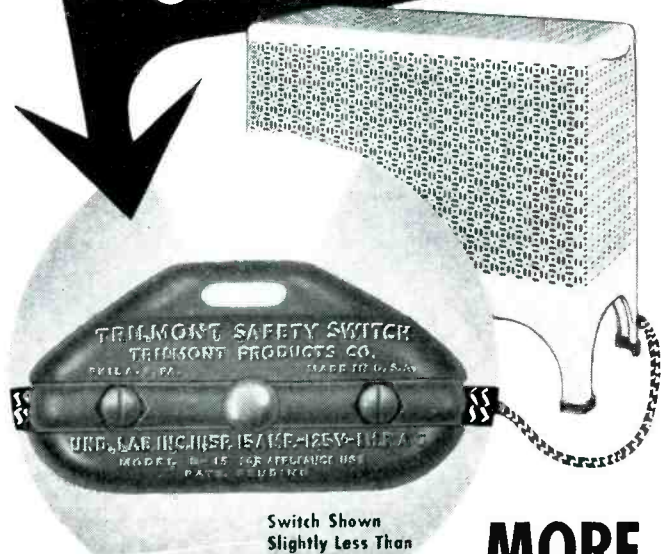

Switch Shown
Slightly Less Than
Actual Size

FIRST CORD SWITCH
WITH A
**Tell-Tale
Glow-Light!**

Tiny neon lamp glows when heater is on, saves current by reminding user to turn heater off when no longer needed.

FIRST CORD SWITCH
RUGGED ENOUGH TO
BEAR A
**One-year
Warranty!**

For additional information on switch, write for Bulletin L-15.

**MORE
TO SELL...AT**

No Increase in Price!

Yes, something NEW has been added to America's No. 1 Heater, at no additional cost to you or your customers! It's the new TRILMONT Safety Cord Switch... a regular \$1.95 retail value... a sensational new convenience, economy and safety feature that means greater sales and profits for YOU! Order your 1948 TRILMONT Heaters now. Write today for name of nearest distributor!

RETAIL \$3.00
PRICE

Includes Federal Tax and Detachable Cord Set with HEAVY-DUTY Switch

95c Extra in Western Zone, Ivory or Brown Baked Enamel. Model A, 1200 Watts. Model AA, 1320 Watts. A.C. or D.C.

*Winner, Lewis & Conger First Annual Home Safety Award

TRILMONT PRODUCTS CO., 2403 Walnut St., Phila. 3, Pa.

Mallory Contributions to Television

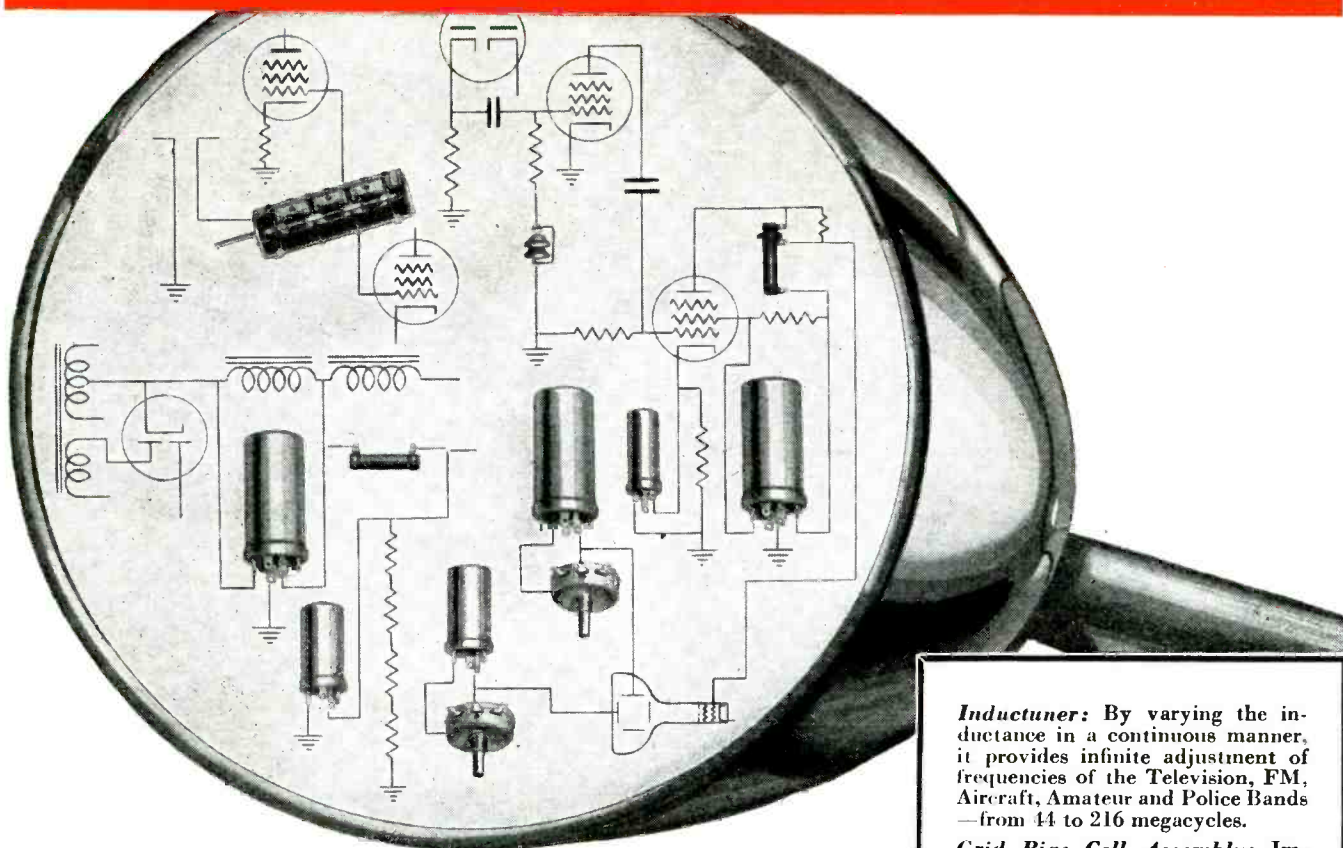

ANTICIPATING the day when servicing of television sets will be as common as present-day servicing of radio sets, Mallory has long been engaged in planning, designing and building television components.

The result of this foresight is shown in the typical television circuits illustrated above—circuits in which no less than ten different Mallory parts find an important place. Three of these parts—the Inductuner*, the Videocoupler and the Grid Bias Cells—are of exclusive Mallory design.

The important point about these products is that they conform to standards for which Mallory is famous. Each in its own right is a true "Approved Precision Product." Each has the earmark of premium quality. You expect more and get more from Mallory components. That's true, too, of these television products.

*Reg. U. S. Pat. Off.

Inductuner: By varying the inductance in a continuous manner, it provides infinite adjustment of frequencies of the Television, FM, Aircraft, Amateur and Police Bands—from 44 to 216 megacycles.

Grid Bias Cell Assembly: Improves picture quality by aiding low frequency response and effectively eliminating stray pick-up.

Videocoupler: Widens frequency response, resulting in better picture definition.

FP 550 Capacitor: A unique decoupling and screen bypass capacitor.

10 Watt Vitreous Enamel Resistor: Used as a voltage dropping or bleeder resistor in low voltage power supply.

WP 540 Capacitor: Bypass for vertical centering.

WP 510 Capacitor: Bypass for horizontal centering.

WP 505 Capacitor: Bypass in compact container for video stage cathode circuit.

FP 135 Capacitor: Filter in low voltage power supply; effectively eliminates 60-cycle "hum band" distortion.

Carbon Controls: Used as tone, volume and contrast controls. (Not shown.)

Wire Wound Controls: Used for horizontal and vertical centering.

P. R. MALLORY & CO. Inc.
MALLORY

VIBRATORS . . . VIBRAPACKS* . . . CAPACITORS . . . VOLUME
CONTROLS . . . SWITCHES . . . RESISTORS . . . FILTERS
. . . RECTIFIERS . . . POWER SUPPLIES.

*Reg. U. S. Pat. Off.

APPROVED PRECISION PRODUCTS

P. R. MALLORY & CO., Inc., INDIANAPOLIS 6, INDIANA

SERVICE & SOUND

Section of **RADIO & Television RETAILING**

Tune-Up Service Profits Now!

Get Your Repair Dept. Geared to Promote Fall Business

● Each Fall the radio broadcasting networks put on large-scale promotions on their new and revived radio shows. This year, with a greatly increased number of broadcasting outlets, competition for the listening ear will be stronger, and bigger and better shows will be promoted on AM, FM and television. Which is, of course, where the radio servicer comes in!

No experienced radioman need be told of the high percentage of radios, in daily use in people's homes, in sad states of disrepair. At almost any time of year, a local dealer's "radio check up" promotion will bring in a certain amount of business from this source.

The obvious time for such a campaign, however, is in the early Fall, tying in with the local radio station's own efforts to put the radios of their audience in 100% condition.

Planning the Program

Build your campaign around the parts and services with which most set-owners are familiar, and normally expect to buy periodically. Use a window for a technically-flavored display of tubes, batteries, antenna materials, noise eliminators . . . and, space permitting, an actual service bench or a tagged display of test equipment with posters explaining their function. Across the window run strong streamers urging Tune-Up, Tube-Up, Check-Up.

FM, with its rapidly spreading program service, is making folks throughout the country conscious of the pleasure to be experienced from



a background of interference-free silence against which the full dynamic range of the program may be heard. "AM-only" owners want that same sort of reception . . . and they'll respond to an effort to get it for them with the judicious use of noise-suppressing filters, new antennas, fresh tubes and batteries.

There's a big and growing market too, for parts and units which may be added to all types of receivers. The field for replacement automatic changers as substitutes for old and antiquated phonos has received only superficial treatment in many communities, while the sales possibilities in high quality speaker and amplifier units installed in attractive furniture and baffles hasn't even been scratched.

Brand New Market

The emergence of FM tuning units for attachment to AM receivers is proving to be a big profit-stirring factor. Several makes have hit the market in recent months, including one selling for less than \$30. The work of installing one of these units, while definitely requiring a capable servicer, is clean and uncomplicated, and should provide many a profitable

hour for the service department.

Auto radios, as many a smart servicer knows, are especially ripe fruit, ready to be gathered in by an aggressive radioman. The clicks and buzzes and fading which are all too often tolerated in a home set, generally cause far greater concern when they appear in an auto radio, especially when the car owner does much traveling outside of town.

Save These Listings!

To help you plan a Tune-Up campaign and purchase the supplies you'll need while the drive is on, save the directory pages included in this issue, listing the major manufacturers of every item in the radio and sound field, and refer to them when you want full information in a hurry.

Make plans now to work up printed material, posters, streamers, displays, mass advertising; arrange for tie-ins with publicity value; stress Tune-Up with appliance and record customers; get going, for now's the time!

Be sure to read and save the listing of recommended replacements for phono pickup cartridges, pages 125 and 134.



MORE TYPES of RCA Batteries

Representative types from
RCA's complete battery line.

... for more sales ... for more profit

• RCA puts you in the lead with a completely rounded-out line of RCA batteries for radio and industry. Now there are more new production types of batteries for servicing the enormously increased numbers of portables and farm sets. You can also obtain limited-demand types on a special order basis.

This expanded line combined with RCA's sales policy of selling primarily through *radio retail* outlets—and authorized RCA Tube Distributors—creates real sales potential for you.

There's a strong customer preference for the famous "red-white-and-black batteries" with the RCA emblem. They're smartly pack-

aged, competitively priced . . . and *Radio Engineered for Extra Listening Hours.*

Strategically located warehouses carry stocks of *fresh* RCA batteries at all times. Get the facts on the complete RCA battery line now . . . from your RCA Tube Distributor . . . and start cashing in on this fast-moving line.



TUBE DEPARTMENT

RADIO CORPORATION of AMERICA

HARRISON, N. J.

Religious Sound Systems

A Big Factor in the PA Business: Dealers Need This Information. Part I

● In a highly competitive field like PA, the dealer must keep on his toes to discover how best to direct his selling activities. To help him do this, RADIO & Television RETAILING recently queried a selected group of sound men scattered from Texas to New England, and from California to New York, in small town and large city.

According to almost 25% of the men queried, all of whom are active in the PA business, installations in churches will provide the greatest single market for sound in the coming year, not counting intercommunication systems.

For all this huge interest in religious sound systems, however, not many PA men are familiar with the technical and sales problems that enter into this type of work. In a short series of articles, therefore, we will cover the most important factors. For a good deal of this practical advice, the editors are indebted to L. A. Randall of Stromberg-Carlson's sound equipment division, whose activities in this field are well known.

Sound equipment installation in churches normally fall into three classifications or a combination of these groupings, namely, auditorium PA systems, hard of hearing systems and the reproduction of chimes from the church tower.

Many churches also purchase or

rent portable systems for use during lectures, entertainment, banquets and various social events. A good portable system for this purpose must be adaptable to an easy set-up anywhere in a church room, and provide the flexibility required in a religious institution. Good results must be secured, as a rule, with a comparatively inexperienced operator.

Choosing the System

The relative merits of a single centralized system as compared to a combination of several distinct ones has occupied the attention of church PA installers for many years, and arguments have been developed pro and con. While in the final analysis the choice must be made on the basis of conditions in a given church, the arguments offered for separate units are often quite attractive to a smaller religious institution or to the smaller PA dealer.

For one thing, the fact that the system will probably be operated by unskilled individuals will emphasize the need to keep controls and switches for any given application to a minimum. In this respect, a highly centralized system can prove confusing.

Furthermore, a single system to take care of the auditorium, hard of hearing, Sunday School rooms,

tower reproducers, banquet hall, overflow rooms, chapel and recreational area, requires a specially engineered model with its increase in cost that frequently motivates the church committee to postpone or abandon the purchase of any sound equipment for lack of funds or because they cannot be sold on the intrinsic value of the benefits of the system, compared to the initial expenditure.

With these facts in mind, the sound engineer, during his survey of the institution, in estimating the costs and in talks with the committee may find it expedient to break down the requirements into several simple systems, which may be installed at separate times.

List the Requirements

The auditorium and hard of hearing section could constitute one system, with a few speakers for the overflow room. Another system could consist of the tower reproducers, amplifier and chime program equipment, while the third system could cover the recreational or social areas.

The auditorium system will require the most study and careful consideration before any recommendation is made. This system must come as close as possible to creating the il-

(Continued on page 134)



At left, the two altar mikes blend with their surroundings. Below, the specially-constructed case containing the amplifier and controls for the sound attendant matches the interior woodwork. At right, high above the pulpit, two speakers are entirely hidden behind miniature organ pipes. Because of strategic location, all the sound seems to come from the pulpit. Installation by McKee Electric.

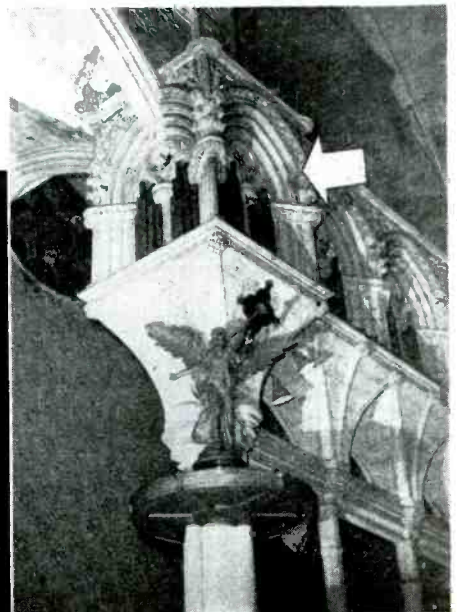

Replacing Xtal Pickups

Tune-Up Those Changers and Players! What Cartridge and Needle to Use?

● Scattered through manufacturers' radio set data sheets, service manuals, printed advertising brochures and catalogues are found references to the correct pickup cartridge and needle replacements to be used in repairing radio-phono combinations. So far as we know, however, nowhere but on these pages can be found a list, even though admittedly incomplete, of the parts recommended by each manufacturer for use on his own radio.

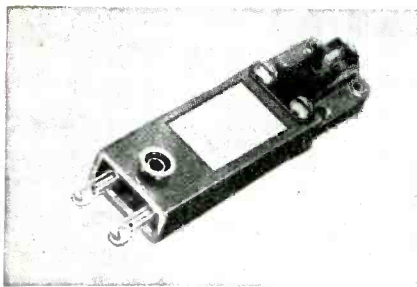

Astatic 1-J Nylon-Chuck crystal cartridge.

The brand names listed here are those of the companies who have responded to a recent request for information from RADIO & Television RETAILING.

Crystal cartridges may be very quickly tested for breakage by hand, and since the largest number of crystal failures are caused by rough handling resulting in a broken crystal, this test is naturally the first one made when a record player produces low squeaks.

The test is made by feeling the needle tip's side to side play. In an unbroken crystal the movement is firm, resilient, and restricted to approximately a quarter of an inch of movement. In a broken crystal the needle flops from side to side.

The other causes for crystal failure altogether comprise a small minority, and the connections from the pickup and the amplifier itself should be

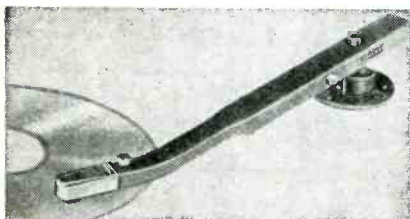

New Audax Tuned-Ribbon reproducer, model 74-A uses a replaceable jewel stylus, linear response to 10,000 cycles, point-pressure of 24 grams. Audax Co., 500 Fifth Ave., N. Y., N. Y. is maker.

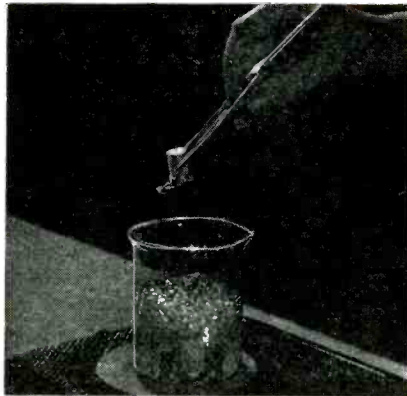

They're hard boiled. Resistance to heat and humidity of Brush's new BR-903 PN crystal cartridge proved by 10-min. dunk in boiling water.

checked for operation before the crystal is tested any further.

If the connections and the phono circuit are in good condition and by deduction the crystal is deemed defective, its failure may have resulted from one or more of the following causes.

Overheated. Raising the temperature of some crystals to above 120° F will permanently destroy their piezo-



G. E.'s hi-fi variable reluctance pickup.

electric properties. This may occur when the cartridge is displayed in the window, unprotected from sunlight. Sometimes the dealer's storage bin is too hot, or the soldering iron is held too long on the solder lugs, and too close to the body of the cartridge, during installation.

Dried out. Too long exposure to excessively hot and dry air will permanently dehydrate the crystal.

Moist. Too much moisture will cause the crystal to absorb an excessive amount of water which will also affect its operation. However, this condition is not permanent, and can be cured by removing to a dry atmosphere or by placing the cartridge in a closed jar containing a moisture-absorbing chemical.

Internal leads break. They can be

repaired by opening the cartridge and refastening. However, breaks that can be repaired by the service man occur so infrequently that the opening of a cartridge is virtually a waste of time.

When the crystal has to be replaced *don't* follow the old maxim, "If the shoe fits, wear it." *Don't* select at random from the more than 140 types now being made just because you haven't the exact replacement on hand, and can somehow manage to get the cartridge to stick to the pick-up arm. Any crystal will work. *But how?*

Crystal cartridges are manufac-

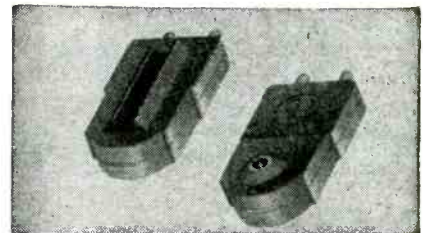

New Pickering hi-Z pickup has sapphire stylus.

tured with various frequency cut-offs or responses, various voltage outputs, requiring various needle pressures, in addition to a variety of shapes and weights. Any difference between the original and the replacement, slight or extreme, in any or all of these basic characteristics may give considerable trouble.

Voltage outputs are purposely set at various levels from as low as .12 volts (RCA 39550) to 3.50 volts. (Astatic L72.) It may readily be seen

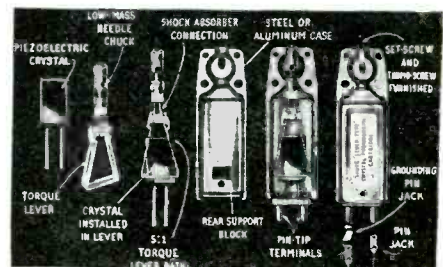

Internal construction on Shure's new "lever-type" crystal cartridge shows novel features.

that a low voltage crystal used to replace a high voltage type may not have sufficient voltage output to drive the amplifier satisfactorily, especially in cases where the amplifier is already turned up full.

The reverse is also true since the high voltage crystal may overload

in Phono-Radio Combos

Here's a Hot New Pin Up . . . a Valuable List to Keep Handy

and distort the phono output, and may also bring the room volume point on the tapered volume control to where a slight movement of the control will greatly change volume.

The system may also go into audio oscillation, since the pickup may now be sensitive enough to respond to speaker vibrations. Still more: difference in impedances of different crystal pickup types will cause a change in the audio response.

If, for this reason, or if the replacement crystal itself has a different frequency response the phono may sound unfamiliar to the user. If it is lower, the customer may complain about the lack of highs. If it is higher, and the set a low priced unit depending upon crystal cut-off to reduce needle scratch, and using a speaker that is particularly sensitive to highs, the scratch noise

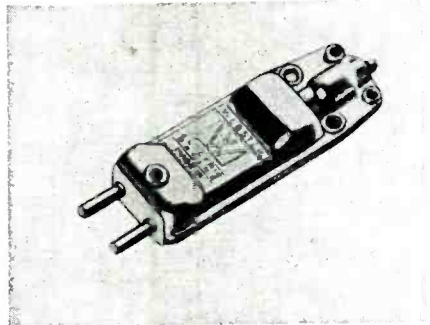

Webster-Electric makes big replacement line.

may be objectionable, and, by comparison, there may be a loss of bass.

Needle pressures vary from as low as .7 of an ounce (Webster AJ2) to as much as 3.75 ounces (RCA 14820). A light needle pressure cartridge in a heavy pressure arm may ruin the sapphire needle. Placing a heavy pressure cartridge in a light pressure arm may reduce the signal output.

Placing a heavy weight cartridge (inconsiderate of needle pressure, but heavy by actual weight) in an arm designed for a light weight cartridge will change the pressure on the needle, for better or worse as the case may be, and destroy the balance of the arm so far as the record changer mechanism is concerned.

If the new cartridge is light in weight and the old was heavy, but balanced for a light needle pressure, the counter balance may lift the replacement clear off the record.

Brand Name	Models	Cartridge	Needle
Admiral	All 1946:		Admiral N-1
	5RP47		Admiral N-1
	6RC46, 6RC51		Admiral N-1
	3A1-6RP48		Admiral N-1
	3A1A-6RP48		Admiral N-1
	3A1-6RP49		Admiral N-1
	3A1A-6RP49A		Admiral N-1
	3A1-6RP50		Admiral N-1
	3A1A-6RP50A		Admiral N-1
	5B1-6RT41		Admiral N-1
	5B1A-6RT41A		Admiral N-1
	5B1-6RT42		Admiral N-1
	5B1A-6RT42A		Admiral N-1
	5B1-6RT43		Admiral N-1
	5B1A-6RT43A		Admiral N-1
	7B1-6RT44		Admiral N-1
	7B1A-6RT44A		Admiral N-1
	6C71-10A1		Admiral N-1
	6C71A-10A1		Admiral N-1
	All 1947:		Special cartridge and needle (Admiral part #A1372)
	7RT41-6L1		Special cartridge and needle (Admiral part #A1372)
	7RT42-6L1		Special cartridge and needle (Admiral part #A1372)
	7RT43-6L1		Special cartridge and needle (Admiral part #A1372)
	7C62A-6M1		Special cartridge and needle (Admiral part #A1372)
	7C62-6M1		Special cartridge and needle (Admiral part #A1372)
	7C63-7C1		Special cartridge and needle (Admiral part #A1372)
	7C73W-9A1		Special cartridge and needle (Admiral part #A1372)
Air King	A-403	Astatic L-26A	
	4704	Astatic L-71A	
Andrea	CO-U15	Astatic L-70	
	CO-VJ12 Television	Shure P-30	
Ansley	All current	Astatic 1-J	Sapphire tipped nylon
Arvin (Noblitt-Sparks)	302	Magnetic	Fidelitone DeLuxe No-100 (Arvin part #A19850)
	558	Astatic L-40AS, L-70AS	Fidelitone DeLuxe No-100 (Arvin part #A19850)
	665	Astatic L-70S	Fidelitone DeLuxe No-100 (Arvin part #A19850)
	150-TC	Astatic L-70S	Fidelitone DeLuxe No-100 (Arvin part #A19850)
	151-TC	Astatic L-70S	Fidelitone DeLuxe No-100 (Arvin part #A19850)
Autocral	APR-157	Shure P-93	Fidelitone Supreme, or Jensen #10
	RPT-547	Astatic L-70, L-72	Fidelitone Supreme, or Jensen #10
Delco	R-1242	Shure P-90S (Delco part #1216574)	Miller type 570, 1/8" offset shank with osmium tip (Delco part #1217322)
Detrola	N-100	Astatic L-40	
	N-200	Astatic L-40	
	550	Astatic L-70	
	650	Astatic L-70	
DeWald (United Scientific Labs.)	All current	Astatic L-70	Duotone
Electronic Labs.	All current	Astatic Nylon	
Emerson	506	Astatic L-70S (Emerson part #820034)	
	525	Astatic L-70S (Emerson part #820034)	
	552	Astatic L-70S (Emerson part #820034)	
	546	Astatic L-70S (Emerson part #820034)	
	521	Astatic L-70AS	
	542	Astatic L-70AS	
	549 537	Astatic L-70 Astatic L-70S or Webster Nylon	
Farnsworth	All current	Astatic L-71 (Farnsworth part #71231) or Webster N6 (Farnsworth part #71237)	Permo floating point (Farnsworth part #71223) Permo floating point (Farnsworth part #71223)
Freed-Eisemann	46	Astatic L-75	Fidelitone FM-150
	37	Astatic L-75	Fidelitone FM-150
	30 (Serial Nos. 1 to 9490)	Astatic L-75	Fidelitone FM-150
	30 (Serial Nos. 9491 and up)	Astatic QTM	Replaceable permanent needle
	32 (Serial Nos. 1 to 12493)	Astatic L-75	Fidelitone FM-150
	32 (Serial Nos. 12494 and up)	Astatic QTM	Replaceable permanent needle
	31 AC-DC 33 AC-DC	Astatic QTM Astatic QTM	Replaceable permanent needle Replaceable permanent needle
Garod	6DPS-6	Astatic nylon 1-J	
	6DPS-7	Astatic nylon 1-J	
	6DPS-8	Astatic nylon 1-J	
	45APA	Astatic nylon 1-J	
	5AP-1	Astatic L-40	

(This listing continued on page 134)

Troubleshooting

Serviceing the New-Band Receivers Calls for Attention

● FM servicing is here. No longer something to anticipate, it's now a concrete factor to deal with. To keep servicers abreast of the latest circuits and to allow them to get the benefit of early field experiences in FM servicing, RADIO & Television RETAILING will report the information offered by the various managers of the service departments handling the most widely distributed FM receivers. The following advice

from the antenna, is connected to chassis ground; the other wire is connected to a tap on the antenna coil. The tap location has been selected for maximum signal voltage delivery to the 6SG7 r-f amplifier grid and is correct for use with transmission line impedances of 50-300Ω

The tuned circuits, both physically and electrically, are more or less conventional, as compared with regular AM circuits, except for the size

The oscillator circuit is a conventional tapped-coil Hartley type. The coil and resistor network, L13 and R50, is a parasitic suppressor circuit.

Electrically, the i-f amplifier circuits of the H-119 are more or less conventional. The 10.7 mc. i-f transformer windings are connected in series with the regular 455 kc. AM i-f windings. In tuning such composite i-f units, the AM or 455 kc. trimmers are adjusted first and the FM or 10.7 mc. trimmers last.

It will be noticed that a 22,000 ohm loading resistor is connected across the secondary winding of the first i-f transformer and 12,000 ohm resistors across the primary and sec-

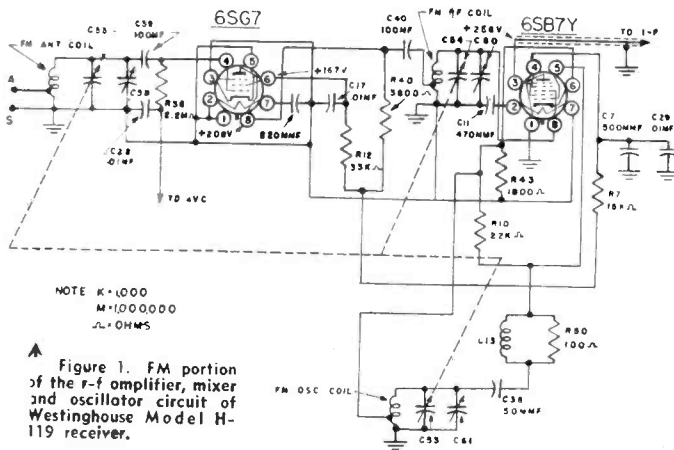

NOTE K=1,000
M=1,000,000
Ω=OHMS

Figure 1. FM portion of the r-f amplifier, mixer and oscillator circuit of Westinghouse Model H-119 receiver.

and data is available through the courtesy of Westinghouse Electric Corp.

The r-f end of an FM receiver has somewhat the same functions to perform as in an AM receiver. However, i-f rejection is of less importance, as the 10.7 mc i-f is comparatively interference free. Image rejection also is not a major problem, as the high i-f places images of FM stations outside the band.

The major function of the r-f end of the receiver, therefore, is to add as much as possible to the gain of the set so that a good signal-to-noise ratio will be obtained.

Details of RF Circuit

Figure 1 shows the r-f amplifier, mixer and oscillator circuits of the Westinghouse Model H-119 AM-FM receiver. Only the FM portion of the circuit is shown; all band switches and components associated with AM have been deleted for the sake of simplicity in following the FM operation.

It will be noticed that one wire of the two-wire transmission line

of the tuning capacitors and coils. One and one-half volts of negative bias for the 6SG7 r-f amplifier tube is obtained from the voltage drop across a resistor in series with the power transformer high-voltage winding center tap and additional bias from the AVC circuit.

The r-f energy from the 6SG7 plate is fed to a tap on the mixer r-f coil in order to obtain the proper impedance match between the 6SG7 plate and the 6SB7Y signal grid.

This mixer-oscillator tube is a 6SB7Y which is a special metal-shell type developed for converter service on the new 88-106 mc. FM band. The circuit and connections are similar to those of the ordinary 6SA7 type; however, the interelectrode capacitance of the 6SB7Y is much lower than that of the 6SA7 and the 6SB7Y is fitted with a low-loss base.

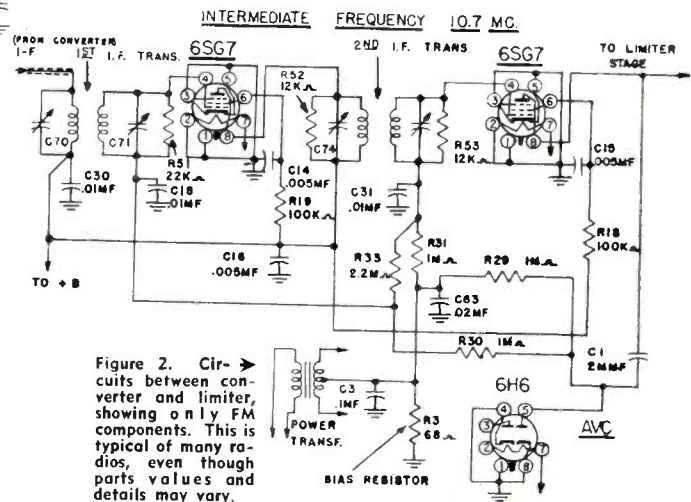

Figure 2. Circuits between converter and limiter, showing only FM components. This is typical of many radios, even though parts values and details may vary.

ondary windings of the second i-f transformer.

The purpose of the resistors is to permit "peaking" of the i-f circuits; unless resistor loading is used, it would be necessary to "flat-top" the i-f circuits in order to obtain proper band-pass characteristics. There is some curvature, of course, in the top portion of the resistance-loaded frequency response curve but the limiter acts to clip off this curvature providing, in effect, a wide-band flat-top response at the discriminator input.

Figure 2 shows the 68 ohms voltage dropping bias resistor in the power transformer high-voltage center tap. Note that the signal for the AVC rectifier is taken directly from the plate of the 6SG7 second i-f tube through a fixed capacitor. This permits the same AVC circuit to func-

Modern FM Circuits

to Novel Features. Short Cuts and Helpful Hints Given.

tion on both AM and FM without becoming involved in complex switching arrangements. In every other respect the i-f amplifier is strictly conventional.

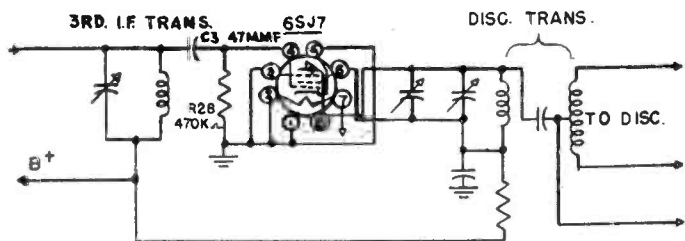

Figure 3. The limiter circuit of any FM set involves components having critical values. Check voltages with a very high impedance instrument, such as a VTVM, after first trying one or two new tubes.

The limiter circuit is shown in Figure 3. Limiter tube voltages are quite critical. When replacing the grid condenser or the grid and plate resistors, the exact value specified by the manufacturer must be used.

Figure 4 illustrates the discriminator, typical of many used in a wide range of other models and makes of FM receivers. At the right of this illustration is seen a de-accentuator network.

The time constant of this network is from 70 to 100 micro-seconds and the values are quite critical. When replacing these components, be certain that the values are identical with those specified by the manufacturer.

CHECK LIST OF FM SERVICE TIPS

A. Noise and Hiss

1. Noisy r-f or converter tube.
2. Defective antenna system.
3. Excessive plate voltage on limiter.
4. Regeneration.

B. Regeneration

1. Improper lead dress.
2. Incorrect alignment.
3. Defective shield or ground straps.
4. Open bypass condenser (r-f or i-f circuits).

C. Distortion and Poor Tone Quality

1. Limiter not functioning due to
 - a. Bad 6SJ7 limiter tube.
 - b. Incorrect limiter voltage.
 - c. Limiter circuit not properly aligned.
 - d. I-F circuits not properly aligned.
 - e. Bad i-f amplifier tube.
 - f. Open loading resistor across i-f winding.
 - g. Open bypass condenser, i-f circuit.
 - h. Incorrect voltages on i-f tubes.

2. Bad resistors or capacitors in de-accentuator network.
3. Insufficient signal for limiter saturation due to
 - a. R-F circuits out of alignment.
 - b. Bad r-f tube.
 - c. Inefficient antenna system.

half of the discriminator transformer secondary winding may be open; or, the phasing condenser between the primary and secondary windings may be open. Either of these troubles will cause loss of one reference voltage and thereby introduce distortion.

G. Trouble Shooting in the Limiter

Trouble: Distortion in Discriminator A-F Output.

The same basic operating principle is involved in all present-day limiter circuits. A 6SJ7 sharp cut-off pentode is operated so that grid swing conditions between cut-off and zero

Figure 4. For a full explanation of the functioning of a discriminator for FM, refer to standard texts or manufacturers' service manuals. Several basic types are in use in the newest receivers.

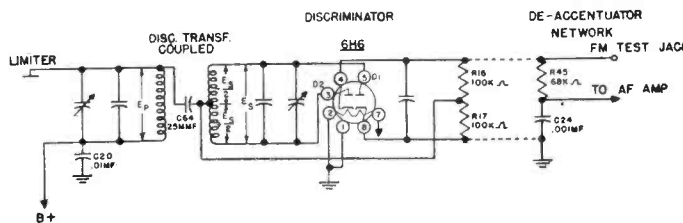

D. Dynamic Range or Reproduction Poor

1. Limiter not functioning properly.
2. Regeneration in i-f due to open bypass condenser or open loading resistor across i-f transformer.
3. I-F circuits, limiter or discriminator not properly adjusted.

E. Lack of Highs on FM Stations

1. Check resistance-capacitance values in de-accentuator network.

F. Trouble Shooting in the Discriminator

Trouble: Severe Amplitude Distortion During High Audio Signal Levels.

Remedy: This trouble is frequently due to poor discriminator alignment. High level audio signals correspond to wide frequency deviations around the center intermediate frequency. If the discriminator is far out of alignment, the widely deviated signal, which corresponds to a loud noise, will go over the "hump" of the characteristic curve and distortion will result. If the discriminator is only slightly out of alignment, the audio quality will be good except on the very loud passages where the response leaves the linear portion of the curve and passes over to the peak. To correct, realign the discriminator transformer primary and secondary trimmers. Another possibility is that one-

grid volts is of the order of 3 or 4 volts. The plate and screen voltage is maintained at approximately 63 volts. Under such operating conditions, with a strong signal applied to the limiter grid, plate current saturation is quickly reached.

The most frequent trouble in limiter circuits, with the possible exception of tube trouble, is a change in plate voltage due to changes in the value of the plate load resistor or to partial short-circuit of the plate circuit bypass condenser. If the plate and screen voltages are too high, the "threshold" voltage may change as much as 50 to 150 microvolts or more.

This means that the limiter will function as an i-f amplifier and little or no limiting action will take place. As the signal frequency swings with modulation, it passes over the slope of the i-f characteristic curve generating an AM signal which can be passed on to the discriminator. The discriminator will respond to AM as one-half of the 6HG tube can act as diode rectifier. Unless the limiter removes the AM response, this condition will occur. The i-f response curve is not linear, so considerable distortion will take place when the FM signal is converted to AM. This is not normal FM reception and the conditions just described are due to a lack of limiter action.

Audible Signal Tracers

Line-Up of the New Time-Saving Instruments Show Greatly Improved Features.

● In 1944, a well known radio equipment manufacturer conducted a nationwide survey among radio servicers. They found, among other things, that during the height of the phenomenal service activity, with the radioman's every moment in huge demand, less than 5% of the men owned audible-indicating signal tracers, and hardly more than 1% wanted to buy one.

Some 2 years later servicers were slowly beginning to realize the value of these instruments, to judge from an informal survey conducted among members of a local servicers organization through the sponsorship of a nationally known parts manufacturer.

At that time it was found that of 137 purchases of test equipment planned by a group of the members, 10 were to be signal tracers . . . something over 7%. This, of course was no indication of the number who already owned signal tracers.

Most recently, a nation-wide survey has been conducted by John F. Rider, Publisher, Inc., among radio servicers. While the final results have not yet been released, it is already clear that a sharp upward trend is evident in the use of the signal tracer. According to Rider, whose original Chanalyst introduced the method of visual signal tracing in 1938, a spot check of a representative number of responses selected at random indicate that about 55% of servicers owning tube testers and voltmeters also possess some form of signal tracer.

The very recent increase in popularity of the instrument is reflected by the new audible-indicating tracers being marketed today. On this page are shown some of the popular makes, including several which are being reported for the first time.

The signal tracer is not a substitute for any other type of instrument. It is completely unique among service equipment, and is designed to help "localize" troubles. In general, it performs the function which up to its invention, was done by "clicking" tube caps, careful listening and deductive reasoning. While it is no automatic brain, it can definitely save many hours of troubleshooting time for both novice and old-timer. Look 'em over and take your pick:

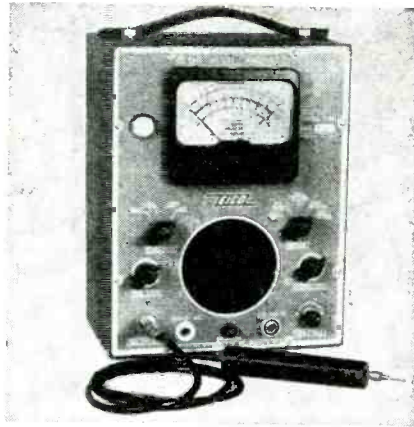

Electronic Instrument Co. Model 113A



Philco Corporation Model 7030

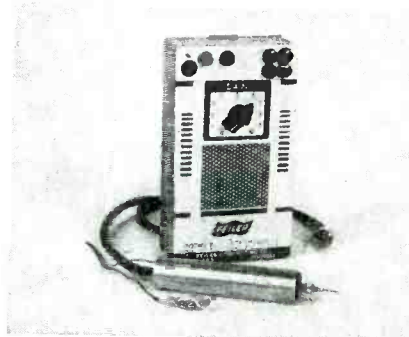

Feiler Instrument Co. Model TS-5

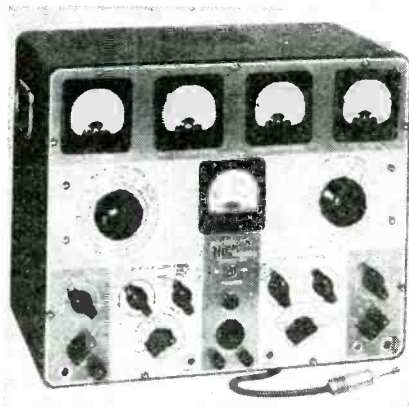

Hickok Elec. Instr. Co. Model 156
McMurdo Silver Co. Model 905

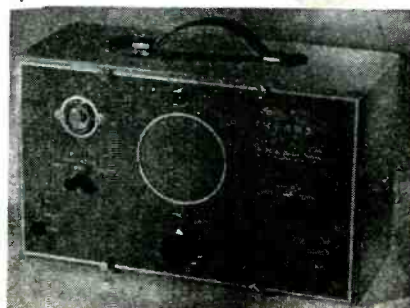

Precision Electronics Model 250

WHEN SERVICERS USE THE SIGNAL TRACER:

- Locating of "dead" stages in receivers and amplifiers.
- Locating of noise, hum, crackling, distortion.
- Finding location of minimum hum pickup when mounting transformers, "dressing" leads, and placing component parts.
- Finding trouble source in "intermittents", "faders", and weak or distorted signals.
- Determining local oscillator frequency shift "dead" output of osc.
- Finding weak, microphonic, noisy, or shorted tubes.
- Locating defective RF and IF transformers.
- Locating defective speakers.
- Testing phono pickups and microphones.
- Use as a low power hi-fidelity amplifier (for record demonstrations, etc.).
- Locating noisy or intermittent volume controls.
- Locating defective gang condensers (noisy—crackling—microphonic, etc.).
- Locating noisy resistors.
- Checking power line noise or noise that may be picked up by the receiver antenna.
- Use as a "stage by stage output meter" for alignment operations.
- Motorboating or Squealing.
- Check gain per stage by VTVM right from ant.



Handle FM, AM, and Tele!

More Sensitive Probes, Wider Frequency Coverage Permit Faster Work

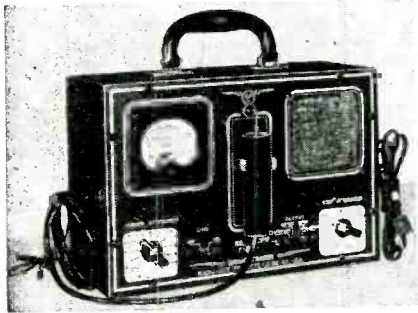

Radio City Products Co. Model 777

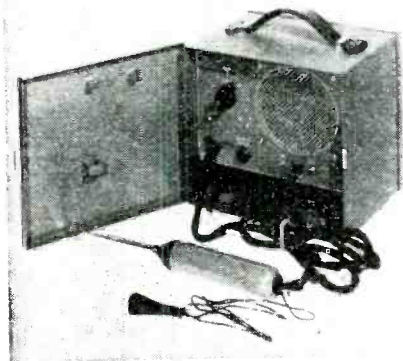

Special Products Co. Model STAB



Superior Instruments Co. Model CA-12
Supreme Instruments Co. Model 562

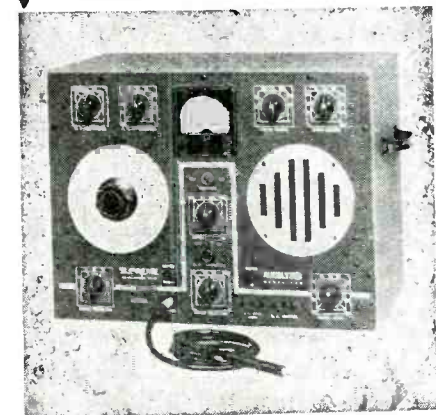

ELECTRONIC INSTRUMENT CO., INC.

Model 113A Multi-Analyst

Indications: Audible, visual (meter)
Power: AC with transformer. Portable, 15½ lbs.
Range: 60 cy. to 100 mc.
DC Voltmeter: Five ranges to 1000V. External multiplier to 5000V, 26 megohms input.
AC Voltmeter: VTVM, 1.5 megohms input, diode tube rectifier. Five ranges to 1000 V.
Ohmmeter: Five ranges in multiple of 10, covering from .2 ohm to 1000 megohms. Electronic type.
Output Meter: Five ranges, covering from -20 to +60 db.
Features: Speaker, self-contained; 6 tubes; VTVM polarity switch; no tuning controls; see picture

FEILER ENGINEERING CO.

Model TS-1 Signal Tracing Analyzer

Indications: Audible
Power: Battery. Portable, 4 lbs.
Features: Uses one tube, mounted in probe at end of 3' cable; requires 22½V bat. and one #2 flash cell; works with headphones 1000 ohms or higher; meter for visual indications can be substituted for headphones; no tuning controls

Model TS-2 Electronic Stethoscope

Indications: Audible
Power: Battery. Portable, 10½ lbs with battery
Features: Uses 3 direct-heater tubes, including one in probe at end of 3' cable; 90V battery; 5" PM speaker; jacks for RF and VTVM indicating meter, AF output meter and headphone of 1000 ohms or higher; no tuning controls.

Model TS-3 Electronic Stethoscope

Same characteristics as Model TS-2, for AC operation, using static-shielded transformer; four tubes including rectifier.

Model TS-5 Pocket Stethoscope

Indications: Audible
Power: AC with transformer. Portable, 3½ lbs.
Size: 4½"x2¾"x8¾"
Features: Uses 4 tubes, including rectifier, with one in probe; cables and probe fit into very small case; entire apparatus fits into palm of hand or pocket; self contained 3" PM speaker; jacks for headphones, output meter, and standard V-O-M for use as RF VTVM; no tuning controls; see picture

HICKOK ELECTRICAL INSTRUMENT CO.

Model 156 Indicating Traceometer

Indications: Audible, visual (meters)
Power: AC, with transformer. For bench, 32 lbs.
Tuned ranges:
RF-IF, 95-1700 kc, 5000 μ V—25V full scale readings, .85 mmf input capacity;
Oscillator, 600 kc—15 mc, 7 voltage scales to 750V, 1.2 mmf input capacity
Untuned ranges:
AF, 20—20,000 cycles \pm 2 db, 7 scales to 500V, 2 megohms input resistance;
DC volts, 7 range to 500V, 18 megohms input;
Watts, 0-150W, connects by plugging receiver under test into front panel receptacle
Features: Speaker, mounted inside top of case, plugs into front panel; each channel separately metered, may be used simultaneously for troubleshooting intermittents; uses 5 tubes including voltage regulator; supplied with four RC filtered probes; see picture.

McMURDO SILVER CO.

Model 905 Sparx

Indications: Audible, visual (electron-ray tube)
Power: AC with shielded trans. Portable, 14 lbs.
Frequency range: From 20 cy. to over 200 mc, input is 3 mmf, over .5 megohm
Features: Five tubes, including 6E5 electron-ray, plus crystal diode rect. in probe; AF amp. has 65 db gain; self contained PM speaker, with jacks and switch for external speaker; 3-position switch connects 6E5 for various uses; no tuning controls; see picture.

PHILCO CORP.

Model 7030 Dynamic Tester

Indications: Audible
Power: AC with transformer. Portable
Frequency range: higher than 100 mc
Features: Four tubes, with 6AQ6 in probe having lucite tip lighted with pilot lamp; self-contained loudspeaker; gain ratio is 10,000; adjustable probe input loading; no tuning controls; see picture

PRECISION ELECTRONICS, INC.

Model 250 DeLuxe

Indications: Audible, visual (meter)
Power: AC with transformer. Portable
Frequency range: 20 cy to 300 mc, 3 mmf Input
VTVM range: Comparative readings
Features: 4 stage VTVM; 5 tubes; illuminated meter and probe; 5" PM speaker; 6AT6 triode in probe; no tuning control; see picture.

Model 200 Standard

Same characteristics as Model 250, with different case and no VTVM.

RADIO CITY PRODUCTS CO., INC.

Model 776 Dynatracer

Indications: Audible
Power: AC, with transformer
Frequency range: Through 150 mc, 3 mmf input
Features: Detector and amplifier in probe at end of 50" cable; 4" PM speaker; microphone and phono input jack; no tuning control.

Model 777 Dynatracer

Indications: Audible, visual (meter)
Features: In general, same as Model 776, plus self-contained meter with step and vernier attenuators providing 10,000—1 ratio; 10,000 μ V full scale deflection; switch for meter and speaker; no tuning control; see picture.

SPECIAL PRODUCTS CO.

Model STAB Speco

Indications: Audible
Power: Battery. Portable, 4 lbs. 10 oz.
Features: Extra long fine probe with long leads suited for troubleshooting auto radio while in car; instrument cover cannot be closed without turning off battery switch; tube in probe; also sold in kit form; no tuning control; see picture.

Model STAC Speco

All features of Model STAB above, plus visual indications with electron-ray tube also sold in kit form.

Model STP Speco

This is the probe used on above models, sold separately.

SUPERIOR INSTRUMENTS CO.

Model CA-12

Indications: Audible, visual (meter)
Power: Battery. Portable, 8 lbs.
Frequency range 60 cy to over 20 mc.
VTVM range: Comparative readings
Features: IT4 tube in probe; jack for headphones; metal case; one connecting cable; no tuning controls; see picture.

Model CA-11

In wooden case, with visual and audible indications; small in size; portable.

SUPREME INSTRUMENTS CORP.

Model 562 Audolyzer

Indications: Audible, visual (meter)
Power: AC, with transformer. For bench.
Tuned ranges: 5 bands covering 95 kc—14.5 mc; input resistance 15 megohms
Features: Step and vernier attenuators; one probe; pin jacks, probe and meter selector switches arrange measurements of all radio circuits plus external resistances in 5 ranges from 200 ohms to 20 megohms full scale, and 7 VTVM ranges from 1V to 1000V full scale; jack for delivering amplified AF as driver power for audio signal substitution testing; see picture

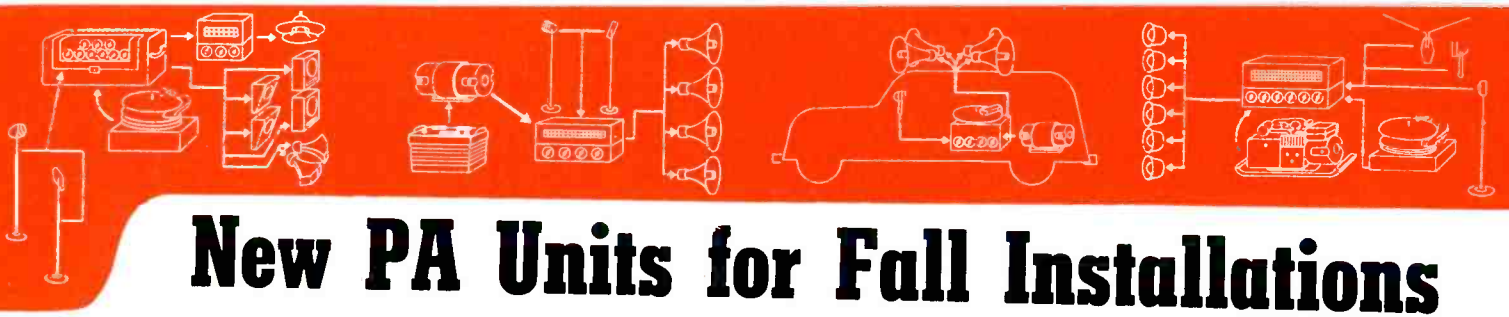

New PA Units for Fall Installations

Eastern ROBOMAT

The Robomat is a completely self-contained, automatic sound system, containing a record changer, sensitive AM receiver, and amplifier. The changer is of continuous heavy duty construction and is

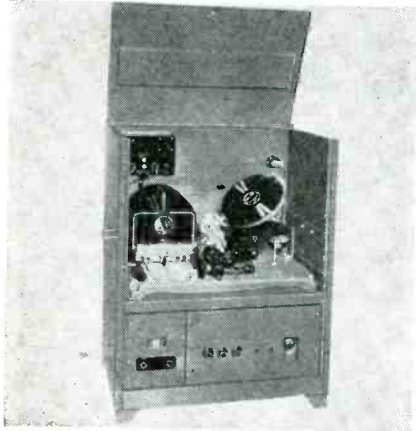

automatic, stacking 20 records and playing both sides. By means of a switch, it will play continuously or every 3 minutes. The amplifier is rated at 90W, while a timer is incorporated by means of which the Robomat is turned on and off at any pre-adjusted times. A microphone is included for paging. Eastern Amplifier Corp., 794 E. 140th St., New York 54, N. Y.—RADIO & Television RETAILING

Stromberg-Carlson RECORD AMPLIFIER

Model 37 is a 5-tube phono amplifier using 6F6G tubes in push-pull to provide 10 watts with less than 5% total harmonics into an impedance of 618 ohms. The jack marked "phono" is a 5-megohm impedance input providing 56 db gain with equalization for crystal pickups, while the "input" jack offers a 250,000 ohm impedance with 78 db gain, and a wide range of equalization possible by means of three controls, for bridging across 500-600 ohm circuits. Stromberg-Carlson Co., 100 Carlson Rd., Rochester 3, N. Y.—RADIO & Television RETAILING

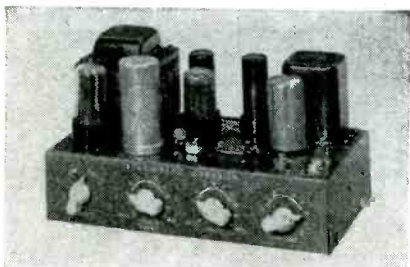

University TWIN TWEETER

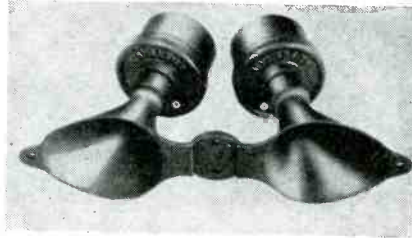

A die cast twin horn design offering a horizontal dispersion angle of 100° and a vertical distribution of 50°, is featured in the new University speaker. The frequency range from 2000 to 15,000 cycles is covered, permitting its use as a high frequency section of a wide range system, in conjunction with any efficient 12" cone speaker. No dividing network is needed for the twin unit, which can handle up to 16W of audio. University Loudspeakers, Inc., 225 Varick St., New York, N. Y.—RADIO & Television RETAILING

Radio-Music Corp. REPRODUCERS

Three types of Para-Flux Reproducers have a linear response from 40 cps to well above 11,000 cps. The interchangeable vertical, lateral and universal heads use the same arm and equalizer. Model VL-1DA uses a diamond stylus for vertical "hill-and-dale" recordings, Model LL-1DA is sensitive to lateral reproduction, while universal head Model UL-1DA with diamond stylus operates on both lateral and vertical reproduction. Radio-Music Corp., East Port Chester, Conn.—RADIO & Television RETAILING.

Webster-Chicago RECORDED MUSIC AMP

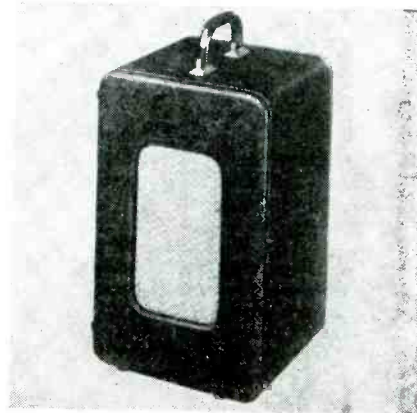

Model 66 is a portable amplifier in leatherette case, for reproducing high qual-

ity recorded music. Designed especially for use with the Webster portable record changer model 65, or as an external amplifier and speaker for model 80 wire recorder, the unit has push-pull output, delivering 8W to an 8" PM self contained speaker. Net weight 18 lbs. Webster-Chicago Corp., 5610 Bloomingdale Ave., Chicago 39, Ill.—RADIO & Television RETAILING

Altec Lansing THEATRE SPEAKER SYSTEM

Model 800 "Voice of the Theatre" speaker system measures only 23" in depth, making installation possible in

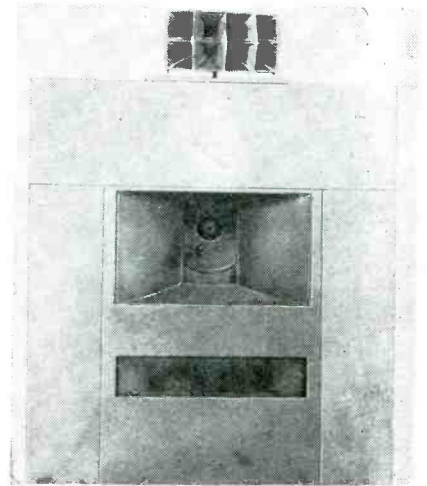

small motion picture theatres, for which it was designed. The low frequency speaker radiates directly through an exponential horn, covering up to 800 cycles, while the high-frequency unit uses a 2 x 4 cell wide-angle exponential horn, covering 800-15000 cycles. Altec Lansing Corp., 250 W. 57th St., New York 19, N. Y.—RADIO & Television RETAILING

ACA AMPLIFIER for GE PICKUP

Model ACA-100GE direct-coupled amplifier was developed specifically to accommodate the GE variable reluctance pickup without the use of any additional preamps or equalized circuits. An independent 1/2-megohm input provides 117 db gain, developing 23W output with less than 1% total distortion. Response is flat within 1 db from 20 to 20,000 cycles. Hum and noise level is -40 VU. Balanced output terminals are provided for 8/16/20/500 ohms, with in-between terminals providing additional impedances of 2/4/5/10/80/125/160/175 ohms. Amplifier Corp. of America, 396-7 Broadway, N. Y. 13, N. Y.—RADIO & Television RETAILING

WHAT SERVICEMAN COULDN'T MAKE MORE MONEY THIS WAY?

The business-like way to make money is to keep plugging ahead at your bench. If your stock is lean and you have to run to the distributor every time you need a volume control, you're frittering away your valuable "bench time" and income. Stock up too high on "special" volume controls and you may wind up behind an inventory 8-ball.

HERE'S THE RIGHT ANSWER 9 OUT OF 10 TIMES

The sensible solution to your volume control replacements is the IRC *Century Line*. Over 90% (by actual analysis) of all jobs can be taken care of by these 112 types of volume controls. As a matter of fact, you don't even need the entire 112; a selection of only 70 Type D IRC Volume Controls and 11 Tap-In Shafts may handle most of your work. So see your IRC Distributor right away and save your bench time, patience, and money with IRC.

THE IRC CENTURY LINE

The 112 Volume Controls and 5 Switches That Solve Over 90% of Your Replacement Problems.

70 Universal Type D Controls with 11 easily installed Tap-in Shafts.

16 Popular Type Controls with Fixed Shafts

8 Clutch Type Controls with Fixed Shafts

7 Dual Controls with Fixed Shafts

9 Controls for Specific Service Uses with Fixed Shafts

2 Special Controls for Power Requirements with Tap-in Shafts

5 Switches

All IRC Volume Controls have the famous IRC permanently bonded Resistance Element, the Five-Finger "Knee Action" Contactor, the Silent Spiral Spring Contactor, and the Steel Coil Spring Thrust Washer.

Bring yourself up to date with the new No. 4 Edition of this amazingly popular and useful manual. Contains detailed replacement information on nearly all models up to 1946. Complete listing of 1941-42 models . . . the ones now coming in for repair. 156 pages. 25c at your IRC Distributor.



INTERNATIONAL RESISTANCE COMPANY

Wherever the Circuit says Ω

401 N. BROAD ST., PHILADELPHIA 8, PA.

In Canada: International Resistance Co., Ltd., Toronto, Licensee

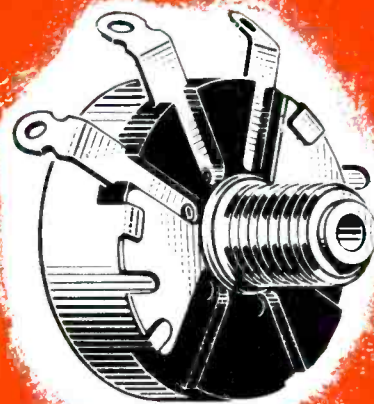

ONE OF THE 70 BASIC
TYPE D IRC VOLUME
CONTROLS



HOW THE CONVENIENCE OF 11 IRC TAP-IN SHAFTS!
— FOR ALMOST EVERY REPLACEMENT NEED.

New Bench Aids Speed Service

Brach SIGNAL BOOSTER

Brach's "Puratone" Signal Booster is designed to eliminate interference and noise from the dealer's demonstration antenna setup. Carrying AM, FM and tele antennas on the same single mast, signals are fed through a shielded coaxial cable to a distribution amplifier on the sales floor. From the amplifier a radiating wire is run around the display space. A 30-40 db gain on FM and a 40-60 db gain on AM is provided. Comes with all material, including mast. L. S. Brach Mfg. Co., 200 Central Ave., Newark 4, N. J.—RADIO & Television RETAILING

Precision MULTI-MASTER

Series 858 is a push-button-operated 20,000-ohm-per-volt test set covering 54 a-c and d-c ranges. One row of five buttons selects all functions, while the other row

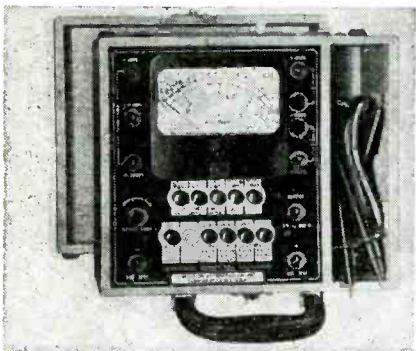

of six buttons selects all ranges, going up to 6000V a-c or d-c (d-c ranges at 1000 ohms and 20,000 ohms per volt) 8 d-c current ranges to 12 amps, 6 resistance ranges to 600 megohms, and 8 decibel ranges from -26 to +70 db. Precision Apparatus Co., Inc., 92-27 Horace Harding Blvd., Elmhurst, L. I., N. Y.—RADIO & Television RETAILING

Walsco UNIVERSAL BELT

The new Walsco Unibelt is a universal dial belt, manufactured in continuous lengths and put up on stools containing enough belting for between 5 and 8 replacements. Since the dial belt comes in open lengths, it can be installed without taking apart the dial mechanism. To close the loop, a patented zipper-like connector is inserted in each end. A thin flexible steel core makes stretch impossible. Walter L. Schott Co., Beverly Hills, Cal.—RADIO & Television RETAILING

Weston ANALYZER



Model 769 Electronic Analyzer features a VTVM which, by means of a small r-f probe having an input resistance of 5 megohms with 5 mmf capacity, covers full-scale ranges from 3 to 150 volts in a frequency band from 50 cycles to 300 mc. In addition, another electronic volt-ohmmeter circuit covers up to 1200V d-c and 2000 megohms, while the analyzer section of the instrument contains six 10,000-ohms-per-volt ranges, six rectifier-type a-c voltage ranges to 1200V, three ohmmeter ranges to 200,000 ohms, and six d-c ranges to 600 ma. A special d-c probe containing a 5-megohm resistor is furnished for measuring d-c. Weston Electrical Instrument Corp., Newark 11, N. J.—RADIO & Television RETAILING

Bendix FACTOMETER

Model 847S FactoMeter is a service and sales aid for FM. Consisting mainly of a portable FM chassis with a field strength indicating meter and telescoping antenna.



it can be used to test or check an antenna or set installation location or position for signal level, and as a standard of comparison against which to check noise or interference complaints, quality, and the like. Bendix Radio Division, Bendix Aviation Corp., Baltimore 4, Md.—Radio & Television RETAILING

Franklin SELF-SOLDERING TAPE

Neither soldering iron nor torch is needed for use with "Neat-N-Nitty" self-soldering tape. Just twist the wires to be connected, wrap some of the tape around

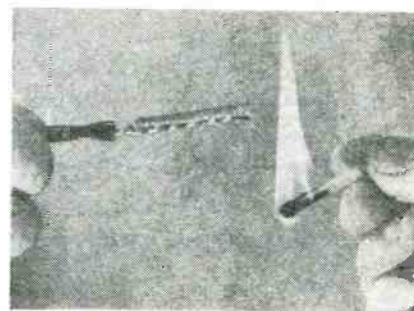

the joint, light it with a match, and the inflammable material burns off, leaving a perfectly soldered splice. A wonderful idea for antenna installation work! W. B. Franklin Co., P. O. Box 910, San Fernando, Cal.—RADIO & Television RETAILING

Approved Electronic SIGNAL GENERATOR

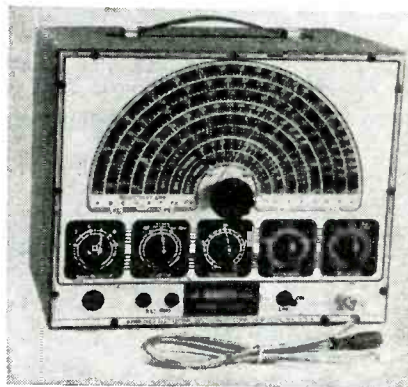

Model A-200 signal generator uses a large multicolor frequency dial scale on 8 r-f bands covering from 100 kc up to 25 mc on fundamentals and to 75 mc on harmonics. Both internal (440 cycle) and external modulation can be varied 0-100%. Electrostatically shielded power transformer cuts leakage of signal, while both step and continuous controls provide attenuation. Cathode follower output is featured, and a coaxial output lead is furnished. Approved Electronic Instrument Corp., 142 Liberty St., New York, N. Y.—RADIO & Television RETAILING

Listen

it's a

Jensen

SPEAKER

3 New

CONCERT* SERIES PM SPEAKERS

with Alnico 5 "R" Motors

The new JENSEN Concert Series speakers illustrated are now available at price levels only slightly higher than the well-known Standard Series models P12-S, P10-S and P8-S. These new "R" speakers offer unequalled values in power handling capacity, in efficiency, and in response-frequency. Overall performance is just a notch below that of the famous JENSEN PM12-H (now P12-Q), PM10-H (now P10-Q) and PAH-8 (now P8-Q), at substantial price savings.

Model P12-R, ST-103 — 12 watts \$19.50
 Model P10-R, ST-121 — 10 watts 18.50
 Model P8-R, ST-169 — 9 watts 15.25

For complete information on *all* models in the Concert series, as well as on other JENSEN equipment, send today for JENSEN Catalog No. 1010. Use the handy coupon below.

JENSEN MANUFACTURING CO.
 6625 South Laramie, Chicago 38, Illinois
 Please send me a copy of the 1947 Jensen catalog.

Name _____
 Address _____
 City _____ Zone _____ State _____

*Trade Mark Registered

JENSEN
 MANUFACTURING
 COMPANY

In Canada: Copper Wire Products, Ltd.
 11 King St. W., Toronto 1

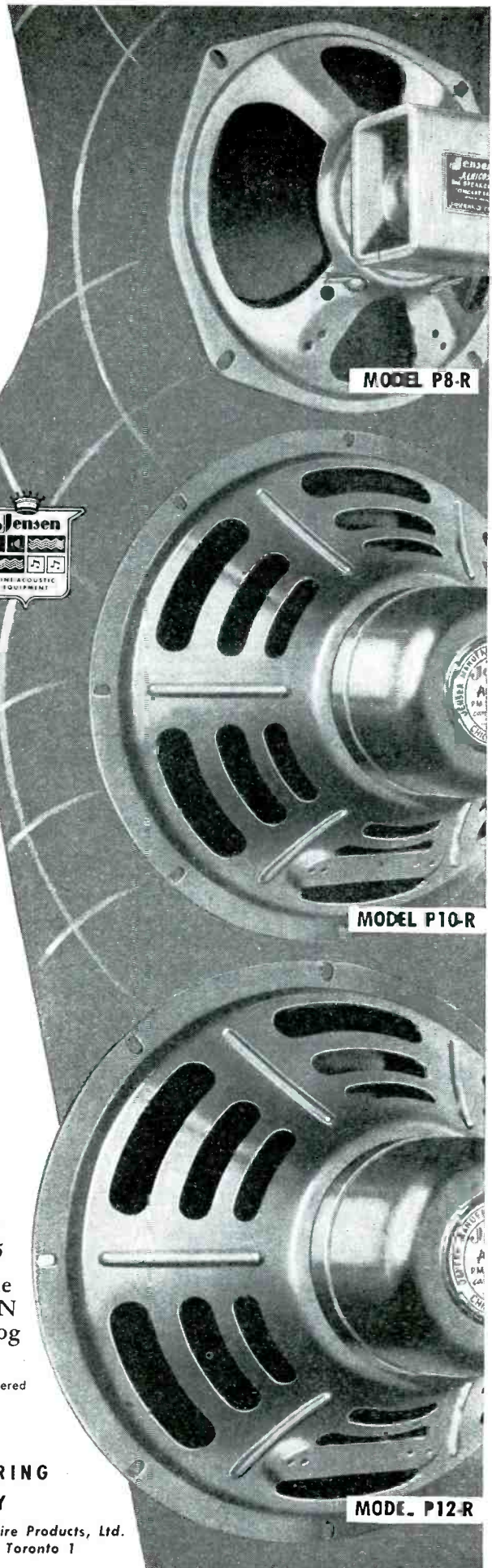

Replacement Crystal Pickups

(Continued from page 125)

Brand Name	Models	Cartridge	Needle
Giffillan	66P 86P	Shure M-93 Shure M-93	Walco Floating Jewel Sapphire #400 Walco Floating Jewel Sapphire400
Hoffman	B400 A401 B500 B501 B1000	Astatic L-71 Astatic L-71 Astatic L-71 Astatic L-71 Astatic nylon 1-J	Walco Sapphire Walco Sapphire Walco Sapphire Walco Sapphire
Jewel	All current	Magnavox part #560052G1	Magnavox part #102500
Meissner	All current	Astatic MLP-2	
Olympic	6-504 6-617	Astatic L-40 Astatic L-70	Fidelitone Fidelitone
RCA	63E 65U 65AU 65U-1 67V1 58V 58AV 610V1 610V2 711V2 641TV television 59V1 59AV1 612V1 612V3 55U Tuscany	RCA part #70338 RCA part #70338 RCA part #70338 RCA part #70338 RCA part #70338 RCA part #39851 RCA part #39851 RCA part #39851 RCA part #39851 RCA part #39851 RCA part #39851 RCA part #39851 RCA part #70332 RCA part #70332 RCA part #70339 RCA part #70339 Astatic (RCA part #71173) Astatic MLP-1 or Astatic Nylon Astatic MLP-1 or Astatic Nylon	RCA part #72345 RCA part #72345 RCA part #72345 RCA part #72345 RCA oart #62345 RCA part #39863 RCA part #39863 RCA part #39863 RCA part #39863 RCA part #39863 RCA oart #39863 RCA part #38449 RCA part #38449 RCA part #70915 RCA part #70915
Brunswick (Radio & Television, Inc.)	Darby Plymouth Buckingham	Astatic MLP-1 or Astatic Nylon Astatic MLP-1 or Astatic Nylon	
Scott	Early 800-B Late 800-B	Astatic L-75A or Astatic L-75S Astatic L-75A or Astatic L-73S	Permo Products Permo Products Aerophon 88 Nylon
Sparton (Sparks-Withington)	10AB76PA 10AM76PA 10BM76PA 10BW76PA 7BM46PA 7BW46PA 6AW26PA 201 1005 1006 1007	Astatic QTM Astatic QTM Astatic QTM Astatic QTM Astatic L-71 Astatic L-71 Astatic L-71 Shure P90 Astatic L-71 Astatic L-71 Astatic L-71	Sparton #1 Sapphire Sparton #1 Sapphire Sparton #1 Sapphire Sparton #1 Sapphire Sparton Ruby Needle Sparton Ruby Needle Sparton Ruby Needle
Televox	Juke Boxes	Astatic L-72	
Temple (Templetone)	E-511 G-516 G-518 F-617-D F-617-S G-722 G-723 G-725 E-301	Astatic L-70A Astatic L-70A Astatic P-93 Astatic L-70A Astatic L-70 Astatic P-93 Astatic P-93 Astatic P-93 Astatic P-93 Astatic L-72A	Temple part #ER2-3 Temple part #ER2-3 Temple part #ER2-3 Temple part #ER2-3 Temple part #ER2-3 Temple part #ER2-3 Temple part #ER2-3 Temple part #ER2-3 Temple part #ER2-3 Temple part #ER2-3
Clarion (Warwick Mfg. Co.)	All current	Astatic L-70	Fidelitone Master Floating Point
Trav-ler	7003 7004 7005	Astatic L-72A Astatic L-72A Astatic L-75	
Recordio (Wilcox-Gay)	6A10, 6A20 (Serial Nos. to 4691) 6A10, 6A20 (Serial Nos. above 4691) 6B10, 6B20, 6B30, 6B40, 6B42 6B45, 7E40, 7D40	Astatic LP-21 Astatic L-70 Astatic L-70 Shure P-30	Permanent Sapphire (Not replaceable)

Brand Name	Used in Phono	Radio Model	Cartridge
Zenith	Record Player Record Player Record Player 169-31 Record Player Record Player Record Player 169-36 Record Player Record Player 169-42 Record Player Record Player 169-48 169-55 169-50 169-60 169-50 169-51 169-53 169-60 169-63 169-80 169-65 169-83 169-68 169-76 169-86 169-87 169-70 168-72 169-74 169-78 142-5051	63-203 6D-302 6S-305 9S-307 S-5452 S-6622 S-7000 7S-487 S-8500 7S-581 7S-582 6S-580 6R-583 6S-596 7S-591 8S-593 8S-594 8S-593 S-9000 8S-594J 10S-599 10S-690 5R-680 12H-678 12H696 6R-683 7S-681 7S-681J 7S-685 6R-688 6R-684 5R-686 S-9001-2	Astatic B-3 Webster X78H5 Webster X78B5-1 RCA 31156 Webster X73C Astatic M-22 Webster RA Astatic B1 Webster RA Astatic L-22A Astatic L-22 Astatic L-26A Astatic L-26A Astatic L-26 Astatic L-26, L-24 Astatic L-24 Astatic L-24 Shure 96-11B, or 9601-B3 Shure 96-11B, or 9601-B3 Webster X82L J22798 Astatic LP-21 Astatic LP-21 Webster RA Astatic LP6 Astatic LP6 Webster RA Shure 99-182 Shure 99-182 Shure 99-182 Shure 99-182 Webster N-1 Webster N-1 Webster N-1 Webster N-1

Religious PA

(Continued from page 123)

lusion to the listener that he is hearing the original, and not an amplified voice. The loud speakers must be unobtrusive. This often means special housing or baffles to blend with the architecture of the auditorium. A speaker that attracts the attention of the worshipper defeats the illusion you try to create.

The amplified sound from the speakers must reach the worshipper from the direction of the sanctuary, chancel, or altar, where the service is being conducted. Sound directed to the worshipper in the nave from the sides or rear of the auditorium will not create the illusion we want to attain. Loudness is not necessarily essential; in fact, it can be annoying and defeat the illusion we are trying to create. A successful installation permits everyone with normal hearing to hear comfortably without being aware that they are listening to amplified sound.

Building the Illusion

While concealment of loudspeakers and microphones are not always possible, the installer's imagination should be strained when necessary, to take advantage of dark areas, architectural features and the like.

The installation of the auditorium and hard-of-hearing system in the Episcopal All-Angels church of New York City, handled by McKee Electric Co. of that city, provides several good illustrations of this point.

The two horns used in the auditorium part of this church are concealed high above the pulpit, behind the miniature organ pipes which enclose a small space at the top of the column. They are completely hidden from the audience.

Five microphones, placed at the altar, pulpit, prayer desk and reading desk, are all but invisible from the pews. The two altar mikes are seen at opposite ends of the altar, submerged in shadow, and blending with the surroundings.

The 12 hard of hearing control units situated at various points, are mounted below the seats, and are found and adjusted without being seen by the worshippers.

A vital part is the control point. In this instance, it is seen concealed in a desk which matches the woodwork of the church interior.

Further details of church PA will be discussed, and important technical factors explained in the next article of this series, to appear soon.

HICKOK

The Finest Complete
Line of Radio

Test Equipment made

...and the most profitable to use

Hickok has been producing fine Test Equipment since 1910 and has never compromised with quality. The Hickok philosophy has always been, "make it better than anything else available".

It would be relatively easy to bring Hickok Instruments down to a so-called "popular price" by eliminating certain exclusive features and by skimping in quality of materials and construction. But, it has been proven over the years that the best service men want top performance and accuracy, long life and completeness of design. They know that Hickok Instruments are **more profitable to use** in the long run.

Here are three of the newest and most profitable service instruments in the Hickok line. Write today for complete information.

OTHER HICKOK INSTRUMENTS OF MATCHLESS ACCURACY

Signal Generators, with or without crystal—Traceometers—Channel Testers—Oscillographs—Electronic Volt Ohm Milliammeters—Vacuum Tube Volt Ohm Milliammeters—Volt-Ampere Wattmeters.

Made by the exclusive manufacturers of Dynamic Mutual Conductance Tube Testers. All HICKOK equipment employs HICKOK meters—the standard of quality in electrical indicating instruments since 1910. Write today for fully illustrated literature and prices.

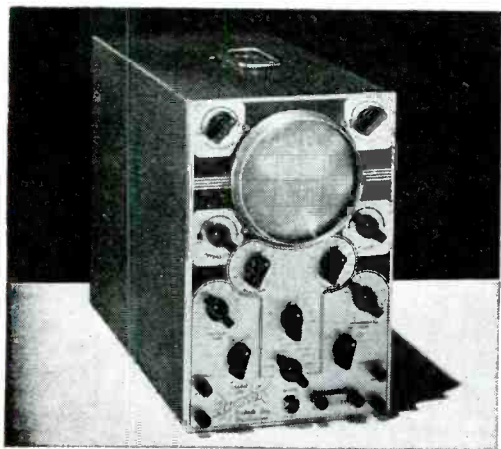

Model 288 X Crystal Controlled Signal Generator.

Provides necessary test voltages, with a high degree of accuracy and dependability, for servicing amplitude and frequency modulated and television equipment. Wide frequency range. Crystal Controlled Signal accurate to .01%. Has self-contained decibel meter for convenient means of measuring power and voltage and determining resonance in alignment work. An ideal bench mate for Model 195.

The Model 195 is a 5 inch Oscillograph using the new 5 UP-1 Cathode Ray Tube. It has extra high gain vertical amplifiers and both sinusoidal and linear sweep circuits, with phasing control. With this Oscillograph you can—Align I. F. and R. F. stages; determine causes of trouble; analyze wave shape of signal; determine unknown frequencies; amplify and view very weak signals.

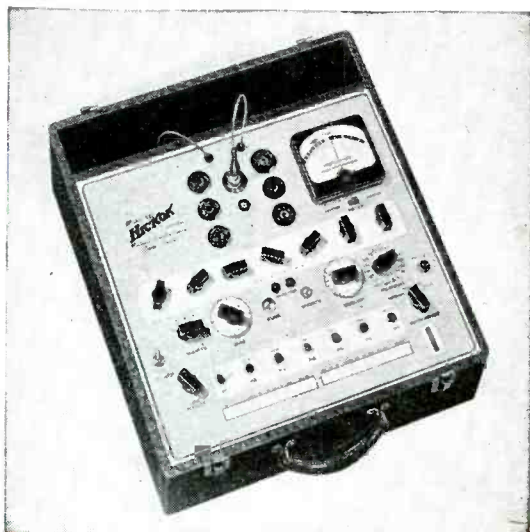
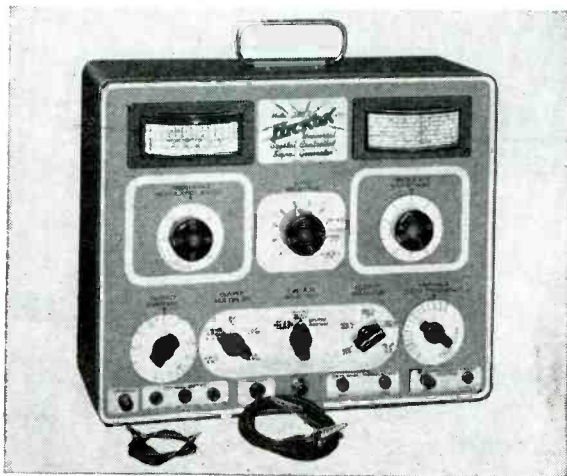

Model 532P, is the most popular of the Hickok Tube Testers. Tests all makes of tubes under actual use conditions, and measures them more accurately. No bad tubes get by. Has many features found in no other make of Tube and Set Tester, foremost of which is DYNAMIC MUTUAL CONDUCTANCE. The additional accuracy made possible by using this principle was acknowledged by the armed forces during war time use of Hickok Instruments.

THE HICKOK ELECTRICAL INSTRUMENT CO.

• 10523 Dupont Avenue, Cleveland 8, Ohio

New 7-INCH

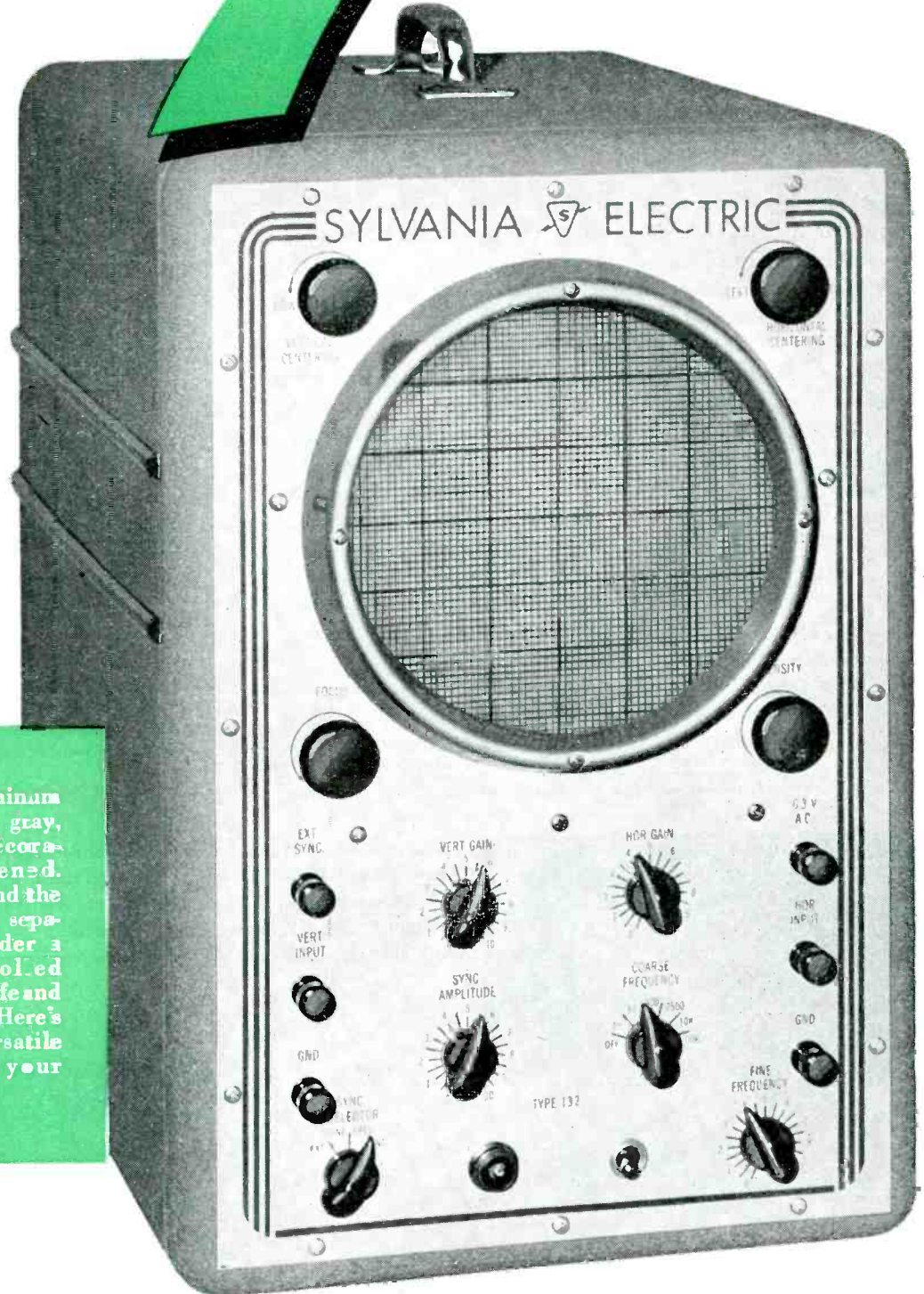

Panel is heavy aluminum finished in silver gray, with type and decorations hand screened. Each finish coat and the silk screening are separately baked under a carefully controlled process—for long life and maximum beauty. Here's an impressive, versatile instrument for your establishment.



SYLVANIA

MAKERS OF RADIO TUBES; CATHODE RAY TUBES; ELECTRONIC DEVICES;

OSCILLOSCOPE ONLY \$124.50 EXCELLENT FOR RAPID RECEIVER ALIGNMENT, TROUBLE-SHOOTING!

Now, for little more than you would pay for a smaller instrument, you can obtain a big, beautiful, 7-inch Oscilloscope that's the last word for your service department. Great for rapid receiver alignment and trouble-shooting!

The Sylvania Oscilloscope Type 132 is an AC operated general purpose cathode

ray instrument used to study waveforms, measure voltages and currents of various types of circuits. Excellent for audio circuit analysis, transmitter checking, filter circuit and hum analysis, vibrator waveform checking.

Every progressive, well-equipped radio retailer's service department needs one.

CHARACTERISTICS AND SPECIAL FEATURES

Large 7-inch cathode ray tube provides "Jumbo" patterns.

A new push-pull deflection circuit provides clearer patterns, less distortion and more gain.

Observation of a wider variety of phenomena is made possible by the addition of a Z axis input for intensity modulation. This feature is useful in studying pulses and portions of cycles, and leads to many applications in industry.

Panel binding post provides 6.3 volt AC .3 ampere supply for convenient external use.

Subdued red-jeweled panel lamp assembly with removable cap for easy replacement of lamp.

Extra-long, heavy-duty line cord.

Externally accessible line fuse at rear of cabinet.

Power Supply

105-125 volts - 50-60 cycle - 35 watts

Accelerating potential, 1400 volts.

Horizontal Sweep

Left to right with frequency from 15 to 30,000 cycles.

Synchronizing signal sources: internal (vertical), external, *line frequency*

Deflection Factor at 1000 cycles

Amplifiers

VERTICAL .21 volt rms per inch peak to peak deflection

HORIZONTAL .25 volt rms per inch peak to peak deflection

Direct

VERTICAL 15 volts rms per inch peak to peak deflection

HORIZONTAL 18 volts rms per inch peak to peak deflection

Amplifier frequency response is flat to within 3 db. from 7 cycles to 140 kc. at full gain.

Input Impedance

Amplifiers

VERTICAL .5 megohm; 26 mmfd.

HORIZONTAL .5 megohm; 33 mmfd.

Direct-Vertical and Horizontal

3.9 megohms; 20 mmfd.

Intensity Modulation

.5 megohm; 30 mmfd.

For more complete information on the Type 132 Oscilloscope, together with application notes, hints and suggestions on the use of Oscilloscopes, write Sylvania Electric Products Inc., Radio Division, Emporium, Pa.

SOLD THROUGH YOUR SYLVANIA DISTRIBUTOR

ELECTRIC



FLUORESCENT LAMPS, FIXTURES, WIRING DEVICES, ELECTRIC LIGHT BULBS

New Jersey Dealer Draws Crowds with Outdoor Video Shows

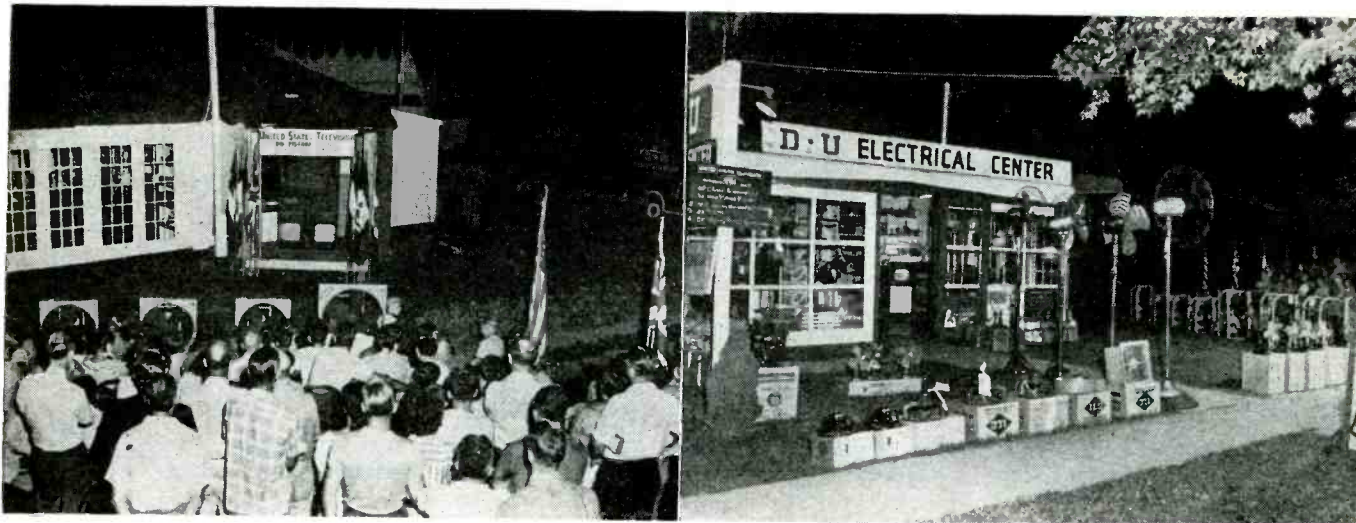

As many as 500 persons a night gather at the D-U Electrical Center, Linden, N. J., where proprietor Charles Diou is staging outdoor TV theater performances at the suburban store. Summer merchandise is displayed all over the lawn and hundreds of prospects learn about D-U values as well as television appeal. The set is platform-mounted at rear of store and its 25" by 19" picture can be seen by guests 400 ft. away. Store is kept open after evening shows. These crowds were photographed by Steve Huszar.

Television Today

"Another Stride in Forward March of Civilization"

In a memorable description of the art of television, FCC Chairman Charles R. Denny, speaking at the opening of TV Station WNBW, Washington, said that the potentialities of video are unsurpassed. Chairman Denny referred to the poet John Keats' lines about "magic casements" and continued:

"Today thousands of American homes have a 'magic casement'—not in fantasy but in actuality. Your television set is an electronic window through which you look from your living room beyond the horizon, over mountains, through the darkness of night, to far distant scenes. Your life takes on a new dimension. A new world opens.

"Television is another stride in the forward march of civilization. In terms of mass education, information, culture and entertainment, it has potentialities that are unsurpassed.

"Fifty-four additional television stations are under construction in 38 cities throughout the country. Most of these will be completed and on the air by the middle of next year.

"Sets are being purchased as fast as they come off the production lines and the rate of production is increasing rapidly. Last month more than 8,500 sets were produced. This is about the total number of sets we had in the country on V-J Day.

"The Federal Communications Commission has firm confidence in the future of television and will take every step to

assist the radio industry in giving the American people the finest television service attainable."

Service Centers for Videorama

Seven more appointments under the new installation and service plan for Stewart-Warner "Videorama" television receivers have been announced by N. J. Cooper, service manager, radio division.

Named as "Authorized Stewart-Warner Television Service Stations" were the Missouri Research Laboratories, St. Louis, Mo.; National Radio and Television Service, Washington, D. C.; Arlington Television Laboratories, Arlington, Va.; Television Sales and Service, Inc., Newark, N. J.; Short Hills Radio and Appliance Co., Short Hills, N. J.; Pioneer Television Co., Philadelphia, Pa., and Minor's Radio and Television Co., Baltimore, Md.

Two-Unit Video Sets Are Ready

Horace Atwood, Jr., president of Industrial Television, Inc., 34 Franklin Ave., Nutley, N. J., recently announced a number of features built in the firm's television receivers for public viewing. These are (1) two-unit construction permitting the viewing screen to be located independently of the control unit; (2) provision to control any number of viewing screens and sound systems from one control point; and (3) arrangement to use the sound system as a public address system without interfering with reception of the television picture.

Zenith's Plan for "Phone-Vision" Sets

Following the Chicago demonstrations of "phone vision"—the new system of pay-as-you-see television—by Zenith Radio Corp., the Illinois Bell Telephone Co. and Zenith have been "swamped with telephone calls from people who want to get phone vision service immediately." Zenith reported that "most of the callers have received the garbled pictures on their own television receivers, and wish to receive over their telephone wires the key signals which will make the pictures clear."

Commander E. F. McDonald, Jr., Zenith president, said that phone vision is not yet ready for public use, since it will take from six to twelve months to finish working out details and get the new receivers into production.

Picture Caravan Continues Video Shows

Seven more performances remain for the RCA Victor-Allied Stores Corp. television caravan touring the country with video demonstrations in stores. The tour started in May and will end in October.

The remaining stops for September are at The Golden Rule Store, St. Paul, Minn., on the 5th; the C. C. Anderson store, Boise, Idaho, on the 13th; the Bon Marche, Seattle, Wash., on the 20th; and Anderson's, Spokane, Wash., on the 26th. During October the show will be at The Paris, Great Falls, Mont., on the 1st; Donaldson's, Minneapolis, Minn., on the 11th, and at Polsky's, Akron, Ohio, on the 18th.

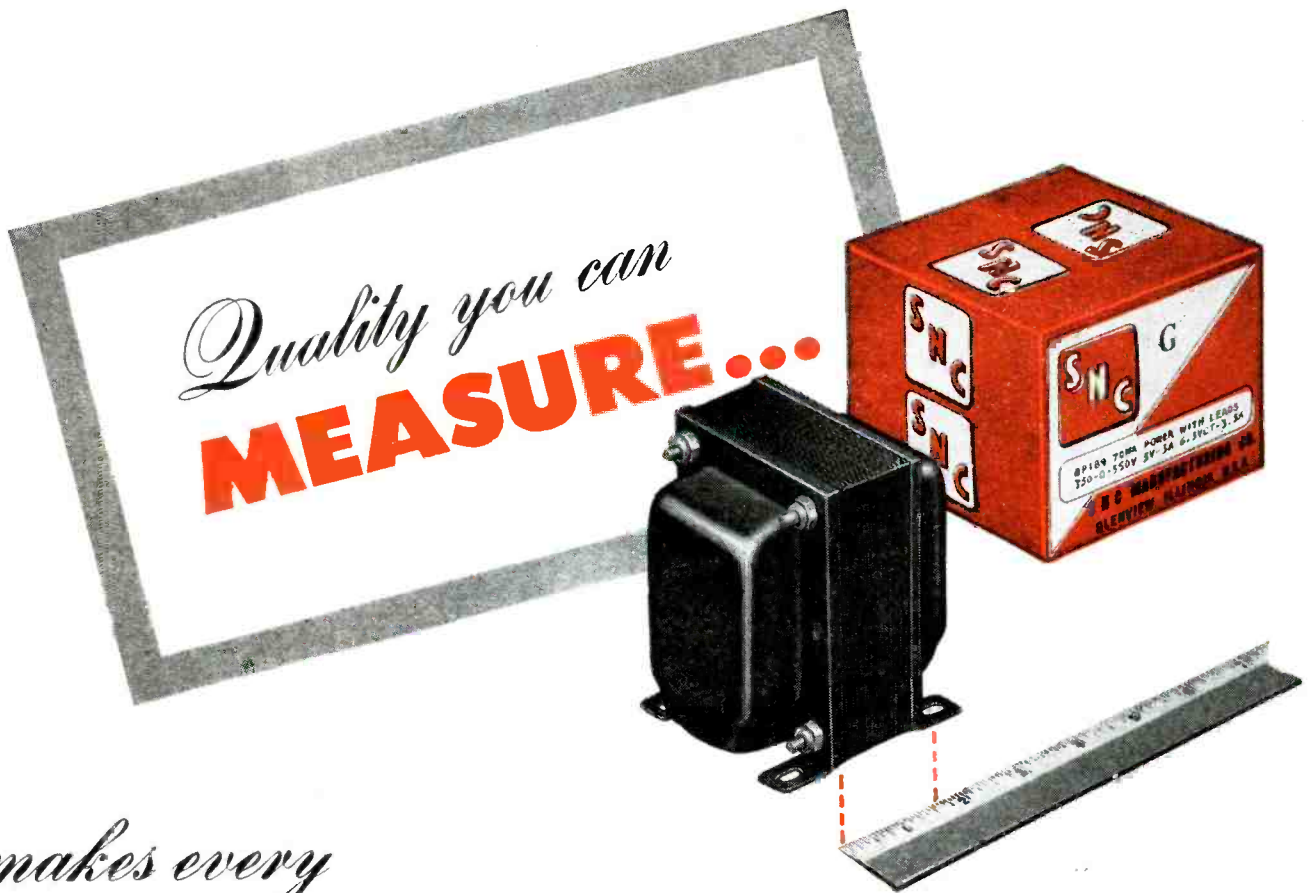

makes every
SNC TRANSFORMER *give outstanding performance*



Join the increasingly large number of manufacturers, retailers, hams and other component part buyers who rely on SNC for quality, trouble-free equipment. Write for catalog today.

Place a rule against the stack of an SNC No. 8P189 transformer and the *extra* width clearly indicates the added quality built into every item in the complete SNC line.

Skillful engineering, latest production techniques and highest quality materials . . . backed by careful workmanship, exacting step-by-step inspection and rigorous final testing . . . are just a few of the reasons why SNC transformers keep rejects at a minimum and give outstanding performance.

Remember! SNC gives MORE applications with SMALLER inventories for GREATER profits!

SNC MANUFACTURING CO., INC.
Quality Transformers
 WEST LAKE AVE. NEAR LEHIGH • GLENVIEW, ILLINOIS

Classy Display for FM Combination



Eye-grabbing display in the Euclid Ave. window of the National City Bank of Cleveland used a single unit, the Farnsworth FM-AM GK-143 combination, as the star of the striking arrangement. The stunt was worked out with 9 local dealers, whose addresses were shown. The display also included photos of Farnsworth's four plants in Indiana.

FM Sales News

Biggest Gains Made in Production of FM-AM and TV Sets

The latest production figures from the Radio Manufacturers Association show that during the first six months of 1947, the member manufacturers made their biggest gains over 1946 in the production of FM-AM and tele sets. The grand total of AM, FM and TV sets was 8,610,644 for the period.

The total of FM-AM receivers made during the six months was 445,563, as compared with 181,485 in 1946. The half year's output was thus two and a half times that of the previous year. As for video, more tele sets were made in June alone than in the entire year of 1946. June's record output of 11,484 in this group brought the half year's total to 46,389, as compared with 6,476 in the whole of 1946.

The proportion of FM-AM receivers to the total set production rose from 1.4 to more than 5 per cent during the first half of 1947. An RMA survey last spring indicated that total FM-AM set production in 1947 would run between 1.8 and 2.1 million this year, rising sharply during the last half of the year.

A decline in the proportional number of table models and a slight rise in the percentage of consoles characterized the

1947 half year's production. Table models dropped from 77 per cent in 1946 to 63 per cent during the first six months of this year. Console production rose from 7 to almost 11 per cent during the same period. Of the 932,420 consoles reported, 867,910 were radio-phonograph combinations.

Automobile radio production during the first half of 1947 exceeded the total for 1946, the respective figures being 1,208,159 (1947) and 1,153,458 (1946).

Of the 46,389 TV sets produced in the past six months, 32,769 were table models, 9,229 were consoles, 3,517 were radio-phonograph combination models, and 874 were converters.

The FM-AM output during the half year was largely in console models although table model production has shown an increase in recent months. A total of 361,689 radio-phonograph combinations, 15,615 straight consoles, and 68,259 table models made up the FM-AM total.

Receiver-Tuner Ready

The "Combinette in FM" receiver-tuner FM unit, announced earlier by Electronics, Inc., Washington, D. C., as the low-priced "people's FM" now has a suggested list price of \$56.95. The firm, located at 934 Bowen Bldg., Washington 5, D. C., states that the units are now available for immediate delivery.

This table model job has 8 tubes plus rectifier, and can be used separately as a complete FM receiver or as an FM tuner with any AM receiver. It is an ac-dc set, with built-in line-cord antenna, housed in a mahogany cabinet.

Survey Shows Need for Cheaper FM, Says Report

The FM Association, Washington, D. C., has revealed that out of the returns of a questionnaire sent out by FMA, 94% indicated a public demand for lower-priced FM receiving sets. FMA said that "the unanimous opinion of those who replied indicated that dealer surveys made in their territories, which are scattered throughout the country, showed conclusively that the average prospect for a new radio is unwilling to pay the high prices asked now for FM-AM consoles, with phonographs."

Other conclusions were that "in some areas, dealers and distributors are loaded with AM sets and they are reticent in informing customers of the advantages of FM—when a new FM station goes on the air, cooperation with dealers loaded with straight AM sets is impossible in the majority of cases, but dealers who have smaller inventories of straight AM sets and are in a position to stock FM-AM receivers are enthusiastic over FM broadcasting and, through experience, are convinced that their future profits will be measured by the extent to which they promote FM. In the majority of cities and towns having FM service, however, the station operators and dealers have held cooperative meetings which are producing profitable results for both."

How to "Demonstrate in Forty-Eight," Being Shown

Now being shown at dealers' meetings held throughout the U. S. on the new Westinghouse radio line, is a half-hour sound slide film entitled "Demonstrate in Forty-Eight." The show is attracting wide attention as an example of the trend back to vigorous merchandising, as it gives full details on how to demonstrate new radios effectively.

The film was written, directed and produced by William Alley of Depicto Film, 245 W. 55th St., New York 19, N. Y. It deals with 15 different features of the Westinghouse line, and how these features can be shown to today's customers.

The features include Rainbow Tone FM, Plenti-Power, Electronic Feather, Rainbow Dial, Auto-Mix record changer, Signal Light control, Dual Tone Balancer, Lift-out radio, the Jewel receiver, cabinet quality, Double Range dual speakers, Disappearing Speakers, record storage space, built-in FM dipole antenna and the Giant Chassis.

Zenith Teaches FM Service

The series of FM servicing schools for dealers' and distributors' technicians which was started in Milwaukee in June by the Zenith Radio Corp., under general service manager Frank Smolek's direction, has been scheduled for 21 cities from coast to coast.

Distinctive beauty

SUPERB PERFORMANCE



TURNER COLORTONE DYNAMIC—MODEL 5D

SPECIFICATIONS

MODEL 5D COLORTONE DYNAMIC

EFFECTIVE OUTPUT LEVEL: 52 db below 1 volt/dyne/sq. c. m. at high impedance.

FREQUENCY RESPONSE: Flat within ± 5 db from 50-9000 c. p. s.

OUTPUT IMPEDANCE: 50, 200, 500, ohms, high.

DIRECTIONAL CHARACTERISTICS: Semi-directional. Non-directional when tilted back 90°.

DIAPHRAGM: Highest quality, corrosive resistant aluminum.

MAGNETIC CIRCUIT: Employs highest quality Alnico V magnet. Highly shielded output transformer excludes all hum pickup.

CASE: Tenite. With 90° tilting head. Rubber tilt brake holds in any position.

FINISH: Choice of yellow, green, ivory, orange.

MOUNTING: $\frac{5}{8}$ "—27 standard coupler.

CABLE: 20 ft. removable, shielded, single conductor, with connector.

DIMENSIONS: $4\frac{1}{4}$ " long x $2\frac{7}{8}$ " wide x $4\frac{5}{8}$ " high.

WEIGHT: 17 ounces.

TYPICAL
FREQUENCY RESPONSE
HIGH IMPEDANCE

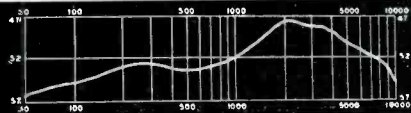

ALSO AVAILABLE WITH HIGH QUALITY CRYSTAL CIRCUIT AS MODEL 5X

THE TURNER COMPANY
903 17th Street N. E.
Cedar Rapids, Iowa

Microphones licensed under U.S. patents of the American Telephone and Telegraph Company, and Western Electric Company, Incorporated. Crystals licensed under patents of the Brush Development Company

• The post-war microphone sensation. Beauty that sings to the eye and ear. Turner Colortones bring sparkling color to stage and orchestra settings, home recorders, television studios, night spots, etc. Their high quality reproduction accents the performance of finest recording and sound system equipment. Cases are styled in a choice of gleaming ivory, rich orange, bright yellow, and soft pastel green finishes. Improved dynamic circuit with Turner precision diaphragm and Alnico V magnets provides extremely accurate pickup and smooth wide-range response to voice and music. Shielded output transformer excludes all annoying hum pickup. Available in four standard impedances with or without built-in slide switch. See them today at your dealer.

MICROPHONES IN COLOR

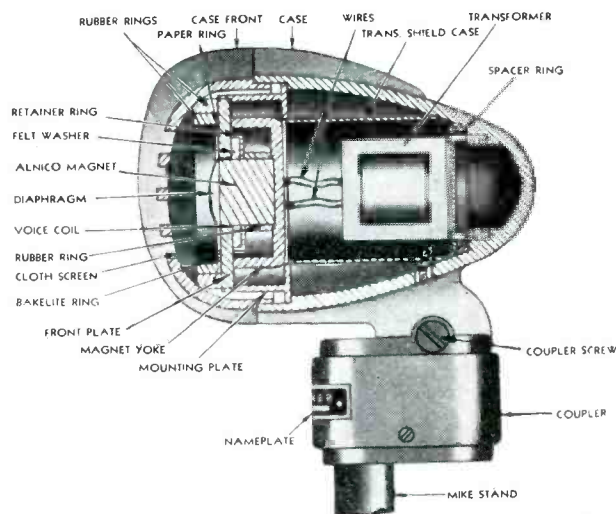

INTERIOR CONSTRUCTION MODEL 5D
Turner Colortone Dynamics will stop you with their beauty—you'll choose one for its superior quality.



Sales Tips and Profit Pointers

Deep are the roots of customer skepticism toward what the salesman has to say. An old proverb has it that "the buyer needs a hundred eyes, the seller not one". Most of such suspicion, however, is felt toward salesmen who are *strangers* to the buyer. That's why it's so important to make friends of one's customers—gain their confidence through sincere, honest dealings, and by showing interest in the buyer *after* the sale has been made.

Salesmanship as a career offers unlimited earning possibilities. In addition to the financial aspect, the salesman has a golden opportunity to "go places" in this man's world. Moreover, salesmanship does not impose any age or academic standing requirements.



There's a tendency among salesmen to class all sales meetings as hogwash and as time-wasting practices. The best way to make them feel favorably inclined toward merchandising sessions is to keep the *blue-sky* and *hokum* stuff out.

Too many consumers still believe that if they buy "on time" they will get better service on their radio and appliances, because they hold the whip-hand via power to withhold payments if equipment fails to function properly. No reputable dealer makes any such distinction in his service policy, and he should seek to impress every purchaser that such is the case. Should point out, too, that finance contract terms *do not* permit customer to hold back due payments.

Margin can never be considered alone. It must always be balanced against your turnover of stock. High-margin goods are not the most profitable if they are slow-moving. Even on merchandise that is intrinsically good, you may be tempted by quality discounts to buy such a large stock that your stock turn suffers.

Genuine salesmen are never clock-watchers or minute-pinchers, but are guys who realize that they're actually putting in hours working for *themselves*.

The Guest Experts of the Month Say—

The easy days of selling from incomplete catalog descriptions and offering of vague promises of delivery are over. The prospective customer today is once again a critical and exacting buyer and expects to see and be shown before placing the order. Operating displays of inter-comms, microphones, pickups, loud speakers, etc., are practically a must if the dealer or sound specialist is to be recognized as a legitimate supplier of sound equipment. There is no "short cut" to the profits that should be enjoyed from this branch of your business.—*R. C. Reinhardt, president and sales manager, Atlas Sound Corp., Brooklyn, N. Y.*

If we are to maintain our present day economy, the retailer must look forward to dealing in a volume approximately double that of 1941 . . . and he cannot handle such volume without the creation and training of an adequate sales organization. This is the retailer's biggest responsibility in the months immediately ahead.—*Charles T. Lawson, vice-president in charge of sales, Nash-Kelvinator Corp., Kelvinator Div., Detroit, Mich.*

Because of overstock on some items which have become slow-moving, there is a growing tendency among jobbers and dealers to reduce inventory below a reasonable minimum. Overstocking is not advocated. But cutting inventory to the point where customers are disappointed is not good business. Overstock on some items does not justify being out-of-stock on others. Watch the demand.—*John Q. Adams, sales manager, Hytron Radio & Electronics Corp., Salem, Mass.*

Smart merchandising means building friends for your store. A clever dealer will

- (1) Feature merchandise with a background of reputable service—a dealer's good name is only as good as the stock he carries.
- (2) Sell the "use to her" features of a product. A customer should not be high-pressured into buying what she does not need.
- (3) Win confidence in his store by his friendly consideration of his customer's needs and his willing cooperation in helping her satisfy them.—*Oswald MacCarthy, Eastern regional sales manager, Proctor Electric Co., Philadelphia, Pa.*

now more profits
per counter inch

BRIGHT STAR

batteries



Packs a big sales wallop wherever displayed. Attractive 3-color pop-up dispenser catches the eye and ready cash. Rigid box holds 2 dozen fast selling Bright Star No. 10M metal top batteries.

flashlights

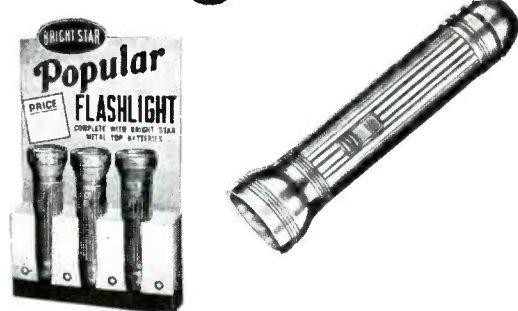

Cash in with the fastest selling metal flashlight on the market. Popular priced to sell on sight. Colorful new easel card holds 3 No. 57 2-cell Nickel Plated Flashlights. 98¢ retail, complete with cells.

NATIONALLY ADVERTISED TO OVER 51,771,633 READERS

Write your jobber now for details of Bright Star's big profit-making merchandise display deals.

BRIGHT STAR BATTERY CO.,
CLIFTON, N. J.
BRANCHES: CHICAGO • SAN FRANCISCO

CHICAGO, ILL.—William W. Boyne, Zenith district sales manager, has been appointed general manager of *Zenith Radio Distributing Corp.*, 912 W. Washington Blvd., here. The distributing corporation is a wholly-owned sales subsidiary of Zenith Radio Corp., covering Chicago and 31 northern Illinois counties. There's a display salon at 680 N. Michigan Ave. here, and to provide additional space for improved service to its radio dealers and for the expansion of its M-G-M record distribution, the distributing corporation recently purchased the two-story and basement building at 912-22 Washington Blvd.

BOSTON, MASS.—James M. Tighe has been named advertising and sales promotion manager for *Northeastern Distributors, Inc.*, 588 Commonwealth Ave., here. He will work closely with Northeastern's dealers to assist them in their advertising and sales promotion problems.

Grand Opening

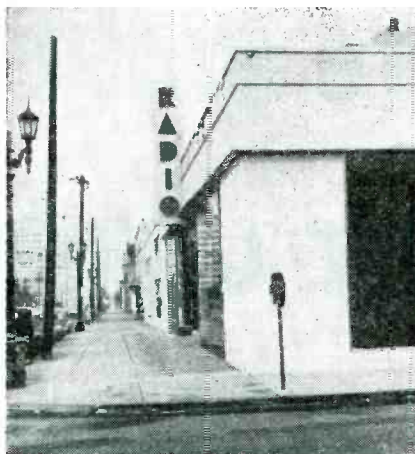

Here is the new \$250,000 plant of Radio Products Sales, Inc., at 238 W. 15th St., Los Angeles, where president C. F. Sexton staged a 3-day grand opening that drew 5,000 guests. De luxe building has 36,000 sq. ft., 50-car parking lot, streamlined section for each type of product.

ST. LOUIS, MO.—Sixteen different lines of sound equipment are now carried by the *Phonecraft Co.*, specialists in the public address field with wholesale distributor offices and display rooms at 3904-06 Olive St., St. Louis 8, Mo. The lines are American Communications, Astatic, Atlas Sound, Dalmo Victor, Electro-Voice, Electronic Labs, Eltram, Guided Radio, International Industries, Kainer, Scientific Radio, Snyder, Sound, Inc., Stromberg Carlson, Telex, and Turner.

CHARLOTTE, N. C.—Just franchised by Garod Radio is the *Household Distributors Division, Southern Friction Materials Co.*, P. O. Box 1475, here. The firm is covering North and South Carolina with four salesmen traveling over 10 routes. The president is Howard Snow and the department managers are Edgar L. Jones, Jr., R. Hovan Hocutt, and Wallace C. Gilbertson.

Jobbers in Action

Distributor News Across the U. S.

BOSTON, MASS.—Bendix Radio and *Allied Appliance Co.*, Bendix radio distributor in the New England region recently joined forces in a novel sales drive on the Consolette radio-phonograph. Bendix cooperated with Decca Records in offering the Consolette at the regular price of \$179.95—plus four most popular albums free of charge. The report was that "scores of customers took advantage of the value."

Success of this campaign was due to "the excellent support of alert Bendix Radio dealers in the area we serve," stated Ralph S. Cron, vice-president and general manager of Allied Appliance.

St. Louis Distributor Expands Operations



Night view of the big new location of ARA Distributing Co. at 2300 Olive St., St. Louis, Mo., where the firm has 10,000 sq. ft. of space. In addition to handling Crosley products, ARA has become one of the largest phono record distributors in St. Louis.

NEW YORK, N. Y.—Distributors in New York City who will handle the Webster-Chicago wire recorder have been announced recently by W. S. Hartford, general sales manager. They are: *Gross Distributors, Inc.*, 570 Lexington Ave., and *Sanford Electronics, Inc.*, 136 Liberty St.

WHEELING, W. VA.—*General Distributors*, electronic parts distributors of this city, have moved into their new quarters at 26 Tenth St. The company, which started in business only a year and a half ago, now has a store with eight times the floor space of their former location.

DETROIT, MICH.—C. W. Strawn, vice-president of the *RCA Victor Distributing Corp.*, at 1930 E. Jefferson Ave., here, has resigned his post to form his own business in wholesaling radio and appliances. Mr. Strawn is a veteran jobber of this area and has represented such lines as Zenith, Tappan, ABC, in addition to RCA and other major lines.

PITTSBURGH, PA.—Motorola, Inc., has announced the appointment of *Electric Products, Inc.*, as exclusive wholesale distributors for Motorola products in this area. Electric Products, Inc., will handle the entire line of Motorola FM and AM home radios, auto radios, automatic gasoline car heaters and television receivers. Officials of the firm are: R. E. Staffan, president; A. J. Curry, vice-president; and F. D. Hoyt, sales manager. All were formerly principals of Electric Products Corp., distributors of Frigidaire products for 20 years.

SPRINGFIELD, MASS.—*Milhender Distributors, Inc.*, has formally opened its new branch at 324 Columbus Ave., here.

SAN FRANCISCO, CALIF.—Appointment of the *J. N. Ceazan Co.*, as distributor of Farnsworth products in 47 counties in Northern California and 10 counties in Western Nevada has been announced by the Farnsworth Television & Radio Corp. Julius N. Ceazan, who founded the company 28 years ago, is president; B. T. Roe, vice-president and general manager; Bernard M. Ceazan is treasurer; and Mose Katsev is secretary and sales manager of the radio and appliance division.

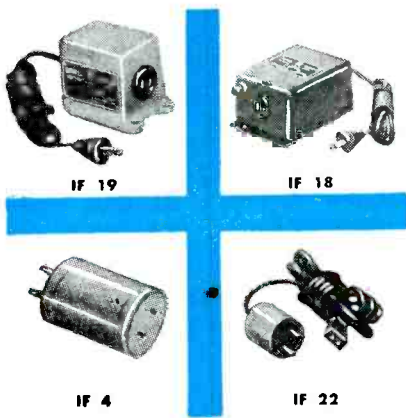

EARN EXTRA PROFITS with these standard C-D Quietone Interference Filters. Other types available for difficult cases, including television. Every radio home is a live prospect for these man-made noise eliminators.

Radio repairs alone bring you bread-and-butter business. But you can have *that* and a rich "cake" too.

Thousands of successful servicemen have already discovered how C-D Quietones step up their profits *over and above* their normal business. And it's easy as pie!

Here's a popular, proven method. Simply hook up an old-fashioned brush-type fan, or any noise-making modern appliance, right on your sales counter. Plug in the customer's own set — cut the C-D Quietone in and out — and then and there your demonstration will "wrap up" an extra, profitable sale. Sound easy? It *is* — and you'll multiply your profits with every customer who steps into your shop.

Broaden your profit opportunities NOW with famous C-D Quietones. Mail coupon below for complete descriptive catalog. Cornell-Dubilier Electric Corporation, Dept. JD9 South Plainfield, N. J. Other large plants in New Bedford, Brookline, and Worcester, Mass., and Providence, R. I.

FREE! Your permanent subscription to "The Capacitor" — the serviceman's own monthly magazine.

Illustrates and describes latest circuits, equipment, etc. — free want-ads and swap notices for servicemen — exclusive hints on repairing every type of radio, phonograph, television set, etc.

MAIL COUPON NOW — your free subscription starts at once.



CORNELL-DUBILIER ELECTRIC CORP., DEPT. JD9
SOUTH PLAINFIELD, NEW JERSEY

- Rush my copy of Catalog No. 195A describing C-D Quietones.
- You bet I want "The Capacitor". Please start my FREE subscription at once.

Name.....

Address.....

City..... Zone..... State.....

1" TRANSVISION SCOOP!

NEW! SENSATIONAL! 12" TELEVISION KIT by TRANSVISION It's TOPS IN TELEVISION VALUE!

**1½ times bigger picture
than with 10-inch tube!**

Again! Transvision leads the field with a magnificent 12 inch Television Kit! Engineered for easy, rapid assembly.

See it!

Hear it!

The great performance of this superb set will shatter all your previous conceptions of television quality and value.

It's the TOPS IN TELEVISION!



Check These Features—STANDARD MODEL

- 12 inch picture tube (magnetic type).
- Picture size 75 square inches (1½ times bigger picture than with 10" tube).
- R. F. Unit factory wired and pre-tuned gives reception on all television channels.
- 4 mc. bandwidth for full picture definition.
- 9,000 volts second anode potential for brightness and contrast.
- 3 stages of picture I. F. factory wired and pre-tuned.
- 2 stages of factory pre-tuned and aligned I. F. coils.
- High fidelity FM sound reproduction.
- 22 tubes and 12 inch picture tube.
- Maximum picture sensitivity (better than 50 microvolts).
- Stabilized synchronizing circuit assures firm picture.
- Advanced Transvision television circuit provides exceptionally clear pictures.
- As easy to tune as your home radio.
- Finest quality, guaranteed parts used throughout.
- Complete with all tubes, 12 inch picture tube, *SPECIALLY DESIGNED FOLDED DIPOLE ANTENNA* with 60 ft. of lead-in cable, and complete easy-to-follow instructions.

DE LUXE MODEL with SUPERB BUILT-IN FM RADIO

Same as above, plus the following **ADDITIONAL FEATURES:**

- 50-216 mc. *continuous tuning*. Covers the entire FM band and all 13 television channels.
- Cut-off switch eliminates unused tubes when set is used only as FM receiver.

CABINETS—table and console models with beautiful rubbed wood finish available at moderate additional cost. Fully dried, packed in air-cushioned carton. Table model measures 24" wide x 17" high x 18" deep.

See your local distributor, or for further information write to:

TRANSVISION, Inc. Dept. R.R. 385 North Ave., New Rochelle, N.Y.

NEDA Adds New Chapter at Greensboro Meeting

At a meeting sponsored by the Middle-Atlantic States Chapter of the National Electronic Distributors Association in Greensboro, N. C., Louis B. Calamaras, executive secretary of NEDA, presided at the formation of a new chapter for that area.

Twelve distributors of the Carolinas and eastern Tennessee became members of NEDA and were joined by five members of the Middle-Atlantic States Chapter to form the new group.

Mr. Calamaras commended A. W. Greeson of Johannesen Electric Co., Greensboro, N. C., and F. E. Beaudry of Lambeth Electric Supply Co., Winston-Salem, N. C., for their cooperation in the formation of this new chapter. The following officers were elected: president, B. W. Krell, Dixie Radio Supply Co., Columbia, S. C.; treasurer, Al Rothstein, Southeastern Radio Supply Co., Raleigh, N. C.; director, A. W. Greeson, Jr., Johannesen Electric Co., Greensboro, N. C.; and secretary, F. E. Beaudry, Lambeth Electric Supply Co., Winston-Salem, N. C.

Present at the meeting, in addition to Messrs. Krell, Rothstein, Greeson and Beaudry, were H. W. Hunt, Jr., C. W. Fields, C. Lee Clarke, Mr. and Mrs. L. B. Thompson, T. T. Freck, Jack Farmer, W. K. Stoner, B. W. Krice, L. Julian Long, A. L. Hege, L. M. Vick, H. L. Dalton, H. M. Sherard, Jr., Leslie Rucker, Mr. and Mrs. R. J. Rothstein, Alfred B. Geer, J. Gasser, R. M. Johannesen, James Leonard, H. B. Grice, Gordon C. Hoffman, J. A. Gettman, C. W. Ferguson, L. T. McCollum, W. R. Murray, F. C. Mitchell, Mr. and Mrs. W. G. Ashman, H. B. Bennett, and W. D. Jenkins, a national NEDA director.

PhotoFact Aids Free to Servicers

A complete cumulative index to more than 1000 postwar radio receivers, combinations, record changers, recorders and sound amplifiers, arranged alphabetically and by model number and indicating the correct PhotoFact Folder to use for servicing information, is included in a group of three folders being offered free to radio servicers by Howard W. Sams & Co., Inc., Indianapolis, Ind.

In addition to the index, a second brochure describes five simple ways to file PhotoFact Folders and other servicing material, while a third free item is a specimen PhotoFact covering a popular radio-phonograph combination. All can be obtained from local parts jobbers or from the publishers.

ICA Has New Plant

Insuline Corp. of America has added another 25,000 square feet to its modern plant facilities. The new annex is located at 19th Ave. and 36th St., Long Island City, N. Y.

In announcing this expansion, S. J. Spector, president of Insuline, said that "ICA's new plant has been set up and streamlined to insure the most efficient methods of operation in keeping with Insuline's long-standing policy of producing quality products for volume business".

Just roll it open!

SIMPSON Model 260 Volt-Ohm Milliammeter

...with Roll Top Safety Case*

• The world's finest high sensitivity set tester certainly deserves the best in carrying cases. So we decided to give it just that by *building* the tester into the case to make an integral unit of case and instrument. Here's how we do it: we take the standard Model 260, place it inside a housing of heavily molded bakelite, and permanently fasten it there. Instrument and case become one unit. Beneath the instrument is a compartment for test leads. Over the face of the instrument a roll top (of molded bakelite, too) slides up to open, down to close, the case. With a flick of the

finger you roll it up and out of sight and the instrument is ready to carry, and fully protected. With the Roll Top Safety Case you cannot leave your carrying case behind. It is never in the way. And you have *constant, important protection to your 260 from damage, whether in use or not.*

Just remember this fact, always: You cannot touch the precision, the useful range, or the sensitivity of Simpson Model 260 in any other instrument of equal price or in some selling for substantially more.

*The regular Model 260, without Roll Top Safety Case, is always available, of course.



Simpson 260, High Sensitivity Set Tester for Television and Radio Servicing

At 20,000 Ohms per volt, this instrument is far more sensitive than any other instrument even approaching its price and quality. The practically negligible current consumption assures remarkably accurate full scale voltage readings. D.C. current readings as low as 1 microampere and up to 10 amperes are available.

Resistance readings are equally dependable. Tests up to 20 megohms and as low as 1/2 ohm can be made. With this super sensitive instrument you can measure a wide range of unusual conditions which cannot be checked by ordinary servicing instruments.

Model 260—Size 5 1/4" x 7" x 3 1/8" \$38.95
 Model 260, in Roll Top Safety Case—Size 5 3/8" x 9" x 4 3/4" \$43.75
 Both complete with test leads

Volts D.C. (at 20,000 ohms per volt)	Volts A.C. (at 1,000 ohms per volt)	Output	Milliamperes D.C.	Microamperes D.C.	Ohms
2.5	2.5	2.5 V.	10	100	0-2000 (12 ohms center)
10	10	10 V.	100		0-200,000 (1200 ohms center)
50	50	50 V.	500		0-20 megohms (120,000 center)
250	250	250 V.			Amperes
1000	1000	1000 V.			D.C. (5 Decibel ranges: -10 to +52DB)
5000	5000	5000 V.			10

SIMPSON ELECTRIC COMPANY
 5200-5218 West Kinzie Street, Chicago 44, Illinois
 In Canada, Bach-Simpson Ltd., London, Ont.

Simpson
 INSTRUMENTS THAT STAY ACCURATE

ASK
 YOUR
 JOBBER

New Westinghouse Sets; Television Ready Soon

With its large Sunbury, Pa., plant in full production, Westinghouse has ended allocation of merchandise, brought out a new line of radio receivers, and promises a television set before the end of the present year.

The new models are being introduced to the firm's distributors by J. H. Stickle, advertising and sales promotion manager, Edgar G. Hermann, manager of home radio sales, and other executives. The firm has launched a huge advertising and sales promotion campaign, sales training courses, and a new series of dealer helps.

At the top of the new line is the model 169, which will sell for about \$600. This console, with 25 watts undistorted

output, is an AM-FM combination, having 14 tubes, short-wave, dual disc storage space, dual speakers, and the new "Electronic Feather" tone arm.

The model 166, an AM-FM combination, is a 12-tube console, which will sell for approximately \$379.95. It will be available in mahogany and blond finishes, has the new tone arm, and like the other Westinghouse changers, it plays 10 and 12 inch records inter-mixed automatically.

An 11-tube AM-FM, model 164, is the only console in the line which does not have a record player. The 164 has 15 watts undistorted output and will sell for about \$187.50. Model 168 is an 8-tube console combination, featuring increased record storage space. It is available in mahogany and blond finishes, and will sell for about \$249.95. A table model, number

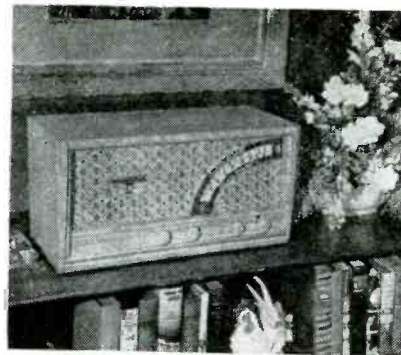

Model 161. AM-FM, 8 tubes; price about \$99.95.

157, featuring push-pull and a 3-gang condenser, will sell for approximately \$39.95.

The firm's new three-way portable, model 165, features a luggage-type case, disappearing handle, 3-gang condenser, and six tubes. Its approximate price is \$59.95. Model 161 is an AM-FM, 8-tube table model, available in mahogany and blond, and will be priced at about \$99.95. Within a short time Westinghouse plans to have a six-tube, AM-FM table model ready for the market.

The "Consolette," an AM-combination, will list at \$139.95. A table model battery farm set will sell at \$41, less batteries. Other popular models in the line introduced earlier by the company will be retained.

Westinghouse is also actively promoting sales of its new "Stratovision" FM antenna, listing at \$9.95, and its radio tubes and radio batteries.

Five Ways to Sell Electric Ranges to Women

"Women are not as much interested in the way an electric range is made as they are in what it will do for them," declares H. M. Parsons, vice-president of Landers, Frary & Clark, in an outline of the fundamentals of merchandising electric cooking. Mr. Parsons continues: "Women do not want the cold, fundamental facts that a range is made of steel, wires and other materials, but they insist upon knowing that it will last, and that it will carry out the various cooking operations with ease and quickness.

"Dealers should concentrate on five fundamental features: it's (1) clean, (2) automatic, (3) safe, (4) fast, and (5) economical.

Sets Shown at NAB Convention

A number of the 1947-48 lines of home radio sets, AM, FM, and television, are being displayed in the Atlantic City Municipal Auditorium during the 25th Annual Convention and Exposition of the National Association of Broadcasters, September 15-18.

Displays of equipment manufacturers and transcription companies and program services, occupy the largest amount of space in the hall, however.

BUILD BIGGER PROFITS

with

ESPEY

CUSTOM BUILT

CHASSIS

YES! These ESPEY custom-built radio receiver chassis are really designed to make bigger profits for YOU—the Serviceman and Serviceman-Dealer! They are ruggedly constructed of only the finest materials, and are electronically designed to give your customers maximum reception-pleasure over the years ahead, thereby assuring your reputation as "knowing your stuff!"

Engineered to meet all requirements for an excellent receiver chassis to be installed in your customer's cabinets, these ESPEY models are priced far within the competitive range. With three models to select from, your replacement worries are over. May we suggest that you contact your regular jobber, and examine these sets at your leisure? We feel certain that you will be just as enthusiastic about them as we are!

In the event that your jobber does not have these chassis as yet, write us for full details!

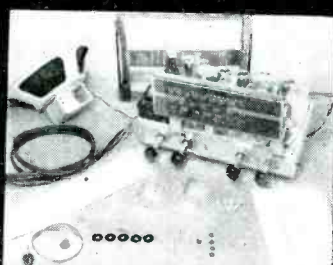

MODEL 7-B: 11 tube Superhet AM-FM. For 105 125V AC. Automatic and full range volume controls. 10" Alnico V speaker, wired for phono. AM-FM antennas supplied. RMA listed. Supplied complete, ready to install and operate.

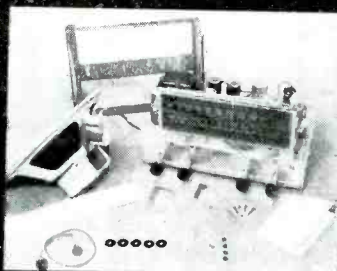

MODEL RR-14: 8 tube Superhet. For 105/125V AC. Automatic and full range volume controls. 10" speaker. Covers Broadcast and 2 short wave bands. Wired for phono. Built-in loop. All climates.

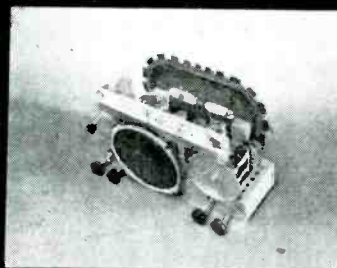

MODEL 97A: 6 tube Superhet. 105 125V AC/DC. 6" speaker. Automatic and full range volume controls. Broadcast and shortwave. Wired for phono. Built-in loop. Tone control. RMA listed. Complete and ready to install.

ESPEY MFG. CO., INC.

528 EAST 72ND ST., N.Y. 21, N.Y.

A SIGN OF SUCCESSFUL SERVICING

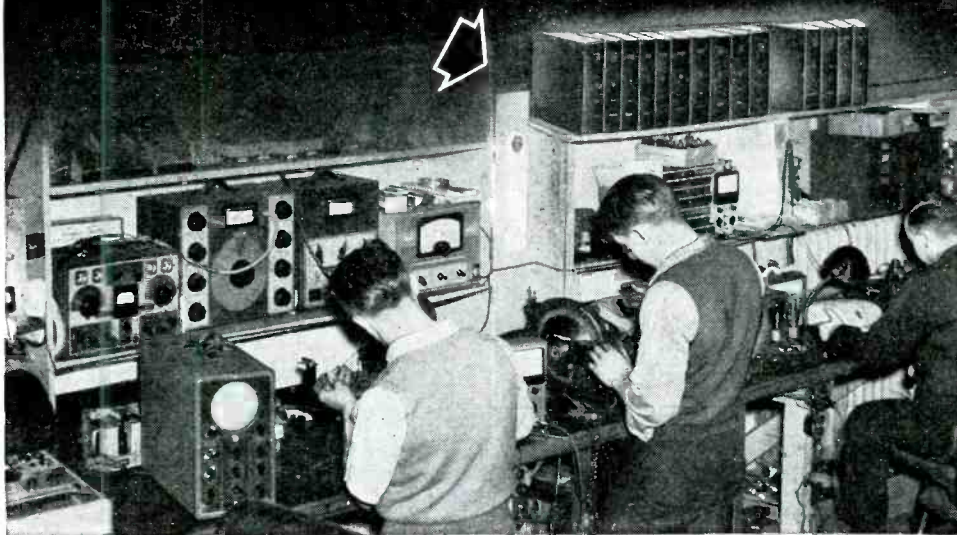

Community has all fifteen Rider Manuals* *(and Volume XVI on order)

In national magazines it's the successful shops that are featured editorially. Note how many carry photographs showing complete libraries of Rider Manuals. Community Radio and Electric Service of Wilkensburg, Pa. is an example; was recently featured in *Radio Retailing* for its "Plus-Service". At Community you will find all fifteen volumes in daily use. For, from no other single source is such essential information available to shops called upon to service all makes and all types of radio receivers — of all ages.

For this reason the first fourteen volumes of Rider Manual are time-savingly essential to the average shop. These volumes alone cover the years when over 80% of the sets now in American homes were issued. (From 1920 to 1942 inclusive.)

Too, the information on these receivers is the OFFICIAL AUTHORIZED servicing data direct from the service departments of the companies that made the sets. No one knows better than the manufacturer what procedures are best for his product. That is the basis for the authority and the success of Rider Manuals.

And you get this dependable information at the earliest possible date. For, Rider Manuals are now being issued three times a year!

Rider Manuals are investments. They keep pouring out profits for you. Copies of Volume 1, bought 17 years ago, are still benefiting their owners. So, be sure your shop has the sign of successful servicing — all fifteen Rider Manuals.

RIDER MANUALS NOW IN 16 VOLUMES

Volume X+1 (To be published in Oct.)...\$ 6.60
Volume X+2 (Incl. "How It Works" book) 18.00
Volumes XIV to VII (Each volume)..... 15.00
Volume VI..... 11.00
Abridged Manuals I to V (one volume).... 17.50
Record Changers and Recorders..... 9.00

VOL. XV

2000 Pages, plus 200 page "How It Works" Book

Covers sets issued during 1946 and some previously unpublished pre-war models. Contains 530 Rider-exclusive "clarified-schematics."

\$18.00 COMPLETE

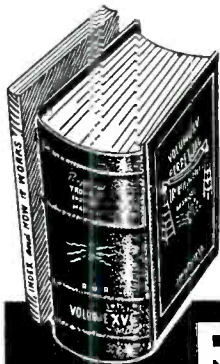

Just Out!

THE TIME-SAVING MASTER INDEX For Rider Manuals

For Vols. I to XV; Abridged Vols. I to V and RCA-Cunningham Edition. It covers 21,384 pages of Rider Manuals (all editions except Vol. XVI) for years 1919 through 1946.

Contains 40,000 chassis-model cross references and listings. 204 Pages — 8½ x 11 inches.

\$1.50

RIDER MANUALS MEAN SUCCESSFUL SERVICING

Out in Oct!

**VOL
XVI**

RIDER MANUAL

704 Pages . . . \$6.60
PLUS SEPARATE
"HOW IT WORKS"
BOOK

*Important
Policy*

Announcement

Because of the current high receiver production rate, Rider Manuals will be issued three times a year, as long as existing conditions continue. This will provide independent servicemen and dealer-service-shops with complete information at the earliest possible date, on those new sets which may require adjustment or repair. This accelerated publishing schedule is but another example of our alertness to meet your radio receiver servicing data needs with greatest economy to you. Rider Manuals represent, "Seventeen Years of Service to the Servicing Industry".

**JOHN F. RIDER
Publisher, Inc.**

404 — 4TH AVE., N. Y., (16) N. Y.

Export Agent:
Rocke International Corp.
13 E. 40th St., New York City
Cable ARLAB

Million Dollar Sales Contest Under Way

A nationwide \$1,000,000 contest for distributors and dealers of Bendix automatic washers has been announced by W. F. Linville, general sales manager, Bendix Home Appliances Inc.

Prizes totalling this sum will range from merchandise to trips to Florida and will be available to 20,000 retail salesmen, 250 wholesale salesmen and the sales managers of 79 distributors. The contest will close December 13. Distributors will participate with the manufacturer in the setting up of the prizes.

Both Bruno-New York, Inc., and Krich-Radisico, Newark, N. J., held big dealer meetings in their areas, at which the con-

test plan was vigorously applauded.

Mr. Linville said that in one-third of the Bendix automatic washer markets, dealers are getting from 33 1/3 to 100% more units than their established quotas. "Quotas are based on a monthly production of 55,000 units figured against distributors' and dealers' potentials," Mr. Linville stated.

Heads Television Net

Lawrence Phillips, executive vice-president of USO-Camp Shows, Inc., has been named for the post of director of the DuMont television network, according to Dr. Allen B. DuMont, president of Allen B. DuMont Laboratories, Inc.

Heads Festival Series



Harriet H. Higginson is the general manager of the newly formed RCA Victor Consumer Custom Products Dept. Department was formed to develop and market RCA's new "Festival Series" line of high-fidelity custom built radio-phonos, to be distributed direct through selected dealers. Deliveries start this month on these deluxe FM-AM combos (some with TV) priced at \$1800 to \$4000. Fine-furniture cabinets come in variety of styles.

More Colors in New Tele-Tone Table Models

In introducing its new sets, for \$12.95 and \$24.95 respectively, the Tele-tone Radio Corp. is placing fresh emphasis on the matter of color. The cheaper one, the "Leader" table model, is offered in ebony and gold, ivory, dusty pink, blue and chartreuse; the new "Constellation" portable (See "New Lines" section) comes in ebony, ivory, sand and maroon.

John S. Mills, the Tele-tone vice-president in charge of sales, said that "we believe that introduction of more pastel and other colorful shades will immensely enhance the sales appeal of a set to the average woman, who, after all, spends most of the dollars earned in the country today."

The \$12.95 "Leader" has 4 tubes including selenium rectifier—a 3 1/4 lb. superhet measuring 5 1/4" by 3 7/8" by 8 1/4".

Bright Star Offers "More Bright Light Longer"

Bright Star Battery Co., Clifton, N. J., has started an extensive advertising and promotion campaign to continue through the fall and winter seasons.

The theme, "More bright light longer," is based on actual laboratory findings. The consumer media list includes general magazines, scientific, farm and youth publications. The space campaign will be augmented with direct mail and point-of-sale aids, including new display pieces.

Nate Hast Heads Midwest Sales for Lee 400

Nate Hast, well known radio merchandising figure who has previously held key positions with Emerson, Philco and Lear, has been appointed head of Mid West sales for the Lee 400 radio. The set is made by Lee Radio Co., 1331 Halsey St., Brooklyn, N. Y., and sells for \$12.95.

FOR '47

Portable P.A. Profit-Package!



**PD - 835
35-WATT
PORTABLE
SYSTEM**



SELL THE COMPLETE PUBLIC ADDRESS LINE!

You'll have a big edge in portable sales with the outstanding RAULAND Portable System illustrated. It's only one of the many systems and amplifiers that make up the RAULAND line—the most complete in the Public Address field. For complete Sound sales, line up with RAULAND mobile, portable, permanent indoor and outdoor Systems—as well as amplifiers for every application. Each system and unit, from 14 to 60 watts, is RAULAND-designed-and-built throughout to assure perfect performance . . . full-rated output, superb tonal response, trouble-free operation. For bigger Sound Sales and profits, push RAULAND, the Public Address line that sells and stays sold. Write for complete details today.

PD-835 PORTABLE SYSTEM

The RAULAND 35-Watt PD-835 Portable System illustrated will cover approximately 20,000 people indoors, or 50,000 square feet outdoors. Two sturdy carrying cases house entire system: 35 Watt Amplifier, 2—12" PM Dynamic Speakers, Dynamic Microphone, mike floor stand, all necessary cables and plugs. Features: 4 Microphone Inputs; 2 Phono Inputs with Dual Fader; Separate Bass and Treble Tone Controls; illuminated amplifier panel. (Optional: remote mixing of 3 microphones.)

Electroneering is our business

**SOUND
TELEVISION**



**INTER-
COMMUNICATION**

THE RAULAND CORP. • 4247 N. KNOX AVE. • CHICAGO 41, ILL.

Now *One* INSTRUMENT FOR ELECTRONIC MEASUREMENTS

WESTON ELECTRONIC ANALYZER

Incorporating:

1. A conventional Volt-Ohm-Milliammeter with self-contained power source.
2. A high impedance electronic Volt-Ohmmeter using 115 volt, 60 cycle power.
3. A stable, probe-type, Vacuum Tube Voltmeter, for use to 300 megacycles.

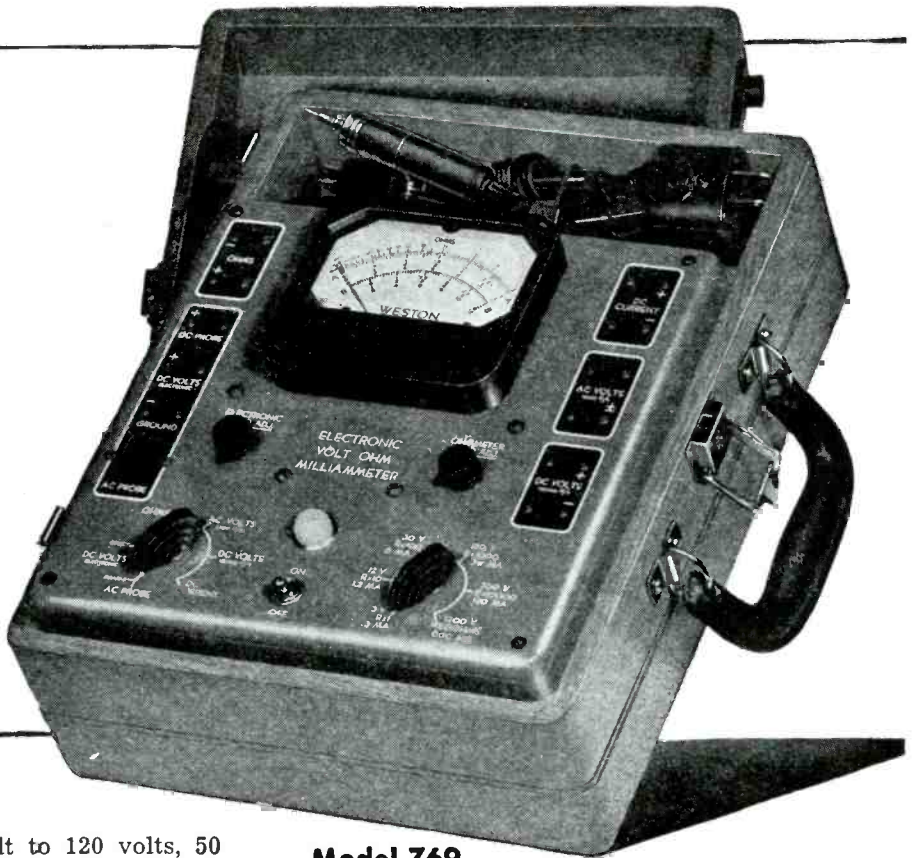

Model 769

Accurate a-c measurements .25 volt to 120 volts, 50 cycles to 300 megacycles.

Extremely small R.F. Probe ($3\frac{1}{2}$ " x $\frac{3}{4}$ " dia.). Probe constants, 5 megohms paralleled by 5 mmfd., approx.

New unity gain d-c amplifier provides absolute stability with line voltage variations from 105 to 130 volts.

D-C Electronic amplifier ranges 3 to 1200 volts at 15 megohms, resistance ranges 3000 ohms to 3000 megohms.

Conventional 10,000 ohm per volt d-c ranges 3 to 1200 volts, 1000 ohm per volt a-c rectifier ranges 3 to 1200 volts.

Resistance ranges 3000 to 300,000 ohms where a-c power is not available.

Entire Model 769 protected from external RF influences.

Uses standard commercial types of tubes replaceable without recalibration.

Size only 10" x 13" x $6\frac{1}{8}$ ".

Full details from your jobber or local WESTON representative. Literature available... Weston Electrical Instrument Corporation, 581 Frelinghuysen Avenue, Newark 5, New Jersey.

WESTON

Instruments

ALBANY · ATLANTA · BOSTON · BUFFALO · CHARLOTTE · CHICAGO · CINCINNATI · CLEVELAND
DALLAS · DENVER · DETROIT · JACKSONVILLE · KNOXVILLE · LITTLE ROCK · LOS ANGELES
MERIDEN · MINNEAPOLIS · NEWARK · NEW ORLEANS · NEW YORK · PHILADELPHIA
PHOENIX · PITTSBURGH · ROCHESTER · SAN FRANCISCO · SEATTLE · ST. LOUIS
SYRACUSE · IN CANADA, NORTHERN ELECTRIC CO., LTD., POWERLITE DEVICES, LTD.

New AM-FM-TV Lines Shown by Farnsworth

Farnsworth Television & Radio Corp. is in production on TV sets and is placing them on the market this month, according to president E. A. Nicholas.

Mr. Nicholas told Farnsworth distributors at their national convention that the company is accumulating its production of television receivers to release them in quantity in TV areas.

The models are table sets retailing at \$349.50, and consolettes priced at \$497.50. The consolettes have FM-AM radio in addition to television and both models have 10" direct-view picture tubes.

The Farnsworth executive predicted that telecasting stations would be in operation in at least 37 cities by the end

of 1948, adding that areas served would include more than 40% of the nation's population. He said that the sale of 5,000,000 sets in the next 5 years was likely.

The 1947-1948 Farnsworth radio and phonograph-radio line, presented by John S. Garceau, advertising and sales promotion manager, includes 15 new models available in 24 different cabinet designs and finishes. Following introduction of the line to distributors, all new models are being shown to franchised dealers at special presentation meetings in principal cities.

The firm's new line of FM-AM phonograph-radios, ranging in retail price from \$219.50 to \$425, includes four 8-tube and four 11-tube instruments. The newly designed P-56MP record changer being used

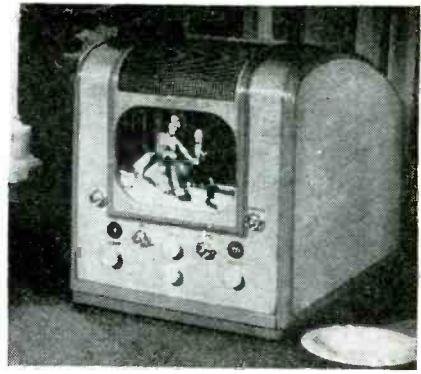

Farnsworth's table model TV set GV-220 comes in a compact modernistic blonde cabinet. Ten-inch picture tube gives picture of 52 sq. in. Controls unfamiliar to user are in bright plastic, others are opaque.



No. 8401 MICROPHONE CABLE

*Specify the Belden Trade Number
for Genuine Belden Wire*

Belden
Radio WIRE

in all 11-tube models.

Included also are two 6-tube AM combinations — a chairside similar to the Farnsworth model of the past year, and a compact lowboy.

Farnsworth's new triple-play portable radio, Model GP-350, is attracting much interest, and the new 5-tube and 6-tube table model radios include a wide selection in cabinet designs and finishes.

"Happier Homes Make Happier Employes"

An unusual folder has been issued by Shure Bros., Inc., 225 W. Huron St., Chicago 10, Ill., titled "Understanding". It concerns the firm's factory classes in child care training, for which the company has been widely complimented, and points up the general value of the "understanding" quality of people. Shure says that "we want our customers and suppliers to know that Shure Bros. is not an abstract corporate name—that Shure Bros. is *people*."

Glo-Drum Lamp



New lamp with all-plastic red-white-and-black drum that glows in the dark, is offered by Lamp Dept., Radio Frequency Laboratories, Inc., Boonton, N. J. For bedroom, hallway, nursery or den, it has 12" parchment shade in standard or child's design. Decler price is \$3.60; list is \$6.95.



SPEAKERS

ALUMINUM FOIL BASE VOICE COILS PROVIDE

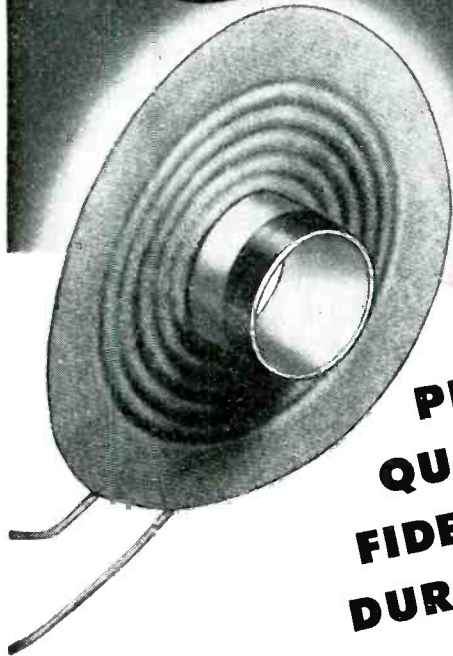

**PERFORMANCE
QUALITY
FIDELITY
DURABILITY**

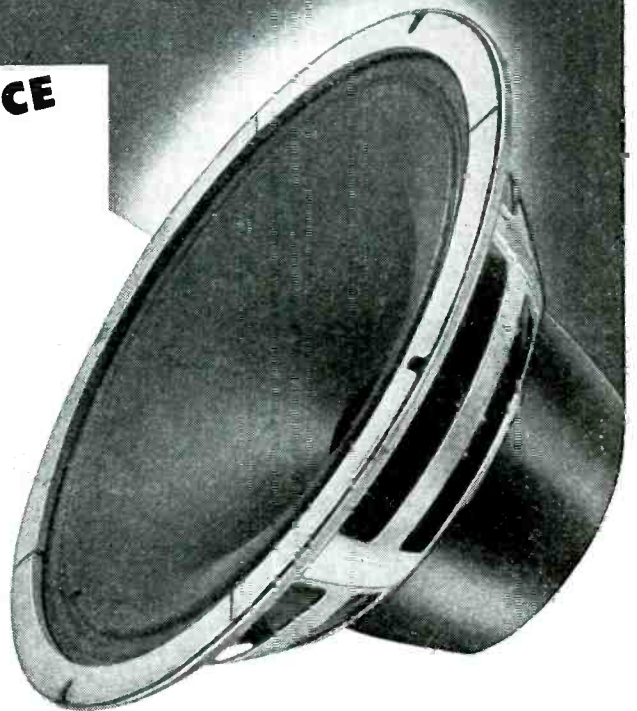

EVERY General Electric Speaker—from the smallest to the largest—has aluminum foil base voice coils. This G-E development makes possible their high quality performance, tone fidelity, and operating durability. Whether you use them by the hundreds of thousands in production lines, or purchase a single unit for an individual replacement, your customers will appreciate the extra quality performance of G-E Speakers.

G-E Speaker construction gives you these excellent features which assure dependable performance and fine quality reproduction:

- High wattage handling capacity. The metal construction provides much better heat dissipation. This permits operation of the speaker at increased wattages.
- No warping of voice coil. The metal base will not introduce internal stresses, and it is not subject to separation of laminations or to other adverse effects which might result in distortion.
- The aluminum foil base voice coil will not absorb moisture under high humidity conditions.
- Internal stresses which result in dimensional distortion are eliminated through the aluminum foil base voice coil construction.
- Metal construction assures better control of clearance between moving parts.
- Better tone quality and reproduction.

PLUS...

● **ALNICO-5 PERMANENT MAGNETS FOR OVERALL EFFICIENCY AND SENSITIVITY.**



● **DURABLE CONSTRUCTION THROUGHOUT.**

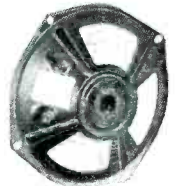

Write now for complete information on speakers to: *General Electric Company, Electronics Department, Syracuse 1, New York.*

GENERAL ELECTRIC

169-F7

John F. Rider, Publisher, Inc., 404 Fourth Ave., New York 16, N. Y., has released the new time-saving master index to the "Perpetual Troubleshooter's Manuals." All editions of the Rider manuals through Vol. XV, which appeared in 1946, as well as the Abridged Vol. I-V manuals and the RCA-Cunningham manuals are covered. Selling for \$1.50, it has 204 pages with 40,000 chassis-model references and listings.

Hytron Radio & Electronics Corp., 76 Lafayette St., Salem, Mass., is making available upon request, their latest catalog of Hytron transmitting and special purpose tubes, just released. Using a new, attractive two-color format, the catalog fits standard three-ring binders.

New Booklets

Western Electric Co., 195 Broadway, New York 7, N. Y., leads off Issue No. 8 of its publication "Oscillator" with an article entitled "Sound Reproduction Comes of Age," by E. M. Hall. The history and advancement of sound, and its influence on modern society is discussed, followed by two articles on loudspeakers.

Centralab, Division of Globe-Union, Milwaukee, Wis., are distributing free copies of their interesting booklet "Why Ceramic Capacitors" to radio servicers. The origin, development and reasons for the superiority of ceramic

dielectric are described in this two-color 8-page booklet, which shows the new BC Hi-Kaps line of ceramic bypass and coupling capacitors.

Sprague Products Co., North Adams, Mass., distribution organization for Sprague capacitors and Koolohm resistors, are giving free copies of a giant wall chart for radio services. The chart includes diagrams and descriptions of common circuit troubles involving capacitors and their remedies, and many other useful features.

Shure Brothers, 225 W. Huron St., Chicago, Ill., feature their entire new line of microphones and pickups in the 1947-8 catalogs No. 157 and 158.

New Haven Quilt & Pad Co., 86 Franklin St., New Haven 11, Conn., offer a catalog describing their line of padded covers which eliminate damage claims arising from scratch, burns and water damage to radios and appliances passing through the repair department.

Sound Apparatus Co., 233 Broadway, New York 7, N. Y., is offering free to sound specialists engaged in acoustical measuring work their brochure on a "Portable Reverberation Analyzer," containing detailed data on reverberation time measurements, solutions of acoustic problems, absorption coefficients, reverberation time limits for auditoriums, studios and homes, and other sound subjects.

Waldom Electronics, Inc., 911 N. Larrabee St., Chicago 10, Ill., is making available to the trade a new catalog which is cited by the firm as "the most complete listing of speaker cones ever recorded."

Pyramid Electric Co., 155 Oxford, Paterson, N. J., is offering a new 3-color catalog (J-4) called "Long Life DC Dry Electrolytic Capacitors." The 8-page bulletin has a wide variety of the capacitors, in cardboard and metal containers, with capacities ranging from 5 mfd. to 2000 mfd., at voltages from 6 v. to 600 v. working. Complete with detailed specs, illustrations, etc.

Refrigeration Specialties Dept., Norge Division, Borg-Warner Corp., 670 Woodbridge St., Detroit, Mich., makes available a 38-page "Frozen Food Digest," in a two-color "small magazine" style. It handles 24 different frozen-food topics, includes illustrations, and is available for 10¢ a copy.

Seletron Division of the Radio Receptor Co., Inc., 251 W. 19th St., New York 11, N. Y., has a new 8-page bulletin on selenium rectifiers for d-c requirements. Included are illustrations of rectifiers covering a range of voltage and currents, together with their electrical characteristics, dimensions and weights.

**These Newcomb selling features
are important to you!**

KX-30 Deluxe
30-Watt Amp.

COMPLETENESS: Two complete lines of amplifiers and portable systems . . . utility and deluxe . . . provide great flexibility in meeting various customer requirements.

QUALITY: Top-flight performance and dependable, low-cost operation . . . these qualities are carefully planned and built into every Newcomb amplifier.

PRICE RANGE: No other line of amplifiers offers so wide a price range . . . from very moderately priced utility models to the finest deluxe amplifiers for your most discriminating customers.

The proven quality of operation . . . the perfect suitability to every requirement . . . the wide price range . . . these mean greater customer satisfaction and more REPEAT SALES for you.

NEWCOMB—the logical choice of the quality-minded buyer—is your key to a continued, expanding success in the sound equipment field.

Let us send you complete information.



KX-60 Deluxe
60-Watt Amp.



KX-6 Deluxe
Mixer Pre-Amp.



K-60P Deluxe
Power Amp.



KXP-30 Deluxe
Phonograph Amp.



H-10 Standard
10-Watt Amp.



H-14 Standard
14-Watt Amp.



H-30 Standard
30-Watt Amp.



H-60 Standard
60-Watt Amp.



AUDIO PRODUCTS CO.

Dept. A 6824 Lexington Ave., Hollywood 28, Calif.

"NOT MERELY AS GOOD AS THE OTHERS . . . BUT BETTER THAN ALL OTHERS."

NOW

625 NA VOLT-OHM-MIL-AMMETER

RANGES
 Six D.C. Volts to 2,500 at 20,000 Ohms per Volt.
 Six D.C. Volts to 5,000 at 10,000 Ohms per Volt.
 Six A.C. Volts to 5,000 at 10,000 Ohms per Volt.
 Six Current Ranges: 0-50 Micro-amperes to 10 Amperes.
 Three Resistance 0-2000-200,000 Ohms; 0-4 Megohms.
 Six Decibel Ranges: -30 to +69.
 Six Output Ranges to 5,000 Volts.



*High Ohms—Mirror Scale—Thirty-Nine Ranges

For the Man Who Takes Pride in His Work

The new Model 625NA, with 39 ranges and many added features, is the widest range tester of its type. Note the long mirror scale on the large 6" meter for easier more accurate reading. Resistance ranges to 40 megohms give you all the ranges

needed for general servicing, plus Television and FM. And with 10,000 ohms per volt A. C. you can check many audio and high impedance circuits where a Vacuum Tube Volt meter is ordinarily required. A proverb super-service instrument.

Write for details today about Model 625NA and the many other new Triplet testers. Address Dept. G97.

*Precision first
 ...to last*

Triplet



ELECTRICAL INSTRUMENT CO. BLUFFTON, OHIO

Ten New Receivers Shown by Sonora

New models of the Sonora Radio & Television Corp., Chicago 12, Ill., have been shown to distributors, with a total of ten sets in the line-up including an emphasis on FM and a television unit.

Of the five FM sets, four are console radio-phonos priced from \$179.95 to \$280. The other FM receiver is a plastic table model which, in walnut, is tagged at \$59.95; in white plastic, \$62.95.

Among the AM units, three are phonoradios—a table model and two consoles. These are priced at \$149.95 and \$240, respectively, for the consoles, and \$89.95 for the table model. The latter unit, Model WBRU-239, is a compact job with automatic record changer, walnut veneer cabinet with roll-over design on top.

Another set is the plastic table model (see "New Lines" section) for \$17.95 in walnut, \$18.95 in ivory, and \$19.95 in the buff and burgundy combination, billed as "the world's most powerful small set." The tenth set in the line is the Sonora ivory plastic bedlamp-radio. This is the "Nightingale" model No. WCU-246, an ac-dc superhet with enclosed lamp for reading, at \$29.95.

Sparton District Manager

The Sparks-Withington Co., has announced the appointment of H. L. Pierce as district merchandising manager of the Sparton radio and appliance division. His territory will cover all of eastern Pennsylvania and southern New Jersey. He has been active in the electrical appliance business for 25 years.

BACK-TO-SCHOOL TIME MEANS TIME FOR SIGNAL PORTABLE SALES

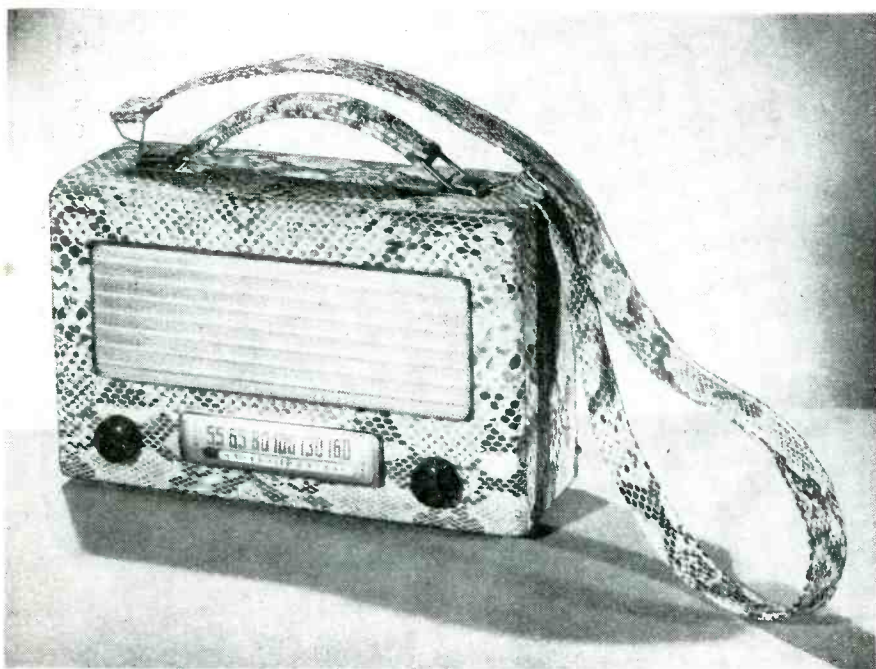

- The new 1948 *Signal EMPRESS* leads the profit parade of portables.
- A distance champion in reception, the *EMPRESS 3-way portable* features the patented *Signalloop* built-in antenna.
- A 5-inch Alnico No. 5 speaker produces exceptional clarity and richness of tone.
- The *EMPRESS* contains 4 tubes plus selenium rectifier. Weighs only 5½ pounds. Plays an average 100 hours per set of Batteries.
- Beautifully designed with full-vision slide rule dial and handsome leatherette covering.
- The *EMPRESS* is the ideal traveling companion for the school-bound girl or boy. Excellent also for hunting and fishing enthusiasts. A year-round sales leader.

\$29.95 List price less batteries

See *Signal's* entire 1948 line

"It's *Signal* for Sales"

Signal Electronics, Inc. Domestic:
SIGNAL SALES CORP.
114 E. 16th St., New York 3, N. Y.

Lewyt Distributors in Sales Clinic

Lewyt Corp., 60 Broadway, Brooklyn 11, N. Y., was host at a five day sales clinic for its distributors of the new Lewyt vacuum cleaner, at the Hotel New Yorker New York City.

Heading the list of speakers was Alex M. Lewyt, company president. Others in-



Getting a look at the new Lewyt vacuum cleaner here is Stan Lomax, famous sports commentator, who was the guest speaker at Lewyt's sales clinic. At center is Mr. Lewyt and at right is Mr. Daily.

cluded Walter J. Daily, manager of the vacuum cleaner division; J. Gordon Lippencott, industrial designer; Arthur Grossman, Chicago advertising display executive, and E. Harold Greist, vice-president of Hicks and Greist.

Sales Reps Named for RE

Radio Essentials, Inc., the distributing agency for American Radio Hardware Co., Inc., has announced a number of changes among its sales reps. The new set-up is:

James J. Becker, 2321 Second Ave., Seattle, Wash., will cover Oregon, Washington, Alaska and British Columbia. L. A. Chambers Co., 565 W. Washington Blvd., Chicago, will cover Illinois and Indiana. Floyd Fausett & Son, 1316 Allegheny St., S. W., Atlanta, Ga., will cover Alabama, Florida, Georgia, Mississippi, North and South Carolina and Tennessee. Massey Associates, Inc., 1124 Vermont Ave., N. W., Washington, D. C., will cover Delaware, D. C., Maryland, eastern Pennsylvania, Virginia and West Virginia. Segar & Taylor Co., 4508 E. Genesee St., Syracuse, N. Y., will cover upstate New York.

Heads New Proctor Development Division

Walter H. Vogelsberg has been named manager of the new equipment division of the Proctor Electric Co., according to Walter M. Schwartz, Jr., president. Mr. Vogelsberg formerly was associated with General Electric.

In the Proctor research department a number of improvements for electric ranges have been developed. The purpose of this new division is to further develop these improvements and to perfect plans for marketing them.

Don't Miss PHOTOFACT Set No. 23!

WITH EXCLUSIVE NEW "Standard Notation" SCHEMATICS

The Greatest Service Data Development in 20 Years!

I am proud to announce to my Servicemen friends the successful development of a new system of "Standardized Schematics" that is now yours exclusively in PHOTOFACT Folders. We have worked on this project for over one year, because we knew that uniform, standardized schematics would save you hours of time and countless headaches—would help you earn more. NOW—we have developed uniform, standardized diagrams on all sets. Now—you can save time—go from diagram to diagram and see the same, easy-to-understand symbols and designations. You no longer have to puzzle out the differences in schematic notations or bang your head against queer-looking diagrams. You'll recognize instantly the functions of all parts in any circuit. The standards used in our new diagrams are yours—the result of the PHOTOFACT "Standards Poll" and thousands of interviews with Servicemen. I wish space would permit me to tell you more—but PHOTOFACT Set No. 23 speaks for itself. You owe it to yourself to see the new diagrams. Use them—learn what a difference they'll make in faster, more profitable servicing.

Howard W. Sams

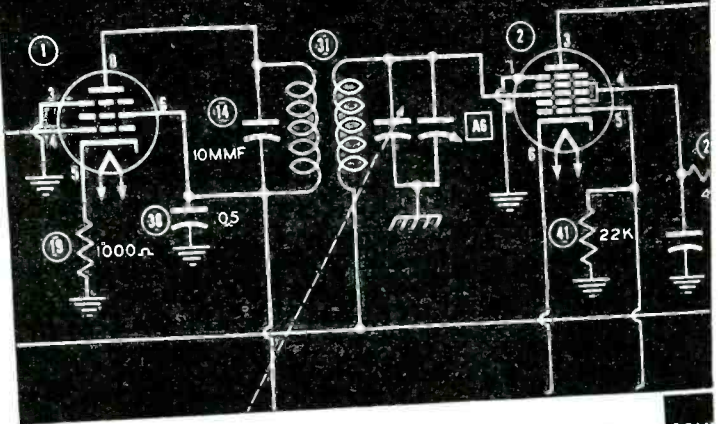

NOW! UNIFORM SCHEMATICS FOR FASTER, MORE PROFITABLE WORK!

Beginning with Set No. 23, and thereafter, all PHOTO-FACT Folders will feature the new, uniform "Standard Notation" schematics. Each and every diagram is drawn to the same basic set of clear, uniform, easy-to-understand standards. Here's what the new "Standard Notation" Schematics mean to you: Makes circuit analysis simple, quicker, fool-proof, more accurate! No more time wasted puzzling over odd-looking diagrams! No more trouble with varying symbols and confusing styles! Just ONE CLEAR STANDARDIZED STYLE FOR ALL CIRCUITS—SAVES YOU TIME—HELPS YOU EARN MORE. Only PHOTOFACT offers you the "Standard Notation" Schematics!

TWO IMPORTANT NEW HOWARD W. SAMS PUBLICATIONS

DIAL CORD STRINGING GUIDE

There's only one *right* way to string a dial cord. And there's only one book that shows you how. It's the Howard W. Sams DIAL CORD STRINGING GUIDE. Here, for the first time, in one handy pocket-sized book, are all available dial cord diagrams and data covering 1938 through 1946 receivers. Licks the knottiest dial cord problem in a matter of minutes. This low-cost book is a "must" for servicing. You'll want two copies—one for your tool kit and one for your shop bench. Order them today. **75c ONLY**

1947 AUTOMATIC RECORD CHANGER MANUAL

Nothing like it! COVERS MORE THAN 40 DIFFERENT POST-WAR MODELS. Absolutely accurate, complete, authoritative—based on actual study of the equipment. Shows exclusive "exploded" views, photos from all angles. Gives full change cycle data, information on adjustments, service hints and kinks, complete parts lists. Shows you how to overcome any kind of changer trouble. PLUS—for the first time—complete, accurate data on leading WIRE, RIBBON, TAPE, and PAPER DISC RECORDERS! Over 400 pages; hard cover; opens flat. No modern service shop can afford to be without this manual. **\$4.95 ONLY**



HOWARD W. SAMS & CO., INC.
INDIANAPOLIS 6, INDIANA

Export—Ad. Auriema—89 Broad St., New York 4, N. Y.—U. S. of America
Canada—A. C. Simmonds & Sons, 301 King St., East—Toronto, Ontario

PHOTOFACT SERVICE

"The Service that pays for itself over and over again"

FREE PHOTOFACT AIDS!

FREE. PHOTOFACT CUMULATIVE INDEX
—Your guide to more than 1800 receiver models and chassis (1946 and 1947 models covered in PHOTOFACT Folder Sets 1 through 20).

FREE. HOW TO FILE FOLDER—Shows 5 good ways to file PHOTOFACT Folders, including new "30-Second" filing method.

Ask your parts jobber for FREE copies of these PHOTOFACT aids, or write us direct.

RESERVE SET NO. 23 TODAY

MAIL THIS ORDER FORM TO YOUR PARTS JOBBER TODAY—or send directly to HOWARD W. SAMS & CO., INC., 2924 E. Washington Street, Indianapolis 6, Indiana.

My (check) (money order) for \$..... enclosed.

- Send PHOTOFACT Set No. 23 (at \$1.50).
- Send . . . SAMS' DIAL CORD STRINGING GUIDE(S), at \$0.75 per copy.
- Send . . . SAMS' 1947 AUTOMATIC RECORD CHANGER MANUAL(S) at \$4.95 per copy.
- Send PHOTOFACT Volume No. 1 (including Sets Nos. 1 through 10) with DeLuxe Binder, \$18.39.
- Send PHOTOFACT Volume No. 2 (including Sets Nos. 11 through 20) in DeLuxe Binder, \$18.39
- Send FREE PHOTOFACT Aids.

Name

Address

City State

Garod's New Line Includes Television

Garod Radio Corp., is now showing its new line-up of AM-FM and television developments at previews for its distributors.

Garod president Max W. Weintub presented a new television console receiver with a direct viewing 10" projection tube, including AM-FM and shortwave reception, and automatic record changer, to retail at less than \$700.

Lou Silver, national sales manager, displayed the new Garod "Starlet" personal portable radio (see "New Lines" section) to retail at \$29.95 (less batteries). These two units were features of the new line.

Also featured was a new "Radalarm" clock-radio combination, in a two-tone

plastic cabinet, to sell at \$39.95. A new "chairside" was demonstrated, featuring standard broadcast and short wave bands, and automatic record changer, made to retail at \$149.95.

Garod's FM sets were shown by Mr. Silver in a choice of three price ranges. The "Sherwood" AM-FM short wave console with automatic record changer was shown at \$249.50. The "Hardwick" is also a three-band console combination with two-post record changer featuring a "duo-sonic" speaker system to support the FM tuning, and retailing at \$285. The remaining period style combination the "Chesterfield" model, is largest in the group with dual speaker system for high fidelity FM reception and record reproduction, retailing at \$350.

Joseph G. DeVico, advertising manager,

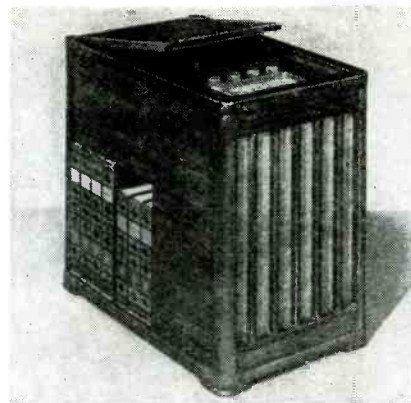

Garod's chairside Model 6DCP2 is a 2-band automatic radio-phonograph in mahogany. It has 2-post disc changer, handles twelve 10" or ten 12" records, and retails at \$149.95 in Zone 1.

outlined a national advertising program to include copy in several mass consumer magazines and an increased schedule in local newspapers.

(News of the sale of the Garod firm to Leonard Ashbach of Chicago appears on page 177.)

Low-Priced TV Receiver Kit

A new Telekit, a product of Electro-technical Industries of Philadelphia, is a television kit with all component parts except tubes, to be marketed "for less than \$100." Photographs, diagrams and illustrations are provided to make the assembly job easy.

The 7-inch kit is listed at \$77.50 less tubes, and includes FM sound reception and pre-tuned I.F. coils. The larger ten inch Telekit sells for \$124.50, less tubes, and has electro-magnetic scanning and focusing to hold the picture steady. The power supply is a full 10,000 volts.

Telekit service stations have been set up in principal cities to give the purchaser help or advice in his assembly.

The firm is located at 121 N. Broad St., Philadelphia, with sales headed by former Army Captain Milton J. Shapp.

They Got It Covered!

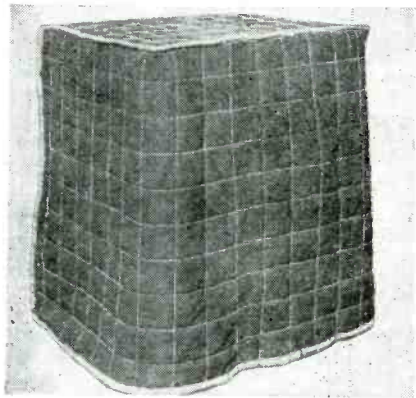

Above is one of the padded covers for radios and appliances, made by New Haven Quilt & Pad Co., 84-86 Franklin St., New Haven 11, Conn. The firm's line of covers, web straps, carrying harness, etc., is sold direct to dealers—it prevents chipping, nicking, scratching, etc.; cuts delivery costs and reduces damage claims and customer complaints. This style is \$8.



OLSON RADIO WAREHOUSE, INC. AKRON, OHIO

A Radio Man's Best Pal!



Resist-O-Guide

LIMIT—
ONE TO EACH RADIO MAN

3¢ that's all
A Postage Stamp is O.K.

You can read all resistor code-colors in a flash with this handy pocket guide! Revolving wheels in color show all resistance values. OLSON gives you this valuable tool (size 4 1/4" x 2 1/4") for a piffling 3c. GET ONE NOW.

This offer good only in U. S. A.

RADIO REPAIRMEN'S PRICE GUIDE

— and you get this big new **CATALOG FREE!**

60 rip-snortin' pages of special OLSON Bargains in Standard Radio Parts, Sound and Testing Equipment.

Clip the coupon and **MAIL TODAY**

OLSON RADIO WAREHOUSE INC.

73 E. MILL ST., DEPT. 98, AKRON, OHIO

I enclose 3c. Send me 1 "Resist-O-Guide" & new Free Catalog of Olson Bargains.

I am a Repair Man. I am an Amateur or Experimenter.

NAME _____

ADDRESS _____

CITY _____ STATE _____

We Tap a New Market!

... With a New Intercommunication System for the HOME



"Telehome" Master Station



BY THE MAKERS OF
Teletalk

The New Telehome Models for Living Room or Kitchen . . . Special Speaker for the Door

• Intercommunication Systems invade the home with the same high quality units that are available for commercial use:

This opens up the opportunity to sell to retail outlets and the widespread consumer market.

Designed and built specially for home use, it will be sold as a package consisting of a master unit and one speaker unit and one hundred feet of wire at a moderate price within range of everyone.

The new "Telehome" is available as a complete line, with additional speaker units available for those who want them. In addition, a special door speaker can be had separately. A Master wall-type station is provided for new home builders and is constructed as a built-in for modern kitchen cabinets or kitchen wall.

Complete promotion material is available to back up their sale with advertising in the Saturday Evening Post to tell the story to millions of consumers.

If you haven't already had the complete story, write to Webster Electric, Racine, Wisconsin for complete details:

Licensed under U. S. Patents of Western Electric Company, Incorporated, and American Telephone and Telegraph Company.

WEBSTER
RACINE



ELECTRIC
WISCONSIN

Established 1909

Export Dept. 13 E. 40th Street, New York (16), N. Y. Cable Address "ARLAB" New York City

"Where Quality is a Responsibility and Fair Dealing an Obligation"

Master Station, Speaker unit and 100 feet of wire . . . complete in one package \$49.50
Extra speaker unit 9.50
Door speaker 7.75
Prices slightly higher west of Rockies

As
Advised
in
Saturday
Evening
Post

New... Instant, low-cost
INTERCOMMUNICATION
made expressly
for home use!

"Telehome" permits two-way conversation between say two or more rooms . . . or with callers at your outside doors . . .

Saves countless time and steps . . . provides added protection and convenience . . .

"Telehome" - the new home intercommunication system - brings any two rooms within speaking distance of each other . . . if you wish, the user answers the outside door without opening it . . . gives instant voice-to-voice contact between any living room and kitchen or bathroom or garage or nursery . . .

By adding extra speaker units, your central master station can carry on two-way conversations with as many as three other locations . . . or five or more additional spaces of the house and steps "Telehome" will save in your home - no more tramping running up and down stairs or fatiguing distant rooms!

With all its advantages of control, ease and protection, "Telehome" comes but little, you can install it yourself - quickly and easily. It is hard-to-undo, nature is long-lasting . . . desirable . . . it is a precision quality product of Webster Electric, makers of "Teletalk" - the most widely used commercial intercommunication system.

Master station, speaker unit, and 100 ft. of wire \$49.50
Extra speaker unit \$9.50
Door speaker with push \$7.75
From Agents before end of the month.

Send for attractive picture booklet
Write for free copy of new booklet, "A new telephone system for your home - answering 'Telehome' and its many benefits to your home."

WEBSTER ELECTRIC COMPANY, Racine, Wisconsin, Established 1909
13 E. 40th Street, New York (16), N. Y. Cable Address "ARLAB" New York City
"Where Quality is a Responsibility and Fair Dealing an Obligation"

WEBSTER ELECTRIC

Special Intercommunication Systems • Land Developer Systems • Police Room Units and Police Control for multi-departments • Fire Units for all districts in districts of homes • Fire Alarm Systems • Thermostat for homes with air flow systems.

Expansion Announced for Coiled Kords, Inc.

Graybar Electric Co., with offices and warehouses in 96 principal cities, has been appointed exclusive distributor of all Coiled Kord products except telephone retractable cords of which they will share the distribution with several telephone manufacturers.

At the same time it was announced that The Whitney Blake Co., New Haven, Conn., is now teamed with the West Coast interests of Ralph Collins and Charles F. Mason, in the ownership of Coiled Kords, Inc., successor to Cordage, Inc.

According to John Brown Cook, the new K-K president who is also president of Whitney Blake and the Reliable Electric Co. of Chicago, the new arrangement will effect immediate economies in manu-

facturing and in sales distribution. All manufacturing operations are now at the W.B. factory in New Haven. Sales activities of Coiled Kords are directed by Col. E. L. Love, formerly in charge of Coiled Kords, Division of Kellogg Switchboard Co., of Chicago.

Mallory's New Offices in New York City

P. R. Mallory & Co., Inc., has announced a new address for its New York office at 41 E. 42nd St., Suite 1215. Mallory manufactures electrical, electronic and metallurgical components; dry cell batteries, resistance welding electrodes and special metals, with headquarters and main plants at Indianapolis, Ind., and branch plants at North Tarrytown, N. Y., and Tipton, Ind.

Arcturus Firm to Offer Popular-Priced TV Sets

"Surprising departures from present designs and styles" in popular-priced television sets are promised by Arcturus Radio & Television Corp., a newly



John V. Rice

James R. Donahue

formed associate company of Standard Arcturus Corp. The new firm has offices and factory at 19 Nebitt St., Newark, N. J.

James R. Donahue, veteran of the radio and electronic fields who was formerly sales manager of Standard Arcturus, has been named president of the new company.

An executive appointment in the Standard Arcturus company was also announced with the naming of John V. Rice as sales manager of the tube division. He is now planning "extensive jobber promotion of Arcturus tubes . . . with many sales helps for both distributors and dealers." Mr. Rice was formerly with National Union.

Mueller Rep Named

Mueller Electric Co., has announced the appointment of Leroy W. Beier as its exclusive sales representative in the Chicago area. His headquarters address is: 600 S. Michigan Ave., Chicago 5, Ill.

Faucet Water Heater

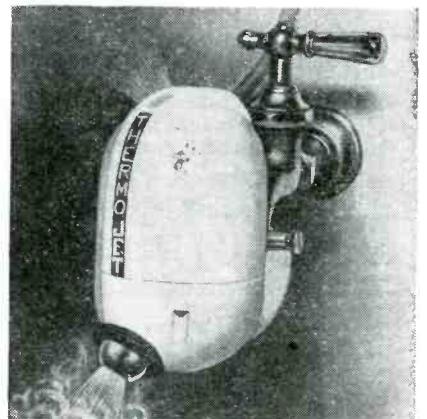

This new "Thermojet" is an automatic electric hot water heater for attachment to any size or shape faucet. It gives steady flow of water—lukewarm to boiling, has no moving parts and uses 110 or 220 volts—ac only. Thermo Electric Corp. of America, 55 W. 42nd St., New York 18, N. Y., fair trades the product at \$15.95.

FOR FM AND AM SERVICING



SIGNAL GENERATOR

SERVICE men, research technicians and design engineers find this new General Electric Signal Generator an extremely valuable aid in their work.

Four basic units have been combined to form one compact, labor-saving, portable equipment which is simple in construction and easy to operate.

The General Electric Signal Generator, Type YGS-3, con-

sists of an RF oscillator (fundamental frequency range 10 kc to 150 mc); an FM oscillator (center frequencies of 1, 20 and 50 mc and frequency deviations of ± 20 , ± 300 and ± 750 kc); a 1 mc crystal calibrator and a variable frequency audio oscillator. This combination of units enclosed in a single case will help to simplify and speed up FM and AM receiver analysis.

NOTE FOLLOWING DISTINCTIVE FEATURES:

- Economical and convenient to use.
- Constant output impedance attenuator. Wide Frequency range.
- Extremely wide sweep deviation.
- Lines up any FM or AM receiver, stage by stage by visual alignment methods.
- Reference level indicator for output.

New free booklet on FM servicing available.

Write: General Electric Company, Electronics Department, Syracuse 1, New York.

GENERAL ELECTRIC

Save SPACE, TIME and MONEY!

with the new **PYRAMID**
"TUBE-U-LAR"
 PAPER CAPACITOR

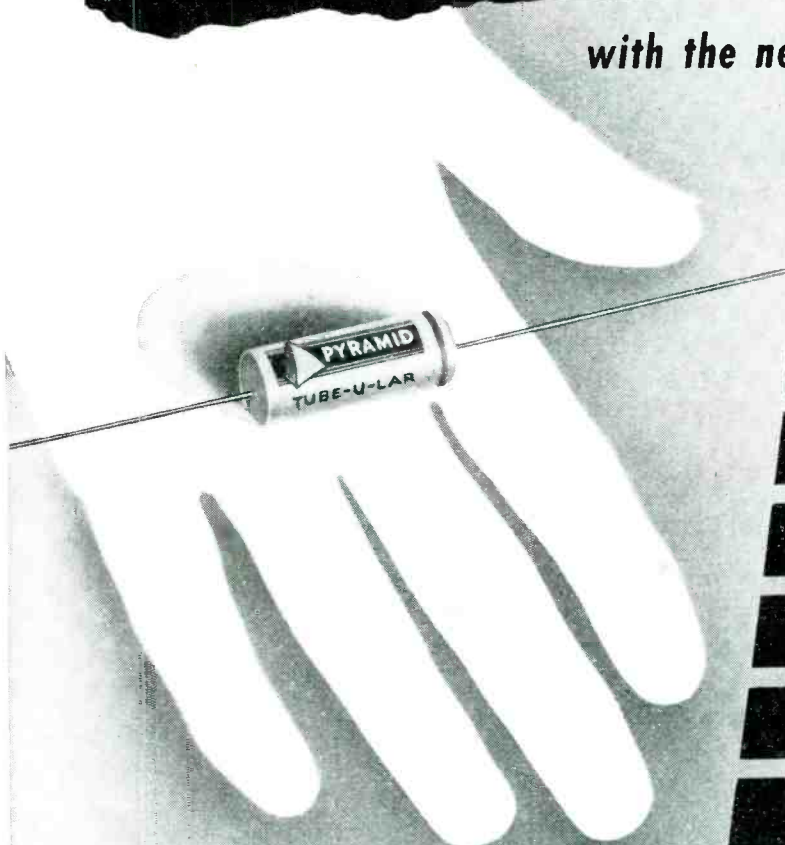

ULTRA-COMPACT

EXCELLENT QUALITY
at modest cost

HIGH INSULATION RESISTANCE
lengthens life

HIGH DIELECTRIC STRENGTH
assures against breakdowns

CLEAN CONSTRUCTION
and better appearance

LARGE, LEGIBLE MARKINGS
make identification easy

SUPERIOR SEAL
means dependability in all climates

PART NUMBER	CAPACITY MFD.	D.C. VOLTS WORKING	BODY SIZE, INCHES		LIST PRICE
			DIAMETER	LENGTH	
T6-D1	.001	600	3/8	1 1/8	\$.25
T6-D2	.002	600	3/8	1 1/8	.25
T6-D5	.005	600	3/8	1 1/8	.25
T6-D6	.006	600	3/8	1 1/8	.25
T6-S1	.01	600	3/8	1 1/8	.30
T6-S2	.02	600	3/8	1 1/8	.30
T6-S5	.05	600	3/8	1 1/8	.40
T6-P1	.1	600	5/8	1 3/4	.45
T6-P25	.25	600	3/4	2	.55
T6-P5	.5	600	1	2	.80

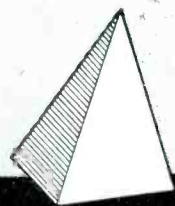

PYRAMID
 "LONG-LIFE"
 PAPER & ELECTROLYTIC
Capacitors

PYRAMID ELECTRIC COMPANY

155 OXFORD STREET, PATERSON, N.J.

YOU'RE ALWAYS RIGHT
WITH RAYTHEON



Tested in the Factory
Tested in the Warehouse
Tested in the Engineering Department
Tested in the Quality Control Department
**TESTED BY MILLIONS
OF SATISFIED USERS**
BUY RAYTHEON TUBES



Excellence in Electronics
RAYTHEON MANUFACTURING COMPANY
RADIO RECEIVING TUBE DIVISION
NEWTON, MASSACHUSETTS CHICAGO, ILLINOIS

Permoflux SPEAKERS

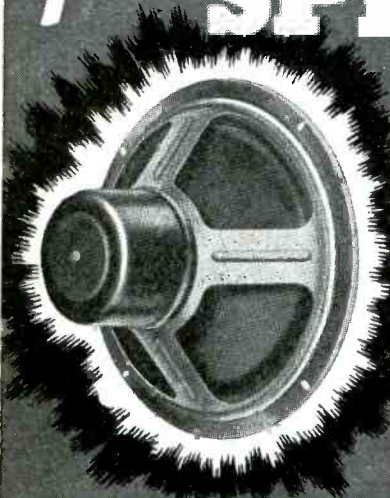

An OLD name in Speakers
*a NEW high in Performance**

ANNOUNCES... a COMPLETE JOBBER LINE of standard replacement and hi-fidelity deluxe loud speakers with both permanent and electro-magnet fields. These quality speakers embody the same skillfully engineered features used in the units that PERMOFLUX now supplies to major set manufacturers.

* Sound room laboratory tests prove greater uniformity in frequency response, than other comparable makes.

• WRITE FOR FREE BULLETIN •

PERMOFLUX

TWO COMPLETE FACTORIES TO SERVE YOU

PERMOFLUX CORPORATION

4900 WEST GRAND AVE., CHICAGO 39, ILLINOIS
236 SOUTH VERDUGO ROAD, GLENDALE 5, CALIFORNIA

PIONEER MANUFACTURERS OF PERMANENT MAGNET DYNAMIC TRANSDUCERS

Remler Sales Head



Jack Totten has been named Vice-president in charge of sales for Remler Co., 2101 Bryant St., San Francisco. He has had extensive experience in both radio and appliances. President R. C. Gray has announced that Remler's western distribution will be expanded—the firm will "go national" with complete new radio line priced from \$19.95 up. Jobbers are now being appointed.

Rider Reads New 99c Technical Books

The first six books of the Rider 99c bookshelf, scheduled for Fall and Winter publication, will cover some of the most important service subjects of the day announces John F. Rider, Publisher, Inc., 404 Fourth Ave., New York 16, N. Y.

To be released in pairs, the six 99c books will be entitled: "Understanding Vectors & Phase in Radio Work"; "Signal Generator at Work"; "RF/IF Selectivity"; "Adjusting Transmitters with the Scope"; "Understanding Transmitters", and "Installation & Servicing of Low Power PA Systems".

The books will be 5¼" x 7¼", on English finish paper with sturdy cover and sewed binding, having a minimum of 128 pages and a maximum of 160 pages. Hard covered books at a somewhat higher price will be available for libraries.

Other books scheduled for publication in the immediate future will include a Broadcast Operator's Handbook, and a text on FM transmission and reception.

More Reps for Merit

Continued expansion of its sales force has been announced by Merit Coil & Transformer Corp., Chicago, with the appointment of additional representatives.

Southern California and Arizona will be covered for Merit by Herb Becker, 1406 S. Grand Ave., Los Angeles 15, Calif. Indiana, Tennessee and Kentucky (except Covington and Newport) will be covered by Bullock-Cobb Co., 233 E. Market St., Louisville 2, Ky.

John I. Crockett is sales manager of the firm.

C-D Plant Expansion

Factory capacity of the power factor division of Cornell-Dubilier Electric Corp. has practically doubled with the completion of an additional plant of 41,000 square feet in area, according to Octave Blake, C-D president.

SPRAGUE TRADING POST

**SWAP • BUY •
• SELL •**

URGENTLY NEEDED—All tube testing information on Triplett #1501 tube and set analyzer. Will pay to borrow if necessary. J. B. Bunyon, 39 Bedford Rd., Summit, N. J.

SWAP OR SELL—Sprague Tel-Ohmike #18 in good condition, \$40 cash, or will swap for equivalent in Rider Manuals or ham gear. Send list. John F. Petit de Mange, 909 Macadam St., Chester, Pa.

WILL TRADE—Five 200 ohm ladder type attenuators (General Radio) for three 500 ohm ladder type attenuators of any make. Willard Barkdoll, 904 W. Fullerton St., Chicago 14, Ill.

WILL TRADE—Model airplane engines Class A Atom Glass B DeLong "30", Class C O. K. Super "60". Want communications receiver. E. Gosdin, 711 W. 180 St., New York 33, N. Y.

FOR SALE—Supreme V.O.M. #616. In fair condition, uses lack for settings. Good for beginners, \$15. Manford Trees, Armstrong, Iowa.

FOR SALE—Coilns ART-13 T/4A transmitter, complete as purchased, in good condition, \$125. Also pair of 814 tubes, new, not in cartons. Hugh Ware, WIPYD, 11 Hillside St., Milton, Mass.

WANTED—Radio set BC-610 complete for ham operator. Must be fully equipped. In good condition, and for use on 110V. Chas. E. Haley, 28 Church St., New Britain, Conn.

SWAP OR SELL—Halliater S-20 Receiver, 70w CW transmitter, less power supply, 24v D-C, 540r D.C. 450 ma. dynamotor; O-5 R-B Weston 2" round ammeter; 807 tubes; Millen 70-70 mmfd. 3000v. variable split stator. D. M. Frantz, 1400-B Washington St., Amarillo, Texas.

SWAP OR SELL—8mm. movie capt. 150-watt 'fone transmitter, complete, Abbott MRT-3. Evan Boden, Bucknell Village, Lewisburg, Pa.

WILL TRADE—Clough Brenzel Type OM FM and AM oscillator (range 100 kc-30 mc.). Want communication receiver. M. J. Nanken, W52HW, Rio Theater, Odessa, Texas.

WANTED—Any information concerning a naval receiver & xmitter unit used in Corsair airplane during early part of the war. Manufactured by Northern Electric in Canada. Is a 6-tube, 4-crystal channel receiver and 3-tube, 4-crystal channel xmitter. Technical no. is "Type 25 (Can) REF. No. 1107/763". For the receiver and "Type 22 (Can) REF. No. 1107/764" for the xmitter. Unit is operated by remote control. Court Balrd, 221 Wilson Ave., Wollaston, Mass.

WILL SWAP—Complete N. R. J. radio course with kits of parts. Want instruction-graph with tapes; good camera, or what have you? John Brotz, 6100 Buchanan Place, West New York, N. J.

WANTED—Field strength meter, 10 to 150 mc. approx.; television sweep generator RCA models 709B or 352A or Boonton 160A Q meter or General Radio 650A impedance bridge. Also want Rider Manuals. W. J. Luckas, 56 Spooner St., Floral Park, L. I., N. Y.

FOR SALE—Used Kyaltron WE417A, \$2; Magnetron with magnet, \$2; Jan 715B, \$1. D. Birnbaum, Box 1022, Kingsville, Texas.

WILL TRADE—Juke box amplifier using 2-30's; 3-45's and 523 complete with scratch filter and 12" dynamic speaker. Want sig. generator 550 kc. to 30 mc. or

DOUBLY SEALED AGAINST HEAT and MOISTURE

Sprague High-Voltage Paper Tubular Vibrator Condensers are especially designed in every respect to stand the severe conditions of auto radio operation. They're oil impregnated against intense heat. They're over-all wax dipped—and they've got special end seals for really top notch humidity protection. The working voltage rating of 1600V.



D.C. is honestly conservative. Capacity ratings mean exactly what they say.

Use 'em on all auto radio jobs—and other high-voltage applications as well. They'll stand the gaff! They will not let you down!

As always, we'll appreciate it if you order them by name—Sprague Type TR High-Voltage Paper Tubulars.

SPRAGUE VIBRATOR CONDENSERS

what have you? James E. Holt, 417 Niles St., Dayton 4, Ohio.

FOR SALE—Stancor 60-1" 60-watt 'phone-C. W. transmitter in de luxe cabinet with coils for 80 and 40 meters, \$90 f.o.b. Paul J. Zink, W208M, 1246 St. Lawrence Ave., New York 60, N. Y.

FOR SALE—McMurdo Silver Vomax, used 30 days, \$50 plus express charges. Ralph Beales, 341 S. Garfield St., Hynes, Calif.

SELL DR TRADE—Radio service business in North Hollywood, Calif. complete with best service eqpt. and stock. Rent 10% of net profits. 'Phone and lights free. Want new 1947 Chrysler or best offer. P. O. Box 1298, Hollywood 28, Calif.

FOR SALE—Ampro precision 16mm. sound projector model UA with case, less speaker. Will consider trade for AIR-7 type RCVR. F. L. Mickie, WFTN, Huntsville, Ala.

WANTED—Halliater SX-28 or SX-28A, used but in A-1 condition, complete for 110-120v. A. C. Gordon C. Johnson, 2908 E. 6th St., Superior, Wis.

FOR SALE—Signal tracer, new, 3-tube circuit, speaker output, complete with cabinet, batteries and tube, \$14.25 plus postage. J. T. Cataldo, 222 St. Marks Ave., Brooklyn 17, N. Y.

WANTED—Position in radio work. Have completed radio course in DeForest Radio School, Marion H. DeForest, Mahomet, Ill.

FOR SALE—Used Superior #450 tube tester in good condition. Also ATR #6. D. C. 110v. A. C. inverter 75-85 W.,

used only 4 times. Nels M. Berge, Dolliver, Iowa.

WANTED—Auto receiver, any condition, providing high voltage is working properly, and including vibrator and transformer. Describe fully. All inquiries answered. A. L. Oliveira, 94 Potomska St., New Bedford, Mass.

FOR SALE—Custom-built hi-fi amplifier. Tube complement: 4-6J7; 2-6L6; 1-5U4-G. Output 25 watts, gain 43 db. Frequency response within .5 db. from 20 to 15,000 cps. 250-ohm input, multiple line output. \$65. Max McKahan, 412 S. Hill St., Buchanan, Mich.

FOR SALE—Antique Grebe receiver, 1914 patent, model CR13, perfect condition. Suitable for museum, window display or laboratory. Will trade for xmitter such as Stancor 10, Harvey U.H.X. or Abbott transceiver. G. Sankofsky, 527 Bedford Ave., Brooklyn 11, N. Y.

WANTED—DB-20 preselector in good condition or any preselector tuning both BCH and SW. Give full details. Richard Daneker, 316 E. 2nd St., Lansdale, Pa.

FOR SALE—Have 80 new G. E. 5U4G tubes in sealed cartons. 35c ea. in lots of 10, or 25c ea. if you take the lot. I. Susman, 1052 Blake Ave., Brooklyn, 8, N. Y.

SWAP OR SELL—Rider Manual XI, fine condition, \$13. German Walther 9 mm. pistol, \$45. Will swap for Sonar XE-10 or EC-221, or for plate transformer delivering 2500v. at 450 ma. Desi Argentin, W3NJJN, 118 Lowell St., Vandergrift, Pa.

WANTED—750v. 250 mil. power supply. L. D. Shapiro, W2URX, 4 Elizabeth St., Glen Cove, N. Y.

FOR SALE—Triplett sig. generator #1632, new, \$60. Also several good used speakers, tubes, parts, etc. Write for list. M. O. Smith, Box 301, Enid, Okla.

WILL TRADE—General Industries home recording assemblies, both single and dual speed. Also one changer model. All new. What have you? Can use std. brand tubes in original cartons Arrow Radio, 125 E. 1st St., Duluth, Minn.

FOR SALE—Solid silver wire for uhf or jewelry, 18-gauge, guaranteed, \$1.25 per roll. Also, one RCP #448 multimeter, never used, \$20; Remington noiseless typewriter, almost new; LS-3 speaker and Jensen 8" speaker, both perfect. All inquiries answered. R. J. Cartwright, 69 Mountfort St., Boston, Mass.

FOR SALE—1 through 14 Rider Manuals, excellent condition, \$30. #330 Simpson tube tester, new Aug. 1946, \$100. Leland Jensen, Belmond, Iowa.

FOR SALE—Hande grinder, good condition, \$15; 450v. @ 25 ma. 8.3v. @ 1 amp. power supply, \$8; up-to-date RCA IIB-3 tube handbooks, \$5; new head-phones, \$5; two National ACN dials, \$2.50 ea.; 6" magnetic speaker, \$1. All postpaid. Harry C. Aichner, Jr., 1116 W. 25th St., Erie, Pa.

FOR SALE—Used Hammarlund HQ-129-X receiver with matching speaker, perfect, \$125. Used Jackson audio osc. #652, \$45. 1623 and 1625 tubes, odd parts and meters. Will take good comb. form model radio as part trade. Pat Brick, 111 E. Washington St., Charleston 1, W. Va.

WANTED—S-W receiver and any radio equipment. Will swap 2 Control Line model planes, never flown, with motors. Also have control handle wire wheels. Exacto knife set and one extra motor. Ernest A. Sawyer, P. O. Box 346, Marshall, N. C.

WILL SWAP—Portable voltmeter, ac & dc in 0-1000v in 4 steps (1,000 ohm D. x 1); ohms 1-100,000; contains 2 3" meters; 9" x 9" x 4". Good condition. Also one new Rider vol. #14. Want Arg. C3 camera, case and flashgun in good condition. Geo. Simmons, Route #5, Morrisstown, Tenn.

WANTED—Circuit diagram of old model #1200 Triplett test kit, giving construction details and values. B. McNamara, 4544 Ramona Blvd., Jacksonville 5, Fla.

FOR SALE—Used spring-wound Instructograph, Jr. code machine with ear phones, key, oscillator and 4 rolls tape (Rolls 2, 3, 4, 5). Ideal for learning code. \$15. Melvin Jordan, Rt. #1, Oblong, Ill.

FOR SALE—Complete DeForest television course, \$20. Gerald Spector, 158 Chestnut St., Lakewood, N. J.

FOR SALE—R. C. P. sig. generator #705, perfect working condition, practically new. Complete with instructions. L. Marek, 32 Chestnut St., Holyoke, Mass.

WANTED—Rider manuals 2, 3, 4 and 5; 2-meter rig complete; 3" scope (must be reasonable); 3000-3000 volts 350 mil. pwr. xformer; pair of sockets for VT 327A tubes; condenser tester. Boney Radio Service, 115 Cleveland St., Butler, Pa.

SWAP OR SELL—B-45 sig. generator good as new. Want Rider manual XII or set of Coyne Applied Practical Radio books. Obern Vanover, Wise, Va.

WANTED—Altec Duplex with dividing network or test eqpt. such as tube tester, sig. generator and meter, also hi-quality Halliater receiver. Have for trade Zeiss Dekarem binoculars, 10x50 case and straps, perfect, original carton. O. L. Vosburgh, c/o S. P. & S. Telegraph Office, Vancouver, Wash.

YOUR OWN AD RUN HERE FREE

The Sprague Trading Post is a free advertising service for the benefit of our radio friends. Providing only that it fits in with the spirit of this service, we'll gladly run your own ad in the first available issue of one of the six radio magazines in which this feature appears. Due to the large number of ads received, it is not always possible to have them appear as fast as

we would like to. Write CAREFULLY or print. Hold it to 40 words or less. Confine it to radio subjects. Make sure your meaning is clear. No commercial advertising or the offering of merchandise to the highest bidder is acceptable. Sprague, of course, assumes no responsibility in connection with merchandise bought or sold through these columns or for the resulting transactions.

Send your ad to Dept. RRT-97

SPRAGUE PRODUCTS COMPANY, North Adams, Mass.
(Jobbing distributing organization for products of the SPRAGUE ELECTRIC COMPANY)

ASK FOR SPRAGUE CAPACITORS and *KOOLOHM RESISTORS by name!

*Trademark Reg. U. S. Pat. Off.

Prices in England 250% Higher Than Those in U. S.

Recently returned from a trip to England, Leonard Carduner, sales promotion manager of Garrard Sales Corp., 315 Broadway, New York, has written this interesting article exclusively for *RADIO & Television RETAILING*:

Some months after 1947 was ushered in, the radios shown in the shop windows of England were for display only. Today you'll see signs beside most displays announcing that they are available for delivery—soon, if not immediately.

Indeed, in the industry abroad, it is generally agreed that the shortage will be ended early in 1948, possibly before, and that within a year the production will exceed the potential sales.

This forecast is being made despite the

fact that some 50 per cent of each manufacturer's output is required by the British Board of Trade to be exported now, and that this percentage will continue to be substantial. Also it's made in the face of a purchase tax of 33 1/3 per cent on all radio and television receivers, and consumer prices that are about 250 per cent higher than those prevailing on standard merchandise in the United States.

If you were selling radios in England today, you'd be handling mostly 4- and 5-tube superheterodyne sets in plastic cabinets, retailing around \$65. This price includes the 33 1/3 per cent purchase tax, which is calculated on the price at which wholesaler invoices the dealer on each radio and television set.

You would be selling quite simple sets, too, with two and occasionally three

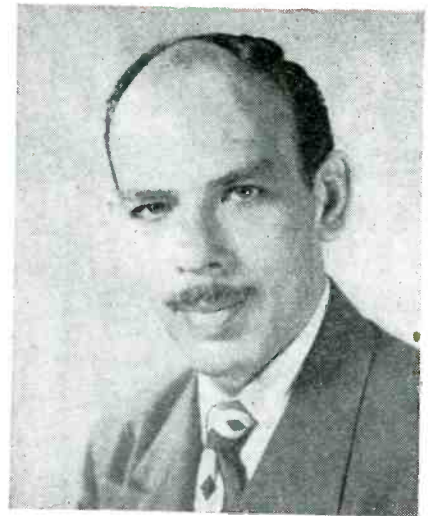

Leonard Carduner, Garrard sales promotion mgr.

wavebands with manual tuning. Slightly more elaborate sets in wood cabinets would retail at \$100, including tax.

It would be about impossible for you to get hold of consoles and radio-phonograph combinations, for they just haven't been made. Those that are being turned out range around \$800, and are generally comparable to those that retail for about \$300 in the States. Many manufacturers are planning to launch small combinations at about \$200, including tax, in the big Radio Show that is to be held in England in October of this year. Many of the manufacturers of combinations will be using Garrard phonograph equipment and dual-speaker systems.

Only one personal radio comparable to those sold in America has been announced in England. This set—with two wavebands and somewhat resembles the Emerson Personal—retails at \$80.

Auto Sets Up

Today there's much more interest in radios for automobiles than there was before the war. In fact, some of the leading manufacturers, including E. M. I. and E. K. Cole, have set up separate factories for the manufacture of these sets. Some of the automobile manufacturers are now fitting radios as standard equipment in the higher price model cars. All these car radios have two wavebands. Alternative models are available for either 6 or 12 volts, and run around \$60 and \$120, including tax. Most of them incorporate some form of push button or pre-set tuning.

The BBC television service was started again in June, 1946. The general opinion of most visitors to England—including my own—is that this BBC service is superior to that in any other part of the world. Three programs are sent out daily, seven days a week. At present there is only one transmitter in London, which has a service area of about thirty-five miles. However, in extremely favorable locations, reception can be obtained up to 90 miles. British television today serves a potential public of about nine million people.

The production of television receivers

Masco News

NEW BIG VALUE INTERCOM. MODEL JMR MASTER AND REMOTE U. L. APPROVED!



Opens Up New Markets



OFFICES



HOMES



DOCTORS
Stores, dentists, lawyers, merchants, farms all potential sales.

Complete, Ready-to-Use

Model JMR consists of a packaged Master and Remote, including tubes and 50 feet of cable. Latest design! Top quality! Low priced! Simple to install. Easy to operate.

List Price **\$39.95**
Add 5% West of Rockies

Contact your local Masco distributor for immediate delivery.

Features of Model JMR

- 117 Volt AC or DC operation.
- 2.5 watts of power.
- 4 in. PM Alnico V Speaker.
- Volume control with on-off switch.
- Separate press-to-talk switch.
- Remote station has press-to-talk switch.
- Attractive cast aluminum housing. Hammertone finish.

ALSO AVAILABLE... A complete line of U.L. Approved Intercommunication Equipment.
For descriptive literature or other information write directly to factory. Dept. D.



MARK SIMPSON MANUFACTURING CO., Inc.
32-28 49th Street, Long Island City 3, N.Y.

SOUND SYSTEMS and Accessories

RAVENSWOOD 8-5810-1-2-3-4

has been considerably lower than was expected, due entirely to the extreme shortage of cathode ray tubes. In a recent issue of "Wireless Trader," prices listed on about a dozen table and console models ranged from about \$300 (including purchase tax) to \$480, tax also included. These prices are about three times what they were before the war, although it must be remembered that they include the purchase tax in each case. You will notice that, in comparison with prices for table model and "personal" radios, television set prices are quite low.

It is estimated that the E. M. I., whose transmission system is used by the BBC and who manufacture the H. M. V. and Marconiphone receivers, is responsible for about 50 per cent of all the sets which have been made since the war. The H. M. V. Model 1803 television set incorporates a 15-inch tube, which gives a particularly good picture.

Jobbers Come Back

Just before the war, many set manufacturers tried to cut distribution costs by eliminating the jobbers and wholesalers to deal directly with the retailers. It is significant that they have reversed this trend somewhat since the end of the war. Now the move is back to distribution of radio sets through wholesalers or jobbers. At the moment the market appears to be split about half and half between manufacturers who have gone back to wholesalers and jobbers and those who are still selling directly to dealers.

Another interesting development in England is the fact that manufacturers who make both home sets and automobile radios almost invariably distribute these through separate channels. The home sets are sold through the ordinary radio dealers, whereas the automobile sets are sold through motor car distributors.

Manufacturer Services

Probably the only unusual distribution method introduced since the war is that of Sobell Industries, Ltd. This company sells its sets at prices that include two years of free service. If trouble develops in a set made by this company, the consumer sends a telegram to the Sobell head office, after which one of the company's engineers calls and services the set in the home.

The net result of this merchandising is that this company has been able to distribute its sets through many retailer, such as furniture dealers and the like, who never stocked radios before, because the problem of servicing is eliminated. This company's sets cost about \$10 more than similar models that do not include servicing.

Of course, everybody in the radio and television industry is looking forward to what will be revealed when the National Radio Exhibition is held in London in October. It is expected that at this show the real postwar receivers will be seen for the first time.



JFD
PRECISION
MADE

Fills a Long-Felt Need

New Improved JFD REMOTE-O-CABLE REPLACER



Control Shafting & Casing

- Available in coils, or cut to length. Exact duplicate cables for Philco, Arvin, Delco, Motorola. Also, standard shaft and casing assemblies.



Most Efficient Auto Radio Tuning Cable-Servicing Machine in Use Today!

1. SWEDGES SHAFTING TO PREVENT UNRAVELLING.
2. CUTS SHAFTING TO EXACT LENGTH.
3. REPLACES OLD FITTINGS ON SHAFTING.
4. CASING GROOVE MAKES CUTTING EASY.



SERVICEMEN'S COMPLETE COMBINATION KIT OF CABLE, HOUSING and FITTINGS

30 different types of fittings — 120 assorted pieces. 50 ft. of cable, 50 ft. of housing. A single compact kit that fills all servicemen's needs for cable, housing, and fittings. Used in Philco, Motorola, RCA, United Motors, Bosch, Crosley, Sparton, Atwater-Kent, Stewart-Warner, Arvin, Zenith, Emerson, and other auto radio sets. All compactly packed in a FREE durable steel box. Model CK200.

EVERY SERVICEMAN MUST OWN ONE!

WRITE FOR LITERATURE

J.F.D. MANUFACTURING CO.
4109-4123 FORT HAMILTON PARKWAY, BROOKLYN 19, N. Y.



A STAR IS BORN . . .

THE *Lenk* "GUN-GRIP"
ELECTRIC SOLDERING IRON

A tough, compact, versatile soldering iron that does the work of four for the price of one! Equipped with four detachable tips, the "Gun-Grip" simplifies soldering in hard-to-reach places. It's accurate . . . fast . . . dependable!

A perfectly balanced tool, the "Gun-Grip" appeals to the skilled mechanic . . . the novice . . . the hobbyist. Built-in stand prevents scorching table-top or workbench. The Lenk "Gun-Grip" Electric Soldering Iron can be used all day on only a few cents' worth of current.



THE Lenk MFG. COMPANY
30-38 CUMMINGTON STREET
BOSTON 15, MASS.

Manufacturers of Soldering Equipment Since 1919

Dept. S

★ ★ ★

WRITE FOR COMPLETE INFORMATION AND PRICES TODAY



"Every Season"

BURGESS IS THE LINE THAT SELLS"

This Fall and every season means battery business for Burgess dealers. And Fall means these two big battery markets:

1. Farm Battery 2. Portable Radio Battery

The Farm Market:

Recognized quality makes Burgess a favorite on farms—for radios, flashlights, lanterns. Get stock in now on all these popular items.



Burgess Standard Flashlight Battery



Ignition Battery for General Farm Use



Portable Radio "A"



Popular Portable "B"

The Portable Radio Market:

Back to school means more portable radio battery sales. Outdoors—at the game, on the picnic—the portable radio goes along in the Fall. Be sure your stock of portable batteries is complete for this Fall trade.

National Advertising to over 40 million battery buyers in national and farm magazines prompts YOUR CUSTOMERS to buy Burgess.

Promotional Helps . . . window and counter display material, enclosures, newspaper mats are available.

Ask Your Burgess Distributor



BURGESS

IS THE COMPLETE QUALITY LINE

BURGESS BATTERY COMPANY

FREEPORT,

ILLINOIS

Sales Helps

Packaged Window Displays by Norge

A set of five window display "packages" for use during the last half of the year has been prepared by Norge.

Designed according to season, or most prominent activity of the month, and to tie in with current national advertisements, each window display is a complete unit. As many as six or seven colors are used.

A descriptive portfolio, pointing up the benefits of such application of showmanship principles, is being provided as an aid in this endeavor. Monthly prizes for best windows are being offered the retailers as an incentive to dramatic employment of the material.

Beach Beauties



Now being shipped to dealers by RCA Victor is this full-color, 3-dimensional display for portables. Jeanne Moore is shown at left.

Eye-Catcher

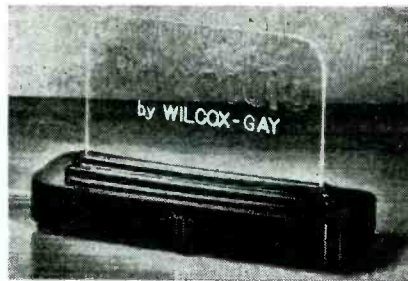

Edge-lighted identification sign—a lucite panel in a bakelite case, is offered by Wilcox-Gay Corp. Lettering has brilliant glow and there's no static interference.

electronic hardware and radio products and can display four times the amount of merchandise.

Neon for Motorola Dealers

Motorola, Inc., has contracted with Neon Products, Inc., Lima, Ohio, to furnish Motorola dealers with neon illuminated displays for their store fronts. The signs tie in with Motorola's national advertising and become a where-to-buy identification.

New Display Light for Counters and Windows

"Lite-Master"—a new display device for dealers to use—is now being offered by Photo-Vision, Inc., 35 W. 43rd St., New York 18, N. Y. It consists of a fluorescent reflector supported by an adjustable easel, designed to convert a show card or photo into an electric sign. Smaller items of merchandise may also be placed under the light to attract buyers' attention. Lite-Master is also recommended as an ideal night light for dealers.

There are two models—No. 500 is adjustable up to 12" and is \$9.75. Model 501 goes up to 18" and is \$11.75. Both 6 and 8 watt fluorescent tubes are used.

"Black and Gold" Promotion

Emerson Radio and Phonograph Corp. has announced a national advertising tie-up with Allied Artists for the use of newspaper ads to exploit Emerson's "Black Gold" radio Model 543 and the cinecolor moving picture, "Black Gold."

Versatile Display for Hardware and Parts

General Cement Mfg. Co., Rockford, Illinois, is ready with a new display idea, the "Wall View Display," which can be used in four different ways.

In addition to the semi-circle, square and triangle, the new "Wall View Display" can be hung on walls flat to show all four lines of merchandise easily. The device is thus a wall display, counter display and excellent device for creating interest at point of sales.

The patented display holds bags of

Convenient Cabinet

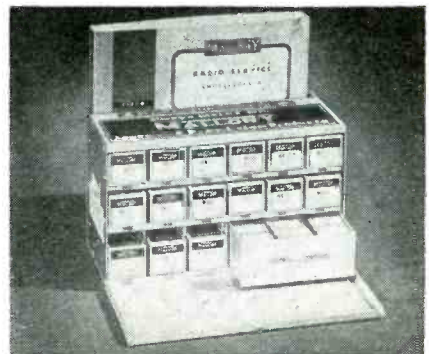

In a new volume control deal for servicers, P. R. Mallory & Co., Inc., Indianapolis, Ind., offers a sturdy steel cabinet with an inventory and recorder guide and a rack for their copy of the Mallory Radio Service Encyclopedia at no extra cost with their purchase of an assortment of 15 Mallory controls and 9 a-c switches. The assortment, which will cover about 90% of ordinary service requirements, sells to the trade for \$14.85, including cabinet.

Self-Selling Display



New package released by Bright Star Battery Co., Clifton, N. J., is a colorful display which holds 24 of the 10M cells, retailing at 10c each. The lid of the carton folds back for display piece.

Big Sales Kit on Electric Heaters

Electromode Corp., Rochester, N. Y., is supplying its electric heater retailers with a complete complimentary promotion kit.

Included are two display pieces for the dealer's store; a window streamer; samples of the company's complete selection of consumer literature; an instruction booklet for retail clerks; newspaper ads; spot radio announcements; publicity stories for local release; price sheets; and folder showing these and other selling aids available.

Coffee Making Demonstration Kit

Cory Corp., manufacturers of Cory glass coffee brewers and Fresh'nd-Aire circulators, is ready with a new demonstration kit for territory managers.

The kit consists of the new Model DEA, domestic automatic coffee brewer and the new Model DEG electric coffee grinder. The two units, with a supply of whole bean coffee, a Cory measuring cup and safety stand for glass upper bowl are packaged in a plush lined, fitted, leather traveling case.

Doll Up Your Store

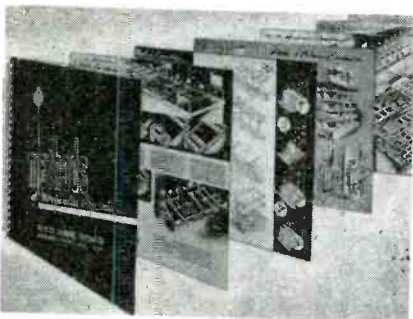

This elaborate 45-page presentation on "Methods of Merchandise Presentation" has been issued by Reflector-Hardware Corp., Western Ave. at 22nd Place, Chicago, Ill. It deals with store fixtures and displays for all types of products.

EASILY ADJUSTABLE FOR THE JOB

ADJUSTOHM RESISTORS

Seven Stock Sizes from 10 watts to 200 watts

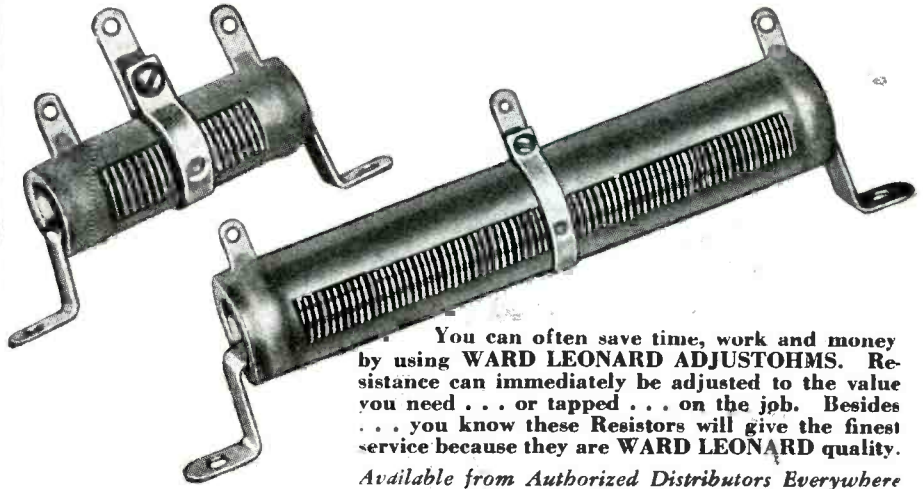

You can often save time, work and money by using WARD LEONARD ADJUSTOHS. Resistance can immediately be adjusted to the value you need . . . or tapped . . . on the job. Besides . . . you know these Resistors will give the finest service because they are WARD LEONARD quality.

Available from Authorized Distributors Everywhere

WARD LEONARD ELECTRIC CO.

Radio and Electronic Distributor Division

53H W. Jackson Blvd., Chicago 4, Illinois

Send for Catalog D-2 Gives handy data and information on various types of Resistors and Rheostats available from stock.



WARD LEONARD RELAYS • RESISTORS • RHEOSTATS

Electric control devices since 1892



TELEVISION and F. M. ANTENNAS

The requirements of superior Television and Frequency Modulation reception dictate a precisely designed and engineered antenna. Your receiver is no better than your antenna. The Camco "Featherlite" Antenna gives you all the latest design features at low cost.

It is extremely simple to install, since it is pretuned at the factory. No length adjustment is required. It is cut to deliver optimum signal over the entire Frequency Range.

WRITE FOR DESCRIPTIVE LITERATURE

CAMBURN, INC.

32-40 57th ST., WOODSIDE, N. Y.

In CANADA—the ASTRAL ELECTRIC COMPANY, Scarborough Bluffs, Ontario

A MESSAGE TO DEALERS

GRAMAVOX HI-POWER PHONOGRAPHS MEAN LARGER PROFITS FOR YOU

Gramavox dealers EARN EXTRA PROFITS by receiving the beautiful color display of Gramavox Super Range Permanent Needles, retail value \$37.50, FREE WITH THEIR FIRST ORDER OF GRAMAVOX PHONOGRAPHS.

Gramavox dealers MAKE MORE MONEY selling Gramavox Super Power Phonographs, with many custom features—at Competitive Prices; enjoy Franchised Territories, receive Beautiful Selling Catalogues and other Sales Helps. Gramavox cooperates all the way.

Gramavox 5 tube phonographs sell easily, keep customers satisfied and build repeat business for you—because they have so many Outstanding Features, the Greatest being the 5 tube High-Fidelity Push-Pull Amplifier with Heavy Duty 6½ Inch Speaker.

Gramavox means Larger Profits for you because YOU BUY DIRECT AT THE LOWEST PRICE.

Sell Gramavox Phonographs—the line that means MORE MONEY IN YOUR POCKET.

Write immediately for all details on this great new Sales Plan—the Plan that means Prosperity for you—new markets—MORE MONEY.

Attach coupon to your letterhead or business card. JOIN UP TODAY WITH GRAMAVOX.

Very truly yours,
GRAMAVOX RADIO & PHONOGRAPH CO.

Nate Colbert

Gramavox Radio & Phonograph Co.
799 Broadway
New York 3, N. Y., MI

Dear Mr. Colbert:

Of course, I want full details on the Gramavox Sales Plan and Free Gift Offer. Please rush details to me at once.

Name

Address

No obligation, of course.

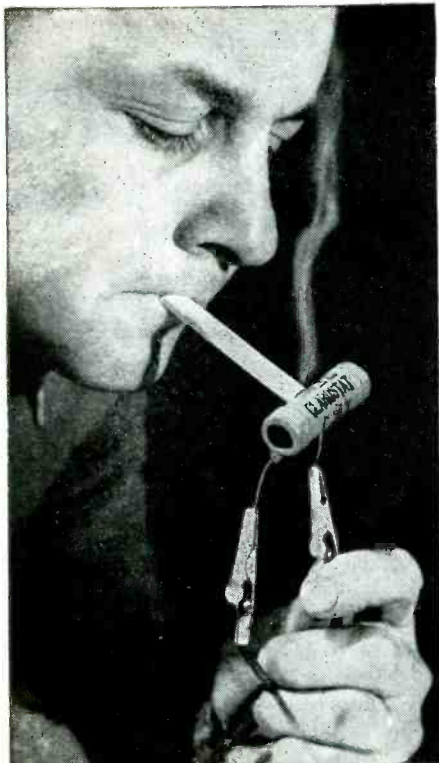

*It's a
GREENOHM!*

★ Try this overload test on your favorite power resistor. Here's a GREENOHM on 500% overload. It's hot enough to light a cigarette. Yet its special cold-setting inorganic cement coating doesn't soften, bubble or change. When cooled, it doesn't crack, peel, flake. Yes, GREENOHMS can take it. They're tough.

Other GREENOHM advantages are: Excellent heat-shock qualities. Minimum through-coating leakage. Wire winding unimpaired in manufacture. No wire corrosion because cement does not contain usual water glass. In fixed and adjustable types; 5 to 200 ohms; standard resistance values.

★ Ask Our Jobber ...

Order Greenohms. Try them in your work. Give them any comparative tests you wish. You be the judge. Ask for bulletin "Why Cement-Coated Power Resistors?" Or write us.



CLAROSTAT MFG. CO., Inc. • 285-7 N. 6th St., Brooklyn, N. Y.

Dealers Are Key Men in "More Radio" Drive

Strong emphasis is being placed on the radio retailer as the "Number One Man" in the success of the big "Radio in Every Room" campaign of the Radio Manufacturers Association. The drive, in which RMA has been joined by the National Association of Broadcasters, is a year-round program. The observance of National Radio Week, Oct. 26 to Nov. 1 this year is a separate event although the RMA-NAB promotion experts are also behind it.

A new sound slide film showing radio retailers how to cash in on the "every room" campaign is now available for local showing, RMA has announced. The 35 m.m. Kodachrome strip entitled "Let's Get Personal" runs 12 minutes.

The film explains that 93% of American homes now have at least one radio set and that increased future sales depend on selling radios of their own to individual family members. It points out that retailers and manufacturers can tap an unlimited market by playing up the advantages of personal ownership of sets by Mother, Father, Sis and Johnny. The convenience of having "a radio at your elbow wherever you are, whatever you're doing" also should be stressed, according to the film.

Plans of manufacturers for advancing the campaign in national advertising and sales promotion are shown and suggestions made for dealers to follow. Ideas are given for window and interior displays and for special promotions throughout the year.

Print and record combinations of "Let's Get Personal" cost \$15. and stores are urged to purchase them for periodic showings to sales forces. They can be obtained through the Fred Eldean Organization, 670 Fifth Ave., New York 19, N. Y. Film and pressing may be borrowed for a limited time from Eldean.

Eureka Executives

Frank W. Noble has been appointed as-

25 Years as President



Celebrating 25 years service as president of Emerson Radio & Phonograph Corp., Benjamin Abrams, left, receives an engrossed testimonial from Charles O'N. Weisser, sales manager. A quarter of a century ago, Emerson was a small firm; it is now said to be "the world's largest manufacturer of small radios."

assistant to George T. Stevens, executive vice-president and manager of the Eureka division, Eureka Williams Corp. He will supervise the division's advertising, merchandising and sales promotion activities. Mr. Noble, who has previously sales promotion manager, has been associated with the company since 1943.

Richard S. Holtzman will replace Mr. Noble as sales promotion manager. He joined Eureka in 1941. During the war he served as a Lieutenant (S. G.) in the Navy and in 1945 rejoined the company.

Kessler Joins UST

A. E. Kessler is the new public relations director of United States Television Mfg. Corp., according to Hamilton Hoge, president of the firm. Mr. Kessler has had 19 years in the newspaper and public relations fields. He was formerly with Viewtone and during the war was public relations officer of the anti-aircraft artillery school and served in the China-Burma-India Theatre as information officer.

Radio Star Takes Recorder on Tour



Illustrating another use for wire recorders, this unit by Webster-Chicago will be used by Herb Shriner, Indiana humorist and radio star, to gather material for his radio show. He'll take the unit on tour to make on-the-spot records of conversations. He's shown here with Shirley Jewell, dancing starlet.

Celebration by Specialists in Quick Service



Staff members of the New York Service Station of Proctor Electric Co. now celebrate their 5th anniversary and "54,000 satisfied customers." Members of the war-born maintenance organization, front row, left to right, Florence Van der Drift, Laura Fleming (first employe), James Francese, Mory Furey, John Romano. Back row: Larry Di Dio, James Murphy, Thomas Fazio, Arthur Hart (manager), and Milton Scharn.

Westinghouse Brings Out New Fluorescent

A new semi-circular fluorescent lamp that provides more light than a 50-watt incandescent bulb, but consumes only about one-third the power, has been introduced by the Westinghouse lamp division.

Designated "Circlarc," the new lamp is ideal for table and floor lamps, for wall and ceiling fixtures, for merchandising displays and for interiors where the lamp itself will add a decorative dash.

The Circlarc plus its ballast, required to operate all fluorescent lamps off regular lighting circuits, will sell for about one-third the price of the circular fluorescent lamp and its ballast. The ballast for the Circlarc is one-third as large and only one-fifth the cost of the circular lamp ballast.

The Circlarc is an 18-watt tube curved to form a half circle 12-inches in diameter. It has a useful life expectancy of 2,500 hours at three hours average burning for each start. This is the same burning life as for the circular lamp and



The new Circlarc is shown on easel at right, and in foreground is illustrated one of its uses as light source under circular display shelves.

two and one-half times longer-lived than the 50-watt incandescent bulb. A two-pin plastic base at each end of the semi-circular lamp connects it to the electric current. The base pins are located 45 degrees to the plane of the lamp, which arrangement allows the pins of the two opposing lamps to overlap and reduces the thickness of the two-lamp holder to a minimum.

JFD Offers New Auto Radio Accessory Line

A complete auto radio accessory line for the radio industry has been announced by Julius Finkel, president of the JFD Mfg. Co., Inc.

The new line consists of, (1) The Remote-O-Cable Replacer—the JFD auto radio tuning cable-servicing machine, (2) A line of recently re-designed auto antennas, (3) Exact duplicate replacement cables for all popular types of radios, (4) A wide assortment of auto radio fittings and connectors, and (5) A varied assortment of all popular types of suppressors and condensers, antenna mounting hardware, antenna lead cables, static eliminators, plugs and jacks, extension leads, shielded loom, auto body plugs, adaptors, servicemen's handy cable replacement kits, etc.

An 8-page folder describing this auto radio accessory line is available from the company at 4117 Ft. Hamilton Parkway, Brooklyn 19, N. Y.

McLoud for Quam

Appointment of the W. Cliff McLoud Co., 711 Colorado Bldg., Denver, as sales representatives for the state of Colorado, Wyoming, Utah, New Mexico and eastern Montana is announced by the Quam-Nichols Co., Chicago, manufacturers of Quam Adjust-a-Cone speakers.



Andrea LARGE-SCREEN "Sharp-Focus" TELEVISION is here!

Andrea has done it *again*. The 1947-48 television line, living up to the tradition of Andrea pioneering and precision, introduces big-picture receivers with unusual brilliance and sharp focus—three magnificent receivers—2 deluxe consoles and a table model.

ALL using identical chassis with the same 12-inch picture tube, giving intensely brilliant and sharp pictures with an area of 7½ x 10 inches—41% larger than any 10-inch tube.

ALL combining superior television plus static-free, high fidelity FM and standard AM broadcast—one model, Co-VJ12, illustrated above, with automatic phonograph.

ALL with superb cabinetry, designed for the average home yet worthy of a mansion.

Plus

many other outstanding features such as:

Andrea Super-sensitive Channel Selector Turret covering all 13 television bands, the heart and nerve-center of Andrea sharp-focus, big-picture receivers.

Automatic electronic picture-locking system to minimize auto and electrical interference on picture and preserve brightness and clarity.

Receivers have 27 tubes plus 3 rectifiers and a 12 inch picture tube.

Write for full information on prices, delivery and the Andrea plan of television merchandising with its attractive dealer profits.

ANDREA RADIO CORP.

27-01 Bridge Plaza North
Long Island City 1, N. Y.

RADIO Since 1920
TELEVISION Since 1938

NOW! in 1,000 pages

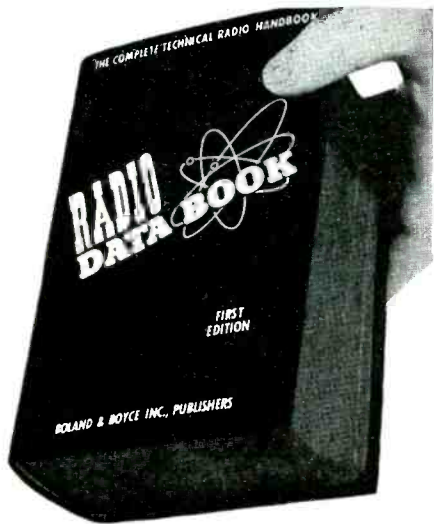

Handsomely bound in RED and GOLD

All data and basic knowledge in radio and electronics digested into 12 sections... in a complete, quick to find, easy to read, handbook form.

Plan every operation in radio and electronics with the *Radio Data Book*. This new radio bible will be your lifelong tool... you will use it every day, on the board, at the bench, in the field! Use it for construction, troubleshooting and testing. The *RADIO DATA BOOK* will be your invaluable aid in design, experiment and in layout. It will help make your production better, faster and easier. In any and every operation in radio and electronics, you will use the *RADIO DATA BOOK*!

The *RADIO DATA BOOK* is a work of complete authority, prepared by engineers with many years of practical experience. They have been assisted by the Boland & Boyce staff of editors skilled in preparing electronics manuals for the U. S. Signal Corps for many years. These men have worked for several years gathering material for this book... all the knowledge of radio principles and operation... all the statistics... all the newest developments in electronics... every possible angle and detail. Eighteen months were spent digesting this material into the most concise, the clearest, and the most readable form. The result is this invaluable manual... The *RADIO DATA BOOK*. Whether you use this book for general reference, for scientific instruction, or for education, one thing is certain—the practical help, the daily usefulness you will derive from it will prove to be worth many, many times its astonishingly low price!

Advanced Sale... first printing, only 10,000 available... To make sure to get your *RADIO DATA BOOK*, mail your order **NOW!**

- 12 sections... 1000 pages... Completely Illustrated
- Section 1. THE 150 BASIC CIRCUITS IN RADIO.
 - Section 2. COMPLETE TEST EQUIPMENT DATA.
 - Section 3. TESTING, MEASURING AND ALIGNMENT.
 - Section 4. ALL ABOUT ANTENNAS.
 - Section 5. SOUND SYSTEMS.
 - Section 6. ELECTRICAL AND PHYSICAL CHARACTERISTICS OF RADIO COMPONENTS.
 - Section 7. COMPLETE TUBE MANUAL.
 - Section 8. CHARTS, GRAPHS AND CURVES.
 - Section 9. CODES, SYMBOLS AND STANDARDS.
 - Section 10. 50 TESTED CIRCUITS DESIGNED FOR OPTIMUM PERFORMANCE.
 - Section 11. DICTIONARY OF RADIO AND ELECTRONIC TERMS.
 - Section 12. RADIO BOOK BIBLIOGRAPHY.

12 complete books in one only **\$5.00!**
Less than 42c per book!

MAIL THIS COUPON TODAY!

BOLAND & BOYCE INC., PUBLISHERS
460 BLOOMFIELD AVE. MONTCLAIR 4, N. J.

Please send me a copy of THE RADIO DATA BOOK Enclosed is \$5.00

NAME
ADDRESS
CITY ZONE
STATE

BOLAND & BOYCE INC., PUBLISHERS

Furniture Styling in Motorola Promotion

"The biggest advertising campaign in company history" is starting for this fall on the new 1948 Motorola home radios, it was announced by Victor A. Irvine, advertising manager of Motorola, Inc.

The new campaign will feature the "Furniture Styling" theme, showing the various models of the line in harmonious room settings. The company found this trend to be a leader in consumer buying in recent survey.

Mr. Irvine said that dealers agree with the findings of the survey, "and agree almost universally that the most important single radio selling point today is cabinet design."

Center of the new campaign will be full-color, full-page advertisements and columns in *Saturday Evening Post*, *Colliers* and *Better Homes and Gardens*. Also there will be full-color, full-page ads in *The American Weekly* and *This Week*, plus a large-scale cooperative advertising program. Advertising will be backed up by a full-scale point-of-sale promotion program.

New Lines

Motorola has a complete new line of 27 home radios (FM and AM Golden-Voice consoles, radio-phonographs, portables, FM and AM table models and TV receivers) and has held distributor pre-showings in Chicago, New York, New Orleans and San Francisco. These were staged under the direction of general sales manager W. H. Kelley, assisted by W. H. Stellner, vice-president in charge of the home radio division, and Victor A. Irvine, advertising and sales promotion manager.

In television, the firm has introduced two of the "Golden Voice" sets. The screen for both the console and the

Meck Model



Wide publicity for the "Plymouth" model radio made by John Meck Industries, Plymouth, Ind., results from its use as a prize award in the "Lead the Band" contest at Martinique Supper Club, Chicago. Winner Lila Lennon is shown here with band leader Gay Claridge.

table model have 10" picture tubes, with picture area of about 55 sq. in. The units are pre-aligned to cover all 13 TV channels.

Other featured sets are the Golden-Voice FM-AM console lowboy, the Motorola spinet, and the new portable Play-boy, Jr.

Gerber for Lyman Intercoms

The appointment of Gerber Sales Co., 739 Boylston St., Boston, Mass., as exclusive sales representative for "Callmaster" inter-communicators, has been announced by the manufacturer, Lyman Electronic Corp. Gerber will cover the states of Maine, Vermont, New Hampshire, Massachusetts, Connecticut and Rhode Island. John R. Lyman, general manager of the Lyman firm says that one of the factors behind recent sales peaks in Callmaster products is "the fact that its price has made possible many applications of the intercom." The Lyman company is located at 12 Cass St., Springfield, Mass.

Exhibit of Tele Kits Draws Thousands



Part of the crowd at the jobber meeting held by Transvision, Inc., 385 North Ave., New Rochelle, N. Y., at the Waldorf Astoria in New York. Meeting preceded 3-day public showing which, according to the firm's ad agency man, H. J. Gold, attracted over 30,000 people. Behind this counter, left to right, are Herb Suesholtz, Transvision general manager; Dave Kubrick, eastern sales rep; and Irving Brown, Mr. Kubrick's associate. They're showing features of new 12" tele kit, which has FM sound and built-in FM radio.

Gibson Hikes Range Production Pace

New machinery at the Belding, Mich., factories of the Gibson Refrigerator Co. will more than double present electric range production. According to officials construction of one new building has started and extensive remodeling is under way in buildings housing the present range facilities.

The Gibson management says that the new facilities will include the latest production methods available to the industry, plus various efficiency features devised by Gibson plant engineers.

All range operations at Gibson were moved from the Greenville, Mich., plant to one of the plants in Belding, Mich., at the end of the war, to release more Greenville factory space for refrigerators and home freezers.

"There Came a Day When the Item Did Not Sell"

The merchandising department of Graybar Electric Co., has recently issued a novel bulletin which tells "The Fable of the 'Merchant Electropolous.'" The "fable," which is not without its lessons for radio-appliance men, runs like this:

"—and so it came to pass that for many moons the appliance merchant lived in a strange interlude. As fast as he placed an electrical gadget on the counter, the item was immediately sold.

"And it was good.

"But behold, there came a morning when a gadget the merchant had placed on the counter the day before was still there. And it remained there the next day, and the next, and the next, until many days had passed.

"And the appliance merchant became sore perplexed.

"And one day there came to him a certain one of his elder clerks who said: 'Master, I remember in the days of my fathers that in order to sell wares we placed notices and descriptions in public places, and when customers came to our shop we talked diligently and meaningfully to them about the benefits of our gadgets. Can it not be that such action would be proper now?'

"Then saith the merchant: 'Thou sayest wisely and so shall we do. But first let me see a man about a pair of shoe laces.' And after the manner of his kind, he continued to postpone taking action day after day. And day by day his business declined.

"And it was bad!"

New Perma-Power Units for Battery Set Users

Two new "Perma-Power" units, (successors to Porta-Power) with which owners of battery sets can convert to all-electric operation, have been introduced by General Transformer Corp., 4321 N. Knox Ave., Chicago 41, Ill. The units feature selenium rectifiers, universal sockets, hum-free design, negligible power consumption, and a 3-year guarantee.

Model A is for 1½ volt sets and is priced at \$16.75 list. Model B handles 6 volt sets and lists at \$19.95. Each unit has its own promotional material on the shipping container; jobbers need not rehandle them.

GTC recently expanded its factory operations into 100,000 sq. ft. of space at its ultra-modern Chicago plant. Officials say the firm's steady growth can be traced to its guarantee policy, which has been in force for 20 years.

Headquarters Honors the Sales Reps



This photo was taken when home office executives of Mark Simpson Mfg. Co., Inc., got together with Masco sales reps from all parts of U. S. The meeting honored new Masco PA lines, sales plans, and price protection policy. Front row, l. to r., Lou Weinrib, Delores Smith, Len Werner, Mark Simpson, Miryam Simpson, Herman Hughes and David Libsohn. Second row, Paul Scholz, Phil Optner, Henry Segel, Sonny Simberkoff, Les Logan, Ed Colman, Jack Perlmuth, Herb Erickson, Jose DePedro and Felix Simon. Third row, Tom Frye, Mike Berns, Rinald Nordstrom, Ed Schulz, G. E. Watt, Andy Anderson, Milly Anderson, J. E. Liedtke and Doc Pepper. Fourth row, David Sonkin, Ted Thibou, Earl Smith, Ira Edmundson and Harold Newman.

Meet Current's Favorite Conductor!

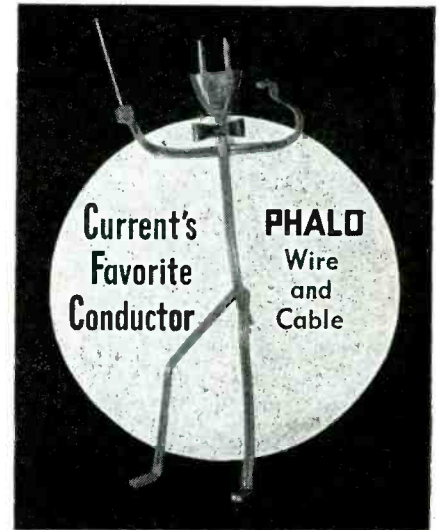

PHALO Twin Transmission Lines



- Weather Resistant
- Inexpensive
- Highly Efficient

Phalo Low Loss Twin Transmission Line is insulated with proved polyethylene, the insulation that has made coaxial cable lines practical.

Phalo Twin Transmission Line is water repellent, weather resistant, highly resistant to corrosion, highly efficient and inexpensive. Here is a lead-in that offers a perfect solution to FM and Television reception problems.

A complete selection of lead-in lines for 75, 150, 300 ohms impedance is available.

Other PHALO Products for Radio Include
HOOK-UP WIRE, PARALLEL RIP CORD,
POWER CORD ASSEMBLIES—LEADS—MULTI-
CONDUCTOR SHIELDED CABLES—TELEVI-
SION ANTENNA LEADS—TUBING

For Complete Information Write—

PHALO
Plastics Corporation

25 FOSTER ST. WORCESTER 8, MASS.

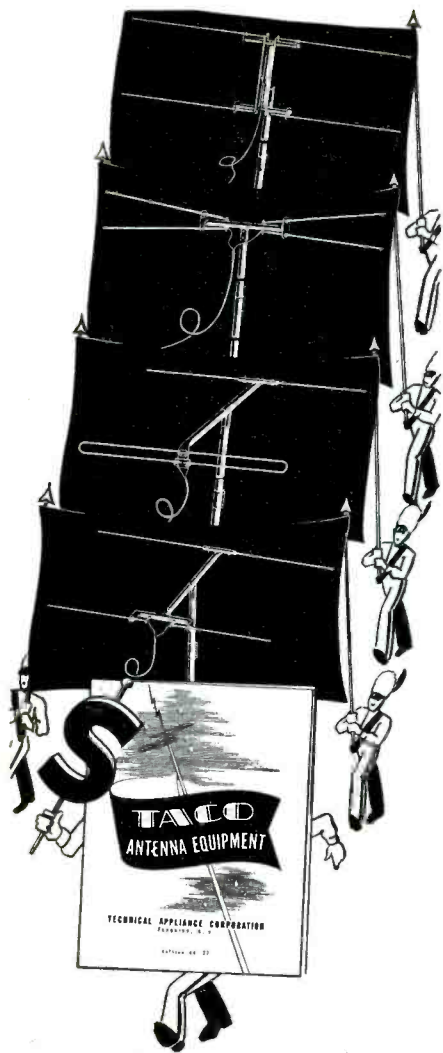

The PROFIT PARADE . . .

★ March along in this profit parade of TACO antenna equipment! There's a type for every kind of receiver—AM, FM and Television — properly engineered and built to take full advantage of present frequency bands. Also the TACO Master Antenna System.

Those postwar sets are no better than their antenna equipment. Former makeshift jobs won't do. Set owners expect, demand and will pay for superlative performance. And that's where you come marching along with the right TACO antenna at the right price and with the right profit for you.

★ Ask Your Jobber . . .

If you're after more money, ask your jobber for the latest TACO catalog of postwar antenna equipment. Or write us direct.

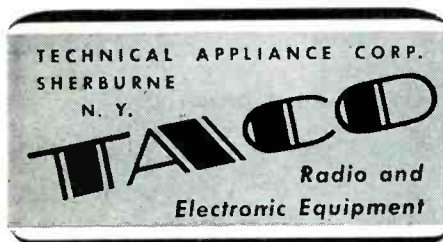

In Canada: STROMBERG-CARLSON CO., Ltd. TORONTO 4, ONT.

"Lee 400" Styling

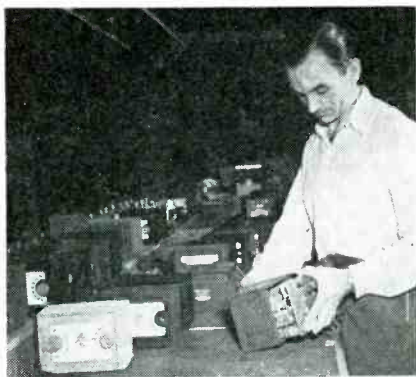

Here's a factory assembly scene at Lee Radio Co., 1331 Halsey St., Brooklyn, N. Y., where the \$12.95 "Lee 400" sets are finished by the hundreds. The novel cabinet is Tekwood—a veneer-kraft laminate made by U. S. Plywood Corp.—which Lee sprays with varnish adhesive and finally rayon filaments to get unusual color combinations and effects.

Recordio Show for Mid-West Distributors

Over 150 radio men gathered at the Charlotte, Mich., Country Club to view the new line of Recordios as guests of the Wilcox-Gay Corp., Charlotte, when the company was host to distributors from the Midwest accompanied by their salesmen and key dealers. Factory tours and a luncheon were on the program. W. L. Hasemeier, vice-president in charge of sales, led the sales meeting. C. S. Blakelee, sales promotion manager, presented the national advertising and merchandising program and G. E. Murphy, sales supervisor, demonstrated the new models. Wilcox-Gay reports that a record volume of business was booked for early fall delivery following the meeting.

Admiral's New "Moistrol"

In refrigerator demonstrations at the Furniture Market in Chicago, Admiral Corp. said that "the last inconvenience of the modern refrigerator has been eliminated with development of our new moisture evaporator".

In the new model of its "Dual-Temp" refrigerator Admiral has eliminated the need for emptying the drip tray. Moisture condensed from within the storage space is evaporated from the pan through use of a warm coil, known as the "Moistrol," which uses heat generated by the cooling unit.

Arcturus Appointment

James S. Donahue, president of Arcturus Radio & Television Corp., Newark, N. J., has announced the appointment of Corbin Advertising Agency, New York City, as its advertising agent to handle its advertising, sales promotion and publicity.

An extensive promotion program on Arcturus products will be announced shortly. Harold Metzendorf, president of the Corbin firm is the account executive.



Featuring Outstanding Values in:
**RADIO PARTS • RADIO SETS
 RECORD CHANGERS • PLAYERS
 HAM GEAR • AMPLIFIERS • TESTERS**

This is it—the new 1947 Concord Catalog—a vast, complete selection of everything in Radio and Electronics—thousands of items available for IMMEDIATE SHIPMENT from CHICAGO or ATLANTA—hundreds now available for the first time—featuring new, latest 1947 prices. See now LOWER PRICES on RADIO SETS, PHONO-RADIOS, RECORD CHANGERS, RECORD PLAYERS, PORTABLES, AMPLIFIERS, COMPLETE SOUND SYSTEMS, TESTERS. See latest listings of standard, dependable lines of radio parts and equipment—tubes, condensers, transformers, relays, etc. Write for FREE COPY—NOW! Address Dept. RT-97

TIME PAYMENTS: Write us for details of time payment plan on Communications Receivers, Amplifiers, Test Equipment: Radios, Phono-Radios, etc.



TWISTED PAIR INTERCOM WIRE. #20 Ga. solid copper coated steel conductors; ivory plastic insul. Priced ridiculously low. 1000 ft. spool 3.95 100 ft. coil .59

TUBE SPECIALS

Well known brands in perfect condition, but not in sealed cartons. Most types in stock at up to 80% off list. Every tube guaranteed for 90 days.

#20, 26, 27, 48 or 56	.29
#42, 45, 75, 77, 78, 80, 5Y3, 6H6 or 6K7	.39
#35, 36, 37, 39, 84, 5Y4, 6A8, 6C5, 6D6, 6F5, 6J7, 6N7, 6T7, 6SA7, 6SK7, 12SA7, 12SK7 or 12SQ7	.49
#1A7, 1H5, 1N5, 6A3, 6U5, 6X5, 7A7, 7C5, 7C6, 7X4 or 50	.59

TUBE CARTONS: Plain white. GT size 1 1/4" sq.; 3 1/4" long) Per 100 .125
 Medium size (1 1/2" sq.; 4 1/4" long) Per 100 .149
 Victor Power Transformer for models R-32, 45, 52, or 75. Unshielded .595
 3" MAGNETIC SPEAKER. For Majestic portables or general replacement .198

SERVICEMEN'S KITS

#2—Speaker Cones; 12 asstd. 4" to 12", moulded & free-edge (magnetic) incl. Less voice coils	2.00
#3—MOULDED BAKELITE CONDENSERS. 50 asstd. .0001 to .2mfd, 200-600V. Clearly marked	2.95
#4—TUBULAR BY-PASS CONDENSERS. 50 asstd. .001 to .25mfd, 200-600V. Standard brands	2.49
#6—Dial Scales; 25 asstd. airplane & slide-rule (acetate & glass included)	2.98
#17—Dial Windows; 12 asstd. including flat & moulded acetate & glass	1.29
#20—Speaker REPAIR KIT. A real time & money saver for the serviceman. Contains: 25 asstd. paper rings, 10 spiders, strips, 20 chammois leather segments, & money saver for the serviceman. Conk-it of 16 shim & tube of cement	2.49
#23—RADIO CEMENT & SOLVENT. 3 oz. each of all-purpose cement & thinner. With brush	.69
#26—SPEAKER CONE RINGS. 50 asstd. cardboard rings in popular sizes 3" to 12"	1.49

PROMPT SERVICE ON ALL SPEAKER & PHONO PICK-UP REPAIRS
 Minimum Order \$2.00—20% Deposit Required on All Orders. Please Add Sufficient Postage

LEOTONE RADIO COMPANY
 67 DEY STREET, NEW YORK 7, N. Y.

A New Hit



DeWald B-400 "Companionette"

NEW MINIATURE \$20.95
PERSONALIZED LESS BATTERIES
PORTABLE RADIO

Featuring amazing performance, this battery operated miniature portable is the ideal companion for bungalow, auto, yacht, canoe . . . perfect reception everywhere. And, it's a timely promotional number for volume selling.

Write for literature on the complete line, from \$14.95 up.

JOBBERs: Some Choice Territories NOW AVAILABLE

DeWald Radio Manufacturing Corp.

35-17 37th AVENUE, LONG ISLAND CITY 1, N. Y.
 Chicago Office: BERNAT SALES CO., 624 South Michigan Avenue

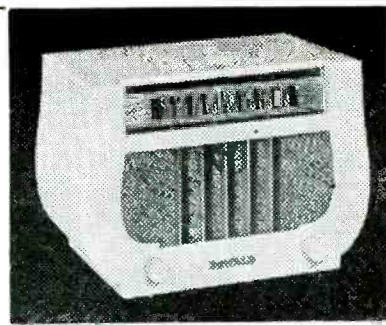

DeWald A-501 "Lyre"

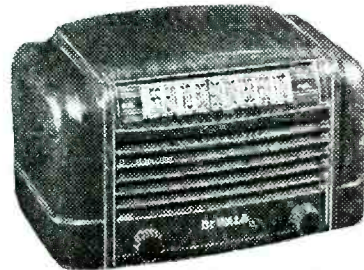

DeWald A-500 "Leader"

If you want
SOMETHING BETTER

Demand

DEWALD RADIO

A FAMOUS NAME IN
 SINCE 1921

RIDER Radio Publications

Builders of Successful Servicing

YOU HAVE TO KEEP UP-TO-DATE IF YOU WANT TO KEEP AHEAD

New fields of activity and profit are constantly being opened to radio men who are equipped with the knowledge to take advantage of the opportunities.

RIDER CLASSICS

The Meter at Work	\$2.00
The Oscillator at Work . .	2.50
Vacuum Tube Voltmeters . .	2.50
Automatic Frequency Control Systems	1.75
A-C Calculation Charts . . .	7.50
The Cathode Ray Tube at Work	4.00
Frequency Modulation	2.00
Servicing by Signal Tracing .	4.00

ORDER TODAY!

By The Publisher of
RIDER MANUALS

THREE OF RIDER'S LATEST!

"Inside The Vacuum Tube"

Theory and operation of basic types of tubes \$4.50

"Understanding Microwaves"

Foundation for understanding developments \$6.00

"Radar"

Explains fundamentals \$1.00

Hour-A-Day-with-Rider Series—

- On "Alternating Currents in Radio Receivers"
- On "Resonance & Alignment"
- On "Automatic Volume Control"
- On "D-C Voltage Distribution" 1.25 each

JOHN F. RIDER PUBLISHER, INC.
 404 FOURTH AVENUE, NEW YORK 16, N. Y.

Precision Built for Precision Work . . .

VACO Break-proof,
 Shock-proof
 Screw and Nut Drivers



Top quality in tools has always been a "must" in radio. Only precision built driver equipment prevents burred screw slot edges . . . provides sureness in making delicate adjustments . . . draws metal or wood firmly together. Break-proof, shock-proof Vaco screw and nut drivers are your assurance of the right tool for the job. Write for descriptive catalog, today. Vaco Products Co., 317 E. Ontario Street, Chicago 11, Illinois.

173 TYPES AND SIZES

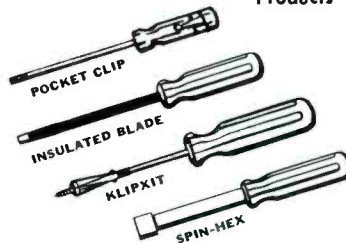

NEW . . . Colored Spin-Hex Handle Caps

Developed by Vaco to end confusion of similar sizes, speed up production. Color of cap indicates size of driver.





ATLAS

The Seal of Sound Supremacy



REENTRANT PROJECTORS



DRIVER UNITS



BOOSTER UNITS



RADIAL PROJECTORS



"MIKE" STANDS

- Baffles
- Enclosures
- Desk Stands
- Speaker Stands
- Adaptors
- Wall Boxes
- Boom Stands

Write for illustrated catalog sheets

ATLAS SOUND CORPORATION

1451—39th Street, Brooklyn 18, N. Y.

NEW BOOKS

Applied Architectural Acoustics

By Michael Rettinger, B.A., M.A., published by Chemical Publishing Co., Inc., 26 Court St., Bklyn 2, N. Y., 208 pages—price \$5.50

Room acoustics is an extremely important factor in PA work, as evidenced by the fact that Mr. Rettinger is an RCA engineer, rather than a worker for an acoustic conditioning firm. In 17 chapters of practical explanation both theoretical and actual conditions are studied, covering sound work in hospitals, churches, auditoria, theatres and other places. Technicians and engineers concerned with both design and installation will find the book very much worthwhile.

New Book on Power Factor

"Power Factor in Your Plant," by W. C. King, Cornell-Dubilier Electric Corporation, South Plainfield, N. J. 208 pages, \$3.00.

Technical information of the first importance to an electrical maintenance or appliance man, the subject of power factors has long been misunderstood, and even feared, by the practical worker. Here Mr. King, sales engineer, has turned out a technical handbook that's not only easy to read but quickly understandable.

This is an informally-written book, with amusing and instructive illustrations, built on the question-and-answer technique. In the first place King puts the questions—hard, commonsense queries about power factor—in everyday language. He lists these questions instead of a table of contents, then devotes a series of brief chapters to them. All in all, it's a fine book that should be in every appliance serviceman's library.

Principles of Electrical Engineering

By T. F. Wall, D.Sc., D. Eng., published by Chemical Publishing Co., Inc., 26 Court St., Bklyn 2, N. Y., 576 pages—price \$8.50

This book presents a comprehensive but compact account of the basic principles of electrical engineering. For the radioman who has taken college or equivalent courses in mathematics and physics, the principles of electrical engineering need present no great stumbling block in his progress along the path of understanding the growing complexity of modern circuits. A companion volume to Principles, is "Problems and Their Solutions" by the same author, which contains a great quantity of practical work for the man who studies on his own. The latter book contains 312 pages, and sells for \$5.00.

Ever Sit On A Gold Mine?



YOU can build a business of your own NOW — either part or full time—with TRADIO, the radio functionally designed for coin-operation in hotels, motels, stop-overs, hospitals, etc. Big earnings... Steady income... and no clock to punch unless you want to.

★ Only Small Investment Needed

Tradio has pioneered in this new and fast-growing industry. Get in on the ground floor and assure yourself of financial independence for life.

★ Tradio—Tried, Tested, Proven

Thousands of others all over the country have learned that "Tradio Pays While it Plays." Send for complete information today. Write to Dept. X-9.



TRADIO, Inc. ASBURY PARK NEW JERSEY

SENSATIONAL SELLER!

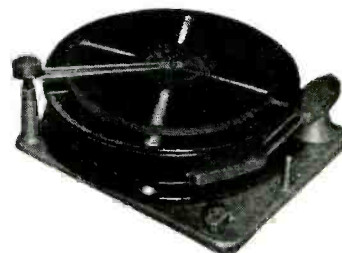

LAKE DELUXE CHANGER

Revolutionizes the Industry! An Excellent Seller!

11 Outstanding Features:

- Positive intermix
- Service Adjustments Eliminated
- Minimizes Record Wear
- Single Knob Control
- Plays ALL Records
- Pick-up arm may be grasped at any time and changer will not be thrown out of adjustment
- Resonance-free ball bearing tone arm
- Easily operated—any child can do it
- Completely Jam-proof
- Records Gently Lowered on Spindle—not dropped
- Automatic Shut-off on last record

Dimensions: 13 13/16" W x 12 1/4" D x 7 3/4" H. No. 118A.....YOUR NET **\$28.73**

SERVICEMEN—RETAILERS Write for our new, illustrated 16-page catalog NR-118. It's free. Get on our mailing list!

Write for our Special Catalog on Microphones, Amplifiers and Sound Equipment!

Lake Radio Sales Co.
615 W. Randolph Street
Dept. B
Chicago 6, Ill.

...and now Television!

FRONT END

Will handle 13 television channels. It is so flexible that any number of channels from 1 to 13 can be used. This allows a start with the channels now in use 2-4-5-7-9-11-13 and then install the others as desired for a slight additional cost.

TUBES

6AK6—Tuned R.F. Amplifier
6AK5—Mixer
6C4—Oscillator

ANTENNA INPUT

Balanced 300 ohm line.

Aligned and tested, ready to use when delivered. Merely connect B plus, filament and output I.F. leads to the television chassis. It is not necessary to make any R.F. alignments.

• 5. TUBES:

Five 6J6 — Picture I.F. Amplifier
One 6J6 — Picture I.F. Amplifier & Detector
One 6AU6 — 1st Video Amplifier
One 6K6GT — 2nd Video Amplifier

All of the above circuits are contained on one chassis delivered completely wired, tested, tuned and tubed ready for installation.

• 6. I.F. FREQUENCY — AUDIO 21.6 — PICTURE 26.1

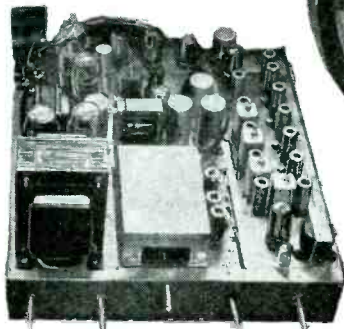

I. F. VIDEO & SOUND STRIP (PATENTS PENDING)

- 1. PICTURE I.F. STAGES:
Five I.F. Picture Stages of Amplification.
- 2. SOUND I.F. STAGES:
Two I.F. Stages with Limiter & Discriminator.
- 3. VIDEO STAGES:
Two Video Stages of Amplification with a flat response of 4.5 M.C.
- 4. ONE D.C. RESTORER.
One 6AL5 — D.C. Restorer
One 6AU6 — Limiter
Two 6BA6 — Sound Amplifier
One 6AL5 — Discriminator

SIZE OF
CHASSIS
19"x17"x3"

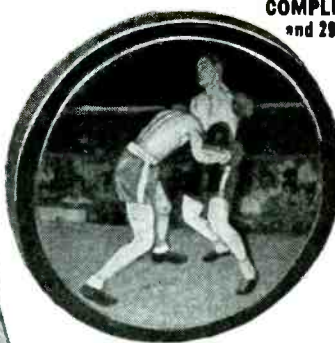

COMPLETE WITH ALL COMPONENTS
and 29 RCA Tubes Plus—10" CR Tube

\$22950

Also Available with 12" CR
Tube for

\$25950

All Prices F.O.B. B'klyn, N.Y.

10% Deposit with Order

AUDIO

Two stages of Audio Amplification are used.

TUBES

One 6AT6 — 1st Audio Amplifier
One 6V6GT — 2nd Audio Output Amplifier

POWER SUPPLIES

Low voltage power supply is a well filtered supply using full wave rectification. Delivers 300V positive and 100V negative at 250 M.A. with good regulation at continuous duty. High Voltage Supply is of the Fly-Back type delivering approximately 10 K.V. Power consumption approx. 30J watts. Both Supplies use the following tubes:
Two 5U4G — rectifiers as full wave rectification.
One 8016 — H.V. rectifier half wave rectification.

SYNCHRONIZATION SEPARATOR

SYNCHRONIZATION AMPLIFIER SWEEP CIRCUITS

TUBE COMPLEMENT:

One 6J5 — Vertical Blocking Oscillator
One 6SN7GT — Horizontal Blocking Oscillator
One 6K6GT — Vertical Output Amplifier
One 6BG6G — Horizontal Output Amplifier
One 5V4G — Damper
One 6SK7GT — 1st Sync Amplifier
One 6SH7 — Sync Separator
One 6SN7GT — 2nd Sync Amplifier
One 10" — Flat-faced Cathode Ray Tube

"GUARANTEED to operate to your satisfaction when simple directions are followed."

Also 1—12" RCA 8, 6 oz. PM Speaker, 1 Specially Designed Dipole Antenna with 60 ft. Lead-in and Complete Pictorial Data, Schematic
TELEVISION ASSEMBLY CO., 387 Bushwick Ave., Brooklyn 6, N. Y.

SPECIALS FOR SEPTEMBER

AERIAL WIRE

100 ft. coil, 7/23 tinned aerial wire 69c each
50 ft. coil (same as above) 36c each

PUSH-BACK WIRE

Solid or stranded, tinned copper conductors with cotton serve and waxed cotton outer braid for easy push-back; available in all standard colors.

Per 100 ft. coil—22 Ga. Solid	61c
22 Ga. Stranded	68c
20 Ga. Solid	71c
20 Ga. Stranded	82c
Per 1000 ft. spool—22 Ga. Solid	\$5.72
22 Ga. Stranded	6.45
20 Ga. Solid	6.51
20 Ga. Stranded	7.38

18 GAUGE SOLID FIXTURE WIRE

Solid, tinned copper conductor with weatherproof compound under lacquered braid; Type R.F. Underwriters Approved; a real buy at this low price:
\$6.50 per 1000 ft.

We carry in stock for immediate delivery many types of wire and cable in gauges of from 23 to 2, in addition to various types of multi conductor cable for many uses. We also manufacture cord sets and cables to specifications. Send us your inquiries for prompt attention.

Our new catalog is now available for distribution. Write for your copy today.

COLUMBIA WIRE & SUPPLY CO.
5734 ELSTON AVE., CHICAGO 30, ILLINOIS

Electro
ELECTRICAL AND RADIO EQUIPMENT



BATTERY ELIMINATORS

MODEL "P"

A Complete Line for Every Requirement!

Models to convert dry battery radios to efficient AC receivers. Other models to convert dry battery radio for use only with 6 volt storage battery.

Cost but a few cents per hundred hours of operation. Completely filtered—hum free—silent and efficient. Sturdily constructed—no liquids or moving parts—operate in any position.

MODEL "Q"—Operates any 1.4 volt 4, 5 or 6 tube radio from 6 volt storage or dry battery, or Wincharger. Ideal for farms, camps, autos, boats, etc.

MODEL "R"—Operates 2 volt 4, 5, 6 or 7 tube radio from 6 volt storage or dry battery, or Wincharger. (0.5 Amp. filament max.)

MODEL "P"—Operates any 1.4 volt 4, 5 or 6 tube radio from 110 volt 60 cy. source. Cuts down current use and saves batteries for portable use.

MODEL "F"—Operates any 2 volt 4, 5, 6 or 7 tube radio from 110 volt, 60 cy. source. (0.5 Amp. filament max.)

Canadian representative, ATLAS RADIO CORP., Toronto, Canada

ELECTRO PRODUCTS LABORATORIES

Pioneer Manufacturers of Battery Eliminators
549 WEST RANDOLPH STREET CHICAGO 6, ILL.

30,000 RADIO SERVICE- TECHNICIANS READ



EVERY MONTH

RADIO MAINTENANCE today fills a breach that has existed in the radio field for a long time. Already 30,000 servicemen read RADIO MAINTENANCE every month because it is devoted entirely to the radio serviceman.

The RADIO MAINTENANCE staff specializes in the preparation of articles on every phase of Radio Maintenance in series form which may be filed and used for reference. The leading articles cover everything for the radio serviceman on Television, FM and AM; Test Equipment; Electronic Appliances; Tools; Antennas; Alignment; Troubleshooting; Repair; Construction; Pick-Ups and Sound Amplification and Reproduction Equipment. Also, in RADIO MAINTENANCE each month there are departments on hints and kinks, the latest news of the trade, review of trade literature, radiomen's opinions, new products and news from the organizations. All articles are presented in a step-by-step precision style, clearly illustrated, with schematics, accurate photographs, specially prepared drawings, white on black charts, color diagrams, isometric projections and exploded views.

Tear off coupon below, and mail today. Your first issue will be mailed immediately on receipt of this coupon. One issue FREE if payment is enclosed.



RADIO MAINTENANCE
MAGAZINE
460 Bloomfield Avenue,
Montclair 4, N. J.
Please send me RADIO
MAINTENANCE every month
for

- 1 year at \$2.50 Payment enclosed
 2 years at \$4.00 Bill me later

Name
Address
City—State
* Occupation
Title
Employed by
* Independent Serviceman—Dealer Serviceman—Service
Manager—Dealer—Distributor—Jobber.

BOLAND & BOYCE INC., PUBLISHERS

20 Years Ago

From the September, 1927 Issue of
Radio Retailing

FALL BUYING—Dealer should be guided by demand, inventory, permanency and prices.

NEW DEVELOPMENTS in radio reception—inventors predict that several new circuits are forthcoming.

RADIO RETAILING announces radio window display contest for dealers.

SERVICE & SALES—Maintenance is the stepping stone to more sales at Haynes-Griffin, New York retailer.

FARM RADIO is a life-saver for Ohio farmer who needs to know weather forecasts.

BETTER CABINETS for radio homes mean larger sales, greater profits and cleaner merchandising.

TRADE NEWS—Atwater Kent signs licensing agreement with RCA; Radio Worlds Fair Opens Sept. 19th; Radio Protective Association formed by manufacturers; Prince of Wales broadcasts opening of International Peace Bridge at Niagara Falls.

Sylvania Transfers Maguire

Wm. M. Maguire has been transferred from the Salem, Mass., plant to the distributor sales department of the radio tube division of Sylvania Electric Products Inc., according to news from C. W. Shaw, general sales manager. Mr. Maguire will serve as products specialty salesman in cooperation with Sylvania sales division managers and distributors in the eastern half of the United States. He joined the company in 1930.

Steam Iron Price Upped

Price of the Silex Steam Iron has been increased to \$21.95, Federal Excise Tax included, (\$20.90 plus \$1.05 tax), according to an announcement by J. M. Moore, general sales manager of The Silex Co., Hartford 2, Conn. Mr. Moore said that "while we are reluctant to advance our price, the fact is that we are in a period of the highest production costs in the history of this country and in order to return a reasonable profit such action is necessary."

TELETABLE

FOR ALL TABLE TELEVISION SETS

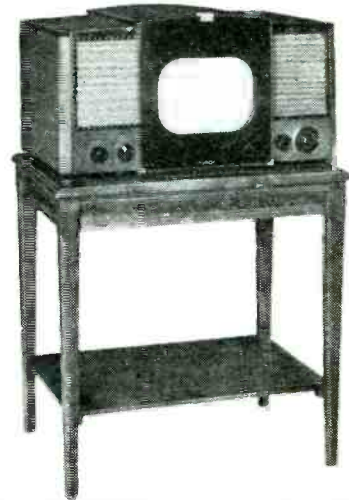

Sell a TELETABLE with every Table Television set. The TELETABLE, beautifully made and finished, can be retailed at a good profit. We have the proper size table, in a matching finish, for every make on the market.

THE ELLIS MFG. CO.

130 West 3d Street New York 12, N. Y.

You satisfy every
COMMERCIAL
and
INDUSTRIAL
SOUND NEED

with the
complete line of

**BELL SOUND
EQUIPMENT**

and at the same time

- Simplify Your Inventory
- Increase Stock Turnover
- Boost Your Profits



Ask your
nearby Bell
distributor
for details

**BELL SOUND
SYSTEMS, INC.**

1186 Essex Avenue
Columbus 3, Ohio

Artists Try Recorder



Wire recorders are useful in many fields. Ann Crowley and Eric Mattson, stars of "Carousel," try out Webster-Chicago unit during Chicago convention of National Ass'n. of Visual Education Dealers. With them are W.C.'s S. T. Seaman and A. S. Johnson.

Ashbach Buys Garod in Large Cash Transaction

Leonard Ashbach, president of Leonard Ashbach Co., Chicago, has completed the purchase of 100% of the stock of the Garod Radio Corp., Brooklyn, N. Y. While officials would not reveal the exact amount involved, they readily admitted that the large cash transaction greatly exceeded a million dollars.

Previous owners were Max W. Weintraub, president, and Barney Trott, secretary-treasurer and chief engineer.

Mr. Weintraub becomes Garod's metropolitan distributor through Belle Electronics Corporation, and Mr. Trott has been retained as chief engineer under a long-term contract. Mr. Ashbach stated that the plant will continue operating, without interruption, at its present location. In announcing the purchase, the new owner lauded the record of Lou Silver, sales manager for the past 8 years, who remains with the company in an important executive position.

In addition to planning greatly increased production in the radio and television field, Mr. Ashbach said that a Garod electric refrigerator would be marketed as soon as sufficient materials are available.

First Distribs Named for New Lewyt Cleaner

Distributors in 26 areas have been appointed by the Lewyt Corp., 60 Broadway, Brooklyn 11, N. Y., for the new Lewyt vacuum cleaner.

This first group of jobbers are listed as follows: for the Indianapolis and South Bend, Ind., areas, Appliance Distributors, Inc., 421 E. Market St., Indianapolis; for Portland, Maine, Appliance Distributors, Inc., 33 Commercial St., Portland; for Cleveland, Ohio, Arnold Wholesale Corp., 5209 Detroit Ave., Cleveland; for Baltimore, Md., D & H Distributing Co., Inc., 31 E. Lee St., Baltimore; for Scranton, Pa., (part to Morris Dist. Co.), D & H Distributing Co., Inc., 487 Pine St., Scranton; for Harrisburg, Pa., D & H Distributing Co., Inc., 311 S. Cameron St., Harrisburg; for Charlotte, N. C., (in part), Gas Engine & Electric Co., 280 Meeting St., Charleston; for Cincinnati, O., Home Products, Inc., 104 Garfield Place, Cincinnati; for Providence, R. I., R. U. Lynch, Inc., 9 Federal St., Providence; for Binghamton, N. Y., Morris Distributing Co., 185 Water St., Binghamton; for Scranton, Pa. (part to D & H)

RCA Vice-President



Orrin E. Dunlap, Jr., has been elected vice-president in charge of advertising and publicity for Radio Corp. of America, according to an announcement by Brigadier General David Sarnoff, president and board chairman. Mr. Dunlap, well known as former New York Times radio editor and author of 10 books on radio, joined RCA in 1940. His radio experience dates back to 1912.

Morris Distributing Co., 616 Mulberry St., Scranton; for Syracuse, N. Y., Morris Distributing Co., Inc., 412 S. Clinton St., Syracuse; for Pittsburgh, Pa., Moto Radio Distributing Co., 5732 Baum Blvd., Pittsburgh; for Minneapolis, Minn., Motor Power Equipment Co., 2446 University Ave., St. Paul; for Milwaukee, Wis., Taylor Electric Co., 112 N. Broadway, Milwaukee; for Boston, Mass., Northeastern Distributors, Inc., 388 Commonwealth Ave., Boston; for Burlington, Vt., Albany, and Poughkeepsie, N. Y., R. T. A. Distributors, Inc., 36 Broadway, Albany; for Atlanta, Ga., W. T. Shackelford Co., 393 Peachtree St., N. E., Atlanta; for Flint and Grand Rapids, Mich., Silkworth Distributing Co., 1659 N. Saginaw St., Flint; for Columbus and Dayton, O., Tracy Wells Co., 175 N. Front St., Columbus; and for Charlotte, N. C., (in part) Williams & Shelton Co., Inc., 801 S. Tryon St., Charlotte.

**NEW HAVEN QUILT & PAD CO.'S
PADDED COVERS
ELIMINATE DAMAGE CLAIMS**

Completely covers all standard floor models. Waterproof canvas outside, mole-skin lined. Send for catalog of all appliance covers.

RADIO COVERS

One-Piece
Padded Range
and Stove Covers

NEW HAVEN QUILT & PAD CO.
15-88 Franklin St., New Haven 11, Conn.

For Originality

LOOK TO

BETTER GRIPPING — BETTER SELLING

There's sales appeal galore in the new XCELITE screw driver! It has all standard XCELITE quality points—plus the new streamlined handle. New comfort in gripping! New eye appeal! It's shock and fire resistant, of course, mar-proof and break-proof. The blade? CHROME VANADIUM, precision-ground on the flat belt. It's an all-around beauty. Sells itself, once customers feel the sure grip and perfect balance. Don't neglect this profit item! Write now for all the facts.

Originators—not Imitators

PARK METALWARE CO., INC.
Dept. M Orchard Park, New York
PREFERRED BY EXPERTS

Quality Tools

The LABORATORY Antenna for Television and F-M Receivers

Model 300
**ALLWAVE
TELEVISION
FM Antenna**

- FULL COVERAGE of both television bands and FM bands.
- REDUCES NOISE to a minimum.
- DESIGNED TO MATCH all sets with the standard 300-ohm input.
- LOW STANDING WAVE RATIO, which means increased signal strength for your set.
- EASY TO INSTALL—anyone can erect the antenna on flat roof, slanting roof, or wall. The only tools needed are a screwdriver and pliers.
- COMES COMPLETE—with all mounting hardware and 65 feet of 300-ohm twin-lead transmission line. Complete instructions included.
- STRIKING APPEARANCE—Attractively proportioned to improve the appearance of any structure, yet sturdy enough to be completely weatherproof.
- ECONOMICALLY PRICED.

JOBBERS: Write for illustrated and technical literature and quantity prices.

TRICRAFT PRODUCTS COMPANY
1535 North Ashland Ave. Dept. R Chicago 22, Ill.

"HOT"
ON THE JOB BUT
COOL
TO HANDLE...



SOLDERING IRONS

FOR service men, mechanics of all types and "handy" men who want quality tools... G-E Calrod Soldering Irons meet every requirement.

CALROD ELEMENT

Cartridge type, insulated with highly compacted magnesium oxide which maintains full insulation properties and dependably protects against grounding. The Calrod element conducts heat so rapidly that there is little temperature drop from the resistance wire. High efficiency and quick recovery permit fast work with minimum loss of time.

CALORIZATION

Much longer life can be expected from the calorized tip. Calorization also makes tip removal easy and prevents "freezing in". Corrosion of the tip is greatly retarded by calorization.

HEAT RESERVOIR

An ample heat reservoir is provided by a calorized copper heat conductor which also serves as the tip holder.

STAINLESS STEEL BARREL

There is very low heat loss through the barrel because stainless steel has less than half the conductivity of plain steel. The barrel will withstand extremely hard usage without ill effects.

COOL HANDLE

The smooth, plastic handle remains cool to the touch. The heat is in the working tip where it belongs.

For complete information write: General Electric Company, Electronics Department, Syracuse 1, N. Y.

169-F6

GENERAL ELECTRIC

DATES AHEAD

Future Events of Interest to Readers

- Sept. 16-21: National Hardware Show, Grand Central Palace, N. Y.
 Oct. 7-8: National Farm Electrification Conference, Claypool Hotel, Ind.
 Oct. 26-Nov. 1: National Radio Week
 Nov. 3-7: Second International Lighting Exposition and Conference, Stevens Hotel, Chicago
 Nov. 3-5: National Electronics Conference, Edgewater Beach Hotel, Chicago
 Nov. 23-30: Second Annual National Crafts & Hobby Show, Madison Square Garden, N. Y.
 Dec. 2-7: Tenth Annual Electrical & Home Appliance Show, Bureau of Radio & Electrical Appliances, Federal Bldg., Balboa, Park, San Diego, Calif.

Heads Permoflux Jobber Sales Program

M. B. Leskin has been named head of jobber sales and advertising at Permoflux Corp. The firm has two factories—one at 4900 W. Grand Ave., Chicago 39; the other at 236 S. Verdugo Rd., Glendale 5, Calif.

"Permoflux is now presenting a complete line of loudspeakers and transformers to the jobber... besides a standard replacement line, the extended range hi-fidelity series has been added for the jobber field," Mr. Leskin stated. "Permoflux has entered the jobber field after years of engineering and manufacturing experience in supplying major radio set producers. Odd size and elliptical models will augment the standard line so that there is a Permoflux speaker for every purpose and every installation."

Refrigerator Demand to Continue Strong

It will take 54½ months to catch up with the normal demand for quality refrigerators, according to L. H. D. Baker, vice-president of Admiral Corp.

Between V-J Day and the end of 1949, he said, there will have accumulated a demand for 17,644,000 refrigerators in the U. S. By the end of 1946, only 2,400,000 has been produced, and so far in 1947 the rate has been approximately 280,000 units a month. At this rate, it will take 54½ months to catch up with normal demand, assuring a steady market for all-out production well into 1950.

District Manager

A. Earle Fisher, in merchandising for the last 20 years, has been appointed southeastern district manager for the Westinghouse home radio division. Mr. Fisher will headquarter in Atlanta and his territory will include North Carolina, South Carolina, Georgia, Florida, Alabama, Louisiana, and parts of Tennessee and Mississippi.



Phono Needle Repair Kit

Turntable Felt - Lubriplate

G-C MASTER POINT PHONO NEEDLE

Quality needle, over 5,000 plays because of special perfectly formed tip of precious metal. Excellent reproduction. Easy on the record.

List each \$1.00
 No. 1435-D Display—13 needles (1 free)—List \$12.00



G-C RECORD

TURNTABLE FELT

Replaces wornout felt; keeps record firmly in place; round pieces, center hole punched. No. 1292—7½" dia. List 39c. (Other sizes available)



G-C LUBE-REX "LUBRIPLATE"

Best contact cleaner on market. Prevents corrosion. Applicable for switches, attenuators, contacts, etc. Moisture repellent, rust-preventing.

No. 1209—2 oz. bottle—List 50c

G-C DELUXE CABINET REPAIR KIT

Comes in handy black leatherette finish box.



Contains shellac, sticks, stain, varnish, polish, alcohol lamp, spatula, brushes, wiping cloth, directions, etc.

No. 901 List \$4.50

Write for our complete catalog! Sold by all Jobbers.

RADIO DIVISION DEPT. G

GENERAL CEMENT Mfg. Co., Rockford, Ill., U. S. A.
 Manufacturers of over 3,000 products
 Sales offices in principal cities

WE

manufacture

THE MOST COMPLETE LINE OF REPLACEMENT CONE and VOICE COIL ASSEMBLIES

Also

THE MOST COMPLETE LINE OF UNIVERSAL TYPE FIELD COIL REPLACEMENTS

Our new catalog is now available. Write

WALDOM ELECTRONICS INC.

911 N. LARRABEE STREET
 CHICAGO 10, ILL.

INDEX To Advertisers

SEPTEMBER, 1947

Acton Co., Inc., H. W.	102	Newcomb Audio Products Co.	154
Admiral Corp.	Insert	New Haven Quilt & Pad Co.	177
Adventure Records	101	Noblitt-Sparks Industries, Inc.	28
Air King Radio Div., Hytron Radio & Electronics Corp.	9	Norge Div., Borg-Warner Corp.	104
Alliance Mfg. Co.	102		
American Telephone & Telegraph Co.	115	Olsen Radio Warehouse, Inc.	158
Andrea Radio Corp.	169	Olympic Radio & Television, Inc.	73
Armstrong FM System	10		
Atlas Sound Corp.	174	Park Metalware Co., Inc.	177
		Peerless Album Co.	99
Belden Mfg. Co.	152	Permo, Inc.	93
Bell Sound Systems, Inc.	176	Permoflux Corp.	162
Bendix Radio Div., Bendix Aviation Corp.	6	Phalo Plastics Corp.	171
Boland & Boyce, Inc., Publishers	170, 176	Philco Corp.	3, 30, 31
Bright Star Battery Co.	143	Pilot Radio Corp.	69
Burgess Battery Co.	166	Presto Recording Corp.	95
		Proctor Electric Co.	117
		Pyramid Electric Co.	161
Coldwell-Clements, Inc.	98	Radio Corp. of America:	
Camburn, Inc.	167	RCA Victor Div.	46, 47
Chicago Tribune	16	RCA Victor Records	80
Clarostat Mfg. Co., Inc.	168	Tube Department	122, Cover 4
Collier's	70, 71	Rauland Corp.	150
Columbia Records, Inc.	87	Raytheon Mfg. Co.	162
Columbia Wire & Supply Co.	175	Rider Publisher, Inc., John F.	149, 173
Concord Radio Corp.	172		
Continental Records	94	Sams & Co., Inc., Howard W.	157
Cornell-Dubilier Electric Corp.	145	Scott Radio Laboratories, Inc.	38
Crosley Div., Avco Mfg. Corp.	34, 35	Seeburg Corp., J. P.	Cover 3
		Signal Electronics, Inc.	156
Delco Radio Div., General Motors Corp.	8	Simpson Electric Co.	147
DeWald Radio Mfg. Corp.	173	Simpson Mfg. Co., Inc., Mark	164
DuMont Laboratories, Inc., Allen B.	14	SNC Mfg. Co., Inc.	139
Duotone Co.	90	Snyder Mfg. Co.	179
		Sonora Radio & Television Co.	74, 75
Electro Products Laboratories Electronics, Inc.	175, 40	Sparks-Withington Co.	29
Ellis Mfg. Co.	176	Sprague Products Co.	163
Emerson Radio & Phonograph Corp.	12, 13	Standard Register Co.	111
Espey Mfg. Co., Inc.	148	Stewart-Warner Corp.	41
		Stromberg-Carlson Co.	42
Fada Radio & Electric Co.	15	Sylvania Electric Products, Inc.	136, 137
Farnsworth Television & Radio Corp.	24		
Furniture Specialties Co.	98	Technical Appliance Corp.	172
		Television Assembly Co.	175
Garod Radio Corp.	5	Templetone Radio Mfg. Corp.	39
General Cement Mfg. Co.	178	Thermo Electric Corp. of America	119
General Electric Co.	7, 11, 153, 160, 178	Tradio, Inc.	174
General Industries Co.	100	Transvision, Inc.	146
Gramavox Radio & Phonograph Co.	167	Tricraft Products Co.	177
Graybar Electric Co.	113	Trilmont Products Co.	119
		Triplett Electrical Instrument Co.	155
Hallicrafters Co.	22, 23	Turner Co.	141
Hickok Electrical Instrument Co.	135		
Howard Radio Co.	180	U. S. Television Mfg. Corp.	33
Hytron Radio & Electronics Corp.	21		
		Vaco Products Co.	173
International Resistance Co.	131	Vitacoustic Records, Inc.	96, 97
Jensen Mfg. Co.	133		
J. F. D. Mfg. Co.	165	Waldom Electronics, Inc.	178
		Ward Leonard Electric Co.	167
Lake Radio Sales Co.	174	Ward Products Corp.	25
Landers, Fray & Clark	108, 109	Warwick Mfg. Corp.	32
Lenk Mfg. Co.	165	Waters Canley Co.	89
Leotone Radio Co.	172	Webster Chicago Corp.	91
		Webster Electric Co.	159
Maguire Industries, Inc.	77	Weston Electrical Instrument Corp.	151
Majestic Radio & Television Corp.	78	Westinghouse Radio Corp.	26, 27
Mallory & Co., Inc., P. R.	120, Cover 2	Wilcox-Gay Corp.	37
Merit Coil & Transformer Corp.	4		
Milwaukee Stamping Co.	92	Zenith Radio Corp.	36
Minnesota Mining & Mfg. Co.	2		

While every precaution is taken to insure accuracy, we cannot guarantee against the possibility of an occasional change or omission in the preparation of this index.

SNYDER MIKE STANDS



MODEL MS-1	HEAVY DUTY
ILLUSTRATED	MS-5
LIST PRICE	LIST PRICE
\$860	\$1050

The quality appearance of Snyder Mike Stands is reflected in the beauty of design and finish.

Shown is MS-1 two-section telescopic 30" to 60" triple chrome staff. Rich grey crackle finish 10" base with chrome trim.

OTHER MODELS

18" Banquet Mike Stand . . . \$2.95
8" Desk Mike Stand . . . \$1.95
WRITE FOR FREE ILLUSTRATED CATALOG.

MANUFACTURERS . . . START TO FINISH

SNYDER

ANTENN-GINEERS
PHILADELPHIA 40, U. S. A.

EXPORT DIVISION:
ROBURN AGENCIES, INC.,
NEW YORK 7, N. Y.

3 *Brilliant*
NEW
FM-AM
HOWARD
Radios



MODEL 474

A SENSATIONAL VALUE!

\$39.50 in Walnut Plastic. \$41.50 in ivory.
 (West coast prices slightly higher.)

Full range FM band . . . Extreme sensitivity. Built-in FM and AM antennas. Beautiful tone.

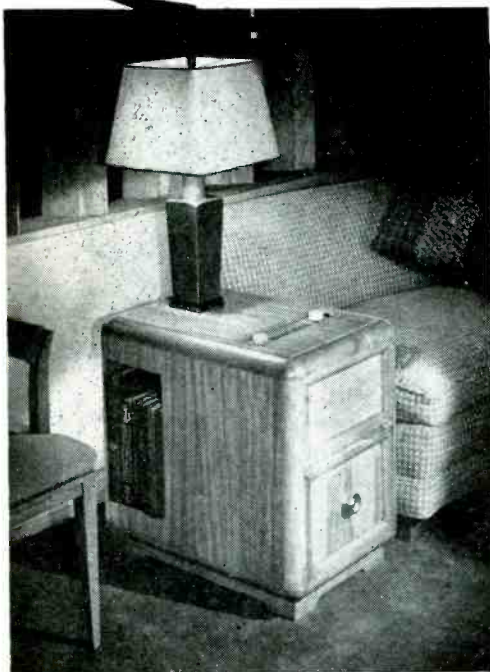

MODEL 472-C

Superb FM and AM reception. Record changer in handy "Roll-out" drawer at front. No top to lift. Usable at either side of chair. Roomy record album compartment. Available in blonde or standard mahogany.

**NOTED
 FOR
 TONE!**

**FAMED
 FOR
 PERFORMANCE**



MODEL 472-F

FM, AM and automatic phonograph in beautiful English Regency mahogany cabinet. "Roll-out" drawers for both radio and record changer. Large compartment for album storage. Outstanding Howard craftsmanship.

HOWARD RADIO COMPANY

CHICAGO 13, ILLINOIS

America's Oldest Radio Manufacturer

SEE YOUR HOWARD DISTRIBUTOR FOR COMPLETE DETAILS



Choose the changer

**TO ADD SALES APPEAL
TO YOUR INSTRUMENT**

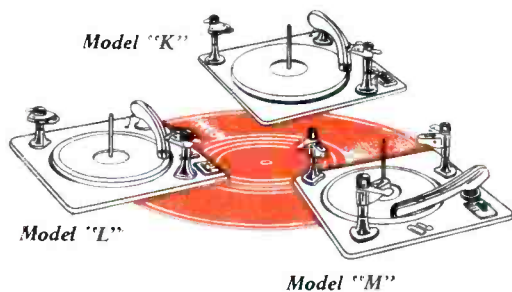

Let the record changers you select help to sell your beautiful, up-to-the-minute radio phonograph combinations by equipping them with Seeburg changing mechanisms.

The advantages you gain by installing Seeburg include simple, dependable operation . . . long, trouble-free performance . . . constant speed, free running turntable.

The Seeburg line includes three fine changers—each designed for receivers of varying price range . . . all engineered to assist you in building every possible value into your combinations. Seeburg's long and successful experience in the development of changing mechanisms of all kinds is your assurance of satisfaction.

Seeburg
RECORD CHANGERS ★ MUSIC SYSTEMS
J. P. SEEBURG CORPORATION
1500 N. Dayton St., Chicago 22

You're in the lead with RCA ...*here's why*



Completeness...RCA brings you the widest range of tubes in the field

Practically every make and model of radio you are called upon to service can be re-equipped with *standard available* RCA tubes.

When you supply a set owner with a tube he couldn't get next door . . . he becomes a steady customer! RCA's tube line has a wide range of the most popular types of tubes . . . from glass and metal types to the latest miniatures. And . . . your RCA distributor carries extensive stocks for your convenience.

In power tubes, too . . . for broadcast transmitters, amateur equipment, and industrial applications . . . RCA has the most comprehensive line in the field. A family of tubes that is setting the highest standards for quality and dependability, and accounting for universal customer preference.

"Completeness of line" is another important reason why you're in the lead with RCA! So . . . push RCA tubes and watch your business grow.

THE FOUNTAINHEAD OF MODERN TUBE DEVELOPMENT IS RCA



TUBE DEPARTMENT

RADIO CORPORATION of AMERICA

HARRISON, N. J.