

1947 JUNE

RADIO RETAILING
& Television

CALDWELL-CLEMENTS, INC.

FM • TELEVISION

RADIO

*Special
MUSIC SHOW
Number*

ELECTRICAL

APPLIANCES

PHONOGRAPHS &

RECORDS

SOUND &

SERVICE

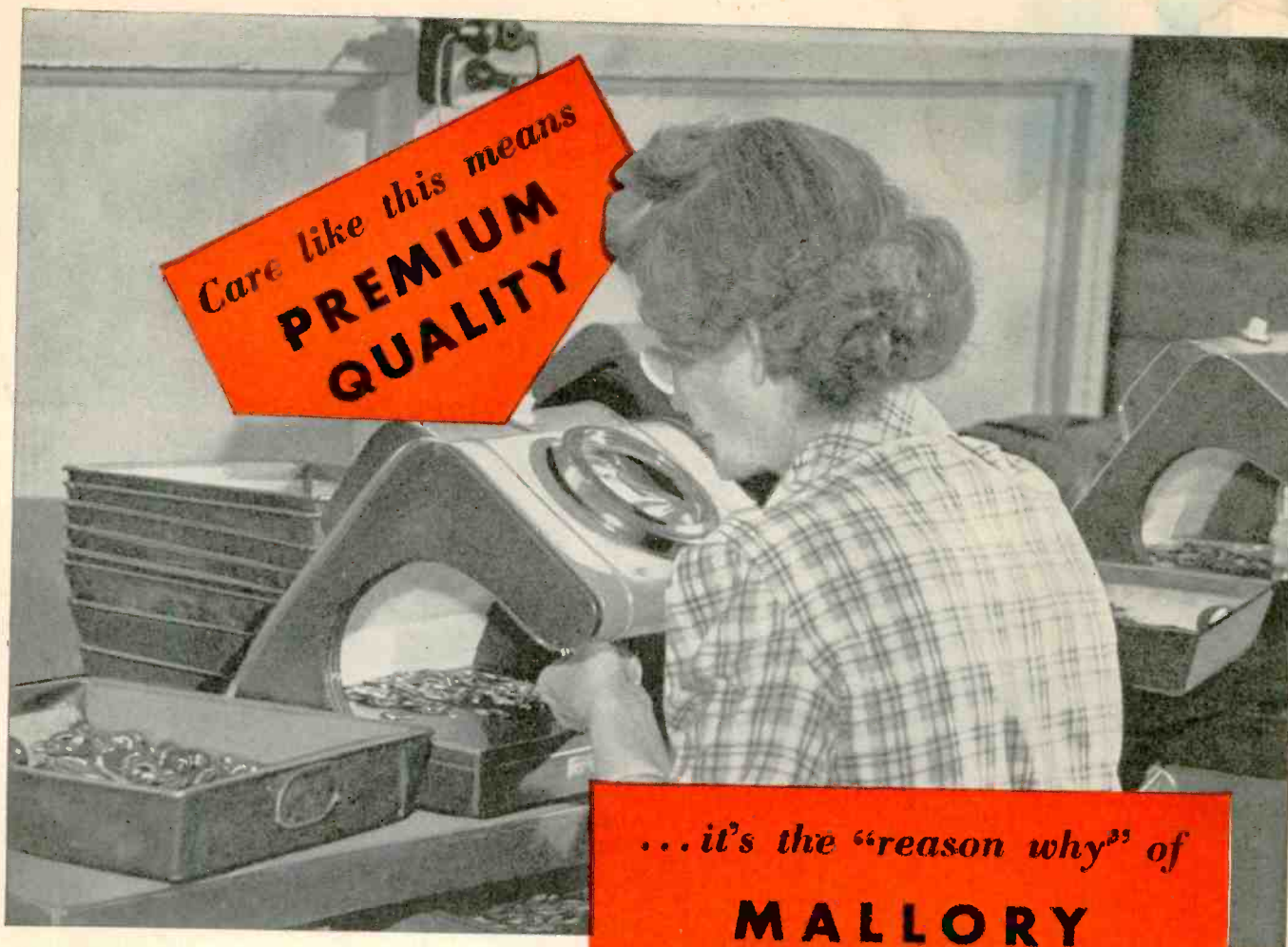

Care like this means
**PREMIUM
 QUALITY**

Inspecting metal parts of Mallory Volume Controls. Note the huge magnifying glass, used to detect possible flaws.

... it's the "reason why" of
**MALLORY
 PERFORMANCE**

Why is it that Mallory replacement controls represent premium quality to service men? Because Mallory controls are synonymous with low noise level, accurate taper construction, high humidity protection, closer tolerances—"plus values" that are "built in" during precision manufacturing operations like the one pictured.

What's more, the Mallory line is *complete*—so complete that no matter what kind of control you need, you're sure of finding it in stock. These controls are available to you through experienced distributors known for their ability and willingness to serve. What it all adds up to—what fifteen years of experience have proved—is that

YOU EXPECT MORE AND GET MORE FROM MALLORY

P. R. MALLORY & CO. Inc.
MALLORY
 VIBRATORS . . . VIBRAPACKS* . . . CAPACITORS . . . VOLUME
 CONTROLS . . . SWITCHES . . . RESISTORS . . . FILTERS
 . . . RECTIFIERS . . . POWER SUPPLIES.

*Reg. U. S. Pat. Off.

APPROVED PRECISION PRODUCTS

P. R. MALLORY & CO., Inc., INDIANAPOLIS 6, INDIANA

RADIO & Television RETAILING

Including RADIO & Television TODAY

ORESTES H. CALDWELL

Editor

M. CLEMENTS

Publisher

JOHN L. STOUTENBURGH

Executive Editor

DARRELL BARTEE

Managing Editor

HAROLD R. ELLIS

Technical Editor

RUTH MORRIS

Records Editor

M. R. LABATT-SIMON

Assistant Editor

CHARLES F. DREYER

Art Director

BUSINESS DEPARTMENT

LEE ROBINSON

Sales Manager

M. H. NEWTON

Business Manager

EDWIN WEISL, JR.

R. A. WHITE

BEN MORRIS

Promotion Manager

BETTY HALL

Production

CIRCULATION DEPARTMENT

B. V. SPINETTA

Circulation Manager

W. W. SWIGERT

Credit Manager

BRANCH OFFICES

CHICAGO 6

R. Y. FITZPATRICK, Manager

S. GASKINS DAVID J. O'ROURKE

201 N. Wells St. RAN. 9225

LOS ANGELES 5

THE ROBERT W. WALKER CO.

684 S. Lafayette Park Pl.

Drexel 4388

SAN FRANCISCO 4

58 Post St. Sutter 5568

RADIO & Television RETAILING

June 1947, Vol. 45, No. 6. 25 cents

per copy. Published monthly by Cald-

well-Clements, Inc. Publication Office

1309 Noble St., Philadelphia 23, Pa.

Editorial and Executive Offices 480

Lexington Ave., New York 17, N. Y.

M. Clements, President; Orestes H.

Caldwell, Treasurer. Subscription rates

United States and Latin American

countries \$1.00 for one year, \$2.00 for

three years. Canada \$1.50 for one

year, \$3.00 for three years. All other

countries \$2.00 for one year, \$4.00 for

three years. Printed in U. S. A.

Entered as second class matter March

20, 1947, at the Post Office at Phila-

delphia, Pa., under the act of March

3, 1879. Member of Audit Bureau of

Circulations. Copyright by Caldwell-

Clements, Inc., 1947.

*Trade-Mark Reg. U. S. Pat. Off.

IN THIS ISSUE

JUNE, 1947

★ *Radio, FM, Television*

COVER—The Big Four
 EDITORIAL—Visits to Manufacturer and Jobber... 37
 WHAT'S AHEAD IN RADIO APPLIANCES, RECORDS AND TELEVISION... 38
 1947 MUSIC TRADE SHOW... 42
 DISCOUNTS—LONG OR SHORT... 44
 DOOR TO DOOR SELLING... 46
 SERVICE AS A FEEDER FOR SALES... 48
 NEW SETS ARE SALES CLINCHERS... 50
 DEALER CASHES IN ON TELE... 52
 YEAR 'ROUND MERCHANDISING... 56
 MORE NEW RADIO LINES... 58

★ *Records, Phonographs, Accessories*

COVER—Platter Profit Pointers... 61
 SELF SERVICE PLUS... 63
 NEW RECORDS FOR MORE SALES... 64
 THE MUSIC CENTER UPS DISC SALES... 66
 LEADING TUNES... 70
 NEW PHONO LINES... 72
 NEWS OF THE RECORD INDUSTRY... Starts on page 74

★ *Electrical Appliances*

COVER—How Do You Treat the Tinkerer... 91
 USE THOSE DEALER HELPS!... 93
 BIG PROFITS FROM SMALL APPLIANCES... 94
 WHAT'S NEW IN LIGHTING... 96
 SERVICING ELECTRICAL HOME APPLIANCES... 98
 NEW ELECTRICAL HOME APPLIANCES... 100
 DEALER PROFIT MAKERS... 102
 NEW APPLIANCE ITEMS... 104
 NEWS OF THE INDUSTRY... Starts on page 106

★ *Service and Sound*

COVER—Dealer Service Groups... 111
 PA IN THE "SHOW BIZ"... 113
 SPEED UP AUTO RADIO INSTALLATIONS... 114
 CIRCUIT POINTS ON NEW SETS... 116
 NEW AIDS FOR FASTER REPAIRING... 120
 MORE ON FIXING METERS... 122
 NEW TELE HV CIRCUITS... 126
 NEW ITEMS FOR SOUND PA PROFITS... 130
 SALES TIPS AND PROFIT POINTERS... 136
 FM SALES TRENDS... 138
 TELEVISION TOPICS... 140
 JOBBERS IN ACTION... 142
 GENERAL INDUSTRY NEWS... Starts on page 143



**29,000 COPIES
THIS ISSUE**

Member of
AUDIT BUREAU
OF CIRCULATIONS

CALDWELL-CLEMENTS, INC. 480 LEXINGTON AVE., NEW YORK 17, N. Y.

TEL.: PLAZA 3-1340

STRETCHING FOR THREE SQUARE BLOCKS across the New Jersey landscape at Belleville, is a dream factory — a triumph of plant construction — lighted, temperature controlled and air conditioned in the ultra-modern manner. It is fitting that America's most advanced radio — FADA — the radio of tomorrow . . . today should be produced in such a plant.

EACH FADA RADIO is precision made on vast production lines. Every device known to engineering science is used to test each FADA part — to make sure that no radio receiver is superior to FADA, in tone, quality, performance, styling and appearance . . . to make sure that FADA receivers are as salesworthy as they are trustworthy!

NOW — MORE THAN EVER, you can place your faith in the year-in and year-out sales appeal of FADA radios. Look to FADA for the finest; the radio of tomorrow . . . today.

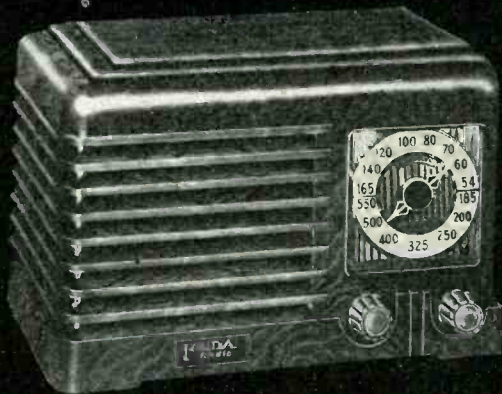

MODEL 740

AC-DC Superheterodyne in gleaming urea, ivory or walnut bakelite cabinets. Full size chassis; not a miniature. Extra heavy cabinet for durability. The last word in value.



MODEL P80

Fada "Personal" Tri-powered portable receiver. AC-DC Superheterodyne. Combines unusual sensitivity and performance. In gleaming ebony, translucent maroon and gorgeous ivory and bakelite cabinets (small — compact; light in weight).

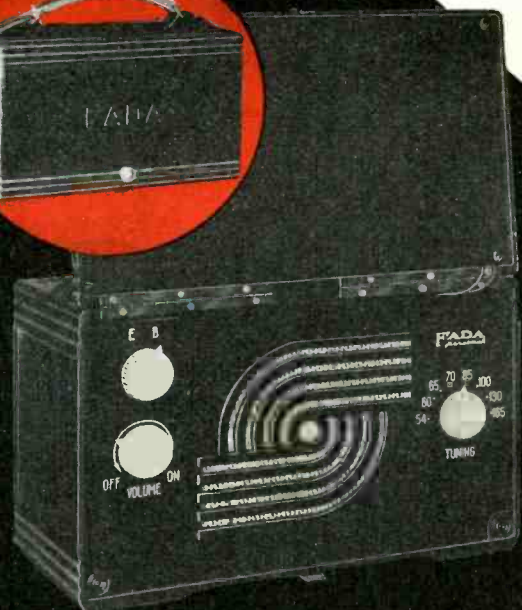

FADA Radio

THE HOME OF
FADA Radio
 Radio of Tomorrow...Today

Just a few of FADA's newest models are illustrated here. More on the way!



MODEL 700
 AC-DC Superheterodyne Table Model in exquisite "FADA-Lucent" cabinets in a variety of smart colors. For good looks and compelling value, this model has no equal anywhere.



MODEL 711
 AC-DC Superheterodyne Table Model. Gleaming "FADA-Lucent" cabinets in attractive colors to blend with any decorative color scheme.



MODEL 605 W AND V
 AC-DC Superheterodyne in lustrous ivory or walnut plastic cabinets. A modern receiver with superb performance — certain to attract volume sales.



MODEL P100
 Tri-power portable AC-DC Superheterodyne Hi-Gain "Sensive-Tone" tuned R.F. stage. Built to pull in stations at great distances with clarity and unsurpassed tone perfection. 3 gang condenser. Simulated leather wood cabinet.

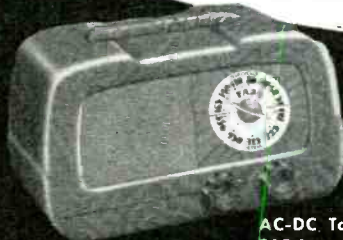

MODEL 1005
 AC-DC Table Model . . . a unique FADA creation employing polished Styrene cabinets in rich decorative colors.

FADA RADIO & ELECTRIC COMPANY, Inc.
 BELLEVILLE, NEW JERSEY

Merit's doubly-enlarged plant,
most modernly equipped, gives
widest play to engineering de-
sign, as well as production.
These are facts for your satis-
faction in your transformer
needs.

MERIT QUALITY.

MERIT COIL & TRANSFORMER CORP.
TELEPHONE
4427 North Clark St. Long Beach 6311 CHICAGO 40, ILL.

Television Is —Are You? . . .

If you're in one of the rapidly growing television areas, you'll want to study this column carefully.

The television boom which has been "just around the corner" for ten years or more, looks as if it will really arrive this Fall. Ten cities now have telecasts, more and more TV receiving sets are being produced, considerable consumer promotion is scheduled to begin in September, and enough tele stations have been authorized so that, when completed, they'll cover a large part of the U. S. population.

But just as trains need tracks on which to run, so does television need enough well-trained and equipped dealers to see that it is properly sold, installed and maintained. For tele knowledge is not something that the average radio and service retailer can *feel* he knows. It requires special study, special equipment, and a special recognition on the part of local customers that *their* retailer *has* all these. Unless the retailer does, he'll lose out on the tele boom.

- **Tele installation:** What kind of antenna should be used in the individual family houses and in the apartment houses in your area? In crowded cities, where tele's greatest immediate future lies, how would you proceed to avoid multi-path reflections, and adequately receive stations transmitting from several compass points? How can you make a good original installation, to cut down on call-backs and later trouble? Can you clearly explain the 15 or more controls or adjustments to your customers?

- **Tele servicing:** Special equipment is necessary. Do you have some or any of the following: a wide-band oscilloscope, an i-f and r-f sweep generator, a marker generator, a square wave generator, a high voltage tester? These are among important items you'll need for a properly equipped shop. And, would you know how to use these tools?

- **Tele selling:** Have you attended any courses given by manufacturers or distributors on selling tele? Do you know the sales appeals when sight is combined with sound? Or will you merely use glib phrases that, more than anything else, reveal to customers "this dealer doesn't know what he's talking about"?

Television offers excellent profit-making opportunities for dealers. But already a shortage exists of well-trained personnel to sell, install and service it. Chances are someone in your neighborhood will get, or already has, a flying start because he is well equipped with knowledge, equipment and merchandise. Plan now to be the dealer whose store is Television headquarters in your community. And in the meantime, remember there's a big job to do *now* on F M.

The Publishers



The wolf never fooled Red Riding Hood!

WE NEVER went for that one about the wolf fooling Red Riding Hood.

Most of the girls we know handle wolves pretty well . . . and Grandmother's disguise would have fooled them about as long as it takes to say Sparton Co-operative Merchandising Plan!

The S.C.M.P.* was our answer to the wolves that have been lurking in the forest of post-war radio retailing. Pretty rugged wolves they've been, too—price cutting, unfair trade-ins, unequal advertising support, multiple mark-ups, dumping, and over-franchising—all of them merchandising headaches the Sparton dealer has happily missed.

In advertisement after advertisement Sparton has pointed out the probable reappearance of these pre-war stumbling blocks—

pointed out, too, that the Sparton franchise, based on the S.C.M.P.* was planned specifically to eliminate them.

Results? *Plenty!* . . . Sparton national advertising works exclusively for each Sparton dealer . . . leads customers to his door and his door alone . . . for his is the only franchise in his community. Sparton retail prices are uniform. Sparton factory prepared promotional helps are individualized. Seasonal promotions break at the same time.

Study the features of the S.C.M.P.* and you'll agree, too—with thousands of Sparton dealers everywhere—

It *pays* to be a Sparton dealer!

THE SPARKS-WITHINGTON CO., JACKSON, MICH.
Radio and Appliance Division—Plant 5

ONE *Sparton*
DEALER
in each community

Check These
Profit-Increasing Features

- One exclusive dealer in each area
- National advertising that works locally
- Direct factory-to-dealer shipment
- Low consumer prices
- Factory prepared and distributed promotion helps
- Seasonal promotions
- Uniform retail prices
- Products styled by outstanding designers

Sparton

Radio's Richest Voice Since 1926

* **S·C·M·P·** SPARTON CO-OPERATIVE MERCHANDISING PLAN. A proven exclusive method of profitably retailing radios and home appliances that has been and is being advertised regularly to consumers in leading magazines.

marks the spot for a
Motorola Radio in this
 new, California style home

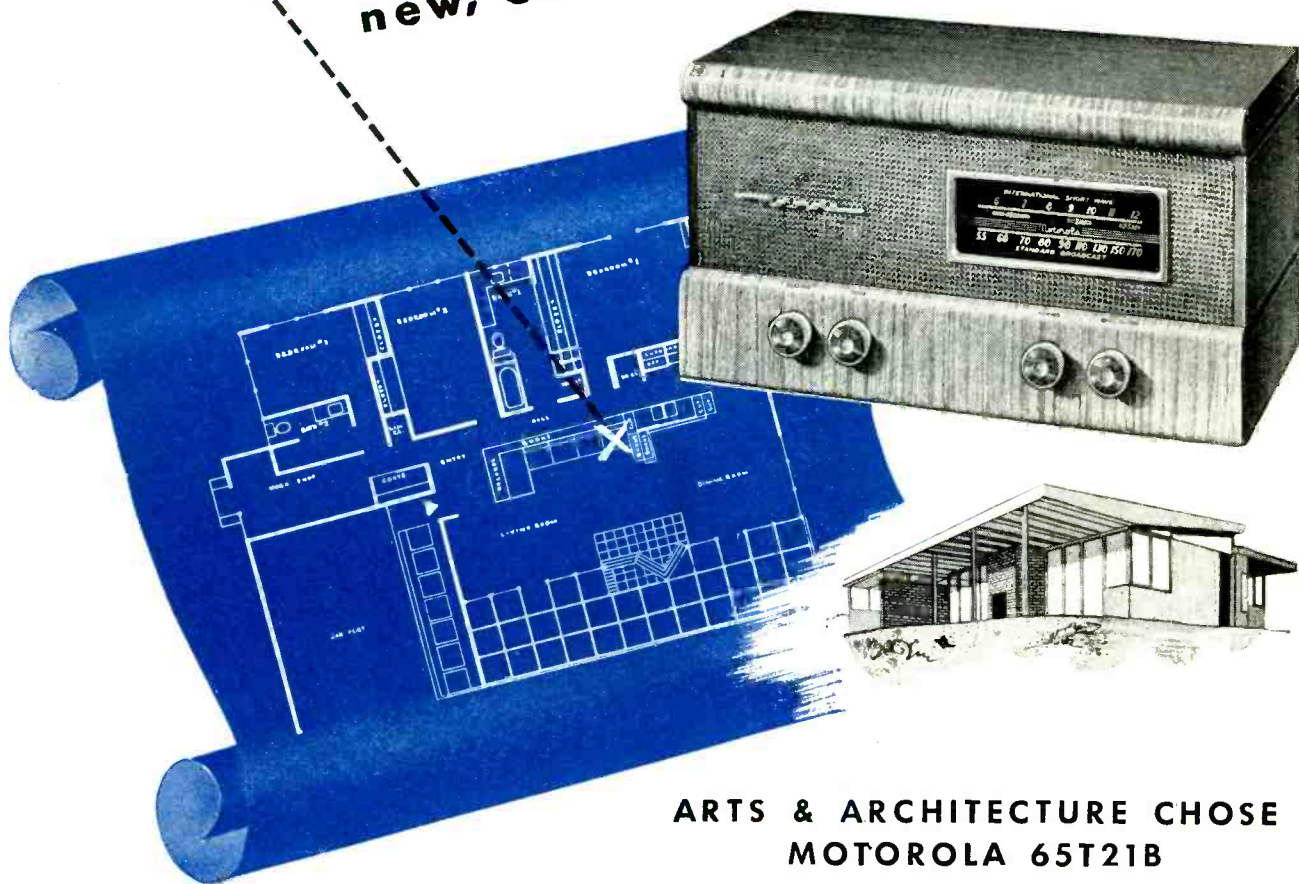

ARTS & ARCHITECTURE CHOSE MOTOROLA 65T21B

The Case Study house program of Arts & Architecture is a spectacular success. The public, we hear, is tremendously excited and housing experts from coast to coast have indicated that "These are the homes of tomorrow... livable, lovable and economical..."

Motorola Radios have been an integral part of the furnishings scheme of the designers responsible for the Case Study homes because Motorola Radios are... to quote a member of the Arts & Architecture staff... "The finest commercial radios we have ever seen."

Dealers everywhere are displaying and demonstrating the complete line of Motorola Radios... the perfect gift for every occasion.

merit specified



MOTOROLA INC. • CHICAGO 51, ILLINOIS

ABLE RADIO SERVICE

KEN-RAD RADIO TUBES



**"QUALITY TUBES
make my clients' sets play better.
...That's why I install and sell KEN-RADS!"**

THERE'S real satisfaction in knowing that the owners of radios you've repaired will be *pleased customers*. And your income will benefit accordingly, for repeat business makes your cash register sing a merry tune indeed!

When you install Ken-Rad Quality Tubes, you've taken the first step toward building a clientele of friendly boosters. Continuous General Electric and Ken-Rad research assures a product superior in tone-performance. Scientific large-scale production gives *uniformity*—Ken-Rad tubes do what their ratings call for.

High now, the graph of Ken-Rad tube performance keeps climbing. Great facilities in laboratory study and development, its designing skill, in manufacturing know-how, join to create a product that grows steadily better—one that remains ahead, both electrically and in length of usable life.

Anchor your repair business to *customer satisfaction* by installing and selling Ken-Rads! Then use the brilliant, effective 1947 Ken-Rad displays and other sales aids to enlarge your list of new clients. That is the tested recipe for **PROFITS!**

178-F5-8880

● Write for Booklet ETR-62, which pictures and describes Ken-Rad's outstanding group of 1947 displays, counter-cards, and other sales aids for tube dealers and service-men. Here are brand-new pieces that will do a real job of promoting your business and increasing your profits! Send for Booklet ETR-62 today!



KEN-RAD

DIVISION OF GENERAL ELECTRIC COMPANY
SCHENECTADY, NEW YORK

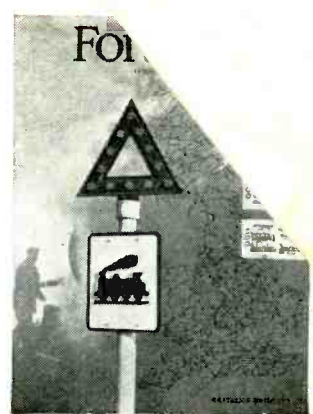
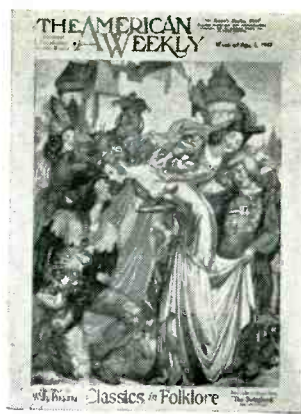
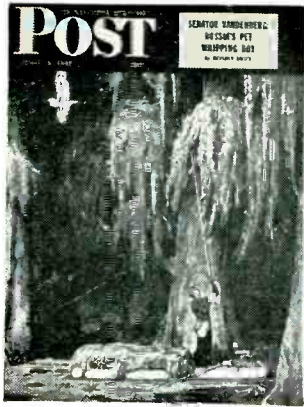

1,000,000,000 MESSAGES

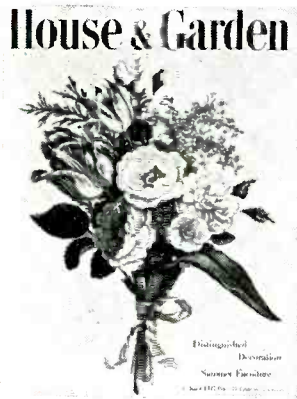
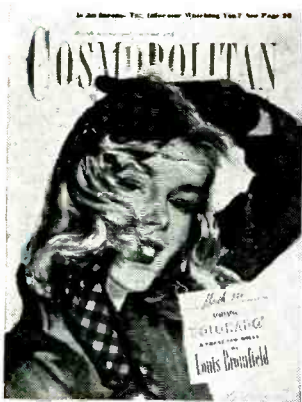

**WATCH FOR
THE MONTHLY
FEATURES IN
FACTORY MAILINGS**

Largest List of National Magazines Ever Used

Never before in the radio industry has there been such a mass advertising schedule in leading national magazines.

Emerson

In a continuous, hard-hitting series of dramatic advertisements—with powerful point-of-sale promotion—Emerson Radio is promoting the merchandising and profits of all Franchised Dealers.

Lead with the

EMERSON RADIO AND PHONOGRAPH CORP., New York 11, N. Y.

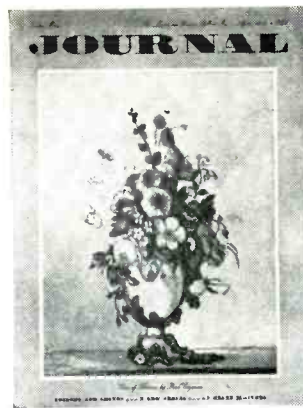
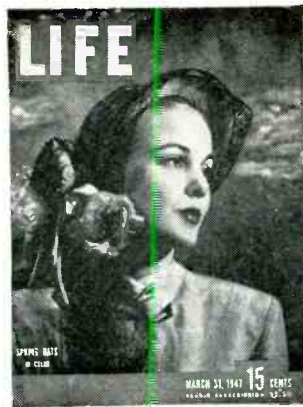

BACKING NEW LOW PRICES

Featuring Emerson Radio Sets of the Month

Every week — every month — it spotlights a selected group of Emerson Radio sets and boosts the entire line.

Radio



Supplementing the recent announcement of **NEW LOW PRICES** of selected models, this campaign is a **VOLUME BUILDER** for the entire trade. Ask your Emerson Radio distributor how you can capitalize it.

Leader in '47

WORLD'S LARGEST MAKER OF SMALL RADIO

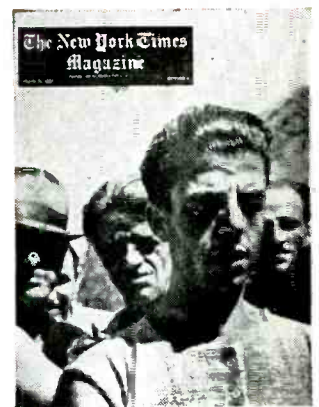

TIE UP WITH THIS MIGHTY PROMOTION IN YOUR BEHALF

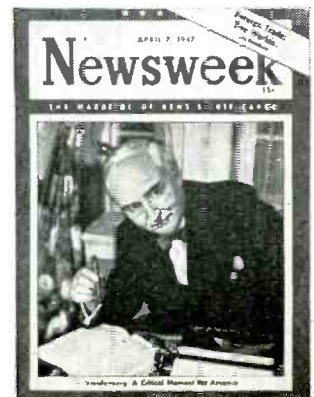
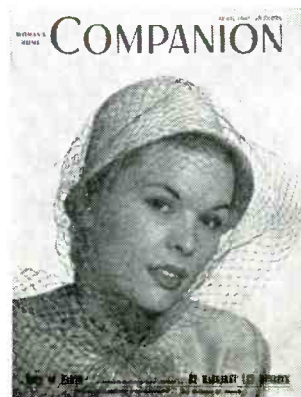



Manufacturer enthusiastically adopts Plan



Okays proofs for new campaign



Mrs. Chicago sees ad with dealer's name in Tribune

Get the Jump
on competition
 WITH THE CHICAGO TRIBUNE'S
 SELECTIVE AREA ADVERTISING PLAN



Mr. and Mrs. Chicago hurry to dealer and buy!

Identifying your local outlets — prominently — can pay fast dividends and build a stronger selling organization. The Chicago Tribune's Selective Area Advertising Plan does this for you. Under this plan—

EACH DEALER GETS:

- 1** Selective coverage of his local market
- 2** Prominent display of his name and location
- 3** The low rate of just 2½¢ a line!

YOU GET:

- 1** Better identification of your local outlets
- 2** Enthusiastic dealer support
- 3** Advertising that pays off right away!

Not only do you steal a march on competition, but you can corral more of the Great Chicago Market . . . a market so large it can take all or the greater part of the production of many manufacturers. This plan will make more valuable to you the exhaustive findings of the Tribune's Durable Goods Study among dealers and consumers.

To learn how it will meet your specific needs, write your nearest Tribune representative as shown below.

For quick, effective coverage of the Great Chicago Market, there is no medium quite like the Chicago Tribune. 63.4% of the \$414,757,552 volume for home appliance purchases during the first year they are available will be spent by Tribune-reading families. Rates per line per 100,000 circulation are among the lowest in America.

Chicago Tribune

The World's Greatest Newspaper

April average net paid total circulation:
 Daily, over 1,040,000; Sunday, over 1,500,000

- A. W. Dreier, Chicago Tribune
810 Tribune Tower, Chicago 11
- E. P. Struhsacker, Chicago Tribune
220 E. 42nd St., New York City 17
- Fitzpatrick & Chamberlin
155 Montgomery St., San Francisco 4
- W. E. Bates, Chicago Tribune
Penobscot Building, Detroit 26

MEMBER: AMERICAN NEWSPAPER ADVERTISING NETWORK, INC., FIRST 3 MARKETS GROUP, AND METROPOLITAN SUNDAY NEWSPAPERS, INC.

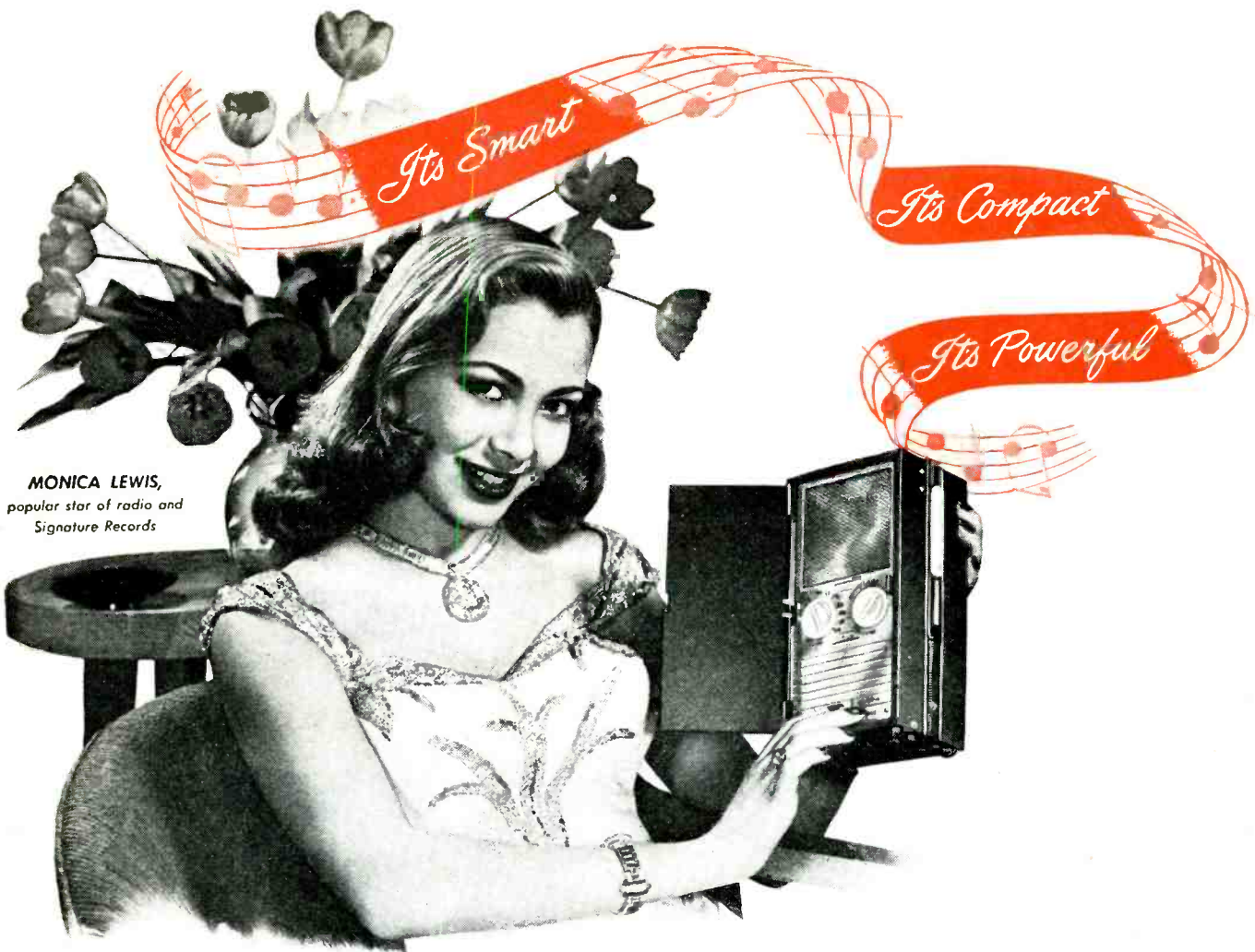

MONICA LEWIS,
popular star of radio and
Signature Records

Plus sales... with the ideal gift for all occasions!

*New 3-way
Personal
Radio*



RING up extra sales by selling this attractively priced 3-way G-E personal radio as a gift for graduation, for birthdays, for every occasion. Every one of your customers going on a vacation is a hot prospect, too.

It's a set you can sell with pride. Plays on a-c, d-c, or batteries. Gang condenser tuning. Amazing tone. Sturdy case—smart as a Hollywood fashion—remarkably low-priced.

For full information, see your G-E Radio Distributor or write to Electronics Department, General Electric Company, Bridgeport, Conn.

LEADER IN RADIO, TELEVISION AND ELECTRONICS

GENERAL  ELECTRIC

175-98

PORTABLES • TABLE MODELS • CONSOLES • FARM SETS • AUTOMATIC PHONOGRAPH COMBINATIONS • TELEVISION

Listen IT'S A New Jensen SPEAKER

MODEL HNP-51 Coaxial with frequency range control adjusts performance to program quality

For home entertainment, studio, monitoring and moderately high-level sound reinforcement Jensen Model HNP-51 Coaxial has no equal at any price. Actually it is a loud speaker "system" consisting of two loud speakers and a frequency-dividing network. Frequency selector switch permits adjustment to program quality and insures correct frequency response whether operating with "FM," "AM," phonograph records or transcriptions. Cut-away section shows how precision construction and workmanship is combined with the achievement of Jensen engineering traditionally committed to the highest standards in the acoustic industry. The result creates another superlative Jensen product heading the family of Jensen Coaxial speakers ranging in price from \$30.00 to \$125.00.

All Jensen Coaxials are available in a variety of "Bass Reflex" Cabinets to make complete Reproducers. List prices of complete reproducers range from \$84.00 to \$212.00.

Ask for Data Sheet No. 136 and get complete information about Jensen Coaxial Speakers and Reproducers—all are now ready for immediate delivery. A new 24-page Jensen Catalogue also awaits your request.

*Trade mark registered

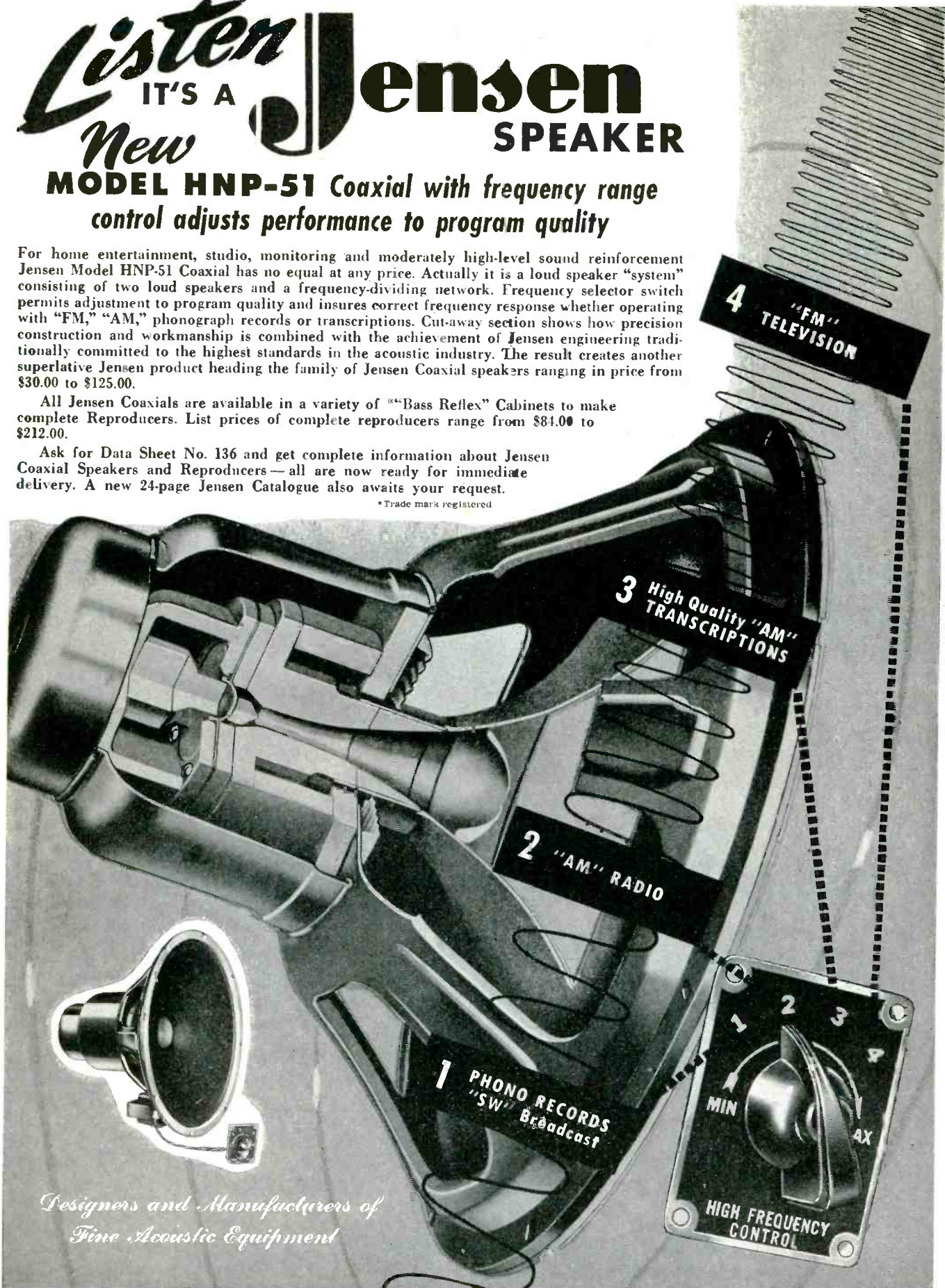

*Designers and Manufacturers of
Fine Acoustic Equipment*

**JENSEN MANUFACTURING CO., 6625 S. LARAMIE AVE., CHICAGO 38, U.S.A.
IN CANADA: J. R. LONGSTAFFE, LTD., 11 KING STREET, TORONTO**



\$48.85
INC. FED. TAX
PLUS BATTERY

THE SONORA ALL-ROUNDER—20,600,000 readers of five of America's major magazines will see SONORA's sales-packed ad on this model—will be eager to hear its matchless "Clear as a Bell" tone... see its eye-catching beauty. More than just a portable, the ALL-ROUNDER is large enough to give complete *big-set performance*, light enough to carry *anywhere*. Covers the full standard broadcast band. Plays from a self-contained battery pack, AC and DC. This beautifully designed two-tone model is your profitable answer to the huge demand for portables. 12" wide, 9" high, 6" deep. Get full details today!

The choice
in '47 is
Sonora
Clear as a Bell
with
"Clear as a Bell"
Tone



Combination in Ivory Plastic
\$42.95 LIST, INC. FED. TAX

Combination in Walnut Plastic
\$39.95 LIST, INC. FED. TAX

THE SONORA SERENADE—Take profitable advantage of the demand for compact phono-radio combinations with this sleek, nationally advertised SONORA model in gleaming white plastic. Reproduces records and plays full standard broadcast band with famous "Clear as a Bell" tone. Phonograph equipped with new type lightweight pick-up arm. No aerial or ground required. Get your share of the big phono-radio business with the *exceptionally low-priced* SONORA Serenade!

Sonora
Clear as a Bell

HOME ENTERTAINMENT AT ITS BEST

SONORA RADIO & TELEVISION CORP.
325 North Hoyne Avenue • Chicago 12, Illinois

RADIOS • FM • TELEVISION SETS • RECORDS • PHONOGRAPHS • RECORDERS



How to splice that split decision

If you're at the end of your rope wondering how to match a husband's practical viewpoint of appliances with his wife's intuitional analysis (object: family sale!) here's something to think over. The American Magazine's famous "split decision" presents no problem at all to that greatest little splicer in the world . . . the Crosley line. You're asking why? Well . . .

let's take *HER* side
on the question of refrigerators

then take *HIS* side

on the question of refrigerators



The Crosley Shelvador* tickles every woman's love-of-beauty spot. Its style and finish are all but breathtaking. And that Shelvador!* So much extra front-row shelf space—that practically hands things to a busy woman. THAT is the everybody-else-no-got feature of the Crosley. It's a feature that works for a woman hundreds of times every day—day in and day out. Along with this champion of convenience features are the Crosley double crispers, the roominess of the food compartment, the big ice cube capacity, the non-tipping shelves.



*Trade Mark Reg. U. S. Pat. Off.
†Patented

Hmm — that mechanism! That's where a man's practical nature lands first — QUIET! Must be a fine job of precision workmanship. Sealed for life with its supply of lubricant. Warranted for five years. Rugged hardware—and good looking lines, too. The door of Shelvador* swings light as a feather. That door latch actually pulls the door snugly and silently shut. Swell job! Heavy-duty construction—finished off like a high-priced watch. Well, how-do-you-like THAT?



And THAT'S how the "split decision" gets UNSPLIT and spliced! That's how YOU get the nod from those bi-focal buyers—Mamma and Papa America!

SHE SAYS, "THE RANGE IS *MY* BABY!"



A range is for cooking . . . and nuthin' else but! These Crosley models do it by gas, or electricity. But the waist-high broiler is the sockeroo for the girls! That get's 'em. No more standing on your ear to get a broiling job done. BIG oven! Fast surface units. And what soul-satisfying styling and eye-full appearance.

HE SAYS, "WE'LL SEE ABOUT THAT!"

Single core construction! Like a sky-scraper, eh? Yes, sir, that appeals to MY unerring mechanical instinct. Nice door mechanism—smooth, quiet! I can always pick out real workmanship, every time. By golly, THERE'S a range that is put together right! Takes a practical mind to understand such things.

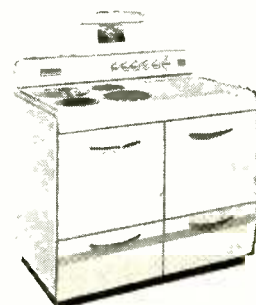

when it comes to the
complete planned kitchen . . .

SHE HAS IDEAS; YOU CAN BET ON THAT!

FURNISH YOUR KITCHEN!—that's the Crosley system and I'm for it! No building jobs. Fit units right into your kitchen space just the way you want 'em. Big or small, long or wide—no matter. A place for everything right where you want it. That sink! Busiest spot in the kitchen, and keeps everything you need right at hand. And knee-room that enables you to sit comfortably while you work!



HE KNOWS HIS WAY AROUND KITCHENS, TOO!

Look at those full-lined doors! That's real construction. Finished smooth as a silk glove! Quiet! Bonderized, you said? That means no rust. Sound-deadened, too? Great! I hate a rattley sink. Hmm . . . I'd go for this. And those swell looking cabinets, easy sliding glass doors, ready to hang up like a picture. That makes sense to me. Could even move 'em if we wanted to. Yes, sir, the most practical kitchen idea a practical man ever saw.

THERE'S PERFECT HARMONY ON RADIO AND RECORDED MUSIC

That soprano chimes in, "What lovely tone . . . how nice there's no needle noise . . . that smart styling will blend in perfectly with our other furnishings . . . why, there's a model for every room in our home."

You see, she instinctively selects characteristics that mean sweet music to her . . . and that means sweet business for the Crosley dealer.

Here's the bass: "The Crosley Floating Jewel Tone System, with a permanent sapphire stylus that plays on sides of record grooves, virtually eliminates scratching? Swell! Master Tone Control with 64 tonal combinations? That's it! Crosley FM . . . plus the finest electronic engineering backed up by precision manufacturing? Sure, Crosley's a sound buy here, too!

Patented



and that's how split
decisions are spliced—
the Crosley way!



Talk about a happy blending! The Crosley line certainly gives you a grand combination of appeals for both men and women. So when a family shopping expedition walks into a Crosley dealer, split decisions are spliced in a hurry. Everyone's happy . . . including the dealer!

Refrigerators • Home Freezers • Kitchen Sinks and Cabinets • Ranges • Laundry Equipment • Radios • Radio-Phonographs • FM • Television • Short Wave • Radar • Home of WLW, "The Nation's Station."

CROSLEY

Division — **AVCO** Manufacturing Corporation
Cincinnati 25, Ohio

Dizzy over Battery Inventory?

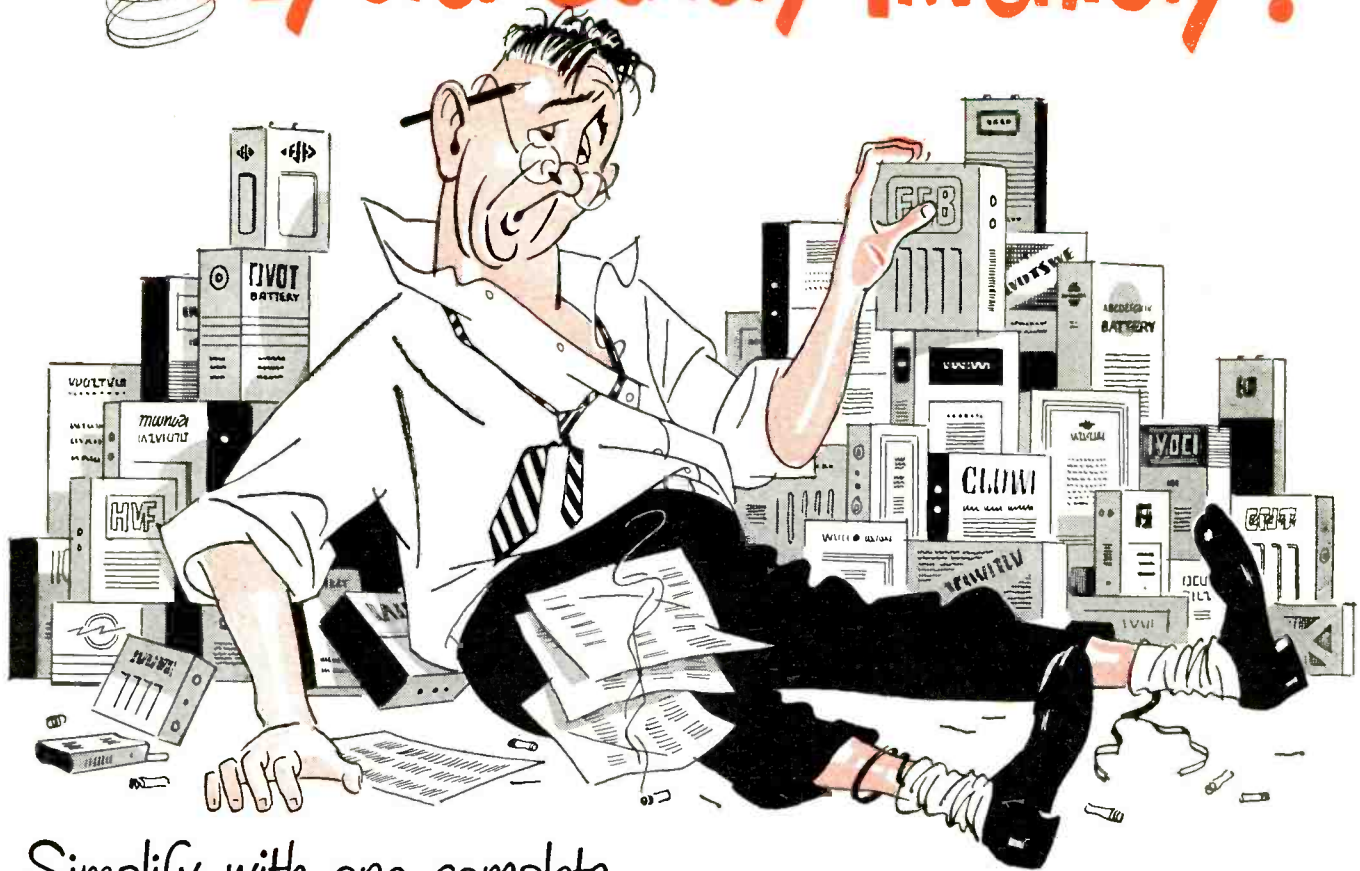

Simplify with one complete line—**"EVEREADY" RADIO BATTERIES!**

IF YOUR shelves are so jammed with odd-brand radio batteries that the mere thought of taking inventory makes you want to grab for a headache powder—here's a tip:

"Eveready" radio batteries will fit virtually all makes of sets on the market. Moreover, the famous "Eveready" trade-mark is so well known

that customers want these batteries the minute they see them...no long sales talk needed! And "Eveready" "Mini-Max" batteries will outlast any other "B" batteries of comparable size.

Standardize on "Eveready" radio batteries...simplify your stock with *one* complete line...increase your sales and profits!

The registered trade-marks "Eveready" and "Mini-Max" distinguish products of National Carbon Company, Inc.



NATIONAL CARBON COMPANY, INC.
30 East 42nd Street, New York 17, N. Y.
Unit of Union Carbide and Carbon Corporation



Go to a Radio Manufacturer for Radios — a Battery Manufacturer for Batteries!

**MORE VALUE
SENSATIONS.....from**

Admiral



7T10C Big! Powerful! Such a TREMENDOUS package for the price that it's putting Admiral dealers 'way out ahead! Lovely ebony, mahogany or ivory cabinet in polished plastic. AC-DC.

\$19⁹⁵
Ebony



7T01 Here's amazing radio reception in an exquisite plastic cabinet. Picks up distant stations easily. "S-t-r-e-t-c-h" dial. Smart louver grille. Gleaming ebony, mahogany, or ivory. AC-DC.

\$22⁹⁵
Ebony



7T04 Unmatched for tonal quality and beauty. The perfect small radio for any room. "S-t-r-e-t-c-h" dial. Superb solid wood cabinet in modern two-tone natural and walnut finish. AC-DC.

\$29⁹⁵



Portable Pleasure..

Admiral
"THIN MAN"
PORTABLE RADIOS

7P34 New! A portable radio patterned after the finest luggage. Exclusive saddle-stitched, lightweight case in richly grained leatherette. Triple-tuned R.F. circuit assures amazing performance. Travelscope for plane, train, or ship (optional at extra cost). AC-DC-Battery.

\$54⁹⁵

7P33 A style and value leader . . . fit companion for the stunning 7P34 in boosting portable sales. Lightweight, richly grained leatherette case. Triple-tuned R.F. circuit. Travelscope for plane, train or ship (optional at extra cost). AC-DC-Battery.

\$49⁹⁵

Brilliant New Models from

Admiral

EACH A MONEY SAVING TRIUMPH!

EACH A RECORD PLAYING SENSATION!

EACH WITH MIRACLE TONE ARM!



7C73 Admiral proud AM-FM radio and a brilliant tone is a record loading. Stat tuned throughout for chassis. Dual R.F. Bass boost. AM an speaker. Tilt-tuning Cabinet of choices Walnut, Mahog Bleached.

(Note: All prices slightly higher in Western zone.)

Wartime Secret Formula Makes Possible NEW MIRACLE Tone Arm

Plays records like magic! You'll hear never imagined were there! Even old come to life with brilliance unmarred scratch, "talk back" or other disturbance. In Admiral's new *Miracle Tone Arm*, you'll be greatest advance in high fidelity record reproduction since invention of electrical recording itself. Uses no coil, no crystal no special tube! Nothing to deteriorate and thus distort tones. Retains its ultra-sensitivity for years! No needle to no tricky adjustments. Music lovers are won by a single disc.



7RT43 (6 Tubes) Those who demand perfection will take this glorious automatic radio-phonograph to their hearts. Here is the world's best table combination unexcelled for the home, parties, schools, clubs. 5 tubes *plus* rectifier for reserve volume. Variable tone control. Bass compensation. In matchless walnut or mahogany veneers *hand-rubbed throughout* to give beautiful life-long luster. **\$99⁹⁵**



7RT42 (6 Tubes) Exciting new features make this superb automatic radio-phonograph a fast selling item. 5 tubes *plus* rectifier give great volume. Variable tone control. Bass compensation. Wedge-edge cabinet in topgrade walnut veneers. High luster *hand-rubbed* cabinet top. **\$89⁹⁵**



7RT41 (6 Tubes) Automatic radio-phonograph. Styling, rich tone an exceptionally engineered through *plus* rectifier. Variable Bass compensation. any plastic cabinet money-saving value that is rocking the industry back on its heels.

7RT41

FM *at its best*

(Frequency Modulation)

Frequency Modulation as developed by Admiral offers all the well known benefits of FM—PLUS several additional advantages, thanks to Admiral's sensational "ratio detector" FM circuit. To mention only two: (1) absolute freedom from between-station noise while tuning; (2) far simpler identification and rejection of false tuning points. Both features are easily demonstrated on your floor by Admiral's quicker, easier, more positive tuning. Truly, FM at its newest and best!

Admiral Corporation

CHICAGO 47, ILLINOIS

World's Largest Manufacturers of Radio-Phonographs
With Automatic Record Changers



ly presents a peerless achievement in automatic record playing. To listen to a thrilling experience. Easy full view, ic-free FM reception. Permeability-maximum sensitivity. Rugged dual stage. Variable tone control. Super d FM Aeroscopes. 12" Auditorium Lucite dial. Record storage space. t veneers: any, or **\$289⁹⁵**

ir tones you
dest records
d by needle
ing surface
offering the
ce the inven-
, no filament,
original true
o change...
emonstration!

A compact auto-
nograph with every-
mend it... tasteful
e and great volume,
low price. Precision-
ghout with 5 tubes
variable tone control.
on. Gleaming mahog-
inet. A tremendous
g
x-
y
s!



7C62 America's *lowest priced* nationally advertised console model radio-phonograph combination! Dynamic speaker—bass boost and other engineering achievements. Beautiful walnut veneer cabinet. An amazing value that's taking the public by storm!

\$129⁹⁵

7C63 An AM-SHORT WAVE triumph... PLUS automatic record playing. Two short wave bands. Magna Band for easy foreign tuning. Bass boost. Powerful 10" dynamic speaker. Fast, simple full view record loading. Exquisite walnut veneer.

\$189⁹⁵

~~79⁹⁵~~

\$69⁹⁵

VISIT ADMIRAL AT THE MUSIC SHOW PALMER HOUSE, CHICAGO, JUNE 2 TO 5, ROOMS 642-4

P-S-T!

You get all three in



Performance

Style

Tone

**SENSATIONAL
NEW...**

Admiral

AUTOMATIC RADIO-PHONOGRAPHS

WITH *MIRACLE* TONE ARM



See inside spread for Sensational Values!

MAKING TUBES IS

Easy

IF YOU KNOW HOW!



Life racks (sides) and voltage distribution panels (rear) at Hytron's Newburyport plant. Up to 2880 tubes can be life-tested simultaneously.

TO GIVE YOU TUBES THAT LIVE LONGER

Tubes are like folks. Some live longer than others. That is why you are protected by your Hytron service guarantee. More important to you, statistical information amassed by continual life testing provides Hytron engineers with the means to control and extend the life of the average tube.

Of necessity, life tests are limited samplings. An adequate number of tubes from each day's production are plugged into life racks. Positive potentials are patched in from distribution panels. The life racks themselves supply other potentials. Time meters count the hours of operation. Cycling controls permit adjustable intermittent tests. Repetitive, paralleled circuits, such as those diagramed, simulate worst-possible maximum operating conditions.

Tubes run to predetermined life test end points — adequate to control deterioration of characteristics during normal life. At frequent intervals, engineers check important characteristics like transconductance, gas current, and power output. Special dynamic life tests help determine ratings and overload capabilities of newly developed tubes. For example, the 5516 was life-tested intermittently and continuously at 160 mc.

Life will vary from tube to tube. But such careful, persistent checking makes it much easier to assure you of uniform Hytron tubes which live longer.

STATIC LIFE TEST — 6SK7GT

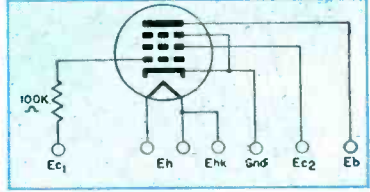

Static class A amplifier with fixed bias, maximum operating potentials, and heater-cathode potential to test breakdown of h/k insulation.

DYNAMIC LIFE TEST — 2E30

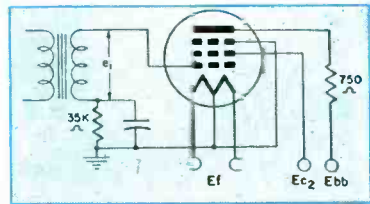

Dynamic class C amplifier with grid leak bias and maximum operating potentials. Note rms voltage in series with rectified d-c grid potential.

SPECIALISTS IN RADIO RECEIVING TUBES SINCE 1921

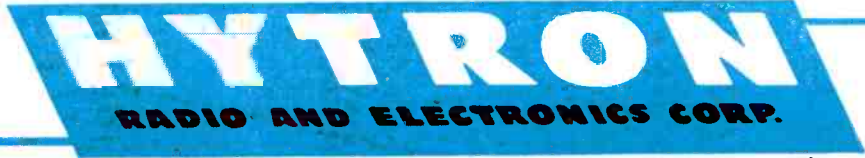

MAIN OFFICE: SALEM, MASSACHUSETTS



ARVIN

TWO NEW



THESE NEWEST ADDITIONS
to the Arvin line have

Eye-Appeal

Play-Appeal

Price-Appeal

They'll be fast-stepping num-
bers in this fast-moving line.

Lovelies

● **The Arvin 140-P** — a hot number in any weather! The market is big as all outdoors and the low price is an added charm! Top, bottom and grille are metal, finished in silver-grey in pleasing contrast to the tan middle section of weather-proof, crack-proof laminate. Four miniature tubes plus rectifier. Model 140-P—List \$34.95 plus batteries.

● **The Arvin 150TC** — Here's a winner in any company! The most in radio in the least space at the lowest price. Time-proven, dependable automatic record changer. Five miniature tubes plus rectifier. Heavy-duty 5¼" Alnico V PM speaker. Resistance-coupled R.F. stage. Beam power output. Unique chassis design provides greatest compactness and handy service accessibility. Beautiful cabinet in either full-grained mahogany or walnut veneer with artistic escutcheon and control knobs. Overall size only 14¾" wide by 16⅝" deep by 9½" high. Model 150 TC (walnut or mahogany veneer)—List \$89.95. *All prices slightly higher in zone 2.*

ARVIN SETS THE PACE :::: LEAD WITH ARVIN!



... the name on many fine products from

NOBLITT-SPARKS INDUSTRIES, INC. • COLUMBUS, INDIANA

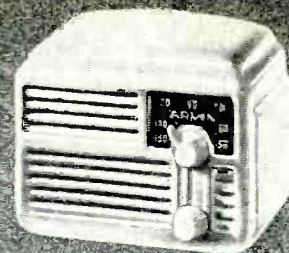

The ARVIN Minky Mini — low-
• priced appeal on the market
today, with unbreakable cabinet.
Brown only \$14.95, Ivory \$15.95.

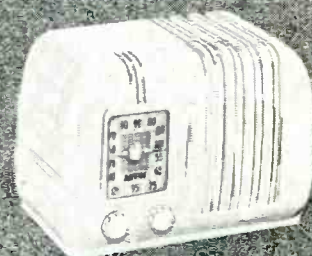

The ARVIN 544 — Beauty,
• performance, compactness and low price
sell this model like hot cakes! Walnut
only \$19.95, Ivory \$21.95.

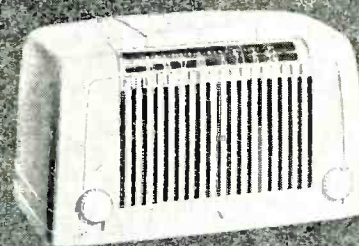

The ARVIN 552 — Plays its way
• into anybody's head, and pays its
way over and over on your sales
floor! Walnut \$22.95, Ivory \$26.95.

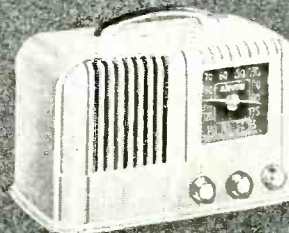

The ARVIN 664 — This favorite is
• truly a radio for upstairs, downstairs,
all thru the house. You'll like the way
it sells! Walnut \$29.95, Ivory \$30.95.



THE FARNSWORTH CHIPPEDALE CONSOLE • Brilliant phonograph radio in a cabinet of truly regal beauty—pride master of the Farnsworth line. Short-wave, standard and FM (Frequency Modulation) reception. Treble and bass tone controls. Automatic record-changer. Beautifully finished in rich mahogany.

DEPEND ON

Farnsworth for Fidelity

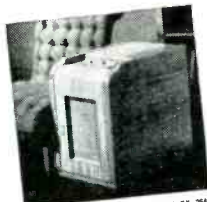

THE FARNSWORTH CHAWSIDE (MODEL GR-264) Finger tip convenience—all photographs and radio controls accessible from your seat. The modern enclosed battery set circuit and 3 speed suspension record-changer in walnut or genuine South American crime ivory.



TELEVISION TABLE MODEL • Brilliantly engineered by Farnsworth, television's pioneer. Covers all commercial television channels in both wave and line groups. Clear, sharp pictures on 10-inch, portrait face tube. AM radio also available. Compact modern cabinet.

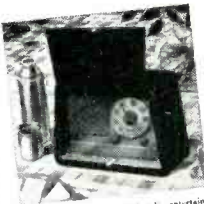

MODEL EP-350 • A world of radio entertainment wherever you go. 11.41 for beach, picnic or country (long-lasting battery). Use it also as a home table radio on either AC or DC. Built-in automatic sharp, quick tuning. Excellent tone. Handmade, lightweight, easy to carry.

Here, to bring you sparkling radio entertainment and the musical riches of your favorite records, is a full range of brilliant new Farnsworth radios and phonograph-radios. Bearing one of the most celebrated names in electronic research, these instruments re-create in your home the clear detail and tonal vitality of the original performance, whether broadcast or recorded. The larger console models are equipped for static-free FM (Frequency Modulation) reception. They are fitted, too, with the famous Farnsworth three-point suspension changer that handles, swiftly and gently, 12 ten-inch or 10 twelve-inch records. Made by the makers of the incomparable Capehart, these new Farnsworths combine, in unusual measure, quality with modest price (\$28 to \$425). Hear one today at your nearest Farnsworth dealer's. He has been carefully selected for his integrity, his willingness and ability to serve you expertly.

FARNSWORTH TELEVISION & RADIO CORPORATION, FORT WAYNE 1, INDIANA

**ADVERTISING LIKE THIS
MEANS MORE PROFIT FOR
THE FARNSWORTH DEALER**

Appearing in the June 23 issue of Life Magazine

Next month, LIFE Magazine will place this Farnsworth message—in striking full color—before its 22,500,000 readers.

People interested in new radios will identify these outstanding models . . . will read anew of Farnsworth fidelity and quality . . . will note that the Farnsworth dealer has been selected for "his integrity, his willingness and ability" to serve

them expertly.

Thus, through quality advertising of its quality line, Farnsworth creates more business for the Farnsworth dealer . . . re-emphasizes the value of the Farnsworth franchise.

Farnsworth Television and Radio Corporation, Fort Wayne 1, Indiana.

Farnsworth
Television • Radio • Phonograph-Radio

Farnsworth Radio and Television Receivers and Transmitters • Aircraft Radio Equipment • Farnsworth Television Tubes • Mobile Communications and Traffic Control Systems for Rail and Highway • The Farnsworth Phonograph-Radio • The Capehart • The Panamuse by Capehart



1947 PARADE OF VALUES

**SPEARHEAD THE WAY TO INCREASED SALES
WITH ULTRA QUALITY RECORD PLAYERS!**

PREP

LIST
\$2450



- 2-tube amplifier (3-tube performance)
- 5/2" Alnico-5 Permalloy G. E. Speaker
- Acoustically designed for fine tone
- Two-tone simulated leather cabinet

TEEN AGER

LIST
\$3250



- 2-tube amplifier (3-tube performance)
- 5/2" Alnico-5 Permalloy G. E. Speaker
- Separate volume and tone control
- Portable case in two-tone leatherette. 3 colors: Brown, Blue, Maroon.

CO-ED

LIST
\$3650



- 2-tube amplifier (3-tube performance)
- 5/2" Alnico-5 Permalloy G. E. Speaker
- Separate volume and tone control
- Portable case, ostrich finish leatherette

Alert dealers and distributors are profitably playing a Symphonic tune! These seven outstanding record players are bound to ring your cash registers to new musical heights! All have exceptional versatility, superb tone, functional beauty and advanced engineering features. Critics have acclaimed them . . . and you will sell them . . . because they are the most exciting values of the year!

RCA Licensed Manufacturers **RMA**



LIST

**\$109.95
CONCERTO**

Deluxe Automatic RECORD PLAYER

- Handsome solid mahogany custom-built cabinet with storage space for 10 and 12 inch record albums.
- 4-tube amplifier (including Selenium rectifier) with voltage doubler circuit for twice the power output.
- Full range tone control from bass to treble, with inverse feedback to assure perfect reproduction.
- 10" G. E. speaker with 6.8 oz. magnet of Alnico-5 Permalloy.
- Foolproof, two post automatic record changer with noiseless 60 cycle AC motor.
- Minimum surface noise with lightweight pickup arm and permanent needle.

List 5% Higher west of Rockies

VARSITY

LIST
\$3995



- 3-tube amplifier (4-tube performance)
- 6/2" Alnico-5 Permalloy G. E. Speaker
- Separate volume and tone control
- Portable case in two-tone leatherette
- Lightweight pickup arm, permanent needle

FRATERNITY

LIST
\$6450



- 3-tube amplifier (Super performance)
- 6/2" Alnico-5 Permalloy G. E. Speaker
- Separate volume and tone control
- Deluxe portable case, two-tone leatherette
- Lightweight pickup arm, permanent needle
- Gearless, foolproof automatic changer

Model
YCA3

LIST
\$5395



- 3-tube amplifier (4-tube performance)
- 6/2" Alnico-5 Permalloy G. E. Speaker
- Separate volume and tone control
- Solid mahogany, hand rubbed cabinet
- Lightweight pickup arm, permanent needle
- Gearless, foolproof automatic changer

*Symphonic Record Players Perform
a New High in Music Pleasure!*



RADIO & ELECTRONIC CORP., 292 MAIN STREET • CAMBRIDGE • MASS.



THE SYMPHONETTE

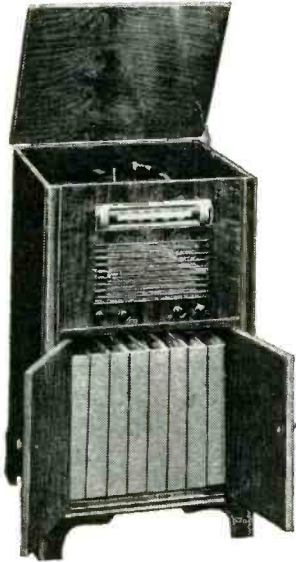

THE CLARIONETTE



MANHATTAN



THE 3-WAY PORTABLE



Calls the customer to your door

NECK... and NECK...

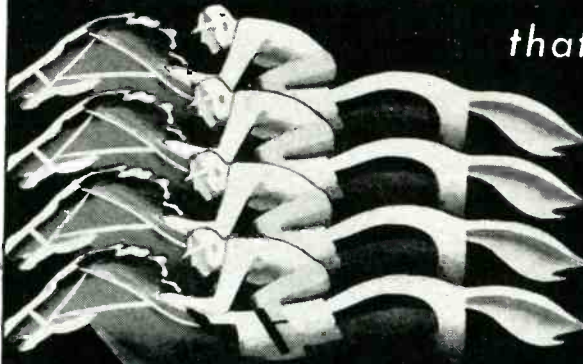

that's today's
story of new
models
by...

Clarion

There are no "also rans" in the distinguished CLARION line of receivers. Each model is a thoroughbred in its class. Each is a favorite at the start and a winner at the finish. All the way, from engineering department to the customer's home, they run "neck and neck" in popularity. If you want an inside Profit Tip write for name of your CLARION Distributor and copy of new booklet, Sound Selling Steps.

WARWICK MANUFACTURING CORP.
4640 WEST HARRISON STREET • CHICAGO 44, ILLINOIS

Calls the World to your Door

Clarion

America's first
Audibel Rated **RADIO**

GET MORE OUT OF LIFE WITH TELEVISION



Illustrated: The Hampshire with Television, FM-AM Radio, Automatic Phonograph — Cabinets designed by Herbert Rosengren.

*Get the most out of television with a Du Mont Teleset**

Du Mont's outstanding superiority becomes very apparent when you make direct comparison with other sets. Compare the size, brilliance and clarity of the image. Compare the quality of sound. Compare the ease and accuracy of tuning. Compare styling and workmanship of the cabinets. See and hear the new Du Mont Telesets.* See; Hear; and Compare.

DU MONT *First with the finest in Television*

ALLEN B. DU MONT LABORATORIES, INC. • GENERAL TELEVISION SALES OFFICES AND STATION WABD, 515 MADISON AVE., NEW YORK 22, N. Y.
DU MONT'S JOHN WANAMAKER TELEVISION STUDIOS, WANAMAKER PLACE, NEW YORK 3, N. Y. • HOME OFFICES AND PLANTS, PASSAIC, NEW JERSEY
Copyright 1947, Allen B. Du Mont Laboratories, Inc. *Trade-mark

New Westinghouse DUO Consolette

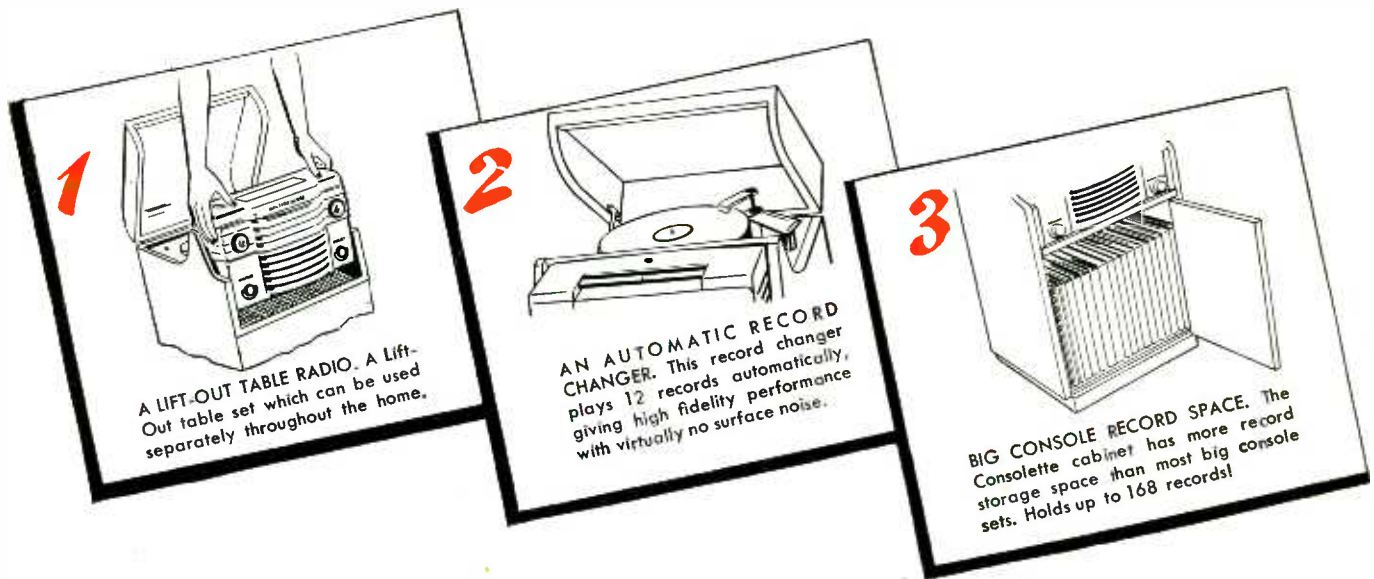

Your customers will really go for this new Westinghouse Consolette. It is a console radio phonograph; the sturdy limed-oak cabinet is ideally designed for the modern home.

Only Westinghouse Radio offers 3 sets in 1 . . . the original LIFT-OUT table set for use in any room in the home . . . an automatic record changer that plays 50 minutes of music merely by pressing the single button control . . . plus a console cabinet with more record storage space than most big sets.

TWICE the undistorted power output of comparable pre-war sets gives this Consolette tone and performance surpassing many full-sized consoles.

Because this unique set fills the immediate needs of a large number of your customers and delivers big set performance at a modest price, you'll want to give it a prominent location in your radio lineup. Retail price is \$139.95. Place your order for this 3-in-1 Consolette today.

Home Radio Division, Westinghouse Electric Corp., Sunbury, Pa.

Powerful promotion will help you sell this sensational 3-in-1 set



This eye-catching four color Consolette poster is now in the mail to dealers using the Miniature Billboard Display. When prominently placed in your window it will quickly urge prospects inside to see and hear this new Westinghouse set.

Hundreds of your local prospects will see this full page advertisement in Saturday Evening Post on June 7 and Life on June 9. This national advertising does a direct, demonstration-in-print selling job for you on the Consolette.



RADIO'S FIRST NAME IS

Tune in Ted Malone, Monday through Friday, 11:45 E.D.T., A.B.C. Network.

gives you 3 times the sales power

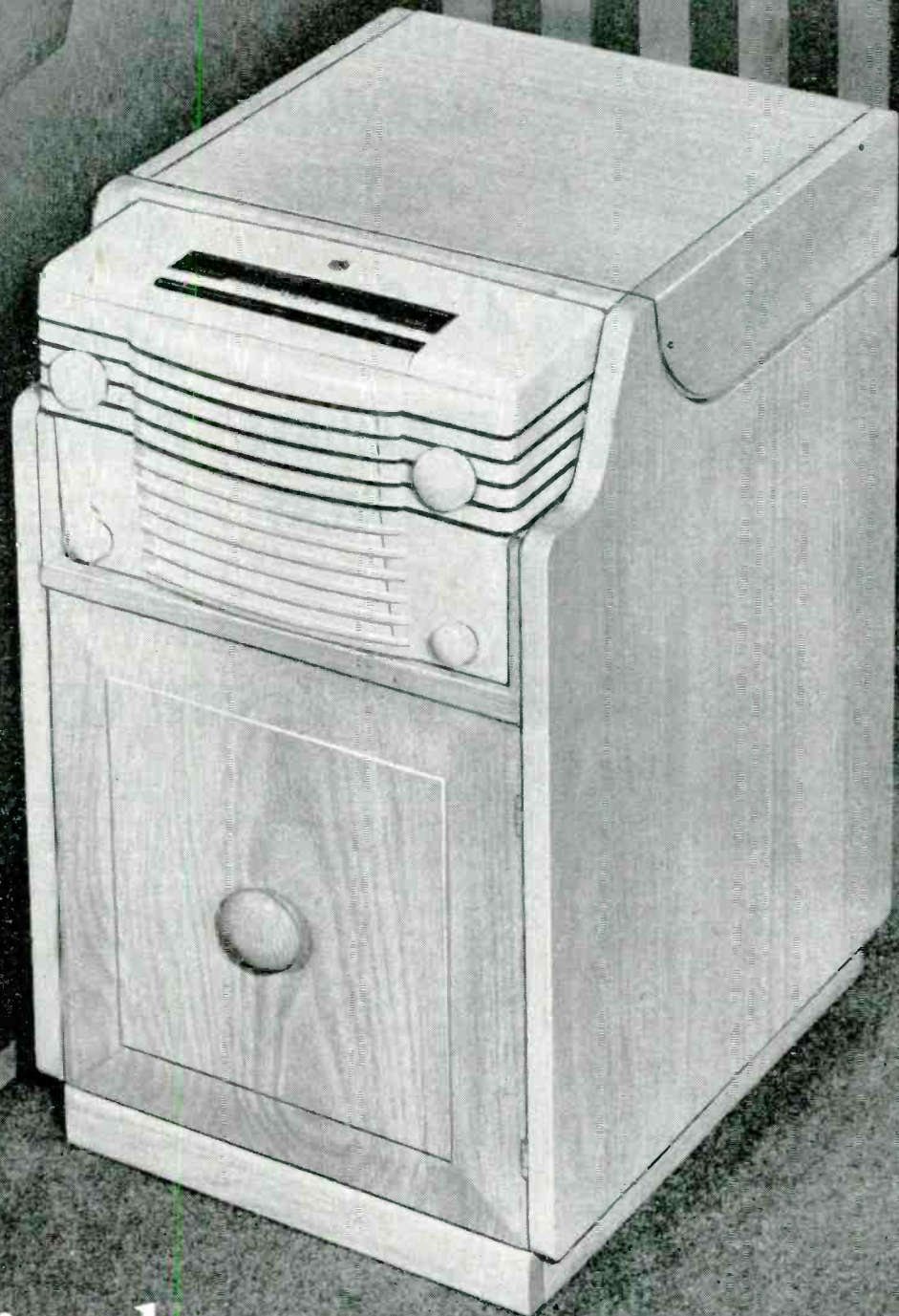

Westinghouse
RADIO TELEVISION

NEW BAR SET! 40% BIGGER PICTURES — 25% LESS COST

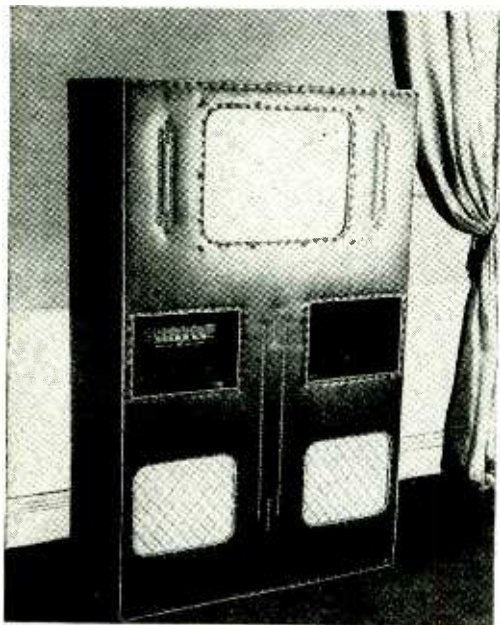

Tavern Tele-Symphonic. ONLY SIZE for bars and taverns. Includes radio. Special Bausch & Lomb lens for sharp focus. Unique UST refractive optical projection for safe, service-free operation. Set pictured above used to cost \$2595, including tax. Now without phonograph, but with the new screen, 40% bigger than ever, price is reduced to only \$1995, including tax. The world's biggest television screen is available in two models: T-525, mahogany wood or T-525-L, rich leatherette.

**WORLD'S
BIGGEST
TELEVISION
PICTURE**

3 1/3 SQ. FT.

**IMMEDIATE
DELIVERY**



The "Tele-Symphonic." Complete musical instrument for the home. Exquisite period cabinet with 35 tube chassis (including 5 rectifiers) for high-fidelity sight and sound. Includes standard, FM and short-wave radio, automatic phonograph. Foldaway screen. Pictures 6 times the size of ordinary sets. Model T-507. (Also available in modern blonde mahogany: T-507-M) \$2275, tax included. Reduced from \$2540

NEW TELEVISION-RADIO PHONOGRAPH SET - - \$895

The "Telesonic" combining a 10-inch direct view picture with standard broadcast, FM, and short wave radio plus automatic phonograph. Model T-502, graceful period cabinet. Model T-502-M, modern blonde mahogany. Immediate delivery. \$895 plus \$100 installation plus \$50 Federal Excise Tax. Home sets may be sold only to qualified dealers who stock them.

**DEALER EARNS \$20,000
IN 60 DAYS**

One medium-sized New Jersey retailer earned gross profits of more than \$20,000 in just 60 days by selling "Big Picture" sets to 33 taverns in his own area. Another small dealer earned \$12,000 and still another earned \$8,000 in a two-month period even though radio sales were slow. You don't have to stock your UST set.

Canvass bars and grills without first investing in a floor model. But demonstration sells television faster! And the bar or tavern owner is quick to spot the advantages of "Big Picture" television for his business.

Even if radio business is slow, you can sell the new T-525 at this sensational low price for the "Biggest Picture" television set in the world. Only \$1995 including tax for this BAR SIZE model with a screen 3 and 1/3 square feet . . . 9 times the size of the average 10-inch set.

Bar owners report profits up from 100% to 500% after installing UST "Big Picture"

projection sets. They claim it's the biggest business builder of all. Survey of owners indicates they would advise no bar or grill to use smaller size sets than the UST "Big Picture" screen. You can promise your tavern prospect immediate delivery—within 24 hours in New York City and vicinity. For taverns with limited space, UST offers Ceiling Models T-525-3P. Hangs from ceiling with remote controls behind bar. No lost table space.

HOME SET PRICE REDUCED

For the home, there is no finer musical instrument than the UST "Tele-Symphonic". Retail price for this magnificent console combination with the "Big Picture" screen (340 square inches) is now reduced \$265 to only \$2275, tax included. Ready now for immediate delivery. Offers the ultimate in television, radio and automatic phonograph without peer.



**"One Full Year Ahead!"
UNITED STATES TELEVISION
MFG. CORP.**

3 W. 61st Street, New York 23, N. Y.

Telephone Circle 6-4255

Recordio



The Coronet

THE WORLD'S FINEST HOME RECORDING INSTRUMENT

Premiere showing at the N.A.M.M. Convention, Chicago,
June 2—5, 1947, in the Palmer House — Rooms 881,
882 and 883. Admission by personal invitation only.

SEE YOUR **Recordio** DISTRIBUTOR

T.M. REG. U. S. PAT. OFF.

196-M

W I L C O X - G A Y C O R P O R A T I O N • C H A R L O T T E , M I C H I G A N



RAYTHEON

Excellence in Electronics

- RADIO RECEIVING TUBES
- SPECIAL PURPOSE TUBES
- TRANSMITTING TUBES
- HEARING AID TUBES

Your RAYTHEON DISTRIBUTOR will be glad to explain how you can qualify as a Bonded Electronic Technician.

RAYTHEON MANUFACTURING COMPANY
 RADIO RECEIVING TUBE DIVISION
 NEWTON, MASSACHUSETTS CHICAGO, ILLINOIS

Even Warped Records Play Perfectly

Here's how to prove it



Place an ordinary book of matches on the turntable, under the outer edge of a record. Then, play the record with the Cobra Tone Arm. Obviously, no record would ever be warped so badly—yet the Cobra floats gently in the grooves without bouncing or skipping—reproduces every note perfectly. Yes, here is another demonstrable feature of Zenith's superiority . . . use it in your sales presentations.

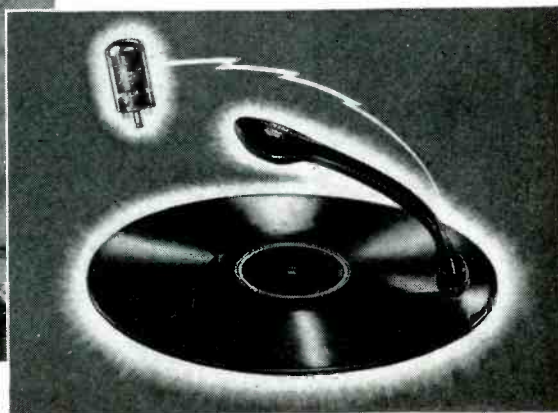
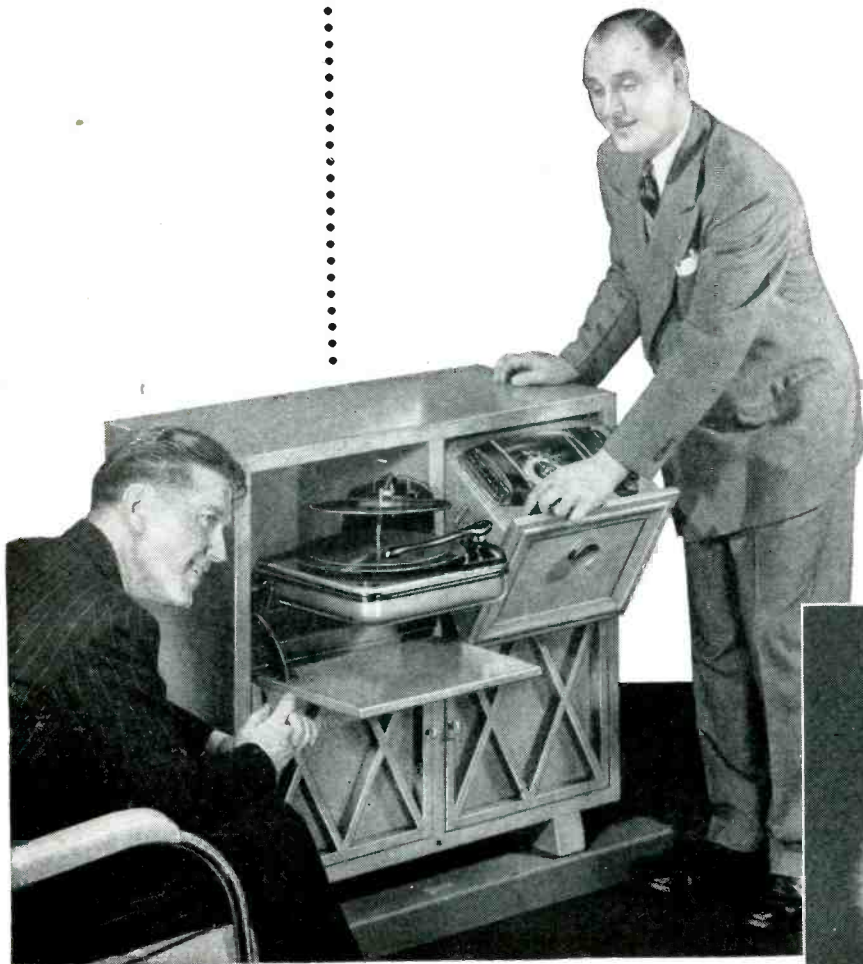

ONLY ZENITH HAS THE **COBRA** TONE ARM

The Cobra brings out every note of every instrument . . . the sparkling highs . . . the mellow bass notes . . . the rich overtones—just as the artist himself would like to hear them. And, complementing this new method of reproducing records radionically, Zenith's Silent-Speed Record Changer operates so quickly, so quietly, that there is virtually an unbroken flow of music. Once your prospects listen and hear the difference, only Zenith will satisfy them.

**The Sensational
NEW WAY
to Play Records!**



BACKED BY 30 YEARS OF RADIONICS EXCLUSIVELY

THE NEW **MEISSNER** RADIO - PHONO - RECORDER

A Four-Way Performer

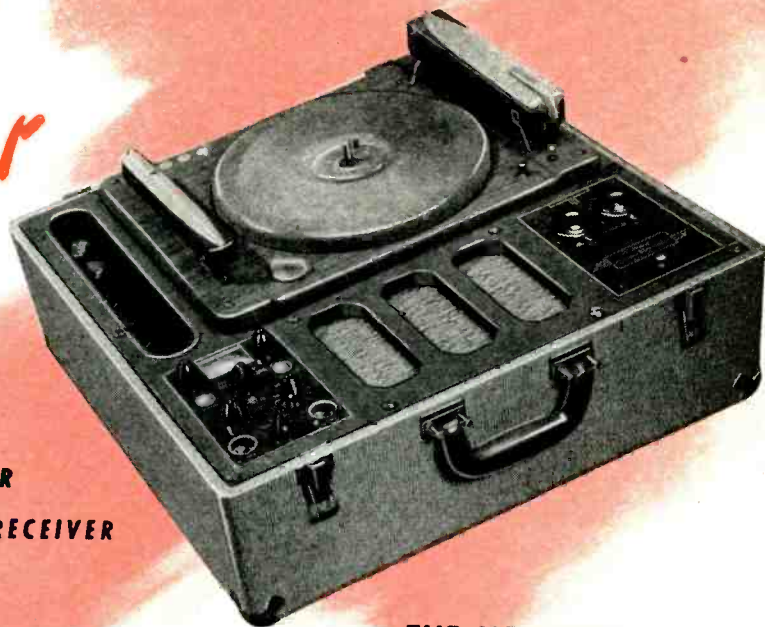

- A VERSATILE RECORDER
- A HIGH FIDELITY RECORD PLAYER
- A SENSITIVE, SELECTIVE RADIO RECEIVER
- AN AUXILIARY P.A. AMPLIFIER

Here is the combination you've been waiting for and the outstanding entertainment value of the year. A four-way performer, the new Meissner Radio-Phono-Recorder combines the functions of a versatile home recorder; a high quality, high-fidelity record player; a sensitive seven-tube super heterodyne radio receiver and a low power public address system . . . all in one unit that easily surpasses anything now being offered. Compact in design, precision-built and easy to operate, this super combination is now available at your jobber's. See it today or write for full information to the address below;

THE MEISSNER RADIO-PHONO-RECORDER

A Versatile Recorder. For faithful reproduction of all radio programs or "live" talent. Crystal cutting head makes perfect records up to 10" in diameter. Crystal microphone. 2 turntable speeds for recording and playback.

High Fidelity Record Player. For playback of home recordings or commercial discs up to 12". Featherweight crystal pick-up arms. Ample storage space in lid for blanks.

Sensitive Superheterodyne Receiver. 6 Tubes Plus Rectifier. A sensitive, selective radio receiver built in for direct program recording without room noise. Both radio programs and "live" talent may be blended simultaneously on one record.

Public Address Amplifier. For "announcing" to small groups. Ideal for school & church use. May be connected to external speaker for greater volume.

Meissner

A DIVISION OF

MAGUIRE INDUSTRIES, INCORPORATED
936 N. MICHIGAN AVENUE, CHICAGO 11, ILLINOIS

EXPORT ADDRESS: SCHEEL INTERNATIONAL, INCORPORATED
4237 N. LINCOLN AVE., CHICAGO 18, ILLINOIS, CABLE HARSHEEL



SCOTT

PEOPLE ARE PLANNING

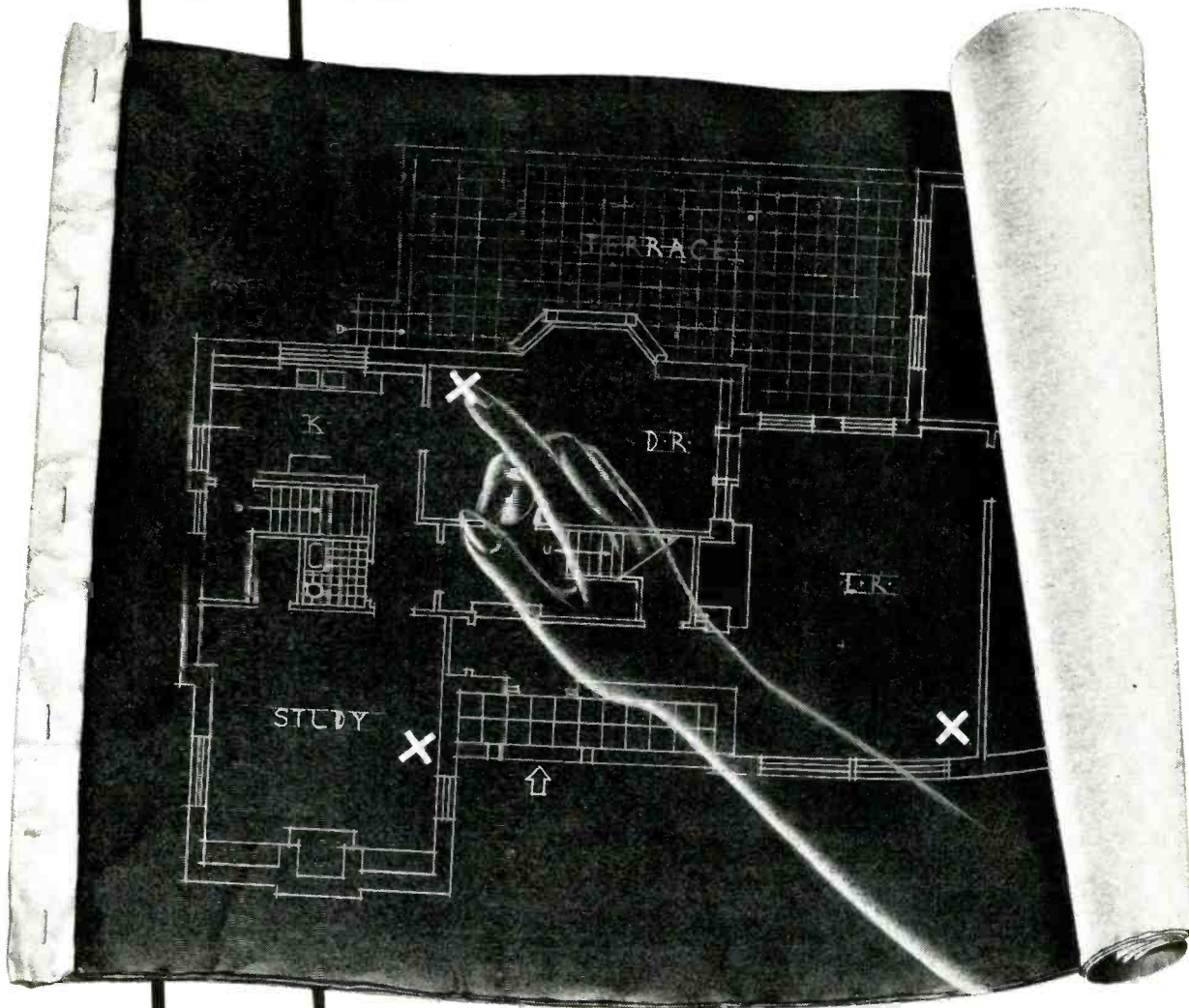

Those with the means to enjoy "the world's finest" are planning, many of them, to build into their living scheme the Scott radio-phonograph with strategically located speakers and remote control. This, of course, puts Scott dealers in an enviable position. Scott Radio Laboratories, Inc., 4450 Ravenswood Avenue, Chicago 40, Illinois.

See *The Autograph* at the
National Music Show, Chicago
June 2 to June 5 incl.

The Autograph—Model 1135-PL—
A distinguished automatic radio-phonograph in a classic 18th century cabinet. In either mahogany or walnut veneers, carefully matched and rubbed to emphasize the natural beauty of the rare woods. Push-button selections of both AM and FM stations. Exclusive "Acoustical Labyrinth" and matchless Carpinchoe speaker. Plays 10 and 12-inch records intermixed. With complete FM.



Brilliant conception of cabinetry is only one of the distinguishing features of the famous Stromberg-Carlson 1135 series . . . represented by "The Georgian" and "The Autograph."

But Stromberg-Carlson craftsmanship goes further than that alone. *Listen!*

Listen for that exquisiteness of tone—for that fidelity in all tonal ranges, at any volume level.

Yes, put these brilliant performers to the test. They give your ear an education!

**They give your ear
an education . . .**

For the main radio in your home . . .

There is nothing finer than a **STROMBERG-CARLSON**



The Georgian—Model 1135-PF—
The finest Stromberg-Carlson automatic radio-phonograph ever made. In an exquisitely-rich cabinet of matched African swirl mahogany. Push-button selections of both AM and FM stations. Exclusive "Acoustical Labyrinth" and matchless Carpinchoe speaker. Plays 10 and 12-inch records intermixed. With complete FM.

See *The Georgian* at the
National Music Show, Chicago
June 2 to June 5 incl.

RADIO *& Television* RETAILING

Including Radio and Television Today

G. H. CALDWELL, Editor * M. CLEMENTS, Publisher * 480 LEXINGTON AVENUE, NEW YORK 17, N. Y.

Visits to Manufacturer and Jobber Are Profitable

Time and money spent in visiting manufacturing plants and wholesale establishments is money well spent by the retailer and members of his sales staff.

Such visits create more enthusiasm for the product, more service and sales knowledge about the various makes and a greater appreciation of the magnitude of the industry we are all a part of.

Furthermore, visits by the merchant to his suppliers can result in valuable business contacts and friendships which will be mutually beneficial. The merchant who has personal friends among firms manufacturing the products he sells, and among those who distribute them, is in line to get cooperation on a more "personal" basis than he could ever hope to obtain so long as he remains a stranger—just a name in a ledger, or upon a letterhead.

You may be the nicest guy in the world; a pleasing and interesting personality; a merchant whose head is crammed full of sparkling business ideas, but so long as your suppliers have never met you, they can only base their picture of you upon a financial basis—your reputation for paying bills, etc.

While it's a very fine thing to have a good reputation as a large buyer and a prompt payer, it's still better for the dealer to throw in a measure of his own personality along with it.

Often, too, the retailer can ring in a well-earned vacation through visiting a quite distant factory, thus combining business with pleasure. Dealers can often make arrangements with manufacturers whereby their quota-reaching or quota-busting salesmen can avail themselves of personally-conducted tours through plants, thus exposing them to the before-mentioned benefits resulting from seeing how the goods are made and distributed, and meeting the men who make brand-names famous.

What's Ahead!—in Radio,

MORE BOOBY TRAPS THAN THE COLLYER MANSION had are floating around in this market. The situation has manufacturers, wholesalers and retailers on tenterhooks. Scads of one product and none of another. The maker wants to know how much to make, the jobber how much to take and the dealer how much to stock. Experts believe, though, that there will be a steady, wholesome buying wave this fall, figuring that consumers will at that time commence to buy along normal patterns.

DEALER CREDIT STANDINGS EXCELLENT at this time, report a number of leading wholesalers. This is a most healthy sign in radio/appliance retail circles.

BOTTLENECK IN GLASS ENVELOPES FOR tele picture tubes still at hand. Manufacturers faced with a great clamor on the part of the public who want to buy video sets, are bending every effort toward obtaining scarce tubes and scarce cabinet materials.

ORCHIDS TO HOWARD W. SAMS, who recently went to much expense polling servicers in the interest of saving their working time. Basic plan for a poll evolved at a recent RMA service section meeting, as a double play. *RADIO & Television RETAILING's* Harola Ellis pitched the idea, Howard W. Sams' Ben French caught it up and hurled it higher, wider and handsomer. All agree it's made a hit.

NO APPLIANCE PRICE INCREASE BY WESTINGHOUSE contemplated at this time, according to company officials, who point out that the firm's prices at today's level on the average have gone up only 24.5 per cent since 1939.

"T" WEEK—TELEVISION, THAT IS, opened in Washington, D. C., with a bang. The Electric Institute in the nation's capital reports "more television sets than have ever been seen in Washington." Various estimates place the total number of video receivers delivered to dealers at between five hundred and a thousand.

600,000 AUTOMATIC WASHERS in 1947. That's the production aim of Bendix. Current output of washers, ironers and dryers now at 2,800 units per day.

IMPOSSIBLE TO REDUCE PRICES in face of upped costs, and still show a satisfactory profit, points out C. G. Frantz, president Apex Electrical Mfg. Co. He describes some alarming rises in costs of basic materials. For instance, copper formerly 12c now costs 21½c a pound; aluminum, 9c after the War is now 15c a pound. Steel, rubber, etc., have risen correspondingly. Labor costs have increased 50% to 60% or even more over pre-war levels.

CABINET WOODS AND PLASTIC MATERIALS are still supply problem-children. In spite of the considerably improved volume of woods being received, and the upped-production of plastics, the pent-up demand is so large that the stuff just seems to melt away as it reaches the market.

ON THE DAY WHEN CUSTOMERS STOPPED begging for merchandise, and expected a salesman to sell them something, many a merchant permitted himself to develop a recession-depression complex. This defeatist attitude hurts business; puts the damper on salesmanship. The thing to do is to remember that there is always a market for every product if we're willing to be order-makers instead of order-takers.

ONE OF THE MORE NOTICEABLE TRENDS in salesmanship circles in retail stores throughout this field is that the average age of the personnel is considerably younger than it was before the war. This means that there are more salesmen-by-choice than salesmen by force of circumstances. Such condition should result in cleaner, brighter selling methods, and, in increased volume.

MANY LEADING STORES FORMERLY SPECIALIZING in music are taking on electrical appliances, and doing good jobs with them. The evolution of the one-time "straight" music establishment is interesting. First, pianos, sheet-music, band instruments, etc., then records and radios and now full-fledged "Big Four" merchants, selling radios, records, appliances and service.

LOTS OF FAVORABLE COMMENT on the plan to sell more than one vacuum cleaner to each home originated by *RADIO & Television RETAILING*. Numbers of dealers are ready to increase sales volumes via this modern technique.



"OUTSIDE" SELLING IS COMING BACK. Dealers are getting ready to resume this one-time popular sales technique. How to operate, how to hire and pay salesmen, and what sort of reception the householder is likely to dish out are some of the subjects in an interesting article in this issue, entitled: "Preparing for Door-to-Door Selling."

Appliances, Records and Television

PUBLIC GETTING BACK INTO THE INSTALLMENT-buying groove need plenty of advice on the subject, say dealers. "Easy Terms" being ballyhooed in many show windows again, and experts look for wide-scale resumption of financed purchases before the year is out.

NOW THAT NEED FOR INCREASING SALES volume is so important, many retail merchants and jobbers are planning to re-employ the once-familiar sales contest as a means of stimulating business.

TELE FANS ERECTED "GRANDSTAND" in front of one Eastern dealer's show window in order to watch a scheduled-in-advance video show. Seems they borrowed saw-horses and planks from an adjacent construction project. Sympathetic police controlled the situation without spoiling the show, and were among the most interested of all the spectators.

REPORTS FROM ALL OVER THE COUNTRY indicate that more and more radio/appliance retailers are buying broadcast time outright, or are participating in some of the cooperative programs.



"HOW DO YOU TREAT THE TINKERER?" tells the merchant what sort of action he should take when the amateur repairman brings in a bag of stuff which was once a radio or an appliance. It's all in an article elsewhere in this issue. Merchandising facts plus human interest.

SELL ELECTRIC BLANKETS THE YEAR 'ROUND urges J. E. McCarthy, General Electric's automatic blanket sales manager. For some time this publication has been urging the dealer to shy away from getting his mind into the "seasonal-selling" rut, pointing out that there isn't an item in his store which cannot be sold any time of the year. Read the article. Year 'Round Selling" in this issue. It coincides with the views of many experts like Mr. McCarthy.

IT'S AN AGE OF AMPLIFIERS, reports Miryam Simpson, the Masco VP, after a plane trip through western U. S. She found Texas cowhands using jeep-borne PA to bellow across the range; Good Humor carts playing records; stunt planes soundcasting ad messages; ham rigs with extra amplifiers. PA all over the plains.

MORE AND MORE CONSUMERS are asking for home demonstrations on radios and appliances these days. Merchants who have first-class in-store demonstrating facilities are finding that they can make numbers of sales without having to take the products into the home. Retailers agree, though, that after-sale "show-how" in the home is necessary with many appliances, saving as it does, needless service calls, and also serving to keep the customer happy.

NEW ELECTRIC FOOD WASTE DISPOSER has been perfected by the Eureka William Co., according to George T. Stevens, executive vice-president. Volume output is expected by next month.

"RADIO DEALERS CAN GET ACTION if they decide to apply brain power and leg work when sales slow up."—From a bulletin issued by Harry Alter Co., Chicago distributors.

"EVERY DEALER CAN SELL SOUND PROFITABLY," Ben Gross, well-known New York distributor, told a recent gathering of Stromberg-Carlson retail merchants.

LESS FANTASY, MORE FACT in modern manufacturers' advertising copy. Time was when "smart" slogans and arty layouts were carried on to such an extent that viewers were bewildered. Today, factual stuff is what radio and appliance makers are using in publications, and on material for dealer stores and show windows. What the product is, the brand-name, and what the item will do for the customer is the modern theme.

BETTER-THAN-EVER COOPERATIVE AD plans seen throughout the industry, and many manufacturers who haven't announced plans yet are busy cooking them up right now.

NORGE IS NOW IN PRODUCTION on a new electric water heater. There are five models in the line: 30, 52, 66 and 80 gallon capacities.



PHONO RECORDS SELL LIKE HOT-CAKES when the dealer puts sizzle into his selling. How one dealer keeps disc sales soaring is in this issue, and it's titled: "The Music Center Ups Disc Sales."

Powerful RCA VICTOR promotion builds



RCA Victor
68 R 3

FM-AM

Two different methods of radio broadcasting are now in use. First, the standard kind—technically called AM or Amplitude Modulation; second, the newer FM or Frequency Modulation. This outstanding new table set brings you both—the great variety of standard programs plus the clear, quiet, static-free beauty of FM radio! Available in smooth brown or ivory-finish plastic or in fine wood veneers.

With the
“Golden Throat”
you hear both kinds of radio
in full tonal beauty

AM

For AM radio—that’s the regular, standard kind of broadcasting—this graceful, little table set is extra selective, extra sensitive. Colorful, easy-to-read, straight-line dial, built-in antenna and ground, 2-point tone control. Case in smooth, Antique Ivory-finish plastic for bedside or breakfast table, or in a variety of more formal cabinet styles.



RCA Victor
66 x 12

FINEST TONE SYSTEM IN RCA VICTOR HISTORY

This symbolizes the “Golden Throat”—RCA Victor’s exclusive 3-Way Acoustical system. Precision-engineered for each different model, this thrilling development reproduces the full, clear depth and brilliance of both AM and FM radio—and, in the Victrola radiophonograph, of records, too. It is explained technically in a booklet attached to RCA Victor instruments.

ONLY RCA VICTOR MAKES THE VICTROLA
*Patented in U. S. & Foreign Countries

RCA VICTOR  
DIVISION OF RADIO CORPORATION OF AMERICA

OVER 44 MILLION READERS EVERY MONTH see sparkling RCA Victor advertisements in Life, Look, Collier’s, and the Saturday Evening Post. People right in your neighborhood—potential customers of yours—are learning about . . . thinking about . . . wanting to own one of these superb radios and Victrola radio-phonographs.

See the latest RCA Victor advertisement (shown here) featuring the 68R3 and the 66X12 in:

- Life—June 23
- Look—June 10
- Collier’s—June 21
- S. E. P.—June 21

ONLY RCA VICTOR MAKES THE VICTROLA

“MUSIC AMERICA LOVES BEST”

stars Robert Merrill every Sunday on 148 NBC stations. Over 6 million listeners from coast to coast enjoy his rich voice. They are sold RCA Victor instruments and recordings by announcer Ken Banghart’s warm commercials.

Listen to “Music America Loves Best”—build *your* sales and profits. Tune in your nearest NBC Station—2:00 P.M., E.D.T.—this Sunday.



a steady volume of sales for you!



THE DEALER CO-OPERATIVE ADVERTISING CAMPAIGN helps you advertise to your customers. Here are newspaper mats featuring RCA Victor radios and Victrola radio-phonographs. The variety of sizes and amazing flexibility of these advertisements make it possible to fit every budget.

Radio commercials, billboard advertisements and materials to help you produce your own advertisements, round-out this dynamic campaign. See your distributor for your copy of "Here's How to Use RCA Victor Dealer Co-operative Advertising," and for all the details.

What a help to your sales program! Full-color and black-and-white advertisements in four of the nation's top magazines . . . "Music America Loves Best," the famous RCA Victor Show on 148 NBC stations . . . the dynamic Dealer Co-operative Advertising Campaign . . . beautiful display merchandise. All especially designed to build a demand that will last.

Take full advantage of this powerful RCA Victor promotion. You'll be rewarded with sales and steady, big-dollar profits.

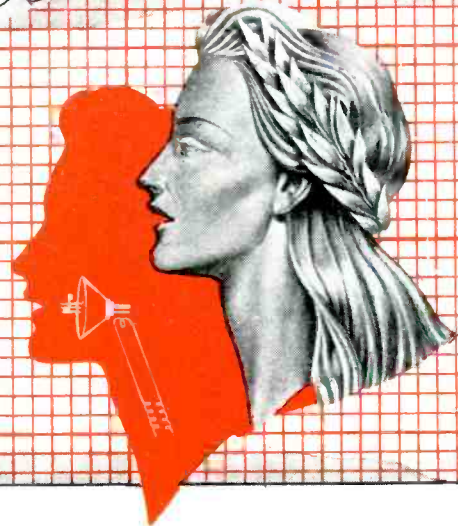

*You are cordially invited
to the
RCA VICTOR DISPLAYS
at the
NATIONAL ASSOCIATION
OF MUSIC MERCHANTS
CONVENTION*

PALMER HOUSE,
CHICAGO, ILL.
JUNE 2-7



ROOM 14
(Private Dining
Room Floor)
ROOM 893

BOOTHS 90-91

DRAMATIC PROMOTION PLUS THE

"Golden Throat"

mean steady profits for you from RCA Victor's greatest line of instruments. Listen to these radios and Victrola radio-phonographs. Notice the pure, rich tone produced by the exclusive "Golden Throat" acoustical system.

Bring the full effect of your advertising and RCA Victor promotion right into your radio department. Put the attractive RCA Victor display and identification properties to work today! They'll remind your customers that you have the instruments they've been looking for—RCA Victor.



RCA VICTOR

DIVISION OF RADIO CORPORATION OF AMERICA

"Victrola"—T.M. Reg. U.S. Pat. Off.

1947 Music Trade



Louis G. LaMair, of Lyon & Healy, Inc., Chicago, is president of the NAMM.



William A. Mills is executive secretary of the organization.



E. R. McDuff, Grinnell Bros., Detroit, is chairman of NAMM's board of directors.



George L. Byerly, Byerly Bros. Music Store, Peoria, Ill., is vice-president.



Secretary Bernie May heads May's Music Co., Inc., Albuquerque, N. M.

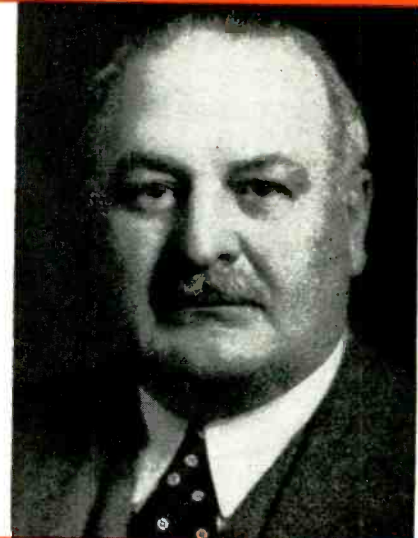

William R. Steinway, Steinway & Sons, New York City, is association treasurer.

● Visitors to the National Association of Music Merchants' Trade Show and Convention, Chicago, June 1 to 5, will find more exhibitors, using more exhibit space, and displaying more new musical instruments and musical merchandise than at any previous trade show, stated Louis G. LaMair, president NAMM. Mr. LaMair also revealed that several innovations in the field of musical instruments, radio and television will be unveiled.

Advance registration showed the greatest enrollment of members in

Largest Turnout of Dealers and Manufacturers in NAMM's History Will Attend Chicago Convention

NAMM's history, with music merchants coming from all over the world to attend the convention at the Palmer House.

This year's program is keyed to the convention theme, "The Music Industry Plans Its Future." Mr. LaMair stated that, "With consumer demand considerably tighter than at any time since pre-war days, and costs of both labor and material still rising, the music industry must aggressively

plan ahead to assure itself future markets. . . . Primary emphasis this year will be placed upon the development of better selling techniques, the creation of consumer demand, and more efficient store operation."

Initial groundwork has been laid for the setting up of a coordinated plan of trade promotion and public relations activity, Mr. LaMair continued. At this year's convention

(Continued on page 87)

Show Looks to Future

EXHIBITORS INCLUDE:

Acme Accordion Co., 421 Canal St., New York, N. Y.
 Admiral Corp., 3800 Cortland St., Chicago 47, Ill.
 Aeolian American Corp., East Rochester, N. Y.
 Aero Needle Co., 619 N. Michigan Ave., Chicago, Ill.
 Alcoa-Aluminum Co. of America, 520 W. Michigan Ave., Chicago, Ill.
 Altec Lansing Corp., 250 W. 57th St., New York, N. Y.
 American Plating & Mfg. Co., 2241 Indiana Ave., Chicago 16, Ill.
 American Rawhide Mfg. Co., 1103 N. Branch St., Chicago, Ill.
 Amer. Society of Piano Tuner-Technicians, 8209 Escanaba Ave., Chicago, Ill.
 Ansley Radio Corp., 41 St. Joe's Ave., Trenton 9, N. J.
 W. T. Armstrong Co., 200 E. Sycamore St., Elkhart, Ind.
 K. O. Asher, 1418 Hyde Park Blvd., Chicago, Ill.
 Associated Card & Stationery Co., 134 W. 18th St., New York 11, N. Y.
 Audience Records, Inc., 230 Park Ave., New York 17, N. Y.
 Audio Industries, Michigan City, Ind.
 Vincent Bach Corp., 621 E. 216th St., Bronx, N. Y.
 The Baldwin Piano Co., 1801 Gilbert Ave., Cincinnati.
 Herb C. Barger Mfg. Co. Inc., 2770-72 W. Colfax Ave., Denver 4, Colo.
 Sam Barodkin & Associates, 1553 N. Mohawk, Chicago, Ill.
 Barth-Feinberg, Inc., 17 Union Sq. W., N. Y., N. Y.
 Earle J. Beach & Son, 227-231 Mulberry St., Newark 5, N. J.
 Bendix Radio, Div. of Bendix Aviation Corp., Baltimore 4, Md.
 Bibletone, Inc., 354—4th Ave. New York 10, N. Y.
 Black & White Recording Co., 4910 Santa Monica Blvd., Hollywood 27, Calif.
 Boetsch Bros., 221 E. 144th St., New York 51, N. Y.
 The Bonot Co., 114 Manhattan St., Stamford, Conn.
 Boosey & Hawkes (USA) Ltd., 668 Fifth Ave. New York, N. Y.
 Boosey & Hawkes (London), 668 Fifth Ave., N. Y., N. Y.
 Arnold Brillhart, Ltd., Box 321, Great Neck, N. Y.
 Brush Development Co., 3405 Perkins Ave., Cleveland, Ohio
 Buegeleisen & Jacobson, 5 Union Square, N. Y., N. Y.
 Buescher Band Instr. Co., 225 E. Jackson Blvd., Elkhart, Ind.
 R. Burkhalter Musical Specialty Co., 658 State St., Madison 6, Wis.
 Capehart Div., Farnsworth Radio & Television, 3700 E. Pontiac St., Fort Wayne, Ind.
 Capitol Records, Inc., 1483 N. Vine St., Hollywood 28, Calif.
 Castiglione Accordion Co., 9150 Gratiot Ave., Detroit 13, Mich.
 Central Commercial Co., 332 S. Michigan Ave., Chicago, Ill.
 Chart Music Publ. House, Inc., 506 S. Wabash Ave., Chicago 5, Ill.
 E. Chiassarini & Co., 1595 Broadway, New York, N. Y.
 Chicago Album & Specialty Co., Inc., 503 S. Jefferson St., Chicago, Ill.
 Chicago Musical Instrn. Co., 30 E. Adams St., Chicago, Ill.
 Chicago Music Sales, 1836 S. Halsted St., Chicago 1, Ill.
 M. M. Cole Publishing Co., 823 S. Wabash, Chicago, Ill.
 Columbia Industries, 19th Ave. & 36th St., Long Island City 5, N. Y.
 Columbia Recording Corp., 1473 Barnum Ave., Bridgeport 8, Conn.
 C. G. Conn, Ltd., Elkhart, Ind.
 C. G. Conn (Pan American), Elkhart, Ind.
 Consonata, Div. of C. G. Conn Ltd., Elkhart, Ind.
 Continental Music Co., 630 S. Wabash Ave., Chicago, Ill.
 Cordell Industries, 41 E. 32nd St., N. Y., N. Y.
 The Danelectro Corp., 274 S. Bridge Ave., Red Bank, N. J.
 Davidson Mfg. Co., 75 E. Wacker Dr., Chicago, Ill.
 J. C. Deagan, Inc., 1770 Berteau Ave., Chicago 13, Ill.
 Decatur Industries, Inc., Decatur, Ind.
 Decca Records, Inc., Decca Dist. Co., 22 W. Hubbard St., Chicago, Ill.
 DeLuxe Records, 19 E. Elizabeth Ave., Linden, N. J.
 Allen DuMont Lab., 515 Madison Ave., New York 22, N. Y.
 Duotone Co., Inc., 799 Broadway, New York, N. Y.
 Electro-Voice, Inc., Buchanan Mich.
 Electrovox Co., Inc., 31 Fulton St., Newark, N. J.
 Enterprise Records, Inc., 8109 Santa Monica Blvd., Hollywood 45, Calif.
 Ediphone, Inc., 142 W. 14th St., New York, N. Y.
 Estey Organ Co., Brattleboro, Vt.
 Estey Piano Corp., Bluffton, Ind.
 Everett Piano Co., So. Haven, Mich.
 Excelsior Accordion, Inc., 333 Sixth Ave., New York, N. Y.
 Exclusive Records, 6272 Sunset Blvd., Hollywood 28, Calif.
 Farnsworth Television & Radio Corp., 3700 E. Pontiac St., Fort Wayne 1, Ind.
 Carl Fischer Musical Instr. Co., 62 Cooper Sq., New York 3, N. Y.
 Freed Radio Corp., 200 Hudson St., New York, N. Y.
 Theodore Freilich, N. E. Cor. 8th & Cherry Sts., Philadelphia, Pa.

Jesse French & Sons Div., Elkhart, Ind.
 Furniture Specialties Co., 331 Commercial Trust Bldg., Philadelphia 2, Pa.
 Gamble-Hinged Music Co., 218 Wabash Ave., Chicago, 4, Ill.
 Garod Electronics Corp., 70 Washington St., Brooklyn 1, N. Y.
 Geib, Inc., 1751-1759 W. Central Park Ave., Chicago, Ill.
 Gem Phono Mfg., Inc., 33 W. 46th St., New York 19, N. Y.
 General Electric Co., 1285 Boston Ave., Bridgeport, Conn.
 Graphic Educational Productions, Inc., 1108 Lillian Way, Hollywood 38, Calif.
 Gretsch & Brenner, Inc., 42 E. 20th St., New York 3, N. Y.
 The Fred Gretsch Mfg. Co., 60 Broadway, Brooklyn 11, N. Y.
 Grossman Music Co., 210 Prospect Ave., Cleveland, Ohio
 Haddorff Piano Co., 630 S. Wabash Ave., Chicago, Ill.
 Hammond Instrument Co., 2915 N. Western Ave., Chicago, Ill.
 Hardman, Peck & Co., 33 W. 57th St., New York 19, N. Y.
 Harmonia Records Corp., 1328 Broadway, New York, N. Y.
 Harmonic Reed Corp., 350 W. 16th St., Philadelphia, Pa.
 The Harmony Co., 3633 S. Racine Ave., Chicago 9, Ill.
 Hershman Musical Inst. Co., 242-250 Fourth Ave., New York, N. Y.
 Frank Holton & Co., Elkhorn, Wis.
 Humes & Berg Mfg. Co. Inc., 525 W. 76th St., Chicago, Ill.
 Internat'l Merit Prod. Corp., 254 W. 54th St., New York 19, N. Y.
 Janssen Piano Co., Inc., 243 W. 23rd St., New York 10, N. Y.
 Jenkins Music Co., Kansas City, Mo.
 G. C. Jenkins, Box 168, Decatur, Ill.
 Just-Rite Metal Specialties Co., 3911 Roosevelt Rd., Chicago 24, Ill.
 Kay Musical Inst. Co., 1640 Walnut St. W., Chicago 12, Ill.
 Keynote Recordings, Inc., 522—5th Ave., New York, N. Y.
 W. W. Kimball Co., 306 S. Wabash Ave., Chicago, Ill.
 King Record Dist. Co., 1540 Brewster Ave., Cincinnati 7, Ohio
 Kohler & Campbell, Inc., 25 E. 163rd St., N. Y., N. Y.
 Krakauer Bros., 191 Cypress Ave., Bronx 54, N. Y.
 Krauth & Benninghofen, 940 Symmos Ave., Hamilton, Ohio
 G. Leblanc Co., 2210 Sixtieth St., Kenosha, Wis.
 Leedy Drum Co., 225 E. Jackson Blvd., Elkhart, Ind.
 Lester Piano Mfg. Co., Inc., 1533 Chestnut St., Philadelphia 2, Pa.
 William Lewis & Son, 207 S. Wabash Ave., Chicago 4, Ill.
 Liberty Carillons, Inc., 551 Fifth Ave., New York, N. Y.
 Linguaphone Institute, 30 Rockefeller Plaza, New York 20, N. Y.
 Maurice Lipsky Music Co., 45 E. 17th St., New York, N. Y.
 Loew's, Inc.—MGM Record Div., 701 Seventh Ave., New York 19, N. Y.
 Ludwig & Ludwig, Inc., 1101 E. Beardsley, Elkhart, Ind.
 John Luellen & Co., 17034 Page Ave., Hazel Crest, Ill.
 Maas Organ Co., 3015 Casitas Ave., Los Angeles 26, Calif.
 The Magnavox Co., Bueter Rd., Fort Wayne, Ind.
 Maquire Industries, Inc., Meissner Mfg. Div. 936 N. Michigan Ave., Chicago 11, Ill.
 Majestic Records, Inc., Elgin, Ill.
 Manor Record Co., 162 Prince St., Newark 3, N. J.
 E. & O. Mari, Inc., 38-01—23rd Ave., Long Island City, N. Y.
 P. Marrazza, Inc., 308 St. Catherine St. W., Montreal, Canada
 The Martin Band Inst. Co. & The Pedler Co., Elkhart, Ind.
 C. F. Martin & Co., Inc., 10 W. North St., Nazareth, Pa.
 John Meck Industries, Plymouth, Ind.
 Melody Record Supply, Inc., 314 W. 52nd St., New York, N. Y.
 Mercury Records, 839 S. Wabash Ave., Chicago, Ill.
 Merson Musical Products Corp., 111 E. 14th St., New York 3, N. Y.
 Maxwell Meyers, Inc., 628 S. St. Mary's, San Antonio, Texas
 Mills Music, Inc., 1617 Broadway, New York, N. Y.
 Minshall-Estey Organ, Inc., 46 Birge St., Brattleboro, Vt.
 Musicraft Corp., 245 E. 23rd St., New York 10, N. Y.
 The Music Trades Corp., 113 W. 57th St., N. Y., N. Y.
 Musitron Co., 223 W. Erie St., Chicago 10, Ill.
 National Acoustic Products, 120 N. Green St., Chicago 7, Ill.
 National Piano Corp., 1200 Broadway, New York, N. Y.
 National Sales Co., 101 Hopkins Pl., Baltimore, Md.
 New York Band Inst. Co., 270 Fourth Ave., New York 10, N. Y.
 Do-Noble & Co., Inc., 6565 Yale Ave., Chicago 21, Ill.

Oahu Publishing Co., 2108 Payne Ave., Cleveland 14 Ohio
 Organox Organ Co., P. O. Box 1607 West Palm Beach, Fla.
 Pancordion, Inc., 33-10—29th St., Long Island City, N. Y.
 Peerless Album Co., Inc., 352 Fourth Ave., New York 10, N. Y.
 Penzel, Mueller & Co., Inc., 36-11—33rd St., Long Island City, N. Y.
 Peripole Products, 3620 Bedford Ave., Brooklyn 10, N. Y.
 Permo, Inc., 6415 N. Ravenswood Ave., Chicago 26, Ill.
 Pfanstiehl Chemical Co., 104 Lake View Ave., Waukegan, Ill.
 Piatanesi Accordion Mfg. Co., 1514 Milwaukee Ave., Chicago, Ill.
 Pilot Radio Corp., 3706 36th St., Long Island City, N. Y.
 Portem Dist. Co., 33 W. 46th St., New York, N. Y.
 Portofonic Mfg. Corp., 54 Franklin St., New York 13, N. Y.
 Pratt, Read & Co., Ivoryton, Conn.
 RCA Victor, Div. of Radio Corp. of Amer., Front & Cooper Sts., Camden, N. J.
 Rainbow Records, Inc., 150 W. 44th St., New York, N. Y.
 Record Album-of-the-Month Associates, Inc., 116 Main St., White Plains, N. Y.
 The Recordplate Co., 30 N. Raymond Ave., Pasadena 1, Calif.
 Recoton Corp., 212 Fifth Ave., New York, N. Y.
 John H. Reuther Co., 311 Washington Ave., Brooklyn 5, N. Y.
 Rexon, Inc., 295 Fifth Ave., New York, N. Y.
 Rippen Pianofabrik, Bilderdijkstraat 29-41, Den Haag Holland
 Rowe Industries, 3120 Monroe St., Toledo, Ohio
 Rubank, Inc., Campbell Ave. & Lexington St., Chicago 12, Ill.
 Sacred Records, Inc., 207 W. Pico Blvd., Los Angeles, Calif.
 Santy Runyon Products, 192 N. Clark St., Chicago, Ill.
 St. Louis Music Supply Co., 4400 Delmar Blvd., St. Louis, Mo.
 Herman Saver & Son, 117 W. Wabash, Chicago, Ill.
 Scherl & Roth, Inc., 2845 Prospect Ave., Cleveland, Ohio
 Scott Radio Lab., 4541 N. Ravenswood Ave., Chicago, Ill.
 H. & A. Selmer, Inc., Elkhart, Ind.
 Signature Recording Corp., 601 W. 26th St., New York, N. Y.
 Slingerland Drum Co., 1325 Belden Ave., Chicago 14, Ill.
 Wm. J. Smith Music Co., Inc., 254 W. 31st St., New York 1, N. Y.
 Sohmer & Co., Inc., 31 W. 57th St., New York 19, N. Y.
 Sorkin Music Co., Inc., 251 Fourth Ave., New York 10, N. Y.
 Southern Music Co., 830 E. Houston St., San Antonio, Texas
 The Starr Piano Co., Inc., Richmond, Ind.
 Steinway & Sons, 109 W. 57th St., New York 19, N. Y.
 Story & Clark Piano Co., 64 E. Jackson Blvd., Chicago, Ill.
 Stromberg-Carlson Co., 100 Carlson Rd., Rochester 3, N. Y.
 Targ & Dinner, Inc., 425 S. Wabash, Chicago 5, Ill.
 Tele-Tone Corp., 609 W. 51st St., New York 19, N. Y.
 Henry Teller & Son, 5490 Dorchester Ave., Chicago, Ill.
 Tilben Co., 526 Woodward Ave., Detroit 26, Mich.
 Tone Products Corp. of Amer., 351—4th Ave., New York, N. Y.
 Tonk Mfg. Co., 1912 N. Magnolia Ave., Chicago, Ill.
 Toono, Inc., 1156 Main St., Hartford, Conn.
 United Loose Leaf Corp., 233 Spring St., New York 15, N. Y.
 United States Television Mfg. Corp., 3 W. 61st St., New York, N. Y.
 Valco Mfg. Co., 4700 W. Walton, Chicago 61, Ill.
 The Vega Co., 155 Columbus Ave., Boston, Mass.
 Vox Productions, Inc., 236 W. 55th St., New York, N. Y.
 Waters Conley Co., 224 S. Michigan Ave., Chicago, Ill.
 Weaver Piano Co., Inc., Broad & Walnut Sts., York, Pa.
 Webster-Chicago Corp., 5610 Bloomingdale Ave., Chicago 39, Ill.
 David Wexler & Co., 1243 S. Wabash Ave., Chicago 5, Ill.
 W. F. L. Drum Co., 1728 N. Damon Ave., Chicago, Ill.
 The H. N. White Co., 5225 Superior Ave., Cleveland 3, Ohio
 White-Gerlat Co., 1600 Junction Ave., Racine, Wis.
 Wilcox-Gay Corp., Charlotte, Mich.
 The Willis Music Co., 124 E. Fourth St., Cincinnati 2, Ohio
 Winter & Co., 849-863 E. 141 St., New York 54, N. Y.
 The Woodwind Co. & Ernest Deffner, 461 Eighth Ave., New York 1, N. Y.
 The Rudolph Wurlitzer Co., DeKalb, Ill.
 Zenith Radio, 6001 W. Dickens Ave., Chicago 39, Ill.
 Avedio Zildjian Co., 39 Fayette St., N. Quincy, Mass.
 Zimberoff "house of note", 6320 Yucca St., Hollywood 28, Calif.

Discounts—Long or Short?

“Present Margins with Few Trade-Ins” vs. “Return to Pre-War Rates?” Dealers Divided

54% of Dealers quizzed want return to Pre-War Long Discounts (with Trade-Ins).

46% are satisfied with present rates, with few, if any, Trade-Ins.

● A great many radio/appliance dealers would like to continue to operate their business along the present pattern—short discounts, with few if any trade-ins. Of course, human nature being what it is, we'd all like to have longer discounts and still *no* bidding for the customers' junk, but such utopian merchandising plan will never be possible.

In spite of the fact that most economists believe that the retail merchant is totally dissatisfied with the present short discount set-up and that he cannot operate profitably under it, the retailers themselves don't go all out for such beliefs as applied to their respective establishments until they have weighed all the evidence—pro and con. Then they come up with a down-to-earth answer.

Few, if any retailers actually *want* pre-war discounts along with *slues* of trade-ins. Most of those who vote in favor of such return to former practice do so because wide-scale trading-in is now in their midst, or because they see its return imminent.

See Longer Discounts

Talks with merchants all over the country reveal that they are well aware of the fact that customers in increasing numbers will offer used merchandise to them. Furthermore, they realize that the day when such practice will be generally employed is not far off.

Most merchandisers feel that the entire discount structure operates via an automatically administered economic law. It makes sense to say

that discounts *will* lengthen when production hits a pace step-in-step with the buying rate—or even a little ahead of it. Competition is the governing factor. Even though labor and material costs continue at high levels, America's mass-producers will be able to operate profitably when they can roll out enough stuff.

But the problem confronting the dealer right now is the question as to whether he'll get caught with his margins down, meaning, will his discount rate remain as short as it is now for too long a period of time during which trade-in deals will make it impossible for him to run his business at a profit?

The American retailer in this field is a smart guy. He doesn't view his sales in the light of gross business. He wants to know how much cold profit he can put in the bank. That's why he wants to operate under the plan which gives him the most *net* profit.

He isn't concerned with what the actual discount is. He *is* concerned with how much of it he can keep. For instance, he would rather sell a hundred-dollar item for a gross profit of thirty dollars than to get a gross profit of fifty dollars out of which he has to give a customer \$25.00 for some broken-down, worthless product.

Because of the fact that trading-in is about here, many dealers are clamoring for more discount. They know that they cannot do business under present rates and participate in a competitive trade-in market too.

“I'm going to stave off trade-ins as long as I can,” one merchant told

us. “Such methods will keep us al on our toes in an effort to substitute *salesmanship* for *inducement*.”

Right now, many of those manufacturers who are still confronted with high-labor costs, upped material expense and very limited production, are marketing goods at a loss. In order to include more profit for the dealer and distributor under such conditions, the maker would have to raise his prices at the consumer level.

He would have to raise this price considerably higher than the slight increase some have already made. The manufacturer does not want to raise retail prices, nor does the dealer. In the face of the present agitation to lower prices, and the already stiffening up of consumer buying, large price increases would be *unwise*.

But, as pointed out before, experts feel certain that discounts will be back where they were before the War, when production hits record-high levels in a competitive market.

Since there is such a close relationship between discounts and trade-ins so far as the dealer is concerned, RADIO & Television RETAILING quizzed a number of leading dealers throughout the country asking them, among other things, which method they preferred to operate under: 1. Under the pre-war set-up, long discount, with trade-ins. 2. The present shorter rate, with few, if any trade-ins. We also asked the dealers whether they were accepting trade-ins at this time, and if not, were trade-ins being offered.

What Dealers Say

Following are some of the interesting comments received:

Voting for pre-war discounts, Louis C. Bush, of Atchison, Kansas, is now accepting trade-ins. “We are forced to,” he explains.

“If proper service is rendered, no dealer should be expected to handle a radio for less than 37½% to 40% gross profit, plus 2%, 10th prox. As soon as conditions return to normal, the radio dealer will be forced to make trade-ins whether he wants to or not,” declares J. Harry Kleckley, president Kleckley's, Inc., Gaines-

Trade-Ins? What Do You Favor?

No Wide-Scale Offering of Used Items Yet, But the Day is Seen Not Far Distant

ville, Georgia. Mr. Kleckley is now accepting trade-ins but "only on the basis where the old merchandise is salable and can be sold with at least 25 to 33 $\frac{1}{4}$ % gross profit."

Joe F. Zebor, Akron, Ohio, is not taking trade-ins, but they are being offered to him. This dealer votes for pre-war long discounts with trade-ins.

A Southern dealer is temporarily getting out from under the trade-in picture by accepting the customer's used equipment which he offers to sell for a slight fee.

"We are taking trade-ins as we are forced to do so or lose the sale," says Fred C. Helwig, Helwig Radio

"Long discounts definitely," reports Richard A. Bryan, Columbus, Miss. "Trade-ins are being offered by nearly all customers and we are making more money from them than from the new merchandise we sell. (This applies only to radios.)"

Frederick's, Washington, D. C., operated by Frederick Hurwich, prefers pre-war pattern. "They are offering trade-ins, and I am taking them," says Mr. Hurwich.

From Rockland, Maine, Calvin A. Sherman, of House-Sherman, Inc., says: "Either way is O. K. with us. Believe that there is less work with short discounts and few trade-ins, but there is a heck of a lot of fun and, we believe, more money and more friends to be made if we can take the old jalopies in and allow something for them. Some of the old stuff will sell, too. We are taking trade-ins if they are not too old (since 1940) . . . with present discounts we are playing pretty close to the vest, and not going overboard on allowances . . ."

Paul J. Rayburn, Chadds Ford, Pa., is not taking trade-ins, nor is his firm being offered any. He prefers to operate on the present basis.

Turn Trades Down

Oliver's at Danielson, Connecticut, is being offered trade-ins, but is not accepting them. The present discount set-up is satisfactory to this firm provided there are no trade-ins. Otherwise, they'd expect a longer rate.

"Pre-war basis by all means," votes Frank F. Violyn, of Violyn's Sales & Service, Amsterdam, N. Y. ". . . today the margin is too small . . . I am not taking trade-ins . . . politely turn them down."

Short discounts without trade-ins, appeals to John E. Minor, Minor's Radio & Television Co., Baltimore, Md. Some trade-ins are being accepted "only on very high-priced sets, and then only as a last resort. . ."

Leon's Radio Sales and Service, Cambridge, Mass., is turning down trade-ins because of low margins. Leon Krikorian wants to see pre-war rates return.

"Not taking trade-ins yet. Customers are offering trade-ins and will have to take them later," reports T. B. Winstead who operates a radio/appliance business in Elm City, North Carolina.

Plenty of trade-ins are being offered in the Bronx, N. Y. territory, reports Irving Breindel. However, he is turning them down, preferring to operate under the present short-discount, no trade-in practice.

In Emporia, Kansas, trade-ins are being offered to dealer Walter H. Schultz, but he is not accepting them. Mr. Schultz prefers operating under the present discount-no-trade-in system of doing business.

Minority Say the Present Set-Up

Is not good business.

That they can't work under it with present upped-expenses.

That profit-rate should be increased before trade-ins start rolling.

That trade-ins help to make sales.

& Appliances, Decorah, Iowa. Mr. Helwig would like to see the discount rate return to its pre-war level.

At Charlotte, N. C., Radio-Electronic Sales and Service Co., votes for the present short discount rate with no trade-ins. The firm finds that very few used products are being offered: none are accepted.

From Martinsville, Indiana, Davee Radio & Appliance Co., likes the present set-up; is not taking trades.

Bill J. Fair, Cave Springs, Arkansas, would rather do business with present short discounts, with few, if any trade-ins. "Trade-ins are being offered by my customers who expect more for them than we can possibly give and retain our margin of profit."

Majority Think the Present Set-Up

Is more profitable in the long run.

That it helps prevent price-cutting.

It stops dealers from making overboard allowances to customers; curbs inducement-making.

An analysis of the results in the study conducted by this publication shows that opinion is quite evenly divided on the subject of discounts. But the fact remains that trade-ins are coming back—but fast, in most sections of the country.

All agree that they cannot operate on present markup rate when trade-ins are thrown in to cut the margin still lower. Nor can dealers see themselves able to do business totally devoid of trade-ins when full-scale competition arrives.

Additional comment by dealers, and further discussion on the subject of discounts and trade-ins will appear in a future issue of this publication.

Preparing for Door-



Out-of-Store Merchandising is Coming Back and Merchants

ARE YOU READY FOR WORK IN OUTSIDE SALES?

In This Article Read How to

HIRE OUTSIDE SALESPEOPLE

HOW TO COMPENSATE THEM

HOW TO "CONDITION" THE TERRITORY

• Outside selling is commencing to resume its place of former importance in the retailing of radios and electrical appliances. In many communities, salesmen are now calling upon established clientele, and some are making "cold turkey" calls as well.

As a consequence of this renewed activity in out-of-the-store merchandising, retailers all over the country are considering enlarging their salesforces, or at best are making plans calling for use of some of their present personnel for sales work in the field.

There are several problems associated with the consideration of resumption of outside selling which the merchant must face and solve in these days of increased operating expenses, lowered profit margins, and more sales resistance upon the part of the customer.

Is the Time Ripe?

First, there is the question of whether in his particular locality, outside selling is actually necessary now. The dealer who is still doing a large walk-in business may be justified in feeling that it's wiser to concentrate on in-store merchandising.

Second, the retailer who's planning an outside force, is faced with a very real problem in obtaining the services of capable salespeople. In addition, the salesman compensation question is still unsettled so far as outside men are concerned. At this time, very few merchants have been able to agree on methods and rates of

payment for their outside salesmen.

Then, too, there is a widespread lack of knowledge on just what the outside selling field looks like now. Dealers are asking themselves all sorts of questions about it. They want to know, for instance, more about what sort of reception the outdoor salesman is going to get from the housewife who hasn't been "pestered" for a number of years.

Particularly, they want to find out whether or not door-to-door canvassing is going to be as tough as it formerly was.

They feel that the experienced outdoor man can stand the gaff associated with "cold turkey" work, but are wondering how soon some of the green youngsters would blow their tops under the system of door-slaming which was in effect just before the War.

By and large, there are two reasons why any retail merchant should plan to enter or re-enter the outside selling picture at this time. First, because he needs to increase his sales volume in proportion to the top capacity of his sales force, and second, if competitors are presently soliciting among the homes in his trading area.

Having decided that the time is ripe for outdoor selling, the merchant needs to select salespeople for the

job; adopt a plan for compensating them. Next, he should undertake to "prepare" the outside territory for visits by his salesmen. When he has settled the two foregoing angles, he should train his men to operate correctly and efficiently.

In most sections of the country there is a dearth of experienced salespeople. On the other hand, there are considerable numbers of inexperienced young people anxious to get into the selling game.

Hiring Salesmen

In considering the hiring of "green" men and women for the outside selling job, the merchant must keep in mind that experience doesn't mean as much as it would appear to. Adaptability and natural bent, plus a pleasing personality, alert mind and willingness to work are the qualifications the dealer should look for in prospective additions to his salesforce.

In hiring salespeople, even the smallest dealer should demand a written application. Having secured such information from his would-be employes, he should investigate references given.

Next, he should put all newly-engaged salespeople upon a trial basis. The employe should be thor-

to-Door Selling



Are Familiarizing Themselves With the New Trends

oughly posted on all phases of his job. He should understand exactly what his pay and commission rate is: working hours, and duties extraneous to selling, if any.

Increasing numbers of dealers expect to participate in the new trend toward engaging services of women for outside sales work. Hiring of both sexes seems to be a smart operation at this time.

Though there are many variations to payment plans, four basic ones exist, as follows: 1. Straight salary. Right now, sales salaries in stores of all sizes, range roughly from \$25 to \$50 weekly, most carrying incentive bonuses and commissions in addition. Most straight salaries are being paid to inside salespeople at this time, and most require that employes perform some non-selling tasks too.

The second most popular plan today is that involving a comparatively small salary plus a fairly high commission rate. When and if discounts to the dealer become longer, the commission rate usually will be increased.

Compensating Salespeople

Because of the various margin rates under which he operates today, the dealer would be wise in setting different commission amounts for the several products the salesman will offer his customers.

As an example of salary and commission setups, one large Eastern merchant plans to pay his inside-and-outdoor salespeople \$35 per week and commissions running from five to twenty per cent, depending upon class of articles sold and volume per month.

The salesman paid on the above scale must operate his own car and must devote certain days and nights to work on the sales floor. This dealer has a well-patronized, long-established store, and many leading brands. He feels that a good sales-

person can make a minimum average of \$100 weekly in return for hard-hitting effort.

The third plan is the old familiar drawing account against straight commission. Today, this plan is hard to operate under because of the low profit margins the dealer has. On the other hand, the trade-in volume is not now large enough to become a serious factor. Moreover, there is a great ready sale for many products

in spite of the fact that some radios and appliances are now being sold in a buyers' market.

In order to earn a salary of about \$5,000 a year, the salesman working under the drawing account-against commission plan, would have to sell more than \$50,000 business annually on a 15 per cent commission basis, against a drawing of \$50 per week.

Throughout the nation, merchants

(Continued on page 162)



Service as a



Entire Structure of Illinois Dealer's Business Is Built for Sound and Profitable Merchandising

● "One reason we maintain a high-class service department is because repair work is a feeder of new sales. We want to give unexcelled service on the products we sell. We want customers to 'stay sold' so we must have a good service department to keep up our reputation. With us, merchandise is not sold until it has been in the home long enough to give complete satisfaction. *That we are on the right track is proved by the fact that in the approximately 11 months since we started the business, we have increased our business more than 600% over the first month.*"

This is a statement of the sales-and-service policy of Peoria Radios, Inc., 1705 Prospect Road, Peoria, Ill., as delivered by Joe R. Koch, manager. The store is one of the best appointed and best equipped outlets for radios,

appliances and records in the area, and the slogan is "Buy Where Sales Are Backed by Service!"

In 1945 the Peoria Radio owners wanted to start the business, and because merchandise was not available, they decided to make it a service business in the basement of a drug store at 700 Knoxville Avenue, adding as much new merchandise as they could as they went along.

The Business Expands

On May 15, 1946, they opened a second store at 1701 Prospect Road, still maintaining the store on Knoxville with both sales and service in addition to using it as a warehouse for both places.

The new location is on one of the main traffic streets of the city in a new and rapidly growing middle-

class neighborhood shopping center. The store occupies at present a room 25 x 25 feet in a neat brick building. Nearly all the space is used for a display and sales room, with only a small service department in the rear behind a counter. Much of the heavier service work is done at the Knoxville address.

Several nationally known lines of both radios and major electrical appliances are handled, along with car radios and a complete line of small appliances. Many of the latter, along with table models of radios are on display along with a wide variety of small electrical gadgets. A record department has also been established and a nice stock of albums and single records is now on display.

"We intend to give expert service on any and all sales we make," says

Impressive array of test equipment is shown in the repair shop at Peoria, where good servicing is practically regarded as the heart of the business. Joe R. Koch, proprietor, left, is in a bout with a record changer; shop assistant Robert Summers at right.



"Feeder" for Sales

Mr. Koch. "While sales will be our main activity, we shall continue to service any make or model of radio. Our idea is to give customers the best service they ever had—to shorten, if at all possible, the service period, trying to render service within 48 hours. With all the latest and best repair equipment, we believe we can achieve this result."

The sales room has two large display windows. The ledges of these are covered with carpet. There are no high backgrounds and the entire room is visible through the windows, in effect making the whole room a window display.

Displays Are Dynamic

The room has an asphalt tile floor. At one end is a slightly raised dais covered with carpet similar to that used on the window ledges. This is used for the display of cabinet models of radios. On one side is a series of neat shelves devoted to display of light bulbs and small electrical merchandise. There are two island fixtures of three-stepped shelves each. The shelves are covered with cork linoleum and devoted to small appliances. The merchandise of these two island displays is frequently rearranged so the displays do not become

monotonous. Another series of shelves on the rear wall is devoted to records and table size radios.

The little shop in the rear is provided with attractive shelves for the storage of parts and with a clean, well-appointed work bench. The equipment of the bench includes two multimeters, an oscillator, a tube tester, a signal tracer, and all kinds of regular and special small tools for radio work. A large inventory of parts and tubes is constantly carried.

"We do not believe a good major repair job can be done in the home," says Mr. Koch, "and so we bring practically all such jobs to our shop. In order to service a radio properly, we must have all conveniences at hand. For light pick-up and delivery we use a neatly painted coupe rather than a truck as it is more comfortable for service men to drive and more versatile. It is also better looking and so gives customers and others who see it a good impression of our business."

A job card in duplicate is used on all jobs, with the customer receiving one copy and the other being filed alphabetically in the office. As soon as enough merchandise is available, these office copies will serve as a mailing list for future sales.

The proprietors believe in printed

advertising and get most of their new business from this type of promotion. A classified ad appears in the two daily papers each day. In order to make it different from other ads, the ads are placed in the "Lost and Found" column. These ads make use of the firm slogan in this manner: "Found, a place to buy where sales are backed by service." An occasional display ad is also used in the newspapers.

Ads Cover the Area

An ad is also carried in the Peoria Shopping News, a city-wide house-to-house-distributed shopping paper. Ads also appear in the Masonic Shoppers' Guide; in Peoria Central High School's publication, Opinion; and in various other school and church leaflets. Occasionally hand bills are used. These are distributed by boys engaged for the purpose from house to house—about 500 at a time, each time covering a different territory.

Profitable business-bringers are the two large ads used in the classified section of the telephone book, these appearing under both Radios and Appliances.

A large neon sign extending the

(Continued on page 144)

In this corner of the Peoria, Ill., store, the neat shelves match the island displays in a big show-off of smaller electrical products. Shelves are covered with cork linoleum which helps in keeping everything clean, and gives the area a more modern appearance.



RCA-Victor PORTABLE

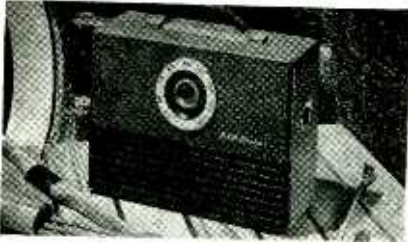

"Escort" model portable 3-way receiver with rechargeable battery. Operates from house current or from self-contained 2-volt storage battery. Will play during recharging. Tunes 540 to 1600 kc. Safety fuse prevents damage to battery. Golden Throat tone system. Vinyl plastic-coated luggage type covering on compact cabinet. Chromium-plated fixtures, leather-covered handle. Measures 10½" by 14½" by 5½". Suggested list price is \$89.95. RCA Victor Division, Radio Corp. of America, Camden, N. J.—RADIO & Television RETAILING.

Garod TABLE COMBO

Model 5AP1 "Companion" ac superhet table radio-phonograph, handling 10" or 12" records changed manually. Built-in loop antenna, five tubes, tunes 540 to 1650



kc. Crystal pickup, featherweight tone arm. Plastic cabinet comes in ivory, walnut or pastel colors. Measures 14½" wide by 7¼" high by 11½" deep. Garod Radio Corp., 70 Washington St., Brooklyn 1, N. Y.—RADIO & Television RETAILING.

Zenith COMBO

Model 12H091E chairside FM-AM radio-phonograph with "Electro-Glide" feature which slides changer unit out at touch of button. Cobra tone arm. Armstrong FM coverage of both bands, plus international short wave with spread band tuning. Nine radio tubes plus one power rectifier tube plus one 3-purpose phono tube and one cathode tuning indicator. Both Wavemagnet and FM "power line" antenna provided. Dual channel frequency transformers, avc, tuned r-f, automatic silent-speed record changer. Storage space for records. Bleached mahogany cabinet with special



mar-resistant finish. Measures 22" high by 18¾" wide by 28⅞" long. Zenith Radio Corp., 6001 W. Dickens Ave., Chicago 39, Ill.—RADIO & Television RETAILING.

Fada PERSONAL RADIO



Model P80 tri-powered portable receiver, ac-dc battery superhet tuning 538 to 1650 kc. Designed for convenient battery replacement. Six tuned circuits, High-Q loop antenna, 4" speaker with 1-oz. Alnico 5 magnet. Battery-electric switch on front panel; all chassis parts cadmium plated. Four tubes plus selenium long-life rectifier. Cabinet of high-impact bakelite—available in black, walnut, maroon or ivory. Measures 4⅝" wide by 5⅞" high by 8⅞" long; weighs 5½ lbs. without batteries. Fool-proof phosphor bronze snap-catches on front and rear lids. Fada Radio & Electric Co., Inc., Belleville, N. J.—RADIO & Television RETAILING.

Westinghouse FARM RADIO

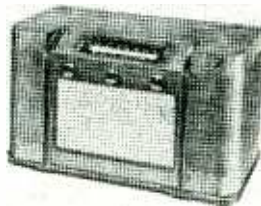

Model H-133 table battery receiver tuning 550 to 1700 kc. Powered by one V-3594 "AB" battery and two V-3595 "C" Westinghouse batteries. Five tubes. Speaker is 5½" PM unit. Cabinet measures 10¼" high by 17½" wide by 9" deep. Westinghouse Electric Corp., Home Radio Division, Sunbury, Pa.—RADIO & Television RETAILING.

Lee 400 RADIO

Model 400 mite-sized table receiver with 4" PM speaker. Wood cabinet finished with "magic carpet" texture, available in a variety of color combinations. Measures

New Sets Are

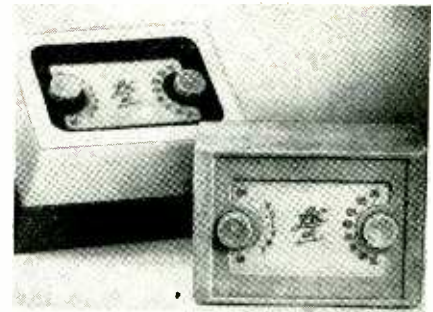

7½" by 5¼" by 43/16" and weighs 3½ lbs. Comes packed in carton with cellophane window. Engineered and designed by Jason Electronics Corp. \$12.95. Lee Radio Co., 1331 Halsey St., Brooklyn, N. Y.—RADIO & Television RETAILING.

Temple RADIO

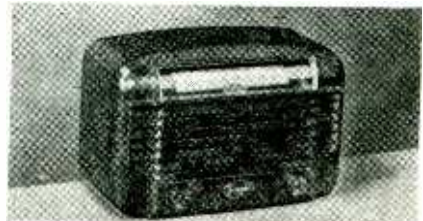

Model G-513 ac-dc table receiver with Alnico 5 PM dynamic speaker. Fitted cellulose dial cover for all-directional viewing—illuminated slide rule dial. Plastic cabinet in walnut grain or ivory finish. Templetone Radio Mfg. Corp., New London, Conn.—RADIO & Television RETAILING.

Echophone FM-AM COMBO

Model EC-403 console AM-FM combination with "automatic frequency control." Push button & manual tuning on broadcast—manual on short wave. AM range is 540 kc to 18 mc; 2 spread bands. Bass boost, automatic disc changer, 15" speaker.

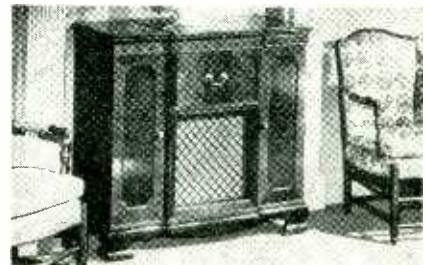

Walnut Chippendale, \$550. Hallicrafters Co., 2611 S. Indiana Ave., Chicago 16, Ill.—RADIO & Television RETAILING.

Sales Clinchers

Minerva PORTABLE RADIO

Model 729 "Porta Pal" three-way portable receiver with battery life rated at over 125 hours. Built-in loop antenna. Two-tone fabric covering, modern honeycomb grille, leather push-up handle with brass fittings and leather identification tag. Measures 13" long by 7" high by 6½"



deep. Lists at \$29.95 less batteries. Minerva Corp. of America, 238 William St., New York, N. Y.—RADIO & Television RETAILING.

Porty RADIO

Model 601 portable battery receiver, designed to produce sufficient volume for group as well as individual listening. Finger-tip control for tuning and volume.



Four-inch PM Alnico speaker. Leatherette covered in different styles and colors with adjustable matching shoulder strap. Measures 7½" by 9½" by 3" and weighs 72 ounces. Arc Radio Corp., 523 Myrtle Ave., Brooklyn, N. Y.—RADIO & Television RETAILING.

Andrea RADIO

Model T-U15 two-band ac-dc table receiver tuning 545 to 1700 kc on standard and 5.85 to 22.5 on short wave. Edge-



lighted glass dial, avc, beam power output of 2 watts. Self-contained loop antenna, plus provision for outside aerial. All parts "Climate Sealed"—rust-proofed cadmium-plated chassis. Molded walnut plastic cabinet measures 12" wide by 8½" high by 6½" deep. Andrea Radio Corp., 27-01 Bridge Plaza North, Long Island City 1, N. Y.—RADIO & Television RETAILING.

Sonora TABLE COMBO



Model WGFU-241 phonograph radio playing 10" or 12" discs changed manually. Superhet tuning 535 to 1620 kc. built-in loop antenna, featherweight crystal pickup, push-button motor switch. Ivory plastic cabinet. Lists at \$42.95. (WGFU-242 is walnut plastic and lists at \$39.95.) Sonora Radio & Television Corp., 325 N. Hoyne Ave., Chicago, Ill.—RADIO & Television RETAILING.

Audar DISC RECORDER



Model RE-8 portable ac disc recorder and playback with 6½" PM dynamic speaker. Recording level indicators, one-control switching from recording to playback. Automatic tone compensation. Includes hands microphone with 7 ft. of mike cable. Two-toned leatherette carrying case. Audar, Inc., Argos, Ind.—RADIO & Television RETAILING.

Stewart-Warner AM-FM RADIO

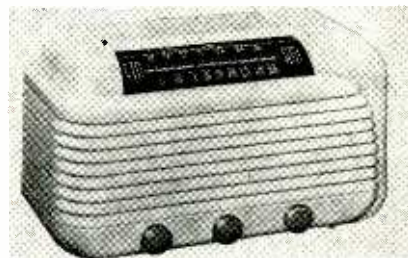

Model A72T2 table ac-dc set with 7 tubes, tuning 540 to 1600 kc on AM and 88 to 108mc on FM. Selenium type dry rectifier, built-in antenna for both AM and FM bands. Five-inch PM dynamic speaker. Ivory plastic cabinet (A72T1 is mahogany plastic). Stewart-Warner Corp., 1826 Diversey Parkway, Chicago, Ill.—RADIO & Television RETAILING.

Admiral COMBO

Model 7RT42-6LI table radio-phonograph ac superhet, tuning 540 to 1630 kc. Beam power output, avc, continuously variable tone control, Aeroscope, 5" Alnico 5 PM dynamic speaker. Improved disc changer handling twelve 10" or ten 12" records at 3½ sec. per disc. "Miracle" tone arm:



snap-in cartridge. Cabinet of straight-grain walnut, hand-rubbed top, French gold grille. \$89.95. Admiral Corp., Chicago 47, Ill.—RADIO & Television RETAILING.

Air King COMBO

"Crown Princess Console" model automatic radio-phonograph console, superhet with 6 tubes including rectifier. Built-in loop aerial, Alnico 5 PM speaker, automatic volume control, edge-lighted slide rule dial. Dual post automatic disc changer handles 10" or 12" records; featherweight tone arm, crystal pickup, permanent needle.



Hand-rubbed finish, space for 180 discs. \$134.75. Air King Products Co., Inc., Div. of Hytron, 1523 63rd St., Brooklyn 19, N. Y.—RADIO & Television RETAILING.

(Continued on page 58)

Dealer Cashes In on

Jersey City Firm Launches How-to-Do-It is

Effective advertising plays a big part in the success of the Goodman store.

● When a retail firm, whose guiding lights are men of vision and action, decides to do an all-out sales promotion job on television, results little short of phenomenal can be expected.

Such a store is Goodman's, 830 Bergen Avenue, Jersey City, N. J.

And the satisfactory results attained in the year-and-a-half merchandising campaign on television prove that the dealer who capitalizes on television in areas now receiving programs can make himself some real money by cashing in on public interest.

How Goodman's publicizes itself as television headquarters in order to sell television, radio sets and electrical appliances is a profit-pattern many another dealer can follow to good advantage. Boiling the whole operation down to its simplest form, we see three basic elements which join to make this drive for business a success. These elements are: 1. Clever promotion. 2. Effective display. 3. Adequate selling and demonstrating facilities.

Clever promotion at Goodman's consists of active participation and cooperation in all sorts of community events; newspaper and radio advertising, direct-mail campaigns, and a hard-hitting bid for the tavern business.

Effective display starts on the outside of the Goodman store where features are a large modern store front, and a huge side-of-building sign, and extends into the store where departmentalized merchandise is shown in great variety, and under most attractive surroundings.

Adequate Selling and Demonstrating Facilities include an in-store television theatre, skilled demonstrators, numbers of "live" demonstra-

Seen just inside show-window is the television set Goodman's uses to entertain the visiting crowds.



Public Interest in Tele

Bang-Up Promotion Campaign—Uses Video to Spearhead Sales of All Lines in Store—Their Profit Pattern for Other Merchants to Follow

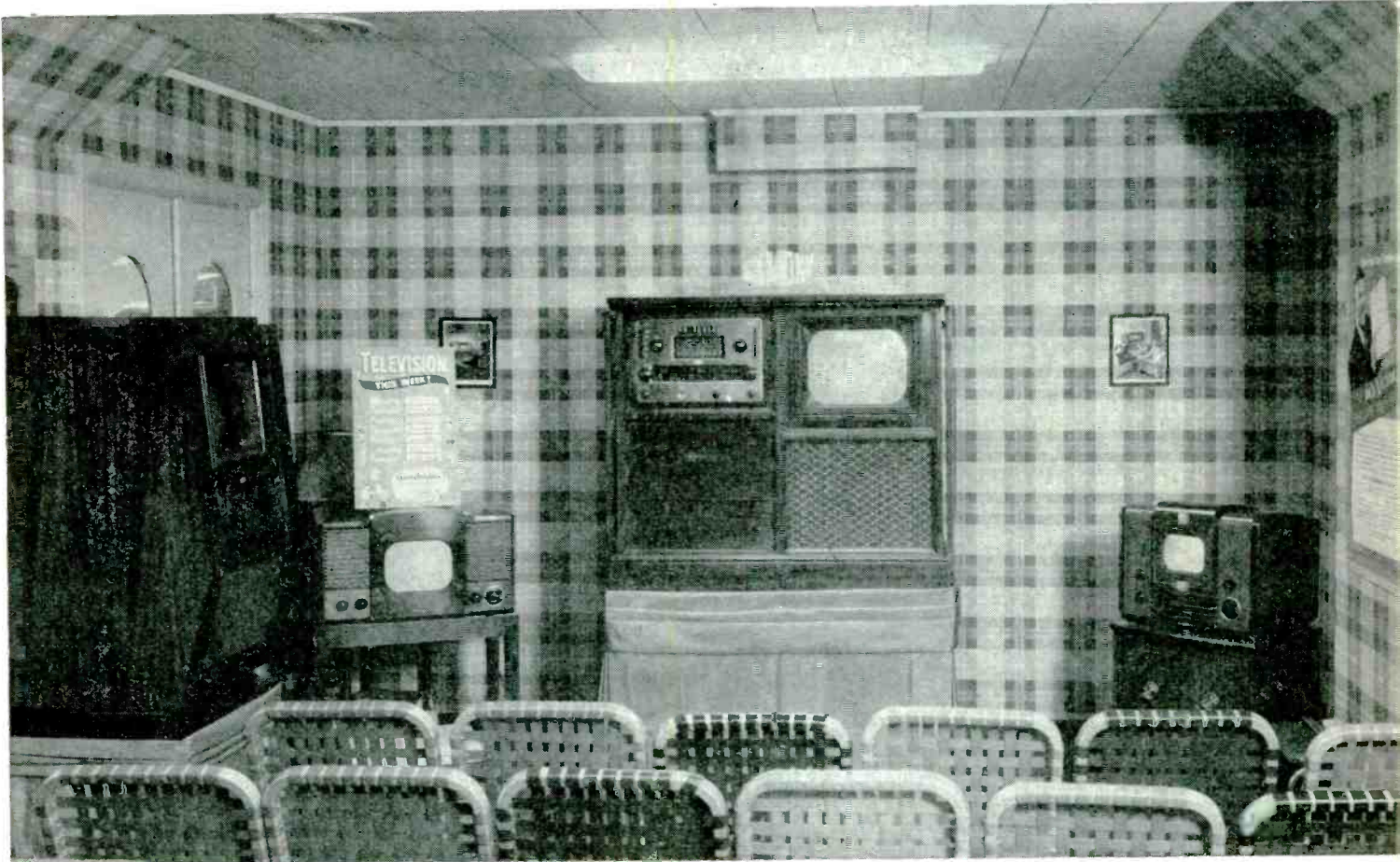

In this modern television theatre, the Jersey City firm acts as host to various groups. Every Saturday morning, sales meetings are held in theatre.

tion models and a well-trained sales-force.

A breakdown of each element employed by this organization in stressing itself as television headquarters in a trading area of about 600,000 people, reveals information valuable to any dealer who wants to get aboard the video sales bandwagon.

Profitable Promotion

Page ads headed "There IS Something NEW Under the Sun" announced the opening of the new radio and electrical appliance section, which is run entirely separate from the furniture and storage warehouse business which was founded about a half-century ago. The main floor is devoted entirely to television, radio and appliances. The page ads show views of the store, inside and out,

and list prominently the name-brands handled by the organization.

Aware of the great interest in television in its territory, Goodman's decided to use tele to spearhead sales

promotion for the entire store. A drive was made to sell video sets to taverns, bars and grills. This effort, which was launched some time ago,

(Continued on next page)

The interest in television is terrific. Goodman's displays sets at gatherings all over its trading area.





This Garden State dealer has done a bang-up job selling television sets to tavern owners. Above, a typical installation in Jersey City. Three large receivers were sold for one bar and grill.

met with instant success, and a great many installations were made. Two sets were sold in one tavern, and the owner now has a third unit on order at Goodman's.

Each public place purchasing a television set from the firm is furnished one or more attractive counter cards titled "TELEVISION This Week." Opposite each day of the week is a cut-out slot into which the new program slip is inserted. The Goodman store name is prominently displayed, along with the legend, "Showplace for Television."

In making sales presentations to owners of public places one of the most effective selling tools the salesman has at his disposal is a bound portfolio of photographs of installations made in other local bars and grills, etc. It is a hard-and-fast rule in this store that every public place where a television set has been sold be photographed.

Crowds—Inside and Out

Another bit of promotion which puts Goodman's in the limelight is the evening exhibit staged in the show-window. Large crowds gather in front of the establishment to watch the television set in action. People begin to assemble in front of the store a long time before the scheduled events; attend in all sorts of weather, and, on numerous occasions crowds have been so great that police assistance was needed.

In addition to the outside shows, Goodman's modern television theatre is open two nights a week to the public. The theatre is of modern construction, seating about forty people. Audiences are secured through a card in the window inviting adults to witness the exhibits, and via in-

vitations sent to different religious, social and civic organizations.

In order to induce certain organizations to attend tele shows in a body, Goodman's offers to pay such club a certain amount for each person who visits the in-store theatre on special occasions.

When the group arrives, the members are first escorted through the store, where they see demonstrations going on in the various departments. Next, they are taken to the television theatre, where they hear a short talk on what television is and how it works. Following the talk, the large set is turned on for the entertainment of the guests.

It is important to note that Goodman's makes no effort to sell anything to any of the visitors who attend the shows in groups. This practice permits guests to feel entirely at ease. It also serves to build up a lot of good-will for the store.

The Goodman television theatre serves another worthwhile purpose. Each Saturday morning it is used as headquarters for the weekly sales meeting. Here, the staff can meet and discuss problems without interruption. Now and then, sales executives of manufacturing and distributing firms are invited to address such gatherings.

Right now the Goodman organization, in common with dealers in all other television areas, can sell all of the receivers it can get its hands on, and for this reason the all-out promotion now being undertaken is designed to help pave the way for effective merchandising of sets when the competitive market is at hand, and for the purpose of selling radios and appliances now available.

Goodman's maintains a first-class service department for the mainte-

nance of radios and appliances, and stresses this feature in advertising copy. The importance of proper installation of video sets is well-known to the firm, which is set up to service television sets in cases where the maker does not insist upon performing this work through his own service department.

DuMont and RCA television receivers are the two makes being featured at this store.

This progressive Jersey City firm never loses a bet to promote sales of electrical appliances, radios, records, etc. For instance, the organization recently equipped a model home in a nearby development, where as many as a thousand people have visited in a single day.

To aid customers in the proper selection and use of appliances, Goodman's engaged a full-time "home service director," Miss Dorothy Covert. Her appointment was announced via radio and newspaper advertising, and through news items in the local papers.

Follow-Up Plan Pays

Tying in directly with the activities of the "home service" department, Goodman's employs smart sales strategy in a follow-up plan aimed not only to please the new owner of an automatic washer, a food freezer, or some other home product, but to sell *additional* products as a result of making the original sale.

Here's how it works: A short while after a customer has purchased appliances—say, for instance, a washing machine and an ironer, the new owner gets a letter from Goodman's offering to present the customer with a gift if she will invite a few neighbors in, and permit Goodman's to demonstrate the appliances at such gathering.

Subscribing to a service which furnishes them with names and addresses of newlyweds and engaged couples in the territory, the firm secures very good results through a direct-mail campaign. A "Bride's Booklet," which has among other features, places for the newlyweds to list their wedding presents, and perforated sheets of numbers to be stuck on gifts for identification purposes, is first mailed. This is followed by a letter, and next by another interesting booklet on home-making. The booklets carry a minimum amount of advertising.

Included in the firm's radio broadcast advertising is the use of a foreign language station to beam messages to the large population of Po-

(Continued on page 145)

*Top Stars of the
Summer Furniture Market!*

Bendix Radio

Presents

FM AT ITS FINEST!

BENDIX EXCLUSIVE
RATIO-DETECTOR FM

ADVANCED RADIOS AND
RADIO-PHONOGRAPHS!

FURNITURE STYLING!

NEW BENDIX TELEVISION!

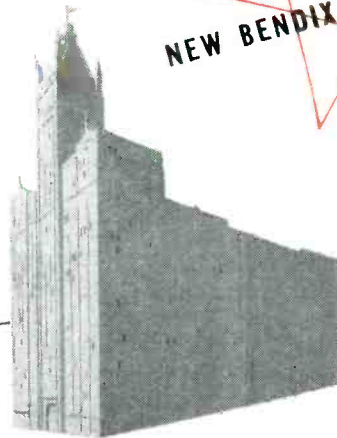

SEE THE NEW

Bendix Radios

SPACE 545-D

MERCHANDISE MART
CHICAGO • JULY 7-18

BENDIX RADIO

BENDIX RADIO DIVISION OF
Baltimore 4, Maryland





'Round

Merchandising

Selling the So-Called "Seasonal" Items Twelve Months of the Year

● Any legitimate device that keeps a dealer's merchandise really moving out of the store is a fine thing for business.

If a retailer can put some effective sales pressure on those stocks which are likely to gather dust at certain times of the year, he'll have a better time of it. The profits will become more steady and sizable.

One way to do this is simply to develop a new attitude toward seasonal sales; that is, to conduct the business with the basic conviction that all merchandise has year 'round possibilities. This means a departure from the traditional idea of "timely" promotion. It means that the old theories about certain merchandise being seasonal at certain definite times should be regarded as doubtful.

There was a time when all appliance men jumped into vacuum cleaner promotion in the Spring, and almost forgot about everything else in the store. In the Fall, the same thing happened with oil burners and heaters; in the Summer the accent shifted to fans and refrigerators. Retailers did not take this action without good reason, because the sales curves in this merchandise *did* take seasonal jumps. To some degree, the public fell into the habit, and had a tendency to select certain purchases while they were "in season."

Sales Do Jump

Certainly it is true that most people buy their fans in the warm weather. Retailers should not lose sight of this fact, and they should be ready with impressive stocks of items when they are wanted most. But if a retail man will start thinking of the hundreds of uses of fans, for example, in all kinds of weather, he will find that

long-range sales improve strongly.

The portable radio is another item which has been regarded as basically a Spring-and-Summer product. Big promotions are based on the fact that people take vacations in Summer and buy the take-along sets for that purpose. That's fine. But retailers are becoming more and more aware of portable sales possibilities all the year 'round. Here are a number of reasons for the new attitude: (1) Many of the new sets are designed for use inside the home as well as out, (2) there is a lot of traveling done *all* the time and radio fans should be reminded of the extra enjoyment possible, (3) thousands of people take winter vacations, and (4) more of the youngsters are carrying the portables around in Summer *and* Winter.

A similar number of comparatively

new market factors could be outlined for nearly any item that has been thought of as strictly "seasonal." Most all the radio/appliance products have uses that will stand developing into 12-month propositions. The situation keeps changing, because the improvement in merchandise keeps right on; its application to home life is under constant development.

Years of Profits

Electric blankets are sold in mid-Summer as an insurance against extra cool nights. Fans are sold in the Winter to plenty of people—including thousands of photography hobbyists who use them to dry film. Hundreds of home cleaning systems are sold to brides who are only faintly aware of the "Spring housecleaning" custom. If a retailer will give the matter some careful attention, he'll find that he can sell extra merchandise for a string of extra applications.

One dealer who has checked out the "seasonal" theme says that he puts the "timely" promotions **ON TOP** of steady year 'round merchandising. That is, he sells portable radios twelve months of the year, but when vacation time comes in his area, he adds the extra emphasis of a big window display of the appropriate sets. This dealer is aware of the importance of promoting everything all the time, with **PLUS** merchandising when the time is ripe.

This policy has the effect of leveling off the promotion expense of the store, and of avoiding the slow periods when the gross income ordinarily slips to its lowest level.

The year 'round way of doing business gives the retailer the benefit of peaks, without the disadvantages of the old-fashioned slump.

Portables Are Always in Season

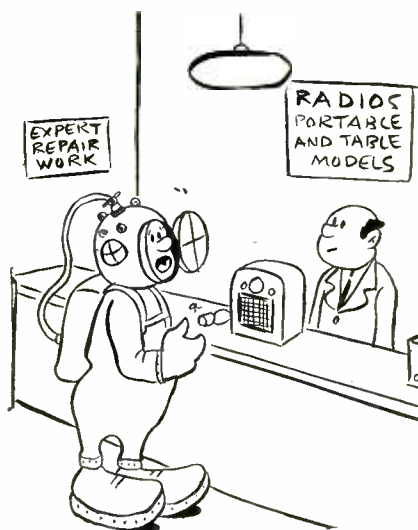

"Do you have a set that will play under water?"

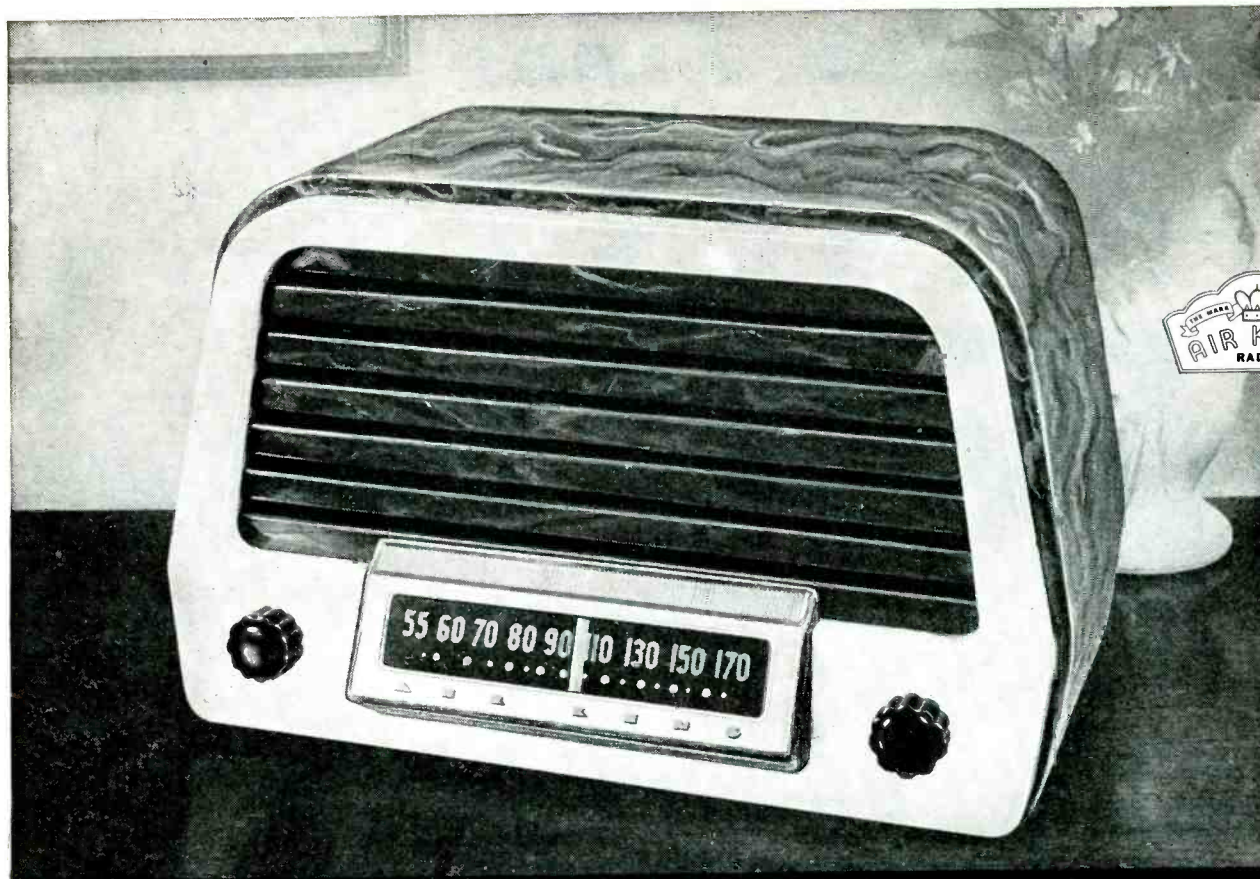

MODEL
A-600

AIR KING *Duchess*

*Encased in Luxurious Catalin
Engineered for Glorious Tone...*

• Air King proudly presents the "Duchess"—a perfect combination of the two vital factors of good radio merchandising: Incomparable cabinet design and magnificent depth of tone.

The polished brilliance and magnetic colors of the catalin cabinet plus super-sensitive, high fidelity reception and over-all precision construction makes the "Duchess" the outstanding new radio of the year.

No matter how you look at it, inside or out, the Air King "Duchess" represents the ultimate in eye and sales appeal.

★ We Have a Limited Number of Distributor and Dealer Territories Open ★

Write or wire: Air King Products Co., Inc., 1523-29 63rd St., Brooklyn, N. Y.

Export Address: Air King International, 75 West Street, New York 6, N. Y.

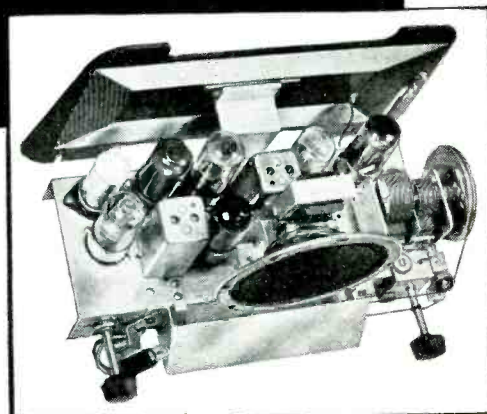

BEAUTY FROM WITHIN!—Superheterodyne receiver with five tubes plus rectifier (two dual-purpose tubes); Miracle precision die-cut antenna; 5 inch Alnico V PM Speaker; Automatic volume control; Hermetically sealed power condenser; Three dimensional edge-lighted slide rule dial; Full-floating tuning drive system; AC-DC.

The Royalty of Radio Since 1920

AIR KING RADIO

Division of HYTRON RADIO & ELECTRONICS CORP.

Royal Family of Radio

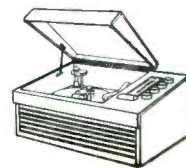
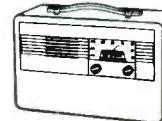
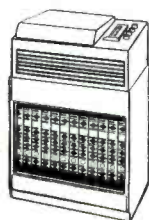
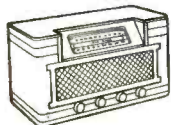

"Twenty-six years of Specialized Electronic Skill

Behind Every Air King Radio"

More New Lines Shown

Emerson TABLE COMBO

Model 546 ac superhet automatic radio-phonograph, tuning 550 to 1600 kc. Handles 10" or 12" discs. Cabinet in mahogany veneers with front-panel slide-rule dial



and control knobs. \$89.95. Emerson Radio & Phonograph Corp., 111 Eighth Ave., New York 11, N. Y.—RADIO & Television RETAILING.

Fun Fair ELECTRIC MOTOR KIT



Model 11 kit with 33 parts for assembly into electric motor, for youngsters and hobbyists. Designed especially to illustrate how electrical energy performs. Operates on either dry cell batteries or transformers. Includes 32-page book in color, giving complete instructions, plus discussions of radio and electrical subjects handled in a way to interest beginners. Suggested list, \$3.95. Toy Division, Fun Fair Industries, Inc., 66 Beaver St., New York, N. Y.—RADIO & Television RETAILING.

Ansley DYNATONE

Period style electronic piano combined with FM-AM radio and automatic record changer. Piano tones are amplified electrically instead of by a mechanical sounding board. Volume control provided to give "grand piano" effects or soft tones of harpsichord. Record player speed is ad-



justable, so that pianist can accompany records. Ansley Radio Corp., Trenton 9, N. J.—RADIO & Television RETAILING.

Bendix FM ANTENNA

Model AD1F00 dipole antenna and twin-lead transmission line. Streamlined and rugged construction using weather-proof components. Kit parts list for the assembly

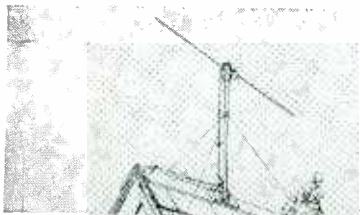

includes 75 ft. of 300-ohm cable. Bendix Radio Division, Bendix Aviation Corp., Baltimore 4, Md.—RADIO & Television RETAILING.

E-L VIBRATOR INVERTER

Model 2115 current conversion vibrator type unit to provide a-c radio and appliances to those customers with 32-volt farm power plants. Maximum continuous load capacity of 100 watts. Dual output system—one socket for appliance operation and one for radio. Inverter turned on and off by control on appliance. Measures 9½" long by 7½" wide by 6½" high; weighs 13 lbs. \$39.95. Electronic Laboratories, Inc., 24 W. 24th St., Indianapolis, Ind.—RADIO & Television RETAILING.

Burgess RADIO BATTERY

No. 2R battery—the first "A" unit designed for personal portable radios by this firm. Constructed to give longer life than



ordinary flashlight batteries. Brightly packaged—offered in counter display pack. Burgess Battery Co., Freeport, Ill.—RADIO & Television RETAILING.

Jewel RADIO

Model 503 ac-dc superhet table receiver tuning 550 to 1700 kc. Alnico PM 5" speaker, built-in Hi-Q loop antenna, automatic volume control. Four tubes plus "miracle" rectifier; slide rule dial with pilot light. New process textile grille in variety of color combinations. Hand fabricated lucite cabinet, two-tone style. Measures 8¼" high by 12" wide by 6" deep; weighs 4 lbs. 5 oz. Jewel Radio Corp., 583 Avenue of the Americas, New York 11, N. Y.—RADIO & Television RETAILING.

Casco ELECTRO-TOOL KIT



New electric tool kit for craftsmen, hobbyists, etc., with 20 different accessories. Attachments include steel cutter, abrasive and buffer wheels, etc., for working in wood, glass, plastic and metal. Includes hobby booklet "Things to Make and How to Make Them." \$14.95 list. Casco Products Corp., 512 Hancock Ave., Bridgeport, Conn.—RADIO & Television RETAILING.

Symphonic PHONOGRAPH

"Prep" model record player—compact table model with two tubes, Alnico 5 dynamic speaker. Simulated leather cov-



ering. \$24.50. Symphonic Radio & Electronic Corp., Cambridge, Mass.—RADIO & Television RETAILING.

Rek-O-Kut RECORDING CABINET

Console recording or transcription cabinet, to be sold separately or with any regular Rek-O-Kut recording turntables. Drop front door, holds about 100 sixteen-inch discs. Outlets and terminal blocks for motor line and pickup mounted on motor board. Sturdy construction, finished in two-tone metallic grey. Measures 32"



high by 24" wide by 26" deep. Rek-O-Kut Co., 146 Grand St., New York, N. Y.—RADIO & Television RETAILING.

It's Here!

THE TEMPLE 2-BAND "VACATIONER"

Most Sensational PORTABLE
Ever Made



● Just check those big, extra, all-new features of this truly great 2-band Temple "Vacationer" and you'll know why it outperforms, outsmarts, outfeatures and outvalues any Portable anywhere near its price. Better contact your Temple Distributor now, and place your order TODAY to insure early delivery.

**TEMPLE TONE
RADIO MFG. CORP.**
NEW LONDON, CONN.

Executive Offices
220 East 42nd St., New York, N. Y.

**ONLY THE TEMPLE
"VACATIONER"
has ALL these
advance features**

- 2-band operation—local or world-wide reception
Broadcast band from 535 to 1620 KC
Short wave band from 5.6 to 18.5 MC
- Five hi-efficiency tubes plus dry-disc, rectifier, giving normal 7-tube performance
- Economical—power drain only 13 watts during electric operation
- Large 6" Alnico V PM dynamic speaker
- Collapsible whip antenna
- Built-in loop antenna
- Automatic bass tone compensation on volume control
- Special safety battery-electric switch eliminates shock hazard in replacing batteries
- Automatic volume control
- Has 2 I.F. stages for extra high sensitivity
- Plastic roll-back curtain completely protects controls and dial window
- Built-in recess for line cord in battery operation
- Special battery retainer holds batteries solidly in cabinet
- Completely enclosed aluminum chassis for lighter weight and elimination of shock hazard
- Adjustable strap for carrying with handle or slung on shoulder
- Smart luggage effect exterior with beautiful simulated leather covering

3-way operation—AC, DC, or Batteries

TEMPLE
MODEL
G-521



"Where FM also means Finest Made"

In January we reported--

DEALERS SAY

STEWART-WARNER SETS ARE EASIER TO SELL
and they'll be still easier throughout 1947!

Everywhere people know Stewart-Warner know ever to sell... exciting new models in AM-FM sets, radio-phonographs, etc.

Now customer preference proves it!



FOR THE BUYERS' MARKET! Stewart-Warner has priced these superior FM models for the buyers' market. Richer in features... greater in values you can demonstrate... this FM line has real customer acceptance. It offers *you* attractive discounts. Both are vital points in today's changing market.

THE MUSIDORA—today's superior FM-AM console radio-phonograph. Full-cycle AC tonal range. Improved FM circuit, intermix record changer, 2 built-in Radair Antennae, 2 roomy compartments. Just *listening* reveals the difference!

Only Stewart-Warner gives you
Strobo-Sonic Tone!



THE CONSOLETTA—new AM radio-phonograph. Smooth, full-cycle AC performance. Handles 12 records automatically. Four quickly detachable legs quickly convert this set into a table or chairside model.



THE BALLADEERS—today's superior FM-AM table radios. Brilliant reception for all FM and standard programs. AC-DC, 7 tubes *plus* rectifier, PM dynamic speaker, 2 built-in Radair Antennae.

A Model for Every Purpose—a Radio for Every Room

Stewart-Warner

FM Radios **AM** • Radio-phonographs • Television

CHICAGO 14  ILLINOIS

RECORDS

Section of **RADIO & Television RETAILING**

Platter Profit-Pointers

\$ WHEN A CUSTOMER walks into a record store he should not be approached by a salesman who utters the meaningless phrase "Can I help you?" The salesman should *know* that he can be of some help, otherwise he would not be employed in the store. After greeting the customer, the smart record clerk should immediately begin "selling" with a positive statement of suggestion, not by posing a meaningless question.

\$ BOTH CITY AND SUBURBAN dealers find that increased advertising peps up summer platter sales. City folk have to be continually reminded to visit their favorite dealer, and to keep abreast of the current record releases. On the other hand, visitors and vacationers at summer resorts will be encouraged to visit Mr. Smith's establishment, if they see his ads around town.

\$ SHOWMANSHIP is an important asset of selling. Certain sides of albums are "better" and "more colorful" listening than other portions. Mark these "best sides" on your demonstration copies, and play them for quicker and better sales.

\$ UPSURGE OF INTEREST in recorded classical music clearly demonstrated by New York Yankees baseball club sponsoring a recorded air show of "long-hair" music. Dealers finding the same thing to be true among their customers—with same folk who previously bought only "pops" now going in for "culture" in a big way.

\$ AS SOON AS the record dealer knows a big-shot platter performer is going to visit his store, he gets right on the job preparing his publicity material. He takes advantage of all the display pieces his distributor can offer which will tie in with the event, and any cooperative advertising which may be available. Like the circus advance agent, the live-wire disc merchant knows that his show will be a flop unless everyone and his brother knows that it's coming to town.

\$ THE VALUE OF SIMPLE, sound-proofing devices used at important spots throughout the store will more than pay for installation costs in increased sales. Music lovers who come into a store to listen to serious pieces are driven frantic by several record players in operation throughout the store at high volume levels. The sound penetrates to listening booths and demonstration rooms, much to everybody's distraction. A simple type of acoustic board can be installed by the dealer, if he does not wish to engage in the expense of professional sound-proofing.



\$ NOW THAT THE "PORTABLE" season is here, and plenty of take-along phonos are being sold, a retailer is missing a bet if he doesn't help the portable fan to select a nice string of discs to go with the purchase.

\$ "DID-SO-AND-SO ever make such-and-such record?" is a frequently-asked question in the store. Dealers and salespeople should never answer such a question by saying "I don't know." Company catalogs and independent record guides are available which give this type of valuable information. If a store is to become "record headquarters" the people who man the counters should be known as "experts."

\$ CONTESTS ARE STIMULATING, and are good sales boosters. Dealers who employ a number of record clerks will find that a sales contest, offering prizes, will help sell accessories. Clerks will get into the habit of asking every customer to buy a new needle or record holder, as a result.

\$ AMPLE COUNTER room is more important than it would seem to be. Customers have very definite habits, for instance, the one where they select a couple of discs, put them on the counter, and then go in search of more. The records left on small, cluttered counters often get broken, sometimes are picked up by other customers, or by clerks who may put them in stock. Such confusion slows sales.

\$ ALL POLLS prove that youngsters buy a goodly percentage of the records the family enjoys. Psychologists also know that young people, particularly in their teens, are sensitive about the manner in which they are treated. Dealers should recognize these two factors, and go out of their way to welcome the young buyers into their stores.

To be featured next month in YOUR RCA VICTOR ADS!

Popular —

Something here for every customer!
Boogie woogie . . . sweet swing . . . plus a touch
of the classics, Spivak-style. To be featured in
July "LOOK" and 6 top teen-age magazines.



CHARLIE SPIVAK and his Orchestra and their
new album of **KREISLER FAVORITES** . . . turned
into smooth, dance magic! Includes *Liebesfreud*,
Caprice Viennois, *The Old Refrain*, *Liebesleid*,
Schön Rosmaren, *La Gitana*,
Tambourin Chinois, *Mighty*
Lak' a Rose. P-179, \$3.15.

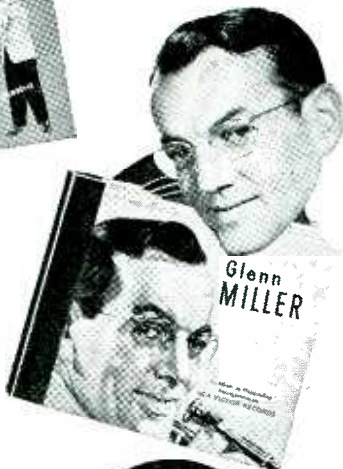

GLENN MILLER . . . and his
Orchestra in eight famous
numbers: *American Patrol*,
Song of the Volga Boatmen,
Tuxedo Junction, *In the*
Mood, *Little Brown Jug*,
Moonlight Serenade, *Star*
Dust, and *Pennsylvania Six-*
Five Thousand. P-148, \$3.15.



8 TO THE BAR (Two-Piano
Boogie Woogie for Dancing): Pete
Johnson and Albert Ammons, plus
drums, in some of the best pianis-
tics ever cut. Have it on display
when the ads run! P-69, \$3.15.

Don't miss our N.A.M.M. Convention Exhibit,
Booth 90-91, June 1-5. There's an interesting
treat in store for you . . . and a royal welcome!

Red Seal —

Again, your "LIFE" page, July 7, carries news
of the entire *Red Seal* release for the month . . .
headlining 3 top sellers. Your "TIME" page,
July 14, features Jeanette MacDonald's new-
est single. Plan your displays for these dates—and
pull in sales, ready-made!



DOROTHY MAYNOR, So-
prano: *Sacred Songs*. Includes
selections from "Elijah," "The
Messiah," "St. Matthew Pas-
sion," "Mass in B Minor,"
others. With the RCA Victor
Orchestra, Sylvan Levin, Con-
ductor, and Joseph Fuchs, Vio-
linist. Album M-1043, \$3.85. To
be featured in "LIFE," July 7.



GLADYS SWARTHOUT,
Mezzo-soprano: *Gladys*
Swarthout Sings (Popular
Song Album). Includes "Fall-
ing in Love with Love," "Sep-
tember Song," "I'll Remember
April," "In the Still of the
Night," others. With Russ Case
and his Orchestra. Album M-
1127, \$3.00. In "LIFE," July 7.



JEANETTE MACDONALD,
Soprano: *Mi Chiamano Mimi*
(*My Name is Mimi*) *La Bohème*;
Un Bel Di, Vedremo (*One Fine*
Day), from *Madama Butterfly*.
RCA Victor Orchestra, Frieder
Weissmann, Conductor. Rec-
ord 11-9599, \$1.00. In "LIFE,"
July 7 and "TIME," July 14.

Prices shown are suggested
list prices, exclusive of taxes.

Leading *Red Seal* and "Pop" items are featured
on your RCA Victor Show, Sundays (2 PM, EDT, over
all NBC stations). Follow up with a tie-in promotion!

Your RCA VICTOR distributor





Attractive album display encourages customers to browse and then buy.

● Although self-service departments have been carefully planned and executed to facilitate the sale of records, the need for "living" salespeople has not been eliminated. Dealers cannot place all the responsibility for operation of their record departments on inanimate display pieces. The "human factor" in selling is always with us, and open displays and record racks cannot smile, talk or offer "alternate" suggestions to customers. Self-selection definitely does have its place in helping cut down personnel expenses as well as aiding sales, but it is not the whole story.

Sales volume and profits are the yardsticks by which a successful business is measured. Expenses incurred in maintaining a salaried employee to bring about "more" sales, do pay off in the long run. The importance of the help-yourself types of display racks should not be under or over estimated. They are valuable man-made assistants to the store's sales force—but they will not do the selling job alone.

"Just Looking"

People undoubtedly do like to browse before they buy. But the dealer's selling story need not end after the customer has selected a disc from a nearby shelf. Willing employees, properly selected and trained, can do more to increase rec-

Self-Service PLUS . . .

Active Salesmanship is Needed for Bigger Disc Sales: Record Racks Cannot Do a Merchandising Job Alone

ord volume if they take over at this opportune moment.

Once the merchandise is in the customer's hands, all his "sensory perceptions" are stimulated. He can feel the record, read the label—experience pride of possession. He is in a buying mood.

This receptive condition on the part of the customer can be capitalized upon by suggesting an album of the artist's works, or another album along similar lines to the one purchased. Necessary conclusions of each sale, such as taking cash and wrapping, should be supplemented with interest-intriguing comments about other merchandise. "Companion selling" is an important function of each clerk on the floor, and a duty that inanimate objects cannot perform.

Power of Suggestion

The power of selling by suggestion cannot be overestimated, and many dealers find a good percentage of their sales are chalked up because the customer was "reminded" to buy something. Many people can look directly at an object without having it "register." The right word or two at the right time brings the point home. And only a "live salesman" can inject the stimulus of the spoken word into the prospective purchaser.

Inestimable good-will can be built up through a friendly and courteous greeting to a customer who enters the store, and an equally pleasant "call again" as he leaves. The value of the greeting is twofold as it unquestionably serves to put the

prospective purchaser in a more friendly frame of mind. An agreeable salesperson is frequently the determining factor in the customer's decision to buy at that immediate moment in that store.

Personal Touch

A skillful record clerk can handle more than one person at a time, particularly in a store aided and abetted by self-service displays. In addition, the salesperson should inquire what it is the customer is looking for and can fill out "want slips" for those discs which were requested, but not in stock.

Judicious, courteous use of this "personalized" element in selling will also help the retailer build up his "repeat" trade. Customers who keep coming back to one store are found to be the best buyers, and are an excellent class of trade to cultivate.

Customers favor self-selection racks because this system avoids the "pushing and prodding" that is mentally associated with "salesmen." The person who is selling records should be cautioned that, even though he knows what the customer likes, and may aid in suggesting titles, the patron should be allowed to make the final choice.

Self-service can never supplant the salesman. Even those masters of the "super self-service" marts in the food business have found it necessary to employ men on the floors to increase efficiency. Record racks are not robot salesmen—it still takes personality plus to consistently make sales.

New Records

Merchandising Notes and Highlights of
Current Additions to Disc Catalogs

VOCAL ARTISTS

ANDERSON, MARIAN: "Poor Me"—"Hold On." RCA Victor 10-1278

Two negro spirituals done "from the soul" as only Marian Anderson can do them.

EDDY, NELSON: "Patter Songs From Gilbert and Sullivan," Volume II; orchestra conducted by Robert Armbruster. Columbia M-MM-670

Success of first Nelson Eddy G & S album of songs should assure continued sales of follow-up collection.

TRAUBEL, HELEN: "Italian Operatic Arias," with orchestra conducted by Charles O'Connell. Columbia M-MM-675

Fans who are accustomed to hearing Miss Traubel in Wagnerian roles will be interested in this anthology of selections from Italian opera.

LIGHT CONCERT FAVORITES

ADLER, LARRY: "Roumanian Rhapsody," Part I and Conclusion. Harmonica solos with Georgie Stoll's Orchestra. Decca 23880

This is one of the numbers Larry Adler includes on his concert list. He makes personal appearances frequently, so this disc should provide ready tie-ins.

BLOCH, RAY: "Duel In The Sun, Parts I & II." Signature.

Theme music from the picture of the same name has Larry Douglas doing the vocal on one side, backed with a Bloch instrumental.

CARNEGIE HALL, recorded by D'Artega, featuring Milton Kaye, Jacques Margolies, Will Bradley and Tony Russo. Sonora album 490

Performed in D'Artega rhythm the album contains selections from the picture "Carnegie Hall."

FINIAN'S RAINBOW, featuring original cast singers Ella Logan, Albert Sharpe, Donald Richards, David Wayne, plus the Lyn Murray Singers. Columbia MM-686

Album of tunes from current

Broadway musical comedy highlights many of the dramatic spoken interludes, as well as musical score. Tremendous popularity of hit songs makes this album "on the beam" for retailers.

MUSICAL TRAVELOGUE, recorded by Spitalny. Sonora 493

A wide variety of selections providing for a musical cruise through Europe are incorporated into this album.

SELECTIONS FROM BLOSSOM TIME: Al Goodman and his orchestra, with Earl Wrightson, Mary Briney, Donald Dame, Blanka Peric. RCA Victor P-173

The familiar Schubert themes are re-created again in the melodic Goodman manner. Sales should be spurred by ad build-up Victor has given album.

STREET SCENE, recorded with original Broadway stars Polyna Stoska, Anne Jeffreys, Brian Sullivan and conductor Maurice Abravanel. Columbia MM683

Elmer Rice's drama "Street Scene," has been transformed into a Broadway opera that has been talked about from coast to coast. Richness of new musical form, coupled with familiarity of story, makes this album appealing to those who have seen the play, as well as to those who have only heard about it.

CLASSICAL WORKS

BARTOK, BELA: "Concerto for Violin and Orchestra," Yehudi Menuhin, violinist, Dallas Symphony Orchestra, Antal Dorati, conductor. RCA Victor DM 1120

Bartok's only violin concerto, performed on these records, was written especially for Menuhin. First recording of this Menuhin concert favorite.

BLITZSTEIN, MARC: "The Airborne Symphony," Leonard Bernstein, conductor, and featured at the piano; Robert Shaw, narrator and choral conductor; Charles Holland; Walter Scheff; RCA Victor Chorale and New York City Symphony Orchestra. RCA Victor DM 1117



Leonard Bernstein fills dual role as conductor and pianist on RCA Victor's recording of Marc Blitzstein's outstanding "Airborne Symphony."



This new Capitol album will be the object of a national promotion campaign. Music of Buddy De Sylva is sung by top Capitol artists.



Kathryn Grayson is another notable performer appearing on MGM discs.

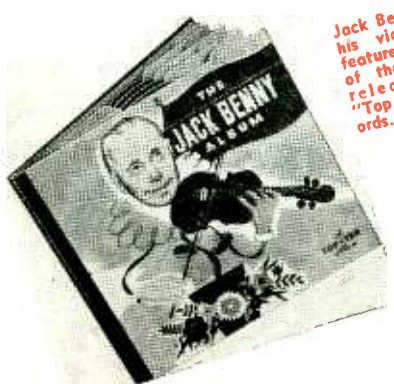

Jack Benny and his violin are featured in one of the albums released by "Top Ten" Records.

for More Sales

Music and commentary fused together to tell story of aviation. First appearance on records makes this release significant.

BRAHMS: "Sonata In F Minor," William Primrose, violist, William Kapell, pianist. RCA Victor album DM-1106

First recording of this piece of Brahms chamber music, as well as initial teaming of these notable artists should be of exceptional interest to music lovers.

DELIUS: "Concerto for Violin and Orchestra," Albert Sammons, violin, with the Liverpool Philharmonic Orchestra conducted by Malcolm Sargent. Columbia M-MM-672

Good addition to dealer's classical catalog.

KHATCHATURIAN, "Masquerade Suite"; **KABALEVSKY,** "Fete Populaire"; Santa Monica Symphony Orchestra, Jacques Rachmilovich, conductor. Asch Classics album 800

These works by the two Soviet composers are available for the first time on records. Louis Biancolli does the album notes.

MENDELSSOHN: "Piano Music," Vladimir Horowitz, pianist. RCA Victor DM 1121

This new album is a good tie-in with other Horowitz recordings, especially recent "Moonlight Sonata" and Chopin's "Waltz in C Sharp Minor."

MENDELSSOHN: "Symphony No. 5, in D Minor"; **MOZART:** "La Clemenza Di Tito"; Sir Thomas Beecham, and the London Philharmonic Orchestra. RCA Victor, Album DM-11046

Sir Thomas Beecham, who has done a lot to revive interest in Mendelssohn, ably handles this release, which has been recorded by Victor for the first time.

MOZART: "Quartet No. 2 in E-Flat Major," George Szell, piano, with members of the Budapest String Quartet. Columbia M-MM-669

Fact that Mr. Szell abandons the conductor's podium for the piano bench, to perform with the quartet, should be of special interest.

THOMSON, VIRGIL: "The Plow That Broke The Plains," Leopold Stokowski and the Hollywood Bowl Symphony Orchestra. RCA Victor DM 1116

Music originally written for documentary film of the same name, and revised into a symphonic suite. For contemporary music lovers.



"A DATE WITH DINAH," Dinah Shore with orchestra and chorus under direction of Morris Stoloff. Columbia set C-125

Miss Shore's first album contains four platters which offer folk tunes, blues songs, and romantic and rhythmic ballads. Where they love Dinah, they'll love this collection.

"NEW ORLEANS JAZZ," Kid Ory and his Creole Jazz Band. Columbia album C-126

This recorded album of New Orleans jazz is a good merchandising tie-up with "New Orleans" movie, which tells the story of jazz.

"THE HIPSTER," featuring Harry "The Hipster" Gibson. Diamond album.

"The Wolf Song," "Beer Party Saturday Night," "It Ain't Hep" and "Bob Bop" are some tunes The Hipster presents in this collection.

"TRIBUTE TO GLENN MILLER," Under the direction of Ralph Flanagan, featuring original Glenn Miller musicians. Rainbow 304

Utilizing something old, new, borrowed, and blue theme album packs a bit of each, imitating the Miller manner, into eight sides.

ARMSTRONG, LOUIS, "It Takes Time"—"I Wonder, I Wonder, I Wonder." RCA Victor 20-2229

Look to Louis' husky lyricizing to tie-in with "New Orleans" film in which he is featured.

AUGUST, JAN, "O ye Negra"—"Jan's Cucarracha"; "Tango Of The Roses"—"Jan's Boogie." Diamond

This keyboard artist's discs in the Latin-American way have been going great guns.

BAILEY, MILDRED, "Almost Like Being In Love"—"All Of Me." Majestic 1140

The hit song from the musical "Brigadoon" and the old standard are sung in the typical Bailey-blues manner.

BARNET, CHARLIE, "Bunny"—"Atlantic Jump." Apollo 1065

(Continued on page 68)



Columbia has recorded gems from the musical "Street Scene," featuring the original artists who made the score famous.

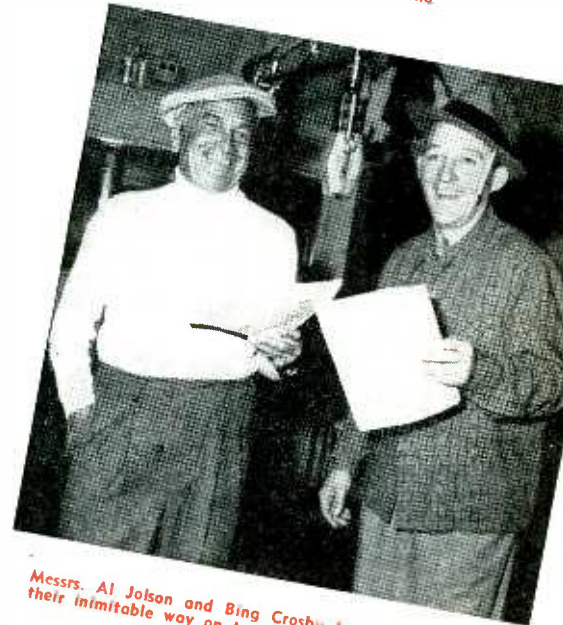

Messrs. Al Jolson and Bing Crosby harmonize in their inimitable way on two sides for Decca.

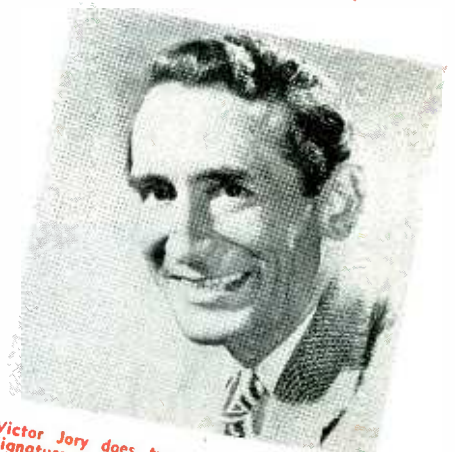

Victor Jory does two new children's albums on Signature records.



Richard Cannon is a new Diamond Records singing discovery.

New Records

(Continued from page 65)

Two instrumentals mark Barnet's Apollo premiere.

BOSWELL, CONNIE, "There's That Lonely Feeling Again"—"Chi Baba Chi Baba." Apollo 1064; "Passing By"—"After You Get What You Want You Don't Want It." Apollo 1066

Boswell marks her Apollo debut with songs of her own choosing. She thinks "Chi Baba" her best recording in ten years. "After You Get What You Want" is a new Irving Berlin tune.

BUDDY WEED TRIO, "I Had Too Much To Dream Last Night"—"Whoopsie Doodle." M G M 10025

"Real" jazz for the collector, as well as the bobby-soxer.

BUTTERFIELD, BILLY, "Stella by Starlight"—"Maybe You'll Be There." Capitol 397

"Stella" started out as theme from "The Uninvited," and is climbing fast.

CARROLL, JACK, "Mam'selle"—"I Wonder, I Wonder." National 9032

Both these tunes are on the "top" song lists.

CLARK, BUDDY, "If I Had My Life to Live Over"—"It Might Have Been a Different Story," Mitchell Ayres' orchestra. Columbia 37302

Good coupling of appealing tunes.

COOPER, JERRY, "I Wonder Who's Kissing Her Now"—"Apple Blossom Wedding"; "Another Night, Another Dream"—"Meditate." Diamond.

Jerry Cooper, recently signed by Diamond, does some oldie ballads for the label.

CROSBY, BING; JOLSON, AL, "Alexander's Ragtime Band"—"The Spaniard That Blighted My Life." Decca 40038

In addition to the fact that the inimitable duo, Crosby and Jolson, are teamed, in this, their first disc, the films "Alexander's Ragtime Band" and "The Jolson Story" (in which "The Spaniard" is featured), are currently enjoying repeat runs throughout the country.

CUGAT, XAVIER, "Cu-Tu-Gu-Ru"—"Illusion." Columbia 37319

The Rhumba King presents two typical south-of-the-border ballads.

DIX, TOMMY, "Buckle Down Winssocki"—"Old Man River"; "I Got Plenty of Nothing" coupled with "A Dream Ago," Barbara Leeds doing the latter vocal. Coronet

Baritone Tommy Dix revives his "Buckle Down" tune for Coronet.

DONAHUE, SAM, "Why Did It Have to End So Soon"—"I Never Knew." Capitol 405

Highly rhythmic dance music.

DONEGAN, DOROTHY, "Jumping Jack Special"—"Little Girl From St. Louis." Continental

Swing pianist Donegan pairs two tunes for a "bouncy" platter.

DORSEY, JIMMY, "A Sunday Kind of Love"—"Pots and Pans." MGM 10023

Jimmy's saxophone shares spotlight with vocalist, Dee Parker.

DOSH, JOE, "As Long as I'm Dreaming"—"My Future Just Passed." Continental

The initial side is from the new film, "Welcome Stranger." This platter is the first release in Continental's 60c series.

DOUGLAS, LARRY, "Linda"—"Beware My Heart"; "No Greater Love"—"The Egg and I"; "I Can't Get up the Nerve to Kiss You"—"That's Where I Came In." Signature

Douglas sings six top sides in his new Signature releases.

ECKSTINE, BILLY, "Time on My Hands"—"I Love the Loveliness of You." National 9030

Oldie "Time on My Hands" is a favorite of Eckstine fans.

ELLIS, ANITA, "Ask Anyone Who Knows"—"As Long as I'm Dreaming." Mercury 3059

Thrush beats a pop path to Mercury's door.

GOODMAN, BENNY, "Fine and Dandy"—"The Lonesome Road." Capitol 394

Two old-timers done by the Goodman Quintet.

HAMPTON, LIONEL, "I Want to Be Loved"—"Limehouse Blues." Decca 23879

Hampton used a vocal group backed by his quartet for the first time. The initial side got off to a big start in race locations.

HAYMES, DICK, "They Can't Convince Me"—"Ivy," Gordon Jenkins and orchestra. Decca 23877

The first side is from the picture, "Down to Earth"; "Ivy" is from the flicker of the same name.

HENDERSON, SKITCH, "Would You Believe Me"—"A Thousand and One Nights." Capitol 402

"Would You" is situation number from film of the same name; latter side is an adaptation of the theme from Rimsky Korsakoff's "Scheherazade," which runs through the moving picture.

(Continued on page 74)

[See pages 78 and 80 for Folk, Novelty, and Children's Music.]



Thrush Apollo, Connee Boswell, newly signed with Apollo, sings four tunes on her initial waxings.



Asch Records has selected the "Masquerade Suite" to inaugurate its new symphonic series.



Louis Prima does the vocals, as well as lead the band on new Majestic discings.



Baritone Joe Dosh, Continental's pop label singing star.

Tommy Dix has recorded several sides for Coronet.



COLUMBIA'S MUSIC "SHOPPING LIST" PRE-SELLS MASTERWORKS FOR JUNE

10 GREAT NEW MASTERWORKS OF THE MONTH

Featured in Life, June 23; Saturday Evening Post, June 28; Time, June 30.

MASTERWORKS OF THE MONTH
Here's more great music to delight everyone who collects records! Here's rich and exciting variety... brilliant performances recorded with the fidelity and beauty that causes the great artists to choose to record exclusively on Columbia Masterworks Records.

ANDRE KOSTELANETZ
and his Orchestra
Master of Modern Masters
Columbia Masterworks Set No. 404-630 \$3.00*

LIT PONS Stevens Pinza
with the Carnegie Hall
A World of Carnegie Hall
Columbia Masterworks Set No. 404-630 \$3.00*

GYORGY SANDOR
with the Philadelphia Orchestra, Eugene Ormandy, conductor
Borlas, Concerto for the Piano and Orchestra
Columbia Masterworks Set No. 404-630 \$3.00*

Bruno Walter
conducting the Philadelphia Orchestra of New York
Schubert's Symphony No. 8 & Wagner's Die Walkure
Columbia Masterworks Set No. 404-630 \$3.00*

HELEN TRAUBEL
with soloists conducted by Charles D'Amico
Italian Operatic Arias
Columbia Masterworks Set No. 404-630 \$3.00*

THE Philadelphia Orchestra
Eugene Ormandy, conductor
Mahler's Symphony No. 2 in C Major for String Orchestra
Columbia Masterworks Set No. 404-630 \$3.00*

Edward Kilenyi
Wendell Loomis, soloist
Bach's Brandenburg Concerto No. 1
Columbia Masterworks Set No. 404-630 \$3.00*

VRONSKY -- BABIN
in collaboration with
Columbia Masterworks Set No. 404-630 \$3.00*

Don Cossack Chorus
SERGE JAROFF, conductor
Shostakovich's Symphony No. 10
Turkish Lullaby and the Zaporozhian Cossacks
Columbia Masterworks Set No. 404-630 \$3.00*

IGOR STRAVINSKY
conducting the Philadelphia Orchestra of New York
Symphony in Three Movements
Columbia Masterworks Set No. 404-630 \$3.00*

*All prices shown are estimates of the
retail value of the records.
© 1947 Columbia Records Co., Inc.
New York, N. Y.

ANDRE KOSTELANETZ... unique interpreter of the music master's tone, one of the best known men of music today.

ANDRE KOSTELANETZ wants you to hear his music faithfully reproduced
... so he is recording exclusively on **Columbia Records**
MASTERWORKS

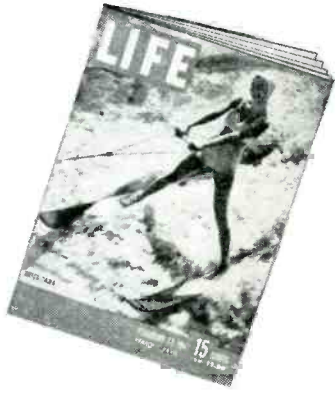

**VISIT US
AT BOOTHS
9-10-11,
AT N.A.M.M.
CONVENTION**

The roll call of Columbia Record Artists for June includes many of music's most brilliant stars. Be sure to check the "Shopping List"—a guide to millions who buy recorded music!

Contact your
**COLUMBIA
RECORDS
DISTRIBUTOR**
for Stock

Motion Pictures Provide Ample Merchandising Tie-Ins for Dealer

Films listed all feature outstanding hit tunes which have been recorded by a variety of artists. Watch for movies to hit local theaters—then cash in on added box-office appeal.

ALEXANDER'S RAGTIME BAND

"Tune title" is particularly "hot" at the moment; although any of the other Berlin oldies from the Tyrone Power-Alice Faye-Don Ameche vehicle are still good.

CARNEGIE HALL

"Beware My Heart" is top pop tune, and is sung by Vaughn Monroe in film. Notable recording artists who appear in film include: Lily Pons, Jan Peerce, Ezio Pinza, Artur Rubinstein, Rise Stevens and Leopold Stokowski.

DOWN TO EARTH

Watch for song, "They Can't Convince Me."

HIT PARADE OF 1947

"It Could Happen to Me," "I Guess I'll Have That Dream Right Now" are featured tunes.

I'LL BE YOURS

"It's Dreamtime" is starrer from this film.

IT HAPPENED IN BROOKLYN

Star-studded cast, and all-star tunes, "It's the Same Old Dream," "The Brooklyn Bridge," "Time After Time," and "I Believe," should make songs from this flicker easy to promote.

IVY

Title tune, "Ivy," has been recorded by a number of artists.

LADIES' MAN

Eddie Bracken comedy movie comes up with two hits, "I Got a Gal I Love," and "What Am I Gonna Do About You."

MY FAVORITE BRUNETTE

Bob Hope and Dorothy Lamour featured in flicker, but top tunes, "Beside You" and "My Favorite Brunette," have been recorded by a variety of songsters.

MY HEART GOES CRAZY

Title tune plus "So Would I" have been recorded.

NEW ORLEANS

Real-life and fiction folk sing songs they made famous, as well as some new ones. Numbers include: "Endie"; "Do You Know What It Means to Miss New Orleans?"; "Mahogany Hall Stomp"; "Where the Blues Were Born in New Orleans."

PERILS OF PAULINE

Songs from film are: "Poppa Don't Preach to Me"; "Rumble, Rumble, Rumble"; "I Wish I Didn't Love You So"; "Sewing Machine."

SONG OF SCHEHERAZADE

Film of life of Rimsky-Korsakov, features in addition: "A Thousand and One Nights"; Hymn to the Sun"; "Gypsy Dance."

SMASH-UP

"Life Can Be Beautiful" is from this picture.

SUDDENLY IT'S SPRING

Title tune, "Suddenly It's Spring," has been waxed.

SUMMER HOLIDAY

Wax favorite, "Spring Isn't Everything," is from this movie.

THE EGG AND I

Novelty tune of same name, takes its lead from picture title.

THE JOLSON STORY

Enjoying a cross-country re-issue, this film contains many famous numbers the dealer can latch onto, the most popular being: "Anniversary Song"; "April Showers"; and "The Spaniard That Blighted My Life."

THE RAZOR'S EDGE

"Mam'selle" got its music from this flicker.

WELCOME STRANGER

Tunes that have got off to a good start are: "As Long As I'm Dreaming"; "My Heart Is a Hobo"; "Smile Right Back at the Sun" and a square dance, "Country Style."

Hit Parade Tunes

Featured on Air-Show.

Linda

Anniversary Song

Mam'selle

Managua Nicaragua

Heartaches

How Are Things in Glocca Morra

My Adobe Hacienda

"Linda" has been recorded by Buddy Clark, with Ray Noble's orchestra; Charlie Spivak; Gordon Jenkins orchestra; Paul Weston; Bob Chester; Larry Douglas and Chuck Foster. "Anniversary Song" from "The Jolson Story" is available on discs by Al Jolson, Tex Beneke-Miller orchestra; Dinah Shore; Guy Lombardo; Kate Smith; Andy Russell; Larry Douglas; George Towne; and Anita Ellis. "Mam'selle" from film "The Razor's Edge" has been waxed by Art Lund, Dennis Day, Frank Sinatra; Dick Haymes; The Pied Pipers; George Towne; Marshall Young; and Jack Carroll.

"Managua Nicaragua" has been recorded by: Jose Curbelo orchestra; Kay Kyser; Freddy Martin; Guy Lombardo; Julie Conway; The Gordon Trio; Two-Ton Baker; and Bill McCune. "Heartaches" is available on discs by Ted Weems; Joe Alexander, Harry James; Jimmy Dorsey; Richard Cannon; Monica Lewis; Gordon MacRae; Ted Straeter and Bobby True Trio.

Best Sellers on Coin-Machines

Mam'selle

Heartaches

Linda

Anniversary Song

Peg o' My Heart

My Adobe Hacienda

That's My Desire

How Are Things in Glocca Morra?

I Do Do Do Like You

Guilty

—Coming Up—

Sunday Kind of Love

Across the Alley From the Alamo

Managua Nicaragua

Santa Catalina

Moon Faced, Starry Eyed

Red Silk Stockings, Green Perfume

That's Where I Came In

I Tipped My Hat and Slowly Rode

Away

Midnight Masquerade

Jack, Jack, Jack

You Can't See the Sun When You're

Crying

When Am I Gonna Kiss You Good-

Morning?

That's How Much I Love You

Who Cares What People Say?

It's Dreamtime

—Reprinted from "Variety"—

No finer
needle
at any
price



the needle with **Spring** in its heart

Fidelitone
Supreme

FLOATING POINT NEEDLE

RECORD
BRUSH

\$2.50



Beautifully packaged
in a useful record
brush

Through the unending efforts of PERMO
engineers and technicians,
you have the spring-action Fidelitone
Supreme— the needle you can recommend with
the full knowledge
"there's no finer needle at any price".

PERMO, Incorporated
CHICAGO 26

More Permo Needles sold than all other longlife needles combined

New Phono Lines

Disc-Playing Accessories and Equipment

Ultratone RECORD PLAYER



Model PM-70 phonograph playing 10" or 12" discs. Two tubes (including rectifier), 5" PM speaker with 1.5 oz. Alnico magnet. Playwood case covered with blue leatherette with contrasting lining. \$29.95. Audio Industries, Inc., Michigan City, Indiana.—RADIO & Television RETAILING.

Small Fry Juke Box RECORD PLAYER



Phonograph for youngsters, featuring a plastic insert in front panel illuminated by interior light. Two-tube amplifier, ac, 5" Alnico speaker. Astatic pickup. Can be used as stool. Cabinet is blue with red top, brightly decorated with decals. Measures 19" high by 13 3/4" wide by 14 3/4" deep. Ben-Her Industries, Inc., 11 W. 42nd St., New York 18, N. Y.—RADIO & Television RETAILING.

Morton COMBINETTE

Combined record-and-book cabinet holds 12" disc albums and has space for books. Space on top for phono or small radio. May be used as "sectionals." Glass-covered door, brass double-lined grill. Mahogany or walnut veneer, hand-rubbed finish. Measures 16" deep, 24" wide, 40" high.



Lists at about \$49.50. R. P. Morton Co., 666 Lake Shore Drive, Chicago 11, Ill.—RADIO & Television RETAILING.

FURNITURE SPECIALTIES Record Cabinet

Model 500 record cabinet in Chinese modern style. Concealed full-length piano hinge. Hand-rubbed satin finish in mahogany, walnut or bleached blonde. Entire cabinet is walnut or mahogany veneer. Measures 18" by 24" by 32"; weighs

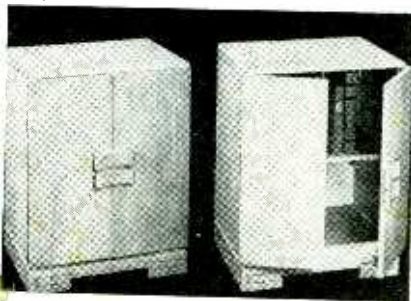

about 50 lbs. Furniture Specialties Co., 15th St. & S. Penn Square, Philadelphia, Pa.—RADIO & Television RETAILING.

United STORAGE ALBUM

Model 109 album for storage of 10" discs beginning new line by United. Available



in ivory, green or black. United Loose Leaf Corp., 233 Spring St., New York 13, N. Y.—RADIO & Television RETAILING.

Malone RECORD CABINET



Model 700 record cabinet with concealed hinges and double supports on drop side. Top is 18 1/2" by 25" and cabinet stands 25" high. Brown mahogany finish, designed to fit in with walnut furniture also. Lists at about \$30. Malone Products Corp., 1451 Broadway, New York N. Y.—RADIO & Television RETAILING.

Kiddi-Trola PHONOGRAPH

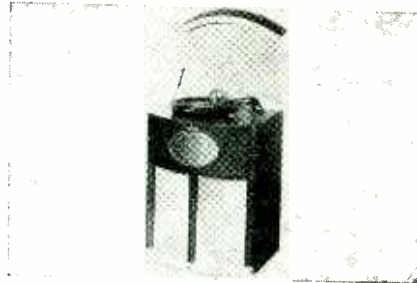

Electrically operated console record player for youngsters. On-off switch, ac, needle cup, decorative metal grille. Plays any size record up to 12" with the lid closed. Finished in maroon simulated leatherette, with painted ivory trim; antique brass upholstery tacks used in design. Two compartments for disc storage. Lid will support seated adult. \$24.95. Herold Mfg. Co., 1 Romney Place, Scarsdale, N. Y.—RADIO & Television RETAILING.

Mel-O-Tone PHONOGRAPH

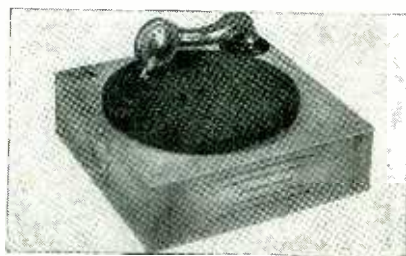

Model 901 children's electric record player, table unit playing 10" and 12" discs. Air-cooled 78 RPM motor. Finished in pastel pink and blue enamel, with colorful decals. Measures 11 5/8" by 11 1/4" by 4". List \$11.95. Edgar J. Horn, 673 Broadway, New York 12, N. Y.—RADIO & Television RETAILING

National Acoustic RECORD PLAYER

Model 4RP completely self-contained automatic record changer phonograph, with its own 5" PM speaker, amplifier unit, tone and volume controls. Organ-type push-button keys, aluminum lightweight crystal cartridge. Changer handles as many as fourteen 10" or twelve 12" discs. Measures 13 1/2" by 13 1/8" by 1 1/4".



Weighs 12 lbs. 7 oz. National Acoustic Products, 120 N. Green St., Chicago 7, Ill.—RADIO & Television RETAILING



CONNIE BOSWELL

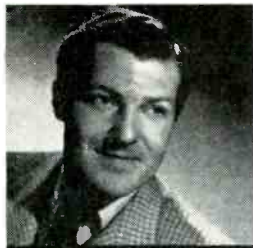

CHARLIE BARNET
AND HIS ORCHESTRA



GORDON MacRAE



EDDIE DAVIS
AND HIS BAND



ILLINOIS JACQUET
AND HIS ALL STARS



MURPHY SISTERS

Great Apollo Artists...
**WILL CONTINUE TO MAKE
HIT RECORDS!**

POPULAR SERIES:

- CHARLIE BARNET and His Orchestra**
1065 Sunny
Atlantic Jump
- CONNIE BOSWELL**
1064 Chi Baba Chi Baba
(My Bambino Go To Sleep)
There's That Lonely Feeling Again
Passing By
1066 After You Get What You Want
You Don't Want It
- LUIS RUSSELL and His Orchestra**
1012 The Very Thought Of You
Sad Lover Blues
1020 Don't Take Your Love From Me
Sweet Memory
1046 I'm Yours
I'm In A Lowdown Mood
- THE MURPHY SISTERS**
1048 The Egg And I
Rumble Rumble Rumble
1053 Country Style
As Long As I'm Dreaming
1059 Mahzel (Means Good Luck)
You're Breaking In A New Heart
(While You're Breaking Mine)
- GORDON MacRAE**
1045 Heartaches
If I Had My Life To Live Over
1067 Old Devil Moon
I Want To Be Loved (But Only By You)

BLUES SERIES:

- WILLIE BRYANT**
364 Blues Around The Clock
(Part I and Part II)
369 It's Over Because We're Through
Amateur Night In Harlem
- WYNONIE HARRIS**
360 Young Man's Blues
Straighten Him Out
362 Somebody Changed The Lock On My Door
Wynonie's Blues
372 Playful Baby
Papa Tree Top
- DUKE HENDERSON**
373 Lottery Blues
Fool Hearted Woman
384 Woman's Blues
(Part I and Part II)
- MELODY MASTERS**
379 Wig Blues
My Baby
383 Subway Cutie
Don't You Ever Mind Them

DINAH WASHINGTON

- 368 Wise Woman Blues
No Voot No Boot
371 My Lovin' Papa
Mellow Mama Blues
374 Walking Blues
Rich Man's Blues

JAZZ SERIES:

- GEORGIE AULD and His Orchestra**
763 I Can't Get Started With You
(Part I and Part II)
- EDDIE DAVIS and His Band**
767 Lover
Licks A Plenty
- ILLINOIS JACQUET and His All Stars**
756 Bottoms Up
Ghost Of A Chance
760 Memories Of You
Merle's Mood
766 Jumpin' At Apollo
Jacquet Bounce
- JACK McVEA and His All Stars**
761 Don't Blame Me
O-Key For Baby

FOLK SERIES:

- BARTON BROS.**
138 Joe And Paul (In Yiddish)
(Part I and Part II)
139 Cock-Eyed Jennie (In Yiddish)
Minnie The Flapper (In Yiddish)
- BOBBY GREGORY**
111 You Were Once My Sunshine
My Good Gal's Gone Away
- ALBUM A-4**
Hobo Songs—Bobby Gregory
And His Ramblin' Hoboes
- KING HOUDINI**
123 Bobby Sox Idol
Moan, People, Moan
- ALBUM A-8**
Calypso—King Houdini
And His Calypso Parliament
- RELIABLE JUBILEE SINGERS**
112 God's Eye Is On The Sparrow
Jesus, Lover Of My Soul
131 Tell Me Why You Like Roosevelt
(Part I and Part II)
133 Standing On The Highway
Didn't It Rain
- TOMMY SOSEBEE (The Voice of the Hills)**
140 Scars Upon My Heart
Death By The Roadside



WILLIE BRYANT



WYNONIE HARRIS



LUIS RUSSELL
AND HIS ORCHESTRA



BARTON BROTHERS



KING HOUDINI



TOMMY SOSEBEE
(The VOICE of the HILLS)

SOON TO BE RELEASED: *Arnett Cobb...*
THE WILDEST TENOR SAX MAN IN THE LAND

APOLLO RECORDS, INC.

EXECUTIVE OFFICES: 342 MADISON AVE., NEW YORK CITY

NEW YORK • 615 10th Ave., New York 19, N. Y.

CHICAGO • 719 South State Street, Chicago, Ill.

DETROIT • 100-02 E. Atwater St., Detroit 26, Mich.

LOS ANGELES • 2705 W. Pico Blvd., L. A. 6, Cal.

ATLANTA • 367 Edgewood Ave., S.E., Atlanta, Ga.

BALTIMORE • 2015 Maryland Ave., Balt. 18, Md.

NEW ORLEANS • 418 Gravier St., New Orleans, La.

PHILADELPHIA • 1639-41 Vine St., Phila. 5, Pa.

WRITE FOR COMPLETE CATALOG

WEBSTER CHICAGO

MODEL 80

WIRE RECORDER



BIG SALES
coming up!

Be one of the first in your area to feature the outstanding, sales-making Webster-Chicago Portable Wire Recorder. Efficient — beautiful — complete — backed by the biggest consumer promotional campaign in Webster-Chicago's 33 year history — Model 80 Wire Recorder is portable, has a big market in business, in the home or for professional use. And don't overlook the profitable repeat sales of Webster-Chicago Recording Wire! Don't wait — order from your distributor. Deliveries are now being made.

SELLING AIDS TO HELP YOU INCLUDE: STRONG NATIONAL ADVERTISING, WINDOW AND COUNTER DISPLAYS, POINT OF SALE LITERATURE, CONSUMER MAILING PIECES, FREE MAT SERVICE.

WEBSTER CHICAGO

5610 BLOOMINGDALE AVENUE

CHICAGO 39

The Choice of Music Lovers

John G. Wilson



Operating vice-president of the RCA Victor division of the Radio Corp. of America for the past three years, John G. Wilson has been appointed vice-president and general manager.

New Releases

(Continued from page 68)

JAMES, HARRY, "What Am I Gonna Do About You"—"I Can't Get Up the Nerve to Kiss You," vocals by Art Lund. Columbia 37301

The first side is from "Ladies' Man."

JOHNSTON, JOHNNIE, "Stella by Starlight"—"Spring Isn't Everything." MGM 10019

The Johnston lad is making a reputation for himself in the films to bolster his radio and wax following. "Spring" tune is from "Summer Holiday" film.

KING COLE TRIO, "You Don't Learn That in School"—"Meet Me at No Special Place." Capitol 393

Nat Cole on the keys, and the boys' vocalizing are the usual high-lights of King Cole recordings, and this one is no exception.

LAURENZ, JOHN, "There Is No Greater Love"—"Here We Are." Mercury 5049

Romantic balladeering of two top popular tunes.

MADRIGUERA, ENRIC, "The Cowbell Song"—"Guatemala." National 9031

Catchy Latin novelty tunes.

MARTIN, FREDDY, "Beside You"—"Your Wish Is My Command." RCA Victor 20-2208; "When Am I Gonna Kiss You Good Morning"—"Serenade to Love." RCA Victor 20-2233

"Beside You" tune is from film "My Favorite Brunette." In "Serenade" Martin adapts "Maid of Cadiz" theme to dance tempo.

MERRY MACS, "We Knew It All the Time"—"Poppa, Don't

(Continued on page 76)

PICTUR TONE PRESENTS

Something to Sing About!

A line of unbreakable, plastic picture records in full color whose high fidelity recording can be played hundreds of times!

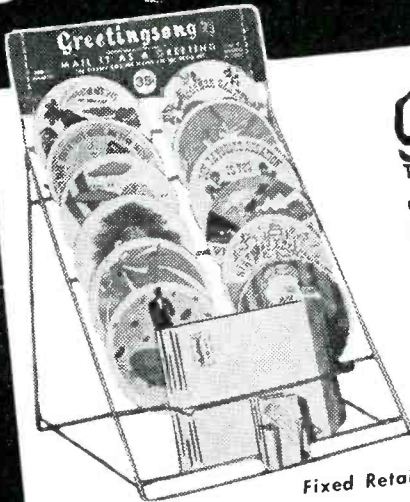

Firmly established in thousands of outlets.
Greetingsong • THE PICTURE GREETING-RECORD.

The unbreakable, record greeting that can be mailed anywhere through normal postal channels. GREETINGSONG titles include Birthday Greetings, Mother Dear, Dear Dad, To the Sweetest Girl In the World, Congratulations, My Favorite Relation Is You, Cheer Up—Hurry and Get Well, Hello Bouncing Baby, and many others. Every GREETINGSONG is a delight to see and hear!

Initial orders are packed 72 assorted GREETINGSONGS, plus the pictured metal and wire combination Display and Merchandiser which is included at no extra cost to the dealer.

Fixed Retail Price (Complete with mailing envelope and card); **35c** (Fed. tax incl.)



For Fun and Education
Treasure Tales FOR CHILDREN

These classic stories every child should know are attractively boxed in Volumes I and II—Six Stories—Three records to the Volume. Children Love 'em, Play 'em, Can't break 'em!

Fixed Retail Price **\$1.05** per Volume (Fed. tax incl.)



An Ideal Gift for the Child
THE ABC BOOK & RECORD COMBINATION

The PICTURE-TONE Record Book is a most exciting item for the developing child. Its 32 pages of four color illustrations are synchronized with the recording to delight and teach the child.

Fixed Retail Price **\$1.39** Complete (Fed. tax incl.)

picturtone records, inc.

38-40 TIFFANY PLACE • BROOKLYN 2, N. Y.

D I S T R I B U T E D B Y

BARTH-FEINBERG, INC., New York, N. Y.
 JAMES H. MARTIN, INC., Chicago, Ill.
 PENNSYLVANIA RECORD SUPPLY, INC., Phila., Pa.
 MUSIC SUPPLIERS OF N.E., INC., Roxbury, Mass.
 MIDCO DISTRIBUTING CO., St. Louis, Mo.

SOUTHLAND DISTRIBUTING CO., Atlanta, Ga.
 TRIANGLE RECORD DISTRIBUTORS, Pittsburgh, Pa.
 F AND F ENTERPRISES, Fayetteville, N. C.
 KAY BROTHERS, Los Angeles, Calif.
 WM. B. ALLEN SUPPLY CO., New Orleans La.

**SEE THE PICTURTONE CONVENTION DISPLAY AT THE BARTH-FEINBERG ROOMS
 776 & 777 THE PALMER HOUSE, CHICAGO, ILL.**

**ZOOM YOUR
SALES & PROFITS
WITH**



THIS
EXCLUSIVE
LINE OF RECORD ALBUMS

REG. U. S. PAT. OFF.
is one of the fastest
selling albums on
retailers and Job-
bers shelves. It's
not a here today and
gone tomorrow
seller and that's
because it's Rec-
Album, made to
sell for years.

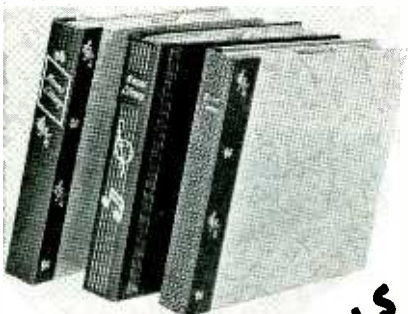

**L. H. SYMONS
ASSOCIATES**
345 HUDSON STREET
NEW YORK 14, N. Y.

Nevada Store Features Modern Design, Efficient Layout



Interior of the Garehime Music Co., Las Vegas, Nev., incorporating some of the newest architectural ideas in store layout. The 2-story building utilizes glass, in both plate and block form, throughout. There are five record booths and two offices on the first floor record department; the booths have double glass sides and fronts, with slab birch doors finished in natural wood. Side panels are divided with Celotex making them practically soundproof. The circle record counter has glass top with drawers underneath for needles and accessories.

New Releases

(Continued from page 74)

"Preach to Me." Majestic 1134
"Poppa" novelty tune is from the flicker, "Perils of Pauline."

MODERNAIRES, "I Want to Be Loved"—**"Santa Catalina."** Columbia 37328

Santa Catalina has unusual "surf sounds" in background for new baladeering twist.

MONROE, VAUGHN, "You Can't Hide Your Heart Behind a Kiss"—**"Dreams Are a Dime a Dozen."** RCA Victor 20-2226

Moon-Maids vocals with Monroe and band combine for two sides.

MOONEY, ART, "Mahzel"—**"That's My Desire."** MGM 10020

"Genial Irish Gentleman" makes his MGM debut with a novelty tune and a rhythmic ballad.

O'NEIL, DANNY, "After Graduation Day"—**"Passing By."** Majestic 7230

The Irish tenor tackles the first side from the musical, "Barefoot Boy With Cheek," and the "Passing By" ballad in a lyrical style.

PIED PIPERS, "Mam'selle"—**"It's the Same Old Dream."** Capitol 396

First side from "The Razor's Edge"; "Same Old Dream" is from "It Happened in Brooklyn." Movie tie-ins good platter promotion.

PRIMA, LOUIS, "Mahzel"—**"Chi-Baba Chi-Baba."** Majestic 1135

Cathy Allen and Prima do the lyrics in both these tunes in double-voval style.

RHODES, BETTY, "Tonight Be Tender to Me"—**"The Man Who Paints the Rainbow in the Sky."**

RCA Victor 20-2227

Sincere singing sparks two ditties. **SHERWOOD, BOBBY, "We Knew It All the Time"**—**"There's Them That Do."** Capitol 404

Lyrics and tunes made to order for teenster consumption.

SINATRA, FRANK, "Time After Time"—**"I Believe."** Columbia 37300

Both tunes are from the Sinatra film, "It Happened in Brooklyn," and the swoon-soxers will carry the disc out of the store.

SMITH, KATE, "After Graduation Day"—**"Dreams Are a Dime a Dozen."** MGM 10024

"Graduation Day" side is from musical, "Barefoot Boy With Cheek."

SMITH, JACK, "Cu-Tu-Gu-Ru"—**"Oh, My Aching Heart."** Capitol 403

Novelty rumba and rhythm ballad offered by the "man who smiles when he sings."

SONNY BOY AND LONNIE, "Southwest Pacific Blues"—**"Quincy Avenue Boogie."** Continental

A blues platter by two Cleveland boys.

STAFFORD, JO, "Almost Like Being in Love"—**"Smoke Dreams."** Capitol 401

The first side of this platter is from the Broadway musical "Brigadoon." "Smoke Dreams" is Jo's radio theme song. The two sides should create more than occasional interest from the platter purchasers.

TILTON, MARTHA, "I Wonder, I Wonder, I Wonder"—**"That's My Desire."** Capitol 395

Popularity of first side going strong.

(Continued on page 78)



DISC ASCH

records have built a balanced catalog of 100 albums, to date. Under the Asch Label, a new Series of popular symphonic classics with the great, nationally applauded **SANTA MONICA SYMPHONY ORCHESTRA**—conducted by Jacques Rachmilovich—is now being released . . . and American folk and documentary recordings of the authentic kind and genuine merit always identified with that pioneering label.

Authorized distributors of DISC and ASCH records

ARTHUR RIXON & SON	209 W. Washington St., Greeneville, S. C.
DIXIE RECORD SUPPLIERS, Inc.	731 W. Cary St., Richmond 20, Va.
BERGER ELECTRIC CORP.	1358 N.E. First Ave., Miami 35, Fla.
DON SHERWOOD CO.	2213 San Pablo Ave., Berkeley, Calif.
HALIFAX DISTRIBUTING CO.	428 S. Salina St., Syracuse 2, N. Y.
HERBERT H. HORN, Inc.	2401 S. Hill St., Los Angeles 7, Calif.
HOUSEHOLD DISTRIBUTING CO.	1233 N.W. 12th Ave., Portland, Ore.
JAMES H. MARTIN, Inc.	1407 Diversey Blvd., Chicago, Ill.
MALVERNE DISTRIBUTORS, Inc.	1700 Broadway, New York City
HERB E. ZOBRIST CO.	2125 Westlake Ave., Seattle, Wash.
MONARCH SALES CO.	210 N. 22nd St., Birmingham, Ala.
MUSIC SUPPLIERS OF NEW ENGLAND, Inc.	561 Warren St., Roxbury 21, Mass.
NIAGARA-MIDLAND CO.	881 Main St., Buffalo, N. Y.
PENNSYLVANIA RECORD SUPPLY	1224 Arch St., Philadelphia, Pa.
POST & LESTER CO.	10 Chestnut St., Hartford 5, Conn.
ROBERTS-NICHOLSON CO.	1201 Commerce Ave., Houston 2, Texas
SOUTHLAND DISTRIBUTING CO.	441 Edgewood Ave., S.E., Atlanta, Ga.
SNI-DOR RADIOELECTRIC, LTD.	455 Craig St., W., Montreal, Que., Can.
STANDARD DISTRIBUTING COMPANY OF PITTSBURGH	1729 Fifth Ave., Pittsburgh, Pa.
UNITED WHOLESALE CO.	510 Poydras St., New Orleans, La.
W. E. HARVEY CO., Inc.	1312 Ontario St., Cleveland 13, Ohio

Write for complete price lists to Distributor in your area, or to:

DISC COMPANY OF AMERICA • 117 W. 46th St., N. Y. 19, N. Y.

"The Folkways of the World on Records"

New Releases

(Continued from page 76)

VENTURA, CHARLIE, "Moon Nocturne, Parts 1 and 2." National 9029

A mood piece in the modern jazz idiom.

WELK, LAURENCE, "My Pretty Girl" — "Chi-Baba, Chi-Baba." Decca 28876

Novelty tunes played in Welk's "champagne music" manner.

CHILDREN'S

DAVID AND GOLIATH, Victor Jory narrating. Signature album

Biblical tale, featuring a moving recitation of the Lord's Prayer. IT'S FUN TO EAT, created by Sylvia and Murray Winant. Winant Productions

Doc Clock, Happity-Yappity Appetite, and Sip-Sip Supper are the characters who people this unique album, designed to help parents.

PAUL BUNYAN, Victor Jory narrating. Signature album

Tale of Bunyan and his blue ox, Babe, heroes of the Northwest.

SONGS OF SAFETY, done by Frank Luther, with sound effects and orchestra directed by Harry Breuer. Decca album 543

Reissued to meet huge demand by educators and parents. Particularly

timely with vacations coming up, and the children with more time to get into mischief.

THE CITY SINGS FOR MICHAEL, narration and songs by David Wayne. Disc 740

Simple story about a boy who uses familiar sounds as sign posts to lead him to his destination. Excellent for youngsters who do live in the city.

THE STORY OF CELESTE, Victor Jory narrating. Ray Bloch and orchestra. Signature album

Written by Kleinsinger and Tripp, album relates story of Celeste, an orphan melody who got lost, and was found again.

SEE "The Last Word in Children's Entertainment"

(WOMAN'S HOME COMPANION)

BOOTH 74

AT THE MUSIC SHOW, PALMER HOUSE, CHICAGO



MERRY-GO-SOUND PHONOGRAPH

There is a big "Children's Market"—and it can be yours with Merry-Go-Sound phonographs and records. The high fidelity electrically amplified phonograph plays 7", 10" and 12" records with concert hall clarity. The Carousel and Calliope set the circus scene. The turntable is the Carousel. The Calliope holds the speaker, tone arm and the single control. It is a red, gold and blue unit, scratch-proof and washable, made of steel and plastic. The unbreakable Vinylite records are in special albums, each a complete educational story with sound effects: Rumpelstiltskin, Mother Goose, Aesop's Fables, etc. Stock Merry-Go-Sound—the dominant line in quality, in performance, in preference.

- Electronic Model—C
- Portable Model—P-1
- Acoustic Model—A

PORTELEC

PORTABLE

TRANSCRIPTION PLAYERS AND P. A. SYSTEMS

Professional Type Recorder and Playback Instrument. Fine Quality . . . Precision Made . . . Large Variety for Every Purpose.

MERRY-GO-SOUND

CHILDREN'S

UNBREAKABLE RECORDS

STONE PRODUCTS CORP. OF AMERICA

351 Fourth Avenue

New York 10, N. Y.



ALLEN, ROSALIE: "Hitler Lives" — "I Can't Tell That Lie To My Heart." RCA Victor, 20-2237

Western songstress puts over tunes with zest.

DEXTER, AL: "Down At The Roadside Inn"—"My Love Goes With You." Columbia 37303

Two Al Dexter originals in the Western vein.

GUTHRIE, JACK: "You Laughed And I Cried"—"It's Too Late To Change Your Mind." Capitol 406

Jack's following will go for this disc.

JOHNSON, TED: "Glada Toner"—"Paa Bejaron." RCA Victor 26-0055

(Continued on page 80)

Capitol Album Promotion



Colorful dealer display piece for Capitol's big promotion of "Somebody Loves Me" album. Ad mats are available for dealer use in local newspapers.

Musitron Has Three New Phonograph Models

Three new model phonographs are now being introduced by Musitron Co., 223 W. Erie St., Chicago 10, Ill.

Model 105 (illustrated) is the Piccolo portable electric unit, retailing at \$29.95.

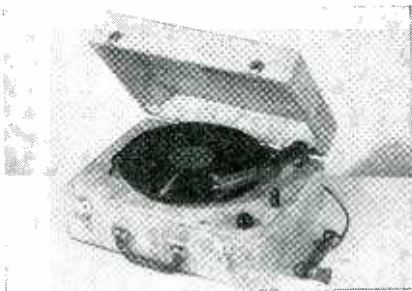

Musitron Model 105 electric portable phonograph.

It has a 2-tube amplifier, with a 4" Alnico 5 PM speaker, and plays 10" and 12" discs. The crystal pickup is a new Astatic unit. The cabinet is leatherette covered with brass-plated hardware and post type plastic handles.

Another electric unit is Model 202, tagged at \$24.50, a table job measuring 12½" by 11¼" by 6¾". It has similar specifications to No. 105 except that the case is designed with two contrasting plastic strips. The third model is No. 107 Piccolo, a hand-wound portable phonograph retailing at \$19.95. This one has an acoustical tone arm and reproducer head; the case is covered with pyroxylin-coated airplane tweed leatherette with either one or two stripes.

Recoton Exec Reports

Jack Karns, national sales representative of Recoton Co., New York City, makers of Recoton phono needles, has returned from a survey of prominent distributors and dealers across the country. Mr. Karns reports dealers commenting favorably on record business with indications pointing to increased sales for at least the next five years.

Mr. Karns' survey showed that accessories sales should also benefit by the increased record buying trend. Mr. Karns had the opportunity to check the operation of Recoton's Needle Vendor among dealers in every part of the country. He found dealers particularly enthusiastic with the effectiveness of the Vendor in promoting jewel-tipped needles.

The Vendor is distributed through wholesalers and is currently being offered free with one dozen of Recoton's jewel-tipped needles.

Recordplate Co. Moves

The Recordplate Co., Pasadena, Calif., designers of a record indexing system for dealer use, and for the home, announce that they have moved their offices to a new and permanent location at 16 E. Holly St., Pasadena 1.

Victor Replacements

RCA Victor has announced its intention to supply dealers with replacement records on all albums that are currently in the RCA Victor catalog. Dealers are asked to limit their replacement orders only to those records required to complete or re-fill albums. Local distributors will order the necessary discs from the factory.

Apollo Sales Aid

Apollo Records, New York City, is distributing a "disc-decal" to dealers, stressing Apollo name and label in the popular, folk, jazz and blues fields. Decal can be used in windows, show-cases, and in displays.

RAM Consumer Contest

The Record Album-of-the-Month Club, New York City, is conducting a monthly series of contests for the RAM consumers. To be eligible, the record purchaser must attach to his competing letter, a sales slip showing that an album has been purchased from a RAM dealer. The subject of the contest will vary monthly.

Black & White Folders

Black & White Records, Hollywood, has adopted a modernistic envelope. Their slogan, "contrasts in music from Hollywood," is featured on the front of the envelope, and black and white stripes are employed to set off the slogan.

DeLuxe RECORD CABINETS

ORDER NOW FOR PROMPT DELIVERY

The Cabinets Your Customers Want

Large enough to hold the largest size Combination Radio-Record Players. Made of hardwoods—strongly constructed like a piece of fine furniture. Walnut or Mahogany finish. Packed 1 to a Carton. F.O.B. Factory, Philadelphia, Pa.



**LARGE SIZE DELUXE
RECORD CABINET**

24" wide, 18" deep, 26" high.
Weight 23 lbs.

No. 350
\$11.95



**LARGE SIZE
DE LUXE
RECORD
CABINET —
WITH DOOR**

24" wide, 18" deep,
26" high
Weight 28 lbs.
No. 400
\$14.95



**LARGE
SIZE
DE LUXE
DOUBLE
TIER
RECORD
CABINET**

24" wide, 18"
deep, 32" high,
Weight 39 lbs.

No. 450
\$17.95



**CHINESE
MODERN
RECORD
CABINET**

24" wide, 18" deep,
32" high

Constructed of ¾ inch mahogany or walnut veneer with solid doors. Concealed full-length piano hinges. Invisible dividers for albums. Hand-rubbed satin finish in mahogany, walnut or bleached blonde.

Weight approx. 50 lbs.

No. 500 **\$39.95**

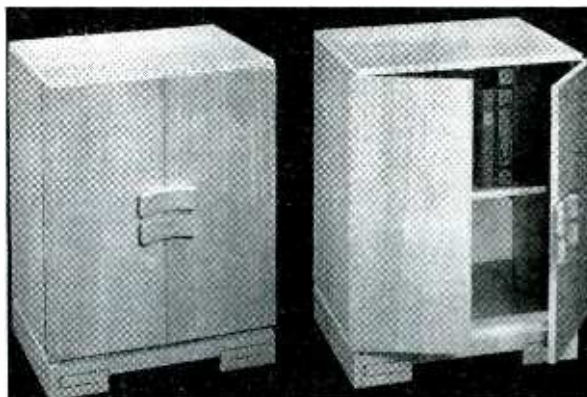

Jobber inquiries invited—See our Representative at Booth 71,
N. A. M. Show, Palmer House, Chicago, June 1-5

FURNITURE SPECIALTIES CO.

Commercial Trust Building,

Philadelphia 2, Pa.

This DISPLAY RACK sells more RECORDS

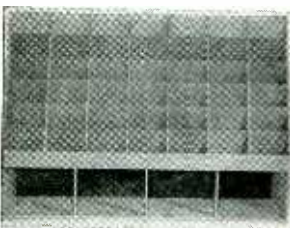
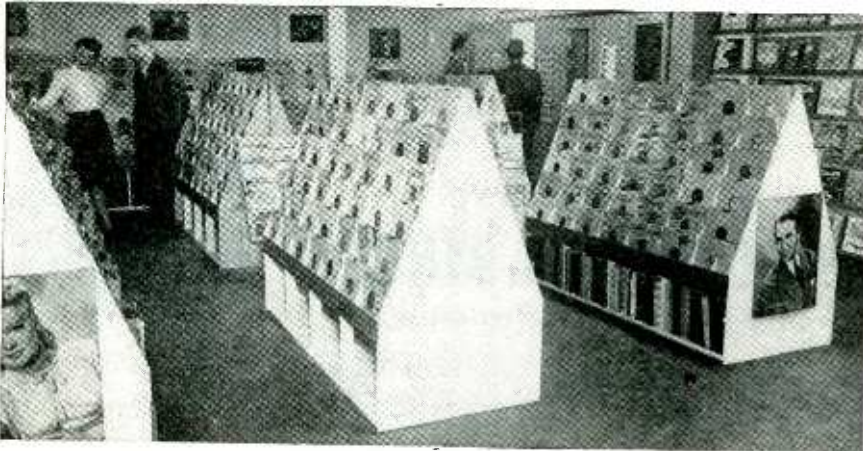

Above — complete store installation showing nine record display racks back to back.

Left—record rack empty, showing available display space.

Right — rack completely stocked for ready sales.



Width: 6'4" — Depth: 1'3" — Height: 4'5½".
42 record compartments—capacity 840 records
and 100 10" albums.

Sturdy construction—seasoned wood
and masonite.

Finish—light oak stain

PRICE \$32.50 each F.O.B. Gettysburg, Pa.

Shipping weight 105 lbs.

1/3 deposit with order, balance C.O.D.

Specify freight or express.

THE RECORD SHOP

32 North Main Street
CHAMBERSBURG, PA.

Good Publicity for Cowboy Record Co.



Sammy Penn of Cowboy Record Co., 138 N. 12 St., Philadelphia 7, Pa., is shown in front of the firm's truck. Driver and colorful car attract attention on cruises through city streets.

New Releases

(Continued from page 78)

Scandinavia is spot-lighted in these two Swedish dances, the schottische and the hambo.

JONES, ETTA: "I Sold My Heart To The Junkman"—"My Sleepy Head." RCA Victor 20-2231

Miss Jones is now on a series of theatre dates across the country which may provide good tie-ins.

MERCER, JOHNNY: "A Little Too Fer" — "The Covered Wagon Rolled Right Along." Capitol 400

Johnny Mercer turns singing cowboy in two unique sides that the Mercer fans will go for.

REED, SUSAN: *Album of "Folk Songs and Ballads," Volume 2.* RCA Victor M-1107

Follow-up of initial album presents same type of material Miss Reed has made famous in New York clubs.

ROGERS, ROY: "Dangerous Ground"—"I'm Restless." RCA Victor 20-2236

Roy Rogers fans will go for these two tunes.

SONS OF THE PIONEERS, "Cowboy Classics" album. RCA Victor P-168

Four sagebrush platters by talented vocal group, who have established a name in moving pictures and on the radio.

TUTTLE, WESLEY: "I'll Trade All of My Tomorrows"—"Excess Baggage." Capitol 398

A ballad and popular folk-rhythm type song, with instrumental background provided by Texas Stars.

NOVELTY MUSIC

ABBOTT & COSTELLO: "Who's on First?" Enterprise 501

Comedy team's famous routine recorded with organ.

BARTON BROS.: "Joe and Paul." Apollo

Comical take-off on an old radio program, utilizing Yiddish lyrics.

BLOCH, RAY: "The Giants March"—"The Umpire Is a Most Unhappy Man." Signature

Leader Ray Bloch comes up with the N. Y. Giants baseball club cheering song, and teams it with a tune from the film, "I Wonder Who's Kissing Her Now," for a timely disc.

Victor Disc Merchandiser

A new record sales promotion merchandiser providing displays for 88 different single discs is being made available to RCA Victor dealers by a manufacturer who is building the merchandiser in accordance with company specifications, it was announced by the RCA Victor Record Department.

The sales aid, an "island cluster" for single records, is a four-cluster plywood fixture with plate glass shelves which display the record selections. One of its outstanding features is that although it is 5'8" high, the record merchandiser occupies only four square feet of dealer floor space. The bottom of each cluster is equipped with storage space for albums or additional singles.

The "island cluster" is priced at \$99 for the four separate sections, and this price includes all plate glass shelving and metal title strip holders.

Wins Apollo Contest

Announcing final results in the Apollo contest inaugurated to stimulate nationwide sales, Apollo Records, New York City, is awarding Charles Kaiton, Detroit branch salesman, the \$150 first prize, and Merle Schneider, the branch manager, prize of \$100.

Kaiton obtained the largest number of new accounts, as well as the topping initial orders, in Apollo's eight branches located throughout the country.

Schneider captured remaining honors also for Detroit by hitting high score for the branch manager to show the greatest percentage increase in sales in his territory.

Sacred Distributor

Sacred Records, Los Angeles, Calif., has announced the appointment of the West Coast Church Supply Co., of Stockton, Calif., as northern California distributor of Sacred Records.

Introduces Disc Cabinet



Adelphia Industries, 419 Arch St., Philadelphia, has introduced a new record cabinet in classic Chippendale style. Contains two shelves, available in one- and two-door styles, the cabinet is made of mahogany or walnut veneer over hardwood.

New Continental Series

Donald H. Gabor, president of the Continental Record Co., New York City, has announced the issuance by his firm of a new popular record series at a 60c list price. Continental will continue with its established line of records, in addition to the lower-priced label.

Foreign language, international, spirituals, hillbilly, westerns, rumbas, tangos, children's and race records will remain at the fixed price of 75c.

Tempo Head Reports

Irving Fogel, president Tempo Record Co., Los Angeles, Calif., in describing his company's production stated that "Our operation must necessarily remain a limited one, if we are to maintain that careful

supervision over every detail of production which has made Tempo custom-made records so outstanding.

He explained however, that the company has been expanding at a steady rate. Thirty-eight distributors have already been signed, and a company pressing plant has been opened in the East to better serve distributors in that area.

Capitol Disc Catalog Available for Dealers

Capitol Records, Hollywood, Calif., has issued its new 1947 record catalog. The 96 pages have been designed for easy, quick reference to any Capitol record or album. Photographs and biographical sketches of Capitol artists are also in the catalog.

for a **STEADY** resource
stick to 

The **STEELMAN POLICY** insures the profitable development of your record player department, because:

1. Steelman started as makers of record players . . .
2. Steelman is still making record players . . .
3. Steelman will continue making record players!



Acoustic-angled lid directs sound waves from speaker to listener.



Model No. 200

Compact, lightweight, attractive duo-tone overnight luggage type case. 5" Alnico V heavy slug speaker. 2 Watt output. AND! improved tone quality attained through reflection of sound by lid placed at an acoustically designed angle (see sketch).

Retails for **\$2995**



Model No. 303

A phonograph with that PLUS value! 3 tube amplifier with **POWER TRANSFORMER!** 5" Alnico V heavy slug speaker and continuously variable tone control. 5 Watt output with wide, undistorted frequency response. Compact—yet plays 12" record with lid closed! Cased in beautiful duo-tone leatherette.

Retails for **\$3995**



USE
this coupon
TODAY!

Made by America's oldest manufacturer—devoted exclusively to the creation of electric phonographs.

STEELMAN RADIO CORPORATION RT 6
742 East Tremont Ave., Bronx 57, N. Y.
I am interested in the complete Steelman line; please send me descriptive literature.

Store.....
(please print)

Address.....

City..... Zone..... State.....

My regular jobber is.....

STEELMAN
RADIO CORPORATION

742 East Tremont Avenue, Bronx 57, N. Y.

Columbia Signs Group

Leonard De Paur's Infantry Chorus, a group of 35 Negro Veterans who sang together during World War II as a U. S. Army Unit, has signed an exclusive contract with Columbia Records, Inc., it was announced by Goddard Lieberman, vice-president in charge of masterworks artists and repertoire.

Names Eastern Rep

National Hollywood, Pasadena, Calif., western manufacturers of recording discs and needles, announced today their appointment of Land-C-Air Sales, Inc., 14 Pearl Street, New York City, to represent the firm in the eastern territory.

Blind Dealer Operates Successful Platter Business



Blindness is no handicap for Jim Albertson, owner of the Queen Anne Record Shop, Seattle, Wash., who conducts a thriving record business through use of Braille markings. Note the well-laid out interior of Albertson's store.

NOT \$5.00—NOT \$4.00—BUT...

ONLY \$3.50 FOR THE FAMOUS DUOTONE RUBY!

RUNS RINGS AROUND ANY OTHER RUBY-TIPPED NEEDLE SELLING UP TO \$5.00. AGAIN, DUOTONE SKILL AND KNOW-HOW PAYS OFF!

JUST compare the Duotone Ruby, feature by feature. It's easy on expensive recordings—plays for months and months with minimum surface noise—reproduces every tone with lifelike brilliance. Frankly, it's a \$5.00 value for only \$3.50!

Your customers get perfect performance and you get a generous slice of the permanent needle market—at a handsome profit.

Brother, you can't miss on this deal! The price is right, the profit is right, and Duotone is right behind you with eye-catching packages, colorful displays, and attractive folders.

So stock the Duotone Ruby—push it—and watch your inventories take a nose-dive. Now!—contact your distributor, or write direct for details and prices.

KEEP DUOTONE UP FRONT!



DUOTONE

DUOTONE COMPANY
799 Broadway, New York 3, N. Y.
Stephen Nester, President

EXPORT DEPARTMENT: American Steel Export Co., Inc., 347 Madison Ave., New York 17, N. Y.

Adds Phono Dept.

The Dachert Piano Co., 639 Pruitt Ave., San Antonio, Tex., has opened a new department featuring radios, players, combination machines and recorders, with Bill Tietze as manager.

Getting Ready for Father's Day

The Father's Day Council, 50 E. 42nd St., New York 17, N. Y., is now releasing its official store window and interior point-of-sale poster and display material for Father's Day, June 15th, to the stores of the country through its broadside, which is being mailed to 100,000 outlets. These materials are distributed at a low cooperative cost price.



De luxe display for use now—a wallboard unit in full color, 60" high. It's available from Father's Day Council, 50 E. 42nd St., New York 17, at \$67.50.

The council has released a complete schedule of prices for posters, displays, streamers, card toppers, pennants, wrapping paper, stickers and badges. The material is available from Father's Day Service Dept., 175 Varick St., New York 14, N. Y.

Helps Retailers During Price Changes

In an effort to clear up some of the "price" confusion now prevalent in the New York area, L. L. Suritz, president of Majestic Brands, Inc., distributors, has sent a special letter to his dealers.

The message says, in part, that "in the event of a downward revision of list prices on Majestic radio sets, authorized or established by either the Majestic Radio & Television Corp. or Majestic Brands, Inc., all retailers will be rebated for their inventory on hand, purchased within 60 days prior to such a list price revision."

The rebate will consist of the difference between the dealer's discount from the old list and the same discount from the new list as established and publicly announced by the factory, or by this distributor.

"Top-Ten" Albums

Audience Records, Inc., New York City, under the name "Top-Ten," has issued a series of comedy routine albums featuring Amos 'n' Andy, Jack Benny, Edgar Bergen, George Burns and Gracie Allen, Eddie Cantor, Ed Gardner, and Fibber McGee and Molly.

Each album contains a complete story, specially cut for phonographs, before a live audience. The albums range from 4 separate and distinct routines per album to 8 per album. They represent the artist at his best, and sell at \$4.50 each.

The copyright notice for Top-Ten labels states that the material cannot be played on radio stations or juke boxes.

Officers of the firm are: H. Paul Warwick, president; C. P. Jaeger, vice-president in charge of sales and manufacture; Norman Morrell, vice-president in charge of production; T. Newman Lawler, secretary and general counsel.

Decca Award to Artist



Dave Kapp, vice-president in charge of recording for Decca Records, recently presented Louis Jordan with Decca's famous "gold record." Presentation symbolized Jordan's membership in "One Million Club," members of which are Decca artists who have sold over a million copies of any single record.

Radio Homes Counted in Survey by CBS

Ninety-three per cent of all U. S. homes have radios, says a new survey which the Columbia Broadcasting System made with the Market Research Co. of America and the Nielsen Radio Index. CBS said that a record total of 39,900,000 homes now have sets in use, in this "first all-inclusive postwar circulation statement." Total sets in use was 52,500,000, exclusive of auto and portable sets, the survey said.

It was also found that one out of every three U. S. families has more than one radio, an increase of 89% over the comparable multiple-set figures for 1944, as reported by OCR. One in every five families in the U. S. bought a new radio in 1946. The exact percentage, according

to the new CBS study, is 20.5. Total of home sets bought in 1946 was 8,500,000; 30% purchased by prosperous families; 40% by average families; 30% by poor families.

In urban areas, 18% of the families bought single sets in 1946; 21% in rural non-farm areas; 22% in rural farm communities. In each of these three categories, 1% of all families bought 2 sets or more in 1946.

Texas Retailer

The new Goodman Radio & Record Shop, 5411-13 E. Grand, Dallas, Tex., has been opened by Mervin and Benny Goodman, brothers and co-owners, who are featuring a complete line of radios and records, as well as an expert repair department.

Words and Music by —



PORTABLE ELECTRIC PHONOGRAPHS



Model 90—FUN-O-GRAPH
Kiddie Phonograph



Featuring

MODEL 110
WITH THE
WEBSTER-CHICAGO
AUTOMATIC RECORD CHANGER

- High-gain 3-tube amplifier
- Needle scratch filter
- Two-tone DuPont Fabric-covered luggage case
- Automatic bass compensation
- Large Alnico 5 P. M. Speaker
- Variable Tone Control
- 110 volt, 60 cycle A. C. operation
- Fully guaranteed



Model 80—Two-tube
Portable Phonograph

Model 100—Three-tube
Portable Phonograph



TERRITORIES AVAILABLE
FOR SELECTED DISTRIBUTORS

WRITE OR WIRE

Troylon

RADIO LABORATORIES

3955-57 NORTH BROAD STREET
PHILADELPHIA 40, PENNSYLVANIA

Distinctive

IT'S *Sky-Weight*



Model 82 Radio-Phonograph
Combination with exclusive
Miracle Eye Tuning.

Really Portable

Sky-Weight—featured by better shops throughout the country

MODEL 81

- 3-Tube Phonograph
- Concealed Alnico V Speaker
- Tone and Volume Controls
- Plays 10" - 12" Records
- Size: 5½ x 11½ x 15½ Inches
- Ten Pounds

MODEL 82

- 5-Tube Radio-Phonograph
- Built-In Antenna
- Radio-Phono Selector
- Plays 10" - 12" Records
- Concealed Alnico V Speaker
- Sizes: 5½ x 11½ x 15½ Inches
- Eleven Pounds

Both models in real leather-bound luggage cases.
Also available without case for desk drawer or shelf mounting.

CONTINENTAL ELECTRONICS LTD. • BROOKLYN 22, N. Y.

CUTS RECORDS UP TO 10" DIAMETER

PLAYS RECORDS UP TO 12"



**MODEL GI-R90
DUAL-SPEED HOME
RECORDING AND
PHONOGRAPH ASSEMBLY**

**ONE BUTTON CONTROLS SPEED
78 or 33 1/3 R.P.M.**

JUST LOWER CUTTING ARM TO START RECORDING

Smooth Power... FOR HOME RECORDING

Your customers will be delighted with the high-quality home recordings they can make on this GI Dual-Speed Home Recording and Phonograph Assembly. Equipped with ample *Smooth Power* for recording or reproducing, it's simple as ABC to operate. It's sturdily built to stand up under hard use . . . and it's remarkably low-priced for volume sales.

Send for details on this fine unit, and for complete information on the complete *Smooth Power* line of Phonomotors, Recorders and Combination Record-Changer Recorders.

THE GENERAL INDUSTRIES CO.
DEPT. MV • ELYRIA, OHIO

Permo Jingle Contest

Dealers and record clerks are evincing much interest in Permo, Inc.'s jingle contest. Sample verses sent out to the trade by E. C. Steffens, Permo's vice-president and general manager, dealt with the "Smiling Sue" vs. the "Dumb Dora" type record clerk.

Any topical treatment, in rhyme, that deals with the clerical or merchandising methods to be used in selling Fidelitytone phonograph needles is acceptable. Contestants who write the best verses will receive \$10.00. Entries should be sent to Permo, Inc., 6415 Ravenswood Ave., Chicago 26. Record clerks should give the name of the store where employed, and the department manager.

Store Modernization Show in July

The first annual Store Modernization Show to be held at Grand Central Palace, New York, July 7-12, will have as one of its features the newest styles in radio store modernization.

Radio men will have the opportunity to see and compare for the first time under one roof competing systems of store modernization. In addition, all phases of store modernization will be considered in 6 days of discussion, reading of prepared papers and question clinics.

On exhibition will be displays of the latest techniques of store exteriors, interiors and all the furnishings and decorations that make the modern store. Lighting fixtures, floorings, wall coverings, ceilings, paints, display cases, escalators, air conditioning, refrigeration and heating equipment, business machines, cash registers, mechanical and merchandising equipment, fixtures and all other related modern methods of winning and keeping customers will be shown.

Capt. Sarnoff Joins Jobber

It has been announced by Louis K. Roth, president of Radio & Appliance Distributors, Inc., East Hartford, Conn., that Captain Edward Sarnoff has joined the company as advertising and sales promotion manager. Captain Sarnoff is the son of General David Sarnoff, president of Radio Corp. of America.

Sonora Orch Leader



Sonora's Bob Chester, center, is shown autographing records for fans in a dealer's store during a recent tour with his band.

Duotone Display Piece



Duotone Co. is offering dealers its "show window" selling aid for displaying phonograph needles. Made of wood and lucite, the display is a combination counter card, storage bin and silent salesman.

Columbia Prexy Returns

Edward Wallerstein, president of Columbia Records, Inc., has returned from an inspection tour of Columbia's newest factory, just outside Mexico City. Mr. Wallerstein reported on his return that work was progressing rapidly on the new plant and that it would be in operation and pressing records by the end of the summer. The Mexican factory will produce Columbia Records to supply the Mexican and Central American market. This new plant is under the direction of Michael S. Kestler.

The Mexico City factory will mark Columbia's fourth record pressing plant. Other Columbia factories now in operation are located at Bridgeport, Conn.; Kings Mills, Ohio, and in Hollywood, Calif.

DeLuxe Store Fixture



This floor fixture has antiqued white leatherette background with rich green shelves, topped with glowing lucite sign—for mass display of smaller sets by Westinghouse. It's about 6 ft. high by 5 ft. wide, with multiple outlets.

Trimming Store Windows

Many dealers feel unable to do the work of trimming windows themselves. If you wish, you may be able to hire a window trimmer from the outside to come in and dress your windows. Have your sales force cooperate with and work with this window trimmer. They can add the "salesmanship" while he adds the "theatre."

If you have the time and the talent in your store, you may not need a window trimmer. You can get ideas from movies, ads and department store windows. You can also learn how to arrange your own stage "props". Companies that sell these "props" will give you a certain amount of help and ideas in setting up your window displays. Crepe paper and bunting manufacturers

may make many useful suggestions. Manufacturers of racks and stands may be similarly helpful. You may get good ideas on designs and layouts from the man who makes up your display cards.

Cohen Manager of Philco's N. Y. Branch

Joseph Cohen, a veteran of radio and appliance distribution who has been with Philco for 11 years, has been appointed general manager of the New York branch of Philco Distributors, Inc., 120 E. 23rd St., N. Y. C. The announcement was made by Hal Sheer, vice president and general manager of Philco Distributors.

Since October 1945, he has been sales manager of the New York branch, the company's largest wholesale distributor.

4

TOP SALESMEN
CARRYING SIGNATURE'S MESSAGE
INTO
10,000,000
HOMES

TOPS IN NATIONAL ADVERTISING

Through the columns of such best-selling magazines as Life, Look, Colliers and Seventeen, Signature reaches more people than ever before. Every week, everyone sees a Signature ad somewhere.

SELLING AIDS THROUGH PROMOTIONAL MATERIAL

With many fine counter displays and colorful streamers, Signature boosts sales with eye-catching, appealing literature and posters. Signature goes all out with the dealer in helping him sell—dealer aids are an important phase of the campaign.

IN THE IMPORTANT TRADE JOURNALS

Leading trade papers such as Billboard, Cash Box, Record Retailing and Record Industry bring the Signature Message to the dealer and the distributor in a forceful manner each week.



THE FINEST NAME IN AMPLIFIED PHONOGRAPHS

Dynavox

SMASH SURE-FIRE HITS FOR 1947 . . . Superior Style, Tone, Quality and Value are embodied in Dynavox Electric Amplified Phonographs.



The Swingmaster

Outstanding for low-priced entertainment . . . Compact, 2 tubes, 110V AC, 60 cycles . . . High-fidelity crystal pickup . . . 5" Alnico V Speaker . . . Console quality tone . . . Handsomely designed 2-tone solid wood cabinet . . . Truly an achievement in popular phonographs.

. . .

A few territories still available. Write for particulars.

Dynavox CORPORATION
40-05 21 ST., LONG ISLAND CITY I, N. Y.

SOLD THROUGH AUTHORIZED DISTRIBUTORS

IGOR STRAWINSKY

conducting his

DUMBARTON OAKS CONCERTO

the first of the new

KEYNOTE MANUSCRIPT SERIES

*for catalog
and list of distributors write*

KEYNOTE RECORDINGS, INC.

522 Fifth Ave., New York

Duotone Disc for Home Recording

The Duotone Co., Inc., 799 Broadway, New York City, producers of phonograph needles and record accessories, announced through its sales manager, William A. Boeger, Jr., that a new and improved red label Duodisc is currently on the market. Dealers can obtain pamphlets from the company for distribution giving hints and advice on home recording. The Duodisc uses an aluminum base and runs in sizes from 6½ inches to 12 inch blanks.

Webster-Chicago Sales Rep

The appointment of R. R. Hutmacher, of Salescrafters, Inc., 512 N. Dearborn St., Chicago, as sales representative of Webster-Chicago, has been announced by W. S. Hartford, Webster sales manager. Ray Hutmacher will cover Wisconsin, northern Illinois, upper Michigan and Lake and LaPorte Counties in Indiana for the record changer and wire recorder manufacturer.

Mr. Hutmacher has been associated with the industry since 1926.

Disc Co. Pamphlets

Disc Co. of America, New York City, has prepared a series of recordings called "Young Folksay," stressing the musical needs of growing children. It consists of ten albums covering all the phases of activity that interest the child from nursery days through school.

A special booklet has been issued by the firm for this series, profusely illustrated with photographs of children at work and at play.

Majestic West Coast Mgr.

The appointment of J. George Miles, Jr., as West Coast divisional manager for Majestic Radio & Television Corp. and Majestic Records, Inc., has been announced by Parker H. Ericksen, vice-president. Since 1939, Mr. Miles has been northwest merchandising manager for Westinghouse.

Winant Children's Album



Winant Productions kiddie album, "It's Fun To Eat," introduces fun before and at mealtimes for the pre-school child. This is the first of a series of albums based on the same instructional entertainment pattern.



**with the "Knee-Action"
nylon-cushioned
jewel tip . . .**

Nylon, the miracle plastic, provides a gentle, floating "knee-action" ride for the sapphire tip, effectively diminishing needle scratch and surface noises.

Enthusiastic listeners report finer tonal qualities and more life-like reproduction of favorite records with the new Webster Nylon Needle.

Stock it, display it now. Its outstanding performance will multiply your customers' record enjoyment and your needle sales.

FREE, attractive lucite display with initial order, to help you merchandise the Webster Needle profitably.

WEBSTER  CHICAGO

5610 BLOOMINGDALE AVENUE, CHICAGO 39

The Choice of Music Lovers

PRESENTED BY
THE MAKERS OF
WEBSTER
RECORD CHANGERS



NAMM Trade Show

(Continued from page 43)

music merchants will decide on the method of financing their share of the promotion program.

Merchandising clinics on June 3 and 4 will discuss store operation problems—selling, expense control, and sales through service; other sessions will deal with the theme "how to expand your business."

As Mr. LaMair said, the trade show serves a two-fold purpose.

1. It permits the manufacturer and music store supplier to show a comprehensive assortment of musical merchandise at one central location, thereby reducing the merchant's buying expense, and the manufacturer's selling costs.

2. Through the programmed convention activities, members of NAMM will have an opportunity to attend group meetings, and to participate in merchandising clinics to be addressed by experts in their fields. Those attending the clinics will not only hear specialists in the various phases of merchandising music, but will have an opportunity to discuss current operating problems.

Board Members

NAMM's Board of Directors include the officers and the following members: Wm. Howard Beasley, Whittle Music Co., Dallas 2, Tex.; Jerome F. Murphy, M. Steinert & Sons, Inc., Boston, Mass.; Russell B. Wells, Chas. E. Wells Music Co., Denver, Colo.; Ray S. Erlandson, San Antonio Music Co., San Antonio, Tex.; Melville Clark, Clark Music Co., Syracuse, N. Y.; George Beasley, Beasley Music Co., Texarkana, Ark.-Tex.; Paul W. Jenkins, Jenkins Music Co., Kansas City, Mo.; E. E. Forbes, E. E. Forbes & Sons Piano Co., Birmingham, Ala.; Otto B. Heaton, Heaton's Music Store, Columbus, O.; Thomas Dahl, Thayer Piano Co., Ltd., Honolulu; T. H. Hugh Randall, J. B. Bradford Co., Milwaukee, Wis.; Frank O. Wilking, Wilking Music Co., Indianapolis, Ind.; Emory Penny, Penny-Owsley, Los Angeles, Calif.; Parker M. Harris, Philip Werlein, Ltd., New Orleans, La.; Earl Campbell, Campbell Music Co., Washington, D. C.; John C. Weisert, Bissell Weisert Piano Co., Chicago, Ill.; Robert A. Schmitt, Paul A. Schmitt Music Co., Minneapolis 7, Minn.; Harry E. Callaway, Thearle Music Co., San Diego, Calif.; W. Perry Chrisler, Aeolian Co. of Missouri, St. Louis, Mo.; Carl Wittich, Wittich's, Reading, Pa.; S. H. Galperin, Galperin Music Co., Charleston, W. Va.; A. P. Avery, Avery Piano Co., Providence, R. I.

COMING . . .

Watch for new AUDAX products to be announced soon



Audax* REPRODUCERS

*"The Standard
by which
Others
Are Judged
and Valued"*

AUDAX has mastered wide-range so thoroughly that, today, even the lowest priced AUDAX has a range to 7000 cycles—(other models over 10,000 cycles). True,—wide-range makes for naturalness but,—it is highly objectionable if without quality. For example, of two singers, each capable of reaching high C, one may have a pleasing voice—the other, not at all.

It is the same with pickups. To achieve EAR-ACCEPTABILITY, all other factors must be satisfied. Of these, VIBRATORY-MOMENTUM is most important. The only way to test EAR-ACCEPTABILITY of a pickup is to put it to the EAR-TEST. The sharp, clean-cut facsimile performance of AUDAX — regardless of climatic conditions—is a marvel to all who know that EAR-ACCEPTABILITY is the final criterion.

AUDAX COMPANY

Dept. R.

**500 Fifth Avenue
New York 18, N. Y.**

*"Creators of Fine Electronic-
Acoustical Apparatus since 1915"*

*Trademark

THE TOP

Cowboy
 Artists

RAY
 WHITLEY
 MOTION
 PICTURE STAR
 SHORTY LONG
 RUSTY KEEFER
 BILLY WILSON
 HAYLOFT HOEDOWN STARS



ELMER NEWMAN
 PANCAKE PETE NEWMAN
 PEE WEE MILLER
 MURRAY SISTERS
 MONTY ROSCI
 JACK DAY

SINGING THE TOP

Cowboy
 SOUNDS

- 101 ROSE OF THE ALAMO
COWBOY DAD
- 102 WESTWARD BOUND
JUST SAY SO LONG
- 103 DO YOU THINK IT'S FAIR
IT'S HARD TO SAY GOOD BYE
- 104 DILLY DALLY POLKA
SLEEPY HOLLOW POLKA
- 201 BLUE RANGER
SIDE SADDLE JOE
- 202 I ROUND-UP THE STARS
YOU'VE GOT MY HEART IN TROUBLE
- 203 BLUE ROSE OF THE RIO
I'LL STILL GO ON LOVIN' YOU
- 204 WHEN I HOLD A BIT OF HEAVEN
I'M GONNA DRY UP MY TEARS
- 301 JUKE BOX CANNON BALL
BETWEEN THE LINES
- 401 MY BEAUTY FROM BUTTE
THE COWBOY'S LAMENT
- 302 TEN GALLON STETSON
WITHIN THIS BROKEN HEART OF MINE
- 402 I'LL FIND SOMEONE
BLUE TAIL FLY

ARE ON

Cowboy
 RECORDS

Exclusively
 The Newest Name
 on the
 Cowboy Label
 BILLY WILSON
 THE COWBOY POET
 and Singer of American Folk Ballads



Distributors—There is still choice territories
 available—Write to
COWBOY RECORD CO.
 138 N. 12th Street Phila. 7, Pa.

New Disc Player

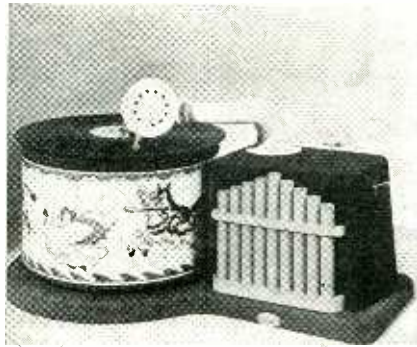

Tone Products Corp. of America, 351 Fourth Ave., New York, N. Y., now offers this new Model A acoustic phonograph with electric motor, \$17.95.

Victor Promotions

Frank M. Folsom, executive vice-president, of the Radio Corporation of America, in charge of the RCA Victor Division, announced the appointment of Fred D. Wilson, as vice-president in charge of operations and Joseph H. McConnell as vice-president in charge of law and finance.

Reps for Webster-Chicago

Appointment of Patterson & Co., Dallas, Texas, as representative of Webster-Chicago has been announced by W. S. Hartford, Webster sales manager. M. B. Patterson has taken over the trading area of Dallas, Houston, San Antonio, Amarillo, Shreveport, Oklahoma City and Little Rock.

Lee W. Maynard was also named Webster representative for the basic trading areas of Kansas City and Omaha, in addition to the territory he is now covering in the areas of St. Louis, Davenport and Des Moines.

Production Head

Robert Walker, formerly production manager for Pacific Electronics of Los Gatos, Cal., has been appointed to the staff of General Electronics, Inc., of Paterson, N. J., where he has the same post.

Capitol Artists



Bob Hope and Dorothy Lamour recording tunes from their latest picture "My Favorite Brunette" for Capitol.

PORTABLE PHONOGRAPHS

Portable Record Changers—V.M. Automatic Mixer Changer, 3 Tube Amplifier, tone and volume controls, 5" Alnico P.M. Speaker, in simulated leather carrying case \$42.50
 Lots of 3 each 33.00

Portable Record Players—Alliance Motor, Shure or Astatic Crystal Pickup, 3 Tube Amplifier, tone and volume controls, Alnico P.M. Speaker, in simulated leather carrying case \$23.95
 Lots of 3 each 16.75
 Same components as above in a Walnut Finish Table model cabinet \$21.95
 Lots of 3 each 14.95

Record Players—attach to any radio, Alliance Motor, Shure or Astatic Pickup in Walnut Finish Cabinet \$ 9.95
 Lots of 6 each 7.95

Shure or Astatic Crystal Pickups \$ 2.15
 Lots of 10 each 1.85

Alliance Phono Motors \$ 3.50
 Lots of 10 each 1.85

5" Alnico P.M. Speakers \$ 1.45
 Lots of 10 each 1.30
 Above with 50L6 output transformers 1.95
 Lots of 10 each 1.85

3 Tube Phono Amplifiers use 35Z5, 50L6, 12SK7, volume and tone controls, less tubes \$ 3.50
 Lots of 10 each 2.65

2 Tube Phono Amplifiers use 35Z5, 50L6, less tubes \$ 2.40
 Lots of 10 each 2.05

All Prices F.O.B. our warehouse N. Y.
 25% Deposit — Balance C.O.D.

RAYTONE ELECTRONIC COMPANY
 Wholesale Distributors
 25A Frankfort St. New York 7, N. Y.

see
 page
 141

New Victor Artists

Beryl Davis, British singing importation, and Bill Johnson and his Musical Notes, have been signed to RCA Victor contracts, according to James W. Murray, vice-president in charge of RCA Victor record activities.

GE Offers Program for Public Demonstration

An entertaining educational program, tracing the development of the phonograph and the radio-phonograph combination over more than half a century, has been prepared by the receiver division of General Electric Co. and will soon be released to field offices for public demonstrations in all parts of the country, Arthur A. Brandt, general sales manager, electronics department, has announced.

The show, titled "The Evolution of Tone," has been prepared to appeal to all types of audiences from school groups to business men's luncheon and dinner assemblies. Scripts are being provided to make the program of special interest also to radio distributors, dealers and servicemen.

Eastern Names Two New Executives

Eastern Amplifier Corp. has announced that S. K. Lackoff has joined its organization as chief engineer and Gerson Lewis as executive assistant to Leon Alpert, who is vice-president and general manager. This is a part of the current expansion of the company as to its products and sales activities.

K. Streuber, who was recently placed in charge of export sales for Eastern Amplifier, has announced that Walter B. LaChicotte is now associated with him in Eastern Amplifier export activities.

New Sangamo Line

Paper tubular capacitors in thermo-setting plastic sealed off against humidity are being offered by Sangamo Electric Co., Springfield, Ill. Known as type 30, they are available impregnated in tan halowax, and in red diacolor.

Black & White Album

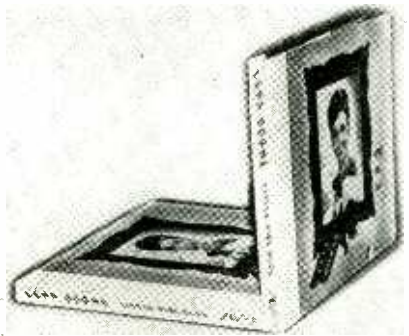

Black & White Recording Co., Hollywood, has adopted the album binding shown. Lettering is at a 45 degree angle to facilitate easy reading of titles.

CLASSIC Chippendale RECORD CABINETS



Styled to fit in with period or modern furniture. Holds 10" and 12" record albums UPRIGHT. This record cabinet can also serve a double purpose as a dining room server. Exquisitely styled in selected hardwood with genuine mahogany or walnut veneer top and doors, hand-rubbed to a rich satiny finish.

PM414—Double-door style—28½" wide, 17" deep, 32½" high.

PM415—Double-door style—24" wide, 17" deep, 32½" high.

Manufactured by National Furniture Corporation, Adelpia Industries sole national distributors.

WRITE FOR PHOTOGRAPHS AND PRICES OF COMPLETE LINE

Salesmen's and Distributors' Correspondence Invited.

Adelpia INDUSTRIES

DIVISION OF ADELPHIA CO. — EST. 1932

419 ARCH STREET • PHILADELPHIA 6, PA.

• THE WORLD'S FASTEST SELLING PHONOGRAPH NEEDLES!

BRILLIANTONE

The Standard Steel Needle of the World... leader in sales and quality for over a quarter of a century!

ACTON'S TAPER-TONE

The high-fidelity steel needle that is famous for its "shouldered" shape... and scratch-free tone.

ACTONE TRANSCRIPTION NEEDLE

The favorite of record collectors everywhere because of its perfect, shadowgraphed point.

Products of *Bagshaw*

Famous for Fine Needles Since 1892
Sole Distributor **H. W. ACTON CO., Inc.**
370 Seventh Ave., New York 1, N. Y.

Send for New Catalog "E" and Current Price Lists

• BAGSHAW

Melodee

RECORDS INC.

A New Name

Specializing in CHILDREN'S

Non-Breakable Records

Album 10—PINOCCHIO
Album 12—SNOW WHITE
Album 16—SLEEPING BEAUTY
Album 18—CINDERELLA
Album 20—FAVORITE NURSERY SONGS AND GAMES
Album 22—ALICE IN WONDERLAND
Album 14—Irving Caesar's SONGS OF SAFETY (Music and Sound Effects)

LIST \$2.95 plus tax

Each Album Contains 2 Records—4 Sides

Vinylite & Vinyl Plastic—In Colors

Music Show — Booth 5, Palmer House

MELODEE RECORDS, INC.
314 W. 52 St. N. Y. 19, N. Y.

Some Distributor Territories Still Open

PHILCO
ACCESSORY PRODUCT

**PROMOTION GUNS
ARE BOOMING!**

**For Extra June Profits
with Philco Accessory Products**
*Get in now on this
Sensational Offer...
Hurry!*

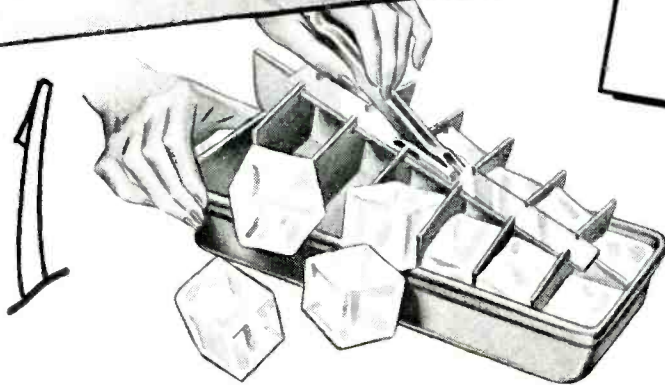

- ★ NO SPLASHING
- ★ NO MELTING
- ★ NO FORCING

**FAMOUS
PHILCO EASY-OUT
ICE CUBE TRAY**

**Frees All Cubes Instantly
FITS ALL STANDARD REFRIGERATORS**

2



**SPECIAL TRADE-IN
ALLOWANCE OF**

27¢

for old tray
on purchase of each new Philco Easy-out Tray

**NATIONALLY
ADVERTISED
LOCALLY PROMOTED**

- ★ DON McNEILL
BREAKFAST CLUB PROGRAM
- ★ DISPLAY MATERIAL
FOR YOUR STORE
- ★ ADS FOR YOUR
LOCAL NEWSPAPER

**SPECIAL OFFER
IS LIMITED**

Hurry!

**SEE YOUR
PHILCO DISTRIBUTOR
TODAY!**

3

**RADIO!
DISPLAYS!
ADS!**



- Act at once! Add extra June volume and profits with this sure-fire Philco Ice Tray Promotion. Display it! Advertise it! Talk about it! Use Philco's famous "share-the-cost" Cooperative Advertising Plan to make it your most profitable retail promotion in years.

ELECTRICAL APPLIANCES

Section of **RADIO Television RETAILING**

How Do You Treat the Tinkerer?

What do you do when a guy brings in a paper bag filled with pieces of what was once a hand-iron? How do you react to the customer's request that you reassemble and make work

proceeds to treat it with medicine of his own choice. The next step is often a fast and furious game of tag with the Grim Reaper, followed by a visit to the doctor. The medico

operates from a money-saving reason, or from sheer sadistic glee, who becomes a genuine pest to the dealer, needs to be given the old heave-ho. No merchant can afford to have his store haunted by crackpots.

Unless He's a Chronic Pest, the Amateur Repairer is a Guy in Trouble, and You Should Give a Tinkerer's Dam About His Problem

the radio which junior ("who is really a mechanical genius") has torn apart in what you determine is one of the most complete dismantling jobs you ever saw?

Do you tackle the tinkerer with a flood of caustic comment?

Or do you take the job with a smile and the firm resolution to make your charges cover well the tinkerer's clumsy efforts to fix the product himself?

When customer X lays a greasy motor on your counter and says he thinks it's "burned out" because the refrigerator or oil-burner won't run, do you refuse to test it, insisting upon a call at the home? Or do you test it, and finding it in good working order, tactfully suggest that Mr. X bring in the controls—which you know almost to a certainty, that he's already torn apart?

Most of us are tinkerers at heart—both men and women, and certainly great numbers of young fry. Though casual consideration of the question of what makes us "tink" would lead to the belief that most tear into fixing things because of a desire to save money, a more painstaking examination of the subject would reveal that money is seldom the prime mover.

Without even considering the money angle, many a guy diagnoses some ailment in his own body and

then has on his hands a counterpart of the same sort of tinkerer who rolls into the dealer's with a hopeful gleam in his eye and a shoe-box filled with the remains of an automatic toaster which he has yanked apart, seemingly with a crowbar and a sledge hammer.

But there's a serious side to all of this tinkering business.

There's a financial and good-will angle too.

The chronic tinkerer—whether he

operates from a money-saving reason, or from sheer sadistic glee, who becomes a genuine pest to the dealer, needs to be given the old heave-ho. No merchant can afford to have his store haunted by crackpots. But the garden variety tinker, the guy who, in weaker moments, succumbs to the powerful urge to tamper with the radio or other home product, and who failing to fix it, brings it into the dealer's store, or calls the service man into his home, is a man to be pitied.

The Good-Will Angle

He's a man in trouble. He's worried, but he's hopeful that the dealer, whom he knows to be an expert, will make things all right for him again. He goes to the retailer with a feeling

(Continued on page 144)

If he's willing to take the tinkerer's work, the dealer should take it with a smile.

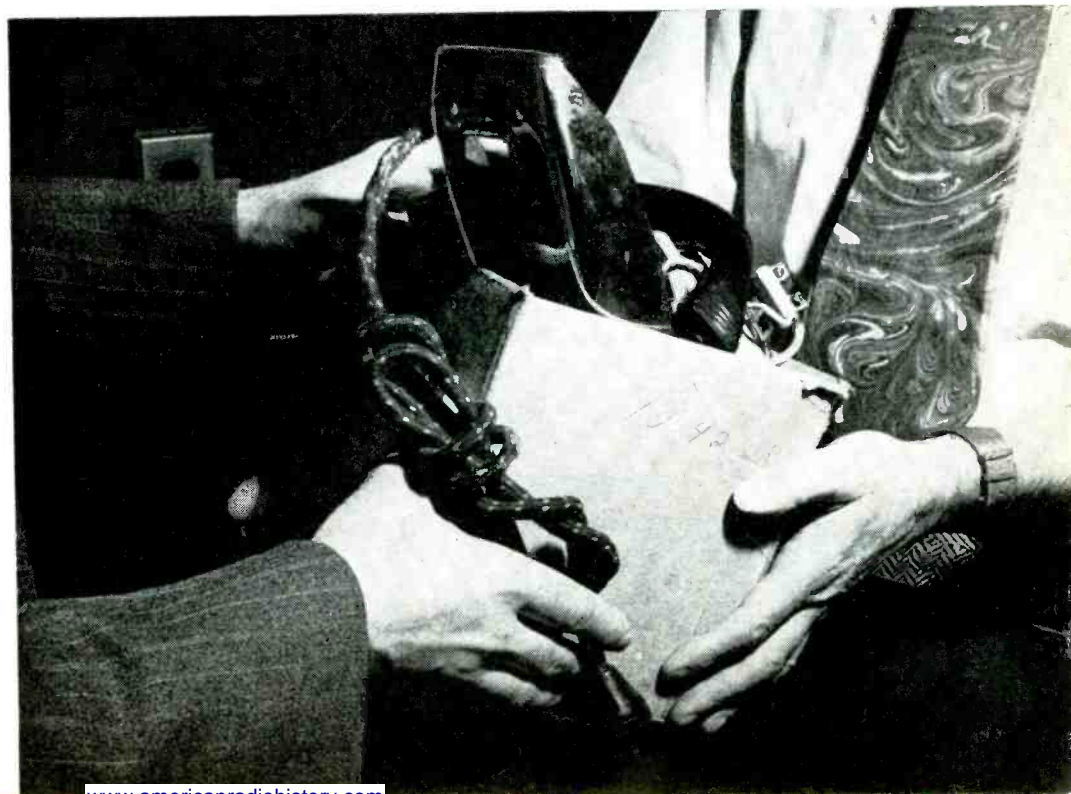

Heat Control where it Counts — at the Fabric



Light
ONLY 3
POUNDS

Fast
HEAT IN
30 SECONDS

Low
THE SHELL IS JUST
1 INCH HIGH

Durabilt's exclusive thermostatic control guarantees the *right* temperature at the *right* place — on the soleplate surface. Here is the only iron in the world in which the soleplate controls the ironing temperature. The new Durabilt Automatic Iron Model 10 offers a full heat range with the exact temperature for every fabric — quickly, evenly. Light — only three pounds, Durabilt assures easier, faster ironing. Low—the shell is just one inch high, Durabilt provides all around visibility in ironing. Fast—Durabilt reaches ironing heat in less than 30 seconds.

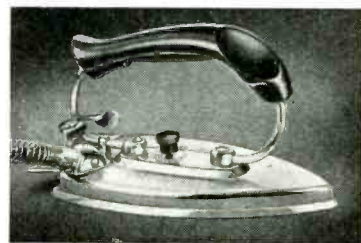

Companion on your shelves is the famous Durabilt all-purpose Folding Iron. Place your order with your distributor now for both Durabilt Automatic Irons!

Manufactured by WINSTED HARDWARE MANUFACTURING COMPANY, WINSTED, CONNECTICUT

DURABILT *Fully Automatic* IRON



Use Those Dealer Helps!

Attractive Promotion Material is Coming in—
Here's How to Make the Most of It

● To get the most out of valuable sales help material he gets from the manufacturer, the dealer should use it. It's simple as all that.

Envelope stuffers which get put away in some dusty nook, carry no sales message to the merchant's customer. One day they'll be out of date due to model change. Counter cards earn the small space they occupy only if they are put on display, and signs having lighting features can't do a good merchandising job unless they're plugged in.

Many a window-dresser tosses out a descriptive color blow-up which should accompany a product because he can't make it fit into a certain space. Under such conditions, customers viewing the radio or appliance will more often than not be unable to identify the make, and certainly will not be able to know about the newest features which could add heavily to the sales-appeal.

Never before has the dealer been able to get such effective and attractive material. Great strides in advertising techniques have been made. There's much less blue-sky and much more right-to-the-point sincerity and clarity in the message of today's promotional piece.

Good Supply Coming

Though a lot of material has been slow in coming, a speed-up is generally looked for in the near future. Material scarcities have held up metal signs, and numbers of large blow-ups made of cardboard, etc. Deliveries of most printed and lithographed display pieces have taken a terrific spurt just recently.

The dealer will benefit, too, via

the improved cooperative advertising plans many makers are offering through their jobbers. Such plans not only permit the merchant to buy newspaper display space at reasonable rates, but he is often furnished with mats, made-to-order copy, and write-ups which he can often get into the local newspaper.

One of the display problems which the dealer shares with the manufacturer and the jobber is that of keeping the right piece of advertising material with the right product.

Keeping Them Straight

This is an age-old headache which is met with in many a store. It's like this: Manufacturer X sends a neat pyramid stand to Dealer Doakes. The stand is conspicuously lettered with X's name, a famous one in manufacturing circles. Naturally, he wants his products to go on this stand. But it doesn't always happen that way. Busy clerks start putting *other* makes on it, and customers pick 'em up, and start beefing along such lines as "I thought this was an X toaster."

In the old days, a few sharpshooting dealers thought it was smart merchandising to put some cheap unknown makes on the stand of a well-known maker. They felt that they could fool the customer that way.

Nowadays, such things happen by accident, but since mixed displays confuse the customer, and often arouse his suspicion, every effort is made to keep the product with the sign or on the right display table or stand.

Easel sales presentations are welcomed by merchants, and are being used successfully throughout the country. Clever salesmen utilize these for two purposes. First, to familiarize themselves with the features of the product, step by step, and second to make doubly effective sales presentations in which the cus-

tomers can both see and hear the entire story.

While much of the material furnished the dealer is free, going along with the contract franchises, some of the more elaborate is charged for at prices lower than cost. Dealers find that life-size display pieces are fine "backs" for window displays, and lend color to the inside of the store when used along walls, and as islands.

The four-way dealer finds that he's able to get material for all of his departments. He gets colorful pieces from his radio manufacturer, bright, informative material from phonograph record makers, and a variety of selling helps from the record accessory firms as well.

Major appliances are glamorized via some of the most striking displays ever seen before. Too, for the first time, there's a great variety of exhibit material for the stressing of traffic appliances.

Eye-Catchers Issued

Tube and accessory manufacturers are furnishing dealers with effective cards, window streamers and other exhibit pieces designed to help the dealer sell more service, and to identify his store as a reputable maintenance headquarters.

The whole trick is to use to best advantage the selling aids at his disposal. Too often the window dresser or clerk is likely to overlook the importance of such material, taking it for granted that because he knows the product, the customer must.

The dealer who takes every advantage of the advertising value of the display pieces, large and small, which come into his store today, will be putting to work a lot of silent salesmen whose sales presentations have been well thought out and have cost, in the aggregate, many millions.

To be effective, sales material must be used.

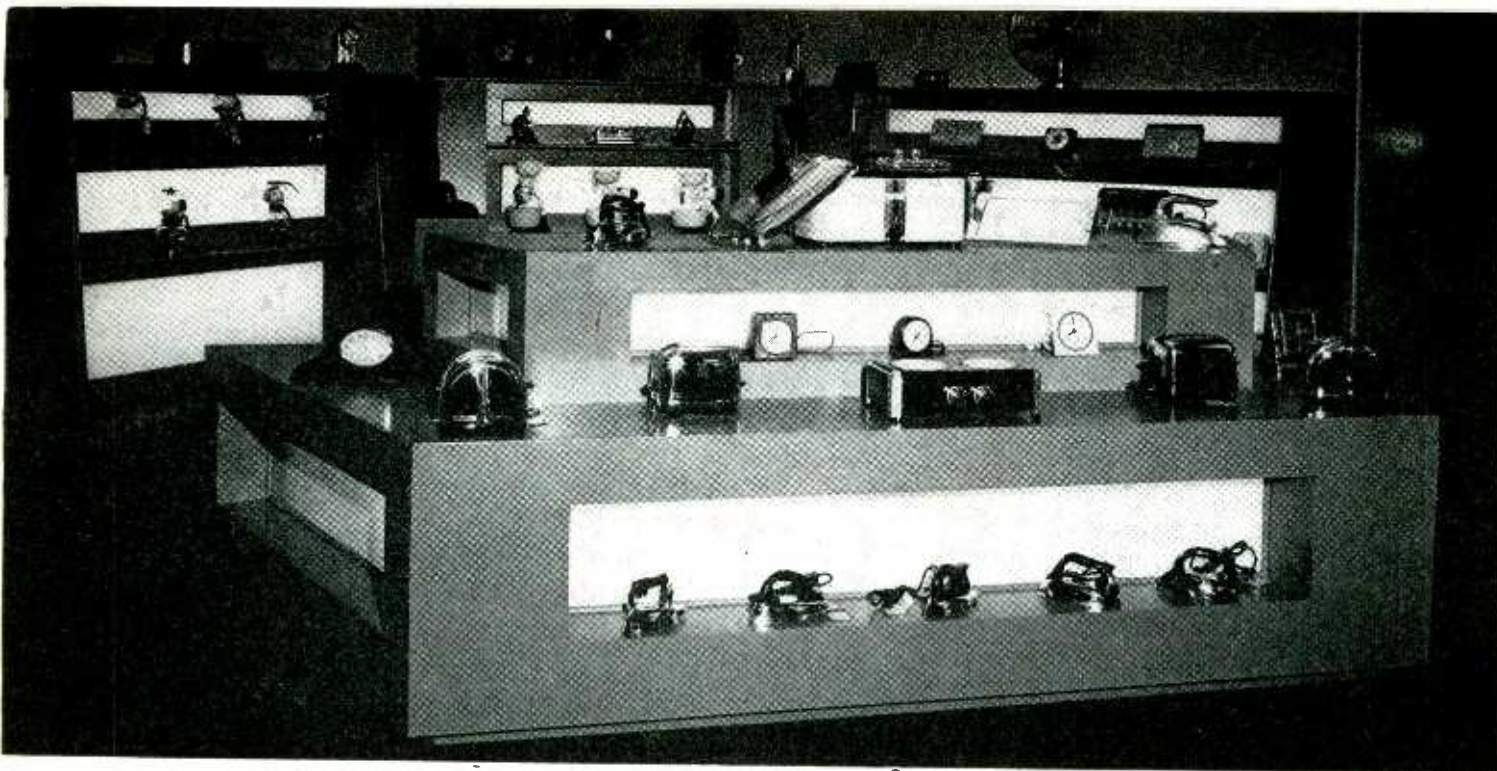

Set off by indirect lighting and not crowded, these traffic items are given new prominence in a deluxe display at W & J Sloane in San Francisco.

Big Profits from Small Appliances

Excitement and Cash in Turnover of New Traffic Items

● One of the notable things about the hundreds of new store lay-outs these days is this: the great majority of them have added special, streamlined shelves and fixtures for the display of traffic appliances.

This is only one of the market indications that the smaller items are now getting the break they deserve. Dealers and distributors are giving them more attention because of their unique position in the opening months of the buyer's market.

The thing a retailer needs most, in these days when competitive conditions are beginning to return, is probably *contact with large numbers of prospects*. Traffic appliances supply this. Many merchandisers are beginning to regard it as a genuinely vital sales factor.

This does not mean that every time a customer steps in the store to buy a 15c light bulb, the sales force should leap at him with a million suggestions that he buy this and that. If

a dealer regards his lower-priced items simply as "bait," it may bring the general tone of his selling down to an unfortunate level. The situation requires tact, skill and planning, just as any other merchandising project. It's an important business.

The customer must be treated with sense and courtesy, even if the dealer has a feeling that this is the first and probably the last time the fellow will ever be in the store. The idea of locating the traffic displays to the rear of the store and deliberately operating the set-up as a kind of "trap" just will not work out in the long run.

It Means Volume

Aside from the traffic-creating advantages of smaller items, these products can rest on their own volume. It is not a case of showing half a dozen cheap toasters and hoping for the best. Manufacturers have im-

proved their designs and added to their lines to such an extent that the actual sales to be made are enormous. If a family already has a toaster that works, an electric iron which just has the fundamentals and that's all, and an electric clock of ancient vintage—that family is definitely a prospect for a string of new appliances that will add up to important sales totals. In addition to such merchandise as door chimes, sunlamps, electric blankets, etc., that they may not own at all.

Dealers Have Help

The number of aggressive suppliers in this business is something to think about. It is the kind of a group that can always add something to the market which will mean a lift in sales. If it isn't a popular-priced sunlamp, it's a familiar appliance with an automatic feature added. To the fast-moving and resourceful ranks of

these manufacturers the raw materials have now begun to flow. The result will be a matter to invite the immediate attention of the retailer. And this includes the dealer who thinks he knows most of what there is to know about the traffic appliance industry. There are new things to learn in the summer of 1947.

Appeal Is Universal

Another basic quality of this business is its *variety*. The industry aims at selling health, comfort and convenience at a profit, and that's the widest appeal to be found in any business. Sometimes a dealer may think he's in the medical business, with his heat applicators and his heating pads. Or it may seem like the electrical contracting business, with the cord sets and reflectors. Even the food business, with the coffee makers and cookers. Or the cosmetic business, with the curling irons and hair dryers. Maybe the ventilating business, with the fans and heaters.

Anyway, the retailer should congratulate himself that the combined usefulness of his merchandise is as big as modern American living itself. There's hardly any limit to the variety and interest that a dealer can get in his stocks of these products, if his merchandising is geared to the levels of 1947 developments.

A part of the news in the small appliance business is that the promo-

tion efforts back of the merchandise are reaching a peak. The support which is already lined up for the products is strictly big-scale, both in national advertising and in point-of-sale materials. It puts the retail man in an excellent position, as of now, to stock a *wanted* item and to show it effectively in his store.

As far as store display is concerned, dealers have found that the smaller item is a "natural." When a new window display is being put in, there is always room for a number of the small items. This merchandise adds life, variety and interest to almost any window, whether refrigerators or radios are being played up. And there are always enough of the traffic items to fit in with seasonal exhibits. Fans in summer and heaters in winter, is the simplest illustration. And the dealer knows, whenever he fills up a corner space with a small appliance, it may well mean a sale that equals the price of a small radio.

Making a Big Noise

When the retail man plans his local advertising, he finds that a lot of the smaller appliances will go into one ad. It is not a case of offering a single appliance—a washer for instance—and limiting the appeal of the ad to just the folks who are interested in a home laundry. A whole series of table appliances will often

go into the same space, and grab the eye of more people interested in more conveniences in the home.

Smaller appliances are also easier to demonstrate, and they offer a pleasant and valuable relief from the complications and intricacies of some of the major products. To explain how a coffee-maker works and to outline its features is often only a matter of a very few minutes. A good salesman can often extract an "I'll take it" from a customer in very short order. In many cases this is exactly what a salesman needs and enjoys, after long and exhausting sessions with such matters as hermetically sealed compressors and water connections to automatic washers. In the traffic appliance department, a salesman can get a quick check on his work; this is a fact that adds more interest and variety to selling than many dealers realize.

An added advantage of the small appliance business is that its delivery and collection problems are fewer. Mrs. Jones buys an iron, pays cash, and takes the iron with her. This is clean and profitable business, free of many of the tag ends connected with delivering and arranging time payments on larger items.

Many retailers will decide to review the whole picture of traffic selling, so that they can relate these long-since-recognized characteristics of the business to the new products and the new market conditions.

SALES-MAKERS IN SMALL APPLIANCES

Retailer's Check-List for Leading Traffic Items

Barbecues
Bed Lamps
Broilers
Coffee Makers
Cord Sets
Control Clocks
Cookers
Desk Lamps
Door Chimes
Electric Clocks
Electric Blankets
Electrical Toys
Electric Shavers
Fans

Flashlights
Germicidal Lamps
Griddles
Grill-Waffle Combinations
Hair Curlers
Hair Dryers
Hand Irons
Hand Tools
Heating Pads
Heat Regulator Sets
Hot Plates
Infra-red Lamps
Juicers
Mixers

Noise Filters
Photo Timers
Pressure Cookers
Reflectors
Roasters
Sandwich Grills
Soldering Irons
Space Heaters
Sunlamps
Toasters
Timing Devices
Vibrators
Waffle Irons
Wall Lamps

What's New in Lighting

Verd-A-Ray Tells How to Turn "Bugs into Bucks"

Verd-A-Ray Corporation, Toledo, Ohio, manufacturers of insect-repellent lamps, is offering a number of excellent sales helps to dealers, through its jobbers. In addition to a fifty-fifty advertising allowance, without limit as to size or frequency, the firm offers a handsome sales-making display unit free. Assortment A-72 contains 72 popular size lamps, a window streamer and 50 colored folders. The lamps cost the dealer \$14.00; retail for \$21.00. The company's sales goal for 1947, is ten million lamps.

GE Urges "Related" Selling

Lamp merchandising experts at General Electric are urging dealers to sell related items with bulbs, and to use related products along with lamp displays. Lamp shades, traffic appliance and cord sets are some of the things GE suggests should be offered to the customer along with bulbs.

New Royal Bubble Lamps

Joseph G. Riesman, president of Royal Electric Co., Inc., Pawtucket, R. I., has announced that production has begun on new Royal Sparkling Bubble-Lamps, for decorative lighting. The new lamps will be available in 9-light Christmas tree sets and also individually.

Feature of the new lamp is a new and better bubbling action, according to the announcement, for which Royal patents are pending. The candles containing the bubbling liquid are supported by colorful, 2-tone plastic holders which also enclose the small lamp that lights both the candles and the translucent base.



"Royal Sparkling Bubble-Lamps" will be packaged in new, modern, full-color boxes, designed to achieve the maximum display value in retail stores. Distribution will be through the wholesale trade.

Buy the Right Voltage

It is important that the dealer sell correct voltage lamps to his customer. In cases where he is not certain, he should secure the necessary information from his distributor or from the local utility. Undervoltage lamps are likely to be short-lived; over-voltage lamps will lack brilliance.

Adjustable Outdoor Spot



Mitchell's model 1902 is designed for use with the PAR-38 bulb. The holder is made by Mitchell Mfg. Co., 2525 Clybourn Ave., Chicago 14, Ill.

Variety of Stock Pays

The dealer who has a lamp to fit every sewing machine, vacuum cleaner, electric oven, or what-have-you, keeps customers coming back to buy. The hard-to-get items are great traffic builders.

Aids Lamp Inventory-Taking by the Dealer

Orderly, well-planned arrangement of lamp stock makes inventory-taking quicker, easier and more accurate. When stock is scattered all over a place, the physical stock-counting chore is doubly difficult.

Acme's New Fluorescent Lighting Fixture

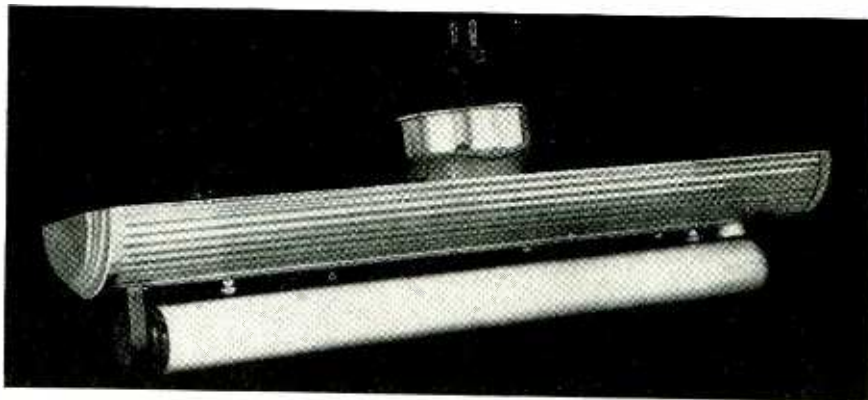

Offered by the Acme Fluorescent Co., 391-8th Ave., New York 1, N. Y., the unit shown is model 203. It has a ribbed chrome finish; is plug-in type and comes in 14, 15 and 20 watt capacities. Over-all sizes of the fixtures are 17, 20 and 25 inches.

Solar Dealer-Help Ready

To promote rapid sale, a colorful and powerful "silent salesman" display card that carries an actual Heat-Ray infrared lamp, and a supply of descriptive circulars are included in a new deal offered by Solar Electric Corp., 110 William St., New York, N. Y.

Apollo Names Four New Lamp Distributors

The addition of four new distributors to the growing chain of Apollo lamp merchandisers, is announced by M. L. Altheimer, president of Altheimer & Baer, manufacturers of the nationally-advertised lamp line.

Bringing the total number of distributors to 37, the addition to the Apollo roster bring Omaha, Milwaukee, Denver, and St. Paul into the merchandising campaign inaugurated in late 1946 by Altheimer & Baer.

For the Omaha territory the Jelco Omaha Company was issued distribution rights in handling the line. Similarly named was the Albert Sechrist Company of Denver, the Blaine Electric Company of St. Paul, and the Lappin Electric Company of Milwaukee.

Mr. Altheimer echoed his original stand on consumer buying-habits relative to lamps: "In spite of the fact that lamps fall into the classification of being easily-produced hard goods which market is near saturation, it has been emphatically proven to me that Mrs. America will choose a well-known nationally-advertised lamp when she plans changes in her home."

FOUR FAMOUS FIRSTS

THAT MAKE GIBSON THE FIRST LINE FOR

Dealer Profits!

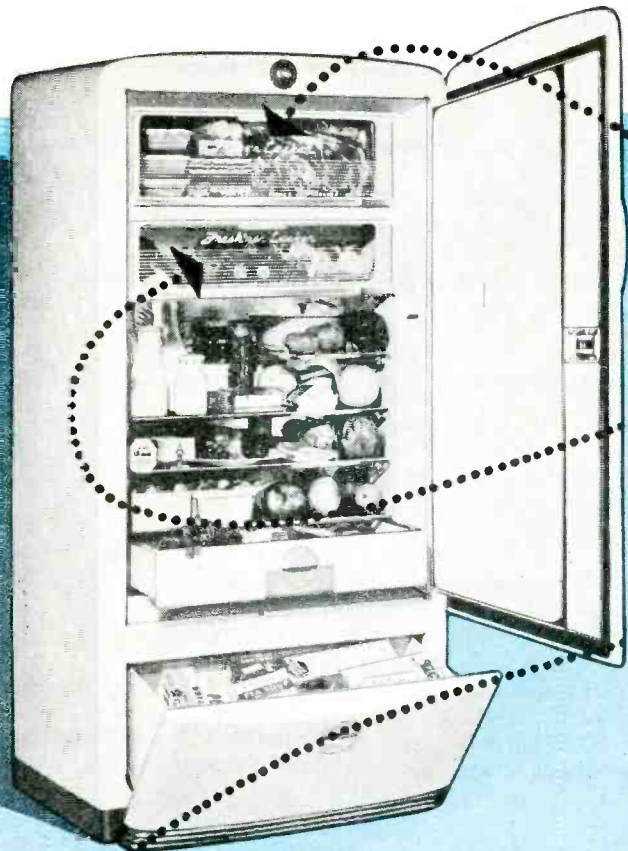

1 FREEZ'R LOCKER

One of the finest selling points ever incorporated in a modern refrigerator, the Freez'r Locker provides a spacious unit for storage of frozen foods. A generous, unobstructed, wall-to-wall shelf that appeals to every woman who sees it, makes her decision to buy easier.

2 FRESH'NER LOCKER

Another Gibson first that alert dealers everywhere applaud. Perfect refrigeration for vegetables, fresh meats, fruits and salads. Provides special temperature and humidity that keeps energizing vitamins intact, helps foods retain their moist freshness.

3 UPRIGHT HOME FREEZER

First again, Gibson introduced upright construction for downright convenience. Here's a Gibson feature you can really talk about . . . no fumbling for packages, easy identification of every package, broad, unobstructed shelves that provide more storage space; every shelf a freezing shelf.

4 UPS-A-DAISY

Only the Gibson range offers the advantages of Ups-A-Daisy, the innovation that provides four surface units, or three surface units plus a Deepwell Kookall. Another Gibson first for faster sales.

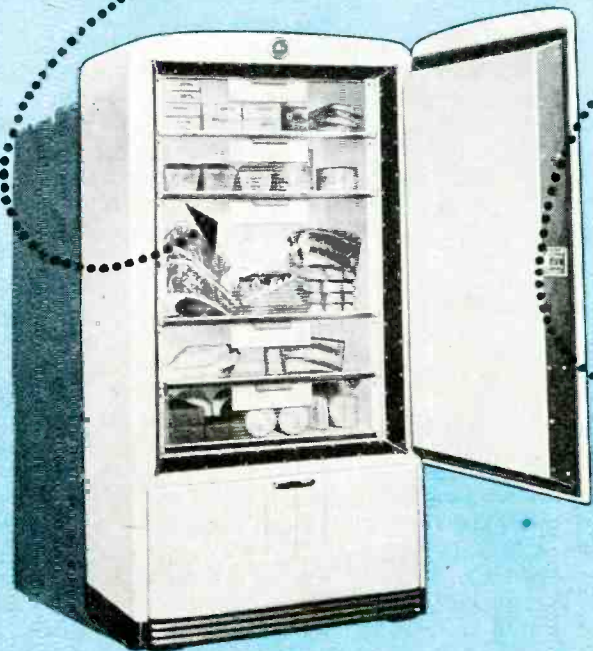

GIBSON REFRIGERATOR COMPANY
GREENVILLE, MICHIGAN

Visit the Gibson Space July 7 to 18
No. 537-B American Furniture Mart, Chicago

Gibson

Servicing Electrical

Money-Making Ideas for the Busy

Motor Terminal Leaks in Norge Hermetic Rollator Dome

A slight refrigerant leak at the motor terminal at the top of the Norge hermetic Rollator dome may be stopped by tightening the lock nut holding the assembly in place.

Check with an ammonia swab to locate the leaking terminal. Pull the attachment plug out of the wall and remove the motor terminal cap and wire.

Take a $\frac{3}{8}$ " socket wrench, preferably with the short handle attachment, and tighten the lock nut carefully by turning in a clockwise direction.

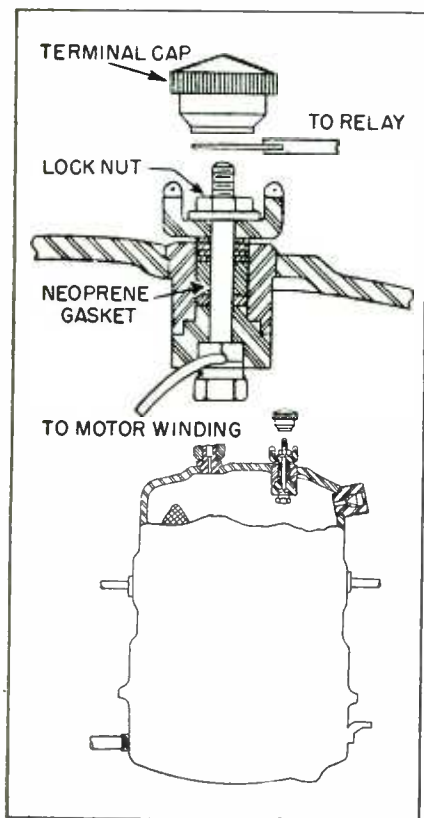

Norge Rollator dome.

It is only necessary to exert a small amount of pressure to tighten the assembly in place.

Check with the ammonia swab to be sure the leak has been corrected.

If enough of the refrigerant has leaked out to cause a shortage which would be indicated by a low frost line on the freezer, do not add refrigerant, but remove the unit and tag it with the information that the

terminal leak resulted in the shortage of refrigerant.

Williams socket No. B-1212 will fit the 10-32 hex lock nut holding the assembly in place.

Tightening this lock nut spreads the Neoprene gasket in the terminal opening.

Too much pressure exerted on the lock nut may crack the bakelite terminal and result in a ground to the motor dome. The tightening operation must be done carefully.

Washer Tears Clothes

On complaints that clothes are being torn in conventional type washers, investigate the following parts: 1. Check agitator for rough or jagged spots. 2. Check drain collar for rough spots. 3. Check wringer assembly to look for rough spots or nicks on metal skirts or metal plates facing roller ends.

If no reason for tearing can be discovered, find out if customer is overloading the washer. Garments are frequently ripped in washer tubs which have been crammed with over-capacity loads.

Novel Repair Conveyors

To save steps, one dealer built a pair of conveyors between his showroom and shop. The gravity-operated conveyors were built ladder-like with revolving rungs. One sloped into the shop to carry articles in for repairs, the other sloped into the showroom and brought in finished jobs. The opening between shop and showroom was at floor level, behind a counter in the sales department. Heavy wooden boxes were used as carriers for appliances.

Installing Chimes With Other Signalling Devices

Valuable information on hooking up door chimes with other signalling devices, comes from the A. E. Rittenhouse Co., Inc., Honeoye Falls, N. Y. The firm points out that chimes generally cannot be operated satisfactorily in the same circuit with vibrating bells and buzzers because they cause electrical fluctuations in the circuit which interfere with the proper operation of the chime.

If, for any reason, Rittenhouse ad-

vises, it is desired to operate chimes simultaneously with bells or buzzers from a single pushbutton, a special 4-contact sort may be used. This type pushbutton allows the closing of two independent circuits at once and permits the chime and the bell or buzzer to be connected in separate circuits. (See illustration below.)

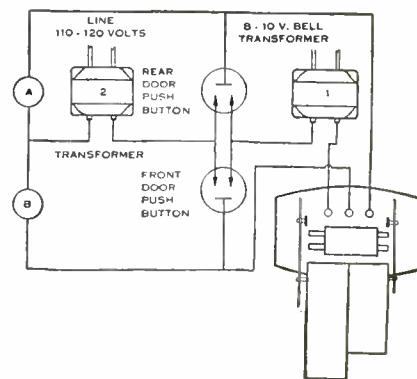

General Information on Servicing Mixmasters

Models 5 and 5B are just alike except for color. Models 5-1 and 5B1 differ from 5 and 5B in the design of the juicer attachment and the bearing under the revolving disc, and the Models 7 and 7B differ from 5-1 and 5B1 in the arrangement for removing the whippers. The 7 and 7B have automatic beater ejectors. All have the patented Mix-Finder Dial Motor Control.

The motor speed is controlled by a centrifugal governor. As in previous automatic models, the governor consists of tungsten contact breaking points placed in series with the motor coils. The breaker points open at a predetermined speed and close again at a speed only slightly lower. Thus a constant speed is maintained, even with variations in the load and line voltage, and full power is available at all speeds.

The breaker points are mounted on a lever arm and are so arranged on a disc which revolves with the armature, that centrifugal force opens the breaker points as the speed goes above a certain value. The value is varied when the Mix-Finder Control Dial is turned, changing the distance between the governor slide and the governor breaker point arm and de-

Home Appliances

Shop — Latest Factory Procedures

termining the speed at which the contact points will open.

The mechanical design and arrangement of the governor and governor carbon brushes is sturdy and simple. The brushes are at right angles to the armature shaft and the current is led into the governor through hard brass alloy collector rings mounted around the hub of the governor. The circumference of the collector rings is equalized, so that the "distance of travel" is the same for both brushes. This not only provides even wear on the carbons, but prolongs the life of the brushes.

As in the preceding automatic models, a condenser and a resistor are shunted across the breaker points to give them long life. The resistor also helps to smooth out the motor's speed by allowing a small part of the current to flow through the motor

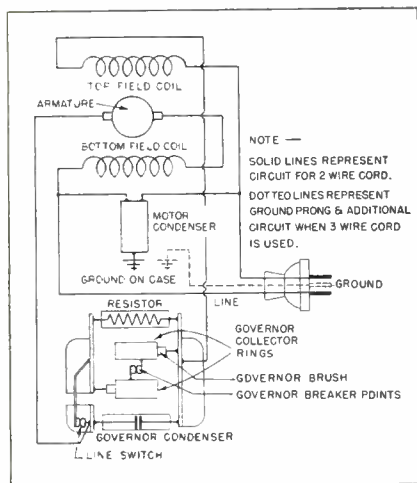

Mixmaster wiring diagram.

while the governor points are open. The resistor and condenser assemblies are conveniently held in place by brackets, thus eliminating lead wires and fastening screws. A second condenser is installed in the front part of the motor to eliminate radio interference.

How to Polish and Buff Premier Vacuum Cleaners

The following information, and the illustrations accompanying this article, were furnished by the Premier Vacuum Cleaner Division of the General Electric Co., 1734 Ivanhoe Road, Cleveland, Ohio:

In polishing and buffing a cleaner it is sometimes necessary to perform

three operations. In order to obtain the best results, it is important to have the following equipment in addition to the buffing facilities: sewed white buffs, polishing grease, Tripoli Compound, and White Diamond Compound.

The three operations are:

- Polishing**—It is not necessary to polish repaired vacuum cleaners if there are no deep scratches. However, if polishing is required use four sections of sewed buff and balance them to eliminate vibration. After these are fastened securely together apply glue

the emery. This prevents the emery from dragging and leaving streaks in the casting.

- Buffing**—When buffing a cleaner use four new sections of sewed buff. Tripoli is employed for buffing to remove the fine scratches resulting from polishing and also to eliminate the miscellaneous mars and discolorations.
- Color Buffing**—To produce a finish "like new" use White Diamond on four new sections of sewed buff.

All of these materials may be obtained from the Premier factory.

If the buffing wheel is not in balance, the lathe will vibrate. To overcome this, loosen up the nut on the end of the spindle. Take two sections of the wheel and turn them half way around and the other two turn in the opposite direction. If this does not true the wheel, repeat the operation again, reducing the turn to one-quarter. The buffs come in sections which make it easy to adjust the balance of the wheel. The Diagrams illustrate the proper method of handling cleaners while buffing.

Appliance Service Tips

In numbers of cases, poor contact of carbon brushes is due to lack of tension in the brush spring. When new brushes are installed, new springs should be put in too.

* * *

Here's a refrigerator cabinet repair hint from the Norge appliance service department: "Since porcelain is glass, broken or chipped porcelain panels cannot be repaired in the field to their original degree of perfection. However, porcelain patching kits are available which will permit very satisfactory jobs of patching, providing the broken or chipped place is not too large. These kits are equipped with various tinting materials to permit matching the various shades of porcelain.

Small scratches in porcelain panels can frequently be ground out by the use of "Frit." To grind with Frit, secure a piece of soft wood approximately 1" x 1" x 6" and round one end. Moisten the rounded end in water, dip in the Frit and grind the scratch to be removed, vigorously.

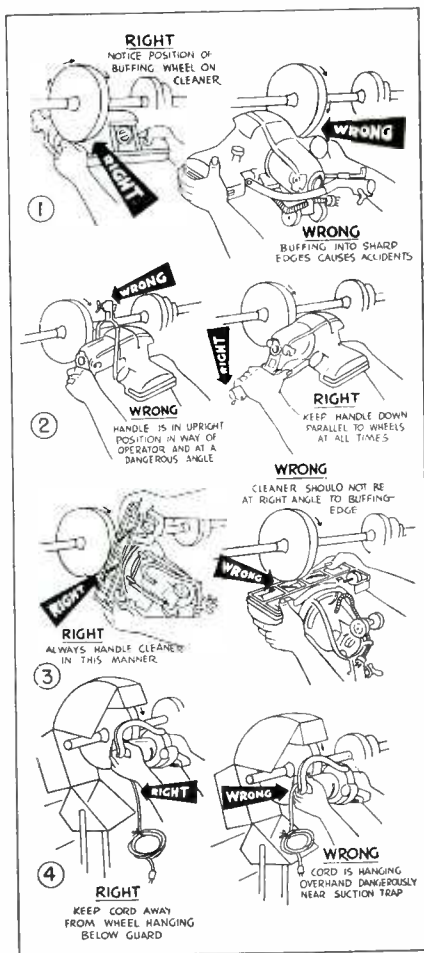

on the working edge of the wheel and roll in powdered emery. When polishing scratches out of a cleaner, polishing grease should be used on the wheel to keep it from overheating, as well as to soften down the cutting of

Refrigerators ★
 ★ Washers
 Ironers ★
 ★ Ranges
 Vacuum Cleaners ★
 ★ Food Freezers

New Electrical

Universal RANGES

Eight outstanding range models each designed to meet specific consumer demand have been announced under the heading "Speedliner" Ranges. Features include: a new Thermo-Chef auxiliary oven, heated by side wound unit and thermostatically controlled; super-heat monotube thrift units with multi-heat control; Tel-a-Switch panel on back splasher; Trubake oven with auto-



matic temperature control; "wraparound" white porcelain enamel steel body. The deluxe model has extra desired features. Included in the eight models are the deluxe, standard, stripped models which include some of the features, a combination coal or oil and electric range, and the Bantam range. Landers, Frary & Clark, New Britain, Conn.—RADIO & Television RETAILING.

Westinghouse WATER HEATER

Table-top water heater with four sq. ft. acid-resisting porcelain enameled work

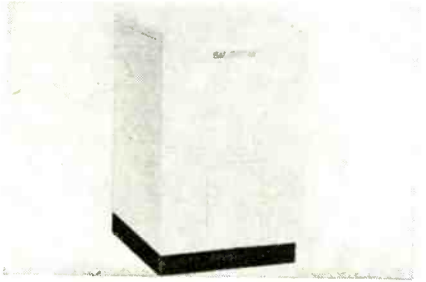

surface. 40-gallon capacity. Unit can replace a 24-inch base cabinet in kitchen.

Features: thermostat with adjustment range; immersion type heating element that puts heat directly into water; Fiberglass insulation; scientifically designed cold water baffle. Westinghouse Electric Corp., Electric Appliance Div., Mansfield, O.—RADIO & Television RETAILING.

Deepfreeze FREEZER

Deluxe model, C10-47, has a capacity of 10 cu. ft. Holds approximately 350 lbs. food. Special fast-freezing compartment. Temperature control located on the front of the cabinet; temperature indicator on front, too. Lids are counterbalanced, raised and lowered easily; equipped with tumbler lock. Three removable metal baskets for



the upper half of the storage compartment; adjustable metal dividers for the bottom half. Three large trays for extra ice cube capacity. Dual interior lights; automatic battery operated alarm system; powered by over-sized freezing unit of 1/4 h.p. Size: 36 inches high, 26 3/4 inches deep, 55 3/4 inches wide. Deepfreeze Div., Motor Products Corp., Chicago, Ill.—RADIO & Television RETAILING.

Tip Toe IRON

Electric iron with hinged sole plate; toe in flexed position, when forward pressure is exerted on the handle. Each sec-

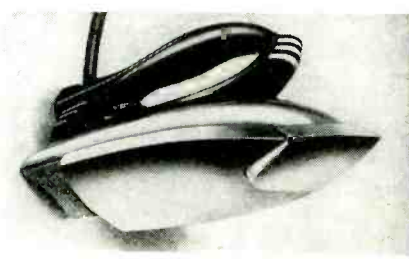

tion of the sole plate has cast-in-tubular element, both controlled by same thermostat. Special construction, plus smooth interlocking of the two sections of the sole plate eliminate "marks" on material. Yale & Towne Mfg. Co., Empire State Bldg., New York 1, N. Y.—RADIO & Television RETAILING.

Norge WATER HEATERS

Electric water heaters being offered in five sizes, with gallonage capacities of 80, 66, 52, 40 and 30. They are of the round, upright type, are finished in high-gloss baked white enamel, and are insulated with 5-inch thickness of glass wool. Features a diffusion baffle which prevents mixing of cold and heated water. Norge Div., Borg-Warner Corp., Detroit, Mich.—RADIO & Television RETAILING.

Hotpoint WATER HEATER

Automatic electric water heater features pressurized direct contact Calrod units. Installed under a holding band and held in place against tank with tension spring. Galvanized steel tank surrounded by one-piece blanket of glass fiber insulation.



In its newly designed heaters Hotpoint has standardized on two diameters of tanks with a 16-inch in the 15, 30, and 40 gal. sizes and 20-inch diameter tank used in the larger ones. Hotpoint, Inc., 5600 W. Taylor St., Chicago 44, Ill.—RADIO & Television RETAILING.

Home Appliances

★ Toasters
★ Roasters
★ Hand Trons
★ Mixers
★ Blenders
★ Coffee Makers

Gibson ELECTRIC RANGE

Model ER-197-D electric range. Dimensions: 48 $\frac{3}{4}$ inches high, 40 inches wide, 25



inches deep. Features: steel one-piece inner structure; fiberglass insulation; seven-heat surface elements; six-quart kookall; lamp and oven timer. Gibson Refrigerator Co., Greenville, Mich.—RADIO & Television RETAILING.

Electro-Shav RAZOR

Electric safety razor with a moving blade. Shaver has cross-cutting blade action. Light weight, balanced, and uses

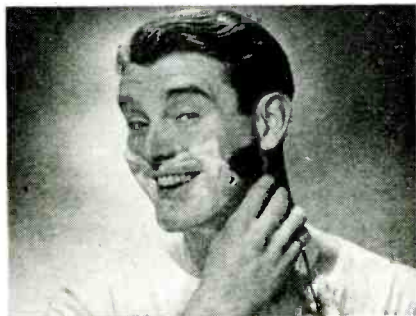

standard safety razor blades. Razor is precision built, plastic handle. Mechanism hermetically sealed. H. D. Campbell Co., Rochelle, Ill.—RADIO & Television RETAILING.

Chrysler AIR CONDITIONER

Room air conditioner designed for simple installation in any type window. Features: high capacity, light weight, wide range adjustment of air delivery and adjustable outside air intake. Heart of the unit is the

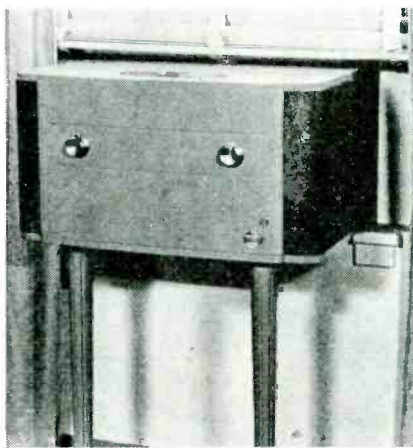

Airtemp sealed radial compressor. Dial-like knob on cabinet front can be turned to "fan" position for ventilating, and to "cooling" for cool, dehumidified and filtered air. Unit weighs 196 lbs. Airtemp Div., Chrysler Corp., Dayton 1. O.—RADIO & Television RETAILING.

Telechron LUMINOUS CLOCK

Luminous electric alarm clock, which glows in the dark. May also serve as a "night light." Ivory-colored plastic case; control-a-tone alarm can be regulated low

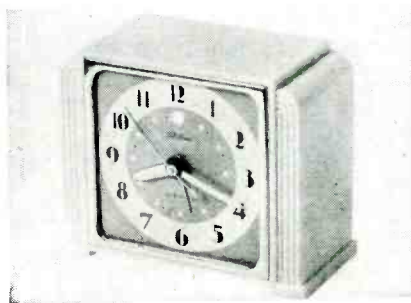

or loud and keeps ringing until shut-off; self-starting synchronous motor. Telechron, Inc., Ashland, Mass.—RADIO & Television RETAILING.

Casco HEATING PAD

Three-fixed heat electric heating pad, with 3 thermostatic controls for each heat.

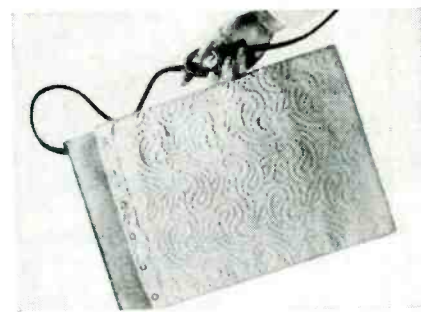

Pad has illuminated nitelite switch facilitating use of selection of heat point. Attractive outer cover provides protection for pad, and is removable. Casco Products Corp., Bridgeport, Conn.—RADIO & Television RETAILING.

Hygeator PORTABLE INCINERATOR

Portable incinerator has a capacity of 2 bushels. Size: 20 inches square, and 32 inches high. Finished in white or red



enamel. Safety opening handle, grates can be easily shaken and dumped; available in gas and electric units. Hygeator Corp., Buffalo, N. Y.—RADIO & Television RETAILING.

Dealer Profit-Makers

Fowler WATER HEATER

Table top electric water heater. Cabinet size: 36 inches high, 23½ wide and deep.



designed to fit into compact kitchen. 30-gallon capacity. Baked porcelain enamel finish with black enamel base. Fowler Mfg. Co., Aurora, Ill.—RADIO & Television RETAILING.

Armstrong HEATER

Portable electric heater, model 616. Shell of 22 gauge enameling iron; finished in porcelain enamel, walnut, or ivory. Dimensions: width, 12¼ inches; height, 19 inches, 9 inches deep. Equipped with handle and 6 feet of heavily insulated cord. Armstrong Products Corp., Huntington, West Virginia.—RADIO & Television RETAILING

Electromode MILK HOUSE HEATER

Model AN-30 milk house heater, thermostatically equipped for complete automatic control. Heater distributes safe, fan-circulated air, heat free of dust or dirt; no



fumes. Resistor is enclosed within a metal tube. Size: 13 inches high, 11½ inches wide, 11¼ inches deep. Can be mounted on wall or ceiling if desired. Electromode Corp., Rochester 3, N. Y.—RADIO & Television RETAILING.

Silex COFFEE MAKER



"Commodore" commercial coffee maker. Range body of stainless steel, 2 burners. Three and four burner models also available. The Silex Co., Hartford 2, Conn.—RADIO & Television RETAILING.

HarderFreez FREEZER

Farm and home freezer with 12 cu. ft. capacity. Features: "freez basket," rust-proof wire basket will hold up to 50 lbs.



of food for processing; chrome plated instrument panel; wire compartment dividers; heavy chrome plated hardware; E-Z lift top cover. Tyler Fixture Corp., Niles, Mich.—RADIO & Television RETAILING.

Wil-Stan IRON HOLDER

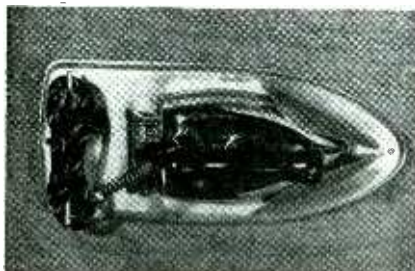

Hot iron storage holder easily attached to wall, enabling housewife to place hot iron in its berth out of reach of children. Evans Mfg. Co., 15 Park Row, New York 7, N. Y.—RADIO & Television RETAILING.

Sentinel CLOCK

Arlington model, SD-146 wood-case electric self-starting desk or table clock. Grained



walnut, 6 inches high. Priced at \$12.50. E. Ingraham Co., Bristol, Conn.—RADIO & Television RETAILING.

Monitor WASHER

Washer features: new type wringer with jumbo rollers; self-lubrication; modern design; easy washing action; finger-tip control; powerful motor; mounted on wheels for portability. Monitor Home Appliances, Riverdale, New York.—RADIO & Television RETAILING.

Sanitaire GERMICIDAL UNIT

Ultraviolet germicidal unit designed to meet clinical and industrial requirements. 4-watt utility unit, overall dimensions: 7 3/16 inches long, 2¾ inches wide, 7¾

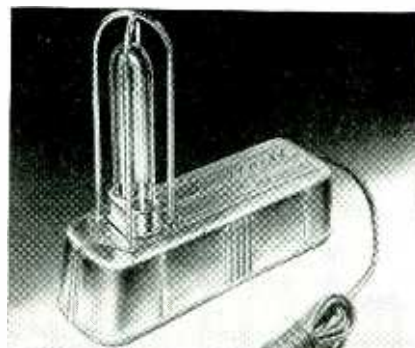

inches deep. Equipped with safety hood, 4-watt germicidal tube, conductor cord and plug, automatic starter. Sanitron, Inc., 29-26 41st Ave., Long Island City 1, N. Y.—RADIO & Television RETAILING.

Sprouse KITCHEN VENTILATOR

Ventilating system to eliminate objectionable cooking odors. Unit can be incorporated into any home, can be used with any type of range burning any kind of fuel. Hood visible just a few inches above and behind range. Power unit compactly designed. V. E. Sprouse Co., Inc., Columbus, Ind.—RADIO & Television RETAILING

Products of
BORG-WARNER

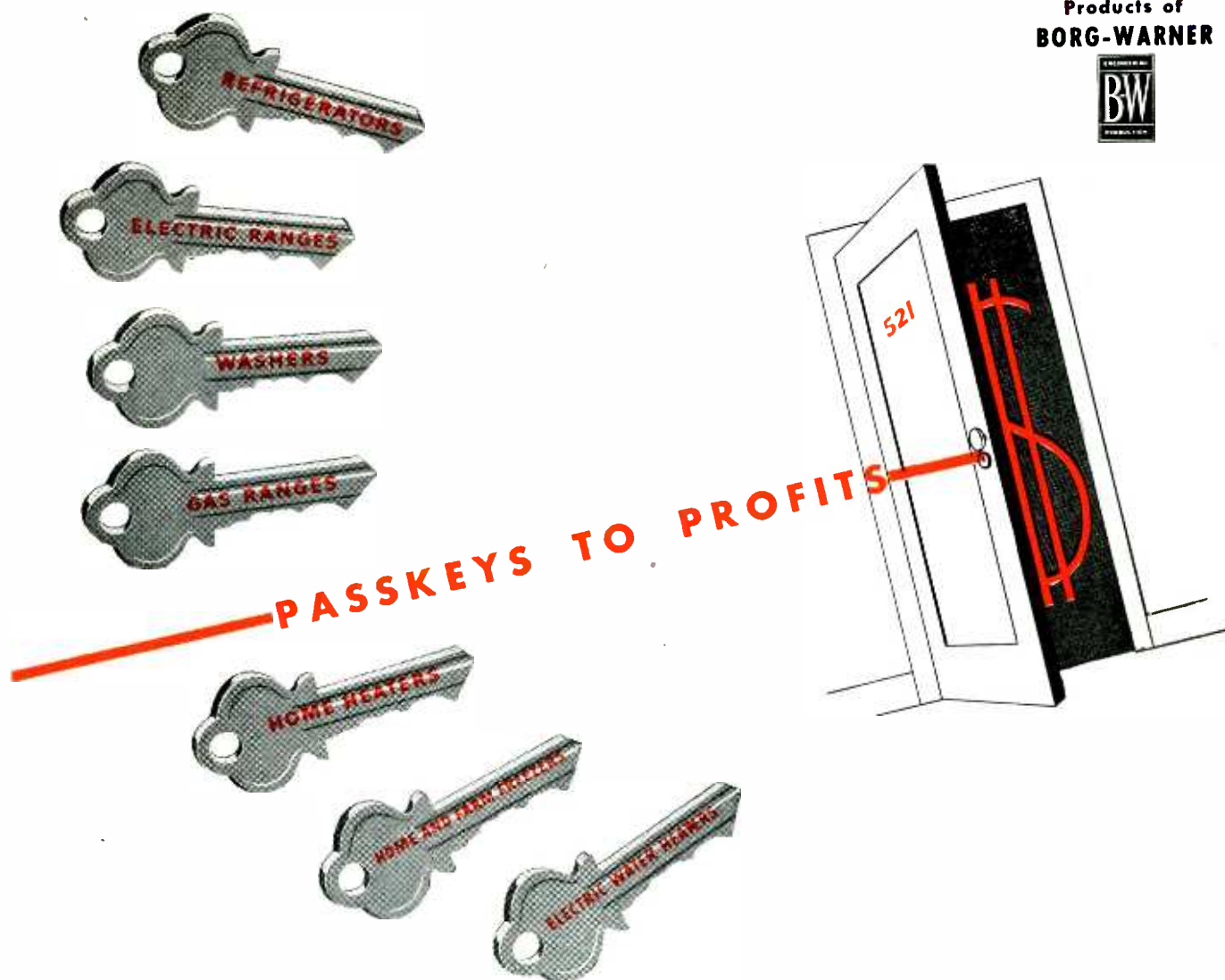

At the July Market (Furniture Mart, Chicago, July 7-19,
Space 521-522) we'll have some shiny new "keys" for
retailers to use in unlocking new portals to profits.
We expect to "steal the show" again this year . . . for
Norge retailers the future never looked brighter!

"The Best Dealer in Town Sells NORGE!"

Norge is the trade-mark of Norge Division, Borg-Warner Corporation,
Detroit 26, Mich. In Canada: Addison Industries Ltd., Toronto, Ontario.



**SEE
NORGE
BEFORE YOU BUY**

New Appliance Items

Bersted SANDWICH TOASTER

Model No. 320N sandwich toaster features: toasts either thick or thin sand-



wiches; grills; chrome plated; double long-life elements; removable grease cup; walnut bakelite handles; cord and plug included. Bersted Mfg. Co., Fostoria, O.—RADIO & Television RETAILING.

Ranger INVERTER

Electronic inverter changes ac into dc, increasing electric shaver cutting efficiency and power. Styled of ivory plastic and is available in two models, one a cordless type for direct plugging into an outlet, and the other with a cord and male plug. Both models retail for \$4.95. Electronic Specialty Co., 3456 Glendale Blvd., Los Angeles 26, Calif.—RADIO & Television RETAILING

Lasko TOASTOVE

Automatic hydraulic pop-up toaster, combined with toast-warming compartment, hot plate. Size: 13¼ inches long by 9¾ inches

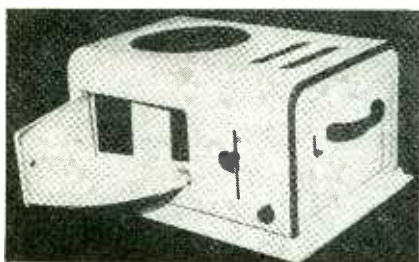

wide by 7½ inches high. All-white porcelain cabinet; thermo-plastic handles and knobs; heavy gauge all-steel construction. Lasko Metal Products, Inc., West Chester, Pa.—RADIO & Television RETAILING.

Eagle WALL PLATE

Streamlined wall plate glows in the dark; indicates location of switches. No wires or bulbs. Available in single gang toggle type and single gang duplex receptacle type. Eagle Electric Mfg. Co., Inc., Long Island City, N. Y.—RADIO & Television RETAILING.

Therm-Aire MATTRESS PAD

Pad designed for use under sheet; heat may be concentrated along spinal system; pad stays in place; operates on a minimum



of current. Available for single and double beds, the latter size equipped with individual bedside controls. Therm-Aire Equipment Co., Nashville, Tenn.—RADIO & Television RETAILING.

Aerapel VENTILATOR

Built-in wall ventilator; gleaming white grill 12 inches x 12 inches. Designed to offer a minimum of resistance to air flow. 3-bladed propeller type fan driven by enclosed constant speed motor. American Blower Co., Detroit, Mich.—RADIO & Television RETAILING.

Allied Lab OUTLET BOX

Multi-plug outlet box, model 3001-A. Small unit containing eight receptacles. Designed for widespread applications in laboratories, schools, hospitals and the home. Neon pilot light; long stroke toggle



switch; 12 ft. rubber appliance cord, and unbreakable flat plug. Cabinet dimensions are: 3 inches x 4 inches x 5 inches. Allied laboratory Instrument, Inc., 355 W. 26th St., New York 1, N. Y.—RADIO & Television RETAILING

Kisco CIRCULAIR

Airspray model; two-tone ivory and green plastic finish. Rugged construction. Compact, portable air recirculator. Kisco Co., Inc., St. Louis 10, Mo.—RADIO & Television RETAILING.

Vapomat INSECTICIDE SPRAYER

Automatic electric insecticide sprayer housed in aluminum case, weighs 8 lbs. Automatic shut-off; dial control regulates



volume of dispersal. Available with a specially prepared insecticide. West Disinfecting Co., 42-16 West St., Long Island City 1, N. Y.—RADIO & Television RETAILING.

Murphy RANGETTE

Portable electric combination stove, broiler and griddle. Top surface is 12 inches x 22 inches; 6 inches high over-all. Frame is solid cast in aluminum. Two burners, each equipped with 2-heat switch control. One burner is supplemented with a cast aluminum hinged griddle for frying. Other burner has bright nickel-plated wire rack for broiling and toasting. Murphy Appliance Mfg. Co., 1610 N. Vermont Ave., Los Angeles, Calif.—RADIO & Television RETAILING

Littelfuse SWITCH PLATE

Luminous "switch-like," neon-illuminated, sealed-in neon bulb directs light over toggle switch handle. Plastic plate glows in dark after being exposed to



light. Neon bulb glows only when lights are "off." Can be used as an indicator on remote control circuits in halls, etc. Easily installed. Littelfuse Inc., 4757 Ravenswood Ave., Chicago 40, Ill.—RADIO & Television RETAILING

FOR LATEST RADIO MERCHANDISE, SEE PAGES 50, 51 and 58

What you should know about SEX to sell Washing Machines



Just because some young man may favor old-fashioned longies doesn't make him impervious to the charms of a modern Miss! For sex is an ageless male-female affinity—its basic premise hasn't changed since Eve discovered the fig leaf.

Male and female have *always* had to reckon with this mutual magnetism. And the popular solution *today* is to face it *together*—for richer or poorer. When that decision is made, another family unit of purchasing power shows up in the Market Studies.

Under "Durable Goods" you'll find that male and female plan to buy, among other things, a washing machine. And though the *female* throws the switch that takes the Blue out of Blue Monday, it's the *male*

who works through Friday to make the payments. So male and female *both* are vital factors in the purchase.

Ditto when it comes to signing them up for any other major appliance. Of course, if, say, they each want an electric toothbrush, *each* can buy their *own*—no agreement is necessary. But you've still got to sell *two* sexes—males and females. Either *together* or *separately*.

And who can woo males and females like THE AMERICAN MAGAZINE!

Dollar for dollar, page for page, *no other* magazine can match the multimillion male-female circulation delivered by...

*The American
Magazine*

THE CROWELL-COLLIER PUBLISHING CO., 250 PARK AVE., NEW YORK 17, N. Y., PUBLISHERS OF THE AMERICAN MAGAZINE, COLLIER'S, AND WOMAN'S HOME COMPANION

Before you sell
a toaster...

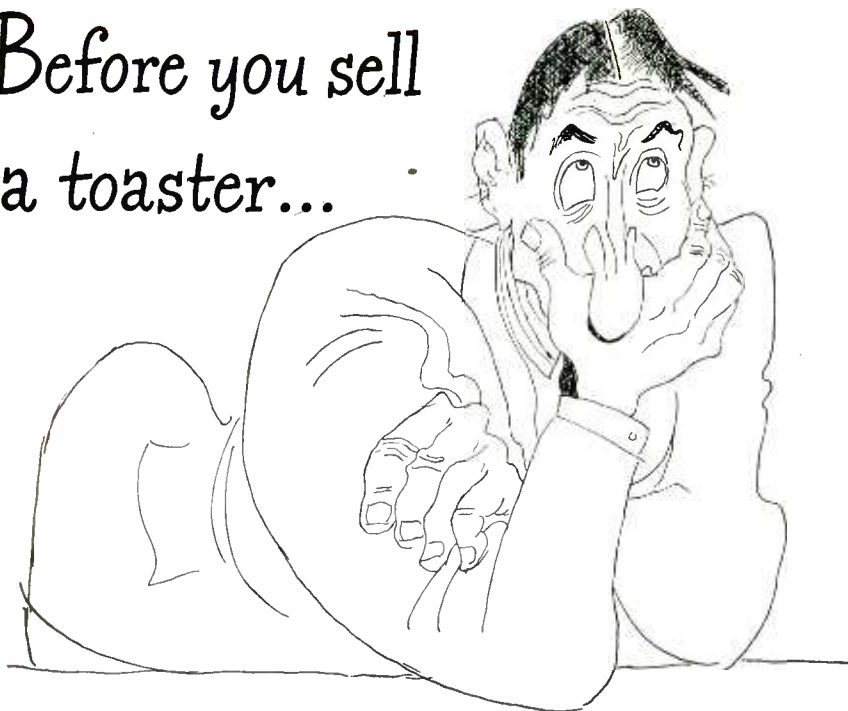

think... of how absolutely d-e-e-lighted your customers will be with a toaster that makes perfect toast without adjusting from the very first slice and on... and on... and on!
(only the Proctor Toaster actually does it... automatically)

think... of their unbounded joy when they discover that this toaster makes exactly the kind of toast it says it will on the dial setting. With any kind of bread, too!
(only the Proctor Toaster actually does it... automatically)

think... of their amazement when they learn that *this* toaster won't burn toast... not even when you toast bread twice!
(only the Proctor Toaster actually does it... automatically)

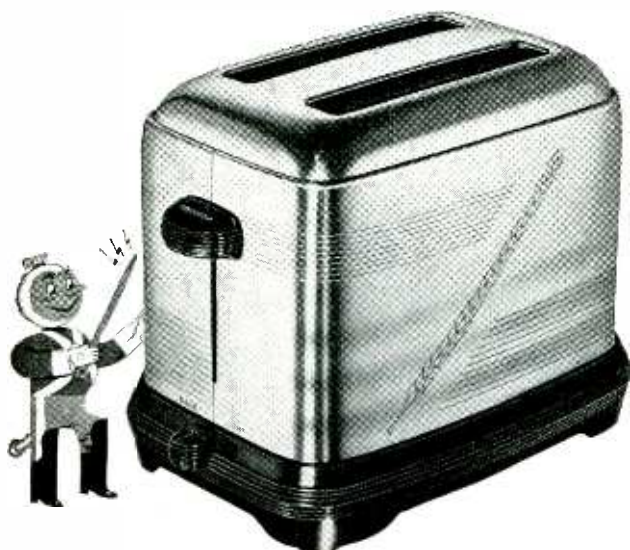

Surely you'll want your nice customers to have the toaster that does all these things...so sell 'em

The
PROCTOR
Automatic
Pop-up
Toaster
with the "Color Guard"
Fair Traded

PROCTOR

NEWSMAKER IN APPLIANCE MERCHANDISING

PROCTOR ELECTRIC COMPANY, PHILADELPHIA 40, PENNSYLVANIA



Rheem Ad Manager



Henry C. L. Johnson is the new advertising manager for Rheem Mfg. Co., 570 Lexington Ave., New York 22, N. Y., makers of water heaters, home cooling & heating equipment, etc. Mr. Johnson is well known as the former ad manager for the radio, electronics and international divisions of Sylvania Electric Products, Inc.

First All-Postwar Hotpoint Range

Production of its 1,500,000th electric range has been celebrated by Hotpoint, Inc., with the showing of its first "all-postwar" range with several design departures since the last completely new models in 1941. The models are in volume production as the firm's "largest output in the company's 40 years of Chicago manufacturing."

Leonard C. Truesdell, vice-president of marketing, reported that "our 1946 production was below expectations, but we have retained our position as the nation's largest range manufacturer." Even the increased 1947 production will not meet consumer demands as reflected in dealers' orders, he said.

New features include the "sealed heat" device, improved flexibility of cooking units, new grouping of controls, etc.

EEI Holds Its 15th Annual Convention

The Edison Electric Institute held its 15th annual convention June 2-5—the first one since prewar days—at Atlantic City, N. J., with sessions at Convention Hall and at various resort hotels.

The meetings began with EEI committee meetings on Monday, and ended with a luncheon meeting on Thursday at the Traymore Hotel. Many prominent speakers addressed the group during the lively sessions. During the evening events a number of manufacturers were hosts to the EEI guests.

Engineering Director

David C. Peterson, former industrial consultant, has been named director of engineering and research at the main Chicago plant of Stewart-Warner Corp., according to F. A. Hiter, senior vice-president of Stewart-Warner Corporation.

It takes keen analysis



...to pick tomorrow's champs

... or to pick the radio and appliance lines that will "win the purse" in big-time competition. The fight for business is getting tougher, and dealers everywhere realize that their continued success depends increasingly upon the relative merits of the merchandise they offer, compared with the values a customer can find in the store around the corner.

That's one of the reasons why thousands of dealers throughout the nation are glad they're associated with Graybar. They have confidence in Graybar's ability to compare competing lines and to select for distribution those with the most built-in value... offering the greatest assurance of steady, profitable business.

Graybar not only knows how to size them up but is free to recommend lines on the basis of *saleability*. As a solidly established national distributor, we have the confidence of leading manufacturers; at the same time, we are an independent, self-directing organization. Our merchandising recommendations to dealers are, therefore, unbiased.

Graybar dealers enjoy the convenience of obtaining popular merchandise from local Graybar warehouses, and they get the profit-building assistance of our Merchandising Specialists. *Merchandising Department, Graybar Electric Company. Offices in over 90 principal cities.* 4762

HOME RADIO
MAJOR APPLIANCES
TRAFFIC APPLIANCES



... an independent
distributor with a
talent for picking
best-sellers

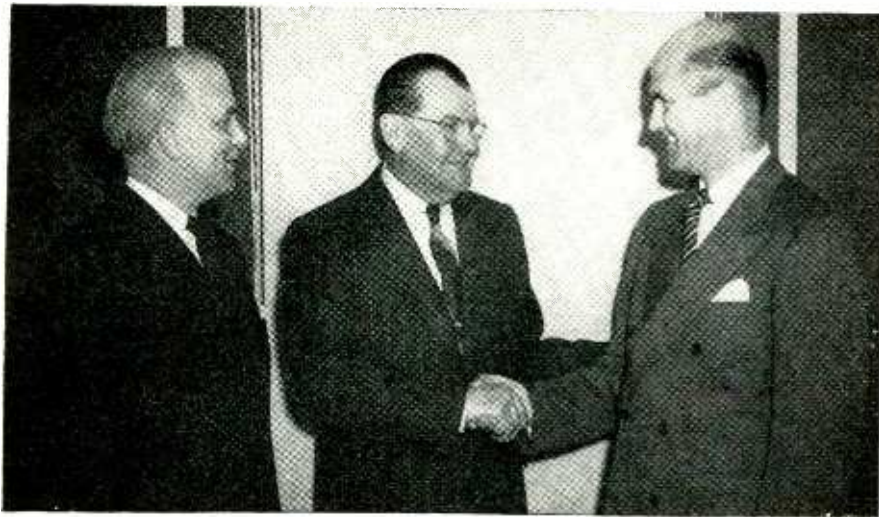

Philco executives, left to right, Fred Ogilby, sales manager of the radio division; Thomas A. Kennally, vice-president in charge of sales; and John M. Otter, general sales manager.

Philco Names Otter to Post of General Sales Manager

John M. Otter has been promoted to the position of general sales manager of Philco Corp., according to an announcement by Thomas A. Kennally, vice-president in charge of sales. Mr. Otter has been with Philco since 1926 and for the past three years has been sales manager of the radio division.

Mr. Kennally declared that the promotion "continues our policy of choosing top sales executives from the ranks of men who have spent many years building

Philco distribution with distributors and dealers throughout the U. S." Mr. Otter was cited for his record in helping to create the nationwide Philco selling organization of over 134 distributors and about 27,000 dealers.

Mr. Otter was district sales representative for northeastern Pennsylvania until 1935, when he was named sales manager of Philco Distributors, Inc., Philadelphia.

In 1937 he was appointed manager of the Detroit office, and was then made general manager of the Chicago branch. Two years later he was named sales

manager for the Middle West and in 1944 was made sales manager of the radio division with headquarters in Philadelphia, when the company's selling organization was being strengthened for the postwar period.

Heads Appliance Sales for General Mills

William A. MacDonough, assistant sales manager for General Mills' home appliance department, has been promoted to sales manager, according to R. E. Imhoff, mechanical division vice-president and manager.

Mr. MacDonough was formerly vice-president in charge of sales and advertising for Burr, Patterson & Auld Co., and held positions with Graybar Electric and with Jam Handy. He has been responsible for inaugurating sales and marketing programs for his company's Tru-Heat iron during the opening of sales districts from coast to coast. He is now directing introduction of the "second fine" appliance, the PressureQuick saucepan.

George Johnson Retires

George H. Johnson, well known retailing authority, has retired as president of Lit Brothers, Philadelphia. His duties at the big department store will be taken over by Harold W. Brightman, who has been senior vice-president and director of Lit Brothers since October 1, 1945.

ORDER NOW!! IMMEDIATE DELIVERY

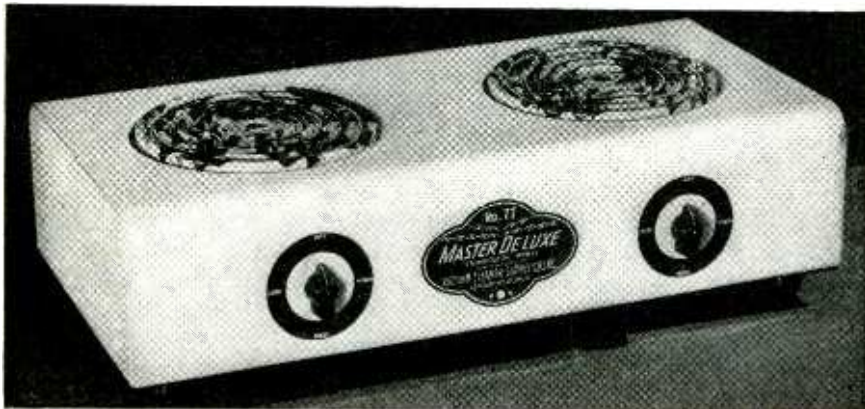

Finished in a high-gloss, heat resisting, baked enamel, nichrome refractors porcelain glazed in two tones, elements of pure nichrome metal. Lifetime guarantee attached to each.

#20 gauge cold-rolled steel, electrically welded. Equipped with rotary switches giving range of three separate heats, low at 250 W., medium 500 W., high at 750 W. AC or DC.

MASTER DeLUXE DIVISION of the VACUUM CLEANER SUPPLY CO., Inc.

5079-81-83 BROADWAY, CHICAGO 40, ILLINOIS

Established over 30 years at the same location
1% discount when check or M. O. accompanies order.

OUR REFERENCES: DUN & BRADSTREET, National — UPTOWN NATIONAL BANK, CHICAGO, Local

FAST TURNOVER
INCREASED PROFITS
FOR ALERT DEALERS

TABLE MODEL ELECTRIC RANGETTE

Retail List Price . . . \$16.65
Dealer's Cost \$7.95
Lots of 12 \$7.75

Terms to Rated Dealers

WAFFLE IRONS

Immediate Delivery 110 or 32 V.
Specify Voltage Desired When Ordering

Beautiful chrome plated finish. All steel construction. Heavy duty cast aluminum grids. 600 watts. Free floating hinge. Imbedded elements for faster baking. Mounted on attractive tray with beautiful wood handles. Bakes large 8-inch waffles. Retail \$14.95 each.

Dealer's Cost \$9.95 each

TERMS: Check with Order or
C. O. D. Railway Express. F. O. B. Chicago.

Now! Get records that do these 9 vital jobs...easier, simpler, faster!

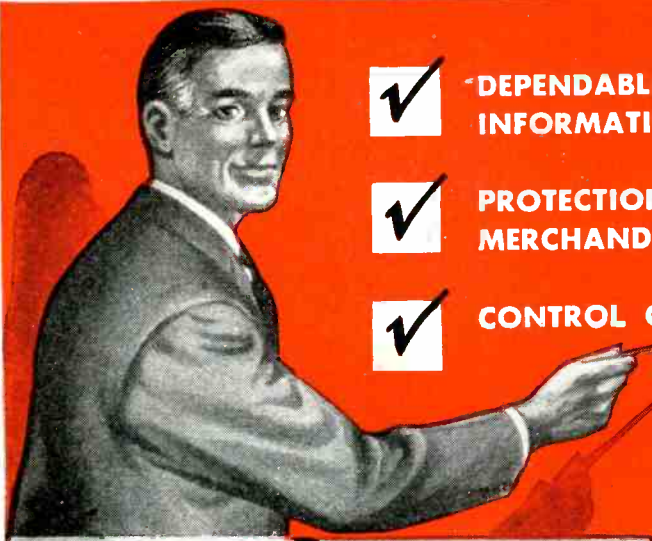

- ✓ **DEPENDABLE TAX INFORMATION**
- ✓ **PROTECTION OF MERCHANDISE**
- ✓ **CONTROL OF CASH**
- ✓ **DETAILED SALES ANALYSIS**
- ✓ **INFORMATION ON PROFITABLE LINES**
- ✓ **ACCURATE INVENTORY CONTROL**
- ✓ **RECEIPTS FOR CUSTOMERS**
- ✓ **COMPLETE CUSTOMER LISTS**
- ✓ **ADEQUATE INFORMATION**

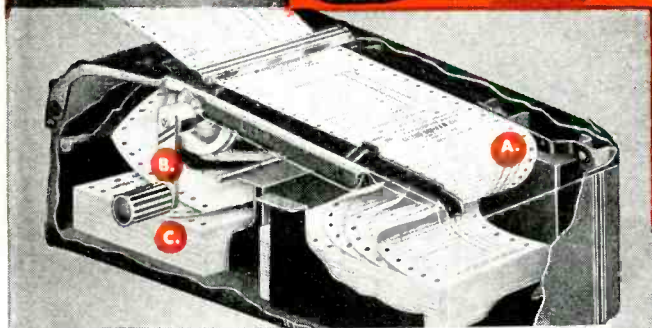

- A. Marginally punched Standard Register forms can't slip.
- B. Pin-wheel feed means extra speed, extra carbons, perfect alignment.
- C. Locked-in copies provide extra protection, positive control.

Radio and Appliance Dealers GET THESE SPECIAL BENEFITS

All records clear, legible, at one writing. Copies for customer, office, delivery and locked-in audit records. No copying errors. Foolproof check against lost records. Fixed responsibility, including delivery receipt. No confusion on terms of sale, payment, or delivery instructions. Complete legal contract and copies with *one* customer signature.

THE STANDARD REGISTER COMPANY

Manufacturers of Registers and Forms
for ALL Business and Industry
DAYTON 1, OHIO

Write for **FREE folder!** Discover how Standard's pre-tested Formcraft continuous forms and **STANDARD'S FORM FLOW REGISTERS** give you more complete records with less writing, less work

Many a record system that was "good enough" a few years ago is totally inadequate for the job it must do, today. That's why thousands of firms have adopted Standard Register's modern, exclusive, pre-tested systems and Form-Flow Registers. Standard Register systems help you get better, more useful records *faster*—records that conform to government regulations, income tax reports, and at the same time protect cash, merchandise and consumer good will. Get all the facts. Mail the coupon, today. There's no obligation.

The **STANDARD REGISTER** Company
 Dept. 1306, Dayton 1, Ohio
 Please send me Free Standard Register Business
 Digest which tells me how I can write better records
 in my business . . . easier . . . simpler . . . faster!
 NAME _____
 COMPANY _____
 STREET _____
 CITY _____ ZONE _____ STATE _____

Pacific Coast: Sunset McKee-Standard Register Sales Co., Oakland 6, Calif. Canada: R. L. Crain Ltd., Ottawa. London: W. H. Smith & Son, Ltd.

THE ONLY BOOK OF ITS KIND IN THE WORLD

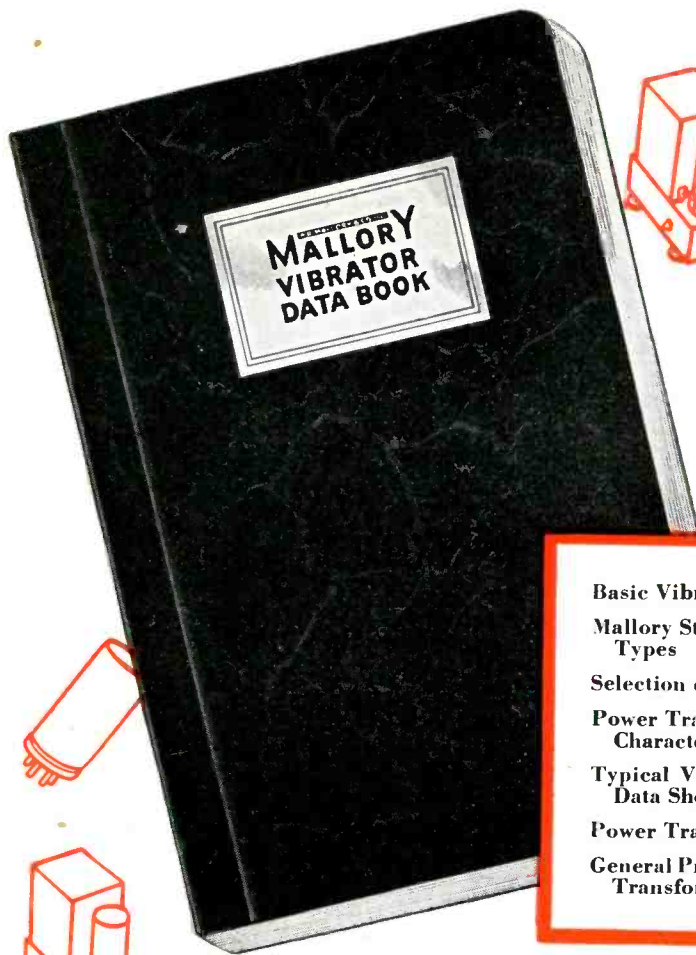

Has the answers to your questions about vibrator power supply designs...

Basic Vibrator Structures	Examples of Transformer Design
Mallory Standard Vibrator Types	Design Considerations for Other Applications
Selection of Correct Vibrator	High Frequency Vibrator Power Supply
Power Transformer Characteristics	Timing Capacitor Considerations
Typical Vibrator Characteristic Data Sheets	Design Practices and Methods of Interference Elimination
Power Transformer Design	Vibrator Power Supply Circuits
General Procedure in Designing Transformers	Vibrator Inspection Procedures

What do you want to know about vibrators or vibrator power supplies? What kind of problems are you called on to solve? This book gives you the answers to your "why" questions. It will help you to understand the basic principles involved in vibrator power supplies as well as the designing of such equipment.

The information brought you in the Mallory Vibrator Data Book is complete, original and easy to understand. Produced by the country's largest makers of vibrators, it shares with you sixteen years of highly specialized power supply experience—and cannot be duplicated anywhere else. It embodies the same kind of "know how" that Mallory has brought you in such outstanding volumes as the Radio Service Encyclopedia, the Mallory Technical Manual and others.

Although just published, this great new book—the only one of its kind in the world—is already in large demand. Order now before the first edition runs out. See your Mallory Distributor. Price \$1.00.

See Your Mallory Distributor for a free copy of the 1947 Replacement Vibrator Guide

P. R. MALLORY & CO. Inc.

MALLORY

VIBRATORS . . . VIBRAPACKS* . . . CAPACITORS . . .
 VOLUME CONTROLS . . . SWITCHES . . . RESISTORS
 . . . FILTERS . . . RECTIFIERS . . . POWER SUPPLIES.
*Reg. U. S. Pat. Off.

APPROVED PRECISION PRODUCTS

P. R. MALLORY & CO., Inc., INDIANAPOLIS 6, INDIANA

SERVICE & SOUND

Section of **RADIO Television RETAILING**

How Service Group Builds Business

Your Association Will Help Weather Competitive Days Ahead

● "Confidentially", said an ex-president of the Radio Servicemen of America to us about a year ago, "the re-organization of the radio servicemen's associations in this country will come only when things begin getting tough".

Perhaps, then, it is a sign of the times, when we today witness the rapid re-formation of the many radiomen's groups which existed before the war, and the beginning of a flock of totally new ones.

On the other hand, perhaps it is more than simply evidence of a tightening up of business conditions. Evidence exists that the advantages of mutual cooperation, brought home to every one of us during the war for the preservation of Democracy, are being hopefully sought for in the form of postwar radiomen's groups.

The Big Question

"What are we getting together for?", is the question being asked at every reorganization meeting of the radio servicemen's associations throughout the nation. While no pat answer has been offered thus far, here are some of the comments made by association leaders, and selections from resolutions passed at formative meetings:

Radio Technicians' Association of Long Beach, California — "MORE BUSINESS."—"To help each other by exchanging ideas in everyday technical and business problems which may be unusual or difficult for the individual member; but simple to solve as a group."—"Technical improvement; raise . . . knowledge in radio techniques and business practice; present to members the latest infor-

mation . . . from manufacturers, engineers and other members"—"Social betterment"—"MORE BUSINESS; advertising tie-ins and Certificate to display."

RSA Southern Tier Chapter, Binghamton, N. Y.—" . . . keep ethics on a high standard in the radio service business in our area"—" . . . talks by nationally-known engineers and members"—" . . . social activities . . . banquets, ladies' nights, picnics . . ."

RSA of Luzerne County, New Jersey—" . . . exchange suggestions and ideas . . . with other active groups of servicemen"—" . . . cooperate to increase interest . . ."

which the individual would find beyond his strength or ability"—" . . . obtain a better understanding between the servicer and the manufacturer, distributor and dealer . . . to place before the public the facts that a radio technician is not just anyone who can use a soldering iron, but a man who has spent much time in study and practice in his field, which qualifies him for this occupation."—" . . . to present to our members lectures and demonstrations on the latest developments in the electronic field, data and service information necessary to all qualified radio technicians."



Radio Service Association of Baltimore, Md.—Organized to successfully oppose a bill before the City Council which would have required the licensing of radio servicers and the payment of an annual license fee, the RSA " . . . has pledged itself to promote the interests and well-being of radio technicians."—" . . . one of the chief aims is to elevate his status, and place him on a professional level."—" . . . membership pledged to dependable service and fair dealing . . ."

Philadelphia Radio Service Men's Association, Pa.—"An organized group can usually accomplish things

It seems quite likely that these are the principal aims for which radio servicers and dealer get together. To accomplish these aims, however, takes more than just a general desire. It takes organized planning and action, and a great deal of experience in solving this problem, which few radiomen have acquired.

Taking advantage of other men's spadework, the following ideas can be put to use, to help build your own organization in your own area:

● Stress to yourself, your fellow members, your association leaders, the manufacturers, distributors, deal-

(Continued on page 132)



Radio-Engineered for Extra Listening Hours

The Spotlight's on the RCA steel-clad, leak-resistant A Battery

It's new — it's different — a high-performance radio A battery . . . packed with extra energy for extra hours of small-set enjoyment. RCA presents this latest item in the hot-selling line of RCA Preferred-Type Radio Batteries.

Features? It is sealed in steel . . . leak-resistant and swell-proof . . . won't expand in those compact little personal and portable sets. There's no "shelf" problem, either . . . it stays powerful and fresh for years and years.

Cash in on the universal acceptance of RCA Preferred-Type Radio Batteries. This means a more extensive and profitable battery business for you.

RCA Batteries are smartly packaged and competitively priced. You can get your stock conveniently and quickly from the same RCA Distributor who supplies you with RCA tubes, parts, and test equipment.

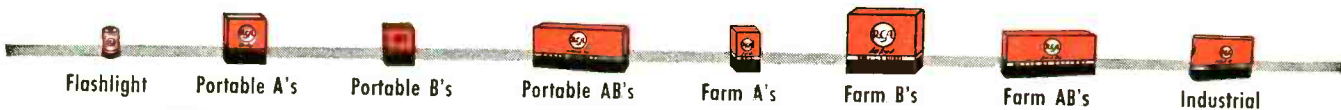

TUBE DEPARTMENT

RADIO CORPORATION of AMERICA
HARRISON, N. J.

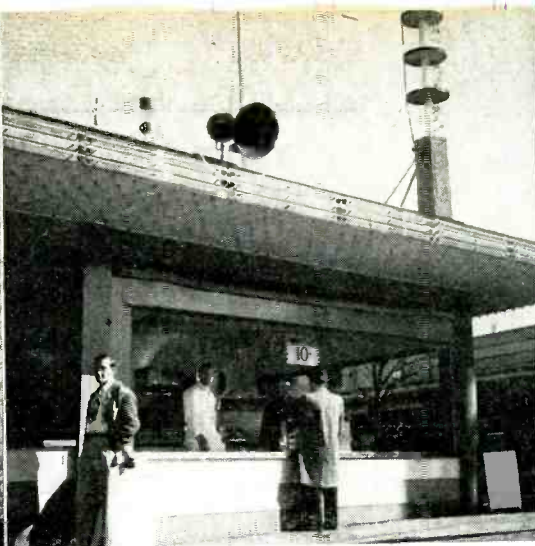
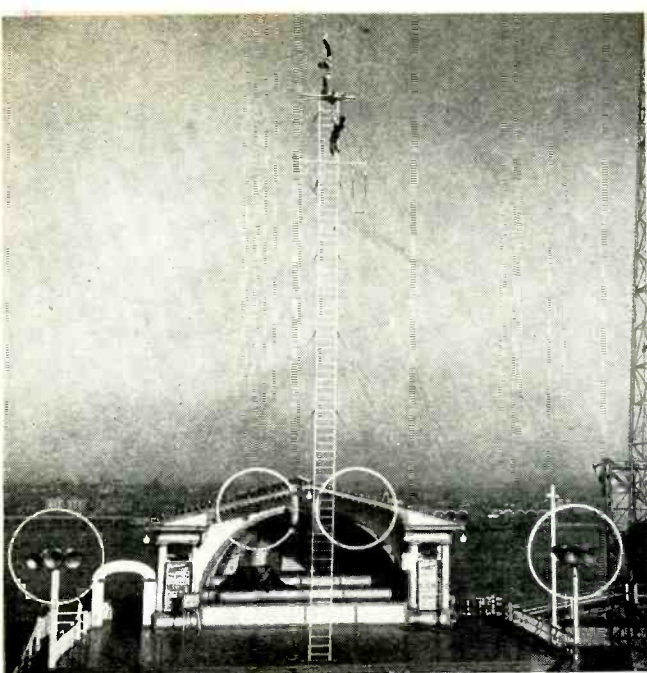

"Showmanship" is what must be expressed by means of an amusement-park sound system, as it is eloquently done at the left. This free-act stage uses two clusters of three cueing speakers each, to cover the open-air theatre with sound effects, music and voice, while two smaller cueing speakers are seen under the eaves. In the center is one of the Jensen SPH main system speakers which blanket sound throughout the Park, picked from the main amplifier bank at the right. Manager Jack Rosenthal at Turner 33 Dynamic.

PA In the "Show Biz"

Prospects Continue Good in This Industry Where Sound Is a "Must"

● During the balmy days of June, what is more pleasant for the hard working sound dealer than a trip with the wife and kids to a nearby resort. Nor need this kind of recreation be considered pleasurable alone; for in fairs, carnivals and amusement parks are found some of the most highly-concentrated mar-

kets for small and medium-sized PA installations.

Consider a unit of this sort known far and wide as the Palisades Amusement Park, on the edge of New Jersey's "grim grey Palisades." In the 1000 foot-square heart of this famous park can be found no less than 18 amplifiers, feeding a total of 52

speakers, serving a multitude of purposes and representing typical installations of many varieties.

Main park-wide system, powered by three amplifiers conservatively rated at 150 watts (class B operation), feed pleasant music from a record-changer, and important announcements through the office microphone, into 25 weatherproofed speakers located at vantage points throughout the entire park. AM and FM tuners are also used.

An absolute must in any such amusement park, the main sound system is in operation from 10:00 AM in the morning to 1:00 AM at night. "Lost kid" announcements alone, run to 75 or 100 each Saturday or Sunday during the Summer. Special police guards and first-aid personnel are paged by code number, to avoid hysterical misinterpretations.

While all but the main music-paging system and free-act stage system are operated by individual concessionaires, placement of speakers and output level are rigidly controlled by a sound supervisor who is able thereby to prevent sound wars and competitions between concessionaires, and avoid "kicks" from the residential and business neighborhoods not far away.

An opportunity to design a fool-proof and fire-proof park-wide installation was created by a spectacular fire which destroyed 95% of the park in 1944, carrying with it all but one speaker of the main system and

(Continued on page 134)

Vocalized, animated slap-stick figures draw the crowd with their boisterous laughter on records, leaving the wired-for-sound Barker with little "pitching" to do. Speakers are University type SMH.



Speed Up Auto

A Good Understanding of Causes of Noisy Reception

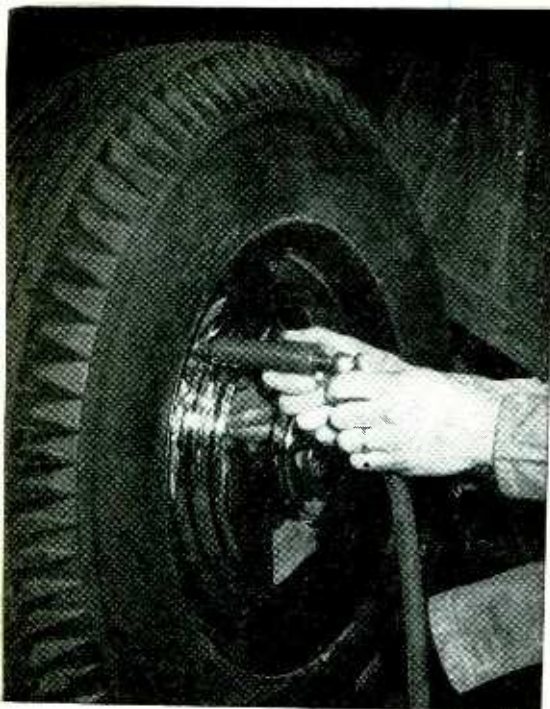

Blowing anti-static powder into tube.

• The demand for auto radio work, far from slacking off, has been increasing steadily. Bulking up especially important in the general picture has been the installation end of the business . . . which should be in a boom state for a long time to come.

Dealers who have had much experience at installations, whether because of special attention to auto radio sales, by way of contractual arrangements with local automobile agencies or by virtue of membership in "authorized service" setups, have evolved quick and easy ways of doing the job.

Especially is this true of the problems connected with the elimination of noise in the completed job . . . a tricky problem that often burns up the expected profits no less than the servicer who must deal with it.

The amount of time that can be eliminated by standardizing installation procedures may well be an untapped source of income. Here are some of the key methods for clearing noises . . . tips that take the "stalling" out of "installing" sets.

Distribution of negative and positive static charges on a car in motion. Electrons, picked up by tire, induce high positive area at fender, producing negative charges elsewhere. Positive road surface draws concentration of negative charges to bottom of car.

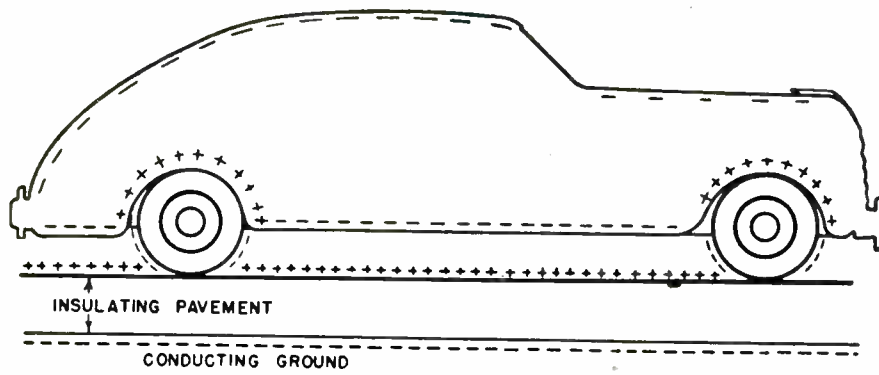

Most elusive of all auto radio noise is that caused by tire static. Of recent years much research work has been done on this peculiar problem, until today it is quite fully understood by the engineers concerned. Unfortunately, however, this is not likewise true of all radiomen.

Inspection of the outline drawing of the car will reveal the fact that unequal potentials exist over its surface while it is in motion. The source of this static voltage is the contact between the rubber tire and the pavement, during which some of the negative electrons of the road surface are transferred to the tire.

While the resulting potential is very small at the point of contact, it rises rapidly as the tire turns, so that as much as 5000 volts are generated.

These high voltages are induced into the nearby metal body of the car. Aside from direct induction due to proximity, some of the charges reach fenders of the car body through leakage along the sidewalls of the tire to the wheel hub and axle, which are in contact with the tire, and even by radiation.

Why Noise Results

Such charges, in fact, are responsible for the mild shocks passengers sometimes feel when alighting from an automobile, and gasoline trucks drag chains behind them as a means of grounding the static charge to prevent sparks which might start fires.

It is not sparks, however, which

cause the static charges to be heard in the radio, even though the strong bursts sometimes sound like a nearby lightning storm, and are able to block out reception by action on the auto radio's sensitive AVC circuit.

The static noise is caused, rather, by instantaneous shifting and changes in the charge on the car's surface. Such a shift of charge may

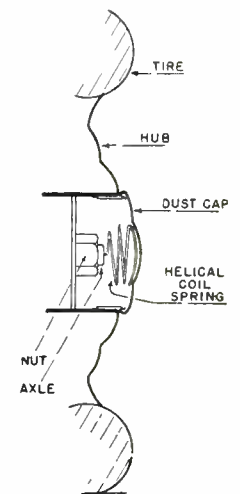

Poor body connections, especially at front wheels, cause noise. One way to correct.

have thousands of causes, but one is very outstanding . . . poor electrical connections between the wheels (especially the front wheels) and the axles.

Several solutions to this problem are used. Electrically conductive tires help, but are not adequate in themselves. Another well-known method is to use a helical-shaped spring inside the hub dust cap to make a better electrical contact between the axle and the wheel. A newer and still more effective method, now becoming very popular, is to blow a powder such as acetyle black into the inner tube.

This very finely-divided electrically-conductive powder acts with the outside of the tire as a sort of capacitor. Its ultimate effect is to suppress the picking up of more than a relatively small static charge. The U. S. Rubber Co., which developed and patented a powder of this type just before the war, is distributing a container of the powder which, as pictured, can be blown into the inner tube by means of an air hose. Sev-

Radio Installations

Takes the "Stall" Out of New Installations. Sources and Cures Clearly Explained.

eral radio manufacturers are also making such a powder available through their distributors.

Since the car surfaces furthest away from the point at which the

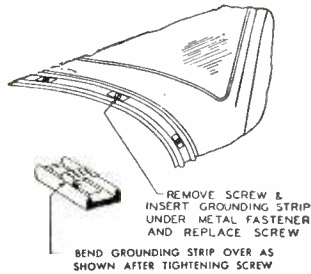

Correcting poor connection at hood lowers noise from shifting static charges.

static charges are generated will experience the least movement of its charge, it is clear now why auto antennae placed high, above the roof or the windshield, have less static pickup than those which are lower, or under the running board . . . a point to keep in mind during installations.

As shown in the block diagram on a later page, radio noise has quite a number of sources. Some of these are also of a static nature, such as that which is caused by incorrectly adjusted brakes, acting pretty much in the same fashion as does the tire already described.

Another immediate cause of static noise caused by shifting charges, is a poor electrical contact between the car's hood and the main part of the body or chassis. To remedy this, standard procedure calls for the installation of sharp-surfaced tabs which are installed as shown in front of the windshield, under the rear edge of the hood.

A simple test for wheel or brake static is to set the car in motion so that the offending noise is produced; then, with the motor shut off and the clutch disengaged, apply the brakes. If the noise stops, the source of static is in the wheels.

Although far worse than static noise, ignition noise is so familiar as to give little trouble today. The steps to prevent and clear up such noise are well-known, and if adhered to for each make of auto, will be fully effective.

In general, following the instructions of the auto set manufacturer, a suppressor resistor is placed in series with the central lead of the distributor or ignition coil, while several capacitors are strategically placed at various parts of the 6-volt electrical circuit.

The most important point for attaching a filter capacitor is at the car generator, but about this a word of precaution: in cars with automatic regulators, don't by-pass the field terminal. Look to the instruction book for the radio or the car, to see which is the battery terminal, and connect from that one through the capacitor to ground.

Should ignition noise still be experienced after this standard precaution, try .5 mf filter capacitors in the following locations, from the indicated points to ground, making permanent connections where the unit definitely helps: ammeter, car fuse, ignition switch, tail light and stop light connections, windshield wiper connections, "hot" side of the ignition coil primary and at the dome light lead where it leaves the pillar post.

The electrically-operated oil, water temperature and gas gauges are often hot points for ignition noise, as is the voltage regulator, and filter capacitors by-passing them

to ground should be tried, connecting to the end of the line nearest the instrument, rather than at the panel connector. Typical mounting positions are shown.

If further searching is necessary, make full use of the bonding technique. Using a short length of one-inch braided shielding, try grounding to the fire wall all cabling and tubing which pass through it, such as oil and gas lines. The steering column, foot pedals and brake lever are also suspect.

Correct Bonding Technique

For a permanent bonding to ground, use available screw-heads rather than attempting wrap-around connections. In any event, carefully clean the metal surfaces being bonded, and leave only enough slack to prevent hampering of the movement of parts or even the slightest strain on the braiding.

In case the motor is not well grounded to the frame of the car, it is necessary to bond it with a very heavy braided lead, similar to the storage battery ground lead. The same consideration is true of the metal fire wall, instrument panel, transmissions, radiator, and muffler. In some cases, too, spark plug sup-

(Continued on page 134)

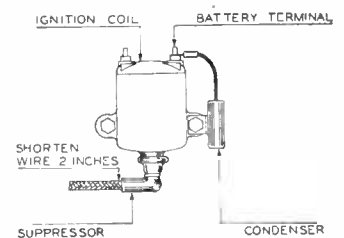
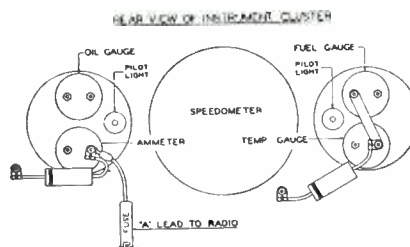

Some typical points at which .5 mf filter capacitors can be installed to suppress ignition noise, aside from all-important generator. Others are mentioned in the text. Few are needed in any one installation. Try them all to locate the most important, and wire those few in permanently.

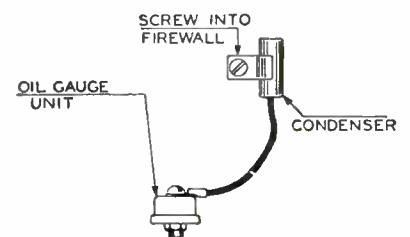
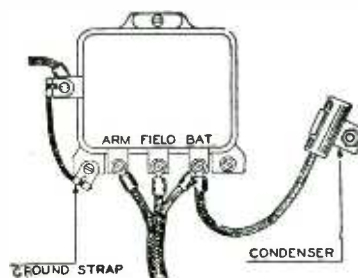

Circuit Points on Popular

How to Make Speedy Alignments. Simplified Schematics and Parts Listings Help

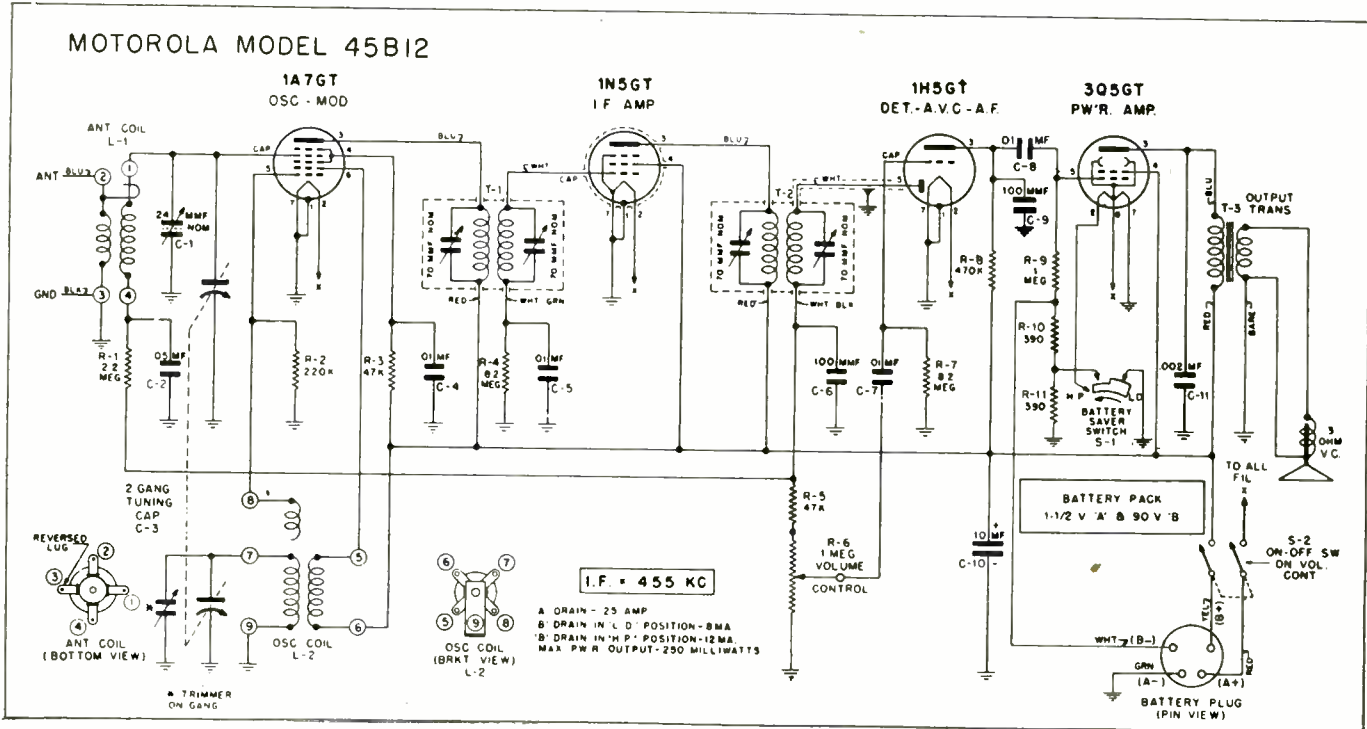

To check electrolytic capacitor C-10, disconnect from circuit. Pairing similar polarities, the resistance should be .5 megohm or better.

MOTOROLA MODEL 45B12 is a four-tube battery operated receiver covering from 538 to 1720 kc. A "battery saver" switch is used to reduce the B-supply drain. During alignments, this switch should be in the H.P. (high power) position.

For the i-f adjustments, connect the 455 kc signal generator through a .1 mf dummy antenna to the grid (cap) of the oscillator-modulator tube, 1A7GT. With the ganged capacitor at minimum, adjust the trimmers atop both i-f transformers T1 & T2 for maximum output across the speaker voice coil.

The output reading should reach a standard value of .38 volts at .05 watts, with a signal of 80 microvolts to the oscillator-modulator grid, or one of 3750 microvolts to the grid of the i-f amplifier.

For broadcast alignment, change the signal generator frequency to 1720 kc and vary trimmer C3 atop the front section of the variable for maximum output.

Next, with the generator at 1400 kc, feeding through a 200 mmf capacitor to the antenna lead, adjust

the r-f trimmer C1 through the side of the chassis for maximum, making sure to secure the standard .38 volt output with a maximum of 10 microvolts input. For maximum accuracy, repeat the entire procedure.

GAROD MODEL 6DPS8 is a six-tube, two-band, superhet-phono combination, covering from 540 to 1650 kc on broadcast, and 5.7 to 18.5 mc on short wave.

To make the i-f adjustment, connect the 455 kc generator to the lower side of the loop antenna trimmer through a .1 mf capacitor, with the ground connection made to the chassis. Shunt an output meter across the voice coil connections, and turn the variable capacitor to the extreme clockwise position (minimum capacity).

Adjust the trimmers located atop the first and second i-f transformers for maximum output as indicated on the output meter.

The broadcast r-f alignment should be made by feeding the test signal through a two or three turn loop to the receiver's loop. With the ganged

capacitor dial on the 1650 kc calibration mark with minimum capacity, vary the broadcast oscillator trimmer C2 (the outside trimmer of the group of three behind the ganged capacitor) to pick up the 1650 kc signal generator and secure maximum output.

Next, with the generator and tuning dial at 1500 kc, vary the antenna trimmer C1 atop the loop for maximum indicated output. Finally, with 600 kc signal from the test generator, and the receiver dial set to match, adjust the broadcast oscillator padder C3 (the inside trimmer of the group of three) for maximum response while rocking the ganged capacitor. The 1500 kc high frequency adjustment trimmer C2 can be checked to make certain the padding step has not thrown it off.

The short wave alignment is made with the band switch in the center position, using a standard short wave dummy antenna to the antenna (green wire) and the ground lead to the chassis of the receiver.

Set the signal generator to 18.5 mc, and with the variable capacitor

New Sets

Clear Troubleshooting Bench.

set to the extreme clockwise position (minimum capacity), tune in the 18.5 mc signal by means of the short wave oscillator trimmer C4 (the middle trimmer of the group of three located behind the ganged capacitor). Turn the signal generator to 16 mc, and set the receiver's dial to the same frequency. Adjust the antenna trimmer C5 on the short wave coil for maximum output while rocking the variable capacitor from left to right for maximum output. No other adjustments are necessary.

MAJESTIC MODELS 7C432 & 7C447, with chassis 4706, 4707 and 4708 are seven-tube a-c superhets with a separate oscillator. In removing the chassis from the cabinet, always slide it out through the back, never through the bottom. On some cabinets there is a reinforcing block in the rear, lower left corner. Remove this block which is held in place by two wood screws before sliding out the chassis.

Some attention must be paid to the dress of certain leads within the chassis. The green lead from the r-f coil on the tuner to pin #8 of the 6SA7 socket should be dressed well over toward the 6J5 socket, around the ceramic capacitor C2.

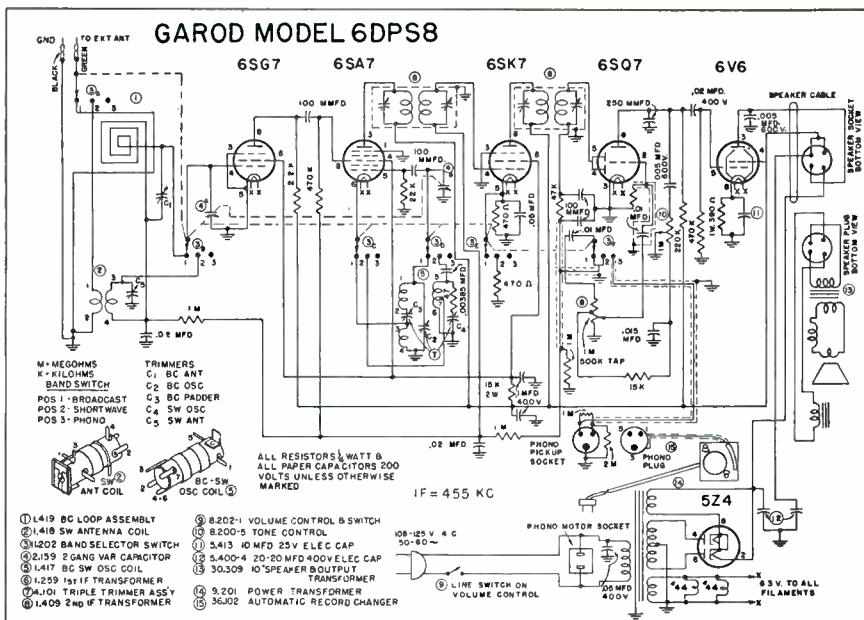

This Garod receiver uses the speaker field coil as a filter choke, with a hum-bucking winding.

While the blue plate leads of both i-f transformers should be run close against the chassis, the green grid leads must be dressed as high as possible, away from ground. The first audio input d-c blocking capacitor C13 must be arranged as far over as possible toward the electrolytic, with the 6V6 plate by-pass C17 clearing C13 as far as its leads permit.

For the i-f alignment, connect the 455 kc i-f generator through a .01 mf capacitor to the 6SA7 mixer grid pin #8, with the receiver tuned to a quiet spot, and vary i-f trimmers C6, C7, C9 and C10 atop the i-f transformers for maximum signal output. Repeat the adjustments for accuracy.

The r-f alignment is a bit extraordinary, since permeability tuning is used in the r-f end of the set. Both oscillator and r-f stages use trimmer capacitors, while the oscillator uses as well a padding coil shunted across the main tuning coil element.

The signal generator should be coupled to the receiver by means of a two or three turn loop of 12" diameter placed about a foot away from and parallel to the receiver loop. The receiver loop antenna should be in about the same position relative to the chassis as it is when installed in the cabinet.

(Continued on page 132)

The Majestic circuit shows inductive shunt padding of the oscillator with high-frequency trimmers for both r-f and oscillator circuits.

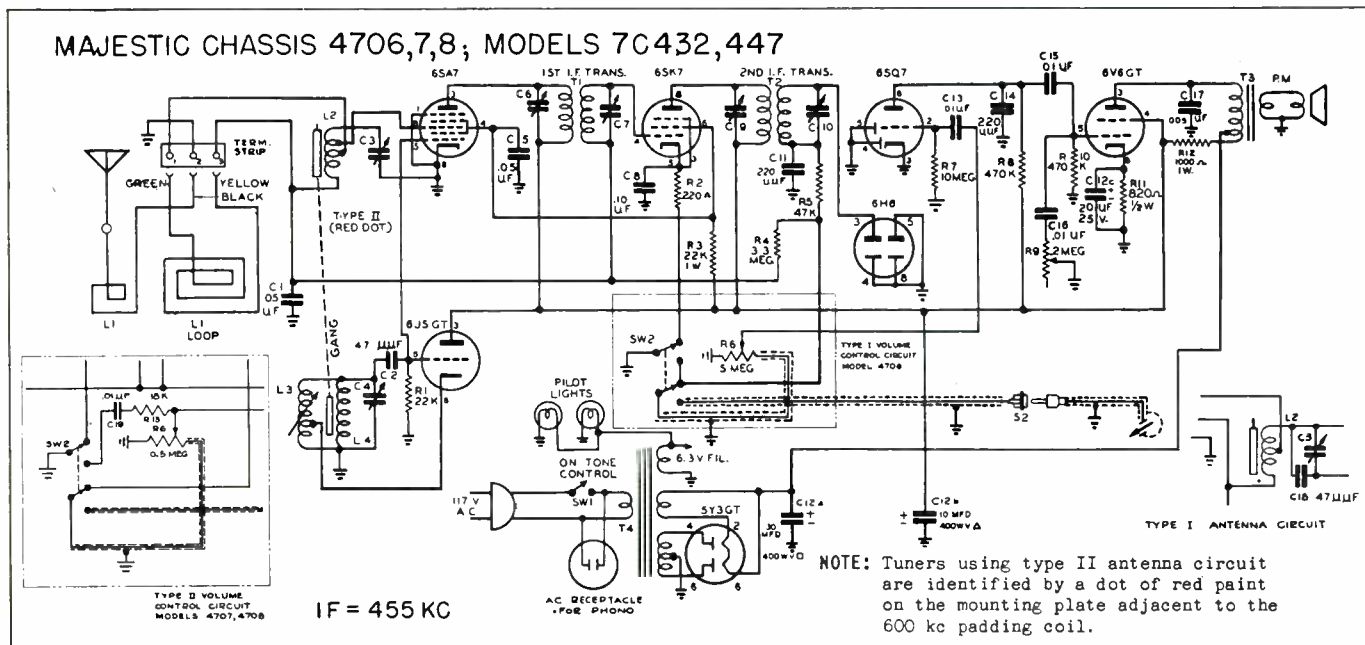

NOTE: Tuners using type II antenna circuit are identified by a dot of red paint on the mounting plate adjacent to the 600 kc padding coil.

IT PAYS!

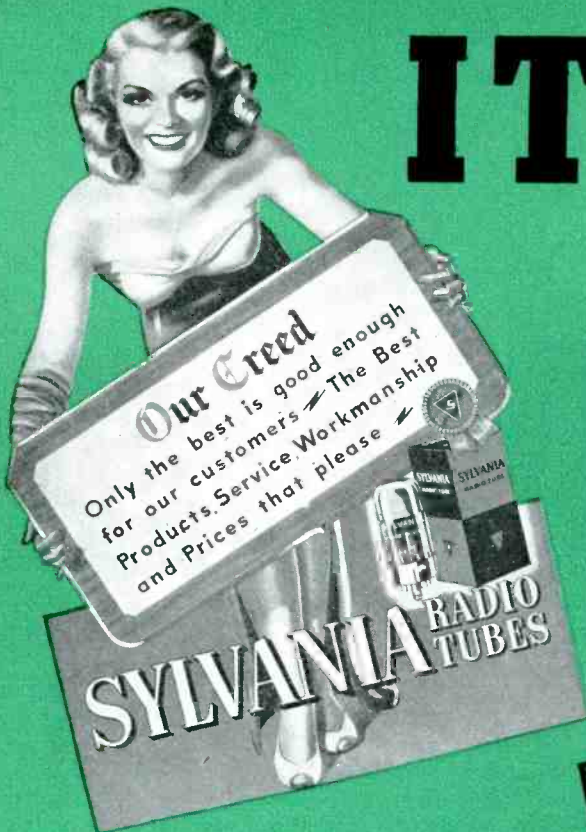

FREE!

This attractive display, for window use, is approximately 3½ feet high. It's an eye-catcher . . . and sales catcher! Also miniature size, 11" high, for counter or window use. Available only from your Sylvania Distributor.

Standing 14½" high, 10¾" wide and 7" deep, this colorful display is fitted with a flasher unit that lights the message every other second. A must for your window! Only \$2.00.



Get this low-priced weatherproof service banner, today! Size 46" x 28". For truck, shop, window! 40¢ each; 3—\$1.00.



FREE!

Green and white decal for store doors or windows. See your Sylvania Distributor.



FREE!

Authentic dummy carton in standard and giant (20") sizes. At your Sylvania Distributor.



SYLVANIA

MAKERS OF RADIO TUBES; CATHODE RAY TUBES; ELECTRONIC DEVICES;

- IDENTIFY YOUR STORE

WITH THESE NOMINALLY PRICED AND **FREE** SELLING AIDS

Take full advantage of these specially prepared sales aids—it pays! High quality store identification is one of the best means of notifying your customers of the type of radio service you are prepared to offer. And when these attractive displays show that you're selling the finest line of radio tubes made—well, you have the ideal way to build up sales.

One of the finest of these identification items is the electric clock shown on the right. It has a Telechron movement sealed in oil; case in brown crinkle finish with silver-colored rim around face! Only \$8.50 including tax.

ORDER ANY OF THESE ITEMS FROM YOUR SYLVANIA DISTRIBUTOR or write SYLVANIA ELECTRIC PRODUCTS INC., Emporium, Pa.

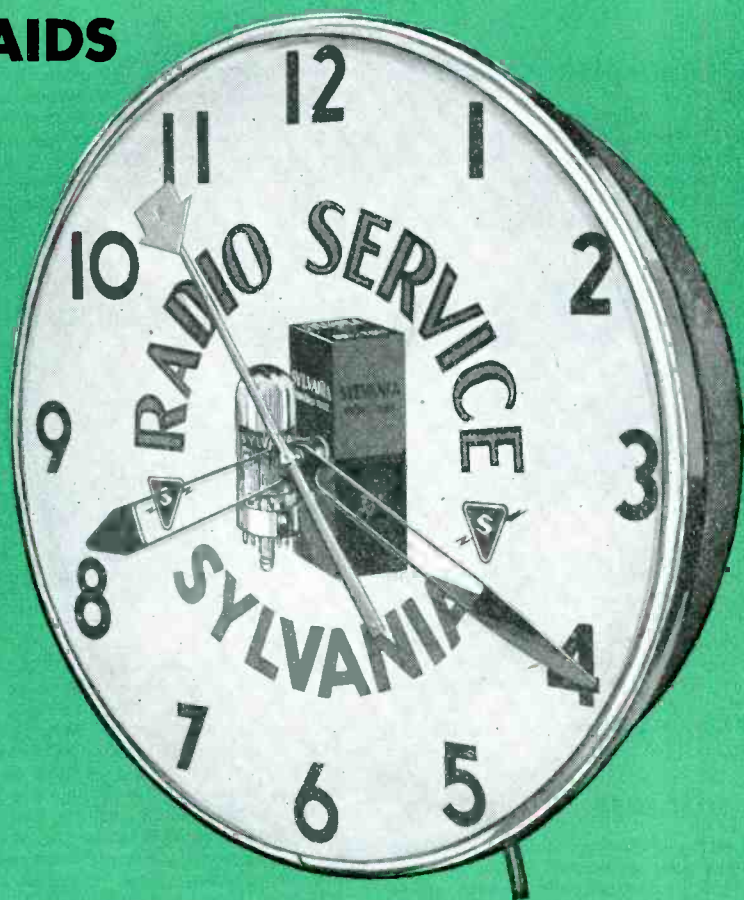

SUPPLEMENT SYLVANIA'S GRAND ADVERTISING CAMPAIGN with the sales aids shown. Life, Collier's, Saturday Evening Post, with a combined weekly circulation close to 12,000,000, carry ads that sell you, your products and service.

To profit from this national sales campaign, use these tested, "on the spot" selling aids.

ELECTRIC



FLUORESCENT LAMPS, FIXTURES, WIRING DEVICES; ELECTRIC LIGHT BULBS

New Aids for Faster Repairing

Measurements MEGACYCLE METER

Model 59 Megacycle Meter covers from 2.2 mc to 400 mc with seven plug-in coils. Basically a greatly modified grid dip meter, this instrument is used to check values of frequency, capacitance, inductance and Q.



With it preliminary alignment and tracking of receiver circuits without power, as well as final alignments with power on, the measurement of bandwidths and frequency marking for use with a sweep frequency oscillator may be accomplished. Both internal and external modulation is provided. Measurements Corp., Boonton, N. J.—RADIO & Television RETAILING

Luma SOLDERER

Eight styles of carbon electrode soldering tools using heat generated at the point of contact are available. The smaller types weigh between 5 and 7 ounces with 5 ft. cable, using a cork handle and radiating fins on the carbon holders. Four different power units from 1050-2500 watts are available. Luma Electric Equipment Co., P. O. Box 132, Toledo 1, Ohio.—RADIO & Television RETAILING

Silver AM-FM SIGNAL GENERATOR

Model 906 am-fm signal generator employs an 8-range rotary turret-type oscillator to cover from 90 kc through 170 mc on fundamentals. The main dial is vernier

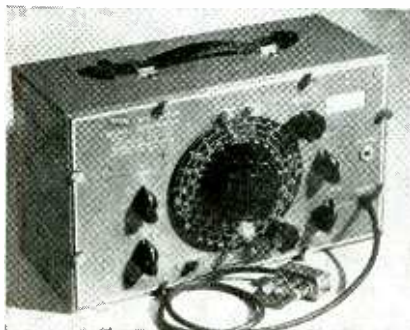

driven at 10:1 ratio. 400-cycle, 0-100% amplitude modulation is provided, as is frequency modulation between 90 kc and 210 mc. Sweep rate is 60 cycles, with total frequency swing variable from 0 to 500 kc. Output controllable from less than 1 micro-volt to 1 volt. McMurdo Silver Co., Inc., 1249 Main St., Hartford, Conn.—RADIO & Television RETAILING.

Chicago Industrial MULTIPLEX METER



Model 458 Multiplex Volt Ohm Milliammeter covers 25 ranges of measurement on a 5½ in. meter. 6 DC ranges to 2000 volts and 3 more to 100 mils plus 5 AC voltage ranges to 1250 volts, 3 ranges to 250 mils AC. 5 output ranges and 3 resistance ranges to 2 megohms are selected by the single switch and pin jack connections on this slant front bench type instrument. Chicago Industrial Instrument Co., 219 W. Chicago Ave., Chicago 10, Ill.—RADIO & Television RETAILING

Sylvania POCKET-SIZED OHMMETER



A 1.5 ma full-scale sensitivity Weston meter built into a tubular plastic case ¾ in. in diameter and 5¼ in. overall length provides direct resistance readings from 0 to 10,000 ohms. Designed as a pocket indicator for quick preliminary isolation of troubles, the miniature ohmmeter can be used to spot check any type of radio or electrical appliance. Radio Tube Div., Sylvania Electric Products, Inc., 500 Fifth Ave., New York 18, N. Y.—RADIO & Television RETAILING

IRC RESISTOR KIT



A new basic kit contains a complete stock of the resistors a servicer normally needs in day-to-day work. An assortment of 471 basic resistors of the most-used types and ranges, plus 6 additional bands for adjustable types, are packed in a sturdy metal cabinet for hanging on wall or placing on bench. The selected values are arranged so that lack of stock on one range may be compensated for by using two other ranges in series or parallel. International Resistance Co., 401 N. Broad St., Philadelphia 8, Pa.—RADIO & Television RETAILING

Holub FLEX SPOT

Three kinds of flashlights with flexible metallic tubing enable light to be placed in hard-to-get-at places from any angle. The tubing can be hooked over wiring, chassis corners, etc., or when laid on a ledge gives a spotlight where wanted. Holub Industries, Inc., Sycamore, Ill.—RADIO & Television RETAILING

Gulow TRANSFORMER

Three types of 220 volt and 110 volt step down transformers for 100-250 watts, 500-750 watts and 1000 watts are available. Illustrated is the type enclosed in a steel case, potted in compound to keep out moisture. This is for use as a separate unit and is furnished with a 6 ft. cord, plug and receptacle. Gulow Corp., 99 Park Place, New York 7, N. Y.—RADIO & Television RETAILING

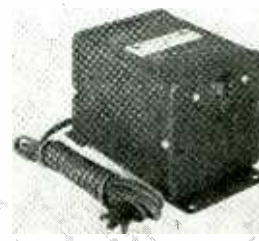

Meets **EVERY** Testing Requirement **BETTER**

NEW model 3413 ...LEVER SWITCHING... tube tester

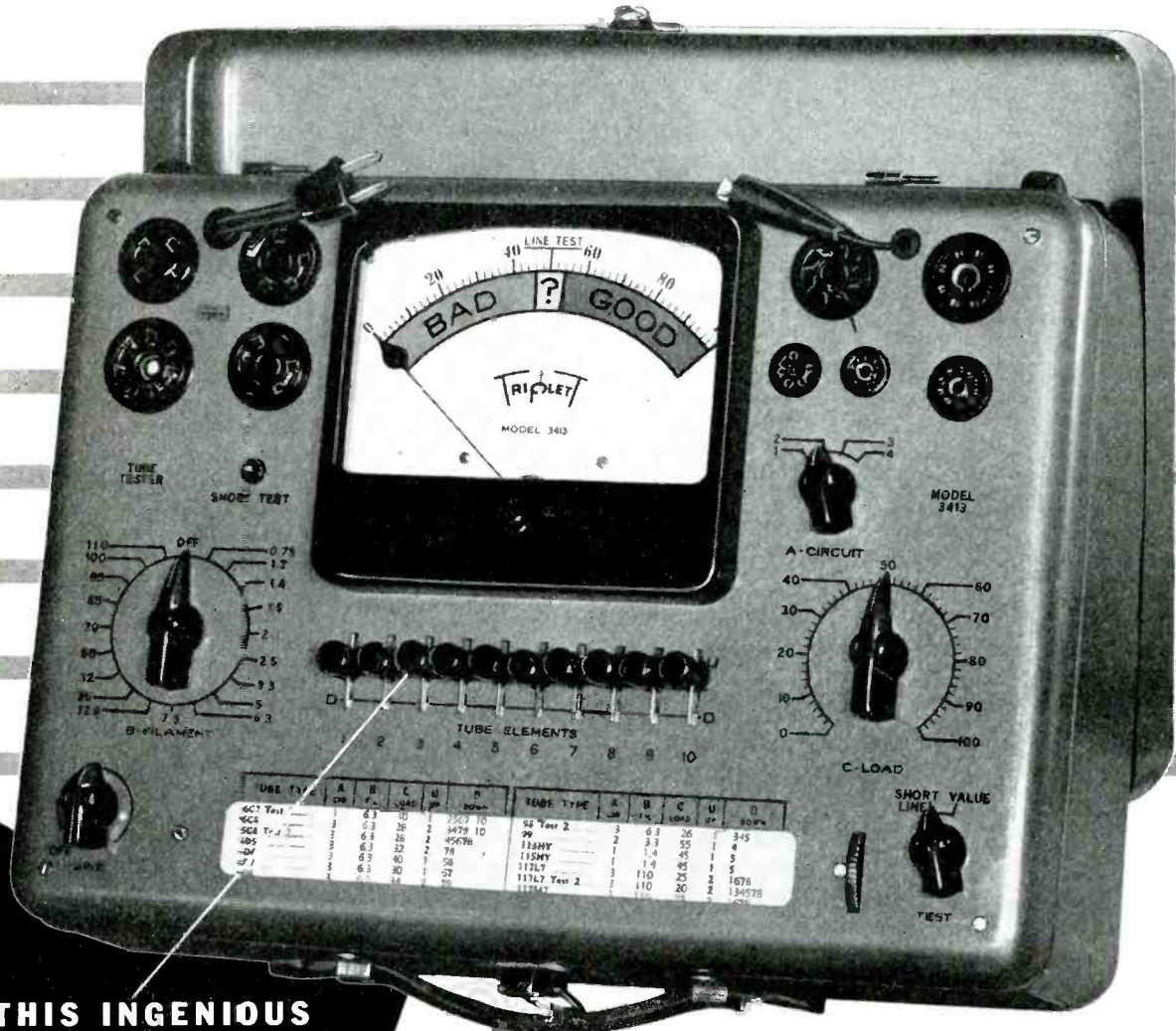

**THIS INGENUOUS
LEVER SWITCHING**

"Pictures your circuit"

FAST • SIMPLE • FLEXIBLE
Provides individual
control of each
tube element

With the new Model 3413 you can make your settings instantly—just snap the switch up or down. You actually "picture" the circuit. Usually not more than five of the ten lever switches need be set, yet you have individual control of each tube element. Many other convenient features make Model 3413 the buy of its field—such as the handy, built-in SPEED-ROLL tube chart, the larger easy-reading meter, the handsome new case with streamlined design. For either counter or portable use you will find Model 3413 a quality-packed tester that you'll be proud to own. Write today. Address Dept. Q67.



*Precision first
...to last*

Triplet

ELECTRICAL INSTRUMENT CO. BLUFFTON, OHIO



More on Fixing Meters

Short-Cuts of the Meter Repairman's Trade, for Making Quick Adjustments on Minor Troubles. Continued from April Issue.

● The April 1947 issue of RADIO & Television RETAILING discussed simple meter repairs involving the pointer, bearings, bobbin and springs. We continue now with further procedures to use on damaged springs.

As illustrated in the first article, for making a correction in the round, along the convolution of the spring, make your bend ninety degrees away. To make a correction in the flat, to shift the horizontal plane of the coil spring, make the bend one hundred and eighty degrees away, on the opposite or far side of the coil. Both cases are illustrated.

If the spring forms an "umbrella" do not push down on each turn, but bend the spring where it is fastened to the lug. Consider this a sort of wrist and manipulate there to correct, as shown.

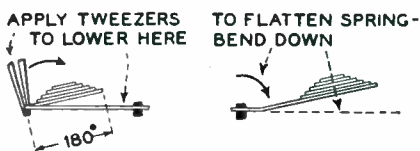

In correcting springs "in the flat," apply tweezers 180 degrees from displaced side.

When soldering the spring back into place use as little heat as will allow a good joint. First melt a drop of solder on the lug, then hold the spring in place with a tooth pick, and apply the heat to the end of the lug. Clean the joint with grain alcohol to prevent corrosion.

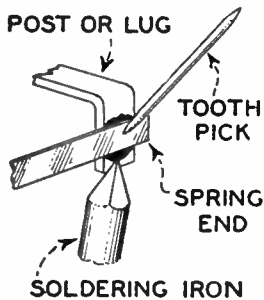

Technique for fine spring solder joints.

With everything in place, pivots, springs, etc., put the meter on its back, face up and adjust the needle

for zero. Then turn the meter up on its side so that the needle is in the horizontal position. Now adjust the counter weight opposite the pointer until the needle is back to zero.

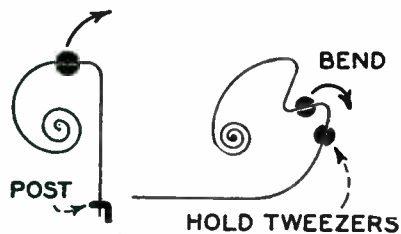

How to correct springs "in the round".

Some of the counter balances are merely drops of solder on an extended piece of the spring. Others, are coils of wire wound around the tail of the pointer. Squeeze this type with a pair of pliers and shift. Another type is threaded on the needle's tail.

After the needle is balanced horizontally, swing the zero point around until the needle, to point to zero, is vertical. Now adjust the two side weights. A single counter weight will have to be moved to right or left for correction. Put the meter on its back again. The needle should remain at zero.

Checking Magnetic Circuit

Now run the needle up to full scale with some sort of potentiometer in series with a known standard or instrument. Another ohmmeter with a zero control will do nicely. Check the full scale reading. If it is too high or low it may be corrected by means of the magnetic shunt, if there is one.

The more iron shunted across the air gap, the less the magnetism and the lower the reading for the same current. Do not change the series or shunt resistor unless the meter is being used as a single meter only, for a change in shunt or series resistance will throw the meter off on all the rest of the scales.

Run the needle up to full scale again and slowly let it down by reducing the current. As it goes down tap the glass every now and again to see whether or not the needle sticks. If it does, and the needle and bobbin are in the clear, the sticking is in the bearings or pivots.

The meter might be checked at various other points along its scale against a standard, and if incorrect the inaccuracies noted. These errors may be due to a change in the spring torque, irregularities that were not there before, internal shorts in the moving coil, or bearing friction. In any event, the error should be considerable before the meter is considered useless.

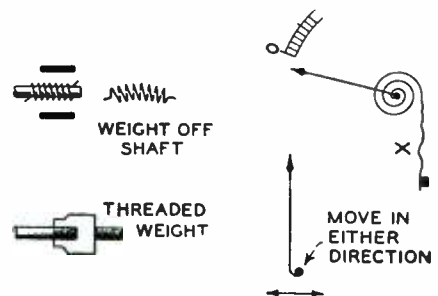

▲ Four different types of correcting adjustments found on various meters. ▼ Weights A & B zero pointer with meter upright. Weight C zeros pointer with meter on side.

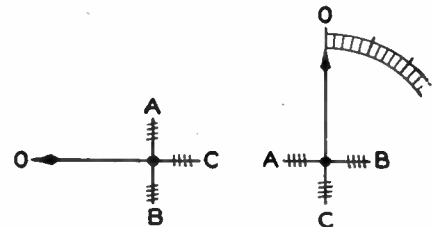

In the final analysis, it must be pointed out that the repair of a precision meter is a matter best left to the service facilities of your instrument supplier. The simple repairs outlined here are suggested only for inexpensive or outmoded meters, particularly where time is the chief factor.

TUNE IN TO MORE PROFITS* WITH GENERAL ELECTRIC ANTENNAS

AUTO ANTENNAS

New cars are rolling off the lines . . . older cars are taking to the road . . . both mean more car radios in service. But car radio reception can only be as good as the antenna that picks up the program. That is why G-E quality antennas are your best bet in getting this business.

General Electric auto antennas are easy to install, bring a big return for labor, have features that will appeal to every motorist and give satisfaction in operation.

***SUGGESTION TO DEALERS**—Keep in touch with new and used car dealers for leads to more business.



UKA-002
Television

Supplied in Kit form, complete with 60' of 300 ohm lead-in Cable and installation accessories.

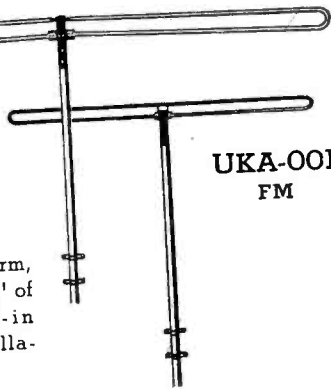

UKA-001
FM

FM & TELEVISION ANTENNAS

New FM and television stations are being erected. Receiver stocks are being built up by dealers and public enthusiasm is at a high pitch. Cash in on this market—grow with it . . . specialize in General Electric FM and Television antennas.

Simple in construction and highly efficient, General Electric antennas are designed to assure maximum reception.

Be first in the field—first to realize the profit in this rapidly expanding field.

G-E LOW-LOSS LEAD-IN CABLE

G-E polyethylene lead-in cables have been especially designed to provide better reception in FM and television installations. They assure that energy received by the antennas is transmitted with minimum loss.

Radio amateurs may also use this cable with transmitters, and instrument engineers have found it excellent for special purpose wiring. Selling these additional markets can mean additional profits for you.

For complete information on these products, write: *General Electric Company, Electronics Department, Syracuse 1, New York.*

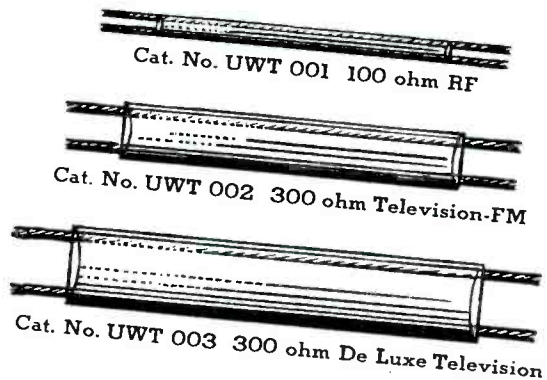

160-F4

GENERAL ELECTRIC

THIS IS THE WORLD'S FINEST SET TESTER

...because it is Simpson-built!

Simpson Model 260 Volt-Ohm-Milliammeter

There has never been any serious question, since its introduction several years ago, that the Simpson Model 260 is the world's finest high sensitivity set tester for television and radio servicing. It has always been in advance of its field because it has been kept there by Simpson design and Simpson manufacture. Today the statement we have often made is truer than ever: that you cannot touch its precision, its useful ranges, or its sensitivity in any other instrument of equal price or selling for substantially more.

You need only remove Model 260 from its handsome case of black, molded bakelite to see how it differs from other instruments. Look at the sub-panel—here are a score of small recesses, each one holding a separate resistor. All connections are short and direct, eliminating the need for cable wiring. Here is a kind of strength and firmness of assembly you will not see elsewhere, the finest of insulation with reduced chances of shorts, the highest degree of accessibility of components. The front panel shows similar refinements: pin jacks firmly set into molded recesses so that there are no exposed metal parts on the panel; all figures and symbols molded into the heavy bakelite panel, then filled with white, so that they have greatest legibility and longest wearing qualities.

These refinements are, of course, what you expect from a manufacturer able to produce a circuit design and meter movement construction that have made this the most wanted set tester ever marketed.

★ **All this, and the Roll Top Safety Case, too—**

Simpson has a new kind of answer to the carrying case problem—the Roll Top Safety Case. Here's how we do it: we take the Model 260, place it inside a housing of heavily molded bakelite, and permanently fasten it there. Instrument and case become one unit. Beneath the instrument is a compartment for test leads. Over the face of the instrument a roll top (of molded bakelite, too) slides up to open, down to close, the case. With a flick of the finger you roll it up and out of sight and the instrument is ready to use. Another flick, and the roll top is down and the instrument is ready to carry, and fully protected. With the Roll Top Safety Case you cannot leave your carrying case behind. It is never in the way. And you have *constant, important protection to your 260 from damage, whether in use or not.*

The Model 260, like other Simpson test equipment, is made almost entirely within the various Simpson plants. Each component part has been designed and completely tooled and manufactured in our own plants, with very unimportant exceptions. The Simpson Model 260 is not an assembly job, as is true of so many testers on the market. Its unvarying quality is the result of control at every minute step of its manufacture. That is why your investment in a Simpson Model 260 is a lifetime investment in that famous Simpson accuracy which lasts as long as the instrument itself.



JUST ROLL IT UP



Simpson

INSTRUMENTS THAT STAY ACCURATE

SIMPSON ELECTRIC COMPANY

5200-5218 W. Kinzie Street, Chicago 44, Ill.

In Canada, Bach-Simpson, Ltd., London, Ont.

SIMPSON 260, HIGH SENSITIVITY SET TESTER FOR TELEVISION AND RADIO SERVICING

Ranges to 5000 Volts—Both A.C. and D.C.
20,000 Ohms per Volt D.C.
1000 Ohms per Volt A.C.

At 20,000 ohms per volt, this instrument is far more sensitive than any other instrument even approaching its price and quality. The practically negligible current consumption assures remarkably accurate full scale voltage readings. D.C. current readings as low as 1 microampere and up to 10 amperes are available.

Resistance readings are equally dependable. Tests up to 20 megohms and as low as 1/2 ohm can be

made. With this super sensitive instrument you can measure automatic frequency control diode balancing circuits, grid currents of oscillator tubes and power tube, bias of power detectors, automatic volume control diode currents, rectified radio frequency current, high-mu triode plate voltage and a wide range of unusual conditions which cannot be checked by ordinary servicing instruments.

Model 260 \$38.95

Model 260, in Roll Top Safety Case . . \$43.75

Both complete with test leads

ASK YOUR JOBBER



RANGES

Volts D.C. (At 20,000 ohms per volt)	Volts A.C. (At 1,000 ohms per volt)	Output	Milli- amperes D.C.	Micro- amperes D.C.	Ohms
2.5	2.5	2.5 V.	10	100	0 2000 (12 ohms center)
10	10	10 V.	100		0 200,000 (1200 ohms center)
50	50	50 V.	500	Amperes D.C.	0 20 Megohms (120,000 ohms center)
250	250	250 V.		10	
1000	1000	1000 V.			
5000	5000	5000 V.			

(5 Decibel ranges: -10 to +52 DB)

New Tele HV Circuits

Functioning of the RCA, GE & Dumont C-R Tube Supplies. Part III of Series.

● Our discussion in the two preceding articles of this television servicing series, which appeared in previous issues, has explained the relation between the high-voltage supply portion of the television receiver and the balance of the set, and has given details of various troubles

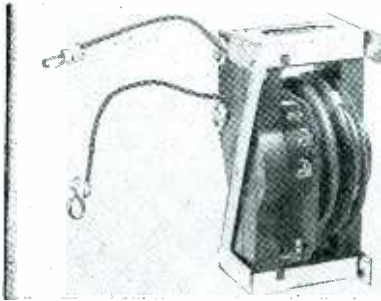

Heart of the new horizontal-deflection "flyback" RCA power supplies is the auto-transformer.

which have occurred in viewers marketed during past years.

The new television receivers have eliminated virtually all of these sources of faults. As an illustration, consider the new Dumont Telesets, of which the power supply circuit of one is shown.

It will be noticed immediately that a voltage doubler is used in this supply. The doubler, once quite the rage in early ac-dc radios, fell out of general use for many years. Tele receivers, however, will probably bring it back in a big way . . . for by means of the doubler, the high voltage-low current requirements of the cathode ray tube circuit are more easily met.

How Doubler Is Used

In the case of the Dumont power supply illustrated, 12,000 volts are generated in the output of the filter, although, of course, the high-voltage transformer need produce a good deal less than that value, measured in volts rms. Unfamiliar as this circuit may be to some radio servicers, its novelty is not as striking as another new tele power supply circuit.

For some time, engineering literature has carried information on the application of series resonant cir-

cuits and of inductive current surges in producing the high potentials used for television.

Based on the low current requirements of the high-voltage circuits connected with the kinescope, systems have been designed which avoid the separate power transformer, providing d-c which is adequate for the purpose, yet reduces the danger involved in working around such radios by virtue of the low current-delivering ability of the circuits.

The new RCA and General Electric television sets are among those which employ this principle. As an illustration, note the partial schematic of the GE Model 801, which develops 8300 volts at the filament pin #2 of the type 8016 HV rectifier (V13).

For the practical radio servicer the most striking feature of this new circuit is, of course, the absence of a 110V primary on the HV transformer. Tracing through the dia-

gram reveals the primary to be an auto-transformer of a kind which will require sober study by any servicer who expects to make money in television. More about this later, however.

As is evident from the schematic,

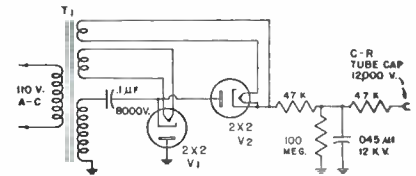

Circuit of Dumont Type 266 HV power supply, for several recent Teleset models.

primary current variations in the plate circuit of the horizontal-deflection output amplifier V12 induce voltages in the two secondaries. Shown opposite the lower primary winding is the circuit connected with damping tube V14, which has as its purpose the final shaping of the hori-

(Continued on page 134)

General Electric Model 801 high voltage power supply uses the "flyback" principle.

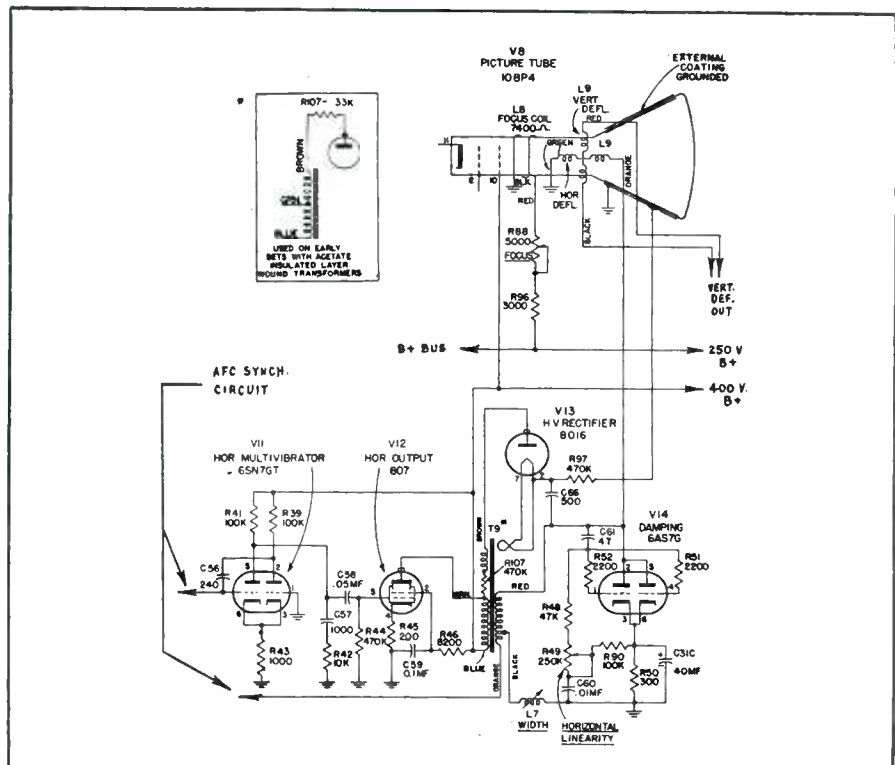

STANCOR

really has something
to meet your servicing needs



POWER PACK ••• Model 752

The Model 752 power pack provides a well filtered 6 volt D.C. supply from any standard 115 volt, 60 cycle source. Replacing messy and troublesome storage batteries for numerous types of service it is ideal for automobile radio sales demonstration or service test bench, effectively operating most push button tuning auto sets. Useful apparatus for industrial or laboratory testing. Best all purpose low voltage pack. All controls, knobs, voltmeter and terminals are visible and accessible on plainly marked escutcheon panel. Pack may also be used for auto accessories testing, battery charging, magnetic field exciting, electroplating, etc.

ask your jobber for the STANCOR 752

STANDARD TRANSFORMER CORPORATION
ELSTON, KEDZIE AND ADDISON • CHICAGO, ILLINOIS

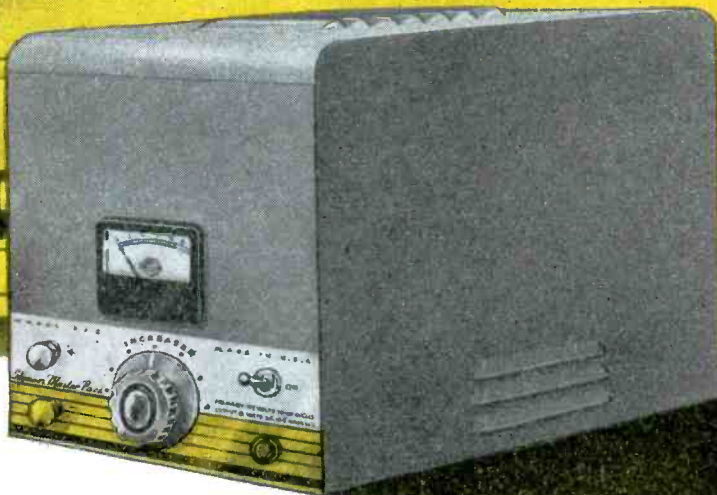

FOR DEMONSTRATING AND SERVICING

AUTO RADIOS AND
OTHER AUTO
ACCESSORIES

BATTERY CHARGING

OPERATING RELAYS
AND SOLENOIDS

REPLACING STORAGE
BATTERIES

LABORATORY
TESTING

BRUSH PLATING



Will your soldering iron support a new home?

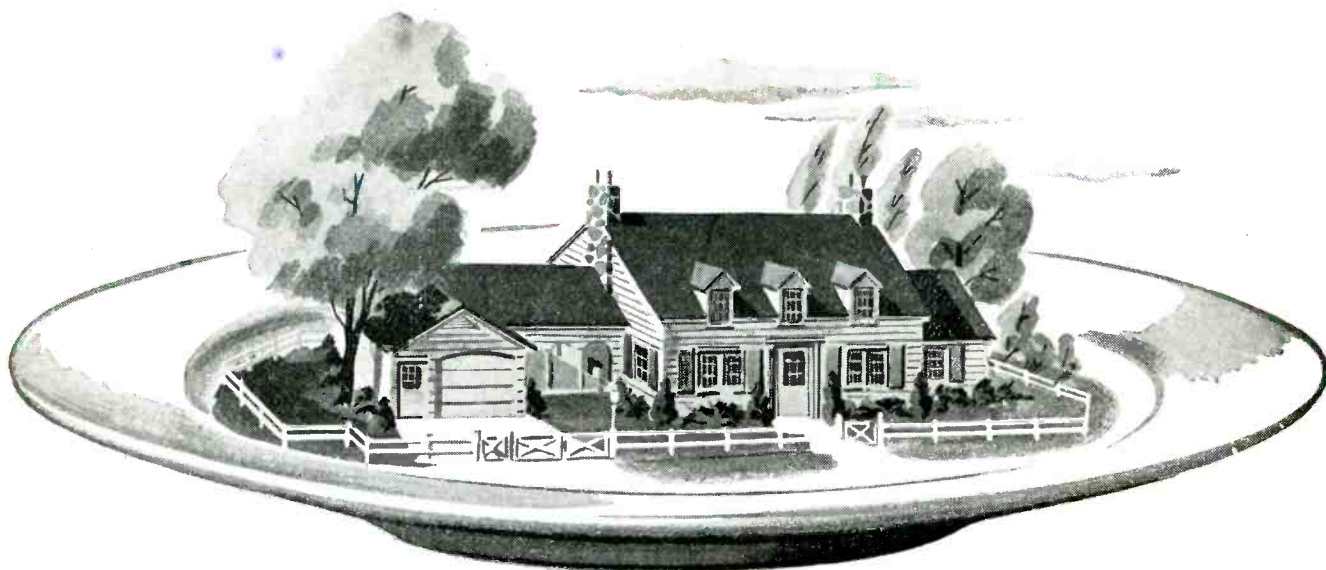

Yes!

We don't blame you or any radio technician for wanting a new home only you can't get it by wishing. You can with your soldering iron. Every electronic device you service requires the use of your soldering iron. Therefore, anything that gives you more time behind your soldering iron means more cash for you.

NEW BOOKLET FULL OF MONEY-MAKING IDEAS

What can you do to make more money? This question is answered by a straight-shooting booklet called "Keep Your Iron In The Fire", part of a complete service-sales program initiated by IRC in the interest of servicemen. Ask your IRC Distributor for your copy . . . today. International Resistance Company, 401 N. Broad Street, Philadelphia 8, Pennsylvania. In Canada: International Resistance Company, Ltd., Toronto, Licensee.

HOT TIP* Canvass your locality for service business with a postcard mailing. Business reply mailing pieces are available through your IRC Distributor . . . 2 colors, imprinted with your name and address. * From "Keep Your Iron In The Fire"

IRC



11

SHORT CUTS TO SERVICING

"Quick, easy and efficient" . . . that's how servicemen describe IRC's 11 Tap-In Shafts. No fiddling or fussing with shaft inserts or "build-ups" . . . no money tied up in stocks of exact replacements. A smart tap of the hammer and the tapered surfaces of control and shaft lock together, forming a permanently tight attachment.

In combination with the IRC Century Line of Volume Controls, these 11 Tap-In Shafts are the logical answer for over 90% of your replacement problems. Save you time and money. Time saved means extra time for other money-making jobs . . . money saved means greater profits. The latest edition of the popular IRC Volume Control Replacement Manual is now available. Contains information on nearly all models up to 1946, complete listings for the 1941-42 sets coming in now for repair. 156 pages. 25c at your IRC Distributor. International Resistance Company, 401 N. Broad St., Philadelphia 8, Pa. *In Canada:* International Resistance Co., Ltd., Toronto, Licensee.

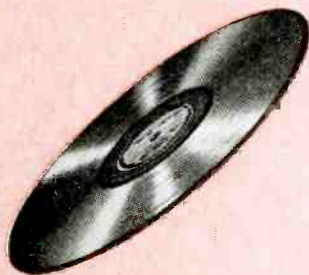

YOU'RE ON THE AIR! A sensational new one minute spot announcement to boost service business has just been released by IRC through IRC Distributors. Listen in and cash in on this promotion!

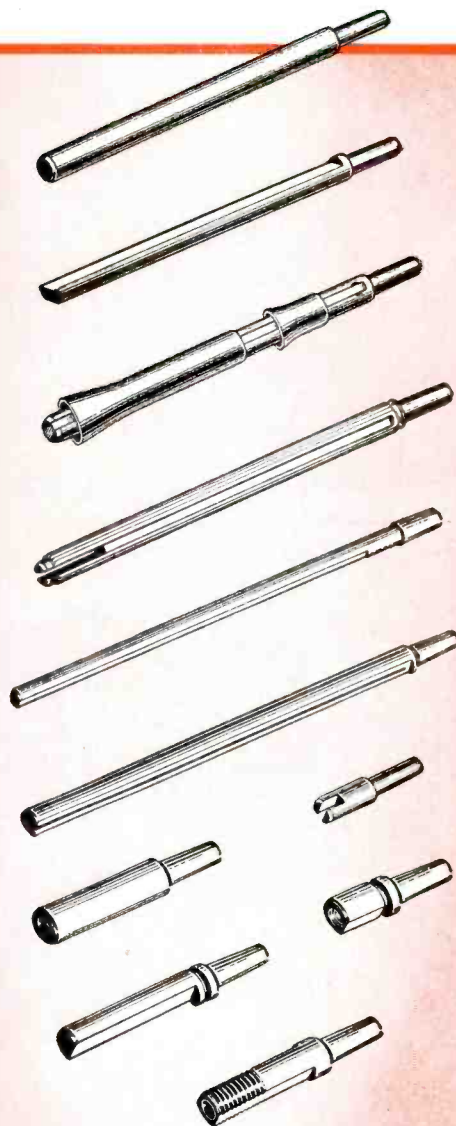

INTERNATIONAL **IRC** RESISTANCE COMPANY
Wherever the Circuit says Ω

Newest Items for Sound PA Profits

Universal Microphone STROBOSCOPE

Phonograph turntable speed can be checked with the Universal Stroboscope selling for 25 cents. The 6 in. cardboard disc is imprinted with four circles checking standard speed 78 RPM and transcription turntables 33 $\frac{1}{3}$ RPM under either 25, 50, or 60 cycle light. Universal Microphone Co., Inglewood, Calif.—RADIO & Television RETAILING

Atlas MIKE STAND

Model CS-1 is a microphone support stand which collapses to a length of 23", and extends to full standard length. Leg braces are above the actual legs, lessening obstructions when grouped with other

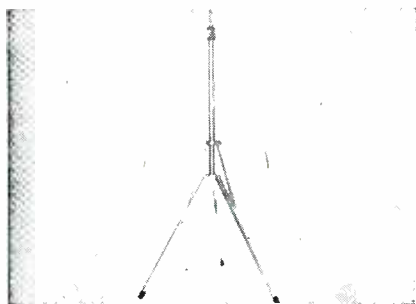

stands. Collapsible legs are plated steel for strength and stabilizing weight, while the tubes are brass, chromium plated. Leg assembly locking screws are staked in place, and the clutch assembly is the "velvet action full-grip" as used on the standard models. Legs are tipped at bottom with rubber bumpers. Atlas Sound Corp., 1451-39th St., Brooklyn, N. Y.—RADIO & Television RETAILING.

Western Electric AC-DC AMPLIFIER

Model 140A ac-dc amplifier is designed especially for wired program service tie-ins, and can be operated directly from telephone lines without isolating coils. No special grounding arrangement is required, eliminating the internal noise sometimes caused by such a connection. Western Electric Co., Inc., 195 Broadway, New York 7, N. Y.—RADIO & Television RETAILING.



Audar BINGO AMPLIFIER

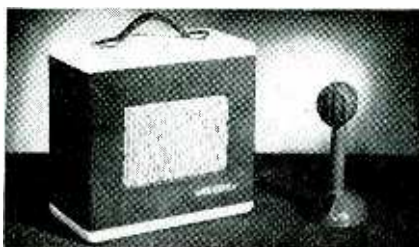

Model MAS-4 comes in a leatherette carrying case with handle including a 6 $\frac{1}{2}$ in. speaker and 115 volt AC amplifier. A hand microphone with 20 ft. of mike cable is normally used for close talking. Audar, Inc., Argon, Indiana.—RADIO & Television RETAILING.

Dormitzer UTILITY AMPLIFIER

Designed to withstand the abuse typical of restaurants and garages, as well as office to stock room paging and in small stores, this 4-5 watt amplifier has provision for 4 microphones at 50 ohms balanced line providing a gain of 60 db. A switch

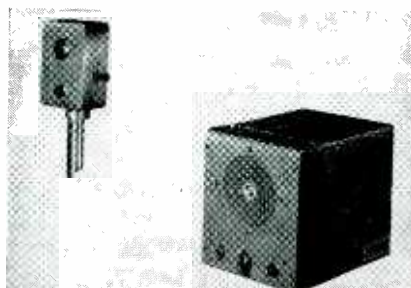

and busy signal lamp lights when more than one microphone is used. The microphone is a low impedance dynamic type with a push to talk operating lever. Dormitzer Electric & Mfg. Corp., 782 Commonwealth Ave., Boston 15, Mass.—RADIO & Television RETAILING

Masco PORTABLE SOUND SYSTEM

Model MAS-808 consists of an 8-watt amplifier and one heavy duty 10 in. P.M. speaker with 25 ft. of cable and plug mounted in a two-tone fabricoid covered carrying case. The amplifier has sufficient power to drive a second speaker. This portable unit is designed for small halls, lodge rooms, hotel meeting rooms and similar uses where a permanent sound system is not warranted. Mark Simpson Mfg. Co., Inc., Long Island City, N. Y.—RADIO & Television RETAILING.

Shure SONODYNE

The new Sonodyne moving coil dynamic microphone covers from 70 to 9000 cps. The die cast case is mounted on a swivel to take advantage of the semi-directional



characteristic of the microphone. Output level is 52 db below 1 volt per dyne per square centimeter. The instrument can be used in high temperature and high humidity locations. Shure Brothers, Inc., 225 W. Huron St., Chicago 10, Ill.—RADIO & Television RETAILING

Newcomb SCRATCH FILTER

Model LP-1 is a filter and equalizer to reduce needle scratch when wired between a crystal pickup and an amplifier. Four steps of adjustment provide control on pickup response for all types of records. Suitable for installation either in commercial and professional systems or in the home phonograph. The LP-1 is designed to be connected by a servicer. Newcomb Audio Products Co., Hollywood, Calif.—RADIO & Television RETAILING

Western Electric LOUDSPEAKER

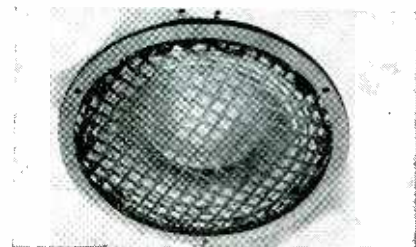

Model 750 A loudspeaker, illustrated, within a specially constructed box becomes a model 751B, with a frequency range from 80 to 10,000 cycles and an impedance of 8 ohms. A peak power input of 20 watts can be used in this permanent-magnet speaker, which provides a coverage angle of 60 degrees. Western Electric Co., Inc., 195 Broadway, New York 7, N. Y.—RADIO & Television RETAILING.

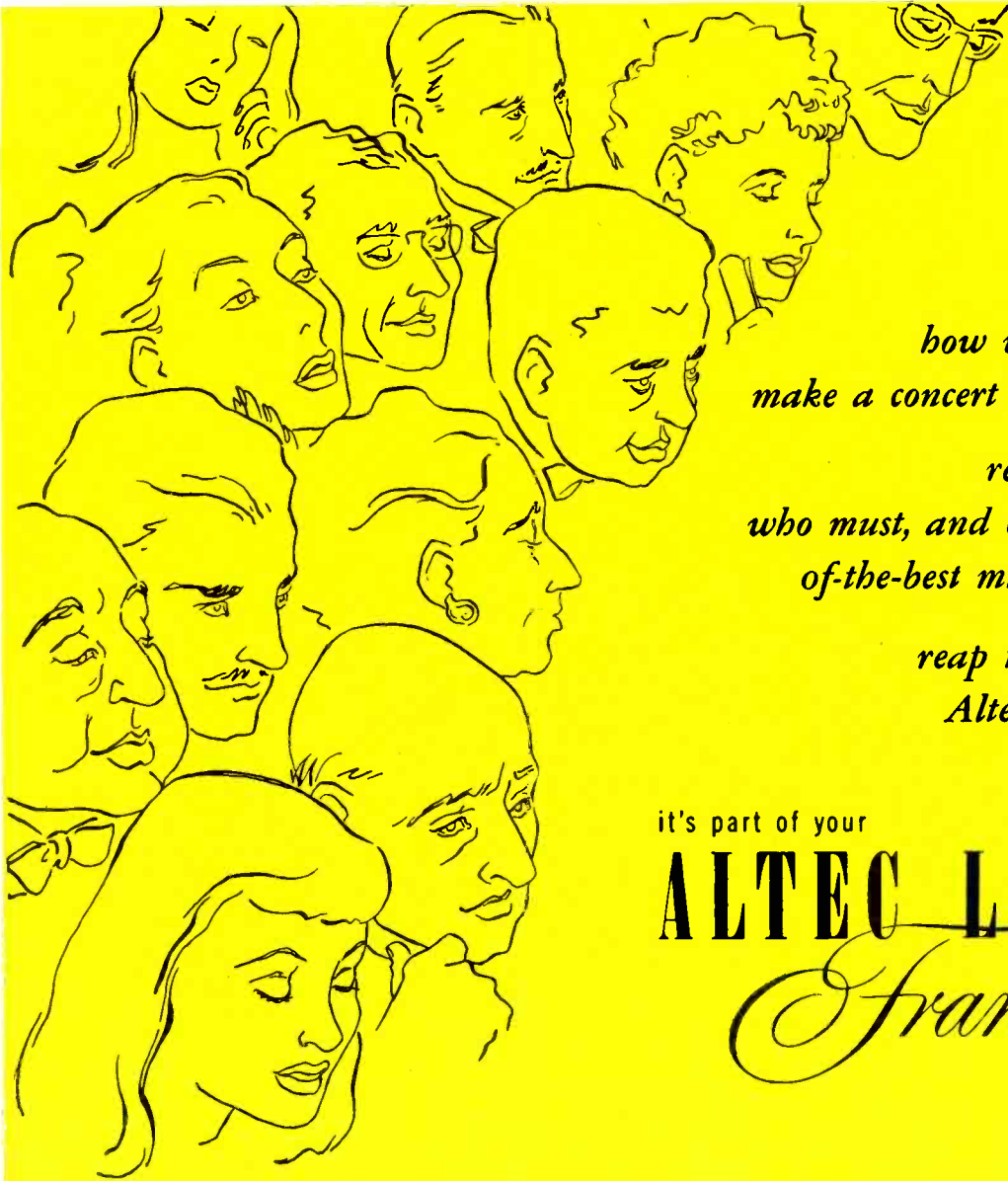

*how would you like to
make a concert hall appearance;
reach the audience
who must, and can, buy the best-
of-the-best musical equipment;
reap the prestige of an
Altec Lansing tie-in?*

it's part of your

ALTEC LANSING *Franchise*

Altec Lansing ads featuring the famous Duplex Speaker and names of franchised dealers appear regularly in important concert programs throughout the country. Now that production is back to normal, we are ready to award more franchises to select dealers. If you are interested in handling the unique Duplex Speaker, with its equally attractive profit opportunities, write us at once.



ALTEC
LANSING CORPORATION
4161 N. VINE ST., HOLLYWOOD 38, CAL.
250 W. 57th ST., NEW YORK 19, N. Y.

"KEEP ADVANCING WITH ALTEC LANSING"

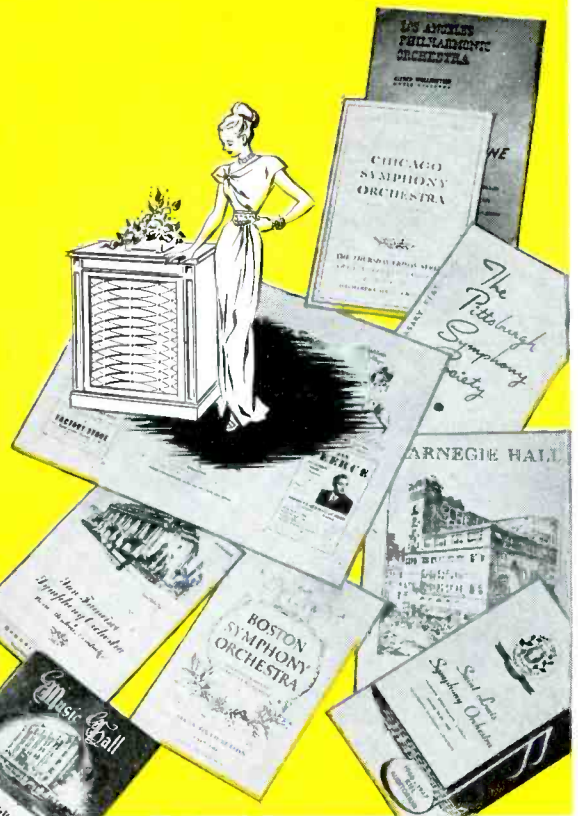

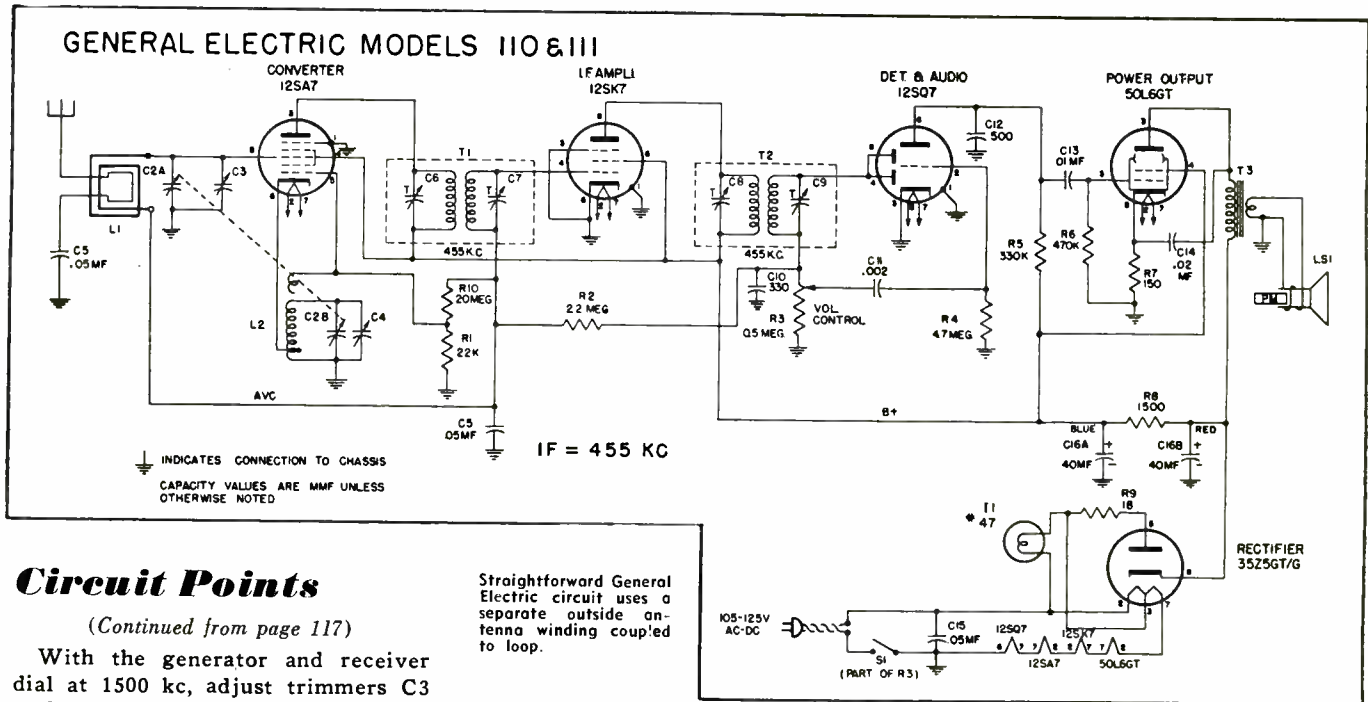

Circuit Points

(Continued from page 117)

With the generator and receiver dial at 1500 kc, adjust trimmers C3 (r-f) and C4 (oscillator) located directly behind the dial drive, for maximum signal output. Next, turn both receiver dial and generator frequency to 600 kc, and while rocking the tuning dial of the receiver vary L3, located between C3 and C4, for maximum signal. This 600 kc adjustment can be done only with an all-plastic or fibre screwdriver, as the insertion of the slightest bit of metal into the coil will detune the circuit.

The next adjustment is made at 1500 kc, by varying trimmer C4 for maximum signal output. Do not touch the C3 trimmer adjustment, however. Finally, retune L3 and C4.

GENERAL ELECTRIC MODELS 110 & 111 are five-tube superhets covering the broadcast band from

Straightforward General Electric circuit uses a separate outside antenna winding coupled to loop.

540 kilocycles to 1600 kilocycles.

The 455 kc i-f alignment is made by connecting the modulated signal generator through a .05 mf capacitor to the 12SK7 amplifier's grid pin #4. With the receiver's dial at the 1500 kc calibration point, adjust the 2nd i-f transformer trimmers atop the unit for maximum signal output across the voice coil leads.

Before making an alignment, turn the variable plates to the counter-clockwise stop, and make sure the dial pointer lines up horizontally. If it does not, remove the dial window and adjust by slipping the pointer on its shaft. Connect the line cord through an isolation 1:1 ratio transformer.

The first i-f transformer trimmers are varied in the same manner while feeding the generator signal into the 12SA7 converter's grid pin #8, with a further final adjustment of the 2nd i-f transformer as well.

For the r-f alignment, the Beam-a-scope assembly should be connected and dressed in exactly the same location it would occupy if installed in the cabinet. With the 1500 kc generator connected to the antenna post through a 50 mf capacitor, and the receiver's dial set for that frequency, vary the oscillator trimmer C4 atop the front section of the ganged capacitor for maximum signal output, and then do the same for the r-f trimmer C3 atop the rear variable section.

Service Groups

(Continued from page 111)

ers, and above all, the general public, the importance of technically-perfect, completely reliable servicing.

- Back up your demand for top-grade servicing, by giving an all-out guarantee that counts . . . and back up the guarantee by putting every type of heat on members who fail to meet the standard. Publicity in your association periodical, and at meetings, are the channels for criticism.
- Get business for your members by two-way advertising deals with radio stations, by supplying accredited dealer and servicemen's lists to manufacturers, distributors, non-service dealers, and other organizations.
- Have monthly closed meetings for informal round-table discussion

of every type of immediate technical and business problems, such as financing and bookkeeping methods, selecting test equipment, how and where to buy parts, merchandising and selling methods, and servicing problems.

- Promote feelings of good will between servicers, dealers, distributors and manufacturers, to inspire greater public confidence in the qualified radioman.
- Organize classes on advanced radio, television and FM to be held after closed meetings as well as at weekly gatherings, with good lecturers.

Of outstanding interest in recent developments in radio service association work is the June 14-15 convention in Philadelphia of all radio servicers' organizations of Pennsylvania, called by the Federation of

Radio Servicemen's Associations of Pa.

To this meeting are expected to come representatives of other organizations from every part of the country, for the working out of ways and means of spreading the work and making a more prosperous business out of the radio service industry.

Why not take steps to see to it that your own organization is represented there, or at least is in touch with the convention? In fact, why not use this occasion to work for a revival of your prewar association, if it has been defunct since then? And while you're at it . . . will we see you there?

The columns of RADIO & Television RETAILING are open for news and opinions . . . applause and appeals . . . from yourself and your association. *Let's get together!*

NO OTHER SERVICE GIVES YOU THESE EXCLUSIVE PHOTOFACT* ADVANTAGES



PHOTOFACT FOLDERS are based on OUR actual study of the equipment covered. We **ORIGINATE** information — we do not copy it! Every fact is quadruple-checked for accuracy. **NO OTHER SERVICE COMPARES WITH PHOTOFACT.**

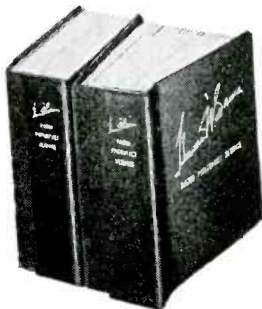

PHOTOFACT VOLUMES I and II

The first 20 Sets of PHOTOFACT Folders are now available in Two Volumes—Think of it! Almost 3800 pages, covering approximately 1800 NEW 1946 & 1947 Models and Chassis designations—Yours for only \$18.39 each. If you prefer drawer filing, order any or all of the 20 individual sets of folders @ \$1.50 per set—Less than two cents a model.

HOWARD W. SAMS & CO., INC.
Indianapolis 6, Indiana
My (check) (Money order) is enclosed.
Send Vol. I () Vol. II ()
Set No. ()

Name _____
Address _____
City _____ State _____

COMPARE BEFORE YOU BUY

Ask to see PHOTOFACT VOLUMES I and II the next time you visit your parts distributor. Look through the books. Notice these Points: The same complete data always in the same easy-to-find location! The schematic and pictorial diagrams for every Post War set—**BIG, CLEAR, ACCURATE PICTURES**—Each with its simple coding system keyed for instant reference to

complete parts lists for every instrument! The full alignment and circuit data! The disassembly instructions! The Dial Cord Drawings. And, even RECORD CHANGERS are completely diagrammed.

Now put any other service beside PHOTOFACT and compare—That's all we ask. Use PHOTOFACTS once—You'll use them forever.

YOU'LL WANT PHOTOFACT

Individual PHOTOFACT Folder Set #20 available June 15 at the same low cost of \$1.50. Order PHOTOFACT Volumes I

and II or the individual sets of Folders from your distributor, OR directly from us.

ASK THE MAN THAT USES PHOTOFACTS

Export—Ad. Auriema—89 Broad St., New York 4, N. Y.—U. S. of America
Canada—A. C. Simmonds & Sons, 301 King St. East—Toronto, Ontario

HOWARD W. **SAMS** & CO., INC.
INDIANAPOLIS 6, INDIANA

PHOTOFACT SERVICE

"The Service that pays for itself over and over again"

*Reg. U. S. Pat. Off.

Show Biz PA

(Continued from page 113)

the six speakers and amplifier of the free-act stage.

During the reconstruction work, five sets of twisted pair, lead-covered 500-ohm lines were run through underground conduit, along with the electric light and power wiring, in accordance with the newest electrical codes. Terminating in concrete vaults, feeders in turn radiate to individual speaker outlet boxes with matching transformers.

Since the five lines, when completed, will ultimately make a complete circuit of the park, with at least one available as a spare at any point, it will be possible to cut in a mike and amplifier at any area of special interest, to "take over" the entire 25-speaker string.



Five of the 6 speakers used on Bingo game.

Music from the dance-floor namebands will be piped in this manner, with only a remotely-controlled relay operated from a spare line needed to turn on the main phonograph-music pickup during the band's rest periods.

Sound is used for many purposes, in smaller systems all over the park. Main business-puller-bally at the Cockeyed Circus or Fun House are three animated figures, each wired for sound with a separate amplifier and speaker, while indoors, a fourth independent system is used to issue advice to fun-loving customers.

Two speakers, an amplifier and a record changer replace the old-fashioned organ at the Merry-Go-Round, while a six-speaker setup with microphone takes care of the Bingo game. The Auto Scooter requires 2 speakers for music and directions, as does the Motordrome, and so on around the entire area.

While a complete installation such

as this may well cost \$25,000, sound dealers desiring more modest jobs will find plenty of work to their liking wherever there are fairs, carnivals and amusement parks. Why not try it this month?

Tele HV Circuits

(Continued from page 126)

zontal saw-tooth wave, its application to the horizontal deflection coils and the suppression of all but the first half cycle of shock-excited oscillation resulting from the horizontal yoke coil and output transformer inductances.

Since scanning and deflection will be treated in a coming issue, this part of the T9 output transformer circuit will be left for then. Above the saw-tooth output winding, however, can be seen another, smaller winding, which by means of a severe step-down ratio provides filament voltage for the type 8016 rectifier. Attached to the filament circuit is a 500 mmf capacitor C66 and 470,000 ohm resistor, R97, which are sufficient to filter the HV for application to the 2nd anode, consisting of an internal coating along the flared portion of the cathode ray tube. The small size of this capacitor aids in making the power supply less dangerous, because less energy is stored within it.

The illustration of a horizontal deflection and high voltage transformer, used on all directly viewed RCA television receivers, according to Antony Wright in the RCA Review, shows the two-turn HV rectifier filament coil of polyethylene insulated wire supported between two textolite discs, at the right side of the photo. The molded sponge iron powder core consists of three elements clamped on top and bottom with sheet metal clips and strapped together with the long tiestrap.

The remaining three windings are

arranged to provide safe operation at the high voltages involved. The lowest-potential secondary shown between terminals 4 and 6 of the RCA circuit is wound next to the core. The primary winding is on top of this, and then the high voltage winding, which is a continuation of the primary, is wound on the outside. The last-named winding may be seen to the left of the inner textolite strip.

The principle behind this "flyback" circuit about which experienced television servicers have been hearing, is simple to understand. The power for the HV supply is obtained from the energy stored in the deflection inductances during each horizontal scan. When the 6BG6G amplifier's plate current is suddenly cut off by the negative portion of the incoming saw-tooth signal, a very strong positive pulse appears on the T109 primary due to the collapsing field in the deflection coil. This pulse of voltage is stepped up, rectified, filtered and applied to the second anode of the kinescope. Another important use for this source of voltage will be discussed in the next installment of this series on practical television repairs appearing soon.

Auto Radio

(Continued from page 115)

pressors must be installed, one in each plug lead.

Still other causes of noise may be encountered. Severe generator noise, for example, may not be entirely eliminated by the filter previously mentioned. To check it, drive the car at a speed well above that necessary to cause the ammeter to indicate a charging current, then turn the ignition switch off, with the car still in gear.

If, even with the ignition off, a whining noise is heard from the

(Continued on page 144)

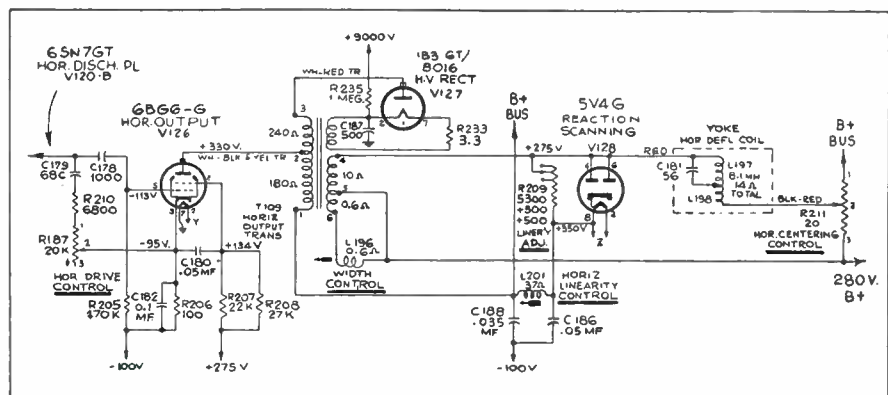

Horizontal and high voltage circuits of RCA's new model 630 TS television receiver.

Nationally
FAMOUS
GIFTS

FREE



DORMEYER
Electric Mixer



HEALTH-O-METER Scale

MARLIN Rifle
.22 Caliber

REMINGTON
Electric
Shaver



DELTA
SPOTLIGHT



EASTMAN KODAKS

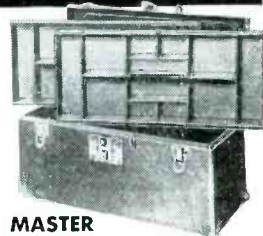

MASTER
METAL Radio
Tool Box

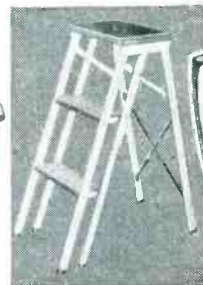

STEP-STOOL
Folding Ladder

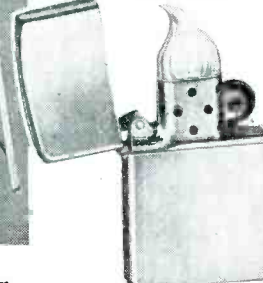

ZIPPO Lighter

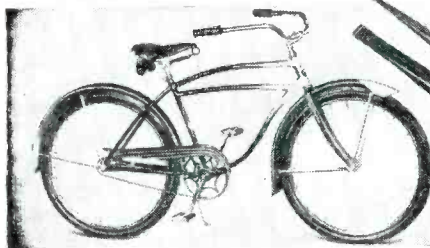

ARNOLD SCHWINN BICYCLE



PIPES
by
KAYWOODIE



RADIO-STEEL
Scooter

**NOBODY BUT OLSON
GIVES YOU A BREAK
LIKE THIS!**



WESTINGHOUSE
Electric Roaster

**RADIO REPAIRMEN'S
PRICE GUIDE**

FREE!

60 pages of new
Olson Bargains in
Radio Parts, Sound
and Testing Equip-
ment. Includes sec-
tion of FREE GIFTS.



PASTE COUPON
ON POSTCARD

**GET
THIS
BARGAIN
BOOK
NOW!**

Remember, our nationally advertised Radio Parts are priced very low, so you get a better deal in every way at OLSON RADIO WAREHOUSE. Don't wait another minute. Send the coupon for our big new Catalog of Radio Parts and Free Gifts NOW, and start saving those Olson Pointers!

CALLING all radio servicemen and amateurs! You get an honest-to-gosh share in the profits when you buy your Radio Parts from OLSON. We sell the dependable quality Parts you need, and we GIVE AWAY these fine premiums and many others listed in our new Catalog. No strings to these gifts; you don't pay a cent of cash for them. You get them with OLSON POINTERS. Read on!

Olson sends you a free POINTER for every dollar's worth of Parts you order from us. Just pick out the gifts you want and save enough Olson Pointers to get them FREE. No cash, no "box-tops" required. There is NO LIMIT to the number of Free Gifts you can get. Look at the famous brand names on our premium gifts! We selected them carefully so you won't be disappointed. It's all GOOD STUFF!

OLSON RADIO WAREHOUSE, Inc.

73 E. MILL ST., DEPT. 86, AKRON, OHIO

I want to save Olson Pointers for premium gifts. Send me your new FREE Premium Book and Price Guide right away.

NAME _____

ADDRESS _____

CITY _____

STATE _____

Sales Tips and Profit Pointers

When he considers the huge resources, know-how and facilities of the manufacturers who make the products he sells, the salesman can well feel that he is a partner in big business. He has plenty of sales ammunition to use in impressing the customer when he describes the importance of the manufacturer and the reputation and ability of his firm to back up the products offered the customer.

Don't you believe that you've got to be a stereotyped salesman type in order to succeed in selling radios and appliances. Be an *individual*—a *personality*. Customers will remember *acceptable* distinctiveness in the individual from whom they buy.

The good merchant is always on his guard to avoid doing anything which will make his competitor dislike him—complain about him publicly. When one merchant launches a campaign of attack on another, indulging in personalities, he's bound to make numbers of customers believe that his competitor is a dog, and impress certain others that he (the complainer) is a sorehead and a poor loser.



In selling customers "up", the smart salesman should realize that *more* people are skeptical of *low prices* than of *high prices*. This is a merchandising truth overlooked by far too many merchandisers.

Some dealers are "stuck" with shortage-bought "cats and dogs" and are worrying about moving such merchandise out. While it's certainly smart to leave no stone unturned in offering good buys on such stuff, it's very risky to keep *nothing* but these "distressed" products on display. The dealer should keep his permanent lines and brand-names in front of the public even if such exhibits are made up of samples only. In this way the store will not lose its identity as a good merchandising center.

The salesman should not feel in awe of "great" persons. After all, the man who's selling the products usually knows a great deal more about them than the prospective buyer who may be a big-shot politician, a movie star or a business tycoon. It's unwise to develop an inferiority-complex just as it is to build oneself up to be a smart aleck.

The Guest Experts of the Month Say—

The importance of sales people in customer relations is now almost back to its pre-war level. Today the men and women at the point of sales again hold the key to successful development of new business. The product, its quality and its components, must be known and thoroughly understood now more than ever before.—*Floyd W. Bittaker, national sales manager, Capitol Records, Inc., Hollywood, Cal.*

The byword for the discerning retailer will be "Give the customer what he wants" and this will mean streamlining his entire sales line to include those brand names backed up with production experience and trade reputation. Under the reasonably free economy of the near future, reliability and performance set the theme. This theme carries out the desires not only of the retailer, but of the customer himself.—*William Kelley, general sales manager, Galvin Mfg. Co., (Motorola) Chicago, Ill.*

Radio-combination and phono record salesmen should never get drawn into arguments about music or musicians. One salesman sneered at a certain crooner, only to find, to his dismay, that the prospective customer was a music arranger for the famous man-with-the-voice.

Should-Demonstrate days are back with us again. But a short time ago, many a consumer accepted a wrapped package containing a small appliance, or took delivery on a large one without even knowing what the products looked like. Now that the buyers' market is virtually here, the need for telling the customer how the appliance works is more apparent than ever.



It's bad business to comment upon the unusualness of a customer's name, speech accent, odd dress, etc. It's also unnecessary to tell the customer about yourself unless asked to do so. Most customers will be bored to the point of non-purchase by the salesman who explains the origin of his name, his place of birth, former occupations, etc. Confine sales talks to the worth of the products and the reputation of the firm.

Here's Your Answer

to

① **Smaller Inventories**

② **Greater Profits**



New, Streamlined **SNC Transformer Line Is First With More Applications From Fewer Styles**



SNC Model 8P205
...A popular type of
Power Transformer

Now, for the first time in history both manufacturers and dealers in electrical equipment can meet their widest transformer installation requirements with a minimum of stock. The entire SNC line of quality transformers is engineered to eliminate the endless variety of sizes, shapes and restricted applications that have afflicted the industry in the past.

Only 10 pages of specifications in the new SNC easy-to-read catalog cover most modern small transformer applications! This means money saved both through elimination of frozen inventories and through greater stock turnover. *Either saving means more profits for you.*

Send for the SNC catalog shown above. A quick reading will convince you of the many advantages offered by this quality transformer line.

*Remember! SNC gives MORE applications with
SMALLER inventories for GREATER profits!*

SNC **MANUFACTURING CO., INC.**
Quality Transformers
WEST LAKE AVE. AND LEHIGH • GLENVIEW, ILLINOIS

FM Sales Trends

Low-Priced Receiver-Tuner with FM Only

A new FM-only table model, which is introduced as "the people's FM radio set—priced to reach the listening masses" is now being marketed by Electronics, Inc., 934 Bowen Building, Washington, D. C. The firm is the exclusive sales agency for the unit, a combined FM receiver and tuner with 7 tubes, covering the 88 to 108 mc. band.

The company announced that "the set is not only self-sufficient as a tuner-receiver unit, but it can be instantly



The new set is styled to blend with regular console styles—in hand-rubbed mahogany.

'jacked' into AM console-type sets to take advantage of larger speaker set-ups . . . thus, people who have good AM consoles may now obtain high-fidelity FM reception with a minimum additional investment."

Electronics, Inc., said that it plans to deal with FM broadcasters in promoting volume sales of the unit. It was hoped that by keeping the price low, and offering the AM-converter feature, that the big-scale merchandising of the set "will cut to months what might otherwise be years of unprofitable FM broadcasting."

The company said that the FM antenna transformer used in the set "is a specially designed broad-band unit which needs no further tuning after installation and makes possible excellent sensitivity, without the necessity of an external antenna." The receiver is made by Airadio, Inc., Stamford, Conn.

Ward Products' New Line of FM Antennas

In announcing its new line of popularly-priced FM antennas the Ward Products Corp., 1523 E. 45th St., Cleveland 3, Ohio, says that "it marks the initial application of mass-production technique into what heretofore has been largely a field of expensive custom-built designs."

The antennas are available in both folded and straight dipole types, either of which may be equipped with a reflector to

provide maximum directional gain without interfering reflections. Sturdily constructed, and easy to install, the units are designed to operate in the 88 to 106 mc band, and to assure matched impedance to the sixty-foot polyethylene-insulated 300 ohm colinear transmission line.

A universal base mounts at any angle on roof or wall. The sturdy vertical element revolves or tilts in the base allowing complete flexibility in orienting for maximum gain. The dipole element is constructed of corrosion-preventative aluminum. All other parts are completely weatherproofed inside and out. A ring is provided for attaching guy wires. Exclusively designed stand-off insulators for the transmission line minimize capacity to ground and eliminate reflections on the line.

Stewart-Warner FM-AM Receivers Arrive

Initial shipments of the new Stewart-Warner FM-AM radio sets, including two console type radio-phonograph combinations, have begun with distributor and dealer sales meetings in ten eastern and southern cities.

With the first deliveries, J. R. Brandenburg, assistant sales manager of the Stewart-Warner radio division conducted successive promotional meetings in Newark, New York City, Philadelphia, Baltimore, Jacksonville, Miami, Atlanta and Chattanooga. Edward Rutledge, eastern sales manager, held meetings in Boston and Manchester, N. H.

The console type FM-AM radio-phon-

graph combination, the "Musidora," comes in standard and deluxe models. The latter has an intermix record changer, a slanting dial panel and two storage compartments for records. The other model has a standard changer, a straight panel and one compartment.

Both sets are a-c and tune AM band 540-1600 kc., and the FM band 88-108 mc.

Sharp Advances in FM Receiver Production

That the production of FM receivers this year will be twelve to fifteen times the number made in 1946, has been predicted by H. C. Bonfig, vice-president of Zenith Radio Corp. Mr. Bonfig's estimate for total output of "over two million" was nevertheless more conservative than the recent one made by RMA, whose figure was 2,600,000.

The Zenith executive's estimate for 1948 was a round 5,000,000. He said further that as of today anybody who buys any radio set—other than a portable, inexpensive table model, or automobile set—that does not contain FM, is buying a radio that is already obsolete.

Bonfig declared that, in his opinion, the predicted business recession, if it comes, will not cause any slowing up of FM; that it might do just the opposite. "A trend toward tighter buying," he said, "would cause people to think again before purchasing even a second radio without FM. The result could be a noticeable slackening on straight AM sets, and growing pressure for more with FM."

Meeting on FM and Tele Test Equipment



The need for modern servicing equipment in handling FM and tele sets was emphasized by Raymond Andrews, merchandising manager, Sylvania Electric Products' radio tube division, at this sales meeting held by Dale Distributing Co., New York. Front row, l. to r., Larry Vogel; Sig Gordon; Gerry Brandwin; Milton Saper. Second row, Nick Savage; Paul Smith; Harvey Appelbaum; Cy Joseph. Third row, William Haberman; Al Land; Charlie Fox. Standing are Rene Jacobs of Dale; Mr. Andrews; Sam McDonald, also of Sylvania; Warren Pringle of Dale's New Jersey branch; R. A. Penfield and R. E. Lamar of Sylvania.

**224
OPPORTUNITIES
TO WIN!**

\$4,325⁰⁰
WORTH
OF

PRIZES

**IN CASH
and
Servicing Equipment**

JUST TELL WHY
(in 100 words or less)

**"RIDER MANUALS
MEAN
SUCCESSFUL SERVICING"**



Yes, that's all you need do. Nothing to buy, nothing on which to beat your brains out.

Anyone of the tens-of-thousands of servicemen who have enjoyed the many benefits of RIDER MANUALS during any of the past seventeen years has the answers at the end of his pencil, ready for placing on the official entry blank available at all jobbers. And, a newly established serviceman has an equally good chance of winning by merely going over RIDER MANUALS at his jobbers' and reading the RIDER MANUAL ads appearing in national radio publications every month. You don't need to be a fancy writer, even spelling and grammar are unimportant. Just, in plain, everyday conversational English, write us 100 words or less on why you believe "RIDER MANUALS mean SUC-

CESSFUL SERVICING." The first thing you write may win you one of the many substantial cash or servicing equipment prizes.

Note the rules which have been kept easy in order to promote the purpose of the contest, i.e., to quickly acquaint as many servicemen as possible with the many time-saving, profit-making features of RIDER MANUALS.

Entries should be submitted on the official RIDER MANUAL CONTEST entry blanks which are available at your local parts jobbers. It is designed to make it still easier for you to win one of the 224 valuable prizes. Do it today. Send in your entry early!

**DON'T PUT IT OFF—WRITE IT DOWN!
SEND IN YOUR ENTRY TODAY.**

SUCH EASY CONTEST RULES!

1. Nothing to buy. Just send in 100 words or less giving your reasons why "Rider Manuals mean Successful Servicing," and indicate on the official form, the name of your preferred parts jobber.

2. Mail entry on the official contest entry blank obtainable from parts jobbers, or write direct to John F. Rider Publisher, Inc. for blank.

3. Entries must be postmarked no later than Sept. 15, 1947.

4. Entries will be judged on completeness, compactness and originality of expression of reasons. Judges will be John L. Stoutenburgh, Executive Editor of "Radio Retailing"; Herman L. Finn, C.P.A.; Lansford F. King, Advertising Agent. The decision of the judges will be final. Duplicate prizes will be awarded in case of a tie. All entries become property of John F. Rider Publisher, Inc.

5. Contest open to anyone interested in radio servicing, living in continental U.S., its possessions and Canada, except employees (and their families) of John F. Rider Publisher, Inc., its advertising agency, accounting company, the principals and executives of Rider jobbers, or Caldwell-Clements, Inc., publishers of "Radio Retailing."

LOOK AT THESE PRIZES!

For Contestants

1st Prize	Cash	\$500
2nd Prize	Cash	300
3rd Prize	Cash	200
4th Prize	Cash	100
5th Prize	Cash	75
6th to 10th Prizes (\$50 each)	Cash	250
11th to 40th	(30 equipment Prizes worth \$25 each)	750
41st to 80th	(40 equipment Prizes worth \$15 each)	600
81st to 140th	(60 equipment Prizes worth \$10 each)	600
141st to 224th	(84 equipment Prizes worth \$7.50 each)	530

For Jobbers of Winning Contestants

1st Prize	Cash	\$100
2nd Prize	Cash	75
3rd Prize	Cash	50
4th Prize	Cash	25
5th Prize	Cash	20
6th to 10th Prizes (\$10 each)	Cash	50
	Total	\$4,325

JOHN F. RIDER PUBLISHER, INC. • 404 Fourth Ave., New York 16, N. Y.
Export Division, Rocke International Corp., 13 East 40th Street, New York City. Cable ARLAB

Broadcasting to the Fans at Home



Video programming makes a home run by picking up the big ball games. The scene is at New York's Polo Grounds, with the cameras of NBC's Station WNBT set to cover all New York Giants home games.

Television Topics

Twenty-Five States on New Video Station List

The latest count on the commercial television stations in the country shows that there are 73 transmitters in the works, in various stages of progress. Twenty-five states are represented.

The commercial licensees on the air include the well known stations in Chicago, New York City, Schenectady and Philadelphia. The CP (construction per-

mit) holders on the air include stations in Los Angeles, Washington, Detroit and St. Louis.

The list of stations with CP's outstanding is the longest one. There are ten of these in California; three in Washington, D. C.; three in Illinois; one each in Florida, Indiana, Iowa, Kentucky, Louisiana, New Jersey, New Mexico, Oregon, Rhode Island, Utah, Virginia, Washington and Wisconsin; two each in Massachusetts, Michigan, Minnesota and Texas; three in Maryland; four in New York; six in Ohio; and four in Pennsylvania.

The group of stations with applications pending includes two in California and two in Ohio; one each in Indiana, Massachusetts, Michigan, Pennsylvania and Texas.

Installation Meetings for Dealers and Servicemen

Another weekly series of weekly demonstration and discussion sessions on the installation and servicing of television receivers are now being sponsored by Viewtone Television & Radio Corp., at its plant at 81 Willoughby St., Brooklyn, N. Y. Robert Stuhler, the Viewtone vice-president, said that the meetings will help dealers in handling all makes of video sets not just the Viewtone models. Such matters as the alignment of the

← De Luxe Entertainer

Feature movies and baseball games are shown on this RCA television unit for veterans at Mt. Alto hospital, Washington. VFW presented the set.

video units, locating and correcting trouble—and the details of installation procedure will be dealt with at the sessions. Viewtone engineer Julie Jonas will be in charge. The know-how and the experience gained by dealers, engineers and servicemen who have already installed over 4,000 viewtone receivers in various localities, will be used as a basis for the weekly instruction.

Big-Picture Sets in Nation's Capitol

A group of Washington, D. C., dealers including Ballard's Music Store, George's Radio Co., Yost's Electronics of Bethesda, W. & J. Sloane, Jack Stone Co., Electronic Engineers, Inc., and others welcomed viewers during "Television Week" in the city and stated that many were prospective customers for either the "Tavern-Telesymphonic" or the big-screen home model, the "Tele-Symphonic." Both are "Big-Picture" units made by U. S. Television Mfg. Corp.

Mr. Walter Ballard, Manager of Ballard's said, "So many people crowded outside our windows as soon as the UST Big-Picture sets were in operation that I was afraid police would complain about stopping traffic." The manager of W. & J. Sloane said, "I had no idea television had reached the perfection it has in the UST Big-Picture receiver." Bill Yost, Jr. of Yost Electronics put one set in a neighboring bowling alley to accommodate over 200 viewers.

Later, UST also demonstrated its sets at the Metropolitan Horse Show in New York City, where the total attendance was estimated at 100,000

Video Show Boosts Store Sales

Gimbel Brothers, television-minded Philadelphia department store, is back on the air with a new program on Philco television station WPTZ, featuring Jack B. Creamer, "The Handy Man," network radio star in a 15-minute program.

This new Gimbel's show is built around post-war home furnishings and is designed to make housework easier. It follows the store's basic television plant of showing and describing merchandise in action.

David Arons, Gimbel publicity director, points out that the series of 21 television shows on WPTZ sponsored by Gimbel's in 1946, when the viewing audience was much smaller, produced as high as 3% sales return. He also notes that a recent study in Philadelphia proved today's average tele-customer is in the higher-than average income bracket and, in one big retail store, bought \$45 worth of merchandise over a given period as against average store sales of \$8 per customer.

Motorola Video Expansion

Paul K. Povlson, vice-president in charge of operations for Motorola, has announced that work on a one-story production building has begun. The structure will contain 22,000 sq. ft. of space, designed for production of the Motorola television receiver.



RADIO *& Television* RETAILING

DIRECTORY ISSUE

September

THE FIRST DIRECTORY of

"Big 4" **PRODUCTS**

RADIO • APPLIANCES • RECORDS • SERVICE

The "Big Four" DIRECTORY issue will contain the names, addresses and products of manufacturers in the four chief merchandising groups selling through retailers in this trade: **RADIO** (AM, FM, television); **ELECTRICAL APPLIANCES**; **RECORDS** (phonographs, needles, albums, cabinets, accessories), **SERVICE** (replacement parts, tubes, sound and test equipment). While RADIO & Television RETAILING has published the annual Radio Trade Directory for many years, this is the first Big Four DIRECTORY. *For the first time in a regular monthly magazine*, the principal Big Four suppliers will meet the largest group of buyers.

RADIO & Television RETAILING editorially advocates the Big Four plan* to help dealers sell and service this variety of products. Now, the Big Four DIRECTORY issue will give the latest information on where to buy. With dealers and distributors using this issue for the next twelve months, it is important that manufacturers supplement the editorial listings with their full-line product advertising. Whatever else you do, tell and sell your trade in September RADIO & Television RETAILING. Deadline is August 1.



* Side-by-side merchandising of related products like radio, appliances, records, plus servicing, is this field's greatest postwar trend. For the increasing thousands of Big Four dealers, RADIO & Television RETAILING

is published as a four-sectioned magazine each month. This is the only publication supplying dealers full information on their chief retailing and servicing needs --within the covers of regular monthly issues.

CALDWELL - CLEMENTS, INC.

480 Lexington Avenue
Chicago 6

New York 17
Cleveland 14

New York 17
Los Angeles 5

PLaza 3-1340
San Francisco 4

Jobbers in Action

Coast-to-Coast News Bulletins on Distributors

EL PASO, TEX.—W. C. Johnson, general sales manager, Admiral Corp., has announced the appointment of *E. H. Krohn & Co.*, Box 185, this city, as distributor for all Admiral products in the Phoenix, Ariz., El Paso, Texas, and Albuquerque, New Mex., territories. Krohn will distribute both Admiral radios and appliances in these areas. This company has been in the distributing business for the past 24 years and is widely known throughout the southwest.

SOUTH BEND, IND.—Appointment of the *Andrews Distributing Co.* here as exclusive distributor of Stewart-Warner radios in 18 counties of northern Indiana and southern Michigan was announced by Floyd D. Masters, sales manager for the radio division of Stewart-Warner.

Located at 406 S. Columbia St. in South Bend, the Andrews firm is also represented in Fort Wayne and will serve dealers in both areas.

CINCINNATI, OHIO—Richard M. Lagatella has been appointed sales manager of the Cincinnati Branch of *General Electric Appliances, Inc.*, it has been announced by L. A. Isermann, branch manager.

MEMPHIS, TENN.—Now in its new building at 187 S. Dudley St., here, is the *Mills-Morris Co.*, well known distributors of radios and parts. J. M. Allen and C. P. Jones are recent additions to the radio parts department. Many leading products are distributed, including RCA electron tubes, Eveready radio batteries, Motorola aeriels and parts, etc.

The territory covered includes Western Tennessee, Northern Mississippi, and parts of Arkansas, Kentucky, Alabama and Missouri.

Olympic Branch



Jay Gardiner is the head of the newly formed *Olympic Appliances, Inc.*, Long Island City, N. Y., wholly-owned distributor to cover metropolitan New York (including Westchester county) for *Olympic Radio & Television, Inc.*

CHICAGO, ILL.—Howard Radio Co. has announced several new distributors to handle its complete line of radio receivers and radio-phonograph combinations. The new distributors are: *Allen & Jemison Co.*, Tuscaloosa, Ala.; *Tubbs Electric Co.*, South 165 Post St., Spokane 8, Wash.; *United Appliance Wholesalers*, 110½ W. Second St., Grand Island, Neb.; and *Grand Forks Supply Co.*, Grand Forks, N. Dak.

Arvin Appointment



Irving Leon, right, Cleveland, Ohio, jobber located at 214 National Terminals Bldg., is shown signing distributor franchise with Noblitt-Sparks Industries, to handle Arvin radios and electrical appliances in 23 counties of his area. At left is Gordon T. Ritter, Arvin director of sales; standing is Joseph Pelton, Middle Western district manager.

BOSTON, MASS.—Further expansion of the *Allied Appliance Co.*, distributing from 111 Berkeley St., here has been announced by Samuel Dane, president of the firm, and Ralph S. Cron, vice-president and general manager. One of the recent additions to the company is William L. Lever as head of the floor covering division. Roy Davey has been appointed director of promotion, as another part of the plan to provide full merchandising support to the dealers served by Allied.

PITTSBURGH, PA.—Harold W. Goldstein, president of *Anchor Distributing Co.*, here, reports that business has increased to such proportions that Anchor has taken over the second floor of the adjoining building for office use. Before the war Anchor was the exclusive distributor in the tri-state area for Crosley, Apex, and Domestic Sewing Machines. In addition the firm now handles Coleman heating equipment, Schaefer Pak-A-Way low temperature freezers and ice cream cabinets, Sloane-Blabon linoleum, Sanitas wall covering and a representative line of nationally advertised traffic appliances and housewares.

OMAHA, NEB.—Appointed as distributor for the Apex Rotarex Corp., Cleveland, is the *General Appliance Co.* of this city. General will handle Apex cleaners, washers and ironers in Nebraska and southwestern Iowa.

The organization, headed by Morris Levey, president, has 500 dealers and an experienced sales and service organization headed by Charles J. Kleyla, general sales manager, and Earl Brayman, service manager.

General is also distributor for Philco radios, refrigerators and room air conditioners, Grand gas ranges, and other lines.

LOS ANGELES, CALIF.—Selling, geared up to the buyers market, was the keynote of the two day sales meeting of the *Bandoli-McIntyre Co.* here, southern California electric appliance, radio and housewares distributor organization, in the Hollywood Roosevelt Hotel, Hollywood. V. J. McIntyre presided, and speakers in addition to M. S. Bandoli included C. H. Wilson of the Intercostal Co., and Joe Shull and A. A. Zoll of the D. E. Sanford Co.

SALT LAKE CITY, UTAH—Dealers of this area were guests of *Radio Supply Co.* of this city, Utah distributors for Hoffman Radio Co., at a sales conference here last month. Round table discussion among the retailers was led by D. D. Spence, assistant sales manager of the Hoffman firm.

PHILADELPHIA, PA.—Warren J. Miller has been named the new advertising manager of *Peirce-Phelps, Inc.*, prominent jobber in this city and Harrisburg. Jack Siegrist was appointed assistant advertising manager.

LANSING, MICH.—Duo-Therm Division, Motor Wheel Corp., has named the *Southwestern Appliance Co.*, Amarillo, Texas, and the South Texas Appliance Corp., San Antonio, as distributors for Duo-Therm fuel oil space heaters and water heaters. The former company will cover northwestern Texas; the latter will serve southern Texas.

AMARILLO, TEX.—Harvey H. Corn is now the president of *Consolidated Appliances, Inc.*, and the *Cosmopolitan*, both of this city, following his purchase of a substantial interest in each. Consolidated Appliances is distributor of Farnsworth products in the Texas Panhandle territory. The *Cosmopolitan*, a leading retail appliance and furniture store, carries Farnsworth radios and phonograph-radios exclusively.

NEW YORK, N. Y. — William P. Mackle is the new sales manager of the appliance division of Bruno-New York, Inc., prominent distributors here. Mr. Mackle previously spent 12 years as retail promotion director for the Union Electrical Co. of Missouri and held other key sales posts in St. Louis; more recently he was eastern district manager for Lidgerwood Mfg. Co. At Bruno-New York he will head the merchandising of American kitchens, Eureka vacuum cleaners, Presto pressure cookers, GE appliances, and other traffic products.

BILLINGS, MONT. — The appointment of Walter Larson to the sales and service department of the *Taylor Distributing Co., Inc.*, distributor of Farnsworth products in Montana and Northern Wyoming, has been announced by L. I. Taylor, manager.

Mr. Larson has been associated with Taylor for more than seven years.

PITTSBURGH, PA.—*I. and M. Suf-rin*, wholesale distributors of Stewart-Warner radios and electrical appliances, have announced the appointment of George A. Hoeverler as their general manager.

CLEVELAND, OHIO.—*The K & F Distributing Co.*, here, distributors of Temple radios for Northeastern Ohio, have started two new radio programs to be sponsored in cooperation with ten Temple radio dealers in this city. The programs, which consist of popular recorded selections, will be heard daily on local Station WHK.

WASHINGTON, D. C. — Announcement from the *Simon Distributing Corp.* at 615 Pennsylvania Ave., here, names two managers for the firm's MGM record activities. For the Baltimore division the MGM disc manager is William Ellis; the same post in Washington is held by Jack Whitney.

PITTSBURGH, PA.—For the fourth time it has expanded since it started 28 years ago, the *Allied Electric Supply Co.*, of this city, has occupied its new building at 1201 Forbes St. A. Samuels is the founder and president of the prominent firm. Allied serves Garod Radio as exclusive distributor in 38 counties in Pennsylvania, Ohio and West Virginia. Employing five road men they also distribute a complete line of electrical supplies and appliances. The new building has a floor area of 24,000 square feet, with new warehousing facilities, gravity conveyors, extra parking space, etc.

NEW YORK, N. Y.—*The Arvin-Salmanson Co.*, 1107 Broadway, this city, has signed a distributor franchise with Noblitt-Sparks Industries. It was reported that a \$2,000,000 order for radios, appliances and heaters accompanied the signing of the franchise. Principals in the event were Gordon Ritter, Arvin director of sales; Robert Smith, Arvin eastern district manager; and David Goldman, manager of Arvin-Salmanson.

4 Steps to GREATER PROFITS

1. A complete line of sound equipment for any type of installation that your customers may require. Look at these four outstanding examples!

2. Manufactured with the same skills and experience that make the famous Stromberg-Carlson radios, telephones and telephone switchboards.

3. Consistently advertised for you in: Business Week, Hotel Management, Modern Hospital, Railway Age, American School Board Journal, Nation's Schools and Architectural Record . . . plus a wide range of available point-of-sale material.

4. Nationwide distributor organization to serve you.

SOUND SYSTEM, MODEL SS-750

A completely pre-engineered system. Incorporates AM-FM radio tuner, record changer, controls, provision for wired music, and 90 watts of audio-power divided into four output circuits. Wired for optional remote control turret. All-metal cabinet in glacier-grey finish. Underwriters approved.

PORTABLE SOUND SYSTEM, MODEL PS-32

In a three-section, compact case. 15 watt amplifier with one phonograph and two microphone inputs, two heavy duty Alnico V reproducers, and 25 feet of durable cord with connectors attached. One case has the reproducer receptacle for connecting in cascade. Underwriters approved.

AMPLIFIER, MODEL AR-37

Two input jacks, one provides equalization network for crystal pick up, the other may be bridged across 500-600 ohm circuits without change in level. Treble attenuation and boost, base boost, base compensated volume control, separate gain control and fidelity control give the finest in record and wired music reproduction.

AMPLIFIER, MODEL AU-35

One phonograph and three microphone high impedance inputs, separate base and treble controls, 50-watt divided output with separate master volume controls. Amplifier jack for tandem operation. Hum adjuster, resistor board construction and rugged copper plated steel chassis. Underwriters approved.

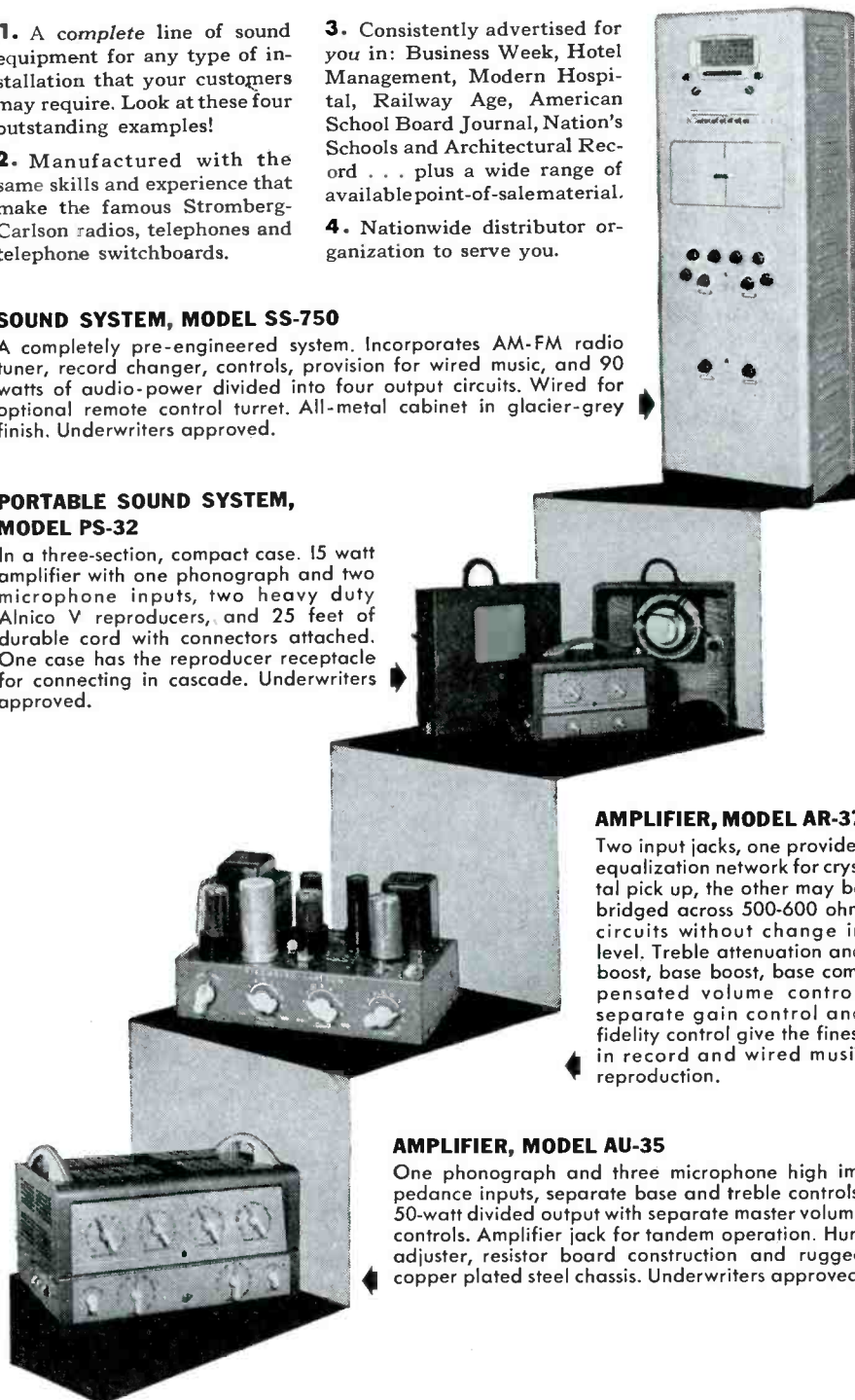



STROMBERG-CARLSON

NATURAL-VOICE  SOUND SYSTEMS



Tinkers

(Continued from page 91)

of trepidation. He needs help badly.

The smart dealer knows how to handle the non-habitual tinker. If he decides that the would-be fixer's product hasn't been hopelessly ruined, he will set a fair price for the job, and be courteous about it. He would not think of scolding a customer or prospective customer for attempting to repair his own property. Such dealer will not fix the customer with a steely eye, and say, "someone's been tampering with this." If he's going to accept the job, he'll do it gracefully, and earn the undying gratitude of the tinkerer. He won't even let on that he knows the customer's been at work on the item.

On the other hand, if the product's past the salvage status, he'll tell the customer so in such a manner that while the person will go away disappointed, he will be well sold on the dealer's ability and honesty. Also, he'll think twice before he again attempts to take over such complicated work.

All in all, the dealer who doesn't give a tinker's damn for the now-and-then tinkerer's good-will, may lose business in the long run.

Auto Radio

(Continued from page 134)

radio, which finally cuts off when the car's road speed falls low enough to cut out the generator (as indicated by the ammeter suddenly reading zero), the fault is definitely in the generator. To lower its effect, try an additional capacitor from the main output terminal of the generator to its case.

Static discharge from the fan belt or pulley may be cured by applying a light coating of graphite to the fan belt. Defective ignition wiring may cause very annoying leakages and arc-overs, which may be most easily found by watching under the hood while the motor is running in the dark. If high tension leads are run together with d-c leads, particularly inside the same conduit, the latter should be removed and run far apart from the former.

It would hardly be necessary to say to an experienced auto radio servicer that not all of the sources of noise have been covered here. The remainder, however, are generally too individual to be worth writing about at length. Suffice it to say that loose connections which show up on a bumpy road or street car line can be isolated either to the radio or the rest of the installation by dis-

connecting the antenna at the receiver and retracing the route just taken by the car, with full volume on.

The presence only of a normal hiss indicates trouble in the installation, and most likely, in extremely bad cases, in the antenna connections.

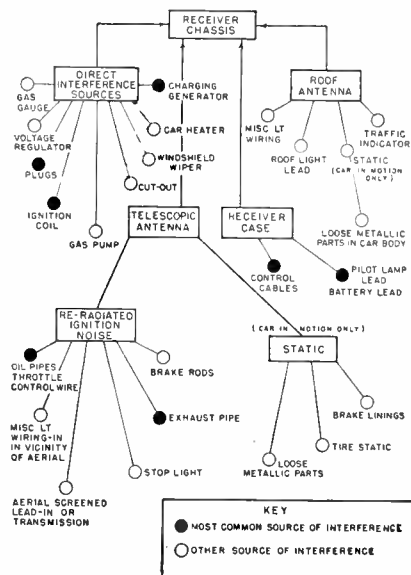

Sources of auto radio noise interference.

In this check, of course, make sure that neon signs, street car trolley lines or other outside electrical noise generators are not being picked up.

We all have our own methods for troubleshooting car radio troubles or making installations. Why not pass them on to the next servicer? Time saved is money earned; send your time-saving suggestions to the editor, for publication in the Service Section of RADIO & Television RETAILING.

Service Feeds Sales

(Continued from page 49)

entire length of the front of the building attracts much attention from passers-by and directs their notice to the well-lighted window displays and the floor displays beyond them.

With the exception of getting sufficient merchandise, the greatest problem of the firm at the present time is the shortage of certain repair parts. The firm does not like to use substitute parts and refrains from this as much as possible but occasionally has to resort to them in an emergency when they could not otherwise maintain a reasonably prompt repair service. When other sources fail, all parts possible are made in the shop.

The corporation consists of four stockholders, Mr. Koch and his wife, Jeanette C.; and Robert H. Nichols

and his wife, Helen. Mr. Koch is president and Mrs. Koch, vice-president; Mr. Nichols, treasurer, and Mrs. Nichols, secretary.

Not only does Peoria Radios, Inc. do business in a business-like manner, but the firm organization itself is on a business-like basis. In regard to the organization, Mr. Koch says:

"When we started business, we considered whether to go into partnership, an individual operation with a silent partner, or a corporation. Upon investigation, we found that by far and large that we would have a greater latitude of operation if organized as a corporation. We therefore engaged a corporation attorney and he drew up the corporation paper. We then elected a board of directors and appointed officers. As soon as this was completed, and before we opened our doors for business, we hired an accountant and tax expert to set up a complete set of books. Our bookkeeping system is based on a daily work sheet, the usual journal and ledger and a complete record book.

"We set up the books in such a manner that they reflect the cost of merchandise; overhead, which breaks down into rent, labor, etc.; cost of sales; and gross sales. We have established a figure which we use as a percentage to determine the approximate inventory in comparison to sales so that at the end of each month we have a fairly accurate inventory without taking a physical inventory.

Sound Structure

"At the end of each month we make up a Profit and Loss statement and we will make an annual report at the end of the year, which will be distributed to the officers.

"We have only the four stockholders mentioned. We have issued stock so that there will be no controversies at any time about what the earnings of each principal will be. We also have a corporate agreement whereby no one of the stockholders can sell or offer for sale his stock without first offering it to the remaining stockholders.

"Our accounting system is such that we can tell at the end of any day, week, month or year whether we have operated at a profit or a loss and can compare any period with any other given period.

"We not only took out insurance on our stock but also liability insurance on our customers. Later we are considering taking out insurance on the principals of the firm so that if one dies, the corporation will have him insured in the amount of his hold-

ings and the corporation can in that way buy the stock and hold it as secretary stock for issuance to any of the remaining stockholders if and when desired.

"We incorporated for a larger amount than the stock holdings so that should we desire to put more money into the organization at any time, we can do so under our charter without the necessity of again applying to the state for permission to issue additional stock.

"Our bookkeeping system includes a sinking fund and a building fund in addition to the tax reserve and the usual list of accounts. We have been investigated twice by Dun & Bradstreet and have been given an excellent rating. We have been able to discount all our bills, which gives us a good credit rating. We are members of the local credit bureau. We believe that our good accounting system and our corporate form of organization have been partly responsible for the large increase of business we have had—more than six times what we had the first month—under adverse conditions."

Interest in Tele

(Continued from page 54)

lish extraction in the trading area.

In all instances, the broadcast programs stress brand names, which include such famous brands as DuMont, RCA, Crosley, Philco, Norge, Westinghouse, Proctor, Frostair, Bendix, Laundromat, Maytag, ABC, Thor, Apex, Universal (Landers, Frary & Clark), Caloric, Estate, General Electric, Zenith, Emerson, Motorola, Sonora, Stromberg-Carlson, Pilot, Sentinel, Olympic, Hoover, Eureka, Royal, Manning Bowman, Silex, Toastmaster, Knapp-Monarch, etc. Victor, Columbia and Decca records are sold in the modern disc section.

Nathan L. Goodman is president and general manager of all the departments of the business. The appliance merchandising manager is Nathan Goodman, who served as a major in the European Theatre of Operations. Milton Goodman is manager of the furniture department, and David Witty is vice-president of the appliance division only.

The advertising manager of all departments is Lee Goodman, who served as an Army captain in the Pacific. Executives in departments other than radio and appliance, include Alfred Goodman, who was a captain in the ETO; Jerome Goodman, who served as a non-com in the Pacific area, and Saul and Harry Goodman, and Harry Gross.

ANOTHER
ORTHOSONIC

Beauty...



Electronic's New Apartment Console Combination

Here is the radio-phonograph of distinction . . . the instrument for your discriminating clientele. In it are combined the incomparable tone quality of Electronic's exclusive Orthosonic System of Sound Reproduction and the matchless charm of superb cabinetry—the two together a triumph of elegance to delight all who appreciate the finer things. Just the right size to fit into apartment arrangements, it appears to equal advantage where space presents no problem. With its handsome styling and lovely hand-rubbed finish it adds grace and character to any surroundings. To you, along with Electronic's unique, new Chairside Radio-

Phonograph with the exclusive "electro-lift," it offers a new and better opportunity for increasing sales at the more profitable luxury level.

Send for catalog and full information on these and 12 other glorious Electronic table models in the lower as well as more expensive price ranges. They have something special . . . different . . . and new that your customers want! Write us today!

Model 710 PC, 710 PB Console—8 tubes and 2 rectifiers, superheterodyne circuit, Orthosonic Sound Reproduction, exclusive Electronic Vario-Tuner, push-pull output, dark red, or blond mahogany cabinets.

First

TO MEET NEW FACTS ABOUT HUMAN HEARING

ORTHOSONIC Radio Sound Reproduction is an entirely new and exclusive principle developed by Electronic Laboratories for separating the low and high notes in the audio spectrum—reproducing them independently through separate amplifiers combined with the Orthosonic speaker system—each with individual tone control to permit listener to adjust sound to produce total effect most pleasing to his own auditory system.



ELECTRONIC LABORATORIES, INC. • Indianapolis, Ind.

Howard W. Sams Polls Servicemen on Symbols

Radio servicemen were recently asked by Howard W. Sams & Co., Inc., 2924 East Washington St., Indianapolis, Indiana, to read, mark and mail back a voting ballot on the subject of standardization of schematic tube and socket symbols.

Sams, publisher of the Photofact Folders, is cooperating with the RMA service committee currently studying the problem of establishing a uniform industry standard.

As pointed out by Sams, there are in use today a number of ways of representing tubes in schematic diagrams. The existence of these variations irrespective of their individual merits, tends to be confusing.

Since service manuals are designed for the assistance of radio repairmen, it should be their privilege to express a preference, says Sams, in the introductory paragraphs of the self-addressed, postage-paid ballots.

Seven different tube representation methods as used by manufacturers and reproduced in schematics published in Photofact Folders were described and examples given. Servicemen were asked to indicate first choice on the basis of speed, economy and minimum of effort needed to read and use the various schematics.

Results of the voting will be forwarded to the RMA service committee.

Bendix Radio District Men in Huddle



Sales strategy for the summer is discussed by Bendix Radio district managers with J. T. Dalton (back to camera), general sales manager for radio & television, heading the session. At Mr. Dalton's right is H. H. Silliman, Bendix manager of distribution.

Chief Engineer for Minerva

Ignatius Volpe has been appointed chief engineer of the Minerva Corp. of America, according to an announcement by Sidney R. Berens, president.

Mr. Volpe is well-known as an inventor and author of articles on electronics—he holds several patents in the radio and recording fields. He was previously senior engineer for Air King.

Coffee-Makers as Prizes

Hill-Shaw Co., Chicago, has announced an addition to its list of sales promotions—the use of Vaculators as prizes on radio programs with large audiences. The leading audience participation shows in 15 major markets plus several important network programs are now featuring Vaculator glass coffee-makers and electric coffee-maker stoves as special prize awards.

NEW! SENSATIONAL!

Outsells Everything
IN RADIO WHEREVER INTRODUCED

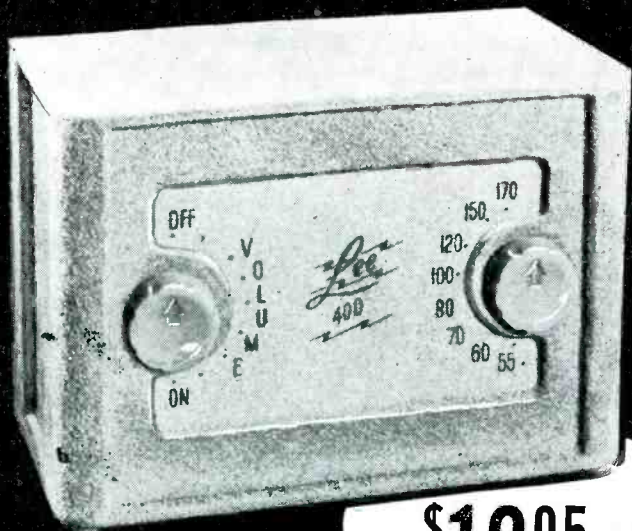

AN ANSWER TO THE PRESIDENT'S PLEA

\$12⁹⁵ RETAIL

the

Lee
400

**WOOD
CONSTRUCTED
CABINET**

**A NEW NOTE IN LOW PRICES
SELLS ON SIGHT!**

It's here! The Lee 400.

Designed and packaged for fast over-the-counter selling.

Only 7" High.

Its wood cabinet construction and its colorful suede-like finish makes it the biggest little package of radio power to hit the market at such a low price.

Not Distressed Merchandise!

Tops in engineering! And it can't be beat for price, quality and attractiveness.

A Variety of Colors!

Gold • Red • Emerald • Pastel Pink
Blue • Silver-Grey • Brown

Be the first in your territory. Wire or write now for a sample case of 12 assorted colors at \$9.75 each.

LEE RADIO COMPANY
131 HALSEY ST., BROOKLYN, N. Y.

Fada Expands Into Big Plant in New Jersey

A modern and streamlined manufacturing plant, located on a 10-acre site in Belleville, New Jersey, on the main highway, is the new home of Fada Radio and Electric Company, one of the pioneer manufacturers of the industry. The 26-year-old firm, headed by J. M. Marks, president, was previously located in Long Island City, New York.

The expansion move into its own new plant was made in order to handle Fada's fast-growing activities in serving its dis-



Fada president J. M. Marks has announced expanded facilities for the company, in Belleville, New Jersey.

tributor and dealer organization throughout the world. It was pointed out by Mr. Marks that the company's successful experience in the rapid and expert production of radio products during war years had enabled the firm to take new strides in the design and production of radio receivers to meet all requirements of the present day market. The former facilities of the company were found to be inadequate for this purpose, even though factory space was increased only a few years ago.

The new building, 700 feet long x 288 feet wide, located at 525 Main Street, Belleville, New Jersey, is an up-to-the-minute structure, air-conditioned and fluorescent-lighted throughout, and contains all modern and improved facilities to help Fada meet its growing commitments. Spacious loading platforms, fully enclosed, operated by electrical doors with push-button controls, can accommodate the largest sized trucks. Incoming materials move with no lost motion in feeding the long production lines through the various processes, that are set up to achieve every possible economy in the manufacture of the company's products. Fada's new cafeteria is adequate to take care of all of its employees.

The plant itself has 200,000 square feet of space on one floor and occupies about five acres on a site conveniently accessible to New York City.

Mr. Marks extends a cordial invitation to all its jobbers and franchised dealers and its many friends in the industry to visit its new home.



10-STATION MASTER UNIT

Every Business is a Prospect!

FLEXIFONE
INTERCOMMUNICATION SYSTEMS

OPERADIO...THE OUTSTANDING SOUND EQUIPMENT LINE FOR YEAR 'ROUND SALES AND PROFITS!

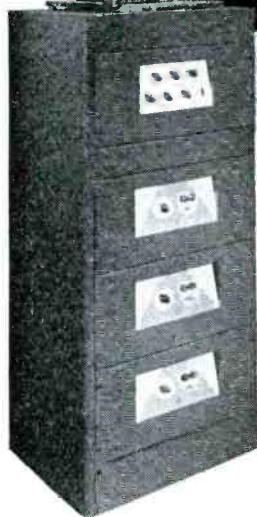

PRE-AMPLIFIERS — BOOSTERS AND MOUNTING RACKS

Smart New Designs... New Features!

Outstanding . . . that's the word for the new OPERADIO sound equipment line! Every unit is designed, engineered and constructed to OPERADIO-quality standards . . . with important new features and smart styling for added sales-appeal. OPERADIO sound equipment is nationally advertised to assure you of steady, successful sales.

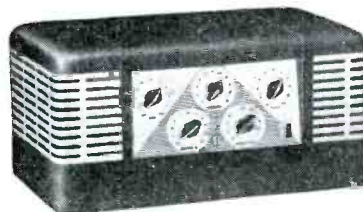

20-WATT AMPLIFIER

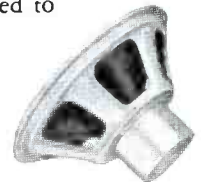

SPEAKERS

OPERADIO
Sound Equipment

SEND COUPON FOR COMPLETE DETAILS

OPERADIO MFG. CO., Dept. RTR-12, ST. CHARLES, ILL.

Gentlemen:
Please send us free information on the items checked:
 Operadio Sound Equipment
 FLEXIFONE Intercommunication

Name _____
Address _____
City _____ State _____

New Admiral Lines Offer Improvements; Lower Prices

A number of brand new features and "sensationally low prices" are being accentuated by Admiral Corp., 3800 Cortland St., Chicago 47, Ill., in its introduction of its new lines. The company's offerings now include three table-model combinations, three console combos, six table-model radios and a "Thin Man" portable—a total of 13 units some of which come in three different finishes.

Prices on the sets range from \$19.95 to \$289.95. The tags were described by the Admiral president, Ross D. Siragusa, as "comparable to pre-war values . . . a result of untiring effort on the part of everyone in the Admiral organization to

produce top quality merchandise that can be delivered to the consumer at mass-market prices."

"Startling" features of the units include a new "energy converter" that eliminates need for crystals, filaments or special tubes—providing improved reproduction at lower cost. A series of improvements in the tone arm, including a replaceable snap-in cartridge containing the pick-up point and the energy converter, are also featured.

A new Admiral-developed FM system was also demonstrated, and Mr. Siragusa declared that "it provides better reception than any FM system yet devised, and will be available at lower prices."

The major features of the line and their list prices are: a deluxe AM-FM radio-phonograph combination, in a choice of



The new model 7C62-6M1 Admiral combination lists at \$129.95. Improved 3½-second automatic record changer has new tone arm, snap-in cartridge, etc. Superhet radio section has 8" Alnico 5 PM dynamic speaker.



KX-30 Deluxe 30-Watt Amp.

These Newcomb selling features are important to you!

COMPLETENESS: Two complete lines of amplifiers and portable systems . . . utility and deluxe . . . provide great flexibility in meeting various customer requirements.

QUALITY: Top-flight performance and dependable, low-cost operation . . . these qualities are carefully planned and built into every Newcomb amplifier.

PRICE RANGE: No other line of amplifiers offers so wide a price range . . . from very moderately priced utility models to the finest deluxe amplifiers for your most discriminating customers.

The proven quality of operation . . . the perfect suitability to every requirement . . . the wide price range . . . these mean greater customer satisfaction and more REPEAT SALES for you.

NEWCOMB—the logical choice of the quality-minded buyer—is your key to a continued, expanding success in the sound equipment field.

Let us send you complete information.



KX-60 Deluxe 60-Watt Amp.



KX-6 Deluxe Mixer Pre-Amp.



K-60P Deluxe Power Amp.



KXP-30 Deluxe Phonograph Amp.



H-10 Standard 10-Watt Amp.



H-14 Standard 14-Watt Amp.



H-30 Standard 30-Watt Amp.



H-60 Standard 60-Watt Amp.



NEWCOMB AUDIO PRODUCTS CO.

Dept. A 6824 Lexington Ave., Hollywood 28, Calif.

"NOT MERELY AS GOOD AS THE OTHERS . . . BUT BETTER THAN ALL OTHERS."

three fine-wood cabinets, with 9 tubes, the new "Miracle Tone Arm," improved record-changer, and the new energy converter for \$289.95; a console radio-phonograph combination, with all the new phonograph features, six tubes, and a walnut-veneer cabinet for \$129.95; a table model radio with automatic record-changer having all the new phonograph features, in plastic, for \$79.95 (in walnut for \$89.95); the new 3-way portable, in a "class" case of rich-grained, brown leatherette (5 tubes; 13½ pounds) for \$49.95; and a five-tube table set in plastic for \$19.95.

Motorola Previews for Distributors Next Week

The first of a series of four Motorola Radio sectional distributor meetings is scheduled for June 3rd at the Drake Hotel, Chicago. Executive and key personnel present at the meeting will include: P. V. Galvin, president of the firm; E. H. Wavering, vice-president automotive division; W. H. Stollner, vice-president home radio division, and W. H. Kelley, sales manager. Distributors from the North Central, Mid-West, Allegheny and Great Lakes areas will attend. Developments in the car radio and car heater fields will be shown in addition to the home radio line.

During the week of June 9th, a similar meeting will be held for eastern distributors in the New York area, followed by meetings in New Orleans and San Francisco.

Big Service Meeting on Tele Technique

Four hundred radio service men of the Metropolitan St. Louis area were guests at a recent meeting where Myron F. Melvin, field engineer for P. R. Mallory, Inc. discussed the latest developments in television and FM broadcasting. The meeting was held at the St. Louis House. Service techniques developed for the eleven television components manufactured by Mallory were discussed and demonstrated. The meeting was sponsored by Ebinger Radio & Supply Co., 2211 Gravois, local distributors for Mallory.

12,000 Ranges a Week



"A production capacity for 12,000 ranges weekly" is what James J. Nance, newly elected president of Hotpoint, Inc., announced for the firm. The company has picked a 38-acre site on Chicago's west side for its new range factory.

Clough Celebrates 25th Year With Belden

H. W. Clough, vice-president of the Belden Mfg. Co., Chicago, maker of electrical wire and cable products, has just celebrated 25 years with the company. His interest in radio began in 1918 when he went overseas with the U. S. Army Signal Corps.

Mr. Clough joined Belden in 1922 as a member of the magnet wire sales service department. Regular promotions followed until he was elected vice-president in 1940.

He is on four committees, and holds the chairmanship of two, of NEMA; is a member of the manufacturers board of the National Automotive Parts Association; chairman, industry coordinating committee of the Radio Parts and Electronic Industry, and president of the board of education in his home town of Glen Ellyn, Ill.

Rider Lauds New RCA Service Manuals

The distribution, during April, of new RCA service manuals utilizing the "clarified schematics" method of presenting complicated circuits is seen by John F. Rider as illuminating a significant trend in the educational elevation of the radio servicer.

Long a strong exponent of the mastering by the servicer of the basic but essentially complex theory upon which modern radio is built, Rider has frequently sounded a warning note to radiomen, to prepare in time to meet the developing needs of the industry.

"Back in April, 1941, exactly six years ago," says Rider, publisher of the Manuals which bear his name, "we began including clarified schematics in our books. This feature commenced in Volume 12, and has been steadily expanded since."

Rider, as World War II Colonel in command of the Army agency which published all technical manuals used by

the Signal Corps, saw the incorporation of his pet "clarified schematics" principle into official Army procedure, and has since perfected the technique for inclusion into his latest Volume 15, published in January, 1947.

As practiced in RCA's new service manuals on Chassis No. RC-529A and RC-612 (superseding the 1946X3 Service Data), each of the five antenna and oscillator tuned circuits set up by the five positions of the band change switch are shown, with the physical positioning of the switch section plates illustrated each time.

The Rider "clarified schematic" method, while presenting the same basic information, eliminates the actual band switch sketch, using the usual schematic symbols instead, for purposes of clarity.

Progressive Marketers Doing Business

Dave Kubrick and Irv Brown have recently organized the firm of Progressive Marketers, 41 Union Square, New York City, to serve as manufacturers' sales representatives to the radio, electronic and television industries.

Mr. Kubrick has some 15 years of merchandising and technical experience and Mr. Brown is credited with 10 years of sales and advertising background. Lines now handled are Transvision Television, Oak Ridge TV and FM Antenna Co., Adaptol Co. and Premier Electronic Labs to jobbers and manufacturers in the territory of Metropolitan New York, New Jersey, Philadelphia, Baltimore and Washington, D. C.

TEST

... for volts, amperes, or watts with this one small, compact instrument

Here is the first appliance tester ever made that gives you volt, ampere, and wattage readings all from one small, compact instrument.

Model 390 slips easily into a large pocket, weighs only a pound and a half, is designed for hard, continuous service.

The range of uses for this volt-amp-wattmeter is almost unlimited in checking line voltage, current drain and power consumption, the three simple tests which will diagnose most cases of electrical trouble. In fact, practically any household electrical appliance that has a motor or a heating element, can be tested by the 390, as well as certain industrial installations.

You merely plug Model 390 and appliance to be tested into the Break-In plug furnished—voltage will read. To read watts or amperes, simply press one of the two buttons at bottom of the panel.

Aside from its unique features, Model 390 has no equal among appliance testers in quality alone. The famous Simpson quality makes investment in the Model 390 an investment that will return a rich yield in satisfactory service through the years.

USE MODEL 390 FOR TESTING

Refrigerators	Motors
Deep Freezers	Electric Heaters
Washing Machines	Radio Sets
Irons	Lamps
Toasters	Vacuum Cleaners

and all similar appliances

Ranges—A.C. Current, 60 cycles

Volts: 0-150, 0-300.

Amperes: 0-3, 0-15.

Watts: 0-300, 0-600, 0-1500, 0-3000.

Size: 3" x 5 7/8" x 2 1/2". Weight 1 1/2 lbs.

Shipping weight 3 lbs.

Price, with Break-In plug and leads \$39.50

Leatherette carrying case, with leads compartment..... 4.00

Genuine leather carrying case, with leads compartment..... 8.00

SIMPSON ELECTRIC COMPANY
5200-5218 W. Kinzie St., Chicago 44, Ill.
In Canada Bach-Simpson, Ltd., London, Ont.

Simpson
INSTRUMENTS THAT STAY ACCURATE



Simpson Model 390 Volt-Amp-Wattmeter

Radio Industry to Reach Great New Goals

The following statement on the future of the radio industry as he sees it was prepared especially for *RADIO & Television RETAILING* by E. C. Bonia, vice-president in charge of sales, the Sparks-Withington Co., Jackson, Michigan:

Any discussion of the future of radio must include all of its phases—broadcasting, manufacturing, and distribution.

Naturally, the only excuse for radio receiving sets is broadcasting. The networks and the local stations have done a splendid job over the years in entertaining, educating and informing the masses of the people in the country. They must and they will, I am sure, continue to improve the quality of broadcasting

material to conform to the increasing sophistication of the listening audience.

Radio manufacturers have an obligation no less great than the broadcasters. During the war many electronic marvels were promised to people through advertising. It is now up to the manufacturers to make good on these promises. There are many possible innovations in cabinets which I feel sure would please the American public. And many things can be done to the receiving-set chassis to make it perform better than ever before.

The distribution of radios must also be improved. Dealers and distributors have an obligation to see that the public gets the finest available sets at the best possible prices. They must stop many of the excesses engaged in in the name of competition. Price wars, dumping, mis-



E. C. Bonia

FOR FM AND AM SERVICING



SIGNAL GENERATOR

SERVICE men, research technicians and design engineers find this new General Electric Signal Generator an extremely valuable aid in their work.

Four basic units have been combined to form one compact, labor-saving, portable equipment which is simple in construction and easy to operate.

The General Electric Signal Generator, Type YGS-3, con-

sists of an RF oscillator (fundamental frequency range 10 kc to 150 mc); an FM oscillator (center frequencies of 1, 20 and 50 mc and frequency deviations of ± 20 , ± 300 and ± 750 kc); a 1 mc crystal calibrator and a variable frequency audio oscillator. This combination of units enclosed in a single case will help to simplify and speed up FM and AM receiver analysis.

NOTE FOLLOWING DISTINCTIVE FEATURES:

- Economical and convenient to use.
- Constant output impedance attenuator. Wide Frequency range.
- Extremely wide sweep deviation.
- Lines up any FM or AM receiver, stage by stage by visual alignment methods.
- Reference level indicator for output.

New free booklet on FM servicing available.

Write: General Electric Company, Electronics Department, Syracuse 1, New York.

GENERAL ELECTRIC

leading advertising, and all of the other disagreeable practices can only do damage to the whole industry. And this, in turn, will react on the distributors and dealers themselves.

It seems to me that the radio industry has its destiny in its own hands and that it can continue to grow and develop. Or it can languish, depending on how well the industry does its job as a whole.

I personally believe that the radio industry is going to reach new undreamed-of production and sales goals. And I am looking forward to the rapid growth of television as the last word in efficient communication. I only hope that television will not be marketed prematurely. Its progress can be seriously retarded if inefficient broadcasting or receiving equipment is put on the market . . . or if poor programming is permitted.

Here, at Sparton, we have been building radio receivers for more than twenty years. The radio business has been good to us and we propose, in the years to come, to contribute our own full share to the growth and improvement of radio and television.

Galvin Firm Now "Motorola Inc."

The corporate name of the Galvin Mfg. Corp., makers of Motorola home and car radios and car heaters, has been officially changed to Motorola Inc.

Paul V. Galvin, president, said that "We feel that the word 'Motorola' has been so closely associated with us—our products and services—that there is great advantage from an advertising and merchandising angle in making Motorola Inc. our legal title."

Sylvania Signs With Sams

Sylvania Electric has entered into a participation agreement with Howard W. Sams & Co., Inc., according to an announcement made recently by R. W. Andrews, merchandising manager of Sylvania's radio division. Sylvania radio tubes will be mentioned in connection with servicing information given in the Photofact Folders, while Sylvania test equipment will be employed in the Howard W. Sams Radio Servicing Institute.

Another New Home



Gibson dealers and distributors awarded this refrigerator to newlyweds Donna and John Wyatt, Grand Rapids, Mich., on a "honeymoon couple" radio program.

Walsco Markets Contest—Winning Product Ideas

Self-adhering flexible patches which are shaped to conform with the curvature of a speaker cone and do not change the cone's tone characteristics have been announced by Walter L. Schott, president of the Walter L. Schott Co., Beverly Hills, Cal., manufacturers of the Walsco line of radio repair items.

Like many of the other products now being added to the Walsco line, the idea



The Walsco cone patches, with other new items.

was suggested by prize-winning servicers in a recent suggestion contest. Runners-up to the patches, which took first prize, included ideas for magnetic probes, neon light turntable speed checker, and auto radio installation tools.

Presented simultaneously with the speaker cone patches, were new phono plugs, friction washers, hair spring cotter clips and a standard test record for changers.

Rep's Historical Site

Robert E. Sargent, vice-president of Land-C-Air Sales, Inc., manufacturers' representatives of electronic parts and equipment, has announced new offices and show rooms for the firm at 14 Pearl St.,

New York 4, N. Y. This site was, in 1636, the meeting place of the board of 19 first Dutch settlers of New Amsterdam.

Karet to Salescrafters

R. M. Karet, sales manager of the Thordarson, Meissner and Radiart divisions of Maguire Industries, Inc., and former sales manager of the wholesale and sound divisions of Utah Radio Products Co., has resigned. He will enter the manufacturers' representative field and will join Ray R. Huttmacher under the firm name of Salescrafters, Inc., 510 No. Dearborn St., Chicago.

Chicago Reps Plan Talks

At the latest meeting of the Chicago-land Chapter of "The Representatives" plans were discussed regarding the establishment of an educational program for the group. This program will start in the fall of 1947 and will offer an opportunity for manufacturers, jobbers and representatives to attend talks on different phases of the technical and merchandising aspects of the radio industry.

An appropriation for this program has been recommended and the Educational Committee, whose chairman is Leo McCarthy, has started scheduling the meetings.



They Came! They Saw! They Want—

THE NEW

**ELECTRONIC
AMPLICALL
INTERCOMMUNICATION**

America's Finest

Business Communication Systems

"Smash hit of the Show!" "Sensational advance in Intercom styling and design!" "We want it!" That's what they said about the New AMPLICALL at the 1947 Radio Parts Show. We practically had to post a guard around our display to restrain enthusiasts from gliding off with a sleek Master Station or two. That will give you some idea of the selling appeal packed into the New AMPLICALL. To see it is to want it. To hear it and operate it is a new experience in communication performance. Here's the Intercom you'll sell as you've never sold before!

**SEE YOUR AUTHORIZED
AMPLICALL DISTRIBUTOR**

Get the complete selling story on the New AMPLICALL! See your Authorized AMPLICALL Distributor for full details and descriptive catalog. There's a New AMPLICALL System for every business communication prospect—a system that sells on sight and on superior performance. Don't miss out on the biggest profit opportunity ever to come your way in the Intercommunication field.

Electroneering is our business

RADIO • RADAR **COMMUNICATIONS**
SOUND **Rauland** **TELEVISION**

THE RAULAND CORP. • 4247 N. KNOX AVE. • CHICAGO 41, ILL.

Minimum Space for
Multiple Sales

Self-Serve
AERIAL DISPLAY *Free!*

Model FD-5 Floor rack and display board is free—you pay only for the 29 aerials it contains.

Place this colorful new sales-builder in a traffic spot and watch it sell! Requiring only an investment of a 15-inch square of floor space, and very few dollars, this new self-serve floor display stores a complete stock of 25 fast-selling Ward Aerials. The handsome display board holds four more. Display is completely assembled, ready for instant use. List price of all 29 aerials, only \$166.75. Order your FD-5 display immediately.

THE WARD PRODUCTS CORPORATION

1523 E. 45th ST., CLEVELAND 3, OHIO

WARD *Aerials*

EXPORT DEPARTMENT: C. O. Brandes, Mgr., 4900 Euclid Ave., Cleveland 3, Ohio
IN CANADA: Atlas Radio Corp., 560 King St., W., Toronto, Ontario, Canada

WHAT IS THE
Second Necessity
FOR PROFITABLE
RADIO SERVICE?

Of course, the first requirement for profitable radio service is a good service man. The second necessity is good equipment. A good service man with poor equipment is a losing combination. Supreme test equipment has been proved accurate, dependable—"Supreme by Comparison" for nearly 20 years.

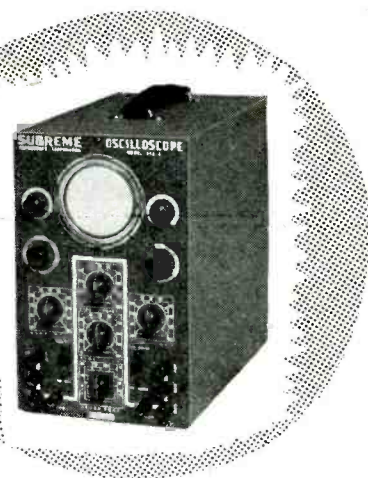

SUPREME MODEL 546-A OSCILLOSCOPE, above, is one of the more popular instruments in the complete new Supreme line. Ask your nearest Supreme jobber to show you and demonstrate this finer radio test equipment.

SUPREME



WRITE FOR
NEW
CATALOG

SUPREME INSTRUMENTS CORP., Greenwood, Miss., U.S.A.

Export Department: THE AMERICAN STEEL EXPORT CO., Inc.,
347 Madison Ave., New York 17, N. Y., U.S.A.

Bendix Radio Freezes Prices for 1947

Bendix Radio Division of the Bendix Aviation Corp. has issued to its national distributor organization a guarantee of existing list prices on its entire current line of receivers. According to J. T. Dalton, general sales manager for radio and television, the understanding holds for the balance of the year.

W. P. Hilliard, general manager of the division said that "We have consistently sought to decrease prices throughout the entire period of our postwar production. Our efforts have not succeeded in reducing prices but rather have kept them from untoward increases. Much as we would like to meet the present demand for reduced prices, we cannot see a possibility for such action when increased cost notices on most components and other materials are reaching us every several days. Most of these are apparently due to readjustments with labor."

\$4,325 Rider Manual Contest Has 234 Prizes

With \$500 in cash as first prize, John F. Rider, Publisher, Inc., will launch a contest on June 1, for the purpose of discovering which of the features contained in Rider Manuals are proving of greatest value to the servicer.

224 cash and servicing equipment prizes, plus cash awards for jobbers designated by the first ten prize-winning servicers, are offered, totaling \$4,325 in value. Nothing need be bought to enter the contest, which closes Sept. 15, 1947.

Official entry blanks are available from radio parts jobbers, and from John F. Rider, Publisher, Inc., 404 Fourth Ave., New York 16, N. Y. The official contest forms also contain complete details about the prizes. The most complete, compact and original letters of 100 words or less on "Why Rider Manuals Mean Successful Servicing" will be selected, while spelling, grammar and writing style will not be factors in judging awards.

Marion Lighted Meter Dials Are Dustproofed

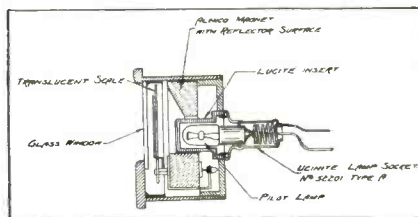

Marion dial—illuminated meter with lucite insert.

A new design in several meters manufactured by the Marion Electrical Instrument Co., Manchester, N. H., utilizes a transparent lucite insert as a chamber for a pilot lamp in dial-illuminated panel-type instruments. Principal advantages are a resultant dust-proof seal and a simple control over the size of bulb used, preventing damage from two common sources.

Reports Strong Sales of Tele-tone Sets



John S. Mills, vice-president of Tele-tone.

The results of a sales survey among dealers in Georgia, Florida, Louisiana, Texas, California, and Cuba, have been made public by John S. Mills, vice-president of Tele-tone Radio Co., 609 W. 51st St., New York City. Mr. Mills returned from a 3-week tour among these retailers and reported that "dealers placed orders as though this were last October."

Mr. Mills said that there was continued strong sales of his firm's \$17.95 Dynamite model and large initial orders for the company's new \$29.95 3-way portable set.

Cash Prizes to Fixture Design Winners

Winners of the four major awards in Sylvania Electric's third annual fluorescent fixture design competition, concentrated this year on improved schoolroom lighting, have been presented with \$1,100 in cash prizes by Robert H. Bishop, vice-president in charge of sales for the company. The names of 18 men who will be given \$50 meritorious awards were also announced.

First prize of \$500 went to Lymm L. Sweetland, Jr., of the New York State Electric & Gas Corp., Binghamton, N. Y. Gerald E. Parks, of the Metropolitan Edison Co., Reading, Pa., won second prize and \$300. Robert M. Francis, Public Service Co. of Northern Illinois, Joliet, Ill., was awarded third prize of \$200, and Warren W. Weiss, Pacific Gas Electric Co. of San Francisco, Calif., received fourth prize of \$100.

Electronic Hardware Reps and Lines

Herman H. Smith, owner of Herman H. Smith, Inc., manufacturers of electronic hardware has announced the appointment of Land C Air Sales, Inc., 14 Pearl St., New York, N. Y., to represent his firm in the eastern territory. Smith also appointed Henry M. Krueger, of 990 Fulton St., San Francisco, Calif., to represent the firm in the northern part of California.

The Smith firm, located at 405 44th

St., Brooklyn 20, N. Y., has released a series of new items including several display cards of propeller dial pointers, screw drivers, plugs, phone tip plugs, pulleys, etc.

New Parts Manager for Admiral Corp.

Admiral Corp., Chicago, has named Joe Marty, Jr., as manager of its parts and accessory division. Mr. Marty will also act as assistant to Richard A. Graver, who is the firm's vice-president in charge of radio. For the past year, Mr. Marty has been a field engineer for the firm; previously he was the founder and organizer of the Radio Servicemen of America.

Qualities of Good Farm Receivers

In the May issue of the *Country Gentleman*, published by Curtis Publishing Co., the magazine suggests that its readers check a number of points with local radio retailers before buying a radio.

The points are as follows: (1) High sensitivity to pick up stations remote from the receiver, (2) receiver should have provisions for connecting an outside antenna to provide greater pickup and higher signal to noise ratio, (3) good automatic volume control, to eliminate fading in reception of weak signals, and (4) large speaker to reproduce the lower tonal register so essential to fidelity in musical programs.



For Truest Tone Quality
**MASCO'S MA-121 12 WATT
HIGH FIDELITY AMPLIFIER**

Wherever the most beautiful, roundest, clearest tone is required . . . whether in studios or in broadcast stations, by music lovers or in wired music systems . . . THERE IS NOTHING FINER THAN MASCO'S MA-121 12 WATT HIGH FIDELITY AMPLIFIER.

Engineered for high fidelity record reproduction bridging and remote amplifier application it brings you FAMOUS MASCO VALUE NEVER BEFORE EQUALED in high fidelity amplifiers.

Among its excellent features are

- Two high impedance inputs, one compensated for crystal pick-up, the other for signal of constant amplitude. (Also easily adaptable for low impedance input)
- Individual bass and treble equalizers.
- Separate line and voice coil output impedances.
- Frequency response ± 2 db. 50 to 10,000 cps. at rated output.

MA-121, High Fidelity Amplifier with cover, less tubes . . .	List Price
Kit of matched tubes	\$61.25
	\$ 9.75
	Add 5% west of Rockies

Contact your local Masco distributor for immediate delivery.
For descriptive literature or other information
write direct to factory . . . Dept. D.



MARK SIMPSON MANUFACTURING CO., Inc.
32-28 49th Street, Long Island City 3, N.Y.

SOUND SYSTEMS and Accessories

RAvenswood 8-5810-1-2-3-4

The precise capacitor
for the precise
application...

AEROVOX
ELECTROLYTICS



● Aerovox offers an exceptional range of metal-can electrolytics—upright or inverted, or flat mounting; adjustable ring, lock nut, twist-prong, cleat or strap; handy plug-ins; cardboard-case and tubular cardboard types; bathtub electrolytics; etc. Take full advantage of these many different types!

● Use Our Catalog . . .

Ask our distributor for your copy. Keep the Aerovox catalog handy so you can always pick out that type best fitted to the job. Or if you prefer, write us direct for your copy.



FOR RADIO-ELECTRONIC AND INDUSTRIAL APPLICATIONS

AEROVOX CORP., NEW BEDFORD, MASS., U.S.A.
Export: 13 E. 40th St., New York 16, N.Y. • Cable: 'ARLAB'
In Canada: AEROVOX CANADA LTD., Hamilton, Ont.

SALES HELPS

New Bureau for House Cleaning Research

To conduct a broad and continuing research and educational program for the advancement of all new house-cleaning techniques, a new home research bureau has been established by the Eureka division of the Eureka Williams Corp., according to George T. Stevens, executive vice-president of the company and manager of the Eureka division.

Some initial activities the new bureau will engage in are: the establishment of a research foundation at a leading university where studies and surveys of home cleaning problems will be conducted; new cleaning equipment tested, and time and motion-saving methods devised; and the staging of home cleaning clinics in department stores and at public utility companies.

Other projects include a handbook on house cleaning; home organization work charts for housewives, and the distribution of facts and information to housewives, home economists, editors, and students through publication of pamphlets and literature.

For Filter Sales



This dispenser display from Cory Corp. holds 12 glass filter rod cartons. In 3 colors, it is shipped flat with orders of 12, 24 or 144 of the rods.

Sales Calendar for Battery Retailers

A new "seasonal sales calendar," designed to tie up dealer effort and consumer advertising in April, May, and June, is currently offered by the Ray-O-Vac Co., Madison 3, Wisconsin.

The new "Leakproof" battery sales calendar suggests a variety of timely cross-merchandising possibilities for added flashlight battery sales. In addition, it offers free dealer sales helps to tie up with regular Spring and Summer promotions on housewares, outdoor and sporting goods, motoring, travel and picnic supplies.

Merchandising Aids for Auto Aerials

In step with the current interest in auto radios and accessories, the Philco Corp. offers complete promotion materials for its car aerials. The materials include suggested ad copy, display stands, sample radio announcements, etc., for dealer use.

These merchandising aids are part of a full set of such sales helps, offered



One of Philco's new accessory merchandisers.

for Philco's accessories — including all types of aerials, phono needles, ice cube trays, flashlights, microphones, batteries, tubes, furniture and refrigerator polish, home recording blanks, etc. The firm is assuring retailers that "Philco Accessory Products Are Big Business!"

C-D Has Bright New Placards

Cornell-Dubilier Electric Corp. now offers its distributors and dealers two-color easel-back display placards to be used as wall posters or for window display.

Shown against a striking background of blue is an assortment of C-D capacitors. The text, in yellow and white, is limited to identification of the capacitors by name and trademark and the single



CD's new 2-color easel-back display placard.

message—"a complete line for all applications." The charts are 22 x 30 inches in size.

These display show cards will be sent free from South Plainfield.

Dealer's Shadow-Box



An attention-getter for Proctor's Never-Lift iron is this series of shadow boxes used by Meier Frank Co., Portland, Ore. It's simple, inexpensive, and adaptable.

Motorola Manager



V. A. Kamin has just been appointed merchandise manager for the home audio division of Motorola, Inc., Chicago. He was previously regional manager for the firm in the New York and New England areas, and during the war was a Lt. Col. in the Signal Corps.

FM Set Completes Auto-Home Communication

Comdr. E. F. McDonald, Jr., president of Zenith Radio Corporation, tells us about a novel use which his friend, Thomas Beck, president of Collier's, makes of a Zenith table-model FM set.

Mr. Beck has had a mobile telephone installed in his automobile by the N. Y. Telephone Co., and recently attracted wide attention by calling up Europe while whizzing along Park Avenue.

When Mr. Beck drives to his home at Wilton, Conn., 40 miles from New York, he runs out of the 20-mile radius of his automobile phone. But if the Zenith FM set in his home is turned on, at a certain setting on the 40-mc band, his family up in Connecticut can hear him clearly as he speeds up the Connecticut parkway. So as he leaves his office, he telephones his house and gives instruction to have the FM receiver set tuned in. For the first 20 miles of his drive, his car phone keeps him in two-way contact with the New York City telephone central office. Then during the latter half of his trip he has continuous one-way communication with his home at Wilton through the FM table model, and can telephone instructions ahead.

He even orders his dinner this way while en route home!

Bittan-Nevins for Telex

Bittan-Nevins Co., 53 Park Place, New York City, has been named eastern representative of the electro-acoustic division of Telex, Inc., according to Kenneth H. Dahlberg, manager of the division. Dan Bittan and Irvin Nevins have wide acquaintances among eastern jobbers, and have represented radio parts manufacturers for more than 25 years. They will represent Telex in New York and the New England states in the handling of radio pillow speakers, Monoset and radio component parts.

**FASTER-BETTER
SOLDERING!**

SEVEN TIP STYLES

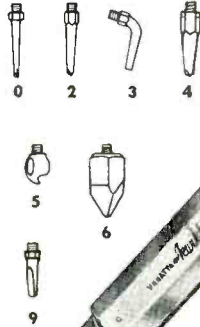

A scientifically engineered thermostat built into each Kwikheat Iron automatically maintains the proper temperature for maximum soldering efficiency. Not only that, but each Kwikheat Iron gets hot . . . ready for use . . . within 90 seconds after plugging in. Seven different tip styles adapt the iron to almost any job . . . the handle design protects the hand from contact with hot metal parts. Not since 1883, when soldering irons were first electrified, have there been so many improvements in one soldering tool.

See Kwikheat Demonstrated

HOT IN 90 SECONDS

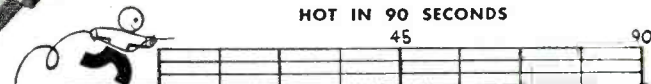

**KWIKHEAT
THERMOSTATIC SOLDERING IRON**

Sound Equipment Corp. of Calif. • 3903 San Fernando Rd., Glendale 4, Calif.

new

CONCORD

Radio

Catalog



**RADIO PARTS • RADIO SETS
RECORD CHANGERS • PLAYERS
HAM GEAR • AMPLIFIERS • TESTERS**

It's here—the new 1947 Concord Catalog—a vast, complete selection of everything in Radio and Electronics. See these value-packed pages showing thousands of items available for IMMEDIATE SHIPMENT—hundreds of them now available for the first time—featuring new, latest 1947 prices. See new LOWER prices on finest-quality RADIO SETS, PHONO-RADIOS, RECORD CHANGERS, RECORD PLAYERS, PORTABLES, AMPLIFIERS, COMPLETE SOUND SYSTEMS, TESTERS. See latest listings of well-known, standard, dependable lines of radio parts and equipment—tubes, condensers, transformers, relays—available for IMMEDIATE SHIPMENT from huge stocks in CHICAGO and ATLANTA. Mail coupon NOW!

free

Mail COUPON TODAY!

Concord Radio Corporation, Dept. RT-67
901 W. Jackson Blvd., Chicago 7, Ill.
Yes, rush FREE COPY of the comprehensive new Concord Radio Catalog.

Name

Address

City State

CONCORD
RADIO CORPORATION
LAFAYETTE RADIO CORPORATION
CHICAGO 7, ILL. ATLANTA 3, GA.
901 W. Jackson Blvd. 265 Peachtree St.

YOUR OPPORTUNITY

to become a DICTOGRAPH DISTRIBUTOR



Here is one of the most profitable and satisfying propositions ever offered in the business equipment field . . . the opportunity to become a distributor of the new Dictograph Electronic Intercom!

Designed by DICTOGRAPH—the intercommunication system used by top executives of the world's largest firms—this new low-priced Dictograph system brings quality intercom at last within reach of the small and medium-sized firm!

The sales potential is enormous. And the selling is easy because you have the backing of the most famous name in the field of intercommunication—DICTOGRAPH. In addition, because the DICTOGRAPH Electronic is engineered around only two basic instruments, your stock problem is simplified and you carry only fast-moving merchandise!

So, if you have or can build a full-fledged sales force, plus service and maintenance facilities, write today to see whether the franchise is open in your territory.



Please address

General Sales Manager

DICTOGRAPH PRODUCTS, INC.

580 Fifth Avenue New York 19, N. Y.

NEW LITERATURE

Premier Vacuum Cleaner Division, General Electric Co., Cleveland 14, Ohio, now offers to its dealers a complete, compact file of information and sales helps in the form of a "Premier Sales Binder." It is a loose-leaf, 3-ring binder covering the complete Premier line, including a sales training manual, and other items. The binder is sold to dealers through distributors at \$1.50.

Ward Products Corp., 1523 E. 45th St., Cleveland 3, Ohio, is now ready with a free catalog which describes in detail the firm's new line of FM antennas. The line includes both folded and straight dipole types, designed to operate in the 88 to 108 mc band.

Libbey-Owens-Ford Glass Co., Nicholas Bldg., Toledo 3, Ohio, has issued a new booklet showing many uses of Tuf-flex tempered plate glass doors. Illustrated in pictures are Tuf-flex door installations in many types of stores. A copy may be obtained free by requesting form TF-2.

Stephens Mfg. Co., 10416 National Blvd., Los Angeles 34, Cal., are distributing a new circular 109 of theatre and home speaker systems. Coaxial and separate 2-way systems are shown, including their new Co-Spiral Model P-52FR, which uses a molded curvilinear cone known as the "Silver Spiral," to cover from 40 to 14,000 cycles.

JFD Mfg. Co., 4117 Ft. Hamilton Pkway, Bklyn. 19, N. Y., has started production of a new plug-in type step down ballast resistor which permits the operation of American 110-volt radios on 220-volt circuits such as used in many foreign countries. Descriptive literature on this new item, as well as a bulletin dealing with servicers' essentials such as dial pointers and knobs, switches, phono adapters, connectors, plugs, cables, loops and filters may be had free upon request to JFD's Dept. U.

Sylvania Electric Prods., Inc., Emporium, Pa., is distributing its new technical manual covering 545 types of radio receiving tubes. Available for 85 cents from Sylvania or its distributors.

Radio Condenser Co., Camden, N. J., announces a new bulletin describing the Rotonoid, a power unit with a constant torque through 180 degrees of rotation.

Allied Radio Corp., 833 W. Jackson Blvd., Chicago, has released its new 1947 catalog, featuring in 164 pages the new information and prices on radio and electronic products. Listings include over 10,000 radio & electronic parts, test units, batteries, radios and phonographs, public address and intercommunication equipment, recorders and accessories, communications receivers, kits, record changers, phonograph motors, tools, books, diagrams, and a large variety of

other items in the electronics field for radio servicemen and dealers, radio amateurs, experimenters, engineers, schools, and industry. All items are arranged in clearly defined sections and carefully indexed for speedy reference.

Federal Telephone & Radio Corp., 67 Broad St., New York 4, N. Y. are offering an illustrated booklet showing 20 circuits for using their selenium rectifier in audio amplifiers, phono oscillators, speaker field, d-c filament and relay power supplies, as well as many other applications. Full explanations and parts lists accompany the tested schematics. Available free upon request to the company.

Westinghouse Electric Corp. has announced a "Farmstead Wiring Booklet" (B-3874) for dealers, farmers, jobber salesmen and contractors, available from the nearest Westinghouse jobber at 25c per copy if less than 100 are ordered. The 44-page booklet covers all steps in farm wiring and electrification, and handles the technical aspects in simple popular terms.

Olson Radio Warehouse, Inc., 73 E. Mill St., Akron, Ohio, has published a new 48-page catalog listing all radio parts, tubes, accessories, etc., in uniform column width, complete with easy-to-read prices in heavy type. The convenient pocket size has been specially prepared for handy use by servicemen. Olson plans to issue a new catalog every 30 to 60 days.

Perpetual Troubleshooter's Manual, Vol. XV

Published by John F. Rider, Publisher, Inc., 404 Fourth Ave., New York 16, N. Y. 2,000 pages plus 200 page "How It Works" supplement. Price \$18.00.

"Who's to stand the loss for the time a servicer spends tracing the schematics of today's complex multi-band receivers . . . the customers or the servicers?" asks Mr. Rider in a recent news release on his new Volume XV.

Answer to the question is offered by Rider himself, in the form of a separate "Clarified schematic" diagram for every band of every multi-band set put out by manufacturers in 1946, and covered in the new manual.

Rider engineers and draftsmen have traced down the combination sets into as many as eighteen individual schematics, showing which components are in operation under each switch position.

Other circuits cover the new "ham" receivers and all Scott radios not shown in previous volumes. Record changers and players are included. The "How It Works" supplement explains the theory and functioning of technically new features used in the sets reported in Volume XV.

**JOBBER!
QUANTITY
BUYERS!** **DOUBLE
your profits**

**With MID-AMERICA'S
SENSATIONAL BARGAINS!**



**FREE
CATALOG**

**...and Monthly
Bulletins Keep
You Posted on
Late, Great
Buys in**

**RADIO PARTS AND
ELECTRONIC EQUIPMENT**

You can't beat Mid-America's rock-bottom prices for top-quality radio parts and electronic equipment. MID-AMERICA has 70,000 square feet of warehouse space jam-packed with relays, chokes, tubes, condensers, resistors, meters, plugs, jacks, wire, cable, sockets, switches, generators, dynamotors, volume controls, knobs—all new, unused and in perfect condition—AND ALL AT THE LOWEST PRICES YOU'VE EVER SEEN! Write today for MID-AMERICA'S big, complete catalog—and get your name on the list to receive FREE MONTHLY BULLETINS. Rush your name and address today to Mid-America's store address, Desk A.T.67

MID-AMERICA CO. Inc.
STORE 2412 S. MICHIGAN AVE. CHICAGO 16, ILL.
WAREHOUSE 2307 S. ARCHER AVE. CHICAGO 16, ILL.

THIS SPACE FOR RENT

Smart advertisers can enlarge to any size—from this 1/6th page to 32-page insert. Fine location for radio's heaviest dealer and distributor traffic. Rates reasonable. Business prospects excellent. Apply to your advertising agent, or phone, write, wire collect, to

**RADIO & Television
RETAILING**

**CALDWELL-CLEMENTS,
INC.**

480 Lexington Ave., N. Y. 17
PLaza 3-1340

Parts Show Is Host to Thousands

Radio's most successful parts show—the big 1947 Radio Parts & Electronic Equipment exhibition at the Stevens Hotel in Chicago, ended May 16 on a note of general industry optimism.

Thousands of distributors and other radio men came from all parts of the U. S. to crowd the exhibit floors of the show. There was a tendency among the guests to wait to be sold, rather than to place immediate orders, according to officials. Great interest was shown in the brand new products which were exhibited for the first time during the event.

Noticeable among those attending the show was a larger number of radio men from abroad. The event ordinarily attracts big groups of engineers and distributors from other countries, but this year the delegation was exceptional.

The show, one of the most successful ever staged in the industry, was sponsored by the Radio Manufacturers Association (Parts Division), Sales Managers Club (Eastern Division), the Association of Electronic Parts & Equipment Manufacturers, and the National Association of Electronic Distributors. Kenneth C. Prince is general manager of the show corporation.

Reps Hold Annual Dinner Meeting

The New York Chapter of The Representatives staged its annual dinner festival on the evening of May 21st at the Hotel New Yorker, N. Y. This was the 12th successive annual event and many well known radio men of the area were among the guests. Executives of radio and electronic manufacturing concerns together with executives of the various distributing houses in the territory all took part in the lively meeting.

Southwestern Officers

"The Reps" Southwestern Chapter has held an election, and Hal F. Corry, secretary-treasurer, incumbent last year and re-elected, has announced the new officers as J. Y. Schoonmaker, president; and Edward F. Aymond, vice-president.

The Delegates chosen to the national meeting are: J. Y. Schoonmaker, A. L. Berthold and Mose Branum.

This chapter has been very active in its membership drive and cooperation with the Southwestern Chapter of N.E.D.A. The latest joint meeting recently at the Blackstone Hotel, Fort Worth, Texas.

New Service Department

The appointment of Lt. Commander William J. Rooke (USNR) as director of a newly organized service department has been announced by Lloyd A. Hammarlund, president of Hammarlund Mfg. Co., New York.

You satisfy every
COMMERCIAL

and
**INDUSTRIAL
SOUND NEED**

with the
complete line of
**BELL SOUND
EQUIPMENT**

and at the same time

- Simplify Your Inventory
- Increase Stock Turnover
- Boost Your Profits



Ask your
nearby Bell
distributor
for details

**BELL SOUND
SYSTEMS, INC.**

1186 Essex Avenue
Columbus 3, Ohio

TUBES

All Types in Stock

STANDARD BRANDS

Minimum Order—10 Tubes

- 10 to 25—40% off List
- 26 to 100—50% off List
- 101 to 500—50% and 10% off List
- 501 and over—60% off List

OUR SPECIALS

20 x 20—150V	\$.45
1S5—1T4—3S4—1R569
25Y5—same as 25Z559
6AH6—same as 6AK569
6AK5—Brand New Standard Makes89
Acorn Tubes 954-955-956-95749
Hearing Aid Tubes 501AX to 509AX ..	.49
All American Kit 50L6-35Z5-12SA7- 12SK7-12SQ7	2.65
Miniature Kit 50B5-35W4-12BE6- 12BD6-12AT6	2.65

OUR OWN BRAND "COMMERCIAL" TUBE
GUARANTEED UNCONDITIONALLY—100%

All Types in Stock 60% off List

MADE BY STANDARD BRAND
MANUFACTURER

Write for Catalog



COMMERCIAL RADIO
36 BRATTLE ST., BOSTON 6, MASS.

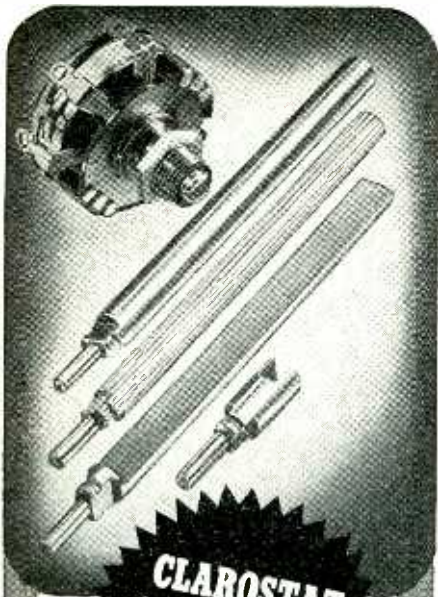

**CLAROSTAT
AD-A-SHAFT
CONTROLS**

**NO WIGGLE
NO WOBBLE
NO TROUBLE**

★ Select that control for ohmage, taper, tap. Then select the required shaft—round, flat knurled, auto-radio, etc. They go together with a bang. Just a blow on the shaft and it's permanently fastened. No wiggle. No wobble. No coming out again. It's as rigid as the factory-riveted job.

That's what servicemen like about the new Clarostat Ad-A-Shaft. Mechanically, it's tops—fully matching the electrical perfection of the Clarostat control.

With each Ad-A-Shaft Control Series AM (Standard) or AT (Tapped) you select any type shaft you need. Minimum stock, maximum uses. You can now afford to have controls on hand. No need wasting time chasing down to the jobbers' each time. No tying up of real money. Here's the right control and right shaft right at hand.

Ask our jobber about the new Clarostat Ad-A-Shaft. By all means try it. You'll want it after that!



CLAROSTAT MFG. CO., Inc. • 285-7 N. 6th St., Brooklyn, N. Y.

RMA Convention June 10-12 to Set Industry Record

Exceptional trade interest is being shown in the 23rd Annual Convention of the Radio Manufacturers Association, which is expected to attract a record number of industry leaders to the Stevens Hotel, Chicago, for the June 10-12 sessions.

Meetings of the RMA divisions, comprising set, tube, parts, transmitter, and amplifier and sound equipment manufacturers, are scheduled to be held during the three-day event. Two meetings of the RMA board of directors, first the old board and afterward the new board, will be held.

Brig. Gen. David Sarnoff, president of the Radio Corp. of America, and Charles R. Denny, Jr., chairman of the FCC, are scheduled to address the industry leaders if prior engagements do not interfere. General Sarnoff will speak at the industry banquet on June 12, while Mr. Denny will address the membership luncheon on the same day.

RMA treasurer, Leslie F. Muter, of the Muter Co., Chicago, is chairman of the convention committee and is arranging an elaborate entertainment program for the industry banquet.

RMA president, R. C. Cosgrove, of the Crosley Division, Cincinnati, will preside at the business session of RMA members and at the meetings of the RMA board of directors. Mr. Cosgrove is ending his third term as RMA president. New officers will be elected at the June 12 meeting of the directors.

Helps to Sell Sound

For a semi-technical explanation of 20 important characteristics of amplifiers, written in a way which will help the sound dealer explain amplifier details to prospects, send a 3c stamp to Amplifier Corp. of America, 396-7 Broadway, New York 13, N. Y. By chief engineer A. C.

Shaney, the 24-page booklet, "20 Steps to Perfect Amplification," covers subjects such as scratch suppression, signal expansion, frequency and dynamic range, cross modulation, balancing and attenuation, microphonics, distortion, and noise.

Emerson's Price Reduction on Nine Models

In the midst of widespread comment by the trade, the Emerson Radio & Phonograph Corp. declared that its recent price reductions on nine of its models was part of "a nationwide move to help bring component and production costs and retail prices to levels which will be more consistent with the economic needs now confronting the consumer, the trade and the country as a whole."

Benjamin Abrams, the Emerson president, said that "This is the key to our national prosperity—lower prices and full production and employment at wages which will enable everyone to share in the necessities and luxuries of life—and it is the responsibility of business management to make the formula work."

Emerson executives stated that the company's distributors agreed in conference that the new prices of the nine models would stimulate greater retail sales and that the stepped up volume would react not only to the benefit of dealers, but to the public as well. It was pointed out that the company's policy in the past has always been to establish list prices first and then set about the task of bringing basic costs in line, which procedure is being followed in the present instance.

Westinghouse Promotion

Will M. Kline, Jr., is the new assistant sales promotion manager for the Westinghouse Electric Appliance Division, Mansfield, Ohio, according to Roger H. Bolin, manager of appliance advertising.

Industry-Wide Group Acts to Aid Servicemen



A merchandising and market research program, aimed at all-industry aid to the radio serviceman and sponsored by the Radio Industry Parts Co-ordinating Committee, was the subject of this meeting of the group's Merchandising and Research Sub-Committee. Left to right, Jack Berman of the Electronic Parts & Electronic Manufacturers Ass'n.; Harry Kalker of the RMA; Robert Baggs of the Sales Managers' Club; William Schoning of NEDA; and Louis Calamaras, also of NEDA. Another member, Lou Hatry of NEDA was not present. Mr. Baggs is chairman of the sub-committee; H. W. Clough heads the Industry Committee. First action was to start a "Code of Ethics" program.

“*Accwire*”
**FLEXIBLE
 CORD AND
 CORD SETS**



- Cord Assemblies — standard and to specifications for all types of Radios and Electrical Appliances.
- Cotton and Rayon Braided Wire for all general flexible cord applications.
- Send for Sample Card . . . inspect 14 different “Accwire” Cords and judge quality for yourself.
- Special Cables and Portable Cords.
- Rubber and Synthetic Cords and Cables in a wide range of sizes, stranding and conductors.
- The right cord for each job.

THE ACCURATE INSULATED WIRE CORP.

Manufacturers of Insulated Wire for a “Quarter of a Century”

30 FOX STREET • NEW HAVEN, CONN.

*Quality you can
 see in*
**VACO
 screw drivers**

These transparent Amberyl plastic handles tell their story at a glance... break-proof strength, shock-proof safety... shafts and bits of the finest steel alloy, treated to insure lasting dependability on every type of job.



There are 173 types of Vaco screw drivers. Type shown above is designed to take care of many radio requirements.

VACO PRODUCTS CO.
 317 E. ONTARIO ST.
 CHICAGO 11, ILL.
CANADIAN WAREHOUSE
 560 KING STREET WEST, TORONTO 2, ONT.

Write for catalog.

New and Exclusive! Nothing Else Like It!

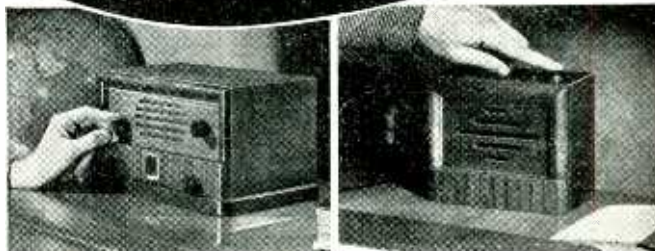

Master station (left) and sub-station (right) housed in handsome walnut veneer cabinets. (At top and left) Radio-Utiliphone in use as inter-com. (Right) Sub-station in operation.

Radio Utiliphone

COMBINATION INTER-COM AND RADIO — MODEL 76 RU

THE SALES OPPORTUNITY OF THE YEAR!

• Now, for the first time, combined in one handsome, compact instrument, executives can have all of the advantages of inter-communication *plus* the convenience of radio. News of the world, market reports, the scores of other radio features . . . as well as contact with key men in the organization are both instantly available at the touch of a control! What a natural for sales . . . what an opportunity for profit! *Radio-Utiliphone* accommodates up to 4 sub-stations, includes high-fidelity, super-heterodyne radio circuit, 5 tubes plus rectifier. Handsome . . . easy to use . . . easy to install.

List price master and one sub-station, \$89.50; additional sub-stations \$15.00 each, list. All Utiliphone prices slightly higher Denver and West.



Limited Number of Distributorships Available
 Wire or Phone Sales Division, Indianapolis, Riley 1551
ELECTRONIC LABORATORIES, Inc.
 INDIANAPOLIS, INDIANA



ACCURATELY TESTS
ALL F.M. CIRCUITS

Clippard

Model 406 Electronic Volt-Ohmmeter

We invite comparison of this instrument with any at any price for appearance, ruggedness, accuracy, stability.

\$89.50

From Jobber F.O.B. Cincinnati

No extras to buy. Send for details or order today.

CLIPPARD INSTRUMENT LAB., Inc.
1135 Bank St., Dept. 8, Cincinnati 14, Ohio

Demonstrates Inter-modulation Analyzer

Scores of Chicago's leading radio and sound engineers were recent guests at a dinner meeting at the Hotel Continental, sponsored by Allied Radio Corp., distributors of Altec-Lansing equipment. John K. Hilliard, chief engineer of the Altec-Lansing Corp., described and demonstrated the "intermodulation distortion analyzer" for the group.

Allied reported that "the great interest shown in Mr. Hilliard's demonstration seems to indicate that the public will benefit before long from higher standards in the manufacture of receiving, transmitting and public address equipment."

Stromberg-Carlson Holds Prices at Present Levels

Stromberg-Carlson does not expect to reduce prices of any of its line of radio receivers at this time, according to Lloyd Spencer, vice-president and general sales manager.

This was revealed at the first Stromberg-Carlson combined dealer meeting to be called since before the war. Mr. Spencer, speaking before more than 700 dealers, their wives and factory representatives who were guests of Gross Distributors, Inc., explained upped costs of production, the firm's desire to maintain the quality of its merchandise, and the fact that the line had been priced right in the first place, as factors which justified maintenance of present prices.

Mr. Spencer promised the retailers that if at any time price reductions on any particular model or models was decided upon, the company would notify its franchised dealers thirty days in advance.

Benjamin Gross, president of the distributing firm which services Stromberg's New York, New Jersey, Connecticut and Massachusetts territory, opened the meeting, held in the Waldorf-Astoria, New York, by announcing the resumption of a merchandising policy based upon consolidated advertising. The firm's "Preferred Delivery" plan will be stressed in copy directed to the consumer.

Blvss Gates, sales manager of the Gross organization, acting as toastmaster, introduced Dr. Ray H. Manson, Stromberg-Carlson president, and Stanley H. Manson, manager of public relations. Dr. Manson reviewed the entire field of the company's activity since 1941, covering advances made in FM and television. He predicted that it will take four to five years to get FM into every wired home, stating that not more than two million of the static-free sets will be made this year. Dr. Manson foresaw FM and television assuring a bright future for the firm's dealers.

Clifford Hunt, sales manager radio and television divisions of Stromberg, reviewed the current line, using receivers to illustrate his talk. He also introduced two new television receivers. One of the latter is a console instrument embodying AM and FM radio, phonograph and television on a ten inch screen; the other is a smaller console, housing the same tele chassis and sound as the larger model.

20 Years Ago

From the June, 1927 Issue of
Radio Retailing
(256 pages)

TIME PAYMENTS — How the contract-purchasing companies work with the dealer.

LESSONS FROM FAILURE — A retailer who closed his doors says that he should have (1) Made a shirt-sleeve job of it and (2) Counted no profits except actual cash.

OUTSIDE SALESMEN — It takes a good system to keep them supplied with sufficient leads.

RADIO TRADE IS CONFIDENT — Good market exists amid favorable economic conditions—twenty million homes still without radios.

MODERN JOBBER'S job is to be the business counselor of his dealers.

WIRED WIRELESS — A system of broadcasting over the electric light lines is planned for some cities.

TELEVISION — Extremely complicated and expensive, it is seen only as a future market possibility.

LEADING SETS — Retailers in 600 towns rank the best-selling receivers as (1) Atwater Kent, (2) RCA, (3) Crosley, (4) Freshman, and (5) Kolster.

In closing, Mr. Gross urged dealers to get rid of slow-moving merchandise, and he pointed out that the day for widespread trade-in allowances could be warded off for a long time by tackling the job of selling early. He stated that the Gross distributing organization has no trade-in plan for its dealers in effect at this time, but said that his company will have one ready when the need for it is at hand.

New Sales Manager

The appointment of A. John Bodenmuller as sales manager of Traubee Products, Inc., 924 Bergen St., Brooklyn, N. Y., makers of the Time-Saver pressure cooker and waterless cookware lines, has been announced by Jacques Traubee, president of the company.

A veteran of specialty merchandising, Mr. Bodenmuller was previously on the executive sales staff of Westinghouse Electric Co., at Mansfield, Ohio. He was also assistant sales manager of Servel, Inc., and wholesale sales manager of E. A. Wildermuth, New York metropolitan area distributors.

TUBES: Perfect condition, but not in sealed cartons. Guaranteed 90 days.	
#26, 27, 46 or 56	.29
#42, 45, 75, 77, 78, 80, 5Y3, 6H6 or 6K7	.59
#6A8, 6C5, 6F5, 6J7, 6SA7, 6SK7, 12SA7, 35, or 39	.49
#1A7, 6A3, 6U5/6G5 or 50	.59
2 Gang Variable Condensers, .365 mmfd, ball-bearing shaft, 3/4" shaft, 3/4" long	.75
Victor Power Transformer for models R-32, 45, 52 or 75. Unshielded	5.95
IPHONO MOTORS!! Twin-coil, 110 V. AC quiet rim-drive, fan cooled. With 9" turntable	2.95
9" Alliance Turntables rim-drive. 3/4" hole	.98
RADIO HARDWARE TREASURE. An indispensable assortment of approx. 1000 screws, nuts, washers, etc	.49
SERVICEMEN'S KITS	
#2—Speaker Cones: 12 asstd. 4" to 12" moulded & free-edge (magnetic incl.). Less voice coils	2.00
#3—BAKELITE MICA CONDENSERS: 50 asstd. .00001 to .2 mfd, 200-600 WV. Clearly marked	2.95
#4—TUBULAR BY-PASS CONDENSERS: 50 asstd. .001 to .25 mfd, 200-600 WV. Standard brands	2.49
#6—Dial Scales: 25 asstd. airplane & slide-rule (acetate & glass included)	2.98
#7—Escutcheon Plates: 25 asstd. airplane, slide-rule & full-vision types	2.95
#8—Knobs: 25 asstd. replacements including setscrew, spring & push-button types	1.00
#17—DIAL WINDOWS: 12 asstd. popular sizes, incl. flat & moulded acetate & convex glass	1.29
#20—SPEAKER REPAIR KIT. A real time & money saver. Contains: 25 asstd. paper rings, 10 splders, 25 asstd. voice coil forms, 3 yds. felt strips, 20 chamalos leather segments, kit of 16 centering shims & tube of Speaker Cement. All for	2.49
#23—RADIO CEMENT & SOLVENT KIT. Contains 3 oz. each of all-purpose cement & solvent. With applicator brush	.69
#24—Shaft Extenders, Reducers, Couplings: 10 asstd. of the most popular types used in servicing	.98
#25—SPRING ASSORTMENT. 20 asstd. compression & expansion for dials, push-buttons, relays, etc	.25
AC-DC NEON TEST-LITE. Use as probe or fixed indicator. 90 to 550 V. Each .15; 8 for 1.00	
PROMPT SERVICE ON ALL SPEAKER & PHONO PICK-UP REPAIRS	
Minimum Order \$2.00—20% Deposit Required on All Orders. Please Add Sufficient Postage.	
LEOTONE RADIO COMPANY	
67 DEY STREET, NEW YORK 7, N. Y.	

SPECIALS for JUNE

3 CONDUCTOR FLAT RUBBER COVERED AC CORD

An ideal cord for replacement purposes on AC-DC Radios, etc., where third lead is used for antenna. Has many other uses. Priced very special for this month only.

Per 1000 Ft. Spools \$30.00
Per 100 Ft. Coils \$ 3.38

SIX FOOT 3 CONDUCTOR CORD SET

A six foot cord set of the above material with molded unbreakable rubber plug and open end of cord stripped and tinned ready for attaching.

Per each \$0.38

AC-DC AERIAL WIRE

An extra flexible rubber covered wire, excellent for replacement aerial wire on small radios. A real value.

Per 1000 Ft. Spool \$ 4.13
Per 100—20 Ft. Hanks \$11.25

BARE AND TINNED AERIAL WIRE

Columbia's finest aerial wire. Guaranteed as to gauge and length. Stock up on these scarce items at this low price.

19 Ga. 7x27 Bare \$0.36
Per 100 Ft. Coil
18 Ga. 7x26 Tinned \$0.49
Per 100 Ft. Coil
15 Ga. 7x23 Tinned \$0.66
Per 100 Ft. Coil \$0.66

TWISTED PAIR INTERCOM WIRE

Here is a 22 Ga. Solid Twisted Pair with plastic insulation at rock bottom prices. This is a never to be duplicated value.

Per 1000 Ft. Spools \$7.35

We carry in stock for immediate delivery many types of wire and cable in gauges of from 23 to 2, in addition to various types of multi-conductor cable for many uses. We also manufacture cord sets and cables to specifications. Send us your inquiries for prompt attention.

Our new catalog is now ready for distribution. Send for your copy today.

COLUMBIA WIRE & SUPPLY CO.

5734 ELSTON AVE., CHICAGO 30, ILLINOIS

FOR SALE

Because of ill health, will sell old established **Sound Equipment, Radio and Appliance** store located in mid-west city serving a population of 300,000. New building with garage; good lease. Price: \$40,000.

Box 601, **RADIO & Television RETAILING**
480 Lexington Avenue New York 17, N. Y.

CLOSING DATES FOR

**RADIO Television
RETAILING**

5th of preceding month for all ads requiring proofs, composition, foundry work, key changes, etc.

10th of preceding month for complete plates only—no setting.

1st of month—Publication Date.

Cancellations not accepted after 5th of preceding month.

CALDWELL-CLEMENTS, INC.
480 LEXINGTON AVENUE, NEW YORK 17

NOW!

END WORRY...MESS...
UNCERTAINTY OF
STORAGE BATTERIES!

Enjoy

PERFECT Radio Reception When Servicing
Car, Marine and Aircraft Radios!

NEW *Electro*
ELECTRICAL AND RADIO EQUIPMENT

Model "A"
**POWER
SUPPLY**

DC Output

Operates latest type auto
radios with solenoid tuning
and tone controls . . . also 12 volt marine and aircraft radios.

Height, 7 $\frac{3}{4}$ "
Width, 7 $\frac{3}{4}$ "

Length, 11 $\frac{3}{4}$ "
Ship. Wt. 31 lbs.

Always dependable! Reserve power a-plenty! Big, heavy duty transformers and chokes — large capacity condensers, for exceptional voltage regulation — instantaneous power for solenoid operation. Two separately filtered DC output sources: in parallel supply 6V at 15 amps. series, 12V at 7 $\frac{1}{2}$ amps. Separately 6 V at 7 $\frac{1}{2}$ amps.

Compact. Sturdy. 18-gauge steel construction. Handsome blue Hammerloid finish. Comes completely equipped including 6' rubber cord and plug. Vastly superior and costs no more than batteries for equal service.

Send for complete description of this up-to-the-minute power supply.

ELECTRO PRODUCTS LABORATORIES

Pioneer Manufacturers of Battery Eliminators

549 West Randolph Street

Chicago 6, Illinois



the *Service* line
of **CORDS** and **CORD SETS**
specified by top manufacturers of



LAMPS

RADIOS

IRONS

FANS

PORTABLE TOOLS

VACUUM CLEANERS

REFRIGERATORS

RANGES

WASHERS

HEATERS

MIXERS

A full line of Flexible Cords for the repair and service industry, obtainable through jobbers and distributors.

CORNISH WIRE CO., INC.
15 Park Row • New York City, 7



Needle Packet Turntable Stand



Lubricant—Tester
G-C NEEDLE PACKET



Handy to carry. Sell replacements with this convenient packet. Ten needles, 2 each type, 2 recording stylus
No. 1432—Dealers Net \$4.25

G-C PHONO TURNTABLE MOTOR & GEAR LUBRICANT

Special lubricant for phonographs; clings to surface of parts. Eliminates repair trouble. No. 1223—tube—Dealers Net 25c



G-C PHONO TURNTABLE STAND

Steel stand on which you can replace phono turntables, ideal for repairmen, easily adjusted, very sturdy. No. 5205
Dealers net \$3.99

G-C Thermo-Volt CIRCUIT TESTER

For 15-60 volts AC or DC. Durable pocket type tester housed in plastic case; has long test leads and handy clips for attaching. Useful to engineer, radio man, electrician etc. No. 5150
Dealers net \$1.05 Sold by all jobbers.

Write for your copy of our catalog

RADIO DIVISION DEPT. G
GENERAL CEMENT Mfg. Co., Rockford, Ill., U. S. A.
Manufacturers of over 3,000 products
Sales offices in principal cities

Door to Door

(Continued from page 47)

are becoming more and more opposed to the straight commission, no-draw plan. They feel that the largest personnel turnover rate will be experienced under such operation.

Too, they know that the straight commission man's time is his own, and that the employer is limited in his efforts to compel such salesman to adhere to the firm's selling methods, and to stop him from misrepresenting goods and services, as well as high-pressuring, in attempts to force sales.

Straight commission pay doesn't appeal to the salesman either, unless the dealer is able to offer nothing but fast-selling brands, floor-time, hot-leads and high commission rates.

Conditioning Process

Having selected and trained his salespeople, and having settled upon plans for paying them, the dealer's next step is to "condition" the outside field. Because the established dealer has many bonafide customers on his list today, he doesn't need to plan to do much cold canvassing. His first tour on the outside should comprise calls on established clientele—people who know the store's name.

Reports from outside salesmen at this time indicate that because this selling technique hasn't been overdone for some years, receptions and results are most encouraging. They say that housewives are extending cordial welcomes to today's doorbell ringer.

As competition increases, outdoor selling will be used more and more, and when this day of all-out canvassing comes, the going will be much tougher. Since the greatest door-opener of all is the name of a dealer which is known to the prospective customer, the alert merchant needs to keep his firm's name in the limelight.

The Right Approach

In addition to paving the way for his salesmen via advertising, the merchant who's going in for outdoor selling needs to exercise the greatest care in preservation of his good-will by insisting that each salesperson use a tactful, pleasant approach.

Indirect approaches and beating around the bush tactics should never be employed. Such methods are door-slamming bait to the householder. No door-to-door salesman should be permitted to trick the home-owner into permitting him to get into the house. The salesman should intro-

DATES AHEAD

Future Events of Interest to Readers

June 1-5: National Association of Music Merchants (NAMM) Trade Show, Palmer House, Chicago

June 2-5: 15th Annual Convention, Edison Electric Institute, Traymore Hotel, Atlantic City, N. J.

June 10-13: Radio Manufacturers Association (RMA) Convention, Hotel Stevens, Chicago

June 12-22: Second Annual Construction Industries Exposition and Home Show, Pacific Auditorium, Los Angeles

June 23-30: New York Furniture Show, Grand Central Palace, New York City

July 7-13: Store Modernization Show, Grand Central Palace, New York City

July 7-19: Summer Furniture Show, Furniture and Merchandise Mart, Chicago, Ill.

Oct. 7-9: National Farm Electrification Conference, Claypool Hotel, Indianapolis, Ind.

Nov. 3-5: National Electronics Conference, Edgewater Beach Hotel, Chicago

Nov. 23-30: Second Annual National Crafts & Hobby Show, Madison Square Garden, N. Y.

duce himself, mention the firm, and next state the purpose of the call. This is the ideal method because it is honest, informative and time-saving.

Outside selling is beginning again, and even the dealer who feels he doesn't have to engage in it right now, should make his plans for future participation because it is more likely that the competitive efforts of others will sooner or later force him to do so.

Sit-Down News



Sit-down style of ironing is being recommended by Proctor Electric Co., for housewives using the new Proctor electric Never-Lift iron. The firm has an explanatory booklet on this.

LAKE AMPLIFYING SYSTEM



Excellent designed, compact amplifiers, ideal for students, professional entertainers, homes, factories, schools, etc. Perfect for voice, musical instruments, pickups and contact microphones; clear, rich tone; heavy plywood in luxurious leatherette-covered stream-lined portable cabinets. As listed below:

No.	Watts	Inputs	List	Your Cost
A16	16	4	\$110.00	\$62.50
A15	15	3	97.50	52.86
A12	12	2	87.50	45.00
A 8	8	3	87.50	45.00
A 6	6	2	75.00	44.10
A 5	5	2	60.00	26.95

Hawaiian Electric Guitar
—Beautiful black plastic finish, trimmed with chrome. 23" scale. 4½ octaves of playing range.
List—\$50. Your Cost—**\$29.40**

SERVICEMEN and RETAILERS
Write today for our new, illustrated 16-page catalog NR-116. It's free. Get on our mailing list! Write for our special catalog on microphones, amplifiers and sound equipment.

Lake Radio Sales Co.
615 W. Randolph Street
Dept. B
Chicago 6, Ill.

INDEX To Advertisers

JUNE 1947

	Page		Page
Accurate Insulated Wire Corp.	159	Mid-America Co., Inc.	157
Acton Co., Inc., H. W.	89	Motorola, Inc.	6
Adelphia Industries	89	National Carbon Co., Inc.	16
Admiral Corp.	Insert	Newcomb Audio Products Co.	148
Aerovox Corp.	154	Noblitt-Sparks Industries, Inc.	22, 23
Air King Radio Div. Hytron Radio & Elec- tronics Corp.	57	Norge Div., Borg-Warner Corp.	103
Altec-Lansing Corp.	131	Olson Radio Warehouse, Inc.	135
American Magazine	105	Operadio Mfg. Co.	147
Apollo Records, Inc.	73	Permo, Inc.	71
Audak Co.	87	Philco Corp.	80
Bell Sound Systems, Inc.	157	Picturetone Records, Inc.	75
Bendix Radio Div. Bendix Aviation Corp.	55	Proctor Electric Co.	106
Caldwell-Clements, Inc.	141	Quam-Nichols Co.	163
Chicago Tribune	10	Radio Corp. of America: RCA Victor Div.	40, 41
Clarostat Mfg. Co., Inc.	158	RCA Victor Records	62
Clippard Instrument Lab., Inc.	160	Tube Division	112, Cover 4
Columbia Records, Inc.	69	Rauland Corp.	151
Columbia Wire & Supply Co.	161	Raytheon Mfg. Co.	32
Commercial Radio	157	Raytone Electronic Co.	88
Concord Radio Corp.	155	Record Shop	80
Continental Electronics Ltd.	84	Rider Publisher, Inc., John F.	139
Cornish Wire Co., Inc.	161	Sams & Co., Inc., Howard W.	133
Cowboy Record Co.	88	Scott Radio Laboratories, Inc.	35
Crosley Div. Avco Mfg. Corp.	14, 15	Seeburg Corp., J. P.	Cover 3
Dictograph Products, Inc.	156	Signature Records	85
Disc Co. of America	77	Simpson Electric Co.	124, 125, 149
DuMont Laboratories, Inc., Allen B.	27	Simpson Mfg. Co., Inc., Mark	153
Duotone Co.	82	SNC Mfg. Co., Inc.	137
Dynavox Corp.	86	Sonora Radio & Television Corp.	13
Electro Products Laboratories	161	Sound Equipment Corp. of Calif.	155
Electronic Laboratories, Inc.	145, 159	Sparks-Withington Co.	5
Emerson Radio & Phonograph Corp.	8, 9	Standard Register Co.	109
Fada Radio & Electric Co., Inc.	2, 3	Standard Transformer Corp.	127
Farnsworth Television & Radio Corp.	24	Steelman Radio Corp.	81
Furniture Specialties Co.	79	Stewart-Warner Corp.	60
General Cement Mfg. Co.	162	Stromberg-Carlson Co.	36, 143
General Electric Co.	11, 123, 150	Supreme Instruments Corp.	152
General Electronic Distributing Co.	164	Sylvania Electric Products, Inc.	118, 119
General Industries Co.	84	Symons Assoc., L. H.	76
Gibson Refrigerator Co.	97	Symphonic Radio & Electronic Corp.	25
Graybar Electric Co.	107	Templetone Radio Mfg. Corp.	59
Hytron Radio & Electronics Corp.	21	Tone Products Corp. of America	78
International Resistance Co.	128, 129	Triplett Electrical Instrument Co.	121
Jensen Mfg. Co.	12	Trylon Radio Laboratories	83
Ken-Rad Div. General Electric Co.	7	United States Television Mfg. Corp.	30
Keynote Recordings, Inc.	86	Vaco Products Co.	159
Lake Radio Sales Co.	162	Vacuum Cleaner Supply Co., Inc.	108
Lee Radio Co.	146	Ward Products Corp.	152
Leotone Radio Co.	160	Warwick Mfg. Corp.	26
Maguire Industries, Inc.	34	Webster Chicago Corp.	74, 87
Mallory & Co., Inc., P. R.	110, Cover 2	Westinghouse Radio Corp.	28, 29
Melodee Records, Inc.	89	Wilcox-Gay Corp.	31
Merit Coil & Transformer Corp.	4	Winsted Hardware Mfg. Co.	92
		Zenith Radio Corp.	33

While every precaution is taken to insure accuracy, we cannot guarantee against the possibility of an occasional change or omission in the preparation of this index.

What

Adjust-a-Cone

Means to **YOU**

The patented Adjust-A-Cone construction provides a method for precision centering of the voice coil in every Quam Speaker before it leaves the factory.

With ordinary speaker construction, such precision is almost impossible, even under the most ideal production methods, and, as a result, the slightest warping or expansion of the cone may produce a rubbing voice coil.

Rubbing voice coils, so frequent with speakers of conventional construction, are practically eliminated in Quam Speakers.

Always specify Quam Speakers for finest performance and long, trouble-free service.

Write for
Catalog



**LOOK
for the
'U'-SHAPED COIL POT**

QUAM

Adjust-a-Cone

SPEAKERS

**QUAM-NICHOLS
COMPANY**

33rd Place and Cottage Grove
Chicago 16, Illinois

SENSATIONAL VALUE

BUILD YOUR OWN VOLT-OHM-MILLIAMMETER

and save!!

The Model-KT 20 kit provides ALL components, including meter, panel, cabinet, resistors, condensers, tip jacks, control, selector switch, copper oxide rectifier, pre-cut wires—in fact every component and part needed to complete the unit.

Complete kit including ALL PARTS assembled and ready for wiring, circuit diagram, easy-to-follow instructions and detailed operating data for the completed instrument.



THE KIT COMES COMPLETELY ASSEMBLED. Can be wired in 15 minutes. Components and circuit guaranteed to meet the following specifications:

- 4 A.C. VOLTAGE RANGES:
0-15/75/300/1500 volts.
- 4 D.C. VOLTAGE RANGES:
0-15/75/300/1500 volts.
- 2 D.C. CURRENT RANGES:
0-15/150 MA.
- 2 RESISTANCE RANGES:
0-10,000 ohms; 0-1 Meg.

\$950
NET

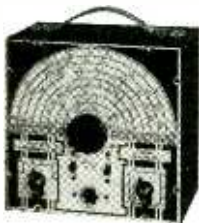

THE NEW MODEL B-45

SIGNAL GENERATOR

Complete, ready to operate. . . . **\$27⁷⁵**

Self-modulated — provides a highly stable signal. RF frequencies from 150 Kc. to 12.5 Mc. on Fundamentals and from 11 Mc. to 50 Mc. on Harmonics.

Modulation is accomplished by grid-blocking action — equally effective for alignment of amplitude and frequency modulation as well as for television receivers. Self-contained batteries. All calibrations are etched on the front panel, permitting DIRECT READING.

Model B-45 uses a beautifully processed dualtone front panel. Comes housed in a heavy-gauge crystalline steel cabinet complete with shielded test lead, self-contained batteries and instructions.



THE NEW MODEL 670

SUPER METER \$28⁴⁰

A Combination VOLT-OHM-MILLIAMMETER plus CAPACITY REACTANCE, INDUCTANCE and DECIBEL MEASUREMENTS

D.C. VOLTS: 0 to 7.5/15/75/150/750/1500/7500.
A.C. VOLTS: 0 to 15/30/150/300/1500/3000 Volts.
OUTPUT VOLTS: 0 to 15/30/150/300/1500/3000.
D.C. CURRENT: 0 to 1.5/15/150 Ma.; 0 to 1.5 Amps.

RESISTANCE: 0 to 500/100,000 ohms 0 to 10 Megohms.
CAPACITY: .001 to .2 Mfd., .1 to 4 Mfd. (Quality test for electrolytics).
REACTANCE: 700 to 27,000 Ohms; 13,000 Ohms to 3 Megohms.
INDUCTANCE: 1.75 to 70 Henries; 35 to 8,000 Henries.
DECIBELS: -10 to +18, +10 to +38, +30 to +58.
The Model 670 comes housed in a rugged, crackle-finished steel cabinet complete with test leads and operating instructions. Size 5½" x 7½" x 3".



THE NEW MODEL CA-11

SIGNAL TRACER \$18⁷⁵

Simple to operate . . . because signal intensity readings are indicated *directly on the meter!*

- ★ SIMPLE TO OPERATE — only 1 connecting cable — NO TUNING CONTROLS.
- ★ HIGHLY SENSITIVE — uses an improved Vacuum Tube Voltmeter circuit.
- ★ Tube and resistor-capacity network are built into the Detector Probe.

- ★ COMPLETELY PORTABLE — weighs 5 lbs. and measures 5" x 6" x 7".
- ★ Comparative Signal Intensity readings are indicated directly on the meter as the Detector Probe is moved to follow the Signal from Antenna to Speaker.
- ★ Provision is made for insertion of phones.

The Model CA-11 comes housed in a beautiful hand-rubbed wooden cabinet. Complete with Probe, test leads and instructions.



THE NEW MODEL 450

TUBE TESTER \$39⁵⁰

Speedy operation — assured by newly designed rotary selector switch which replaces the usual snap, toggle, or lever action switches.

SPECIFICATIONS

- Tests all tubes up to 117 volts.
- Tests shorts and leakages up to 3 Megohms in all tubes.
- Tests both plates in rectifiers.
- New type line voltage adjuster.
- Tests individual sections such as diodes, triodes, pentodes, etc., in multi-purpose tubes.
- Noise Test — detects microphonic tubes or noise due to faulty elements and loose internal connections.
- Uses a 4½" square rugged meter.
- Works on 90 to 125 volts 60 cycles A.C.

EXTRA SERVICE — May be used as an extremely sensitive condenser Leakage Checker. A relaxation type oscillator incorporated in this model will detect leakages even when the frequency is one per minute.

OUR POLICY

We do not advertise any unit which is not available for immediate shipment from stock. • Less flowery adjectives, more detailed specifications. • All units are sold subject to one year guarantee except when components are damaged through misuse. • We do

not solicit orders for any unit that does not meet our requirements for accuracy and honest value. Any item purchased from us is sold with the understanding that it may be returned for full refund after a 10 day trial.

20% DEPOSIT REQUIRED ON ALL C.O.D. ORDERS

GENERAL ELECTRONIC DISTRIBUTING CO.

DEPT. RT-6, 98 PARK PLACE, NEW YORK 7, N. Y.

3 fine SEEBURG CHANGERS

for your radio-phonograph combinations



**FOR
SIMPLICITY
RELIABILITY
LONG-LIFE**

Manufacturers know how much sales appeal a dependable record changer adds to a radio-phonograph combination. That is why Seeburg mechanisms have become standard equipment on so many fine combination instruments.

Seeburg produces three changers—the new intermix “M”, the “L” and the “K”. Each is designed for combinations of varying price range—yet all three are engineered to bring the last word in listening pleasure. When the changer is Seeburg, you can count on quiet, simple operation . . . constant, sustained speed . . . minimum time between changes . . . long record life.

SEEBURG “L”

Two-post construction. Capacity of fourteen 10-inch records or ten 12-inch records. Automatic shut-off. Size: 14¼ x 14¼ inches.



SEEBURG “M”

Three-post construction. Capacity of fourteen 10-inch records, twelve 10-inch records, or twelve 10 and 12-inch records intermixed. Automatic shut-off. Size: 14¼ x 14¼ inches.



SEEBURG “K”

Two-post construction. Capacity of fourteen 10-inch records or ten 12-inch records. Size: 12½ x 12½ inches.

MINIMUM FRICTION
SILENT
LONG LIFE
CONSTANT SPEED
TROUBLE-FREE OPERATION

Seeburg

RECORD CHANGERS ★ MUSIC SYSTEMS

J. P. SEEBURG CORPORATION
1500 N. Dayton St., Chicago 22

You're in the lead with RCA ...*here's why*



Guidance ...
by the better informed men in the industry



Your RCA Tube Distributor is usually better informed, more progressive. In addition to his own experience, he has the benefit of counsel from RCA's field merchandising specialists. These men cover the nation's trade fronts . . . keep distributors up to date on management strategy, market trends, sales methods, and technical information.

Backing up the field representatives are top-flight RCA personnel, constantly studying marketing and distribution problems.

And, in turn, your RCA distributor makes it his business to help you get the right answers to your own business problems.

Your identification with RCA brings you unquestioned customer acceptance . . . prestige . . . quality products . . . and engineering leadership. Seasoned *guidance* is one more big reason why—*you're in the lead with RCA.*

So, push RCA Tubes and watch your business grow!

THE FOUNTAINHEAD OF MODERN TUBE DEVELOPMENT IS RCA



TUBE DEPARTMENT

RADIO CORPORATION of AMERICA

HARRISON, N. J.