

1947 APRIL

CALDWELL-CIFMENTS, INC.

RADIO *& Television* **RETAILING**

FM • TELEVISION

RADIO



ELECTRICAL

APPLIANCES

PHONOGRAPHS &

RECORDS

SOUND &

SERVICE

**PREMIUM
QUALITY**

begins here . . .



... and is a
continuing
factor in all
**APPROVED
PRECISION
PRODUCTS**

(Above) Mallory operators wind resistance wire on vitreous enamel resistors. This is a precision job. Operators chalk numbers of turns being wound by use of gauge. Resistance value of each resistor is kept within rigid tolerance specifications. Note the straight line production set up. After resistors are wound and welded, they move on to enameling and baking operations in the background.

When a resistor is made at the Mallory plant, it is wound with an accuracy of $\pm 5\%$ —then provided with an improved vitreous enamel that gives greater protection, keeps out moisture, minimizes warping, stretching and shifting of wire. It is subjected to tests every step of the way to make sure that "hidden corrosion" won't shorten its life.

As a result, Mallory resistors remain free from failures. They stay accurate and dependable.

They deliver premium quality. Only rigid manufacturing control can give you *that*.

Yet, like other items in the Mallory line, Mallory resistors cost no more. What's more, they cover the power range from 10 watts to 200 watts with a wide variety of convenient values. And they're easy to get—from well-located distributors who are willing to give you any help you ask. What's the real meaning of "Approved Precision Products?" Just that you expect more and get more from Mallory.

See You at the Radio Parts Show in Chicago—Booth 106

P. R. MALLORY & CO., Inc.
MALLORY

VIBRATORS . . . VIBRAPACKS* . . . CAPACITORS . . . VOLUME
CONTROLS . . . SWITCHES . . . RESISTORS . . . FILTERS
. . . RECTIFIERS . . . POWER SUPPLIES.

*Reg. U.S. Pat. Off.

APPROVED PRECISION PRODUCTS

P. R. MALLORY & CO., Inc., INDIANAPOLIS 6, INDIANA

RADIO & Television RETAILING

Including RADIO & Television TODAY

ORESTES H. CALDWELL
Editor

M. CLEMENTS
Publisher

JOHN L. STOUTENBURGH
Executive Editor

DARRELL BARTEE
Managing Editor

HAROLD R. ELLIS
Technical Editor

RUTH MORRIS
Records Editor

CHARLES F. DREYER
Art Director

LUCILLE M. JONES
Assistant Editor

READER SERVICE
JANE NORMAN

BUSINESS DEPARTMENT
LEE ROBINSON

Sales Manager
M. H. NEWMAN
Business Manager

EDWIN WEISL, JR.

R. A. WHITE

BEN MORRIS

Promotion Manager

BETTY HALL

Product or

CIRCULATION DEPARTMENT
B. V. SPINETTA

Circulation Manager

W. W. SWICERT

Credit Manager

BRANCH OFFICES
CHICAGO 6

FITZPATRICK, Manager
S. GASKINS, THOMAS FAHEY
201 N. Wells St. RAN. 9225

CLEVELAND 14
DAVID J. O'Rourke, Manager
Citizens Bldg., 850 Euclid Ave.
Main 8270

LOS ANGELES 5
THE ROBERT W. WALKER CO.
584 Lafayette Park P.
Drexel 4288

SAN FRANCISCO 4
68 Post St. SUI 5-5568

RADIO & Television RETAILING
April 1947: Vol. 45 No. 4, 25 cents
a copy. Published monthly by Cald-
well-Clements, Inc., Publication Office
1309 Noble St., Philadelphia 23, Pa.
Editorial and Executive Offices 480
Lexington Ave., New York 17, N. Y.
M. Clements, President; Orestes H.
Caldwell, Treasurer. Subscription rates
United States and Latin American
countries \$1.00 for one year, \$2.00 for
three years. Canada \$1.50 for one
year, \$3.00 for three years. All other
countries \$2.00 for one year, \$4.00 for
three years. Printed in U. S. A.
Entered as second class matter at the
Post Office at Philadelphia, Pa., under
the act of March 3, 1879. Member of
Audit Bureau of Circulations. Copyright
by Caldwell-Clements, Inc., 1947.
Trade-Mark Reg. U. S. Pat. Off.

IN THIS ISSUE

APRIL, 1947

★ *Radio, FM, Television*

COVER—The Big Four	
EDITORIAL—Tighten Up On Credit	29
RADIO, APPLIANCES, RECORDS & TELEVISION TODAY	30
PORTABLES PILE UP THE PROFITS	34
SHOWING A STORE TO THE PUBLIC	36
SHOW WINDOWS SHOULD DRAW THEM IN	38
HOW ONE SALE LEADS TO ANOTHER	40
NEW SETS FOR SPRING SALES	42
FM HITS STRIDE	44
LIST OF HOME RADIO MANUFACTURERS	46

★ *Records, Phonographs, Accessories*

COVER—Record News Flashes	49
RECORD STORAGE SALES	51
DISCS ABOUND IN SUPER SALES	52
EFFICIENCY INCREASES RECORD PROFITS	56
LEADING SONGS SURVEY	58
NEW PHONO LINES	60
NEWS OF THE RECORD INDUSTRY	62

★ *Electrical Appliances*

COVER—Users As Free Lance Salespeople	73
NEWS ABOUT LIGHTING	75
PUT YOUR STORE IN THE LOCAL LIMELIGHT	76
ELECTRICAL APPLIANCE SERVICE PROCEDURES	78
STORE CLEANING IS A MERCHANDISING FUNCTION	80
NEW ELECTRICAL APPLIANCES	82
NEWS OF THE APPLIANCE INDUSTRY	Starts on page 86

★ *Service and Sound*

COVER—Time-Saving Tips on New Receivers	95
CLEARING FAULTS IN TELEVISION	97
MONEY-MAKING REPAIRS ON 3-WAY PORTABLES	98
NEW TRI-POWER RADIO CIRCUITS	102
RESTAURANTS WANT QUALITY PA MUSIC	104
NEWEST EQUIPMENT FOR PA PROFITS	106
SIMPLE METER REPAIRS	110
SAVE TIME WITH NEW METERS	112
BUILDS PA TRUCK FLEET ON SOUND "BALLYHOOD"	116
SERVICE NOTES	118

JOBBERS IN ACTION	120
TELEVISION NEWS	122
HOW TO SELL HEAT PADS	124
NEWS OF THE INDUSTRY	Starts on page 126



**29,000 COPIES
THIS ISSUE**

**Member of
AUDIT BUREAU
OF CIRCULATIONS**

**PORTABLE RADIO CUT
20% BY EMERSON**

Abrams Explains Reduction
From \$49.95 to \$39.95 Was
Made to Widen Demand

FIGHT IS SEEN FOR MARKET

Price Given as 25% Be-

**Emerson Radio
Cuts Price \$10
On New Model**

Move Is Called Step Toward
Effecting Lower Levels
on Parts for Receivers

Emerson Radio & Phonograph
yesterday a price

**Emerson Radio
Model Cut 20 PC**

Highlighting the intense competi-
tion in the radio field, Emerson
Radio & Phonograph Corp. yester-
day announced a 25 per cent cut
for what was described as "one
of its most popular" portable ra-

HEADLINES EVERYWHERE PROCLAIM

Emerson

TO WIDEN THE



It's NEWS when a leading manufacturer cuts the price on rapid selling products when demand is greater than supply.

But IT IS NOT NEWS that this has ALWAYS been the POLICY of Emerson Radio — to buy more — produce more—sell more—cut overhead costs all along the line.

Today the demand for Emerson Radio, in all categories, is the greatest in our history. Factory production is at an all-time peak. Feature for fea-

Progressive Policy in the Emerson Radio Tradition

ture, every Emerson Radio represents the greatest market value. But Emerson Radio is looking ahead.

The models shown here are typical "VALUE" examples in a new 1947 line which conforms with the mass production and lowest-possible-price policy of this company.

By thus widening the market for QUALITY merchandise—by larger material purchases—and through progressive local and national promotion—the economics work to the advantage of our distributors and dealers and the buying public.

Lead with the Leader in '47

Call Your Emerson Radio Distributor Now

EMERSON RADIO AND PHONOGRAPH CORPORATION • NEW YORK 11, N. Y.
World's Largest Maker of Small Radio

POLICY OF

Radio

MARKET WITH GREATER VALUES



3-Way Portable Model 536

6 Tubes and Rectifier
3-Gang Condenser

Super Power Output 5
TIMES greater socket power.

Resonance Mounted Alnico 5
Permanent Magnet Dynamic
Speaker.

Unheard-of Performance and
TONE.

Definitely the greatest Portable value in the entire industry, giving Emerson Radio dealers a sensational quality and price leader to spearhead spring and summer business at Substantial Profit.

It was a BARGAIN at \$49.95

It's a Sensation at

\$39⁹⁵

Less Batteries



World's Smallest AC-DC Superheterodyne Model 540. A handful of POWER, TONE and STYLE. In Walnut, Ivory, Red, Green.

\$19⁹⁵

In Walnut Finish

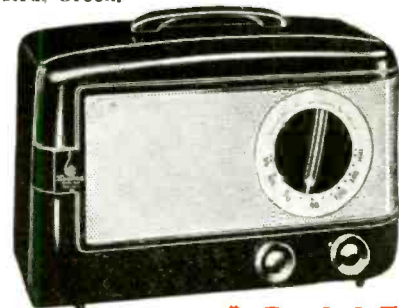

Model 543. AC-DC Superheterodyne with all new 1947 features.

\$24⁹⁵

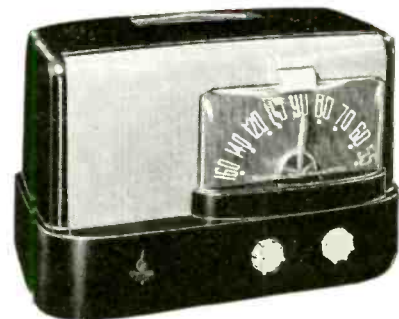

"Moderne" Model 511. AC-DC Superheterodyne. New style and performance leader. Available in Ivory and Ebony combination.

\$29⁹⁵

EMERSON RADIO AND PHONOGRAPH CORPORATION • NEW YORK 11, N. Y.
World's Largest Maker of Small Radio



Routine production and inspection to specifications do not end Merit's responsibility. Every transformer that leaves the factory must individually assure efficiency for severest and longest service. That's Merit Quality.

EXPORT DEPT.
1607 Howard St.
Chicago 26



MERIT COIL & TRANSFORMER CORP.

TELEPHONE
4427 North Clark St. Long Beach 6311 CHICAGO 40, ILL.

Feel Like Traveling?

There's a pair of good trade shows coming up in Chicago that are of considerable interest to you as a dealer.

The Radio-Electronic Parts and Equipment Show, at the Stevens, May 11-16, is primarily of interest to "Big Four" retailers and to service retailers, plus parts jobbers and manufacturers' representatives. This is the annual showing of new lines of parts and tubes, test and sound equipment and other technical services for the trade.

Dealers are invited to attend on Friday, May 16. This will be a special "dealers' day" and manufacturers are preparing to devote full time to dealers' problems, their merchandise and activities. Further, you'll have a chance to meet many of your distributors and original suppliers who can talk merchandising and servicing to you on the all-important retailing level.

The National Association of Music Merchants (NAMM) meets June 1-5 at the Palmer House. This annual show is the world's largest gathering of the retailers of musical products. On display there will be many of the new lines manufacturers and dealers will be promoting heavily for the Fall and Christmas seasons.

Included are radios and radio-phonograph combinations, records and albums, needles, cabinets and all the accessories that help build up your sales volume. The record business this year expects to sell about a half-billion records—*think of it!* You'll find it well worth your time to talk with these manufacturers and their distributors. Incidentally, if you're unable to attend these shows, our May and June issues will report fully new lines, products and developments to you.

RADIO & Television RETAILING welcomes shows like these because they act as stimulants for business. Trade enthusiasm can be generated in connection with a show as for few other activities. Dealers exchange ideas and find how diversification of lines, as advocated in the "Big Four" retailing plan of RADIO & Television RETAILING, actually increases business. When that happens, everybody benefits.

The Publishers

Only
**Bendix
 Radio
 Dealers**

HAVE THIS

*"All Star"
 Combination!*

★ *All Star Models*

PACKED WITH SALES APPEAL!

Every model in the Bendix Radio line is star-studded with extra selling punch, extra demonstration magic—extra profit for you! Bendix Radios are styled to decorators' standards—engineered for Aviation Quality—priced to your biggest market! Bendix, always first with the finest, now brings tested FM at its very best into your showroom. In every model—in every style—in every feature—Bendix is built to sell!

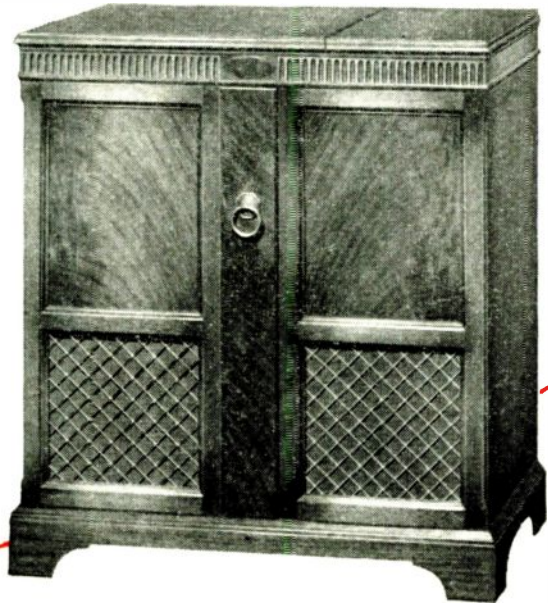

THE ADVERTISING PUNCH OF



Radio's top Stars

Advertising that gets action—for you! Radio's best known names step into America's biggest magazines to help draw customers into your store! Bendix Radio advertising sells "radio", sells merchandise, sells your customers! One more proof that the smartest franchise in radio today is Bendix Radio!

Build with

Bendix Radio

FOR PRESTIGE • PERMANENCE • PROFITS



BENDIX RADIO DIVISION of
 BALTIMORE 4, MARYLAND



Beautifully
Styled

TABLE RADIO

the
Motorola
CONTINENTAL

Satisfying to look at, superb to listen to . . . truly a beautiful radio in every sense of the word, whether the judge be your eye or your ear. And no matter what you seek in radio reception . . . depth, timbre, sensitivity, volume . . . Motorola has it. See it, hear it . . . be convinced instantly there's no other radio like Motorola.

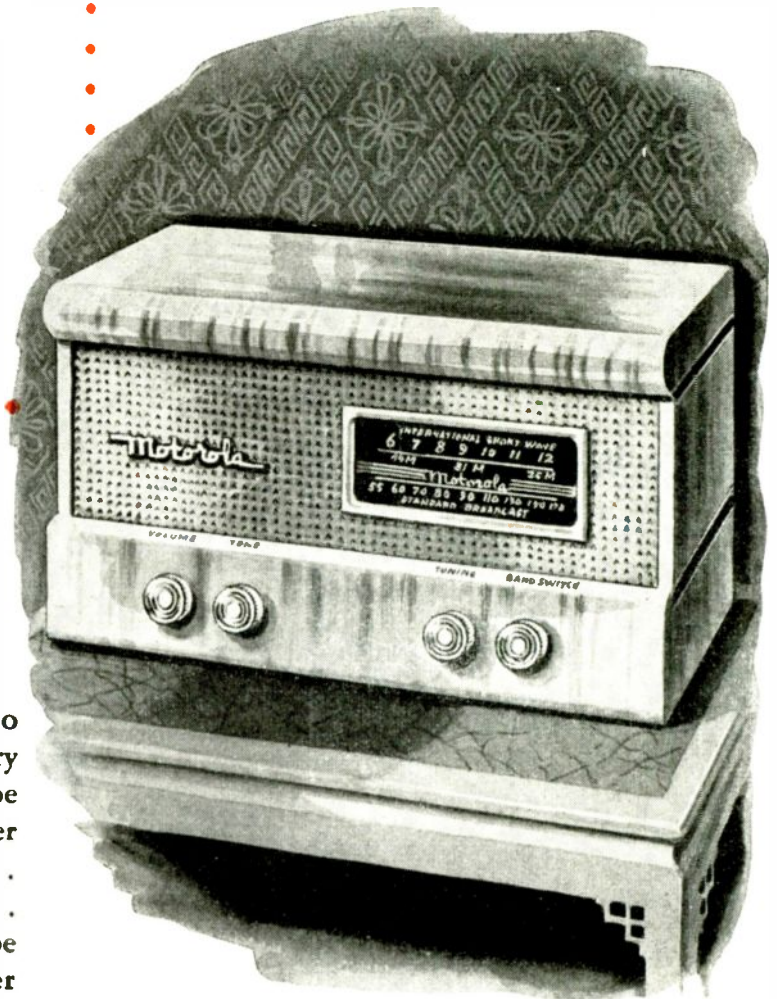

**... and don't forget the
FAMOUS PLAYMATE Jr.**

Yes...it's the little giant of the radio world...the palm-size midget with the big rich voice of a console! Its tone for its size will astonish you! For games, picnics, trips—in the car . . . it's wonderful.

See Your
Motorola Distributor



GALVIN MFG. CORPORATION • CHICAGO 51

DISPLAYS LIKE THIS make selling tubes a cinch!

In four colors, 21" by 26½"; varnished, backed, and eased for effective window mounting. Just ONE OF MANY Ken-Rad 1947 PROFIT-BUILDERS for radio servicemen and tube dealers!

Ken-Rad's sales-aids Booklet ETR-62 illustrates and describes the whole big, elaborate line of Ken-Rad 1947 display and promotion material—available to you to help you sell more radio tubes! Also explains how to use each item most effectively and profitably. Write for your free copy TODAY.



KEN-RAD wants more radio owners needing service, needing new tubes, to come to *your* store. So . . . 1947 offers you the biggest, best, most colorful group of Ken-Rad displays and sales aids ever!

Like the large window-card shown here, each Ken-Rad display—window or counter—does a bang-up advertising job for you. Many stress the high-grade repair service you give, subordinating the Ken-Rad message to your own facilities.

Signs and decalcomanias—letterheads, blotters, postcards for mail advertising—

ready-to-run newspaper mats—job tickets—shipping labels—radio chassis stickers—these and other promotion items you need to widen your customer-list, to sell more service, parts and tubes, to *make more money*, are included.

1947 is your year to climb on the Ken-Rad bandwagon, if you haven't already. Topflight advertising material, practical merchandising counsel, unexcelled tube quality—the three march hand-in-hand to give Ken-Rad a position of leadership on which *you* can capitalize . . . profitably!

KEN-RAD

DIVISION OF GENERAL ELECTRIC COMPANY
SCHENECTADY, NEW YORK

170-F3-0880

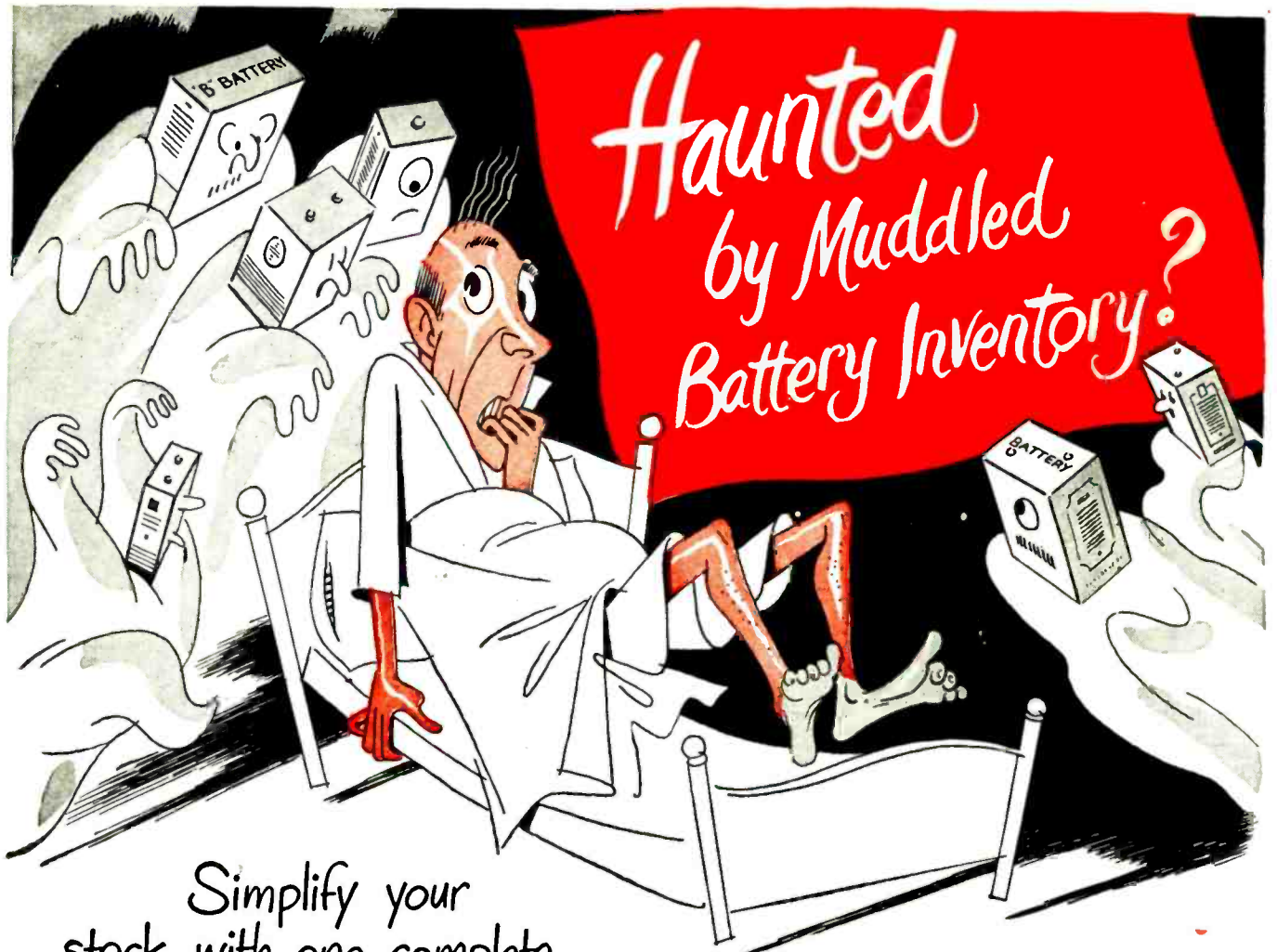

Simplify your stock with one complete line—**"EVEREADY" RADIO BATTERIES!**

IT'S GOOD BUSINESS to concentrate your selling . . . to get your biggest volume on the line that moves without resistance.

"Eveready" radio batteries carry a name and reputation that's unexcelled; more customers ask for "Eveready" batteries than any other brand. And "Eveready" radio batteries fit virtually all

makes of sets; you freeze less capital, and please more customers, when you specialize on these famous power units!

There's no need to be haunted by the nightmare of slow-moving, private-label battery brands—wake up to the profit opportunities in "Eveready" brand radio batteries!

The registered trade-marks "Eveready" and "Mini-Max" distinguish products of National Carbon Company, Inc.



NATIONAL CARBON COMPANY, INC.
30 East 42nd Street, New York 17, N. Y.
Unit of Union Carbide and Carbon Corporation



Go to a Radio Manufacturer for Radios — a Battery Manufacturer for Batteries!

Distinguished period cabinet
Superlative engineering and craftsmanship
Priced to prove that quality need not be expensive



A Standout in any Farnsworth showroom!

The new Farnsworth GK-141—a brilliant example of traditional Farnsworth styling and quality in a phonograph-radio for the discriminating, *value-minded* buyer.

A charming cabinet of authentic Heppelwhite design—to attract the prospect's eye! Farnsworth's famous tone quality, Farnsworth's dependable 3-point suspension record changer—to rivet his attention! Deluxe Farnsworth features... push button tuning on both FM and AM, individual tone control on both treble and bass, outstanding performance—to whet his desire!

And a price tag surprisingly low—to impel him to buy!

With distinguished self-selling models such as this, Farnsworth emphasizes the superior quality built into all Farnsworth sets—emphasizes Farnsworth's ability to prove that real quality need not be expensive. This reputation for quality—combined with the Farnsworth policy of proper margins and ample “elbow room” for its dealers—continues to be their most valuable asset. Farnsworth Television & Radio Corporation, Fort Wayne 1, Indiana.

Farnsworth
Television • Radio • Phonograph-Radio

Farnsworth Radio and Television Receivers and Transmitters • Aircraft Radio Equipment • Farnsworth Television Tubes • Mobile Communications and Traffic Control Systems for Rail and Highway • The Farnsworth Phonograph-Radio • The Capehart • The Panamuse by Capehart.

you can profit

more

using the Chicago Tribune's
more effective
Selective Area Advertising Plan

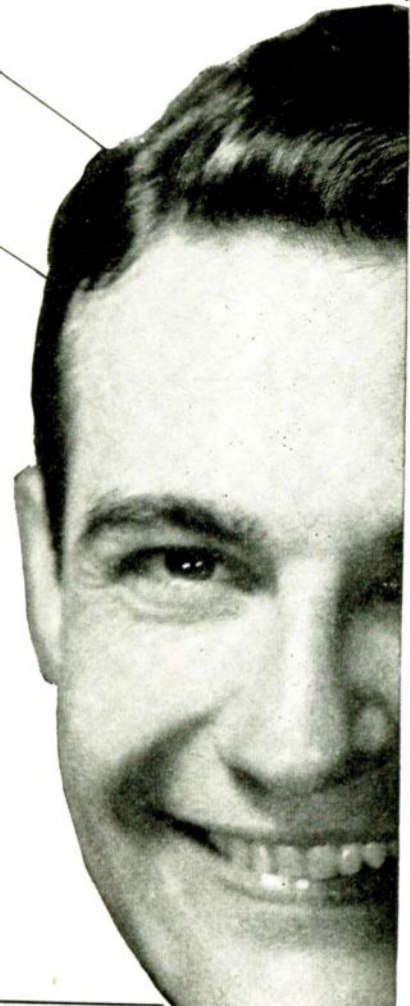

Your advertising dollars do a better job . . . bring results faster for you and your dealers . . . when you take advantage of the Tribune's Plan.

The Chicago Tribune's Selective Area Advertising Plan gives prominent display of each dealer's name and address . . . closely identifies your product with your *local outlets*. Result: more sales in the Great Chicago Market—a market so large it can take all or the greater part of the production of many manufacturers. Under this plan—

EACH DEALER GETS:

- 1** Selective coverage of his local market
- 2** Prominent display of his name and location
- 3** The low rate of just 2¢ a line!

YOU GET:

- 1** Better identification of your local outlets
- 2** Enthusiastic dealer support
- 3** Advertising that pays off right away!

Put the Tribune's Selective Area Advertising Plan to work for you. Thru it, you can best implement the significant market data revealed in the Tribune's Durable Goods Study among consumers and dealers.

To learn how this plan fits your specific needs, write your nearest Tribune representative as shown below.

Tribune families tell us that they will spend \$263,000,000 for home appliances the first year they are available. This is 63.4% of the total indicated volume in the Great Chicago Market. No other medium covers this staggering potential so effectively. Tribune rates per line per 100,000 circulation are among the lowest in America.

Chicago Tribune

The World's Greatest Newspaper

February average net paid total circulation:
Daily, over 1,040,000; Sunday, over 1,500,000

H. N. King, Chicago Tribune
810 Tribune Tower, Chicago 11

E. P. Struhsacker, Chicago Tribune,
220 E. 42nd St., New York City 17

Fitzpatrick & Chamberlin
155 Montgomery St.,
San Francisco 4

W. E. Bates, Chicago Tribune
Penobscot Building, Detroit 26

MEMBER: AMERICAN NEWSPAPER ADVERTISING NETWORK, INC., FIRST 3 MARKETS GROUP, AND METROPOLITAN SUNDAY NEWSPAPERS, INC.

*You'll be proud
to sell*

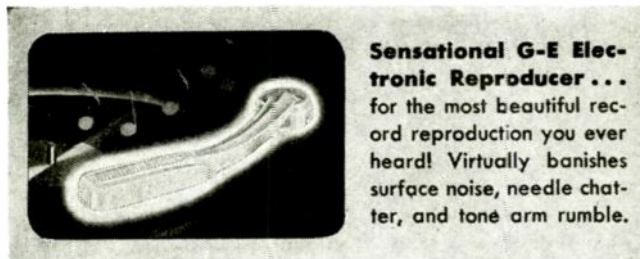

Sensational G-E Electronic Reproducer . . .
for the most beautiful record reproduction you ever heard! Virtually banishes surface noise, needle chatter, and tone arm rumble.

General Electric's finest table radio-phonograph



HEDY LAMARR, star of Hunt Stromberg's production **DISHONORED LADY**, released through United Artists.



Featuring the famous new G-E Electronic Reproducer and G-E Natural Color Tone Radio

Compare Model 304's tone quality and power—both as a phonograph and as a radio—with any table model you ever handled. You'll see why your customers will thank you for selling them this outstanding performer.

What features you have for demonstration! First the sensational G-E Electronic Reproducer. (See above.) Then the sure-action record changer—the big (6½") Dynapower speaker—the exclusive built-in Beam-a-scope antenna—the easy radio tuning (no need to lift the lid) and the beauty of the handsome American walnut cabinet.

For full information, see your G-E Radio Distributor or write to Electronics Department, General Electric Co., Bridgeport, Conn.

THE FIRST AND GREATEST NAME IN ELECTRONICS

GENERAL  **ELECTRIC**

PORTABLES • TABLE MODELS • CONSOLES • FARM SETS • AUTOMATIC PHONOGRAPH COMBINATIONS • TELEVISION

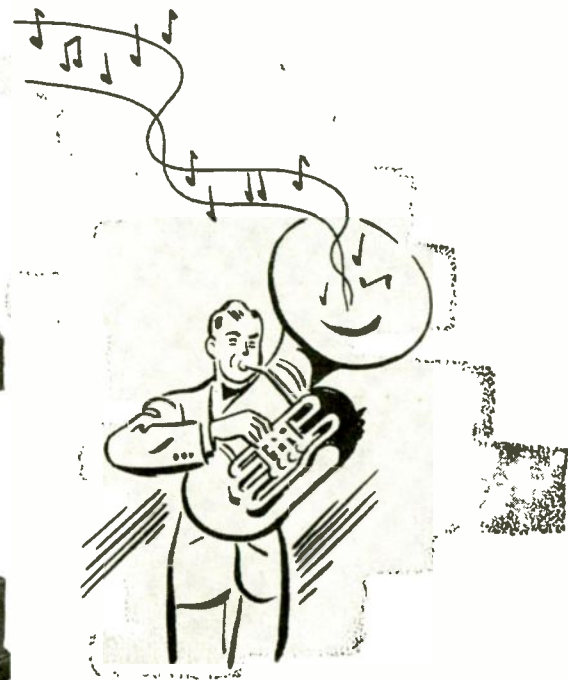

MODEL 710W

First..

to be designed to meet newly discovered facts about human hearing!

MODEL 710CB



MODEL 710PC



Orthosonic Radio Sound Reproduction is an entirely new and exclusive principle developed by Electronic Laboratories for separating the low and high notes in the audio spectrum—reproducing them independently through separate amplifiers combined with the Orthosonic speaker system—each with individual tone control to permit listener to adjust sound to produce total effect most pleasing to his own auditory system.

Offered in many great models, these new Electronic Orthosonic Radios make an important and unique contribution to radio listening pleasure. They offer brand new sales advantages that are business getters in any market! All have superheterodyne circuits with built-in bass boost and treble boost, and twin amplifiers each with independent tone control.

Model 710W, 710M, 710B—Smartly-styled table model in walnut, dark red or blond mahogany. 8 tubes and 2 rectifiers—standard broadcast band reception only (540 to 1620 kilocycles).

Model 710PC, 710PB—Apartment Console Combina-

tion. Automatic record-changer, complete broadcast coverage. 8 tubes and 2 rectifiers; just the right size to fit into apartment arrangements. Available in dark red or blond mahogany.

Model 710CS and 710CB—The Chairside Combination. Automatic record-changer, motor-driven lift mechanism which electrically raises at the touch of a button, the record changer into an easy to load position. Record player compartment lid remains horizontal so articles on top are undisturbed. 8 tubes and 2 rectifiers; provides broadcast band coverage. Available in dark red or blond mahogany.

Limited Number of Territories Still Available. Wire or Phone Sales Division, Riley 1551.

ELECTRONIC LABORATORIES, INC.

INDIANAPOLIS, INDIANA

MODEL 76K



MODEL 76E

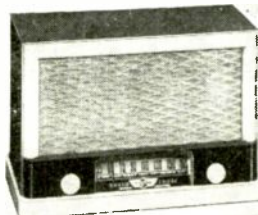

MODEL 2701



SIX OTHER BIG SELLERS IN THE TABLE MODEL FIELD

In the lower price range, Electronic brings you six other Orthosonic models—all superheterodyne table sets, 5 tubes plus rectifier. They add new zip to small-set sales with their handsome continental

cabinet styling and effective color combinations. Excellent selectivity. 5" speaker, standard broadcast band. Model 2701, old-world brown, or blond mahogany; Model 76M, old-world brown mahogany

with antique white trim; Model 76W, white with ebony trim; Model 76E, ebony with antique white trim; Model 76K, porcelain white. All models available for DC operation.



MAKING TUBES IS EASY...

If YOU KNOW HOW!

Meet **OUR MUTUAL FRIEND
THE COMMERCIAL ENGINEER**

► **Friendly**, tactful, impartial, trained to serve, these Hytron commercial engineers form the liaison between us—maker and user of electronic tubes. Few in the radio tube plant can be circuit specialists. Few outside the tube plant can be tube specialists. Both of us need these commercial engineers trained to see clearly both sides of our common problems and help us solve them.

Often their job begins with a request for advice in selecting a tube. Investigation of the circuit application helps them recommend an available type, a slight redesign, or a brand new type. If a new type is found to be the only practicable and economical solution, they cooperate with design and production engi-

neers to achieve the performance desired.

Specification of adequate factory testing procedures and preparation of characteristics sheets do not end their work. Returns are closely checked. If trouble occurs, they go into the field, help dig out the facts, and offer possible solutions—improvements in tube or application. And they stick tenaciously with the problem until it is solved.

Using a wealth of test equipment and know-how, these boys really sweat to make it easy to make Hytron tubes which will make you happy. Busy as the one-armed paperhanger, yet they always welcome the tube problems of equipment engineers. They are nice guys, and we thought you would like to meet them.

SPECIALISTS IN RADIO RECEIVING TUBES SINCE 1921



HYTRON
RADIO AND ELECTRONICS CORP.

MAIN OFFICE: SALEM, MASSACHUSETTS

No Sales Slowdown



**LIGHTENS AND BRIGHTENS
KITCHEN HOURS.**



**TAKES ONLY 6" x 6" TABLE-
SPACE AT YOUR BEDSIDE.**



**TAKE YOUR FAVORITE PROGRAMS
WITH YOU WHEN YOU WORK.**



**LIGHT AND EASY TO CARRY
FROM ROOM TO ROOM.**



RADIO'S FIRST

with *This* Table Model

The Westinghouse Little Jewel is selling faster than ever!

Here's one table model that hasn't had a sales slump! Ever since it was introduced, the Westinghouse Little Jewel has broken sales records—sold where other table models stood still—created widespread public comment and acceptance.

It's a perfect example of Westinghouse Radio originality in engineering and design. 1. It's a real *postwar* radio—not a warmed over prewar model. 2. A console radio in capsule form with power and tone you have to hear to believe! 3. It's a beauty from any angle, because, it's styled on *all* six sides and has an easy-to-use disappearing handle that folds into the back. 4. It takes only 6" x 6" table space and will fit on crowded table-tops where most table models won't go. 5. It's got *double* bass

compensation and automatic volume control, two unusual features in a set of this price. 6. It's simple to service. Simply remove one screw, lift the plastic side, and the chassis is ready for inspection and repair if needed.

It's got more features than any other set in its price class . . . that's why it's the leader! Because it's the ideal radio for kitchen, bedroom, bathroom, playroom or workshop, many of your customers will want *more than one* so that the whole family can enjoy its outstanding performance. Be sure to show your customers how compact, convenient and powerful the Little Jewel is and tell them how they can use several in their home.

Home Radio Division, Westinghouse Electric Corp., Sunbury, Pa.

TIE IN YOUR WINDOW, YOUR STORE, AND YOUR PROMOTION WITH THESE SALES HELPS



BILLBOARD INSERT

A 4-color miniature billboard insert that hammers home the convenience and multi-use features of the Little Jewel is now in the mail. Feature it prominently.

FREE MATS AND INTERIOR STORE DISPLAY

For another knockout display featuring the Little Jewel ask for the Golden Pedestal display RD-126.

Your distributor can supply newspaper advertising mats on the Little Jewel.

GOLDEN SHELL DISPLAY

A golden shell with a rich red frame sets off the beauty of the Little Jewel in this effective 3-dimensional display for window or counter. Ask your distributor for RD-37.

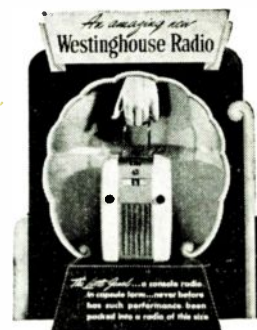

NAME IS

Westinghouse

RADIO TELEVISION

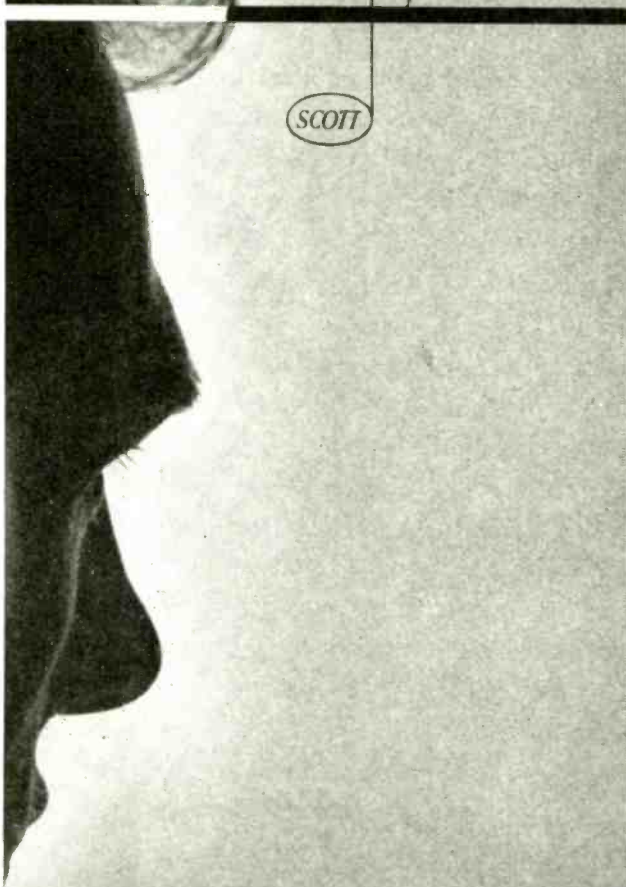
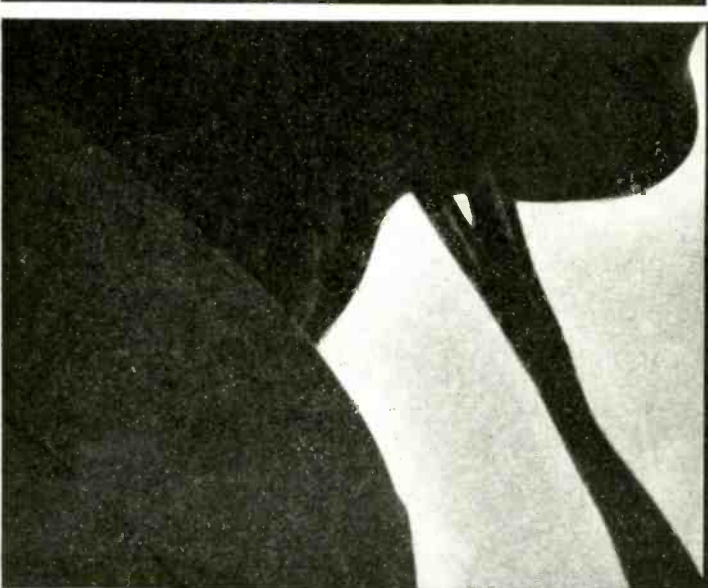
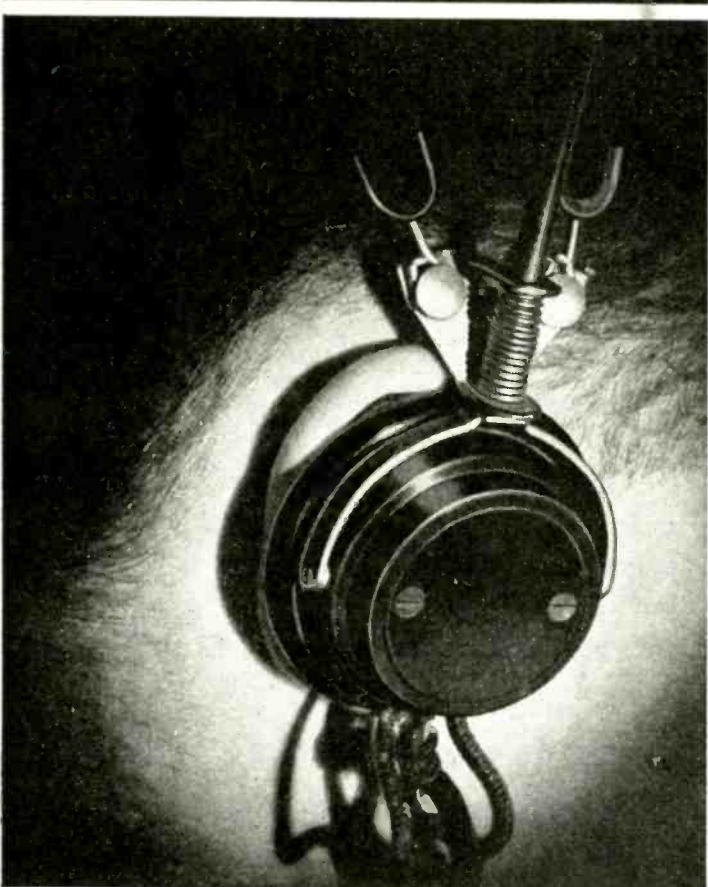
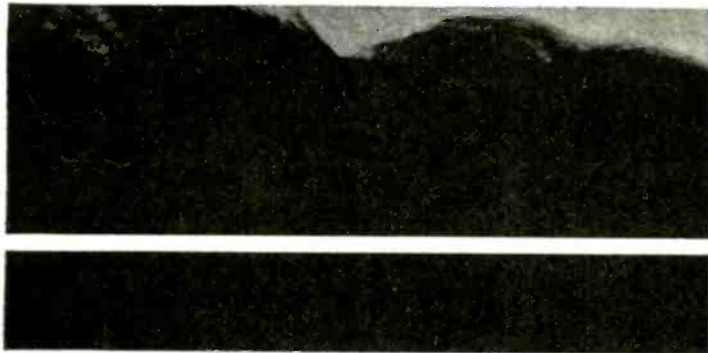

The man with the "golden ear"—one with that rare combination of musician's ear and engineer's mind who listens to, checks, and adjusts every finished Scott radio-phonograph before it's released to a dealer as ready for some appreciative home . . . to make sure that the Scott's technical and tonal perfection has come true . . . to protect every Scott dealer's growing reputation for handling truly "the world's finest" radio-phonograph. Scott Radio Laboratories, Inc., 4450 Ravenswood Avenue, Chicago 40, Illinois.



● RMR 219... Beautifully styled cabinet of finest selected and matched ribbon-striped mahogany. Gives "Clear As A Bell" reception for complete shortwave and standard band broadcasting. Variable tone control gives every possible tonal variation with a simple twist of the wrist. Fast action record changer plays twelve 10" or ten 12" records.

Leaders in beauty—champions of tone... the new SONORA radio phonograph combinations have a buy-compelling eye appeal topped only by the famous "Clear As A Bell" Tone that has made SONORA a leader in perfect tone reproduction for over 50 years. Watch for the dramatic national ads in eleven of America's major magazines that tell your customers of the tonal brilliance of new SONORA models. And watch the increased consumer preference for SONORA in '47.



The choice
in '47 is
Sonora 
Clear as a Bell
with
"Clear as a Bell"
Tone

● RKR-215... Table model phono-radio with automatic Record Changer. Plays ten 12" or twelve 10" records. New low-pressure crystal pickup and long-life needle. Big dynamic speaker, no aerial or ground required. Cabinet of choicest walnut veneer, glamorously styled with handsome curved lid that adds a note of distinction.

Sonora 
Clear as a Bell

HOME ENTERTAINMENT AT ITS BEST

SONORA RADIO & TELEVISION CORP
325 North Hoyne Avenue • Chicago 12, Illinois

RADIOS • FM COMBINATIONS • TELEVISION SETS • RECORDS • PHONOGRAPHS • RECORDERS



It's always fair weather on the Sparton side

NO COMPETITIVE storm clouds for Sparton dealers. Not a chance! One big reason: Sparton national magazine advertising does an exclusive local job for them.

Yes, that's right! Those beautiful, full-page, four-color Sparton ads you see in *Life*, *Saturday Evening Post*, *Collier's*, *Ladies' Home Journal* and *McCall's* are *local* ads for Sparton dealers.

Here's how it works

There's only one Sparton dealer in each community—so every copy of these mass-circulation magazines to reach an area sends prospects to *one and only one* dealer—(easily located through the yellow pages of the tele-

phone directory). As these magazines are read by people who'd be interested in a Sparton, it's rifle-accurate coverage of the best prospects in the area.

Look at the ads themselves. They're gorgeous, appealing—they feature the work of Michael, famous magazine illustrator—and “in demand” radio-phonographs get top billing.

Combine outstanding national advertising that works *locally* with the other features of S.C.M.P.* (Sparton's method of distribution that ends the headaches of radio retailing) and you have the answer:

It *pays* to be a Sparton dealer!

THE SPARKS-WITHINGTON CO., JACKSON, MICH.
Radio and Appliance Division—Plant 5

ONE
Sparton
DEALER

in each community

Check These Profit-Increasing Features

- One exclusive dealer in each area
- National advertising that works locally
- Direct factory-to-dealer shipment
- Low consumer prices
- Factory prepared and distributed promotion helps
- Seasonal promotions
- Uniform retail prices
- Products styled by outstanding designers

Sparton

Radio's Richest Voice Since 1926

*S.C.M.P. SPARTON CO-OPERATIVE MERCHANDISING PLAN. A proven exclusive method of profitably retailing radios and home appliances that has been and is being advertised regularly to consumers in leading magazines.

FADA

The Radio of
TO-MORROW... TO-DAY!



BEAUTY... COLOR... PERFORMANCE

MODEL 602

New Superheterodyne A C Table Model Radio Phonograph Combination with Automatic Record Changer in a Case net of beautiful Monocopy Veneers.

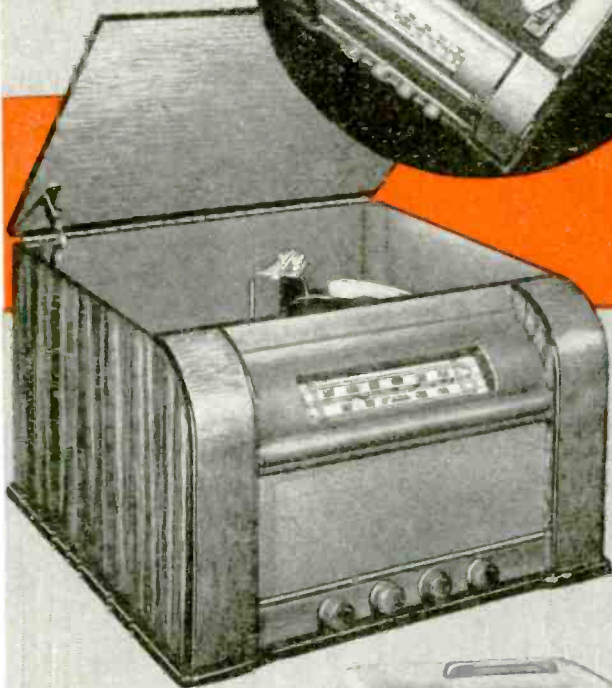

Glamorous star of the radio field... tops in Beauty and Color and Performance... that's FADA. Since the very beginnings of radio broadcasting, the name FADA has signified the finest in radio receivers — now proved in the crucial test of day by day performance in more than 5,000,000 American homes!

You can always depend upon the year in and year out sales appeal of FADA... the radio of tomorrow — today!



MODEL P82

Tri-power portable Superheterodyne with High-Gain tuned RF stage in rich two-tone simulated leather covering wood cabinet. 5 tubes plus rectifier tube.

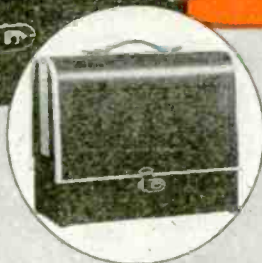

MODEL 605 — 5 TUBES

AC-DC Superheterodyne in modern walnut plastic cabinet. Four tubes plus rectifier tube.



FADA 5-tubes — plus-rectifier-tube models are equipped with the new FADA "Sensitive-Tone" — assuring greater sensitivity and clearer reception.



MODEL 1000

AC-DC Superheterodyne in beautiful gem-like "Fada-lucent" cabinets. Five Tubes plus Rectifier Tube.

YOU CAN ALWAYS DEPEND ON

FADA Radio

Famous Since Broadcasting Began!

FADA RADIO AND ELECTRIC COMPANY, INC., LONG ISLAND CITY, N. Y.

A NEW BOOKLET THAT CAN MEAN

More Profits
For You!

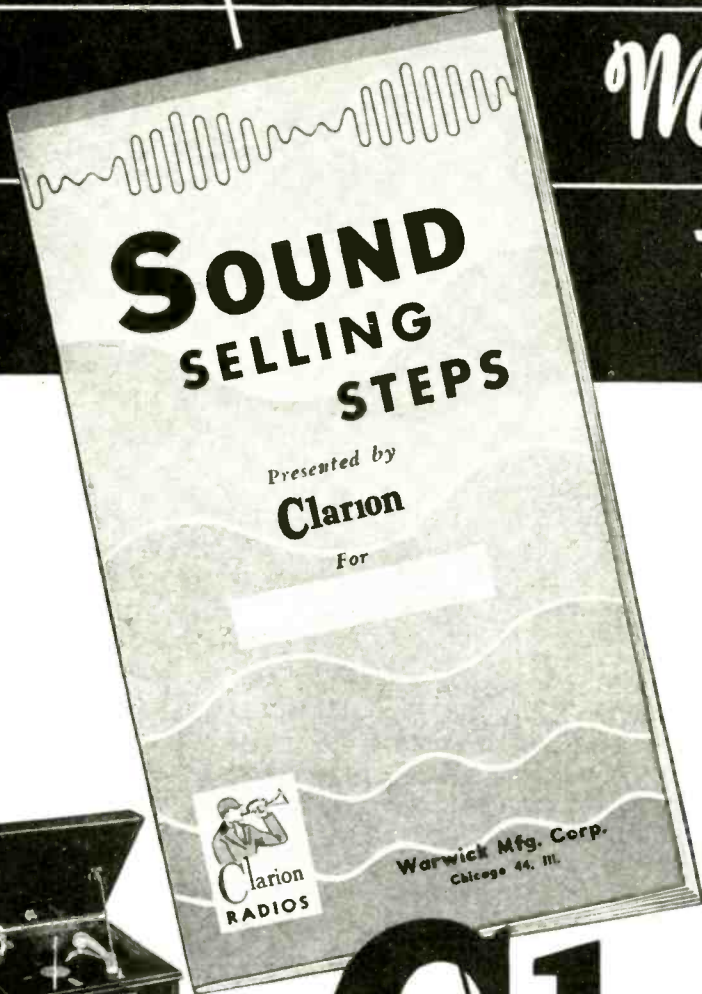

Just off the press.
A remarkable new publication,
presenting an opportune
message that cannot fail to
be of interest to all radio
Dealers and their retail
salesmen. ☆ A request on
your letterhead will bring a
complimentary copy to you.
Send for it TODAY.

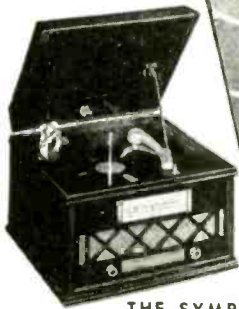

THE SYMPHONETTE



MANHATTAN



THE 3-WAY PORTABLE



THE CLARIONETTE

Clarion RADIO



*Calls the World
to your Door*

WARWICK MANUFACTURING CORPORATION

4640 WEST HARRISON STREET • CHICAGO 44, ILLINOIS

GET MORE OUT OF LIFE WITH TELEVISION



Illustrated: Sherwood model—
with television, radio, automatic
phonograph—Cabinets de-
signed by Herbert Rosengren.

*Get the most out of television
with Du Mont Telesets*

The most convincing proof of Du Mont superiority lies in comparison with other sets. Compare the size, brilliance, and clarity of the image. Compare the quality of sound. Compare the ease and accuracy of tuning. Compare styling and workmanship of the cabinets. See; Hear; and Compare.

DU MONT *First with the finest in Television*

ALLEN B. DU MONT LABORATORIES, INC. • GENERAL TELEVISION SALES OFFICES AND STATION WABD, 515 MADISON AVE., NEW YORK 22, N. Y.
DU MONT'S JOHN WANAMAKER TELEVISION STUDIOS, WANAMAKER PLACE, NEW YORK 3, N. Y. • HOME OFFICES AND PLANTS, PASSAIC, NEW JERSEY.
Copyright 1947, Allen B. Du Mont Laboratories, Inc. *Trade-mark

Listen...IT'S A Jensen SPEAKER!



Model HMP-51
(15-inch)



Model JAP-60
(15-inch)

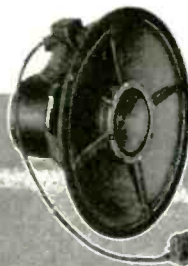

Model JHP-52
(15-inch)

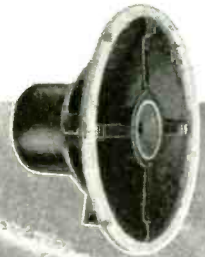

Model JCP-40
(12-inch)

JENSEN BASS REFLEX* REPRODUCERS with COAXIAL SPEAKERS

TYPE "RD"

REPRODUCER NO.	STOCK NO.	CABINET NO.	SPEAKER NO.	IMPEDANCE, OHMS	LIST PRICE
RD-122	ST-159	D-121	JCP-40	6-8	\$120.00
RD-151	ST-160	D-151	HNP-51	500-600	212.00
RD-152	ST-161	D-151	JAP-60	500-600	164.00
RD-153	ST-162	D-151	JHP-52	500-600	151.00

TYPE "RA"

RA-124	ST-134	A-121	JCP-40	6-8	\$ 76.45
RA-151	ST-136	A-151	HNP-51	500-600	177.40
RA-153	ST-138	A-151	JAP-60	500-600	128.90
RA-154	ST-139	A-151	JHP-52	500-600	115.90

JENSEN BASS REFLEX* CABINETS

TYPE "D"

MODEL NO.	STOCK NO.	SPEAKER SIZE	DIMENSIONS			LIST PRICE
			HEIGHT	WIDTH	DEPTH	
D-121	ST-156	12"	27 1/8"	31 3/8"	13 3/8"	\$75.00
D-151	ST-157	15"	27 1/8"	31 3/8"	13 3/8"	75.00

TYPE "A" (Finished)

A-81	ST-123	8"	24"	18"	9 1/4"	\$24.55
A-121	ST-124	12"	27"	24 3/4"	13 1/2"	34.05
A-151	ST-125	15"	32 3/8"	27 3/8"	13 1/2"	42.15

TYPE "A" (Unfinished)

A-82	ST-145	8"	24"	18"	9 1/4"	\$24.55
A-122	ST-146	12"	27"	24 3/4"	13 1/2"	34.05
A-152	ST-147	15"	32 3/8"	27 3/8"	13 1/2"	42.15

*Designers and Manufacturers
of Fine Acoustic Equipment*

JENSEN MANUFACTURING COMPANY

6625 SOUTH LARAMIE AVE., CHICAGO 38, U. S. A.
IN CANADA: Copper Wire Products Ltd., 11 King St. W., Toronto, Ont.

*Trade Mark Registered

Jensen
SPEAKERS
WITH **ALNICO 5**



Stewart-Warner



Strobo-Sonic Tone

Tone so faithful you can understand each word, distinguish every instrument, hear music in its true dimensions . . . real as life and picture-clear.



MUSIDORA

FM-AM Console Radio-Phonograph
All FM and standard AM broadcasts. New automatic intermix changer mixes both 10-in. and 12-in. records. Two album compartments. AM push-button tuning. Two built-in antennae. Smooth AC operation for full-cycle tonal range. Rectifier plus 8 tubes, inverse feed-back, RF stage both bands. Handsome mahogany styling.



BALLADEER FM-AM TABLE RADIOS

Here's genuine FM *plus* AM performance in new table models suited for every room in the house. Everything on the air . . . for kitchen, bedroom, study, recreation room, living room.
Seven tubes plus rectifier, PM dynamic speaker, AC-DC.
FOUR MODELS—Ivory plastic (shown above), walnut plastic, desert-tan wood and walnut wood (below).



The littlest BIG radio
you'll find anywhere!



AIR PAL

Smaller than a phone—plays like a console!

Stewart-Warner Air Pal is a full-power AC-DC set that performs brilliantly *anywhere* you plug it in . . . trains, planes, ships, hotels, offices, and every room in the house.

Not a toy that annoys customers with tinny tone. It has a pack of power and performance inside!

LOOK AT ALL THESE FEATURES!

Air Pal has vernier planetary tuning, 4 tubes plus rectifier, built-in Radair Antenna, PM dynamic speaker, accurate slide-rule dial, complete AM band.

It's a "radio console" in a jewel case! Air Pal slips easily into a brief case or a handbag, and is ready with full-voiced radio power the minute you plug it in.

THREE STUNNING CABINETS!

Air Pal's supersmart plastic design comes in three colors . . . gleaming ivory, rich walnut, and a night-black beauty in ebony.

No Stewart-Warner dealer has ever had a set that packs so much punch . . . in performance and in sales appeal . . . as Air Pal. Just let them *listen* to it!

VIDEORAMA Direct-View TELEVISION

Stewart-Warner has put 23 years of electronics experience into this beautiful "radio theater." All 13 telecast bands with genuine FM sound, plus all standard broadcasts. Big bright pictures under living-room lights. The finest custom-built cabinets in modern and Georgian styling.

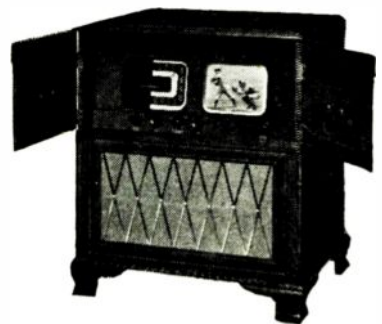

A Model for Every Purpose—a Radio for Every Room

Stewart-Warner

AM Radios FM

Radio-phonographs • Television

CHICAGO 14, ILLINOIS



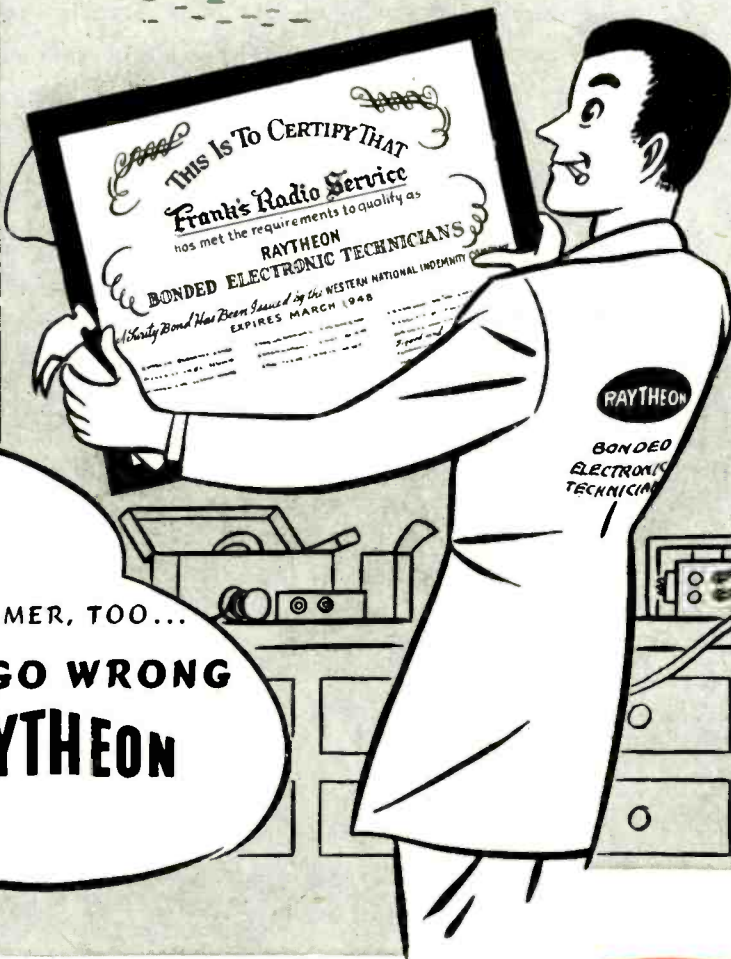

IT'S GOOD FOR YOU
AND THE CUSTOMER, TOO...
**YOU CAN'T GO WRONG
WITH RAYTHEON**



Ask your Raytheon Distributor for details on how you can qualify as a Bonded Electronic Technician.

RAYTHEON MANUFACTURING COMPANY
RECEIVING TUBE DIVISION
NEWTON, MASSACHUSETTS CHICAGO, ILLINOIS



Excellence in Electronics

- RADIO RECEIVING TUBES
- SPECIAL PURPOSE TUBES
- TRANSMITTING TUBES
- HEARING AID TUBES



TUNG-SOL
6X4 MINIATURE
POWER RECTIFIER

TUNG-SOL DEALERS *can't help talking about it!*



"It has taken a lot of us a long time to learn the radio service business. With television and FM coming along, it will take us a lot longer. We have a real stake in our businesses and something real to offer to set and equipment users. The only way we can insure our stake is to use parts that back up our skill and experience.

"A good reputation is a fine thing but we want profits too. We get them by selling quality parts and using quality parts in repair work. They usually pay a fair profit and do not require free 'call backs' for part failures in repair work, that are so frequent when you use inferior parts.

"That is why I am a TUNG-SOL dealer and use TUNG-SOL Tubes for all service work. And I also notice that TUNG-SOL wholesalers are usually the best source of supply for other quality parts. And the line is complete, G-GTs—metal and large glass tubes as well as miniatures so I can service about any set that comes in... too bad, Joe, you have dubbed your shot."

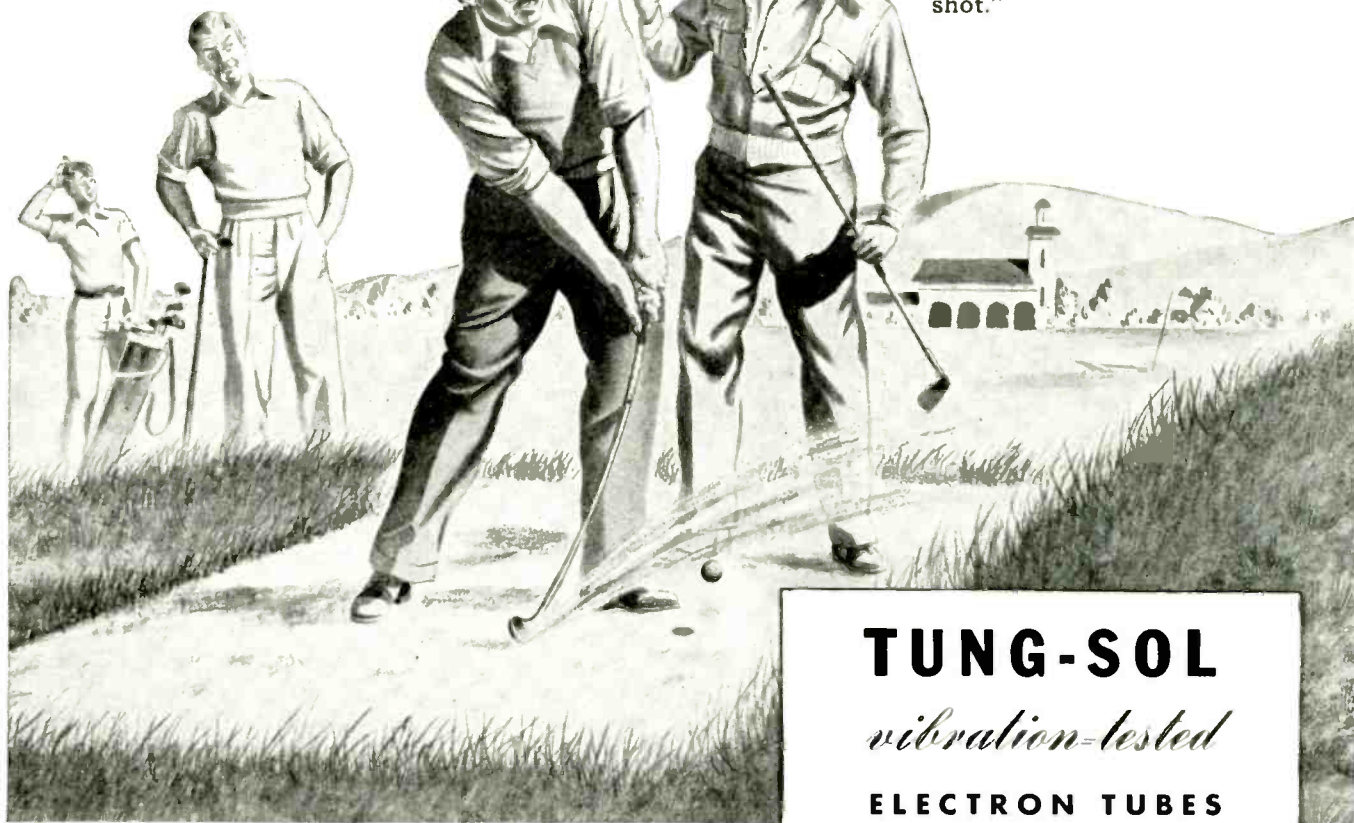

TUNG-SOL

vibration-tested

ELECTRON TUBES

TUNG-SOL LAMP WORKS INC., NEWARK 4, NEW JERSEY
Sales Offices: Atlanta • Chicago • Dallas • Denver • Detroit • Los Angeles • New York
Also Manufacturers of Miniature Incandescent Lamps, All-Glass Sealed Beam Headlight Lamps and Current Intermittors

it's **LOWEST PRICED!**

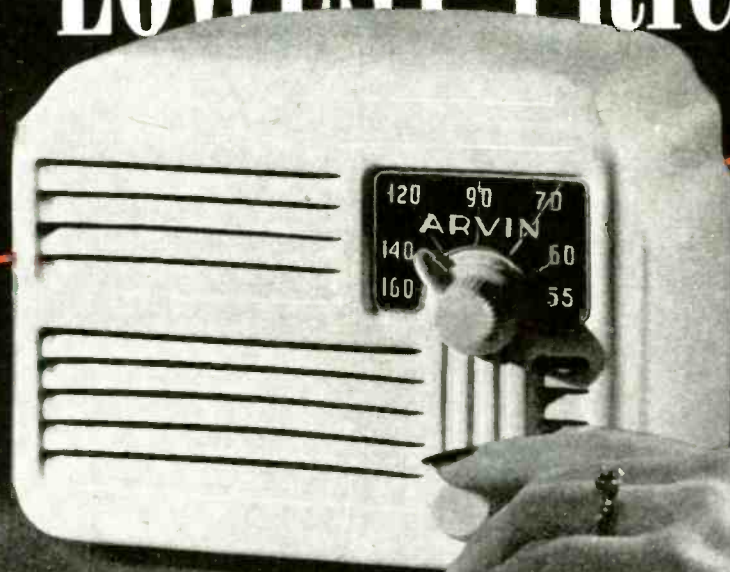

THE
Mighty-mite

ARVIN

\$15⁹⁵ RETAIL
\$16.45 • ZONE 2

Here's quality performance and beauty at the lowest price. It's the outstanding leader in small radios. You owe it to yourself to get your share of the extra store traffic, the quick sales, big volume and handsome profits the Arvin Mighty-mite brings.

Order Arvin Model 444A.



Another lovely Arvin, at a trade-pleasing low price, Model 552 AN—one of the many splendid Arvin Radio money makers.



... the name on profit-building products from

NOBLITT-SPARKS INDUSTRIES, INC., COLUMBUS, INDIANA

Good news that means good business...



Yes... good news!

The Salem Chest — one of Stromberg-Carlson's most beautiful cabinet designs — is back in production. By popular request.

It's easy to see *why* such popularity! Just look at that Early American styling. Right for most decorating schemes. *Perfect* for the antique-furnished home. And, in addition to advanced electronic design, it has *complete FM* and is engineered for wire recording!

The Salem Chest really rounds out the line. It's the perfect sales-companion to those other outstanding performers like the New World and the Autograph!

THE SALEM CHEST—Model 1121-PS—Automatic radio-phonograph combination. Antique mahogany. Push buttons for eight stations. Exclusive full-floating 12-inch electro-dynamic speaker suspended in live rubber. Plays ten 12-inch or twelve 10-inch records in sequence. With *complete FM* and engineered for wire recording.



For the main radio in your home

There is nothing finer than a **STROMBERG-CARLSON**



THE NEW WORLD—Model 1121-M2—Automatic radio-phonograph combination. In bleached mahogany. Push buttons for eight stations. Exclusive full-floating 12-inch electro-dynamic speaker with cone suspended in live rubber. Plays ten 12-inch or twelve 10-inch records in sequence. With *complete FM* and engineered for wire recording.



THE AUTOGRAPH—Model 1135-PL—Automatic radio-phonograph. In mahogany or walnut veneers. Push-button control of both AM and FM programs. Automatic push button AM-FM switching. Exclusive "Acoustical Labyrinth" and matchless Carpinchoe speaker. Plays 10- and 12-inch records intermixed. With *complete FM* and engineered for wire recording.

RADIO *& Television* RETAILING

Including Radio and Television Today

O. H. CALDWELL, Editor ★ M. CLEMENTS, Publisher ★ 480 LEXINGTON AVENUE, NEW YORK 17, N. Y.

Tighten Up on Credit as Money Gets Tighter

"Some of my 'open accounts' are going bad," a dealer told us the other day. "Money is getting tighter and I propose to clamp down on easy credit and swing over to finance contracts," he declared.

This is smart business. The dealer who continues to employ lax methods in extending credit to customers now that lush money is commencing to disappear, will find that a number of his heretofore prompt payers have flown the coop—skipped to parts unknown leaving him to hold the bag.

"French leave-taking" on the part of numbers of his customers is more than a mere possibility among the ranks of the transients in his territories. Many thousands of families have migrated hither and yon during the war, and among them are, of course, those who will feel no compunction in failing to pay bills when their jobs in the vicinity end, or better ones are offered elsewhere.

Most dealers have numbers of splendid charge account customers who buy on open credit. Losses to such customers are extremely low, merchants report, and these only in instances where such customer's financial status takes a sudden, unexpected drop.

On the other hand, retailers' losses to customers they know little about and with whom they opened charge accounts carelessly, have been quite heavy.

Now that conditions are changing, it's up to the smart dealer to change along with them. A thorough going-over of his customer-credit facilities and methods is in order at this time.

He should have his financing agency lined up, his "open-credit" requirements decided upon and his stewardship over his charge account business alerted in this market when money is getting tighter every day.

RADIO, Electrical Appliances,

THREE BILLION DOLLARS MAY BE SPENT by customers for radio-appliance products in 1947. Experts believe that more than two billion of such purchases will be made via time-payment plan financing.

MORE TRENDS SHOWING RETURN TO buyers' market. Customers asking immediate delivery, even on small products . . . consumers wanting detailed information on guarantees . . . requests for cash discounts . . . shopping around by persons having trade-ins . . . demands for free special services, installing outlets, etc. . . . refusals to take displayed merchandise off showroom floors, wanting products in original packages.

RMA MEMBERSHIP INCREASES to a new all-time high of 346 companies. About fifty radio companies have joined since the end of the war. In 1939 and '40 the organization's roster held a total of 104 members.

THEY JUST CAN'T SEEM TO CATCH UP with the terrific demand for fractional horsepower motors, and this is one of the reasons for the continued shortage of washers, refrigerators and other power-operated appliances.

POPULAR - PRICED, EASY - TO - USE HEALTH LAMPS are bringing extra dollars into the tills of the nation's bulb retailers. The huge ad campaigns being carried on by lamp makers are being capitalized upon by smart window displays and modern merchandising by merchants. Noted too, is a greatly increased demand for photo lamps of all sorts.

"LAUNDRIES' DILEMMA BOON TO WASHER TRADE," says William Shaw of the American Washer and Ironer Manufacturers' Assn. "Accompanied by as little publicity as possible, laundrymen throughout the country are raising their prices as much as 15-20 per cent," Shaw's publicity bulletin points out. "Significantly, all the increased items of expense in the case of the laundry, excepting soap and one or two insignificant costs, do not occur at all in washing at home."

GOOD SERVICE IS A BIGGER FACTOR in the consumer's mind right now than ever before in governing his decision to buy from a certain retailer. Nowadays, merchants report that more and more people are talking after-purchase service because they were made so keenly aware of the value of good maintenance during the days they had to make the old products "do."

SHORTAGE OF WASHING MACHINES continues in spite of the fact that the industry broke production records in '46, in which year they got off to a late start. More than two million washers were turned out, exceeding the number manufactured in 1941.

GREATER AWARENESS TO VALUE OF CUSTOMER SATISFACTION noted in radio appliance field. Manufacturers, jobbers and dealers *insisting* that automatic washers be properly hooked up; that FM and tele receivers be installed to give best possible reception; that all large and small appliances be properly demonstrated. This well-defined trend toward keeping the customer "sold" is responsible for the more-than-ever-careful selection of retailers by the makers and distributors.

RESISTANCE TO SIGNING "PRIORITY" orders on part of public is being viewed with alarm by many alert merchants. Asking for a certain brand radio or appliance and being unable to get immediate delivery, too many customers express wish to look elsewhere for it, and, as dealers point out, often settle for a competitive make in another store.

NEW INTEREST IN AN OLD PRODUCT is visualized for the electric dishwasher, and merchandising experts see the cue to upped sales for the product in the general acceptance of the all-electric kitchen. In the all-electric home laundry, the clothes dryer is the something new which is expected to take hold in a satisfactory way after some ambitious promotion plans get rolling.

"BEFORE THE YEAR IS OVER, PERHAPS EVEN WITHIN a few months—lines of buyers in appliance showrooms will come shorter and shorter—and eventually will vanish completely. . . . It's time to start selling products again—on the basis of quality and dollar-for-dollar value."—P. M. Bratten, general sales manager, Frigidaire Div. of General Motors.

"MANY DEALERS ARE LOADED WITH slow moving merchandise which they bought when national brands were extremely scarce. The public no longer buys whatever the dealer has to offer. The customer is again in the driver's seat. If the dealer hasn't got what the customer wants—and if the customer can't get what he wants in other stores—he's willing to wait, for he's waited this long—unless—unless a good salesman meets this prospect and sells him what the dealer has in and can deliver."—Tom Joyce, general manager, Raymond Rosen & Co., Philadelphia.

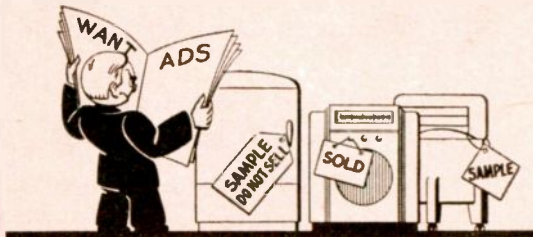

UPPED SALESMAN TURNOVER RATE worrying some of the large retail outlets throughout the country. Seems many a salesperson changes a job simply because the other fellow has more merchandise for him to sell.

Records, and Television, **TODAY**

ELECTRIC DOOR-CHIME MAKERS see their business skyrocketing as soon as new home building really gets under way. Many new models are on the market or are being readied.

BIGGER-THAN-EVER PARTS SHOW FOR CHICAGO being planned, the occasion being the annual Radio Parts and Electronic Equipment Show. The place, Hotel Stevens—the dates, May 11 to 16.

GLASS COFFEE MAKER BOWL REPLACEMENT situation is easing, according to leading manufacturers. Shortage expected to end before Fall.



TRADE-INS COMMENCE BIG PARADE TO DEALERS' DOORS. Stimulated by advertising offering large allowances in some cities, and by greater supply of available products, the trade-in movement is on. Because they may have paid high prices for their radio or appliance, or have spent large sums on service, customers are asking for large allowances—away out of line, say merchants.

BENDIX RADIO SCHEDULES ITS NEW 10" DIRECT-VIEW Television set for limited production this year. The receiver will have AM-FM and automatic phonograph reception.

APEX SHOOTS AT UPPED PRODUCTION. According to C. G. Frantz, president of Cleveland's Apex Electrical Mfg. Co., the firm expects to turn out 720,000 units, comprising vacuum cleaners, washers and ironers. The announced rate does not include calculations for the company's new automatic washer which is now in the earlier stages of production.

TREND TOWARD BUYING LARGER, MORE COSTLY radio-phonograph consoles seen in survey made by Collier's magazine. Nearly half of Collier's families expect to buy a new radio in '47, and of this number 49.3 per cent plan to buy console combos, paying \$194 for the upright model; \$89 for a table model combination.

BENDIX WASHER ANNOUNCES a new, easily-installed kit to permit use of its automatic washers in areas having low water pressures. This suspended timer kit provides a means of interrupting current flow to the timer motor while the washer tub is filling. Its effect is to lengthen the complete cycle by the time required to fill the tub in the soak, wash and deep water rinses.

CHICAGO'S PALMER HOUSE WILL house the trade show of the National Association of Music Merchants, June 1 to 5. This promises to be a whale of an event—full of real interest to the industry.

"A STEAM IRON THAT KNOCKS THE SPOTS off anything you've ever seen" is in the works at General Electric. The firm, it seems, was all set to go on production of a pre-war model, when its engineers came across with plans for a new type, "enormously improved."

MANY NEW AM, FM AND TELE STATIONS throughout the country will add millions of dollars to the market for air conditioning equipment, according to an estimate of the Refrigeration Equipment Manufacturers Assn., following an analysis of the '47, '48 construction programs of broadcasters.

MUSIC GROUP NOW DOING SPADEWORK on promoting National Music Week, May 4 to 11. National Association of Music Merchants urges manufacturers and jobbers to include Music Week promotion in their advertising; reminds retailers to plan now to publicize the event.

HYTRON'S NEW SUNLAMP BULB, announced in our February issue, will retail for \$9.95. Lamp has a built-in reflector, and it screws into regular electric outlet without use of auxiliary equipment.



ONE MERCHANT WAS SURPRISED to learn that many of his phono record customers were using old hand-wound players. He discovered this fact when he and his clerks made a drive to sell more players. Quizzing each platter buyer, disclosed the information; resulted in a sharp increase in sale of modern instruments.

A NEW SOUND RECORDER using magnetic paper tape was demonstrated by Indiana Steel, in New York. The tape, known as Hyflux has a magnetic coating consisting of a new war-born material discovery, according to officials of the company. It is expected that the recorder can be made to retail for about \$100; the tape at \$1.50 for a half hour's recording.

A DRY BATTERY WEIGHING ONLY one pound but suitable, among other uses, as a source of excitation voltage supply in portable television pick-up devices has been developed by "Eveready." The battery, no larger than two king-size cigarette packs, contains 300 volts.

 ONLY RCA VICTOR MAKES THE VICTROLA

"Music America

Heard over NBC coast-to-coast... a great sales-building show!

The RCA Victor Show reaches into the homes of over 6 million listeners *every Sunday*... building sales for you for today—and for a year from today!

Your customers hear the glorious baritone of Robert Merrill—Roy Shield's superb RCA Victor Orchestra—back-stage gossip of the music world by Johnnie Victor—and announcer Ken Banghart's enthusiastic "sell" of RCA Victor Instruments and Records.

These compelling sales messages *every week*—PLUS dominant full-color advertisements regularly in *Life*, *Saturday Evening Post* and *Collier's*—help make the demand for RCA Victor radios and radio-phonographs still greater than we can supply.

Listen to the RCA Victor Show building sales for you! Tune in your nearest NBC station this Sunday—2 P.M., EST.



ROBERT MERRILL—Metropolitan Opera star and Bobby Soxers' love—sings his way into thousands of feminine hearts every week.



Announcer KEN BANGHART sells RCA Victor instruments and recordings with a warm, believable voice.



ROY SHIELD conducts the 36-piece RCA Victor Orchestra through one of the intricate, but smooth-flowing arrangements that are the trade mark of his outstanding musical skill.

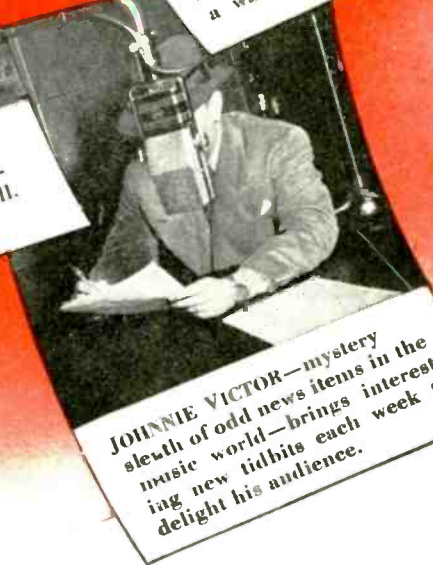

JOHNNIE VICTOR—mystery sleuth of odd news items in the music world—brings interesting new tidbits each week to delight his audience.

Loves Best™



Heard at its best with the
RCA VICTOR

"Golden Throat"

Both radio programs and records have richer, more mellow tone with the exclusive "Golden Throat" . . . the finest tone system in RCA Victor history. This exclusive 3-way system—the exact co-ordination of cabinet, speaker and audio-amplifier—is made possible only by RCA's 27 years of experience in electronic engineering and Victor's 48 years of leadership in sound reproduction.

Hear the "Golden Throat" tone in any of the instruments illustrated here. Compare them with any other make in the same price range. You'll understand why your customers are looking for . . . waiting for . . . RCA Victor radios and radio-phonographs.



THE "CRESTWOOD" SERIES. Superb Victrola radio-phonographs bring the "Golden Throat" to peak performance. *Life*, April 22; *Saturday Evening Post*, April 19 and *Collier's*, April 26, carry full-color advertisements on the 612V3.



65U RADIO-PHONOGRAPH. The table model Victrola radio-phonograph with the "Silent Sapphire" permanent-point needle that floats like a feather on records . . . adds years to record life . . . eliminates needle chatter. Plays 10 twelve-inch, or 12 ten-inch records.



THE MODERN 66X SERIES. For those who want less expensive, completely modern radios. The 66X2, shown here, is smartly cased in gleaming ivory-finish plastic—others in a wide range of beautiful plastics and veneers. The "Golden Throat" makes it outstanding among table radios.



THE "GLOBE TROTTER." New RCA Victor portable . . . handsome in aluminum and plastic. Open the lid and it instantly plays *anywhere!* AC, DC, or battery—ample volume even for outdoor dancing.



"Victrola"—T.M. Reg. U.S. Pat. Off.

RCA VICTOR

DIVISION OF RADIO CORPORATION OF AMERICA

Portables Pile Up

*Improved Sets and Better Demand
Add Interest to a Rich Market*

● A tremendous rush of interest in vacationing and holiday travel is now an accepted fact for the Spring-Summer-Fall season of 1947.

Millions of Americans are planning to take an extended "time off" and they're going to take those sleek new portable radios along on the trips. Outdoor radio is getting a play it never got before. Now is the time for retailers to take action on this market,—to stock up on the nifty new receivers which are appropriate for their customers, and to make definite plans for aggressive sales promotion for this type of unit.

Whether the typical American family takes a formal vacation or not, portable sets are needed for weekends. The take-along jobs are needed by the million for camp and cabin, lake and lodge, boat and barbecue, ranch and resort, cruise and club. Somebody remarked that radios will now be called upon "to swim, fish, play golf and climb mountains as never before."

Packed with Features

Dealers surveying the lists of new portable models will find that the new units are decorated with plenty of down-to-earth selling points. The old business of "lessons learned during the war" comes up again, because it happens that a portable receiver is a compact instrument and that compactness was one of the chief qualities of wartime radio devices so deftly designed by manufacturers. Radio men got a real workout in building equipment that was small and rugged; today these designs are showing up in the new carry-about sets. In the case of many a 1947 go-along model, "there has never been anything like it" and there is a surprising amount of radio genius packed into a few cubic inches of receiver. The sets range from the newly-designed pocket-sized jobs to the jumbo radio-phonograph models, just as they always did, but something has been added.

The improvements include more use of new and light-weight metals, a greater number of the battery-rejuvenation circuits, simplified battery replacement facilities, more shortwave, automatic power features, quick-starting circuits, improved an-



RADIO fans by the thousands will shortly take to the beaches, mountains



tennas, advanced use of plastics on the cases, etc. Outside and inside, most of them are designed so that it's a pleasure to stock them, a treat to display them, a delight to demonstrate them and a cinch to sell them.

As for the looks of the new portables, they've got class and color. Most of them are leatherette covered, but there are varied cases in new metals, fabricoid, airplane cloth, wood, alligator, gold-plate, simulated English saddle leather, plasticized

fabric (washable) and canvas. Two-tone color jobs are in the swim.

All these features are jam-packed into units alertly designated by such trade names as Vagabond, Sophisticate, Portabout, Companion, Playboy, Dude, Beachcomber, Global, Hi-Power, Playmate, Diplomat, etc. They are offered by an estimated 40 manufacturers who have introduced from one to four models each.

As the retailer sails into this rich market, he will, fundamentally, want

the Profits



trains and boats—creating big seasonal demand for new take-along RADIO



to make sure of at least three things: (1) That these sets are moved into prominent display areas—such as windows and high-traffic sections of the store, (2) That the latest information on the sets gets a thorough circulation among those on the mailing lists of the store, (3) That the units are all set for demonstration on both kinds of power, and (4) that the new receivers get a brisk emphasis in newspaper and radio advertising.

In addition to these basic things to

do, there are a number of specific sales ideas which are remembered from previous seasons, and which therefore are to be regarded as "tested". For instance, some dealers have had good luck with the plan of contacting sporting goods stores with the idea of putting portables in "sport" displays. A portable neatly shown along with exhibits of such merchandise as fishing tackle, boat gear, beach equipment, etc., has a good effect, and is accompanied by a

card saying where the receiver is available. Such arrangements may also be made with apparel stores and hardware outfits who do not carry radio lines, during the season when their displays are of the "outdoor" type.

Other retailers have done a great deal with the matter of cost of operating a portable set. This feature of the handled sets is probably not to be listed among buying factors as a distinctly major one; nevertheless the cost of operation is an interesting and little known fact about these radios and can be used as the eye-catching point of an advertisement or a display. When a set will play for 20 hours for 1c, and a dealer says so in large type, a lot of people will be interested.

Also reported to be a good merchandising stunt is the practice of radio men taking a portable along with them wherever they go, during the height of the season. If the radio is kept playing, it creates a lot of interest on the street, or on service calls to homes. Some dealers have made small cards to attach to the sets, with the name of the store and the phone number.

Attracting Vacationists

It is an easy matter to build a window display around portable sets, because an outdoor "flavor" can be readily depicted in the average window. A beach umbrella, a string of travel folders, or fishing rods will help out. Large photos of famous resorts have been used effectively and of course the manufacturers themselves are quick to supply colorful point-of-sale materials.

A good example of an effective "portable" window was the one used by the prominent Chicago organization, Lyon & Healy, and reported in these columns some time ago. The store had made a "lake" out of the window, and dotted the "water" with a number of lily pads. Portable sets were shown afloat on the pads; in the background was a small boat and the whole effect was certainly "music outdoors." This display was also an illustration of an alert emphasis on take-along radio-phonos, with records coming in for a major

(Continued on page 130)

Showing a Store

Don Leary of Minneapolis Sells the "Big Four" Through Extensive Advertising

● A retail organization which is earning a wide reputation for a really hard-hitting sales promotion job is Don Leary's, now doing business in a newly enlarged store at 56 E. Hennepin Ave., Minneapolis.

The company has been in business for 15 years, and by way of being a "Big Four" dealer, is handling radios and appliances in addition to featuring a "Service Guarantee" and making a specialty of one of the biggest stocks of phonograph records in the whole area.

Typical of the Don Leary promotion work is the full-hour radio program sponsored on local station WLOL every Saturday night. The firm is also sending a letter—a conversational communique—to all new residents of Minneapolis, welcoming them to the city. ("It's a great town—famous for many things and the home of one of the most unusual phonograph stores in the entire world!")

Jumbo Mailing

Another unusual stunt being done by this firm is the publication of the *Don Leary Record News*—a 12-page store newspaper mailed to over 25,000 people every month. It goes to the store's regular mail order customers, and to all local residents who wish to be on the list. The paper presents to its readers the whole operation of the store in news form, with an emphasis on record bulletins and lists. Its activities in radio, appliances, service and home furnishings are also reported.

Mr. Leary reports that "we have been the largest user of newspaper advertising space of any record store in this part of the country, and have tied in very closely with any promotion drives that the newspapers organize from time to time."

In addition, Mr. Leary makes a point of having friendly relations with the newspaper writers of the area, and is proud of past associations with them. The result is that Mr. Leary and his store become the subjects of many write-ups in the local papers. Columnists regard him as an authority on the trends of the times in radios—what's new in records, pho-

nographs, juke boxes, etc. They like to quote him on these subjects.

Some of the stories which have appeared about Mr. Leary have had a definite "family" interest. This fact puts him in an interesting position, since his business is essentially the merchandising of home equipment. For instance, Mr. Leary was recently quoted in the *Minneapolis Star-Journal* as saying that the popularity of juke boxes was, in general, a good thing for the welfare of city youngsters.

The opinions of this retailer were fully quoted as those of an expert. He pointed out that the juke boxes in drug stores, ice cream parlors and youth centers are keeping the kids from overcrowded homes off the

ord & Appliance Shop" and says that "it has been our policy to carry all of the lines for which there is any demand at all, although the large percentage of our sales are concentrated on the major companies, of course."

One of Don Leary's most interesting approaches to the combined radio-and-record business is the following "business philosophy" taken from one on his promotion letters: "We feel that the logical place for you to buy your radio or phonograph is from the store that sells you your records. We just *have* to see that you're satisfied in order to keep you as a record customer—that's only good business."

Whenever Leary needs a dramatic reason why people should drop into the store and look around—to see

**BIG 4 - RADIO
APPLIANCES
RECORDS
SERVICE**

COMBINED IN AGGRESSIVE PROMOTION

streets and out of trouble. "If it weren't for the juke boxes," he said, "these kids would be roaming the streets in the evenings. But in the juke-box spots for teen-agers they can sit, sipping cokes and sodas together, and listen to the music they love. The music itself is getting better and better all the time. In the past three months there's been a definite trend to the classical, with Rachmaninoff's Concerto No. 2 and Tchaikowsky's Nut Cracker Suite very much in demand. Hot jazz is getting a very definite frost bite from young music lovers, and sweet music is in the ascendancy. Old-time tunes are also very much in demand."

The store bills itself as "The Northwest's Most Talked About Rec-

new washers or refrigerators—he mentions that "we are sure that you will get a 'kick' out of visiting our store and seeing what a stock of over a quarter of a million records looks like in one establishment!"

Design for Profits

The big Leary store has a very modern aspect but there's no such thing as streamlining for its own sake. This retailer would not consider the idea of designing a fancy curve into a counter unless he could definitely see that he'd get his money's worth from the change. After all, the chief function of a store is to dish out a lot of merchandise to a lot of people.

to the Public

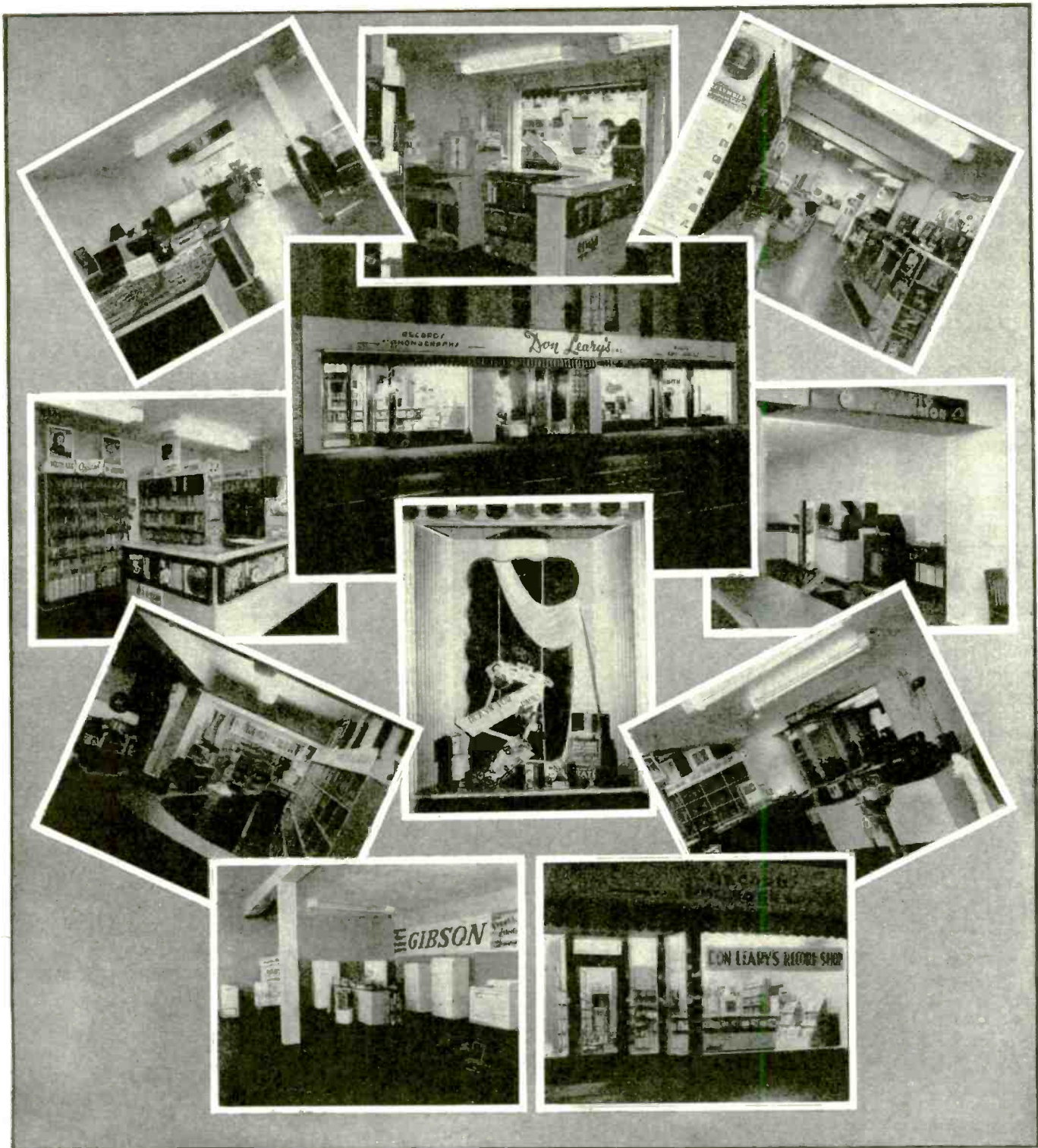

Above is an elaborate series of photos of Don Leary's store, shown here just as he used them in his advertising and promotion. The Minneapolis retailer put a big store-front picture in the center of the layout and included two of his current window displays. All the other photos show the various sections of the store in detail, including radio, appliances, service and records, with appropriate emphasis on the modernized decor of the disc department. Not often does a retailer take such pains to photograph and publicize all aspects of his business. When the above combination of photos appeared in Leary's store publication, some 25,000 prospects in the area were on the list and got a lively introduction to the store by this stunt alone.

Show Windows Should

**Displays Should "Sell" Old Customers as Well as New.
How to Plan Result-Getting Exhibits**

● The merchant who throws just anything that's readily available into his show windows is neglecting to capitalize upon one of his most important potential assets. Hit-or-miss methods used in changing window displays always result in dull and confusing exhibits. The retailer who looks upon window-dressing as a routine chore instead of what it actually is—a chance to gain new customers and to get more business from established clientele, is deliberately injuring his own business.

Show window display should be considered a *merchandising* and *advertising* art. Every new display going into a show window should be carefully planned in advance.

Steps to Take

In making a show-window layout, the experienced window dresser always visualizes the finished display from the viewpoint of the passerby.

Next, he develops a theme, some seasonal angle, for instance, or it may be that he wants to stress a certain single item. He does this by placing a de luxe radio, for instance, in the center of the "stage"—which is the show window. In making a display of this sort, his decorations, beams of light and other elements employed should all lead the viewer's eye to the radio set which is the chief center of attraction.

Where a number of large and small products are to be featured there are

two sorts of displays which may be used. First, there is the "symmetrical" sort where patterns such as pyramids, squares and "steps" are used to present an extremely orderly display.

Second, there is the "artistic" display which purposely portrays an informal picture. This window setup is usually employed for the showing of high-priced or high quality merchandise, and the number of items one can use in this kind of display is limited.

The orderly, mass-display before-outlined lends itself well to the featuring of attractive prices. When used for this purpose, most experts consider that *all* of the items shown should be price-ticketed. They base this belief on the fact that many viewers who see a great many articles priced will make up their minds that those *not priced* are expensive.

A Merchandising Art

All of the foregoing things about show windows stress their importance to the modern merchant. They should help him to realize more than ever that window-dressing is a merchandising art which he should not perform arbitrarily, carelessly or haphazardly. Business comes in directly from the exhibits in the show window. Good displays pay profits. Moreover, they "label" the store in the eyes of the passerby.

There is a step-by-step formula in

window dressing, as follows:

1. The show windows themselves must be clean.
2. Floors, walls, backdrops, etc., must be clean. Materials used must be fresh in appearance.
3. The radios and appliances to be placed on exhibit must be in first-class condition.
4. The windows must be adequately and attractively lighted through the use of spots, floods, color-shields, flashers, etc.
5. The show window displays should result from a planned-in-advance layout design.
6. The windows should be changed frequently.

Who'll Do the Work?

The merchant who *knows why* he needs to employ striking show window displays can always learn *how* to install them.

Dealers who feel that they cannot afford the services of a professional window-dresser can do creditable jobs themselves if they will consider the job in the light of being an interesting and necessary sales adjunct—and will take time to learn. No dealer can *afford not* to have up-to-the-minute displays.

The man dressing the show window should look at himself in the light of being an artist who is creating a picture that people will feel an urge to look at. He should consider himself an advertising man who is laying out a desire-to-buy ad which he can show to a lot of people who pass his store. An ad which he doesn't have to pay for, and which he *knows* will get results.

Mass-display, price-ticketed show window arrangements are almost universally employed by "chain" stores. Owners of some of the most prosperous drug and "cut-rate" cosmetic shops have found that they can attribute fifty percent of their sales directly to persons brought in from the street by mass-displays which feature price.

Radio-appliance retailers report good results from "price-stressing" window displays. This is particularly true in the sale of small appliances

DRESS SHOW WINDOWS ATTRACTIVELY BECAUSE—

They advertise your business—free of charge

They bring in new business

They keep old customers posted on new things

They help customer's "classify" the store

They bring in the "impulse-buyer"

Draw Them In!

There Are Themes Galore Which Will Help Advertise Your Business—Increase Your Sales

and electrical supplies. Every retailer in this field knows that many sales result directly from attractive displays of large, expensive radios and appliances, too.

In normal business time, it is not the usual practice for a stranger to walk into a store from the street and order then and there a high-priced item such as a refrigerator, a washer or a radio-phonograph combination. But there are numerous instances where show-window attracted "suspects" have become "prospects" — then buyers. Too, there are a great many large sales made, as it were, on the spur of the moment. Such sales are usually motivated, on the part of the customer, by several factors. For instance, a customer has already decided upon purchasing a certain piece of equipment of a certain make, and seeing it in a show window, drops in and buys it. A certain type person, known as an "impulse buyer" frequently makes a "flash" decision—buys even an expensive product without having thought much, if anything at all, about it previously.

Information Please!

Show windows bring regular customers in, too, therefore interest-getting displays are equally important in selling the steady patron. Mrs. Jones may see a certain radio or appliance of a particular make, in her favorite dealer's window which she did not know that he stocked. Since she already knows that the merchant is reputable, the latter can make a sale, often with the utmost ease, because he made his windows an "information center." In considering the regular patron in dressing the windows, the retailer should remember that the windows are the ideal medium for helping to tell the old-line clients about new things he has to offer.

Some dealers make up a window-dressing schedule far in advance in order to tie in with special holidays and special seasons. Such practice offers an ideal opportunity for increasing sales and for catching the eye of the passerby.

There are themes aplenty for the dealer who will look into them—plan them in advance. He can stress

such ideas as health, freedom from labor, entertainment and economy.

He can show the vast technical improvement we have made in manufacturing items for the home by showing "antique" models alongside the present-day ones.

"Live" displays too will lend great interest to any display. These can include washers washing clothes; coffee-makers making coffee; fans in operation, etc.

Revolving displays for exhibiting large and small products are sure-fire attention-getters too, as are the old reliable "guess how" illusion devices, such as bulbs lighted without any signs of wiring, etc.

In every town and city in the country, the bright-looking stores with attractive show-window displays are usually the most prosperous ones.

As far as the mechanics of successful window-dressing is concerned there is nothing more to be desired than orderly procedure. Window-dressing materials such as crepe paper, tacks, borders, adhesives, panels, backs, pedestals and stands, should be stored in a space of adequate size, easily accessible to the window dresser.

The appearance of window cards and signs is very important too, and if the merchant does not want to use a professional's services for his lettering, he should invest in one of the many devices on the market which permit the layman to produce creditable show cards simply and quickly.





De Padro Started with a Few Contacts and Developed a Big Following

At left, this Illinois store is shown playing host to the mayor of the town. Berwyn's mayor William J. Kriz presented a range to a contest winner, with CBS star Gloria Van cutting the ribbon. At right is the street view of the new De Padro establishment. Small store at the left of the picture was used by Mr. De Padro before he bought the whole building.

How One Sale

● In developing a big postwar business at De Padro Electric Co., near Chicago, proprietor Michael A. De Padro is concentrating his efforts "in his own back yard."

Previously, Mr. De Padro had ranged far and wide to get business for his store on busy Cermak Road in Berwyn, Ill., but now he says that "any store which specializes in customer satisfaction must have a *local* business to show a steady profit."

Berwyn is a thriving town of 60,000 people, just west of Chicago. Among its people there is the usual tendency to shop in the nearby city. When Mr. De Padro first opened his store, the radio-appliance business in Berwyn was so bad that there were only two appliance stores and one radio outfit in town.

Contacts Are Pyramided

But whether Mr. De Padro made his appeal to the folks of Berwyn or to Chicagoans, his merchandising methods had the "personal" flavor through all phases of his business. To start with, he used his business background and contacts in going out after friends and acquaintances. He sold them, and he got leads from them. Whenever he sold one member of a family, he found that other members were likely to come into the store to have a look around.

He adopted a practice of saying to a woman, "Bring your family in to see this—let them help you decide." Often the whole family did come, and when Mother's washing machine was selected, Father had become inter-

ested in a water heater, and big brother was considering a radio phonograph.

He continued to make calls, getting more and more people into the little store. At the end of the first year he had done enough business to show a net profit of \$7200. He gives an example to show how his system worked.

"A family living in an apartment bought a washing machine. A brother, living upstairs, wanted a range, and he drove his wife over to Berwyn to look. They bought. A grown son, living at home, came with them and bought his mother a refrigerator." In less than six months, De Padro had sold appliances to twenty-two families in that block—many of them related to the first family.

Mr. De Padro believes that nothing puts a woman into the refrigerator market more surely and quickly than a sister or sister-in-law with a new refrigerator. Also, he says, selling a second appliance is half-done when you sell the first. But—

"You must do everything to satisfy the customer. We will not sell an appliance the customer does not need, or cannot afford," he says firmly. The store asks a generous down payment, takes no trade-ins, and in eleven years of doing business, has never re-possessed an appliance. Once sold, they will exchange, give refunds, make repairs or service any model bought from them which does not give complete satisfaction.

Mr. De Padro was soon able to buy the building which housed the little store and extended to the corner of

the block on Cermak Road. He moved his business to the corner location, increasing his window frontage from 25 feet to 40 feet on the Berwyn-Cicero main business street, and gaining a high visibility for the heavy traffic going both ways on the crowded thoroughfare used by west suburban residents motoring to and from Chicago. Residents of these suburbs began stopping to look, and staying to buy.

Prospects See Big Stocks

Instead of constructing deep display windows, De Padro installed shallow (three feet deep) displays for small appliances, with a low background making the show-room visible. In the store he arranged major appliances in "mass-displays" near the center. A passer-by gains the impression that hundreds of appliances are being shown.

On one side of the show-room are freezers, stoves, water heaters, refrigerators and ironers, with a complete all-electric kitchen set-up, with cabinets, in the rear. The other side is carpeted. Along the wall are console type radios and end tables with lamps to harmonize. Vacuum sweepers are at the rear of this side, in front of a tiered counter displaying small radios and record-changers. Behind all this are the business offices on one side, and a service desk at the other. The store now carried twenty nationally-known lines.

Today De Padro has a permanent section of children's supplies in his store because a Grand Rapids furni-



Leads to Another

ture factory sold him a lot of child's chairs in 1943 that netted a \$1,000 profit. In that year, his worst of the war, the store made a total profit of \$2200. Important, De Padro says, was that all the business came from the town of Berwyn. He visualized a new position in his home community.

"You learn something every year in this business," he says. "You take those children's chairs. That started me, and I still carry a full line of juvenile furniture, toys, bi-

cycles, scooters—they sell as fast as I get them in, and they are wonderful traffic builders.

De Padro is now doing a bigger business than he did in 1941, and is doing 75% of it with the people of Berwyn, who got to know the store during the war. He has been so successful that there are now twenty stores in Berwyn carrying radios and appliances, in place of the three who were there in 1940.

Recently, when a local resident was the winner of an electric range

in a radio contest, the De Padro store was the scene of the presentation. Leading civic figures and celebrities were there, and Mayor Kriz of Berwyn made the award speech.

One of the statements of Mayor Kriz was this: "Berwyn is proud that one of its leading stores was chosen to make this presentation from among the hundreds of appliance stores in this great area of one-half million population."

It was another example of local recognition for De Padro methods.

This dealer makes a practice of showing major appliances in mass formation in the center of the store, with smaller units around the edges.

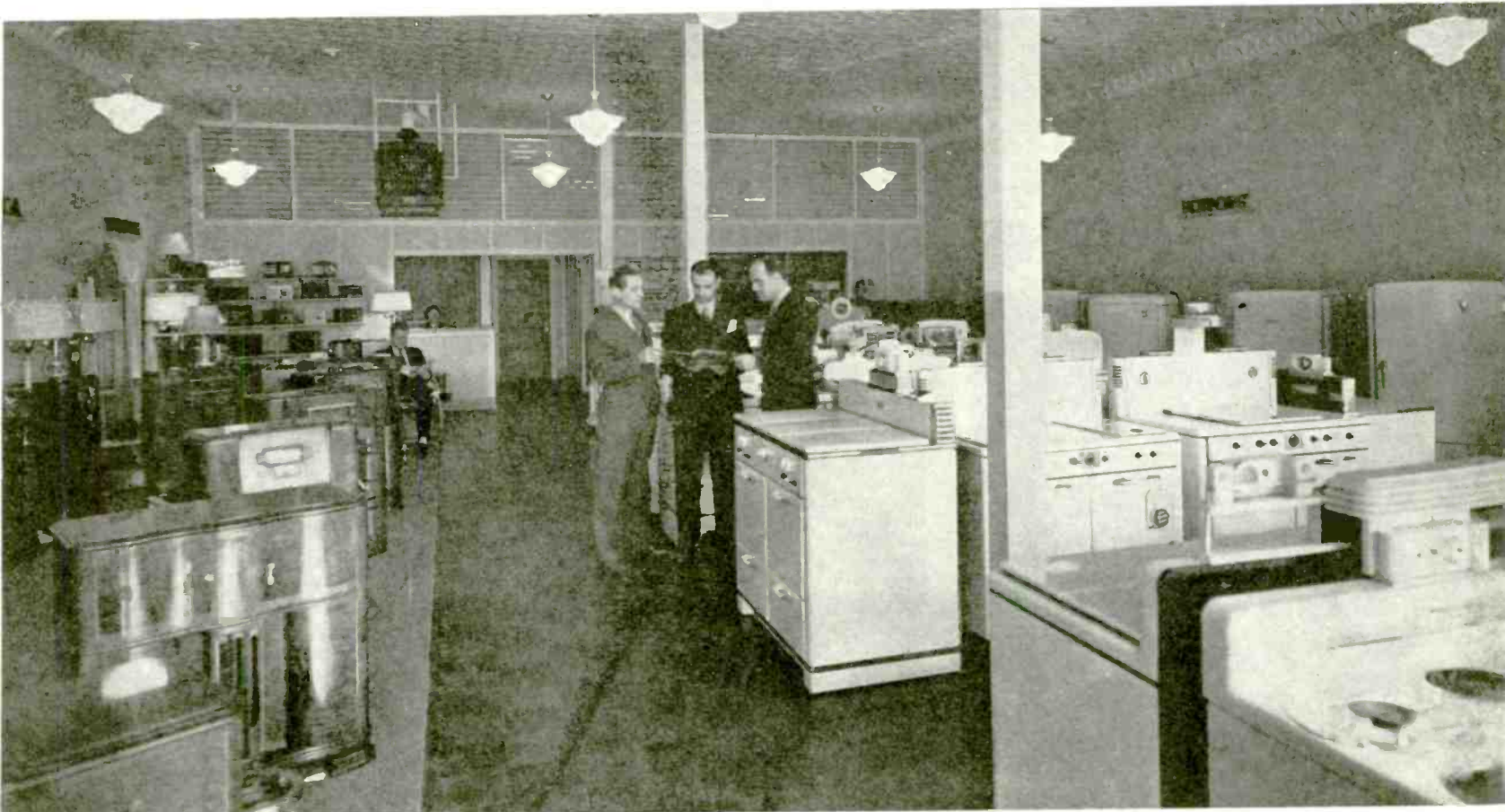

Sentinel PORTABLE RADIO

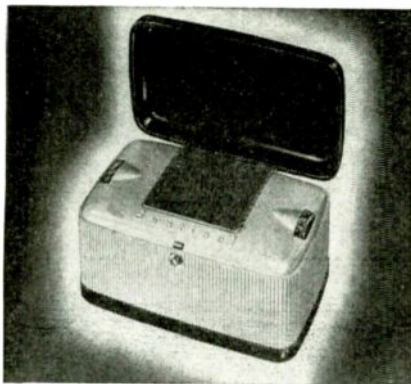

"Treasure Chest" model portable receiver billed as "the tiniest radio yet offered to the trade" operates on ac, dc or battery, 5 tubes. Measures 4" high by 4" deep by 8" wide—designed to bring in programs even when cover is down, by holding set to ear. Two-tone plastic cabinets available in variety of colors. Sentinel Radio Corp., 2020 Ridge Ave., Evanston, Ill.—RADIO & Television RETAILING

Hoffman RADIO

Model A-309 table receiver, ac-dc superhet with 6 tubes. "Unitune" system of tuning. Alnico 5 PM speaker, built-in loop antenna, automatic volume control. Decorative treatment of illuminated slide rule dial; metallic grille trim. Cabinet of mod-

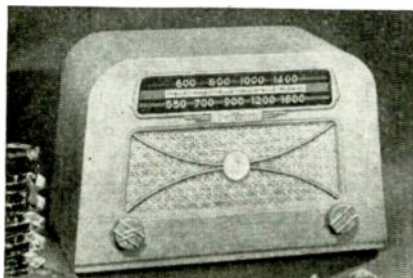

ern blonde hardwood. Tunes 550 to 1600 kc. Hoffman Radio Corp., 3430 S. Hill St., Los Angeles, Calif.—RADIO & Television RETAILING

Farnsworth FM-AM COMBO

Model GK-102 automatic radio phonograph with FM. Drift-corrected push-button electric tuning, 9 tubes plus rectifier, avc, band spread tuning. Two built-in antennas—shielded rotatable one for AM and dipole unit for FM. Beam power output, push-pull amplification, 12" reverberation-insulated PM Alnico speaker. Modern



New Sets for

style cabinet available in walnut or blonde Golden Harvest. Farnsworth Television & Radio Corp., Fort Wayne, Ind.—RADIO & Television RETAILING

Emerson PORTABLE RADIO



Model 536 portable receiver, ac-dc-battery. Compact, 7-tube circuit using smaller tubes. Previously \$49.95—now \$39.95. Emerson Radio & Phonograph Corp., 111 Eighth Ave., New York 11, N. Y.—RADIO & Television RETAILING

E-L RADIO-INTERCOM

Radio-Utiliphone model with master-and-radio unit designed for use with as many as 4 "slave" units. Radio tunes 540 to 1620 kc, an ac-dc superhet type circuit with 6

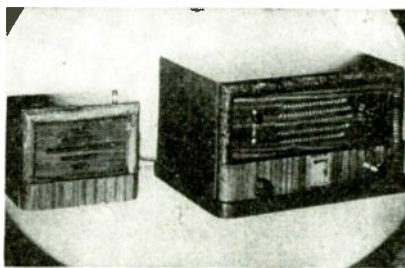

tubes, permeability type tuning, crystal detector, avc, beam power output tube and tuned r-f stage, mounted on heavy cadmium plated chassis. Uses E-L vario tuner, built-in Hi-Q loop antenna. Operating range for each slave station is 500'. Mahogany veneer cabinets, finished on all sides. Master measures 12" by 9" by 7"; slaves are 7" by 4" by 5". Master and one slave retail at \$89.50—additional slaves at \$15 each. Electronic Laboratories, Inc., 122 W. New York St., Indianapolis 4, Ind.—RADIO & Television RETAILING

National Union PORTABLE

Model G-613 "Commuter" three-way portable superhet, two-gang tuned condenser, built-in high-gain plug-in loop antenna. Automatic volume control, 5" plug-in PM speaker, American broadcast band coverage slide rule dial. Panel-mounted power selector switch, unbreakable dial window, recessed controls. Operates on two NU 4½-volt "A" pack batteries plus two 45-volt "B" pack (or equivalent Eveready, Burgess, or Ray-O-Vac). Genuine leather carrying handle, felt-cushioned feet. Cabinet of simulated



leather in luggage brown measures 13" wide by 6" deep by 10¾" high. Weighs 8 lbs, 8 oz. less batteries. National Union Radio Corp., 57 State St., Newark 2, N. J.—RADIO & Television RETAILING

RCA FM-AM RADIO

Model 68R3 table receiver with both AM and FM bands, 7 tubes plus rectifier. "Golden Throat" tone system, 3-point tone control. Two built-in antennas—one for each band. Phono input jack and phono switch position on front panel. Automatic

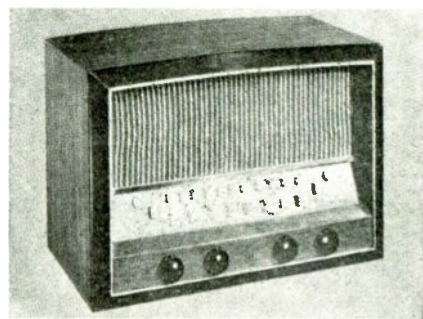

volume control. FM circuit designed on Seeley principle. RCA Victor Division, Radio Corp. of America, Camden, N. J.—RADIO & Television RETAILING

Spring Sales

Bendix FM-AM RADIO

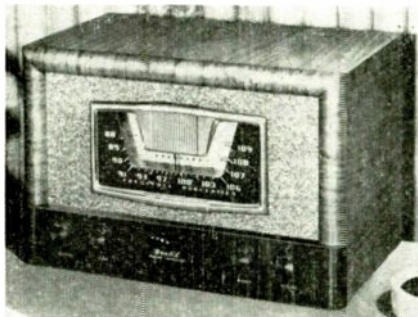

Model 847-A table superhet. ac. with FM (88 to 108 mc) and standard broadcast (540 to 1620 kc). R-F amplification on both FM and AM. FM circuit uses radio detector. Dual 3-gang tuning, 4" by 6" Alnico 5 oval speaker, built-in FM line-coupler antenna plus super-signal AM antenna. Continuously variable tone, 7 tubes and rectifier, bass tone compensation, dual channel I-f transformer. Continental modern-styled cabinet in fawn walnut, accentuated by lustre-brown control panel board. Measures 16¾" wide by 10½" high by 10½" deep. Bendix Radio Division, Bendix Aviation Corp., Baltimore 4, Md.—RADIO & Television RETAILING

Sonora COMBO

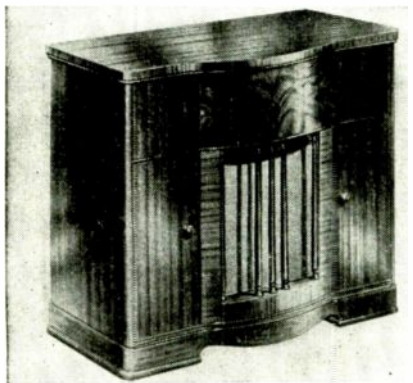

Model RMR-219 superhet ac console radio phonograph tuning 535 to 1620 and 5.65 to 18.3 mc. New type built-in loop antenna, variable tone control, automatic volume control. New type quick-reading dial, 8 tubes. Automatic record changer with low-pressure crystal pickup—long life needle. Plays twelve 10" or ten 12" discs. Two record storage compartments. Cabinet of fine-figured selected mahogany—measures 38½" wide by 34" high by 18" deep. Shipping weight is 105 lbs. Lists at \$235 including tax. Sonora Radio & Television Corp., 325 N. Hoyne Ave., Chicago 12, Ill.—RADIO & Television RETAILING

Fada PORTABLE RADIO

Model P82 tri-power portable superhet. ac-dc or self contained batteries. Tuned r-f stage, 5 tubes plus rectifier, uses two 45-volt B batteries plus two 4½-volt A batteries. Tunes 538 to 1650 kc plus some State police. Reduction drive tuning ratio of 10 to 1, automatic volume control, diode low distortion detector, beam power output system—power output of .3 watts. I-f of 456 kc, 5" dynamic Alnico 5 speaker, slide rule dial. Fa-da-Scope loop antenna. Weight with batteries is 15 lbs 10 oz. Two-tone simulated-leather-covered wood cabi-



net measures 7" wide by 12½" high by 14¼" long. Fada Radio & Electric Co., Inc., Long Island City, New York—RADIO & Television RETAILING

Stewart-Warner RADIO

Model A51T2 "Air Pal" receiver tuning 535 to 1600 kc. Compactly designed into unit smaller than a cradle telephone. Four tubes plus rectifier, ac-dc, built-in Radair antenna, PM dynamic speaker. Brown

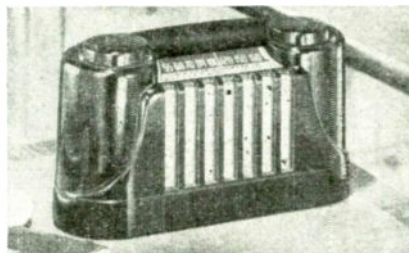

plastic cabinet. (A51T3 is ivory plastic; A51T4 is ebony) Stewart-Warner Corp., 1826 Diversey Parkway, Chicago, Ill.—RADIO & Television RETAILING

GE FARM RADIO



Model 180 table receiver with self-contained batteries ("A" pack of 1.5 volts, "B" pack of 90 volts—made by Burgess, Eveready, General or Ray-O-Vac) tuning 540 to 1710 kc. I-f of 455 kc, undistorted power output of 0.15 watt. Six inch PM Alnico speaker. Modern style cabinet and dial. Measures 9¾" high by 18" wide by 12" deep. General Electric Co., Bridgeport, Conn.—RADIO & Television RETAILING

Jewel RADIO



Model 504 Deluxe ac-dc superhet table receiver tuning 550 to 1700 kc. Hi-Q built-in loop antenna, 4 tubes plus "Miracle" rectifier. Slide rule dial, pilot light, automatic volume control, Alnico PM 5" speaker. New process textile grille in variety of colors—all wood cabinet. Jewel Radio Corp., 583 Ave. of the Americas, New York 11, N. Y.—RADIO & Television RETAILING

Zenith CHAIRSIDE COMBO

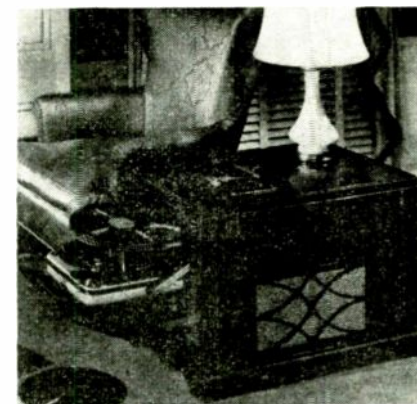

Model 12H093R chairside radio-phonograph with Armstrong FM on both bands, international shortwave with spread-band tuning, the Electro-Glide feature which brings automatic record changer unit out at touch of button. Cobra tone arm, 9 radio tubes plus power rectifier plus 3-purpose phono tube plus tuning indicator tube. Tuned r-f, avc, new dual channel frequency transformers. Has both Wavemagnet and FM "power-line" antenna. Zenith Radio Corp., 6001 W. Dickens Ave., Chicago 39, Ill.—RADIO & Television RETAILING



Carolina Jobbers

To speed up distribution of FM sets in North and South Carolina, some 55 jobbers of the two states have organized the Charlotte Radio & Appliance Distributors Association. The action was taken at a WBT (Charlotte) luncheon, where general manager C. H. Critchfield outlined a jobber-station sales drive. J. P. McMillian, Southern Radio Corp. (RCA Victor) is chairman. Other officers, l. to r., C. D. Mitchell, Southern Appliances, Inc. (Majestic) member steering committee; A. K. Sutton, A. K. Sutton, Inc., (Philco) member steering committee; J. L. Pleasants, Allison-Erwin Co. (Zenith), vice-chairman; Mr. McMillian; R. L. Chapman, Chapman-Wilhelm Co., (Stromberg-Carlson) chairman steering committee; Enloe McClain, McClain Distributing Co., (Admiral), secretary-treas.

FM Hits Stride

● As FM increases its coverage at a brisk pace, the national interest in the frequency-modulated signal grows stronger and stronger.

With over two hundred stations on the air, and doing a job which makes the demonstration of receivers a dramatic cinch, there's bound to be tremendous wave of interest. In many towns, the new FM transmitter is getting the best publicity that a radio retailer ever got. Thousands of U. S. prospects are hearing about FM; the local dealers consequently get the public reaction in very short order, and the new industry is well on its way to popular marketing on a big scale.

A marked increase in dealer advertising of one type or another, in which the retailer is identified as the place to make the FM purchase, has been noted in the business. Local distributors have also waded into the

uproar by lining up their dealers in cooperative ads on FM.

In some cases (see above) jobbers or dealers have taken cooperative action with the local broadcaster, in order to get things done in an orderly fashion. Many favorable comments have been made on this activity, as it provides a very sensible coordination between the elements of the trade at a time when it is most needed. Radio men have pointed out that this kind of action was often lacking in AM.

What is happening, then, is that FM is getting a well deserved break in point of national publicity and the public gets some interesting reading from several directions. By the time the local retailer's ad is read in the town paper, the popular appetite for at least a demonstration of FM has reached a new peak.

So far as is known, no cases have

been reported of new businesses being started for merchandising of FM alone, but considering the interest in it, such action would not be surprising. Certainly there are plenty of cases in which large sections of stores have been given over to the demonstration, sales and installation of the static-free units. The complete array of all types of the sets, antennas, etc. makes a big department by itself and since the popular interest has begun to manifest itself, this part of the store is a very busy place.

Production Grows

As the Spring showings of new sets were completed and the new models were eyed by the trade, it began to be clear that the number of manufacturers ready with FM radios was growing steadily. The newer lines began to show more of the table types and there was more of an attempt to bring FM within the reach of the folks with more modest incomes.

It is a sign of great popular interest in a line, and an indication that within a few short years, FM of one type or another will be enjoyed by millions.

Proper Installation

One of the major reasons for such extensive dealer activity in FM is that it requires a lot of extra attention for its installation and service. Retailers realize that they must be careful in this regard, in order to get FM off on its best possible foot. It is a major undertaking, and most dealers know it. It is not a matter of showing a couple of extra sets on the floor, and announcing to the public that the store is featuring FM.

Association Goes to Work



Shown at the Washington, D. C., meeting of the FM Association are, left to right, Dr. Ray H. Manson, president of Stromberg-Carlson; Charles R. Denny, FCC chairman; and Hugh D. Lavery of McCann-Erickson.

The Smart
NEW
3-way Portable



MODEL A-510

AIR KING *Royal Troubador*

THE 3-WAY PORTABLE WITH TRIPLE SALES APPEAL

You can wrap the whole sales story of the Air King "Royal Troubador" in three words — Price, Performance and Eye-Appeal. It is a 3-way portable designed for beauty and tone with sales potential to match.

Your customers will be proud to own the new Air King "Royal Troubador"—proud as you will be to show it. Highly sensitive . . . critically selective . . . playable anywhere. The "Royal Troubador" can easily be the fastest moving portable you've so far seen.

The Royalty of Radio Since 1920

AIR KING
RADIO

Division of HYTRON RADIO & ELECTRONICS CORPORATION

★ WE HAVE A LIMITED NUMBER OF DISTRIBUTOR AND DEALER TERRITORIES OPEN ★

Write or wire: Air King Products Co., 1523-29 63rd St., Brooklyn, N. Y. Export Address: Air King International 75 West Street, New York 6, N. Y.

SELLING FEATURES

- Latest design high-performance miniature tubes (3) plus metallic selenium rectifier
- Superheterodyne with automatic volume control
- Special Alnico V PM Speaker
- Precision die-cut antenna for maximum signal
- 3-way power; AC-DC or battery
- Provision for external aerial
- All wood case bound in striking simulated leather

\$37⁹⁵

Retail Price (Tcx Incl.) Less Batteries

The Royal Family of Radios



"Twenty-Six Years of Specialized Electronic Skill Behind Every Air King Radio"

PRODUCTS OF RADIO AND TELEVISION MANUFACTURERS

Listing the companies whose lines cover one or more of the six groups of greatest importance to retailers and distributors
 Compiled by RADIO & Television RETAILING, 480 Lexington Ave., New York 17, N. Y.

The following manufacturers of radio receivers have returned our editorial questionnaire giving the information needed for these listings	Home AM-FM	Combinations	Television	Auto Radio	Amateur	Commercial*	Manufacturers not listed may furnish data for the next issue. No advertising obligation. Additions or revisions will be made monthly.									
							Home AM-FM	Combinations	Television	Auto Radio	Amateur	Commercial*				
Abbott Instrument, Inc., 8 W. 18th St., New York, N. Y.							Fred M. Link, 125 W. 17th St., New York, N. Y.									
Admiral Corp., 3800 W. Cortland St., Chicago, Ill.							Magnavox Co., 2131 Bueter Rd., Ft. Wayne 4, Ind.									
Aero Communications Co., 231 Main St., Hempstead, L. I.							Maguire Industries, Inc., 936 No. Michigan Ave., Chicago, Ill.									
Air Associates, Inc., 5827 W. Centry Blvd., Los Angeles 45, Calif.							Majestic Radio & Television Corp., St. Charles, Ill.									
Air Communications Co., 2233 Grand Ave., Kansas City, Mo.							Mareo Industries, 245-A So. Beverly Dr., Beverly Hills, Calif.									
Air King Prod. Co., Inc., 1523 63rd St., Brooklyn, N. Y.							Mason Radio Products Co., Kingston, N. Y.									
Airplane & Marine Instruments, Clearfield, Pa.							E. W. McGrade Mfg. Co., 406 W. 31st St., Kansas City, Mo.									
Allied Radio Corp., 833 W. Jackson Blvd., Chicago 7, Ill.							Mer-Rad Div., Black Industries, 1400 E. 222nd, Cleveland 17, O.									
American Communications Co., 306 Broadway, New York, N. Y.							John Weck Industries, Plymouth, Ind.									
Andrea Radio Corp., 43-20 34th St., Long Island City, N. Y.							Medco Mfg. Co., 5 W. 45th St., New York, N. Y.									
Anley Radio Corp., 41 St. Joes Ave., Trenton, N. J.							Megard Corp., 1601 S. Burlington Ave., Los Angeles, Calif.									
Apex Industries, 192 Lexington Ave., New York 16, N. Y.							Meissner Mfg. Co., 936 N. Michigan Ave., Chicago, Ill.									
Atlantic Mfg. Co., Hamburg, Pa.							Midwest Radio Corp., 909 Broadway, Cincinnati, Ohio									
Atomic Heater & Radio Corp., 104 Park Row, New York, N. Y.							James Millen Mfg. Co., 150 Exchange St., Malden, Mass.									
Autocrat Radio Co., 3855 N. Hamilton Ave., Chicago							Minerva Corp. of America, 238 William St., New York, N. Y.									
Automatic Radio Mfg. Co., Inc., 122 Brookline Ave., Boston							Molded Insulation Co., 335 E. Price St., Philadelphia 44, Pa.									
Aviola Radio Corp., Phoenix, Ariz.							Monitor Equipment Co., 640 W. 249th St., Riverdale, N. Y.									
Baronette Radio & Tube Corp., 220 Fifth Ave., New York, N. Y.							Musitron Co., The 223 W. Erie St., Chicago, Ill.									
Rex Bassett, Inc., 311 N. W. 1st Ave., Ft. Lauderdale, Fla.							National Co., Inc., 61 Sherman St., Malden, Mass.									
Bell Radio Co., 125 E. 46th St., New York, N. Y.							National Design Service, 96 Liberty St., New York, N. Y.									
Belmont Radio Corp., 5921 W. Dickens Ave., Chicago, Ill.							National Union Radio Corp., 57 State St., Newark 2, N. J.									
Bendix Radio, Div. of Bendix Aviation Corp., Baltimore, Md.							Nobilit-Sparks Industries, Inc., Columbus, Ind.									
Biltmore Radio Corp., 15 Ave. "A", New York 3, N. Y.							Northeastern Engineering, Inc., Canal St., Manchester, N. H.									
Cavaleade Industries, 39 S. La Salle St., Chicago, Ill.							Northern Radio Co., 2208 4th Ave., Seattle, Wash.									
Collins Radio Co., 2920 First Ave., Cedar Rapids, Iowa							Olympic Radio & Tele., Inc., 510 Sixth Ave., New York, N. Y.									
Colonial Radio Corp., 254 Rano St., Buffalo, N. Y.							Packard-Bell Co., 3443 Wilshire Blvd., Los Angeles, Calif.									
Columbia Electronic, Inc., 185 E. 122nd St., New York, N. Y.							Panoramic Radio Corp., 242 W. 55th St., New York 19, N. Y.									
Communications Co., Inc., 300 Greco Ave., Coral Gables, Fla.							Philo Corp., Tioga & C Sts., Philadelphia, Pa.									
Communications Equip. Corp., 134 W. Colo. St., Pasadena, I, Cal.							Pilot Radio Corp., 37-06 36th St., Long Island City, N. Y.									
Concord Radio Co., Cincinnati, Ohio							Port-O-Matic Corp., 985 Madison Ave., New York, N. Y.									
Continental Electronics Ltd., 252 Norman Ave., Brooklyn, N. Y.							Precision Specialties, 210 N. Western Ave., Los Angeles, Calif.									
Crosley Corp., 1329 Arlington St., Cincinnati, Ohio							Press Wireless, Inc., 1475 Broadway, New York 18, N. Y.									
Crystal Products Co., 1519 McGee Trafficway, Kansas City, Mo.							Quality Industries, 25 E. Jackson Blvd., Chicago 4, Ill.									
Deles Radio, Div. of General Motors Corp., Kokomo, Ind.							Radio Craftsmen, Inc., 1341 S. Michigan Ave., Chicago									
DeWald Radio Mfg. Corp., 35-15 39th Ave., Long Is. City, N. Y.							Radio Engineering Laboratories, Inc., 36th St., L. I. City, N. Y.									
Allen B. DuMont Laboratories, 515 Madison Ave., New York							Radio Laboratories, 2701 California Ave., Seattle 6, Wash.									
Dynavox Corp., 40-35 21st St., Long Island City, N. Y.							Radio Mfg. Engineers, Inc., Peoria 6, Ill.									
Eastern Electronics Corp., 41 Chestnut St., New Haven, Conn.							Radio Navigational Inst. Corp., 305 E. 63rd St., New York 21									
Echophone Radio Co., 2611 So. Indiana Ave., Chicago, Ill.							Radio & Television, Inc., 100 Ave. of the Americas, New York									
Eckenroth Co., 32 Ross Street, Brooklyn, N. Y.							Radio Process Co., 7618 Melrose Ave., Los Angeles, Calif.									
Eckstein Radio & Television Co., 1400 Harmon Pl., Minneapolis							Radio Wire Television Inc., 100 Ave. of the Americas, New York									
Electromatic Mfg. Co., 88 University Pl., New York, N. Y.							RCA Victor Div., Radio Corp. of America, Camden, N. J.									
Electronic Corp. of America, 170 53rd St., Brooklyn, N. Y.							Real Electronics Corp., 20 W. 20th St., New York, N. Y.									
Electronic Devices Co., 601 W. 26th St., New York, N. Y.							Remler Co., Ltd., 2101 Bryant St., San Francisco, Calif.									
Electronic Laboratories, Inc., 24 W. 24th St., New York, N. Y.							E. M. Sargent Co., 219 9th St., Oakland, Calif.									
Emerson Radio & Phone Corp., 111 8th Ave., New York, N. Y.							Scophony Corp. of America, 527 5th Ave., New York, N. Y.									
Emor Radio, Ltd., 400 East 118th St., New York, N. Y.							Scott Radio Labs., Inc., 4450 Ravenswood Ave., Chicago, Ill.									
Espey Mfg. Co., Inc., 528 E. 72nd St., New York, N. Y.							Searle Aero Industries, Inc., P. O. Box 111, Orange, Calif.									
Fada Radio & Electric Co., Inc., Long Island City, N. Y.							Selectograph Mfg. Co., 502 W. Colo. Ave., Colorado Spgs., Colo.									
Farnsworth Television & Radio Corp., Fort Wayne, Ind.							Sentinel Radio Corp., 2020 Ridge Ave., Evanston, Ill.									
Federal Telephone & Radio Corp., 591 Broad St., Newark, N. J.							Setchell-Carlson, Inc., 2233 University Ave., St. Paul, Minn.									
Fisher Radio Co., 41 E. 47th St., New York, N. Y.							Sheridan Electronics Corp., 2850 S. Michigan Ave., Chicago									
Fisher Research Lab., 1961 University Ave., Palo Alto, Calif.							Signal Electronics, Inc., 114 E. 16th St., New York, N. Y.									
Flush Wall Radio Co., 15 Washington St., Newark, N. J.							Silver Co., MeLardo, 1240 Main St., Hartford 3, Conn.									
F. M. Radio Mfg. Co., Inc., 10314 Superior, Cleveland, Ohio							Sonora Radio & Television Corp., 325 N. Hoyne Ave., Chicago									
Freed Radio Corp., 200 Hudson St., New York, N. Y.							Sparks-Withington Co., Jackson, Mich.									
Galvin Mfg. Corp., 45-45 Augusta Blvd., Chicago, Ill.							Stewart-Warner Corp., 1826 Diversey Pkway., Chicago, Ill.									
Garod Radio Corp., 70 Washington St., Brooklyn, N. Y.							Stromberg-Carlson Co., 100 Carlson Rd., Rochester, N. Y.									
General Electric Co., Bridgeport, Conn.							Symphonic Radio & Electronic Corp., Main St., Cambridge, Mass.									
Gilfillan Bros., 1815 Venice Blvd., Los Angeles, Calif.							Taybren Equipment Co., 120 Greenwich St., New York, N. Y.									
Globe Electronics, Inc., 225 W. 17th St., New York, N. Y.							Teletone Radio Co., 1901 S. Washtenaw Ave., Chicago, Ill.									
Hammarlund Mfg. Co., 460 W. 34th St., New York, N. Y.							Teletone Radio Co., 609 W. 51st St., New York, N. Y.									
Harris Mfg. Co., 2422 W. 7th St., Los Angeles							Televox, Inc., 451 S. 5th Ave., Mt. Vernon, N. Y.									
Harvey Machine Co., Inc., 6200 Avalon Blvd., Los Angeles							Telicon Corp., 831 Madison Ave., New York, N. Y.									
Harvey Radio Labs., Inc., 447 Concord St., Cambridge, Mass.							Templestone Radio Mfg. Corp., New London, Conn.									
Harvey-Wells Electronics, Inc., Southbridge, Mass.							Transmitter Equipment Co., 345 Hudson St., New York 14, N. Y.									
Herbach & Rademann Co., 522 Market St., Philadelphia, Pa.							Tray-Ler Radio & Tel. Corp., 571 W. Jackson, Chicago									
Hoffman Radio Corp., 3130 So. Hill St., Los Angeles, Calif.							Union Electronics Corp., Box 497, Pasadena, Calif.									
Howard Radio Co., 1735 Belmont Ave., Chicago, Ill.							United States Television Mfg. Co., 3 W. 61st St., New York, N. Y.									
Hudson-American Corp., 25 W. 43rd St., New York 18, N. Y.							Vibratone Mfg. Co., 325 Miguel St., San Francisco, Calif.									
Industrial Electronic Corp., 505 Court St., Brooklyn 31, N. Y.							Viewtone Co., 31 Willoughby St., Brooklyn, N. Y.									
Industrial Tool & Die Works, Inc., Minneapolis, Minn.							Vietrical Engineering Co., 828 N. Highland Ave., Los Angeles									
International Detroit Corp., Beard Ave., Detroit, Mich.							Walker, Inc., 684 S. La Fayette Park Pl., Los Angeles, Calif.									
Ray Jefferson, Inc., 40 E. Merrick Rd., Freeport, L. I., N. Y.							Warwick Mfg. Corp., 4610 W. Harrison St., Chicago, Ill.									
Jewel Radio Corp., 583 Sixth Ave., New York 11, N. Y.							Waterson Radio Mfg. Co., 2700 Swiss Ave., Dallas, Texas									
Kear Engineering Co., 619 Emerson St., Palo Alto, Calif.							Wells-Gardner & Co., 2701 N. Kildare Ave., Chicago, Ill.									
Kingston Radio Co., Inc., Kokomo, Ind.							Western Electric Co., 120 Broadway, New York									
Kluge Electronics, Inc., 1031 N. Alvarado St., Los Angeles 36, Cal.							West'n Sound & Elec. Labs., Inc., 2512 W. St. Paul Ave., Milwaukee									
La Magna Mfg. Co., 51 Clinton Pl., E. Rutherford, N. J.							Westinghouse Electric Corp., Receiver Div., Sunbury, Pa.									
Lawreth Radio Mfg. Co., 3931 Monroe Ave., Wayne, Mich.							Wilcox Electric Co., Inc., 1400 Chestnut St., Kansas City, Mo.									
Lear, Inc., 110 Ionia Ave., N. W., Grand Rapids 2, Mich.							Wilson-Gay Corp., 601 Seminary St., Charlotte, Mich.									
Lostradio Corp., 4 St. Francis St., Newark, N. J.							Zenith Radio Corp., 6001 Dickens Ave., Chicago, Ill.									
Lozola Electronics Corp., 653 11th Ave., New York, N. Y.																

*Commercial or Special.

Republication prohibited. See copyright notice, page 1.



Cabinets of the new Delco Console Combinations are 18th Century in design, superbly executed by master cabinet-makers. Model R-1252 in mahogany (illustrated here) and Model R-1251 in walnut are truly exquisite furniture pieces as well as musical instruments of outstanding quality. These Combinations feature 14 tubes plus rectifier—five bands with push-button tuning on both AM and FM—a record changer that has a capacity of fourteen 10-inch or ten 12-inch records, with automatic shut-off after the last record is played.

Engineered
FOR TOMORROW
Styled FOR THE
DISCRIMINATING

The New **DELCO RADIO** *Combinations*

INSIDE and out, artistically and mechanically, the new Delco Console Combinations reflect only the finest of craftsmanship and the most advanced engineering.

There are superior features and refinements to be found throughout: the tone control, providing 24 different bass and treble combinations . . . the 15-inch speaker, for truer reproduction . . . the beautifully *etched* and edge-lighted dial . . . the specially designed, ball-bearing roller mechanism that protects the phonograph and lets it ride in and out easily . . . the precision-designed selector blades that prevent record-chipping . . . the

lightweight tone arm with *jeweled-point* pick-up.

It's to such years-ahead features as these that the new Delco Combinations owe their magnificent reproduction of recordings and radio broadcasts and their owner-pleasing ability to perform faultlessly year after year. But you really have to see and hear these great new Delco Combinations to realize how fully they provide *the best of all that's new in radio*. Along with other outstanding Delco radios, they are available through United Motors Service distributors everywhere.



DELCO RADIO
A GENERAL MOTORS PRODUCT

Delco radios are distributed nationally by United Motors Service. See your United Motors distributor about the Delco radio line.

What you should know about SEX to sell Vacuum Cleaners

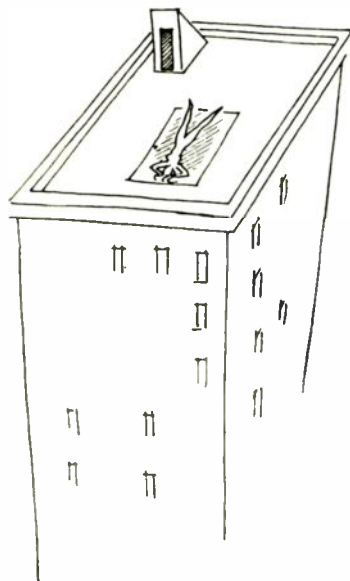
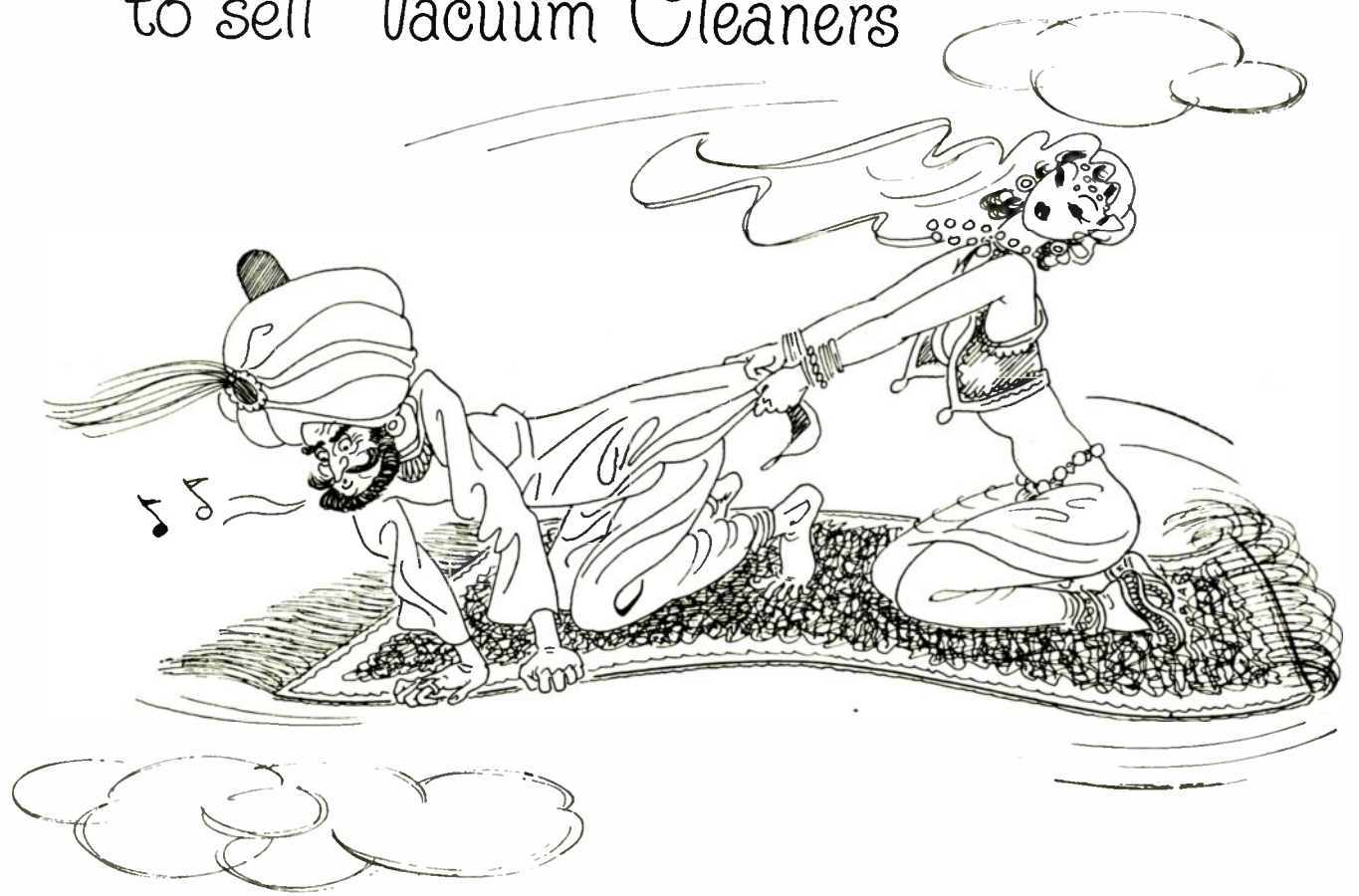

Long before some medieval genius invented the magic carpet, well-turned female ankles were turning male heads (and vice-versa). Psychiatrists attribute this interest in the opposite sex to something they call the *id*. When a couple of *ids* see eye to eye, the Couple usually blurts out "I do"—and after their pulse-rates return to normal they set out in pursuit of the American standard of living.

It isn't long before *she* discovers that piles of dirt accumulate in the pile of a carpet. And when *he's* whacked at the rugs till his arms ache, there'll be one more family in the market for a vacuum cleaner. But you can bet the sale will wait till they've *both* agreed on the brand.

Yes, whether you sell vacuum cleaners or video, phonographs or freezing units, you've got to sell *two* sexes, males and females. Either *together* or *separately*.

And who can woo *males* and *females* like The American Magazine! Dollar for dollar, page for page, *no other* magazine can match the multimillion male-female circulation delivered by . . .

*The American
Magazine*

RECORDS

Section of *RADIO & Television* RETAILING

DEALERS ARE GETTING USED TO "mysterious" runs on certain erstwhile "dormant" records, and are now capitalizing on them. For instance, one dealer suddenly commenced getting demands for a certain standard number which hadn't been selling well, and of which he had a considerable stock. Come to find out, a local school play used the tune as a theme song. Merchants are finding that numbers of seemingly out of date records are being requested too where "revival" movie programs are being shown.



TREMENDOUS SELLING POWER of discs is made even more impressive when one realizes that over 300,000 platters each of several hit tunes have been sold; a few other outstanding songs show signs of going to the 500,000 and 700,000 all-high platter mark.

ACTUAL PERFORMANCES given by the Metropolitan Opera Company, will be duplicated on Columbia records, announced Edward Wallerstein, president of the Columbia Recording Corp.

MORE NEW MONEY being poured into independent recording firms. Investors hoping to receive returns during next few years of record sales sprees. Despite bankruptcy of some firms, several new manufacturers have announced disc production; shares in another record company have been offered to the public; and some big industrialists have hyped the finances of another disc firm.

UPON PRESENTATION OF A MAILING PIECE which he sent out, a Middle West record dealer is offering free a high fidelity phonograph needle. "And it certainly brings them into the store," he says, "in addition to boosting sales." He finds that customers invariably purchase a record or two after being presented with the needle.

MANY MERCHANTS REQUIRE SALES-PEOPLE to offer accessories to each disc purchaser in order to get clerks into the habit of trying to sell more needles, record cabinets, etc. Such merchants find that they can increase volume considerably by making a hard-and-fast rule of asking the customer to buy other things that go with discs.

"RECORD ACCESSORIES WILL CONTINUE TO BE an important factor in retail sales for the next five years, due to the relaxation of necessary materials for their production," states Stephen Nester, president of the Duotone Company.

RESUMPTION OF RCA VICTOR'S "Dealer Training Programs" after an interlude of six years was announced by James W. Murray, vice-president in charge of RCA Victor Record activities. The sessions featured various aspects of record merchandising that were of direct concern to dealers.



CONCENTRATE DISPLAYS—Records are small items, and windows that continually carry a multitude of albums and singles are sometimes too confused for the casual shopper to receive any distinct impression. Now and then, one artist, album, or type of recording should be featured in each window display thereby conveying a forceful and distinct impression, and enticing the customer to come in and buy.

FAMILY RECORD BUYING HABITS, indicated in a Crowell-Collier research report, show that in spite of a big customer interest for popular records, 75% also buy classical and light classical recordings. Families with children buy all types of records. And the median library of discs owned is about 103 records, with high income groups reporting many more discs than the less wealthy ones.

JUKE BOXES IN OPERATION at present, number approximately 315,000, with many more on the way. Five leading manufacturers can turn out about 60,000 new boxes annually, at a cost averaging \$850.

PUSH with your **RCA VICTOR ADS**

for "Pop"

next month!

AL GOODMAN is your May headliner with his spring-fresh album of 10 *Blossom Time* melodies—featuring an all-star cast. Ads in "LIFE," "LOOK" and other magazines will awaken big demand... for you to cash in on with display! Order Album P-173, \$4.50.

Al Goodman's Blossom Time Album

for "Red Seal"

Musical treats for every taste in your May Red Seal list! 4 albums and 6 singles—all winners and all are announced in your "LIFE" page, May 12! Be sure your stocks and promotions are ready when the ads appear!



Alexander Brailowsky

Pianist: *Ondine* (No. 1 from "Gaspard de la Nuit")—Ravel. RCA Victor Record 11-9260, \$1. To be featured in "LIFE" May 12.



Marian Anderson

Contralto: *Poor Me*, from "Folk Songs of American Negro"; *Hold On!*, traditional Negro Spiritual. Record 10-1278, 75¢. "TIME" May 5.



Allan Jones

Tenor: *I Love You Truly*, *Just A-Wearyin' for You*—Bond. Robert Armbruster and his Orchestra. 10" Red Seal Record 10-1289, 75¢.



William Primrose

Violist: *Sonata in F Minor*, Op. 120, No. 1—Brahms. With William Kapell, pianist. Album M/DM-1106, \$3.85. To be featured in "LIFE" May 12.

Prices are suggested list, exclusive of taxes.



Your RCA Victor Distributor



Relax AND Listen

By John Hallstrom

At last, a book about music that all your customers will understand and enjoy. Profit for you when they buy it, and more profit when they read it! 300 pages, \$2.50.

Record Storage Sales

Customers Realizing Importance of Keeping Discs Properly in Specially Adapted Units

● The selling of "storage space" is a relatively unexploited angle of the record accessory business.

With estimates for 1947 disc sales exceeding the 500,000,000 mark, the problem of where to keep several hundred million platters is a growing one. Energetic dealers can pep up this profitable sales market by pointing out to customers the need for adequate record storage space, and by providing the proper units.

Approximately 1,077,000 table model combinations were sold during 1946, and estimates for '47 show that the demand will reach unprecedented heights. Combos should be located on a stationary piece of furniture, and not shunted from table to table, as they are easily damaged when moved too frequently. Dealers should stress the fact that a record cabinet is the logical permanent unit on which to place combos, and should try to sell them together.

Lack of Space

Floor model combinations, although boasting some storage space, still do not provide enough. A few models may provide more room than others for albums, but the space allotted is not sufficient for even the most casual collector. Inadequate storage facilities can be capitalized upon by selling a good-looking cabinet which will complement the set, and provide the necessary space.

It is important that records be kept properly, in orderly albums, or in a special single-disc dispenser. Albums should have a place of their own, where they can be left in an upright position, like books, and where they are easily accessible. Breakage, warpage, scratches and other hazards are eliminated by proper handling and storage. Customers are impressed when faced with these facts, and cabinet sales readily accomplished once the advantages are pointed out.

Record cabinets and storage racks are available in a number of different styles and wood finishes. Some are simple expanding shelves, others form two-tier "book-cases," and

other models are highly styled furniture pieces with doors fashioned of mahogany veneers.

If a customer is just starting his record collection a relatively inexpensive unit like the "expanding record rack" can be suggested. This shelf is expanded as the record collection grows.

Other record cabinets which are built low, are particularly adaptable for children's rooms, as the albums can be readily reached by the youngsters. This type unit should be pointed out with each kiddie phonograph sold, as well as the fact that a cabinet will encourage children to take care of the discs and keep the room neat.

Cabinets that make first-rate bases for table model combinations are made of strong hardwoods, veneered in walnut, mahogany and other finishes to match the sets. One or two tiers, depending on the style, can be used for storing singles and albums. Some deluxe models feature specialized styling representing the various furniture periods such as Hepplewhite, Chippendale, Modern, etc., to blend with home furnishings.

Record storage cases are also available in "portable" models. The "has-sock" type can be utilized as a foot-rest, and when the top is lifted, pro-

vides space for disc storage. The "suitcase" type can be carried by the handle, and is constructed solidly, and usually covered in some form of leatherette, sharkskin, etc. Teenagers, particularly, go in for portable types, as they are light in weight and easy to carry from place to place.

For best sales results record cabinets should be grouped together and displayed "en masse," not merely as an adjunct to a table model. The display should be important-looking and convey the impression that the product shown is worthy of floor space on its own merit.

Good Display

An attractive array should consist of at least one of each available model, possibly in light and dark wood. Record cabinets are primarily "furniture" pieces, and should be kept highly polished and in excellent condition.

Wood cabinets were difficult to obtain for some time, but the situation has eased up considerably, and dealers will find it well worth their time to go out after the merchandise, and garner the resultant business. Storage facilities are badly needed for records, and people are more than willing to pay to get it.

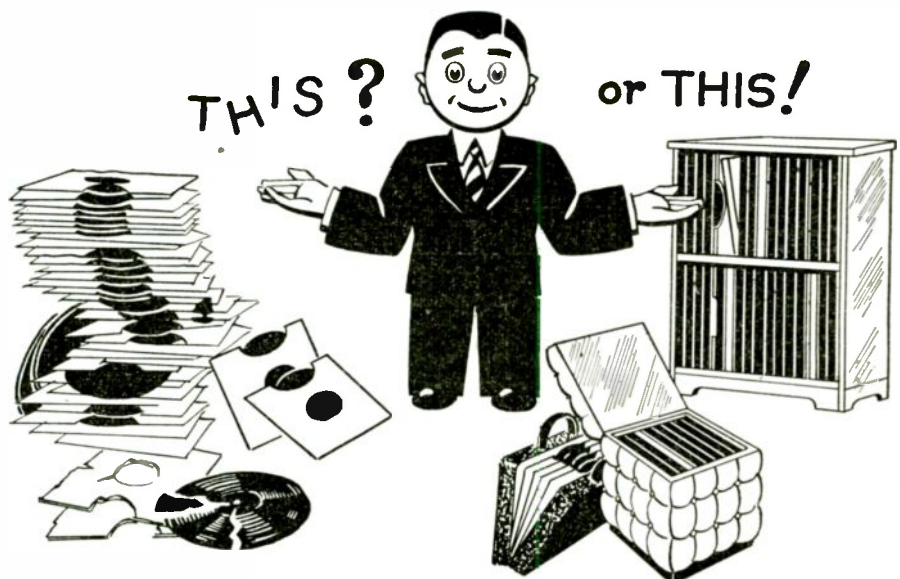

Importance of albums, storage units, etc., should be pointed out to customers.

Records Abound in Sales Appeal

(Continued from page 53)

Waltz" from "Eugen Onegin" with the Halle Orchestra conducted by Malcolm Sargent.

Columbia stars Woody Herman, Xavier Cugat, The Charioteers, and Johnny Bond give out with their own specialized treatment of pop tunes on new waxings. Frank Sinatra's "Why Shouldn't It Happen To Us" and "I Want To Thank Your Folks" is super romantic balladeering. Frankie Carle's boys do "Roses In The Rain" flipover "You Are There"; Harry James and orch. play two new instrumentals, "You'll Never Know" and "Keb-Lah"; Claude Thornhill does "Far Away Island" and "Why Did I Have To Fall In Love With You" on other Columbia platters.

Classical Albums

RCA Victor has released an album of religious music "Organ Recital" played by Charles M. Courbin, organist of St. Patrick's Cathedral. This album is particularly suited for the Easter trade. Stravinsky's ballet "The Rite of Spring" is presented by Pierre Monteux, conducting the San Francisco Symphony Orchestra in a noteworthy Victor album. Other Red Seal albums are: Walter Piston's "Prelude And Allegro", performed by E. Power Biggs and the Boston Symphony Orchestra under the direction of Serge Koussevitzky; Manuel De Fallas "El Amor Brujo", interpreted by Leopold Stokowski and the Hollywood Bowl Symphony; James Melton's romantic recordings of "Irish Songs"; Chopin's "Concerto No. 2" featuring Artur Rubinstein as soloist with the NBC Symphony Orchestra.



Marshall Young, Rainbow recording artist, waxes "Moonglow" and "I Wonder Who's Kissing Her Now" for his first release.

Red Seal singles feature Leonard Warren singing two famous arias from "Rigoletto"; Edmund Kurtz playing Milhaud's "Elegie" and the "Arietta" of Frescobaldi; "Fatinitza Overture" of Von Suppe, with Boston "Pops" Orchestra, Arthur Fiedler conducting; Marian Anderson singing "Lullaby" and "Hear The Wind Whispering."

Victor releases in the popular field present a variety of favorites. Perry Como sings two timely tunes "Song of Songs" and "Easter Parade." Phil Harris in his inimitable patter style delivers "The Preacher And The Bear" flipover, "Where Does It Get You In The End?" and on another single "It's A Good Day" and "The 'Possum Song". Charlie Spivak's trumpet invites listeners to "Let's Put Our Dreams Together" and "Leave Some." "If I Had My Life To Live Over" backed with "Beatrice" is the debut recording of The Three Suns on the Victor label.



Elie Siegmeister, composer, accompanies the American Ballad Singers in the Disc album of "American Legends."

Irish tenor Christopher Lynch delights with "Mother Machree" and "Macushla." Count Basie's latest is "Free Eats" and "Bill's Mill." Western and blues discs were waxed for Victor by Billy Williams, The Blue Sky Boys, Ruby Smith, and Dr. Clayton.

The initial Freddy Martin album, "Concerto", features his most popular adaptations, presented in his effective "concert" style. "Harmonica Classics" is the title of virtuoso John Sebastian's first Victor album, with Russ Case and his orchestra. Al Goodman has recorded several "double feature" discs including: "La Paloma" and "That Naughty Waltz"; "Nola" flipover, "Beautiful Ohio";

and "Undercurrent" backed with "Traumerei."

Capitol Records has released Betty Hutton's first record under her new contract "Rumble, Rumble, Rumble" backed with "Poppa Don't Preach To Me", the latter from her movie "Perils of Pauline." Bob Hope and Dorothy Lamour have waxed "Beside You" and "My Favorite Brunette".



The Smoothies, and Apollo's musical director Jerry Jerome, waxing "Wyoming" and "I Tip My Hat."

The first in Stan Kenton's "Artistry In Jazz" series is "Concerto To End All Concertos." Margaret Whiting warbles "Time After Time" and "Spring Isn't Everything" on new Capitol discs. A new kiddie single, available in colorful envelope wrapper, is Smilin' Ed McConnell's "The Doctor Song" and "Funny Things."

Benny Goodman's first for Capitol is "Lonely Moments" backed with "Whistler's Blues." Peggy Lee's "Speaking Of Angels" and "Swing Low Sweet Chariot" is another Capitol recording. Benny Goodman and Johnny Mercer combine their talents for "It Takes Time" and "Moon-Faced, Starry-Eyed." Blues singer Julia Lee pounds the keys and sings "Young Girl's Blues" backed with "I'll Get Along Somehow."

New Singles

Capitol's album of "Square Dances" provides instructions and music for community dance enthusiasts and listeners alike.

Singles released by MGM Records feature Jimmy Dorsey and orchestra, in revival of "Heartaches" backed by "There Is No Greater Love". Sy Oliver waxed "Hey Daddy-O" and "Slow Burn." Popular favorite Kate Smith, presents "Anniversary Song" and the nostalgic "If I Had My Life To Live Over," the latter with the

(Continued on page 62)

AMERICA'S MOST FAMOUS MUSIC "SHOPPING LIST"

RECORD NEWS!

This is an exciting month for record collectors! These finest interpretations of great music bring the true spirit, warmth and brilliance of music into your own home. Hear them... enjoy them... and you'll know why the great artists and orchestras now are recording exclusively for Columbia Masterworks Records.

BRUNO WALTER
conducting the Philadelphia Orchestra
Boston: Symphony Ser. 8-11 Walter (17-10144) Columbia Masterworks Ser. MW-423 \$4.00*

Risë Stevens
with orchestra conducted by Sybil...
Boston: The Three Masters... Ser. 8-11 Stevens (17-10145) Columbia Masterworks Ser. MW-424 \$4.00*

ZINO FRANCESCATTI
with Wm. L. ...
Boston: ... Ser. 8-11 Franciscatti (17-10146) Columbia Masterworks Ser. MW-425 \$4.00*

PHILHARMONIC-SYMPHONY ORCHESTRA of NEW YORK
conducted by ...
Boston: ... Ser. 8-11 Philharmonic (17-10147) Columbia Masterworks Ser. MW-426 \$4.00*

Errol Flynn
with supporting cast, and orchestra...
Boston: The Three Masters... Ser. 8-11 Flynn (17-10148) Columbia Masterworks Ser. MW-427 \$4.00*

EGON PETRI
with the London Philharmonic Orchestra...
Boston: ... Ser. 8-11 Petri (17-10149) Columbia Masterworks Ser. MW-428 \$4.00*

the Philadelphia Orchestra
Egon Ormandy conducting
Boston: ... Ser. 8-11 Philadelphia (17-10150) Columbia Masterworks Ser. MW-429 \$4.00*

Nelson Eddy
singing in his best moments, with Thomas...
Boston: ... Ser. 8-11 Eddy (17-10151) Columbia Masterworks Ser. MW-430 \$4.00*

CAROL BRICE
with the Pittsburgh Symphony Orchestra...
Boston: ... Ser. 8-11 Brice (17-10152) Columbia Masterworks Ser. MW-431 \$4.00*

VITTA VICTOR VRONSKY and BABIN
with the Boston and ...
Boston: ... Ser. 8-11 Vronsky (17-10153) Columbia Masterworks Ser. MW-432 \$4.00*

*Think of it... there are hundreds and hundreds of selections listed in the new 1947 Columbia Record Catalog. A lifetime of wonderful music! Why not see your Columbia Record dealer now... a small investment in records brings years of pleasure. All prices shown are net prices of new records. *Columbia Masterworks Ser. MW-423 to MW-432. Price \$1.10 per set.

BRUNO WALTER... a great conductor of our time. Under his inspired direction, nearly 40 "Masterworks" have been recorded for Columbia.

BRUNO WALTER wants you to hear music as he creates it... so he is recording exclusively for **Columbia Records**

10 great new "Masterworks" for April as presented in LIFE, April 21...Saturday Evening POST, April 12...TIME, April 28

The Columbia Masterworks Records "Playbill" offers the latest "News" of the great artists to more than 30,000,000 readers—thousands within reach of your sales influence.

contact your
COLUMBIA RECORDS
DISTRIBUTOR
for stock



Efficiency

**Memphis Dealer Conducts
His Business in a
"Business-Like" Fashion**

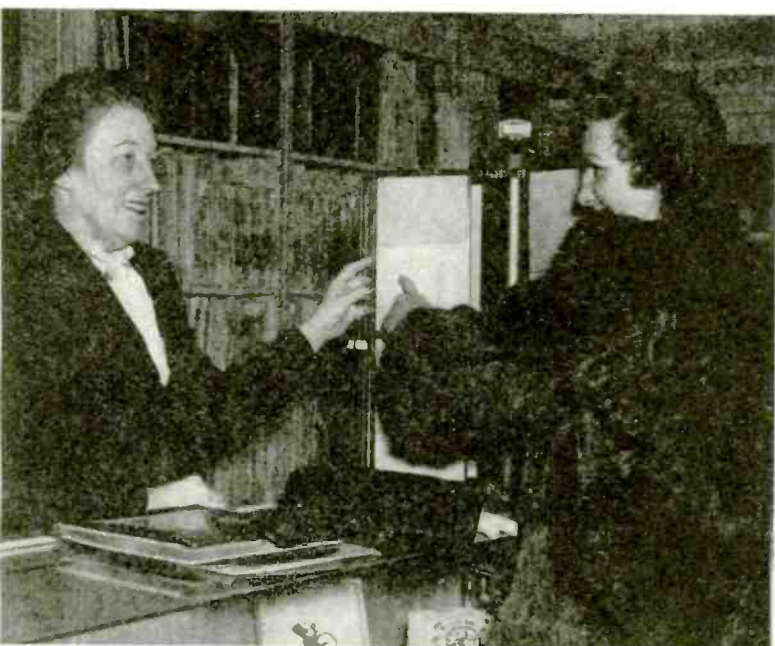

Top, Olswanger's is located in one of the city's exclusive residential sections. Center, Dorothy Carrier, record sales manager, shown with customer, is using rotary index file. Picture below shows part of the attractive interior of the Memphis store which covers an area 30 by 70 feet.

● Berl Olswanger's radio and record mart, in Memphis, Tenn., incorporates the newest in merchandising trends with tried and tested ideas.

Radios and records are displayed in adjoining departments in an attractive, well organized store; an ample stock of the latest recordings and standards, and albums in the classical field is maintained; an efficient filing system that can be understood by clerks and customers alike is kept up-to-date; and a competent repair department for radios and players is managed by a skilled mechanic.

Olswanger's is located in an exclusive suburban residential section, and caters to buyers of records, radios, phonographs, sheet music and pianos. Berl Olswanger is known in Memphis as a talented musician and the store capitalizes on his reputation. Dorothy E. Carrier is record sales manager.



Increases Record Profits

The 28-year-old pianist now combines overall supervision of the store operations with his musical career. He gives frequent impromptu performances for the clientele, and since his selections run from boogie-woogie to Beethoven, his concerts attract persons of varied tastes.

Distributors collaborated on blueprints with the owner in planning the streamlined record establishment. The store covers an area of thirty by seventy feet. The building is set sufficiently far back from the street to provide spacious parking accommodations for motoring patrons.

From start to finish, the new music mart is a product of the Pacific Island dreams of the owner, who is a widely-known musician. The present layout is a reasonable facsimile of the one Olswanger drafted, mentally, while with the armed forces. A regular patron of music stores himself, he resolved that his store would embody the ultimate in efficiency and customer-comfort.

Wide display windows make up the front of the store. Since pedestrian traffic is particularly heavy in the evening, the brightly lit, easily visible interior attracts many customers.

Bleached mahogany record racks devoted to single records and albums are spotted around the establishment. A good Olswanger selling idea is that of featuring the top ten tunes in a large rack, with recessed spaces for the various artists who have waxed each of the tunes. Utilizing this time-saving display piece, patrons may make their disc choices easily.

For Easy Selling

Another record rack is devoted exclusively to new releases. Platters displayed here are constantly pruned, with the brand new records rating a spot at the top of the rack, while others are shifted.

The classical albums are kept alphabetically.

"A boon for the record shopper," says Mrs. Carrier, "is the rotary index file which lists every pop and classical record in stock. Customer confusion is minimized by the use of colored cellophane to differentiate between classical and popular listings. This file gives artists and record numbers, and has resulted in the sales of disc favorites of other years—previously neglected by customers

because they didn't know about the recordings, or had forgotten about them."

An efficient filing system has also increased sales in the sheet music department. Mrs. Carrier explains that "sheet music sales have spurted since neighborhood school teachers discovered the file containing material cataloged according to grade of school."

Another "indispensable" at Olswanger's is Virgil Toomey, in charge of the radio and record player maintenance department. Dispensing efficient repair is considered an essential record store service by Berl Olswanger and his associates. The proprietor feels that dependable service creates goodwill from record purchasers, as well as a feeling of confidence in the minds of prospective combination buyers.

Advertising Gets Results

A file recording past purchases of record customers has been helpful in enabling the sales staff to learn each patron's musical tastes, and to aid in suggesting other records. This file is also used for dispatching cards informing customers of new shipments containing records which may be of interest.

A mailing list of seven hundred names has been compiled, and litera-

ture is sent out to these customers monthly. Other advertising is done in Memphis newspapers, and in publications sponsored by private schools, colleges, music clubs and Little Theatre groups.

Great care is exercised in preparing advertising copy. This firm believes in keeping its name in front of the public, and in preparing newspaper ad copy designed to pull direct sales.

Frequently a single disc is featured in an ad, two columns by 4½ inches.

A typical ad run by this progressive Memphis merchant lists the firm name prominently at the top. Also conspicuously displayed is the telephone number. The body of the ad stresses the disc, and is illustrated with a large phono record.

Plan for Profits

Good management, an attractive store, and a wisely chosen radio and record stock are the three things that have enabled Berl Olswanger to reap his share of profits.

Berl Olswanger not only saw his dream of a modern, efficient store come true, but he has now found out that his vision was a practical one. He can base such feeling on the success he has attained in giving the Memphis folk a fine store, plus profitable merchandising methods.

Impromptu "concerts" by Berl Olswanger, shown at piano, help keep this progressive merchant in the sales limelight. His selections run from boogie-woogie to Beethoven.



Leading Songs Survey

Air Tunes Played Indicate Popular Trends; Provide Dealer Check-List

● Songs that the "whole U. S. is singing" provide a tuneful galaxy for easy listening and smooth dancing. Some numbers take root in a section of the country, and then spread like wild-fire to the rest of the nation. Other ditties become popular because of a unique presentation by an outstanding artist. "Anniversary Song" which tops this month's list, undoubtedly reached its peak because of Al Jolson's superior rendition in the "Jolson Story" film. In addition to Jolson, Dinah Shore, Tex Beneke, Guy Lombardo, Artie Shaw, Louis Prima, Anita Ellis and Larry Douglas have waxed the tune.

Favored Songs

"Open the Door, Richard" originated on the West Coast, and subsequently found its way into the nation's juke boxes, consumer advertising, and American slang. Platters have been pattered by Count Basie, Jack McVea, The Charioteers, Three Flames, Pied Pipers, "Lips" Page, Dusty Fletcher, Bill Samuels, Tiny Grimes, and the Merry Macs.

Other tunes which appear on the survey for the first time include: "My Heart Goes Crazy" disc'd by Bing Crosby, Modernaires, and Charlie Spivak; "It's a Good Day" which receives good treatment in the hands of Phil Harris, Peggy Lee, Gene Krupa and Harry Cool; Sammy Kaye and Sam Donahue have recorded "I Can't Believe It Was All Make Believe."

Vaughn Monroe has recorded the up-and-coming "You Can't See the Sun When You're Crying" also one of the newcomers to the list. "So Would I" from the film, "My Heart Goes Crazy," recorded by Charlie Spivak, Paul Weston, Claude Thornhill, Bing Crosby, Georgia Gibbs, and Skinnay Ennis is another tune slated for bigger things.

On Way Up

Worthy of notice are: "Through a Thousand Dreams" with versions by Jo Stafford, Dinah Shore, Desi Arnaz, Carmen Cavallaro and George Olsen; "In My Adobe Hacienda" waxed by Billy Williams, Frankie Carle, West-erners, Dinning Sisters, Dave Denney, Art Kassel, and Eddy Howard; "Connecticut" by Herbie Fields, Modernaires, Bing Crosby, Artie Shaw and Martha Tilton.

Songs that are still going up in the number of times they are heard via the air-waves are: "How Are Things in Glocca Morra"; "Sometimes I'm Happy"; "Guilty"; "Sonata"; "The Girl That I Marry"; "It Might Have

THE NATION'S MOST POPULAR TUNES ON THE AIR

Listed in Order of Their Popularity
(RADIO & Television RETAILING'S Own Survey)

Current Ranking		Trend of Popularity
1	Anniversary Song	↑
2	For Sentimental Reasons	↑
	A Gal In Calico	↓
3	On A Rainy Night In Rio	↑
4	Managua Nicaragua	↑
5	Bless You	↑
6	How Are Things In Glocca Morra	↑
7	Oh, But I Do	↑
8	Sometimes I'm Happy	↑
9	Guilty	↑
	Sonata	↑
10	Zip-A-Dee-Doo-Dah	↑
11	It's All Over Now	↑
12	I'll Close My Eyes	↑
13	Gotta Get Me Somebody To Love	↑
14	The Girl That I Marry	↑
15	Open The Door Richard	↑
	It Might Have Been A Different Story	↑
16	Sooner Or Later	↑
	My Heart Goes Crazy	↑
	And So To Bed	↑
	You'll Always Be The One I Love	↑
17	It's A Good Day	↑
	Ole Buttermilk Sky	↓
	Same Time Same Place	↑
18	All By Myself	↑
19	I Can't Believe It Was All Make Believe	↑
	Stardust	↑
	Too Many Times	↑
20	You Broke The Only Heart That Ever Loved You	↑
	Years And Years Ago	↑
	That's The Beginning Of The End	↑
21	In The Blue Of Evening	↓
	There Is No Greater Love	↑
22	You Can't See The Sun When You're Crying	↑
	This Is The Night	↑
	Twilight Time	↑
23	Smoke Dreams	↓
	It's The Talk Of The Town	↓
24	Sunset To Sunrise	↑
	Another Night Like This	↑
25	Uncle Remus Said	↓
	On The Other End Of A Kiss	↑
26	For You For Me Forever More	↓
	So Would I	↑
27	The Old Lamplighter	↓
28	Through A Thousand Dreams	↑
	Why Oh Why Did I Ever Leave Wyoming	↑
29	Oh You Beautiful Doll	↑
	This Time	↑
30	In My Adobe Hacienda	↑
	Connecticut	↑

Been a Different Story"; "My Heart Goes Crazy"; "It's A Good Day"; "Same Time Same Place"; "All By Myself"; "Too Many Times"; "You Broke the Only Heart that Ever Loved You"; "That's the Beginning of the End"; "Another Night Like This".

Motion Pictures Provide Ample Dealer Tie-Ins

Films listed all feature outstanding hit tunes which have been recorded by a variety of artists. Watch for movies to hit local theatres—then cash in on added box-office appeal.

Bathing Beauties
Blue Skies
Canyon Passage
Carnegie Hall
Carnival In Costa Rica
Dead Reckoning
Down to Earth
Duel In The Sun
Humoresque
If I'm Lucky
I'll Be Yours
It Happened In Brooklyn
I've Always Loved You
Jolson Story
Lydia
My Heart Goes Crazy
Margarie
New Orleans
Night And Day
Nora Prentiss
Smash-Up
Song of Scheherazade
Song Of The South
Sweetheart Of Sigma Chi
Till The Clouds Roll By
The Best Years Of Our Lives
The Egg And I
The Shocking Miss Pilgrim
The Fabulous Dorseys
The Night Is Young
The Time, The Place, And The Girl
The Thrill Of Brazil
Three Little Girls In Blue

10 Best Sellers on Coin-Machines

1 Anniversary Song
2 For Sentimental Reasons
3 Managua, Nicaragua
4 Open the Door, Richard
5 Sonata
6 How Are Things In Glocca Morra
7 I'll Close My Eyes
8 The Old Lamplighter
9 Guilty
10 Linda

Coming Up

Gal In Calico
Oh, But I Do
Huggin' And Chalkin'
Old Buttermilk Sky
Jalousie
I Want To Thank Your Folks
Misirlou

Reprinted from "Variety"



THE COMPANY THAT GIVES YOU Hits Every Month

ANOTHER PROVEN HIT!
Jan August

"JAN AUGUST FAVORITES" D-10

2069 Malaguena Ay Ay Ay
2029 Besame Mucho Dark Eyes

"PIANO MAGIC" D-5

2009 Misirlou Babalu
2032 My Shawl Without You

2010 Tea For Two
A Pretty Girl Is Like A Melody

2030 Make Believe My Melancholy Baby

2031 O! Man River Some of These Days



ANOTHER HIT!
Richard Cannon

SENSATIONAL VOCAL DISCOVERY!

- 2057 Maybe Heartaches
2058 It's A Sin To Tell A Lie Tomorrow
List.....79¢



Album D-10
List.....\$3.91
Album D-5
List.....\$3.12
Records Sold
Singly, List...79¢

ANOTHER HIT!
Joan Brooks

NATIONALLY KNOWN - EVER POPULAR
SINGING STAR!

2064 Take Your Shoes Off, Baby
Tonight You Belong To Me
List.....79¢



ALBUM HITS!

	List Price
D-1 "WEDDING ALBUM"	\$2.80
D-2 "MEMORY WALTZES"	3.91
D-3 "RHUMBA RHYTHMS"	3.12
D-4 "CAMP MEETIN' CHOIR SPIRITUALS".....	3.12
D-6 "HILLBILLY SONGS"	3.12
D-7 "MANHATTAN AT MIDNIGHT".....	3.91
D-8 "SAMBAS"	3.12
D-21 "THE THREE BEARS".....	1.05
D-22 "LITTLE RED RIDING HOOD".....	1.05
D-23 "THE THREE LITTLE PIGS".....	1.05
D-24 "CINDERELLA"	1.05
3103 "PRESIDENT ROOSEVELT'S WAR ADDRESS TO CONGRESS".....	2.09

DIAMOND RECORD CORP.
1650 Broadway
New York 19, N. Y.

Ship me at once the following:

SHIP C.O.D.
 PAYMENT ENCLOSED
 OPEN ACCOUNT
(No shipments sent open account unless rated in Dun & Bradstreet)

D-10.....	2010	D-1.....	D-8.....
2069.....	2030.....	D-2.....	D-21.....
2009.....	2031.....	D-3.....	D-22.....
2029.....	2057.....	D-4.....	D-23.....
2032.....	2058.....	D-6.....	D-24.....
D-5.....	2064.....	D-7.....	3103.....

NAME.....
ADDRESS.....
CITY..... ZONE NO..... STATE.....

All shipments F.O.B. nearest distributor

New Phono Lines

Latest Disc-Playing Equipment and Accessories

Ultratone PHONOGRAPH

Model PM-61 portable record player with room for disc storage in cover. Three-tube amplifier, tone control, 5" PM speaker.

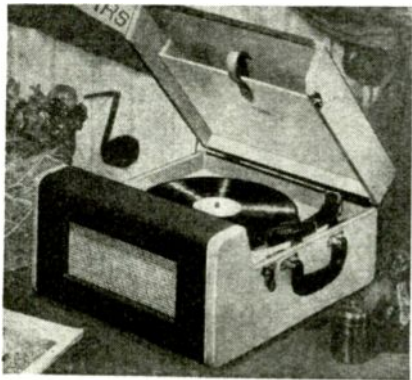

Case is plywood covered with two-tone fabricoid. Audio Industries, Michigan City, Ind.—RADIO & Television RETAILING

Televox JUKE-BOX RECORD PLAYER

Junior model record player in colorful "juke-box" cabinet, for youngsters. Plays 10" and 12" discs. Astatic lightweight crystal pickup, Alnico 5 speaker. Alliance motor, on-off switch, volume and tone control. Sturdy design, with interior light showing through plastic multi-colored "windows." Cabinets come in ruby ma-



roon, Capri blue or Miami sand. List at \$29.95. Televox, Inc., 451 S. 5th St., Mt. Vernon, N. Y.—RADIO & Television RETAILING

Mel-O-Tone KIDDIE CONSOLE

Model 950 console phonograph designed for nursery use. Plays 10" and 12" records, a-c, regular 78 RPM, 6' line cord. Plays with lid down; record storage space provided. Comes in pastel pink and blue enamels—with colorful decals. Weighs 18



lbs. Measures 13 3/4" by 13 3/4" and stands 28" high. \$24.99. Edgar J. Horn, 673 Broadway, New York 12, N. Y.—RADIO & Television RETAILING

Autocrat RECORD PLAYER



Model AEP-347 table style phonograph playing 10" or 12" discs. Three-tube amplifier, Alnico PM speaker. Push-button reject and on-off controls. Cabinet of walnut veneer, hand finished. Overall dimensions are 13" by 12 1/2" by 10 1/2". Weighs 16 lbs. Autocrat Radio Co., 3855 N. Hamilton Ave., Chicago 18, Ill.—RADIO & Television RETAILING

Musagrاند RECORD CABINET

Deluxe record cabinet with room for 22 albums—or 264 records. Finished in walnut and mahogany—spacious top to accomo-



date any size table model radio-phonograph. Measures 31" by 18" by 23 1/2". Retail at about \$39.50. Eckenroth Co., 32 Ross St., Brooklyn, N. Y.—RADIO & Television RETAILING

Birch RECORD PLAYER

Model 700 hand-wound portable phonograph with ball bearing throw-back tone arm. Automatic starting and stopping device. Speed plate and indicator knobs of catalin; polished hardwood motorboard. Record carrying compartment. Cabinet of



tan simulated leather—measures 16 1/2" by 7" by 14 1/4". Shipping weight is 16 1/2 lbs. Boetsch Bros., 221 E. 144th St., New York 51, N. Y.—RADIO & Television RETAILING

Reco-Play RECORDER

Model 10 portable voice recorder and play-back unit using single tone arm with cutting head unit attached. Can be used as PA system, or to play records and



speak through microphone at the same time. Compact design, easy to operate, pilot light. Volume and tone control for microphone. Record storage space in lid. \$79.50. Reco-Play Corp., Buffalo, N. Y.—RADIO & Television RETAILING

ANOTHER

IN A FAMILY OF
10 ELECTRICAL
AND MECHANICAL
Record Players

Brock

**COMPARE . . .
COMPARISON PROVES**



No. 7X-75

Ideal for College, Camp,
Beach or Home, because
these features are all
wrapped into one:

- BIG VOLUME
- COMPACT
- EXCELLENT TONE
- LIGHTWEIGHT
- CLASSIC PERFORMANCE
- SIMPLE BEAUTY
- MODERN DESIGN

Electrically Amplified **PORTABLE RECORD PLAYER**

78 R. P. M. Rim-Drive Motor. 110-120 volts, 60 cycles, AC current.
9-in. flock-sprayed turntable. Plays 10 and 12 in. records. 5-in.
speaker. Tone and volume control.

SOLD through LEADING DISTRIBUTORS from COAST to COAST



No. 7X-15

DAVIDSON



Manufacturing Co.

FACTORY • EATONTON, GEORGIA
GENERAL SALES OFFICES • 133 CARNEGIE WAY, N. W., ATLANTA, GA.

FOR RECORD ENJOYMENT ONE NAME STANDS OUT-



Quality-built and conservatively priced, Webster record changer units move fast—stay sold. Their plus-value features are easy to demonstrate—help make your sales easier.

Best of all, Webster units are built for lasting service—service that gains customer good will for you. If you are an accredited music or radio dealer, see your distributor today.

WEBSTER MODEL 60 AUTOMATIC PHONOGRAPH

Youngsters love this one! Complete in itself, this model has fine tone, handles records gently—features a "Manual" play position. \$55.00 Retail.



WEBSTER MODEL 55 PLAYS THRU THE RADIO

A proved best seller. Simply plugs into most radios—gives outstanding service. \$35.00 Retail.

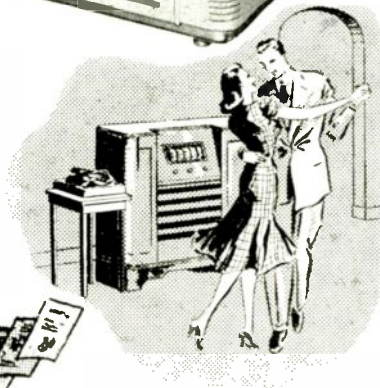

THESE WEBSTER SALES HELPS BUILD BUSINESS FOR YOU

DISPLAY CARDS

Attractive window or counter displays compel valuable attention—help build business for you.

CONSUMER PAMPHLETS

For mailing or counter distribution. A big help in your selling job.

FREE NEWSPAPER MATS

Complete ads—photos of Webster machines—all are yours for the asking when you tie in with Webster.

Are You Handling The Webster Nylon Needle? See our ad in this issue.

The Choice of Music Lovers

WEBSTER CHICAGO

5610 BLOOMINGDALE AVENUE



CHICAGO 39, ILLINOIS

Record Sales Appeal

(Continued from page 54)

harmonies of Four Chicks and Chuck. Metropolitan Opera star Lauritz Melchior sings "For You Alone" backed by the ballad "Without A Song" on MGM waxing.

MGM's talent roster includes the artists already mentioned and: Blue Barron, Lionel Barrymore, Jimmy Dorsey, Jimmy Durante, "Ziggy" Elman, Helen Forrest, "Slim" Gaillard, Kathryn Grayson, Harry Horlick, Van Johnson, Johnnie Johnston, Gene Kelly, King's Men, Korn Kobbler, Art Lund, Hal McIntyre, Lauritz Melchior, "Sy" Oliver, Carson Robinson, David Rose, Allen Roth, Raymond Scott, Kate Smith, Mark Warnow, Keenan Wynn, "Buddy" Weed.

Decca Records is featuring an eight record album entitled "Our Common Heritage." The album contains poetic masterpieces of noted American writers, with special music and sound effects. Outstanding screen stars Bing Crosby, Brian Donlevy, Walter Huston, Frederic March, Agnes Moorhead and Pat O'Brien speak the lines of the famous poems, which together trace America's growth from its discovery to the end of the Civil War and the beginning of the first World War.

New Releases

Signature's new releases include: Mary Osborne Trio in two new discs, "Hoodle Addle," "What To Do" and "Blues In Mary's Flat" backed by "Oops My Lady", Monica Lewis' warbling of "Midnight Masquerade" flipover, "A Thousand And One Nights"; Larry Douglas sings "Old Devil Moon" and "Another Night Like This" and on another single "Why Did It Have To End So Soon" sided with "I Want To Thank Your Folks"; Curly Gribbs and his Texas Ranchers do "Wyoming" and "You Never Knew What It Meant To Be Lonesome" plus "So Round, So Firm, So Fully Packed" flipover, "I Just Fell Out Of Love With You."

A variety of pop and westerns have been recorded by Mercury records. Released are: Bobby True Trio "My Adobe Hacienda" and "Heartaches"; Jack Fina and orchestra, "That's Where I Came In" and "Maybe You'll Be There"; Glen Gray's "Midnight Masquerade" flipover "Speaking of Angels"; Prairie Ramblers in "Open Up That Door, Hiram" backed by "Jolie Blonde" and "The Girl At The End Of The Bar" teamed with "I'm A Married Man"; Harry Babbitt's waxings of "Far Away Island" and

(Continued on page 64)

Phoneedle* Sales Leaders—from coast to coast!

PRECISION-TURNED SHANK
for clear, faithful performance!

NEEDLE SCIENTIFICALLY ANGLED to eliminate "needle talk" (hiss and surface noise).

WHAT A POINT! It's a fine sapphire jewel cut, ground, polished and re-polished by highly skilled craftsmen. Unconditionally guaranteed!

Primus \$2.50

Tie-in with Recoton—rationally known, nationally preferred for quality . . . featured in leading magazines . . . and effectively merchandised with displays . . . selling aids . . . valuable prizes to salespeople. And here's still another Recoton plus—to power your jewel-tipped needle sales like never before . . . a sensational new display case that gives the entire Recoton jewel-tipped line a terrific lift. "A tremendous success!" say dealers across the nation. Ask your wholesaler for all the details of the Recoton campaign.

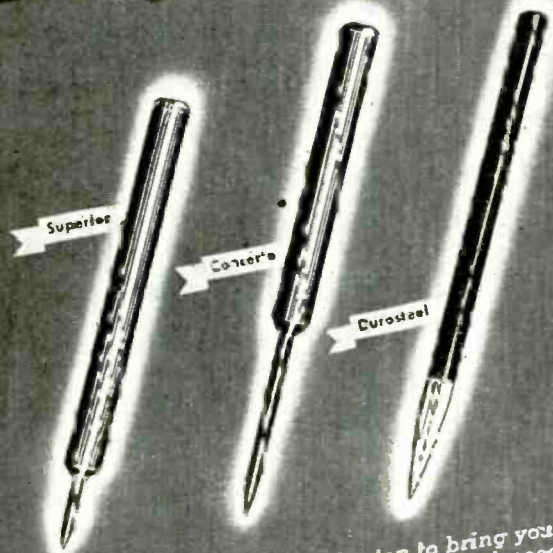

STEEL NEEDLES BY RECOTON. Trust Recoton to bring you the finest in steel needles! These precision-turned needles, made in Switzerland, maintain the same high standards of quality and performance that have made Recoton the standard among the world's finest phoneedles.

*Reg. U. S. Pat. Off.

RECOTON

Always faithful

... AND EVER PROFITABLE

Classical Disc Awards

Prizes for the best classical records produced in 1946 were presented at the inaugural dinner of the Annual Recorded Music Awards. Awards were given to RCA Victor, Columbia Recording, Decca, Disc and Concert Hall Society. Artists singled out for honors included Arturo Toscanini, Serge Koussevitzky, Ezio Pinza, Lotte Lehmann, Bruno Walter, Licia Albanese and Robert Merrill.

Victor Dealer Aid

For the first time since pre-war days, RCA Victor has made available to dealers 15½ inch high "walking

figures" of leading Victor artists. These are constructed of sturdy, die-cut cardboard, and mounted upon a record facsimile which bears the legend "World's Greatest Artists Are on RCA Victor Records." This display can be used in the window, in booths, top of stock racks, counters and shelves.

Tempo Head Honored

Irving Fogel, president of Tempo Record Co. of America, has received notification from the Mediterranean Theatre of Operations, U. S. Army, that he has been made a Knight of The Order of The Crown by the Italian Government.

Record Sales Appeal

(Continued from page 62)

"To Me" plus "When Am I Going To Kiss You Good Morning" flipover "The Egg And I."

Latest Pilotone record album is "Square Dances" by Tiny Clark and his Village Barn Gang. Future albums will feature the start of a "Radio City Music Hall Series" with Charles Previn, Radio City orchestra conductor. The first two scheduled albums in this series are: "Gilbert & Sullivan" and "Choice Selections From Victor Herbert."

Apollo Records have released a new disc with The Smoothies "Wyoming" and "I Tipped My Hat." Other platters include: John Conte's "Beware My Heart" flipover "Midnight Masquerade"; Gordon McCrea vocalizing on "Heartaches" coupled with "If I Had My Life To Live Over"; and the Four Vagabonds in "Do You Know What It Means To Miss New Orleans?" plus "The Pleasure's All Mine."

Ted Straeter, pianist and conductor, first wax impressions on Sonora label are: "Midnight Masquerade" coupled with "You'll Know When It Happens" and "Heartaches" backed with "That's Where I Came In." On the same label, Roy Smeck does "The Anniversary Waltz" and "My Little Grass Shack"; Snub Mosley waxed "Blues At High Noon" and "Snub's Boogie"; Jerry & Sky do "Am I Still P-A-R-T Of Your H-E-A-R-T" paired with "Left By The Wayside."

Other Sonora discings are: Clyde Bernhardt's "I'm Henpecked" and "My Little Dog Got Kittens"; Fred Kirby's "Downright Lonely Downright Blue" and "I Can't Tell That Lie To My Heart"; plus other singles by Alice Cornett, Stanislaw Mroczek,

(Continued on page 68)



**KEEPS DUOTONE UP FRONT EVERY MINUTE...
GET YOURS NOW AND WATCH SALES SKYROCKET!**

Here's a counter card, storage bin and silent salesman all in one!

The brand new Duotone "Show Window" is a smartly-styled counter display case of wood and lucite that features the fast-selling line of Duotone Needles. Each package in the "Show Window" nestles in a handsome blue plush lining. An attractive glass top protects the contents. It's only 20" high, 12" long — takes up little room on your counter.

Your customers will stop, look and buy when they see this handsome display. You simply serve them from the built-in stock compartment. Here's an easy way of selling that gives you quick turnover . . . and rings up more profits.

Phone or wire your distributor today (or inquire direct) for our Special Introductory Offer on the new Duotone "Show Window".



DUOTONE

DUOTONE COMPANY
799 Broadway, New York 3, N. Y.
Stephen Nester, President

Export Dept.: American Steel Export Company, Inc., 347 Madison Avenue, New York 17, N. Y.

Portofonic Carrying Case

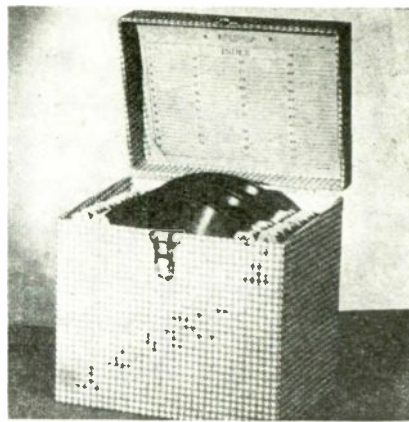

Portofonic Mfg. Co., 54 Franklin St., New York City, is featuring the disc carrying case shown, available in a variety of coverings at popular prices.



Daniel G. Zahorik, Asst. Treasurer, J. Bradford Piano Co., Milwaukee, Wis.

**INCREASE YOUR SALES FORCE WITH THESE
"TALKING SALESMEN" ... AT 2½¢ EACH**

Give your customers their own voice recordings!

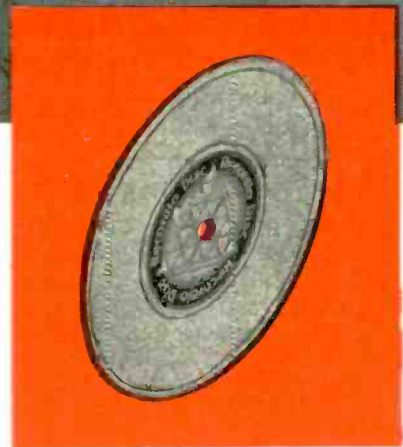

What is a better salesman for you than a gift recording of the customer's voice—made right in your store? Taken home with her it serves as a constant reminder of RECORDIO ... an exclusive, in-the-home sales builder for you.

Once purchased, a RECORDIO starts a regular series of repeat sales of RECORDIO DISCS and RECORDIPOINT NEEDLES. Another home recording enthusiast is started on

the way to making your store her headquarters for high quality recording aids.

Build profits quickly ... with the versatile RECORDIO and its many exclusive sales features. Sell *complete* home entertainment in the uncrowded field of home recording. Increased store traffic and higher net profits will reward such farsighted wisdom. Investigate the RECORDIO franchise now.

Recordio
T. M. Reg. U. S. Pat. Off.
by WILCOX-GAY



"the Prestige line"

112-M

WILCOX-GAY CORPORATION

CHARLOTTE, MICHIGAN

RECORDING *Exclusively*
for NATIONAL Records

Enric Madriguera
AND HIS ORCHESTRA
—ON THE MOST
EXCITING DANCE
RECORD IN
YEARS!

**cu-tu-gu-ru
(JACK, JACK, JACK)**
backed by
MADE FOR EACH OTHER
NATIONAL 9028

*— a fascinating Rumba beat
for dancing feet!*



Dusty Fletcher

**I'M GOING BACK
IN THERE** 4014

**OPEN THE DOOR,
RICHARD** 4012



Red McKenzie

**ACE IN THE HOLE
PEG O' MY HEART** 9027

**IF I HAD MY LIFE
TO LIVE OVER** 9026
HEARTACHES



**Joe Turner and his
Boogie Woogie Boys**

MISS BROWN BLUES
I'M SHARP WHEN I 4011
HIT THE COAST



**Monchito and his
Rumba Orchestra**

ROCK AND RYE
LA NEGRA 8003
CACHON



1841 BROADWAY NEW YORK, N. Y.

Victor Artist Appears at Dealer's Store



Popular Victor recording artist Tex Beneke, greets fans as they line up for an autographed record at the Markham Appliance Co., Santa Ana, Calif.

Columbia and Met Opera Sign Recording Contract

The Metropolitan Opera Association and the Columbia Recording Corp. signed a long-term contract to provide the recording of complete operas directly from the stage of the Metropolitan Opera House. The recordings will duplicate the performances actually given by the Met company.

The agreement, signed by Edward Johnson, general manager of the Metropolitan Opera Association, and Edward Wallerstein, president of the

sions at the Metropolitan Opera House.

Mr. Wallerstein expressed his belief that the people all over the country would welcome the new association of the two musical organizations. "Our company regards the signing of this contract as a milestone in music-making," he said. "Today, Columbia and the Metropolitan are inaugurating a new phase in opera appreciation and musical education for the nation. We feel that music lovers everywhere will welcome the opportunity to hear in their own homes a complete recording of an opera exactly as it is produced on the stage of the Metropolitan in New York."



L. to r.: Edward Wallerstein, president of Columbia Recording Corp., Edward Johnson, general manager of the Metropolitan Opera, and Goddard Lieberston, vice-president in charge of Masterworks, after the signing of a five year contract to record Met performances.

Columbia Recording Corp., stipulates that Columbia will have the exclusive right in this long-term contract, to record performances by the Metropolitan Opera Co. Columbia will issue two entire operas each year. In addition, all recordings of operatic excerpts will be made in special ses-

Promoted by Aero

Paul D. Bezazian, treasurer of the Aero Needle Co., Chicago, since its organization, has been elected general manager of the firm. The company manufactures a complete line of Aeropoint long life needles for home phonographs and the coin operated phonograph field.

Add National Jobbers

A. B. Green, president of the National Records, announces the following new distributors: The Kentworth Corp., of Louisville, Ky., The Gas Engine and Electric Co. of Charleston, S. C., and Amusement Enterprises of London, Ontario.

Rainbow Sales Bonus

Rainbow Records, New York City, has inaugurated a bonus plan for distributors' salesmen, which will be awarded monthly to the salesman who sells the most discs. Part of this same plan for distributors, will permit the return of discs at certain times. Harry Fromkes is president of the firm.



The needle with  saving in its heart

Fidelitone Supreme

FLOATING POINT NEEDLE

Like a soaring sky-scraper, the recently introduced Fidelitone SUPREME is a "stand-out" . . . Ever since 1929 — when the first precious-metals tipped long-life phonograph needle was introduced by PERMO — its leadership in the field of good needle construction has never been challenged . . . There always have been more PERMO needles sold than all other long-life needles combined. Fidelitone SUPREME is the crowning achievement of PERMO'S research and engineering. Dealers, nation-wide, proclaim the SUPREME "the greatest ever."

A
S
T
A
N
D
O
U
T

\$2.50



Beautifully packaged in a useful record brush.

PERMO, Incorporated
CHICAGO 26

More Permo Needles sold than all other long-life needles combined

Portofonic presents

3 SURE-FIRE HITS for 1947

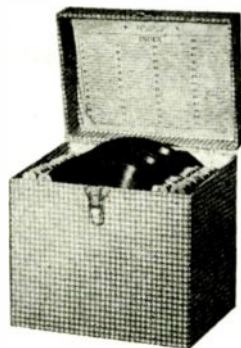

The famous Josephson line of record carrying cases now bears the name PORTOFONIC. With production improving every day, our distributors will soon be able to fill all your orders on these big sales builders. There is no finer record carrying case made than the PORTOFONIC line—at any price.

Watch for future announcement of our new line of portable phonographs.



LIST \$3.95

MODEL No. 30—A compact portable record carrying case of solid "steel bound" construction. Plastic handle. Covered in beautiful simulated leatherette which is durable, washable and water repellent. Contains patented permanent numerical index. Holds 50 10" records.

MODEL No. 32—Same as above. Holds 28 12" records.

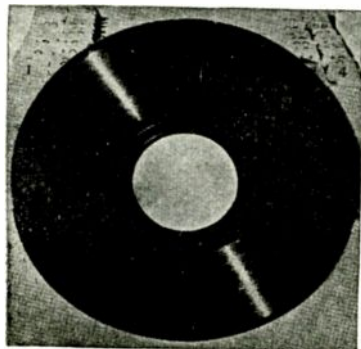

INSIDE VIEW of the special patented index found only in every PORTOFONIC case. This permanent index has an individual specially shaped compartment that holds each record rigid to prevent breakage. Records cannot move or hit one another and they are easily removed.



LIST \$7.50

MODEL No. 40—A DeLuxe record carrying case of wood construction. Locked corners insure durability. Covered in rich Brown Pig Tex Fabri-koid. Contains patented index. Holds 50 10" records.

MODEL No. 42—Same as above. Holds 30 12" records.

MODEL No. 10—Handy compact, lightweight carrying case covered in beautiful simulated leatherette. Holds 12 10" records. Weighs less than 8 pounds when full. Ideal companion for any portable phonograph. List \$1.95.



PORTOFONIC MANUFACTURING CORP.

Subsidiary of JOSEPHSON MANUFACTURING CORP.

4116 FIRST AVE., BUSH TERMINAL

BROOKLYN 32, N. Y.



with
"TIP LOC"
THE SLIP PROOF, BREAK
PROOF SAFETY FEATURE

Exclusive with REC-ALBUM, Records won't fall out. Most advanced type DISK-ALBUM made. 10" & 12" storage, package type from 2, 4, 6, 10 or 12 heavy Kraft envelopes which lay flat with edges recessed. Merchandise your album space with NEW, FRESH & SMART REC-ALBUMS. The album they're all talking about. See your jobber or Write...

L. H. SYMONS ASSOC.

345 HUDSON STREET,
NEW YORK 14, N. Y.

MGM Recording Session



Jimmy Dorsey, one of the many MGM stars, talks it over with vocalist Dee Parker, prior to waxing their first record for MGM.

Record Sales Appeal

(Continued from page 61)

Jim Jam Trio, Stu Davis, The Moore Sisters, and the Carolina Playboys.

Baritone Marshall Young recording for Rainbow Records, first release is "Moonglow" and "I Wonder Who's Kissing Her Now." "Show Parade," a new Rainbow album with Larry Clinton and The Toon Timers, contains hit songs from the six top musical shows of 1946-47. This album will be issued once a year. The "Movie Parade" album, also a yearly proposition, features the top musical themes from the six best pictures of the year. Bobby Byrne and a concert orchestra provide the music.

Disc Co. of America has released a new album of "American Legends" sung by the American Ballad Singers, accompanied by Elie Siegmeister, Composer-pianist. Elie Siegmeister is also featured in another Disc album "American Sonata." "Modern Piano Music" played by Alan Hovhaness and Maro Ajemian, with music written by John Cage and Alan Hovhaness is another addition to the Disc catalog.

Pan-American record releases feature: Don Alfredo's versions of "Guabina Chiquinquirena" and "You Are Everything To Me."

Stinson Trading Company new jazz album releases the "Jerry Jerome Trio."

Sterling Records, Inc., introduces two new Hillbilly records: "Wealth Won't Save Your Soul" flipover "When God Comes And Fathers His Jewels" by Hank Williams and the Country Boys; "I'm Sorry If That's The Way You Feel" vocal by Skeeter Willis, coupled with "Farther And Farther Apart" with the Oklahoma Wranglers, vocal by Guy Willis.

Vanguard Record releases are: Jo Anne Lowell and the Red Camp Quintet, "Sloe Gin" and "Whatta Ya Gonna Do."

Incomparable Results!

WEBSTER
NYLON PHONOGRAPH NEEDLE

1. NYLON KNEE—Produces a floating "knee-action" which absorbs and reduces needle and surface noises and prolongs record life.

3. ALUMINUM SHAFT—Light-weight, great-strength, fits securely in the pickup without danger of twisting or loosening.

2. JEWEL TIP—A top quality, hand-polished sapphire assures the complete satisfaction of discriminating music lovers.

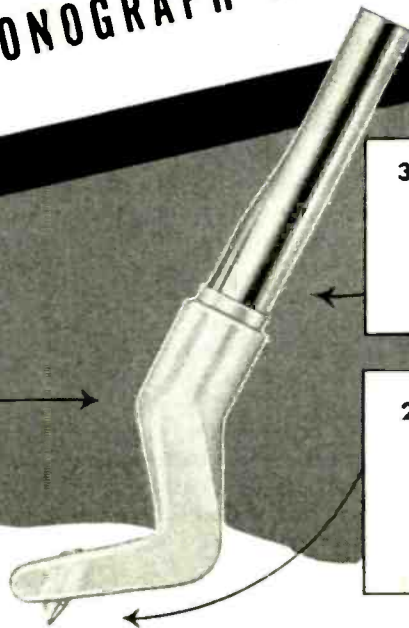

Nylon **THE MIRACLE PLASTIC**

produces a "knee-action" needle ride which achieves an entirely new quality of record reproduction.

Protects valuable records from unnecessary wear. Gives greater effectiveness to the superior playing qualities of the sapphire jewel tip. Virtually eliminates breakage of playing tip by accidental dropping. Greatly lengthens needle life. Produces a pleasing harmonious tonal balance. Yields a minimum of needle talk. Delivers a remarkably authentic record reproduction.

Completely new in design and construction, the Webster Nylon Needle was created to give dealers a needle they can recommend, without reservation, to their most discriminating patrons.



Presented by the Makers of



WEBSTER RECORD CHANGERS

WEBSTER



CHICAGO

5610 Bloomingdale Avenue, Chicago 39

Now...as always...Webster means finer record reproduction



EASY ON THE EAR WITH

Smooth Power

• That's what counts with your customers! Give them faithful reproduction, free from wow and rumble, and your selling job will be easier and more profitable.

You'll get that fine performance from our complete *Smooth Power* line of phonomotors, recorders and combination record-changer recorders. They're carefully engineered and faithfully built for quick pick-up, constant speed and freedom from noise and vibration. They're *easy on the ear*.

They'll make fitting companions for your own fine products.

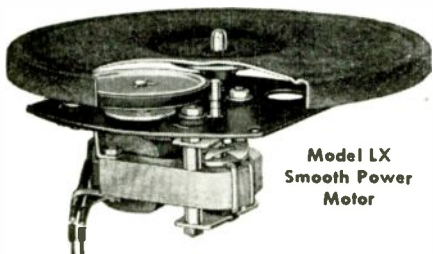

Model LX
Smooth Power
Motor



DEPT. MV • ELYRIA • OHIO

Southard of Columbia Welcomes District Manager



L. to r.: District Managers Bob Pampe, Tom Cade, Paul Southard, vice-president in charge of sales, Columbia Recording Corp., Gene Chandler and Chuck Morgan. Occasion was the welcoming to the fold of Tom Cade, district manager operating from Memphis, Tenn.

RCA Victor Plans Complete Opera Series

Plans for a projected series of recordings of full length operas by leading singers of the Metropolitan Opera Co., to be made in this country with specially assembled orchestra and chorus, were disclosed by James W. Murray, vice-president in charge of RCA Victor Record activities.

Outlining the project, which has been under consideration for many months, Mr. Murray pointed out that public reaction to the company's recent release of a recorded version of "Boris Godounoff," starring Metropolitan Opera's basso, Alexander Kipnis, and "Carmen," featuring Gladys Swarthout, Robert Merrill, and other leading singers of the Metropolitan Opera Co., has convinced RCA Victor officials that this method of recording operatic repertoire is very satisfactory.

For more than a year RCA Victor has been concentrating on building up a roster of top-flight vocal talent with the opera project in mind, Mr. Murray said. The recent acquisition of Madame Lotte Lehmann, who has returned to RCA Victor as an exclusive artist, and other Metropolitan Opera stars, such as Wagnerian tenor, Set Svanholm, and baritone, Joel Berglund, has been part of the plan to assemble star singers who will be available for the recorded operas, as well as concert repertoire, he said.

Keynote Head Honored

Eric Bernay, president of Keynote Recordings, received a special commendation from the board of trustees of New York's Sydenham Hospital for his work as co-chairman of a group that staged fund-raising benefits to help wipe out the hospital's deficits.

Duotone Reports Increase

Ending its fiscal year, the Duotone Co., Inc., of 799 Broadway, New York, producers of a full line of phonograph needles and record accessories, announced through its president, Stephen Nester, that the firm showed a 50% increase over last year in dollar volume. Additional counter displays, counter cards, and dealer-sales promotion helps have been placed on the 1947 schedule.

Melody Adds Line

Morty Kline, president of the Melody Record Supply Co., 314 West 52nd St., New York City, announces that Melody has been appointed exclusive distributor for Horizon Record Co., who are the producers of a new vinylite album called "Beethoven for Young People."

Melody's other new note is their appointment as distributor for the new Monarch "Fala" album.

Frazer Named by Decca



Robert Frazer has been appointed head of distribution and merchandising of Decca London (full frequency range recording) records and parlophone records, both of which are being handled in the U. S. by Decca Distributing Corp.

Victor Appoints Finn



J. W. Murray, vice-president in charge of the RCA Victor record department announced that J. (Dave) Finn has been named general sales manager of the department.

Kiddie Disc-Book

A new children's record called "Talking Komics" is available for dealers. A 20-page full color comic book plus a two-side talking-musical record are offered in the package. Retail sales price is \$1.55. Package-Album No. 1 is the story of the "Lonesome Octopus" and No. 2 is entitled "Grumpy Shark." National Cart Corp., 234 E. Colorado St., Pasadena, Calif., is taking orders for the sets.

President Audio Devices Sees Big Disc Future

Although 1946 witnessed the manufacture of more than 300,000,000 phonograph records, plus countless thousands of other types of transcribed recordings, the year 1947 promises even greater record production. Such was the recently expressed opinion of William Speed, president of Audio Devices, Inc., New York City, producers of the master

Shawline Record Holder



Capable of holding 24 records, the record holder shown, manufactured by Shawline, Inc., 117 W. 25 St., retails at \$9.95.

discs on which the original sound for phonograph records is recorded.

"We in the recording industry," Mr. Speed emphasized, "definitely believe that the popularity phonograph records and recorded radio programs enjoyed during the past year is only the beginning of a trend that will soon see more and more people enjoying recorded entertainment in their homes."

New Firm Organization

The Record Album-of-the-Month Associates, Inc., New York City, has announced the completion of its plans for dealer franchising. Established dealers throughout the country have

been appointed to serve consumer members in their respective areas.

Dealers who become RAM franchised clubs provide RAM with a list of the best customers in his territory, and RAM then uses this list for a comprehensive direct mail solicitation on the part of the dealer. Many other types of promotional material for use in the dealer's store have also been made available. Consumers receive the firm magazine, "Record Review," and incentive gifts such as needles, books, etc., upon joining. The cost to the franchised dealer is based upon the area he serves, which in turn determines his quota.

Peerless
HASSO-RAK
THE INGENUOUS HOME SPACE SAVER

NOW YOU CAN ACTUALLY SIT ON A RECORD!

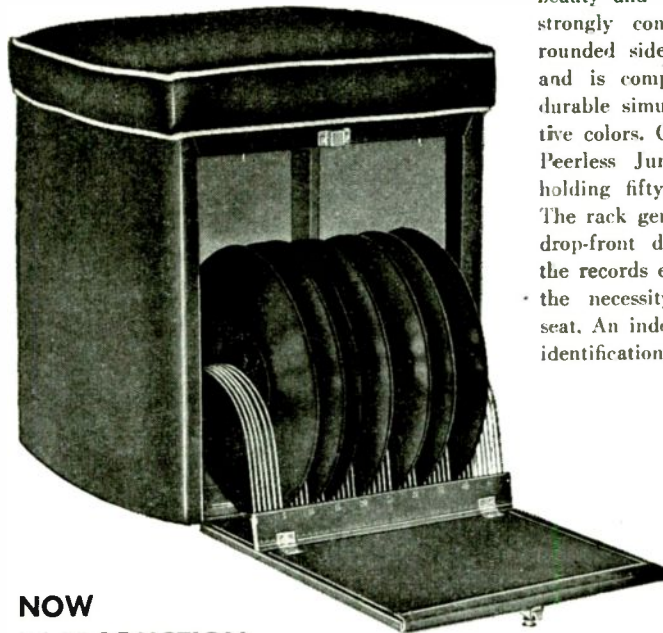

Here is a hassock-rack combination that not only answers the record storage problem but does so with beauty and utility. Hasso-Rak is a strongly constructed hassock with rounded sides and 3" padded seat, and is completely covered with a durable simulated leather in attractive colors. Combined with it is the Peerless Junior Rack capable of holding fifty 10" and 12" records. The rack gently slides out when the drop-front door is opened, making the records easily accessible without the necessity of rising from the seat. An index is provided for quick identification.

List Price
\$22.95
slightly higher west of the Rockies

NOW IN PRODUCTION

Contact Your Distributor for Prompt Delivery

The **PEERLESS** *ALBUM COMPANY*
352 Fourth Avenue, New York 10, N. Y.

WEST COAST PLANT—5523 East Slauson Ave., Los Angeles 22, Cal.

INSTANT

ACTION

• WHEN YOU WANT IT • WHERE YOU WANT IT... WITH
alliance MOTORS

The Model 80 Phonomotor has been the outstanding favorite of manufacturers and jobbers who want a power source that's smooth, quiet, and time-tested. This is the No. 1 motor for driving turntables and record changers!

Other Alliance Powr-Pakt Motors will open and close valves, switches, operate toys and motion displays, actuate parts in business and vending machines, and can be used as component power sources in electronic control systems.

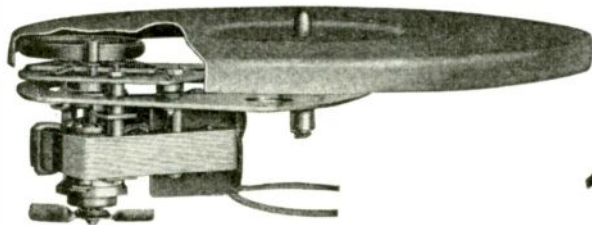

WHEN YOU DESIGN ... KEEP

alliance

MOTORS IN MIND

ALLIANCE MANUFACTURING COMPANY • ALLIANCE, OHIO



RECORD CARRYING AND STORAGE CASE

HOLDS TWENTY-FOUR 10" OR 12" RECORDS

Brand New! It sells on sight. . . . It's different. . . .
It's practical. There's nothing else like it.

This smartly styled case is constructed like a fine piece of modern luggage . . . made in beautiful navy, tan, brown and red simulated leather, with a double zipper for easy handling. It is lightweight, durable and waterproof. Record envelopes may be quickly removed and the Rec-carrier used as overnight bag, sheet music case or picnic bag.

To retail at about \$10.00.

PROMPT DELIVERY

(Also made in Genuine Leather)
Write for Details at Once

Distributed by
General Electric

SHAWLINE, INC.

117 WEST 25th STREET, NEW YORK 1, N. Y.

Made of Clear Plastic

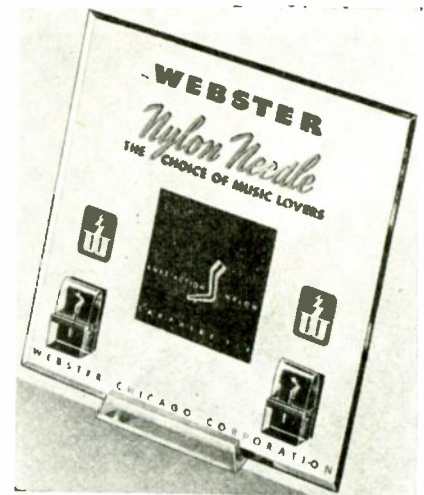

Distinctive and compact, this permanent display case for the Nylon needle is a new sales aid available free from Webster-Chicago Corp., 5610 Bloomingdale, Chicago 39. It's made of clear plastic—for counters, show cases, or walls.

RCA Victor Resumes Dealer Training

Resumption of RCA Victor's "dealer training programs" after an interlude of six years was announced by James W. Murray, vice-president in charge of RCA Victor record activities. The record department's 1947 seminar got underway in New York, and was followed by regional meetings in Atlanta, Cleveland, Chicago, Dallas and San Francisco.

Picking up where the pre-war program left off, the 1947 program, known as the "How School," employed novel presentation techniques to drive home to personnel of distributor organizations a wide range of subjects including market analysis, inventory, merchandising, self-selection, related selling, and the relationship of RCA Victor's 1947 national advertising and dealer aid program to sales and merchandising. Mr. Murray explained.

National Signs Maestro

Enric Madriguera, Latin-American bandleader, has signed a long term recording contract with National Records, New York City. Herb Abramson, artist and repertoire director, disclosed that Madriguera has been signed for two years with options and guarantees.

Stinson Jazz Series

Exclusive rights to a new album of the "Jazz at the Philharmonic" series has been acquired by Stinson Records. Norman Granz, jazz critic, who selected the players, also edited the cuttings.

ELECTRICAL APPLIANCES

Section of *RADIO & Television* RETAILING

Users as Free-Lance Salespeople

How to Get Recommended Business from Satisfied Customers

● The day is almost here when retail salesmen will once again be "using" the "user," and often the "user's" home, to demonstrate residence-installed equipment to prospective buyers.

This merchandising practice, once very effective in selling oil burners, refrigerators, attic-ventilating systems, electric ranges, lighting fixtures and many other products, promises to be widely used as a selling technique in the electric kitchen field as well as in the sales of numerous other modern-day home equipment products.

User-recommendation and home demonstrations *by the home-owner* can be used to clinch many a sale. The prospective buyer sees and hears many things which are bound to impress him favorably. He finds the satisfied user's description of the

value and good performance of the appliance to be an unbiased yardstick which he can use in judging the product. He sees the equipment in actual use in home surroundings similar to those in his own house.

In "using users," the salesman must exercise great judgment. He must be tactful and considerate. Moreover, he should always ascertain *in advance* of any visit whether the time proposed will be convenient to the householder. And, of course, he should have the well-established knowledge that the customer will be entirely willing to give his services, for either visits by the salesman and his "prospects," or is agreeable to having prospects call, write or telephone him directly to ask about the products.

Tactful Approach

There are a number of things the salesman who's interested in using users should practice. As previously stated, he will first have to secure permission to bring visitors or use customer's name. No pressure of any sort should ever be used in getting such consent. The user must be voluntarily receptive to the idea. The dealer will find that many customers enjoy acting as salesmen-without-salary in plugging the merchandise they are well pleased with.

There are many cooperative and appreciative gestures which the salesman can employ in "paying" those customers who recommend over the telephone and in the home those appliances and special home installations which the retail firm has sold them.

Now and then a user makes an out-

and-out proposition to a dealer through which a pre-arranged fee or commission is to be paid the customer for each lead furnished or for each sale made as a result of a lead. Since this is a legitimate business deal such customer should be looked upon as being a sort of free-lance member of the firm's salesforce. The merchant should see to it that all promises made to such free-lancers are kept. Members of the salesforce should be required to report to the dealer any and all arrangements made between lead-furnishers and salesmen.

To the customer who opens his home and his ear to the prospective purchaser in recommending the dealer's products, asking nothing in return, a little gift, such as an electric clock, a toaster, etc., now and then is certainly in order.

Considerate Treatment

The return to "user-using," particularly in the complete electric kitchen business, will again be employed as an effective merchandising method, and the retailer who uses the user in the right fashion is in line to make more money.

The things to remember in using the user and, at the same time, retaining his friendship, are: "Use" willing users only. Make salesmen keep promises to users who free-lance their services for remuneration. Show your appreciation to those who "work for you" without pay, and, above all, don't go barging in unannounced or become a nuisance by too-frequent calls.

Use the user—but not as a "good thing."

There's nothing more sales-producing than a visit by the dealer and his "prospects" to the home of a satisfied user.

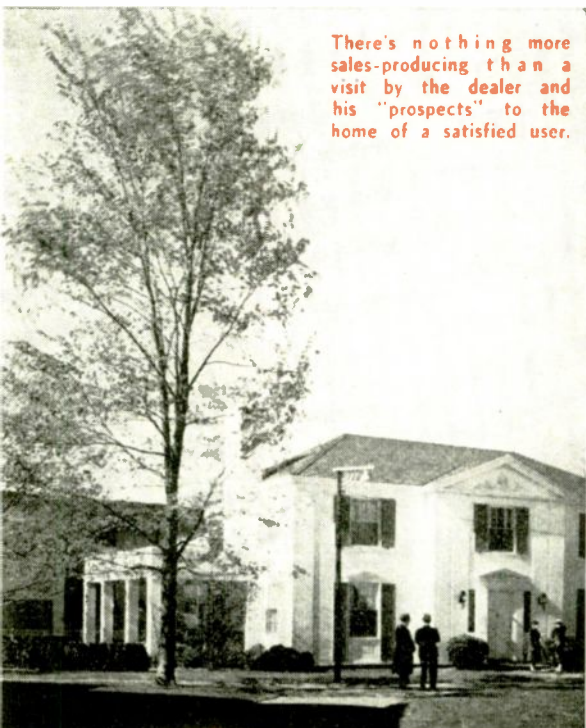

Products of
BORG-WARNER

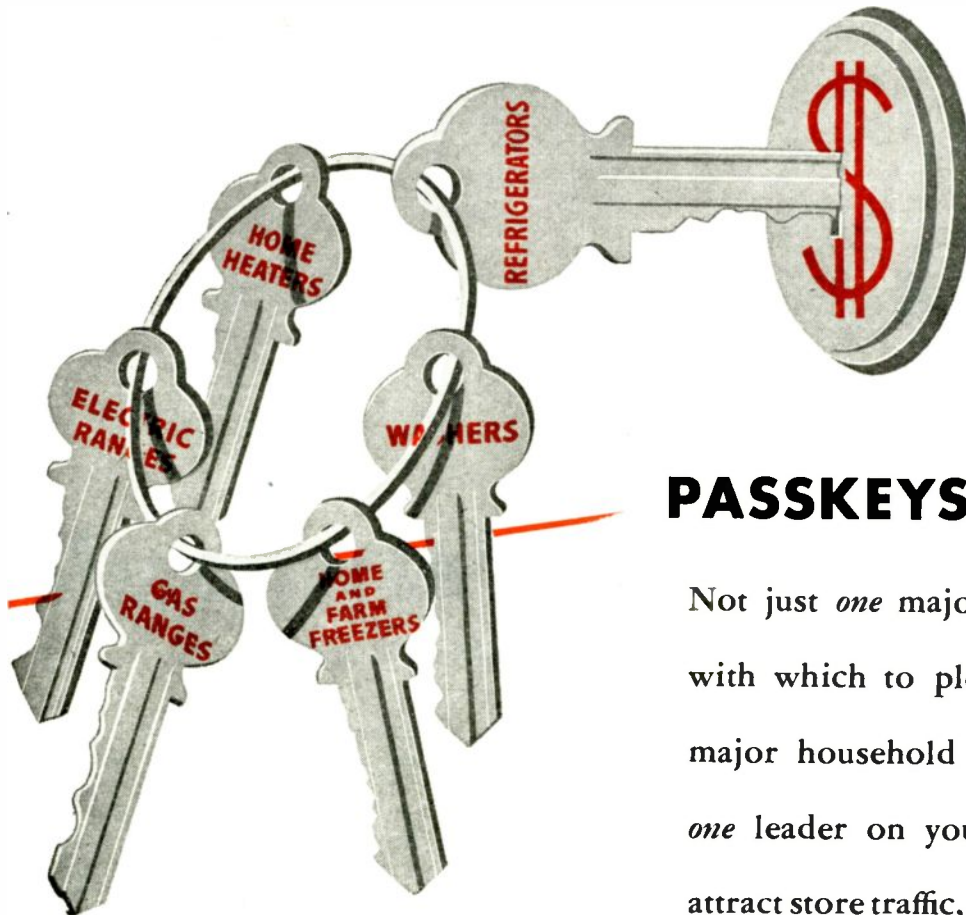

PASSKEYS TO PROFITS

Not just *one* major household appliance with which to please customers, but *six* major household appliances . . . not just *one* leader on your floor with which to attract store traffic, but *six* leaders . . . not just *one* big-ticket item with which to build your future and your fortune, but *six* big-ticket items! That's the Norge franchise story. Six lines, six leaders. "Passkeys to profits" we call them, and *passkeys to profits* they have proved to be for Norge dealers in every state in the union!

The Best Dealer in Town Sells NORGE!

Norge is the trade-mark of Norge Division, Borg-Warner Corporation, Detroit 26, Michigan. In Canada: Addison Industries, Ltd., Toronto, Ont.

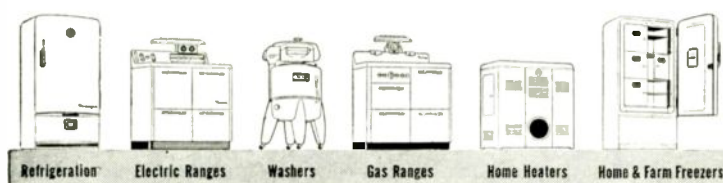

News About Lighting

New Products Hit Markets for Home and Commercial Use

New Westinghouse Select-O-Ray Lamp

Combining a 275-watt RS sun lamp and a 250-watt R-40 heat ray lamp in one fixture, the new Select-O-Ray floor or table model unit is announced by the Westinghouse Electric Corp.

The lamp container, base-mounted tubing and base are finished in an ivory baked-on-enamel, with the bow and adjustable-height tubing chromium plated. A 2-way, 3-position toggle action switch mounted on side of

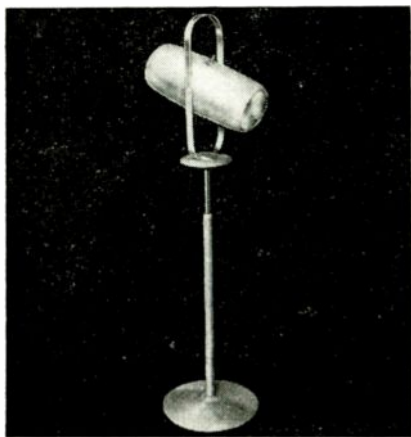

the lamp container enables the user to operate either the ultra-violet or the infrared lamp individually. Completely flexible, the unit may be used either as a floor model or by unscrewing the upper portion from the sliding tube, as a table model. The frame can be extended to 63 inches or lowered to 40 inches. The unit weighs only 12 pounds.

Operating life of the heat lamp is in excess of 5000-burning hours, and the sun lamp will provide more than 400 applications. Reflectors on both lamps are built in, and the position of the switch when in use and the direction of arrows on the name plate indicate whether the lamp is emitting ultra-violet or infrared rays.

Joins Sylvania Lighting

Leo E. Duval, Jr., has joined the commercial engineering staff of the Lighting Products Division of Sylvania Electric Products, Inc., at Salem, Mass.

"Better Sight" Campaign

The most comprehensive educational activity on the benefits of better light that has ever been sponsored by the Better Sight Better Light Bureau will be ready for use within the near future, according to Harry Restofski, Bureau chairman. Among the materials included in the program are sound-slide, films, newspaper advertising suggestions, booklets, teachers' guides, displays, radio scripts and many other forms of educational aids, he said. The Bureau's headquarters are at 420 Lexington Ave., New York 17, N. Y.

Sales Tips from GE

Here are a few "do's" for lamp salespeople from General Electric's lamp department: 1. Greet with a smile that looks helpful. 2. Suggest the right size GE bulbs to the doubtful customer. 3. Sell extra spares to the one-bulb customer. 4. Act alert and eager to help your customer. 5. Talk intelligently about watts and volts.

New Sylvania Lamp is a Dual-Purpose Type

A new 200-watt ruby infrared photographic lamp designed for dual purpose as a drying device and dark room safelight for use with ortho films has been announced by Wabash-Sylvania.

Designated as R-35, the new lamp employs a mushroom-shaped natural ruby glass bulb, silvered from neck half-way down the bowl inside and out for maximum reflectivity. It is equipped with a medium screw base.

The natural ruby glass possesses the ability to transmit infrared energy while at the same time filtering out visible light. Its cutoff is at approximately one micron (10,000 angstroms) and is practically complete, less than 1% of the visible energy being transmitted.

In the past, infrared lamps have served only one purpose—the generation of heat. They have had the darkroom failing of providing too much visible light. In the R-35, the ruby red glass holds back the visible rays that would affect red-sensitive

materials. Hence it serves ideally as a darkroom safelight with ortho films, and as a heat lamp to bring up temperatures of chemicals or to dry negatives. Unlike other heat mechanisms, infrared dries from the inside out, thereby eliminating the possibility of blisters or bubbles in negatives.

New Fluorescent Models

New "Smithcraft" fluorescent lighting fixtures are made in two types by the Smithcraft firm, Chelsea, Mass. These are the K2 for permanent installation, which has a canopy, fixture strap and wire leads to fasten directly

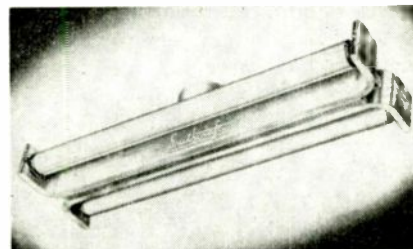

to outlet box, and the K1 which may be plugged into any light socket. The K1 has an adapter top which is fastened with set screws to the 4-in. holder in the same way as the bowl of the incandescent unit it replaces. Finished in white baked enamel with polished trim and end caps. Uses two 20-watt lamps.

New Socket-Starter

A new lock action fluorescent lamp socket and starter combination is announced by the Lasser Mfg. Co., 40 N.E. 22 St., Miami, Fla. The new

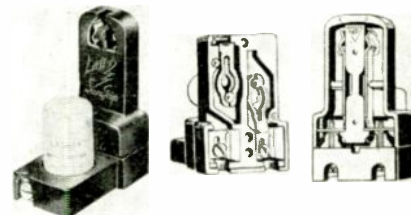

lamp socket has sure-grip terminals and the starter features a positive, turn-lock action. Both socket and starter holder are precision molded of bakelite with brass inserts and carry Underwriters' approval.

Put Your Store in the

Ways to Capitalize on the Appearance of Store Fronts and Interiors

● Retailers by the hundreds have already remodeled their stores, and many others are planning to do so. It has been said that radios and appliances are getting the best "break" they ever had, in point of store backgrounds against which the products are shown and sold.

After a dealer spends thousands of dollars to bring his store up to date and to make it a notable place, certainly the next thing to do is to make a loud noise about it. A fine store is too important a light to be hidden under a bushel. The thing to do is to exploit the new and interesting qualities of the store to the limit. This is a sound business principle and it will be profitable.

A lot of retailers, when they complete an expansion, or open a new store, or finish a revamping job, run a photo of the store in a local news-

paper ad, and let it go at that. They're missing a bet. A new and modern store is a community high spot, and the local folks should continue to hear about it.

Suggestions as to why and how this can be done, will apply to older store buildings as well as new ones, if they have characteristics that will stand talking about. Nearly every store has some unique physical qualities and it's no good making a secret of them.

Increasing Business

There are at least three major advantages to this policy of exploiting the looks of the store. First, it identifies the place in the minds of prospects. After all, practically every store in the world has a front with display windows in it. If a dealer can

bring his particular address into the consciousness of the public, it will be an asset. Buyers are courted by dozens of merchants whose stores stand with uninspired uniformity along Main Street. The trick is to get them to remember one individual store whenever they think of a particular line of merchandise.

Second, the practice of publicizing the appearance of the store helps to label it as a progressive outfit. When a store merely advertises its values and its selection of merchandise, there is nothing about the copy to indicate what kind of place it is. If the material contains some illustration of a modern store, the prospect gets the added impression that what is said about the values is supported by progressive and up-to-date methods and facilities in general.

Of course, in small communities where an established store is very well known, there is no sense in repeated emphasis on the looks of the store as if it had just been opened. That is, unless a small sketch or photo of the place is used in advertising as a trade mark. But as competition gets keener, new folks come to town, and stores by the dozen have their old faces lifted, the device is certainly an important element in how a merchant makes a long-time impression on the community.

Promotion Looks Better

Third, an eye-catching photo or illustration of the store has the effect of adding a sure-fire element of interest to the promotional material used by the firm. Actual photographs always have an attention-getting quality wherever they are used, particularly in cases where long lists of merchandise are not otherwise illustrated and are apt to look dull. There is a real psychological advantage in having the merchandise visually linked with the place where the merchandise can be bought. Such a device will do more good over a period of years than most dealers think, if the principle is applied in a sensible and consistent way. It works particularly well if the view of the store is regularly linked in some way with the name and address of the organization.

In order to enjoy these three ad-

IDENTIFY YOUR STORE—

On Mailing Pieces

In Advertising

On Give-Away's

On Letterheads

Local Limelight

vantages, a dealer should keep on hand a supply of pictures and illustrations of his store. These should of course be kept up to date, and should show the store at its very best. If the design of the place has some features that distinguish it from other stores, these features should be played up.

These illustrations may well show the features of the interior as well as the exterior, so that the dealer may supplement his store-identification drive by having additional "departmental" views to use when appropriate. For instance, if the appliance section of the store has some notable aspects—variety of merchandise, unusual displays, new models—it's too bad not to let the folks know about the atmosphere.

Specifically, all these photos or drawings can be used to advantage in newspaper ads, mailing pieces, letterheads, give-aways, etc. They can be incorporated in local publicity stories, movie ads, stories in trade journals, or even (in miniature form) on business cards.

Focus Attention

All of this will make hundreds of people know *which* store is yours, and to what degree you can make a claim to genuinely modern business methods. Needless to say, it cannot be regarded as a spectacular sales promotion which will result in instant profits; it is just another of those over-all policies which helps business in the long run.

There is also another type of store scene which can be used in the dealer's effort to get wide circulation for the appearance of the store. These are "current" illustrations which show the store in action. They may show window displays, store demonstrations, record artists autographing discs, etc., or any special event.

Other events of this kind include cooking schools held on the retailer's premises, or meetings of music groups in dealer studios. These shots have the advantage of showing the folks of the community, and therefore have more interest.

The conclusion is that if a dealer has a store that's worth talking about—and most stores are, in one way or another—he should be sure that the talking is loud and effective.

An example of a store with distinctive qualities—easy for customers to remember—is stone-fronted Suburban Radio, Orange, N. J.



Electrical Appliance

Timely Tips to Use in Speeding up Repairs on Refrigerators,

Noise in Refrigerators

In addition to checking up on the location of the refrigerator for noise due to uneven floors, etc., the servicer should make sure that no tubing touches other metal parts; that the condenser is not rubbing against the housing, or is loose, and that the compressor mounting is properly sound-dampened.

Replacement Motors for Ingraham Clocks

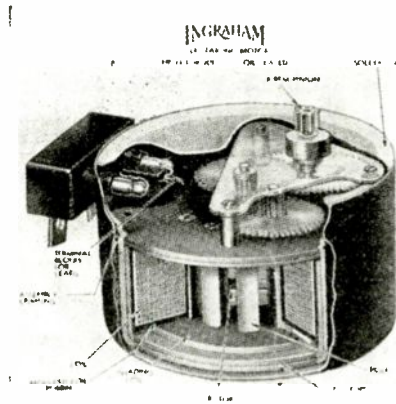

Above, Ingraham's new sealed-in-oil clock motor. Old type has been discontinued.

The new Ingraham self-starting synchronous clock motor replaces the exposed field motor which has been discontinued. The old type motor may be replaced with sealed-in-oil motor by removing the entire assembly, including the pole pieces and coil and supplying in their place the new unit with strap, pillar extensions, spacers, screws and a different depth

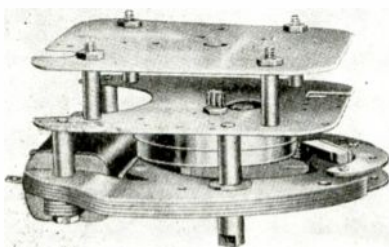

Exposed field motor. No longer made.

of back—the latter being necessary to compensate for the difference in thickness of the two motors.

Every Ingraham clock has a model number on a small metal plate attached to the back shell. When ordering a new motor to use in place

of the discontinued exposed field job, be sure to specify the number. The Bristol, Connecticut, firm will then send the correct fittings to effect the change. When Ingraham first produced electric clocks it came out with

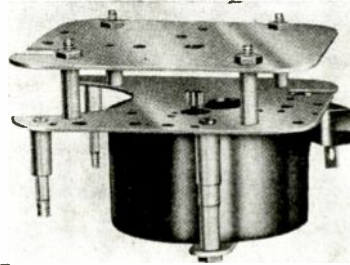

Old-type Ingraham equipped with the new replacement self-starting motor.

a model having two exposed coils. Such motors cannot be replaced by the new motors. When two-coil jobs come in for repair, they should be sent to the factory.

Servicing Kelvinator Refrigerator Controls

One control (Part 1101601) is used on models CS-7, C-7 and CD-7 of the 1946 line of cabinets. This control has 12 points of temperature selection including the "Vacation" setting. There is also a "Defrost" setting and an "Off" position. Defrosting is accomplished by setting the indicator at the "Defrost" position and then resetting to normal after the defrosting has been completed. Re-

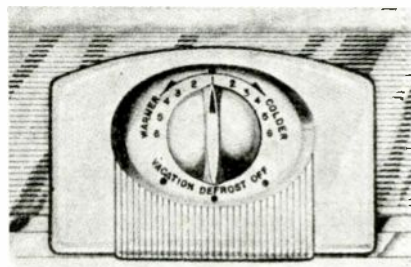

Kelvinator cold control panel.

turn to normal after defrosting is not automatic. For normal operation, the indicator should be set at number one position as shown in illustration.

The entire assembly can be easily and quickly removed for service.

1. Remove the selector knob by pulling straight out. Attach adhesive tape to the selector knob if necessary to help removal.
2. Two Phillips head screws are then

exposed. When these are removed, the selector plate can be taken off.

3. Take out the two flat Phillips head screws that hold the thermostat bracket to the inner trim.
4. Release the thermostat tube from the clamp on the freezing unit.
5. Remove the insulation packing from around the thermostat. Shift the thermostat to the left to bring the right hand side of the bracket through the opening. Shift the thermostat to the right until the left hand side of the bracket clears the opening.
6. Take out the two screws on the back of the thermostat and disconnect the wires from the terminals.
7. After installing the new thermostat, replace the insulation packing. Be sure the packing does not interfere with the thermostat action.

Replacing Elements in Everhot 900 Roaster

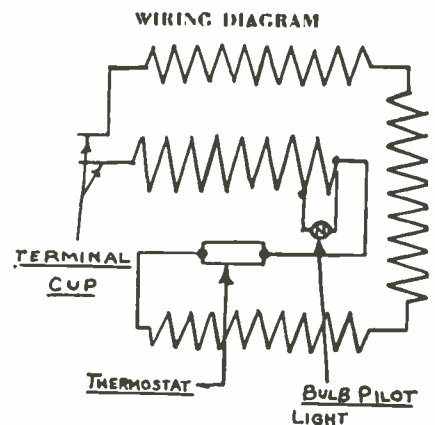

Following is the factory-recommended method to be used in replacing elements in the Schwartzbaugh Manufacturing Company's Everhot roaster, model 900:

Replacement of Side Element

1. Take off cover and turn upside down.
2. Same as No. 1 under pilot light.
3. Remove bottom. Take out packing and lay to one side.
4. Disconnect all wires attached to elements, noting where they are attached.
5. Remove roaster body. Element and insulation will probably come with it.

Service Procedures

Washers, Clocks, Sunlamps, Heaters, etc.

6. Replace side element. Return body, then repack insulation, packing it between element and body.

7. Replace wires to proper terminals, replace bottom, replace knobs.

Replacement of Bottom Element

1. Proceed as outlined in (1) and (3) under replacement of side element.

2. Bottom element is exposed and can be replaced.

3. Return wires to proper terminals. Replace packing and bottom to original positions.

When testing, usually the first cycles of the thermostat are abnormal. The first cut-out is 30-60 degrees higher than the setting. Likewise the first cut-in temperature is lower than normal.

Temperatures should not be read until the thermostat has operated a few times.

All roasters will preheat to 500° in 20 minutes or less when operated at their rated wattage. If you time the preheating until the pilot light goes out for the first time, you will probably get something near 30 minutes. This does not mean that the roaster is heating slowly, but actually to a higher temperature because of the over-travel on the thermostat's first cycle.

This is not a disadvantage, as it definitely helps to compensate for the cold food, pans or racks.

Use for Old Washers

The busy shop that has some old washing machines kicking around will find that they are just what the doctor ordered to be used for washing out wiping rags. Many dealers have found a ready sale in garages, car laundries, etc., for washers which are outdated and which because of their appearance cannot be sold to householders.

Repair Tip

Every mechanic who has ever disassembled an appliance he has not worked on previously, knows that it's often the devil's own job getting the thing together again. One shop uses a piece of corrugated box with circles drawn on it, each circle numbered, upon which are laid odd washers, nuts, etc. Number one "goes in first," etc.

Design Changes in 1961 Proctor Hand Iron

There have been a few changes in the construction of Proctor's present model 961 Never-Lift iron as compared with the pre-war 961. These changes are noted below:

1. **Thermostat Assembly:** The cam lever is now rectangular in shape. Previously it was in the shape of a horseshoe. However, this new thermostat assembly is interchangeable with the pre-war 960 and 961 irons.

2. **Adjusting Knob and Cam Assembly:** The new style "cam" is made of porcelain. This complete adjusting knob and cam assembly—consisting of adjusting knob, porcelain cam, washers and cotter pin are interchangeable with the pre-war 960 and 961 irons and will be furnished as replacement parts.

3. **Leg Assembly:** The new style leg assembly is now permanently attached to the shaft, ready to assemble to the heel bracket. This assembly replaces the old leg assembly, the leg hinge pin and the two leg spacers. It can be used on the pre-war 960, 960D, 961, 965 and 966 irons by bending one "ear" of the heel bracket to insert the leg assembly, then rebending the ear to its original position.

4. **Bracket, Heel:** The left ear of the new bracket has a "slot" for assembling the new style leg assembly. However, it can be used on the pre-war 961 iron.

5. **Cord Assembly:** The present cord assembly will have a "metal adapter" attached to the Model 965 and 970 "smooth" rubber cord guard. This cord assembly is interchangeable in the pre-war 960, 960D and 961 iron.

a. Rubber cord guard only. This smooth rubber cord guard plus the metal adapter can be used on the pre-war 960 and 961 iron.

b. This adapter permits the use of cord guards which were not originally used with this model. The wide groove in the guard is filled by the adapter.

The following assemblies remain the same and are interchangeable in the following pre-war irons:

1. Ssoleplate and element—960 and 961.
2. Cover—961.
3. Handle complete—961.
4. Handle beam and heel assembly—960 and 961.
5. Dial of fabrics—960 and 961.
6. Leg spring—960, 961, 965 and 966.

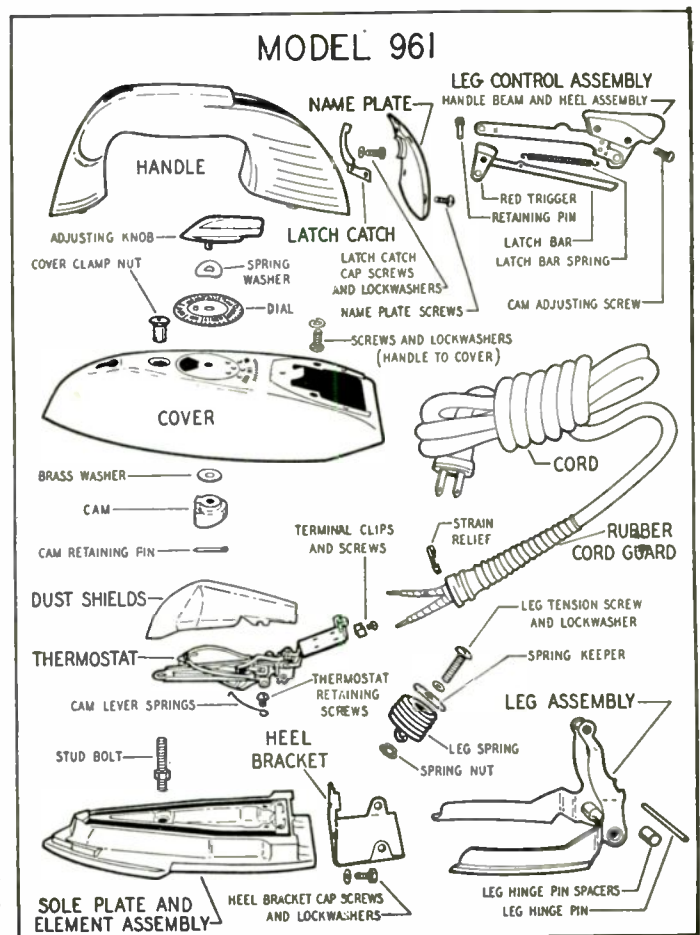

Store-Cleaning is a

The old saying has it that "Cleanliness is next to godliness."

Modern-minded merchants know that a clean store with clean merchandise is next to nothing else in importance. A clean store tells the customer that the establishment is progressive and up-to-the-minute. A dirty, dingy place of business creates a bad impression upon the visitor. It beats down the value of the merchandise in the shopper's mind. Dust-laden radios and appliances take on a "used," shopworn appearance. They have a touch-me-not-buy-me-not look which no profit-minded retailer would tolerate. Importantly, too, most customers will refuse to accept merchandise off shelves when goods are not immaculately clean.

What Customers Expect

The necessity for keeping an immaculately clean store is readily seen through the positive fact that prospective customers looking at radios and appliances visualize such products in their *own homes*. They see that de luxe radio set in the living room; the electric range or refrigerator in their modern kitchen, the automatic toaster on the dining table.

This being an era of "package" merchandise we must keep the radio and electrical appliance stores up to the times. The old-fashioned "general" store with its conglomeration of dusty merchandise, its bins and

barrels of food exposed to flies, dirt and handling by human hands has about faded out of the picture. The few remaining old-fashioned "general" stores are located in out of the way places, and their present stocks of food, for instance, are practically all sanitary packaged products.

Since the public is accustomed to expect clean food in stores and in restaurants, and because of the high-standards of living in general which is being maintained in the homes of the sort of customers who buy the bulk of electrical appliances and radios, they are certainly not going to be attracted sufficiently to buy dusty, finger-marked and dull products displayed in the dealer's store or show windows.

Cleaning is just as important as painting and decorating. It is a necessary adjunct to profitable selling.

Cleanliness, then, is a merchandising function which, though it costs money and time to perform, is something which just has to be done—and done right.

The monotonous job of cleaning the store's floors, counters, display stands, etc., is always staring the dealer in the face. In addition to keeping up the appearance of his furniture and fixtures, the merchant has radios and appliances of all sorts of shapes, sizes and finishes which need polishing and dusting. In most stores, dust and dirt collects with most un-

welcome rapidity. In no time at all the bright work on a few appliances, the glossy finish on the radio cabinets has been marred by fingerprints of customers who handle the goods.

Catch-as-catch can store and merchandise maintenance will never produce the desired results; will cost more money than a planned method will, and, in addition, will make a store present a clean-one-day, dirty-the-next appearance to customers.

The first step in proper implementing of a store-cleaning system is to have a plan. Such plan should assign the duties of cleaning to certain employees and should include a hard-and-fast when-to-do-it schedule, plus a how-to-do-it formula.

How Dealers Operate

"Extra" people to do cleaning are usually hired by large stores. Such persons may be permanent workers, porters, for instance, who do various other tasks, such as wrapping, delivering, etc., or they may be outsiders who come in to do work at regular intervals.

A great many stores find that because of financial reasons the staff must pitch in to keep the place clean. The difficulty with this is that it seldom happens that regularity can be maintained. "Something else" frequently crops up to prevent the scheduled "cleaner" from doing his bit in manicuring the floors and shining up the goods. Under such circumstances, the job is frequently put off, and the store is quite likely to look like Duffy's Tavern until the chore of cleaning can be gotten "around to."

A RADIO & Television RETAILING reporter, recently conducting a general survey of a number of large and small stores, collected advice on store-cleaning techniques for the benefit of other readers. Following are some of the comments:

"I wouldn't use anything but 'outside' help to clean my store and stock. Used to be that whoever was supposed to do cleaning would invariably be tied up with something else."

"Part-time helpers now do all of the cleaning in this establishment. I find it's cheaper and it has eliminated all the inter-employee bickering I

A bright, clean store is a must. Photo from Landers, Fray & Clark.

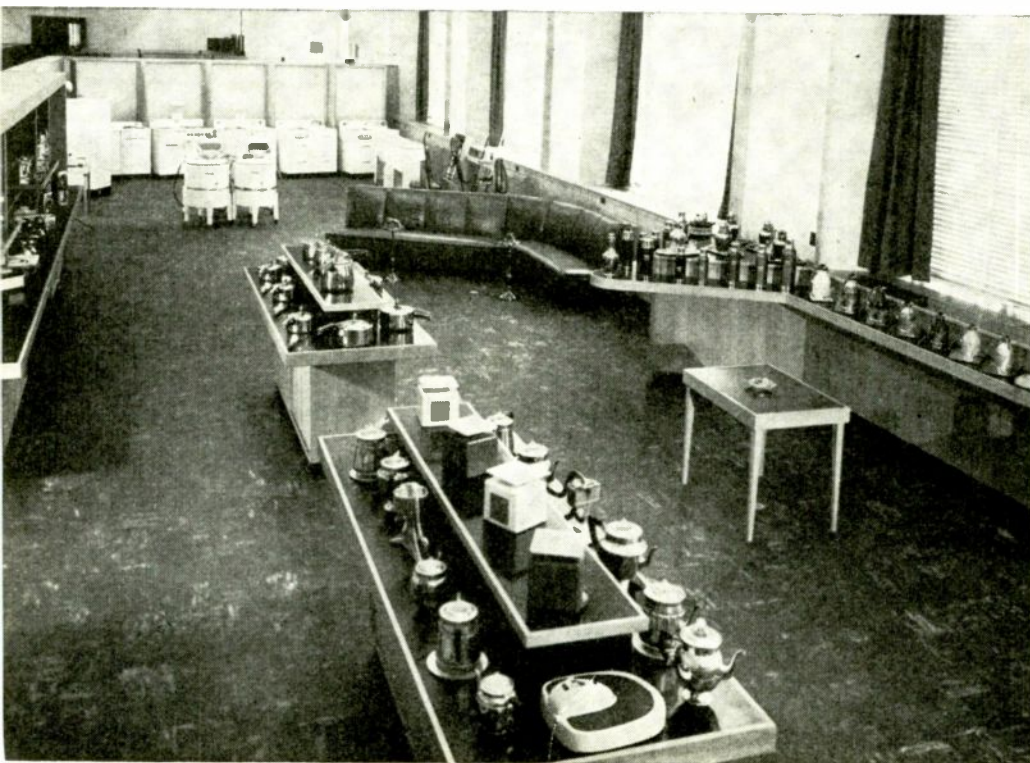

Merchandising Function

used to have to put with. Besides, it's not good business to have high-pay employes do cleaning."

"I hire professional window-washers to keep show windows and display cases clean. Also hire an outside firm to polish floors. Members of the sales staff polish appliances and radios. This works out very well."

"In normal times our employes did all of the cleaning, window-washing, etc., because we found that this kept us all busy through slack periods. I expect to use this method again whenever conditions warrant"

"All of our cleaning is done by part-time workers hired especially for this purpose. This is a large store, employing five salesmen and six servicers. I want my salesmen to present good appearances and cannot expect them to do dirty work. My servicers are paid salaries much too high to put them at store cleaning jobs. The biggest cleaning job I have is to keep my large display of lighting fixtures in good condition. Every few days the finishes must be brightened up, the glassware washed and polished."

Dealers report that *methods* of cleaning are equally important phases of the cleanliness chore. Many point out that proper cleaning and polishing of linoleum will prolong the life of the floor covering, render it more "slip-proof" and make polish jobs last longer. Merchants have found that great care must be exercised in choosing the right sorts of cleaning and polishing agents. Certain kinds of polish, for example, will leave a film on chrome finishes, stain service cords, etc., while still others are not desirable because of greasy, dust-retaining qualities.

Pays to Know How

The job of store cleaning is a large-scale task.

Taking proper care of a store from the cleaning viewpoint alone can be seen in its true proportion by comparing it with taking care of a home. The store is large, to begin with, and it has many more appliances and radios than the residence. Then too, the store has a great many more visitors to "clean up after" than does the private dwelling.

A person might fail to re-visit a dirty home and as a result the householder might lose such person's friendship. The dealer has just as much, if not more at stake, because if he should lose a customer because of unattractive, dirty store conditions, he loses money too.

Every dealer knows the importance of good store lighting, but too many spend their good money on new fixtures and on electric current bills, yet fail to keep such fixtures clean.

The lighting fixtures and the bulbs, whether they be incandescent or fluorescent need frequent cleaning. The bulbs themselves should be washed and polished, and the reflectors should be kept in a sparkling condition. If kept clean, the lighting equipment will operate much more efficiently. There will be a lot more illumination for the same amount of current consumed.

Eliminates Hazards

Enclosed globes and shades should be taken down and washed. One will find that the inside surfaces of such glassware become coated with dust, grime, etc.

In addition to presenting an attractive appearance, the clean store has other features which save time and money for the merchant. For in-

stance, fire and accident hazard rates are always low in the store where rubbish is not allowed to accumulate.

Another important point to remember is that major cleaning jobs should not be done during rush hours. Such practice makes shoppers feel ill at ease, and often presents hazard angles.

Other Problems

Customers may fall over pails, mops and brooms. Cleaners may spill things on shoppers.

There is a difference of opinion on the value of washing painted walls. Some dealers prefer to repaint them at frequent intervals, stating that they find that the cost is not much more than the washing job, and is, of course, much more satisfactory.

Every merchant has a problem too in keeping the outside front of his store clean. This chore involves elimination of litter which accumulates on the sidewalk. No matter how attractive a store-front may be, a sidewalk full of rubbish certainly spoils the whole effect.

As stated before in this article, store cleaning is a definite part of the merchant's business. It costs him real money, and, therefore, he should plan to clean house in the most economical and efficient manner possible.

Keeping Radios and Appliances Bright, Sales-Inviting is a Must. Planned Methods Pay.

A CLEAN STORE SELLS MORE!

Customers visualize those radios and appliances as being in their own homes

They will accept merchandise off a shelf or display table only if it is bright and clean

So Make a Plan—

Assign work to regular or part-time workers

Arrange regular cleaning schedule

Outline methods to be used

Refrigerators ★

★ Washers

★ Ironers ★

★ Ranges

Vacuum Cleaners ★

★ Food Freezers

New Electrical

Universal WASHER

Two-speed washer permits "controlled speed" washing for silks and for heavy pieces. Wringer has "control-roll" with patented pull stop control for both wringer rolls; wringer locks automatically in 5 positions. Washer is 49½ inches high, 29 inches x 29 inches in floor space; select-



a-matic pressure indicator; wide stainless-steel trim. Safety switch shuts off motor in case of overloading; rubber cushioned motor. Landers, Frary & Clark, New Britain, Conn.—RADIO & Television RETAILING

Apex IRONER

Fold-a-matic ironer introduces improvements in technical and operating features,



and introduces a design principle which enables the roll shoe and other operating parts to be "folded away" in a vertical position in the ironer cabinet, which is 36

inches high, 18 inches wide and 25 inches deep. Ironer has standard 26 inch roll; knee and finger-tip controls; two ironing speeds; dual thermostats; ½ horsepower motor. Apex Electrical Manufacturing Co., Cleveland, O.—RADIO & Television RETAILING

Blackstone WASHER

Automatic washer utilizes agitator washing principle. Cabinet is 25 inches x 25 inches x 36 inches, provides standard toe room at lower front; decorative trim; tub consists of hot galvanized cast iron bot-



tom, stainless steel sides; ¼ horsepower heavy duty motor; water mixing controls and operating cycle control key. Automatic operating cycle carries out washing, rinsing, and damp drying of clothes. Blackstone Corp., Jamestown, N. Y. — RADIO & Television RETAILING

Stedi-Glo WAFFLE BAKER

Constructed of 20 gauge steel; plated with tarnish proof chrome. Cool bakelite

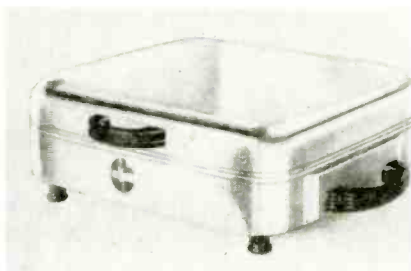

handles on cover and sides; scratch-proof black bakelite feet. New type hinge to assure even thickness of waffles. Appliance Industries of America, Chicago, Ill.—RADIO & Television RETAILING

Westinghouse TOASTER

Automatic pop-up toaster, features clock-type timer and thermal compensator. Curved top treatment and decorative de-

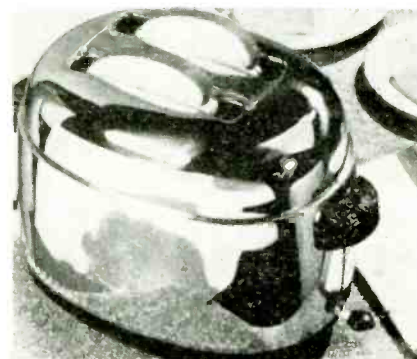

sign on chrome plate. Hinged bottom cover for crumbs. Westinghouse Electric Corp., Mansfield, O.—RADIO & Television RETAILING

Laundry Master IRON

Model 333, electric iron, draws 32 volts making it a popular "farm" iron. Highly



polished; 4 lbs. Complete with heavy duty cord. Haines Mfg. Corp., 4754-56 N. Clark St., Chicago 40, Ill.—RADIO & Television RETAILING

another *striking campaign* sparks **SHELVADOR*** sales



•Trade Mark
Reg. U. S. Pat. Off.

CROSLEY
SHELVADOR*

CROSLEY dealers aren't backed by any single-shot activities. Every line has its own promotion . . . that works to build sales for every unit, to build traffic throughout the dealer's store.

For example, shoppers who come in to buy the PorTABLE and Rondo radios are also A-1 prospects for the Crosley Shelvador* . . . the "Speed Way For Meals." Here's the only refrigerator that puts 28 feet of front-row food at a housewife's fingertips . . . helps her get easier, faster breakfasts, lunches and dinners.

The Crosley Shelvador* story is already being broadcast in a smashing national advertising campaign. But just as a reminder, look why . . .

the *speed way to sales* campaign is moving merchandise... *fast!*

NATIONAL ADVERTISING

98,568,598 advertising messages are appearing in national magazines over a 60-day period. That's a real sales stimulus, directed to the top-buying shoppers in the country. Full-color, full-page ads are plugging the Shelvador's* advantages, building future business for Crosley dealers.

STORE DISPLAYS

Attention-getting displays carry the "Speed Way For Meals" theme right into dealers' windows . . . onto sales floors . . . direct store traffic to dramatic, visual demonstrations . . . capitalize to the fullest on national advertising.

NEWSPAPER ADS

A hard-hitting array of newspaper ads is appearing in local newspapers, over the signature of Crosley dealers. These local ads tie-in with national magazine advertising and the display materials. They're supplied in easy-to-use, ready-to-run mat form.

RADIO SCRIPTS

In addition to a half-hour program produced and recorded in New York and made available to Crosley dealers in handy "platter" form, there's a hard-working set of scripts for spot radio announcements. Every Crosley dealer can tailor his local advertising to his own best advantage.

HELPFUL BOOKLET

"How to Arrange Foods in Your Refrigerator" . . . a helpful chart that every woman will value . . . gives dealers an additional opportunity to build goodwill along with sales. It's full of specific information on efficient loading and storage of meats, vegetables, processed foods and all the other items that require careful refrigeration. Every woman will want a copy, will keep it, will remember and thank her Crosley dealer for it.

In short . . . These are busy months, *active* months for Crosley dealers. They'll be profitable months, too . . . for they cover

2 big profit promotions **synchronized for sales!**

Refrigerators • Home Freezers • Kitchen Sinks and Cabinets • Ranges • Laundry Equipment • Radios • Radio-Phonographs • FM • Television • Short Wave Radar • Home of WLW, "The Nation's Station"

CROSLEY

CROSLEY Division — The Aviation Corporation,
Cincinnati 25, Ohio



**New Hotpoint Lines
Shown Distributors**

Hotpoint Inc., introduced four "completely postwar" model ranges to open its West Coast distributor meetings at San Francisco, Seattle, Los Angeles, and Salt Lake City in late March. The ranges are in full production at Chicago. The preview meetings are the first that the company has held since 1941 with the Coast sessions to be followed by similar events in the Eastern, Central, and Southern regions. The sessions are being timed to coincide with carload appliance deliveries.

In addition to ranges shown at the meetings, the distributors are seeing Hot-

point's new automatic electric storage water heaters which have been redesigned to standardize tank diameters and to apply the heat by a new external Calrod unit "under 200 pound spring tension."

The company is also showing new designs of electric clothes washers and ironers—rotary and flatplate. Previously the distributors were shown 1947 home freezers and the deluxe refrigerators at district meetings in January.

Oklahoma Dealer

R. J. Wisinger, M. S. Harber of Shawnee, Okla., and O. R. Dill of Seminole, have incorporated the Modern Appliance Co., Inc., to operate a retail organization in Seminole.

All-Purpose Mixer

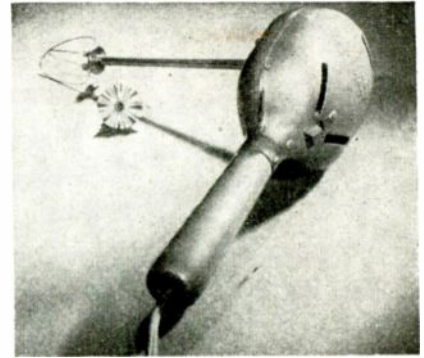

The Royal Rochester "Quick Mix" Model 15530 portable electric kitchen and cocktail mixer is available again from jobbers of the Robeson-Rochester Corp., Rochester 7, N. Y., to retail under \$10. It whips, stirs, mixes and beats with stainless steel agitator, comes in variety of colors.

**Universal Ready with
New Home Cleaner Line**

In announcing Universal's new line of home cleaning and floor maintenance equipment, Lee Moss, sales manager of this division of Landers, Frary & Clark, said that the new "Suction Regulator" feature "is one of the greatest advances in conventional type vacuum cleaners for over a generation." The Regulator permits the operator to adjust the suction according to rug thickness and weight, so that no sealing or dragging occurs on any rug.

This cleaner is model VC5701—a set of 10 attachments is optional. The firm lists 11 different features for this unit.

Universal's new line also includes two tank types, a floor polisher, hand cleaner, and carpet sweeper.

Johnson Joins Easy

The district sales manager staff of Easy Washing Machine Corporation's Chicago division under the direction of G. F. Graalman has recently been augmented by the addition of Paul E. Johnson of Chicago. Mr. Johnson, for eleven years with Commonwealth Edison, major appliances, and three years with Firestone Tire and Rubber Co., fleet accounts and postwar dealer franchises, will serve Easy in Lake county, Indiana, and in the following Illinois counties: Cook (exclusive of Chicago), Lake, McHenry, Kane, Kendall, Will and DuPage.

Swartzbaugh Sales Head

Roy J. Baunach has been appointed to succeed the late Jason B. Swartzbaugh as sales manager of the Swartzbaugh Mfg. Co., Toledo, Ohio. Mr. Baunach has been with the company since 1935 in important sales posts.

Pacific Manager for GE

William E. Dennler, assistant to the general manager of General Electric's appliance and merchandise department, has been appointed Pacific district manager of appliance sales. His headquarters will be in San Francisco.

Here it is!
THE BARONETTE LINE
SOMETHING NEW IN TOASTERS
"POP-DOWN"

"POP-DOWN" Toaster is fully automatic. Chrome plated. Toast rests in bottom of toaster and keeps warm until ready for use. Comes in 110- or 220V AC-DC. Beautifully styled for easy selling.



\$15.98
LIST

SPECIALS



FLIP-FLOP all aluminum toaster is a BARONETTE special. This distinctive toaster competitively priced at ... **\$5.98**
List

AUTOMATIC ELECTRIC IRON lists at \$9.95. Dealers price \$6.00
In lots of 12 **\$5.50**
or more

THREE TUBE PHONOGRAPH with 5" speaker. 110V AC only. Luggage type cabinet. Single record operation. Former dealer price \$24.50.
Special in lots of 6 or more **\$15.00**

All aluminum hot plate combines grace with utility. Ceramic insulated heating element is steel plate protected. Specially priced to list at: **\$4.98**



Toasters and hot plate are 110 or 220 volt AC-DC with cord attached and are Underwriter Lab approved.

TUBES

All standard types of radio tubes at pre-war discounts. All tubes are new, individually boxed and carry RMA guarantee.

Ask for special dealer prices

Write for additional lists of *BARONETTE* specials



BARONETTE Radio & Tube Corp.
220 FIFTH AVENUE NEW YORK 1, N. Y.

How to turn Bugs into Bucks



**"INSECT-REPELLENT"
LAMP**

DISPLAY AND SELL THE ORIGINAL



The Preferred All-year All-purpose Outdoor Lamp



10,000,000 will be sold from retail counters in 1947. Latch onto this sure-fire traffic builder.

National advertising in Saturday Evening Post, Look, Colliers, Holiday, Better Homes and Gardens and Billboard will spearhead Insect Repellent promotion for '47.

High profit per sale makes small counter space pay off big (see profit on A-72 Assortment, for example).

50/50 Advertising allowance on all local newspaper advertising. No limit on size or frequency using our mat or copy.

Stock up now — call your distributor today!



FREE! This sales-making display unit. Ask your jobber for Assortment A-72. Contains 72 popular size lamps—a window streamer—50 colorful folders.

42 — 60 watt @ 25¢ list	\$10.50
30 — 100 watt @ 35¢ list	10.50
72 — Sell for	\$21.00
Cost you	14.00
Your profit (plus Federal Tax)	\$ 7.00

VERD-A-RAY CORPORATION
TOLEDO 5, OHIO

CANADA: Verd-A-Ray Electric Products, Ltd., 350 Des Recollets, Montreal, Quebec.

EXPORT: F. Marti and Co., Inc., 90 Wall St., New York City

Blacklight Luminous Display Signs by Vion

A newcomer in the luminous display sign field, the Vion Corp., 1331 First Ave., New York City, has announced the first installations of its "blacklight" signs. The new Vion signs are plastic units plugging into any outlet, "burning steadily without flicker or vibration—cool in operation and non-flammable."

Illumination for Vion signs comes for a regular low-wattage fluorescent lamp, with special filters which give off invisible "blacklight" rays, to light up the transparent plastic letters of the sign seemingly without a light source.

The signs come in a large selection

of colors. Complete units are now available at \$24.75 and up.

Schick Production Rate is Speeded Up

The advertising catchline, "Slick Schick," which has been applied to the Schick Electric Shaver in the current campaign can be applied with equal truth to the company's plant in Stamford, Conn. The Schick factory, which goes from Garden to Atlantic Street, and where almost a thousand skilled workers turn out the Schick Shaver models and the Shaverest, has been given a complete re-furbishing, inside and out, with realignment of production lines, addition of new machinery, and other improvements which

will add materially to the high production rate which has been maintained since the end of the war.

Carton Designed to Help Selling

Now appearing in dealers' stores is the new package carton for the "Duolectric" steam iron made by the Silex Co., Hartford 2, Conn. The new box is a sturdy eye-catcher designed after extensive sales research in retailers stores as to what type of package would be both decorative and useful.

Silex reports that many users of the iron are keeping the box to house the unit while not in use. The colors used in the design give it a "family resemblance" to other Silex products.

Sales Booster for Century's Glide-O-Matic

A new display for the Glide-O-Matic iron made by Century Precision Works, Inc., 503-507 W. 56th St., New York 19, N. Y., is a 3-dimensional attention-getter for counters, windows or walls. The display has a "pocket," and leaflets are supplied by the firm, for distribution to prospects.

The display measures 14" by 18" and carries a life-sized reproduction of the iron in metallic foil. Century presents the unit as "an unusually effective sales booster when store traffic is extra heavy."

Expansion for Perlmuth Firm

The well known Pacific Coast "rep" organization, J. J. Perlmuth & Associates, will now be known by a new name—Perlmuth-Colman & Associates. The firm, which Jack J. Perlmuth started in 1923, is located at 942 Maple Ave., Los Angeles 15, Calif., and recently opened a branch office in Seattle, Wash. Edward J. Colman, formerly vice-president and general sales manager of the Insuline Corp. of America, joined the company last year as an associate and co-owner. Also on the staff are Paul F. Wiley, Al Biegel, Samuel Stroum, William F. Neal and Edward A. Hornstein.

Hamilton Sales Reps

The appointment of two new sales representatives for the Hamilton automatic clothes dryer has been announced by W. A. Friedrich, director of sales, home appliance division, Hamilton Mfg. Co., Two Rivers, Wisconsin. They are Ralph L. Ferguson, Midwest representative, and Morgan J. Busch, who will represent the Hamilton dryer in the Middle Atlantic and New England territories, with headquarters in Harrisburg, Pa.

Open New Ohio Store

The Arnold Wholesale Corp., Zenith distributor at Cleveland, Ohio, has announced that the Ohio Appliance Co., owned by Fred J. Hushea, is now settled in its modern new store. Located in Canton's St. Francis Hotel building, the store occupies two floors and has a street frontage of 40 feet.

ORDER NOW . . . To Insure Immediate Delivery on these outstanding Electrical Appliances

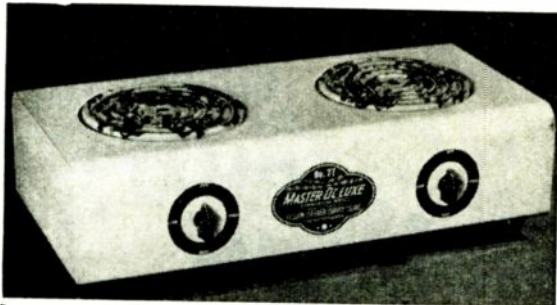

New Approved Master De Luxe Table Model Stove complete with 6 foot cord. Two tone, high gloss heat resisting baked enamel. Constructed of #18 and #20 gauge, cold rolled steel, all seams electrically welded. Cooking range of six separate heats, from simmering low 250 watts, to high 750 watts

\$16⁶⁵ Approved O.P.A. List
Plus 5% in Zone 2
\$7⁹⁵ Dealer's Cost

Bona Fide Lifetime Guarantee with Each Unit

"CALKINS BREAKFASTER" Oven Style Toasting

For toasting bread, muffins, rolls, toasted cheese sandwiches, etc.

Approved O.P.A. List
Price **\$12.95**
Plus 5% in Zone 2
Dealer's Cost **\$8.65**

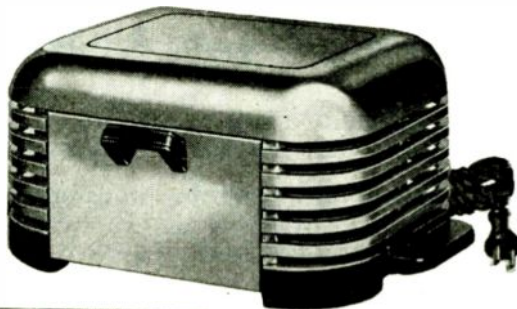

Top plate is ideal for frying meat, eggs, or potatoes, cooking vegetables, heating soup, etc.

TERMS: All prices include manufacturers Federal Excise Tax and FOB Chicago, Illinois. When check or money order accompanies purchase order deduct 2%. Shipments will be made per your instructions.

MASTER DE LUXE Division of the
VACUUM CLEANER SUPPLY CO., INC.
Manufacturers—also Jobbers and Distributors of Electrical Household Appliances
In Business Over 30 Years at the Same Location

5081 N. BROADWAY

CHICAGO 40, ILL.

AVAILABLE. REBUILT VACUUM CLEANERS. ALL NATIONALLY KNOWN BRANDS.

Write for price quotation on make and model desired.

Attention Exporters, Jobbers and Distributors. Write for information on territories and franchises now open.

Now! Get records that do these 9 vital jobs... easier, simpler, faster!



DEPENDABLE TAX INFORMATION



PROTECTION OF MERCHANDISE



CONTROL OF CASH



DETAILED SALES ANALYSIS



INFORMATION ON PROFITABLE LINES



ACCURATE INVENTORY CONTROL



RECEIPTS FOR CUSTOMERS



COMPLETE CUSTOMER LISTS



ADEQUATE INFORMATION

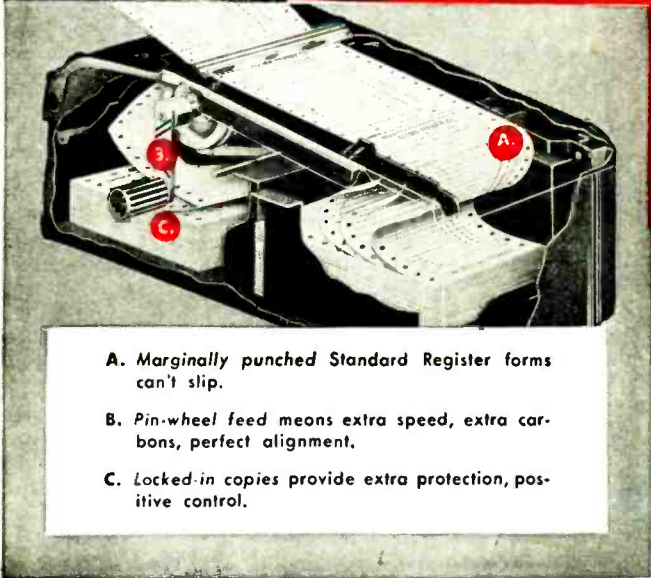

- A. Marginally punched Standard Register forms can't slip.
- B. Pin-wheel feed means extra speed, extra carbons, perfect alignment.
- C. Locked-in copies provide extra protection, positive control.

Radio and Appliance Dealers GET THESE SPECIAL BENEFITS

All records clear, legible, at one writing. Copies for customer, office, delivery and locked-in audit records. No copying errors. Foolproof check against lost records. Fixed responsibility, including delivery receipt. No confusion on terms of sale, payment, or delivery instructions. Complete legal contract and copies with *one* customer signature.

THE STANDARD REGISTER COMPANY

Manufacturers of Registers and Forms
for ALL Business and Industry

DAYTON 1, OHIO

Write for **FREE** folder! Discover how Standard's pre-tested Formcraft continuous forms and **STANDARD'S FORM FLOW REGISTERS** give you more complete records with less writing, less work

Many a record system that was "good enough" a few years ago is totally inadequate for the job it must do, today. That's why thousands of firms have adopted Standard Register's modern, exclusive, pre-tested systems and Form-Flow Registers. Standard Register systems help you get better, more useful records *faster*—records that conform to government regulations, income tax reports, and at the same time protect cash, merchandise and consumer good will. Get all the facts. Mail the coupon, today. There's no obligation.

The **STANDARD REGISTER** Company
Dept. 1304 Dayton 1, Ohio

Please send me Free Standard Register Business Digest which tells me how I can write better records in my business . . . easier . . . simpler . . . faster!

NAME _____

COMPANY _____

STREET _____

CITY _____ ZONE _____ STATE _____

Pacific Coast: Sunset McKee-Standard Register Sales Co., Oakland 6, Calif. Canada: R. L. Crain Ltd., Ottawa. London: W. H. Smith & Son, Ltd.

THE **NEW** PROCTOR ROAST-OR-GRILLE

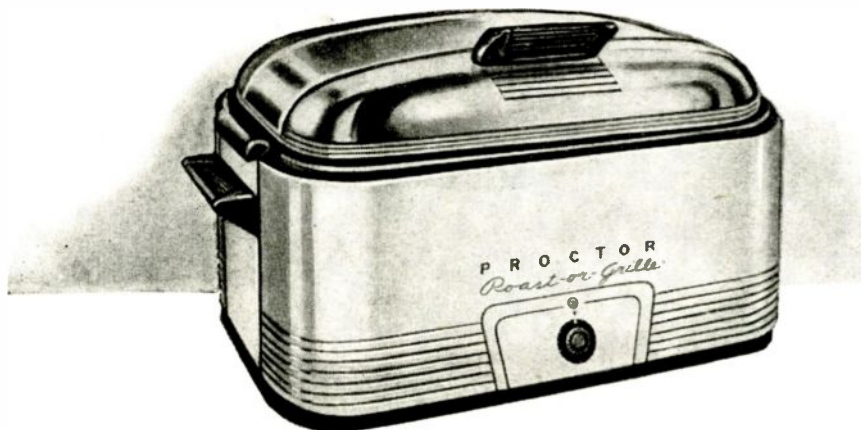

and what **you'll** have to say about it!!



HERE, Madam, is the Proctor Roast-or-Grille, the only automatic Roaster with the grille in the lid. The grille is an integral, self-cleaning part...not an extra as in other roasters.



IT bakes, broils, roasts and grills. Eighteen quart capacity cooks a whole meal at one time, a large roast or a twenty pound turkey. Comes with three porcelain enamel cooking pans and an enamel roasting pan.



IT has accurate thermostat heat control like all Proctor appliances. No special wiring is required for the Roast-or-Grille. Use it as your main oven or as an extra oven on festive occasions. Order one today!

PROCTOR

NEWSMAKER IN APPLIANCE MERCHANDISING

PROCTOR ELECTRIC COMPANY, PHILA. 40, PA.



SEE the Proctor Roast-or-Grille at the Philadelphia Housewares Show, Apr. 27 to May 3.

Record Production Announced by Norge

New all-time highs have been reached in the production of Norge gas and electric ranges and home heaters, and record output peaks on domestic refrigerators and washing machines should be achieved by mid-year, according to M. G. O'Harra, vice-president and director of sales, the Norge division of Borg-Warner Corp., Detroit.

O'Harra stated further that it was the company's intention to "forge ahead to new production records and continue to assist in alleviating the hardships which have been suffered by so many who have been unable to obtain urgently-needed appliances."

He predicted that despite the efforts of Norge and other producers in the field, there would be no clearly evident "buyers market" for household appliances for many months to come. "New families, obsolescence of old models and modern features of the new ones, are just a few of the factors which will maintain consumer demand at its present strength."

Commenting on the high output rates thus far attained, O'Harra said the company had reached these peaks "much sooner than many thought possible" and in the face of seemingly insurmountable manufacturing difficulties.

Westinghouse Supply Corp. Personnel Changes

A number of personnel changes and promotions have been made by the Westinghouse Electric Supply Corp. Among the changes made are the following:

George R. Filson has taken over the duties as appliance manager at the Toledo branch. D. A. Heator has been named district sales promotion manager of the central district at Detroit. J. H. Stratton has assumed duties as appliance manager of the St. Paul, Minn., WESCO branch. G. L. Washington is the new stores manager at Atlanta. He had been appliance sales manager for the firm since his return from war service.

Chollar With Lektro

John S. Chollar, overseas veteran, has been named export sales manager by Lektro Products, Inc., Milford, Connecticut. A graduate chemist, John Chollar has had a varied career with several nationally known manufacturers, both in production and sales. Chollar, who became a civilian after five years of service, three in foreign lands, retains his commission as a Major in the Medical Administration Corps Reserve. Lektro introduced the first postwar electric shaver—Packard, and was first on the market with four separate heads. Now Lektro is rapidly expanding its foreign markets under the direction of Mr. Chollar, who finds his service overseas a real asset.

Johnson Opens

The Johnson Radio Co., Inc., 2215 North B St., Ft. Smith, Ark., has been incorporated here, to operate a radio and appliance business.

IT TAKES A TRAINED EYE



Photo courtesy Sackett and Prince Television Productions, Inc.

... to recognize tomorrow's stars

... or to tell which radio or appliance lines will sell best. Graybar has a highly trained eye for merchandise. We've been in this business long enough to acquire the judgment it takes to pick lines that will sell. This "wisdom of selection" is of special importance to our dealers today — when there are so many new lines, as well as old ones, to choose from.

Equally advantageous to our dealers is the fact that Graybar is an independent, self-directing organization. This means we're free to select lines on the basis of reliability and saleability ...

lines that will be most profitable for our dealers. It means, too, that we can be unbiased in recommendations to our dealers concerning their merchandising methods.

From the local Graybar organization which serves them, Graybar dealers in every section of the nation get time-saving deliveries of fast-selling lines — plus a wealth of profit-building merchandising ideas. For information about a Graybar dealership, write *Merchandising Department, Graybar Electric Company, Graybar Building, New York 17, N. Y.*

4720



... an independent distributor with a talent for picking best-sellers

HOME RADIO • MAJOR APPLIANCES • TRAFFIC APPLIANCES

New Appliance Products

Samson FAN

Model 1244-N, 12-inch, oscillating, 2-speed electric fan. Exclusive-patent rubber blades. Choice of two speeds for moderate or greater volume. Overall di-

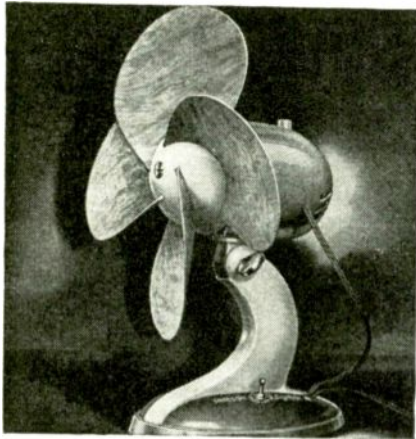

mensions: height to top of blades 15¼ inches, depth 9½ inches; base 9 inches x 6½ inches. Wall mounting easily accomplished. Samson United Corp., Rochester, N. Y.—RADIO & Television RETAILING

Princess COOKING UNIT

All purpose unit for grilling, frying and toasting. Sturdily constructed; features ceramic balanced heat unit, all steel rack,

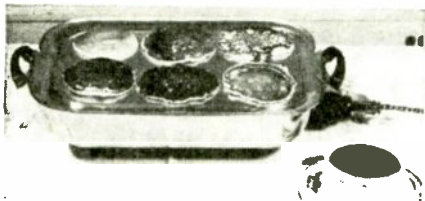

aluminum reversible tray; heat resistant plastic accessories. Overall grill size 16¾ inches x 10 inches x 3¾ inches. Newark Appliance Corp., Inc., 92 So. 6th St., Newark 7, N. J.—RADIO & Television RETAILING

Utili-Lite SHELF

General utility shelf with self-contained light; built-in lamp; portable; comes com-

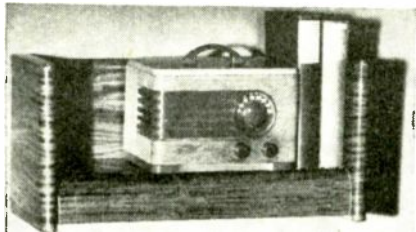

plete with cord and plug. Streamline design, all-metal construction. Available in mahogany, walnut, maple and white enamel finishes. American Utility Products, Inc., 2555 Bellevue Ave., Detroit 7, Mich.—RADIO & Television RETAILING

Oster MIXER

Mixer for blending, liquefying and mixing etc. Detachable container base; heat resistant glass container. Black rubber container cover. Agitator assembly is

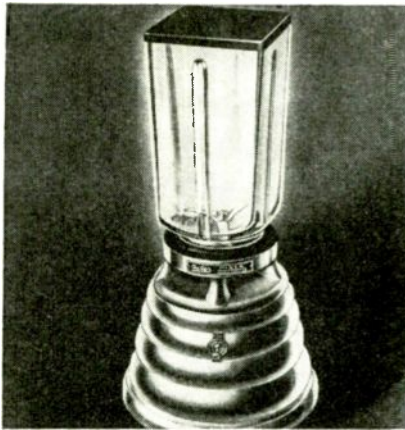

stainless steel. Sturdy die-cast base. 6 ft. rubber covered cord and plug. John Oster Mfg. Co., Racine, Wis.—RADIO & Television RETAILING

Air-D-Lux HEATER-COOLER-COOKER

Tri-utility, all-season portable unit features specially designed heating element combining radiant heat and convection heat; set switches give choice of fresh air

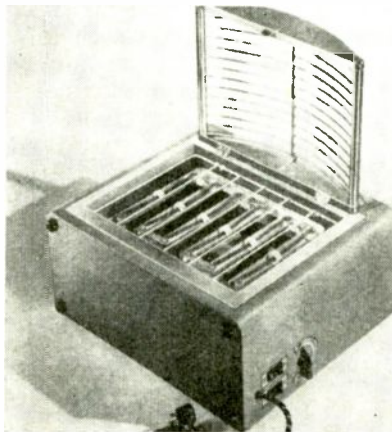

currents or high breeze; appliance can be turned and hinged grill pulled up from bottom. As a cooker, unit is functionally equivalent to two-plate electric stove. Warren Simpson Corp., Mt. Vernon, New York—RADIO & Television RETAILING

Walker HEATING PAD

Electric heating pad shaped to fit curvature of the body; can be used open or

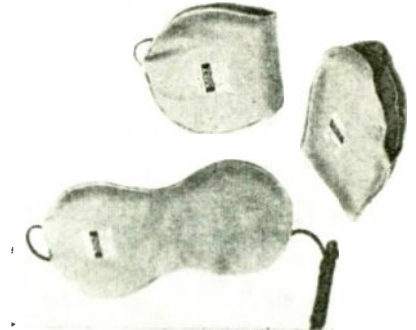

with sides folded together. Pad slips into "snap-on" cover designed for travel use. Overall size is 8½ inches x 8½ inches x 2 inches. Can be used on "high" and "medium" heat. Walker Co., Inc., Middleboro, Mass. — RADIO & Television RETAILING

Titan ROOM HEATER

Model 401, fan-forced circulating heater utilizes flat ribbon of special alloy instead of coiled wire element. Metal duct directs flow of air. Heavy gauge drawn steel construction. Unit completely enclosed. Functional styling. Titan Mfg. Co., Inc., Buffalo, N. Y.—RADIO & Television RETAILING.

AerVoID WATER HEATER

Automatic electric water heater features thermostatic control which holds water at 180 degrees, adaptable both as primary heating units and as auxiliary or booster units where additional hot water capacity



needed. Consist of inner stainless steel tank, encased in outer steel shell with insulation between water tank sides, top and bottom. Vacuum Can Co., South Hoyne Ave., Chicago 12, Ill.—RADIO & Television RETAILING

FOR LATEST RADIO MERCHANDISE, SEE PAGES 42, 43

RADIO *& Television* RETAILING

now has
29,000
circulation

Our circulation continues to increase because more and more independent dealers who sell radio, appliances, records — and service retailers—find they get complete information on ALL their retailing activities from the "Big Four" magazine.



Caldwell-Clements, Inc.
 480 Lexington Ave. New York 17

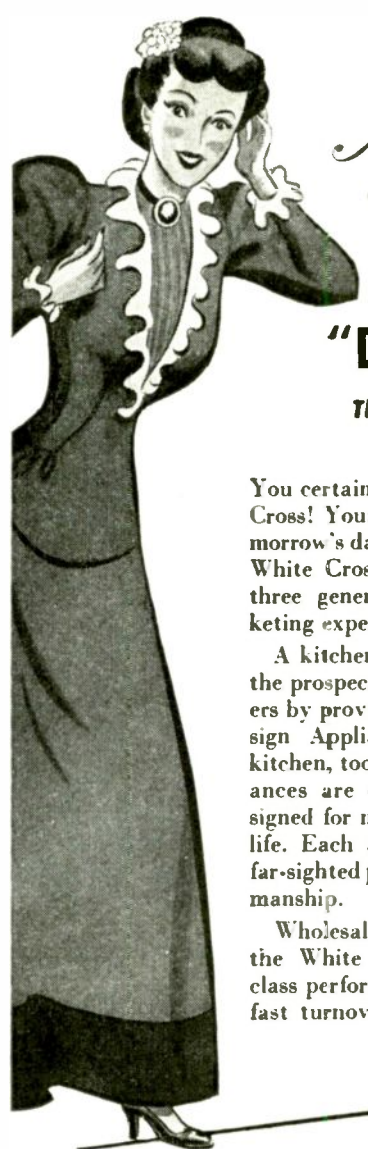

Miss White Cross says:

"Do I Look 55?"

There's profits aplenty in the answer!

You certainly don't look it, Miss White Cross! Your line is as up-to-date as tomorrow's dawn . . . ultra-modern *because* White Cross has been outstanding for three generations of making-and-marketing experience!

A kitchen styled in harmony—that's the prospect White Cross offers customers by providing beautiful Matched Design Appliances. A smooth-operating kitchen, too, because White Cross appliances are completely functional—designed for maximum efficiency and long life. Each appliance is the product of far-sighted planning, highly skilled workmanship.

Wholesalers are increasingly aware of the White Cross reputation for first-class performance—they know it means fast turnovers, consistent profits!



NO. 628X—Combination Sandwich Toaster and Waffle Baker—Large interchangeable aluminum grids. Expanding hinges for "double-deckers." Special support permits frying on both grids. Matched design.



NO. 302—Instant Heat Hot Plate—Two 6-inch, 3-heat 750-watt elements with individual 3-heat reciprocating switches to insure faster, better regulated heat. Well insulated; gives maximum heat for current consumed.

NATIONAL STAMPING AND ELECTRIC WORKS
 3220 WEST LAKE STREET • CHICAGO 24, ILLINOIS

MAKERS OF
WHITE CROSS
 PRODUCTS

SUBSIDIARY OF
EUREKA WILLIAMS
 CORPORATION

PLANTS IN CHICAGO, ILL. • BLOOMINGTON, ILL. • DETROIT, MICH.



What's The Indian Rope Trick Got To Do With MALLORY CAPACITORS?

MALLORY originated and produced the first type "FP" capacitor. These have been famous for performance for so long—have been so consistently preferred for original equipment—it follows they naturally become first choice of radio servicemen. You might imagine there was some special magic in their making.

The popularity of FPs, however, has never depended on tricks of engineering or manufacture. Yesterday, as today, it has been a matter of *quality*. Careful control of materials . . . painstaking manufacturing methods that keep impurities down to a fraction of a part per million . . . rigid standards of testing and inspection . . . explain why Mallory FPs are preferred.

They are the reasons why Mallory FP capacitors *last* . . . why millions are in use all over the world . . . why they can be counted upon for service beyond the normal. They are your assurance that when you install a Mallory FP, the customer can depend on a job well done.



YOU EXPECT MORE AND GET MORE FROM MALLORY

P. R. MALLORY & CO. Inc.
MALLORY

VIBRATORS . . . VIBRAPACKS* . . . CAPACITORS . . . VOLUME
CONTROLS . . . SWITCHES . . . RESISTORS . . . FILTERS
. . . RECTIFIERS . . . POWER SUPPLIES.

*Reg. U. S. Pat. Off.

APPROVED PRECISION PRODUCTS

P. R. MALLORY & CO., Inc., INDIANAPOLIS 6, INDIANA

SERVICE & SOUND

Section of RADIO & Television RETAILING

Time-Saving Tips on New Sets

Advice on Repairing New Receivers, From Factory Service Managers

● Tips on the easiest and quickest solution to radio troubles are welcomed by any radio servicer. This can hardly be more true than in the case of servicing hints which are forwarded by the manufacturers of the very radios involved. The contents of this page, therefore, will be of great interest to practical radiomen.

Listed below are changes which have been made in the recent produc-

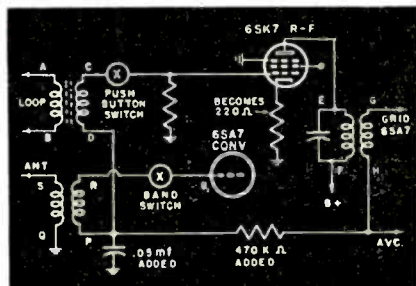

Simplified Stewart-Warner corrected circuit.

tion runs of several popular makes and models. They have been submitted to RADIO & Television RETAILING by the factory service managers, and it is through their cooperation that they may now be reported for the benefit of radio servicers throughout the country.

While each of the manufacturers have found the changes definitely worthwhile, servicers need incorporate the modifications only when necessary to accomplish adequate reception, since in many specific installations the added performance ability is not required.

In later production of Stewart-Warner's models 9001-C, D, E & F and 9003-B says service manager N. J. Cooper, appears an avc filter consisting of a 470,000 ohm resistor and a .05 mf capacitor which is inserted between the junction of the s-w and b-c coils' grid returns and ground.

Improved sensitivity on push-button tuning and short wave operation may be obtained in this manner.

Chassis which have a letter "S" stamped on the rear surface adjacent to the model number already incorporate this change. In addition, models 9001-C, D, E & F can be improved in sensitivity for manual tuning on the b-c band by changing the value of the 6SK7 r-f amplifier's self-biasing R18 from 560 to 220 ohms.

Howard Radio model 901-AP-A, according to service manager Fred Westaway, was originally susceptible to modulation hum in abnormally bad localities, and would overload on a long outside antenna. By making the

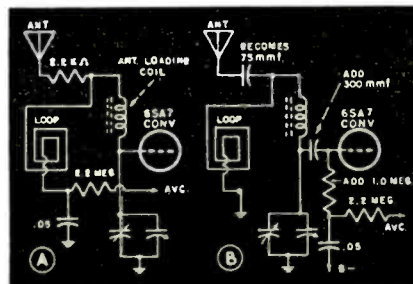

At A, old Howard Circuit. B, with changes.

wiring changes shown, requiring simply the addition of a .1 megohm 12SA7 input grid return resistor, a 300 mmf d-c blocking capacitor, and a 75 mmf outside-antenna coupling capacitor, the troubles can be corrected.

Hum in General Electric model 250 portable, advises technical service supervisor W. L. Parkinson, can be cured by making the following checks. 1—Bring the battery electrolyte level to its recommended value; 2—Make sure that the battery is well charged. When nearly discharged, hum may appear; 3—Early production sets may need a rubber insert between the split spring contacts of the battery connec-

tors. This item, stock V61J551, may be secured from GE Technical Service Section, Bridgeport, Conn. Since a dirty or loose negative battery terminal contact causes excessive hum, remove the battery and clean its terminals as well as the negative prong located in the battery compartment, with fine emery. When reinstalling, spread a thin layer of petroleum jelly on the contacts; 4—Check the spring washer on the opposite end of the negative prong for a good chassis bond, by removing the front part of the receiver case and installing a bonding strap as shown in the illustration. If available, use a 3/8" soft copper strip .010" thick, fastened between the spring washer and the 1LH4 socket saddle hole as shown.

RCA Service Company's Camden office suggests that low volume and distortion complaints in the RCA 54B series "personal" radios point to leakage trouble in capacitor C19, a .002 mf unit located between the 3S4 output tube's control grid and the plate of the 1S5 audio amplifier. In the same sets, when replacing capacitors C10, C14, C15 or C19 use an RCA 200-volt type instead of the 100- or 150-volt unit which may be found.

Information of the sort given above can often save troubleshooting and call-back time. It will be helpful to file these notes in a card index. The next group will appear soon.

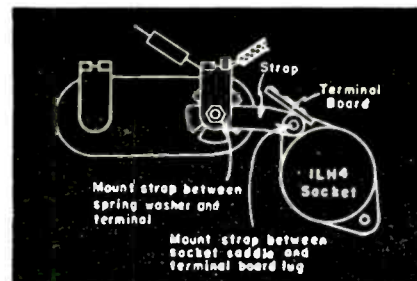

Detail of G. E. spring washer bonding strap.

**OVERWHELMING
ACCEPTANCE...**



**because they're
Radio-Engineered for
Extra listening hours**

THE VERY FACT that RCA Batteries are designed *for radio by radio engineers*, is the reason why dealers and servicemen everywhere are turning to RCA *Preferred Type* Radio Batteries for greater profit and customer satisfaction.

Each radio-engineered battery type has the right capacity for the current drain of the sets it is designed for. And all "A-B" types are engineered so that *both* sections

deliver effective voltage for the *full* life of the battery pack.

Add this to the fact that RCA is the greatest name in radio, and you'll understand why the smartly packaged and competitively priced RCA Radio Batteries lead the way today. You can get your stock conveniently and quickly from the same RCA Distributor who supplies you with RCA tubes, parts, and test equipment.



TUBE DEPARTMENT

RADIO CORPORATION of AMERICA

HARRISON, N. J.

Clearing Faults in Tele

First of a Series Showing How to Trace Troubles Quickly

• This article is the first in a series on practical television servicing. While time-saving procedures for tele troubleshooting will be described, and lengthy theoretical discussion by-passed, every effort will be made to present actual concrete examples of common troubles found in specific receivers.

Since even at this writing the majority of tele receivers in operation are of pre-war vintage, and because no great body of experience has been built on postwar sets, many of the concrete examples will concern older models. For these down-to-earth, practical repair notes, the editors acknowledge the invaluable contributions of Louis A. Loshak, a New York servicer well known to our readers, and a man who is backed by many years of television maintenance.

Outlining the Problem

A television set must receive two carrier signals, one which is amplitude modulated for the video or picture, and one which is frequency modulated for the audio or sound. Except for the power supply, antenna and "r-f chassis" consisting of an oscillator, mixer, and perhaps an r-f amplifier or the first stage of i-f amplification, the two signals are channeled into completely separate circuits.

Audio signal troubles are handled, practically speaking, as if they had occurred in an ordinary FM receiver. Therefore they will not be analyzed in this series, and will be considered only insofar as their presence and quality can give help in tracing down faults of the picture screen pattern.

In the television end of the set, the kinescope or picture tube is the output medium. It is what the output tube is to the radio receiver. All results and circuits terminate there, and that is where final efforts will register. For a quick receiver check, the kinescope is almost a self-contained oscilloscope.

To move the electron beam, single-frequency voltages of a general saw-tooth type must be generated by a 15,750 cycle horizontal oscillator and 60 cycle vertical oscillator, amplified, controlled as to wave shape, size and synchronization with the received

television signal, and applied to beam deflecting elements in or around the picture tube, whether it be of the electrostatic or magnetic deflection type. See section A of the block diagram.

To make the electron beam move so as to accurately follow the movement of the same kind of beam in the transmitting station's pick-up camera tube, synchronization circuits known as clippers and separators are required, as indicated in section B, which also includes the usual synchronization amplifier.

To create any desired picture or pattern, the intensity of the electron beam is varied as it moves over the screen. Besides the r-f, mixer or oscillator (section F) shared by the sound receiver, the i-f amplifiers, detector, video amplifiers and several accessory circuits are needed for this purpose as shown in section C.

It is obvious then, that troubles may be isolated to certain sections of the receiver by noting which of the required actions are not occurring properly.

Assume, for example, that an inoperative tele receiver is being checked on a complaint of lack of reception. Having turned on the set, and allowing a normal heating period, it may be found that there is no illumination on the screen.

As is obvious from the block diagram, lack of illumination can be caused only by lack of an electron beam. Even if the saw-tooth circuits are inoperative, at least a fixed spot of light would be seen—provided, of

course, another fault was also present. In almost all cases, this eliminates section A.

Section B is also eliminated, since it only controls section A, as is section C, which may vary the instantaneous intensity of the beam, but cannot cut it off for more than a moment.

By this process of deduction, it can be seen that the only circuits which cut off the beam permanently are in section D, to wit: 1—the high voltage supply for the cathode ray tube; 2—the d-c restorer circuit which has direct coupling to the picture tube's control grid; 3—the low-voltage filament supply of the kinescope.

Some Current Troubles

So much for the general plan of attack. It is here, however, that the dictates of practical experience become paramount. If you are checking a pre-war RCA or a DuMont receiver, leave the back on while peering through the ventilating holes to determine if the kinescope filament is lit. It will easily be evident should this not be the case.

If the filament is cold and the other video tubes do not light either, the trouble will generally lie in a burned out power fuse. All the large RCA prewar receivers had fused power supplies, as did all DuMont sets.

Another source of trouble may lie in the cover interlock switches found on all of these receivers. Check these

(Continued on page 118)

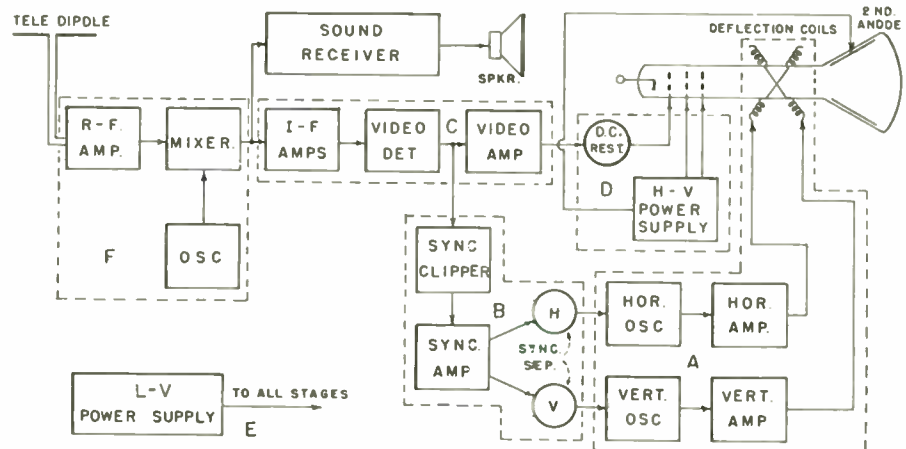

For troubleshooting purposes, the main sections of a television receiver are considered separately. Where used, electrostatic deflecting plates are considered as in the dotted area D.

Money-Making Repairs

How to Troubleshoot AC-DC Battery Radios Using New Circuits.

● The ac-dc-battery and straight ac-dc portables hitting the market this year have a number of improvements over their predecessors. While the additional circuits lead to some slight complications which make it necessary for the servicer to pause for study, once having acquired a good understanding of these radios so popular in the summertime radio men will find good profits in playing up portable servicing to the locality.

Filament circuits have always been a source of trouble in three-power and universal receivers. Partly, this has been as a result of the need to switch the filament leads in changing from battery to line operation.

Causes of Heater Troubles

A greater cause for trouble, however, has arisen from the variation in voltages which reach the filament. As explained in the August 1946 issue of RADIO & Television RETAILING, variations in the values of the relatively large number of shunt balancing resistors and erratic tube plate currents may cause changes in the voltage drops across the sensitive battery tube filaments of 3-way sets.

As shown in the diagram, the shunt resistors must have the correct value, to shunt the added plate currents out of the following filaments.

It should be remembered as well, that lowered filament voltages can result from a lowered-capacity 30 mf electrolytic, a leaky 40 mf electrolytic, an opened section in the dual rectifier, a varying line voltage, and a 1000-ohm series dropping resistor with a bad temperature coefficient.

The last named source of trouble, of course, refers to poor resistors having "positive" temperature coefficients . . . that is, those which increase their resistance undesirably

as they warm up after current is turned on.

There are, however, other types of resistors which for very good reason, are made with a "negative" temperature, so that they have a high resistance when cold, as at room temperature, and a much lower resistance when warm, as immediately after the current has been turned on.

Special resistors of this type will be found in a number of new 3-way portables and ac-dc sets this year. Servicers with experience in ac-dc sets will immediately recognize the importance of such a device, in preventing pilot-light burn-outs, the instantaneous flaring up of high-voltage series filaments, and the deterioration of such tubes long before their normal life expectancy.

A glance at the 3-section diagram shows the reason. Ordinary tube filaments have a positive temperature coefficient—that is, they have lower resistance when cold than when hot, and will permit more current to flow when cold. Section A of the diagram shows a simplified circuit of this kind.

Facts of Filament Life

In ac-dc sets, with very little resistance in the filament circuit other than the filament resistances themselves, a relatively huge current flows when the voltage is applied, and it is this current which may burn out the pilot light and damage the tubes. A burned-out pilot, as shown in B will in turn overload the shunting resistor.

As the filaments warm up, the current drops to normal. However, in an effort to prevent the pilot light from blowing out, virtually all manufacturers shunt it with a second resistor as in C, dividing the current which otherwise would pass through

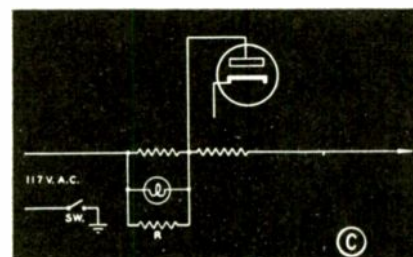
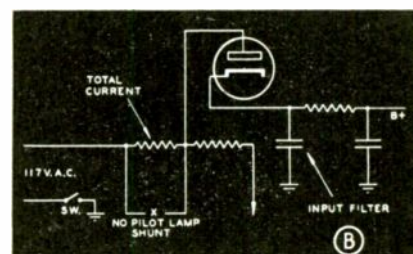
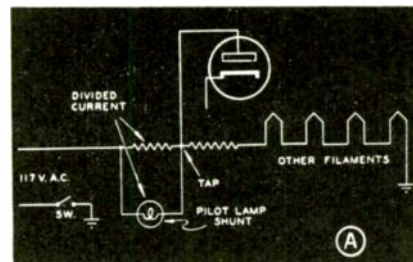

AC-DC sets use some variation of this standard series filament circuit. In A, the two resistors shown usually consist of the rectifier filament. At B, what happens when the pilot light blows. At C, a circuit used to minimize overloads on the pilot.

the light alone. Therefore, at "normal" series filament current, the pilot actually receives insufficient current, and glows very dimly.

To compensate for this, tubes such as the 35Z5 and 45Z5 incorporate the pilot shunt resistor within their envelopes, and draw line voltage for rectification into B-plus, from the mid-tap.

New Stabilizing Circuits

Because of this feature, as the tube cathodes heat up another 50 milliamperes of plate current flows through the pilot circuit, increasing the light somewhat. This results in the light flickering with the signal.

It has the disadvantage of overloading part of the rectifier filament should the set be operated with a blown pilot light. To prevent this, some servicers place an additional

Typical 3-way filament string shows how voltages are easily affected by current variations

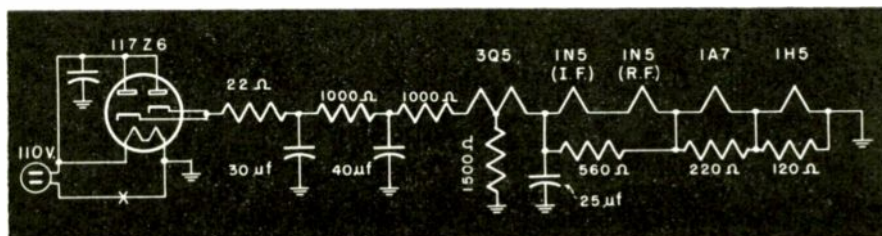

on 3-Way Portables

Offer Customers Increased Tube, Battery and Set Life

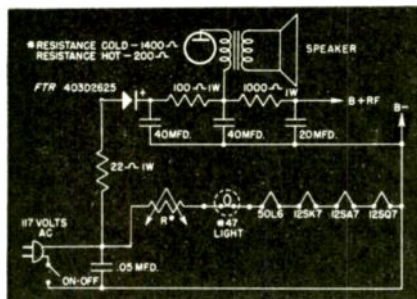

AC-DC circuit using selenium rectifier and negative temperature coefficient resistor.

shunt across the pilot. At best, however, this is a compromise.

To avoid all of this, one of the new negative temperature coefficient resistors, which are marketed by more than one company, may be found in small ac-dc sets using series filaments.

At room temperature, a typical sample of this special resistor has a value of 1400 ohms. In series with the cold filaments, the starting current will be brought down to a relatively low value. As the set warms up, the filament resistances increase at about the same rate that the special resistor's value drops to 200 ohms. Thus, all danger of tube and pilot damage is avoided.

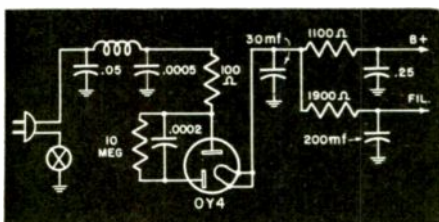

Gas rectifier circuit, Automatic Model C60.

It should be remembered, however, that the residual 200 ohms is still in the circuit even during continued operation, and in installing this unit the other series dropping resistors will be found reduced or shunted with such value as will decrease theirs by a total of 200 ohms, in this instance, as compared to other equivalent circuits.

The diagram shows another typical instance along this line, this time using as well another important development for small sets, the midget selenium rectifier such as manufactured by Federal Telephone & Radio Corp., Newark 4, New Jersey. This particular tube complement, it may

be noted, does not require an additional dropping resistor, other than the special one.

A considerable number of portables are being produced with means for recharging the batteries. Some manufacturers use a vibrator pack power supply, with a 2-volt storage cell recharged from the a-c line through copper oxide rectifiers. Such, for example, is the General Electric Model 250.

Others, like Stewart-Warner in their Models 9007-A, F and G, and Delco (United Motors Service) in their Model R-1408-9, have a second 35Z5GT operating on "line" or "charge" position of the power switch to rejuvenate the dry batteries on a slow charge. In both of these cases, the latter of which is shown, the condition of the batteries is indicated by the relative frequency at which a neon glow lamp flashes.

Innovations Save Power

Automatic Model C60 shows a further interesting innovation in the form of an 0Y4 gas rectifier tube. Since the cathode is of the cold type, without a filament, very little power is consumed on line operation, with a corresponding absence of series a-c filament troubles.

In this case, the "charge" position of the 3-way power switch arranges for a rejuvenating charge of the dry batteries at a relatively minute expense. The circuit is shown.

Battery-saving devices, as they are known, are sometimes used in the form of a switch shunted across a re-

sistor in series with the series filaments.

When, in the normal course of operation, the A-battery voltage becomes low, the switch can be closed permitting operation for an extra length of time before the battery is too far gone.

More New Features

Another circuit which radio men will encounter in the new 3-way radios is that used in the Philco Model 46-350. The plate circuit of the 1T4 265-kc i-f amplifier stage is coupled back to its own screen grid from a tertiary winding in the second i-f transformer, thus increasing the sensitivity considerably by means of positive feed-back.

While all of these circuits are relatively new to wide-scale employment in receivers, they bid fair to become standard in many manufacturers' lines. No doubt variations will appear, but the basic ideas require circuits which cannot be greatly different from those shown here.

The new portable sets have not all been announced, by any means, at this writing. To make the most of the opportunity for new service business which comes with summertime radios, alert retailers will watch for new circuits and learn how to troubleshoot and install these innovations wherever they appear. In fact, why not advertise that knowledge with a window streamer suggesting a "tune-up, tube-up, check-up" on new and old 3-way radios?

Delco Model R 1408-9 uses two 35Z5 tubes with series filaments across the 110V line

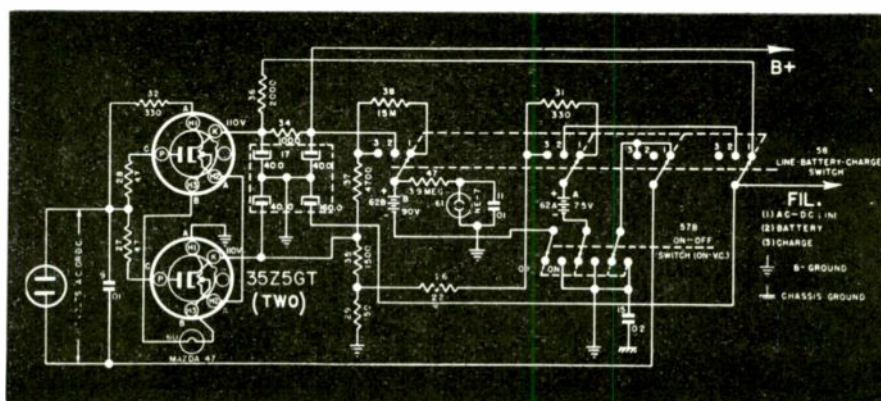

EVERY SECOND COUNTS-

FOR RADIO SERVICE DEALERS . . .



**FAMOUS-MAKE CLOCK
IDENTIFIES QUALITY STORES
SELLING
SYLVANIA RADIO TUBES**

Once you place this big, colorful Telechron electric clock—with its “Radio Service” face—in *your* store, you’ll have an attractive sales aid that identifies your business . . . through every second of the day . . . as carrying the finest line of radio tubes made.

Through far-reaching advertising campaigns, your customers are being advised of the advantages of placing Sylvania “quality-controlled” radio tubes in their equipment. By displaying this on-the-spot sales help you’re telling them that you sell these highest quality tubes. Get this wonderful sales aid now!

ORDER FROM YOUR SYLVANIA DISTRIBUTOR or write SYLVANIA ELECTRIC PRODUCTS INC., Emporium, Pa.



SYLVANIA

MAKERS OF RADIO TUBES; CATHODE RAY TUBES; ELECTRONIC DEVICES;

**...WITH SYLVANIA'S COLORFUL NEW CLOCK
TO HELP SELL YOUR SERVICE!**



- Fifteen-inch diameter!
- Bright white face ...black numerals!
- Minute and hour hands in black...unique second hand in attractive red!
- The words "RADIO SERVICE" in green and black. The word "SYLVANIA" in identifying green!
- Radio tube in silver and black...design of carton in familiar green and black!
- Telechron movement, sealed in oil; case in brown crinkle finish with silver-colored rim around face! Nominally priced at only \$7.50!

ELECTRIC



FLUORESCENT LAMPS, FIXTURES, WIRING DEVICES; ELECTRIC LIGHT BULBS

New Tri-Power Radio

Complete Alignments, Parts and Schematics for Latest AC-DC Battery Sets. Hitherto Unpublished Schematics.

WESTINGHOUSE Model H-148 is the company's newest tri-power portable. The accompanying diagram is published in advance of the distribution of printed service information, through courtesy of the manufacturer.

A few steps suffice for fast alignment of this portable. Connect an output meter across the speaker voice coil for visual indications of peak adjustment, while the volume control is set for maximum output and the signal generator output is kept attenuated as much as possible to avoid AVC action.

The i-f stages are adjusted by feeding the 455 kc signal generator's output into the 3E6 i-f amplifier's control grid, pin 6, through a .1 mf capacitor, and varying primary and secondary of the 2nd i-f transformer for maximum output. Both of these trimmers are found atop the can located behind the 3E6.

A similar adjustment is made to both tuned circuits of the 1st i-f transformer, located beside the ganged tuning capacitor, while feeding the 455 kc signal through the same capacitor to the control grid, pin 6, of the 1LA6 converter.

For a final peaking of the i-f stages, use a 200 mmf capacitor in series with the hot lead of the generator and the antenna terminal, with the generator still on 455 kc. During the entire i-f alignment the receiver's tuning dial is left at 550 kc, or as near to this point as possible without picking up interfering signals from powerful transmitters.

Since the padding adjustment is preset, only the oscillator and antenna trimmers need be adjusted for r-f alignment. The oscillator trimmer is found atop the smaller-plate section of the variable, towards the front of the radio, and the antenna trimmer is behind it, atop the larger-plate section.

With the signal generator on 1600 kc, feeding to the antenna terminal through a 200 mmf capacitor, and with the dial pointer mechanically balanced and then carefully rotated to 1600 kc on the dial, peak the oscillator trimmer for maximum output on a modulated signal.

The final adjustment is made with the generator disconnected from the receiver, but coupled either by stray radiation or a 2-turn loop of wire lying

several inches away from the receiver's loop. With the generator and the radio dials at 1400 kc, vary the antenna trimmer for maximum output, and the alignment is completed.

CLARION Model 11011 incorporates a battery power switch with a large lever knob so oriented that the ac-dc power plug must be removed for battery operation. The easy alignment is made with the volume control fully on, and the output from the signal generator as low as possible, to prevent AVC operation from interfering with correct alignment.

Although a "floating ground" is used, it is best to insert isolating capacitors in both leads from the signal generator to the receiver during alignment, as is customary with ac-dc radios.

For i-f alignment, couple the 455 kc generator through a .1 mf dummy antenna capacitor to the 1R5 mixer grid, pin 6, or the stator of variable capacitor rear section C1A, which has been set to a fully open position. Vary the trimmers atop both i-f transformers for maximum output on the output meter.

For r-f adjustment, with the variable

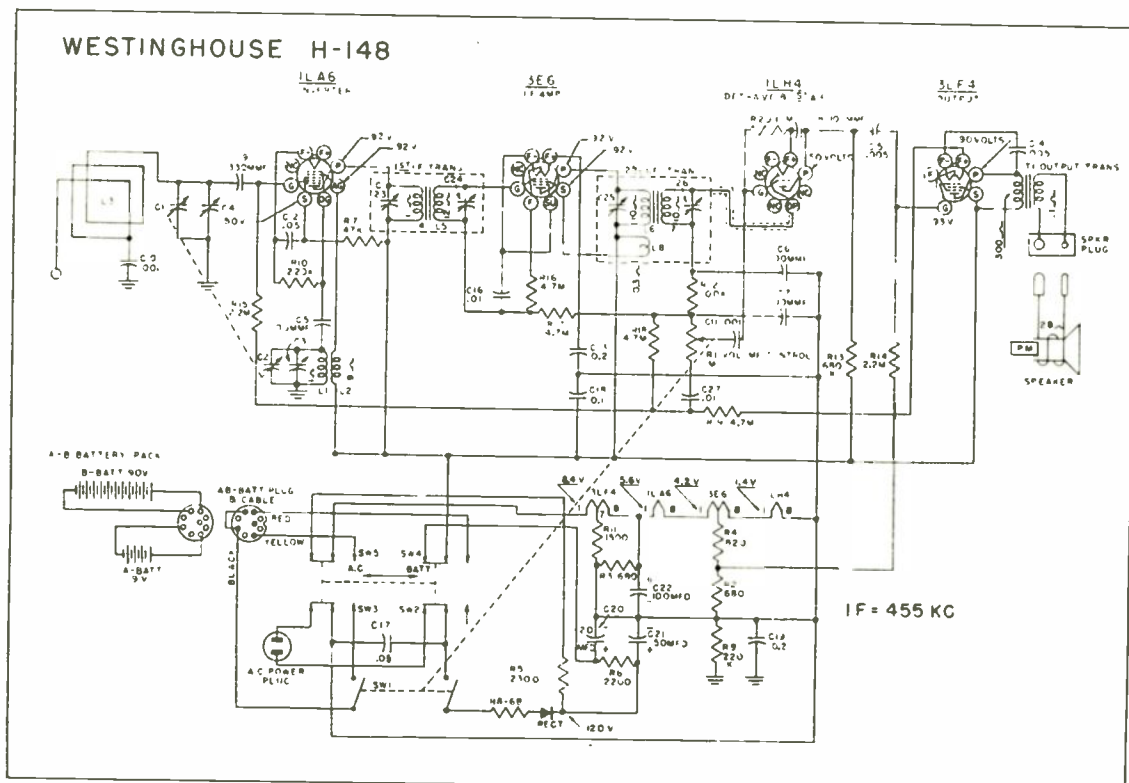

Westinghouse Model H-148 uses four tubes and a selenium rectifier. Within the i-f amplifier stage's output transformer, a feedback winding L8 couples back to the screen of the 3E6 for increased sensitivity.

Circuits

capacitor at the same fully open setting, tune the generator to 1600 kc and couple to the antenna lead stapled inside the cabinet through a .00025 mf capacitor. The generator's ground lead should also be connected, through its isolating capacitor (about .2 mf) to the ground wire stapled alongside the antenna wire.

After varying oscillator trimmer C1B atop the front section of the ganged capacitor, tune the signal generator to 1400 kcs, with the receiver dial at the same figure, and adjust trimmer C1A for maximum output.

The alignment procedure, being simple and quick, should be repeated if an output reading of .4 volts at 50 milliwatts level across the voice coil of the speaker cannot be obtained with a 400 cycle modulated signal input.

LEWYT Model 711 service data is submitted through the courtesy of the manufacturer, printed literature not being distributed at this writing.

For i-f alignment, remove the chassis from the case, and note that the adjustments are located through the holes on the top and bottom of each i-f transformer. These units are K-Tran transformers, and require a square end tuning wrench, .124" maximum on a side. The adjustment should rotate

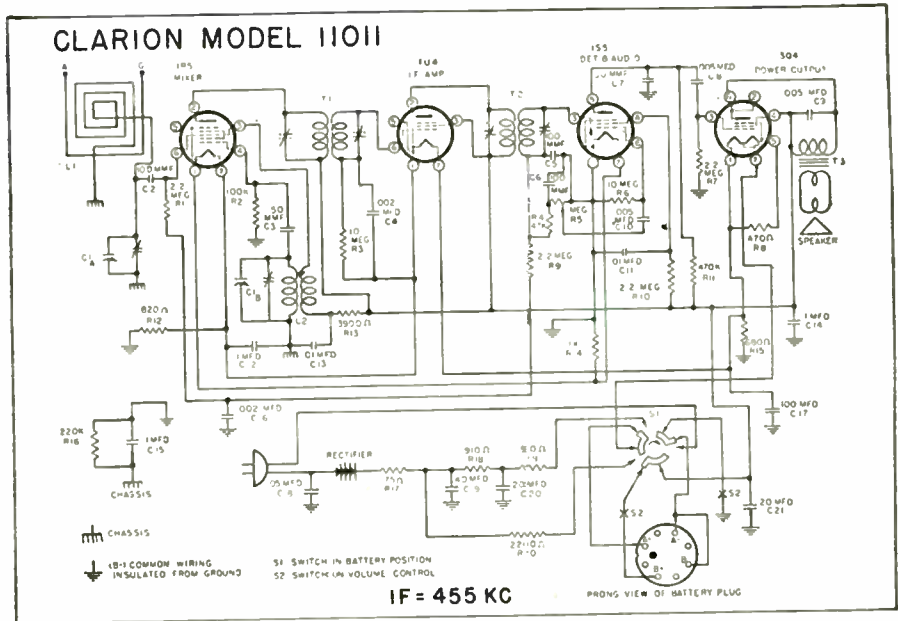

Clarion Model 11011 uses a separate winding on the loop in order to couple the outside antenna. Four tubes and a selenium rectifier are employed.

easily, and under no circumstances should force be used since such treatment may damage the K-Tran.

Set the signal generator to 455 kc and completely mesh the plates of the variable capacitor. Align the 2nd i-f and then the 1st i-f transformers to maximum output readings, reducing the output of the signal generator but not the volume control when necessary.

The r-f stages are aligned with the batteries in place. Fully open the variable capacitor, and set the pointer horizontal. Next, mesh the capacitor about 30 degrees until the pointer is opposite a dot provided on the pointer background.

Set the signal generator to 1400 kc, and adjust the oscillator and antenna

trimmers for maximum output. Now tune the generator to 600 kc and pick up the signal on the receiver. A dot is provided on the pointer background for checking the location of the pointer at 600 kc.

Test the antenna trimmer for adjustment. If out of adjustment, leave the trimmer in the original position and vary the slack wire on the receiver loop for maximum output, fastening it down with scotch tape when finished.

Reset the signal generator and receiver to 1400 kc as before, and adjust the antenna trimmer. Finally, place the chassis in the case and make sure the pointer lines up with the dial calibrations.

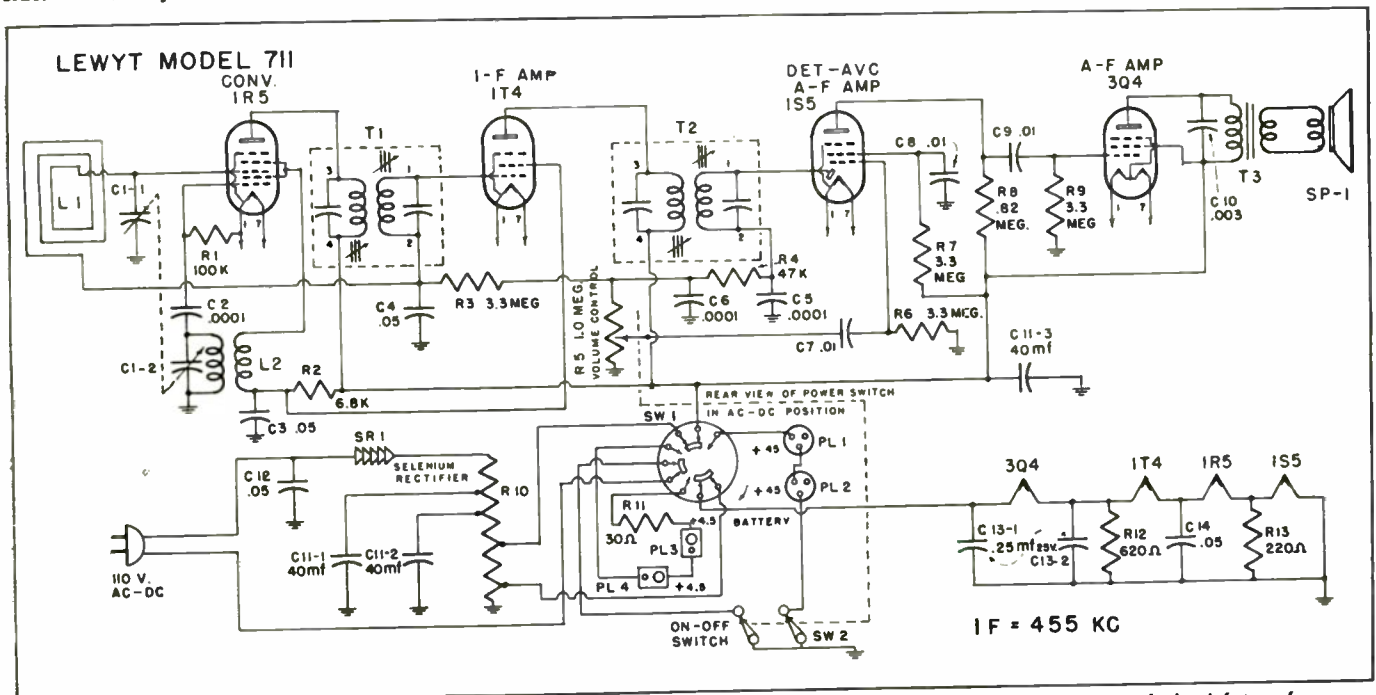

Lewyt Model 711's straightforward circuit employs a selenium rectifier plus four tubes, with permeability tuning of the i-f transformers.

Restaurants Want Quality PA Music



Amplifier and control rack in anteroom distribute music through Stouffer's, Cleveland.

Restful Sound at Mealtime Is Fast Gaining Favor

• Restaurant owners have a new topic of conversation nowadays. From coffee, they've turned to Chopin, and for sweetening they're adding more Shubert than sugar. For once again, restaurateurs have become sound-conscious in a big way.

PA dealers may remember many a discouraging story or experience involving unsatisfactory sound equipment installations in eating places some years ago, and the same sort of remembrance in the mind of potential customers' has undoubtedly been a big factor in delaying the present rebirth of interest.

The experience of the leaders in high quality sound installations has, during the past two years, revealed a strong new demand. As in every other line of business, the gradual stiffening of competition for the best slice of the dining-out trade is causing restaurant men to modernize, enlarge, and merchandise their institution. The leaders in the field having discovered the value of quality music in the dining room, all others are hastening to catch up. The key to selling sound to restaurant men is high quality music. An offensive distortion, excessive loudness, irritating shrillness or poor choice of program material can drive the patrons away in droves.

Three Guiding Rules

These faults, which pretty well killed sound sales in this field before the war, must be corrected by careful study of the requirements in individual cases. Nevertheless, several rules will be found to hold true in most instances.

First of all, the sound must be produced at extremely low level. It is essential that no diner be subjected to irritating loudness as a result of sitting near a speaker which must cover a large area.

Secondly, then, this requires the use of a great many speakers, each having a very limited range. But in large restaurants, the central area of the dining rooms can therefore be

conveniently covered only by mounting the speakers into the ceiling; requiring the use of a third general rule of spacing overhead outlets closely.

Another factor enters at this point. Loudness, as we all know, is relative. You can hear a pin drop in a quiet room, but in a noisy restaurant, a low-level sound reproduction may be badly drowned out.

This condition can be quite irritating to customers who are attracted to the room by the lure of music with the meal, while the callous solution of turning up the sound level will inevitably cause as much loss of goodwill as it might gain.

In such a case, which is really the usual thing in this business, the correct solution lies in a certain amount of acoustic treatment of the rooms. This, in general, is done on the ceiling. The installation of a "drop" ceiling will generally provide the easiest approach to the problem.

A Successful Job

In the installation of a low level sound distribution system in the new Stouffer's Shaker Square Restaurant in Cleveland, Ohio, are illustrated some of the typical methods as practiced by the Smith-Meeker Engineering Company of New York, N. Y. The newly-constructed Oval Room was easily permeated with an even level of high-fidelity sound.

Nine speakers, spaced ten feet between centers, were mounted in the 14-foot-high ceiling. Figuring a 30-degree conical-shaped projection of the high frequencies from Western Electric type 728B loud speakers, a feeling of liveness and "presence" was obtained at every chair.

In all, three cocktail lounges and three dining rooms, covering 3,000 square feet of floor space, required 29 speakers arranged in two strings and driven by two Western Electric 118A and 124D amplifiers rated at 50 watts and 20 watts respectively. A line preamplifier, monitor and control panel are also used.

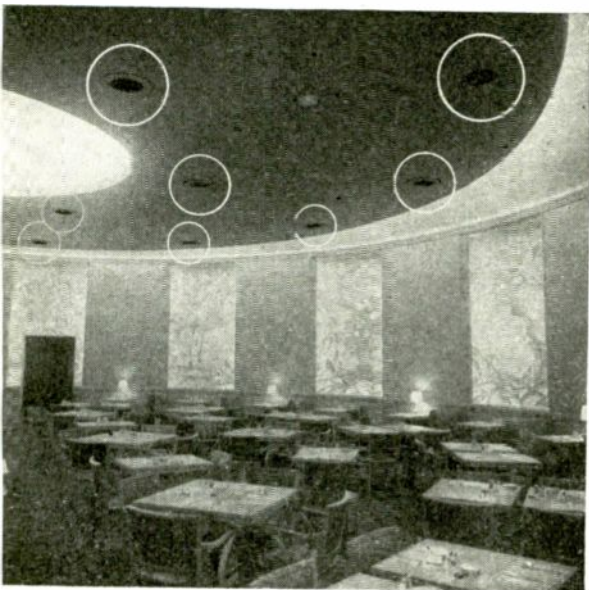

Oval room speakers spread sound smoothly.

Older room uses wall units at higher level.

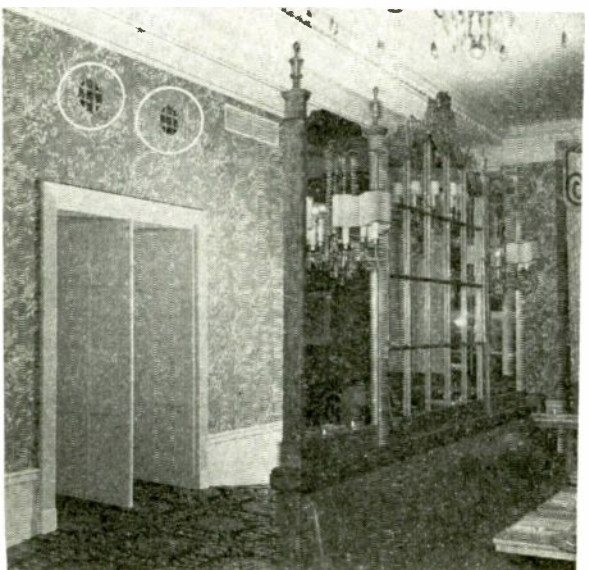

Now

... you can test for volts, amperes or watts with this one small, compact instrument

No larger than a man's hand, no heavier than an average novel, as rugged as a bull-pup—that's the Simpson Model 390, the first appliance tester ever made that gives you volt, ampere and wattage readings all in one compact instrument.

Here is a tester that will slip easily into a large pocket (it is 3" x 5 7/8" x 2 1/2"); so lightweight that it is the most completely portable appliance tester ever made (it weighs only a pound and a half); so ruggedly built, from molded black bakelite case to sturdy Simpson dynamometer movement, that it is designed for hard and continuous service.

The Break-In plug, furnished with the instrument, has 4 color-coded leads which are first attached to the instrument. Next, the plug is placed in an electrical outlet and the appliance to be tested is plugged into it. Voltage readings will then register. In order to test for amperes or watts, all that is necessary is to press down one of the two buttons at the bottom of the panel.

The range of uses for this volt-amp-wattmeter is almost unlimited in checking line voltage, current drain and power consumption, the three simple tests which will diagnose most cases of electrical trouble. In fact, practically any household electrical appliance that has a motor or a heating element, can be tested by the 390, as well as certain industrial installations.

The unusually big scale of the meter is extremely easy to read. A unique feature is the uniform wattmeter scale with its equal graduations, permitting more accurate readings.

And accuracy, of course, is the distinguishing feature of this, as of all Simpson instruments. The years of experience in precision engineering and manufacturing that have made Simpson slogan "Instruments That Stay Accurate" an accepted truth throughout the electrical instrument industry, are evident in the Model 390. Aside from its unique features, in quality alone it has no equal among appliance testers. It is that quality, "the indispensable component of every Simpson instrument", which makes an investment in the Model 390 an investment that will return a rich yield in satisfactory service throughout the years.

SIMPSON ELECTRIC COMPANY
5200-18 W. Kinzie Street, Chicago 44, Ill.
In Canada, Bach-Simpson, Ltd., London, Ont.

Simpson

INSTRUMENTS THAT STAY ACCURATE

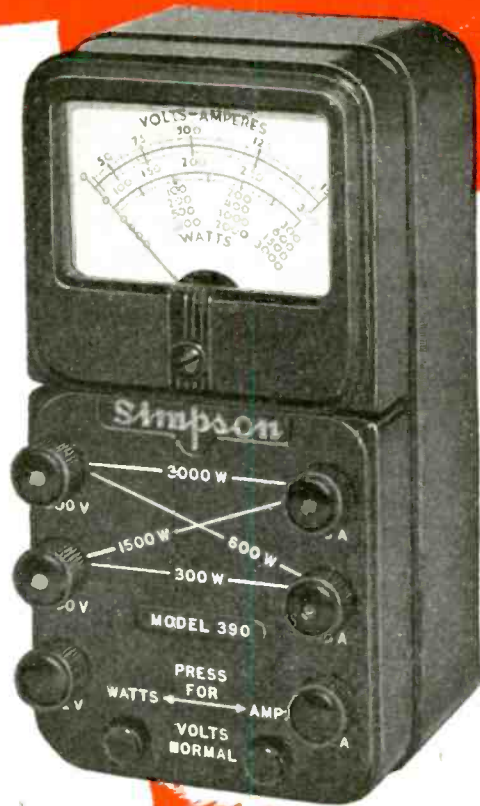

The Simpson Model 390 Volt-Amp-Wattmeter

Use Model 390 for Testing

Refrigerators	Roasters
Deep Freezers	Hair Dryers
Washing Machines	Hair Waving Machines
Ironers	Electric Blankets
Irons	Heating Pads
Toasters	Neon & Fluorescent Signs
Motors	Hot Plates
Electric Heaters	Vacuum Cleaners
Radio Sets	Sewing Machines
Waffle Irons	Floor Sanders
Percolators	Floor Polishers
Curling Irons	Food Mixers
Oil Burners	Air Conditioning Units
Fans	
Lamps	
Health Lamps	

and all similar appliances

RANGES—A.C. Current, 60 cycles
Volts: 0-150, 0-300.
Amperes: 0-3, 0-15.
Watts: 0-300, 0-600, 0-1500, 0-3000.
Size: 3"x5 7/8"x2 1/2". Weight 1 1/2 lbs.
Shipping weight 3 lbs.
Price, with Break-In plug and leads\$39.50
Leatherette carrying case, with leads compartment 4.00
Genuine leather carrying case, with leads compartment..... 8.00

Write for our Bulletin 14-F for the complete Simpson line of Radio and Television Test Equipment, and Panel Meters.

Newest Equipment for PA Profits

Thordarson AMPLIFIERS

8, 25 and 50 watt amplifiers, a pre-amplifier and a booster form a new Thordarson line. The 8W unit has one 115-db microphone and one 72-db phono high-impedance channels, with high frequency attenuation tone control and a response flat within 1 db from 50 to 10,000 cycles. The

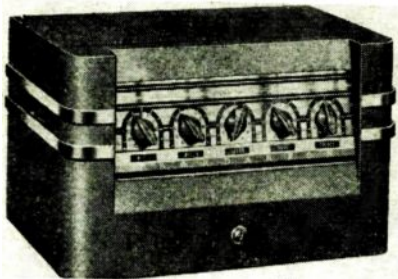

25W unit, as shown, containing 3 separately controlled inputs and individual bass and treble controls, is flat to 1 db from 30 to 15,000 cycles. The 50W model is capable of 65W peak output, and has 3 microphone and 2 phono channels, all separately controlled. The pre-amplifier unit drives a large number of 25W booster amplifiers in a rack and panel mounting. Thordarson Elec. Mfg. Div., Maguire Industries, Inc., 936 N. Michigan Ave., Chicago 11, Ill.—RADIO & Television RETAILING

E-V CRYSTAL MIKE

Model 905 crystal microphone has a frequency response substantially flat from 50 to 7,500 cycles, with an output level of -54 db. The polar pattern is non-directional at low frequencies, becoming directional at higher frequencies. Employs a high-capacity, high-impedance moisture sealed crystal, with a 22-degree fixed-tilt head, and a satin-chrome finish. Electro-Voice, Inc., Buchanan, Mich.—RADIO & Television RETAILING



Shure VERSATEX MIKE

This versatile crystal mike is for table top, hand, or floor stand use. With 7' cable, output is semi-directional. 53 db



below 1 V/Dyne/Sq.Cm. Plastic case. Designed for P.A. recording. Shure Bros., Inc., 225 W. Huron St., Chi. 10, Ill.—RADIO & Television RETAILING

Kwikheat IRON

Two new sizes—225 W and 450 W—have been added to the Kwikheat line of soldering irons. Like the preceding models, the temperature of the irons is controlled by built-in thermostats. Seven interchangeable tips, including very heavy, light thin, offset and dip-cup types, can be used. Sound Equipment Corp. of Calif., 3903 San Fernando Rd., Glendale 4, Calif.—RADIO & Television RETAILING

Turner HAND MIKE

Model 20X uses a Metalseal crystal which withstands abnormal humidity conditions, with good response from 50 to 7,000 cycles. Effective output level is 54

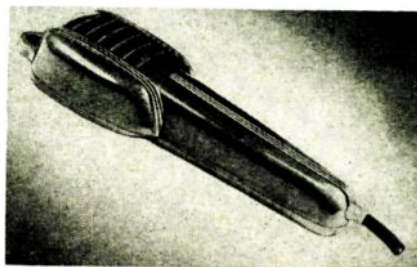

db below 1 volt/dyne/sq. cm. A high impedance unit, it is finished in baked bronze enamel, and comes with 7 feet of cable. The Turner Co., Cedar Rapids, Iowa—RADIO & Television RETAILING

Masco MUSICAL AMPLIFIER

Model MAP-120 is a 12-watt musician's amplifier. For fingertip operation of the controls while playing, a recessed panel on top mounts the tone and volume controls. Two separate inputs provide for instruments or microphones, with .015 volts input driving the system to 12 watts output at less than 5% distortion, over a fre-

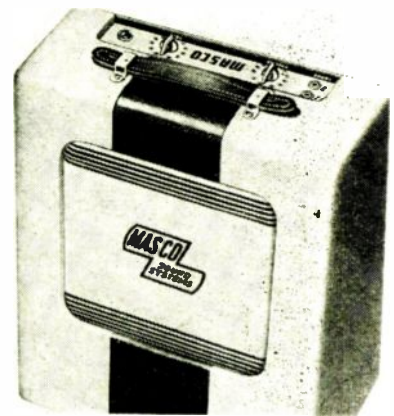

quency response within 2 db from 50 to 10,000 cycles. Hum level is 20 db below .006 watt zero level. The amplifier and a 10" heavy duty PM speaker are contained in the slant-front carrying case. Mark Simpson Mfg. Co., Inc., 32-28 Forty-Ninth St., Long Island City 3, N. Y.—RADIO & Television RETAILING

University AIRTIGHT SPEAKERS

Models MSR and MM-2TC are designed to operate in the most adverse surroundings found in industrial plants such as laundries, dye houses, etc. Impervious to dust, wind, and most industrial chemicals, they will operate under water and are explosion-proof, an essential feature in mines, flour mills and powder factories. Model MSR, shown at right, has a dispersion angle of 360 degrees, while at the left is a model MM-2TC, having a dispersion of 120 degrees. Both handle 15 watts. University Loudspeakers, Inc., 225 Varick St., New York 14, N. Y.—RADIO & Television RETAILING

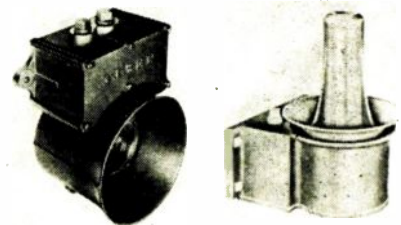



A SIGN OF SUCCESSFUL SERVICING

Bradley's has all fifteen RIDER MANUALS

A leading radio publication recently featured Bradley's of Red Bank, N. J. on an editorial spread, which told of the profitable efficiency of its service department. Characteristically, Bradley's has all fifteen RIDER MANUALS, depending upon them for authoritative information supplying all necessary servicing data on American-made receivers issued from 1930 to 1947.

From no other single source is this information available. In no other way can you have at your fingertips the information you need to diagnose troubles in any and all radio receivers that come to your shop for repair; receiver schematics, voltage data, alignment data, resistance values, chassis layouts and wiring, and trimmer connections.

Volume XV, covering sets issued during 1946, includes the exclusive Rider "clarified-schematics" which break down the composite diagrams of hundreds of complicated multi-

band receivers into individual schematics of each circuit as it exists with each turn of the wave band or equipment switch.

Also with each copy of Volume XV is included the 150 page "How It Works" book, a practical guide to the theory of operation of the new technical features in the latest receivers. These exclusives are but two of the many important features in Volume XV, which also includes all popular "Ham" communication receivers, Scott receivers, Magnavox RA combinations and record player combinations.

RIDER MANUALS provide a systematic, compact, indexed data service, always in order, always ready with the information you must have for efficient, time-saving, profitable servicing. Year after year, after year, RIDER MANUALS keep pouring out profits for servicemen. Owners of Volume I, who bought it 17 years ago are still deriving benefits from it.

In spite of greatly expanded production, demand for RIDER MANUALS still exceeds supply. Place your order today.

JOHN F. RIDER PUBLISHER, INC.

404 FOURTH AVENUE, NEW YORK 16, N. Y.

Export Division, Rocke International Corp., 13 E. 40th St., New York City. Cable ARLAD

VOLUME XV — JUST OUT!

2000 pages, plus 150 page "How It Works" Book
\$18.00 complete

Volumes XIV to VII (each volume)..... 15.00

Volume VI..... 11.00

Abridged Manuals I to V (one volume).... 17.50

Record Changers and Recorders..... 9.00



OTHER RIDER BOOKS

Inside the Vacuum Tube Solid concept of theory and operation . . .	\$4.50	Vacuum Tube Voltmeters Both theory and practice	\$2.50
Understanding Microwaves Provides foundation for understanding . . .	6.00	Automatic Frequency Control Systems —also automatic tuning systems	1.75
Radar Entertaining, revealing, in lay language . . .	1.00	A-C Calculation Charts Two to five times as fast as slide rule . . .	7.50
The Cathode Ray Tube at Work Accepted authority on subject . . .	4.00	Hour-A-Day-with-Rider Series— On "Alternating Currents in Radio-Receivers" On "Resonance & Alignment" On "Automatic Volume Control" On "D-C Voltage Distribution"	\$1.25 each
Frequency Modulation Gives principles of FM radio . . .	2.00		
Servicing by Signal Tracing Basic method of radio servicing . . .	4.00		
The Meter at Work An elementary text on meters . . .	2.00		
The Oscillator at Work How to use, test and repair . . .	2.50		



This new Rider Book, soon to be announced, will be of lasting usefulness to everyone interested in any phase of radio.

RIDER MANUALS

MEAN SUCCESSFUL SERVICING

Will your soldering iron support a new home ?

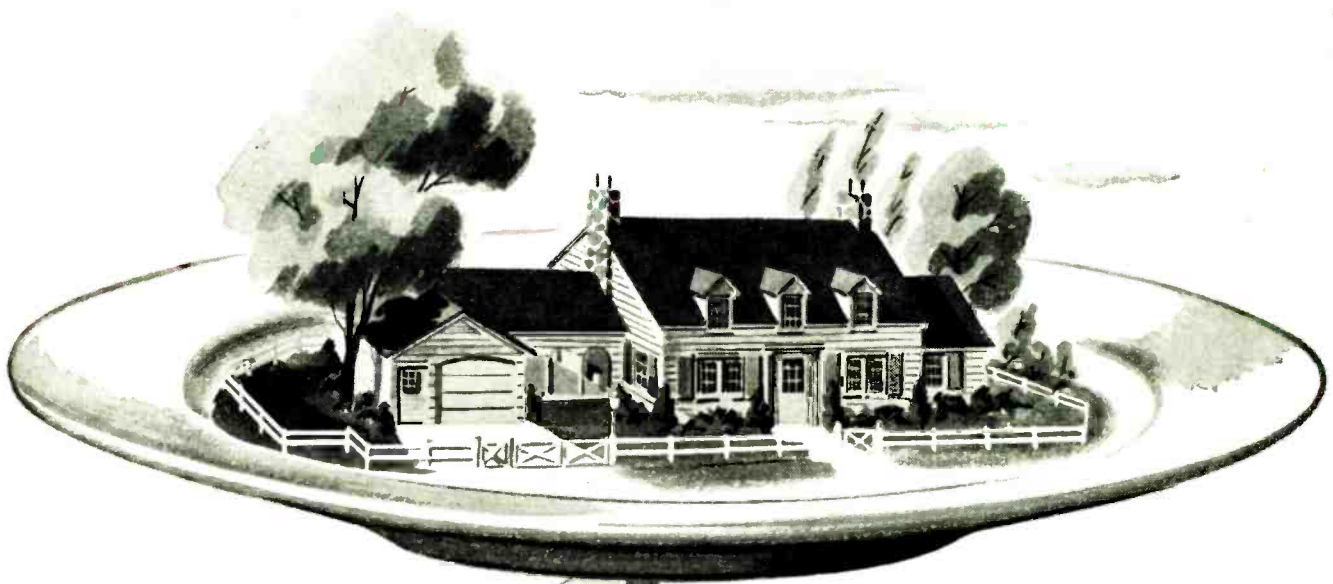

Yes!

We don't blame you or any radio technician for wanting a new home only you can't get it by wishing. You can with your soldering iron. Every electronic device you service requires the use of your soldering iron. Therefore, anything that gives you more time behind your soldering iron means more cash for you.

NEW BOOKLET FULL OF MONEY-MAKING IDEAS

What can you do to make more money? This question is answered by a straight-shooting booklet called "Keep Your Iron In The Fire", part of a complete service-sales program initiated by IRC in the interest of servicemen. Ask your IRC Distributor for your copy . . . today. International Resistance Company, 401 N. Broad Street, Philadelphia 8, Pennsylvania. In Canada: International Resistance Company, Ltd., Toronto, Licensee.

HOT TIP* Canvass your locality for service business with a postcard mailing. Business reply mailing pieces are available through your IRC Distributor . . . 2 colors, imprinted with your name and address. *From "Keep Your Iron In The Fire"

IRC



11

SHORT CUTS TO SERVICING

"Quick, easy and efficient" . . . that's how servicemen describe IRC's 11 Tap-In Shafts. No fiddling or fussing with shaft inserts or "build-ups" . . . no money tied up in stocks of exact replacements. A smart tap of the hammer and the tapered surfaces of control and shaft lock together, forming a permanently tight attachment.

In combination with the IRC Century Line of Volume Controls, these 11 Tap-In Shafts are the logical answer for over 90% of your replacement problems. Save you time and money. Time saved means extra time for other money-making jobs . . . money saved means greater profits. The latest edition of the popular IRC Volume Control Replacement Manual is now available. Contains information on nearly all models up to 1946, complete listings for the 1941-42 sets coming in now for repair. 156 pages. 25c at your IRC Distributor. International Resistance Company, 401 N. Broad St., Philadelphia 8, Pa. *In Canada:* International Resistance Co., Ltd., Toronto, Licensee.

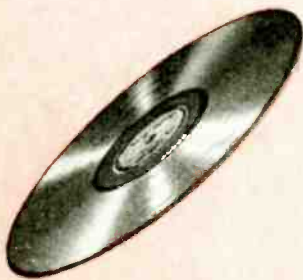

YOU'RE ON THE AIR! A sensational new one minute spot announcement to boost service business has just been released by IRC through IRC Distributors. Listen in and cash in on this promotion!

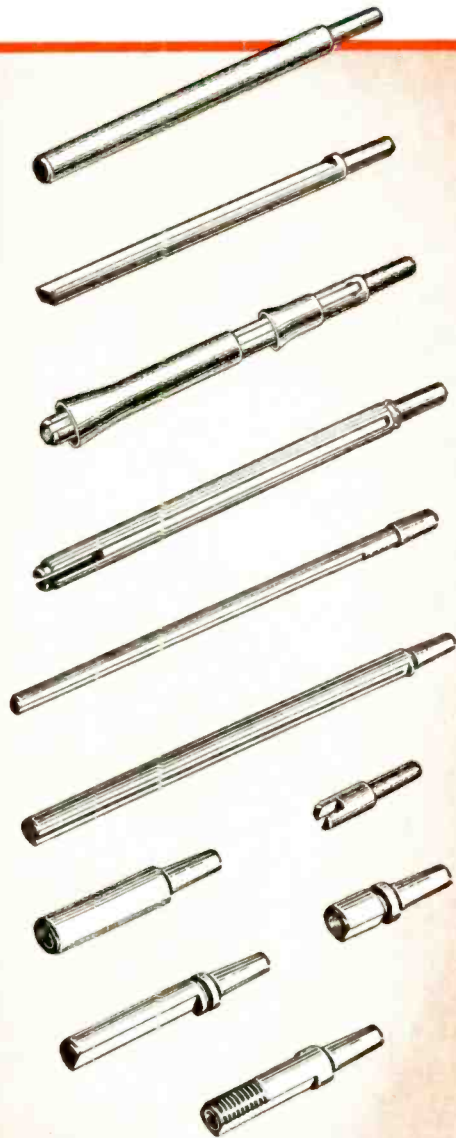

INTERNATIONAL **IRC** RESISTANCE COMPANY

Wherever the Circuit says Ω

Simple Meter Repairs

Tips on Short-Cuts Used by Test Equipment Servicers. How to Fix Minor Faults Easily

● Be he ever so careful, there comes a time in every servicer's career when he tries to measure volts with a millimeter. The damage, while embarrassing, is not necessarily fatal.

It need hardly be pointed out that any but a thoroughly trained meter repairman should never attempt complicated repair jobs on delicate indicating instruments of the precision calibrated type.

Nevertheless, there are certain minor damages, especially on inexpensive or outmoded meters, which the servicer might well correct on his own. The repairs, while never up to factory standards, may be quite

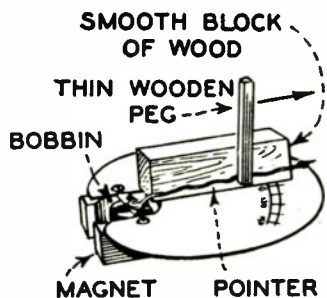

How to straighten meter knife-edge pointer.

satisfactory for ordinary requirements, particularly in cases where time is a factor. Here are the general steps to take.

First the works should be disconnected, and removed from its case. Shunts, series resistors, and the like should be removed and disconnected so that the movement can easily be worked upon. A few sheets of white paper spread over the bench top will aid the servicer in seeing the small parts.

Check the moving coil for continuity and shorts. Look to see whether or not the coil springs have been damaged by heat. This can be detected by a dull brown look, possibly with the solder joint melted open (not broken or pulled apart). If the springs are softened, and the coil open or shorted, the inexperienced meter repairman had best purchase a new movement or a complete new meter from the factory.

If the springs or coils are not damaged, and the pointer has been bent around the stop, realign it perpendicular to the bobbin, and straighten

it to approximately its former shape. Final straightening can be done by placing a small square-sided piece of wood on the dial face and wiping the pointer smooth against the side with a thin peg of wood as shown. Some pointers are constructed of aluminum

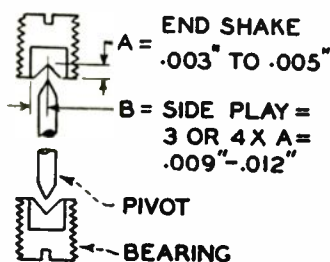

Correct values of pivot-bearing play.

tubing and care should be exercised so as not to flatten the tube.

Now check the bobbin. See that it is square and swings free and clear in the air gap. See if the pivots are square against the bobbin. If the bobbin or the pivots are bent, back the bearings off and slip the bobbin out of its supports before making any bends.

Do not use the bearings as a fulcrum for straightening operations. Check the angles by eye, and correct if necessary with a pair of long nose pliers. If you have the pivots clear, inspect them with a magnifying glass or a jeweler's loupé for bent, broken or scored points. They should be cone-shaped with the tip rounded off, and highly polished. If they are not, the movement will stick, and more than likely the bearings are cracked. These should be removed and also inspected.

Do not use a needle to search for cracks, as a needle will start cracks in a sapphire bearing. The cracks start as tiny lines, and it takes experience to detect them, which means that an uneducated eye will let a

Alternate methods of straightening springs. Triangle at right represents supporting post.

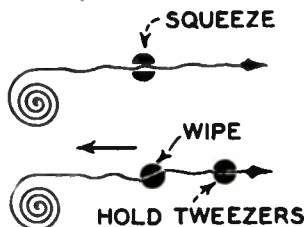

bearing pass that will shortly become defective. While the bearings are free they should be cleaned with a wisp of cotton dipped in pure grain alcohol. Meter bearings are never oiled. They work dry.

To repair defective pivots requires that they be removed from the bobbin, chucked, and spun at 200 to 500 RPM while their tips are reground with a piece of #0000 emery paper. This is quite an operation involving the unwinding of the coil, the removal of the pivots, and their restaking or crimping back into place afterwards. Here, too, the advice of experienced meter repairmen is to purchase a complete new movement.

Now replace the bobbin in its supports and screw down the bearings very slowly, and carefully. The end play or shake should be adjusted to

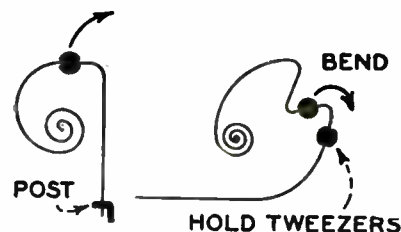

For major bends, work 90 degrees away.

make it from three to five thousandths of an inch as illustrated. Do this by trying the side movement of the pivot point. This point will move three and four times further sidewise than it will endwise. Adjust until the end play is barely perceptible.

The springs should now be straightened, and afterwards resoldered to the lug if necessary. Use two pairs of tweezers, and remove all the kinks either by a series of squeezes, catching the bend between the flat of the tweezers, or by holding the spring fast with one tweezers and "wiping off" the bend with the other.

While the repairs outlined here are among the simplest, it must be reiterated that a great deal of care is required even for minor adjustments. More details will be found in a coming issue, in which will be illustrated the matter of pointer balance, calibration, fine soldering, and manipulation of springs. For repairs on new or precision meters, however, be sure to see your instrument supplier.

For Better Testing!

NEW GENERAL ELECTRIC SERVICE TEST EQUIPMENT FOR UP-AND-COMING SERVICE MEN

IT'S NEWS—and good news for service men who want to see work move into the shop fast—and out again. The new line of General Electric service test equipment has been designed to do just that. Quick, accurate, efficient service work means more dollars, more satisfied customers and more business.

First in this list of fine equipment is the Capacitance-Resistance Bridge, YCW-1. Check the jobs it can do to make your job easier.

- Measures capacitance from .000005 to 200 microfarads $\pm 1\%$ in three convenient ranges.
- Measures resistance 5 ohms to 20 megohms $\pm 2\%$ in two convenient ranges.
- Power factor is measured on the high capacitance range by a potentiometer in series with the standard which has a scale of 0 to 50 percent.
- Insulation resistance is indicated directly by a panel meter. A 0 to 2500 megohm range is covered with a dc voltage supply of 500 volts.
- Electrolytic leakage test is provided which will indicate whether the leakage is excessive.
- Polarizing voltage — a continuously variable dc voltage supply from 0 to 500 volts is available for polarizing the electrolytic condensers.
- Turn ratio of transformers is measured by switching one coil or section of a coil into the Wien bridge circuit and the other section of secondary coil is compared with it.

The YCW-1 is compact, portable and needs only to be plugged into any 115 volt 50 or 60 cycle line to operate.

GENERAL ELECTRIC ELECTRONIC VOLTOHMETER

The Type PM-17 permits measurement of actual operating voltages without excessive circuit loading or detuning. In addition to dc voltages, both audio and radio frequency voltages may be measured from 200 cycles to more than 100 megacycles. An ohmmeter circuit is included for convenience in measuring high and low ohmic values of resistance. Fluctuations in line voltage and changing of tubes have little or no effect on calibrations. Entirely portable, it can be carried anywhere and can be plugged into any 115 volt 60 cycle line. Supplied with the Electronic Voltmeter are two alligator clips, two pairs of leads, and an r-f probe.

GENERAL ELECTRIC OSCILLOSCOPE

The CRO-5A is really a laboratory quality unit for service work. Accurate and rapid, it was designed primarily for studying voltage and current wave-forms, but it also can be used to study any variable which may be translated into electrical potentials by means of associated apparatus.

All amplifier and sweep d-c potentials are electronically regulated to give a stable trace even under adverse power line variations. The unit is compact, portable, and sturdy in construction so that ordinary jars and vibration will not damage it. Completely self-contained, it will operate on any 115 volt, 60 cycle ac power source.

For complete information on these General Electric Service Test instruments, write to: *General Electric Company, Electronics Department, Syracuse 1, New York.*

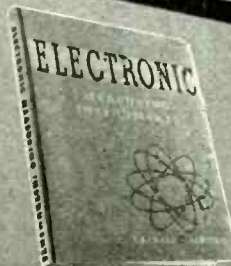
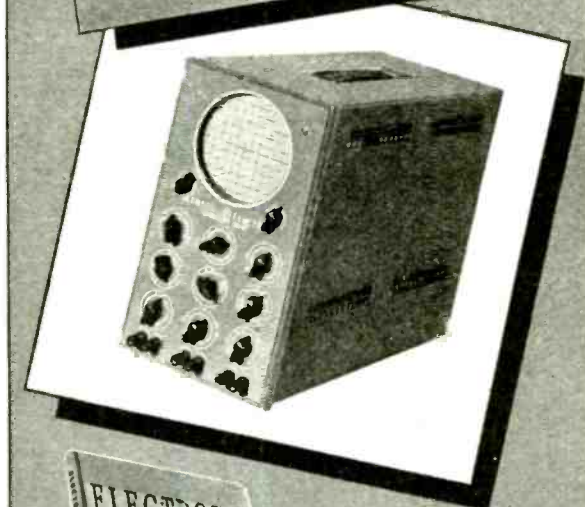
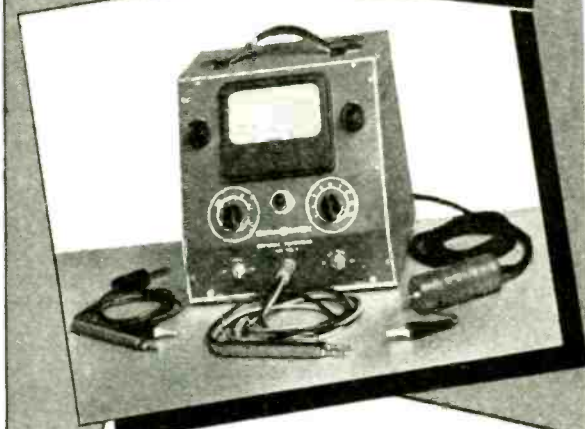
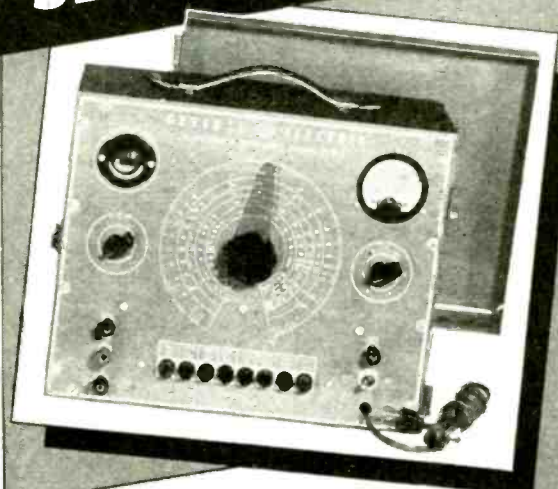

● Write for your copy of General Electric's Electronic Measuring Equipment Catalog. IT'S FREE!

GENERAL  ELECTRIC

104-P2

Save Time With New Meters

Star SET TESTER

A combination set and tube tester, model MT-12 provides for checking 450 types of receiving and other tubes, including individual sections of multipurpose tubes. Tube noise and capacitor leakage tests may also be made on the 27 ranges of voltage, current and resistance measurements. The instrument and a separate compartment for test leads and line cord



are housed in a wooden cabinet with removable cover. Star Measurements Co., 442 E. 166 St., New York 56, N. Y.—RADIO & Television RETAILING

Hickok OSCILLOGRAPH

A sinusoidal sweep with phasing control is a feature of the new model 195 oscillograph. A deflection of 1" per .05 volts input to the vertical amplifier, and a 5" screen on the 5 UP-1 cathode ray tube provide accurate viewing of i-f, r-f and discriminator alignment curves facilitated by the phasing control. All other, standard, measurements can be made as well. Hickok Electrical Instrument Co., 10523 Dupont Ave., Cleveland 8, Ohio.—RADIO & Television RETAILING

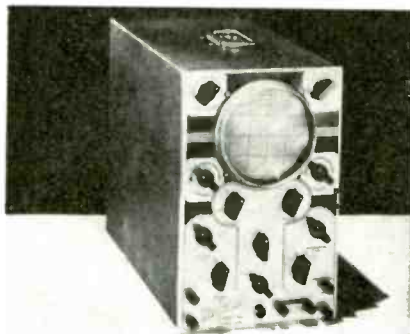

Waterman 3" SCOPE



Model S-11-A is slightly larger than the older model S-10-A, but uses a 3" screen instead of a 2". Designed to augment the Pocketscope line, it is useful for more exacting work that its sister model. D-c as well as a-c measurements are made, with other features including push-pull vertical and horizontal amplifiers, intensity modulation amplifier, linear time sweep from 3 cycles to 50 kc, and all the usual controls, including direct-connection posts for deflection plates and intensity grid, a retractable light shield and a detachable graph screen. Waterman Products Co., Philadelphia 25, Pa.—RADIO & Television RETAILING

Ox-Wall COMBINATION TESTER-SCREW DRIVER

A sturdy electrician's screw driver as well as troubleshooting helper for sound and radio work is combined in the Ox-Wall tester. The test lamp sealed into the transparent plastic handle checks a-c and d-c voltages up to 550 volts including

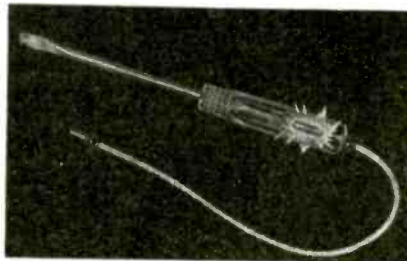

ordinary house current. Fuses, outlets, cables and sound levels are checked by means of a plug-in cord that connects to the back of the screw driver, while ignition and r-f can be detected with the plug-in wire removed. Ox-Wall Tool Co., 928 Broadway, New York, N. Y.—RADIO & Television RETAILING

Kay MEGA-SWEEP JR.

A frequency sweep up to 30 mc over the entire frequency spectrum from 400 kc to 500 mc is provided by the servicer's Junior model. Covering r-f and i-f frequencies of all FM, black-and-white and color television receivers, the output frequencies may be advanced to 1000 mc



when necessary. Video band pass from .4 mc to the highest limit may be covered by oscilloscope measurements in conjunction with the Mega-sweep Jr. The output frequency is measured by a calibrated wave-meter without switching. Kay Electric Co., East Orange, N. J.—RADIO & Television RETAILING

Triplet APPLIANCE TESTER

Model 2470 is an electrical circuit analyzer with five a-c wattage scales from 0-20W to 0-4,000W at either 130 or 260 volts, four a-c current scales from 0-26A to 0-26A, and two ac-dc voltage scales of 0-130-260V. All appliances and small motors may be measured under operating conditions, including 220V single-phase 3-wire and 3-phase 3-wire systems. Double-primary transformers and "Y" box resistors are included for testing on lines with unbalanced currents or voltages. Triplet Electrical Instrument Co., Bluffton, Ohio.—RADIO & Television RETAILING

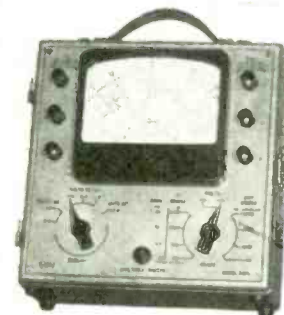

Free To Servicemen...

this great source
of money-making ideas



Mail coupon below—
your subscription
will start at once

Meet "The Capacitor"—the magazine that's published by Cornell-Dubilier solely to help servicemen speed up their work—build up their business.

It has no frills—it isn't cluttered up with complicated mathematics—and you could read it for years without learning how to build a crystal set. Instead its articles are meaty, down-to-earth—practical discussions of the problems every serviceman meets every day. Never before has there been such a great demand for helpful servicing ideas—and "The Capacitor" is C-D's answer to this demand.

Use "The Capacitor" to help build up *your* service business—as it has for thousands of other successful servicemen. Don't wait—mail coupon NOW and your FREE subscription will start immediately.

THE TRADING POST—Looking for a new 'scope at a bargain price? Need a helper? Have you anything to sell? If so, write up an ad and send it in to "The Trading Post"—the serviceman's clearing house—which appears every month in "The Capacitor." This feature alone may make "The Capacitor" worth many dollars to you.

LATEST FM CIRCUITS—"It works all right on AM but when I try to use FM all I get is a lot of noise." You'll be hearing that story more and more as the new FM jobs come on the market. Get set for them now by keeping up with the new FM circuits as they appear in "The Capacitor."

"THE CAPACITOR IS EXCELLENT"—"I received my first copy of 'The Capacitor' the other day and I want to tell you that I think it is excellent. The articles are very interesting and clearly written. You have my congratulations on a very fine magazine." Culled from the hundreds of letters received every week.

1910 1947

CORNELL-DUBILIER
WORLD'S LARGEST MANUFACTURER OF
CAPACITORS

MICA • DYKANOL
PAPER • ELECTROLYTIC

CLIP COUPON—MAIL NOW

Cornell-Dubilier Electric Corporation Dept. JD-4
South Plainfield, New Jersey

Please start my FREE subscription to "The Capacitor"
at once.

Name.....

Address.....

City..... Zone..... State.....

MANUFACTURERS
★ WHOLESALERS
★ JOBBERS

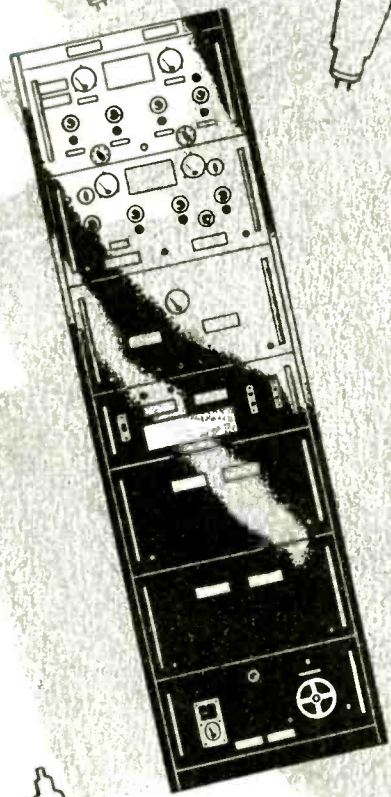
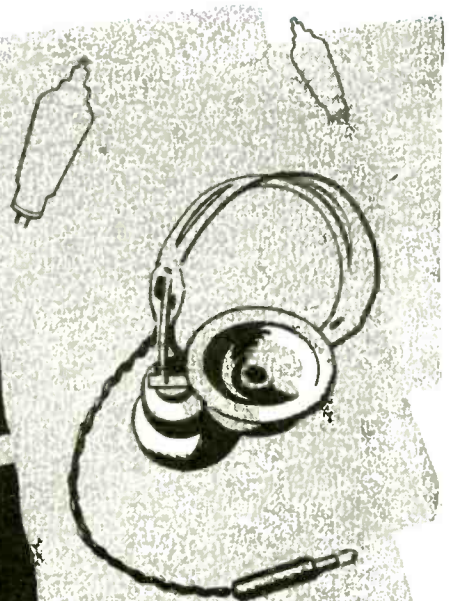

MANUFACTURERS
WHOLESALERS
JOBBERS . . .

to obtain this desirable material get in touch with your WAA approved Distributor!

Much of the huge inventory of electronic tubes and equipment, declared surplus by the armed forces, has been allocated to approved distributors for disposal.

The names and addresses of our distributors are listed here. They are equipped to serve your needs and will know what is immediately available.

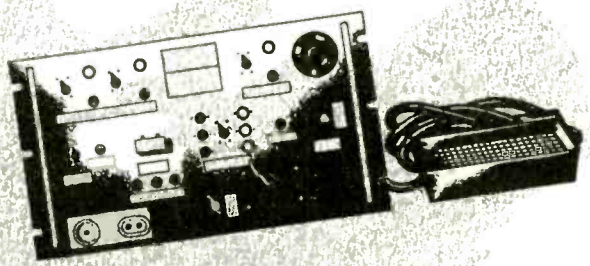
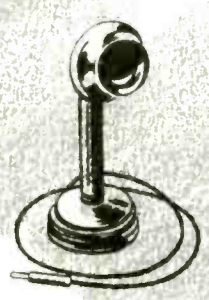

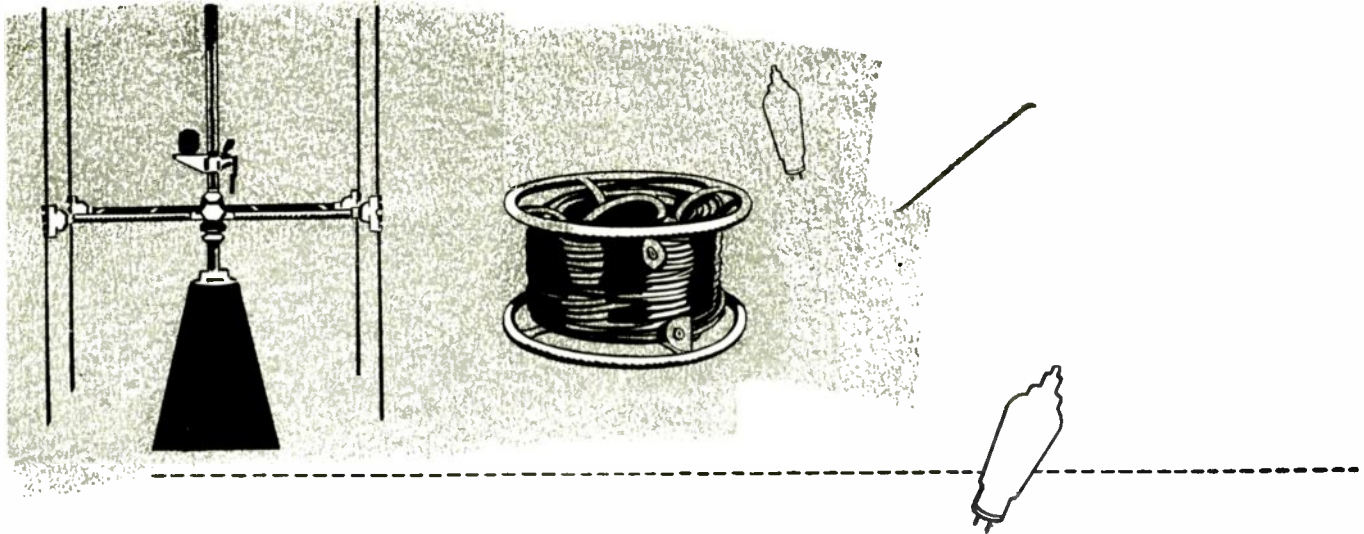

**THESE ARE THE APPROVED DISTRIBUTORS APPOINTED
BY THE WAR ASSETS ADMINISTRATION TO SERVE YOU:**

American Condenser Co.
4410 Ravenswood Avenue
Chicago 40, Illinois

Automatic Radio Mfg. Co., Inc.
122 Brookline Avenue
Boston 15, Massachusetts

Belmont Radio Corporation
3633 So. Racine Avenue
Chicago 9, Illinois

Communication Measurements Laboratory
120 Greenwich Street
New York 6, New York

Cole Instrument Co.
1320 So. Grand Ave.
Los Angeles, California

Electronic Corporation of America
353 West 48th Street
New York 19, New York

Electro-Voice, Inc.
Carroll & Cecil Streets
Buchanan, Michigan

Emerson Radio & Phonograph Corporation
76 Ninth Avenue
New York 11, New York

Essex Wire Corporation
1601 Wall Street
Ft. Wayne 6, Indiana

General Electric Company
Building 267-1 River Road
Schenectady 5, New York

Raytheon Manufacturing Company
60 East 42nd Street
New York 17, N. Y.

Smith-Meeker Engineering Company
125 Barclay Street
New York 7, New York

Southern Electronic Company
512 St. Charles Street
New Orleans 12, Louisiana

Standard Arcturus Corporation
99 Sussex Avenue
Newark, New Jersey

Sylvania Electric Products, Inc.
Emporium, Pennsylvania

Technical Apparatus Company
165 Washington Street
Boston 8, Massachusetts

Tobe Deutschmann Corporation
863 Washington Street
Canton, Massachusetts

Tung-Sol Lamp Works, Inc.
95 Eighth Avenue
Newark 4, New Jersey

General Electronics Inc.
1819 Broadway
New York 23, New York

Hammariund Mfg. Company, Inc.
460 West 34th Street
New York 1, New York

Hoffman Radio Corporation
3761 South Hill Street
Los Angeles 7, California

Hytron Radio & Electronics Corporation
76 LaFayette Street
Salem, Massachusetts

E. F. Johnson Company
206 Second Avenue, S. W.
Waseca, Minnesota

Majestic Radio & Television Corporation
125 West Ohio Street
Chicago 10, Illinois

National Union Radio Corporation
57 State Street
Newark 2, New Jersey

Navigation Instrument Co., Inc.
2007 Capitol Avenue
Houston 3, Texas

Newark Electric Co., Inc.
242 West 55th Street
New York 19, New York

Radio Parts Distributing Company
128 W. Olney Road
Norfolk 10, Virginia

ELECTRONICS DIVISION



WAR ASSETS ADMINISTRATION



Offices located at: Atlanta • Birmingham • Boston • Charlotte • Chicago • Cincinnati • Cleveland • Dallas
Denver • Detroit • Fort Worth • Helena • Houston • Jacksonville • Kansas City, Mo. • Little Rock • Los
Angeles • Louisville • Minneapolis • Nashville • New Orleans • New York • Omaha • Philadelphia • Port-
land, Ore. • Richmond • St. Louis • Salt Lake City • San Antonio • San Francisco • Seattle • Spokane • Tulsa

1000

Builds PA Truck Fleet on Sound "Ballyhoo"

Many Local Civic Groups Served by This Dealer



More prominent than the game itself is the 6-speaker basket, part of Joe's rental system.

● In Schenectady, N. Y., wherever you find an active club or lodge, be it the Elks, Moose, K. of C., Chamber of Commerce or many another, there you're likely to find Joseph Formichelli of 2425 Broadway—and a sound truck from his fleet.

Joe's history in the "sound ballyhoo business", as he calls it, dates back to 1933, when, taking a tip from a radio parts salesman who had come North from Florida greatly impressed by the activity in mobile PA there, he put on the street "the

first complete sound truck in Schenectady".

Backed by experience in repairing auto radios and sound amplifiers, Joe began merchandising his truck with two rules in mind: "No job is too small or too big", and "show a clean, neat appearance and up-to-date high-quality sound self-advertised to as many people as possible".

Up to date, these principles have enabled him to keep three trucks on the go at any one time, each equipped to provide sound for a crowd of 10,000 persons.

One Job Gets Another

A great deal of Formichelli's work is picked up at field days, ball games, horse shows, county fairs and public gatherings, as well as the clam bakes which are so popular in his part of the country. By doing impressive work at such well-attended affairs, Joe is assured of other indoor jobs such as the weekly bingo parties, as well as rentals for business purposes by individual members.

Virtually every job results in direct requests for radio repair service, which also helps feed the kitty. The same is true of the orders from people who stop the well-lettered trucks and cars on the street, attracted by the clean, professional appearance.

In line with Formichelli's ideas about getting his equipment before as many people as possible, he makes a special effort to do the sound work at special outdoor events such as those pictured here.

At the left can be seen the unit lowered from the rafters for coverage of the large crowds that attend the basketball games at the local armory. When necessary, the same rig of six speakers can be used for fights, hockey games and other large indoor arena events.

Typical Sound Setups

A recent soap-box derby, sponsored by the Schenectady Gazette, drew a grand audience for Joe's equipment, which served as a center of activity for the entire affair. Shown at lower right are two Panama-hatted officials, the man at the mike representing the Jr. Chamber of Commerce, while the newspaper's photographer stands by watching for good shots.

At lower left, one of Formichelli's smaller cars has been positioned for coverage of the swank Ballston Spa Horse Show, a feature attended by some of the most influential citizens in town.

In order to assure proper coverage of varied-shaped areas often from positions determined by other than acoustic considerations, Formichelli finds it necessary to design his equipment for the greatest flexibility. All speakers are rotatable, so as to be able to project over the full 360 degrees, turned broadside to lay down a strong field of sound in one direction, or effect any intermediate combination.

Amplifiers used are 35-watt Bogen mobile units, Model EX-632, while both drivers and cones are used for

(Continued on page 118)

Formichelli in sweater, at left, with sound manager Al Colandra. At right, de-luxe "mobile unit" provides meeting point for officials.



Radiart

MANUFACTURERS OF
QUALITY
VIBRATOR EQUIPMENT
SINCE 1932

From the very beginning, the history of Radiart has been closely allied with modern vibrator development. Back in 1932 this company, foreseeing the need for a complete line of correct replacement vibrators, was the first to design such a line and to place it on the market. Radiart pioneering may also be credited with many revolutionary changes in vibrator design. Floating center reeds, all-riveted assembly and hermetic sealing through the famous Red Seal process . . . all are exclusive innovations which came into being through Radiart research. Today over 76% of all popular replacements are serviced by 12 Radiart vibrators and more than six million of these units have been sold.

In 1936 Radiart developed the first streamlined aerial to match existing car contours. The first truly waterproof aerial; the first all-metal anti-rattler design and the new Plasti-Loom Lead were all evolved by Radiart engineers and did much to increase public acceptance for this type of equipment.

There has never been any change in Radiart's original policy of quality manufacture. The same high standards still govern Radiart production and are your assurance of obtaining a product which is as perfect as modern methods of engineering and manufacture can make it.

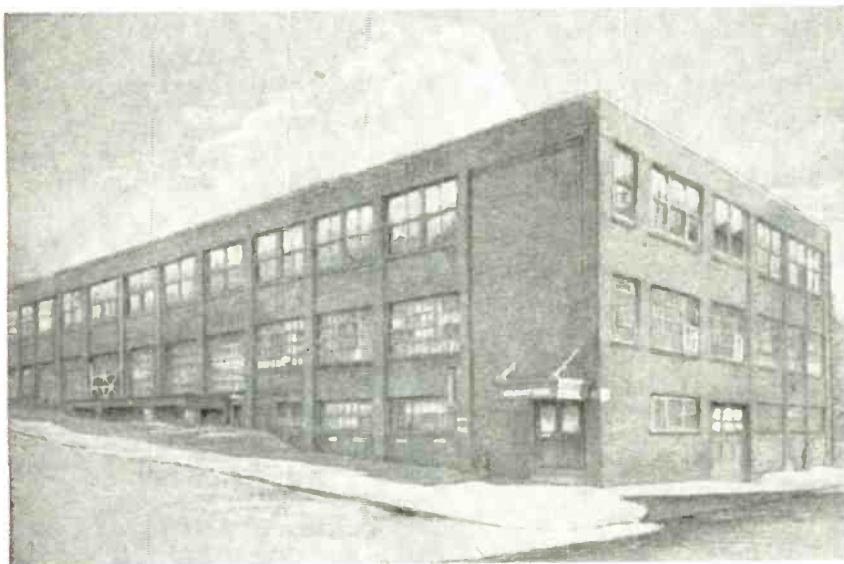
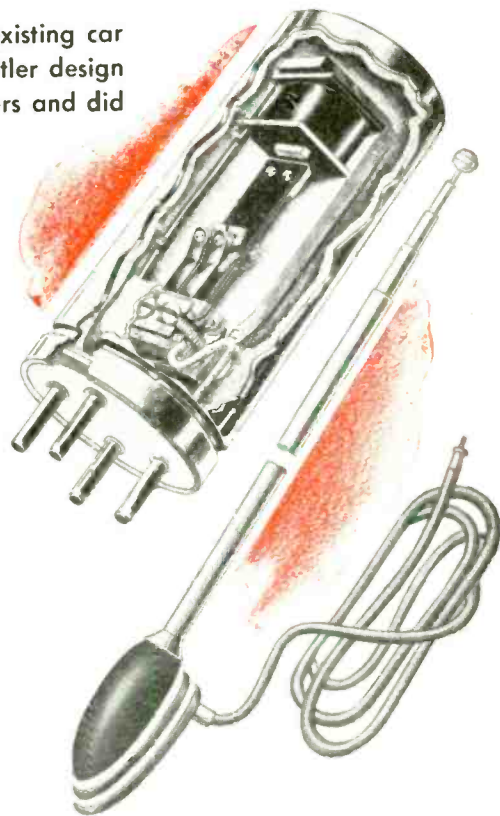

R A D I A R T , C L E V E L A N D , O H I O

**ELECTRONIC DISTRIBUTOR AND
INDUSTRIAL SALES DEPARTMENT**

Radiart

MAGUIRE INDUSTRIES, INC., 936 N. MICHIGAN AVENUE, CHICAGO 11, ILLINOIS
EXPORT SALES DIVISION • SCHEEL INTERNATIONAL INCORPORATED
4237-39 N. LINCOLN AVENUE, CHICAGO 18, ILL. U.S.A. CABLE ADDRESS—HARSHEEL

Builds PA Fleet

(Continued from page 116)

loudspeakers in different arrangements, according to Joe. Shure 55C Dynamics and Turner 22X microphones complete the systems.

Aside from the regular technician-attendants, Formichelli employs a sound manager, whose function is to double-check all bookings, physical arrangements and represent the company as a "contact man".

Joe sees his present business as a creditable beginning, but confidently expects a strong expansion in sound.

Preserve Loose Schematics

Certain regionally-distributed receivers are serviced with the wiring diagram found tucked between tubes or other parts or folded so that some part value is not legible.

Transparent tape is handy, inexpensive.

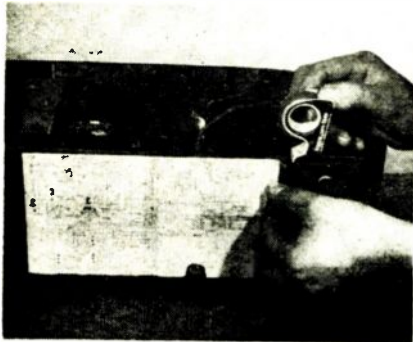

Since the owner wishes to keep the diagram and such diagrams are often not in the regular manuals, it is worth while to tape such data to the cabinet as shown. It will be there for you or some other serviceman when needed.

Rewiring Current Checker

A simple wiring change, consisting merely of placing the resistor in the lower, rather than upper, pin-jack of the current quick-tester shown in the February issue, p. 118, is necessary for correct operation. The right way to do it is illustrated here.

Resistor shown correctly, in lower lead.

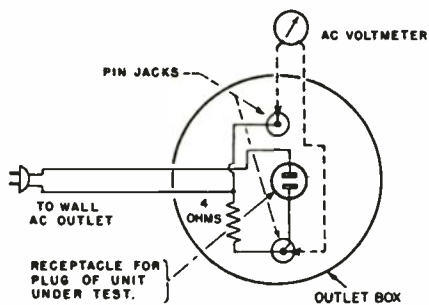

Simple Speaker Repair for Rattling Dynamics

Many times, when small electromagnetic speakers rattle, the trouble may be caused by a warped voice coil scraping the pole piece. In cases where a replacement cone is not available, this can be remedied by means of the following procedure.

Remove the felt dust cap from the center of the speaker cone, using cement solvent, thereby exposing the pole piece. Now place a sharp center punch on the pole piece and with a hammer drive the pole slightly in the direction of most clearance.

This procedure will leave a small nick in the pole piece, but the operation is quite effective. The same repair used on PM speakers might effect the magnetism because of the sharp hammer blows, and should be practiced only in cases where the speaker would otherwise be useless and irreparable.

Clearing Tele Faults

(Continued from page 97)

units if the fuse is good and the set is still not getting current. If, upon replacing the fuse with one of the proper rating the replacement pops immediately, the next order of business is first to change the high voltage rectifier, and then the fuse, and to test for results once again.

About 70% of all service calls on pre-war television sets were caused by defective rectifier tubes. The two tubes most commonly used were the 2X2 and the 2V3G. The large RCA receivers used the 2V3G tube.

It is automatic procedure when servicing a 9 inch or 12 inch tube model to replace the rectifier immediately, if the fuse has popped. A word of caution, however: sometimes you will find an RCA job that has had the socket changed for the 2X2 type.

It is wise to carry both numbers when going on an outside call since there was a great deal of rectifier substitution during the war years when the 2V3 type was unavailable. Servicemen also replaced the latter tube because they became exasperated with constant callbacks for the same complaint.

The pre-war Stromberg-Carlson receiver used an RCA type power supply, and service procedure on this instrument is similar to that on the RCA TRK-12.

The next article in this series will present further notes on common faults and proper procedure in television receivers.

Pick-up Pliers Useful in Servicing

So called "pick-up pliers" as illustrated may be purchased at auto supply stores. This tool has a plunger-spring flexible rod running through a cable and has four thin fingers on the end to hold or pick up small articles as nuts or bolts.

This handy tool makes assembling easier.

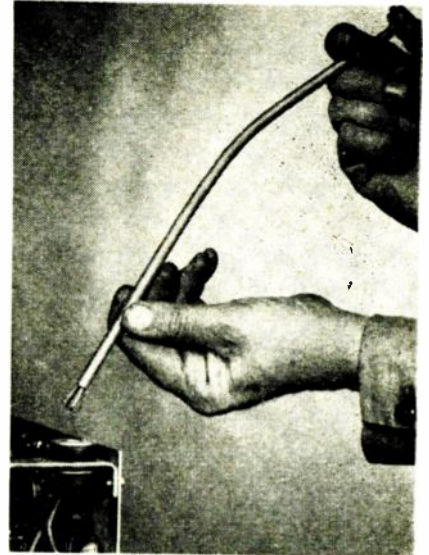

One of the chief advantages over other common radio tools is the flexible shaft or rod—enabling the operator to use in cramped parts of radio equipment.

Wire Skinner Removes Knobs

Wire skinning tools of the type shown which are made from spring steel with notches in the bent ends, may also be used to remove radio control knobs.

One way to stop chipping fingernails.



To avoid scratching the radio cabinet place strips of adhesive tape over the parts of the tool which will contact the cabinet. Tape may likewise be placed on the inside of the springs to prevent possible damage to the finish of the knobs.

\$400,000 WORTH OF RADIO SERVICE DATA

A Continuous Service for less than 9¢ a day in

PHOTOFACT* FOLDERS



VOLUME 1, containing first ten sets of PHOTOFACT FOLDERS in deluxe binder, \$18.39. Individual sets Nos. 1 to 10, \$1.50 each. De Luxe Binder alone, \$3.39.



DISASSEMBLING RECEIVER FOR ANALYSIS



PARTS ANALYSIS



CHECKING OVERALL PERFORMANCE

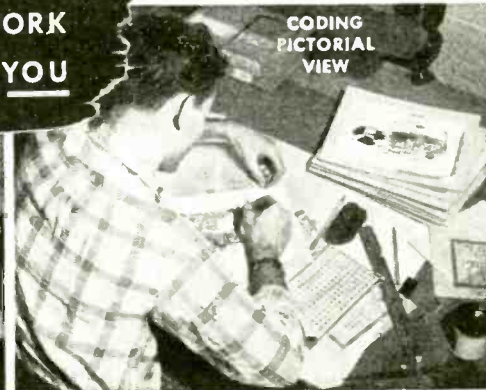

CODING PICTORIAL VIEW

**PHOTOFACT
RESEARCHERS
AT WORK
FOR YOU**

COMPLETE

Everything you need in one handy, unified form—large schematics, pictorials keyed to parts lists and alignment data, complete listings of parts values and replacements, alignment, stage gain, circuit voltage and resistance analysis, coil resistances, dial cord stringing, disassembly instructions, record changer analysis and repair.

ACCURATE

All sets are taken apart and analyzed by experts in the Sams Laboratories. Every part is measured, tested and triple-checked for accuracy. All data is original. This means the data you get is right.

CORRECT

PHOTOFACT FOLDERS are issued twice monthly as the new receivers come off production lines. You don't have to wait for information. As receiver changes are made, you get correction and addition sheets for your files. Your data is always up to the minute.

EASY TO USE

All diagrams and pictures are coded to numbered parts lists. Everything is positively identified for fast work. All folders are set up in uniform, easy-to-follow style: big type, big illustrations—no hunting, guessing or eye strain—no more loss of time and temper.

\$403,531.05†—that's what it actually cost us to create, print and distribute Volume 1 of Sams PHOTOFACT FOLDERS. Every penny of that money has been spent to bring the industry the most accurate, complete, up-to-the-minute data ever produced for radio servicemen. And this continuing service, designed to help you make up to *twice as many repairs daily*, actually costs you less than 9 cents a day.

PHOTOFACT FOLDERS could not be produced without the support of America's leading replacement parts manufacturers—without the support, too, of thousands of enthusiastic PHOTOFACT subscribers. With their cooperation, we will continue to place in your hands ALL the information you need to do a better job—facts, figures, photographs, full-page schematics—*information compiled from actual first-hand analysis of all*

* Trade Mark Reg.

new instruments. PHOTOFACT FOLDERS cover *all* radios, phonographs, record changers, recorders, communications systems and power amplifiers—and are *timed to reach you as these instruments are released.* The cost is only \$1.50 per set of 30 to 50 folders and includes membership in the Howard W. Sams Institute.

Set No. 17 will be ready for mailing April 10th. Set No. 18 on April 25th. Sets Nos. 11 to 16 inclusive, also priced at \$1.50 each, are available for immediate order.

Start using PHOTOFACTS to make more profits. Remember, PHOTOFACT FOLDERS actually cost you nothing: *they pay for themselves over and over!* See your replacement parts distributor—or write us direct. In Canada, address A. C. Simmonds & Sons, 301 King Street East, Toronto, Ontario. Canadian price, \$1.75.

†C.P.A. Statement Available

HOWARD W. **SAMS** & CO., INC.

2924 EAST WASHINGTON STREET, INDIANAPOLIS 6, INDIANA

PHOTOFACT SERVICE

"The service that pays for itself over and over again"

JOBBER'S IN ACTION

Coast-to-Coast Activities of Distributors

PHILADELPHIA, PA.—The "open house" events in the new offices and showrooms of *Emerson Radio of Pennsylvania, Inc.*, at 223-225 N. Broad St., here were continued a full 10 days. Visitors were given personal service in viewing the new stock, display and service facilities, as well as the first Emerson television sets and 1947 radios.

A huge new neon sign has been installed by the distributor over its new site. One of the largest signs on the popular thoroughfare, it measures 20 ft. high by 25 ft. long.

Portland Distributor in Exceptional New Home

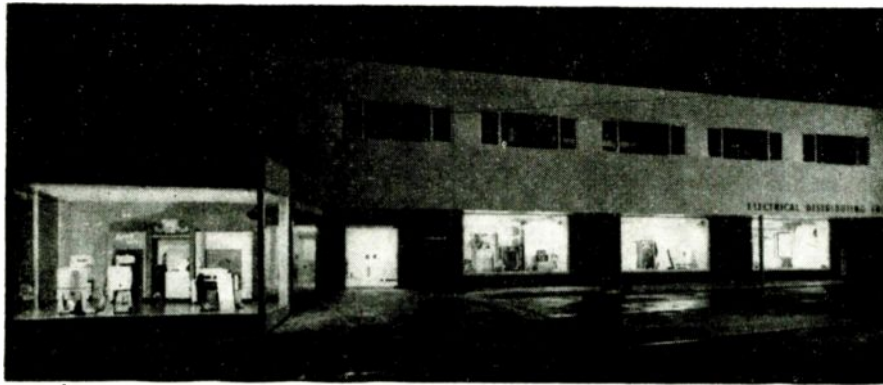

Here's a new building where a jobber features (1) Storage space on the 1st floor for all merchandise (2) Second floor with auditorium, parts room and service shop, (3) Wide expanse of displays in front and (4) Extra parking space. It's Electrical Distributing, Inc., Portland, Ore., jobber for Apex, Zenith, Duo-Therm, Gibson and others.

BRIDGEPORT, CONN.—First of a series of television courses to give distributors the technical aspects of television installation and service has been completed by the receiver division of General Electric Co. here.

The 25 service managers and personnel who attended the course represented distributors in present television areas. As new distribution areas are opened up through the installation of television transmitters, similar service programs will be provided.

Those attending represented independent distributors and the *General Electric Supply Corp.* They were H. R. Griswold, Hartford; R. L. Cam, E. F. Alesh, J. J. Zazula, W. A. Peterson and C. Czeropski, Chicago; H. Van Alstine and A. Baron, Albany; C. J. Laby, J. Genova, B. Meisles, W. Weber and H. Diedrich, New York; A. Schoenberg, Newark; J. Abramson, Philadelphia; E. H. Miller, Washington, D. C.; J. W. Meyers and H. M. Stephens, Los Angeles; E. C. Davis, Baltimore; W. E. Snouffer, Wilmington, and H. J. Gensler, Detroit. GE representatives present were G. D. Day, San Francisco; H. C. Manthey, Chicago, and J. Catterall and F. Miller, Bridgeport.

EL PASO, TEX.—R. J. McNeeley, director of sales for Hoffman Radio Corp., Los Angeles, has announced the appointment of *Diehl & Lehman* here, as jobbers for Western Texas and Southern Mexico.

BOSTON, MASS.—The newly appointed sales manager for MGM records at *Northeastern Distributors, Inc.*, here, is F. Gilbert "Gil" White, who as a Navy lieutenant was in charge of communications on the staff of Commander-in-Chief of the Atlantic Fleet.

ORLANDO, FLA.—L. B. Calamaras, executive secretary of the *National Electronic Distributors Association*, wound up a tour of the southwestern and southern states with a meeting of distributors here. Mr. Calamaras had previously held NEDA chapter meetings in San Antonio, Tex., and in New Orleans. Local and national problems, as well as plans for the coming Parts Show in Chicago, were discussed at the meetings.

MINNEAPOLIS, MINN.—Arnold Frishberg has been appointed as manager of the Premier vacuum cleaner division of *The Roycraft Co.*, the northwest distributors for Philco, Thor, Premier, American Central, New Home, Martin motors and Columbia records. Mr. Frishberg is just back from a 4-year stretch in the Navy—most of it in the Pacific. He is the son of Harry Frishberg, formerly a star salesman for Roycraft, now owner of the Chaix Copley store in St. Paul, Minn.

SYRACUSE, N. Y.—A two-day open house was staged by the *Onondaga Supply Co.*, Zenith distributor here, to celebrate the opening of its new building at 344 W. Genesee St., with a 30th anniversary dinner for 180 employes as a feature event. The guests included A. V. Duke, assistant to Zenith's vice-president and director of sales, and Hugh Boyer, district sales manager.

Hosts at both dinner and open house were: H. Hiram Weisberg, president; Benjamin S. Arnold, vice-president; Jack B. Phillips, treasurer; and Theodore Pierson, secretary.

SEATTLE, WASH.—A newcomer to the radio and appliance field, *Washington Distributors*, 115-117 Madison St., here, has been named exclusive jobbers for Air King radios. The Washington firm had previously handled housewares, novelties, toys and allied products. The firm is a partnership of Jack Kessler, Boris Merport and Wilbur Nagel, and maintains a large staff traveling in the Pacific Northwest states. The concern recently moved to new quarters where modern offices are combined with extensive warehousing facilities.

NORFOLK, VA.—A big Spring Show event was held by the *Norfolk Distributing Co.* at 135 Church St. here, attended by some 400 retailers from the Virginia and North Carolina trading areas. The featured attractions were displays of new nationally branded lines, scarce merchandise for immediate delivery, and nearly 50 representatives of leading manufacturers on hand to help introduce the new products. Harry L. Snyder is general manager of the firm.

OKLAHOMA CITY, OKLA.—*Southwest Radio & Equipment Co.* of this city, has been named a distributor for Duo-Therm fuel oil space heaters and water heaters. Announcement of the appointment was made by M. F. Cotes, executive vice-president of Motor Wheel Corp. and general manager of the Duo-Therm division. Mr. Cotes said that the new Duo-Therm distributor would serve all Oklahoma except for ten counties in the eastern section of the state.

CHICAGO, ILL.—The new sales manager for *Appliance Distributors, Inc.*, 444 Lake Shore Drive, here, is Frank Hogan, according to a bulletin from Clarence Tay, manager of the firm. Mr. Hogan was formerly district manager for Crosley and previous to that time was district manager for Philco.

COLUMBUS, OHIO—Just appointed sales director of the *Tracy-Wells Co.*, here is George E. Maness, who was promoted to the position from the sales staff. Vice-president and general manager R. C. Hager made the announcement. Mr. Maness has been with Tracy-Wells since 1928.

Here's Your Answer

to

① **Smaller Inventories**

② **Greater Profits**

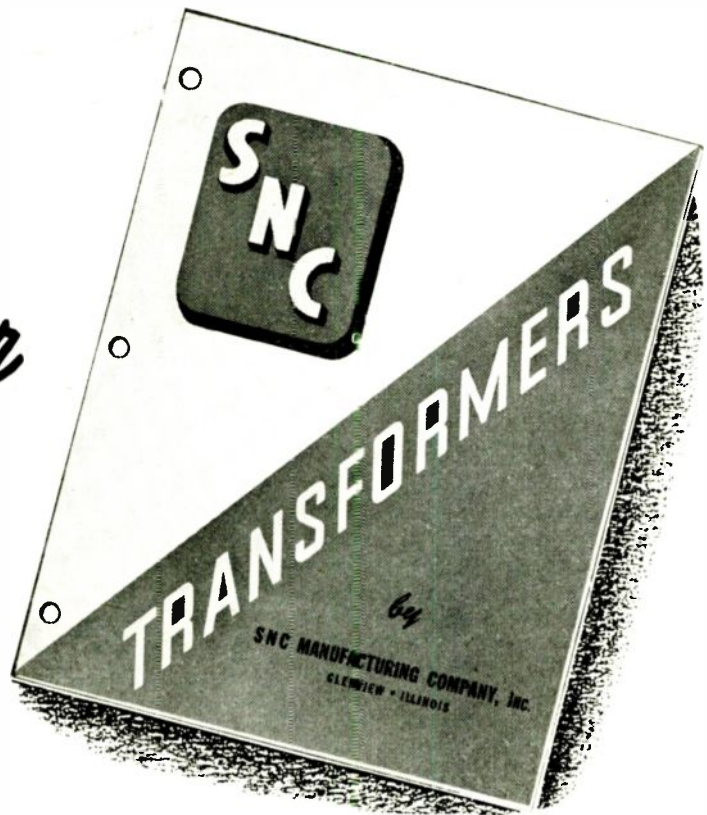

New, Streamlined SNC Transformer Line Is First With More Applications From Fewer Styles



SNC Model 8P205
...A popular type of
Power Transformer

Now, for the first time in history both manufacturers and dealers in electrical equipment can meet their widest transformer installation requirements with a minimum of stock. The entire SNC line of quality transformers is engineered to eliminate the endless variety of sizes, shapes and restricted applications that have afflicted the industry in the past.

Only 10 pages of specifications in the new SNC easy-to-read catalog cover most modern small transformer applications! This means money saved both through elimination of frozen inventories and through greater stock turnover. *Either* saving means more profits for you.

Send for the SNC catalog shown above. A quick reading will convince you of the many advantages offered by this quality transformer line.

*Remember! SNC gives MORE applications with
SMALLER inventories for GREATER profits!*

SNC MANUFACTURING CO., INC.
Quality Transformers
WEST LAKE AVE. AND LEHIGH • GLENVIEW, ILLINOIS

TELEVISION TODAY

St. Louis Becomes a Television City

Regular commercial television service in St. Louis began recently when Station KSD-TV went on the air, announcing "the first newly equipped post-war television station to go on the air, and the first to be operated by a newspaper . . . using entirely new equipment, the St. Louis Post-Dispatch station began to promote public interest in sight-and-sound broadcasting with 25 hours of varied programming during Edison Centennial Week."

The Pulitzer Publishing Co., owner of KSD-TV, has pioneered in radio for 25 years. George M. Burbach, general manager of KSD, pointed out in a message for the inaugural telecast. KSD was established in 1922, and before the war, the Post-Dispatch was first in operating a regular daily newspaper by facsimile broadcast.

The Broadcasts Begin

St. Louisans had their initial glimpse of public telecasts when, on channel five, KSD-TV televised street interviews, puppet shows, the Golden Gloves fights, news, drama, and other programs for RCA-Victor dealers and guests at Hotel Statler. KSD-TV already has agreements with local athletic directors to telecast baseball games of the Cardinals and Browns, wrestling, boxing, and sports of Washington and St. Louis Universities.

Sponsors of programs for the first week of television in St. Louis include Union Electric Co., Shell Oil Co., Bulova and Elgin (watches), Trimfoot and Rhythm Step (shoes), Hyde Park (beer), Botany (ties), Monsanto (chemicals), Bemis Bag Co., St. Louis Independent Packers and American Packing Co., and the Missouri-Kansas-Texas railroad.

Picture Brightness Featured by Bendix

Bendix Radio has introduced its first video unit, Model TRP10, hailed as having "superior brightness which makes it possible to view the picture in a room with ordinary lighting."

A development of the research and engineering group of the Bendix Radio Division, Bendix Aviation Corp., with factory headquarters in Baltimore, the system was demonstrated in a ten-inch direct view black and white receiver for which limited production is scheduled this year. This model, also includes AM-FM

radio and automatic phonograph reception. It is not planned to commercialize on the first production of the set, but rather "to carefully distribute it on a control basis for the purposes of field checking and research."

A second feature of the Bendix black and white television is automatic synchronization which prevents static "tearing" of the picture. Both features were noted by the trade at the initial demonstrations of Bendix black and white at the Winter Furniture and Appliance Market held in Chicago in January.

Business Services Due for Video Art

"Television may soon lay aside the evening clothes of the entertainer each weekday morning and don business clothes," according to Dr. Allen B. Du Mont, television pioneer and manufacturer, speaking before the Newark, N. J., Safety Council recently. As soon as television production catches up with its enormous backlog of orders for transmitters and receivers, the industry will be set for an equally great if not greater exploitation of its see-hear medium on behalf of the best interests of labor and management, of greater safety and productivity, of industry and business, of producer and consumer, and of citizen, nation and world, according to Dr. Du Mont.

With television pictorial standards rapidly approximating those of theatre movies and already on a par with the best home movies, this medium is technically prepared to enter the industrial field, said Dr. Du Mont.

Viewers' Room Style



In the "Pageant of Progress" staged by the furniture design experts at Macy's in New York City, this model room demonstrated how an RCA tele set fits into advanced styling.

Chicago Passes 1,000 Mark in Video Coverage

Television in the Chicago area reached a new milestone in its progress when WBKB, the Balaban & Katz video station there, announced its new rates based on a circulation of 1,000 to 5,000 receivers in use. The station got started on the second bracket of its rate structure and revealed that the new basic cost to advertisers would be \$200 an hour.

Provision for the change was made at the time the Balaban & Katz station's commercial structure was originally announced. Cost to the advertiser is based entirely on guaranteed circulation. Initial fee, in effect while there were between 0 and 1,000 receivers was \$100 per hour. Top figure in present schedule is \$1,000 an hour, to apply when there are more than 35,000 sets in the area.

Many Fans for Each Set

For the present \$200 an hour, the advertiser buys an audience of approximately 11,000 persons. WBKB's surveys show an average of 11.4 viewers per set. Home receivers average 4.5 viewers and the balance of the audience sees its television shows on receivers in public places.

WBKB recently created extra interest by televising the Golden Gloves tournament of champions—amateur boxing's top event. The station also broadcast pictures of the midwest premiere festivities of the motion picture, "The Yearling," and presented an interview with the young star of the show.

Outlines Growth of Tele Industry

Citing the television industry as "an instructive example of the hazardous but beneficial operation of free enterprise," Joseph Gerl, president of Sonora Radio & Television Corp. and a director of RMA, told the Oklahoma City Chamber of Commerce that "despite the halting pace of television in this country, . . . by the end of 1947 we anticipate we will have produced better sets and better programs than England has been able to produce in 9 years under government operation."

"Since 1925," said Mr. Gerl, "when RCA began research in television, until today, when we have eleven operating television stations in eight cities with six to follow shortly hereafter, and with about 25,000 television sets now in homes, we have seen, on a small scale, how American industry is born and develops."

Markets Are Added

"The outlook for the year 1947 is such that besides the television stations in Chicago, New York, Philadelphia, Washington, Los Angeles, Detroit, Schenectady and St. Louis, we will shortly have stations in operation in Boston, Pittsburgh, San Francisco, Kansas City, Portland and Seattle. Hand in hand with the increase in the number of stations, the radio and television industry estimates that there will be approximately 300,000 television sets built and sold this year."

SPRAGUE TRADING POST

**SPRAGUE
IF-37
FILTER**



STOP RADIO NOISES FROM FLUORESCENT LAMPS!

Radio noises caused by fluorescent lamps CAN be suppressed—easily, quickly and effectively. No lost time or motion. Just install a Sprague IF-37 Filter on each fixture, connecting it directly across the incoming leads. IF-37's are especially designed for the job—and you'll be pleasantly surprised how effective they are in suppressing "hard-to-stop" interference that is so often conducted down the power lines, even to remotely located receivers. Buy them from your nearest Sprague jobber today.

WRITE for a copy of the complete 40 page Sprague Catalog of capacitors, resistors, interference filters & test equipment.



SWAP - BUY - SELL

FOR SALE—Stancor 60X with 40, 20 meter coils \$85; 2-meter transmitter with HY75 \$10; BC-1068-A converted for 2-meter reception, with tubes \$25. L. Phelps, U.S.N.R.A., Qtrs 105 C, Port Blakely, Wash.

FOR SALE—Millen exciter with tubes, two Xtals, coils for 10-20-30 meters \$40; Pair new RCA 812 tubes, Bud 500W 10M coil and swinging link, pair NC-75 neut. cond., THM-50-D cond. All only \$18. 5BP4 kinescope \$10; PE-103A Dynamotor \$9. D. F. Wald, 692 Sutter St., San Francisco 2, Calif.

FOR SALE—NC-100-AND National communications receiver complete with speaker, slightly used. Robert L. Smith, Human House, Northwestern University, Evanston, Ill.

FOR SALE—Slightly used wireless oscillator uses 12SA7, 35Z5, with tubes. Excellent fidelity \$6; 1-tube amplifier (117LM7) superb volume, fidelity. Complete with speaker and tube \$5.50. Units only. Frank Pelaggl, 43 Perry Ave., Shelton, Conn.

FOR SALE—Code practice machine, 8-rolls of tape, book of instructions, excellent condition \$10; Dynamotor 24-28 V input, 1000 V, 500 mls output, new, original carton \$10. J. Barrett, 1410 Custer Dr., Erie, Pa.

FOR SALE—BC 312M; tank transformer 19 Mk2; 813's; 814's; Sky Buddy; 110V-voltage supply complete; can-type bypass cond.; Candelum resistors; relays. Full information on request. Ralph Hittman, W854CP, 600 S. Boston St., Gallon, Ohio.

FOR SALE—Instructograph senior, tapes, oscillator, brand new \$25; CREI course, lessons 1-20 in binders \$10; Swap Radio News and CQ for old QST and CQ. W2RPZ, 211 Munro Blvd., Valley Stream, N. Y.

WANTED—Wiring diagrams for German Siemens Luftwaffen-Koffer K-32GWTB radio, Albert C. Hart, 4848 Linden Ave., Hammond, Ind.

WANTED—Marine transmitter-receiver with Xtal control covering 2126, 2670, 2738 KC cash or trade 20 watt amplifier, record changer 32 V d-c light plant 1500 watt. O. Bossette, 38 Main, Danielson, Conn.

WANTED—Rider's service manuals for cash; new tubes and parts. Have a RCA Test set (87-B new) for sale \$55.50. Charles Fleisher, Rm. 1218, 15 Park Row, New York 7, N. Y.

WANTED—Receiver such as 8-39 or 8X-25 preferably or 8-20R, 8-19R. Describe fully, price and condition. David Gifford, Laurel Heights, Shelton, Conn.

WANTED—Rider manual vol. 2, must be in good condition. Have abridged I-V, new condition \$15. Kearns Radio Service, 5510 Memphis Ave., Cleveland 9, Ohio.

FOR SALE—Radio shop, modern equipment, complete stock of tubes and parts. Good location and lease. Sacrifice at inventory. Write for details. Publix Radio Service, 816 E. Washington St., Orlando, Florida.

FOR SALE—NC-100-AND receiver with speaker. Used one month, excellent condition. Geo. C. Robinson, 56 Redfield Pkwy., Batavia, N. Y.

FOR SALE—2-meter receiver with built-in speaker, 110V, \$20; Deluxe code osc., speaker, key, \$10; IRC resistance analyzer \$9. 20% with order, balance C.O.D. Bruce Radio, 1171 Union St., Manchester, N. H.

WANTED—Rimco signal tracer, Advice condition, price and guarantee if any. Radioservice, 920 Pine St., St. Louis 1, Mo.

SELL OR SWAP—QST's for Oct., Nov., Dec, 1930; Nov, 1931; Jan., April, June 1932; Feb., April, Aug., Oct, 1933; Feb., June, July, Oct, 1934; Feb, 1935 to Oct, 1936. Smajd Radio, 721 Meadow Ave., Joliet, Ill.

SELL OR SWAP—Triplet tube checker 1210A with adapters a-c-d in good condition. Carl Groeteka, Glen Carbon, Ill.

FOR SALE—Weston 775 Servisvet consists of 772 analyzer, 772 tube checker in portable oak case. Includes complete set Weston socket selectors, 2500-5000-10,000V d-c multiplier, test leads, \$90 plus shipping costs. Phillip Hoshert, P. O. Box 905, Hoboken, N. J.

FOR SALE—50Y6, 43, 37, 6A8, 7A8, 1417, 58, 71A, 1LA6, 1LE3, 35A5, 84, 2X1, 117L7, 2A6 all sealed tubes at good discounts. New, guaranteed, sealed cartons. Write for list. Commercial Radio, 36 Brattle Street, Boston 8, Mass.

FOR SALE—These new tubes in original cartons, 65% off list: 6E5, 6SP7, 6AC7, 6SL7, 6SH7, 6F8, 6AD7, 6SN7, 6SD7, 6C8, 6B4, 6AD6, 7K7, 1LD5, 284, 14C5, 11Y1, 1417, 14F7. Anniston Radio Hospital, 503 S. Noble Street, Anniston, Ala.

FOR SALE—Newly developed record changer and chassis repair stand, for all makes of radios. Made of steel and semi-steel castings. \$3.50 postpaid. Hansen, 252 Grant Ave., Jersey City 5, N. J.

FOR SALE—1947 Wilcox-Gay portable recordio. Used just two months, perfect condition. \$150. Daniel Seely, 232 Front Street, Franklin, Pa.

FOR SALE—Collins 30-J-18 complete with mike, xtals and coils for 80, 40, 20, 11, 10 meters. 400 watts phone or CW. Photos and details on request. Not surplus. WOQFZ, 2705 S. 7th St., Council Bluffs, Iowa.

FOR SALE—Scarce radio tubes, attractive prices. Standard brands only. Send for list. Vogue Radio Co., 1740 Coney Island Ave., Brooklyn 30, N. Y.

FOR SALE—Standard model volt-ohm milliammeter, \$25. 157 Fulton Place, Paterson, N. J.

FOR SALE—1947 Buick Motorola auto radio with push-button tuning, in original carton \$75 postpaid; new Philco auto radios. H. H. Sillo, 225 Sutton Ave., E. Providence, R. I.

FOR SALE—Hallcraft receiver S 22, good condition \$60. A. L. Moore, 1169 S. Jackson Street, Auburn, Ind.

FOR SALE—Rider's manuals 1 to 8, \$80; Extra Rider Indexes, 50c each; Gernsback manuals 1 to 4, \$20; Ghirardi's Radio Physics, 1942, \$2.00; HRO coils ham bands, \$9.95; IC-375 E transmitter, A. Livingston, 1200 Ellis Ave., Fair Lawn, N. J.

FOR SALE—Tubes, standard brands 50% off list: 50L3, 35Z5, 12SA7, 12SK7, 12SQ7, 50A5, 35Y4, 14A7, 14Q7, 14B6, 1LE3, 1LA6; all others 40% off. Morris Sable, 1259 E. 13th St., Brooklyn, N. Y.

FOR SALE—Weston model 685 selective analyzer with portable case. New, in original carton, \$65; 4 tube amplifier, 110V, 400 cy easily converted to 110V, 60 cy, \$5.95. Raynard Haulto, 2375 N. 3rd Street, Milwaukee, Wis.

FOR SALE—Triplet tube tester, model 1185; Triplet combination signal generator; volt-ohm meter 1175A, good condition, both for \$75. George D. Pixley, 204 N. Walnut Street, Mt. Pleasant, Iowa.

FOR SALE—New, in original carton 28½V d-c 2-amp. aircraft type generator. Suitable for G.I. receivers and transmitters, charging batteries, electric welder. D. M. Curry, 117 E. Kensington Blvd., Milwaukee, Wis.

FOR SALE—Used tubes, repair parts, supplies at bargain prices. Write for price list. J. C. Thimijan, 715 N. 7th St., Lake City, Mich.

FOR SALE—1946 Jackson VTVM and tube checker; RCP signal generator; misc. condensers, resistors, volume controls, transformers, coils, new tubes. Wholesale inventory over \$600. Sell as unit \$400. K. Dillman, Rt 9, Box 43, Akron, Ohio.

FOR SALE—Olympic long-wave portable, a.c. d.c. battery receiver. Lee Kent, 6507 N. Bell Ave., Chicago 5, Ill.

FOR SALE—Masco 50 watt amplifier; Two 25 watt University horns; 999 Turner mike with floor stand; Webster model 50 chamber optional, never used, in original carton. Martin Electronics, 142 Ralph Ave., Brooklyn, N. Y.

FOR SALE—Rider's Perpetual trouble shooters, Vol. 1 to 10. Almost new. Oscar S. Marder, 1694 Selwyn Ave., Bronx 57, N. Y.

FOR SALE—Complete material and test equipment used in sound systems shop. Many hard to get items. Free list. Beltone Sound Systems Co., 341 Madison Ave., New York 17, N. Y.

WANTED—8mm projector. Bell & Howell, Ampro, De Jur Keystone, Kodak. Will trade for Price card outfit portable radio, cash. Also want 8mm features good condition. G. Samkofsky, 527 Belford Ave., Brooklyn 11, N. Y.

SELL OR SWAP—Raytheon RK-20 tube good condition, hardly used, \$7.50 or what do you have? Warren E. Allen, 1838 S. 5th Ave., Maywood, Ill.

SELL OR SWAP—RCA service manuals, 1928-1931 and 1933 2 Vols.; Atwater-Kent service manual complete; Supreme Publications radio course 1 Vol. Smajd Radio, 721 Meadow Ave., Joliet, Ill.

YOUR OWN AD RUN HERE FREE

The Sprague Trading Post is a free advertising service to our radio friends. Providing only that it fits in with the spirit of this service, we'll gladly run your own ad in the first available issue of one of the six radio magazines in which this feature appears. Write CAREFULLY or print. Hold it to 40 words or less, and confine it to

radio subjects. Make sure your meaning is clear. No commercial advertising or advertising offering merchandise to the highest bidder is acceptable. Obviously, Sprague assumes no responsibility in connection with merchandise bought or sold through these columns or the resulting transactions.

Send your ad to
Dept. RRT-47, SPRAGUE PRODUCTS COMPANY
North Adams, Mass.

(Jobbing distributing organization for products of the Sprague Electric Co.)

ASK FOR SPRAGUE CAPACITORS and *KOOLOHM RESISTORS by name!

*Trademark Reg. U. S. Pat. Off.

How to Sell Heat Pads

Proper Display and Suggestions for Year 'Round Use Help to Increase Volume

The following interesting article was prepared especially for *RADIO & Television RETAILING* by A. O. Samuels, vice-president and general sales manager, Casco Products Corp., Bridgeport, Conn.

The "I must be first to have it" buying spree is over. Dealers might as well face it; customers aren't buying electrical appliances and housewares at just any price. They are stopping to consider formerly scarce items in light of the value and service to be derived from these purchases. Accordingly, the day has come for the retailer to put "more sell" into his merchandising program.

This call for down-to-earth salesmanship is going to catch many salesmen, old timers as well as newcomers, short. Why? Because the sad fact is that in the era just past when a postcard announcement or the appearance of a sample appliance in the window brought a flood of orders, they have forgotten how to sell.

The solution of the problem seems easier to find than that of selecting the most efficient method to fit the situation. The natural solution is stronger salesmanship but the method must be sound and applicable to the merchandising story.

Stress Product Uses

In searching for the way to build year 'round sales for their electric heating pad family, Casco has found that the fundamental answer lies in emphasizing the uses to which its products can be applied. The method evolved into the creation of a "wrap up" plan which provides the electrical appliance retailer with the elements for building a solid footing for his business future.

Facing the fact that electric heating pads represented a seasonal item to be used only in the winter to the general public, Casco took the first important step which today's appliance salesman must also take. This move was to find the way to build steady demand for the product throughout 12 months of the year.

The first step of the "wrap up" should be an analysis of the product in relation to the scope of its uses and the reaction of the consumer to the merchandise.

Contrary to the accepted concept that a heating pad is an electrified

water bottle for warming limbs chilled by the wintry blasts, it was found that this electrical appliance could be used throughout the year. The range of its applications includes providing soothing warmth for "difficult nights," comfort for aches and pains caused by over-strained muscles, relief for mid-season colds and insomnia sufferers.

All of which adds up to making heating pads a practical gift item for all ages. When surveys revealed that these applications were generally not known, it became evident that a sound consumer education program was required to change the seasonal sales peak to a steady year 'round market for heating pads.

This step is coupled with a "get acquainted" training course for salesmen through which they became fully familiar with the uses and special qualities of heating pads. Accordingly a special sales person's manual was prepared for the purpose of supplying the salesman with the answers to his customers' questions about the uses and special features, operation procedure of the appliance. The working principles of the heating pads were simply but fully described along with definition of special terms, such as nite lite, three-speed pad and fixed heat pad, wetproof and cushion-heat construction. Rounding out the course were numerous tie-in selling suggestions through which daily sales records can be built up such as with the sale of a small traffic appliance which is a natural opener for the clerk to say "I have another hand ap-

pliance which you may not have thought about."

Likewise, the person buying for baby furnishings proved to be a potential customer for a heating pad to keep the infant warm when he follows the traditional baby custom of kicking off his covers at night.

Step two which the appliance retailer in his consumer education plans to take is the development of a consistent program of promotions which dramatize the "use" merchandising story behind the product. This phase of the "wrap up" is divided into three parts, eye-catching windows and counter displays, newspaper advertisements and "still action" performance displays. To be truly effective, the displays and advertisements featuring various uses must be keyed to the time of the year.

Best Sales Builders

Moreover, tested displays which have proven to be the best sales builders have been those which are simple and direct in their approach. An example of this is the tie-in window display built around the timely question: "Got a Mid Season Cold?" Against a backdrop of numerous familiar cold remedies and supplies, the heating pad is featured as a convenient adjunct to help cold sufferers to drive out a cold with warmth. Similar displays and advertisements can be created to illustrate the electric appliance as a gift item and other applications of which the customer rarely thinks.

Still-action displays perform as helpful silent salesmen by demonstrating the working principles or other unusual features of the appliance in a striking and highly graphic manner. By plugging a wetproof heating pad into the wall current and placing it in a bowl filled with water and tropical fish, the dealer is able to demonstrate the super-safety of the pad for use with wet dressings in addition to rousing the customer's curiosity.

Providing natural conversation openers, these performance demonstrations set-ups enables the salesman to contact the shopper when his interest is most receptive to the product.



A. O. Samuels

(Continued on page 130)

*a new thrill in
musical entertainment
for your customers;
a new approach in
profit for you*



The **ALTEC LANSING** *Duplex Speaker and Cabinet*

It looks for all the world like a distinctive piece of furniture . . . it makes a conversation piece in any home. That was our intention in designing a cabinet worthy of the famous Altec Lansing Duplex.

Customers who had heard the speaker knew beyond a doubt that this was "something to be owned". But we knew that this "perfect" speaker needed an equally superb setting — to help it find its way into the most fastidiously-furnished homes.

True, not every customer on your books can afford the Duplex. But sales records of stores that have promoted it among their select clientele, prove that there is a surprisingly large and able-to-pay market for the luxury-priced Duplex.

Now that we are catching up on production, we are able to grant additional franchises to interested dealers. Write us for technical data. Advertising and display material are available for your promotion.

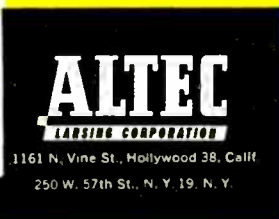
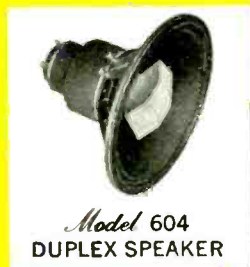

“ K E E P A D V A N C I N G W I T H A L T E C L A N S I N G ”

*Another
Brilliant New*
HOWARD
RADIO PHONOGRAPH



**NOTED
FOR TONE!**

- Compact Design • Fast Action Record Changer
- Beautiful Claro-Walnut Cabinet • Transformer Powered AC Chassis • Selenium Rectifier • Full Variable Tone Control

HOWARD RADIO COMPANY

CHICAGO 13, ILLINOIS

America's Oldest Radio Manufacturer

**Silliman Heads
Bendix Distribution**

Appointment of Horace H. Silliman as manager of distribution for radio and television has been announced by W. P. Hilliard, general manager, Bendix Radio Division, Bendix Aviation Corp.

As district manager for New England and up-state New York territories, Mr. Silliman has been with Bendix Radio for

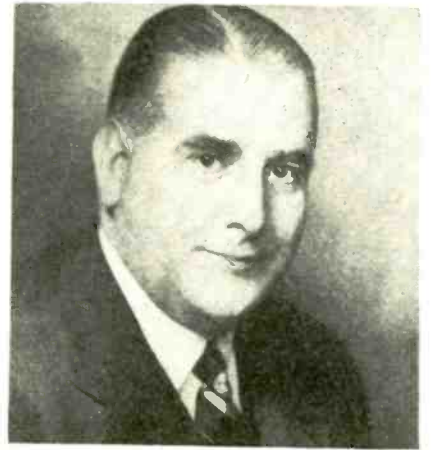

Horace H. Silliman

three years. He is a veteran of 20 years in domestic and export marketing, with such firms as A. C. Gilbert, Splittdorf, United American Bosch, Detrola, and Thomas A. Edison.

The position of manager of distribution was recently vacated by J. T. Dalton, who was promoted to general sales manager.

**New Clarion Model
Is Introduced**

At meetings held in various large cities, Chicago's Warwick Manufacturing Corporation introduced a new table model radio-phono combination, the Clarion Symphonette, retailing at \$99.95. The new receiver employs the Clari-Disc, a selenium rectifier which provides 275 per cent more power, according to officials. The power is applied to tonal quality instead of merely to increased volume, the firm points out.

In addition to showing the Symphonette, the company's entire line now in high production, is being shown, and regular deliveries are being made to dealers.

The meetings are being presided over by Reau Kemp, sales manager, and are being attended by John Holmes, Warwick president and Gordon Brittan, vice-president.

Asks Aid for PA Dealers

Wider attention by new radio engineers to the needs of PA and sound merchandisers for better and more easily installed equipment was stressed by Saul White, chief engineer of University Loudspeakers, Inc., in his lecture and demonstration on loudspeaker design before the March meeting of the IRE student section's March meeting at New York's City College.

ANOTHER GREAT *New* UTILIPHONE

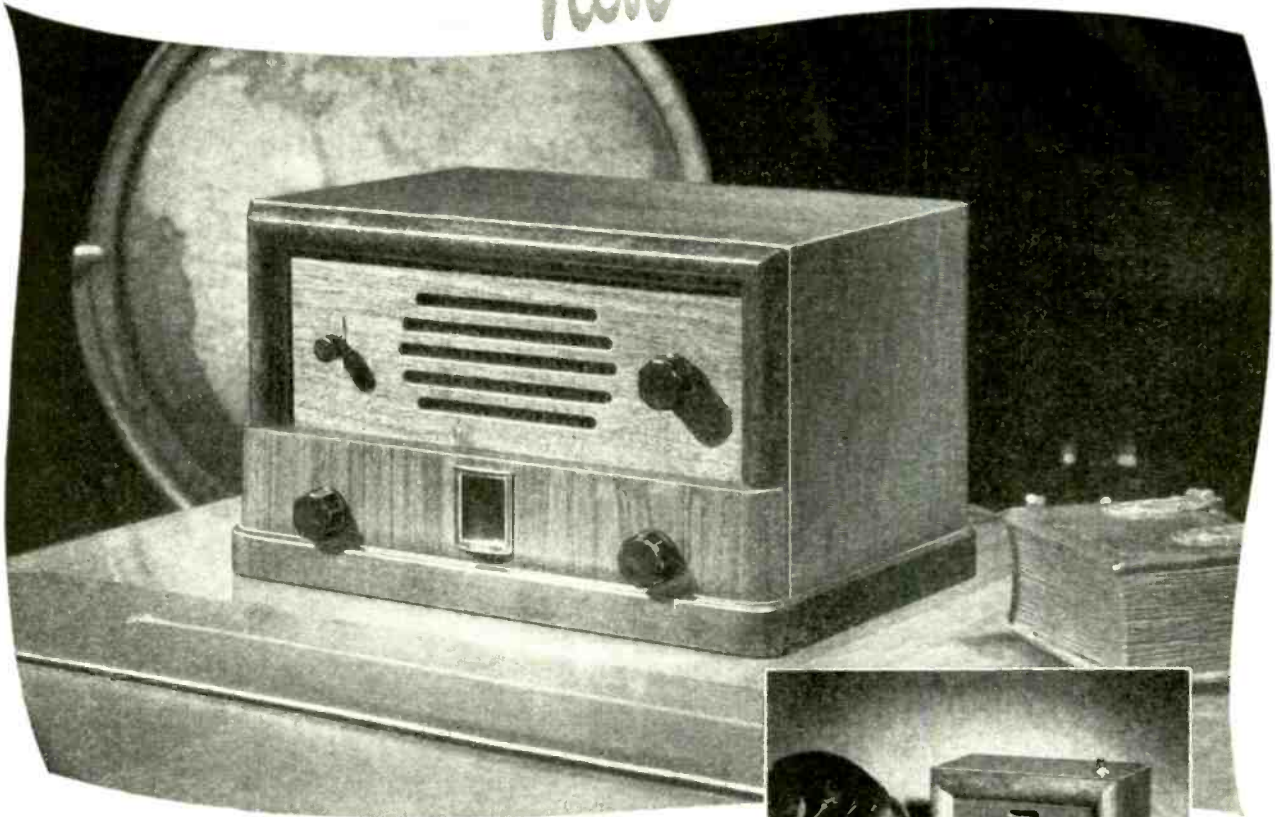

ELECTRONIC

Announces the
RADIO-UTILIPHONE
 (INTERCOM · RADIO RECEIVER)

● Increasingly vital to business and professional men are up-to-the-minute news . . . market reports, important addresses, and scores of other features made available instantly by radio. Now Electronic combines all these advantages with the convenience of an intercom system in a single top-quality instrument—the Radio-Utiliphone. It unites a powerful Electronic 6-tube superheterodyne radio, with the famous high-amplification Utiliphone Intercom System. It's handsome . . . it's easy to use . . . it's easy to install . . . it's something new, *essential* and exclusive to make volume sales for Utiliphone distributors and dealers. Write for full information on the Radio-Utiliphone (Model 76 RU) . . . and regular Utiliphone Intercom Systems, 5-station (Model 73S4) and 2-station (Model 2660).

ELECTRONIC LABORATORIES, INC., INDIANAPOLIS, INDIANA



Limited Number of Distributorships Available • Wire or Phone Sales Division, Indianapolis, RI ley 1551

Master station (at top) and sub-station (above), housed in handsome walnut veneer cabinets, add distinction to any surroundings. List price for these 2 units, \$89.50. Additional sub-stations, \$15.00 each, list. (Prices slightly higher Denver and West.)



Ease and convenience of Radio-Utiliphone give complete satisfaction on intercall service. Accommodates up to 4 sub-stations. Operated as radio receiver, provides powerful and high-fidelity broadcast-band reception.



*One Reason why
LEAR DEALERS are
a Jump Ahead*

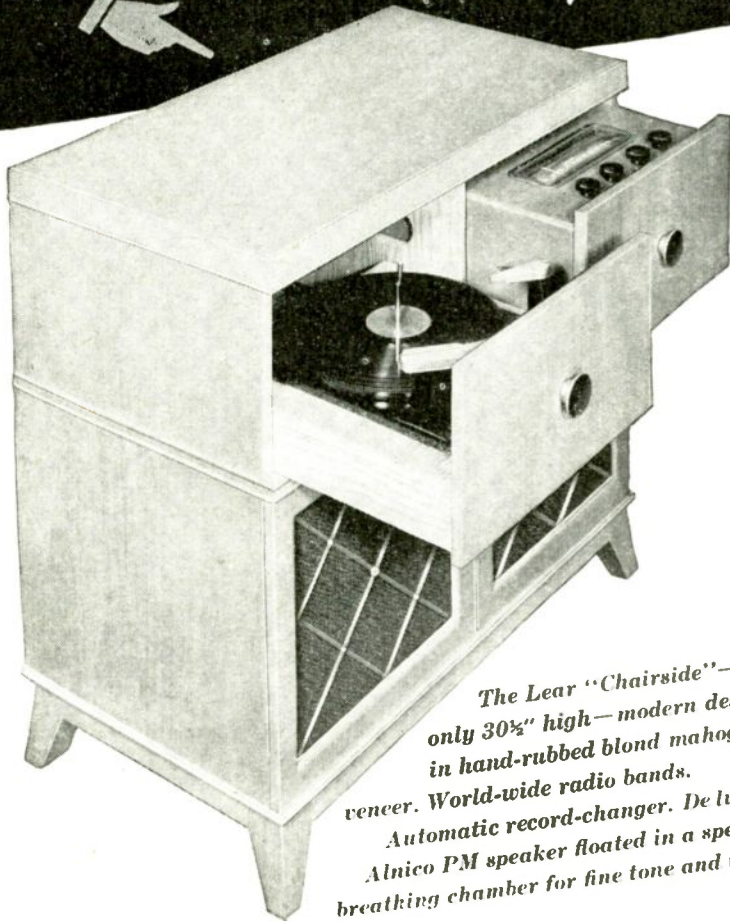

*The Lear "Chairside"—
only 30½" high—modern design
in hand-rubbed blond mahogany
veneer. World-wide radio bands.
Automatic record-changer. De luxe
Alnico PM speaker floated in a special
breathing chamber for fine tone and volume.*

When the Lear labs engineered and tested the chassis for this sweetheart, they beamed and said "this is it." When the sketches for the cabinet were shown, everyone agreed this one would be a honey.

So we lavished everything we had on it—fashioned it in hand-rubbed woods for beauty—gave it a refined hook-up and double duty tubes for power. Then we took a big 10" Alnico dynamic speaker and floated it in a special breathing chamber for full-throated reproduction.

And Bingo! we had a combination that one store manager proclaims the "finest value in the radio market today."

Yes, the Chairside's a great value. And so are all the other radios Lear makes. Every last one of them reflects the skill and habit-for-precision that have been bred in us through 17 years of building aircraft radios.

So you see, together with all the fine sales and merchandising features of the Lear Franchise, the prime reason Lear Dealers are a jump ahead is the outstanding quality of the Lear Radios themselves.

Coming! The Learecorder—"The wire that remembers" in the new Lear "Dynatropo"

LEAR RADIO



LEAR, Incorporated, Home Radio Sales and Merchandising Division, 110 Iowa Avenue, N. W., Grand Rapids 2, Michigan

Stewart-Warner Gets Ready for "Buyers' Year"

In the belief that 1947 will be "a buyers' year on radio sets", Stewart-Warner Corp., is "more than doubling" its 1946 advertising and merchandising program, Leo B. Pambrun, advertising manager for the radio division of the company, declares. In announcing the company's plans Mr. Pambrun said:

"Anticipating that 1947 will be a buyers' year Stewart-Warner has planned an advertising and merchandising program more than doubling the outstanding effort made for its dealers in 1946. Displays, identification signs, and real feature-selling literature are now in preparation for the all-new models recently introduced and full line schedules have been released for color pages in such national magazines as *Saturday Evening Post*, *Collier's*, *Time*, *New Yorker*. Dealers will be well informed of latest Stewart-Warner developments via full page ads in all leading radio and appliance trade journals. Also doubled down the line this year will be merchandising aids designed to stress outstanding Stewart-Warner radio features that make for easier sales, such as superior tone, finer cabinet design, and greater values."

Frigidaire's New Line

A complete new 1947 line of electric household ranges is being introduced to thousands of dealers throughout the nation by Frigidaire Division of General Motors, according to an announcement by H. M. Kelley, appliance sales manager.

"Manufacture of the new ranges is well underway with five streamlined models rolling from our production lines in Dayton," he pointed out. The new series includes two deluxe models, one with two ovens. "Design and construction are completely new—from the ground up—making these ranges the most beautiful models we have ever built," Mr. Kelley explained.

Sound Sales Manager



Arch Samuelson, formerly a Midwest district manager for Operadio Mfg. Co., has been upped to the post of sales manager for the firm's commercial sound division. Operadio also named J. F. McCraigh as West Coast district manager and Fred H. O'Kelley as southeastern district manager.

**A
Smash
Hit!**

**GENERAL ELECTRIC LINE
OF
UNIVERSAL PARTS**



SPEAKERS



ATTENUATORS



COMPOSITION RESISTORS



**FIXED AND ADJUSTABLE
WIRE-WOUND RESISTORS**



RHEOSTATS

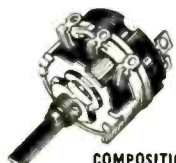

**COMPOSITION
CONTROLS**



GENERAL ELECTRIC Line of Universal Parts—it's the name you'll see as the star in the parts picture—because it's a name known everywhere for Quality.

Every unit was screened and tested before it was accepted as a part of the line. Now, this top hit production of all-star parts is rolling across the country making new records wherever it has been shown.

It's the easy-to-sell line, the quality line—backed with plenty of promotion and push. Action now will bring you quicker profits.

*Write to: General Electric Company,
Electronics Department, Syracuse, N.Y.*

**THE FIRST AND GREATEST NAME
IN ELECTRONICS**

GENERAL  ELECTRIC

180-72



**RESISTOR
TUBES**



L-PADS

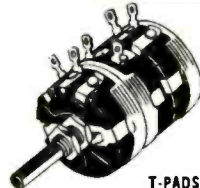

T-PADS



AUTO ANTENNAS



**FM AND TELEVISION
ANTENNAS**



**FM AND TELEVISION
LEAD-IN CABLE**

Announcing...THE NEW TURNER MODEL 20X HAND MICROPHONE

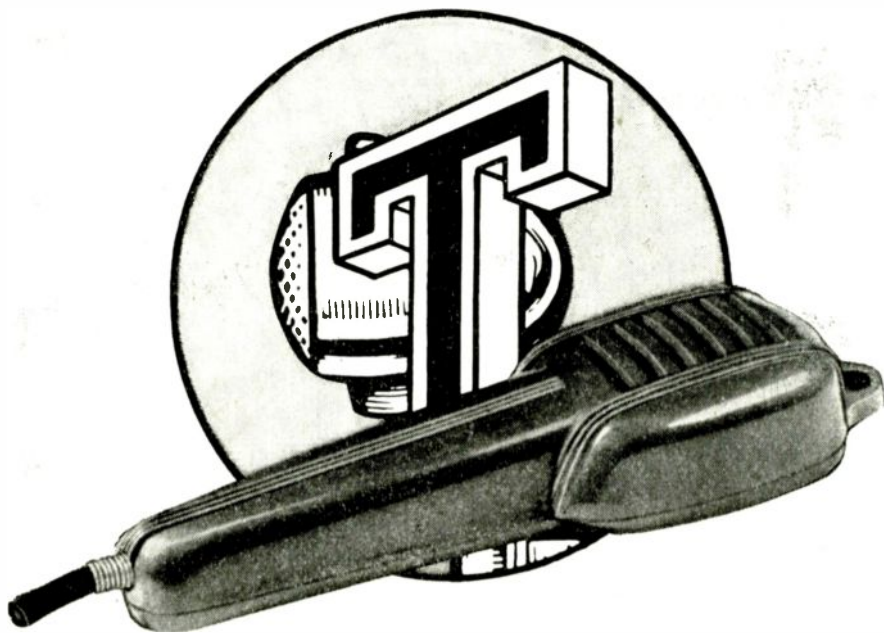

**a little mike
with a BIG future**

We're mighty proud of this new addition to the line of Microphones by Turner. Small in size yet *big in performance* it inherits those qualities of sound engineering and careful workmanship that have made the name Turner a symbol for precision and dependability.

The New Model 20X is designed to appeal to owners of home recorders and amateur communications equipment. It has innumerable applications in offices and factories and for paging and call system work. Sound pressure tests reveal remarkable performance characteristics for a low priced unit. Its circuit features a Metalseal crystal which withstands humidity conditions not tolerated by the ordinary crystal. Response to voice and music is smooth and flat within ± 5 db from 40-7000 c. p. s. Level is 54db below 1 volt/dyne/sq. cm. Finished in lustrous brown baked enamel, the Model 20X is light in weight and natural to hold. It may be hung on a hook. Furnished complete with 7 ft. attached shielded cable.

WRITE FOR BULLETIN

THE TURNER COMPANY

903 17th Street N. E. • Cedar Rapids, Iowa

Microphones **BY TURNER**



"THE PASSWORD TO SOUND PERFORMANCE"

LICENSED UNDER U. S. PATENTS OF THE AMERICAN TELEPHONE AND TELEGRAPH COMPANY, AND WESTERN ELECTRIC COMPANY, INCORPORATED. CRYSTALS LICENSED UNDER PATENTS OF THE BRUSH DEVELOPMENT COMPANY.

Portable Profits

(Continued from page 35)

part of the promotion.

There's also an eye-catching kind of window to be built around the portable radio batteries used in the sets. This is particularly true since the battery-replacement methods in radios have been improved; sets can be shown "open" so as to exhibit the new feature and attract the attention of the folks who are interested in more than just the appearance of the radio. Also, batteries are usually brightly packaged and add color to a display. Prospects can see prices and note that some of the batteries are the familiar flashlight units. Of course it is never a good idea to show batteries in such unexplained masses as to indicate that a pile of them is required to keep the radio going.

Electric kitchens and model rooms are two more places where a retailer can promote the interests of the portable. It is a fact that portable radios are now widely used as an extra set around the house, during periods when the sets are not required for outdoor listening. Some of the radios are designed with this fact in mind. Now that the day of the three-way portable has arrived in great style, owners of portables do not plan to store them away while they are not in use outside.

Selling Heat Pads

(Continued from page 124)

Departmentalizing the appliance with either a distinctive floor or counter display is another element which has proven helpful to create sales. By grouping the product with special display cards, catalogues and other data pertinent to its merchandising story, the dealer creates a mass display which has a natural drawing power in itself for the buying public.

These elements wrap up a realistic and thorough-going merchandising program because they make the salesman aware of his necessary working tools; 1) acquaintance with the product and what it can and cannot do; 2) sound promotion including displays and advertising to tell this story; 3) salesmanship based upon customer service.

The holiday of easy selling is over, but in its place the dealer can apply these tested merchandise mover methods as the foundations for steady year 'round business and customer good will. Moreover the wrap up is sound formula for today's selling problems as well as the future because it is the call for down-to-earth salesmanship.

2 UP-TO-THE-MINUTE HANDBOOKS



6x9 inches
\$4.50 each

Written and published as a day-in day-out working tool for engineers interested in electronic applications in the industrial and communication fields. Edited by Ralph R. Batcher and William Moulic, this book contains the writings of the foremost men in the particular phases of electronics covered by the book. Yet its messages are presented in a manner easily understood by any engineer with a basic knowledge of electrical principles.

From fundamentals the book proceeds logically through detailed discussions, covers every important circuit and essential application.

We could reprint many words of praise from owners of this book, but we prefer that you come to your own considered opinion of its value. Therefore we want to send you a copy for your five day free inspection. Use the coupon below, today. Get this book working for you.

Read This List of Contents!

Vacuum Tube Fundamentals
Electronic Principles
Principles of Diodes
Principles of Multi-Element Tubes
Principles of Photo-electric Tubes
Cathode Ray Tubes
Special Purpose Tubes
Materials in Tube Construction
Vacuum Tubes as Circuit Elements

Electronic Circuit Fundamentals
Principles of Rectification
Principles of Amplification
Low Frequency Amplifiers
High Frequency Amplifiers
Principles of Oscillators
Principles of Modulation
Principles of Detection
Cathode Ray Oscillographs
Relaxation Oscillators
Photo-electric Circuits

Electron Tube Circuit Application
Electronic Applications
High Frequency Heating
Industrial Sound Systems
Vacuum Tube Data
Electronic Tube Data and Tables



456 pages—Over
200 illustrations

CALDWELL-CLEMENTS, INC.

480 e Lexington Ave. New York 17, N. Y.

Publishers to the electronic industries since 1925

Send books checked below. If not satisfied, I will return books to you within five days. Otherwise I will remit payment.

ELECTRONIC ENGINEERING HANDBOOK \$4.50

ELECTRONIC CONTROL HANDBOOK \$4.50

Name.....

Address.....

City and State.....

Company Name.....

Tailor-made as a Daily-aid for every radio man who reads this magazine

ELECTRONIC ENGINEERING HANDBOOK

ELECTRONIC CONTROL HANDBOOK

Here is a valuable storehouse of reference material on the *fundamentals* of electronic control principles used in industry. Here is the first and only single source providing the essential data you must have to accurately appraise the value and specify an electronic control device. Electronic controls are everywhere today cutting manufacturing costs, speeding production and improving quality of products. This book gives you authoritative, factual information from which you can safely conclude when, how and where they can improve efficiency in your plant.

The condensed contents listed below give a general idea of the material in this book, but nothing less than your personal inspection of the volume itself will enable you to appraise its constant value. That is why we have arranged to send you a copy of the book at our risk, for your five day perusal. Send for it by using the convenient coupon below. Today.

Read This List of Contents!

Section I—Basic Elements of Control
Chapter 1—Theory of Control Systems
Chapter 2—Signal Transmission Systems
Section II—Conversion Elements
Chapter 1—Displacement and Pressure Conversion Elements

Chapter 2—Temperature Conversion Elements
Chapter 3—Miscellaneous Conversion Elements
Section III—Electronic Modification Circuits
Chapter 1—Control Amplifiers
Chapter 2—Control Oscillators
Chapter 3—Counting and Timing Circuits
Chapter 4—Rectifiers and Miscellaneous Circuits
Chapter 5—Passive Networks
Chapter 6—Error Detectors
Section IV—Activation Elements
Chapter 1—Synchros
Chapter 2—Solenoids and Relays
Chapter 3—Saturable Reactors
Chapter 4—Amplidynes
Chapter 5—Control Motors
Section V—Control Applications
Chapter 1—Welding Control
Chapter 2—Motor Speed Control
Chapter 3—Temperature Control
Chapter 4—Miscellaneous Applications



Both books bound in limp leatherette, open flat for easy reference.
\$4.50 each

344 pages.
Hundreds of charts, diagrams, tables, drawings and photographs.

Completely indexed for reference purposes.

MAIL THIS

NO RISK COUPON

Emerson Favors Lower Consumer Prices

The action of the Emerson Radio & Phonograph Corp. in making a price cut from \$49.95 to \$39.95 on its portable radio was explained by Benjamin Abrams, president, who said that "the company's expectations in reducing the price are that, by thus further widening the consumer market and immediately stepping up production to a point where suppliers of raw materials and components will be warranted in quoting lower bids as a result of manufacturing and overhead economies on their own volume, it will be possible to maintain the new low figure."

Model 536, selected by Emerson for

the experiment, was described as "the fastest selling item in the company's portable radio line, the demand for which is considerably greater than its present rate of production."

Mr. Abrams said that "it seems crystal clear to us that the mass production which this country needs in order to maintain full employment must find a corollary in lower consumer prices."

St. Louis Dealer

Joe and Isadore Roth with Maurice Schechter have incorporated the Rothman Radio & Appliance Co., 1605 Mississippi Valley Trust Building, St. Louis, Mo., to operate a retail radio and appliance business.

Truesdell Heads Hotpoint Marketing

Leonard C. Truesdell is the new vice-president in charge of marketing for Hotpoint, Inc., Chicago, James J. Nance, executive vice-president has announced. He will have responsibility for all commercial phases of the company's operations, including that of general sales management.

Mr. Truesdell has long been a well-known figure in the appliance industry;



Leonard C. Truesdell

his last affiliation having been that of general sales manager of the Radio Division of Bendix Aviation Corp., from which he resigned to accept his new post at Hotpoint. Previous to joining Bendix, he had been, for eleven years, associated in marketing capacities with Frigidaire.

New Magnetic Tape for Recorder

Hyflux, a new magnetic recording tape made by the Indiana Steel Products Co., Chicago, and a magnetic sound recorder, especially developed to use this tape, was demonstrated last month at showings in New York City.

The new tape lays claim to better fidelity, extended frequency response, and a high energy quality which its makers claim make it superior to contemporary sound recording materials.

Cooper Co. New Lines

Cooper & Co., 110 W. 42nd St., New York City, manufacturers' representatives, is now the radio and electrical representative of Parisian Novelty Co. of Chicago. Parisian is a fabricator of plastic parts for radios such as dial faces, windows, name plates and other special laminated components. The design and engineering staff of Parisian is ready to extend any assistance incidental to its service.

Another line, the Resistance Products Co. of Harrisburg, Pa., makers of precision resistors, has also been added to Cooper & Co. accounts. Through Cooper & Co., they will extend special development facilities for use of their products in test and other precision instruments. Reconstituted since V-J Day, Cooper's personnel is entirely composed of veterans.



THE NAME OF GROWING IMPORTANCE IN SOUND EQUIPMENT

THE MASCO line has earned a unique position in the sound field.

Standard component parts of nationally advertised manufacturers are used in the manufacture of Masco equipment . . . the same parts that you regularly merchandise . . . none but the finest!

Superior engineering and precision manufacture are the key to Masco performance. High factory morale, extensive inspections and executive know-how play their role in maintaining Masco quality.

And of highest importance is Masco's VALUE concept. In building for the future we believe that the widest use of sound equipment can result only from a pricing policy that expands the market to the greatest possible number of users.

Compare Masco values with those of ANY other line.

MASCO

MARK SIMPSON MANUFACTURING CO., Inc.
32-28 49th Street, Long Island City 3, N.Y.

SOUND SYSTEMS and Accessories



RAvenswood 8-5810-1-2-3-4

Universal Bantam Range on Market



Included in the new line of electrical appliances just announced by Landers, Frary & Clark, New Britain, Connecticut manufacturers, is the Universal Speedliner "bantam" electric range. The oven is large enough to roast a 22 pound turkey, and the new appliance bakes, broils, roasts and cooks. It draws 1650 watts, is thermostatically controlled and plugs into a regular outlet.

Radio-In-Every-Room All Set to Go

Further action on the big "Radio-In-Every-Room" sales promotion campaign to be sponsored by the Radio Manufacturers Association was taken at the recent meeting of the RMA board of directors held at the Stevens Hotel in Chicago.

Upon recommendation of the RMA advertising committee of the set division, the directors gave a green light to the launching of the \$50,000 campaign and the employment of the Fred Eldean Organization, of New York, to handle the details of the merchandising program, under the direction of the advertising committee.

In other fields, the directors authorized a full survey of FM production. Declaring that the radio industry is doing everything possible to expedite the production of FM-AM receivers, the board authorized President R. C. Cosgrove to appoint a special committee to canvass RMA set and transmitter manufacturers, prepare a "factual" report on FM production both current and through 1947, and confer with the FM Association on FM production problems.

Larry F. Hardy, vice-president of the Philco Corp., was appointed chairman of the special committee by Mr. Cosgrove, and the other members are: Ben Abrams, president of Emerson Radio & Phonograph Corp.; H. C. Bonfig, vice-president of Zenith Radio Corp.; E. A. Nicholas, president of Farnsworth Television & Radio Corp.; and S. P. Taylor, chairman of the RMA transmitter division and sales manager of Western Electric Co., Mr. Cosgrove will be an ex officio member of the committee.

The action was taken in response to a formal request from Roy Hofheinz, president of the FM Association, which had set up a liaison committee to confer with RMA on the whole question of FM set

production, particularly in the low cost field. The FMA committee comprises Mr. Hofheinz; Arthur Freed, vice-president of the Freed Radio Corp., Dr. Ray H. Manson, RMA director and president of Stromberg-Carlson Co.; and Bill Bailey, FMA executive secretary.

The board voted unanimously to revive the prewar practice of holding an industry banquet during the next RMA annual convention June 10-13 at the Stevens Hotel.

New Retailer

Pfister's, Inc., appliance dealers, Las Cruces, New Mexico, has been incorporated with \$25,000 authorized capital stock.

Crosley Sales Executive

Appointment of Victor R. Lindemann as southwestern regional sales manager for the Crosley Division, Aviation Corp., has been announced by E. C. Brode, manager of distribution. Lindemann served as district sales manager of Crosley from 1939 until last in 1941, when he entered the Air Corps.

Hallcrafters Official

The appointment of Sam J. Muly as assistant purchasing agent for the Hallcrafters Co. has been announced by Raymond W. Durst, executive vice-president of the firm.

171 Miles of OXFORD SPEAKERS

PHILADELPHIA PA.
WASHINGTON D.C.
BALTIMORE
PITTSBURGH
RICHMOND VA.

ACROSS THE COUNTRY!

WHILE one does not think of speakers spread out across the land, still if the OXFORD SPEAKERS already sold to over 77 leading radio receiver firms for their 1946-1947 line were laid end to end, they would reach almost from Philadelphia to Richmond! And at the end of this year, they should reach nearly three times that far.

THAT'S a lot of loudspeakers, and attests to the excellence of their construction and their unquestioned popularity. The Jobber who knows this fact, can stock up on OXFORD SPEAKERS with the foregone conclusion that he can meet every requirement any customer can bring. And he can do it without a "special speaker." For the OXFORD SPEAKER line is designed to give the "Maximum Customer Coverage" with only the average Jobber stock pile.

THAT'S why the better Jobbers heartily endorse the statement that OXFORD SPEAKERS are the ALL JOBBERS' CHOICE!

***OS/AJC**

***OXFORD SPEAKERS/ALL JOBBERS' CHOICE**

(Coming soon: The New Oxford Catalog. Write for your free copy.)

ALL JOBBERS' CHOICE

Copyright, OXFORD ELECTRIC CORPORATION, 1947.

OXFORD ELECTRIC CORPORATION

3911 SOUTH MICHIGAN AVE., CHICAGO

E-L Shows New Orthosonic Line

A "lift", or a built-in elevator, operated electrically, for the benefit of the automatic record player in a console combination made by Electronic Laboratories, Inc., Indianapolis, Ind., has been shown to the trade.

Incorporated only in the chairside console, the "lift" provides easy access to the record player by simply pressing a button. As the largest of the new models offered by Electronic Laboratories, the chairside is expected to retail at \$350.

Announcing the new line of radio receivers under the trade name "Orthosonic", William W. Garstang, president

of Electronic Laboratories, said "each model is keyed around a special amplifier speaker system permitting dual adjustment of high and low notes in reception to suit the individual listener." Each radio was also designed to meet some specific need in the industry, hitherto unavailable, he added.

Emerson Sales Rep

Charles Weisser, Emerson Radio and Phonograph Corp. sales manager, has announced the appointment of Leslie M. Graham of Indianapolis as a company sales representative in the Mid-Western area.

Norge Executives



Thurlo F. Johnson, below, has been appointed sales manager, central region, Norge Division, Borg Warner Corp. L. B. Cash (above) who was formerly his assistant, has been promoted to Mr. Johnson's former position as national service manager.



Three New Reps for Mallory

Walter E. Harvey, manager, wholesale division, P. R. Mallory & Co., Inc., Indianapolis, Ind., has announced the appointment of representatives in three key sales areas to work with Mallory distributors in the sale of Mallory products to the radio service trade and to the industrial market for electronic parts.

Clint Bowman has been named to handle the territory including Chicago, northern Illinois, Iowa and Wisconsin.

Allen Shaw will represent Mallory in Pennsylvania, Maryland, Delaware, Virginia, District of Columbia and eastern New York.

Ray Bridge has been assigned to cover the New England States.

New Motorola Official

Daniel E. Noble, general manager of the communications and electronics division of Motorola has been appointed to the position of vice-president in charge of the division. Motorola president Paul V. Galvin made the announcement.

MASCO SOUND
puts everyone
up front!



MASCO Mobile MC-25P for 6 Volt D. C. and 115 Volt A. C.

Wherever a sound truck rolls there's a sale to be made for MASCO's MOBILE MC-25P 25 watt amplifier with built-in phono-top. For elections, parades, resort work, fairs, playgrounds, tent meetings! It operates on battery where A.C. current is not available. And operates on 115 volt A.C. 60 cycles. For all outdoor audiences. A MASCO precision-built amplifier... a great MASCO value.

	List Prices
MC-25P, phono-top amplifier, less tubes	\$131.25
Kit of matched tubes	\$16.00
MAC-25P complete portable system available, see catalog 45 ML. . . .	\$223.75

Add 5% west of Rockies

Contact your local Masco distributor for immediate delivery. For descriptive literature or other information write directly to factory.

MASCO

MARK SIMPSON MANUFACTURING CO., Inc.

32-28 49th Street, Long Island City 3, N.Y.

SOUND SYSTEMS and Accessories

RAvenswood 8-5810-1-2-3-4

RADIO SERVICE-MEN-SAVE 20%-70% ON RADIO PARTS

COMPLETE RADIO KITS—FACTORY ENGINEERED!

NEW PLASTIC CABINET AC-DC SUPERHET KIT. Cabinet size 7x6½x10½". Attractive slide rule dial. 2-gang tuning condenser. Receives broadcast 550 to 1650 KC. Has latest Alnico 5 PM speaker. Loop antenna; all parts simplified diagram and tubes 12SA7, 12SK7, 12SQ7, 50L6 and 35Z5 furnished. Kit P-48. Net \$12.95



4 TUBE 1½-90 VOLT FARM RADIO KIT. Offered in same cabinet as the above Kit Model P-48. The same high gain broadcast superhet circuit. Complete with 4 tubes; 1R5, 1T4, 18S, 384 and diagram. Less battery pack. Kit model PB-48. Your cost \$10.95

DELUXE AC-DC KIT J-D5

Beautiful walnut cabinet and all the parts to build a broadcast 5 tube AC-DC radio. Superhet with slide rule dial, 2 gang tuning condenser and loop aerial. Everything furnished; includes speaker and tubes 12SA7, 12SK7, 12SQ7, 35Z5 and 50L6 and diagram. Kit J-D5. Net \$14.95



KIT K-5D. Similar cabinet to above J-D5 except it is AC Trans. type and has 6 volt tubes. Net \$16.95

KIT K-7A.

Easily assembled into a fine working, attractive, transformer type AC broadcast receiver; 550 to 1700 KC. Has push-pull audio, tone control and 6½" Alnico 5 PM speaker. Beautifully made 14" walnut cabinet. Incorporates a standard superhet circuit, with AVC and loop antenna. All parts, schematic and tubes 6SA7, 6SK7, 6L6, 6SN7, 2-6G6's and 5Y3 furnished. Nothing else to buy. Dealers Net \$19.95

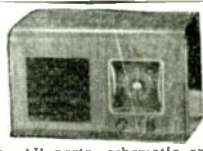

KIT J-15X SINGLE RECORD PLAYER.

Attractive ready cut walnut cabinet, with latest 78 RPM phono motor and light weight crystal pick-up. Complete with a ready to play (wired and tested) 3 tube AC-DC amplifier; with tubes and 4" Alnico 5 PM speaker. You can assemble this kit in a few minutes. Dealers Net \$13.95



Single Player Kit W-L3.

Has beautifully made walnut cabinet, with hinged lid. Plays 10" records with lid closed. Complete with rim-drive motor, crystal pickup and 3 tube AC-DC amp. (wired and tested ready to play). 4" Alnico 5 PM speaker. Readily assembled into an easy to sell player. Dealers Net \$19.95



20 WATT PORTABLE AMP KIT PN-21

Has attractive split case, with cut-out for 2 12" speakers. (Snaps together). We furnish all parts, punched chassis, diagram and tubes 6SN7, 6SN8, 2-6L6A, and 6T4C. Has full 150 Mill power transformer. PN-21 with 12" G.E. PM Speaker \$34.95 PN-21 with 2 12" G.E. PM Speakers \$43.95 Crystal Mike and stand \$7.95



KIT SB-10

Something new in record players. G.I. spring wound motor, crystal pick up and a powerful push pull 1½-90 volt amp. (wired and tested, ready to play) No AC power needed. Plays on self-contained portable batteries. Has attractive small leatherette case; 5" Alnico 5 PM speaker. You can assemble this unit in a few minutes. Priced complete with tubes and batteries. Dealers Net \$17.95



KIT ST-10

Similar in appearance to above SB-10, except has rim-drive motor, crystal pick-up and 3 tube AC-DC amp. (wired and tested ready to play). Priced complete with tubes. Dealers Net \$17.95

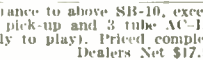

CHANGER—VERY SPECIAL \$14.95

Made to fit walnut base \$2.49 extra. B-4 Phono oscillator (fits base) \$3.69 Single Record Attachment (motor, pick-up and walnut base) not shown \$8.95. With phono oscillator \$12.64

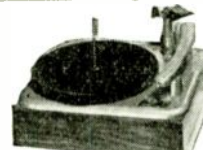

SCOOP . . .

DALBAR. 5 tube AC-DC Broadcast Radio (not a kit) Beautifully made walnut cabinet with back. Has tone control and phono plug, 5" PM speaker; with tubes 12SA7, 12SK7, 12SQ7, 35Z5 and 50L6. Dealers Net \$16.95 Lots of 6 \$16.45 each

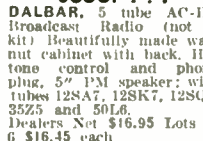

JAN OR REGULAR BRAND TUBES

CARTONED OR UNCARTONED SPECIAL at .49		SPECIAL at .69	
39/44	27	1J6	6F6
76	185	6Y6	1V
37	6H6	1D5	6V6
5Y3GT	6AC7	1H4	12SF7
5Y3GT	6SH7	3A4	12SQ7
6CNG	56	1R5	5Z3
6FNG	6H4G	59A5	6SA7GT
1633	80	35A5	38
1634	6K7	50B5	6SK7GT
12SN7	12A5	12AT6	6SJ7
6SN7	6L6	12BA6	6G6
6SD7	6C6	12BE6	5C4
41		35W4	6T4
42			6K6

VERY SPECIAL JAN 6L6M99

SCOOP IN RADIO TUBES 6 & 12 VOLT LOCAL TUBES			
7A4	7B7	7C7	7D7
7A6	7C7	7E7	7F7
7C5	7Q7	7V7	7Z7

14Q7 14H6 35V4 79c EACH
14A7 14H7 14H7 79c EACH

1½ VOLT LOCAL TUBES

1L45	1LH4	99c EACH
1L44	1LN5	
1L46	1L46	\$1.49 EACH

Regular net on these tubes is \$1.81. These tubes are all of leading make.

Save 30% to 70% on Vibrators

WAR SURPLUS AND REGULAR CARTONED	
Midget 4 prong, for Ford sets	\$1.49
Off set 4 prong 6 volt	1.79
5 prong sync. 6 volt	1.95
Stan. 6 prong sync. 6 volt	1.95
SP-55, off set 5 prong sync. 6v	2.59
SP-62 reversible 6 prong sync.	2.59
Syn. unit only, long leads 6 volt	1.69
SL-5 sync. unit with buffers	2.59
Midget 6 prong sync	1.49
32 volt standard 4 prong	1.49
7 prong 2 volt sync.	1.95
Heavy duty 6 prong sync. for 30 watt 6 volt amplifiers. Special	2.95

SENSATIONAL 4-PRONG VIB. SCOOP

Genuine 4 prong 6 volt vibrator. This is the reg. type and size, just like you use every day. Fits Philco and many others. Very special. Net \$1.29

Syn. Vibrator Unit Save 75%

Standard size replacement, 6 volt sync. vibrator unit; long leads. Ideal for all types of replacements. Easily fits in any can. Net \$0.99

McGEE SPECIAL TUBULAR ELECTROLYTIC CONDENSERS

8 MFD 450 V PAPER TUBULAR	\$0.29
16 MFD 450 V PAPER TUBULAR	.39
8 S MFD 450 V PAPER TUBULAR	.39
16 MFD 150 V PAPER TUBULAR	.29
40 MFD 150 V PAPER TUBULAR	.39
20-20 MFD 150 V PAPER TUBULAR	.39
40-30 MFD 150 V PAPER TUBULAR	.49
100 MFD 25 V PAPER TUBULAR	.24

These are first class electrolytics. Guaranteed 1 year.

McGEE SPECIAL PAPER TUBULAR 600 V TUBULAR

.001	\$0.07
.002	.07
.01	.07
.05	.09

ASSORTMENT OF 100; TAKE OFF 1c EACH

FINEST QUALITY TUBULAR ELECTROLYTICS IN ALUMINUM CASES WITH PAPER INS. SLEEVES.

8 Mfd. 450 volt midget tubular	\$0.39
8A8 Mfd. 450 volt midget tubular	.69
16 Mfd. 450 volt midget tubular	.64
20x20 Mfd. 150 volt tubular	.59
40x20 Mfd. 150 volt tubular	.69
50x30 Mfd. 150 volt tubular	.79

We guarantee these condensers for 1 year and are as fine as any produced. Money back guarantee.

40 MIL POWER TRANSFORMER

Flush mounting 6.3, 5 volts. Special \$1.98

GENERAL ELECTRIC 12" PM SPEAKER

7 oz. Alnico 5. Beats anything you ever heard. Last \$16.50

GENERAL ELECTRIC 10" PM SPEAKER

7 oz. Alnico 5. Net \$7.35

SCOOP ON ALNICO—5 PM SPEAKERS

4" 1 oz.	\$1.49
5" 1 ½ oz.	1.59
5" 1 ½ oz.	1.69
6" 1 ½ oz. square	1.95
6 ½" 1 ½ oz. round	1.95
8" 8 oz. Alnico 3	2.95

PORTABLE BATTERY SPECIALS

GENERAL TYPE 45 VI, V-30A, V-30AA and V-30B spec. 79c. General 1½ volt port. A type 6F1 spec. 29c. All the above parts, were made in June and July 46 and are guaranteed.

Send 20% Deposit—Bal. Sent C.O.D. With Full Remittance, Include Ample Postage

SMALL SLIDE RULE DIAL

All assembled, ready to mount on top of 5" speaker. Special	\$0.39
Small Universal Output Trans.	.99
Medium Universal Output Trans.	1.29
Large Universal Output Trans.	1.49

PARTS SALVAGE SPECIAL

ARMY BC-745 Power Supply (Vib. Type) THIS IS A HOT SALVAGE SPECIAL. A multitude of usable radio parts. Transformers, chokes, relays, condensers, 4" Alnico 5 PM speaker, resistors, cables, etc. All housed in a handy usable portable hinged metal case. These units are new and worth lots more than our price. Complete, less vibrators. Shipping weight 20 lbs. 2000 to sell \$2.95 each.

ARMY BC-645 I.F.F.

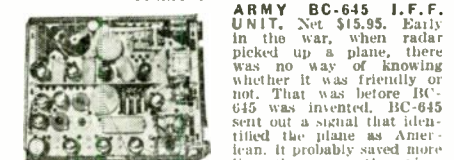

ARMY BC-645 I.F.F. UNIT. Net \$15.95. Early in the war, when radar picked up a plane, there was no way of knowing whether it was friendly or not. That was before BC-645 was invented. BC-645 sent out a signal that identified the plane as American. It probably saved more lives than any other piece of electronic equipment made. With some modifications the set can be used for 2-way communication voice or code on the following bands: ham band 420-450 mc., citizens radio 460-470 mc., fixed and mobile 450-460 mc., television experimental 470-500 mc. Equipment capable of doing the jobs of the modified set sells for hundreds and hundreds of dollars. The 15 tubes alone are worth more than the sale price. 4-7F7, 4-7H7, 2-7E6, 2-6F6, 2-9Z5 and 1-6W6. It now covers 400 to 450 mc. Each BC-645 is shipped with a Remont factory printed conversion diagram, showing how to make AC power supply modulator and how to make Transmitter and Receiver changes. Most Hams and experimenters already have the few parts necessary. Now BC-645 with tubes less power supply \$15.95—Two for \$31.00

SMALL OUTPUTS

Clamp on Type as Used in Original Equipment.	
2,000 ohm for 50L6	\$0.59
7,000 ohm	.59
25,000 ohm Push Pull	.69

25,000 ohm especially good for battery sets.

2 Gang condenser, cut section \$1.19

2 Gang condenser, THF uncut 1.19

2 Gang condenser, loop, osc. coil 1.69

RECORDING DISCS, ALUMINUM BEST QUALITY

6" Aluminum Blank18

8" Aluminum Blank 24 NO BETTER MADE

10" Aluminum Blank 27

SPECIAL \$1.00 1st permanent needle, Spec. 3 for \$1.00

12" 7 oz. Alnico 5 PM Speaker, with 6V6 output Trans. Special \$7.95

6 ½", 1 ½ oz. Alnico 5 PM Speaker, with PP 6V6 output Trans. Special \$2.49.

ANTENNAS

66" stainless steel, slide coil, 30" shielded lead Spec. \$1.98

60" Chrome slide coil, 30" lead not shielded. Spec. .59

SPECIAL UNYOUNT 72" antenna, chrome plated brass, 3 sections, universal under-hook mounting. Spec. 1.95

THE PRESIDENT ANTENNA 96" slide coil. Heavy shielded lead. \$3.90 value. Special 1.98

TOP COIL 4 section 50" shielded lead. Close out. Very Special99

ARMY 4 prong vibrators. Zinc cases are bent from lying together, but guaranteed new. Special only 2000 /79 ea. 10 for 6.95.

Top quality auto antennas all have 30" shielded lead in, individually packed.

3 Section Side Coil 60" C-3L Net \$1.79

4 Section Side Coil 100" C-4 Net 2.49

3 Section Fender Cowl only 8" closed, 55" extended FC-4 Net \$3.95

4 Section Deluxe swing angle Net 2.65

4 Section Side Coil 72" C-43 2.29

4 sizes of beautiful walnut cabinets (not ordinary kind)

No. 1 7 ½" L 4" W 5" H 2.69

No. 2 9 ½" L 5" W 5 ½" H 3.29

No. 3 11 ½" L 6" W 6" H 3.98

No. 4 12 ½" L 6 ½" W 7" H 4.29

ALL WALNUT INTER-COMM CABINET.

Walnut front Will hold 4 or 5" speaker. 2.95

Heavy Duty 4" Inter-Comm speaker, 4 oz. Alnico 5 magnet and heavy cone. Special 1.49

5" 150 ohm dynamic speaker, hum bucking coil, fully shielded output, mounting screws. Heavy duty pre-war quality. Special 2.49

6 ½" 450 ohm speaker, less transformer 2.49

VOLUME CONTROLS

full 2 ½" shaft. Manufacturers type (small size) Audio type with off on switch, 500,000 ohm. Net 10. 10 for 4.50

BATTERY SET CONTROLS same as above, only with double pole switch. Net. 50. 10 for 5.50

SPECIALS IN CONDENSERS—FABRICATED PLATE

16 MFD. 450 volt 20-10 MFD. 450 v.

20 MFD. 450 volt 20 MFD. 25 v.

10-10-10 MFD. 450 v. 40-20-20 MFD. 150 v.

16-16 MFD. 450 volt.

These are all late production; factory overruns.

A BUY OF YOUR LIFE.

50-30 MFD. 150 volt Tubular AC-DC condenser with Strap. 1" x 3". Special \$4

10 for 4.90 50 22.50

SPECIALS IN MICROPHONES

CRYSTAL recording mike. Special 4.90

HIGH GRADE DYNAMIC mike with 20 ft. coil. Made for Uncle, swivel head, beautifully chrome plated. Original carton (Regular wholesale net \$11.70) Special \$9.95

LATEST SMALL CONTACT microphone. Special \$5.95

LATEST SMALL CONTACT microphone with VOLUME CONT. 7.45

Table Stand, black base, chrome shaft. Special \$1.49

2 Section Chrome Floor Stand, with black wrinkle base. This is a high grade stand 4.95

VOLT OHM METER—ROBSON BURGESS with ohm motor. Res. 25-50 value. Special \$16.95. (only 10 to sell).

PILLOW SPEAKER, very thin, 4 ft. lead, jack and plug furnished. Easy to attach. Special \$2.95

456 osc. coil 3 tap \$2.24 Iron Core I.F. Trans. 49

456 osc. coil 4 tap 24 456 49

Set of hi-gain I.F.'s 98 Small loop ant. 39

Ant. & IF coils Pair 49 Medium loop ant. 39

Two-Tube Phono Oscillator. \$3.69

COMPLETE, WIRED AND TESTED, 800 to 1500 KC. Model B-4. Has audio gain stage for proper power output. Complete with tubes ready to operate. \$3.69

Mike Oscillator model C-4 is similar to model B-4 except has added gain stage for crystal mike. Complete with 3 tubes and fader control \$4.95. Crystal mike \$4.90 extra.



McGEE RADIO CO.
1226 McGee St., KANSAS CITY, MO.

Raytheon Set Tube Division in Chicago

Headquarters of the sales department of Raytheon Mfg. Company's radio receiving tube division has been established at 445 Lake Shore Drive, Chicago, according to word received from Carl J. Hollatz.

All activities of the division with respect to sales engineering and advertising and the sale of radio receiving tubes to equipment manufacturers and to the distributor trade are under the direction of Ernest Kohler, Jr., sales manager.

Curtis R. Hammond has been appointed distributor sales manager in charge of all Raytheon renewal tube sales activities per-

taining to jobber distribution of receiving, transmitting and special purpose tubes. Mr. Hammond will continue his activities in connection with receiving tube equipment sales and sales engineering service.

F. E. Anderson continues in charge of the Raytheon radio receiving tube division sales office at the plant in Newton, Mass., where his services are conveniently available to Eastern manufacturers.

Raytheon's hearing aid tube division continues under the direction of Norman B. Krim at Newton, Mass. Mr. Krim also manages the radio receiving tube division's special tube section for the manufacture of special purpose tubes for industrial and scientific electronic applications.

Radio Sales Head



Eugene B. Lucas has been named sales manager for Air King radios, according to word from president David H. Cogan of Air King Products Co., Inc., Division of Hytron Radio & Electronics Corp. Mr. Lucas will supervise sales through the Air King coast-to-coast jobber set-up.

Dopkins Heads Majestic Radio Sales

The new radio sales manager of Majestic Radio & Television Corp., is Loyd Dopkins, according to an announcement by vice-president Parker H. Erickson.

Mr. Dopkins was previously eastern divisional manager for the firm, and earlier experience has included posts with DeForest, Atwater Kent, Crosley and Zenith. He has been in radio for 24 years; his wide experience is expected to be of material assistance to Majestic jobbers and dealers. His headquarters are at the company's new executive offices in Elgin, Ill.

MGM Discs Popular

H. J. Wines, general manager of the Zenith Radio Corp. of New York, has announced that the first releases of M-G-M Records has been shipped to dealers in New York and New Jersey. The dealers response to the new M-G-M label has been very gratifying and Mr. Wines said that expansion of distribution would have to be slow due to the large demand for the new records from the already franchised dealers.

Olympic Vice-President

A. A. Juviler, president of Olympic Radio & Television, Inc., New York, has announced the appointment of Ralph H. Langley as vice-president in charge of engineering. At the same time, the announcement that Morris Sobin had been elected vice-president and treasurer was released by Mr. Juviler.

Joins Sylvania Ad Staff

The appointment of Robert E. Lamar to the advertising staff of the radio tube division of Sylvania Electric has been made public by Henry C. L. Johnson, advertising manager.

AMERICA'S TOP QUALITY AMPLIFIER

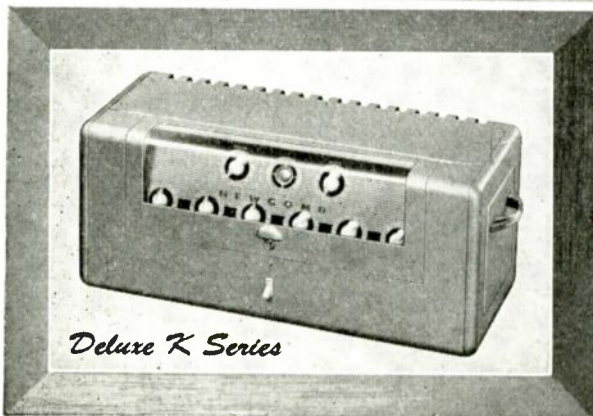

A reputation for quality is our most priceless asset. The performance and operation of the Newcomb Deluxe K-Series of amplifiers form outstanding proof of the reason for that reputation.

Incorporated in every K-Series model is a combination of control features never before offered in any amplifier, plus — Uniform power output throughout the useful band of frequencies . . . Frequency response: 20 to 20,000 cycles within 1 d.b. . . . Master volume control . . . Individual, dual-acting tone controls for bass and treble . . . Thru-vision, plastic keylock control panel cover . . . Exclusive plug-in input transformer socket for instant conversion from high to low impedance . . . and many other features that spell top quality in sound reproduction.

• All NEWCOMB amplifiers are precision-built, tested and re-tested, to guarantee laboratory performance and long, dependable operation.



NEWCOMB AUDIO PRODUCTS COMPANY

Dept. A, 6824 Lexington Avenue • Hollywood 38, California

Send for details of our complete line of sound equipment.



Note well...

 **NAMM Show**

(National Association of Music Merchants)

PALMER HOUSE, Chicago, JUNE 1-5

Here is the world's biggest audience of the retailers of musical products: radios and phonograph combinations, phonographs, records, needles, albums and accessories. Here they are in a buying mood. Come to the Show to buy and to sell!

RADIO & Television RETAILING's

 **JUNE MUSIC SHOW NUMBER**

Here is your chance to tell the largest ABC paid circulation in the radio-music field about your products. If you plan to exhibit, promote your display through space in this issue. If not in the Show, you can reach the thousands of dealers there through our extra distribution of the June Show Number at the Palmer House, plus the tremendous buying power of our 29,000 circulation throughout the trade. Deadline May 5.

Caldwell-Clements, Inc.

480 Lexington Ave., New York 17 PLaza 3-1340
Chicago 6 Cleveland 14
Los Angeles 5 San Francisco 4

Just 3 JFD
ADJUSTABLE BALLASTS
 Replace Over **3000** Exact Duplicate AC-DC Resistance Tubes!

New features!

- ✓ 1. Air-Cooled Perforated Shell
- ✓ 2. Larger Insulating Surface
- ✓ 3. Longer Life, Heavier Resistance Wire
- ✓ 4. Exact Adjustments made

List Price \$1.50 each

USE JFD BALLASTS	TO REPLACE AC-DC RESISTANCE TUBES		
	Beginning with	With Numbers	Ending with
"A" Ballasts	K, L, M, BK, BL, or BM	6 through 42	A, B, C, D, F, G, or H
"B" Ballasts	K, L, M, BK, BL, or BM	45 through 105	A, B, C, D, F, G, H, S1, S2, S3
"C" Ballasts	All 4 prongs	80 through 350	R, R4, R8, L, L4, L8

JFD
PRECISION MADE

J. F. D. Manufacturing Co.
 4111 Ft. Hamilton Parkway Brooklyn 19, N. Y.

MORE, BETTER JOBS PER DOLLAR.



SUPREME 504-B TUBE AND SET TESTER—
 the portable lab that gives you everything.

ASK YOUR SUPREME JOBBER FOR A FREE DEMONSTRATION

WRITE TODAY FOR New CATALOG

EXPORT DEPT.: The American Steel Export Co., Inc.
 347 Madison Ave., New York 17, N. Y., U. S. A.

SUPREME INSTRUMENTS CORP., Greenwood, Miss., U. S. A.

HERE'S WHY AND HOW

- METER—large 4-inch square-face meter, 500 microampere.
- SPEED—push-button operated.
- FLEXIBLE—simple, yet Universal Floating Filaments feature insures against obsolescence.
- SIMPLICITY—roll chart carries full data for tube setting. No roaming test leads when using multi-meter—only push a button.

SPECIFICATIONS

DC VOLTS—1000 Ohms per volt: 0-5-25-100-250-500-1000-2500.
 AC VOLTS—0-5-10-50-250-1000.
 OUTPUT VOLTS—0-5-10-50-250-1000.
 OHMMETER—0-200-2000-20,000 Ohms. 0-2-20 Megohms.

Condenser Check:
 Electrolytics checked on English reading scale at rated voltages of 25-50-100-200-250-300-450 volts.

Battery Test:
 Check dry portable "A" and "B" batteries under load.

SALES

"See for Yourself"



A 3-color shadow box with interior lights and a black-lacquered base for a washer are features of this new "Junior Spot" display. Directions for reaching demonstration area to be lettered in.

Record-Breaking Ads in Big Weeklies

Following its announcement that its advertising program has been expanded to include double-page spreads this year in leading weekly magazines, the Cory Corp., 221 N. La Salle St., Chicago, has now mailed announcement broadsides to 200,000 jobbers and dealers of the U. S.

The broadside tells about the big ads to appear in *Life*, *Saturday Evening Post* and *Collier's*, with the statement that "never before has a manufacturer of small appliances extended such advertising support to its jobbers and dealers." The new ads appear in addition to Cory's 4-color campaign in *Ladies' Home Journal*, *McCall's Better Homes & Gardens*, and many other publications.

The spreads will boost the firm's commercial coffee equipment in addition to the domestic units, to recommend Cory-made coffee served in public places.

Continuous Tie-In



Proctor's 3-way advertising tie-in window and counter displays represent a new device in appliance promotion—dealers can tie in progressively with national ads by removing obsolete ad.

HELPS

New Floor Display

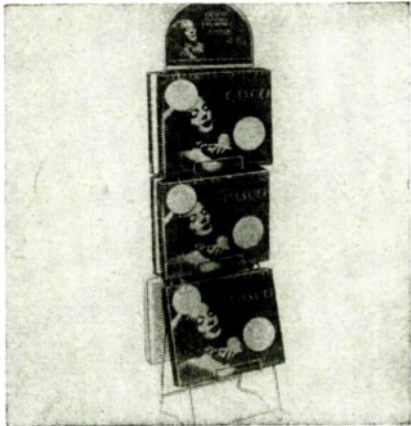

Space-saving floor display stand has room for each of 6 electric heating pads offered by Casco. Convenient "Facts for Buyers" are on the back of each box.

"Perfect Housewife" Contest Promotion

Promotion experts travelling in the interest of the Traubee Products Company's "Perfect Housewife" contest are making flying visits to various key resort towns and cities throughout the country.

Plans call for tieups with local newspapers and radio stations. Purpose behind the contest is to prove to women that homemaking is a "glamorous" business. The judges include Jacques Traubee, president of the Brooklyn, N. Y., company bearing his name; Mr. and Mrs. Fred Allen, and various home economists.

Danville Supply Opens

The Danville Supply Co., Danville, Ark., has been incorporated here to deal in radios, automobile appliances and accessories, washing machines, clocks, etc., by John Ed Chambers Jr., Jim Gatlin and Clarence M. Pledger, all of Danville.

For Retailers



Official Mother's Day poster for 1947 is a 6-color eye-catcher, available with other promotion materials from 393 Seventh Ave., New York 1, N. Y.

New Displays by Premier Division

An illuminated, mirrored-glass sign to identify Premier dealers, is being offered by the Premier Vacuum Cleaner Division, General Electric Co., as part of the division's identification sign program.

Constructed of plastic and glass, and a sturdy metal cabinet, this sign is designed to be equally effective in a window or anywhere in a dealer's store. It is colored in rich maroon, ivory and white, with a mirror-silvered background. Its 40-watt bulb also illuminates the colored plastic tubes at the top and bottom of the sign, making them glow like neon. The

size is 10" high, 11" wide, 3 3/4" deep.

This sign is available through Premier distributors at a cost of \$4 each, f.o.b., Cincinnati, Ohio.

Premier has also made available a new, 3-dimensional window display featuring the Premier all-purpose, cylinder-type vacuum cleaner, the Aire-Matic "80."

One section of this display is stepped forward from the background panel, providing a place where several of the Premier's cleaning tools can be attached. An adjoining section provides a place to put the Premier cleaner itself and its remaining attachments.

These displays are \$2.25 each.

P.A. Performance That Sells!



The Line That Stays Sold!

Sound users everywhere recognize and accept RAULAND as the standard by which fine P. A. performance is judged. Every Sound System bearing this distinguished name is RAULAND-designed-and-built throughout . . . guaranteed to deliver full rated output, to stand up and perform flexibly under the most demanding operating conditions, to deliver the maximum in tonal response and in completely satisfying, trouble-free performance.

That's why RAULAND Sound Systems *stay sold!* Every RAULAND sale is a clean-cut transaction you can make with confidence, a sale that builds your business, boosts your profits, adds to your reputation in the field. Remember, too—RAULAND is the *complete* Sound Line—offering you a full choice of systems (12 to 120 watts) to meet any P.A. need. Get behind RAULAND—the line that *sells on its performance*, the line that *stays sold!* For your own profit and reputation, write for selling details today.

Electroneering is our business

RADIO • RADAR
SOUND

Rauland

COMMUNICATIONS
TELEVISION

THE RAULAND CORP. • 4247 N. KNOX AVE. • CHICAGO 41, ILL.

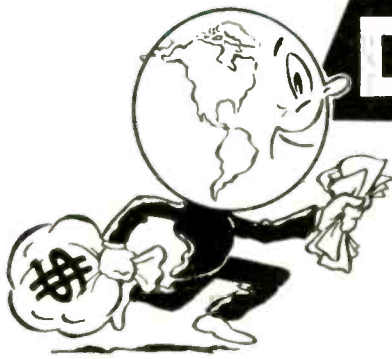

DEALERS

**A WORLD OF BUSINESS
Comes a Runnin'**

When You Handle the
World's Most Complete Line
of Inter-Communication

You don't have to beat the bushes for business, when you are a Talk-A-Phone dealer.



TALK-A-PHONE

is Nationally advertised, has won National recognition as the standard of perfection in the most advanced field of inter-communication. Scores of prospects in *your* territory are *already* sold on Talk-A-Phone... inter-communication that "Has Everything." A unit for every requirement. Prices attractively low. Profits *more* than liberal.

Ask Your Jobber

Do *more* business, make *more* money with the world's most complete line of inter-communication. Catalog upon request. Address Dept. RT.

Talk-A-Phone Co.

1512 S. Pulaski Road Chicago 23, Ill.

28
IS YOUR LUCKY NUMBER

That's the number of years of good will built into the Lenk line of Soldering Irons, Solder and Blotorches. For 28 years the Lenk line has ranked *first* with men who demand reliable soldering equipment.

Imitators come and go, but quality has given Lenk the selling power to stay out front. Feature and display the entire Lenk line for extra sales and profits.

BLOTORCHES

ELECTRIC SOLDERING IRONS

SOLDER

Lenk ★ ★ ★
THE MFG. COMPANY
DEPT. 5, NEWTON LOWER FALLS 62, MASS.
★ ★ Manufacturers of Soldering Equipment Since 1919

On Flying Tour



Miryam Simpson, the energetic vice-president of Mark Simpson Mfg. Co., Inc., Long Island City, N. Y., has just completed an airplane tour of Western and South Central states, calling on jobbers and reps for Masco sound equipment.

Brock Phonograph Sales on Upgrade

New peaks in monthly sales of Brock electrical and mechanical record players have been reported by Davidson Mfg. Co., 133 Carnegie Way, N. W., Atlanta, Ga., manufacturers of the units.

The firm is headed by Polk C. Brockman, a pioneer in the phonograph industry and for 25 years a key figure in the phonograph and record industry in the southern areas. Mr. Brockman has an extensive knowledge of dealer requirements, and emphasizes the retail sales value of merchandise, along with sound selling policies.

Donald Jones is sales manager of the company, working in close cooperation with dealers. T. P. Davidson is vice-president and general manager, a veteran manufacturing executive now in charge of the firm's factory at Eatonton, Ga.

Portable with SW



The new Model T-570 portable is a 3-way superhet with shortwave offered by Pilot Radio Corp., 37-06 36th St., Long Island City, N. Y. Five tubes plus selenium rectifier, 5 1/4" PM speaker, tuned r-f stage. Alligator leatherette case in brown or blue, folding front panel.

IRE Holds Annual Meet in New York

Almost 200 exhibitors of radio and electronic devices and developments drew interested crowds to the 1947 Annual Convention of the Institute of Radio Engineers, held Mar. 3 to 6th at the Grand Central Palace in New York City. Many of the technical sessions and meetings were held at the Hotel Commodore nearby where thousands of radio men from all over the world jammed the gatherings.

The annual dinner of the IRE was held Mar. 5th, with FCC chairman Charles R. Denny as a featured speaker. In this address Mr. Denny declared that "we are on the threshold of an immense expansion in the use of radio in our everyday lives . . . in the next ten years things practically unheard of now will be contributing importantly to the health, safety, culture, comfort and well-being of men everywhere."

Among the new developments shown at the convention and of most interest to radio men were "printed" circuits, new recording devices, microwave transmissions, facsimile and television equipment, etc.

New Atlas Building

Atlas Sound Corp., Brooklyn, N. Y., has purchased a modern fireproof building and now has available additional pro-

Thousands of Disc Changers Rolling to Market



Increasing popularity of record changers is indicated by this shipment of another carload of Milwaukee-Erwood changers from the manufacturers, the Milwaukee Stamping Co., to the Majestic Radio & Television Corp., Elgin, Ill. This new disc-changing device is the "no gears, belts or castings" unit.

duction space. R. C. Reinhardt, president of the firm, stated that he anticipated a tremendous increase in the sale of sound equipment, due, he says, to industry's recognition of the value of intercommunication and paging installations. He also pointed out that another reason for the up-trend is the increasing awareness to the advantages of music systems to relieve the monotony of repetitious work in factories.

Kelly in New Post With Emerson Radio

Edward J. Kelly has been appointed works manager of Emerson Radio & Phonograph Corp., according to an announcement made by Benjamin Abrams, president. Mr. Kelly comes to Emerson after serving as vice-president of the North American Phillips Co., and prior to this connection he was affiliated with RCA for twenty-five years.

Take your choice of these FREE GIFTS from OLSON

100 POPULAR CIGARETTES

Free

with your purchase of \$15 or more in Radio Parts. Lucky Strikes, Camels or Chesterfields — smoke 'em or give 'em away! Make up an order and use the coupon TODAY.

Vacuum-Packed Tin of Planters Peanuts

Free

with your purchase of \$10 in Radio Parts; a \$20 purchase brings you TWO tins, etc. Big 1/2 lb. can of fresh, delicious Salted Jumbo Peanuts of famous quality! Use the coupon TODAY.

NEW, 200-PAGE HANDBOOK

Free

with your purchase of \$10 or more in Radio Parts. A practical guide to help you operate a shop or store successfully. Packed with valuable information! Use the coupon today.

Help yourself to a gift from Olson Radio Warehouse, and get a square deal in Radio Parts too! These gifts are free to our customers — proving that you get MORE for your money when you buy from OLSON. Try it and see!

Here's how to get your Free Gift: Look through our

catalog (you should have one) and make up an order in the amount specified for the gift you want. Mail this order to us and enclose the coupon below. Do it NOW!

IF YOU DON'T HAVE A COPY OF OUR LATEST CATALOG, SEND FOR IT. NO CHARGE, OF COURSE.



Mail us an order today, and attach this coupon for your Free Gift!

OLSON RADIO WAREHOUSE, Inc.

73 E. MILL ST., DEPT. 78, AKRON, OHIO

OLSON RADIO WAREHOUSE 73 E. MILL ST., AKRON, OHIO

I enclose an order totalling \$ _____ Send me FREE the gift checked below.

100 CIGARETTES Luckies Comels Chesterfields)

PLANTERS JUMBO PEANUTS 200-PAGE HANDBOOK

NAME _____

ADDRESS _____

CITY _____ STATE _____ 78

ELECTROLYTIC REPLACEMENTS

in a

JIFFY

with

AEROVOX TYPE PRVC

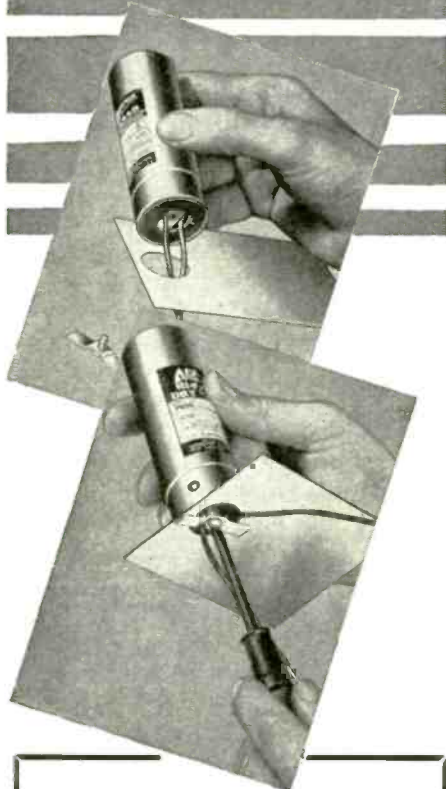

● Jiffy replacements mean more service calls . . . more jobs daily . . . more dough in your till.

It's all done with the AEROVOX-originated cleat-mounting jiffy-installed AEROVOX Type PRVC. This idea saved the day for many an overworked serviceman during the war. And it's been plenty copied.

So remember, where hole-mounting replacements are in order, use the Type PRVC. Just remove cleat. Slip leads through hole. Replace cleat. Tighten screw. Make connections.

It's as simple as all that! Your AEROVOX distributor stocks them! Ask for AEROVOX Type PRVCs, FIRST!



FOR RADIO-ELECTRONIC AND INDUSTRIAL APPLICATIONS

AEROVOX CORP., NEW BEDFORD, MASS., U.S.A.
 Export: 13 E. 40th St., New York 16, N.Y. • Cable: 'ARLAB'
 In Canada: AEROVOX CANADA LTD., Hamilton, Ont.

Portable PA Comes to the Rescue



After a spectacular train wreck near Fresno, Calif., a 20-mile traffic jam clogged the area and there's where Harry H. Billings (second from left), radio jobber of Fresno, helped out. He supplied a Newcomb portable sound system and police were able to clear up the traffic confusion.

Special Award to Philco's Ballantyne

John Ballantyne, president of Philco Corp., has been awarded a special Certificate of Appreciation for his wartime services in directing the development and production of radar for the armed forces.

In accepting the Certificate of Appreciation from Lt. Col. Arnold T. Gallagher, commanding officer, Philadelphia Storage and Issue Agency, Signal Corps, Mr. Ballantyne said that the Philco achievements in designing and manufacturing radar for the Army were possible only because of the individual contributions made by the company's many thousands of employees. He indicated that the Philco research and engineering laboratories are continuing advanced development work on new radar and electronic devices for the Army Signal Corps and other branches of the armed forces.

General Instrument Enters Video Field

General Instrument Corp., Elizabeth, N. J., producer of radio components and automatic record changers, announces entry into the television field through the facilities of its wholly-owned subsidiary, the F. W. Sickles Co., of Chicopee, Mass.,

where special techniques are now being applied in the production of parts for television receivers and improvement of picture images.

Richard E. Laux, executive vice-president of General Instrument and president of Sickles, said that the companies' business would be substantially augmented as a result of these developments, and that production of television parts on an economical mass production basis is a further step in the popularizing of television.

Hoffman Sales Drive Gets Going

Hoffman Radio Corp., Los Angeles, has started its 1947 advertising and sales promotion campaign with a big program to back up its franchised dealers in merchandising aids.

The plan includes outdoor advertising and displays; newspaper copy and point-of-sales aids.

The company has also started an extensive community dealer cooperative campaign in strategic locations of the eleven western states with one, two and three column mats. Local dealer imprint will be used and tailor-made publicity will be designed for local needs and with full credit to local Hoffman franchise holder.

"Warehouse on Wheels" Keeps Stocks Moving



A Spring 1947 "payload" is pictured by Gibson Refrigerator Co. The company's new semi-trailer "rolling warehouse" transports 44 refrigerators or 28 ranges.

Ohio Wholesaler



Irving J. Olson, head of Olson Radio Warehouse, Inc., Akron, Ohio, reports that "thousands of letters of approval from radio servicemen have been received," praising the "Gift - of - the - Month" plan sponsored by ORW.

"Hap" Hunter Joins Clarion Radio Firm

Reau Kemp, sales manager of Clarion Radio, Chicago, announces that C. H. Hunter has joined the organization as divisional sales manager for the South and Southeastern territories.

"Hap" as he is known to the trade, has been occupied in appliance merchandising for almost twenty years. Most recently he was a district manager for Proctor Electric Co., and previous to that he was manager of the Bendix branch at St. Louis.

On Emerson Sales Force

Charles Weisser, Emerson Radio and Phonograph Corp. sales manager, has made public the appointment of Melvin A. Protas as company sales representative in the New York state territory. The area to be covered by Mr. Protas includes Rochester, Buffalo, Syracuse and Albany, N. Y., and Erie, Pa., and Springfield, Mass.

Teletone Sales Rep



Mort Gellard is the new sales representative for Tel-tone Radio Corp. in Pennsylvania, Delaware & southern New Jersey. He was previously radio & television sales manager for Raymond Rosen & Co., RCA jobbers in Philadelphia.

WARD

WORLD'S FINEST AND FASTEST SELLING

Aerials

Here's Your Newest Profit Builder! A striking, three-dimensional display which catches the eye of every customer. It's completely assembled, ready to place on your counter and bring in easy, extra sales. You pay only for the four fast moving models mounted. The display itself is FREE!



PROFIT BUILDER

LIST \$22.00

Each of these models is engineered and equipped to fit every car!

WARD

Aerials

Every Ward model has been tested and approved by car and radio set manufacturers—your proof of quality inside and out.

THE WARD PRODUCTS CORPORATION • 1525 E. 45th STREET, CLEVELAND 3, OHIO
EXPORT DEPARTMENT: C. O. BRANDES, MGR., 4900 EUCLID AVENUE, CLEVELAND 3, OHIO
IN CANADA: ATLAS RADIO CORP., 560 KING STREET, WEST, TORONTO, ONTARIO, CANADA

A Quick Flip-Ready for a Trip!

BELL BAND-MASTER 10-Watt Phono-P.A. Unit

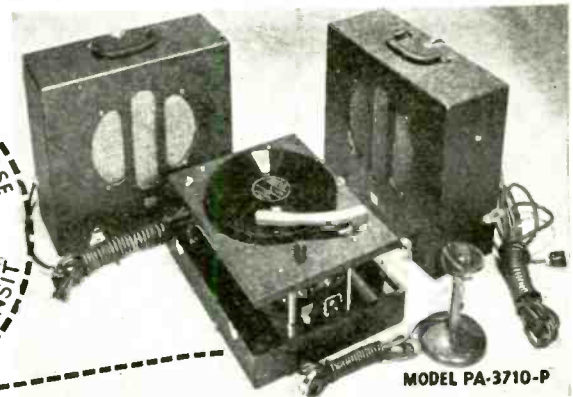
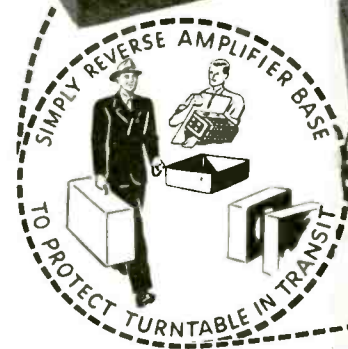

MODEL PA-3710-P

COMPLETE IN 3-SECTION CASE

- 10-Watt Amplifier
- 2-10" Heavy-Duty Speakers
- Self-Contained 12" Phono Unit
- 3 Inputs—Phono, Mike, Instrument
- Controls—2 Volume; 1 Tone
- 1 Crystal "Mike" with Stand
- All Cables, Plugs, Connectors

For carrying ease, simple operation, and top-flight results, the low-cost Bell BAND-MASTER is highly popular with "pros" and amateurs alike. Sets up speedily for full sound coverage—speech, recordings, musical instruments—in any medium-sized auditorium. Beam power output tubes and inverse feedback circuit achieve true, clear tone. Boost your sales and profits with the complete Bell line of permanent and portable sound systems. Ask your nearby Bell distributor for details.



BELL SOUND SYSTEMS, INC.
1197 ESSEX AVENUE COLUMBUS 3, OHIO
Export Office: 4900 Euclid Ave., Cleveland 3, Ohio

NOW!

**BIG-BUSINESS EFFICIENCY
FOR ALL FIRMS**

**at
low
cost!**



Dictograph

Electronic

INTERCOM

with "VOICE-MIRROR" reproduction

Big-business efficiency in intercommunication is no longer reserved for big business! Because DICTOGRAPH—the system used by top executives of the world's largest firms—has created a new Electronic Intercom designed and priced for small and growing firms!

DICTOGRAPH Electronic keeps the president in split-second contact with secretary of sales manager, plant or stockroom—keeps staff members at their desks, working. Saves time, steps, nerves. Keeps switchboard clear for calls from customer or client.

"VOICE-MIRROR" reproduction provides startling clarity—you never have to repeat to be understood.



**DEALER FRANCHISES OPEN
IN CERTAIN TERRITORIES**

So great is the demand for this new system that the DICTOGRAPH branch-office setup is unable adequately to take care of the potential volume. Consequently, in certain territories, we are seeking top-calibre dealers.

A full-fledged sales force, plus service and maintenance facilities are necessary. Firms which qualify will find that they have one of the most profitable and satisfying propositions in the business equipment field.

Please address all communications to General Sales Manager.

DICTOGRAPH PRODUCTS, INC., 580 Fifth Avenue, New York 19, N. Y.

Tube Sales Expert



P. R. Dawson is the new sales manager of renewal tubes for Tung-Sol Lamp Works, Inc., Newark, N. J. He has been manager for the firm's central sales division, Chicago, and has been with Tung-Sol for 19 years.

Oak Ridge Antenna to Distribute Nationally

Howard S. Levy, general sales manager of the Oak Ridge Antenna Company, 717 Second Avenue, New York City, has announced that plans are being formulated for national distribution of the company's products. Mr. Levy said that radio parts jobbers throughout the country will soon be featuring the sturdy, weatherproof, aluminum television and FM antennas, and other Oak Ridge products.

The company is now expanding its distribution nationally, the sales manager explained, to meet the increased country-wide demand for an attractive durable, weather-proof antenna. This demand has been growing ever since television sets were released by manufacturers after the war.

Joins Salescrest Co.

M. W. Neries has been appointed merchandise manager for the Salescrest Co., manufacturers' sales organization, 222 West Adams St., Chicago, Ill. Prior to joining the organization, he had held several important merchandising positions.

Ranch-House Elegance



In West Coast areas there's a trend toward "ranch house" designs in furniture, and the Magnavox Co. has introduced this "French Provincial" combination there. Simple and casual, it's an eye-catcher with antique brass fittings.

OHMITE RESISTORS



**a Complete Line for
the Radio Serviceman**

You can get exactly the type and size you want when you select an Ohmite resistor. Ohmite's extensive line includes Little Devil composition resistors (available only from Ohmite distributors), Brown Devil vitreous enameled wire-wound resistors, and Dividohm adjustable resistors. All are made in a wide variety of resistance values and wattage ratings, with a tolerance of $\pm 10\%$. All will provide trouble-free operation—and complete customer satisfaction.

Send for Catalog No. 19



OHMITE MANUFACTURING CO.
4872 Flournoy St., Chicago, Ill.

NEW Ohm's Law Calculator



A new and improved handy pocket size (9" x 3") calculator. All computing scales on one side. Shows RMA resistor color code. Only 25c.



Be Right with...

OHMITE

RHEOSTATS • RESISTORS • TAP SWITCHES

Stout Chassis



In the market news again for the portable sales season is the new General Electric model in which non-shielding special plastics are used for the chassis frame instead of metal. It's a high impact material with long wood fibre base shown here by engineer E. H. Hobbs.

Westinghouse Ups Cabinet Facilities

A long-term contract to purchase the entire output of radio cabinets manufactured at the woodworking shops of the Mifflinsburg Body Works, Mifflinsburg, Pa., has been signed by the home radio division of the Westinghouse Electric Corp., according to a joint announcement made by the two companies. The Mifflinsburg Works will deliver 40,000 console and table cabinets in the next four months, the announcement said.

Since the small supply of radio cabinets has been one of the component shortages plaguing the radio industry in the past year, this contract will have the primary advantage of providing another source of high quality cabinets for the division.

JFD FM-Tele Dipoles Back

Once again among the suppliers of antennas for FM and television receivers is JFD Mfg. Co., 4111 Ft. Hamilton Parkway, Brooklyn 19, N. Y. Just off the press is a new circular describing several types of single and double dipoles, as well as mounting brackets, poles and hardware, showing a very complete line of units available.

Tiniest Tube



Described by Sylvania Electric as the smallest tube in the world, the tube at the extreme left measures only 7/8" long and about 1/8" in diameter. For comparison, right to left, the tube of ten years ago, the current lock-in job and the wartime proximity fuze tube.

Distinctive

IT'S Sky-Weight

Model 82 Radio-Phonograph
Combination with exclusive
Miracle Eye Tuning.

Really Portable

Sky-Weight — featured by better shops throughout the country

<p>MODEL 81</p> <ul style="list-style-type: none"> • 3-Tube Phonograph • Concealed Alnico V Speaker • Tone and Volume Controls • Plays 10"-12" Records • Size: 5 1/2 x 11 1/2 x 15 1/2 Inches • Ten Pounds 	<p>MODEL 82</p> <ul style="list-style-type: none"> • 5-Tube Radio-Phonograph • Built-In Antenna • Radio-Phono Selector • Plays 10"-12" Records • Concealed Alnico V Speaker • Size: 5 1/2 x 11 1/2 x 15 1/2 Inches • Eleven Pounds
---	--

Both in fine leather-bound luggage cases

CONTINENTAL ELECTRONICS LTD. • BROOKLYN 22, N. Y.

Burned up — but still "alive"!

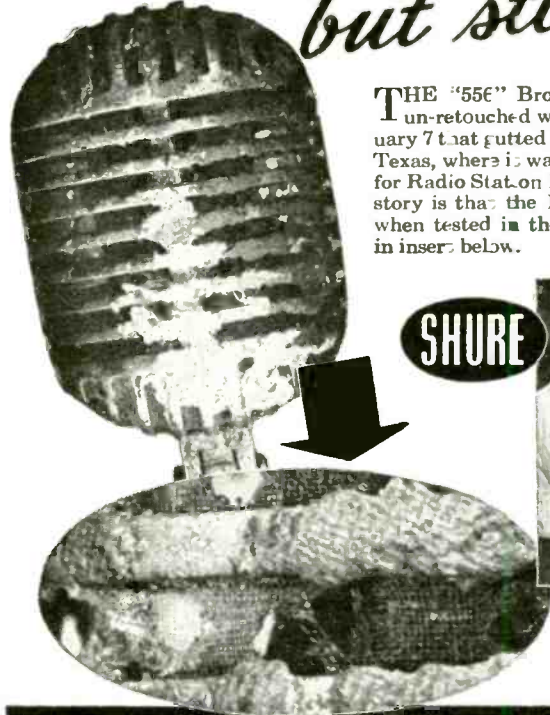

THE "556" Broadcast Dynamic shown here un-retouched was badly burned in a fire January 7 that gutted the Rita Theatre in Longview, Texas, where it was being used in a remote show for Radio Station KFRO. Surprising part of the story is that the Microphone worked perfectly when tested in the Service Department, shown in insert below.

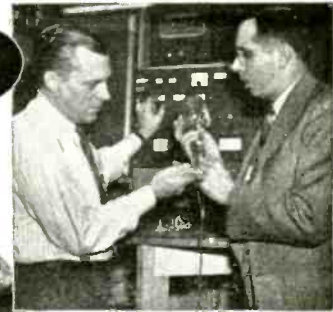

Farley Westphal, Service Manager, and Mel Krumrey, Jobber Sales, testing the "Burned-Up—But Still Alive" Shure "556" Broadcast Dynamic.

SHURE BROTHERS, INC.
Microphones and Acoustic Devices
225 West Huron Street Chicago 10, Illinois



Power Resistor Decade Box

★ Here's a "must" for every well-equipped service shop, lab, plant, ship, school, etc. The unique Clarostat Power Resistor Decade Box solves resistance problems under actual working conditions. No calculations. No guesswork. No extensive experimentation. Instead, just insert in actual circuit, adjust decade knobs until best results are attained, and then read the correct resistance value right off the dials!

Covers resistance range of 1 ohm to 999,999 ohms.

Each decade dissipates up to 225 watts. Greenohm (wire-wound cement-coated power resistors) used throughout. Glass-insulated wiring.

Six decade switches on sloping panel. Direct-reading in ohms. Maximum current per decade: 5, 1.5, .5, .15, .05 and .005 amp.

Frosted-gray metal case. Etched black-and-aluminum panel. Dual binding post terminals for left and right-hand duty.

Grille at bottom and louvres at side for adequate ventilation.

13" long; 8½" deep; 5¾" high. Weight, 11 lbs.

★ Ask Our Jobber . . .

Ask him to show you the Clarostat Power Resistor Decade Box. Ask for literature. And get in your order as quickly as possible to get delivery as quickly as possible! Or write us.

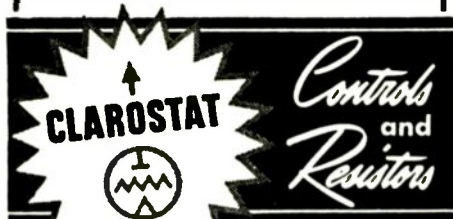

CLAROSTAT MFG. CO., Inc. - 285-7 N. 6th St., Brooklyn, N. Y.

Electrovoice, Concord Hold Joint Meeting

An event of more than ordinary interest was a joint meeting of the executives and their staffs of Concord Radio Corp. and officials of the Electrovoice Corp., in Chicago.

The occasion was highlighted by talks given by Al Kahn and Web Soules, president and chief engineer respectively, of Electrovoice Corp., in which the outstanding characteristics, features, and salient sales-points of microphones in general and of Electrovoice microphones in particular were presented.

The meeting, which was attended by the engineering, sales, advertising, purchasing, and correspondence departments of Concord Radio Corporation's Chicago headquarters was pronounced an unqualified success as an education in modern and advanced microphone engineering.

State Convention for Radio Servicemen?

At recent meeting of the Federation of Radio Servicemen's Associations of Pennsylvania, held in Harrisburg, Pa., a proposal for holding a state convention of radio servicemen was discussed.

A. R. Guild, secretary of the Federation, says that "I do not believe that such a gathering, sponsored by the servicemen themselves, has ever been held . . . we are interested in getting the reaction of individuals and groups to such a suggestion . . . we will welcome any suggestions."

Mr. Guild's offices are at 410 Campbell St., Williamsport 11, Pa.

Antenna Display in Five Colors

National Electronic Mfg. Corp. (NAMCO), 22-78 Steinway St., Long Island City, N. Y., makers of auto radio antennas and accessories, are offering a new antenna display in connection with its expanded sales activities.

Finished in five colors, suitable for window or counter, the unit is shipped with four antennas fully mounted, ready for immediate use. The antennas include side cowl, underhood, single stanchion and fender and cowl mount types.

On EL Directors Board

L. C. McCarthy, of Chicago, nationally known radio sales representative, has been elected to the board of directors for Electronic Laboratories, Inc., Indianapolis, according to William W. Garstang, president.

Heads Jewel Sales

A. Earle Fisher has been named sales manager of the Jewel Radio Corp., 583 Avenue of the Americas, New York City, according to an announcement made by Don Ferraro, Jewel president.

Aero Needle Rep

Arthur E. Akeroyd has been appointed New England representative for Aero-point phonograph needles, according to E. Ralph Haines, Aero sales manager.

- LAKE - Amplifying System

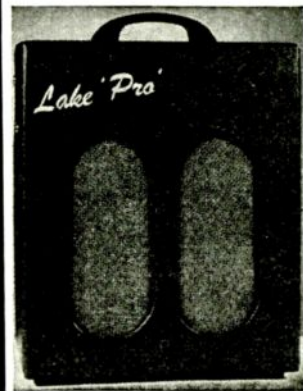

Excellent designed, compact amplifiers, ideal for students, professional entertainers, homes, factories, schools, etc. Perfect for voice, musical instruments, pickups and contact microphones; clear, rich tone; heavy plywood in luxurious leatherette-covered, streamlined portable cabinets.

AS LISTED BELOW:				
No.	Watts	Inputs	List	Your Cost
A16	16	4	\$110.00	\$64.68
A15	15	3	97.50	52.86
A12	12	2	87.50	51.45
A8	8	3	87.50	51.45
A6	6	2	75.00	44.10
A5	5	2	60.00	35.28
ACDC	8	3	75.00	44.10

Model

HAWAIIAN ELECTRIC GUITAR

Beautiful black plastic, trimmed with chrome 23" scale, 4½ octaves of playing range
List—\$50.00—Your Cost . . . \$29.40

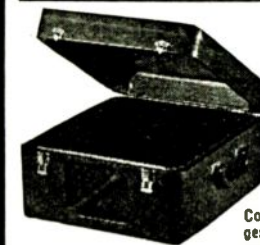

De Luxe PHONO CABINET

Covered in luxurious genuine brown leatherette, has deluxe brass hardware throughout, made completely of plywood with brown plastic handle, has padded top and bottom. Motor board 14" x 14½". Overall dimensions 16" L x 15" W x 8" H.
Your special net price \$8.95



Portable Phonograph case, of sturdy durable plywood in handsome brown leatherette finish. Inside dimensions 16½" long, 14" wide, 9½" high. Has blank motor board. As illustrated specially priced at

\$6.95

Also blank table cabinets of walnut veneer in the following sizes, with speaker opening on left front side:

(*Note: #7 has center speaker grill)

#1	— 8½"	L x 5½"	H x 4"	D \$1.95
#2	— 10½"	L x 6¾"	H x 5"	D \$2.75
#3	— 13½"	L x 7¾"	H x 6¼"	D \$3.25
#7	— 10¾"	L x 7"	H x 5½"	D \$2.50

Speaker Opening in center of front side
All types of radio cabinets and parts are available at Lake's lower prices. A large stock is listed in our catalog.

SERVICEMEN—RETAILERS

Write for our new, illustrated 16 page catalog NR-116. It's free. Get on our mailing list! Write for our special catalog on microphones, amplifiers and sound equipment.

Order from Lake!
You'll make no mistake!

Lake Radio Sales Co.
615 W. Randolph Street
Dept. B
Chicago 6, Ill.

ELECTRO
ELECTRICAL AND RADIO EQUIPMENT

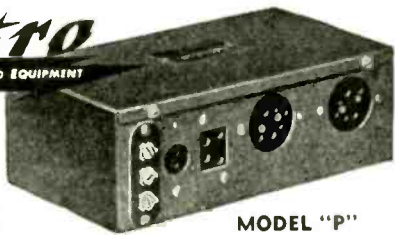

**BATTERY
ELIMINATORS**

MODEL "P"

Sell Them Now for Winter Use With Portable Radios

A Complete Line for Every Requirement!

Models to convert dry battery radios to efficient AC receivers. Other models to convert dry battery radio for use only with 6 volt storage battery.

Cost but a few cents per hundred hours of operation. Completely filtered—hum free—silent and efficient. Sturdily constructed—no liquids or moving parts—operate in any position.

MODEL "Q"—Operates any 1.4 volt 4, 5 or 6 tube radio from 6 volt storage or dry battery, or Wincharger. Ideal for farms, camps, autos, boats, etc.

MODEL "R"—Operates 2 volt 4, 5, 6 or 7 tube radio from 6 volt storage or dry battery, or Wincharger. (0.5 Amp. filament max.)

MODEL "P"—Operates any 1.4 volt 4, 5 or 6 tube radio from 110 volt 60 cy. source. Cuts down current use and saves batteries for portable use.

MODEL "F"—Operates any 2 volt 4, 5, 6 or 7 tube radio from 110 volt, 60 cy. source. (0.5 Amp. filament max.)

Canadian representative, **ATLAS RADIO CORP.**, Toronto, Canada

ELECTRO PRODUCTS LABORATORIES

Pioneer Manufacturers of Battery Eliminators

549 WEST RANDOLPH STREET CHICAGO 6, ILL.

APRIL SPECIALS!

2, 3 and 4 CONDUCTOR TWISTED 22 GA. SOLID PLASTIC INSULATED WIRE



For use in intercommunication, public address, telephone systems, and many other applications. An exceptional value. While quantities last.

	Per 1,000 ft.	
2 cond.		\$8.70
3 cond.		12.70
4 cond.		18.60
BARE and TINNED ANTENNA WIRE		
	Per 100 ft. Coil	
14 ga. 16/26 Bare braided		.87
19 ga. 7/27 "		.28
15 ga. 7/23 tinned		.67
18 ga. 7/26 "		.47

SHIELDED TWISTED PAIR

18 ga. stranded conductors, twisted with paper wrap. Closely woven tinned copper shield and weather proof waxed cotton braid overall.

100 ft. coil	\$4.80
500 ft. spool	21.90

Many other types of cord, cable and wire are carried in stock, in gauges of from 24 to 0. We also manufacture a complete line of replacement cord sets. Send for our latest catalog listing all available items.

See your Local Jobber or Write Direct
TEL.: SPRING 1515-1516-1517

COLUMBIA WIRE & SUPPLY CO.

5740 ELSTON AVE., CHICAGO 30, ILLINOIS

AT THE RADIO SHOW!

MAY 13th to 16th, INCLUSIVE
HOTEL STEVENS, CHICAGO

Bogen

**COMMUNO-PHONES • SYSTEMS
AMPLIFIERS • ACCESSORIES**

The latest BOGEN equipment will be on exhibit at the show. Stop at Booth #40 and see what's new in this famous line of inter-communication and amplifier equipment. Our engineers will be on hand to answer all technical questions.

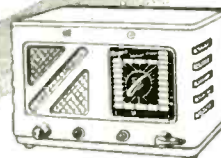

Type A Communo-phones are designed for efficient service where economy is essential.

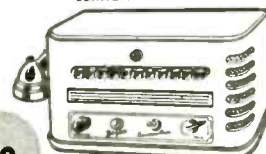

Type L Communo-phones offer exclusive features and flexibility, capable of meeting any requirement.



David Bogen CO. INC.

OFFICES: 663 BROADWAY, NEW YORK 12, N. Y.

BOGEN SOUND SYSTEMS • AMPLIFIERS
COMMUNO-PHONES • ELECTRONIC EQUIPMENT

Newly Discovered "Miracle" Fluid



Cleans! Preserves! Renews! Dissolves! Lubricates!

NO-OX LABORATORIES

1515 W. Pico Boulevard, Los Angeles 15, Calif.

***No Pre-cleaning required!**

Gentlemen:

■ Send me 2 oz. bottle of NO-OX today. Enclosed find \$1.00.

■ Send me free literature on NO-OX.

Name: _____
Address: _____
City: _____ Zone: _____
State: _____

Satisfaction Guaranteed or Your Money Back!

Most Outstanding of All

FLEXIFONE

INTERCOMMUNICATION EQUIPMENT!

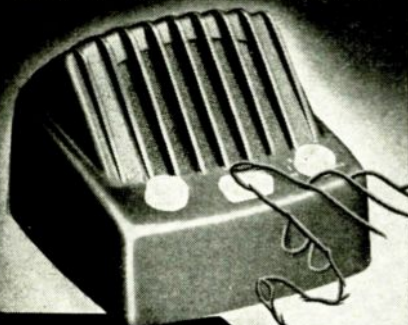

FLEXIFONE
6-STATION MASTER

Supervisor Models

... THE LINE THAT GIVES YOU
SALES LEADERSHIP TODAY!

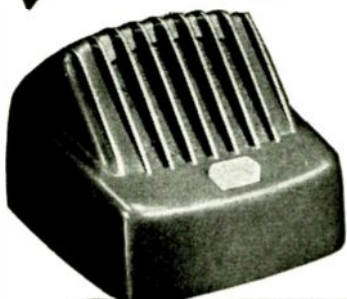

FLEXIFONE
SPEAKER STATION

FLEXIFONE Models Are Available Now!

FLEXIFONE offers you two profit lines—Supervisor Models for small, low-cost systems and Executive Models for large installations. FLEXIFONE's smart new styling, quality construction, and free sales helps mean new business for you!... Investigate FLEXIFONE today!

★ **NATIONALLY ADVERTISED** in TIME, FORTUNE, U. S. NEWS, BUSINESS WEEK, MODERN INDUSTRY, AMERICAN BUSINESS and other best-read magazines.

OPERADIO MFG. CO., DEPT. RTR-11,
ST. CHARLES, ILL.

Gentlemen:

Please send us the profit story on FLEXIFONE Executive and Supervisor intercommunication systems.

Name _____

Address _____

City _____ State _____

OPERADIO

FLEXIFONE

INTERCOMMUNICATION SYSTEMS

20 Years Ago

From the April 1927 Issue of
Radio Retailing

SELLING RADIO MUSIC — How the broadcasts of good music can become the dealer's best argument in selling more sets.

BRANCH STORE AT HOME — Dealers in Illinois make money by using basement of their home as store, in addition to part-time downtown store.

FIRST TRADE SHOW of the industry scheduled for June 13 to 17 at the Stevens Hotel in Chicago.

SUMMER SIDELINES — Retailers should supplement radio merchandise in hot weather in order to offer the public year-round continuity of service.

STORE BUILT ON SERVICE— Two brothers in Indiana store pyramid their profits from basis of service calls.

DANGER IN TRADE-INS — Dealer in San Francisco cuts his allowances and sells the old sets out quickly — minus any remodeling.

NATIONAL RADIO WEEK proposed by *Radio Retailing* in order to stir public interest in radio during "slow" months.

Sams Using New Idea

Maximum and minimum values of the ganged capacitors used in all new receivers are being given in the recent PhotoFact Folders, as an aid to radio-men in making the generally tricky replacement of this unit. The PhotoFacts, published twice monthly by Howard W. Sams & Co., Indianapolis 6, Ind., give schematic diagrams, alignment instructions, replacement parts values and ordering information, as well as clear pictures of the chassis and components.

Gibson Range Feature

Gibson Refrigerator Co. has received United States Letters patent No. 2416645, covering the Ups-A-Daisy feature in the Company's line of electric ranges. The Ups-A-Daisy device provides for the raising or lowering of the heating unit in the deep well cooker on the Gibson range, enabling the user to employ the unit for surface cooking along with the other three standard surface units or to utilize it in the bottom of the cooker well in the conventional manner.

ATTENTION

"SPARKS"

"THE BEST, SMALLEST, LOWEST-PRICED PORTABLE POLICE CALL RECEIVER ON THE MARKET."

PORTABLE POLICE AND FIRE CALL RECEIVER!



Receives all police and fire calls in whatever locality used. Can be tuned and reset for reception on police, fire and amateur bands on AM, FM and Ultra-high Frequency. Contains 1T4 Tube operated off

1½ Volt "A" and 67½ Volt "B" Batteries. Very low current drain—"B" battery lasts approximately 6 to 8 months. No drift... just switch on and signal comes in immediately. In attractive, sturdy case, heavy black plastic front panel. Has handle for easy carrying. Dimensions: 6½" x 3¾" x 3¾" ... weighs about 2 lbs.

Complete with 8,000 ohm crystal ear-phones, batteries and plug-in antenna... ready to operate... Price \$19.50

(without phones \$17.95)

SCARCE RADIO TUBES

Discounts Up to 60% off

NEW • GUARANTEED • POPULAR BRANDS
OZ4, 1LA6, 1LN5, 1P5, 2A3, 5Z4, 6AB, 2A5, 2A6, 6E5, 6F5, 6J8, 6K5, 6K8, 6P5, 6Q7, 7A8, 7B4, 7B8, 7B5, 7B7, 7C5, 7F8, 7G7, 12A8, 12F5, 12J7, 12K7, 12Z3, 14Q7, 14R7, 25A7, 25L6, 25Y5, 25Z5, 25Z6, 30, 32L7, 33, 35, 35A5, 35Y4, 35Z3, 43, 45, 47, 50A5, 50Y6, 55, 57, 58, 59, 70L7, 71A, 84, 117L7, 117M7, 117N7, 117P7, 117Z3, 117Z6, XXL... and many others.

8 SPECIAL OFFERS 8

- 25Y5 (Exact replacement for 25Z5) List price \$3.20 Your cost ea. \$.85
- ACORN TUBES, Guaranteed 954, 955, 956, 957 ea. .49
- 6AK5 Tubes, Guaranteed ea. .89
- HEARING AID TUBES, all types, 501ax —509ax ea. .49
- 6AH6 Tubes ea. .49
- 1T4, 1R5, 1S4, 3S4 Tubes ea. .49
- 6J5GT Tubes ea. .49
- 6SN7GT Tubes ea. .49

CONDENSERS

AT A PRICE YOU CAN'T BEAT

Brand new... Individually boxed... Fully Guaranteed for One Year. "The American Radio Repairman's First Choice in a Condenser."
20/20 MFD @ 150 volts \$.45
10 MFD @ 450 volts32
16 MFD @ 450 volts45
20 MFD @ 150 volts32

SPECIAL DISCOUNTS ON ALL LARGE ORDERS
We Ship Anywhere — Write for Catalog



COMMERCIAL RADIO
36 BRATTLE ST., BOSTON 8, MASS.

IT CAN'T HAPPEN HERE!

No Sir...
No Shock.

because
VACO
screw drivers are shock-proof!

In addition, these gleaming
Amberyl handles are break-proof
... fit the hand correctly... grip
firmly...do each job requiring the
use of a screw driver
better, faster, easier!

Write for
catalog.

There are **173** types
of Vaco screw drivers. Type
shown is especially
suited for electrical
maintenance work.

VACO 317 E. ONTARIO ST.
PRODUCTS CO. CHICAGO 11, ILL.
CANADIAN WAREHOUSE
560 KING STREET WEST TORONTO 2, ONT.

CORWICO

the *Service* line
of **CORDS** and **CORD SETS**
specified by top manufacturers of

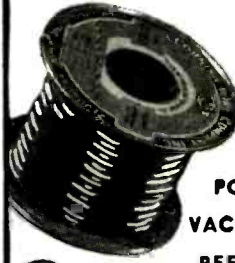

LAMPS
RADIOS
IRONS
FANS
PORTABLE TOOLS
VACUUM CLEANERS
REFRIGERATORS

RANGES WASHERS
HEATERS MIXERS

A full line of Flexible Cords for the
repair and service industry, obtain-
able through jobbers and distributors.

CORNISH WIRE CO., INC.
15 Park Row • New York City, 7

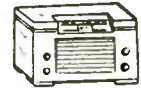

RADIO Television
RETAILING

RADIO Television
RETAILING

RADIO Television
RETAILING

RADIO Television
RETAILING

We'll be at

BOOTH 20¹/₂

RADIO Television
RETAILING

Parts Show

Hotel Stevens, Chicago, May 11-16

We look forward
to seeing you.

CALDWELL - CLEMENTS, INC.
480 Lexington Ave., N. Y. 17

RADIO Television
RETAILING

RADIO Television
RETAILING

RADIO Television
RETAILING

RADIO Television
RETAILING

NEON WINDOW SIGNS

COMPLETE SIGNS READY TO PLUG INTO 110 VOLT A.C., 50-60 C.

RADIO FM SERVICE

RADIO AND SERVICE 4"
PINK TRIM IN GREEN.
FM 6" GREEN GLASS
FRAME \$46.50

RADIO - APPLIANCES

LETTERING IN 4" PINK
TRIM IN POWER GREEN
GLASS FRAME **\$53.50**

REPAIR

SIGNS BELOW ARE 5" MODERN BLOCK 6" x 24" Two
LETTERS, ANY COLOR. Colors, Pink &
Radio, Tubes, or Sales Ea. \$20.75 Green or Gold
Radios, Repair, or Supply Ea. \$22.75 & Blue \$23.50

Repairs, Service, or Supplies Ea. \$24.75
COMBINATION OF TWO ABOVE 10% Down on All C.O.D.
To be used as one sign, 20% less total price Orders

INTER-STATE LABORATORIES

4049 MINNEHAHA AVENUE

MINNEAPOLIS 6, MINN.

**SPECIAL DEALS
FOR RADIO
DEALERS AND
SERVICEMEN**

The
**HOUSE OF A
MILLION RADIO PARTS**

Kit No. 85 Heavy Duty Rim
Drive Motor and Turntable List \$9.95
Crystal Pickup 6.50
Waterfall Walnut Open Case 4.95
1 Meg Vol. Control with switch 1.50
1 six-foot AC Cord40

Kit No. 87—3 Tube Amplifier Kit
complete with tubes and instruc-
tions—simple to build \$5.73
Kit No. 88—Above Amplifier com-
pletely wired 8.70

Kit Total List \$23.30
Your cost only 11.85

Kit No. 89—5 Inch P. M.
Speaker 1.95

Thousands of radio and sound equipment parts and supplies.
Tubes, record changers, amplifiers, speakers, etc. Write for catalog No. TV-18.

Lifetime Sound Equipment Co.
911-913 Jefferson Ave., TOLEDO 2, OHIO

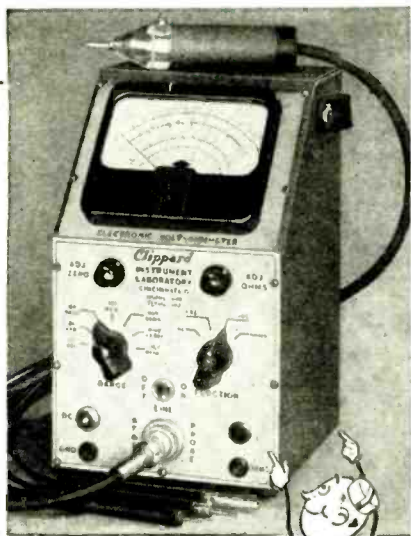

ACCURATELY TESTS
ALL F.M. CIRCUITS

Clippard

Model 406 Electronic Volt-Ohmmeter

We invite comparison of this instrument with any at any price for appearance, ruggedness, accuracy, stability. 0-1 to 1,000 volts U. H. F., A. C., D. C., 0-1,000 megohms. Pen-type dual-diode A.C. probe. No extras to buy. **\$89.50** From Jobber or F.O.B. Cincinnati. Send for details or order today.

CLIPPARD INSTRUMENT LAB., Inc.
1135 Bank St., Dept. 6, Cincinnati 14, Ohio



Ne-O-Lite Tester
Phono Needles

Flock Finish Kit — Lubricant
G-C NE-O-LITE TESTER

Handy, inexpensive, applicable for countless uses. For 60 V. A.C. to 500 V. A.C. or D.C. No. 5100-D—display of 20 # 5100 List \$10.00



G-C MASTER POINT PHONO NEEDLE
The "Concert Grand"—our finest needle; scratch-free reproduction, long-life, special metal tip, for use on automatic record players. No. 1436 List 50c each

G-C PHONO TURNTABLE MOTOR & GEAR LUBRICANT

Special lubricant for phono-graphs; formulated so lubricant clings to surface of parts. Eliminates repair trouble. No. 1223—tube List 42c



G-C FELT-KOAT "FLOCK FINISH KITS"

Complete kit for applying soft felt-like flock to phono-turntables, cabinets, etc. Prevents scratching various colors, easy to apply. No. 180-Q—Deluxe kit List \$2.00

At leading distributors. Write for catalog SEE OUR EXHIBIT, Booth #96, 1947 Radio Parts Conference, Stevens Hotel, Chicago—May 13-16.

RADIO DIVISION DEPT. G

GENERAL CEMENT Mfg. Co., Rockford, Ill., U.S.A.
Manufacturers of over 3,000 products
Sales offices in principal cities

DATES AHEAD

Future Events of Interest to Readers

- Apr. 5-12: Electric Home Show, Municipal Auditorium, Birmingham, Ala.
- Apr. 12-19: Home & Building Show, Reading Fair Grounds, Reading, Pa.
- Apr. 14-15: Second Annual Television Institute, Hotel Commodore, New York City
- Apr. 19-26: Metropolitan Home Show, Grand Central Palace, New York City
- Apr. 22-24: Electrical Trades Show, Alcazar Hotel, Baltimore, Md.
- Apr. 27-May 3: National Housewares Show, Convention Hall, Philadelphia, Pa.
- May 4-11: National Music Week
- May 4-11: Houston National Home Show, Sam Houston Coliseum, Houston, Tex.
- May 5-9: National Electrical Wholesalers Assn., Hotel Traymore, Atlantic City, N. J.
- May 5-11: National Plastics Exposition, Coliseum, Chicago.
- May 11-16: Radio-Electronics Parts Show, Hotel Stevens, Chicago
- June 1-5: National Assn. of Music Merchants (NAMM), Trade Show, Palmer House, Chicago
- June 10-13: Radio Manufacturers Assn. (RMA), Convention, Hotel Stevens, Chicago
- June 12-22: Second Annual Construction Industries Exposition and Home Show, Pacific Auditorium, Los Angeles
- June 23-30: New York Furniture Show, Furniture Exchange, New York City
- July 7-13: Store Modernization Show, Grand Central Palace, New York City

Big Plans for NAMM Convention

Interest in the annual convention and trade show of the National Association of Music Merchants, scheduled for June 2 to 5 at the Palmer House in Chicago, indicates that last year's record-breaking crowd will be exceeded.

The convention itself will be held for four days—June 2nd through June 5th. Several committee meetings have been planned for Saturday and Sunday, May 31 and June 1. The NAMM board of directors will meet on June 1, and it is suggested to NAMM members that they plan to arrive in Chicago on that date.

The trade show will be open for four days beginning Monday, and plans may possibly be completed for opening the exhibits Monday and Tuesday nights.

Dinner meetings of the various state NAMM organizations will be held on Wednesday night. Several of these have been organized since last year and others are just being formed. Show officials believe that initial plans for these gatherings should be made by the groups themselves. NAMM also has tentative plans for a state regional meeting on Wednesday, June 4.

R-L SPECIALS for IMMEDIATE delivery



PORTABLE AUTOMATIC PHONOGRAPH

Featuring a famous automatic record changer which plays 12-10" or 10-12" records. 8 tube amplifier provides 4 watt power output. Equipped with external on-off switch, volume and tone control and 6" dynamic speaker. Housed in portable carrying case of simulated leather. B-6205 Net.

\$32.95

WIRELESS PHONOGRAPH WITH AUTOMATIC RECORD CHANGER



No wires to connect. Just plug in and play through radio, 45 minutes of uninterrupted plays of 10 or 12 inch records without reloading. For 110 V. 60 cycle operation. Complete with open type walnut veneer cabinet. Shipping weight 14 1/2 pounds. D6200 Net, each \$28.50

Write for FREE Parts Catalog



731 West Washington Boulevard
Dept. N Chicago 6, Illinois

PHONO MOTORS—115V. AC, self-starting with 9" rim-drive turntable, flocked. \$2.95

Victor Power Transformers for models R-32, 45, 52 or 75. Unshielded. 5.95
TUBES: Perfect condition, but not in sealed cartons. Guaranteed for 90 days.
#26, 27, 46 or 58.29
#24, 42, 75, 77, 78, 80, 89, 5Y3, 6H8 or 6K7. .39
#6A8, 6C5, 6F5, 6J7, 6SA7, 6SK7, 12SA7 or 12SK7. .49. #1A7, 6A3, 605/6U5, or 50. .59

RADIOMAN'S HARDWARE TREASURE. Over 1000 nuts, screws, washers, etc. PLUS handy 36 compartment cardboard kit box. 59

"Ouncer" Input Transformers (3/4" x 1 1/4")
#58—Low impedance pick-up or dynamic mike to grid; #56—Carbon mike to grid
—Either49 12 for 5.00

SERVICEMEN'S KITS
#1—R.F., Antenna & Osc. coils; 10 asstd. .98
#2—Speaker Cones; 12 asstd. 4" to 12" moulded & free-edge (magnetic incl.). Less voice coils 2.00

#3—BAKELITE MICA CONDENSERS; 50 asstd. .0001 to 2 mfd, 200-800 V. 2.95

#4—TUBULAR BY-PASS CONDENSERS; 50 asstd. .001 to 25 mfd, 200-800 V. 2.49

#5—Dial Scales; 25 asstd. airplane & slide-rule (acetate & glass included). 2.98

#7—Encutcheon Plates; 25 asstd. airplane, slide-rule & full-vision types. 2.95

#8—Knobs; 25 asstd. wood & bakelite incl. push-on, setscrew & push-button types. 1.00

#9—Wider Sockets; 12 asstd. 4 to 7 prong. .25

#10—Voltage Dividers; 10 asstd. standard multi-taped. High wattages included 1.98

#11—Shield Cans; 15 asstd. for coils, tubes, transformers, etc. 1.00

#12—Mica Padders & Trimmers; 15 asstd. incl. multiple & ceramic base types.69

#14—Volume & Tone Controls; 10 asstd. wire-wound & carbon. Less switches. 1.49

#15—Wire-Wound Resistors; 15 asstd. 5 to 20 watts; incl. enam. & canohms98

#16—1 F Coils; 6 asstd. including shielded & slug tuned. Peaks unmarked. 1.95

#17—DIAL WINDOWS; 12 asstd. sizes incl. flat & moulded acetate and convex glass. 1.29

#20—SPEAKER REPAIR KIT. A real money & time saver. Contains: 20 asstd. paper rings, 10 spiders, 25 asstd. voice coil forms, 3 yds. felt strips, 20 ehamois leather segments, kit of 16 shims & tube of speaker cement. All for 2.49

PROMPT SERVICE ON ALL SPEAKERS AND PHONO PICK-UP REPAIRS

Min. Order \$2.00—20% deposit required on all Orders Please add sufficient postage. Write Dept. RT-4

LEOTONE RADIO COMPANY
65-67 DEY STREET, NEW YORK 7, N. Y.

INDEX To Advertisers

APRIL 1947

	Page		Page
Aerovox Corp.	142	National Carbon Co., Inc.	8
Air King Radio Div., Hytron Radio & Electronics Corp.	45	National Record Co.	66
Alliance Mfg. Co.	72	National Stamping & Electric Works Div., Eureka-Williams Corp.	93
Altec-Lansing Corp.	125	Newcomb Audio Products Co.	136
American Magazine	48	Noblitt-Sparks Industries, Inc.	27
		No-Ox Laboratories	147
Baronette Radio & Tube Co.	86	Norge Div., Borg-Warner Corp.	74
Bell Sound Systems, Inc.	143		
Bendix Radio Div., Bendix Aviation Corp.	5	Ohmite Mfg. Co.	144
Bogen Co., Inc., David ...	147	Olson Radio Warehouse	141
		Operadio Mfg. Co.	148
Caldwell-Clements, Inc. 93, 131,	137	Oxford Electric Corp.	133
Chicago Tribune	10		
Clarostat Mfg. Co., Inc.	146	Peerless Album Co.	71
Clippard Instrument Lab., Inc.	150	Permo, Inc.	67
Columbia Recording Corp.	55	Portofonic Mfg. Corp.	68
Columbia Wire & Supply Co.	147	Proctor Electric Corp.	90
Commercial Radio	148		
Continental Electronics, Ltd.	145	Quam-Nichols Co.	151
Cornell-Dubilier Electric Corp.	113		
Cornish Wire Co., Inc.	149	Radio Corp. of America:	
Crosley Div., The Aviation Corp. 84,	85	RCA Victor Division	32, 33
		RCA Victor Records	50
		Tube Division	96, Cover 4
Davidson Mfg. Co.	61	Rauland Corp.	139
Delco Radio Div., General Motors Corp.	47	Raytheon Mfg. Co.	25
Diamond Record Corp.	59	Recoton Corp.	63
Dictograph Products, Inc.	144	Rider Publisher, Inc., John F.	107
DuMont Laboratories, Inc., Allen B.	21	R-L Electronic Corp.	150
Duotone Co.	64		
		Soms & Co., Inc., Howard W.	119
Electro Products Laboratories	147	Scott Radio Laboratories, Inc.	16
Electronic Laboratories, Inc. 12,	127	Seeburg Corp., J. P.	Cover 3
Emerson Radio & Phonograph Corp. 2,	3	Shawline, Inc.	72
		Shure Brothers, Inc.	145
Foda Radio & Electric Co., Inc.	19	Simpson Electric Co.	105
Farnsworth Television & Radio Corp.	9	Simpson Mfg. Co., Inc., Mark	132, 134
		SNC Mfg. Co., Inc.	121
Galvin Mfg. Corp.	6	Solar Capacitor Sales Corp.	152
General Cement Mfg. Co.	150	Sonora Radio & Television Corp.	17
General Electric Co. 11, 111,	129	Sparks-Withington Co.	18
General Industries Co.	70	Sprague Products Co.	123
Graybar Electric Co.	91	Standard Register Co.	89
		Stewart-Warner Corp.	23
Howard Radio Co.	126	Stromberg-Carlson Co.	28
Hytron Radio & Electronics Corp.	13	Supreme Instruments Corp.	138
		Sylvania Electric Products, Inc.	100, 101
International Resistance Co.	108, 109	Symons Assoc., L. H.	68
Inter-State Laboratories	149		
Jensen Mfg. Co.	22	Talk-A-Phone Co.	140
J. F. D. Mfg. Co.	138	Tung-Sol Lamp Works, Inc.	26
		Turner Co.	130
Ken-Rad Div., General Electric Co.	7		
Lake Radio Sales Co.	146	Vaco Products Co.	149
Lear, Inc.	128	Vacuum Cleaner Supply	88
Lenk Mfg. Co.	140	Verd-A-Roy Corp.	87
Leotone Radio Co.	150		
Lifetime Sound Equipment Co.	149	War Assets Administration ...	114, 115
		Word Products Corp.	143
McGee Radio & Electric Co.	135	Warwick Mfg. Corp.	20
Maguire Industries, Inc.	117	Webster Chicago Corp.	62, 69
Mallory & Co., Inc., P. R.	94, Cover 2	Westinghouse Electric Corp.	14, 15
Merit Coil & Transformer Corp.	4	Wilcox-Gay Corp.	65
		Zenith Radio Corp.	24

While every precaution is taken to insure accuracy, we cannot guarantee against the possibility of an occasional change or omission in the preparation of this index.

LOOK
FOR THE
'U'-SHAPED
COIL POT

THE MARK OF
QUAM
QUALITY

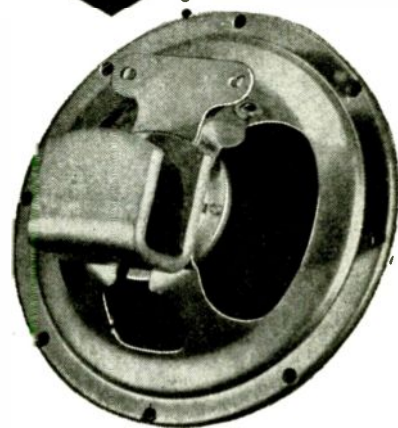

QUAM
Adjust-a-Cone
SPEAKERS

**QUAM-NICHOLS
COMPANY**

Builders of Quality
Speakers Since 1923
33rd PLACE AT COTTAGE GROVE
CHICAGO 16, ILL.

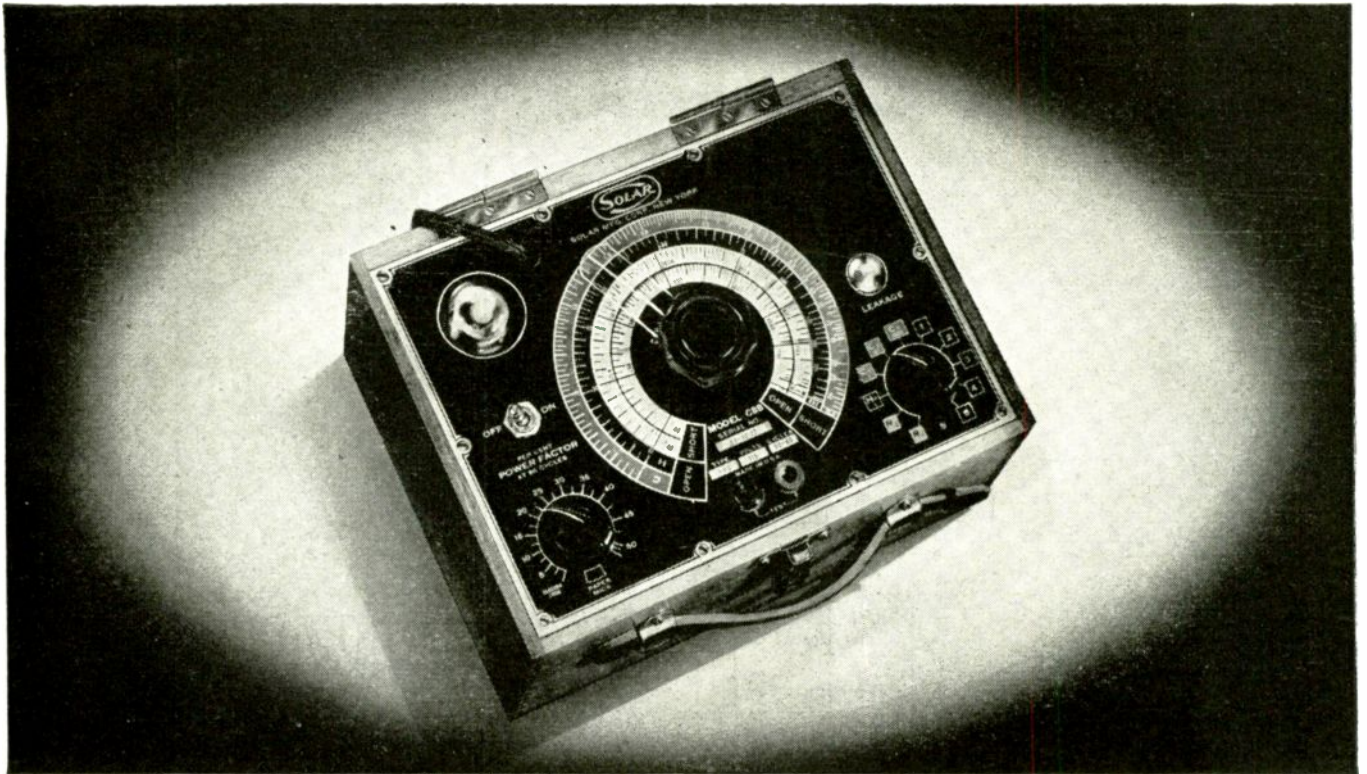

QUICK—RELIABLE—PORTABLE!

the new Solar Model CBB Capacitor Analyzer

Check these features:

- ✓ CAPACITANCE RANGE
10 mmf to 800 mf
- ✓ POWER FACTOR RANGE
0 to 50 percent
- ✓ "QUICK AS A WINK"
C-R tube Wien bridge
balancing
- ✓ BUILT-IN ADJUSTABLE VOLTAGE
POWER SUPPLY
- ✓ SIMPLIFIED LEAKAGE
AND I-R TESTS
- ✓ EASY TO READ
COLOR-CODED SCALES
- ✓ RESISTANCE RANGE
50 to 2,000,000 ohms

Here is a capacitor analyzer with both proved and improved features that is a worthy successor to Solar's famous Model CB, which outsold all other capacitor analyzers combined.

Small in size, light in weight and big in performance and dependability, Model CBB analyzer is the ideal low-cost instrument for the service industry.

Catalog IN-2 gives a full description of the reasons why it should be in every service shop.

**Solar Capacitor Sales Corp.
285 Madison Ave., New York 17, N. Y.**

Ⓢ 8871

SOLAR CAPACITORS

"Quality Above All"



3 WAYS TO ADD Sales Appeal TO RADIO-PHONOGRAPH COMBINATIONS



Radio-phonograph combinations take on new glamour and sales appeal when the record changer matches the beauty and dignity of the instrument itself. That's why Seeburg changers have become standard equipment on so many of America's finest combinations.

Seeburg offers three changers—the new intermix "M," the "L" and the "K." Each is designed for radio-phonograph combinations of varying price ranges. All are engineered to give simple, dependable and trouble-free operation.

The years of experience in engineering all types of changing mechanisms, the reputation of Seeburg changers to stand up under tough service are your assurance that you may rely on Seeburg.

Seeburg

RECORD CHANGERS ★ MUSIC SYSTEMS

J. P. SEEBURG CORPORATION
1500 N. Dayton St., Chicago 22

1. with the Seeburg "M"

Enhances the appeal and performance of even the finest combinations. Exclusive, 3-post construction for intermix playing. Capacity of fourteen 10-inch records, twelve 12-inch records or twelve 10-inch and 12-inch records intermixed. Size: 14¼ x 14¼ in.



2. with the Seeburg "L"

A finely engineered changer that will add to the listening pleasure of your beautiful console radio-phonograph combinations. Two-post construction. Capacity of fourteen 10-inch records or ten 12-inch records. Size: 14¼ x 14¼ in.



3. with the Seeburg "K"

A simplified, compactly built mechanism for popularly priced consoles and deluxe table model combinations. Two-post construction. Capacity of fourteen 10-inch records or ten 12-inch records. Size: 12½ x 12½ in.





Authoritativeness... **the fountainhead of tube information is RCA**



Throughout the radio and electronic worlds, the RCA symbol on a tube publication has become synonymous with the latest in tube development, accurate data, unquestioned *authoritativeness*.

RCA tube publications are standard reference works wherever tube information is needed . . . in the laboratory . . . in industry . . . in the shop . . . at the counter. They have had an important part in spreading the popularity of RCA tubes.

All of this authoritative tube information is yours . . . to keep you up-to-date

and help you become the best-informed man on tubes in your locality.

Here's the latest! Booklet 1275-C on Receiving Tubes for Television, FM and Standard Broadcasting. It has the newest data on tubes, both new and older types . . . easy-reference method of identifying miniature and metal tubes . . . and socket diagrams for all types. Get your copy from your RCA Distributor.

The best in technical literature is another reason why *you're in the lead with RCA*. So, push RCA Tubes and watch your business grow!

THE FOUNTAINHEAD OF MODERN TUBE DEVELOPMENT IS RCA



TUBE DEPARTMENT

RADIO CORPORATION of AMERICA

HARRISON, N. J.