

RADIO *& Television* RETAILING

Including
**ELECTRICAL
APPLIANCES**

Pages 47-66

CALDWELL-CLEMENTS, INC.



APRIL 1946



NEW "HOME-MAKERS" MARKET
For Radios, Home Appliances, FM,
Service and Records



Speeds up repair work... makes it more profitable

The Most Valuable Edition Ever Published!

**You Expect More—
and You Get More
from Mallory**

These typical Mallory publications are especially prepared to assist your service department in doing better work—in less time. Others are in preparation. See your Mallory Distributor!

1946 Fifth Edition Radio Service Encyclopedia

Replacement Vibrator Guide

Mallory Technical Manual

Approved Precision Parts Catalog

NOW comes the most complete Mallory Radio Service Encyclopedia of all—listing 4,000 radio sets never before included—with invaluable information for your service department on *every* pre-war model.

Complete tube complements. I.F. Peaks. Original part numbers and recommended replacements that are *readily available*. Circuit references. In short everything your service engineers need to know to do a thoroughgoing job—to insure profits—to build and maintain consumer good-will.

At your cost of \$1.25 net, this new 1946 Fifth Edition of the Mallory Radio Service Encyclopedia is decidedly the buy of the year. It's another example of Mallory service beyond the sale—the kind of help you naturally expect from Mallory. Place orders now with your Mallory distributor.

P. R. MALLORY & CO., INC.
MALLORY

VIBRATORS... VIBRAPACKS*... CAPACITORS... VOLUME CONTROLS
... SWITCHES... RESISTORS... FILTERS... RECTIFIERS...
POWER SUPPLIES. ALSO MALLORY TROPICAL* DRY BATTERIES,
ORIGINALLY DEVELOPED BY MALLORY FOR THE U. S. ARMY.
*Reg. U. S. Pat. Off.

APPROVED PRECISION PRODUCTS

P. R. MALLORY & CO., Inc., INDIANAPOLIS 6, INDIANA

RADIO & Television RETAILING *

Including Radio and Television Today

Including
**ELECTRICAL
APPLIANCES**
Section

IN THIS ISSUE

APRIL, 1946

★ Radio, Television and Records

COVER: New "Home-Makers'" Market

FM = FOLDING MONEY FOR MERCHANTS	27
RADIO, ELECTRICAL APPLIANCES, RECORDS, AND TELEVISION TODAY..	28
FARM SELLING YIELDS PROFITS	30
INTENSIVE SALES TO CUSTOMERS NOW	32
NEW RADIO MERCHANDISE COMING GREAT GUNS	34
EXPANDS SERVICE LAYOUT FOR HIGH PROFITS	38
BLACK-WHITE VS. COLOR-TELEVISION	40
IS YOUR STORE A LEADER IN RECORD SALES?	42
DIRECTORY OF RADIO AND TELEVISION MANUFACTURERS	46

★ Electrical Appliances

COVER: Use What You Have to Make the Sale

NEW METHODS OF DEMONSTRATION	49
DEALERS WILL SOON BUY ELECTRICAL APPLIANCES	50
NEW ELECTRICAL APPLIANCE PRODUCTS	52
TIE WINDOWS TO SEASONS	62
DIRECTORY OF ELECTRICAL APPLIANCE MANUFACTURERS	66
ROUND-TABLE SALES MEETING	68

★ Service and Sound

USES TELEVISION TO BOOST SERVICE	73
SERVICE DATA ON NEWEST RECEIVERS	74
ALIGNING SUPERHETS, PART II	76
IMPROVED SERVICE LAYOUT INCREASES \$-INTAKE	38
RADIO SERVICE METHODS	84
DISCS INCREASE PA SALES	94
LATEST TECHNICAL PRODUCTS	98, 102
TELEVISION TODAY	110
JOBBER TALK	114
NEWS OF THE INDUSTRY	86-138

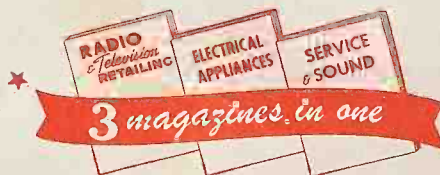

**27,000 COPIES
THIS ISSUE**

CALDWELL-CLEMENTS, INC.—TEL.: PLAZA 3-1340—480 LEXINGTON AVE., NEW YORK

ORESTES H. CALDWELL
Editor

M. CLEMENTS
Publisher

JOHN L. STOUTENBURGH
Managing Editor

STEPHEN I. HALL
Merchandising Editor

HELEN THURMAN
Associate Editor

DARRELL BARTEE
News Editor

CHARLES F. DREYER
Art Director

Assistant Editors

RUTH MORRIS

E. T. BENNETT

BUSINESS DEPARTMENT

LEE ROBINSON
Sales Manager

M. H. NEWTON
Business Manager

G. B. ANDREWS

EDWIN WEISL, JR.

B. V. SPINETTA
Circulation Manager

BEN MORRIS
Promotion Manager

J. COSIN
Research

B. HALL
Production

Branch Offices

CHICAGO

R. Y. FITZPATRICK
201 N. Wells St.
RAN. 9225

CLEVELAND

Citizens Bldg., 850 Euclid Ave.
MAin 8270

LOS ANGELES

ROBERT W. WALKER
Walker & Minton
403 W. 8th St.
VAndyke 9348

SAN FRANCISCO

ELI C. MINTON
Walker & Minton
68 Post St.
SUtter 5568



more efficient
... in miniature

At the press of a button, the modern fire siren screams its warning for miles. In contrast, it took a husky man to strike an iron tire hard enough, with a heavy sledge, to sound an alarm even over a comparatively small area. Greater efficiency in miniature is as evident in the fire alarm as it is in the Electronic Tube.

TUNG-SOL Miniature Tubes are more impervious to the effects of shock and vibration as they are constructed with smaller, lighter parts. The glass button base has better dielectric properties than the old style bases. Lower lead inductance, lower inter-element capacities, and higher mutual conductance are characteristics of TUNG-SOL Miniatures that assure superior performance in high frequency currents. The advantages of smaller

lighter tubes in over-all set design needs no amplification.

Manufacturers of radio sets and other electronic equipment see the many advantages of TUNG-SOL Miniatures and are designing them into new products. TUNG-SOL Jobbers and Dealers are in position to furnish TUNG-SOL Miniatures as well as large glass tubes for servicing every type of equipment.



ACTUAL SIZE

TUNG-SOL

vibration-tested

ELECTRONIC TUBES

TUNG-SOL LAMP WORKS, INC., NEWARK 4, NEW JERSEY
 Sales Offices: Atlanta • Chicago • Dallas • Denver • Detroit • Los Angeles • New York
 Also Manufacturers of Miniature Incandescent Lamps, All-Glass Sealed Beam Headlight Lamps and Current Intermittors

Presto Cutting Needles
 in a "Trouble-Proof" Container
at no extra cost



FOR YOUR CONVENIENCE! Presto Sapphire Recording Needles *now* come to you in a *new* package, designed for utmost needle protection in shipping and handling.

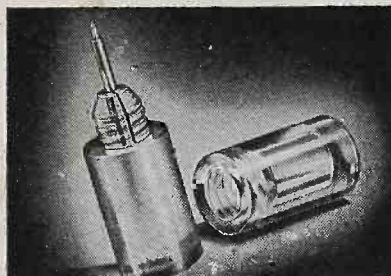

NEW! A transparent lucite container keeps Presto Cutting Needles *safe*. Nothing can harm the precision ground point and cutting edges.

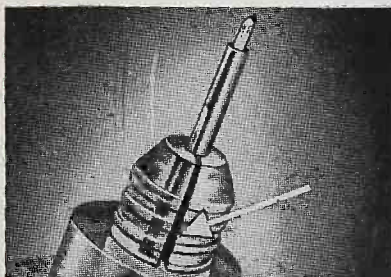

TIGHT! This ingenious chuck holds the needle *tight*—no chance of damage to the point in shipment.



EASY! Just slip used needles (safe in their containers) into this handy mailing bag and send them off to Presto for resharpening.

FREE! To Presto-equipped recording studios: a convenient rack holding six Presto Cutting Needles, with special "point-control" chart recording number of hours each needle is used.

PRESTO Cutting Needles are packed in a Distributor's Carton of six. Each needle container is individually boxed with mailing bag. Order a dozen. Keep 6 in use—6 in transit.



RECORDING CORPORATION
 242 W. 55th St., New York 19, N.Y.

WALTER P. DOWNS, LTD., in Canada

WORLD'S LARGEST MANUFACTURER OF INSTANTANEOUS SOUND RECORDING EQUIPMENT AND DISCS



***We would like
to see you at the
1946***

**Radio Parts and Electronic
Equipment Conference and
Show.**

Booth No. 52

**STEVENS HOTEL
CHICAGO**

May 13th - 16th

MERIT COIL & TRANSFORMER CORP.

4427 North Clark St.

TELEPHONE

Long Beach 6311

CHICAGO 40, ILL.

Color Television and Trade Magazine Coverage —A Statement from the Publisher

The recent announcement by the Columbia Broadcasting System of its new color-television system has stirred controversy throughout the nation on the question of color vs. black-white television. CBS introduced its newly-developed system with demonstrations to selected press representatives. The ensuing public interest, engendered by the reams of publicity it caused, has pushed public speculation to a new high, and has caused the industry itself to watch still more closely.

Actually, the radio industry leaders agree there is no controversy. The industry is agreeably surprised to see the excellence of CBS' mechanical means of color transmission, but the majority of television manufacturers are going ahead with black-white immediately, as originally planned. And, they are continuing to study and develop tele color so that an adequate—a truly fine color system—will be ready in three to five years.

On pages 40, 41 and 106 of this issue you will find an analysis of the current CBS tele developments, written by Dr. O. H. Caldwell, editor of our publications, and two of his technical assistants, who are among the better-known tele engineers. It is interesting to note the degree of exactness and analysis in this article, especially when compared with other business paper comment. We don't hesitate to state that articles of this sort are what help keep RADIO & Television RETAILING in the dominant position it has maintained since 1925.

The field work of our editors—the largest staff of any radio trade publication—makes the vast difference between other publications in this field and RADIO & Television RETAILING. The first is content to publish publicity releases—hand-outs. In contrast, we prefer to make our own surveys, to go out and ask questions, to analyze in the light of our own knowledge, and to prepare for you the magazine material you can obtain from no other publication.

Publisher

FOUR

Bendix Radio

BULL'S-EYES

from the industry's finest
line-up of radio "firsts"

NEW,
different, desirable—
the chair-size space-
saver Console Radio
Phonograph

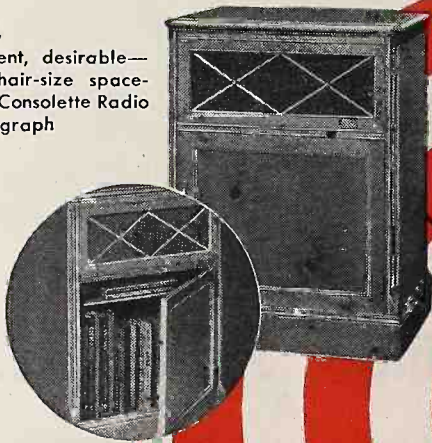

OFF—
A Sheraton
end table



NEW,
sensational,
crowd-stopping
—the Invisible
Radio with the
"Sans-Arb" Phan-
tom Dial



ON—
The Real
Voice of Radio



NEW,
double-faced plastic
table model with built-
in handle



NEW,
compact Swing-A-Door Consoles
—no lid to lift, no drawers to
pull, 100 record storage space



The more new lines that reach the market the more the trade agrees—Bendix Radio has beaten the industry to the punch on everything the public wants and needs. Check the great Bendix "Firsts" above . . . imagine the broad market awaiting

sets and features like these . . . think of their potentials for crowd-pulling, for easy, fast-selling demonstrations. The Franchise With a Future gives you *features with a future*—advancements bound to build bigger sales and profits because they're *made-to-order for modern living*.

BUILD BEST WITH BENDIX • FOR PRESTIGE • PROFIT • PERMANENCE!

Bendix Radio Division, Bendix Aviation Corporation, Baltimore 4, Maryland





WHO'S WHO

in collecting and interpreting today's sales facts

A FAST-GROWING list of manufacturers, distributors and dealers throughout the country are availing themselves of the kind of cooperation rendered by Hearst Advertising Service.

For today's H-A-S man is more than a space representative laying before you the value of his newspaper. He's a man who makes a specialty of knowing what goes on, sales-wise, in ten key markets of America—a man who can talk to you in sales language that makes sense.

What the H-A-S man can lay before you is a *newspaperman's* knowledge of the town he works in—information gathered by "reporters with a nose for sales"—facts that are accu-

rate, complete and up to the minute because they come, as news comes, from continuing sources.

Such sources include not only dealer contacts in the field, but also distributors, wholesalers, jobbers, branch managers, district managers and sales managers—men on the sales firing line whom the H-A-S organization contacts and cooperates with daily.

CALL THE H-A-S MAN

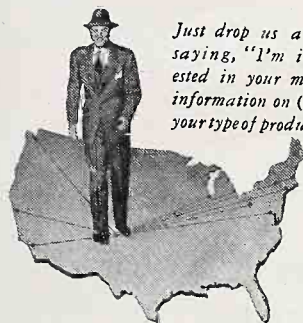

Just drop us a note saying, "I'm interested in your market information on (name your type of product)."

H-A-S men have assisted in setting up territorial quotas—in securing manufacturers' representatives—in allocating dealers by markets and divisions within markets—in hundreds of other ways.

Why not call the H-A-S man today?

HEARST ADVERTISING SERVICE

HERBERT W. BEYEA, Manager

959-8th Ave., New York 19, N. Y.—Offices in principal cities

Representing:

New York Journal-American • Pittsburgh Sun-Telegraph • Chicago Herald-American
 Baltimore News-Post-American • Boston Record-American-Advertiser • Detroit Times • Albany Times-Union
 San Francisco Examiner • Los Angeles Examiner • Seattle Post-Intelligencer

KEN-RAD



Two of Ken-Rad's window displays—all of them vividly attractive in four colors—are shown here. They will introduce your store to hundreds of new radio tube buyers.



You'll do more business as a Ken-Rad tube dealer

because KEN-RAD HELPS YOU SECURE NEW CUSTOMERS!

ONCE you handle Ken-Rad radio tubes, every aid is given you to increase your volume of business. Colorful window cards and streamers build greater patronage for your store. There are attractive Ken-Rad blotters which carry your name and address—handy for you to mail out, sure to be kept by prospects. Imprinted stationery, bill

heads, shipping labels—these and other individualized items help widen your circle of customers. Ken-Rad wants your business to grow—knows how to make it grow! Best of all, Ken-Rad tube quality—now *better than ever*—is assurance that your customers will remain loyal, and will recommend your store to other tube buyers!

• Write for Ken-Rad's "Sales Helps" Folder ETR-4, describing material to help you build a bigger tube business.

178-E3-8880

KEN-RAD

DIVISION OF GENERAL ELECTRIC COMPANY
OWENSBORO, KENTUCKY

BUSINESS GETTERS

REVOLUTIONARY! — a BONDED 90-day Guarantee on all Radio Repairs...

by **RAYTHEON BONDED ELECTRONIC TECHNICIANS**

• Because it is our sincere aim to give you and all radio users in our community the finest service, we have been proud to announce that Bonded Electronic Technicians. This is a high honor for which only the most experienced, most reputable and best equipped radio service dealers could qualify. Here's what our appointment means to you. When your radio is with us, you can have it repaired completely confident that it will be repaired properly by expert electronic technicians, and that both parts and labor will cost a 90-day guarantee. The bond of one of the largest surety companies in the National Industrial folder for direct mail service. Read the business guarantee in the Code of Ethics which we are bonded to you when you bring your radio to us.

Offered only by RAYTHEON BONDED ELECTRONIC TECHNICIANS

NOW for the FIRST TIME RADIO SERVICE with a BONDED 90 DAY GUARANTEE!

• You can have complete confidence when you turn your radio over to us for repairs. It will be serviced by the best methods in the electronic industry... by the most skilled and experienced men in this community... with your satisfaction assured by a 90-day guarantee backed by the bond of the Western National Indemnity Company. Bonded Electronic Technicians as a result of our reputation in repairing, makes in any service job. We offer you the very best in the Code of Ethics in the industry. In fact, we will probably cost you less when you need us.

Something NEW UNDER THE SUN!

With direct mail, you can multiply the prospects who come to your door—bring in new customers to keep your business and your profits steadily growing. Raytheon Bonded Electronic Technicians have a big story to tell—and have effective self-mailers to tell that story to the public. These direct mail pieces are only a part of the broad program of *selling helps* made available *only* to Raytheon Bonded Electronic Technicians. Bonded service means better customer relations. For full details to qualify, see your Raytheon distributor today.



Excellence in Electronics



ANOTHER REASON WHY IT PAYS TO QUALIFY AS A RAYTHEON BONDED ELECTRONIC TECHNICIAN

**RADIO RECEIVING TUBE DIVISION
NEWTON, MASS. • NEW YORK • CHICAGO**

GAROD NOW... *and later*

The Sheraton



6 TUBE AUTOMATIC RADIO PHONOGRAPH
Walnut and Bleached Oak.



The Senator

6 TUBE AC-DC SUPERHET
Ivory or Walnut Plastic Cabinet Model.

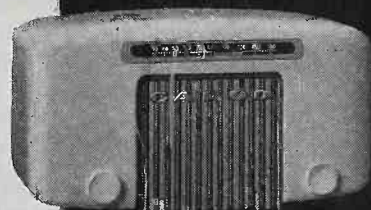

The Commodore

5 TUBE AC-DC SUPERHET
Ivory, Blue, Green or Maroon Plastic with Contrasting Grill.

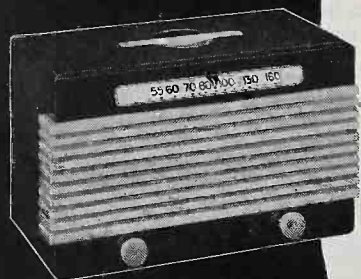

The Commander

6 TUBE AC-DC SUPERHET
Two-Tone "Catalin" Plastic Combinations.



The Playmate

3-WAY PORTABLE
AC-DC-Battery.

The radios illustrated are only a few from the complete GAROD line— which includes portables, table sets, radio-phonograph combinations, farm sets, AM, FM, etc. You'll sell them now when selling is easy — and you'll sell them later when competition is keener — because GAROD quality and GAROD beauty are a natural go-getting team. Starting with an extra-fast-selling line of table models, the GAROD line includes all models competitively up to \$350.00. Full-line national advertising campaign is now under way. Displays, mats, selling helps are ready. See your nearest GAROD distributor.

The Moderne



6 TUBE AUTOMATIC RADIO PHONOGRAPH
Bleached Mahogany—Walnut—Mahogany

GAROD



RADIO

GAROD RADIO CORPORATION • 70 WASHINGTON STREET BROOKLYN 1, N. Y.

What DOES Make a BETTER Loud Speaker?

WILL the possession of physical facilities and desire create a better product? No, because for all of their importance, these possessions are certainly not unique. All institutions have them to some degree. Is it fanciful claims and fluent use of superlatives in product description that make a product better? Obviously not. Is it the achievement of theoretically perfect performance in the laboratory? No, not that either, for perfection in such respects does not necessarily create the practical ideal.

The simple truth is that no product can be better than *know how* and the honest application of that *know how* as the product is created and its virtues described.

What is the yardstick of these ingredients in a product? The record of achievements and the list of contributions to the advancement of science and art is one good measurement. The First PM Speaker, the Bass Reflex Principle, the Hypex Formula are just a few of the advancements contributed to the industry by JENSEN. There is also the endorsement by those users and connoisseurs of Loud Speaker performance whose first and last emphasis is always on superiority. JENSEN Loud Speakers and Reproducers are the overwhelming choice of such people. Finally, and perhaps most important of all, there is the established custom of the manufacturer to make honest statements as to the *real ability* as well as *limitations* of the product. Here at JENSEN this has always been a fixed policy, an absolutely essential ingredient in *honesty of purpose*, even though by some standards it is called "selling down."

And so, a better Loud Speaker is created because of *know how*, achievement as shown by the record, significant endorsement and integrity of purpose from start to finish. JENSEN Loud Speaker Products, personnel and policy meet these requirements.

For those interested in the proper appraisal, selection, use and operation of Loud Speakers, JENSEN is publishing a series of Technical Monographs—of which five issues are now in print. Note the titles listed below and write for one or all of them.

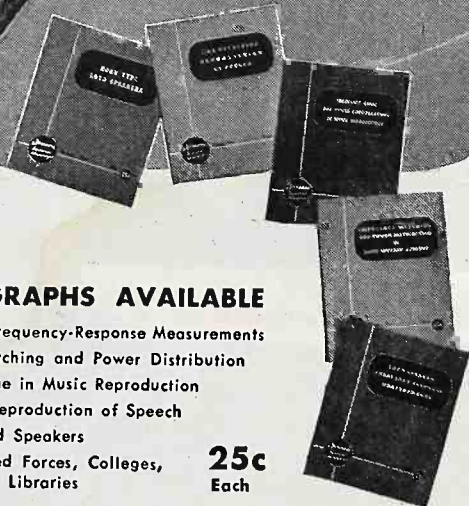
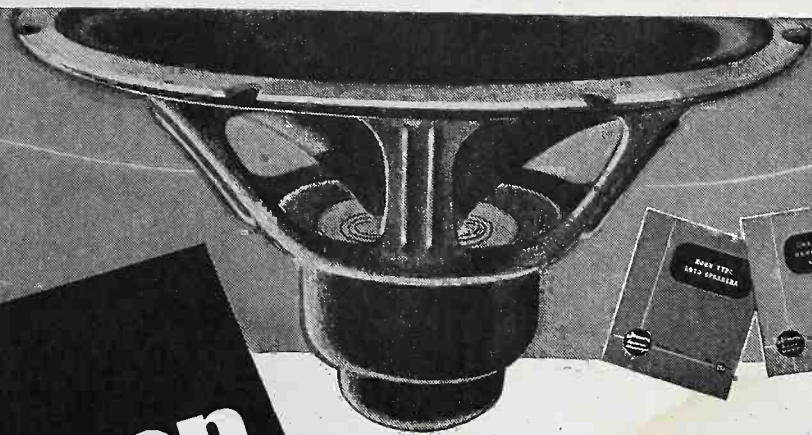

5 MONOGRAPHS AVAILABLE

1. Loud Speaker Frequency-Response Measurements
2. Impedance Matching and Power Distribution
3. Frequency Range in Music Reproduction
4. The Effective Reproduction of Speech
5. Horn Type Loud Speakers

FREE to the Armed Forces, Colleges, Technical Schools, Libraries

25c
Each

JENSEN RADIO MANUFACTURING CO.
6625 SO. LARAMIE AVENUE, CHICAGO 38, ILLINOIS
In Canada: Copper Wire Products, Ltd., 137 Oxford Street, Guelph, Ont.

Specialists in Design and Manufacture of Fine Acoustical Equipment

THESE RADIOS WILL

Stay sold

BECAUSE OF



quality

CONSTRUCTION!



● QUALITY MODEL 326—Radio Phonograph, 7 tubes (including rectifier); automatic record changer; standard and short wave bands; 12" Dynapower speaker; tone control; new G-E Electronic Reproducer. Underwriters' approved.

ANY RADIO WILL SELL TODAY—

but only a good radio will stay sold! Keeping radios sold depends on the performance of the sets you sell. If you're selling General Electric it's easy because every one of the entirely new G-E radios is built of the highest quality parts and components—designed for peak performance and extra long life with a minimum of service.

COMPARE! The simple way to get acquainted with G-E Quality is to compare General Electric radios with any of the better performing sets. Remove the chassis from their cabinets; count the components and examine their ratings; inspect all parts and materials; look at the workmanship—quickly you'll discover why G-E sets have greater sensitivity, selectivity, far better tone... why G-E radios stay sold!

ASK YOUR NEAREST G-E radio distributor for the complete story of General Electric Quality or write to: Electronics Department, General Electric Company, Bridgeport, Connecticut.

THE FIRST AND GREATEST NAME IN ELECTRONICS



● QUALITY MODEL 103—Deluxe 5 tubes (incl. rectifier), AC-DC; standard broadcast band; Multi-weave grill; solid mahogany. Underwriters' approved.

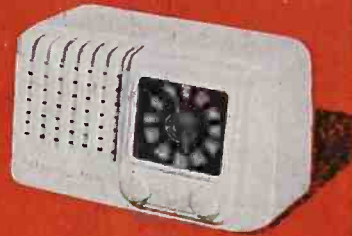

● QUALITY MODEL 111—Compact 5 tubes (including rectifier), AC-DC; standard broadcast band; G-E Alnico 5 speaker; molded ivory plastic cabinet.



● QUALITY MODEL 101—Deluxe 5 tubes (including rectifier), AC-DC; standard broadcast band; ivory plastic cabinet; handsome Multi-weave speaker grill. Underwriters' approved.



● QUALITY MODEL 321—6 tubes (incl. rectifier), AC-DC; standard broadcast band, tone control; electric push button tuning; solid walnut cabinet.

GENERAL ELECTRIC

17B-E4

PORTABLES • TABLE MODELS • CONSOLES • FARM SETS • AUTOMATIC PHONOGRAPH COMBINATIONS • TELEVISION



**Only WARD gives you all
These Dominant Plus-Features**

- Easy One Man Installation
- Patented Fluid Type Anti-Rattle Construction
- Positive Silver-to-Silver Contacts
- Extra Heavy Triple Chrome Rust-proof Plating
- Top Section, Stainless Steel
- Heavy Admiralty Brass Tubing
- Hi-Q Detachable Low Loss Lead-ins with Polyethylene Insulation and Vinylite Covering
- Complete with all Fittings and Conversion Kit for Torpedo Bodies
- Smooth Action Telescoping Sections
- 100% Shielded

"KNOW-HOW"

The superiority of WARD Antennas reflects the "know-how" gained through many years' experience devoted to the exclusive manufacture of precision-built antennas. WARD'S excellence in this field has won the high favor of America's auto dealers, manufacturers, and motorists. All products bearing the WARD name are the finest in modern design, materials and craftsmanship, and can be counted upon for their consistent trouble-free performance. That's why WARD is "first choice" in antennas for all automobile and home radio applications.

*World's Finest for Car and Home . . .
Combining Precision and Streamlined Beauty*

WARD "HiQ" Antennas

THE WARD PRODUCTS CORPORATION
1523 EAST 45th ST., CLEVELAND 3, OHIO

EXPORT DEPT.—C. O. Brandes, Mgr., 4900 Euclid Avenue, Cleveland 3, Ohio
IN CANADA—Atlas Radio Corp., 560 King Street, W., Toronto 1, Ont., Canada

Designed with **EXTRAS...**
to sell that **EXTRA set!!**

FADA

**5 EXQUISITE COLORS TO
MATCH ANY COLOR SCHEME
IN THE HOME OR OFFICE!**

Illustrated are two of the new exciting line of 1946 FADA Table Models. Beautifully designed in 5 scintillating colors, these FADA radio receivers provide those "extras" that make your customers anxious to buy more than one.

FADA extra sales mean extra profits!



FADA 6 tube models are equipped with the new FADA "Sensitive-Tone" . . . assuring greater sensitivity and clearer reception.

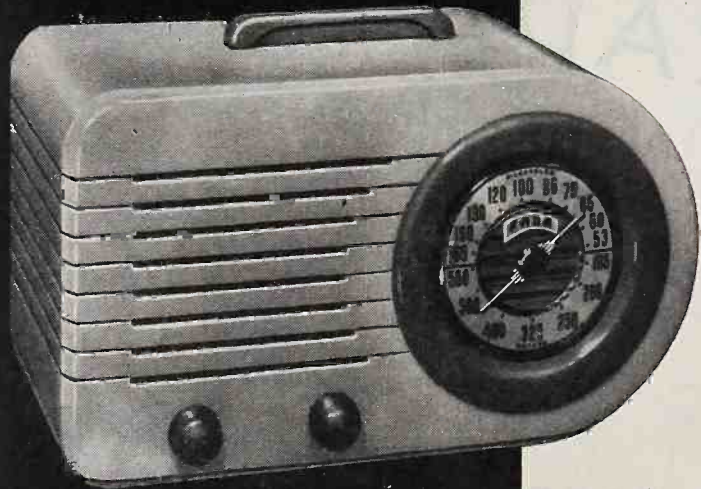

1000 SERIES

6 Tube A.C.-D.C. Superheterodynes . . . In Gemlike "FADA-LUCENT" Cabinets with the New Gemloid Illuminated Dial and Noise Reducing R.F. Stage.

8 tube performance with 6 full working tubes; FADA-SCOPE built-in loop ANTENNA; Beam Power Output System; Automatic Volume Control; New Wonder Speaker ALNICO V. Housed in beautiful "FADA-LUCENT" Cabinets in Five Gorgeous COLOR COMBINATIONS resembling precious stones.



652 SERIES

6 Tube A.C.-D.C. Superheterodynes with the R.F. Noise Reducing Stage with Slide Rule Dial in Gemlike "FADA-LUCENT" Cabinets.

6 tube radio with 8 tube performance. Features include the new Lock in type tubes; Beam Power Output System; New Wonder Speaker ALNICO V; Automatic Volume Control and FADA-SCOPE built-in LOOP ANTENNA. Housed in beautiful "FADA-LUCENT" Cabinets in Five Gorgeous COLOR COMBINATIONS resembling precious stones.

YOU CAN ALWAYS DEPEND ON

FADA Radio

Famous Since Broadcasting Began!

FADA RADIO AND ELECTRIC COMPANY, INC., LONG ISLAND CITY, N. Y.

REMEMBER FOR PRECISION-BUILT

MEISSNER
THORDARSON
RADIART

Look!

FASTER • BETTER • MORE
COMPLETE SERVICE BECAUSE ALL 3
ARE NOW SOLD FROM A SINGLE SOURCE

ELECTRONIC DISTRIBUTOR AND
INDUSTRIAL SALES DEPARTMENT

THESE 3 NAMES ELECTRONIC PRODUCTS

- MEMO -
REMEMBER . . .

MEISSNER

FOR

✓ Service Instruments, including the famous Meissner Analyst and Meissner Signal Calibrator.

✓ Components . . . R.F. and Oscillator Coils; Standard, Plastic and Ferricart Transformers; Windings, Chokes, Coils, Etc.

- MEMO -
REMEMBER . . .

THORDARSON

FOR

✓ Quality-built Transformers for all requirements.

✓ True-Fidelity Amplifiers in new, modern designs and containing many exclusive features and improvements.

- MEMO -
REMEMBER . . .

RADIART

FOR

✓ Correct Replacement Vibrators . . . individually-engineered to meet exactly the physical as well as the electrical requirements.

✓ Rust-Proof Aerials . . . newly designed to fit all cars . . . cowl, hood and under-hood types.

IMPORTANT! The Electronic Distributor and Industrial Sales Department of Maguire Industries, Incorporated, was formed primarily to offer better, faster service . . . to assume all merchandising, sales and customer relation duties and responsibilities essential in marketing the combined, precision-built products of the Thordarson Division, Meissner Division and Radiart Corporation . . . For complete information, write to the address below . . . today.

MAGUIRE INDUSTRIES, INC.

6 NORTH MICHIGAN AVENUE, CHICAGO 11, ILLINOIS

PREMIER PRESENTS

The Triumph in Tone

The Model 15 is only the first in the new Premier line—the line aimed at the discriminating buyer in the mass market—the line that's engineered for excellence!

Tone that is surprisingly full and rich—ingeniously engineered into a table model! Tone that helps these sets sell themselves—tone that speaks *quality* to the customer!

Superb styling! The Premier radio is designed to sell by *sight and sound*—to reach the high-quality, high-profit market. The rich, natural wood cabinet harmonizes with the most distinctive furnishings.



FEATURES:

- 1 . . . Genuine solid hardwood cabinet—lustrous walnut finish.
- 2 . . . Three-dimensional inclined dial, with edge lighting.
- 3 . . . Five-tube ac-dc superheterodyne circuit.
- 4 . . . Ingenuity in circuit design provides sharper tuning with outstanding sensitivity and selectivity.
- 5 . . . Ample reserve power—gives finer tone at high volume levels.
- 6 . . . Tone enhanced by extra power . . . Alnico #5 p.m. dynamic speaker . . . heavy, rigid cabinet.
- 7 . . . Lasting customer satisfaction assured by rugged construction . . . quality components . . . careful workmanship . . . thorough inspection.

With features such as these, the Premier line will help you build for a lasting, profitable future. For seventeen years Premier has been a leader in the engineering and production of electronic equipment requiring utmost precision and painstaking craftsmanship. This same leadership . . . this same engineering . . . this same craftsmanship have gone into the *new* Premier radio.

And Premier promises continuous improvements. You can count on getting ahead—and *keeping* ahead—with Premier!



PREMIER CRYSTAL LABORATORIES, INC.

67 PARK ROW (PULITZER BLDG.) • NEW YORK 7, N. Y.



V. J. Corsaro, Graybar Divisional Merchandising Manager at Buffalo, is a graduate of Bethany College. His experience includes selling vacuum cleaners door to door; designing kitchen layouts; selling for an appliance dealer; operating an advertising trailer for an electrical distributor; serving with an appliance manufacturer as refrigerator specialist and factory branch manager.



J. J. Martineau, Graybar Merchandising Manager at Salt Lake City, is a graduate of the University of Portland. He began his Graybar career as a stock clerk. Then followed several years of calling on and working with appliance dealers. Next, as credit manager at our Salt Lake City office, he acquired the further knowledge and ability demanded for his present dealer-service assignment.



L. J. Olivier, Graybar Merchandising Manager at New Orleans, came to Graybar with wide experience as electrical engineer, electrical inspector, electric products developer, and consultant in organizing campaigns for selling electrical merchandise — including personnel training and preparation of promotional material.

Graybar Merchandising Men can help solve your sales problems

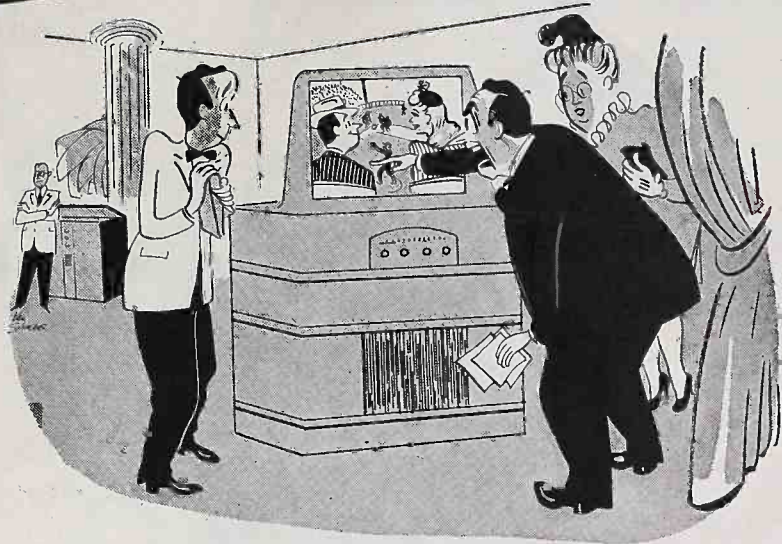

"... AND HE ASKED FOR THE DAY OFF TO GO TO A FUNERAL!"

The men you see at the left are specialists in radio and appliance sales. Many other Graybar merchandising experts throughout the nation are helping dealers with personnel training, store display, and local advertising and promotion.

Dealers get top-flight merchandise from Graybar, too. The lines we distribute include many of the biggest names in radio, traffic appliances, and major appliances. They're all products of responsible manufacturers. They're all backed by effective consumer advertising. And our nation-wide warehousing system enables us to deliver available models to Graybar dealers locally — at a moment's notice.

You can find out anything you want to know about Graybar service by calling our nearest office. *Graybar Electric Company ... in over 90 principal cities. Executive offices: Graybar Building, New York 17, N. Y.*

4647



MERCHANDISING
DEPARTMENT

HOME RADIOS

MAJOR APPLIANCES

TRAFFIC APPLIANCES

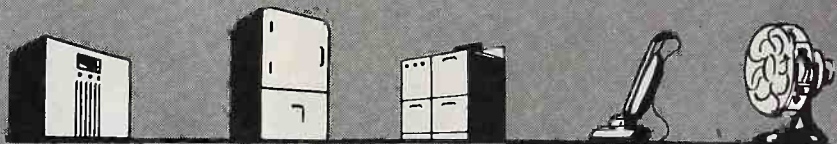

→ *Partners in Progress*



Collier's

PEOPLE WHO THINK AHEAD READ COLLIER'S

Upright and fearless in editorial policy . . . modern, educational and entertaining in features and fiction, Collier's has a hand in shaping America's future. Now more than ever before, the readers of Collier's are thinking ahead with the magazine of progress. They are anxious for new and better things, and today American cash reserves per family are the highest in the world. There is money for new clothing, new furniture, new homes, new gadgets, more complete health supplies. Tables will be "better set" and luxury items will assume the status of necessities. Whose products will they buy? Market studies always establish this fact: that people who think ahead buy the products of advertisers who think ahead with them. They are the real partners in progress.

MILESTONES IN MAGAZINE HISTORY

Collier's Made the Drug Industry Safe for Honest Advertisers

Collier's launched a campaign against patent medicine fakes in 1904. Samuel Hopkins Adams, one of Collier's writers of 40 years ago, headed the staff of writers and investigators who eventually drove unscrupulous men out of this field. Today, more alert than ever, Collier's retains its place as a leader in progressive American thinking.

Collier's



The Connecting Link
...for Action

ADVERTISERS WHO THINK AHEAD USE COLLIER'S

Ninety-nine chances out of a hundred, no formal sales agreement is signed when Mr. or Mrs. America buys an advertised product. Yet a very definite agreement does exist between customer and advertiser—one *wanted*, the other *had*, and the right medium brought them together in a meeting of minds. For over fifty years, Collier's has helped to build a fuller, richer life for all Americans through a policy of progressive leadership. Thinking ahead, year after year, Collier's becomes the *connecting link* between advertisers and American families with an eye to the future—men and women who are working to make their wishes for tomorrow the realities of today. That's why advertisers in Collier's are partners in progress—why today, more than ever before, they depend on Collier's for action:

Thinks Ahead



Centralab

The Mark of **QUALITY**

The initials "CRL" in the diamond have identified Centralab products for a quarter of a century. Due to new techniques and production procedures, this hallmark of quality will continue to represent the latest developments in components for the electronic field . . . *always specify Centralab.*

Centralab

Division of GLOBE-UNION INC., Milwaukee

PRODUCERS OF



Ceramic Trimmers
Bulletin 695



Ceramic High Voltage Capacitors
Bulletin 814



Variable Resistors
Bulletin 697

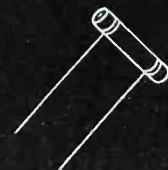

Tubular Ceramic Capacitors
Bulletins 630 and 586

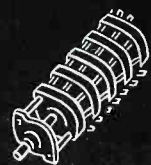

Selector Switches
Bulletin 722

watch Sonora go places!

Sonora delivers the goods and They're Good!



RY-224: 5-tube superhet red and tan portable, 3-way reception: battery, AC, DC. Big dynamic speaker gives "Clear as a Bell" tone of fine home radio, anywhere, any time.

It's been a battle—the battle of production—but Sonora is fighting hard, bending every effort to deliver radios as fast as possible to all Sonora dealers. And the radios Sonora delivers are delivering the goods, too—with standout performance, knockout styling, *plus* the famous Sonora tone that's "Clear As A Bell!" Watch Sonora—and Sonora dealers—go places!



RBU-176: 5-tube AC-DC plastic superhet table model. Gleaming ivory finish cabinet—the last syllable in modern design!



RCU-208: Deluxe 6-tube AC-DC superhet table model in walnut. Newly perfected patented chassis circuit gives big set reception!

THE RADIO QUESTION OF THE MONTH

Asked by Sonora Dealer, M. J. Adams, O. K. Furniture & Rug Co., Oklahoma City, Okla.

Answered by Mr. Joe Gerl, president of Sonora

Q. Will the dealer have any unusual service problems with the new FM radios?

A.: We must remember that the final proving ground of any laboratory product is actual usage. Until the new F-M stations are established—until successful reception is proved—it would be unwise for dealers to sell FM sets.

Joe Gerl

Sonora

Clear as a Bell

HOME ENTERTAINMENT AT ITS BEST

SONORA PRODUCTS, Inc., 2023 W. Carroll, Chicago 12

RADIOS . . . FM COMBINATIONS . . . TELEVISION . . . RECORDS . . . PHONOGRAPHS . . . RECORDERS



PROFIT RECIPE

TAKE: YOUR RADIO SERVICE DEPARTMENT



ADD: THIS LINE OF HIGHEST QUALITY TUBES

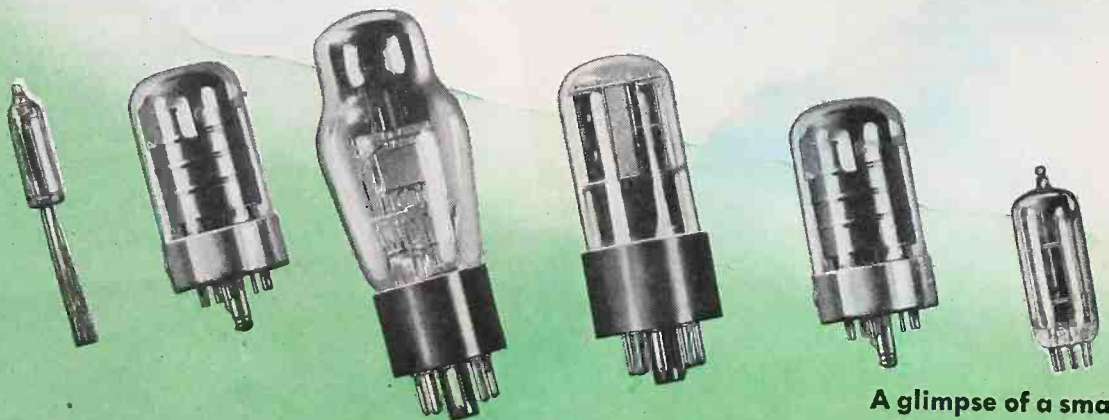

A glimpse of a small
part of the famous Sylvania line.

for
**RADIO
RETAILERS**

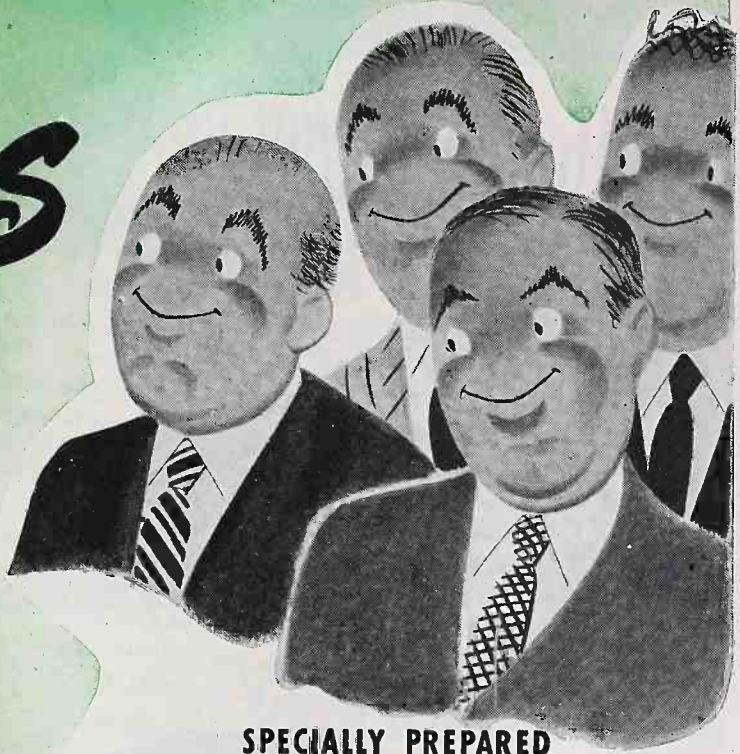

TO THESE BASIC INGREDIENTS
SYLVANIA ADDS THE CROWNING SAVOR
OF NATIONAL CONSUMER ADVERTISING

SPECIALLY PREPARED
MERCHANDISING AIDS
FOR YOU

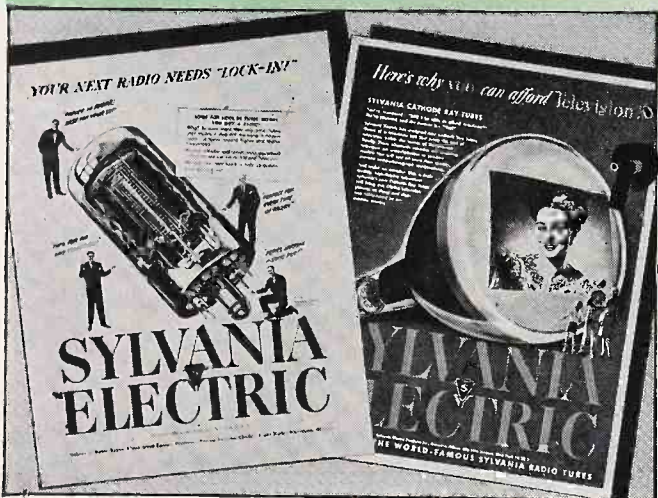

PLUS



RESULT *an unbeatable combination for successful radio retail selling.*

Your service department is an important part of your business. You know that. What better way is there to keep your customers' trust in that department than by safeguarding its repair work through the use of tubes unsurpassed in quality—and known from coast to coast.

Retailers carrying the Sylvania line are realizing gratifying profits. They have built up a faithful following through the customer-pulling power of satisfactory repair jobs. This satis-

faction is assured by using nationally advertised Sylvania tubes—famous for their performance in the field.

Through extensive national advertising, Sylvania backs radio retailers to the limit. People know and respect the research and workmanship involved in the manufacture of Sylvania tubes.

Finally, the radio retailer has at his service the wealth of special merchandising, sales and technical aids Sylvania is constantly amplifying. Result: an unbeatable recipe for success—that you should take advantage of.

SYLVANIA  **ELECTRIC**
Emporium, Pa.

MAKERS OF RADIO TUBES; CATHODE RAY TUBES; ELECTRONIC DEVICES; FLUORESCENT LAMPS; FIXTURES; WIRING DEVICES; ELECTRIC LIGHT BULBS

Where will you be when the GOLD RUSH is over?

The answer to that question will be decided by the way you promote your service business now! The farther you fall behind in your service calls, the more important sound promotion of your business becomes. That is why Cornell-Dubilier has developed for you a 1946 sales promotion program that looks ahead to 1948. Here is a plan—written for you—by people who know your problems! It is just as you would prepare it if you had the time and money. That is why we urge you to see your local C-D jobber today. He has the full details on this hard-hitting sales program—designed especially for you! GET THEM NOW!



HERE ARE YOUR NEW 'LEG MEN'—
AVAILABLE THROUGH YOUR LOCAL C-D JOBBER



NEWSPAPER MATS—all ready—just deliver to your local newspaper.

WINDOW CARDS—sell you as a reliable service shop to the community.



POST CARDS—with your name! Will keep your regular customers sold on your shop!

DECALS—identify you as a user of top quality replacement parts.



LET YOURSELF GROW
WITH A QUALITY LINE!



Here's a capacitor you should get acquainted with. These E-Z's are the most practical, all around replacement units available. They incorporate C-D's superior features which give them C-D's longer lasting quality.

KEEP UP-TO-DATE
WITH THE "CAPACITOR"



The one and only pocket-sized encyclopedia of radio technical data. Keep up to date on new radio data, reprinted in condensed, easy-to-read style. FREE, every month. Get on the mailing list now. Write: Cornell Dubilier Electric Corp., South Plainfield, New Jersey.

Cornell-Dubilier WORLD'S LARGEST MANUFACTURER OF Capacitors



MICA • DYKANOL • PAPER • ELECTROLYTICS

TEMPLE MODEL E-511
Radio-Phonograph
Combination



MORE THAN A RADIO- PHONOGRAPH COMBINATION

**—A COMBINATION OF
ENGINEERING AND FURNITURE
CRAFTSMANSHIP
PERFECTLY ATTUNED*
TO PROVIDE THE UTMOST IN
ACOUSTICAL ACHIEVEMENT**



**TEMPLETONE
RADIO MFG. CORP.**

New London, Conn.

Exec. Offices—220 E. 42nd St., New York, N. Y.

* By controlling the design and manufacture of both chassis and cabinets, Templetone has the advantage of mating one with the other—insuring a perfect acoustic relationship.

"FM that also means Finest Made"

When dealers agree, that's **NEWS**...

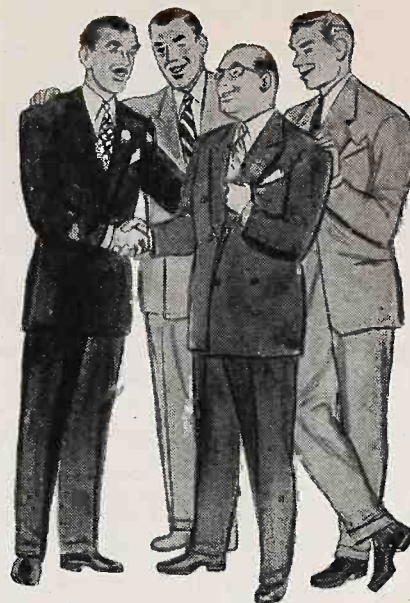

But Authorized Stromberg-Carlson Dealers who have seen the line, do agree—and in most impressive fashion—that Stromberg-Carlson cabinet design is as outstandingly advanced as is Stromberg-Carlson electronic engineering. That Stromberg-Carlson radios and radio-phonographs are as pleasant to look at as they are delightful to listen to. And that the new 1946 Stromberg-Carlson line packs even more meaning into the words: "There is nothing finer than a Stromberg-Carlson"!



"I know furniture from A to Z, and let me tell you the new 1946 Stromberg-Carlson **Georgian** is a piece that will hold its own in *any* company! The smart up-to-the-minute finish on these fine mahogany veneers gives a touch of richness to the basic design that would catch any decorator's eye—just as its splendid tone would attract any musician."

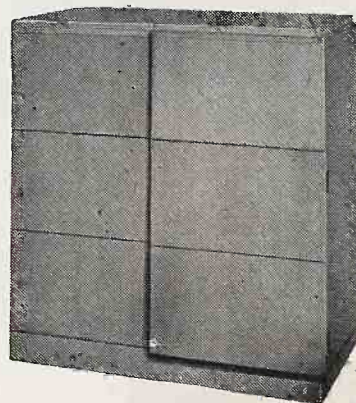

"This new Stromberg-Carlson **Futura** is just about the smoothest piece of modern cabinet making I've ever seen. And what workmanship—inside and out! Those telescoping doors are certainly some smart trick. And how they have been able to fit in those 9 record albums!"



"I always say that, when it's done really well, there just isn't any design that looks so well in so many different surroundings as a good period cabinet such as this Stromberg-Carlson **Hepplewhite**. If I could have only one radio in my showroom, the **Hepplewhite** would be my choice. Not only for its distinguished appearance, but for its fine reception and its faithful reproduction of recordings."



"You don't generally expect to find much real styling in a table radio. That's why the Stromberg-Carlson **Dynatomic** got my interest the minute I set eyes on it. It's one of those 1 in a 1,000 shots—a brand new, up-to-tomorrow design that's still actually good-looking. And that's as great an accomplishment, in its own way, as is the remarkable selectivity that has been engineered into this little receiver."

STROMBERG-CARLSON

ROCHESTER 3, NEW YORK

RADIOS, RADIO-PHONOGRAPHS, TELEVISION, SOUND EQUIPMENT AND INDUSTRIAL SYSTEMS, TELEPHONES, SWITCHBOARDS, AND INTERCOMMUNICATION SYSTEMS

RADIO *& Television* RETAILING

Including Radio and Television Today

O. H. CALDWELL, Editor ★ M. CLEMENTS, Publisher ★ 480 LEXINGTON AVENUE, NEW YORK 17, N. Y.

FM = Folding Money For Merchants!

FM is back!

Nipped in the bud by the war, just as it was really commencing to go places, FM is again readying for the public, with many war-born improvements.

And FM is also ready to blossom forth as a great "natural" in selling customers "up".

FM is made-to-order for the merchandiser who knows it's good business to sell something a little better to his customers. FM is the "something new" in radio which promises to bring increased profits to the dealer—increased enjoyment to the purchaser.

In FM, you are merchandising a product with such features as:

1. Static-free reception—an advantage the prospective buyer can readily understand.
2. Absence of background noise.
3. Wider fidelity range.
4. Superb performance in demonstrating.
5. Many "recommended" sales by users who "demonstrate" their sets to their own home visitors.

Add all of FM's exciting sales stimulators to the fact that FM can be sold in what is virtually a virgin market—99½ per cent of present set-owners are your prospects—and you'll see this new FM art as the answer to the radio merchant's prayer.

In light of the fact that FM's limited pre-war career served only to whet the public's appetite and did not result in any appreciable sales saturation, merchants welcome its return as a great new product, launched in a seller's market. FM's earlier appearance, accompanied by large advertising campaigns, has paved the way for its present re-entry. The stage is all set for FM to make new merchandising history in the radio industry.

* * *

Independent retailers need to alert themselves to the necessity for selling *quality* FM only. As experienced merchandisers who also possess technical knowledge, they will refuse to handle any products which because of low standards in design or manufacture will not perform efficiently. Independent merchants will not be misled by claims that sets merely "will receive FM". They will insist that the FM reception in sets they sell be full FM performance, with noise suppression, tone fidelity, and all!

With *good* FM receivers to sell, the independent merchant and his salesmen will be so thoroughly "sold" themselves that they will find it easy to sell their customers.

Experts in *buying* as well as in *selling*, the independent retailers, together with responsible manufacturers, will in promoting genuine FM contribute much to the good of the radio industry—and will profit in so doing.

RADIO, Electrical Appliances,

CHICAGO SHOW—ACCENT ON RECONVERSION! Terrific interest is being aroused in the coming Radio Parts and Electronic Equipment Show, Stevens Hotel, Chicago, May 13 to 16. New developments and re-conversion items will be featured. The event is being sponsored by leading industry organizations.

CABINET LUMBER is still troubling set makers as furniture manufacturers consume all available stocks. One big radio producer even bought up a forest, also a mill to saw up the logs. Now its scouts are looking for the labor to work their new supply enterprise, before they can get the cabinets they sorely need.

EASING OF BOTTLENECK which has been retarding the production of washers, ironers and stoves is expected when and if OPA adjusts prices upwards on deep-draw enameling stock. Prior to the start of the steel strike this material was highly critical, being deficient both in quantity and in quality. One manufacturer experienced 40% rejects in comparison to a normal rate of 2%.

PHONO MANUFACTURERS BARTER FOR SCARCE PARTS—Two well-known phonograph firms in an eastern city, who make motors for their own sets, are offering to trade these motors to other manufacturers in exchange for tubes and the necessary parts which they need to continue production.

GET SET FOR INSTALLMENT SELLING, advise leading consumer credit experts. Although only a small percentage of radios and electrical appliances are being sold on time, credit men predict a large future volume of installment sales, perhaps before the end of this year.

SOMETHING NEW IN HIJACKING!—The popularity of Frank Sinatra was illustrated recently in New York when thugs attempted to steal a truck-load of The Voice's recordings. The vehicle was on its way to a neighboring state to make a delivery.

IN THE TOP TEN bracket of estimated weekly network program costs are, according to *Variety*:

Program	Cost
Jack Benny	\$22,000
Fred Allen	20,000
Lux Radio Theatre	20,000
Joan Davis	17,500
Danny Kaye	17,500
Bob Hope	17,500
Kraft Music Hall	17,500
Request Performance	17,500
Eddie Cantor	15,000
Theatre Guild of the Air	15,000

"THE MAN ON THE STREET CAR" is title of new type radio program which carries interviews with riders from street cars and buses in transit. A wire recorder is used. The Georgia Power Company sponsors the show which is heard over Atlanta's WGST. Suggested revival for a theme: "The Trolley Song."

TUBES ARE SCARCE because certain fine wires and other components of new types are present bottle-necks. Some tube assembly lines have already closed down, others may follow.

ENVELOPE SHORTAGE is new bottleneck facing record makers. Now that there is plenty of shellac, labor and other components of record manufacturers, it's the paper shortage that has disc distributors worrying.

HOME RADIOS WITH TINY TUBES used in "proximity fuzes" during war, are already in designers' minds, after completing vest-pocket sets. These sub-miniature tubes have no bases, but would be assembled in groups of four or more, on "slugs" which slide out for quick replacement. Thus soldering of tube terminal wires would be done outside set, for individual tubes.

STRUGGLE FOR FRANCHISES goes merrily along with leading radio and appliance manufacturers being besieged by distributors and retailers. One sales representative of a famous make was recently offered a large sum of money for a franchise by a man whom he had unsuccessfully attempted to sell the line to a very few years ago.

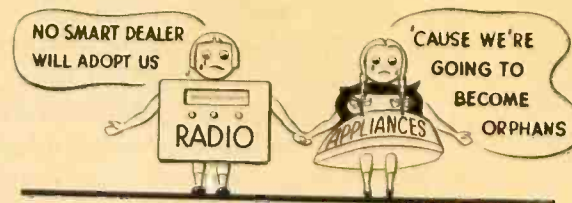

BEWARE OF ORPHANS that will be born from the present price situation. With increased labor costs, a few little-known producers will try to beat price ceilings on radios and electrical appliances by putting out inferior products. Dealers should inspect these lines carefully, because such downgrading will make these producers early postwar casualties.

MANY NEW PRODUCTS being marketed by Cavalcade Industries, Inc., Chicago, which include radios, phonographs, home freezers, refrigerators, washers, ironers, etc. Three sizes of home freezers have already been placed on the market under the Cavalcade names. A complete line of radios is now being placed on the market by the company.

TABLE APPLIANCES CARRIED NOT ONLY for profits the year 'round by radio-appliance retailers, but because they also tie in so well with sales of major appliances. Music merchants stock records to bring in prospects for entertainment instruments, as well as to make money from sales of the discs. Smart combinations!

NEW HOME COOLING UNIT, size of a refrigerator, fits alongside forced air heating or winter air-conditioning unit so that all air passes through cooling chamber before being distributed to rooms. Products being readied by Westinghouse.

Records, and Television, **TODAY**

"INSTANTANEOUS" COFFEE making electrical appliances, serving also as dispensers, foreseen hitting market before long. Such appliances would cash in on present selling campaign on the part of big-name coffee packagers now advertising rapidly dissolving coffee preparations.

MUSIC MERCHANTS READY CHICAGO trade show and convention at Palmer House four days, beginning July 15. NAMM's convention slogan—"The Music Industry Looks Ahead!"

LUMBER DEALERS HOLDING FRANCHISES for electrical appliances and radios, many of them for the first time, are being reported from all over the country. These lumber firms are thronging into this new field because they think sales will be easy, as tie-ins with home building and home modernization.

ATWATER KENT, whose receivers once led the radio industry, has settled in Los Angeles, complete with several million bucks and the announced intention of giving it away to worthy causes. The only man whose full name ever appeared on the name-plate of a leading radio has several special interests for his Foundation to aid; promising graduates of electrical engineering schools, and deserving young singers are among them.

A NEW COUNT on U. S. homes with radios is being readied by the Dept. of Commerce Census Bureau. Due within the next few weeks, the report is expected to reveal new factors in radio ownership, both urban and rural. It is based on a sample survey, conducted last November, of the "characteristics of occupied dwelling units", according to word from Leon E. Truesdell. He's chief of the Population Division of the Bureau, which, by the way, sounds like a full-time job.

COMMITMENTS FOR ONE YEAR from date of original order, is requirement for immediate merchandise delivery demanded by new radio manufacturer.

"OPA PRICES UNACCEPTABLE" say many loft radio manufacturers, refusing to continue production. They're creating a rumpus, claiming basis of comparison with pre-war radios unfair.

HELP IN CLOSING WASHER and dishwasher sales will be provided to the dealers of America through the great expansion of plant capacity now being planned by makers of "soapless soaps." They improve the performance of these appliances even in hard-water areas, since unlike soap they combine with the minerals to form soluble salts which leave no residue. At least one Brand, "Swel," will be sold through H. J. Heinz & Co., at a price not far from that of soap powders.

BUSINESS—BUT NOT AS USUAL! A few years ago purchasing agents for big-name manufacturers in the radio and appliance fields were kowtowed to right and left by their various suppliers. Today these agents are standing in line trying to buy components, materials, etc. Competing with small cash buyers, their huge resources mean nothing in this "high"-shortage market.

VAULTS FOR RADIOS may be the next thing, if the supply of sets continues to run tensely below the demand. By now, the receiver is recognized by everybody, including the rough character in the alley, to be an item of highly concentrated value. The sets are being filched. A truckload of receivers was hijacked in Chicago, and even one of New York's precious-few television sets has been lifted by a midtown lout. Ever think about the gem-like quality of your merchandise?

MAY 12 IS MOTHER'S DAY—"Remember Mother, She's a Veteran, Too!" is this year's official Mother's Day slogan. Retailers throughout the nation are urged to feature appropriate displays, and to stress the date in their tie-in advertising. Reminder: Father's Day comes June 16.

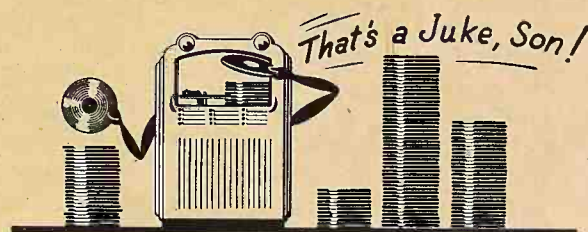

HALF - MILLION JUKE - BOXES—One quarter of the phonograph records produced annually are declared to go into the nation 500,000 juke-boxes in night-spots all over land, which use up records fast through repeated playing. Normal replacement of instruments is estimated at 100,000 annually, although with no production since '42, present demand is for 250,000 boxes.

CHICAGO'S TRAV-LER KARENOLA Radio and Television Corp. enters the electrical appliance field with purchase of the Electrical Research & Mfg. Co., Los Angeles. New plant will be known as Trav-Ler Radio Corp. of California.

RADIO SET-INTERCOMMUNICATOR announced by Lectradio Corp., Newark, N. J. Besides providing radio entertainment, device carries voice over electric light wires without special interconnecting wires from station to station in building. Operates on principle of carrier-currents, superimposed on light wires.

In This Issue—**THREE MAGAZINES IN ONE**, covering **RADIO; ELECTRICAL APPLIANCES; SERVICE**
Latest Radio Merchandise, pages 34, 35, 36, 37, 80, 81, 90, 91 New Things for Service and Sound, pages 98, 102

Newest Electrical Appliances, pages 52 to 60

Listing of Radio Manufacturers, page 46

Listing of Electrical Appliance Makers, page 66

FARM SELLING YEILDS PROFITS



Kansas
State Chick Output

Billion Bushels
Wheat Crop

**GREAT DEMANDS
ON FARMERS ARE
SEEN DURING 1946**

Demand and Prices as Good
as '45 Visioned; Weather
Big Hazard; Growers Hit
Record Level Financially

BY WILLARD ROBERTSON
CHICAGO, Ill. — (AP)—Ameri-
cans reap crops in
and are spreading them out
able to help feed a hungry

are that demand and
fully as good in 1946
could be as high
weather

This year, farmers will be spending the \$21,468,000,000 they took in during 1945. It was a new record in rural income.

Multiple Opportunities for Retailers to Develop Sales Among the World-Feeding Farms of the U. S.

• The immediate selling of radio and appliances to the 6,000,000 farmers of this country is bristling with some brand new factors which make the retailer's line of action several degrees different than in the past.

A survey of farm methods and conditions in eight states of the Midwest (Kansas, Oklahoma, Texas, New Mexico, Colorado, Nebraska, Iowa and Missouri) shows what these new elements are. They have a pretty flashy importance as the production of merchandise for the farmer rolls back to normal.

Everybody agrees that farmers now have an exceptional amount of ready cash. Their radios are

older and more in need of replacement than the sets of their city neighbors. Electrification of farms is coming great guns, sometimes where you'd least expect it. Some 4,650,000 rural residents made a move to the city, during the war, and became accustomed to living in homes fully equipped with electric appliances; most of them are expected back to the RFD with a new attitude toward such equipment.

Sales Factors Blended

Hundreds of new rural homes are being established, in a back-to-the-farm movement that is common

among returned GI's and is generally so popular that prices of land have boomed 51%. What modern farmers have learned to listen to on the air, and what broadcasters have learned to offer them, is far more valuable to rural residents as they operate today, than regular programs are to urban dwellers. Radio, with its weather reports, market bulletins, and farmhouse tips, has a very tangible dollar value to the rural family which today runs the place like a streamlined business.

The national economics of the situation is that Washington has promised to support farm prices at 90% of parity. Secretary of Agri-

culture Anderson describes the need for farm products this year as "almost unlimited". He has recommended a blanket crop goal of 356,244,000 acres, which is an increase of almost 6,000,000 acres over last year.

All Set to Buy

A prominent radio/appliance dealer in Ponca City, Okla., has his own words for it: "You'd be surprised at the roll of dough that the farmers are sporting around here. It's got so that it shows up any time of the year—not only at the time when they get an annual crop—many of them can afford to hold their grain for better prices and besides, their income from livestock and dairy products kind of distributes their ready cash throughout the year. But they are careful buyers and they think a lot about price. Dealers, I think, had better watch their step when selling major appliances and the bigger items of home equipment to farmers. They know a lot about machinery, and they are the type to get suspicious if you make a mistake in explaining how a mechanism works."

In Wichita, Kan., which is a city large enough for a radio man to discourage the farm trade if he so chooses, one dealer was ready with

any preference for the mail-order outfits. The fact is, as they take on new-type radios and appliances for their homes, which they have never before operated, they will need a lot of "education" and service. And of course the mail-order houses do not pretend to be long on that score. Also, the conclusion was that if the modern farmer is a cautious buyer, so are most people who have money because they learned to take care of it.

Power Comes In

A jobber in Amarillo, Tex., was excited about rural electrification and made the statement that "within a year, I expect 75% of our farms to be electrified".

Another jobber in the same city said that "My advice to farm-type dealers is to get ready to sell these new (electrified) customers on some stuff that I happen to know is hot . . . these lines include water heaters, electric ranges, power sewing machines, shallow-well pumps, complete wiring for chicken farms, food freezer units and milk coolers. These will move, in addition to such merchandise as refrigerators and the traffic appliances."

Where the Margins Are

Still another distributor in this area pointed out that the dealer margins on some of the less known types of electric farm equipment are far better than those on the standard lines of appliances that every dealer and his brother are prepared to sell. His idea was that there is good money for a retailer in becoming an electrical farm equipment specialist, with or without electrification. The suggestion was made for the benefit of dealers who happen to be located in trade areas where the retailer competition for the rural business is strong, and where something is needed to give a store an "edge" over the others. On his desk the jobber had a list of electrical farm products which he had compiled from experience and which included 31 separate types of this electrical equipment, marketed by 453 different manufacturers.

Pinning his faith on the market resulting from electrification, a retailer in Hastings, Neb., reported that the average farmer will buy around \$1500 worth of appliances when he's first wired. It's a virgin market, he claims, and about the only one left because the cities are

mainly saturated (at least with old models) but the farms are a long way from it. He believes that the best bets are, besides radios and refrigerators, (1) Washers and ironers, (2) Water systems, (3) Toasters, mixers and the smaller appliances, (4) Electric ranges and (5) Food freezer units.

A specific example of the progress of the Rural Electrification Administration is seen at Hutchinson, Kan. The REA Coop there reported in the survey that "we can add 650 electrified farms (The REA calls them "members") on 320 miles of new lines right away, if we can get the construction materials." This particular organization already has 1,700 members and has recently added 42 of them in spite of the shortages.

It Means Work

The Coop at Hutchinson, by the way, energetically sells and services radio and appliances for its members, with the explanation that it had given the retailers and servicemen in the area a good trial in the beginning, and found that they were by no means aggressive enough in reaching, selling, and servicing the widely scattered farmers of the sector.

In the wake of electrification, two dealers reported heavy traffic in the service department, in conversion jobs for freshly electrified farmers who wanted their old battery sets changed over. A service expert in Hutchinson says he's done plenty of them for \$25 to \$30. In Topeka, Kan., however, the service manager of a big store said that his outfit is making money on these jobs at \$15 per.

Farm Furniture

Not the least of the sales tips collected on this circuit was the one contributed by the saleswoman wife of a retailer in Colorado: "I think what I like most about the farmer and his wife is that a lot of times they agree that the farmhouse needs more pieces of furniture . . . the house is practically never crowded like the little apartment of a city family . . . very often they like the idea of a bigger radio and it's a chance for us to sell a higher-priced set."

She was emphatic in her belief that the modern farm home finds the "furniture pieces" attractive.

Since the farmer and his wife have the room and the money, the floor model is a cinch.

WHAT FARMERS WANT

Among 1,500 rural buyers in Nebraska,

- 44.6% plan to buy refrigerators.
- 23.5% electric radios.
- 23.4% light and power plants.
- 22.7% electric washers.
- 16.6% vacuum cleaners.
- 14.8% electric mixers.
- 6.1% battery radios.

According to a survey of the representative 1946 farm requirements of the state, conducted by Nebraska Farmer.

a sharp rejection of the farmer as a buyer. This retailer said he was fed up because "the farmer is a penny-pinching bargain-hunter who usually makes a bee-line for the nearest mail-order chain store the minute he gets his car parked."

But others agreed that the farm buyers can be weaned away from

Intensive Sales to Customers NOW

3-Way Plan for Selling Proves a Money-Maker. Radio and Record Sales Lead to Purchases of Electrical Appliances

• In the radio and record selling business since 1927, Fred Ferris, of Ferris Radio Co., 91 Pondfield Rd., Bronxville, N. Y., has added a substantial line of electrical appliances, which will account for a good part of his future operation.

Developing his set-up from all angles to make for the maximum in sales in radios, records, appliances and service, this dealer is putting every possible advantage to work for him, and backing it up with sound selling principles and expert service.

The Ferris location is an excellent one. Situated on the town's main thoroughfare, it commands an additional approach from the railroad station, where "commuters", of which the town is largely composed, can see Ferris' wares on their journeys homeward.

\$-Potential High

While carrying several makes of radios in 1942, this retailer did over \$80,000 gross business in one line alone. Setting up his new appliance department well in advance of the actual arrival of merchandise seemed important to Ferris, and he has carried it for a year on the strength of potential business by being established *first* in his community as a merchant of these new lines.

Always a leader in the sale of records, this department is an outstanding feature at Ferris', and continues to grow. Discs are a real source of income to this retailer.

Service has always been expert at Ferris Radio Co. And until new merchandise arrives in volume, this department, a money-maker even in normal times, will continue to keep the old sets playing.

Dealer Ferris has long used his

service calls as a valuable source of radio receiver sales, and he will continue to operate along these lines. A special visit to a home by him in this connection, often enables him to impart valuable information to his customer that leads directly to the sale of a new set. Since there is a limit to the extent of repair practical to the set's owner, Ferris often saves the customer money by recommending the purchase of a new receiver.



Above, portion of Ferris Radio Co.'s active record department. Note display factors, and space-saving use of wall shelving for single disc and album stocks. These are checked daily. Fred Ferris (behind counter) talks over a set repair job with customer. Below, merchandise manager D. A. Turner of the appliance department (right) discusses new model's features and selling points with assistant John P. Geazin.

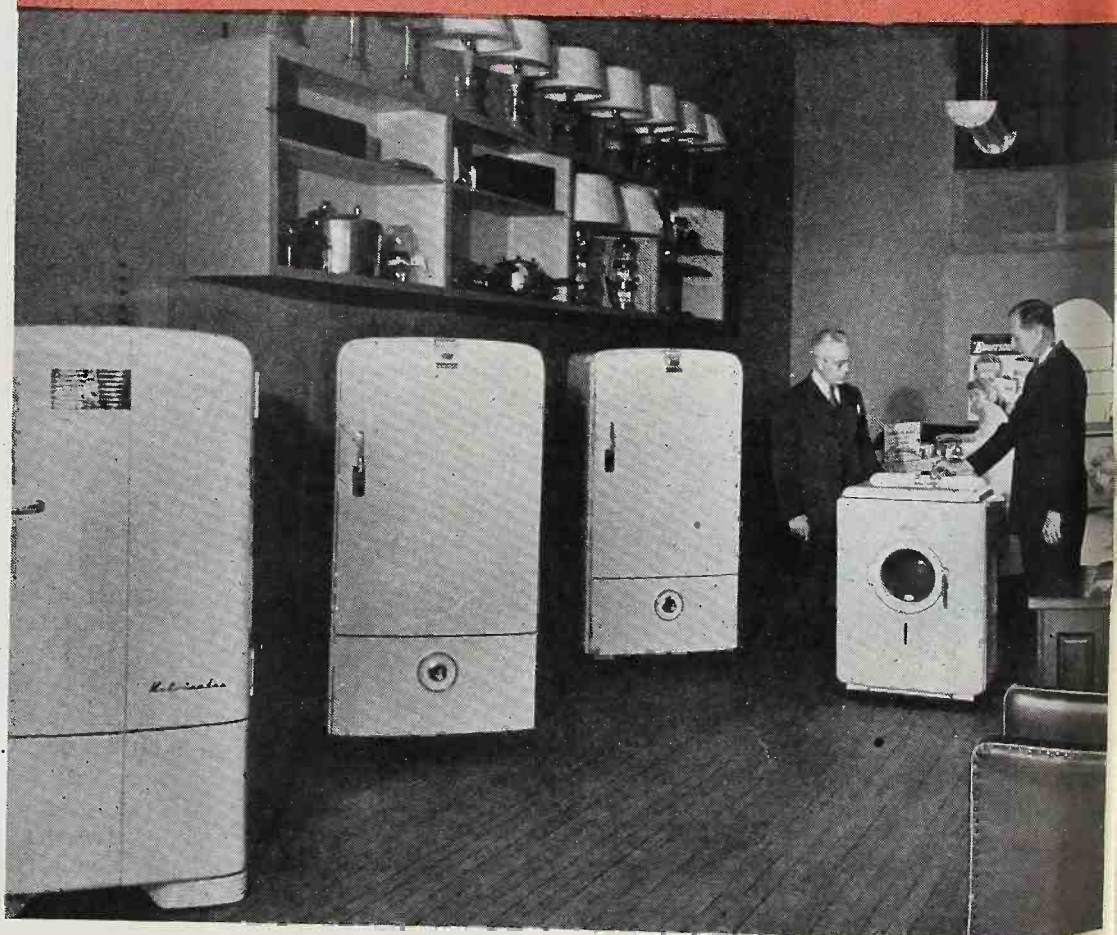



Right, owner Ferris discusses a current job with expert Rudolph Vallee (center). Another member of the technical staff, Walter Nagwak (right) answers one of the department's two direct wires, located in basement.

And, visits to the owners' homes enable Ferris to gauge fairly accurately their financial standings as well as their needs.

Ferris Radio's appliance department is under the capable direction of D. A. Turner, who is extensively experienced in the selling of appliances for the home.

Good Appearance Sells

The town's insistence that all stores be attractively appointed, kept clean and smart in appearance makes the company's location in this community a real drawing card in sales to residents from three large nearby trading centers, in addition to the Bronxville area, which more than offsets any additional expense involved, Manager Turner says. The added volume in business more than compensates for additional rental and appointment costs.

Turner has found that the large record and radio sales volume done by the firm is a natural for numerous leads to the sales of electrical



appliances. However, until the supply catches up with the demand, he is not applying full sales pressure. A large list of customers waiting to buy appliances is ready and indexed, awaiting the arrival of stocks.

Ferris Radio Co. agrees that sell-

ing will have new incentive and a fresh start in many ways, but nothing can replace the basic "big three" for successful independent retail merchandising: Courtesy, Customer Satisfaction, and Friendliness.

One point in appliance retailing which department manager Turner plans to stress is "progressive selling". A refrigerator sale is only the beginning of a long list of purchases by one customer. The model complete kitchen at Ferris' will also be used to promote appliance sales on the add-a-unit basis.

Other sales plans continue to be formulated at this time for future application, when merchandise is available in plentiful supply.

Advantage in Credits

Credit is handled through the local bank, which takes care of all collections, always a welcome release to the dealer from any unpleasantness with his clientele, and any possible "repossession" difficulties.

Ferris' claims that the advantage

of "paper" is that the retailer gets his money with no recourse. This arrangement is especially advantageous where appliances are concerned, this dealer points out, where manufacturers or their agents deliver direct to the con-

(Continued on page 44)

New Radio Merchandise

Zenith RADIO & COMBO

Table model 6D029 has 5 tubes plus one power rectifier tube. Features 3-gang condenser, tuned r-f amplification, improved Wavemagnet. Alnico dynamic speaker; full transverse dial.

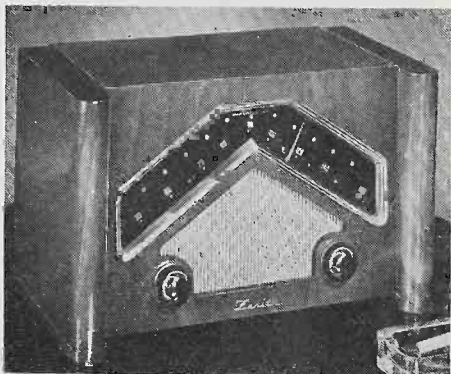

Cabinet is available in genuine walnut or lime walnut veneers. OPA price \$33.75.

Model 12H094E radio-phono receives on broadcast, short wave, and both 45 and 100 mc FM bands. Includes 9 radio tubes plus one power rectifier tube, one 3-purpose phono tube, and one cathode ray indicator tube. Silent-Speed Intermix record changer with new Radionic Cobra tone arm. 14-inch



Concert Grand speaker. 3-gang condenser, tuner r-f stage. Built-in FM antenna. Cabinet comes in modern design with a bisque finish in bleached mahogany veneers. OPA price \$275. Zenith Radio Corp., 6001 Dickens Ave., Chicago 39, Ill.—RADIO & Television RETAILING

Belmont RADIO & COMBO

Model 6D111 is a 6-tube ac-dc superhet table model receiver. Measures 12½" wide, 7" high, 6½" deep.

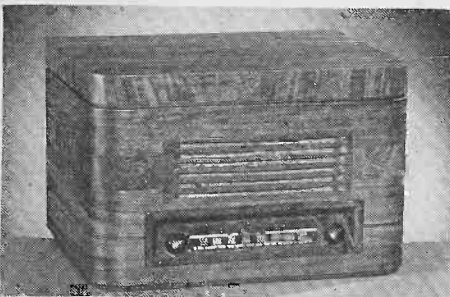
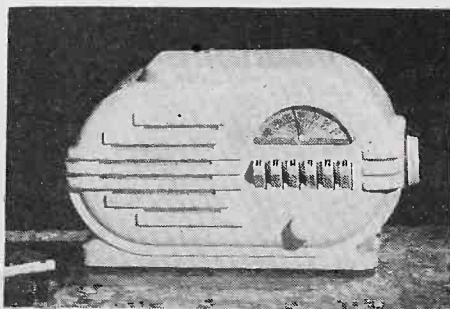

Model 5D19 is a 5-tube ac-dc table model radio-phonograph combination. Single record player. Measures 15" wide, 10¼" high, 12¼" deep. Belmont Radio Corp., 5921 West Dickens Ave., Chicago, Ill.—RADIO & Television RETAILING

Esdy SLIDE VIEWER

Model 50A is viewer for 35mm and 2 x 2 slides. High amplification factor; third dimensional effect. Operates on



110 ac-dc. All metal black crackle finish. List price \$7.95, F.O.B. New York. Scientific Development Corp., 614 W. 49th St., New York, N. Y.—RADIO & Television RETAILING

GE RADIOS

Model 219 is an ac-dc 6-tube superhet. Receives on standard broadcast and short wave bands. Tone control. One-piece molded ivory plastic cabinet.

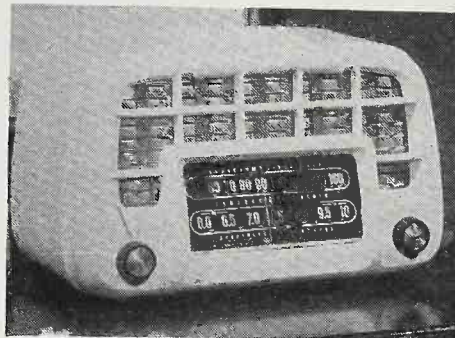

13¼" wide, 8 1/16" high, 8¾" deep.

Model 221 has ac-dc superhet circuit. Receives on standard broadcast

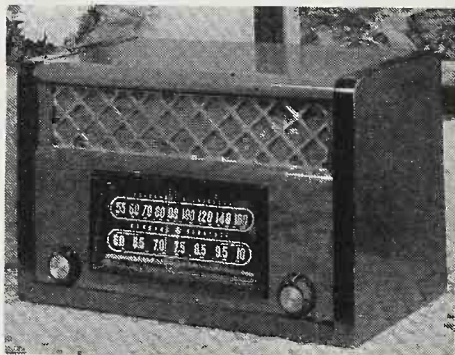

and short wave band. Tone control. Two-tone cabinet of solid brown mahogany with durable hand-rubbed finish. Felt feet on set prevent marring of polished surfaces. 13½" wide, 8 15/16" high, 8 5/32" deep. General Electric Co., Bridgeport, Conn.—RADIO & Television RETAILING

Thorens PORTABLE PHONO

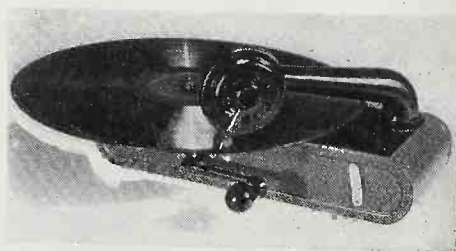

This phono is so small it can be carried like a camera. Measures 11" long, 4¾" wide, 2" deep, choice of colors. Plays 10" or 12" discs. Rexon, Inc., 295 Fifth Ave., New York, N. Y.—RADIO & Television RETAILING

Coming Great Guns

Westinghouse RADIO & COMBO

FM Century model receives on standard broadcast, FM, short wave and facsimile bands. "Plenti-Power" circuit provides 17 watts of undistorted power. 14 tubes, including rectifier. Magic eye for accurate manual tuning.

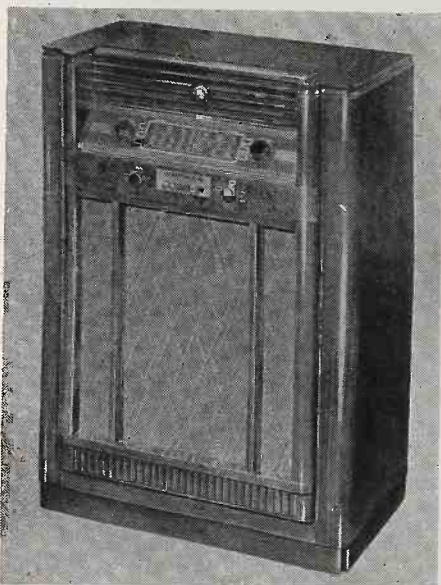

Rich mahogany or walnut veneer cabinet with specially rubbed finish.

The Musicale 14 model is a 14-tube (including rectifier) radio-phono com-



bination that gives 14 watts of undistorted power. Six electric push-buttons; continuous variable tone control. Built-in noise-reducing antenna. Dependable automatic record changer. Features ex-

tra large record storage space. Set receives on standard broadcast, short wave and FM bands. Westinghouse Electric Corp., Home Receiver Division, Sunbury, Pa.—RADIO & Television RETAILING

Fada RADIOS

Model 605W is a 5-tube superhet with 7-tube performance. Features Sensitive-Tone for greater sensitivity and less noise. Automatic volume control, Alnico 5" dynamic speaker. Loop antenna, reduction drive tuning, beam power output system. Measures 10½" wide, 6½" high, 6" deep. Weighs 5 pounds. OPA price \$23.95.

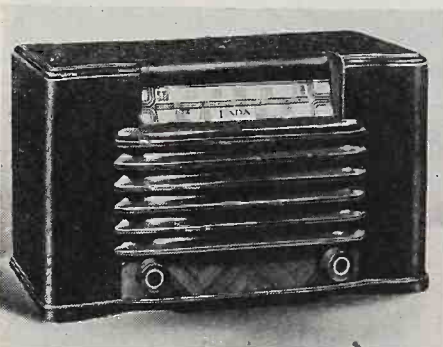

Model 1001 is a 6-tube superhet with 8-tube performance. Comes in walnut wood cabinet. Has Sensitive-Tone for greater sensitivity, less noise. Automatic volume control, reduction drive tuning. High efficiency loop antenna. Operates on ac-dc, 11½" wide, 7" high, 6⅞" deep. Weighs 5½ pounds. OPA price \$33.50. Fada Radio & Electric Co., Inc., 3020 Thomson Ave., L.I.C., New York. RADIO & Television RETAILING

RME RADIO

Model 45 communications receiver is designed for all-band coverage reception, on phone as well as CW, with a

range of 550 kc to 33,000 kc. Features full-vision dial scale indirectly illuminated from front. Band-spreading arrangement has positive action which as-



sure freedom of backlash affecting tuning. Both relay control and break-in connections are provided on the rear of the set. Set offers five positions of crystal selectivity. Net selling price \$166. Radio Mfg. Engineers, Inc., Peoria 6, Ill. RADIO & Television RETAILING

Brunswick RADIO & COMBO

Model 337 is a 5-tube ac-dc receiver; reception is on broadcast band. Has 5" speaker. Available in mahogany, walnut, bleached finishes. Also in plastic cabinet.

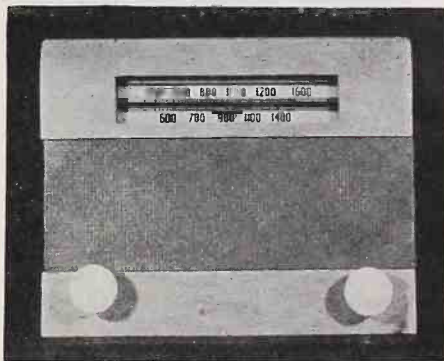

Model 335 is a 6-tube radio-phono-graph combination. Brunswick Radio Division, Radio & Television, Inc., 244 Madison Ave., New York, N. Y.—RADIO & Television RETAILING

(Continued on page 36)

More New Lines for

Admiral PHONOS

Model 6RP48 electric phonograph has automatic record changer. Excellent amplification. Permanent magnet speaker is acoustically matched to cabinet for symphonic tone. Choice of ivory or



mahogany finishes in streamlined plastic cabinet. OPA price \$44.95.

Model 6RC46 automatic record chang-



er makes a radio-phono combination of any radio. Plays ten 12" or twelve 10" records automatically. Changes discs in five seconds. Trouble-free operation. Fool-proof tone arm. Walnut cabinet. Also available in mahogany plastic. OPA price \$37.95. Admiral Corp., Chicago 47, Ill.—RADIO & Television RETAILING

Portelec TRANSCRIPTION PLAYER

Model 20m2 is a portable transcription player and public address system. It is equipped with dual speed professional rim drive motor for playing regular phono records and electrical transcriptions. 12-watt amplifier and featherweight sealed crystal pick-up. Contained in case is high impedance dynamic microphone with 25 feet of cable. Top removes completely and separates

into two sections. Complete F.O.B. factory \$165.50, plus tax. Technical Re-



search of America, Equipment Div., 1526 Cahuenga Blvd., Hollywood 28, Cal.—RADIO & Television RETAILING

Stewart-Warner RADIO & COMBO

Model 9002-A is a single band ac-dc table model that comes in a walnut plastic cabinet. Low impedance loop, 3-gang condensers, and tuned r-f stage for maximum efficiency. Inverse feed-

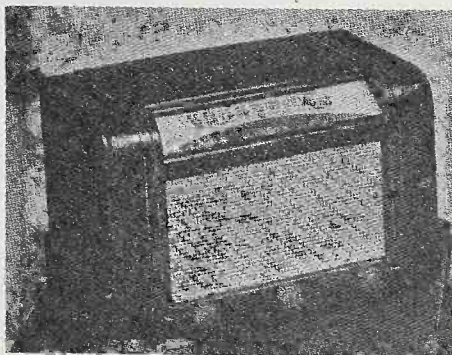

back audio system for fine tone quality. Speaker magnet is new Alnico 5. OPA price \$29.65.



Model 9004-B is a 7-tube, 2-band ac radio-phonograph console. Iron core push-button tuning for greatest stability. Low impedance loop, 3-gang

condenser, and tuned r-f frequency stage for maximum efficiency. Tamper-proof record changer. Low-friction alloy permanent needle good for 5,000 playings. Stewart-Warner Corp., 1826 Diversey Pkwy., Chicago, Ill.—RADIO & Television RETAILING

Hoffman RADIO

Laguna model A-301 comes in a choice of rich-grained mahogany, walnut or blonde wood. Modern styling. Push-button tuning, in addition to manual tuning. 6" oval electrodynamic

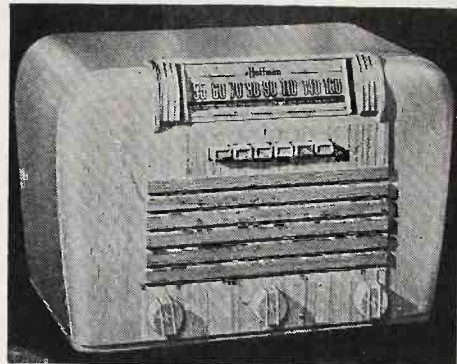

dustproof speaker is concealed behind wood grill. 6-tube ac circuit with tuned r-f amplifier. Automatic volume control and variable tone control. Built-in loop antenna. 14 3/4" wide, 8" deep, 9" high. Hoffman Radio Corp., 3430 S. Hill St., Los Angeles, Cal.—RADIO & Television RETAILING

Packard-Bell RADIO

Model 551-D is available in cabinet of walnut finish with dark plastic trim, as shown, or in special ivory finish with matching plastic trim. Has five tubes; 5" PM dynamic speaker. Plastic handle makes set a convenient "room-to-roomer", and also conceals controls. Front of set is streamlined without pro-

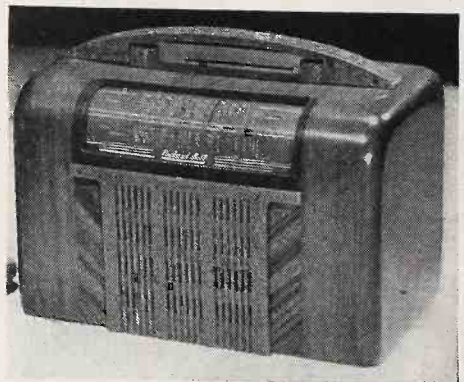

truding knobs. Tubes can be changed conveniently from bottom without taking out screws. OPA price for model pictured is \$34.90. Ivory finish is \$35.90. Packard-Bell Co., 3443 Wilshire Blvd., Los Angeles, Cal.—RADIO & Television RETAILING

Your Selling Schedule

Farnsworth RADIO & COMBO

Model ET-066 is a 6-tube table model in a richly figured mahogany cabinet. Top-mounted moving dial which permits visibility from any angle; illuminated lucite pointer for easy tuning. Dynamic speaker has heavy duty field coil and

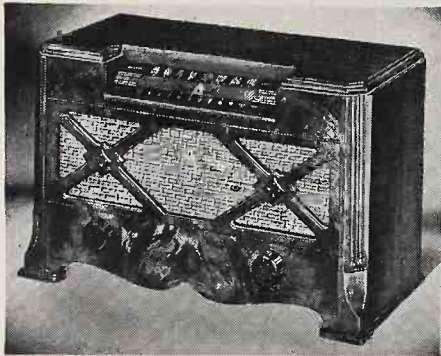

hum suppressor for tonal range.

Model EK-081 receives on broadcast and short wave bands. Large, legible Travelite slide rule dial tuning. Shielded built-in rotatable loop antenna. Has ac superhet circuit. Deluxe 3-point sus-



pension automatic record changer that gently handles up to twelve 10" and ten 12" discs. Automatic stop feature after last record is played. Measures 33 $\frac{1}{16}$ " high, 31 $\frac{1}{2}$ " wide, 16 $\frac{7}{8}$ " deep. Farnsworth Television & Radio Corp., Fort Wayne, Ind.—RADIO & Television RETAILING

Arvin RADIO & COMBO

Model 641B is a 5-tube battery table model in a walnut wood finish. Superhet circuit with 3-gang variable condenser. Batteries included in price. 400-800 hour single pack; 1 $\frac{1}{2}$ volt "A"; 90 volt "B". Built-in loop antenna mounted in back with connection for outdoor aerial if desired. Set is adaptable for ac conversion unit. 16" wide, 12 $\frac{1}{2}$ " high, 11 $\frac{1}{2}$ " deep.

Floor combination model 669X is in walnut wood veneer cabinet with lid

that encloses phonograph mechanism in top; record storage drawer at bottom. 6 tubes including rectifier and two dual-purpose tubes; superhet circuit. Operates on ac. Automatic record changer

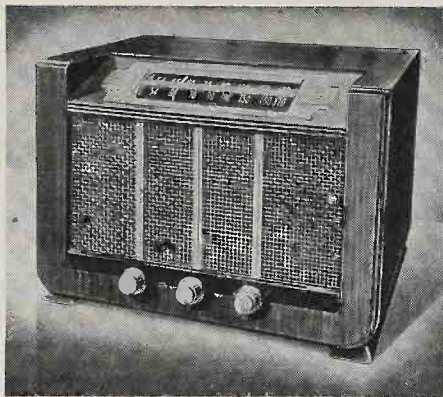

plays twelve 10" or ten 12" discs. Self-starting phono motor. Heavy duty 8"

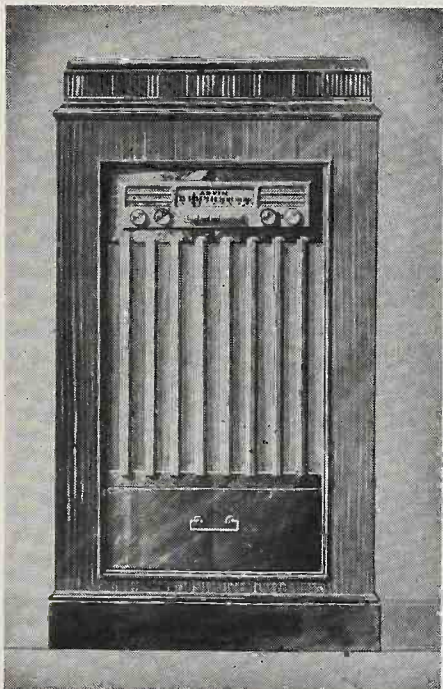

speaker. Built-in loop antenna with connection for external aerial if desired. 23 $\frac{1}{2}$ " wide, 42" high, 16" deep. Noblitt Sparks Industries, Inc., Columbus, Ind.—RADIO & Television RETAILING

Olympic RADIOS

Model 6-502 is a 5-tube ac-dc superhet that gives 7-tube performance. Polished walnut veneer cabinet has novel edge-lighted lucite dial. Automatic volume control and distortion-reducing audio circuit. Improved 5" dynamic speaker. Features built-in "Hyper-Q" antenna. 13 $\frac{3}{4}$ " long, 6 $\frac{3}{4}$ " high, 5" deep.

Model 6-505 is a 5-tube ac table model set. 3-gang tuning condenser is used. Features "Tru-Base" for faithful tonal reproduction. Connection for phono record players; also use of set with converter unit for FM and televi-

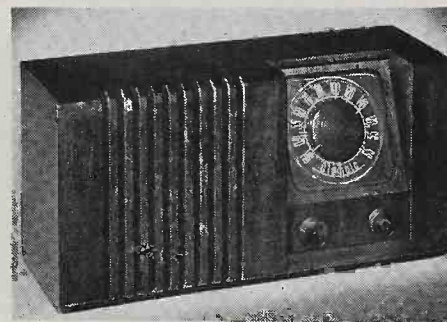

sion sound. Built-in "Hyper-Q" antenna. 16" long, 9" high, 7 $\frac{3}{4}$ " deep. Hamilton Radio Corp., 510 Ave. of the Americas, New York 11, N. Y.—RADIO & Television RETAILING

Cavalcade PHONO

Portable electric phonograph operates on ac. 3-tube amplifier, 1 $\frac{1}{2}$ oz. crystal pick-up, 5" PM speaker. Attractive durable case is available in blue, brown, maroon, or antique white. Plastic han-



dle; easily removable top. Plays 10" or 12" records. 16 $\frac{7}{8}$ " long, 7" high, 12 $\frac{3}{16}$ " wide. Cavalcade Industries, Inc., 39 S. LaSalle St., Chicago 3, Ill.—RADIO & Television RETAILING

(Continued on page 80)

Expands Service Layout for High Profits

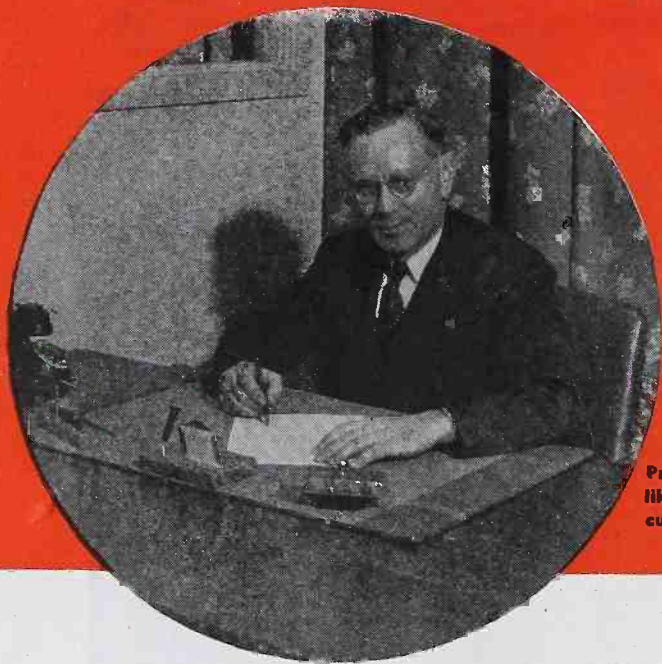

Proprietor C. W. Donaldson likes "drive-in" feature for customer convenience.

De Luxe Arrangement of This Kansas City Store Provides Handsome Space for Diversification, Strictly 1946

• The transition from war to peace, from doing business on a strict service basis to a combination of sales and maintenance, has resulted in many alterations in the methods of operation of numerous Mid-Western radio stores.

For sheer size, the store modernization undergone by one of these establishments, Donaldson Radio & Electric Co., Kansas City, Mo., is outstanding in its area. The aim of this remodeling has one goal: To make more money from servicing and selling radios and electrical appliances.

A large part of the business transacted here is auto radio maintenance. More than 15,000 cars annually pass through the Donaldson driveway to the shop for auto radio service. This figure omits the hundreds of minor, unregistered repair jobs. Many of those who drive in here for auto radio maintenance are also topnotch prospects for sales of home receivers and appliances.

For Buyers on Wheels

Chiefly, the firm's modernized store is designed for a motoring clientele. The spacious inside driveway leads into a roomy shop where prospective purchasers are welcomed.

The location of the establishment is adjacent to a busy boulevard

with a large amount of auto traffic. The store's excellent location is capitalized on, and as a result about 60 per cent of the servicing done here is on car radios.

Approximately 5,000 of the 10,000 square feet of floor space is allocated to auto receiver maintenance. Among the facilities at the store are five soundproof radio service rooms, two technicians to a room, an employes' kitchen and locker room, an attractive lobby and of-

fices, etc. It's complete, unusual.

With such a layout, the energetic Donaldson settled to the task of gearing for bigger-than-ever profits. One of the outstanding features of the \$10,000 store modernization job was the reconverting of the inside driveway into one long dramatic display window.

By inserting full-view glass windows, an *inside* display has been created which is seen by about 15,000 customer and prospective

Below, one of the spacious new "service rooms" which replace the production line method of servicing. There are five of these soundproofed compartments for radio maintenance men.

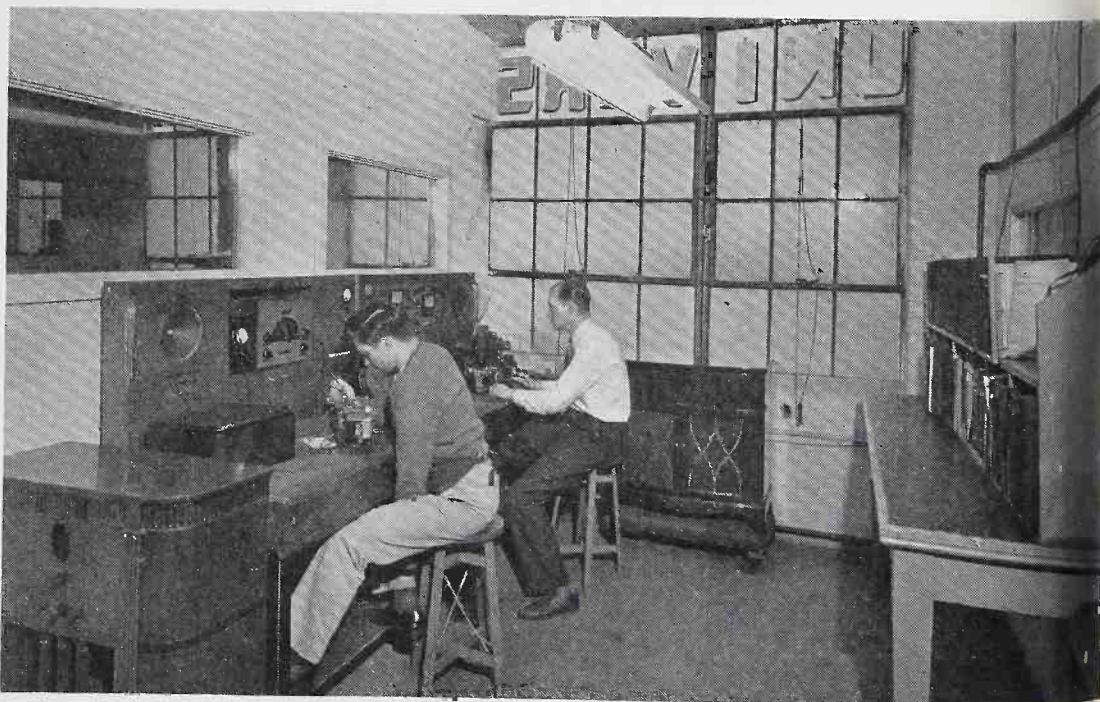

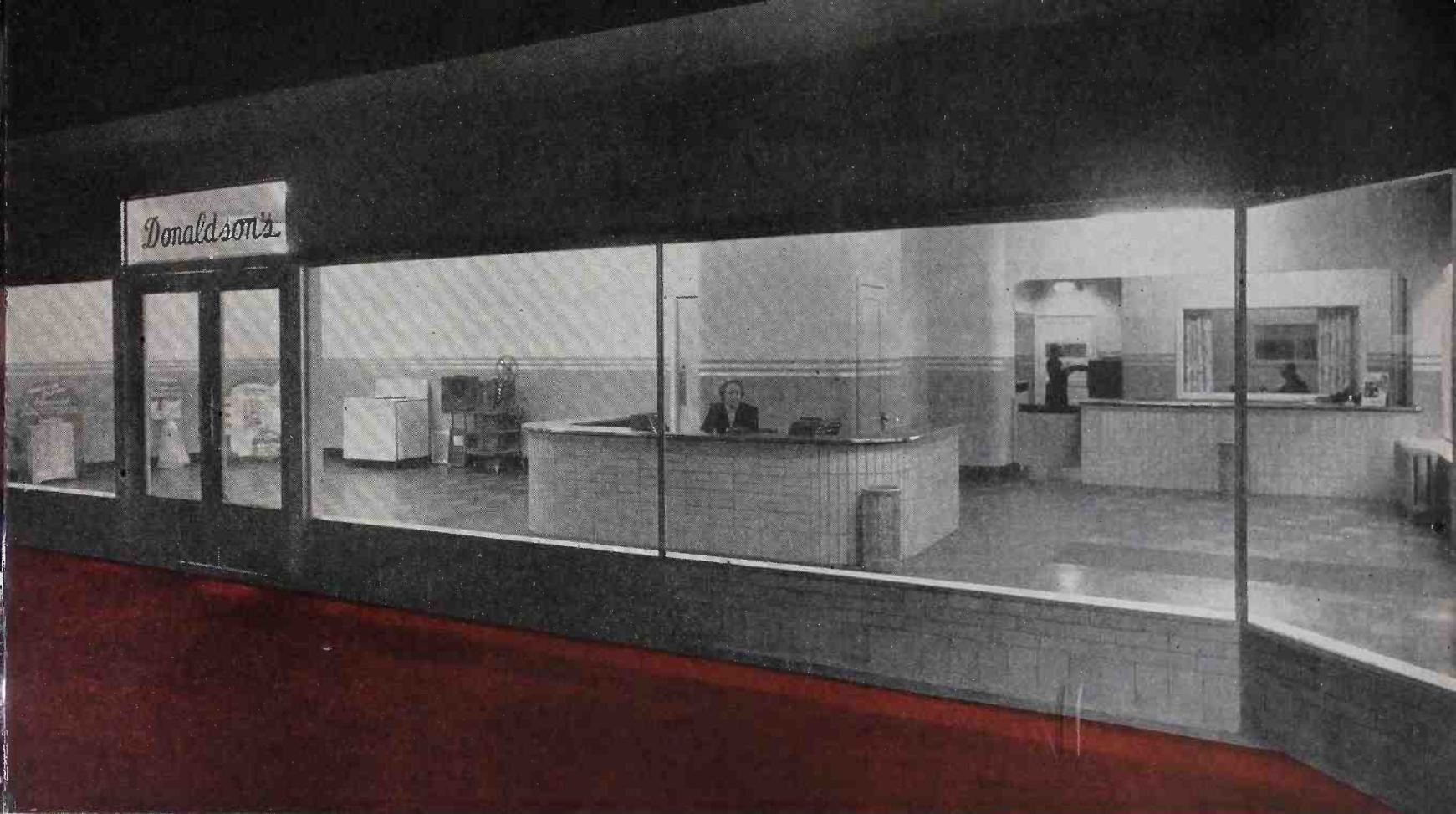

A part of the \$10,000 modernization job was to transform the inside drive way into a dazzling 50-ft. display which put the whole interior on view.

customer motorists a year who drive by the 50 feet long display. Thus countless eye impressions are made of the store and the merchandise on view.

The focal point of the display is the electrical appliance exhibit, which occupies 1,800 square feet of space. In the center of the lobby is a personable young woman around whom most of the store

Central point of the big display rooms is the floor "office" where courtesy and neatness again illustrate the Donaldson store policy gain 20% service increase.



traffic flows. She is a prominent figure in the firm's contacts with service and radio-appliance prospects. And she's kept very busy.

The walls of the store are finished in an attractive and eye-pleasing shade of green. A streamlined effect is achieved by the curved archways and silver striping. Fluorescent lighting illuminates hand-surfaced brick-wood floors, covered with asphalt linoleum.

A small glass opening, in line with the soundproof radio service rooms, enables customers waiting in the store to view technicians at work on sets. This link between sales floor and maintenance shop builds confidence in the business by permitting patrons to see the well-equipped work rooms, and the skilled technicians at work servicing receivers.

Bordering the complete display of home appliances, featuring such well-known names as Philco, RCA, Universal, Sunbeam, etc., is a row of comfortable chairs for the convenience of waiting patrons.

Toaster Tune-Up Dept.

Planned by the company is a special maintenance department tailored exclusively for servicing small appliances—irons, toasters, fans, etc. Installation of this section is contemplated because the firm believes that it is a necessary part of selling traffic appliances. It

is another of the "plus" services which have always figured in the Donaldson sales formula.

To build profits from maintenance and radio-appliance selling, the store finds direct mail advertising to be a high-caliber business booster. Printed material, describing and picturing the services available and the merchandise on sale, is mailed to a prospect list which has been carefully compiled for the last five years.

Service Emphasis

Sales and maintenance receive equal attention in the handsome brochures which go out to customers via the mails.

Despite the return of receivers and electrical appliances, the store intends to keep pushing its service department. Sales are built by service, Donaldson believes; therefore, the firm rates service first, radio-appliance merchandising second. In this way, the company sees more profit from both.

The firm's new service department arrangement is speeding maintenance work. About a twenty percent increase in the number of service jobs handled has been noted since the change was made from the production line method of servicing to the installation of sound-proof, insulated rooms with individual heat control.

Among the results of having two

(Continued on page 106)

Black-White vs. Color-

Facts to Tell Your Customers About the Present Video Controversy. Industry Going Ahead with BW, while Encouraging Color Tests

The newspapers and the general magazines have recently carried a number of articles and statements about new developments in color television. As a result, radio men everywhere are being asked questions about this new art of color video and its relation to the black-white television now being made ready for the public. To help you answer these queries with the latest up-to-date facts of the television situation, the accompanying analysis is presented by the editors.

* * *

Every television man will welcome the "coming of color" in television.

But the issue today is whether the mechanical color-TV proposed by CBS executives, if generally adopted would not limit and hobble the widest development of future color-television—with all its ultimate possibilities of brilliance, size, fidelity and electronic color.

While several radio leaders express themselves enthusiastically about CBS color television, the preponderance of industry opinion seems to be that the best present course will be to

BLACK-WHITE: Big 20-inch pictures, so brilliant (20 ft.-candles) television can be watched comfortably in a brightly-lighted room. Direct-view set being made ready for 1946 market by DuMont.



1. Go ahead immediately with black-white television as originally planned.
2. Study and develop color television so that an adequate color-television system can be ready in 3 to 5 years.

Meanwhile CBS is demonstrating to the press, radio manufacturers and broadcasters, and the public, a most enticing demonstration of color television. This, with postwar refinements, employs the same mechanical principle of rotating color screens, which CBS exhibited before Pearl Harbor.

Dim Illumination

Low intensity of the color picture seems to be one of the abiding drawbacks of the present CBS system. With large percentages of light being subtracted by each of the color screens, the mechanical color system is bound to be wasteful of the precious cathode-tube illumina-

tion. But even if higher screen intensities could be achieved, the 20-frame flicker (which is now not noticeable at low screen brightness) would appear annoyingly at higher illuminations and so spoil seeing. Hence CBS color seems doomed to low-intensity darkroom effects—this in contrast with the brilliant illumination (20-ft.-candles) of new postwar black-white screens.

Absence of "ghosts", usually so annoying in the metropolitan area of big buildings, is one of the striking advantages of uhf demonstrated during the CBS showings. With receiving dipoles (little larger than two lead-pencils) mounted in a rotatable reflector netting on the 9th floor of the CBS building, the uhf color pickup can be taken from any of a number of reflections from nearby buildings. Without the reflector, ghosts would of course be plenty. But the sharpness of the receiving reflector enables clear ghost-like images to be picked up, as

COLOR-TELEVISION: Laboratory model CBS direct-view 9-by-12-inch mechanical-color system (using 10-inch tube with lens magnification). Estimated intensity of screen about 2 ft.-candles.



COLOR-TELE BALANCE SHEET

CBS System (480-496 mc; 525 lines in red, blue and green.
20 complete pictures per second)

Advantages

Greater attractiveness and interest
Better "seeing" through color contrasts
Greater appeal to advertisers
Absence of wide-angle ghosts
Absence of color-fringes with film scanning
Purchasers would willingly pay 100% premium for color, same screen size
In million lots, color sets only 10-15% more costly than black-white sets (Goldmark)
Mechanical color relies on simplicity of wheel principle
Sound carried on same channel as picture
Color offers a powerful new selling appeal for industry

different reflecting structures come into the line of the reflector.

However, at receiver distances of 20 to 30 miles from the transmitter, where other city skyscrapers a mile or so away are also included in the sharp beam of the distant receiving reflector, ghosts transposed by an inch or so would be expected on the color-TV screen, as with black-white. Uhf does not seem to offer any solution of this most annoying ghost trouble for outlying viewers.

But suburban-rural video reception at 20 or 30 miles may not be practicable on the 500-mc band, for at such distances, whatever the height of the antenna structure the blocking of the carrier waves by trees, buildings and foliage, may shut off signals. One prominent television engineer expects the service area of 500-mc station to be only a quarter of that of present 50-mc television. However, one of the CBS technicians, using a home made color-TV receiver, now reports getting good color pictures at his home 10 miles from the CBS antenna. And CBS executives point out that in cases where an owner's receiving antenna is below line-of-sight to the receiver, he can then swing around and focus on the reflection from some higher object beyond (although the possibility of such reflection sources seems unlikely in suburban and rural areas over 15 miles from the transmitter).

Multiple Antenna Arrays

Height of antenna is still desirable for 500-mc color, as for 50-mc black-white. In most residence locations, arrays of multiple small dipoles (16 to 50) may be necessary for adequate pickup, since, in the last analysis, the energy received is proportional to the space spanned by the dipole tips. Hopes that uhf dipole arrays could be concealed inside shingle-roofed attics, are blasted by war experience that at these higher frequencies wooden structures are almost as opaque as metal; especially would this be true in rainy periods.

Laymen and press people who watched the CBS demonstrations, have testified that such is the appeal of color, they would readily pay twice as much for a color television set as for the same size

screen in black-white. Interestingly enough, several experienced television engineers have independently computed that a color set complete with color wheel, should be built in limited quantities for about twice the cost of present black-white sets.

Dr. Peter Goldmark, CBS engineer who is responsible for the CBS color experimentation, thinks that in million lots, color-wheel sets could be produced at 10% to 15% above black and white. (Some 50 color receivers are now being built for CBS by GE at a reported cost of \$3500 each for direct-view sets, and \$5500 each for projection sets. These of course, are experimental models, and such costs have no bearing on future selling prices of similar sets).

The projection color set exhibited by CBS has a screen 22 inches wide, but the picture seems dim and pastel, being annoyingly faint and indistinct even in the darkened room. Since only a colored-lantern slide still was demonstrated on the projection set, one might infer that the serious light losses of the color-wheel precluded any film showing of moving scenes. This projection-set difficulty points up one of the objections to the CBS system, with its distinct limits to future size and brightness. Color wheels cannot be introduced into the Schmidt lens system without some light loss; the regulation optical system permits easy color interception but introduces bulky cabinets.

Some visitors at the CBS demonstrations mention hearing the whirling color wheels; others did

Drawbacks

Low illumination of pictures
Dark room used
Flicker at brighter intensity
Color fringes on fast-moving objects with live pickup
Ghosts from distant (narrow angle) reflecting surfaces
Line-of-sight path essential (to antenna or reflecting object)
Wood structures and foliage tend to block off reception
Attenuation of signal greater than on 50-90 mc
Initial receivers expected to cost double black-white
Mechanical color system limits size, brightness and compactness of receiver
Mechanical-color sets may be useless on eventual electronic-color system
Mechanical-color wheels and drums are bulky; may tend to become noisy
Color networks not feasible with present coaxial equipment
Present projection color pictures dim, flat and wasteful of light or cabinet space
Further field tests needed
No standards available. To adopt standards may take three years

not detect or notice the sound of the moving parts. CBS executives declare that such wheels should introduce no problems after man's long mechanical history. Other engineers suspect that in living rooms, wheels running at 1200 rpm may tend to get noisy and out-of-balance with use, and also may introduce synchronism troubles when transmitter and receivers operate on different power systems.

Time for Standardizing

CBS officials insist that with industry cooperation, color-TV standards can be adopted by the industry and approved by FCC within 6 months, so that color would be ready to start by this coming Fall. But the majority of the radio industry, mindful of the many years which it has taken to refine and standardize black-white television, think that two to five years may be needed for the field tests and standards necessary to put any existing system of color television on a commercial basis.

And still the question would be whether any such mechanical color-

(Continued on page 106)

Photo portrait of Leopold Stokowski, first in a series featured by RCA. Right, Victor's Allan Jones draws customers at Schusters in Milwaukee.



Is YOUR Store A

Are You the Dealer That "Has That Disc" in Your Community? Don't Neglect This Part of Your Business That Helped to Carry You During Wartime.

• In the light of today's constantly expanding market in records, a sales life-saver for radio men during wartime, what is your relation to your community in disc sales volume today?

Still continuing to grow, the disc department of your establishment is now in its full stages of development. It needs your constant attention, however, to insure its continued growth.

Let's start with display. Is your present arrangement of record racks set up to the best advantage? Can the customer easily see what is new, quickly discern where the classical section is? Are your subdivisions of various types of albums and singles easily located?

Self-service, upon which so many dealers had to rely during help shortages, can now be *augmented* by properly trained sales personnel. It is often helpful to customers to have the clerk tactfully indicate the

manner in which music divisions are arranged, for easy finding. And when a buyer seems undecided, suggest some similar number of which you have a large stock.

Along these lines, be familiar, yourself, with the sales potential in interrelated sales. This is especially good business where the classics are concerned. You don't have to be

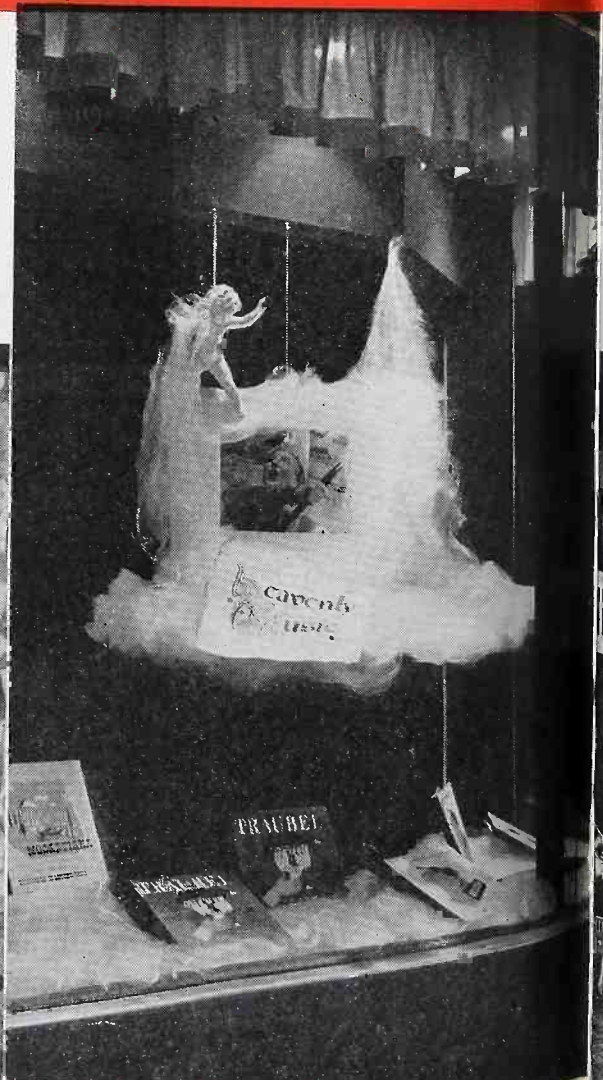
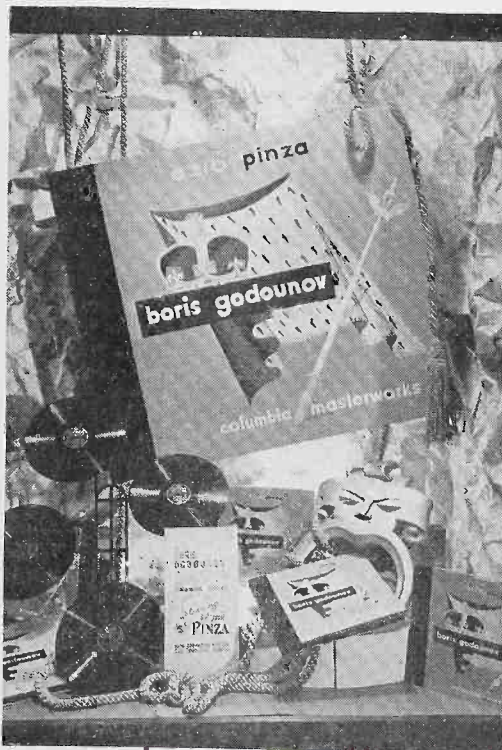

One of Columbia's prize-winning windows (center) was created by the Mary McGwier Music Shop, Chicago, from Columbia's promotion material. Runner-up is Sherman Clay's arrangements (at left and right), San Francisco.

Sonora's first single "pop" record, beginning a new policy, features Mark Warnow and his orchestra, "Slowly", from the 20th Century picture "Fallen Angel".

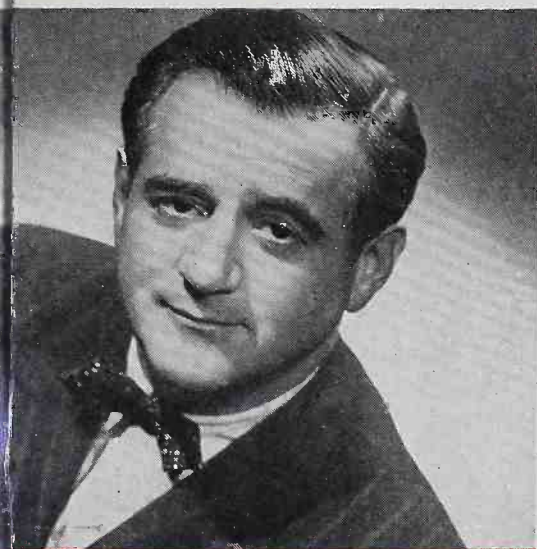

get and hold their confidence. Be sure your sales people pronounce the composers' names correctly and with ease. Never permit them to get into a discussion with the average customer on musical preferences. Teaching your personnel to approach all customers with tact helps to establish and promote a smooth buying mood. The average prospective purchaser is quick to sense whether or not he is being properly handled, and shows his appreciation by buying, if given the chance.

In the populars, hit numbers change swiftly. Know the main hit of the moment.

Make all displays effective, keep

Artie Shaw (right) signed a term contract with Musicraft to record with a full new band. His first disc will be released this month.



Reader in Record Sales?

an expert on music to do this. You can learn a lot on this subject by studying the catalogues and promotion pieces furnished by the manufacturers.

At all times, in the selling of recorded music, remember you are dealing with hobbyists! Don't get caught off base. It is important to

them fresh-looking, and change them often. This is especially true of windows devoted to records. In line with radio selling, record selling, too, should be a lively operation. People are accustomed to looking to their community's radio store as the liveliest store in the neighborhood. Don't let them down on records. Discs should move fast for your best profits, and presenting

(Continued on page 137)

Katherine Dunham, right, famous dancer, also sings, Decca has discovered! She will be featured with her group in an album of native Caribbean songs. Below, Burl Ives has made a new album for Decca, "Burl Ives," which contains 12 folk ballads full of real American tang and folk humor.

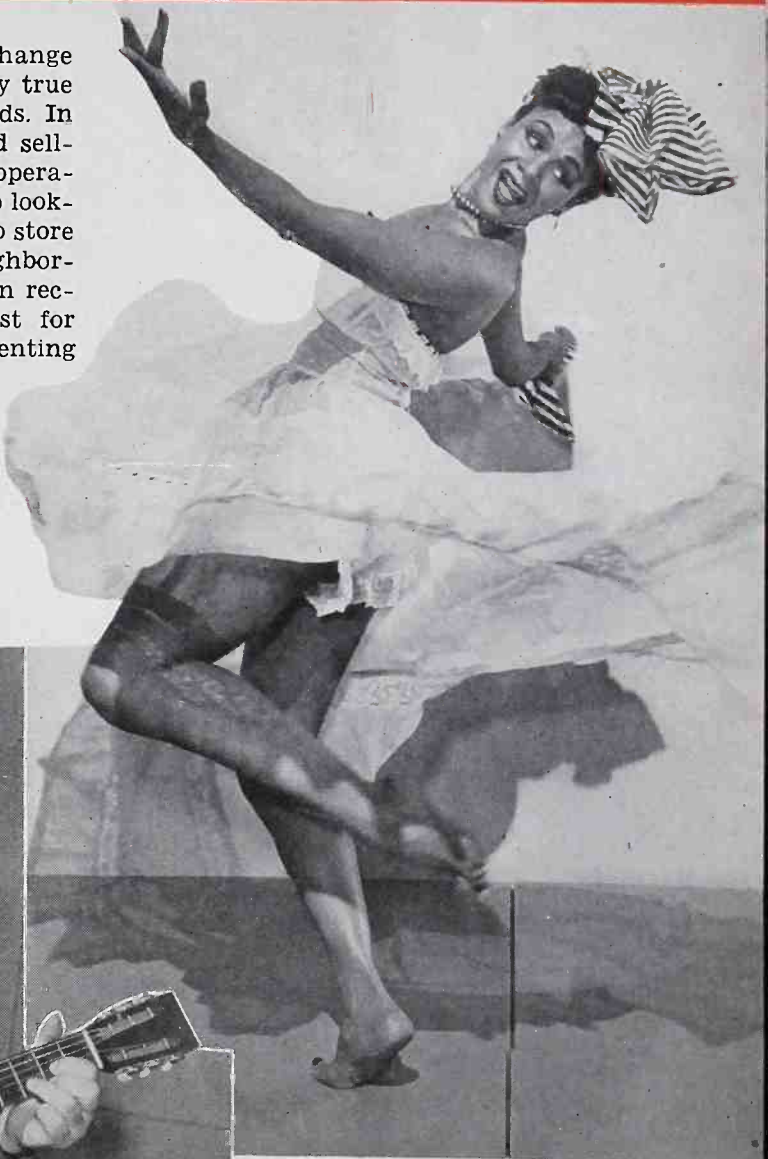

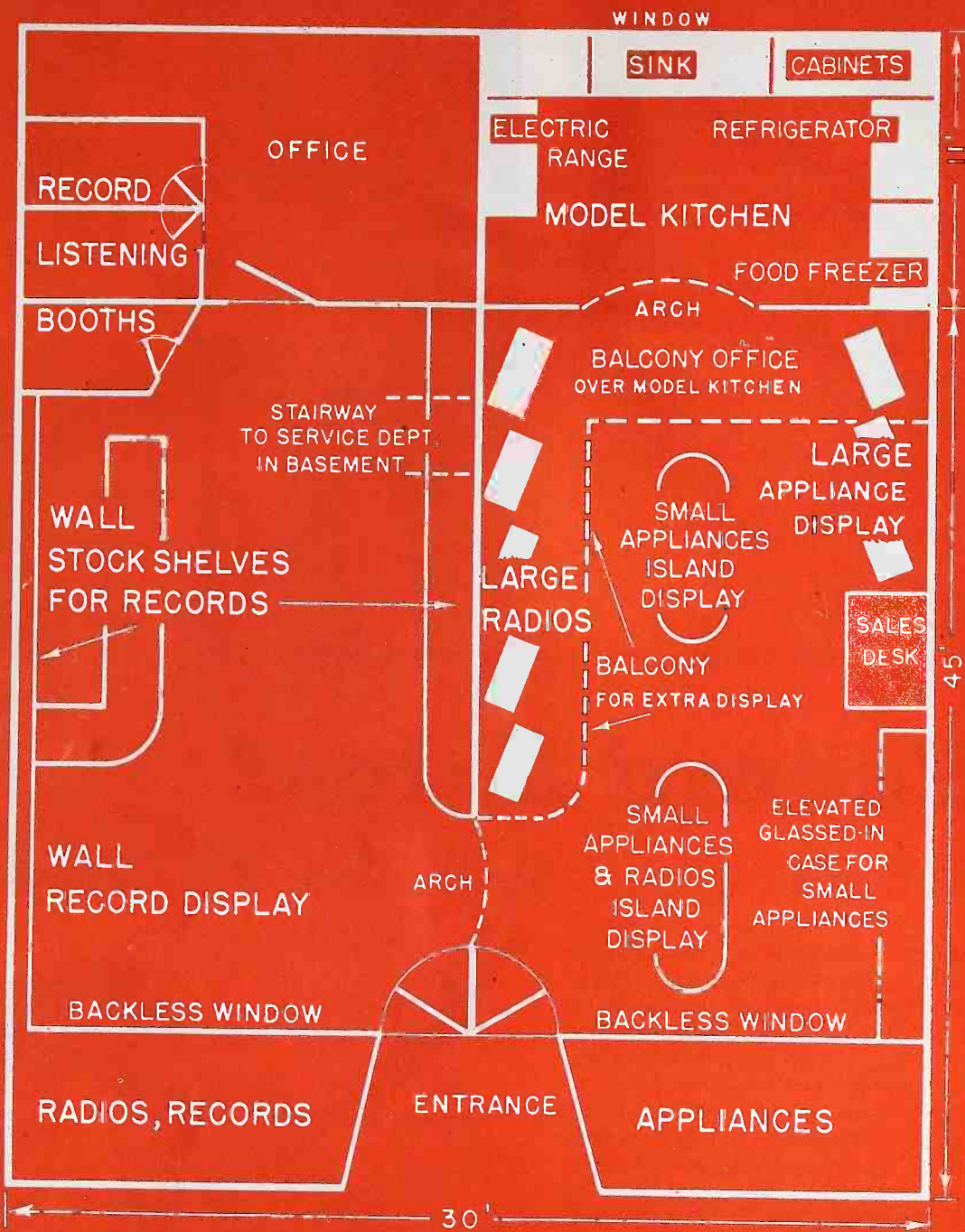

Miss Snyders is responsible for buying, display, sales, inventory check-up and stock arrangement in records, and conducts a thorough-going, all-round operation. One of her sales pointers is: Have *some* knowledge of *all* types of music, and *be pleased to sell them all!* Merchandising music means selling *more* records.

Stocks Important

Stock arrangement is simple and effective. Classical albums are alphabetically arranged by titles under composers' names, which are also kept alphabetically.

(Continued on page 138)

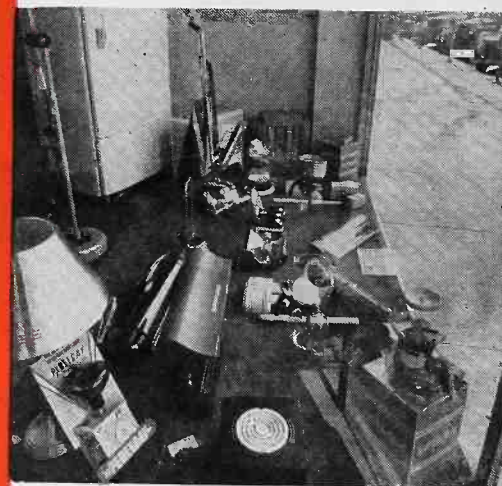

Above, present appliance window shows variety, even though not much merchandise is available. Below, Lea Snyders rearranges her impressive wall album display.



Ferris Radio Co.'s floor plan is an ambitious one! Setup for sales, it uses every available advantage to make customers feel at home and remain to buy.

Ferris Radio

(Continued from page 33)

sumer. C.O.D.'s are impossible, whereas credit arranged through a finance paper is received *before* shipment is made. Down payment is made, paper is sent to the bank, and cash is received by the dealer, *before* goods are delivered. The large number of current cash dealings is an exception, and due to the present-day market. "Financial paper keeps the *dealer's* cash free" claims Ferris.

"Pleased to Sell!"

Miss Lea Snyders is in charge of Ferris Radio's record department, and she maintains a lively and appealing selling atmosphere in this division of the store.

Philco 1213 Radio-Phonograph.

An authentic reproduction of traditional
Chippendale design, typical of the
exquisite beauty and quality which any
1946 Philco brings to your home.

*The most dramatic
advertising campaign
in Philco history!
Breaking now in all
leading weekly and
monthly magazines.*

PHILCO

Famous for Quality the World Over

The patented Philco Dynamic Reproducer . . . the revolutionary Philco
Advanced-FM System . . . these are among the sensational, exclusive
developments through which Philco brings you for 1946 all you have
hoped for in new and greater enjoyment of radio and recorded music.

See them . . . hear them . . . at your Philco dealer now.

Products of RADIO & TELEVISION Manufacturers

Listing the companies whose lines cover one or more of the six groups of greatest importance to retailers and distributors.

The following manufacturers of radio receivers have returned our editorial questionnaire giving the information needed for these listings:

	Home AM-FM	Combinations	Television	Auto Radio	Amateur	Commercial
Abbott Instrument, Inc., 8 W. 18th St., New York, N. Y.						
Admiral Corp., 3800 W. Cortland St., Chicago, Ill.						
Aero Communications Co., 231 Main St., Hempstead, L. I.						
Aero Associates, Inc., 5827 W. Centry Blvd., Los Angeles 45, Calif.						
Air Communications Co., 2233 Grand Ave., Kansas City, Mo.						
Aircron Corp., Fairfax & Funston Rds., Kansas City, Kans.						
Air King Prod. Co., Inc., 1523 63rd St., Brooklyn, N. Y.						
Airplane & Marine Instruments, Clearfield, Pa.						
American Communications Co., 306 Broadway, New York, N. Y.						
Andrea Radio Corp., 43-20 34th St., Long Island City, N. Y.						
Anslay Radio Corp., 41 St. Joos Ave., Trenton, N. J.						
Apex Industries, 192 Lexington Ave., New York 16, N. Y.						
ARF Products, 7713 Lake St., River Forest, Ill.						
Autoerast Radio Co., 3855 N. Hamilton Ave., Chicago						
Automatic Radio Mfg. Co., Inc., 122 Brookline Ave., Boston						
Aviola Radio Corp., 703 Ivy St., Glendale, Calif.						
Baronette Radio & Tube Corp., 220 Fifth Ave., New York, N. Y.						
Barr Electric Co., 1214 Forest Ave., Dallas, Texas						
Beal Radio Co., 125 E. 46th St., New York, N. Y.						
Belmont Radio Corp., 5921 W. Dickens Ave., Chicago, Ill.						
Bendix Radio, Div. of Bendix Aviation Corp., Baltimore, Md.						
Biltmore Radio Corp., 15 Ave. "A", New York 3, N. Y.						
Browning Laboratories, Inc., 750 Main St., Winchester, Mass.						
Capehart Div., Farnsworth Tel. & Radio Corp., Ft. Wayne, Ind.						
Collins Radio Co., 2920 First Ave., Cedar Rapids, Iowa						
Colonial Radio Corp., 254 Rano St., Buffalo, N. Y.						
Columbia Electronic, Inc., 185 E. 122nd St., New York, N. Y.						
Communications Co., Inc., 300 Greco Ave., Coral Gables, Fla.						
Communications Equip. Co., 523 W. 6th St., Los Angeles						
Concert Master Rad. & Tel. Co., 1800 Winnemac Ave., Chicago						
Concord Radio Corp., 901 W. Jackson Blvd., Chicago						
Coronet Radio and Television Corp., Lynbrook, L. I.						
Crosley Corp., 1329 Arlington St., Cincinnati, Ohio						
Crystal Products Co., 1519 McGee Trafficway, Kansas City, Mo.						
Delco Radio, Div. of General Motors Corp., Kokomo, Ind.						
DeWald Radio Mfg. Corp., 440 Lafayette St., New York, N. Y.						
F. E. Dine & Co., Inc., 2221 Warwick, Santa Monica, Calif.						
Allen B. DuMont Laboratories, 515 Madison Ave., New York						
Dynavox Corp., 40-35 21st St., Long Island City, N. Y.						
Eastern Electronics Corp., 41 Chestnut St., New Haven, Conn.						
Echophone Radio Co., 2611 So. Indiana Ave., Chicago, Ill.						
Eckstein Radio & Television Co., 1400 Harmon Pl., Minneapolis						
Electrical Research & Mfg. Co., 3001 E. Pico Blvd., Los Angeles						
Electromatic Mfg. Co., 88 University Pl., New York, N. Y.						
Electronic Corp. of America, 45 W. 18th St., New York, N. Y.						
Electronic Devices Co., 601 W. 26th St., New York, N. Y.						
Electronics Inc., 645 Iowa St., Dubuque, Iowa						
Emerson Radio & Phono Corp., 111 8th Ave., New York, N. Y.						
Espey Mfg. Co., Inc., 33 W. 46th St., New York, N. Y.						
Fada Radio & Electric Co., Inc., Long Island City, N. Y.						
Farnsworth Television & Radio Corp., Fort Wayne, Ind.						
Federal Telephone & Radio Corp., 591 Broad St., Newark, N. J.						
Fisher Radio Co., 41 E. 47th St., New York, N. Y.						
Flush Wall Radio Co., 15 Washington St., Newark, N. J.						
F. M. Radio Mfg. Co., Inc., 10314 Superior, Cleveland, Ohio						
Franklin Photographic Industries, 223 W. Erie St., Chicago						
Freud Radio Corp., 200 Hudson St., New York, N. Y.						
Galvin Mfg. Corp., 4545 Augusta Blvd., Chicago, Ill.						
Garner Electronics Corp., 1100 W. Washington Blvd., Chicago 7						
Garnet Radio Corp., 69 Glenwood Place, E. Orange, N. J.						
Garod Radio Corp., 70 Washington St., Brooklyn, N. Y.						
Gem Radio & Television Co., 140 Liberty St., New York 16, N. Y.						
General Electric Co., Bridgeport, Conn.						
General Television & Radio Corp., 2701 Lehmann Ct., Chicago						
Gilfillan Bros., 1815 Venice Blvd., Los Angeles, Calif.						
Globe Electronics, Inc., 225 W. 17th St., New York, N. Y.						
Gray Radio Co., W. Palm Beach, Fla.						
Hallierafters Co., 2611 S. Indiana Ave., Chicago, Ill.						
Hamilton Radio Corp., 510 6th Ave., New York, N. Y.						
Hammarlund Mfg. Co., 460 W. 34th St., New York, N. Y.						
Harris Mfg. Co., 2422 W. 7th St., Los Angeles						
Harvey Mashine Co., Inc., 6200 Avalon Blvd., Los Angeles						
Harvey-Wells Electronics, Inc., Southbridge, Mass.						
Horbach & Rademann Co., 522 Market St., Philadelphia, Pa.						
Hoffman Radio Corp., 3430 So. Hill St., Los Angeles, Calif.						
Howard Radio Co., 1735 Belmont Ave., Chicago, Ill.						
Hudson-American Corp., 25 W. 43rd St., New York 18, N. Y.						
Industrial Tool & Die Works, Inc., Minneapolis, Minn.						
International Detrola Corp., Beard Ave., Detroit, Mich.						
Islip Radio Mfg. Corp., Beech St., Islip, New York						
Ray Jefferson, Inc., 40 E. Merrick Rd., Freeport, L. I., N. Y.						
Jefferson-Travis Radio Mfg. Corp., 245 E. 23rd St., New York						
Jewel Radio Corp., 583 Sixth Ave., New York 11, N. Y.						
Kaar Engineering Co., 619 Emerson St., Palo Alto, Calif.						
Keith Radio Products, Bedford, Ind.						
Kinetic Electronics Corp., 235 E. 42nd St., New York 17, N. Y.						
Kingston Radio Co., Inc., Kokomo, Ind.						
Laurehk Radio Mfg. Co., 3931 Monroe Ave., Wayne, Mich.						
Lavoie Laboratories, Matawan-Freehold Rd., Morganville, N. J.						
Lear, Inc., 230 E. Ohio St., Chicago, Ill.						
Lewyt Corp., 60 Broadway, Brooklyn 11, N. Y.						
Lincoln Electronics Corp., 653 11th Ave., New York, N. Y.						
Fred M. Link, 125 W. 17th St., New York, N. Y.						
Magnavox Co., 2131 Bueter Rd., Ft. Wayne 4, Ind.						
Maguire Industries, Inc., W. Putnam Ave., Greenwich, Conn.						

Manufacturers not listed may furnish data for the next issue. No advertising obligation. Additions or revisions will be made monthly.

	Home AM-FM	Combinations	Television	Auto Radio	Amateur	Commercial
Majestic Radio & Television Corp., St. Charles, Ill.						
Marco Industries, 245-A So. Beverly Dr., Beverly Hills, Calif.						
Maritime Radio Co., 24 Whitehall St., New York, N. Y.						
Mason Radio Products Co., Kingston, N. Y.						
E. W. McGrade Mfg. Co., 406 W. 34th St., Kansas City, Mo.						
Mec-Rad Div., Black Industries, 1400 E. 222nd, Cleveland 17, O.						
John Meek Industries, Plymouth, Ind.						
Mectron Corp., Lawrence, Mass.						
Medco Mfg. Co., 5 W. 45th St., New York, N. Y.						
Megard Corp., 1601 S. Burlington Ave., Los Angeles, Calif.						
Meissner Mfg. Co., 936 N. Michigan Ave., Chicago, Ill.						
Metropolitan Electronics & Instr. Co., 277 B'way, New York, N. Y.						
Midland Mfg. Co., Decorah, Iowa						
Midwest Radio Corp., 909 Broadway, Cincinnati, Ohio						
James Millen Mfg. Co., 150 Exchange St., Malden, Mass.						
Minerva Corp. of America, 238 William St., New York, N. Y.						
Music Master Radio Corp., 750 Main St., Hartford, Conn.						
National Co., Inc., 61 Sherman St., Malden, Mass.						
National Design Service, 96 Liberty St., New York, N. Y.						
Noblitt-Sparks Industries, Inc., Columbus, Ind.						
Northeastern Engineering, Manchester, Mass.						
Northern Radio Co., 2203 4th Ave., Seattle, Wash.						
Packard-Bell Co., 3443 Wilshire Blvd., Los Angeles, Calif.						
Packard Mfg. Corp., 2900 Columbia Ave., Indianapolis, Ind.						
Pan American Electric Co., Inc., 132 Front St., New York, N. Y.						
Panoramic Radio Corp., 242 W. 55th St., New York 19, N. Y.						
Philco Corp., Tioga & C Sts., Philadelphia, Pa.						
Philharmonic Radio Corp., 528 E. 72nd St., New York, N. Y.						
Pilot Radio Corp., 37-06 36th St., Long Island City, N. Y.						
Precision Specialties, 210 N. Western Ave., Los Angeles, Calif.						
Premier Crystal Laboratories, Inc., 63 Park Row, New York						
Radio Craftsmen, Inc., 1341 S. Michigan Ave., Chicago						
Radio Devel. & Research Corp., 233 W. 54th St., New York 19						
Radio Engineering Laboratories, Inc., 36th St., L. I. City, N. Y.						
Radio Laboratories, 2701 California Ave., Seattle 6, Wash.						
Radio Mfg. Engineers, Inc., Peoria 6, Ill.						
Radio Navigational Inst. Corp., 305 E. 63th St., New York 21						
Radio Process Co., 7618 Melrose Ave., Los Angeles, Calif.						
Radio Receptor Co., 251 W. 19th St., New York, N. Y.						
Radio & Television, Inc., 244 Madison Ave., New York, N. Y.						
Radio Wire Television Inc., 100 Ave. of the Americas, New York						
Rauland Radio Co., 4245 N. Knox Ave., Chicago 41, Ill.						
Ray Victor Radio & Television Corp., 32 W. 22nd St., New York						
Record-O-Vox, Radio Corp. of America, Camden, N. J.						
Regal Electronics Corp., 721 N. Martel Ave., Hollywood 46, Calif.						
Remler Co., Ltd., 2101 Bryant St., San Francisco, Calif.						
Rex Products Co., 1313 W. Randolph St., Chicago, Ill.						
RGH Mfg. Corp., 214 E. 41st St., New York, N. Y.						
Rock-Ola Mfg. Corp., 800 N. Kedzie, Chicago, Ill.						
E. M. Sargent Co., 219 9th St., Oakland, Cal.						
Schuttig & Co., 9th & Kearny St., N.E., Washington, D. C.						
Scophony Corp. of America, 527 5th Ave., New York, N. Y.						
Scott Radio Labs, Inc., 4450 Ravenswood Ave., Chicago, Ill.						
Searle Aero Industries, Inc., P. O. Box 111, Orange, Calif.						
Sentinel Radio Corp., 2020 Ridge Ave., Evanston, Ill.						
Setchell-Carlson, Inc., 2233 University Ave., St. Paul, Minn.						
Sheridan Electronics Corp., 2850 S. Michigan Ave., Chicago						
Signal Electronics, Inc., 114 E. 16th St., New York, N. Y.						
Silver Co., McMurdo, 1240 Main St., Hartford 3, Conn.						
Sonora Radio & Television Corp., 325 N. Hoyne Ave., Chicago						
Sonotone Corp., 570 5th Ave., New York						
Sparks-Withington Co., Jackson, Mich.						
Speak-O-Phone Recording & Equip. Co., 23 W. 69th, New York						
Stewart-Warner Corp., 1826 Diversey Pkwy., Chicago, Ill.						
Stromberg-Carlson Co., 100 Carlson Rd., Rochester, N. Y.						
Symphonic Radio & Electronic Corp., Main St., Cambridge, Mass.						
Taybarn Equipment Co., 120 Greenwich St., New York, N. Y.						
Tech-Master Products Co., 123 Prince St., New York, N. Y.						
Teletone Radio Co., 609 W. 51st St., New York, N. Y.						
Telicon Corp., 851 Madison Ave., New York, N. Y.						
Templestone Radio Mfg. Corp., New London, Conn.						
Transmitter Equipment Co., 345 Hudson St., New York 14, N. Y.						
Tray-Ler Karenola Radio & Tel. Corp., 571 W. Jackson, Chicago						
Trebor Radio Co., Box 497, Pasadena, Calif.						
Union Electronics Corp., 3801 Queens Blvd., Long Island City						
United Cinephone Co., Torrington, Conn.						
United States Television Mfg. Co., 106 7th Ave., New York, N. Y.						
Vibracoe Mfg. Co., 325 Miguel St., San Francisco, Calif.						
Viewtone Co., 203 E. 18th St., New York, N. Y.						
V-I-lectrical Engineering Co., 828 N. Highland Ave., Los Angeles						
Walker, Inc., 403 W. 8th St., Los Angeles, Calif.						
Walsh Engineering Co., 34 DeHart Place, Elizabeth 2, N. J.						
Warwick Mfg. Corp., 4640 W. Harrison St., Chicago, Ill.						
Waterson Radio Mfg. Co., 2700 Swiss Ave., Dallas, Texas						
Wells-Gardner & Co., 2701 N. Kildare Ave., Chicago, Ill.						
Western Electric Co., 120 Broadway, N. Y.						
West'n Sound & Elec. Labs, Inc., 3512 W. St. Paul Ave., Milwaukee						
Westinghouse Electric Corp., Receiver Div., Sunbury, Pa.						
Whiting & Davis, Inc., 23 W. Bacon St., Plainville, Mass.						
Wilcox Electric Co., Inc., 1400 Chestnut St., Kansas City, Mo.						
Wilcox-Gay Corp., 604 Seminary St., Charlotte, Mich.						
Wynn Mfg. Div., Hudson Supply Co., 401 N. 27th, Richmond, Va.						
Zenith Radio Corp., 6001 Dickens Ave., Chicago, Ill.						

*Commercial or Special

Republication prohibited. See copyright notice, page 1.

For "Where to Buy Electrical Appliances," see page 66.

Section of **RADIO & Television RETAILING**

ELECTRICAL APPLIANCES



USE WHAT YOU HAVE TO MAKE THE SALE!

General Mills Home Appliance Plans, Products and Policies

Progress General Mills District Managers have been at work in most territories since mid-January.

Wholesale distributors in many districts are being appointed.

After mid-year the new General Mills Automatic Iron with Safety Side-Rest and Tru-Heat Control will be on sale in the first territory to be opened.

Distribution of the General Mills Iron will go forward district by district. Markets will be opened as swiftly as increasing production can make merchandise available.

Plans To speed production and distribution we are concentrating all our facilities on the manufacture of the General Mills Automatic Iron and PressureQuick Saucepan.

Other products in the General Mills Appliance family will go into production as quickly as conditions permit.

Products The General Mills Automatic Iron has features and advantages that no other iron has ever had.

The unique, scientifically shaped soleplate makes ironing easier and faster than ever before.

Its Safety Side-Rest eliminates tiresome lifting . . . minimizes the danger of tipping the iron off the board.

Tests prove that its exclusive, patented Tru-Heat Control holds temperatures with amazing accuracy . . . provides uniform heat throughout the whole ironing process.

The General Mills PressureQuick Saucepan is different from any other pressure cooking device.

Its automatic features make pressure cooking simpler, faster and safer than ever before.

The Magic Metal Cover automatically vents air from the saucepan and then automatically seals it when cooking conditions are correct.

The exclusive Cookminder Control gives users the convenience and simplicity of a single over-all control for the cooking process.

Other products now in various stages of testing and tooling will also have unusual and practical advantages for users . . . plus potent sales appeal.

Policies General Mills Home Appliances will be distributed to retail trade through wholesale channels.

It is the stated and unswerving policy of General Mills to build only appliances that make a constructive contribution to the industry, the trade and to the public.

General Mills 25-year policy of constructive help for homemakers gives dealers, distributors and consumers the greatest home service program in appliance history.

Betty Crocker, symbol of General Mills Home Service, America's best known and most helpful home service authority, molder of homemaking habits in millions of American homes, actively sponsors General Mills Home Appliances.

A policy of aggressive continuing support for good products has already made General Mills America's sixth largest national advertiser.

The same vigorous policy, plus years of successful advertising, merchandising and selling experience will support General Mills Home Appliances.

General Mills advertising policy is the guide to all advertising for General Mills Home Appliances. It states:

1. That General Mills advertising shall be factual, informative and educational.
2. It shall render the maximum of helpful service.
3. It shall attempt to expand markets rather than merely to take business from competitors.



**General Mills
Home Appliances**

BETTY CROCKER IS A REGISTERED TRADE MARK OF GENERAL MILLS, INC.

GENERAL MILLS, INC., HOME APPLIANCE DEPARTMENT • MINNEAPOLIS 13, MINNESOTA

New Methods of Demonstration

Future Policy of Presenting Radios, FM Receivers and Electrical Appliances Should Combine Best Features of Display in Store and Actual Trial in Home.

● It is necessary to set up a policy concerning demonstrations. They are your most powerful sales tools because actions speak louder than words. People buy appliances because of what they will do for them. They buy radios because of the entertainment and information which they will bring.

Without demonstrations you and your salesmen are limited to words. People may not believe your promises, but seeing is believing.

Invite active customer participation in every demonstration possible. People like to be invited to try an appliance or radio to see how easy it is to operate.

Home Atmosphere

It is extremely important for your sales staff to handle merchandise with care during a demonstration. Careless handling destroys interest. Careful handling does much to increase the value of appliances in the minds of the customers. Value thus helps to avert the obstacle of price.

Every demonstration should have a single aim—to help Mrs. Smith visualize her own use of the appliance or radio in her own home. This means that the entire atmosphere around the demonstration should be as close to that in the customer's home as possible.

Actual Trial Basis

In past years many dealers have capitalized upon this fact about demonstrations to make actual demonstrations in their prospective customers' homes. These demonstrations have taken various forms.

Outside salesmen operating either through crews or from house to

house have offered home trials for appliances and radio sets without requiring down payments.

Some dealers carried this method to the point of having the merchandise in a truck rather than in the store. When the outside salesman who operated in a radius around the truck found someone who was willing to admit a radio or appliance into her home on trial he went back to the truck, obtained the merchandise, and delivered it on the spot.

This method has been used under many circumstances and in many areas. The salesmen spent their time trying to sell the customer the idea of allowing a demonstration rather than trying to sell the merchandise itself.

Failures High

Naturally under such conditions the percentage of people who decide not to keep a radio or appliance is high. Some families after having accepted home demonstrations on one make of product decide to ask other dealers also to send merchandise out on trial. Families have thereby been able to use the product of each of several dealers for a period of perhaps many days.

Under these conditions it has been common for the number of returns of home demonstrators to be high. It has also been common for customers who did not return such merchandise to say to the salesman when he called to close the sale, "I will take this make radio or appliance. Now take this one back and send me a new one right out of the crate!"

There is no doubt that people will always enjoy having demonstra-



To change a woman from a "suspect" into a prospect, get her to operate the electrical appliance.

tions at home where they can watch the product in use at their own leisure, and in comfort. Many salesmen, too, prefer to operate in this way because it gives them an opportunity to make the sale under conditions of far less strain than when people are in the store. The salesman in a prospect's home is never afraid of having a prospect walk out on him.

Reducing Costs

The general opinion of radio-appliance proprietors is that home demonstrations are a wasteful way of selling. Most dealers have adopted a policy of refusing to deliver sets or appliances to the home on trial.

Under this method a dealer will of course send out a radio or appliance actually on a trial basis in that he will allow customers to come back to the store and arrange to substitute a new appliance or radio if the other one doesn't work out to the patron's satisfaction.

The big difference between this and an actual home trial demonstration is that the dealer insists in every case on getting the deposit first. This largely eliminates the situation where customers can have two or three sets or appliances at home on trial, since few people will care to pay multiple deposits to accomplish this. Dealers feel that this system was a vicious one and it not only resulted in much damage to merchandise but also was actually

(Continued on page 106)

Dealers Will Soon BUY



No matter how busy you may be, set aside enough time to listen to each sales proposition offered you. In buying merchandise, the habit of maintaining an open mind will pay you well.

• The era of scarcity will pass, perhaps forever. Radio and electrical appliance dealers are slowly emerging from the four years of merchandising famine that started back in the middle of 1942.

Buying has been a lost art. *Begging* has taken its place. But there are signs which indicate a return to normal buying caution on the part of leading dealers.

As you emerge from the period when you have engaged in a mad scramble to get any and all radios and electrical appliances into your store, you will want to evaluate and form a sound buying policy. There are certain fundamental rules of buying which it is to your advantage to review.

Avoid Speculation

First, you may well consider the amount of merchandise you now have in your store. You need ample stocks to achieve the mass displays which sell most goods. But it is easy for you to get too much merchandise once it starts rolling in.

When you are in a period of firm prices, you need to buy in advance.

However, advance buying beyond a certain point is pure speculation. Stop short of the point where a sudden unexpected drop in prices would cause you financial embarrassment.

Side-step "Orphans"

Even though prices do not fall, piling up of merchandise beyond a certain point ties up your investment needlessly and reduces your stock turn. This is a highly important angle for you to consider now, because in general your trade discounts are lower than they were before the war.

As merchandise becomes more plentiful, you can scrutinize with care the lines you have. Some of them will be outmoded by new inventions.

Many of the original postwar models constitute minor improvements over pre-war models. You cannot afford to gamble that additional improvements will not be made.

The technological advances made in production during the war will be reflected in changes in many of

Rules of Purchasing Again Important Selection Is Affected by Changes in

the products sold to the public during the next few postwar years. The extent to which these new inventions will supplement and the extent to which they will supplant previous products has not yet been fully determined.

Some of the products you took in immediately after the war ended were from companies new to you, whose policies you were unfamiliar with. Perhaps some of these companies gave you little or no advertising or merchandising support.

If you yourself have become thoroughly sold on a product it may be possible for you to build a business on it even though it is not widely advertised. You should, however, recognize the value and power of advertising. In your appraisal of a product consider not only the intrinsic value of the product itself but also the soundness of the merchandising policies with which the manufacturer is promoting the product.

You have had an opportunity to study the reactions of your customers to the products you handle. As the first bloom of great need subsides, people will become more and more critical of inherent defects in the products you are selling. Be alert to notice these attitudes.

Study Customer Wants

Scrutinize your stocks of major appliances. Learn what features your customers prefer. Make sure either that you have products in stock with these features or that you have powerful sales reasons why the features you have are definitely superior.

Electrical Appliances

Transition from "Begging" Takes Place.

...e, Technology and Customer Wants

Some of your customers will want refrigerators with freezing units, or will want separate freezers. Your line should include such appliances.

Study your stock of electric ranges. Do they have the things that most of your customers may want, such as thermostat control, a section to warm dishes or a light in the oven? Are you in a home garden community where you should stock a line of ranges that have an attachment for dehydrating vegetables?

Consider your washing machines. Your customers may prefer the fully automatic type, the wringer type or the spinner type. Do you have a stock of washers that will permit them to exercise their preferences?

Sources of Information

Take a birds-eye look at your radio stock as a whole. Make up your own tabulation of types of radios to be sure that your stock is giving your customers an opportunity to buy what they really want. Have you an ample stock of radios with short-wave? How many of your customers want push-button tuning and do you have ample stock of radios with FM?

In addition to studying your customer's likes and dislikes, there is another excellent basis for establishing a forecast of what you can sell. This is by setting up inventory control records.

The advantage of using records as a buying guide is that they provide a precise measure of what has been sold. The disadvantage of relying on them solely is that they do not reveal the reasons why a product has sold or has not sold. As long as your customers can talk and you can listen, there is no better way than asking to determine what they want.

Another kind of information you can use to aid your buying task is that which relates to the available sources of supply. Competition is such in this field that relatively few dealers feel content to assume that their present suppliers will necessarily have every product they might want to stock. Successful dealers are willing to listen to every proposition.

The salesmen who call on you have a great deal of valuable information. Get into the habit of using them instead of abusing them.

price is the only important factor.

It is possible that you may join with other dealers in forming a buying association to purchase goods at lower prices. If you can depend on the other members, you may be able to effect important savings in the purchase of some products.

You can make money by buying as well as by selling. This does not mean, however, that you should buy on price alone. It is legitimate and worthwhile for you to be known

FACTORS IN BUYING

- Anticipated changes in price of merchandise.
- Technological changes in forthcoming models.
- Merchandising policies of manufacturers.
- Customer preferences for various features.
- Margin offered on merchandise by suppliers.

in the trade as a dealer who has the inclination and the resources to pick up desirable goods at distress prices. It is quite another thing to match your wits against every salesman who comes in by beating him down on any proposition submitted to you.

Always bear in mind that the price you pay is relative. It is important only in terms of the selling price and the resulting margins from which you make your profits. Therefore, buy only to sell.

It will pay you well. The best salesmen are inveterate gossips and you can learn much by listening to them.

As competition among suppliers returns, you will naturally begin to consider a factor which for years has had no place in your buying policies—price. It is easy for a poor buyer to swing to the other end of the pendulum, and consider that

Refrigerators ★
 ★ Washers
 Ironers ★
 ★ Ranges
 Vacuum Cleaners ★
 ★ Food Freezers

New Electrical

Kelvinator HOME FREEZER

6 cu. ft. model, powered by sealed Polarsphere unit. One-piece welded exterior seals cabinet against moisture and heat. 4" insulation for walls and bottom; 2½" insulation in lid; balloon-type gasket keeps cold in and heat out. Interior divided into two sections

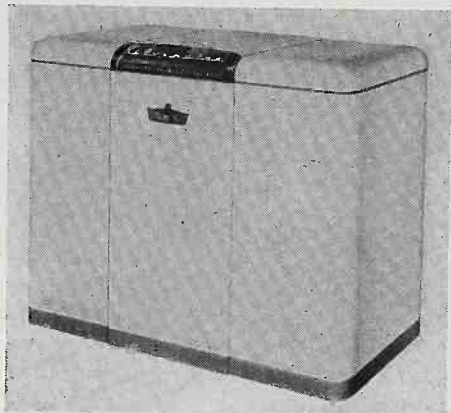

by removable metal grid; quick-freezing compartment. Cabinet is 6.04 cu. ft. in size, with a capacity of more than 210 lbs. Dimensions: 36" high, 39" wide, 23" deep. Finished in white, with chrome and grey trim. Price expected to be "approximately the same as average good household refrigerator." Kelvinator Div., Nash-Kelvinator Corp., Detroit 32, Mich.—RADIO & Television RETAILING

Faraday PLUGMASTER

Cord set with self-adjusting jaws to fit all appliances. Comes with 6 ft. cord.



Faraday Electric Corp., Adrian, Mich.—RADIO & Television RETAILING

Westinghouse HOME COOLING UNIT

Approximately size of average refrigerator, "climate cabinet" fits alongside forced air heating or winter air conditioning unit so that all air passes through cooling chamber before being distributed to rooms. Three-row cooling

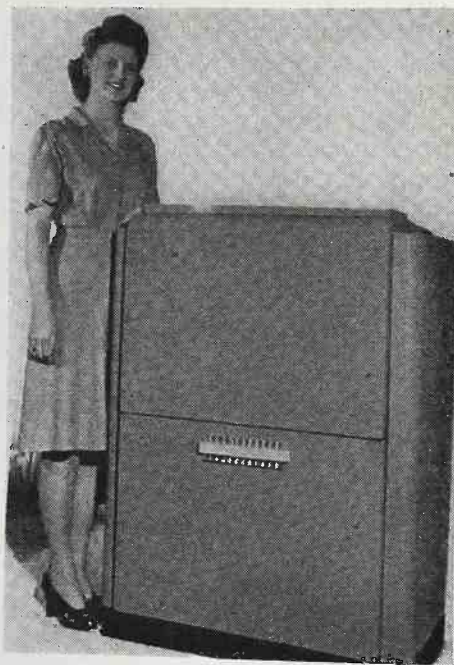

coil for dehumidification as well as cooling. Operation of refrigerant compressor is automatic. Price to depend on new production cost factors, but manufacturers guess cost to be approximately \$350 to \$400. Home cooling unit planned will serve a home with six to eight rooms effectively. B. F. Sturtevant Co., Division of Westinghouse Electric Corp., Hyde Park, Boston 36, Mass.—RADIO & Television RETAILING

Cadillac VACUUM CLEANERS

Model 143-A motor-driven brush. Equipped with removable, adjustable, reversible rotating brush; 2-speed motor. Floor light with independent switch. Automatic tilt device eliminates bending. Nap adjustment for use on rugs and carpets of varying depths. Finished in two tone Hammerloid tan. Priced at \$59.95.

Model 300, cylinder type cleaner, with attachments. Re-inforced hose with bayonet locking device for attaching into cylinder. 2-piece tubular extension

wand; extra wide floor nozzle swiveled for easy operation; bare floor brush with swivel connection; dusting tool; upholstery nozzle; flat crevice tool for

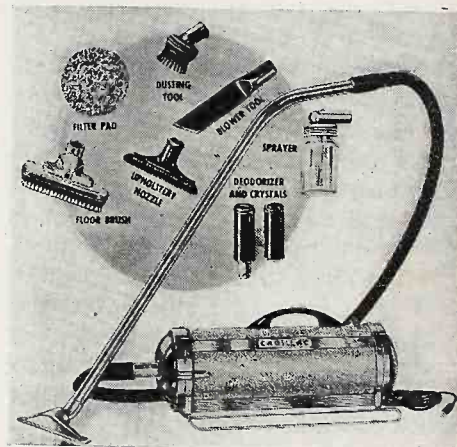
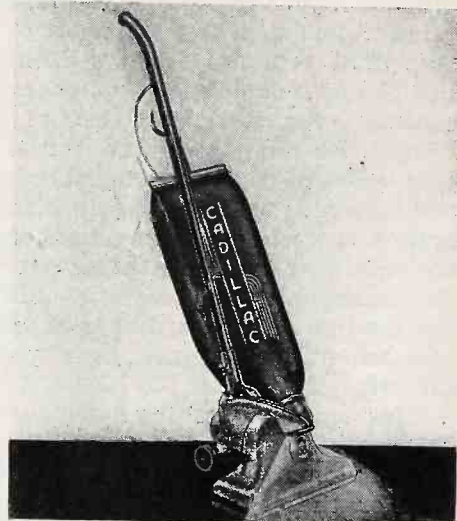

hard-to-get-at places; sprayer; deodorizing attachment. Priced at \$59.95 complete. Clements Mfg. Co., 6650 S. Narragansett Ave., Chicago 38, Ill.—RADIO & Television RETAILING

American Central DISHWASHER

Automatic dishwasher with capacity of sixty pieces of china, glassware, and silver. Installed in 48" cabinet sink unit, adjacent to the sink bowl. Automatic operating cycle consists of preliminary spray, washing cycle, first rinse, second rinse, and drying cycle. Motor, water inlet, drain valve, and detergent dispenser operated by automatic electric

Appliance Products

★ Toasters
★ Roasters
★ Hand Irons
★ Mixers
★ Clocks
★ Coffee Makers

control. Dishwasher has plastic impellor for high speed water action. Dishwasher cover designed as drainboard for sink

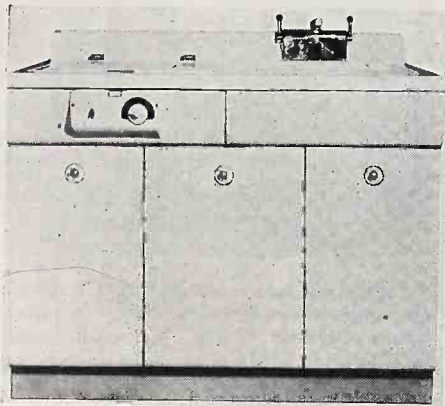

bowl. American Central Mfg. Corp., Connersville, Ind.—RADIO & Television RETAILING

Vogue STOVE

Model B-115A, brewer, tray-type stove. Constructed of chrome, with 6½" circular tray-base; bakelite handles. High and low heat plug. Sheridan Electronics Corp., 2850 S. Michigan Ave., Chicago 16, Ill.—RADIO & Television RETAILING

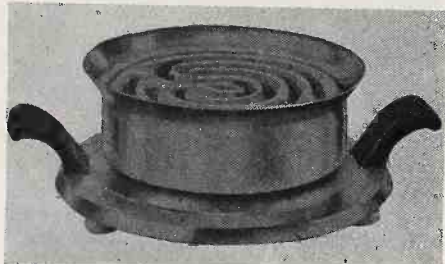

Model B-115A, brewer, tray-type stove. Constructed of chrome, with 6½" circular tray-base; bakelite handles. High and low heat plug. Sheridan Electronics Corp., 2850 S. Michigan Ave., Chicago 16, Ill.—RADIO & Television RETAILING

designed as a furniture piece. Hand sanded and hand rubbed cabinet. Panel on left is hinged and opens out to provide extra space; contains 6-spool pins for thread and sewing accessories.

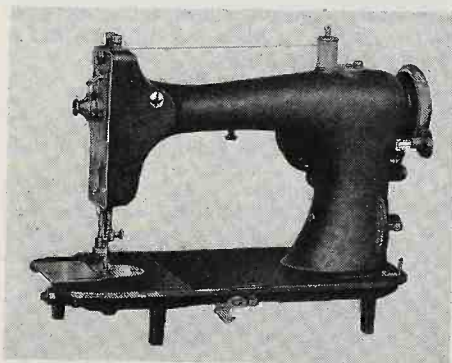

Dimensions: 22" x 16¼" x 20". Cabinet can be furnished with Rotary B or R40 head. Also available in blonde mahogany. National Sewing Machine Co., Belvidere, Ill.—RADIO & Television RETAILING

ing oven with two shelves available as an extra. Dimensions: 22¼" long, 15¾" deep, 7" high. Wattage 1650, ac

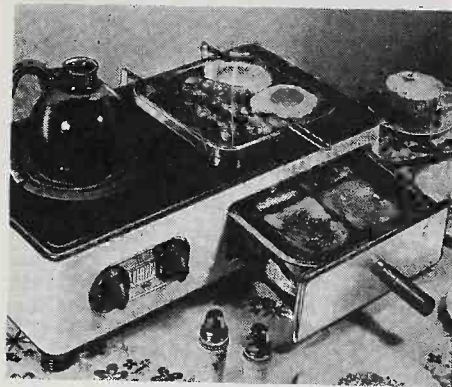

only. (Model No. 821 for ac-dc operation.) Swartzbaugh Mfg. Co., Toledo, Ohio—RADIO & Television RETAILING

Coolstream WATER COOLER

Electric bottle-type water cooler with enclosed and refrigerated bottle. One-piece stainless steel cabinet and top;

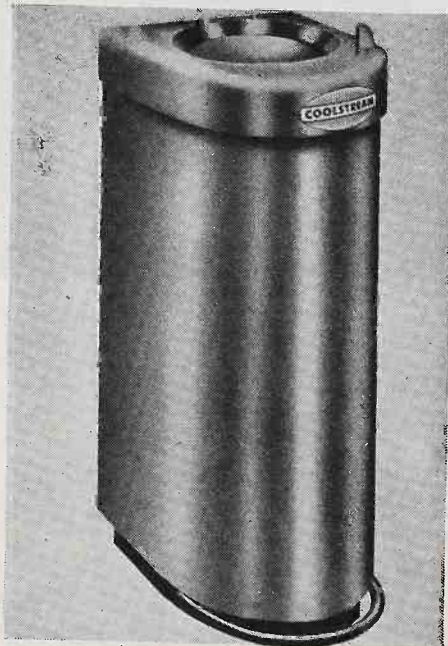

removable; foot pedal can be operated from sides or front. Coolstream Corp., 55 W. 42nd St., New York 18, N. Y.—RADIO & Television RETAILING

(Continued on page 54)

National SEWING MACHINES

Model R40 Rotary sewing head with reverse movement. Features: streamlined head contour; non-clogging mechanism designed to sew either forward or backward; improved feed mechanism; range of stitches from 6 to 20 to the inch; sewing light built into rear of arm; air-cooled motor for operation on dc or ac current; speed regulated by knee control on consoles and foot control on portables.

Model No. 1428, brown mahogany, is in the Swedish modern style, and is

Everhot RANGETTE

Model No. 820. Porcelain enameled top deck; white baked enamel body. Hinged and removable griddle on square burner. Removable pan with two-position broiler rack in oven drawer. Two red 3-heat switches with interlocking mechanism. Baffle or reducing plate for square burner. Attached heater cord. Roasting and bak-

Electrical Appliances

Everhot HEATER

Model No. 815 ray-vector heater. Features foot-pedal damper control which converts heater from radiant to circulating type; long heat rays; foot operation for on-off switch; 40 chrome reflecting surfaces; safety switch to

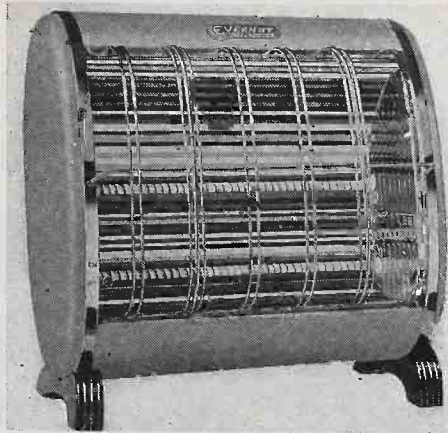

turn current off if heater is tipped over. Dimensions; 15 1/4" high, 16" wide, 9" deep. Wattage 1320, ac only. (Other models available in dc.) Finished in blue grey with blue feet and chrome trim. Swartzbaugh Mfg. Co., Toledo, Ohio—RADIO & Television RETAILING

Vogue KITCHENETTE

Model C-15B, kitchenette combination consisting of tray base; 2-heat and single heat stove; 2-slice toaster finished in chrome; quart double-boiler of glass

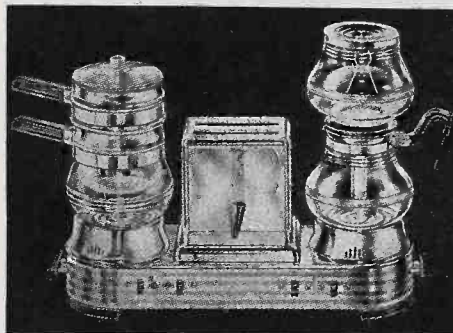

reinforced with stainless steel, and with black plastic handle; 8-cup coffee brewer. Overall size 7 x 20 inches. Sheridan Electronics Corp., 2850 S. Michigan Ave., Chicago 16, Ill.—RADIO & Television RETAILING

Blue Flash FROZEN FOOD REFRIGERATOR

Model R-D, provides 9 1/2 cu. ft. of storage space; one shallow, one deep compartment with lift-out baskets available. Refrigeration coils on sides and bottom of compartments; cabinet insulation 5" thick; heavy gauge rust-proof construction; 1/4 H.P. twin cylinder compressor unit. Covers finished in dark blue high-baked enamel to match base;

body is white. Dimensions: 60 13/16" long, 27 11/16" wide, 39 3/8" high. The

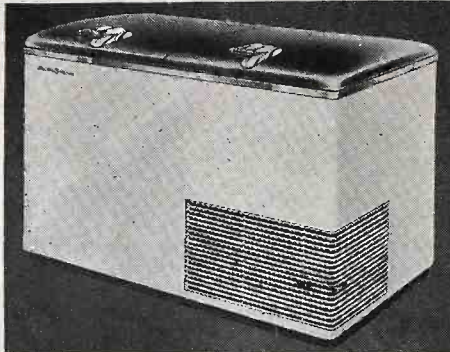

Brunswick-Balke-Collender Co., 623 So. Wabash Ave., Chicago 5, Ill.—RADIO & Television RETAILING

Coldaire FOOD CHEST

3 cu. ft. home freezer designed for average urban family, for use in kitchen. Features flush counter balance lid, table-top height and recessed base.

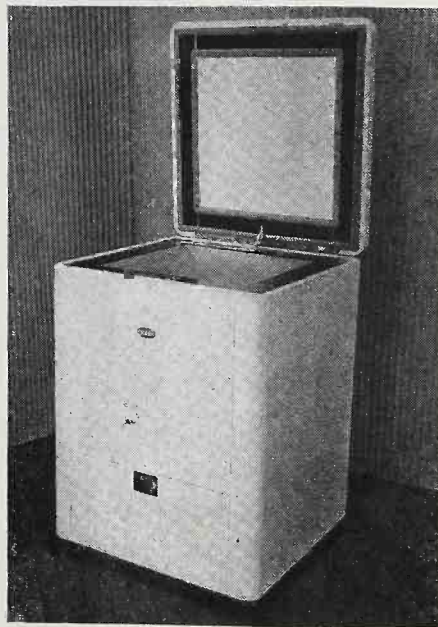

Capacity, 120 lbs. frozen food. List price of cabinet is \$195, F.O.B. Philadelphia. Coldaire Corp., 56 E. Walton Place, Chicago 11, Ill.—RADIO & Television RETAILING

Westinghouse PRECIPITRON

Precipitron home central unit designed to remove dust particles in the air, and help eliminate dusting chores. Can be installed in connection with air duct work of a central warm air heating system or a regular air conditioning system. Dust particles in the flow of air entering the Precipitron pass through a "fence" of highly charged electric wires which impart positive electric charges. Particles are drawn to plates, and clean air distributed throughout the house. Dirt is retained

on the plates until flushed down a drain with water. This is accomplished by pulling handle on unit. Price un-



determined, but manufacturers guess at approximately \$250 to \$300. Westinghouse Electric Corp., Mansfield, Ohio—RADIO & Television RETAILING

Kent ELECTRIC STOVE

All-purpose electric hot plate made of plastic, bakelite base, chrome plated heating unit. Complete with 6 ft. elec-



tric cord, stove is priced at \$4 including federal excise tax. Kent Products Co., 222 W. Monroe St., Chicago 6, Ill.—RADIO & Television RETAILING

Hollywood TABLE BROILER

No. 38T hand-hammered cast aluminum electric broiler. 2-heat model. Scientifically constructed top, retains

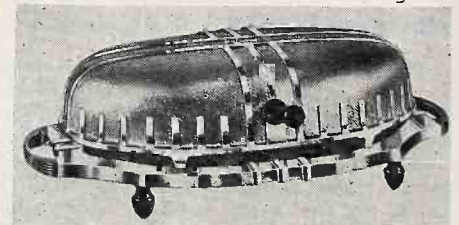

heat; safety hinge for removal of top. Element removable for cleaning. Dimensions: 18 x 10 1/2 x 6 inches. Finders Mfg. Co., 3669 So. Michigan Ave., Chicago 15, Ill.—RADIO & Television RETAILING

for the Merchant

GE Select-O-Switch

Model 8H-58, timer clock, to serve as time control for electrical appliances. Turns appliances on and off for pre-selected intervals over 12 hour period. Mottled chestnut plastic case; dark ma-

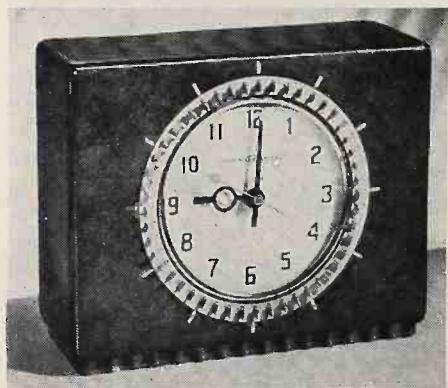

room numerals. Self-starting. Dimensions: 6 1/2" wide, 5 3/16" high, 2 3/4" deep. Priced at \$9.95, excluding tax. General Electric Co., 1285 Boston Ave., Bridgeport, Conn.—RADIO & Television RETAILING

Eskimo MIXER, JUICER

Model No. 560, finished in white enamel. Features: extra powerful motor, detachable and portable beaters; easy to clean; bakelite plastic handles for



easy grip; hinged motors and 2-position turntable permit beaters to be tilted back; varying speeds; juicer detachable. Complete with two glass bowls. \$24.66. Bersted Manufacturing Co., Fostoria, Ohio.—RADIO & Television RETAILING

for freezing. Walls and bottoms have 5" insulation of moisture proofed, low density insulation board and glass wool to permit positive cabinet sealing by

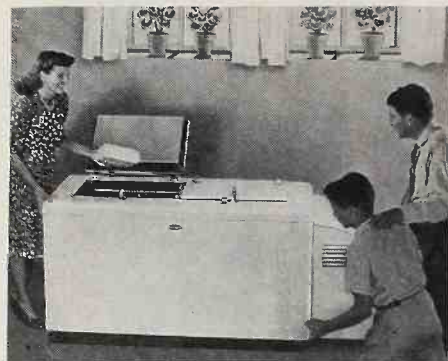

means of hot "Korite" sealer. For use on 60-cycle 110 volt socket. Dimensions: 81 1/2" wide, 27 1/4" deep, 38" high. Sanitary Refrigerator Co., Fond Du Lac, Wis.—RADIO & Television RETAILING

Wilson HOME FREEZER

Hi-Boy reach-in type home freezer, net capacity 6.3 cu. ft. Reach-in door of all-steel warp-proof construction, with semi-rigid fibreglas 3" insulation; 4" semi-rigid fibreglas used inside

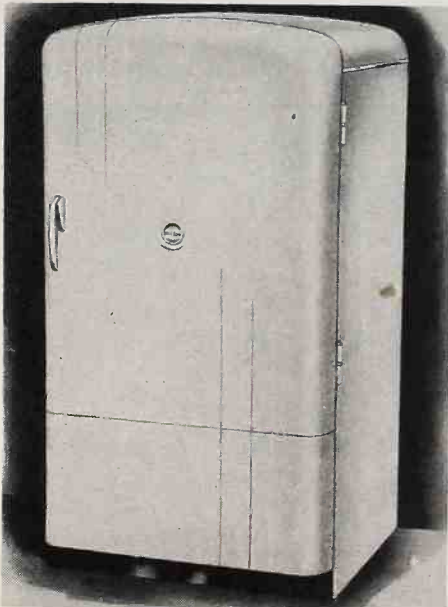

walls and top. Equipped with a Marsh recalibrator thermometer located in the front door panel. Condensing unit. Has removable compartment door. Dimensions: 58" high, 30" wide, 29 5/32" deep. Wilson Refrigeration, Inc., Div. of Wilson Cabinet Co., Smyrna, Del.—RADIO & Television RETAILING

Westclox ALARM CLOCK

"Logan" self-starting electric alarm clock. Two-tone dial, outline numerals and sweep second hand. Bell alarm. Current interruption signal reset by

tilting clock backwards while current is on. Rubber mounted movement. Lacquered metal case, ivory finish with gold trim. 4 3/4" square. Priced at \$4.95

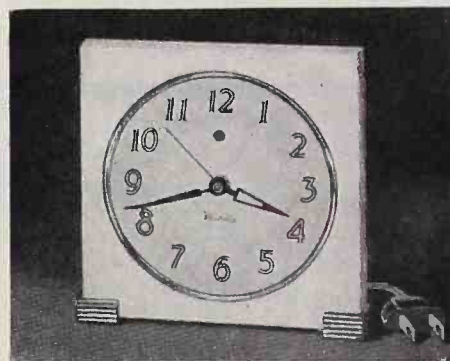

with plain dial; \$6.50 for luminous dial. Westclox Div., General Time Instruments Corp., LaSalle, Ill.—RADIO & Television RETAILING

Norge FREEZER

Home and farm freezer with 18 1/2 cu. ft. capacity. Has three compartments. Adaptable for use in city, suburban and farm homes. Suitable for freezing and

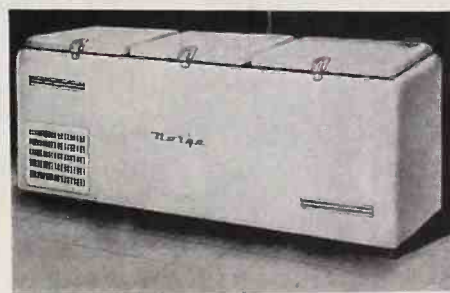

storage. Powered with 1/3 H.P. open type, condensing unit. Norge Div., Borg-Warner Corp., 670 E. Woodbridge, Detroit, Mich.—RADIO & Television RETAILING

Faraday BROILMASTER

Can be used directly on top of regulation pan, or in upright model, for boiling, toasting, and frying. Plugs into



regular 110 volt house current. Faraday Electric Corp., Adrian, Mich.—RADIO & Television RETAILING

(Continued on page 56)

Sanitary FARM LOCKER PLANTS

Model 1245, has total net capacity of 12.5 cu. ft. Finished in high baked exterior. Interior freezer plate arrangement provides separate compartment

New Electrical Items

Williams WINTER AIR CONDITIONER

Model 10, Oil-O-Matic winter air conditioner unit. Automatic oil heating, plus filtering, humidifying and circulation of warmed air. Furnace features: counter

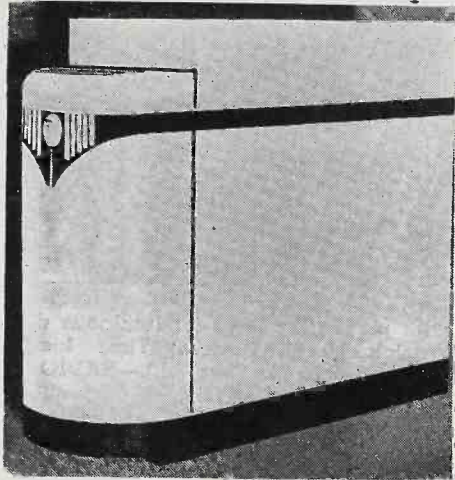

flow heat saver, one-piece gaslight heat exchanger, lo-pressure burner, meter fuel control. Suitable for smaller and average size homes. Also available with Williams hi-pressure burner. Williams Oil-O-Matic Div., Eureka Williams Corp., Bloomington, Ill.—RADIO & Television RETAILING

Stedi-Glo ELECTRIC HEATER

Model C1, radiating type electric heater. OPA price including federal excise tax, \$6.95. Constructed of heavy gauge steel, engineered for maximum

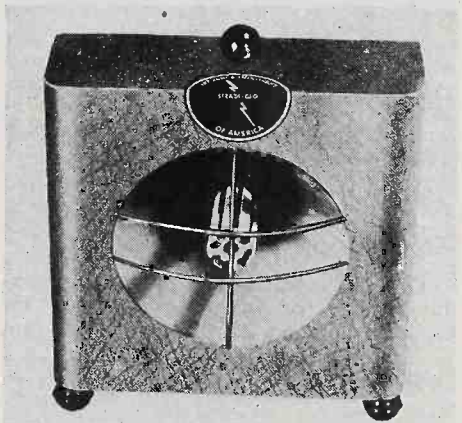

efficiency in streamlined design. Stainless steel reflector; finished in brown baked enamel. Heater comes complete with cord; for use on ac and dc current. Appliance Industries of America, 666 North Lake Shore Drive, Chicago 11, Ill.—RADIO & Television RETAILING

Atlas GENERATOR

Lightweight, portable gasoline engine driven dc generator unit, series "E". Can be used as a portable or

fixed lighting plant, in conjunction with suitable batteries, for farms and cottages, or as emergency equipment. Standard equipment includes oil bath

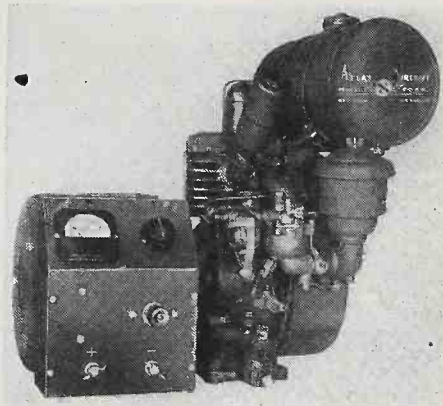

air cleaner, gasoline filter, high tension flywheel magneto, gasoline tank, push button operated electric circuit for battery starting, additional special equipment available. Atlas Aircraft Products Corp., 40 E. 42nd St., New York, N. Y.—RADIO & Television RETAILING

Amana HOME FREEZER

Model 30-R home freezer and frozen food storage cabinet, 30 cu. ft. capacity; occupies floor space 46" x 29". Heavy duty super-powered compressor with 1/2 H.P. single phase motor, 60 cycle. Compressor furnished separately for re-

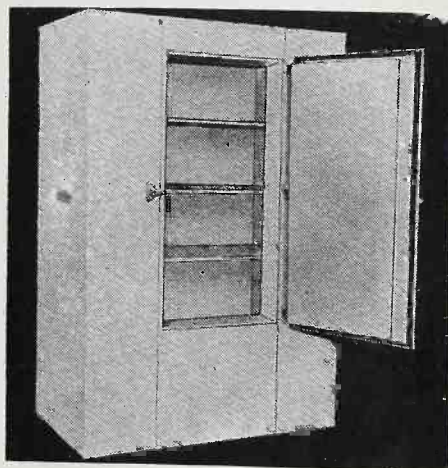

note installation. Cooling coils consist of 4 freezer plates with hold over solution, spaced as shelves for contact freezing. Exterior is steel in grey or white enamel. OPA approved price, \$695. Amana Society, Refrigeration Div., Amana, Iowa—RADIO & Television RETAILING

Lowell MOTH SPRAYER

Thoro-spray electric moth sprayer with special adjustable spray-head providing saturating, fine spray for killing insects. 34 oz. glass jar holds spray. Adjustable shoulder-strap for comfortable carrying while in use. Sprayer weighs 8 lbs. Ten ft. of special rubber-

insulated cord with shock-resistant rubber plug. Finger-tip switch; ac or dc

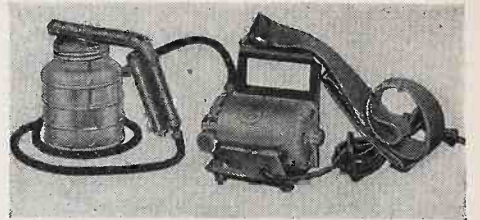

universal motor. \$27.25 complete, F.O.B. Chicago. Lowell Mfg. Co., 589 E. Illinois St., Chicago 11, Ill.—RADIO & Television RETAILING

Edwards DOOR CHIMES

Polished chrome shield flanked on either side by white resonators. Sonoscope tested tone bars. Overall dimen-

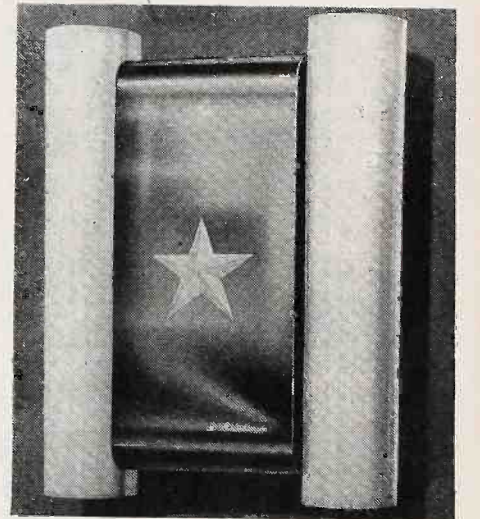

sions: 7 3/4" high, 6" wide, 2 1/4" deep. Priced at \$4.95. Edwards & Co., Norwalk, Conn.—RADIO & Television RETAILING

Hydro-Aire HEATER

Reflector type electric heater, designed to give maximum with minimum economy. Built of steel. Dimensions:



12" high, 17" long, 10" deep. 1320 watts, ac or dc. Hydro-Air Co., 626 N. Robertson Blvd., Los Angeles 46, Cal.—RADIO & Television RETAILING

(Continued on page 58)

seeing is believing

say these 25,003,334 Home Demonstrators

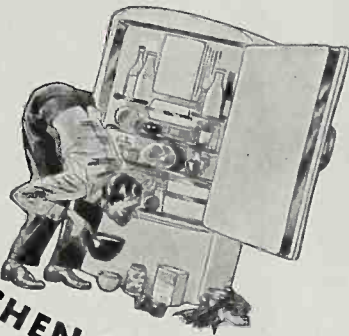

WHY BE A KITCHEN CONTORTIONIST?
Why perform double-bends and twists
to reach back-row foods?

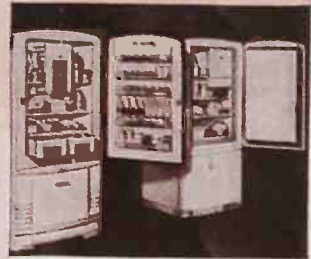

COMPARE a Crosley with any other refrigerator and notice the one important difference — the Crosley Shelvador* puts twice as much food to the front, within easy reach.



OPENING the Shelvador* is like opening the doors of two ordinary refrigerators — double convenience — only half the chance of tipping and spilling.

A FEATURE anyone can SEE—and understand—that's the utterly distinctive and exclusive Crosley Shelvador*. It's so simple and practical that these millions of in-the-home demonstrators are pre-selling countless prospects and sending them to the stores of Crosley dealers for the final clincher—a look at the Crosley Shelvador* itself.

No one could ask for more in beauty, in quality of materials, skilled workmanship and modern improvements than the Shelvador* offers—and ONLY Shelvador* has that completely unique advantage of bringing twice as much food into front-shelf space, within easy reach. Note the pictures and captions (right) appearing in Crosley national advertising.

*REG. U. S. PAT. OFF.

AMONG WISE DEALERS THE WORD IS SPREADING

CROSLEY HAS IT!

CROSLEY

THE CROSLEY CORPORATION, CINCINNATI 25, OHIO



RANGES



HOME FREEZERS



LAUNDRY EQUIPMENT



KITCHEN SINKS AND CABINETS



RADIOS AND COMBINATIONS

Refrigerators • Home Freezers • Kitchen Sinks and Cabinets • Ranges • Laundry Equipment • Radios • Radio-Phonographs • FM • Television • Short Wave • Electronics • Radar • Home of WLW—"The Nation's Station"



SAVE TIME, too, because there's 10 square feet of front row food exposed. Shelvador* is closed sooner—saving electricity.

Electrical Appliance

Meier NU-AIR FILT-R-FAN

Filtered-air unit, can be adjusted for use in any standard size window frame. Rests on window ledge, plugs into light

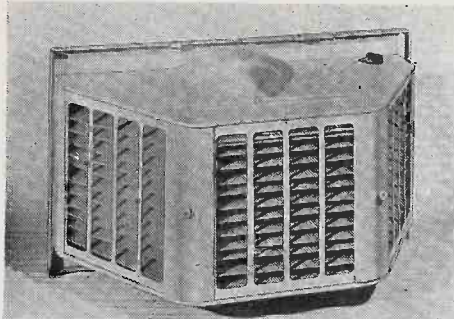

socket, and turns on or off like an electric light. Equipped with three removable filters. Priced in accordance with O.P.A. ceiling at \$49.07 retail. Meier Electric & Machine Co., 3525 E. Washington St., Indianapolis 7, Ind.—RADIO & Television RETAILING

Thermador WATER HEATER

Electric water heater with heavy gauge steel shell, rustproof on the inside. Finished in white baked enamel with black trim. 3" insulation. Double pole, snap acting thermostat. Available

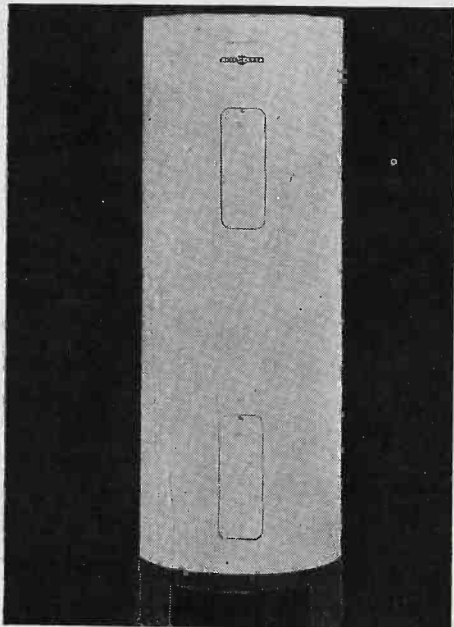

in the "lifetime" model, with a pure monel metal tank, or in the "utility" model, with a galvanized copper bearing steel tank. Legs are removable. Thermador Electric Mfg. Co., 5119 S. Riverside Dr., Los Angeles, Cal.—RADIO & Television RETAILING

Beautiafor ELECTRICAL MANICURIST

Five attachments come with this ivory plastic electrical manicuring set; all attachments can be changed without stop-

ping the motor. Included are: emery file, cuticle wand, cuticle whisk for removing dead cuticle, oil and dry buffer.



Dimensions: 4 1/2" high x 4 1/4" wide. Beautiafor Corp., 8800 Woodland Ave., Cleveland, Ohio.—RADIO & Television RETAILING

GE PORTABLE HEATER

Model PH1A1; heater of radiant convection type. Styled in a semi-circular design with polished metal reflector

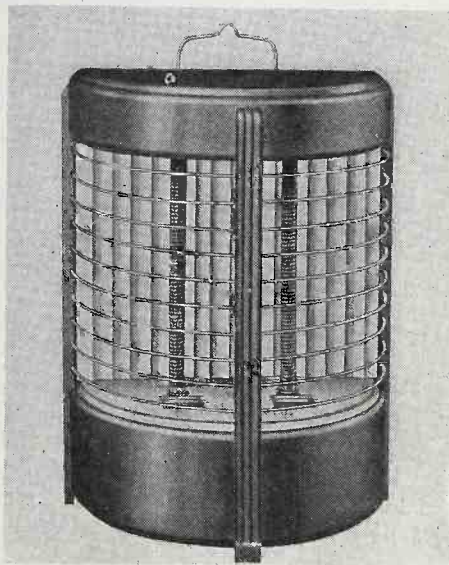

and grey "hammered" exterior finish. Long-life heating unit of nickel-chromium. Cool, convenient handle. General Electric Co., 1285 Boston Ave., Bridgeport 2, Conn.—RADIO & Television RETAILING

Arvin IRONING TABLE

All-metal ironing table with perforated top for evaporation of steam and moisture. Weighs less than 17 1/2 lbs.; cross-braced understructure; tubular, easy-to-fold frame; rubber feet; hangs on wall or closet door from either end.

White baked enamel top, black framework. Dimensions: Top 15" x 54"; height



from floor 32". Noblitt-Sparks Industries, Inc., Columbus, Ind.—RADIO & Television RETAILING

Whirlpool AUTOMATIC WASHER

Whirlmatic automatic washer washes, rinses, and damp dries. Model has one dial setting; top-hatch opening; does not require bolting to floor. Mechan-

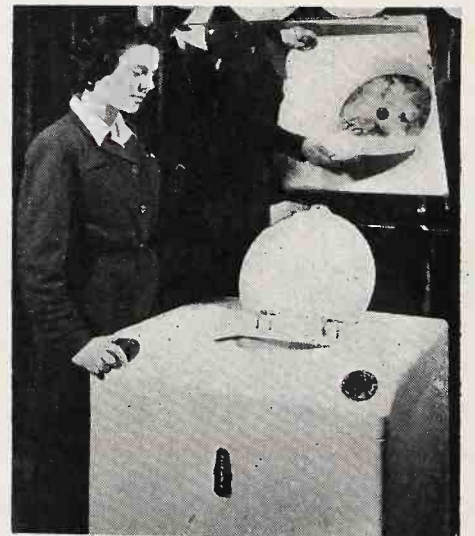

ism designed so that the washing processes can be started or stopped at any point, without the necessity of beginning the cycle anew. Nineteen Hundred Corp., St. Joseph, Mich.—RADIO & Television RETAILING

Models Announced

Knapp-Monarch INFRA-RED LAMP

Portable infra-red unit for relieving muscular aches, pains etc. Patented diffusing disc focuses concentrated



heat: highly polished bowl; wired safety guard. Off-on switch in base. 300 watts. Knapp-Monarch Co., 3501 Bart Ave., St. Louis, Mo.—RADIO & Television RETAILING

Roto Beam AIR CIRCULATOR

Has revolving blades which causes two-way pulsating movement of air within room, resulting in complete circulation of air at all levels. Available in industrial and home sizes. This prin-

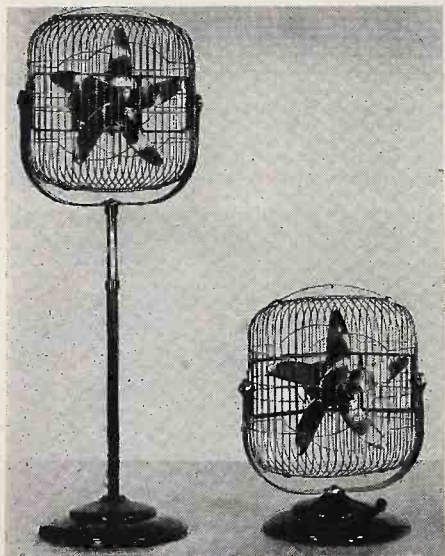

ciple of air circulation, manufacturers say, is adaptable to circulating heated room air in winter as well as cooling in summer. Climax Industries, 1901 So. Western Ave., Chicago 8, Ill.—RADIO & Television RETAILING

Youngstown Kitchen CABINET

"Rolling Door" cabinet, designed to fit under regular wall cabinet and provide extra storage space for small items. Two shelves for storage space for small



articles. Made of white enameled steel; door made of burnished steel strips which slide up and back; door stays open or closed without catches. Cabinet made in 18 and 24 inch widths. Mullins Mfg. Corp., Warren, Ohio.—RADIO & Television RETAILING

Onan ELECTRIC GENERATING PLANT

Models W2M-W2S, 115-volt, 60-cycle; 2000 watts a.c. Designed for continu-

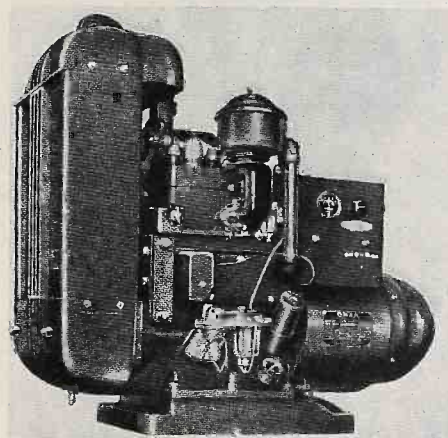

ous operation; control panel available for automatically starting and stopping the plant. D. W. Onan & Sons, 43-51 Royalston Ave., Minneapolis 5, Minn.—RADIO & Television RETAILING

Camfield FLUOR-O-SHIELD

Device for evenly diffusing fluorescent light, eliminating glare, and adding to appearance of open lamp fixtures. Stamped from one piece of aluminum, and finished in white baked enamel. Installed and removed by means of two patented snap-on clamps.

Present models may be installed on any standard 40 watt (48") and 20 watt (24") fluorescent lamp. The 48" size re-



tails at \$1.95, the 24" at \$1.00. Camfield Mfg. Co., Grand Haven, Mich.—RADIO & Television RETAILING

Schaefer PAK-A-WAY

Food cabinet features ample storage space, providing 15 cu. ft. for storage of frozen foods. Finished in white dulux. All-steel construction; hermetic

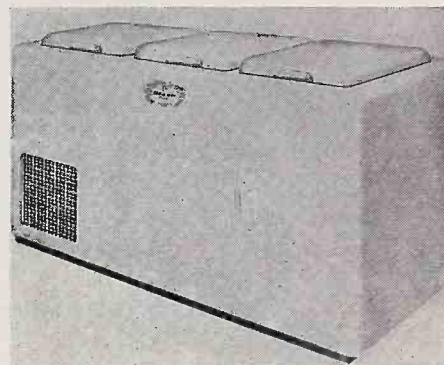

compressors; 5" insulation; dual seal lids minimize heat transfer. Schaefer, Inc., 801 Washington Ave., Minneapolis, Minn.—RADIO & Television RETAILING

Electrical Industries BOTTLE WARMER, VAPORIZER

White, with decal picture on side; heating unit with automatic shut-off. Works on ac only. Bottle warmer has



permanently attached cord; full bottle will heat in three minutes. Separate receptacle for the inhalent, with uni-vent feature permits operation as a vaporizer. Electrical Industries, 42 Summer Ave., Newark 4, N. J.—RADIO & Television RETAILING

(Continued on page 60)

New Appliances

Gilbert FOOD MIXER

16 speeds for varying uses; mixer lifts off stand for mixing or beating. Mixer bowl rotates on special ball-bearing platform. Has extra powerful motor, built-in super power outlet; swivel bracket allows beaters to swing while in motion. Rigid base. Finished



in chrome body with plastic handle. Attachments include: food chopper, can opener, grater and shredder, pea sheller and bean slicer, ice crusher, beverage mixer, flour sifter and dripper, and strainer attachment. Dimensions: 15" high, 8" wide, 12" long. A. C. Gilbert Co., New Haven, Conn.—RADIO & Television RETAILING

HomOzone OZONE GENERATOR

Model AN-2 hom ozone, domestic model; output regulator permits ozone output to be adjusted to exact amount required for individual conditions. 12" high; 4½" wide, 4½" deep. Shipping



weight 10 lbs. Prices quoted upon request to manufacturer. Automatic Electrical Devices Co., 324 E. Third St., Cincinnati, Ohio—RADIO & Television RETAILING

Miracle WAFFLE IRON

Catalog No. 230. Full size, 7" grill; expanding hinge; deep batter trough; 3-point heat indicator set into cover. Chrome finish with contrasting cool



black plastic handle and trim. Operates on either ac or dc. Size: 11½" x 9½" x 4¼". Miracle Electric Co., 36 S. State St., Chicago, Ill.—RADIO & Television RETAILING

Eskimo HAIR DRYER

Model No. 775, hair dryer. Features: extra powerful air-cooled motor; chrome-plated, highly polished finish; 3-position switch for hot, cold, and off; designed



for convenience and light weight; rubber cord and plug included. Priced at \$4.60. Bersted Manufacturing Co., Fostoria, Ohio.—RADIO & Television RETAILING

Fowler FOOD BANK

Model 20C-F. Contains three units or bins for storing of food; high resistant insulation. Holds over 6½ cu. ft. in each storage bin. Finished in various colors. Dale vacuum cold plates act as

dividers, forming compartments. Fowler Equipment Co., 626 N. Highland Ave.,

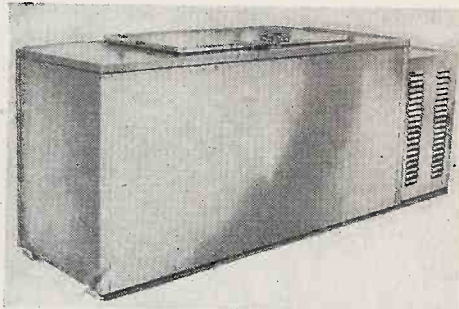

Aurora, Ill.—RADIO & Television RETAILING

Schick ELECTRIC SHAVER

No. 240, Colonel model. 2-M hollow-ground head, built of surgical steel with swaged-edged inner cutter. Powered by high-speed motor, ac or dc.



Styled in ivory plastic with ribbed grip. Built-in bronze "Whisk-Its" to catch beard clippings. List price, \$15.00. Schick Inc., Stamford, Conn.—RADIO & Television RETAILING

Sandel CIRCLINE LAMPS

Table lamp, and two floor lamps, with decorative effects achieved by use of

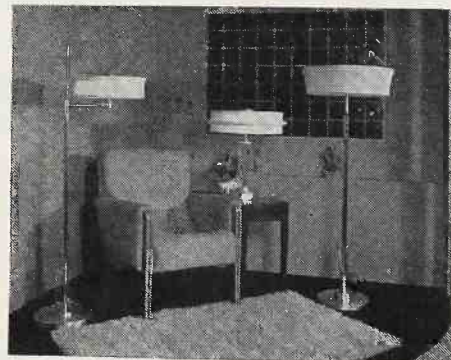

lucite. Sandel Mfg. Co., 3618-3630 So. Loomis Place, Chicago 9, Ill.—RADIO & Television RETAILING

LATEST IN RADIO MERCHANDISE ON PP. 34, 35, 36, 37, 80, 81, 90, 91.

A N N O U N C I N G

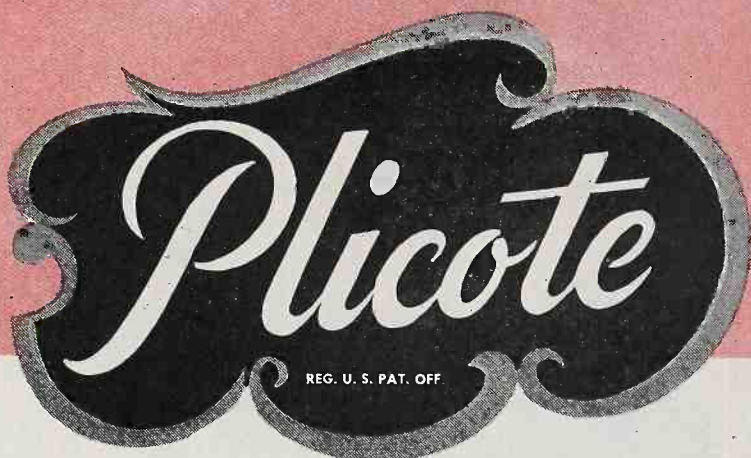

FINISHES

A POST-WAR PRODUCT

For consumer use, now, for the first time . . . these exceptional finishes!

Created by one of America's largest manufacturers, supplying makers of Refrigerators, Radios, Surgical Instruments and other products requiring a beautiful and lasting finish.



PLICOTE INC., PITTSBURGH, PA. • SALES OFFICE: 664 N. MICHIGAN, CHICAGO



Tie Windows to Seasons

Display Each Product During Times of Greatest Interest

• To get the greatest value from your window displays, set up a window calendar. A good way to do this is to make up 52 cards, one for each week, a year in advance.

Then as ideas occur to you, and as display material becomes available, you can schedule it so as to coincide with the peak seasonal sale of the products being featured.

Seasonal Peaks

Spring means housecleaning to millions of housewives. The vacuum cleaner is one product that attracts universal interest at this time. With the advent of warmer weather housewives realize that laundry bills will go up and more washable clothes will be washed. As a result of these seasonal factors washing machines also have their peak demand in Spring months.

Summer universally means vacation time. Small radios, both portable and automobile, are in demand for vacation use. In addition, summer heat means peak sales for re-

frigerators, fans and room coolers.

Fall brings harvest time and cooking interests to the fore. It tends to be a peak season for ranges. Shorter days arouse interest in lamps and lighting fixtures.

The entire Fall and Winter are an excellent season for console radios. Greater interest in the home during the Winter months tends to raise the level of sales of all major appliances.

With these four seasons in mind you may develop a series of successive window displays built around each appliance during the peak weeks of its season.

Repeat Products

It is not necessary for you to display radios, one week, refrigerators another week, washers another week and small appliances a fourth week. Instead you may devote many weeks to the same appliance while the season is at its height. Thus you get the powerful cumulative effect which repetition creates.

When you repeat the same basic product during its peak season this makes it more imperative than ever for you to give variety to your window by the method of presentation. Never keep the same models in the window two weeks running. Show people the variety of stock you carry.

Holiday Themes

Holidays offer great opportunities for promoting the sale of electrical merchandise. First on the list by a wide margin is Christmas. This season offers a wonderful opportunity for attracting attention through window display to a great variety of electrical appliances and radio sets that are suitable as Christmas gifts.

Many other holidays through the year offer sales opportunities through timely window displays. When in doubt, make a window display to tie in with a holiday anyway. It may do good and can do no harm to use a holiday theme.

One of a series of excerpts from the Hotpoint library of Planned Electrical Merchandising.

how **DISPLAY** sells appliances!

● **SELLING** is making people want things. In the appliance field, people are best sold when actually in the store looking at an effective display. There are simple ways to start a display on the right track. One of the easiest is to follow the method theatrical producers use in arresting attention:

Every chorus has a leading lady for us to *start* looking at—even though we may end up thinking a cute chorus girl in the back row is far more attractive!

● The same principle works in an effective refrigerator display. Give customers a place to start looking. Break the classic line-up of appliances. Place a refrigerator at each end of the line slightly on an angle. This frames the display. Center interest on a middle refrigerator by opening the door and pulling out a sliding shelf. Place this sign on it: "See how easily this shelf slides."

Open Speed Freezer door. Pull out a Pop-Ice Tray slightly and place sign below it reading: "Pop-Ice Tray simplifies removal of cubes. Ask for demonstration." High-spot other features with similar signs.

● Try the *chorus and the leading lady* idea for a display that sells for you.

© 1946 EDISON GENERAL ELECTRIC APPLIANCE CO., INC., CHICAGO

Hotpoint

HOME APPLIANCES

Dependability Assured by 40 Years Experience!



Refrigerators



Ranges



Water Heaters



Home Freezers



Clothes Washers



Flat Plate Ironers



Clothes Dryers



Dishwashers



Disposals



Cabinet Sinks



Steel Cabinets

WIDE OR NARROW NECK
**DE LUXE GLASS
 COFFEE VAC**

HAND DECORATED



THE war is won!... now
 ... product by product,
 White Cross Electric Table
 Appliances are marching
 back, greater than ever. Now
 available are the smart, con-
 venient, gas or electric, wide
 or narrow neck Coffee-Vac
 models shown above.

These efficient and luxuri-
 ous coffee-makers come to
 you in eight cup size only... with platinum banding
 ... wide-neck models complete with hinged decanter
 cover and double-purpose top cover with funnel holder
 of attractive, durable bakelite... Specially designed
 features insure tight seal and perfect vacuum. Full-flavor,
 full-strength every time. Clean, easy, fast filtration...



NOTE: Narrow-neck models are similar to
 those illustrated above—but less decanter cover.

★ ★ ★

WHITE CROSS Preview

As materials and facilities become available, White Cross will
 offer an all-star production including our best "performers"!

**THE AUTOMATIC POP-UP TOASTER
 HIGH SPEED HOT-PLATES**

**1000-W LIGHT-WEIGHT AUTOMATIC IRON
 WAFFLE IRONS—SANDWICH TOASTERS**

... And many brand new products for greater convenience, service
 and freedom for America's homemakers.

★

White Cross Delivers the Trend of Tomorrow... Today!

LEADING JOBBERS EVERYWHERE



NATIONAL STAMPING & ELECTRIC WORKS

3242 WEST LAKE STREET • CHICAGO 24, ILLINOIS

TOPS

SINCE 1925

First in Advertising Volume

Averaging 100 pages monthly

First in Total Circulation

27,000—largest in trade

First in Editorial Service

Two Decades of Industry Support

RADIO & Television RETAILING has always
 been first in this industry: YOU MADE IT
 THAT WAY. It has led in every radio
 survey made in the past twenty years. It
 leads jobbers polls. Manufacturers find it
 pays off, too. That's why they use so much
 space, so regularly. Last year we published
 1,156 pages of advertising. Meanwhile, our
 paid circulation has jumped from 19,000 at
 the end of 1944 to 25,000 now, and still
 going up. Continue to look to the leader
 for results. Remember in reading this mag-
 azine now that all of you have put it where
 it is today.

**RADIO *Television*
 RETAILING**

Caldwell-Clements, Inc.

480 Lexington Ave., New York 17

FLASH!

25,000 + PAID

27,000 + Total

Latest word from our Circulation Dept.

700 Orders in One Morning. Thank You.

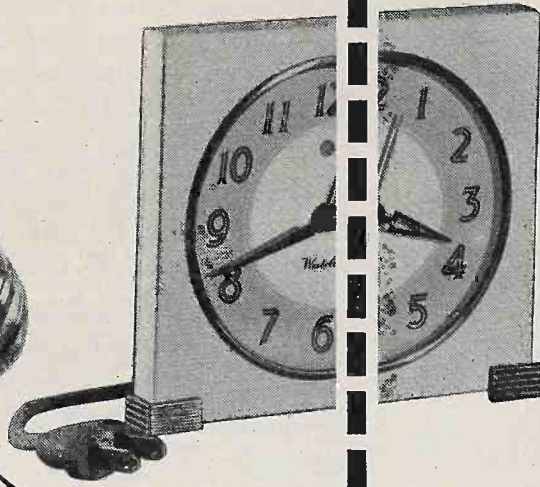

IT'S A BEAUTY,
DICK—JUST
WHAT I WANT!

IF IT KEEPS
GOOD TIME,
I'M FOR IT!

It's a Split Decision!

WESTCLOX
Electrics

Love is a lock linking woman and male,
But that doesn't make their *opinions* dovetail.

Selling the *woman* on beauty and grace
Does not sell the *male* on what's under the face.

When selling a product that *both* sexes use,
You've got to *reach* both sexes, *two* separate views.

Reaching them both's economically sound,
And (to sound our own horn) here's what *Westclox* has found:

The American Magazine double-exposes,
Their ads to both sexes, it's under both noses.

Double exposure, a singular force,
A shot in the arm for your



(sales curve, of course).

**DOUBLE-EXPOSES
ELECTRICAL ADS
TO BOTH SEXES**

THE CROWELL-COLLIER PUBLISHING COMPANY, 250 PARK AVENUE, NEW YORK 17, N. Y.
PUBLISHERS OF THE AMERICAN MAGAZINE, COLLIER'S, AND WOMAN'S HOME COMPANION

"Wide Option"

Fine past performance is the key to this dealer's confidence in Commercial Credit service

Under all normal circumstances, I would continue to line up with Commercial Credit for my financing because your record of past performance in my dealings with you is a very fine one.

"But the extraordinary circumstances under which we will be doing business for the next few years at least, make it more desirable than ever to stay with you. Your **WIDE OPTION** of plans offers me everything I could get elsewhere, and *then* some."



Eugene F. Callarone

Liberty Appliances
Somerville, Mass.

Philco—Frigidaire—Bendix
and other appliance lines

COMMERCIAL CREDIT COMPANY

BALTIMORE 2, MARYLAND

Capital and Surplus more than \$80,000,000



Round-Table Sales Meeting

• One of the easiest kinds of sales meetings to arrange is the round-table discussion. At the same time this is an effective form of meeting.

If you are to have good round-table meetings, it is necessary for you to plan carefully in advance. Decide what the objective of the meeting will be, based on what most of the men need in the way of sales training and help at the particular time.

Next, select the subjects that are to be covered and decide in what way they will be covered. Only in this way can you be sure of ending the meeting with substantial mental progress for everybody present.

No Written Talks

This preparation may take more time than you think. It is worth all the time you can give it.

Do not reduce this preparation

to the form of a written document. Never read a lecture to your organization. It is up to you to know your subject and prepare yourself. When you do this you can hold the attention of your staff, because they feel that you are talking to them rather than handing out some abstract theories which you may have obtained second-hand from someone else.

Light, Not Heat

The opposite extreme is equally bad. There is no occasion for you to get up and give a typical wild-eyed pep talk to your men.

The trouble with this method seems to be that the recipients of this exhortation soon become deflated when they come up against the steely eye of the next housewife they meet. They have to come running back in order to be steamed up all over again.

Use Informal Discussion Group to Create Enthusiasm, Impart Information and Obtain Practical Sales Ideas Based on Field Experience

You will probably do better in conducting your round-table discussions if you substitute for this kind of inspirational monologue sound knowledge of your products, sales methods, and sales obstacles.

Group discussions can accomplish several results. Through them you can teach the general store policy to your staff. They can learn about new products as they come into the store. They can solve sales problems in the field. They can create enthusiasm and develop a spirit of co-operation by uniting your staff in a bond of common understanding.

Go Over Material

There is a certain amount of material which you receive in the form of sales manuals, bulletins, and releases from your suppliers. It is not enough for you to hand out literature of this kind to your salesmen. They do not usually read sales bulletins by themselves.

You should go over every piece of written material which your salesmen receive between meetings again at the meetings. Only in this way can you make sure that they have absorbed the information contained in that material.

Encourage Ideas

A round-table discussion is a two-way street. Ask the advice of your employees freely, and encourage them to express their opinions with no fear of reprisal. Only in this way can you get their active co-operation.

In order to make sure that all the people present obtain the greatest possible good from the meeting, be sure that all are encouraged to express their ideas freely. Do not have a favorite pupil who knows all the answers and who speaks up every time a problem arises. Get the answer to each question in

(Continued on page 106)

Get set for greater profits NOW...



... RCA Sales Aids that will bring more business your way



THE FOUNTAINHEAD OF MODERN TUBE DEVELOPMENT IS RCA

...and your RCA Tube Distributor is the fountainhead for **BATTERIES ... TUBES ... PARTS ... TEST EQUIPMENT**

ONCE AGAIN, RCA brings you a complete and up-to-date line of *time-tested* sales aids designed to place you in the lead. Illustrated are just a few of the many sales and utility aids that have demonstrated their value as business builders in the past.

From posters and illuminated signs to businesslike "laboratory" coats and time-saving package tape, these eye-catching advertisements lend prestige to your business and lead the way to greater tube sales.

Plan now to put these new RCA sales aids to work for you. Get in touch with your RCA Tube Distributor today for full details.

Then—push RCA Electron Tubes and watch your business grow!

Listen to "THE RCA SHOW," Sundays, 4:30 P. M., EST, NBC Network.



TUBE DEPARTMENT

RADIO CORPORATION of AMERICA

HARRISON, N. J.

Hard-hitting consumer advertising



This classic head with its shadow symbolizes the "Golden Throat", RCA Victor's amazing new acoustical system. The "Golden Throat"—development of RCA's 26 years of engineering experience—plus Victor's 47 years of leadership in musical reproduction—is the result of exact co-ordination of cabinet, speaker, electronic amplification!

The exclusive RCA Victor "Golden Throat" feature is pre-sold to potential radio and radiophonograph buyers in national magazines, on the air, and in big Sunday supplements. This potent promotion is creating a demand for RCA Victor instruments that will bring more customers to your store!

RCA Victor's "Personal"—one-third smaller than the prewar "Personal"—pocket size set—room-size volume! It's battery-powered—plays anywhere—at sporting events—picnics—fishing—indoors or out! Has the RCA Victor "Golden Throat" Camera type construction, polished chromium trim, handsome alligator-grained plastic case. RCA Victor 54B. OPA list price—\$26.85.

RCA Victor radios and Victrola* radio phonographs in eight more outstanding models are in the line—all with the RCA Victor "Golden Throat." For further information on the RCA Victor line, get in touch with your distributor, or write: RCA Victor Division, Radio Corporation of America, Camden, New Jersey.

Victrola* TM Reg. U. S. Pat. Off.



"PRE-SELLS" amazing RCA VICTOR

"Golden Throat"

The finest tone system in RCA Victor history!

MAGAZINES!

Spearheading a big national magazine campaign—Life, Saturday Evening Post, and Collier's carry regular big color advertisements promoting the RCA Victor "Golden Throat"—reaching over 31,000,000 readers in the income bracket where most radios are sold.

RADIO!

On the air every Sunday, NBC 4:30 to 5 p.m., EST, the big new RCA Victor Show, featuring Deems Taylor, Kenny Delmar, Raymond Paige's Orchestra—is selling RCA Victor Victrolas* and the "Golden Throat" to people in your neighborhood.

NEWSPAPERS!

Extra-coverage is now given to "Golden Throat" advertising where buying power is greatest—in metropolitan areas—through full-color roto-gravure ads reaching more than 8 million readers in the great metropolitan Sunday supplements.

ONLY RCA VICTOR
MAKES THE VICTROLA



RCA VICTOR



RADIO CORPORATION OF AMERICA

here are
the
market

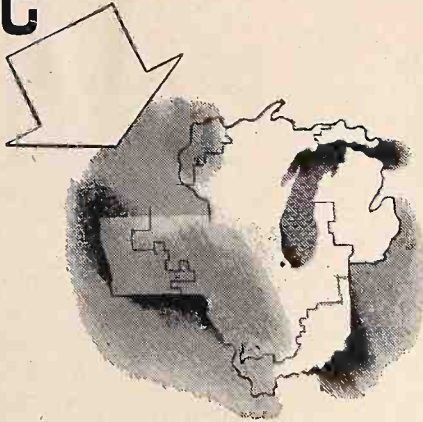

and

the
medium



for

results



DOUBLE DUTY

... You can get *double duty* out of your first year's selling by concentrating on the rich, compact market that is located right in the heart of America—the great Chicago market. You can get started quickly and get set for the days ahead in this strategic market with a single powerful advertising medium—the Chicago Tribune.

One out of every three families in 756 cities and towns of 1,000 or more population in this area reads the Tribune on weekdays. On Sundays, it is practically every other family. The Tribune is bought, read and bought from as is no other medium here.

QUICK VOLUME

... In this easily accessible market, defined by consumer habits and merchandising practice, there is enough business to take the entire output of many manufacturers. Here you can get immediate volume and build solidly for a continuing, profitable operation.

Here is a market with a huge pent-up demand for automobiles, washing machines, refrigerators, radios and "big unit" products generally... a market famous for its tremendous volume purchases... a market that has repeatedly broken factory and branch sales records.

SOLID FUTURE

... No matter whether your production will be large or small, the Chicago market will reward your attention as the place to get the consumer buying you want. It is fortified by diversified income and billions in savings.

This \$4,496,734,000 market offers quick sales now... and solid dealer and consumer preference when the first easy selling conditions pass and competition gets tough. *Now is the time to get going.*

CHICAGO TRIBUNE

The World's Greatest Newspaper

In this market only the Tribune gives you a choice of monochrome, color, comic, newsprint color, or black and white printing at milline rates which are among the lowest in America.

February average net paid total circulation:
Daily, over 1,025,000; Sunday, over 1,450,000.

Now available for your study and use is a specific Tribune sales program based on the findings of an auto and household appliance investigation among consumers and dealers. To get these pertinent facts, address C. S. Benham, Manager, National Advertising, Chicago Tribune, Tribune Tower, Chicago 11, Illinois.

Uses Television to Sell Service

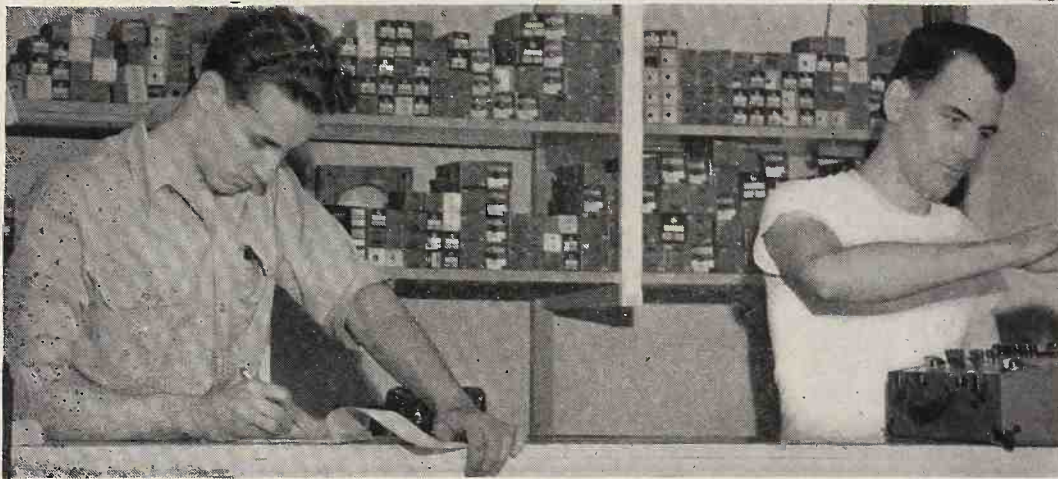

▲ This sign in store's window attracted crowds. ← Co-owners J. Catalano, left, and Robert K. Graham, at work on service jobs brought in by tele.

Chicago Store Cashes In on Video Interest to Build Big Maintenance Business; Shows Bring Customers In

● For the general public, television is the Magic Carpet and Aladdin's Lamp rolled into one.

For the radio service retailer, television is the royal road to more profits.

This was proved recently when the Airwave Radio Sales & Service Shop, 5227 W. Madison St., Chicago, Ill., held tri-weekly video demonstrations to inaugurate the opening of its new quarters in this community.

Co-proprietors of the establishment, Robert K. Graham and James Catalano, have successfully used tele shows to build an active prospect file, draw service customers, and establish a reputation as radio technicians with plenty of know-how.

Simplicity provided the keynote of the video demonstrations. No special announcements were made. Neither were the demonstrations given in a special room. The set was simply placed against the front

window of the store, and a card stated that the tele receiver would be shown in action between 7:30 and 9:30 p. m. This was all the publicity employed to draw crowds to watch the set.

As anticipated by the proprietors, the desired effect—plenty of business—has been brought about by the tele showings. In a matter of a few weeks after the receiver was first demonstrated, the store had won a customer list that would normally take months, and even a longer time, to acquire.

Profits Are Mounting

Radio service work is pouring in, and both men are engaged full time at the bench working on sets. Now the business is on a steady foundation, and from here on, the owners feel, the firm will grow steadily.

The televised showings accomplished two important jobs for the store:

1. The demonstrations provided the establishment with excellent publicity, and at little cost to the operators.

2. The showings marked the store as being advanced in technical radio knowledge, and pioneers in television sales and maintenance.

These two factors resulted in getting the store quickly established and helped to put it on a paying basis in a hurry.

The tele set demonstration attracted a large audience. Placing the set against the window enabled pedestrians to observe the performance without entering the store.

A great number of persons, therefore, witnessed the show, and during the entire two-hour run of the broadcast there was a constant "come and go" audience. Many on-lookers became so engrossed that they stayed for the entire show.

Enthusiastic passers-by entered the store and asked questions pertaining to the tele receiver. The chief question was when video sets would become available. These people, the firm feels, are all prospective buyers of telesets.

Tele to Aid Sales Also

While television shows have enabled the firm to get a flying start on service business, it also intends to use video demonstrations in the future to cash in on sales of radios and electrical appliances.

"At that time," Graham stated, "we will again hold public showings

(Continued on page 106)

Service Data on

Technical Information on and Crosley 106CA-CP-CQ

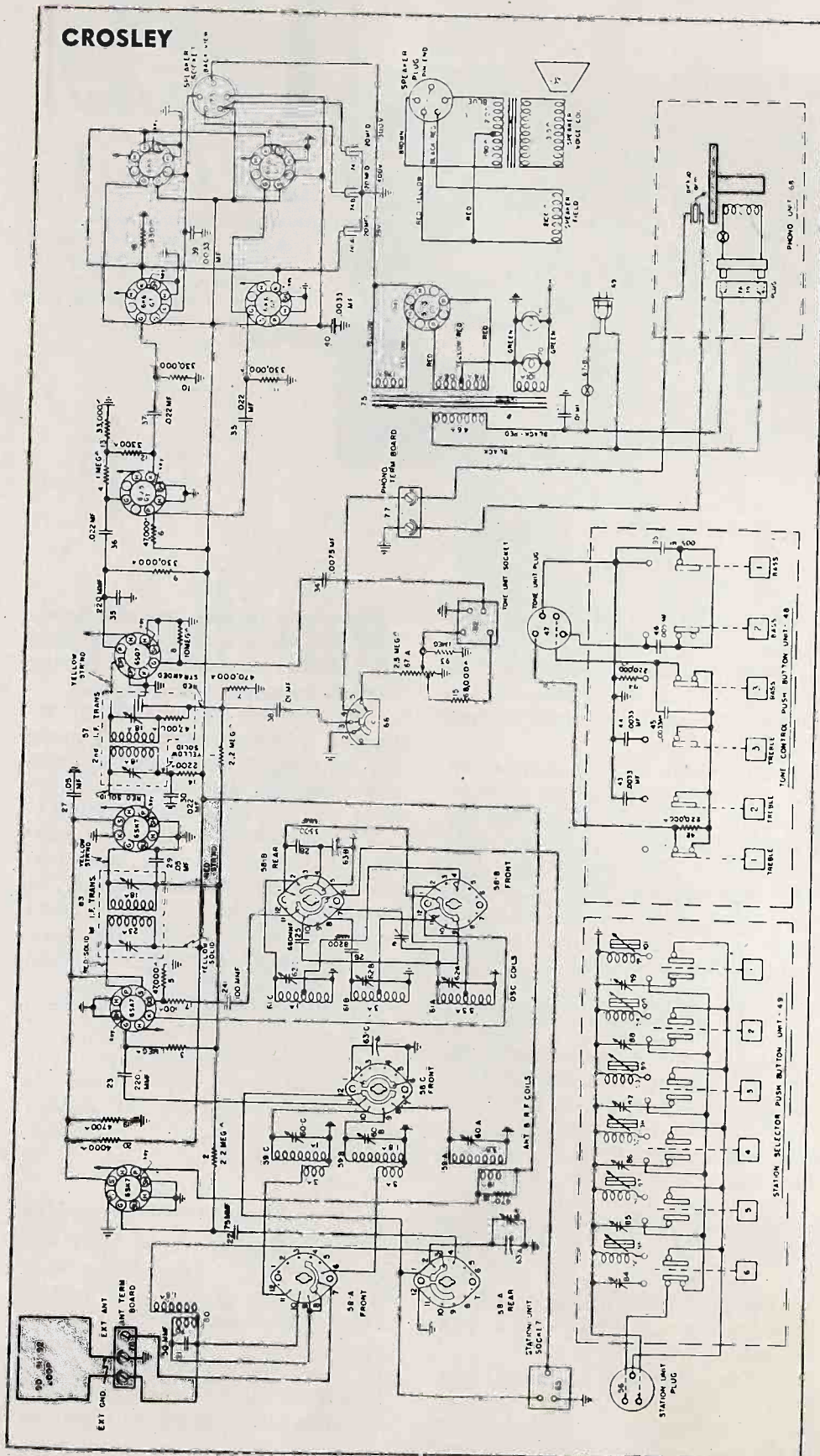

• The schematic at the left covers Crosley's Models 106CA, 106CP, 106CQ and 106CR. This is an AM set with three bands, tuning from 540 kc to 1600 kc, 2.5 mc to 6.0 mc, and 6.0 mc to 18 mc. The tuned r-f stage is used only for manual tuning of the broadcast band.

Permeability-Tuned R-F

Push-button tuning of the broadcast band is accomplished by selecting one of six permeability-tuned coils for the oscillator circuit, and one of six trimmer capacitors shunting a separate mixer grid coil. Six additional push-buttons provide three treble and three bass tone adjustments. The loop antenna is a low impedance type. Four 6K6GT tubes in push-pull parallel drive a 12-inch electro-dynamic speaker.

Although Admiral's Chassis 6A1 has only a 2-gang variable, with sections tuning the oscillator and mixer, it also provides a tuned r-f stage. This is accomplished by using an r-f coil whose core is moved in and out by a lever actuated from the variable capacitor. In aligning, a .1 mf dummy antenna is used in peaking the 455 kc i-f, in setting the oscillator trimmer C19b at the 1630 kc calibration point, and in tuning the slug of r-f coil L2 at 1400 kc. For the final adjustment, also at 1400 kc, the signal generator output lead is run close to the loop, and antenna trimmer C19a is varied for maximum signal.

4-Tube Battery Set

Sentinel's Model 289-T is battery-operated only, using a Sentinel AB-280 Battery Pack to supply 90 v. at 9 ma., and 1.5 v. at 200 ma. In the 455 kc i-f alignment, a .02 mf capacitor is used as a dummy antenna from signal generator to the grid of the 1A7 tube. The grid cap is left in place. For aligning the r-f circuits, a .00025 mf dummy capacitor is used at the antenna lead, and the oscillator calibrated at 1730 kc. The same capacitor serves for the antenna adjustment, made at 1400 kc by rocking the variable.

Newest Receivers

Sentinel 289-T, Admiral 6A1 CR Radios and Combinations

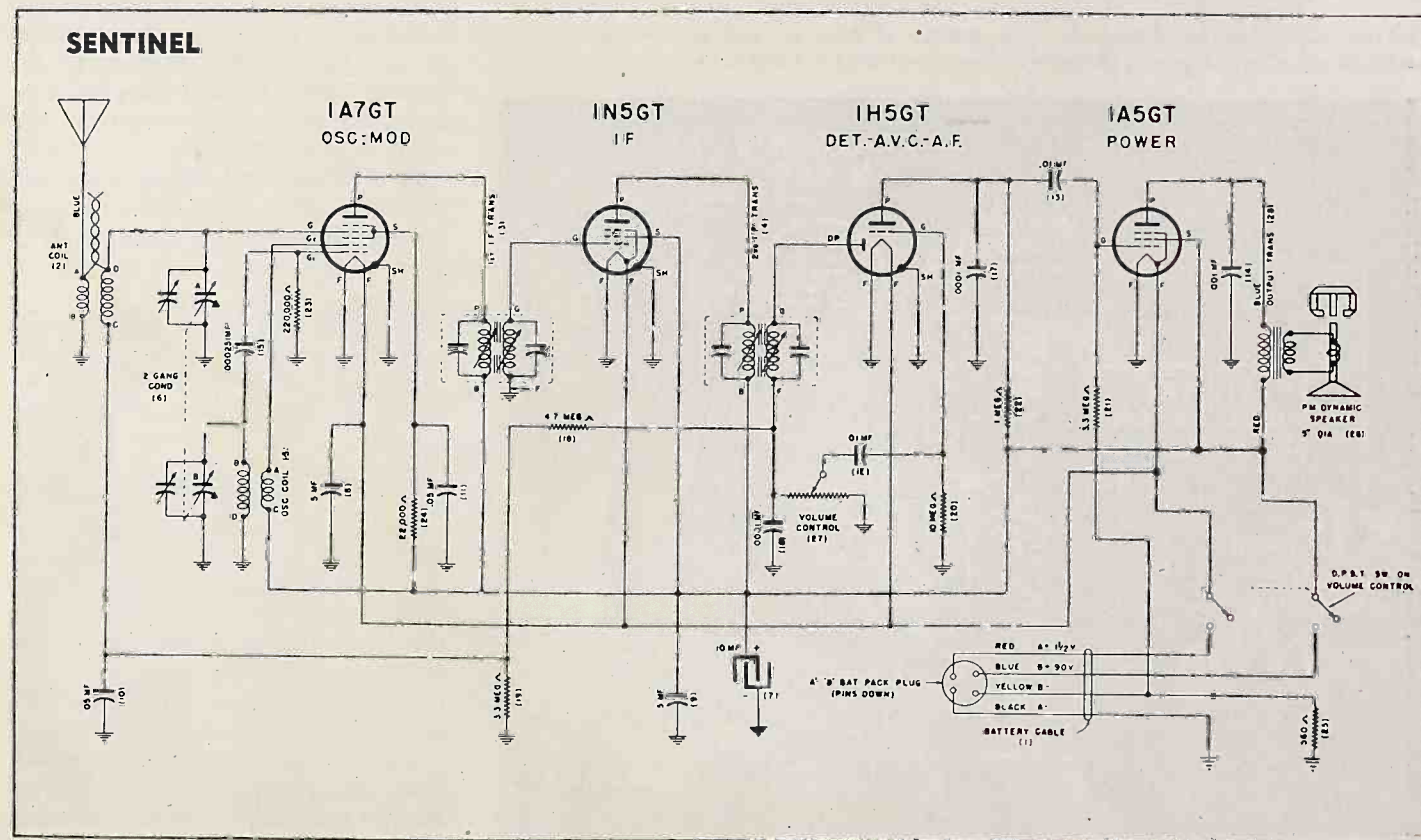
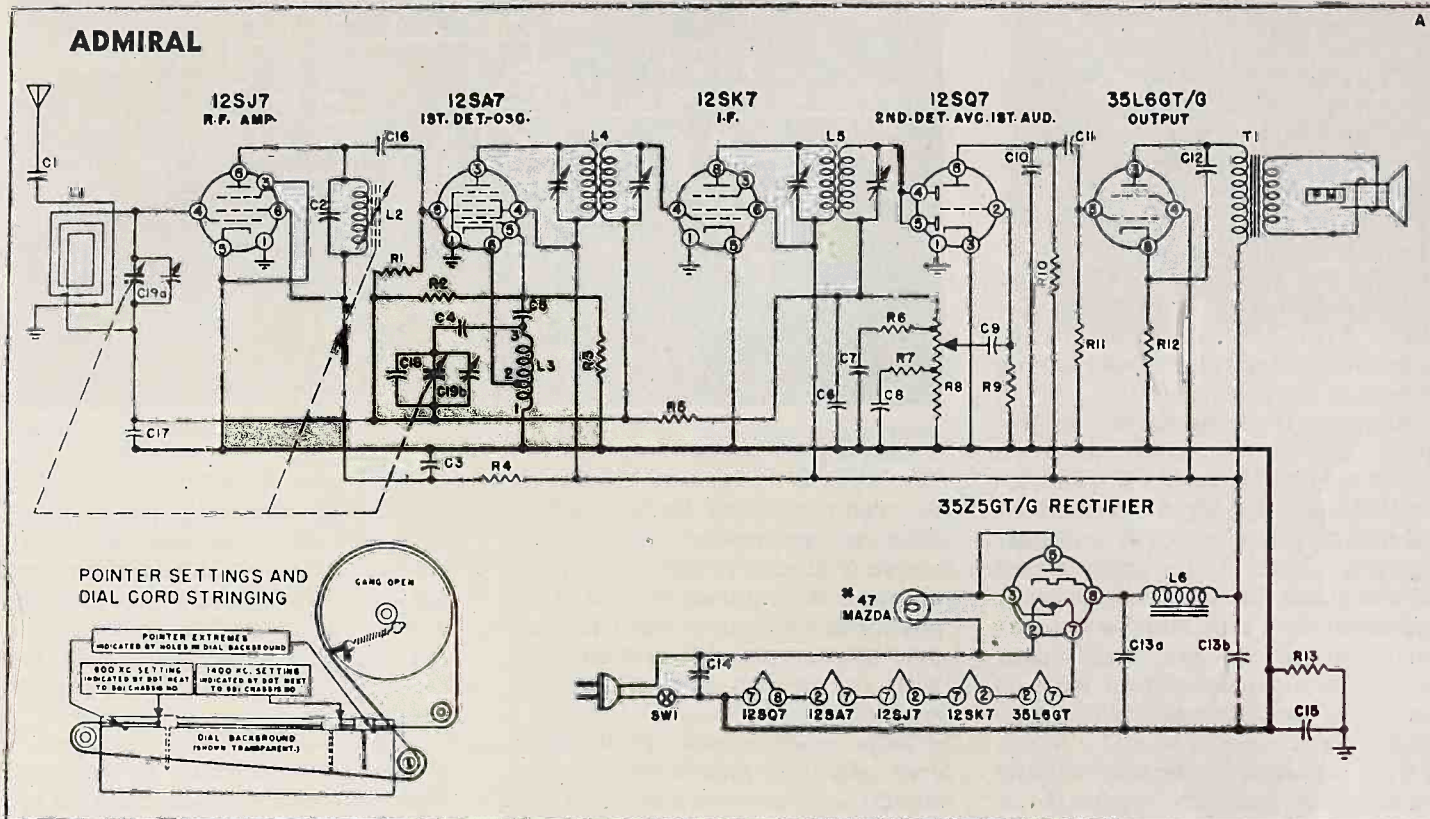

Basic Superhe

A Complete Alignment Procedure Designed

• Last month we discussed alignment preliminaries. This month we shall continue with the details of alignment procedures. Before we do so, however, several cautions on the use of the signal generator may be added to those mentioned in the preceding article.

First, always keep the generator output as low as possible, to prevent action of the avc circuit.

Second, connect the test oscillator only across two points having the same dc potential, otherwise the attenuator may be burnt out. A capacitor of .1 mfd or less should be used in series with one of the leads, when the generator is connected between two circuits having different dc potentials.

Alignment of an ac-dc set requires special precautions. Since an ac-dc chassis is hooked to one side of the line, the signal generator's attenuator may be burnt out during alignment, if the ground lead of the generator is accidentally, or intentionally, attached to an external ground. To eliminate this possibility, two capacitors may be used, one in series with each generator lead.

The capacitor in series with the "hot" lead may also serve as a dummy antenna, and should have

When the mixer tube has a grid cap, it is removed in order to open the r-f signal circuit. The 100,000 ohm resistor used in the dummy antenna provides a d-c grid return.

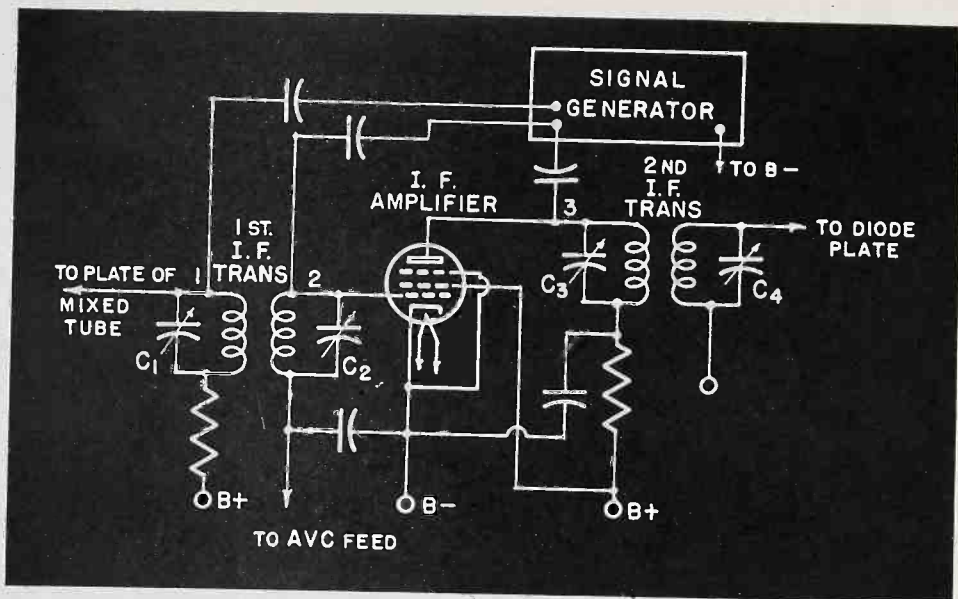

When dummy capacitors are used, the signal generator may be connected without danger of shorts to points such as (1) mixer plate, (2) i-f grid, (3) i-f plate.

the value required by the dummy antenna, as listed in the accompanying chart. When no dummy antenna is required, a .1 mfd capacitor may be used. A .1 mfd capacitor may also be used in series with the ground lead of the generator.

To provide a closed circuit for the grid return, a 100,000 ohm resistor should be connected across the generator leads, at the receiver side of

the dummy capacitors.

If the set manufacturer's instructions regarding alignment are available, they should be faithfully carried out. The information presented here is intended only for cases where such instructions are absent.

When aligning radio stages, a certain sequence must be observed. This sequence may be listed in order as: 2nd i-f (2 i-f transformers are assumed), 1st i-f, oscillator, and r-f stages. If short-wave bands are to be aligned, the short-wave oscillator and r-f trimmers should be adjusted before the broadcast oscillator and r-f units.

It is generally necessary to stop the set oscillator from functioning during i-f amplifier alignment, to prevent the appearance of troublesome beat notes. To do this, connect a .5 mfd capacitor between oscillator grid and ground, or between the stator section of the oscillator tuning capacitor and ground.

Couple to Mixer Grid

The next step in aligning a peaked i-f amplifier stage is to connect the "high" side of the test oscillator to the control grid of the first detector or mixer tube. The connection may be made to a tuning capacitor stator lug, if the control grid is attached to the lug.

The removal of any connection from the previous r-f coil to this control grid is recommended, since

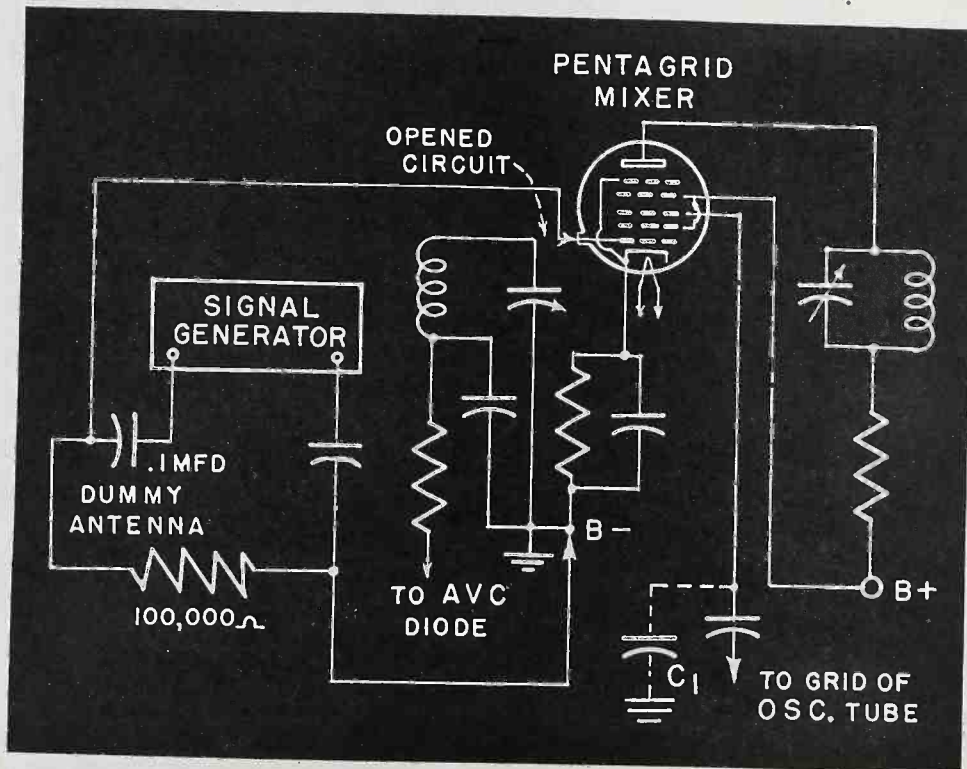

Alignment—II

ver Most All-Wave AM Superhet Receivers

the r-f coil circuit is resonated to a considerably higher frequency than the incoming i-f signal, and may effectively short-circuit the signal generator output. Radio signals received through the r-f stages might also beat with the test oscillator, and produce spurious beat notes, if the r-f circuit leading to the 1st detector grid is not disconnected.

In receivers on which this grid terminates in a top-cap, and self-biasing by means of a cathode resistor is present, the top-cap clip may be removed, and the signal generator output connected between grid cap and chassis.

In cases where control grid bias comes from a voltage divider, the signal generator output may be inserted between the grid cap and the grid clip. The grounded shield lead of the generator should go to the grid clip lead. In the other instances, the generator ground lead is hooked to set ground. Signal generator leads must be kept as far as possible from the grid leads of other tubes.

Final Preliminaries

A .1 mfd capacitor will serve as a dummy antenna when the i-f stages are being aligned. The gang tuning capacitor should be set at a quiet position on the dial, possibly at 600 kc, or 1600 kc.

After allowing the signal generator to warm up and reach a steady state, it is adjusted to deliver the correct i-f for the receiver being aligned. An audio-modulated i-f

signal should be used. Then the output meter may be connected to the receiver, in one of the ways described in last month's article.

After turning the radio on and allowing it to warm up for several minutes, and setting all the controls properly, the attenuator control of the signal generator should be adjusted, so that the output meter gives a readable indication. As low an output as possible should be used.

Correct Trimming Sequence

Adjust the i-f trimmers, starting with the last, for maximum output, as registered on the output meter. When considerable misalignment is present and difficulty is experienced in bringing a signal through the 2nd i-f, one stage at a time should be aligned, instead of both at once.

The signal generator may, in these cases, be connected to the first i-f grid, while the second i-f is being lined up. The first i-f may be aligned with the "high" generator lead hooked to the first detector grid.

If an i-f amplifier doesn't peak, look for an open coil, or shorted turns in the coil winding, or a shorted capacitor in the coil circuit. Infrequently, inability to peak is caused by an incorrectly re-wound coil. Replacement is the best remedy in such a case.

After first adjusting the secondary, then the primary, of the last i-f stage, repeat the procedure for greater accuracy, then go on to the preceding i-f. The attenuator con-

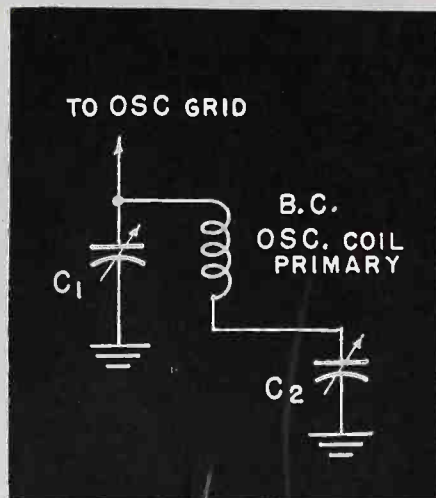

C1 is oscillator trimmer; C2 is padder.

control should be lowered, when necessary, to keep the output meter reading within scale range.

After the i-f stages have been aligned, the oscillator and r-f circuits may be adjusted. The short across the set oscillator should be removed, and the test oscillator coupled to the receiver.

A 200 mmfd (.0002) capacitor may be used as dummy antenna, and inserted in series with the "high" lead of the test oscillator. This lead is then attached to the receiver antenna post.

How to Couple to Loop

When sets having loop antennas are being aligned, another method of coupling the test oscillator output to the receiver is recommended. A loop may be made up from a few turns of wire, and connected to the signal generator output terminals. The generator is placed near the receiver's loop, which then picks up the generator's output.

Since trimmers have greatest effect when the circuit capacitance is low, the oscillator and r-f trimmers should be adjusted at the high frequency (low capacitance) end of the tuning range. A point near, rather than at, the end of the tuning range should be chosen, to avoid mistracking over adjacent parts of the band; 1400 kc is the recommended choice for the broadcast range. The receiver and signal generator should be set for this frequency, and the oscillator high frequency padding capacitor adjusted for maximum output. This capaci-

(Continued on page 78)

i-f wave trap is set last, to give minimum response to a 455 kc signal.

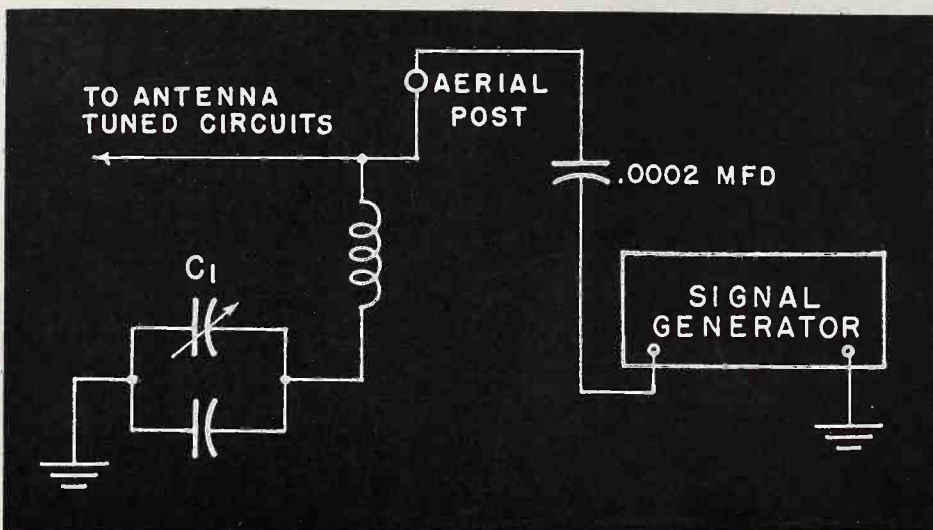

TURN TO TURNER



- ★ for Style
- ★ for Dependability
- ★ for Performance

TURNER Model 22 Microphone Gives You All Three

There's more than beauty of styling behind the Turner 22 Microphone. This famous member of the Turner Line is a precision unit — engineered to faithfully reproduce every desired sound without harmonics or distortions — ruggedly built to perform with unflinching dependability under difficult operating conditions. Good reason why so many leading manufacturers of electronic recording and communications equipment specify the Turner 22 as standard for maximum performance . . . why you want the TURNER 22 for your equipment. Available in both rugged crystal and dynamic models. Ask your distributor or write for complete performance characteristics.



You Get These Features in the Turner 22

- ★ Choice of Moisture Proofed Crystal or Rugged Dynamic Cartridge.
- ★ 90° Tilting Head for Semi- or Non-Directional Operation.
- ★ Removable Cable Set.
- ★ Barometric Compensator.
- ★ Mechanical-Shock Proofing.
- ★ No blasting from Close Speaking.
- ★ Low Feedback.
- ★ Certified Performance.

Turner Microphones Licensed Under U. S. Patents of the American Telephone and Telegraph Company, and Western Electric Company, Inc.

Free Turner Catalog
Write for your copy



The TURNER Co.
903 17th Street N.E., Cedar Rapids, Iowa
Pioneers in the communications field

TURNER

Microphones

Crystals Licensed Under Patents of the Brush Development Co.

Superhets II

(Continued from page 77)

tor may generally be identified by its shunt connection with the oscillator coil.

The antenna and r-f circuits may next be aligned, at the same 1400 kc setting. Following this adjustment, the low frequency oscillator padder should be aligned. This padder is the capacitor in series with the oscillator coil. Signal generator and receiver may be set at 600 kc for this adjustment. The rotor of the gang tuning capacitor should be rocked back and forth, and the trimmer adjusted, until the peak of greatest intensity is obtained.

Choose the Correct Trimmers

Trimmers for the antenna and oscillator coils are often located on the gang tuning capacitor. Usually the front section holds the oscillator trimmer, while the rear section contains the antenna trimmer. In some cases, the trimmers for oscillator and antenna coils are located on the coils themselves.

Where to Find Coils

Antenna coils may be placed above chassis, but oscillator coils are almost invariably located underneath the chassis. This information is given to aid in the identification of oscillator and antenna coils.

When it is desired to align short-wave bands, procedures similar to those outlined for broadcast band r-f and oscillator alignment should be followed. Frequencies to be used depend on the bands present. Some common ones used for alignment are 9.6 mc, 11.8 mc, 15.2 mc, and 18.0 mc. Manufacturers' instructions should be followed whenever they are available.

How to Check Image Response

Care should be taken during the oscillator adjustment, to see that it is aligned to the correct signal frequency, rather than to the "image". For example, assume that our signal generator and receiver are aligned at 20 mc, and that the set's i-f is 455 kc. The image frequency is 910 kc (twice the i-f) higher or lower than the dial setting.

If the set is designed to have the oscillator "track" 455 kc higher than the signal, the image will be

(Continued on page 82)

Phonola

The best-known name in
the portable phonograph field
since 1916 . . . and growing
better-known each year!

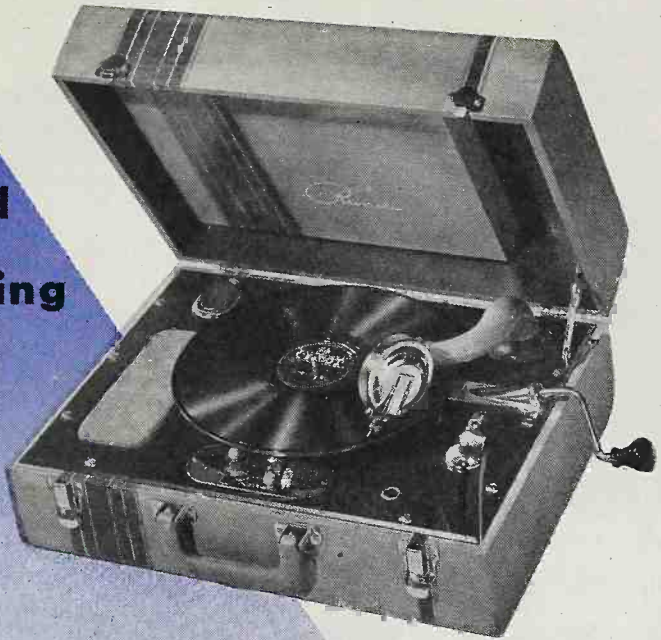

Phonola

complete line of
**ACOUSTIC and ELECTRONIC
PORTABLE PHONOGRAPHS**

● Known the whole world over . . . through
exclusive distributors everywhere! For your distributor
contact our nearest Sales Office:

Eastern and Export Sales Office
17 E. 42nd St. ★ New York 17, VA. 6-2079

Midwestern and Western Sales Office
224 S. Michigan Ave. ★ Chicago 4, HAR. 1880

Factory and Engineering Laboratory
Rochester, Minn.



WATERS CONLEY COMPANY
ROCHESTER, MINNESOTA

Enough New Units

Motorola COMBOS

Model 95F32 automatic radio-phono comes in walnut veneer cabinet. Has Seeburg record changer. Receives on AM, FM, and short wave bands. 6 push-



buttons. 37½" high, 39½" wide 17" deep.

Model 85F21 automatic radio-phono accommodates ten 10" or eight 12" rec-



ords. Available in walnut veneer cabinet. Ac superhet receives on two bands. "Aero-Vane" loop, tone control. 6 push-buttons. 39" high, 30" wide, 17" deep. Galvin Mfg. Corp. 4545 Augusta Blvd., Chicago, Ill.—RADIO & Television RETAILING

Continental PHONO & COMBO

Skyweight Model 81 is an attractive, light weight portable record player encased in leather-bound luggage. Weighs less than ten pounds. Sturdy case includes two safety locks and key. Speaker grille is not exposed. Has light weight pick-up and tone arm, Alnico 5 speaker, Ballentine motor. Plays 10" and 12" discs with faithful reproduction. Uses standard needles. 5½" high, 11½" deep, 15½" wide.

Skyweight model 82 is a portable radio-phonograph combination that

weighs only ten pounds. Has all the features of Model 81 record player, in addition to a five-tube radio receiver



and radio-phono selector switch. Continental Electronics, Ltd., 81 Pine St., New York, N. Y.—RADIO & Television RETAILING

DalBar PHONOS

Model M7 has Webster single post automatic changer on 4" walnut base; 8' cord with 3' shielded cable with phono plug to connect to any radio,

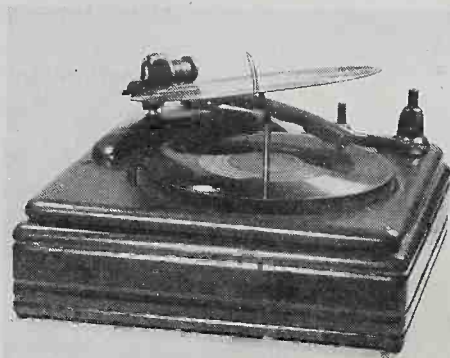

Overall it is 15" square and 5½" high. No top is required as there is no needle scratch. Equipped with Permo-point

needle. Plays twelve 10" and ten 12" discs, with automatic cut-off after last record is played.

Model M8 is the same as M7, except

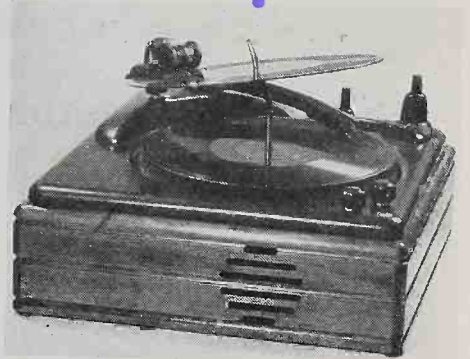

that it has a 3-tube ac amplifier and a heavy PM speaker built in base. Controls for volume and tone are on changer. Barr Electric Co., 1314 Forest Ave., Dallas 15, Tex.—RADIO & Television RETAILING

Meck RADIO & COMBO

Trail-Blazer Model 505-DW9 is a 5-tube superhet in an attractively-finished wood cabinet. Covers full broadcast band. Automatic volume control; built-in loop

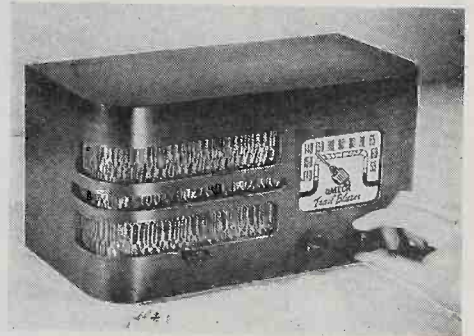

antenna. OPA price is \$25.95.

Trail-Blazer radio-phonograph combination is designed in a wood cabinet that measures 13" x 12" x 8". Phonograph uses a special constant-speed



ac motor, and is equipped with a standard turntable pick-up tone arm. OPA price is \$49.80 in Zone 1. John Meck Industries, Plymouth, Ind.—RADIO & Television RETAILING

or Several Per Home

Clarion RADIO & COMBO

Model C100, "The Apollo," is available in a modern design ivory finish plastic cabinet with turned louvres. 5-tube ac-dc superhet circuit. Automatic volume control. Efficient loop antenna, but may be used with external antenna. 5" high flux density PM speaker

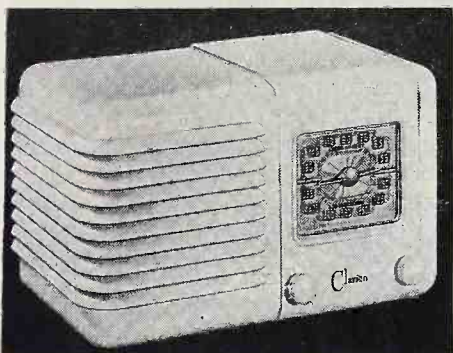

with Alnico 5 speaker. 7" high, 11 $\frac{5}{8}$ " wide, 6 $\frac{1}{2}$ " deep.

"The Clarionette" model C105 is 6-tube (including rectifier) ac superhet console radio-phonograph. Features separate record storage cabinet. Set occupies only 3 square feet of floor space. New full-tone zephyr-weight pick-up with wide frequency range. Floating stylus saves wear on discs; especially suited



for new plastic discs. Plays twelve 10" or ten 12" records; fast changing, easy, quick loading. 33 $\frac{1}{2}$ " high, 20 $\frac{1}{4}$ " wide, 17 $\frac{1}{2}$ " deep. Warwick Mfg. Corp., 4640 West Harrison St., Chicago 44, Ill.—RADIO & Television RETAILING

Setchell-Carlson RADIO

Model 416 has new cabinet design. Back of cabinet is completely enclosed and is molded part of it. Can be used on end tables, center tables, desks, etc. Features "Finger-Tip" controls and "Penthouse" full-vision dial. Cabinet is designed for easy servicing. 5-tube superhet circuit. Operates on ac-dc. Im-

proved detector circuit; 5" PM dynamic speaker. Built-in loop antenna. Standard color is walnut. Also available in black, maroon, blue and ivory combina-

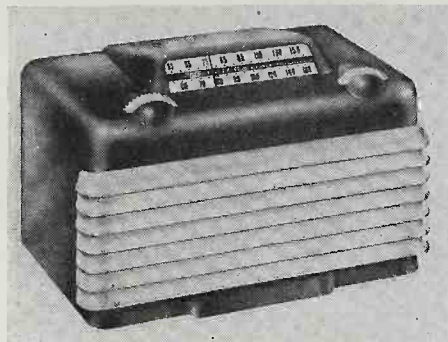

tions. Setchell-Carlson, Inc., 2233 University Ave., St. Paul 4, Minn.—RADIO & Television RETAILING

Arvin RADIO

Battery-electric pocket portable, model 540, with four miniature tubes. Operates on enclosed batteries outdoors, or 110 ac or dc indoors. Molded plastic case with hinged door and handle. Roller-type thumb-wheel tuning. Broadcast coverage 540-1600 kc, on American band. Noblitt-Sparks Industries, Inc., Columbus, Ind.—RADIO & Television RETAILING

Phonola PHONOGRAPHS

Model S-50 hand-wound portable phono has free acting throw-back tone arm. Long-life spring-driven motor. Case covered with leatherette. Built-in record compartment. Weighs approximately 11 $\frac{5}{8}$ pounds. Size 14 $\frac{3}{4}$ " x 11 $\frac{7}{8}$ " x 6".

Model S-90 portable hand wound phono has large molded tone chamber. All wood lock-corner case construction;



high quality coverings. Easily wound spring-driven motor. Built-in record compartment. Weighs about 15 pounds. Size 16 $\frac{7}{8}$ " x 13" x 7". Waters Conley Co., Rochester, Minn.—RADIO & Television RETAILING

Philco RADIOS

Model 201 is an ac-dc superhet. Has 5 tubes, including rectifier. Electro-dynamic speaker. Illuminated dial. Beam power pentode audio system. Built-in loop antenna. Comes in cabinet with new "Philcote" curly maple graining.

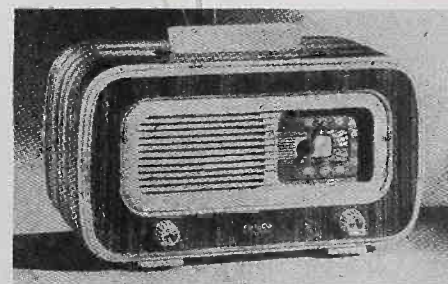
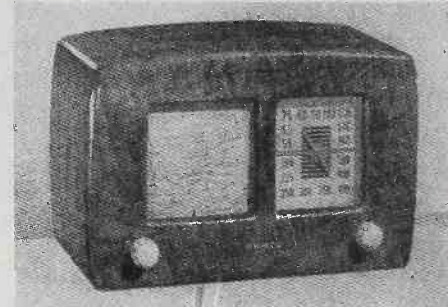

Model 202 is an ac-dc superhet. 5 tubes, including rectifier. Technical features same as Model 201. Available in cabinet with "Philcote Zebrano" graining, trimmed with ivory. Philco Corp., Tioga & C Sts., Philadelphia, Pa.—RADIO & Television RETAILING

Audar PHONOGRAPH

Portable electric record player has new lightweight crystal pick-up to reduce record wear. Plays 10" or 12" discs with lid closed. 3-tube amplifier with broad band bass boost. Extra tone



control to boost the treble. Leatherette carrying case. Constant speed motor. Large 6 $\frac{1}{2}$ " dynamic speaker. Operates on ac. Measures 17 $\frac{5}{8}$ " x 14 $\frac{1}{8}$ " x 7 $\frac{5}{8}$ ". Audar Radio & Electronic Equipment, Argos, Ind.—RADIO & Television RETAILING

(Continued on page 90)

It is more profitable to sell PROVED QUALITY



WEBSTER ELECTRIC Tone Arms and Cartridges Give True Tone Reproduction

Selling quality merchandise is a pleasure that builds business. That's why so many dealers choose Webster Electric Tone Arms and Cartridges for replacement sale.

Chosen by many leading manufacturers as a part of the original equipment for record changers and combination sets, exact replacement is simple and easy. In addition, there is a Webster Electric Tone Arm or Cartridge designed for replacement of wornout units on sets other than those carrying Webster Electric parts as original equipment. Many years' experience in the design and production of high-quality, high-fidelity tone reproducing equipment has made possible a performance that satisfies customers and creates new business.

"Longer Life for Your Phonograph" is the title of an interesting booklet for consumer distribution that will help you to build this business. Write for a supply today. Also send for Chart RC-147 that gives full details on replacement tone arms and cartridges for all types of radio-phonograph equipment.

(Licensed under patents of the Brush Development Company)

WEBSTER

RACINE



Established 1909

ELECTRIC

WISCONSIN

"Where Quality Is a Responsibility and Fair Dealing an Obligation"

(Continued from page 78)

20,910 mc. If the oscillator is supposed to be on the low side, the image should be at 19,090 mc. The presence of the image can be used to check whether the oscillator has been aligned to track on the proper side of the signal.

To find it, leave the set dial untouched and tune the signal generator through the expected image frequency. The response to the image frequency should be much weaker than at the correct signal frequency—such much so, that it may be necessary to increase the generator output in order to hear it. If this image cannot be tuned in, the oscillator trimmer has been incorrectly adjusted, and should be re-aligned.

Test for Wrong Peak

If, on the other hand, the image is stronger than the signal, the r-f and antenna trimmers have probably been incorrectly adjusted. If it is not known on which side of the signal frequency the oscillator is supposed to track, it should be aligned before the r-f and antenna trimmers are touched.

With the signal generator on the correct alignment frequency (20 mc in the above example) and the output turned down low, the strongest, if not the only, generator signal tuned in by the oscillator trimmer will be the proper frequency.

Some superhet receivers use a wave trap, for the purpose of eliminating interference emanating from code stations. These stations operate on a frequency of approximately 455 kc. The wave trap is made up of a coil, a fixed capacitor, and a trimmer capacitor, as shown in accompanying diagram. It should be adjusted after all other alignment operations have been completed.

Wave Trap Is Set Last

To adjust, feed a 455 kc signal from the generator through a 200 mmfd capacitor into the antenna terminal of the receiver, and align trimmer for minimum signal output, as registered by output meter. The gang tuning capacitor should be fully open, and volume control fully on, during this operation.

Proper alignment of modern superhets is not difficult, and is highly essential to flawless set performance. The competent technician will not neglect this important phase of radio maintenance.

Admiral

**GIVES YOU POST-WAR PERFORMANCE
AT PRE-WAR PRICES!**

OPA Ceiling Price
Zone 1

\$44⁹⁵



... in these two popular models

← 6RP48 ELECTRIC PHONOGRAPH

↓ 6RT41 RADIO-PHONOGRAPH

OPA Ceiling Price
Zone 1

\$59⁹⁵



Both with

"CHILDPROOF" AUTOMATIC RECORD CHANGER

Plays ten 12" or twelve 10" records automatically. "Childproof" tone arm may be moved *at any time* without damage to mechanism. PM dynamic speaker with new Alnico No. 5 metal assures superb tone quality. Both models in streamlined plastic cabinet . . . the last word in modern styling. Deliveries of these new value leaders now being made. Admiral Corporation, Chicago 47, Ill.

WORLD'S LARGEST MANUFACTURER OF RADIO-PHONOGRAPHS WITH AUTOMATIC RECORD CHANGER

Radio Service Methods

Filament Test on AC-DC Sets

A simple, quick test for filament continuity on ac-dc sets will determine whether a female outlet, or the

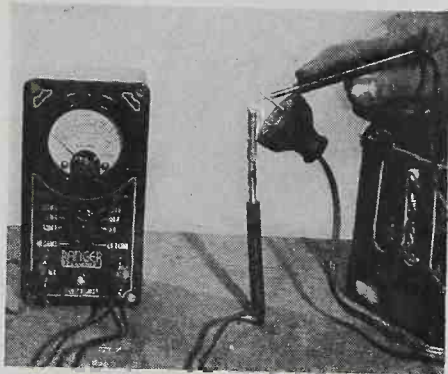

radio itself, is defective. Hook up the ohmmeter across the line plug as shown. If no reading is obtained, it is safe to assume that a tube filament, filament resistor, line cord or switch is open.

Restoring Television Reception

Sometimes a television set owner will find that his reception and picture quality have suddenly or slowly deteriorated.

"In trying to locate the cause of such trouble, the radio serviceman will have to make a complete check-up of the installation, starting with the antenna," advises a television veteran, who writes us as follows:

"Have recent winds loosened or damaged any of the connections, including the co-axial cable? To avoid the trouble of taking down the antenna and lead-in for examination, I have often rigged up a substitute antenna from a dipole and an open transmission line, elevated it temporarily as high as possible, and connected it to the receiver.

Quick Antenna Check

"A weaker signal will be obtained from this set-up than from the original antenna, if the latter is not defective. If it is defective, however, the temporary antenna will give a signal several times as strong as the permanent one, and thus definitely points a finger at the difficulty.

"Has the sensitivity of the receiver

decreased due to aging tubes, or other causes? This can best be determined by using a test oscillator. Without suggesting the addition of many gadgets to the set, it is nevertheless very helpful to install a meter indicating avc voltage on the receiver, because the reading of this meter is proportional to field strength, and in a way provides the same sort of indicator for the user as the ammeter on the dash of an automobile. Have you inquired of neighbors who live on the opposite side of the street whether their reception has also been affected?

"If the antenna installation is in good condition, we must consider whether its design or type is responsible for the unsatisfactory pictures. For those locations where dipoles with reflectors will not give a satisfactory signal, the next best antenna is a V, each side of which is several wave lengths long, and the open angle of which is pointed toward the transmitter.

"A still better but more elaborate installation is a rhombic antenna. This requires 4 supports, whereas the V type only requires 3. Neither of these more efficient antennas, of course, will give a satisfactory signal if there is elevated ground lying between the transmitter and the set, since signal attenuation under these conditions is great.

Interference Identified

"Sometimes there is difficulty due to interference images. Each type of interference has characteristics which enable the expert to identify it—sometimes—merely by looking at the patterns formed on the screen. Parallel bars seem to be definitely connected with either 60-cycle power supply, or interference from another station.

"If international BC stations are being picked up by the intermediate frequency of the receiver, you can eliminate the trouble by placing a wave-trap tuned to the i-f in series with the antenna lead.

Is it possible that a doctor in the neighborhood is operating his diathermy machine in a way to put bars across the picture? This type of interference is usually identified by the fact that the pattern it causes varies continually, and widely, in frequency as the patient being

treated moves. Another point worth noting — diathermy treatments never last longer than 20 minutes, and an interval of 5 minutes generally elapses between treatments, if many patients are being cared for. This peculiarity should help identify diathermy-caused interference."

Testing Bias Cells

Special care must be used in testing the midget bias cells used in battery sets. To check for noise, tap its mounting bracket very gently with a good insulator. To remedy, try tightening the clip which contacts the positive black disc.

According to the manufacturer, bias cells will safely deliver only 1 microampere. Therefore, due to the danger of a momentary short, voltage checks of the cell should be made without removal from the circuit.

Since most voltmeters draw over 1 microampere, the v-t-vm is preferred. An "infinite impedance"

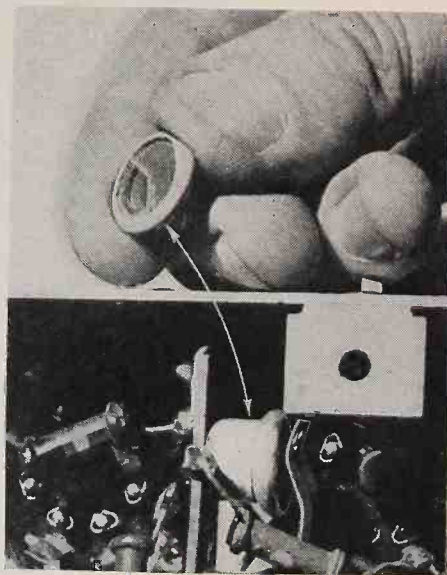

type is recommended for accuracy, when checking through an avc filter or grid decoupling resistor.

Many servicemen report that in testing directly across the cell, a 20,000 ohms-per-volt meter has been used without apparent bad effect.

The bias cells come in two voltages: 1-volt and 1¼-volt. The latter has indentations in the black disc and metal container. Be sure to replace the correct cell. The 1-volt type must not mount with its black disc upward.



The Revolutionary New WESTINGHOUSE DUO

It's a radio-phonograph with automatic record changer . . . but you can lift out the radio and play it anywhere. The hottest sales feature of 1946!

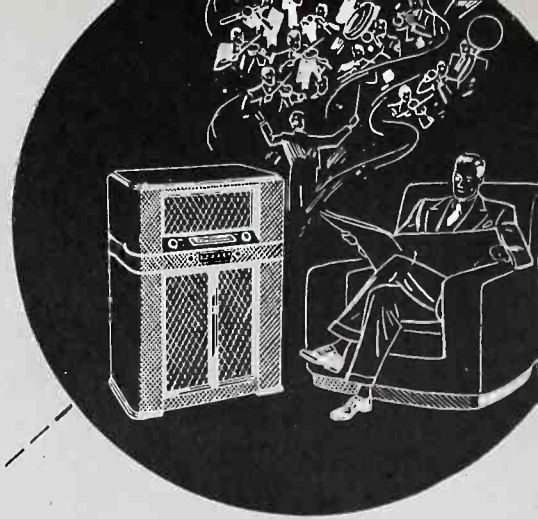

The Amazing PLENTI-POWER CIRCUIT

This exclusive feature gives a low-priced Westinghouse 7-tube set more undistorted output than most 12-tube sets had prewar. *Anyone* can hear the difference . . . *everybody* likes it. It means sales to the millions who want 12-tube performance on a 7-tube budget.

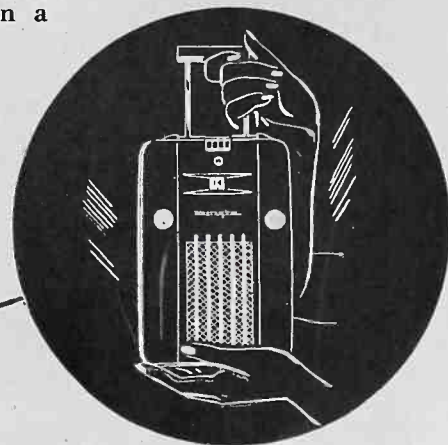

A POWER-HOUSE IN A JEWEL CASE!

Never before has such performance been packed into a set of this size. You'll have to hear it to believe it!

NEW IDEAS

That sell radios

more proof that you can depend on WESTINGHOUSE RADIO for originality

For more information call your Westinghouse Distributor or write Home Radio Division, Westinghouse Electric Corporation, Sunbury, Pa.

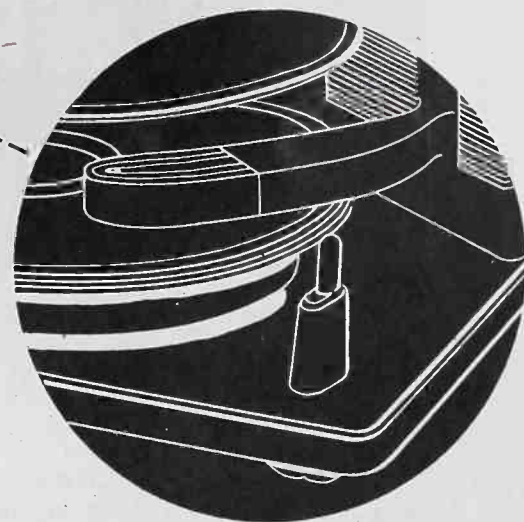

THE EAR-LEVEL SPEAKER

Something new you can demonstrate. The sound originates at the *most natural level* for listening enjoyment. No acoustical loss or distortion from the carpet or floor.

6 TO 10 TIMES AS MUCH RECORD STORAGE SPACE

In most of the new radio-phonographs, Westinghouse has made the entire cabinet width available for record storage space . . . 6 to 10 times as much as prewar cabinets of the same size . . . a realselling feature for people with record libraries.

A completely new AUTOMATIC RECORD CHANGER

Single-button control! No changeover levers to push! No complicated operating instructions.

When you want to operate the tone arm by hand, do so . . . no danger of throwing the automatic mechanism out of adjustment. After the last record is played the tone arm returns to rest and the turntable shuts off automatically.

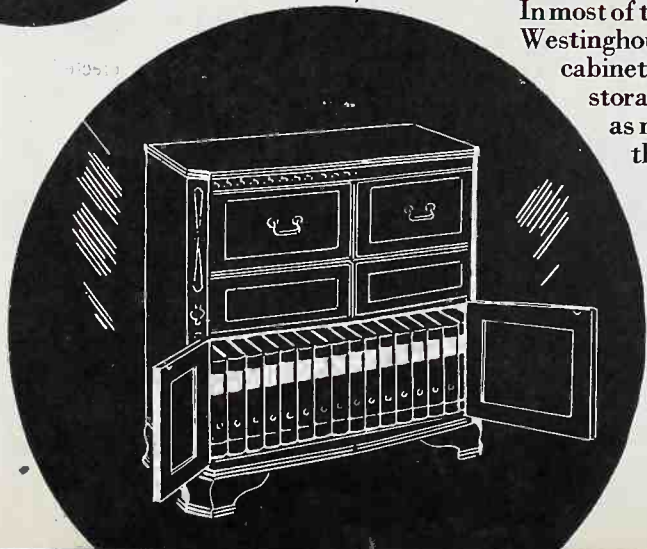

RADIO'S FIRST NAME IS

Westinghouse
Radio Television

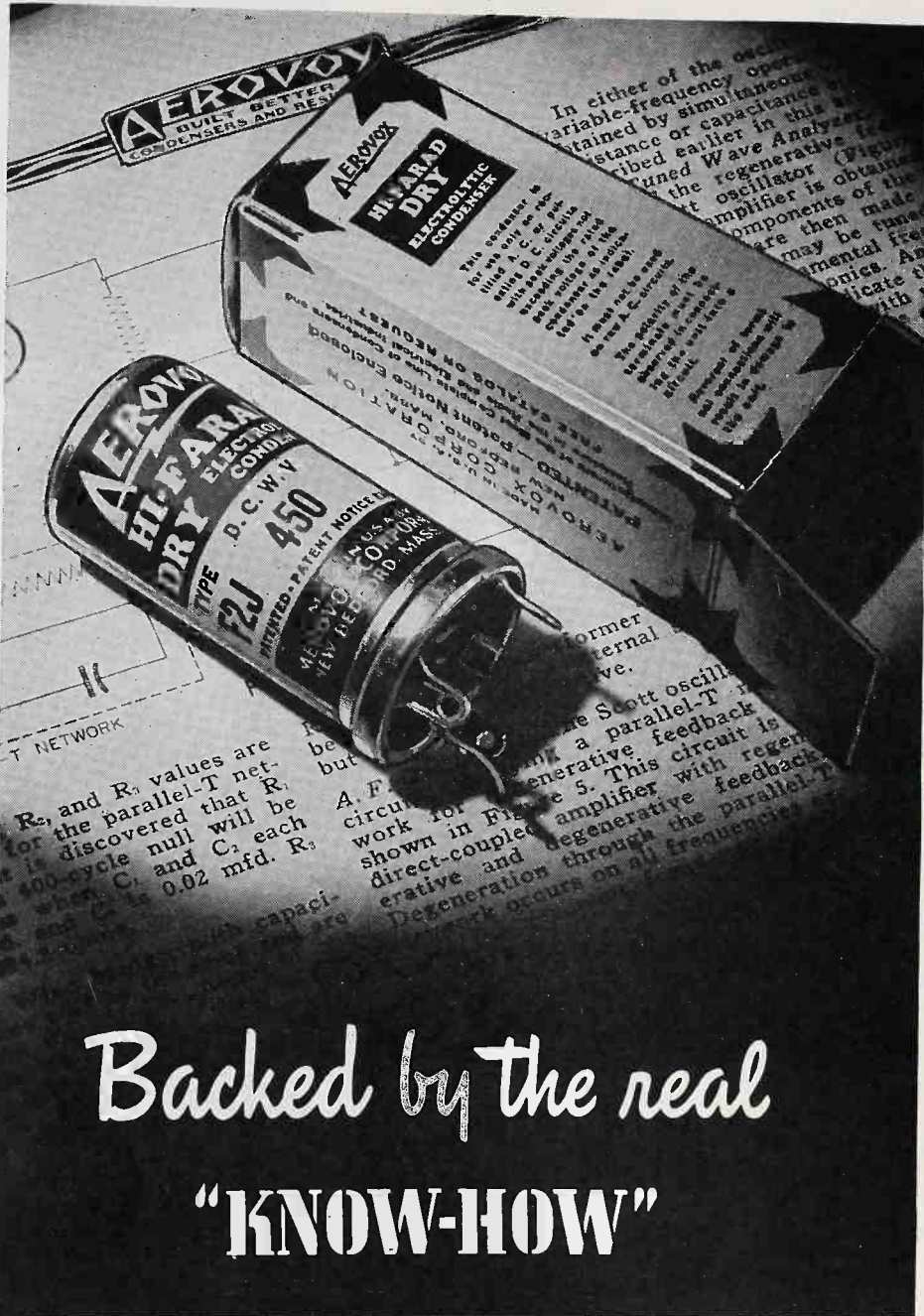

Backed by the real
"KNOW-HOW"

• Most live-wire radio workers are getting the Aerovox Research Worker. If by any chance you're not, then you're missing a steady flow of practical data. Let's correct the oversight.

Remember, good capacitors come first, and that means Aerovox. But how to apply good capacitors is just as important. Especially if you want to get ahead in radio-electronics. Therefore, be sure those Aerovox capacitors are backed by the real "know-how" which is yours for the asking.

- Ask any Aerovox jobber for our postwar catalog—more types, sizes, ratings. Also ask for your FREE subscription to the Aerovox Research Worker. Or write us.



FOR RADIO-ELECTRONIC AND INDUSTRIAL APPLICATIONS

AEROVOX CORPORATION, NEW BEDFORD, MASS., U. S. A.

SALES OFFICES IN ALL PRINCIPAL CITIES • Export: 13 E. 40th St., NEW YORK 16, N. Y.

Cable: 'ARLAB' • In Canada: AEROVOX CANADA LTD., HAMILTON, ONT.

"Sell" Television Now, Emerson Urges Dealers

Emerson's Phillip Gillig, speaking before a meeting of the American Television Society in New York, told retailers that the present time is not too early for dealers to advertise themselves as television merchandisers. He suggested that merchants prepare demonstration sections in their stores and use all means to identify themselves with television.

Emerson sets, in popular price ranges, will be ready before the end of the coming summer, Mr. Gillig said. Direct-view sets will be first off the production lines, with projection sets to follow shortly thereafter. The Emerson official also stated that his firm believes projection viewing will be "the television of the future", and declared that this method will provide better service and will cost less to produce.

Columbia Makes Staff Changes

Paul Southard, vice-president in charge of sales of Columbia Recording Corp., has announced a number of changes in CRC personnel. Jack Hein, formerly district manager for the Chicago territory, is now assistant to Mr. Southard, to handle distribution.

Joe Lucas, district manager for Columbia before the war, has returned from the Navy to take over the Chicago district.

Joseph Bott, formerly record salesman for Tri-State Distributing Corp., Columbia's Cincinnati distributor, replaces Bus Cross in the Charleston-Pittsburgh-Cincinnati-Columbus-Louisville area. Mr. Cross goes to the Cleveland-Detroit-Toledo-Syracuse-Buffalo territory.

Rittenhouse Company Perfects Chime Mechanism

The A. E. Rittenhouse Co., Inc., Honeoye Falls, N. Y., announces that after much research they have perfected, patented, and are installing in each one of their chimes a new chime mechanism called the "floating percussion unit." This new mechanism, it is claimed, eliminates jammed and sticking plungers, and has been activated in the Rittenhouse laboratory over 2 million times without one instance of jamming. The 1946 line of Rittenhouse chimes was designed by Norman Bel Geddes.

Taylor Camfield Partner

Edward L. Taylor has been elected to partnership in the Camfield Mfg. Co., Grand Haven, Mich., of which he is general sales manager, it was announced by Russell W. Camfield, president.

The Camfield company manufactures the Camfield automatic electric toaster, a fluorescent light diffuser called the "Fluor-O-Shield," the Camfield plywood serving trays, and also is continuing the manufacture of special items of formed laminated wood.

MAKING TUBES IS EASY If YOU KNOW HOW!

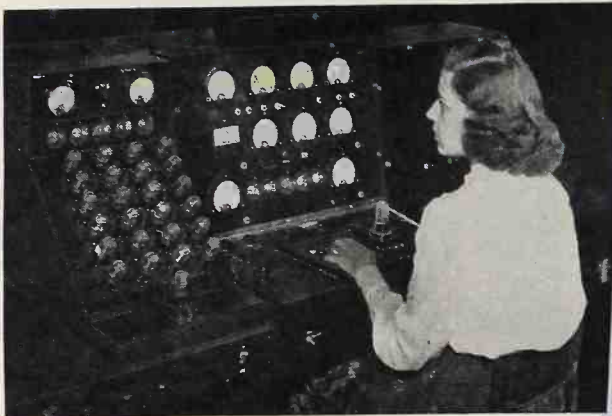

This standardized Hytron production tester is composed of three units: preheater, characteristics tester, noise tester. To permit a better view of the equipment, only one of three operators is shown.

HOW THE HYTRON 12SK7GT IS QUALITY CHECKED

Test	100% Production Test	Central Inspection Sampling	Quality Laboratory Sampling	100% Test at Packing
Shorts				
Base shell connection	X			
Heater current	X	X		
Plate current	X	X		X
Screen current	X	X		
Grid current	X	X	X	
Transconductance	X	X	X	
Suppressor action	X	X	X	
Emission	X	X	X	
Heater-cathode leakage	X	X	X	
R-f noise	X	X	X	
Transconductance cutoff	X	X	X	
Vibration		X		X
Insulation resistance				X
Input capacitance				X
Output capacitance				X
Grid-plate capacitance				X
Grid emission				X
Immersion (basing cement)				X
Life				X
Overall length				X
Mechanical*	X			X
	X	X		X

Mechanical tests are covered by a multipage specification. Typical inspection is conducted visually and/or by gages for the following: pin solder, etching, getter flash, diameter, base-bulb alignment, bent base pins, glass defects, and rigidity of internal elements, bases, and base pins.

AGAIN HYTRON'S LONG EXPERIENCE

GIVES YOU THE BEST...

FOR your protection Hytron tubes are quadruple-checked. On the production floor, each tube is first tested for significant characteristics. In the central inspection department, a random sampling is next taken for statistical control of the production testing—to assure quality within acceptance limits. Failure at this point demands 100% retest.

Daily a smaller random sampling is subjected to a searching design check of characteristics such as inter-electrode capacitances, grid emission, and transconductance cutoff. These characteristics can be controlled by the smaller sampling, and their testing requires laboratory precision. Simultaneously production tests are again repeated for further statistical control. Again failure to meet acceptance limits demands 100% retest—even for design characteristics not production-tested.

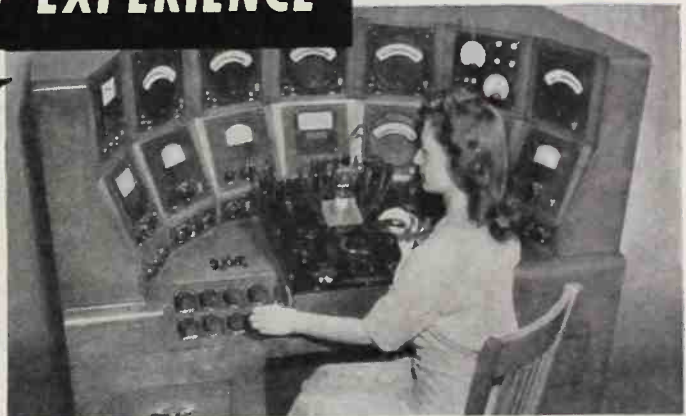

Extreme accuracy and flexibility of this Hytron master test station particularly fit it for quality control.

Finally each tube is once more short-tested and mechanically inspected just before packing.

This painstaking quadruple-checking ensures that specification failures of tubes actually shipped will be a practically irreducible minimum. When you buy a Hytron tube, you can be certain that every ounce of Hytron know-how on quality control—reinforced by wartime experience—has been in there punching to give you only the best.

OLDEST MANUFACTURER SPECIALIZING IN RADIO RECEIVING TUBES



HYTRON

RADIO AND ELECTRONICS CORP.



MAIN OFFICE: SALEM, MASSACHUSETTS

Clarostat Sales Up

A several hundred per cent increase in jobber business is reported by Leon Adelman, advisory sales manager of Clarostat Mfg. Co., Inc., Brooklyn, N. Y.

"Clarostat jobber business is at an all-time high but still climbing week by week", reports this well-known radio parts merchandiser. "Only recently we established a jobber stock at our North Sixth Street plant, whereby we could carry a considerable inventory of standard jobber items for prompt delivery. Our two plants have had big production runs on such items, and we figured our jobber stock would tide us over many months. Instead, the inventory has been quickly accounted

for and our plants have had to keep right on producing for jobber stock. Nevertheless, we are now shipping practically all jobber orders in full within 72 hours."

Maguire Vice-President

Paul K. Povlsen has been named vice-president and general manager of Maguire Industries, Inc., Russell Maguire, president of the company, has announced.

In his new position, Mr. Povlsen will supervise all manufacturing operations of the company, including those of subsidiaries. The company's operations are located at Bridgeport and Stamford, Conn., Chicago and Mt. Carmel, Ill., Cleveland, Ohio, and Jamaica, N. Y.

Pambrun New Exec at Stewart-Warner

Leo B. Pambrun has joined the advertising department of Stewart-Warner Corp. as assistant advertising manager in



Leo B. Pambrun

charge of the radio division, according to news from Fred R. Cross, advertising manager.

Mr. Pambrun was discharged from the U. S. Marine Corps last November, and had previously worked with Crosley Radio Corp. and Brunswick-Balke-Collender.

Espey Buys Philharmonic

The Espey Mfg. Co. has purchased the Philharmonic Radio Corp. and has moved into the latter's modern plant at 528 E. 72nd St., New York City, where the company is completing its expansion plans as a specialist in private brand manufacture. In the deal, the sales contracts, equipment and all other assets of Philharmonic were bought out by Espey.

A limited number of Philharmonic receivers will continue to be produced by Espey, who is now the owner of the name which is well identified with quality units. Espey was formerly located at 33 W. 46th St., New York City.

Farnsworth Promotion

B. R. Cummings, vice-president in charge of engineering for Farnsworth Television & Radio Corporation, Fort Wayne, Ind., has announced that J. D. Schantz has been promoted to assistant manager of the firm's research department.

Export Head for Capitol Discs

Sydney de Azevedo has joined the staff of Capitol Records, Hollywood, as their Export Supervisor, it has been announced by Glenn E. Wallich, executive vice-president of the firm.



DOUBLE YOUR SALES WITH DUODISCS!

Duotone's complete line of recording accessories includes the famous Duodisc for home recording, a fast-selling favorite that means more profits for you, more satisfaction for your customers.

For years, both red and purple label Duodiscs have proved their reputation for greater fidelity, longer wear and noiseless reproduction.

Carry Duotone's Aluminum Base Duodiscs, Cutting Needles and Transcription Needles. Cash in on Duotone's reputation now. Write for details and prices.

Duotone also makes the famous five dollar "Star" Sapphire needle.

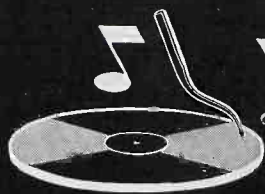

DUOTONE

DUOTONE COMPANY
799 Broadway, New York 3, N. Y.

The Supreme Court of Radio Listening chooses Olympic—with 'TRU-BASE'

THE JUDGES:

MRS. JACK BENNY MRS. EDGAR BERGEN
MRS. PHIL HARRIS MRS. ANDY RUSSELL
MRS. KAY KYSER and many others

ALICE FAYE HARRIS is shown listening to her Olympic. This advertisement in four colors will appear in leading national magazines. It is one of a series telling of the satisfied experiences of 'best judges of radio' with Olympic's 'tru-base.'

ONE OF THE most powerful campaigns in the history of radio advertising starts in April—in full color pages—for Olympic.

Every 30 days this advertising campaign will reach an audience of 19,850,000. A total of 178,650,000 selling messages in 1946.

This year-long national advertising campaign, featuring Olympic's great electronic development—'tru-base,' is based on the authentic testimony of the wives of America's top-ranking radio stars.

These women, expert judges of radio tone, chose Olympic over all other radios for its true-to-life reproductions of their husbands' voices and music.

Therefore, they bring to Olympic's advertising campaign both tremendous attention value and sales conviction.

To 'tru-base' goes the credit, for 'tru-base' faithfully reproduces the voices and music these wives know best—gives the impression that their husbands' programs are broadcast from their own living rooms.

This revolutionary development in the audio circuit, exclusive with Olympic, enables table radios for the first time to reproduce faithfully the full, audible tonal range.

The full beauty and design of Olympic's superb cabinets have been brought out in all their magnificence with full color photographs. Nothing, in fact, has been overlooked to make advertising and sales history in this 1946 Olympic campaign.

That is why we predict Olympics are headed for millions of homes.

Olympic Division of Hamilton Radio Corporation, 510 Avenue of the Americas, New York, N. Y.



ALICE FAYE 20TH-CENTURY-FOX STAR

New thrill in her husband's theme song for

Alice Faye Harris

'TRU-BASE'... Olympic's electronic discovery... gives console tone to table radios

S-h-h-h-h1—it's the familiar strains of "Love in Bloom," opening theme of her husband's orchestra...

True, Mrs. Phil Harris has heard them play it over the air uncounted times. But this time her professionally-trained ear detects a wonderful difference.

For here's radio tone so realistic, so breath-takingly lifelike that it's as if Alice Faye's husband were broadcasting from their living room. Yet the radio at her elbow is a compact table Olympic.

Yes, here's console tone in a table radio! For Olympic, and Olympic alone, has 'tru-base.' And 'tru-base' enables table radios for the first time to reproduce the full audible tonal range, from the richness of deepest bass notes to the wispy delicacy of reediest trebles.

And it's Olympic for beauty, too—cabinets of princely hardwoods and

gleaming plastics gloriously styled by celebrated designers. So for an ear-thrilling, eye-thrilling surprise—just drop in on your Olympic dealer. Now.

Alice Faye Harris is shown above with her new Olympic 'tru-base' automatic table radio-phonograph combination. Plays and swiftly changes up to twelve records... \$119.95*

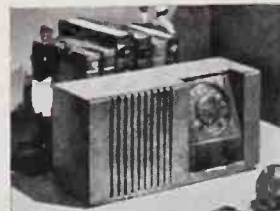

Olympic Model 6-302, 5 tube AC/DC Super-heterodyne 7 tube performance. Modern cabinet in rich woods. Lucite dial... \$51.95*

Other Olympics—portables, table models and console radio-phonograph combinations up to \$600.00*.

*Slightly higher west of the Rockies.

Olympic Radio
The only radio with 'Tru-Base'

OLYMPIC DIVISION OF HAMILTON RADIO CORPORATION • NEW YORK, N. Y.

Attention Merchandisers:

Sonora RADIO-PHONOGRAPH

Model RGF-230 is a 5-tube, ac phono-radio of superhet design. This table unit has automatic volume control, built-in Sonorascope loop, translucent back-lighted dial, dynamic speaker, and tunes 535-1620 kc. Cabinet design features curved lid and louvre-type grille; finish is blonde prima vera.



(Model RGF-212 is walnut finish). Phono mechanism plays both 10" and 12" records, and has feather-weight crystal pick-up with permanent needle; 78 RPM self-starting motor; push button on-off switch. Measures 14⁵/₈" x 9¹/₄" x 11¹/₂". Sonora Radio & Television Corp., 325 N. Hoyne Ave., Chicago 12, Ill.—RADIO & Television RETAILING

Electronic Labs UTILIPHONE

Intercommunicator originally designed as a toy for \$19.95 now released also in adult model office job. New one has switches on both units for controlled 2-way office talk. Three-wire connection. \$29.95. Electronic Laboratories, Inc., 122 W. New York St., Indianapolis, Ind.—RADIO & Television RETAILING

Lavoie RADIO & PHONO

6-tube superhet receiver receives on broadcast and short wave bands. Built-in loop antenna. Full automatic volume

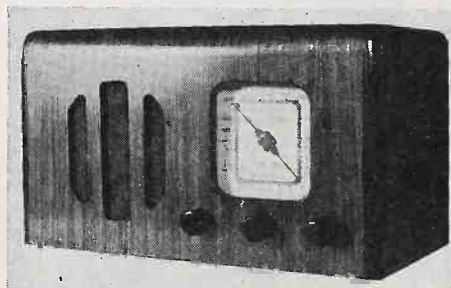

control. Operates on ac-dc. Wood cabinet, walnut or mahogany finish.

Portable automatic record changer comes in wood cabinet with leatherette covering. Two-post, quick action record changer. Mellow-toned 3-tube

amplifier. 6" dynamic speaker. Tone control and volume control. Plays twelve 10" or ten 12" discs with auto-



matic shut-off after last record. Operates on ac-dc. Lavoie Laboratories, Morganville, N. J.—RADIO & Television RETAILING

Bendix RADIOS

Model 526-A has one-piece plastic cabinet with built-in concealed handle for convenient carrying; dust-proof enclosed back. 7-tube performance through

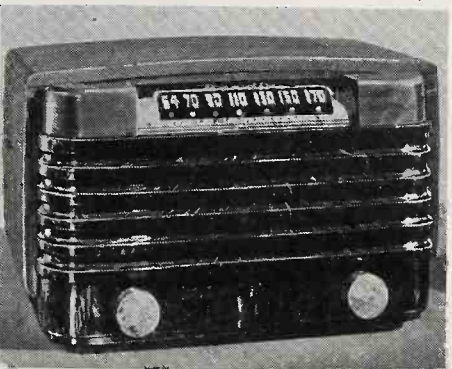

5-tube superhet circuit using two double-purpose tubes. "Super Signal" built-in antenna. Beam power output.

Improved automatic volume control. Operates on ac-dc. 11¹/₄" wide, 7¹/₄" high, 7¹/₄" deep. OPA price \$22.95.

Model 526-C has "Gem-tone" cabinet in jewel-like catalin. Convenient in-set handles at side. Illuminated 3-color curved slide rule glass dial for easier visibility. "Super Signal" built-in antenna. 7-tube performance through 5-tube superhet circuit using two double-purpose tubes. Operates on ac-dc. Choice of green and black, or two-toned brown. 11¹/₄" wide, 7¹/₄" high, 6-5/16" deep. OPA price \$29.95. Bendix Radio Division, Bendix Aviation Corp., Baltimore 4, Md.—RADIO & Television RETAILING

Electro-Tone PHONO

Model 212 portable electric phono is available in alligator or airplane cloth covering. Comes in assorted colors. 4-



tube amplifier; 6" Alnico speaker. Tone control. OPA price \$47.65 in Zone 1. Electro-Tone Corp., 13 East 16th St., New York—RADIO & Television RETAILING

Electro RADIO

Table model set has 6-tube superhet circuit. Operates on ac-dc. 5" PM

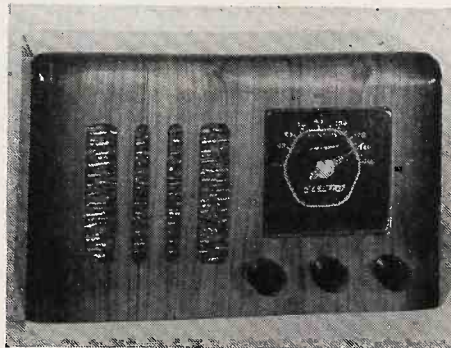

speaker. Mahogany finish cabinet. OPA price \$26.25. Electro Mfg. Co., 102 Park Row, New York 7, N. Y.—RADIO & Television RETAILING

Brand New Lines

LATEST ELECTRICAL
APPLIANCES, PP. 52 - 60

Stromberg-Carlson RADIOS

"The Nocturne" table model receiver comes in a walnut cabinet styled in newest trend, with a louvred front. This ac-dc set features an illuminated slide-rule dial, an electrodynamic speaker, built-in loop antenna, 3-gang tuned r-f stage. Has automatic volume control

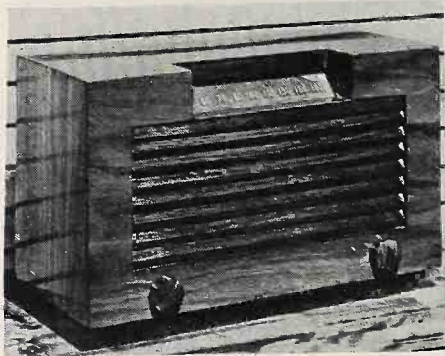

plus manual control. Measures 8" high, 13 1/4" wide, 6 5/8" deep.

"The Cavalier" console radio comes in walnut cabinet of contemporary design. Receives on standard broadcast



and short wave bands. Push-button tuning for six stations. Full-floating 12" electrodynamic speaker. Automatic volume control. Built-in loop antenna. English antique-finished hardware. 39" high, 31 1/4" wide, 13" deep. Stromberg-Carlson Co., Rochester 3, N. Y.—RADIO & Television RETAILING

Novex PROJECTOR-VIEWER

Designed to accommodate all 2" by 2" kodachromes, in addition to black and white slides and dental X-ray mounts. Features tilting segment which permits projection of image either on built-in 7" by 7" ground-glass screen, or on conventional home movie screen or wall. Slide carrier will handle two slides in a way which always exposes

one end, which avoids interruption when changing slides. Novex Division, Utility Supply Co., Chicago, Ill. Dis-

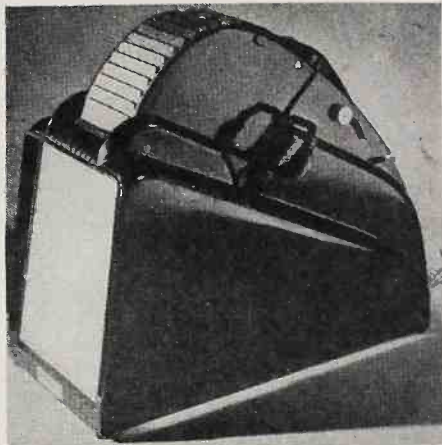

tributed through Pruitt Office Machinery Co., 425 LaSalle St., Chicago 10, Ill.—RADIO & Television RETAILING

U. S. Television RADIO & COMBO

Model R3000 "Chambermusic" receiver gives 8-tube performance with superhet circuit. "Secret Circuit" de-



signed to give this radio fine tone quality. Cabinet of rubbed and polished walnut or mahogany. Operates on ac. Model R6008-FM "The Masterpiece". Multi-tube performance and two speakers designed to give improved recep-

tion. Hepplewhite cabinet. U. S. Television Mfg. Corp., 106 Seventh Ave., New York 11, N. Y.—RADIO & Television RETAILING

Crosley RADIO

Model 66CA console receiver features continuous tone control, signal web antenna. Receives on broadcast and overseas bands. Modern cabinet styl-



ing. Large size electro-dynamic speaker; 6 tube. Automatic sensitivity control. Large size dial. Measures 37 1/2" high, 26 3/4" wide, 12" deep. The Crosley Corp., Cincinnati 25, Ohio.—RADIO & Television RETAILING

Electronx RADIO & INTERCOMMUNICATOR

Model CR-235 is a radio receiver that also carries sound over electric light wires from point to point without special interconnecting wires. Operates on principle of carrier-currents, superimposed on electric light wires. Voice can be picked up through loud speaker



without distortion. Radio cuts out automatically when unit is called by another. Communication can be effected even when radio is turned off. Lectradio Corp., 4 St. Francis St., Newark 4, N. J.—RADIO & Television RETAILING



There's a great demand today for USALITE "A" and "B" Batteries and "A-B" Paks for portable radios. And USALITE is all set now to meet that demand with regular deliveries. Order from your jobber today.

USALITE Radio Batteries come in the same old familiar brown and yellow carton. But inside you'll find better quality and performance than ever... reflecting not only our many years in battery manufacture, but all the added "know-how" built up in the course of our war-time experience.



NO. 75
HEAVY-DUTY CELL
FRESH
DATED 1



"A" & "B" Batteries for Portable Radios

Made by the makers of famous USALITE Flashlights and Batteries

UNITED STATES ELECTRIC MFG. CORP. Factory and Exec. Off.: New York 11, N. Y. Branch Off.: Chicago 7, Ill.

Hytron, Air King in Merger

Hytron Radio & Electronics Corp. has purchased outstanding capital stock of Air King Products Co., Inc., Brooklyn, N. Y. The latter firm will operate as a division of Hytron under the direction of Air King's president, J. P. Lieberman.

The two companies will now have eight modern plants, and according to the joint statement by Hytron president Bruce A. Coffin and Mr. Lieberman, the merger will mean "greater efficiency of manufacturing operations and distribution." Hytron will have a daily capacity of 100,000 radio tubes, and Air King will be rated at 5,000 sets a day.

Air King plans to produce a complete line of FM, AM, and television sets. Hytron reports that "typical of our continued forward strides, we will soon announce our line of miniature versions of the ac/dc tube types." Heads of both companies have stated that sales policies will remain the same.

Philco, Kellogg Join in Mobile Radiotel Plans

Auto radio service organizations are watching with interest the joint plans of Philco Corporation and Kellogg Switchboard & Supply Company to manufacture and distribute FM mobile radiotelephones. No installation and service policy has yet been announced.

Under the newly concluded agreement, Kellogg will furnish and install mobile systems for the independent telephone companies, who serve 12,000 of the nation's 19,000 communities. Philco will produce the equipment on an exclusive basis.

Expect 250,000 Hams

The Federal Communications Commission has resumed issuance of new amateur radio station licenses for the first time since Pearl Harbor. A statement by the American Relay League predicts that the number of amateurs, which before the war totalled 60,000, will grow to 250,000 within the next five years.

Expert Tests Combo



First postwar radio-phonograph off the line at Magnavox gets its tone tested by Ft. Wayne, Ind., Philharmonic conductor, Hans Schwieger, center. He tried everything, then "gave his enthusiastic approval." Magnavox execs are L. E. Quinnell, left, and J. S. Sturgeon.

Join Sprague Products

Sprague Products Company, North Adams, Mass., announces the appointment of George R. Sparks and John N. Leedom as field engineers of that company. Both men will work under the direction of Research Engineer Leon Podolsky in furthering the company's growing line of materials for distribution through the jobbing trade. Both are now busily engaged on the development of new products soon to be announced.

Hydro-Aire Expansion

The Hydro-Aire Co., Los Angeles, Cal., has completed construction of its new \$500,000 plant at Burbank, Cal. Hydro-Aire is still actively engaged in the manufacture of hydraulics for industry, but is continuing to expand production into the home electrical appliances field. One of the company's first appliance products to reach the market was the Hy-Temp electric heater. Homer H. Rhoads is organizer and owner of Hydro-Aire.

Sales Committee Swings into Action



Above is the 5-man "sales committee" named to handle postwar plans and promotion for Jensen Radio Mfg. Co. President and general manager Thomas A. White says the firm will redesign speakers to feature the new Alnico 5 magnet material, and will announce new coaxial units, plus reproducers in bass reflex cabinets. L. to r., R. T. Sullivan, eastern dist. sales manager; C. A. Hansen, western dist. sales manager; S. K. Hughes, sales office manager; H. S. Hoffman, city salesman; and B. H. Clark, advertising and sales promotion manager.

Tone That's Picture-Clear!

in the **ALL-NEW** Stewart-Warner Radios



NEW TABLE RADIO-PHONOGRAPH

has the finger-tip record changer that plays up to 12 discs. New, undistorted volume for dancing... thrilling Strobe-Sonic Tone.

Yes, it's thrilling new tone that makes music's every moment a clear, beautiful "picture"... as though the studio itself had been transported into every owner's home!

All the skill and experience acquired in building fine radios for 22 years have gone into these *all-new* Stewart-Warner sets... new *inside* as well as outside.

Here is thrilling new beauty, to see and to hear, never achieved in prewar radios regardless of price!

Look and *listen* for the remarkable difference.

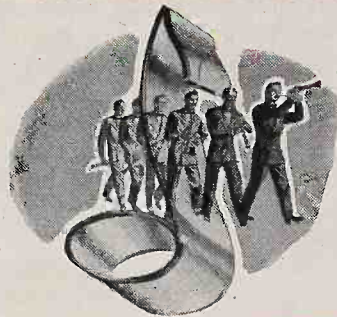

Strobe-Sonic

TO NE

So faithful you can understand each word, distinguish every instrument, hear music in its true dimensions, picture-clear! A revelation in listening pleasure, exclusively Stewart-Warner.



NEW 3-WAY PORTABLE

eliminates messy wet batteries, has safe *dry* cells, yet batteries will last 5 to 7 times longer! Plays on AC, DC, or battery. Charges overnight on AC or DC. New power, new brilliance!



NEW CONSOLE COMBINATION

has all the desired features of the most de luxe consoles. No-lift top, roomy record storage, finger-tip changer, beautiful Sheraton-inspired style, short wave.

Stewart-Warner

Radios · Radio-phonographs

CHICAGO 14



OL' PROF. SQUEEGEE DID THE JOB

... way back when



PROFESSOR SQUEEGEE SMASHES THE ATOM

After walking to his desk, Professor Oswald Z. Squeegee, PDQ., COD, carefully wound his watch, dropped it into the cuspidor and tucked his chew into his vest pocket. Then he faced the eager, upturned faces of his class.

"Listen to me, you intolerable numbskulls," he shouted. "Today we're going to study the Atom. What's more, we're going to smash the Atom right here in this room. S'help me!"

The Professor paused, reached for a coughdrop, got an eraser by mistake and chewed it vigorously. Then he cleared his throat and continued:

"The Atom, as you ought to know but probably don't, is the unit of all matter. It is the alpha of everything—the smallest, theoretically indivisible portion into which anything can be divided and still maintain its identity. In that respect, it is a good bit like the salaries most of you will earn when you graduate—if you ever do.

"How to smash the Atom has long puzzled scientists, including myself. However, we won't go into that today. Instead, we'll deal with an entirely different type of Atom—the Sprague Atom Dry Electrolytic Condenser, appropriately named for its small size and great durability. This, however, is a type of Atom that can be smashed. What's more, I'm gonna smash it!"

After ten minutes search, the Professor finally found an 8 mfd. 450 volt Sprague Atom in his cigar case—also a similar midger dry electrolytic of another make. These he connected into a weird electrical circuit on his desk. Then he slowly turned on the juice.



"Now," he gloated, "both condensers are rated at 450 volts and that's exactly what they're getting. As you see, nothing happens. We'll step the voltage up to 500. Now up to 525. Note that the other condenser is beginning to sizzle, although the Atom is still in good shape. Here we go to 550 volts—now to 575—now to—goodness me!"

There came an explosion not unlike that of a giant firecracker and the heads of the class suddenly disappeared beneath their desks.

"You're all wrong," shouted the Professor sleepily after order had been restored. "You thought I smashed the Atom—but I didn't. It was the other condenser that blew up—not the Atom."

Sure enough, the Atom on the desk was still connected—now hissing a bit under the strain of over 600 volts but functioning perfectly.

"The Atom," continued the professor, "is especially protected against blow-outs—against moisture, heat and whatnot. The way to smash the Atom is not merely a matter of overloading it. The way to smash the Atom is this."

The professor grasped an axe hung over a sign "Use only in case of fire." Swinging this with the skill of a woodchopper and shouting wildly all the while he brought the blunt end down on the Atom—again and again and again.

"There!" he screeched, gleefully looking at the shattered remains. "We've done it. We've succeeded where others have failed. That, gentlemen, is how to smash the Atom. Class dismissed."

A TYPE FOR EVERY DRY ELECTROLYTIC REPLACEMENT NEED

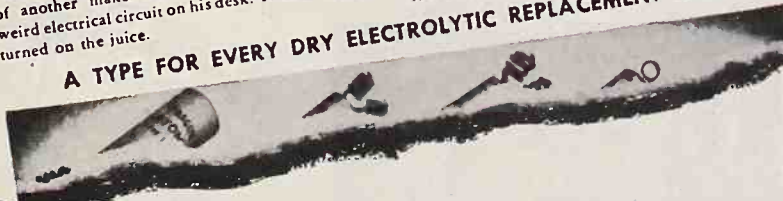

Professor Oswald Z. Squeegee is peeved. Extracts from a recent letter carefully typed on asbestos paper and perfumed with brimstone follow: "Listen here, you jerks. Isn't it about time I got credit as the first man, or reasonable facsimile thereof, ever to smash the Atom? Blow the dust off your files and you'll find I did the job way back in 1940 long before most folks even knew an atom from a dehydrated potato..."

And, ol' Prof. Squeegee is right! Here-with is reprinted the Sprague advertisement of almost six years ago wherein mention was first made of his startling achievement. Credit where credit is due!

(NOTE: Sprague Atoms are even better today than when Prof. Squeegee performed the now famous experiment. Would he accept a challenge to repeat it now?)

SPRAGUE PRODUCTS COMPANY

NORTH ADAMS, MASS.

JOBGING DISTRIBUTING ORGANIZATION FOR PRODUCTS OF THE SPRAGUE ELECTRIC CO.

New Technical Products

Clippard V-T-V-O

Model 406 is a bench-type electronic Volt-Ohmmeter using a bridge circuit and a dual-diode probe on a 36" cable. Full-scale sensitivity of 0-1-3-10-30-100-300-1,000 volts a-c and d-c, and 0-1,000 megohms in seven ranges are provided. A db scale of -20 to +51 also appears on the large square-faced meter. In-

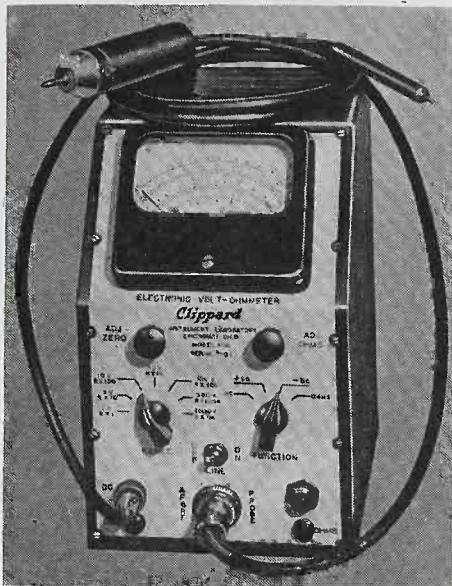

clined-front case is oak, with folding leather carrying handle. Separate d-c and ohms probes are, like the a-c probe, detachable. Input probe capacity is less than 7 mmf. D-c input impedance is 28 megohms, while the a-c input impedance is 7 megohms. Clippard Instrument Laboratory, 1440 Chase Ave., Cincinnati 23, Ohio—RADIO & Television RETAILING

Tri-Core SOLDER

Three rosin flux cores run through the length of this new Tri-Core solder. By bringing the flux closer to the surface of the solder, the iron's heat liquifies the flux quickly, resulting in fast

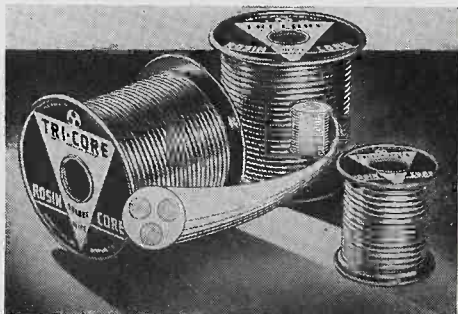

soldering and small tendency toward "dry" or "cold" solder joints. Bulletins and samples are available from Solder Development Division, Alpha Metals, Inc., 369 Hudson Ave., Bklyn 1, N. Y.—RADIO & Television RETAILING

Western Electric DIRECTIONAL MICROPHONE

Western Electric's Model 639-A microphone uses a combination of dynamic moving-coil and ribbon-type velocity elements, in one housing. The result is



cardioid-shaped directional sensitivity. Quality and strength of sound pickup remain practically constant over an angle of 120 degrees at the front of the microphone. Western Electric Company, Inc., 195 Broadway, New York 17, N. Y.—RADIO & Television RETAILING

Eject-O-Matic IRON

The Eject-O-Matic is an electric soldering iron trigger-operated to automatically feed a measured amount of solder from a reel concealed in the handle. A retracting feature prevents the melting of excess solder on the heating tip. The amount of solder is regulated by an adjusting wheel mounted in the handle of the iron near

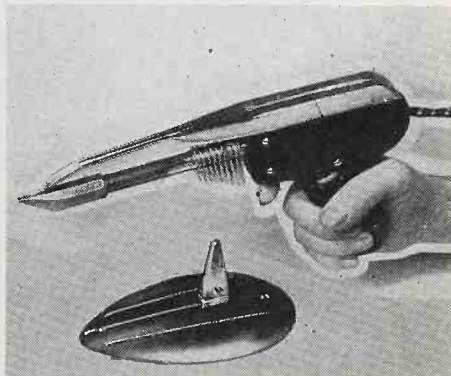

the operator's thumb. A replaceable tip is non-corrosive, and grooved to guide the molten solder. The iron weighs 1 1/4 lbs. loaded, and is balanced to minimize fatigue. In use, the iron is held in the hand as illustrated, or may be left in the stand. In this stand, the iron can be tilted forward, up to

45°. When further equipped with an extension trigger, both hands are left free, and the work may be brought to the iron. Multi-Products Tool Co., 123 Sussex Ave., Newark 4, N. J.—RADIO & Television RETAILING

Sprague TEL-OHMIKE

The De Luxe model TEL-OHMIKE is a bridge-type instrument for measuring capacities from .000010 to 2,000 mf, d-c resistances from .5 ohm to 5 megohms, and insulation resistance up to 10,000 megohms. Also measures power factor and leakage current of electrolytic ca-

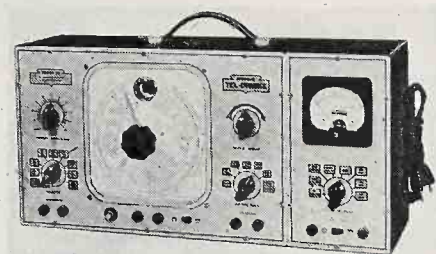

pacitors. A built-in power supply permits measurements under direct working voltage conditions, up to 1,000 volts d-c. A d-c meter, switch and pin jacks are used for measurements external to the TEL-OHMIKE. The meter ranges are: 0-15, -150, -500 and -1500 volts d-c, and 0-1.5, -15 and -50 milliamperes d-c. Sprague Products Co., North Adams, Mass.—RADIO & Television RETAILING

Cinch-Erie BY-PASSING SOCKET

The Plexicon tube socket is a joint development of the Erie Resistor Corp. and the Cinch Manufacturing Co. Having the appearance of an ordinary tube socket, the Plexicon actually contains several silver ceramic capacitors which by-pass the tube pins to either a center connection (loctal socket) or the metal mounting ring (octal socket). The

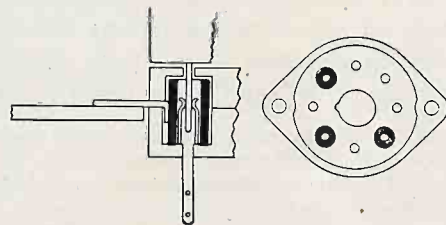

capacitors, which range up to .001 mf, fit around the tube pin and clip jack. The resulting short leads, as well as the reduction of inter-pin and stray wiring capacities, reduce undesired coupling and save space. They are of particular usefulness in VHF circuits, for FM and television work. Cinch Mfg. Co., 2335 W. Van Buren St., Chicago 12, Ill.—RADIO & Television RETAILING

(Continued on page 102)



Radios

DIRECT TO DEALERS

... WITHOUT "DETOURS"

Yes—ECA Radios are sold—and shipped—directly from the factory—to a limited number of selected dealers. Think what this means to you in time saved . . . in heavier deliveries . . . in protected profits . . . in better values for you and your customers!

- Complete range of models and prices.
- Freight paid to your city.
- Advanced electronic features.
- "Pre-Sold" consumers through extensive advertising.
- Warranty Tag of "Accurate Performance Rating" on each ECA Radio.
- Exclusive ECA Radio DI-FUSA-TONE*



Transmits, to every part of the room, all of the bass and treble tones and overtones that give music and voice rich, thrilling beauty! /

*Reg. U.S. Pat. Off.

A few franchises still open . . . write for details now, on your letterhead

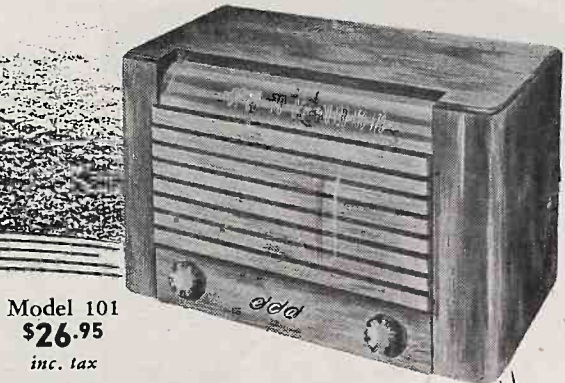

Model 101
\$26.95
inc. tax



Model 106
Automatic
Radio-Phono
Combination
\$79.95
inc. tax



Model 104
Radio-Phono
Combination
\$54.95
inc. tax

ELECTRONIC CORP. OF AMERICA 45 WEST 18TH ST., NEW YORK 11, N. Y.
RADIO • RADIO PHONOGRAPHS • PORTABLES • FM • TELEVISION • RECORD PLAYERS

DRIVE AHEAD WITH

Smooth Power

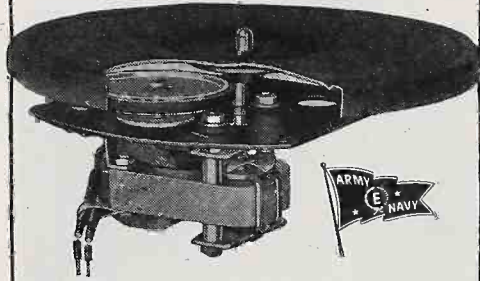

• You'll travel the roads to future markets faster and easier when you standardize on General Industries *Smooth Power* motors. Quick starting, uniform speed and quiet performance have for years made these motors leaders for phonographs, recorders and record-changers. From the GI complete line, select the proper motor for your new design. *For smooth performance, standardize on Smooth Power.*



The General Industries Company
DEPT. M • ELYRIA, OHIO

Sales Helps

Adds to Size of Radio Display

A display trick for dealers to use while sets are short, has been introduced by Sonora Products, Inc. The company is ready with window displays which reproduce in actual size three of the first models in production; these colorful cards may be used in windows, so that the actual sets may be displayed elsewhere. It has the effect of adding three sets to the dealer's stock.

Full color lithography of the displays shows every life-like detail of the receiver, and carries complete "specs" for the model concerned.

Big Eye-Catcher from Clarion

A compact "store within a store" merchandising display is now available to



Three-color floor display of extra size.

Clarion dealers and distributors. Against its colorful red, blue and gold background, 10 sets may be shown effectively.

The display is 7'6" high by 6'11" wide, with neat shelves of reinforced Masonite. It is part of a series of display materials, merchandising manuals, consumer literature and newspaper ads released by Clarion.

Standard Catalog Urged

A four-page printed folder, presenting complete details of dimensional and typographical layout for a "Suggested Standard Page" to provide uniformity and "practical workability" in catalogs used by salesmen of electrical wholesalers, has just been released by the National Electrical Wholesalers Assn.

This is the first step in a comprehensive program being developed by N.E.W.A.'s catalog committee, of which A. C. Prange, General Electric Supply Corp., is chairman.

"Flashlight Dept."



Now available to dealers, through distributors of the United States Electric Mfg. Corp., is a compact assortment of flashlights and cells, backed by the 4-color display shown above. Included are 2 each of 3 flashlight models, plus 48 batteries. The Swivel-Head and Red-Head numbers, promoted in national magazines, are represented in this V-6 assortment.

With Color Scenes

Westinghouse has a new 40-page booklet, titled "Electrical Living" for distribution through dealers and utilities. It's illustrated with color scenes from Walt Disney's "The Dawn of Better Living," available through Westinghouse jobbers at 10c a throw.

Blue Ribbon Display



The Hill-Shaw Co., manufacturers of Vaculator glass coffee makers, offer dealers a counter display of coffee filters, featuring a self-dispensing unit containing 12 individual packages. The display received the blue ribbon award at the Spice Mill 9th National Packaging Show.

Sectional Display for Complete Line

Newest set of point-of-sale displays from Arvin is a 5-unit job, which takes 15 ft. of space when used as a whole, and which will show the entire line of 23 models by placing a combo at each end. Each unit or section can be used separately, if desired, and the various models become available. They have shelves for three or four sets each one colorfully decked with the Arvin suggestion "Upstairs, downstairs, all through the house, outdoors, too." These units are each 30" wide, 5 ft. high.



Receivers from the smallest to the largest can all be shown in this display series.

Heat-Lamp Promoter



This 3-panel window display for dealers comes from Wabash Corp., Brooklyn 31, N. Y., and illustrates the four most common home uses of Birdseye infra-red lamps.

Complete list of promotional helps from this firm includes decals, electric sign, pick-up folders, banners, 8-piece window trim, and special wall charts.

New Booklets

Two new field booklets, "Thirty Second Radio Announcements" and "Newspaper Ad Mats", published by Sylvania Electric Products Inc., are ready for dealers desiring local advertising on Sylvania lighting products.

The radio booklet has pre-tested spot commercials while the newspaper ad mat book presents advertising aids available to the dealer. Copies of both may be had on request to Sylvania Electric Products Inc., 60 Boston St., Salem, Mass.

Store Furniture and Displays from Meck

New series of store suggestions and materials are being issued by John Meck Industries, Plymouth, Ind., to help dealers improve the appearance of their shops.

Plans to date include suggestions for a modern interior paint job; special wallpaper bearing electronic designs; merchandise display material; window displays; special seats and settees; and a specially constructed sound proof test room.

Meck dealers have already been shipped an advertising kit for the Meck "Trail Blazer", new post-war radio set. Included is special window display material, advertising mats, etc.

DISTRIBUTORS: What % of the national total should you do? What counties naturally belong to your area?

► DISTRIBUTION Areas & Quotas answers your questions for postwar selling

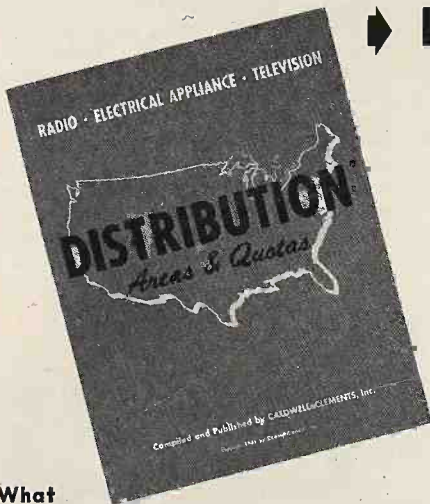

What guides have you for what your sales should be: dollar volume, manufacturers' quotas, local radio homes, availability of retailers, your relation to adjoining areas? These factors, and more, apply in determining your final total. DISTRIBUTION Areas & Quotas goes far to point them up for you.

Just published to help answer your own questions and those asked of you, it is a comprehensive geographical and statistical breakdown of the U. S. by the jobbing areas established as basic for the wholesaling of radio, electrical appliances and television. A special marketing introduction, with emphasis on distributors' importance, accompanies the two-color map and text. Published for the first time in this industry, copies are available in a limited edition at \$10 each. You'll be glad you ordered your copy. Tear out coupon below.

Caldwell-Clements, Inc. 480 Lexington Ave., New York 17
Publishers also of ELECTRONIC INDUSTRIES

What

DISTRIBUTION Areas & Quotas Contains for you

- Seventy basic areas for wholesaling radio, appliances, television
- Large two-color map with tables, potentials, areas outlined in color
- Complete listing of areas with county radio home figures
- Textual analysis of selling through distributors
- Population shifts and how markets are affected
- Relation of Output to Quota

Publishers of

RADIO & Television RETAILING
1946 Profit Manual—Get Ready
Now to SELL TELEVISION

Caldwell-Clements, Inc., 480 Lexington Avenue, New York 17

Gentlemen:

DISTRIBUTION Areas & Quotas sounds like it will be helpful to us in our distributing work. Enclosed is my remittance

- () check for.....copies at \$10 each.
() money order

Name of Distributor _____

Address _____

City _____

Zone _____

State _____

By _____

Position _____

New Technical Products

Langevin AMPLIFIER

The new Langevin Type 108 Amplifier Series consists of a 20-watt power amplifier on which one of four small input panels may be mounted and changed at will. The overall gain depends on whether the Type A, B, C or D panel is used. The Type A is for high-powered monitoring, and has a bridging and 600 ohm input. The Type B panel is for high gain, designed to operate from a source impedance of

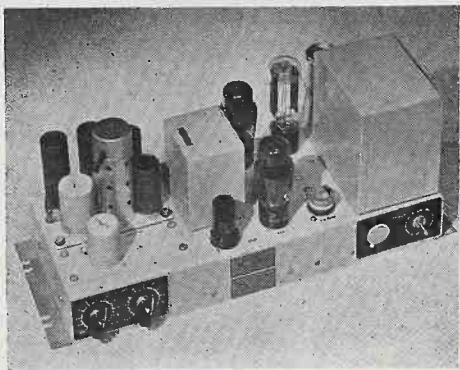

30 to 250 ohms. Type C is a combination of the A and B Types, while Type D panel supplies two high-gain input stages as described for the B Type. The units are designed for high quality audio service, having frequency characteristics better than ± 1.5 db, from 30-15,000 cycles. Power output is 20 watts with less than 3% harmonic content. The Langevin Co., Inc., 37 W. 65th St., New York 23, N. Y.—RADIO & Television RETAILING

Presto RECORDING TURNTABLE

The Presto 14-A is used by sound studios and record shops handling

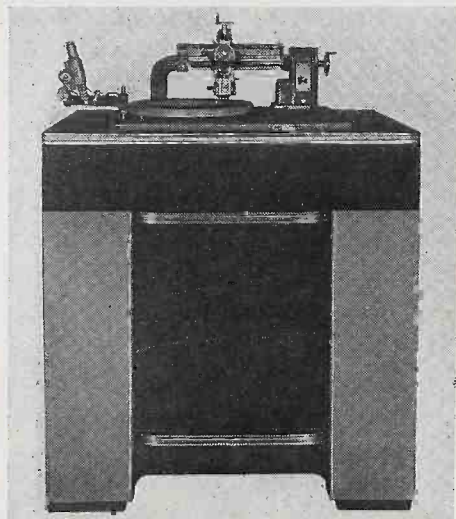

amateur recordings, commercial transcriptions, and off-the-air recordings, as well as by schools, universities and

PA men covering conventions and meetings. The motor is synchronized with the line frequency, while the turntable is directly gear-driven at both 78.26 and 33.33 rpm. The cutting head mounting accepts either a vertical or a lateral recording assembly. A single feedscrew permits cutting either outside-in or inside-out. Vibration is minimized by the use of a mechanical damping filter and by mounting the motor, gear box and transmission shaft on a separate cast-iron base, an assembly weighing 160 lbs. Presto Recording Corp., 242 West 55th St., New York, N. Y.—RADIO & Television RETAILING

Vibracloc BAFFLE

Loudspeaker baffle for corner mounting. Accommodates 8, 10 and 12-inch speakers. Ornamental speaker mounting screws supplied. Lists at \$15 in

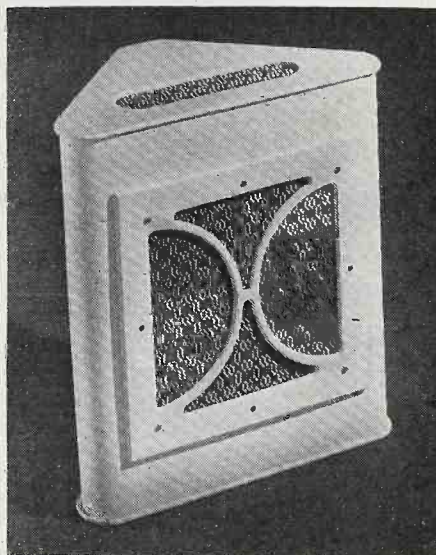

natural brown finish, \$17.50 in sprayed ivory-buff, and \$20 in two-tone leatherette. Vibracloc Mfg. Co., San Francisco, Calif.—RADIO & Television RETAILING

DuMont OSCILLOGRAPH

Type 208-B Cathode-ray Oscillograph uses a 5-inch (5LP1) high-vacuum tube, which employs an intensifier ring. This results in high deflection-plate sensitivity. The four deflection plates are connected to terminals at the back of the instrument. Push-pull horizontal and vertical amplifiers eliminate screen-edge distortion, and are direct-coupled to the deflection plates to prevent centering time-lag. Maximum vertical sensitivity is 10 milli-volts per inch, from 2 to 100,000 cycles. The sweep oscillator ranges from 2 to 50,000 cycles.

Vertical input impedance is 2 megohms shunted by 30 mf. A removable, calibrated scale, which fits directly over

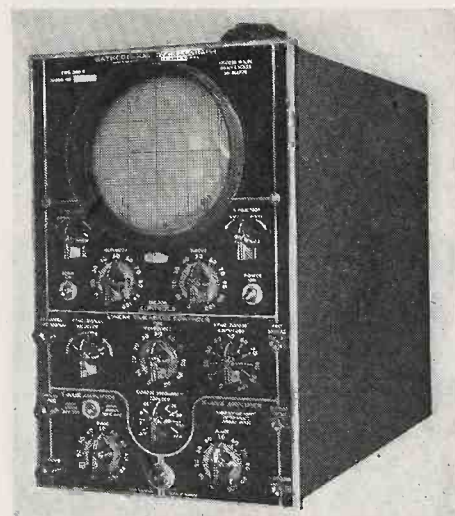

the face of the cathode-ray tube, is supplied with the instrument. Allen B. DuMont Laboratories, Inc., Passaic, N. J.—RADIO & Television RETAILING

Newcomb AMPLIFIER

Model H-30 amplifier uses 7 tubes. Two 6L6's supply 30 watts output with less than 5% distortion. The frequency response holds within 2 DB from 30 to 15,000 cycles, using inverse feedback and resistance-capacity coupling between all stages. Two microphone inputs with separate mixer controls, each have 2-megohm impedances. They may be converted to low impedance by plugging in type TR-91 microphone transformer. A gain of 121 DB is available for microphone use, while the single high-impedance phono input can



provide a gain of 78 DB. Bass and treble responses are adjusted with separate controls. Output impedances are: 3, 4, 6, 8, 16, and 500 ohms. Rated at 144 watts input on 105-129 volts 50-60 cycle a.c. The amplifier measures 7" deep x 8 1/8" high x 15" wide. Newcomb Audio Products Co., Los Angeles, Cal.—RADIO & Television RETAILING

FOR LATEST RADIOS SEE PP 34, 35, 36, 37, 80, 81, 90, 91; ELECTRICAL APPLIANCES, PP 52 TO 60.

Look to **SPARTON** for *Plus-value Radios!*

THE SENSATIONAL new Spartons offer *real* merchandising possibilities.

And no wonder!

They're tops in styling! Tops in tone!

And—best of all—they're *moderately* priced.

Sparton dealers are able to offer these *plus-value* radios at highly-competitive prices due to the S.C.M.P. (Sparton Cooperative Merchandising Plan.)

Under this plan—shipments are made direct from the factory to *exclusive* dealers—one in each community.

The new Sparton Radios and Radio-Phonographs are moving your way—*now*. Shipments are going forward to dealers at an ever increasing rate.

Look to Sparton for radio values in 1946!



SELLING FAST—

Sparton Model 7-BM-46 PA—Compact radio-phonograph—ideal for the small home or apartment. Fully automatic. Plays twelve 10-inch or ten 12-inch records at a single loading. Ample space for records. Available in either mahogany or walnut finish.



ANOTHER GOOD BUY!

Sparton Model 5-06—Compact table model for bedroom or den. In colorful plastic—white, brown and antique ivory.

THE SPARKS-WITHINGTON CO., JACKSON, MICH.

SPARTON

RADIO'S RICHEST VOICE SINCE 1926



*— Designed for dependable
trouble-free operation*



MODEL 56 WEBSTER RECORD CHANGER

Easier to play, because of its simple fool-proof operating principle. This new Webster changer has heavier, more costly parts—and its rugged construction and care in assembly make it dependable—cut service calls to a minimum.

- other important features*
- ★ Fast change cycle
 - ★ Feather-touch pickup
 - ★ Built to last
 - ★ Automatic shutoff
 - ★ Longer record life
 - ★ Dynamically balanced, 4-pole—cushion mounted

The choice of music lovers

WEBSTER  CHICAGO

5610 Bloomingdale Avenue, CHICAGO 39, ILLINOIS

32 years of Continuous Successful Manufacturing

PILOT  RADIO

*your beacon to a better business
in better radios*

Prince Appointed

Kenneth C. Prince has been appointed general counsel for the Hallicrafters Co., Chicago, producers of high frequency radio equipment, according to R. W. Durst, executive vice-president of the firm.

Mr. Prince served for nearly 11 years as the executive secretary of the Association of Electronic Parts & Equipment Manufacturers. He has recently been a Navy lieutenant where he served two years as assistant communications officer to the Commander, Submarine Force, United States Pacific Fleet, and won the Bronze Star Medal.

DuMont's Big Direct-View Sets

Ernest A. Marx, DuMont's general manager of television sales, promises dealers that his firm will offer telesets housed only in the finest cabinets. DuMont, he said, will have nothing to sell along "early atrocious" or "borax period" lines.

The DuMont organization expects to have two types ready for delivery this summer. These models will have 15-inch and 20-inch direct-view tubes, and will be mostly consoles. Mr. Marx discloses that the organization is also doing laboratory work on projection units.

Distribution of DuMont sets will be handled through a select group of retailers. Control will be maintained over installation and service.

\$30 to Change Telesets

Pre-war Victor television receivers will be converted to receive programs on the new frequency channels, it is announced by RCA Service Co., Inc. Service shops in the New York, Philadelphia, Chicago and Los Angeles areas will, on request from a set owner either direct or through an RCA dealer, make the necessary changes for a fee of \$30.

Tele Aid to Rural Life

The rapid growth of television into a commercial reality will bring a new richness into the life of rural families, Joseph Gerl, president of Sonora Radio & Television Corp., pointed out in an address before the Knoxville, Tenn., Kiwanis Club.

"In the past," said Gerl, "and in the present too, the rural life has been held up by youth as a 'dull existence', far from the glamor of big city lights and fashions. Country folks have had to travel to the large centers of their region to see the metropolitan sights and shows. Television, however, will bring such realities into the farm home, right into the living room."

Added to Rep's Staff

Newcomer to the staff of the Jack Karns Co., manufacturers representatives of 154 Nassau St., New York City, is Peter Scardino, recently discharged from the armed forces. Mr. Scardino, a Fordham University man, will contact radio and marine jobbers and manufacturers in the New York area.

HOWARD

Radios

NOTED FOR TONE!

**FAMED FOR
PERFORMANCE!**

**ACCLAIMED
FOR VALUE!**

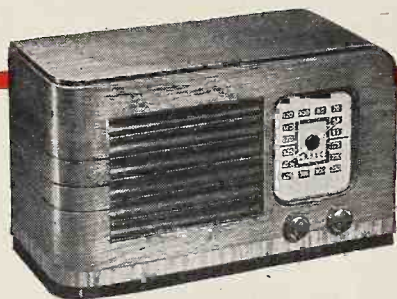

HOWARD ... the Prestige Radio!

Continuously, since the early days of radio, Howard owners have taken pride in the performance and attractiveness of their radio receivers.

Howard's policy of building for quality and value will continue to be a sustaining source of profit to Howard Dealers everywhere.

If you want to benefit by this tremendous background of good-will, and the extensive consumer advertising that keeps selling the Howard name, the first step is to talk with your nearest Howard Distributor. If you do not know his location—write us today.

HOWARD RADIO COMPANY

CHICAGO 13, ILLINOIS

PIONEERS IN FM RADIO



Howard FM-AM Radio-Phonograph Combination with Acousticolor Tone—an Exclusive Howard Feature of Tonal Beauty.

America's Oldest Radio Manufacturer

BW vs Color

(Continued from page 41)

television system now attainable, would not block future electronic color-television possibilities of daylight brightness, large screen, high speed movement, and even greater detail.

The majority of the television industry is therefore preparing to go ahead with black-white television in 1946 as earlier planned, and to get the fullest experience on present standard lines.

Slowing Down BW

Television conservatives who propose to continue pushing black-white television recognize that the presence of color-tele demonstrations in New York, Chicago and possibly other cities, will have a confusing and braking effect on the public's enthusiasm for the new art. But they reason that with bigger and brighter black-white home scenes soon to be available, black-white television sets will be demanded by the buying public as rapidly as the industry can supply them.

So black-white television is scheduled for immediate introduction as originally planned. But everybody is hopefully watching color-video experimentation, ready to embrace it at the moment when full color possibilities will not be stymied by the adoption of an interim color-video system.

Donaldson's Service Layout

(Continued from page 39)

technicians working in each service room, in addition to faster servicing, are less interference among the employes, and increased comfort for these radiomen.

A rosy sales outlook is seen by C. W. Donaldson for all electrical appliances sold by the company, and he is equally enthusiastic when he discusses the sales prospects for sound motion picture projectors.

Movie Equipment

Donaldson has done a profitable business in selling and servicing sound moving picture apparatus, and expects to hit an even bigger sales volume with this merchandise in the future.

This dealer doesn't expect to sell as many projectors (retail price about \$450) as he does receivers, but he anticipates doing a very profitable business with these goods. Among the firm's hot prospects for selling and servicing movie machines are industrial plants, schools, hospitals, etc.

Trained Staff

However, Donaldson also sees a large market for movie equipment in his radio and electrical appliance customers.

The store is sold not only on merchandising movie apparatus, but for using this equipment in training its own staff as well. To keep employes posted on the latest methods in sales and maintenance, movies are shown frequently.

Technical Knowledge

The films provide the sales, technical and clerical staffs with a knowledge of new trends in FM, television, and selling procedures. Donaldson's educational program for his employes keeps them in the know, and helps to operate the business at a highly profitable level.

As indicated by the trend the training sessions are taking, the firm is leaning more and more to electronic servicing to take up the slack in maintenance of sets and appliances.

Intercommunication systems sales and servicing, and motion picture equipment repair are being given increased attention by the organization's technicians.

Air Wave

(Continued from page 73)

as we did when opening our place. Customers will come to see the broadcast, and in so doing will note the products on display in our store.

"We were successful in building a profitable service business by holding video demonstrations, and we feel we can also build sales of sets and appliances by using this type of sales builder."

As these co-owners have found, the public's interest in television is riding a high crest. These dealers believe that the wise service retailer or merchandiser can take advantage of the promotional power of television and capitalize on it.

Round-Table

(Continued from page 68)

turn. By allowing one man to monopolize the conversation you ruin him by flattering him, and you discourage the men in your group who are less apt in their mental processes. The fastest thinker is not always the best salesman.

By obtaining the active co-operation of all the men present, you have a constant source of information concerning practical solutions to sales problems. The experiences of your men are the real place to look for improvement in sales technique. It is only through the constant trial and error of your men working in the field that you can determine what your prospects actually need, why the products you have can fill those needs, and the manner in which your sales force can best offer these products to these customers.

Facts Help Sales

In the actual course of selling and installing appliances and radios, your men develop stories of how customers have obtained satisfaction in using the goods they have bought. These stories are most valuable selling tools.

Have your salesmen constantly search for these stories by asking customers who have bought what uses they have put their products to and what they think about them. The development of these stories will help to personalize the presentations of your men and will be superior to any canned talk that manufacturers will supply.

Develop the knack of summarizing the outstanding developments of each meeting at the end as a sort of review. Encourage the men to carry away notes from each meeting.

Know How to Face Your Public

In these ways you can develop your round-table discussions into a real tool of sales training. You will hold the attention and interest of your men. You will increase the extent of their understanding of the problems they face. Through repetition and active participation they will fix these things in their memory so that they can use them in their sales work for their and your greater profit.

The discussions should be looked forward to, by everyone in the organization, as a profitable treat.

THIS TABLE RADIO HAS

Everything
YOUR CUSTOMERS WANT

ARVIN
Top Flight
RADIOS

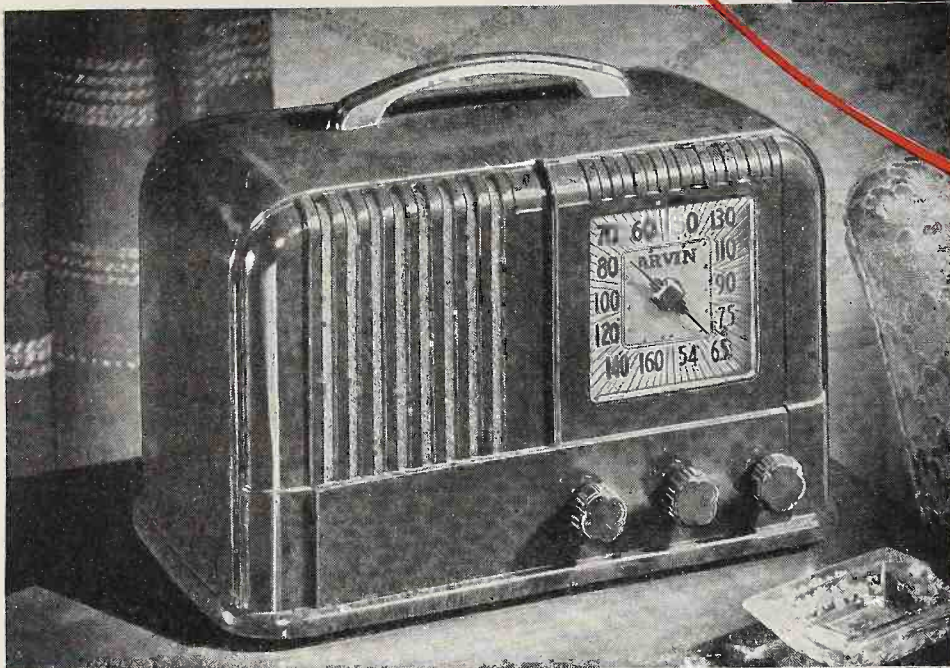

FOR ONLY
\$25⁶⁰
LIST*

This Arvin model 664 has *performance . . . beauty . . . practical utility*. Its many fine features will make it a sales sensation!

Check these topflight performance features!

- Improved, sensitive, selective super-heterodyne.
- Six tubes, including rectifier and two dual purpose tubes.
- AC-DC operation.
- Full RF stage.
- Three-gang condenser.
- Continuously variable tone control.
- AF correction for balanced tonal range.
- Fine permanent magnet speaker.
- Built-in loop.

Look at these topflight beauty and utility features!

- Handsome plastic cabinet, walnut or ivory.
- Molded in one piece and bottom loaded. Good looking back and front. Size 12½" x 7¼" x 7".
- Large, illuminated, metal dial. Art-styled pointer and attractive numerals.
- Convenient carrying handle.

This Arvin and others in the line will give you real sales leaders in every price bracket . . . you'll profit by greater sales volume *with Arvins*.

*Arvin model illustrated 664, walnut plastic. Ivory plastic model 664A, \$25.90. Prices include federal tax—slightly higher in far West.

The Tiniest to the Finest

At Prices Everyone Can Afford!



This tiniest Arvin is being featured in full-page advertisements in national magazines such as Collier's Weekly and The Saturday Evening Post.

The complete Arvin line includes floor and table radios, radio-phonographs with record players and automatic changers, battery sets, and portables.

ARVIN is the name on many fine products of NOBLITT-SPARKS INDUSTRIES, INC., COLUMBUS, INDIANA

ARVIN Radios • Electric Heaters • Electric Irons and Appliances • Outdoor Metal Furniture • Metal-Chrome Dinette Sets • Laundry Tubs • Car Heaters

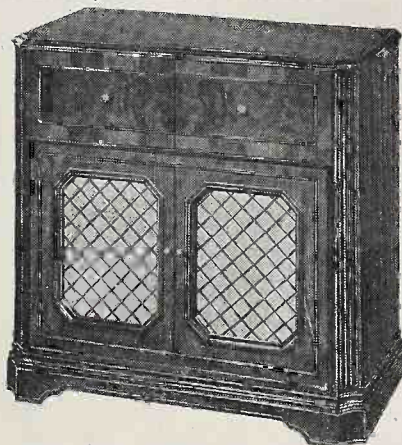

THIS FINEST ARVIN (model 1088) is a 12-tube FM-AM radio-phonograph with automatic record changer, playing 10" and 12" records intermixed. One of several beautiful models with all of the newest radio-phonograph features.

Halligan Heads RMA "Ham" Committee

Radio amateurs, "the only hobbyists on earth who require a government license," now can look forward to the close cooperation and full support of the industry they helped establish.

With "ham" activity at its all time peak and with the number of amateurs expected to increase rapidly within a few years, the Radio Manufacturers Assn., has formed a new amateur radio activities section with William J. Halligan as chairman.

Its purpose is to act as a clearing house of information concerning new products needed by amateurs, to establish standards of good engineering practices relative to amateur radio equipment, and to work closely with the American Radio Relay League, the national organization of "hams," in the support of amateur radio in legislative and regulatory matters.

Raymond Rosen Names Bortnick

At Raymond Rosen & Co., the well known Philadelphia distributors, the new manager of advertising and sales promotion is Harry Bortnick. He's an Army vet with over 3 years' service. The company covers eastern Pennsylvania, southern New Jersey and Delaware.

Ebco Mfg. Appointments

A. R. Benua, general manager, the Ebco Manufacturing Co., Columbus, Ohio, manufacturers of refrigerated electric drinking water coolers, announces the appointment of W. L. Winchester as assistant sales manager. Lee C. Love, general sales manager, announces the appointment of Robert L. "Bob" Coon, as district manager, Oasis Cooler division, with headquarters in Colorado, covering the Rocky Mountain States area.

Big Things Ahead, Says Philco Executive

Tremendous and immediate developments in radar, electronics and television were predicted by Larry E. Gubb, Philco board chairman, in a recent speech at the Cornell Club of Philadelphia.

Mr. Gubb mentioned radar as a guide for planes and ships, and said that "we are at work on a telephone for your automobile." He said that the greatest development would be in television for the home, which he described as "here", but added that it should be put to use rather than restricted to the lab.

Mr. Gubb said that "television is far too big an industry and too important to the American people to be held up for nebulous future developments when the present picture is as good as it is today and can give the American public so much in the way of immediate pleasure."

Jack Siegel at Stamford Transformer

New vice president in charge of sales and advertising for Stamford Electric Products Co., Inc., Stamford, Conn., is Jack R. Siegel. He has had wide sales experience in radio, and previously had been trained in leading technical institutions of the U. S.

The transformer division of the firm is launching a nation-wide advertising and sales promotion program for its line of radio transformers, which will be sold through radio jobber organizations as well as to manufacturers of sets and electronic equipment.

Jack Siegel is announcing to the trade the policies and plans for sales and advertising activities of the Stamford company.

Oklahoma Album Sets a Record

An all-time high for the sales of a record album has been reached by the Decca set on "Oklahoma!", the popular Broadway musical. A half-million of these albums have been sold, according to a recent announcement by Decca. The set, which has been on the market for about two years, retails at \$5.

Makes Rush Calls



He keeps the lines humming in a search for radio parts—Bert Bethel, purchasing agent for John Meck Industries, Plymouth, Ind.

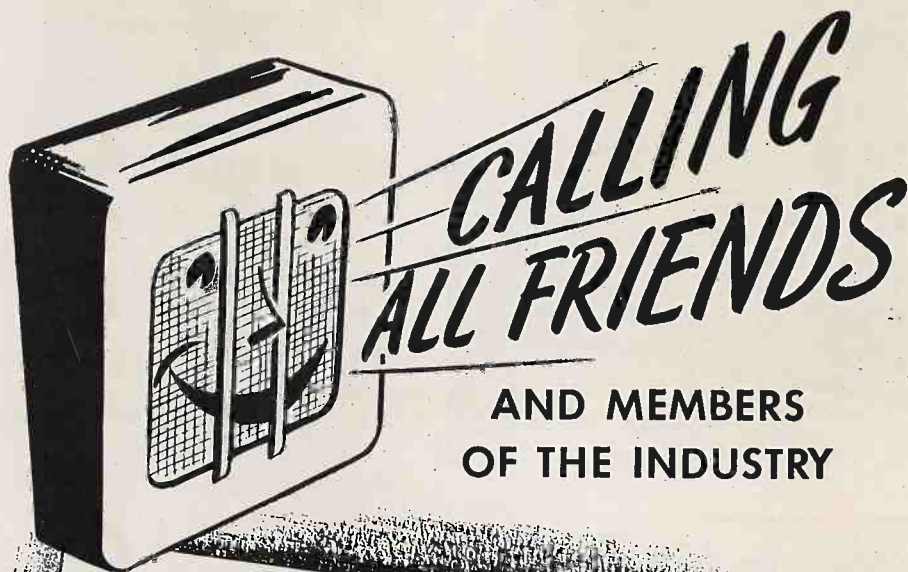

*You Are Cordially Invited
to Visit us at
Booth 46
Hotel Stevens
Chicago, Ill. May 13-16, 1946*

MASCO

MARK SIMPSON MANUFACTURING CO.
186-194 West Fourth Street, New York 14, N.Y.

SOUND SYSTEMS and Accessories

Telephone CHelsea 2-7112-3-4



AUDIBEL RATING

the feature that is
more than a name

The radio industry is rapidly learning that **AUDIBEL RATING** is not "a rose by another name."

Out of their war-time experience, **CLARION RADIO** engineers have evolved a scientific method of evaluating the performance of a receiver which provides a totally new stimulus to retail selling.

The **AUDIBEL WARRANTY** on a **CLARION** model . . . like the stamp of certification on a check . . . means "PRE-PROVED."

The **CLARION** models illustrated are representative of the complete new line. Whether it be in tonal quality, styling or price, **CLARION** meets the preference of individual taste.

The eight great features listed below with Clarion's complete, effective merchandising and promotional helps, plus national advertising make the Clarion dealer franchise one of the most desirable in the industry.

WARWICK MANUFACTURING CORP.
4640 W. HARRISON STREET • CHICAGO #4, ILL.

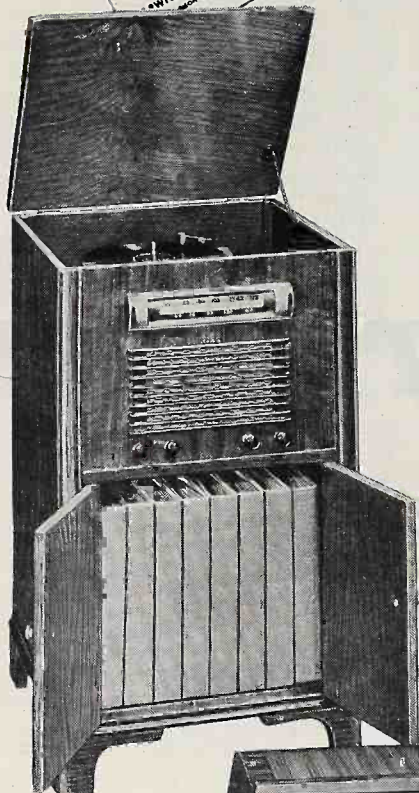

THE CLARIONETTE
MODEL C 105



THE SARATOGA
MODEL C 101

8 GREAT CLARION Features

- 1—New postwar FM circuit.
- 2—Touch-button electric motor tuning.
- 3—New low impedance Super-Interceptor Antenna.
- 4—New Iso-Tron, "climate protected" coils.
- 5—Large Alnico No. 5 speaker magnet.
- 6—3-Dimensional "Magnascopic" dial.
- 7—Jam-proof, rapid cycle automatic record changer.
- 8—Latest full-floating, high fidelity record-saving Transducer, with permanent needle.



Clarion

AMERICA'S FIRST
AUDIBEL RATED

RADIO



THE MANHATTAN
MODEL C 102

YEARS OF PROVED PERFORMANCE



Television room in Stolfi's store introduces new art to Connecticut prospects.

Stolfi's Television Theatre at Stamford, Conn.

Michael Stolfi who has expanded his radio and appliance business, recently moved into new and greatly enlarged sales-and-service quarters at Stamford, Conn. In this new place, he has set aside a large deep room, capable of being darkened, for use as a "theatre" for television demonstrations. Although no general publicity has been given the innovation, crowds regularly show up on the two or three nights each week the television room is open, to watch video programs on Stolfi's DuMont receiver. For several years past, Mr. Stolfi has regularly serviced some 14 television sets in homes in the Stamford-Greenwich area and he has become known as top television expert in the community, which includes the proposed UNO international area.

TELEVISION TOPICS

RCA's First Telesets To Retail at \$200

Table-model telesets are first on the manufacturing agenda at RCA, according to J. B. Elliott, vice-president in charge of the home instrument department. First models of the sets are expected to sell at about \$200, with consoles from \$300 upward. Seven-inch and ten-inch kinescopes will be used. RCA expects to market a deluxe projection set, screen size 18 by 20 inches, for about \$500. This receiver will have AM and FM reception.

Telesets are expected to reach the public this year, said Mr. Elliott, who predicts that by mid 1947, twenty-four per cent of the nation's population in 9,086,000 wired homes will be within the effective service range of television.

Mr. Elliott also disclosed that RCA feels there is a real necessity for arranging with distributors to provide practical low-cost deferred payment plans for set purchasers, and that methods for handling time payment plans have already been initiated.

Parts Holding Up GE's Teleset Production

Ready to go on an all-out basis in producing video sets, General Electric is marking time until sufficient quantities of components are available, according to Sales Manager E. Patrick Toal.

GE plans direct-viewers at prices ranging from \$200 to \$250. These will hit the market first. The sets will have AM and will cover 13 bands in the video channels. The firm is also readying a projection set, providing an image 16 by 22 inches. This receiver will employ the Schmidt system and will use a 5-inch tube.

According to Mr. Toal, GE will make every effort to secure user satisfaction through working closely with its dealers. The firm plans to have district engineers

available to servicers and is scheduling television schools in May and June. In addition, a service manual, part of a course in television, will be distributed in May by GE.

Philco's Video Plans

Television receivers ranging in price from \$150 to \$450 are being readied by Philco, and are expected to reach the market this summer, according to Harry Boyd Brown, merchandising manager. Plans call for the production of direct-view units first. Experimental work on projection types is now going on in Philco laboratories, Mr. Brown said.

A new 35-pound television camera and lightweight "suitcase-type" control equipment, so designed that a television crew can carry their studio with them and have it operating in a few minutes, has been developed by the Philco Television

Engineering Laboratories, according to Frank J. Bingley, chief television engineer of Philco.

"A unique feature of this new equipment," Bingley explained, "is that several television cameras can easily be operated from a single portable master control unit. Also, these new cameras give us a clearer, sharper picture than the heavy and awkward prewar equipment. At a baseball game or track meet, for example, we can quickly set up three television cameras to cover the action from various angles, and control all three cameras from a single lightweight master unit operated by the program director. This director's unit may be 500 feet away from the cameras.

"With a total of only 14 portable units—including three television cameras—none larger than a good-sized suitcase, it is possible to televise outdoor or indoor scenes with excellent results. For instance, we proved our new television camera during commercial telecasts of all the University of Pennsylvania football games at Franklin Field last autumn." Clear pictures of leading sports events arouse a great deal of public interest.

Zenith President Backs Color Television

Comdr. Eugene F. McDonald, Jr., president of the Zenith Radio Corp. opposes the sale to the public, of television sets of the pre-war type in the low frequencies "without putting the public on notice that their 50 mc. receivers will shortly be obsolete," he declares.

Commander McDonald, who also is the owner of Television Station W9XZV in Chicago, declared that it is the Zenith Corp.'s "intention to produce color television receivers for the new high frequencies rather than black and white for the old frequencies." Zenith will also conduct color-television transmission tests in Chicago, using a new uhf transmitter.



W. A. Howard demonstrates the new 35-lb. Philco camera, with auxiliary "suitcase" unit.

DU MONT TELESETS ARE COMING!

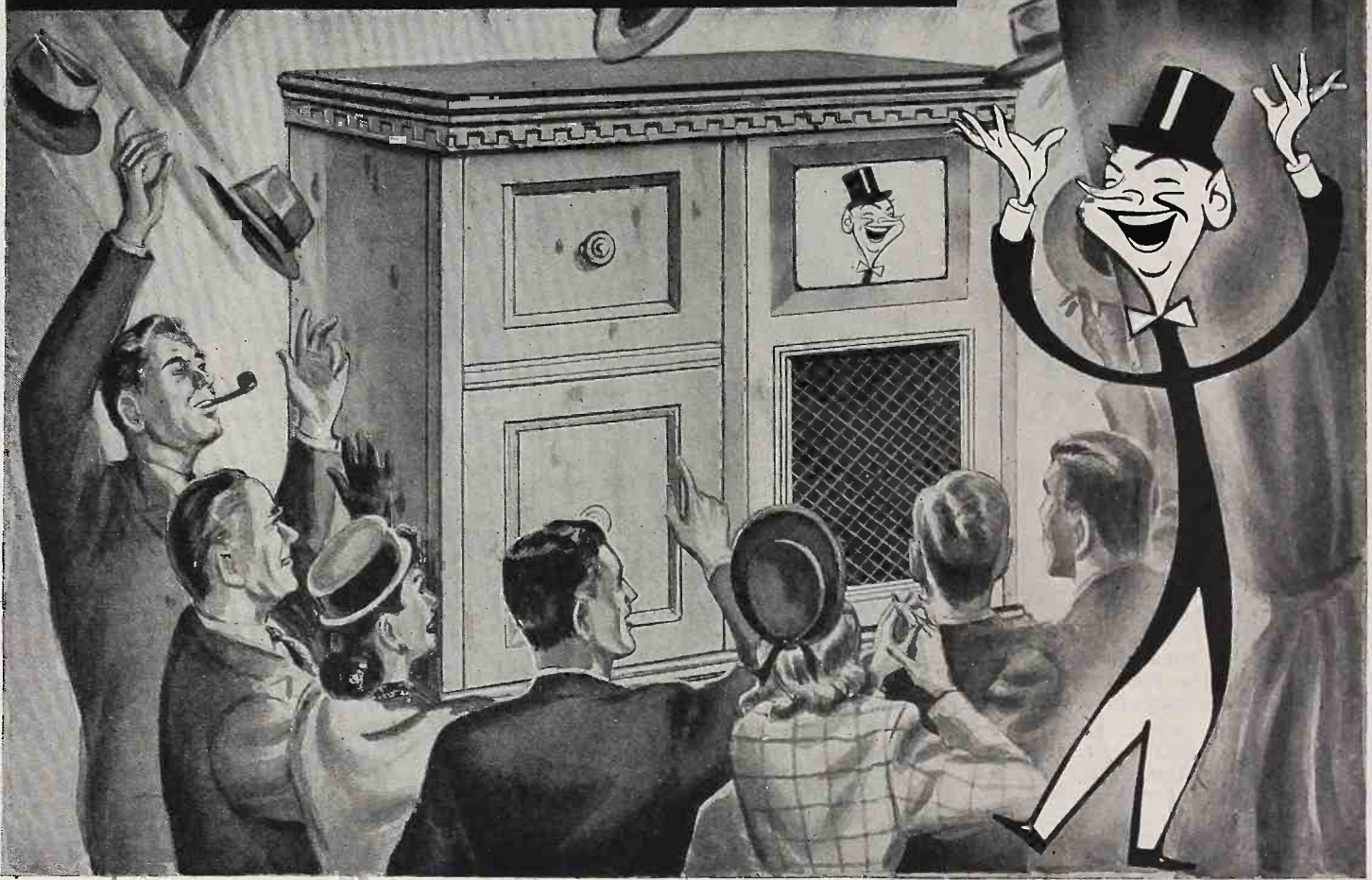

Toss Your Hat in the Air . . .

But Keep Your Feet on the Ground!

As the whole Television picture opens up from all sides, and profits start to roll in, and you feel like tossing your hat in the air . . . keep your feet on the ground. Although the public may buy *any* television set the first few months . . . you know that your reputation and the permanence of your business will depend entirely on the basic *Quality* of the Television sets you sell.

And Du Mont is going to be the Quality Line . . . by deliberate policy, backed by the engineering superiority which began when Allen B. Du Mont first made the

Cathode-ray Tube commercially practical. Du Mont Telesets* with "20-20 teleVISION" will stand out as the most advanced products in the field. Du Mont' designs will incorporate this matchless performance quality in cabinets of superb beauty, together with FM and AM radio, high fidelity phonographs of incomparable quality.

The public will keep on tossing their hats in the air *for you* . . . if you base your business on the Quality Line . . . on the Television leadership that will be exemplified in Du Mont Telesets with "20-20 teleVISION."

*Trade-mark Reg.

Copyright 1946, Allen B. Du Mont Laboratories, Inc.

DU MONT



Precision Electronics and Television

ALLEN B. DU MONT LABORATORIES, INC., GENERAL OFFICES AND PLANT, 2 MAIN AVENUE, PASSAIC, N. J.
TELEVISION STUDIOS AND STATION WABD, 515 MADISON AVENUE, NEW YORK 22, NEW YORK

BUSINESS OPPORTUNITIES

Fashionable hotels, clubs and restaurants installing central loudspeaker facilities

**ALTEC LANSING
LOUDSPEAKER SYSTEMS
PREFERRED**



ANY club, hotel or restaurant that serves discriminating patrons, knows there is no cheap road to customer satisfaction. The management buys the best—and pays for it willingly.

You can talk to them of the technical superiority of the Altec Lansing System. They will not fail to be impressed. But also show them how the Duplex System anticipates the next 10 years of sound developments.

Impress upon them, that this revolutionary speaker has been adopted by leading motion picture studios and theatres throughout the country.

You will make good business sense to the most hard-headed buyer.

THE ALTEC LANSING DUPLEX LOUDSPEAKER



Both high and low frequency units are combined in one horn, reproducing 50 to 15,000 cycles, without intermodulation effects or distortion. In actual performance, this system delivers up to 500% greater efficiency in monitoring, radio, public address and recording. Send for bulletin.

ALTEC
LANSING CORPORATION

1161 NORTH VINE ST.
HOLLYWOOD 38, CALIF.

250 W. 57th ST., NEW YORK 19, N. Y.

Credit Men Map Plans for Postwar Installment Financing

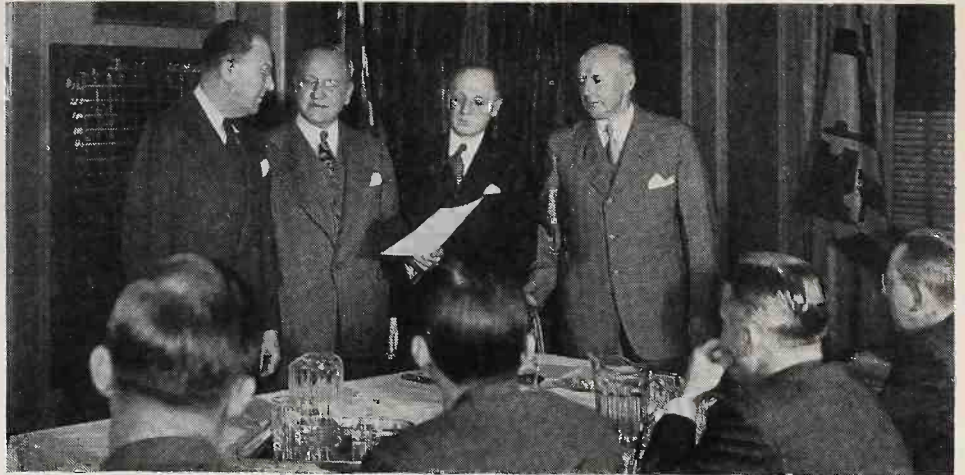

An aggressive campaign in dealer and consumer financing is outlined here by Commercial Credit Co. officials, l. to r., vice pres. H. B. Matthews, president H. L. Wynegar, executive vice pres. E. C. Wareheim, and vice pres. W. C. Wylie. Over 50 divisional and regional managers came from all over the U. S. for this "briefing" in Baltimore.

RCA's Folsom Honored by Washington

Secretary of the Navy James Forrestal, acting for President Truman, has awarded the Medal for Merit to Frank M. Folsom, executive vice-president in charge of the RCA Victor Division, Camden, N. J., for "exceptionally meritorious conduct in the performance of outstanding services as Chief of the Procurement Branch of the Navy Department's Office of Procurement and Material."

Previously, Mr. Folsom had been presented with the Distinguished Civilian Service Award, the Navy's highest civilian honor, by Secretary Forrestal for his services to the Navy.

Colonel Rider Gets Legion of Merit

John F. Rider, Lt. Col. Signal Corps (retired), the well known technical writer and publisher, was recently awarded the Legion of Merit medal for the notably high-standard work he did during his three years in the service.

A part of the citation for the award says that Mr. Rider "... rendered exceptional administrative service to the Signal Corps publication agency ... his ability to organize and effectively utilize available personnel materially contributed to the preparation and production of vitally needed technical manuals. ..."

Many of the manuals urgently needed for radar outfits already in action were rushed through ahead of time by Mr. Rider, and during one critical 12-month period, he managed to produce a total of 1,906 different publications.

Ruby Tipped Needles by Duotone

Stephen Nester, president of the Duotone Co., Inc., manufacturers of phonograph needles and record accessories, has announced that his company has begun production on a ruby tipped needle. Duotone will make the ruby needles available through the usual Duotone channels. Mr. Nester said that the latest addition to his

fast selling line has been in the development stages for well over a year and that recent improvements have satisfied him that it will be the best needle of its kind on the market.

Packard Bell Now a Corp.

Organization of the Packard-Bell Co., makers of radios and PhonOords, combination radio-phonographs and home recording instruments, has been changed from a limited partnership to a corporation. Officers of the new corporation are: Herbert A. Bell, president; Howard D. Thomas, Jr., executive vice president & general manager; Joe M. Spain, vice president in charge of sales; and Lowell R. Day, secretary-treasurer.

Mr. Thomas said that the corporation's first really post-war product, Model 551D, was being delivered to franchised dealers, and other models were following closely behind on the production lines.

Sonora Record Head



Milton R. Benjamin has been appointed manager of the record division of Sonora Products, Inc., and is now touring the U. S. visiting the company's 76 record jobbers. His experience in discs goes back to 1921, including retailing, wholesaling, and manufacture.

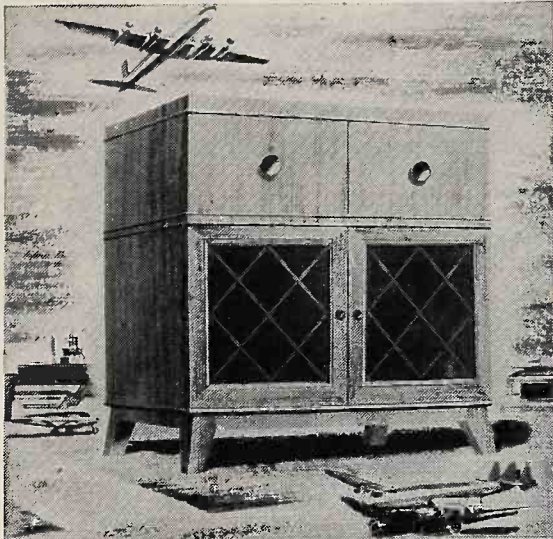

With the airways as a background,

LEAR brings you
New Home Radios ★

Since 1930 Lear has been building aircraft radios — radios that pilots have depended on to guide their precious planes and passengers safely.

It takes extra skill and extra care to build radios like these. And building constantly toward perfection has become a habit with Lear.

Now this kind of manufacture is going

into radios you can buy for your home. In a little while you will see Lear Radios at your dealer's. We won't rush them — Lear Radios cannot be built that way.

Some will include television. Some will have the new Lear Tape Recorder. There'll be radio-phonograph combinations and models with FM and short wave. There will be sets over a wide price range.

But no matter which set you select, you'll be sure that you get the most for every dollar you invest in a Lear Radio.

Lear, Incorporated, 110 Ionia Avenue, N.W., Grand Rapids 2, Michigan.

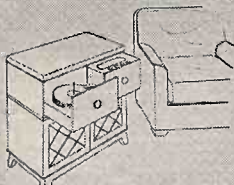

The "Chairside" Lear Console, — other models from \$19.95 to \$300.
Prices slightly higher west of the Rockies



LEAR *The Name Men Fly By*

This advertisement is one in Lear's big national magazine campaign. It appears in April and strikes the opening note on the complete line of Lear Radios.

This advertising campaign, plus aggressive merchandising plans, is adding still further to the growing acceptance of these unusual radios.

LEAR RADIO

If you want to share in the results of these plans and promotions — if you want to be able to offer Lear Radios — get all the information about the valuable Lear Franchise. Write LEAR, Incorporated, Home Radio Sales and Merchandising Division, 110 Ionia Avenue, N. W., Grand Rapids 2, Mich.

JOBBER ON THE JOB

Memphis Jobber in Big Expansion

Mills-Morris Co., wholesaler of Memphis, Tenn., has signed up for the construction of a new building at 183-187 South Dudley Street, adjoining the present quarters of the company. The two buildings will have a combined frontage of 215 feet; construction is to be completed about May 1. The buildings will provide 47,000 square feet compared to its present 23,000.

The new section of this 26 year old concern will be used for display rooms, offices, and warehouse for the distribution of home and auto radios, radio parts and equipment, refrigerators, washing machines, and other electrical appliances. This will be operated as a separate division of its automotive equipment department.

The company, which has 18 salesmen on the road, operates a division in Nashville under the name of Auto Bearings and Parts Co. Branches of Mills-Morris are in Union City and Milan, Tenn., and Greenville and Tupelo, Miss.

Harry Alter Staff Gets Going

The Harry Alter Co., Chicago and New York, wholesalers of refrigeration parts and Crosley distributors in the Chicago area, have announced staff appointments. The radio and major appliance division, covering metropolitan Chicago markets, is headed by vice-president Arthur S. Alter. H. C. Huebner is general sales manager of this division, which distributes Crosley radios, refrigerators, etc., Coleman space heaters, floor furnaces and water heaters, Voss washing machines, Regina floor polishers and Elektribroom vacuum cleaners. Max Geisler is sales promotion manager of this division. W. L. Wood continues in charge of service.

Irving Alter, secretary and treasurer,

is general manager of the refrigeration parts distributing division. Leo Alter, vice-president, heads up Eastern operations. Joseph R. Novotny, has been appointed advertising manager. He has just rejoined the company after spending three years in the Navy. The following are new appointments in this division: Ted Robateau, purchasing agent; Fillmore Weinstein, merchandise manager; Alex Port, export manager; Harry Bernhart, city sales manager, supervising the activities of the following city salesmen and countermen: Joseph Kaplan, Joe Holub, Steve Majeski, Leonard Sostrin, Harold McClure, and Joe Koncak.

Warren R. Kahn, has been appointed manager of the Eastern Division. Martin W. Kent continues as manager of the New York branch, which specializes in wholesale refrigeration parts and supplies. Recent additions to the sales staff here are Murray Addinoff and Armond Nelson.

Harry Alter continues as president, and reports that "prospects in both divisions of the company are exceedingly bright."

Lifetime Sound Co. Now Jobbing Sets and "Sound"

Lifetime Sound Equipment Co., of Toledo, Ohio, formerly engaged in the manufacture of sound equipment, is now engaged solely in the wholesale distribution of radios, sound equipment and various types of electronic equipment. The firm will supply many dealers throughout northwestern Ohio, southern Michigan and northern Indiana.

A special department for radio amateurs has been established and placed in charge of Ray R. Kimberling (W8ESN), who is known among radio amateurs of the Middle West. He is not only sales manager of the amateur department, but is friendly adviser to hams all over the world on a good-will basis.

Sales room at Lifetime is shown below.



Main showroom of the Lifetime firm, where radio, sound, electronics and ham parts divide honors.

Distribute Echophone in Southern California

Announcement of the appointment of the Wm. R. Whittaker Co., Ltd., of Los Angeles, as southern California distributor for the Echophone home radio division of the Hallicrafters Co., Chicago, has been made by Lester L. Kelsey, vice-president of Hallicrafters and general manager of its Echophone division.



D. R. Larabee

W. R. Whittaker

The Whittaker company, one of the newest and most successful firms on the West Coast, specialized in the designing and manufacture of aircraft valves during the war.

Chosen to direct Echophone sales in the Whittaker company was Duane R. Larabee, sales manager. Larabee, former sales manager for the E. J. Jordan Agency which represented the Noblitt-Sparks Industries and Electrical Research Laboratories, served during the war as an officer in naval communications in the Central Pacific area.

Two New Lamp Lines for Pennsylvania Distributors

Pennsylvania Wholesale Distributors, Philadelphia, are now Eastern distributors for the Metallic Arts Co., makers of metal and china table lamps, and the Artistic Lamp and Shade Works, manufacturers of metal table and floor lamps. According to the announcement from Ted Freedoff and David Shinberg, Pennsylvania's newly acquired extra showroom and office space, across the street from their headquarters at 132 N. Fourth St., will be used for display and storage of these new lines.

Fay-San for Admiral

Fay-San Distributors, Inc., is now the exclusive Admiral distributor for the Rochester, N. Y., territory. Fay-San of Buffalo recently opened their Rochester Branch at 95 North Street to handle radio and appliance distribution in this sales area. Richard J. Levi heads up the sales division.

(Continued on page 116)

Recordio

MERCHANDISING...

ZOOMS TRAFFIC



- ... OFFERS FREE RECORDING
- ... EMPHASIZES SIMPLICITY OF RECORDIO RECORDING

The Lucky 13 Sales Plan
Today's Busiest Franchise



DEALERS: Mail This Today!

WILCOX-GAY CORPORATION
Charlotte, Michigan
Gentlemen: Tell me more about the RECORDIO opportunity that is still open in my territory.

Store Name.....
Address.....
City..... Zone..... State.....
R & TR-A-46

• RECORDIO, that recorder-radio-phonograph winning all America to home recording, will be in the store of every franchised RECORDIO dealer by May 1st.

Like the Hollywood Modern shown above, every RECORDIO recorder is simple to operate in three easy steps, simple as 1... 2... 3...

During May every franchised RECORDIO dealer is inviting the public to come in to make a record. Everyone can make his own record, and carry it along home to play back as often as he likes. It will be his record, a constant reminder of the advantages of RECORDIO.

RECORDIO is launching its dynamic national advertising drive in May. Watch for The Ladies' Home Journal... Better Homes and Gardens.

Recordio

T.M. REG. U.S. PAT. OFF.

139-6

RECORDING INSTRUMENTS FOR HOME, COMMERCIAL AND PROFESSIONAL USE

WILCOX-GAY CORPORATION • CHARLOTTE, MICHIGAN
ALSO MANUFACTURERS OF

Recordio Discs and Recordioint CUTTING AND PLAYBACK NEEDLES

(Continued from page 114)



TIME TO ORDER

Portable Radio Batteries



FREE DISPLAY CARD
for more portable radio battery sales—6" x 14" for counter or window.

NATIONALLY ADVERTISED
This ad appears in May in these magazines—*The Saturday Evening Post, Better Homes and Gardens, American Magazine, Collier's, Liberty.*

BURGESS BATTERIES
FOR PORTABLE RADIOS

FOR PORTABLE RADIOS
BURGESS BATTERIES
RECOGNIZED BY THEIR STRIPES • REMEMBERED BY THEIR SERVICE

FREE WINDOW STREAMER
Colorful red-and-black streamer tells buyers your store is portable battery headquarters!

FREE REPLACEMENT GUIDE
Instantly shows you the right battery type for all portable radios! Also free newspaper mats!

ORDER BURGESS BATTERIES TODAY!
Get set for the busy summer-season ahead—stock the Burgess line of portable radio batteries now—your distributor will quickly supply your needs!

CLIP THIS COUPON FOR FREE DISPLAYS



BURGESS BATTERIES

Burgess Battery Company, Dept. 31, Freeport, Illinois

Gentlemen:

Send us the FREE sales helps for the Spring Portable Radio Battery campaign!

Our Burgess distributor is _____

DEALER'S NAME _____

ADDRESS _____

CITY _____ ZONE _____ STATE _____

Distributors Go to Majestic Panel Meets

Another of the distributors panel meetings being scheduled for Majestic Radio and Majestic Records has been held, this one in Chicago, with 14 jobbers on hand to hear product and merchandising plans. Majestic president E. A. Tracey, director of sales Parker H. Ericksen, and others were on the program.

Jobbers there were: Harold V. Bomar, Bomar Mfg. Co., Louisville, Ky.; J. N. Thompson, Maco Appliance Distributors, Inc., Kansas City, Mo.; Gail L. Thompson, Thompson & Hamilton, Inc., Columbus, Ohio; M. M. Gruhn, Colen-Gruhn Co., Inc., New York, N. Y.; A. E. Gross, Recordit Distributing Co., St. Louis, Mo.; J. J. Pocock, J. J. Pocock, Inc., Philadelphia, Pa.; J. W. Scott, Major Appliance Corp., Boston, Mass.; R. A. Gerlinger, Gerlinger Equipment Co., Toledo, Ohio; J. J. Shea, Lone Star Wholesalers, Inc., Dallas, Texas; J. A. Freeman, Reines-Freeman Distributors, Albany, N. Y.; R. E. McGreevy, Chicago-Majestic, Inc., Chicago, Ill.; A. J. Lindholm, McCormack & Co., San Francisco; Carter Mullaly, Hales-Mullaly Co., Oklahoma City; and L. H. Driver, Roach-Driver Co., Los Angeles.

McDavid Birthday Party a Lively Event

Fifteen hundred dealers and their salesmen from all parts of Alabama and west Florida were recently guests at the big 12th anniversary party of the R. P. McDavid & Co., Inc., Birmingham, Ala., distributors. The event was announced by a full page newspaper ad, and was attended by leading city and state officials, as well as reps of 11 manufacturers. Congrats came from all over the U.S., while guests enjoyed refreshments, souvenirs, and movies of the Rose Bowl football game.

Feature displays of new products were supplied by the 28 manufacturers which McDavid represents. The company president, Robert P. McDavid, reports that "already more than \$5,000,000 worth of orders have been received for the various appliances we handle."

Chicago Hotel Rooms

Latest advice from the Housing Committee of the Parts Show was that there are still some rooms available in Chicago hotels, but all those who do not already have a confirmed hotel reservation are urged to act immediately. The committee suggests that letter requests be made at once to one or more of these hotels: Blackstone, Drake, Congress, Palmer House, LaSalle, Sherman, Knickerbocker, or Edgewater Beach.

The general housing shortage in Chicago is critical. Kenneth C. Prince, general manager of the Show Corp. has a word of caution to all radio men planning to attend the event: Be sure to have confirmed hotel accommodations before coming to the show.

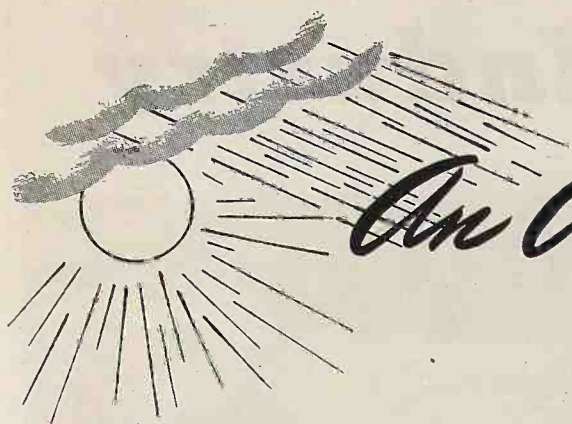

An April Shower

of Majestic releases

for sales now . . .

for profits all year

Louis Prima	<i>Some Sunday Morning</i>	
	<i>Everybody Knew But Me</i>	7163
	<i>Gimme A Little Kiss, Will Ya, Huh</i>	
	<i>Where Did You Learn To Love</i>	7172
The Three Suns	<i>I'm In Love With Two Sweethearts</i>	
	<i>Do You Love Me</i>	7168
Jack Leonard	<i>Welcome To My Dreams</i>	
	<i>Full Moon and Empty Arms</i>	7165
	<i>They Say It's Wonderful</i>	
	<i>September Song</i>	7176
Thelma Carpenter	<i>Seems Like Old Times</i>	
	<i>A Jug Of Wine</i>	1030
5 DeMarco Sisters	<i>One-zy Two-zy (I Love You-zy)</i>	
	<i>I Fall In Love With You Ev'ry Day</i>	7174
Danny O'Neil	<i>One More Tomorrow</i>	
	<i>I Didn't Mean A Word I Said</i>	7171
Ray McKinley	<i>Patience and Fortitude</i>	
	<i>You've Got Me Crying Again</i>	7169
George Paxton	<i>Wave To Me, My Lady</i>	
	<i>You Are Too Beautiful</i>	7167
	<i>Oh, What It Seemed To Be</i>	
	<i>I'm Glad I Waited For You</i>	7164
Jack Smith	<i>I'll Be Yours (J'attendrai)</i>	
	<i>Let's Put Out The Lights</i>	7173

Louis Prima	<i>Brooklyn Boogie</i>	
	<i>You Won't Be Satisfied</i>	1029
	<i>Robin Hood</i>	
	<i>Angelina</i>	1016
The Three Suns	<i>Twilight Time</i>	
	<i>It's Dawn Again</i>	1027
Thelma Carpenter	<i>Bill</i>	
	<i>Can't Help Lovin' Dat Man</i>	1028
5 DeMarco Sisters	<i>Hop, Skip and Jump</i>	
	<i>Flat River, Missouri</i>	7160
Danny O'Neil	<i>Easter Parade</i>	
	<i>My Gal Sal;</i>	
	<i>When You Were Sweet Sixteen</i>	1033
Johnny Guarnieri	<i>Body and Soul</i>	
	<i>Nobody's Sweetheart</i>	1032
The Korn Kobblers	<i>I Don't Care If I Never Go To Bed</i>	
	<i>Our Red Hen</i>	1025
Noro Morales	<i>Walter Winchell Rumba</i>	
	<i>Without You</i>	5000



Majestic

RECORDS

Studio: New York City Sales: St. Charles, Illinois
(Subsidiary of Majestic Radio & Television Corporation)

News of the Industry

Exhibitors All Set for Chicago Parts Show

All of the 164 display booths at the Hotel Stevens, Chicago, have now been contracted for by radio parts and electronic equipment manufacturers, so that the completed floor plan for the coming Parts Show looks like an impressive industry exhibit. The big event, the first of the post-war get-together's, is all set for May 13-16.

All plans surrounding the event have a brisk tone, because the vital matters of reconversion, deliveries, and new product development come in for trade discussion. This 1946 Radio Parts & Electronic Equipment Conference & Show, sponsored by the National Electronic Distributors Association, Sales Managers Club (Eastern Division), the Parts Division of the RMA, and the Association of Electronic Parts & Equipment Manufacturers, is expected to produce some new highs in trade interest.

Directors of the Show corporation are H. W. Clough, Belden Mfg. Co.; Charles Golenpaul, Aerovox Corp.; J. J. Kahn, Standard Transformer Corp.; Sam Poncher, Newark Electric Co.; Leslie F. Muter, The Muter Co.; J. A. Berman, Shure Bros.; R. P. Almy, Sylvania Electric Products, Inc.; and W. O. Schoning, Lukko Sales Co. General manager is Kenneth C. Prince; headquarters are Suite 2214, 221 N. LaSalle St., Chicago 1. See photo, upper right.

Music Week a Big Dealer Event

All elements of the radio and phonograph industry are being asked to participate in Music Week—May 5 to 12. The National Association of Music Merchants, 28 E. Jackson Blvd., Chicago 4, Ill., is taking the lead in securing music industry cooperation for the big event. "Make Someone Happy—Give Music as Gifts" is the slogan adopted. Phonograph records will be featured in the merchants' promotions.

Special newspaper mats are available, and more than \$300 in prize money will be awarded by a well-known wholesaler for the best Music Week windows.

The campaign, according to William A. Mills, executive secretary of NAMM, will be supported by chain broadcasts and will be featured in national advertising.

Ceilings Off Discs and Musical Products

Phonograph records were exempted from OPA price ceilings as of Mar. 6th, according to information received from the governmental agency.

In another order from OPA, decontrol was also applied to pianos, musical instruments and parts, and musical accessories.



Directors of the Show Corporation are shown here at their latest meeting. L. to r., Kenneth C. Prince, J. J. Kahn, H. W. Clough, John W. Van Allen (General Counsel, RMA), Bond Geddes (Executive Secretary, RMA), Leslie F. Muter, R. P. Almy, Sam Poncher, J. A. Berman, Charles Golenpaul, and W. O. Schoning.

Census of Radio Homes and Sets

Questionnaires have been sent by the Census Bureau to radio manufacturers for a compilation of production of radio receiving sets, radio-phonograph combinations and electronic phonographs. Bureau officials informed Radio & Television Retailing that it was hoped some conclusive report would be available before the end of April.

The last Census reports on the radio manufacturing industry covered various phases of retail statistics of sales of sets and parts, exports of receiving sets, radio repair shops and production of radio receiving tubes in the 1939 Census of Manufactures. The latest production figures by the government were for 1941, the last prewar year, showing that, not counting auto radios, more than 9 million receiving sets, valued at about \$119 million, were produced. The 1941 figures were compiled by the War Production Board.

The most recent governmental survey of home radio-receiving sets was made in April, 1945, in the Fourth Survey of Consumer Requirements by the Census Bureau. After three and one-half years of

war, this Survey showed that an estimated 7 million households, nearly one in five, had no radio in order. Nearly 3 million of these were estimated to have had one or more radios out of order.

Some other estimates yielded by the survey:

About two out of three American households—24,241,000 out of 37,798,000—had the use of one radio. An estimated 2,657,000 of these also had one or more radios out of order.

About 5,059,000 households had the use of two radios, and 722,000 of these also had one or more radios out of order. About 1,131,000 households had the use of three radios, and 218,000 of these also had one or more radios out of order. The remaining estimated 355,000 households had four or more radios in order.

The Reps in the News

New officers for the coming year have been elected by the Southwestern Chapter of The Representatives. Ernest L. Wilks is president; M. F. Klicpera, vice president; Hal F. Corry, secretary-treasurer. Named as delegates to the forthcoming national convention were Mr. Wilks, G. G. Willison and John M. Maynard.

The Los Angeles Chapter named the following delegates: Norman Neely, J. T. Hill, Vern T. Rupp and Herb Becker.

Samuel A. Jeffries, secretary of the Mid-Lantic Chapter, reports the acceptance by that group of the Associate membership of Richard F. Brookfield, Times Medical Bldg., Springfield, Pa.

The Missouri Valley Chapter will be represented at the national meeting of The Representatives by R. W. Farris, F. C. Somers, Sr., and E. B. Lundgren.

The following members have announced new mailing addresses: Byron L. Moore, 202 Wardman Road, Kenmore 17, N. Y.; G. L. Koenig, 19 West Linwood Blvd., Kansas City 1, Mo.; E. B. Lundgren, 402 Manufacturers Exchange Bldg., Kansas City 6, Mo.; James Millar, 1000 Peachtree St., N.E., Atlanta, Ga.



"I guess we won't need you after all, I finally got it working."



HERE'S A STAND-OUT! The ET-061—traffic-stopping design with simulated wood grain band across top and sides. Ivory plastic cabinet with grille in red, blue, or black. ET-060, (right) has contrasting grille and tuning knobs, mahogany-plastic cabinet.

Surprised? No, but we're mighty happy!

We weren't surprised when we began getting reports—wonderful reports—from our distributors and dealers about the outstanding performance of the new Farnsworth table model radios. Everybody seems pleased that the Farnsworth reputation for quality—that same reputation which has attached itself so firmly to our phonograph-radio combinations—should be so evident among Farnsworth table models.

We planned it that way! Every number in the Farnsworth table model line was designed, engineered and produced in accordance with Farnsworth's high standards. Every set has been rigidly inspected. There has been no compromise with

quality, no use of "so-so" parts in order to gain a temporary production advantage.

We feel that our dealers and the public have a right to expect topnotch performance and full dollar value from *every* Farnsworth set—no matter what model, style or price! And so, we're mighty pleased that our table models, as well as our phonograph-radios, are making such a big hit among the men "out on the firing line." It again proves that Farnsworth's manufacturing ability and engineering skills plus the Farnsworth Selected Dealer Policy is an unbeatable combination. Farnsworth Television & Radio Corporation, Fort Wayne 1, Indiana.

FARNSWORTH

TELEVISION • RADIO
PHONOGRAPH-RADIO

Farnsworth Radio and Television Receivers and Transmitters • Aircraft Radio Equipment • Farnsworth Television Tubes • Halstead Mobile Communications and Traffic Control Systems for Rail and Highway • the Farnsworth Phonograph-Radio • the Capehart • the Fanamuse by Capehart

Check These Exclusive

KWIKHEAT

SOLDERING

IRON Advantages!

*KWIKHEAT'S Built-in
Thermostat is Thrifty*

- ★ SAVES TIPS
- ★ SAVES TIME
- ★ SAVES EFFORT
- ★ SAVES WEIGHT
- ★ SAVES CURRENT
- ★ SAVES THE IRON

**HOT IN 90 SECONDS
READY FOR USE . . . !**

Kwikheat's built-in thermostat maintains proper, even heat for most efficient, economical operation. Can't overheat . . . saves tips . . . requires less retinning. Powerful, 225 watts, yet light weight (14 oz.), well-balanced with cool, protecting handle. With choice of any one tip . . . \$11.00

6 TIP STYLES
Interchangeable

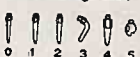

Kwikheat
THERMOSTATIC SOLDERING IRON
A Division of
Sound Equipment Corp. of California.
3903 San Fernando Rd., Glendale 4, Calif.
... ASK YOUR JOBBERT

Haag Joins Aerovox

Aerovox Corporation, New Bedford, Mass., makers of radio and electronic capacitors, announces the appointment of Vernon L. Haag as a vice-president.

Mr. Haag comes to Aerovox with a comprehensive background of 13 years in manufacturing, personnel, security, engineering, production control, methods, and maintenance of buildings.

**Marden in RCA
Ad Post**

The naming of John C. Marden as assistant advertising manager and sales promotion manager of the RCA Victor Home Instruments department has been announced by J. David Cathcart, advertising manager of the department. Mr. Cathcart also announced the appointment of William H. Tindall and Frank Schmitt as staff assistants.

Mr. Marden, product manager for Radiola before the war and procurement official in Washington for RCA during the past four years, will be in charge of merchandising, advertising, dealer-point-of-sale advertising and sales promotion.

Dealers See New Player

The new Ultratone phonograph, model PM-6, was unveiled to retailers from northern California territory at a dealer meeting held by the Edward F. Hale, Co., San Francisco distributors.

**Astatic Execs
on Sales Tour**

On a recent trip among jobbers in through eastern New York State, was Ray T. Schottenberg, jobber sales manager for Astatic Corp., Conneaut, Ohio. He was accompanied by the Astatic rep Leonard Allen, and with J. K. Poff, Astatic service engineer, he attended the formal opening of the new headquarters of the Rochester Radio Supply Co., Rochester, N. Y.

Chicago Radio Men of a New Legion Post



Above are the officers of the new John Halligan Post of the American Legion, whose members are ex-servicemen of the Hallicrafters Co., Chicago, being congratulated by William J. Halligan, second from left, president of the firm. Others, l. to r., Woody Thomas, senior vice-commander; Sam Cascio, commander; and Arlene Chesebro, ex-Wave. Mr. Halligan is a nephew of the late Rear Admiral John Halligan, after whom the post was named.

Mother's Day, May 12



New 1946 Mother's Day poster says to remember mother by an appropriate gift or action. Retailers can help promote Mother's Day, Father's Day, June 16, by displaying official posters with store merchandise.

Raytheon Division Head

Irving C. Brown has been appointed sales manager of industrial electronics division, Raytheon Manufacturing Co., Waltham, Mass., it is announced by John M. Cage, manager of the division.

Before joining Raytheon, Mr. Brown was sales manager of Thomson-Gibb Electric Welding Co., Lynn, Mass., manufacturers of resistance welding equipment. Mr. Brown had charge of four district offices as well as the home office and sales agents throughout the United States and Canada.

**Ten Million Backlog
for Meck**

John Meck, president of the John Meck Industries, Plymouth, Indiana, recently reported a backlog of \$10,000,000 in orders for Meck radios and combinations.

4 Good Reasons!

...why profit-minded dealers and distributors everywhere are stocking *E-L* Vibrators.

**SIMPLIFIED STOCK!
LOWER STOCK INVESTMENT!
FASTER TURNOVER!
GREATER PROFITS!**

That's the story in a nutshell! With *E-L*'s unique standardization plan, now you need stock only 4 models to serve the 1122 auto-radio models which comprise 95 per cent of the vibrator replacement demand.

LONGER LIFE . . . PROVEN DEPENDABILITY

E-L Vibrators are of the balanced resonance type, with 8 contacts instead of 4—*twice* as

ASK ABOUT "UTILIPHONE" . . . *E-L*'s new, practical, low-cost 2-station intercommunication system. Ideal for offices, factories, homes and schools. No installation service is required . . . gives long-time, trouble-free operation.



many as other makes in the non-synchronous types. Tests show they provide *33 per cent longer vibrator life*, with output and starting voltages held virtually constant throughout the entire life-span. The exclusive features and outstanding performance of *E-L* Vibrators are a product of exhaustive research into auto-radio requirements.

Order from your *E-L* distributor today! Your shipment will include a free copy of the new *E-L* Auto-Radio Vibrator Replacement Guide designed for your handy reference.

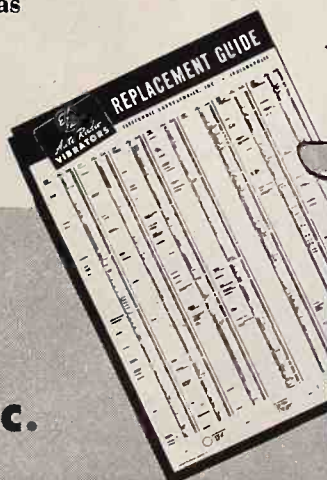

**Auto Radio
VIBRATORS**

Electronic

LABORATORIES, INC.
INDIANAPOLIS

VIBRATORS AND VIBRATOR POWER EQUIPMENT FOR LIGHTING, COMMUNICATIONS, ELECTRIC AND ELECTRONIC APPLICATIONS

SUPREME

TESTING INSTRUMENTS

AFTER A GREAT
WAR RECORD

**BACK
AGAIN!**

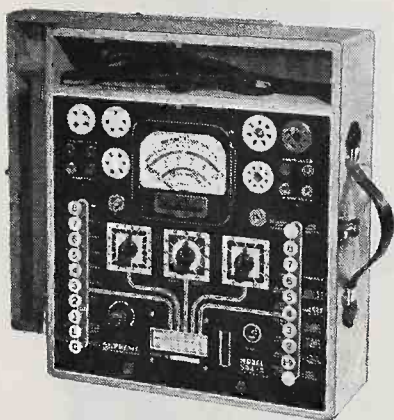

SUPREME MODEL 504-A TUBE AND SET TESTER

SUPREME regrets that war necessitated an interruption of service to its customers and friends. We are genuinely glad to get back into peacetime production—production for YOU.

MANY SUPREME INSTRUMENTS NOW AVAILABLE

—But not enough to take care of all orders at one time. Demand for accurate, dependable SUPREME equipment is such that we suggest you make arrangements for your needed new SUPREME models without delay.

SEE YOUR NEAREST SUPREME
JOBBER NOW!

SUPREME

SUPREME INSTRUMENTS CORP.
GREENWOOD, MISS.
U. S. A.

Export Department:
THE AMERICAN STEEL EXPORT CO., Inc.
374 Madison Ave., New York 17, N. Y.

Shift in Wesco Managers

The transfer of Ralph H. Sroufe to Portland, Oregon, as manager of the Westinghouse Electric Supply Co., there has been announced by Henry Czech, Northwestern district manager. Mr. Sroufe has been manager of the Iowa Division of the Northwestern District, with headquarters in Des Moines, Iowa. Robert T. Rogers, recently a Major in the Army Air Corps, will succeed Mr. Sroufe at Des Moines.

Buys Stern-Kay Firm

Edward J. Kelsey, president of the Keps Electric Co., 636-38 Grant St., Pittsburgh, Pa., has announced that this company has purchased the Stern-Kay Distributing Co., 808 Penn Ave., wholesalers of Admiral radios and appliances, Speed-Queen washers and ironers, Cadillac and McAllister vacuum cleaners.

Southern Jobber Stages Dealer Contest

In a new contest, Shobe, Inc., Memphis jobbers, will award two plaques for the best merchandising of new Zenith radios. One will be awarded to the dealer who has the best display of the sets, and the general appearance of his store will be taken into consideration. The other plaque will be awarded for the best presentation of the new radio, to a dealer's community. In both cases modernization, if advertised specifically as in preparation for the coming of the new Zenith line, will be considered.

Displays and presentations must have occurred within fifteen days of the date the dealer receives new radios, and entries must be in the hands of the judges within thirty days from date Shobe Inc., made shipment to the dealer. Judging will be on the basis of photographs and scrapbook material submitted by the dealer. Closing date for contest will be set when the sets are delivered.

Other Shobe news is that Al Deal has been added to the sales staff.

Dealer Delivery Aids



Keen Mfg. Co., Flat Rock, Mich., is featuring a line of rubber-covered handles for lifting and carrying appliances. Shown is Model D1-4S, equipped with four short handles for easy loading. Keen also manufactures delivery appliance movers, rubber-covered refrigerator and water heater movers, warehouse load movers, rubberized dollies, and web straps.

Allied Mails '46 Catalog

Allied Radio Corp's first postwar catalog lists 10,000 items for the radio and electronic field. Test equipment, PA and intercoms, record changers and phono motors are among the items described.

A large section is devoted to replacement parts, while of special interest are the pages of feature values and the listing of tools, books and circuit diagrams.

This 1946 catalog is available free on request from Allied Radio Corp., 833 W. Jackson Blvd., Chicago 7, Ill.

Temple Honored in Philly Area

The Philadelphia distributing firm of Slap & Lasky have been holding a number of new-line presentations in their area, introducing new Temple receivers to the trade. Harry Lasky of the jobber company says that the reception given the line has been exceptionally enthusiastic.



The Tennessee jobber, Cy Shobe (center), is shown here with the plaques to be awarded to dealers. At right is E. F. Lindgren of Zenith, and left is T. A. Johnson, local public relations man.

YOU ARE SELLING QUALITY ENTERTAINMENT...



Living Inspired Music - Unexcelled Charm

For enjoyment and inspiration... for the superb listening thrill that will come when you hear the music of your choice reproduced with full-scale fidelity... select a Meissner Radio Phonograph. All the distinctive harmonies and overtones of the living performance... precise, colorful, flawless, clearly defined... yours in the supreme tonal realism of each Meissner instrument.

Meissner cabinets, authentic masterpieces of dignity and luxury, are fitting companions for its glorious voice. You can make your selection from traditional Sheraton, Chippendale, English Regency and 18th Century periods or from outstanding contemporary designs, if you prefer. Veneered in finely figured swid mahogany, the Meissner Chippendale illustrated above has top sections bordered with curiously carved moulding typical of this period. Upper corners of the bottom doors are decorated with beautifully carved acanthus leaf pieces, the overall design is truly a masterful interpretation. To complete deluxe entertainment, Meissner provides the finest in radio features, automatic intermixing type record changer... improved stand and broadcast... FM (Frequency Modulation) sensationally free from static, station interference and fading... Super Shortwave... and many other new electronic improvements.

Your Meissner Dealer will be glad to arrange a demonstration or you can obtain more detail by writing to Meissner, 936 North Michigan Avenue, Chicago 11, Illinois.



MEISSNER MANUFACTURING DIVISION OF MAGUIRE INDUSTRIES, INCORPORATED

WHEN YOU SELL MEISSNER!

Faced with the problem of choosing the higher quality radio-phonographs they will sell, many top dealers have "taken the word" of a large number of internationally famous artists and have selected Meissner.

Meissner quality instruments... accepted by artists and music lovers alike... are fashioned for pleasure and surpassing in charm... true perfection in fine music and authentic cabinet design.

Examine the completely new Meissner line with its many outstanding features. You will want one of these superb radio-phonographs for your discerning customers and for yourself. A few exclusive Meissner dealerships are still open. Write today to the address below for full information. A Meissner sales executive will contact you at once.

936 NORTH MICHIGAN AVENUE, CHICAGO 11, ILL.
MEISSNER MANUFACTURING DIVISION OF MAGUIRE INDUSTRIES, INCORPORATED

Watch Meissner's great consumer advertising campaign in leading class publications. Inquiries are pouring in daily and public acceptance for Meissner is on the march.



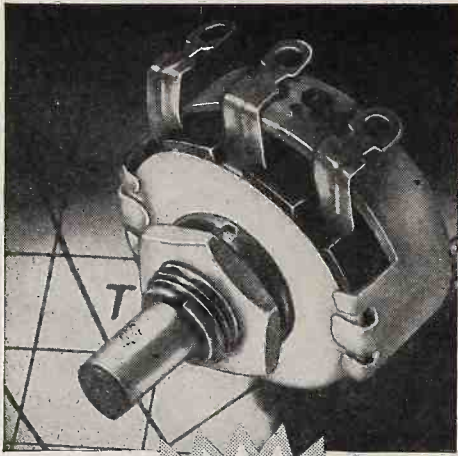

*It's a
CLAROSTAT!*

★ AND that tells the story. For Clarostat is the name and guarantee of a better composition-element control such as is now found in the finest radio-electronic assemblies where trouble and failure just can't be tolerated.

The *stabilized* element, exclusive in Clarostat controls, sets new performance standards. Extreme immunity to humidity, temperature and other severe climatic conditions. Rated at 1 watt. Resistance values of 500 ohms to 5 megohms. With or without power switch.

★ Ask your jobber . . .

Ask for these Clarostat servicing aids . . . Composition-element Controls, Wire-Wound Controls, Green-ohms (those tougher power resistors), Power Rheostats, Ballasts, etc. Ask for catalog—or write us.



CLAROSTAT MFG. CO., Inc. • 285-7 N. 6th St., Brooklyn, N. Y.

New Radio Merchandise Flown to Coast Jobbers



Radio men from E. C. Wenger Co., Oakland, Calif., distributors, were on hand to welcome first shipment of Clarion radios. Air freight got there in time for Furniture Mart's Spring Show.

Hoffman Sets for Wounded Vets

For wounded veterans recovering in service hospitals, a total of 75 brand new Hoffman table model radios, have been delivered to the American Red Cross for distribution where they are needed most.

The gift was made possible through the co-operation of the Menswear Manufacturers of Los Angeles, Hoffman Radio, and the American Red Cross. Presentation of the radios was made in Los Angeles by R. J. McNeely, sales manager of Hoffman where Mrs. Emma Jones, chairman of the American Red Cross Camp and Hospital Committee, accepted the radios for distribution.

Arvin Promotes Farr

Promotion of E. A. Farr, chief engineer of the electric appliance division to works manager in charge of the Arvin electrical appliance division, was announced by president Glenn W. Thompson of Noblitt-Sparks Industries, Columbus, Indiana. In his new position, Mr. Farr has complete charge of the design, development and production of Arvin electrical household appliances.

Mr. Farr is very optimistic about the future of the electrical household appliance industry as a whole. He predicts an even greater number of appliances for the convenience of the housewife. The Arvin light-weight electric iron has already made its debut on the 1946 market and is a forerunner of a complete quality line of Arvin appliances to come.

NESCO Appoints Slaby

Announcement has been made by M. N. Brady, vice-president—sales, National Enameling and Stamping Co., Milwaukee, Wis., of the appointment of Charles O. Slaby as assistant sales manager of the Nesco stove and heater division. Mr. Brady also announces the opening of a new district sales office in St. Louis, in charge of district manager, T. Stran Jones.

Henry Johnson Rejoins Sylvania

Back to his work at Sylvania Electric Products Inc., after three years of service in the Navy is Lt. Henry C. L. Johnson. He is advertising manager of the radio division and he will also direct the advertising and sales promotion of the industrial electronics and international divisions at Sylvania.

In the Navy, Mr. Johnson was at Cornell and Ohio State Universities, and later assigned to the U. S. S. Thuban, a combat-cargo vessel on which he was successively Gunnery Officer, Navigation



Henry C. L. Johnson

Officer, Executive Officer and Commanding Officer. His South Pacific experience included nine major battles. Following the Aleutians campaign in the early part of the war, he participated in the initial assault invasions of Tarawa, Saipan, Tinian, Leyte, Luzon, Mindoro and Iwo Jima. During the last chapters of the war, as Commanding Officer of the U.S.S. Thuban, he served with Admiral Halsey's Third and Fifth Fleets.

All roads lead to

CHICAGO RADIO SHOW

Hotel Stevens, May 13-16

Parts Manufacturers: Your first show in five years, your largest show, your first chance to meet the industry and sell it since 1941. Don't miss this opportunity—reach manufacturer, distributor, dealer, serviceman, sound specialist through the radio trade's dominant medium for twenty-five years—**RADIO & Television RETAILING.**

Set Manufacturers: While no assembled home receivers may be displayed at the Show, many of your best outlets will be there. They, among our 27,000 total distribution, rely on the Maytime SHOW Number of **RADIO & Television RETAILING** to tell them all about it. Your story, your product, should have a prominent place in this issue.

Deadline for copy in the MAYTIME Show Number is April 5.

**RADIO & Television
RETAILING**

CALDWELL - CLEMENTS, INC. 480 Lexington Ave., New York 17. PLaza 3-1340

Cleveland 14

Chicago 6

San Francisco 4

Los Angeles 14

P.S. We'll be at Booth 27--and we'll be happy to see YOU

IMMEDIATE DELIVERY

on the best in

TEST EQUIPMENT

All types and makes of test equipment available on our easy payment plan. Place your orders now for preferred delivery. Write for prices and terms.

Exclusive WRL MULTITESTER



- Sturdy Steel Case
 - 30-60-Degree Angle
 - Stand It Up or Lay It Down
- Model MT-100
Catalog No. 16-491

\$18.75

Less Leads

Handles AC DC Voltmeter. DC Milliammeter, high and low range Ohmmeter. 3" meter with sturdy D'Aronsva movement. Size 5½x8x3¼.

MAINTENANCE PART KITS

Handy, compact wood kits with sectional trays, two metal handles, and hasp lock. Size, 16"x7"x9". Contains Audio transformers and chokes, relay contacts, RF chokes, fuses, grid clips, and various quantities and types of capacitors, resistors, and rheostats. 83 items in all. Box alone worth \$4. Catalog No. 30-555.....

\$5.95

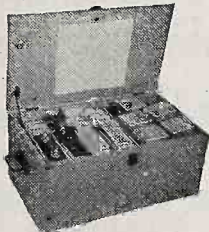

NEW 52 PAGE FLYER

Jammed with values in radio, electronics, and general merchandise. It's Free for the asking. Write for your copy today.

- Send for these exclusive items:
- Tube and Circuit Book10c
 - Giant Radio Reference Map (size 3½'x4½') 15c
 - Handy Tube-Base Calculator ...25c

We invite industrial inquiries for electronic equipment and devices of all kinds.

- **ANTENNA LOOPS** for midgets and portables. Replaces antenna coils; good pickup and selectivity, each 39c
- **RESISTOR KITS** Top quality merchandise. Many uses. 100 to Kit, each \$1.15
- **MICA CONDENSER KITS**—Handy kits of best quality that will find a multitude of uses around the shop. 100 to box, each 98c

Leo also carries a complete line of tools, replacement parts, intercom and P.A. systems everything for the progressive service dealer.

QUICK SERVICE FROM LEO
"same day" delivery service from the heart of the nation . . . on anything in radio.

EASY TERMS always the lowest in the country, to help you get that much needed merchandise NOW! Write Leo today.

Address Dept. RT-3
Council Bluffs, Iowa



Formerly Wholesale Radio Laboratories

Famous New York Store Shows New Scott Radios



Dealers are now getting first postwar Scott radios; above is George Lohman, President of the well known Haynes-Griffin store at 391 Madison Ave., New York City, with his feature display of the 24-tube, FM-AM combination of the 800-B series priced at \$937.50 for Zone 1. Features include new "Teague" dial, plus a de luxe English-style record changer. "Quality" dealer Lohman reports he already has a number of orders for units.

Coldaire Plans Complete Storage-Freezer Line

With the announcement of a new, simplified three cubic feet home freezer designed for the average urban family, the Coldaire Corp., Chicago 11, Ill., is entering the frozen food field.

Formation of the Coldaire Corp., and its first cabinet have been announced simultaneously by Charles W. Stillman, executive vice-president of the new corporation. Stillman also directs frozen food activities of the Bob White Organization, food industry consultants, Chicago, and prior to joining Bob White, he was international sales manager for Carrier Corp.

Coldaire cabinets will be manufactured by Kellett Aircraft Corp., Philadelphia, Pa. The Coldaire Corp., has been established to sell, merchandise and distribute the cabinets and equipment.

Factory Men Do N Y Tele Re-alignment

A "first come first served" policy for the quickest possible changeover of all DuMont tele receivers in the New York area which must be re-aligned for the new FCC frequency assignments, has been announced by Ernest A. Marx, general manager of the tele division of Allen B. DuMont Laboratories, Inc., 2 Main Ave., Passaic, N. J. Several hundred DuMont sets are being used in the sector.

Mr. Marx said that "We are advising all owners of DuMont tele sets that our service organization is ready to change over their sets to receive all three New York television stations—WABD, WNBT and WCBW. This work, as well as pickup and delivery of the set, will be accomplished for a flat fee.

"Obviously, if work other than the frequency changeover is required, a slight additional charge for labor and material will be necessary.

"Orders for realignment service should be placed as soon as possible, so that our factory-trained technicians may provide the best possible service."

Bendix Appointments

The appointment of J. Warren Russell as a divisional sales manager for Bendix Home Appliances, Inc., South Bend, Ind., was announced by W. F. Linville, general sales manager. Mr. Russell will have headquarters in Garfield, N. J. He has had 15 years' experience in appliance sales positions.

Appointment of two executives in the distribution department of Bendix Home Appliances, Inc., was announced by Harlow K. Lyons, director. Anthony E. Cascino, Chicago, was named as head of market research and statistics. George T. Wrasse, returned from service with the Navy, is assistant export manager.

Gunn to Cleveland

D. W. Gunn has been transferred from the firm's New York office, and will now make his headquarters at Cleveland, Ohio, for the Radio Tube Division of Sylvania Electric Products. He will cover the states of Michigan, Ohio and Indiana, with offices at 295 Union Commerce Building, Cleveland.

Has \$15 FM Converter

Hallicrafters Co., Chicago, has placed in volume production a new low-priced converter which can be used to adapt prewar FM sets to the new band of 88 to 108 megacycles.

Employing a single tube and small enough to fit inside practically any FM set cabinet, the converter is designed to prevent obsolescence of prewar FM receivers estimated to number as many as 500,000. Priced to sell at \$15 retail, it makes possible the operation of any FM receiver with a tuning range of 42 to 50 megacycles in the new channel. Installation is easily accomplished.

Initial production of the converter will be shipped to Hallicrafters distributors. Because of expected widespread demand, however, it is believed by company officials that sales will be expanded to the entire radio field.

Not too many... not too few!

Also at
your IRC
Distributor's



TYPE BT INSULATED METALLIZED and
TYPE BW INSULATED WIRE WOUNDS
... the perfect combination.

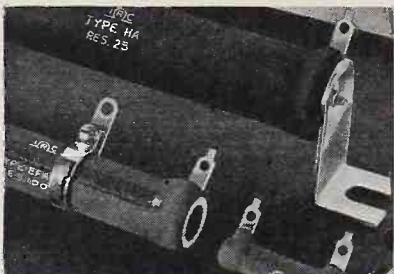

POWER WIRE WOUNDS... rugged,
moisture proof, completely dependable.

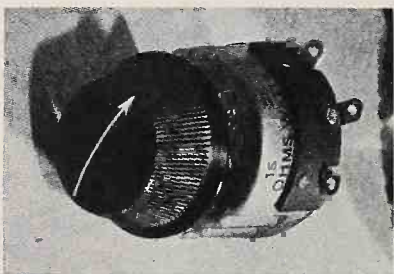

POWER RHEOSTATS (above). Pre-
cisions, Wire Wound Controls, Bleeders,
Non-inductive Wire Wounds, etc. (be-
low)—for many service needs.

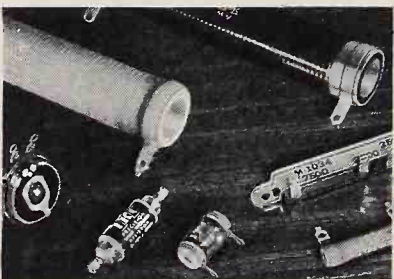

The IRC *Century Line* is a commonsense selection of the controls you need for complete service

The controls in the *IRC Century Line* were carefully selected after exhaustive study of IRC sales records and of the requirements of receivers and equipment now in use.

These studies showed that the number of types previously listed could be reduced considerably, yet give adequate coverage. But it also proved that reducing the number of available types to anything *less* than the 100 now comprising the *Century Line*, would make the service engineer's replacement problem extremely difficult.

On that basis, we established the *Century Line*—not too many, not too few—but just right to give you properly designed, easily installed con-

trols for the widest variety of replacement needs.

Best of all, it's *not* necessary for you to actually stock all the 100 *Century Line* types! We recommend you maintain a minimum stock of at least the 18 Type D Controls listed on page 6 of IRC Catalog #50—they'll handle 87% of your replacements—and you can depend upon your IRC distributor for other types, as required.

And don't forget, *only IRC controls* give you such quiet, smooth, dependable performance!... because they're the only controls with the famous IRC Metallized Element, the Five Finger Contactor, and the Silent Spiral Connector!

YOUR IRC DISTRIBUTOR is the man to know when you need *any type* of resistor... there is an IRC resistance unit for almost every servicing requirement. Ask him for your copy of IRC Service Catalog #50.

FOR BETTER-THAN-STANDARD QUALITY... *Standardize on*

INTERNATIONAL RESISTANCE CO.

Dept. 21-D, 401 N. BROAD ST., PHILA. 8, PA.

Canadian Licensee: International Resistance Co., Ltd., Toronto



MAKERS OF MORE TYPES OF RESISTANCE UNITS, IN MORE SHAPES, FOR
MORE APPLICATIONS, THAN ANY OTHER MANUFACTURER IN THE WORLD.

**Order from LAKE!
You'll Make No Mistake!**

RADIO CABINETS & PARTS

Now Available!



**Postwar
2 Post
RECORD-
CHANGER**

In luxurious brown leatherette portable case, 15" L x 15" W x 10" D. Latest electronic developments make this modern

record-changer the finest on the market today! List price—\$49.95. Dealer's net—\$29.97

DE LUXE RECORD-CHANGER AND AMPLIFIER CASE

De luxe changer case with ample room for amplifier. Overall dimensions: 20" L x 16" W x 10" H. Sturdily built of 5/8" plywood, deluxe brass hardware throughout. Inside dimensions: 15 1/2" L x 14 3/4" W x 9 1/2" H. Net price.....\$12.95



**De Luxe
PHONO
CABINET**

Covered in luxurious, genuine brown leatherette, has deluxe

brass hardware throughout, made completely of plywood with brown plastic handle, has padded top and bottom. Motor board 14" x 14 1/2". Overall dimensions 16" L x 15" W x 8" H.

Your special net price\$8.95

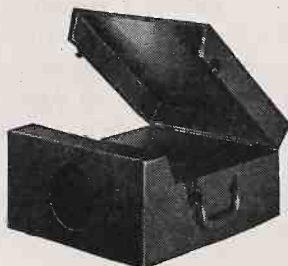

Portable Phonograph case in brown leatherette covering. Inside dimensions 17 1/2" long, 13" wide, 7 1/2" high. Has blank motor board and opening for speaker. As illustrated at left, specially priced at..

\$7.95

Also blank table cabinets of walnut veneer in the following sizes, with speaker opening on left front side: (*Note: *7 has center speaker grille)

#1	8 1/4"	L x 5 1/4"	H x 4"	D \$1.95
#2	10 1/4"	L x 6 3/4"	H x 5"	D \$2.75
#3	13 1/2"	L x 7 3/4"	H x 6 1/4"	D \$3.25
#7	10 1/4"	L x 7"	H x 5 1/2"	D \$2.50

*Speaker Opening in center of front side.

All types of radio cabinets and parts are available at Lake's Lower prices. A large stock is listed in our catalog.



SERVICEMEN—RETAILERS
Join our customer list today.
Dept. B

Write for our NEW 12 page, illustrated, elaborate catalog!

Lake Radio Sales Co.
615 W. Randolph Street
Chicago 6, Ill.

**New Yorker Has
"New Store" Ideas**

Formal opening of the completely re-modeled store of Donald Murray, Inc., 33 Irving Place, New York City, was staged last month with an all-day "open house" in the colorful and up-to-the-minute "local dept. store."

Ultra-modern treatment at this big outfit includes fluorescent lights plus display spots. Appliances and an electric kitchen are at the rear, next to the record dept.; radios and traffic appliances are shown on floor islands. Streamlined mezzanine has bamboo finish and back-lighted wall display insets; inside are the offices and stock rooms.

The 6,000 sq. ft. store is air conditioned, complete with service dept. and staffed by eight people. Mr. Murray has given diversification more of a try than most; waiting for radio & appliances, he's selling jewelry, housewares, photo equipment, sporting goods and some clothing.

Veterans with Blackstone

Marshall A. Larson, sales department, Blackstone Corp., Jamestown N. Y., has returned from active service in the U. S. Army to resume new duties in the company as manager of order service, according to John M. Wicht, vice-president and general manager. Mr. Wicht also announced that James E. Peters, has joined the Blackstone Corp., as advertising manager.

E. B. Lawson, former advertising manager, has returned to the company after 3 1/2 years in the U. S. Navy.

Koiled Kord Names Two

R. H. Carlsen has been appointed sales promotion manager of the Koiled Kord division of Kellogg Switchboard and Supply Co., Chicago. William A. McCracken, has been named as works manager.

Powerful Show Window

An attractive show window of the modernized Powers, Inc., store, 887 Broad St., Newark, N. J., is shown on the cover opening the Electrical Appliances section of this publication.

New Jobber Showroom

Appliance Distributors, Inc., 51 Lawton St., New Rochelle, N. Y., has opened a new showroom for the display of Stewart-Warner radios and a complete new line of electrical appliances. In addition to Stewart-Warner receivers, the firm will distribute the following brands: Manning-Bowman, Samson United, Modern Maid, Electric Steem radiators, "Eveready" products, Westinghouse lamps, Steam-O-Matic irons, Waring products, Sessions clocks, Hammond clocks, Bengal ranges, Delta lanterns, Ray-O-Vac batteries, Cory coffee brewers, Victor and Diehl ventilating fans, Noma space heaters, Casco heating pads and Kitchen-Aid mixers.

**Capitol Offers
Transcriptions**

News from Hollywood is that Capitol Records has formed the Capitol Transcription Service, a division of Capitol Records, with program service for radio stations available July 1st of this year.

Walt Davison, formerly the sales head for the NBC Radio Recording Division, will supervise national sales for Capitol Transcriptions,

**Rube Coburn SM
at Panoramic**

R. M. (Rube) Coburn has been appointed sales manager of Panoramic Radio Corp., 242 W. 55th St., New York City, manufacturers of Panoramic communication receivers.



"I asked you to go out and get me a new 'coil', not goil!"

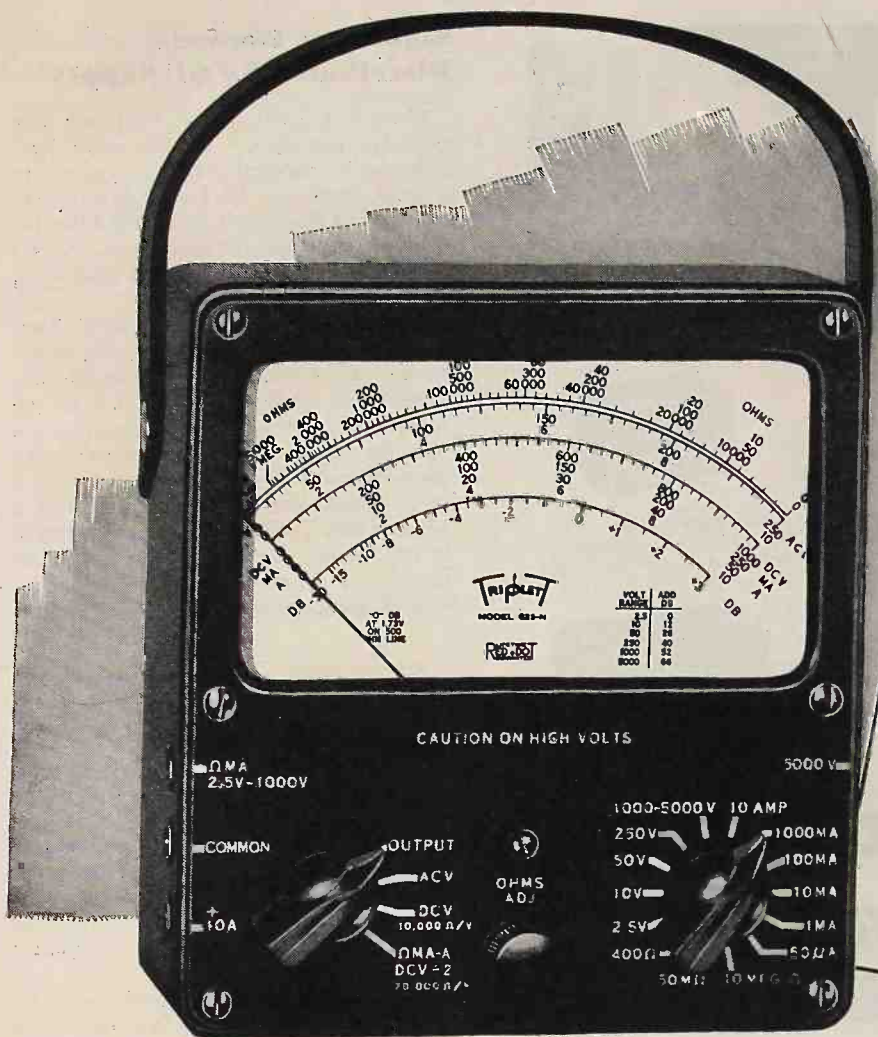

HERE'S THAT NEW
TRIPLETT
625-N

LONG SCALE, WIDE RANGE VOLT-OHM-MILLIAMMETER

DOUBLE SENSITIVITY D. C. VOLT RANGES

0-1.25-5-25-125-500-2500 Volts,
at 20,000 ohms per volt for greater accuracy on
Television and other high resistance D.C. circuits.
0-2.5-10-50-250-1000-5000 Volts,
at 10,000 ohms per volt.

A. C. VOLT RANGES

0-2.5-10-50-250-1000-5000 Volts,
at 10,000 ohms per volt.

OHM-MEGOHMS

0-400 ohms (60 ohms center scale)
0-50,000 ohms (300 ohms center scale)
0-10 megohms (60,000 ohms center scale)

DIRECT READING OUTPUT LEVEL DECIBEL RANGES

-30 to +3, +15, +29, +43, +55, +69 DB

TEMPERATURE COMPENSATED CIRCUIT FOR ALL CURRENT RANGES D.C. MICROAMPERES

0-50 Microamperes, at 250 M.V.

D. C. MILLIAMPERES

0-1-10-100-1000 Milliampere, at 250 M.V.

D. C. AMPERES

0-10 Amperes, at 250 M.V.

OUTPUT READINGS

Condenser in series with A.C. Volts for output
readings.

ATTRACTIVE COMPACT CASE

Size: 2½" x 5½" x 6". A readily portable, completely
insulated, black, molded case, with strap handle.
A suitable black, leather carrying case (No. 629)
also available, with strap handle.

LONG 5" SCALE ARC

For greater reading accuracy on the Triplet
RED • DOT Lifetime Guaranteed meter.

SIMPLIFIED SWITCHING CIRCUIT

Greater ease in changing ranges.

Write for descriptive folder giving full technical details

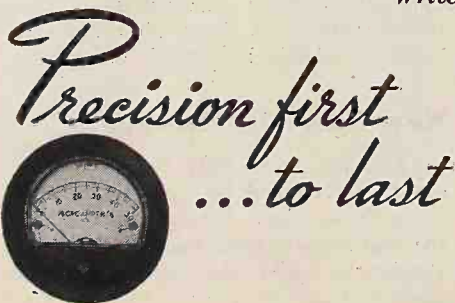

Triplet

ELECTRICAL INSTRUMENT CO. BLUFFTON, OHIO

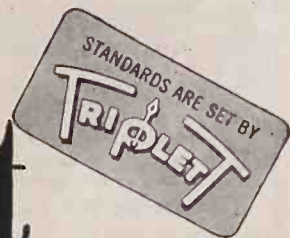

AMPLICALL

A stand-out name in
— Intercommunication
— Paging
— PA Systems

RAULAND distributors from coast to coast are enthusiastic about the way business executives are going for AMPLICALL Systems. During the war most of these businesses had to do without plant or office communications. Now they realize they can't afford to be without AMPLICALL, the stand-out System, which offers them so many advanced features for increasing overall efficiency. AMPLICALL's design-flexibility, multiple uses, clear tone quality, day-in-and-day-out dependability and trouble-free operation are just a few reasons for its remarkable performance record.



AMPLICALL
Weatherproof
Speaker



AMPLICALL
Paging Control
Unit



AMPLICALL
Audio Amplifier unit for labora-
tory, test equipment and general
applications



AMPLICALL
Intercommunication unit, available
for two-way communication between
multiple stations

Electroneering is our business

RADIO · RADAR
SOUND



Rauland

COMMUNICATIONS
TELEVISION

THE RAULAND CORPORATION • CHICAGO 41, ILLINOIS

NEW SOLDERING GUN

THE SPEED IRON*



Patent Applied For

100 Watts 115 Volts 60 Cycles

Soldering Heat in 5 Seconds

Wherever you have a soldered joint in radio, electrical or electronic repair and service work, the Speed Iron will do the job faster and better.

The transformer principle gives high heat—in 5 seconds—after you press the trigger switch. Convenient to hold with a pistol grip handle, the compact dimensions of this new soldering tool permit you to get close to the

*T.M. Reg. U. S. Pat. Off.

joint. The copper loop soldering tip permits working in tight spots. The heat is produced by the high current flowing through the soldering tip—permitting direct and fast transfer to the soldered connection.

If you want to save time on soldering jobs with a tool that is ready to use in 5 seconds, get a Speed Iron today. See your radio parts distributor or write direct.

WELLER MFG. CO.

516 NORTHAMPTON ST. • EASTON, PA.

Signature Records Distributed by GE Supply

General Electric Supply Corp. are now exclusive distributors for Signature Records on a national basis, according to a joint statement by L. G. Moore, Jr., manager of Radio and Electronic Sales for General Electric Supply, and Robert Thiele, president of Signature Recording Corp.

Mr. Moore stated that "General Electric Supply has been studying the record business for sometime because we are convinced that wholesale distribution of records by our company is a natural, not only for us but for our retail dealers. We have chosen Signature Records because it is a young, aggressive company with a high quality product and we know that it is the management's intent to create for themselves a position in the recording industry second to none."

Outline Plans

Mr. Thiele has outlined the immediate and future plans for expansion of the artists department with top name orchestras and singers being added to the roster. George Jaycox, vice president of Signature, explained the technical improvements already achieved and contemplated, with production plans that will enable Signature, through General Electric Supply Corp. to attain a national distribution promptly.

In addition to Signature Records, the General Electric Supply Corp. distributes at wholesale, General Electric radio and electronic equipment, radios and radio-phonographs, electrical appliances, supplies, and apparatus and construction materials. Over one hundred offices and warehouses are maintained and operated, in addition to approximately fifteen thousand dealers. The corporation specializes in "assisting the dealer in his merchandising activities and helping him to obtain an increased profitable sales volume through the use of product training, store displays, sales promotion, and special campaigns."

Kwikheat Sales Agents

The following sales agents have been appointed to represent the Kwikheat thermostatic soldering iron, announces Howard M. Irwin, sales and advertising manager for Sound Equipment Corp., of California, manufacturers of the product:

J. Y. Schoonmaker, Dallas, Tex.; Maitland K. Smith, Atlanta, Ga.; George O. Tanner, Pittsburgh; L. A. Chambers, Chicago; John O. Olsen, Cleveland; John V. Coestello, Buffalo; Howard D. Wixon, Detroit; Samuel S. Egert, New York and Emery B. Hatch, Melrose, Mass.

New Name is "Sunbeam"

The Chicago Flexible Shaft Co., Chicago, has changed its name to the Sunbeam Corporation. Among other products, the firm manufactures electrical household appliances under the Sunbeam brand-name.

Armstrong and McDonald Answer FCC on FM

Major Edwin H. Armstrong, commenting on the Federal Communication Commission's report of March 5 containing the reasons for the decision of January 23, when it denied the Zenith Radio petition to retain the low FM band, said:

"The Commission's report virtually admits that its Engineering Department has made one of the colossal mistakes of radio history.

"Controversies concerning the laws of nature are never closed until the facts come out. The only way the facts in this situation can be suppressed is by shutting down the present (low-band) 40-mc stations before the comparative performance of the two bands can be observed in actual practice by engineers and the public alike."

Comdr. E. F. McDonald, Jr., Said:

"Erasing the technical whiskers, the FCC report reveals the following facts:

"1. The Commission has ignored the first actual, extensive field tests ever made of FM on the 50-mc and 100-mc bands, which show that FM will be crippled if left on the 100-mc band exclusively;

"2. The Commission has again acted on the theories of its own employee, K. A. Norton, and ignored the advice of seven distinguished scientists, all of whom recommended that FM be assigned to the 50-mc band;

"3. The Commission has strengthened the relative monopoly that now exists in broadcasting."

Herrmann Sales Manager

Edgar G. Herrmann, veteran radio sales and advertising executive and former assistant vice-president of the Zenith Radio Corp., has been named sales manager of the Westinghouse home radio division, Sunbury, Pa. Announcement of the appointment, which completes organization of the division's headquarters staff, was made by Manager Harold B. Donley.

Accessory Manager



Back to Philco Corp. after four years of Signal Corps service during which he rose to rank of Major, Raymond B. George has been named sales manager of the firm's accessory division.

Where lasting appearance counts . . .

SNYDER

Antennas

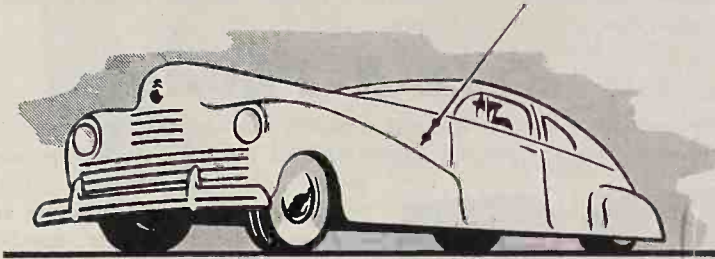

SNYDER

MANUFACTURING COMPANY

PHILADELPHIA

MANUFACTURERS . . . START TO FINISH

Sweet Savings ON 600-V. CONDENSERS

Here's a great OLSON bargain: 70 By-Pass Condensers, made to rigid Olson specifications. Will withstand voltages higher than ratings. Worth much more than our low price. Order now!

\$4.95
POSTPAID

Small size (approx. 1 1/2" long, 1/2" dia.) makes these units right for compact circuits. Long tinned copper leads. You get SEVENTY 600-V. Tubulars, as follows:

QUANTITY	CAPACITY	QUANTITY	CAPACITY
20	.01	20	.05
10	.02	20	.1

This offer good only in U. S. A.

MAIL TODAY



RADIO WAREHOUSE

Stock #TC-A

73 E. Mill St., Dept. 20, Akron, Ohio

Send me . . . Kits of 70 Condensers each, at \$4.95 per Kit postpaid. I enclose \$. . . I will receive a Panel Lamp Tool FREE with each Kit ordered.

NAME

ADDRESS

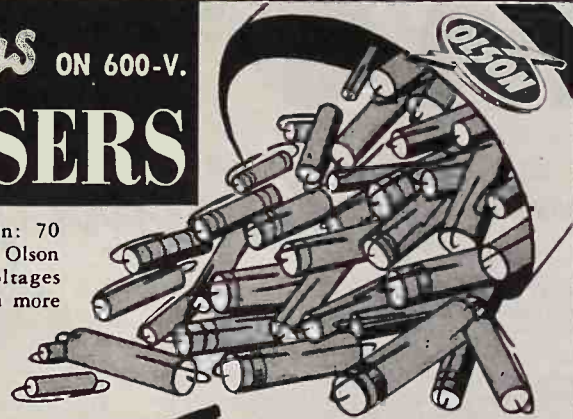

FREE

Panel Lamp Tool

with each Condenser Kit ordered. Rubber tool grips bulb for easy installation or removal in hard-to-get-at positions. Mighty handy!



Send for our free Bargain Catalogs

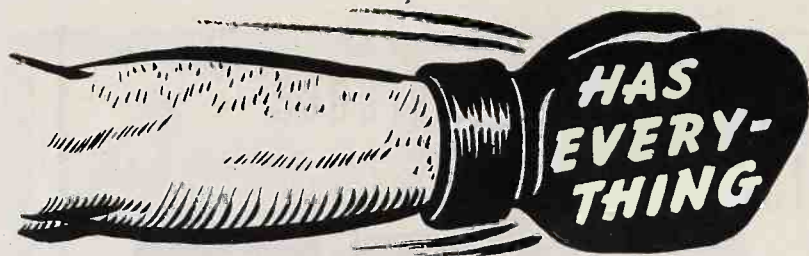

The Champ of Inter-comm Has An Unbeatable Sales's PUNCH!

Talk-A-Phone "Has Everything" and everything is at the peak of perfection. When you make *that* statement and back it up with actual *performance*, you deliver a snappy, persuasive sale's presentation that just can't be topped.

Talk-A-Phone

the world's most advanced and complete line of inter-communication, provides units especially engineered to meet the widest possible range of requirements. Every prospect is a potential customer and customers are supremely satisfied. You do a thriving good business *and* build priceless good will.

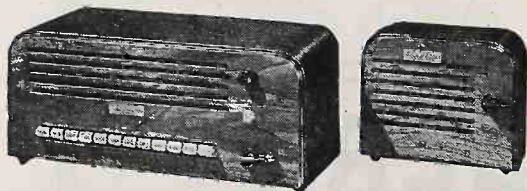

Write for particulars and catalog, today.

Talk-A-Phone Mfg. Co.
1512 So. Pulaski Rd. Chicago 23, Ill.

MOTORS

SMALL . . . BUT *Mighty!*

Besides the millions of Phonomotors made for the radio industry, Alliance builds the line of Powr-Pakt motors.

Radio and electrical manufacturers, jobbers and retailers will soon see these compact, light-weight power plants in action! They'll actuate radio and electronic controls, heating controls, merchandise dispensers, motion displays . . . all kinds of automatic devices.

So watch for Alliance Powr-Pakt Motors! They'll make a great addition to the famous Model 80 Phonomotor!

Alliance Powr-Pakt Motors Power Ratings run from 1-400th to 1-20th horsepower. Shaded Pole induction and Split-phase resistor types for continuous or intermittent duty—reducing gears available.

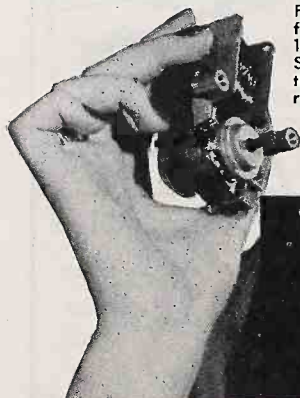

WHEN YOU DESIGN . . . KEEP

alliance

MOTORS IN MIND

ALLIANCE MANUFACTURING COMPANY • ALLIANCE, OHIO
Alliance Tool and Motor Ltd., Toronto 14, Canada

20 Years Ago

Radio Retailing
From the April, 1926, Issue of
RADIO & Television RETAILING

"DEALER DIFFICULTIES"—1) Lack of consideration for the "other fellow," in the manufacture-jobber-dealer chain. 2) Under-selling. 3) New set model announcements at one time only during the year.

STOCK CONTROL—Daily check-up to keep salesmen acquainted with shelves, analyzing buying trends, weekly inventories is all-important in retail radio business. GOOD WILL—Fair Dealing and Courtesy are Twin Factors Which Build that Great Intangible Asset—Good Will.

"KEEP THE CUSTOMER INTERESTED IN THE DEMONSTRATION" Is a Sales Commandment Every Dealer Should Heed.

RADIO BENEFICIAL, NOT DETRIMENTAL TO PLAYS—Editorial.

WHAT'S NEW—Cone reproducer on pedestal; battery eliminator said to be noiseless and humless; tube for last audio stage; tube rejuvenator; roof type aerial mast; straight line frequency condenser.

Marion Guarantees Free Replacement

Correspondence and red tape is minimized by Marion Electrical Instrument Company's plan for replacing ruined meters.

A 100% guarantee for six months has been offered to all users of their glass-to-metal hermetically sealed instruments, regardless of the nature of the fault, provided the seal has not been broken.

After the initial six-months period, under the same conditions, Marion will replace any 2½" or 3½" type having a range of 200 microamperes or more, for a flat fee of \$1.50. Those with a range lower than 200 microamperes, will be replaced for \$2.50.

A catalog is supplied on request to Marion Electrical Instrument Company, Manchester, N. H.

Ideal Changes Name

To provide for expansion now under way, Ideal Commutator Dresser Co., Sycamore, Ill., has changed to a corporation to be known as Ideal Industries, Inc. There will be no change in management, personnel, location nor in distribution methods, announces J. Walter Becker, general manager.

Stromberg Plans in Sound Market

Backed by a record advertising program, the Stromberg-Carlson sound equipment division has begun "to clinch our claim to a major share of the multi-million dollar business."

The program set up for 1946 was announced at a three-day sales conference for the division's distributors and sales representatives from all over the United States and Canada.

The 1946 line to be featured a variety of amplifiers, a standard sound system, both telephone and amplified inter-communication systems, and a wide assortment of loud speakers. The standard sound system has a standard design "which makes for easier installation, and makes special engineering unnecessary."

Allan R. Royle, division sales manager, described the 1946 line as "bearing one of the brightest profit-opportunities and values ever offered by the 52-year old company."

SC advertising programs are directed at six individual markets. The programs will reach the schools, business and industry, hospitals, railroads, hotels and the architectural markets, through each market's key trade publications. A series of brochures on the lines will be channelled into direct mail programs.

Among the sales representatives who attended the sales conference were: C. Bond Barney of San Francisco, Cal.; Carl Howard and Howard Wilson of Chicago, Ill.; Ben Saxton of Pittsburgh, Pa.; R. E. Gray of Dallas, Tex.; J. T. Fulwiler and Carey Chapman of Atlanta, Ga.; and A. S. McPhail and Del Black of Toronto, Ontario.

Estate Stove Officials

S. C. Bernhardt, vice-president in charge of sales, Estate Stove Co., Hamilton, O., announced the appointment of Russell L. Schwab as district manager in New York and northern New Jersey. Mr. Bernhardt also revealed that Ned Weinman had been appointed service manager for Estate.

Merchandise Manager



Allan B. Mills has been appointed merchandise manager for the Home Instrument Division of RCA Victor. He was in charge of RCA home product postwar planning, when the war ended, and has been with Victor since 1923.



And that is all important to the service man. Making good on a job because of a resistor failure takes the profit out of the job. Ward Leonard Resistors are being shipped from stock . . . no delays. Order them from your jobber now.

WARD LEONARD RESISTORS • RELAYS • RHEOSTATS

Electric Control Devices Since 1892

Send for Resistor Bulletin D-2 Today

WARD LEONARD ELECTRIC COMPANY,
Radio and Electronic Distributor Division 53H West Jackson Blvd., Chicago, Ill.

DESIGN FOR QUALITY

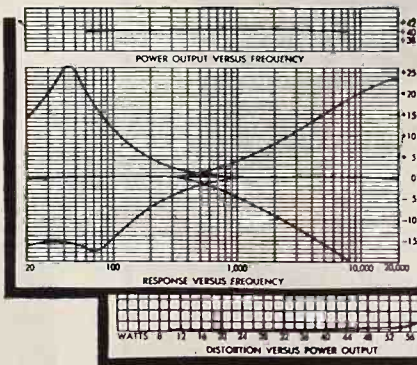

Actual curves from Model KX-60, 60 watt amplifier.

Newcomb course is plotted for true reproduction . . . minimum distortion.

Newcomb design goes beyond that of conventional amplifiers, whose power output is likely to be measured only at their most favorable frequency. Newcomb engineering considers it important that the power output curve versus frequency be as uniform as possible and that you get a full measure of power from any output tap. You are assured a full-powered sound system whatever frequency or output impedance is considered.

True reproduction . . . wide, smooth response characteristics . . . these qualities are not coincidence. They are carefully planned and built into every Newcomb sound system. Judged by the strictest standards . . . by any means you wish . . . a Newcomb amplifier is a powerful piece of sound engineering. It's built to give a brilliant performance on the toughest job . . . and it does.

Write for details on complete Newcomb line.

THE SOUND OF QUALITY

Newcomb

AUDIO PRODUCTS CO.

MANUFACTURERS
DEPT. A. 2815 S. HILL STREET, LOS ANGELES 7, CALIFORNIA

Majestic Vice-Pres.



Parker H. Ericksen, director of sales for Majestic Radio & Television Corp., has been appointed a vice president by the firm's Board of Directors. He's been in radio and appliances for almost 20 years.

Lewis on NERA Staff

The National Electrical Retailers Assn., Chicago, Ill., announced the addition to its staff of Leslie Llewellyn Lewis as sales training consultant. Mr. Lewis has been identified with the electrical industry since 1929, having prepared sales training courses and related material for many of the leading manufacturers, wholesalers and dealer groups.

Kelvinator Lines Stress New Features, Styling

Detailed changes in the four new 1946 Leonard refrigerators now rolling off assembly lines in increasing numbers are revealed by Walter Jeffrey, sales manager of the Leonard Division, Nash-Kelvinator Corp., Detroit 32, Mich.

New interior and exterior styling mark the new Leonards—three seven-foot models and one nine-foot model. New features include increased beauty, greater emphasis on frozen food storage and many mechanical and convenience developments.

The new Kelvinator range line is comprised of three models, headed up by the Kelvinator "Automatic Cook" feature that starts, times and stops all cooking operations.

Proctor Names Officials

T. P. (Tom) James and H. S. (Cy) Perkins have been appointed assistant general sales managers of the Proctor Electric Co., Philadelphia, by Robert M. Oliver, vice-president and general sales manager.

Ward Leonard Adds Office

Ward Leonard Electric Co., Mount Vernon, N. Y., announces the establishment of a North Jersey office, in the Industrial Office Building, Newark 2, N. J. R. W. Vonasch, formerly attached to the home office, is district manager.

Contacting Dealers



Ed Furbish, a new sales supervisor with Motorola, is now calling on dealers in the Ohio and Allegheny area. Before joining Galvin Mfg. Corp. last August, he had wide experience in promotion and sales, starting in 1921.

Homozone Dealers Named

The Automatic Electrical Devices Co., Cincinnati 2, Ohio, manufacturers of ozone machines, announce that dealers have been appointed throughout the country to handle their line of Homozone generating units. Many territories are still open, and the firm welcomes inquiries from interested dealers.



Yes, Xcelite Tools are matched to your merchandising skill, just as they are to your customers' skill in using them. Maybe that's why we are still unable to supply the demand for Xcelite Tools. However, new equipment is being added which will double present production before long. Our new catalog will be off the press shortly. See you at the Radio & Electronic Show, Stevens Hotel, May 13-16, Booth 128.

Dept. M

PARK METALWARE CO., INC.

Orchard Park, New York



QUALITY TOOLS
PREFERRED BY THE EXPERTS

ELECTRO
ELECTRICAL AND RADIO EQUIPMENT

BATTERY ELIMINATORS



FEATURING! OUR NEW MODEL "Q"

For use anywhere beyond high line connections. The better eliminator every farmer, camper, sportsman, trailer or boat owner, etc., has been waiting for. Lifts battery radio reception to new heights of satisfaction for isolated listeners. For auto service will save three-quarters of normal battery drain.

OPERATES ANY 1.4 VOLT—4, 5 OR 6 TUBE RADIO FROM 6 VOLT STORAGE OR DRY BATTERY OR WINCHARGER

Costs but a few cents per hundred hours of operation. Sturdily constructed—no liquids or moving parts—operates in any position. Completely filtered—hum free—silent and efficient in operation. Universal plugs and sockets to fit any radio. Weight packed—only 3 1/2 lbs.

FOR 2-VOLT RADIO FROM STORAGE BATTERY SOURCE—
SELL OUR MODEL "R"

NOTE: Due to critical material shortages at this time, our production is necessarily limited and deliveries can be made only through our present established jobbers. Canadian representative, Atlas Radio Corp., Toronto, Canada.

ELECTRO PRODUCTS LABORATORIES

Pioneer Manufacturers of Battery Eliminators
549 WEST RANDOLPH STREET

CHICAGO 6, ILL.

Zenith Sales Managers

H. C. Bonfig, Zenith vice-president in charge of household radio, has announced the following appointments of district sales managers:

Hugh H. Boyer for the Albany, Buffalo, Syracuse, Harrisburg, Johnstown and Scranton districts; William W. Boyne for Grand Rapids, Detroit, Fort Wayne and



One of the six district sales managers appointed by Zenith is a Lt. Col. on terminal leave—Fred H. Strayer who takes over in 5 cities in Okla. and Tex.

Indianapolis; James W. Henry for Kansas City, Springfield, Wichita, Des Moines and Omaha; Harold O. Hilding for Minneapolis, Fargo, Aberdeen, Green Bay and Milwaukee; Martin J. Toohill for Terre Haute, Louisville, St. Louis, Cincinnati, Charleston and Williamson; Fred R. Strayer for Oklahoma City, Amarillo, Dallas, El Paso and San Antonio.

Phonola Ceiling Tags Announced

OPA approved prices on three models of the Waters Conley Co.'s portable acoustic Phonola phonographs, have been announced by Glen Waters, the firm's president.

Retail ceiling prices, including excise taxes are as follows: Model S-50, Zone I \$15.45, Zone II \$16.20; Model S-60, Zone I \$16.85, Zone II \$17.70; Model S-80, Zone I \$20.25; Zone II \$21.25. Shipments of these models have already been made from the Rochester, Minn., plant to the 48 exclusive domestic distributors and export agents for Phonola.

Production Stepped Up at Sentinel

Report from Sentinel Radio Corp., Evanston, Ill., is that "materials are beginning to come in . . . assembly lines are moving . . . employees are being recalled . . . our story is a million sets for 1946-47 at the rate of 3,000 a day."

Sales manager E. G. May says that "all materials received these days are put promptly on the move, but just how soon we can reach full production on our complete line depends on factors as yet beyond our control."

The new Sentinel plant is almost complete; it will feature straight-line production on a single-shift basis.



MANUFACTURERS OF RADIO, ELECTRICAL AND ELECTRONIC COMPONENTS

VOKAR Corporation

7300 HURON RIVER DRIVE • DEXTER, MICHIGAN

TAB SPECIAL BUY (Limited Quantity)



ELECTRONIC VOLT-OHM METER BRAND NEW U. S. ARMY TYPE 1-107-F PRECISION UNIT. Rugged design housed steel case 6"x 9/4"x4/8" leather carrying handle. Contains Simpson 4" highly damped 400 microamp Alnico meter. Clear visible scale large numerals easily readable at all points. All voltage ranges ten megohms sensitivity; reads 0-3 volts in .05 v steps; 0-10 volts in .2 v steps; 0-30 volts in .5 v steps; 0-100 volts in .2 v steps; 0-300 volts in 5 v steps—OHMS Rx1 from .02 to 1000 ohms; Rx10 from 2 to 10000 Ω ; Rx100 from 20 to 100000 Ω ; Rx1000 from 200 to 1 meg Ω ; Rx10000 from 2000 to 10 meg Ω (center scale is 10) Unit complete with 3 test leads; batteries and instructions. Cost gov't \$65. "TAB" special \$29.70. Additional V.T.V.M. Loctal tube 1 LE 3/SP Sig C \$1.15.

Condenser TUB. DUAL 40mfd 150WV Ten for \$4.50
Cond. Sprague Gvt. insp. 15mfd 35WV ten for \$1.50
Resistors 100 ass't 1/2 & 1 W BT \$2.50
RCA 6AC7 new gvt. insp. (L.P. \$1.75) \$0.65
Radio Noise Filter MALLORY oil cond & chokes .49
Socket Octal Amphenol 78-58T-HF ins. 25 for 1.48

\$1 Min. orders FOB, N.Y.C. Add Postage all orders and 25% deposit. Whitehall 3-3557. Send for catalog 300. Don't wait, rush orders as quantities are limited.

"TAB", Dept. RR4

Six Church Street, New York 6, N. Y.
Our Central Location

Bagshaw's NEEDLES

FAMOUS SINCE 1892

for Better Record Performance



Above is illustrated the nationally identified envelope containing the shadowgraphed playback needle preferred by professionals. Just one of a most complete line, for cutting and playback . . . each stylus purposefully built to vindicate the fine old BAGSHAW slogan:—

After all . . . you can't beat the BEST!

H. W. ACTON CO., INC.
SOLE DISTRIBUTOR
370 SEVENTH AVENUE NEW YORK 1, N. Y.

Midget by Mallory

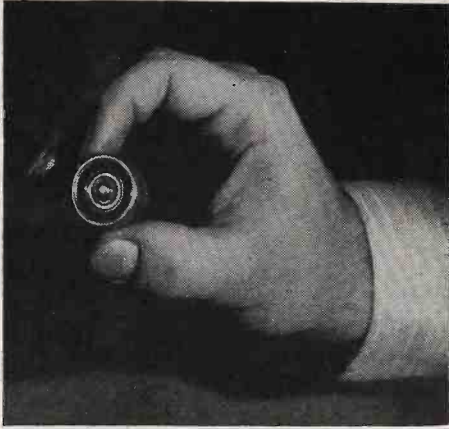

Now being produced by P. R. Mallory & Co., Inc. is this first commercial model of the tiny "Tropical Dry Battery", 1" in diameter and 5/8" high. This mercuric oxide cell emphasizes constant output under all conditions. Production now goes to makers of hearing aids, but pocket sets and compact electronic devices are potential users.

West Coast Reps Expand

Ernest V. Roberts, of Fry & Roberts, West Coast manufacturers reps, has announced the removal of their offices to new and larger quarters at 6516 Selma Ave., Hollywood 28, Calif.

The new location provides additional office and display facilities, plus free parking space.

Cavalcade to Make Radios and Home Appliances

Cavalcade Industries, Inc., Chicago, Ill., has started marketing initial products in its planned production of home furnishings items. Included in the Cavalcade line are radios and phonographs, small and large electrical appliances, housewares, juvenile furniture and toys.

Forerunners of the radio line are now on the market, and three sizes of home freezers, under the Cavalcade name, are also available. Washing machines, ironers and electric refrigerators are being planned for the future.

Eureka Appointment

Samuel B. Peppers has been named Southeastern regional sales manager of the Eureka Vacuum Cleaner Co., according to George H. Wilkens, eastern sales manager. He will make his headquarters in Atlanta, Ga.

Demonstrations

(Continued from page 49)

confusing to the customers to have two or three products being tried out in the home at one time.

Another reason why home demonstrations are being avoided by many dealers revolves around the expensive installation required for many modern appliances and re-

ceivers. Much major radio and appliance apparatus requires elaborate installations. This is especially true of FM and television receivers. It is also true of dishwashers and automatic washing machines.

Even if you are able to arrange a temporary installation of an appliance or radio, the work of doing this often is a distraction from a good demonstration. Too much preliminary fiddling around destroys much of the effectiveness of the home demonstration.

Cuts Expenses

Many dealers have adopted an expedient which enables them to have customers visualize the product in their own homes readily and at the same time eliminate the expense of unnecessary home demonstrations. The solution of the problem is for the dealer to arrange to take a prospect to the home of a present user who has just bought the product. This often costs nothing at all where the user is an enthusiastic purchaser. At most the monetary consideration need not be great.

When you arrange to take a prospect to a user's home, you may get the advantage not only of hav-

Electricity

Models range from 350 to 35,000 watts. A. C. types from 115 to 660 volts, 50, 60, 180 cycles, single or three-phase and 400, 500 and 800 cycles, single phase. D. C. types from 6 to 4000 volts. Also available in dual voltage and special frequency types.

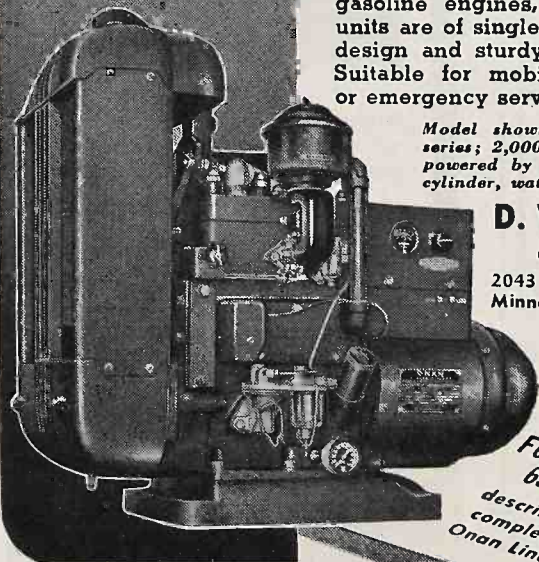

FOR RADIO AND ELECTRONIC APPLICATIONS

• ONAN ELECTRIC GENERATING PLANTS supply reliable, economical electrical service for electronics and television applications as well as for scores of general uses.

Driven by Onan-built, 4-cycle gasoline engines, these power units are of single-unit, compact design and sturdy construction. Suitable for mobile, stationary or emergency service.

Model shown is from W2C series; 2,000 to 3,500 watts; powered by Onan-built, two-cylinder, water-cooled engine.

D. W. ONAN & SONS

2043 Royalston Ave.
Minneapolis 5, Minn.

Write For Folder 690-A describing complete Onan Line

BOOKKEEPING SYSTEM

Epecially Designed For
RADIO & APPLIANCE RETAILERS

A direct, easy-to-understand system, devised by experienced men in your line of business. It is in practical use by many leading retailers throughout the country.

This system provides for: Cash Receipts; Cash Disbursements; Purchases; Sales Register; General Journal; General Ledger Control Accounts; Daily Cash Sheet; Stock Record; Customer's Ledger Record; Analysis Sheets; Rebuilding Cost Cards; and Individual Employee's Earning Record with Binders and Indexes for all forms.

Write today for price quotations

HOFFMAN SYSTEMS

2653 NO. MILWAUKEE AVE.
CHICAGO

NO TEDIOUS HAND TURNING!

That's What SELLS It

KASSON Electric Bar-B-Q MEAT TURNER

NEW ELECTRIC Meat Turner revolves three times a minute without drudgery of hand turning. Meats barbecued evenly, effortlessly. Equipped with 50 feet of cord, ELECTRIC BAR-B-Q is sturdy, all-metal—won't tip over. Operates on house current (110 Volts AC). Height and width adjustable. Extra, short set of uprights included for use in indoor fireplaces. Holders for drip pan permit basting with natural juices.



Distributors, Dealers: Write or wire for literature and discounts on this tested, fast-selling product. Immediate Delivery.

List Price \$39.50 F.O.B. New York

GENERAL DIE & STAMPING CO., 263 Mott St., New York 12, N. Y.

(Continued from page 136)

ing the prospect visualize the product in use but also in listening to the recommendation of the user. This frequently is more effective than anything you can say.

It is essential that you do not barge in unannounced on present users for such demonstrations with a prospect. This is not merely because you might annoy the prospect. It is also because conditions may not be at all favorable for a good demonstration. Thus you may do more harm to your own cause than good.

Local Needs

Home demonstrations accomplish one result which you must be careful not to lose sight of if you confine all of your demonstrations to your store. This is that they make sure proper results are obtainable for the appliance or radio in the home.

The FM set you sell, for example, must be adapted to the local conditions of the buyer. It is your responsibility to install it properly with whatever antenna proves necessary. You should refuse to sell an FM set if your customer is not will-

ing to pay for the proper installation.

Following a store demonstration, therefore, you should offer to send a man out to test the location and to recommend the particular FM receiver which is best adapted for use in that home.

Today's Trend

Store demonstration is the modern trend. Large stores have put in expensive, complete kitchens and home laundries that operate down to the last detail. Outside salesmen are bringing customers in to see these complete demonstrations.

You do not need expensive installations, but you do need an intensive program of store demonstrations.

Record Sales

(Continued from page 43)

them constantly in an up-to-the-minute, interesting manner will help you accomplish this.

When the market is normal, don't overload; and do everything you can to keep any "slow-movers" MOVING. If you find, for instance, that a certain number is not selling as fast as you expected, bring it up

Disc Sales Aid



Capitol Records, Inc., Hollywood, presents a new attention-getting album rack for dealers.

front with your island display of the newest stock. Or plan a special window display, using a new approach to this number. If it is an expensive item, send out a special promotion postcard to your preferred mailing list.

There's money in moving records swiftly and with sparkle. Make your disc department headquarters for the record purchasers in your community!

"Columbia" is a reliable source

THE MODERN INSULATED WIRE

PLASTIC COVERED WIRE

Flame Resistant—High Dielectric

Excellent for hook-up wire use in modern radio and electrical work

	Per 1000 ft.
22 ga. stranded	\$3.50
20 ga. "	3.85
18 ga. "	4.95
16 ga. "	6.80
14 ga. "	8.75

Quantities on the above items are limited. Black only. Get your order in now.

18 Ga. Stranded HIGH VOLTAGE WIRE

	Per 1000 ft.
Guaranteed breakdown 1000 volts.....	\$7.95

Flat tinned copper braided shielding soft drawn tinned copper, flexible and strong, used extensively for shielding and bonding on home and auto radios and electronic devices

	Per 1000 ft.
5/32" width rolled flat	\$11.50
1/4" width rolled flat	14.90
1/2" width rolled flat	32.50

4 CONDUCTOR WIRE

Suitable for intercom work, flexible

	Per 1000 ft.
(A) Cotton braid overall	\$22.50
(B) Rubber Jacket	24.90

Order from your jobber or write direct.

COLUMBIA WIRE & SUPPLY CO.

4104 N. PULASKI RD., CHICAGO 41, ILLINOIS

MORE SPEED · LESS TROUBLE

with
VACO
SCREW DRIVERS
for Every
INDUSTRIAL NEED

They win employee good-will . . . help promote efficiency, because Vaco drivers, with gleaming Amberyl handles, fit the hand comfortably, are shock-proof and break-proof. There is a Vaco driver for every radio, automotive, laboratory need . . . all industrial uses. Special drivers designed to fill special needs.
Write for catalog

VACO
PRODUCTS CO.

317 E. Ontario St., Chicago 11, Ill. - In Canada: 560 King St. W., Toronto

*Manufacturers
Jobbers*

*Inquiries
Invited*

AVCO
dependable



Standard
Replacement
Volume
Control

Manufactured and Distributed By

**AMERICAN VOLUME CONTROL
CORPORATION**

115 Liberty St., New York 6

there is
NO SUBSTITUTE

for GOOD communications
and industrial wire. We are
shipping you more and
more of it now . . .



WIRES



cornish

WIRE COMPANY, INC.

15 Park Row, New York 7, N. Y.

"Made by Engineers for Engineers"



**Dates of Future Events for
Dealers to Remember**

- Apr. 22-25: NEWA (Nat'l Elec. Whlstr. Ass'n.) Annual Convention, Stevens Hotel, Chicago
- Apr. 22: Spring Furniture Show, Mechanics Bldg., Boston
- Apr. 25-30: International Lighting Exposition, Stevens Hotel, Chicago
- Apr. 26-May 2: Elec. Home Appliances Show, Will Rogers Memorial Coliseum, Ft. Worth, Tex.
- May 4-11: New York New Products Show, Madison Square Garden
- May 4-11: Nat'l Modern Homes Exposition, Grand Central Palace, N.Y.
- May 12: Mother's Day
- May 13-17: Housewares Show, Convention Hall, Atlantic City, N.J.
- May 13-16: Radio Parts and Elec. Equip. Show, Stevens Hotel, Chicago
- May 15-17: Electrical Mfrs. Reps. Club of New England, Mechanics Bldg., Boston, Mass.
- June 16: Father's Day
- July 8-20: Furniture Show, Summer Market, American Furniture Mart, Chicago
- July 14-18: Trade Show, Palmer House, Chicago
- July 22: New York Lamp Show, Hotel New Yorker, N.Y.
- Oct. 10-11: TBA (Television Broadcasters Ass'n.) First Postwar Tele Conference, Waldorf Astoria, N. Y.
- Oct. 28-Nov. 1: Refrig. Equip. Mfrs. Ass'n. Show, Public Auditorium, Cleveland
- Jan. 6-18: Furniture Show, Winter Market, Furniture Mart, Chicago

Ferris Radio

(Continued from page 44)

Popular albums are arranged by catalogue number, for easier finding, since they are so varied and move faster in accordance with popular demand. Singles are also stocked by catalogue number.

"Keep stock in good shape daily", is Miss Snyders' advice.

She also features a "What's New" section in the front of the store, where it is quickly seen.

"Slow-movers? We have very few of those" Miss Snyders said, "but when we do, I bring them forward where they can be brought to the prospective purchaser's attention."

Miss Snyders approaches each customer with an open mind, makes him feel at home, preserves a friendly atmosphere. She finds that they stay to buy, and keep coming back for more!

Dealer Ferris, himself, is active in his community, is a member of the American Legion, the Lions, Masons, and various local dealer organizations. He "gets along" with his employees and with his public, both of which he finds enables him to do a better selling job.

RADIO PARTS
and Sound Equipment
IMMEDIATE DELIVERY

- 6 ft. cord sets—high grade—soldered—molded rubber plug at one end. 10 for \$2.75. Each 29c
 - Mike Cable—superior quality, single conductor, shielded pre-war quality natural rubber cover. Per ft., only 8c
 - Dual conductor as above. Per ft. 10c
 - Carbon Resistor Kit No. 16, 100 RMA coded, 1/2 and 1 Watt, assorted. Our price, only \$2.94
 - Aerial Kit, containing aerial wire, insulators, rubber-covered lead-in, ground clamp, window strip, complete set, only 89c
 - 10 MFD 50 WV Tubular Pigtail Electrolytic Condensers. Year guarantee. 10 for \$2.25. Each, only 24c
 - 20 MFD 150 WV Tubular Pigtail Electrolytic Condensers. Guaranteed one year. 10 for \$3.80. Each 35c
 - 10 MFD 450 WV Tubular Pigtail Electrolytic Condensers. Year guarantee. 10 for \$3.95. Each 43c
 - 20-20 MFD 150 WV Tubular Pigtail Electrolytic Condenser. Year Guarantee. Each 59c
 - Bakelite Set-Screw Knobs. DeLuxe assortment of 50 for 1/4 inch shaft . . \$3.93
- Write for latest bargain bulletin of hard-to-get parts, supplies and sound equipment.

Lifetime
SOUND EQUIP. CO., Dept. TV-4
911-913 JEFFERSON AVE., TOLEDO 2, OHIO

**ROEHR
DISTRIBUTING
COMPANY**

**St. Louis' Radio
Mail Order House**

- TUBES**
- TRANSFORMERS**
- CONDENSERS**
- RESISTORS**
- SPEAKERS**
- MIKES**
- ANTENNAS, ETC.**

Distributors for
BELL SOUND EQUIPMENT
and
TEMPLE RADIOS

Write for our list of tubes
ST. LOUIS 3, MO.

INDEX To Advertisers

APRIL, 1946

	Page		Page
Acton Co., Inc., H. W.	135	Maguire Industries, Inc.	14, 15
Admiral Corp.	83	Majestic Radio & Television Corp.	117
Aerovox Corp.	86	Mallory & Co., Inc., P. R.	Cover 2
Alliance Mfg. Co.	132	Meissner Mfg. Co., Div. Maguire Industries, Inc.	123
Alltec-Lansing Corp.	112	Merit Coil & Transformer Corp.	4
American Magazine	65	Muter Co.	96
American Volume Control Corp.	138		
		National Stamping & Electric Works	64
Bendix Radio Div., Bendix Aviation Corp.	5	Newcomb Audio Products Co.	133
Burgess Battery Co.	116	Noblitt-Sparks Industries, Inc.	107
Caldwell-Clements, Inc.	64, 101, 125	Olson Radio Warehouse	131
Centralab	20	Onan & Sons, D. W.	136
Chicago Tribune	72		
Clarostat Mfg. Co., Inc.	124	Park Metalware Co., Inc.	134
Collier's	18, 19	Philco Corp.	45
Columbia-Wire & Supply Co.	137	Pilot Radio Corp.	104
Commercial Credit Co.	67	Plicote, Inc.	61
Cornell-Dubilier Electric Corp.	24	Premier Crystal Laboratories, Inc.	16
Cornish Wire Co., Inc.	138	Presto Recording Corp.	3
Crosley Corp.	57		
		Quam-Nichols Co.	139
DuMont Laboratories, Inc., Allen B.	111	Radio Corp. of America	
Duotone Co.	88	RCA Victor Div.	70, 71
		Tube Div.	69
Edison General Electric Appliance Co.	63	Rauland Corp.	130
Electro Products Laboratories	134	Raytheon Mfg. Co.	8
Electronic Corp. of America	99	Roehr Distributing Co.	138
Electronic Laboratories, Inc.	121		
Emerson Radio & Phonograph Corp.	95	Seeburg Corp., J. P.	Cover 3
		Simpson Mfg. Co., Mark	108
Fada Radio & Electric Co., Inc.	13	Snyder Mfg. Co.	131
Farnsworth Television & Radio Corp.	119	Solar Capacitor Sales Corp.	140
		Sonora Products, Inc.	21
Galvin Mfg. Corp.	Cover 4	Sparks-Withington Co.	103
Garod Radio Corp.	9	Sprague Products Co.	97
General Die & Stamping Co.	136	Stewart-Warner Corp.	93
General Electric Co.	11	Stromberg-Carlson Co.	26
General Industries Co.	100	Supreme Instruments Corp.	122
General Mills, Inc.	48	Sylvania Electric Products, Inc.	22, 23
Graybar Electric Co.	17		
Hamilton Radio Corp.	89	Tab	135
Hearst Advertising Service	6	Talk-A-Phone Mfg. Co.	132
Hoffman Systems	136	Templetone Radio Mfg. Corp.	25
Howard Radio Co.	105	Triplett Electrical Instrument Co.	129
Hytron Radio & Electronics Corp.	87	Tung-Sol Lamp Works, Inc.	2
		Turner Co.	78
International Resistance Co.	127	U. S. Electric Mfg. Corp.	92
Jensen Radio Mfg. Co.	10	Vaco Products Co.	137
		Vokar Corp.	135
Ken-Rad Div. General Electric Co.	7		
Kwikheat Div. Sound Equipment Corp.	120	Ward Leonard Electric Co.	133
		Ward Products Corp.	12
Lake Radio Sales Co.	128	Warwick Mfg. Corp.	109
Lear, Inc.	113	Waters Conley Co.	79
Lifetime Sound Equipment Co.	138	Webster Chicago Corp.	104
		Webster Electric Corp.	82
		Weller Mfg. Co.	130
		Westinghouse Electric Corp.	85
		Wilcox-Gay Corp.	115
		World Radio, Inc.	126

While every precaution is taken to insure accuracy, we cannot guarantee against the possibility of an occasional change or omission in the preparation of this index.

QUAM

the speaker that's

2 STEPS AHEAD

with

Adjust-A-Cone

and Alnico 5

You can always depend on Quam for the most advanced speaker design. The new Quam Speakers are not one, but two steps ahead. First, all Quam P. M. Speakers use Alnico 5, the magic magnet metal, that provides better performance with greatly reduced weight and size. Second, there's the new patented Adjust-A-Cone speaker construction, a revolutionary new development that permits precise centering of the voice coil on every Quam Speaker before it leaves the factory, and assures trouble free sales for distributors and dealers. For tops in speaker performance and design—look to Quam.



QUAM-NICHOLS COMPANY

33rd Place at Cottage Grove
Chicago 16, Illinois



Capacitor

Quality...

To Solar "CQ" means Capacitor Quality because Solar lives up to its famous by-word "Quality Above All" . . . by manufacturing every type of capacitor, from tiny tubulars to solder-sealed high-voltage oil papers, with uniform care and modern engineering skill.

To millions of users, Solar's "Quality Above All" Sealdtite wax-molded paper tubulars mean an ultra-neat, ultra-rugged, moisture-proof capacitor with a longer life expectancy than any other tubular on the market. Solar's "Minicap" cartridge dry electrolytics are famous among radio servicemen for their tiny size, excellent electrical characteristics and long life.

Thousands of radio service dealers have given Solar a well-merited reputation for a complete line of "Quality Above All" capacitors. "Sets repaired with Solar capacitors don't come back to the shop", they say, and that's why they stick to Solar for safety.

Why not join the thousands of service dealers and repairmen who have benefited by Solar's "Quality Above All" standards. Get in touch with your nearest Solar distributor today.

SOLAR CAPACITOR SALES CORP.
285 Madison Avenue • New York, New York



ELECTROLYTIC, PAPER AND MICA CAPACITORS

Ⓢ 1075 x

DEPENDABLE OPERATION—BECAUSE THEY HAVE FEWER MOVING PARTS



SEEBURG
Record Changers
**ALWAYS
RELIABLE
...ALL WAYS**

Don't Handicap

Tomorrow's Phonograph

with Yesterday's *Record Changer*

SEEBURG has devised many types of special apparatus and test equipment that predetermine the performance values of phonographs . . . New sound equipment data is continually developed by SEEBURG to supplement their already vast knowledge gained through their

many years' experience in building dependable mechanism. This continuous research effort has led to the development of better performance values in SEEBURG RECORD CHANGERS . . . minimum friction, silent, constant speed, long life, trouble-free operation.

SEEBURG *Wire* RECORDER

This SEEBURG WIRE RECORDER is the result of the combined knowledge of the nation's top scientists . . . An electronic device in which SEEBURG engineering and

research have played a major role in perfecting . . . There are no needles or discs. Its compactness is matched only by its simplicity of operation.

IT WILL BE NECESSARY...

for radio manufacturers to make provisions in their circuits to accommodate the SEEBURG WIRE RECORDER. We therefore invite prompt inquiries from interested radio manufacturers.

1902 DEPENDABLE MUSIC SYSTEMS 1946

J. P. SEEBURG CORP. • CHICAGO

Seeburg

THE **TONE** ALONE DOES YOUR SELLING JOB

JUST **DEMONSTRATE** AND YOU'LL SELL
THE NEW *Motorola* AUTO RADIO 

Here's an auto radio that requires no long and involved sales talk; the magnificent depth and brilliance of its tone says, "Look no further—*this is the finest!*" True, it's years ahead of the field in features (fits and matches each individual car, may be transferred from car to car, electric push-button tuning, 3-dimensional VITA-TONE) but you won't have to emphasize them. Just flick the switch; the tone alone will do your selling job for you.



GALVIN MFG. CORPORATION • CHICAGO 51